



HAL
open science

Investigation of the roles of ghrelin in experimental models of early stages of Parkinson's disease : towards a clarification of ghrelin's diagnostic and therapeutic potentials

Alicia Stiévenard

► **To cite this version:**

Alicia Stiévenard. Investigation of the roles of ghrelin in experimental models of early stages of Parkinson's disease : towards a clarification of ghrelin's diagnostic and therapeutic potentials. Human health and pathology. Université du Droit et de la Santé - Lille II, 2016. English. NNT : 2016LIL2S041 . tel-02448918

HAL Id: tel-02448918

<https://theses.hal.science/tel-02448918>

Submitted on 22 Jan 2020

HAL is a multi-disciplinary open access archive for the deposit and dissemination of scientific research documents, whether they are published or not. The documents may come from teaching and research institutions in France or abroad, or from public or private research centers.

L'archive ouverte pluridisciplinaire **HAL**, est destinée au dépôt et à la diffusion de documents scientifiques de niveau recherche, publiés ou non, émanant des établissements d'enseignement et de recherche français ou étrangers, des laboratoires publics ou privés.

UNIVERSITE DE LILLE / 2 DROIT ET SANTE
FACULTE DE MEDECINE HENRI WAREMBOURG

THESE DE DOCTORAT D'UNIVERSITE
En Neurobiologie, Spécialité Neurosciences

**INVESTIGATION OF THE ROLES OF GHRELIN IN EXPERIMENTAL MODELS
OF EARLY STAGES OF PARKINSON'S DISEASE: TOWARDS A CLARIFICATION
OF GHRELIN'S DIAGNOSTIC AND THERAPEUTIC POTENTIALS.**

Présentée par
Aliçia Stiévenard

Présentée le 9 décembre 2016, devant le jury composé de :

Monsieur le Professeur Ayikoé-Guy Mensah-Nyagan <i>Université de Strasbourg (France), INSERM U1119</i>	Rapporteur
Madame le Professeur Suzanne Dickson <i>Université de Göteborg (Suède)</i>	Rapporteur
Monsieur le Docteur Henri Schroeder <i>Université de Lorraine (France), INRA UR AFPA</i>	Rapporteur
Madame le Docteur Marie-Christine Chartier-Harlin <i>Université de Lille (France), INSERM UMR-S1172</i>	Examineur
Monsieur le Professeur Alain Destée <i>Université de Lille (France), INSERM UMR-S1172, CHRU de Lille</i>	Examineur
Monsieur de Docteur Francisco Pan-Montojo <i>Ludwig-Maximilians Universität München (Allemagne), Munich Cluster for Systems Neurology</i>	Examineur
Madame le Docteur Christel Vanbesien-Mailliot <i>Université de Lille (France), INSERM UMR-S1172</i>	Directeur de thèse

**UNIVERSITE DE LILLE / 2 DROIT ET SANTE
FACULTE DE MEDECINE HENRI WAREMBOURG**

**THESE DE DOCTORAT D'UNIVERSITE
En Neurobiologie, Spécialité Neurosciences**

Etude du rôle de la ghréline dans des modèles expérimentaux de stades précoces de la maladie de Parkinson : vers une clarification des potentiels diagnostique et thérapeutique de ce peptide orexigène.

**Présentée par
Aliçia Stiévenard**

Présentée le 9 décembre 2016, devant le jury composé de :

Monsieur le Professeur Ayikoé-Guy Mensah-Nyagan <i>Université de Strasbourg (France), INSERM U1119</i>	Rapporteur
Madame le Professeur Suzanne Dickson <i>Université de Göteborg (Suède)</i>	Rapporteur
Monsieur le Docteur Henri Schroeder <i>Université de Lorraine (France), INRA UR AFPA</i>	Rapporteur
Madame le Docteur Marie-Christine Chartier-Harlin <i>Université de Lille (France), INSERM UMR-S1172</i>	Examineur
Monsieur le Professeur Alain Destée <i>Université de Lille (France), INSERM UMR-S1172, CHRU de Lille</i>	Examineur
Monsieur de Docteur Francisco Pan-Montojo <i>Ludwig-Maximilians Universität München (Allemagne), Munich Cluster for Systems Neurology</i>	Examineur
Madame le Docteur Christel Vanbesien-Mailliot <i>Université de Lille (France), INSERM UMR-S1172</i>	Directeur de thèse

Acknowledgments / Remerciements

To Professor Suzanne Dickson,

Who accepted to read this work and share with us her expertise in the ghrelin field during this PhD defense and for her detailed examination of our work.

A Monsieur le Professeur Ayikoé-Guy Mensah-Nyagan,

Qui a répondu présent, s'est montré disponible et a accepté d'être rapporteur de ce travail. Je vous adresse mes remerciements les plus sincères.

A Monsieur de Docteur Henri Schroeder,

Qui m'a soutenue et conseillée ces trois dernières années et qui a montré son intérêt pour les résultats obtenus à chaque comité de suivi de thèse. Vous avez toujours pris le temps pour conseiller ce travail et je suis heureuse que vous le fassiez une fois de plus pour participer à cette soutenance de thèse.

A Madame le Docteur Chartier-Harlin,

Qui m'a accueillie dans son équipe de recherche et a partagé sans limite son expérience et son savoir dans le domaine de la maladie de Parkinson, des études génétiques. Soyez remerciée pour votre soutien.

A Monsieur le Docteur Alain Destée,

Qui m'a accueillie dans son équipe de recherche dès le master et a transmis sans restriction son savoir de clinicien et son aide dans l'interprétation de données qui dépassaient mes compétences de « scientifique ». Merci d'avoir accepté de participer à ce jury de thèse.

To Doctor Francisco Pan-Montojo,

Thank you for your help during this thesis. You opened the doors of your lab for me and provided me with constant support and all the help I needed to continue the research. I learnt a lot during my stay in your lab.

A Madame le Docteur Christel Vanbesien-Mailliot,

Merci pour ces quatre années de patience, de pédagogie et de soutien. Vous avez su accompagner mes pas dans cette thèse, me ramener sur la voie quand il le fallait et me laisser m'y aventurer seule et faire mes preuves le reste du temps. Merci pour votre implication et votre disponibilité à toute heure. Vous avez forgé l'étudiante et la personne que je suis aujourd'hui. Vous avez été bien plus qu'une tutrice de thèse et je vous en remercie.

A Monsieur le Docteur Luc Buée,

Qui m'a accueillie ces quatre dernières années au sein du centre de recherche Jean-Pierre Aubert et qui contribue chaque jour à la mise en place d'un environnement favorable pour chaque étudiant en recherche.

A Aurore Nkiliza,

Pour ton amitié et ton soutien, même de l'autre côté de la planète. Je ne garderais pas le même souvenir de la thèse si tu ne l'avais pas vécue avec moi. Les soirées et weekends au labo semblaient moins longs en chantant sous l'océan avec toi.

A Messieurs Pierre Semaille et Thomas Comptdaer

Qui ont supporté mon caractère et mes manies avec patience et ont su me transmettre une partie de leurs savoirs. Vous avez vécu avec moi les réussites et les échecs, Merci !

A tous les étudiants, post-doctorants et chercheurs de l'équipe qui ont contribué par une discussion, un encouragement ou une aide technique à la réalisation de ces travaux de thèse.

To Ines Ramirez-Alvarez and Yanina Dening. *This PhD wouldn't have been the same without you. I came in a different country, with no family, no friends, and strange pastries. Although you did not find a solution for the food, you have been my family and my friends. Thank you.*

A Madame le Docteur Odile Viltart et Monsieur le Docteur Mathieu Méquinion, *pour mes premiers marquage TH sur cerveau, les journées de dissection à l'animalerie, la ghréline, la revue, les discussions (scientifiques ou non) et surtout pour votre présence.*

A tous ceux dont la collaboration a été essentielle à l'obtention des résultats présentés dans ce manuscrit : Docteur Virginie Tolle, Docteur Philippe Zizzari, Monsieur Dominique Grouselle, Docteur Anna Bensick, Monsieur Mickael Leboindre, Madame Delphine Taillieux, Monsieur Julien Devassine, Thierry Chassat.

A l'Université Lille2/Droit & Santé,

Qui m'a permis grâce à une allocation de recherches de me consacrer plus sereinement à l'élaboration de ma thèse.

Au personnel administratif de l'Ecole Doctorale de Lille, du centre de recherche Jean-Pierre Aubert et de l'IRCL qui a su répondre à toutes mes questions durant cette thèse.

A mes parents, à ma sœur,

Qui ont fait preuve d'un soutien sans faille depuis toujours. Ce travail n'aurait pas vu le jour sans vous.

A Johnny,

Pour ces dix dernières années et pour toutes celles qui suivront.

This work led to the following publications and oral presentations:

Peer-reviewed journal articles :

Alicia Stievenard, Mathieu Méquinion, Zane B. Andrews, Alain Destée, Marie-Christine Chartier-Harlin, Odile Viltart, Christel C. Vanbesien-Mailliot. Is there a role for ghrelin in central dopaminergic systems? Focus on nigrostriatal and mesocorticolimbic pathways. Accepted with minor revisions in *Neuroscience & Biobehavioral Reviews*.

Mathieu Méquinion, Emilie Caron, Sarah Zgheib, **Alicia Stievenard**, Philippe Zizzari, Virginie Tolle, Bernard Cortet, Stéphanie Lucas, Vincent Prevot, Christophe Chauveau, and Odile Viltart. Physical activity: benefit or weakness in metabolic adaptations in a mouse model of chronic food restriction? *American Journal of Physiology - Endocrinology and Metabolism* 2014 Dec.

Oral presentations:

Alicia Stievenard, Yanina Dening, Mathieu Méquinion, Virginie Tolle, Dominique Grouselle, Thomas Comptdaer, Pierre Semaille, Odile Viltart, Marie-Christine Chartier-Harlin, Francisco Pan-Montojo, Christel Vanbesien-Mailliot. Clarifying the potential roles of ghrelin in early stages of Parkinson's disease. *Société du cerveau et des maladies cérébrovasculaires*. Paris, June, 1st, 2016.

Alicia Stievenard, Yanina Dening, Mathieu Méquinion, Virginie Tolle, Dominique Grouselle, Thomas Comptdaer, Pierre Semaille, Odile Viltart, Marie-Christine Chartier-Harlin, Francisco Pan-Montojo, Christel Vanbesien-Mailliot. Evaluation of the potential roles of ghrelin in early stages of Parkinson's disease. *7th Ph.D. Student Day*. April 19th, 2016

Alicia Stievenard, Yanina Dening, Lisa Catsburg, Mathieu Méquinion, Thomas Comptdaer, Pierre Semaille, Odile Viltart, Marie-Christine Chartier-Harlin, Alain Destée, Francisco Pan-Montojo, Christel Vanbesien-Mailliot. Which role for ghrelin in Parkinson's Disease? *André Verbert's Day*. Lille, September 14th, 2015.

Alicia Stievenard, Yanina Dening, Paul Bourgois, Matthias Schwarz, Lisa Catsburg, Mathieu Méquinion, Thomas Comptdaer, Pierre Semaille, Odile Viltart, Marie-Christine Chartier-Harlin, Alain Destée, Francisco Pan-Montojo, Christel Vanbesien-Mailliot. Chronic oral exposure to low doses of pesticide rotenone induces alteration in the expression of PD-related gene in the ileum of mice. *6th Ph.D. Student Day*. 28 January 2015.

Christel C. Vanbesien-Mailliot, Anna Bencsik, **Alicia Stievenard**, Yanina Dening, Emilie Antier, Matthias Schwarz, Mikael Leboire, Marie-Christine Chartier-Harlin, and Francisco Pan-Montojo. Gastrointestinal dysfunctions in Parkinson's Disease: contribution of rotenone model. *10th International Congress on Non-Motor Dysfunctions in Parkinson's Disease and Related Disorders*. Nice, December 4-7, 2014

Poster presentations:

Alicia Stievenard, Yanina Dening, Dominique Grouselle, Virginie Tolle, Odile Viltart, Marie-Christine Chartier-Harlin, Francisco Pan-Montojo, Christel Vanbesien-Mailliot. Is ghrelin really neuroprotective against complex I inhibition-induced cell death? *10th Federation of European Neurosciences Societies Forum of Neurosciences*, Copenhagen, June, 2-6, 2016.

Aliçia Stievenard, Yanina Dening, Paul Bourgois, Matthias Schwarz, Lisa Catsburg, Mathieu Méquinion, Thomas Comptdaer, Pierre Semaille, Odile Viltart, Marie-Christine Chartier-Harlin, Alain Destée, Francisco Pan-Montojo, Christel Vanbesien-Mailliot. Chronic oral administration of rotenone low doses alters gene expression profiles in the gastrointestinal tract of one-year-old mice: significance for alpha-synuclein aggregation. MDS course « *Alpha-synuclein: the gateway to Parkinsonism* », Innsbruck, February, 11-13, 2015.

Christel Vanbesien-Mailliot, **Aliçia Stievenard**, Odile Viltart. Modeling early stages of Parkinson's disease in vivo: are we there yet?" MDS course « *Alpha-synuclein: the gateway to Parkinsonism* », Innsbruck, February, 11-13, 2015.

Christel Vanbesien-Mailliot, Francisco Pan-Montojo, **Aliçia Stievenard**, Paul Bourgois, Thomas Comptdaer, Yanina Dening, Alain Destée, Richard Funk and Marie-Christine Chartier-Harlin. 11th Meeting of the French Society for Neurosciences. Lyon, May 21-24, 2013. Expression pattern of PD-related genes and pathways is altered in the intestine of oral rotenone treated mice.

Aliçia Stievenard, Francisco Pan-Montojo, Paul Bourgois, Thomas Comptdaer, Yanina Dening, Alain Destée, Richard Funk, Marie-Christine Chartier-Harlin and Christel C. Vanbesien-Mailliot. The 17th Annual Meeting of the LARC-Neuroscience Rouen, October 25, 2013. Long-term gastric exposure to low doses of rotenone alters expression pattern of PD-related genes in the intestine of mice.

SUMMARY

GENERAL OVERVIEW	19
1. History of the discovery of Parkinson's disease	19
2. Epidemiological data	19
CHAPTER 1: PARKINSON'S DISEASE	21
1. Symptomatology and clinical diagnosis	21
1.1. Motor symptoms	21
1.1.1. Bradykinesia	21
1.1.2. Resting tremor	21
1.1.3. Rigidity or stiffness of the muscles	22
1.1.4. Postural instability	22
1.2. Non-motor symptoms	24
1.2.1. Olfactory dysfunctions	24
1.2.2. Mood disorders	24
1.2.3. Dementia	25
1.2.4. Rapid eye movement sleep behavior disorders	25
1.2.5. Gastro-intestinal disorders	26
1.3. Evolution of the disease and clinical diagnosis	27
1.3.1. Evolution of the disease	27
1.3.2. Clinical diagnosis	28
2. Neuropathological characterization	30
2.1. Neuropathological hallmarks of Parkinson's disease	30
2.1.1. Dopaminergic cell death	31
2.1.2. Lewy bodies and Lewy neurites	32
2.1.2.1. In the central nervous system	32
2.1.2.2. In the enteric nervous system	33
2.1.3. Braak's staging hypothesis	34
2.1.4. Other neuropathological hallmarks	36
2.2. Functional consequences	38
2.2.1. Anatomy of basal ganglia	38
2.2.2. Basal ganglia dysfunction in PD	40
2.2.3. Potential for neuroimaging investigations	42
3. Aetiology	43
3.1. Environmental factors	43
3.1.1. Environmental risk factors for Parkinson's disease	43
3.1.1.1. Von Economo disease	43

3.1.1.2.	MPTP	43
3.1.1.3.	Rotenone and paraquat	44
3.1.1.4.	Brain injury	44
3.1.2.	Environmental factors inversely correlated to Parkinson's disease	45
3.2.	Genetic factors	45
3.2.1.	Genetic risk factors.....	48
4.	Currently available therapeutic options.....	49
4.2.	Pharmacological therapies	50
4.2.1.	The L-DOPA replacement therapy.....	50
4.2.2.	The use of dopamine agonists.....	50
4.2.3.	The use of inhibitors of dopamine catabolism	51
4.3.	Surgical therapies	52
4.3.1.	Dopaminergic cell grafts.....	52
4.3.2.	Deep-brain stimulation.....	52
4.4.	Alternative therapies.....	54
CHAPTER 2: RELEVANCE AND CONTRIBUTION OF EXPERIMENTAL MODELS OF PARKINSON'S DISEASE IN UNDERSTANDING THE UNDERLYING PATHOPHYSIOLOGICAL MECHANISMS.		55
1.	What is an animal model?.....	55
1.1.	The definition of a model in experimental sciences	55
1.2.	Internal validity criteria	56
1.3.	External validity criteria.....	57
1.3.1.	Construct validity.....	57
1.3.2.	Face validity	57
1.3.3.	Predictive validity	58
1.4.	What criteria for modelling Parkinson's disease?	58
2.	Currently available models of Parkinson's disease	59
2.1.	<i>In vitro</i> models.....	59
2.1.1.	Established cell lines.....	60
2.1.2.	Primary neuronal cells.....	61
2.2.	<i>In vivo</i> models.....	63
2.2.1.	Genetic models of Parkinson's disease	63
2.2.2.	Environmentally-induced experimental analogs of Parkinson's disease	65
2.2.1.1.	Reserpine	66
2.2.1.2.	6-hydroxydopamine	67
2.2.1.3.	MPTP	67
2.2.1.4.	Paraquat	68

2.2.1.5. Rotenone	69
3. Contribution of PD experimental models to the understanding of underlying molecular mechanisms.....	70
3.1. Mitochondrial dysfunction and oxidative stress	71
3.2. Degradation of misfolded protein: autophagy and ubiquitin proteasome system	73
3.3. Alpha-synuclein: conformation and aggregation	76
3.4. Proximal cell-to-cell alpha-synuclein spreading and the “prion-like” hypothesis.....	78
CHAPTER 3: THE POTENTIAL OF THE OREXIGENIC PEPTIDE GHRELIN IN PARKINSON’S DISEASE.	81
1. Ghrelin: a pleiotropic hormone?	81
1.1. Origin and biosynthesis	81
1.2. Ghrelin receptors.....	83
1.3. Functions of ghrelin.....	86
2. Ghrelin / dopamine interactions in the nigrostriatal pathway and therapeutic potential in PD	89
2.1. Diagnostic potential of ghrelin in PD.....	89
2.2. Therapeutic potential of ghrelin against PD non-motor symptoms	90
2.3. Therapeutic potential of ghrelin as a disease-modifying agent in PD.....	91
OBJECTIVES OF THE Ph.D. WORK	94
CHAPTER 4: MATERIAL AND METHODS	98
1. <i>In vivo</i> experiments	98
1.1. Animal model of early parkinsonism.....	98
1.1.1. Rotenone exposure.....	98
1.1.2. Non-invasive intestinal motility test	99
1.1.3. Spontaneous activity cylinder test.....	99
1.1.4. Challenging beam traversal test.....	100
1.1.5. Euthanasia and collection of samples	101
1.2. Transcriptome analysis	101
1.2.1. RNA extractions	101
1.2.2. Reverse transcription.....	103
1.2.3. Primer design	103
1.2.4. Quantitative PCR.....	105
1.3. Immunohistochemistry.....	105
1.4. Ghrelin dosage in the plasma	107
1.4.1. Blood sampling	107
1.4.2. Dosage of acyl- and desacyl-ghrelin in plasma samples.....	107
1.5. Western blot analyses.....	108

1.5.1.	Protein extractions for western blot.....	108
1.5.2.	SDS-PAGE and western blot.....	109
2.	<i>In vitro</i> experiments.....	109
2.1.	Primary cultures of mouse mesencephalic neurons.....	109
2.1.1.	Coating conditions.....	109
2.1.2.	Isolation of mouse primary mesencephalic cells.....	110
2.1.3.	In vitro model of dopaminergic degeneration.....	111
2.2.	Immunocytology.....	112
2.3.	Automated PI-positive nuclei quantification.....	112
2.4.	Sampling of the culture medium.....	112
3.	Statistical analyses.....	113
CHAPTER 5: RESULTS.....		114
I.	Ghrelin: a potential disease-modifying agent in PD? Study in primary mesencephalic cultures	114
1.	Effect of acyl-ghrelin exposure on primary mesencephalic cells.....	114
1.1.	Long term ghrelin exposure and survival of TH+ cells.....	115
1.2.	Acyl-ghrelin half-life in the culture medium.....	116
2.	Investigation of ghrelin's neuroprotection potential in a cellular model of parkinsonism.....	118
2.1.	Assessing construct and face validities of the cellular model.....	118
2.2.	Effect of short and long-term acyl-ghrelin on primary mesencephalic cells exposed to rotenone.....	120
2.3.	Effect of short-term desacyl-ghrelin in primary mesencephalic cultures exposed to rotenone.....	126
II.	Investigation of ghrelin's potential as a biomarker of PD early stages.....	129
1.	Variation of <i>GHRLOS</i> in samples from PD patients.....	129
2.	<i>In vivo</i> study in an experimental analog of early parkinsonism.....	130
2.1.	Physiologic variations of plasma ghrelin in mice.....	130
2.1.1.	Plasma ghrelin variations in healthy 4-5 months old female mice before and after a meal	131
2.1.2.	Plasma ghrelin variations in healthy 1 year old male mice before and after a meal	132
2.2.	Validation of the mouse model of early parkinsonism after chronic exposure to low doses of the pesticide rotenone.....	133
2.2.1.	Animals well-being throughout the experimental procedure.....	133
2.2.2.	Evaluation of non-motor symptoms after 1.5 months of exposure to low doses of the pesticide rotenone.....	135
2.2.3.	Investigation of the motor behavior after 1.5 months of exposure to low doses of the pesticide rotenone.....	138
2.2.3.1.	Analysis of the global motor behavior.....	138

2.2.3.2. Analysis of the fine motor coordination between mouse fore- and hindlimbs.....	139
2.2.4. Post-mortem analyses	140
2.2.4.1. Histopathological analysis of the substantia nigra	140
2.2.4.2. Analysis of the intestinal neuronal populations.....	141
2.3. Ghrelin variations in a mouse model of early parkinsonism	147
2.3.1. Plasma ghrelin variations after 1.5 months of rotenone exposure.....	147
2.3.2. Ghrelin-related gene expression in the duodenum of rotenone-exposed mice.....	148
CHAPTER 6: DISCUSSION.....	151
1. Ghrelin as a disease-modifying agent in PD: is the good player acyl- or desacyl-ghrelin?	152
2. Can ghrelin be used as a biomarker of PD early stages?.....	154
3. Implication for patient-based investigations: is the translation "from the bench to the bedside" always possible?	156
4. Experimental perspectives	159
CHAPTER 7: CONCLUSION	161
CHAPTER 8: REFERENCES	165
CHAPTER 9 : ANNEXES	205
Annex 1: Document de synthèse en français	205
Annex 2: NMS-Quest	225
Annex 3: Hoehn and Yahr scale.....	226
Annex 4 : Unified Parkinson's Disease Rating scale	227
Annex 5: article 1: Is there a role for ghrelin in central dopaminergic systems? Focus on nigrostriatal and mesocorticolimbic pathways.	237
Annex 6: article 2: Physical activity: benefit or weakness in metabolic adaptations in a mouse model of chronic food restriction?.....	297
Annex 7: article 3: Physiological and pathological changes in the enteric nervous system of rotenone treated mice as possible early biomarkers for Parkinson's disease	332

INDEX OF FIGURES

Figure 1: Prevalence and incidence of Parkinson's disease in France in 2010 as estimated from databases on the social security system.

Figure 2: Representation of the motor symptoms of Parkinson's disease and the tests used to diagnose them.

Figure 3: Time course of the appearance of clinical features of Parkinson's disease.

Figure 4: Establishment of the clinical diagnosis of Parkinson's disease by the neurologist.

Figure 5: Dopaminergic neuronal death within the SNc in PD.

Figure 6: Lewy body pathology in Parkinson's disease.

Figure 7: Alpha-synuclein inclusions in the peripheral nervous system of PD patients.

Figure 8: Suggested pattern of progression of PD-specific alpha-synuclein inclusions in the brain of PD patients.

Figure 9: Schematic representation of the main functional organization of the basal ganglia.

Figure 10: Schematic representation of the main functional organization of the basal ganglia in Parkinson's Disease.

Figure 11: Dopamine transporter imaging in PD.

Figure 12: Chemical structure of some PD-related environmental factors.

Figure 13: Schematic representation of dopamine synthesis and metabolism.

Figure 14: Mitochondrial dysfunction in PD.

Figure 15: Autophagy-lysosome degradation pathways: macroautophagy, microautophagy and chaperone-mediated autophagy.

Figure 16: Involvement of degradation processes dysfunctions in neurodegenerative disease.

Figure 17: Schematic representation of alpha-synuclein aggregation.

Figure 18: Synthesis and post-translational processing of ghrelin precursor peptides: from the *GHRL* gene to acyl-ghrelin.

Figure 19: Schematic representation of ghrelin-dependent signaling pathways.

Figure 20: Main physiological functions of ghrelin.

Figure 21: Schematic representation of the time course of the experimental procedure applied in C57BL/6J mice.

Figure 22: Representation of the experimental setting used for assaying spontaneous activity in mice.

Figure 23: Schematic representation of the beam used for assaying skilled motor behavior in C57BL/6J mice.

Figure 24: Representation of the variants of the mouse *Ghrl* gene and the respective positions of the primers used to amplify them.

Figure 25: Illustration of the procedures for embedding mouse brain and intestinal samples.

Figure 26: Principle of the enzyme immunometric assay for measuring acyl- and desacyl-ghrelin concentrations.

Figure 27: Pictures showing the different steps of the isolation of mouse embryonic mesencephalon.

Figure 28: Acyl-ghrelin does not alter primary mesencephalic cells.

Figure 29: Kinetic study of acyl- and desacyl-ghrelin concentrations after the addition of acyl-ghrelin in the culture medium.

Figure 30: Acyl- and desacyl-ghrelin concentrations after the addition of acyl-ghrelin in the culture medium.

Figure 31: Mean number of tyrosine hydroxylase-positive neurons in mouse primary mesencephalic cells exposed to rotenone during two or three days.

Figure 32: Morphology of tyrosine hydroxylase-positive primary mesencephalic cells after three days of exposure to the pesticide rotenone.

Figure 33: Effect of three days of acyl-ghrelin on tyrosine hydroxylase-positive mouse primary mesencephalic cells exposed to rotenone.

Figure 34: Mean number of propidium iodide-positive cells after exposure to rotenone and acyl-ghrelin during three days.

Figure 35: Acyl-ghrelin alters mouse primary mesencephalic cells exposed to rotenone in a dose-dependent manner.

Figure 36: Acyl-ghrelin alters mouse primary mesencephalic cells exposed to rotenone (confirmation).

Figure 37: Effect of desacyl-ghrelin on mouse primary mesencephalic cells exposed to rotenone.

Figure 38: Mean number of propidium iodide-positive cells after exposure to rotenone and desacyl-ghrelin during three days.

Figure 39: Relative gene expression of the ghrelin opposite strand/antisense RNA in Parkinson's disease patients compared to controls.

Figure 40: Mean variations of acyl- and desacyl-ghrelin concentrations (pg/mL) after an overnight fast and at different time-points after food intake in 4-5-months old C57BL/6J female mice.

Figure 41: Mean variations of acyl- and desacyl-ghrelin concentrations after an overnight fast and at different time-points after 30 min food intake in 1 year old C57BL/6J male mice.

Figure 42: Individual variations of acyl- and desacyl-ghrelin concentrations after overnight fast followed by 30min ad libitum access to food.

Figure 43: Daily body weight variations and mean food consumption throughout the experiment.

Figure 44: Chronic low doses of the pesticide rotenone alter intestinal motility in 1 year old C57BL/6J male mice.

Figure 45: Spontaneous motor activity in response to novelty as measured in the cylinder test.

Figure 46: Fine motor coordination as analyzed using the challenging beam traversal test.

Figure 47: Immunohistological analysis of the substantia nigra.

Figure 48: Rotenone-induced modifications of neuronal markers in the intestine of 1 year old mice after 2 months of exposure as analyzed by western blot.

Figure 49: Relative expression of several neuronal markers in the intestine of 1 year old mice exposed to the pesticide rotenone for 2 months.

Figure 50: Rotenone-induced modifications of neuronal markers in the intestine of 1 year old mice after 4 months of exposure.

Figure 51: Relative expression of several neuronal markers in the intestine of 1 year old mice exposed to the pesticide rotenone for 4 months.

Figure 52: Variations of plasma acyl- and desacyl-ghrelin concentrations throughout the experimental procedure.

Figure 53: Relative gene expression in the duodenum of C57BL/6J mice as measured by qPCR.

INDEX OF TABLES

Table 1: Main non-motor symptoms of Parkinson's disease.

Table 2: Genetic loci and genes associated with monogenic forms of parkinsonism (PARK loci).

Table 3: Example of cellular models of parkinsonism with their respective external validity criteria.

Table 4: External validity of genetic models of parkinsonism in animals.

Table 5: Main characteristics of neurotoxin-induced animal models of parkinsonism.

Table 6: Primers designed for the present study and primer conditions.

Table 7: *GHRLOS* expression is down-regulated in peripheral blood mononuclear cells of PD patients as assessed by Illumina microarrays.

Table 8: Mean number of emitted feces per group and per time spent in the intestinal motility test before and after 1 and 1.5 months of the experimental procedure.

List of abbreviations

6-OHDA	6-hydroxydopamine
AgRP	Agouti-related protein
AMPK	5' adenosine monophosphate-activated protein kinase
APT1	Acyl-protein thioesterase 1
BSX	Brain-specific homeobox
CMA	Chaperone-mediated autophagy
CREB	c-AMP response element-binding protein
DAG	Desacyl-ghrelin
DIV	Day <i>in vitro</i>
EDTA	Ethylene diamine tetra-acetic acid
ERK 1/2	Extracellular signal-regulated kinase 1/2
FoxO1	Forkhead box O1
GBA	Glucocerebrosidase
GHSR	Growth hormone secretagogue receptor
GWAS	Genome-wide association studies
HCl	Hydrogen chloride
HEK	Human embryonic kidney
HLA	Human Leucocyte Antigen
IMAO	Inhibitors of monoamine oxidase
IP3	1,4,5-trisphosphate
L-DOPA	L-3,4-dihydroxyphenylalanine
LRRK2	Leucine-rich repeat kinase 2
LUHMES	Lund Human Mesencephalic cells
MAO-B	Monoamine oxydase-B
MAPT	Microtubule-associated protein tau
MPP+	1-methyl-4-phenylpyridinium
MPPP	1-methyl-4-phenyl-4-propionpiperidine
MPTP	1-methyl-4-phenyl-1,2,3,6-tetrahydropyridine
mTOR	Mammalian target of rapamycin
n.s.	Not significant
NMS-Quest	Non-Motor-Symptoms questionary
NPY	Neuropeptide Y
paraquat	N,N--dimethyl-4,4--bipyridinium dichloride
PD	Parkinson's disease
PHMB	4-hydroxymercuribenzoic Acid
PI3K	Phosphatidylinositol-4,5-bisphosphate 3-kinase
PINK1	P-TEN-induced putative kinase 1
PI	Propidium iodide
POLG	Mitochondrial DNA polymerase gamma
POMC	Pro-opiomelanocortin
RBD	Rapid eye movement sleep behavior disorders
ROS	Reactive oxygen species
RT	Reverse transcription
SEM	Standard error of the mean
SN	Substantia Nigra
SNc	Substantia Nigra pars compacta
SNr	Substantia nigra pars reticulata

SOPF	Specific and opportunistic pathogen free
TH	Tyrosine hydroxylase
TNF- α	Tumor necrosis factor α
UCP2	Uncoupling protein 2
UPS	Ubiquitin-proteasome system
VPS35	Vacuolar protein sorting-associated protein 35

GENERAL OVERVIEW

1. History of the discovery of Parkinson's disease

The first description of Parkinson's disease (PD) was made in 1817 by James Parkinson in his "*Essay on the shaking palsy*". Based on the observation of six persons met on the hospital or in the street, this medical doctor describes an "*Involuntary tremulous motion, with lessened muscular power, in parts not in action and even when supported; with a propensity to bend the trunk forwards, and to pass from a walking to a running pace: the senses and intellects being uninjured*". This publication will stay with no major consequence during six decades until the French neurologist, Jean-Martin Charcot, acknowledges it, completes it with the addition of the bradykinesia to the resting tremor already described and names it Parkinson's disease (PD, Goetz, 2011). It was not until 1919 that Konstantin Tretiakoff determined the neuropathological source of such symptoms as a degeneration of melanin-containing neurons in the substantia nigra (SN; Tretiakoff, 1919). From 1920 to 1925, an epidemic of encephalitis following the so-called "Spanish flue" gave rise to the identification of post-encephalitic syndromes with parkinsonism, suggesting for the first time a possible environmental origin of the disease and highlighting the third characteristic symptom of PD: the slowness of movement called akinesia. In 1958, Arvid Carlsson discovered the role of 3-hydroxytyramine as a neurotransmitter, also named dopamine, only known until then as a synthesis intermediate of noradrenalin and adrenalin from tyrosine (Carlsson et al., 1958). In addition he also demonstrated that a dopamine precursor, the L-3,4-dihydroxyphenylalanine most commonly known as L-DOPA, could restore the motor function in akinetic animals after an exposure to a blocker of the vesicular monoamine transporter named reserpine (Carlsson et al., 1957). In 1959, the main source of dopamine was localized in the striatum (Bertler and Rosengren, 1959). This led Oleh Hornykiewicz and Herbert Ehringer to study the distribution of dopamine in the human post-mortem brain, quickly followed by the identification of a dopamine depletion in the striatum of parkinsonian patients (Ehringer and Hornykiewicz, 1960). Those data led to the first assays of L-DOPA in parkinsonian patients (Barbeau, 1962; Birkmayer and Hornykiewicz, 1961) and the discovery in 1967 of the most efficient dose of oral treatment still used nowadays (Cotzias et al., 1967; Fahn, 2015).

2. Epidemiological data

PD is the second most frequent neurodegenerative disease in the world after Alzheimer's disease. Its incidence varies from 5 to 346 for 100 000 persons in European countries (von Campenhausen et al., 2005). Its prevalence depends on the age of the population studied. Beginning with 0.3% in the entire population, it reaches 0.9% in people

aged of 65-69 years and up to 5% from 80 to 89 years. The age is therefore one of the most important risk factor for PD (Fig.1; Abdullah et al., 2015; Elbaz et al., 2016). As a matter of fact, the progressing aging of the population in industrialized countries combined with the absence of treatment to cure the disease is expected to dramatically increase the burden of PD at several levels notably in terms of economy, and society (Dorsey et al., 2007). Indeed, in the United States, the number of parkinsonian patients aged of 65 years or more is expected to increase of 77% by 2030 (Dorsey et al., 2013).

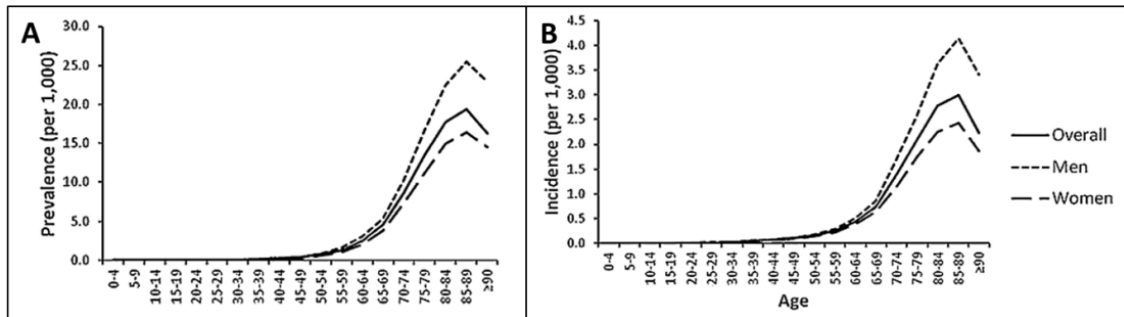

Figure 1: Prevalence and incidence of Parkinson's disease in France in 2010 as estimated from databases on the social security system. Prevalence (A) and incidence (B) increase with age until 85 years old. The decrease observed after this age could be due to misdiagnosis of Parkinson's disease due to comorbid diseases. From Elbaz et al., 2016.

Apart from the age, the gender has been proposed to also play a role in the development of the disease and impacts the risk to develop PD. Indeed, recent analyses showed that the male/female ratio in the prevalence of the disease is of 1.8 and increases by 0.05 per ten years of age of the patients studied (Mayeux et al., 1992; Pringsheim et al., 2014). This difference in prevalence could arise from a protective role of the estrogen in women, or a higher exposure to environmental deleterious agents in men (Haaxma et al., 2007). The prevalence of PD seems also to be dependent on the geographical region studied. Indeed, the prevalence of PD was not different between men and women in Asia (Pringsheim et al., 2014). Moreover, whereas the overall prevalence is similar among European countries, differences have been observed compared to African countries where the prevalence is much lower (Okubadejo et al., 2006). This could be partially explained by the different methodology used to diagnose the disease and a shorter lifespan in Africa. Indeed, a study undertaken in Africans living in the United States revealed a prevalence of PD that equaled the one of Caucasian persons living in the same area but was five times higher than the one in Nigeria (Schoenberg et al., 1988). Such a difference could also be explained by a different lifestyle including different diet and environmental exposures. Indeed, in Mediterranean countries such as Sardinia or Italy, the prevalence of PD is around 0.065%, while the access to health supply, doctor or medication is not different than in other European countries (Rosati et al., 1980). Many questions therefore remain regarding the

events which could influence the development of PD. As presented here the age, the gender and the geographical situation of the individual are linked to the prevalence of the disease. In the previous decade, many other factors have been linked to PD and will be presented below with a description of the disease, its characteristic symptoms and the current treatments available.

CHAPTER 1: PARKINSON'S DISEASE

1. Symptomatology and clinical diagnosis

1.1. Motor symptoms

PD is primarily known as a motor disorder characterized by four motor symptoms: bradykinesia, resting tremor, rigidity and postural instability (Lees et al., 2009).

1.1.1. Bradykinesia

Bradykinesia is defined as a slowness of the movements and is mainly observed when the patient performs a repetitive task (<https://www.parkinsons.org.uk/content/parkinsons-symptoms>). In the daily life, bradykinesia can lead to increased times to perform simple actions such as shaving or eating, smaller letters during writing also called parkinsonian micrographia, or difficulties to initiate or keep doing any other precise voluntary movement. This symptom can be difficult to register by the patient or his/her family as it is often considered as a sign of aging. Its severity is linked to the evolution of the degeneration in the brain of PD patients (Pikstra et al., 2016). As illustrated in figure 2A, the neurologist can easily diagnose bradykinesia when asking the patient to repetitively open and close the hand. Indeed, the repetitive opening and closing of the hand will be slower, with hesitations in patients with bradykinesia or can also be almost impossible in patients with akinesia.

1.1.2. Resting tremor

The resting tremor is an involuntary movement which affects 75% of the parkinsonian patients. It is characterized by a low frequency, of only 4-6 Hz, in a resting member, i.e. a member which does not move, and disappears when the patient moves (see Fig. 2B). At the beginning of the disease, it is usually unilateral but, as the disease progresses, it becomes bilateral. Based on this symptom, two categories of PD patients can be distinguished: the tremor-dominant parkinsonian patients and non-tremor patients also called akinetic-rigid patients (Zetuský et al., 1985). Tremor-dominant patients have a more benign PD as they less often develop cognitive troubles and dementia and their disease progresses at a slower rate (Burn et al., 2006; Williams-Gray et al., 2007; Zetuský et al., 1985). However, the disease duration before the death of the patient is similar in both groups of patients, suggesting that this advantage is present at the beginning of the disease but is lost later in its

evolution (Selikhova et al., 2009). Contrary to the other symptoms of PD, the tremor responds less to the dopaminergic therapy and its severity does not correlate with the progression of the degeneration in the brain of PD patients (Hallett, 2012; Rossi et al., 2010).

1.1.3. Rigidity or stiffness of the muscles

Rigidity or stiffness of the muscles begins unilaterally, most of the time at the same side than the tremor, if the patient presents with tremor, and progresses to the other side of the body over time. Rigidity is due to a hypertonia of the muscles and can be observed differently depending on the patient. Indeed, in some patient rigidity can lead to a “mask-like” face, i.e. a face without expression which hinders social communication (see Fig. 2C), or an absence of arm swing during the walk for example (Pfeiffer et al., 2012; <https://www.parkinsons.org.uk/content/parkinsons-symptoms>). It can be assessed by the neurologist when asking the patient to perform a rotative movement of the wrist. Indeed, patients with rigidity will have difficulties to perform a smooth movement. In the contrary they will make a jerky movement called “cogwheel” rotation (see Fig. 2 D). Rigidity of the muscles may be the cause of pain and greatly impact patients’ daily life and social interactions.

1.1.4. Postural instability

Postural instability corresponds to a difficulty for the patient to keep his/her balance; it often leads to falls and highly decreases the quality of life. It is easily observed when the neurologist gently pushes the shoulders of the patient backwards. Indeed, contrary to a healthy person who would adjust his/her position to prevent a fall, a patient with postural instability will be unable to recover his/her balance (Fig. 2E).

This short list of symptoms could lead to the conclusion that PD is easy to recognize from a clinical perspective. However, it has to be noted that every patient diagnosed with PD presents with a specific individual phenotype. The presence and the intensity of each motor symptom at the onset of the disease and their appearance throughout the progression of the disease vary between patients. In addition, some symptoms reported by the patient him/herself or by his/her family are sometimes absent at the time of the examination performed by the neurologist. This heterogeneity makes it difficult to diagnose PD. Moreover, several disorders which look like PD by some aspects but are different by many others have been described. They are called atypical parkinsonism (Stamelou and Bhatia, 2015). The term parkinsonism refers to a collection of PD symptoms with different etiology and neuropathological and clinical hallmarks which may differ from the ones of PD. Atypical parkinsonism usually progresses faster than PD and includes drug-induced parkinsonism (such as 1-methyl-4-phenyl-1,2,3,6-tetrahydropyridine (MPTP), cf. below §3.1.1.), progressive supranuclear palsy, corticobasal degeneration, multiple system atrophy and dementia with Lewy bodies. The follow up of the patients during several months or years is

therefore necessary to ascertain the differential diagnosis and to propose the adequate treatment.

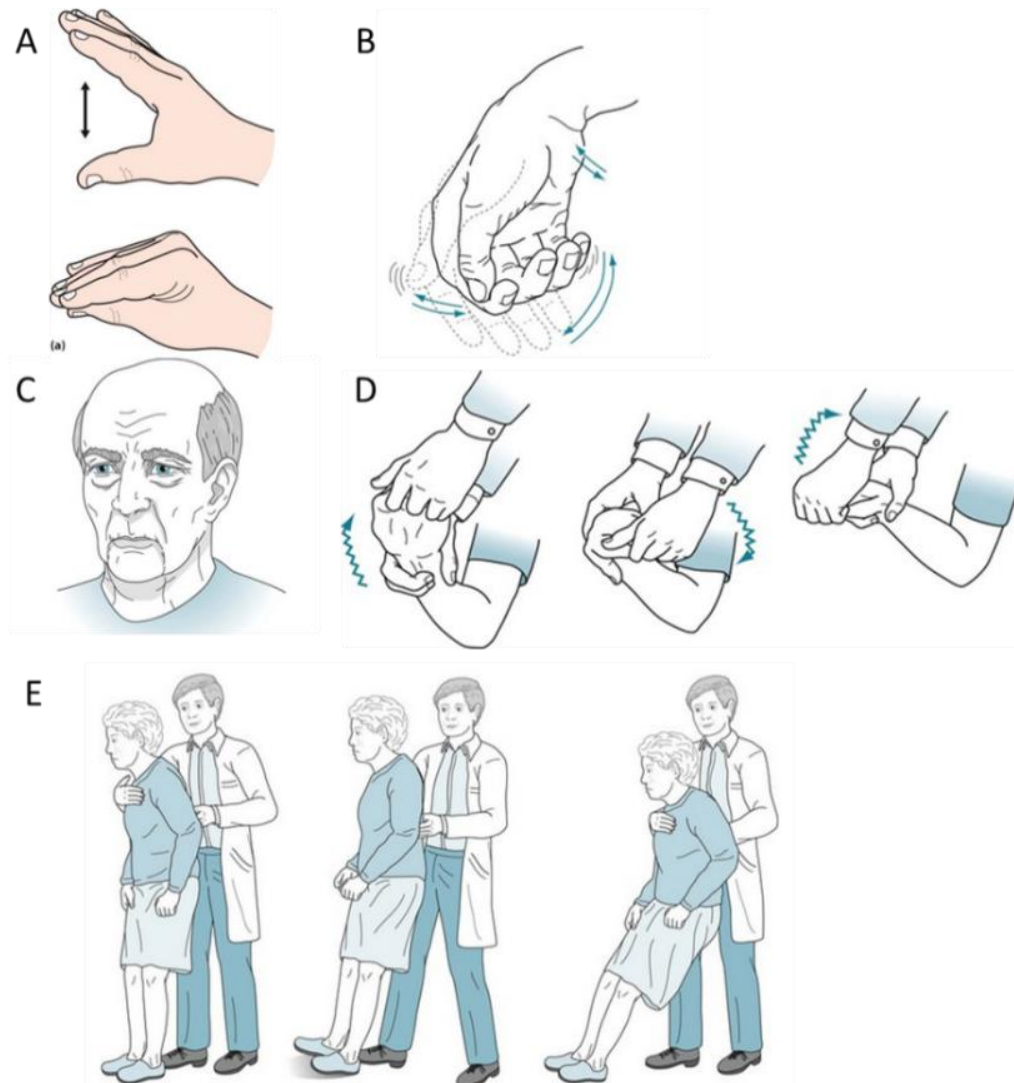

Figure 2: Representation of the motor symptoms of Parkinson's disease and the tests used to diagnose them. A) Bradykinesia can be assessed by asking the patient to tap his/her fingers together quickly. In patients with bradykinesia the movement is slowed and, in the worst cases, the patient has difficulties to initiate the movement. B) Resting tremor is a low frequency tremor (4-6Hz) of the wrist, hand and fingers appearing when the patient is at rest and absent when the patient initiates a voluntary movement. C) Rigidity induces a slowness of the facial movements which can be recognized in patient by a masked face without expressions. D) Rigidity is assessed by rotating the patient's wrist and perceiving an increased muscular tone leading to a resistance to the movement. E) Postural instability is assessed by the pulling test. The neurologist is placed behind the patient and gently pulls the shoulders of the patient. Patients with postural instability will not be able to adjust their posture as quickly as control subjects and will need to make several steps backward or will fall. Illustration from *clinicalgate.com*

1.2. Non-motor symptoms

Apart from the classical motor symptoms, parkinsonian patients often complain about non motor symptoms which include mood disorders, dysautonomia, sensory troubles, pain, cognitive decline or sleep disturbances (Chaudhuri and Schapira, 2009). They usually worsen in the advanced stages of the disease (cf. below §1.3.), and impact the patients' quality of life and life expectancy. Some of these non-motor symptoms may appear many years before the initial motor deficits (Bhidayasiri and Truong, 2012; Chaudhuri et al., 2006; Noyce et al., 2016). In his description of the shaking palsy, James Parkinson already mentioned that "*The urine and feces are passed involuntary; and at the last, constant sleepiness, with slight delirium, and other marks of extreme exhaustion, announce the wished-for release.*" (Parkinson, 2002)¹. In this view, olfactory dysfunctions, anxiety, depression, dementia, rapid eye movement behavior disorder (RBD) and gastro-intestinal disorders including nausea, vomiting, constipation and gastroparesis are considered as non-motor symptoms of PD and will be briefly discussed (see Table 1; Poewe, 2008).

1.2.1. Olfactory dysfunctions

Olfactory dysfunctions are described in almost 90% of PD patients (Doty, 2012; Haehner et al., 2009). Moreover, hyposmia has been associated with a 10% higher risk to develop PD (Ponsen et al., 2004). Therefore, olfactory dysfunctions could be used to improve the sensitivity of PD diagnosis and eliminate other possible causes of the symptoms such as atypical parkinsonism as it is absent in corticobasal degeneration and progressive supranuclear palsy (Hoyles and Sharma, 2013; Kranick and Duda, 2008; Morley and Duda, 2010). It has however to be noted that olfactory dysfunctions are also present in the early stages of Alzheimer's Disease (Kovács et al., 2001). This symptom is therefore not specific of PD and has rather been suggested as a biomarker of early stages of neurodegenerative diseases (Ross et al., 2008). Due to this lack of specificity, olfactory dysfunctions *per se* cannot be used alone to identify individuals at risk for PD. They could however be of interest if used in combinaison with other more specific symptoms.

1.2.2. Mood disorders

PD patients also present with generalized anxiety, depression, panic disorders, phobia, apathy, alexithymia, and psychoses (Alzahrani and Venneri, 2015; Assogna et al., 2016). The prevalence of anxiety in PD patients worldwide is estimated between 5.3 and 40% while depression is present in 10-45% of PD patients (Dissanayaka et al., 2010; Gotham et al., 1986; Lauterbach and Duvoisin, 1991; Leentjens et al., 2008; Starkstein et al., 1993; Walsh and Bennett, 2001). Among the different forms of depression, anxiety, social phobia, generalized anxiety disorder and panic disorder are the most described in PD patients

¹ Re-edition of the original manuscript written by James Parkinson in 1817.

(Dissanayaka et al., 2010). Such neuropsychiatric disorders are now recognized as an intrinsic component of the disease, notably due to their persistency over time despite the amelioration of motor symptoms in medicated patients (Connolly and Fox, 2014). This can be considered in light of the premorbid personality often encountered in many patients. Indeed, PD subjects often display over-controlled, introspective, anhedonic and low sensation seeking personality traits which are considered as emotional and attitude inflexibility (Evans et al., 2006; Poewe et al., 1983; Todes and Lees, 1985). Anxious patients have a 38% higher risk to develop PD. Similarly, the risk to develop PD is twice higher in patients undergoing depression than in healthy subjects (Lin et al., 2015).

1.2.3. Dementia

Dementia is one of the most debilitating non-motor symptoms of PD. It is present in 12-48% of PD patients as identified in community-based studies undertaken in Australia and in the United States (Hely et al., 2005; Mayeux et al., 1992). This prevalence depends on the age of the subjects as it ranges from zero before the age of 50 to 787,1 for 100 000 in individuals older than 80 years (Mayeux et al., 1992). Although highly present in advanced stages of PD, dementia is also reported in other diseases and most of all, it is mainly described in patients diagnosed with Alzheimer's disease. Moreover, the development of dementia in the few years following the appearance of motor symptoms mostly suggest the development of atypical parkinsonism such as dementia with Lewy bodies instead of PD (Levin et al., 2016; National Parkinson Foundation, n.d.). It is thus too early to decipher if dementia arises as a symptom of advanced PD, due to the presence of PD-specific lesions in the cerebral cortex, or if it is a classical manifestation of a comorbid disease.

1.2.4. Rapid eye movement sleep behavior disorders

Rapid eye movement sleep behavior disorders are characterized by an excessive motor activity of the eyes during the dreams. It is retrospectively described in many PD patients. Indeed, among 29 men diagnosed with RBD, 38% developed PD in the 13 years following the onset of RBD (Schenck et al., 1996). Moreover, a study performed in PD patients and healthy controls with an interval of two years also showed a greater increase in the occurrence of RBD in PD patients compared to controls. Within two years, the amount of PD patients suffering from RBD increased from 25% to 43% whereas in the control group it increased non significantly from 2% to 4% (Sixel-Döring et al., 2016). Although they are not specific of PD and are usually misdiagnosed (Stores, 2007), sleep disorders are currently considered as early non motor symptoms of PD which greatly impact the quality of life of PD patients. A better understanding of these symptoms and their neurobiological causes should improve the patient's quality of life and alleviate the burden of PD in the daily life.

1.2.5. Gastro-intestinal disorders

Gastro-intestinal disorders, including excess of saliva, constipation and delayed gastric emptying are common in all stages of PD (Pfeiffer, 2011). Indeed, 70-78% of PD patients display an excess of saliva whereas only 6% of control subjects report it (Eadie and Tyrer, 1965; Edwards et al., 1991). As the amount of saliva produced is lower in PD patient, this excess of saliva in the mouth is thought to be the result of swallowing difficulties and could cause lack of saliva control (Bagheri et al., 1999; Edwards et al., 1991).

Neuropsychiatric symptoms	Anxiety Depression Dementia Attention deficit Anhedonia
Sleep disorders	Rapid eye movement behavior disorder Insomnia
Autonomic dysfunctions	Dribbling of saliva Erectile dysfunction Sweating Orthostatic hypotension
Gastro-intestinal symptoms	Constipation Dysphagia Vomiting Nausea Gastroparesis
Sensory symptoms	Hyposmia / anosmia Pain Olfactory disturbance

Table 1: Main non-motor symptoms of Parkinson’s disease. The non-motor symptoms of Parkinson’s disease include neuropsychiatric symptoms, sleep disorders, autonomic dysfunctions, gastro-intestinal symptoms and sensory symptoms (adapted from Bonnet et al., 2012).

Concerning constipation, a prospective study undertaken in 6790 control men during 24 years showed that subjects with one bowel movement or less per week had a three times higher risk of developing PD in the ten years following the beginning of constipation (Abbott et al., 2001). Delayed gastric emptying, also called gastroparesis, is present in all stages of PD. It affects the quality of life of the patients, their nutrition states and the absorption rate of their medications (Heetun and Quigley, 2012). Indeed, a study showed that an intra-duodenal L-DOPA administration was able to improve motor symptoms in a PD patient with motor fluctuations while oral-administered L-DOPA could not (Kurlan et al., 1988). This could be explained by the fact that, in patients with gastroparesis, L-DOPA stays longer in the stomach and is therefore more

susceptible to degradation into dopamine by dopa-decarboxylase present in the stomach. Since dopamine cannot cross the blood-brain-barrier, the amount of available L-DOPA reaching the brain is lower than it would be in a patient with normal transit time.

These non-motor symptoms, their frequency and their severity can be evaluated with a rating scale named Non-Motor-Symptoms questionnaire (NMS-Quest, see Annex 2; Chaudhuri and Martinez-Martin, 2008; Romenets et al., 2012). Although these non-motor symptoms are not specific of PD, they are known risk factors for the disease and could be useful in understanding the early stages of PD (Lin et al., 2015, 2014; Ponsen et al., 2004; Postuma et al., 2015; Walter et al., 2015). Moreover, the presence of several of these non-motor symptoms, now recognized in the general population as early signs of PD, might lead the patient to consult a neurologist without delay, therefore allowing the early treatment of the first motor deficits and a longer time for the patient to adjust to his/her new condition.

1.3. Evolution of the disease and clinical diagnosis

1.3.1. *Evolution of the disease*

PD is a neurodegenerative disease of insidious onset with a slow and irreversible progression. The disease evolves in three stages. The first one regroups the first years following the clinical diagnosis of PD. It is often called “honeymoon stage” as most patients experience an improvement of their motor symptoms and their general quality of life after the beginning of dopaminergic therapy. As the disease evolves, the cerebral lesions in the brain keep progressing and the medication becomes less efficient. Indeed, the patient will experience “on” phases during which the motor symptoms are controlled by the medication and “off” phases during which the dose of the treatment is not sufficient anymore to compensate the neuronal damage causing the motor symptoms. These “off” phases appear at the end of the intervals between two medication doses. This second stage of the disease, known as fluctuation phase, is also characterized by the development of motor side effects of dopaminergic treatment such as involuntary movements called dyskinesia. Finally, the last and final stage of PD is characterized by a worsening of the previous motor complications and a decrease in autonomy notably due to reduced mobility and cognitive dysfunctions.

In several cases, such as PD genetic forms (cf. chapter 1, §3.2.), the disease starts from the very beginning of the life (Fig. 3; Kalia and Lang, 2015). Therefore, a more general overview of PD, which will be used in this dissertation, considers its evolution from a cellular and molecular point of view and is also divided in three stages. The first stage is asymptomatic from a clinical point of view and represents the insidious development of the disease. The second stage of the disease is called the pre-diagnosis or prodromal phase. It

is characterized by the progressive appearance of the first non-motor symptoms as well as of slight motor symptoms which, alone, cannot lead to the classical clinical PD diagnosis. At the end of this second phase, the motor symptoms are clearly noticed by the patient and often lead to the patient to consult a neurologist who will evoke the diagnosis of PD. The third stage corresponds to the diagnosed phase and includes the presence of motor symptoms, their treatment and the potential complications of the disease.

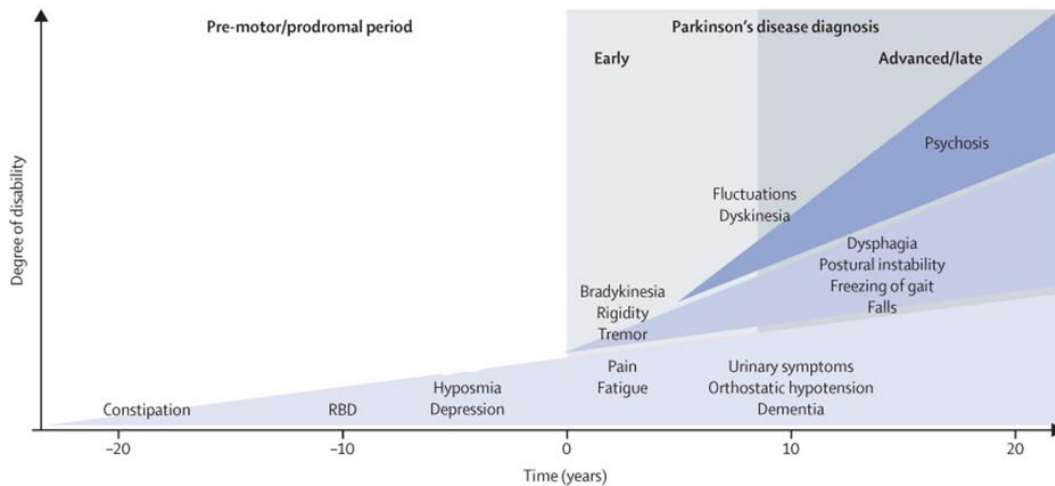

Figure 3: Time course of the appearance of clinical features of Parkinson's disease.

During the pre-diagnosis stage of the disease, patient often complain about non-motor troubles such as constipation, rapid eye movement sleep behavior disorder (RBD), depression and hyposmia. The clinical diagnosis occurs with the beginning of the characteristic motor symptoms (resting tremor, bradykinesia and rigidity). As the disease progresses, other non-motor symptoms are described by the patients including pain, fatigue, orthostatic hypotension, dementia and urinary symptoms. In the advanced stages of the disease, fluctuations and dyskinesia may appear in patient receiving dopaminergic therapy (Adapted from Kalia and Lang, 2015).

It is estimated that PD first motor symptoms appear only after at least 50% of SN *pars compacta* (SNc) dopaminergic neurons are dead (Bernheimer et al., 1973; Riederer and Wuketich, 1976). PD clinical diagnosis is therefore established late in the course of the disease considering its molecular and cellular progression. Consequently, a better understanding of the phases preceding the diagnosed phase of the disease is essential to anticipate the diagnosis of PD before the molecular and cellular alterations lead to the degeneration of SN dopaminergic neurons.

1.3.2. Clinical diagnosis

The clinical diagnosis of PD relies on the identification of the characteristic motor symptoms described in §1.1. above. Because the disease can only be diagnosed with certainty after autopsy upon detailed examination of the brain of the patient (see below §2), neurologists try to be as accurate as possible in the criteria used to diagnose the disease and have developed rating scales assessing motor symptoms and their severity, as well as

exclusion criteria, i.e. criteria which suggest the development of another disease, to eliminate possible other causes of the symptoms. The clinical diagnosis is currently reached in three steps shown in figure 4.

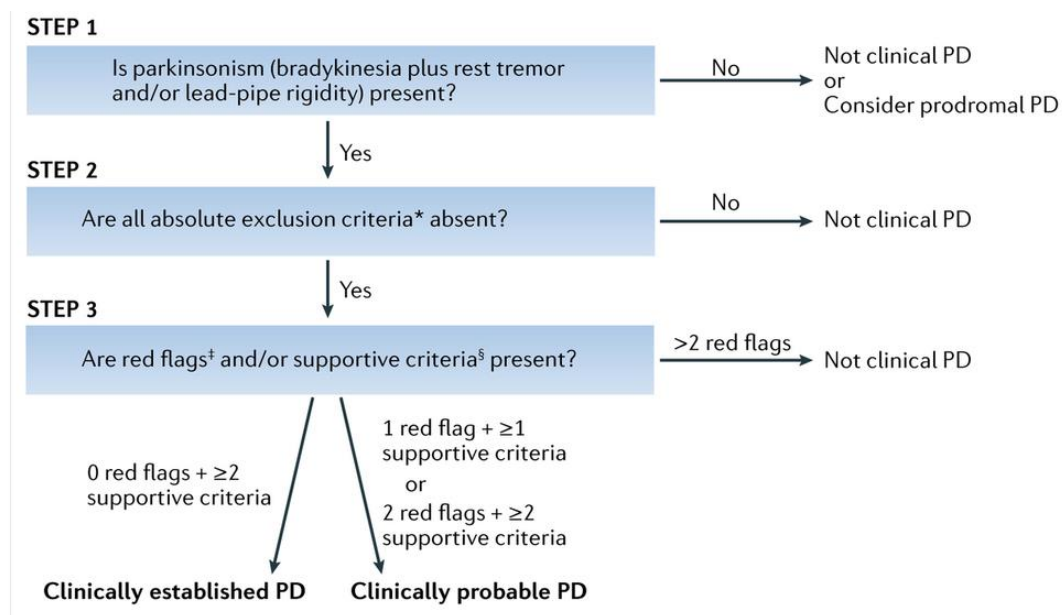

Figure 4: Establishment of the clinical diagnosis of Parkinson’s disease by the neurologist. First, the patient must present with bradykinesia and resting tremor or rigidity of the muscles. Second, exclusion criteria such as a precocious cognitive impairment or a cerebellar syndrome, must be excluded. Last, supportive criteria such as a unilateral begin and a slow progression of the disease must be described whereas “red flags”, i.e. symptoms or reaction to the treatment which are not characteristic of the disease but have already been observed in clinically established PD patients, must be avoided. Based on the number of red flags and supportive criteria presented by the patient, the neurologist will establish or suggest a diagnosis of PD (from Kalia and Lang, 2015).

First, the patient must suffer from bradykinesia AND at least one of the following symptoms: muscular rigidity, resting tremor or postural instability. Second, the patient should not present an exclusion criterion for the diagnosis of PD. Indeed, several diseases, other than PD, can explain some of the symptoms developed by parkinsonian patients. It is thus important to exclude any other potential disorder before applying the diagnosis and the treatments. The neurologist will thus interview the patient and/or his/her family and search for a potential familial history of PD, neuroleptic treatments preceding the development of the symptoms, repeated brain damages or stroke, encephalitis, cerebellar syndrome, severe and precocious dysautonomia, severe and precocious dementia, memory or language disturbances, brain tumor, exposure to MPTP or a negative response to L-DOPA the main medical treatment of PD. Last, the neurologist must find three supportive criteria which confirm the diagnosis. A unilateral beginning of the disease, the presence of a resting tremor, a progressive evolution, a positive response to L-DOPA treatment during at least five years

and choreic movements induced by L-DOPA are some of these supportive criteria. These two last criteria require to wait several years during which the patient is treated with L-DOPA while the clinical diagnosis is not really established, therefore some clinicians prefer not to use these criteria. According to Postuma and colleagues, patients are divided into two groups regarding the certainty of the diagnosis: patients with a clinically established PD and patients with a probable PD (Postuma et al., 2015). In the first category, specificity is maximized to reach at least 90% of diagnosis accuracy, taking into account that maybe some true PD patients will not reach the threshold. Indeed, a patient with clinically established PD must present bradykinesia and resting tremor or muscles rigidity plus at least two supportive criteria and no exclusion criteria of any kind. In the second category both specificity and sensitivity of the diagnosis are important, therefore diminishing diagnosis accuracy but also including more patients who might suffer from PD. Indeed, patient presenting with exclusion criteria might be diagnosed with PD if they also present supportive criteria to counterbalance (Postuma et al., 2015). It is estimated that, using these tools, 88% of the „*probable PD with a disease duration superior to 5 years*“ diagnosed by a neurologist are confirmed after the autopsy (Adler et al., 2014).

Once the patient has been diagnosed with PD, rating scales are used to study the progression of the disease and to assess the efficiency of the treatments proposed. The two most widely used scales are the Hoehn and Yahr scale (Bhidayasiri and Tarsy, 2012) and the Unified Parkinson's disease rating scale (Annex 3 and 4; Goetz et al., 2007). The latter one is the most recent. It is composed of six parts assessing the severity of PD, its impact on daily life and the potential side effects of the treatment. Briefly, questions of Part 1 evaluate the non-motor symptoms of PD. Part 2 refers to the motor symptoms of PD. Part 3 refers to the clinical examination performed by a neurologist. Part 4 evaluates motor complications. Part 5 and part 6 respectively refers to Hoehn and Yahr staging of severity of PD and Schwab and England scale. For each question, a 0-4 rating is used to evaluate the severity of the symptom described from normal (rate 0) to severe (rate 4) (Movement Disorder Society Task Force on Rating Scales for Parkinson's Disease, 2003; Ramaker et al., 2002).

2. Neuropathological characterization

2.1. Neuropathological hallmarks of Parkinson's disease

The definite diagnosis of PD is made after autopsy, upon detailed observation and immunological staining of the brain of the patient. Macroscopically, the neurodegeneration of the ventral tier of the SN can be easily observed as the nigral dopaminergic neurons contain neuromelanin, a pigment which gives them a black colour. Thus, SN can be quickly identified in the mesencephalon of control subjects and is strongly attenuated in the brain of PD patients (Fig. 5).

The second characteristic hallmark of PD is the presence of intra-cytoplasmic inclusions named Lewy bodies, observed in the surviving neurons after immunological staining (Braak et al., 1998; Dickson, 2012; Dickson et al., 2009). Several other neuropathological alterations such as an extranigral neuronal death and the presence of neurofibrillary degeneration or senile plaques have also been described in the brain of PD patients (Braak et al., 2003).

2.1.1. Dopaminergic cell death

PD is characterized by a progressive loss of dopaminergic neurons of the ventral tier of the SNc therefore leading to a striatal depletion of dopamine as detailed in §2.2.1. below (Fig. 5). It is estimated that more than 50% of the neurons of the SNc are dead when the first motor symptoms appear (Bernheimer et al., 1973; Riederer and Wuketich, 1976).

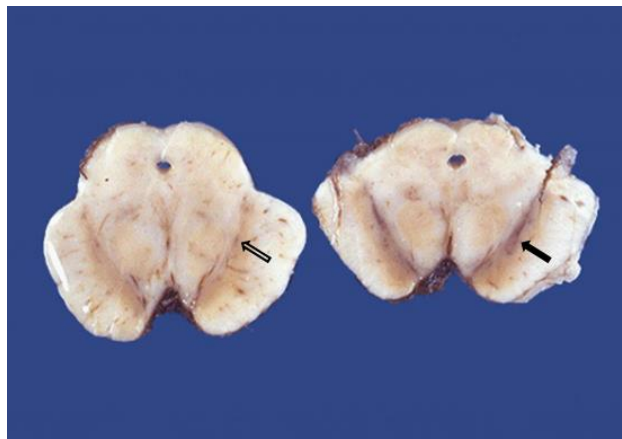

Figure 5: Dopaminergic neuronal death within the SNc in PD. Pictures of the brain of a control subject (right) and a parkinsonian patient (left) showing the degeneration of the melanin-containing neurons of the substantia nigra (empty white arrow). (Adapted from Poh, 2013).

A neuronal death has also been described in several other brain areas. Indeed, neuronal loss within the pigmented parabrachial nucleus and the parapeduncular nucleus reaches 50% in PD brains (McRitchie et al., 1997). A neuronal loss is also reported in the intralaminar nuclei and the centromedian parafascicular complex of the thalamus, the noradrenergic neurons of the locus ceruleus, the dorsal nucleus of the vagus and the nucleus basalis of Meynert (Dickson, 2012; Halliday, 2009). Although still controversial, a neuronal loss in the ventral tegmental area has also been reported. However, the different studies did not agree on the extend of this degeneration. Indeed, some studies reported a more severe neurodegeneration in the ventral tegmental area more severe than the one observed in the SN while other studies observed a less severe neuronal death in the ventral tegmental area (Alberico et al., 2015; Kay et al., 2015). In summary, although the degeneration of the ventral tier of the SN is one of the main neuropathological features of PD, the disease also affects several other areas of the brain. This extranigral degeneration

may not be related to the appearance of the motor symptoms but could be important regarding the development of several non-motor symptoms. It is thus essential to further characterize the neuropathological consequences of the disease to adapt the current therapies.

2.1.2. *Lewy bodies and Lewy neurites*

2.1.2.1. In the central nervous system

In 1912 Friedrich Heinrich Lewy briefly described the presence of globular inclusions in the neurons of the dorsal vagal nucleus and the substantia innominate and, later, in the SN of parkinsonian patients (Goedert et al., 2013; Holdorff, 2002; Lewy, 1912, 1921). However, Lewy did not recognize a special link between these inclusions and PD at that time and did not pay much attention to them in his later descriptions. Konstantin Tretiakoff acknowledged them as Lewy bodies in 1919, based on the anatomic study of the SN of six parkinsonian patients, and described at the same time the presence of neurofibrillary changes that will later be called Lewy neurites (Lees et al., 2008; Tretiakoff, 1919). In 1953 the Lewy bodies were also described in the locus ceruleus of patients with Paralysis agitans as 5-25µm round shape cytoplasmic inclusions surrounded by a pale halo with an acidophilic core (Greenfield and Bosanquet, 1953). A later immunohistological study of Lewy bodies revealed that they did not contain lipids, fibrin, mucopolysaccharids, mucin, glycogen, heavy metals or calcium (Bethlem and Den Hartog Jager, 1960). However, neurofilaments were shown to partially compose the Lewy bodies (Goldman et al., 1983) and ubiquitin was stained in the exterior part of these inclusions (Kuzuhara et al., 1988). The most important discovery regarding the composition of Lewy bodies was made by Spillantini and colleagues who showed that the inclusions and Lewy neurites were stained by antibodies raised against full length alpha-synuclein, a protein present in pre-synaptic terminals whose function is not fully understood yet but could involve the regulation of synaptic vesicles trafficking (Burré et al., 2010; Spillantini et al., 1998). Since that time, immunohistochemical studies have been using alpha-synuclein antibody in order to study the presence of Lewy bodies. In the following years, staining for proteins encoded by PD-related genes have been observed in Lewy bodies as well, including parkin and a faint staining for DJ-1 (Bandopadhyay et al., 2004; Schlossmacher et al., 2002). Further information concerning the different steps of the formation of Lewy bodies and their potential role on the development of PD have been obtained in models of parkinsonism and will be described in chapter 2 §3.3. The exact role of Lewy bodies is still uncertain. Indeed, as pathological hallmarks of PD, present in the areas of the brain with neurodegeneration, Lewy bodies could be considered as deleterious for the neuronal cells. However, in the last decades this hypothesis has been challenged by the study of the different forms of alpha-synuclein present in PD brains which suggested that Lewy bodies could actually have a protective function in the cell by aggregating misfolded

proteins together, therefore delaying their deleterious action in the cell (Greffard et al., 2010; Ross and Poirier, 2005; Terry, 2000). Although the exact role of Lewy bodies is still a matter of debate, their presence in specific areas of the brain and the peripheral nervous system of PD patients has provided new insights in the evolution and the progression of PD.

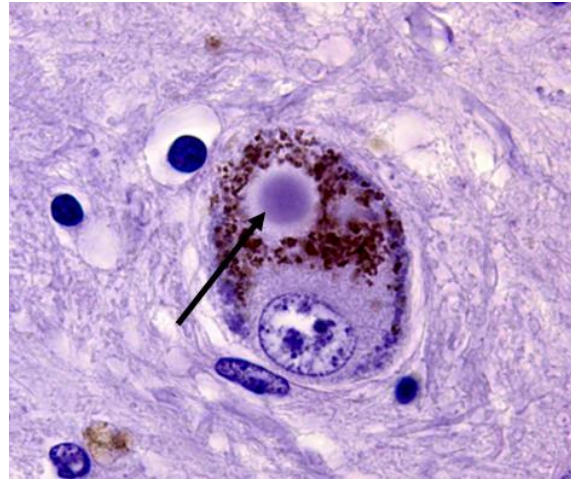

Figure 6: Lewy body pathology in Parkinson's disease. Lewy bodies are observed here after eosine / hematoxylin staining of brain slices of PD patients at the level of the Substantia Nigra. Lewy bodies are 5-25 μ m globular inclusions (cf. black arrow) surrounded by a pale halo. To ascertain their presence in PD brain, immunological analyses must be performed notably with antibodies raised against alpha-synuclein and ubiquitin. (From <http://neuropathology-web.org/chapter9/chapter9dPD.html>)

2.1.2.2. In the enteric nervous system

Recently, Lewy body-like inclusions composed of alpha-synuclein have been described in the peripheral nervous system, in particular in the neuronal plexuses of the stomach and the intestine (Fig. 7; Braak et al., 2006; Derkinderen et al., 2011; Lebouvier et al., 2010a). This discovery challenged the vision of PD as a disease of the central nervous system only and led to the hypothesis that Lewy bodies could first appear in the periphery, where they would be linked to the development of the early non-motor symptoms, and progress *via* a neuron-to-neuron transport towards the brain thus reaching dopaminergic neurons of the SN. This hypothesis has not yet been proven in humans, but it has been studied in animals. Indeed, injections of PD brain lysates into the intestine of mice leads to the propagation of alpha-synuclein through the vagal nerve to the dorsal motor nucleus of the vagus nerve (Holmqvist et al., 2014). Similarly, chronic oral exposure to the pesticide rotenone induces the formation of alpha-synuclein-positive aggregates in the enteric nervous system which propagate to the brain in a retrograde manner (Pan-Montojo et al., 2010). Moreover, the hemi vagotomy of mice prevented such a retrograde propagation in a model of parkinsonism induced by environmental exposure (Pan-Montojo et al., 2012, 2010). The vagus nerve is an essential connection between the intestine and the dorsal motor nucleus of the vagus nerve in the brain. It transmits information from the intestine to the brain but also from the brain to

the intestine. Therefore, the vagus nerve could be the physical support underlying the propagation of alpha-synuclein aggregates from the intestine to the brain. However, these studies do not prove that PD starts in the periphery. As it has been shown that alpha-synuclein could be transported in both directions through the blood brain barrier (Sui et al., 2014), it is still possible that PD characteristic lesions first appear in the brain and propagate to the enteric nervous system (Sui et al., 2014).

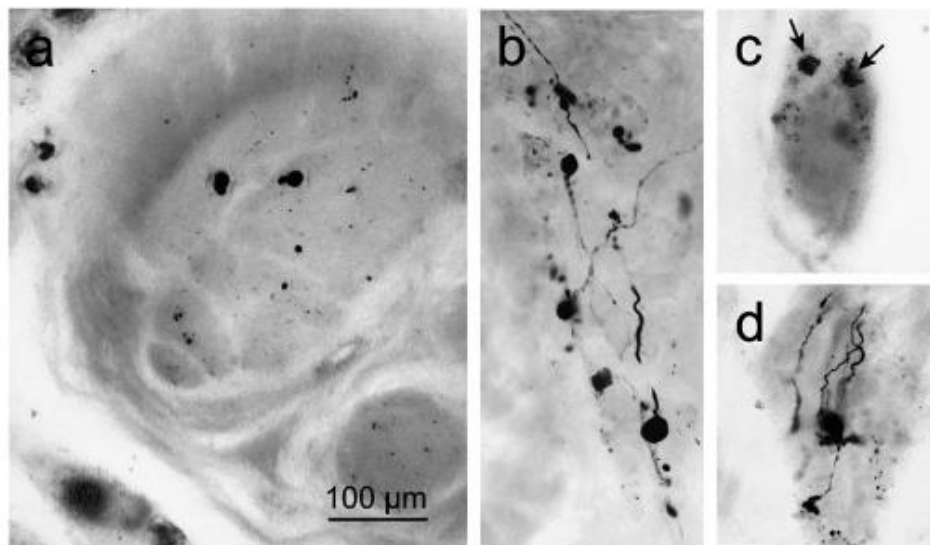

Figure 7: Alpha-synuclein inclusions in the peripheral nervous system of PD patients. A) alpha-synuclein staining within a peripheral nerve in the fundic adventitia. B-D) Globular and fibrillary alpha-synuclein inclusions in the Auerbach plexus of a PD patient (from Braak et al., 2006).

2.1.3. Braak's staging hypothesis

Braak and colleagues studied the presence and the localization of Lewy bodies and Lewy neurites in the brain of 41 PD patients, 69 subjects with Lewy body pathology but no clinical sign of PD and 58 age- and gender-matched controls (Braak et al., 2003). Based on the observations undertaken after the staining of the brains for alpha-synuclein inclusions, β -amyloid plaques and neurofibrillary tangles, they documented the pattern of progression of the disease, known as Braak's staging. Based on the severity of the lesions, referred to as Lewy pathology, and their localization in the brain, these neuropathologists identified six stages in PD progression (Fig. 8). For all stages described, Lewy neurites seem to appear before Lewy bodies. At stage 1, Lewy neurites are observed in the dorsal motor nucleus of the vagus nerve and the intermediate reticular zone. At stage 2, Lewy neurites are more numerous in these initial areas and are also found in some neurons of the caudal raphe nuclei and the reticular formation. Stage 3 is characterized by the aggravation of the lesions described for stages 1 and 2, i.e. more Lewy neurites in the concerned areas of the brain and the appearance of Lewy bodies, as well as the propagation of the lesions to melanin-

containing neurons of the SN. Several projection neurons in the basal forebrain are also affected and Lewy neurites are observed in the compact portion of the pedunculopontine tegmentum nucleus. At the same stage, Lewy bodies are observed in the tuberomammillary nucleus.

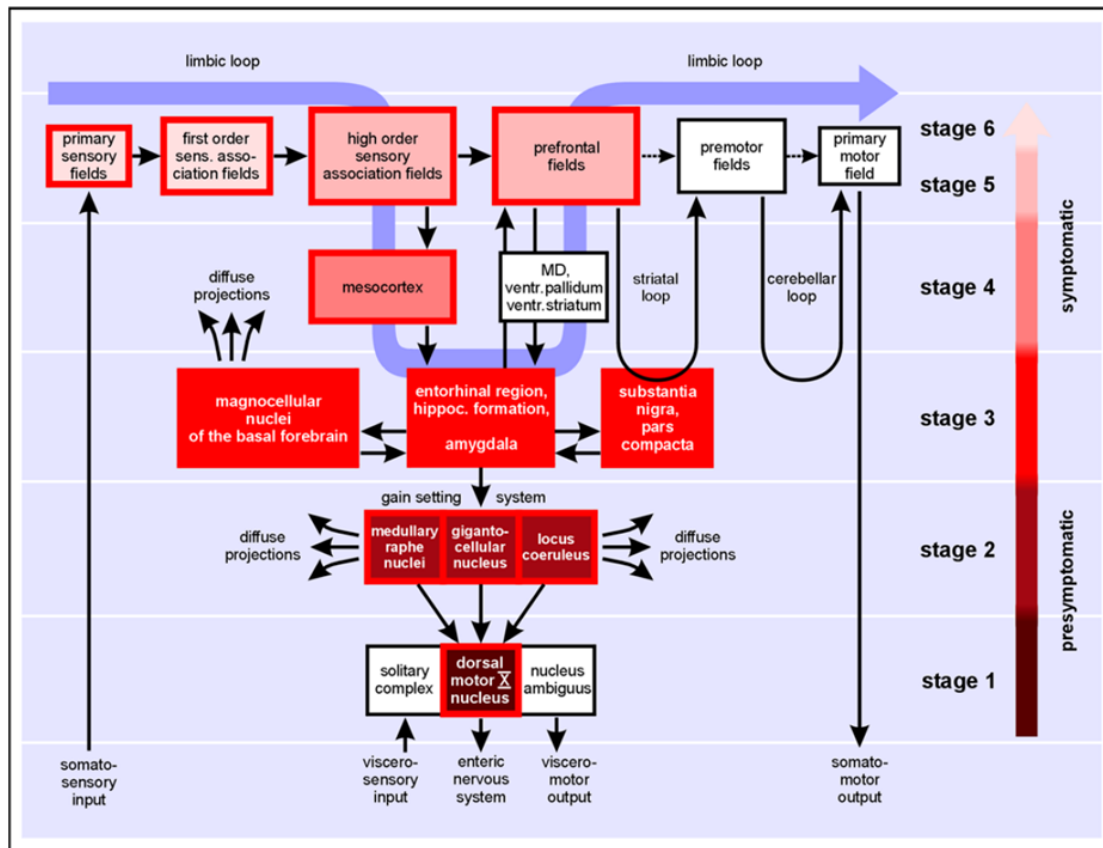

Figure 8: Suggested pattern of progression of PD-specific alpha-synuclein inclusions in the brain of PD patients. The uninvolved areas are presented in white. The involved areas are presented with different shades of red depending on the quantities of lesions observed, the darker areas being the most affected ones. Black arrows represent connections between the brain areas. Braak's staging hypothesis divides the progression of PD-related lesions, i.e. globular and fibrillary inclusions composed of alpha-synuclein, in 6 stages. Stages 1-3 correspond to the presymptomatic stages of the disease and would be characterized by the progression of Lewy bodies and Lewy neurites from the dorsal motor nucleus to SN pars compacta (SNc). Stages 4-6 represent the symptomatic stages of PD during which the lesions spread from the SNc to the cortex. (From Braak et al., 2004)

Stage 4 is differentiated by an important degeneration of melanin-containing neurons within the SNc, which can be observed macroscopically, and the appearance of Lewy neurites and Lewy bodies in the anteromedial temporal mesocortex. A severe impairment of the magnocellular nuclei of the basal forebrain and the anterior olfactory nucleus is also observed while Lewy bodies are observed in the stria terminalis, some parts of the amygdala and the claustrum.

At stage 5, a massive loss of dopaminergic neurons of the SN is accompanied by a loss of neurons in the dorsal motor nucleus of the vagus nerve, the intermediate reticular zone, the reticular formation and the locus coeruleus. Sensory association areas of the neocortex, anterior cingulate cortex and prefrontal areas start to present Lewy pathology also. Finally, stage 6 represents a wide distribution of Lewy pathology throughout the brain including the entire neocortex (Braak et al., 2003). Braak and colleagues therefore reported a stereotypical pattern of progression of Lewy pathology within the brain of PD patients starting in the the dorsal motor nucleus of the vagus nerve, innervating peripheral organs such as the intestine and the lungs, at stage 1 and propagating to the SN at stage 4. Stage 4 is supposed to correlate with the appearance of the motor symptoms. Lately, Lewy neurites and Lewy bodies propagates to the cerebral cortex where they could cause the non-motor symptoms of advanced PD-like dementia. This staging hypothesis, although needing to be confirmed and correlated with clinical data, provides new insights into the progression of PD-related lesions and could be of great interest in the search for therapeutic strategies able to stop this progression.

2.1.4. Other neuropathological hallmarks

Lewy pathology is not the only lesion found in the brain of parkinsonian patients. Indeed, tau-positive neurofibrillary lesions and extracellular neuritic plaques composed of amyloid beta ($A\beta$) accumulation, characteristic lesions of Alzheimer's disease, can be observed at the autopsy (Braak and Braak, 1990; Irwin et al., 2013; Kalaitzakis et al., 2008). Whether they represent less common lesions due to PD or they highlight a misdiagnosis is not clear. Whether they represent less common lesions due to PD itself, or whether they highlight the co-occurrence of both PD and Alzheimer's disease in the same patients, or whether they indicate a misdiagnosis is not clear. Thus, as the clinical phenotype of PD varies greatly between patients, it would be possible than, apart from the characteristic neuronal death and the Lewy pathology within the SN, some atypical parkinsonian patients present other types of lesions. In fact, neurofibrillary tangles were described in the brain of patients diagnosed with post-encephalitic parkinsonism, progressive supranuclear palsy and Parkinson-dementia complex of Guam (Geddes et al., 1993). The accumulation of alpha-synuclein, $A\beta$ peptide or tau were further described in the cortex of demented PD patients (Braak and Braak, 1990; Kotzbauer et al., 2012). Interestingly, the localization of these lesions did not allow the diagnosis of a concomitant Alzheimer's disease (Braak and Braak, 1990). The existence of common lesions between the two most frequent neurodegenerative diseases suggests that, despite differences in the implicated brain areas and the clinical symptoms, Alzheimer's disease and PD could arise from common deregulated molecular and cellular mechanisms. In addition, the study of these less described lesions in the brain of

PD patients might contribute to a better understanding of PD-linked neuropathological modifications and more largely lead to a better understanding of the causes of the disease.

Neuroinflammation associated with glial cell activation is another common feature of PD (Brochard et al., 2009; Long-Smith et al., 2009). Indeed, cytotoxic T cells have been observed in the SN of a parkinsonian patients. More precisely, the quantity of CD4+ and CD8+ T cells has been described as ten times higher in the SNc of PD patients compared to controls (Brochard et al., 2009). Moreover, astrogliosis is observed during post-mortem evaluation of PD brains using antibodies against glial fibrillary acidic protein and the concentrations of pro-inflammatory mediators such as tumor necrosis factor- α (TNF α), interferon- γ and interleukin-1 β are increased in the cerebrospinal fluid and the striatum of PD patients (Damier et al., 1993; Leal et al., 2013; Mogi et al., 1996; Nagatsu et al., 2000). Whether inflammation is one of the causes or the consequence of SN dopaminergic cell death is still controversial (Hirsch et al., 2005; Tansey and Goldberg, 2010). Indeed, glial cells are known to release neurotrophic factors and protect neurons from oxidative stress (Bélanger and Magistretti, 2009; Desagher et al., 1996). However, in pathological conditions, activated microglia express pro-inflammatory cytokines which could be deleterious for the SN dopaminergic cells (Nagatsu et al., 2000; Orr et al., 2002). Although this latter hypothesis has not been confirmed in humans, anti-inflammatory treatment has shown interesting neuroprotective action in animal models of parkinsonism and seem to decrease the risk to develop PD (Bredert et al., 2002; Chen et al., 2003).

In summary, the two main neuropathological hallmarks of PD have now been extensively characterized and allow the definite diagnosis of the disease. However, several other neuropathological changes, which have been less studied, are observed in the brain of PD patients. Among them, the presence of beta-amyloid plaques and neurofibrillary tangles suggest a common mechanism between Alzheimer's disease and PD. Finally, the neuroinflammatory processes observed in the brain of PD patients and animal models of parkinsonism has aroused the interest of researchers as a potential target for the neuroprotection of the SN neurons. The study of neuropathological changes linked to PD is therefore crucial in the understanding of the potential causes of the disease and in the search for a cure.

2.2. Functional consequences

2.2.1. Anatomy of basal ganglia²

The precise orchestration of voluntary movements is allowed by brain structures called basal ganglia. These subcortical nuclei are composed of the caudate and the putamen, which together form the dorsal striatum, as well as the globus pallidus, the SN and the subthalamic nucleus (Fig. 9). First named locus niger or “*tâche noire*” by the French neuroanatomist Vicq-D’Azyr in 1805 (Vicq-d’Azyr and Moreau, 1805) due to the presence of melanin inside its neurons, the SN can be divided in two major parts differing in their function and respective connections with other basal ganglia structures: the *pars compacta* and the *pars reticulata* (SNr). The SNr contains 70% GABAergic neurons and 30% dopaminergic neurons (Nair-Roberts et al., 2008). Together with the internal part of the globus pallidus, it represents the main inhibitory output of the basal ganglia, projecting on the ipsilateral motor thalamus to inhibit its signaling to the motor cortex (see Fig. 9). The SNc is mainly composed of dopaminergic neurons but also contains 29% of GABAergic neurons. The ventral tier sends projections to the dorsal striatum *via* the so-called nigrostriatal pathway whereas its dorsal tier is contiguous to the ventral tegmental area and therefore connected to limbic-related regions which do not participate in the nigrostriatal pathway *per se* (Haber and Fudge, 1997). According to the canonical basal ganglia model, when a voluntary movement is initiated, the motor cortex sends a glutamatergic excitatory signal to striatal GABAergic neurons, which will result in the release of the thalamic excitatory glutamatergic output on the motor cortex, thus allowing the selection of the adapted motor program. This cortical activation is however tightly modulated by nigral dopaminergic inputs through the direct and indirect pathways to enable a smooth and nicely coordinated movement (Albin et al., 1989; Calabresi et al., 2014; DeLong, 1990). Indeed, through the direct pathway, nigral dopaminergic neurons will enhance the activation of the striatal GABAergic output, thus further amplifying the selection of the adapted motor program and facilitating the movement initiated by the cortical input. In parallel, nigral dopaminergic neurons will also activate, through the indirect pathway, successive GABAergic outputs from the striatum and the external part of the globus pallidus which will in turn activate the inhibitory output from the SNr/globus pallidus internalis, thus preventing undesired movements. This classical model explains how information flows through the basal ganglia back to the cortex with opposite effects for the proper execution of a movement initiated by the motor cortex (Albin et al., 1989; DeLong, 1990; Lanciego et al., 2012; Fig. 9). Such opposite effects within the nigrostriatal pathway rely on a differential sensitivity to dopamine within the striatum. Indeed, two types of dopamine receptors are

² This paragraph is largely inspired by the Review “Is there a role for ghrelin in central dopaminergic systems? Focus on nigrostriatal and mesocorticolimbic pathways”. Alicia Stievenard, Mathieu Méquinion, Zane B. Andrews, Alain Destée, Marie-Christine Chartier-Harlin, Odile Viltart, Christel C. Vanbesien-Mailliot. In press in Neuroscience & Biobehavioral Reviews. Annex 5.

expressed by striatal GABAergic neurons: the D1-type, including D1 and D5 receptors, and the D2-type composed of D2, D3 and D4 receptors (Missale et al., 1998). On one hand, the binding of dopamine onto D1-type receptors within the striatum activates the direct pathway and leads to a disinhibition of the ipsilateral thalamus, thus facilitating the contralateral movement initiated by the cortex.

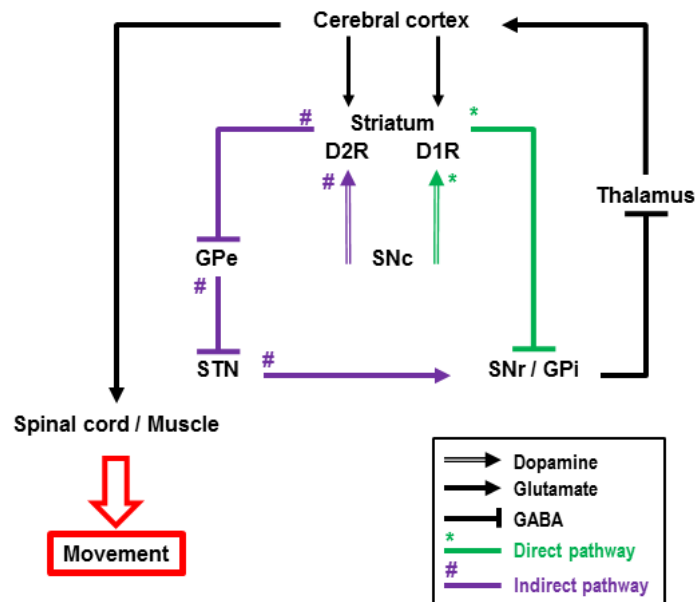

Figure 9: Schematic representation of the main functional organization of the basal ganglia. To initiate a voluntary movement, the motor cortex sends glutamatergic excitatory projections to the striatum whose resulting GABAergic outputs aimed at releasing the thalamic excitatory glutamatergic projections onto the cortex are modulated by nigral dopaminergic inputs. Indeed, within the direct pathway, dopaminergic signals from the substantia nigra pars compacta (SNc) activate the striatal inhibitory projections to the substantia nigra pars reticulata (SNr) / internal part of the globus pallidus (GPi), thus removing their basal inhibitory output to the thalamus. This results in the activation of thalamic glutamatergic (excitatory) signals to the ipsilateral motor cortex, allowing the selected movement to be appropriately performed by the contralateral part of the body. In parallel, within the indirect pathway, nigral dopaminergic outputs inhibit striatal GABAergic projections to the external part of the globus pallidus (GPe), which releases its inhibition of the subthalamic nucleus (STN). As a result, the glutamatergic (excitatory) action onto the SNr/GPi will be increased, therefore reducing thalamic glutamatergic signals to the ipsilateral motor cortex and suppressing undesired movements. This ultimately contributes to the realization of a smooth and nicely coordinated move. D1R, dopamine type 1 receptors; D2R, dopamine type 2 receptors. (From Stievenard et al., in press)³

³ This figure corresponds to the figure 5 of the review « Is there a role for ghrelin in central dopaminergic systems? Focus on nigrostriatal and mesocorticolimbic pathways. Alicia Stievenard, Mathieu Méquinion, Zane B. Andrews, Alain Destée, Marie-Christine Chartier-Harlin, Odile Viltart, Christel C. Vanbesien-Mailliot. In press in *Neuroscience & Biobehavioral Reviews*. Annex 5.

On the other hand, the binding onto D2-type receptors results in the inhibition of the indirect pathway thus preventing involuntary movements (Da Cunha et al., 2015; Guatteo et al., 2009; Haber, 2014). This classical model has recently been challenged by the identification of regulatory loops at several levels within the basal ganglia suggesting a direct interaction between both pathways (Cazorla et al., 2014; Lanciego et al., 2012; Watabe-Uchida et al., 2012). In summary, the nigrostriatal pathway, and more particularly the SNc, holds a central role in the basal ganglia system and is essential for the selection of the appropriate motor program and the realization of finely coordinated movements.

2.2.2. Basal ganglia dysfunction in PD⁴

PD is the most emblematic disorder affecting the nigro-striatal pathway. Its characteristic dopaminergic neuronal death within the SN leads to modifications of the basal ganglia motor circuits. Indeed, as presented previously, in physiological condition dopamine is essential to balance the activation between the direct and the indirect pathway. This neurotransmitter is able to prevent inadequate movement and to facilitate the adapted sequence of movement. In PD patients, the amount of dopamine produced by the neurons of the SN and released in the striatum is decreased. This dopamine depletion induces an imbalance in the basal ganglia motor circuits. On one hand, dopamine depletion in the striatum induces a lower activation of the D1-type receptors present in the striatum, therefore leading to a lower inhibitory signal to the SNr/ globus pallidus internalis which in turn will send stronger inhibitory signal to the thalamus, thus leading to a weaker signal from the thalamus to the cortex. This sequence of modifications finally induces a decrease in the motor function of the patient in the contralateral side of the body. On the other hand, the dopamine depletion in the striatum leads to a higher activation of the indirect pathway, starting with a stronger inhibitory signal from the striatum to the external part of the globus pallidus which in turn inhibits the subthalamic nuclei to a lesser extend, therefore inducing a more important signal from the subthalamic nuclei to the SNr/ globus pallidus internalis. As it is the case for the modulation of the direct pathway, the dopamine depletion in the striatum leads also to a weaker activation of the thalamus and a decrease in motor function (Fig. 10; Albin et al., 1989; DeLong, 1990). It is estimated that PD characteristic motor symptoms appear only after more than 50% of the dopaminergic of the SN are dead, suggesting that during the pre-motor stages of the disease, the feedback networks present in the basal ganglia circuits allow a compensation of the slight decrease in the dopamine content.

⁴ This paragraph is largely inspired by the Review “Is there a role for ghrelin in central dopaminergic systems? Focus on nigrostriatal and mesocorticolimbic pathways”. Alicia Stievenard, Mathieu Méquinion, Zane B. Andrews, Alain Destée, Marie-Christine Chartier-Harlin, Odile Viltart, Christel C. Vanbesien-Mailliot. In press in Neuroscience & Biobehavioral Reviews. Annex 5.

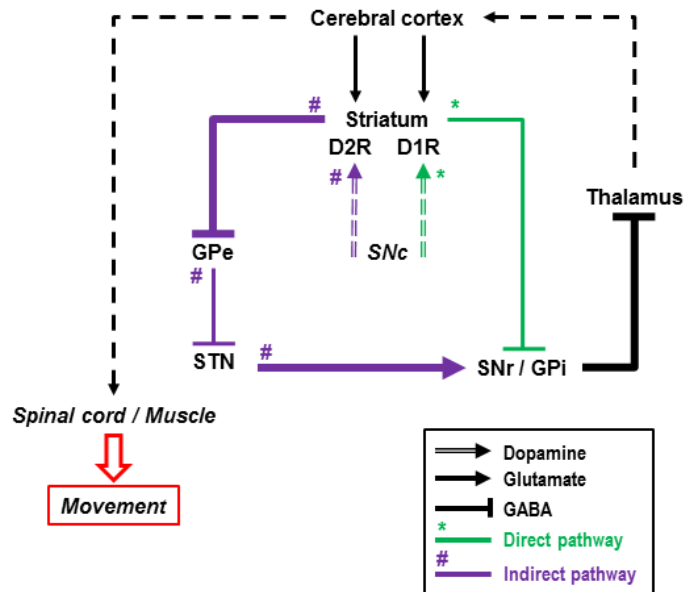

Figure 10: Schematic representation of the main functional organization of the basal ganglia in Parkinson’s Disease. The ongoing degeneration of dopaminergic neurons of the substantia nigra in Parkinson’s disease (PD) directly impacts the proper functioning of basal ganglia, which is at the origin of the motor symptomatology observed in PD patients. In particular, as a result of this nigral dopaminergic degeneration, striatal neurons involved in the direct pathway send weaker inhibitory projections to the substantia nigra pars reticulata (SNpr) / internal part of the globus pallidus (GPi) compared to healthy conditions. As a consequence, these signals are insufficient to fully release the basal inhibitory output onto the thalamus. In turn, the thalamus excitatory signal to the ipsilateral motor cortex is weaker and does not enable a proper initiation of the movement in the contralateral part of the body. In parallel, within the indirect pathway, due to the lower dopamine input from the SNc, GABAergic striatal neurons are not enough inhibited anymore and thus exert a stronger inhibitory output to the external part of the globus pallidus (GPe), which in turn does not inhibit the subthalamic nucleus (STN) enough. As a result, the STN sends increased excitatory projections to the SNr/GPi, whose GABAergic control over the thalamus will therefore also be reinforced. This further prevents the thalamic motor cortex activation. The end-result is a weaker selection of the proper motor program by the cortex, which leads to the bradykinesia observed in PD patients. The thickness of the arrows corresponds to the functional state of a given connection between two structures: thicker and thinner arrows show respectively over-active and hypo-active circuits compared to healthy conditions. D1R, dopamine type 1 receptors; D2R, dopamine type 2 receptors. (From Stievenard et al., in press)⁵

However, as the neurodegeneration progress within the SN, this compensation becomes inefficient and the classical motor symptoms appear. In order to apply potential neuroprotective agents, it will thus be important to detect and diagnose the disease before it

⁵ This figure corresponds to the figure 6 of the review « Is there a role for ghrelin in central dopaminergic systems? Focus on nigrostriatal and mesocorticolimbic pathways. Alicia Stievenard, Mathieu Méquignon, Zane B. Andrews, Alain Destée, Marie-Christine Chartier-Harlin, Odile Viltart, Christel C. Vanbesien-Mailliot. In press in *Neuroscience & Biobehavioral Reviews*. Annex 5.

reaches this threshold of compensation. The knowledge of the neuroanatomical structures involved in PD is also essential to design surgical therapies that will be presented in chapter 1 §4.3.

2.2.3. Potential for neuroimaging investigations

Although PD definite diagnosis can only be made after brain autopsy, the knowledge of the neuropathological condition of the brain of a living patient could facilitate PD clinical diagnosis. Indeed, the well-known neurodegeneration of the dopaminergic neurons of the SN and the consequent biochemical modifications which precede the clinical diagnosis of PD have been the focus of imaging approaches to refine PD diagnosis. These techniques include magnetic resonance imaging, transcranial B-mode-Doppler-sonography and functional imaging with radiotracers. Such techniques could be used to detect asymptomatic persons with a high risk to develop PD and propose neuroprotection while the neurodegeneration is not too advanced, i.e. before the onset of motor symptoms (Godau et al., 2012).

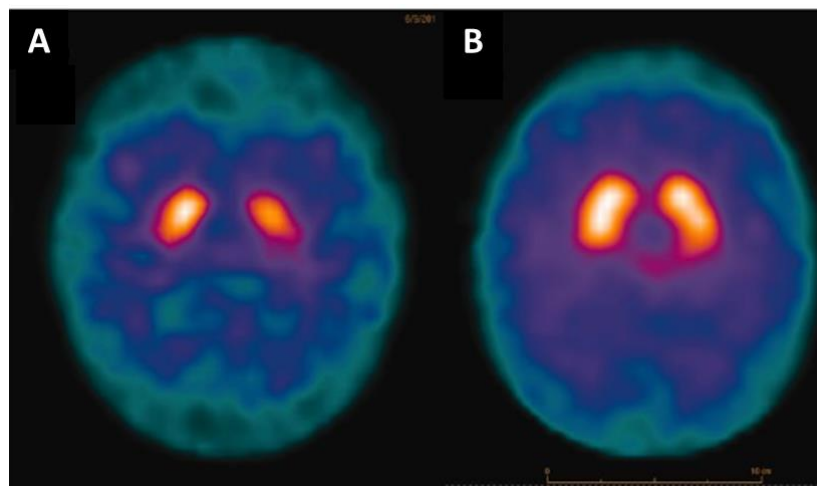

Figure 11: Dopamine transporter imaging in PD. Dopamine transporter binding, assessed using DaTSCAN™, is reduced in PD patients (A) compared to healthy controls (B). (Tzoulis et al., 2013)⁶

Among the functional imaging techniques with radiotracers, positron emission tomography, DaTSCAN™ or single photon emission computed tomography have been used to study the uptake of 6-[¹⁸F] fluoro-L-dopa which is changed into dopamine and stored in synaptic vesicles, the density of dopamine transporters or vesicular monoamine transporters. Indeed, in the brain of parkinsonian patients, even before the appearance of motor symptoms and the clinical diagnosis, the uptake of fluoro-L-DOPA is asymmetrically reduced

⁶ DaTSCAN™ is a specialized imaging technique involving the injection of a radiopharmaceutical agent specifically entering the dopaminergic neurons which will be observed with single photon emission computed tomography. DaTSCAN™ is used to assess a potential reduction of the number of dopaminergic cells within the SN.

in the putamen of asymptomatic twins and has shown dopaminergic impairments in asymptomatic subjects with a familial history of PD but no mutation described (Piccini et al., 1999; Sawle et al., 1992). A similar pattern has been observed with dopamine transporters ligands and is available in clinic to help neurologists in their diagnosis (Booij et al., 2001; Mutez et al., 2011). However, despite the huge potential for neuroimaging techniques in the diagnosis of PD, it has to be noted that these techniques have a huge cost. Some authors then advised to consult other specialists and colleagues instead of choosing such techniques (Morrish, 2005).

3. Aetiology

3.1. Environmental factors

The etiology of PD is complex, multifactorial and involves genetic factors, environmental factors, and their interactions.

3.1.1. Environmental risk factors for Parkinson's disease

3.1.1.1. Von Economo disease

Shortly after the naming of PD by Charcot, a pandemic of encephalitis spread across Europe, characterized by somnolence, fever, ophthalmoplegia and accompanied in some patients by aphasia or hemiplegia. Many surviving subjects quickly developed a post-encephalitic parkinsonism, also called von Economo disease, giving weight to the hypothesis according to which PD could result from a viral infection or the exposure to an infectious agent (Rail et al., 1981).

3.1.1.2. MPTP

Six decades later, the environmental hypothesis of PD was further supported by the development of severe PD characterized by a frozen behavior with incapacity to walk or to speak in a 23 years old student after self-injection of MPTP, an inhibitor of complex I of the mitochondrial respiration chain (Davis et al., 1979). The induced bradykinesia was only improved after treatment with L-DOPA. MPTP is a derivative in the production of a drug of abuse called 1-methyl-4-phenyl-4-propionpiperidine (MPPP). Several years later, this phenomenon happened in four other students who developed parkinsonism after intravenous injection of MPTP (Langston et al., 1983). To better understand the link between MPTP exposure and the development of PD, injections of MPTP were undertaken in monkeys. The studies showed that few seconds after its injection, MPTP crosses the blood-brain barrier, is then oxidized by monoamine oxidase-B (MAO-B) in glial cells and serotonergic cells and further transformed in 1-methyl-4-phenylpyridinium (Chiba et al., 1985, MPP⁺; 1984). MPP⁺ is released in the extra cellular space and enters dopaminergic neurons *via* a dopaminergic transporter (Bezard et al 1999). Once inside the neurons, MPP⁺ accumulates in the synaptic vesicles and the mitochondrial matrix and inhibits the complex I

of mitochondria (Davey et al., 1992; Hoppel et al., 1987; Liu et al., 1992) leading to an increase in reactive oxygen species (ROS; Rossetti et al., 1988). Autopsy performed 1.5 years after the initial exposure of students to the MPTP revealed damages of the dopaminergic neurons of the SN and activation of the microglia but no alpha-synuclein inclusions (Davis et al., 1979; Langston et al., 1999).

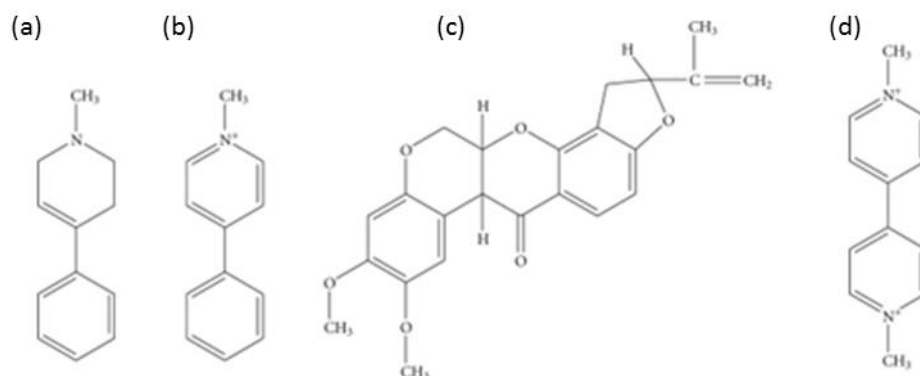

Figure 12: Chemical structure of some PD-related environmental factors. (a) MPTP, (b) MPP+, (c) Rotenone, and (d) Paraquat. Note the high chemical similarity between MPTP, MPP+ and Paraquat. (From Keane et al., 2011)

3.1.1.3. Rotenone and paraquat

The high similarity between the chemical structures of MPTP, MPP+ and the herbicide paraquat, as illustrated figure 12, led to further investigations of the hypothesis of a link between pesticides and PD. Several pesticides have been investigated, among which rotenone and paraquat have been associated with the development of PD with an odds ratio of 2.5 (Elbaz et al., 2016; Tanner et al., 2011a). While rotenone and MPTP both interact with dopamine transporters and inhibit the mitochondrial complex I, paraquat acts in a different way, potentially through the production of oxidative stress (Richardson et al., 2005; Schuler and Casida, 2001; Tanner et al., 2011a). The mechanisms involved in the development of PD after exposure to MPTP, rotenone and paraquat have been further explored in animal models of parkinsonism and will be detailed in chapter 2 below.

3.1.1.4. Brain injury

The exposure to environmental molecules is not the only environmental factor linked to the development of PD. Indeed, the practice of fighting sport causing repeated traumatic brain damage has been suggested to increase the risk to develop PD. This association between brain injury and PD is still controversial. It seems that brain injury with loss of consciousness in the early life increases the risk to develop PD with an odds ratio of 1.57. Similarly, a study undertaken in subjects aged of 55 years or more and hospitalized in California for traumatic brain injury showed a 1.7% increased risk to develop PD in the following years compared to 1.1% for the falls without brain injury (Gardner et al., 2015).

3.1.2. *Environmental factors inversely correlated to Parkinson's disease*

Many factors inversely correlated to PD therefore called “protective factors” have been reported in the last decade including cigarette smoking, caffeine drinking or tea drinking (Elbaz et al., 2016). Indeed, an inverse correlation between smoking and PD has been described in the last thirty years in men and women with a 60 % lower risk to develop PD in smokers compared to persons who had never smoked. This inverse correlation was stronger in subjects smoking more than 10 packs per year and even stronger for the ones who had been smoking since a longer time (Hernán et al., 2002). This could be due to an inhibition of MAO-B in dopaminergic neurons of smokers (Fowler et al., 1997) or an antioxidant effect of nicotine (Ross and Petrovitch, 2001). Moreover, coffee consumptions was linked to a 30% lower risk to develop PD and up to a 40% lower risk in subjects who drink at least three cups of coffee per day (Hernán et al., 2002; Sääksjärvi et al., 2008). This association was stronger in men than in women taking postmenopausal hormone therapy (Ascherio et al., 2003). In the same way, tea consumption has been linked to a lower risk of developing PD, with a mean odds ratio of 0.85 (Li et al., 2012). More precisely, black tea consumption and green tea consumption have been inversely correlated to the development of PD (Tan et al., 2008). The discovery of the link between these environmental factors and PD prove again, if necessary, that the etiology of the disease is complex and involves many factors, including some factors encountered and consumed in the daily-life.

3.2. Genetic factors

The “genetic” history of PD began in the 1980s when researchers tried to determine a genetic factor explaining the familial cases of the disease. Indeed, it had been shown that 2% of first degree relatives of PD patients were parkinsonian patients compared to 1% in the general population, suggesting some inheritance of the disease in the family or a shared environmental exposure (Marder et al., 1996). As, it is often the case in epidemiology, the first studies were undertaken in monozygotic and dizygotic twins, searching for a common factor associated with PD in both monozygotic adults. The studies revealed no difference in the rate of PD between monozygotic twins compared to dizygotic twins. However, they included only a few number of subjects and the duration of the studies were short with no follow-up during the aging of the subjects (Duvoisin et al., 1981; Eldridge and Ince, 1984; Ward et al., 1983). The hypothesis of a genetic cause of PD was then abandoned until the suggestion, by Sommer and Rocca, that a mutation in a prion-analogue-protein could cause its accumulation in the neurons and the degeneration observed in the brain of PD patients as it is the case in prion diseases (Sommer and Rocca, 1996). This hypothesis was later confirmed after the improvement and modernization of linkage analyses techniques that allowed the identification of several monogenic forms of PD and genetic risk factors linked to

the development of the disease when combined with environmental or other genetic risk factors. The main PD-related genes identified so far in monogenic forms of the disease are summarized in Table 2. Nowadays, monogenic forms of PD are separated in two categories: the autosomal dominant mutations inducing a loss of function of the encoded protein and the autosomal recessive mutations inducing a gain of function of the encoded protein. Among the dozens of monogenic mutations which have been linked to the development of PD, only six are now officially acknowledged as disease-causing mutations: the autosomal dominant mutations in the *SNCA*, *LRRK2* and Vacuolar protein sorting-associated protein 35 (*VPS35*) genes, and the autosomal recessive mutations in the *PARK2*, P-TEN-induced putative kinase 1 (*PINK1*) and *DJ-1* genes (Kalinderi et al., 2016).

Mutations and multiplications of *SNCA* gene were the first autosomal dominant-inheriting disease-causing mutations discovered. Indeed, in 1996, a genome scan approach revealed for the first time a link between PD and the chromosomal 4q21-23 region (Polymeropoulos et al., 1996). This genomic sequence notably includes the *SNCA* gene, coding for a protein named alpha-synuclein. Later on, a missense mutation changing the alanine in position 53 of the protein sequence into a threonine (A53T) was identified in several families suffering from PD but not in controls (Nussbaum and Polymeropoulos, 1997; Polymeropoulos, 1998). Further studies failed to identify this mutation in hundreds of parkinsonian patients in the United States and in Europe (Muñoz et al., 1997) suggesting a rare distribution among the population. In the months following the discovery of this mutation, histological experimentations highlighted the presence of alpha-synuclein in the pathological hallmarks of PD, the Lewy bodies (Mezey et al., 1998; Spillantini et al., 1998). The clinical evaluation of PD patients with the A53T mutation of *SNCA* showed a younger age of onset (10.8 years earlier), a tremor less present and a longer duration of the disease than in sporadic patients with no familial history of the disease. However, the other clinical motor symptoms of the disease, including rigidity, bradykinesia and postural instability were not different between the two groups (Papapetropoulos et al., 2001). Later on, four others mutations in alpha-synuclein have been described in PD patients: the A30P (Krüger et al., 1998), the E46K (Zarranz et al., 2004), the G51D (Lesage et al., 2013) and H50Q (Appel-Cresswell et al., 2013) as well as multiplications of this gene (Bradbury, 2003; Chartier-Harlin et al., 2004; Ferese et al., 2015; Singleton et al., 2003). The clinical examination of PD patients with multiplications of *SNCA* suggested that the disease severity was correlated with the number of *SNCA* copy found in the genome of the patients. Thus, the more *SNCA* copy, the earlier the disease started and the most severe were the symptoms (Ibáñez et al., 2009).

As of today, 23 loci, named PARK loci, have been associated with PD. The discovery of these monogenic forms of the disease with Mendelian inheritance led to important

advances in the understanding of the molecular mechanisms involved in PD development. However, these monogenic forms are estimated to be present in only 5-10% of PD patients (Verstraeten et al., 2015). The scarcity of these genetic causes of the disease confirm the importance of understanding other risk factors as well as of the interplay between environmental risk factors and genetic susceptibilities.

Locus	Gene	Protein	Chromosome	Tr.	Mutation	LP	References
PARK1	SNCA	alpha-synuclein	4q21-q23	AD	A53T, A30P, E46K, G51D	+	(Krüger et al., 1998; Lesage et al., 2013; Polymeropoulos, 1998; Zarranz et al., 2004)
PARK2	PARK2	parkin	6q25.2-q27	AR	deletions	±	(Kitada et al., 1998; Matsumine, 1999)
PARK3	ND	ND	2p13	AD	ND	ND	(Gasser et al., 1998)
PARK4	SNCA	alpha-synuclein	4p14-16.3	AD	multiplication	+	(Chartier-Harlin et al., 2004; Farrer et al., 1999)
PARK5	UCHL1	Ubiquitin c terminal hydrolase	4p14	AD	S18Y	+	(Leroy et al., 1998)
PARK6	PINK1	Pten-induced putative kinase 1	1p35-p36	AR	G309D, W437X	+	(Valente et al., 2004)
PARK7	PARK7	DJ-1	1p36.33 - p36.12	AR	L166P and deletion	+	(Taipa et al., 2016; van Duijn et al., 2001)
PARK8	LRRK2	Leucine-rich repeat kinase 2	12p11.23-q13.11	AD	>80 mutations	+	(Funayama et al., 2002)
PARK9	ATP13A2	Lysosomal type 5 ATPase	1p36	AR	truncating	-	(Hampshire et al., 2001)
PARK10	ND	ND	1p32	RF	ND	ND	(Hicks et al., 2002)
PARK11	<i>GIGYF2</i>	GRB interacting GYF protein 2	2q36-q37	AD	9 mutations		(Pankratz et al., 2003)
PARK12	ND	ND	Xq21-q25	X-linked	ND	ND	(Pankratz et al., 2003)
PARK13	HTRA2	HTRA serine peptidase 2	2p12	AD	ND	ND	(Strauss et al., 2005)
PARK14	PLA2G6	Phospholipase A2	18q11	AR	missense	-	(Gao et al., 2009)
PARK15	FBXO7	F-box only protein 7	22q12-q13	AR	truncating	ND	(Shojaee et al., 2008)
PARK16	ND	ND	1q32	RF	ND	ND	(Satake et al., 2009)

PARK17	VPS35	Vacuolar protein sorting 35	16q11.2	AD	D620N	ND	(Vilariño-Güell et al., 2011)
PARK18	EIF4G1	Eukaryotic translation initiation factor 4 gamma 1	3q27.1	AD	5 mutations	+	(Chartier-Harlin et al., 2011)
PARK19	<i>DNAJC6</i>	DNAJ/HSP40 homolog subfamily C member 6	1p31.3	AR	splice site / truncating	ND	(Edvardson et al., 2012)
PARK20	SYNJ1	Synaptojanin 1	21q22.11	AR	R258Q	ND	(Olgiati et al., 2014)
PARK21	DNAJC13	DnaJ Heat Shock Protein Family (Hsp40) Member C13	3q22	AD	N855S	+	Vilariño-Güell et al., 2014
PARK22	CHCHD2	Coiled-Coil-Helix-Coiled-Coil-Helix Domain-Containing protein 2	7p11.2	AD	T61I, R145Q	ND	(Funayama et al., 2015)
PARK23	VPS13C	Vacuolar Protein Sorting 13 Homolog C	15q22.2	AR	truncating	+	(Lesage et al., 2016)

Table 2: Genetic loci and genes associated with monogenic forms of parkinsonism (PARK loci). Tr. Type of transmission, AD: autosomal dominant, AR: autosomal recessive, RF: risk factor, LP: Lewy pathology, ND: not determined.

3.2.1. Genetic risk factors

Apart from the above-described PD-causing mutations, genomic variants with low penetrance have been described to play a role in the risk of developing PD in sporadic patients. These variants, common in the genome of PD patients compared to controls, are considered as risk factors and could lead to the development of the disease when combined with other factors such as other genetic risk factors or environmental risk factors (Kalinderi et al., 2016). They however do not lead to the development of the disease alone. Genome-wide association studies (GWAS), which study millions of markers along the genome without *a priori*, confirmed the major role of SNCA in the development of the disease but also revealed many genomic regions containing variants associated with PD (Nalls et al., 2014). Contrary to PD-causing mutations, these variants have shown small effects and do not modify the disease phenotype. To date, 21 susceptibility loci have been described (Labbé and Ross, 2014). Among them, three variants, present in the SNCA gene, the Human Leucocyte Antigen (*HLA*) gene and the microtubule-associated protein tau (*MAPT*) have been considered as genomic variants linked to PD in several studies (Do et al., 2011; Edwards et

al., 2010; Simón-Sánchez et al., 2009; Zimprich et al., 2004). Later on, GWAS have suggested other common variants in the following genes: *GBA*, coding for the enzyme glucocerebrosidase, *HLA* locus, and *GAK*, coding for a cyclin G–associated kinase (Holmans et al., 2013; Pankratz et al., 2009). The progress in science and the available techniques to study genetic modifications in large cohorts of patients and controls should still provide important insights in PD molecular deregulations.

4. Currently available therapeutic options

Most therapeutic strategies currently applied in PD tend to manage the motor symptoms of the disease by a compensation of the striatal dopamine depletion. As illustrated figure 13, this aim can be reached by modulating either the synthesis, or the release, or the turnover of dopamine by directly activating the dopaminergic receptors even in absence of dopamine itself or by electric stimulation of the basal ganglia.

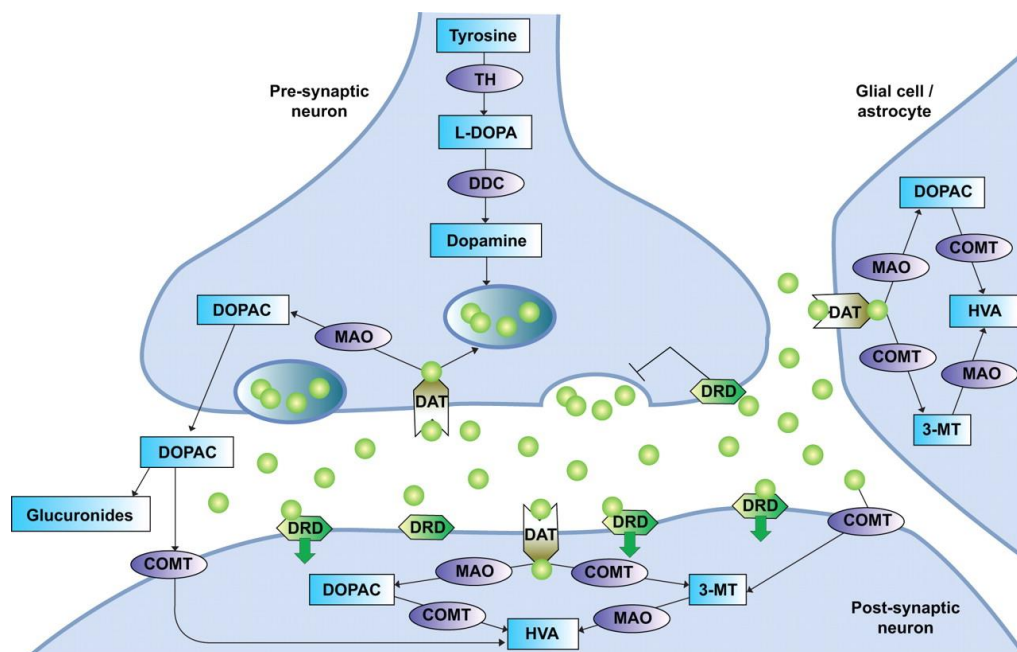

Figure 13: Schematic representation of dopamine synthesis and metabolism.

Dopamine is synthesized from the amino acid L-phenylalanine, provided by food. This amino acid is later converted into L-tyrosine which is converted into L-DOPA by the enzyme tyrosine hydroxylase (TH). L-DOPA is further transformed into dopamine by the 3,4-dihydroxyphenylacetic acid carboxylase (DDC). Dopamine, here represented as green circles, is stored in synaptic vesicles and later released in the synaptic cleft to activate dopamine receptors (DRD) in the pre- and post-synaptic neurons. Dopamine can enter the neurons through dopamine transporters (DAT) present in the pre- and post-synaptic terminals. Monoamine oxidase (MAO) and catechol-O-methyl transferase (COMT) degrade dopamine into 3,4-dihydroxyphenylacetic acid (DOPAC), homovanillic acid (HVA) or 3-methoxytyramine (3-MT). (Quaak et al., 2009).

4.2. Pharmacological therapies

4.2.1. *The L-DOPA replacement therapy*

The main current drug treatment for PD was discovered in the sixties concomitantly with the discovery of dopamine and its depletion in the striatum of PD patients (Carlsson et al., 1957; Ehringer and Hornykiewicz, 1960). Indeed, Carlsson and colleagues demonstrated that L-DOPA, the precursor of dopamine, was able to restore motor function in akinetic animals after an exposure to reserpine (Carlsson et al., 1957). As PD was also characterized by an akinetic state, and was apparently due to a depletion of dopamine, researchers decided to treat PD patients with L-DOPA in order to restore the coordination of direct and indirect pathways within the basal ganglia. Several years were necessary to determine the effective dosage but since 1967, L-DOPA has proven its efficacy in the treatment of motor symptoms (Cotzias et al., 1967; Fahn, 2015). Now used for more than fifty years, L-DOPA is still the gold standard in the treatment of PD and the most powerful treatment against the motor symptoms of the disease. L-DOPA can cross the blood-brain barrier and, in healthy individuals, enters dopaminergic neurons where it is transformed into dopamine by the L-DOPA decarboxylase. The simultaneous use of decarboxylase inhibitors, which block the transformation of L-DOPA into dopamine in the periphery but not in the brain, enhance the availability and the efficacy of L-DOPA within the central nervous system. In most PD patients, this pharmacological therapy is so efficient to alleviate motor symptoms in the first years after the diagnosis that the length of time following its first delivery to the patient is called honeymoon period. However, as the number of dopaminergic neurons diminishes over time in PD, in more advanced stages of the disease, L-DOPA will preferentially be taken up by serotonergic neurons of the basal ganglia and transformed into dopamine (Carta et al., 2008; Ng et al., 1971, 1970; Svenningsson et al., 2015). The dopamine released from such activated serotonergic neurons is thought to stimulate post-synaptic dopamine receptors in an uncontrolled manner, thus participating in the development of abnormally regulated movements. Therefore, prolonged DOPA-therapy induces strong side effects including dyskinesia or motor fluctuations, i.e. a period with a decreased benefit of L-DOPA against motor symptoms (LeWitt, 2015; Sharma et al., 2015). It is estimated that 89% of PD patients develop dyskinesia after 10 years of L-DOPA therapy (Fabbrini et al., 2007). Moreover, L-DOPA worsens PD-related gastro-intestinal disorders (Özge et al., 2003; Poewe, 2008). These side effects can be more debilitating than PD symptoms. It is therefore important to find another treatment to delay or replace L-DOPA therapy.

4.2.2. *The use of dopamine agonists*

Among the other available pharmacological strategies for PD, the direct stimulation of dopaminergic receptors with dopamine agonists has shown its efficacy (Blandini and

Armentero, 2014). Although less effective than L-DOPA to treat PD motor symptoms (Blandini and Armentero, 2014), dopamine agonists provide a continuous stimulation of dopaminergic neurons, thus avoiding the rhythmic peak and decrease in the release of dopamine causing the motor fluctuation phases of L-DOPA treatment. Indeed, when used in first instance during the early phases of clinical PD, dopamine agonists have been shown to induce less dyskinesia than L-DOPA therapy (Holloway et al., 2004). Dopamine agonists are used in monotherapy as a first treatment in patients aged of 65-70 years (Parkinson Study Group, 2000). Two to five years after the appearance of PD initial motor symptoms, L-DOPA is often added to dopamine agonists to better manage motor symptoms. However, the intake of dopamine agonists has been linked to the development of impulse control disorders in 14% of PD patients compared to 1.1-1.6% in the general adult population (Callesen et al., 2013; Poletti et al., 2012; Probst and van Eimeren, 2013). Impulse control disorders include pathological gambling, hypersexuality, compulsive buying or compulsive eating that negatively impact the quality of life and can be as debilitating for the patient as PD itself. It is therefore essential for PD patients to pay attention and to report quickly every possible behavioral trouble to their neurologist to modulate the dosages or change for a different treatment.

4.2.3. The use of inhibitors of dopamine catabolism

A third pharmacological option to compensate PD-related striatal dopamine depletion is to reduce the degradation of dopamine, thus increasing the concentration of dopamine in the synaptic cleft *via* an inhibition of the MAO. Two types of MAO are described: the type A, called MAO-A, deaminating tyramine, serotonin and noradrenaline, and the type B, called MAO-B which deaminates b-phenylethylamine (Johnston, 1968). Both forms of the MAO metabolize dopamine. However, dopamine has a higher affinity for MAO-B in the human brain (Oreland, 1991). This strategy has been used for several decades. Indeed, inhibitors of monoamine oxidase (MAO) have been used alone or in combination with L-DOPA in many PD patients. Although showing low therapeutic benefit when given alone, MAO increase the efficacy of L-DOPA when administered simultaneously (Riederer and Wuketich, 1976).

In summary, pharmacological interventions in PD have proven good therapeutic strategies but they lose efficacy over time and induce many side-effects. It is therefore crucial to find new non-invasive therapeutic strategies able not only to prevent the dopaminergic neuronal death within the SN but also to alleviate PD non-motor symptoms from the earliest stages of the disease. Such novel treatment options would undoubtedly contribute to increased quality of life for PD patients.

4.3. Surgical therapies

Surgical therapeutic options, essentially deep brain stimulation, are available for patients who develop severe motor complications with pharmaceutical interventions and would therefore need higher doses of dopaminergic treatment, accompanied by their side-effects, to achieve effective modulation of motor symptoms. These therapeutic options involve long and difficult surgical procedures which cannot be performed in all patients.

4.3.1. *Dopaminergic cell grafts*

The better knowledge of PD-induced neuropathological alterations as well as of basal ganglia functional neuroanatomy paved the way for alternative surgical therapies involving dopaminergic cell grafts. Indeed, the neuronal death within dopaminergic populations of the SN is the known cause of motor symptoms of PD. Therefore, dopaminergic neuronal grafts were expected to replace the missing dopaminergic cells in the brain of PD patients. This experimental therapeutic strategy proved its efficacy against PD motor symptoms (Lindvall and Björklund, 2004), however, fetal grafted cells developed Lewy body-inclusions over time as reported at the autopsy in several patients after 11-16 years post-graft (Kordower et al., 1995; Li et al., 2010). As Lewy pathology seems to slowly appear in grafted neurons, mesencephalic grafts could still provide the benefit of many years of motor improvement to the patients before a potential aggravation of the situation. So far, the transplant of dopamine-producing neurons derived from stem cells has been undertaken in rodents and monkeys and led to an improvement of some motor features of mice (Barberi et al., 2003; Kriks et al., 2011; Studer et al., 1998). However, several years will be necessary before the first clinical trials in humans bring conclusive results regarding the efficacy and the safety of this promising technique in the treatment of PD. Until then, another surgical therapeutic option is currently available on a routine basis for PD patients: deep brain stimulation.

4.3.2. *Deep-brain stimulation*

From 1940 on, Wilder Penfield and Herbert Jasper used destruction of brain areas to treat medicamentous-resistant forms of severe epilepsy, an approach referred to as the Montreal procedure (Amberson, 1954; Avoli, 2012). During the surgical procedure, they used electrical stimulations of the brain of conscious subjects to better determine the target area and to reduce side effects of the procedure. Similar procedures targeting various structures of the basal ganglia have been applied as the only treatment of PD motor symptoms until the sixties. Thus surgical ablation of the motor cortex and premotor areas or pyramidotomy have been used to reduce the tremors in the contralateral side despite an important mortality rate and few long-term improvements for the patient (Gross et al., 1999). With the progressive better knowledge of the extrapyramidal system and nuclei of the basal ganglia, Russell Meyers decided to test the partial ablation of the caudate nucleus and the putamen and

observed an improvement of tremor and rigidity in the patients (Gildenberg, 2006). This procedure has been reproduced during the following years and largely improved through the use of stereotaxic apparatus (Fenelon, 1955a, 1955b; Guiot and Brion, 1953). The discovery of L-DOPA and its powerful effect against motor symptoms drastically changed the treatment of parkinsonian patients during decades. However, the progressive modernization of imaging techniques, the better understanding of basal ganglia circuits and the discovery of neuropathological hallmarks of the disease brought the surgery back into the list of available strategies in the treatment of PD motor symptoms. Deep-brain stimulation (DBS) is a high frequency stimulation (100Hz-200Hz) of specific brain nuclei to modulate their activity within the basal ganglia loops. Thus, the stimulation of the internal globus pallidus or the subthalamic nucleus aims to compensate the neuronal consequences of striatal dopamine depletion by reducing the inhibitory signal from Gpi and SNpr (Fig. 10). This therapeutic strategy modulates PD motor symptoms but is not able to stop the progression of the disease nor to reduce non-motor symptoms (Obeso et al., 1997). DBS was first used in patients planned to undergo surgical ablation of the thalamic nucleus ventralis intermedius in order to identify the target area through a temporary improvement of resting tremor (Benabid et al., 1987). Indeed, DBS is a reversible treatment as its effects stop as soon as the stimulation is turned off. DBS was next used in patients with unilateral lesions in order to complement the effect of the contralateral ablation without the side effects of a bilateral ablation (Benabid et al., 1987). The efficiency of this reversible stimulation on tremor in the absence of histological modifications was later preferred to the ablation of a brain area but was however unable to improve PD other symptoms such as muscle rigidity and bradykinesia (Benabid et al., 1991). Neurologists and researchers thus tried to stimulate different areas of the brain in animal models of PD and in PD patients in order to identify the ideal target area to improve all motor symptoms of PD and showed that the stimulation of sub-thalamic nuclei (STN) was successful in this respect (Benabid et al., 1994; Limousin et al., 1998, 1995; Pollak et al., 1993). The data obtained in the hospital of Lille in 100 patients with DBS in the STN confirmed the improvement of all motor symptoms characteristics of PD one year after the surgery (Tir et al., 2007). Indeed, compared to patients without pharmaceutical treatment during the motor evaluation, patients with 1 year of stimulation presented a 43% decrease in the UPDRS III score evaluating the severity of PD motor symptoms and a 34% decrease in the Schwab & England score evaluating the impact of PD on the activities of daily life (Tir et al., 2007). These data confirm the efficacy of DBS in the treatment of PD motor symptoms. In another cohort of patients, such an improvement of motor symptoms was still detected five years after bilateral DBS of subthalamic nuclei (Krack et al., 2003). Nowadays, DBS is proposed to patients younger than 75 years of age presenting with severe motor complications, no adequate response to pharmaceutical

treatment, a satisfying cognitive state and a good general health condition to avoid surgery-related problems (Destée A. personal communication, Lille, 2016).

4.4. Alternative therapies

Several alternative therapies are available for PD patients and aim at complementing or delay conventional pharmaceutical and surgical therapies and their related side effects. In 2001, almost 40% of PD patients used alternative therapies in the United States. This proportion rises to 76% in Eastern counties (Kim and Jeon, 2012; Rajendran et al., 2001). These alternative solutions include acupuncture, speech therapy, dance, cognitive therapy or physiotherapy among others (Bega and Zadikoff, 2014; Bloem et al., 2015). Most of them are designed to improve PD patients' quality of life through the management of motor and non-motor symptoms which are not completely responsive to the conventional treatments and do not aim at slowing or stopping the progression of the disease. It has to be noted that, although alternative therapies may improve the patient's quality of life and his/her motor function, they are not as effective as pharmaceutical and surgical treatments of motor symptoms. However, PD is characterized by many non-motor symptoms that are not improved under conventional therapies and most neurologists agree with the use of alternative therapies to complement the conventional therapies. Multidisciplinary approaches proposing an adapted program of speech, cognitive, physical and social therapies and the help of trained coaches could increase the benefit of alternative therapies and the general well-being of both patients and caregivers.

In conclusion, since its description in 1817 by James Parkinson in a handful of persons, PD has emerged as the second most frequent neurodegenerative disease in the world. It affects people from all countries and all social levels and its social and economic burden is expected to dramatically increase in the next decades. During the last century, researchers have studied the anatomopathological origin of PD, the motor and non-motor symptoms developed by patients and the genetic and environmental factors implicated in its etiology to understand and target the molecular and cellular mechanisms leading to the degeneration of dopaminergic neurons within the SN. Unfortunately, despite these discoveries, we are still not able to fully understand how PD starts, progresses and leads to a total lack of autonomy in the advanced stages. Indeed, the treatment currently proposed to the patient are designed to alleviate the symptoms of the disease but are not yet able to cure PD or to stop its progression. It is thus essential to maintain the efforts of research in this field starting with studies in adapted models of parkinsonism which should enable the discovery of new therapeutic strategies either disease-modifying or curative ones to be used from the very beginning of the degenerative process.

CHAPTER 2: RELEVANCE AND CONTRIBUTION OF EXPERIMENTAL MODELS OF PARKINSON'S DISEASE IN UNDERSTANDING THE UNDERLYING PATHOPHYSIOLOGICAL MECHANISMS.

1. What is an animal model?⁷

The main challenge in collecting significant or at least relevant results in a laboratory resides in the appropriate choice of the experimental model used to investigate a scientific question. In various fields of experimental biology, it has been essential to develop animal models of human disorders, notably due to evident ethical concerns in conducting some studies in human beings. The term '*model*' encompasses however two symmetrical and opposed meanings. Indeed, on one hand, it is used for a concept or an object which is the representation of another one, such as the reduced-scale model; the scientific model falls in this first category. On the other hand, this term is also used to designate a real object that one tries to perfectly reproduce such as the model for the painter⁸. These two meanings implicitly refer respectively to the tool and the example. Such a dual meaning for the same term might explain the classical lexical confusion encountered among scientists when it comes to animal models. This confusion has ultimately led to the misinterpretation too often encountered in the medical field according to which the results obtained in an animal model should entirely be translatable to the human being: the laboratory animal would thus get the status of a laboratory for the production of future medications. The subsequent disappointments were scaled to those false hopes, as reminded in a number of recent papers (Begley and Ellis, 2012; Perrin, 2014).

1.1. The definition of a model in experimental sciences

In experimental sciences, and especially since Claude Bernard's seminal work and shaping of the field of Biology, a model is a simplified representation of the reality. When the reality refers to an object with relatively well-defined frontiers, such as the conformation of a protein, it is rather easy and straightforward to define the elements to be represented in the model and to reproduce them. However, when it comes to more complex phenomena such as cell growth or uncontrollable proliferation as encountered in cancer, it is rather difficult to distinguish their exact delimitations. The choice of the elements to be put in a model is therefore an essential step in its construction. This choice is most often based on a theory

⁷ This paragraph has been largely inspired by a review currently under redaction. Vanbesien-Mailliot, Stievenard, et al. "Modeling early stages of Parkinson's disease *in vivo*: are we there yet?" and Viltart O, Vanbesien C, Méquinion M, Chauveau C. (2015) Modèles animaux et anorexie mentale, in "L'anorexie mentale, des théories aux prises en charge." JL Nandrino et al (Editor). Dunod (Paris) NB: ISBN = 978-2-10-072184-9)

⁸ Definition according to the Dictionary of Mr. Littré, <http://www.littre.org/>

which emphasizes some aspects of the reality and even deliberately ignores others. The ultimate goal of this simplification step is to give a precise and objective form to hypothetical links between elements of the reality, often through the mean of experimentations or the use of datasets. In this view, the model may describe a whole as a subset of elements and their interactions, or it may not possess all properties of the original but only those interesting the researcher, or even it may not display a 'natural' relationship with the original but only an instrumental one. Nevertheless, the experimental model will respectively serve representative, reductionist or subjective functions (Stachowiak, 1973). Therefore, the animal model corresponds to an experimental situation developed in animal species to study a phenomenon originally displayed in another species (McKinney, 1984). Keeping this in mind, one can thus understand why the data generated in one animal model must be interpreted in respect to its initial aim and use. As a consequence, an animal model which has been developed in a specific context should never systematically be used in any other biomedical study without this mandatory preliminary verification.

1.2. Internal validity criteria

The choice of an experimental model by a research team to study a pathological phenomenon relies on strict internal and external validity criteria. The internal validity of an experimental model, often associated to its reliability, corresponds to the coherence, consistency and stability with which the variable of interest is measured; such a criterion therefore entirely relies on the experimental plan chosen (Belzung and Lemoine, 2011). Indeed, it corresponds to the capacity to objectively measure the variable of interest, the low intra- and inter-individual variability of the measures, as well as the reproducibility of the phenomenon of interest in similar conditions. One has however to keep in mind that variations in a dataset are not always errors and might rather have sometimes a tremendous interest in research. The lack of variation could even be the result of manipulations of data sets. Other methodological requirements greatly enhance the internal validity of any experimental model and thus also apply to animal models. First, randomization enables avoiding selection biases of individuals included in a cohort, ensuring the reliability of measures and observations between different experimenters and is therefore expected to contribute to a better internal validity. Second, the choice of control groups is crucial; mainly for cost reasons, most studies only include a control of the compound tested whereas the procedures and technical gestures –such as surgery- should also be controlled. Moreover, the choice of the sex of the animals used can direct research towards a result which would not be applicable to the other sex. Indeed, most experiments undertaken in rodents have used male animals to study diseases which often affect both men and women. Third, double-blinded experimentations, a thorough validation of all reactives used and the implementation

of an adequate statistical design to analyze the data should be more carefully examined by the scientific community. Such internal validity criteria are not specific of animal studies but rather apply to all strategies implemented in experimental sciences. In addition, they can be used to carefully examine preclinical studies which would not reach their promises as recently highlighted by Steve Perrin, chief scientific officer at the ALS Therapy Development Institute in Cambridge, Massachusetts, USA (Begley, 2013a; Perrin, 2014).

1.3. External validity criteria

Beyond its internal validity, an experimental model should also display a strong external validity. This is a more complex notion, which questions the capacity to transfer to the target population the results obtained on a usually small sample in a different species. In the context of models of psychiatric disorders, this concern led to the definition of particularly demanding criteria: construct, face and predictive validities (Belzung and Lemoine, 2011; Willner, 1984).

1.3.1. *Construct validity*

The construct validity, also called theoretical validity, literally refers to how the model is initially built. This criterion considers the elements used to generate the model and therefore assesses the reliability with which the latter measures what it has been designed to measure (Abramson and Seligman, 1977). In the biomedical field, this criterion is used to evaluate the similarity between the triggering conditions of the natural phenomenon (i.e. the disease to be modeled) and the ones used to generate a similar but not identical phenomenon in the model (see §1 p.56); it is thus often referred to as the etiological validity of the experimental model. In this context, it is appropriate to base the construction of the experimental model on epidemiological studies conducted in human cohorts to introduce (at least partially) in the experimental model the suspected causes of the disease studied in the experimental model. However, when the etiology of complex multifactorial human disorders is not fully understood, as it is often the case with neurological diseases, it will be difficult for any experimental model to fully meet this criterion.

1.3.2. *Face validity*

Face validity refers to the phenotype observed in the animal model compared to the phenotype of the patients. In this regard, scientists have to be aware that one unique underlying cause might lead to different symptoms in different species (Hinde, 1976). The possibility to perfectly reproduce a human phenotype in the chosen species is weak and this aspect should be taken into account in the creation of the experimental model. It is for example easier to study a paralysis phenotype, obvious at the first look to the animal, than to study a psychiatric phenotype such as hallucinations or addictive-compulsive behaviors. In addition, face validity mainly relies on the observation of qualitative variables and a

descriptive analysis of behaviors. It is therefore highly dependent on the skills of the experimenter, on his/her training and abilities and is subsequently highly subjective. While creating or choosing their animal model, scientist should thus rather rely on quantifiable variables such as those obtained from blood test or behavioral tests with performance scales while keeping in mind that they are working with animals which are not human beings and thus do not react as humans (Jacob, 1996).

1.3.3. Predictive validity

The understanding of an entire phenomenon allows the prediction of its evolution. Predictive validity corresponds to the capacity of a test to predict a criterion of interest, i.e. a human phenomenon, from an animal model with good face and construct validities. In the biomedical field, this criterion corresponds to the similarity in the response to treatments, to the reversibility of disorders and dysfunctions present in the animal model by using therapeutics that have shown good efficacy in humans. Due to differences in the metabolism between species, this criterion is the hardest to fulfil. Indeed, some medications efficient in humans can have no effect on mice or rats because they are degraded by the liver before they reach their target or in the contrary they can induce strong side effects in mice and be inoffensive in humans. This is probably one of the reasons explaining why so many promising treatments developed in animals failed to treat analogous symptoms in humans⁹.

If we consider these external and internal validity criteria, which allow to assess the validity of an animal model to the scientific question to be addressed, it is therefore easy to understand the difficulty to reproduce human-specific diseases such as PD. In the next paragraphs, the criteria used to create animal models of parkinsonism will be described as well as some of the most widely used PD animal models which, despite their imperfections, provided important insights in some aspects of the pathophysiology of this neurodegenerative disease.

1.4. What criteria for modelling Parkinson's disease?

PD is a complex multifactorial human specific disorder, which has never been described as a spontaneous condition in animals. As such, there will never be a single animal model fully reproducing all the symptoms of the human disease. However, the progress in research highlighted many new aspects in the etiology, the symptomatology, the molecular alterations and the neuropathological hallmarks of PD which should be used to increase the external validity and create more accurate models of PD. Indeed, several

⁹ For a broader discussion on this topic, see the blog "*The scandal of medications which heal mice but not humans*" written by the French scientific journalist Pierre Barthelemy at <http://passeurdessciences.blog.lemonde.fr/2014/04/13/ces-medicaments-testes-sur-la-souris-mais-qui-ne-soignent-pas-humain/>

etiological aspects, such as the age, environmental and genetic factors as well as their interactions should be included in the construct validity of animal models of PD. In the contrary, most animal models of PD developed so far involve the use of young animals (Betarbet et al., 2000; Lee et al., 1996). Moreover, to have good face validity, an animal model of PD should present with the classical motor symptoms of PD, bradykinesia, resting tremor, rigidity and postural instability as well as the neuropathological hallmarks of the disease. Bradykinesia and muscle rigidity can indeed be observed in some models. They are however often accompanied by ataxia in animals, which is not characteristic of the human phenotype (Mougenot et al., 2011; Saigoh et al., 1999). Moreover, the classical motor symptoms of PD are preceded and accompanied by non-motor symptoms and the latter should also be reproduced in animals. Regarding the neuropathological hallmarks of the disease, only few animal models of PD created so far reproduce the progressive neuronal death within the SN and the appearance of Lewy body-like inclusions (Blesa et al., 2012). More importantly some models should be able to reproduce the early stages of the disease during which molecular alterations and non-motor symptoms appear at a time when the central dopaminergic degeneration within the SNpc is not important enough to induce motor symptoms while other models should reproduce the more advanced stages of the disease characterized by the presence of Lewy bodies, a huge neuronal death in the SNpc and severe motor symptoms. Finally, a good animal model of PD should present a good predictive validity, meaning present a phenotype which is reversed by the current symptomatic treatments used in PD patients such as L-DOPA or dopamine agonists.

No animal model fulfilling all these criteria has been created so far. Despite these limitations, several experimental analogues of PD have proven their usefulness in the study of the development of the disease, PD-induced molecular and cellular modifications, the spreading of the Lewy pathology or the development of treatments and will be shortly presented here.

2. Currently available models of Parkinson's disease

2.1. *In vitro* models

Several cellular models have been used to investigate the pathogenic mechanisms and the biochemical pathways involved in PD (Falkenburger et al., 2016). As every model, cellular models are limited in the reproduction of this complex and multifactorial disease (Falkenburger and Schulz, 2006). However, they represent useful, fast and reproducible tools which allow the investigation of specific mechanisms, the screening of numerous drug candidates as well as transcriptomic approaches (Alberio and Fasano, 2011). A cellular model of early stages of parkinsonism must satisfy the following molecular and cellular criteria: moderate neuronal death (as a reminder, motor symptoms appear when 50% of the

dopaminergic neurons of the SN are dead) caused by the expression of one or several genetic factors or the exposure to an environmental factor known to induce PD in human, a dysfunction of mitochondrial complex I, a modification of the degradation systems for misfolded proteins (which could lead to the development of alpha-synuclein aggregates) and a glial activation. Cellular models of parkinsonism are divided in two categories: established cell lines and primary cells.

2.1.1. Established cell lines

Established cell lines are populations of cells which have been produced from a unique cell, share the same genetic background and possess the capacity to undergo mitosis to proliferate or be differentiated into a neuron-like state. Moreover, cells lines are often characterized by the accumulation of genetic aberrations such as chromosomic duplications (Kim et al., 2001; Spengler et al., 2002). Such models therefore present *per se* a weak construct validity as they do not reproduce the limited life expectancy of post-mitotic dopaminergic neurons of the SNc. However, these established cell lines can be differentiated into neuronal cells which therefore increases their construct validity. Among the available established cell lines, SH-SY5Y cells, PC-12 cells and LHUMES cells are the most used to model PD.

SH-SY5Y cells are human cells derived from the bone marrow of a patient with neuroblastoma (Biedler et al., 1973). SH-SY5Y cells are adrenergic cells but also express the dopamine transporter 1, dopaminergic receptors and the vesicular monoamine transporter type 2 (Korecka et al., 2013; Lopes et al., 2010). They also express PD-related genes (Krishna et al., 2014). They can be cultivated in their proliferative state or in a neuron-like differentiated state after exposure to retinoic acid or 12-O-tetradecanoylphorbol-13-acetate (Lopes et al., 2010). In their proliferative state, their expression of dopaminergic receptor is higher and thus allow a greater entry of toxins targeting dopaminergic cells such as the 6-hydroxydopamine (6-OHDA) or MPP⁺ and the study of the subsequent oxidative stress and neuronal death (Lopes et al., 2010; Schüle et al., 2009).

PC-12 cells are derived from a rat pheochromocytoma (Goodman and Herschman, 1978). They thus exhibit the morphology, the biochemistry and the physiology of adrenal chromaffine cells. When cultivated with neurotrophic factors, they can differentiate into sympathetic neurons and release neurotransmitters such as dopamine, norepinephrine or acetylcholine (Shafer and Atchison, 1991). Moreover, they are sensitive to toxins and mitochondrial inhibitors including 6-OHDA, paraquat, rotenone and MPP⁺. Therefore, they represent a good *in vitro* model to study the molecular pathways implicated in PD-related neurodegeneration (Grau and Greene, 2012; Hirata and Nagatsu, 2005; Nakamura et al., 2000; Sherer et al., 2003; Walkinshaw and Waters, 1994; Yang and Sun, 1998).

Lund Human Mesencephalic cells, or **LUHMES cells**, are subclones of human primary cells from the developing mesencephalon which overexpress the myc-family transcription factor (Lotharius et al., 2002). They express functional dopamine transporter, TH and vesicular monoamine transporter type 2 and can be differentiated into dopaminergic neurons with electrophysiological properties when cultivated with tetracycline, glial cell line-derived neurotrophic factor and N⁶,2'-O-Dibutyryl adenosine 3',5'-cyclic monophosphate sodium salt (Lotharius et al., 2002). When differentiated and exposed to environmental factors linked to the development of PD such as MPTP, LUHMES cells are a useful model to test anti-parkinsonian therapeutics (Zhang et al., 2014).

2.1.2. Primary neuronal cells

Primary cells are directly isolated from non-cancerous living tissues and grown *in vitro*. Due to their post-mitotic status, they cannot proliferate and their lifespan is limited, complicating their use compared to established cell lines. However, their heterogeneity, due to the co-isolation of other cell types such as glial cells, makes them more physiological models of what happens in the three-dimensional organs of the patients.

- Animal-derived primary cells

Primary cultures from embryonic mesencephalic cells have been widely used as an *in vitro* model of PD to study the sensitivity of dopaminergic cells to environmental factors linked to the development of PD and test possible therapeutics to protect these cells against neuronal death (Radad et al., 2009; Tolosa et al., 2013; Tönges et al., 2012). Most protocols isolate such cells from the mesencephalon of rodents. The percentage of cells producing TH, therefore representing the number of catecholaminergic neurons, including dopaminergic neurons, is really low, around 5-10%, and without treatment to inhibit the growth of glial cells, these cultures are mostly heterogeneous (Falkenburger et al., 2016; Ikemoto et al., 1998). However, as it is the case in the human brain, glial cells also provide primary neurons with the support they need to defend themselves against infectious threats, oxidative stress and could even play a role in the protection against alpha-synuclein aggregation (Brück et al., 2016; Lee et al., 2010). The *in vitro* models of PD using primary mesencephalic cells are thus an adapted tool to investigate the cascade of molecular events triggering SNc neuronal death in PD patients.

- Patient-derived cells

As detailed in § 3.2.1. of chapter 1, the discovery of genetic forms of PD has provided new insights in the molecular pathogenesis of the disease. However, the familial cases are rare and although some mutations are present in both familial and sporadic cases of PD, the molecular and cellular dysfunctions leading to the development of PD are not fully

understood yet. Thus, the study of cells issued from familial PD patients is a great opportunity in the search for undiscovered genetic mutations and the screening of drug candidates.

	Construct validity		Face validity						Predictive validity	References
	Species	Conditions	DD	LP	Mt	DS	Inf.	OS		
Diff. SH-SY5Y	Human	overexpression of SNCA	ND	+	ND	ND	ND	ND	ND	(Hasegawa et al., 2004)
		overexpression of SNCA	ND	+	ND	+	ND	ND	ND	(Kim et al., 2015)
Rotenone		+	ND	ND	+	ND	ND	ND	(Jang et al., 2015)	
Expression of SNCA (WT, A30P, A53T)		ND	+	ND	ND	ND	ND	ND	(Smith et al., 2005)	
Diff. PC12 cells		Expression of p25 α	ND	+	ND	+	ND	ND	ND	(Ejlertskov et al., 2013)
Primary hippocampal cells	Rat	Expression of human WT SNCA or aggregation-prone SNCA-T	ND	+	ND	ND	ND	ND	ND	(Poehler et al., 2014)
	Mouse	exogenous human alpha-synuclein protofibrils	+	+	ND	ND	ND	ND	ND	(Volpicelli-Daley et al., 2011)
	Mouse SncA KO		ND	+	ND	ND	ND	ND	ND	(Volpicelli-Daley et al., 2014)
primary mesecephalic cells	Rat	Overexpression of SNCA (WT, A30P, A53T)	-	ND	ND	+	ND	ND	ND	(Koch et al., 2015)
	Chicken	MPP+	+	ND	ND	ND	ND	ND	ND	(Tolosa et al., 2013)
	Mouse	Rotenone	+	ND	+	ND	ND	+	ND	(Radad et al., 2009, 2008)

Table 3: Example of cellular models of parkinsonism with their respective external validity criteria. Diff.: differentiation of the cells, DD: dopaminergic death, LP: Lewy-like pathology, Mt: mitochondrial impairment, DS: degradation system impairment, Inf: inflammation, OS: oxidative stress, ND: not determined.

Since primary cells obtained from post-mortem brains of patients have a short lifespan *in vitro* and, obviously, obtaining SN neurons from living patients is complicated from an ethical and a medical point of view, researchers have focused their work on peripheral tissues and more precisely the skin and the blood. Indeed, fibroblasts can be isolated from skin biopsies and maintained in culture for short-term studies, as they become senescent in the long term (Munro et al., 2001). Such cells possess the genetic background of the patient, including potential PD-causing mutations. Their use and investigation could lead to the era of individual treatment of PD / personalized medicine as they will allow the search for treatment specifically effective in the donor patient (Hoepken et al., 2008).

In vitro models of PD have been fundamental in the last decades in the study of alpha-synuclein conformation and pathogenicity, the dissection of the molecular pathways altered during PD neuronal degeneration as well as in the large-scale testing of therapeutics. Most of them present good face validity from a molecular point of view as they exhibit neuronal death among the dopaminergic population and aggregates of alpha-synuclein. They are however inadequate for the study of clinical phenotypes or the investigation of the disease spreading in the brain as they are composed of isolated cells. It is also possible to obtain a good construct validity in cellular models using PD-related environmental or genetic factors to induce neuronal death. As the main drug treatment of PD is symptomatic, the evaluation of predictive validity is impossible for the moment. Cellular models of PD therefore do not provide a full reconstitution of what happens in a living brain undergoing degeneration or Lewy pathology.

2.2. *In vivo* models

Although PD is a human-specific disease which has never been spontaneously observed in non-human animals, many different experimental analogues of PD have been generated and described in the previous decades, each modeling some aspects of the disease (Javier Blesa et al., 2012). According to the most important PD etiological hypotheses, we will distinguish in the following pages environmentally-induced experimental analogs of PD from PD genetic models.

2.2.1. *Genetic models of Parkinson's disease*

Since the discovery of the monogenic familial forms of PD, many researchers have tried to reproduce the disease in animals with genetic mutations or overexpression of the genes of interest (Blesa and Przedborski, 2014; Jagmag et al., 2016). Among mammals, rodents are the most used animals due to their short life span, small size and large litters. Pigs are also used to generate genetic models of PD as their physiology is closer to the physiology of humans. Many genetic models of PD have also been created in non-mammalian animals such as flies or the nematode *Caenorhabditis elegans*. Indeed, despite the fact that these animals do not have a SN, they possess dopaminergic neurons, exhibit complex motor behaviors, express homologs of most PD-related genes and have the essential advantage to be easily reproduced, therefore allowing the large scale screening of potential therapeutics (Sakaguchi-Nakashima et al., 2007; Sämman et al., 2009; Springer et al., 2005). The summary of the principal genetic animal models created so far and their respective external validity criteria are presented in Table 4.

In conclusion, many animal models have been created by mutation, overexpression or deletion of genes linked to monogenic forms of PD. However, apart from some transgenic alpha-synuclein models, no convincing parkinsonian-like phenotype has been observed. It is

thus important to further characterize the few existing genetic animal models of PD and reproduce every experiment in several models before concluding on the effect of a potential new therapeutic strategy for PD.

Species	Construct Validity			Face validity				Predictive validity	References
	Gene	Gene form	Pr.	SN	LP	MS	NMS		
Mouse	SNCA ⁺	WT	Thy1 or PDGR-B	+	+	+	+	-	(Chesselet et al., 2012; Masliah et al., 2000)
Mouse	SNCA ⁺	WT	Prp	-	-	-	ND	ND	(Lee et al., 2002)
Mouse	SNCA ⁺	A53T	Prp	ND	+	+	ND	ND	
Rat	SNCA ⁺	WT	CBA	+	+	+	ND	ND	(Kirk et al., 2002)
Rat	SNCA ⁺	WT A30P A53T	PGK	+	+	ND	ND	ND	(Lo Bianco et al., 2002)
Rat	SNCA ⁺	WT S87A S87E	BND	+	+	+	ND	ND	(Oueslati et al., 2012)
Drosophila	SNCA ⁺	WT A30P A53T	elav-GAL-4	+	+	+	ND	ND	(Feany and Bender, 2000)
Drosophila	SNCA ⁺	WT 71-82 removed	elav-GAL-4	-	-	ND	ND	ND	(Periquet et al., 2007)
Mouse	LRRK2 ⁺	WT	mLRRK2	-	ND	-	ND	ND	(Li et al., 2009)
Mouse	LRRK2 ⁺	R1441G		-	-	+	ND	ND	
Mouse	LRRK2 ⁺	G2019S	CMVE-PDGF β	+	ND	+	ND	ND	(Chen et al., 2012; Ramonet et al., 2011)
Mouse	LRRK2 ⁺	R1441C	ROSA26	-	-	-	-	ND	(Tsika et al., 2014)
Rat	LRRK2 ⁺	WT	SYN1	-	-	ND	ND	ND	(Dusonchet et al., 2011)
Rat	LRRK2 ⁺	G2019S		+	-	ND	ND	ND	
Drosophila	LRRK2 ⁺	WT	elav-GAL-4	-	ND	-	ND	ND	(Ng et al., 2009)
Drosophila	LRRK2 ⁺	G2019S, Y1699C, G2385R		+	ND	+	ND	ND	
Mouse	PARKIN #	Exon 3 del.	-	-	ND	+	ND	ND	(Goldberg, 2003)
Mouse	PARKIN #	Ex 2 del.	-	-	ND	ND	-	ND	(Perez and Palmiter, 2005)
Mouse	PARKIN #	Truncated, Q311X	DAT	+	+	ND	+		(Lu et al., 2009)

Rat	PARKIN	WT (KO-Exon 4)	-	-	ND	-	ND	ND	(Dave et al., 2014)
Drosophila	PARKIN*	P21 insertion (null)	-	-	ND	ND	ND	ND	(Pesah et al., 2004)
Mouse	PINK1 #	4-7 Exon mutation	-	-	-	ND	ND	+	(Kitada et al., 2007)
Rat	PINK1 °	WT (KO-Exon 4)	-	+	ND	+	ND	ND	(Dave et al., 2014)
Drosophila	PINK1 *	UTR + part of exon 1		+	ND	+	ND	ND	(Park et al., 2006)
Mouse	DJ-1 #	Ex 3-5 del.	-	-	ND	+	ND	ND	(Kim et al., 2005)
Mouse	DJ-1 #	Ex 7	-	-	ND	+	ND	ND	(Manning-Boğ et al., 2007)
Mouse	DJ-1 #	Ex 2 del.	-	ND	ND	+	ND	ND	(Chandran et al., 2008)
Mouse	DJ-1 #	Ex 1 stop	-	+	ND	+	ND	ND	(Rousseaux et al., 2012)
Rat	DJ °	WT (KO-Ex 5)	-	+	ND	+	ND	ND	(Dave et al., 2014)
Drosophila	DJ-1*	DJ-1β del.	-	-	ND	+	ND	ND	(Park et al., 2005)
Drosophila	DJ-1*	DJ-1α RNAi	-	-	ND	+	ND	ND	(Lavara-Culebras and Paricio, 2007)
Drosophila	DJ-1*	DJ-1β null	-	-	ND	+	ND	ND	

Table 4: External validity of genetic models of parkinsonism in animals. Pr.: promotor, SN: degeneration within the substantia nigra, LP: Lewy pathology, MS: motor symptoms, NMS: non-motor symptoms, ND: not determined, °: human gene, *: fly homolog, °: rat homolog, #: mouse paralog, del.: deletion, Ex: exon.

2.2.2. Environmentally-induced experimental analogs of Parkinson's disease

Many environmental factors have been linked to the development of PD in humans, as discussed previously (cf chapter 1 §3.1.). Although the mode of action of these environmental agents is known, like the inhibitory action of rotenone on the complex I of mitochondrial respiratory chain for example, the molecular cascades linking a first exposure to a deleterious environmental compound to the full PD phenotype is still not fully understood. In order to fill this gap, animals have been exposed to environmental or chemical factors known to induce PD-like neuronal damages into the SN, motor impairments or non-motor dysfunctions which could mimick some aspects of PD. The face validity criteria of the main environmental models of PD are presented in table 5, as well as their principal disadvantages and their main usefulness.

Model	Behavioral symptoms	Nigrostriatal damage	Synuclein aggregation/Lewy body formation	Uses of the model	Disadvantages
6-OHDA	Rotational behavior after unilateral injection	Loss of DA innervation at injection site (striatum)	No inclusions	Screen therapies that may improve PD symptoms. Study mechanisms of cell death	Require intracerebral injection, very little synuclein involvement
MPTP	Motor impairments in primates. Less obvious motor impairments in acute rodent models	Loss of DA neurons dependent on dosing regimen, reaching 95% in acute high-dose conditions. Reduced DS levels in striatum concurrent with midbrain DA neuron loss	Inclusions not prevalent. Few cases of synuclein aggregation in nonhuman primates, as well as increased synuclein immunoreactivity in rodents	Screen therapies that may improve PD symptoms. Study mechanisms of cell death	Nonprogressive model of cell death. Inclusions are rare.
Rotenone	Reports of decreased motor activity in rodents	Loss of DA neurons accompanied by reduced DA innervation in striatum	Synuclein aggregation in DA neurons	Test neuroprotective compounds	Substantial morbidity and mortality. Labor and time intensive
Paraquat	No clear motor deficits	Decreased striatal TH immunoreactivity	No inclusions present but increased synuclein immunoreactivity in DA neurons of the SN	Test neuroprotective strategies	Not extensively tested. Effects on either neurotransmitter systems.

Table 5: Main characteristics of neurotoxin-induced animal models of parkinsonism.
(From Javier Blesa et al., 2012).

2.2.1.1. Reserpine

Reserpine has been used to create interesting models of PD. This alkaloid is a monoamine depleting agent inhibiting the vesicular monoamine transporter type 2 (Erickson et al., 1995). Such depletion results in the accumulation of dopamine in the synapses and increased oxidative stress in the brain (Caudle et al., 2008). At doses ranging from 1 to 10mg/kg, reserpine induces akinesia, limb rigidity and jaw movements also called oral tremor in rats (Baskin and Salamone, 1993; Colpaert, 1987). Repeated subcutaneous injections of low doses of reserpine (0.1mg/kg) to rats lead to the development of progressive motor dysfunctions, striatal oxidative stress and decrease in the number of TH-positive cells in the SN preceded by short-term memory impairments (Fernandes et al., 2012; Santos et al., 2013). Reserpine models of PD have been used to assess the efficacy of many treatments of PD now currently used for PD patients such as L-DOPA and apomorphine (Carlsson et al., 1957; Goldstein et al., 1975). The reserpine model thus possesses strong face and predictive

validities regarding motor symptoms and cognitive impairments. However, as reserpine has never been linked to the development of PD in human, its construct validity is very low.

2.2.1.2. 6-hydroxydopamine

6-hydroxydopamine is a chemical agent killing catecholaminergic neurons which include dopaminergic, adrenergic and noradrenergic neurons. When injected with a selective inhibitor of noradrenergic uptake, 6-OHDA induces a huge death of dopaminergic neurons, possibly through the production of ROS and the inhibition of the mitochondrial respiratory chain complexes I and IV (Glinka et al., 1997; Luthman et al., 1989; Soto-Otero et al., 2000). Three days after 6-OHDA injections in the SNc, striatal dopamine is decreased by more than 80% while five weeks after the injection, the rate of degeneration within dopaminergic cells reaches 90% (Przedborski et al., 1995). This model is thus useful to study the therapeutic potential of candidate drugs against massive dopaminergic degeneration. However, it has to be noted that the administration of L-DOPA in 6-OHDA-lesioned rodents led to unpredictable results on the rotating behavior, therefore decreasing the predictive validity of this model (Kääriäinen et al., 2012). Since injections can be performed in one hemisphere of the brain, the other hemisphere can be used as a “control”, taken into account that even if the brain is separated into two hemispheres, it functions as a whole and altering of side could lead to alterations in the other side through the corpus callosum. This model also exhibits other drawbacks. Indeed, the motor behavior associated to 6-OHDA exposure, a stereotypic rotating behavior, does not resemble the motor disorders observed in PD patients and Lewy bodies have not been reported in this model (Blesa and Przedborski, 2014; Dunnett and Lelos, 2010). Moreover, since this toxin does not cross the blood-brain barrier, it has to be injected directly into the brain in order to trigger neuronal death (Ungerstedt, 1968), therefore being far from the mode of exposure of humans to toxic environmental compounds. The 6-OHDA-induced animal model of PD therefore possesses poor construct validity, as it has never been linked to the development of PD in humans, moderate face validity, as it mimics the dopaminergic neuronal death but does not reproduce the characteristic motor symptoms of the disease, and moderate predict validity as contradictory results have been reported after the administration of L-DOPA (Kääriäinen et al., 2012).

2.2.1.3. MPTP

As detailed in chapter 1 §3.1.1.2., the identification of MPTP/MPP+ as the toxic agent which damaged SNc dopaminergic neurons in young drug-abusers established the environmental origin of PD. In the years following this discovery, several teams developed experimental analogues of PD by exposing different animal species to MPP+: rodents (Alvarez-Fischer et al., 2008), monkeys (Eidelberg et al., 1986) or even worms (*C. Elegans*, Braungart et al., 2004) and flies (*Drosophila*, Meulener et al., 2005). Several species

developed strong parkinsonism while others seemed to be more resistant. In rats, injections of MPTP induced only transitory symptoms resembling the ones observed in PD or neurodegeneration in the SN and motor alterations depending on the studies (Chiueh et al., 1984; Prediger et al., 2009, 2006). However, injections of MPTP in monkeys produced a permanent parkinsonian phenotype associated with a degeneration of mesencephalic cells (Blesa et al., 2012). In mice, the effects of MPTP depend on the strain, the gender, the age and the weight of the mouse as it seems to be more efficient in males of at least 8 weeks weighing more than 22g (Petzinger and Jakowec, 2005; Sedelis et al., 2000). The dose and the interval between injections will also modulate the effects of MPTP on rodents' dopaminergic neurons. Thus, two protocols are usually distinguished: the acute regimen and the sub-acute regimen.

The acute regimen involves 4 injections of 20mg/kg with intervals of two hours and leads to a 90% depletion of striatal dopamine and a death of SN dopaminergic neurons reaching 70% (Jackson-Lewis et al., 1995) while the sub-acute regimen induces a more progressive degeneration through daily intraperitoneal injections of 30mg/kg during five days (Tatton and Kish, 1997). The striatal dopaminergic depletion reaches 40-50% and the neuronal death 30 to 40%. The dopaminergic lesion stabilizes in the weeks following the last MPTP injection (Petzinger and Jakowec, 2005). MPTP-induced primate models of parkinsonism therefore possess a good construct validity as MPTP exposure is known to induce parkinsonism in humans, although this kind of exposure is rare. Moreover, the face validity of such models is good, since the animals exposed to MPTP develop resting tremor, rigidity, bradykinesia and postural instability. However, such exposure does not reproduce the Lewy pathology even ten years after the last injection (Halliday et al., 2009) as it was the case in MPTP-exposed humans, therefore differing from the characteristic Lewy pathology observed in sporadic and most of genetic forms of PD (Lewy, 1912).

Recently, a new MPTP model was designed by exposing mice to 3 subcutaneous injections of 20mg/kg per week, every week during three months (Muñoz-Manchado et al., 2016). This exposure leads to a progressive degeneration of the SN neurons over 3 months and a striatal dopaminergic depletion paralleled with alterations of the motor coordination. This more progressive appearance of the phenotype increases the face validity of the MPTP model, although still lacking the development of Lewy pathology (Muñoz-Manchado et al., 2016). Added to a good construct validity and predictive validity, these characteristics make the MPTP model one of the best animal model of advanced PD in non-human primates.

2.2.1.4. Paraquat

Due to its high structural similarity with MPP⁺, N,N-dimethyl-4,4'-bipyridinium dichloride, or **paraquat**, has also been used to reproduce the PD phenotype in animals (Fig.

14; Woolley et al., 1989). Paraquat is a herbicide widely used in Europe until 2007 which modulates oxidative stress by increasing the levels of ROS in the cells (Day et al., 1999). The transport of paraquat to the brain is still a matter of debate. Some studies showed that it reaches the brain *via* dopamine transporters but cannot cross the blood-brain barrier (McCormack and Di Monte, 2003; Shimizu et al., 2001) while, when injected systematically into mice, this herbicide induces neuronal death within the SNpc and a dose-dependent loss of dopaminergic fibers in the striatum (Brooks et al., 1999). Twenty four doses of paraquat (10mg/kg), injected 2-3 times per week, are necessary to induce a significant decrease in striatal dopamine levels (Prasad et al., 2009) while the first injection is enough to induce the activation of microglial cells (Wu et al., 2005). Thioflavine S-positive alpha-synuclein fibrils are found in dopaminergic neurons two days after the third injection (Manning-Bog et al., 2002). This model thus possesses a good construct validity, as exposure to paraquat has been linked to the development of PD and a good face validity, as neuronal death and alpha-synuclein aggregates are reproduced in the mice. However, the predictive validity of the paraquat model has not been assessed yet.

2.2.1.5. Rotenone

The pesticide **rotenone** is a potent inhibitor of mitochondrial complex I which has long been used as a pesticide in Europe until its ban in 2008 by decision of the European commission (Directive 2008/58/EC) for security reasons. Indeed, this molecule has also been used to induce parkinsonism in different animal species. Different procedures of rotenone exposure have been tested in rats and mice, trying to reproduce the cardinal features of PD. The results obtained varied a lot between the different models. Indeed, intravenous and subcutaneous injections of 10-18mg/kg of rotenone did not affect the SN in rodents (Ferrante et al., 1997; Thiffault et al., 2000) whereas continuous systemic exposure through osmotic minipumps delivering 2-3mg/kg of rotenone in the jugular vein of rat induced major striatal denervation and neuronal degeneration within the SN as well as alpha-synuclein aggregates in the nigral neurons (Betarbet et al., 2000). Moreover these animals developed motor impairments such a hypokinesia and postural instability which were improved by apomorphine (Betarbet et al., 2000). However, intra-venous and subcutaneous exposures are both far from the way humans could be exposed to rotenone while eating food exposed to low doses of rotenone or inhaling rotenone during pesticide spreading in the fields for example. To overcome these limitations, Dr. Pan-Montojo used chronic oral exposure of low doses of rotenone (5mg/kg 5d/week) in one year aged mice (Pan-Montojo et al., 2010). After 2 months exposure to such a regimen, mice start developing intestinal motility alterations and inclusions of alpha-synuclein in the neurons of the enteric nervous system. At this stage, the alpha-synuclein inclusions are restricted to the enteric nervous system and no neuronal

death is observed in the SN. After 3 months of exposure, alpha-synuclein aggregates and a decrease in the number of TH-positive cells are found in the SN neurons and mice exhibit motor dysfunctions (Pan-Montojo et al., 2010). This progression of alpha-synuclein lesions from the peripheral nervous system to the SN was prevented by hemivagotomy therefore supporting Braak's staging hypothesis (Braak et al., 2006; Pan-Montojo et al., 2012). This last animal model therefore presents a strong construct validity *per se*, by using one year old mice (age being the most important risk factor for PD) and a pesticide that is known to induce parkinsonism-like symptoms in humans (Tanner et al., 2011a). In addition, it presents a good face validity as mice sequentially developed gastro-intestinal troubles followed by motor impairments as well as alpha-synuclein aggregates and neuronal death within the SN. The predictive validity of this animal model has not been assessed so far. This model is therefore a valuable asset in the study of the early stages of PD, the research for biomarkers of these stages as well as the search for potential neuroprotective medication able to delay or stop the progression of the disease.

In conclusion, in the last decades, many animal models of parkinsonism have been created based on the known genetic and environmental factors involved in the etiology of PD. To our knowledge not a single one was able to fully reproduce the human disease. However, some of these models have shown interesting features. Among them, mice overexpressing the human wild-type SNCA gene and mice chronically and orally exposed to low doses of the pesticide rotenone present the best external validities (Chesselet, 2008; Chesselet et al., 2012; Pan-Montojo et al., 2012, 2010). Indeed, they both reproduce the progressive development of non-motor and motor alterations, the neuronal death and the presence of alpha-synuclein aggregates within the SN. Such models are therefore essential tools in the search for biomarkers of the disease progression or disease-modifying strategies as well as in the understanding of the molecular mechanisms underlying the development of PD.

3. Contribution of PD experimental models to the understanding of underlying molecular mechanisms

All above mentioned experimental analogues of PD, whether cellular or animal models, have been highly instrumental in deciphering PD-related pathophysiological mechanisms. Indeed, for obvious ethical reasons, the dissection of molecular pathways deregulated in PD is complicated or impossible in patients. Therefore, despite their limitations which have largely been discussed in chapter 2 §2, such tools have been essential to elucidate the molecular and cellular events contributing to the neurodegeneration of dopaminergic neurons of the SNc.

3.1. Mitochondrial dysfunction and oxidative stress

Mitochondria are essential organelles which provide energy to the cells through aerobic respiration whose final objective is to create ATP using oxygen. However, such a process also generates ROS which, if they are not adequately eliminated by the cell, can damage all cellular components including RNA, DNA and proteins. Due to its high consumption of energy, the brain is very sensitive to mitochondrial dysfunctions. Such dysfunctions have been associated with aging and neurodegenerative diseases (Navarro and Boveris, 2010).

The first evidence of a link between PD and mitochondrial dysfunctions arose from the study of humans developing atypical parkinsonism after the exposure to the inhibitor of the mitochondrial complex I MPTP. Although this exposure induced a rapid debilitating motor impairment which did not resemble the slow and progressive evolution of PD, the autopsies of the subjects revealed an important neuronal death within the SN looking like the one observed in PD brains (Langston et al., 1999, 1983). This hypothesis was later reinforced by the discovery of the involvement of the pesticide rotenone, another inhibitor of the mitochondrial complex I, in the etiology of PD. Many research therefore focused on the study of mitochondrial dysfunctions and the subsequent production of high levels of ROS in PD patients and models of parkinsonism. Due to oxidation of dopamine by monoamine oxidase, generating oxidative stress by itself, and poor antioxidative system, dopaminergic nigral neurons present a high sensitivity to oxidative stress (Braak et al., 2004; Wang and Michaelis, 2010) therefore explaining, at least partially, the important neuronal death in SNc whereas some other parts of the brain are less affected in PD. Mitochondrial impairment leads to the production of ROS which further cause lipid peroxidation and damage of the structure and function of proteins, including alpha-synuclein (Dias et al., 2013). Corroborating the hypothesis of an involvement of mitochondrial dysfunctions and oxidative stress in PD, oxidative damage to DNA, proteins and lipids as well as a decrease in mitochondrial complex I activity have been described in post-mortem SN samples from PD patients (Dauer and Przedborski, 2003; Greenamyre et al., 2001). Moreover, mutations in mitochondrial DNA polymerase gamma (*POLG*) have been linked to the development of parkinsonism with neuronal death within the SN but no Lewy pathology (Luoma et al., 2004) and the accumulation of multiple mitochondrial DNA deletions have been reported in the post-mortem SN of aged subjects and sporadic PD patients (Bender et al., 2006; Kraytsberg et al., 2006). In addition, several genetic forms of PD led to the identification of genes such as *PARKIN*, *PINK1*, *DJ1* or *ATP13A2* encoding proteins involved in mitochondrial functions, therefore reinforcing the hypothesis of the involvement of mitochondrial dysfunctions in PD (Hampshire et al., 2001; Matsumine et al., 1997; Valente et al., 2004; van Duijn et al., 2001). Based on these discoveries, researchers hypothesized that the mitochondrial impairment observed in

PD patients might be caused by a deficient clearance of damaged mitochondria. Indeed, in physiological condition, Pink1 recruits parkin to the membrane of damaged or unfunctional mitochondria where it will ubiquitinate mitochondrial proteins in order to facilitate their identification by the autophagosome (Narendra et al., 2008). This process is called mitophagy. As *PARKIN* and *PINK1* genes have been implicated in mitophagy and PD, studies have been conducted in cellular and animal models of PD to better understand the molecular modifications involved in the development of the disease and therefore develop therapeutic strategies. In induced pluripotent stem cells generated from *PINK1*-mutated PD patients, PINK1 was not able to recruit PARKIN to the membrane of impaired mitochondria, therefore altering the targeting by PARKIN and their subsequent degradation (Seibler et al., 2011). Similarly, induced pluripotent stem cells-derived neurons isolated from patients with *LRRK2* R1441C mutation showed mitochondrial fragmentation, increase in ROS production and decrease in energy production (Bahnassawy et al., 2013) while the transfer of PD mitochondrial DNA into neuroblastoma cells depleted of their own mitochondrial DNA induced the formation of Lewy body-like structures within the cells (Trimmer et al., 2004) therefore demonstrating that mitochondrial dysfunctions contribute largely to the pathogenesis of PD.

Further *in vitro* and *in vivo* investigations of the potential mitochondrial dysfunction in PD have highlighted the importance of alpha-synuclein and LRRK2 in the development of mitochondrial impairment. Indeed, mice overexpressing alpha-synuclein showed stronger impairment after exposure to the mitochondrial complex I inhibitors MPTP and rotenone than *Snca* knock-out mice, potentially due to a better management of oxidative stress in *Snca* knock-out mice (Klivenyi et al., 2006; Ryan et al., 2014; Thomas and Beal, 2007). Such an impairment was dependent on the brain areas studied since overexpression of alpha-synuclein induced a decrease in the activity of complexes I, II, IV and V in the midbrain while complexes IV and V only were altered in the striatum (Subramaniam et al., 2014). Moreover, oligomers of alpha-synuclein, but not fibrils, decreased calcium storage into the mitochondria leading to the loss of mitochondrial membrane potential (Luth et al., 2014). In addition, G2019S-LRRK2 expressing SH-SY5Y are characterized by a 80% higher oxygen consumption and a decrease in the mitochondrial membrane potential (Papkovskaia et al., 2012). These studies suggest a common impairment between mitochondrial production of ROS and mitochondrial membrane potential stress in response to mutations in two different genes linked to the development of the disease.

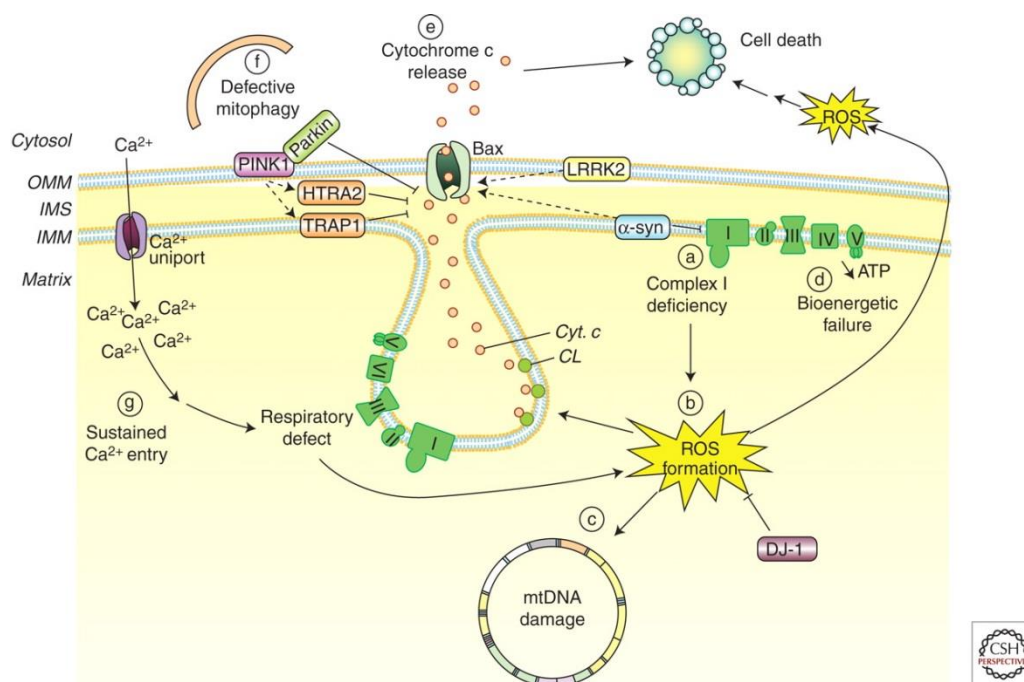

Figure 14: Mitochondrial dysfunction in PD. Several mitochondrial impairments have been observed in PD patients and models of parkinsonism. Such impairment includes inhibition of the complex I of the respiratory chain (a), high levels of reactive oxygen species (ROS) (b), mitochondrial DNA damages (d), cytochrome c release (e), impaired mitophagy (f) and sustained calcium entry (g). Several PD-related genes including *SNCA*, *LRRK2*, *PINK1* and *PARKIN* genes have been involved in the regulation of mitochondrial function. CL, cardiolipin; Cyt. c, cytochrome c; HTRA2, high temperature requirement A2; IMM, inner mitochondrial membrane; IMS, intermembrane space; LRRK2, leucine-rich-repeat kinase 2; OMM, outer mitochondrial membrane; PINK1, phosphatase and tensin homolog-induced kinase 1; ROS, reactive oxygen species; TRAP1, tumor necrosis factor receptor-associated protein 1; α -syn, alpha-synuclein. (From Perier and Vila, 2012)

In summary, mitochondrial dysfunction and oxidative stress are essential elements of the molecular cascade leading to the neuronal degeneration within the SN and the formation of alpha-synuclein inclusions. The understanding of the proteins involved in this cascade in cellular and animal models of PD led to a better apprehension of what happens in the brain of PD patients therefore offering the keys for the development of future anti-parkinsonian drugs.

3.2. Degradation of misfolded protein: autophagy and ubiquitin proteasome system

As described chapter 1 §2.1.2., Lewy bodies are aggregates of misfolded proteins which progressively accumulate in surviving neurons of the SNc of PD patients. Their presence and hypothetical mechanisms of formation suggest a deficiency in the dopaminergic neurons degradation processes such as autophagy and ubiquitin-proteasome system (UPS). In physiological conditions, short half-life misfolded proteins are targeted by the

addition of ubiquitine, unfolded, and incorporated into the proteasome core through a small pore where they will be degraded (Pasquali et al., 2009). The autophagy system, whose importance has just been acknowledged through the attribution of the Nobel price in Medicine and Physiology to the Japanese researcher Yoshinori Ohsumi, degrades the long-half-life proteins. This degradation system is enhanced in stressful conditions and is able to compensate UPS dysfunctions (Hideshima et al., 2005; Klionsky and Emr, 2000; Levine and Klionsky, 2004; Olanow and McNaught, 2006). Three types of autophagy mechanisms have been described so far: macroautophagy, microautophagy and chaperone-mediated autophagy (CMA, Fig. 15). The study of PD brains as well as studies undertaken in models of PD have shown the implication of dysfunctions in the cellular degradation processes in PD. First, Lewy bodies are mainly composed of misfolded alpha-synuclein proteins which are normally degraded by autophagy and UPS in healthy subjects (Cuervo et al., 2004; Webb et al., 2003). In addition, autophagosomes and lysosomal depletion have been observed in the nigral neurons of PD patients (Anglade et al., 1997; Dehay et al., 2010). Moreover, some of the monogenic forms of the disease are caused by mutations within genes involved in the degradation systems such as *UCHL1*, *ATP13A2*, or *GBA*.

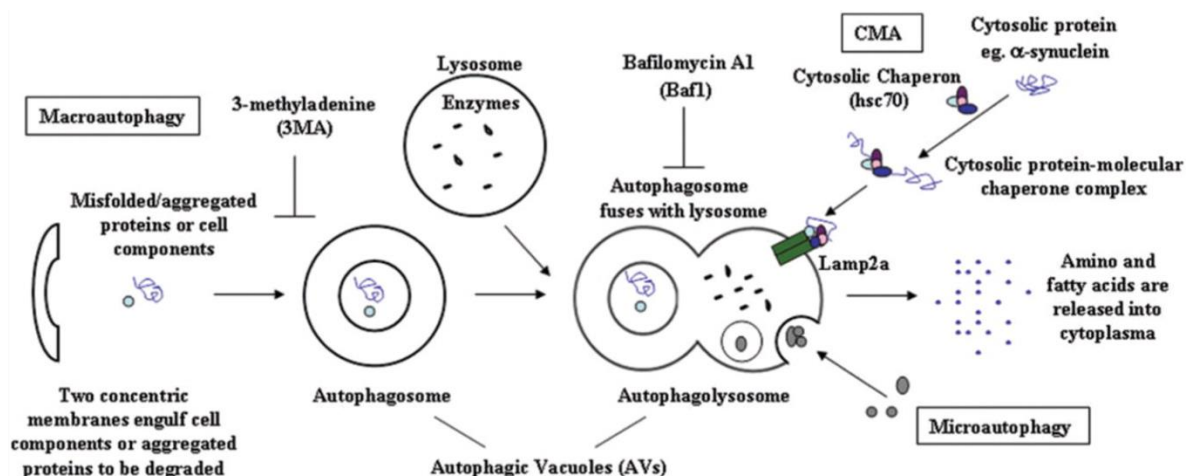

Figure 15: Autophagy-lysosome degradation pathways: macroautophagy, microautophagy and chaperone-mediated autophagy. Macroautophagy involves the degradation of entire regions of the cytosol containing organelles and proteins *via* the formation of a phagopore in the trans-golgi network, which leads to the formation of a double-membraned autophagosome. The latter will merge with lysosomes containing acid hydrolases. Microautophagy involves the direct entrance of misfolded proteins in the lysosome where they will be degraded. Chaperone-mediated autophagy (CMA) involves the specific recognition of misfolded proteins by a KFERQ motif signal which will be recognized by the heat-shock cognate 70 chaperone and transported to the lysosome where they will be degraded. (From Pan et al., 2008)

The involvement of impairments of the UPS and the autophagy system in the development of PD has been further studied in *in vitro* and *in vivo* models of parkinsonism

(Fig. 16; Spencer et al., 2009). Such studies revealed that mutated alpha-synuclein was recognized by heat-shock cognate 70 and brought to CMA receptor at the lysosomal membrane where it stayed attached, which prevented its degradation by the CMA but also the degradation of other substrates of the CMA (Bandyopadhyay et al., 2007; Cuervo et al., 2004; Xiong et al., 2013; Zhang et al., 2012). The accumulation of these misfolded proteins could lead to a cellular stress causing the neuronal death within the SN (Trojanowski and Lee, 2000; Yang et al., 2009). The experiments undertaken in models of PD revealed an involvement of the degradation systems during the early stages of the disease. These studies suggest that autophagy could be a protective mechanism which would later be overwhelmed by the quantity of misfolded proteins to degrade, therefore leading to their accumulation into aggregates and neuronal death (González-Polo et al., 2007a, 2007b; Marin and Aguilar, 2011; Meredith et al., 2002; Öztaş and Topal, 2003).

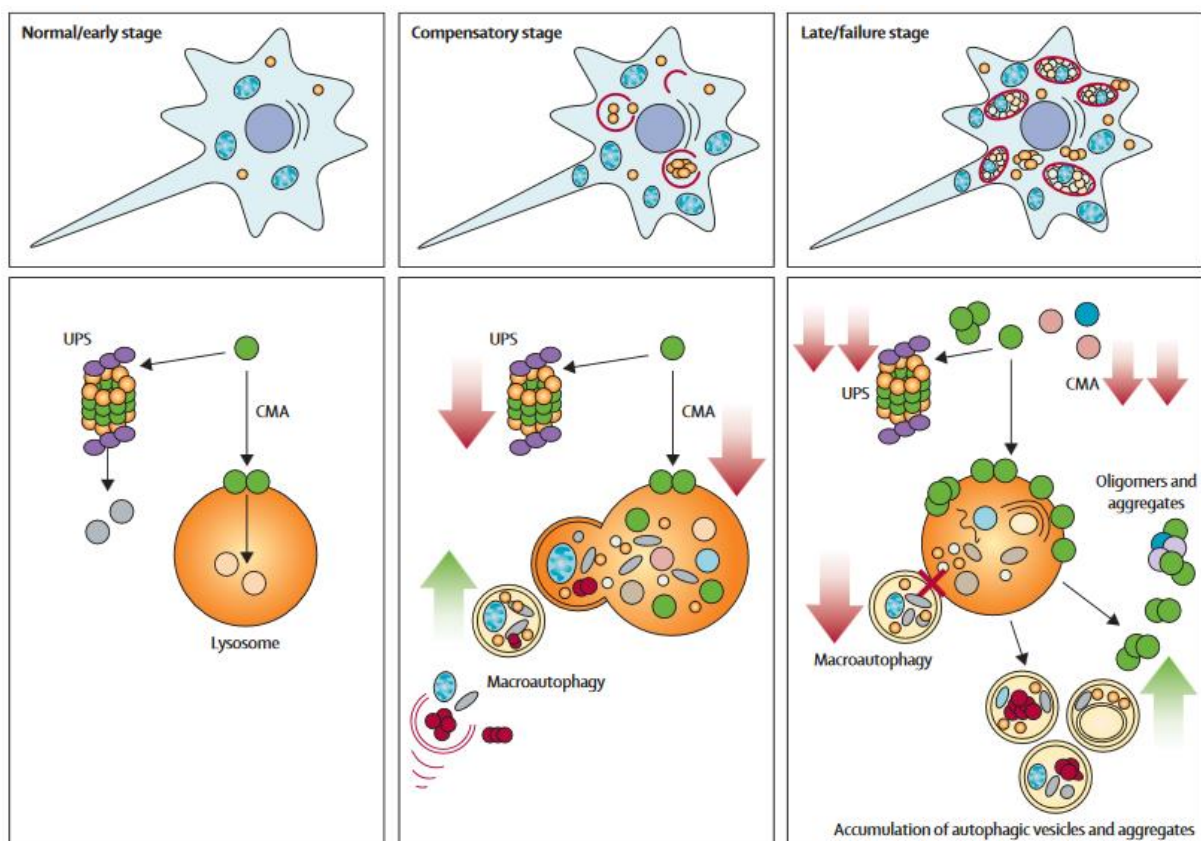

Figure 16: Involvement of degradation processes dysfunctions in neurodegenerative disease. In physiological condition, most soluble misfolded proteins are degraded through the ubiquitine proteasome system (UPS). The accumulation of misfolded proteins impacts the UPS and the chaperone-mediated autophagy (CMA). At this stage, named compensatory stage, the misfolded proteins assemble into larger aggregates which are degraded by macroautophagy. In the late stage, the important quantity of misfolded proteins overwhelm all the degradation processes (From Martinez-Vicente and Cuervo, 2007).

Based on this evidence, several studies have been conducted to activate autophagy, therefore improving the clearance of misfolded proteins and delaying or preventing their accumulation (Pagan et al., 2016). Many other therapeutic strategies have been assessed in cellular and animal models of PD, which are further described by Martinez-Vicente and colleagues (2015). However, it has to be noted that autophagy and UPS are essential systems in the cells which do not only lead to the degradation of misfolded alpha-synuclein but also degrade intracellular regulators of proliferation whose increased degradation could lead to the development of cancers (Pan et al., 2008).

In summary, dysfunctions in the degradation systems of misfolded protein are strongly suggested to be implicated in the development of PD (Cheung and Ip, 2009; Pan et al., 2008). However, the essential role of the degradation processes in the cells complicates the development of therapeutic strategies for PD. Several long-term experiments will thus be necessary before we can conclude on the therapeutic potential of autophagy-modifying molecules.

3.3. Alpha-synuclein: conformation and aggregation

Since the discovery of the role of mutations in the *SNCA* gene and the presence of alpha-synuclein within the Lewy bodies, researchers have tried to understand the molecular modifications implicated in the formation of Lewy bodies. The conformation of alpha-synuclein in control and in pathological conditions has been studied. Under physiological conditions, alpha-synuclein is a 14kDa protein of 140 amino acids which is found in a α -helical conformation when binding to synaptic vesicles or in a disordered conformation in the cytosol (Auluck et al., 2010; Spillantini and Goedert, 2000). In the brain of PD patients however unfolded alpha-synuclein proteins gather into high-molecular weight aggregates (Forman et al., 2004; Spillantini et al., 1998). To understand the process leading misfolded proteins to aggregate, researchers studied the alpha-synuclein at different stages of the formation of aggregates and separated it into three global conformations: monomers, oligomers and fibrils (see Fig. 17; Dettmer et al., 2015). Monomers represent alpha-synuclein in its native disordered form. Monomers with helicoidal conformation can regroup into multimeric assemblies, notably in helix-rich tetramers in order to maintain the solubility of the protein and prevent its aggregation (Dettmer et al., 2015). In a physiological condition, oligomers are unstable structures which rapidly disassemble (Lashuel et al., 2013). During aging or in pathological conditions involving an accumulation of ROS, multiple oligomers can assemble into more stable multimers named protofibrils which can lead to the formation of mature fibrils (Kalia et al., 2013). Indeed, oligomers can associate together or with monomers along the axis of a fibril in order to form amyloid fibrils with β -sheet conformation of several

megadaltons, and a stable hydrophobic core (Eichner and Radford, 2011; Knowles et al., 2014; Lorenzen et al., 2014; Tuttle et al., 2016).

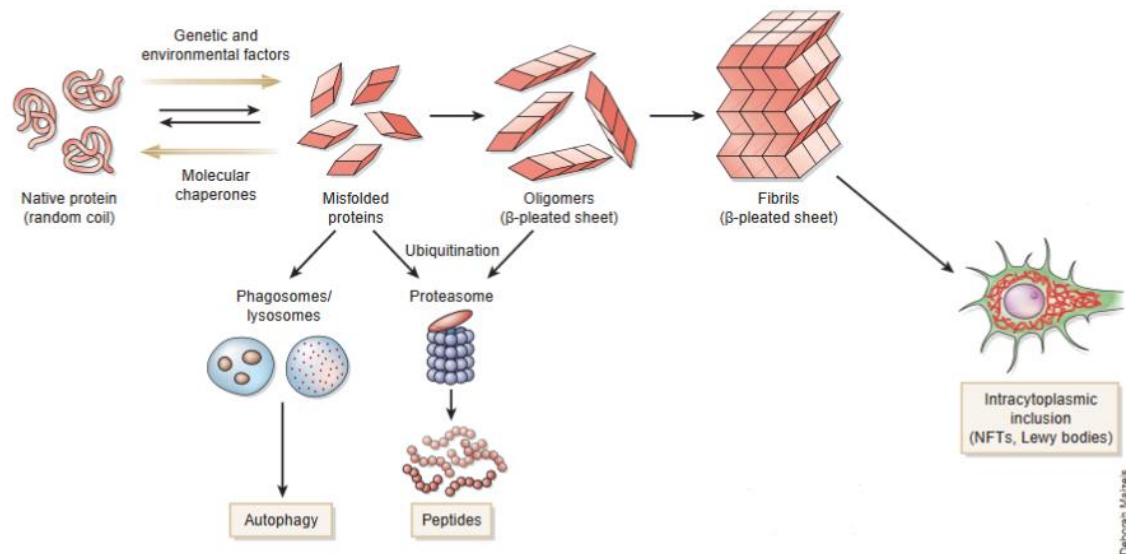

Figure 17: Schematic representation of alpha-synuclein aggregation. In pathological conditions, such as after exposure to genetic and environmental factors, misfolded monomers of alpha-synuclein assemble into prefibrillar oligomers which will form protofibrils. The assembly of protofibrils create mature fibrils composing the Lewy bodies in PD. (From Forman et al., 2004)

The different alpha-synuclein assemblies with specific structural characteristics named alpha-synuclein strains are suggested to be the cause of the different phenotypes among synuclein-based diseases such as PD and multiple system atrophy (Peelaerts et al., 2015; M. G. Spillantini et al., 1998). Moreover, the comparative analysis of assembly process of fibrils of WT alpha-synuclein and alpha-synuclein with A53T, A30P, H50Q or E46K mutations revealed different assembling profiles into aggregates, therefore partially explaining the clinical diversity of phenotypes among PD patients (Lemkau et al., 2013, 2012; Porcari et al., 2015).

The study of alpha-synuclein sequence and its different conformation states not only led to a better understanding of the molecular deregulations observed in the brain of PD patients but also provided information which could be essential in the search for a treatment of PD able to delay the propagation of the aggregates of alpha-synuclein. Indeed, a recent structural analysis showed that the core of the fibrils was too protected to be targeted by potential radiotracers or drugs, contrary to the extremities of its β -sheet structure which might be accessible to the binding of small molecules (Tuttle et al., 2016).

3.4. Proximal cell-to-cell alpha-synuclein spreading and the “prion-like” hypothesis

Following the publication of the Braak staging hypothesis, suggesting that PD could start in the peripheral nervous system and the olfactory bulbs and progress to the SN following a stereotypical pattern (cf. chapter 1 §2.1.3.), and the discovery of Lewy pathology in grafted neurons of PD patients more than a decade after the graft, many studies have been conducted to assess the hypothesis of a prion-like propagation of alpha-synuclein (Braak et al., 2006, 2004; Kordower et al., 2008). The use of experimental analogues of PD has also been crucial in this field of research to ascertain this hypothesis. Desplats and colleagues were the first to describe the transfer of alpha-synuclein from neurons to embryonic stem cells *in vitro* and *in vivo* and demonstrated that this induced neuronal death and inclusions of alpha-synuclein (Desplats et al., 2009). Later studies confirmed these results and showed the implication of exocytosis or exosomes to secrete alpha-synuclein, endocytosis or direct cell-to-cell transmission for the entry of misfolded alpha-synuclein in neighboring cells and for the seeding of aggregation of endogenous native alpha-synuclein (Angot et al., 2012; Aulić et al., 2014; Dunning et al., 2012; Tyson et al., 2015). Based on this knowledge, a new therapeutic strategy has been tested, based on the specific binding of antibodies raised against the C-terminal part of recombinant human alpha-synuclein. Indeed, as alpha-synuclein transfer from one cell to another seems to be the cause of the propagation of the disease, the clearance of extra-cellular alpha-synuclein could limit its transmission to other cells, therefore delaying or stopping its pathological progression. This immunotherapy has shown interesting promises in an alpha-synuclein transgenic animal model of PD with improvement of behavioral function such as motor performance and memory, reduced Lewy pathology in the neocortical neuropil and neuronal degeneration in the SN (Masliah et al., 2011; Tran et al., 2014; Valera and Masliah, 2013). However, the current knowledge on the exact role of alpha-synuclein extracellular forms is too limited to determine which forms of alpha-synuclein would be eliminated and what could be the consequences of such removal on neuronal function, or neurotransmitter release for which alpha-synuclein is involved.

These transmission mechanisms have been studied *in vivo* using animal models of PD. The intra-peritoneal injection of alpha-synuclein fibrils to mice overexpressing the human A53T mutated alpha-synuclein led to the development of alpha-synuclein aggregates in the brain (Breed et al., 2016). Moreover, injections of brain homogenates of A53T alpha-synuclein overexpressing mice led to the development of a “*paralysis of the hindlimbs and the impairment of the rotation to upright posture*” (Mougenot et al., 2012). Many other models of alpha-synuclein spreading have been created (Iljina et al., 2016; Rey et al., 2016; Watts and

Prusiner, 2014). Among them, the model of Dr. Pan-Montojo is of particular interest as it does not involve exposure to alpha-synuclein. As described in chapter 2 §2.2.1.5., in this mouse model, oral exposure to low doses of rotenone induced a local effect on mitochondrial complex I in the gastro-intestinal tract without any impact on muscles, blood or brain (Pan-Montojo et al., 2010). Interestingly, this mode of exposure generated alpha-synuclein inclusions in the intestinal neuronal plexuses of the mice which propagated to the brain through the vagus nerve (Pan-Montojo et al., 2012). This study brought the proof that alpha-synuclein misfolding and spreading could happen in WT animals orally exposed to the pesticide rotenone, a mode of exposure closer to what could happen in humans than any other model created so far, therefore further increasing the face validity of this animal model.

Altogether these studies, showed common mechanisms between alpha-synucleinopathies and the prion diseases (PrP^{Sc}). Prion diseases are characterized by the aggregation of a misfolded protein which propagates to neighboring cells and induce the misfolding of endogenous native proteins. Prion diseases are recognized by a long incubation period, an important neuronal death leading to a spongy aspect of the brain without inducing an inflammatory response¹⁰. As described above (cf. chapter 2 §3.3.), in physiological conditions, alpha-synuclein presents a α -helical conformation when bound to synaptic vesicles and a β -sheet-enriched conformation leading to the formation of oligomers and fibrils in PD. As in prion diseases, oligomeric misfolded forms of alpha-synuclein are thought to be responsible for neuronal death (Peelaerts et al., 2015; Stein and True, 2014). Moreover, the presence of misfolded alpha-synuclein in one neuron is able to induce misfolding and aggregation of endogenous WT alpha-synuclein in neighboring neurons (Olanow and Prusiner, 2009).

In conclusion, each model has intrinsic advantages and limits. As discussed in Chapter 2 §1.1., and according to the reductionist principles of the scientific method, experimental tools are simplified representations of the reality. This is further reinforced by the fact that PD is a human-specific disease which has never been spontaneously observed in other animal species. Although some cases of spontaneous motor deficits have been described in rodents (Saigoh et al., 1999), they however do not fully meet the criteria of parkinsonism. Therefore, the results obtained in one species must be verified in other species before any definite conclusion can be reached. Knowing these limits and the characteristics of each model should enable scientists to better select appropriate tools to address their specific questions. Nevertheless, such models are adapted tools to discover new therapeutic targets aiming to delay, stop or reverse the progression of the disease, provided they have

¹⁰ <http://www.cdc.gov/prions/>

been fully proofed for their construct, face and predictive validities using rigorous experimental designs. Among the currently tested therapeutic strategies, some have shown huge potential in the prevention of alpha-synuclein spreading or degeneration of nigral neurons at the origin of the motor symptoms of the disease (Masliah et al., 2011). However, as we do not know yet if alpha-synuclein aggregation in the peripheral nervous system and extra nigral areas of the brain is at the origin of PD non-motor symptoms, only few of these strategies are expected to treat both motor and non-motor symptoms of the disease.

CHAPTER 3: THE POTENTIAL OF THE OREXIGENIC PEPTIDE GHRELIN IN PARKINSON'S DISEASE¹¹.

1. Ghrelin: a pleiotropic hormone?

1.1. Origin and biosynthesis

The orexigenic hormone ghrelin has initially been discovered in rat stomach extracts and is implicated in numerous functions as detailed below in §2.3. (Kojima et al., 1999; Méquinion et al., 2013; Müller et al., 2015; Zigman et al., 2016). The gene encoding ghrelin has been identified in numerous species and its sequence is highly conserved among mammals such as humans, rhesus monkeys, rats, mice, cows, pigs, sheep, dogs and gerbils (Angeloni et al., 2004; Tomasetto et al., 2001). The human *GHRL* gene is located on chromosome 3 at position 3p25-26 which is composed of six exons (Ex0 – Ex5), including three non-coding exons (Ex0, Ex1 and Ex5). The transcription of the *GHRL* gene produces a 511bp RNA whose translation generates a 117 amino acid-long preprohormone, named preproghrelin (Fig. 18; Seim et al., 2007). This precursor is cleaved into obestatin and proghrelin, a 94 amino acid-long peptide (Kojima and Kangawa, 2005). In the endoplasmic reticulum, proghrelin will undergo acylation through the action of the enzyme ghrelin-octanoyl-acyltransferase which enables the transfer of an octanoyl group from the octanoyl-coenzyme A to the hydroxyl group of the proghrelin third N-terminal serine (see Fig. 18; Bayliss et al., 2016a; Kojima and Kangawa, 2005; Labarthe et al., 2014; Zhu et al., 2006). Proghrelin is further cleaved by the prohormone convertase 1/3 into a 28 amino acid-long peptide named ghrelin (Zhu et al., 2006). Ghrelin is released into the bloodstream in two biologically distinct states, acyl- and desacyl-ghrelin, the latter being the major form (Takagi et al., 2013). A large proportion of acyl-ghrelin is indeed rapidly converted to desacyl-ghrelin in the plasma by 1'acyl-protein thioesterase 1' "(APT1)/lysophospholipase 1 (Satou et al., 2010).

¹¹ This paragraph is largely inspired by the Review "Is there a role for ghrelin in central dopaminergic systems? Focus on nigrostriatal and mesocorticolimbic pathways". Alicia Stievenard, Mathieu Méquinion, Zane B. Andrews, Alain Destée, Marie-Christine Chartier-Harlin, Odile Viltart, Christel C. Vanbesien-Mailliot. In press in Neuroscience & Biobehavioral Reviews. Annex 5.

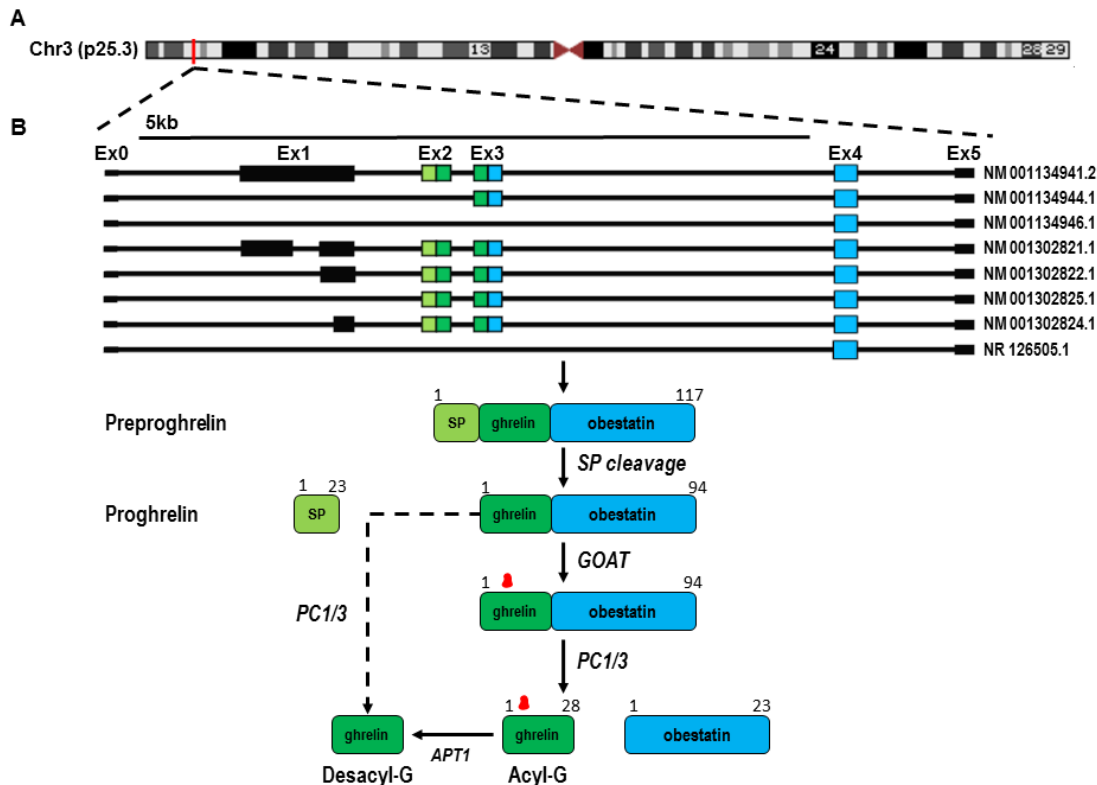

Figure 18: Synthesis and post-translational processing of ghrelin precursor peptides: from the *GHRL* gene to acyl-ghrelin. A) The human ghrelin gene (*GHRL*) is located on chromosome 3 at position 3p25-26 indicated by the red bar. B) Enlargement of the 3p25-26 chromosomic region showing the eight currently identified *GHRL* variants as listed in the UCSC database genome browser (https://genome.ucsc.edu/cgi-bin/hgTracks?db=hg38&lastVirtModeType=default&lastVirtModeExtraState=&virtModeType=default&virtMode=0&nonVirtPosition=&position=chr%3A10285675%2D10292947&hgsid=504045775_bG7QQtnAIsUTI9KS40bAsPrCC4ia, accessed on July 23rd 2016). As shown on the upper line, the human ghrelin gene contains six exons (Ex0 – Ex5), including three non-coding exons (Ex0, Ex1 and Ex5) represented by the black boxes. *GHRL* codes for preproghrelin, a peptide composed of 117 amino acids including a signal peptide (SP, light green boxes), the ghrelin peptide (dark green boxes) partly encoded by exons 2 (Ex2) and 3 (Ex3), as well as a C-terminal peptide named obestatin (blue boxes) encoded by part of Ex3 and the exon 4 (Ex4). Preproghrelin is first processed to remove the signal peptide, which generates a 94 amino acids-long peptide named proghrelin. This precursor is then acylated (red symbol) by the ghrelin O-acyltransferase (GOAT) within the endoplasmic reticulum and further cleaved by the prohormone convertase 1/3 (PC1/3). The resulting peptides are then secreted and released in the blood, where acyl-ghrelin is rapidly desacylated in the plasma by endogenous esterases such as acyl-protein thioesterase 1 (APT1) /lysophospholipase 1 or butyl choline esterase (Satou et al., 2010). (From Stievenard et al., in press)¹²

¹² This figure corresponds to the figure 2 of the review « Is there a role for ghrelin in central dopaminergic systems? Focus on nigrostriatal and mesocorticolimbic pathways. Alicia Stievenard, Mathieu Méquignon, Zane B. Andrews, Alain Destée, Marie-Christine Chartier-Harlin, Odile Viltart, Christel C. Vanbesien-Mailliot. In press in *Neuroscience & Biobehavioral Reviews*. Annex 5.

Ghrelin is mainly expressed in the stomach by X/A-like oxyntic gland cells of the gastric fundus mucosa (Kojima et al., 1999; Müller et al., 2015). It is also expressed at lower levels in many other tissues including the intestinal tract, the pancreas, the gall bladder, the liver, the gonads or the breast (Gnanapavan et al., 2002). Ghrelin is however not expressed in the brain. The initial report of ghrelin expression within the hypothalamus (Cowley et al., 2003) was in fact based on non-specific antibody staining as demonstrated later (Furness et al., 2011). Similarly, other authors have not been able to find any preproghrelin mRNA in this brain structure (François et al., 2015). Despite the lack of centrally produced ghrelin and the limited capacity of ghrelin to cross the blood-brain barrier (Banks, 2002; Cabral et al., 2013; Schaeffer et al., 2013), ghrelin receptors have been described in the SNc and ventral tegmental area (Andrews et al., 2009; Mani et al., 2014; Wellman and Abizaid, 2015; Zigman et al., 2006), suggesting that brain cells expressing ghrelin receptors might respond to ligands other than centrally produced ghrelin. Nevertheless, SNc neurons expressing ghrelin receptors readily respond to ghrelin in slice preparations (Abizaid et al., 2006; Andrews et al., 2009).

1.2. Ghrelin receptors

Ghrelin is the only known endogenous ligand of the growth hormone secretagogue receptor (GHSR) (Gutierrez et al., 2008; Howard et al., 1996). It was identified in 1996 as an orphan receptor encoded by the *GHSR* gene (Howard et al., 1996). Two splicing variants were further isolated (Kojima et al., 1999) and give rise to two forms of the receptor: GHSR1a and GHSR1b, which belong to the family of G protein-coupled receptor. Acyl-ghrelin binds GHSR1a, the full length receptor with seven transmembrane domains, through its 10 N-terminal amino acids (Kojima et al., 1999). The GHSR1a activates several intracellular cascades in different cell types and tissues, including Extracellular signal-regulated kinase 1/2 (ERK 1/2), Phosphatidylinositol-4,5-bisphosphate 3-kinase (PI3K)/Akt/mTOR and 5' adenosine monophosphate-activated protein kinase (AMPK) signaling pathways, thus mediating the different physiological functions of ghrelin. In particular, within the central nervous system and anterior pituitary, the binding of acyl-ghrelin onto GHSR1a increases growth hormone release *via* the increase of intracellular calcium following the activation of the inositol 1,4,5-trisphosphate (IP3) / diacyl glycerol pathway (Fig. 19; Camiña et al., 2007; Ghigo et al., 2005). In addition, in the arcuate nucleus of the hypothalamus, GHSR1a activation triggers the phosphorylation of both AMPK, a sensor of energy homeostasis, and of mammalian target of rapamycin (mTOR), thus leading to an increase of brain-specific homeobox (BSX), c-AMP response element-binding protein (CREB) and forkhead box O1 (FoxO1) transcription factors (Lage et al., 2010; Martins et al., 2012). The activation of these signaling cascades results in the synthesis of the orexigenic

NPY (neuropeptide Y) / AgRP (Agouti-related protein) neuropeptides therefore triggering food intake (Fig. 19). More precisely, this signaling pathway simultaneously inhibits acetyl coenzyme A carboxylase and increases the activity of carnitine palmitoyltransferase 1 therefore activating fatty acid β -oxidation within mitochondria and the resulting production of ROS. This activates, in turn, the mitochondrial uncoupling protein 2 (UCP2), which neutralizes ROS and promotes mitochondrial biogenesis in order to maintain the activation of NPY/AgRP neurons (Andrews et al., 2008). Conversely in the liver and adipose tissues, acyl-ghrelin inhibits AMPK, therefore increasing the expression and activity of acetyl coenzyme A carboxylase and fatty acid synthase, thus controlling lipid metabolism and therefore glucose homeostasis in these tissues (Theander-Carrillo et al., 2006). In other non-neuronal tissues and cell types, the binding of acyl-ghrelin to GHSR1a activates either the phospholipase C/inositol trisphosphate or the adenylate cyclase/protein kinase A pathways, resulting in an increase in intracellular calcium levels (See Fig. 20). As a result, the calcium calmodulin kinase kinase, a sensor of intracellular calcium, activates the Akt/MAPK pathways, thus modulating proliferation and apoptosis (Baldanzi, 2002; Granata et al., 2007; Kim et al., 2004; Yang et al., 2013).

GHSR1b is a C-terminal truncated receptor with only five transmembrane domains located in the endoplasmic reticulum (Chow et al., 2012). It seems to exert a dominant negative effect on GHSR1a trafficking and its ability to modify its conformation in order to activate the above-described downstream cellular cascades (Mary et al., 2013). The GHSR1a receptor is distributed in various organs both in the periphery (Guan et al., 1997) and in different parts of the rodent brain including the hypothalamus, the SNc, the ventral tegmental area, the hippocampus, the amygdala and the olfactory bulb (Andrews et al., 2009; Mani et al., 2014; Zigman et al., 2006). However, a definitive proof of the presence of GHSR1a in the human brain is still lacking.

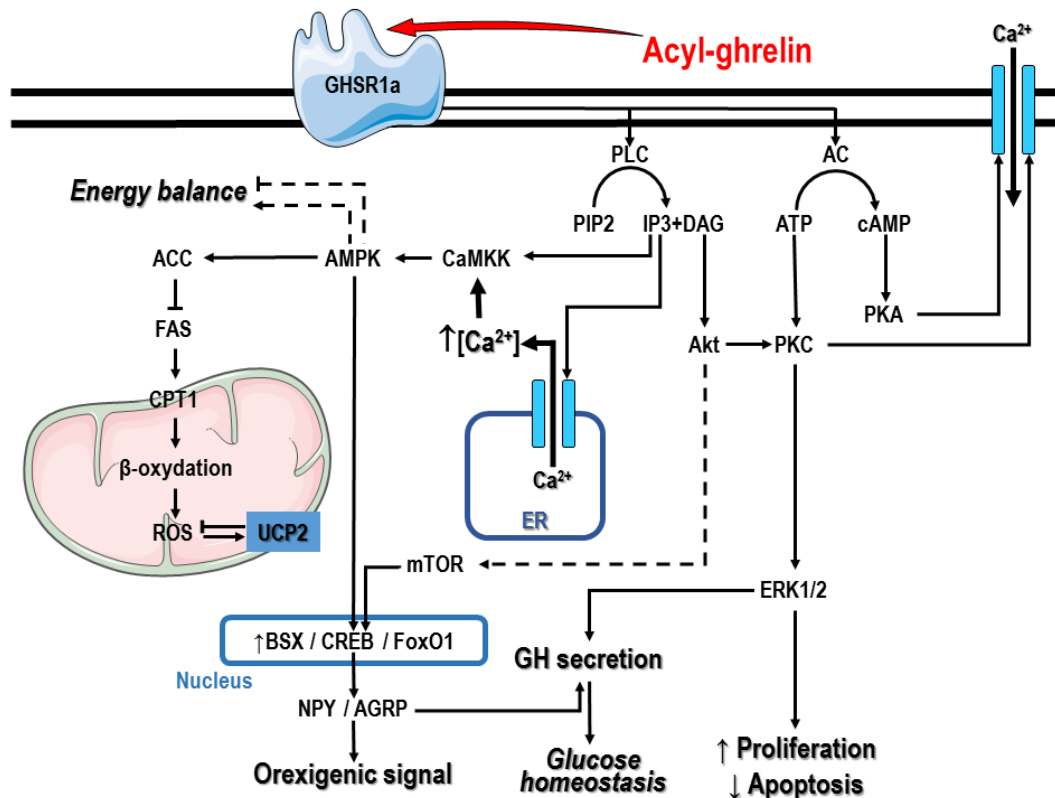

Figure 19: Schematic representation of ghrelin-dependent signaling pathways. Acyl-ghrelin binding to GHSR1a triggers G protein-coupled signaling cascades and activates both phospholipase C (PLC) and adenylate cyclase (AC). PLC hydrolyses phosphatidylinositol 4,5-bisphosphate (PIP2) into inositol 1,4,5-trisphosphate (IP3) and diacylglycerol (DAG). IP3 induces the release of calcium (Ca^{2+}) from endoplasmic reticulum storages while AC and DAG respectively activate the protein kinase A (PKA) and the protein kinases B (Akt) / C (PKC) cascade, thus resulting in the entry of extracellular Ca^{2+} through calcium channels. In all cases, the resulting increase in intracellular Ca^{2+} concentrations in the brain activates calmoduline and calmoduline-dependent protein kinase kinase (CamKK), and modulates its action on β -oxidation through AMPK phosphorylation. Ghrelin binding to GHSR1a also activates the PI3K/Akt and PKC/extracellular signal-regulated kinases 1/2 (ERK1/2) pathways, thus inducing the release of growth hormone from pituitary cells. The activation of these cascades upon ghrelin binding has also been observed in cancer cells and leads to increased proliferation and prevention of apoptosis (Majchrzak et al., 2012). In hypothalamic neurons, ghrelin binding to its receptor triggers the AMPK and mammalian target of rapamycin (mTOR) pathways, which increase brain-specific homeobox (BSX), c-AMP response element-binding protein (CREB) and forkhead box O1 (FoxO1) transcription factors (Lage et al., 2010; Martins et al., 2012). This results in an orexigenic signal mediated by the neuropeptide Y (NPY) and agouti-related protein (AgRP) neuropeptides. Note that only the main partners within the discussed signaling pathways are represented on the figure. Plain arrows represent direct interactions. Dotted arrows indicate indirect actions where intermediate molecules have been omitted for clarification purposes. Created with illustrations from Servier Medical Art (used under the following agreement: *Creative Commons Attribution 3.0 France*). (From Stievenard et al., in press)¹³

¹³ This figure corresponds to the figure 3 of the review « Is there a role for ghrelin in central dopaminergic systems? Focus on nigrostriatal and mesocorticolimbic pathways. Alicia Stievenard, Mathieu Méquignon, Zane B. Andrews, Alain Destée, Marie-Christine Chartier-Harlin, Odile Viltart, Christel C. Vanbesien-Mailliot. In press in *Neuroscience & Biobehavioral Reviews*. Annex 5.

GHSR1a also displays a high constitutive activity in the absence of its ligand (Holst et al., 2003). A rare GHSR1a missense mutation (A204E) prevents the constitutive activity of the receptor while preserving its ability to bind ghrelin and is associated with a familial short stature (Pantel et al., 2006). Therefore, the constitutive activity of the GHSR1a receptor could contribute to growth hormone secretion and/or body weight regulation (Mear et al., 2013). In addition, GHSR1a is able to adopt homodimer and heterodimer conformations, notably with the melanocortin-3 receptor, the serotonin 2C receptor, the dopamine 1 receptor (D1R), the dopamine 2 receptor (D2R) and the somatostatin receptor subtype 5 (for review, see 2015). Such heterodimers have mainly been described *in vitro* using co-immunoprecipitation and resonance energy transfer-based techniques (Kern et al., 2012; Rediger et al., 2012; Schellekens et al., 2013; Wellman and Abizaid, 2015). These heterodimers affect receptor signal properties by changing G protein-coupled signaling cascades, as well as modifying the trafficking and internalization of both partners of the dimer complex, either in the presence or in the absence of ghrelin (Wellman and Abizaid, 2015). For instance, in the presence of both dopamine and ghrelin, GHSR1a amplifies dopamine-induced cAMP accumulation *via* D1R in human embryonic kidney (HEK) 293 cells (Jiang et al., 2006). However, in the absence of ghrelin but presence of dopamine, GHSR1a/D2R dimerization in hypothalamic neurons increases intracellular calcium levels independently of the GHSR1a constitutive activity (Kern et al., 2012). Therefore, dopamine alone is able to activate GHSR1a at least *in vitro*, which might be of particular interest within the central nervous system, more precisely in dopaminergic brain areas where the receptor is highly expressed and where ghrelin is not locally produced. This dimerization capacity of GHSR1a needs however to be further confirmed *in vivo*. In summary, the large distribution of GHSR1a throughout the brain, its high constitutive activity and its propensity towards heterodimerization highlight the functional importance of this receptor within the brain beyond the sole binding of ghrelin.

1.3. Functions of ghrelin¹⁴

Ghrelin targets various brain structures and peripheral organs (Fig. 20). Its first role has been demonstrated in pituitary somatotrophic cells as a secretagogue of the growth hormone acting in synergy with the hypothalamic peptide growth hormone releasing hormone (for review, see Steyn et al., 2016). Ghrelin also modulates food intake behavior, body weight, energy expenditure, glucose and lipid homeostasis, neurogenesis, blood pressure, heart rate and gastro-intestinal motility (Kojima and Kangawa, 2005). In addition, ghrelin increases gastric acid secretions in a dose-dependent manner by a mechanism implicating the vagus nerve (Date et al., 2001).

¹⁴ This paragraph presents a summary of ghrelin's major functions; for further details, please refer to Méquinion et al., 2015; Delporte et al., 2013.

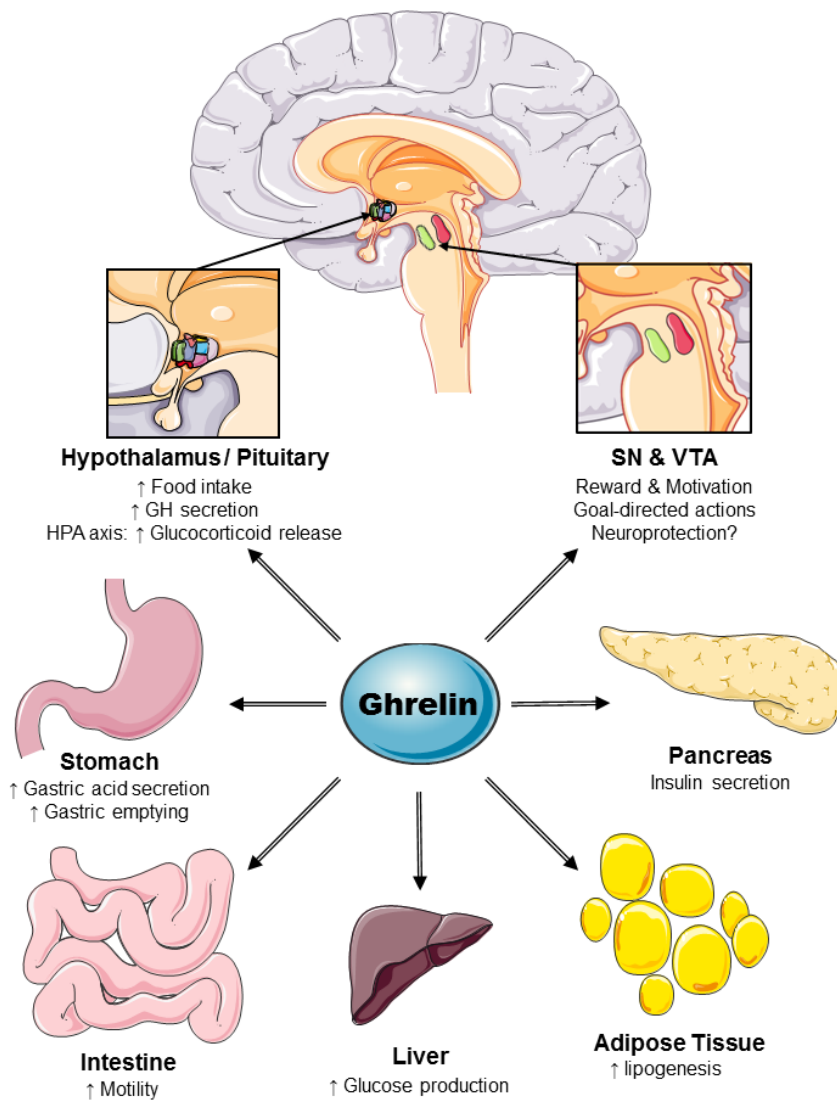

Figure 20: Main physiological functions of ghrelin. Ghrelin is involved in numerous functions. In the central nervous system, acyl-ghrelin acts in the hypothalamus (top left) to induce food intake and to increase growth hormone (GH) secretion from somatotrophs cells in the pituitary gland. It also plays an important role in the hypothalamo-pituitary-adrenal axis (HPA); in particular it modulates glucocorticoid release and is therefore involved in adaptation to stress and anxiety. In dopaminergic neurons of the ventral tegmental area (VTA, top right, green area), ghrelin has been shown to regulate reward and motivation processes whereas in the substantia nigra (SN, top right, red area) of animal models it is suggested to act as a neuroprotective agent against toxic compounds-induced neuronal death. Ghrelin also regulates goal-directed actions *via* its effects on both VTA and SN. In the gastro-intestinal tract (bottom part of the figure), ghrelin activates the secretion of gastric acid, gastric emptying and intestinal motility (left-hand side). Ghrelin also modulates energy metabolism through a regulation of insulin pancreatic secretion and lipogenesis (right-hand side). Its main role is however to increase glucose production from the liver (bottom center of the figure), especially under conditions of energy deficit like severe caloric restriction (Goldstein et al., 2011). Created with illustrations from Servier Medical Art (used under the following agreement: *Creative Commons Attribution 3.0 France*). (From Stievenard et al., in press)¹⁵

¹⁵ This figure corresponds to the figure 4 of the review « Is there a role for ghrelin in central dopaminergic systems? Focus on nigrostriatal and mesocorticolimbic pathways. Alicia Stievenard, Mathieu Méquignon, Zane

This hormone also modulates gastric emptying and intestinal transit time (Levin et al., 2006). Furthermore, plasma ghrelin levels depend on the metabolic state, the food consumption and the physical activity (Lemarié et al., 2016; Méquinion et al., 2015; Nishi et al., 2013). In healthy subjects, plasma ghrelin concentrations are elevated just prior to meal initiation and decrease after food intake (Cummings et al., 2001). Therefore, inter-meal levels of ghrelin display a diurnal rhythm which can be further amplified through fast/food restriction protocols. In addition, a single injection of acyl-ghrelin enhances food intake in both rodents and humans (Cummings et al., 2001; Wren et al., 2001). Ghrelin is thus considered as the main signal for the initiation of the meal, acting notably through a finely tuned regulation of both hypothalamic and brainstem neurons. More precisely, within the arcuate nucleus, ghrelin activates orexigenic NPY/AgRP cells. These neurons project onto various hypothalamic nuclei such as the paraventricular and dorsomedial nuclei, and the lateral hypothalamus to regulate the feeding behavior (Delporte, 2013; Olszewski et al., 2008). This orexigenic action of ghrelin on hypothalamic NPY/AgRP neurons is further amplified through their GABA-ergic inhibitory outputs targeting arcuate anorexigenic pro-opiomelanocortin (POMC) neurons (Cowley et al., 2003; Kojima and Kangawa, 2005). Yet, the effects of ghrelin on energy metabolism also involve non-hypothalamic structures implicated in the food intake : the ventral tegmental area activating the reward system, the hippocampus facilitating learning and memory, and the central nucleus of amygdala modulating emotional arousal and cue-potentiated feeding (Bali and Jaggi, 2016; Diano et al., 2006; Müller et al., 2015).

However, it has to be noted that most studies investigated ghrelin independently of its acylation state. Only few studies distinguished the effects of acyl- and desacyl-ghrelin (Andrews et al., 2009; Bayliss et al., 2016a; Bayliss and Andrews, 2013; Broglio et al., 2004a; Delhanty, 2006; Delhanty et al., 2014; Zizzari et al., 2011). Desacyl-ghrelin as long been thought to be a degradation product of acyl-ghrelin because of its incapacity to bind GHSR1a at physiological concentrations. However, evidence progressively accumulated for a role of desacyl-ghrelin by itself, in combination or in opposition with acyl-ghrelin (Delhanty et al., 2013, 2014). Indeed, when injected with acyl-ghrelin, desacyl-ghrelin is able to counteract its effect on glucose production and insulin release but had no effect when injected alone (Broglio et al., 2004a). Moreover, in obese patients, acyl-ghrelin concentrations are either similar or higher than healthy subjects while desacyl-ghrelin concentrations are lower (Barazzoni et al., 2007; Rodríguez et al., 2009). Desacyl-ghrelin is also able to decrease gastric emptying and food intake in rats and to increase glucose metabolism in healthy human subjects (Asakawa et al., 2005; Benso et al., 2012; Zhang et

al., 2008). Moreover, recent studies using GHSR1a knock-out mice and cells which do not express GHSR1a showed that acyl- and/or desacyl-ghrelin induced adipogenesis in bone marrow, impaired atrophy of skeletal muscles after fast, increased glucose intake in myoblasts, enhanced mitogenesis in osteoblasts and increased gluconeogenesis in the liver (Callaghan and Furness, 2014; Costa et al., 2011; Gauna et al., 2005; Gershon and Vale, 2014; Porporato et al., 2013; Reano et al., 2014; Thompson et al., 2004). Altogether, these data suggest that acyl-ghrelin, like desacyl-ghrelin, could play physiological roles independently of GHSR1a.

2. Ghrelin / dopamine interactions in the nigrostriatal pathway and therapeutic potential in PD

As presented above, the study of the role of ghrelin in the brain has long focused on areas related to food intake modulation and reward-based activities. However, several *in vitro* and *in vivo* studies having shown neuroprotective potential of ghrelin in several types of injuries such as ischemia or oxygen deprivation as well as its effects on peripheral functions impacted in PD, its potential benefit in PD was logically investigated.

2.1. Diagnostic potential of ghrelin in PD

As described in chapter 1 § 3.2. the progress in the science and the development of technics allowing the study of the genome of PD patients and healthy subjects revealed many genes linked to PD. Their discovery raised the hope that they could be used as biomarkers to facilitate the diagnosis of the disease. However, apart from the rare familial forms of the disease, the genetic factors revealed by these studies do not reach the expectancies of ideal biomarkers. Indeed, the Coriell Institute for Medical Research defines an ideal biomarker as a biomarker with a good sensitivity and specificity for the disease of interest or for one stage of progression of this disease in order to be used in the diagnosis or the prognosis of the disease. It should be easily assayed with standardized procedures available at low cost in clinics. More important, the ideal biomarker should be obtained with low-risk and low-pain procedures, such as blood sampling or urine sampling more than biopsies. Recent studies have suggested ghrelin as a biomarker of the early stages of PD.

Indeed, plasma ghrelin concentrations are known to decrease with aging. In particular, plasma ghrelin concentrations after fast are lower in healthy elderly subjects than in young non-obese individuals (Rigamonti et al., 2002). As aging is a well-known PD risk factor (Elbaz et al., 2016), lower ghrelin plasma concentrations would be expected in PD patients. Indeed, plasma acyl-ghrelin concentrations after fast tend to decrease in PD patients compared to patients suffering from other non-neurodegenerative diseases (Fischer et al., 2010). But, these

results fail to reach statistical significance due to the small size of the cohort studied and the absence of a standard meal before blood sampling. Similarly, a slower increase of plasma total ghrelin concentrations between two standard meals has been reported in PD patients and patients suffering from RBD, a non-motor symptom preceding the diagnosis of PD and often associated with pre-motor stages of the disease, compared to healthy subjects (Unger et al., 2011). Therefore, altered plasma concentrations of acyl-ghrelin after a standard meal could be used as a biomarker of early PD stages. Such studies need however to be replicated in larger cohorts of patients and should systematically assess the two main forms of ghrelin; they should also take into account sex differences both in PD itself as well as in circulating concentrations of ghrelin and in GHSR1a expression as reported in rodents (Kamegai et al., 1999). Moreover, the dosage of ghrelin can easily be performed on blood samples with assay kits already available in the market. Taken together, these observations suggest that ghrelin could be a valuable biomarker of PD, especially in its early stages: in this view, the ratio of acyl-ghrelin *versus* desacyl-ghrelin appears as an adapted indicator of potential disease-related alterations either in the synthesis or the release of ghrelin, or in its action on target cells/tissues. However, such evidence is only at early stages and, due to the pleiotropic functions of ghrelin, its sensitivity and specificity for PD still has to be demonstrated. Many research still need to be done. Most particularly, the use of animal models to study the potential of ghrelin as a biomarker is for now limited as the pattern of secretion of ghrelin after food intake or fast for example has not been studied in rodents, therefore complicating the design of standardized blood sampling procedures in these animals.

2.2. Therapeutic potential of ghrelin against PD non-motor symptoms

Most PD patients lose weight during the progression of the disease (Abbott et al., 1992). While L-DOPA-treated patients keep losing weight, PD patients under deep brain stimulation regain weight in the year following surgery without modifying their food intake habits (Perlemoine et al., 2005). Such a weight gain after deep brain stimulation is paralleled by an increase in circulating ghrelin concentrations (Markaki et al., 2012). Therefore, not only could ghrelin levels reflect such weight variations, but ghrelin could also be a direct actor of PD-related weight modifications. The assessment of plasma ghrelin concentrations in patients undergoing deep brain stimulation and/or L-DOPA therapies has however generated controversial results. On one hand, plasma concentrations of total ghrelin during fast are unchanged either by L-DOPA alone or by deep brain stimulation alone when evaluated up to 12 months after the surgery. On the other hand, when applied together, deep brain stimulation and L-DOPA reduced the levels of plasma ghrelin (Corcuff et al., 2006). Further studies on larger cohorts of patients are therefore needed to clarify these data. In addition, a

detailed evaluation of circulating acyl- and desacyl-ghrelin concentrations in PD patients under deep brain stimulation after fast and better study designs, with the intake of a standard meal and stratifications by sex, stage of the disease and medication status, should help resolving such contradictory results, especially in a longer follow-up setting.

The potential role of ghrelin in anxiety, often described by PD patients, is still controversial. Indeed, the study of plasma ghrelin concentrations in depressed patients and healthy controls did not reveal any difference (Schanze et al., 2008). The link between ghrelin and mood disorders has been further studied in animals. Unfortunately, opposite results have been obtained so far. Indeed, the injection of ghrelin led to anxiolytic-like responses in mice as evaluated by the elevated plus maze test (Asakawa et al., 2001) while an intra-cerebral injection of ghrelin led to anxiety-like behaviors in rats as assessed in the same test (Carlini et al., 2002). These opposite results could be explained by differences in the protocol of ghrelin administration, assessment of anxiety levels or species. Further studies, using identical procedures are therefore essential to determine the role of ghrelin in anxiety behaviors and its potential use in the treatment of this non-motor symptoms in PD.

Finally, since ghrelin agonists have shown beneficial effects on the delayed-gastric emptying in diabetes (Ejskjaer et al., 2013, 2010; McCallum et al., 2013; Shin et al., 2013; Wo et al., 2011), ghrelin and its agonists were explored in PD-related gastro-intestinal disorders using well-validated rodent models of parkinsonism. In rats injected with 6-OHDA, injections of ghrelin or Rikkunshito, a herbal medicine stimulating the secretion of ghrelin and its orexigenic effect, or HM01, a ghrelin agonist, prevent the L-DOPA-induced decrease in gastric emptying (Karasawa et al., 2014; Takeda et al., 2012b, 2012a, Wang et al., 2014, 2012). This effect is partially reversed by a co-injection of d-Lys(3)-GHRP-6, an inhibitor of ghrelin receptor, suggesting that GHSR1a could also be a target for the treatment of delayed-gastric emptying in PD (Wang et al., 2014, 2012). Such benefits of ghrelin or ghrelin agonists on PD-related gastrointestinal symptoms are likely to be exerted at the peripheral level. Additional studies should further investigate this local effect of ghrelin especially on the enteric nervous system in animal models with documented early gastro-intestinal alterations. In summary, both human-based and animal studies highlighted ghrelin therapeutic potential against the non-motor symptoms of PD. However, such studies must be reproduced in adequate animal models of parkinsonism and human cohorts using comparative procedures in to validate this potential.

2.3. Therapeutic potential of ghrelin as a disease-modifying agent in PD

Based on the neuroprotection potential of both acyl- and desacyl-ghrelin after transient focal ischemia/reperfusion (Hwang et al., 2009) or in microglial cell cultures exposed to A β peptide (Bulgarelli et al., 2009), as well as neuroprotection of growth hormone

secretagogues against cerebellar cell death in aged rats (Pañeda et al., 2003), the neuroprotective actions of ghrelin in PD have been studied both *in vivo* and *in vitro*. Indeed, intraperitoneal injections of acyl-ghrelin in mice protect SN dopaminergic neurons against MPTP-induced neuronal death (Andrews et al., 2009; Bayliss et al., 2016a). Interestingly, this neuroprotective effect is particularly evidenced after mice have been submitted to a mild form of food restriction in which ghrelin was injected immediately before the dark phase and food was removed overnight; the following morning each mouse was given 85% of its standard ration. Therefore, ghrelin can restrict the SN dopaminergic neuronal loss and subsequent striatal dopamine depletion in this PD mouse model only when circulating ghrelin levels are boosted at the time when endogenous ghrelin is naturally induced (Andrews et al., 2009; Bayliss et al., 2016a). Moreover, this neuroprotection effect is specific of acyl-ghrelin (Andrews et al., 2009; Bayliss et al., 2016a) and involves an increase in the concentration of TH and the dopamine turnover in the striatum, as well as an upregulation of UCP2-dependant mitochondrial mechanisms (see §1.2., Fig.19 ; Andrews et al., 2009; Bayliss et al., 2016a). Similarly, 30% caloric restriction for 6 months in adult rhesus monkeys protects against the MPTP-induced striatal dopamine depletion (Maswood et al., 2004). Indeed, chronic caloric restriction elevates plasma ghrelin concentrations as demonstrated in humans suffering from restrictive anorexia nervosa and in rodent models of chronic food restriction (Germain et al., 2010, 2009, Méquinion et al., 2015, 2013). In support of this, a recent study showed that ghrelin mediated the neuroprotective capacity of caloric restriction in a mouse model of PD: the protective action of ghrelin was mediated by AMPK activation in dopamine neurons since acyl-ghrelin failed to increase neuroprotection in mice lacking AMPK subunits only in dopamine neurons (Bayliss et al., 2016b). Furthermore, MPTP injections in homozygous knock-out mice lacking ghrelin or its receptor induced a higher rate of neuronal death compared to wild-type mice, suggesting a protective role of endogenous ghrelin against MPTP toxicity (Andrews et al., 2009; Bayliss et al., 2016a). Therefore, chronically increased plasma ghrelin concentrations, whether endogenously produced or from exogenous origin, might mediate this neuroprotective action in animal models of parkinsonism. This neuroprotective effect of ghrelin and growth hormone secretagogues extends well beyond neurodegenerative conditions, as reviewed by Frago and colleagues (2011). Cellular and molecular mechanisms underlying the neuroprotective effect of ghrelin involve anti-inflammatory and anti-apoptotic mechanisms as well as regulation of mitochondrial function as shown both *in vivo* and *in vitro*. For instance, in mouse models of parkinsonism induced by exposure to MPTP, ghrelin decreased the expression of pro-inflammatory agents such as TNF- α , interleukine 1 β , and the activation of inducible nitric oxide synthase and prevented the activation of macroglia (Moon et al., 2009). Moreover, the protective action of ghrelin has been shown to involve UCP2 which regulates the redox state

of mitochondria, as well as ROS production and mitochondrial biogenesis in mice exposed to MPTP (Andrews et al., 2009). Similar *in vitro* experiments undertaken in rat primary mesencephalic cells exposed to MPTP showed that ghrelin suppresses MPTP-induced microglial activation and reduces the expression of microglia-derived pro-inflammatory cytokines such as TNF- α and interleukin-1 β two cytokines which are up-regulated in PD (Hwang et al., 2009; Mogi et al., 1996; Nagatsu et al., 2000; Sawada et al., 2006). Ghrelin also prevents the MPTP-induced apoptosis in MES23.5 cells, an effect which is paralleled by the inhibition of lactate dehydrogenase release, the nuclei fragmentation, the reduction of the mitochondrial membrane potential and the activation of caspase 3 (Dong et al., 2009). Similar anti-apoptotic mechanisms are triggered upon ghrelin exposure in MES23.5 cells exposed to rotenone, another potent inhibitor of mitochondrial complex 1 known to induce parkinsonism in animals and humans (Tanner et al., 2011a; Yu et al., 2016). However, MES23.5 cells were created by the somatic fusion of neuroblastoma-glioma mouse cells and primary mesencephalic rat cells. Although they express TH and GHSR1a, their physiology might not fully reproduce the one of natural dopaminergic cells of the SN. These results should thus be reproduced in other *in vitro* PD models before being fully validated. Similarly, future experiments should address the neuroprotective mode of action of ghrelin in order to assess whether peripherally injected ghrelin acts only at the peripheral level, the central neuroprotection then being an indirect effect, or both at central and peripheral levels. In this view, despite the lack of evidence that ghrelin crosses the blood-brain barrier in healthy organisms (Banks, 2002; Cabral et al., 2013; Schaeffer et al., 2013), it is interesting to note that a transient opening of the blood-brain barrier might occur in PD. Indeed, blood-brain barrier dysfunctions have been reported in living PD patients (Bartels et al., 2008; Gray and Woulfe, 2015; Kortekaas et al., 2005) and CD8+ and CD4+ T cells have been observed at autopsy within the PD brain parenchyma in the vicinity of midbrain dopaminergic neurons (Brochard et al., 2009), suggesting that peripheral molecules and/or cells could reach central dopaminergic regions in a context of PD-induced neurodegeneration.

Altogether these studies highlight the importance of ghrelin in PD. The therapeutic potential of this orexigenic peptide being now largely recognized in the treatment of several non-neurological conditions, it deserves to be further explored in PD to confirm its potential as a biomarker of early stages of the disease as well as a disease-modifying agent. If validated, the latter aspect could be rapidly translated in everyday clinical practice, for ghrelin is already currently used as a therapy against cachexia in ageing and cancer (Molfino et al., 2014).

OBJECTIVES OF THE Ph.D. WORK

As detailed in the introduction, PD is the second most common neurodegenerative disease worldwide. Its onset is insidious and its progression can be divided in three stages: 1/ an asymptomatic stage where molecular and cellular modifications happen in absence of clinical symptoms, 2/ a pre-clinical/prodromal stage during which the patients often experience non-motor symptoms such as depression, anosmia or gastro-intestinal troubles, and 3/ a clinical stage corresponding to the period following the appearance of motor symptoms. The latter corresponds to the time when the clinical diagnosis of the disease is established by a neurologist and a symptomatic treatment is installed (Stern and Siderowf, 2010). The clinical stage is itself subdivided in 3 periods according to the evolution of PD clinical symptoms: the honeymoon period when patients experience a relief of motor symptoms thanks to medical therapy, the complication stage when medications are not sufficient enough to counterbalance motor symptoms, therefore leading to increased medication dosages for a lower therapeutic benefit and thus favoring motor fluctuations and dyskinesia, and the advanced/end stage of the disease. PD multifactorial etiology has become better understood over the past years and involves environmental and genetic factors as well as their interactions (de Rijk et al., 1997; Elbaz et al., 2016; Nussbaum and Polymeropoulos, 1997). Moreover, PD neuropathological hallmarks are now well characterized and definite criteria have long been established and acknowledged for PD post-mortem diagnosis (Mackenzie, 2001). Yet the earlier stages of the disease, when few or even no motor symptoms are evident for the neurologist but when some non-motor symptoms are already largely present and might interfere with the patients' daily life activities, still remain to be deciphered. Moreover, it is estimated that 50% of the SN neurons are already dead when the first motor symptoms appear (Bernheimer et al., 1973; Riederer and Wuketich, 1976). The clinical diagnosis of PD, relying on the presence of such motor symptoms, is thus established really late in the course of the disease compared to its molecular and cellular evolution. As a consequence, it is essential to better understand the molecular modifications underlying the development of the disease and its progression from this pre-motor stage to the clinically-diagnosed stage. This would ultimately ease the finding of biomarkers which could be used to specifically diagnose early stages of PD, therefore allowing an optimal design of clinical trials for the development of disease-modifying drugs (Kim et al., 2014). In parallel, huge efforts have been made by the scientific and medical communities to improve existing PD therapeutic options and discover new ones essentially aimed at alleviating PD motor symptoms which have long been considered as the most debilitating ones. However, none of these currently available strategies apply to the treatment of non-motor symptoms and they have not yet proven successful to cure PD, nor

to stop it (Oertel and Schulz, 2016). Interestingly, the recent discovery of Lewy body-like inclusions in the intestine of PD patients (Aldecoa et al., 2015; Lebouvier et al., 2010b; Stokholm et al., 2016), corroborating Braak's staging hypothesis according to which, within the brain, PD-specific lesions would first appear in the dorsal motor nuclei of the vagus, an area of the brain strongly connected to the peripheral nervous system, suggested that PD could start in the peripheral nervous system and slowly progress towards the brain. This hypothesis could explain why PD patients often complain about gastro-intestinal non-motor symptoms many years before noticing the first motor symptoms (Poewe, 2008). This could also be a reason why current therapeutic options, mainly aimed at compensating the striatal dopamine depletion, are unable to improve non-motor dysfunctions. Braak's staging hypothesis also suggests that, if PD is identified in its earlier stages, PD progression could be delayed or stopped with the use of efficient neuroprotective strategies at a stage when the degeneration of the SNc has no motor consequences (Oertel and Schulz, 2016; Stern and Siderowf, 2010). In this regard, recent research have therefore focused on the discovery of not only biomarkers of PD early stages but also of neuroprotective strategies.

In the last decade, several molecules related to PD pathogenesis have been reported as potential biomarkers of the disease (Xu and Pu, 2016). However, as discussed in the introduction, such diagnostic tools should present a good sensitivity, i.e. being detected in most PD patients tested but not in the subjects with another disease, and a good specificity, i.e. being positive in PD patients compared to controls. In addition, a "good" biomarker of PD early stages should also be easily accessible using non-invasive techniques. Based on these criteria, decreased concentrations either of dopamine metabolites, including dihydroxyphenylacetate and homovanillic acid, or of total alpha-synuclein as well as of A β 1-42, phosphorylated-tau, total-tau, and total-tau/A β 1-42, have been described in the cerebrospinal fluid of PD patients compared to either healthy controls or patients suffering from atypical parkinsonism (Andersen et al., 2016; Kang et al., 2013; Xu and Pu, 2016). However, none of these potential biomarkers has been validated as a diagnostic tool yet (Halbgebauer et al., 2016). Moreover, most studies describing potential new biomarkers of PD were undertaken in clinically-diagnosed parkinsonian patients already presenting with motor symptoms, therefore excluding the earliest stages of the disease (Andersen et al., 2016). Interestingly, many researchers recommend combining several potential biomarkers instead of focusing on a single molecule fulfilling all above-mentioned criteria. Indeed, combining several potential biomarkers should provide a signature of PD early stages with much higher specificity and sensitivity (Schapira, 2013). As far as potential disease-modifying agents are concerned, current studies are often limited by the small size of the cohorts of patients used and the misdiagnosed patients included. Nevertheless, promising

drugs have been identified in cellular and animal models of parkinsonism and translated into clinical trials. For instance, Deferiprone, an iron chelator, has been shown to reduce the accumulation of iron in the SN and improve motor performances in PD patients as evaluated with the Unified Parkinson's Disease Rating Scale (Devos et al., 2014). Recently, another molecule, named ghrelin, has raised interest not only for its potential neuroprotective action in cellular and animal models of parkinsonism but also for its potentials in the treatment of PD gastro-intestinal non-motor symptoms and as a biomarker of PD early stages (Andrews et al., 2009; Moon et al., 2009; Unger et al., 2011; Wang et al., 2012). However, the studies conducted so far either lacked of power and generated controversial data (as reviewed in chapter 3 §2.1.) for patients-based investigations (Fischer et al., 2010; Unger et al., 2011) or have been obtained in PD cellular and animal models exhibiting rapid and massive loss of dopaminergic neurons or cancer cells (Dong et al., 2009; Moon et al., 2009; Yu et al., 2016). Such models are not adapted to the study of neuroprotection therapies as they do not reproduce the progressive aspect of the disease and the specific sensitivity of SN dopaminergic neurons to deleterious insults.

In this scientific context, the aim of my thesis work was to clarify the potential roles of ghrelin in PD using cellular and animal models adapted for the study of early stages of the disease. This question was investigated following two specific objectives. The first aspect of my work was indeed to study the role of ghrelin in a cellular model of parkinsonism reproducing a moderate and progressive neuronal death among the dopaminergic population of the SN. We have therefore chosen to study the effect of different doses of ghrelin on the survival of primary mesencephalic cells exposed to an environmental agent triggering mitochondrial dysfunction, namely the pesticide rotenone. The second specific objective of my thesis consisted in the investigation of the potential of ghrelin as a biomarker of PD early stages. The initial goal was to use blood samples collected from PD patients in order to clarify the contradictions found in the literature. We have thus used a dataset generated from a transcriptomic analysis conducted on peripheral blood mononuclear cells of PD patients using expression microarrays and conducted further analyses on PD patients Epstein Barr virus (EBV) transformed lymphoblastoid cell lines. In parallel, we designed a study in an experimental model of early parkinsonism using C57BL/6J mice. The first step of this *in vivo* approach was to validate this experimental analogue of PD in our animal facility in Lille. The results generated during my thesis work will be exposed in the next pages according to these two specific objectives.

CHAPTER 4: MATERIAL AND METHODS

1. *In vivo* experiments

1.1. Animal model of early parkinsonism

1.1.1. Rotenone exposure

All animal studies were carried out in accordance with international standards, the French Animal Protection Law, and all protocols have been approved by the Nord/Pas-de-Calais Ethical Committee (CEEA 75 N°: 0535.01). Thirty male C57BL/6J mice (Janvier, St. Germain-sur-L'Arbresle, France) aged of one year were housed in a specific and opportunistic pathogen-free (SOPF) animal facility at 5 per cage in a dark/light cycle (12 hours /12 hours) with *ad libitum* access to food and water. Mice were divided in three groups (n=10/group) according to their exposure regimen. Control mice did not receive anything: the gavage needle was just gently introduced in the esophagus of the mouse and immediately removed; in the solvent group, mice received an oral gavage with a solution composed of 2% carboxymethylcellulose and 1.25% chloroform five days per week during 1.5 months; in the rotenone group, mice received an oral gavage with 5mg/kg/d rotenone resuspended in the solvent solution five days per week during 1.5 months. All animals were handled and weighted five days per week in order to adjust the rotenone dose administered to daily weight variations. A timeline of the experimental procedure is presented figure 21 below.

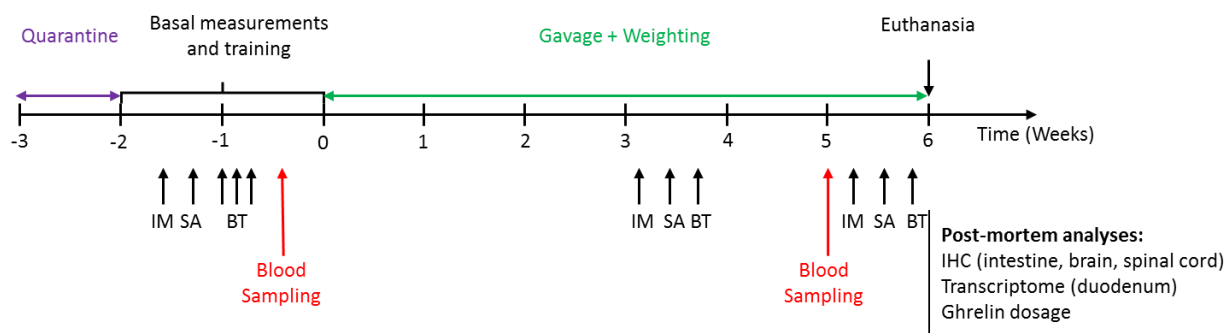

Figure 21: Schematic representation of the time course of the experimental procedure applied in C57BL/6J mice. At their arrival in the animal facility, 30 male mice aged of 1 year were placed in quarantine for one week. After the quarantine, mice were assigned to the different experimental groups (control, solvent- and rotenone-exposed groups). The next week, basal measurements and trainings were performed for the intestinal motility test (IM), the spontaneous activity test (SA) and the challenging beam traversal test (BT). Blood sampling were performed for all mice before the start of the experimental procedure (T0) to evaluated basal plasma ghrelin variations for each individual mouse, as well as after 5 weeks of experimental procedure. After 1 month and 1.5 months of exposure, behavioral tests including intestinal motility, spontaneous activity and beam tests were performed. After 6 weeks of exposure, animals were euthanized and organs were collected for post-mortem analyses.

1.1.2. Non-invasive intestinal motility test

In order to study the intestinal motility without euthanizing the animals, we adapted a test from Wang et al. (2008). On the morning of the tests, mice were individually housed for 2 hours, between 08h30 and 10h30, in a cage equipped with a grid on the bottom to prevent coprophagy. This new environment activates the autonomic nervous system, triggering intestinal transit, and induces an exploratory behavior. The number of excreted feces was counted for each mouse every 15 min for 1 hour, and after 2 hours. 15 animals were submitted to the test at the same time, and 3 different experimenters were scoring 5 animals each, checking one another for accuracy of counting. The number of excreted feces was later calibrated for 30 grams of body weight. All measures are expressed as mean \pm standard error of the mean (SEM) of the number of feces excreted by each mouse of the same group after 15, 30, 45, 60 and 120 min in the cage for each time-point of the exposure: T0 before the beginning of the exposure, T1 after one month and T1.5 after 1.5 months of exposure.

1.1.3. Spontaneous activity cylinder test

The spontaneous activity cylinder test, initially developed by Fleming et al. (2004), was used to assess the spontaneous motor behavior of mice in a new environment. The mice were individually placed for 3 min in a glass cylinder (Fig. 22). A mirror placed under the cylinder allowed the precise observation of the movements made by the mouse with its fore- and hindlimbs. Each session was recorded using a camera (Sony DCR-SX30), and later analyzed in slow motion by several experimenters among whom one was blind to experimental groups. The number of rearings, the time spent grooming, and the number of steps with fore- and hindlimbs were counted. A rearing was defined as a vertical movement with both forelimbs off the floor so that the mouse was standing only on its hindlimbs and stretched its back. A step was counted when an animal sequentially moved both forelimbs across the floor in one consecutive movement. A step was not counted if the time between the movement of one limb and the other limb was longer than 5 sec. This test was performed during the morning between 08h00 and 12h00, once before the beginning of the exposure (T0), after 1 month (T1, Day 23) and after 1.5 months of the experimental procedure (T1.5, Day 34). All data are presented as mean \pm SEM.

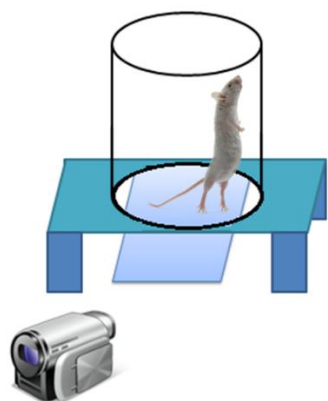

Figure 22: Representation of the experimental setting used for assaying spontaneous activity in mice. A glass cylinder (height: 15.5 cm; diameter: 12.7cm) was placed on a transparent elevated surface under the safety cabinet in the SOPF animal facility. A mirror was placed under the cylinder to allow recording the animal's movements with a camera (Sony DCR-SX30).

1.1.4. Challenging beam traversal test

The fine motor coordination between fore- and hindlimbs was assessed using the challenging beam traversal test (Fleming et al., 2004). The beam test was constructed out of Plexiglas, and consisted of four sections. Each section of 25 cm in length decreased in width, starting from 3.5 cm and narrowing by 1 cm at each section (see Fig. 23). Before starting the exposures, i.e. at T0, the mice were initially trained for 2 days to walk the length of the beam starting at the widest part of the beam and ending at the narrowest section in their home cage.

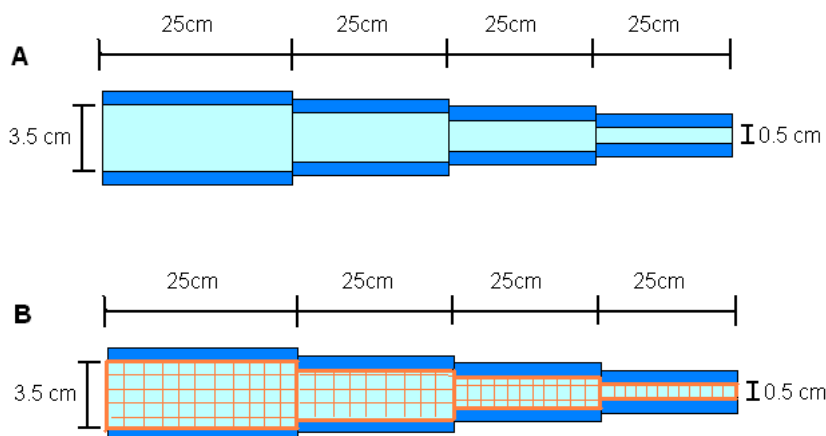

Figure 23: Schematic representation of the beam used for assaying skilled motor behavior in C57BL/6J mice. A) The beam test was constructed out of Plexiglas, and consisted of four sections. Each section of the beam measured 25 cm in length. The width of the beam decreased of 1 cm at each section, starting from 3.5 cm and finishing to 0.5 cm. B) On the test day, a mesh wired grid (1.2 cm² squares) was placed 1 cm above the beam and the mice had to walk over the grid.

No further training was necessary throughout the duration of the experiment. On the test days, a mesh wired grid (1.2 cm² squares) was placed 1 cm above the beam and the mice had to walk over the grid. Each test session consisted of 5 beam traversals per mouse. The sessions were recorded using a camera (Sony DCR-SX30), and each video was later analyzed in slow motion by several experimenters among whom one was blind to experimental groups. The number of missteps, called errors, the time needed for crossing

and the number of steps needed to cross the beam were counted. A misstep through or outside the grid was considered an error when a limb slipped beyond 0.5 cm below the grid surface. All missteps made when a mouse stopped walking or when orientating its head in another direction than forward, were not considered errors. The counting of the time and number of steps started from the moment the mouse first moved forward and ended when the first forelimb was placed in the home cage, at the end of the beam. It takes ~11 sec for a well-trained healthy mouse to cross the beam.

1.1.5. Euthanasia and collection of samples

Six weeks after the beginning of exposures, mice were euthanized by an overdose of anesthetics using intra-peritoneal injections of ketamine (120mg/kg) and xylazine (20mg/kg). Once deeply anesthetized, 6 mice per group (control, solvent and rotenone) were decapitated before rapid sampling and freezing in liquid nitrogen of the brain (olfactory bulb, mesencephalon and rest of the brain separated), the spinal cord (segments C1-C8, T1-L2 and L3-S4 separated), the small intestine (duodenum, jejunum and ileum separated), the colon, the subcutaneous adipose tissue (SCAT), the stomach mucosa, the liver, the heart, the kidneys together with adrenal glands, the gastrocnemius and soleus muscles for transcriptomic studies. These samples were stored at -80°C until further use. The 4 remaining mice per group received a trans-cardiac perfusion with a 4% paraformaldehyde solution (weight/volume) to later undertake immunohistochemistry analyses. From these 4 mice, the brain, the full spinal cord, the small intestine (according to the Swiss roll technique described by Moolenbeek and Ruitenbergh, 1981), the SCAT, the liver, the stomach, the heart, the kidneys plus adrenal glands, the spleen, and the gastrocnemius and soleus muscles were collected. All samples were post-fixed in a 10X volume of 4% paraformaldehyde solution and kept at 4°C for at least 48 hours before further processing. In parallel, our collaborator from Munich Cluster for Systems Neurology, Zentrum für Neuropathologie und Prionforschung, Dr. Pan-Montojo collected the intestines of 1 year old mice exposed or not to 5mg/kg/d rotenone for 2 or 4 months. At the end of this exposure, mice were euthanized and intestinal samples were washed in PBS, immediately frozen in liquid nitrogen and stored at -80°C until further use.

1.2. Transcriptome analysis

1.2.1. RNA extractions

Total RNA was extracted from the duodenum of control, solvent and rotenone-exposed mice (n=5 per group) using the RNeasy mini kit 250 (Qiagen, Courtaboeuf, France) in accordance with the manufacturer's instructions. Briefly, intestinal tissues were first weighted and mortared in liquid nitrogen to prevent RNA degradation. The samples were then homogenized in Qiazol Lysis buffer (1mL/100mg tissue, Qiagen, ref. 79306) using a potter

tube. 200 μ L chloroform per 1mL Qiazol was immediately added, followed by centrifugation (15 min, 10000G) to separate the solution in three phases. The nucleic acid phase was transferred to a new tube. 500 μ L isopropanol and 1mL ethanol per mL of Qiazol were added for nucleic acid precipitation. Total RNA was also extracted from human peripheral blood mononuclear cells and Epstein-Barr virus (EBV)-transformed lymphoblastoid cell lines of PD patients. Tubes containing cells frozen in RLT buffer (Qiagen, ref. 79216) were slowly thawed on ice. Micropestles were used to mechanically dissociate the cells and break the cellular membranes. 350 μ L of 70% ethanol were added for each 700 μ L of RLT buffer for nucleic acid precipitation. After all RNA extractions, an additional purification step was performed using Qiagen columns (Qiagen, RNeasy Mini Kit, ref. 74104) for all samples to remove any leftover genomic DNA and salts. The quality of the extracted RNA was assessed as followed:

a. **RNA concentration** of the samples was measured using a Nanodrop ND-1000 spectrophotometer (NanoDrop Technologies, Wilmington, USA). The Nanodrop also enabled to check for the purity of the samples, by detecting the presence of residual salts or DNA. Nanodrop uses absorbance measurements in which RNA will absorb at 260 nm. The 260/280 ratio is used to assess the purity of the RNA/DNA as it represents the ratio of acid nucleic quantities compared to protein quantities. A ratio of ~2 is generally expected to represent pure RNA. The 260/320 ratio is used as a secondary measure of RNA/salt purification. A ratio of 2-2.2 is commonly expected.

b. **RNA integrity** was visualized on a 0.8% agarose gel (Invitrogen™ UltraPure™ Agarose, Thermo Fisher Scientific, Illkirch, France) diluted in 0.5X TBE buffer (Eppendorf, Montesson, France). Two microliters of ethidiumbromide (MP, Q-Bio gene, Illkirch, France) were added as a nucleic acid intercalating agent. A 1kb ladder was loaded together with the RNA samples, and the gel was run for 25 min at 150 V. The gel was later observed in an Image lab application system (Gel doc XR+, Bio-Rad, Marnes-la-Coquette, France) using the Image lab software 3.0 (Bio-Rad). In absence of RNA degradation, the agarose gel electrophoresis shows two main bands corresponding to 28S and 18S ribosomal RNA, whose ratio is respectively 2:1.

c. Potential genomic or bacterial **DNA contamination** was assessed by PCR. RNA polymerase alpha-subunit (*Rpoa*) primers were used for the detection of bacterial DNA, the presence of which would result from a contamination of the sample by intestinal microbiota during the extraction process, and primase DNA polypeptide 2 (*Prim2*) primers, whose binding sites are located within introns, were used for the detection of eucaryotic genomic DNA (both primers were ordered at Eurogentec, Angers, France; see table 6 below). A

The criteria imposed for the design of forward and reverse primers were no hairpin formation, a minimum length of 16 bases, duplexes energies between 0 and 5kcal/mol, a product length between 100-600bp, a similar GC content in each primer, and a difference between primers melting points lower than 2.5°C. Table 6 below lists the primers designed for each gene investigated in this study. We created primers for three of the four existing variants of the mouse *ghrelin* gene. Figure 24 shows the position of each primer in these three variants.

Since the main innervation of the gastro-intestinal tract is cholinergic, we designed primers for choline acetyltransferase (*Chat*), an enzyme specific of mouse cholinergic neurons. In addition, we also designed primers for the gene coding for the mouse homologue of prohormone convertase 1/3 (*Pcsk1*), an enzyme implicated in post-translational modifications of ghrelin, as well as for the human ghrelin opposite strand RNA (*GHRLOS*). All primers were ordered at Eurogentec, France.

Gene		Species	Primer sequence	Tm (°C)	Product Length (bp)	Primer set Efficiency (0-2)
<i>Rpoa</i>	F	B	GTGACCCTTGAGCCATTAG	62	75	NA
	R		AGACGAAAGCAGAATACGG	62		
<i>Prim2</i>	F	M	GGAGTCTCTGGGCATCTTTA	59	300	NA
	R		CGAGTCCGCTTTCATCTTTTG	59		
<i>Ghrl-1</i>	F	M	TGAGCAGGCACCACATC	65.5	250	1.67
	R		GCTTGTCCTCTGTCCTCTG	65.5		
<i>Ghrl-2</i>	F	M	AGAAAGCCCAGAGAAAGGAA	69	262	1.67
	R		GTCCGTGGTTACTTGTGTCAGC	69		
<i>Ghrl-4</i>	F	M	GCCCAGTTCAATGCTCCCTTC	69	146	1.88
	R		CCTGTCCGTGGTTACTTGTGTC	69		
<i>Pcsk1</i>	F	M	CAAACAGGGGAGACAAGG	65.5	119	1.69
	R		TGATAGAGATGGTGTAAATGCTG	65.5		
<i>Chat</i>	F	M	GTGAGACCCTGCAGGAAAAG	59.0	100	1.67
	R		GCCAGGCGGTTGTTTAGATA	59.0		
<i>GHRLOS</i>	F	H	TGCCCTGTCAGTTACGGA	60	179	1,93
	R		TTCGTCCTCACCTCAAG	60		

Table 6: Primers designed for the present study and primer conditions. For transcriptome analyses, primers were designed using the OLIGO primer analysis software 5.0 (Molecular Biology Insights, USA). For each primer, the sequence, the melting temperature, the product length and the efficiency of the primers to bind specifically to their target DNA are presented *Ghrl-1 to 4* represents ghrelin transcript variant 1 to 4. *Chat* primers were designed to amplify choline acetyltransferase. *Pcsk1* primers were designed to recognize the mouse prohormone convertase 1/3. *Prim 2* primers recognize the sequence of the gene which codes for the Primase DNA polypeptide 2 and *Rpoa* primers amplify a sequence of the RNA polymerase alpha-subunit gene. Primers were also designed for the ghrelin opposing stand (*GHRLOS*) human gene. B: bacteria; M: *Mus musculus*; H: *Homo sapiens*.

The conditions for each set of primers were first validated using PCR and qPCR to determine their actual optimum temperature, and to observe whether they amplify only one amplicon at the expected size, as given by the OLIGO program and *in silico* predictions.

1.2.4. Quantitative PCR

Real-time quantitative PCR (qPCR) were performed using 1µL cDNA, a power SYBR-green qPCR mastermix (Thermo Fisher Scientific) and the specific primers for each gene to be amplified. qPCR were run in a StepOne plus real-time PCR system (Applied Biosystems) following the earlier determined optimum amplifying temperatures for each set of primers. A 10 cycle-long touchdown starting 10°C higher than the optimum temperature and decreasing of 1°C per cycle was included in to obtain higher amplification specificity. The touchdown was followed by a 40 cycle-long stage with primer specific optimum temperatures, and at last an additional melting curve step was included. All samples, including the negative controls in which no DNA was included, were analyzed in triplicate, and peptidylprolyl isomerase A (*Ppia*) was used as a reference gene for mouse samples whereas Mannosidase Alpha Class 2B Member 1 (*MAN2B1*) was used as a reference gene for human samples. Strict criteria were applied for the reference genes. Indeed, the reference gene should have the same expression in all 3 groups and similar cycle/threshold (CT) values should be observed compared to the interest gene. The results were analyzed using LineRegPCR program (version 2012.3, the Netherlands), which performs a baseline correction and calculates the primer efficiency (Ruijter et al., 2009). Quantitative gene expression was expressed as CT. For each sample this value was normalized to the expression of the reference gene as delta CT represented as $2^{-\Delta\text{CT}}$ (Livak and Schmittgen, 2001).

1.3. Immunohistochemistry

Immunohistochemical analyses were performed in collaboration with Dr. Anna Bencsik and Mr. Mikaël Leboindre (ANSES, department of Neurodegenerative diseases, Lyon, France). The post-fixated tissues (brains and intestines) were processed in an automatic inclusion system (Gemini 2012) with three steps of 60 min incubations in increasing concentrations of ethanol (75%, 80% and 95%), followed by three 90 min-long incubations in 100% ethanol and three incubations of 60 min in xylene for dehydration. After processing, brains were cut rostro-caudally into 5 pieces (Fig. 25A). These pieces were then placed into a dish and embedded in the same paraffin block (Fig. 25B). Such a disposition enables to quickly visualize the whole brain on one slide. The Swiss-rolled intestines were put in a dish and were embedded in paraffin. The Swiss-roll method allowed us to visualize all parts of the tissue on the same slide. The paraffin blocks were then cut on a microtome (Thermo-Electron) in 5µm-thick slices. Sliced tissues were directly put on poly-L-lysine coated slides and washed with citrate and PBS. The slides were incubated for 5 min with 0.3% H₂O₂ to eliminate endogenous peroxidase activity, followed by 2 washing steps with PBS-tween. Proteinase K (Roche Diagnostic, Meylan, France, 50 µg/mL) diluted in PBS was added and incubated for 10 min at 37°C. Slides were then saturated with blocking reagents (Roche

Diagnostic) for 30 min at room temperature, followed by an overnight incubation at room temperature with the primary antibody raised against tyrosine hydroxylase in 0.1M PBS and 0.1X Triton X-100.

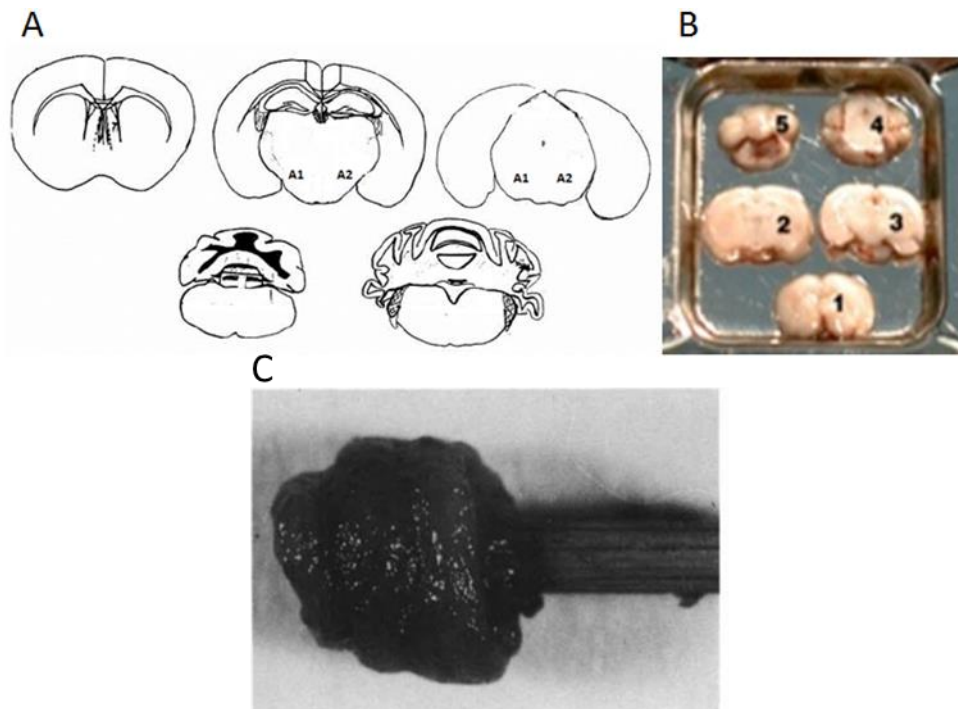

Figure 25: Illustration of the procedures for embedding mouse brain and intestinal samples. A) Schematic representation of the different positions of the section of mouse brains before embedding. Whole brains were sectioned into 5 pieces at Bregma +0.38mm, -1.82mm, -3.80mm, -5.40mm, and -6.24mm to allow the observation of respectively the striatum, the hippocampus, the mesencephalon and the cerebellum on one slide. A1 and A2 represent the reference sites of the SNc. B) Photographs showing the 5 sections of the same brain once placed into a dish before paraffin embedding. 1-5 corresponds to the rostro-caudal orientation of the sections as presented in A. C) The intestines were rolled around a wound stick and transferred into an inclusion plastic dish for further paraffin embedding as detailed by Moolenbeek and Ruitenberg (1981).

After incubation, the slides were washed twice in PBS-Tween. They were further incubated for 1 hour at room temperature in the secondary antibody (biotinylated anti-rabbit IgG, BA-1000, Vector Laboratories, Burlingame, CA, USA) 7.5 μ g/mL in 0.1M PBS and 0.1X Triton X-100). The slides were then washed with PBS and incubated with the ABC complex (pk6100, Vector Laboratories) for 30 min to reveal the antibody staining. The staining was observed using DAB (SK-4100, Vector Laboratories) for 10 min. The slides were analyzed under a light microscope Zeiss Axiolmager Z2 using the 10X objective.

1.4. Ghrelin dosage in the plasma

1.4.1. Blood sampling

To characterize the pattern of ghrelin production in the mouse plasma, acyl- and desacyl-ghrelin plasma concentrations were measured in 1 year old males and 4/5 months old C57BL/6J female mice after an overnight fast (food removed at 19h00) and at different time-points after access to the food. The blood sampling procedure for female mice was undertaken as followed: blood was sampled around 08h00 the following morning. Immediately after the first sampling, mice were given *ad libitum* access to food and blood was sampled again after 30, 60, 90, 120, 150 and 180 min. Blood was collected in microvette CB 300 K2E capillarity tubes (Sarstedt AG & Co, Nümbrecht, Germany) and kept on ice before further processing. These tubes contain ethylene diamine tetra-acetic acid (EDTA) (Sarstedt) to prevent blood clotting, and 2 μ L 4-hydroxymercuribenzoic acid (PHMB, Sigma-Aldrich, Saint-Quentin-Fallavier, France) per 100 μ L blood was added to prevent protein degradation. Samples were centrifuged to collect the plasma and 0.1M hydrogen chloride (HCl, Sigma-Aldrich) was added to prevent the degradation of acyl-ghrelin. The samples were stored at -80°C until further use.

In 1 year old C57BL/6J male mice blood samples were collected after an overnight fast. Immediately after the first sampling the mice were given access to food for 30 min only, and blood was immediately sampled again after 30 min. After this sampling the mice were put in a clean cage without food to prevent irregular variations of ghrelin concentrations due to continuous food intake. Blood was sampled again after 1.5 hours, after which mice were placed back in their home cages. According to the current ethical standard, the total volume of blood taken over 3 samplings did not exceed 15% of one mouse's body weight, which represents 450 μ L for a mouse of 30 grams. For mice weighing less than 30 grams only two samples were taken. Blood-containing tubes were processed as described above.

1.4.2. Dosage of acyl- and desacyl-ghrelin in plasma samples

Ghrelin assays were performed by Dr. Virginie Tolle, Dr. Philippe Zizzari and Mr. Grouselle (INSERM UMR894, department of neuroendocrinology of growth senescence, center of psychiatry and neurosciences, Paris). Both acyl- and desacyl-ghrelin were measured using an enzyme immunometric assay (EIA) kit (respectively A05117 and A05118, Bertin Pharma, Montigny-le-Bretonneux, France). The procedure is based on a double-antibody technique as shown figure 26 below. Briefly, plasma samples or the culture medium in the case of in vitro studies were diluted 5 times in the EIA buffer to avoid matrix effect. A standard curve was generated with either acyl- or desacyl-ghrelin concentrations ranging from 1.96pg/mL up to 250pg/mL. The wells of the plate supplied with the kit are coated with a monoclonal antibody specific to the C-terminal part of ghrelin, and will therefore bind all forms of ghrelin present in the plasma samples. An anti-acetylcholinesterase (AChE) - Fab'

conjugate antibody (or Tracer) which recognizes the N-terminal part of either acyl- or desacyl-ghrelin was added to the reaction mixture.

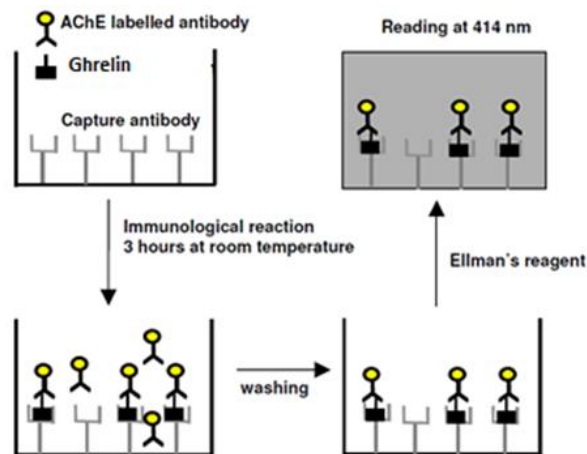

Figure 26: Principle of the enzyme immunometric assay for measuring acyl- and desacyl-ghrelin concentrations. The dosage of ghrelin was performed with the double-binding procedure of the enzyme immunometric assay (EIA) kit (A05117 and A05118, Bertin Pharma). Plasma samples were added in pre-coated wells which contain a monoclonal antibody specific to the C-terminal part of both acyl- and desacyl-ghrelin. An anti-acetylcholinesterase (AChE) - Fab' conjugate antibody (called Tracer) which recognizes the N-terminal part of either acyl- or desacyl-ghrelin was added to the wells and the plate was incubated 3 hours at room temperature. Each well was washed 5 times with the commercial washing buffer provided in the kit: this removes excess unbound antibodies from the well. After addition of Ellman's reagent, which recognizes the Tracers bound to acyl- or desacyl-ghrelin, the yellow substrate was detected on a spectrophotometer plate reader after excitation at 414nm (Adapted from Bertin Pharma kit instructions).

This technique allows the two antibodies to form a sandwich by binding different parts of the acyl- or desacyl-ghrelin. The immunological reaction was incubated for 3 hours at room temperature followed by several washing steps in the washing buffer provided. Ghrelin concentrations were determined by measuring AChE enzymatic activity using Ellman's reagent. The plates were read between 405-414 nm with a spectrophotometer plate reader.

1.5. Western blot analyses

1.5.1. Protein extractions for western blot

Protein extractions were performed in an ice-cold eppendorf holder using 300µL ice-cold protein extraction buffer (60 mM TrisHCl (pH 6.8), 1mM Na₃VO₄, 1% SDS) in the presence of protease and phosphatase inhibitors (phenylmethylsulphonyl fluoride (PMSF, Sigma-Aldrich ref. 78830-5g), leupeptin (ref. 11017101001, Roche Applied Science, Mannheim, Germany), aprotinin (Roche, ref. 10236624001) and sodium fluoride (NaF, Sigma-Aldrich, ref. S7920-100g)). Frozen (-80°C) intestine samples were cut in smaller pieces and immediately homogenized using a homogenizing micro-pestle in 1.5 mL Eppendorf tubes. Homogenized samples were then placed in a sonicator (Merck eurolab,

Darmstadt, Germany) during 2 min, heated at 99°C during 5 min and centrifuged at 1400 rpm for 5 min. Supernatants were collected and stored at -80°C until use.

1.5.2. SDS-PAGE and western blot

These experiments were undertaken in part in the laboratory of Lille and completed in the laboratory of Dr. Pan-Montojo in München. The protein concentration from intestine extracts was measured using the Nanodrop X100. Samples were further diluted to adjust the final protein concentration to 30µg. Twenty µL of protein extracts per sample were loaded together with 5 µL of loading buffer (Thermo Fisher Scientific) onto a 4-12% polyacrylamide gel. Page ruler 10-250 kDa molecular weight markers (Thermo Fisher Scientific, ref. 26619) were used for size estimation. Proteins were separated by electrophoresis migration at 80V in the 4% acrylamide stacking gel followed by migration at 120V in the 12% acrylamide gel. Proteins were then transferred onto a nitrocellulose membrane (0.45µm, ref. 10600002, Amersham™ Protran™ Velizy-Villacoublay, France) in transfer buffer (191.8mM glycine, 231.1mM Tris Base, 5% Methanol), at 10V for 3 hours. To check for the efficiency of the transfer, membranes were incubated in a Red Ponceau solution (3.94µM, ref. 5938.1, Carl Roth, Karlsruhe, Germany) for 2 min and washed 3 times 5 min in deionised water. The aspecific signal was then blocked by incubation of the membranes in Tris-buffered saline + 0.1% Tween 20 (1X TBST) and 5% (w/v) non-fat dry milk. Membranes were subsequently incubated overnight at 4°C in the blocking solution containing either a rabbit anti-tyrosine hydroxylase antibody (TH, 1:1000, P40101-150, Pel Freez Biologicals, Rogers, AR, USA), or a mouse anti-glyceraldehyde 3-phosphate dehydrogenase (*Gapdh*, 1:1000, Thermo Fisher Scientific, ref. QL229972), or a rabbit anti-choline acetyltransferase antibody (*Chat*, 1:1000, ref. ab181023, Abcam, Cambridge, UK), or a rabbit anti-Pgp9.5 antibody (1:1000, Millipore, Molsheim, France, ref. AB1761-I). On the following day, membranes were washed 3 times 5 min in 1X TBST and incubated with horseradish peroxidase-conjugated anti-rabbit or anti-mouse secondary antibodies (1:5000, Thermo Fisher Scientific) at room temperature for 1 hour. The blots were subsequently washed 3 times for 5 min in 1X TBST and revealed with the Prime Western Blotting Detection Reagent (ref. RPN2232, GE Healthcare Amersham) using the LAS3000 bioimager (Fujifilm, München, Germany, EU). Images were analyzed using the open access and the ImageJ-based program FIJI (www.fiji.sc), where only minor adjustments of the brightness and contrast were performed.

2. *In vitro* experiments

2.1. Primary cultures of mouse mesencephalic neurons

2.1.1. Coating conditions

Two days before isolation of the cells, the wells of a TPP® 96 wells plate or a Greiner 96 wells plate were coated with 55µL of 50µg/mL poly-D-lysine (PDL, Sigma-Aldrich, ref.

P7280-5mg) The plate was then incubated at 37°C during 20 min and placed in the fridge until the next day. One day before the isolation, the PDL was aspirated and the wells were washed with PBS for 5 min before adding another 55µL of PDL for further incubation during 20 min at 37°C. The plate was then stored overnight in a sterile environment of the microbiological safety cabinet. The day of the experiment, the PDL solution was aspirated and 3 washings with PBS were done for 5 min each.

2.1.2. Isolation of mouse primary mesencephalic cells

C57BL/6J gestating mice were euthanized by cervical dislocation at the 14th day of gestation. A laparotomy was performed in order to identify the horns of the uterus, isolate them and transfer them in a petri dish containing ice-cold PBS. After opening the uterus horns, the embryos were transferred into a new dish with ice-cold PBS and immediately decapitated. The heads were transferred into another Petri dish containing ice-cold PBS. Whole brains were extracted from the skulls and transferred in another Petri dish containing ice-cold PBS. One mesencephalon is shown on the picture through the white dotted line. Mesencephalon are isolated using two sharp forceps and transferred in a new Petri dish. The meninges, indicated by the white arrow, are then removed from each tissue.



Figure 27: Pictures showing the different steps of the isolation of mouse embryonic mesencephalon. A) The mouse is euthanized through cervical dislocation and placed on a clean surface in dorsal decubitus position. B) An incision is made in the abdomen of the mouse to perform a laparotomy. C) The opening is enlarged to have full access to the internal organs. The uterus horns should be observed at this step as indicated here by the white arrow. D-F) The uterus horns are isolated, taken out and placed in a Petri dish containing ice-cold sterile PBS. G-H) Each embryo is freed from the amniotic bag and transferred into a new Petri dish with ice-cold sterile PBS. I-J) Embryos are rapidly decapitated using two sharp forceps. The heads are transferred into another Petri dish containing ice-cold PBS. K) Whole brains are extracted from the skulls and transferred in another Petri dish containing ice-cold PBS. One mesencephalon is shown on the picture through the white dotted line. L) Mesencephalon are isolated using two sharp forceps and transferred in a new Petri dish. The meninges, indicated by the white arrow, are then removed from each tissue.

The entire brain was removed from the skull and the mesencephalon was isolated as shown figure 27 below. Briefly, meninges were removed before transferring all mesencephalon into a new empty petri dish. Two milliliters of trypsin/EDTA (Thermo Fisher Scientific, ref. 25200072) were added on the top of the mesencephalon. The enzymatic solution was then aspirated with a 1000 μ L pipet and transferred into a 15 mL falcon tube containing 3 mL of Hank's Balanced Salt Solution and 60 μ L of DNase (0.02% solution in water). This tube was incubated at 37°C during 7 min with moderate shaking of the tube, every minute to increase the surface of contact of trypsin with the tissues while being gentle enough to keep the tissues in the enzymatic solution. At the end of the incubation, 2 mL of N2 medium (Neurobasal-A, L-glutamine 2mM, 1% N2 supplement, 200u/mL penicillin, 200u/mL streptomycin, 10% fetal bovine serum, 2mM glucose) were added into the tube to stop the reaction. After 2 min of centrifugation at 800rpm, the pellet was suspended in N2 medium containing DNase (20 μ L/mL of medium at 0.02% concentration) and the tissue was further dissociated into a cell suspension through mechanical dissociation using a Pasteur pipet. Cells were then counted onto a Malassez system and N2 medium was added to the solution to obtain a final concentration of 1.10^6 cells/mL (for information, it takes about 6 embryos to obtain 6 mL of cell suspension at 1.10^6 cells/mL). 100 μ L of this cell suspension were plated in each well. After 4 hours, 20 μ L of medium were removed from each well to eliminate dead floating cells. Isolation day is considered as day *in vitro* 0 (DIV 0). The next day (DIV 1), 40 μ L of medium were replaced in the well by 40 μ L of new N2 medium. On DIV 4, 60 μ L of medium were removed from each well and replaced by 60 μ L of Medium A (Neurobasal-A, 2mM L-glutamine, 10mL B-27® Supplement (50X), 200u/mL penicillin, 200u/mL streptomycin, 2mM glucose). This procedure was further repeated on DIV6 and DIV8. On DIV10, cells were fixated during 20 min with 4% paraformaldehyde for immunocytology or proteins were extracted in an adapted lysis buffer (see §1.3.1. above) for WB analyses.

2.1.3. *In vitro model of dopaminergic degeneration*

A stock solution of 8mM of the pesticide rotenone was first prepared in pure ethanol and stored at -20°C. Before each use, the tube containing the stock solution was placed in the ultrasound bath during 2 min to fully dilute the rotenone which tends to precipitate in ethanol at this concentration. Two sequential intermediate dilutions were prepared to obtain a final concentration of 5nM or 10nM in the wells. Primary mesencephalic cells were exposed to the pesticide from DIV7 to DIV10. A solvent condition, in which cells were exposed to the same quantity of ethanol used to dilute the rotenone, and a control condition, in which cells were only exposed to the culture medium, were included for all experiments.

2.2. Immunocytology

After ten days of culture, the medium was removed from the wells and replaced by a solution of propidium iodide (PI, ref. 81845-25mg, Sigma-Alfrich) diluted to 1/75. The plate was then placed in the incubator at 37°C for 30 min. Propidium iodide is a nuclear staining molecule which enters only the cells with a damaged membrane. After incubation, the plate was placed into the Opera, an automatic confocal fluorescent microscope with climatization control allowing the study of fluorescent staining in a chamber with controlled temperature, humidity and CO₂ concentration. Pictures of 10 fields per well were taken following a circular pattern at the periphery of the well and later analyzed with the Image J software. The cells were then incubated in 4% paraformaldehyde for 20 min at 37°C for fixation. After removal of the paraformaldehyde, three washes with PBS were performed for 5 min each. Blocking of non-specific antigens was achieved using 5% donkey serum and 0.05% Triton-X100 in PBS during 1 hour at room temperature. The cells were then incubated overnight with the anti-tyrosine hydroxylase primary antibody (1:500, Millipore, ref. MAB318) at 4°C. The following day, after three washes of 5 min each with PBS, cells were incubated with the Alexa Fluor® 488 donkey anti-mouse IgG secondary antibody (1/500, Thermo Fisher Scientific, ref. A21202). After three washes in PBS, TH-positive cells were manually counted following a cross pattern, therefore allowing the quantification of TH-positive cells in the periphery of the well where they are numerous and the center of the well where they are sparse, under an inverted microscope (Olympus IX50).

2.3. Automated PI-positive nuclei quantification

The number of PI-positive cells was automatically quantified in ten fields per well using the Image J software. Briefly, images were duplicated and their intensity adjusted with the “Otsu dark” function of the software, therefore transforming the fluorescent stained-nuclei into black dots with a white background. Adjacent nuclei were separated with the “Watershed” function. Finally, the number of particles whose size was comprised between 10 pixels and the infinity was counted, therefore excluding the artefactual particles. The number of PI-positive cells for each field of the same well was then manually added to obtain the total number of PI-positive cells per well and per condition.

2.4. Sampling of the culture medium

In separated plates which were not used for immunocytology analyses, cells were exposed to acyl- or desacyl-ghrelin at DIV7 for up to two days. At the end of this exposure, 50µL of culture medium were collected from each well and transferred into an Eppendorf tube. For each time of exposure and each condition twelve tubes were sampled: 3 tubes of medium were immediately frozen in liquid nitrogen without any further processing, 3 tubes

contained medium and HCl 0.1M to acidify the plasma and prevent desacylation of acyl-ghrelin, 3 tubes contained medium and 1mM PHMB to inhibit the activity of proteases, and the last 3 tubes contained medium, 0.1M HCl and 1mM PHMB. Moreover, additional controls were prepared at the same time with solutions which were not in contact with the cells: 1 tube containing medium, 1 tube containing medium and 0.1M HCl, 1 tube containing medium and 1mM PHMB, and 1 tube containing medium, 0.1M HCl and 1mM PHMB.

3. Statistical analyses

All data are presented as mean \pm SEM except when specified. Since the number of samples per condition was inferior to 30, non-parametric statistics were applied. The data are processed using GraphPad Prism 5.04. Unless noted otherwise, all data are tested for significance ($p < 0.05$) using Kruskal-Wallis (for the comparison of variables in *in vivo* behavioral analyses at one specific time-point of exposure to the pesticide rotenone (for example comparison between control, solvent- and rotenone-exposed mice at the beginning of the experimental procedure) and of ghrelin concentrations between control, solvent- and rotenone-exposed mice at each time-point of the *in vitro* exposure), Mann Whitney (for western blot data) or Friedman (for repeated measures such as food consumption, daily weight and behavioral data acquired for each mouse throughout all the experimental procedure), and a Dunn's multiple comparison post-hoc.

CHAPTER 5: RESULTS

I. Ghrelin: a potential disease-modifying agent in PD? Study in primary mesencephalic cultures

No mouse dopaminergic neuronal cells endogenously expressing the ghrelin receptor GHSR1a was commercially available at the beginning of our work. After a detailed review of the literature, we identified the MES23.5 cells as fulfilling both criteria. However, as detailed in chapter 3 §2.3., these proliferative cells do not reproduce the natural physiology of dopaminergic cells of the SN. We therefore decided to develop a model of primary mesencephalic cultures reproducing a moderate death rate of TH-positive cells after exposure to low doses of the pesticide rotenone. These cultures contain 2-4% of TH-positive cells and a majority of glial cells, providing the neurotrophic factors needed to maintain TH-positive cells in a good condition throughout the duration of the culture (Gaven et al., 2014). Subchronic exposure to low doses of the pesticide rotenone induces a moderate rate of TH-positive cell death which was estimated between 30% and 70% with 10nM of rotenone for 2 and 4 days respectively (Radad et al., 2008; Dr. Pan-Montojo's personal communication). This is an important face validity criterion since PD motor symptoms appear when 50% of SN dopaminergic neurons are dead (Bernheimer et al., 1973; Riederer and Wuketich, 1976), therefore an accurate model of PD early stages must present less than 50% neuronal death. In addition, this cellular model presents good construct validity since exposure to the pesticide rotenone is known to induce PD in humans (Tanner et al., 2011a). Based on previous experiences of our collaborator Dr. Pan-Montojo with such cultures, we modified the protocol published by Radad and colleagues (2008) as detailed in the Material and Methods section (§ 2.1.2., p109).

1. Effect of acyl-ghrelin exposure on primary mesencephalic cells

Before studying the potential role of ghrelin as a disease-modifying agent in mouse primary mesencephalic cells exposed to rotenone, several parameters needed to be determined. Indeed, although ghrelin had already been studied as a disease-modifying agent in several PD-related *in vitro* studies (Bayliss and Andrews, 2013; Kenny et al., 2013; Moon et al., 2009), its effect on mouse primary dopaminergic cells had never been described. It was therefore essential to check that it was not toxic in our conditions of culture. Primary mesencephalic cells were thus exposed from DIV3 to DIV10 to increasing concentrations of acyl-ghrelin alone (0.3, 1, 3, 10, 30, 100, 300 and 1000nM). These exposures were performed in sextuplets. As readouts, we assessed the number of TH-positive cells and the half-life of acyl-ghrelin in the culture medium after its addition to the wells to determine the best interval between two consecutive additions of ghrelin in the medium.

1.1. Long term ghrelin exposure and survival of TH+ cells

The effect of acyl-ghrelin alone for seven days on mouse primary mesencephalic cells was determined by evaluating the morphology and counting the number of TH-producing cells. As shown figure 28A, the total number of TH-positive primary mesencephalic cells did not significantly differ between conditions compared to control cells (mean number = 38.40 ± 2.16 TH-positive cells in control conditions compared to 48.80 ± 7.37 for the highest dose of ghrelin, n.s.). Similarly, acyl-ghrelin had no effect on the morphology of TH-positive cells (Fig. 28B). Indeed, TH-positive cells present an oval soma and numerous and well extended processes in all conditions tested. We chose the dose of 100nM of acyl-ghrelin for the following experiments since it did not alter the number of TH-positive neurons in culture and corresponds to the mean dose used in most published studies.

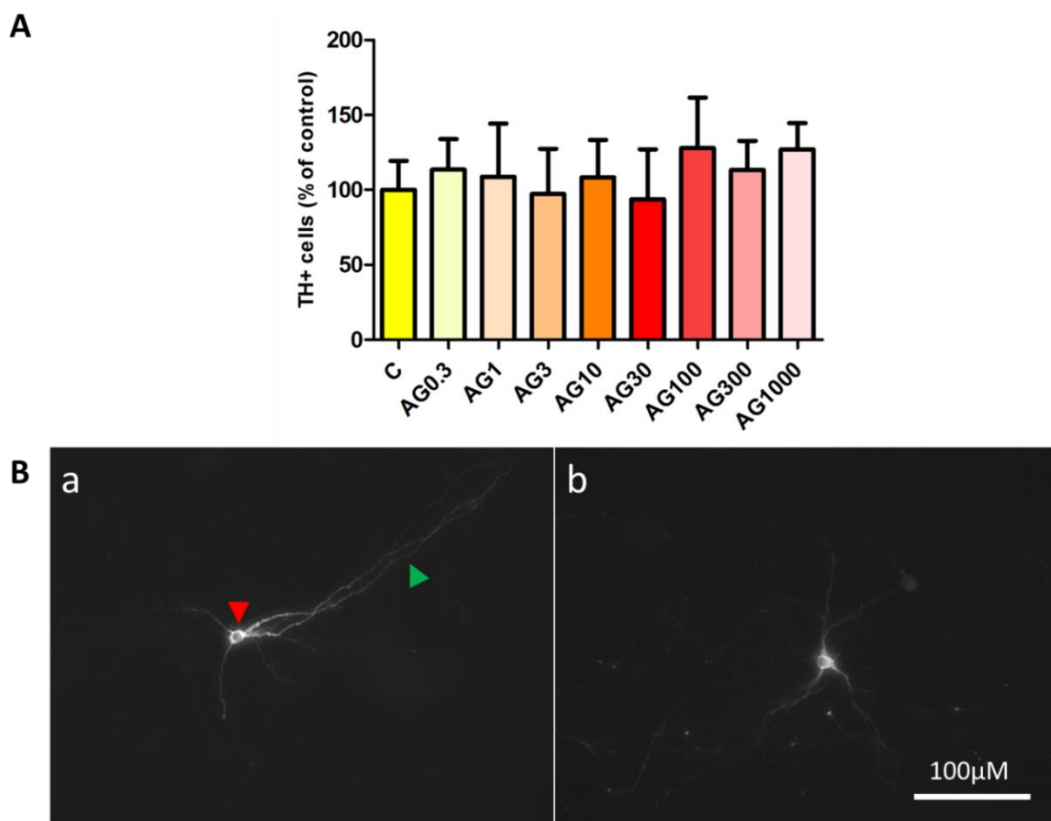

Figure 28: Acyl-ghrelin does not alter primary mesencephalic cells. A) Mean number of tyrosine hydroxylase (TH)-positive cells in control conditions (C) and after seven days of increasing concentration of acyl-ghrelin (AG0.3, AG1, AG3, AG10, AG30, AG100, AG300 and AG1000). The number of TH-positive cells is expressed as a percentage of control cells. The exposure was performed in sextuplets. Data are plotted as mean \pm SEM. B) Representative photographs of the global morphology of TH-positive primary mesencephalic cells under control conditions (a) or after seven days of exposure to 1000nM of acyl-ghrelin (b) as assessed by immunocytochemistry using an anti-TH antibody (clone LNC1, MAB318 Millipore) under a light microscope (Olympus IX50) at the 20X objective. Red and green arrowheads indicate the soma and the processes respectively.

In conclusion, the exposure of mouse primary mesencephalic cells to acyl-ghrelin alone for seven days does not alter the global morphology or the number of tyrosine hydroxylase-producing cells. This indicates that long-term exposure to acyl-ghrelin has no deleterious effect on the survival of TH-positive primary mesencephalic neurons in culture.

1.2. Acyl-ghrelin half-life in the culture medium

Acyl-ghrelin is known to exhibit a short half-life in biological fluids (Delhanty et al., 2015), which has been for example estimated at 8 min in the rat blood (Hosoda and Kangawa, 2012; Tong et al., 2013). It was therefore also expected to exhibit a short half-life *in vitro*. The next step of our study consisted in investigating the half-life of acyl-ghrelin in the culture medium. It was indeed essential to determine not only the stability of acyl-ghrelin in our culture conditions, but also the frequency at which it should be added in long-term exposure protocols.

After exposure of primary mesencephalic cells to acyl-ghrelin during different length of time, the medium was collected for each condition. Different storage conditions were tested to determine the best adapted procedure for further use of the samples. The results, presented in figure 29, showed that acyl-ghrelin concentrations greatly decreased in the minutes following its addition in the culture medium while desacyl-ghrelin concentrations, although heterogeneous during the experiment, stayed high for several hours.

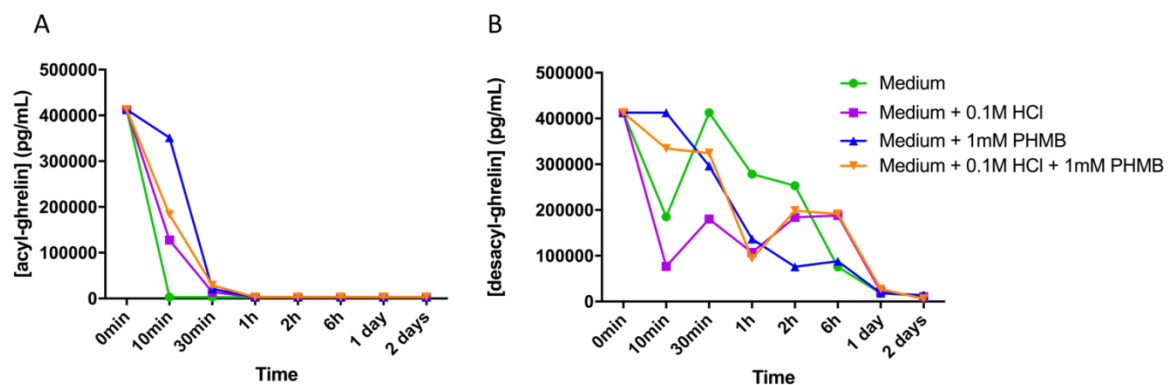

Figure 29: Kinetic study of acyl- and desacyl-ghrelin concentrations after the addition of acyl-ghrelin in the culture medium. Variation of acyl-ghrelin (A) and desacyl-ghrelin (B) concentrations in the culture medium over time. 100nM of acyl-ghrelin were initially added in the culture medium (time 0 min) at DIV 7 until DIV9. The experiment was performed in triplets for each condition tested. In green the medium was collected and immediately frozen at -80°C until further processing; in violet, 0.1M HCl was added after collection of the medium; in blue 1mM of PHMB was added after collection of the medium; in orange 0.1M HCl and 1mM of PHMB were added to the samples before freezing at -80°C .

Acyl-ghrelin was indeed rapidly degraded in the culture medium and was not detected anymore after 10 min of its addition if no further processing of the collected medium was

ensured (Fig. 29A, green curve). The addition of the protease inhibitor PHMB immediately before freezing the samples prevented further degradation of acyl-ghrelin. However, even in presence of PHMB, acyl-ghrelin was fully degraded one hour after its addition to the culture medium. Surprisingly, although only pure acyl-ghrelin was resuspended in solution, desacyl-ghrelin concentrations were elevated from the beginning of the experiment until one day after the addition of acyl-ghrelin. The addition of PHMB and/or HCl did not clearly modify the concentrations of desacyl-ghrelin in the culture medium.

In the contrary, the addition of the protease inhibitor PHMB to the culture medium prior to freezing enabled a better preservation of ghrelin acylation state. This protocol was therefore adopted as the standard procedure for all further experiments assaying ghrelin concentrations in the culture medium. These results were confirmed in a second independent experiment undertaken in triplicate in primary mesencephalic cells exposed or not to 100nM acyl-ghrelin for 10 min.

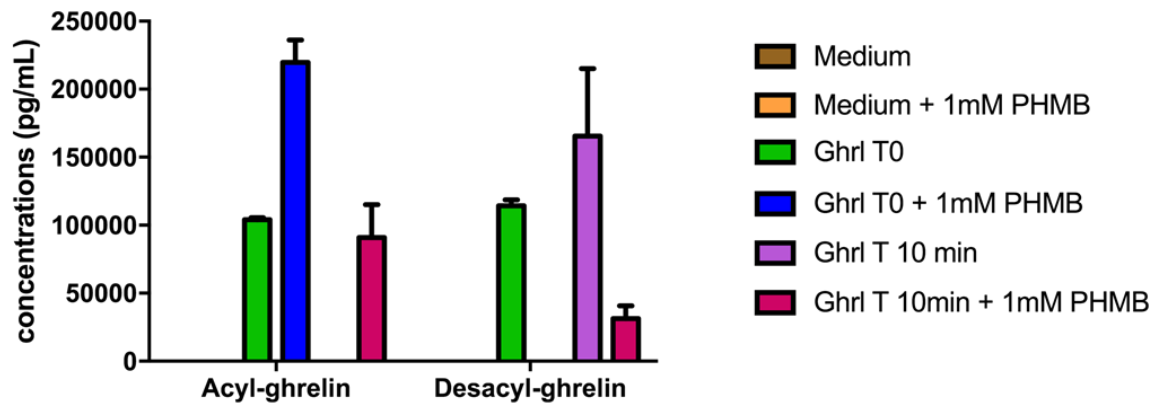

Figure 30: Acyl- and desacyl-ghrelin concentrations after the addition of acyl-ghrelin in the culture medium. This graphs represents variations of acyl- and desacyl-ghrelin concentrations in samples immediately frozen after the initial addition of 100nM of acyl-ghrelin (Ghrl) in the culture medium at DIV 7 (T0) or after 10 min of exposure to the cells (T 10 min). In brown the medium was collected and immediately frozen at -80°C until further analyses; in orange 1mM of 4-hydroxymercuribenzoic acid (PHMB) was added after collection of the medium. The medium frozen directly after the addition of ghrelin (T0) is presented in green and in blue, in absence or presence of PHMB respectively. The medium frozen 10 min after the addition of acyl-ghrelin to the culture medium is represented in violet and pink, in absence or presence of PHMB respectively. The experiment was performed in triplets for each condition tested. Data are plotted as mean \pm SEM.

Like in the previous experiment, acyl-ghrelin concentrations were higher after 10 min of exposure to the cells if PHMB was added to the collecting tubes compared to directly frozen culture medium after sampling (mean values = 90980 pg/mL \pm 13948 *versus* 10 pg/mL \pm 0 respectively, cf. Fig. 30). Desacyl-ghrelin concentrations after 10 min of exposure were lower when PHMB was added to the collecting tubes compared to directly frozen culture medium after sampling (mean values = 31380 pg/mL \pm 5370.70 *versus* 165480 pg/mL \pm 28694 respectively).

In conclusion, this set of experiments established the absence of toxicity of acyl-ghrelin on primary mesencephalic cells whatever the concentrations used. Moreover, acyl-ghrelin was fully degraded within 1 hour of its addition in the culture medium, even in the presence of the protease inhibitor PHMB. This observation should therefore be taken into account for long-term experiments. Finally, caution must be taken in the storage and further use of the culture media after ghrelin exposure, notably with the addition of the protease inhibitor PHMB in the collecting tubes as it is the case for handling plasma samples.

2. Investigation of ghrelin's neuroprotection potential in a cellular model of parkinsonism

2.1. Assessing construct and face validities of the cellular model

As detailed in the introduction (cf. chapter 1 §2.2.1.3.), exposure to the pesticide rotenone is known to induce PD in humans (Tanner et al., 2011a). Moreover, PD being a progressive neurodegenerative disease evolving over decades, it is important to develop a protocol of exposure to rotenone which involves at least several days of exposure to the pesticide. In addition, it is estimated that PD characteristic motor symptoms appear after 50% of the dopaminergic neurons of the SN are dead (Bernheimer et al., 1973; Riederer and Wuketich, 1976). We therefore determined the dose and duration of exposure to rotenone necessary to reproduce, as closely as possible in an *in vitro* model limited by the maximum length of culture for primary cells, the progressive neuronal death occurring in the brain of PD patients. Based on data available in the literature, and previous experiments undertaken in the laboratory of Dr. Pan-Montojo, mouse primary mesencephalic cells were exposed to 5nM or 10nM of rotenone during 2 or 3 days from DIV8 or DIV7 respectively. The number of tyrosine hydroxylase-positive cells in the wells was assessed at DIV 10 at the end of this exposure. The exposure of mouse primary mesencephalic cells to 5nM rotenone did not induce a significant decrease in the number of TH-positive cells after two or three days of exposure (Fig. 31A). Similarly, it did not modify the global morphology of TH-producing neurons (Fig. 32). In the contrary, 10nM of rotenone decreased the number of TH-positive primary mesencephalic cells by 32% or 61% after two days or three days of exposure respectively (mean number of TH-positive neurons: C = 17.81 ± 3.94, R5 = 17.66 ± 4.17, R10 = 12.16 ± 6.76, n.s. compared to controls after two days of exposure; C = 17.00 ± 4.60, R5 = 14.33 ± 4.12, R10 = 6.66 ± 2.08, n.s. compared to controls after three days of exposure).

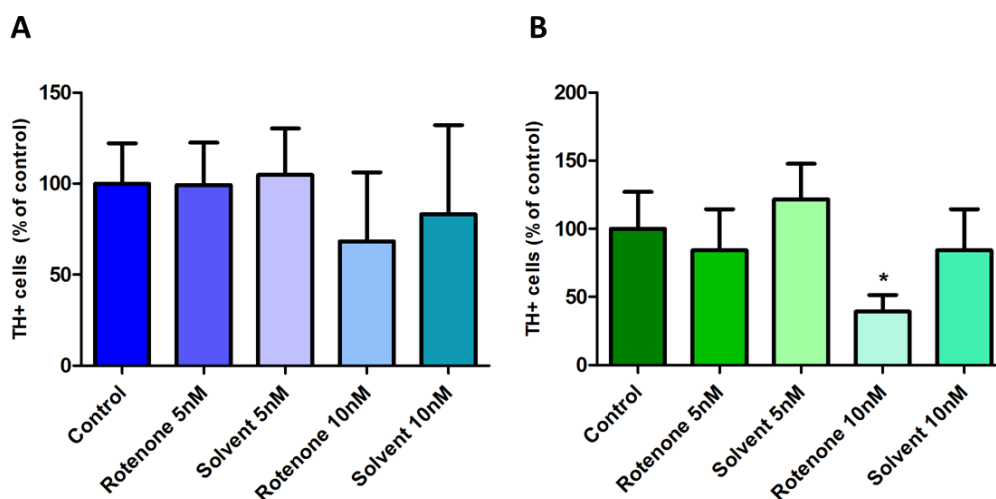

Figure 31: Mean number of tyrosine hydroxylase-positive neurons in mouse primary mesencephalic cells exposed to rotenone during two or three days. A) Number of tyrosine hydroxylase (TH)-positive cells after two days of exposure to 5 or 10nM rotenone. B) Number of TH-positive cells after three days of rotenone exposure (* $p < 0.05$, compared to solvent 5nM). For each condition, TH-positive primary mesencephalic cells were counted in 6 wells. Data are normalized and presented as percentage of control cells. Data are plotted as mean \pm SEM.

Moreover, the exposure to 10nM of rotenone strongly modified the morphology of the surviving neurons which present less developed and less branched processes, as if the cells would be shrinking (Fig. 32).

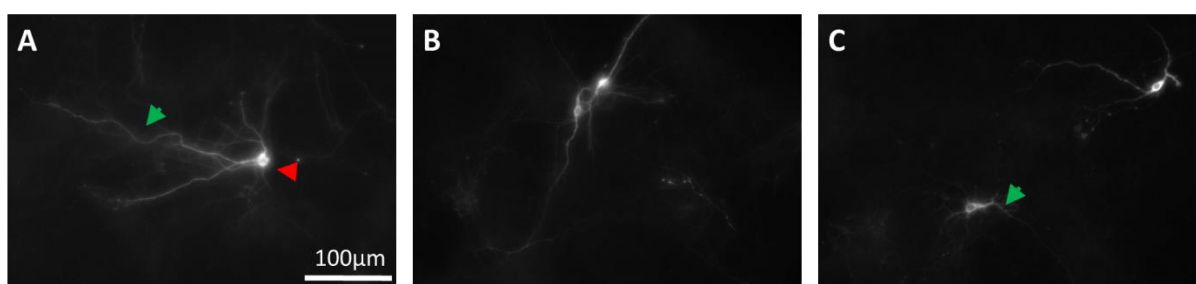

Figure 32: Morphology of tyrosine hydroxylase-positive primary mesencephalic cells after three days of exposure to the pesticide rotenone. Representative photographs: A) of control cells showing an oval soma, indicated by a red arrowhead, and numerous long and branched processes, as indicated by a green arrowhead, B) of cells exposed to 5 nM rotenone during three days from DIV7 to DIV10, and C) of cells exposed to 10nM rotenone during three days from DIV7 to DIV10.

In conclusion, for the following experiments, mouse primary mesencephalic cells were exposed to the two doses of rotenone when possible, i.e. when a sufficient number of cells per isolation could be reached. We focused on the exposure to 10nM of rotenone during three days from DIV7 to DIV10 when the number of cells isolated was limited as this protocol induced a significant deleterious effect on the cells, therefore allowing the study of a potential protective effect of ghrelin with more accuracy than the exposure to 5nM of rotenone itself.

2.2. Effect of short and long-term acyl-ghrelin on primary mesencephalic cells exposed to rotenone

We next investigated the potential of ghrelin as a neuroprotective agent in PD-related conditions. As discussed earlier in chapter 3§2.3., various *in vivo* or *in vitro* studies from the literature support such a disease-modifying role for this orexigenic peptide (Andrews et al., 2009; Bayliss et al., 2016a; Dong et al., 2009; Moon et al., 2009). Most results showing such a neuroprotective action of ghrelin *in vitro* have been obtained in cells exposed to ghrelin 20 min prior to the exposure to the deleterious agents (MPTP or rotenone) followed by a simultaneous exposure to ghrelin and the deleterious agent during 24 hours. Based on the above described results showing a rapid degradation of acyl-ghrelin in the culture medium (within 1 hour of its addition), mouse primary mesencephalic cells were simultaneously exposed to rotenone and acyl-ghrelin for a short period of three days. For these experiments, mouse primary mesencephalic cells were exposed to acyl-ghrelin and rotenone from DIV7 to DIV10. In particular, acyl-ghrelin was added in the wells every 24 hours while rotenone was added to the well every two days. Tyrosine hydroxylase-positive cells were analyzed for their global morphology, their number, as well as the number of cells stained with PI, an intercalating agent binding nucleic acids in cells with perforated membranes. The latter staining therefore reveals the nuclei of dead or dying cells only.

The number of TH-positive cells significantly decreased in the wells exposed to 10nM rotenone (C: 26.30 ± 3.38 ; R: 9.70 ± 2.08 , $p < 0.01$) or 10nM rotenone plus 0.1nM acyl-ghrelin (R + AG0.1: 6.66 ± 1.60 , $p < 0.05$), 1nM acyl-ghrelin (R + AG1: 8.60 ± 1.24 , $p < 0.01$), 10nM acyl-ghrelin (R + AG10: 10.80 ± 1.84 , $p < 0.05$) and 100nM acyl-ghrelin (R + AG100: 11.80 ± 3.39 , $p < 0.05$) compared to the control condition (Fig. 33A). No significant difference was observed in the mean number of TH-positive cells between cells exposed to 10nM rotenone alone and to 10nM rotenone plus increasing concentrations of acyl-ghrelin. In addition, TH-positive cells exposed to the solvent alone or to acyl-ghrelin alone presented an oval soma and numerous and long branched processes, a morphology which did not differ from the control condition (Fig. 33B conditions a and b). However, cells exposed to 10nM of rotenone during three days presented shorter processes (Fig. 33B, condition c). This morphology was further modified in mouse primary cells simultaneously exposed to 10nM rotenone and 10 or 100nM acyl-ghrelin: in these conditions the processes shortened and progressively disappeared (Fig. 33B, condition d).

A**B**

Figure 33: Effect of three days of acyl-ghrelin on tyrosine hydroxylase-positive mouse primary mesencephalic cells exposed to rotenone. A) Mean number of tyrosine hydroxylase (TH)-positive cells in primary mesencephalic cultures exposed to acyl-ghrelin (AG) and rotenone. Primary mesencephalic cells were exposed to increasing doses of acyl-ghrelin (0.1nM, 1nM, 10nM and 100nM) and 10nM of rotenone (R) during three days (DIV7-10). The data are normalized and presented as a percentage of the mean number of TH-positive cells in control wells. For each condition, 6 wells have been counted. Data are plotted as mean \pm SEM. B) Representative photographs of TH-producing cells in control condition (a), after three days of exposure to 100nM of acyl-ghrelin alone (b), after three days of exposure to 10nM rotenone alone (c) and after three days of simultaneous exposure to 10nM rotenone and 100nM of acyl-ghrelin (d). Red and green arrowheads indicate respectively the soma and processes.

Similarly, cells exposed to 10nM rotenone alone and cells jointly exposed to 10nM rotenone and increasing concentrations of acyl-ghrelin showed a greater number of PI-positive nuclei compared to the control conditions (mean values in C = 1781 ± 226, R = 2491 ± 301, R + AG100 = 3553 ± 158, n.s.), although this difference did not reach the statistical significance threshold (Fig. 34). The number of PI-positive cells is however significantly reduced between the cells exposed to 10nM rotenone plus 0.1nM and 10nM of acyl-ghrelin and cells exposed to 0.1nM and 10nM of acyl-ghrelin alone (*p<0.05, ***p<0.001 respectively).

In conclusion, the exposure of mouse primary mesencephalic cells to rotenone alone as well as to acyl-ghrelin and rotenone during three days from DIV7 to DIV10 altered the number and the morphology of TH-positive cells, and slightly increased the number of PI-positive cells. Therefore, instead of exerting a protective action against rotenone-induced cell death of dopaminergic primary mesencephalic cells, acyl-ghrelin seems to potentiate rotenone-induced deleterious action.

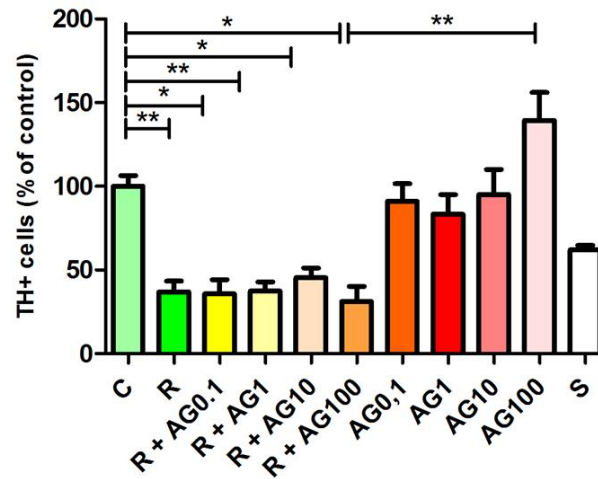
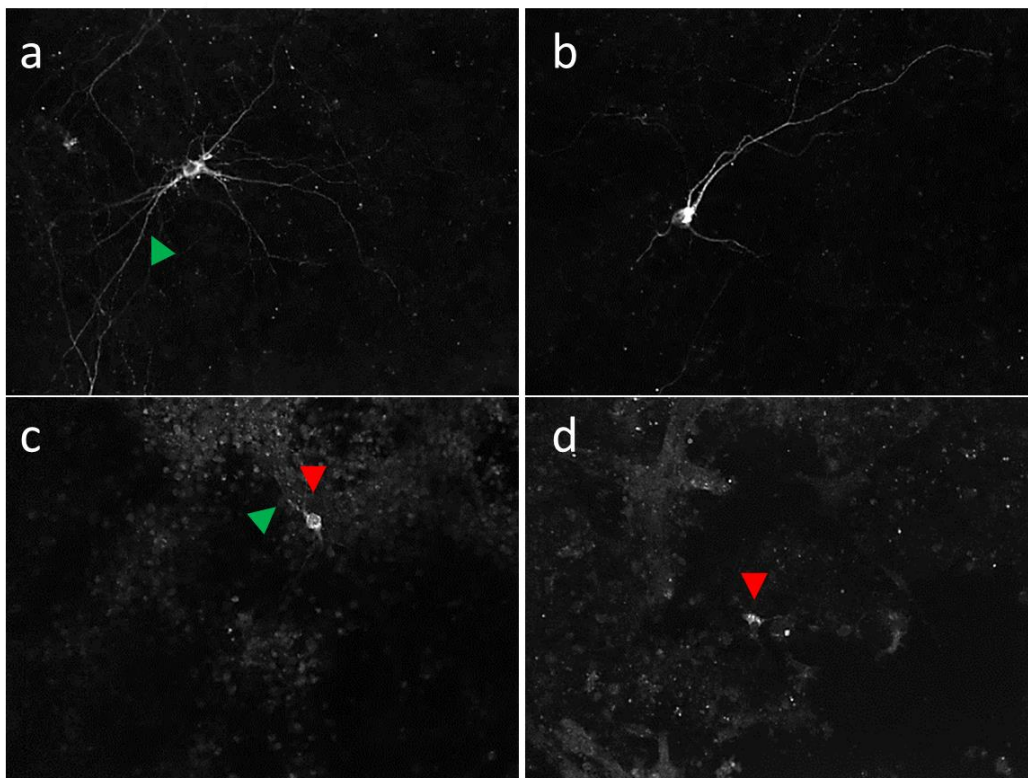
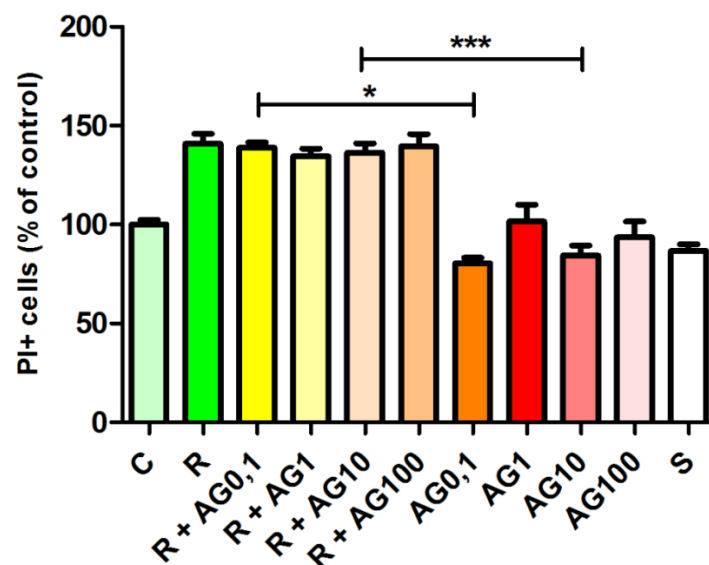

Figure 34: Mean number of propidium iodide-positive cells after exposure to rotenone and acyl-ghrelin during three days. Mean number of propidium iodide (PI)-positive cells after three days of exposure to 10nM rotenone (R) and increasing doses of acyl-ghrelin (0.1nM, 1nM, 10nM and 100nM) from DIV 7 to DIV10. For each condition, the number of PI-positive cells was automatically counted with the Image J software in ten fields per well and 5-11 wells per condition as detailed in the Material & Methods section. The data were normalized to the mean number of PI-positive cells in the control condition and plotted as mean ± SEM.

Since some of the studies having shown a protective effect of acyl-ghrelin in other *in vitro* models of PD involved a pre-treatment with acyl-ghrelin alone before exposure to the deleterious compound inducing dopaminergic cell death (Dong et al., 2009; Yu et al., 2016),

we next studied the effect of a long-term pre-treatment with ghrelin, from DIV3 to DIV10, prior to rotenone exposure during the last three days of culture only. In this protocol, both rotenone and acyl-ghrelin were added in the culture medium every two days.

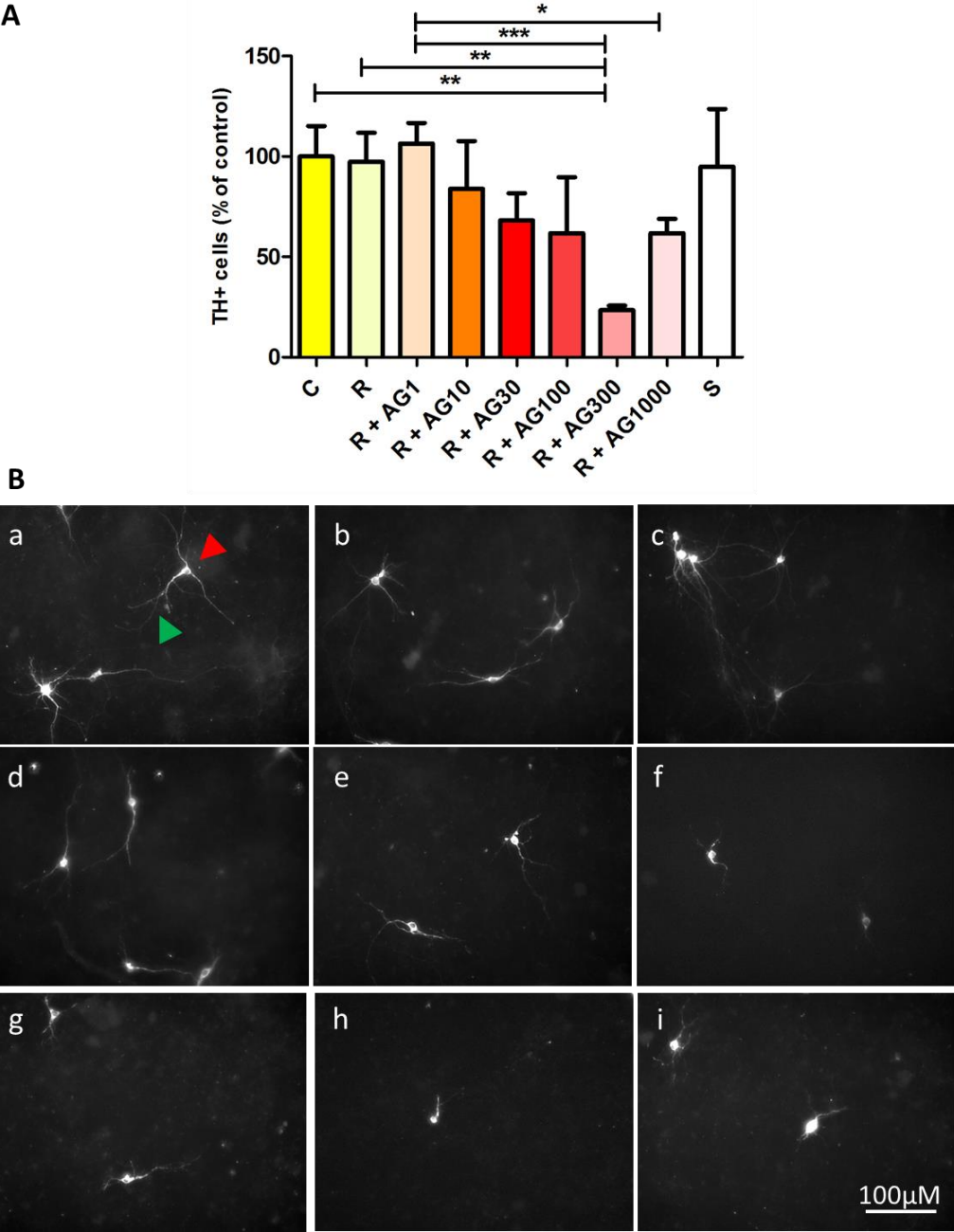

Figure 35: Acyl-ghrelin alters mouse primary mesencephalic cells exposed to rotenone in a dose-dependent manner. A) Mean number of tyrosine hydroxylase (TH)-positive cells in mouse primary mesencephalic cultures exposed to different doses of acyl-ghrelin (1nM, 10nM, 30nM, 100nM, 300nM and 1000nM, DIV3-10) and to 5nM rotenone (DIV7-10). The data are normalized and expressed as a percentage of the mean number of TH-positive neurons in the control wells and plotted as mean \pm SEM. For each condition, 6 wells have been counted. B) Representative photographs of TH-producing cells in control condition (a) and after seven days of exposure to 5nM rotenone (b), or to the solvent (c), and after seven days of exposure to 1nM (d), 10nM (e), 30nM (f), 100nM (g), 300nM (h) or 1000nM (i) of acyl-ghrelin and to simultaneous exposure to 5nM rotenone during the last three days. Red and green arrowheads indicate respectively the soma and processes.

No long-term exposure to acyl-ghrelin had been reported in vitro in the available literature. However, several in vivo studies had shown a protective effect of ghrelin in rodent models of parkinsonism. In particular, a pretreatment with ghrelin for three days prior to the simultaneous injection of ghrelin and MPTP for five days had shown a protective effect against dopaminergic cell death in the SN (Jiang et al., 2008). Based on this protocol, we started by exposing mouse primary mesencephalic cells to ghrelin during four days, corresponding to two changes of medium, before further exposing the cells to both acyl-ghrelin and rotenone during three additional days. We first studied the effect of several doses of ghrelin from DIV3 to DIV10 on cells exposed to 5nM of rotenone during the last three days, i.e. from DIV7 to DIV10.

The global morphology of cells exposed to the solvent or to 5nM of rotenone is similar to the morphology of control cells (cf. Fig. 35B). They all have an oval soma, long and developed processes. Similarly, for the lowest concentrations of ghrelin (1 and 10nM) in presence of 5nM of rotenone, the morphology of TH-positive cells seems identical to the morphology of control cells (cf. Fig. 35B, conditions d and e). From 30nM on, acyl-ghrelin alters the morphology of mouse primary mesencephalic cells as their processes progressively shorten in a dose-dependent manner. In addition, this experiment confirms that the exposure to 5nM of rotenone for 3 days does not significantly reduce the number of TH-positive cells (mean number in control cells = 51.80 ± 3.15 versus 50.50 ± 2.77 in rotenone-exposed cells, n.s.; cf. Fig. 35A). However, a decreased number of TH-positive cells is observed in the wells exposed to both 300nM of acyl-ghrelin and 5nM of rotenone (mean number of TH-positive cells in R + AG300 = 12.16 ± 0.43 , $p < 0.01$; cf. Fig. 35A) suggesting a synergistic toxic effect between rotenone and acyl-ghrelin. This deleterious effect of the combined exposure to acyl-ghrelin and rotenone was confirmed in a second experiment in which two doses of rotenone (5nM and 10nM) and one dose of acyl-ghrelin (100nM) were applied. We chose the dose of 100nM of ghrelin for it was the one used in many published experiments and it seemed to induce a slight increase in the number of dopaminergic neurons after seven days of exposure to acyl-ghrelin alone in our conditions of experiment (see Fig. 28.).

These results confirm the deleterious effect of a long-term exposure to acyl-ghrelin (seven days) prior to rotenone (three last days) as the number of dopaminergic neurons significantly decreased when cells were exposed to 100nM acyl-ghrelin and 5nM or 10nM rotenone compared to control cells (mean number of TH-positive primary mesencephalic cells in control wells = 54.20 ± 5.30 versus 3.00 ± 0.76 in the R5 + AG100 condition, $p < 0.01$; versus 5.20 ± 2.26 in the R10 + AG100 condition, $p < 0.05$). Moreover, the global morphology of TH-positive primary cells exposed to ghrelin and rotenone was dramatically different from the

morphology of control cells (Fig. 36). Indeed, it was impossible to distinguish the processes in the rotenone plus acyl-ghrelin condition.

In conclusion, this series of experiments demonstrates that both short- and long-term exposures to acyl-ghrelin were not able to protect TH-positive mouse primary mesencephalic cells against rotenone-induced alterations. In particular, acyl-ghrelin did not prevent the rotenone-induced decrease in the number of TH-positive cells, nor their morphological modifications.

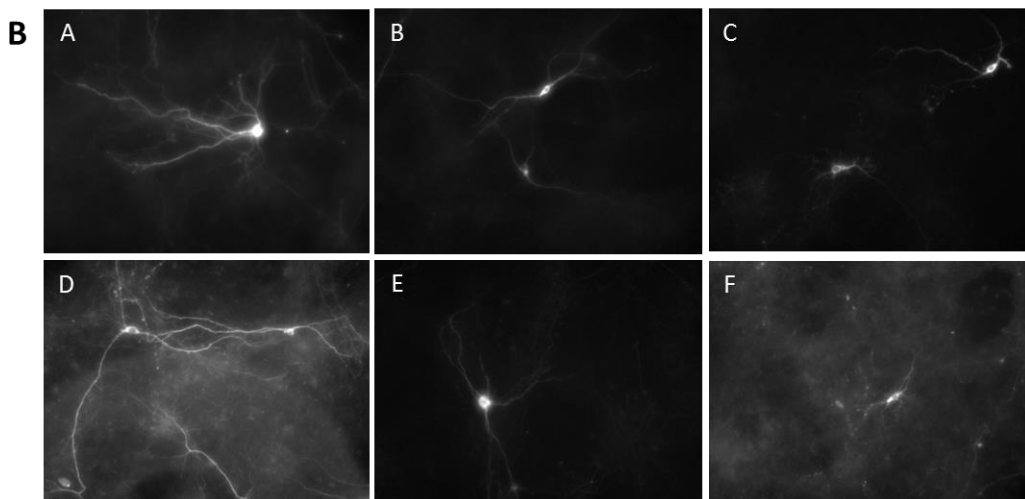
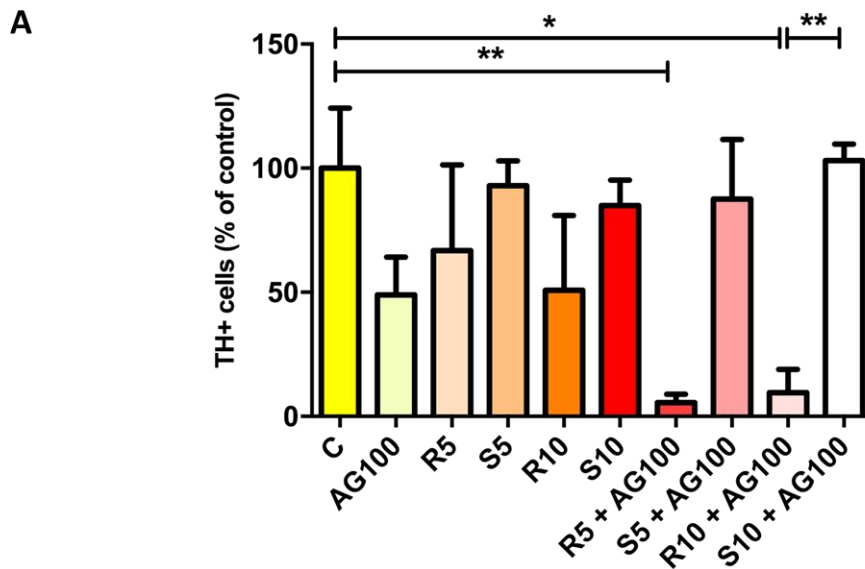

Figure 36: Acyl-ghrelin alters mouse primary mesencephalic cells exposed to rotenone (confirmation). A) Mean number of tyrosine hydroxylase (TH)-positive cells in mouse primary mesencephalic cultures exposed to 100nM of acyl-ghrelin (DIV3-10) and to 5nM or 10nM rotenone (DIV7-10). The data are normalized and expressed as a percentage of the mean number of TH-positive neurons in control wells \pm SEM. For each condition, 6 wells have been counted. B) Representative photographs of TH-producing cells in control condition (a), after seven days of exposure to 10nM rotenone (b), or to 100nM of acyl-ghrelin (c), and after seven days of exposure to 100nM of acyl-ghrelin and simultaneous exposure to 10nM rotenone for the last three days. Red and green arrowheads indicate respectively the soma and processes.

2.3. Effect of short-term desacyl-ghrelin in primary mesencephalic cultures exposed to rotenone

We next studied the effect of desacyl-ghrelin in this *in vitro* model of parkinsonism. Indeed, the acylation state of the ghrelin used to induce the neuroprotective effect described in the literature was rarely specified, and most published studies used total ghrelin, which includes both acyl- and desacyl-ghrelin. Therefore, the reported neuroprotective effect could be attributed to either ghrelin-derived molecule. In this view, mouse primary mesencephalic cells were simultaneously exposed to increasing doses of desacyl-ghrelin (0.1, 1, 10 and 100nM) and 10nM rotenone for the last three days of culture. The mean number and the global morphology of TH-positive cells as well as the number of PI-positive cells were assessed.

The number of dopaminergic neurons significantly decreased after exposure to 10nM rotenone alone or to 10nM rotenone plus 1nM of desacyl-ghrelin (Fig. 37A, mean number of TH-positive cells in control wells = 79.41 ± 4.19 versus 13.96 ± 1.97 in rotenone-exposed cells, $p < 0.01$; versus 34.41 ± 6.58 in the R + DAG1 condition, $p < 0.05$). However, no decrease was observed in cells simultaneously exposed to 10nM rotenone and 10 or 100nM desacyl-ghrelin (mean number of TH-positive cells in control wells = 79.41 ± 4.19 versus 56.50 ± 6.87 in the R + DAG10 condition and 48.8 ± 9.63 in the R + DAG100 condition, n.s.). In addition, primary mesencephalic cells simultaneously exposed to increasing doses of desacyl-ghrelin and 10nM rotenone showed an oval soma and numerous long branched processes similar to the morphology of control cells (Fig. 37B, conditions a and d). On the contrary, cells exposed to 10nM of rotenone alone during three days showed much shorter processes (Fig. 37B, condition c).

A

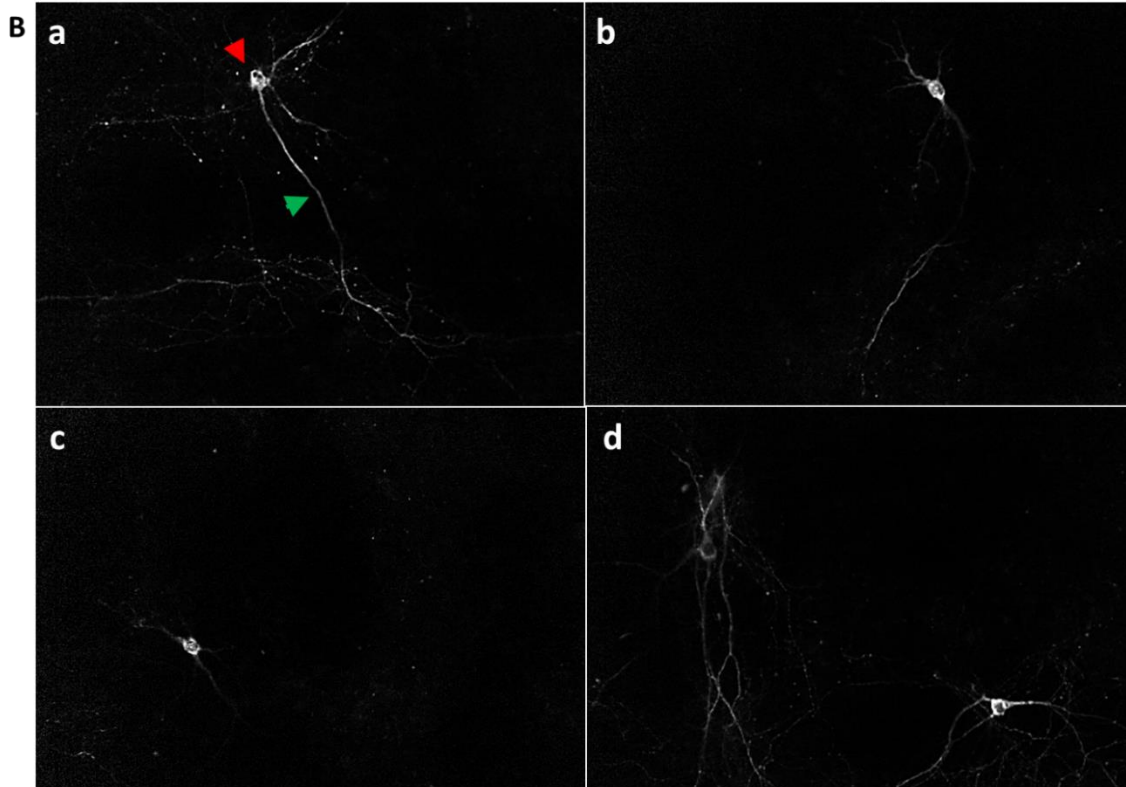
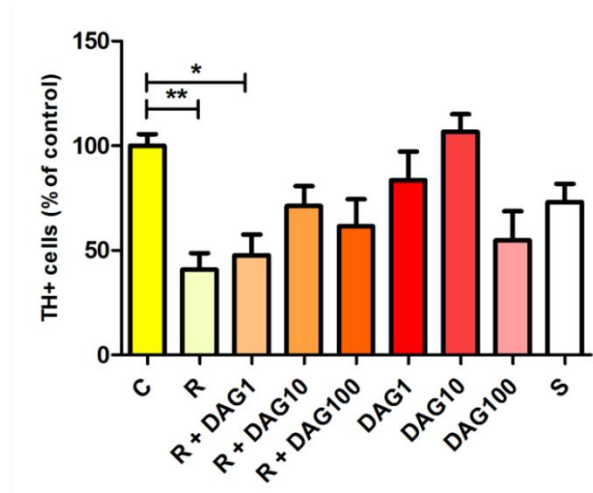

Figure 37: Effect of desacyl-ghrelin on mouse primary mesencephalic cells exposed to rotenone. A) Mean number of tyrosine hydroxylase (TH)-positive cells in mouse primary mesencephalic cultures simultaneously exposed to increasing doses of desacyl-ghrelin (DAG; 1, 10 and 100nM) and 10nM rotenone (R) from DIV7 to DIV10. The data are normalized and expressed as a percentage of the mean number of TH-positive neurons in the control wells and plotted as mean \pm SEM. For each condition, 6 wells have been counted. B) Representative photographs of TH-producing cells in control condition (a), after three days of exposure to 100nM of desacyl-ghrelin (b) or to 10nM rotenone (c), and after three days of simultaneous exposure to 10nM rotenone and 100nM of desacyl-ghrelin (d). Red and green arrowheads indicate respectively the soma and processes.

The number of PI-positive cells was investigated in each condition to determine if this exposure to rotenone and desacyl-ghrelin affected all primary cells in the wells or if it was restricted to TH-positive cells.

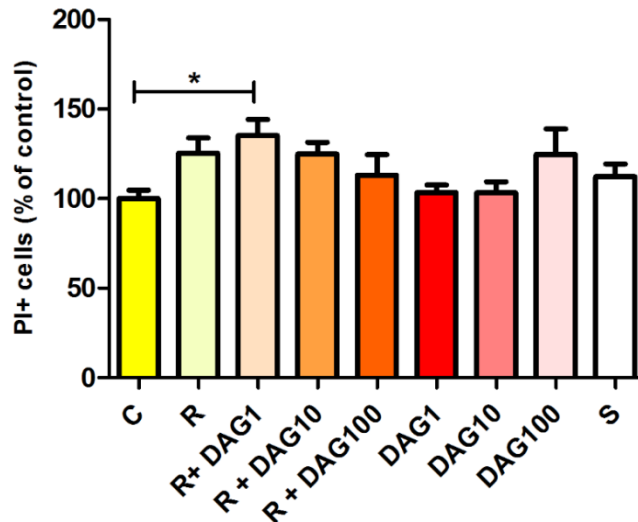

Figure 38: Mean number of propidium iodide-positive cells after exposure to rotenone and desacyl-ghrelin during three days. The mean number of propidium iodide (PI)-positive cells after three days of exposure to 10nM rotenone (R) and increasing doses of desacyl-ghrelin (1nM, 10nM and 100nM respectively) was automatically counted with the Image J software in ten fields per well and 3-10 wells per condition as detailed in the Material & Methods section. The data were normalized to the mean number of PI-positive cells in the control condition and plotted as mean \pm SEM.

PI-positive cells significantly increased when primary mesencephalic cells were exposed to 10nM rotenone and 1nM desacyl-ghrelin compared to the control condition (Fig. 38, mean values in control cells = 1285.66 ± 67.80 versus 135.26 ± 8.38 in the R + DAG1 condition, $p < 0.05$). A similar increase was observed in cells exposed to 10nM rotenone alone or 10nM rotenone plus to 10nM or 100nM desacyl-ghrelin, although it did not reach the statistical significance (mean value of 1677.37 ± 140.45 in rotenone-exposed cells, n.s. compared to controls; mean value of 124.93 ± 5.93 in the R + DAG10 condition, n.s. compared to controls; mean value of 113.06 ± 10.89 in the R + DAG100 condition, n.s. compared to controls).

In summary, desacyl-ghrelin seems to prevent rotenone-induced modifications of TH-positive mouse primary mesencephalic cells. This effect was not observed when studying PI staining, suggesting a TH-specific effect.

In conclusion, this first part of my thesis work aimed to investigate the neuroprotection potential of ghrelin against rotenone-induced neuronal death in mouse primary mesencephalic cultures. Our results establish that although acyl-ghrelin alone was not toxic for primary dopaminergic neurons over seven days in culture, when simultaneously exposed with toxic doses of rotenone, this did not prevent the rotenone-induced decrease in the number of TH-positive primary cells. More importantly, and unexpectedly, a long-term pre-treatment with acyl-ghrelin before rotenone exposure further decreased this number and

altered the morphology of TH-producing mouse primary mesencephalic cells. On the contrary, a short-term simultaneous exposure of mouse primary mesencephalic cells to desacyl-ghrelin and rotenone slightly increased the number of TH-positive cells compared to cultures exposed to rotenone only. This *in vitro* study did not confirm the disease-modifying role of acyl-ghrelin in primary mesencephalic cells exposed to low doses of rotenone. However, it suggested a potential role of desacyl-ghrelin as a disease-modifying agent in rotenone-exposed cells.

II. Investigation of ghrelin’s potential as a biomarker of PD early stages

1. Variation of *GHRLOS* in samples from PD patients

Our laboratory has been collecting various biological samples such as blood or cerebrospinal fluid samples (or even fibroblasts) from genetic and sporadic PD patients and age- and sex-matched controls for more than a decade. Previously published papers using powerful without *a priori* genome-wide transcriptomic approaches have identified deregulations in cellular pathways involved in apoptosis, cell survival, inflammation and immune processes, as well as protein production and endocytosis in peripheral blood mononuclear cells of PD patients compared to age- and sex-matched controls (Mutez et al., 2014, 2011). As shown in table 7 below, the ghrelin opposite strand RNA (*GHRLOS*) was identified among the significantly deregulated genes in peripheral blood mononuclear cells from both sporadic PD patients and patients carrying the G2019S mutation of LRRK2 (FC: -0.167 and FC: -0.23 respectively). This non-coding RNA is encoded by a gene present on the opposite strand of the ghrelin gene which spans its promoter and untranslated regions over 44kb on 3p25.3 and could exert potential regulatory and functional roles in ghrelin expression (Seim et al., 2008a).

Gene	Gene Name	Probe	FC	Patient
<i>GHRLOS</i>	ghrelin opposite strand RNA (non coding)	ILMN_364273	-0.167	Mutation G2019S LRRK2
			-0.23	Sporadic

Table 7: *GHRLOS* expression is down-regulated in peripheral blood mononuclear cells of PD patients as assessed by Illumina microarrays. This experiment was performed on total RNA extracted from peripheral mononuclear cells of sporadic PD patients, i.e. PD patients without a familial history of the disease (9 men, 11 women; mean age = 62.3 ± 8.9 years) and G2019S carriers PD patients (4 men, 5 women; mean age = 66.2 ± 17.4 years) and age- and sex- matched healthy subjects with no personal and familial history of neurological disorders (20 men, 20 women; mean age = 52.9 ± 19; 20 years). The name of the Illumina probe binding *GHRLOS* is provided, as well as the fold change value calculated between PD patients and healthy controls for each probe.

We therefore studied the expression of *GHRLOS* in peripheral blood mononuclear cells and Epstein-Barr virus (EBV)-transformed lymphoblastoid cell lines of PD patients using qPCR. *GHRLOS* expression was decreased in PD patients compared to healthy controls (Fig. 39, relative *GHRLOS* expression in controls = 1.30 ± 0.29 versus 0.74 ± 0.14 in PD patients, $p=0.08$).

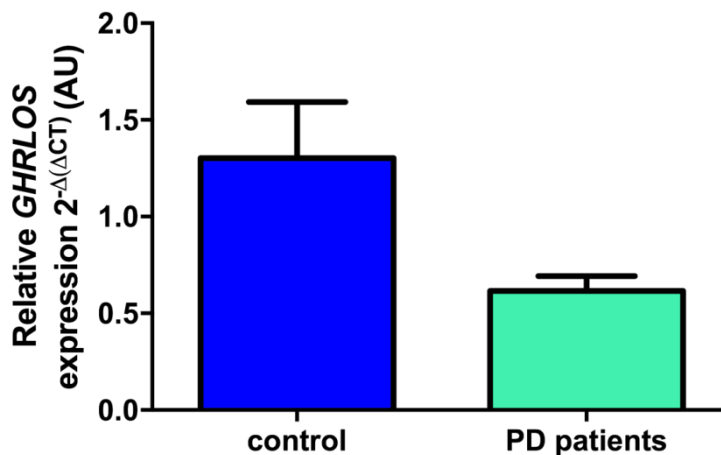

Figure 39: Relative gene expression of the ghrelin opposite strand/antisense RNA in Parkinson's disease patients compared to controls. The expression of ghrelin opposite strand RNA (*GHRLOS*) was assessed in sex/age matched Parkinson's disease (PD) patients (1 man, 5 women; mean age = 65.5 ± 15.6 years) and control groups (2 men, 3 women; mean age = 63.2 ± 18.6 years). Control subjects included in this study were healthy volunteers without any neurological impairment. Informed consent was collected for all participants under the ethical agreement CPP N°2008/009. The details on the experimental procedure are presented in the Material and Methods section. Each RNA sample was loaded in triplicate. *MAN2B1* (Mannosidase Alpha Class 2B Member 1) was used as a housekeeping gene for normalization purposes. Each bar represents the mean + the SEM of the ratio of relative gene expression of *GHRLOS* for each subject as determined by the $2^{-\Delta(\Delta CT)}$ method.

In conclusion, this first set of experiments revealed a decreased expression of *GHRLOS* which could result in altered ghrelin expression. This prompted us to further investigate ghrelin expression in biological samples of mice exhibiting a PD-related phenotype.

2. *In vivo* study in an experimental analog of early parkinsonism

2.1. Physiologic variations of plasma ghrelin in mice

As we could not initiate a patient-based study during the time of the PhD, we decided to further investigate ghrelin variations in an animal model of early parkinsonism induced by chronic exposure to low doses of the pesticide rotenone (Pan-Montojo et al., 2012, 2010). Based on the study conducted by Unger and colleagues (Unger et al., 2011) showing a delayed return to basal ghrelin concentrations after a standard meal in PD patients compared to control subjects, we wanted to investigate plasma ghrelin variations after a meal in

C57BL/6J exposed or not to low doses of the pesticide rotenone. However, at the beginning of this study, the variations of plasma ghrelin under physiological conditions before and after a meal were not described in mice in the available literature. We therefore conducted a study in both female and male C57BL/6J mice.

2.1.1. *Plasma ghrelin variations in healthy 4-5 months old female mice before and after a meal*

A preliminary study was first conducted before and after a meal on 20 female mice to assess the duration of food intake necessary to induce a decrease in plasma acyl-ghrelin concentrations in C57BL/6J mice. For this procedure, blood samples were taken from overnight fasted mice and at several time-points after placing the mouse back in its cage with *ad libitum* access to food. Both acyl- and desacyl-ghrelin were assayed in the plasma (Fig. 40).

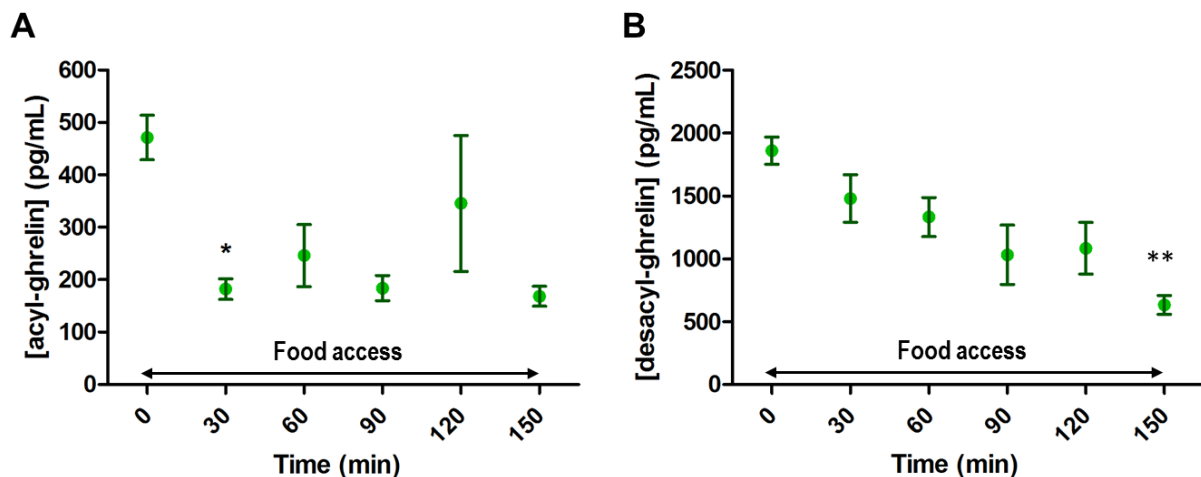

Figure 40: Mean variations of acyl- and desacyl-ghrelin concentrations (pg/mL) after an overnight fast and at different time-points after food intake in 4-5-months old C57BL/6J female mice. A) Plasma acyl-ghrelin concentrations are elevated after the overnight fast and fluctuate during the 150 min-long period of access to food. A significant decrease in acyl-ghrelin concentrations is observed after 30 min of food access (* $p < 0.05$). B) Desacyl-ghrelin concentrations progressively decrease over the 150 min-long period of food access. A significant decrease is observed only after 150 min (** $p < 0.01$).

As described in other species, plasma acyl- and desacyl-ghrelin concentrations are elevated after an overnight fast (Fig. 40). Thirty minutes of access to food induced a significant decrease in plasma acyl-ghrelin concentrations (T0: 462 ± 209 pg/mL *versus* T30: 182 ± 47.59 pg/mL, $p < 0.05$). In addition, mice were eating at least 2 meals in 90 min as shown by the decreases in acyl-ghrelin at T30 and T90. In parallel, concentrations of desacyl-ghrelin were high after an overnight fast and progressively decreased after the mice regained access to food.

2.1.2. Plasma ghrelin variations in healthy 1 year old male mice before and after a meal

Since the animal model of early parkinsonism selected for this study was developed in 1 year old male mice and considering the well documented variations in ghrelin concentrations with sex and age (Al-Massadi et al., 2010; Makovey et al., 2007), we also investigated the variations in plasma acyl- and desacyl-ghrelin before and after a meal in 1 year old C57BL/6J male mice. Based on the results obtained on younger females (cf. supra), the protocol was modified to allow a limited access to food for 30 min only (after the first blood sampling), after which the food was removed again thus preventing further variations in plasma acyl-ghrelin concentrations. This enabled to mimic the procedure followed in humans by Unger and colleagues (2011). Figure 41 below represents the variations of plasma acyl-ghrelin (Fig. 41A) and desacyl-ghrelin (Fig. 41B) concentrations throughout the procedure. These results show that acyl-ghrelin concentrations peak after an overnight fast, decrease after food intake and increase again until the next meal. These data thus reproduce the variations of plasma ghrelin concentrations observed in human beings, therefore validating the protocol of temporary food access for the study of plasma ghrelin variations in mice after overnight fast.

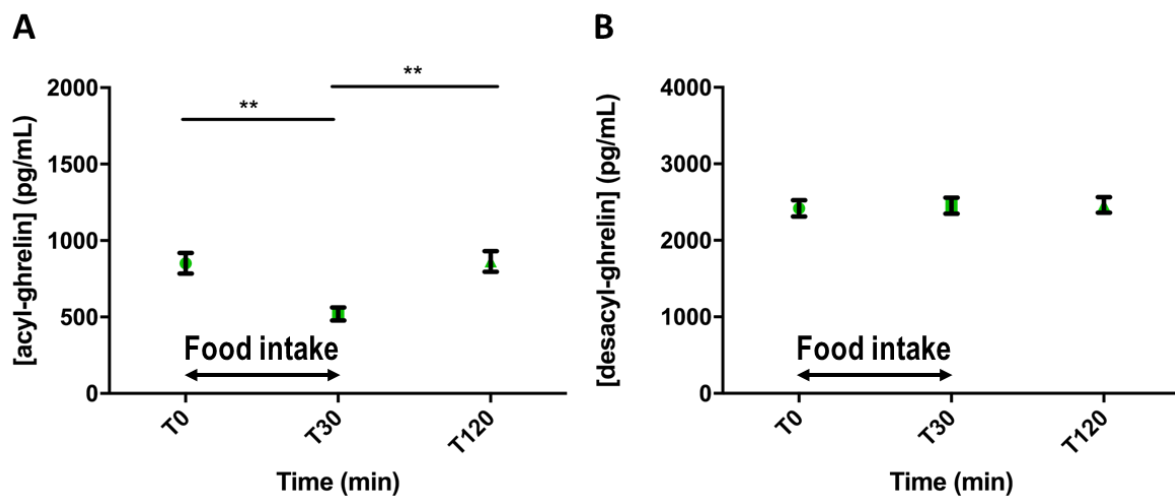

Figure 41: Mean variations of acyl- and desacyl-ghrelin concentrations after an overnight fast and at different time-points after 30 min food intake in 1 year old C57BL/6J male mice. The first blood sample was taken after an overnight fast of 13 hours. The second sample was collected 30 min after unlimited access to food. The last blood sample was taken 120 min after the first sample and was preceded by 90 min without access to food. A) A significant decrease in acyl-ghrelin concentrations was observed after 30 min of food access (**p<0.01). The concentrations of plasma acyl-ghrelin increased again when the food was removed after this 30 min period (**p<0.01). B) Desacyl-ghrelin concentrations were stable throughout all the experiment.

When looking at the dispersion of individual values for each time point of this kinetic study (Fig. 42), one can see that the values for acyl-ghrelin are more heterogeneous for the first

and the third blood sampling taken after fast (Fig. 42A) whereas desacyl-ghrelin concentrations are quite stable throughout the experiment, although some inter-individual variations exist (Fig 42B).

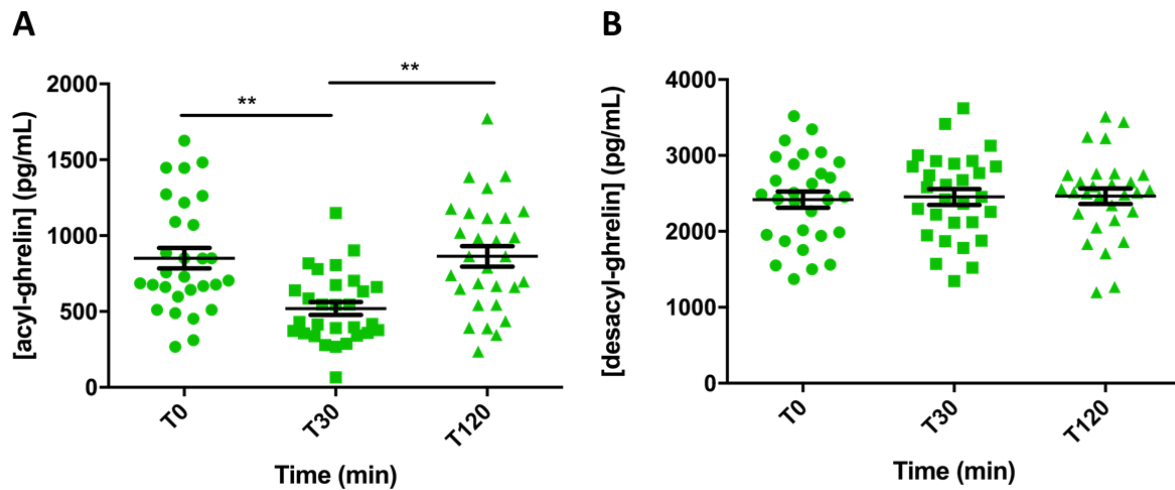

Figure 42: Individual variations of acyl- and desacyl-ghrelin concentrations after overnight fast followed by 30 min *ad libitum* access to food. A) Acyl-ghrelin concentrations (pg/mL) after overnight fast (T0), 30 min *ad libitum* access to food (T30) and 90 min after removal of the food (T120) (n=30). B) Desacyl-ghrelin concentrations (expressed in pg/mL) in the same conditions (n=30).

In conclusion, provided the access to food after an overnight fast is limited to 30 min the following morning, plasma acyl-ghrelin concentrations are elevated after fast, quickly decrease after 30 min *ad libitum* food intake and increase again until the next meal. Such a standardized procedure avoids hectic acyl-ghrelin variations due to a continuous food intake (limited to few pellets of food) during the whole period of mice activity. It therefore ensures a rigorous study in pathological conditions.

2.2. Validation of the mouse model of early parkinsonism after chronic exposure to low doses of the pesticide rotenone

2.2.1. Animals well-being throughout the experimental procedure

General health conditions of the animals were surveyed throughout the experiment. At the dose of 5mg/kg rotenone per day, all animals remained alive during the 1.5 months of the experimental procedure and showed no sign of general alteration except for one mouse in the control group which showed a propensity to spontaneously turn on its right side. Although, all mice were able to perform all behavioural tests without experiencing any difficulty, this animal was later removed from the cohort after observing a cerebellar malformation at autopsy. Since PD is often accompanied with involuntary weight loss (Abbott et al., 1992), the mice were daily weighted (Fig. 43A). Their mean food consumption per cage was monitored to exclude possible weight loss due to a decreased food intake which

was the case when assessing plasma ghrelin concentrations after overnight fast on day 30 (Fig. 43B). Note that the design of the whole experiment procedure is summarized figure 21 in the Material and Methods section.

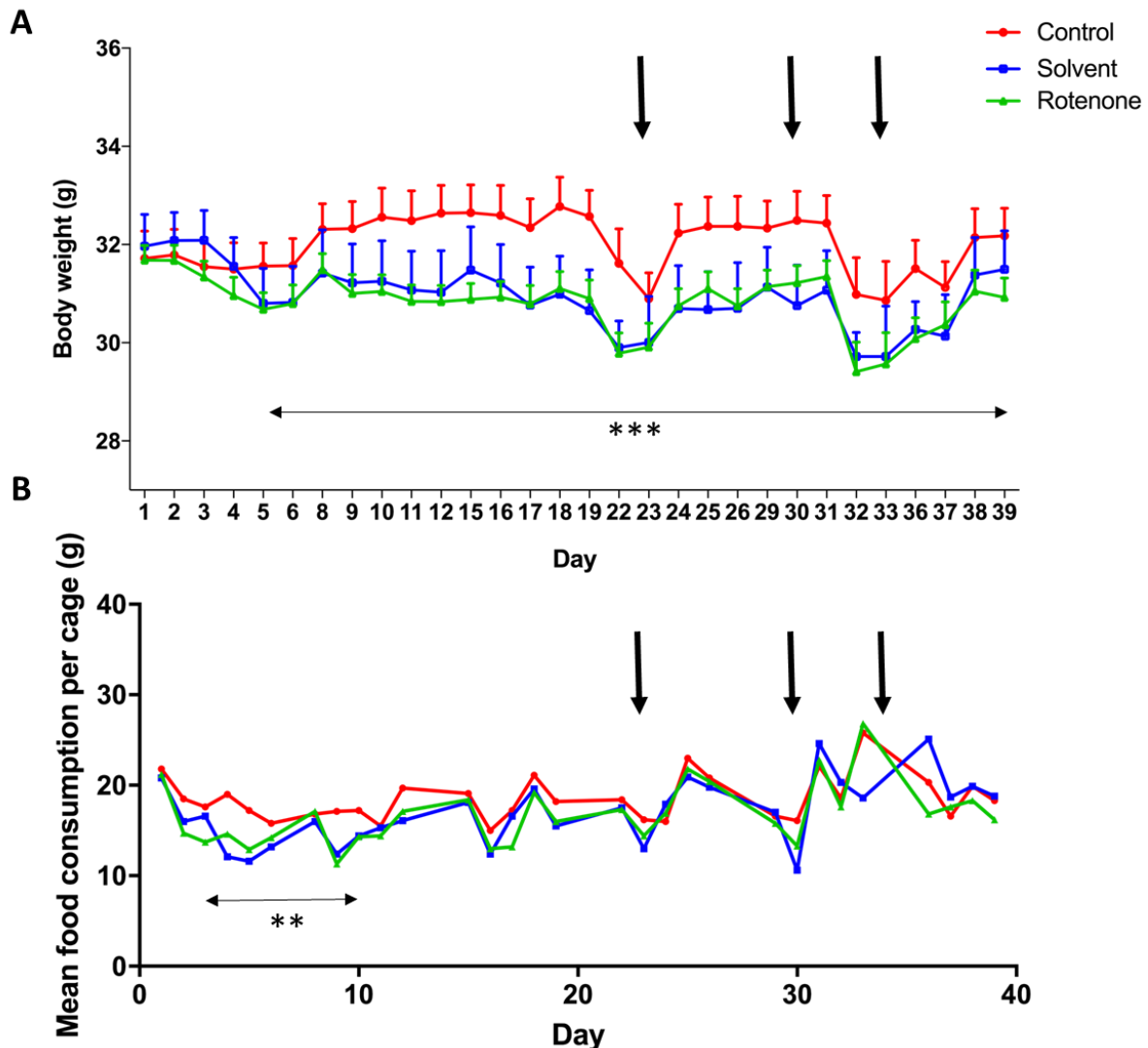

Figure 43: Daily body weight variations and mean food consumption throughout the experiment. A) Graphic representation of the mean daily body weight \pm SEM per experimental group during the six weeks of the experimental procedure. Body weight of control mice was significantly higher than the body weight of animals in both solvent and rotenone-exposed groups ($***p < 0.001$). B) Graphic representation of the mean daily food intake per cage with 2 cages ($n=5/\text{cage}$) per group. A significant decrease in solvent and rotenone groups was observed during the first 10 days of the experimental procedure ($**p < 0.01$). Black arrows indicate the days when blood sampling (day 30) and intestinal motility tests (days 23 and 34) were performed.

Solvent and rotenone-exposed mice lost weight after 1.5 months of the experimental procedure (mean weight difference between the first and the last day of experimental procedure in control mice = $+0.39 \pm 0.27$ versus -0.59 ± 0.44 in solvent mice and -0.75 ± 0.32 in rotenone mice, $p < 0.001$). This loss appeared in the first days of the procedure (post-hoc

analysis, $p < 0.001$ between control and rotenone-exposed mice from D5 to D9, and between solvent and rotenone-exposed animals on D8) and was accompanied by a transient decrease in food consumption (Day 4-10, $p < 0.01$). No further decrease in body weight or in the food consumption was observed after this first week. The gavage alters the body weight during the first days of the experimental procedure. However, this alteration was observed both in solvent and rotenone-exposed mice, suggesting that rotenone itself does not affect the body weight or the food consumption after 1.5 months of the experimental procedure. In addition, the weight of several organs (liver, kidneys, gastrocnemius, soleus and heart) removed at the autopsy at the end of the experiment was similar between the three groups. **This suggests that orally administered-rotenone for 1.5 months has no systemic effect at the concentration of 5mg/kg/day.**

2.2.2. Evaluation of non-motor symptoms after 1.5 months of exposure to low doses of the pesticide rotenone

During the years preceding the appearance of motor symptoms, PD patients often complain about non-motor symptoms among which gastro-intestinal are very common (Cloud and Greene, 2011; Poewe, 2008). In order to assess mouse gastro-intestinal function during the whole experimental procedure, we adapted a non-invasive test assessing intestinal motility in a novel environment (Wang et al., 2008). The day of the test, the mice were individually placed in a new cage similar to their home cage but with no litter and a grid at the bottom to avoid coprophagy. This new environment, combined with the social isolation, generated a mild stress for the mice which enhanced the activity of the autonomic nervous system therefore increasing the excretion of feces. Each mouse was observed during 2 hours by an experimenter and the number of feces was counted every 15 min during the first hour and at the end of the 2 hours period (see the Material and Methods section for further details on the protocol). The number of excreted feces was counted for all groups at different time-points of rotenone exposure (before the beginning of rotenone exposure (Fig. 44A), after one month of rotenone exposure (Fig. 44B) and after 1.5 months of rotenone exposure (Fig. 44C), and the cumulative number of emitted feces after 1.5 months was compared to the number monitored before the beginning of the experiment (Fig. 44D). As expected, the intestinal motility test in reaction to novelty activated the autonomic nervous system as shown by the global increase in the cumulative number of feces emitted by all animals before the beginning of the experimental procedure. Note that at this time-point, all animals were already assigned to an experimental group (Fig. 44A).

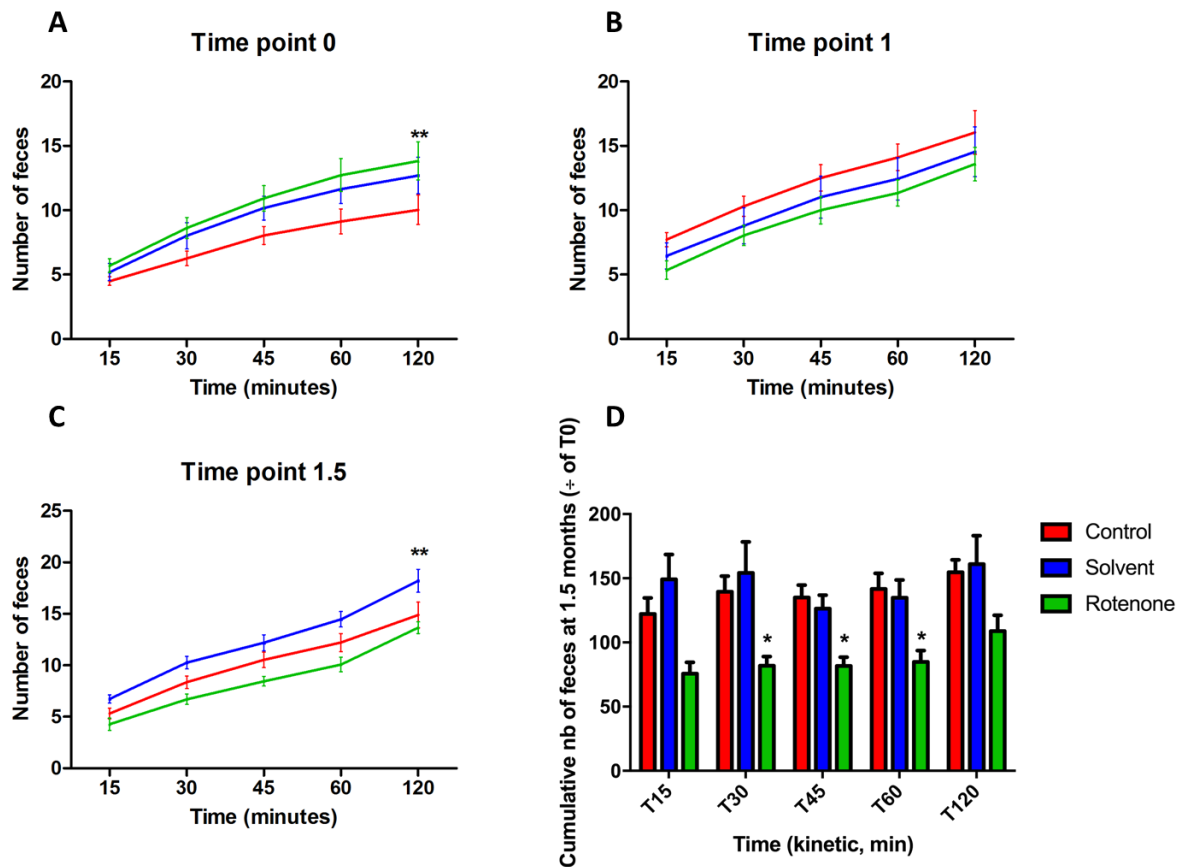

Figure 44: Chronic low doses of the pesticide rotenone alter intestinal motility in 1 year old C57BL/6J male mice. The cumulative number of excreted feces after 15, 30, 45, 60 and 120 min in the cage was assessed before the beginning of rotenone exposure (A), after 1 month of the experimental procedure (B) and at the end of rotenone exposure (C). D) Cumulative number of excreted feces after 15 min (T15), 30 min (T30), 45 min (T45), 60 min (T60) and 120 min (T120), represented as a ratio between the beginning and the end of the experimental procedure and expressed in percentage. The data is plotted as mean \pm SEM (n=10 mice per group).

Interestingly, mice exposed to rotenone emitted less feces compared to other experimental groups from 1 month of the experimental procedure, an effect which became significant after 1.5 months of pesticide exposure (Fig. 44C and 44D). Table 8 below shows the detailed mean number of feces emitted across the study.

In conclusion, of the exposure to low doses of the pesticide rotenone during 1.5 months significantly reduced the intestinal motility in 1 year old C57BL/6J male mice, therefore mimicking one of the non-motor symptoms of PD early stages as documented in humans. This satisfies one important face validity criterion for an experimental model of early parkinsonism (i.e. presence of non-motor alterations at an early stage of the disease).

TIMING OF THE EXPERIMENT EXPERIMENTAL GROUP	Before Exposure					After 1 month Exposure					After 1.5 months Exposure				
	T15	T30	T45	T60	T120	T15	T30	T45	T60	T120	T15	T30	T45	T60	T120
Control (n=10)	4.49 ± 0.33	1.76 ± 0.40	1.78 ± 0.28	1.08 ± 0.34	0.90 ± 0.34	7.72 ± 0.55	2.58 ± 0.39	2.20 ± 0.53	1.59 ± 0.34	1.94 ± 0.80	5.31 ± 0.50	3.04 ± 0.50	2.17 ± 0.30	1.68 ± 0.30	2.66 ± 0.51
Solvent (n=10)	5.19 ± 0.67	2.82 ± 0.51	2.15 ± 0.43	1.46 ± 0.27	1.06 ± 0.49	6.45 ± 1.02	2.34 ± 0.51	2.23 ± 0.40	1.42 ± 0.37	2.10 ± 0.54	6.73 ± 0.39	3.53 ± 0.52	1.93 ± 0.23	2.26 ± 0.48	3.74 ± 0.81
Rotenone (n=10)	5.69 ± 0.53	2.92 ± 0.62	2.30 ± 0.39	1.80 ± 0.36	1.10 ± 0.35	5.35 ± 0.72	2.70 ± 0.48	1.95 ± 0.41	1.34 ± 0.37	2.24 ± 0.45	4.27 ± 0.58	2.43 ± 0.33	1.75 ± 0.41	1.61 ± 0.46	3.57 ± 0.47

Table 8: Mean number of emitted feces per group and per time spent in the intestinal motility test before and after 1 and 1.5 months of the experimental procedure. The number of feces emitted after 15, 30, 45, 60 and 120 min spent in the cage was adjusted to 30g of body weight. Data are presented as mean ± SEM.

2.2.3. Investigation of the motor behavior after 1.5 months of exposure to low doses of the pesticide rotenone

2.2.3.1. Analysis of the global motor behavior

The global motor behavior was assessed using the spontaneous activity test (adapted from Fleming, 2004, as detailed in the material and methods section.)

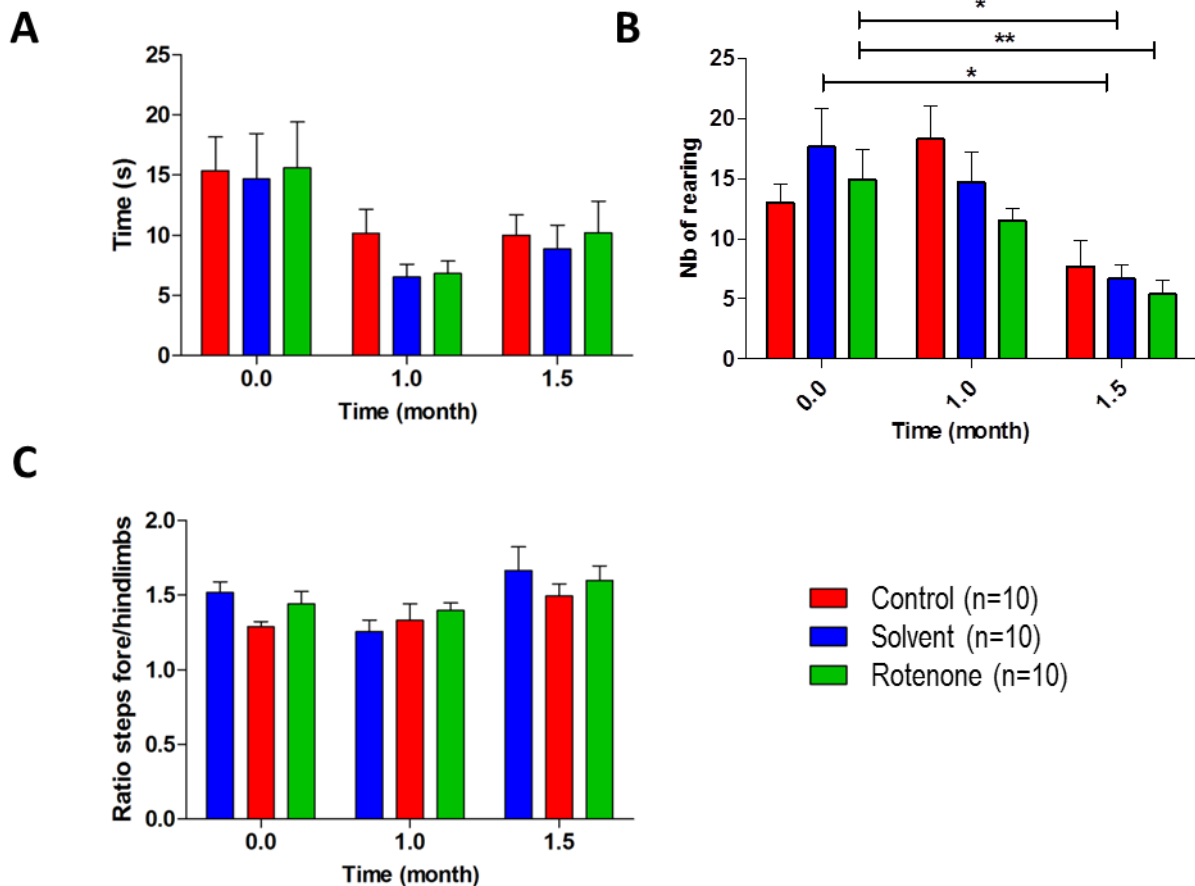

Figure 45: Spontaneous motor activity in response to novelty as measured in the cylinder test. A) Mean time spent grooming per group at the beginning, after 1 and 1.5 months of the experimental procedure. B) Mean number of rearings per group at the beginning, after 1 and 1.5 months of the experimental procedure. C) Ratio of the mean number of steps made with respectively forelimbs and hindlimbs per group across the study. A step was counted when an animal sequentially moved both forelimbs across the floor in one consecutive movement. A step was not counted if the time between the movement of one limb and the other limb exceeded 5 sec. All results are presented as mean \pm SEM (n=10/group).

No significant difference was observed in between groups for the time spent grooming (Fig. 45A) and for the number of steps (Fig. 45C). However, solvent and rotenone-exposed mice reared less after 1.5 months of the experimental procedure compared to controls (* $p < 0.05$ and ** $p < 0.001$ respectively) suggesting a global habituation of these mice to the test, resulting in decreased exploratory behavior. As this effect is not specific to rotenone mice, we concluded that **the exposure to low doses of the pesticide rotenone during 1.5**

months does not affect the spontaneous motor behavior as measured in the cylinder test.

2.2.3.2. Analysis of the fine motor coordination between mouse fore- and hindlimbs

Since PD symptoms appear progressively over time, the absence of global motor deficits could mask subtle alterations of motor capacities such as the coordination between the animals' fore- and hindlimbs. The challenging beam traversal test was therefore used to assess the fine motor coordination in mice as described in the Material and Methods section.

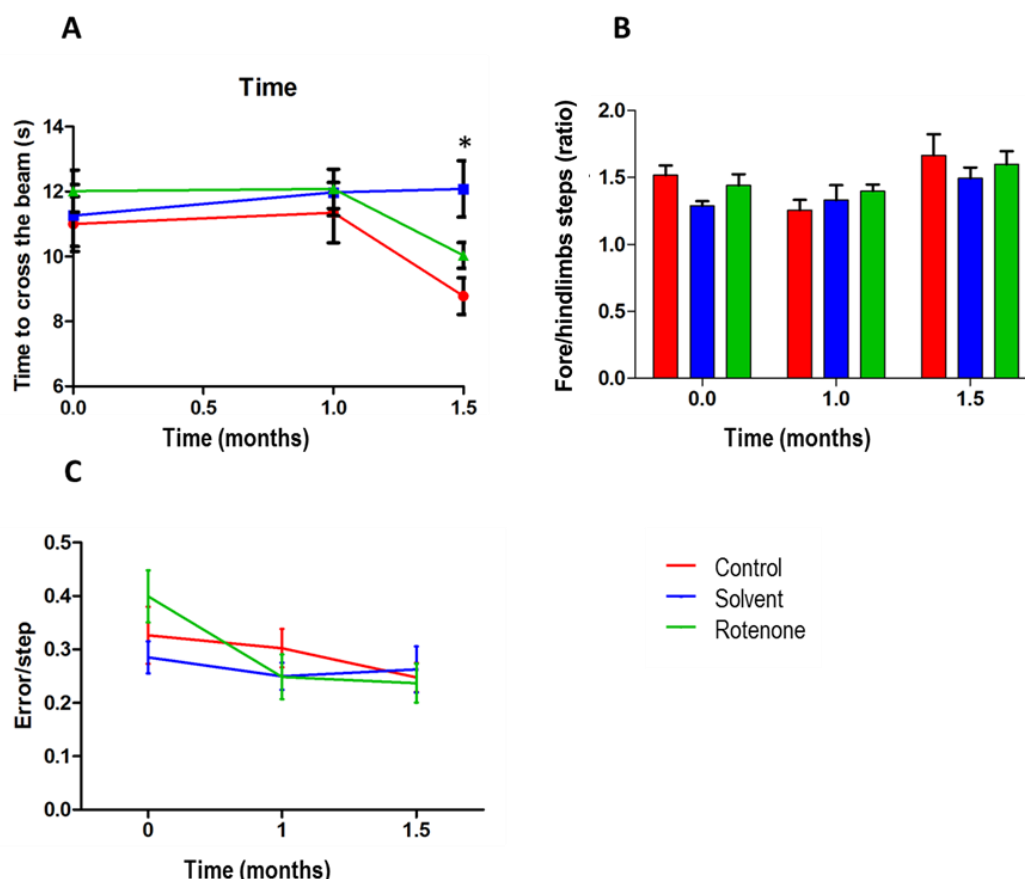

Figure 46: Fine motor coordination as analyzed using the challenging beam traversal test. A) Time needed to cross the beam as measured in the three experimental groups (controls in red, n=10; solvent in blue, n=10; rotenone in green, n=10) before (time 0) and after 1 and 1.5 months of exposure. B) Number of steps, defined as a sequential movement of fore- or hind-limbs across the floor in less than 5 sec, while crossing the beam in the three experimental groups at each time point of the experiment. C) Number of errors per step in the different experimental groups at each time-point of the experiment. All data are expressed as mean \pm SEM.

Exposure to low doses of rotenone does not alter the fine motor coordination in the challenging beam traversal test (Fig. 46). Indeed, rotenone-exposed mice needed 10.1 ± 0.38 sec to cross the 1m-long beam whereas solvent and control mice needed respectively 11.6 ± 0.60 sec and 8.9 ± 0.53 sec. Similarly, all mice made more errors in the third section of the beam, when the task became more complex (mean errors per step in control mice =

3.53 ± 0.44 versus 3.28 ± 0.30 in solvent and 3.26 ± 0.27 in rotenone-exposed mice), but there was no between group difference, either for the number of steps needed to cross the beam or for the number of errors per step.

In conclusion, chronic exposure to low doses of rotenone does not alter the global or the fine motor behavior as assessed with the cylinder test and the challenging beam traversal test. This animal model therefore presents good face validity for the reproduction of PD early stages when no motor symptoms can be noticed.

2.2.4. Post-mortem analyses

2.2.4.1. Histopathological analysis of the substantia nigra

To further assess the face validity of this mouse model of early parkinsonism induced by exposure to low doses of the pesticide rotenone, the number of TH-positive neurons was counted in the SN of C57BL/6J mice from the control group and after 1.5 months of exposure to either the solvent or rotenone (Fig. 47).

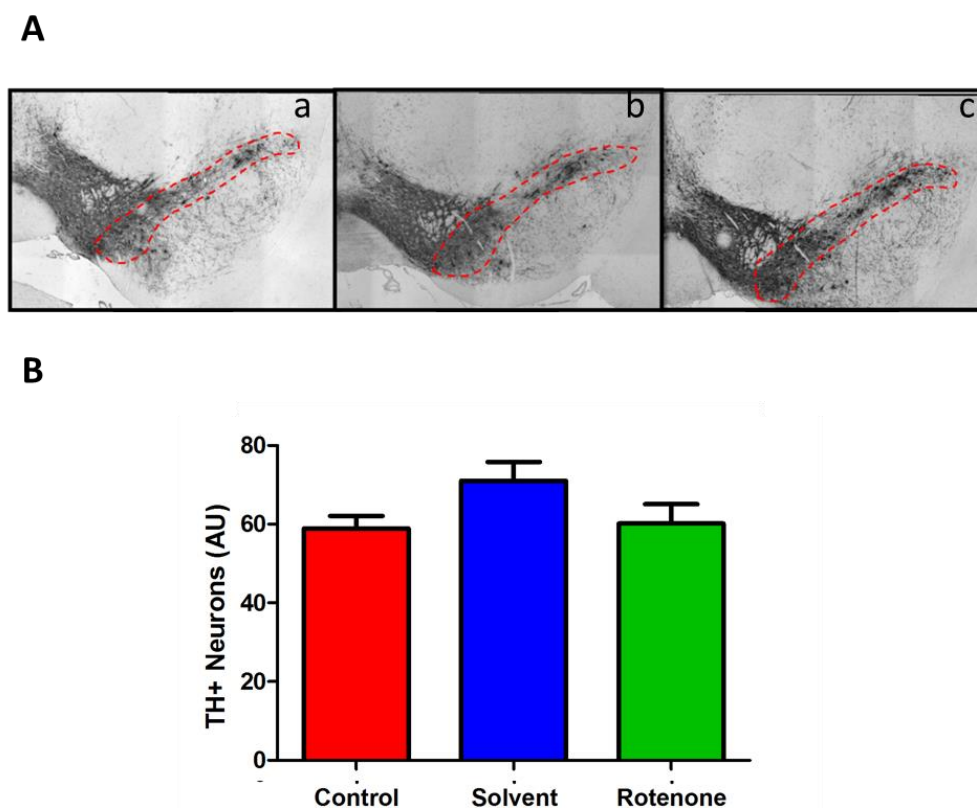

Figure 47: Immunohistological analysis of the substantia nigra. A) Representative photographs of the substantia nigra (SN) as observed on a frontal section at Bregma - 3.52mm in control (a), solvent-exposed (b) and rotenone-exposed (c) mice. The SNc is surrounded with a red dotted line. B). The mean number of tyrosine hydroxylase (TH)-producing cells does not significantly differ in the SN between the experimental groups. The results are presented as mean ± SEM (n=4/group).

Figure 47A shows representative images of TH-positive within the right SN (at Bregma -3.52mm) taken at the X100 magnification in the three groups. The mean number of TH-positive neurons did not significantly differ in between groups (Fig. 47B, control = 58.89 ± 3.21 versus 71.04 ± 4.81 in solvent and 60.16 ± 4.96 in rotenone-exposed mice, n.s.). The counting of TH-positive neurons did not reveal any difference in between groups (mean number of dopaminergic neurons per section of SNc in control mice = 58.89 ± 3.21 versus 71.04 ± 4.81 in solvent and 61.16 ± 4.96 in rotenone-exposed mice, n.s.). Therefore, the exposure to low doses of rotenone for 1.5 months did not alter the number of dopaminergic neurons within the SN.

In conclusion, both behavioral and histological analyses show an absence of effect of exposure to low doses of the pesticide rotenone for 1.5 months on both the motor function and the SN dopaminergic population, which is consistent with the requirements for modeling PD premotor stages in animals. However, this regimen of exposure altered the intestinal motility. This therefore satisfied the face validity criteria of this rodent model of early stages of parkinsonism in our animal facility.

2.2.4.2. Analysis of the intestinal neuronal populations

In order to further characterize this animal model at later time-points of exposure, the different neuronal populations present in the intestine of mice exposed to 5mg/kg/d of rotenone or to the solvent during 2 or 4 months were analyzed using western blots. The intestinal tissues were collected from an independent study conducted by Dr. Pan-Montojo (Germany) after 2 and 4 months of experimental procedure and stored at -80°C until further use. Duodenum, jejunum, ileum and colon samples from solvent and rotenone-exposed mice were individually analyzed. Pgp9.5, a ubiquitin carboxy-terminal hydrolase mainly expressed in nerve cells, was used as a marker of neurons and compared to glyceraldehyde-3-phosphate-dehydrogenase (Gapdh), which is stably expressed in all intestinal cell populations.

After two months of exposure to rotenone, no difference in the protein expression of Pgp9.5 was detected in the intestine compared to solvent-exposed mice (Fig. 48 ; Fig. 49). The relative protein expression of choline acetyltransferase, the rate limiting enzyme involved in the synthesis of acetylcholine within cholinergic neurons, was analyzed in all intestinal samples of rotenone-exposed mice compared to solvent-exposed mice. Chat-normalized expression (normalization to the neuronal marker Pgp9.5) was not significantly modified after two months of oral exposure to low doses of the pesticide rotenone when compared to controls (relative Chat expression in the duodenum: 1.00 ± 0.10 in solvent versus 0.83 ± 0.16 in rotenone-exposed mice; relative Chat expression in the jejunum: 1.00 ± 0.10 in solvent versus 0.90 ± 0.09 in rotenone-exposed mice; relative Chat expression in the ileum: 1 ± 0.02

in solvent *versus* 0.80 ± 0.13 in rotenone-exposed mice; relative Chat expression in the colon: 1.00 ± 0.15 in solvent *versus* 0.56 ± 0.06 in rotenone-exposed mice).

Tyrosine hydroxylase relative protein expression, the enzyme implicated in the synthesis of catecholamines such as dopamine, epinephrine and norepinephrine, was analyzed in parallel within the same samples. After two months of rotenone exposure, normalized-TH expression was significantly higher in the duodenum (Fig. 48A and 49A, $p < 0.05$) and the colon (Fig. 48D and 49D, $p < 0.05$) of rotenone-exposed mice compared to solvent. However, no difference was observed in the ileum and the jejunum.

After 4 months of exposure to rotenone, no change in Pgp9.5, ChAT and TH protein expression was observed in the four intestinal region tested (see Fig. 50 and 51; relative Chat expression in the duodenum: 1.00 ± 0.17 in solvent *versus* 0.58 ± 0.09 in rotenone-exposed mice; relative Chat expression in the jejunum: 1.00 ± 0.23 in solvent *versus* 0.58 ± 0.07 rotenone-exposed mice; relative Chat expression in the ileum: 1.00 ± 0.04 in solvent *versus* 0.96 ± 0.13 in rotenone-exposed mice; relative Chat expression in the colon: 1.00 ± 0.15 in solvent *versus* 1.00 ± 0.04 in rotenone-exposed mice; relative Th expression in the duodenum: 1.00 ± 0.17 in solvent *versus* 0.78 ± 0.19 in rotenone-exposed mice, n.s.; relative Th expression in the jejunum: 1.0 ± 0.22 in solvent *versus* 0.98 ± 0.24 in rotenone-exposed mice, n.s.; relative Th expression in the ileum: 1.00 ± 0.15 in solvent *versus* 1.50 ± 0.34 rotenone-exposed mice, n.s.; relative Th expression in the colon: 1.00 ± 0.24 in solvent *versus* 1.29 ± 0.16 in rotenone-exposed mice, n.s.). In summary, the chronic oral exposure to low doses of the pesticide rotenone for two and four months modifies TH-positive neuronal populations within the intestine in a region and treatment-dependent manner. Indeed, TH-normalized expression was significantly increased in the duodenum and the colon after two months of rotenone exposure, therefore confirming the impact of rotenone on TH-producing cells in the peripheral nervous system.

In conclusion, the exposure of 1 year old C57BL/6J male mice to low doses of rotenone for 1.5 months altered intestinal motility as evidence in the non-invasive intestinal motility test. However, the global motor behavior and the fine motor coordination were not affected in these mice and the number of SN dopaminergic neurons was similar between all groups studied. Such non-motor impairments in the absence of motor dysfunction and of neuronal degeneration within the SN are the hallmarks of early stages of PD in humans. We therefore validated this animal model of early stages of parkinsonism after chronic oral exposure to low doses of the pesticide rotenone in our animal facility.

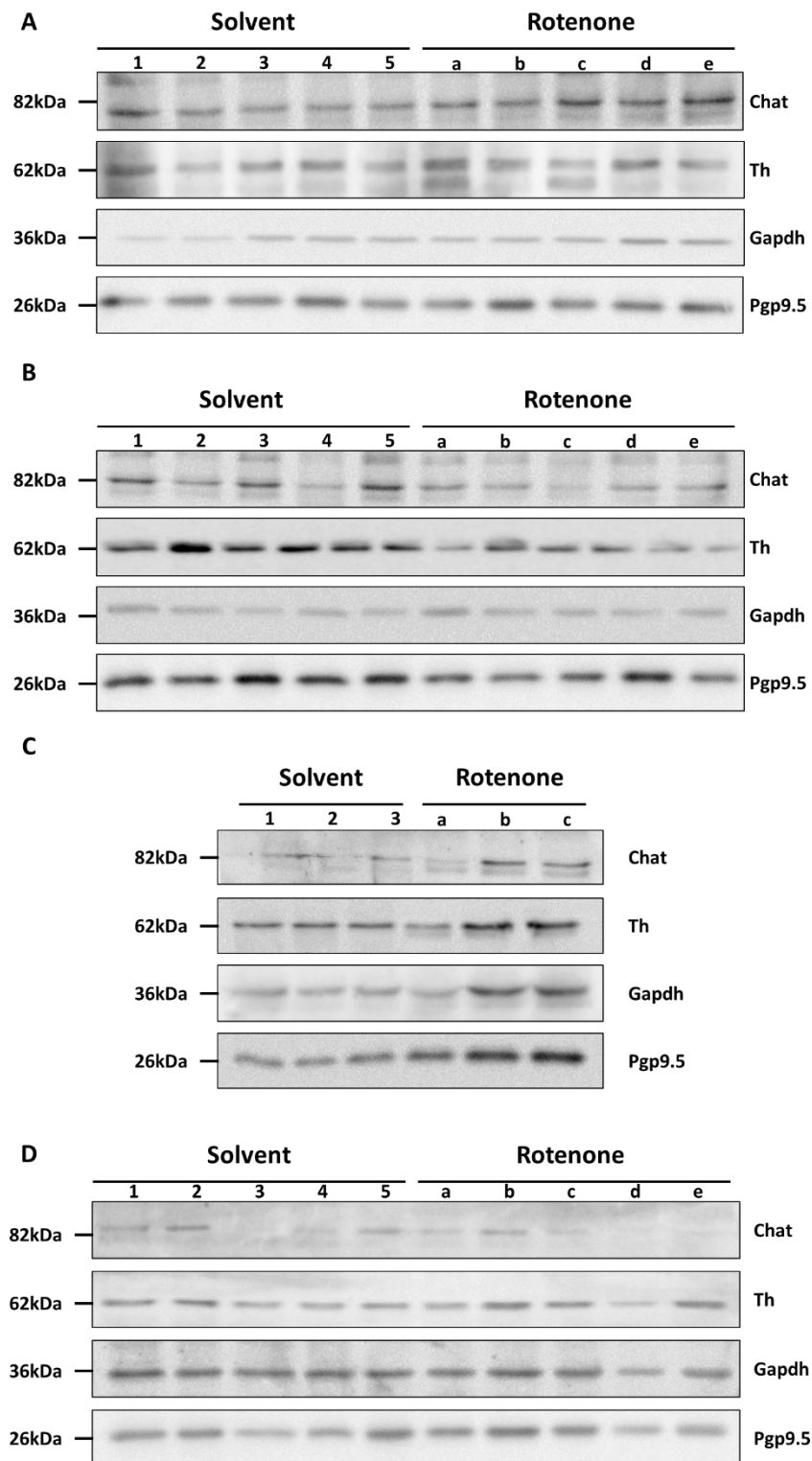

Figure 48: Rotenone-induced modifications of neuronal markers in the intestine of 1 year old mice after 2 months of exposure as analyzed by western blot. A-D) Representative western blots using antibodies raised against choline acetyltransferase (Chat), tyrosine hydroxylase (Th), Pgp9.5 and glyceraldehyde-3-phosphate-dehydrogenase (Gapdh), respectively undertaken in the duodenum (A), the jejunum (B), the ileum (C) and the colon (D) of mice exposed to the solvent or to chronic low doses of rotenone (5mg/kg/day) during 2 months. Gapdh expression was used as a loading control.

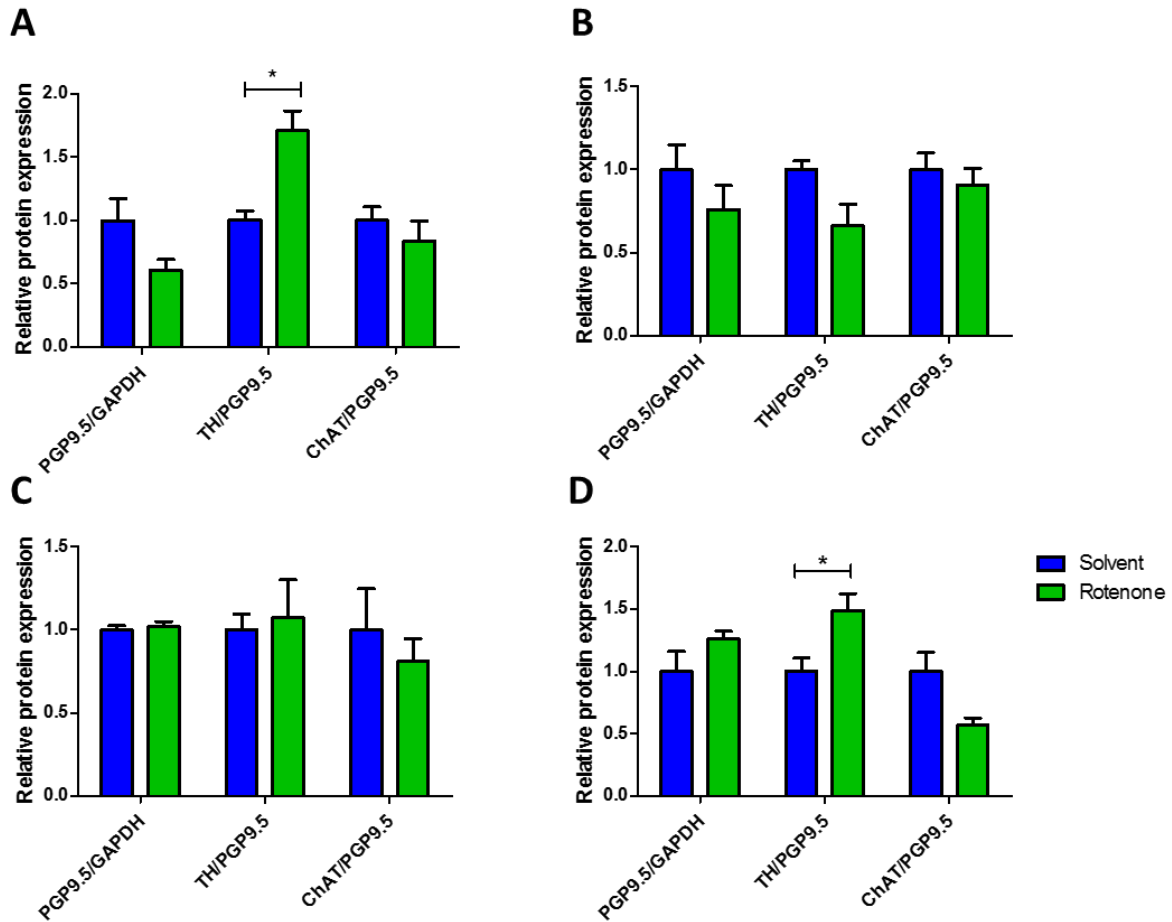

Figure 49: Relative expression of several neuronal markers in the intestine of 1 year old mice exposed to the pesticide rotenone for 2 months. A-D) Graphic representation of the relative protein expression of choline acetyltransferase (Chat) and tyrosine hydroxylase (Th) both normalized to the expression of Pgp9.5, and of Pgp9.5 normalized to the expression of glycerinaldehyde-3-phosphat-dehydrogenase (Gapdh) in respectively the duodenum (A; n=5/group), the jejunum (B; n=5/group), the ileum (C; n=3/group) and the colon (D; n=5/group) (*p<0.05).

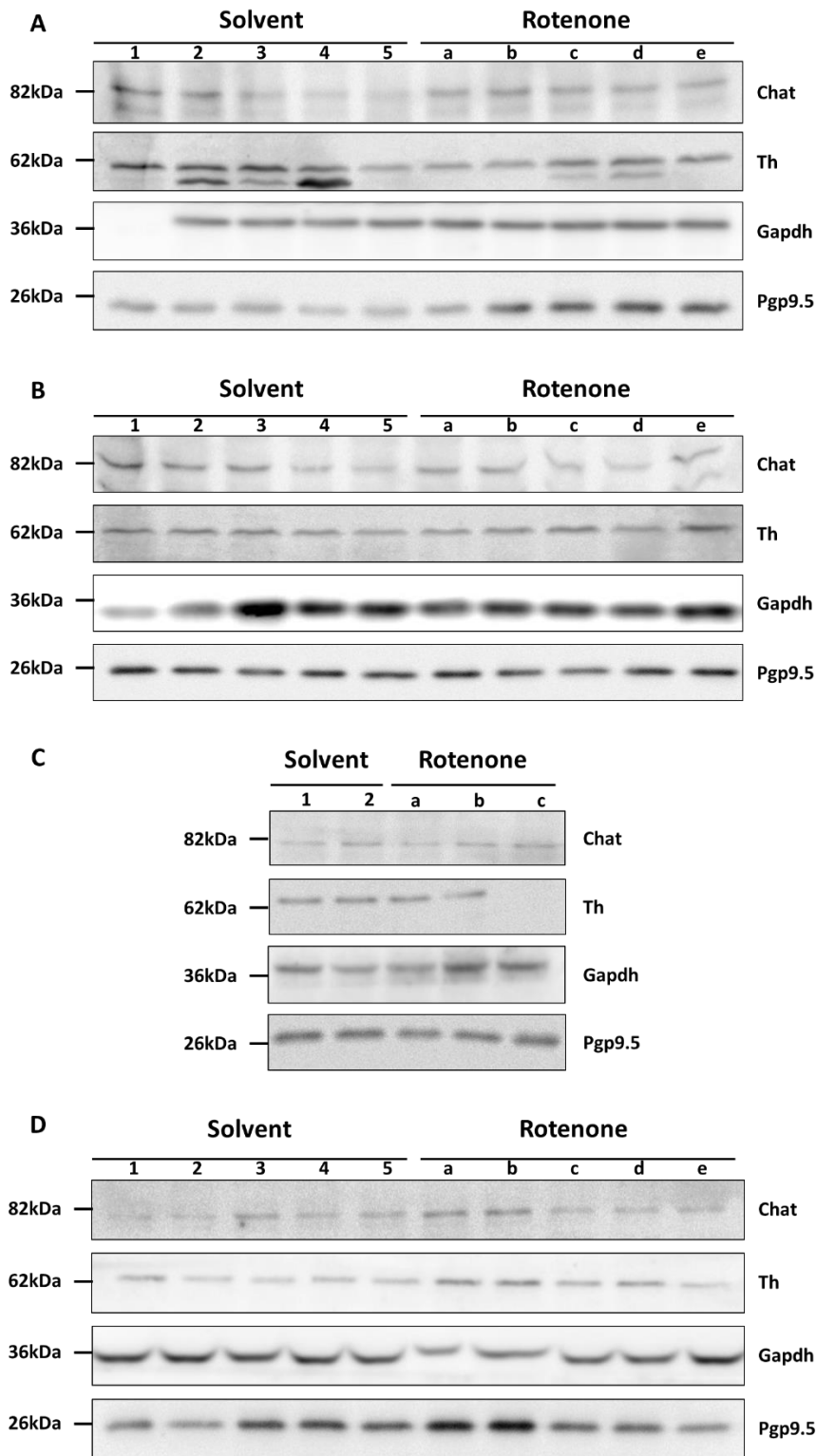

Figure 50: Rotenone-induced modifications of neuronal markers in the intestine of 1 year old mice after 4 months of exposure. A-D) Representative western blots using antibodies raised against choline acetyltransferase (Chat), tyrosine hydroxylase (Th) and Pgp9.5 normalized to the expression of glyceraldehyde-3-phosphat-dehydrogenase (Gapdh), respectively undertaken in the duodenum (A), the jejunum (B), the ileum (C) and the colon (D) of mice exposed to the solvent or to chronic low doses of rotenone (5mg/kg/day) during 4 months. Gapdh expression was used as a loading control.

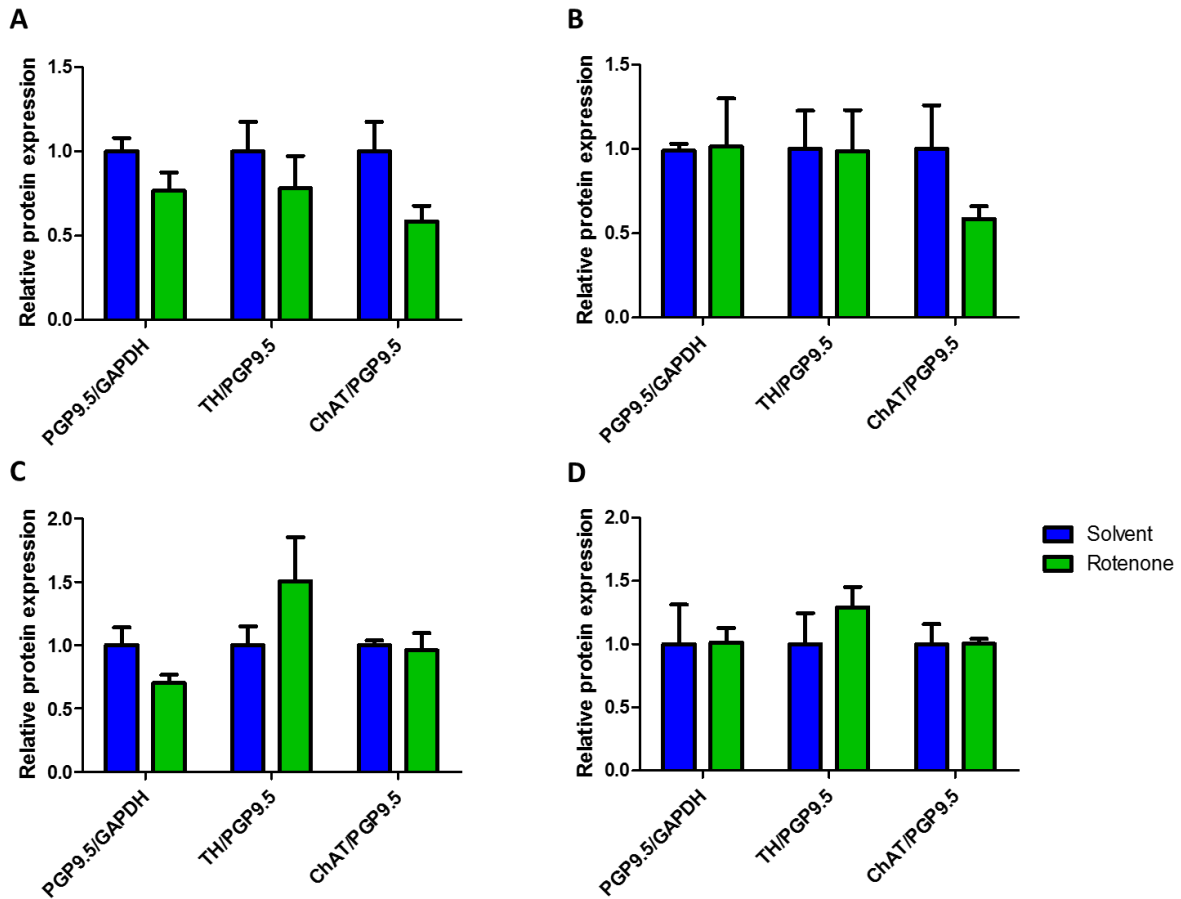

Figure 51: Relative expression of several neuronal markers in the intestine of 1 year old mice exposed to the pesticide rotenone for 4 months. A-D) Graphic representation of the relative protein expression of choline acetyltransferase (Chat) and tyrosine hydroxylase (Th) both normalized to the expression of Pgp9.5, and of Pgp9.5 normalized to the expression of glycerinaldehyde-3-phosphat-dehydrogenase (Gapdh) in respectively the duodenum (A; n=5/group), the jejunum (B; n=5/group), the ileum (C; n=2/ solvent group, n=3/rotenone group) and the colon (D; n=5/group).

2.3. Ghrelin variations in a mouse model of early parkinsonism

2.3.1. Plasma ghrelin variations after 1.5 months of rotenone exposure

Based on the satisfying level of validation of this rodent model of early stages of parkinsonism, plasma acyl- and desacyl-ghrelin concentrations were investigated after rotenone exposure in 1 year old male mice. The details of the experimental procedure are exposed in the Material et Methods section and results are shown figure 52 below.

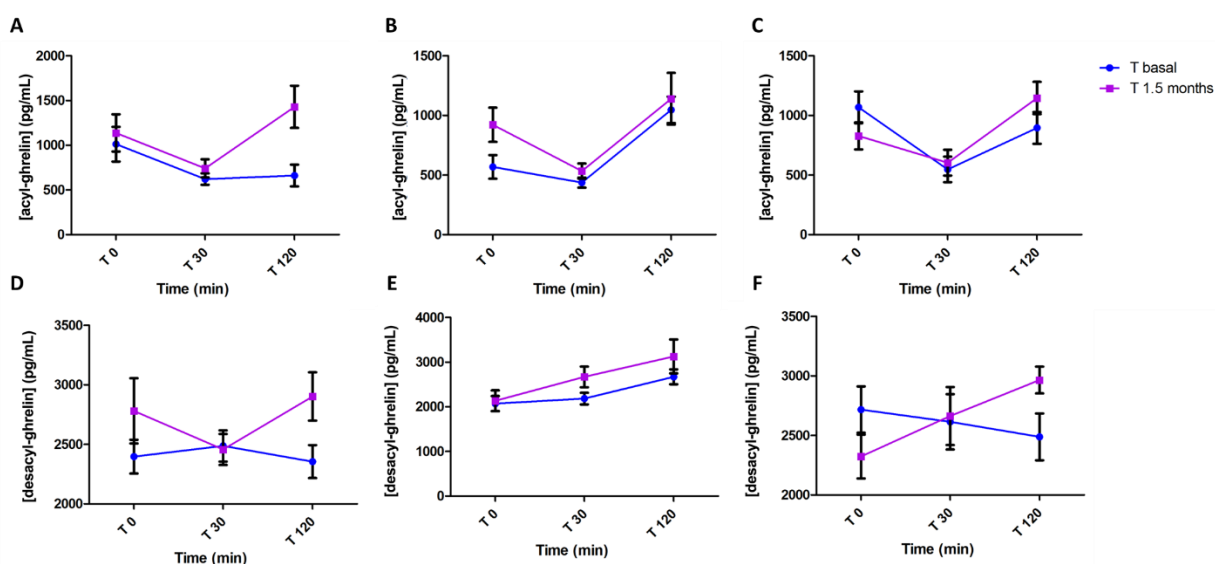

Figure 52: Variations of plasma acyl- and desacyl-ghrelin concentrations throughout the experimental procedure. A-C) Ratio of mean acyl-ghrelin concentrations in the plasma of control (A, n=10), solvent (B, n=10) and rotenone-exposed mice (C, n=10) before and after 1.5 months of exposure. D-E) Ratio of mean desacyl-ghrelin concentrations in the plasma of control (D, n=10), solvent (E, n=10) and rotenone-exposed mice (F, n=10) after 1.5 months of exposure. Blood samples were collected from all mice before and after a standard meal as described in the Material and Methods section. The data are presented as mean \pm SEM.

For the three experimental groups, plasma acyl-ghrelin concentrations were higher after an overnight fast, decreased after the food access and increased again at 120 min both before and after 1.5 months of experimental procedure, except in the control group before the experiment. Acyl-ghrelin concentrations in the plasma of rotenone and solvent animals were similar at the beginning of the experimental procedure and after 1.5 months. For the three experimental groups, plasma desacyl-ghrelin concentrations were highly variable between mice of the same group. Moreover, no significant difference was observed in plasma desacyl-ghrelin concentrations after 1.5 months of exposure.

In conclusion, the exposure to low doses of the pesticide rotenone for 1.5 months did no alter plasma acyl- and desacyl-ghrelin concentrations.

2.3.2. Ghrelin-related gene expression in the duodenum of rotenone-exposed mice

Last, to further characterize this animal model of early parkinsonism in relation to ghrelin, we analyzed ghrelin-related gene expression within the duodenum using qPCR. In particular, we focused on the expression of three of the four existing transcript variants of the mouse *Ghrl* gene (see Fig. 53) and of the prohormone convertase 1/3 (*Pscck1*), an enzyme implicated in the processing of proghrelin into mature ghrelin protein (see introduction, chapter 3, Fig. 18). Since the main innervation of the gastro-intestinal tract consists in cholinergic neurons, the gene expression of *Chat* was also studied in parallel. The peptidylprolyl isomerase A was used as a reference gene to normalize gene expression between mice.

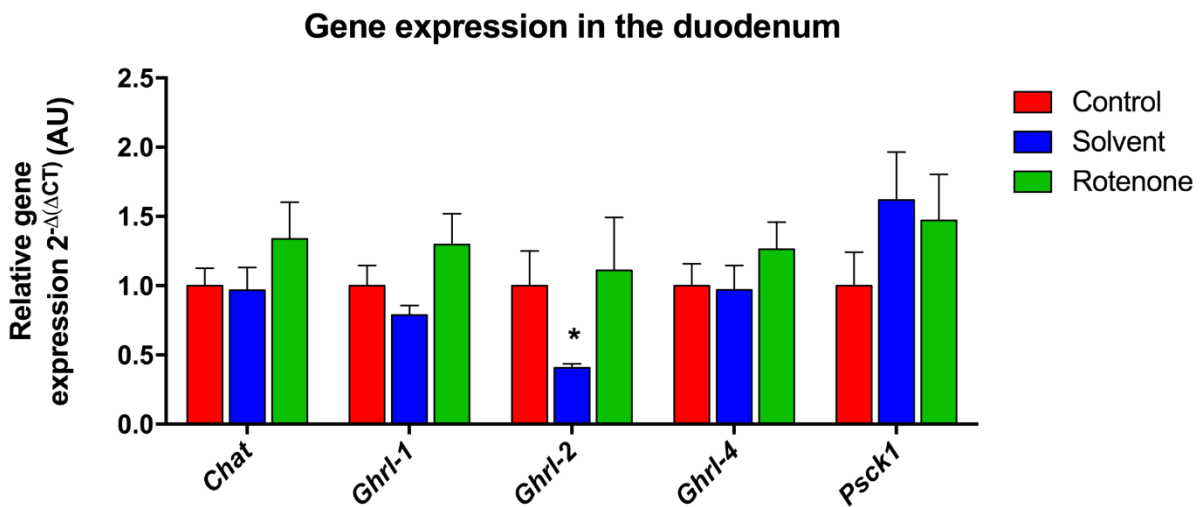

Figure 53: Relative gene expression in the duodenum of C57BL/6J mice as measured by qPCR. The results are plotted as mean ratio of 5 independent samples per group and expressed using the $2^{-\Delta(\Delta CT)}$ method as detailed in the Material and Methods section. The relative gene expression of choline acetyl transferase (*Chat*), of *ghrelin* gene variants 1, 2 and 4 (*Ghrl-1*, *Ghrl-2* and *Ghrl-4*) and the prohormone convertase 1/3 (*Pscck1*) were compared to the expression of the reference gene *peptidylprolyl isomerase A*.

Figure 53 shows a global tendency to increase in the expression of all genes investigated in the rotenone group compared to controls and solvent-exposed animals, although it did not reach statistical significance. One can note a similar increase of *Ghrl-2* variant expression which was significantly higher in rotenone-exposed mice compared to the solvent group. This latter group showed an unexpected reduced expression for this specific variant.

In summary, no significant differences in the protein and mRNA levels of ghrelin were observed after 1.5 months of exposure to low doses of the pesticide rotenone.

To conclude, 1 year old C57BL/6J male mice exposed to 5mg/kg/day of rotenone during 1.5 months progressively developed an altered intestinal motility but did not

present any global or fine motor impairment, as evaluated with the spontaneous activity test and the challenging beam traversal test. Brain immunohistopathological analyses did not reveal differences in the number SN dopaminergic neurons between groups. We therefore validated the animal model of early stages of parkinsonism in our animal facility. This *in vivo* study did however not reveal differences in acyl- or desacyl-ghrelin concentrations in this mouse model of early parkinsonism after 1.5 months of cumulative low doses of the pesticide rotenone. This therefore does not validate the potential of ghrelin as a biomarker of PD early stages.

CHAPTER 6: DISCUSSION

At the beginning of the present work, and in view of the divergent data from the literature, our objectives were to clarify the potential roles of ghrelin as a biomarker of early PD stages and as a disease-modifying agent having shown interesting neuroprotective properties in specific *in vitro* and *in vivo* models (cf. introduction chapter 3, §2.3.). As exposed earlier in this manuscript, we chose to investigate the disease-modifying properties of this orexigenic peptide in mouse primary mesencephalic cells exposed to low doses of the pesticide rotenone. This *in vitro* model presents a good internal validity as these cultures are heterogeneous and contain a small amount of TH-positive cells together with a majority of other cell types such as glial cells which provide trophic support to neighboring neurons (Falkenburger et al., 2016; Ikemoto et al., 1998): this reproduces the cerebral microenvironment of the SN more closely than other *in vitro* models. Moreover, this model also displays good construct and face validities since the exposure to low doses of rotenone, a pesticide known to induce parkinsonism in humans (Tanner et al., 2011b), induces a progressive neuronal death among primary dopaminergic cells. This model therefore allows to study the progressive molecular and cellular modifications ultimately leading to the characteristic neurodegeneration of dopaminergic SNc neurons as observed in PD brain (Tretiakoff, 1919). Our data suggest that, whereas acyl-ghrelin did not exert any neuroprotective effect in our experimental conditions, desacyl-ghrelin seemed to prevent the rotenone-induced reduction in the number of TH-positive cells. In parallel, the transcriptomic analyses conducted on patients-derived samples showed a reduced expression of the ghrelin opposite strand/antisense non-coding RNA *GHRLOS* in PD samples. Since *GHRLOS* is a known regulator of ghrelin expression (Seim et al., 2008b), such a reduced expression in PD patients is therefore expected to alter ghrelin concentrations in biological fluids: if specific and sensitive enough, this indicator could be used as a biomarker of PD, and possibly of early phases of the disease including the premotor stage. However, our preliminary *in vivo* study in a model of chronic exposure of 1 year old male mice to low doses of the pesticide rotenone, a protocol mimicking premotor stages of PD, showed similar plasma concentrations of acyl- and desacyl-ghrelin between mice exposed to rotenone for 1.5 months and control animals. In the next pages, we intend to first discuss the relevance and limits of using acyl-ghrelin *versus* desacyl-ghrelin as disease-modifying strategies in experimental analogues of PD. We will also discuss the potential of desacyl-ghrelin in the context of PD taking into account the currently limited knowledge on its physiological roles. Last, the relevance of conducting human-based studies for further validation of ghrelin-derived molecules in PD patients will be commented before addressing the experimental perspectives of this thesis work.

1. Ghrelin as a disease-modifying agent in PD: is the good player acyl- or desacyl-ghrelin?

As described in the introduction, recent research have suggested a disease-modifying role of ghrelin in *in vivo* and *in vitro* models of parkinsonism (Andrews et al., 2009; Dong et al., 2009; Moon et al., 2009; Yu et al., 2016). Our *in vitro* investigations in mouse primary mesencephalic cells exposed to low doses of the pesticide rotenone did not confirm this neuroprotective role of acyl-ghrelin. Indeed, the number of TH-positive primary cells did not differ when exposed to rotenone alone and after three days of exposure to acyl-ghrelin plus rotenone. More importantly, after seven days of exposure to acyl-ghrelin and exposure to rotenone for the last three days, the number of TH-positive cells was significantly lower than in cells exposed to rotenone alone. Such a decrease in the number of TH-positive cells, only observed after seven days of exposure to acyl-ghrelin, suggests a time-dependent synergistic deleterious effect of the exposition of primary mesencephalic cells to acyl-ghrelin and rotenone. The results obtained in our conditions of culture therefore oppose to data from the literature. Such divergent results are surprising, in particular compared to another published *in vitro* investigation undertaken in rat primary mesencephalic cells exposed to MPTP (Moon et al., 2009). Indeed, in both our study and the work published by Moon and colleagues (2009), rodent primary mesencephalic cells were exposed to two inhibitors of the mitochondrial complex I, respectively rotenone and MPTP, which resulted in a 60% decrease in the number of TH-positive cells. Although ghrelin exposure started at DIV6 in the study of Moon and colleagues (2009) and at DIV7 in our experiment, this should not play a significant role since rat and mouse embryonic developments are slightly shifted of 0.5 to 1 day (Pruszek et al., 2009). However, ghrelin neuroprotection against TH-positive cell death in primary rat mesencephalic cells and MES23.5 cells was achieved after only 20 min of pre-incubation with ghrelin followed by 24 hours of simultaneous incubation with either MPTP or rotenone (Dong et al., 2009; Moon et al., 2009; Yu et al., 2016). As we did not observe a deleterious effect of acyl-ghrelin on rotenone-exposed cells after three days of incubation, the different timing of exposures and therefore the design of our protocol might explain such divergent results.

Beyond differences in culture and exposure protocols, it has to be stressed out that most published *in vitro* studies did not take into account ghrelin acylation state, therefore the reported neuroprotective effect of ghrelin might be attributed to either acyl- or desacyl-ghrelin (Dong et al., 2009; Moon et al., 2009; Yu et al., 2016). Indeed, due to its short half-life in the blood, mature acyl-ghrelin is rapidly deacylated by cytosolic lysophospholipid hydrolyzing enzyme, namely APT1/lysophospholipase I, therefore deacyl-ghrelin is the major form of circulating ghrelin (Delhanty et al., 2015; Satou et al., 2010). Similarly, this ghrelin

deacylation enzyme can be purified from the medium of cultured cells expressing APT1 as well as from the fetal bovine serum which was used as an additive in culture media of all above-mentioned *in vitro* studies (Satou et al., 2010). Thus, any ghrelin added into the culture medium or injected into rodents is rapidly transformed into desacyl-ghrelin; this is again in support of a probable role of desacyl-ghrelin in all phenomena reported independently of ghrelin acylation state. Nevertheless, the exposure of rat primary mesencephalic cells to D-Lys-3-GHRP-6, an inhibitor of the ghrelin receptor GHSR1a, strongly attenuated the protective effect of ghrelin against MPTP-induced neuronal death (Moon et al., 2009). Since desacyl-ghrelin does not bind the GHSR1a at physiological concentrations (Gauna et al., 2007; Kojima et al., 1999), such a result would suggest an acyl-ghrelin-dependent effect. Yet, this neuroprotective effect of ghrelin in TH-positive rat primary mesencephalic cells was evidenced in presence of ghrelin concentrations in the culture medium ranging from 0.1 to 10nM (Moon et al., 2009; Yu et al., 2016). Considering the estimation of mean desacyl-ghrelin physiological concentrations which amount to 2406.2 ± 105.21 pg/mL in our cohort of 30 C57BL/6J male mice and based on desacyl-ghrelin molecular weight, the concentrations of ghrelin used in these *in vitro* experiments equal up to 31.88×10^3 pg/mL which largely exceeds physiological concentrations. Therefore, one cannot rule out a probable effect of desacyl-ghrelin at the concentrations used in these *in vitro* studies. In the contrary, recent experiments undertaken in a mouse model of advanced parkinsonism induced by intraperitoneal injections of 30mg/kg MPTP over two days showed a neuroprotective effect of acyl-ghrelin in a context of chronic food deprivation, whereas desacyl-ghrelin did not prevent MPTP-induced neuronal death (Bayliss et al., 2016a). Interestingly, this neuroprotective effect of acyl-ghrelin was only evidenced after mice had been submitted to a mild form of food restriction in which ghrelin was injected immediately before the dark phase and food was removed overnight; the following morning each mouse was given 85% of its standard ration. Therefore, ghrelin can restrict the SN dopaminergic neuronal loss and subsequent striatal dopamine depletion in this PD mouse model only when circulating ghrelin levels are boosted at the time when endogenous ghrelin is naturally induced (Andrews et al., 2009; Bayliss et al., 2016a). Similarly, the continuous injection of acyl-ghrelin with an osmotic pump in *ad libitum*-fed mice did not prevent the MPTP-neuronal death within the SN (Andrews et al., 2009), thus further reinforcing the importance of the nutritional status and the timing of ghrelin delivery for observing a protective effect of this orexigenic peptide. Indeed, since the effect of acyl-ghrelin on the number of SNc TH-positive neurons was assessed two weeks after the implantation of acyl-ghrelin-containing osmotic pumps and, based on the short half-life of acyl-ghrelin in biological fluids, the different results obtained in mice submitted or not to caloric restriction might not only arise from the different nutritional status of the animals but also from different methods of ghrelin administration

(continuous delivery *versus* repeated injections), as well as from the rapid deacylation of acyl-ghrelin at the beginning of the exposure. In addition, the different effect of acyl-ghrelin according to the nutritional status of mice can be correlated to the protective effect of caloric restriction against MPTP in mice and non-human primates as discussed earlier in this manuscript (Duan and Mattson, 1999; Maswood et al., 2004). Altogether these observations challenge the hypothesis of a disease-modifying role of acyl-ghrelin in PD.

Interestingly, in our *in vitro* experiments, the simultaneous exposure to desacyl-ghrelin and rotenone for three days induced a slight although non-significant increase in the number of TH-positive cells compared to the cells exposed to rotenone alone. If confirmed, such results would suggest a protective role of desacyl-ghrelin against rotenone-induced neuronal death in primary mesencephalic cells, therefore challenging the above-discussed *in vivo* results (Bayliss et al., 2016a). Desacyl-ghrelin has long been thought to be an inactive peptide resulting from the degradation of acyl-ghrelin with no documented biological activity (Kojima et al., 1999). It is now suggested to antagonize the effects of acyl-ghrelin, notably on glucose metabolism and food intake, which could be of interest in the search for therapeutic strategies against obesity and metabolic syndrome (Asakawa et al., 2005; Broglio et al., 2004b; Delhanty et al., 2014). Moreover, a protective role of desacyl-ghrelin has already been shown against apoptosis in cardiomyocytes, microendothelial cells or islets of Langerhans (Baldanzi et al., 2002; Granata et al., 2007; Shimada et al., 2014). Since rotenone is known to induce apoptosis in mesencephalic primary cells (Liu et al., 2015; Yu et al., 2015), the potential protective effect of desacyl-ghrelin observed in our experimental conditions might involve its anti-apoptotic effect (Li, 2003). As this is, to our knowledge, the first investigation of the role of desacyl-ghrelin in a cellular model of parkinsonism, further investigations are needed to conclude on a potential protective effect of desacyl-ghrelin against the rotenone-induced dopaminergic neuronal death.

2. Can ghrelin be used as a biomarker of PD early stages?

Recent research conducted on human-based samples have shown altered concentrations of ghrelin in PD patients with weight loss (Fiszer et al., 2010) or suffering from RBD, a non-motor symptom preceding the diagnosis of PD and often associated with premotor stages of the disease (Unger et al., 2011). This indicated a potential role of ghrelin as a biomarker of PD early phases and prompted us to further investigate this aspect in human biological samples. Our transcriptomic analyses conducted on patients-derived samples showed a reduced expression of the ghrelin opposite strand/antisense non-coding RNA *GHRLOS* in PD samples. Since *GHRLOS* is a known regulator of ghrelin expression (Seim et al., 2008b), this could alter circulating ghrelin concentrations in PD subjects. Whether such altered ghrelin concentrations are a cause of the disease or a consequence of

the nutritional status of PD patients still needs to be clarified. Indeed, most PD patients experience involuntary weight loss during the progression of the disease (Abbott et al., 1992) and regain it placed under deep brain stimulation (Perlemoine et al., 2005). Such body weight modifications could result either from difficulties to eat, swallow or digest (Kim and Sung, 2015; Nozaki et al., 1999) or from a higher energy consumption by hypertonic muscles of PD patients with rigidity (Broussolle et al., 1991; Levi et al., 1990; Markus et al., 1992). These aspects deserve further investigations in patient-based cohorts. However, considering the many challenges in recruiting patients for clinical trials (which are not specific to PD, as largely commented elsewhere¹⁶), implementing such a properly designed study during my Ph.D. was not feasible. We therefore decided to further investigate ghrelin's potential as a biomarker of early PD in a mouse model of early parkinsonism (i.e. mimicking PD premotor stage). Our investigations revealed similar plasma acyl- and desacyl- ghrelin concentrations between mice exposed to low doses of the pesticide rotenone for 1.5 months and control mice. In addition, no difference in the mRNA expression of the three mouse *Ghrelin* gene variants investigated was observed in the duodenum of rotenone-exposed mice compared to controls, although a global increased gene expression was reported in the rotenone group. On one hand, these results could be attributed to an investigation at too early stages of the pathological process as developed in this experimental model. Indeed, after 1.5 months of exposure to low doses of rotenone, C57BL/6J mice develop intestinal motility impairments in the absence of motor dysfunctions which are observed only after 3 months of exposure to the pesticide. Interestingly, mice show increased intestinal motility alterations after 2 months of rotenone exposure and start developing alpha-synuclein-positive neuronal inclusions restricted to the enteric nervous system whereas no neuronal death is observed in the SN (Pan-Montojo et al., 2010). After 3 months of exposure, alpha-synuclein aggregates and a decrease in the number of TH-positive cells are reported in SN neurons and mice start exhibiting motor dysfunctions (Pan-Montojo et al., 2010; 2012). Therefore, the experiment should be further replicated at later time-points when the phenotype progressively evolves towards the motor stage. On the other hand, the inter-individual variability in mouse plasma ghrelin concentrations measured in our experiment could explain this absence of difference. This can be commented in light of the similar inter-individual variability observed in PD patients (Unger et al., 2011): ghrelin is an orexigenic peptide whose inter-individual variations might indeed be difficult to control if rigorous procedures at the time of collecting blood samples are not implemented and if a careful examination of the status of individuals included in each experimental group is not ensured. This applies not only to the nutritional

¹⁶ For further comments on such recruitment and retention difficulties of patients in clinical trials, see <http://www.appliedclinicaltrials.com/print/209555?page=full> and <https://www.ncbi.nlm.nih.gov/books/NBK92105/>

status of animals as discussed above, but also to any other parameter which might affect ghrelin concentrations. It is therefore essential to better control the whole experimental procedure. We have already developed a standardized blood sampling procedure after an overnight fast, which prevents irregular plasma ghrelin variations due to continuous food intake in mice. However, another important parameter to control is the anxiety levels of the mice before the start of the experiment as well as during blood sampling. In this view, a new cohort of 1 year old male C57BL/6J mice will be exposed to the solvent or to rotenone (5mg/kg/day) during 2 and 4 months. Non-motor behaviors will be extensively studied with a particular focus on anxiety and stress. More precisely, the elevated plus maze and the white and black box will be used to assess anxiety levels of the mice before their assignment to the different experimental groups: this should enable to stratify the animals based on their anxiety levels and therefore reduce the important variability of acyl-ghrelin concentrations between mice of the same group. In addition, a kinetic of blood sampling over a much longer exposure to the pesticide and following the standardized procedure with strict criteria used during this thesis should allow concluding on the potential role of ghrelin as a biomarker of early stages of parkinsonism in this animal model. This study is about to start in the laboratory of Dr. Pan-Montojo in Munich where I am now hired. In conclusion, although the discovery of PD biomarkers from biological fluids is important and has been the focus of several research efforts, one recent study highlighted the importance of a different type of biomarkers (Jain et al., 2015). Indeed, whereas PD non-motor symptoms, including cognitive, olfactory, autonomic, psychiatric and sleep disturbances, allowed the recognition of early drug-naïve PD patients with 89% sensitivity and 79% specificity, the use of cerebrospinal fluids biomarkers such as alpha-synuclein, tau phosphorylated at threonine 181, total tau, and A β 1-42 did not improve the accuracy of the diagnosis. The study of such non-motor symptoms in subjects at-risk to develop PD might therefore not only improve the knowledge of PD earlier stages but also provide crucial information for an earlier diagnosis of the disease which could ultimately lead to a better design of clinical trials set up to discover new therapeutic strategies.

3. Implication for patient-based investigations: is the translation "from the bench to the bedside" always possible?

As already briefly discussed in the introduction, the search for biomarkers and the development of new therapeutics are currently the two most important challenges for research in the PD field. In the last decades, many independent studies have been initiated aiming to reach either objective (Alberio and Fasano, 2011; Blennow et al., 2016; Devos et al., 2014; Radad et al., 2009). Unfortunately, most molecules tested in these preclinical studies gave disappointing results once translated into clinical trials (Duty and Jenner, 2011).

This had also been the case for other neurological diseases and the ability of preclinical works to accurately predict drug effects in humans has largely been discussed elsewhere: the conclusion is always disappointing, indeed “*even after animal studies suggest that a treatment will be safe and effective, more than 80% of potential therapeutics fail when tested in people*” as wrote Steve Perrin, chief scientific officer at the ALS Therapy Development Institute in Cambridge, Massachusetts, USA (Perrin, 2014)¹⁷. The main explanation for this discrepancy between animal and clinical studies is often a lack of rigor in the design and realization of preclinical experiments (Begley and Ellis, 2012). In addition, the design of cohorts of subjects to be investigated in human studies might further increase this gap between preclinical studies and clinical trials, notably due to the inclusion of either misdiagnosed patients in the cohorts as it is the case for neurodegenerative diseases whose definite diagnosis can only be established upon autopsy or a lack of appropriate differential diagnosis between closely related pathological conditions. Recently, a worldwide program named Parkinson’s Progression Markers Initiative (PPMI)¹⁸ was initiated to “*comprehensively evaluate people with PD and those at greater risk of developing the disease*”, an effort which should improve the quality of cohorts recruited for clinical trials. It consists in a landmark observational clinical study aiming at collecting imaging data, biological samples and clinical evaluations from PD patients, subjects at risk to develop PD, i.e. subjects with a familial history of PD or a genetic mutation linked to the development of PD, subjects with or without motor symptoms, with or without non-motor symptoms, as well as from healthy volunteers. This program gathers 33 clinical sites in Europe, the United States, Israel and Australia. The final objective of this program is to identify biomarkers of PD and of its progression in order to improve the design of clinical trials and increase the chances to discover new therapeutics.

In this scientific context, ghrelin has been proposed as a potential biomarker of PD early stages. To our knowledge, only two published studies investigated the potential of ghrelin as a biomarker of PD (Fiszer et al., 2010; Unger et al., 2011). However, these studies provided controversial results. While Fiszer and colleagues did not observe differences in plasma acyl-ghrelin concentrations in PD patients compared to controls (Fiszer et al., 2010), Unger and colleagues described a slower increase of plasma concentrations of total ghrelin, including both acyl- and desacyl-ghrelin, during the late postprandial phase (Unger et al., 2011). This difference was observed both in PD patients and in subjects with RBD, a non-motor symptom often associated with PD early stages. As already discussed, such opposite results might arise from differences in the sampling procedure and the nutritional state of the

¹⁷ For a broader discussion on this topic, see the blog “*The scandal of medications which heal mice but not humans*” written by the French scientific journalist Pierre Barthelemy at <http://passeurdessciences.blog.lemonde.fr/2014/04/13/ces-medicaments-testes-sur-la-souris-mais-qui-ne-soignent-pas-humain/>

¹⁸ <http://www.ppmi-info.org/>

patients (Kadas et al., 2014). Indeed, human ghrelin concentrations are known to be higher after fast and decrease after a meal before progressively increasing again until the next meal (Inui, 2001; Unger et al., 2011). It is therefore essential to standardize the food intake of patients or animals before blood sampling to limit such an inter-individual variability. Based on these criteria, we designed a protocol of blood sampling in mice after fast and 30 min access to the food. This standardized protocol relies on a strict procedure including an overnight fast, a sampling undertaken in the morning between 08h00 and 10h00, a limited period of access to the food to control the food ingestion pattern of mice and the addition of the protease inhibitor PHMB + HCl in the collecting tube prior to the sampling to avoid rapid deacylation of acyl-ghrelin. Although this standardized procedure allowed the reproduction in mice of human plasma ghrelin variations after fast and consumption of a standard meal (Unger et al., 2011), it did not reveal differences between rotenone-exposed and control mice. The main difference between the procedure used in humans and the one applied in mice is that patients and controls had the same standard meal whereas the mice were not isolated during the feeding but placed in a cage together with their littermate. It is thus possible that some mice ate more than others due to dominancy behaviors (Tamashiro et al., 2007). This bias could be avoided by placing mice in metabolic cages which enable recording individual food intake. However, this solution, although available in our animal facility, was not selected because social isolation is a known source of stress for mice (Ieraci et al., 2016) and stress and stress-related factors like glucocorticoids are known to increase ghrelin concentrations (Jaremka et al., 2014). In this view, a stratification of mice based on their basal anxiety levels before the assignment to the different experimental groups would be useful to minimize such an inter-individual variability. However, such stratification is not realistic to implement in PD patients as a good biomarker should be detected in all patients independently of their stress levels. Interestingly, since their initial publication in 2011, Unger and colleagues repeated their experiment in a larger cohort of patients and, although they still observed the lower increase of ghrelin during the late postprandial phase in PD patients compared to controls, they concluded that the important inter-individual variations of ghrelin concentrations were a limiting parameter for the use of ghrelin as a biomarker of PD¹⁹.

In summary, the use of ghrelin as a biomarker of PD early stages is currently limited by an important inter-individual variability. This variability could be reduced with better design of the experimental procedure. Such studies must therefore involve a tight collaboration between neurologists and researchers to create well-defined large cohorts of PD patients with detailed information about the age, the sex, the body weight variations, the global

¹⁹ Data not yet published but available on https://www.michaeljfox.org/foundation/grant-detail.php?grant_id=704

anxiety levels, the treatments, the disease duration and the clinical phenotype of the subjects included, as well as highly standardized sampling procedures. However, the power of such a biological marker could be reinforced if used in combination with several other indicators of altered functions in PD premotor stages, such as reduced signals in the DaTSCAN™ (Booij et al., 2001) or olfactory dysfunction (Morley and Duda, 2010).

4. Experimental perspectives

As discussed above, the results from our *in vitro* study challenge the data available in the literature by highlighting a potential disease-modifying role for desacyl-ghrelin rather than acyl-ghrelin. Further investigations are however needed to confirm such results and to understand the molecular and cellular modifications induced by desacyl-ghrelin. First, the presence of the ghrelin receptor GHSR1a has to be demonstrated in primary mesencephalic cultures from mouse embryos (embryonic day 14) and more precisely in TH-producing neurons. Indeed, its expression has been established in the mesencephalon of adult mice as well as in MES23.5 cells (Dong et al., 2009; Moon et al., 2009; Zigman et al., 2006), but it has never been validated in mouse primary mesencephalic cultures of embryonic origin. Our first attempt to identify GHSR1a by immunocytochemistry or western blotting in these primary cultures failed due to non-specific binding of all commercially available anti-GHSR1a antibodies tested (Santa Cruz Biotechnology, sc-10359 and sc-374515). An alternative option is therefore to study GHSR1a mRNA using either PCR or *in situ* hybridization. If GHSR1a is expressed in these primary mesencephalic cells, the concomitant exposure to acyl- / desacyl-ghrelin and low doses of the pesticide rotenone will be repeated in presence of the GHSR1a inhibitor D-Lys-3-GHRP-6 to determine its potential role in the deleterious/protective effect of long-term exposure to, respectively, acyl-/desacyl-ghrelin in rotenone-exposed cells. Similarly, the signal transduction of GHSR1a in both conditions will be investigated, with a particular emphasis on the phosphorylation state of ERK1/2, mTOR, Akt and AMPK which have been implicated in ghrelin's action in other physiological or pathological contexts. Moreover, as ghrelin has been shown to protect MES23.5 cells exposed to rotenone *via* an inhibition of rotenone-induced mitochondrial impairments and apoptosis (Yu et al., 2016), the study of the mitochondrial membrane potential as well as the concentrations in ROS generated in our conditions of culture should enable clarifying the mechanism of action of acyl- *versus* desacyl-ghrelin in these mouse primary mesencephalic cells. Last, the potential expression of markers of apoptosis such as nuclear condensation and activated-caspase 3 should be performed to further characterize cellular and molecular events underlying the deleterious *versus* protective effect of respectively acyl- and desacyl-ghrelin in mouse primary mesencephalic cultures.

CHAPTER 7: CONCLUSION

Most age-related neurodegenerative diseases such as Alzheimer's disease and related disorders, PD and other atypical parkinsonian conditions, or even amyotrophic lateral sclerosis evolve slowly and insidiously before the onset of clearly detectable clinical symptoms. As a consequence, they represent a difficult challenge in terms of diagnosis for our clinician colleagues. Tremendous efforts have been made in the last decades up to very recently to improve the quality of the differential diagnosis of neurodegenerative disorders using for example structural magnetic resonance imaging data (Koikkalainen et al., 2016) single photon emission computed tomography approaches (Nuvoli et al., 2016), genetic or demographic information (Karch et al., 2016), or even motor performances (Fritz et al., 2016). Similarly, countless studies have explored the potential of blood or cerebrospinal fluid biomarkers in these specific neurological contexts (see for example among others, Llorens et al., 2016; Shahim et al., 2016). All those efforts have however proven very limited impact in daily clinical practice and neurologists still have to face many unsolved challenges for taking care of patients and their specific disease phenotypes (Griggs et al., 2011). This is of particular concern in a context of increasing life expectancy in developed and developing countries: indeed, the prevalence of neurodegenerative diseases in these countries keeps increasing and brain disorders are estimated to represent 35% of all disease burden in the world (Olesen and Leonardi, 2003). Although important breakthroughs have been made in understanding the possible causes, the specific clinical manifestations and the pathophysiological alterations of age-related neurodegenerative disorders, their diagnosis remains uncertain without a detailed post-mortem neuropathological examination of the patient's brain and some phenotypic manifestations might not always be confirmed at the autopsy (see for instance, Koga et al., 2015). Other efforts towards increasing the accuracy of this differential diagnosis were based on brain biopsy simulations from actual autopsy-confirmed data and have shown a sensitivity ranging from 75% up to 100% for most disorders investigated although some pathological contexts such as progressive supranuclear palsy or amyotrophic lateral sclerosis showed poor sensitivity (King et al., 2013; Venneti et al., 2011). It has to be emphasized however that brain biopsies not only represent a technical/surgical risk for the patients but also raise ethical concerns and are expected to be restricted to a limited number of cases in atypical pathological contexts. Alternative initiatives have been encouraged to increase the diagnosis accuracy of age-related neurodegenerative disorders and international multicenter-based research programs like the PPMI for PD (discussed in previous pages) have been created to collect biological and clinical data from patients worldwide in order to identify reliable biomarkers at different stages of the disease. The PPMI for instance should enable diagnosing subjects at risk to develop PD and to treat them earlier while adapting treatment options as the disease progresses.

This has already generated interesting results, notably by highlighting the importance of non-motor symptoms in the diagnosis of PD early stages (Jain et al., 2015). Such encouraging data bring new hopes for the earlier detection of such debilitating neurological disease. However, currently available treatments for age-related neurodegenerative disorders only alleviate clinical symptoms and do not stop or reverse the disease progression. Again, this is a source of ethical concerns: is it ethical to potentially establish an early diagnosis of a disease which cannot be cured and for which most currently available treatments induce strong side effects in the long term? In this regard, the current debate within the French administration to stop reimbursing four Alzheimer's disease-related medications based on the argumentation that they show insufficient therapeutic benefit to justify their coverage by the national solidarity is particularly worrying²⁰. Can some of the answers to such concerns come from preclinical studies and basic science? Many research have been conducted in cellular and animal models of parkinsonism to find such answers and in particular to explore new disease-modifying molecules. However, despite the discovery of several interesting candidates, the translation of preclinical studies into clinical trials in humans has been unsuccessful so far. As largely discussed in this manuscript (see introduction, chapter 2), the resulting disappointment might originate from the use of inadequate models and/or the poor reproducibility of the data due to a lack of rigor in the design of preclinical studies. If animal models of human-specific diseases are just tools created to investigate a specific working hypothesis, and should only be considered as a simplified representation of the much more complex reality of the human disorder, this should however not become a pretext for not satisfying elementary scientific rules. Animal models are expensive tools, especially when it comes to reproduce age-related disorders in mammals. As highlighted on several occasions in the literature, there is no scientific justification for using cohorts of young animals whose nervous system is not fully mature at the time of the study, or to investigate mutant strains whose life expectancy is sometimes tremendously reduced compared to their wild-type littermates, but still most studies deliberately use young animals having reached only ¼ of their life expectancy (Johnson, 2015). The scientific community should therefore develop adapted aging models to investigate age-related neurodegeneration questions. Similarly, preclinical studies should include animals of both sexes in the investigated cohorts for most age-related neurodegenerative diseases affect both men and women, and the difference in sex ratio is not sufficient enough to suspect a major role of sex hormones in the phenotypes of such diseases (Pringsheim et al., 2014). Last, huge efforts should be concentrated on increasing the reproducibility of preclinical data by increasing the size of the cohorts of animals, by including all control groups (and not only the control of the compound tested, but

²⁰ http://www.has-sante.fr/portail/jcms/c_2679466/fr/medicaments-de-la-maladie-d-alzheimer-un-interet-medical-insuffisant-pour-justifier-leur-prise-en-charge-par-la-solidarite-nationale?cid=fc_1250094

also positive and negative controls of all procedures) and by using appropriate statistical tests (Begley, 2013b). Such quality improvements of preclinical studies can only be reached at an important financial cost for basic science laboratories. This should focus the attention of all funding agencies when they reach their decisions to support, or not, preclinical work. This should also be examined in the context of the European legislation on the use of animals in research. The “3R rule” is indeed often misinterpreted when it comes to the “*reduction in the number of animals used*”: such a reduction cannot be made at the expense of the scientific result, and the legislator has made it perfectly clear in the law. To conclude, PD research, and more largely the research on age-related disorders, is now experiencing a crucial period as it is time not only to improve the standards of preclinical studies but also to optimize the design of clinical trials in humans following standardized and reproducible procedures, and by including better diagnosed patients. Such improvements should ultimately open the way for improved diagnosis and treatment options for the patients.

CHAPTER 8: REFERENCES

- Abbott, R.A., Cox, M., Markus, H., Tomkins, A., 1992. Diet, body size and micronutrient status in Parkinson's disease. *Eur. J. Clin. Nutr.* 46, 879–884.
- Abbott, R.D., Petrovitch, H., White, L.R., Masaki, K.H., Tanner, C.M., Curb, J.D., Grandinetti, A., Blanchette, P.L., Popper, J.S., Ross, G.W., 2001. Frequency of bowel movements and the future risk of Parkinson's disease. *Neurology* 57, 456–462.
- Abdullah, R., Basak, I., Patil, K.S., Alves, G., Larsen, J.P., Møller, S.G., 2015. Parkinson's disease and age: The obvious but largely unexplored link. *Exp. Gerontol.* 68, 33–38. doi:10.1016/j.exger.2014.09.014
- Abizaid, A., Liu, Z.-W., Andrews, Z.B., Shanabrough, M., Borok, E., Elsworth, J.D., Roth, R.H., Sleeman, M.W., Picciotto, M.R., Tschöp, M.H., Gao, X.-B., Horvath, T.L., 2006. Ghrelin modulates the activity and synaptic input organization of midbrain dopamine neurons while promoting appetite. *J. Clin. Invest.* 116, 3229–3239. doi:10.1172/JCI29867
- Abramson, L., Seligman, M., 1977. Modeling psychopathology in the laboratory: history and rationale., in: *Psychology: Experimental Models*. W.H. Freeman, San Francisco, pp. 1–26.
- Adler, C.H., Beach, T.G., Hentz, J.G., Shill, H.A., Caviness, J.N., Driver-Dunckley, E., Sabbagh, M.N., Sue, L.I., Jacobson, S.A., Belden, C.M., Dugger, B.N., 2014. Low clinical diagnostic accuracy of early vs advanced Parkinson disease: clinicopathologic study. *Neurology* 83, 406–412. doi:10.1212/WNL.0000000000000641
- Agamonis, D., n.d. Chapter 9 Degenerative diseases [WWW Document]. *Neuropathol. Illus. Interact. Course Med. Stud. Resid.* URL <http://neuropathology-web.org/chapter9/chapter9dPD.html> (accessed 9.16.16).
- Alberico, S.L., Cassell, M.D., Narayanan, N.S., 2015. The Vulnerable Ventral Tegmental Area in Parkinson's Disease. *Basal Ganglia* 5, 51–55. doi:10.1016/j.baga.2015.06.001
- Alberio, T., Fasano, M., 2011. Proteomics in Parkinson's disease: An unbiased approach towards peripheral biomarkers and new therapies. *J. Biotechnol.* 156, 325–337. doi:10.1016/j.jbiotec.2011.08.004
- Albin, R.L., Young, A.B., Penney, J.B., 1989. The functional anatomy of basal ganglia disorders. *Trends Neurosci.* 12, 366–375.
- Aldecoa, I., Navarro-Otano, J., Stefanova, N., Sprenger, F.S., Seppi, K., Poewe, W., Cuatrecasas, M., Valldeoriola, F., Gelpi, E., Tolosa, E., 2015. Alpha-synuclein immunoreactivity patterns in the enteric nervous system. *Neurosci. Lett.* 602, 145–149. doi:10.1016/j.neulet.2015.07.005
- Al-Massadi, O., Crujeiras, A.B., Gonzalez, R.C., Pardo, M., Dieguez, C., Casanueva, F.F., Seoane, L.M., 2010. Age, sex, and lactating status regulate ghrelin secretion and GOAT mRNA levels from isolated rat stomach. *AJP Endocrinol. Metab.* 299, E341–E350. doi:10.1152/ajpendo.00057.2010
- Alvarez-Fischer, D., Guerreiro, S., Hunot, S., Saurini, F., Marien, M., Sokoloff, P., Hirsch, E.C., Hartmann, A., Michel, P.P., 2008. Modelling Parkinson-like neurodegeneration via osmotic minipump delivery of MPTP and probenecid. *J. Neurochem.* 107, 701–711. doi:10.1111/j.1471-4159.2008.05651.x
- Alzahrani, H., Venneri, A., 2015. Cognitive and neuroanatomical correlates of neuropsychiatric symptoms in Parkinson's disease: A systematic review. *J. Neurol. Sci.* 356, 32–44. doi:10.1016/j.jns.2015.06.037
- Amberson, W.R., 1954. *Epilepsy and the Functional Anatomy of the Human Brain*. Wilder Penfield and Herbert Jasper. Little, Brown, Boston, 1954. 896 pp. Illus. + plates. \$16.00. *Science* 119, 645–646. doi:10.1126/science.119.3097.645-a
- Andersen, A.D., Binzer, M., Stenager, E., Gramsbergen, J.B., 2016. Cerebrospinal fluid biomarkers for Parkinson's disease – a systematic review. *Acta Neurol. Scand.* n/a-n/a. doi:10.1111/ane.12590
- Andrews, Z.B., Erion, D., Beiler, R., Liu, Z.-W., Abizaid, A., Zigman, J., Elsworth, J.D., Savitt, J.M., DiMarchi, R., Tschöp, M., Roth, R.H., Gao, X.-B., Horvath, T.L., 2009. Ghrelin Promotes and

- Protects Nigrostriatal Dopamine Function via a UCP2-Dependent Mitochondrial Mechanism. *J. Neurosci.* 29, 14057–14065. doi:10.1523/JNEUROSCI.3890-09.2009
- Andrews, Z.B., Liu, Z.-W., Wallingford, N., Erion, D.M., Borok, E., Friedman, J.M., Tschöp, M.H., Shanabrough, M., Cline, G., Shulman, G.I., Coppola, A., Gao, X.-B., Horvath, T.L., Diano, S., 2008. UCP2 mediates ghrelin's action on NPY/AgRP neurons by lowering free radicals. *Nature* 454, 846–851. doi:10.1038/nature07181
- Angeloni, S.V., Glynn, N., Ambrosini, G., Garant, M.J., Higley, J.D., Suomi, S., Hansen, B.C., 2004. Characterization of the rhesus monkey ghrelin gene and factors influencing ghrelin gene expression and fasting plasma levels. *Endocrinology* 145, 2197–2205. doi:10.1210/en.2003-1103
- Anglade, P., Vyas, S., Hirsch, E.C., Agid, Y., 1997. Apoptosis in dopaminergic neurons of the human substantia nigra during normal aging. *Histol. Histopathol.* 12, 603–610.
- Angot, E., Steiner, J.A., Lema Tomé, C.M., Ekström, P., Mattsson, B., Björklund, A., Brundin, P., 2012. Alpha-synuclein cell-to-cell transfer and seeding in grafted dopaminergic neurons in vivo. *PLoS One* 7, e39465. doi:10.1371/journal.pone.0039465
- Appel-Cresswell, S., Vilarino-Guell, C., Encarnacion, M., Sherman, H., Yu, I., Shah, B., Weir, D., Thompson, C., Szu-Tu, C., Trinh, J., Aasly, J.O., Rajput, A., Rajput, A.H., Jon Stoessl, A., Farrer, M.J., 2013. Alpha-synuclein p.H50Q, a novel pathogenic mutation for Parkinson's disease. *Mov. Disord. Off. J. Mov. Disord. Soc.* 28, 811–813. doi:10.1002/mds.25421
- Asakawa, A., Inui, A., Fujimiya, M., Sakamaki, R., Shinfuku, N., Ueta, Y., Meguid, M.M., Kasuga, M., 2005. Stomach regulates energy balance via acylated ghrelin and desacyl ghrelin. *Gut* 54, 18–24. doi:10.1136/gut.2004.038737
- Asakawa, A., Inui, A., Kaga, T., Yuzuriha, H., Nagata, T., Fujimiya, M., Katsuura, G., Makino, S., Fujino, M.A., Kasuga, M., 2001. A role of ghrelin in neuroendocrine and behavioral responses to stress in mice. *Neuroendocrinology* 74, 143–147. doi:54680
- Ascherio, A., Chen, H., Schwarzschild, M.A., Zhang, S.M., Colditz, G.A., Speizer, F.E., 2003. Caffeine, postmenopausal estrogen, and risk of Parkinson's disease. *Neurology* 60, 790–795.
- Assogna, F., Cravello, L., Orfei, M.D., Cellupica, N., Caltagirone, C., Spalletta, G., 2016. Alexithymia in Parkinson's disease: A systematic review of the literature. *Parkinsonism Relat. Disord.* 28, 1–11. doi:10.1016/j.parkreldis.2016.03.021
- Aulić, S., Le, T.T.N., Moda, F., Abounit, S., Corvaglia, S., Casalis, L., Gustincich, S., Zurzolo, C., Tagliavini, F., Legname, G., 2014. Defined α -synuclein prion-like molecular assemblies spreading in cell culture. *BMC Neurosci.* 15, 69. doi:10.1186/1471-2202-15-69
- Auluck, P.K., Caraveo, G., Lindquist, S., 2010. α -Synuclein: membrane interactions and toxicity in Parkinson's disease. *Annu. Rev. Cell Dev. Biol.* 26, 211–233. doi:10.1146/annurev.cellbio.042308.113313
- Avoli, M., 2012. Herbert H. Jasper and the Basic Mechanisms of the Epilepsies, in: Noebels, J.L., Avoli, M., Rogawski, M.A., Olsen, R.W., Delgado-Escueta, A.V. (Eds.), *Jasper's Basic Mechanisms of the Epilepsies*. National Center for Biotechnology Information (US), Bethesda (MD).
- Bagheri, H., Damase-Michel, C., Lapeyre-Mestre, M., Cismondo, S., O'Connell, D., Senard, J.M., Rascol, O., Montastruc, J.L., 1999. A study of salivary secretion in Parkinson's disease. *Clin. Neuropharmacol.* 22, 213–215.
- Bahnassawy, L. 'a, Nicklas, S., Palm, T., Menzl, I., Birzele, F., Gillardon, F., Schwamborn, J.C., 2013. The parkinson's disease-associated LRRK2 mutation R1441G inhibits neuronal differentiation of neural stem cells. *Stem Cells Dev.* 22, 2487–2496. doi:10.1089/scd.2013.0163
- Baldanzi, G., 2002. Ghrelin and des-acyl ghrelin inhibit cell death in cardiomyocytes and endothelial cells through ERK1/2 and PI 3-kinase/AKT. *J. Cell Biol.* 159, 1029–1037. doi:10.1083/jcb.200207165
- Baldanzi, G., Filigheddu, N., Cutrupi, S., Catapano, F., Bonisconi, S., Fubini, A., Malan, D., Baj, G., Granata, R., Broglio, F., Papotti, M., Surico, N., Bussolino, F., Isgaard, J., Deghenghi, R., Sinigaglia, F., Prat, M., Muccioli, G., Ghigo, E., Graziani, A., 2002. Ghrelin and des-acyl ghrelin

- inhibit cell death in cardiomyocytes and endothelial cells through ERK1/2 and PI 3-kinase/AKT. *J. Cell Biol.* 159, 1029–1037. doi:10.1083/jcb.200207165
- Bali, A., Jaggi, A.S., 2016. An Integrative Review on Role and Mechanisms of Ghrelin in Stress, Anxiety and Depression. *Curr. Drug Targets* 17, 495–507.
- Bandopadhyay, R., Kingsbury, A.E., Cookson, M.R., Reid, A.R., Evans, I.M., Hope, A.D., Pittman, A.M., Lashley, T., Canet-Aviles, R., Miller, D.W., McLendon, C., Strand, C., Leonard, A.J., Abou-Sleiman, P.M., Healy, D.G., Ariga, H., Wood, N.W., de Silva, R., Revesz, T., Hardy, J.A., Lees, A.J., 2004. The expression of DJ-1 (PARK7) in normal human CNS and idiopathic Parkinson's disease. *Brain J. Neurol.* 127, 420–430. doi:10.1093/brain/awh054
- Bandyopadhyay, U., Bandhyopadhyay, U., Cuervo, A.M., 2007. Chaperone-mediated autophagy in aging and neurodegeneration: lessons from alpha-synuclein. *Exp. Gerontol.* 42, 120–128. doi:10.1016/j.exger.2006.05.019
- Banks, W.A., 2002. Extent and Direction of Ghrelin Transport Across the Blood-Brain Barrier Is Determined by Its Unique Primary Structure. *J. Pharmacol. Exp. Ther.* 302, 822–827. doi:10.1124/jpet.102.034827
- Barazzoni, R., Zanetti, M., Ferreira, C., Vinci, P., Pirulli, A., Mucci, M., Dore, F., Fonda, M., Ciochi, B., Cattin, L., Guarnieri, G., 2007. Relationships between desacylated and acylated ghrelin and insulin sensitivity in the metabolic syndrome. *J. Clin. Endocrinol. Metab.* 92, 3935–3940. doi:10.1210/jc.2006-2527
- Barbeau, A., 1962. The pathogenesis of Parkinson's disease: a new hypothesis. *Can. Med. Assoc. J.* 87, 802–807.
- Barberi, T., Klivenyi, P., Calingasan, N.Y., Lee, H., Kawamata, H., Loonam, K., Perrier, A.L., Bruses, J., Rubio, M.E., Topf, N., Tabar, V., Harrison, N.L., Beal, M.F., Moore, M.A.S., Studer, L., 2003. Neural subtype specification of fertilization and nuclear transfer embryonic stem cells and application in parkinsonian mice. *Nat. Biotechnol.* 21, 1200–1207. doi:10.1038/nbt870
- Bartels, A.L., Willemsen, A.T.M., Kortekaas, R., de Jong, B.M., de Vries, R., de Klerk, O., van Oostrom, J.C.H., Portman, A., Leenders, K.L., 2008. Decreased blood-brain barrier P-glycoprotein function in the progression of Parkinson's disease, PSP and MSA. *J. Neural Transm. Vienna Austria* 115, 1001–1009. doi:10.1007/s00702-008-0030-y
- Baskin, P., Salamone, J., 1993. Vacuous jaw movements in rats induced by acute reserpine administration: interactions with different doses of apomorphine. *Pharmacol. Biochem. Behav.* 46, 793–797.
- Bayliss, J.A., Andrews, Z.B., 2013. Ghrelin is neuroprotective in Parkinson's disease: molecular mechanisms of metabolic neuroprotection. *Ther. Adv. Endocrinol. Metab.* 4, 25–36.
- Bayliss, J.A., Lemus, M., Santos, V.V., Deo, M., Elsworth, J., Andrews, Z.B., 2016a. Acylated but not des-acyl ghrelin is neuroprotective in an MPTP mouse model of Parkinson's Disease. *J. Neurochem.* doi:10.1111/jnc.13576
- Bayliss, J.A., Lemus, M.B., Stark, R., Santos, V.V., Thompson, A., Rees, D.J., Galic, S., Elsworth, J.D., Kemp, B.E., Davies, J.S., Andrews, Z.B., 2016b. Ghrelin-AMPK Signaling Mediates the Neuroprotective Effects of Calorie Restriction in Parkinson's Disease. *J. Neurosci. Off. J. Soc. Neurosci.* 36, 3049–3063. doi:10.1523/JNEUROSCI.4373-15.2016
- Bega, D., Zadikoff, C., 2014. Complementary & Alternative Management of Parkinson's Disease: An Evidence-Based Review of Eastern Influenced Practices. *J. Mov. Disord.* 7, 57–66. doi:10.14802/jmd.14009
- Begley, C.G., 2013a. An unappreciated challenge to oncology drug discovery: pitfalls in preclinical research. *Am. Soc. Clin. Oncol. Educ. Book ASCO Am. Soc. Clin. Oncol. Meet.* 466–468. doi:10.1200/EdBook_AM.2013.33.466
- Begley, C.G., 2013b. Six red flags for suspect work. *Nature* 497, 433–434. doi:10.1038/497433a
- Begley, C.G., Ellis, L.M., 2012. Drug development: Raise standards for preclinical cancer research. *Nature* 483, 531–533. doi:10.1038/483531a
- Bélanger, M., Magistretti, P.J., 2009. The role of astroglia in neuroprotection. *Dialogues Clin. Neurosci.* 11, 281–295.

- Belzung, C., Lemoine, M., 2011. Criteria of validity for animal models of psychiatric disorders: focus on anxiety disorders and depression. *Biol. Mood Anxiety Disord.* 1, 9. doi:10.1186/2045-5380-1-9
- Benabid, A.L., Pollak, P., Gervason, C., Hoffmann, D., Gao, D.M., Hommel, M., Perret, J.E., de Rougemont, J., 1991. Long-term suppression of tremor by chronic stimulation of the ventral intermediate thalamic nucleus. *Lancet Lond. Engl.* 337, 403–406.
- Benabid, A.L., Pollak, P., Gross, C., Hoffmann, D., Benazzouz, A., Gao, D.M., Laurent, A., Gentil, M., Perret, J., 1994. Acute and long-term effects of subthalamic nucleus stimulation in Parkinson's disease. *Stereotact. Funct. Neurosurg.* 62, 76–84.
- Benabid, A.L., Pollak, P., Louveau, A., Henry, S., de Rougemont, J., 1987. Combined (thalamotomy and stimulation) stereotactic surgery of the VIM thalamic nucleus for bilateral Parkinson disease. *Appl. Neurophysiol.* 50, 344–346.
- Bender, A., Krishnan, K.J., Morris, C.M., Taylor, G.A., Reeve, A.K., Perry, R.H., Jaros, E., Hersheson, J.S., Betts, J., Klopstock, T., Taylor, R.W., Turnbull, D.M., 2006. High levels of mitochondrial DNA deletions in substantia nigra neurons in aging and Parkinson disease. *Nat. Genet.* 38, 515–517. doi:10.1038/ng1769
- Benso, A., St-Pierre, D.H., Prodam, F., Gramaglia, E., Granata, R., van der Lely, A.J., Ghigo, E., Broglio, F., 2012. Metabolic effects of overnight continuous infusion of unacylated ghrelin in humans. *Eur. J. Endocrinol. Eur. Fed. Endocr. Soc.* 166, 911–916. doi:10.1530/EJE-11-0982
- Bernheimer, H., Birkmayer, W., Hornykiewicz, O., Jellinger, K., Seitelberger, F., 1973. Brain dopamine and the syndromes of Parkinson and Huntington. Clinical, morphological and neurochemical correlations. *J. Neurol. Sci.* 20, 415–455.
- Bertler, A., Rosengren, E., 1959. Occurrence and distribution of dopamine in brain and other tissues. *Experientia* 15, 10–11.
- Betarbet, R., Sherer, T.B., MacKenzie, G., Garcia-Osuna, M., Panov, A.V., Greenamyre, J.T., 2000. Chronic systemic pesticide exposure reproduces features of Parkinson's disease. *Nat. Neurosci.* 3, 1301–1306. doi:10.1038/81834
- Bethlem, J., Den Hartog Jager, W.A., 1960. The incidence and characteristics of Lewy bodies in idiopathic paralysis agitans (Parkinson's disease). *J. Neurol. Neurosurg. Psychiatry* 23, 74–80.
- Bhidayasiri, R., Tarsy, D., 2012. Parkinson's Disease: Hoehn and Yahr Scale, in: *Movement Disorders: A Video Atlas, Current Clinical Neurology*. Humana Press, pp. 4–5. doi:10.1007/978-1-60327-426-5_2
- Bhidayasiri, R., Truong, D.D., 2012. Therapeutic strategies for nonmotor symptoms in early Parkinson's disease: the case for a higher priority and stronger evidence. *Parkinsonism Relat. Disord.* 18 Suppl 1, S110-113. doi:10.1016/S1353-8020(11)70035-9
- Biedler, J.L., Helson, L., Spengler, B.A., 1973. Morphology and growth, tumorigenicity, and cytogenetics of human neuroblastoma cells in continuous culture. *Cancer Res.* 33, 2643–2652.
- Birkmayer, Hornykiewicz, 1961. The L-3,4-dioxyphenylalanine (DOPA)-effect in Parkinson-akinesia. *Wien Klin Wochenschr* 10, 787–8.
- Blandini, F., Armentero, M.-T., 2014. Dopamine receptor agonists for Parkinson's disease. *Expert Opin. Investig. Drugs* 23, 387–410. doi:10.1517/13543784.2014.869209
- Blennow, K., Biscetti, L., Eusebi, P., Parnetti, L., 2016. Cerebrospinal fluid biomarkers in Alzheimer's and Parkinson's diseases-From pathophysiology to clinical practice. *Mov. Disord. Off. J. Mov. Disord. Soc.* 31, 836–847. doi:10.1002/mds.26656
- Blesa, J., Phani, S., Jackson-Lewis, V., Przedborski, S., 2012. Classic and New Animal Models of Parkinson's Disease. *J. Biomed. Biotechnol.* 2012, 1–10. doi:10.1155/2012/845618
- Blesa, J., Piffl, C., Sánchez-González, M.A., Juri, C., García-Cabezas, M.A., Adánez, R., Iglesias, E., Collantes, M., Peñuelas, I., Sánchez-Hernández, J.J., Rodríguez-Oroz, M.C., Avendaño, C., Hornykiewicz, O., Cavada, C., Obeso, J.A., 2012. The nigrostriatal system in the presymptomatic and symptomatic stages in the MPTP monkey model: a PET, histological and biochemical study. *Neurobiol. Dis.* 48, 79–91. doi:10.1016/j.nbd.2012.05.018

- Blesa, J., Przedborski, S., 2014. Parkinson's disease: animal models and dopaminergic cell vulnerability. *Front. Neuroanat.* 8, 155. doi:10.3389/fnana.2014.00155
- Bloem, B.R., de Vries, N.M., Ebersbach, G., 2015. Nonpharmacological treatments for patients with Parkinson's disease. *Mov. Disord.* 30, 1504–1520. doi:10.1002/mds.26363
- Bonnet, A.M., Jutras, M.F., Czernecki, V., Corvol, J.C., Vidailhet, M., 2012. Nonmotor symptoms in Parkinson's disease in 2012: relevant clinical aspects. *Park. Dis.* 2012, 198316. doi:10.1155/2012/198316
- Booij, J., Speelman, J.D., Horstink, M.W., Wolters, E.C., 2001. The clinical benefit of imaging striatal dopamine transporters with [¹²³I]FP-CIT SPET in differentiating patients with presynaptic parkinsonism from those with other forms of parkinsonism. *Eur. J. Nucl. Med.* 28, 266–272.
- Braak, H., Braak, E., 1990. Cognitive impairment in Parkinson's disease: amyloid plaques, neurofibrillary tangles, and neuropil threads in the cerebral cortex. *J. Neural Transm. Park. Dis. Dement. Sect. 2*, 45–57.
- Braak, H., de Vos, R.A., Jansen, E.N., Bratzke, H., Braak, E., 1998. Neuropathological hallmarks of Alzheimer's and Parkinson's diseases. *Prog. Brain Res.* 117, 267–285.
- Braak, H., de Vos, R.A.I., Bohl, J., Del Tredici, K., 2006. Gastric α -synuclein immunoreactive inclusions in Meissner's and Auerbach's plexuses in cases staged for Parkinson's disease-related brain pathology. *Neurosci. Lett.* 396, 67–72. doi:10.1016/j.neulet.2005.11.012
- Braak, H., Ghebremedhin, E., Rüb, U., Bratzke, H., Tredici, K., 2004. Stages in the development of Parkinson's disease-related pathology. *Cell Tissue Res.* 318, 121–134. doi:10.1007/s00441-004-0956-9
- Braak, H., Tredici, K.D., Rüb, U., de Vos, R.A., Jansen Steur, E.N., Braak, E., 2003. Staging of brain pathology related to sporadic Parkinson's disease. *Neurobiol. Aging* 24, 197–211.
- Bradbury, J., 2003. α -synuclein gene triplication discovered in Parkinson's disease. *Lancet Neurol.* 2, 715. doi:10.1016/S1474-4422(03)00601-X
- Braungart, E., Gerlach, M., Riederer, P., Baumeister, R., Hoener, M.C., 2004. Caenorhabditis elegans MPP+ model of Parkinson's disease for high-throughput drug screenings. *Neurodegener. Dis.* 1, 175–183. doi:10.1159/000080983
- Breid, S., Bernis, M.E., Babila, J.T., Garca, M.C., Wille, H., Tamgüney, G., 2016. Neuroinvasion of α -Synuclein Prionoids after Intraperitoneal and Intraglossal Inoculation. *J. Virol.* doi:10.1128/JVI.01399-16
- Breidert, T., Callebert, J., Heneka, M.T., Landreth, G., Launay, J.M., Hirsch, E.C., 2002. Protective action of the peroxisome proliferator-activated receptor-gamma agonist pioglitazone in a mouse model of Parkinson's disease. *J. Neurochem.* 82, 615–624.
- Brochard, V., Combadière, B., Prigent, A., Laouar, Y., Perrin, A., Beray-Berthet, V., Bonduelle, O., Alvarez-Fischer, D., Callebert, J., Launay, J.-M., Duyckaerts, C., Flavell, R.A., Hirsch, E.C., Hunot, S., 2009. Infiltration of CD4+ lymphocytes into the brain contributes to neurodegeneration in a mouse model of Parkinson disease. *J. Clin. Invest.* 119, 182–192. doi:10.1172/JCI36470
- Broglio, F., Gottero, C., Prodam, F., Gauna, C., Muccioli, G., Papotti, M., Aribat, T., Van Der Lely, A.J., Ghigo, E., 2004a. Non-acylated ghrelin counteracts the metabolic but not the neuroendocrine response to acylated ghrelin in humans. *J. Clin. Endocrinol. Metab.* 89, 3062–3065. doi:10.1210/jc.2003-031964
- Broglio, F., Gottero, C., Prodam, F., Gauna, C., Muccioli, G., Papotti, M., Aribat, T., Van Der Lely, A.J., Ghigo, E., 2004b. Non-acylated ghrelin counteracts the metabolic but not the neuroendocrine response to acylated ghrelin in humans. *J. Clin. Endocrinol. Metab.* 89, 3062–3065. doi:10.1210/jc.2003-031964
- Brooks, A.I., Chadwick, C.A., Gelbard, H.A., Cory-Slechta, D.A., Federoff, H.J., 1999. Paraquat elicited neurobehavioral syndrome caused by dopaminergic neuron loss. *Brain Res.* 823, 1–10.
- Broussolle, E., Borson, F., Gonzalez de Suso, J.M., Chayvialle, J.A., Beylot, M., Chazot, G., 1991. [Increase of energy expenditure in Parkinson's disease]. *Rev. Neurol. (Paris)* 147, 46–51.

- Brück, D., Wenning, G.K., Stefanova, N., Fellner, L., 2016. Glia and alpha-synuclein in neurodegeneration: A complex interaction. *Neurobiol. Dis.* 85, 262–274. doi:10.1016/j.nbd.2015.03.003
- Bulgarelli, I., Tamiazzo, L., Bresciani, E., Rapetti, D., Caporali, S., Lattuada, D., Locatelli, V., Torsello, A., 2009. Desacyl-ghrelin and synthetic GH-secretagogues modulate the production of inflammatory cytokines in mouse microglia cells stimulated by beta-amyloid fibrils. *J. Neurosci. Res.* 87, 2718–2727. doi:10.1002/jnr.22088
- Burn, D.J., Rowan, E.N., Allan, L.M., Molloy, S., O'Brien, J.T., McKeith, I.G., 2006. Motor subtype and cognitive decline in Parkinson's disease, Parkinson's disease with dementia, and dementia with Lewy bodies. *J. Neurol. Neurosurg. Psychiatry* 77, 585–589. doi:10.1136/jnnp.2005.081711
- Burré, J., Sharma, M., Tsetsenis, T., Buchman, V., Etherton, M.R., Südhof, T.C., 2010. Alpha-synuclein promotes SNARE-complex assembly in vivo and in vitro. *Science* 329, 1663–1667. doi:10.1126/science.1195227
- Cabantchik, Z.I., Munnich, A., Youdim, M.B., Devos, D., 2013. Regional siderosis: a new challenge for iron chelation therapy. *Front. Pharmacol.* 4. doi:10.3389/fphar.2013.00167
- Cabral, A., Fernandez, G., Perello, M., 2013. Analysis of brain nuclei accessible to ghrelin present in the cerebrospinal fluid. *Neuroscience* 253, 406–415. doi:10.1016/j.neuroscience.2013.09.008
- Callaghan, B., Furness, J.B., 2014. Novel and Conventional Receptors for Ghrelin, Desacyl-Ghrelin, and Pharmacologically Related Compounds. *Pharmacol. Rev.* 66, 984–1001. doi:10.1124/pr.113.008433
- Callesen, M.B., Scheel-Krüger, J., Kringelbach, M.L., Møller, A., 2013. A systematic review of impulse control disorders in Parkinson's disease. *J. Park. Dis.* 3, 105–138.
- Camiña, J.P., Lodeiro, M., Ischenko, O., Martini, A.C., Casanueva, F.F., 2007. Stimulation by ghrelin of p42/p44 mitogen-activated protein kinase through the GHS-R1a receptor: role of G-proteins and beta-arrestins. *J. Cell. Physiol.* 213, 187–200. doi:10.1002/jcp.21109
- Carlini, V.P., Monzón, M.E., Varas, M.M., Cragolini, A.B., Schiöth, H.B., Scimonelli, T.N., de Barioglio, S.R., 2002. Ghrelin increases anxiety-like behavior and memory retention in rats. *Biochem. Biophys. Res. Commun.* 299, 739–743. doi:10.1016/S0006-291X(02)02740-7
- Carlsson, A., Lindqvist, M., Magnusson, T., 1957. 3,4-Dihydroxyphenylalanine and 5-hydroxytryptophan as reserpine antagonists. *Nature* 180, 1200.
- Carlsson, A., Lindqvist, M., Magnusson, T., Waldeck, B., 1958. On the presence of 3-hydroxytyramine in brain. *Science* 127, 471.
- Carta, M., Carlsson, T., Muñoz, A., Kirik, D., Björklund, A., 2008. Serotonin-dopamine interaction in the induction and maintenance of L-DOPA-induced dyskinesias. *Prog. Brain Res.* 172, 465–478. doi:10.1016/S0079-6123(08)00922-9
- Caudle, W.M., Colebrooke, R.E., Emson, P.C., Miller, G.W., 2008. Altered vesicular dopamine storage in Parkinson's disease: a premature demise. *Trends Neurosci.* 31, 303–308. doi:10.1016/j.tins.2008.02.010
- Cazorla, M., de Carvalho, F.D., Chohan, M.O., Shegda, M., Chuhma, N., Rayport, S., Ahmari, S.E., Moore, H., Kellendonk, C., 2014. Dopamine D2 receptors regulate the anatomical and functional balance of basal ganglia circuitry. *Neuron* 81, 153–164. doi:10.1016/j.neuron.2013.10.041
- Chandran, J.S., Lin, X., Zapata, A., Höke, A., Shimoji, M., Moore, S.O., Galloway, M.P., Laird, F.M., Wong, P.C., Price, D.L., Bailey, K.R., Crawley, J.N., Shippenberg, T., Cai, H., 2008. Progressive behavioral deficits in DJ-1-deficient mice are associated with normal nigrostriatal function. *Neurobiol. Dis.* 29, 505–514. doi:10.1016/j.nbd.2007.11.011
- Chartier-Harlin, M.-C., Dachsel, J.C., Vilarinho-Güell, C., Lincoln, S.J., Leprêtre, F., Hulihan, M.M., Kachergus, J., Milnerwood, A.J., Tapia, L., Song, M.-S., Le Rhun, E., Mutez, E., Larvor, L., Dufлот, A., Vanbesien-Mailliot, C., Kreisler, A., Ross, O.A., Nishioka, K., Soto-Ortolaza, A.I., Cobb, S.A., Melrose, H.L., Behrouz, B., Keeling, B.H., Bacon, J.A., Hentati, E., Williams, L., Yanagiya, A., Sonenberg, N., Lockhart, P.J., Zubair, A.C., Uitti, R.J., Aasly, J.O., Krygowska-

- Wajs, A., Opala, G., Wszolek, Z.K., Frigerio, R., Maraganore, D.M., Gosal, D., Lynch, T., Hutchinson, M., Bentivoglio, A.R., Valente, E.M., Nichols, W.C., Pankratz, N., Foroud, T., Gibson, R.A., Hentati, F., Dickson, D.W., Destée, A., Farrer, M.J., 2011. Translation initiator EIF4G1 mutations in familial Parkinson disease. *Am. J. Hum. Genet.* 89, 398–406. doi:10.1016/j.ajhg.2011.08.009
- Chartier-Harlin, M.-C., Kachergus, J., Roumier, C., Mouroux, V., Douay, X., Lincoln, S., Levecque, C., Larvor, L., Andrieux, J., Hulihan, M., Waucquier, N., Defebvre, L., Amouyel, P., Farrer, M., Destée, A., 2004. α -synuclein locus duplication as a cause of familial Parkinson's disease. *The Lancet* 364, 1167–1169. doi:10.1016/S0140-6736(04)17103-1
- Chaudhuri, K., Schapira, A.H., 2009. Non-motor symptoms of Parkinson's disease: dopaminergic pathophysiology and treatment. *Lancet Neurol.* 8, 464–474.
- Chaudhuri, K.R., Healy, D.G., Schapira, A.H.V., National Institute for Clinical Excellence, 2006. Non-motor symptoms of Parkinson's disease: diagnosis and management. *Lancet Neurol.* 5, 235–245. doi:10.1016/S1474-4422(06)70373-8
- Chen, C.-Y., Weng, Y.-H., Chien, K.-Y., Lin, K.-J., Yeh, T.-H., Cheng, Y.-P., Lu, C.-S., Wang, H.-L., 2012. (G2019S) LRRK2 activates MKK4-JNK pathway and causes degeneration of SN dopaminergic neurons in a transgenic mouse model of PD. *Cell Death Differ.* 19, 1623–1633. doi:10.1038/cdd.2012.42
- Chen, H., Zhang, S.M., Hernán, M.A., Schwarzschild, M.A., Willett, W.C., Colditz, G.A., Speizer, F.E., Ascherio, A., 2003. Nonsteroidal anti-inflammatory drugs and the risk of Parkinson disease. *Arch. Neurol.* 60, 1059–1064. doi:10.1001/archneur.60.8.1059
- Chesselet, M.-F., 2008. In vivo alpha-synuclein overexpression in rodents: a useful model of Parkinson's disease? *Exp. Neurol.* 209, 22–27.
- Chesselet, M.-F., Richter, F., Zhu, C., Magen, I., Watson, M.B., Subramaniam, S.R., 2012. A Progressive Mouse Model of Parkinson's Disease: The Thy1-aSyn ("Line 61") Mice. *Neurotherapeutics* 9, 297–314. doi:10.1007/s13311-012-0104-2
- Cheung, Z.H., Ip, N.Y., 2009. The emerging role of autophagy in Parkinson's disease. *Mol. Brain* 2, 29. doi:10.1186/1756-6606-2-29
- Chiba, K., Peterson, L.A., Castagnoli, K.P., Trevor, A.J., Castagnoli, N., 1985. Studies on the molecular mechanism of bioactivation of the selective nigrostriatal toxin 1-methyl-4-phenyl-1,2,3,6-tetrahydropyridine. *Drug Metab. Dispos. Biol. Fate Chem.* 13, 342–347.
- Chiba, K., Trevor, A., Castagnoli, N., 1984. Metabolism of the neurotoxic tertiary amine, MPTP, by brain monoamine oxidase. *Biochem. Biophys. Res. Commun.* 120, 574–578.
- Chiueh, C.C., Markey, S.P., Burns, R.S., Johannessen, J.N., Pert, A., Kopin, I.J., 1984. Neurochemical and behavioral effects of systemic and intranigral administration of N-methyl-4-phenyl-1,2,3,6-tetrahydropyridine in the rat. *Eur. J. Pharmacol.* 100, 189–194.
- Chow, K.B.S., Sun, J., Man Chu, K., Tai Cheung, W., Cheng, C.H.K., Wise, H., 2012. The truncated ghrelin receptor polypeptide (GHS-R1b) is localized in the endoplasmic reticulum where it forms heterodimers with ghrelin receptors (GHS-R1a) to attenuate their cell surface expression. *Mol. Cell. Endocrinol.* 348, 247–254. doi:10.1016/j.mce.2011.08.034
- Cloud, L.J., Greene, J.G., 2011. Gastrointestinal Features of Parkinson's Disease. *Curr. Neurol. Neurosci. Rep.* 11, 379–384. doi:10.1007/s11910-011-0204-0
- Colpaert, F.C., 1987. Pharmacological characteristics of tremor, rigidity and hypokinesia induced by reserpine in rat. *Neuropharmacology* 26, 1431–1440.
- Connolly, B., Fox, S.H., 2014. Treatment of cognitive, psychiatric, and affective disorders associated with Parkinson's disease. *Neurother. J. Am. Soc. Exp. Neurother.* 11, 78–91. doi:10.1007/s13311-013-0238-x
- Corcuff, J.-B., Krim, E., Tison, F., Foubert-Sanier, A., Guehl, D., Burbaud, P., Cuny, E., Baillet, L., Gin, H., Rigalleau, V., Perlemoine, C., 2006. Subthalamic nucleus stimulation in patients with Parkinson's disease does not increase serum ghrelin levels. *Br. J. Nutr.* 95, 1028–1029. doi:10.1079/BJN20051678

- Costa, J.L., Naot, D., Lin, J.-M., Watson, M., Callon, K.E., Reid, I.R., Grey, A.B., Cornish, J., 2011. Ghrelin is an Osteoblast Mitogen and Increases Osteoclastic Bone Resorption In Vitro. *Int. J. Pept.* 2011, 605193. doi:10.1155/2011/605193
- Cotzias, G.C., Van Woert, M.H., Schiffer, L.M., 1967. Aromatic amino acids and modification of parkinsonism. *N. Engl. J. Med.* 276, 374–379. doi:10.1056/NEJM196702162760703
- Cowley, M.A., Smith, R.G., Diano, S., Tschöp, M., Pronchuk, N., Grove, K.L., Strasburger, C.J., Bidlingmaier, M., Esterman, M., Heiman, M.L., others, 2003. The distribution and mechanism of action of ghrelin in the CNS demonstrates a novel hypothalamic circuit regulating energy homeostasis. *Neuron* 37, 649–661.
- Cuervo, A.M., Stefanis, L., Fredenburg, R., Lansbury, P.T., Sulzer, D., 2004. Impaired degradation of mutant alpha-synuclein by chaperone-mediated autophagy. *Science* 305, 1292–1295. doi:10.1126/science.1101738
- Cummings, D.E., Purnell, J.Q., Frayo, R.S., Schmidova, K., Wisse, B.E., Weigle, D.S., 2001. A preprandial rise in plasma ghrelin levels suggests a role in meal initiation in humans. *Diabetes* 50, 1714–1719.
- Damier, P., Hirsch, E.C., Zhang, P., Agid, Y., Javoy-Agid, F., 1993. Glutathione peroxidase, glial cells and Parkinson's disease. *Neuroscience* 52, 1–6.
- Date, Y., Nakazato, M., Murakami, N., Kojima, M., Kangawa, K., Matsukura, S., 2001. Ghrelin Acts in the Central Nervous System to Stimulate Gastric Acid Secretion. *Biochem. Biophys. Res. Commun.* 280, 904–907. doi:10.1006/bbrc.2000.4212
- Dauer, W., Przedborski, S., 2003. Parkinson's disease: mechanisms and models. *Neuron* 39, 889–909.
- Dave, K.D., De Silva, S., Sheth, N.P., Ramboz, S., Beck, M.J., Quang, C., Switzer, R.C., Ahmad, S.O., Sunkin, S.M., Walker, D., Cui, X., Fisher, D.A., McCoy, A.M., Gamber, K., Ding, X., Goldberg, M.S., Benkovic, S.A., Haupt, M., Baptista, M.A.S., Fiske, B.K., Sherer, T.B., Frasier, M.A., 2014. Phenotypic characterization of recessive gene knockout rat models of Parkinson's disease. *Neurobiol. Dis.* 70, 190–203. doi:10.1016/j.nbd.2014.06.009
- Davey, G.P., Tipton, K.F., Murphy, M.P., 1992. Uptake and accumulation of 1-methyl-4-phenylpyridinium by rat liver mitochondria measured using an ion-selective electrode. *Biochem. J.* 288 (Pt 2), 439–443.
- Davis, G.C., Williams, A.C., Markey, S.P., Ebert, M.H., Caine, E.D., Reichert, C.M., Kopin, I.J., 1979. Chronic Parkinsonism secondary to intravenous injection of meperidine analogues. *Psychiatry Res.* 1, 249–254.
- Day, B.J., Patel, M., Calavetta, L., Chang, L.Y., Stamler, J.S., 1999. A mechanism of paraquat toxicity involving nitric oxide synthase. *Proc. Natl. Acad. Sci. U. S. A.* 96, 12760–12765.
- de Rijk, M. d, Tzourio, C., Breteler, M.M., Dartigues, J.F., Amaducci, L., Lopez-Pousa, S., Manubens-Bertran, J.M., Alperovitch, A., Rocca, W.A., 1997. Prevalence of parkinsonism and Parkinson's disease in Europe: the EUROPARKINSON Collaborative Study. European Community Concerted Action on the Epidemiology of Parkinson's disease. *J. Neurol. Neurosurg. Psychiatry* 62, 10–15.
- Dehay, B., Bové, J., Rodríguez-Muela, N., Perier, C., Recasens, A., Boya, P., Vila, M., 2010. Pathogenic Lysosomal Depletion in Parkinson's Disease. *J. Neurosci.* 30, 12535–12544. doi:10.1523/JNEUROSCI.1920-10.2010
- Delhanty, P.J., Neggers, S.J., van der Lely, A.J., 2013. Des-acyl ghrelin: a metabolically active peptide. *Endocr. Dev.* 25, 112–121. doi:10.1159/000346059
- Delhanty, P.J.D., 2006. Ghrelin and unacylated ghrelin stimulate human osteoblast growth via mitogen-activated protein kinase (MAPK)/phosphoinositide 3-kinase (PI3K) pathways in the absence of GHS-R1a. *J. Endocrinol.* 188, 37–47. doi:10.1677/joe.1.06404
- Delhanty, P.J.D., Huisman, M., Julien, M., Mouchain, K., Brune, P., Themmen, A.P.N., Aribat, T., van der Lely, A.J., 2015. The acylated (AG) to unacylated (UAG) ghrelin ratio in esterase inhibitor-treated blood is higher than previously described. *Clin. Endocrinol. (Oxf.)* 82, 142–146. doi:10.1111/cen.12489

- Delhanty, P.J.D., Neggers, S.J., van der Lely, A.J., 2014. Should we consider des-acyl ghrelin as a separate hormone and if so, what does it do? *Front. Horm. Res.* 42, 163–174. doi:10.1159/000358345
- DeLong, M.R., 1990. Primate models of movement disorders of basal ganglia origin. *Trends Neurosci.* 13, 281–285.
- Delporte, C., 2013. Structure and Physiological Actions of Ghrelin. *Scientifica* 2013, 1–25. doi:10.1155/2013/518909
- Derkinderen, P., Rouaud, T., Lebouvier, T., Des Varannes, S.B., Neunlist, M., De Giorgio, R., 2011. Parkinson disease The enteric nervous system spills its guts. *Neurology* 77, 1761–1767.
- Desagher, S., Glowinski, J., Premont, J., 1996. Astrocytes protect neurons from hydrogen peroxide toxicity. *J. Neurosci.* 16, 2553–2562.
- Desplats, P., Lee, H.-J., Bae, E.-J., Patrick, C., Rockenstein, E., Crews, L., Spencer, B., Masliah, E., Lee, S.-J., 2009. Inclusion formation and neuronal cell death through neuron-to-neuron transmission of alpha-synuclein. *Proc. Natl. Acad. Sci. U. S. A.* 106, 13010–13015. doi:10.1073/pnas.0903691106
- Dettmer, U., Newman, A.J., von Saucken, V.E., Bartels, T., Selkoe, D., 2015. KTKEGV repeat motifs are key mediators of normal α -synuclein tetramerization: Their mutation causes excess monomers and neurotoxicity. *Proc. Natl. Acad. Sci. U. S. A.* 112, 9596–9601. doi:10.1073/pnas.1505953112
- Devos, D., Moreau, C., Devedjian, J.C., Kluza, J., Petrault, M., Laloux, C., Jonneaux, A., Ryckewaert, G., Garçon, G., Rouaix, N., Duhamel, A., Jissendi, P., Dujardin, K., Auger, F., Ravasi, L., Hopes, L., Grolez, G., Firdaus, W., Sablonnière, B., Strubi-Vuillaume, I., Zahr, N., Destée, A., Corvol, J.-C., Pörtl, D., Leist, M., Rose, C., Defebvre, L., Marchetti, P., Cabantchik, Z.I., Bordet, R., 2014. Targeting chelatable iron as a therapeutic modality in Parkinson's disease. *Antioxid. Redox Signal.* 21, 195–210. doi:10.1089/ars.2013.5593
- Diano, S., A Farr, S., Benoit, S., McNay, E., da Silva, I., Horvath, B., Gaskin, F., Nonaka, N., Jaeger, L., Banks, W., Morley, J., Pinto, S., Sherwin, R., Xu, L., Yamada, K., Sleeman, M., Tschöp, M., Horvath, T., 2006. Ghrelin controls hippocampal spine synapse density and memory performance. *Nat. Neurosci.* 9, 381–388.
- Dias, V., Junn, E., Mouradian, M.M., 2013. The Role of Oxidative Stress in Parkinson's Disease. *J. Park. Dis.* 3, 461–491. doi:10.3233/JPD-130230
- Dickson, D.W., 2012. Parkinson's Disease and Parkinsonism: Neuropathology. *Cold Spring Harb. Perspect. Med.* 2, a009258. doi:10.1101/cshperspect.a009258
- Dickson, D.W., Braak, H., Duda, J.E., Duyckaerts, C., Gasser, T., Halliday, G.M., Hardy, J., Leverenz, J.B., Del Tredici, K., Wszolek, Z.K., Litvan, I., 2009. Neuropathological assessment of Parkinson's disease: refining the diagnostic criteria. *Lancet Neurol.* 8, 1150–1157. doi:10.1016/S1474-4422(09)70238-8
- Dissanayaka, N.N.W., Sellbach, A., Matheson, S., O'Sullivan, J.D., Silburn, P.A., Byrne, G.J., Marsh, R., Mellick, G.D., 2010. Anxiety disorders in Parkinson's disease: prevalence and risk factors. *Mov. Disord. Off. J. Mov. Disord. Soc.* 25, 838–845. doi:10.1002/mds.22833
- Do, C.B., Tung, J.Y., Dorfman, E., Kiefer, A.K., Drabant, E.M., Francke, U., Mountain, J.L., Goldman, S.M., Tanner, C.M., Langston, J.W., Wojcicki, A., Eriksson, N., 2011. Web-based genome-wide association study identifies two novel loci and a substantial genetic component for Parkinson's disease. *PLoS Genet.* 7, e1002141. doi:10.1371/journal.pgen.1002141
- Dong, J., Song, N., Xie, J., Jiang, H., 2009. Ghrelin Antagonized 1-Methyl-4-Phenylpyridinium (MPP+)-Induced Apoptosis in MES23.5 Cells. *J. Mol. Neurosci.* 37, 182–189. doi:10.1007/s12031-008-9162-7
- Dorsey, E.R., Constantinescu, R., Thompson, J.P., Biglan, K.M., Holloway, R.G., Kieburtz, K., Marshall, F.J., Ravina, B.M., Schifitto, G., Siderowf, A., Tanner, C.M., 2007. Projected number of people with Parkinson disease in the most populous nations, 2005 through 2030. *Neurology* 68, 384–386. doi:10.1212/01.wnl.0000247740.47667.03

- Dorsey, E.R., George, B.P., Leff, B., Willis, A.W., 2013. The coming crisis. *Neurology* 80, 1989–1996. doi:10.1212/WNL.0b013e318293e2ce
- Doty, R.L., 2012. Olfactory dysfunction in Parkinson disease. *Nat. Rev. Neurol.* 8, 329–339. doi:10.1038/nrneurol.2012.80
- Duan, W., Mattson, M.P., 1999. Dietary restriction and 2-deoxyglucose administration improve behavioral outcome and reduce degeneration of dopaminergic neurons in models of Parkinson's disease. *J. Neurosci. Res.* 57, 195–206. doi:10.1002/(SICI)1097-4547(19990715)57:2<195::AID-JNR5>3.0.CO;2-P
- Dunnett, S.B., Lelos, M., 2010. Behavioral analysis of motor and non-motor symptoms in rodent models of Parkinson's disease. *Prog. Brain Res.* 184, 35–51. doi:10.1016/S0079-6123(10)84003-8
- Dunning, C.J.R., Reyes, J.F., Steiner, J.A., Brundin, P., 2012. Can Parkinson's disease pathology be propagated from one neuron to another? *Prog. Neurobiol.* 97, 205–219. doi:10.1016/j.pneurobio.2011.11.003
- Dusonchet, J., Kochubey, O., Stafa, K., Young, S.M., Zufferey, R., Moore, D.J., Schneider, B.L., Aebischer, P., 2011. A rat model of progressive nigral neurodegeneration induced by the Parkinson's disease-associated G2019S mutation in LRRK2. *J. Neurosci. Off. J. Soc. Neurosci.* 31, 907–912. doi:10.1523/JNEUROSCI.5092-10.2011
- Duty, S., Jenner, P., 2011. Animal models of Parkinson's disease: a source of novel treatments and clues to the cause of the disease: Animal models of Parkinson's disease. *Br. J. Pharmacol.* 164, 1357–1391. doi:10.1111/j.1476-5381.2011.01426.x
- Duvoisin, R.C., Eldridge, R., Williams, A., Nutt, J., Calne, D., 1981. Twin study of Parkinson disease. *Neurology* 31, 77–77. doi:10.1212/WNL.31.1.77
- Eadie, M.J., Tyrer, J.H., 1965. ALIMENTARY DISORDER IN PARKINSONISM. *Australas. Ann. Med.* 14, 13–22.
- Edvardson, S., Cinnamon, Y., Ta-Shma, A., Shaag, A., Yim, Y.-I., Zenvirt, S., Jalas, C., Lesage, S., Brice, A., Taraboulos, A., Kaestner, K.H., Greene, L.E., Elpeleg, O., 2012. A deleterious mutation in DNAJC6 encoding the neuronal-specific clathrin-uncoating co-chaperone auxilin, is associated with juvenile parkinsonism. *PloS One* 7, e36458. doi:10.1371/journal.pone.0036458
- Edwards, L.L., Pfeiffer, R.F., Quigley, E.M., Hofman, R., Balluff, M., 1991. Gastrointestinal symptoms in Parkinson's disease. *Mov. Disord. Off. J. Mov. Disord. Soc.* 6, 151–156. doi:10.1002/mds.870060211
- Edwards, T.L., Scott, W.K., Almonte, C., Burt, A., Powell, E.H., Beecham, G.W., Wang, L., Züchner, S., Konidari, I., Wang, G., Singer, C., Nahab, F., Scott, B., Stajich, J.M., Pericak-Vance, M., Haines, J., Vance, J.M., Martin, E.R., 2010. Genome-wide association study confirms SNPs in SNCA and the MAPT region as common risk factors for Parkinson disease. *Ann. Hum. Genet.* 74, 97–109. doi:10.1111/j.1469-1809.2009.00560.x
- Ehringer, H., Hornykiewicz, O., 1960. [Distribution of noradrenaline and dopamine (3-hydroxytyramine) in the human brain and their behavior in diseases of the extrapyramidal system]. *Klin. Wochenschr.* 38, 1236–1239.
- Eichner, T., Radford, S.E., 2011. A diversity of assembly mechanisms of a generic amyloid fold. *Mol. Cell* 43, 8–18. doi:10.1016/j.molcel.2011.05.012
- Eidelberg, E., Brooks, B.A., Morgan, W.W., Walden, J.G., Kokemoor, R.H., 1986. Variability and functional recovery in the N-methyl-4-phenyl-1,2,3,6-tetrahydropyridine model of parkinsonism in monkeys. *Neuroscience* 18, 817–822.
- Ejlertskov, P., Rasmussen, I., Nielsen, T.T., Bergström, A.-L., Tohyama, Y., Jensen, P.H., Vilhardt, F., 2013. Tubulin polymerization-promoting protein (TPPP/p25 α) promotes unconventional secretion of α -synuclein through exophagy by impairing autophagosome-lysosome fusion. *J. Biol. Chem.* 288, 17313–17335. doi:10.1074/jbc.M112.401174
- Ejskjaer, N., Dimcevski, G., Wo, J., Hellström, P.M., Gormsen, L.C., Sarosiek, I., Søfteland, E., Nowak, T., Pezzullo, J.C., Shaughnessy, L., Kosutic, G., McCallum, R., 2010. Safety and efficacy of ghrelin agonist TZIP-101 in relieving symptoms in patients with diabetic gastroparesis: a

- randomized, placebo-controlled study. *Neurogastroenterol. Motil. Off. J. Eur. Gastrointest. Motil. Soc.* 22, 1069–e281. doi:10.1111/j.1365-2982.2010.01519.x
- Ejskjaer, N., Wo, J.M., Esfandyari, T., Mazen Jamal, M., Dimcevski, G., Tarnow, L., Malik, R.A., Hellström, P.M., Mondou, E., Quinn, J., Rousseau, F., McCallum, R.W., 2013. A phase 2a, randomized, double-blind 28-day study of TZP-102 a ghrelin receptor agonist for diabetic gastroparesis. *Neurogastroenterol. Motil. Off. J. Eur. Gastrointest. Motil. Soc.* 25, e140–150. doi:10.1111/nmo.12064
- Elbaz, A., Carcaillon, L., Kab, S., Moisan, F., 2016. Epidemiology of Parkinson's disease. *Rev. Neurol. (Paris)* 172, 14–26. doi:10.1016/j.neurol.2015.09.012
- Eldridge, R., Ince, S.E., 1984. The low concordance rate for Parkinson's disease in twins A possible explanation. *Neurology* 34, 1354–1354. doi:10.1212/WNL.34.10.1354
- Erickson, J.D., Eiden, L.E., Schafer, M.K., Weihe, E., 1995. Reserpine- and tetrabenazine-sensitive transport of (3)H-histamine by the neuronal isoform of the vesicular monoamine transporter. *J. Mol. Neurosci.* MN 6, 277–287. doi:10.1007/BF02736786
- Evans, A.H., Lawrence, A.D., Potts, J., MacGregor, L., Katzenschlager, R., Shaw, K., Zijlmans, J., Lees, A.J., 2006. Relationship between impulsive sensation seeking traits, smoking, alcohol and caffeine intake, and Parkinson's disease. *J. Neurol. Neurosurg. Psychiatry* 77, 317–321. doi:10.1136/jnnp.2005.065417
- Fabbrini, G., Brotchie, J.M., Grandas, F., Nomoto, M., Goetz, C.G., 2007. Levodopa-induced dyskinesias. *Mov. Disord. Off. J. Mov. Disord. Soc.* 22, 1379–1389; quiz 1523. doi:10.1002/mds.21475
- Fahn, S., 2015. The medical treatment of Parkinson disease from James Parkinson to George Cotzias. *Mov. Disord. Off. J. Mov. Disord. Soc.* 30, 4–18. doi:10.1002/mds.26102
- Falkenburger, B.H., Saridaki, T., Dinter, E., 2016. Cellular models for Parkinson's disease. *J. Neurochem.* doi:10.1111/jnc.13618
- Falkenburger, B.H., Schulz, P.D.J.B., 2006. Limitations of cellular models in Parkinson's disease research, in: Riederer, P.D.P., Reichmann, P.D.H., Youdim, P.D.M.B.H., Gerlach, P.D.M. (Eds.), *Parkinson's Disease and Related Disorders, Journal of Neural Transmission. Supplementa.* Springer Vienna, pp. 261–268. doi:10.1007/978-3-211-45295-0_40
- Farrer, M., Gwinn-Hardy, K., Muenter, M., DeVrieze, F.W., Crook, R., Perez-Tur, J., Lincoln, S., Maraganore, D., Adler, C., Newman, S., MacElwee, K., McCarthy, P., Miller, C., Waters, C., Hardy, J., 1999. A chromosome 4p haplotype segregating with Parkinson's disease and postural tremor. *Hum. Mol. Genet.* 8, 81–85.
- Feany, M.B., Bender, W.W., 2000. A Drosophila model of Parkinson's disease. *Nature* 404, 394–398. doi:10.1038/35006074
- Fenelon, F., 1955a. [Neurosurgery of the ansa lenticularis in dyskinesia and Parkinson's disease; principles and technic of own procedure]. *Sem. Hôp. Organe Fondé Par Assoc. Enseign. Méd. Hôp. Paris* 31, 1835–1837.
- Fenelon, F., 1955b. [Subpallidal extrapyramidotomy by electrocoagulation in the treatment of dyskinesia; personal technic]. *Rev. Esp. Oto-Neuro-Oftalmol. Neurocir.* 14, 99–104.
- Ferese, R., Modugno, N., Campopiano, R., Santilli, M., Zampatti, S., Giardina, E., Nardone, A., Postorivo, D., Fornai, F., Novelli, G., Romoli, E., Ruggieri, S., Gambardella, S., 2015. Four Copies of SNCA Responsible for Autosomal Dominant Parkinson's Disease in Two Italian Siblings. *Park. Dis.* 2015, 546462. doi:10.1155/2015/546462
- Fernandes, V.S., Santos, J.R., Leão, A.H.F.F., Medeiros, A.M., Melo, T.G., Izídio, G.S., Cabral, A., Ribeiro, R.A., Abílio, V.C., Ribeiro, A.M., Silva, R.H., 2012. Repeated treatment with a low dose of reserpine as a progressive model of Parkinson's disease. *Behav. Brain Res.* 231, 154–163. doi:10.1016/j.bbr.2012.03.008
- Ferrante, R.J., Schulz, J.B., Kowall, N.W., Beal, M.F., 1997. Systemic administration of rotenone produces selective damage in the striatum and globus pallidus, but not in the substantia nigra. *Brain Res.* 753, 157–162.

- Fiszer, U., Michałowska, M., Baranowska, B., Wolińska-Witort, E., Jeske, W., Jethon, M., Piaścik-Gromada, M., Marcinowska-Suchowierska, E., 2010. Leptin and ghrelin concentrations and weight loss in Parkinson's disease. *Acta Neurol. Scand.* 121, 230–236. doi:10.1111/j.1600-0404.2009.01185.x
- Fleming, S.M., 2004. Early and Progressive Sensorimotor Anomalies in Mice Overexpressing Wild-Type Human α -Synuclein. *J. Neurosci.* 24, 9434–9440. doi:10.1523/JNEUROSCI.3080-04.2004
- Fleming, S.M., Salcedo, J., Fernagut, P.-O., Rockenstein, E., Masliah, E., Levine, M.S., Chesselet, M.-F., 2004. Early and progressive sensorimotor anomalies in mice overexpressing wild-type human α -synuclein. *J. Neurosci. Off. J. Soc. Neurosci.* 24, 9434–9440. doi:10.1523/JNEUROSCI.3080-04.2004
- Forman, M.S., Trojanowski, J.Q., Lee, V.M.-Y., 2004. Neurodegenerative diseases: a decade of discoveries paves the way for therapeutic breakthroughs. *Nat. Med.* 10, 1055–1063. doi:10.1038/nm1113
- Fowler, J.S., Volkow, N.D., Wang, G.J., Logan, J., Pappas, N., Shea, C., MacGregor, R., 1997. Age-related increases in brain monoamine oxidase B in living healthy human subjects. *Neurobiol. Aging* 18, 431–435.
- Frago, L., 2011. Neuroprotective actions of ghrelin and growth hormone secretagogues. *Front. Mol. Neurosci.* 4. doi:10.3389/fnmol.2011.00023
- François, M., Barde, S., Achamrah, N., Breton, J., do Rego, J.-C., Coëffier, M., Hökfelt, T., Déchelotte, P., Fetissov, S.O., 2015. The number of proghrelin mRNA expressing cells is increased in mice with activity-based anorexia. *Neuropeptides* 51, 17–23. doi:10.1016/j.npep.2015.04.003
- Fritz, N.E., Kegelmeyer, D.A., Kloos, A.D., Linder, S., Park, A., Kataki, M., Adeli, A., Agrawal, P., Scharre, D.W., Kostyk, S.K., 2016. Motor performance differentiates individuals with Lewy body dementia, Parkinson's and Alzheimer's disease. *Gait Posture* 50, 1–7. doi:10.1016/j.gaitpost.2016.08.009
- Funayama, M., Hasegawa, K., Kowa, H., Saito, M., Tsuji, S., Obata, F., 2002. A new locus for Parkinson's disease (PARK8) maps to chromosome 12p11.2-q13.1. *Ann. Neurol.* 51, 296–301.
- Funayama, M., Ohe, K., Amo, T., Furuya, N., Yamaguchi, J., Saiki, S., Li, Y., Ogaki, K., Ando, M., Yoshino, H., Tomiyama, H., Nishioka, K., Hasegawa, K., Saiki, H., Satake, W., Mogushi, K., Sasaki, R., Kokubo, Y., Kuzuhara, S., Toda, T., Mizuno, Y., Uchiyama, Y., Ohno, K., Hattori, N., 2015. CHCHD2 mutations in autosomal dominant late-onset Parkinson's disease: a genome-wide linkage and sequencing study. *Lancet Neurol.* 14, 274–282. doi:10.1016/S1474-4422(14)70266-2
- Furness, J.B., Hunne, B., Matsuda, N., Yin, L., Russo, D., Kato, I., Fujimiya, M., Patterson, M., McLeod, J., Andrews, Z.B., Bron, R., 2011. Investigation of the presence of ghrelin in the central nervous system of the rat and mouse. *Neuroscience* 193, 1–9. doi:10.1016/j.neuroscience.2011.07.063
- Gao, X., Martin, E.R., Liu, Y., Mayhew, G., Vance, J.M., Scott, W.K., 2009. Genome-wide linkage screen in familial Parkinson disease identifies loci on chromosomes 3 and 18. *Am. J. Hum. Genet.* 84, 499–504. doi:10.1016/j.ajhg.2009.03.005
- Gardner, R.C., Burke, J.F., Nettiksimmons, J., Goldman, S., Tanner, C.M., Yaffe, K., 2015. Traumatic brain injury in later life increases risk for Parkinson disease. *Ann. Neurol.* 77, 987–995. doi:10.1002/ana.24396
- Gasser, T., Müller-Myhsok, B., Wszolek, Z.K., Oehlmann, R., Calne, D.B., Bonifati, V., Bereznoi, B., Fabrizio, E., Vieregge, P., Horstmann, R.D., 1998. A susceptibility locus for Parkinson's disease maps to chromosome 2p13. *Nat. Genet.* 18, 262–265. doi:10.1038/ng0398-262
- Gauna, C., Delhanty, P.J.D., Hofland, L.J., Janssen, J.A.M.J.L., Broglio, F., Ross, R.J.M., Ghigo, E., van der Lely, A.J., 2005. Ghrelin stimulates, whereas des-octanoyl ghrelin inhibits, glucose output by primary hepatocytes. *J. Clin. Endocrinol. Metab.* 90, 1055–1060. doi:10.1210/jc.2004-1069
- Gauna, C., van de Zande, B., van Kerkwijk, A., Themmen, A.P.N., van der Lely, A.J., Delhanty, P.J.D., 2007. Unacylated ghrelin is not a functional antagonist but a full agonist of the type 1a

- growth hormone secretagogue receptor (GHS-R). *Mol. Cell. Endocrinol.* 274, 30–34. doi:10.1016/j.mce.2007.05.010
- Gaven, F., Marin, P., Claeysen, S., 2014. Primary culture of mouse dopaminergic neurons. *J. Vis. Exp. JoVE* e51751. doi:10.3791/51751
- Geddes, J.F., Hughes, A.J., Lees, A.J., Daniel, S.E., 1993. Pathological overlap in cases of parkinsonism associated with neurofibrillary tangles. A study of recent cases of postencephalitic parkinsonism and comparison with progressive supranuclear palsy and Guamanian parkinsonism-dementia complex. *Brain J. Neurol.* 116 (Pt 1), 281–302.
- Germain, N., Galusca, B., Grouselle, D., Frere, D., Billard, S., Epelbaum, J., Estour, B., 2010. Ghrelin and obestatin circadian levels differentiate bingeing-purging from restrictive anorexia nervosa. *J. Clin. Endocrinol. Metab.* 95, 3057–3062. doi:10.1210/jc.2009-2196
- Germain, N., Galusca, B., Grouselle, D., Frere, D., Tolle, V., Zizzari, P., Lang, F., Epelbaum, J., Estour, B., 2009. Ghrelin/obestatin ratio in two populations with low bodyweight: constitutional thinness and anorexia nervosa. *Psychoneuroendocrinology* 34, 413–419. doi:10.1016/j.psyneuen.2008.10.001
- Gershon, E., Vale, W.W., 2014. CRF type 2 receptors mediate the metabolic effects of ghrelin in C2C12 cells. *Obes. Silver Spring Md* 22, 380–389. doi:10.1002/oby.20535
- Ghigo, E., Broglio, F., Arvat, E., Maccario, M., Papotti, M., Muccioli, G., 2005. Ghrelin: more than a natural GH secretagogue and/or an orexigenic factor. *Clin. Endocrinol. (Oxf.)* 62, 1–17. doi:10.1111/j.1365-2265.2004.02160.x
- Gildenberg, P.L., 2006. Evolution of basal ganglia surgery for movement disorders. *Stereotact. Funct. Neurosurg.* 84, 131–135. doi:10.1159/000094844
- Glinka, Y., Gassen, M., Youdim, M.B., 1997. Mechanism of 6-hydroxydopamine neurotoxicity. *J. Neural Transm. Suppl.* 50, 55–66.
- Gnanapavan, S., Kola B, Bustin SA, Morris DG, McGee P, Fairclough P, Bhattacharya S, Carpenter R, Grossman AB, Korbonits M, 2002. The tissue distribution of the mRNA of the ghrelin and subtypes of its receptor, GHS-R, in humans. *J. Clin. Endocrinol. Metab.* 87, 2988–2991.
- Godau, J., Hussl, A., Lolekha, P., Stoessl, A.J., Seppi, K., 2012. Neuroimaging: Current role in detecting pre-motor Parkinson’s disease. *Mov. Disord.* 27, 634–643. doi:10.1002/mds.24976
- Goedert, M., Spillantini, M.G., Del Tredici, K., Braak, H., 2013. 100 years of Lewy pathology. *Nat. Rev. Neurol.* 9, 13–24. doi:10.1038/nrneuro.2012.242
- Goetz, C.G., 2011. The History of Parkinson’s Disease: Early Clinical Descriptions and Neurological Therapies. *Cold Spring Harb. Perspect. Med.* 1, a008862–a008862. doi:10.1101/cshperspect.a008862
- Goetz, C.G., Fahn, S., Martinez-Martin, P., Poewe, W., Sampaio, C., Stebbins, G.T., Stern, M.B., Tilley, B.C., Dodel, R., Dubois, B., Holloway, R., Jankovic, J., Kulisevsky, J., Lang, A.E., Lees, A., Leurgans, S., LeWitt, P.A., Nyenhuis, D., Olanow, C.W., Rascol, O., Schrag, A., Teresi, J.A., Van Hilten, J.J., LaPelle, N., 2007. Movement Disorder Society-sponsored revision of the Unified Parkinson’s Disease Rating Scale (MDS-UPDRS): Process, format, and clinimetric testing plan. *Mov. Disord. Off. J. Mov. Disord. Soc.* 22, 41–47. doi:10.1002/mds.21198
- Goldberg, M.S., 2003. Parkin-deficient Mice Exhibit Nigrostriatal Deficits but Not Loss of Dopaminergic Neurons. *J. Biol. Chem.* 278, 43628–43635. doi:10.1074/jbc.M308947200
- Goldman, J.E., Yen, S.H., Chiu, F.C., Peress, N.S., 1983. Lewy bodies of Parkinson’s disease contain neurofilament antigens. *Science* 221, 1082–1084.
- Goldstein, J.M., Barnett, A., Malick, J.B., 1975. The evaluation of anti-parkinson drugs on reserpine-induced rigidity in rats. *Eur. J. Pharmacol.* 33, 183–188.
- González-Polo, R.A., Niso-Santano, M., Ortíz-Ortíz, M.A., Gómez-Martín, A., Morán, J.M., García-Rubio, L., Francisco-Morcillo, J., Zaragoza, C., Soler, G., Fuentes, J.M., 2007a. Relationship between autophagy and apoptotic cell death in human neuroblastoma cells treated with paraquat: could autophagy be a “brake” in paraquat-induced apoptotic death? *Autophagy* 3, 366–367.

- González-Polo, R.A., Niso-Santano, M., Ortiz-Ortiz, M.A., Gómez-Martín, A., Morán, J.M., García-Rubio, L., Francisco-Morcillo, J., Zaragoza, C., Soler, G., Fuentes, J.M., 2007b. Inhibition of paraquat-induced autophagy accelerates the apoptotic cell death in neuroblastoma SH-SY5Y cells. *Toxicol. Sci. Off. J. Soc. Toxicol.* 97, 448–458. doi:10.1093/toxsci/kfm040
- Goodman, R., Herschman, H.R., 1978. Nerve growth factor-mediated induction of tyrosine hydroxylase in a clonal pheochromocytoma cell line. *Proc. Natl. Acad. Sci. U. S. A.* 75, 4587–4590.
- Gotham, A.M., Brown, R.G., Marsden, C.D., 1986. Depression in Parkinson's disease: a quantitative and qualitative analysis. *J. Neurol. Neurosurg. Psychiatry* 49, 381–389.
- Granata, R., Settanni, F., Biancone, L., Trovato, L., Nano, R., Bertuzzi, F., Destefanis, S., Annunziata, M., Martinetti, M., Catapano, F., Ghè, C., Isgaard, J., Papotti, M., Ghigo, E., Muccioli, G., 2007. Acylated and unacylated ghrelin promote proliferation and inhibit apoptosis of pancreatic beta-cells and human islets: involvement of 3',5'-cyclic adenosine monophosphate/protein kinase A, extracellular signal-regulated kinase 1/2, and phosphatidylinositol 3-Kinase/Akt signaling. *Endocrinology* 148, 512–529. doi:10.1210/en.2006-0266
- Grau, C.M., Greene, L.A., 2012. Use of PC12 Cells and Rat Superior Cervical Ganglion Sympathetic Neurons as Models for Neuroprotective Assays Relevant to Parkinson's Disease. *Methods Mol. Biol. Clifton NJ* 846, 201–211. doi:10.1007/978-1-61779-536-7_18
- Gray, M.T., Woulfe, J.M., 2015. Striatal blood-brain barrier permeability in Parkinson's disease. *J. Cereb. Blood Flow Metab. Off. J. Int. Soc. Cereb. Blood Flow Metab.* 35, 747–750. doi:10.1038/jcbfm.2015.32
- Greenamyre, J.T., Sherer, T.B., Betarbet, R., Panov, A.V., 2001. Complex I and Parkinson's Disease. *IUBMB Life* 52, 135–141. doi:10.1080/15216540152845939
- Greenfield, J.G., Bosanquet, F.D., 1953. The brain-stem lesions in Parkinsonism. *J. Neurol. Neurosurg. Psychiatry* 16, 213–226.
- Greffard, S., Verny, M., Bonnet, A.-M., Seilhean, D., Hauw, J.-J., Duyckaerts, C., 2010. A stable proportion of Lewy body bearing neurons in the substantia nigra suggests a model in which the Lewy body causes neuronal death. *Neurobiol. Aging* 31, 99–103. doi:10.1016/j.neurobiolaging.2008.03.015
- Griggs, R.C., Fontaine, B., Sobue, G., 2011. Global imperatives and challenges facing the practice of neurology. *Neurol. Clin. Pract.* 1, 49–54. doi:10.1212/CPJ.0b013e31823b4e83
- Gross, C.E., Boraud, T., Guehl, D., Bioulac, B., Bezard, E., 1999. From experimentation to the surgical treatment of Parkinson's disease: prelude or suite in basal ganglia research? *Prog. Neurobiol.* 59, 509–532.
- Guan, X.-M., Yu, H., Palyha, O.C., McKee, K.K., Feighner, S.D., Sirinathsinghji, D.J., Smith, R.G., Van der Ploeg, L.H., Howard, A.D., 1997. Distribution of mRNA encoding the growth hormone secretagogue receptor in brain and peripheral tissues. *Mol. Brain Res.* 48, 23–29.
- Guiot, G., Brion, S., 1953. [Treatment of abnormal movement by pallidal coagulation]. *Rev. Neurol. (Paris)* 89, 578–580.
- Gutierrez, J.A., Solenberg, P.J., Perkins, D.R., Willency, J.A., Knierman, M.D., Jin, Z., Witcher, D.R., Luo, S., Onyia, J.E., Hale, J.E., 2008. Ghrelin octanoylation mediated by an orphan lipid transferase. *Proc. Natl. Acad. Sci.* 105, 6320–6325.
- Haaxma, C.A., Bloem, B.R., Borm, G.F., Oyen, W.J.G., Leenders, K.L., Eshuis, S., Booij, J., Dluzen, D.E., Horstink, M.W.I.M., 2007. Gender differences in Parkinson's disease. *J. Neurol. Neurosurg. Psychiatry* 78, 819–824. doi:10.1136/jnnp.2006.103788
- Haehner, A., Boesveldt, S., Berendse, H.W., Mackay-Sim, A., Fleischmann, J., Silburn, P.A., Johnston, A.N., Mellick, G.D., Herting, B., Reichmann, H., Hummel, T., 2009. Prevalence of smell loss in Parkinson's disease--a multicenter study. *Parkinsonism Relat. Disord.* 15, 490–494. doi:10.1016/j.parkreldis.2008.12.005
- Halbgebauer, S., Öckl, P., Wirth, K., Steinacker, P., Otto, M., 2016. Protein biomarkers in Parkinson's disease: Focus on cerebrospinal fluid markers and synaptic proteins. *Mov. Disord. Off. J. Mov. Disord. Soc.* 31, 848–860. doi:10.1002/mds.26635

- Hallett, M., 2012. Parkinson's disease tremor: pathophysiology. *Parkinsonism Relat. Disord.* 18 Suppl 1, S85-86. doi:10.1016/S1353-8020(11)70027-X
- Halliday, G., Herrero, M.T., Murphy, K., McCann, H., Ros-Bernal, F., Barcia, C., Mori, H., Blesa, F.J., Obeso, J.A., 2009. No Lewy pathology in monkeys with over 10 years of severe MPTP Parkinsonism. *Mov. Disord. Off. J. Mov. Disord. Soc.* 24, 1519–1523. doi:10.1002/mds.22481
- Halliday, G.M., 2009. Thalamic changes in Parkinson's disease. *Parkinsonism Relat. Disord.*, Proceedings of WFN XVIII World Congress on Parkinson's Disease and Related Disorders 15, Supplement 3, S152–S155. doi:10.1016/S1353-8020(09)70804-1
- Hampshire, D.J., Roberts, E., Crow, Y., Bond, J., Mubaidin, A., Wriekat, A.L., Al-Din, A., Woods, C.G., 2001. Kufor-Rakeb syndrome, pallido-pyramidal degeneration with supranuclear upgaze paresis and dementia, maps to 1p36. *J. Med. Genet.* 38, 680–682.
- Hasegawa, T., Matsuzaki, M., Takeda, A., Kikuchi, A., Akita, H., Perry, G., Smith, M.A., Itoyama, Y., 2004. Accelerated alpha-synuclein aggregation after differentiation of SH-SY5Y neuroblastoma cells. *Brain Res.* 1013, 51–59. doi:10.1016/j.brainres.2004.04.018
- Heetun, Z.S., Quigley, E.M.M., 2012. Gastroparesis and Parkinson's disease: a systematic review. *Parkinsonism Relat. Disord.* 18, 433–440. doi:10.1016/j.parkreldis.2011.12.004
- Hely, M.A., Morris, J.G.L., Reid, W.G.J., Trafficante, R., 2005. Sydney multicenter study of Parkinson's disease: Non-L-dopa-responsive problems dominate at 15 years. *Mov. Disord.* 20, 190–199. doi:10.1002/mds.20324
- Hernán, M.A., Takkouche, B., Caamaño-Isorna, F., Gestal-Otero, J.J., 2002. A meta-analysis of coffee drinking, cigarette smoking, and the risk of Parkinson's disease. *Ann. Neurol.* 52, 276–284. doi:10.1002/ana.10277
- Hicks, A.A., Pétursson, H., Jónsson, T., Stefánsson, H., Jóhannsdóttir, H.S., Sainz, J., Frigge, M.L., Kong, A., Gulcher, J.R., Stefánsson, K., Sveinbjörnsdóttir, S., 2002. A susceptibility gene for late-onset idiopathic Parkinson's disease. *Ann. Neurol.* 52, 549–555. doi:10.1002/ana.10324
- Hideshima, T., Bradner, J.E., Chauhan, D., Anderson, K.C., 2005. Intracellular protein degradation and its therapeutic implications. *Clin. Cancer Res. Off. J. Am. Assoc. Cancer Res.* 11, 8530–8533. doi:10.1158/1078-0432.CCR-05-2305
- Hinde, R., 1976. Animal models in human psychobiology, in: *The Uses of Similarities and Differences in Comparative Psychopathology*. Plenum Press, New York, pp. 187–202.
- Hirata, Y., Nagatsu, T., 2005. Rotenone and CCCP inhibit tyrosine hydroxylation in rat striatal tissue slices. *Toxicology* 216, 9–14. doi:10.1016/j.tox.2005.07.010
- Hirsch, E.C., Hunot, S., Hartmann, A., 2005. Neuroinflammatory processes in Parkinson's disease. *Parkinsonism Relat. Disord.* 11, S9–S15. doi:10.1016/j.parkreldis.2004.10.013
- Hoepken, H.-H., Gispert, S., Azizov, M., Klinkenberg, M., Ricciardi, F., Kurz, A., Morales-Gordo, B., Bonin, M., Riess, O., Gasser, T., Kögel, D., Steinmetz, H., Auburger, G., 2008. Parkinson patient fibroblasts show increased alpha-synuclein expression. *Exp. Neurol.* 212, 307–313. doi:10.1016/j.expneurol.2008.04.004
- Holdorff, B., 2002. Friedrich Heinrich Lewy (1885-1950) and his work. *J. Hist. Neurosci.* 11, 19–28. doi:10.1076/jhin.11.1.19.9106
- Holloway, R.G., Shoulson, I., Fahn, S., Kieburtz, K., Lang, A., Marek, K., McDermott, M., Seibyl, J., Weiner, W., Musch, B., Kamp, C., Welsh, M., Shinaman, A., Pahwa, R., Barclay, L., Hubble, J., LeWitt, P., Miyasaki, J., Suchowersky, O., Stacy, M., Russell, D.S., Ford, B., Hammerstad, J., Riley, D., Standaert, D., Wooten, F., Factor, S., Jankovic, J., Atassi, F., Kurlan, R., Panisset, M., Rajput, A., Rodnitzky, R., Shults, C., Petsinger, G., Waters, C., Pfeiffer, R., Biglan, K., Borchert, L., Montgomery, A., Sutherland, L., Weeks, C., DeAngelis, M., Sime, E., Wood, S., Pantella, C., Harrigan, M., Fussell, B., Dillon, S., Alexander-Brown, B., Rainey, P., Tennis, M., Rost-Ruffner, E., Brown, D., Evans, S., Berry, D., Hall, J., Shirley, T., Dobson, J., Fontaine, D., Pfeiffer, B., Brocht, A., Bennett, S., Daigneault, S., Hodgeman, K., O'Connell, C., Ross, T., Richard, K., Watts, A., Parkinson Study Group, 2004. Pramipexole vs levodopa as initial treatment for Parkinson disease: a 4-year randomized controlled trial. *Arch. Neurol.* 61, 1044–1053. doi:10.1001/archneur.61.7.1044

- Holmans, P., Moskva, V., Jones, L., Sharma, M., International Parkinson's Disease Genomics Consortium, Vedernikov, A., Buchel, F., Saad, M., Sadd, M., Bras, J.M., Bettella, F., Nicolaou, N., Simón-Sánchez, J., Mittag, F., Gibbs, J.R., Schulte, C., Durr, A., Guerreiro, R., Hernandez, D., Brice, A., Stefánsson, H., Majamaa, K., Gasser, T., Heutink, P., Wood, N.W., Martinez, M., Singleton, A.B., Nalls, M.A., Hardy, J., Morris, H.R., Williams, N.M., 2013. A pathway-based analysis provides additional support for an immune-related genetic susceptibility to Parkinson's disease. *Hum. Mol. Genet.* 22, 1039–1049. doi:10.1093/hmg/dds492
- Holmqvist, S., Chutna, O., Bousset, L., Aldrin-Kirk, P., Li, W., Björklund, T., Wang, Z.-Y., Roybon, L., Melki, R., Li, J.-Y., 2014. Direct evidence of Parkinson pathology spread from the gastrointestinal tract to the brain in rats. *Acta Neuropathol. (Berl.)*. doi:10.1007/s00401-014-1343-6
- Holst, B., Cygankiewicz, A., Jensen, T.H., Ankersen, M., Schwartz, T.W., 2003. High Constitutive Signaling of the Ghrelin Receptor—Identification of a Potent Inverse Agonist. *Mol. Endocrinol.* 17, 2201–2210. doi:10.1210/me.2003-0069
- Hoppel, C.L., Grinblatt, D., Kwok, H.C., Arora, P.K., Singh, M.P., Sayre, L.M., Greenblatt, D., 1987. Inhibition of mitochondrial respiration by analogs of 4-phenylpyridine and 1-methyl-4-phenylpyridinium cation (MPP+), the neurotoxic metabolite of MPTP. *Biochem. Biophys. Res. Commun.* 148, 684–693.
- Hosoda, H., Kangawa, K., 2012. Standard sample collections for blood ghrelin measurements. *Methods Enzymol.* 514, 113–126. doi:10.1016/B978-0-12-381272-8.00008-8
- Howard, A., Feighner, S., Cully, D., Arena, J., Liberators, P., Rosenbaum, C., Hamelin, M., Hreniuk, D., Palyha, O., Anderson, J., Paress, P., Diaz, C., Chou, M., Liu, K., McKee, K., Pong, S., Chaung, L., Elbrecht, A., Dashkevich, M., Heavens, R., Rigby, M., Sirinathsinghji, D., Dean, D., Melillo, D., Patchett, A., Nargund, R., Griffin, P., DeMartino, J., Gupta, S., Schaeffer, J., Smith, R., Van der Ploeg, L., 1996. A receptor in pituitary and hypothalamus that functions in growth hormone release. 16 August 1996 273, 974–977.
- Hoyle, K., Sharma, J.C., 2013. Olfactory loss as a supporting feature in the diagnosis of Parkinson's disease: a pragmatic approach. *J. Neurol.* 260, 2951–2958. doi:10.1007/s00415-013-6848-8
- Hwang, S., Moon, M., Kim, S., Hwang, L., Ahn, K.J., Park, S., 2009. Neuroprotective effect of ghrelin is associated with decreased expression of prostate apoptosis response-4. *Endocr. J.* 56, 609–617.
- Ibáñez, P., Lesage, S., Janin, S., Lohmann, E., Durif, F., Destée, A., Bonnet, A.-M., Brefel-Courbon, C., Heath, S., Zelenika, D., Agid, Y., Dürr, A., Brice, A., French Parkinson's Disease Genetics Study Group, 2009. Alpha-synuclein gene rearrangements in dominantly inherited parkinsonism: frequency, phenotype, and mechanisms. *Arch. Neurol.* 66, 102–108. doi:10.1001/archneurol.2008.555
- Ieraci, A., Mallei, A., Popoli, M., 2016. Social Isolation Stress Induces Anxious-Depressive-Like Behavior and Alterations of Neuroplasticity-Related Genes in Adult Male Mice. *Neural Plast.* 2016, 6212983. doi:10.1155/2016/6212983
- Ikemoto, K., Nagatsu, I., Nishimura, A., Nishi, K., Arai, R., 1998. Do all of human midbrain tyrosine hydroxylase neurons synthesize dopamine? *Brain Res.* 805, 255–258.
- Iljina, M., Garcia, G.A., Horrocks, M.H., Tosatto, L., Choi, M.L., Ganzinger, K.A., Abramov, A.Y., Gandhi, S., Wood, N.W., Cremades, N., Dobson, C.M., Knowles, T.P.J., Klenerman, D., 2016. Kinetic model of the aggregation of alpha-synuclein provides insights into prion-like spreading. *Proc. Natl. Acad. Sci. U. S. A.* 113, E1206-1215. doi:10.1073/pnas.1524128113
- Inui, A., 2001. Ghrelin: An orexigenic and somatotrophic signal from the stomach. *Nat. Rev. Neurosci.* 2, 551–560. doi:10.1038/35086018
- Irwin, D.J., Lee, V.M.-Y., Trojanowski, J.Q., 2013. Parkinson's disease dementia: convergence of α -synuclein, tau and amyloid- β pathologies. *Nat. Rev. Neurosci.* 14, 626–636. doi:10.1038/nrn3549
- Jackson-Lewis, V., Jakowec, M., Burke, R.E., Przedborski, S., 1995. Time course and morphology of dopaminergic neuronal death caused by the neurotoxin 1-methyl-4-phenyl-1,2,3,6-

- tetrahydropyridine. *Neurodegener. J. Neurodegener. Disord. Neuroprotection Neuroregeneration* 4, 257–269.
- Jacob, F., 1996. *Souris, la Mouche et l'Homme* -. Éditions Odile Jacob.
- Jagmag, S.A., Tripathi, N., Shukla, S.D., Maiti, S., Khurana, S., 2016. Evaluation of Models of Parkinson's Disease. *Front. Neurosci.* 9. doi:10.3389/fnins.2015.00503
- Jain, S., Young Park, S., Comer, D., Rudoy, D., Ivanco, L., 2015. Identifying drug-naïve Parkinsonism with Non-motor features & CSF biomarkers: A case-control study.
- Jang, W., Kim, H.J., Li, H., Jo, K.D., Lee, M.K., Yang, H.O., 2015. The Neuroprotective Effect of Erythropoietin on Rotenone-Induced Neurotoxicity in SH-SY5Y Cells Through the Induction of Autophagy. *Mol. Neurobiol.* 53, 3812–3821. doi:10.1007/s12035-015-9316-x
- Jaremka, L.M., Belury, M.A., Andridge, R.R., Malarkey, W.B., Glaser, R., Christian, L., Emery, C.F., Kiecolt-Glaser, J.K., 2014. Interpersonal stressors predict ghrelin and leptin levels in women. *Psychoneuroendocrinology* 48, 178–188. doi:10.1016/j.psyneuen.2014.06.018
- Jiang, H., Betancourt, L., Smith, R.G., 2006. Ghrelin Amplifies Dopamine Signaling by Cross Talk Involving Formation of Growth Hormone Secretagogue Receptor/Dopamine Receptor Subtype 1 Heterodimers. *Mol. Endocrinol.* 20, 1772–1785. doi:10.1210/me.2005-0084
- Jiang, H., Li, L.-J., Wang, J., Xie, J.-X., 2008. Ghrelin antagonizes MPTP-induced neurotoxicity to the dopaminergic neurons in mouse substantia nigra. *Exp. Neurol.* 212, 532–537. doi:10.1016/j.expneurol.2008.05.006
- Johnson, I.P., 2015. Age-related neurodegenerative disease research needs aging models. *Front. Aging Neurosci.* 7, 168. doi:10.3389/fnagi.2015.00168
- Johnston, J.P., 1968. Some observations upon a new inhibitor of monoamine oxidase in brain tissue. *Biochem. Pharmacol.* 17, 1285–1297.
- Kääriäinen, T.M., Käenmäki, M., Forsberg, M.M., Oinas, N., Tammimäki, A., Männistö, P.T., 2012. Unpredictable rotational responses to L-dopa in the rat model of Parkinson's disease: the role of L-dopa pharmacokinetics and striatal dopamine depletion. *Basic Clin. Pharmacol. Toxicol.* 110, 162–170. doi:10.1111/j.1742-7843.2011.00782.x
- Kadas, G., Klotz, M., Schäfer, K.-H., Fassbender, K., Thomi, D., Oertel, W.H., Unger, M.M., 2014. Do different assays for human acylated ghrelin concentrations provide comparable results? *Neuro Endocrinol. Lett.* 35, 37–41.
- Kalaitzakis, M.E., Graeber, M.B., Gentleman, S.M., Pearce, R.K.B., 2008. Striatal beta-amyloid deposition in Parkinson disease with dementia. *J. Neuropathol. Exp. Neurol.* 67, 155–161. doi:10.1097/NEN.0b013e31816362aa
- Kalia, L.V., Kalia, S.K., McLean, P.J., Lozano, A.M., Lang, A.E., 2013. α -Synuclein oligomers and clinical implications for Parkinson disease. *Ann. Neurol.* 73, 155–169. doi:10.1002/ana.23746
- Kalia, L.V., Lang, A.E., 2015. Parkinson's disease. *Lancet Lond. Engl.* 386, 896–912. doi:10.1016/S0140-6736(14)61393-3
- Kalinderi, K., Bostantjopoulou, S., Fidani, L., 2016. The genetic background of Parkinson's disease: current progress and future prospects. *Acta Neurol. Scand.* doi:10.1111/ane.12563
- Kamegai, J., Wakabayashi, I., Kineman, R.D., Frohman, L.A., 1999. Growth hormone-releasing hormone receptor (GHRH-R) and growth hormone secretagogue receptor (GHS-R) mRNA levels during postnatal development in male and female rats. *J. Neuroendocrinol.* 11, 299–306.
- Kang, J.-H., Irwin, D.J., Chen-Plotkin, A.S., Siderowf, A., Caspell, C., Coffey, C.S., Waligórska, T., Taylor, P., Pan, S., Frasier, M., Marek, K., Kieburz, K., Jennings, D., Simuni, T., Tanner, C.M., Singleton, A., Toga, A.W., Chowdhury, S., Mollenhauer, B., Trojanowski, J.Q., Shaw, L.M., Parkinson's Progression Markers Initiative, 2013. Association of cerebrospinal fluid β -amyloid 1-42, T-tau, P-tau181, and α -synuclein levels with clinical features of drug-naïve patients with early Parkinson disease. *JAMA Neurol.* 70, 1277–1287. doi:10.1001/jamaneurol.2013.3861
- Karasawa, H., Pietra, C., Giuliano, C., Garcia-Rubio, S., Xu, X., Yakabi, S., Taché, Y., Wang, L., 2014. New ghrelin agonist, HM01 alleviates constipation and L-dopa-delayed gastric emptying in 6-

- hydroxydopamine rat model of Parkinson's disease. *Neurogastroenterol. Motil.* n/a-n/a. doi:10.1111/nmo.12459
- Karch, A., Llorens, F., Schmitz, M., Arora, A.S., Zafar, S., Lange, P., Schmidt, C., Zerr, I., 2016. Stratification by Genetic and Demographic Characteristics Improves Diagnostic Accuracy of Cerebrospinal Fluid Biomarkers in Rapidly Progressive Dementia. *J. Alzheimers Dis. JAD* 54, 1385–1393. doi:10.3233/JAD-160267
- Kay, S., Josefine, M., Siswanto, S., Reijko, K., Helmut, H., Georg, A., Mohamed, B., Grinberg, L., Helmut, W., Horst-Werner, K., Wilfred, den D., Udo, R., 2015. The brainstem pathologies of Parkinson's disease and dementia with Lewy bodies. *Brain Pathol. Zurich Switz.* 25, 121–135. doi:10.1111/bpa.12168
- Keane, P.C., Kurzawa, M., Blain, P.G., Morris, C.M., 2011. Mitochondrial Dysfunction in Parkinson's Disease. *Park. Dis.* 2011, e716871. doi:10.4061/2011/716871
- Kenny, R., Cai, G., Bayliss, J.A., Clarke, M., Choo, Y.L., Miller, A.A., Andrews, Z.B., Spencer, S.J., 2013. Endogenous ghrelin's role in hippocampal neuroprotection after global cerebral ischemia: does endogenous ghrelin protect against global stroke? *AJP Regul. Integr. Comp. Physiol.* 304, R980–R990. doi:10.1152/ajpregu.00594.2012
- Kern, A., Albarran-Zeckler, R., Walsh, H.E., Smith, R.G., 2012. Apo-Ghrelin Receptor Forms Heteromers with DRD2 in Hypothalamic Neurons and Is Essential for Anorexigenic Effects of DRD2 Agonism. *Neuron* 73, 317–332. doi:10.1016/j.neuron.2011.10.038
- Kim, C., Rockenstein, E., Spencer, B., Kim, H.-K., Adame, A., Trejo, M., Stafa, K., Lee, H.-J., Lee, S.-J., Masliah, E., 2015. Antagonizing Neuronal Toll-like Receptor 2 Prevents Synucleinopathy by Activating Autophagy. *Cell Rep.* 13, 771–782. doi:10.1016/j.celrep.2015.09.044
- Kim, D., Paik, J.H., Shin, D.-W., Kim, H.-S., Park, C.-S., Kang, J.-H., 2014. What is the Clinical Significance of Cerebrospinal Fluid Biomarkers in Parkinson's disease? Is the Significance Diagnostic or Prognostic? *Exp. Neurobiol.* 23, 352–364. doi:10.5607/en.2014.23.4.352
- Kim, G.J., Park, S.Y., Kim, H., Chun, Y.H., Park, S.H., 2001. Chromosomal aberrations in neuroblastoma cell lines identified by cross species color banding and chromosome painting. *Cancer Genet. Cytogenet.* 129, 10–16.
- Kim, J.-S., Sung, H.-Y., 2015. Gastrointestinal Autonomic Dysfunction in Patients with Parkinson's Disease. *J. Mov. Disord.* 8, 76–82. doi:10.14802/jmd.15008
- Kim, J.-Y., Jeon, B.S., 2012. Complementary and alternative medicine in Parkinson's disease patients in Korea. *Curr. Neurol. Neurosci. Rep.* 12, 631–632. doi:10.1007/s11910-012-0309-0
- Kim, M.S., Yoon, C.Y., Jang, P.G., Park, Y.J., Shin, C.S., Park, H.S., Ryu, J.W., Pak, Y.K., Park, J.Y., Lee, K.U., Kim, S.Y., Lee, H.K., Kim, Y.B., Park, K.S., 2004. The mitogenic and antiapoptotic actions of ghrelin in 3T3-L1 adipocytes. *Mol. Endocrinol. Baltim. Md* 18, 2291–2301. doi:10.1210/me.2003-0459
- Kim, R.H., Smith, P.D., Aleyasin, H., Hayley, S., Mount, M.P., Pownall, S., Wakeham, A., You-Ten, A.J., Kalia, S.K., Horne, P., Westaway, D., Lozano, A.M., Anisman, H., Park, D.S., Mak, T.W., 2005. Hypersensitivity of DJ-1-deficient mice to 1-methyl-4-phenyl-1,2,3,6-tetrahydropyridine (MPTP) and oxidative stress. *Proc. Natl. Acad. Sci. U. S. A.* 102, 5215–5220. doi:10.1073/pnas.0501282102
- King, A., Maekawa, S., Bodi, I., Troakes, C., Curran, O., Ashkan, K., Al-Sarraj, S., 2013. Simulated surgical-type cerebral biopsies from post-mortem brains allows accurate neuropathological diagnoses in the majority of neurodegenerative disease groups. *Acta Neuropathol. Commun.* 1, 53. doi:10.1186/2051-5960-1-53
- Kirik, D., Rosenblad, C., Burger, C., Lundberg, C., Johansen, T.E., Muzyczka, N., Mandel, R.J., Björklund, A., 2002. Parkinson-like neurodegeneration induced by targeted overexpression of α -synuclein in the nigrostriatal system. *J. Neurosci.* 22, 2780–2791.
- Kitada, T., Asakawa, S., Hattori, N., Matsumine, H., Yamamura, Y., Minoshima, S., Yokochi, M., Mizuno, Y., Shimizu, N., 1998. Mutations in the parkin gene cause autosomal recessive juvenile parkinsonism. *Nature* 392, 605–608. doi:10.1038/33416

- Kitada, T., Pisani, A., Porter, D.R., Yamaguchi, H., Tscherter, A., Martella, G., Bonsi, P., Zhang, C., Pothos, E.N., Shen, J., 2007. Impaired dopamine release and synaptic plasticity in the striatum of PINK1-deficient mice. *Proc. Natl. Acad. Sci. U. S. A.* 104, 11441–11446. doi:10.1073/pnas.0702717104
- Klionsky, D.J., Emr, S.D., 2000. Autophagy as a regulated pathway of cellular degradation. *Science* 290, 1717–1721.
- Klivenyi, P., Siwek, D., Gardian, G., Yang, L., Starkov, A., Cleren, C., Ferrante, R.J., Kowall, N.W., Abeliovich, A., Beal, M.F., 2006. Mice lacking alpha-synuclein are resistant to mitochondrial toxins. *Neurobiol. Dis.* 21, 541–548. doi:10.1016/j.nbd.2005.08.018
- Knowles, T.P.J., Vendruscolo, M., Dobson, C.M., 2014. The amyloid state and its association with protein misfolding diseases. *Nat. Rev. Mol. Cell Biol.* 15, 384–396. doi:10.1038/nrm3810
- Koch, J.C., Bitow, F., Haack, J., d'Hedouville, Z., Zhang, J.-N., Tönges, L., Michel, U., Oliveira, L.M.A., Jovin, T.M., Liman, J., Tatenhorst, L., Bähr, M., Lingor, P., 2015. Alpha-Synuclein affects neurite morphology, autophagy, vesicle transport and axonal degeneration in CNS neurons. *Cell Death Dis.* 6, e1811. doi:10.1038/cddis.2015.169
- Koga, S., Aoki, N., Uitti, R.J., van Gerpen, J.A., Cheshire, W.P., Josephs, K.A., Wszolek, Z.K., Langston, J.W., Dickson, D.W., 2015. When DLB, PD, and PSP masquerade as MSA: an autopsy study of 134 patients. *Neurology* 85, 404–412. doi:10.1212/WNL.0000000000001807
- Koikkalainen, J., Rhodius-Meester, H., Tolonen, A., Barkhof, F., Tijms, B., Lemstra, A.W., Tong, T., Guerrero, R., Schuh, A., Ledig, C., Rueckert, D., Soininen, H., Remes, A.M., Waldemar, G., Hasselbalch, S., Mecocci, P., van der Flier, W., Lötjönen, J., 2016. Differential diagnosis of neurodegenerative diseases using structural MRI data. *NeuroImage Clin.* 11, 435–449. doi:10.1016/j.nicl.2016.02.019
- Kojima, M., Hosoda, H., Date, Y., Nakazato, M., Matsuo, H., 1999. Ghrelin is a growth-hormone-releasing acylated peptide from stomach. *Nature* 402, 656–660.
- Kojima, M., Kangawa, K., 2005. Ghrelin: structure and function. *Physiol. Rev.* 85, 495–522. doi:10.1152/physrev.00012.2004
- Kordower, J.H., Chu, Y., Hauser, R.A., Freeman, T.B., Olanow, C.W., 2008. Lewy body-like pathology in long-term embryonic nigral transplants in Parkinson's disease. *Nat. Med.* 14, 504–506. doi:10.1038/nm1747
- Kordower, J.H., Freeman, T.B., Snow, B.J., Vingerhoets, F.J., Mufson, E.J., Sanberg, P.R., Hauser, R.A., Smith, D.A., Nauert, G.M., Perl, D.P., 1995. Neuropathological evidence of graft survival and striatal reinnervation after the transplantation of fetal mesencephalic tissue in a patient with Parkinson's disease. *N. Engl. J. Med.* 332, 1118–1124. doi:10.1056/NEJM199504273321702
- Korecka, J.A., van Kesteren, R.E., Blaas, E., Spitzer, S.O., Kamstra, J.H., Smit, A.B., Swaab, D.F., Verhaagen, J., Bossers, K., 2013. Phenotypic Characterization of Retinoic Acid Differentiated SH-SY5Y Cells by Transcriptional Profiling. *PLoS ONE* 8. doi:10.1371/journal.pone.0063862
- Kortekaas, R., Leenders, K.L., van Oostrom, J.C.H., Vaalburg, W., Bart, J., Willemsen, A.T.M., Hendrikse, N.H., 2005. Blood-brain barrier dysfunction in parkinsonian midbrain in vivo. *Ann. Neurol.* 57, 176–179. doi:10.1002/ana.20369
- Kotzbauer, P.T., Cairns, N.J., Campbell, M.C., Willis, A.W., Racette, B.A., Tabbal, S.D., Perlmutter, J.S., 2012. Pathologic accumulation of α -synuclein and A β in Parkinson disease patients with dementia. *Arch. Neurol.* 69, 1326–1331. doi:10.1001/archneurol.2012.1608
- Kovács, T., Cairns, N.J., Lantos, P.L., 2001. Olfactory centres in Alzheimer's disease: olfactory bulb is involved in early Braak's stages. *Neuroreport* 12, 285–288.
- Krack, P., Batir, A., Van Blercom, N., Chabardes, S., Fraix, V., Ardouin, C., Koudsie, A., Limousin, P.D., Benazzouz, A., LeBas, J.F., Benabid, A.-L., Pollak, P., 2003. Five-year follow-up of bilateral stimulation of the subthalamic nucleus in advanced Parkinson's disease. *N. Engl. J. Med.* 349, 1925–1934. doi:10.1056/NEJMoa035275
- Kranick, S.M., Duda, J.E., 2008. Olfactory dysfunction in Parkinson's disease. *Neurosignals* 16, 35–40. doi:10.1159/000109757

- Kraytsberg, Y., Kudryavtseva, E., McKee, A.C., Geula, C., Kowall, N.W., Khrapko, K., 2006. Mitochondrial DNA deletions are abundant and cause functional impairment in aged human substantia nigra neurons. *Nat. Genet.* 38, 518–520. doi:10.1038/ng1778
- Kriks, S., Shim, J.-W., Piao, J., Ganat, Y.M., Wakeman, D.R., Xie, Z., Carrillo-Reid, L., Auyeung, G., Antonacci, C., Buch, A., Yang, L., Beal, M.F., Surmeier, D.J., Kordower, J.H., Tabar, V., Studer, L., 2011. Dopamine neurons derived from human ES cells efficiently engraft in animal models of Parkinson's disease. *Nature* 480, 547–551. doi:10.1038/nature10648
- Krishna, A., Biryukov, M., Trefois, C., Antony, P.M.A., Hussong, R., Lin, J., Heinäniemi, M., Glusman, G., Köglberger, S., Boyd, O., van den Berg, B.H.J., Linke, D., Huang, D., Wang, K., Hood, L., Tholey, A., Schneider, R., Galas, D.J., Balling, R., May, P., 2014. Systems genomics evaluation of the SH-SY5Y neuroblastoma cell line as a model for Parkinson's disease. *BMC Genomics* 15, 1154. doi:10.1186/1471-2164-15-1154
- Krüger, R., Kuhn, W., Müller, T., Voitalla, D., Graeber, M., Kösel, S., Przuntek, H., Epplen, J.T., Schöls, L., Riess, O., 1998. Ala30Pro mutation in the gene encoding alpha-synuclein in Parkinson's disease. *Nat. Genet.* 18, 106–108. doi:10.1038/ng0298-106
- Kurlan, R., Rothfield, K.P., Woodward, W.R., Nutt, J.G., Miller, C., Lichter, D., Shoulson, I., 1988. Erratic gastric emptying of levodopa may cause "random" fluctuations of parkinsonian mobility. *Neurology* 38, 419–421.
- Kuzuhara, S., Mori, H., Izumiyama, N., Yoshimura, M., Ihara, Y., 1988. Lewy bodies are ubiquitinated. A light and electron microscopic immunocytochemical study. *Acta Neuropathol. (Berl.)* 75, 345–353.
- Labarthe, A., Fiquet, O., Hassouna, R., Zizzari, P., Lanfumey, L., Ramoz, N., Grouselle, D., Epelbaum, J., Tolle, V., 2014. Ghrelin-Derived Peptides: A Link between Appetite/Reward, GH Axis, and Psychiatric Disorders? *Front. Endocrinol.* 5. doi:10.3389/fendo.2014.00163
- Labbé, C., Ross, O.A., 2014. Association studies of sporadic Parkinson's disease in the genomic era. *Curr. Genomics* 15, 2–10. doi:10.2174/1389202914666131210212745
- Lage, R., Vázquez, M.J., Varela, L., Saha, A.K., Vidal-Puig, A., Nogueiras, R., Diéguez, C., López, M., 2010. Ghrelin effects on neuropeptides in the rat hypothalamus depend on fatty acid metabolism actions on BSX but not on gender. *FASEB J.* 24, 2670–2679. doi:10.1096/fj.09-150672
- Lanciego, J.L., Luquin, N., Obeso, J.A., 2012. Functional neuroanatomy of the basal ganglia. *Cold Spring Harb. Perspect. Med.* 2, a009621. doi:10.1101/cshperspect.a009621
- Langston, J.W., Ballard, P., Tetrud, J.W., Irwin, I., 1983. Chronic Parkinsonism in humans due to a product of meperidine-analog synthesis. *Science* 219, 979–980.
- Langston, J.W., Forno, L.S., Tetrud, J., Reeves, A.G., Kaplan, J.A., Karluk, D., 1999. Evidence of active nerve cell degeneration in the substantia nigra of humans years after 1-methyl-4-phenyl-1,2,3,6-tetrahydropyridine exposure. *Ann. Neurol.* 46, 598–605.
- Lashuel, H.A., Overk, C.R., Oueslati, A., Masliah, E., 2013. The many faces of α -synuclein: from structure and toxicity to therapeutic target. *Nat. Rev. Neurosci.* 14, 38–48. doi:10.1038/nrn3406
- Lauterbach, E.C., Duvoisin, R.C., 1991. Anxiety disorders in familial parkinsonism. *Am. J. Psychiatry* 148, 274.
- Lavara-Culebras, E., Paricio, N., 2007. Drosophila DJ-1 mutants are sensitive to oxidative stress and show reduced lifespan and motor deficits. *Gene* 400, 158–165. doi:10.1016/j.gene.2007.06.013
- Leal, M.C., Casabona, J.C., Puntel, M., Pitossi, F.J., 2013. Interleukin-1 β and tumor necrosis factor- α : reliable targets for protective therapies in Parkinson's Disease? *Front. Cell. Neurosci.* 7, 53. doi:10.3389/fncel.2013.00053
- Lebouvier, T., Neunlist, M., Bruley des Varannes, S., Coron, E., Drouard, A., N'Guyen, J.-M., Chaumette, T., Tasselli, M., Paillusson, S., Flamand, M., Galmiche, J.-P., Damier, P., Derkinderen, P., 2010a. Colonic Biopsies to Assess the Neuropathology of Parkinson's Disease and Its Relationship with Symptoms. *PLoS ONE* 5, e12728. doi:10.1371/journal.pone.0012728

- Lebouvier, T., Tasselli, M., Paillusson, S., Pouclet, H., Neunlist, M., Derkinderen, P., 2010b. Biopsable Neural Tissues: Toward New Biomarkers for Parkinson's Disease? *Front. Psychiatry* 1. doi:10.3389/fpsyt.2010.00128
- Lee, C.S., Sauer, H., Bjorklund, A., 1996. Dopaminergic neuronal degeneration and motor impairments following axon terminal lesion by intrastriatal 6-hydroxydopamine in the rat. *Neuroscience* 72, 641–653.
- Lee, H.-J., Suk, J.-E., Patrick, C., Bae, E.-J., Cho, J.-H., Rho, S., Hwang, D., Masliah, E., Lee, S.-J., 2010. Direct transfer of alpha-synuclein from neuron to astroglia causes inflammatory responses in synucleinopathies. *J. Biol. Chem.* 285, 9262–9272. doi:10.1074/jbc.M109.081125
- Lee, M.K., Stirling, W., Xu, Y., Xu, X., Qui, D., Mandir, A.S., Dawson, T.M., Copeland, N.G., Jenkins, N.A., Price, D.L., 2002. Human alpha-synuclein-harboring familial Parkinson's disease-linked Ala-53 --> Thr mutation causes neurodegenerative disease with alpha-synuclein aggregation in transgenic mice. *Proc. Natl. Acad. Sci. U. S. A.* 99, 8968–8973. doi:10.1073/pnas.132197599
- Leentjens, A.F.G., Dujardin, K., Marsh, L., Martinez-Martin, P., Richard, I.H., Starkstein, S.E., Weintraub, D., Sampaio, C., Poewe, W., Rascol, O., Stebbins, G.T., Goetz, C.G., 2008. Anxiety rating scales in Parkinson's disease: Critique and recommendations. *Mov. Disord.* 23, 2015–2025. doi:10.1002/mds.22233
- Lees, A.J., Hardy, J., Revesz, T., 2009. Parkinson's disease. *The Lancet* 373, 2055–2066. doi:10.1016/S0140-6736(09)60492-X
- Lees, A.J., Selikhova, M., Andrade, L.A., Duyckaerts, C., 2008. The black stuff and Konstantin Nikolaevich Tretiakoff. *Mov. Disord. Off. J. Mov. Disord. Soc.* 23, 777–783. doi:10.1002/mds.21855
- Lemarié, F., Beauchamp, E., Legrand, P., Rioux, V., 2016. Revisiting the metabolism and physiological functions of caprylic acid (C8:0) with special focus on ghrelin octanoylation. *Biochimie* 120, 40–48. doi:10.1016/j.biochi.2015.08.002
- Lemkau, L.R., Comellas, G., Kloepper, K.D., Woods, W.S., George, J.M., Rienstra, C.M., 2012. Mutant protein A30P α -synuclein adopts wild-type fibril structure, despite slower fibrillation kinetics. *J. Biol. Chem.* 287, 11526–11532. doi:10.1074/jbc.M111.306902
- Lemkau, L.R., Comellas, G., Lee, S.W., Rikardsen, L.K., Woods, W.S., George, J.M., Rienstra, C.M., 2013. Site-specific perturbations of alpha-synuclein fibril structure by the Parkinson's disease associated mutations A53T and E46K. *PloS One* 8, e49750. doi:10.1371/journal.pone.0049750
- Leroy, E., Anastasopoulos, D., Konitsiotis, S., Lavedan, C., Polymeropoulos, M.H., 1998. Deletions in the Parkin gene and genetic heterogeneity in a Greek family with early onset Parkinson's disease. *Hum. Genet.* 103, 424–427.
- Lesage, S., Anheim, M., Letournel, F., Bousset, L., Honoré, A., Rozas, N., Pieri, L., Madiona, K., Dürr, A., Melki, R., Verny, C., Brice, A., French Parkinson's Disease Genetics Study Group, 2013. G51D α -synuclein mutation causes a novel parkinsonian-pyramidal syndrome. *Ann. Neurol.* 73, 459–471. doi:10.1002/ana.23894
- Lesage, S., Drouet, V., Majounie, E., Deramecourt, V., Jacoupy, M., Nicolas, A., Cormier-Dequaire, F., Hassoun, S.M., Pujol, C., Ciura, S., Erpapazoglou, Z., Usenko, T., Maurage, C.-A., Sahbatou, M., Liebau, S., Ding, J., Bilgic, B., Emre, M., Erginel-Unaltuna, N., Guven, G., Tison, F., Tranchant, C., Vidailhet, M., Corvol, J.-C., Krack, P., Leutenegger, A.-L., Nalls, M.A., Hernandez, D.G., Heutink, P., Gibbs, J.R., Hardy, J., Wood, N.W., Gasser, T., Dürr, A., Deleuze, J.-F., Tazir, M., Destée, A., Lohmann, E., Kabashi, E., Singleton, A., Corti, O., Brice, A., French Parkinson's Disease Genetics Study (PDG), International Parkinson's Disease Genomics Consortium (IPDGC), 2016. Loss of VPS13C Function in Autosomal-Recessive Parkinsonism Causes Mitochondrial Dysfunction and Increases PINK1/Parkin-Dependent Mitophagy. *Am. J. Hum. Genet.* 98, 500–513. doi:10.1016/j.ajhg.2016.01.014
- Levi, S., Cox, M., Lugon, M., Hodkinson, M., Tomkins, A., 1990. Increased energy expenditure in Parkinson's disease. *BMJ* 301, 1256–1257. doi:10.1136/bmj.301.6763.1256

- Levin, F., Edholm, T., Schmidt, P.T., Grybäck, P., Jacobsson, H., Degerblad, M., Höybye, C., Holst, J.J., Rehfeld, J.F., Hellström, P.M., Näslund, E., 2006. Ghrelin Stimulates Gastric Emptying and Hunger in Normal-Weight Humans. *J. Clin. Endocrinol. Metab.* 91, 3296–3302. doi:10.1210/jc.2005-2638
- Levin, J., Kurz, A., Arzberger, T., Giese, A., Höglinger, G.U., 2016. The Differential Diagnosis and Treatment of Atypical Parkinsonism. *Dtsch. Ärztebl. Int.* 113, 61–69. doi:10.3238/arztebl.2016.0061
- Levine, B., Klionsky, D.J., 2004. Development by self-digestion: molecular mechanisms and biological functions of autophagy. *Dev. Cell* 6, 463–477.
- LeWitt, P.A., 2015. Levodopa therapy for Parkinson's disease: Pharmacokinetics and pharmacodynamics. *Mov. Disord. Off. J. Mov. Disord. Soc.* 30, 64–72. doi:10.1002/mds.26082
- Lewy, F., 1912. Paralysis agitans. I. Pathologische Anatomie, in: *Handbuch der Neurologie*. Lewandowski M, Berlin, pp. 920–933.
- Lewy, F.H., 1921. Zur pathologisch-anatomischen Differentialdiagnose der Paralysis agitans und der Huntingtonschen Chorea. *Z. Für Gesamte Neurol. Psychiatr.* 73, 170–187. doi:10.1007/BF02895294
- Li, F.-J., Ji, H.-F., Shen, L., 2012. A Meta-Analysis of Tea Drinking and Risk of Parkinson's Disease. *Sci. World J.* 2012. doi:10.1100/2012/923464
- Li, J.-Y., Englund, E., Widner, H., Rehncrona, S., Björklund, A., Lindvall, O., Brundin, P., 2010. Characterization of Lewy body pathology in 12- and 16-year-old intrastriatal mesencephalic grafts surviving in a patient with Parkinson's disease. *Mov. Disord. Off. J. Mov. Disord. Soc.* 25, 1091–1096. doi:10.1002/mds.23012
- Li, N., 2003. Mitochondrial Complex I Inhibitor Rotenone Induces Apoptosis through Enhancing Mitochondrial Reactive Oxygen Species Production. *J. Biol. Chem.* 278, 8516–8525. doi:10.1074/jbc.M210432200
- Li, Y., Liu, W., Oo, T.F., Wang, L., Tang, Y., Jackson-Lewis, V., Zhou, C., Geghman, K., Bogdanov, M., Przedborski, S., Beal, M.F., Burke, R.E., Li, C., 2009. Mutant LRRK2(R1441G) BAC transgenic mice recapitulate cardinal features of Parkinson's disease. *Nat. Neurosci.* 12, 826–828. doi:10.1038/nn.2349
- Limousin, P., Krack, P., Pollak, P., Benazzouz, A., Ardouin, C., Hoffmann, D., Benabid, A.L., 1998. Electrical stimulation of the subthalamic nucleus in advanced Parkinson's disease. *N. Engl. J. Med.* 339, 1105–1111. doi:10.1056/NEJM199810153391603
- Limousin, P., Pollak, P., Benazzouz, A., Hoffmann, D., Broussolle, E., Perret, J.E., Benabid, A.L., 1995. Bilateral subthalamic nucleus stimulation for severe Parkinson's disease. *Mov. Disord. Off. J. Mov. Disord. Soc.* 10, 672–674. doi:10.1002/mds.870100523
- Lin, C.-H., Lin, J.-W., Liu, Y.-C., Chang, C.-H., Wu, R.-M., 2015. Risk of Parkinson's disease following anxiety disorders: a nationwide population-based cohort study. *Eur. J. Neurol.* 22, 1280–1287. doi:10.1111/ene.12740
- Lindvall, O., Björklund, A., 2004. Cell therapy in Parkinson's disease. *NeuroRx J. Am. Soc. Exp. Neurother.* 1, 382–393. doi:10.1602/neurorx.1.4.382
- Liu, L.-F., Song, J.-X., Lu, J.-H., Huang, Y.-Y., Zeng, Y., Chen, L.-L., Durairajan, S.S.K., Han, Q.-B., Li, M., 2015. Tianma Gouteng Yin, a Traditional Chinese Medicine decoction, exerts neuroprotective effects in animal and cellular models of Parkinson's disease. *Sci. Rep.* 5, 16862. doi:10.1038/srep16862
- Liu, Y., Peter, D., Roghani, A., Schuldiner, S., Privé, G.G., Eisenberg, D., Brecha, N., Edwards, R.H., 1992. A cDNA that suppresses MPP+ toxicity encodes a vesicular amine transporter. *Cell* 70, 539–551.
- Livak, K.J., Schmittgen, T.D., 2001. Analysis of relative gene expression data using real-time quantitative PCR and the 2(-Delta Delta C(T)) Method. *Methods San Diego Calif* 25, 402–408. doi:10.1006/meth.2001.1262
- Llorens, F., Schmitz, M., Varges, D., Kruse, N., Gotzmann, N., Gmitterová, K., Mollenhauer, B., Zerr, I., 2016. Cerebrospinal α -synuclein in α -synuclein aggregation disorders: tau/ α -synuclein ratio

- as potential biomarker for dementia with Lewy bodies. *J. Neurol.* 263, 2271–2277. doi:10.1007/s00415-016-8259-0
- Lo Bianco, C., Ridet, J.-L., Schneider, B.L., Deglon, N., Aebischer, P., 2002. alpha -Synucleinopathy and selective dopaminergic neuron loss in a rat lentiviral-based model of Parkinson's disease. *Proc. Natl. Acad. Sci. U. S. A.* 99, 10813–10818. doi:10.1073/pnas.152339799
- Long-Smith, C.M., Sullivan, A.M., Nolan, Y.M., 2009. The influence of microglia on the pathogenesis of Parkinson's disease. *Prog. Neurobiol.* 89, 277–287. doi:10.1016/j.pneurobio.2009.08.001
- Lopes, F.M., Schröder, R., Júnior, M.L.C. da F., Zanotto-Filho, A., Müller, C.B., Pires, A.S., Meurer, R.T., Colpo, G.D., Gelain, D.P., Kapczinski, F., Moreira, J.C.F., Fernandes, M. da C., Klamt, F., 2010. Comparison between proliferative and neuron-like SH-SY5Y cells as an in vitro model for Parkinson disease studies. *Brain Res.* 1337, 85–94. doi:10.1016/j.brainres.2010.03.102
- Lorenzen, N., Nielsen, S.B., Buell, A.K., Kaspersen, J.D., Arosio, P., Vad, B.S., Paslawski, W., Christiansen, G., Valnickova-Hansen, Z., Andreasen, M., Enghild, J.J., Pedersen, J.S., Dobson, C.M., Knowles, T.P.J., Otzen, D.E., 2014. The role of stable α -synuclein oligomers in the molecular events underlying amyloid formation. *J. Am. Chem. Soc.* 136, 3859–3868. doi:10.1021/ja411577t
- Lotharius, J., Barg, S., Wiekop, P., Lundberg, C., Raymon, H.K., Brundin, P., 2002. Effect of mutant alpha-synuclein on dopamine homeostasis in a new human mesencephalic cell line. *J. Biol. Chem.* 277, 38884–38894. doi:10.1074/jbc.M205518200
- Lu, X.-H., Fleming, S.M., Meurers, B., Ackerson, L.C., Mortazavi, F., Lo, V., Hernandez, D., Sulzer, D., Jackson, G.R., Maidment, N.T., Chesselet, M.-F., Yang, X.W., 2009. Bacterial artificial chromosome transgenic mice expressing a truncated mutant parkin exhibit age-dependent hypokinetic motor deficits, dopaminergic neuron degeneration, and accumulation of proteinase K-resistant alpha-synuclein. *J. Neurosci. Off. J. Soc. Neurosci.* 29, 1962–1976. doi:10.1523/JNEUROSCI.5351-08.2009
- Luoma, P., Melberg, A., Rinne, J.O., Kaukonen, J.A., Nupponen, N.N., Chalmers, R.M., Oldfors, A., Rautakorpi, I., Peltonen, L., Majamaa, K., Somer, H., Suomalainen, A., 2004. Parkinsonism, premature menopause, and mitochondrial DNA polymerase gamma mutations: clinical and molecular genetic study. *Lancet Lond. Engl.* 364, 875–882. doi:10.1016/S0140-6736(04)16983-3
- Luth, E.S., Stavrovskaya, I.G., Bartels, T., Kristal, B.S., Selkoe, D.J., 2014. Soluble, Prefibrillar α -Synuclein Oligomers Promote Complex I-dependent, Ca²⁺-induced Mitochondrial Dysfunction. *J. Biol. Chem.* 289, 21490–21507. doi:10.1074/jbc.M113.545749
- Luthman, J., Fredriksson, A., Sundström, E., Jonsson, G., Archer, T., 1989. Selective lesion of central dopamine or noradrenaline neuron systems in the neonatal rat: motor behavior and monoamine alterations at adult stage. *Behav. Brain Res.* 33, 267–277.
- Mackenzie, I., 2001. The pathology of Parkinson's disease. *Br. Columbia Med. J.* 43, 142–147.
- Makovey, J., Naganathan, V., Seibel, M., Sambrook, P., 2007. Gender differences in plasma ghrelin and its relations to body composition and bone - an opposite-sex twin study. *Clin. Endocrinol. (Oxf.)* 66, 530–537. doi:10.1111/j.1365-2265.2007.02768.x
- Mani, B.K., Walker, A.K., Lopez Soto, E.J., Raingo, J., Lee, C.E., Perelló, M., Andrews, Z.B., Zigman, J.M., 2014. Neuroanatomical characterization of a growth hormone secretagogue receptor-green fluorescent protein reporter mouse: Characterization of Ghsh-egfp reporter mouse. *J. Comp. Neurol.* 522, 3644–3666. doi:10.1002/cne.23627
- Manning-Bog, A.B., Caudle, W.M., Perez, X.A., Reaney, S.H., Paletzki, R., Isla, M.Z., Chou, V.P., McCormack, A.L., Miller, G.W., Langston, J.W., Gerfen, C.R., Dimonte, D.A., 2007. Increased vulnerability of nigrostriatal terminals in DJ-1-deficient mice is mediated by the dopamine transporter. *Neurobiol. Dis.* 27, 141–150. doi:10.1016/j.nbd.2007.03.014
- Manning-Bog, A.B., McCormack, A.L., Li, J., Uversky, V.N., Fink, A.L., Di Monte, D.A., 2002. The herbicide paraquat causes up-regulation and aggregation of alpha-synuclein in mice: paraquat and alpha-synuclein. *J. Biol. Chem.* 277, 1641–1644. doi:10.1074/jbc.C100560200

- Marder, K., Tang, M.-X., Mejia, H., Alfaro, B., Cote, L., Louis, E., Groves, J., Mayeux, R., 1996. Risk of Parkinson's disease among first-degree relatives A community-based study. *Neurology* 47, 155–160. doi:10.1212/WNL.47.1.155
- Marin, C., Aguilar, E., 2011. In vivo 6-OHDA-induced neurodegeneration and nigral autophagic markers expression. *Neurochem. Int.* 58, 521–526. doi:10.1016/j.neuint.2011.01.010
- Markaki, E., Ellul, J., Kefalopoulou, Z., Trachani, E., Theodoropoulou, A., Kyriazopoulou, V., Constantoyannis, C., 2012. The Role of Ghrelin, Neuropeptide Y and Leptin Peptides in Weight Gain after Deep Brain Stimulation for Parkinson's Disease. *Stereotact. Funct. Neurosurg.* 90, 104–112. doi:10.1159/000335045
- Markus, H.S., Cox, M., Tomkins, A.M., 1992. Raised resting energy expenditure in Parkinson's disease and its relationship to muscle rigidity. *Clin. Sci.* 83, 199–204. doi:10.1042/cs0830199
- Martinez-Vicente, M., 2015. Autophagy in neurodegenerative diseases: From pathogenic dysfunction to therapeutic modulation. *Semin. Cell Dev. Biol.* 40, 115–126. doi:10.1016/j.semcdb.2015.03.005
- Martinez-Vicente, M., Cuervo, A.M., 2007. Autophagy and neurodegeneration: when the cleaning crew goes on strike. *Lancet Neurol.* 6, 352–361.
- Martins, L., Fernández-Mallo, D., Novelle, M.G., Vázquez, M.J., Tena-Sempere, M., Nogueiras, R., López, M., Diéguez, C., 2012. Hypothalamic mTOR Signaling Mediates the Orexigenic Action of Ghrelin. *PLoS ONE* 7. doi:10.1371/journal.pone.0046923
- Mary, S., Fehrentz, J.-A., Damian, M., Gaibelet, G., Orcel, H., Verdié, P., Mouillac, B., Martinez, J., Marie, J., Banères, J.-L., 2013. Heterodimerization with Its Splice Variant Blocks the Ghrelin Receptor 1a in a Non-signaling Conformation. *J. Biol. Chem.* 288, 24656–24665. doi:10.1074/jbc.M113.453423
- Masliah, E., Rockenstein, E., Mante, M., Crews, L., Spencer, B., Adame, A., Patrick, C., Trejo, M., Ubhi, K., Rohn, T.T., Mueller-Steiner, S., Seubert, P., Barbour, R., McConlogue, L., Buttini, M., Games, D., Schenk, D., 2011. Passive immunization reduces behavioral and neuropathological deficits in an alpha-synuclein transgenic model of Lewy body disease. *PLoS One* 6, e19338. doi:10.1371/journal.pone.0019338
- Masliah, E., Rockenstein, E., Veinbergs, I., Mallory, M., Hashimoto, M., Takeda, A., Sagara, Y., Sisk, A., Mucke, L., 2000. Dopaminergic loss and inclusion body formation in alpha-synuclein mice: implications for neurodegenerative disorders. *Science* 287, 1265–1269.
- Maswood, N., Young, J., Tilmont, E., Zhang, Z., Gash, D.M., Gerhardt, G.A., Grondin, R., Roth, G.S., Mattison, J., Lane, M.A., Carson, R.E., Cohen, R.M., Mouton, P.R., Quigley, C., Mattson, M.P., Ingram, D.K., 2004. Caloric restriction increases neurotrophic factor levels and attenuates neurochemical and behavioral deficits in a primate model of Parkinson's disease. *Proc. Natl. Acad. Sci. U. S. A.* 101, 18171–18176. doi:10.1073/pnas.0405831102
- Matsumine, H., 1999. [A Parkin gene (PARK 2) and Parkinson's disease]. *Rinshō Shinkeigaku Clin. Neurol.* 39, 9–12.
- Matsumine, H., Saito, M., Shimoda-Matsubayashi, S., Tanaka, H., Ishikawa, A., Nakagawa-Hattori, Y., Yokochi, M., Kobayashi, T., Igarashi, S., Takano, H., Sanpei, K., Koike, R., Mori, H., Kondo, T., Mizutani, Y., Schäffer, A.A., Yamamura, Y., Nakamura, S., Kuzuhara, S., Tsuji, S., Mizuno, Y., 1997. Localization of a gene for an autosomal recessive form of juvenile Parkinsonism to chromosome 6q25.2-27. *Am. J. Hum. Genet.* 60, 588–596.
- Mayeux, R., Denaro, J., Hemenegildo, N., Marder, K., Tang, M.X., Cote, L.J., Stern, Y., 1992. A population-based investigation of Parkinson's disease with and without dementia. Relationship to age and gender. *Arch. Neurol.* 49, 492–497.
- McCallum, R.W., Lembo, A., Esfandyari, T., Bhandari, B.R., Ejskjaer, N., Cosentino, C., Helton, N., Mondou, E., Quinn, J., Rousseau, F., The TZIP-102 Phase 2b Study Group, 2013. Phase 2b, randomized, double-blind 12-week studies of TZIP-102, a ghrelin receptor agonist for diabetic gastroparesis. *Neurogastroenterol. Motil.* 25, e705–e717. doi:10.1111/nmo.12184
- McCormack, A.L., Di Monte, D.A., 2003. Effects of L-dopa and other amino acids against paraquat-induced nigrostriatal degeneration. *J. Neurochem.* 85, 82–86.

- McKinney, W.T., 1984. Animal models of depression: an overview. *Psychiatr. Dev.* 2, 77–96.
- McRitchie, D.A., Cartwright, H.R., Halliday, G.M., 1997. Specific A10 dopaminergic nuclei in the midbrain degenerate in Parkinson's disease. *Exp. Neurol.* 144, 202–213. doi:10.1006/exnr.1997.6418
- Mear, Y., Enjalbert, A., Thirion, S., 2013. GHS-R1a constitutive activity and its physiological relevance. *Front. Neurosci.* 7. doi:10.3389/fnins.2013.00087
- Méquinion, M., Caron, E., Zgheib, S., Stievenard, A., Zizzari, P., Tolle, V., Cortet, B., Lucas, S., Prévot, V., Chauveau, C., Viltart, O., 2015. Physical activity: benefit or weakness in metabolic adaptations in a mouse model of chronic food restriction? *Am. J. Physiol. - Endocrinol. Metab.* 308, E241–E255. doi:10.1152/ajpendo.00340.2014
- Méquinion, M., Langlet, F., Zgheib, S., Dickson, S., Dehouck, B., Chauveau, C., Viltart, O., 2013. Ghrelin: Central and Peripheral Implications in Anorexia Nervosa. *Front. Endocrinol.* 4. doi:10.3389/fendo.2013.00015
- Meredith, G.E., Totterdell, S., Petroske, E., Santa Cruz, K., Callison, R.C., Lau, Y.-S., 2002. Lysosomal malfunction accompanies alpha-synuclein aggregation in a progressive mouse model of Parkinson's disease. *Brain Res.* 956, 156–165.
- Meulener, M., Whitworth, A.J., Armstrong-Gold, C.E., Rizzu, P., Heutink, P., Wes, P.D., Pallanck, L.J., Bonini, N.M., 2005. Drosophila DJ-1 mutants are selectively sensitive to environmental toxins associated with Parkinson's disease. *Curr. Biol. CB* 15, 1572–1577. doi:10.1016/j.cub.2005.07.064
- Mezey, E., Dehejia, A.M., Harta, G., Tresser, N., Suchy, S.F., Nussbaum, R.L., Brownstein, M.J., Polymeropoulos, M.H., 1998. Alpha synuclein is present in Lewy bodies in sporadic Parkinson's disease. *Mol. Psychiatry* 3, 493–499.
- Mogi, M., Harada, M., Narabayashi, H., Inagaki, H., Minami, M., Nagatsu, T., 1996. Interleukin (IL)-1 β , IL-2, IL-4, IL-6 and transforming growth factor- α levels are elevated in ventricular cerebrospinal fluid in juvenile parkinsonism and Parkinson's disease. *Neurosci. Lett.* 211, 13–16. doi:10.1016/0304-3940(96)12706-3
- Molfino, A., Formiconi, A., Fanelli, F.R., Muscaritoli, M., 2014. Ghrelin: from discovery to cancer cachexia therapy. *Curr. Opin. Clin. Nutr. Metab. Care* 17, 471–476. doi:10.1097/MCO.0000000000000075
- Moolenbeek, C., Ruitenber, E.J., 1981. The "Swiss roll": a simple technique for histological studies of the rodent intestine. *Lab. Anim.* 15, 57–59.
- Moon, M., Kim, H.G., Hwang, L., Seo, J.-H., Kim, S., Hwang, S., Kim, S., Lee, D., Chung, H., Oh, M.S., Lee, K.-T., Park, S., 2009. Neuroprotective Effect of Ghrelin in the 1-Methyl-4-Phenyl-1,2,3,6-Tetrahydropyridine Mouse Model of Parkinson's Disease by Blocking Microglial Activation. *Neurotox. Res.* 15, 332–347. doi:10.1007/s12640-009-9037-x
- Morley, J.F., Duda, J.E., 2010. Olfaction as a biomarker in Parkinson's disease. *Biomark. Med.* 4, 661–670. doi:10.2217/bmm.10.95
- Morrish, P., 2005. The meaning of negative DAT SPECT and F-Dopa PET scans in patients with clinical Parkinson's disease. *Mov. Disord. Off. J. Mov. Disord. Soc.* 20, 117; author reply 117-118. doi:10.1002/mds.20304
- Mougenot, A.-L., Nicot, S., Bencsik, A., Morignat, E., Verchère, J., Lakhdar, L., Legastelois, S., Baron, T., 2012. Prion-like acceleration of a synucleinopathy in a transgenic mouse model. *Neurobiol. Aging* 33, 2225–2228. doi:10.1016/j.neurobiolaging.2011.06.022
- Mougenot, A.-L.J., Bencsik, A., Nicot, S., Vulin, J., Morignat, E., Verchère, J., Bétemps, D., Lakhdar, L., Legastelois, S., Baron, T.G., 2011. Transmission of prion strains in a transgenic mouse model overexpressing human A53T mutated α -synuclein. *J. Neuropathol. Exp. Neurol.* 70, 377–385. doi:10.1097/NEN.0b013e318217d95f
- Movement Disorder Society Task Force on Rating Scales for Parkinson's Disease, 2003. The Unified Parkinson's Disease Rating Scale (UPDRS): status and recommendations. *Mov. Disord. Off. J. Mov. Disord. Soc.* 18, 738–750. doi:10.1002/mds.10473

- Müller, T.D., Nogueiras, R., Andermann, M.L., Andrews, Z.B., Anker, S.D., Argente, J., Batterham, R.L., Benoit, S.C., Bowers, C.Y., Broglio, F., Casanueva, F.F., D'Alessio, D., Depoortere, I., Geliebter, A., Ghigo, E., Cole, P.A., Cowley, M., Cummings, D.E., Dagher, A., Diano, S., Dickson, S.L., Diéguez, C., Granata, R., Grill, H.J., Grove, K., Habegger, K.M., Heppner, K., Heiman, M.L., Holsen, L., Holst, B., Inui, A., Jansson, J.O., Kirchner, H., Korbonits, M., Laferrère, B., LeRoux, C.W., Lopez, M., Morin, S., Nakazato, M., Nass, R., Perez-Tilve, D., Pfluger, P.T., Schwartz, T.W., Seeley, R.J., Sleeman, M., Sun, Y., Sussel, L., Tong, J., Thorner, M.O., van der Lely, A.J., van der Ploeg, L.H.T., Zigman, J.M., Kojima, M., Kangawa, K., Smith, R.G., Horvath, T., Tschöp, M.H., 2015. Ghrelin. *Mol. Metab.* 4, 437–460. doi:10.1016/j.molmet.2015.03.005
- Muñoz, E., Oliva, R., Obach, V., Martí, M.J., Pastor, P., Ballesta, F., Tolosa, E., 1997. Identification of Spanish familial Parkinson's disease and screening for the Ala53Thr mutation of the alpha-synuclein gene in early onset patients. *Neurosci. Lett.* 235, 57–60.
- Muñoz-Manchado, A.B., Villadiego, J., Romo-Madero, S., Suárez-Luna, N., Bermejo-Navas, A., Rodríguez-Gómez, J.A., Garrido-Gil, P., Labandeira-García, J.L., Echevarría, M., López-Barneo, J., Toledo-Aral, J.J., 2016. Chronic and progressive Parkinson's disease MPTP model in adult and aged mice. *J. Neurochem.* 136, 373–387. doi:10.1111/jnc.13409
- Munro, J., Steeghs, K., Morrison, V., Ireland, H., Parkins, K., 2001. Human fibroblast replicative senescence can occur in the absence of extensive cell division and short telomeres. *Publ. Online* 14 June 2001 Doi101038sjonc1204460 20. doi:10.1038/sj.onc.1204460
- Mutez, E., Larvor, L., Leprêtre, F., Mouroux, V., Hamalek, D., Kerckaert, J.-P., Pérez-Tur, J., Waucquier, N., Vanbesien-Mailliot, C., Dufлот, A., Devos, D., Defebvre, L., Kreisler, A., Frigard, B., Destée, A., Chartier-Harlin, M.-C., 2011. Transcriptional profile of Parkinson blood mononuclear cells with LRRK2 mutation. *Neurobiol. Aging* 32, 1839–1848. doi:10.1016/j.neurobiolaging.2009.10.016
- Mutez, E., Nkizila, A., Belarbi, K., de Broucker, A., Vanbesien-Mailliot, C., Bleuse, S., Dufлот, A., Comptdaer, T., Semaille, P., Blervaque, R., Hot, D., Leprêtre, F., Figeac, M., Destée, A., Chartier-Harlin, M.-C., 2014. Involvement of the immune system, endocytosis and EIF2 signaling in both genetically determined and sporadic forms of Parkinson's disease. *Neurobiol. Dis.* 63, 165–170. doi:10.1016/j.nbd.2013.11.007
- Nagatsu, T., Mogi, M., Ichinose, H., Togari, A., 2000. Cytokines in Parkinson's disease. *J. Neural Transm. Suppl.* 143–151.
- Nakamura, K., Bindokas, V.P., Marks, J.D., Wright, D.A., Frim, D.M., Miller, R.J., Kang, U.J., 2000. The selective toxicity of 1-methyl-4-phenylpyridinium to dopaminergic neurons: the role of mitochondrial complex I and reactive oxygen species revisited. *Mol. Pharmacol.* 58, 271–278.
- Nalls, M.A., Pankratz, N., Lill, C.M., Do, C.B., Hernandez, D.G., Saad, M., DeStefano, A.L., Kara, E., Bras, J., Sharma, M., Schulte, C., Keller, M.F., Arepalli, S., Letson, C., Edsall, C., Stefansson, H., Liu, X., Pliner, H., Lee, J.H., Cheng, R., International Parkinson's Disease Genomics Consortium (ipdgc), Parkinson's Study Group (PSG) Parkinson's Research: The Organized GENetics Initiative (progeni), 23andMe, GenePD, NeuroGenetics Research Consortium (ngrc), Hussman Institute of Human Genomics (hihg), The Ashkenazi Jewish Dataset Investigator, Cohorts for Health and Aging Research in Genetic Epidemiology (charge), North American Brain Expression Consortium (nabec), United Kingdom Brain Expression Consortium (ukbec), Greek Parkinson's Disease Consortium, Alzheimer Genetic Analysis Group, Ikram, M.A., Ioannidis, J.P.A., Hadjigeorgiou, G.M., Bis, J.C., Martinez, M., Perlmutter, J.S., Goate, A., Marder, K., Fiske, B., Sutherland, M., Xiromerisiou, G., Myers, R.H., Clark, L.N., Stefansson, K., Hardy, J.A., Heutink, P., Chen, H., Wood, N.W., Houlden, H., Payami, H., Brice, A., Scott, W.K., Gasser, T., Bertram, L., Eriksson, N., Foroud, T., Singleton, A.B., 2014. Large-scale meta-analysis of genome-wide association data identifies six new risk loci for Parkinson's disease. *Nat. Genet.* 46, 989–993. doi:10.1038/ng.3043
- Narendra, D., Tanaka, A., Suen, D.-F., Youle, R.J., 2008. Parkin is recruited selectively to impaired mitochondria and promotes their autophagy. *J. Cell Biol.* 183, 795–803. doi:10.1083/jcb.200809125

- National Parkinson Foundation, n.d. What are the Different Types of Atypical Parkinsonism Syndromes? | National Parkinson Foundation [WWW Document]. URL <http://www.parkinson.org/understanding-parkinsons/diagnosis/What-are-the-different-types-of-atypical-Parkinsonism-Syndromes> (accessed 9.12.16).
- Navarro, A., Boveris, A., 2010. Brain mitochondrial dysfunction in aging, neurodegeneration, and Parkinson's disease. *Front. Aging Neurosci.* 2. doi:10.3389/fnagi.2010.00034
- Ng, C.-H., Mok, S.Z.S., Koh, C., Ouyang, X., Fivaz, M.L., Tan, E.-K., Dawson, V.L., Dawson, T.M., Yu, F., Lim, K.-L., 2009. Parkin protects against LRRK2 G2019S mutant-induced dopaminergic neurodegeneration in *Drosophila*. *J. Neurosci. Off. J. Soc. Neurosci.* 29, 11257–11262. doi:10.1523/JNEUROSCI.2375-09.2009
- Ng, K.Y., Chase, T.N., Colburn, R.W., Kopin, I.J., 1970. L-Dopa-induced release of cerebral monoamines. *Science* 170, 76–77.
- Ng, K.Y., Colburn, R.W., Kopin, I.J., 1971. Effects of L-dopa on efflux of cerebral monoamines from synaptosomes. *Nature* 230, 331–332.
- Nishi, Y., Mifune, H., Yabuki, A., Tajiri, Y., Hirata, R., Tanaka, E., Hosoda, H., Kangawa, K., Kojima, M., 2013. Changes in Subcellular Distribution of n-Octanoyl or n-Decanoyl Ghrelin in Ghrelin-Producing Cells. *Front. Endocrinol.* 4. doi:10.3389/fendo.2013.00084
- Noyce, A.J., Lees, A.J., Schrag, A.-E., 2016. The prediagnostic phase of Parkinson's disease. *J. Neurol. Neurosurg. Psychiatry.* doi:10.1136/jnnp-2015-311890
- Nozaki, S., Saito, T., Matsumura, T., Miyai, I., Kang, J., 1999. [Relationship between weight loss and dysphagia in patients with Parkinson's disease]. *Rinsho Shinkeigaku* 39, 1010–1014.
- Nussbaum, R.L., Polymeropoulos, M.H., 1997. Genetics of Parkinson's disease. *Hum. Mol. Genet.* 6, 1687–1691.
- Nuvoli, S., Spanu, A., Madeddu, G., 2016. Brain SPECT with perfusion radiopharmaceuticals and dopaminergic system radiocompounds in dementia disorders. *Curr. Alzheimer Res.*
- Obeso, J.A., Rodríguez, M.C., Gorospe, A., Guridi, J., Alvarez, L., Macias, R., 1997. Surgical treatment of Parkinson's disease. *Baillière's Clin. Neurol.* 6, 125–145.
- Oertel, W., Schulz, J.B., 2016. Current and experimental treatments of Parkinson disease: A guide for neuroscientists. *J. Neurochem.* doi:10.1111/jnc.13750
- Okubadejo, N.U., Bower, J.H., Rocca, W.A., Maraganore, D.M., 2006. Parkinson's disease in Africa: A systematic review of epidemiologic and genetic studies. *Mov. Disord. Off. J. Mov. Disord. Soc.* 21, 2150–2156. doi:10.1002/mds.21153
- Olanow, C.W., McNaught, K.S.P., 2006. Ubiquitin-proteasome system and Parkinson's disease. *Mov. Disord. Off. J. Mov. Disord. Soc.* 21, 1806–1823. doi:10.1002/mds.21013
- Olanow, C.W., Prusiner, S.B., 2009. Is Parkinson's disease a prion disorder? *Proc. Natl. Acad. Sci. U. S. A.* 106, 12571–12572. doi:10.1073/pnas.0906759106
- Olesen, J., Leonardi, M., 2003. The burden of brain diseases in Europe. *Eur. J. Neurol.* 10, 471–477.
- Olgati, S., De Rosa, A., Quadri, M., Criscuolo, C., Breedveld, G.J., Picillo, M., Pappatà, S., Quarantelli, M., Barone, P., De Michele, G., Bonifati, V., 2014. PARK20 caused by SYNJ1 homozygous Arg258Gln mutation in a new Italian family. *Neurogenetics* 15, 183–188. doi:10.1007/s10048-014-0406-0
- Olszewski, P.K., Schiöth, H.B., Levine, A.S., 2008. Ghrelin in the CNS: from hunger to a rewarding and memorable meal? *Brain Res. Rev.* 58, 160–170. doi:10.1016/j.brainresrev.2008.01.004
- Oreland, L., 1991. Monoamine oxidase, dopamine and Parkinson's disease. *Acta Neurol. Scand. Suppl.* 136, 60–65.
- Orr, C.F., Rowe, D.B., Halliday, G.M., 2002. An inflammatory review of Parkinson's disease. *Prog. Neurobiol.* 68, 325–340.
- Oueslati, A., Paleologou, K.E., Schneider, B.L., Aebischer, P., Lashuel, H.A., 2012. Mimicking phosphorylation at serine 87 inhibits the aggregation of human α -synuclein and protects against its toxicity in a rat model of Parkinson's disease. *J. Neurosci. Off. J. Soc. Neurosci.* 32, 1536–1544. doi:10.1523/JNEUROSCI.3784-11.2012

- Özge, A., Bugdayci, R., Togrol, E., Saracoglu, M., 2003. The relation of gastrointestinal symptoms to duration of loveo-dopa treatment and severity of Parkinson's disease. *J. Appl. Res.* 3, 349–355.
- Öztaş, E., Topal, T., 2003. A Cell Protective Mechanism in a Murine Model of Parkinson's Disease. *Turk. J. Med. Sci.* 33, 295–299.
- Pagan, F., Hebron, M., Valadez, E.H., Torres-Yaghi, Y., Huang, X., Mills, R.R., Wilmarth, B.M., Howard, H., Dunn, C., Carlson, A., Lawler, A., Rogers, S.L., Falconer, R.A., Ahn, J., Li, Z., Moussa, C., 2016. Nilotinib Effects in Parkinson's disease and Dementia with Lewy bodies. *J. Park. Dis.* 6, 503–517. doi:10.3233/JPD-160867
- Pan, T., Kondo, S., Le, W., Jankovic, J., 2008. The role of autophagy-lysosome pathway in neurodegeneration associated with Parkinson's disease. *Brain J. Neurol.* 131, 1969–1978. doi:10.1093/brain/awm318
- Pañeda, C., Arroba, A.I., Frago, L.M., Holm, A.M., Rømer, J., Argente, J., Chowen, J.A., 2003. Growth hormone-releasing peptide-6 inhibits cerebellar cell death in aged rats. *Neuroreport* 14, 1633–1635. doi:10.1097/01.wnr.0000086252.76504.e3
- Pankratz, N., Nichols, W.C., Uniacke, S.K., Halter, C., Murrell, J., Rudolph, A., Shults, C.W., Conneally, P.M., Foroud, T., Parkinson Study Group, 2003. Genome-wide linkage analysis and evidence of gene-by-gene interactions in a sample of 362 multiplex Parkinson disease families. *Hum. Mol. Genet.* 12, 2599–2608. doi:10.1093/hmg/ddg270
- Pankratz, N., Wilk, J.B., Latourelle, J.C., DeStefano, A.L., Halter, C., Pugh, E.W., Doheny, K.F., Gusella, J.F., Nichols, W.C., Foroud, T., Myers, R.H., PSG-PROGENI and GenePD Investigators, Coordinators and Molecular Genetic Laboratories, 2009. Genomewide association study for susceptibility genes contributing to familial Parkinson disease. *Hum. Genet.* 124, 593–605. doi:10.1007/s00439-008-0582-9
- Pan-Montojo, F., Anichtchik, O., Dening, Y., Knels, L., Pursche, S., Jung, R., Jackson, S., Gille, G., Spillantini, M.G., Reichmann, H., Funk, R.H.W., 2010. Progression of Parkinson's Disease Pathology Is Reproduced by Intragastric Administration of Rotenone in Mice. *PLoS ONE* 5, e8762. doi:10.1371/journal.pone.0008762
- Pan-Montojo, F., Schwarz, M., Winkler, C., Arnhold, M., O'Sullivan, G.A., Pal, A., Said, J., Marsico, G., Verbavatz, J.-M., Rodrigo-Angulo, M., Gille, G., Funk, R.H.W., Reichmann, H., 2012. Environmental toxins trigger PD-like progression via increased alpha-synuclein release from enteric neurons in mice. *Sci. Rep.* 2. doi:10.1038/srep00898
- Pantel, J., Legendre, M., Cabrol, S., Hilal, L., Hajaji, Y., Morisset, S., Nivot, S., Vie-Luton, M.-P., Grouselle, D., de Kerdanet, M., Kadiri, A., Epelbaum, J., Le Bouc, Y., Amselem, S., 2006. Loss of constitutive activity of the growth hormone secretagogue receptor in familial short stature. *J. Clin. Invest.* 116, 760–768. doi:10.1172/JCI25303
- Papapetropoulos, S., Paschalis, C., Athanassiadou, A., Papadimitriou, A., Ellul, J., Polymeropoulos, M., Papapetropoulos, T., 2001. Clinical phenotype in patients with α -synuclein Parkinson's disease living in Greece in comparison with patients with sporadic Parkinson's disease. *J. Neurol. Neurosurg. Psychiatry* 70, 662–665. doi:10.1136/jnnp.70.5.662
- Papkovskaia, T.D., Chau, K.-Y., Inesta-Vaquera, F., Papkovsky, D.B., Healy, D.G., Nishio, K., Staddon, J., Duchon, M.R., Hardy, J., Schapira, A.H.V., Cooper, J.M., 2012. G2019S leucine-rich repeat kinase 2 causes uncoupling protein-mediated mitochondrial depolarization. *Hum. Mol. Genet.* 21, 4201–4213. doi:10.1093/hmg/dds244
- Park, J., Kim, S.Y., Cha, G.-H., Lee, S.B., Kim, S., Chung, J., 2005. Drosophila DJ-1 mutants show oxidative stress-sensitive locomotive dysfunction. *Gene* 361, 133–139. doi:10.1016/j.gene.2005.06.040
- Park, J., Lee, S.B., Lee, S., Kim, Y., Song, S., Kim, S., Bae, E., Kim, J., Shong, M., Kim, J.-M., Chung, J., 2006. Mitochondrial dysfunction in Drosophila PINK1 mutants is complemented by parkin. *Nature* 441, 1157–1161. doi:10.1038/nature04788
- Parkinson, J., 2002. An essay on the shaking palsy. *J. Neuropsychiatry Clin. Neurosci.* 14, 223–236.

- Parkinson Study Group, 2000. Pramipexole vs levodopa as initial treatment for Parkinson disease: A randomized controlled trial. *Parkinson Study Group. JAMA* 284, 1931–1938.
- Pasquali, L., Ruggieri, S., Murri, L., Paparelli, A., Fornai, F., 2009. Does autophagy worsen or improve the survival of dopaminergic neurons? *Parkinsonism Relat. Disord.* 15 Suppl 4, S24–27. doi:10.1016/S1353-8020(09)70830-2
- Peelaerts, W., Bousset, L., Van der Perren, A., Moskalyuk, A., Pulizzi, R., Giugliano, M., Van den Haute, C., Melki, R., Baekelandt, V., 2015. α -Synuclein strains cause distinct synucleinopathies after local and systemic administration. *Nature* 522, 340–344. doi:10.1038/nature14547
- Perez, F.A., Palmiter, R.D., 2005. Parkin-deficient mice are not a robust model of parkinsonism. *Proc. Natl. Acad. Sci. U. S. A.* 102, 2174–2179. doi:10.1073/pnas.0409598102
- Perier, C., Vila, M., 2012. Mitochondrial biology and Parkinson's disease. *Cold Spring Harb. Perspect. Med.* 2, a009332. doi:10.1101/cshperspect.a009332
- Periquet, M., Fulga, T., Myllykangas, L., Schlossmacher, M.G., Feany, M.B., 2007. Aggregated alpha-synuclein mediates dopaminergic neurotoxicity in vivo. *J. Neurosci. Off. J. Soc. Neurosci.* 27, 3338–3346. doi:10.1523/JNEUROSCI.0285-07.2007
- Perlemoine, C., Macia, F., Tison, F., Coman, I., Guehl, D., Burbaud, P., Cuny, E., Baillet, L., Gin, H., Rigalleau, V., 2005. Effects of subthalamic nucleus deep brain stimulation and levodopa on energy production rate and substrate oxidation in Parkinson's disease. *Br. J. Nutr.* 93, 191–198.
- Perrin, S., 2014. Preclinical research: Make mouse studies work. *Nature* 507, 423–425. doi:10.1038/507423a
- Pesah, Y., Pham, T., Burgess, H., Middlebrooks, B., Verstreken, P., Zhou, Y., Harding, M., Bellen, H., Mardon, G., 2004. *Drosophila parkin* mutants have decreased mass and cell size and increased sensitivity to oxygen radical stress. *Dev. Camb. Engl.* 131, 2183–2194. doi:10.1242/dev.01095
- Petzinger, G.M., Jakowec, M.W., 2005. Animal models of basal ganglia injury and degeneration and their application to Parkinson's disease research, CRC Press LLC. ed. CRC Press, Boca Raton.
- Pfeiffer, R., Zbigniew Wszolek, Ebadi, M., 2012. Parkinson's Disease, Second Edition, second. ed. Pfeiffer, R.F., 2011. Gastrointestinal dysfunction in Parkinson's disease. *Parkinsonism Relat. Disord.* 17, 10–15. doi:10.1016/j.parkreldis.2010.08.003
- Piccini, P., Burn, D.J., Ceravolo, R., Maraganore, D., Brooks, D.J., 1999. The role of inheritance in sporadic Parkinson's disease: Evidence from a longitudinal study of dopaminergic function in twins. *Ann. Neurol.* 45, 577–582. doi:10.1002/1531-8249(199905)45:5<577::AID-ANA5>3.0.CO;2-O
- Pikstra, A.R.A., van der Hoorn, A., Leenders, K.L., de Jong, B.M., 2016. Relation of 18-F-Dopa PET with hypokinesia-rigidity, tremor and freezing in Parkinson's disease. *NeuroImage Clin.* 11, 68–72. doi:10.1016/j.nicl.2016.01.010
- Poehler, A.-M., Xiang, W., Spitzer, P., May, V.E.L., Meixner, H., Rockenstein, E., Chutna, O., Outeiro, T.F., Winkler, J., Masliah, E., Klucken, J., 2014. Autophagy modulates SNCA/ α -synuclein release, thereby generating a hostile microenvironment. *Autophagy* 10, 2171–2192. doi:10.4161/auto.36436
- Poewe, W., 2008. Non-motor symptoms in Parkinson's disease. *Eur. J. Neurol.* 15, 14–20.
- Poewe, W., Gerstenbrand, F., Ransmayr, G., Plöner, S., 1983. Premorbid personality of Parkinson patients. *J. Neural Transm. Suppl.* 19, 215–224.
- Poletti, M., Perugi, G., Logi, C., Romano, A., Del Dotto, P., Ceravolo, R., Rossi, G., Pepe, P., Dell'Osso, L., Bonuccelli, U., 2012. Dopamine agonists and delusional jealousy in Parkinson's disease: A cross-sectional prevalence study. *Mov. Disord.* 27, 1679–1682. doi:10.1002/mds.25129
- Pollak, P., Benabid, A.L., Gross, C., Gao, D.M., Laurent, A., Benazzouz, A., Hoffmann, D., Gentil, M., Perret, J., 1993. [Effects of the stimulation of the subthalamic nucleus in Parkinson disease]. *Rev. Neurol. (Paris)* 149, 175–176.

- Polymeropoulos, M.H., 1998. Autosomal dominant Parkinson's disease and alpha-synuclein. *Ann. Neurol.* 44, S63-64.
- Polymeropoulos, M.H., Higgins, J.J., Golbe, L.I., Johnson, W.G., Ide, S.E., Di Iorio, G., Sanges, G., Stenroos, E.S., Pho, L.T., Schaffer, A.A., Lazzarini, A.M., Nussbaum, R.L., Duvoisin, R.C., 1996. Mapping of a gene for Parkinson's disease to chromosome 4q21-q23. *Science* 274, 1197–1199.
- Ponsen, M.M., Stoffers, D., Booi, J., van Eck-Smit, B.L.F., Wolters, E.C., Berendse, H.W., 2004. Idiopathic hyposmia as a preclinical sign of Parkinson's disease. *Ann. Neurol.* 56, 173–181. doi:10.1002/ana.20160
- Porcari, R., Proukakis, C., Waudby, C.A., Bolognesi, B., Mangione, P.P., Paton, J.F.S., Mullin, S., Cabrita, L.D., Penco, A., Relini, A., Verona, G., Vendruscolo, M., Stoppini, M., Tartaglia, G.G., Camilloni, C., Christodoulou, J., Schapira, A.H.V., Bellotti, V., 2015. The H50Q mutation induces a 10-fold decrease in the solubility of α -synuclein. *J. Biol. Chem.* 290, 2395–2404. doi:10.1074/jbc.M114.610527
- Porporato, P.E., Filigheddu, N., Reano, S., Ferrara, M., Angelino, E., Gnocchi, V.F., Prodam, F., Ronchi, G., Fagoonee, S., Fornaro, M., Chianale, F., Baldanzi, G., Surico, N., Sinigaglia, F., Perroteau, I., Smith, R.G., Sun, Y., Geuna, S., Graziani, A., 2013. Acylated and unacylated ghrelin impair skeletal muscle atrophy in mice. *J. Clin. Invest.* 123, 611–622. doi:10.1172/JCI39920
- Postuma, R.B., Berg, D., Stern, M., Poewe, W., Olanow, C.W., Oertel, W., Obeso, J., Marek, K., Litvan, I., Lang, A.E., Halliday, G., Goetz, C.G., Gasser, T., Dubois, B., Chan, P., Bloem, B.R., Adler, C.H., Deuschl, G., 2015. MDS clinical diagnostic criteria for Parkinson's disease. *Mov. Disord.* 30, 1591–1601. doi:10.1002/mds.26424
- Prasad, K., Tarasewicz, E., Mathew, J., Strickland, P.A.O., Buckley, B., Richardson, J.R., Richfield, E.K., 2009. Toxicokinetics and toxicodynamics of paraquat accumulation in mouse brain. *Exp. Neurol.* 215, 358–367. doi:10.1016/j.expneurol.2008.11.003
- Prediger, R.D.S., Batista, L.C., Medeiros, R., Pandolfo, P., Florio, J.C., Takahashi, R.N., 2006. The risk is in the air: Intranasal administration of MPTP to rats reproducing clinical features of Parkinson's disease. *Exp. Neurol.* 202, 391–403. doi:10.1016/j.expneurol.2006.07.001
- Prediger, R.D.S., Rial, D., Medeiros, R., Figueiredo, C.P., Doty, R.L., Takahashi, R.N., 2009. Risk is in the air: an intranasal MPTP (1-methyl-4-phenyl-1,2,3,6-tetrahydropyridine) rat model of Parkinson's disease. *Ann. N. Y. Acad. Sci.* 1170, 629–636. doi:10.1111/j.1749-6632.2009.03885.x
- Pringsheim, T., Jette, N., Frolkis, A., Steeves, T.D.L., 2014. The prevalence of Parkinson's disease: a systematic review and meta-analysis. *Mov. Disord. Off. J. Mov. Disord. Soc.* 29, 1583–1590. doi:10.1002/mds.25945
- Probst, C.C., van Eimeren, T., 2013. The Functional Anatomy of Impulse Control Disorders. *Curr. Neurol. Neurosci. Rep.* 13. doi:10.1007/s11910-013-0386-8
- Pruszk, J., Just, L., Isacson, O., Nikkhah, G., 2009. Isolation and culture of ventral mesencephalic precursor cells and dopaminergic neurons from rodent brains. *Curr. Protoc. Stem Cell Biol.* Chapter 2, Unit 2D.5. doi:10.1002/9780470151808.sc02d05s11
- Przedborski, S., Levivier, M., Jiang, H., Ferreira, M., Jackson-Lewis, V., Donaldson, D., Togasaki, D.M., 1995. Dose-dependent lesions of the dopaminergic nigrostriatal pathway induced by intrastriatal injection of 6-hydroxydopamine. *Neuroscience* 67, 631–647.
- Quaak, M., van Schayck, C.P., Knaapen, A.M., van Schooten, F.J., 2009. Genetic variation as a predictor of smoking cessation success. A promising preventive and intervention tool for chronic respiratory diseases? *Eur. Respir. J.* 33, 468–480. doi:10.1183/09031936.00056908
- Radad, K., Gille, G., Rausch, W.-D., 2008. Dopaminergic neurons are preferentially sensitive to long-term rotenone toxicity in primary cell culture. *Toxicol. In Vitro* 22, 68–74. doi:10.1016/j.tiv.2007.08.015
- Radad, K., Moldzio, R., Taha, M., Rausch, W.-D., 2009. Thymoquinone protects dopaminergic neurons against MPP⁺ and rotenone. *Phytother. Res.* 23, 696–700. doi:10.1002/ptr.2708

- Rail, D., Scholtz, C., Swash, M., 1981. Post-encephalitic Parkinsonism: current experience. *J. Neurol. Neurosurg. Psychiatry* 44, 670–676.
- Rajendran, P.R., Thompson, R.E., Reich, S.G., 2001. The use of alternative therapies by patients with Parkinson's disease. *Neurology* 57, 790–794.
- Ramaker, C., Marinus, J., Stiggelbout, A.M., Van Hilten, B.J., 2002. Systematic evaluation of rating scales for impairment and disability in Parkinson's disease. *Mov. Disord. Off. J. Mov. Disord. Soc.* 17, 867–876. doi:10.1002/mds.10248
- Ramonet, D., Daher, J.P.L., Lin, B.M., Stafa, K., Kim, J., Banerjee, R., Westerlund, M., Pletnikova, O., Glauser, L., Yang, L., Liu, Y., Swing, D.A., Beal, M.F., Troncoso, J.C., McCaffery, J.M., Jenkins, N.A., Copeland, N.G., Galter, D., Thomas, B., Lee, M.K., Dawson, T.M., Dawson, V.L., Moore, D.J., 2011. Dopaminergic neuronal loss, reduced neurite complexity and autophagic abnormalities in transgenic mice expressing G2019S mutant LRRK2. *PloS One* 6, e18568. doi:10.1371/journal.pone.0018568
- Reano, S., Graziani, A., Filigheddu, N., 2014. Acylated and unacylated ghrelin administration to blunt muscle wasting. *Curr. Opin. Clin. Nutr. Metab. Care* 17, 236–240. doi:10.1097/MCO.0000000000000049
- Rediger, A., Piechowski, C.L., Habegger, K., Grütters, A., Krude, H., Tschöp, M.H., Kleinau, G., Biebermann, H., 2012. MC4R Dimerization in the Paraventricular Nucleus and GHSR/MC3R Heterodimerization in the Arcuate Nucleus: Is There Relevance for Body Weight Regulation? *Neuroendocrinology* 95, 277–288. doi:10.1159/000334903
- Rey, N.L., George, S., Brundin, P., 2016. Review: Spreading the word: precise animal models and validated methods are vital when evaluating prion-like behaviour of alpha-synuclein. *Neuropathol. Appl. Neurobiol.* 42, 51–76. doi:10.1111/nan.12299
- Richardson, J.R., Quan, Y., Sherer, T.B., Greenamyre, J.T., Miller, G.W., 2005. Paraquat neurotoxicity is distinct from that of MPTP and rotenone. *Toxicol. Sci. Off. J. Soc. Toxicol.* 88, 193–201. doi:10.1093/toxsci/kfi304
- Riederer, P., Wuketich, S., 1976. Time course of nigrostriatal degeneration in parkinson's disease. A detailed study of influential factors in human brain amine analysis. *J. Neural Transm.* 38, 277–301.
- Rigamonti, A.E., Pincelli, A.I., Corrà, B., Viarengo, R., Bonomo, S.M., Galimberti, D., Scacchi, M., Scarpini, E., Cavnagnini, F., Müller, E.E., 2002. Plasma ghrelin concentrations in elderly subjects: comparison with anorexic and obese patients. *J. Endocrinol.* 175, R1-5.
- Rodríguez, A., Gómez-Ambrosi, J., Catalán, V., Gil, M.J., Becerril, S., Sáinz, N., Silva, C., Salvador, J., Colina, I., Frühbeck, G., 2009. Acylated and desacyl ghrelin stimulate lipid accumulation in human visceral adipocytes. *Int. J. Obes.* 2005 33, 541–552. doi:10.1038/ijo.2009.40
- Rosati, G., Granieri, E., Pinna, L., Aiello, I., Tola, R., De Bastiani, P., Pirisi, A., Devoto, M.C., 1980. The risk of Parkinson disease in Mediterranean people. *Neurology* 30, 250–255.
- Ross, C.A., Poirier, M.A., 2005. Opinion: What is the role of protein aggregation in neurodegeneration? *Nat. Rev. Mol. Cell Biol.* 6, 891–898. doi:10.1038/nrm1742
- Ross, G.W., Petrovitch, H., 2001. Current evidence for neuroprotective effects of nicotine and caffeine against Parkinson's disease. *Drugs Aging* 18, 797–806.
- Ross, G.W., Petrovitch, H., Abbott, R.D., Tanner, C.M., Popper, J., Masaki, K., Launer, L., White, L.R., 2008. Association of olfactory dysfunction with risk for future Parkinson's disease. *Ann. Neurol.* 63, 167–173. doi:10.1002/ana.21291
- Rossetti, Z.L., Sotgiu, A., Sharp, D.E., Hadjiconstantinou, M., Neff, N.H., 1988. 1-Methyl-4-phenyl-1,2,3,6-tetrahydropyridine (MPTP) and free radicals in vitro. *Biochem. Pharmacol.* 37, 4573–4574.
- Rossi, C., Frosini, D., Volterrani, D., De Feo, P., Unti, E., Nicoletti, V., Kiferle, L., Bonuccelli, U., Ceravolo, R., 2010. Differences in nigro-striatal impairment in clinical variants of early Parkinson's disease: evidence from a FP-CIT SPECT study. *Eur. J. Neurol.* 17, 626–630. doi:10.1111/j.1468-1331.2009.02898.x

- Rousseaux, M.W.C., Marcogliese, P.C., Qu, D., Hewitt, S.J., Seang, S., Kim, R.H., Slack, R.S., Schlossmacher, M.G., Lagace, D.C., Mak, T.W., Park, D.S., 2012. Progressive dopaminergic cell loss with unilateral-to-bilateral progression in a genetic model of Parkinson disease. *Proc. Natl. Acad. Sci. U. S. A.* 109, 15918–15923. doi:10.1073/pnas.1205102109
- Ruijter, J.M., Ramakers, C., Hoogaars, W.M.H., Karlen, Y., Bakker, O., van den Hoff, M.J.B., Moorman, A.F.M., 2009. Amplification efficiency: linking baseline and bias in the analysis of quantitative PCR data. *Nucleic Acids Res.* 37, e45. doi:10.1093/nar/gkp045
- Ryan, B.J., Lourenço-Venda, L.L., Crabtree, M.J., Hale, A.B., Channon, K.M., Wade-Martins, R., 2014. α -Synuclein and mitochondrial bioenergetics regulate tetrahydrobiopterin levels in a human dopaminergic model of Parkinson disease. *Free Radic. Biol. Med.* 67, 58–68. doi:10.1016/j.freeradbiomed.2013.10.008
- Sääksjärvi, K., Knekt, P., Rissanen, H., Laaksonen, M.A., Reunanen, A., Männistö, S., 2008. Prospective study of coffee consumption and risk of Parkinson's disease. *Eur. J. Clin. Nutr.* 62, 908–915. doi:10.1038/sj.ejcn.1602788
- Saigoh, K., Wang, Y.L., Suh, J.G., Yamanishi, T., Sakai, Y., Kiyosawa, H., Harada, T., Ichihara, N., Wakana, S., Kikuchi, T., Wada, K., 1999. Intragenic deletion in the gene encoding ubiquitin carboxy-terminal hydrolase in *gad* mice. *Nat. Genet.* 23, 47–51. doi:10.1038/12647
- Sakaguchi-Nakashima, A., Meir, J.Y., Jin, Y., Matsumoto, K., Hisamoto, N., 2007. LRK-1, a *C. elegans* PARK8-related kinase, regulates axonal-dendritic polarity of SV proteins. *Curr. Biol. CB* 17, 592–598. doi:10.1016/j.cub.2007.01.074
- Sämann, J., Hegermann, J., von Gromoff, E., Eimer, S., Baumeister, R., Schmidt, E., 2009. *Caenorhabditis elegans* LRK-1 and PINK-1 act antagonistically in stress response and neurite outgrowth. *J. Biol. Chem.* 284, 16482–16491. doi:10.1074/jbc.M808255200
- Santos, J.R., Cunha, J.A.S., Dierschnabel, A.L., Campêlo, C.L.C., Leão, A.H.F.F., Silva, A.F., Engelberth, R.C.G.J., Izídio, G.S., Cavalcante, J.S., Abílio, V.C., Ribeiro, A.M., Silva, R.H., 2013. Cognitive, motor and tyrosine hydroxylase temporal impairment in a model of parkinsonism induced by reserpine. *Behav. Brain Res.* 253, 68–77. doi:10.1016/j.bbr.2013.06.031
- Satake, W., Nakabayashi, Y., Mizuta, I., Hirota, Y., Ito, C., Kubo, M., Kawaguchi, T., Tsunoda, T., Watanabe, M., Takeda, A., Tomiyama, H., Nakashima, K., Hasegawa, K., Obata, F., Yoshikawa, T., Kawakami, H., Sakoda, S., Yamamoto, M., Hattori, N., Murata, M., Nakamura, Y., Toda, T., 2009. Genome-wide association study identifies common variants at four loci as genetic risk factors for Parkinson's disease. *Nat. Genet.* 41, 1303–1307. doi:10.1038/ng.485
- Satou, M., Nishi, Y., Yoh, J., Hattori, Y., Sugimoto, H., 2010. Identification and characterization of acyl-protein thioesterase 1/lysophospholipase I as a ghrelin deacylation/lysophospholipid hydrolyzing enzyme in fetal bovine serum and conditioned medium. *Endocrinology* 151, 4765–4775. doi:10.1210/en.2010-0412
- Sawada, M., Imamura, K., Nagatsu, T., 2006. Role of cytokines in inflammatory process in Parkinson's disease. *J. Neural Transm. Suppl.* 373–381.
- Sawle, G.V., Wroe, S.J., Lees, A.J., Brooks, D.J., Frackowiak, R.S., 1992. The identification of presymptomatic parkinsonism: clinical and [18F]dopa positron emission tomography studies in an Irish kindred. *Ann. Neurol.* 32, 609–617. doi:10.1002/ana.410320503
- Schaeffer, M., Langlet, F., Lafont, C., Molino, F., Hodson, D.J., Roux, T., Lamarque, L., Verdié, P., Bourrier, E., Dehouck, B., Banères, J.-L., Martinez, J., Méry, P.-F., Marie, J., Trinquet, E., Fehrentz, J.-A., Prévot, V., Mollard, P., 2013. Rapid sensing of circulating ghrelin by hypothalamic appetite-modifying neurons. *Proc. Natl. Acad. Sci. U. S. A.* 110, 1512–1517. doi:10.1073/pnas.1212137110
- Schallert, T., Fleming, S.M., Leasure, J.L., Tillerson, J.L., Bland, S.T., 2000. CNS plasticity and assessment of forelimb sensorimotor outcome in unilateral rat models of stroke, cortical ablation, parkinsonism and spinal cord injury. *neuropharmacology* 39, 777–787.
- Schanze, A., Reulbach, U., Scheuchenzuber, M., Groschl, M., Kornhuber, J., Kraus, T., 2008. Ghrelin and eating disturbances in psychiatric disorders. *Neuropsychobiology* 57, 126–130. doi:10.1159/000138915

- Schapira, A.H.V., 2013. Recent developments in biomarkers in Parkinson disease: *Curr. Opin. Neurol.* 26, 395–400. doi:10.1097/WCO.0b013e3283633741
- Schapira, A.H.V., 2009. Neurobiology and treatment of Parkinson's disease. *Trends Pharmacol. Sci.* 30, 41–47. doi:10.1016/j.tips.2008.10.005
- Schapira, A.H.V., Emre, M., Jenner, P., Poewe, W., 2009. Levodopa in the treatment of Parkinson's disease. *Eur. J. Neurol.* 16, 982–989. doi:10.1111/j.1468-1331.2009.02697.x
- Schellekens, H., Dinan, T.G., Cryan, J.F., 2013. Taking two to tango: a role for ghrelin receptor heterodimerization in stress and reward. *Front. Neurosci.* 7. doi:10.3389/fnins.2013.00148
- Schenck, C.H., Bundlie, S.R., Mahowald, M.W., 1996. Delayed emergence of a parkinsonian disorder in 38% of 29 older men initially diagnosed with idiopathic rapid eye movement sleep behavior disorder. *Neurology* 46, 388–393. doi:10.1212/WNL.46.2.388
- Schlossmacher, M.G., Frosch, M.P., Gai, W.P., Medina, M., Sharma, N., Forno, L., Ochiishi, T., Shimura, H., Sharon, R., Hattori, N., Langston, J.W., Mizuno, Y., Hyman, B.T., Selkoe, D.J., Kosik, K.S., 2002. Parkin localizes to the Lewy bodies of Parkinson disease and dementia with Lewy bodies. *Am. J. Pathol.* 160, 1655–1667. doi:10.1016/S0002-9440(10)61113-3
- Schoenberg, B.S., Osuntokun, B.O., Adeuja, A.O., Bademosi, O., Nottidge, V., Anderson, D.W., Haerer, A.F., 1988. Comparison of the prevalence of Parkinson's disease in black populations in the rural United States and in rural Nigeria: door-to-door community studies. *Neurology* 38, 645–646.
- Schüle, B., Pera, R.A.R., Langston, J.W., 2009. Can cellular models revolutionize drug discovery in Parkinson's disease? *Biochim. Biophys. Acta BBA - Mol. Basis Dis.* 1792, 1043–1051. doi:10.1016/j.bbadis.2009.08.014
- Schuler, F., Casida, J.E., 2001. The insecticide target in the PSST subunit of complex I. *Pest Manag. Sci.* 57, 932–940. doi:10.1002/ps.364
- Sedelis, M., Hofele, K., Auburger, G.W., Morgan, S., Huston, J.P., Schwarting, R.K., 2000. MPTP susceptibility in the mouse: behavioral, neurochemical, and histological analysis of gender and strain differences. *Behav. Genet.* 30, 171–182.
- Seibler, P., Graziotto, J., Jeong, H., Simunovic, F., Klein, C., Krainc, D., 2011. Mitochondrial Parkin recruitment is impaired in neurons derived from mutant PINK1 iPS cells. *J. Neurosci. Off. J. Soc. Neurosci.* 31, 5970–5976. doi:10.1523/JNEUROSCI.4441-10.2011
- Seim, I., Carter, S.L., Herington, A.C., Chopin, L.K., 2008a. Complex organisation and structure of the ghrelin antisense strand gene GHRLOS, a candidate non-coding RNA gene. *BMC Mol. Biol.* 9, 95. doi:10.1186/1471-2199-9-95
- Seim, I., Carter, S.L., Herington, A.C., Chopin, L.K., 2008b. Complex organisation and structure of the ghrelin antisense strand gene GHRLOS, a candidate non-coding RNA gene. *BMC Mol. Biol.* 9, 95. doi:10.1186/1471-2199-9-95
- Seim, I., Collet, C., Herington, A.C., Chopin, L.K., 2007. Revised genomic structure of the human ghrelin gene and identification of novel exons, alternative splice variants and natural antisense transcripts. *BMC Genomics* 8, 298. doi:10.1186/1471-2164-8-298
- Selikhova, M., Williams, D.R., Kempster, P.A., Holton, J.L., Revesz, T., Lees, A.J., 2009. A clinico-pathological study of subtypes in Parkinson's disease. *Brain J. Neurol.* 132, 2947–2957. doi:10.1093/brain/awp234
- Shafer, T.J., Atchison, W.D., 1991. Transmitter, ion channel and receptor properties of pheochromocytoma (PC12) cells: a model for neurotoxicological studies. *Neurotoxicology* 12, 473–492.
- Shahim, P., Blennow, K., Johansson, P., Svensson, J., Lista, S., Hampel, H., Andersson, L.C., Zetterberg, H., 2016. Cerebrospinal Fluid Stanniocalcin-1 as a Biomarker for Alzheimer's Disease and Other Neurodegenerative Disorders. *Neuromolecular Med.* doi:10.1007/s12017-016-8439-1
- Sharma, S., Singh, S., Sharma, V., Singh, V.P., Deshmukh, R., 2015. Neurobiology of L-DOPA induced dyskinesia and the novel therapeutic strategies. *Biomed. Pharmacother. Biomed. Pharmacothérapie* 70, 283–293. doi:10.1016/j.biopha.2015.01.029

- Sherer, T.B., Betarbet, R., Testa, C.M., Seo, B.B., Richardson, J.R., Kim, J.H., Miller, G.W., Yagi, T., Matsuno-Yagi, A., Greenamyre, J.T., 2003. Mechanism of toxicity in rotenone models of Parkinson's disease. *J. Neurosci. Off. J. Soc. Neurosci.* 23, 10756–10764.
- Shimada, T., Furuta, H., Doi, A., Ariyasu, H., Kawashima, H., Wakasaki, H., Nishi, M., Sasaki, H., Akamizu, T., 2014. Des-acyl ghrelin protects microvascular endothelial cells from oxidative stress-induced apoptosis through sirtuin 1 signaling pathway. *Metabolism.* 63, 469–474. doi:10.1016/j.metabol.2013.12.011
- Shimizu, K., Ohtaki, K., Matsubara, K., Aoyama, K., Uezono, T., Saito, O., Suno, M., Ogawa, K., Hayase, N., Kimura, K., Shiono, H., 2001. Carrier-mediated processes in blood–brain barrier penetration and neural uptake of paraquat. *Brain Res.* 906, 135–142.
- Shin, A., Camilleri, M., Busciglio, I., Burton, D., Smith, S.A., Vella, A., Ryks, M., Rhoten, D., Zinsmeister, A.R., 2013. The ghrelin agonist RM-131 accelerates gastric emptying of solids and reduces symptoms in patients with type 1 diabetes mellitus. *Clin. Gastroenterol. Hepatol. Off. Clin. Pract. J. Am. Gastroenterol. Assoc.* 11, 1453–1459.e4. doi:10.1016/j.cgh.2013.04.019
- Shojaee, S., Sina, F., Banihosseini, S.S., Kazemi, M.H., Kalhor, R., Shahidi, G.-A., Fakhrai-Rad, H., Ronaghi, M., Elahi, E., 2008. Genome-wide linkage analysis of a Parkinsonian-pyramidal syndrome pedigree by 500 K SNP arrays. *Am. J. Hum. Genet.* 82, 1375–1384. doi:10.1016/j.ajhg.2008.05.005
- Simón-Sánchez, J., Schulte, C., Bras, J.M., Sharma, M., Gibbs, J.R., Berg, D., Paisan-Ruiz, C., Lichtner, P., Scholz, S.W., Hernandez, D.G., Krüger, R., Federoff, M., Klein, C., Goate, A., Perlmutter, J., Bonin, M., Nalls, M.A., Illig, T., Gieger, C., Houlden, H., Steffens, M., Okun, M.S., Racette, B.A., Cookson, M.R., Foote, K.D., Fernandez, H.H., Traynor, B.J., Schreiber, S., Arepalli, S., Zonozi, R., Gwinn, K., van der Brug, M., Lopez, G., Chanock, S.J., Schatzkin, A., Park, Y., Hollenbeck, A., Gao, J., Huang, X., Wood, N.W., Lorenz, D., Deuschl, G., Chen, H., Riess, O., Hardy, J.A., Singleton, A.B., Gasser, T., 2009. Genome-wide association study reveals genetic risk underlying Parkinson's disease. *Nat. Genet.* 41, 1308–1312. doi:10.1038/ng.487
- Singleton, A.B., Farrer, M., Johnson, J., Singleton, A., Hague, S., Kachergus, J., Hulihan, M., Peuralinna, T., Dutra, A., Nussbaum, R., Lincoln, S., Crawley, A., Hanson, M., Maraganore, D., Adler, C., Cookson, M.R., Muentner, M., Baptista, M., Miller, D., Blancato, J., Hardy, J., Gwinn-Hardy, K., 2003. alpha-Synuclein locus triplication causes Parkinson's disease. *Science* 302, 841. doi:10.1126/science.1090278
- Sixel-Döring, F., Zimmermann, J., Wegener, A., Mollenhauer, B., Trenkwalder, C., 2016. The Evolution of REM Sleep Behavior Disorder in Early Parkinson Disease. *Sleep.*
- Smith, W.W., Margolis, R.L., Li, X., Troncoso, J.C., Lee, M.K., Dawson, V.L., Dawson, T.M., Iwatsubo, T., Ross, C.A., 2005. Alpha-synuclein phosphorylation enhances eosinophilic cytoplasmic inclusion formation in SH-SY5Y cells. *J. Neurosci. Off. J. Soc. Neurosci.* 25, 5544–5552. doi:10.1523/JNEUROSCI.0482-05.2005
- Sommer, S.S., Rocca, W.A., 1996. Prion analogues and twin studies in Parkinson's disease. *Neurology* 46, 273–275.
- Soto-Otero, R., Méndez-Alvarez, E., Hermida-Ameijeiras, A., Muñoz-Patiño, A.M., Labandeira-Garcia, J.L., 2000. Autoxidation and neurotoxicity of 6-hydroxydopamine in the presence of some antioxidants: potential implication in relation to the pathogenesis of Parkinson's disease. *J. Neurochem.* 74, 1605–1612.
- Spencer, B., Potkar, R., Trejo, M., Rockenstein, E., Patrick, C., Gindi, R., Adame, A., Wyss-Coray, T., Masliah, E., 2009. Beclin 1 gene transfer activates autophagy and ameliorates the neurodegenerative pathology in alpha-synuclein models of Parkinson's and Lewy body diseases. *J. Neurosci. Off. J. Soc. Neurosci.* 29, 13578–13588. doi:10.1523/JNEUROSCI.4390-09.2009
- Spengler, B.A., Biedler, J.L., Ross, R.A., 2002. A corrected karyotype for the SH-SY5Y human neuroblastoma cell line. *Cancer Genet. Cytogenet.* 138, 177–178.

- Spillantini, M.G., Crowther, R.A., Jakes, R., Cairns, N.J., Lantos, P.L., Goedert, M., 1998. Filamentous alpha-synuclein inclusions link multiple system atrophy with Parkinson's disease and dementia with Lewy bodies. *Neurosci. Lett.* 251, 205–208.
- Spillantini, M.G., Crowther, R.A., Jakes, R., Hasegawa, M., Goedert, M., 1998. α -Synuclein in filamentous inclusions of Lewy bodies from Parkinson's disease and dementia with Lewy bodies. *Proc. Natl. Acad. Sci.* 95, 6469–6473.
- Spillantini, M.G., Goedert, M., 2000. The alpha-synucleinopathies: Parkinson's disease, dementia with Lewy bodies, and multiple system atrophy. *Ann. N. Y. Acad. Sci.* 920, 16–27.
- Springer, W., Hoppe, T., Schmidt, E., Baumeister, R., 2005. A *Caenorhabditis elegans* Parkin mutant with altered solubility couples alpha-synuclein aggregation to proteotoxic stress. *Hum. Mol. Genet.* 14, 3407–3423. doi:10.1093/hmg/ddi371
- Stachowiak, H., 1973. *Allgemeine Modelltheorie*, Springer-Verlag. ed. Wien, Osterreich.
- Stamelou, M., Bhatia, K.P., 2015. Atypical parkinsonism: diagnosis and treatment. *Neurol. Clin.* 33, 39–56. doi:10.1016/j.ncl.2014.09.012
- Starkstein, S.E., Robinson, R.G., Leiguarda, R., Preziosi, T.J., 1993. Anxiety and depression in Parkinson's disease. *Behav. Neurol.* 6, 151–154. doi:10.3233/BEN-1993-6306
- Stein, K.C., True, H.L., 2014. Prion strains and amyloid polymorphism influence phenotypic variation. *PLoS Pathog.* 10, e1004328. doi:10.1371/journal.ppat.1004328
- Stern, M.B., Siderowf, A., 2010. Parkinson's at risk syndrome: Can Parkinson's disease be predicted? *Mov. Disord.* 25, S89–S93. doi:10.1002/mds.22719
- Steyn, F.J., Tolle, V., Chen, C., Epelbaum, J., 2016. Neuroendocrine Regulation of Growth Hormone Secretion. *Compr. Physiol.* 6, 687–735. doi:10.1002/cphy.c150002
- Stokholm, M.G., Danielsen, E.H., Hamilton-Dutoit, S.J., Borghammer, P., 2016. Pathological α -synuclein in gastrointestinal tissues from prodromal Parkinson disease patients. *Ann. Neurol.* 79, 940–949. doi:10.1002/ana.24648
- Stores, G., 2007. Clinical diagnosis and misdiagnosis of sleep disorders. *J. Neurol. Neurosurg. Psychiatry* 78, 1293–1297. doi:10.1136/jnnp.2006.111179
- Strauss, K.M., Martins, L.M., Plun-Favreau, H., Marx, F.P., Kautzmann, S., Berg, D., Gasser, T., Wszolek, Z., Müller, T., Bornemann, A., Wolburg, H., Downward, J., Riess, O., Schulz, J.B., Krüger, R., 2005. Loss of function mutations in the gene encoding Omi/HtrA2 in Parkinson's disease. *Hum. Mol. Genet.* 14, 2099–2111. doi:10.1093/hmg/ddi215
- Studer, L., Tabar, V., McKay, R.D., 1998. Transplantation of expanded mesencephalic precursors leads to recovery in parkinsonian rats. *Nat. Neurosci.* 1, 290–295. doi:10.1038/1105
- Subramaniam, S.R., Vergnes, L., Franich, N.R., Reue, K., Chesselet, M.-F., 2014. Region specific mitochondrial impairment in mice with widespread overexpression of alpha-synuclein. *Neurobiol. Dis.* 70, 204–213. doi:10.1016/j.nbd.2014.06.017
- Sui, Y.-T., Bullock, K.M., Erickson, M.A., Zhang, J., Banks, W.A., 2014. Alpha synuclein is transported into and out of the brain by the blood-brain barrier. *Peptides* 62, 197–202. doi:10.1016/j.peptides.2014.09.018
- Svenningsson, P., Rosenblad, C., Af Edholm Arvidsson, K., Wictorin, K., Keywood, C., Shankar, B., Lowe, D.A., Björklund, A., Widner, H., 2015. Eltopazine counteracts l-DOPA-induced dyskinesias in Parkinson's disease: a dose-finding study. *Brain J. Neurol.* 138, 963–973. doi:10.1093/brain/awu409
- Taipa, R., Pereira, C., Reis, I., Alonso, I., Bastos-Lima, A., Melo-Pires, M., Magalhães, M., 2016. DJ-1 linked parkinsonism (PARK7) is associated with Lewy body pathology. *Brain J. Neurol.* 139, 1680–1687. doi:10.1093/brain/aww080
- Takagi, K., Legrand, R., Asakawa, A., Amitani, H., François, M., Tennoune, N., Coëffier, M., Claeysens, S., do Rego, J.-C., Déchelotte, P., Inui, A., Fetissov, S.O., 2013. Anti-ghrelin immunoglobulins modulate ghrelin stability and its orexigenic effect in obese mice and humans. *Nat. Commun.* 4, 2685. doi:10.1038/ncomms3685
- Takeda, H., Muto, S., Nakagawa, K., Ohnishi, S., Asaka, M., 2012a. Rikkunshito and ghrelin secretion. *Curr. Pharm. Des.* 18, 4827–4838.

- Takeda, H., Muto, S., Nakagawa, K., Ohnishi, S., Sadakane, C., Saegusa, Y., Nahata, M., Hattori, T., Asaka, M., 2012b. Rikkunshito as a ghrelin enhancer. *Methods Enzymol.* 514, 333–351. doi:10.1016/B978-0-12-381272-8.00021-0
- Tamashiro, K.L.K., Nguyen, M.M.N., Ostrander, M.M., Gardner, S.R., Ma, L.Y., Woods, S.C., Sakai, R.R., 2007. Social stress and recovery: implications for body weight and body composition. *Am. J. Physiol. Regul. Integr. Comp. Physiol.* 293, R1864-1874. doi:10.1152/ajpregu.00371.2007
- Tan, L.C., Koh, W.-P., Yuan, J.-M., Wang, R., Au, W.-L., Tan, J.H., Tan, E.-K., Yu, M.C., 2008. Differential effects of black versus green tea on risk of Parkinson's disease in the Singapore Chinese Health Study. *Am. J. Epidemiol.* 167, 553–560. doi:10.1093/aje/kwm338
- Tanner, C.M., Kamel, F., Ross, G.W., Hoppin, J.A., Goldman, S.M., Korell, M., Marras, C., Bhudhikanok, G.S., Kasten, M., Chade, A.R., Comyns, K., Richards, M.B., Meng, C., Priestley, B., Fernandez, H.H., Cambi, F., Umbach, D.M., Blair, A., Sandler, D.P., Langston, J.W., 2011a. Rotenone, Paraquat, and Parkinson's Disease. *Environ. Health Perspect.* 119, 866–872. doi:10.1289/ehp.1002839
- Tanner, C.M., Kamel, F., Ross, G.W., Hoppin, J.A., Goldman, S.M., Korell, M., Marras, C., Bhudhikanok, G.S., Kasten, M., Chade, A.R., Comyns, K., Richards, M.B., Meng, C., Priestley, B., Fernandez, H.H., Cambi, F., Umbach, D.M., Blair, A., Sandler, D.P., Langston, J.W., 2011b. Rotenone, Paraquat, and Parkinson's Disease. *Environ. Health Perspect.* 119, 866–872. doi:10.1289/ehp.1002839
- Tansey, M.G., Goldberg, M.S., 2010. Neuroinflammation in Parkinson's disease: its role in neuronal death and implications for therapeutic intervention. *Neurobiol. Dis.* 37, 510–518. doi:10.1016/j.nbd.2009.11.004
- Tatton, N.A., Kish, S.J., 1997. In situ detection of apoptotic nuclei in the substantia nigra compacta of 1-methyl-4-phenyl-1,2,3,6-tetrahydropyridine-treated mice using terminal deoxynucleotidyl transferase labelling and acridine orange staining. *Neuroscience* 77, 1037–1048.
- Terry, R.D., 2000. Do neuronal inclusions kill the cell? *J. Neural Transm. Suppl.* 59, 91–93.
- Theander-Carrillo, C., Wiedmer, P., Cettour-Rose, P., Nogueiras, R., Perez-Tilve, D., Pfluger, P., Castaneda, T.R., Muzzin, P., Schürmann, A., Szanto, I., Tschöp, M.H., Rohner-Jeanrenaud, F., 2006. Ghrelin action in the brain controls adipocyte metabolism. *J. Clin. Invest.* 116, 1983–1993. doi:10.1172/JCI25811
- Thiffault, C., Langston, J.W., Di Monte, D.A., 2000. Increased striatal dopamine turnover following acute administration of rotenone to mice. *Brain Res.* 885, 283–288.
- Thomas, B., Beal, M.F., 2007. Parkinson's disease. *Hum. Mol. Genet.* 16 Spec No. 2, R183-194. doi:10.1093/hmg/ddm159
- Thompson, N.M., Gill, D.A.S., Davies, R., Loveridge, N., Houston, P.A., Robinson, I.C.A.F., Wells, T., 2004. Ghrelin and des-octanoyl ghrelin promote adipogenesis directly in vivo by a mechanism independent of the type 1a growth hormone secretagogue receptor. *Endocrinology* 145, 234–242. doi:10.1210/en.2003-0899
- Tir, M., Devos, D., Blond, S., Touzet, G., Reyns, N., Duhamel, A., Cottencin, O., Dujardin, K., Cassim, F., Destée, A., Defebvre, L., Krystkowiak, P., 2007. Exhaustive, one-year follow-up of subthalamic nucleus deep brain stimulation in a large, single-center cohort of parkinsonian patients. *Neurosurgery* 61, 297-304-305. doi:10.1227/01.NEU.0000285347.50028.B9
- Todes, C.J., Lees, A.J., 1985. The pre-morbid personality of patients with Parkinson's disease. *J. Neurol. Neurosurg. Psychiatry* 48, 97–100.
- Tolosa, A., Zhou, X., Spittau, B., Krieglstein, K., 2013. Establishment of a Survival and Toxic Cellular Model for Parkinson's Disease from Chicken Mesencephalon. *Neurotox. Res.* 24, 119. doi:10.1007/s12640-012-9367-y
- Tomasetto, C., Wendling, C., Rio, M.C., Poitras, P., 2001. Identification of cDNA encoding motilin related peptide/ghrelin precursor from dog fundus. *Peptides* 22, 2055–2059.
- Tong, J., Dave, N., Mugundu, G.M., Davis, H.W., Gaylenn, B.D., Thorner, M.O., Tschop, M.H., D'Alessio, D., Desai, P.B., 2013. The pharmacokinetics of acyl, des-acyl, and total ghrelin in healthy human subjects. *Eur. J. Endocrinol.* 168, 821–828. doi:10.1530/EJE-13-0072

- Tönges, L., Frank, T., Tatenhorst, L., Saal, K.A., Koch, J.C., Szego, É.M., Bähr, M., Weishaupt, J.H., Lingor, P., 2012. Inhibition of rho kinase enhances survival of dopaminergic neurons and attenuates axonal loss in a mouse model of Parkinson's disease. *Brain J. Neurol.* 135, 3355–3370. doi:10.1093/brain/aws254
- Tran, H.T., Chung, C.H.-Y., Iba, M., Zhang, B., Trojanowski, J.Q., Luk, K.C., Lee, V.M.Y., 2014. A-synuclein immunotherapy blocks uptake and templated propagation of misfolded α -synuclein and neurodegeneration. *Cell Rep.* 7, 2054–2065. doi:10.1016/j.celrep.2014.05.033
- Tretiakoff, K.N., 1919. Contribution à l'étude de l'anatomie pathologique du locus niger de Soemmering avec quelques deductions à la pathologie des troubles musculaires et de la maladie de Parkinson. Paris, Paris.
- Trimmer, P.A., Borland, M.K., Keeney, P.M., Bennett, J.P., Parker, W.D., 2004. Parkinson's disease transgenic mitochondrial cybrids generate Lewy inclusion bodies. *J. Neurochem.* 88, 800–812.
- Trojanowski, J.Q., Lee, V.M., 2000. "Fatal attractions" of proteins. A comprehensive hypothetical mechanism underlying Alzheimer's disease and other neurodegenerative disorders. *Ann. N. Y. Acad. Sci.* 924, 62–67.
- Tsika, E., Kannan, M., Foo, C.S.-Y., Dikeman, D., Glauser, L., Gellhaar, S., Galter, D., Knott, G.W., Dawson, T.M., Dawson, V.L., Moore, D.J., 2014. Conditional expression of Parkinson's disease-related R1441C LRRK2 in midbrain dopaminergic neurons of mice causes nuclear abnormalities without neurodegeneration. *Neurobiol. Dis.* 71, 345–358. doi:10.1016/j.nbd.2014.08.027
- Tuttle, M.D., Comellas, G., Nieuwkoop, A.J., Covell, D.J., Berthold, D.A., Kloepper, K.D., Courtney, J.M., Kim, J.K., Barclay, A.M., Kendall, A., Wan, W., Stubbs, G., Schwieters, C.D., Lee, V.M.Y., George, J.M., Rienstra, C.M., 2016. Solid-state NMR structure of a pathogenic fibril of full-length human α -synuclein. *Nat. Struct. Mol. Biol.* 23, 409–415. doi:10.1038/nsmb.3194
- Tyson, T., Steiner, J.A., Brundin, P., 2015. Sorting out release, uptake and processing of alpha-synuclein during prion-like spread of pathology. *J. Neurochem.* doi:10.1111/jnc.13449
- Tzoulis, C., Tran, G.T., Schwarzlmüller, T., Specht, K., Haugarvoll, K., Balafkan, N., Lilleng, P.K., Miletic, H., Biermann, M., Bindoff, L.A., 2013. Severe nigrostriatal degeneration without clinical parkinsonism in patients with polymerase gamma mutations. *Brain J. Neurol.* 136, 2393–2404. doi:10.1093/brain/awt103
- Unger, M.M., Möller, J.C., Mankel, K., Eggert, K.M., Bohne, K., Bodden, M., Stiasny-Kolster, K., Kann, P.H., Mayer, G., Tebbe, J.J., Oertel, W.H., 2011. Postprandial ghrelin response is reduced in patients with Parkinson's disease and idiopathic REM sleep behaviour disorder: a peripheral biomarker for early Parkinson's disease? *J. Neurol.* 258, 982–990. doi:10.1007/s00415-010-5864-1
- Ungerstedt, U., 1968. 6-Hydroxy-dopamine induced degeneration of central monoamine neurons. *Eur. J. Pharmacol.* 5, 107–110.
- Valente, E.M., Abou-Sleiman, P.M., Caputo, V., Muqit, M.M.K., Harvey, K., Gispert, S., Ali, Z., Del Turco, D., Bentivoglio, A.R., Healy, D.G., Albanese, A., Nussbaum, R., González-Maldonado, R., Deller, T., Salvi, S., Cortelli, P., Gilks, W.P., Latchman, D.S., Harvey, R.J., Dallapiccola, B., Auburger, G., Wood, N.W., 2004. Hereditary early-onset Parkinson's disease caused by mutations in PINK1. *Science* 304, 1158–1160. doi:10.1126/science.1096284
- Valera, E., Masliah, E., 2013. Immunotherapy for neurodegenerative diseases: focus on α -synucleinopathies. *Pharmacol. Ther.* 138, 311–322. doi:10.1016/j.pharmthera.2013.01.013
- van Duijn, C.M., Dekker, M.C.J., Bonifati, V., Galjaard, R.J., Houwing-Duistermaat, J.J., Snijders, P.J.L.M., Testers, L., Breedveld, G.J., Horstink, M., Sandkuijl, L.A., van Swieten, J.C., Oostra, B.A., Heutink, P., 2001. PARK7, a Novel Locus for Autosomal Recessive Early-Onset Parkinsonism, on Chromosome 1p36. *Am. J. Hum. Genet.* 69, 629–634. doi:10.1086/322996
- Venneti, S., Robinson, J.L., Roy, S., White, M.T., Baccon, J., Xie, S.X., Trojanowski, J.Q., 2011. Simulated brain biopsy for diagnosing neurodegeneration using autopsy-confirmed cases. *Acta Neuropathol. (Berl.)* 122, 737–745. doi:10.1007/s00401-011-0880-5

- Verstraeten, A., Theuns, J., Van Broeckhoven, C., 2015. Progress in unraveling the genetic etiology of Parkinson disease in a genomic era. *Trends Genet.* TIG 31, 140–149. doi:10.1016/j.tig.2015.01.004
- Vilariño-Güell, C., Wider, C., Ross, O.A., Dachsel, J.C., Kachergus, J.M., Lincoln, S.J., Soto-Ortolaza, A.I., Cobb, S.A., Wilhoite, G.J., Bacon, J.A., Behrouz, B., Melrose, H.L., Hentati, E., Puschmann, A., Evans, D.M., Conibear, E., Wasserman, W.W., Aasly, J.O., Burkhard, P.R., Djaldetti, R., Ghika, J., Hentati, F., Krygowska-Wajs, A., Lynch, T., Melamed, E., Rajput, A., Rajput, A.H., Solida, A., Wu, R.-M., Uitti, R.J., Wszolek, Z.K., Vingerhoets, F., Farrer, M.J., 2011. VPS35 mutations in Parkinson disease. *Am. J. Hum. Genet.* 89, 162–167. doi:10.1016/j.ajhg.2011.06.001
- Volpicelli-Daley, L.A., Gamble, K.L., Schultheiss, C.E., Riddle, D.M., West, A.B., Lee, V.M.-Y., 2014. Formation of α -synuclein Lewy neurite-like aggregates in axons impedes the transport of distinct endosomes. *Mol. Biol. Cell* 25, 4010–4023. doi:10.1091/mbc.E14-02-0741
- Volpicelli-Daley, L.A., Luk, K.C., Patel, T.P., Tanik, S.A., Riddle, D.M., Stieber, A., Meaney, D.F., Trojanowski, J.Q., Lee, V.M.-Y., 2011. Exogenous α -synuclein fibrils induce Lewy body pathology leading to synaptic dysfunction and neuron death. *Neuron* 72, 57–71. doi:10.1016/j.neuron.2011.08.033
- von Campenhausen, S., Bornschein, B., Wick, R., Bötzel, K., Sampaio, C., Poewe, W., Oertel, W., Siebert, U., Berger, K., Dodel, R., 2005. Prevalence and incidence of Parkinson's disease in Europe. *Eur. Neuropsychopharmacol. J. Eur. Coll. Neuropsychopharmacol.* 15, 473–490. doi:10.1016/j.euroneuro.2005.04.007
- Walkinshaw, G., Waters, C.M., 1994. Neurotoxin-induced cell death in neuronal PC12 cells is mediated by induction of apoptosis. *Neuroscience* 63, 975–987.
- Walsh, K., Bennett, G., 2001. Parkinson's disease and anxiety. *Postgrad. Med. J.* 77, 89–93.
- Wang, L., Fleming, S.M., Chesselet, M.-F., Taché, Y., 2008. Abnormal colonic motility in mice overexpressing human wild-type α -synuclein: *NeuroReport* 19, 873–876. doi:10.1097/WNR.0b013e3282ffda5e
- Wang, L., Mogami, S., Karasawa, H., Yamada, C., Yakabi, S., Yakabi, K., Hattori, T., Taché, Y., 2014. Preventive effect of rikkunshito on gastric motor function inhibited by l-dopa in rats. *Peptides* 55, 136–144. doi:10.1016/j.peptides.2014.02.011
- Wang, L., Murphy, N.P., Stengel, A., Goebel-Stengel, M., Pierre, D.H.S., Maidment, N.T., Taché, Y., 2012. Ghrelin prevents levodopa-induced inhibition of gastric emptying and increases circulating levodopa in fasted rats: Ghrelin prevents l-dopa-delayed gastric emptying. *Neurogastroenterol. Motil.* 24, e235–e245. doi:10.1111/j.1365-2982.2012.01904.x
- Wang, X., Michaelis, E.K., 2010. Selective Neuronal Vulnerability to Oxidative Stress in the Brain. *Front. Aging Neurosci.* 2. doi:10.3389/fnagi.2010.00012
- Ward, C.D., Duvoisin, R.C., Ince, S.E., Nutt, J.D., Eldridge, R., Calne, D.B., 1983. Parkinson's disease in 65 pairs of twins and in a set of quadruplets. *Neurology* 33, 815–815. doi:10.1212/WNL.33.7.815
- Watabe-Uchida, M., Zhu, L., Ogawa, S.K., Vamanrao, A., Uchida, N., 2012. Whole-brain mapping of direct inputs to midbrain dopamine neurons. *Neuron* 74, 858–873. doi:10.1016/j.neuron.2012.03.017
- Watts, J.C., Prusiner, S.B., 2014. Mouse models for studying the formation and propagation of prions. *J. Biol. Chem.* 289, 19841–19849. doi:10.1074/jbc.R114.550707
- Webb, J.L., Ravikumar, B., Atkins, J., Skepper, J.N., Rubinsztein, D.C., 2003. Alpha-Synuclein is degraded by both autophagy and the proteasome. *J. Biol. Chem.* 278, 25009–25013. doi:10.1074/jbc.M300227200
- Wellman, M., Abizaid, A., 2015. Growth Hormone Secretagogue Receptor Dimers: A New Pharmacological Target. *eNeuro* 2. doi:10.1523/ENEURO.0053-14.2015
- Williams-Gray, C.H., Foltynie, T., Brayne, C.E.G., Robbins, T.W., Barker, R.A., 2007. Evolution of cognitive dysfunction in an incident Parkinson's disease cohort. *Brain J. Neurol.* 130, 1787–1798. doi:10.1093/brain/awm111
- Willner, P., 1984. The validity of animal models of depression. *Psychopharmacology (Berl.)* 83, 1–16.

- Wo, J.M., Ejskjaer, N., Hellström, P.M., Malik, R.A., Pezzullo, J.C., Shaughnessy, L., Charlton, P., Kosutic, G., McCallum, R.W., 2011. Randomised clinical trial: ghrelin agonist TZP-101 relieves gastroparesis associated with severe nausea and vomiting--randomised clinical study subset data. *Aliment. Pharmacol. Ther.* 33, 679–688. doi:10.1111/j.1365-2036.2010.04567.x
- Woolley, D., Gietzen, D., Gee, S., Magdalou, J., Hammock, B., 1989. Does paraquat (PD) mimic MPP+ toxicity? *Proc. West. Pharmacol. Soc.* 191–193.
- Wren, A.M., Seal, L.J., Cohen, M.A., Brynes, A.E., Frost, G.S., Murphy, K.G., Dhillo, W.S., Ghatei, M.A., Bloom, S.R., 2001. Ghrelin enhances appetite and increases food intake in humans. *J. Clin. Endocrinol. Metab.* 86, 5992. doi:10.1210/jcem.86.12.8111
- Wu, X.-F., Block, M.L., Zhang, W., Qin, L., Wilson, B., Zhang, W.-Q., Veronesi, B., Hong, J.-S., 2005. The role of microglia in paraquat-induced dopaminergic neurotoxicity. *Antioxid. Redox Signal.* 7, 654–661. doi:10.1089/ars.2005.7.654
- Xiong, N., Xiong, J., Jia, M., Liu, L., Zhang, X., Chen, Z., Huang, J., Zhang, Z., Hou, L., Luo, Z., Ghoorah, D., Lin, Z., Wang, T., 2013. The role of autophagy in Parkinson's disease: rotenone-based modeling. *Behav. Brain Funct. BBF* 9, 13. doi:10.1186/1744-9081-9-13
- Xu, L., Pu, J., 2016. Alpha-Synuclein in Parkinson's Disease: From Pathogenetic Dysfunction to Potential Clinical Application. *Park. Dis.* 2016, 1720621. doi:10.1155/2016/1720621
- Yang, D., Liu, Z., Zhang, H., Luo, Q., 2013. Ghrelin protects human pulmonary artery endothelial cells against hypoxia-induced injury via PI3-kinase/Akt. *Peptides* 42, 112–117. doi:10.1016/j.peptides.2013.01.012
- Yang, Q., She, H., Gearing, M., Colla, E., Lee, M., Shacka, J.J., Mao, Z., 2009. Regulation of neuronal survival factor MEF2D by chaperone-mediated autophagy. *Science* 323, 124–127. doi:10.1126/science.1166088
- Yang, W.L., Sun, A.Y., 1998. Paraquat-induced cell death in PC12 cells. *Neurochem. Res.* 23, 1387–1394.
- Yu, J., Xu, H., Shen, X., Jiang, H., 2016. Ghrelin protects MES23.5 cells against rotenone via inhibiting mitochondrial dysfunction and apoptosis. *Neuropeptides* 56, 69–74. doi:10.1016/j.npep.2015.09.011
- Yu, J., Xu, H., Shen, X., Jiang, H., 2015. Ghrelin protects MES23.5 cells against rotenone via inhibiting mitochondrial dysfunction and apoptosis. *Neuropeptides*. doi:10.1016/j.npep.2015.09.011
- Zarranz, J.J., Alegre, J., Gómez-Esteban, J.C., Lezcano, E., Ros, R., Ampuero, I., Vidal, L., Hoenicka, J., Rodriguez, O., Atarés, B., Llorens, V., Gomez Tortosa, E., del Ser, T., Muñoz, D.G., de Yebenes, J.G., 2004. The new mutation, E46K, of alpha-synuclein causes Parkinson and Lewy body dementia. *Ann. Neurol.* 55, 164–173. doi:10.1002/ana.10795
- Zetuský, W.J., Jankovic, J., Pirozzolo, F.J., 1985. The heterogeneity of Parkinson's disease: clinical and prognostic implications. *Neurology* 35, 522–526.
- Zhang, L., Dong, Y., Xu, X., Xu, Z., 2012. The role of autophagy in Parkinson's disease. *Neural Regen. Res.* 7, 141–145. doi:10.3969/j.issn.1673-5374.2012.02.011
- Zhang, W., Chai, B., Li, J., Wang, H., Mulholland, M.W., 2008. Effect of Des-acyl Ghrelin on Adiposity and Glucose Metabolism. *Endocrinology* 149, 4710–4716. doi:10.1210/en.2008-0263
- Zhang, X.-M., Yin, M., Zhang, M.-H., 2014. Cell-based assays for Parkinson's disease using differentiated human LUHMES cells. *Acta Pharmacol. Sin.* 35, 945–956. doi:10.1038/aps.2014.36
- Zhu, X., Cao, Y., Voodg, K., Steiner, D.F., 2006. On the Processing of Proghrelin to Ghrelin. *J. Biol. Chem.* 281, 38867–38870. doi:10.1074/jbc.M607955200
- Zigman, J.M., Bouret, S.G., Andrews, Z.B., 2016. Obesity Impairs the Action of the Neuroendocrine Ghrelin System. *Trends Endocrinol. Metab. TEM* 27, 54–63. doi:10.1016/j.tem.2015.09.010
- Zigman, J.M., Jones, J.E., Lee, C.E., Saper, C.B., Elmquist, J.K., 2006. Expression of ghrelin receptor mRNA in the rat and the mouse brain. *J. Comp. Neurol.* 494, 528–548. doi:10.1002/cne.20823
- Zimprich, A., Biskup, S., Leitner, P., Lichtner, P., Farrer, M., Lincoln, S., Kachergus, J., Hulihan, M., Uitti, R.J., Calne, D.B., Stoessl, A.J., Pfeiffer, R.F., Patenge, N., Carbajal, I.C., Vieregge, P.,

Asmus, F., Müller-Myhsok, B., Dickson, D.W., Meitinger, T., Strom, T.M., Wszolek, Z.K., Gasser, T., 2004. Mutations in LRRK2 cause autosomal-dominant parkinsonism with pleomorphic pathology. *Neuron* 44, 601–607. doi:10.1016/j.neuron.2004.11.005

Zizzari, P., Hassouna, R., Grouselle, D., Epelbaum, J., Tolle, V., 2011. Physiological roles of preproghrelin-derived peptides in GH secretion and feeding. *Peptides* 32, 2274–2282. doi:10.1016/j.peptides.2011.04.014

CHAPTER 9 : ANNEXES

Annex 1: Document de synthèse en français

Etude du rôle de la ghréline dans des modèles expérimentaux de stades précoces de la maladie de Parkinson : vers une clarification des potentiels diagnostique et thérapeutique de ce peptide orexigène.

1. Contexte scientifique

La maladie de Parkinson (MP) est une maladie neurodégénérative qui se développe progressivement et entraîne des atteintes cérébrales irréversibles telles que la mort de neurones dopaminergiques au sein de la Substance Noire (SN) et la présence d'inclusions intra-cytoplasmiques, nommées corps de Lewy, dans les neurones survivants (Parkinson, 2002). A l'heure actuelle les stratégies thérapeutiques utilisées visent à réduire les symptômes moteurs causés par cette perte neuronale massive (estimée à plus de 50% du nombre initial de neurones dopaminergiques de la SN à l'apparition des symptômes moteurs) au sein des ganglions de la base : le tremblement de repos, la bradykinésie et la rigidité des membres, conduisant progressivement à une instabilité posturale (Fahn, 2015). Il est pour l'instant impossible de stopper ou de contrer la mort neuronale et les traitements disponibles offrent un répit de courte durée puisqu'ils nécessitent la présence des neurones dopaminergiques survivants pour fonctionner (Schapira, 2009; Schapira et al., 2009). Des stratégies neuroprotectrices pourraient cependant ralentir la mort neuronale et retarder l'apparition des symptômes moteurs (Cabantchik et al., 2013). Pour ce faire, il nous faut trouver une solution pour diagnostiquer les patients parkinsoniens bien avant l'apparition des premiers troubles moteurs, à un stade où la mort neuronale n'est pas encore trop importante.

Le diagnostic de certitude de la maladie de Parkinson ne peut être effectué qu'après observation des lésions neuropathologies caractéristiques dans le cerveau du patient lors de l'autopsie. Néanmoins, depuis quelques années, des travaux ont révélé la présence de symptômes non moteurs tels que l'anosmie, la dépression ou des troubles gastro-intestinaux, plusieurs années avant l'apparition des premiers symptômes moteurs (Poewe, 2008). De plus, la présence d'agrégats d'alpha-synucléine ressemblant à des corps de Lewy dans le système nerveux périphérique des patients, et plus précisément dans les plexus de Meissner et d'Auerbach innervant le tractus gastro-intestinal, suggère que la maladie pourrait débiter en périphérie puis progresser lentement jusqu'au cerveau (Braak et al., 2006, 2003). Ces découvertes nous offrent des pistes pour cibler les personnes à risque pour la MP et leur offrir des solutions neuroprotectrices lorsque la mort neuronale au sein de la SN n'est

pas trop importante. Malheureusement, les troubles non moteurs tels que l'anosmie ou la constipation ne sont pas spécifiques de la maladie de Parkinson et ne peuvent être utilisés seuls pour poser un diagnostic. L'objectif désormais est donc de trouver un ou plusieurs biomarqueurs des stades plus précoces de la maladie.

Nous nous sommes basés sur des études transcriptomiques réalisées au laboratoire ainsi que sur les données de la littérature pour identifier une molécule qui pourrait servir de biomarqueur des stades précoces de la maladie. Notre choix s'est porté sur la ghréline. En effet, les concentrations plasmatiques de ce peptide orexigène après un repas standard semblent différentes chez les patients parkinsoniens par rapport à celles mesurées chez des sujets sains (Unger et al., 2011) et son utilisation dans des modèles *in vitro* et *in vivo* de stades avancés de syndrome parkinsonien a révélé un rôle neuroprotecteur potentiel pour les neurones dopaminergiques de la SN (Andrews et al., 2009; Bayliss and Andrews, 2013). Cette molécule pourrait ainsi servir à la fois de biomarqueur des stades précoces de la MP mais aussi d'agent neuroprotecteur potentiel, sous réserve d'en comprendre les mécanismes d'action sur les neurones présentant des corps de Lewy dans les systèmes nerveux périphérique et central.

2. Ghréline : un peptide neuroprotecteur dans la MP ? Etude dans les cellules mésencéphaliques primaires

Avant d'étudier les effets neuroprotecteurs potentiels de la ghréline *in vivo*, il est indispensable d'établir ce rôle *in vitro*. Puisqu'aucune lignée cellulaire neuronale dopaminergique exprimant le récepteur de la ghréline (GHSR1a) n'est disponible dans le commerce, nous avons souhaité développer un modèle de culture primaire de neurones mésencéphaliques dopaminergiques reproduisant des stades précoces d'un syndrome parkinsonien. Pour cela, ce modèle devrait présenter les critères moléculaires et cellulaires suivants : mort neuronale présente mais modérée (pour rappel lorsque les symptômes moteurs apparaissent environ la moitié des neurones dopaminergiques de la SN sont morts) causée par une exposition chronique à de faibles doses de roténone (connues pour induire des syndromes parkinsoniens chez l'homme et chez les rongeurs), un déficit du complexe 1 de la chaîne respiratoire mitochondriale, une modification du système de dégradation des protéines mal conformées (pouvant conduire à l'apparition des agrégats d'alpha-synucléine) et une activation de la glie.

2.1. Effet de l'exposition à l'acyl-ghréline sur des cellules primaires mésencéphaliques

Notre premier objectif était de déterminer le rôle potentiel de la ghréline sur des cultures primaires de neurones dopaminergiques exposées à la roténone. Plusieurs paramètres étaient cependant à préciser avant de pouvoir effectuer cette étude. En effet, bien que la ghréline ait déjà été utilisée en tant que molécule protectrice dans de nombreuses études de cultures cellulaires (Baldanzi, 2002; Bayliss and Andrews, 2013; Kenny et al., 2013; Moon et al., 2009), aucun article ne relate son usage sur des cultures primaires murines de neurones dopaminergiques. Nous devions donc tout d'abord nous assurer que son utilisation n'était pas toxique pour nos cellules. Pour ce faire, nous avons exposé une première série de cultures primaires à différentes concentrations de ghréline seule (0.3, 1, 3, 10, 30, 100, 300 et 1000 nM) et avons effectué un comptage des neurones dopaminergiques survivants (positifs pour la tyrosine hydroxylase (TH+), clone LNC1, MAB318 Millipore) après 10 jours en culture (DIV10), dont 7 jours d'exposition à la ghréline (DIV3-DIV7). Le nombre moyen de neurones produisant de la tyrosine hydroxylase (TH+) pour chaque condition étudiée ainsi que des photos représentatives des cellules cultivées dans du milieu classique ou exposées à la plus forte dose de ghréline (1000 nM) sont présentées en figure 28. Le nombre moyen de neurones dans chaque condition est normalisé par rapport au nombre moyen de neurones dans les puits sans exposition à la ghréline. La ghréline seule ne semble pas délétère pour les neurones primaires dopaminergiques dans nos conditions de culture (nombre moyen de cellules TH+ : 38.40 ± 2.16 en condition contrôle *versus* 48.80 ± 7.37 pour la plus haute dose d'acyl-ghréline, n.s.). Une légère tendance à l'augmentation est même observée dans les puits exposés à 100nM ou plus de ghréline. De plus, toutes les cellules, qu'elles soient exposées ou non à la ghréline présentent un corps cellulaire de forme ovale et de nombreux prolongements longs et fins (Fig. 28B). La ghréline ne semble donc pas altérer la morphologie neuronale aux doses étudiées. Nous avons choisi la dose de 100nM d'acyl-ghréline pour les expériences suivantes puisqu'à cette dose le nombre et la morphologie des neurones TH+ n'étaient pas modifiés et que cela correspondait à la dose moyenne utilisée dans la littérature.

En conclusion, l'exposition de cellules primaires murines mésencéphaliques à l'acyl-ghréline seule durant sept jours ne modifie pas la morphologie globale et le nombre de cellules produisant la TH. Ceci indique qu'une exposition à long-terme à l'acyl-ghréline n'a pas d'effet délétère sur la survie des neurones produisant la TH dans les cultures primaires murines mésencéphaliques.

2.2. Temps de demi-vie de l'acyl-ghréline dans le milieu de culture

L'acyl-ghréline a un temps de demi-vie très court dans les fluides biologiques (Delhanty et al., 2015) qui est par exemple de 8 minutes dans le sang de rats (Hosoda and Kangawa,

2012; Tong et al., 2013). La prochaine étape de notre étude était donc d'étudier le temps de demi-vie de la ghréline dans le milieu de culture. Il était en effet essentiel de déterminer non seulement la stabilité de l'acyl-ghréline dans nos conditions de culture mais aussi la fréquence à laquelle elle devrait être ajoutée lors d'expositions à long terme.

Après une exposition de cellules primaires mésencéphaliques à l'acyl-ghréline durant différentes périodes, le milieu a été collecté pour chaque condition. Différentes conditions de stockage ont été testées pour déterminer le protocole le plus adapté pour une utilisation ultérieure des échantillons. Les résultats présentés en figure 29 montrent que les concentrations d'acyl-ghréline diminuent fortement dans les minutes suivant son ajout dans le milieu de culture tandis que les concentrations de desacyl-ghréline, bien que hétérogènes durant toute l'expérience, restaient élevées pendant plusieurs heures. L'acyl-ghréline était en effet dégradée rapidement dans le milieu de culture et n'était plus détectée 10 minutes après son ajout si un traitement supplémentaire du milieu de culture n'était pas effectué (Fig. 29A, courbe verte). L'ajout de l'inhibiteur de protéase 4-hydroxymercuribenzoic acid (PHMB) immédiatement avant congélation des échantillons empêchait une plus ample dégradation de l'acyl-ghréline. Cependant, même en présence de PHMB, l'acyl-ghréline était totalement dégradée une heure après son ajout dans le milieu de culture. De façon surprenante, bien que seule l'acyl-ghréline pure ait été resuspendue en solution, les concentrations de desacyl-ghréline étaient élevées dès le début de l'expérience jusqu'à un jour après l'ajout d'acyl-ghréline dans le milieu. L'ajout de PHMB ou d'HCl n'entraînait pas de modification des concentrations de desacyl-ghréline dans le milieu de culture. Au contraire, l'ajout de PHMB permettait une meilleure préservation du groupement acyl de l'acyl-ghréline. Ce protocole a donc été adopté comme procédure standard pour les expériences suivantes de dosage des concentrations de ghréline dans le milieu de culture. Ces résultats ont été confirmés dans une seconde expérience réalisée en triplicats sur des cellules primaires mésencéphaliques exposées ou non à 100nM d'acyl-ghréline pendant 10 minutes. Tout comme pour l'expérience précédente, les concentrations de ghréline étaient plus élevées après 10 minutes d'exposition des cellules à l'acyl-ghréline si le PHMB était ajouté dans les tubes collecteurs comparé à la congélation des milieux de culture directement après récupération (valeurs moyennes = 90980 pg/mL \pm 13948 *versus* 10pg/mL \pm 0 respectivement, cf. Fig. 30). Les concentrations de désacyl-ghréline après 10 minutes d'exposition des cellules étaient plus basses quand le PHMB était ajouté dans les tubes collecteurs comparé aux milieux de cultures congelés directement après leur prélèvement (valeurs moyennes = 31= 31380 pg/mL \pm 5370.70 *versus* 165480 pg/mL \pm 28694 respectivement).

En conclusion, ces expériences ont établi l'absence de toxicité de l'acyl-ghréline sur les cellules primaires mésencéphaliques à toutes les concentrations utilisées. De

plus, l'acyl-ghréline était totalement dégradée dans l'heure suivant son ajout dans le milieu de culture, même en présence de l'inhibiteur de protéase PHMB. Ceci devrait donc être pris en compte lors d'expositions à long-terme. Enfin, des précautions doivent être prises lors du stockage et de l'utilisation des milieux de culture après exposition à l'acyl-ghréline, notamment avec l'ajout de PHMB dans les tubes collecteurs comme lors d'utilisation d'échantillons de plasma.

3. Etude du potentiel neuroprotecteur de la ghreline dans un modèle cellulaire de syndrome parkinsonien

3.1. Evaluation des validités de construction et d'apparence du modèle cellulaire

L'exposition au pesticide roténone produit un syndrome parkinsonien chez l'homme (Tanner et al., 2011a). De plus, la MP étant une maladie neurodégénérative progressive évoluant sur plusieurs décennies, il est important de développer un protocole d'exposition à la roténone qui implique au moins plusieurs jours d'exposition au pesticide. De plus, il est estimé que les symptômes moteurs caractéristiques de la MP apparaissent après disparition de plus de 50% des neurones dopaminergiques de la SN (Bernheimer et al., 1973; Riederer and Wuketich, 1976). La dose et la durée d'exposition à la roténone ont ainsi été déterminées de façon à reproduire, autant que possible dans un modèle *in vitro* limité par la durée maximum de vie des cellules primaires, la mort neuronale progressive se déroulant dans le cerveau des patients parkinsoniens. En nous basant sur des données de la littérature et des expériences précédentes réalisées dans le laboratoire du Dr. Pan-Montojo, les cellules primaires mésencéphaliques ont été exposées à 5nM ou 10nM de roténone durant 2 ou 3 jours à partir du 8^{ème} jour en culture (DIV8) ou du 7^{ème} jour en culture (DIV7) respectivement. Le nombre de cellules TH+ est évalué au 10^{ème} jour en culture (DIV10) à la fin de l'exposition. L'exposition de cellules primaires mésencéphaliques à 5nM de roténone n'induisait pas de diminution significative du nombre de cellules TH+ après deux ou trois jours d'exposition (Fig. 31A). De manière similaire, cela ne modifiait pas la morphologie des cellules TH+ (Fig. 32B). Au contraire, 10nM de roténone diminuait le nombre de cellules TH+ de 32% ou 61% après deux ou trois jours d'exposition respectivement (nombre moyen de cellules TH+ : C = 17.81 ± 3.94, R5 = 17.66 ± 4.17, R10 = 12.16 ± 6.76, n.s. comparé aux cellules contrôles après deux jours d'exposition à la roténone ; C = 17.00 ± 4.60, R5 = 14.33 ± 4.12, R10 = 6.66 ± 2.08, n.s. comparé aux cellules contrôles après trois jours d'exposition). De plus, comme présenté en figure 32C, l'exposition à 10nM de roténone modifiait fortement la morphologie des neurones survivants qui présentait des prolongements moins développés et moins ramifiés.

En conclusion, pour les expériences suivantes, les cellules primaires mésencéphaliques ont été exposées aux deux doses de roténone quand cela était possible, i.e. quand un nombre suffisant de cellules pouvait être obtenu lors de l'isolation. Nous nous sommes concentrés sur l'exposition à 10nM de roténone durant trois jours (DIV7-DIV10) quand le nombre de cellules isolées était limité puisque ce protocole induisait un effet délétère sur les cellules, permettant ainsi l'étude du rôle potentiellement protecteur de la ghréline avec plus de précision que l'exposition à 5nM de roténone.

3.2 Effet d'exposition à court et long-terme à l'acyl-ghréline sur des cellules mésencéphaliques primaires exposées à la roténone

Nous avons ensuite étudié le potentiel rôle neuroprotecteur de la ghréline dans des modèles de syndrome parkinsonien. Plusieurs études *in vivo* et *in vitro* argumentent en faveur un rôle neuro-protecteur de ce peptide orexigène dans la MP (Andrews et al., 2009; Bayliss et al., 2016a; Dong et al., 2009; Moon et al., 2009). La plupart des résultats montrant un effet neuro-protecteur de la ghréline *in vitro* ont été obtenus dans des cellules préalablement exposées à la ghréline seule durant 20 minutes puis à la ghréline et l'agent délétère (roténone ou MPTP) durant 24 heures. Les cellules mésencéphaliques primaires ont été exposées à la roténone et à l'acyl-ghréline pour une courte période de trois jours (DIV7-DIV10). L'acyl-ghréline était ajoutée dans le milieu de culture toutes les 24 heures, en raison de la dégradation rapide de l'acyl-ghréline dans le milieu de culture, alors que la roténone était ajoutée tous les deux jours. Le nombre de cellules TH+, leur morphologie, ainsi que le nombre de cellules marquées par de l'iodure de propidium (IP+), un intercalant de l'ADN des cellules aux membranes perforées révélant ainsi la présence des noyaux de cellules mourantes ou mortes, ont été analysés.

Comme présenté en figure 33A, le nombre de cellules TH+ diminuait dans les puits exposés à 10nM de roténone (C: 26.30 ± 3.38 ; R: 9.70 ± 2.08 , $p < 0.01$) ou 10nM de roténone plus 0.1nM d'acyl-ghréline (R + AG0.1: 6.66 ± 1.60 , $p < 0.05$), 1nM d'acyl-ghréline (R + AG1: 8.60 ± 1.24 , $p < 0.01$), 10nM d'acyl-ghréline (R + AG10: 10.80 ± 1.84 , $p < 0.05$) et 100nM d'acyl-ghréline (R + AG100: 11.80 ± 3.39 , $p < 0.05$) comparé à la condition contrôle. Aucune différence significative n'était observée dans le nombre moyen de cellules TH+ entre les cellules exposées à la roténone seule ou à la roténone plus des doses croissantes d'acyl-ghréline. De plus, les cellules TH+ exposées au solvant seul ou à l'acyl-ghréline seule présentaient un corps cellulaire ovale et des prolongements neuronaux longs et ramifiés, une morphologie similaire à celle des cellules en condition contrôle (Fig. 33B conditions a et b). Cependant, les cellules exposées à 10nM de roténone durant trois jours présentaient des

prolongements plus courts (Fig. 33B, condition c). Cette morphologie était plus amplement modifiée pour les cellules exposées simultanément à la roténone et à l'acyl-ghréline (10 ou 100nM), dans ces conditions les prolongements rétrécissaient et disparaissaient progressivement (Fig. 33B, condition d). De façon similaire, comme présenté en figure 34, les cellules exposées à 10nM de roténone seule et les cellules exposées à 10nM de roténone et à l'acyl-ghréline comportaient un nombre de cellules IP+ plus important comparé à la condition contrôle (Fig. 34 ; valeurs moyennes C = 1781 ± 226, R = 2491 ± 301, R + AG100 = 3553 ± 158, n.s.), bien que cette différence n'atteigne pas le seuil de significativité statistique.

En conclusion, l'exposition de cellules murines primaires mésencéphaliques à la roténone seule ainsi qu'à la roténone et à l'acyl-ghréline durant trois jours altérait le nombre et la morphologie des neurones TH+ et augmentait légèrement le nombre de cellules IP+. Ainsi, plutôt que d'exercer une action protectrice contre la mort cellulaire induite par la roténone dans des cellules mésencéphaliques primaires, l'acyl-ghréline semble potentialiser l'action délétère de la roténone dans nos conditions de culture.

Puisque des études montrant un rôle neuro-protecteur de la ghreline incluait une phase de prétraitement à l'acyl-ghréline, nous avons ensuite étudié l'effet d'une exposition à long terme à l'acyl-ghréline (DIV3-DIV10) sur des cellules primaires mésencéphalique exposées à la roténone durant les trois derniers jours (DIV7-DIV10). Pour ce protocole l'intervalle d'ajout dans le milieu de culture était de deux jours pour la ghreline et la roténone. Puisqu'aucune exposition à long terme à la ghreline n'a été publiée *in vitro*, nous nous sommes basés sur les résultats de Jiang et collaborateurs montrant que des injections quotidiennes de ghreline réduisaient la mort des neurones dopaminergiques et la déplétion en dopamine striatale induites par le MPTP (un inhibiteur mitochondrial induisant une mort rapide et importante des neurones dopaminergiques de la substance noire) dans un modèle murin (Jiang et al., 2008). La ghreline était administrée en prétraitement durant 3 jours puis conjointement avec le MPTP pendant 5 jours. Nous avons donc étudié les effets d'un prétraitement à la ghreline en exposant les cellules à la ghreline seule durant 4 jours (le milieu de culture étant changé toutes les deux jours dans notre protocole cela correspondait à deux changements de milieu), puis à la roténone en poursuivant l'exposition à la ghreline durant 3 jours avant de fixer les cellules. Des photos représentatives des neurones dopaminergiques pour chaque condition sont présentées en figure 35. D'après ces résultats, et comme déjà décrit plus haut, la morphologie des cellules exposées au solvant ou à 5nM de roténone ne semble pas différer de celle des cellules contrôles. Leurs corps cellulaires sont ovales, les prolongements sont longs et nombreux. De même, pour les faibles concentrations de ghreline (1 et 10nM), la morphologie des neurones semble identique à

celle des cellules contrôles (Fig. 35B). A partir de 30nM de ghréline, la morphologie des neurones se modifie, l'arbre dendritique disparaît et le corps cellulaire s'arrondit. Il en est de même pour les concentrations plus fortes de ghréline. Les résultats de cette étude nous confirment qu'une concentration de 5nM de roténone n'est pas suffisante pour induire une perte significative des cellules TH+. De plus, une diminution significative du nombre de neurones dopaminergiques était observée pour les puits exposés à la roténone et à 30, 100, 300 ou 1000nM de ghréline (R+ AG30 : 35, +/-2.55, n.s., R+ AG100 : 32 +/-5.39, n.s., RG +A300:12.16 +/-0.43, ** p<0.01, R + AG1000: 32 +/-5.39, n.s.). Ce résultat étant inattendu, au regard de l'effet neuro-protecteur de la ghréline observé dans les autres modèles *in vitro* et *in vivo* de syndromes parkinsoniens notamment après exposition au MPTP, nous avons reproduit cette expérience. Les résultats obtenus confirmaient l'effet délétère d'une exposition à long terme à l'acyl-ghréline sur des cellules primaires dopaminergiques (Fig. 36).

En conclusion nous avons démontré ici qu'une exposition à court ou long terme à l'acyl-ghréline ne protégeait pas les cellules des modifications du nombre de cellules TH+ et de leurs morphologies induites par la roténone dans nos conditions de culture.

3.3 Effet d'une exposition à court terme à la desacyl-ghréline sur des cellules primaires mésencéphaliques exposées à la roténone.

Nous avons ensuite étudié l'effet de la desacyl-ghréline dans notre modèle de syndrome parkinsonien. En effet, aucune précision n'était donnée concernant l'état d'acylation de la ghréline utilisée pour induire l'effet neuroprotecteur décrit dans la littérature. Nous avons ainsi réalisé une exposition à court terme à différentes doses de desacyl-ghréline (0.1, 1, 10 et 100nM) sur des cellules exposées ou non à 10nM de roténone et avons analysé le nombre de cellules TH+ ainsi que leur morphologie et le nombre de cellules IP+. La figure 37A montre le nombre moyen et la morphologie des cellules TH+ dans les différentes conditions étudiées. Nous avons observé une diminution du nombre de cellules TH+ après l'exposition à 10nM de roténone seule ou accompagnée de 1nM ou 100nM de desacyl-ghréline (C: 79.41 ± 4.19, R: 13.96 ± 1.97, **p<0.01; R+DAG1: 34.41 ± 6.58, *p<0.05; R+DAG100: 48.8 ± 9.63, n.s.). Cependant, cette diminution était moins importante après exposition conjointe à la roténone et à la desacyl-ghréline. Nous avons également étudié le nombre de cellules IP+ dans chaque condition pour déterminer si cet effet était commun à toutes les cellules en culture ou spécifique des cellules TH+ (Fig. 38). Le nombre de cellules IP+ était significativement augmenté dans les puits exposés à 10nM de roténone et à 1 nM de desacyl-ghréline comparé à la condition contrôle (C: 1285.66 ± 67.80; R: 1677.37 ± 140.45, n.s.; R+DAG1: 135.26 ± 8.38, p<0.05; R+DAG10: 124.93 ± 5.93, n.s. ;

R+DAG100: 113.06 ± 10.89 , n.s.). Cependant, aucune différence n'était observée dans les autres conditions.

En conclusion, l'exposition à court terme à la desacyl-ghréline semble protéger les cellules primaires mésencéphaliques des modifications du nombre et de la morphologie des cellules TH+ induites par la roténone. Cet effet n'était pas observé dans l'étude du nombre de cellules IP+, suggérant une action spécifique des neurones TH+. En résumé, notre étude *in vitro* ne confirme pas le rôle neuro-protecteur de l'acyl-ghréline dans les cellules primaires mésencéphaliques exposées à de faibles doses de roténone. Cependant, la desacyl-ghréline semble capable de protéger ces cellules.

4. Etude du potentiel de la ghreline en tant que biomarqueur des stages précoces de la maladie de Parkinson

4.1. Variation de *GHRLOS* dans des échantillons de patients parkinsoniens

Notre laboratoire a collecté différents échantillons biologiques tels que le sang ou le liquide cébrospinal à partir de patients parkinsoniens sporadiques ou porteurs d'une mutation génétique ainsi que de contrôles appariés (sexe et âge) depuis plus d'une décennie. Des articles publiés précédemment en utilisant des approches transcriptomiques puissantes sans *a priori* ont identifié des dérégulations des voies cellulaires impliquées dans l'apoptose, la survie cellulaire, l'inflammation et la réponse immunitaire ainsi que la production de protéines et l'endocytose dans des cellules mononucléaires périphériques de patients parkinsoniens comparé aux contrôles appariés (Mutez et al., 2014, 2011). Comme présenté dans le tableau 7, l'ARN situé sur le brin opposé du gène de la ghreline (ghrelin opposite strand RNA, *GHRLOS*) était identifié parmi les gènes significativement dérégulés dans les cellules mononuclées sanguines périphériques de patients parkinsoniens sporadiques ou porteurs de la mutation G2019S du gène *LRRK2* (FC : -0.167 et FC : -0.23 respectivement). Cet ARN non codant est transcrit par un gène qui étend son promoteur et ses régions non traduites sur 44kb sur le brin opposé au gène de la ghreline et pourrait exercer de potentiels rôles régulateur et fonctionnel sur l'expression de la ghreline (Seim et al., 2008a). Nous avons ainsi étudié l'expression de *GHRLOS* dans les cellules mononuclées sanguines périphériques et les lignées cellulaires lymphoblastoïdes immortalisées par le virus Epstein-Barr de patients parkinsoniens par qPCR. Comme montré en figure 39, l'expression de *GHRLOS* était diminuée chez les patients parkinsoniens comparés aux contrôles (expression relative de *GHRLOS* dans le groupe contrôle = 1.30 ± 0.29 versus 0.74 ± 0.14 chez les patients parkinsoniens, $p=0.08$).

En conclusion, cette première série d'expériences a révélé une diminution de l'expression de *GHRLOS* qui pourrait conduire à une altération de l'expression de la ghréline. Ceci nous a donc conduit à étudier l'expression de la ghréline dans des échantillons biologiques de souris présentant un phénotype proche de celui de la MP.

4.2. Etude *in vivo* dans un analogue expérimental de syndrome parkinsonien précoce

4.2.1. Variations physiologiques des concentrations plasmatiques de ghréline chez la souris

Puisque nous ne pouvions pas initier une étude chez les patients durant la thèse, nous avons étudié les variations de ghréline dans un modèle animal de stades précoces de syndrome parkinsonien induit par l'exposition chronique à de faibles doses du pesticide roténone (Pan-Montojo et al., 2010 ; 2012). Considérant l'étude conduite par Unger et collaborateurs (2011) montrant un retour aux concentrations basales de ghréline retardé après un repas standard chez les patients parkinsoniens comparés aux sujets contrôles, nous souhaitons étudier les concentrations plasmatiques de ghréline après un repas faisant suite à un jeûne nocturne chez des souris exposées ou non à de faibles doses du pesticide roténone. Cependant, au début de notre étude, les variations des concentrations plasmatiques de ghréline en condition physiologique avant et après un repas n'étaient pas décrites dans la littérature disponible. Nous avons donc conduit une étude pilote sur des souris C57BL/6J mâles et femelles.

4.2.1.1. Variations des concentrations plasmatiques de ghréline avant et après un repas chez des souris saines âgées de 4-5 mois.

Une étude préliminaire a tout d'abord été conduite avant et après un repas chez 20 souris femelles C57BL/6J pour évaluer la durée de prise alimentaire nécessaire pour induire une diminution des concentrations plasmatiques d'acyl-ghréline. Pour cette expérience, des échantillons sanguins ont été prélevés sur des souris soumises à un jeûne de nuit et à différents temps après le retour des souris dans leurs cages avec accès *ad libitum* à la nourriture. L'acyl- et la desacyl-ghréline étaient dosées dans le plasma (Fig. 40). Comme décrit dans d'autres espèces, les concentrations plasmatiques d'acyl- et de desacyl-ghréline étaient élevées après un jeûne nocturne. Trente minutes d'accès à la nourriture induisaient une diminution significative des concentrations plasmatiques d'acyl-ghréline (T0 : 462 ± 209 pg/mL *versus* T30: 182 ± 47.59 pg/mL, $p < 0.05$). De plus, les souris mangeaient au moins deux repas en 90 minutes comme montré par les diminutions des concentrations d'acyl-

ghréline à T30 et T90. En parallèle, les concentrations de desacyl-ghréline étaient élevées après un jeûne nocturne et diminuaient progressivement après que les souris ont retrouvé un accès à la nourriture.

4.2.1.2. Variations plasmatiques des concentrations de ghréline chez des souris saines mâles âgées de 1 an

Puisque le modèle animal de syndrome parkinsonien précoce sélectionné pour cette étude a été développé chez des souris mâles âgées de un an et considérant les variations de concentrations de ghréline liées à l'âge et au sexe (Al-Massadi et al., 2010; Makovey et al., 2007), nous avons aussi étudié les variations des concentrations plasmatiques d'acyl- et de desacyl-ghréline avant et après un repas chez des souris C57BL/6J mâles âgées de un an. Basé sur les résultats obtenus sur les femelles plus jeunes (cf. supra), le protocole a été modifié pour autoriser un accès limité à la nourriture durant 30 minutes seulement (après le premier prélèvement sanguin), après quoi la nourriture était de nouveau retirée pour empêcher les variations supplémentaires des concentrations plasmatiques d'acyl-ghréline. Ce protocole permettait de mimer la procédure suivie chez l'homme par Unger et collaborateurs (2011). La figure 41 représente les variations des concentrations plasmatiques d'acyl- (Fig. 41A) et de desacyl-ghréline (Fig. 41B) durant l'expérience. Les concentrations plasmatiques d'acyl-ghréline étaient plus élevées après un jeûne nocturne, diminuaient après la prise alimentaire et augmentaient de nouveau jusqu'au prochain repas. Ces données reproduisaient ainsi les variations des concentrations d'acyl-ghréline plasmatique observées chez l'homme, validant ainsi ce protocole d'accès temporaire à la nourriture pour l'étude des variations de concentrations plasmatiques de ghréline chez la souris après un jeûne nocturne. La figure 42 montre également que les valeurs de concentrations d'acyl-ghréline étaient plus hétérogènes lors du premiers et du dernier prélèvement sanguin tandis que les concentrations de desacyl-ghréline étaient stables tout au long de l'expérience bien qu'une certaine variabilité interindividuelle existe.

En conclusion, lorsque l'accès à la nourriture est limité à 30 minutes après un jeûne nocturne, les concentrations plasmatiques d'acyl-ghréline sont élevées après le jeûne, diminuent rapidement après 30 minutes d'accès *ad libitum* à la nourriture et augmentent de nouveau jusqu'au prochain repas. Une telle procédure standardisée évite les variations de ghréline dues à la prise alimentaire continue (limitée à quelques croquettes) pendant toute la période d'activité de la souris. Cela assure donc une étude rigoureuse des variations de ghréline dans les conditions pathologiques.

4.2.2. Validation du modèle animal de syndrome parkinsonien précoce après exposition chronique à de faibles doses du pesticide roténone

4.2.2.1. Bien-être animal tout au long de la procédure

Trente souris mâles C57BL/6J âgées de 1 an ont été réparties en 3 groupes (n=10/groupe) : contrôle, solvant et roténone. Pour les souris du groupe contrôle, la sonde de gavage était introduite délicatement dans l'œsophage de la souris puis retirée ; les souris du groupe solvant recevaient un gavage avec une solution de carboxyméthylcellulose 2% et de chloroforme 1.25% durant 1.5 mois alors que les souris du groupe roténone recevaient un gavage avec 5mg/kg/jour de roténone diluée dans la solution solvant durant 1.5mois. Toutes les souris étaient manipulées et pesées cinq jours par semaine. La procédure expérimentale suivie est détaillée en figure 21. Les conditions générales de santé des animaux ont été surveillées tout au long de l'expérimentation. A la dose de 5mg/kg, tous les animaux sont demeurés en vie durant les 6 semaines de procédure expérimentale et n'ont montré aucun signe d'altération générale. A l'exception d'une souris dans le groupe contrôle qui montrait une tendance à tourner spontanément sur le côté droit, toutes les souris étaient capables de réaliser les tests comportementaux. Cet animal a été retiré de la cohorte après observation, lors de l'autopsie, d'une atrophie du cervelet. Comme la MP est souvent accompagnée d'une perte de poids involontaire, les souris ont été pesées quotidiennement (Fig. 43A). Leur prise alimentaire par cage a aussi été étudiée pour exclure une perte de poids due à une diminution de la prise alimentaire (Fig. 43B). La mesure du poids montre que les souris exposées au solvant ou à la roténone semblent perdre du poids après 1,5 mois d'expérimentation (différence de poids moyenne entre le premier et le dernier jour de procédure expérimentale pour le groupe contrôle = $+0.39 \pm 0.27$ *versus* -0.59 ± 0.44 pour les souris solvant et -0.75 ± 0.32 pour les souris roténone, $p < 0.001$). Cette perte apparaît durant les premiers jours de procédure (analyse post-hoc $p < 0.001$ entre les souris contrôles et les souris roténone à partir du jour 5 de la procédure expérimentale, et entre les souris contrôles et les souris roténone à partir du jour 8) et était accompagnée par une diminution de la prise alimentaire (Jour 4-10 de la procédure expérimentale, $p < 0.01$). Aucune diminution supplémentaire du poids ou de la prise alimentaire n'était observée après cette première semaine. Ces résultats suggèrent que la roténone n'affecte pas le poids ni la prise alimentaire des souris après 1.5 mois de procédure expérimentale. De plus, le poids de plusieurs organes (foie, reins, gastrocnémien, soléus et cœur) prélevés à l'autopsie était similaire entre les trois groupes (données non présentées). **Ceci suggère que la roténone n'a pas d'effet systémique dans notre protocole.**

4.2.2.2. Evaluation des symptômes non moteurs après 1.5 mois d'exposition à de faibles doses du pesticide roténone

Durant les années précédant l'apparition des symptômes moteurs, les patients parkinsoniens souffrent souvent de symptômes non moteurs parmi lesquels les troubles gastro-intestinaux sont fréquents (Cloud and Greene, 2011; Poewe, 2008). Pour évaluer l'effet de la roténone sur la motilité intestinale, les souris étaient placées individuellement dans une cage, similaire à leur cage habituelle, mais dans laquelle la litière avait été retirée et qui était équipée d'une grille de fond destinée à éviter la coprophagie fréquente chez les rongeurs, sans nourriture mais avec accès illimité à l'eau. Ce nouvel environnement, combiné à l'isolement social, générait un stress modéré pour la souris qui augmentait l'activité du système nerveux autonome, augmentant ainsi l'excrétion des fèces. Le nombre de fèces a été compté toutes les 15 minutes durant une heure et à la fin de la seconde heure (Wang et al., 2008). La figure 44 (A, B and C) montre le nombre de fèces excrétés pour tous les groupes et tous les temps d'étude. La figure 44 D montre le nombre cumulé moyen de fèces émis par les souris d'un même groupe après 1.5 mois d'exposition comparé au nombre enregistré avant le début de l'expérience. Comme attendu, le test de motilité intestinale en réaction à la nouveauté activait le système nerveux autonome comme montré par l'augmentation globale du nombre cumulatif de fèces émis par tous les animaux avant le début de la procédure expérimentale. A ce temps, tous les animaux étaient déjà assignés à un groupe expérimental (Fig. 44A). De manière intéressante, les souris exposées à la roténone émettaient moins de fèces comparées aux deux autres groupes expérimentaux à partir d'un mois de procédure expérimentale, un effet qui devenait significatif après 1.5 mois d'exposition au pesticide (Fig. 44C and 44D). Le tableau 8 montre les nombres détaillés de fèces émis lors de cette expérience.

En conclusion, les résultats du test de motilité intestinale montrent que l'exposition de souris C57BL/6J mâles âgées de un an à de faibles doses du pesticide roténone durant 1.5 mois affecte la motilité intestinale, mimant ainsi un des symptômes non moteurs documentés par les patients parkinsoniens durant les stades précoces de la maladie.

4.2.2.3. Etude du comportement moteur après 1.5 mois d'exposition à de faibles doses du pesticide roténone

4.2.2.3.1. Analyse du comportement moteur global

Le comportement moteur global a été étudié à l'aide du test d'activité spontanée (adapté de Fleming et al., 2004). Brièvement, chaque souris a été placée dans un cylindre de verre (15.5cm de haut, 12.7cm de diamètre) pendant 3 min (Schallert et al., 2000). La

réaction des animaux en réponse à ce nouvel environnement était enregistrée, un miroir étant placé sous le cylindre pour faciliter l'enregistrement de tous les mouvements dans le cylindre par une caméra (Sony DCR-SX30). Les vidéos ont été analysées par la suite à vitesse ralentie pour dénombrer le nombre de redressement (en réaction à un nouvel environnement), indice de la réactivité de l'animal à son nouvel environnement, le temps passé à se toiletter, indice d'anxiété si frénétique, le nombre de pas réalisés avec les pattes avant et les pattes arrière (Fig. 45). Aucune différence statistique n'a été observée entre les différentes sessions de tests pour le temps de toilettage et le nombre de pas avec les pattes avant et arrière. Le groupe control ne montre aucune différence dans les nombre de redressement mais le groupe solvant ($p < 0.05$) et le groupe roténone ($p < 0.001$) se redressent moins après 1,5 mois, suggérant une habituation globale de ces souris au test, résultant en une diminution du comportement exploratoire. Puisque cet effet n'est pas spécifique des souris exposées à la roténone, nous en avons conclu que **l'exposition à la roténone durant 1,5 mois n'affectait pas le comportement moteur spontané comme mesuré par le test du cylindre.**

4.2.2.3.2. Analyse de la coordination motrice entre les pates avant et arrière de la souris

Puisque les symptômes moteurs de la MP apparaissent progressivement dans le temps, l'absence de déficit moteur global pourrait masquer de plus subtiles altérations des capacités motrices telle que la coordination des pattes avant et arrière de l'animal. Le test de traversée de la poutre (adapté de Fleming et al., 2004) a donc été utilisé pour étudier la coordination motrice des souris. Brièvement, ce test consiste en une poutre de 1 mètre de long qui diminue de 0.5cm en largeur tous les 25cm. L'extrémité la plus étroite conduit directement dans la cage de l'animal. Avant le début de la procédure expérimentale, les souris étaient entraînées durant deux jours à traverser la poutre. Le troisième jour, une grille (quadrillage 12.7x12.7mm) était placée 1 cm au-dessus de la poutre. Les souris traversaient cinq fois la poutre pour chaque session de test (avant le début du gavage, après un mois de gavage et après 1.5 mois de gavage). Chaque traversée était enregistrée par une caméra Sony DCR-SX30 pour analyser les vidéos à vitesse ralentie et étudier le temps de traversée, le nombre de pas et le nombre d'erreurs. La figure 46 présente les résultats obtenus pour chaque paramètre. Il n'y a pas de différence dans le temps de traversée de la poutre au sein des groupes mais il y a une différence entre les souris contrôles et les souris solvant après 1.5 mois de procédure expérimentale ($p < 0.05$). En effet, les souris solvant semblaient nécessiter moins de temps pour traverser la poutre après 1.5 mois et ne faisaient pas plus d'erreurs par pas (temps moyen pour traverser la poutre pour le groupe contrôle : 8.9 ± 0.53 sec ; pour le groupe solvant : 11.6 ± 0.60 sec et pour le groupe roténone : 10.1 ± 0.38 sec).

Nous en avons donc conclu que la roténone ne semblait pas affecter la coordination motrice dans le test de traversée de la poutre après 1.5 mois d'exposition.

En conclusion, l'exposition chronique à de faibles doses du pesticide roténone n'altère pas le comportement moteur, tel qu'analysé avec le test d'activité spontanée et le test de traversée de la poutre. Ce modèle animal présente donc une bonne validité d'apparence pour la reproduction des stades précoces de la MP durant lesquels aucun symptôme moteur n'est détecté.

2.2.2.4. Analyses post-mortem

2.2.2.4.1. Analyse histopathologique de la substance noire

Pour analyser plus amplement la validité d'apparence de ce modèle animal induit par exposition à de faibles doses du pesticide roténone, le nombre de cellules TH+ a été compté dans la SN de souris C57BL/6J pour les trois groupes expérimentaux, (n=4/groupe) par un marquage en DAB utilisant un anticorps anti-tyrosine hydroxylase (AB112, Abcam). Un exemple de marquage effectué sur des souris de chaque groupe est présenté en figure 47A. Le comptage des neurones dopaminergiques de la SN (voir figure 47B) ne montrait aucune différence entre les groupes étudiés (nombre moyen de cellules TH+ dans le groupe contrôle = 58.89 ± 3.21 versus 71.04 ± 4.81 dans le groupe solvant et 60.16 ± 4.96 dans le groupe roténone, n.s.), validant ainsi un nouveau critère additionnel pour l'établissement de ce modèle animal dans notre laboratoire. En effet, dans les travaux du Dr. Pan-Montojo, aucune mort neuronale n'est observée au sein de la substance noire après 1.5 mois d'exposition à la roténone.

En conclusion, les analyses comportementales et histologiques montrent une absence d'effet de l'exposition de 1.5 mois à de faibles doses du pesticide roténone, ce qui est cohérent avec les critères à respecter dans la modélisation des stades précoces de la MP chez l'animal. Cependant, ce type d'exposition altère la motilité intestinale. Ceci satisfait donc les critères de validité d'apparence pour ce modèle murin de stades précoces des syndromes parkinsoniens.

2.2.2.4.2. Analyse des populations neuronales de l'intestin

Pour caractériser d'avantage ce modèle animal après une plus longue exposition au pesticide, les différentes populations neuronales de l'intestin de souris exposées à la roténone durant 2 ou 4 mois ont été analysées par western blots. Les tissus intestinaux ont été collectés lors d'une expérience indépendante réalisée par le Dr. Pan-Montojo et stockés à -80°C jusqu'à leur utilisation. Le duodénum, le jéjunum, l'iléon et le colon de souris exposées au solvant ou à la roténone ont été analysés individuellement. Pgp9.5, une

ubiquitine carboxy-terminal hydrolase principalement exprimée dans les cellules nerveuses, a été utilisée comme marqueur neuronal et comparée à la glycérinaldehyde-3-phosphate-dehydrogenase (Gapdh) qui est exprimée de façon stable dans toutes les populations intestinales, permettant ainsi une normalisation de l'expression protéique relative.

Après deux mois d'exposition à la roténone, les niveaux de Pgp9.5 diminuaient non-significativement dans le duodénum et le jéjunum comparés aux souris exposées au solvant (Fig. 48A and 48B; Fig. 49A and 49B). La roténone avait un effet plus hétérogène sur les autres régions intestinales. En effet, les niveaux protéiques de Pgp9.5 étaient soit similaires entre les souris exposées au solvant ou à la roténone dans l'iléon (Fig. 48C and 49C), ou légèrement plus hauts dans le colon des souris exposées à la roténone (Fig. 48D and 49D).

L'expression protéique relative de la choline acétyltransferase (Chat), l'enzyme limitante dans la synthèse de l'acétylcholine au sein des neurones cholinergiques, a été analysée dans toutes les régions de l'intestin de souris exposées au solvant ou à la roténone (Fig. 48, 49). L'expression normalisée de Chat (normalisation à l'expression de Pgp9.5) était légèrement diminuée après deux mois d'exposition au pesticide comparée aux souris solvant (expression protéique relative de Chat dans le duodénum : 1.00 ± 0.10 pour le groupe solvant *versus* 0.83 ± 0.16 pour le groupe roténone; expression protéique relative de Chat dans le jéjunum : 1.00 ± 0.10 pour le groupe solvant *versus* 0.90 ± 0.09 pour le groupe roténone; relative Chat expression in the iléon: 1 ± 0.02 pour le groupe solvant *versus* 0.80 ± 0.13 pour le groupe roténone; expression protéique relative de Chat dans le colon: 1.00 ± 0.15 pour le groupe solvant *versus* 0.56 ± 0.06 pour le groupe roténone).

L'expression protéique relative de la TH, une enzyme impliquée dans la synthèse de la dopamine, l'adrénaline et la noradrénaline, a été analysée en parallèle sur les mêmes échantillons. Après deux mois d'exposition à la roténone, l'expression normalisée de la TH (normalisation à l'expression de Pgp9.5) était significativement plus importante dans le duodénum (Fig. 48A and 49A, $p < 0.05$) et le colon (Fig. 48D and 49D, $p < 0.05$) des souris exposées à la roténone. Cependant, aucune différence n'était observée dans l'iléum. De plus, l'expression normalisée de la TH était légèrement plus faible dans le jéjunum des souris exposées à la roténone comparée aux souris solvant (expression relative de la TH dans le jéjunum pour le groupe solvant : $1 \pm 0,09$ *versus* $0,73 \pm 0,12$ pour le groupe roténone).

Après 4 mois d'exposition à la roténone, une diminution non significative des niveaux de Pgp9.5 était observée dans le duodénum (Fig. 50A and 51A) et l'iléon (Fig. 50C, 51C) des souris exposées à la roténone tandis qu'aucune différence n'était détectée dans le jéjunum (Fig 50B, 51B). Cependant, une augmentation non significative des niveaux de

Pgp9.5 était observée dans le colon des souris exposées à la roténone comparés aux souris solvant (Fig. 50D and 51D). L'expression normalisée de Chat était non significativement diminuée dans le duodénum (Fig. 50A and 51A) et le jéjunum (Fig. 50B, 51B) des souris exposées à la roténone comparées aux souris exposées au solvant mais pas dans l'iléon et le colon pour lesquels l'expression relative de Chat était similaire entre les deux groupes étudiés (Fig. 50 et 51; expression relative de Chat dans le duodénum: 1.00 ± 0.17 des souris solvant *versus* 0.58 ± 0.09 pour le groupe roténone; expression relative de Chat dans le jéjunum: 1.00 ± 0.23 des souris solvant *versus* 0.58 ± 0.07 pour le groupe roténone; expression relative de Chat dans l'iléon: 1.00 ± 0.04 des souris solvant *versus* 0.96 ± 0.13 pour le groupe roténone; expression relative de Chat dans le colon: 1.00 ± 0.15 des souris solvant *versus* 1.00 ± 0.04 pour le groupe roténone). Après 4 mois d'exposition à la roténone, aucune différence significative n'était observée entre les souris exposées à la roténone et celles exposées au solvant pour toutes les régions étudiées (cf. Fig. 50 et 51; expression relative de la TH dans le duodénum: 1.00 ± 0.17 pour le groupe solvant *versus* 0.78 ± 0.19 pour le groupe roténone, n.s.; expression relative de la TH dans le jéjunum: 1.00 ± 0.22 pour les souris solvant *versus* 0.98 ± 0.24 pour les souris roténone, n.s.; expression relative de la TH dans l'iléon: 1.00 ± 0.15 pour les souris solvant *versus* 1.50 ± 0.34 pour les souris roténone, n.s.; expression relative de la TH dans le colon: 1.00 ± 0.24 pour les souris solvant *versus* 1.29 ± 0.16 pour les souris roténone, n.s.). Cependant, une tendance à l'augmentation était observée dans l'iléon et le colon des souris exposées à la roténone comparé aux souris exposées au solvant tandis qu'aucune modification n'était observée dans le jéjunum et qu'une diminution modérée était observée dans le duodénum. En résumé, l'exposition orale chronique à de faibles doses du pesticide roténone durant 2 ou 4 mois modifiait les populations neuronales au sein de l'intestin en fonction de la région étudiée et de la durée d'exposition au pesticide. En particulier, l'expression normalisée de la TH était significativement augmentée dans le duodénum et le colon après deux mois d'exposition à la roténone, confirmant ainsi l'impact de la roténone sur les cellules produisant la TH dans le système nerveux périphérique.

En conclusion, l'exposition de souris mâles C57BL/6J à de faibles doses du pesticide roténone altérait la motilité intestinale, comme mis en évidence par un test non-invasif de motilité intestinale. Cependant, le comportement moteur global et la coordination motrice fine n'étaient pas affectées chez ces souris et le nombre de neurones dopaminergiques de la SN était similaire entre tous les groupes étudiés. De tels troubles non moteurs en absence d'altérations motrices et de neuro-dégénérescence au sein de la SN sont des marqueurs caractéristiques des stades précoces de la MP chez l'homme. Nous validons ainsi ce modèle animal de stades

précoces de syndrome parkinsonien après exposition orale chronique à de faibles doses du pesticide roténone.

2.2.2.5. Variations des concentrations de ghréline dans un modèle de stades précoces de syndrome parkinsonien

2.2.2.5.1. Variations plasmatiques des concentrations de ghréline après 1.5 mois d'exposition à la roténone

Compte tenu du niveau satisfaisant de validation de ce modèle animal de stades précoces de syndrome parkinsonien, les concentrations plasmatiques d'acyl- et de desacyl-ghréline ont été étudiées après exposition à la roténone de souris C57BL/6J mâles âgées d'un an. Pour les trois groupes expérimentaux étudiés, les concentrations plasmatiques d'acyl-ghréline étaient plus élevées après un jeûne nocturne, diminuaient après l'accès à la nourriture et augmentaient de nouveau à 120 min, avant et après l'exposition à la roténone, excepté chez les souris contrôles au début de la procédure expérimentale. Les concentrations d'acyl-ghréline dans le plasma de souris exposées à la roténone ou au solvant durant 1,5 mois étaient similaires à celles observées avant le début de l'exposition (Fig. 52). Pour les trois groupes expérimentaux, les concentrations de desacyl-ghréline plasmatique étaient très variables entre les souris d'un même groupe. De plus, aucune différence significative n'était observée dans les concentrations de desacyl-ghréline plasmatique entre les trois groupes étudiés après 1,5 mois de procédure expérimentale.

En conclusion, l'exposition à de faibles doses du pesticide roténone durant 1,5 mois n'altère pas les concentrations plasmatiques d'acyl- et de desacyl-ghréline.

2.2.2.5.2. Expression de gènes liés à la ghréline dans le duodénum de souris exposées à la roténone

Enfin, pour parfaire la caractérisation de ce modèle animal de stades précoces de syndrome parkinsonien en relation avec la ghréline, nous avons analysé l'expression de gènes liés à la ghréline dans le duodénum par qPCR. En particulier, nous nous sommes focalisés sur l'expression de trois des quatre variants existants du gène murin *Ghrl* (Fig. 53) et l'expression de la prohormone convertase 1/3 (*Psc1*), une enzyme impliquée dans la maturation de la ghréline (Fig. 18). Puisque l'innervation principale du tractus gastro-intestinal est cholinergique, l'expression du gène de Chat était aussi étudiée en parallèle. La peptidylprolyl isomerase A était utilisée en tant que gène de référence pour normaliser l'expression des gènes entre les souris. Une augmentation globale de l'expression des gènes étudiés était observée dans le groupe roténone comparé aux groupes contrôle et solvant (Fig. 53). Cependant, cette différence n'atteignait pas le seuil de significativité

statistique. L'expression de Chat était légèrement augmentée dans le groupe roténone. En résumé, aucune différence significative dans les niveaux protéiques ou ARN de la ghréline n'était observée après 1,5 mois d'exposition à de faibles doses du pesticide roténone.

Pour conclure, les souris mâles C57BL/6J âgées de un an et exposées à 5mg/kg/j de roténone durant 1.5 mois développaient progressivement des altérations de la motilité intestinale mais ne présentaient pas de troubles moteurs tels qu'évalués avec le test d'activité spontanée et le test de traversée de la poutre. Les analyses immunohistopathologiques ne révélaient pas de différence dans le nombre de neurones produisant de la TH au sein de la SN. Nous avons donc validé le modèle animal de syndrome parkinsonien précoce dans notre animalerie. Cette étude *in vivo* n'a cependant pas révélée de différences dans les concentrations d'acyl- et de desacyl-ghréline dans ce modèle animal. Ainsi, nos résultats ne valident pas le potentiel de la ghréline en tant que biomarqueur des stades précoces de la MP.

5. Perspectives expérimentales

Les résultats de notre étude *in vitro*, présentés ci-dessus, remettent en question les données disponibles dans la littérature en mettant en avant un potentiel rôle neuro-protecteur de la desacyl-ghréline. Des études approfondies sont cependant nécessaires pour confirmer ces résultats et pour comprendre les modifications cellulaires et moléculaires induites par la desacyl-ghréline. Tout d'abord, la présence du récepteur de la ghreline GHSR1a doit être démontrée dans les cellules primaires mésencéphaliques isolées d'embryons de souris au 14^{ème} jour de gestation et plus précisément dans les cellules produisant la ghreline. En effet, son expression a été établie dans le mésencéphale de souris adultes ainsi que dans les cellules MES23.5 (Dong et al., 2009; Moon et al., 2009; Zigman et al., 2006) mais n'a, à notre connaissance, jamais été validée dans les cultures primaires mésencéphaliques murines. Notre première tentative pour identifier GHSR1a par immunocytochimie ou western blots dans ces cultures primaires a échoué en raison de marquages non spécifiques des deux anticorps anti-GHSR1a testés (Santa Cruz Biotechnology, sc-10359 and sc-374515). Une solution alternative est donc d'étudier l'expression de GHSR1a par PCR ou par hybridation *in situ*. Si GHSR1a est exprimé dans les cellules primaires mésencéphaliques, l'exposition concomitante à l'acyl- ou la desacyl-ghréline et à de faibles doses du pesticide roténone sera répétée en présence d'un inhibiteur du récepteur, le D-Lys-3-GHRP-6, pour déterminer son rôle potentiel dans l'effet délétère/protecteur de l'exposition à long terme respectivement à l'acyl- / la desacyl-ghréline dans les cellules exposées à la roténone. De façon similaire, la cascade de transduction de GHSR1a sera étudiée dans les deux conditions avec un intérêt particulier pour l'état phosphorylé / déphosphorylé des protéines ERK1/2, mTOR, Akt et AMPK qui ont été impliquées dans l'action de la ghreline dans d'autres contextes physiologiques ou pathologiques. De plus, puisque la ghreline protégeaient les cellules MES23.5 des altérations mitochondriales et de l'apoptose induites par la roténone (Yu et al., 2016), l'étude du potentiel de membrane mitochondrial et des concentrations de ROS dans nos conditions de culture devrait clarifier le mécanisme d'action de l'acyl- *versus* la desacyl-ghréline dans ces cellules mésencéphaliques primaires. Enfin, l'expression potentielle de marqueurs de l'apoptose telles que la condensation du noyau ou l'activation de la caspase 3 devraient être analysée pour caractériser plus amplement les événements moléculaires et cellulaires sous-jacents de cet effet délétère *versus* protecteur de l'acyl- et la desacyl-ghréline respectivement dans les cultures primaires mésencéphaliques.

PD NMS QUESTIONNAIRE

Name: Date: Age:

Centre ID: Male Female

NON-MOVEMENT PROBLEMS IN PARKINSON'S

The movement symptoms of Parkinson's are well known. However, other problems can sometimes occur as part of the condition or its treatment. It is important that the doctor knows about these, particularly if they are troublesome for you.

A range of problems is listed below. Please tick the box 'Yes' if you have experienced it **during the past month**. The doctor or nurse may ask you some questions to help decide. If you have **not** experienced the problem in the past month tick the 'No' box. You should answer 'No' even if you have had the problem in the past but not in the past month.

Yes No

1. Dribbling of saliva during the daytime
2. Loss or change in your ability to taste or smell
3. Difficulty swallowing food or drink or problems with choking
4. Vomiting or feelings of sickness (nausea)
5. Constipation (less than 3 bowel movements a week) or having to strain to pass a stool (faeces)
6. Bowel (fecal) incontinence
7. Feeling that your bowel emptying is incomplete after having been to the toilet
8. A sense of urgency to pass urine makes you rush to the toilet
9. Getting up regularly at night to pass urine
10. Unexplained pains (not due to known conditions such as arthritis)
11. Unexplained change in weight (not due to change in diet)
12. Problems remembering things that have happened recently or forgetting to do things
13. Loss of interest in what is happening around you or doing things
14. Seeing or hearing things that you know or are told are not there
15. Difficulty concentrating or staying focussed Yes No
16. Feeling sad, 'low' or 'blue'
17. Feeling anxious, frightened or panicky
18. Feeling less interested in sex or more interested in sex
19. Finding it difficult to have sex when you try
20. Feeling light headed, dizzy or weak standing from sitting or lying
21. Falling
22. Finding it difficult to stay awake during activities such as working, driving or eating
23. Difficulty getting to sleep at night or staying asleep at night
24. Intense, vivid dreams or frightening dreams
25. Talking or moving about in your sleep as if you are 'acting' out a dream
26. Unpleasant sensations in your legs at night or while resting, and a feeling that you need to move
27. Swelling of your legs
28. Excessive sweating
29. Double vision
30. Believing things are happening to you that other people say are not true

Have you experienced any of the following in the last month?

All the information you supply through this form will be treated with confidence and will only be used for the purpose for which it has been collected. Information supplied will be used for monitoring purposes. Your personal data will be processed and held in accordance with the Data Protection Act 1998.

Developed and validated by the International PD Non Motor Group

For information contact: susanne.tluk@uhl.nhs.uk or alison.forbes@uhl.nhs.uk

Annex 3: Hoehn and Yahr scale

Modified Hoehn and Yahr staging

Stage 0	No signs of disease
Stage 1	Unilateral disease
Stage 1.5	Unilateral plus axial involvement
Stage 2	Bilateral disease, without impairment of balance
Stage 2.5	Mild bilateral disease, with recovery on pull test
Stage 3	Mild to moderate bilateral disease; some postural instability; physically independent
Stage 4	Severe disability; still able to walk or stand unassisted
Stage 5	Wheelchair bound or bedridden unless aided

Annex 4 : Unified Parkinson's Disease Rating scale

I. MENTATION, BEHAVIOR AND MOOD

1. Intellectual Impairment

0 = None.

1 = Mild. Consistent forgetfulness with partial recollection of events and no other difficulties.

2 = Moderate memory loss, with disorientation and moderate difficulty handling complex problems. Mild but definite

impairment of function at home with need of occasional prompting.

3 = Severe memory loss with disorientation for time and often to place. Severe impairment in handling problems.

4 = Severe memory loss with orientation preserved to person only. Unable to make judgements or solve problems.

Requires much help with personal care. Cannot be left alone at all.

2. Thought Disorder (Due to dementia or drug intoxication)

0 = None.

1 = Vivid dreaming.

2 = "Benign" hallucinations with insight retained.

3 = Occasional to frequent hallucinations or delusions; without insight; could interfere with daily activities.

4 = Persistent hallucinations, delusions, or florrid psychosis. Not able to care for self.

3. Depression

1 = Periods of sadness or guilt greater than normal, never sustained for days or weeks.

2 = Sustained depression (1 week or more).

3 = Sustained depression with vegetative symptoms (insomnia, anorexia, weight loss, loss of interest).

4 = Sustained depression with vegetative symptoms and suicidal thoughts or intent.

4. Motivation/Initiative

0 = Normal.

1 = Less assertive than usual; more passive.

2 = Loss of initiative or disinterest in elective (nonroutine) activities.

3 = Loss of initiative or disinterest in day to day (routine) activities.

4 = Withdrawn, complete loss of motivation.

II. ACTIVITIES OF DAILY LIVING (for both "on" and "off")

5. Speech

0 = Normal.

1 = Mildly affected. No difficulty being understood.

2 = Moderately affected. Sometimes asked to repeat statements.

3 = Severely affected. Frequently asked to repeat statements.

4 = Unintelligible most of the time.

6. Salivation

0 = Normal.

1 = Slight but definite excess of saliva in mouth; may have nighttime drooling.

2 = Moderately excessive saliva; may have minimal drooling.

3 = Marked excess of saliva with some drooling.

4 = Marked drooling, requires constant tissue or handkerchief.

7. Swallowing

0 = Normal.

1 = Rare choking.

2 = Occasional choking.

3 = Requires soft food.

4 = Requires NG tube or gastrostomy feeding.

8. Handwriting

0 = Normal.

1 = Slightly slow or small.

2 = Moderately slow or small; all words are legible.

3 = Severely affected; not all words are legible.

4 = The majority of words are not legible.

9. Cutting food and handling utensils

0 = Normal.

1 = Somewhat slow and clumsy, but no help needed.

2 = Can cut most foods, although clumsy and slow; some help needed.

3 = Food must be cut by someone, but can still feed slowly.

4 = Needs to be fed.

10. Dressing

0 = Normal.

- 1 = Somewhat slow, but no help needed.
- 2 = Occasional assistance with buttoning, getting arms in sleeves.
- 3 = Considerable help required, but can do some things alone.
- 4 = Helpless.

11. Hygiene

- 0 = Normal.
- 1 = Somewhat slow, but no help needed.
- 2 = Needs help to shower or bathe; or very slow in hygienic care.
- 3 = Requires assistance for washing, brushing teeth, combing hair, going to bathroom.
- 4 = Foley catheter or other mechanical aids.

12. Turning in bed and adjusting bed clothes

- 0 = Normal.
- 1 = Somewhat slow and clumsy, but no help needed.
- 2 = Can turn alone or adjust sheets, but with great difficulty.
- 3 = Can initiate, but not turn or adjust sheets alone.
- 4 = Helpless.

13. Falling (unrelated to freezing)

- 0 = None.
- 1 = Rare falling.
- 2 = Occasionally falls, less than once per day.
- 3 = Falls an average of once daily.
- 4 = Falls more than once daily.

14. Freezing when walking

- 0 = None.
- 1 = Rare freezing when walking; may have start hesitation.
- 2 = Occasional freezing when walking.
- 3 = Frequent freezing. Occasionally falls from freezing.
- 4 = Frequent falls from freezing.

15. Walking

- 0 = Normal.
- 1 = Mild difficulty. May not swing arms or may tend to drag leg.
- 2 = Moderate difficulty, but requires little or no assistance.

3 = Severe disturbance of walking, requiring assistance.

4 = Cannot walk at all, even with assistance.

16. Tremor (Symptomatic complaint of tremor in any part of body.)

0 = Absent.

1 = Slight and infrequently present.

2 = Moderate; bothersome to patient.

3 = Severe; interferes with many activities.

4 = Marked; interferes with most activities.

17. Sensory complaints related to parkinsonism

0 = None.

1 = Occasionally has numbness, tingling, or mild aching.

2 = Frequently has numbness, tingling, or aching; not distressing.

3 = Frequent painful sensations.

4 = Excruciating pain.

III. MOTOR EXAMINATION

18. Speech

0 = Normal.

1 = Slight loss of expression, diction and/or volume.

2 = Monotone, slurred but understandable; moderately impaired.

3 = Marked impairment, difficult to understand.

4 = Unintelligible.

19. Facial Expression

0 = Normal.

1 = Minimal hypomimia, could be normal "Poker Face".

2 = Slight but definitely abnormal diminution of facial expression

3 = Moderate hypomimia; lips parted some of the time.

4 = Masked or fixed facies with severe or complete loss of facial expression; lips parted 1/4 inch or more.

20. Tremor at rest (head, upper and lower extremities)

0 = Absent.

1 = Slight and infrequently present.

2 = Mild in amplitude and persistent. Or moderate in amplitude, but only intermittently present.

3 = Moderate in amplitude and present most of the time.

4 = Marked in amplitude and present most of the time.

21. Action or Postural Tremor of hands

0 = Absent.

1 = Slight; present with action.

2 = Moderate in amplitude, present with action.

3 = Moderate in amplitude with posture holding as well as action.

4 = Marked in amplitude; interferes with feeding.

22. Rigidity (Judged on passive movement of major joints with patient relaxed in sitting position. Cogwheeling to be ignored.)

0 = Absent.

1 = Slight or detectable only when activated by mirror or other movements.

2 = Mild to moderate.

3 = Marked, but full range of motion easily achieved.

4 = Severe, range of motion achieved with difficulty.

23. Finger Taps (Patient taps thumb with index finger in rapid succession.)

0 = Normal.

1 = Mild slowing and/or reduction in amplitude.

2 = Moderately impaired. Definite and early fatiguing. May have occasional arrests in movement.

3 = Severely impaired. Frequent hesitation in initiating movements or arrests in ongoing movement.

4 = Can barely perform the task.

24. Hand Movements (Patient opens and closes hands in rapid succession.)

0 = Normal.

1 = Mild slowing and/or reduction in amplitude.

2 = Moderately impaired. Definite and early fatiguing. May have occasional arrests in movement.

3 = Severely impaired. Frequent hesitation in initiating movements or arrests in ongoing movement.

4 = Can barely perform the task.

25. Rapid Alternating Movements of Hands (Pronation-supination movements of hands, vertically and horizontally, with as large an amplitude as possible, both hands simultaneously.)

0 = Normal.

1 = Mild slowing and/or reduction in amplitude.

2 = Moderately impaired. Definite and early fatiguing. May have occasional arrests in movement.

3 = Severely impaired. Frequent hesitation in initiating movements or arrests in ongoing movement.

4 = Can barely perform the task.

26. Leg Agility (Patient taps heel on the ground in rapid succession picking up entire leg. Amplitude should be at least 3 inches.)

0 = Normal.

1 = Mild slowing and/or reduction in amplitude.

2 = Moderately impaired. Definite and early fatiguing. May have occasional arrests in movement.

3 = Severely impaired. Frequent hesitation in initiating movements or arrests in ongoing movement.

4 = Can barely perform the task.

27. Arising from Chair (Patient attempts to rise from a straightbacked chair, with arms folded across chest.)

0 = Normal.

1 = Slow; or may need more than one attempt.

2 = Pushes self up from arms of seat.

3 = Tends to fall back and may have to try more than one time, but can get up without help.

4 = Unable to arise without help.

28. Posture

0 = Normal erect.

1 = Not quite erect, slightly stooped posture; could be normal for older person.

2 = Moderately stooped posture, definitely abnormal; can be slightly leaning to one side.

3 = Severely stooped posture with kyphosis; can be moderately leaning to one side.

4 = Marked flexion with extreme abnormality of posture.

29. Gait

0 = Normal.

1 = Walks slowly, may shuffle with short steps, but no festination (hastening steps) or propulsion.

2 = Walks with difficulty, but requires little or no assistance; may have some festination, short steps, or propulsion.

3 = Severe disturbance of gait, requiring assistance.

4 = Cannot walk at all, even with assistance.

30. Postural Stability (Response to sudden, strong posterior displacement produced by pull on shoulders while patient erect with eyes open and feet slightly apart. Patient is prepared.)

0 = Normal.

1 = Retropulsion, but recovers unaided.

2 = Absence of postural response; would fall if not caught by examiner.

3 = Very unstable, tends to lose balance spontaneously.

4 = Unable to stand without assistance.

31. Body Bradykinesia and Hypokinesia (Combining slowness, hesitancy, decreased armswing, small amplitude, and poverty of movement in general.)

0 = None.

1 = Minimal slowness, giving movement a deliberate character; could be normal for some persons. Possibly reduced amplitude.

2 = Mild degree of slowness and poverty of movement which is definitely abnormal. Alternatively, some reduced amplitude.

3 = Moderate slowness, poverty or small amplitude of movement.

4 = Marked slowness, poverty or small amplitude of movement.

IV. COMPLICATIONS OF THERAPY (In the past week)

A. DYSKINESIAS

32. Duration: What proportion of the waking day are dyskinesias present? (Historical information.)

0 = None

1 = 1-25% of day.

2 = 26-50% of day.

3 = 51-75% of day.

4 = 76-100% of day.

33. Disability: How disabling are the dyskinesias? (Historical information; may be modified by office examination.)

0 = Not disabling.

1 = Mildly disabling.

2 = Moderately disabling.

3 = Severely disabling.

4 = Completely disabled.

34. Painful Dyskinesias: How painful are the dyskinesias?

0 = No painful dyskinesias.

1 = Slight.

2 = Moderate.

3 = Severe.

4 = Marked.

35. Presence of Early Morning Dystonia (Historical information.)

0 = No

1 = Yes

B. CLINICAL FLUCTUATIONS

36. Are "off" periods predictable?

0 = No

1 = Yes

37. Are "off" periods unpredictable?

0 = No

1 = Yes

38. Do "off" periods come on suddenly, within a few seconds?

0 = No

1 = Yes

39. What proportion of the waking day is the patient "off" on average?

0 = None

1 = 1-25% of day.

2 = 26-50% of day.

3 = 51-75% of day.

4 = 76-100% of day.

C. OTHER COMPLICATIONS

40. Does the patient have anorexia, nausea, or vomiting?

0 = No

1 = Yes

41. Any sleep disturbances, such as insomnia or hypersomnolence?

0 = No

1 = Yes

42. Does the patient have symptomatic orthostasis?

(Record the patient's blood pressure, height and weight on the scoring form)

0 = No

1 = Yes

V. MODIFIED HOEHN AND YAHR STAGING

STAGE 0 = No signs of disease.

STAGE 1 = Unilateral disease.

STAGE 1.5 = Unilateral plus axial involvement.

STAGE 2 = Bilateral disease, without impairment of balance.

STAGE 2.5 = Mild bilateral disease, with recovery on pull test.

STAGE 3 = Mild to moderate bilateral disease; some postural instability; physically independent.

STAGE 4 = Severe disability; still able to walk or stand unassisted.

STAGE 5 = Wheelchair bound or bedridden unless aided.

VI. SCHWAB AND ENGLAND ACTIVITIES OF DAILY LIVING SCALE

100% = Completely independent. Able to do all chores without slowness, difficulty or impairment. Essentially normal.

Unaware of any difficulty.

90% = Completely independent. Able to do all chores with some degree of slowness, difficulty and impairment. Might

take twice as long. Beginning to be aware of difficulty.

80% = Completely independent in most chores. Takes twice as long. Conscious of difficulty and slowness.

70% = Not completely independent. More difficulty with some chores. Three to four times as long in some. Must spend a large part of the day with chores.

60% = Some dependency. Can do most chores, but exceedingly slowly and with much effort. Errors; some impossible.

50% = More dependent. Help with half, slower, etc. Difficulty with everything.

40% = Very dependent. Can assist with all chores, but few alone.

30% = With effort, now and then does a few chores alone or begins alone. Much help needed.

20% = Nothing alone. Can be a slight help with some chores. Severe invalid.

10% = Totally dependent, helpless. Complete invalid.

0% = Vegetative functions such as swallowing, bladder and bowel functions are not functioning. Bedridden.

Annex 5: article 1: Is there a role for ghrelin in central dopaminergic systems? Focus on nigrostriatal and mesocorticolimbic pathways.

Is there a role for ghrelin in central dopaminergic systems? Focus on nigrostriatal and mesocorticolimbic pathways.

Alicia Stievenard^{a*}, Mathieu Méquinion^{b*}, Zane B. Andrews^b, Alain Destée^a, Marie-Christine Chartier-Harlin^a, Odile Viltart^{a*}, Christel C. Vanbesien-Mailliot^{a*#}.

a Univ. Lille, Inserm, CHU Lille, UMR-S 1172 - JPArc - Centre de Recherche Jean-Pierre AUBERT Neurosciences et Cancer, F-59000 Lille, France ; e-mail addresses: alicia.stievenard@inserm.fr, a-destee@chru-lille.fr, marie-christine.chartier-harlin@inserm.fr, odile.viltart@inserm.fr, christel.vanbesien@inserm.fr

b Department of Physiology, Monash University, Clayton, Victoria 3800, Australia; e-mail addresses: mathieu.mequinion@monash.edu , zane.andrews@monash.edu .

* These authors equally contributed to this work.

Corresponding author.

Full postal address: INSERM UMR-S 1172 / JPArc – Team “Early stages of Parkinson’s disease”, Bat. IRCL – 1 Place de Verdun, FR-59045 LILLE cedex (France).

Abstract:

The gastro-intestinal peptide ghrelin has been assigned many functions. These include appetite regulation, energy metabolism, glucose homeostasis, intestinal motility, anxiety, memory or neuroprotection. In the last decade, this pleiotropic peptide has been proposed as a therapeutic agent in gastroparesis for diabetes and in cachexia for cancer. Ghrelin and its receptor, which is expressed throughout the brain, play an important role in motivation and reward. Ghrelin finely modulates the mesencephalic dopaminergic signaling and is thus currently studied in pathological conditions including dopamine-related disorders. Dopamine regulates motivated behaviors, modulating reward processes, emotions and motor functions to enable the survival of individuals and species. Numerous dopamine-related disorders including Parkinson's disease or eating disorders like anorexia nervosa involve altered ghrelin levels. However, despite the growing interest for ghrelin in these pathological conditions, global integrative studies investigating its role in brain dopaminergic structures are still lacking. In this review, we discuss the role of ghrelin on dopaminergic neurons and its relevance in the search for new therapeutics for Parkinson's disease- and anorexia nervosa-related dopamine deficits.

Key words: anorexia nervosa, dopamine, ghrelin, goal-directed action, motivation, Parkinson's disease.

1. Introduction

Dopamine is a key neuromodulator involved in motivated behaviors, such as feeding, reproduction, the search for a refuge or the flight from a predator. It therefore plays a central role in the survival of species and individuals. Brain areas implicated in the control of such behaviors have been submitted to high selection pressure and were highly conserved across evolution (O'Connell and Hofmann, 2012). These structures, initially identified in rats in 1964 (Dahlström and Fuxe, 1964) and mapped in 1971 (Ungerstedt, 1971), contain dopaminergic neurons and were described not only in mammals, but also in fish, reptiles and birds (O'Connell and Hofmann, 2012; Yamamoto and Vernier, 2011). The number of tyrosine hydroxylase-positive cells, the rate-limiting enzyme of dopamine biosynthesis, is 20-30 000 in mice and 400-600 000 in humans, a difference associated with the expansion of dopaminergic fibers, in particular in the human and non-human primate neocortices (Björklund and Dunnett, 2007; Oades and Halliday, 1987).

Dopaminergic neurons originate from a population of progenitor cells located on the mesencephalic floor plate in rodent embryos, namely the ventral aqueductal ventricular zone (Gates et al., 2006; Hu et al., 2004; Ono et al., 2007; Vitalis et al., 2005). After differentiation, these neurons migrate to form different subgroups of dopaminergic neurons: among them, the A9 group is located in the substantia nigra pars compacta (SNc), and the A10 group in the ventral tegmental area (VTA; Björklund and Dunnett, 2007; Ferreira et al., 2008). SNc dopaminergic neurons send projections to the dorsal striatum within the nigrostriatal pathway and are involved in the control of voluntary movements. VTA dopaminergic neurons project to the ventral striatum containing the accumbens nucleus, as well as to the amygdala and the pre-frontal cortex via the mesocorticolimbic pathway (see Figure 1). The VTA is known for its role in reward and motivational behaviors. Thus, in addition to their anatomical proximity and shared dopaminergic neurochemistry, VTA and SNc both contribute to the fine tuning of motivated behaviors. The mesocorticolimbic pathway provides the motivation to act whereas the nigrostriatal pathway modulates voluntary movements needed to reach the goal.

The appropriate functioning of both dopaminergic circuits contributes to this similar general goal, namely the adaptation to the environment and the maintenance of homeostasis. Their deregulation in humans leads to dysfunctions such as voluntary movement disorders in the case of the nigrostriatal pathway, and alterations of reward or motivational regulation for the mesocorticolimbic system (Berridge and Kringelbach, 2015; Lees et al., 2008; Missale et al.,

1998). In this view, dopaminergic neuronal death occurring within the SNc in Parkinson's disease (PD) and the resulting decrease in striatal dopamine concentrations are responsible for the classical motor phenotype associated to this disorder: bradykinesia, rigidity and resting tremor (Błaszczuk, 1998; Postuma et al., 2015). Similarly, abnormalities in mesocorticolimbic dopaminergic neuronal function impair motivation and reward processes and contribute to pathological conditions such as depression, apathy and addictive-compulsive behaviors (Lammel et al., 2014). Due to their above-mentioned anatomical proximity and shared neurochemistry, drug modulation of one dopaminergic pathway will affect the other. For instance, dopamine agonists used to alleviate motor symptoms in PD patients can trigger a hyperactivity of dopaminergic VTA targets (Vaillancourt et al., 2013). As a consequence, patients under dopaminergic drugs, mainly dopamine agonists, can suffer from impulse control disorders (Sáez-Francàs et al., 2016). However, the interactions between these two dopaminergic pathways are not fully understood yet. Interestingly, SNc and VTA dopaminergic neurons share an additional feature since they both express receptors for the orexigenic hormone ghrelin (Andrews et al., 2009; Mani et al., 2014; Zigman et al., 2006) suggesting a common higher order regulation. Few studies have however investigated the role of ghrelin in both dopaminergic structures. The present review aims to provide a comprehensive picture of the role of ghrelin on SNc and VTA dopaminergic neurons both in physiology and in several pathological conditions and to highlight its potential as a biomarker and a disease-modifying compound in PD and anorexia nervosa (AN) in view of the recent literature.

2. Ghrelin: a pleiotropic hormone?

2.1. Origin and biosynthesis of ghrelin

The orexigenic hormone ghrelin has initially been discovered in rat stomach extracts and is implicated in numerous functions as detailed below in §2.3. (Kojima et al., 1999 ; Méquinion et al., 2013; Müller et al., 2015; Zigman et al., 2016). The gene encoding ghrelin has been identified in numerous species and its sequence is highly conserved among mammals such as humans, rhesus monkeys, rats, mice, cows, pigs, sheep, dogs and gerbils (Angeloni et al., 2004; Tomasetto et al., 2001). The human GHRL gene is located on chromosome 3 at position 3p25-26 and codes for a 117 amino acid-long prohormone, named proghrelin. This precursor is cleaved into proghrelin, a 94 amino acid-long peptide (Kojima and Kangawa, 2005). In the endoplasmic reticulum, proghrelin will undergo acylation through the

action of the enzyme ghrelin-octanoyl-acyltransferase which enables the transfer of an octanoyl group from the octanoyl-coenzyme A to the hydroxyl group of the proghrelin third N-terminal serine (see Figure 2; Bayliss et al., 2016a; Kojima and Kangawa, 2005; Labarthe et al., 2014; Zhu et al., 2006). Proghrelin is further cleaved by the prohormone convertase 1/3 thus generating a 28 amino acid-long peptide named ghrelin and a 23 amino acid-long peptide named obestatin (Zhu et al., 2006). Ghrelin is released into the bloodstream in two biologically distinct states, acyl- and desacyl-ghrelin, the latter being the major form (Takagi et al., 2013). A large proportion of acyl-ghrelin is indeed rapidly converted to desacyl-ghrelin in the plasma by acyl-protein thioesterase 1 (Satou et al., 2010).

Ghrelin is mainly expressed in the stomach by X/A-like oxyntic gland cells of the gastric fundus mucosa (Kojima et al., 1999; Müller et al., 2015). It is also expressed at lower levels in many other tissues including the intestinal tract, the pancreas, the gall bladder, the liver, the gonads or the breast (Gnanapavan et al., 2002). Ghrelin is however not expressed in the brain. The initial report of ghrelin expression within the hypothalamus (Cowley et al., 2003) was in fact based on non-specific antibody staining as demonstrated later by Furness and colleagues (2011). Similarly, other authors have not been able to find any preproghrelin mRNA in this brain structure (François et al., 2015). Despite the lack of centrally produced ghrelin and the limited capacity of ghrelin to cross the blood-brain barrier (Banks, 2002; Cabral et al., 2013; Schaeffer et al., 2013) ghrelin receptors have been described in the SNc and VTA (Andrews et al., 2009; Mani et al., 2014; Wellman and Abizaid, 2015; Zigman et al., 2006), suggesting that brain cells expressing ghrelin receptors might respond to ligands other than centrally produced ghrelin. Nevertheless, SNpc and VTA neurons expressing ghrelin receptors readily respond to ghrelin in slice preparations and to direct microinjections (Abizaid et al., 2006).

2.2. Ghrelin receptors

Ghrelin is the only known endogenous ligand of the growth hormone secretagogue receptor (GHSR; Gutierrez et al., 2008; Howard et al., 1996). It was identified in 1996 as an orphan receptor encoded by the GHSR gene (Howard et al., 1996). Two splicing variants were further isolated (Kojima et al., 1999) and give rise to two forms of the receptor: GHSR1a and GHSR1b, which belong to the family of G protein-coupled receptors. Acyl-ghrelin binds GHSR1a, the full length receptor with seven transmembrane domains, through its 10 N-terminal amino acids (Kojima et al., 1999). The GHSR1a activates several intracellular cascades in different cell types and tissues, including ERK 1/2, PI3K/Akt/mTOR and AMPK signaling pathways, thus mediating the different physiological functions of ghrelin. In

particular, within the central nervous system and anterior pituitary, the binding of acyl-ghrelin onto GHSR1a increases growth hormone release via the increase of intracellular calcium following the activation of the inositol 1,4,5-trisphosphate / diacyl glycerol (IP3/DAG) pathway (see Figure 3; Camiña et al., 2007; Ghigo et al., 2005). In addition, in the arcuate nucleus of the hypothalamus, GHSR1a activation triggers the phosphorylation of both 5' adenosine monophosphate-activated protein kinase (AMPK), a sensor of energy homeostasis, and mammalian target of rapamycin (mTOR), thus leading to an increase in brain-specific homeobox (BSX), c-AMP response element-binding protein (CREB) and forkhead box O1 (FoxO1) transcription factors (Lage et al., 2010; Martins et al., 2012). The activation of these signaling cascades results in the synthesis of the orexigenic NPY (neuropeptide Y) / AgRP (agouti-related protein) neuropeptides therefore triggering food intake (see Figure 3). More precisely, this signaling pathway simultaneously inhibits acetyl coenzyme A carboxylase and increases the activity of carnitine palmitoyltransferase 1 therefore activating fatty acid β -oxidation within mitochondria and the resulting production of reactive oxygen species. This activates, in turn, the mitochondrial uncoupling protein 2 (UCP2), which neutralizes reactive oxygen species and promotes mitochondrial biogenesis in order to maintain the activation of NPY/AgRP neurons (Andrews et al., 2008). Conversely in the liver and adipose tissues, acyl-ghrelin inhibits AMPK, therefore increasing the expression and activity of acetyl coenzyme A carboxylase and fatty acid synthase, thus controlling lipid metabolism and therefore glucose homeostasis in these tissues (Theander-Carrillo et al., 2006). In other non-neuronal tissues and cell types, the binding of acyl-ghrelin to GHSR1a activates either the phospholipase C/inositol trisphosphate or the adenylate cyclase/protein kinase A pathways, resulting in an increase in intracellular calcium levels (see Figure 3). As a result, the calcium calmodulin kinase kinase, a sensor of intracellular calcium, activates the Akt/MAPK pathways, thus modulating proliferation and apoptosis (see Figure 3; Baldanzi, 2002; Granata et al., 2007; Kim et al., 2004; Yang et al., 2013).

GHSR1b is a C-terminal truncated receptor with only five transmembrane domains located in the endoplasmic reticulum (Chow et al., 2012). It seems to exert a dominant negative effect on GHSR1a trafficking and its ability to modify its conformation in order to activate the above-described downstream cellular cascades (Chow et al., 2012; Mary et al., 2013). The GHSR1a receptor is distributed in various organs both in the periphery (Guan et al., 1997) and in different parts of the rodent brain including the hypothalamus, the SNc, the VTA, the hippocampus, the amygdala and the olfactory bulb (Andrews et al., 2009; Mani et al., 2014;

Zigman et al., 2006). However, definitive proof of GHSR1a in the human brain is still lacking. The GHSR1a also displays a high constitutive activity in the absence of its ligand (Holst et al., 2003). A rare GHSR1a missense mutation (A204E) prevents the constitutive activity of the receptor while preserving its ability to bind ghrelin and is associated with a familial short stature (Pantel et al., 2006). Therefore, the constitutive activity of the GHSR1a receptor could contribute to growth hormone secretion and/or body weight regulation (Mear et al., 2013). In addition, GHSR1a is able to adopt homodimer and heterodimer conformations, notably with the melanocortin-3 receptor, the serotonin 2C receptor, the dopamine 1 receptor (D1R), the dopamine 2 receptor (D2R) and the somatostatin receptor subtype 5 (for review see Wellman and Abizaid, 2015). Such heterodimers have mainly been described *in vitro* using co-immunoprecipitation and resonance energy transfer-based techniques (Kern et al., 2012; Rediger et al., 2012; Schellekens et al., 2013; Wellman and Abizaid, 2015). These heterodimers affect receptor signal properties by changing G protein-coupled signaling cascades, as well as modifying the trafficking and internalization of both partners of the dimer complex, either in the presence or in the absence of ghrelin (Wellman and Abizaid, 2015). For instance, in the presence of both dopamine and ghrelin, GHSR1a amplifies dopamine-induced cAMP accumulation via D1R in human embryonic kidney (HEK) 293 cells (Jiang et al., 2006). However, in the absence of ghrelin but presence of dopamine, GHSR1a/D2R dimerization in hypothalamic neurons increases intracellular calcium levels independently of the GHSR1a constitutive activity (Kern et al., 2012). Therefore, dopamine alone is able to activate GHSR1a at least *in vitro*, which might be of particular interest within the central nervous system, more precisely in dopaminergic brain areas where the receptor is highly expressed and where ghrelin is not locally produced. This dimerization capacity of GHSR1a needs however to be further confirmed *in vivo*. In summary, the large distribution of GHSR1a throughout the brain, its high constitutive activity and its propensity towards heterodimerization highlight the functional importance of this receptor within the brain beyond the sole binding of ghrelin.

2.3. Functions of ghrelin

Ghrelin targets various brain structures and peripheral organs (see Figure 4). Its first role has been demonstrated in pituitary somatotrophic cells as a secretagogue of the growth hormone acting in synergy with the hypothalamic peptide growth hormone releasing hormone (for review, Steyn et al., 2016). Ghrelin also modulates food intake behavior, body weight, energy expenditure, glucose and lipid homeostasis, neurogenesis, blood pressure, heart rate and

gastro-intestinal motility (Kojima and Kangawa, 2005). In addition, ghrelin increases gastric acid secretions in a dose-dependent manner by a mechanism implicating the vagus nerve (Date et al., 2001). This hormone also modulates gastric emptying and intestinal transit time (Levin et al., 2006). Furthermore, plasma ghrelin levels depend on the metabolic state, the food consumption and the physical activity (Lemarié et al., 2016; Méquinion et al., 2015; Nishi et al., 2013). In healthy subjects, plasma ghrelin levels are elevated just prior to meal initiation and decrease after food intake (Cummings et al., 2001). Therefore, inter-meal levels of ghrelin display a diurnal rhythm which can be further amplified through fasting/food restriction protocols. In addition, a single injection of acyl-ghrelin enhances food intake in both rodents and humans (Cummings et al., 2001; Wren et al., 2001). Ghrelin is thus considered as the main signal for the initiation of the meal, acting notably through a finely tuned regulation of both hypothalamic and brainstem neurons. More precisely, within the arcuate nucleus, ghrelin activates orexigenic NPY/AgRP cells. These neurons project onto various hypothalamic nuclei such as the paraventricular and dorsomedial nuclei, and the lateral hypothalamus to regulate the feeding behavior (Delporte, 2013; Olszewski et al., 2008). This orexigenic action of ghrelin on hypothalamic NPY/AgRP neurons is further amplified through their GABA-ergic inhibitory outputs targeting arcuate anorexigenic pro-opiomelanocortin (POMC) neurons (Cowley et al., 2003; Kojima and Kangawa, 2005). Yet, the effects of ghrelin on energy metabolism also involve non-hypothalamic structures implicated in the food intake : the VTA activating the reward system, the hippocampus facilitating learning and memory, and the central nucleus of amygdala modulating emotional arousal and cue-potentiated feeding (see §4 below; Bali and Jaggi, 2016; Diano et al., 2006; Dickson et al., 2011; Müller et al., 2015; Skibicka et al., 2013, 2011).

However, it has to be noted that most studies investigated ghrelin independently of its acylation state. Only few studies distinguished the effects of acyl- and desacyl-ghrelin (Andrews et al., 2009; Bayliss et al., 2016a; Bayliss and Andrews, 2013; Broglio et al., 2004b; Delhanty, 2006; Delhanty et al., 2014; Zizzari et al., 2011). Recent studies using GHSR1a knock-out mice and cells that do not express GHSR1a showed that acyl- and/or desacyl-ghrelin induced adipogenesis in bone marrow, impaired atrophy of skeletal muscles after fasting, increased glucose intake in myoblasts, enhanced mitogenesis in osteoblasts and increased glucogenesis in the liver (Callaghan and Furness, 2014; Costa et al., 2011; Gauna et al., 2005; Gershon and Vale, 2014; Porporato et al., 2013; Reano et al., 2014; Thompson et al., 2004). Altogether, these data suggest that acyl-ghrelin, like desacyl-ghrelin, could play

physiological roles independently of GHSR1a. Nevertheless, while the role of ghrelin on VTA dopaminergic neurons in the control of feeding behavior and its motivational/reward aspects is largely documented, much less is known regarding its effects on substantia nigra (SN) dopaminergic neurons.

3. Ghrelin/Dopamine interactions in the nigrostriatal pathway

3.1. The nigrostriatal pathway and the control of motor behavior

The precise orchestration of voluntary movements is allowed by brain structures called basal ganglia. These subcortical nuclei are composed of the caudate and the putamen, which together form the dorsal striatum, as well as the globus pallidus, the SN and the subthalamic nucleus. First named locus niger or “tâche noire” by the French neuroanatomist Vicq-d’Azyr due to its black coloration later associated with the presence of melanin inside its neurons (Vicq d’Azyr, 1786), the SN can be divided in two major parts differing in their function and respective connections with other basal ganglia structures: the pars compacta and the pars reticulata (SNr). The SNr contains 70% GABAergic neurons and 30% dopaminergic neurons (Nair-Roberts et al., 2008). Together with the internal part of the globus pallidus, it represents the main inhibitory output of the basal ganglia, projecting on the ipsilateral motor thalamus in order to inhibit its signaling to the motor cortex (see Figure 5). The SNc is mainly composed of dopaminergic neurons but also contains 29% of GABAergic neurons. The ventral tier sends projections to the dorsal striatum via the so-called nigrostriatal pathway whereas its dorsal tier is contiguous to the VTA and therefore connected to limbic-related regions which do not participate in the nigrostriatal pathway per se (Haber and Fudge, 1997). According to the canonical basal ganglia model, when a voluntary movement is initiated, the motor cortex sends a glutamatergic excitatory signal to striatal GABAergic neurons, which will result in the release of the thalamic excitatory glutamatergic output on the motor cortex, thus allowing the selection of the proper/adapted motor program. This cortical activation is however tightly modulated by nigral dopaminergic inputs through the direct and indirect pathways to enable a smooth and nicely coordinated movement (Albin et al., 1989; Calabresi et al., 2014; DeLong, 1990). Indeed, through the direct pathway, nigral dopaminergic neurons will enhance the activation of the striatal GABAergic output, thus further amplifying the selection of the adapted motor program and facilitating the movement initiated by the cortical input. In parallel, nigral dopaminergic neurons will also activate, through the indirect pathway, successive GABAergic outputs from the striatum and the external part of the globus pallidus

which will in turn activate the inhibitory output from the SNr/globus pallidus internalis, thus preventing undesired movements. As shown in Figure 5, this classical model explains how information flows through the basal ganglia back to the cortex with opposite effects for the proper execution of a movement initiated by the motor cortex (Albin et al., 1989; DeLong, 1990; Lanciego et al., 2012). Such opposite effects within the nigrostriatal pathway rely on a differential sensitivity to dopamine within the striatum. Indeed, two types of dopamine receptors are expressed by striatal GABAergic neurons: the D1-type, including D1 and D5 receptors, and the D2-type composed of D2, D3 and D4 receptors (Missale et al., 1998). On one hand, the binding of dopamine onto D1-type receptors within the striatum activates the direct pathway and leads to a disinhibition of the ipsilateral motor thalamus, thus facilitating the contralateral movement initiated by the cortex. On the other hand, the binding onto D2-type receptors results in the inhibition of the indirect pathway thus preventing involuntary movements (Da Cunha et al., 2015; Guatteo et al., 2009; Haber, 2014). This classical model has recently been challenged by the identification of regulatory loops at several levels within the basal ganglia suggesting a direct interaction between both pathways (Cazorla et al., 2014; Lanciego et al., 2012; Watabe-Uchida et al., 2012). In summary, the nigrostriatal pathway, and more particularly the SNc, holds a central role in the basal ganglia system and is essential for the selection of the appropriate motor program and the realization of finely coordinated movements.

3.2. Dysfunctions of the nigrostriatal pathway in PD

Parkinson's disease is the most emblematic disorder affecting the nigrostriatal pathway. Its clinical diagnosis is based on the observation of the classical motor symptoms: bradykinesia, rigidity, resting tremor, and later postural instability. Its neuropathological diagnosis relies on the report of neuronal death within the ventral tier of the SNc and the presence of intracytoplasmic inclusions named Lewy bodies inside the surviving neurons (Lewy, 1912; Tretiakoff, 1919). Such a dopaminergic neuronal death in PD leads on one hand to dopamine depletion in the striatum and subsequent lower activation of the direct pathway, thus hindering the selection of the appropriate motor program, and on the other hand to a higher activation of the indirect pathway (see Figure 6; Albin et al., 1989; DeLong, 1990). It is estimated that PD first motor symptoms appear only after at least 50% of SNc dopaminergic neurons are dead (Bernheimer et al., 1973; Riederer and Wuketich, 1976), which indicates a high plasticity within this midbrain structure. PD clinical diagnosis is therefore established late in the course of the disease considering its molecular and cellular progression.

L-DOPA is currently the major pharmacological treatment for PD. It aims at compensating the striatal dopamine depletion in order to restore the coordination of direct and indirect pathways within the basal ganglia. L-DOPA can cross the blood-brain barrier and, in healthy individuals, enters dopaminergic neurons where it is transformed into dopamine by the L-DOPA decarboxylase. In most PD patients, this pharmacological therapy alleviates motor symptoms in the first years after the diagnosis. However, as the number of dopaminergic neurons diminishes over time in PD, in more advanced stages of the disease L-DOPA will preferentially be taken up by serotonergic neurons of the basal ganglia and transformed into dopamine (Carta et al., 2008; Ng et al., 1971, 1970; Svenningsson et al., 2015). The dopamine released from such activated serotonergic neurons is thought to stimulate postsynaptic dopamine receptors in an uncontrolled manner, thus participating in the development of abnormally regulated movements. Therefore, prolonged DOPA-therapy induces strong side effects including dyskinesia or fluctuations (Sharma et al., 2015). Moreover, L-DOPA worsens PD-related gastro-intestinal disorders (Poewe, 2008). Such gastro-intestinal manifestations include constipation or gastroparesis, which corresponds to a delayed gastric emptying in the absence of mechanical obstruction, the latter contributing to L-DOPA-induced fluctuations by modulating the amount of bioavailable L-DOPA (Marrinan et al., 2014). Other treatments like dopamine agonists can be used in first instance to delay the use of L-DOPA or later in association when L-DOPA is insufficient to control PD symptoms. However, the intake of dopamine agonists has been linked to the development of impulse control disorders (see below §4.2.; Callesen et al., 2013; Poletti et al., 2012; Probst and van Eimeren, 2013). Other therapeutic options, essentially deep brain stimulation, are available for patients responsive to L-DOPA but who developed severe motor complications. Deep brain stimulation involves long and difficult surgical procedures, which cannot be performed in all patients. The pharmacological strategies are therefore privileged. However, considering the loss of L-DOPA efficacy over time and its above-mentioned side effects, it is crucial to find new non-invasive therapeutic strategies able not only to prevent the dopaminergic neuronal death within the SN but also to alleviate PD non-motor symptoms from the earliest stages of the disease. Such novel treatment options would undoubtedly contribute to increased quality of life for PD patients.

3.3. Therapeutic potential of ghrelin in PD

Ghrelin displays several characteristics of interest suggesting a potential benefit in PD. First, based on the neuroprotection potential of both acyl- and desacyl-ghrelin after transient focal

ischemia reperfusion (Hwang et al., 2009) or in microglial cell cultures exposed to amyloid beta peptide (Bulgarelli et al., 2009), as well as neuroprotection of growth hormone secretagogues against cerebellar cell death in aged rats (Pañeda et al., 2003), the neuroprotective actions of ghrelin in PD have been studied both in vivo and in vitro. Indeed, intraperitoneal injections of acyl-ghrelin in mice protect SN dopaminergic neurons against neuronal death induced by 1-methyl-4-phenyl-1,2,3,6-tetrahydropyridine (MPTP), a toxic compound and inhibitor of mitochondrial complex I targeting dopaminergic neurons (Andrews et al., 2009; Bayliss et al., 2016a). Interestingly, this neuroprotective effect is particularly evidenced after mice have been submitted to a mild form of food restriction in which ghrelin was injected immediately before the dark phase and food was removed overnight; the following morning each mouse was given 85% of its standard ration. Therefore, ghrelin can restrict the SN dopaminergic neuronal loss and subsequent striatal dopamine depletion in this PD mouse model only when circulating ghrelin levels are boosted at the time when endogenous ghrelin is naturally induced (Andrews et al., 2009; Bayliss et al., 2016a). Moreover, this neuroprotection effect is specific of acyl-ghrelin and involves an increase in the concentration of tyrosine hydroxylase and the dopamine turnover in the striatum, as well as an upregulation of UCP2-dependant mitochondrial mechanisms (see §2.2. and Figure 3; Andrews et al., 2009; Bayliss et al., 2016a). Similarly, 30% caloric restriction for 6 months in adult rhesus monkeys protects against the MPTP-induced striatal dopamine depletion (Maswood et al., 2004). Indeed, chronic caloric restriction elevates plasma ghrelin concentrations as demonstrated in humans suffering from restrictive AN and in rodent models of chronic food restriction (see §4.3. below; Germain et al., 2010, 2009, Méquinion et al., 2015, 2013). In support of this a recent study showed that ghrelin mediated the neuroprotective capacity of calorie restriction in a mouse model of PD: the protective action of ghrelin was mediated by AMPK activation in dopamine neurons since acyl-ghrelin failed to increase neuroprotection in mice lacking AMPK subunits only in dopamine neurons (Bayliss et al., 2016b). Furthermore, MPTP injections in homozygous knock-out mice lacking ghrelin or its receptor induce a higher rate of neuronal death compared to wild type mice, suggesting a protective role of endogenous ghrelin against MPTP toxicity (Andrews et al., 2009; Bayliss et al., 2016a). Therefore, chronically increased plasma ghrelin levels, whether endogenously produced or from exogenous origin, might mediate this neuroprotective action in animal models of parkinsonism. This neuroprotective effect of ghrelin and growth hormone secretagogues extends well beyond neurodegenerative conditions, as reviewed by Frago and colleagues (2011). Cellular and molecular mechanisms underlying the neuroprotective effect

of ghrelin involve anti-inflammatory and anti-apoptotic mechanisms as shown both in vitro and in vivo. For instance, in rat primary mesencephalic cells exposed to MPTP, ghrelin suppresses MPTP-induced microglial activation and reduces the expression of microglia-derived pro-inflammatory cytokines such as TNF- α and IL-1 β (Moon et al., 2009). Ghrelin also prevents the MPTP-induced apoptosis in MES23.5 cells, an effect which is paralleled by the inhibition of lactate dehydrogenase release, the nuclei fragmentation, the reduction of the mitochondrial membrane potential and the activation of caspase 3 (Dong et al., 2009). Similar anti-apoptotic mechanisms are triggered upon ghrelin exposure in MES23.5 cells exposed to rotenone, another potent inhibitor of mitochondrial complex 1 known to induce parkinsonism in animals and humans (Tanner et al., 2011; Yu et al., 2016). However, MES23.5 cells were created by the somatic fusion of neuroblastoma-glioma mouse cells and primary mesencephalic rat cells. Although they express tyrosine hydroxylase and GHSR1a, their physiology might not fully reproduce the one of natural dopaminergic cells of the SN. These results should thus be reproduced in other in vitro PD models before being fully validated. Similarly, future experiments should address the neuroprotective mode of action of ghrelin in order to assess whether peripherally injected ghrelin acts only at the peripheral level, the central neuroprotection then being an indirect effect, or both at central and peripheral levels. In this view, despite the lack of evidence that ghrelin crosses the blood-brain barrier in healthy organisms (Banks, 2002; Cabral et al., 2013; Schaeffer et al., 2013), it is interesting to note that a transient opening of the blood-brain barrier might occur in PD. Indeed, blood-brain barrier dysfunctions have been reported in living PD patients (Bartels et al., 2008; Gray and Woulfe, 2015; Kortekaas et al., 2005) and CD8⁺ and CD4⁺ T cells have been observed at autopsy within the PD brain parenchyma in the vicinity of midbrain dopaminergic neurons (Brochard et al., 2009), suggesting that peripheral molecules and/or cells could reach central dopaminergic regions in a context of PD-induced neurodegeneration.

Second, fasting acyl-ghrelin levels tend to decrease in PD patients compared to patients suffering from other non-neurodegenerative diseases (Fiszer et al., 2010). But these results fail to reach statistical significance due to the small size of the cohort studied and the absence of a standard meal before blood sampling. Similarly, a slower increase of plasma total ghrelin concentrations between two standard meals has been reported in PD patients and patients suffering from REM (rapid eye movement) sleep behavior disorder, a non-motor symptom preceding the diagnosis of PD and often associated to pre-motor stages of the disease, compared to healthy subjects (Unger et al., 2011). Therefore, altered plasma levels of acyl-

ghrelin after a standard meal could be used as a biomarker of early PD stages. Such studies need however to be replicated in larger cohorts of patients and should systematically assess the two main forms of ghrelin; they should also take into account sex differences both in PD itself as well as in circulating concentrations of ghrelin and in GHSR1a expression as reported in rodents (Kamegai et al., 1999). In addition, our recent transcriptomic analyses performed on peripheral blood mononuclear cells and Epstein-Barr virus (EBV)-transformed lymphoblastoid cell lines of PD patients showed a lower expression of the ghrelin opposite strand/antisense RNA (GHRLOS; see Figure 7; Chartier-Harlin, unpublished data; Chartier-Harlin et al., 2004; Mutez et al., 2014, 2011). This non-coding RNA is encoded by a gene present on the opposite strand of the ghrelin gene and spans its promoter and untranslated regions over 44kb on 3p25.3 (Seim et al., 2008). GHRLOS is extensively spliced, harbors multiple variable exons, is poorly conserved among vertebrates and is subjected to differential tissue expression with a higher expression in tissues recognized as major sites of non-coding RNA expression such as the thymus, brain and gonads. Therefore GHRLOS could exert potential regulatory and functional roles in ghrelin expression (Seim et al., 2008). Taken together, these observations suggest that ghrelin could be a valuable biomarker of PD, especially in its early stages: in this view, the ratio of acyl-ghrelin versus desacyl-ghrelin appears as an adapted indicator of potential disease-related alterations either in the synthesis or the release of ghrelin, or in its action on target cells/tissues. Further studies should assess the sensitivity and specificity of such an approach for PD.

Third, most PD patients lose weight during the progression of the disease (Abbott et al., 1992). While L-DOPA-treated patients keep losing weight, PD patients under deep brain stimulation regain weight in the year following surgery without modifying their food intake habits (Perlemoine et al., 2005). Such a weight gain after deep brain stimulation is paralleled by an increase in circulating ghrelin concentrations (Markaki et al., 2012). Therefore not only could ghrelin levels reflect such weight variations, but ghrelin could also be a direct actor of PD-related weight modifications. The assessment of plasma ghrelin levels in patients undergoing deep brain stimulation and/or L-DOPA therapies has however generated controversial results. On one hand, plasma concentrations of total fasting ghrelin are unchanged either by L-DOPA alone or by deep brain stimulation alone when evaluated up to 12 months after the surgery (Arai et al., 2012; Corcuff et al., 2006; Novakova et al., 2011). On the other hand, when applied together, deep brain stimulation and L-DOPA reduced the levels of plasma ghrelin (Corcuff et al., 2006). Further studies on larger cohorts of patients are

therefore needed to clarify these data. In addition, a detailed evaluation of circulating acyl- and desacyl-ghrelin concentrations in PD patients under deep brain stimulation after fasting and better study designs, with the intake of a standard meal and stratifications by sex, stage of the disease and medication status, should help resolving such contradictory results, especially in a longer follow-up setting.

Last, since ghrelin agonists show beneficial effects on the delayed-gastric emptying in diabetes (Ejskjaer et al., 2013, 2010; McCallum et al., 2013; Shin et al., 2013; Wo et al., 2011), ghrelin and its agonists were explored in PD-related gastro-intestinal disorders using well validated rodent models of parkinsonism. In rats injected with 6-hydroxydopamine, a toxic agent selectively targeting noradrenergic and dopaminergic neurons, injections of ghrelin, Rikkunshito, a herbal medicine stimulating the secretion of ghrelin and its orexigenic effect, or HM01, a ghrelin agonist, prevent the L-DOPA-induced decrease in gastric emptying (Karasawa et al., 2014; Takeda et al., 2012b, 2012a, Wang et al., 2014, 2012). This effect is partially reversed by a co-injection of d-Lys(3)]-GHRP-6, an inhibitor of ghrelin receptor, suggesting that GHSR1a could also be a target for the treatment of delayed-gastric emptying in PD (Wang et al., 2014; 2012). Such benefits of ghrelin or ghrelin agonists on PD-related gastrointestinal symptoms are likely to be exerted at the peripheral level. Additional studies should further investigate this local effect of ghrelin especially on the enteric nervous system in animal models with documented early gastro-intestinal alterations.

Altogether these studies highlight the importance of ghrelin in PD. The therapeutic potential of this orexigenic peptide being now largely recognized in the treatment of several non-neurological conditions, it deserves to be further explored in PD to confirm its potential as a biomarker of early stages of the disease as well as a disease-modifying agent. If validated, the latter aspect could be rapidly translated in everyday clinical practice, for ghrelin is already currently used as a therapy against cachexia in ageing and cancer.

4. Ghrelin/Dopamine interactions in the mesocorticolimbic system

4.1. Role of the mesocorticolimbic system in the control of reward and reward-based locomotor activity

The mesocorticolimbic pathway is crucial in reward-based behaviors and motivational control. This pathway originates from dopaminergic VTA neurons. Dahlström and Fuxe (1964) delineated the VTA as containing the dopaminergic A10 nucleus while Oades and Halliday (1987) considered the VTA from its cytoarchitecture regrouping midline,

interfascicular, rostral linear and central linear nuclei (see Figure 8; Dahlström and Fuxe, 1964; Oades and Halliday, 1987). The anatomical organization later proposed by Ikemoto was based on the density of dopaminergic cells: he distinguished the paranigral nucleus and the parabrachial pigmented area, which are enriched in dopaminergic neurons, from the parafasciculus retroflex area and the ventral tegmental tail, also called rostromedial tegmental nucleus, which contain less dopaminergic neurons (see Figure 8; Ikemoto, 2007). In addition to its structural heterogeneity, the VTA also displays a cellular heterogeneity where dopaminergic, GABAergic and glutamatergic projection neurons are intermingled (Li et al., 2013; Nair-Roberts et al., 2008; Salamone and Correa, 2012; Yamaguchi et al., 2015). Dopaminergic projections from the VTA principally target the accumbens nucleus (NAc) located in the ventral striatum (see Figure 1). This nucleus is itself differentiated into at least two anatomically and functionally distinct regions: a ventromedial and a dorsolateral area respectively named the accumbens shell and the accumbens core (Heimer et al., 1991). The dopamine released from the VTA binds D1R, D2R and D3R mainly expressed on GABAergic projection neurons, known as medium spiny neurons, the main NAc cell type (Volkow and Morales, 2015). Dopaminergic VTA neurons also project on other brain areas such as the olfactory tubercle, the dorsal striatum and limbic-related regions, including the septum, the hippocampus, the amygdala and the prefrontal cortex (Beier et al., 2015; Ikemoto, 2007; Lammel et al., 2015, 2008; Swanson, 1982). In addition, closed interconnections between the VTA and the SNc were reported (Ferreira et al., 2008). Indeed, the tail of the VTA, and more particularly the rostromedial tegmental nucleus (see Figure 8, bregma -4.04mm), acts as a major GABAergic brake for the nigrostriatal pathway and therefore for the related motor functions: the ablation of the VTA tail results in increased basal activity of SNc dopaminergic neurons and improves performances in motor tasks, thus emphasizing the role of this midbrain area in motor performance and motor skill learning (Bourdy et al., 2014).

Such a neuroanatomical organization underlies a tremendous functional complexity. The dopaminergic VTA-NAc pathway plays a key role in the processing of motivationally relevant reward-related stimuli, including those associated with drugs of abuse (Wise, 2008). Indeed, to adequately cope with the many challenges from the environment, individuals must constantly adapt their behavior. Such an adaptation is deeply shaped by behavioral outcomes whether they are rewarding such as food or mates, or aversive like predators. Reward is a complex process composed of several psychological components, such as liking (pleasure, hedonic reaction of pleasure), wanting (desire, motivational process of incentive salience) and

learning (see Box 1; Berridge and Kringelbach, 2015). The prospect of obtaining reward or avoiding punishment essentially drives decision making, motivates learning and relies upon an adapted voluntary locomotor activity. This requires intact and properly functioning dopaminergic systems both in the VTA and the SNc (Ilango et al., 2014; Rossi et al., 2013; Tellez et al., 2016). Indeed, mice lacking tyrosine hydroxylase in all dopaminergic neurons are hypoactive (Zhou and Palmiter, 1995). Restoration of tyrosine hydroxylase expression in the NAc of these dopamine deficient mice leads to a recovery of locomotor activity (Heusner et al., 2003). In addition, such dopamine deficient mice are aphagic and they starve by four weeks of age (Palmiter, 2008; Zhou and Palmiter, 1995). A daily L-DOPA treatment restores their activity and feeding behavior, further highlighting the tight cooperation between VTA and SNc in maintaining adapted locomotion and motivation-based behaviors. Similarly, the ablation of VTA dopaminergic neurons induces complex sensorimotor alterations and hypophagia both attributed to a lack of reward associated with food intake (Salamone et al., 1993; Szczypka et al., 2001; Zhou and Palmiter, 1995). Furthermore, dopamine plays a major role in reinforcement learning leading to adapted behavioral outputs (Britt and Bonci, 2013; Day et al., 2010). Such reward-related information is integrated within the NAc together with inputs from other brain areas, including the prefrontal cortex, the basolateral amygdala, the ventral hippocampus and the thalamus (Britt et al., 2012; Haber and Knutson, 2010). In addition to dopamine, glutamate also plays a crucial role in reward-related motor activity induced by VTA dopaminergic inputs. Indeed, glutamate agonists or inhibitors of glutamate reuptake activate glutamate receptors located on NAc mesolimbic dopaminergic terminals, thus increasing the release of dopamine and subsequently locomotor activity (Kim and Vezina, 1999; Wu et al., 1993). Antagonists of glutamate receptors have an opposite effect in particular when injections are performed within the NAc core (Pulvirenti et al., 1994). Altogether, these studies highlight the complexity of the integration of dopamine signaling within the NAc. Nevertheless, dopamine is required not only for the motor component of reward-based behaviors through the NAc core (Maldonado-Irizarry and Kelley, 1995), but also for the incentive value of the stimulus through the NAc shell (Di Chiara, 2002; Ghods-Sharifi and Floresco, 2010; Stopper and Floresco, 2011). Therefore, alterations in VTA dopaminergic pathways might compromise motivation and reward.

4.2. Dysfunctions of the mesocorticolimbic system

Dysfunctions of the dopaminergic mesocorticolimbic system have been implicated in various psychiatric disorders such as schizophrenia, manic depressive disorder or addiction (Hyman et

al., 2006; Ikemoto et al., 2015; Simpson et al., 2012), as well as in neurodegenerative diseases like PD (Albin et al., 1989; DeLong, 1990; Wichmann and DeLong, 1996). AN and PD are two diseases in which alterations of either the food intake or the motor behavior or both occur, notably due to maladaptive changes in dopaminergic neuromodulatory systems and neural circuits of voluntary locomotor activity, reward and motivation.

Anorexia nervosa is one of the most severe psychiatric disorders, for it has the highest mortality rates of all psychiatric diseases (Weiselberg et al., 2011). This disease primarily affects female teenagers and young adult women. Excessive physical activity is observed in 40–80% of AN cases (Davis, 1997). The disease is often associated with psychiatric comorbidities including depression, anxiety, obsessive compulsive or personality disorders, chemical drug abuse and somatic complications (Erdur et al., 2012; Kask et al., 2016; Roux et al., 2013; Scanelli et al., 2014). According to the American diagnostic and statistical manual of mental disorders (DSM5; American Psychiatric Association, 2013) the diagnosis of AN relies on three major criteria: 1) a persistent restriction of energy intake relative to requirements, leading to significantly lower body weight; 2) an intense fear of gaining weight or of becoming fat; and 3) an alteration in the evaluation of one's body weight or shape, called dysmorphophobia. Two subtypes of AN are classically described both resulting in a severe loss of body weight: the restrictive type and the binge-eating/purging type. Dopamine dysfunction has been suggested to predispose to AN by disturbing reward associated with food intake and/or by its potential involvement in the development of personality traits associated with this disease (Bailer et al., 2013; Clarke et al., 2016; Kaye et al., 1999; Kontis and Theochari, 2012). Neuroimaging analyses indeed report dopaminergic alterations in AN patients (Fladung et al., 2013; Frank et al., 2012; Kaye et al., 2013; Södersten et al., 2016). Positron emission tomography (PET) studies using the selective D2R/D3R antagonist [11C]raclopride in recovered AN patients compared to controls showed an increased binding in the ventral striatum (Bailer et al., 2013; Frank et al., 2005). Such a difference might be the consequence of either a decrease in intrasynaptic dopamine concentrations or an elevation of the density and/or affinity of the D2R/D3R. The former hypothesis is further sustained by significantly lower concentrations of homovanillic acid, a major metabolite of dopamine, in the cerebrospinal fluid of AN patients of the restrictive type compared to controls (Kaye et al., 1999). Such dopaminergic dysfunctions in AN are further emphasized by the presence of genetic alterations in some patients such as hypermethylation of genes involved in dopamine signaling or D2R and D4R gene polymorphisms (Bergen et al., 2005; Booij et al., 2015;

Boraska et al., 2014; Gervasini et al., 2013; Peng et al., 2016; Rask-Andersen et al., 2010). Taken together, these data have contributed to the recent recognition of AN as an addictive-like behavioral disorder linked to either food deprivation or weight loss or excessive physical activity (Clarke et al., 2016). For instance, dieting might indeed be perceived as a reward by AN patients. These patients also display a tendency to be over-controlled, anhedonic and able to sustain self-denial of food compared to healthy individuals (Steinglass et al., 2012; Wagner et al., 2006). The D2R/D3R system is thought to be overactive in AN, rendering the patients unable to appropriately respond to salient stimuli and affecting their decision-making (see Box 1; Bailer et al., 2013; Frank et al., 2005; O'Hara et al., 2015). On one hand, if AN patients experience food intake-related endogenous dopamine release as anxiogenic rather than hedonic, they will keep avoiding eating: food refusal would thus be an effective means of diminishing such anxious feelings. On the other hand, as shown by fMRI, AN patients exhibit a predominant activation of frontal and parietal brain regions, particularly activated during the cognitive control during task performance and excessive effort, as well as a reduced activation in the thalamus, the ventral striatum, the anterior cingulate cortex and the sensorimotor area, which are involved in motivated behaviors (Zastrow et al., 2009). AN patients might therefore experience an imbalance in their information processing, with an impaired ability to identify the emotional significance of a stimulus like an appetitive food, together with an increased trafficking in neuronal circuits involved in the planning of action. This increased dopaminergic response might reinforce maladapted rewarding behaviors such as dieting and excessive physical activity which become habits over time (Davis and Kaptein, 2006; Davis and Woodside, 2002; Kohl et al., 2004). This physical hyperactivity therefore serves dual functions, to burn excess calories as well as a strategy of hunger reduction (Davis, 1997). Altogether, these data support a strong role for dopamine signaling and more specifically for the D2R/D3R system in the decision-making processes for AN, which involves the integration of reward information. However, it is not clear yet whether these changes are cause or consequence; i.e. due to AN itself, or to the disease-related nutritional deficit. In AN of the restrictive type, malnutrition is associated with central nervous system changes such as a reduction in the gray matter, a greater cerebrospinal fluid volume, and an altered white matter integrity, as well as profound metabolic, electrolytic and endocrine alterations (Kaye et al., 2009). Similarly, studies in animals have shown that diet (enriched food vs low calorie diet) and weight (obese vs lean) can influence dopamine metabolism (Johnson and Kenny, 2010; Méquinion et al., 2015). Further studies should clarify these elements.

Maladaptive changes in dopaminergic neural circuits of voluntary locomotor activity, reward and motivation are also largely documented in PD. Although this neurodegenerative disorder has long been considered as a pure motor disease (see supra §3.2.), its non-motor component has recently focused the attention of the scientific community. Indeed, PD patients also present with generalized anxiety, panic disorders, phobia, apathy, alexithymia, and psychoses (Alzahrani and Venneri, 2015; Assogna et al., 2016). Such neuropsychiatric disorders are now recognized as an intrinsic component of the disease, notably due to their persistency over time despite the amelioration of motor symptoms in medicated patients (Connolly and Fox, 2014). This is reinforced by the better knowledge of anatomical and functional connections between basal ganglia, frontal lobes and limbic system (see supra, §3.1. and 4.1.). Therefore, the related dysfunction of baso-thalamo-cortical circuits is considered at the origin of such psychiatric manifestations of PD. This can be considered in light of the premorbid personality often encountered in many patients. Indeed, PD subjects often display over-controlled, introspective, anhedonic and low sensation seeking personality traits which are considered as emotional and attitude inflexibility (Evans et al., 2006; Poewe et al., 1983; Todes and Lees, 1985). However such personality traits alone are not believed to predispose to PD (Arabia et al., 2010). Besides these intrinsic neuropsychiatric deficits, some pharmacological treatments currently used in PD strongly disturb dopamine signaling in the whole brain. Indeed, impulsive and compulsive behaviors are reported in 14% of PD patients under dopaminergic drugs, mainly dopamine agonists, compared to only 1.1-1.6% of the general adult population (Callesen et al., 2013; Poletti et al., 2012; Probst and van Eimeren, 2013; Weintraub et al., 2010). Impulsive and compulsive behaviors include impulse control disorders such as gambling addiction, hypersexuality, compulsive shopping or binge eating, as well as a compulsive use of dopamine replacement therapy called dopamine dysregulation syndrome, and stereotyped behaviors known as punding. Such disorders negatively impact the patients' quality of life and can be as debilitating as PD itself (Phu et al., 2014). PET studies using the radioligand [¹¹C]raclopride further confirmed alterations of striatal dopamine release in PD patients with and without impulsive-compulsive behaviors to whom neutral or rewarding visual cues were presented (O'Sullivan et al., 2011). PD patients with impulsive and compulsive behaviors exhibited an enhanced dopamine release only in the ventral striatum compared to PD patients without impulsive and compulsive behaviors. This is consistent with the incentive salience theory of compulsive drug use (Berridge et al., 2009; Robinson and Berridge, 1993). Similarly, repeated sensitizations of ventral striatal circuits in a physiological context contribute to the facilitation of appetitive and consummatory aspects of different

behaviors such as sex or food intake. Indeed, rats repeatedly exposed to psychostimulants such as D-amphetamine or cocaine, in which ventral striatal circuits are hyperstimulated by the increased dopamine efflux in the NAc, show increased pursuit of natural rewards (Fiorino and Phillips, 1999a, 1999b; Nocjar and Panksepp, 2002; Wyvell and Berridge, 2001). In this view, impulsive and compulsive behaviors in PD occurring during “ON” dopaminergic states might be the consequence of an enhanced incentive salience attribution to potent reward cues (ie. cues taking on incentive motivational features of their rewards) which, in turn, lead to the compulsive pursuit of various rewards (Lawrence et al., 2003). Impulsive and compulsive behaviors in PD patients have been related to risk factors such as alcohol abuse or addiction to illicit drugs, smoking and high novelty seeking personality traits (Averbeck et al., 2014). Therefore, impulsive and compulsive behavior-related rewarding cues, dopamine itself or dopaminergic medications may explain the pathological incentive salience and the excessive wanting even in the absence of differences in hedonic responses (or liking) as it is the case in other addictions (see Box 1; Robinson and Berridge, 2008). Indeed PD patients are still able of hedonic ratings of “liking” despite extensive dopaminergic depletion in the SNc (Sienkiewicz-Jarosz et al., 2013).

In summary, the implication of dopamine in AN and PD-related impulsive and compulsive behaviors is now largely acknowledged. However, as discussed previously (see §4.1.), the integration of dopaminergic signals involves various other neuromediators and/or neuropeptides such as glutamate, GABA and opioids. Further studies in animal models and in patients are necessary to elucidate the actual contribution of dopamine in the genesis of these conditions. Indeed, prospective studies investigating premorbid dopaminergic status in AN are still lacking. One can also question the possible chronically elevated dopamine levels in the brain before individuals develop an eating disorder. Similarly, considering the complexity and diversity of the neuronal populations of the VTA and SNc, a focus on the regulation of the mesencephalic dopaminergic neuron should enable a better understanding of mechanisms by which peripheral signals reaching these midbrain structures can exert a regulatory role to modulate motivation, reward and the locomotor activity needed to reach a goal. Ghrelin might be one of these potential neuromodulator.

4.3. Ghrelin and reward: physiological role and therapeutic potential

The action of ghrelin in regulating motivational aspects of feeding behavior is largely documented. Indeed, ghrelin whether injected centrally or peripherally increases food intake, triggers dopamine release predominantly in the NAc shell and increases dopamine turnover

(Abizaid et al., 2006; Cone et al., 2014; Jerlhag et al., 2006; Kawahara et al., 2009; Quarta et al., 2009). Similarly, applications of ghrelin on rodent VTA brain sections increase the firing rate of dopaminergic neurons (Abizaid et al., 2006). In addition, intra-VTA injections of the GHSR1a antagonist BIM28163 followed by ghrelin intraperitoneal administration in mice block the accumbal dopamine release (Jerlhag et al., 2011). However, this dopamine release in the NAc is contingent to food consumption (Kawahara et al., 2009). Interestingly, in a context of a free choice between palatable food and standard chow, ghrelin within the VTA plays a key role in the motivation for palatable food and its consumption but not in the homeostatic feeding (Cone et al., 2014; Eggecioglu et al., 2010; McFarlane et al., 2014; Naleid et al., 2005; Overduin et al., 2012; Schéle et al., 2016; Skibicka et al., 2011; St-Onge et al., 2016). The VTA dopamine-related excitatory effect of ghrelin on food intake is also regulated by complex brain circuits activated by the value of food reward. Indeed, intravenous injections of ghrelin in different food contexts stimulate distinct neuronal pathways: an injection of ghrelin followed by consumption of standard chow increases accumbal dopamine through the activation of mu opioid receptors in the VTA whereas a systemic ghrelin injection followed either by the consumption of palatable food or in the absence of food diminishes the increase in accumbal dopamine levels via preferential activation of kappa opioid receptors (Kawahara et al., 2013, 2009). This highlights the complexity of ghrelin signal integration within the VTA. We refer the reader to Kawahara and colleagues (2013) and Lockie and Andrews (2013) for further details on the currently proposed models of neuronal pathways mediating the effect of systemic ghrelin in the mesocorticolimbic dopaminergic system according to the various feeding states, as it is largely beyond the scope of this review.

Besides monitoring motivation for food, ghrelin is also known to stimulate physical activity (Adan et al., 2011; Jerlhag et al., 2007). Ghrelin thus stimulates the locomotor activity necessary to reach the motivating goals, a process also called the motivational drive to eat. In fact, increased plasma ghrelin levels are observed in the anticipation of expected meals in both humans (Cummings et al., 2001) and rodents (Blum et al., 2009; Drazen et al., 2006; Merkestein et al., 2012). The anticipatory locomotor activity, also known as food anticipatory activity, is particularly observed in restricted feeding schedules both in rodents where ghrelin levels correlate with the amount of anticipatory running wheel activity (Mistlberger, 1994; Ribeiro et al., 2011) and in humans in cases of restrictive AN (Scheurink et al., 2010). Systemic injections of ghrelin in Siberian hamsters, a species that does not respond to fasting by increasing its food intake but rather by markedly increasing foraging and food hoarding

before eating, increase these locomotor behaviors only when food is present (Keen-Rhinehart and Bartness, 2005). Furthermore, an intracerebroventricular injection or a chronic peripheral administration of the GHS-R1a antagonist JMV2959 in food restricted rats with free access to a running wheel, a model reproducing several symptoms of AN (the activity-based anorexia (ABA) rodent model; for review, see Méquinion et al., 2015), suppresses the food anticipatory activity without altering food intake (Verhagen et al., 2011). Similar results were obtained in GHS-R1a knock-out mice exposed to the ABA protocol (Verhagen et al., 2011). These data emphasize the dual and complex role of ghrelin on VTA dopaminergic neurons in regulating behavioral aspects of motivational signals. Bearing in mind the complexity of the VTA/SNc dopaminergic system and interactions, there is currently no clear consensus whether ghrelin exerts its action preferentially on dopaminergic neurons that code motivational value signals or motivational salience signals (for review, see Bromberg-Martin and Hikosaka, 2011). A better knowledge of these potential differential interactions might help targeting more specifically mesencephalic dopaminergic populations in order to find novel pharmacological treatments in AN and PD-related neuropsychiatric disorders.

Ghrelin therapeutic potential can also apply to the reward system. Indeed, in AN of the restrictive type, circulating concentrations of acyl-ghrelin are elevated (Germain et al., 2009; 2010). This increase is interpreted as an adaptive feedback mechanism due to the lack of nutrients. Disturbed processes in the emotional and reward response to starvation have been reported in AN and might promote cognitive strategies to maintain such a pathological behavior (Clarke et al., 2016; Gorwood et al., 2016). The inability of AN patients to adopt an adapted response to elevated plasma ghrelin concentrations might be due either to a reduced capacity of ghrelin to be transported to its central hypothalamic targets and to act properly on orexigenic neurons (Collden et al., 2015; Schaeffer et al., 2013), or to an alteration in the GHSR1a sensitivity, or to an alteration in ghrelin signaling within mesencephalic dopaminergic neurons. The consequences of a therapeutic use of ghrelin have been investigated both in animals and patients. In mice submitted to the ABA protocol, a daily intraperitoneal injection of ghrelin significantly increases the physical activity especially after food intake (Legrand et al., 2016). In humans, ghrelin has been mostly devoted to the treatment of excessive weight loss in cachexia such as in congestive heart failure, cancer or end-stage renal disease, where administration of ghrelin stimulates appetite and food intake (Akamizu and Kangawa, 2011). In AN patients, the pharmacological effects of ghrelin remain non-conclusive mainly due to the lack of proper controls and the too small size of AN cohorts.

Indeed, intravenous infusion of 5 pmol/kg/min ghrelin for five hours in nine AN patients induced no clear changes in food intake while increasing sleepiness (Miljic et al., 2006). Conversely, like in control subjects, a sensation of hunger was shown in six out of nine AN patients after a bolus intravenous injection of 1 mg/kg ghrelin (Broglia et al., 2004a). Furthermore, administration of 3 mg/kg ghrelin twice a day in five AN patients decreased gastrointestinal symptoms and increased sensations of hunger and daily energy intake (Hotta et al., 2009). These few published studies not only raise concerns regarding methodological issues but also emphasize the difficulty to properly evaluate the real motivation of patients to eat, their level of physical activity and question the route and frequencies of ghrelin and/or agonists administration (Ueno et al., 2010). Most ghrelin-derived drugs whether agonists or antagonists are currently in the preclinical phase of development. Ghrelin agonists appear promising to potentially treat AN while antagonists might be used for other eating disorders like hyperphagia as seen in some cases of obesity or in Prader-Willi syndrome, a rare genetic disorder characterized by obesity and hyperphagia among other symptoms (Cardona Cano et al., 2012). Last, a novel therapeutic strategy using a traditional herbal medicine called Kampo medicine, and more specifically Rikkunshito, displays interesting features in the context of AN such as the stimulation of ghrelin secretion and its related orexigenic effects, thus ameliorating the decrease in gastric motility and anorexia both in humans and animal models (Saegusa et al., 2015). Altogether, these studies establish the bases for further investigating the therapeutic potential of ghrelin and/or ghrelin-derived compounds in neuropsychiatric disorders.

5. Conclusions

As discussed in this review, ghrelin emerges as a key player in multiple physiological contexts involving dopaminergic inputs/outputs. The complementary roles of mesocorticolimbic and nigrostriatal pathways in finely adjusting motivated behaviors have been discussed from an evolutionary perspective, as both circuits and their complex interplay with other brain areas are crucial for the survival of species and individuals. Goal-directed behaviors are a key to such an adaptation. In particular, the mesocorticolimbic pathway provides the motivation to act whereas the nigrostriatal pathway modulates voluntary movements needed to reach the goal. Numerous studies conducted on animal models and in patients underline the importance of ghrelin in regulating both metabolic and non-metabolic functions involved in reward processes and goal-directed actions. In addition, the implication of ghrelin in the modulation of dopaminergic circuits controlling reward and motivation-

related behaviors highlight its potential as a biomarker and disease-modifying compound for several pathological conditions such as eating (AN, binge-eating) or neurodegenerative (PD) disorders. However, a more thorough knowledge of ghrelin receptor functioning and its related signaling pathways is mandatory before using ghrelin or ghrelin-derived molecules in these pathological conditions. In particular, the entry of peripheral ghrelin into the brain is still a matter of debate. Although an intraperitoneal injection of ghrelin in the mouse increases striatal dopamine levels, expression of midbrain tyrosine hydroxylase mRNA and the number of mitochondria in SN dopaminergic cells (Andrews et al., 2009), no study clearly demonstrates that peripheral ghrelin can cross the blood-brain barrier. Such a crossing appears limited to brain areas where the blood-brain barrier is more permissive like the area postrema or the arcuate nucleus (Banks, 2002; Cabral et al., 2013; Schaeffer et al., 2013). In light of the high propensity of GHSR1a to heterodimerize, it is reasonable to assume that locally produced (ie. within the brain) ligands other than ghrelin might indeed activate this receptor within the central nervous system. In this context, dopamine may represent a key signal among others. One can also question the role of ghrelin-derived peptides such as desacyl-ghrelin and obestatin in reward and motivation. Studies specifically designed for answering these key issues are deeply needed. Nevertheless, ghrelin and ghrelin agonists display a high potential as biomarkers and disease-modifiers as reviewed here. Such potentials extend beyond the pathological conditions discussed here, as they have been evidenced in other diseases such as Prader-Willi syndrome or Alzheimer's disease (Dos Santos et al., 2013).

Acknowledgments

This work was supported by the French Ministry for Higher Education and Research (A.S.), the University of Lille, INSERM, PHRC to A.D. and M.C.C.H. (PARKFANORD 2005/1914, PARADIGME 2002/1918, CONVERGENCE 2008/0811), and by grants and fellowships from the Australian National Health and Medical Research Council to Z.B.A (546131, 1084344). The authors would like to thank the CHU Lille and IRCL, the subjects for their participation in the transcriptomic study of GHRLOS as well as Dr. Bleuse, Mr. Comptdaer, Dr. Mutez, and Mr. Semaille for the collection and preparation of patients' blood samples. We also thank Dr. Nkiliza for her help during the study of the expression of GHRLOS in PD patients, and Dr Tolle for helpful discussions.

Appendix

Box 1: Role of dopamine in reward and motivation: focus on “liking – wanting – learning” processes.

Decision-making is one of the key concepts which has been extensively studied and debated both in psychology and neurobiology fields. This cognitive process identifies the choice between alternative options based on the values and preferences of the organism / individual. The resulting decision might or not induce an action. In this context, goal-directed actions have particularly focused the attention of the scientific community, notably because the underlying motivation needed to accomplish such actions, and the rewards obtained from the associated behaviors, durably shape an individual's response to the environment. Learning processes through which actions and their consequences for the organisms are encoded, as well as factors that influence the choice between actions, are fundamental in goal-directed actions. From a neurobiological perspective, dopamine is the key neuromediator involved in reward and motivation. Indeed, mesencephalic dopamine released in the nucleus accumbens (NAc) has long been described to sustain both the “drive to approach/reach the goal”, also called invigoration of approach, and “the process by which one assigns value to the consequences or goals of goal-directed actions”, known as incentive learning (Balleine, 2011). In highly complex environments, the survival of an organism depends on his ability to predict relevant outcomes of his actions, regardless of whether they are rewarding, such as food, water or mates, or aversive such as predators or rivals. Several models attempt to explain this process of learning, from the earliest component of Pavlov's experiments, “the law of effect” of Thorndike or the Skinner's concepts to the current models of animal neuroeconomic strategies. The current paradigm considers three steps in goal-directed actions: 1) animals experience a motivationally salient outcome (food or mates) and determine the value of that reinforcer, (2) animals detect and attend to cues that predict the outcomes of reinforcers, and (3) the actions necessary to produce and obtain the reinforcer are performed. When multiple outcomes are in competition for attention, animals must evaluate the value of the different reinforcers and the associated energy costs to carry out the related behaviors. Neuronal circuits underlying such goal-directed actions are controlled by dopaminergic ventromedial striatal inputs. This system regulates arousal and more specifically the “general drive state” (for review, see Ikemoto, 2007). Indeed, rewarding, aversive and cues-related stimuli are known to modify the activity of dopaminergic VTA neurons (Bromberg-Martin et al., 2010; Lammel et al., 2014). As an example, in mice, the successive presentation of a

conditioned stimulus followed by an unconditioned stimulus with various outcomes including reward and punishment recruits three types of VTA dopaminergic neurons: those activated solely by the reward, those exclusively by the conditioned stimulus, and those by both (Cohen et al., 2012).

The current model of reward processing considers three relevant components (Berridge et al., 2009; Smith et al., 2011): the pleasure gained from reaching the goal, ie. its hedonic impact also designated as “liking”, the type of incentive motivation that promotes approach towards and consumption of the reward or incentive salience, also known as “wanting”, and the learned associative prediction called “learning”. From the neurobiological perspective, the processing of wanting for and liking of a reward does not involve the same dopaminergic striatal targets. Indeed, the 6-OHDA-induced depletion of about 99% of dopaminergic neuronal fibers in the rat NAc does not modify the “liking” versus “disgusting” orofacial expressions to respectively pleasant (sucrose) or unpleasant (quinine) tastes, but reduces appetitive seeking causing aphagia, which is consistent with a lack of motivation (Berridge et al., 1989; Berridge and Robinson, 1998). These results underline the importance of mesocorticolimbic dopaminergic systems for eliciting motivation (“wanting”) independently of the hedonic assessment, and for the learning of new “likes” and “dislikes” outcomes. The liking/wanting/learning processes thus involve different regulatory pathways (for review, see Berridge et al., 2010). The “liking” neurocircuitry includes brain structures which connect together the neocortex (orbitofrontal cortex, anterior cingulate cortex or anterior insula cortex) with forebrain limbic structures such as the NAc, the ventral pallidum or the amygdala where the sensory pleasure can be amplified through opioid, endocannabinoid or orexin regulatory signals. Mechanisms underlying “wanting” processes include larger opioid networks in the NAc, the striatum and the amygdala, which extend beyond the brain hedonic hotspots, as well as mesocorticolimbic dopamine systems and interconnected corticolimbic glutamate signals. In humans, neuroimaging studies have revealed that dopamine levels may better correlate with subjective ratings of wanting for a reward than with the pleasure associated to ratings of liking the same reward (Leyton et al., 2002; Volkow et al., 2002).

In summary, mesencephalic dopamine underlies several essential aspects of motivational processes which are finely tuned within the striatum. Deregulations of these dopamine signals might not only cause motor troubles as described in Parkinson’s disease, but also disturb liking/wanting/learning processes therefore potentially leading to addictive disorders with the

occurrence of an “irrational wanting” for some rewarding outcomes, such as gambling, sex, eating or dieting.

References

- Abbott, R.A., Cox, M., Markus, H., Tomkins, A., 1992. Diet, body size and micronutrient status in Parkinson’s disease. *Eur. J. Clin. Nutr.* 46, 879–884.
- Abizaid, A., Liu, Z.-W., Andrews, Z.B., Shanabrough, M., Borok, E., Elsworth, J.D., Roth, R.H., Sleeman, M.W., Picciotto, M.R., Tschöp, M.H., Gao, X.-B., Horvath, T.L., 2006. Ghrelin modulates the activity and synaptic input organization of midbrain dopamine neurons while promoting appetite. *J. Clin. Invest.* 116, 3229–3239. doi:10.1172/JCI29867
- Adan, R. a. H., Hillebrand, J.J.G., Danner, U.N., Cardona Cano, S., Kas, M.J.H., Verhagen, L. a. W., 2011. Neurobiology driving hyperactivity in activity-based anorexia. *Curr. Top. Behav. Neurosci.* 6, 229–250. doi:10.1007/7854_2010_77
- Akamizu, T., Kangawa, K., 2011. Therapeutic applications of ghrelin to cachexia utilizing its appetite-stimulating effect. *Peptides* 32, 2295–2300. doi:10.1016/j.peptides.2011.05.018
- Albin, R.L., Young, A.B., Penney, J.B., 1989. The functional anatomy of basal ganglia disorders. *Trends Neurosci.* 12, 366–375.
- Alzahrani, H., Venneri, A., 2015. Cognitive and neuroanatomical correlates of neuropsychiatric symptoms in Parkinson’s disease: A systematic review. *J. Neurol. Sci.* 356, 32–44. doi:10.1016/j.jns.2015.06.037
- American Psychiatric Association, 2013. *Diagnostic and Statistical Manual of Mental Disorders, Fifth Edition.* ed. American Psychiatric Association, Washington, DC.
- Andrews, Z.B., Erion, D., Beiler, R., Liu, Z.-W., Abizaid, A., Zigman, J., Elsworth, J.D., Savitt, J.M., DiMarchi, R., Tschöp, M., Roth, R.H., Gao, X.-B., Horvath, T.L., 2009. Ghrelin Promotes and Protects Nigrostriatal Dopamine Function via a UCP2-Dependent Mitochondrial Mechanism. *J. Neurosci.* 29, 14057–14065. doi:10.1523/JNEUROSCI.3890-09.2009
- Andrews, Z.B., Liu, Z.-W., Wallingford, N., Erion, D.M., Borok, E., Friedman, J.M., Tschöp, M.H., Shanabrough, M., Cline, G., Shulman, G.I., Coppola, A., Gao, X.-B., Horvath, T.L., Diano, S., 2008. UCP2 mediates ghrelin’s action on NPY/AgRP neurons by lowering free radicals. *Nature* 454, 846–851. doi:10.1038/nature07181
- Angeloni, S.V., Glynn, N., Ambrosini, G., Garant, M.J., Higley, J.D., Suomi, S., Hansen, B.C., 2004. Characterization of the rhesus monkey ghrelin gene and factors influencing ghrelin gene expression and fasting plasma levels. *Endocrinology* 145, 2197–2205. doi:10.1210/en.2003-1103
- Arabia, G., Grossardt, B.R., Colligan, R.C., Bower, J.H., Maraganore, D.M., Ahlskog, J.E., Geda, Y.E., Rocca, W.A., 2010. Novelty seeking and introversion do not predict the long-term risk of Parkinson disease. *Neurology* 75, 349–357. doi:10.1212/WNL.0b013e3181ea15fd

- Arai, E., Arai, M., Uchiyama, T., Higuchi, Y., Aoyagi, K., Yamanaka, Y., Yamamoto, T., Nagano, O., Shiina, A., Maruoka, D., Matsumura, T., Nakagawa, T., Katsuno, T., Imazeki, F., Saeki, N., Kuwabara, S., Yokosuka, O., 2012. Subthalamic deep brain stimulation can improve gastric emptying in Parkinson's disease. *Brain* 135, 1478–1485. doi:10.1093/brain/aws086
- Assogna, F., Cravello, L., Orfei, M.D., Cellupica, N., Caltagirone, C., Spalletta, G., 2016. Alexithymia in Parkinson's disease: A systematic review of the literature. *Parkinsonism Relat. Disord.* 28, 1–11. doi:10.1016/j.parkreldis.2016.03.021
- Averbeck, B.B., O'Sullivan, S.S., Djamshidian, A., 2014. Impulsive and compulsive behaviors in Parkinson's disease. *Annu. Rev. Clin. Psychol.* 10, 553–580. doi:10.1146/annurev-clinpsy-032813-153705
- Bailer, U.F., Frank, G.K., Price, J.C., Meltzer, C.C., Becker, C., Mathis, C.A., Wagner, A., Barbarich-Marsteller, N.C., Bloss, C.S., Putnam, K., Schork, N.J., Gamst, A., Kaye, W.H., 2013. Interaction between serotonin transporter and dopamine D2/D3 receptor radioligand measures is associated with harm avoidant symptoms in anorexia and bulimia nervosa. *Psychiatry Res.* 211, 160–168. doi:10.1016/j.psychres.2012.06.010
- Baldanzi, G., 2002. Ghrelin and des-acyl ghrelin inhibit cell death in cardiomyocytes and endothelial cells through ERK1/2 and PI 3-kinase/AKT. *J. Cell Biol.* 159, 1029–1037. doi:10.1083/jcb.200207165
- Bali, A., Jaggi, A.S., 2016. An Integrative Review on Role and Mechanisms of Ghrelin in Stress, Anxiety and Depression. *Curr. Drug Targets* 17, 495–507.
- Balleine, B.W., 2011. Sensation, Incentive Learning, and the Motivational Control of Goal-Directed Action, in: Gottfried, J.A. (Ed.), *Neurobiology of Sensation and Reward*, *Frontiers in Neuroscience*. CRC Press/Taylor & Francis, Boca Raton (FL).
- Banks, W.A., 2002. Extent and Direction of Ghrelin Transport Across the Blood-Brain Barrier Is Determined by Its Unique Primary Structure. *J. Pharmacol. Exp. Ther.* 302, 822–827. doi:10.1124/jpet.102.034827
- Bartels, A.L., Willemsen, A.T.M., Kortekaas, R., de Jong, B.M., de Vries, R., de Klerk, O., van Oostrom, J.C.H., Portman, A., Leenders, K.L., 2008. Decreased blood-brain barrier P-glycoprotein function in the progression of Parkinson's disease, PSP and MSA. *J. Neural Transm. Vienna Austria* 1996 115, 1001–1009. doi:10.1007/s00702-008-0030-y
- Bayliss, J.A., Andrews, Z.B., 2013. Ghrelin is neuroprotective in Parkinson's disease: molecular mechanisms of metabolic neuroprotection. *Ther. Adv. Endocrinol. Metab.* 4, 25–36.
- Bayliss, J.A., Lemus, M., Santos, V.V., Deo, M., Elsworth, J., Andrews, Z.B., 2016a. Acylated but not des-acyl ghrelin is neuroprotective in an MPTP mouse model of Parkinson's Disease. *J. Neurochem.* doi:10.1111/jnc.13576
- Bayliss, J.A., Lemus, M.B., Stark, R., Santos, V.V., Thompson, A., Rees, D.J., Galic, S., Elsworth, J.D., Kemp, B.E., Davies, J.S., Andrews, Z.B., 2016b. Ghrelin-AMPK Signaling Mediates the Neuroprotective Effects of Calorie Restriction in Parkinson's Disease. *J. Neurosci. Off. J. Soc. Neurosci.* 36, 3049–3063. doi:10.1523/JNEUROSCI.4373-15.2016

- Beier, K.T., Steinberg, E.E., DeLoach, K.E., Xie, S., Miyamichi, K., Schwarz, L., Gao, X.J., Kremer, E.J., Malenka, R.C., Luo, L., 2015. Circuit Architecture of VTA Dopamine Neurons Revealed by Systematic Input-Output Mapping. *Cell* 162, 622–634. doi:10.1016/j.cell.2015.07.015
- Bergen, A.W., Yeager, M., Welch, R.A., Haque, K., Ganjei, J.K., van den Bree, M.B.M., Mazzanti, C., Nardi, I., Fichter, M.M., Halmi, K.A., Kaplan, A.S., Strober, M., Treasure, J., Woodside, D.B., Bulik, C.M., Bacanu, S.-A., Devlin, B., Berrettini, W.H., Goldman, D., Kaye, W.H., 2005. Association of multiple DRD2 polymorphisms with anorexia nervosa. *Neuropsychopharmacol. Off. Publ. Am. Coll. Neuropsychopharmacol.* 30, 1703–1710. doi:10.1038/sj.npp.1300719
- Bernheimer, H., Birkmayer, W., Hornykiewicz, O., Jellinger, K., Seitelberger, F., 1973. Brain dopamine and the syndromes of Parkinson and Huntington. Clinical, morphological and neurochemical correlations. *J. Neurol. Sci.* 20, 415–455.
- Berridge, K.C., Ho, C.-Y., Richard, J.M., DiFeliceantonio, A.G., 2010. The tempted brain eats: pleasure and desire circuits in obesity and eating disorders. *Brain Res.* 1350, 43–64. doi:10.1016/j.brainres.2010.04.003
- Berridge, K.C., Kringelbach, M.L., 2015. Pleasure systems in the brain. *Neuron* 86, 646–664. doi:10.1016/j.neuron.2015.02.018
- Berridge, K.C., Robinson, T.E., 1998. What is the role of dopamine in reward: hedonic impact, reward learning, or incentive salience? *Brain Res. Brain Res. Rev.* 28, 309–369.
- Berridge, K.C., Robinson, T.E., Aldridge, J.W., 2009. Dissecting components of reward: “liking”, “wanting”, and learning. *Curr. Opin. Pharmacol.* 9, 65–73. doi:10.1016/j.coph.2008.12.014
- Berridge, K.C., Venier, I.L., Robinson, T.E., 1989. Taste reactivity analysis of 6-hydroxydopamine-induced aphagia: implications for arousal and anhedonia hypotheses of dopamine function. *Behav. Neurosci.* 103, 36–45.
- Björklund, A., Dunnett, S.B., 2007. Dopamine neuron systems in the brain: an update. *Trends Neurosci.* 30, 194–202. doi:10.1016/j.tins.2007.03.006
- Błaszczuk, J.W., 1998. Motor deficiency in Parkinson's disease. *Acta Neurobiol. Exp. (Warsz.)* 58, 79–93.
- Blum, I.D., Patterson, Z., Khazall, R., Lamont, E.W., Sleeman, M.W., Horvath, T.L., Abizaid, A., 2009. Reduced anticipatory locomotor responses to scheduled meals in ghrelin receptor deficient mice. *Neuroscience* 164, 351–359. doi:10.1016/j.neuroscience.2009.08.009
- Booij, L., Casey, K.F., Antunes, J.M., Szyf, M., Joober, R., Israël, M., Steiger, H., 2015. DNA methylation in individuals with anorexia nervosa and in matched normal-eater controls: A genome-wide study. *Int. J. Eat. Disord.* 48, 874–882. doi:10.1002/eat.22374
- Boraska, V., Franklin, C.S., Floyd, J. a. B., Thornton, L.M., Huckins, L.M., Southam, L., Rayner, N.W., Tachmazidou, I., Klump, K.L., Treasure, J., Lewis, C.M., Schmidt, U., Tozzi, F., Kiezebrink, K., Hebebrand, J., Gorwood, P., Adan, R. a. H., Kas, M.J.H., Favaro, A., Santonastaso, P., Fernández-Aranda, F., Gratacos, M., Rybakowski, F., Dmitrzak-Weglarczyk, M., Kaprio, J., Keski-Rahkonen, A., Raevuori, A., Van Furth, E.F., Slof-Op 't Landt, M.C.T.,

Hudson, J.I., Reichborn-Kjennerud, T., Knudsen, G.P.S., Monteleone, P., Kaplan, A.S., Karwautz, A., Hakonarson, H., Berrettini, W.H., Guo, Y., Li, D., Schork, N.J., Komaki, G., Ando, T., Inoko, H., Esko, T., Fischer, K., Männik, K., Metspalu, A., Baker, J.H., Cone, R.D., Dackor, J., DeSocio, J.E., Hilliard, C.E., O'Toole, J.K., Pantel, J., Szatkiewicz, J.P., Taico, C., Zerwas, S., Trace, S.E., Davis, O.S.P., Helder, S., Bühren, K., Burghardt, R., de Zwaan, M., Egberts, K., Ehrlich, S., Herpertz-Dahlmann, B., Herzog, W., Imgart, H., Scherag, A., Scherag, S., Zipfel, S., Boni, C., Ramoz, N., Versini, A., Brandys, M.K., Danner, U.N., de Kovel, C., Hendriks, J., Koeleman, B.P.C., Ophoff, R.A., Strengman, E., van Elburg, A.A., Bruson, A., Clementi, M., Degortes, D., Forzan, M., Tenconi, E., Docampo, E., Escaramís, G., Jiménez-Murcia, S., Lissowska, J., Rajewski, A., Szeszenia-Dabrowska, N., Slopian, A., Hauser, J., Karhunen, L., Meulenbelt, I., Slagboom, P.E., Tortorella, A., Maj, M., Dedoussis, G., Dikeos, D., Gonidakis, F., Tziouvas, K., Tsitsika, A., Papezova, H., Slachtova, L., Martaskova, D., Kennedy, J.L., Levitan, R.D., Yilmaz, Z., Huemer, J., Koubek, D., Merl, E., Wagner, G., Lichtenstein, P., Breen, G., Cohen-Woods, S., Farmer, A., McGuffin, P., Cichon, S., Giegling, I., Herms, S., Rujescu, D., Schreiber, S., Wichmann, H.-E., Dina, C., Sladek, R., Gambaro, G., Soranzo, N., Julia, A., Marsal, S., Rabionet, R., Gaborieau, V., Dick, D.M., Palotie, A., Ripatti, S., Widén, E., Andreassen, O.A., Espeseth, T., Lundervold, A., Reinvang, I., Steen, V.M., Le Hellard, S., Mattingsdal, M., Ntalla, I., Bencko, V., Foretova, L., Janout, V., Navratilova, M., Gallinger, S., Pinto, D., Scherer, S.W., Aschauer, H., Carlberg, L., Schosser, A., Alfredsson, L., Ding, B., Klareskog, L., Padyukov, L., Courtet, P., Guillaume, S., Jaussent, I., Finan, C., Kalsi, G., Roberts, M., Logan, D.W., Peltonen, L., Ritchie, G.R.S., Barrett, J.C., Wellcome Trust Case Control Consortium 3, Estivill, X., Hinney, A., Sullivan, P.F., Collier, D.A., Zeggini, E., Bulik, C.M., 2014. A genome-wide association study of anorexia nervosa. *Mol. Psychiatry* 19, 1085–1094. doi:10.1038/mp.2013.187

Bourdy, R., Sánchez-Catalán, M.-J., Kaufling, J., Balcita-Pedicino, J.J., Freund-Mercier, M.-J., Veinante, P., Sesack, S.R., Georges, F., Barrot, M., 2014. Control of the Nigrostriatal Dopamine Neuron Activity and Motor Function by the Tail of the Ventral Tegmental Area. *Neuropsychopharmacology*. doi:10.1038/npp.2014.129

Britt, J.P., Benaliouad, F., McDevitt, R.A., Stuber, G.D., Wise, R.A., Bonci, A., 2012. Synaptic and behavioral profile of multiple glutamatergic inputs to the nucleus accumbens. *Neuron* 76, 790–803. doi:10.1016/j.neuron.2012.09.040

Britt, J.P., Bonci, A., 2013. Optogenetic interrogations of the neural circuits underlying addiction. *Curr. Opin. Neurobiol.* 23, 539–545. doi:10.1016/j.conb.2013.01.010

Brochard, V., Combadière, B., Prigent, A., Laouar, Y., Perrin, A., Beray-Berthet, V., Bonduelle, O., Alvarez-Fischer, D., Callebert, J., Launay, J.-M., Duyckaerts, C., Flavell, R.A., Hirsch, E.C., Hunot, S., 2009. Infiltration of CD4+ lymphocytes into the brain contributes to neurodegeneration in a mouse model of Parkinson disease. *J. Clin. Invest.* 119, 182–192. doi:10.1172/JCI36470

Broglio, F., Gianotti, L., Destefanis, S., Fassino, S., Abbate Daga, G., Mondelli, V., Lanfranco, F., Gottero, C., Gauna, C., Hofland, L., Van der Lely, A.J., Ghigo, E., 2004a. The endocrine response to acute ghrelin administration is blunted in patients with anorexia nervosa, a ghrelin hypersecretory state. *Clin. Endocrinol. (Oxf.)* 60, 592–599. doi:10.1111/j.1365-2265.2004.02011.x

- Broglio, F., Gottero, C., Prodam, F., Gauna, C., Muccioli, G., Papotti, M., Aribat, T., Van Der Lely, A.J., Ghigo, E., 2004b. Non-acylated ghrelin counteracts the metabolic but not the neuroendocrine response to acylated ghrelin in humans. *J. Clin. Endocrinol. Metab.* 89, 3062–3065. doi:10.1210/jc.2003-031964
- Bromberg-Martin, E.S., Hikosaka, O., 2011. Lateral habenula neurons signal errors in the prediction of reward information. *Nat. Neurosci.* 14, 1209–1216. doi:10.1038/nn.2902
- Bromberg-Martin, E.S., Matsumoto, M., Hikosaka, O., 2010. Dopamine in motivational control: rewarding, aversive, and alerting. *Neuron* 68, 815–834. doi:10.1016/j.neuron.2010.11.022
- Bulgarelli, I., Tamiasso, L., Bresciani, E., Rapetti, D., Caporali, S., Lattuada, D., Locatelli, V., Torsello, A., 2009. Desacyl-ghrelin and synthetic GH-secretagogues modulate the production of inflammatory cytokines in mouse microglia cells stimulated by beta-amyloid fibrils. *J. Neurosci. Res.* 87, 2718–2727. doi:10.1002/jnr.22088
- Cabral, A., Fernandez, G., Perello, M., 2013. Analysis of brain nuclei accessible to ghrelin present in the cerebrospinal fluid. *Neuroscience* 253, 406–415. doi:10.1016/j.neuroscience.2013.09.008
- Calabresi, P., Picconi, B., Tozzi, A., Ghiglieri, V., Di Filippo, M., 2014. Direct and indirect pathways of basal ganglia: a critical reappraisal. *Nat. Neurosci.* 17, 1022–1030. doi:10.1038/nn.3743
- Callaghan, B., Furness, J.B., 2014. Novel and Conventional Receptors for Ghrelin, Desacyl-Ghrelin, and Pharmacologically Related Compounds. *Pharmacol. Rev.* 66, 984–1001. doi:10.1124/pr.113.008433
- Callesen, M.B., Scheel-Krüger, J., Kringelbach, M.L., Møller, A., 2013. A systematic review of impulse control disorders in Parkinson's disease. *J. Park. Dis.* 3, 105–138.
- Camiña, J.P., Lodeiro, M., Ischenko, O., Martini, A.C., Casanueva, F.F., 2007. Stimulation by ghrelin of p42/p44 mitogen-activated protein kinase through the GHS-R1a receptor: role of G-proteins and beta-arrestins. *J. Cell. Physiol.* 213, 187–200. doi:10.1002/jcp.21109
- Cardona Cano, S., Merkesteyn, M., Skibicka, K.P., Dickson, S.L., Adan, R.A.H., 2012. Role of ghrelin in the pathophysiology of eating disorders: implications for pharmacotherapy. *CNS Drugs* 26, 281–296. doi:10.2165/11599890-000000000-00000
- Carta, M., Carlsson, T., Muñoz, A., Kirik, D., Björklund, A., 2008. Serotonin-dopamine interaction in the induction and maintenance of L-DOPA-induced dyskinesias. *Prog. Brain Res.* 172, 465–478. doi:10.1016/S0079-6123(08)00922-9
- Cazorla, M., de Carvalho, F.D., Chohan, M.O., Shegda, M., Chuhma, N., Rayport, S., Ahmari, S.E., Moore, H., Kellendonk, C., 2014. Dopamine D2 receptors regulate the anatomical and functional balance of basal ganglia circuitry. *Neuron* 81, 153–164. doi:10.1016/j.neuron.2013.10.041
- Chartier-Harlin, M.-C., Kachergus, J., Roumier, C., Mouroux, V., Douay, X., Lincoln, S., Levecque, C., Larvor, L., Andrieux, J., Hulihan, M., Waucquier, N., Defebvre, L., Amouyel, P., Farrer, M., Destée, A., 2004. α -synuclein locus duplication as a cause of familial Parkinson's disease. *The Lancet* 364, 1167–1169. doi:10.1016/S0140-6736(04)17103-1

- Chow, K.B.S., Sun, J., Man Chu, K., Tai Cheung, W., Cheng, C.H.K., Wise, H., 2012. The truncated ghrelin receptor polypeptide (GHS-R1b) is localized in the endoplasmic reticulum where it forms heterodimers with ghrelin receptors (GHS-R1a) to attenuate their cell surface expression. *Mol. Cell. Endocrinol.* 348, 247–254. doi:10.1016/j.mce.2011.08.034
- Clarke, J., Ramoz, N., Fladung, A.-K., Gorwood, P., 2016. Higher reward value of starvation imagery in anorexia nervosa and association with the Val66Met BDNF polymorphism. *Transl. Psychiatry* 6, e829. doi:10.1038/tp.2016.98
- Cohen, J.Y., Haesler, S., Vong, L., Lowell, B.B., Uchida, N., 2012. Neuron-type-specific signals for reward and punishment in the ventral tegmental area. *Nature* 482, 85–88. doi:10.1038/nature10754
- Collden, G., Balland, E., Parkash, J., Caron, E., Langlet, F., Prevot, V., Bouret, S.G., 2015. Neonatal overnutrition causes early alterations in the central response to peripheral ghrelin. *Mol. Metab.* 4, 15–24. doi:10.1016/j.molmet.2014.10.003
- Cone, J.J., McCutcheon, J.E., Roitman, M.F., 2014. Ghrelin acts as an interface between physiological state and phasic dopamine signaling. *J. Neurosci. Off. J. Soc. Neurosci.* 34, 4905–4913. doi:10.1523/JNEUROSCI.4404-13.2014
- Connolly, B., Fox, S.H., 2014. Treatment of cognitive, psychiatric, and affective disorders associated with Parkinson's disease. *Neurother. J. Am. Soc. Exp. Neurother.* 11, 78–91. doi:10.1007/s13311-013-0238-x
- Corcuff, J.-B., Krim, E., Tison, F., Foubert-Sanier, A., Guehl, D., Burbaud, P., Cuny, E., Baillet, L., Gin, H., Rigalleau, V., Perlempine, C., 2006. Subthalamic nucleus stimulation in patients with Parkinson's disease does not increase serum ghrelin levels. *Br. J. Nutr.* 95, 1028–1029. doi:10.1079/BJN20051678
- Costa, J.L., Naot, D., Lin, J.-M., Watson, M., Callon, K.E., Reid, I.R., Grey, A.B., Cornish, J., 2011. Ghrelin is an Osteoblast Mitogen and Increases Osteoclastic Bone Resorption In Vitro. *Int. J. Pept.* 2011, 605193. doi:10.1155/2011/605193
- Cowley, M.A., Smith, R.G., Diano, S., Tschöp, M., Pronchuk, N., Grove, K.L., Strasburger, C.J., Bidlingmaier, M., Esterman, M., Heiman, M.L., others, 2003. The distribution and mechanism of action of ghrelin in the CNS demonstrates a novel hypothalamic circuit regulating energy homeostasis. *Neuron* 37, 649–661.
- Cummings, D.E., Purnell, J.Q., Frayo, R.S., Schmidova, K., Wisse, B.E., Weigle, D.S., 2001. A preprandial rise in plasma ghrelin levels suggests a role in meal initiation in humans. *Diabetes* 50, 1714–1719.
- Da Cunha, C., Boschen, S.L., Gómez-A, A., Ross, E.K., Gibson, W.S.J., Min, H.-K., Lee, K.H., Blaha, C.D., 2015. Toward sophisticated basal ganglia neuromodulation: Review on basal ganglia deep brain stimulation. *Neurosci. Biobehav. Rev.* 58, 186–210. doi:10.1016/j.neubiorev.2015.02.003
- Dahlström, A., Fuxe, K., 1964. Localization of monoamines in the lower brain stem. *Cell. Mol. Life Sci.* 20, 398–399.

- Date, Y., Nakazato, M., Murakami, N., Kojima, M., Kangawa, K., Matsukura, S., 2001. Ghrelin Acts in the Central Nervous System to Stimulate Gastric Acid Secretion. *Biochem. Biophys. Res. Commun.* 280, 904–907. doi:10.1006/bbrc.2000.4212
- Davis, C., 1997. Eating disorders and hyperactivity: a psychobiological perspective. *Can. J. Psychiatry Rev. Can. Psychiatr.* 42, 168–175.
- Davis, C., Kaptein, S., 2006. Anorexia nervosa with excessive exercise: a phenotype with close links to obsessive-compulsive disorder. *Psychiatry Res.* 142, 209–217. doi:10.1016/j.psychres.2005.11.006
- Davis, C., Woodside, D.B., 2002. Sensitivity to the rewarding effects of food and exercise in the eating disorders. *Compr. Psychiatry* 43, 189–194.
- Day, J.J., Jones, J.L., Wightman, R.M., Carelli, R.M., 2010. Phasic nucleus accumbens dopamine release encodes effort- and delay-related costs. *Biol. Psychiatry* 68, 306–309. doi:10.1016/j.biopsych.2010.03.026
- Delhanty, P.J.D., 2006. Ghrelin and unacylated ghrelin stimulate human osteoblast growth via mitogen-activated protein kinase (MAPK)/phosphoinositide 3-kinase (PI3K) pathways in the absence of GHS-R1a. *J. Endocrinol.* 188, 37–47. doi:10.1677/joe.1.06404
- Delhanty, P.J.D., Neggers, S.J., van der Lely, A.J., 2014. Should we consider des-acyl ghrelin as a separate hormone and if so, what does it do? *Front. Horm. Res.* 42, 163–174. doi:10.1159/000358345
- DeLong, M.R., 1990. Primate models of movement disorders of basal ganglia origin. *Trends Neurosci.* 13, 281–285.
- Delporte, C., 2013. Structure and Physiological Actions of Ghrelin. *Scientifica* 2013, 1–25. doi:10.1155/2013/518909
- Di Chiara, G., 2002. Nucleus accumbens shell and core dopamine: differential role in behavior and addiction. *Behav. Brain Res.* 137, 75–114.
- Diano, S., Farr, S.A., Benoit, S.C., McNay, E.C., da Silva, I., Horvath, B., Gaskin, F.S., Nonaka, N., Jaeger, L.B., Banks, W.A., Morley, J.E., Pinto, S., Sherwin, R.S., Xu, L., Yamada, K.A., Sleeman, M.W., Tschöp, M.H., Horvath, T.L., 2006. Ghrelin controls hippocampal spine synapse density and memory performance. *Nat. Neurosci.* 9, 381–388. doi:10.1038/nn1656
- Dickson, S.L., Egecioglu, E., Landgren, S., Skibicka, K.P., Engel, J.A., Jerlhag, E., 2011. The role of the central ghrelin system in reward from food and chemical drugs. *Mol. Cell. Endocrinol.* 340, 80–87. doi:10.1016/j.mce.2011.02.017
- Dong, J., Song, N., Xie, J., Jiang, H., 2009. Ghrelin Antagonized 1-Methyl-4-Phenylpyridinium (MPP+)-Induced Apoptosis in MES23.5 Cells. *J. Mol. Neurosci.* 37, 182–189. doi:10.1007/s12031-008-9162-7
- Dos Santos, V.V., Rodrigues, A.L.S., De Lima, T.C., de Barioglio, S.R., Raisman-Vozari, R., Prediger, R.D., 2013. Ghrelin as a neuroprotective and palliative agent in Alzheimer's and Parkinson's disease. *Curr. Pharm. Des.* 19, 6773–6790.

- Drazen, D.L., Vahl, T.P., D'Alessio, D.A., Seeley, R.J., Woods, S.C., 2006. Effects of a fixed meal pattern on ghrelin secretion: evidence for a learned response independent of nutrient status. *Endocrinology* 147, 23–30. doi:10.1210/en.2005-0973
- Egecioglu, E., Jerlhag, E., Salomé, N., Skibicka, K.P., Haage, D., Bohlooly-Y, M., Andersson, D., Bjursell, M., Perrissoud, D., Engel, J.A., Dickson, S.L., 2010. Ghrelin increases intake of rewarding food in rodents. *Addict. Biol.* 15, 304–311. doi:10.1111/j.1369-1600.2010.00216.x
- Ejskjaer, N., Dimcevski, G., Wo, J., Hellström, P.M., Gormsen, L.C., Sarosiek, I., Søfteland, E., Nowak, T., Pezzullo, J.C., Shaughnessy, L., Kosutic, G., McCallum, R., 2010. Safety and efficacy of ghrelin agonist TZP-101 in relieving symptoms in patients with diabetic gastroparesis: a randomized, placebo-controlled study. *Neurogastroenterol. Motil. Off. J. Eur. Gastrointest. Motil. Soc.* 22, 1069-e281. doi:10.1111/j.1365-2982.2010.01519.x
- Ejskjaer, N., Wo, J.M., Esfandyari, T., Mazen Jamal, M., Dimcevski, G., Tarnow, L., Malik, R.A., Hellström, P.M., Mondou, E., Quinn, J., Rousseau, F., McCallum, R.W., 2013. A phase 2a, randomized, double-blind 28-day study of TZP-102 a ghrelin receptor agonist for diabetic gastroparesis. *Neurogastroenterol. Motil. Off. J. Eur. Gastrointest. Motil. Soc.* 25, e140-150. doi:10.1111/nmo.12064
- Erdur, L., Kallenbach-Dermutz, B., Lehmann, V., Zimmermann-Viehoff, F., Köpp, W., Weber, C., Deter, H.-C., 2012. Somatic comorbidity in anorexia nervosa: First results of a 21-year follow-up study on female inpatients. *Biopsychosoc. Med.* 6, 4. doi:10.1186/1751-0759-6-4
- Evans, A.H., Lawrence, A.D., Potts, J., MacGregor, L., Katzenschlager, R., Shaw, K., Zijlmans, J., Lees, A.J., 2006. Relationship between impulsive sensation seeking traits, smoking, alcohol and caffeine intake, and Parkinson's disease. *J. Neurol. Neurosurg. Psychiatry* 77, 317–321. doi:10.1136/jnnp.2005.065417
- Ferreira, J.G.P., Del-Fava, F., Hasue, R.H., Shammah-Lagnado, S.J., 2008. Organization of ventral tegmental area projections to the ventral tegmental area–nigral complex in the rat. *Neuroscience* 153, 196–213. doi:10.1016/j.neuroscience.2008.02.003
- Fiorino, D.F., Phillips, A.G., 1999a. Facilitation of sexual behavior and enhanced dopamine efflux in the nucleus accumbens of male rats after D-amphetamine-induced behavioral sensitization. *J. Neurosci. Off. J. Soc. Neurosci.* 19, 456–463.
- Fiorino, D.F., Phillips, A.G., 1999b. Facilitation of sexual behavior in male rats following d-amphetamine-induced behavioral sensitization. *Psychopharmacology (Berl.)* 142, 200–208.
- Fischer, U., Michałowska, M., Baranowska, B., Wolińska-Witort, E., Jeske, W., Jethon, M., Piaścik-Gromada, M., Marcinowska-Suchowierska, E., 2010. Leptin and ghrelin concentrations and weight loss in Parkinson's disease. *Acta Neurol. Scand.* 121, 230–236. doi:10.1111/j.1600-0404.2009.01185.x
- Fladung, A.-K., Schulze, U.M.E., Schöll, F., Bauer, K., Grön, G., 2013. Role of the ventral striatum in developing anorexia nervosa. *Transl. Psychiatry* 3, e315. doi:10.1038/tp.2013.88
- Frago, L., 2011. Neuroprotective actions of ghrelin and growth hormone secretagogues. *Front. Mol. Neurosci.* 4. doi:10.3389/fnmol.2011.00023
- François, M., Barde, S., Achamrah, N., Breton, J., do Rego, J.-C., Coëffier, M., Hökfelt, T., Déchelotte, P., Fetissov, S.O., 2015. The number of preproghrelin mRNA expressing cells is

increased in mice with activity-based anorexia. *Neuropeptides* 51, 17–23. doi:10.1016/j.npep.2015.04.003

Frank, G.K., Bailer, U.F., Henry, S.E., Drevets, W., Meltzer, C.C., Price, J.C., Mathis, C.A., Wagner, A., Hoge, J., Ziolko, S., Barbarich-Marsteller, N., Weissfeld, L., Kaye, W.H., 2005. Increased dopamine D2/D3 receptor binding after recovery from anorexia nervosa measured by positron emission tomography and [¹¹C]raclopride. *Biol. Psychiatry* 58, 908–912. doi:10.1016/j.biopsych.2005.05.003

Frank, G.K.W., Reynolds, J.R., Shott, M.E., Jappe, L., Yang, T.T., Tregellas, J.R., O'Reilly, R.C., 2012. Anorexia nervosa and obesity are associated with opposite brain reward response. *Neuropsychopharmacol. Off. Publ. Am. Coll. Neuropsychopharmacol.* 37, 2031–2046. doi:10.1038/npp.2012.51

Furness, J.B., Hunne, B., Matsuda, N., Yin, L., Russo, D., Kato, I., Fujimiya, M., Patterson, M., McLeod, J., Andrews, Z.B., Bron, R., 2011. Investigation of the presence of ghrelin in the central nervous system of the rat and mouse. *Neuroscience* 193, 1–9. doi:10.1016/j.neuroscience.2011.07.063

Gates, M.A., Torres, E.M., White, A., Fricker-Gates, R.A., Dunnett, S.B., 2006. Re-examining the ontogeny of substantia nigra dopamine neurons. *Eur. J. Neurosci.* 23, 1384–1390. doi:10.1111/j.1460-9568.2006.04637.x

Gauna, C., Delhanty, P.J.D., Hofland, L.J., Janssen, J.A.M.J.L., Broglio, F., Ross, R.J.M., Ghigo, E., van der Lely, A.J., 2005. Ghrelin stimulates, whereas des-octanoyl ghrelin inhibits, glucose output by primary hepatocytes. *J. Clin. Endocrinol. Metab.* 90, 1055–1060. doi:10.1210/jc.2004-1069

Germain, N., Galusca, B., Grouselle, D., Frere, D., Billard, S., Epelbaum, J., Estour, B., 2010. Ghrelin and obestatin circadian levels differentiate bingeing-purging from restrictive anorexia nervosa. *J. Clin. Endocrinol. Metab.* 95, 3057–3062. doi:10.1210/jc.2009-2196

Germain, N., Galusca, B., Grouselle, D., Frere, D., Tolle, V., Zizzari, P., Lang, F., Epelbaum, J., Estour, B., 2009. Ghrelin/obestatin ratio in two populations with low bodyweight: constitutional thinness and anorexia nervosa. *Psychoneuroendocrinology* 34, 413–419. doi:10.1016/j.psyneuen.2008.10.001

Gershon, E., Vale, W.W., 2014. CRF type 2 receptors mediate the metabolic effects of ghrelin in C2C12 cells. *Obes. Silver Spring Md* 22, 380–389. doi:10.1002/oby.20535

Gervasini, G., Gordillo, I., García-Herráiz, A., Flores, I., Jiménez, M., Monge, M., Carrillo, J.A., 2013. Influence of dopamine polymorphisms on the risk for anorexia nervosa and associated psychopathological features. *J. Clin. Psychopharmacol.* 33, 551–555. doi:10.1097/JCP.0b013e3182970469

Ghigo, E., Broglio, F., Arvat, E., Maccario, M., Papotti, M., Muccioli, G., 2005. Ghrelin: more than a natural GH secretagogue and/or an orexigenic factor. *Clin. Endocrinol. (Oxf.)* 62, 1–17. doi:10.1111/j.1365-2265.2004.02160.x

Ghods-Sharifi, S., Floresco, S.B., 2010. Differential effects on effort discounting induced by inactivations of the nucleus accumbens core or shell. *Behav. Neurosci.* 124, 179–191. doi:10.1037/a0018932

- Gnanapavan, S., Kola B, Bustin SA, Morris DG, McGee P, Fairclough P, Bhattacharya S, Carpenter R, Grossman AB, Korbonits M, 2002. The tissue distribution of the mRNA of the ghrelin and subtypes of its receptor, GHS-R, in humans. *J. Clin. Endocrinol. Metab.* 87, 2988–2991.
- Goldstein, J.L., Zhao, T.–., Li, R.L., Sherbet, D.P., Liang, G., Brown, M.S., 2011. Surviving starvation: essential role of the ghrelin-growth hormone axis. *Cold Spring Harb. Symp. Quant. Biol.* 76, 121–127. doi:10.1101/sqb.2011.76.010447
- Gorwood, P., Richard-Devantoy, S., Sentissi, O., Le Strat, Y., Olié, J.P., 2016. The number of past manic episodes is the best predictor of antidepressant-emergent manic switch in a cohort of bipolar depressed patients. *Psychiatry Res.* 240, 288–294. doi:10.1016/j.psychres.2016.04.071
- Granata, R., Settanni, F., Biancone, L., Trovato, L., Nano, R., Bertuzzi, F., Destefanis, S., Annunziata, M., Martinetti, M., Catapano, F., Ghè, C., Isgaard, J., Papotti, M., Ghigo, E., Muccioli, G., 2007. Acylated and unacylated ghrelin promote proliferation and inhibit apoptosis of pancreatic beta-cells and human islets: involvement of 3',5'-cyclic adenosine monophosphate/protein kinase A, extracellular signal-regulated kinase 1/2, and phosphatidylinositol 3-Kinase/Akt signaling. *Endocrinology* 148, 512–529. doi:10.1210/en.2006-0266
- Gray, M.T., Woulfe, J.M., 2015. Striatal blood-brain barrier permeability in Parkinson's disease. *J. Cereb. Blood Flow Metab. Off. J. Int. Soc. Cereb. Blood Flow Metab.* 35, 747–750. doi:10.1038/jcbfm.2015.32
- Guan, X.-M., Yu, H., Palyha, O.C., McKee, K.K., Feighner, S.D., Sirinathsinghji, D.J., Smith, R.G., Van der Ploeg, L.H., Howard, A.D., 1997. Distribution of mRNA encoding the growth hormone secretagogue receptor in brain and peripheral tissues. *Mol. Brain Res.* 48, 23–29.
- Guatteo, E., Cucchiaroni, M.L., Mercuri, N.B., 2009. Substantia nigra control of basal ganglia nuclei. *J. Neural Transm. Suppl.* 91–101.
- Gutierrez, J.A., Solenberg, P.J., Perkins, D.R., Willency, J.A., Knierman, M.D., Jin, Z., Witcher, D.R., Luo, S., Onyia, J.E., Hale, J.E., 2008. Ghrelin octanoylation mediated by an orphan lipid transferase. *Proc. Natl. Acad. Sci.* 105, 6320–6325.
- Haber, S.N., 2014. The place of dopamine in the cortico-basal ganglia circuit. *Neuroscience* 282, 248–257. doi:10.1016/j.neuroscience.2014.10.008
- Haber, S.N., Fudge, J.L., 1997. The primate substantia nigra and VTA: integrative circuitry and function. *Crit. Rev. Neurobiol.* 11, 323–342.
- Haber, S.N., Knutson, B., 2010. The reward circuit: linking primate anatomy and human imaging. *Neuropsychopharmacol. Off. Publ. Am. Coll. Neuropsychopharmacol.* 35, 4–26. doi:10.1038/npp.2009.129
- Heimer, L., Zahm, D.S., Churchill, L., Kalivas, P.W., Wohltmann, C., 1991. Specificity in the projection patterns of accumbal core and shell in the rat. *Neuroscience* 41, 89–125.
- Heusner, C.L., Hnasko, T.S., Szczyepka, M.S., Liu, Y., During, M.J., Palmiter, R.D., 2003. Viral restoration of dopamine to the nucleus accumbens is sufficient to induce a locomotor response to amphetamine. *Brain Res.* 980, 266–274.

- Holst, B., Cygankiewicz, A., Jensen, T.H., Ankersen, M., Schwartz, T.W., 2003. High Constitutive Signaling of the Ghrelin Receptor—Identification of a Potent Inverse Agonist. *Mol. Endocrinol.* 17, 2201–2210. doi:10.1210/me.2003-0069
- Hotta, M., Ohwada, R., Akamizu, T., Shibasaki, T., Takano, K., Kangawa, K., 2009. Ghrelin increases hunger and food intake in patients with restricting-type anorexia nervosa: a pilot study. *Endocr. J.* 56, 1119–1128.
- Howard, A., Feighner, S., Cully, D., Arena, J., Liberators, P., Rosenbaum, C., Hamelin, M., Hreniuk, D., Palyha, O., Anderson, J., Paress, P., Diaz, C., Chou, M., Liu, K., McKee, K., Pong, S., Chaung, L., Elbrecht, A., Dashkevich, M., Heavens, R., Rigby, M., Sirinathsinghji, D., Dean, D., Melillo, D., Patchett, A., Nargund, R., Griffin, P., DeMartino, J., Gupta, S., Schaeffer, J., Smith, R., Van der Ploeg, L., 1996. A receptor in pituitary and hypothalamus that functions in growth hormone release. 16 August 1996 273, 974–977.
- Hu, Z., Cooper, M., Crockett, D.P., Zhou, R., 2004. Differentiation of the midbrain dopaminergic pathways during mouse development. *J. Comp. Neurol.* 476, 301–311. doi:10.1002/cne.20230
- Hwang, S., Moon, M., Kim, S., Hwang, L., Ahn, K.J., Park, S., 2009. Neuroprotective effect of ghrelin is associated with decreased expression of prostate apoptosis response-4. *Endocr. J.* 56, 609–617.
- Hyman, S., Chisholm, D., Kessler, R., Patel, V., Whiteford, H., 2006. Mental Disorders, in: Jamison, D.T., Breman, J.G., Measham, A.R., Alleyne, G., Claeson, M., Evans, D.B., Jha, P., Mills, A., Musgrove, P. (Eds.), *Disease Control Priorities in Developing Countries*. World Bank, Washington (DC).
- Ikemoto, S., 2007. Dopamine reward circuitry: two projection systems from the ventral midbrain to the nucleus accumbens—olfactory tubercle complex. *Brain Res. Rev.* 56, 27–78.
- Ikemoto, S., Yang, C., Tan, A., 2015. Basal ganglia circuit loops, dopamine and motivation: A review and enquiry. *Behav. Brain Res.* 290, 17–31. doi:10.1016/j.bbr.2015.04.018
- Ilango, A., Shumake, J., Wetzel, W., Ohl, F.W., 2014. Contribution of emotional and motivational neurocircuitry to cue-signaled active avoidance learning. *Front. Behav. Neurosci.* 8, 372. doi:10.3389/fnbeh.2014.00372
- Jerlhag, E., Eggecioglu, E., Dickson, S.L., Andersson, M., Svensson, L., Engel, J.A., 2006. Ghrelin stimulates locomotor activity and accumbal dopamine-overflow via central cholinergic systems in mice: implications for its involvement in brain reward. *Addict. Biol.* 11, 45–54. doi:10.1111/j.1369-1600.2006.00002.x
- Jerlhag, E., Eggecioglu, E., Dickson, S.L., Douhan, A., Svensson, L., Engel, J.A., 2007. Ghrelin administration into tegmental areas stimulates locomotor activity and increases extracellular concentration of dopamine in the nucleus accumbens. *Addict. Biol.* 12, 6–16. doi:10.1111/j.1369-1600.2006.00041.x
- Jerlhag, E., Eggecioglu, E., Dickson, S.L., Engel, J.A., 2011. Glutamatergic regulation of ghrelin-induced activation of the mesolimbic dopamine system. *Addict. Biol.* 16, 82–91. doi:10.1111/j.1369-1600.2010.00231.x

- Jiang, H., Betancourt, L., Smith, R.G., 2006. Ghrelin Amplifies Dopamine Signaling by Cross Talk Involving Formation of Growth Hormone Secretagogue Receptor/Dopamine Receptor Subtype 1 Heterodimers. *Mol. Endocrinol.* 20, 1772–1785. doi:10.1210/me.2005-0084
- Johnson, P.M., Kenny, P.J., 2010. Dopamine D2 receptors in addiction-like reward dysfunction and compulsive eating in obese rats. *Nat. Neurosci.* 13, 635–641. doi:10.1038/nn.2519
- Kamegai, J., Wakabayashi, I., Kineman, R.D., Frohman, L.A., 1999. Growth hormone-releasing hormone receptor (GHRH-R) and growth hormone secretagogue receptor (GHS-R) mRNA levels during postnatal development in male and female rats. *J. Neuroendocrinol.* 11, 299–306.
- Karasawa, H., Pietra, C., Giuliano, C., Garcia-Rubio, S., Xu, X., Yakabi, S., Taché, Y., Wang, L., 2014. New ghrelin agonist, HM01 alleviates constipation and L-dopa-delayed gastric emptying in 6-hydroxydopamine rat model of Parkinson's disease. *Neurogastroenterol. Motil.* n/a-n/a. doi:10.1111/nmo.12459
- Kask, J., Ekselius, L., Brandt, L., Kollia, N., Ekblom, A., Papadopoulos, F.C., 2016. Mortality in Women With Anorexia Nervosa: The Role of Comorbid Psychiatric Disorders. *Psychosom. Med.* doi:10.1097/PSY.0000000000000342
- Kawahara, Y., Kaneko, F., Yamada, M., Kishikawa, Y., Kawahara, H., Nishi, A., 2013. Food reward-sensitive interaction of ghrelin and opioid receptor pathways in mesolimbic dopamine system. *Neuropharmacology* 67, 395–402. doi:10.1016/j.neuropharm.2012.11.022
- Kawahara, Y., Kawahara, H., Kaneko, F., Yamada, M., Nishi, Y., Tanaka, E., Nishi, A., 2009. Peripherally administered ghrelin induces bimodal effects on the mesolimbic dopamine system depending on food-consumptive states. *Neuroscience* 161, 855–864. doi:10.1016/j.neuroscience.2009.03.086
- Kaye, W.H., Frank, G.K., McConaha, C., 1999. Altered dopamine activity after recovery from restricting-type anorexia nervosa. *Neuropsychopharmacol. Off. Publ. Am. Coll. Neuropsychopharmacol.* 21, 503–506. doi:10.1016/S0893-133X(99)00053-6
- Kaye, W.H., Fudge, J.L., Paulus, M., 2009. New insights into symptoms and neurocircuit function of anorexia nervosa. *Nat. Rev. Neurosci.* 10, 573–584. doi:10.1038/nrn2682
- Kaye, W.H., Wierenga, C.E., Bailer, U.F., Simmons, A.N., Bischoff-Grethe, A., 2013. Nothing tastes as good as skinny feels: the neurobiology of anorexia nervosa. *Trends Neurosci.* 36, 110–120. doi:10.1016/j.tins.2013.01.003
- Keen-Rhinehart, E., Bartness, T.J., 2005. Peripheral ghrelin injections stimulate food intake, foraging, and food hoarding in Siberian hamsters. *Am. J. Physiol. Regul. Integr. Comp. Physiol.* 288, R716-722. doi:10.1152/ajpregu.00705.2004
- Kern, A., Albarran-Zeckler, R., Walsh, H.E., Smith, R.G., 2012. Apo-Ghrelin Receptor Forms Heteromers with DRD2 in Hypothalamic Neurons and Is Essential for Anorexigenic Effects of DRD2 Agonism. *Neuron* 73, 317–332. doi:10.1016/j.neuron.2011.10.038
- Kim, J.H., Vezina, P., 1999. Blockade of glutamate reuptake in the rat nucleus accumbens increases locomotor activity. *Brain Res.* 819, 165–169.

- Kim, M.S., Yoon, C.Y., Jang, P.G., Park, Y.J., Shin, C.S., Park, H.S., Ryu, J.W., Pak, Y.K., Park, J.Y., Lee, K.U., Kim, S.Y., Lee, H.K., Kim, Y.B., Park, K.S., 2004. The mitogenic and antiapoptotic actions of ghrelin in 3T3-L1 adipocytes. *Mol. Endocrinol. Baltim. Md* 18, 2291–2301. doi:10.1210/me.2003-0459
- Kohl, M., Foulon, C., Guelfi, J.-D., 2004. [Hyperactivity and anorexia nervosa: behavioural and biological perspective]. *L'Encéphale* 30, 492–499.
- Kojima, M., Hosoda, H., Date, Y., Nakazato, M., Matsuo, H., 1999. Ghrelin is a growth-hormone-releasing acylated peptide from stomach. *Nature* 402, 656–660.
- Kojima, M., Kangawa, K., 2005. Ghrelin: structure and function. *Physiol. Rev.* 85, 495–522. doi:10.1152/physrev.00012.2004
- Kontis, D., Theochari, E., 2012. Dopamine in anorexia nervosa: a systematic review. *Behav. Pharmacol.* 23, 496–515. doi:10.1097/FBP.0b013e328357e115
- Kortekaas, R., Leenders, K.L., van Oostrom, J.C.H., Vaalburg, W., Bart, J., Willemsen, A.T.M., Hendrikse, N.H., 2005. Blood-brain barrier dysfunction in parkinsonian midbrain in vivo. *Ann. Neurol.* 57, 176–179. doi:10.1002/ana.20369
- Labarthe, A., Fiquet, O., Hassouna, R., Zizzari, P., Lanfumey, L., Ramoz, N., Grouselle, D., Epelbaum, J., Tolle, V., 2014. Ghrelin-Derived Peptides: A Link between Appetite/Reward, GH Axis, and Psychiatric Disorders? *Front. Endocrinol.* 5. doi:10.3389/fendo.2014.00163
- Lage, R., Vázquez, M.J., Varela, L., Saha, A.K., Vidal-Puig, A., Nogueiras, R., Diéguez, C., López, M., 2010. Ghrelin effects on neuropeptides in the rat hypothalamus depend on fatty acid metabolism actions on BSX but not on gender. *FASEB J.* 24, 2670–2679. doi:10.1096/fj.09-150672
- Lammel, S., Hetzel, A., Häckel, O., Jones, I., Liss, B., Roeper, J., 2008. Unique properties of mesoprefrontal neurons within a dual mesocorticolimbic dopamine system. *Neuron* 57, 760–773. doi:10.1016/j.neuron.2008.01.022
- Lammel, S., Steinberg, E.E., Földy, C., Wall, N.R., Beier, K., Luo, L., Malenka, R.C., 2015. Diversity of transgenic mouse models for selective targeting of midbrain dopamine neurons. *Neuron* 85, 429–438. doi:10.1016/j.neuron.2014.12.036
- Lammel, S., Tye, K.M., Warden, M.R., 2014. Progress in understanding mood disorders: optogenetic dissection of neural circuits. *Genes Brain Behav.* 13, 38–51. doi:10.1111/gbb.12049
- Lanciego, J.L., Luquin, N., Obeso, J.A., 2012. Functional neuroanatomy of the basal ganglia. *Cold Spring Harb. Perspect. Med.* 2, a009621. doi:10.1101/cshperspect.a009621
- Lawrence, A.D., Evans, A.H., Lees, A.J., 2003. Compulsive use of dopamine replacement therapy in Parkinson's disease: reward systems gone awry? *Lancet Neurol.* 2, 595–604.
- Lees, A.J., Selikhova, M., Andrade, L.A., Duyckaerts, C., 2008. The black stuff and Konstantin Nikolaevich Tretiakoff. *Mov. Disord. Off. J. Mov. Disord. Soc.* 23, 777–783. doi:10.1002/mds.21855
- Legrand, R., Lucas, N., Breton, J., Azhar, S., do Rego, J.-C., Déchelotte, P., Coëffier, M., Fetissov, S.O., 2016. Ghrelin treatment prevents development of activity based anorexia in

- mice. *Eur. Neuropsychopharmacol. J. Eur. Coll. Neuropsychopharmacol.* 26, 948–958. doi:10.1016/j.euroneuro.2016.03.010
- Lemarié, F., Beauchamp, E., Legrand, P., Rioux, V., 2016. Revisiting the metabolism and physiological functions of caprylic acid (C8:0) with special focus on ghrelin octanoylation. *Biochimie* 120, 40–48. doi:10.1016/j.biochi.2015.08.002
- Levin, F., Edholm, T., Schmidt, P.T., Grybäck, P., Jacobsson, H., Degerblad, M., Höybye, C., Holst, J.J., Rehfeld, J.F., Hellström, P.M., Näslund, E., 2006. Ghrelin Stimulates Gastric Emptying and Hunger in Normal-Weight Humans. *J. Clin. Endocrinol. Metab.* 91, 3296–3302. doi:10.1210/jc.2005-2638
- Lewy, F., 1912. Paralysis agitans. I. Pathologische Anatomie, in: *Handbuch der Neurologie*. Lewandowski M, Berlin: Springer Verlag, pp. 920–933.
- Leyton, M., Boileau, I., Benkelfat, C., Diksic, M., Baker, G., Dagher, A., 2002. Amphetamine-induced increases in extracellular dopamine, drug wanting, and novelty seeking: a PET/[11C]raclopride study in healthy men. *Neuropsychopharmacol. Off. Publ. Am. Coll. Neuropsychopharmacol.* 27, 1027–1035. doi:10.1016/S0893-133X(02)00366-4
- Li, X., Qi, J., Yamaguchi, T., Wang, H.-L., Morales, M., 2013. Heterogeneous composition of dopamine neurons of the rat A10 region: molecular evidence for diverse signaling properties. *Brain Struct. Funct.* 218, 1159–1176. doi:10.1007/s00429-012-0452-z
- Livak, K.J., Schmittgen, T.D., 2001. Analysis of relative gene expression data using real-time quantitative PCR and the 2^{(-Delta Delta C(T))} Method. *Methods San Diego Calif* 25, 402–408. doi:10.1006/meth.2001.1262
- Lockie, S.H., Andrews, Z.B., 2013. The hormonal signature of energy deficit: Increasing the value of food reward. *Mol. Metab.* 2, 329–336. doi:10.1016/j.molmet.2013.08.003
- Majchrzak, K., Pawłowski, K.M., Orzechowska, E.J., Dolka, I., Mucha, J., Motyl, T., Król, M., 2012. A role of ghrelin in canine mammary carcinoma cells proliferation, apoptosis and migration. *BMC Vet. Res.* 8, 170. doi:10.1186/1746-6148-8-170
- Maldonado-Irizarry, C.S., Kelley, A.E., 1995. Excitotoxic lesions of the core and shell subregions of the nucleus accumbens differentially disrupt body weight regulation and motor activity in rat. *Brain Res. Bull.* 38, 551–559.
- Mani, B.K., Walker, A.K., Lopez Soto, E.J., Raingo, J., Lee, C.E., Perelló, M., Andrews, Z.B., Zigman, J.M., 2014. Neuroanatomical characterization of a growth hormone secretagogue receptor-green fluorescent protein reporter mouse: Characterization of Ghslr-egfp reporter mouse. *J. Comp. Neurol.* 522, 3644–3666. doi:10.1002/cne.23627
- Markaki, E., Ellul, J., Kefalopoulou, Z., Trachani, E., Theodoropoulou, A., Kyriazopoulou, V., Constantoyannis, C., 2012. The Role of Ghrelin, Neuropeptide Y and Leptin Peptides in Weight Gain after Deep Brain Stimulation for Parkinson's Disease. *Stereotact. Funct. Neurosurg.* 90, 104–112. doi:10.1159/000335045
- Marrinan, S., Emmanuel, A.V., Burn, D.J., 2014. Delayed gastric emptying in Parkinson's disease: Delayed Gastric Emptying in PD. *Mov. Disord.* 29, 23–32. doi:10.1002/mds.25708

- Martins, L., Fernández-Mallo, D., Novelle, M.G., Vázquez, M.J., Tena-Sempere, M., Nogueiras, R., López, M., Diéguez, C., 2012. Hypothalamic mTOR Signaling Mediates the Orexigenic Action of Ghrelin. *PLoS ONE* 7. doi:10.1371/journal.pone.0046923
- Mary, S., Fehrentz, J.-A., Damian, M., Gaibelet, G., Orcel, H., Verdié, P., Mouillac, B., Martinez, J., Marie, J., Banères, J.-L., 2013. Heterodimerization with Its Splice Variant Blocks the Ghrelin Receptor 1a in a Non-signaling Conformation. *J. Biol. Chem.* 288, 24656–24665. doi:10.1074/jbc.M113.453423
- Maswood, N., Young, J., Tilmont, E., Zhang, Z., Gash, D.M., Gerhardt, G.A., Grondin, R., Roth, G.S., Mattison, J., Lane, M.A., Carson, R.E., Cohen, R.M., Mouton, P.R., Quigley, C., Mattson, M.P., Ingram, D.K., 2004. Caloric restriction increases neurotrophic factor levels and attenuates neurochemical and behavioral deficits in a primate model of Parkinson's disease. *Proc. Natl. Acad. Sci. U. S. A.* 101, 18171–18176. doi:10.1073/pnas.0405831102
- McCallum, R.W., Lembo, A., Esfandyari, T., Bhandari, B.R., Ejksjaer, N., Cosentino, C., Helton, N., Mondou, E., Quinn, J., Rousseau, F., The TZP-102 Phase 2b Study Group, 2013. Phase 2b, randomized, double-blind 12-week studies of TZP-102, a ghrelin receptor agonist for diabetic gastroparesis. *Neurogastroenterol. Motil.* 25, e705–e717. doi:10.1111/nmo.12184
- McFarlane, M.R., Brown, M.S., Goldstein, J.L., Zhao, T.-J., 2014. Induced ablation of ghrelin cells in adult mice does not decrease food intake, body weight, or response to high-fat diet. *Cell Metab.* 20, 54–60. doi:10.1016/j.cmet.2014.04.007
- Mear, Y., Enjalbert, A., Thirion, S., 2013. GHS-R1a constitutive activity and its physiological relevance. *Front. Neurosci.* 7. doi:10.3389/fnins.2013.00087
- Méquinion, M., Caron, E., Zgheib, S., Stievenard, A., Zizzari, P., Tolle, V., Cortet, B., Lucas, S., Prévot, V., Chauveau, C., Viltart, O., 2015. Physical activity: benefit or weakness in metabolic adaptations in a mouse model of chronic food restriction? *Am. J. Physiol. - Endocrinol. Metab.* 308, E241–E255. doi:10.1152/ajpendo.00340.2014
- Méquinion, M., Langlet, F., Zgheib, S., Dickson, S., Dehouck, B., Chauveau, C., Viltart, O., 2013. Ghrelin: Central and Peripheral Implications in Anorexia Nervosa. *Front. Endocrinol.* 4. doi:10.3389/fendo.2013.00015
- Merkestein, M., Brans, M.A.D., Luijendijk, M.C.M., de Jong, J.W., Egecioglu, E., Dickson, S.L., Adan, R.A.H., 2012. Ghrelin Mediates Anticipation to a Palatable Meal in Rats. *Obesity* 20, 963–971. doi:10.1038/oby.2011.389
- Miljic, D., Pekic, S., Djurovic, M., Doknic, M., Milic, N., Casanueva, F.F., Ghatei, M., Popovic, V., 2006. Ghrelin has partial or no effect on appetite, growth hormone, prolactin, and cortisol release in patients with anorexia nervosa. *J. Clin. Endocrinol. Metab.* 91, 1491–1495. doi:10.1210/jc.2005-2304
- Missale, C., Nash, S.R., Robinson, S.W., Jaber, M., Caron, M.G., 1998. Dopamine receptors: from structure to function. *Physiol. Rev.* 78, 189–225.
- Mistlberger, R.E., 1994. Circadian food-anticipatory activity: formal models and physiological mechanisms. *Neurosci. Biobehav. Rev.* 18, 171–195.

- Moon, M., Kim, H.G., Hwang, L., Seo, J.-H., Kim, S., Hwang, S., Kim, S., Lee, D., Chung, H., Oh, M.S., Lee, K.-T., Park, S., 2009. Neuroprotective Effect of Ghrelin in the 1-Methyl-4-Phenyl-1,2,3,6-Tetrahydropyridine Mouse Model of Parkinson's Disease by Blocking Microglial Activation. *Neurotox. Res.* 15, 332–347. doi:10.1007/s12640-009-9037-x
- Müller, T.D., Nogueiras, R., Andermann, M.L., Andrews, Z.B., Anker, S.D., Argente, J., Batterham, R.L., Benoit, S.C., Bowers, C.Y., Broglio, F., Casanueva, F.F., D'Alessio, D., Depoortere, I., Geliebter, A., Ghigo, E., Cole, P.A., Cowley, M., Cummings, D.E., Dagher, A., Diano, S., Dickson, S.L., Diéguez, C., Granata, R., Grill, H.J., Grove, K., Habegger, K.M., Heppner, K., Heiman, M.L., Holsen, L., Holst, B., Inui, A., Jansson, J.O., Kirchner, H., Korbonits, M., Laferrère, B., LeRoux, C.W., Lopez, M., Morin, S., Nakazato, M., Nass, R., Perez-Tilve, D., Pfluger, P.T., Schwartz, T.W., Seeley, R.J., Sleeman, M., Sun, Y., Sussel, L., Tong, J., Thorner, M.O., van der Lely, A.J., van der Ploeg, L.H.T., Zigman, J.M., Kojima, M., Kangawa, K., Smith, R.G., Horvath, T., Tschöp, M.H., 2015. Ghrelin. *Mol. Metab.* 4, 437–460. doi:10.1016/j.molmet.2015.03.005
- Mutez, E., Larvor, L., Leprêtre, F., Mouroux, V., Hamalek, D., Kerckaert, J.-P., Pérez-Tur, J., Waucquier, N., Vanbesien-Mailliot, C., Duflot, A., Devos, D., Defebvre, L., Kreisler, A., Frigard, B., Destée, A., Chartier-Harlin, M.-C., 2011. Transcriptional profile of Parkinson blood mononuclear cells with LRRK2 mutation. *Neurobiol. Aging* 32, 1839–1848. doi:10.1016/j.neurobiolaging.2009.10.016
- Mutez, E., Nkiliza, A., Belarbi, K., de Broucker, A., Vanbesien-Mailliot, C., Bleuse, S., Duflot, A., Comptdaer, T., Semaille, P., Blervaque, R., Hot, D., Leprêtre, F., Figeac, M., Destée, A., Chartier-Harlin, M.-C., 2014. Involvement of the immune system, endocytosis and EIF2 signaling in both genetically determined and sporadic forms of Parkinson's disease. *Neurobiol. Dis.* 63, 165–170. doi:10.1016/j.nbd.2013.11.007
- Nair-Roberts, R.G., Chatelain-Badie, S.D., Benson, E., White-Cooper, H., Bolam, J.P., Ungless, M.A., 2008. Stereological estimates of dopaminergic, GABAergic and glutamatergic neurons in the ventral tegmental area, substantia nigra and retrorubral field in the rat. *Neuroscience* 152, 1024–1031. doi:10.1016/j.neuroscience.2008.01.046
- Naleid, A.M., Grace, M.K., Cummings, D.E., Levine, A.S., 2005. Ghrelin induces feeding in the mesolimbic reward pathway between the ventral tegmental area and the nucleus accumbens. *Peptides* 26, 2274–2279. doi:10.1016/j.peptides.2005.04.025
- Ng, K.Y., Chase, T.N., Colburn, R.W., Kopin, I.J., 1970. L-Dopa-induced release of cerebral monoamines. *Science* 170, 76–77.
- Ng, K.Y., Colburn, R.W., Kopin, I.J., 1971. Effects of L-dopa on efflux of cerebral monoamines from synaptosomes. *Nature* 230, 331–332.
- Nishi, Y., Mifune, H., Yabuki, A., Tajiri, Y., Hirata, R., Tanaka, E., Hosoda, H., Kangawa, K., Kojima, M., 2013. Changes in Subcellular Distribution of n-Octanoyl or n-Decanoyl Ghrelin in Ghrelin-Producing Cells. *Front. Endocrinol.* 4. doi:10.3389/fendo.2013.00084
- Nocjar, C., Panksepp, J., 2002. Chronic intermittent amphetamine pretreatment enhances future appetitive behavior for drug- and natural-reward: interaction with environmental variables. *Behav. Brain Res.* 128, 189–203.

- Novakova, L., Haluzik, M., Jech, R., Urgosik, D., Ruzicka, F., Ruzicka, E., 2011. Hormonal regulators of food intake and weight gain in Parkinson's disease after subthalamic nucleus stimulation. *Neuro Endocrinol. Lett.* 32, 437–441.
- Oades, R.D., Halliday, G.M., 1987. Ventral tegmental (A10) system: neurobiology. 1. Anatomy and connectivity. *Brain Res.* 434, 117–165.
- O'Connell, L.A., Hofmann, H.A., 2012. Evolution of a Vertebrate Social Decision-Making Network. *Science* 336, 1154–1157. doi:10.1126/science.1218889
- O'Hara, C.B., Campbell, I.C., Schmidt, U., 2015. A reward-centred model of anorexia nervosa: a focussed narrative review of the neurological and psychophysiological literature. *Neurosci. Biobehav. Rev.* 52, 131–152. doi:10.1016/j.neubiorev.2015.02.012
- Olszewski, P.K., Schiöth, H.B., Levine, A.S., 2008. Ghrelin in the CNS: from hunger to a rewarding and memorable meal? *Brain Res. Rev.* 58, 160–170. doi:10.1016/j.brainresrev.2008.01.004
- Ono, Y., Nakatani, T., Sakamoto, Y., Mizuhara, E., Minaki, Y., Kumai, M., Hamaguchi, A., Nishimura, M., Inoue, Y., Hayashi, H., Takahashi, J., Imai, T., 2007. Differences in neurogenic potential in floor plate cells along an anteroposterior location: midbrain dopaminergic neurons originate from mesencephalic floor plate cells. *Dev. Camb. Engl.* 134, 3213–3225. doi:10.1242/dev.02879
- O'Sullivan, S.S., Wu, K., Politis, M., Lawrence, A.D., Evans, A.H., Bose, S.K., Djamshidian, A., Lees, A.J., Piccini, P., 2011. Cue-induced striatal dopamine release in Parkinson's disease-associated impulsive-compulsive behaviours. *Brain J. Neurol.* 134, 969–978. doi:10.1093/brain/awr003
- Overduin, J., Figlewicz, D.P., Bennett-Jay, J., Kittleson, S., Cummings, D.E., 2012. Ghrelin increases the motivation to eat, but does not alter food palatability. *Am. J. Physiol. Regul. Integr. Comp. Physiol.* 303, R259-269. doi:10.1152/ajpregu.00488.2011
- Palmiter, R.D., 2008. Dopamine signaling in the dorsal striatum is essential for motivated behaviors: lessons from dopamine-deficient mice. *Ann. N. Y. Acad. Sci.* 1129, 35–46. doi:10.1196/annals.1417.003
- Pañeda, C., Arroba, A.I., Frago, L.M., Holm, A.M., Rømer, J., Argente, J., Chowen, J.A., 2003. Growth hormone-releasing peptide-6 inhibits cerebellar cell death in aged rats. *Neuroreport* 14, 1633–1635. doi:10.1097/01.wnr.0000086252.76504.e3
- Pantel, J., Legendre, M., Cabrol, S., Hilal, L., Hajaji, Y., Morisset, S., Nivot, S., Vie-Luton, M.-P., Grouselle, D., de Kerdanet, M., Kadiri, A., Epelbaum, J., Le Bouc, Y., Amselem, S., 2006. Loss of constitutive activity of the growth hormone secretagogue receptor in familial short stature. *J. Clin. Invest.* 116, 760–768. doi:10.1172/JCI25303
- Paxinos, G., Franklin, K.B.J., 2001. *The mouse brain in stereotaxic coordinates.* New York.
- Peng, S., Yu, S., Wang, Q., Kang, Q., Zhang, Y., Zhang, R., Jiang, W., Qian, Y., Zhang, H., Zhang, M., Xiao, Z., Chen, J., 2016. Dopamine receptor D2 and catechol-O-methyltransferase gene polymorphisms associated with anorexia nervosa in Chinese Han population: DRD2 and COMT gene polymorphisms were associated with AN. *Neurosci. Lett.* 616, 147–151. doi:10.1016/j.neulet.2016.01.036

- Perlemoine, C., Macia, F., Tison, F., Coman, I., Guehl, D., Burbaud, P., Cuny, E., Baillet, L., Gin, H., Rigalleau, V., 2005. Effects of subthalamic nucleus deep brain stimulation and levodopa on energy production rate and substrate oxidation in Parkinson's disease. *Br. J. Nutr.* 93, 191–198.
- Phu, A.L., Xu, Z., Brakoulias, V., Mahant, N., Fung, V.S.C., Moore, G.D., Martin, A., Starcevic, V., Krause, M., 2014. Effect of impulse control disorders on disability and quality of life in Parkinson's disease patients. *J. Clin. Neurosci. Off. J. Neurosurg. Soc. Australas.* 21, 63–66. doi:10.1016/j.jocn.2013.02.032
- Poewe, W., 2008. Non-motor symptoms in Parkinson's disease. *Eur. J. Neurol.* 15, 14–20.
- Poewe, W., Gerstenbrand, F., Ransmayr, G., Plörer, S., 1983. Premorbid personality of Parkinson patients. *J. Neural Transm. Suppl.* 19, 215–224.
- Poletti, M., Perugi, G., Logi, C., Romano, A., Del Dotto, P., Ceravolo, R., Rossi, G., Pepe, P., Dell'Osso, L., Bonuccelli, U., 2012. Dopamine agonists and delusional jealousy in Parkinson's disease: A cross-sectional prevalence study. *Mov. Disord.* 27, 1679–1682. doi:10.1002/mds.25129
- Porporato, P.E., Filigheddu, N., Reano, S., Ferrara, M., Angelino, E., Gnocchi, V.F., Prodam, F., Ronchi, G., Fagoonee, S., Fornaro, M., Chianale, F., Baldanzi, G., Surico, N., Sinigaglia, F., Perroteau, I., Smith, R.G., Sun, Y., Geuna, S., Graziani, A., 2013. Acylated and unacylated ghrelin impair skeletal muscle atrophy in mice. *J. Clin. Invest.* 123, 611–622. doi:10.1172/JCI39920
- Postuma, R.B., Berg, D., Stern, M., Poewe, W., Olanow, C.W., Oertel, W., Obeso, J., Marek, K., Litvan, I., Lang, A.E., Halliday, G., Goetz, C.G., Gasser, T., Dubois, B., Chan, P., Bloem, B.R., Adler, C.H., Deuschl, G., 2015. MDS clinical diagnostic criteria for Parkinson's disease. *Mov. Disord.* 30, 1591–1601. doi:10.1002/mds.26424
- Probst, C.C., van Eimeren, T., 2013. The Functional Anatomy of Impulse Control Disorders. *Curr. Neurol. Neurosci. Rep.* 13. doi:10.1007/s11910-013-0386-8
- Pulvirenti, L., Berrier, R., Kreifeldt, M., Koob, G.F., 1994. Modulation of locomotor activity by NMDA receptors in the nucleus accumbens core and shell regions of the rat. *Brain Res.* 664, 231–236.
- Quarta, D., Di Francesco, C., Melotto, S., Mangiarini, L., Heidbreder, C., Hedou, G., 2009. Systemic administration of ghrelin increases extracellular dopamine in the shell but not the core subdivision of the nucleus accumbens. *Neurochem. Int.* 54, 89–94. doi:10.1016/j.neuint.2008.12.006
- Rask-Andersen, M., Olszewski, P.K., Levine, A.S., Schiöth, H.B., 2010. Molecular mechanisms underlying anorexia nervosa: focus on human gene association studies and systems controlling food intake. *Brain Res. Rev.* 62, 147–164. doi:10.1016/j.brainresrev.2009.10.007
- Reano, S., Graziani, A., Filigheddu, N., 2014. Acylated and unacylated ghrelin administration to blunt muscle wasting. *Curr. Opin. Clin. Nutr. Metab. Care* 17, 236–240. doi:10.1097/MCO.0000000000000049

- Rediger, A., Piechowski, C.L., Habegger, K., Grüters, A., Krude, H., Tschöp, M.H., Kleinau, G., Biebrermann, H., 2012. MC4R Dimerization in the Paraventricular Nucleus and GHSR/MC3R Heterodimerization in the Arcuate Nucleus: Is There Relevance for Body Weight Regulation? *Neuroendocrinology* 95, 277–288. doi:10.1159/000334903
- Ribeiro, A.C., Ceccarini, G., Dupré, C., Friedman, J.M., Pfaff, D.W., Mark, A.L., 2011. Contrasting effects of leptin on food anticipatory and total locomotor activity. *PloS One* 6, e23364. doi:10.1371/journal.pone.0023364
- Riederer, P., Wuketich, S., 1976. Time course of nigrostriatal degeneration in parkinson's disease. A detailed study of influential factors in human brain amine analysis. *J. Neural Transm.* 38, 277–301.
- Robinson, T.E., Berridge, K.C., 2008. Review. The incentive sensitization theory of addiction: some current issues. *Philos. Trans. R. Soc. Lond. B. Biol. Sci.* 363, 3137–3146. doi:10.1098/rstb.2008.0093
- Robinson, T.E., Berridge, K.C., 1993. The neural basis of drug craving: an incentive-sensitization theory of addiction. *Brain Res. Brain Res. Rev.* 18, 247–291.
- Rossi, M.A., Sukharnikova, T., Hayrapetyan, V.Y., Yang, L., Yin, H.H., 2013. Operant self-stimulation of dopamine neurons in the substantia nigra. *PloS One* 8, e65799. doi:10.1371/journal.pone.0065799
- Roux, H., Blanchet, C., Stheneur, C., Chapelon, E., Godart, N., 2013. Somatic outcome among patients hospitalised for anorexia nervosa in adolescence: disorders reported and links with global outcome. *Eat. Weight Disord. EWD* 18, 175–182. doi:10.1007/s40519-013-0030-2
- Saegusa, Y., Hattori, T., Nahata, M., Yamada, C., Takeda, H., 2015. A New Strategy Using Rikkunshito to Treat Anorexia and Gastrointestinal Dysfunction. *Evid.-Based Complement. Altern. Med. ECAM* 2015, 364260. doi:10.1155/2015/364260
- Sáez-Francàs, N., Martí Andrés, G., Ramírez, N., de Fàbregues, O., Álvarez-Sabín, J., Casas, M., Hernández-Vara, J., 2016. Clinical and psychopathological factors associated with impulse control disorders in Parkinson's disease. *Neurol. Barc. Spain* 31, 231–238. doi:10.1016/j.nrl.2015.05.002
- Salamone, J.D., Correa, M., 2012. The mysterious motivational functions of mesolimbic dopamine. *Neuron* 76, 470–485. doi:10.1016/j.neuron.2012.10.021
- Salamone, J.D., Mahan, K., Rogers, S., 1993. Ventrolateral striatal dopamine depletions impair feeding and food handling in rats. *Pharmacol. Biochem. Behav.* 44, 605–610.
- Satou, M., Nishi, Y., Yoh, J., Hattori, Y., Sugimoto, H., 2010. Identification and characterization of acyl-protein thioesterase 1/lysophospholipase I as a ghrelin deacylation/lysophospholipid hydrolyzing enzyme in fetal bovine serum and conditioned medium. *Endocrinology* 151, 4765–4775. doi:10.1210/en.2010-0412
- Scanelli, G., Gualandi, M., Simoni, M., Manzato, E., 2014. Somatic involvement assessed through a cumulative score of clinical severity in patients with eating disorders. *Eat. Weight Disord. EWD* 19, 49–59. doi:10.1007/s40519-013-0065-4

- Schaeffer, M., Langlet, F., Lafont, C., Molino, F., Hodson, D.J., Roux, T., Lamarque, L., Verdié, P., Bourrier, E., Dehouck, B., Banères, J.-L., Martinez, J., Méry, P.-F., Marie, J., Trinquet, E., Fehrentz, J.-A., Prévot, V., Mollard, P., 2013. Rapid sensing of circulating ghrelin by hypothalamic appetite-modifying neurons. *Proc. Natl. Acad. Sci. U. S. A.* 110, 1512–1517. doi:10.1073/pnas.1212137110
- Schéle, E., Bake, T., Rabasa, C., Dickson, S.L., 2016. Centrally Administered Ghrelin Acutely Influences Food Choice in Rodents. *PloS One* 11, e0149456. doi:10.1371/journal.pone.0149456
- Schellekens, H., Dinan, T.G., Cryan, J.F., 2013. Taking two to tango: a role for ghrelin receptor heterodimerization in stress and reward. *Front. Neurosci.* 7. doi:10.3389/fnins.2013.00148
- Scheurink, A.J.W., Boersma, G.J., Nergårdh, R., Södersten, P., 2010. Neurobiology of hyperactivity and reward: agreeable restlessness in anorexia nervosa. *Physiol. Behav.* 100, 490–495. doi:10.1016/j.physbeh.2010.03.016
- Seim, I., Carter, S.L., Herington, A.C., Chopin, L.K., 2008. Complex organisation and structure of the ghrelin antisense strand gene GHRLOS, a candidate non-coding RNA gene. *BMC Mol. Biol.* 9, 95. doi:10.1186/1471-2199-9-95
- Sharma, S., Singh, S., Sharma, V., Singh, V.P., Deshmukh, R., 2015. Neurobiology of L-DOPA induced dyskinesia and the novel therapeutic strategies. *Biomed. Pharmacother. Bioméd. Pharmacothérapie* 70, 283–293. doi:10.1016/j.biopha.2015.01.029
- Shin, A., Camilleri, M., Busciglio, I., Burton, D., Smith, S.A., Vella, A., Ryks, M., Rhoten, D., Zinsmeister, A.R., 2013. The ghrelin agonist RM-131 accelerates gastric emptying of solids and reduces symptoms in patients with type 1 diabetes mellitus. *Clin. Gastroenterol. Hepatol. Off. Clin. Pract. J. Am. Gastroenterol. Assoc.* 11, 1453–1459.e4. doi:10.1016/j.cgh.2013.04.019
- Sienkiewicz-Jarosz, H., Scinska, A., Swiecicki, L., Lipczynska-Lojkowska, W., Kuran, W., Ryglewicz, D., Kolaczowski, M., Samochowiec, J., Bienkowski, P., 2013. Sweet liking in patients with Parkinson's disease. *J. Neurol. Sci.* 329, 17–22. doi:10.1016/j.jns.2013.03.005
- Simpson, E.H., Waltz, J.A., Kellendonk, C., Balsam, P.D., 2012. Schizophrenia in translation: dissecting motivation in schizophrenia and rodents. *Schizophr. Bull.* 38, 1111–1117. doi:10.1093/schbul/sbs114
- Skibicka, K.P., Hansson, C., Alvarez-Crespo, M., Friberg, P.A., Dickson, S.L., 2011. Ghrelin directly targets the ventral tegmental area to increase food motivation. *Neuroscience* 180, 129–137. doi:10.1016/j.neuroscience.2011.02.016
- Skibicka, K.P., Shirazi, R.H., Rabasa-Papio, C., Alvarez-Crespo, M., Neuber, C., Vogel, H., Dickson, S.L., 2013. Divergent circuitry underlying food reward and intake effects of ghrelin: Dopaminergic VTA-accumbens projection mediates ghrelin's effect on food reward but not food intake. *Neuropharmacology* 73, 274–283. doi:10.1016/j.neuropharm.2013.06.004
- Smith, K.S., Berridge, K.C., Aldridge, J.W., 2011. Disentangling pleasure from incentive salience and learning signals in brain reward circuitry. *Proc. Natl. Acad. Sci. U. S. A.* 108, E255-264. doi:10.1073/pnas.1101920108

- Södersten, P., Bergh, C., Leon, M., Zandian, M., 2016. Dopamine and anorexia nervosa. *Neurosci. Biobehav. Rev.* 60, 26–30. doi:10.1016/j.neubiorev.2015.11.003
- Steinglass, J.E., Figner, B., Berkowitz, S., Simpson, H.B., Weber, E.U., Walsh, B.T., 2012. Increased capacity to delay reward in anorexia nervosa. *J. Int. Neuropsychol. Soc. JINS* 18, 773–780. doi:10.1017/S1355617712000446
- Steyn, F.J., Tolle, V., Chen, C., Epelbaum, J., 2016. Neuroendocrine Regulation of Growth Hormone Secretion. *Compr. Physiol.* 6, 687–735. doi:10.1002/cphy.c150002
- St-Onge, V., Watts, A., Abizaid, A., 2016. Ghrelin enhances cue-induced bar pressing for high fat food. *Horm. Behav.* 78, 141–149. doi:10.1016/j.yhbeh.2015.11.005
- Stopper, C.M., Floresco, S.B., 2011. Contributions of the nucleus accumbens and its subregions to different aspects of risk-based decision making. *Cogn. Affect. Behav. Neurosci.* 11, 97–112. doi:10.3758/s13415-010-0015-9
- Svenningsson, P., Rosenblad, C., Af Edholm Arvidsson, K., Wictorin, K., Keywood, C., Shankar, B., Lowe, D.A., Björklund, A., Widner, H., 2015. Eltoprazine counteracts I-DOPA-induced dyskinesias in Parkinson's disease: a dose-finding study. *Brain J. Neurol.* 138, 963–973. doi:10.1093/brain/awu409
- Swanson, L.W., 1982. The projections of the ventral tegmental area and adjacent regions: a combined fluorescent retrograde tracer and immunofluorescence study in the rat. *Brain Res. Bull.* 9, 321–353.
- Szczypka, M.S., Kwok, K., Brot, M.D., Marck, B.T., Matsumoto, A.M., Donahue, B.A., Palmiter, R.D., 2001. Dopamine production in the caudate putamen restores feeding in dopamine-deficient mice. *Neuron* 30, 819–828.
- Takagi, K., Legrand, R., Asakawa, A., Amitani, H., François, M., Tennaoune, N., Coëffier, M., Claeysens, S., do Rego, J.-C., Déchelotte, P., Inui, A., Fetissov, S.O., 2013. Anti-ghrelin immunoglobulins modulate ghrelin stability and its orexigenic effect in obese mice and humans. *Nat. Commun.* 4, 2685. doi:10.1038/ncomms3685
- Takeda, H., Muto, S., Nakagawa, K., Ohnishi, S., Asaka, M., 2012a. Rikkunshito and ghrelin secretion. *Curr. Pharm. Des.* 18, 4827–4838.
- Takeda, H., Muto, S., Nakagawa, K., Ohnishi, S., Sadakane, C., Saegusa, Y., Nahata, M., Hattori, T., Asaka, M., 2012b. Rikkunshito as a ghrelin enhancer. *Methods Enzymol.* 514, 333–351. doi:10.1016/B978-0-12-381272-8.00021-0
- Tanner, C.M., Kamel, F., Ross, G.W., Hoppin, J.A., Goldman, S.M., Korell, M., Marras, C., Bhudhikanok, G.S., Kasten, M., Chade, A.R., Comyns, K., Richards, M.B., Meng, C., Priestley, B., Fernandez, H.H., Cambi, F., Umbach, D.M., Blair, A., Sandler, D.P., Langston, J.W., 2011. Rotenone, Paraquat, and Parkinson's Disease. *Environ. Health Perspect.* 119, 866–872. doi:10.1289/ehp.1002839
- Taylor, S.R., Badurek, S., Dileone, R.J., Nashmi, R., Minichiello, L., Picciotto, M.R., 2014. GABAergic and glutamatergic efferents of the mouse ventral tegmental area. *J. Comp. Neurol.* 522, 3308–3334. doi:10.1002/cne.23603

- Tellez, L.A., Han, W., Zhang, X., Ferreira, T.L., Perez, I.O., Shammah-Lagnado, S.J., van den Pol, A.N., de Araujo, I.E., 2016. Separate circuitries encode the hedonic and nutritional values of sugar. *Nat. Neurosci.* 19, 465–470. doi:10.1038/nn.4224
- Theander-Carrillo, C., Wiedmer, P., Cettour-Rose, P., Nogueiras, R., Perez-Tilve, D., Pfluger, P., Castaneda, T.R., Muzzin, P., Schürmann, A., Szanto, I., Tschöp, M.H., Rohner-Jeanrenaud, F., 2006. Ghrelin action in the brain controls adipocyte metabolism. *J. Clin. Invest.* 116, 1983–1993. doi:10.1172/JCI25811
- Thompson, N.M., Gill, D.A.S., Davies, R., Loveridge, N., Houston, P.A., Robinson, I.C.A.F., Wells, T., 2004. Ghrelin and des-octanoyl ghrelin promote adipogenesis directly in vivo by a mechanism independent of the type 1a growth hormone secretagogue receptor. *Endocrinology* 145, 234–242. doi:10.1210/en.2003-0899
- Todes, C.J., Lees, A.J., 1985. The pre-morbid personality of patients with Parkinson's disease. *J. Neurol. Neurosurg. Psychiatry* 48, 97–100.
- Tomasetto, C., Wendling, C., Rio, M.C., Poitras, P., 2001. Identification of cDNA encoding motilin related peptide/ghrelin precursor from dog fundus. *Peptides* 22, 2055–2059.
- Tretiakoff, K.N., 1919. Contribution à l'étude de l'anatomie pathologique du locus niger de Soemmering avec quelques deductions à la pathologie des troubles musculaires et de la maladie de Parkinson. Paris, Paris.
- Tritsch, N.X., Oh, W.-J., Gu, C., Sabatini, B.L., 2014. Midbrain dopamine neurons sustain inhibitory transmission using plasma membrane uptake of GABA, not synthesis. *eLife* 3, e01936.
- Ueno, H., Shiiya, T., Nakazato, M., 2010. Translational research of ghrelin. *Ann. N. Y. Acad. Sci.* 1200, 120–127. doi:10.1111/j.1749-6632.2010.05509.x
- Unger, M.M., Möller, J.C., Mankel, K., Eggert, K.M., Bohne, K., Bodden, M., Stiasny-Kolster, K., Kann, P.H., Mayer, G., Tebbe, J.J., Oertel, W.H., 2011. Postprandial ghrelin response is reduced in patients with Parkinson's disease and idiopathic REM sleep behaviour disorder: a peripheral biomarker for early Parkinson's disease? *J. Neurol.* 258, 982–990. doi:10.1007/s00415-010-5864-1
- Ungerstedt, U., 1971. Stereotaxic mapping of the monoamine pathways in the rat brain. *Acta Physiol. Scand. Suppl.* 367, 1–48.
- Vaillancourt, D.E., Schonfeld, D., Kwak, Y., Bohnen, N.I., Seidler, R., 2013. Dopamine overdose hypothesis: Evidence and clinical implications: Dopamine Overdose Hypothesis. *Mov. Disord.* 28, 1920–1929. doi:10.1002/mds.25687
- Verhagen, L.A.W., Egecioglu, E., Luijendijk, M.C.M., Hillebrand, J.J.G., Adan, R.A.H., Dickson, S.L., 2011. Acute and chronic suppression of the central ghrelin signaling system reveals a role in food anticipatory activity. *Eur. Neuropsychopharmacol.* 21, 384–392. doi:10.1016/j.euroneuro.2010.06.005
- Vicq d'Azyr, 1786. *Traité d'anatomie et de physiologie, avec des planches coloriées. Représentant au naturel les divers organes de l'Homme et des Animaux.* F.A. Didot, Paris.

- Vitalis, T., Cases, O., Parnavelas, J.G., 2005. Development of the dopaminergic neurons in the rodent brainstem. *Exp. Neurol.* 191 Suppl 1, S104-112. doi:10.1016/j.expneurol.2004.05.044
- Volkow, N.D., Fowler, J.S., Wang, G.-J., 2002. Role of dopamine in drug reinforcement and addiction in humans: results from imaging studies. *Behav. Pharmacol.* 13, 355–366.
- Volkow, N.D., Morales, M., 2015. The Brain on Drugs: From Reward to Addiction. *Cell* 162, 712–725. doi:10.1016/j.cell.2015.07.046
- Wagner, A., Barbarich-Marsteller, N.C., Frank, G.K., Bailer, U.F., Wonderlich, S.A., Crosby, R.D., Henry, S.E., Vogel, V., Plotnicov, K., McConaha, C., Kaye, W.H., 2006. Personality traits after recovery from eating disorders: do subtypes differ? *Int. J. Eat. Disord.* 39, 276–284. doi:10.1002/eat.20251
- Wang, L., Mogami, S., Karasawa, H., Yamada, C., Yakabi, S., Yakabi, K., Hattori, T., Taché, Y., 2014. Preventive effect of rikkunshito on gastric motor function inhibited by l-dopa in rats. *Peptides* 55, 136–144. doi:10.1016/j.peptides.2014.02.011
- Wang, L., Murphy, N.P., Stengel, A., Goebel-Stengel, M., Pierre, D.H.S., Maidment, N.T., Taché, Y., 2012. Ghrelin prevents levodopa-induced inhibition of gastric emptying and increases circulating levodopa in fasted rats: Ghrelin prevents l-dopa-delayed gastric emptying. *Neurogastroenterol. Motil.* 24, e235–e245. doi:10.1111/j.1365-2982.2012.01904.x
- Watabe-Uchida, M., Zhu, L., Ogawa, S.K., Vamanrao, A., Uchida, N., 2012. Whole-brain mapping of direct inputs to midbrain dopamine neurons. *Neuron* 74, 858–873. doi:10.1016/j.neuron.2012.03.017
- Weintraub, D., Koester, J., Potenza, M.N., Siderowf, A.D., Stacy, M., Voon, V., Whetteckey, J., Wunderlich, G.R., Lang, A.E., 2010. Impulse control disorders in Parkinson disease: a cross-sectional study of 3090 patients. *Arch. Neurol.* 67, 589–595. doi:10.1001/archneurol.2010.65
- Weiselberg, E.C., Gonzalez, M., Fisher, M., 2011. Eating disorders in the twenty-first century. *Minerva Ginecol.* 63, 531–545.
- Wellman, M., Abizaid, A., 2015. Growth Hormone Secretagogue Receptor Dimers: A New Pharmacological Target. *eNeuro* 2. doi:10.1523/ENEURO.0053-14.2015
- Wichmann, T., DeLong, M.R., 1996. Functional and pathophysiological models of the basal ganglia. *Curr. Opin. Neurobiol.* 6, 751–758.
- Wise, R.A., 2008. Dopamine and reward: the anhedonia hypothesis 30 years on. *Neurotox. Res.* 14, 169–183. doi:10.1007/BF03033808
- Wo, J.M., Ejksjaer, N., Hellström, P.M., Malik, R.A., Pezzullo, J.C., Shaughnessy, L., Charlton, P., Kosutic, G., McCallum, R.W., 2011. Randomised clinical trial: ghrelin agonist TZP-101 relieves gastroparesis associated with severe nausea and vomiting--randomised clinical study subset data. *Aliment. Pharmacol. Ther.* 33, 679–688. doi:10.1111/j.1365-2036.2010.04567.x
- Wren, A.M., Seal, L.J., Cohen, M.A., Brynes, A.E., Frost, G.S., Murphy, K.G., Dhillon, W.S., Ghatei, M.A., Bloom, S.R., 2001. Ghrelin enhances appetite and increases food intake in humans. *J. Clin. Endocrinol. Metab.* 86, 5992. doi:10.1210/jcem.86.12.8111

- Wu, M., Brudzynski, S.M., Mogenson, G.J., 1993. Functional interaction of dopamine and glutamate in the nucleus accumbens in the regulation of locomotion. *Can. J. Physiol. Pharmacol.* 71, 407–413.
- Wyvell, C.L., Berridge, K.C., 2001. Incentive sensitization by previous amphetamine exposure: increased cue-triggered “wanting” for sucrose reward. *J. Neurosci. Off. J. Soc. Neurosci.* 21, 7831–7840.
- Yamaguchi, T., Qi, J., Wang, H.-L., Zhang, S., Morales, M., 2015. Glutamatergic and dopaminergic neurons in the mouse ventral tegmental area. *Eur. J. Neurosci.* 41, 760–772. doi:10.1111/ejn.12818
- Yamaguchi, T., Wang, H.-L., Li, X., Ng, T.H., Morales, M., 2011. Mesocorticolimbic glutamatergic pathway. *J. Neurosci. Off. J. Soc. Neurosci.* 31, 8476–8490. doi:10.1523/JNEUROSCI.1598-11.2011
- Yamamoto, K., Vernier, P., 2011. The evolution of dopamine systems in chordates. *Front. Neuroanat.* 5, 21. doi:10.3389/fnana.2011.00021
- Yang, D., Liu, Z., Zhang, H., Luo, Q., 2013. Ghrelin protects human pulmonary artery endothelial cells against hypoxia-induced injury via PI3-kinase/Akt. *Peptides* 42, 112–117. doi:10.1016/j.peptides.2013.01.012
- Yu, J., Xu, H., Shen, X., Jiang, H., 2016. Ghrelin protects MES23.5 cells against rotenone via inhibiting mitochondrial dysfunction and apoptosis. *Neuropeptides* 56, 69–74. doi:10.1016/j.npep.2015.09.011
- Zastrow, A., Kaiser, S., Stippich, C., Walther, S., Herzog, W., Tchanturia, K., Belger, A., Weisbrod, M., Treasure, J., Friederich, H.-C., 2009. Neural correlates of impaired cognitive-behavioral flexibility in anorexia nervosa. *Am. J. Psychiatry* 166, 608–616. doi:10.1176/appi.ajp.2008.08050775
- Zhou, Q.Y., Palmiter, R.D., 1995. Dopamine-deficient mice are severely hypoactive, adipsic, and aphagic. *Cell* 83, 1197–1209.
- Zhu, X., Cao, Y., Voodg, K., Steiner, D.F., 2006. On the Processing of Proghrelin to Ghrelin. *J. Biol. Chem.* 281, 38867–38870. doi:10.1074/jbc.M607955200
- Zigman, J.M., Bouret, S.G., Andrews, Z.B., 2016. Obesity Impairs the Action of the Neuroendocrine Ghrelin System. *Trends Endocrinol. Metab. TEM* 27, 54–63. doi:10.1016/j.tem.2015.09.010
- Zigman, J.M., Jones, J.E., Lee, C.E., Saper, C.B., Elmquist, J.K., 2006. Expression of ghrelin receptor mRNA in the rat and the mouse brain. *J. Comp. Neurol.* 494, 528–548. doi:10.1002/cne.20823
- Zizzari, P., Hassouna, R., Grouselle, D., Epelbaum, J., Tolle, V., 2011. Physiological roles of proghrelin-derived peptides in GH secretion and feeding. *Peptides* 32, 2274–2282. doi:10.1016/j.peptides.2011.04.014

Figure captions

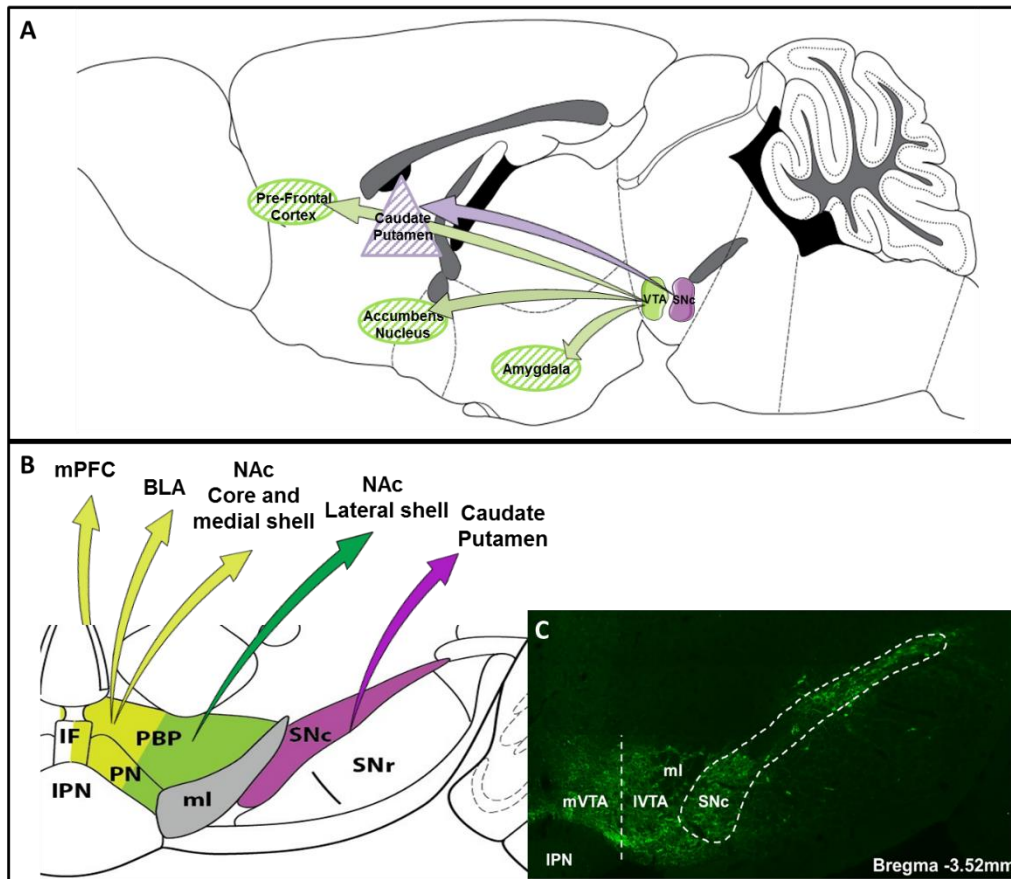

Figure 1: Schematic representation of the two main dopaminergic circuits in the mouse brain. (A) Location of the main dopaminergic mesencephalic structures in the adult mouse brain (sagittal view). Substantia nigra (SNc, in violet) dopaminergic neurons project to the dorsal striatum containing the caudate nucleus and the putamen. Dopaminergic neurons from the ventral tegmental area (VTA, in green) project to the accumbens nucleus located in the ventral striatum, the amygdala and the prefrontal cortex. (B) Schematic representation of the right mouse midbrain (enlargement of a frontal section of the right hemisphere at Bregma - 3.52mm ; Paxinos and Franklin, 2001). The VTA is subdivided in several subregions. The medial part of the VTA (mVTA, represented in light green) contains the interfascicular nucleus (IF), the medial paranigral nucleus (PN) and the medial parabrachial pigmented nucleus (PBP). Dopaminergic neurons from the mVTA project to the medial prefrontal cortex (mPFC), the basolateral amygdala (BLA), the nucleus accumbens (NAc) core, and the NAc medial shell; these mVTA dopaminergic outputs are represented by light green arrows. The lateral part of the VTA contains the lateral PBP. Its dopaminergic neurons project to the NAc lateral shell as shown in dark green. SNc dopaminergic neurons project to the caudate nucleus and the putamen which form together the dorsal striatum; they are shown in violet. (C) Representative photomicrograph of a mouse brain coronal section at Bregma -3.52mm (TH-positive cells as shown by immunocytochemistry in green) showing the location of dopaminergic neurons in the lateral VTA (lVTA), the mVTA and the SNc. (IPN,

interpeduncular nucleus; SNr, substantia nigra pars reticulata; ml, medial lemniscus). Adapted from Lammel et al. (2014).

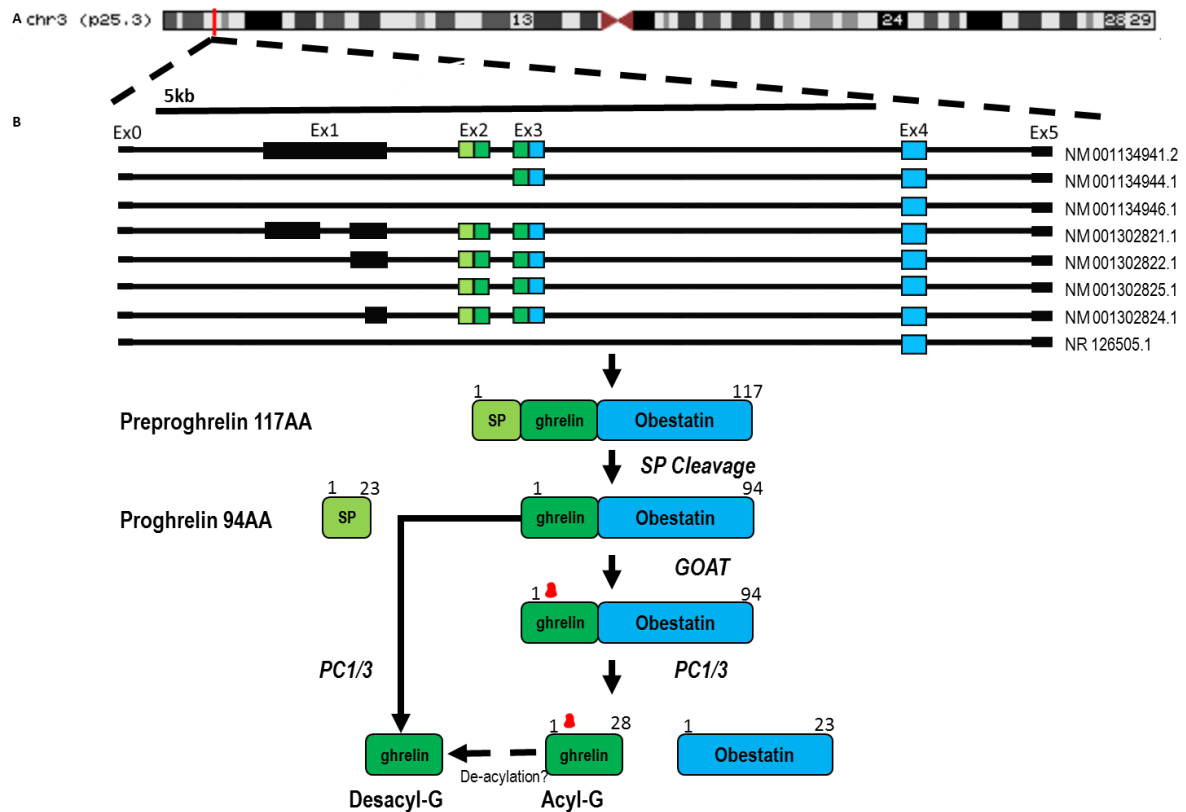

Figure 2: Synthesis and post-translational processing of ghrelin precursor peptides: from the ghrelin gene to acyl-ghrelin. (A) The human ghrelin gene (GHRL) is located on chromosome 3 at position 3p25-26 indicated by the red bar. (B) Enlargement of the 3p25-26 chromosomic region showing the eight currently identified GHRL variants as listed in the UCSC database genome browser (https://genome.ucsc.edu/cgi-bin/hgTracks?db=hg38&lastVirtModeType=default&lastVirtModeExtraState=&virtModeType=default&virtMode=0&nonVirtPosition=&position=chr3%3A10285675%2D10292947&hgscid=504045775_bG7QQtnAIsUTI9KS40bAsPrCC4ia, accessed on July 23rd 2016). As shown on the upper line, the human ghrelin gene contains six exons (Ex0 – Ex5), including three non-coding exons (Ex0, Ex1 and Ex5) represented by the black boxes. GHRL codes for preproghrelin, a peptide composed of 117 amino acids including a signal peptide (SP, light green boxes), the ghrelin peptide (dark green boxes) partly encoded by exons 2 (Ex2) and 3 (Ex3), as well as a C-terminal peptide named obestatin (blue boxes) encoded by part of Ex3 and the exon 4 (Ex4). Preproghrelin is first processed to remove the signal peptide, which generates a 94 amino acids-long peptide named proghrelin. This precursor is then acylated (red symbol) by the ghrelin O-acyltransferase (GOAT) within the endoplasmic reticulum and further cleaved by the prohormone convertase 1/3 (PC1/3). The resulting peptides are then secreted and released in the blood, where acyl-ghrelin is rapidly desacylated in the plasma by endogenous esterases such as acyl-protein thioesterase 1 (APT1) or butyl choline esterase (Satou et al., 2010).

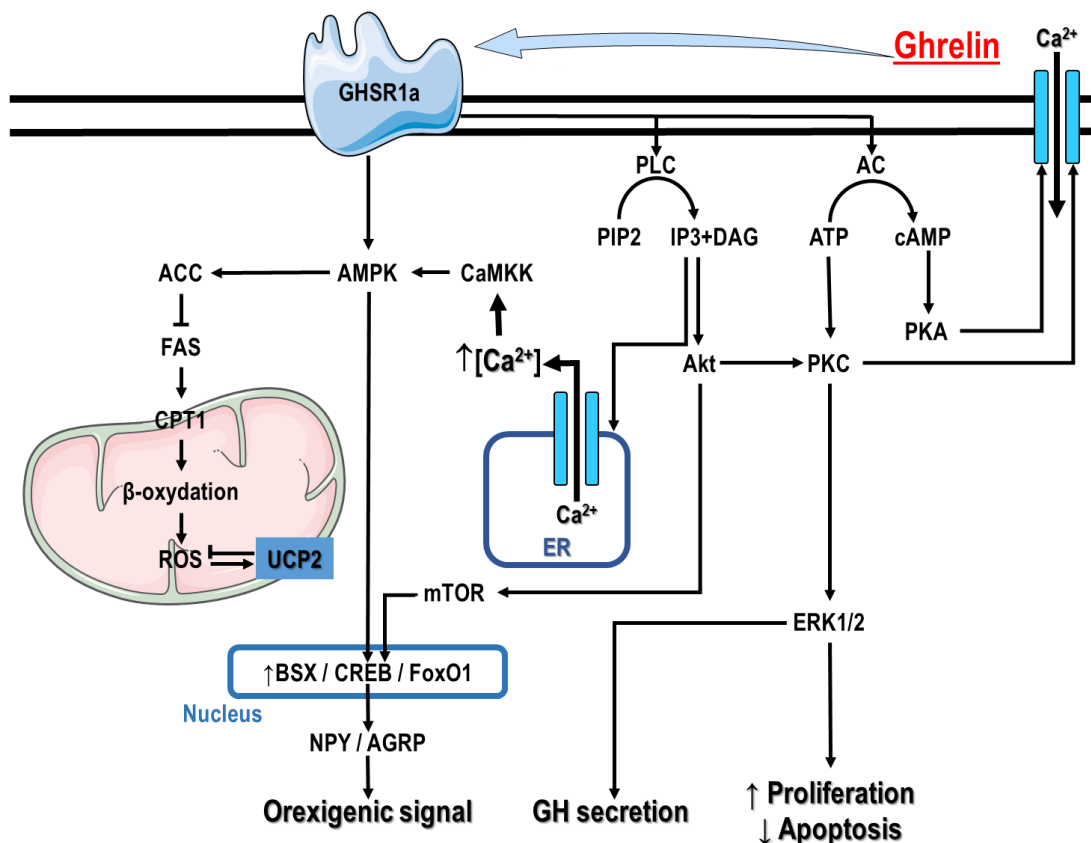

Figure 3: Schematic representation of ghrelin-dependent signaling pathways. Acyl-ghrelin binding to GHSR1a triggers G protein-coupled signaling cascades and activates both phospholipase C (PLC) and adenylate cyclase (AC). PLC hydrolyses phosphatidylinositol 4,5-bisphosphate (PIP2) into inositol 1,4,5-trisphosphate (IP3) and diacylglycerol (DAG). IP3 induces the release of calcium (Ca²⁺) from endoplasmic reticulum storages while AC and DAG respectively activate the protein kinase A (PKA) and the protein kinases B (Akt) / C (PKC) cascade, thus resulting in the entry of extracellular Ca²⁺ through calcium channels. In all cases, the resulting increase in intracellular Ca²⁺ concentrations in the brain activates calmoduline and calmoduline-dependent protein kinase kinase (CamKK), and modulates its action on β-oxidation through AMPK phosphorylation. Ghrelin binding to GHSR1a also activates the PI3K/Akt and PKC/extracellular signal-regulated kinases 1/2 (ERK1/2) pathways, thus inducing the release of growth hormone from pituitary cells. The activation of these cascades upon ghrelin binding has also been observed in cancer cells and leads to increased proliferation and prevention of apoptosis (Majchrzak et al., 2012). In hypothalamic neurons, ghrelin binding to its receptor triggers the AMPK and mammalian target of rapamycin (mTOR) pathways, which increase brain-specific homeobox (BSX), c-AMP response element-binding protein (CREB) and forkhead box O1 (FoxO1) transcription factors (Lage et al., 2010; Martins et al., 2012). This results in an orexigenic signal mediated by the neuropeptide Y (NPY) and agouti-related protein (AgRP) neuropeptides. Note that only the main partners within the discussed signaling pathways are represented on the figure. Plain arrows represent direct interactions. Dotted arrows indicate indirect actions where

intermediate molecules have been omitted for clarification purposes. Created with illustrations from Servier Medical Art (used under the following agreement: Creative Commons Attribution 3.0 France).

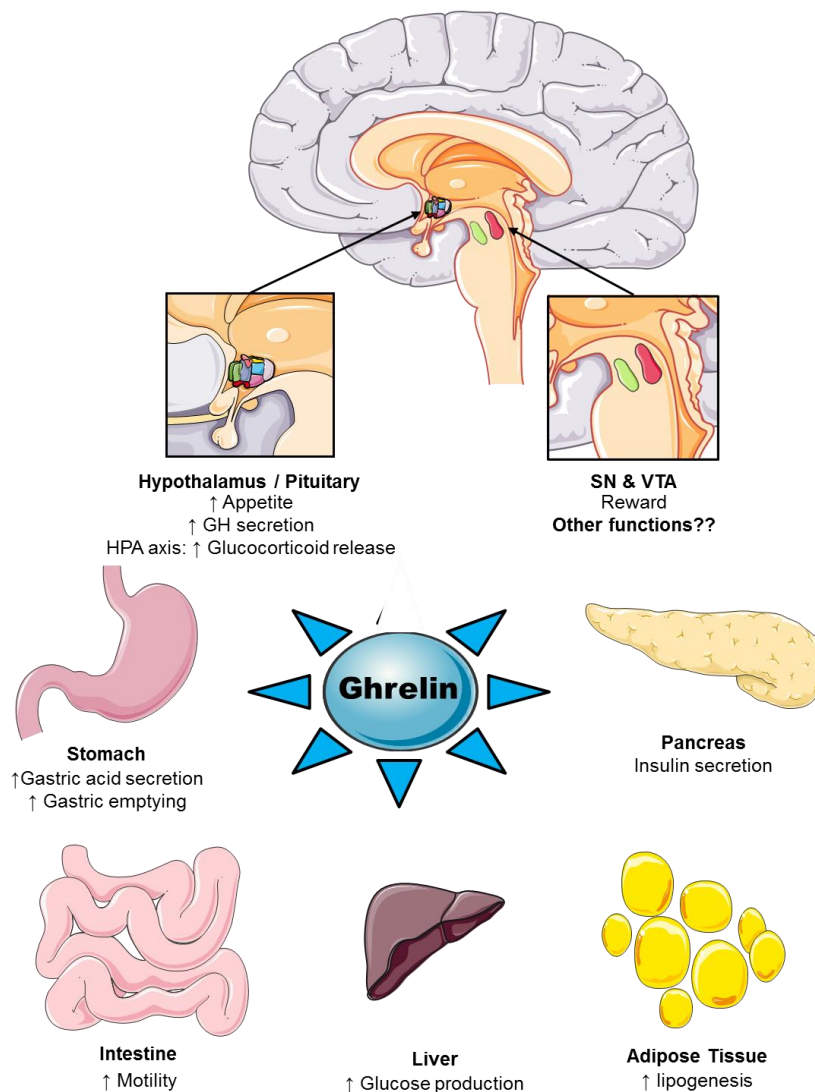

Figure 4: Main physiological functions of ghrelin. Ghrelin is involved in numerous functions. In the central nervous system, acyl-ghrelin acts in the hypothalamus (top left) to induce food intake and to increase growth hormone (GH) secretion from somatotrophs cells in the pituitary gland. It also plays an important role in the hypothalamo-pituitary-adrenal axis (HPA); in particular it modulates glucocorticoid release and is therefore involved in adaptation to stress and anxiety. In dopaminergic neurons of the ventral tegmental area (VTA, top right, green area), ghrelin has been shown to regulate reward and motivation processes whereas in the substantia nigra (SN, top right, red area) of animal models it is suggested to act as a neuroprotective agent against toxic compounds-induced neuronal death. Ghrelin also regulates goal-directed actions via its effects on both VTA and SN. In the gastro-intestinal tract (bottom part of the figure), ghrelin activates the secretion of gastric acid, gastric emptying and intestinal motility (left-hand side). Ghrelin also modulates energy metabolism through a regulation of insulin pancreatic secretion and lipogenesis (right-hand side). Its main role is however to increase glucose production from the liver (bottom center of the figure),

especially under conditions of energy deficit like severe calorie restriction (Goldstein et al., 2011). Created with illustrations from Servier Medical Art (used under the following agreement: Creative Commons Attribution 3.0 France).

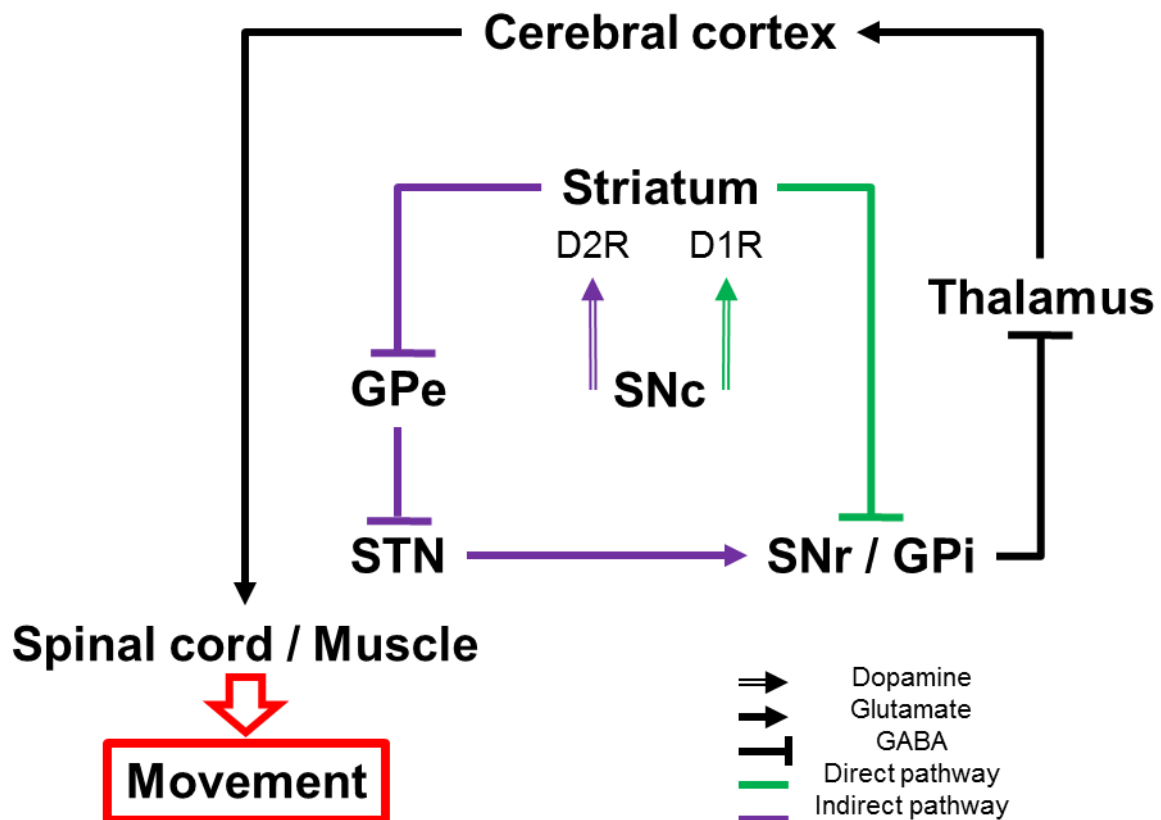

Figure 5: Schematic representation of the main functional organization of the basal ganglia. In order to initiate a voluntary movement, the motor cortex sends glutamatergic excitatory projections to the striatum whose resulting GABAergic outputs aimed at releasing the thalamic excitatory glutamatergic projections onto the cortex are modulated by nigral dopaminergic inputs. Indeed, within the direct pathway, dopaminergic signals from the substantia nigra pars compacta (SNc) activate the striatal inhibitory projections to the substantia nigra pars reticulata (SNr) / internal part of the globus pallidus (GPi), thus removing their basal inhibitory output to the thalamus. This results in the activation of thalamic glutamatergic (excitatory) signals to the ipsilateral motor cortex, allowing the selected movement to be appropriately performed by the contralateral part of the body. In parallel, within the indirect pathway, nigral dopaminergic outputs inhibit striatal GABAergic projections to the external part of the globus pallidus (GPe), which releases its inhibition of the subthalamic nucleus (STN). As a result, the glutamatergic (excitatory) action onto the SNr/GPi will be increased, therefore reducing thalamic glutamatergic signals to the ipsilateral motor cortex and suppressing undesired movements. This ultimately contributes to the realization of a smooth and nicely coordinated move. D1R, dopamine type 1 receptors; D2R, dopamine type 2 receptors.

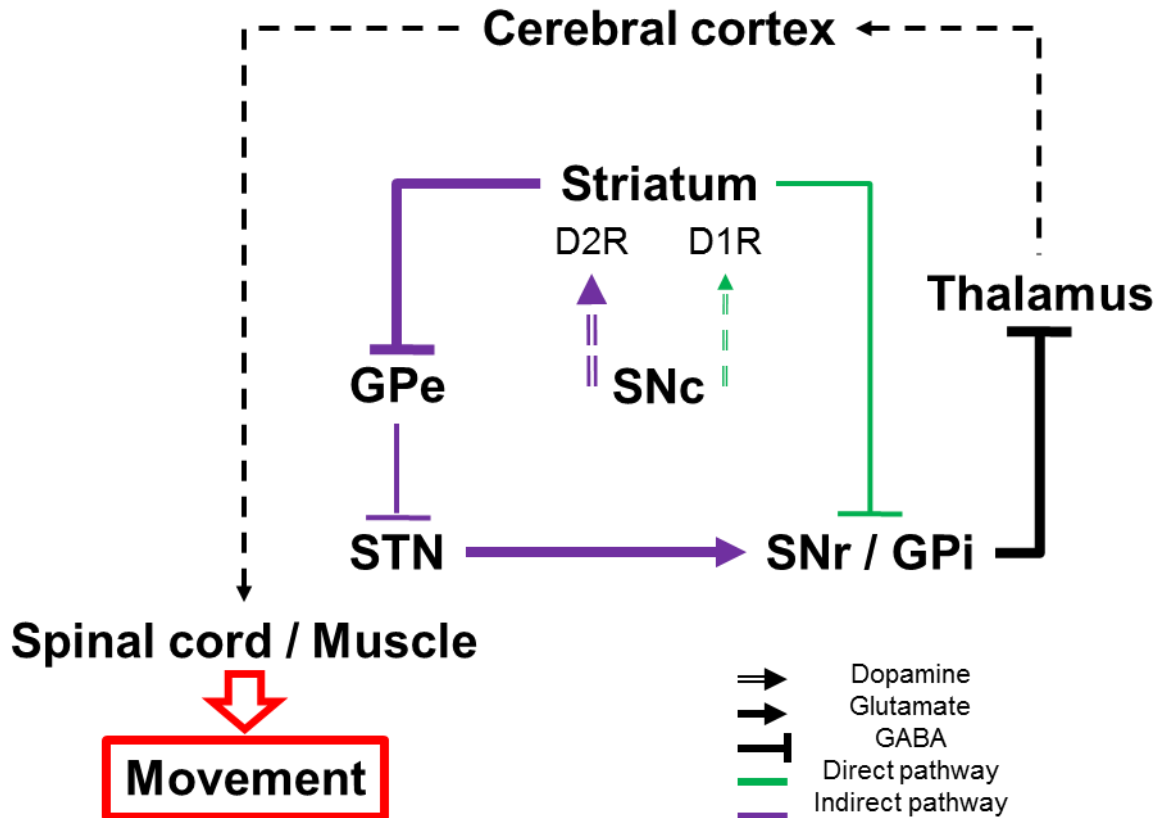

Figure 6: Schematic representation of the main functional organization of the basal ganglia in Parkinson's Disease. The ongoing degeneration of dopaminergic neurons of the substantia nigra in Parkinson's disease (PD) directly impacts the proper functioning of basal ganglia, which is at the origin of the motor symptomatology observed in PD patients. In particular, as a result of this nigral dopaminergic degeneration, striatal neurons involved in the direct pathway send weaker inhibitory projections to the substantia nigra pars reticulata (SNpr) / internal part of the globus pallidus (GPi) compared to healthy conditions. As a consequence, these are insufficient to fully release the basal inhibitory output onto the thalamus. In turn, the thalamus excitatory signal to the ipsilateral motor cortex is weaker and does not enable a proper initiation of the movement in the contralateral part of the body. In parallel, within the indirect pathway, due to the lower dopamine input from the SNc, GABAergic striatal neurons are not enough inhibited anymore and thus exert a stronger inhibitory output to the external part of the globus pallidus (GPe), which in turn does not inhibit the subthalamic nucleus (STN) enough. As a result, the STN sends increased excitatory projections to the SNr/GPi, whose GABAergic control over the thalamus will therefore also be reinforced. This further prevents the thalamic motor cortex activation. The end-result is a weaker selection of the proper motor program by the cortex, which leads to the bradykinesia observed in PD patients. The thickness of the arrows corresponds to the functional state of a given connection between two structures: thicker and thinner arrows show respectively over-active and hypo-active circuits compared to healthy conditions. D1R, dopamine type 1 receptors; D2R, dopamine type 2 receptors.

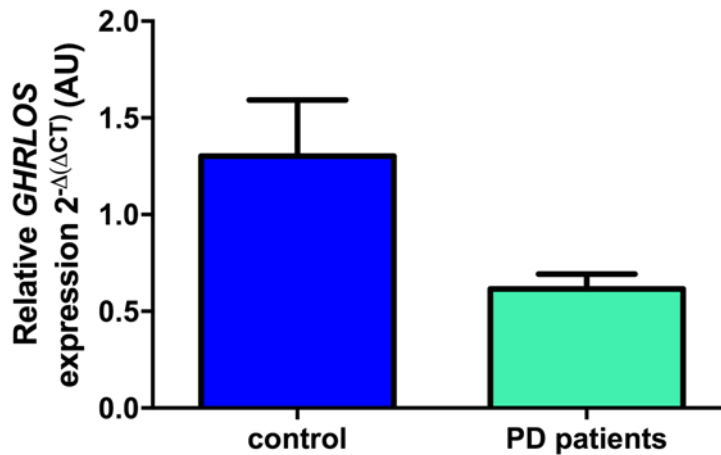

Figure 7: Relative gene expression of the ghrelin opposite strand/antisense RNA in Parkinson's disease patients compared to controls. Ghrelin opposite strand/antisense RNA gene (GHRLOS) is located on the opposite strand of the ghrelin gene and spans its promoter and untranslated regions over 44kb on 3p25.3. It appears to exert potential regulatory and functional roles in ghrelin expression (Seim et al., 2008). Its expression was assessed in sex/age matched Parkinson's disease (PD) patients and control groups. Control subjects included in this study were healthy volunteers without any neurological impairment. Informed consent was collected for all participants under the ethical agreement CPP N°2008/009. The details of several subjects involved in this study can be found in Chartier-Harlin et al., (2004) ; Mutez et al., (2014; 2011). Blood sampling were realized and peripheral blood mononuclear cells were isolated for both controls (2 men, 3 women; mean age = 63.2 ± 18.6 years) and PD patients (1 man, 5 women; mean age = 65.5 ± 15.6 years). Epstein-Barr virus (EBV)-transformed lymphoblastoid cell lines were derived for each subject. Total RNA was extracted and reverse transcribed as previously described (Mutez et al., 2011). Quantitative real-time PCR was used to study GHRLOS expression (primer sequences were as follow: forward, TGCCCTGTCAGTTACGGA; reverse CTTGAGGGTGAGGACGAA). Calculation of RNA expression levels was performed using the $2^{-\Delta(\Delta CT)}$ time method (Livak and Schmittgen, 2001). Each RNA sample was loaded in triplicate. MAN2B1 (Mannosidase Alpha Class 2B Member 1) was used as a house keeping gene for normalization purposes. Each bar represents the mean + the standard error of the mean (SEM) of the ratio of relative gene expression of GHRLOS for each subject.

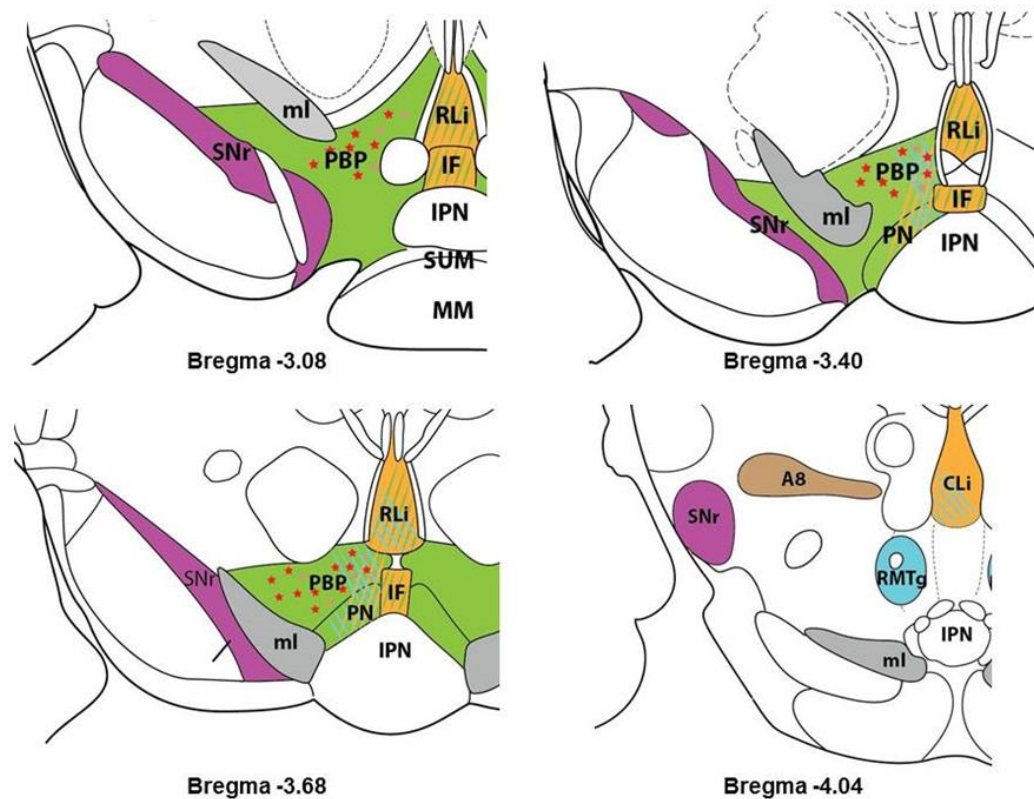

Figure 8: Schematic coronal representation of the antero-posterior organization of the ventral tegmental area in rodents. Dopaminergic neurons are mainly found in the parabrachial pigmented area (PBP, in green) largely spread out from bregma -3.08mm to bregma -3.68mm, and in the more posterior paranigral nucleus (PN, in green) located from bregma -3.40mm to bregma -3.68mm (Ikemoto, 2007). Dopaminergic neurons are also observed at a lower density in other nuclei of the ventral tegmental area (VTA), which mainly contain glutamatergic neurons, and include the rostral linear nucleus (RLi), the interfascicular nucleus (IF) and the caudal linear nucleus (CLi) (RLi and IF are represented in orange ; Ikemoto, 2007; Yamaguchi et al., 2015). Conversely, glutamatergic neurons are present at a lower density (~1 to 3%) in the PBP and the PN (Nair-Roberts et al., 2008; Yamaguchi et al., 2015, 2011) where they can be co-expressed with dopamine (Yamaguchi et al., 2015, 2011). GABA-ergic neurons represent 30% of the PBP and the PN and are localized between bregma -3.40mm and bregma -3.68mm (Nair-Roberts et al., 2008). They are also largely present in the rostromedial tegmental nucleus (RMTg, dark blue area) at bregma -4.04mm (Ikemoto, 2007; Taylor et al., 2014). However, no co-expression of GABA markers (GAD65, GAD67, GAD1 or Vmat2) has been observed in the VTA (Tritsch et al., 2014). The ghrelin receptor GHSR1a is expressed in the anterior part of the PBP (Andrews et al., 2009; Mani et al., 2014; Zigman et al., 2006), more precisely on dopaminergic neurons and GABAergic neurons (70 and 30% of total VTA neurons) respectively represented by red and black stars (Abizaid et al., 2006). The different neuronal populations are shown in green for the dopamine, orange for the glutamate and blue for the GABA. (A8, retrorubral fields/A8 dopamine cells; IPN, Interpeduncular nucleus; ml, medial lemniscus; MM, mammillary nucleus; SUM, supramammillary nucleus).

Annex 6: article 2: Physical activity: benefit or weakness in metabolic adaptations in a mouse model of chronic food restriction?

Physical activity: benefit or weakness in metabolic adaptations in a mouse model of chronic food restriction?

Mathieu Méquinion^{1,2,3}, Emilie Caron², Sara Zgheib^{1,3}, Aliçia Stievenard^{1,4}, Philippe Zizzari⁵, Virginie Tolle⁵, Bernard Cortet^{1,6}, Stéphanie Lucas^{1,3}, Vincent Prévot^{1,2}, Christophe Chauveau^{1,3*}, Odile Viltart^{1,2*}.

¹University Lille Nord de France (ULCO, USTL, Lille2); ²Development and Plasticity of Postnatal Brain, UMR 837 INSERM, Lille, France; ³Physiopathology of Inflammatory Bone diseases, EA4490, Boulogne sur Mer, France; ⁴Molecular Events Associated With Early stages of Parkinson's Disease UMR 837 INSERM, Lille, France; ⁵Psychiatry and Neurosciences Center, UMR 894 INSERM, Paris, France; ⁶ Department of Rheumatology, CHRU, Lille, France

Running Head: Chronic food restriction and physical activity

* same co-authorship

Address for correspondence

Dr Odile Viltart
JPARC – Université Lille de France (USTL)
UMR 837 INSERM
Bat Biserte, Place de Verdun
59045 Lille France
Tel : + 33 6 76 88 06 05 // +33 3 20 62 20 65

Abstract

In restrictive type anorexia nervosa (AN) patients, physical activity is usually associated with food restriction but its physiological consequences remain poorly characterized. In female mice, we evaluated the impact of voluntary physical activity with/without chronic food restriction on metabolic and endocrine parameters that might contribute to AN. In this protocol, FRW mice (i.e. food restriction with running wheel) reached a crucial point of body weight loss (especially fat mass) faster than FR mice (i.e. food restriction only). However, in contrast to FR mice, their body weight stabilized, demonstrating a protective effect of a moderate, regular physical activity. Exercise delayed meal initiation and duration. FRW mice displayed food anticipatory activity compared to FR mice, which was slightly diminished with the prolongation of the protocol. The long-term nature of the protocol enabled assessment of bone parameters, similar to those observed in AN patients. Both restricted groups adapted their energy metabolism differentially in the short and long term, with less fat oxidation in FRW mice and a preferential use of glucose to compensate for the chronic energy imbalance. Finally, like restrictive AN patients, FRW mice exhibited low leptin levels, and high plasma concentrations of corticosterone and ghrelin. In conclusion, our model suggests that physical activity has beneficial effects on the adaptation to the severe condition of food restriction despite the absence of any protective effect on lean and bone mass.

Key words

Food restriction – physical activity – animal model – physiological adaptation – anorexia nervosa

PHYSICAL ACTIVITY is known to have beneficial and protective effects for health exerted both at the peripheral and central levels in mammals. Indeed, exercise reduces the prevalence of obesity and its comorbidities like type 2 diabetes, cardiovascular pathologies and hepatic steatosis but also stress, anxiety, and depression^{14,58,69}. However, excessive physical activity could lead to injuries²⁰ especially when combined with restrictive diet³⁸. Among the various alterations observed in some categories of athletes, growth retardation, muscular atrophy, amenorrhea or metabolic disturbances, and susceptibility to eating disorders might have deleterious consequences on health^{52,61,64,65}. These high-risk conducts are also observed in restrictive anorexia nervosa (AN) with 35 to 80% of patients who present excessive physical activity associated with a severe chronic food restriction^{11,12} even if this last parameter has been omitted from the diagnostic criteria currently used^{1,2}. Beside severe weight loss and metabolic disturbances, AN is also associated with endocrine alterations, reproductive dysfunctions, osteopenia and osteoporosis^{24,29,30,40,41,42,43,47}. The prevalence of AN has drastically increased within recent decades and is currently the third largest cause of chronic illness in teenagers^{35,44}. It leads to poorly known central and/or peripheral reprogramming that permits the individual/organism to adapt to a chronic reduced energy supply. The role of enhanced activity in this reprogramming remains to be determined.

It remains an open question whether the physical activity observed in AN is beneficial or deleterious for health and whether it forms an adaptation to this drastic caloric restriction. Answering this question would inform clinicians as to whether it is better to promote regular physical activity instead of existing hyperactivity or inactivity, in AN patients. For this purpose, the use of animal models mimicking distinct physiological components of AN is essential. A number of different animal models have been developed, especially environmental models, one of these associates wheel running access with time-restricted feeding. This model was inappropriately called “self-starvation” or more recently “Activity-Based Anorexia” (ABA) and was developed in the rat by Routtenberg and Kuznesof⁵⁶. Many symptoms described in AN were reproduced in this model including increased activity and various physiological alterations^{33,34,70}. In the ABA paradigm, the phenotype observed can be amplified or reduced depending on the rodent strain, sex, age^{28,39}. However, most of the studies were performed with male rodents while the majority of AN cases are described in female patients. Regarding self-starvation as a part of a cognitive/emotional aspect of the disease, rendered difficult even impossible to mimic in mice. Indeed, in the ABA model, the self-starvation, which is not always observed³⁶, might be related to physiological adaptations to maintain thermogenesis and to compensate the dryness of the pellets since the presentation

of humidified pellets during the 2h-time restricted feeding or an increasing of the room temperature led to the disappearance of the voluntary food restriction^{6,7}. These data support more adaptations to physiological changes than a cognitive drive to reduce feeding. Moreover, adopting this kind of “self-starvation behavior” conducted the mice to die rapidly (usually 5-7 days) due to important energy deficit and weight loss. This constituted another drawback of the ABA model when we expect to study the evolution of physiological parameters on the long term.

The present study aimed to circumvent these drawbacks. Because self-starvation is not necessary to study physiological consequences of activity associated with food restriction, we have changed the initial protocol by working on female mice and by limiting the amount of food distributed (50%) without time limitation. The female mice of the “activity” groups have a free access to wheel running. Activity added to food restriction allowed fast and severe body weight loss associated with protocol durations as long as 8 weeks. Our data show that when food restriction is associated with physical activity it results in a better metabolic adaptation even though it accelerates weight loss in the short term compared to pair-fed mice without wheel access. Our results provide new insights regarding the potential mechanisms that lead to the physiological deregulations observed in AN patients with or without hyperactivity.

METHODS

Animals and procedures. Adult C57BL/6J female mice (7 week-old, average initial body weight 18.3 ± 0.1 g, Charles River Laboratories, L'Arbresle, France) were housed two per cage to avoid isolation stress effects until the end of the protocol. They were kept in a pathogen-free barrier facility maintained at 21.5°C with a 12:12-h dark-light cycle (lights on at 07:30). During one week acclimation, mice were weighed every day to get used to handling and had free access to water and standard chow diet (Special Diet Service RM3 fat: 4.30%, protein: 22.30%, carbohydrate: 51.20%, Dietex, Essex, United Kingdom). The mice were then divided into 4 groups. In the experimental group “food restriction and wheel” (group FRW), mice were placed in a cage equipped with a free running wheel (Intellibio, Seichamps, France) and submitted to a quantitative food restriction, comprising 30% per day for three days then 50% per day until the end of protocol. This restriction was calculated from the total food eaten by a cage of mice fed *ad libitum* (group AL) the day before to have a standard quantity of food eaten per day. We also used two other control groups: a pair fed group (group FR) and mice fed *ad libitum* but in cages equipped with a wheel (group ALW). The presence of two mice in the home cage did not permit to measure separately the quantity of food ingested by each animal. However, the use of metabolic cages (see below) where mouse was individually studied has permitted to validate the data obtained and to precisely know the food intake pattern of the 4 groups of mice. Body weight and food intake (distribution at 18:30.) were monitored daily in the short-term (15 days) and long-term (up to 55 days) protocols (Figs. 1-2). Control of body weight was done to ensure that the use of two mice in a same cage had similar feeding behavior and activity. If evident differences were noted between the two mice, the data obtained from this cage were excluded of analysis. At different times in the protocol (Fig. 1), some subgroups of mice were isolated for 2-3 days in metabolic cages (TSE Systems, Bad Homburg, Germany), to monitor ambulatory activity, food intake pattern, O₂ and CO₂ consumptions, energy expenditure. The cages of FRW and ALW mice were equipped with a wheel (178 mm diameter) to maintain their physical activity without modifying totally the paradigm. The number of mice that have been used varied between 6 and 24 per group depending of the experiments and the protocols considered. The variation in the number of animals was only due to specific experiments done to obtain the metabolic data or blood samplings performed at different stages of the protocols. Such manipulation might change slightly and transiently the behavior of the mice (feeding or activity). No mice died in any protocol. Further details are given in the legends. All experiments were carried out in accordance with the European Communities Council Directive (86/609/EEC) and approved

by the Regional ethical committee of Nord-Pas de Calais of Lille, France (protocol CEEA 392012).

Activity monitoring. The daily locomotor activity of ALW and FRW mice was assessed in their home cage equipped with a wheel (diameter: 230 mm; width: 50 mm; 1 revolution = 0.72 m) and linked to a computer system that measured interval counts (10 min) mean wheel revolution (ActiWheel Software, Intellibio, Seichamps, France). When the mice were placed individually in the metabolic cages (Fig. 1), the total ambulatory activity of all mice was evaluated with an ambulatory captor (infrared light-beam frame ActiMot2) that measured activity in three dimensions (x-, y- and z- axis).

Reproductive functions. The estrous cycle was assessed by vaginal smears performed before food distribution and at different stages of the procedure: between day 5 before the beginning of the protocol and day 16 for the short-term protocol; between day 48 and day 55 for the long-term protocol. We placed the tip of the pipette filled with saline solution (10 µl NaCl 9 g/l) 5 mm into the vagina, flushed the vagina about 5 times and put the final collect containing the vaginal secretion on glass slide. We observed the cells without coloration under light microscope Leica (Zeiss, Germany) with a final magnification of 100x for immediate estrous cycle stage determination (estrus, diestrus, metestrus). Proestrous stage that corresponds to short transient stages was not determined. The day of sacrifice, days 15 and 55, after estrous cycle determination left and right ovaries were collected and uterus was weighed. Ovaries were then fixed in Bouin fixative and to be processed through graded alcohols until paraffin wax embedding. Paraffin-embedded ovaries were serially sectioned at 5 µm thickness with a microtome Leica Reichert-Jung (Leica Biosystems Gmb, Nussloch, Germany) and stained with eosin/hematoxylin. Observations and photos were made using a Leica microscope (Leica Microsystems GmbH, Wetzlar, Germany) equipped with a camera. Size of ovaries was measured following two axes (width and length) with Image J software (<http://imagej.nih.gov/ij/>/<http://rsbweb.nih.gov/ij/>) from slices containing the largest ovary section.

Body composition. Body composition was determined at different time points during the protocols (D-1/D15 /D55 Fig. 1A) using an “*in Vivo* Micro-CT Scanner for Small Lab Animals” (LaTheta LCT-100, Hitachi Aloka Medical Ltd., Tokyo, Japan) to evaluate bone, lean and fat masses. Mice were anesthetized by intraperitoneal injection of ketamine and xylazine mix. About 60 CT slices per mouse were made at 500 µm intervals between

shoulders and the posterior legs. Slices were analyzed by Aloka software and mouse head and tail were excluded of analysis for bone (bone mineral content: BMC), fat (visceral and subcutaneous) and lean mass measures.

Metabolism and energy expenditure monitoring. The data were obtained in metabolic cages (LabMaster-CalorSys-Calorimetry System, TSE Systems, Bad Homburg, Germany) for a period of 3 days (Fig. 1). Food and water intake patterns were measured every minute by sensing units and the values were added to present cumulative data. The system measured the volume of O₂ consumed and the volume of produced CO₂, over a 15 min period, 4 times per hour. These values were averaged to determine the rate of CO₂ produced (VCO₂) and oxygen consumed (VO₂) in ml/h. We determined respiratory exchange ratio (RER), the energy expenditure (EE) and the fatty acid oxidation (FA) using different equations^{8,45,46} : $RER = VCO_2 / VO_2$; $EE \text{ (kcal/h)} = ((3.815 + 1.232 \times RER) \times VO_2) \times 1000$, $FA \text{ oxidation (kcal/h)} = EE \times ((1-RER)/0.3)$. The RER is an indicator of the proportion of fat and carbohydrate oxidation under specified conditions⁴⁶, ranges between 0.7 (complete reliance on fat oxidation) and 1.0 (complete reliance on carbohydrate oxidation).

Glycemia and intraperitoneal glucose tolerance testing (IPGTT). Glycemia was measured (OneTouch Vita, Lifescan, Milpitas, United States) in the morning (between 08:00 and 10:00) after the night feeding period at different stages (D15 and D50). To assess glucose tolerance, we performed an IPGTT. All mice received the same quantity of food the day before the experiment (at 16:00) to maintain all mice in a similar satiated condition. Then, non-sedated mice were weighed and injected with a glucose solution (1.5 g/kg). Their glycemia were assayed from blood sample drops taken from the tail at 0, 5, 15, 30, 60, 90, and 120 min post-injection.

Sacrifice and tissues collecting. At the end of the short- and long-term protocols, mice were sacrificed. All mice received the same amount of food (about 3.5 g par cage) the day before sacrifice to maintain all mice in similar fasted conditions and minimize intra-group assay variations. They were deeply anesthetized in the morning with an overdose of ketamine (100 mg/kg) and xylazine mix (20 mg/kg). Blood was collected through cardiac puncture with 1 ml syringe, kept at 4°C about 2 hr in neutral tubes, except for ghrelin due to the low stability of this hormone until centrifugation (8000 rpm. for 10 min, 4°C Centrifuge 5414 R, Eppendorf, Hamburg, Germany). Plasma aliquots were then deeply frozen in liquid nitrogen and stored (-80°C) until assayed. Mice were then dissected to weigh liver, and gastrocnemius

muscle. The largest liver lobe was collected and frozen in liquid nitrogen until glycogen liver assay.

Measurement of hepatic glycogen. About 100 mg of the largest liver lobe of each mouse was thawed and homogenized in 0.03 M HCl. Then, 400 μ l of 1.25 N HCl was added to 100 μ l of homogenate and was mixed and heated for 1 hr at approximately 75°C. The samples were centrifuged at 14000 rpm for 30 min. 10 μ l of supernatant was mixed with 1 ml of glucose oxidase reagent (Sigma-Aldrich, Inc., Saint Louis, United States). After 10 min incubation at 37°C, the reaction was stopped by adding 200 μ l of 12 N H₂SO₄. Absorbance was read at 505nm. Glycogen type III from rabbit was used to make the standard curve (Sigma-Aldrich, Inc., Saint Louis, United States).

Blood assays. All the samples were analyzed in duplicate. Plasma leptin was measured using ELISA kit (R&D Systems Quantikine Europe, Abingdon, United Kingdom). Intra and inter-assay coefficients of variations were 4.4% and below 4.7% respectively. Plasma corticosterone was measured using AssayMax Corticosterone ELISA Kit (AssaysPro, Saint Charles, United States). Intra and inter-assay coefficients of variations were <4.8% and <7.3% respectively. Plasma acyl (AG) and des-acyl (DAG) ghrelin concentrations were evaluated by specific EIA (SPIbio Bertin Pharma, A05118 for the acylated form and A05117 for the unacylated form, France). Blood samples were collected on tubes containing EDTA (1 mg/ml final) and PHMB (0.4 mM final), a serine protease inhibitor, then centrifuged (8000 rpm. for 10 min, 4°C Centrifuge 5414 R, Eppendorf, Hamburg, Germany) to sample plasma that was then acidified with HCl (0.1 N final) to preserve acylation. Plasma non-esterified fatty acids (NEFA) were measured by enzymatic Wako kit (Stanbio Laboratory, Boerne, United States) and plasma triglycerides and plasma β -hydroxybutyrate (ketone bodies) were analyzed using an enzymatic Stanbio kits (BDS International Diagnostics GmbH, Schwetzingen, Germany).

Statistical analysis. All results are expressed as mean \pm SE, and the statistical analysis was performed using Statistica software (StatSoft, France). Graphs were generated using GraphPad Prism 5.01 (Abacus Concepts, Berkeley, United States). Analysis of normality and equality of variances were tested to select the adequate statistical test. Two-ways ANOVA followed by a Bonferroni *post-hoc* test or a non-parametric ANOVA followed by Tukey *post-hoc* test were used when appropriate. A two-ways ANOVA for repeated measures were performed to analyze the time course for metabolic data and IPGTT. The Areas Under the

Curve (AUC) were calculated by the trapezoidal method. Significance was set at a $P < 0.05$ and only interaction effects are indicated on the figures.

RESULTS

Physical activity transiently increased food restriction-induced body weight loss. The first and simplest criterion to determine the effect of activity added to food restriction is the body weight gain. Here, we showed that by day 15 (D15) of food restriction there was a significant weight loss in FR and FRW groups compared to the AL and ALW *ad libitum* groups (interaction food x activity, $F_{1-74} = 18.17$, $P < 0.001$, Fig. 2A-B). This decrease was significantly more drastic in FRW than FR mice from D6 to D22 ($P < 0.05$). From D42 to D55, statistical analysis revealed an effect of activity ($F_{1-74} = 6.66$, $P < 0.05$) and food restriction ($F_{1-74} = 1243.05$, $P < 0.001$) on body weight loss, but no interaction between these two parameters. Surprisingly, after 35 days a slight but significant regain of body weight was observed in FRW mice ($P < 0.001$, from D43 to D55) leading to significant differences between body weight of FRW and FR groups. ($P < 0.001$ at D55; Fig. 2A).

Physical activity also impacted on the food intake pattern (Fig. 2C-D). At D15, FRW mice ate their pellets more slowly than FR mice along the first 2 hr after lights off (interaction food x activity $F_{1-23} = 4.71$, $P < 0.05$). FR and FRW mice finished their meal within 3 and 4 hr after food distribution, i.e. at 21:30 and 22:30, respectively. AL and ALW mice ate slowly, but continuously until the end of the dark phase, at 07:30. At D55, FR and FRW adopted the same pattern of feeding (interaction food x activity, $F_{1-22} = 4.15$, $P = 0.054$, Fig. 1D), but they ate all the food within 1.5 hr only. Each group showed a constant water intake pattern throughout the protocol, with FR and FRW mice presenting faster and higher water consumption than AL and ALW mice during the first part of the night, i.e. when they were eating (Fig 2E-F). Thus, during the first weeks of food restriction, physical activity slowed down the food intake. Later, FR and FRW mice presented the same pattern of food intake, with a faster feeding rate than before. Surprisingly, after 35-40 days of protocol, a slight, but significant increase in body weight appeared only in FRW mice (Fig. 2A). Factors potentially involved in the early and fast body weight decrease and in the late body weight increase shown in FRW mice were studied in subsequent experiments.

Decrease in physical activity appeared with body weight regain in food restricted active mice. FRW mice presented a biphasic pattern of daily physical activity during the long-term protocol observed both in home cage (Fig. 3) and in metabolic cages (Fig. 4). From D0 to D35, FRW mice displayed a wheel running activity that was similar to ALW mice (Fig. 3). Then, and until the end of the protocol, FRW mice showed a significant lower daily activity than ALW mice ($P < 0.05$; Figs. 3,4D). These results were confirmed by 24 hr locomotor

activity measured in metabolic cages (Fig. 4), which detailed precise information about the night and day physical activity patterns in all groups. At D15, FRW mice displayed a significant highest activity compared with the other groups during the day (interaction food x activity, $F_{1-36} = 13.24$, $P < 0.01$, Fig. 4B-C), more specially from 12:00 to 19:00, interaction food x activity, $F_{1-36} = 10.83$, $P < 0.01$, Fig. 4C). This phenomenon, which resonates with the increase in physical activity seen in AN before feeding time⁶⁰, is described in the literature as food anticipatory activity (FAA), which began several hours before food distribution. Such activity observed before feeding might be an association of foraging and FAA. Contrary to FRW mice, FR mice did not exhibit a FAA (Fig. 4C). During the dark period, ALW mice presented a constant and higher ambulatory activity compared to AL and FRW mice (interaction food x activity, $F_{1-36} = 5.17$, $P < 0.05$, Fig. 4B,C). At D45, surprisingly in FRW group, the FAA measured at D15 in metabolic cages disappeared (Fig. 4E-F, $P < 0.001$). The persistent activity observed concerned more the activity devoted to food intake as it appeared at the time the food is distributed (Fig. 4F). The disappearance of the FAA was responsible for the observed decrease in daily activity in FRW mice (Fig. 4D). FRW and ALW mice continued to exhibit the highest ambulatory activity during the dark period compared to their respective controls (interaction food x activity, $F_{1-26} = 5.15$, $P < 0.05$, Fig. 4F). These data demonstrate that mice used to run in a wheel (ALW and FRW) are more active than mice that are not used to run (AL and FR). Moreover, FAA is shown only in FRW and not in FR mice. When the protocol is extended, the FRW mice daily activity decreased mainly because of the disappearance of FAA. This decrease of activity that coincided with the body weight regain was observed only in FRW mice.

Food restriction induced alterations in reproductive function. Activity, when it becomes excessive, leads to loss of estrous cycle in restrictive AN patients as well as in athletes. In our study, we showed that food restriction by itself associated or not with physical activity induced rapidly a disruption of the estrous cycle (Fig. 5) associated with a closure of vaginal opening and decrease of uterus mass (Table 1) observed at D15 and D55. The size of ovaries of both FR and FRW mice were significantly reduced compared to AL and ALW mice (Table 1). Thus, physical activity did not exacerbate the impact of reduction of feeding in the reproduction function.

Physical activity precipitated early alterations of fat mass in food-restricted mice. Besides loss of fat, AN patients also show muscular atrophy and osteopenia/osteoporosis in the long term⁴¹ for which the impact/role of physical activity is poorly understood. To this

end, in the present study, we explored fat, lean and bone mineral mass changes. The different measures obtained at different times of the long-term protocol (Fig. 1) with the X-ray CT scanner (Fig. 6) showed more precisely the impact of physical activity associated or not with food restriction on body composition. At D15, food restriction induced a 19 % lower lean mass in FR and FRW mice compared to AL and ALW mice (food effect, $F_{1-20}= 132.02$, $P < 0.001$, Fig 6A). The mass of liver and triceps, components of the lean mass, were actually lowered in FR and FRW groups ($P < 0.001$, Table 1). The body fat mass was strongly affected by both food restriction (food effect, $F_{1-20}= 4.86$, $P < 0.05$, Fig 6B) and physical activity (activity effect, $F_{1-20}= 26.57$, $P < 0.001$, Fig 5B). More particularly, FRW mice exhibited a decrease of -87.20 ± 5.04 % compared to FR mice fat mass. Interestingly, FR mice did not display such a drastic decrease ($-33.90 \pm 11.43\%$) compared to AL mice fat mass. The visceral fat mass was affected by both food ($F_{1-20}= 7.84$, $P < 0.05$, Fig. 6C) and activity ($F_{1-20}= 17.94$, $P < 0.001$, Fig. 6C). The subcutaneous fat mass was only affected by activity ($F_{1-20}= 30.72$, $P < 0.001$, Fig. 6D).

At D55, the differences in lean mass did not change compared to D15 (food effect, $F_{1-20}= 557.48$, $P < 0.001$, Fig. 6A). The weight of the liver was affected by the restriction (food effect, $F_{1-46}= 75.12$, $P < 0.001$, Table 1) whereas the weight of the triceps was conditioned by both food and physical activity (food effect, $F_{1-22}= 175.71$, $P < 0.001$; activity effect, $F_{1-22}= 6.31$, $P < 0.05$, Table 1). For the fat mass, an interaction food x activity was noted ($F_{1-20}= 9.76$, $P < 0.005$, Fig 6B) with a pronounced decrease for FRW and FR mice compared respectively to ALW and AL mice ($P < 0.005$) and ALW to AL mice ($P < 0.005$). Similar comparisons were obtained for visceral fat mass (interaction food x activity, $F_{1-20}= 7.91$, $P < 0.05$, Fig 6C) and subcutaneous fat mass (interaction food x activity, $F_{1-20}= 10.09$, $P < 0.05$, Fig 6D). FR mice presented a higher decrease of fat tissue compared to AL mice (-88.03 ± 2.59 %) than FRW mice compared to ALW and FR mice respectively ($-67,88 \pm 7.76$ % and $+70,8 \pm 40.45$ %, $P < 0.05$). Finally, the bone mass acquisition might be stopped between D15 and D55 in FR and FRW mice. Indeed, restriction did not permit a gain of bone mineral content (BMC; food effect, $F_{1-20}= 43.95$, $P < 0.001$, Fig 6E) for FRW and FR groups compared to ALW and AL groups. As expected ALW mice exhibited a trend to a higher BMC than AL mice. Collectively, these data suggest that physical activity accelerates the effects of food restriction on fat tissue without protecting muscle and bone mass.

Physical activity associated with food restriction induced an adaptation in energy metabolism. Long-term food restriction associated or not with physical activity has been

suggested to induce changes in the energy metabolism, changes that are difficult to assess precisely in AN patients in the long term⁵⁷. Animal models are thus useful to decipher metabolic adaptations that take place in response to long-term energy imbalance. At D15, energy expenditure (EE) was affected both by activity and food restriction during the dark period (interaction food x activity, $F_{1-36} = 15.13$, $P < 0.001$, Fig. 7A-B), with FR and FRW mice having a lower EE than their respective controls AL and ALW mice ($P < 0.001$). During the day, similar differences were observed (food effect, $F_{1-36} = 70.23$, $P < 0.001$, Fig. 7A-B). Over a period of 24 hr, the pattern of EE for ALW followed their ambulatory activity (Fig. 3). By contrast, FRW mice presented the same EE pattern as FR mice (6.15 ± 0.25 kcal/day in FR mice vs. 6.14 ± 0.20 kcal/day in FRW mice, data not shown) even if FRW mice displayed a higher physical activity level than FR mice (Fig. 4C). At D45, regarding the daily EE, FR and FRW mice had a lower EE than *ad libitum* groups (interaction food x activity, $F_{1-26} = 18.41$, $P < 0.001$; AL: 10.14 ± 0.13 kcal/day; ALW: 11.98 ± 0.29 kcal/day; FR: 5.96 ± 0.16 kcal/day; FRW 6.05 ± 0.15 kcal/day). During the dark period, FRW mice showed a higher EE than FR mice, but lower than ALW mice (interaction food x activity, $F_{1-26} = 8.82$, $P < 0.01$, Fig. 7C-D) that might be paralleled with their highest physical activity (Fig. 4F). However, despite a decrease of locomotor activity during the light period between D15 and D45, FRW mice displayed the same level of EE. Thus, these data reveal an uncoupling between physical activity and global EE for FRW mice suggesting different specific metabolic adaptations related to activity. The analysis of RER and FA oxidation was done to explore this further.

At D15, data showed that RER was not affected by food restriction or activity in any group during the overall dark period (Fig. 8A). However, RER determined each hour showed that food delivery was followed by a significant increase in RER in FR and FRW mice between 21:00 and 01:00 compared to AL and ALW mice (food effect, $P < 0.05$, Fig. 8B) with values reaching 1.0 which is generally taken to represent both carbohydrate oxidation and endogenous fatty acid synthesis. Intriguingly, from 07:00 to 19:00, FR mice showed a progressive and significant decrease in RER values that reached ~ 0.7 , suggesting a shift to lipid oxidation when compared to FRW mice ($P < 0.05$, Fig. 8B) that maintained a RER pattern similar to the other groups. During the day, an effect of activity was noted ($F_{1-36} = 12.99$, $P < 0.001$, Fig. 8A). Such data were corroborated by the evaluation of fat oxidation (Fig. 8C-D). During the night, an interaction food x activity ($F_{1-36} = 5.64$, $P < 0.05$, Fig. 8C) revealed that FRW mice had a lower fat oxidation than ALW mice ($P < 0.001$) as well and FR compared to AL mice (tendency $P = 0.07$). However, the high locomotor activity of ALW

compared to AL mice during the night is associated with a similar RER, but the FA oxidation values revealed a higher consumption of both lipid and carbohydrates. FRW and FR mice exhibited the same RER as ALW and AL mice but their low FA oxidation values suggested a lowered use of lipid and carbohydrate stores. During the light period, FR and FRW mice displayed a lower fat oxidation than their control AL and ALW mice (food effect, $F_{1-36}=17.63$, $P < 0.001$, Fig. 8C). These data suggest that food restriction increases the total energy derived directly from fatty acid oxidation, especially for FR mice compared to AL, ALW and FRW mice. At D45, the main changes concerned RER values obtained during the light period, where a food effect was prominent ($F_{1-26}=25.74$, $P < 0.001$, Fig. 8E-F). Throughout the light phase, FRW mice exhibited the lowest fat oxidation levels compared to all other groups (tendency to interaction food x activity, $F_{1-26}=3.71$, $P = 0.06$, Fig. 8G-H). In restricted mice, physical activity balanced the use of carbohydrate and lipids on the short term whereas, when the protocol was extended, it did not impact significantly on lipid or carbohydrate metabolism.

To explore the mechanisms further, we measured different plasma metabolites, which can reflect energy balance. Glycemia was performed in the basal condition in the morning (mice were all given the same amount of food 14 hr before the measurements) or after 14 hr of fasting. At D15, both FR and FRW groups displayed a decreased glycemia in basal or fasted conditions (food effect, $F_{1-67}=73.39$, $P < 0.001$ and $F_{1-36}=14.82$, $P < 0.001$ respectively, Table 2). At D55, food and activity affected the basal glycemia (food effect, $F_{1-43}=45.53$, $P < 0.005$; activity effect, $F_{1-43}=8.58$, $P < 0.001$, Table 2). Regarding the glycogen stock in liver, food restriction induced a significant decrease only at D15 (food effect, $F_{1-23}=4.81$, $P < 0.05$, Table 2). Likewise, only at D55, the plasma levels of ketone bodies were affected by both the food restriction and activity (food effect, $F_{1-25}=13.33$, $P < 0.001$, activity effect, $F_{1-25}=5.63$, $P < 0.05$, Table 2). The NEFA plasma levels were increased both in FR and FRW mice at short-term (food effect, $F_{1-23}=8.35$, $P < 0.01$) and long-term (food effect, $F_{1-25}=6.39$, $P < 0.05$). Finally, no significant difference was detected on the short and long term protocols for the plasma triglycerides (Table 2).

Overall, these results show that FR and FRW groups adopt differential energy metabolism strategies. Interestingly, in FRW mice, activity is not related to a higher EE compared to ALW. Moreover, at D15, contrary to FR mice, FRW mice exhibit a similar metabolism to AL and ALW groups during the light phase. Finally, in the long term, FRW mice displayed a similar metabolic profile (RER, FA oxidation) to that obtained in FR mice.

Physical activity and food restriction increased glucose tolerance. Similar to the other energy metabolism parameters, data on glucose tolerance in AN patients during the course of their disease are sparse⁵⁷. At D15, FR and FRW mice exhibited a lower glycemia compared to AL and ALW (at t0, food effect, $F_{1-36}=14.82$, $P < 0.001$; AUC, food effect, $F_{1-36}=43.97$ $P < 0.001$). Interestingly, at t30 min, FRW mice displayed a significant lower glycemia after glucose injection compared to FR mice (interaction food x activity, $F_{1-36}= 3.94$, $P < 0.05$, Fig. 9A). At D50, FR and FRW mice exhibited a lower glycemia than AL and ALW (at t0, food effect, $F_{1-36}=14.82$, $P = 0.08$; AUC, food effect, $F_{1-36}=37.28$, $P < 0.001$). No difference remained between FR and FRW groups (Fig. 9B).

Here again, physical activity appears to have beneficial effects by enabling a better adaptation to food restriction with a more rapid and more efficient use of the glucose immediately available, but only on the short term.

Physical activity and food restriction modified energy metabolism hormones levels. In AN, patients also display numerous endocrine alterations that can contribute directly or indirectly to maintain and exacerbate the disease^{24,66}. Data related to the understanding of how hormones might contribute to the worsening of the patients are currently lacking. At D15 and D55, the plasma levels of leptin were impacted both by activity and food (interaction food x activity, $F_{1-18}= 4.46$, $P < 0.05$, interaction food x activity, $F_{1-31}= 12.92$, $P < 0.001$, respectively, Table 3) with significant differences noted between AL and ALW mice ($P < 0.05$) and AL compared to FR mice ($P < 0.05$). The plasma levels of corticosterone were increased in FR and FRW mice compared to their respective controls at D15 (food effect, $F_{1-28}= 16.15$, $P < 0.001$, Table 3). At D55, FR mice exhibited the higher corticosteronemia compared to AL and FRW mice (interaction food x activity, $F_{1-20}= 11.06$, $P < 0.01$, Table 3). Plasma levels of ghrelin, the only known circulating hormone that increases food intake, were increased in FR and FRW groups compared to AL and ALW mice at D15 (food effect, $F_{1-26}= 37.72$, $P < 0.001$, Table 3) and at D55 (food effect, $F_{1-23}= 4.76$, $P < 0.05$, Table 3). More precisely, at D15, the acylghrelin form was influenced by the food restriction and activity (food effect, $F_{1-26}= 21.48$, $P < 0.001$; activity effect, $F_{1-26}= 6.24$, $P < 0.05$), whereas desacylghrelin concentrations were increased in FR and FRW mice compared to AL and ALW mice (food effect, $F_{1-26}= 36.81$, $P < 0.001$, Table 3). Thus, the ratio acylghrelin / des-acylghrelin reflected more an impact of activity (activity effect, $F_{1-26}= 10.42$, $P < 0.01$, Table 3) than of the food restriction. At D55, acyl- and des-acylghrelin plasma levels were influenced by activity (activity effect, $F_{1-23}= 8.01$, $P < 0.01$) and food respectively (food effect, $F_{1-23}= 8.32$,

P < 0.01, Table 3) with a ratio acylghrelin / des-acylghrelin higher in ALW and FRW mice (food effect, $F_{1-23} = 5.45$, $P < 0.05$, activity effect, $F_{1-23} = 14.61$, $P < 0.001$, Table 3).

Therefore, our data underscore an impact of physical activity on the ghrelin system. The food restriction led to endocrine changes that could explain the differential adaptations described previously in FR and FRW mice compared the *ad libitum* groups.

DISCUSSION

This study was undertaken to obtain, in a mouse model, data contributing to determine whether the physical activity often described in restrictive AN patients might have beneficial or deleterious effects on bodily functions on the long term. For this purpose, we describe for the first time the physiological consequences of the combination of long-term food restriction with voluntary physical activity in female mice. The main finding is that physical activity induced differential metabolic and endocrine adaptations in chronic food restricted animals.

Considering the different known animal models related to food restriction and activity and their limitations, we modified the initial ABA model to study lasting alterations. We chose to reduce the quantity of food from 30% for the first days to 50% until the end of the protocol as normal mice are usually 30% overfed, taking into account their physiological needs⁴.

We showed rapid body weight stabilization in the 30% restricted and active mice. Following this 30% restriction, the higher diet restriction combined with physical activity induced a more drastic and a more rapid body weight loss on the short term (up to D15). Then, FRW mice showed 2 weeks of stabilized body weight around 20% under their initial body weight. This decrease matched that described previously in long-term 50% FR mice²⁷. After these 2 weeks of stabilization, a slight body weight gain was observed (from D32-35 to D40). Then, body weight remained unchanged until the end of the protocol (D55). The body composition revealed that fat mass was strikingly decreased in FRW mice, while FR and FRW mice showed a moderate reduction in the lean mass and completely stopped bone mass acquisition.

To search for causes of this pattern of body weight changes only observed in FRW mice, we studied the physical activity of mice throughout the protocol. First, FRW mice showed a daily activity equivalent to that of ALW mice, suggesting that our model did not induce a hyperactive behavior, but rather a moderate activity. Second, the period of slight body weight gain in FRW mice took place when physical activity becomes lower in comparison to the beginning of the protocol. This could participate to the weight increase. Further analysis of activity patterns, revealed that before their activity became lower, FRW mice were active both during the night and the day throughout the protocol, while activity in all other groups was restricted to the dark period. FRW mice developed a light period activity close to the feeding time. This activity, usually called food anticipatory activity (FAA), was also described in the ABA paradigm^{23,48,49,68}. The FAA is usually described 2-3h before food distribution. In our model, FRW mice began to be active around 6 h before food, at D15. Such

behavior might reflect an association between foraging and FAA. We hypothesized that the peak of activity observed 2-3h before feeding might really correspond to FAA whereas the previous activity might be related to foraging. Tentatively, we suggest that wheel running impacts on the development of FAA by increasing addictive behavior to exercise³⁷. Indeed, FAA is driven by the dopaminergic motivation/reward system^{31,67}. Alterations of the reward system are increasingly suspected to play a role in keeping AN patients in a vicious circle of food restriction associated usually with activity^{5,60}. Finally, until the end of the protocol, FRW mice maintained a moderate activity, even if a strong decrease was observed for the FAA that resulted in a reduction in their global daily activity.

The relation between leptin and physical activity has been well investigated, especially in the ABA protocol^{25,33,51}. In fasted mice, increases in ambulatory and running wheel activity have been shown to be inhibited by chronic subcutaneous leptin treatment⁵¹. In the ABA protocol, subcutaneous or intracerebroventricular leptin delivery leads to a decrease in running wheel activity^{25,33}. In our study, at D15 as well as at D55, FRW, ALW and FR mice had a similar low plasma leptin level when compared to AL mice, reflecting their fat mass reduction, especially the visceral fat pads. In accordance with the known effect of leptin on activity, the slight increase in plasma leptin levels described in FRW mice between D15 and D55 might be a contributing factor to the disappearance of the FAA at D55. Of note, AN patients also exhibit lower plasma levels of leptin in association with their fat mass reduction⁵⁰. Our data reinforce the importance of studies exploring the impact of food restriction in association with activity in chronic long-term protocols.

Ghrelin is another hormone involved in FAA behavior⁶⁸. As for AN restrictive type patients^{29,30}, at D15, the 2 groups of food restricted mice displayed an increase in plasma acyl and des-acylghrelin levels. The ratio acyl/des-acylghrelin contributes to a better idea of the potential ghrelin activity, because of the controversial functions of these two forms that remain discussed¹³. In our study, at D15, ALW and FRW mice displayed a higher acyl-/des-acylghrelin ratio compared to AL and FR mice suggesting that active ghrelin levels might impact upon physical activity or *vice versa*⁴⁸. On the long term, this ratio in FRW mice decreased and became similar to that of FR and AL mice. This decrease was associated with lowered FAA in FRW mice. Interestingly, in ABA protocol, the stimulatory action of acyl-ghrelin exerted on FAA is abolished by chronic intracerebroventricular GHSR1a antagonist treatment⁶⁸.

Finally, corticosterone plasma levels are increased in AN patients²⁹. Besides its known role in the regulation of stress response, corticosterone was demonstrated to contribute to the

development of FAA in rodents submitted to the ABA protocol²². In the short term protocol, FRW and FR exhibited increases in plasma levels of corticosterone. However, in the long term protocol, FR mice displayed higher levels than AL and FRW mice. Such changes might explain the slight activity observed just around the food distribution for FR mice and again might be one possible explanation to the disappearance of FAA in FRW mice. Once again, such differences between the two restricted groups might explain the differential pattern of activity. Thus, the data we have obtained gave us two main novel findings: 1) FRW mice showed a unique pattern of leptin, ghrelin ratio and corticosterone, that are involved in the regulation of physical activity but also in the regulation of energy metabolism; 2) voluntary and moderate physical activity at the beginning of a protocol of food restriction might be beneficial in the long term since it is associated with a normalization of metabolic hormone levels which may favor a better adaptation to this drastic conditions. These data led us to study the changes that could occur in energy metabolism.

The low energy expenditure observed in FR and FRW mice at D15 and D45 might be associated with low plasma leptin concentrations but also with the food restriction since ALW mice, which also showed low levels of leptin, exhibited high EE during the night. Accordingly, the reduction of lean mass observed in FR and FRW might be a strategy to spare energy used by the organism in such drastic conditions to avoid a too dramatic hypothermia⁶². It might be associated with the persistent high corticosterone levels, which is known to simulate conversion of protein to glucose and increase nitrogen catabolism in muscle. It can also be hypothesized that fat pad decreases might impact EE through the decrease of plasma leptin levels. Indeed, leptin treatment in fasted male mice increased total EE⁵¹. The impact of ghrelin on EE was not clear since intracerebroventricular or intraperitoneal injection of ghrelin decreased EE³ whereas intraperitoneal treatment with proghrelin increased EE⁶⁹. Such data point out the controversial dual effect of acylghrelin and des-acylghrelin on food intake and energy expenditure. Here our data did not permit us to decipher the real impact of ghrelin on EE. Finally, the low EE described both in FR and FRW mice, especially during the light period when only FRW showed a FAA, let us to conclude that EE was not only related to exercise, but reflected an adaptive way to save energy to maintain physiological functions. The impact of food restriction on energy metabolism confirmed data obtained with 30% of food restriction⁸. However, the strategy used by FR and FRW mice were different. In fact, in the short term, FRW mice adopted different fuel utilization than FR, during the light period. FR mice displayed a metabolism that was oriented to FA oxidation, which was not the case for FRW mice despite the food restriction and the FAA.

These metabolic data suggest that, in the short term, FRW mice did not adapt properly their metabolism, with a higher carbohydrate metabolism and a lower fat oxidation during the light period than FR mice. Such a profile was supported by the results obtained in the glucose tolerance test; FRW mice displayed a faster glucose clearance particularly just after glucose injection. This improved glucose capture could explain why FRW mice has a higher RER than FR during the day at D15. When the protocol was extended, FRW mice adopted a similar metabolic profile to FR mice. Thus, physical activity may delay the metabolic adaptations to food restriction even if the other parameters (such as liver weight, hepatic glycogen, basal and fasted glycemia, NEFA, leptin, corticosterone, ghrelin) evolved in a similar way in FR and FRW in the short term. In the long term, FRW mice appeared more adapted to these drastic conditions compared to FR mice. Besides the increased body weight, FRW mice had lower corticosterone and acylghrelin levels compared to D15 whereas they remained constant in the FR group. Due to their role in the regulation of energy metabolism, glycemia and food intake, further studies are needed to explore the precise role of these two key hormones in the adaption process of FRW mice. To our knowledge very few studies focused on metabolite concentrations related to energy metabolism in AN^{9,10,55,72}, likely reflecting the discrepant data obtained and the procedures used to measure these metabolites (times of the day, before or after a meal, fasted conditions etc) rendering the data difficult to interpret. This underscores the necessity to study the evolution of these parameters in relevant animal models.

It is known that physical activity is generally associated with fuel mobilization, reflected by increases in glycemia and plasma NEFA, as well as feeding that participated to an overload of blood nutriment⁵⁹. We showed here that running wheel activity modified the pattern of ingestion of food in FRW mice, in shifting the meal initiation. FRW mice ate the delivered food more slowly than FR mice. One explanation, suggested by Woods⁷¹, considered eating as a homeostatic stressful event, because the digested nutriment that reached the blood during and after a meal markedly disrupt energy homeostasis. Thus, the combination of both events, activity and feeding, could generate a stressful energy event especially on the short term where FRW delayed their time to eat. Thus, the shift in meal initiation observed here might explain the “voluntary food restriction” observed in the ABA protocol³⁸. In fact, no study has measured the meal initiation in the ABA model in which food is available for only 2 hr. Taken together with our data, we hypothesize that the voluntary food restriction described in the ABA model might be due to the physical activity maintained by the mice that could modify the beginning of feeding. Another critical factor in the ABA model is the dehydration. In contrast to what was observed in the ABA protocol, in which the

consumption of water could play a role in the reduction of food intake⁶, we did not observe any modification in the water intake pattern. Thus, here physical activity influenced the meal initiation without affecting the water consumption. It can be hypothesized that the moderate and not high level of activity described in our model is responsible for this observation.

Food restriction is also known to disturb reproduction function both in humans and rodents. As demonstrated by Dos Santos et al., (2010), female rats submitted to treadmill exercise and a 50% of food restriction led to interruption of estrous cyclicity as we observed in our study where the physical activity was voluntary²¹. In AN patients, even if amenorrhea is not anymore considered as a criterion in the DSM-V, disruption of cycles is currently observed in restrictive AN patients^{24,42}. Disruption of estrous cycle as well as reduction of the size of ovaries was here observed in FR and FRW mice along all the protocols. Physical activity alone did not promote such alteration. The combination of energy deficit and activity seems necessary to induce these modifications. These alterations might also be adaptive to avoid the development of offspring in a deleterious nutritional environment. The endocrine changes observed in our study might contribute to the development of this phenotype. Leptin was largely described to play an essential role in reproduction since Indeed, *db/db* mice which are deleted for leptin gene receptor and *ob/ob* mice which deleted for leptin gene are infertile^{6,18}. Moreover, upregulation of ghrelin induced a decrease of LH surge^{26,53}, even if mechanisms involved are yet unknown. Chronic exposition to corticosterone inhibited LH secretion and estrous cycle and ovulation in female rodents^{9,10}. Thus, both FR and FRW mice displayed high plasma corticosterone and ghrelin levels as well as a strong fall in the leptin concentrations. Therefore, the various endocrine alterations observed in our study are likely to alert hypothalamic brain structures involved in reproductive function and energy metabolism of the energy imbalance to preserve sufficient energy to adapt the body both at short and long term protocol. Finally the body weight gain observed in FRW mice after 30 days of protocol is not related to the estrous cycle, since it remained absent until the end of the long term protocol.

Finally, another major alterations of AN is a decrease in bone mineral content (BMC) leading to osteopenia and osteoporosis in 38–50% of cases, associated with high-risk of fracture in patients^{41,42,43}. Alterations in BMC were described in rats and mice aged 3 to 14 weeks old, subjected to protocols where food restriction varied from 30 to 40 % for 3 to 10 weeks^{19,32,54,63}. In FR and FRW mice, bone mass acquisition was stopped similarly after D15, whereas it was increased for AL and ALW mice. Thus, in FRW mice, physical activity that is usually described to stimulate bone formation did not prevent the termination of bone mass

acquisition induced by food restriction. Similar data were also described in female mice subjected to a protocol of chronic stress associated with caloric restriction, the “separation based-anorexia” model⁷³. This confirmed the absence of protective effect of activity on BMC in AN.

In conclusion, here we have characterized a new rodent model of chronic restriction associated with voluntary physical activity that mimics, at least in part, the physiological alternations that occur in AN. This model was used to determine whether physical activity has beneficial or detrimental role in this disease in the long term. Our data lead us to suggest a dual effect of exercise. Moderate voluntary exercise accelerates body weight loss (affecting in particular the fat mass) leading to noticeable endocrine alterations, which could impact food anticipatory activity, effects also observed in AN patients. It did not permit a proper metabolic adaption, on the short term, with a metabolism similar to that of *ad libitum* groups. However, a delayed food intake initiation due to physical activity limited a rapid food intake pattern, which was observed only in FR mice. This behavior resembles to the binge eating behavior observed in some AN patients, which causes abdominal discomfort and possibly also lower nutriment adsorption. In this case, physical activity might have a beneficial effect. In the long term, we suggest that moderate exercise may have positive effects on energy metabolism regulation. Finally, the evolution of hormone levels noted both at short and long term, reflected an effect of both activity and food restriction on adaptation to these drastic conditions of negative energy balance, with a potential positive effect on the long term. However, activity did not contribute to prevent lean and bone mass loss induced by food restriction. It remains to be determined whether these specific physiological adaptations in our AN model (metabolic, endocrine..) that are related to moderate activity could lead to a better or poorer recovery.

ACKNOWLEDGMENTS

We acknowledge the excellent technical assistance provided by the Histological service of the Lille CHRU. Many thanks go to the staff of the animal facility Delphine Taillieu, Mélanie Besegher, Ludovic Mercier and Romain Dehaynin (animal facility, IFR 114) and Flore Miellot (animal facility, PMOI EA 4490) for their help and technical assistance. We are very grateful to Pr Suzanne L. Dickson for their precious scientific counsel and the language spelling of the paper.

GRANTS

This work was supported by grants from the Nord-Pas de Calais Région « ARCIR-GIRAM ». Mathieu Méquinion was supported by a doctoral fellowship from the University of Lille 2.

REFERENCES:

1. **American Psychiatric Association.** Diagnostic and statistical manual of mental disorders. Fourth Edition. Washington, DC: *American Psychiatric Association*, 1994.
2. **American Psychiatric Association.** Diagnostic and Statistical Manual of Mental Disorders, Fifth Edition, DSM-5. *American Psychiatric Association*, 2013.
3. **Asakawa A, Inui A, Kaga T, Yuzuriha H, Nagata T, Ueno N, Makino S, Fujimiya M, Nijima A, Fujino MA, Kasuga M.** Ghrelin is an appetite-stimulatory signal from stomach with structural resemblance to motilin. *Gastroenterology* 120(2):337-45, 2001.
4. **Austad SN.** Does caloric restriction in the laboratory simply prevent overfeeding and return house mice to their natural level of food intake? *Sci Aging Knowledge Environ.* (6):pe3, 2001.
5. **Avena NM, Bocarsly ME.** Dysregulation of brain reward systems in eating disorders: neurochemical information from animal models of binge eating, bulimia nervosa, and anorexia nervosa. *Neuropharmacology* 63(1):87-96, 2012.
6. **Bellefontaine N, Chachlaki K, Parkash J, Vanacker C, Colledge W, d'Anglemont de Tassigny X, Garthwaite J, Bouret SG, Prevot V.** Leptin-dependent neuronal NO signaling in the preoptic hypothalamus facilitates reproduction. *J Clin Invest.* 2;124(6):2550-9, 2014.
7. **Boakes RA, Juraskova I.** The role of drinking in the suppression of food intake by recent activity. *Behav Neurosci.* 115(3):718-30, 2001.
8. **Boakes RA.** Self-starvation in the rat: running versus eating. *Span J Psychol.* 10(2):251-7, 2007.
9. **Brann DW, Mahesh VB.** Role of corticosteroids in female reproduction. *FASEB J.* 5(12):2691-8, 1991.
10. **Breen KM, Thackray VG, Hsu T, Mak-McCully RA, Coss D, Mellon PL.** Stress levels of glucocorticoids inhibit LH β -subunit gene expression in gonadotrope cells. *Mol Endocrinol.* 26(10):1716-31, 2012.
11. **Bruss MD, Khambatta CF, Ruby MA, Aggarwal I, Hellerstein MK.** Calorie restriction increases fatty acid synthesis and whole body fat oxidation rates. *Am J Physiol Endocrinol Metab.* 298(1):E108-16, 2010.
12. **Casper RC, Pandey G, Jaspán JB, Rubenstein AH.** Eating attitudes and glucose tolerance in anorexia nervosa patients at 8-year followup compared to control subjects. *Psychiatry Res.* 25(3):283-99, 1988.
13. **Casper RC.** Carbohydrate metabolism and its regulatory hormones in anorexia nervosa. *Psychiatry Res.* 16;62(1):85-96, 1996.
14. **Dalle Grave R, Calugi S, Marchesini G.** Compulsive exercise to control shape or weight in eating disorders: prevalence, associated features, and treatment outcome. *Compr Psychiatry* 49(4):346-52, 2008.
15. **Davis C.** Eating disorders and hyperactivity: a psychobiological perspective. *Can J Psychiatry* 42(2):168-75, 1997.
16. **de Moura LP, Sponton AC, de Araújo MB, Dalia RA, Pauli JR, Rostom de Mello MA.** Moderate physical activity from childhood contributes to metabolic health and reduces hepatic fat accumulation in adult rats. *Lipids Health Dis.* 6;12:29, 2013.
17. **Delhanty PJ, Neggers SJ, van der Lely AJ.** Should we consider des-acyl ghrelin as a separate hormone and if so, what does it do? *Front Horm Res.*;42:163-74, 2014.

18. **de Luca C, Kowalski TJ, Zhang Y, Elmquist JK, Lee C, Kilimann MW, Ludwig T, Liu SM, Chua SC Jr.** Complete rescue of obesity, diabetes, and infertility in db/db mice by neuron-specific LEPR-B transgenes. *J Clin Invest.* 115(12):3484-93, 2005.
19. **Devlin MJ, Cloutier AM, Thomas NA, Panus DA, Lotinun S, Pinz I, Baron R, Rosen CJ, Boussein ML.** Caloric restriction leads to high marrow adiposity and low bone mass in growing mice. *J Bone Miner Res.* 25(9):2078-88, 2010.
20. **DiFiori JP, Benjamin HJ, Brenner JS, Gregory A, Jayanthi N, Landry GL, Luke A.** Overuse injuries and burnout in youth sports: a position statement from the American Medical Society for Sports Medicine. *Br J Sports Med.* 48(4):287-8, 2014.
21. **Dos Santos ZA, Da Silva RJ, Bacurau RF, Tirapegui J, Ribeiro SM.** Effect of food restriction and intense physical training on estrous cyclicity and plasma leptin concentrations in rats. *J Nutr Sci Vitaminol (Tokyo)* 57(1):1-8, 2011..
22. **Duclos M, Gatti C, Bessière B, Mormède P.** Tonic and phasic effects of corticosterone on food restriction-induced hyperactivity in rats. *Psychoneuroendocrinology* 34(3):436-45, 2009.
23. **Duclos M, Ouerdani A, Mormède P, Kongsman JP.** Food restriction-induced hyperactivity: addiction or adaptation to famine? *Psychoneuroendocrinology* 38(6):884-97, 2013.
24. **Estour B, Germain N, Diconne E, Frere D, Cottet-Emard JM, Carrot G, Lang F, Galusca B.** Hormonal profile heterogeneity and short-term physical risk in restrictive anorexia nervosa. *J Clin Endocrinol Metab.* 95(5):2203-10, 2010.
25. **Exner C, Hebebrand J, Remschmidt H, Wewetzer C, Ziegler A, Herpertz S, Schweiger U, Blum WF, Preibisch G, Heldmaier G, Klingenspor M.** Leptin suppresses semi-starvation induced hyperactivity in rats: implications for anorexia nervosa. *Mol Psychiatry* 5(5):476-81, 2000.
26. **Fernández-Fernández R, Tena-Sempere M, Roa J, Castellano JM, Navarro VM, Aguilar E, Pinilla L.** Direct stimulatory effect of ghrelin on pituitary release of LH through a nitric oxide-dependent mechanism that is modulated by estrogen. *Reproduction*133(6):1223-32, 2007.
27. **Gairdner SE, Amara CE.** Serum leptin is not correlated with body fat in severe food restriction. *Appl Physiol Nutr Metab.* 37(6):1063-71, 2012.
28. **Gelegen C, Collier DA, Campbell IC, Oppelaar H, van den Heuvel J, Adan RA, Kas MJ.** Difference in susceptibility to activity-based anorexia in two inbred strains of mice. *Eur Neuropsychopharmacol.* 17(3):199-205. 2007.
29. **Germain N, Galusca B, Grouselle D, Frere D, Billard S, Epelbaum J, Estour B.** Ghrelin and obestatin circadian levels differentiate bingeing-purging from restrictive anorexia nervosa. *J Clin Endocrinol Metab.* 95(6):3057-62, 2010.
30. **Germain N, Galusca B, Le Roux CW, Bossu C, Ghatei MA, Lang F, Bloom SR, Estour B.** Constitutional thinness and lean anorexia nervosa display opposite concentrations of peptide YY, glucagon-like peptide 1, ghrelin, and leptin. *Am J Clin Nutr.* 85(4):967-71, 2007.
31. **Greenwood BN, Foley TE, Le TV, Strong PV, Loughridge AB, Day HE, Fleshner M.** Long-term voluntary wheel running is rewarding and produces plasticity in the mesolimbic reward pathway. *Behav Brain Res.* 1;217(2):354-62, 2011.
32. **Hamrick MW, Ding KH, Ponnala S, Ferrari SL, Isales CM.** Caloric restriction decreases cortical bone mass but spares trabecular bone in the mouse skeleton: implications for the regulation of bone mass by body weight. *J Bone Miner Res.* 23(6):870-8, 2008.
33. **Hillebrand JJ, Koeners MP, de Rijke CE, Kas MJ, Adan RA.** Leptin treatment in activity-based anorexia. *Biol Psychiatry.* 15;58(2):165-71, 2005a.

34. **Hillebrand JJ, van Elburg AA, Kas MJ, van Engeland H, Adan RA.** Olanzapine reduces physical activity in rats exposed to activity-based anorexia: possible implications for treatment of anorexia nervosa? *Biol Psychiatry*, 15;58(8):651-7, 2005b.
35. **Hoek HW.** Incidence, prevalence and mortality of anorexia nervosa and other eating disorders. *Curr Opin Psychiatry* 19(4):389-94, 2006.
36. **Jésus P, Ouelaa W, François M, Riachy L, Guérin C, Aziz M, Do Rego JC, Déchelotte P, Fetissof SO, Coëffier M.** Alteration of intestinal barrier function during activity-based anorexia in mice. *Clin Nutr.* 15. pii: S0261-5614(13)00310-5, 2013.
37. **Kanarek RB, D'Anci KE, Jurdak N, Mathes WF.** Running and addiction: precipitated withdrawal in a rat model of activity-based anorexia. *Behav Neurosci.* 123(4):905-12, 2009.
38. **Kirialanis P, Malliou P, Beneka A, Giannakopoulos K.** Occurrence of acute lower limb injuries in artistic gymnasts in relation to event and exercise phase. *Br J Sports Med.* 37(2):137-9, 2003.
39. **Klenotich SJ, Dulawa SC.** The activity-based anorexia mouse model. *Methods Mol Biol.*;829:377-93, 2012.
40. **Legroux-Gérot I, Vignau J, Biver E, Pigny P, Collier F, Marchandise X, Duquesnoy B, Cortet B.** Anorexia nervosa, osteoporosis and circulating leptin: the missing link. *Osteoporos Int.* 21(10):1715-22, 2010.
41. **Legroux-Gérot I, Vignau J, Collier F, Cortet B.** Bone loss associated with anorexia nervosa. *Joint Bone Spine* 72(6):489-95, 2005.
42. **Legroux-Gérot I, Vignau J, Collier F, Cortet B.** Factors influencing changes in bone mineral density in patients with anorexia nervosa-related osteoporosis: the effect of hormone replacement therapy. *Calcif Tissue Int.* 83(5):315-23, 2008.
43. **Legroux-Gérot I, Vignau J, D'Herbomez M, Collier F, Marchandise X, Duquesnoy B, Cortet B.** Evaluation of bone loss and its mechanisms in anorexia nervosa. *Calcif Tissue Int.* 81(3):174-82, 2007.
44. **Lucas AR, Beard CM, O'Fallon WM, Kurland LT.** 50-year trends in the incidence of anorexia nervosa in Rochester, Minn.: a population-based study. *Am J Psychiatry*, 148(7):917-22, 1991.
45. **Lusk G.** Animal calorimetry analysis of the oxidation of mixtures of carbohydrate and fat. A correction. *J Biol Chem.*59:41-42, 1924.
46. **McLean JA, Tobin G.** Animal and human calorimetry. New York : Cambridge University Press, 1987.
47. **Méquinion M, Langlet F, Zgheib S, Dickson S, Dehouck B, Chauveau C, Viltart O.** Ghrelin: central and peripheral implications in anorexia nervosa. *Front Endocrinol (Lausanne)*, 26;4:15, 2013.
48. **Merkestein M, Brans MA, Luijendijk MC, de Jong JW, Egecioglu E, Dickson SL, Adan RA.** Ghrelin mediates anticipation to a palatable meal in rats. *Obesity*, 20(5):963-71, 2012.
49. **Merkestein M, van Gestel MA, van der Zwaal EM, Brans MA, Luijendijk MC, van Rozen AJ, Hendriks J, Garner KM, Boender AJ, Pandit R, Adan R.** GHS-R1a signaling in the DMH and VMH contributes to food anticipatory activity. *Int J Obes (Lond)* 38(4):610-8, 2014.
50. **Misra M, Miller KK, Almazan C, Ramaswamy K, Aggarwal A, Herzog DB, Neubauer G, Breu J, Klibanski A.** Hormonal and body composition predictors of soluble leptin receptor, leptin, and free leptin index in adolescent girls with anorexia nervosa and controls and relation to insulin sensitivity. *J Clin Endocrinol Metab.* 89(7):3486-95, 2004.

51. **Morton GJ, Kaiyala KJ, Fisher JD, Ogimoto K, Schwartz MW, Wisse BE.** Identification of a physiological role for leptin in the regulation of ambulatory activity and wheel running in mice. *Am J Physiol Endocrinol Metab.* 300(2):E392-401, 2011.
52. **Nybo L, Secher NH.** Cerebral perturbations provoked by prolonged exercise. *Prog Neurobiol.* 72(4):223-61, 2004.
53. **Ogata R, Matsuzaki T, Iwasa T, Kiyokawa M, Tanaka N, Kuwahara A, Yasui T, Irahara M.** Hypothalamic Ghrelin suppresses pulsatile secretion of luteinizing hormone via beta-endorphin in ovariectomized rats. *Neuroendocrinology* 90(4):364-70, 2009.
54. **Padovani M, Lavigne JA, Chandramouli GV, Perkins SN, Barrett JC, Hursting SD, Bennett LM, Berrigan D.** Distinct effects of calorie restriction and exercise on mammary gland gene expression in C57BL/6 mice. *Cancer Prev Res (Phila).* 2(12):1076-87, 2009.
55. **Pirke KM, Pahl J, Schweiger U, Warnhoff M.** Metabolic and endocrine indices of starvation in bulimia: a comparison with anorexia nervosa. *Psychiatry Res.* 15(1):33-9, 1985.
56. **Routtenberg A, Kuznesof AW.** Self-starvation of rats living in activity wheels on a restricted feeding schedule. *J Comp Physiol Psychol.* Dec;64(3):414-21, 1967.
57. **Russell J, Baur LA, Beumont PJ, Byrnes S, Gross G, Touyz S, Abraham S, Zipfel S.** Altered energy metabolism in anorexia nervosa. *Psychoneuroendocrinology* 26(1):51-63, 2001.
58. **Sasse SK, Greenwood BN, Masini CV, Nyhuis TJ, Fleshner M, Day HE, Campeau S.** Chronic voluntary wheel running facilitates corticosterone response habituation to repeated audiogenic stress exposure in male rats. *Stress* 11(6):425-37, 2008.
59. **Scheurink AJ, Ammar AA, Benthem B, van Dijk G, Södersten PA.** Exercise and the regulation of energy intake. *Int J Obes Relat Metab Disord.* Suppl 3:S1-6. 9, 1999.
60. **Scheurink AJ, Boersma GJ, Nergårdh R, Södersten P.** Neurobiology of hyperactivity and reward: agreeable restlessness in anorexia nervosa. *Physiol Behav.* 14;100(5):490-5, 2010.
61. **Smolak L, Murnen SK, Ruble AE.** Female athletes and eating problems: a meta-analysis. *Int J Eat Disord.* 27(4):371-80, 2000.
62. **Speakman JR, Mitchell SE.** Caloric restriction. *Mol Aspects Med.* 32(3):159-221, 2011.
63. **Tatsumi S, Ito M, Asaba Y, Tsutsumi K, Ikeda K.** Life-long caloric restriction reveals biphasic and dimorphic effects on bone metabolism in rodents. *Endocrinology* 149(2):634-41, 2008.
64. **Torstveit MK, Rosenvinge JH, Sundgot-Borgen J.** Prevalence of eating disorders and the predictive power of risk models in female elite athletes: a controlled study. *Scand J Med Sci Sports* 18(1):108-18, 2008.
65. **Torstveit MK, Sundgot-Borgen J.** Participation in leanness sports but not training volume is associated with menstrual dysfunction: a national survey of 1276 elite athletes and controls. *Br J Sports Med.* 39(3):141-7, 2005.
66. **Uzum AK, Yucel B, Omer B, Issever H, Ozbey NC.** Leptin concentration indexed to fat mass is increased in untreated anorexia nervosa (AN) patients. *Clin Endocrinol (Oxf).*, 71(1):33-9, 2009.
67. **Verhagen LA, Egecioglu E, Luijendijk MC, Hillebrand JJ, Adan RA, Dickson SL.** Acute and chronic suppression of the central ghrelin signaling system reveals a role in food anticipatory activity. *Eur Neuropsychopharmacol.* 21(5):384-92, 2011.
68. **Verhagen LA, Luijendijk MC, Hillebrand JJ, Adan RA.** Dopamine antagonism inhibits anorectic behavior in an animal model for anorexia nervosa. *Eur Neuropsychopharmacol.* 19(3):153-60, 2009.

69. **Wasinski F, Bacurau RF, Moraes MR, Haro AS, Moraes-Vieira PM, Estrela GR, Paredes-Gamero EJ, Barros CC, Almeida SS, Câmara NO, Araujo RC.** Exercise and caloric restriction alter the immune system of mice submitted to a high-fat diet. *Mediators Inflamm.* 2013:395672, 2013.
70. **Watanabe K, Hara C, Ogawa N.** Feeding conditions and estrous cycle of female rats under the activity-stress procedure from aspects of anorexia nervosa. *Physiol Behav.* 51(4):827-32, 1992.
71. **Woods SC.** The eating paradox: how we tolerate food. *Psychol Rev.* 98(4):488-505, 1991.
72. **Žák A, Vecka M, Tvrzická E, Hrubý M, Novák F, Papezová H, Lubanda H, Veselá L, Stanková B.** Composition of plasma fatty acids and non-cholesterol sterols in anorexia nervosa. *Physiol Res.* 54(4):443-51, 2005.
73. **Zgheib S*, Méquinion M*, Lucas S, Leterme D, Ghali O, Tolle V, Zizzari P, Bellefontaine N, Legroux-Gerot I, Hardouin P, Broux O, Viltart O, Chauveau C.** Long-term physiological alterations and recovery in a mouse model of separation associated with time restricted feeding : a tool to study anorexia nervosa related consequences. Accepted in PlosOne, 2014.
74. **Zhang W, Majumder A, Wu X, Mulholland MW.** Regulation of food intake and body weight by recombinant proghrelin. *Am J Physiol Endocrinol Metab.* 297(6):E1269-75, 2009.

FIGURE CAPTIONS

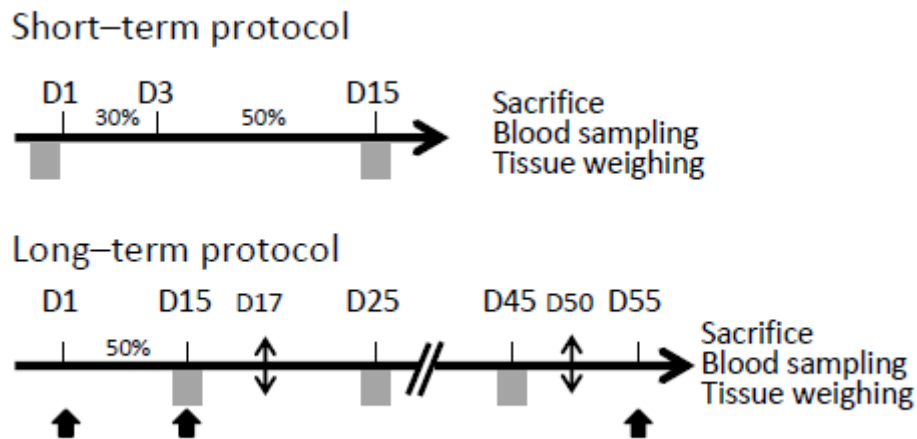

Fig. 1. Study design for the short- and long-term protocols. Arrows indicate X-ray CT scan sessions, double arrows correspond to IPGTT (intraperitoneal glucose tolerance test) and grey squares show the metabolic cage sessions.

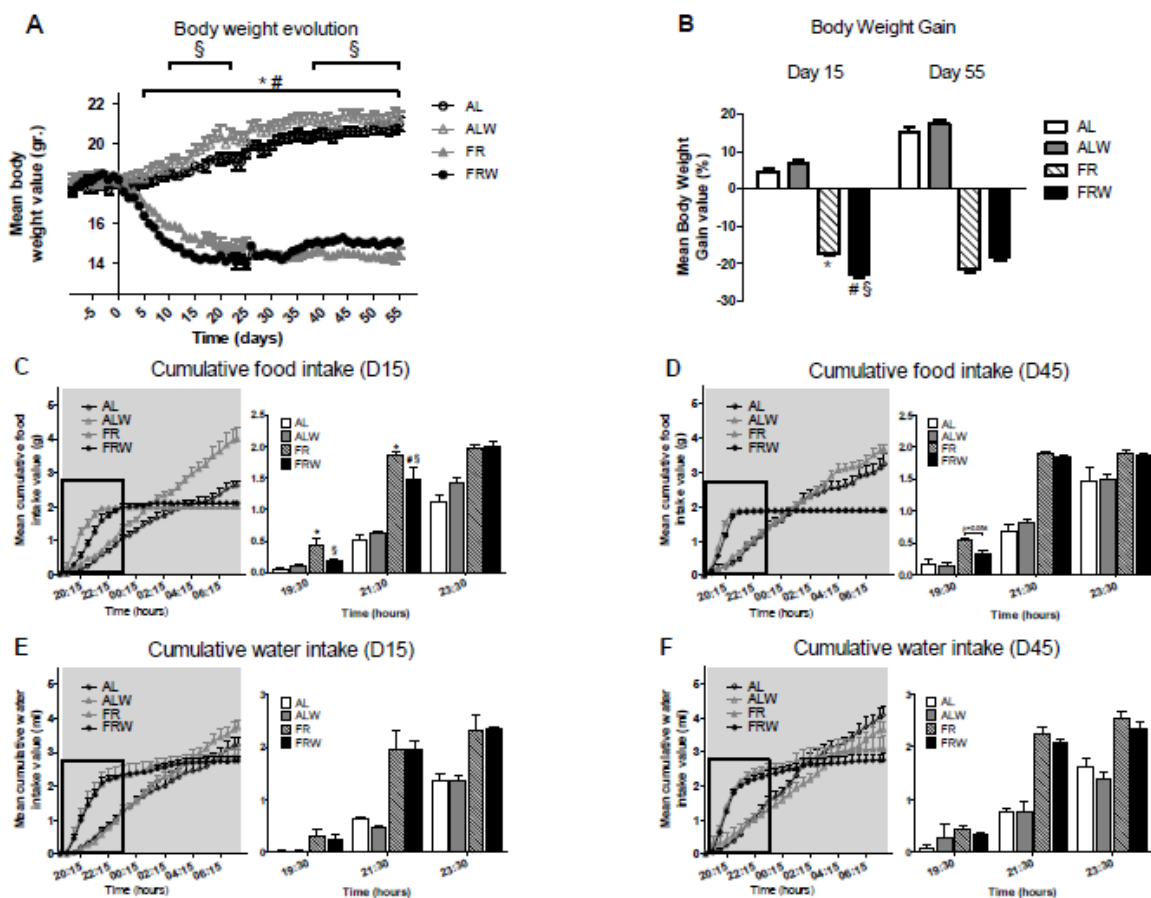

Fig. 2. Effect of food restriction associated or not with activity (wheel running). (A) Body weight evolution of the 4 groups of mice in their home cages. (B) Mean body weight gain obtained after 15

(Day 15) and 55 days (Day 55) of protocol. Mice were weighed every day and body weight gain was calculated from day -1. (C-D) Mean cumulative food intake pattern measured during the night period at D15 (C) and D55 (D). (E-F) Mean cumulative water intake pattern measured during the night period at D15 (E) and D55 (F). Rectangles point out values obtained during the first part of the night (meal distribution for FR and FRW mice). Values are means \pm SE $n=8-22$ /group. AL, *ad libitum*; ALW, *ad libitum* and wheel; FR, food restriction; FRW, food restriction and wheel. * $P < 0.05$ FR or ALW vs. AL; # $P < 0.05$ FRW vs. ALW and § $P < 0.05$ FR vs. FRW. Significance was set following 2-way ANOVA.

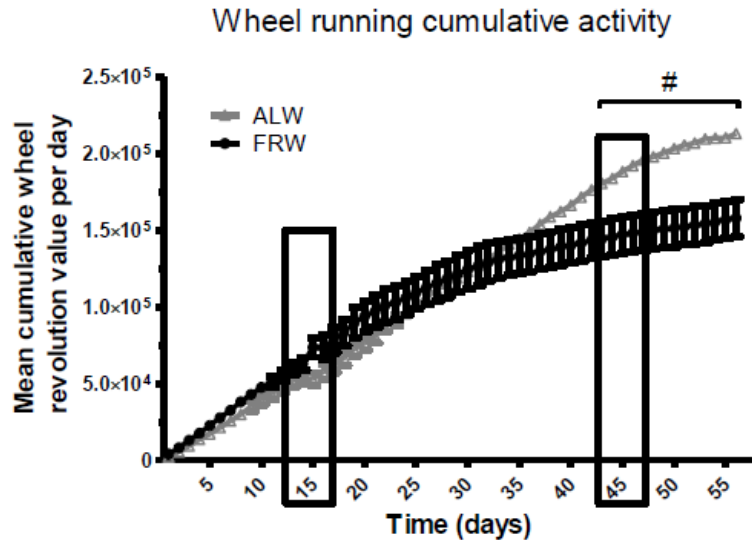

Fig. 3. Effects of food restriction on wheel running activity in the home cages for ALW and FRW groups. The mean cumulative wheel revolution was calculated for ALW and FRW groups ($n=2$ per cage) throughout the protocol. Rectangles indicate the metabolic cage sessions (see fig. 4) to measure ambulatory activity for all groups ($n=1$ per cage). ALW, *ad libitum* and wheel; FRW, food restriction and wheel. # $P < 0.05$ FRW vs. ALW. Significance was set following 2-way ANOVA.

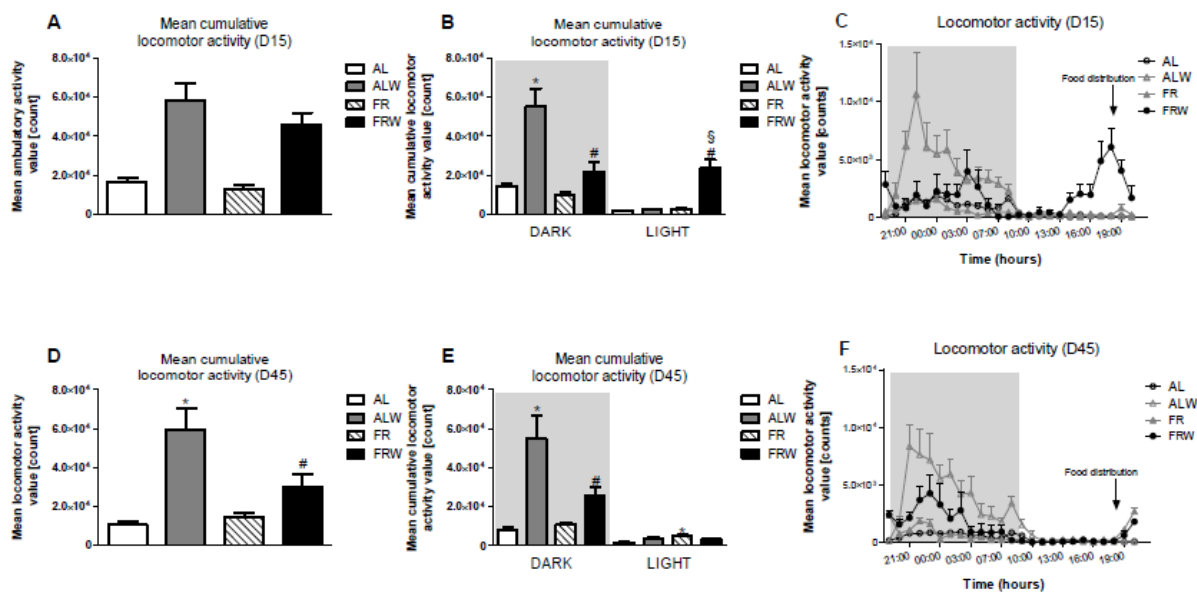

Fig. 4. Effects of food restriction on locomotor activity in the metabolic cages for the four groups. (A,D) Total activity was analyzed throughout the day at D15 (A) and D45 (D), and averaged for the dark (active phase) and light periods (B,E). Measurements were taken at different periods of the

protocol: short term (B-C) and long term (D-E). The locomotor activity was continuously measured and averaged every hour on graphs C (short term) and F (long term). Values are expressed as means \pm SE n=6-10/group. AL, *ad libitum*; ALW, *ad libitum* and wheel; FR, food restriction; FRW, food restriction and wheel. * P < 0.05 FR or ALW vs. AL; # P < 0.05 FRW vs. ALW and § P < 0.05 FR vs. FRW. Significance was set following 2-way ANOVA.

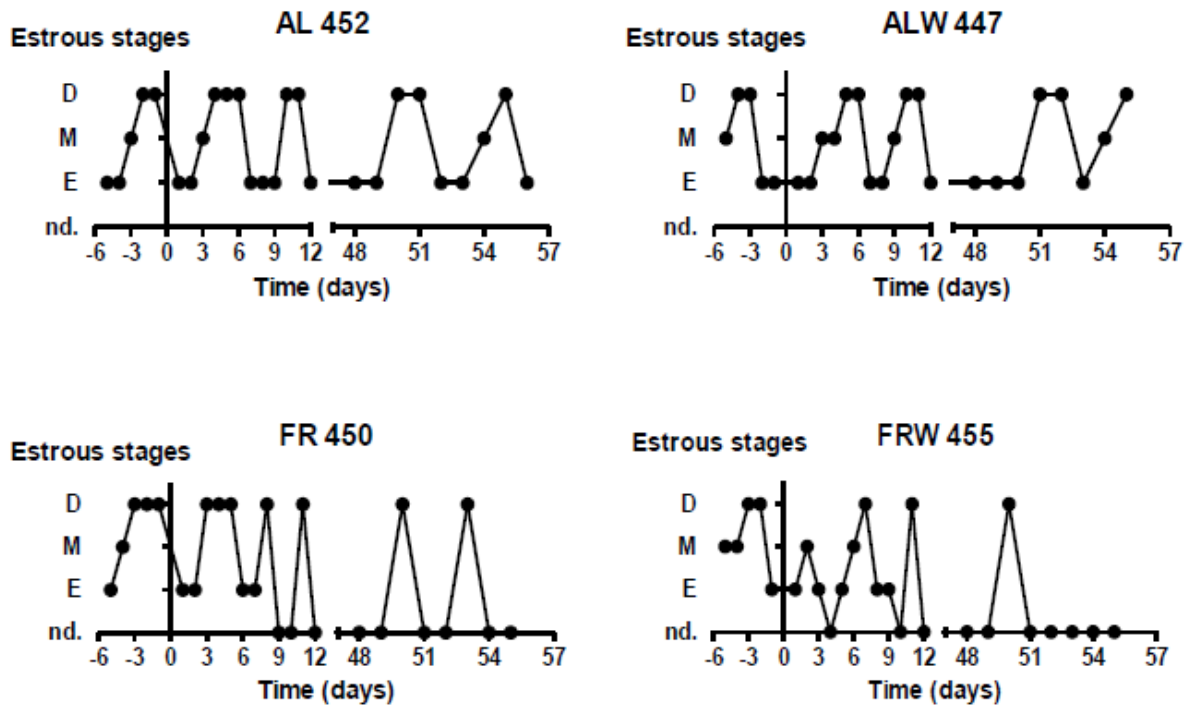

Fig. 5. Impact of food restriction associated or not with physical activity on estrous cycles. One example of mouse from each group was given along the protocol, representing the whole. AL, *ad libitum*; ALW, *ad libitum* and wheel; FR, food restriction; FRW, food restriction and wheel. D: diestrus; m : metestrus; E: estrus; n.d. non detected.

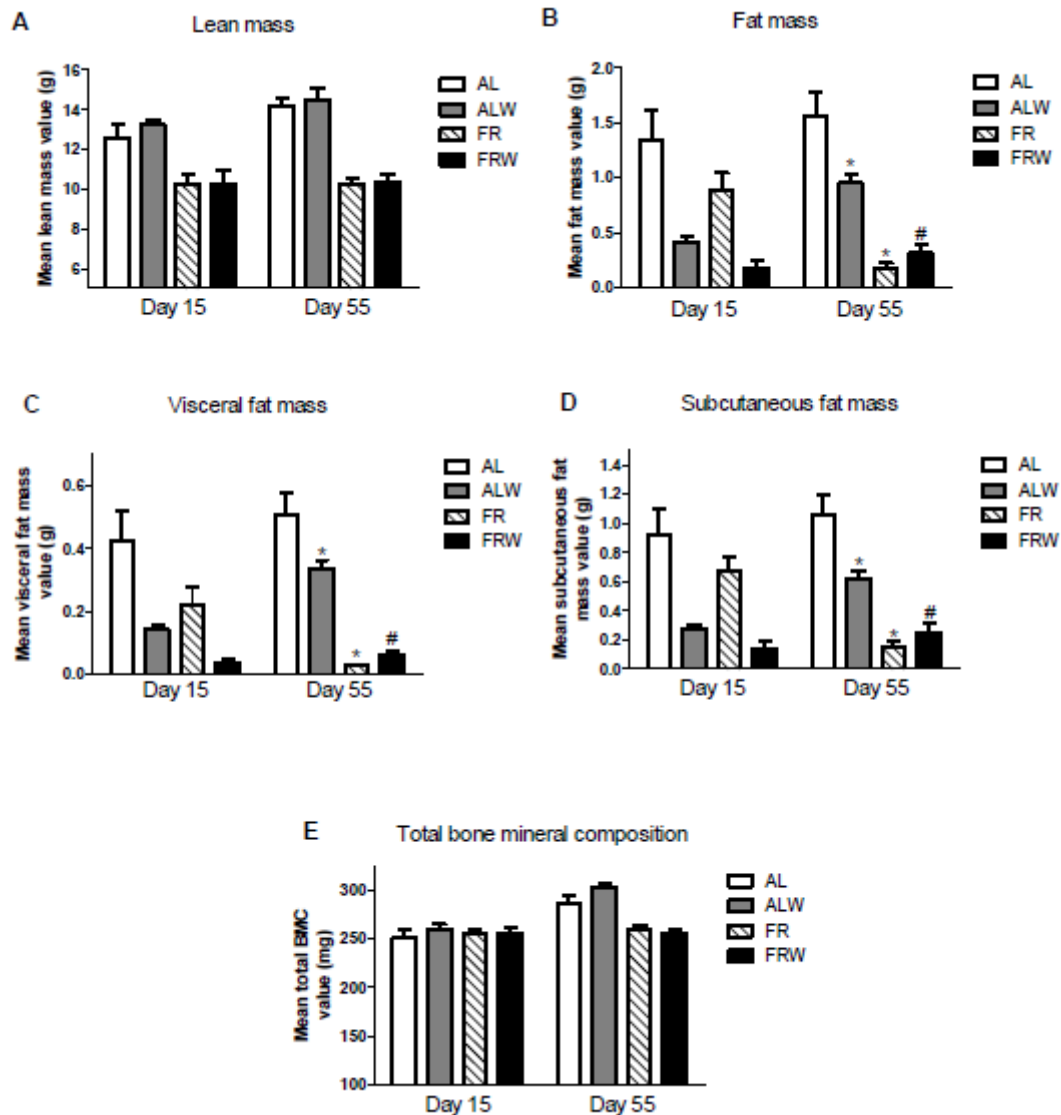

Fig. 6. Impact of food restriction associated or not with physical activity on body composition measured by X-Ray CT scan at D15 and D55. (A) Evaluation of the total lean mass (muscles, glands and organs). (B-D) Combination of physical activity with food restriction (FRW) modified more rapidly the total fat mass, including the visceral fat mass (C) subcutaneous fat mass (D), than food restriction only (FR). (E) Bone mineral composition was modified only at the end of the protocol for FR and FRW mice. All measurements were taken in the morning (between 8:30 and 12:30). Values are expressed as means \pm SE n=6/group. AL, *ad libitum*; ALW, *ad libitum* and wheel; FR, food restriction; FRW, food restriction and wheel. * $P < 0.05$ FR or ALW vs. AL; # $P < 0.05$ FRW vs. ALW and § $P < 0.05$ FR vs. FRW. Significance was set following 2-way ANOVA.

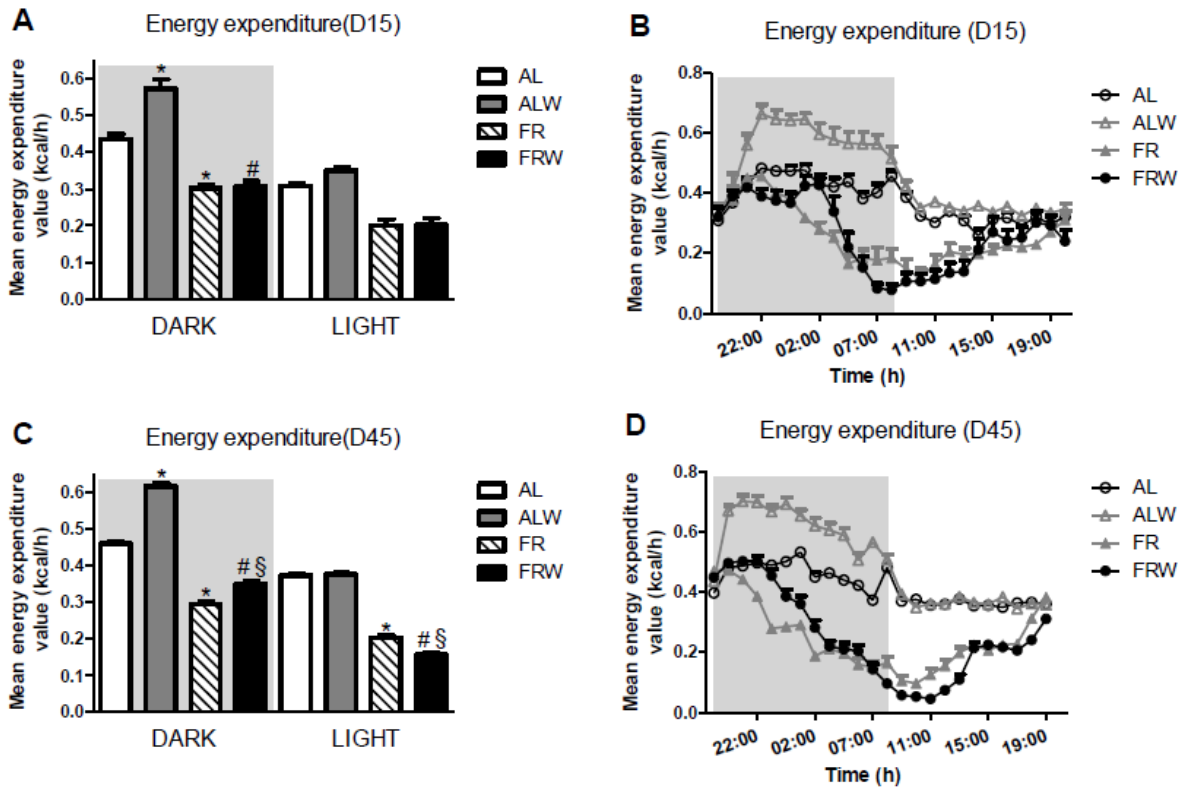

Fig. 7. Time course of effect of the short- and long-term protocols on energy expenditure. Mean energy expenditure was calculated from dark (19:30 to 07:30) and light (07:30 to 19:30) periods at D15 (A-B) and D45 (C-D). Values are expressed as means \pm SE n=6-8/group. AL, *ad libitum*; ALW, *ad libitum* and wheel; FR, food restriction; FRW, food restriction and wheel. * $P < 0.05$ FR or ALW vs. AL; # $P < 0.05$ FRW vs. ALW and § $P < 0.05$ FR vs. FRW. Significance was set following 2-way ANOVA.

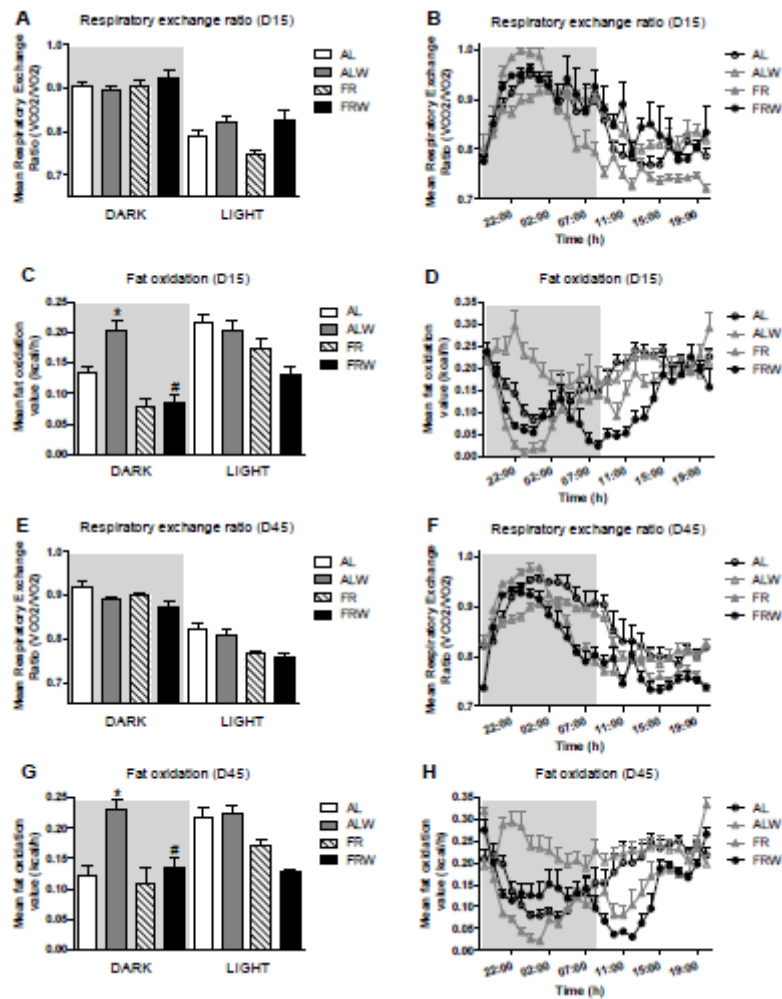

Fig. 8. Time course of effect of protocol on respiratory exchange ratio and fat oxidation measured in metabolic cages ($n=1$ per cage) at different times of the experiment (D15 and D45). Respiratory exchange ratio at short term (A,B) and long term (E,F) was calculated from four measures per hour and averaged from CO_2 and O_2 ratio. Fat oxidation in the short term (C,D) and long term (G,H) was calculated as indicated in METHODS. Mean dark and light RER and fat oxidation were calculated from values obtained between 19:30 to 07:30 and 07:30 to 19:30 respectively. Values are expressed as means \pm SE $n=6-8$ /group. AL, *ad libitum*; ALW, *ad libitum* and wheel; FR, food restriction; FRW, food restriction and wheel. * $P < 0.05$ FR or ALW vs. AL; # $P < 0.05$ FRW vs. ALW and § $P < 0.05$ FR vs. FRW. Significance was set following 2-way ANOVA.

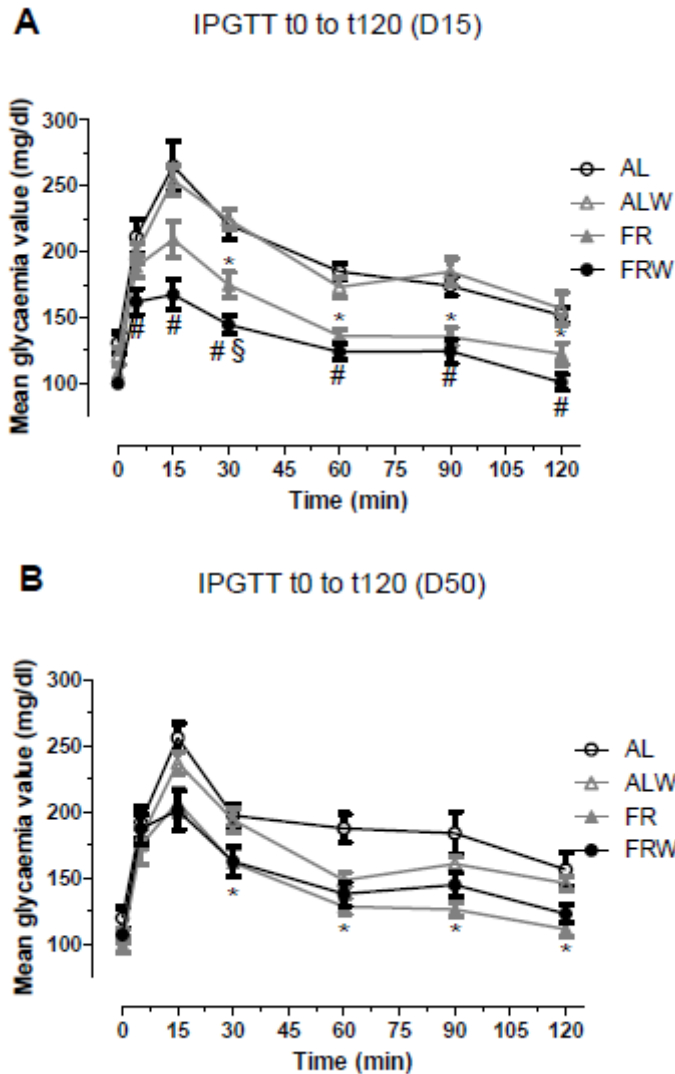

Fig. 9. Impact of food restriction associated or not with physical activity on intraperitoneal glucose tolerance. Blood glucose variations were measured following 1.5g/kg bolus glucose injection at short (A) and long term (B) after 12-14 hr of fasting, at t5, t15, t30, t60, t90 and t120 min. Values are expressed as means \pm SE n=8-12/group. AL, *ad libitum*; ALW, *ad libitum* and wheel; FR, food restriction; FRW, food restriction and wheel. * P < 0.05 FR or ALW vs. AL; # P < 0.05 FRW vs. ALW and § P < 0.05 FR vs. FRW. Significance was set following 2-way ANOVA.

Tissue		AL (n=6)	ALW (n=6)	FR (n=6)	FRW (n=6)
Short Term (D15)	Liver (mg) a	948.03 \pm 30.81	958.55 \pm 19.61	807.22 \pm 18.91	811.40 \pm 30.02
	Triceps (mg) a	108.13 \pm 1.31	117.93 \pm 1.38 π	87.12 \pm 3.19	87.38 \pm 4.85
	Uterus (mg) a	100.23 \pm 15.60	106.83 \pm 18.15	21.18 \pm 0.97	20.85 \pm 1.32
	Ovary length (μ m) a	1658.92 \pm 74.18	1523.80 \pm 63.99	1397.23 \pm 64.83	1351.23 \pm 64.83
	Ovary width (μ m) a	1177.83 \pm 77.85	1226.28 \pm 84.26	988.69 \pm 71.97	918.47 \pm 62.80
Tissue		AL (n=14)	ALW (n=10)	FR (n=14)	FRW (n=14)
Long Term (D55)	Liver (mg) a	996.80 \pm 17.72	984.36 \pm 29.41	799.82 \pm 20.14	820.53 \pm 17.52
	Triceps (mg) a,b	123.97 \pm 4.00	135.08 \pm 2.82	81.78 \pm 3.18	87.68 \pm 2.33
	Uterus (mg) a	71.44 \pm 8.67	67.78 \pm 11.74	16.05 \pm 0.77	17.62 \pm 0.90
	Ovary length (μ m) a	1693.29 \pm 84.13	1757.97 \pm 37.18	1231.11 \pm 50.57	1203.81 \pm 67.08
	Ovary width (μ m) a	1331.97 \pm 49.09	1338.08 \pm 72.83	874.55 \pm 70.04	925.75 \pm 79.12

Table 1. Alterations in metabolic and reproductive tissues. Impact of food restriction associated or not with physical activity on the weight of liver, triceps, uterus and on the ovaries' size. All samplings were done in the morning (8:30 to 13:00). Data are expressed as means \pm SE. AL, *ad libitum*; ALW, *ad libitum* and wheel; FR, food restriction; FRW, food restriction and wheel; n=6-8/group. * P < 0.05 FR or ALW vs. AL; # P < 0.05 FRW vs. ALW and § P < 0.05 FR vs. FRW. Significance was set following 2-way ANOVA. a: food effect; b: activity effect.

Metabolites		AL (n=8)	ALW (n=6)	FR (n=8)	FRW (n=8)
Short term (D15)	Basal glycemia (mg/dl) a	137.59 \pm 7.83	129.39 \pm 5.52	86.67 \pm 3.63	84.61 \pm 4.79
	Fasted glycemia (mg/dl) a	130.63 \pm 8.11	120.80 \pm 6.84	107.85 \pm 3.60	99.92 \pm 4.16
	Triglycerides (mg/dl)	33.75 \pm 2.85	24.78 \pm 2.49	31.5 \pm 3.71	28.40 \pm 4.00
	NEFA (mg/dl) a	8.98 \pm 0.71	11.46 \pm 1.63	14.49 \pm 1.52	13.69 \pm 1.37
	Ketone bodies (mg/dl)	4.01 \pm 0.69	5.14 \pm 0.84	3.18 \pm 0.57	4.04 \pm 0.56
	Liver glycogen (mg/mg tissue) a	9.14 \pm 0.86	9.33 \pm 0.95	7.37 \pm 0.47	7.56 \pm 0.74
Metabolites		AL (n=8)	ALW (n=6)	FR (n=8)	FRW (n=8)
Long term (D55)	Basal glycaemia (mg/dl) a,b	119.93 \pm 5.15	131.17 \pm 5.70	82.85 \pm 4.08	100.86 \pm 3.86
	Fasted glycaemia (mg/dl)	119.56 \pm 7.73	105.80 \pm 4.96	99.15 \pm 6.28	106.88 \pm 3.00
	Triglycerides (mg/dl)	33.03 \pm 2.52	26.40 \pm 1.98	26.02 \pm 2.53	27.86 \pm 3.28
	NEFA (mg/dl) a	12.94 \pm 1.40	17.34 \pm 0.98	21.20 \pm 2.58	18.85 \pm 2.16
	Ketone bodies (mg/dl) a,b	4.11 \pm 0.33	5.53 \pm 0.72	3.00 \pm 0.25	3.58 \pm 0.36
	Liver glycogen (mg/mg tissue)	10.24 \pm 1.56	8.91 \pm 0.96	10.18 \pm 0.52	10.82 \pm 0.59

Table 2. Impact of food restriction associated or not with physical activity on plasma metabolites and hepatic glycogen. All samplings were done in the morning (8:30 to 11:00). Data are expressed as means \pm SE. AL, *ad libitum*; ALW, *ad libitum* and wheel; FR, food restriction; FRW, food restriction and wheel; NEFA, non-esterified (or free) fatty acids. n= 6-8/group. * P < 0.05 FR or ALW vs. AL; # P < 0.05 FRW vs. ALW and § P < 0.05 FR vs. FRW. Significance was set following 2-way ANOVA. a: food effect; b: activity effect.

Hormones		AL (n=6-8)	ALW (n=6-8)	FR (n=6-8)	FRW (n=6-8)
Short term (D15)	Leptin (ng/ml)	5.72 \pm 0.87	3.09 \pm 0.21*	3.55 \pm 0.25*	3.08 \pm 0.20
	Corticosterone (ng/ml) a	147.1 \pm 20.10	196.4 \pm 24.45	271.9 \pm 42.59	276.4 \pm 43.01
	Ghrelin total (pg/ml) a	907.34 \pm 111.75	969.4 \pm 96.24	2158.2 \pm 177.54	2721.3 \pm 396.71
	Acylghrelin (pg/ml) a,b	228.70 \pm 35.38	357.09 \pm 60.68	575.60 \pm 63.66	958.21 \pm 165.69
	Des-acylghrelin (pg/ml) a	678.64 \pm 79.80	612.34 \pm 72.49	1582.56 \pm 177.54	1763.14 \pm 252.69
	Ghrelin Ratio (AG/DAG) b	0,34 \pm 0,03	0,62 \pm 0,09	0,39 \pm 0,06	0,54 \pm 0,06
Hormones		AL (n=6-8)	ALW (n=6-8)	FR (n=6-8)	FRW (n=6-8)
Long term (D55)	Leptin (ng/ml)	4.67 \pm 0,42	3.17 \pm 0.15*	3.37 \pm 0.16*	3.52 \pm 0.09
	Corticosterone (ng/ml)	100.8 \pm 11.60	120.5 \pm 10.19	240.8 \pm 21.16*	178.0 \pm 12.76§
	Ghrelin total (pg/ml) a	1238.6 \pm 151.1	1458.1 \pm 177.8	1605.9 \pm 112.5	1774.4 \pm 165.6
	Acylghrelin (pg/ml) b	145.48 \pm 42.12	277.44 \pm 44.02	147.21 \pm 20.26	240.34 \pm 41.46
	Des-acylghrelin (pg/ml) a	1093.12 \pm 114.96	1180.63 \pm 135.48	1458.69 \pm 108.39	1534.10 \pm 132.16
	Ghrelin Ratio (AG/DAG) a,b	0.12 \pm 0.03	0.23 \pm 0.01	0.10 \pm 0.02	0.15 \pm 0.02

Table 3. Impact of food restriction associated or not with physical activity on plasma hormones. All samplings were done in the morning (8:30 to 11:00). Data are expressed as means \pm SE. AL, *ad libitum*; ALW, *ad libitum* and wheel; FR, food restriction; FRW, food restriction and wheel. n= 6-8/group. * P < 0.05 FR or ALW vs. AL; # P < 0.05 FRW vs. ALW and § P < 0.05 FR vs. FRW. Significance was set following 2-way ANOVA. a : food effect; b: activity effect.

Annex 7: article 3: Physiological and pathological changes in the enteric nervous system of rotenone treated mice as possible early biomarkers for Parkinson's disease
The writing of this article is currently in process.

Physiological and pathological changes in the enteric nervous system of rotenone treated mice as possible early biomarkers for Parkinson's disease

Kai Bötzel^{1,*}, Gabriela Schafernicht^{1,2,*}, Alicia Stievenard^{3,*}, Yanina Dening^{1,2}, Romy Kempe⁴, Christel Vanbesien-Mailliot³, Richard H.W. Funk^{5,6}, Marianne Dieterich^{1,2}, Ursula Ravens⁴ and Francisco Pan-Montojo^{1,2,Ψ}

¹Neurologische Klinik und Poliklinik, Klinikum der Universität München. Marchioninistr. 15, 81377 München.

²Munich Cluster for Systems Neurology, SyNergy

³Univ. Lille, Inserm, CHU Lille, UMR-S 1172 - JPArc - Centre de Recherche Jean-Pierre AUBERT Neurosciences et Cancer, F-59000 Lille, France

⁴Institut für Pharmakologie, TU-Dresden, Fetscherstr. 74, 01307, Dresden

⁵Institut für Anatomie, TU-Dresden, Fetscherstr. 74, 01307, Dresden

⁶Center for Regenerative Therapies Dresden, Tatzberg 47/49, 01307, Dresden, Germany

* These authors contributed equally to the work and are listed in alphabetical order

Ψ Corresponding author: francisco.pan-montojo@med.uni-muenchen.de

Abstract

Involvement of the peripheral nervous system (PNS) and enteric nervous system (ENS) is relatively common in Parkinson's disease (PD) patients. ENS and PNS alterations appear early in the course of the disease and are responsible for some of the non-motor symptoms observed in PD patients. In previous studies, we have shown that environmental toxins can trigger the disease by acting on the ENS and its autonomic innervation. Here, we analyzed the effect of rotenone, a mitochondrial Complex I inhibitor, on the function and structure of the ENS using tissue bath contractility measurements, immunohistochemistry and protein expression analysis. Our results show that rotenone induces changes in the physiology of the intestine modifying its dose response contractility to carbachol, dopamine, serotonin and electric field stimulation. The magnitude of these alterations is region dependent and correlate with a reduction in the total amount of enteric neurons (P.G.P 9.5⁺ cells) as well as a reduction in the expression of ChAT⁺ and TH⁺ cells in rotenone treated mice. Interestingly both alpha-synuclein and phosphorylated alpha-synuclein protein levels are increased. Altogether, these results reveal physiological and biochemical changes in the enteric system that could be used as early diagnostic tools for the diagnosis of the disease.

Introduction

Hallmark lesions of Parkinson's disease (PD) were traditionally considered to be present in the dopaminergic neurons of the substantia nigra (SN) and in the noradrenergic neurons of the locus coeruleus (LC). However, pathological studies showed that typically PD patients have lesions in other CNS and PNS structures (e.g. the ENS, the sympathetic CG, the IML of the spinal cord, the motor nucleus of the vagus or the amigdala) [1, 2]. These lesions are not exclusive of PD [3] and mainly consist in intraneuronal and intraglial alpha-synuclein aggregates called Lewy bodies (LB) and Lewy neurites (LN).

In idiopathic PD most of the patients that show PD related inclusions in CNS sites already present LB and LN in the ENS and the sympathetic ganglia [4]. Based on autopsies performed on PD patients and healthy individuals, Braak and colleagues developed a pathological staging of the disease [5]. According to this staging, PD lesions follow a spatio-temporal pattern that starts in the olfactory bulb (OB) and the ENS progressing into the CNS through synaptically connected structures. This pathological staging of the disease seems to correlate well with the appearance of early non-motor symptoms in PD patients. These include hyposmia, gastrointestinal alterations, autonomic dysfunction and the experience of pain [6].

Little is known about the degenerative process of the ENS in PD patients. Physiological studies in patients revealed delayed gastric emptying, dystonia of the external anal sphincter that causes difficult rectal evacuation and general slow transit constipation probably caused by the loss of dopaminergic neurons [7-9]. In recent years many groups have investigated enteric alpha-synuclein alterations (i.e. expression of the protein, amount of protein and modifications on the protein) in PD patients. Different groups have shown an increase in alpha-synuclein inclusions and phosphorylated alpha-synuclein in patients when compared to controls (Thimbaud, Pascal). However, not many studies show the effects on the function of the ENS and its composition.

In our previous studies, we have shown that orally administered rotenone induces alpha-synuclein accumulation in most of the regions described in Braak's staging [10, 11]. The appearance of these alterations followed a spatio-temporal pattern similar to the one predicted by Braak and the resection of the nerves connecting the gut to the SNC (i.e. the vagus and sympathetic nerves) prevented the progression of the pathology. Interestingly, we also observed gastrointestinal alterations in rotenone treated mice in the form of constipation. In this study we analyzed the effect of orally administered rotenone on the ENS and the gastrointestinal contractility (GC) of the gut. Our results show that rotenone affects the electrophysiological properties of the gut and that these alterations correlate well with differences in the expression of certain neuronal markers.

Materials and methods

Animal model

Animal housing

8 weeks-old or 1 year-old C57/BL6J mice (Janvier, France) were housed at room temperature under a 12-h light/dark cycle. Food and water was provided ad libidum. All animal experiments were carried out in accordance with the National Institutes of Health Guide for the Care and Use of Laboratory Animals, and protocols were approved by the Saxonian Committee for Animal Research in Germany.

Oral rotenone administration

8 weeks and 1 year-old mice were divided into 2 groups (n= 10) and treated 5 days a week for 4 months. A 1,2 mm x 60 mm gavage (Unimed, Switzerland) was used to administer 0.01 ml/g animal weight of rotenone solution corresponding to a 5 mg/kg dose. Controls were treated only with the vehicle solution (2% carboxymethylcellulose (Sigma-Aldrich, Germany) and 1.25% chloroform (Carl Roth, Germany)).

1h Stool collection test

This test was performed every month during treatment. Mice were placed on individual cages for 1 hour. During this hour all pellets in the cage were collected and weighted.

Tissue preparation for organ bath and western-blot

Mice from each group (n=6) were killed with an overdose of ketamine and several adjacent 1 cm long intestine samples from each region (duodenum, jejunum, ileum and colon) were obtained. Pieces were used to perform contractility studies in an organ bath or immediately frozen in liquid nitrogen until protein extraction.

Contractility studies in an organ bath

In order to test the motility of the intestinal fragments we measured the contractility using an isolated organ bath (Glasapparatemeister, Topas GmbH, Germany) as performed by others [12]. Briefly, mice were euthanized and segments of the duodenum, the jejunum, the ileum and the colon were removed, submerged in Krebs's solution (120 mM [NaCl], 5,8 mM [KCl], 2,5 mM [CaCl₂], 1,2 mM [MgCl₂], 1,4 mM [NaH₂PO₄], 15 mM [NaHCO₃], 11 mM [Glucose]). Preparations were gently flushed to removed luminal contents, and cut in 1 cm length segments. Segments were then ligated at each end with silk thread and suspended longitudinally between two platinum electrodes by attaching one end to the isometric force transducer (Transducer Typ SG4-45, SWEMA, Sweden) and the other end to the base of the 15 ml chamber filled with Krebs's solution maintained at 37°C and aerated with 95% O₂/5%CO₂. Samples were stabilized in the Krebs's solution for 45 minutes. During this time the bath solution was changed twice and samples were stretched to their optimal resting tone by step-wise increases until the tension was adjusted at 10 mN. Spontaneous smooth muscle activity (SMA) and responses to electrical field stimulation (EFS) were measured in isometric conditions. The mechanical activity of the muscle was measured using a transducer amplifier relayed to a bioelectric amplifier (Multiplexing Pulse Booster 3165, Gemonio-Varese, Italy) equipped to record muscle contractions via a data acquisition system where the force of contraction was recorded with Chart 4.0TM (AD Instruments, Sydney, NSW, Australia). SMA was characterized for 15 min. after the last bath solution change during stabilization in Krebs's solution and included measurements of tone (minimal force during contraction), amplitude (as the difference between maximal force and minimal

force exerted during contraction) and frequency (as number of spontaneous contractions per minute). Different samples were then exposed to different concentrations (10^{-6} , 3×10^{-6} , 10^{-5} , 3×10^{-5} , 10^{-4} , 3×10^{-4} , 10^{-3} M) of several neurotransmitters (carbachol, dopamine and noradrenaline) and the reaction, determined as differences in maximal force and minimal force exerted, amplitude and frequency, were measured. After several medium changes, samples were subjected to EFS using an electric stimulator (Föhr Medical Instruments, Seeheim/Ober Beerbach, Germany). The optimal EFS parameters were determined after using several values of voltage (5, 10 and 15V) and frequencies (10, 16 and 80 Hz) on test samples. We decided to stimulate the ENS from 2 months treated mice using three different pulse durations (200, 400 and 800 μ s) and reduced the number to two different pulse durations (200 and 400 μ s) for the 4 months treated mice. In all cases a train duration of 30 seconds with a voltage of 10V, a pulse delay of 0 seconds and a pulse rate of 16Hz were used. The reaction of the sample to EFS was determined after the last change of bath solution and after adding each of the following substances: atropine (ATR, 10^{-5} M), guanethidine (GUA, 10^{-5} M), serotonin (SHT, 10^{-4} M) and tetrodotoxin (TTX, 10^{-6} M). These last substances were added without changing the bath solution in-between to investigate the reaction of the ENS first alone and then with i) all cholinergic receptors blocked, ii) all cholinergic and noradrenergic receptors blocked, iii) all cholinergic, noradrenergic and voltage-gated sodium channels blocked.

Contractility data for each time-point was translated into a curve by the data acquisition system. Parameters such as maximal force, minimal force, amplitude and frequency before and after each treatment were automatically extracted using a self-made program written with Matlab (version R2014b, Mathworks, Massachusetts, USA). Additionally, to characterize the sudden increases and decreases in tension caused by the addition of the different substances resulting in an excitation or relaxation curve (see Figure...), an interface was created to manually determine the beginning of the curve, the maximum or minimum of the curve and the end of the curve. The program created with Matlab then automatically determined the slope, the amplitude of the increase/decrease, the e-Factor and the e-Exponent of the curve. The effect for each substance concentration on the different parameters analyzed was determined by normalizing the values obtained for these parameters after the addition of the different concentrations of the substance to the value before any substance was added (Time 0). These values were used to generate a dose-response curve for each of the analyzed parameters.

Protein extraction for western-blot

Protein extraction was done in an ice-cold eppendorf holder using ice cold protein extraction buffer (60 mM TrisHCl (pH 6,8), 1mM Na_3VO_4 , 1% SDS) (300 μ l) in the presence of protease and phosphatase inhibitors (phenylmethylsulphonyl fluoride (PMSF, Sigma Aldrich 78830-5g), leupeptin (Roche, 11017101001) and aprotinin (Roche, 10236624001), sodium fluoride (NaF, Sigma Aldrich, S7920). Intestine samples were cut in smaller pieces, homogenize with the help of a homogenizing micro pestle in 1,5 ml Eppendorf tubes. The homogenized sample was then placed in a sonicator (Merck Eurolab) during 2 minutes, warmed at 99°C during 5min and centrifuged at 1400 rpm for 5 minutes. The supernatant was collected and stored at -80 degrees until use.

SDS-PAGE and Western Blotting

Protein concentration from intestine extracts was measured using the Nanodrop X100. Samples were then diluted in each case to have the same end protein concentration of 30 μ g and 20 μ l of

protein extract were loaded together with 5 µl of loading buffer (Invitrogen, Germany, EU) into a 4-12% polyacrylamide gel.

Page ruler 10-250 kDa molecular weight marker was used for size estimation. Proteins were separated by electrophoresis migration at 80V for the stacking in 4% acrylamide gel followed by migration at 120V in the 12% acrylamide gel. Proteins were then transferred into a nitrocellulose membrane in transfer buffer containing 5% methanol, at 10V during 3 hours. To verify the efficiency of the transfer, membranes were incubated in a Red Ponceau solution during 2 min and washed 3 times (3*5min) in deionised water. The aspecific signal was then blocked by incubation of the membranes in Tris-buffered saline + 0.1% Tween 20 (TBST 1X) and either 5% (w/v) non-fat dry milk for total protein study or 5% (w/v) bovine serum albumine for phosphorylated-antigens. Membranes were subsequently incubated overnight à 4°C with rabbit anti-tyrosine hydroxylase (1:1000, Pel Freez, P40101-150), mouse anti-GAPDH (1:1000, thermofischer scientific, QL229972), rabbit anti ChAT (1:1000, abcam ab181023), rabbit anti PGP9,5 (1:1000, Millipore ref).

On the following day, blots were washed 3 x 5 min. with TBST 1X and incubated with horseradish peroxidase-conjugated anti-rabbit and anti-mouse (1:5000, provider) at room temperature for 1 hour.

The blots were subsequently washed 3 x 5 minutes in TBST 1X and developed with the Prime Western Blotting detection Reagent (GE Healthcare Amersham RPN2232) using the LAS3000 bioimager (Fujifilm, Germany, EU). Images were then processed using the open access and ImageJ based program FIJI (ww.fiji.sc), where only minor adjustment of the brightness and contrast were performed.

Statistical analysis

Western-blot and contractility data regarding frequency and electric field stimulation were analyzed using an unpaired t-Test. Dose-response curves were compared using the 2-way ANOVA test with a Bonferroni's post-hoc test. Significance was set at $p < 0.05$.

Results

Rotenone treatment induces changes in the effect of carbachol and dopamine on gastrointestinal contractility.

In order to analyze the effect of rotenone on the ENS of 1-year-old mice, we tested the effect of carbachol (an acetylcholine agonist), dopamine and electric field stimulation before and after atropine, guanethidine and serotonin addition on the motility of duodenum, jejunum, ileum and colon from vehicle and rotenone treated mice. Our results show that rotenone induces changes in the dose-response curves to carbachol or dopamine in all tested regions. These alterations are region and treatment-time dependent. We did not observe difference in the basal frequency or the basal mean amplitude (max-min) (i.e. after stabilizing the samples and before adding any substances) between the samples coming from rotenone-treated or control mice (Supplementary Figure 1).

Changes in the Response to Carbachol

Carbachol is an acetylcholine agonist that induces an increase in the tone and contractility of the intestine. We compared the GC dose-response curves to carbachol in all different segments from 2 months and 4 months treated control and rotenone-treated mice. Additionally, we looked at other parameters such as the slope, the amplitude of the increase/decrease, the e-Factor and the e-Exponent of the reaction curve (see Supplementary Figure 2). We observed differences in the reactivity and the parameters affected by rotenone treatment between intestinal regions.

After two months of treatment, we observed an increased reaction to carbachol in the duodenum of rotenone treated samples when compared to control. Specifically the Δ maximum ($p < 0.001$), Δ minimum ($p < 0.01$) and the Δ mean amplitude ($p < 0.001$) were higher on rotenone treated samples (Figure 1A-C). No differences between control and rotenone treated samples were detected in any of the other parameters (Δ frequency, slope, amplitude of increase, e-Factor, e-Exponent). After 4 months of treatment, differences are observed in the slope and in the amplitude of increase of the curve generated by carbachol in rotenone treated mice when compared to controls (slope: $p < 0.01$; amplitude of increase: $p = 0.0038$, see Figure 2A and 2B). No differences between control and rotenone treated samples were detected in any of the other parameters (Δ maximum, Δ minimum, Δ mean amplitude, Δ frequency, e-Factor, e-Exponent) (Supplementary Figure 3A-K).

In the jejunum, we observed an increase reaction to carbachol in the Δ maximum ($p < 0.05$) and the Δ mean amplitude ($p < 0.001$) in rotenone-treated samples when compared to control after 2 months (Figure 1D and 1E). Interestingly, the post-pre differences in the frequency ($p < 0.05$), the slope ($p < 0.01$) and the amplitude of increase ($p < 0.05$) were higher in samples coming from control mice (Figure 1F-H). After 4 months of treatment, reaction to carbachol was also increased in samples from rotenone treated mice when compared to control (Δ maximum: $p < 0.001$; Δ minimum: $p < 0.0001$; mean amplitude: $p < 0.001$; amplitude of increase: $p < 0.05$) (see Figure 2C-F). No significant difference was observed in any of the other measured parameters at any time point (Supplementary Figure 4A-G).

Interestingly the effect of rotenone on the ileum was more heterogeneous after 2 months of treatment. Whereas the mean amplitude was higher on rotenone treated samples ($p < 0.01$), the slope ($p < 0.001$), the amplitude of increase ($p < 0.001$) and the e-factor ($p < 0.05$) were higher on control mice (Figure 1I-L). Interestingly, after 4 months of rotenone treatment carbachol induced a higher reaction on samples coming from vehicle treated animals when compared to rotenone treated samples (Figure 2G) ($p < 0.01$). No significant difference was observed in any of the other measured parameters (Supplementary Figure 5A-K).

In the colon, rotenone treatment did not induce any significant change after 2 months of treatment. After 4 months, rotenone treatment increased the mean amplitude ($p < 0.05$) and decreased the frequency ($p < 0.05$) in rotenone-treated mice when compared to control (Figure 2H-I). No significant difference was observed in any of the other measured parameters (Supplementary Figure 6A-O)

Changes in the Response to Dopamine

We then analyzed the effect of dopamine on the different regions of the intestine. Dopamine is a neurotransmitter that induces the relaxation of the intestine reducing the tone and the contractility. Our results show that rotenone treatment has a variable effect depending on the time of treatment

and the region affected. In general, rotenone treatment decreased the reaction to dopamine after 2 months of treatment except in the colon. Interestingly, this effect was the opposite after 4 months of treatment in all regions but the colon.

In the duodenum, 2 months of rotenone treatment led to a bigger decrease in the tone on control samples when compared to treated samples (Δ minimum: $p < 0.05$) (Figure 3A). This effect was reverted after 4 months of treatment. At this time point, rotenone treated samples reacted more strongly to dopamine (Δ minimum: $p < 0.05$) (Figure 4A). Also differences in the mean amplitude (treated > control; $p = 0.0223$) and the slope (treated > control, $p < 0.01$) were bigger in treated samples (Figure 4B-C). No significant difference was observed in any of the other measured parameters (Supplementary Figure 7A-L)

Two months of rotenone treatment also induced a reduced relaxation in the tone of rotenone treated jejunum samples (Δ minimum: $p < 0.001$) (Figure 3B) and a slower recovery of the tone after exposure to dopamine (e-Exponent: $p < 0.05$) (Figure 3C). This effect was also reversed after 4 months of treatment. At this time point, dopamine induces a deeper suppression of the contractility (Δ maximum, $p < 0.0001$); mean amplitude: $p = 0.0120$) (Figure 4D-E). Dopamine also induces a reduction in the contractility frequency of control samples that could not be observed in rotenone treated samples ($p = 0.0028$) (Figure 4F). No significant difference was observed in any of the other measured parameters (Supplementary Figure 8A-K)

Similarly, 2 months of rotenone reduced the effect of dopamine on the intestinal tone of ileum samples (Δ minimum: $p < 0.001$; amplitude of increase: $p < 0.01$). Also the reaction-time to dopamine (slope: $p < 0.01$) and the time to regain the tone were different (e-Factor: $p < 0.01$) (Figure 3D-G). Again, this effect was the opposite after 4 months of treatment (Δ minimum: $p = 0.0114$) and also the decrease on the contractility of rotenone treated samples was higher than in the controls (Δ maximum: $p = 0.001$; mean amplitude: $p < 0.01$) (Figure 4G-I). No significant difference was observed in any of the other measured parameters (Supplementary Figure 9A-I)

We only observed a difference in the speed of relaxation induced by dopamine in the colon (slope: $p < 0.01$) with a higher slope in control samples after 2 months of treatment (Figure 3H). After 4 months, the relaxation induced by dopamine was clearly higher in control samples when compared to rotenone-treated samples (maximum: $p < 0.01$; minimum: $p < 0.01$; slope: $p < 0.01$ and amplitude of increase, $p < 0.05$) (Figure 4J-M). No significant difference was observed in any of the other measured parameters (Supplementary Figure 10A-K).

Rotenone treatment induces changes in the response of the ENS to electric field stimulation

We then tested the effect of rotenone treatment on the ENS using electric field stimulation (EFS). Using certain stimulation parameters it is possible to stimulate the neurons of the ENS without stimulating the enteric muscle. The reaction to the stimulation is different depending on the distribution of the different neuronal subtypes (i.e. cholinergic, serotonergic, dopaminergic, nitrergic, etc...) in the gut. Within the parameters chosen for the experiments (see Material and Methods) EFS using a pulse duration of 200 (EFS 200) and 400 (EFS 400) μ s on control non-treated tissues produced a biphasic TTX-sensitive response as previously reported [13]. This response

consisted in an initial relaxation (R1) during the EFS followed by a contraction (C-Off) when the EFS stopped.

4 months but not 2 months rotenone treatment increases the reaction of jejunum and ileum to EFS in the absence and presence of atropine, guanethidine and serotonin

In order to compare the effect rotenone on the response to EFS on control and treated mice, we performed EFS 200 and EFS 400 in the absence or in the presence of atropine (AT), AT and guanethidine (G) or AT, G and serotonin (S). We then compared both response curves using a 2 way ANOVA. We did not observe any differences between control and rotenone-treated samples after 2 months of treatment (data not shown).

We then compared control and rotenone treated samples after four months of treatment. Whereas we did not observe any significant differences in the reactions during the R1 or C-Off phases in duodenum (Figure 5A-D) or colon (Figure 5M-P) samples, there was a significant increase in the reaction of rotenone treated samples during the C-Off phase (i.e. higher contraction) in the jejunum ($p < 0.001$) and ileum ($p < 0.05$) under EFS 200 and EFS 400 (Figure 5F,H,J and L). Additionally, there was also an increased reaction during the R1 phase (i.e. higher relaxation) on rotenone treated ileum samples ($p < 0.05$) compared to controls when stimulated with EFS 200 (Figure 5I).

We then wanted to investigate the differences in the amount of neurotransmitter or the function of the different neuronal subtypes. For this, we compared the effect of EFS alone and in the presence of i) atropine (AT), a competitive muscarinic acetylcholine (ACh) receptor antagonist to investigate non-cholinergic responses, ii) AT and guanethidine (G), a selective inhibitor of noradrenaline release from postganglionic adrenergic neurons to investigate non-adrenergic non-cholinergic responses and iii) AT, G and serotonin (SHT) to investigate the basal levels of serotonin in the ENS.

Rotenone treatment influences the amount of acetylcholine released during EFS

In order to indirectly determine the amount of ACh released during the EFS responsible for the contraction of the intestinal muscles, we compared the relaxation and contractility during the C-Off and R1 phases respectively in the absence and the presence of 10^{-5} M of AT, a competitive acetylcholine receptor. In all regions, AT induced a deeper relaxation and a lower contraction when compared to the reaction without substances when EFS 200 and EFS 400 were applied (NB: data below is shown as a percentage of the EFS 200 or EFS 400 contraction without substances and the p values refer to this percentage, if an additional significant difference between control and treated samples is shown, the p value will be written separately).

In the duodenum, 2-months rotenone treatment did not induces differences in the effect of AT on the R1-relaxation between controls and treated mice (Figure 6A and C). The effect of AT on the C-Off contraction induced by EFS 200 and EFS 400 was stronger on treated mice (EFS 200: 73.39 ± 11.249 , $p < 0.05$; EFS 400: 90.42 ± 18.88 ; $p > 0.05$) then on control mice (EFS 200: 79.17 ± 14.14 , $p > 0.05$; EFS 400: 95.322 ± 20.113 , $p > 0.05$) (Figure 6B and D). In the duodenum of 4 months treated mice, we did not observe any differences in the effect of AT on the R1-relaxation between controls and treated

mice (Figure 7A and C). The effect of AT on the C-Off contraction induced by EFS 200 and EFS 400 was stronger on treated mice (EFS 200: $65\% \pm 6.538$, $p < 0.001$; EFS 400: $68.9\% \pm 6.566$; $p < 0.001$) then on control mice (EFS 200: $81.3\% \pm 9.268$, $p < 0.05$; EFS 400: $88\% \pm 8.791$, $p < 0.05$) (Figure 7B and D).

In the jejunum, we observed no differences in the effect of AT on the R1 or C-Off phases of EFS 200 or EFS 400 after 2 months of treatment (Figure 6E-H). 4 months after treatment, the effect of AT on R1-relaxation induced by EFS 200 and EFS 400 was significantly different between control and treated samples ($p < 0.05$). AT induced larger R1-relaxation on control samples (EFS 200: $201\% \pm 49.656$, $p = 0.058$; EFS 400: $134.9\% \pm 42.752$, $p = 0.42$) and reduced the R1-relaxation in treated samples (EFS 200: $81.788\% \pm 18.87$, $p < 0.05$; EFS 400: 83.7 ± 13.506 , $p = 0.24$) (Figure 8E and G). The differences observed on the effect of AT on the C-Off phase between rotenone treated and control samples was opposite to the one observed in the duodenum, the ileum and the colon. AT induced a significant decrease in the contractility of control mice (EFS 200: $68.5\% \pm 10.65$, $p < 0.01$; EFS 400: $74\% \pm 7.839$, $p < 0.01$), whereas the decrease observed on treated mice was smaller and non-significant (EFS 200: $79.16\% \pm 10.48$, $p > 0.05$; EFS 400: 82.44 ± 10.5 , $p > 0.05$) (Figure 8F and H).

In the ileum, 2 months treatment induced a higher response to AT ($p < 0.05$) in the R1 phase with higher relaxations during EFS 400 in rotenone treated mice (EFS 400: 136.076 ± 36.44 , $p > 0.05$) when compared to control samples (EFS 400: 30.042 ± 21.168 , $p > 0.01$) (Figure 6K). We also observed a significant reduction of the C-Off contraction in the presence of AT with the EFS 200 on treated samples (EFS 200: $65.94\% \pm 12.992$, $p < 0.05$) but not in controls (EFS 200: 73.371 ± 25.33 , $p > 0.31$) (Figure 6J). No differences in any of the other analyzed parameters were observed (Figure 6I and L). Further 2 months of treatment induced a non-significant higher R1-relaxation in the presence of AT on control mice (EFS 200: $257.8\% \pm 102.348$, $p = 0.12$; EFS 400: $172.55\% \pm 33$, $p > 0.05$) when compared to treated (EFS 200: $185.1\% \pm 57.2$, $p = 0.15$; EFS 400: 155.88 ± 31.187 , $p = 0.09$) (Figure 7I and K). The effect of AT on the C-Off contractility was higher on treated samples (EFS 200: $59.825\% \pm 6.443$, $p < 0.001$; EFS 400: 63.08 ± 6.077 , $p < 0.001$) then controls (EFS 200: $81.07\% \pm 21.46$, $p > 0.05$; EFS 400: 76.07 ± 14.72 , $p > 0.05$) (Figure 7J and L).

In the colon, 2 months treatment induced a significant opposite reaction ($p < 0.05$) between control (EFS 200: $80.848\% \pm 15.44$, $p > 0.05$) and rotenone treated (EFS 200: $230.193\% \pm 98.75$, $p > 0.05$) samples in the R1 phase during the EFS 200 (Figure 6M). Additionally, we also observed a difference on the effect of AT on the C-Off phase of the EFS 200 with a significant reduction of the C-Off contraction in the presence of AT when using the EFS 200 on treated samples (EFS 200: $27.02\% \pm 11.87$, $p < 0.001$) but not in controls (EFS 200: 99.826 ± 36.55 , $p > 0.99$) (Figure 6N). After 4 months of treatment, AT had no effect on the C-Off contractility in control or treated mice (Figure 7N and P). Interestingly, the effect of AT on the R1 EFS-induced relaxation was opposite to all other intestinal regions and to the effect after 2 months of treatment on treated samples. AT diminished the relaxation induced by EFS in both control (EFS 200: $63.8\% \pm 14.30$, $p < 0.05$; EFS 400: $63.56\% \pm 14.458$, $p < 0.05$) and treated (EFS 200: $70.74\% \pm 10.08$, $p < 0.05$; EFS 400: $70.60\% \pm 9.899$, $p < 0.01$) samples (Figure 7M and O). No difference between treatments was observed.

Altogether these results suggest that rotenone treatment affects cholinergic innervation in the intestine. The quality and degree of dysfunction depends on the region affected.

2 months but not 4 months rotenone treatment influences the nonadrenergic, noncholinergic (NANC) reaction to EFS 200 or EFS 400

We then analyzed the NANC reaction of the different regions to EFS 200 and EFS 400. For this we added 10^{-5} M guanethidine to the Krebs's solution, that already contained AT. In general the NANC reaction to EFS showed non-significant increases in the R1 relaxation and non-significant higher C-Off contractions in most of the regions when compared to the reaction with AT at any time point. The only region where we observed a difference between the reaction with AT alone and AT+G was in the colon after 2 months of treatment. In treated samples but not in controls, the addition of guanethidine induces an increased contraction in the C-Off phase during EFS 200 (AT: $27,022\% \pm 11.878$, AT+G: $234,174 \pm 39.16$, $p < 0.001$) and a reduced relaxation in the R1 phase during EFS 400 (AT: $122.885\% \pm 16.826$, AT+G: $72.993\% \pm 5.818$, $p < 0.05$) (Figure 6N and O). After 4 months of treatment, we only observed an increase in the C-Off contraction after addition of guanethidine during EFS 200 and EFS 400 in the ileum of rotenone treated mice (EFS 200: AT: $59.825\% \pm 6.443$, AT+G: 121.528 ± 17.83 , $p < 0.01$; EFS 400: AT: 63.085 ± 6.077 , AT+G: 116.604 ± 14.86 , $p < 0.01$), where the effect of AT had been the highest (Figure 7J and L). Our results show no significant differences in the NANC reaction to EFS 200 and EFS 400 between rotenone treated and control samples in all regions studied (Figure 7A-P).

ENS Reaction to Serotonin is not altered by rotenone treatment

In PD, the serotonergic system in the brainstem is affected. Therefore, we tested the serotonergic system in the gut. For this we added 10^{-4} M of 5HT before performing the EFS. In all regions except the colon, 5HT addition induced an increased contractility. The magnitude of this increase was region dependent. Δ maximum was significantly higher ($p < 0.05$) in the duodenum (Δ maximum: control 1.395 ± 0.13 , treated 1.474 ± 0.127) when compared to the ileum (Δ maximum: control 1.009 ± 0.03 , treated 0.924 ± 0.036) and the colon (Δ maximum: control 0.877 ± 0.055 , treated 0.851 ± 0.04) and in the jejunum (Δ maximum: control 1.209 ± 0.04 , treated 1.205 ± 0.09) when compared to the colon ($p < 0.05$) (Supplementary Figure 11A-F). The effect of 5HT on the intestinal tonus depended on the region. It induced an increase of tonus in the duodenum (Δ minimum: control 1.202 ± 0.0086 , treated 1.249 ± 0.08) and the jejunum (Δ minimum: control 1.118 ± 0.066 , treated 1.068 ± 0.029), it had no effect on the colon (Δ minimum: control 1.03 ± 0.085 , treated 0.972 ± 0.026) and it decreased the tonus in the ileum (Δ minimum: control 0.93 ± 0.033 , treated 0.914 ± 0.055). We did not observe any differences between rotenone treated and control samples ($p > 0.05$) (Supplementary Figure 11A-D).

We then analyzed the effect of EFS 200 and EFS 400 in the presence of 5HT. Our results only show a significant decrease in the C-Off contractility after the addition of 5HT in the duodenum when applying the EFS 400 ($p < 0.05$) (Figure 8D).

Western-Blot

Rotenone treatment induces modifications of neuronal-specific markers in the intestine of 8-weeks-old mice.

In order to analyze the effect of rotenone on the ENS of 8-weeks-old mice, we studied the expression of markers of the different neuronal populations present in the jejunum, ileum and colon from vehicle and rotenone treated mice. Our results show that rotenone induces changes in all tested regions. These alterations are region, and treatment-dependent.

Region-dependent modifications of the neuronal marker PGP9,5 in the intestine of mice exposed to rotenone during 4 months.

To study the effect on rotenone exposure on neuronal cells compared to non-neuronal cells, we analyzed the protein expression of PGP9,5, an ubiquitin carboxy-terminal hydrolase mainly expressed in nerve cells compared to the expression of Glycerinaldehyd-3-phosphat-Dehydrogenase (GAPDH), which is stably expressed among the different cell populations and has been used here as a loading control.

We compared the protein expression of PGP9,5 in all different segments from 4 months-rotenone-treated and control mice and observed differences in the effect of rotenone treatment in the relative protein expression level of PGP between intestinal regions. Indeed, in the ileum and the colon of rotenone-treated mice, PGP9,5 levels were lower compared to control mice ($p=XXX$ and $p=XXX$ respectively, figure Xx and Xx) suggesting that rotenone induced a diminution of the neuronal population within these region compared to the total number of cells. However, in the jejunum, rotenone treatment did not induce any significant change after 4 months of treatment (figure Xx) suggesting a region-specific sensitivity to rotenone within the intestine.

So that we specify which neuronal population was the most affected among the different populations present we studied the effect of rotenone exposure on the cholinergic and catecholaminergic neuronal populations of the intestine.

Rotenone exposure induces a decrease of Choline acetyltransferase, in the intestine of 8-weeks-old mice exposed to rotenone during 4 months.

We analyzed the relative protein level of the choline acetyltransferase, an enzyme implicated in the synthesis of acetylcholine within the cholinergic neurons in the central nervous system and the peripheral nervous system. We compared the protein expression of ChAT in all different segments from 4 months rotenone-treated mice and controls and normalized this expression to the neuronal marker PGP9,5. As presented in figure XXX, XXX and XXX we observed a significant decrease of ChAT protein levels induced by rotenone treatment in all intestinal regions.

Rotenone exposure induces a moderate decrease of Tyrosine hydroxylase, in the intestine of 8-weeks-old mice exposed to rotenone during 4 months.

We also analyzed the relative protein level of the tyrosine hydroxylase (TH), implicated in the synthesis of the catecholamines dopamine, epinephrine and norepinephrine in the central nervous

system and the peripheral nervous system. We compared the protein expression of TH in all different segments from 4 months rotenone-treated mice and controls and normalized this expression to the neuronal marker PGP9,5.

Although a significant decrease of TH protein levels was observed in the jejunum of rotenone-treated mice ($p=xxx$), this reduction did not reach the significance threshold in ileum and colon ($p=xxx$ and $p=xxx$ respectively). We therefore concluded that catecholaminergic neurons of the intestine were less sensitive to the exposure to rotenone than cholinergic neurons.

Rotenone treatment induces modifications of neuronal-specific markers in the intestine of 1-year-old mice.

As this animal model of chronic exposure to low doses of rotenone was first created in 1-year-old mice, we also realized the study of the impact of rotenone in the different neuronal populations present in the jejunum, ileum and colon of 1-year-old mice exposed to rotenone during 2 and 4 months.

Region and age-dependent modifications of the neuronal marker PGP9,5 in the intestine of mice exposed to rotenone during 2 months and 4 months.

As for the samples of younger mice, we first studied the impact of rotenone on the entire neuronal population by comparing the expression of PGP9,5 to the one of GAPDH.

After two months of treatment, the effect of rotenone on the jejunum, ileum and colon was more. Indeed, a non-significant decrease was observed in the jejunum ($p=0,2834$, figure xxx) while PGP9,5 levels were either similar between control and rotenone treated samples in the ileum or lightly higher in the colon .

After 4 months of treatment, a non-significant decrease of PGP9,5 levels was observed in the ileum of 1-year-old treated mice while no difference was detected in the jejunum, correlating the results obtained in the 8-weeks-old mice. However, in the colon, no difference was observed for PGP9,5 levels in the colon of rotenone treated mice when compared to controls ($p=0,9723$, see Figure XX) whereas in the 8-weeks-old mice PGP9,5 levels were decreased in rotenone treated mice compared to control mice. If confirmed in a larger cohort of mice, this analysis in colon would suggest a different reaction of neuronal populations to rotenone exposure depending on the age of the subject.

Rotenone exposure induces modifications of Choline acetyltransferase levels, in the intestine of 1-year-old mice exposed to rotenone during 2 months and 4 months.

We next analyzed the relative protein expression of Choline acetyltransferase compared to PGP9,5 in the duodenum, jejunum, ileum and colon of 1-year-old mice after 2 months and 4 months of rotenone exposure.

In all tested regions, we observed a decrease of ChAT expression in rotenone-treated samples when compared to control after 2 months (fig XX and XX). This decrease was significant only in the colon ($p=0,0309$, Figure XXX).

After 4 months of treatment, ChAT levels were also decreased in samples from rotenone treated mice when compared to control in the jejunum but not in the ileum and colon (see Figure XXX) revealing an age-dependent and region-dependent effect of rotenone on cholinergic neurons of the intestine.

Rotenone exposure modifies Tyrosine hydroxylase protein levels in the intestine of 1-year-old mice exposed to rotenone during 2 months and 4 months.

We realized the analysis of the relative protein level of the tyrosine hydroxylase (TH) normalized to the neuronal marker PGP9,5 in all different segments from 2 months and 4 months rotenone-treated mice and controls.

After two months of rotenone exposure, TH levels were significantly higher in rotenone treated samples compared to control samples in colon ($p=0,0237$), suggesting maybe a compensatory mechanism involving a higher production of TH in order to compensate a moderate cell death of catecholaminergic neurons as it has been observed in the brain in other animal model of parkinsonism (Greenwood et al., 1991; Bubak et al., 2015). In the meantime, no difference was observed in the ileum. Moreover, TH levels were significantly lower in the jejunum of rotenone treated mice ($p=0,0428$), highlighting once again the region-specific effect of rotenone treatment in the intestine.

The results obtained for TH in 1-year-old mice after 4 months of rotenone exposure are surprising compared to the one obtained in 8-weeks-old mice. As a matter of fact, the pattern of TH expression within the intestine does not correlate the observation made in the intestine of 8-weeks-old mice. Indeed, no significant difference was observed between rotenone-treated and control mice for all regions studied after 4 months of exposure, including the jejunum. However, a tendency of increase was observed in the ileum and the colon whereas no modification were observed in the jejunum.

These western blot experiments therefore show that rotenone treatment during two and four months do modify the neuronal population within the intestine in a region, age and treatment-dependent manner. While searching for a potential treatment for the gastro-intestinal non-motor symptoms of PD it will therefore be essential to determine more precisely the affected neuronal population causing the symptoms in order to adapt the therapeutic strategies.

Discussion

In a recent study, Annerino and colleagues did not observe neuronal loss in the myenteric ganglia of PD patients when compared to controls.

Non-motor symptoms in Parkinson's disease are widely spread among patients. Their prevalence varies depending on the type of symptom but, unlike motor symptoms, they are not always observed in PD patients [14-20]. According to Braak's pathological staging, most of the nervous structures whose impairment is thought to give rise to non-motor symptoms (e.g. enteric, sympathetic or parasympathetic systems) are affected in very early stages of the disease showing PD-pathology in the form of LB and LN [1]. In this study we show that rotenone treatment induces alpha-synuclein accumulation and cell death in enteric neurons and the degeneration of the sympathetic enteric innervation in the gut of treated mice. These alterations are correlated with changes in the motility of the gut.

We also characterized the effect of rotenone on sympathetic neurons in vitro. The degenerative process of the sympathetic ganglia has been observed in PD and Lewy Body disease patients and classified within three stages in which neurite loss precedes neuronal loss [21, 22]. In the early stage, a few LBs are observed in the ganglia but the number of neurons and immunoreactivity for TH is well preserved. In the middle stage, many LBs are found in the ganglia and the number of neurons appears to be normal with H&E staining. However, a significant number of neuronal somata (about 20–30% of neurons) are TH-immunonegative. In the advanced stage, there is apparent neuronal loss in the ganglia and the number of LBs is decreased compared with the middle stage. Interestingly, we could observe similar alterations in vitro by treating sympathetic neurons with different concentrations of rotenone. We observed neurite degeneration and LB-like alpha-synuclein inclusions that were also positive for TH. These alterations could be observed with rotenone concentrations higher than 100 μ M and preceded sympathetic neuronal death in the case of the highest concentration of rotenone (5 μ M).

Previous studies have shown both an up-regulation and a down-regulation of alpha-synuclein expression upon exposure to different toxins [23-25]. It is still unclear whether the aggregation of alpha-synuclein is induced by an up-regulation of its expression or by posttranslational modifications. We analyzed the effect of rotenone treatment on alpha-synuclein and TH expression. Despite the appearance of alpha-synuclein inclusions, our results show a down regulation of alpha-synuclein expression upon rotenone treatment. Altogether these results suggest that the appearance of ASYN accumulations within sympathetic neurons is not due to an increase in its expression and is independent of the total alpha-synuclein content. Thus, suggesting that other processes such as alpha-synuclein post-translational modifications may be responsible for the increase in alpha-synuclein to alpha-synuclein interactions. We also speculate that the down-regulation of alpha-synuclein and TH expression could be linked to the neurite degeneration. Alpha-synuclein is a presynaptic protein and TH is an enzyme needed to produce noradrenaline both located to the synaptic terminals. Therefore, the disappearance of the neurites could induce a feedback leading to the down-regulation of alpha-synuclein and TH expression.

Two hypothesis have been postulated to explain the appearance and progression of PD pathology in patients: i) a double action (peripheral and central) of a systemic noxa and ii) the enteric/olfactory spreading hypothesis, that postulates that toxins or infectious agents acting on the enteric nervous system and the olfactory bulb could trigger the appearance of the pathology and its progression into and throughout the CNS. As PD has been related to the exposure to pesticides [26, 27], some authors suggest that the progression pattern observed in PD patients could be explained by the systemic effect of environmental toxins on the nervous system [28-30] leading to the first hypothesis. If we

apply this hypothesis to our model, the pathology progression pattern that we observe would be a consequence of neuronal differences in the sensitivity to Complex I inhibition. Therefore, sympathetic neurons should be more sensitive to rotenone treatment than dopaminergic neurons. In order to test the first hypothesis, we compared the effect of different concentrations of rotenone on sympathetic and dopaminergic neurons in vitro. Our results clearly show that dopaminergic neurons are up to 100 time more sensitive to rotenone than sympathetic neurons, suggesting that the pathology progression observed in oral rotenone treated mice is not due to a systemic effect of the substance. In the last years, different studies have shown that injected or locally produced ASYN can spread from one region to another of the nervous system [31-33]. More recently, a study showed that full and partial vagotomy reduced the risk of developing Parkinson's disease [34]. Thus supporting the spreading hypothesis.

Although clinical studies are needed, PET-CT studies using meta-iodobenzylguanidine (MIBG) or similar radiotracers could be used to detect variations in the sympathetic neurite density of the gut. Our results suggest that the sympathetic denervation of the ENS is an early event in the progression of PD and has the potential to be used as biomarker for the diagnosis of the disease in its initial steps.

Authors Contribution: FP-M designed the study. YD treated the mice. UR and FP-M designed the contractility experiments. RM, YD and FP-M performed the contractility experiments. KB wrote the Matlab quantification program. UR, GS, KB and FP-M analyzed the contractility results. AS and FP-M performed the western-blot, CV-B, AS, RF and FP-M analyzed the western-blot results. MD, KB, RF and FP-M wrote the manuscript.

1. Braak H, Sastre M, Bohl JR, de Vos RA, Del Tredici K: **Parkinson's disease: lesions in dorsal horn layer I, involvement of parasympathetic and sympathetic pre- and postganglionic neurons.** *Acta Neuropathol* 2007, **113**(4):421-429.
2. Wakabayashi K, Takahashi H, Ohama E, Ikuta F: **Parkinson's disease: an immunohistochemical study of Lewy body-containing neurons in the enteric nervous system.** *Acta Neuropathol* 1990, **79**(6):581-583.
3. Wakabayashi K, Takahashi H: **Cellular pathology in multiple system atrophy.** *Neuropathology* 2006, **26**(4):338-345.
4. Braak H, de Vos RA, Bohl J, Del Tredici K: **Gastric alpha-synuclein immunoreactive inclusions in Meissner's and Auerbach's plexuses in cases staged for Parkinson's disease-related brain pathology.** *Neurosci Lett* 2006, **396**(1):67-72.
5. Braak H, Ghebremedhin E, Rub U, Bratzke H, Del Tredici K: **Stages in the development of Parkinson's disease-related pathology.** *Cell Tissue Res* 2004, **318**(1):121-134.
6. Wolters E, Braak H: **Parkinson's disease: premotor clinico-pathological correlations.** *J Neural Transm Suppl* 2006(70):309-319.
7. Krogh K, Christensen P: **Neurogenic colorectal and pelvic floor dysfunction.** *Best practice & research Clinical gastroenterology* 2009, **23**(4):531-543.

8. Marrinan S, Emmanuel AV, Burn DJ: **Delayed gastric emptying in Parkinson's disease.** *Mov Disord* 2014, **29**(1):23-32.
9. Pfeiffer RF: **Gastrointestinal dysfunction in Parkinson's disease.** *Lancet Neurol* 2003, **2**(2):107-116.
10. Pan-Montojo FJ, Funk RH: **Oral administration of rotenone using a gavage and image analysis of alpha-synuclein inclusions in the enteric nervous system.** *Journal of visualized experiments : JoVE* 2010(44).
11. Pan-Montojo F, Schwarz M, Winkler C, Arnhold M, O'Sullivan GA, Pal A, Said J, Marsico G, Verbavatz JM, Rodrigo-Angulo M *et al*: **Environmental toxins trigger PD-like progression via increased alpha-synuclein release from enteric neurons in mice.** *Scientific reports* 2012, **2**:898.
12. Nagy JI, Urena-Ramirez V, Ghia JE: **Functional alterations in gut contractility after connexin36 ablation and evidence for gap junctions forming electrical synapses between nitrergic enteric neurons.** *FEBS Lett* 2014, **588**(8):1480-1490.
13. Bertoni S, Gabella G, Ghizzarda P, Ballabeni V, Impicciatore M, Lagrasta C, Arcari ML, Barocelli E: **Motor responses of rat hypertrophic intestine following chronic obstruction.** *Neurogastroenterology and motility : the official journal of the European Gastrointestinal Motility Society* 2004, **16**(3):365-374.
14. Maass A, Reichmann H: **Sleep and non-motor symptoms in Parkinson's disease.** *J Neural Transm (Vienna)* 2013, **120**(4):565-569.
15. Klingelhoefer L, Reichmann H: **Pathogenesis of Parkinson disease-the gut-brain axis and environmental factors.** *Nature reviews Neurology* 2015, **11**(11):625-636.
16. Aarsland D, Pahlhagen S, Ballard CG, Ehrt U, Svenningsson P: **Depression in Parkinson disease--epidemiology, mechanisms and management.** *Nature reviews Neurology* 2012, **8**(1):35-47.
17. Chen W, Xu ZM, Wang G, Chen SD: **Non-motor symptoms of Parkinson's disease in China: a review of the literature.** *Parkinsonism Relat Disord* 2012, **18**(5):446-452.
18. Pfeiffer RF: **Autonomic dysfunction in Parkinson's disease.** *Expert review of neurotherapeutics* 2012, **12**(6):697-706.
19. Defazio G, Gigante A, Mancino P, Tinazzi M: **The epidemiology of pain in Parkinson's disease.** *J Neural Transm (Vienna)* 2013, **120**(4):583-586.
20. Todorova A, Jenner P, Ray Chaudhuri K: **Non-motor Parkinson's: integral to motor Parkinson's, yet often neglected.** *Practical neurology* 2014, **14**(5):310-322.
21. Amino T, Orimo S, Itoh Y, Takahashi A, Uchihara T, Mizusawa H: **Profound cardiac sympathetic denervation occurs in Parkinson disease.** *Brain Pathol* 2005, **15**(1):29-34.
22. Orimo S, Amino T, Itoh Y, Takahashi A, Kojo T, Uchihara T, Tsuchiya K, Mori F, Wakabayashi K, Takahashi H: **Cardiac sympathetic denervation precedes neuronal loss in the sympathetic ganglia in Lewy body disease.** *Acta Neuropathol* 2005, **109**(6):583-588.
23. Manning-Bog AB, McCormack AL, Li J, Uversky VN, Fink AL, Di Monte DA: **The herbicide paraquat causes up-regulation and aggregation of alpha-synuclein in mice: paraquat and alpha-synuclein.** *J Biol Chem* 2002, **277**(3):1641-1644.

24. Manning-Bog AB, McCormack AL, Purisai MG, Bolin LM, Di Monte DA: **Alpha-synuclein overexpression protects against paraquat-induced neurodegeneration.** *The Journal of neuroscience : the official journal of the Society for Neuroscience* 2003, **23**(8):3095-3099.
25. Di Monte DA: **The environment and Parkinson's disease: is the nigrostriatal system preferentially targeted by neurotoxins?** *Lancet Neurol* 2003, **2**(9):531-538.
26. Gorell JM, Johnson CC, Rybicki BA, Peterson EL, Richardson RJ: **The risk of Parkinson's disease with exposure to pesticides, farming, well water, and rural living.** *Neurology* 1998, **50**(5):1346-1350.
27. Tanner CM, Kamel F, Ross GW, Hoppin JA, Goldman SM, Korell M, Marras C, Bhudhikanok GS, Kasten M, Chade AR *et al*: **Rotenone, paraquat, and Parkinson's disease.** *Environ Health Perspect* 2011, **119**(6):866-872.
28. Betarbet R, Sherer TB, MacKenzie G, Garcia-Osuna M, Panov AV, Greenamyre JT: **Chronic systemic pesticide exposure reproduces features of Parkinson's disease.** *Nat Neurosci* 2000, **3**(12):1301-1306.
29. Sherer TB, Betarbet R, Testa CM, Seo BB, Richardson JR, Kim JH, Miller GW, Yagi T, Matsuno-Yagi A, Greenamyre JT: **Mechanism of toxicity in rotenone models of Parkinson's disease.** *J Neurosci* 2003, **23**(34):10756-10764.
30. Sherer TB, Betarbet R, Greenamyre JT: **Pesticides and Parkinson's disease.** *ScientificWorldJournal* 2001, **1**:207-208.
31. Holmqvist S, Chutna O, Bousset L, Aldrin-Kirk P, Li W, Bjorklund T, Wang ZY, Roybon L, Melki R, Li JY: **Direct evidence of Parkinson pathology spread from the gastrointestinal tract to the brain in rats.** *Acta Neuropathol* 2014, **128**(6):805-820.
32. Luk KC, Kehm V, Carroll J, Zhang B, O'Brien P, Trojanowski JQ, Lee VM: **Pathological alpha-synuclein transmission initiates Parkinson-like neurodegeneration in nontransgenic mice.** *Science* 2012, **338**(6109):949-953.
33. Desplats P, Lee HJ, Bae EJ, Patrick C, Rockenstein E, Crews L, Spencer B, Masliah E, Lee SJ: **Inclusion formation and neuronal cell death through neuron-to-neuron transmission of alpha-synuclein.** *Proc Natl Acad Sci U S A* 2009, **106**(31):13010-13015.
34. Svensson E, Horvath-Puho E, Thomsen RW, Djurhuus JC, Pedersen L, Borghammer P, Sorensen HT: **Vagotomy and subsequent risk of Parkinson's disease.** *Ann Neurol* 2015, **78**(4):522-529.

Figure legends:

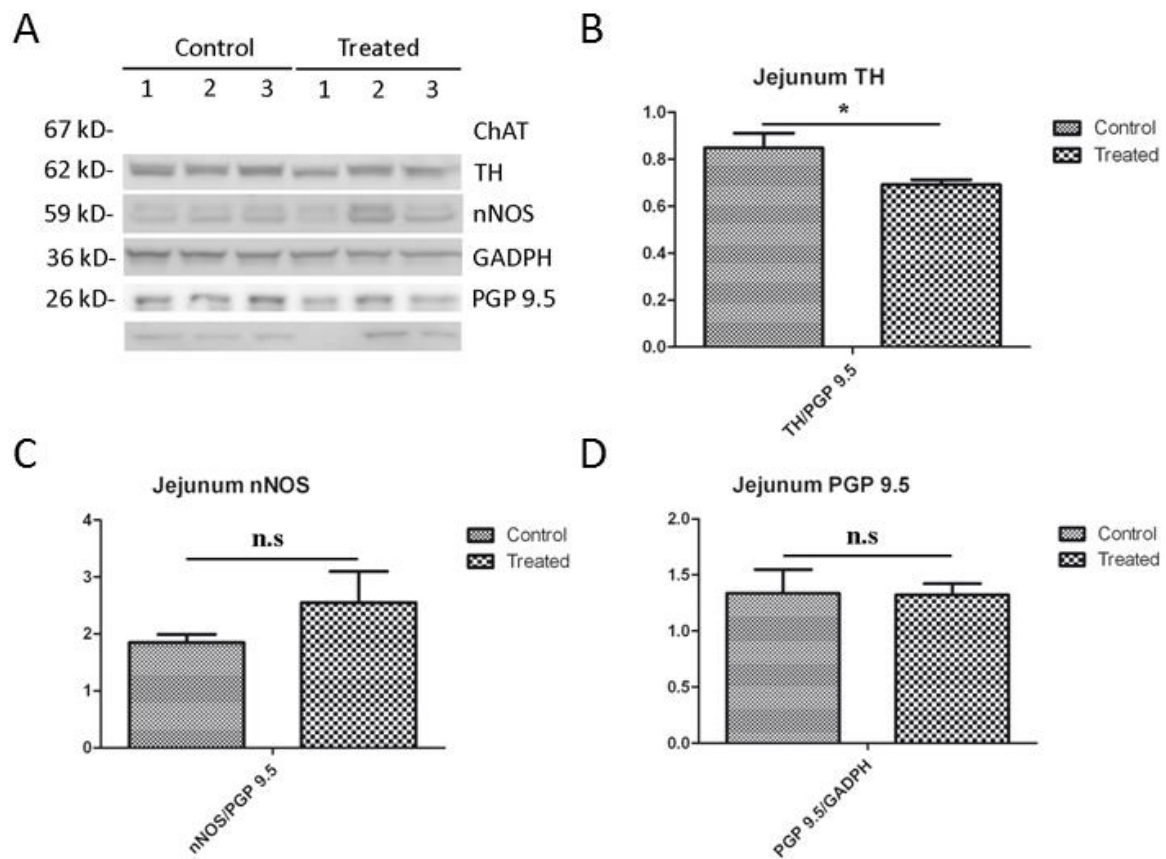

Figure 8: Rotenone-induced modifications of neural markers in the jejunum of 8-weeks-old mice after 4 months of exposure. (A) Representative western blots using antibodies raised against tyrosine hydroxylase (TH), Pgp9.5, nNOS and glycerinaldehyde-3-phosphate-dehydrogenase (GAPDH), respectively realized in the jejunum of mice exposed to the solvent (= Control) or to chronic low doses of rotenone (5mg/kg/day) during 2 months. Gapdh expression was used as a loading control. B-D) Graphic representation of the relative protein expression of tyrosine hydroxylase (TH,) normalized to the expression of PGP9.5 (B), nNOS normalized to the expression of PGP9.5(C) and PGP9.5 normalized to the expression of glycerinaldehyde-3-phosphat-dehydrogenase (Gapdh, D) in the jejunum (n=3 for each condition).

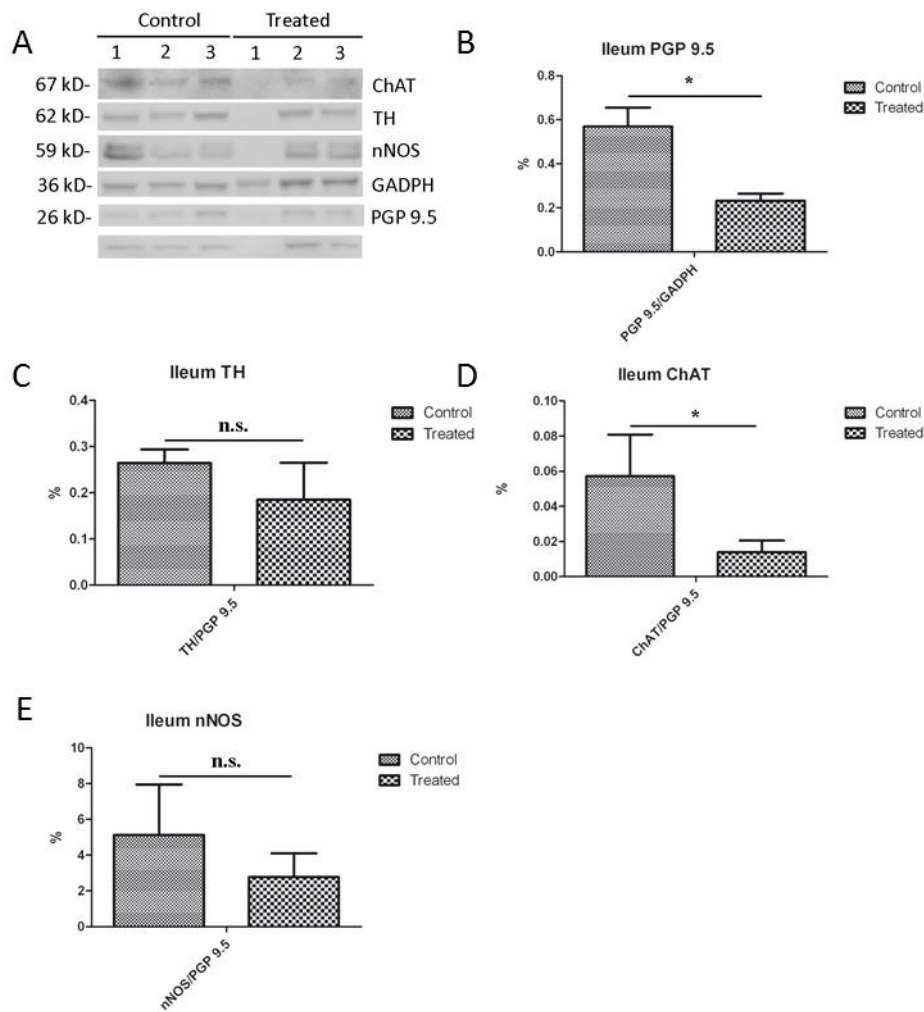

Figure 9: Rotenone-induced modifications of neural markers in the ileum of 8-week-old mice after 4 months of exposure. (A) Representative western blots using antibodies raised against choline acetyltransferase (CHAT), tyrosine hydroxylase (TH), Pgp9.5, nNOS, and glyceraldehyde-3-phosphate-dehydrogenase (GAPDH), respectively realized in the ileum of mice exposed to the solvent (= Control) or to chronic low doses of rotenone (5mg/kg/day) during 2 months. Gapdh expression was used as a loading control. B-E) Graphic representation of the relative protein expression of and PGP9.5 normalized to the expression of glyceraldehyde-3-phosphat-dehydrogenase (Gapdh, B), tyrosine hydroxylase (TH) normalized to the expression of PGP9.5 (C), choline acetyltransferase (ChAT) normalized to the expression of PGP9.5 (D) and nNOS normalized to the expression of PGP9.5(E) in the ileum (n=3 for each condition).

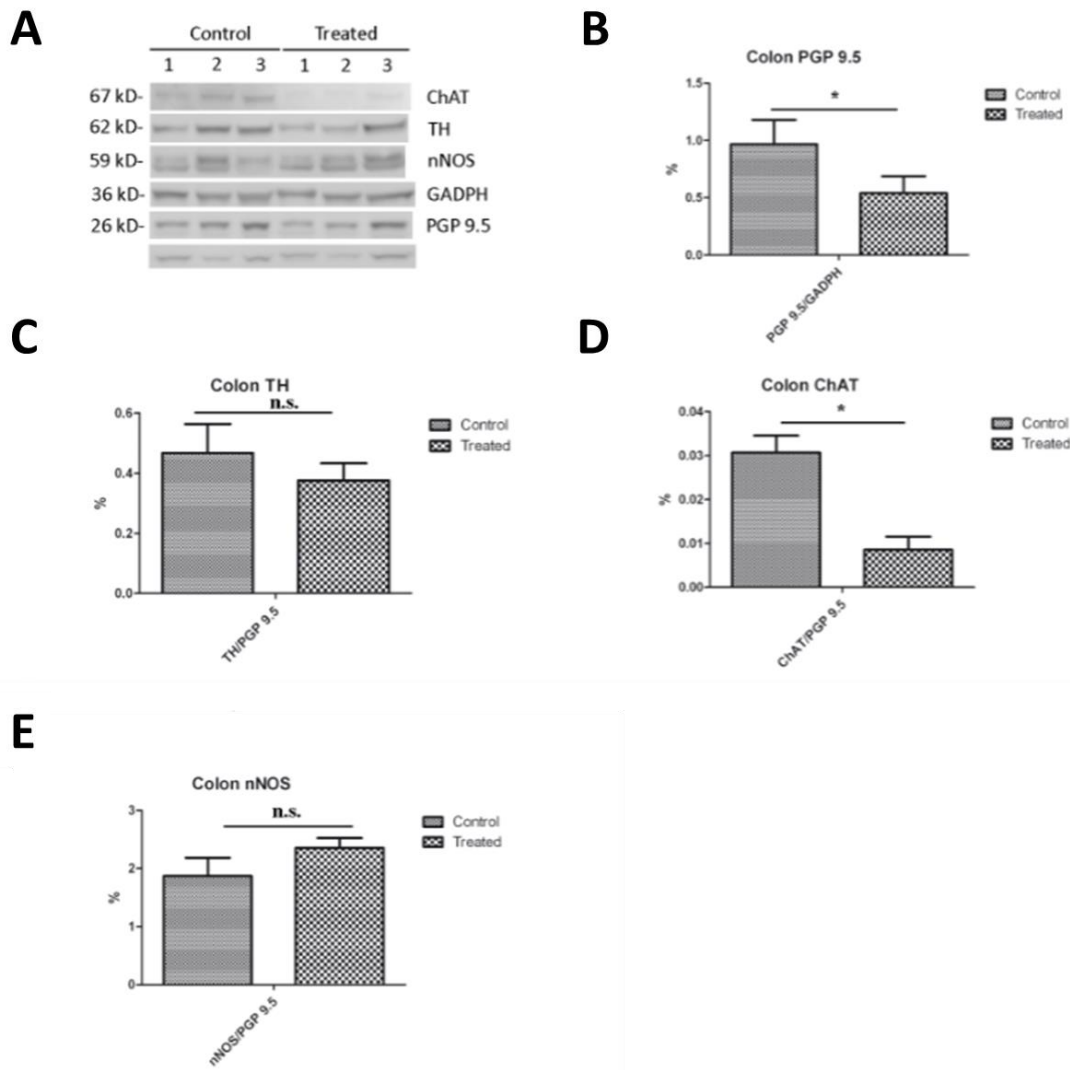
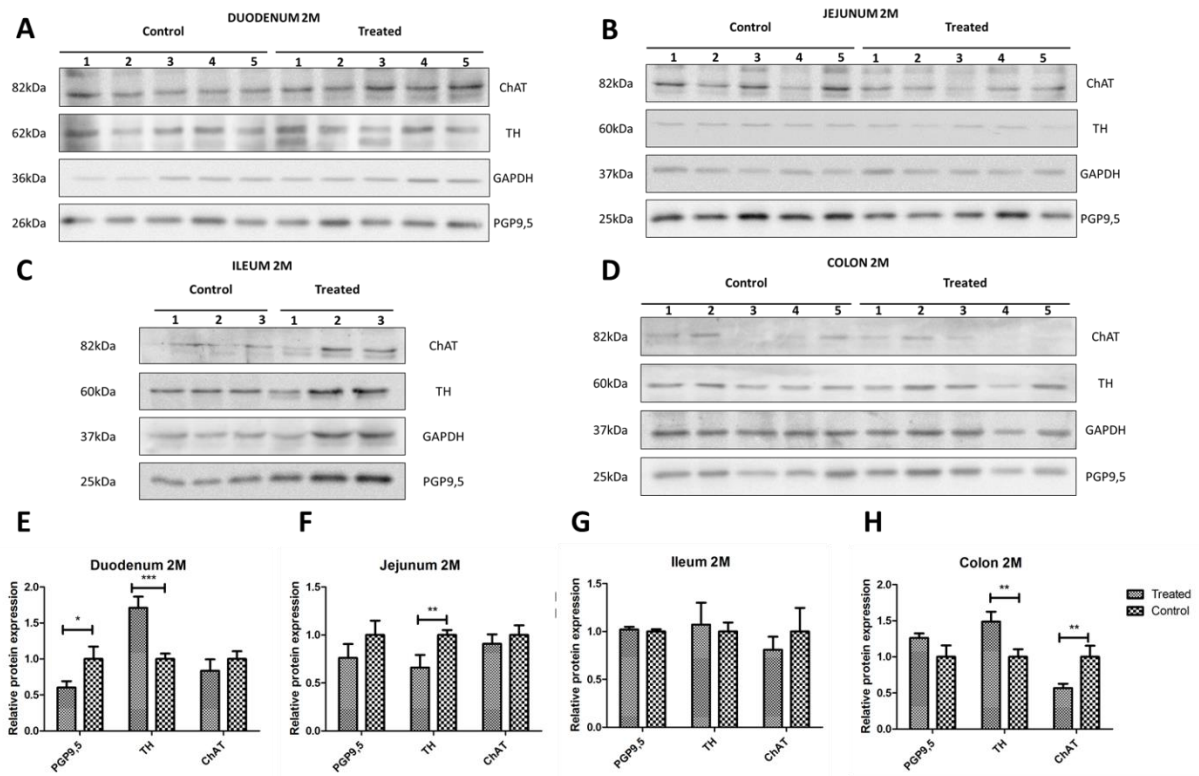
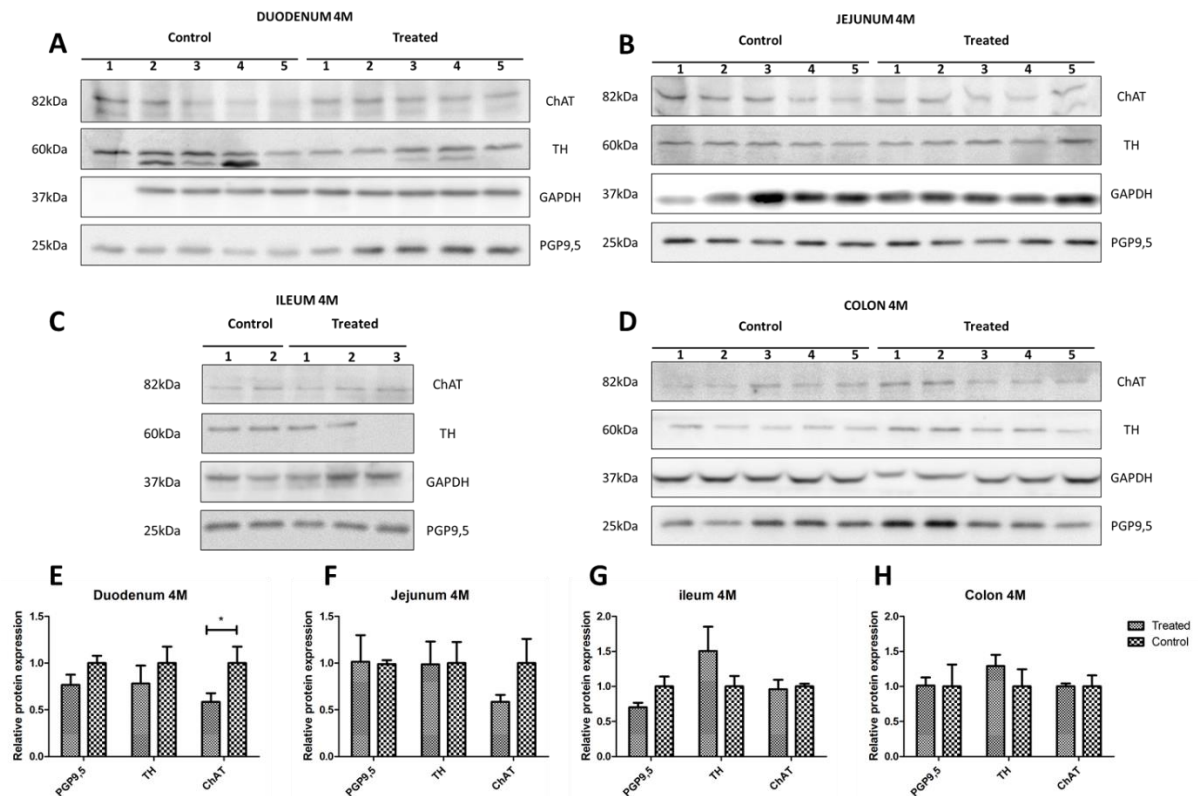

Figure 10: Rotenone-induced modifications of neural markers in the intestine of 8-week-old mice after 4 months of exposure. (A) Representative western blots using antibodies raised against choline acetyltransferase (CHAT), tyrosine hydroxylase (TH), Pgp9.5, nNOS, and glycerinaldehyde-3-phosphate-dehydrogenase (GAPDH), respectively realized in the ileum of mice exposed to the solvent (= Control) or to chronic low doses of rotenone (5mg/kg/day) during 2 months. Gapdh expression was used as a loading control. B-E) Graphic representation of the relative protein expression of and PGP9.5 normalized to the expression of glycerinaldehyde-3-phosphat-dehydrogenase (Gapdh, B), tyrosine hydroxylase (TH) normalized to the expression of PGP9.5 (C), choline acetyltransferase (ChAT) normalized to the expression of PGP9.5 (D) and nNOS normalized to the expression of PGP9.5(E) in the ileum (n=3 for each condition).



Supplementary figure 12: Rotenone-induced modifications of neuronal markers in the intestine of 1-year-old mice after 2 months of exposure. (A) Representative western blots realized in the jejunum of mice exposed to rotenone during 2 months compared to control mice. A significant decrease of tyrosine hydroxylase (TH) levels is observed in rotenone-treated mice (n=5) compared to control mice (n=5; p=0,0428). No difference was observed for Choline acetyltransferase (ChAT) levels and PGP9,5 levels between the two groups. (B) Graphic representation of the western blots results obtained in the jejunum. (C) Representative western blots realized in the ileum of mice exposed to rotenone during 2 months (n=3) compared to control mice (n=3). No significant difference in the levels of PGP9,5, TH and ChAT was observed. (D) Graphic representation of the western blots results obtained in the ileum. (E) Representative western blots and data summary of colon of mice exposed to rotenone during 2 months (n=5) compared to control mice (n=5) showing a significant increase of tyrosine hydroxylase (TH) levels in rotenone treated mice (n=5) compared to control mice (n=5, p=0,0236). A significant decrease of ChAT levels is also observed in the rotenone treated group compared to the control group. No difference was observed for PGP9,5 levels in the condition tested. (F) Graphic representation of the western blots results obtained in the colon.



Supplementary figure 13: Rotenone-induced modifications of neuronal markers in the intestine of 1-year-old mice after 4 months of exposure. (A) Representative western blots realized in the jejunum of mice exposed to rotenone during 4 months compared to control mice. A non-significant decrease of Choline acetyltransferase (ChAT) levels is observed in rotenone-treated mice (n=5) compared to control mice (n=5; p=0,1327). No difference was observed for tyrosine hydroxylase (TH) levels and PGP9,5 levels between the two groups. (B) Graphic representation of the western blots results obtained in the jejunum. (C) Representative western blots realized in the ileum of mice exposed to rotenone during 4 months (n=2) compared to control mice (n=3). No significant difference in the levels of PGP9,5, TH and ChAT was observed. (D) Graphic representation of the western blots results obtained in the ileum. (E) Representative western blots realized in the colon of mice exposed to rotenone during 4 months (n=5) compared to control mice (n=5) showing no significant difference in tyrosine hydroxylase (TH), PGP9,5 and ChAT levels in rotenone treated mice (n=5) compared to control mice (n=5, p=0,0236). (F) Graphic representation of the western blots results obtained in the colon

Résumé

La maladie de Parkinson (MP) est une maladie neurodégénérative caractérisée par trois symptômes moteurs principaux : la bradykinésie, la rigidité et le tremblement de repos. Son diagnostic définitif repose sur l'identification post-mortem d'une importante mort des neurones dopaminergiques de la substance noire (SN) et la présence de corps de Lewy dans les neurones survivants. Cette maladie progresse lentement et les premiers symptômes moteurs n'apparaissent qu'après la dégénérescence de plus de 50% de la SN. Le diagnostic clinique de MP est donc établi tardivement, réduisant ainsi la fenêtre d'action thérapeutique. De plus, les traitements actuels ne soulagent que temporairement les symptômes moteurs. Les défis de la recherche actuelle pour la MP sont donc : 1) d'anticiper le diagnostic de la MP à un stade où la SN est encore suffisamment intacte pour mettre en place des stratégies neuroprotectrices, et 2) d'améliorer les traitements actuels et/ou développer de nouvelles stratégies thérapeutiques pour stopper la progression de la maladie avant que le phénotype moteur ne soit installé. Le stade clinique de la MP est précédé d'une phase prémotrice durant laquelle les patients présentent souvent des symptômes non moteurs tels que l'anosmie, la dépression ou la constipation. Des travaux récents suggèrent que les lésions caractéristiques de la MP pourraient d'abord apparaître dans le système nerveux périphérique puis progresser lentement jusqu'au cerveau. Ces stades précoces de la MP sont cependant mal connus et leurs caractéristiques méritent d'être étudiées dans des modèles expérimentaux appropriés. Ainsi, des études récentes ont montré que la ghréline, un peptide gastro-intestinal, protège les neurones dopaminergiques de la SN contre la mort dans des modèles *in vivo* et *in vitro* de syndrome parkinsonien. De plus, dans un modèle animal de syndrome parkinsonien, la ghréline prévient l'aggravation des symptômes gastro-intestinaux par la L-DOPA, traitement médicamenteux principal de la MP. Enfin, des altérations des concentrations plasmatiques de ghréline ont également été observées chez les patients aux stades précoces de la maladie. Dans ce contexte, nous avons émis l'hypothèse que la ghréline pourrait jouer un rôle important aux stades précoces de la maladie et donc être utilisée comme biomarqueur et/ou agent neuroprotecteur dans la MP. Ainsi, l'objectif de ma thèse était d'étudier les rôles de la ghréline aux stades précoces de la MP par des approches *in vitro* et *in vivo*.

La première étape a consisté à déterminer les effets de la ghréline dans des cultures primaires de cellules mésencéphaliques exposées au pesticide roténone, un inhibiteur du complexe I mitochondrial connu pour son association avec la MP. Contrairement aux données de la littérature, nous montrons un effet délétère en fonction de la dose et du temps sur les cellules exposées à la roténone. Nous ne confirmons donc pas l'effet neuroprotecteur de la ghréline dans nos conditions expérimentales. En parallèle, nous avons étudié le potentiel de la ghréline en tant que biomarqueur dans un modèle murin de syndrome parkinsonien reproduisant les stades précoces de la maladie après exposition orale chronique à de faibles doses de roténone. Nous avons d'abord validé ce modèle et confirmé le développement des altérations non motrices et l'absence de mort neuronale au sein de la SN après 1.5 mois de ce régime. En revanche, nos résultats ne montrent pas de modification des taux plasmatiques de ghréline chez les souris exposées 1.5 mois à la roténone. Cependant, des facteurs tels que l'anxiété pourraient avoir affecté les taux de ghréline. Ces données devront donc être confirmées avec des animaux stratifiés selon leur niveau d'anxiété et/ou de plus longues expositions. En conclusion, nos résultats interrogent le rôle neuroprotecteur de la ghréline dans la MP et posent les bases pour de futures recherches sur l'implication de cette hormone orexigène dans la MP.

Abstract

Parkinson's disease (PD) is the second most frequent neurodegenerative disease in the world. It is characterized by motor symptoms such as bradykinesia, rigidity and resting tremor. Its definite diagnosis relies on the identification of specific neuropathological hallmarks at autopsy including severe neuronal death within the substantia nigra (SN) and the presence of Lewy bodies in the surviving neurons. PD progresses slowly and the first motor symptoms appear when more than 50% of the SN has degenerated. Therefore, the clinical diagnosis is established late in the course of the disease, thus restricting the therapeutic window for clinicians. In addition, the currently available therapeutic options can only temporarily alleviate PD motor symptoms. The challenges of current PD research are: 1) to anticipate the diagnosis and be able to identify the disease as early as possible, when the SN is still intact enough to implement a disease-modifying/neuroprotection strategy to prevent the appearance of motor symptoms, and 2) to improve current medications and/or develop new therapeutic strategies able to stop the disease before the motor phenotype is installed. The decade preceding PD clinical diagnosis is of particular interest since patients often complain about non-motor symptoms such as anosmia, depression or constipation. Moreover, recent evidences suggest that PD-characteristic lesions could first appear in the peripheral nervous system and slowly progress towards the brain. Thus PD earlier stages and their characteristics deserve better investigations using appropriate experimental models. In this regard, recent studies undertaken in animal and cellular models of advanced parkinsonism have suggested that ghrelin, an orexigenic peptide mainly produced in the stomach, could play a neuroprotective role in PD. Indeed, exposure to ghrelin has shown a protective effect against the neuronal death in animal and cellular models of parkinsonism. In addition, in a rodent model of parkinsonism, ghrelin was shown to alleviate the L-DOPA-induced worsening of gastro-intestinal symptoms, L-DOPA being the current main therapeutic option in PD. Moreover, ghrelin plasma concentrations have shown alterations in early stages of the disease in small cohorts of PD patients. We therefore hypothesized that ghrelin might play an important role in PD early stages and could serve as a biomarker and a neuroprotective agent in PD. In this context, the aim of my PhD was to investigate the roles of ghrelin in PD early stages using both *in vitro* and *in vivo* approaches.

We first studied the effects of ghrelin in primary mesencephalic cells exposed to the pesticide rotenone, a potent inhibitor of mitochondrial complex I known for its association with PD. Contrary to the data of the literature, we show a dose and time-dependant deleterious effect of ghrelin on mesencephalic cells exposed to rotenone. This does not confirm the neuroprotective potential of ghrelin in our experimental conditions. In parallel, we investigated the potential of ghrelin as a biomarker in a rodent model of parkinsonism mimicking early stages of the disease after chronic oral exposure to low doses of rotenone. We first validated this model in our animal facility and confirmed that mice exposed to such a regimen develop progressive non-motor alterations but no dopaminergic neuronal death in the SN after 1.5 months. Our initial results do not show a modification of plasma ghrelin levels in rotenone-exposed mice at early stages of the pathological condition. However, confounding factors such as anxiety might have altered ghrelin levels. This should therefore be further ascertained in animals stratified for their anxiety levels and/or in longer exposures. In conclusion, these results challenge the suggested role of ghrelin as a disease-modifying agent in PD and set the bases for future investigations of ghrelin in the context of PD.

Résumé

La maladie de Parkinson (MP) est une maladie neurodégénérative caractérisée par trois symptômes moteurs principaux : la bradykinésie, la rigidité et le tremblement de repos. Son diagnostic définitif repose sur l'identification post-mortem d'une importante mort des neurones dopaminergiques de la substance noire (SN) et la présence de corps de Lewy dans les neurones survivants. Cette maladie progresse lentement et les premiers symptômes moteurs n'apparaissent qu'après la dégénérescence de plus de 50% de la SN. Le diagnostic clinique de MP est donc établi tardivement, réduisant ainsi la fenêtre d'action thérapeutique. De plus, les traitements actuels ne soulagent que temporairement les symptômes moteurs. Les défis de la recherche actuelle pour la MP sont donc : 1) d'anticiper le diagnostic de la MP à un stade où la SN est encore suffisamment intacte pour mettre en place des stratégies neuroprotectrices, et 2) d'améliorer les traitements actuels et/ou développer de nouvelles stratégies thérapeutiques pour stopper la progression de la maladie avant que le phénotype moteur ne soit installé. Le stade clinique de la MP est précédé d'une phase prémotrice durant laquelle les patients présentent souvent des symptômes non moteurs tels que l'anosmie, la dépression ou la constipation. Des travaux récents suggèrent que les lésions caractéristiques de la MP pourraient d'abord apparaître dans le système nerveux périphérique puis progresser lentement jusqu'au cerveau. Ces stades précoces de la MP sont cependant mal connus et leurs caractéristiques méritent d'être étudiées dans des modèles expérimentaux appropriés. Ainsi, des études récentes ont montré que la ghréline, un peptide gastro-intestinal, protège les neurones dopaminergiques de la SN contre la mort dans des modèles *in vivo* et *in vitro* de syndrome parkinsonien. De plus, dans un modèle animal de syndrome parkinsonien, la ghréline prévient l'aggravation des symptômes gastro-intestinaux par la L-DOPA, traitement médicamenteux principal de la MP. Enfin, des altérations des concentrations plasmatiques de ghréline ont également été observées chez les patients aux stades précoces de la maladie. Dans ce contexte, nous avons émis l'hypothèse que la ghréline pourrait jouer un rôle important aux stades précoces de la maladie et donc être utilisée comme biomarqueur et/ou agent neuroprotecteur dans la MP. Ainsi, l'objectif de ma thèse était d'étudier les rôles de la ghréline aux stades précoces de la MP par des approches *in vitro* et *in vivo*.

La première étape a consisté à déterminer les effets de la ghréline dans des cultures primaires de cellules mésencéphaliques exposées au pesticide roténone, un inhibiteur du complexe I mitochondrial connu pour son association avec la MP. Contrairement aux données de la littérature, nous montrons un effet délétère en fonction de la dose et du temps sur les cellules exposées à la roténone. Nous ne confirmons donc pas l'effet neuroprotecteur de la ghréline dans nos conditions expérimentales. En parallèle, nous avons étudié le potentiel de la ghréline en tant que biomarqueur dans un modèle murin de syndrome parkinsonien reproduisant les stades précoces de la maladie après exposition orale chronique à de faibles doses de roténone. Nous avons d'abord validé ce modèle et confirmé le développement des altérations non motrices et l'absence de mort neuronale au sein de la SN après 1.5 mois de ce régime. En revanche, nos résultats ne montrent pas de modification des taux plasmatiques de ghréline chez les souris exposées 1.5 mois à la roténone. Cependant, des facteurs tels que l'anxiété pourraient avoir affecté les taux de ghréline. Ces données devront donc être confirmées avec des animaux stratifiés selon leur niveau d'anxiété et/ou de plus longues expositions. En conclusion, nos résultats interrogent le rôle neuroprotecteur de la ghréline dans la MP et posent les bases pour de futures recherches sur l'implication de cette hormone orexigène dans la MP.

Abstract

Parkinson's disease (PD) is the second most frequent neurodegenerative disease in the world. It is characterized by motor symptoms such as bradykinesia, rigidity and resting tremor. Its definite diagnosis relies on the identification of specific neuropathological hallmarks at autopsy including severe neuronal death within the substantia nigra (SN) and the presence of Lewy bodies in the surviving neurons. PD progresses slowly and the first motor symptoms appear when more than 50% of the SN has degenerated. Therefore, the clinical diagnosis is established late in the course of the disease, thus restricting the therapeutic window for clinicians. In addition, the currently available therapeutic options can only temporarily alleviate PD motor symptoms. The challenges of current PD research are: 1) to anticipate the diagnosis and be able to identify the disease as early as possible, when the SN is still intact enough to implement a disease-modifying/neuroprotection strategy to prevent the appearance of motor symptoms, and 2) to improve current medications and/or develop new therapeutic strategies able to stop the disease before the motor phenotype is installed. The decade preceding PD clinical diagnosis is of particular interest since patients often complain about non-motor symptoms such as anosmia, depression or constipation. Moreover, recent evidences suggest that PD-characteristic lesions could first appear in the peripheral nervous system and slowly progress towards the brain. Thus PD earlier stages and their characteristics deserve better investigations using appropriate experimental models. In this regard, recent studies undertaken in animal and cellular models of advanced parkinsonism have suggested that ghrelin, an orexigenic peptide mainly produced in the stomach, could play a neuroprotective role in PD. Indeed, exposure to ghrelin has shown a protective effect against the neuronal death in animal and cellular models of parkinsonism. In addition, in a rodent model of parkinsonism, ghrelin was shown to alleviate the L-DOPA-induced worsening of gastro-intestinal symptoms, L-DOPA being the current main therapeutic option in PD. Moreover, ghrelin plasma concentrations have shown alterations in early stages of the disease in small cohorts of PD patients. We therefore hypothesized that ghrelin might play an important role in PD early stages and could serve as a biomarker and a neuroprotective agent in PD. In this context, the aim of my PhD was to investigate the roles of ghrelin in PD early stages using both *in vitro* and *in vivo* approaches.

We first studied the effects of ghrelin in primary mesencephalic cells exposed to the pesticide rotenone, a potent inhibitor of mitochondrial complex I known for its association with PD. Contrary to the data of the literature, we show a dose and time-dependant deleterious effect of ghrelin on mesencephalic cells exposed to rotenone. This does not confirm the neuroprotective potential of ghrelin in our experimental conditions. In parallel, we investigated the potential of ghrelin as a biomarker in a rodent model of parkinsonism mimicking early stages of the disease after chronic oral exposure to low doses of rotenone. We first validated this model in our animal facility and confirmed that mice exposed to such a regimen develop progressive non-motor alterations but no dopaminergic neuronal death in the SN after 1.5 months. Our initial results do not show a modification of plasma ghrelin levels in rotenone-exposed mice at early stages of the pathological condition. However, confounding factors such as anxiety might have altered ghrelin levels. This should therefore be further ascertained in animals stratified for their anxiety levels and/or in longer exposures. In conclusion, these results challenge the suggested role of ghrelin as a disease-modifying agent in PD and set the bases for future investigations of ghrelin in the context of PD.