



**HAL**  
open science

# New radical additions of alkylsulfonyl cyanides onto unactivated olefins: enantioselective approaches towards the total synthesis of leucophyllidine

Vincent Pirenne

## ► To cite this version:

Vincent Pirenne. New radical additions of alkylsulfonyl cyanides onto unactivated olefins: enantioselective approaches towards the total synthesis of leucophyllidine. Organic chemistry. Université de Bordeaux, 2018. English. NNT: 2018BORD0438 . tel-02453634

**HAL Id: tel-02453634**

**<https://theses.hal.science/tel-02453634>**

Submitted on 24 Jan 2020

**HAL** is a multi-disciplinary open access archive for the deposit and dissemination of scientific research documents, whether they are published or not. The documents may come from teaching and research institutions in France or abroad, or from public or private research centers.

L'archive ouverte pluridisciplinaire **HAL**, est destinée au dépôt et à la diffusion de documents scientifiques de niveau recherche, publiés ou non, émanant des établissements d'enseignement et de recherche français ou étrangers, des laboratoires publics ou privés.

THÈSE PRÉSENTÉE  
POUR OBTENIR LE GRADE DE

**DOCTEUR DE  
L'UNIVERSITÉ DE BORDEAUX**

ÉCOLE DOCTORALE DES SCIENCES CHIMIQUES  
SPÉCIALITÉ : CHIMIE ORGANIQUE

Par VINCENT PIRENNE

**New radical additions of alkylsulfonyl cyanides onto unactivated olefins.**

**Enantioselective approaches towards the total synthesis of leucophyllidine**

Sous la direction du Prof. Yannick LANDAIS

Co-directeur : Dr. Frédéric ROBERT

Soutenue le 20 décembre 2018

Membres du jury :

M. BASSANI Dario	Directeur de recherche, CNRS	Président
M. GODDARD Jean-Philippe	Professeur, Université de Haute-Alsace	Rapporteur
M. LAKHDAR Sami	Chargé de recherche, CNRS	Rapporteur
M. MELCHIORRE Paolo	Professeur, ICIQ-Tarragona (Spain)	Examineur
M. LANDAIS Yannick	Professeur, Université de Bordeaux	Directeur
M. ROBERT Frédéric	Chargé de recherche, CNRS	Co-directeur



## Remerciements

Le travail présenté dans ce manuscrit a été réalisé au sein du laboratoire de Synthèse Organique et Substances Naturelles (ORGA) sous la direction du Professeur Yannick Landais et financé par l'Académie des Sciences à travers la fondation pour le développement de la chimie des substances naturelles et ses applications.

Je tiens tout d'abord à remercier le Professeur Jean-Philippe Goddard, le Docteur Sami Lakhdar, le Professeur Paolo Melchiorre et le Docteur Dario Bassani d'avoir accepté d'évaluer mon travail et pour les discussions enrichissantes qui en ont résulté.

Je remercie vivement le Professeur Yannick Landais, mon directeur de thèse, pour sa totale disponibilité, son implication dans mon projet de recherche et la liberté qu'il m'a octroyée dans ce projet. Nos débuts en catalyse photoredox ont été laborieux mais ont finalement été récompensés. Cette aventure en photo-catalyse n'aurait jamais été aussi enrichissante sans le soutien du Docteur Dario Bassani avec qui j'ai eu l'occasion d'entreprendre une étude mécanistique approfondie. Je tiens sincèrement à le remercier pour cette collaboration fructueuse.

Je tiens également à remercier le Docteur Frédéric Robert, mon co-directeur, pour la réalisation de calculs théoriques, pour son aide dans l'analyse de spectres RMN et de masse mais aussi pour ses suggestions tout au long de ma thèse.

Au cours de ces trois années, j'ai eu la chance de travailler avec d'excellents partenaires. Ici, je tiens tout d'abord à remercier Jonathan Lusseau, technicien du laboratoire, pour les synthèses à grande échelle de produits de départ. Cela m'a grandement simplifié la vie !

L'encadrement d'étudiants m'a finalement offert une véritable satisfaction au niveau pédagogique. Merci à Lisa Rouvière, étudiante de master 2, pour sa persévérance !

Mes remerciements vont également au Dr. Gülbin Kurtay avec qui j'ai pu travailler sur l'étude mécanistique de la sulfonyl-cyanation. Ses travaux en voltamétrie cyclique et ses calculs DFT ainsi que nos études UV-Visible ont été d'une aide précieuse dans la compréhension du mécanisme. Je tiens aussi à remercier le Dr. Nitin Dange pour ses conseils pratiques et toujours judicieux au début de ma thèse.

Sur le plan personnel, je tiens à remercier mes amis qui m'ont accompagné ces trois dernières années. Merci à Jonathan Lusseau, mon voisin de paillasse, pour sa bonne humeur et son enthousiasme mais aussi de m'avoir suivi lors de mes aventures sportives en tant que supporter et coach (simple précision). Merci à Thomas Cornilleau pour l'accueil chaleureux à mon arrivé sur Bordeaux et son affection pour les belges. Merci à Julien, Nicolas, Maxime, Alexis, Lisa, Baptiste, Anthony, Christophe, Quentin, ... Merci à Philippe, mon ami triathlète. Merci aussi à Stéphanie pour nos excursions au bord des lacs suisses !

Finalement, je tiens à remercier mon ami belge de longue date, Martin, pour ses immanquables appels du samedi et ma famille pour leur indéfectible soutien et leurs visites régulières à Bordeaux.



## List of abbreviations

Å:	Angström
Ac:	acetyl
atm:	atmosphere
add.:	addition
ATRA:	Atom Transfer Radical Addition
μA:	microamper
MeCN:	acetonitrile
atm.:	atmospheric pressure
AIBN:	Azobis(isobutyronitrile)
aq.:	aqueous
Ar:	Aromatic
BDE:	Bond Dissociation Energy
BNAH:	1-benzyl-1,4-dihydronicotamide
β:	beta
BINAP:	2,2'-Bis(diphenylphosphino)-1,1'-binaphthyle
bpy:	bipyridine
Boc:	di- <i>tert</i> -butyloxycarbonyl
Bn:	benzyl
Bz:	benzoyl
<i>i</i> -Bu:	<i>iso</i> -butyl
<i>n</i> -Bu:	butyl
<i>s</i> -Bu:	<i>sec</i> -butyl
<i>t</i> -Bu:	<i>tert</i> -butyl
CAN:	ceric ammonium nitrate
cat.:	catalyst
CBX:	cyanobenziodoxolone
Cbz:	carboxybenzyl
CFL:	Compact Fluorescent Lamp
cm:	centimetre
COD:	1,5-cyclooctadiene
conv.:	conversion
COSY:	COrrrelation SpectroscopY
<i>m</i> -CPBA:	<i>meta</i> -chloro perbenzoic acid
CSA:	camphorsulfonic acid
3-CR:	Three-components reaction
4-CR:	Four-components reaction
DABSO:	1,4-Diazabicyclo[2.2.2]octane bis(sulfur dioxide)
DBP:	dibutyl phthalate
DBU:	1,8-Diazabicyclo[5.4.0]undec-7-ene
DCB:	dicyanobenzene
DCC:	dicyclohexylcarbodiimide
DCE:	dichloroethane
DCM:	dichloromethane
DCP:	dicumyl peroxide
ddpf:	1,10-bis(diphenylphosphino)ferrocene
DEAD:	diethyl azodicarboxylate
DFT:	Density Functional Theory

DIBAL-H:	diisobutylaluminum hydride
DIPEA:	<i>N,N'</i> -diisopropylethylamine
DLP:	dilauroyl peroxide
d.r.:	diastereomeric ratio
DMA:	9,10-dimethoxy-anthracene
DMAP:	dimethylaminopyridine
DME:	dimethoxyethane
DMF:	dimethylformamide
DMSO:	dimethylsulfoxide
DTBHN:	di- <i>tert</i> -butylhyponitrite
DTBD:	di- <i>tert</i> -butyldiazene
DTBP:	di- <i>tert</i> -butyl peroxide
E1 <sub>CB</sub> :	unimolecular elimination conjugated base
E(+):	electrophile
E <sub>ox</sub> :	oxidation potential
E <sub>red</sub> :	reduction potential
e.e.:	enantiomeric excess
equiv.:	equivalent
eV:	electron-volt
Et:	Ethyl
ET:	electron transfer
EtOH:	ethanol
Et <sub>2</sub> O:	diethyl ether
EtOAc:	ethyl acetate
EWG:	electron withdrawing group
EDG:	electron donating group
EPR:	Electron Paramagnetic Resonance
EY:	eosin-Y
FDA:	Food and Drug Administration
FLB:	fluorescent light bulb
FMO:	Frontier Molecular Orbitals
g:	gram
γ:	gamma
GC-MS:	Gas-Chromatography Mass-Spectrometry
Glc:	Glucose
h:	hour
[H]:	reduction
HAT:	hydrogen atom transfer
HIV:	human immunodeficiency virus
HOMO:	highest occupied molecular orbital
HMPA:	hexamethylphosphoramide
HSQC:	heteronuclear single quantum coherence
HMDS:	bis(trimethylsilyl)amide
HRMS:	high resolution mass spectrometry
Hz:	Hertz
IBX:	2-iodoxybenzoic acid
i.c.:	internal conversion
IC <sub>50</sub> :	half maximal inhibitory concentration

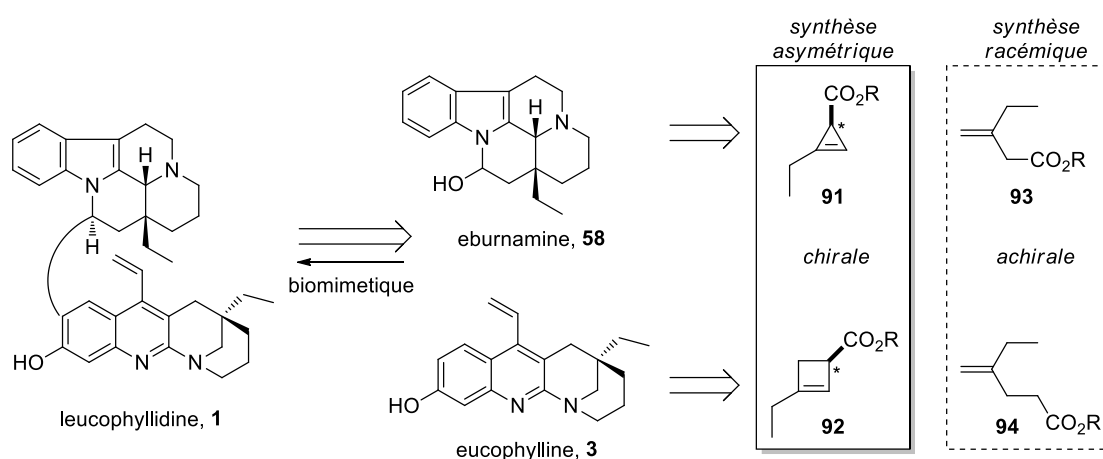
Im.:	imidazole
Init.:	initiation
IR:	infrared spectroscopy
i.s.c.:	intersystem crossing
J:	Joule
kcal:	kilocalorie
kg:	kilogram
kJ:	kiloJoule
LDA:	lithium diisopropylamide
LiHMDS:	lithium bis(trimethylsilyl)amide
LUMO:	Lowest Unoccupied Molecular Orbital
LA:	Lewis acid
LB:	Lewis base
LG:	Leaving group
M:	concentration (mole per liter)
MCR:	Multi-Component Reactions
Me:	methyl
min.:	minute
Ms:	mesylate
MeOH:	methanol
mg:	milligram
MS:	molecular sieves
MW:	molecular weight
NADH:	reduced form of nicotinamide adenine dinucleotide
NCS:	<i>N</i> -chlorosuccinimide
NBS:	<i>N</i> -bromosuccinimide
NHP:	<i>N</i> -hydroxyphthalimide
nm:	nanometer
NMO:	<i>N</i> -methylmorpholine <i>N</i> -oxide
NMP:	<i>N</i> -methyl-2-pyrrolidone
NMR:	nuclear magnetic resonance
ns:	nanosecond
NOE:	nuclear overhauser effect
NOESY:	nuclear overhauser effect spectroscopy
Nu:	Nucleophilic
[O]:	oxidation
<i>p</i> - :	<i>para</i>
PC:	photocatalyst
PDC:	pyridinium dichromate
PE:	petroleum ether
PET:	photoinduced electron transfer
PG:	protecting Group
Ph:	phenyl
Phen:	phenanthrene
PhCl:	chlorobenzene
Piv:	pivlate
PPA:	polyphosphoric acid
PPTS:	pyridinium <i>p</i> -toluenesulfonate



<i>i</i> -Pr:	<i>iso</i> -propyl
Py:	pyridine
quant.:	quantitative
RB:	Ramberg-Backlund
rearrang.:	rearrangement
red.:	reduction
Rf:	retention factor
ROM:	ring-opening metathesis
r.t.:	room temperature
s:	second
SAR:	structure-activity relationship
SCE:	saturated calomel electrode
SEM:	[2-(trimethylsilyl)ethoxy]methyl acetal
SET:	single electron transfer
S <sub>H</sub> 2:	bimolecular homolytic substitution
S <sub>N</sub> 2:	bimolecular nucleophilic substitution
SOMO:	Singly Occupied Molecular Orbital
sub.:	substrate
<i>T</i> :	temperature
<i>t</i> -:	<i>tert</i> -
TBA:	tetrabutylammonium
TBAF:	tetra- <i>n</i> -butylammonium fluoride
TBDPS:	<i>tert</i> -butyldiphenylsilyl
TBPA:	<i>tert</i> -butylperoxyacetate
TBS/TBDMS:	<i>tert</i> -butyldimethylsilyl
TIPS:	triisopropylsilyl
TMS:	trimethylsilyl
<i>t</i> -BuOK:	potassium <i>tert</i> -butoxide
TEMPO:	2,2,6,6-tetramethylpiperidine- <i>N</i> -oxy radical
THF:	tetrahydrofuran
TLC:	thin layer chromatography
Tf:	triflate
TFA:	trifluoroacetic acid
TRIP:	3,3'-bis(2,4,6-triisopropylphenyl)-1,1'-binaphthyl-2,2'-diylhydrogenphosphate
trypt.:	tryptamine
TPAP:	tetrapropylammonium perruthenate
Ts:	tosylate
<i>p</i> -TSA:	<i>para</i> -toluenesulfonic acid
TTMS:	tris(trimethylsilyl)silane
<i>p</i> -Tol:	<i>para</i> -tolyl
UV:	Ultraviolet
V:	Volt
V-40:	1,1'-Azobis(cyclohexanecarbonitrile)
v.r.:	vibrational relaxation
W:	watt
xanth.:	xanthate

## Résumé en français

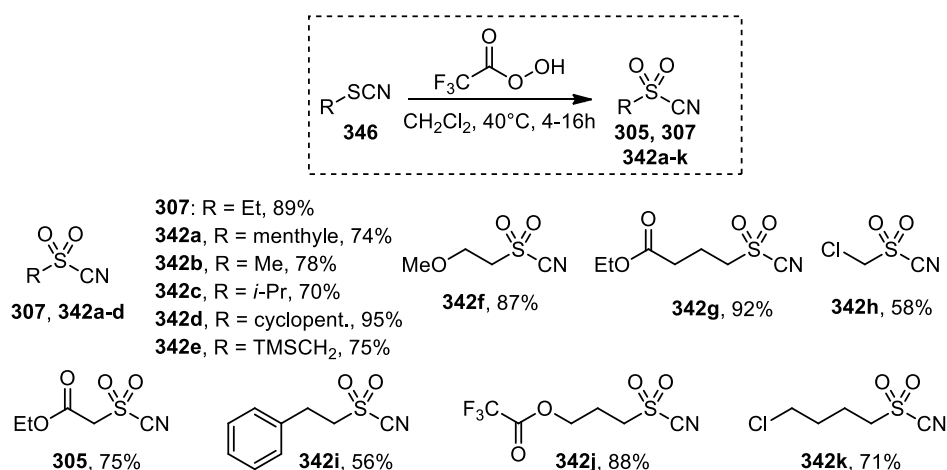
Cette thèse s'inscrit dans un contexte de développement de méthodologies radicalaires pour la synthèse totale d'alcaloïdes et plus particulièrement pour la synthèse asymétrique de la leucophyllidine **1**. Cette dernière est un alcaloïde dimérique présentant des activités cytotoxiques *in vitro* envers des cellules cancéreuses (cellules KB humaines) résistantes à la vincristine. Elle provient de l'union entre un fragment eburnane **58** et un fragment sud nommé eucophylline **3** possédant un nouveau noyau naphtyridine. Dans le cadre de la synthèse totale de la leucophyllidine, il a été envisagé de fonctionnaliser des oléfines cycliques chirales, telles que le cyclopropène **91** et cyclobutène **92**, par des procédés radicalaires générant ainsi un centre quaternaire tout-carboné de manière stéréocontrôlée (Figure 1).



**Figure 1.** Retrosynthèse de la leucophyllidine.

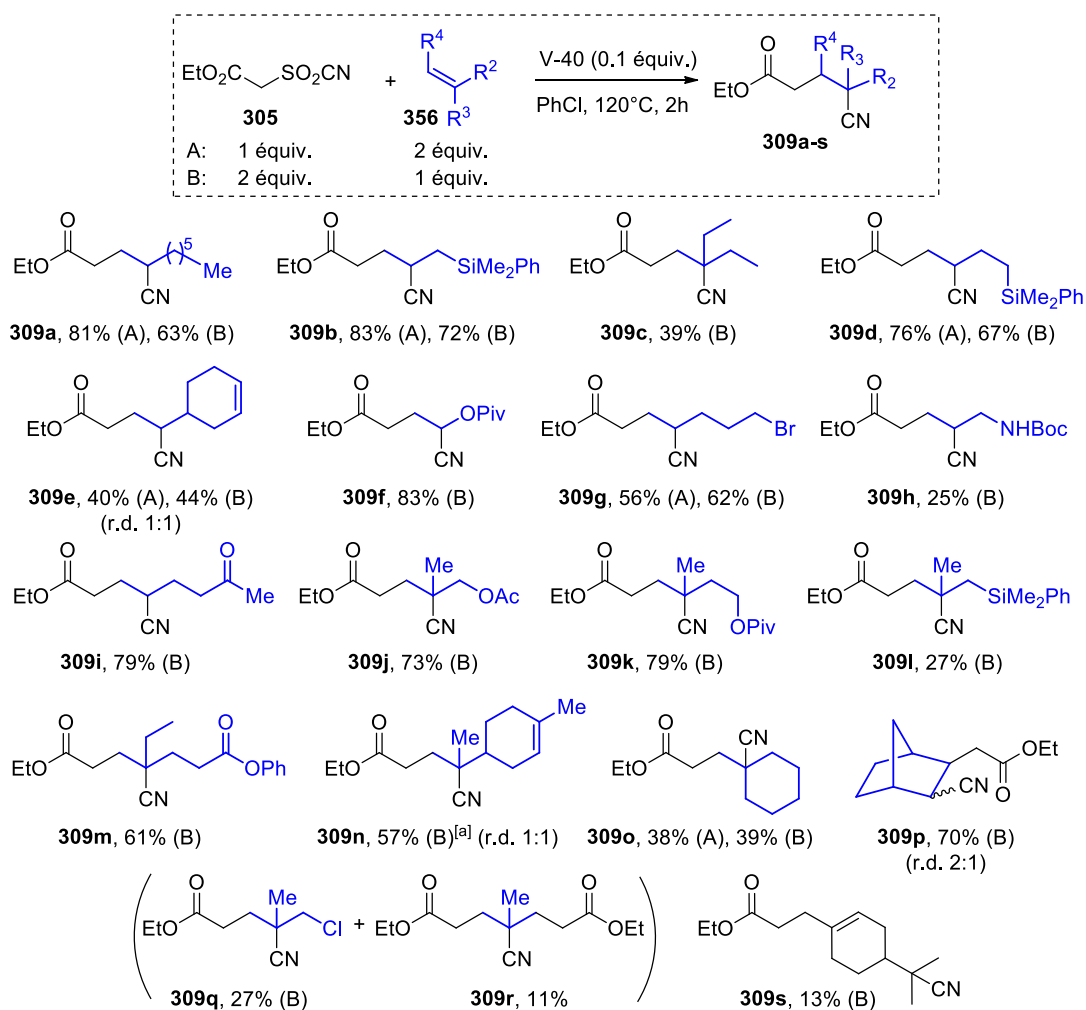
En vue de développer des méthodologies radicalaires sans étain introduisant un groupement nitrile sur un squelette oléfinique, il a été envisagé d'utiliser des cyanures de sulfonyle comme pièges radicalaires. Ces agents de cyanation sont généralement préparés par alkylation de sulfonates en utilisant le chlorure de cyanogène, un réactif extrêmement toxique, qui n'est plus commercialisé. Seul le cyanure de tosyloxy est disponible désormais. Pour accéder à ces composés, une nouvelle méthode d'oxydation de thiocyanates a été développée. Bien qu'un excès de *m*-CPBA fournissait un mélange de cyanures de sulfinyle et sulfonyle, le traitement de la réaction par une solution aqueuse saturée en bicarbonate de sodium entraînait la dégradation totale du produit. L'utilisation d'acide trifluoroperacétique comme oxydant a permis une conversion totale en cyanure de sulfonyle. A la fin de la réaction, l'excès de peracide est éliminé par simple lavage à l'eau fournissant les cyanures de sulfonyle avec une excellente pureté. De cette manière, les cyanures d'alkylsulfonyle **305**, **307** et **342a-k** ont été préparés avec d'excellents rendements (Schéma 1). Cette méthode est compatible avec différents groupements fonctionnels tel que des esters, des éthers, des chlorures, des trifluoroacétates et des groupements aromatiques. Les conditions fortement oxydantes ne nous ont pas permis d'étendre la réaction à d'autres

groupements fonctionnels. Ces composés peuvent être stockés au congélateur pendant plusieurs mois sans décomposition.



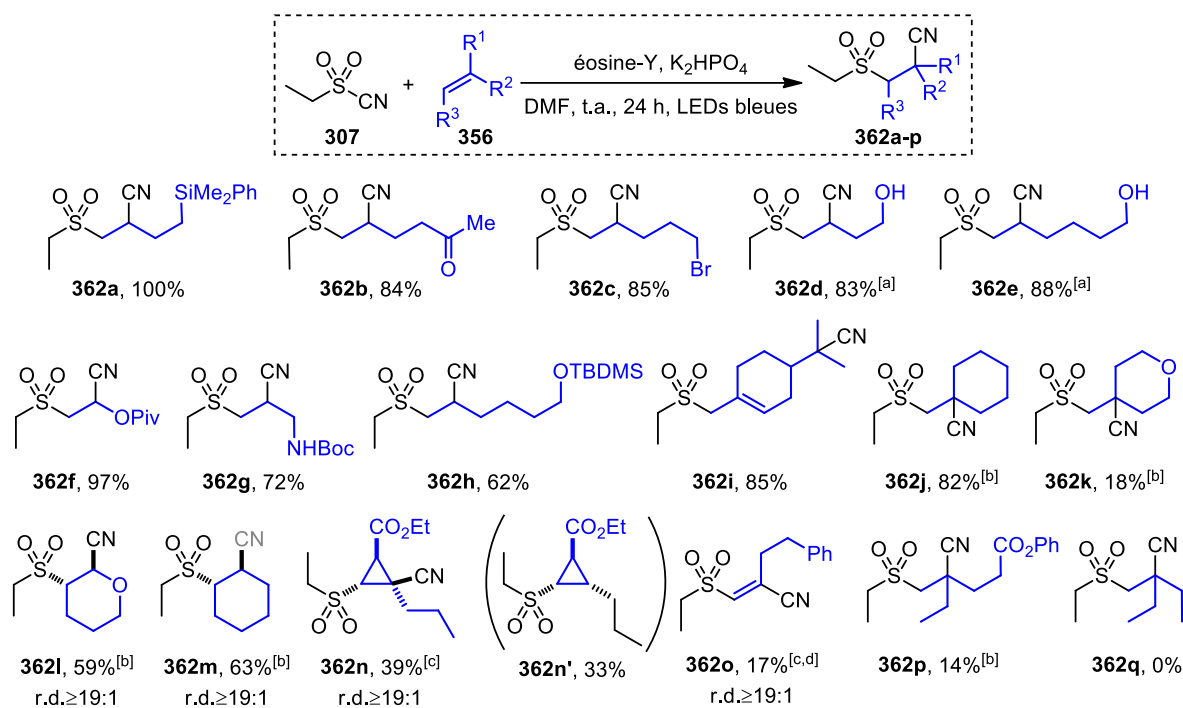
**Schéma 1.** Etendue de la réaction d'oxydation de thiocyanates en cyanures de sulfonyle.

L'intérêt de développer des cyanures d'*alkyl*sulfonyle prend son sens dans le développement d'une réaction de carbo-cyanation désulfonylative, permettant d'éviter l'utilisation de médiateurs radicalaires à base d'étain. Le cyanure de sulfonyle **305** est, en effet, à la fois un piège radicalaire et une source de radicaux alkyles permettant ainsi d'entretenir la chaîne radicalaire. La réaction de carbo-cyanation d'oléfines sans étain a été développée en utilisant le 1,1'-Azobis(cyanocyclohexane) comme amorceur (Schéma 2). Cette réaction installe un groupement ester et un groupement nitrile sur une chaîne carbonée insaturée à travers la formation de deux liaisons carbone-carbone. Sous des conditions de reflux, la réaction est complète en moins de deux heures et les produits **309** sont obtenus avec des rendements modérés à bons. Des groupements fonctionnels tels que des groupes silylés, des esters, des alcènes internes, des bromures et des cétones sont compatibles avec cette transformation. Il est important de mentionner que des centres quaternaires carbonés fonctionnalisés par un nitrile sont préparés avec de très bons rendements (**309j-o**). Cette réaction de carbo-cyanation à deux composants est complémentaire de la réaction de carbo-cyanation médiée par l'étain, précédemment développée.



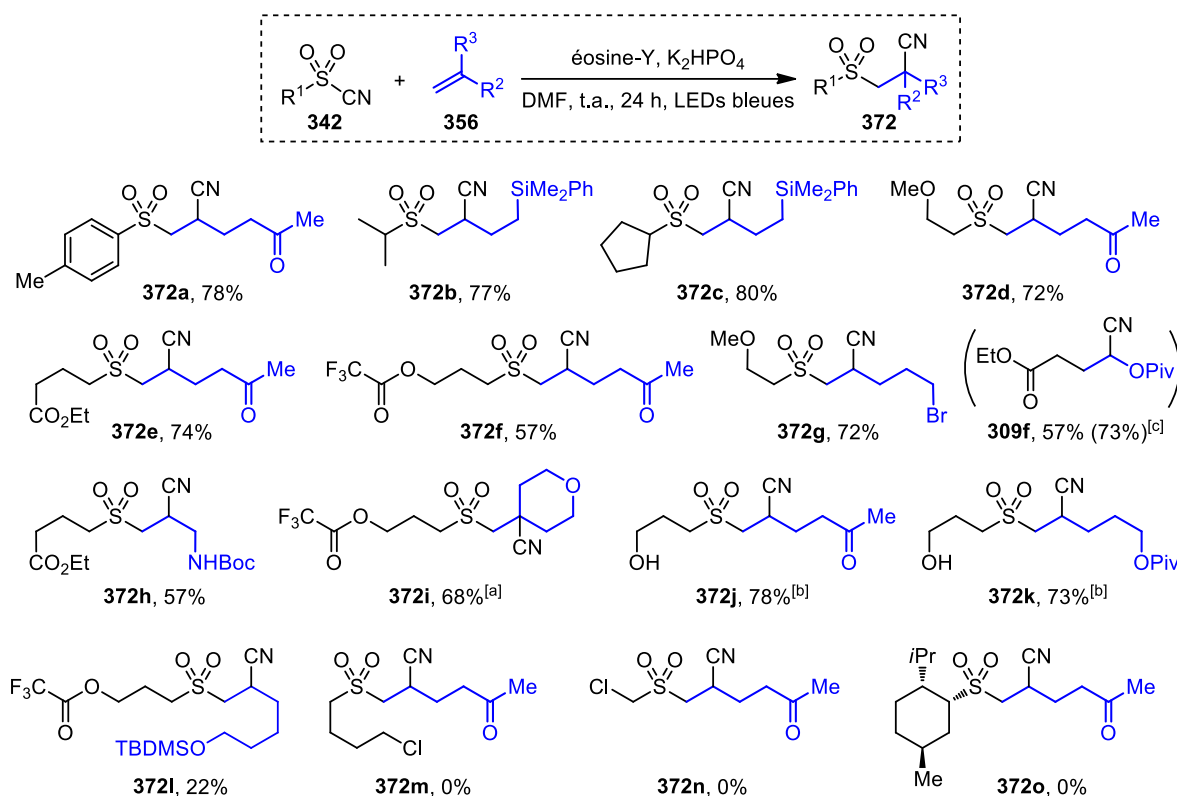
**Sch\u00e9ma 2.** Etendue de la r\u00e9action de carbo-cyanation \u00e0 deux composants ([a] 2 x 0.1 \u00e9quiv. de V-40).

Afin de travailler sous des conditions plus douces, il a \u00e9t\u00e9 anticip\u00e9 que les cyanures de sulfonyle pourraient \u00eatre activ\u00e9s par catalyse photoredox. Une r\u00e9action de carbo-cyanation op\u00e9rant \u00e0 temp\u00e9rature ambiante serait un avantage lors de l'\u00e9laboration st\u00e9r\u00e9os\u00e9lective de la leucophyllidine. L'utilisation de cyanure de sulfonyle en catalyse photoredox n'\u00e9tait pas encore d\u00e9crite dans la litt\u00e9rature au moment de nos investigations. Bien que le d\u00e9veloppement d'une r\u00e9action de carbo-cyanation en catalyse photoredox s'est av\u00e9r\u00e9 tr\u00e8s compliqu\u00e9, la r\u00e9action de sulfonyl-cyanation photocatalys\u00e9e a \u00e9t\u00e9 d\u00e9velopp\u00e9e avec succ\u00e8s. Le produit de sulfonyl-cyanation **362a** a \u00e9t\u00e9 obtenu quantitativement sous irradiation de lumi\u00e8re bleue (LEDs) en utilisant l'\u00e9osine Y comme photocatalyseur organique et le  $\text{K}_2\text{HPO}_4$  comme additif. Le champ d'application et les limites de cette m\u00e9thodologie ont \u00e9t\u00e9 \u00e9tudi\u00e9s. L'\u00e9tendue de la r\u00e9action est pr\u00e9sent\u00e9e au Sch\u00e9ma 3. Cette r\u00e9action a montr\u00e9 d'excellents rendements et tol\u00e8re une multitude de groupements fonctionnels. De plus faibles rendements sont obtenus avec des ol\u00e9fines disubstitu\u00e9es (**362k** et **362p**). La r\u00e9action de sulfonyl-cyanation sur des alc\u00e8nes cycliques produit le diast\u00e9roisom\u00e8re *trans* comme produit majoritaire (**362l-n**).



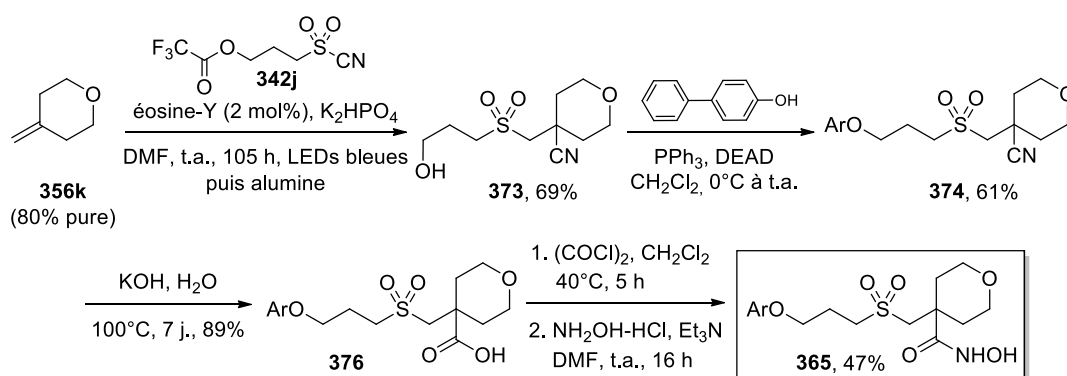
**Schéma 3.** Etendue de la réaction de sulfonyl-cyanation ([a] le rendement inclu l'imidate correspondant, [b] 3 équiv. de EtSO<sub>2</sub>CN, [c] acétone comme solvant, [d] à partir de 4-phényl-1-butyne).

L'étendue de la réaction a également été évaluée au niveau des cyanures de sulfonyle (Schéma 4). De bons rendements ont été obtenus avec le cyanure de tosylo et des cyanures d'alkylsulfonyle secondaires (**372a-c**). La réaction de sulfonyl-cyanation s'opère également avec les cyanures de sulfonyle fonctionnalisés possédant des éthers, esters et trifluoroacétates (**372d-k**). Des groupes alkyles plus encombrés ou des chlorures d'alkyle n'ont donné aucun résultat.



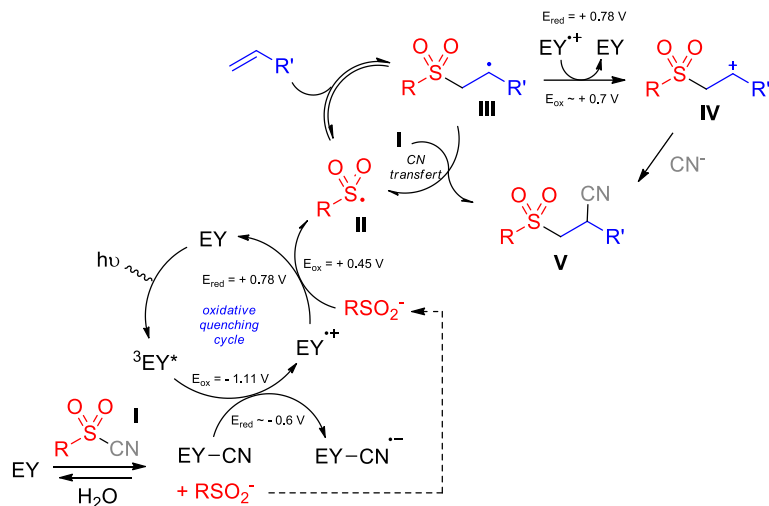
**Schéma 4.** Etendue de la réaction de sulfonyle-cyanation: application de cyanures d'alkylsulfonyles ([a] 4.4 equiv. de  $\text{RSO}_2\text{CN}$ , [b] colonne sur alumine neutre, [c] 5 equiv. de vinyl pivalate).

L'utilité de cette méthodologie a été démontrée par son application à la synthèse d'un agent anti-inflammatoire (Schéma 5). La synthèse en 4 étapes débute par la sulfonyle-cyanation du méthylène tétrahydropyrane **356k**, fournissant l'alcool **373** après déprotection du trifluoroacétate sur colonne d'alumine. L'éther d'aryle **374** est ensuite obtenu par une réaction de Mitsunobu. L'hydrolyse du nitrile en conditions basiques conduit à l'acide carboxylique **376** avec un excellent rendement. Le produit final **365** a été obtenu en convertissant l'acide en chlorure d'acyle, suivie par l'addition nucléophile d'hydroxylamine.



**Schéma 5.** Application de la sulfonyle-cyanation à la synthèse d'un agent anti-inflammatoire.

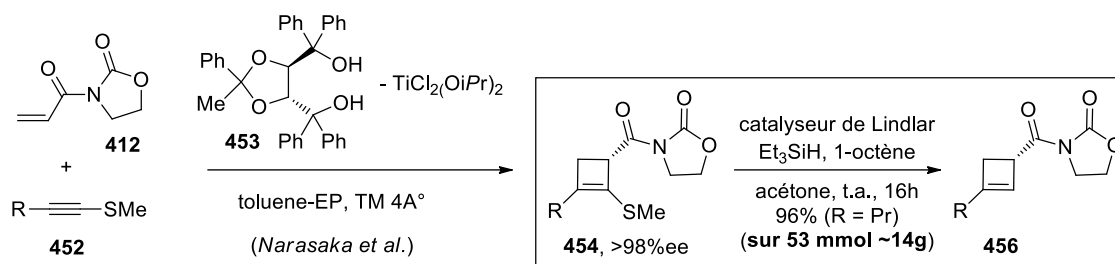
Une étude mécanistique approfondie sur le cycle photo-catalytique de cette réaction a également été réalisée. Sur la base des résultats obtenus par spectroscopie transitoire, spectroscopie UV-visible et d'études de cyclovoltamétrie cyclique, le mécanisme illustré à la Figure 2 a été proposé (Figure 2).



**Figure 2.** Mécanisme de la sulfonyl-cyanation des oléfines.

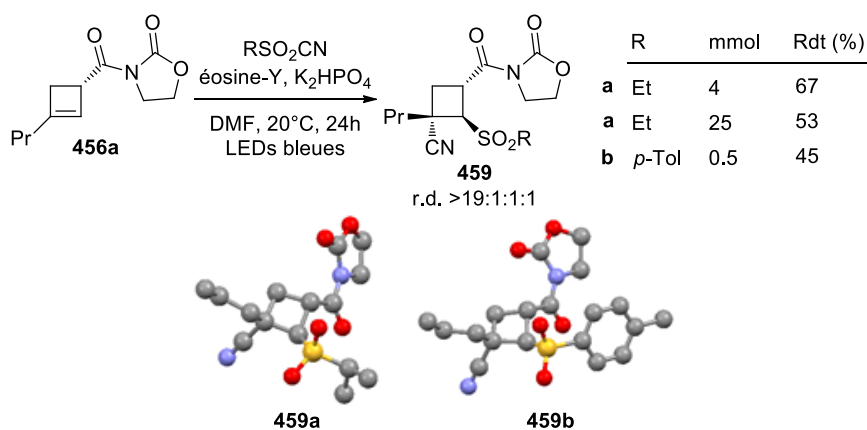
L'éosine-Y, en présence de cyanure de sulfonyle, est partiellement alkylée sous forme de cyanate, libérant ainsi un sulfinate. Le dérivé cyanate oxyde l'état excité triplet  $^3\text{EY}^*$  en radical cation, lequel oxyde à son tour le sulfinate en radical sulfonyl, régénérant l'éosine-Y dans son état fondamental. Le radical sulfonyl s'additionne ensuite sur le squelette oléfinique générant un radical nucléophile qui peut évoluer suivant deux chemins réactionnels : (a) par une réaction de transfert de nitrile avec le cyanure de sulfonyle de départ ou (b) par oxydation du radical en carbocation par l'éosine semi-oxydée suivi du piégeage de ce dernier par un ion cyanure. Sous nos conditions réactionnelles, la route (a) prévaut, bien que la route (b) soit thermodynamiquement possible.

La sulfonyl-cyanation d'oléfines cycliques procédant avec d'excellentes diastéréosélectivités, son application aux cyclobutènes permettrait l'élaboration de l'eucophylline de manière stéréosélective. Cependant, à notre connaissance, il n'existe aucune synthèse énantiosélective de cyclobutènes tels que **456** décrite dans la littérature. Inspiré des travaux de Narasaka sur les cycloadditions [2+2] asymétriques de sulfures d'alkynyle **452**, il a été envisagé qu'une désulfurisation des thioéthers vinyliques **454** devrait fournir directement les cyclobutènes **456** optiquement purs. Une méthode de réduction a donc été développée fournissant les cyclobutènes avec d'excellents rendements et une excellente pureté optique (Schéma 7). De plus, une mise à l'échelle de cette réaction a permis de produire 14 grammes de cyclobutène. De telles quantités sont appréciables pour débiter une synthèse totale.



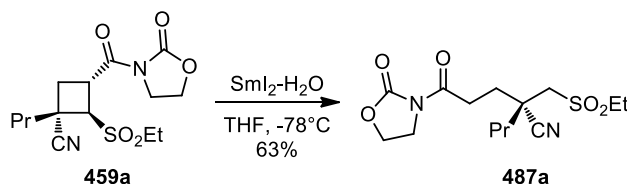
**Schéma 7.** Synthèse énantiosélective de cyclobutènes.

La sulfonyl-cyanation a ensuite été appliquée au cyclobutène **456a** fournissant des cyclobutanes fonctionnalisés **459** avec d'excellentes diastéréosélectivités et des rendements modérés (Schéma 8). Les configurations relatives ont été déterminées par diffraction aux rayons X.



**Schéma 8.** Sulfonyl-cyanation de cyclobutène et structure aux rayons X.

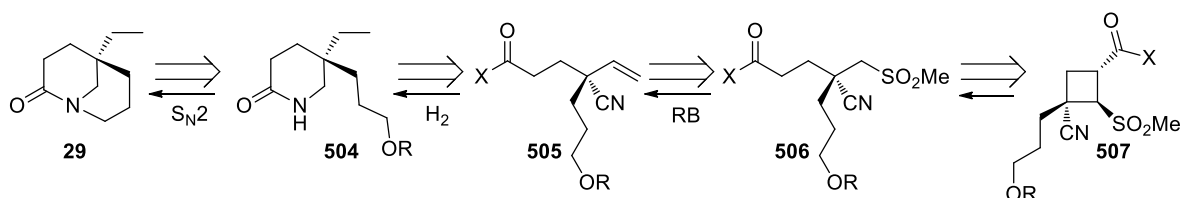
Une méthode d'ouverture du cyclobutane a ensuite été étudiée. Parmi les différentes approches envisagées, la fragmentation radicalaire médiée par le diiodure de samarium a été accomplie avec succès (Schéma 9). Cette ouverture de cycle génère un composé  $\beta$ -sulfonyle nitrile **487a** optiquement pur.



**Schéma 9.** Réaction d'ouverture de cycle médiée par le  $\text{SmI}_2$ .

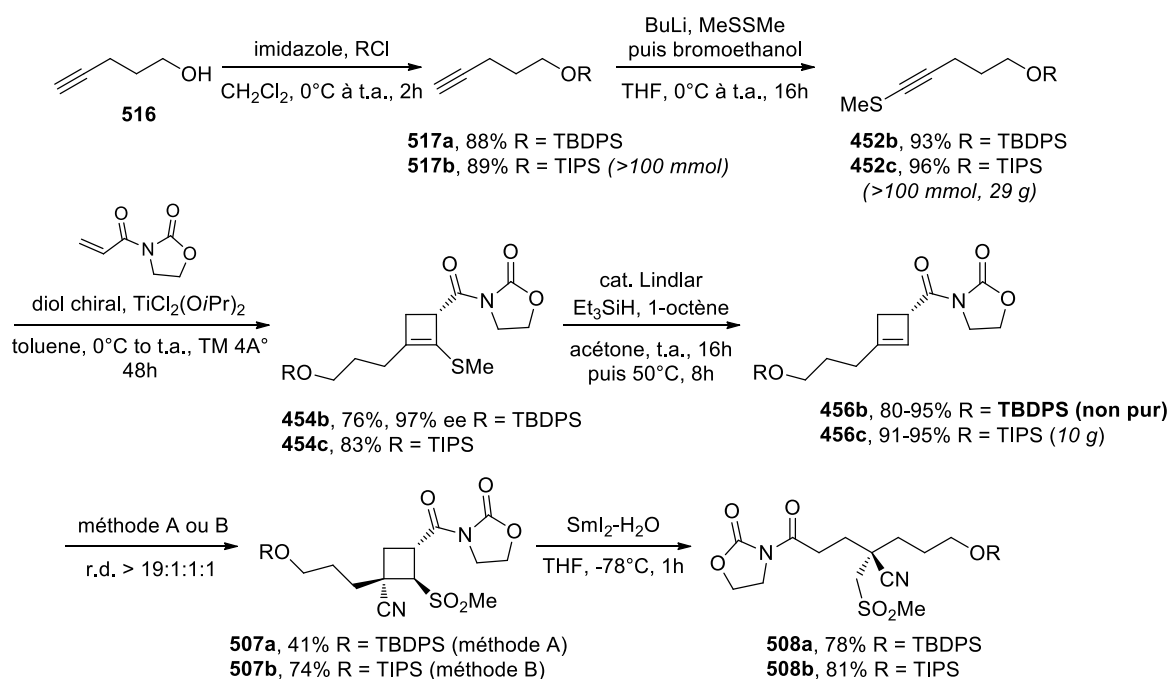
Ayant développé une séquence aboutissant à un centre quaternaire carboné fonctionnalisé par un nitrile, il a été envisagé d'utiliser cette méthodologie pour la synthèse asymétrique de l'eucophilline en convertissant l'alkyle sulfone **506** en alcène terminal **505** par une réaction de Ramberg-Bäcklund (Figure 3).





**Figure 3.** Rétrosynthèse du lactame bicyclique **29** à travers une réaction de Ramberg-Bäcklund.

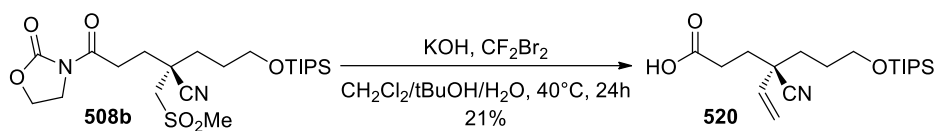
Le précurseur **508c** nécessaire à la réaction de Ramberg-Bäcklund a donc été préparé à l'échelle du gramme (Schéma 10). Le cyclobutène **456c** a été obtenu en synthétisant le sulfure d'alkényle **454c** selon la méthode de Narasaka, suivie de notre désulfurisation. La sulfonylcyanation du cyclobutène **456c** a ensuite conduit au cyclobutane **507b** avec de bons rendements et des diastéréosélectivités élevées en présence de *p*-anisaldehyde sous irradiation ultra-violette (UV-A). L'utilisation d'éosine-Y limitait le rendement à un maximum de 50%. Finalement, l'ouverture du cyclobutane **507** par fragmentation radicalaire au SmI<sub>2</sub> a fourni le produit ouvert **508** avec un très bon rendement.



**Schéma 10.** Synthèse du précurseur pour la synthèse de l'eucophylline (méthode A: éosine-Y, K<sub>2</sub>HPO<sub>4</sub>, acétone, 25°C, 60 h, LED verte; méthode B: *p*-anisaldéhyde, ACN, 35°C, 22 h, 325-400 nm).

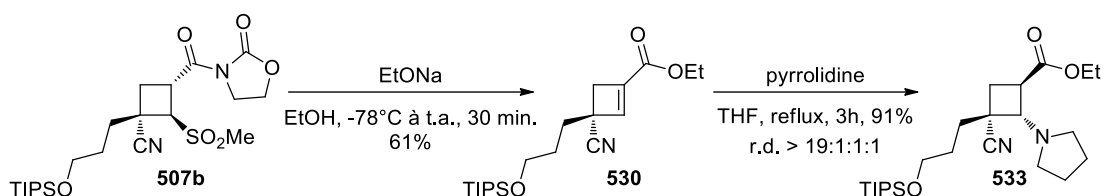
La conversion de la méthylsulfone **508b** en alcène terminale **520** par une réaction de Ramberg-Bäcklund a ensuite été examinée. Malheureusement, après plusieurs essais, un rendement maximum de 21% a été obtenu (Schéma 11). Bien que ce nitrile allylique soit le précurseur requis pour la synthèse totale de l'eucophylline, le rendement très bas de cette réaction

ne nous a pas permis de continuer la synthèse en utilisant cette approche. La modification du substrat n'a pas non plus permis de réaliser cette réaction.



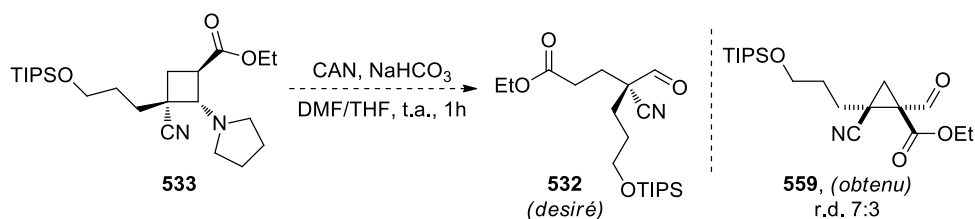
**Schéma 11.** Tentative de réaction de Ramberg-Bäcklund.

Vu les difficultés rencontrées pour éliminer la sulfone après l'ouverture du cyclobutane, nous avons préféré l'éliminer directement après la réaction de sulfonyl-cyanation. Cette élimination donne lieu à un nouveau cyclobutène **530**, de type énone, pouvant être fonctionnalisé par addition conjuguée. Dans le but d'élaborer une réaction d'ouverture de cycle, un amino-cyclobutane donneur-accepteur **533** a été synthétisé par l'addition conjuguée de pyrrolidine (Schéma 12). L'ouverture de ce système "push-pull" par catalyse métallique ou par fragmentation radicalaire devrait fournir un intermédiaire avancé pour la synthèse totale de l'eucophylline.



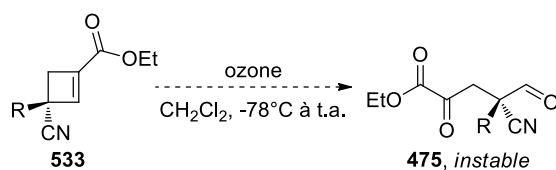
**Schéma 12.** Synthèse d'un amino-cyclobutane donneur-accepteur.

L'activation du cyclobutane par des acides de Brønsted ou de Lewis s'est avéré décevante. La présence du nitrile sur le cyclobutane **533** induit l'existence d'un deuxième système "push-pull" qui provoque des réactions secondaires et empêche la formation de l'aldéhyde **532**. L'utilisation d'acides oxophiles n'a pas permis de diriger l'ouverture dans la direction de l'ester. Les résultats obtenus lors des fragmentations radicalaires sont eux aussi insatisfaisant. L'oxydation de l'amine tertiaire en cation-radical par le nitrate de cérium et d'ammonium entraîne une contraction de cycle fournissant le cyclopropane **559** avec une diastéréoselectivité modérée (Schéma 13). Cette réaction provient de l'ouverture du cycle en direction du nitrile suivie d'une cyclisation.



**Schéma 13.** Tentative de fragmentation radicalaire de l'amino-cyclobutane.

Finalement, des résultats encourageants ont été obtenus lors de nos tentatives d'ouverture de cycle par ozonolyse (Schéma 14). Cependant, l'aldéhyde **475** obtenu est instable sur gel de silice et des conditions appropriées sont actuellement examinées afin de le fonctionnaliser.



**Schéma 14.** Tentative d'ouverture de cycle par ozonolyse.

Outre la synthèse énantiosélective de l'eucophylline, nos études ont également été dirigées vers la synthèse racémique du fragment éburnane. Bien que ne représentant pas l'objectif principal de cette thèse, un intermédiaire avancé a été synthétisé.

## Table of contents

Chapter I : Leucophyllidine – Isolation, biosynthesis and synthesis of precursors .....	21
1. General introductions .....	21
2. Biogenetic origin of dimeric indole alkaloids .....	23
3. Leucophyllidine: structure, biosynthesis and anti-cancer activity .....	27
4. Reported total syntheses of eucophylline and approach to leucophyllidine .....	29
5. Common syntheses of eburnamine and eburnamonine .....	34
6. Initial retrosynthesis of leucophyllidine .....	38
Chapter II : From classical radical chemistry to photoredox catalysis .....	43
1. Historical considerations about radical chemistry .....	43
2. Introduction to radical chemistry .....	44
2.1. Radical initiation .....	45
2.2. Structure and stability of radicals .....	47
2.3. Reactivity of radicals .....	49
2.4. Radical reactions .....	51
2.5. Tin-mediated radical chain reactions .....	55
2.6. Sulfonyl derivatives in tin-mediated and tin-free reactions .....	59
3. Photoredox catalysis .....	69
3.1. Introduction .....	69
3.2. Basic concepts of photoredox catalysis .....	72
3.3. Deactivation by bimolecular processes .....	79
3.4. Photoredox activation of sulfonyl groups .....	87
3.5. Photoredox-catalyzed cyanation reactions .....	103
4. Conclusions .....	107
Chapter III : Development of tin-free radical methodologies .....	111
1. Introduction .....	111
2. Carbo-cyanation using trichloroacetonitrile as radical trap .....	112
3. Carbo-cyanation using isonitriles as radical traps .....	114
4. Carbo-cyanation using sulfonyl cyanides as radical traps .....	119
4.1. Sulfonyl cyanides as electrophiles .....	119
4.2. Sulfonyl cyanides as radical traps .....	120

4.3. Reported methods for the synthesis of sulfonyl cyanides.....	121
4.4. Development of a new method for the synthesis of sulfonyl cyanides.....	122
4.5. Development of a tin-free carbo-cyanation with sulfonyl cyanides .....	128
5. Photoredox activation of sulfonyl cyanides .....	136
5.1. Efforts towards a photoredox-catalyzed carbo-cyanation.....	136
5.2. Development of a photoredox-catalyzed sulfonyl-cyanation .....	140
5.3. Activation of sulfonyl cyanides through sensitization.....	161
6. Conclusions.....	163
Chapter IV : Enantioselective approaches for the total synthesis of eucophylline.....	167
1. Desymmetrization strategy .....	167
1.1. Reported desymmetrization of diester compounds.....	167
1.2. Synthesis of the starting materials .....	169
1.3. Preliminary experiments of the desymmetrization strategy.....	172
2. Efforts towards an enantioselective 3-components carbo-cyanation .....	173
2.1. Short introduction on enantioselective radical reactions .....	173
2.2. Preliminary attempts at enantioselective carbo-cyanation.....	176
3. Synthesis and study on the reactivity of a new cyclobutene motif.....	178
3.1. Short description of small ring systems .....	179
3.2. Reported radical additions to cyclobutenes .....	181
3.3. Development of an enantioselective synthesis of cyclobutene .....	182
4. Development of a cyclobutane ring-opening reaction .....	188
4.1. Sulfone elimination .....	188
4.2. TMS-promoted ring opening reaction.....	190
4.3. Ring-opening reaction from cyclobutene carboxylate.....	191
4.4. Radical fragmentation from an alcohol precursor.....	192
4.5. Radical fragmentation from an iodide precursor .....	195
4.6. SmI <sub>2</sub> -ring opening processes.....	196
5. Total synthesis of eucophylline: model study.....	201
5.1. The Ramberg-Bäcklund reaction .....	201
5.2. Synthesis of precursors .....	202
5.3. Application of the Ramberg-Bäcklund reaction .....	203
6. Approach to eucophylline through a Ramberg-Bäcklund reaction.....	205
6.1. Synthesis of precursors .....	205

6.2. Optimization of the Ramberg-Bäcklund reaction .....	207
7. Approach to eucophylline through an aminocyclobutane .....	211
7.1. Reported ring-opening reactions of aminocyclobutanes .....	211
7.2. Synthesis of our aminocyclobutane precursor .....	214
7.3. Attempts for the ring-opening reaction of aminocyclobutane .....	215
8. Conclusions .....	219
Chapter V : Efforts towards the total synthesis of (+/-) eburnamine .....	223
1. Previous studies on the racemic total synthesis of eburnamine .....	223
2. Previous studies on the enantioselective synthesis of eburnamine .....	225
3. Proposed retrosynthesis of eburnamine.....	225
4. Synthesis of alkene 93a .....	226
5. Efforts towards the total synthesis of racemic eburnamine.....	228
5.1. Synthesis of the aminonitrile precursor.....	228
5.2. Reported activation of nitriles towards nucleophilic additions.....	228
5.3. Attempt at cyclizing aminonitrile precursor.....	231
5.4. Amidation of aminonitrile precursor using harsh acidic conditions .....	233
6. Conclusions .....	234
Conclusions and Perspectives .....	237
1. Conclusions .....	237
2. Perspectives .....	241
Experimental Part.....	247
1. General informations .....	247
2. General procedures.....	249
3. Experimental part: Chapter III .....	251
3.1. Preparation of thiocyanates .....	252
3.2. Preparation of sulfonyl cyanides .....	257
3.3. Tin-free two-components carbo-cyanation of olefins .....	263
3.4. Photoredox-catalysed sulfonyl-cyanation of olefins .....	271
4. Experimental part: Chapter IV .....	292
4.1. Desymmetrization strategy.....	292
4.2. Efforts towards an enantioselective 3-components carbo-cyanation .....	295
4.3. Cyclobutene methodology.....	296
5. Experimental part: Chapter V .....	326

Annex .....	333
1. Emission profile of the LEDs.....	333
2. Enantiomeric excess measurements .....	334
3. Fluorescence lifetime .....	344
4. Crystallographic data .....	346

# Chapter I

## Leucophyllidine – Isolation, biosynthesis and synthesis of precursors





# Chapter I : Leucophyllidine – Isolation, biosynthesis and synthesis of precursors

## 1. General introductions

The search for new pharmaceutical agents has, for decades, strongly been inspired from nature. Natural sources produce a remarkable diversity of substances in such a way that nature can be seen as an inexhaustible source of bioactive compounds. In this context, the isolation and the subsequent chemical transformations of bioactive natural products provide opportunities in research for the development of new anti-cancer agents.<sup>1</sup>

The use of natural products in cancer chemotherapy is incontestable. Most of the anti-cancer agents are derived from natural products. Some of the most notorious examples, isolated from plants, microbes or marine sources, are listed in Figure I.1.<sup>2</sup> Taxol, isolated from the bark of Pacific yew tree (*Taxus brevifolia*), is one of the most famous and is now the largest-selling anti-cancer drug used in chemotherapy. Nowadays, Taxol is produced by hemi-synthesis from 10-deacetylbaccatin III, a related structure isolated from European yew (*Taxus baccata*). This hemi-synthesis completely solved the supply problems of Taxol. Indeed, 4000 Pacific yew trees were needed to produce 360 grams of Taxol for the early clinical trials. Vinca alkaloids, Vinblastine and Vincristine were isolated from Madagascar periwinkle (*Catharantus roseus*) and are used for the treatment of leukaemia and Hodgkin's disease. The epothilones were isolated in 1993 from myxobacteria (*Sorangium cellulosum*) and some derivatives are still under clinical evaluation.<sup>3</sup> In 2007, ixabepilone, a lactam derivative of epothilone B (azaepothilone B), was accepted by the Food and Drug Administration (FDA) for the treatment of advanced breast cancer.<sup>4</sup> Epothilones have a similar mode of action than Taxol (stabilisation of microtubules during cell division) but have better water solubility. Compared to Taxol, the epothilones have simpler structures and several total syntheses have been proposed. Among these, the first syntheses were accomplished by Danishefsky and Nicolaou.<sup>5</sup> Finally, another potent candidate, isolated from marine organisms called bryozoan (*Bugula neritina*), is Bryostatin 1 and is currently under clinical trials.

---

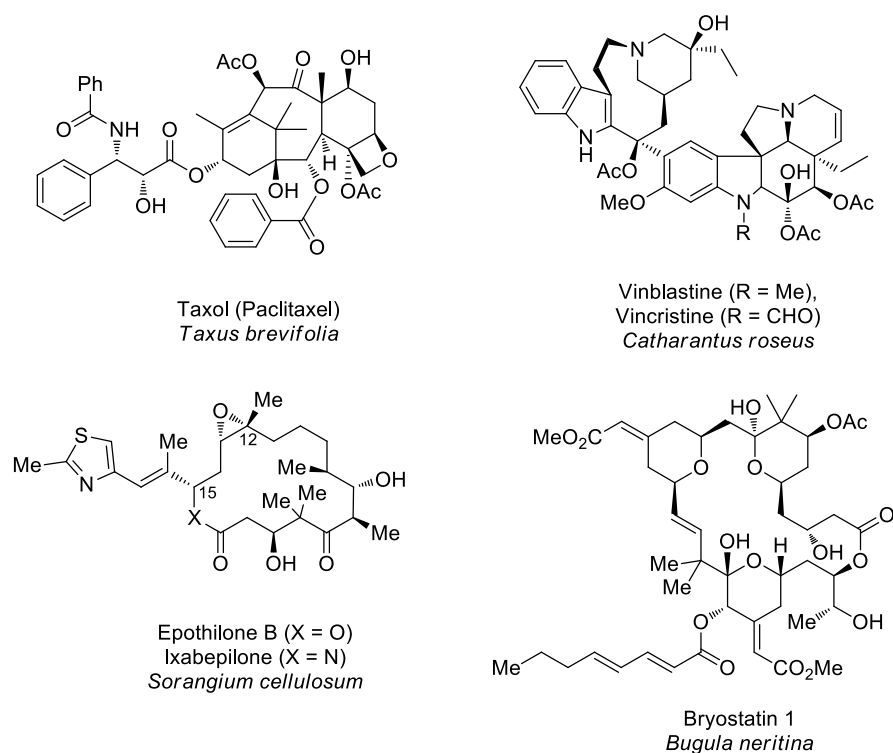
<sup>1</sup> (a) G. M. Cragg, D. J. Newman, *Pure Appl. Chem.* **2005**, *77*, 1923-1942; (b) A. L. Demain, P. Vaishnav, *Microb. Biotechnol.* **2011**, *4*, 687-699.

<sup>2</sup> J. Mann, *Nat. Rev. Cancer* **2002**, *2*, 143-148.

<sup>3</sup> S. Forli, *Curr. Top. Med. Chem.*, **2014**, *14*, 2312-2321.

<sup>4</sup> J. T. Hunt, *Mol. Cancer Ther.* **2009**, *8*, 275-281.

<sup>5</sup> (a) K. C. Nicolaou, Y. He, D. Vourloumis, H. Vallberg, F. Roschangar, F. Sarabia, S. Ninkovic, Z. Yang, J. I. Trujillo, *J. Am. Chem. Soc.* **1997**, *119*, 7960-7973; (b) A. Balog, D. Meng, T. Kamenecka, P. Bertinato, D.-S. Su, E. J. Sorensen, S. J. Danishefsky, *Angew. Chem., Int. Ed.* **1997**, *35*, 2801-2803.



**Figure I.1.** Notorious examples of anti-cancer agents coming from natural sources.

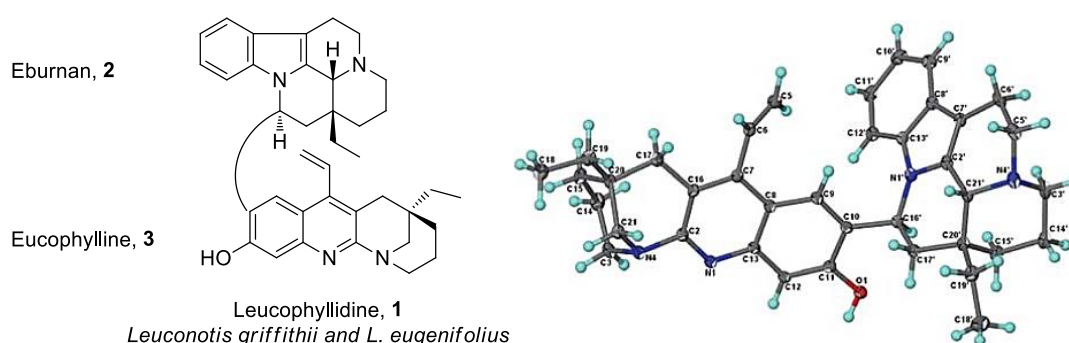
As mentioned for Taxol, the availability of these substances is often limited. Generally, the yield of the natural product after isolation from natural sources is very low and causes a dramatic barrier for the progress of research and clinical studies. For instance, extraction of 14 tons of the marine organism *Bugula neritina* furnished only 18 grams of Bryostatin 1 (0.00014%) to the National Cancer Institute for clinical trials.<sup>6</sup> Chemical synthesis has been one of the solutions to address the natural products supply problem. Recently, Wender *et al.* developed a scalable synthesis of Bryostatin 1 (2 grams produced) proceeding in 29 steps and furnishing others analogues.<sup>7</sup> According to the authors, their synthesis could deliver enough materials for the clinical needs in Bryostatin 1. This example beautifully illustrates the importance of total synthesis of natural products in the development of therapeutic agents. Chemical synthesis is a viable alternative compared to the extraction and isolation of natural products from natural extracts, which contain numerous side-products rendering the purification extremely complicated.

Although the research in chemotherapy has made impressive progresses, potent anti-cancer agents and more selective analogues are still needed due to the severe adverse effects caused by the toxicity of these compounds. Furthermore, cancer cells develop resistance and the cancer treatment becomes then inefficient. The identification of natural products as new chemotherapeutic agents became a priority and their evaluation as potential anti-cancer candidates might be

<sup>6</sup> D. E. Schaufelberger, M. P. Kolec, J. A. Beutler, A. M. Vataki, A. B. Alvarado, P. Andrews, L. V. Marzo, G. M. Muschik, J. Roach, J. T. Ross, W. B. Leber, M. P. Reeves, R. M. Eberwein, L. L. Rodgers, R. P. Testerman, K. M. Snader, S. Forenza, *J. Nat. Prod.* **1991**, *54*, 1265-1270.

<sup>7</sup> P. A. Wender, C. T. Hardman, S. Ho, M. S. Jeffreys, J. K. Maclaren, R. V. Quiroz, S. M. Ryckbosch, A. J. Shimizu, J. L. Sloane, M. C. Stevens, *Science* **2017**, *358*, 218-223.

considered. In this regard, leucophyllidine **1** (Figure I.2), a bis-indole alkaloid, was recently isolated from EtOH extract of the stem bark of Malaysian *Apocynaceae* (*Leuconotis griffithii* and *L. eugenifolius*) and has shown *in vitro* cytotoxicity towards drug sensitive as well as Vincristine-resistant human KB cells with a half inhibitory concentration (IC<sub>50</sub>) of less than 3 µg/mol.<sup>8</sup> In addition to these features, the structure of leucophyllidine, which was confirmed through X-ray diffraction analysis, is unprecedented and close to those of vinca alkaloids. This alkaloid possesses an unusual dimeric structure coming from the union of an Eburnan fragment **2** (north fragment) and Eucophylline **3** (south fragment), the latter possessing a novel naphthyridine core.<sup>9</sup> These unusual structural features as well as the biological activity encouraged us to develop an enantioselective total synthesis for this potential anti-cancer candidate. Our total synthesis will then establish a chemical platform for the development of more potent additional analogues.



**Figure I.2.** Structure of leucophyllidine confirmed through X-ray diffraction analysis.<sup>8</sup>

## 2. Biogenetic origin of dimeric indole alkaloids

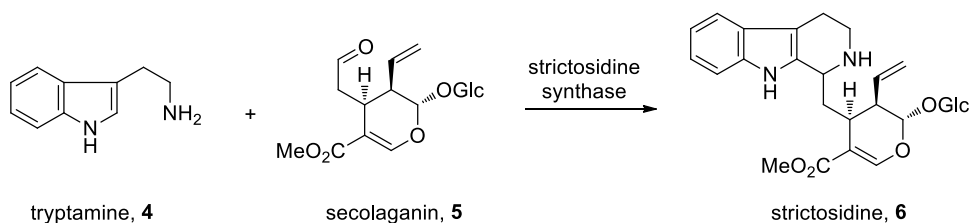
Leucophyllidine and vinca alkaloids are dimeric indole alkaloids isolated from the *Apocynaceae* family. Dimeric indole alkaloids are formed through coupling of the monomeric subunit belonging to the monoterpene indole alkaloids class.<sup>10</sup> Most of them were isolated from three plant families (*Rubiaceae/Nauclaceae*, *Loganiaceae/Strychnaceae* and *Apocynaceae*) and are formed from a similar intermediate, strictosidine **6**, issued from the reaction between tryptamine **4** and secologanin **5** catalysed by the enzyme strictosidine synthase (Scheme I.1).<sup>11</sup> Considering the similar origin (plants and precursor) of these alkaloids, a common biosynthesis from strictosidine is consistent.

<sup>8</sup> C.-Y. Gan, W. T. Robinson, T. Etoh, M. Hayashi, K. Komiyama, T.-S. Kam, *Org. Lett.* **2009**, *11*, 3962-3965.

<sup>9</sup> J. Deguchi, T. Shoji, A. E. Nugroho, Y. Hirasawa, T. Hosoya, O. Shirota, K. Awang, A. H. A. Hadi, H. Morita, *J. Nat. Prod.* **2010**, *73*, 1727-1729.

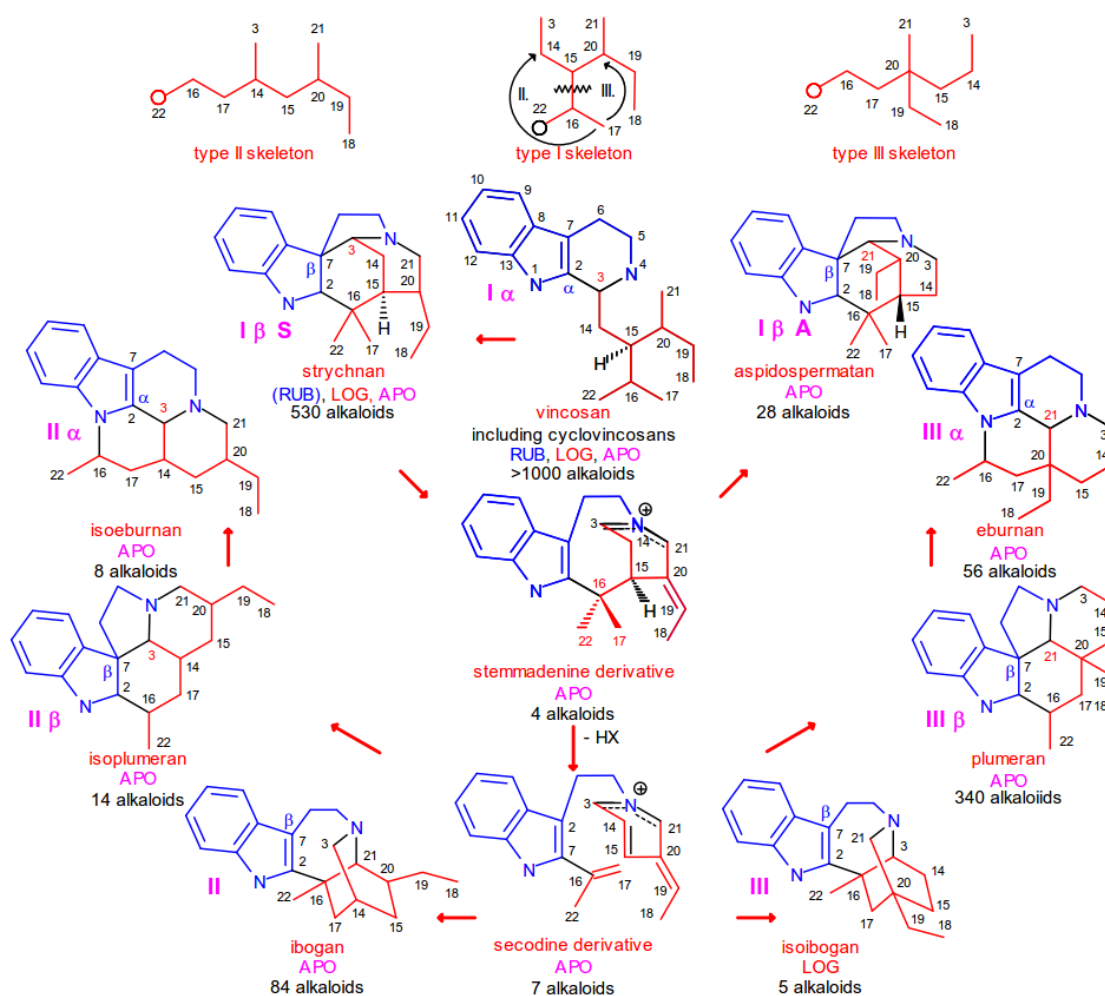
<sup>10</sup> L. F. Szabo, *Molecules* **2008**, *13*, 1875-1896.

<sup>11</sup> L. Barleben, S. Panjikar, M. Ruppert, J. Koepke, J. Stoeckigt, *Plant Cell* **2007**, *19*, 2886-2897.



**Scheme I.1.** Precursors of indole alkaloids.<sup>11</sup>

The rearrangement of strictosidine will define the type of monomeric alkaloid skeleton (I, II or III). More complex structures are thus obtained through rearrangement, ring contraction or expansion leading to different classes of alkaloids, depending on the skeleton of the final structure (Figure I.3).



**Figure I.3.** Indole alkaloids derived from secolaganin.<sup>10</sup>

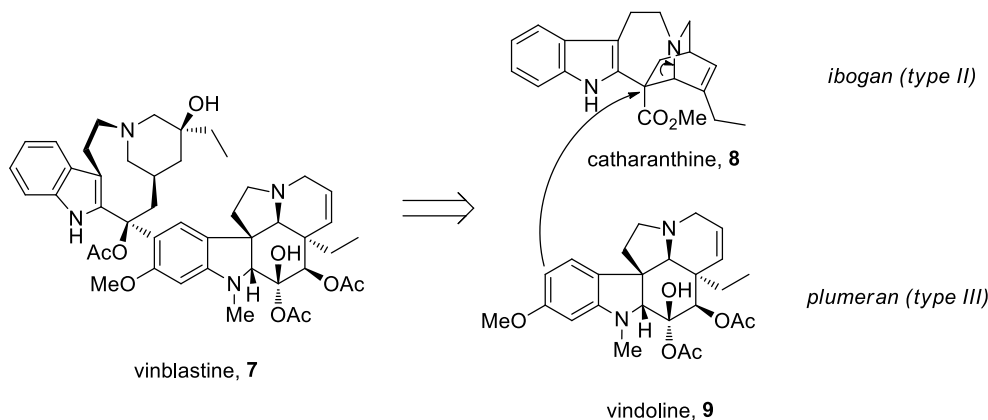
The coupling between two monomeric indole alkaloids leads to a heterodimeric or homodimeric indole alkaloid, the latter being quite rare. A chemotaxonomic network (Figure I.4) was built after isolation of several compounds. This biogenetic network was established on the basis of the three-dimensional structure, taxonomic properties and standard reaction mechanisms.

This network suggests that monomeric indole alkaloids co-exist in the plant and the coupling between them provide heterodimers.

	skeleton	coalkaloid	heterodimer		
type I	vincosan I $\alpha$	found	69	8	24
	strychnan I $\beta$ S	found			
	aspidospermatan I $\beta$ S	indirect			
type II	ibogan II	found	36	4	
	isoplumeran II $\beta$	not found			
	isoeburnan II $\alpha$	not found			
type III	isoibogan III	not found	11		
	plumeran III $\beta$	found			
	eburnan III $\alpha$	found			

**Figure I.4.** Chemotaxonomic network (number of dimeric alkaloids beside bracket).<sup>10</sup>

As an illustration of the above table, the biosynthesis of vinblastine **7** was proposed to occur *via* a direct dimerization between catharanthine **8** (ibogan type II) and vindoline **9** (plumeran type III) because of the structural similarity of these compounds (Figure I.5).<sup>12</sup> This hypothesis was demonstrated *in vivo* by the incorporation of radiolabelled precursors (tritium). Several total syntheses have now validated this direct dimerization.<sup>13</sup>



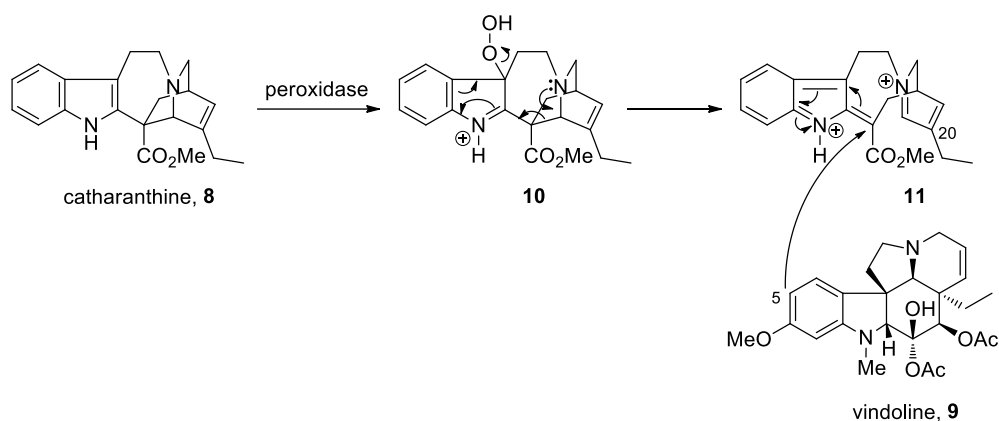
**Figure I.5.** Dimerization between vindoline and catharanthine.

It has been proposed that this coupling is catalysed by a peroxidase, which oxidizes the catharanthine **8** into a hydroperoxide **10**. The latter acts as a leaving group resulting in an electronic reorganisation to give an electrophilic intermediate **11**. Nucleophilic addition of the C5 center of vindoline gives an adduct, which is then reduced by NADH. Vinblastine is then obtained through oxidation at C20 (Scheme I.2).<sup>14</sup>

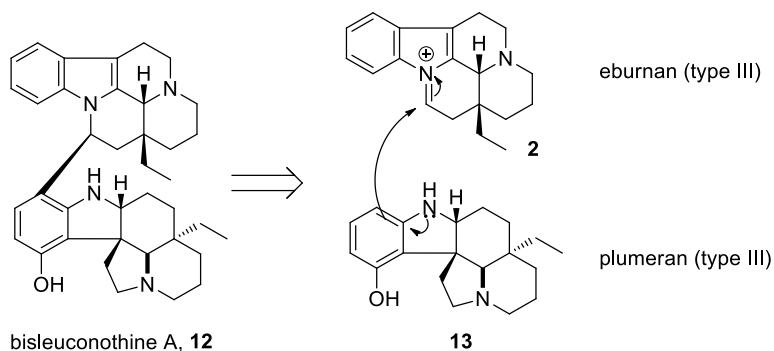
<sup>12</sup> P. E. Daddona, C. R. Hutchinson, *J. Am. Chem. Soc.* **1974**, *96*, 6806-6807.

<sup>13</sup> (a) N. Langlois, F. Gueritte, Y. Langlois, P. Potier, *J. Am. Chem. Soc.* **1976**, *98*, 7017-7024; (b) H. Ishikawa, D. A. Colby, S. Seto, P. Va, A. Tam, H. Kakei, T. J. Rayl, I. Hwang, D. L. Boger, *J. Am. Chem. Soc.* **2009**, *131*, 4904-4916.

<sup>14</sup> A. E. Goodbody, T. Endo, J. Vukovic, J. P. Kutney, L. S. L. Choi, M. Misawa, *Planta Med.* **1988**, *54*, 136-140.

Scheme I.2. Biosynthetic pathway of vinblastine.<sup>14</sup>

Although the mode of coupling has been well investigated for the vinca alkaloids, the mechanisms of dimerization for the others dimers are still under study. Some insights on the biogenetic pathway have been proposed by Morita and co-workers for several alkaloids.<sup>15</sup> Recently, bisleuconotine A (**12**), an eburnan-aspidosperma bisindole alkaloid was isolated from *Leuconotis griffithii*. The dimerization was thought to arise from a Mannich-type reaction between plumeran **13** and eburnan **2** type skeletons (Figure I.6).<sup>16</sup>

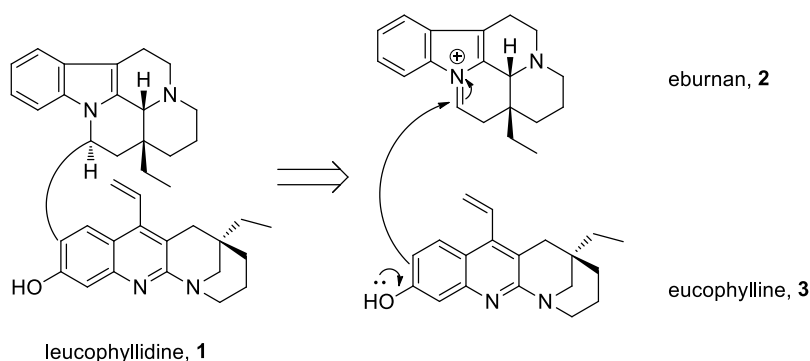
Figure I.6. Proposed biosynthesis of bisleuconotine A.<sup>16</sup>

<sup>15</sup> (a) A. E. Nugroho, Y. Hirasawa, N. Kawahara, Y. Goda, K. Awang, A. H. A. Hadi, H. Morita, *J. Nat. Prod.* **2009**, *72*, 1502-1506; (b) K. Zaima, T. Hirata, T. Hosoya, Y. Hirasawa, K. Koyama, A. Rahman, I. Kusumawati, N. C. Zaini, M. Shiro, H. Morita, *J. Nat. Prod.* **2009**, *72*, 1686-1690; (c) A. E. Nugroho, Y. Hirasawa, T. Hosoya, K. Awang, A. H. A. Hadi, H. Morita, *Tetrahedron Lett.* **2010**, *51*, 2589-2592.

<sup>16</sup> Y. Hirasawa, T. Shoji, T. Arai, A. E. Nugroho, J. Deguchi, T. Hosoya, N. Uchiyama, Y. Goda, K. Awang, A. H. A. Hadi, M. Shiro, H. Morita, *Bioorg. Med. Chem. Lett.* **2010**, *20*, 2021-2024.

### 3. Leucophyllidine: structure, biosynthesis and anti-cancer activity

As mentioned above, leucophyllidine **1** was isolated in 2009 from the stem-bark extract of *Leuconotis griffithii*. The structure of this new bis-indole alkaloid was elucidated through spectroscopic data and X-ray diffraction analysis.<sup>8</sup> It remains unprecedented for several reasons. Considering the monomeric subunit, leucophyllidine is the first member of a new structural subclass of bis-indole alkaloids. The south fragment consists in a new skeleton that includes a novel naphthyridine core, an unique tetrahydrobenzo[b][1,8]naphthyridine. In 2010, this new tetracyclic vinylquinoline alkaloid, named eucophylline **3**, was isolated together with the dimer alkaloid, leucophyllidine **1**, from the bark of *Leuconotis Eugeniaefolius*.<sup>9</sup> A similar coupling to that of bisleuconothine A (Mannich-type coupling) was proposed by Kam *et al.* for the union between eburnan **2** and eucophylline **3** (Figure I.7).<sup>8</sup>

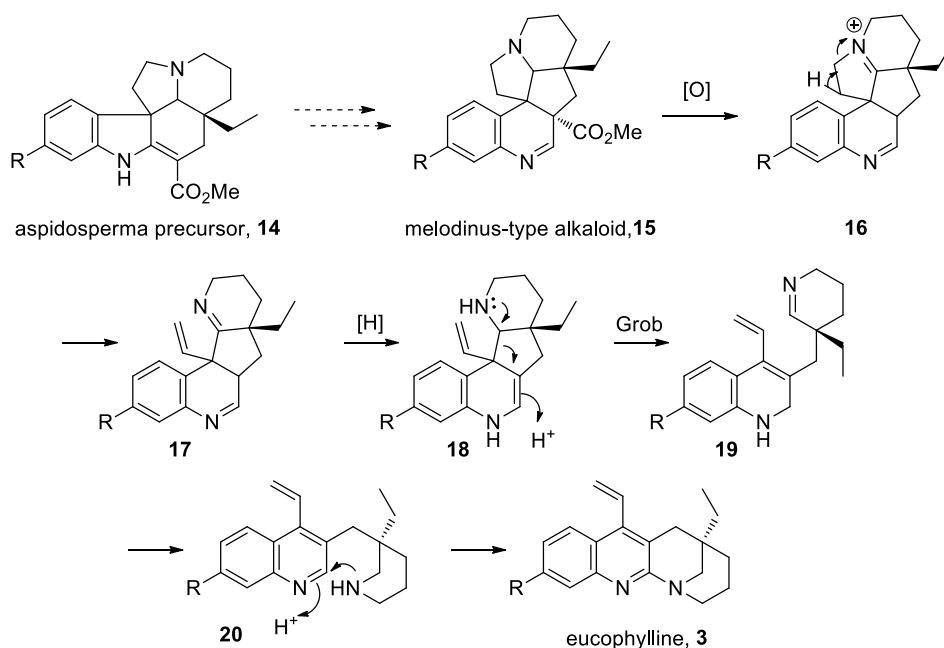


**Figure I.7.** Proposed biosynthesis of leucophyllidine.

The biosynthesis of eucophylline **3** is intriguing due to its uncommon skeleton. Its biogenetic origin was proposed to come from an indole precursor because *Leuconotis* contains only monoterpenoid indole alkaloids. Both Kam and Morita proposed the aspidosperma precursor **14** but their respective biogenetic pathway is different. The pathway from Kam is depicted in Scheme I.3 and was corrected one year later due to an error in the absolute configuration of the aspidosperma precursor.<sup>17</sup> After the formation of the melodinus-type alkaloid **15**, decarboxylation and oxidation give the iminium **16**. The cleavage of the C-N bond furnishes a tetracyclic structure **17**. After imine reduction, the Grob-like fragmentation leads to the vinyl-substituted dihydroquinoline derivative **19**. Aromatization and reduction provide the vinylquinoline derivative **20**. Eucophylline **3** is finally obtained through the nucleophilic addition of the piperidine nitrogen center onto the pyridine ring followed by aromatization.

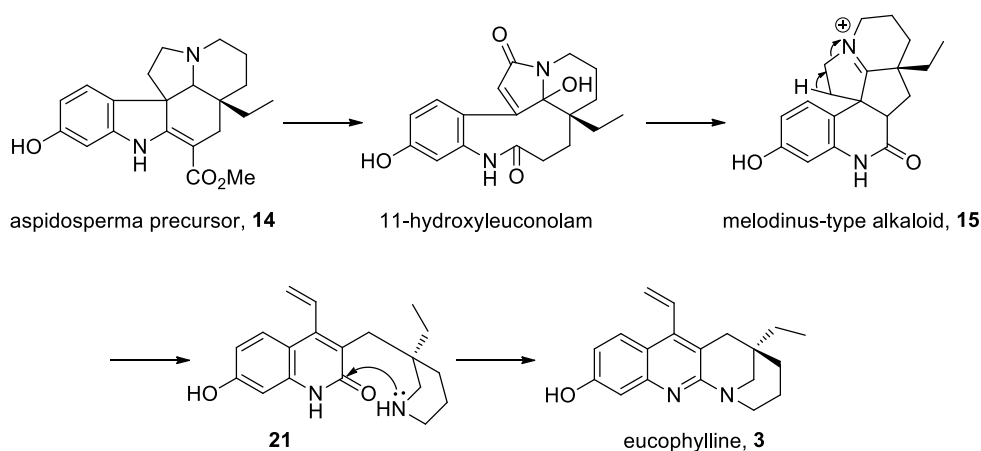
<sup>17</sup> C.-Y. Gan, Y.-Y. Low, W. T. Robinson, K. Komiyama, T.-S. Kam, *Phytochemistry* **2010**, 71, 1365-1370.





**Scheme I.3.** Proposed biogenetic pathway from Kam *et al.*<sup>8</sup>

The biogenetic pathway of Morita *et al.* is depicted in Scheme I.4. The same melodinus-type alkaloid intermediate **15** as well as the C-N bond cleavage were proposed. However, the ring closure involved the attack of the piperidine **21** to the carbonyl followed by dehydration.



**Scheme I.4.** Proposed biogenetic pathway from Morita *et al.*<sup>9</sup>

Besides its complex and original structure, leucophyllidine has shown pronounced *in vitro* cytotoxicity towards vincristine-sensitive (KB/S) and -resistant (KB/VJ300) human oral epidermoid carcinoma cell lines. The half inhibitory concentrations (IC<sub>50</sub>, concentration of the tested compound to give 50% inhibition of the cell growth) were respectively 2.95 (5.16 μM) and 2.92 μg/mL (5.10 μM).

Considering these features, the development of a suitable total synthesis for leucophyllidine appeared of particular interest. Indeed, such studies could improve the understanding of the coupling between the eburnan fragment and the eucophylline. Moreover,

once the total synthesis will be established, different analogues could be produced and lead to a structure-activity relationship (SAR).

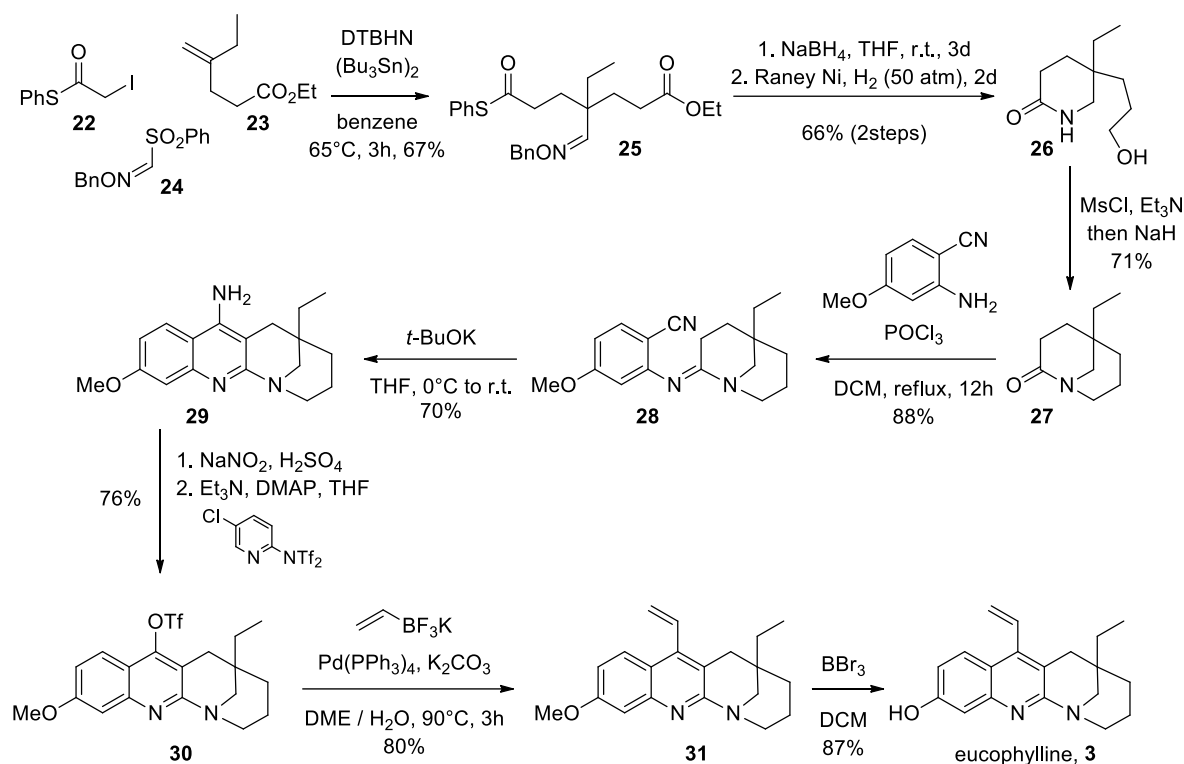
Until now, the total synthesis of leucophyllidine has not been reported. The following paragraph will briefly mention the reported total syntheses of eucophylline. Since the Eburnan fragment has been extensively studied, only a few examples will be described.

#### **4. Reported total syntheses of eucophylline and approach to leucophyllidine**

Landais and co-workers described the first total synthesis of eucophylline **3** (racemic), based on a radical carbo-oximation process as a key step (Scheme I.5).<sup>18</sup> After the carbo-oximation reaction from iodide **22** and alkene **23**, the chemoselective reduction of the thioester **25** followed by hydrogenation of the oxime provided the lactam **26**. The formation of the bicyclic lactam **27** was accomplished by the displacement of the mesylate acting as a leaving group after deprotonation of the amide. The bicyclic lactam **27** was then engaged in a Friedländer-type annulation to give the guanidine **28**, which upon basic treatment furnished the tetracyclic core **29** of eucophylline. According to the Bredt's rule, this Friedländer reaction was however not so trivial, since the bicyclic system of the lactam should prevent the formation of the strained bridgehead Vilsmeier intermediate (anti-Bredt chloro-iminium). Formation of the diazonium salt from the amine **29** gave the alcohol which was converted into the triflate **30**. Then, a Suzuki coupling afforded **31** and a demethylation provided eucophylline **3**, eventually obtained in 10 steps and 10% overall yield from **22**.

---

<sup>18</sup> H. Hassan, S. Mohammed, F. Robert, Y. Landais, *Org. Lett.* **2015**, *17*, 4518-4521.

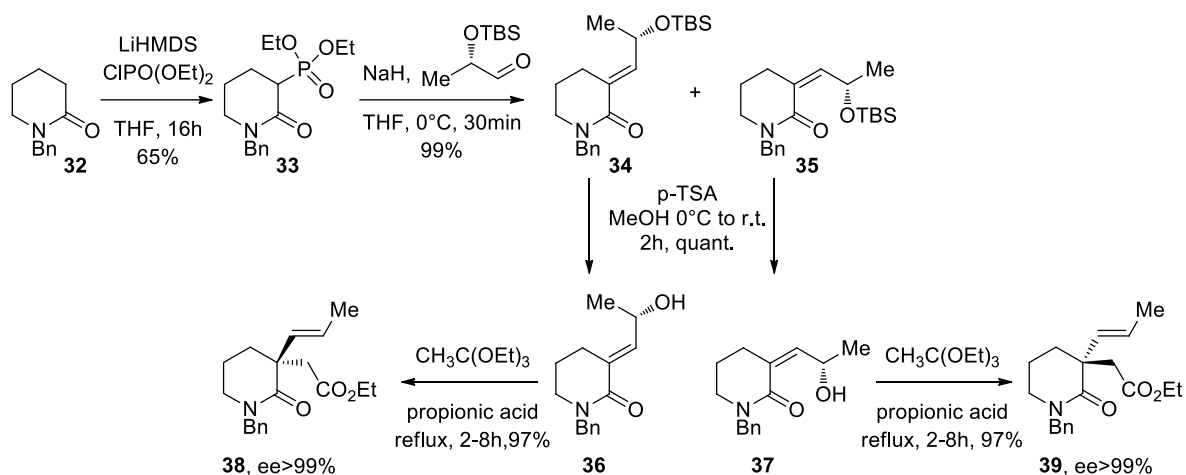


**Scheme I.5.** Racemic synthesis of eucophylline by Landais *et al.*<sup>18</sup>

Recently, Pandey *et al.* developed the first enantioselective total synthesis of eucophylline using their previously developed methodology aiming at introducing an all-carbon quaternary stereocenter at C-3 carbon of lactams via a [3,3]-sigmatropic rearrangement.<sup>19</sup> Enantiopure lactams **38** and **39** were synthesized following a four-step sequence (Scheme I.6).<sup>20</sup> Horner-Wadsworth-Emmons (HWE) olefination on alkylphosphonate **33** (synthesized from protected piperidinone **32**) with TBS-protected L-lactaldehyde gave the corresponding enone as a mixture of two diastereoisomers **34** and **35**. Hydrolysis of the TBS-protecting group gave the alcohols **36** and **37**. A Johnson-Claisen rearrangement furnished the two enantiomeric lactams **38** and **39** with excellent yield and enantiomeric excess.

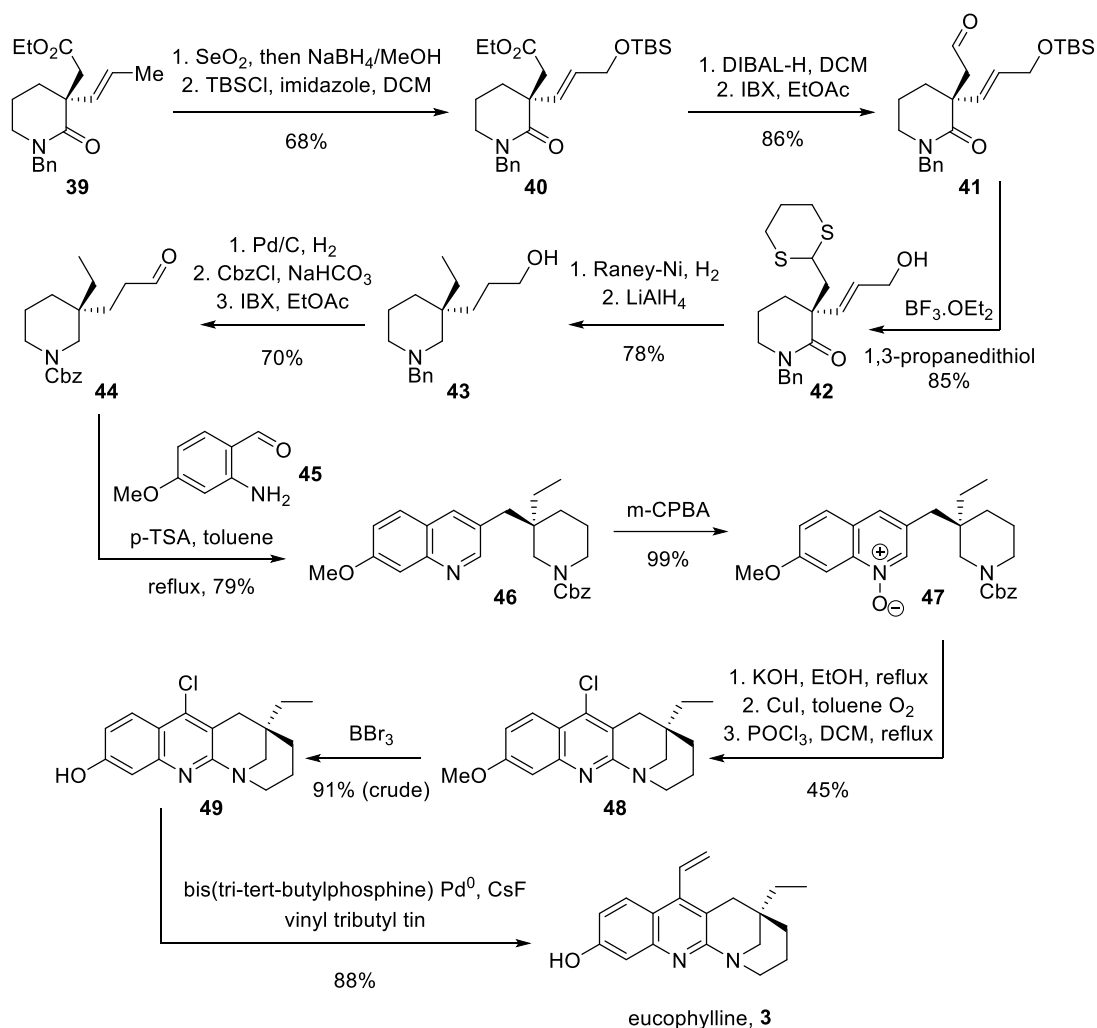
<sup>19</sup> G. Pandey, A. Mishra, J. Khamrai, *Org. Lett.* **2017**, *19*, 3267-3270.

<sup>20</sup> G. Pandey, J. Khamrai, A. Mishra, *Org. Lett.* **2015**, *17*, 952-955.

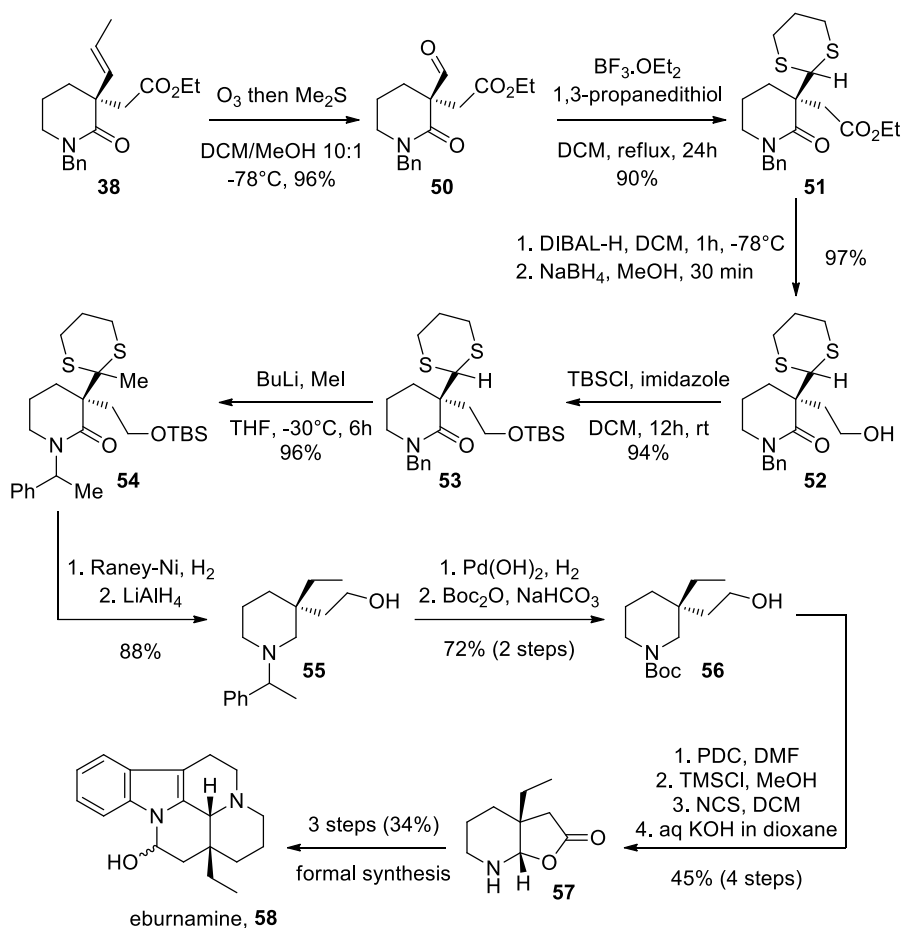


**Scheme I.6.** Previous methodology developed by Pandey.<sup>20</sup>

The synthesis of eucophylline **3** starts by an allylic oxidation of lactam **39** using selenium dioxide followed by the protection of the resulting alcohol to give **40** (Scheme I.7). The reduction of the ester **40** led to a mixture of aldehyde and alcohol which was oxidized with IBX to give the pure aldehyde **41**. Dithioacetalisation of the latter to 1,3-dithiane **42** followed by hydrogenation furnished the benzyl-protected piperidine **43** after reduction of the amide. Protecting group modifications and oxidation of the alcohol gave the corresponding aldehyde **44**. This aldehyde was engaged in a Friedländer-type annulation with **45**, furnishing the key precursor **46**. Oxidation with *m*-CPBA led to the quinoline-N-oxide **47**. With **47** in hand, the CBz deprotection was followed by a copper-catalyzed intramolecular cyclization. Reaction of the nitroxide with phosphorus oxychloride provided the tetracyclic core of eucophylline **48**. A demethylation using boron tribromide gave the phenol **49** which was engaged in a Stille coupling to give eucophylline **3**. According to the authors, this synthesis occurred in 11 linear steps with 7.4% overall yield. But importantly, the authors did not take into account the steps required for the synthesis of the enantiopure lactam precursor. Furthermore, many redox transformations were needed, which finally led to a synthesis of eucophylline in 21 steps from commercially available precursor of **32** (piperidinone) in a 4.8% overall yield.

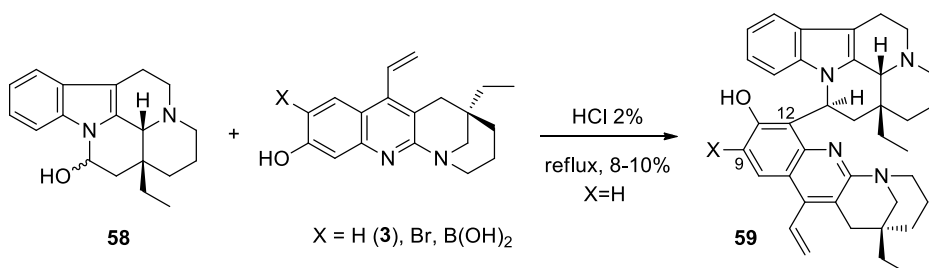
Scheme I.7. Enantioselective synthesis of eucophylline by Pandey *et al.*<sup>19</sup>

A similar approach was used for the synthesis of the eburnan fragment **2** (Scheme I.8).<sup>19</sup> Ozonolysis of the lactam **38** gave the aldehyde **50**. Simple Wittig reaction on this aldehyde did not succeed. As an alternative, the aldehyde was converted into a 1,3-dithiane **51** and the ester was fully reduced into the corresponding alcohol **52**. Basic treatment of the protected alcohol **53** using *n*-BuLi, followed by the addition of iodomethane furnished the methyl-1,3-dithiane **54**. This alkylation also methylated the benzylic center of the NBn protecting group. The piperidine **55** was obtained after reductive desulfurization of 1,3-dithiane and reduction of the amide with lithium aluminium hydride. Protecting groups transformations gave the Boc-protected amide **56**. Oxidation of the alcohol with pyridinium dichromate provided the corresponding carboxylic acid. *N*-Boc deprotection and esterification of the acid gave the methyl ester. The chlorination of the amine followed by basic hydrolysis led to the aminolactone **57**, a known advanced intermediate in the total synthesis of Eburnamine **58** (*vide infra*). According to the authors, this formal synthesis proceeds through 10 linear steps and an overall yield of 7.4%. As above, a more realistic counting from commercially available material led to 21 steps and 4.6% overall yield.



**Scheme I.8.** Enantioselective synthesis of eburnan by Pandey.<sup>19</sup>

With eucophylline **3** and eburnamine **58** in hand, the group of Pandey started to investigate the biomimetic Mannich-type coupling. These two compounds were thus heated in the presence of 2% HCl (Scheme I.9). However, the wrong regioisomer **59** was obtained in low yield after 7 days. This result was explained according to the stability of the Wheland intermediates. Other couplings trials remained unsuccessful: as for example the reaction between the lithiated eucophylline (from lithium-halogen exchange, X = Br) with the iminium (generated in situ by the treatment of  $\text{BF}_3 \cdot \text{OEt}_2$ ) and the Petasis reaction with the boronic acid (X =  $\text{B}(\text{OH})_2$ ) failed.

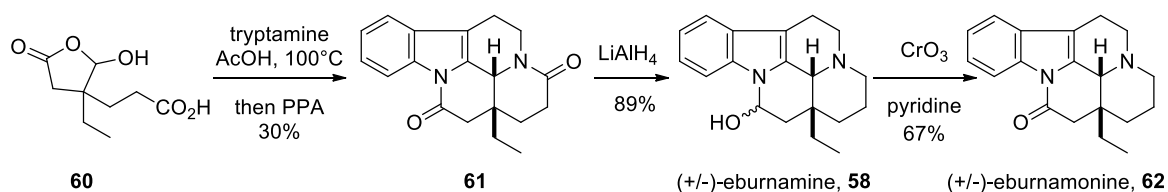


**Scheme I.9.** Attempted biomimetic coupling by Pandey.<sup>19</sup>

## 5. Common syntheses of eburnamine and eburnamonine

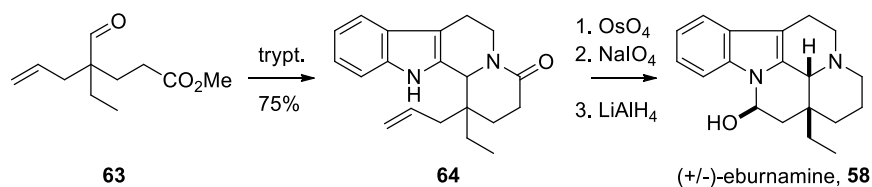
As previously stated, the synthesis of eburnan fragment has been extensively studied.<sup>21</sup> This paragraph will briefly mention the most common approaches and will focus on eburnamine and eburnamonine. In this context, the Pictet-Spengler and the Bischler-Napieralski reactions have been widely used in the synthesis of alkaloids.

Bartlett and Taylor described the synthesis of eburnamine **58** and eburnamonine **62** from lactone **60** and tryptamine through an acid-mediated cyclization to give intermediate **61**. Reduction of the latter gave eburnamine **58**, which was oxidized in eburnamonine **62** (Scheme I.10).<sup>22</sup>



**Scheme I.10.** Eburnamine and eburnamonine synthesis by Bartlett and Taylor.<sup>22</sup>

Barton and Harley-Mason described the condensation of tryptamine with aldehyde **63** through a Pictet-Spengler reaction (Scheme I.11).<sup>23</sup> Osmylation of the alkene **64** followed by oxidative cleavage (Lemieux-Johnson oxidation) and reduction of the amides gave eburnamine **58**.



**Scheme I.11.** Eburnamine synthesis described by Barton.<sup>23</sup>

Wenkert and Wickberg introduced for the first time the use of enamine **68** as a key-intermediate, known as Wenkert's enamine.<sup>24</sup> Starting from the alkylation and cyclization of tryptamine with bromoester **65**, the obtained cyclic amide **66** was submitted to Bischler-Napieralski conditions ( $\text{POCl}_3$ ) to give iminium **67** (Scheme I.12). The enamine **68** was then formed *in situ* under basic conditions and was alkylated with ethyl iodoacetate. The product of alkylation **69** was hydrogenated and basic treatment afforded eburnamonine **62**. Since the Wenkert

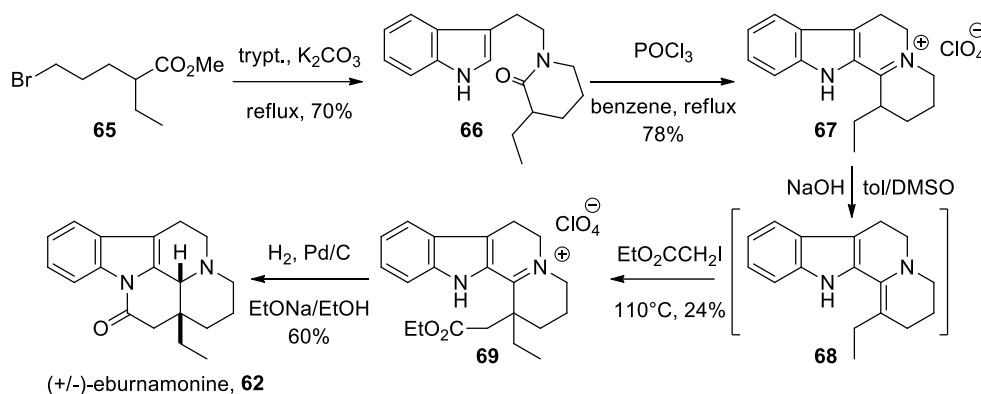
<sup>21</sup> M. Lounasmaa, A. Tolvanen, *The Alkaloids: Chemistry and Pharmacology*, 42 (Ed.: A. C. Geoffrey), Academic Press, **1992**, 1-116.

<sup>22</sup> M. F. Bartlett, W. I. Taylor, *J. Am. Chem. Soc.* **1960**, 82, 5941-5946.

<sup>23</sup> J. E. D. Barton, J. Harley-Mason, *Chem. Commun.* **1965**, 298-299.

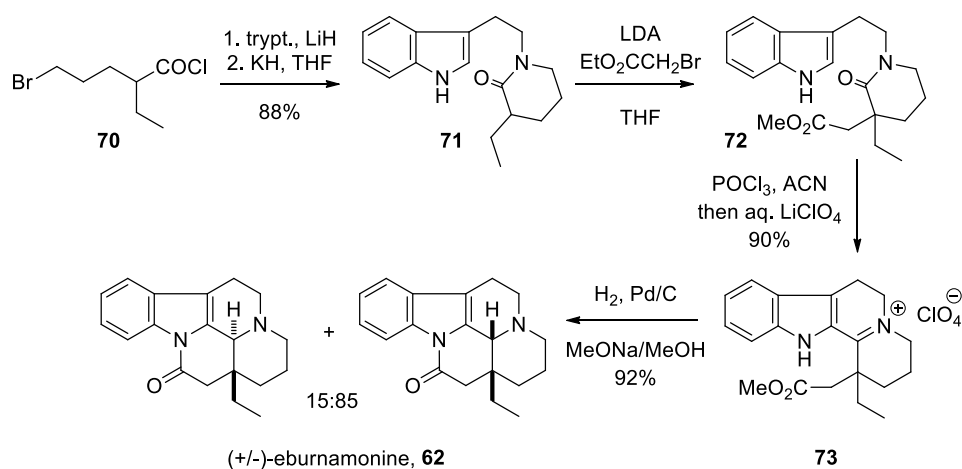
<sup>24</sup> E. Wenkert, B. Wickberg, *J. Am. Chem. Soc.* **1965**, 87, 1580-1589.

synthesis of enamine **68**, several other routes have been proposed to prepare this useful intermediate but they will not be discussed in this chapter.



**Scheme I.12.** Synthesis of eburnamine by Wenkert and Wickberg.<sup>24</sup>

In a similar way, Schlessinger and co-workers started their synthesis from the acyl chloride **70** (Scheme I.13).<sup>25</sup> After alkylation of tryptamine and cyclization, the lactam **71** was then functionalized by adding an ester moiety. Bischler-Napieralski cyclization onto intermediate **72**, followed by treatment of lithium perchlorate furnished the iminium perchlorate **73**, which after hydrogenation and basic treatment provided eburnamine **62** in a 15:85 diastereomeric ratio.



**Scheme I.13.** Synthesis of eburnamine by Schlessinger.<sup>25</sup>

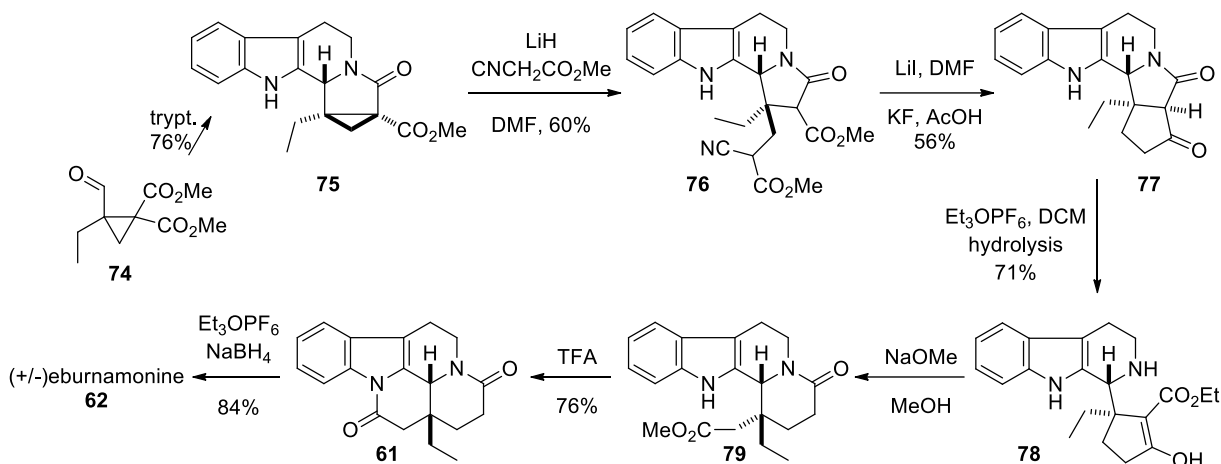
Winterfeldt and co-workers developed a synthesis of eburnamine based on a regioselective ring opening of a suitable cyclopropane derivative (Scheme I.14).<sup>26</sup> Condensation of tryptamine and cyclopropane carboxaldehyde **74** gave adduct **75**. Reaction of the latter with lithium enolate of methyl cyanoacetate caused the ring opening of the cyclopropane leading to **76**. Decarboxylation and cyclization gave lactam **77**. After ring opening of the lactam under acidic

<sup>25</sup> J. L. Herrmann, R. J. Cregge, J. E. Richman, G. R. Kieczkowski, S. N. Normandin, M. L. Quesada, C. L. Semmelhack, A. J. Poss, R. H. Schlessinger, *J. Am. Chem. Soc.* **1979**, *101*, 1540-1544.

<sup>26</sup> F. Klatter, U. Rosentreter, E. Winterfeldt, *Angew. Chem.* **1977**, *89*, 916-917.

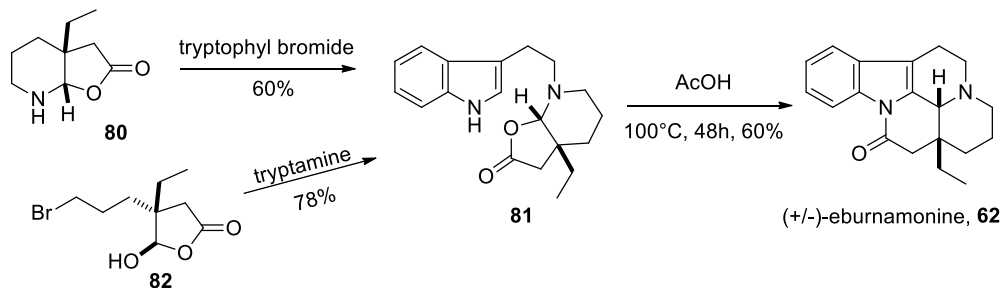


conditions, the oxoester **78** was obtained. Basic treatment gave the cyclic amide **79** which was converted into **61** upon acidic conditions. The reduction of the amide furnished eburnamonine **62**. The asymmetric synthesis of cyclopropane was described later and an enantioselective route to eburnamonine was performed by the same group.<sup>27</sup>



Scheme I.14. Synthesis of eburnamonine by Winterfeldt.<sup>26</sup>

The use of aminolactone **80** for the synthesis of (+/-) eburnamonine was first described by Wenkert *et al.* (Scheme I.15).<sup>28</sup> The intermediate **81** was obtained through a substitution reaction from **80** with tryptophyl bromide. Alternatively, **81** can also arise from bromide **82**. Prolonged acid treatment of the aminolactone intermediate **81** triggered the cyclization, leading directly to eburnamonine **62**. Alternative syntheses have also been described for the preparation of aminolactone **80**.<sup>29</sup>



Scheme I.15. Synthesis of eburnamonine by Wenkert *et al.*<sup>28</sup>

Among the shortest enantioselective synthesis of (-)-eburnamonine **62**, Fuji and co-workers used (*S*)-lactone **83** as a chiral precursor (Scheme I.16).<sup>30</sup> Condensation with tryptamine gave a diastereomeric mixture of lactams **84** and **85**. Lactam **84** can be epimerized into the required *cis*-

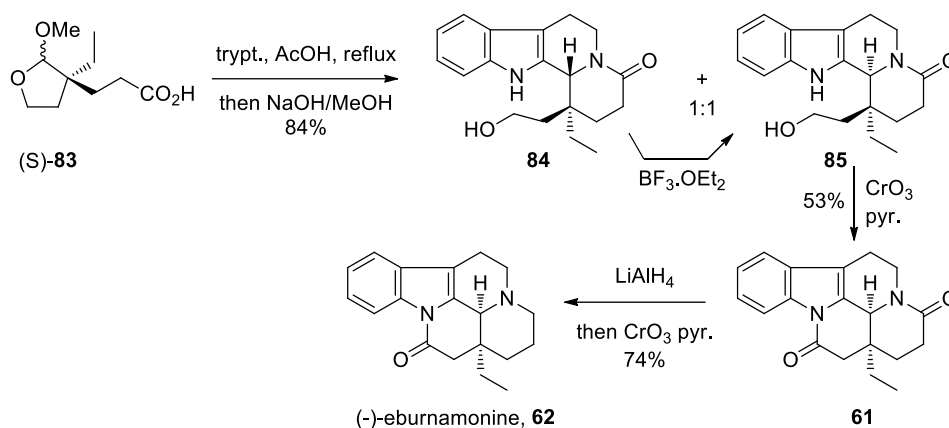
<sup>27</sup> K. Hakam, M. Thielmann, T. Thielmann, E. Winterfeldt, *Tetrahedron* **1987**, *43*, 2035-2044.

<sup>28</sup> E. Wenkert, T. Hudlicky, H. D. H. Showalter, *J. Am. Chem. Soc.* **1978**, *100*, 4893-4894.

<sup>29</sup> (a) K. Irie, M. Okita, T. Wakamatsu, Y. Ban, *Nouv. J. Chim.* **1980**, *4*, 275-277; (b) T. Imanishi, K. Miyashita, A. Nakai, M. Inoue, M. Hanaoka, *Chem. Pharm. Bull.* **1983**, *31*, 1191-1198; (c) T. Shono, Y. Matsumura, M. Ogaki, O. Onomura, *Chem. Lett.* **1987**, 1447-1450.

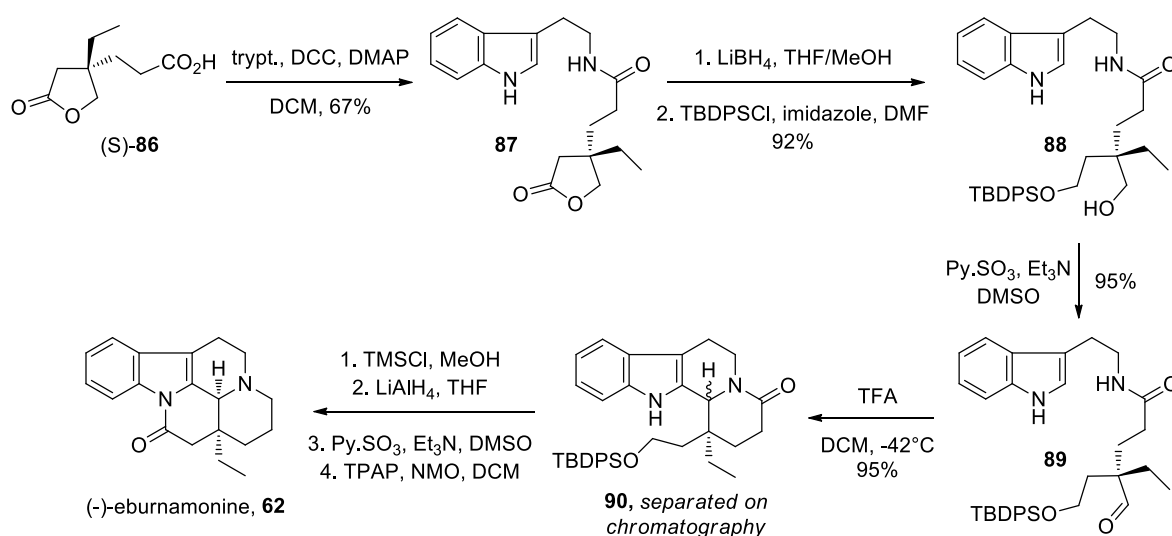
<sup>30</sup> M. Node, H. Nagasawa, K. Fuji, *J. Org. Chem.* **1990**, *55*, 517-521.

diastereoisomer **85**. Oxidation of the alcohol led to the diamide **61**, which was reduced as previously described to give (-)-eburnamonine **62**.



**Scheme I.16.** Enantioselective synthesis of (-)-eburnamonine by Fuji *et al.*<sup>30</sup>

In 2001, Wee *et al.* described the asymmetric synthesis of (-)-eburnamonine **62** starting from (*S*)-butyrolactone carboxylic acid **86** obtained by a Rh(II)-catalyzed tertiary C-H insertion reaction of a diazo compound (Scheme I.17).<sup>31</sup> This precursor strongly resembles to the one of Bartlett and Taylor (Scheme I.10). The carboxylic acid of **86** was coupled with tryptamine using DCC to afford the corresponding amide **87**. The lactone was then reduced into the diol and the less-hindered non-neopentyl alcohol was protected as a silyl ether **88**. Oxidation of the alcohol gave the aldehyde **89**, the latter being engaged in the Pictet-Spengler reaction under acidic conditions. The tetracyclic indole **90** was obtained in a 1:3 ratio ( $\alpha/\beta$ ) and the 2 diastereoisomers could be separated through column chromatography. Finally, (-)-eburnamonine **62** was reached after TBDPS deprotection, reduction of the amide and oxidation of the alcohol.



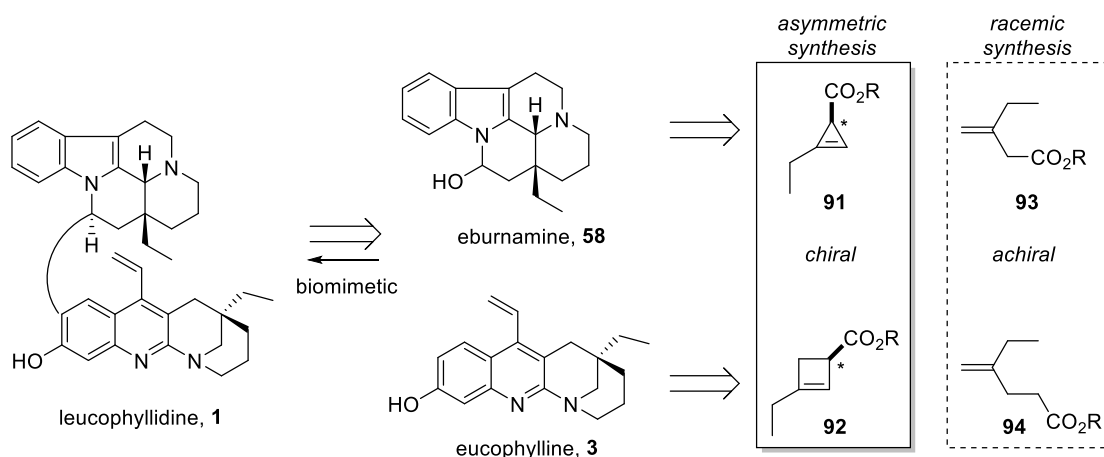
**Scheme I.17.** Enantioselective synthesis described by Wee.<sup>31</sup>

<sup>31</sup> A. G. H. Wee, Q. Yu, *J. Org. Chem.* **2001**, *66*, 8935-8943.

## 6. Initial retrosynthesis of leucophyllidine

Besides its biological activity, leucophyllidine is a quite complex molecule and represents a challenging target for the organic chemist. Among the four stereogenic centers in this natural product, two are all-carbon quaternary stereocenters. In addition to this complex molecular structure, the control of the stereoselectivity of these centers constitutes a second challenge. Finally, the synthesis of complex structures such as leucophyllidine requires the development of robust synthetic methodologies.

In order to study the biogenetic pathway of leucophyllidine **1**, our retrosynthetic analysis, depicted in Figure I.8, starts by a biomimetic coupling leading to two main sub-units of similar size: a north fragment, eburnamine **58** and a south fragment, the eucophylline **3** (or its methoxy analog which might be more reactive in the Mannich coupling). As previously discussed, the union between these two fragments was proposed to be a Mannich-type coupling.<sup>8</sup> The coupling should then occur under acidic conditions. Although this Mannich-type coupling was already studied by Pandey and co-workers,<sup>19</sup> the wrong regioisomer was obtained in very low yield. This suggests that a more complex mechanism is operating and that some efforts are still required to understand the mechanism of this dimerization. The study of this coupling could lead to novel synthetic drugs of biological interest by using other monoterpene indole alkaloids than eucophylline.

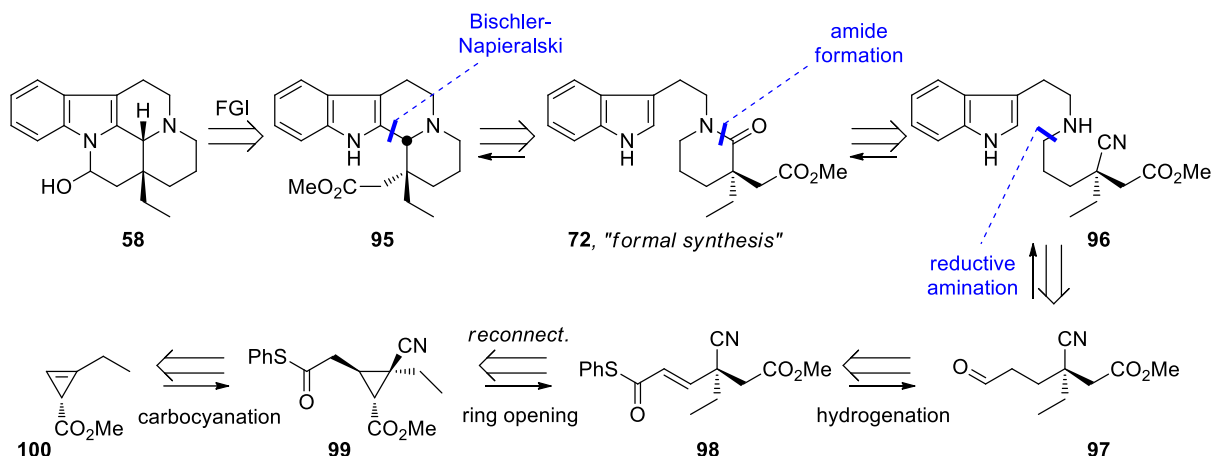


**Figure I.8.** Retrosynthesis of leucophyllidine.

In order to construct the eucophylline and the eburnan fragment in an enantioselective manner using a convergent approach, it was reasoned that small ring olefins such as chiral cyclopropene **91** and cyclobutene **92** would be appropriate starting building blocks. These precursors constitute chiral versions of simple olefins (**93** and **94**) and high stereoselectivities should be attained using radical processes (Figure I.8).

According to the introduction on the total syntheses of eburnamonine and eburnamine, the eburnan skeleton **58** could be attained by the following disconnections depicted in Figure I.9. After functional group transformations, the tetracyclic core of eburnan **95** could be obtained by a

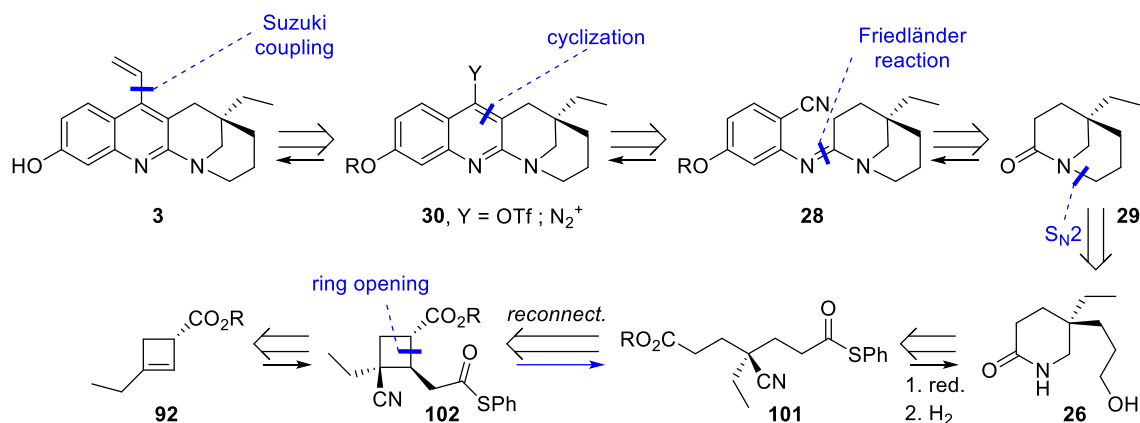
Bischler-Napieralski reaction from amide **72**. The latter being an intermediate in the Schlessinger's eburnamonine synthesis,<sup>25</sup> this approach would constitute a formal synthesis. Acid-mediated cyclization of amine **96** to the nitrile should afford the amide **72**. The amine **96** is the product of a reductive amination of aldehyde **97** with tryptamine. This aldehyde arises from the hydrogenation of the thioester **98**, which is formed after a radical carbo-cyanation of cyclopropene **100**, followed by a ring-opening reaction of the corresponding cyclopropane **99**. The carbo-cyanation of cyclopropenes has already been investigated by Dr. Nitin Dange using model compounds and will be briefly discussed in Chapter V.



**Figure I.9.** Retrosynthesis of eburnan skeleton.

For the retrosynthesis of eucophylline depicted in Figure I.10, the cyclopropene **100** is not an adequate precursor because a homologation reaction would be required later in the synthesis, which would definitely increase the number of steps. For that reason, the cyclobutene ring **92** is preferred. However, the enantioselective synthesis of such cyclobutene is not reported and the radical chemistry on cyclobutene rings is by far less studied as compared to the three-membered ring analogues. This retrosynthesis is thus highly challenging and some modifications will certainly be incorporated later.

The beginning of the retrosynthesis is based on the racemic total synthesis of eucophylline described by our group.<sup>18</sup> Disconnection of **3** relies on the late incorporation of the vinyl moiety through a Suzuki coupling from the corresponding triflate **30** or diazonium salt. A Friedländer-type annulation will furnish the tetracyclic structure of eucophylline from the bicyclic lactam **29** arising from a  $S_N2$  reaction after conversion of the alcohol **26** into a mesylate. The alcohol **26** results from the reduction of thioester **101** and hydrogenation of the nitrile. Reconnection of the acyclic substrate **101** gives the functionalized cyclobutane **102** which is the product of the carbocyanation of cyclobutene **92**.



**Figure I.10.** Retrosynthesis of eucophylline.

The enantioselective synthesis of eburnan was not considered as a priority considering the impressive published syntheses on this structure. However, some improvements were still accomplished on the racemic synthesis. In contrast, the racemic total synthesis of eucophylline being already developed by our group, the development of an enantioselective version was the principal objective of this work. To reach this goal, our efforts were focused on (i) the elaboration of an enantiopure cyclobutene (ii) the stereocontrolled functionalization of cyclobutene through radical processes and (iii) the development of an adequate cyclobutane ring-opening reaction. For the functionalization of cyclobutene, we also reasoned that the mild conditions of photocatalyzed radical processes might afford better stereoselectivities than classical radical chemistry.

This dissertation is composed of five chapters. The chapter II will introduce radical chemistry in which the radical species will be discussed regarding their structure, stability and reactivity. The recent developments of radical reactions and especially tin-free versions involving sulfonyl derivatives will be subsequently discussed. Then, the photoredox catalysis will be presented shortly and the activation of sulfonyl precursor will be discussed.

The chapter III will expose the results obtained during our efforts on the development of new radical traps and new tin-free radical methodologies required for the total synthesis of leucophyllidine.

The chapter IV will introduce the radical methodologies developed on a new cyclobutene motif and our different approaches used for the enantioselective total synthesis of eucophylline.

Finally, the chapter V will describe our efforts directed toward the racemic total synthesis of eburnan fragment.

# Chapter II

From classical radical chemistry to  
photoredox catalysis



## Chapter II : From classical radical chemistry to photoredox catalysis

### 1. Historical considerations about radical chemistry

The use of radical chemistry in organic synthesis is relatively new compared to the ionic chemistry.<sup>32</sup> The existence of radicals was considered as elusive by the scientists until 1900 and only a few chemists reported experiments involving radicals. By heating mercuric cyanide, Gay-Lussac described in 1815 the formation of cyanogen coming from the dimerization of cyanide radical.<sup>33</sup> Alkyl radicals were proposed by Kolbe and Frankland in 1849.<sup>34</sup> According to these authors, the decarboxylation of potassium acetate and the reaction of ethyl iodide with zinc gave methyl and ethyl radical respectively. The discovery of triphenylmethyl radical by Gomberg in 1900 has had a huge impact on the scientific community.<sup>35</sup> Upon treatment with zinc, triphenylmethyl chloride gave a yellow solution which was attributed to the stable and persistent triphenylmethyl radical. Reaction of the latter with oxygen gave the corresponding peroxide. The existence of this radical was confirmed ten years later by Schlenk and co-workers by the preparation of tris(4-biphenyl)methyl radical.<sup>36</sup> Then, radicals were considered as conceivable intermediates in chemistry, allowing the rationalization of so far abnormal reactions. Indeed, the anti-Markovnikov addition of HBr onto olefins was proposed by Kharasch to occur in a free-radical chain mechanism.<sup>37</sup> The production of plastics by free radical polymerisations was already developed before the World War II but the post-war period was characterized by a huge progress in this area. In the sixties, applications of radical chemistry in organic synthesis started to emerge (e.g. D.H.R. Barton).<sup>38</sup> This period was also characterized by the structural analysis of radicals by EPR. From 1990, intensive efforts on stereochemical approaches has been done by Curran, Porter and Giese and free radical chemistry has become a useful synthetic tool for the total synthesis of complex natural products.<sup>39,40</sup>

<sup>32</sup> T. T. Tidwell In *The history of free radical chemistry*, John Wiley & Sons Ltd.: 2012; pp 1-35.

<sup>33</sup> H. L. Gay-Lussac, *Ann. Chim.* **1815**, 95, 172.

<sup>34</sup> (a) H. Kolbe, *Justus Liebigs Ann. Chem.* **1849**, 69, 257-294; (b) E. Frankland, *Justus Liebigs Ann. Chem.* **1849**, 71, 171-213.

<sup>35</sup> M. Gomberg, *J. Amer. Chem. Soc.* **1900**, 22, 757-771.

<sup>36</sup> W. Schlenk, T. Weickel, A. Herzenstein, *Justus Liebigs Ann. Chem.* **1910**, 372, 1-20.

<sup>37</sup> M. S. Kharasch, H. Engelmann, F. R. Mayo, *J. Org. Chem.* **1937**, 2, 288-302.

<sup>38</sup> (a) D. H. R. Barton, D. Crich, W. B. Motherwell, *Tetrahedron* **1985**, 41, 3901-3924; (b) D. H. R. Barton, S. I. Parekh, *Half a Century of Free Radical Chemistry*, Cambridge University Press, Cambridge, **1993**.

<sup>39</sup> (a) N. A. Porter, B. Giese, D. P. Curran, *Acc. Chem. Res.* **1991**, 24, 296-304; (b) D. P. Curran, N. A. Porter, B. Giese, *Stereochemistry of radical reactions*, VCH Verlagsgesellschaft, Weinheim, **1996**.

<sup>40</sup> C. P. Jasperse, D. P. Curran, T. L. Fevig, *Chem. Rev.* **1991**, 91, 1237-1286.



## 2. Introduction to radical chemistry

A radical is a molecule or an ion that possesses an unpaired electron. They are generally highly reactive such that they are transient in opposition to triphenylmethyl radical which is stable and persistent. The notion of transience and persistence is related to the lifetime of radicals. Radicals used in organic synthesis are often transient radicals and are characterized by a half-life below 0.001 second ( $t_{1/2} > 10^{-3}$ s for persistent radicals).<sup>41</sup> Due to the high reactivity of these species, they react rapidly with any neutral organic molecules but also between them at the diffusion-controlled limit. To avoid this radical/radical reaction (known as termination), typical conditions are used. A weak concentration of the radicals in the medium avoids the termination reaction. In contrast, the radical/neutral substrate reaction is more favoured due to the highest concentration of the neutral substrate. These reactions give rise to a new product through chain or non-chain radical processes.

The great advantages of radical chemistry are mild reaction conditions and high functional groups tolerance. Indeed, a radical reaction does not need in most cases protecting groups, such as ketone or even alcohol, typically detrimental in ionic reactions. This does not mean that they are not required in a multistep synthesis. Precautions have to be taken however with the solvent and oxygen (biradical species). Indeed, although the concentration of the radical species is too low to favour the radical/radical reaction, the radical/solvent reaction (basically hydrogen abstraction) might compete with the radical/substrate reaction due to the huge concentration of the solvent. The selection of an adequate solvent will then avoid a competition with the substrate. For that reason, solvents such as benzene, *tert*-butyl benzene, dichlorobenzene or *tert*-butanol are preferred because they are not prone to hydrogen abstraction. These solvents will be used for slow radical/substrate reactions. Others solvents like dichloro-methane (DCM) and -ethane (DCE), acetonitrile and even water are also good candidates. Radical chemistry is not sensitive to water because the O-H bond is very strong. The use of perfectly dry solvents is then not compulsory. Apart from solvent effect, the temperature is another parameter to consider. As in many reactions, lower is the temperature, higher is the stereoselectivity of the radical reaction. However, at low temperatures, the rate of the radical reaction decreases and the radical chains become shorter. This can be counterbalanced by adding higher amount of initiator to restart the radical chain.<sup>42</sup> At this point, it is worth mentioning that photoredox catalysis allows the smooth generation of radical intermediates under very mild conditions and its impact on the development of stereoselective radical reactions is obvious, explaining his current blooming.

---

<sup>41</sup> D. Griller, K. U. Ingold, *Acc. Chem. Res.* **1976**, 9, 13-19.

<sup>42</sup> D. P. Curran, N. A. Porter, B. Giese, *Stereochemistry of radical reactions*, VCH Verlagsgesellschaft, Weinheim, **1996**, p3-4.

## 2.1. Radical initiation

Radicals are formed through the homolytic cleavage of a covalent bond, called homolysis. For obvious reasons, this bond must be weak enough (BDE = 25-50 kcal/mol) to ensure the formation of radicals. The appropriate bonds are usually heteroatom-heteroatom bonds or carbon-heteroatom bonds. A list of typical bond dissociation energies is furnished in Table II.1. The homolysis of a carbon-carbon bond is not really adequate for the formation of radicals due to the high bond dissociation energy of this bond but can happen. In contrast, bonds like oxygen-oxygen are weaker (*e.g.* *t*BuO-*Ot*Bu) and are prone to homolysis by increasing the temperature (thermolysis). Such compounds, called peroxides, constitute a class of radical initiators.<sup>43</sup>

Single bonds	BDE (kcal.mol <sup>-1</sup> )
CH <sub>3</sub> -H	105
CH <sub>3</sub> -CH <sub>3</sub>	90.2
(CH <sub>3</sub> ) <sub>2</sub> CH-I	56.1
PhS-SPh	51.2
<i>t</i> BuO- <i>Ot</i> Bu	38.2
(PhCO <sub>2</sub> ) <sub>2</sub>	30
Sn-Sn	46.6

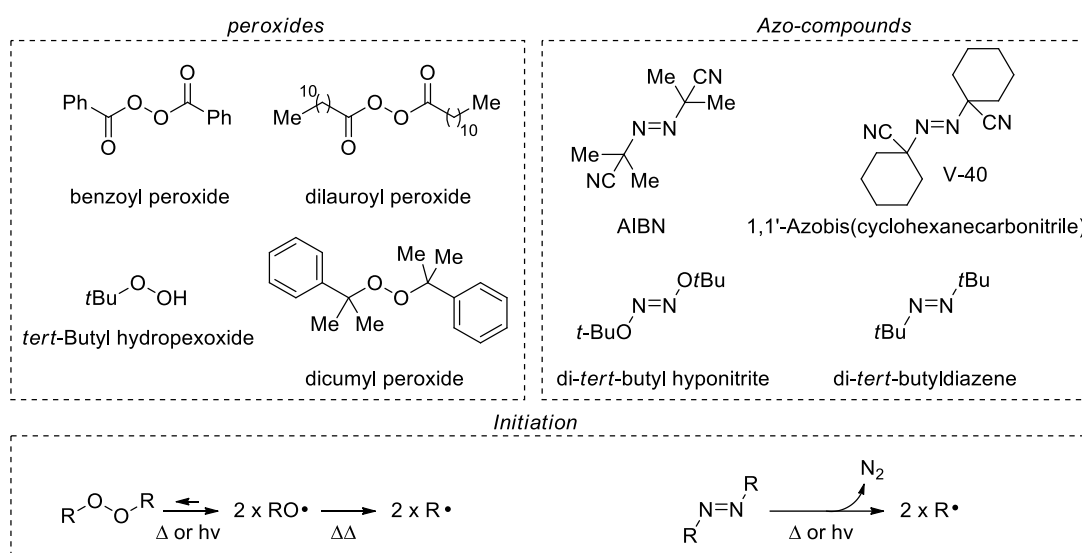
**Table II.1.** List of typical bond dissociation energies.<sup>44</sup>

A radical initiator is defined as a compound that forms free radical under mild reaction conditions and is therefore an unstable compound. The decomposition of the initiator is triggered by thermolysis (application of heat) or photolysis (irradiation by light). In photolysis, the irradiation by light (UV) induces an excited state from which the bond dissociation is easier. Redox reactions can also lead to the formation of radicals but this will be discussed in the photoredox catalysis section. For practical reasons, the initiator should be stable at room temperature but should fragment at slightly higher temperature to generate the targeted radical. In order to keep mild conditions (T<150°C), the initiators should possess a bond dissociation energy below 40 kcal/mol. The Figure II.1 described examples of common initiators used in radical chemistry. Most of them are commercially available. The most popular are peroxides and azo-compounds. The peroxides possess a BDE around 35-50 kcal/mol and produce oxygen-centered radicals which can fragment leading to carbon-centered radicals. For diacyl peroxide, the formation of the alkoxy radical is easier because the BDE is lower due to the stabilisation of the radical by resonance (the unpaired electron is delocalized on two oxygen atoms). Decarboxylation occurs to give the carbon-

<sup>43</sup> J. Lalevee and J. P. Fouassier In *Overview of Radical Initiation*, John Wiley & Sons Ltd., **2012**, pp. 37-55.

<sup>44</sup> E. T. Denisov, T. G. Denisova, and T. S. Pokidova, *Handbook of Free Radical Initiators*, John Wiley & Sons, Inc, Hoboken, NJ, **2003**.

centered radical. For peroxides such as dicumyl and *tert*-butyl peroxide, the fragmentation of the alkoxy radical may occur at higher temperatures to give the corresponding ketone and the methyl radical. The decomposition of azo-compounds is realized through thermolysis or photolysis leading to carbon-centered radicals and molecular nitrogen. The ease of this decomposition depends once again on the stabilisation of the formed radical. Alkyl groups bearing electron withdrawing groups (*e.g.* -CN) will favour the fragmentation. Azobisisobutyronitrile (AIBN) and 1,1'-Azobis(cyclohexanecarbonitrile) (V-40) are used under relatively mild conditions. In contrast, di-*tert*-butyldiazene is not a good thermal initiator but decomposes very efficiently under photolysis. Finally, DTBHN is a very unstable initiator and has to be stored in the freezer because it starts to decompose at room temperature. Other initiation systems such as disulfides, *N*-hydroxypyridine-2-thione, benzophenone and triethylborane are also very often used in radical chemistry. Triethylborane decomposes under an oxygen atmosphere to give ethyl radicals. Such system is particularly interesting because it tolerates low temperatures (-78°C), high stereoselectivities being then accessible<sup>43</sup> and can be used in water.



**Figure II.1.** Common radical initiators.

The selection of an appropriate initiator is crucial for a radical reaction. The production of radical has to be controlled to allow for a clean radical reaction. The half-life temperature and the decomposition rate are two important parameters to consider in the selection of an initiator. The half-life temperature gives the range of application of the initiator and some of them are given in Table II.2. This Table shows the ease of an initiator to decompose and the temperature regime in which it has to be used. Higher temperatures are required for the decomposition of peroxide compared to acyl peroxides and azo-compounds.

Initiators	<i>T</i> for 10h half-life (°C)
2,2'-Azobisisobutyronitrile	65
1,1'-Azobis(cyclohexanecarbonitrile)	88
Lauroyl peroxide	65
Benzoyl peroxide	70
Dicumyl peroxide	115
<i>tert</i> -Butyl peroxide	125
<i>tert</i> -Butyl hydroperoxide	170

**Table II.2.** Ten hours half-life temperatures for commercial initiators (in benzene for peroxides and in toluene for azo-compounds).<sup>45</sup>

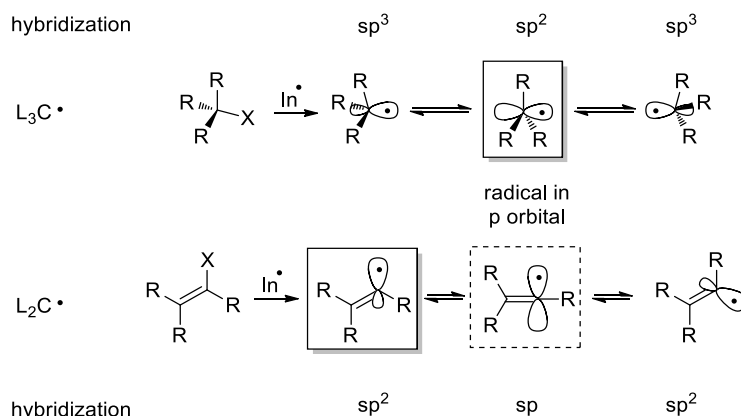
Once radicals are formed through thermolysis or photolysis, atom abstraction or group fragmentation (*e.g.* xanthate) can lead to a new carbon-centered radical which enters into the propagation cycle.

## 2.2. Structure and stability of radicals

The understanding of the structure of radicals is important to predict their behaviour. The structure of carbon-based radicals is in sharp contrast to carbocations. Most of the trivalent carbon-based radical ( $L_3C\bullet$ ) have a planar geometry and are located in a p orbital (Figure II.2). The initial pyramidal geometry ( $sp^3$  hybridized) is lost and the carbon adopts a  $sp^2$  hybridization. This means that the stereochemical information of a radical precursor is usually lost after initiation and that the radical transformations are not stereospecific. Most trivalent carbon-centered radicals are subjected to racemisation due to a tiny barrier of inversion. However, depending on the steric hindrance and the electronic character of the substituent, pyramidalization of the radical may occur because the barrier of inversion slightly increases. In constrained system, the radical can adopt a pyramidal geometry because it has no choice to be  $sp^3$  hybridized. This is the case for adamant-1-yl and cyclopropyl radicals which are conformationally blocked systems. In opposition, cyclohexyl, cyclopentyl and cyclobutyl radicals are almost planar. If electron-donating groups are present  $\alpha$  to the radical, pyramidalization can also occur. For instance, the trifluoromethyl radical is pyramidalized because it is an electronically perturbed system. These remain exceptions and most of the alkyl radicals do not maintain the initial configuration of the stereocenter. For divalent radicals (*e.g.* aryl, alkenyl and acyl radicals), the radical is located in a  $sp^2$  orbital. The inversion

<sup>45</sup> (a) J. Brandrup, E. H. Immergut, and E. A. Grulke, eds., *Polymer Handbook*, 4th edn, John Wiley & Sons, Inc, New York, **1999**, vol. 4, pp. II/2–69; (b) K. Matyjaszewski and T. P. Davis, eds., *Handbook of Radical Polymerization*, John Wiley & Sons, Inc, Hoboken, NJ, **2002**.

of this radical is possible except for cyclic substrates. In general, any electron withdrawing group will favour the inversion due to the radical delocalisation.<sup>46</sup>

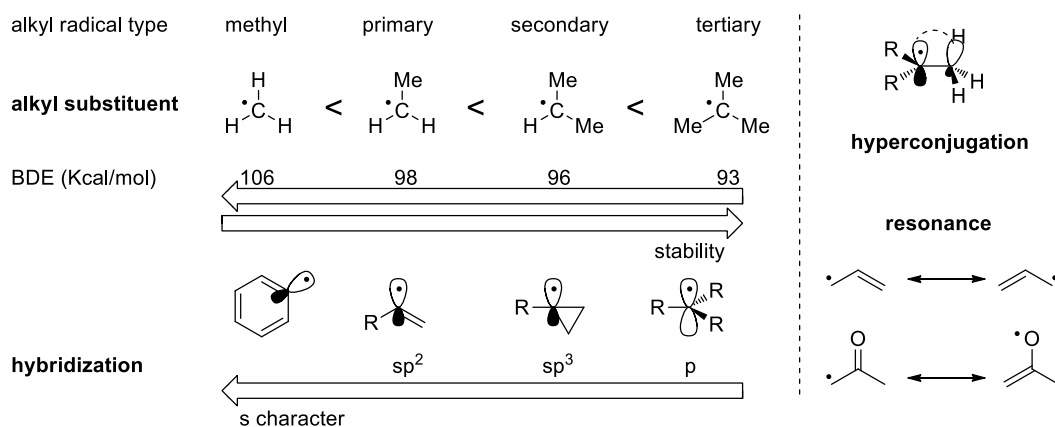


**Figure II.2.** Structure of radicals.<sup>46</sup>

The stability of radicals depends on the following parameters: electronic inductive effect, hyperconjugation, hybridization and resonance (Figure II.3). Concerning the alkyl radicals, the stability follows this trend: Me < Et < *i*-Pr < *t*-Bu (primary < secondary < tertiary). This is the same trend than carbocations: the more substituted by alkyl groups, the more stable the radical is, due to the donor inductive effect. Tertiary radicals are also more stable because they benefit from a hyperconjugation effect corresponding to the overlap of the 2p orbital, in which resides the unpaired electron, with the  $\sigma$  orbital of C-H bonds. The hyperconjugation makes tertiary radicals slightly more pyramidal. Usually, the dissociation energy of the corresponding R-H molecule gives an idea of the stability of the radical. The weaker the BDE, the more stable the radical is.<sup>15</sup>

The radical can also be stabilized by resonance. For instance, allylic or benzylic radicals are stable due to delocalisation in the adjacent  $\pi$  bond (Figure II.3). The stability of the radical also depends on the hybridization. The localisation of a radical in a  $sp^2$  orbital (having high s character) is more unstable than a radical in a p orbital. The s character of the aryl and alkenyl radical make them very unstable and very reactive (Figure II.3).

<sup>46</sup> M. S. Sherburn In *Basic Concepts on Radical Chain Reactions*, John Wiley & Sons Ltd., **2012**, pp. 1-23.



**Figure II.3.** Stability of radicals.<sup>46</sup>

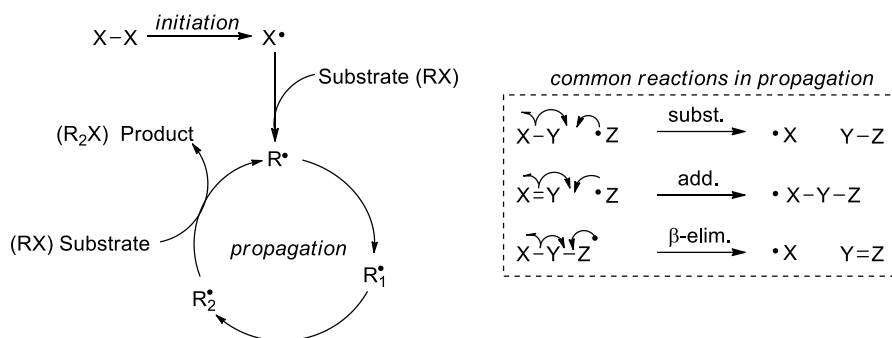
A last parameter to consider for the stability of a radical is the steric hindrance. The steric hindrance will have a strong influence on the reaction rate of a radical (“kinetic stability”). Very hindered radicals can become long-lived radicals (Gomberg’s triphenyl radical). They are also called persistent radicals because they do not react through recombination.<sup>46</sup>

### 2.3. Reactivity of radicals

As mentioned in the introduction, radicals used in organic chemistry are transient. They react with another radical at a rate close to the diffusion-controlled limit. Such radical-radical reactions are not selective. Radical transformations became selective with the development of chain reactions. The mechanism of a typical chain radical reaction is depicted in Figure II.4. The initiation generates few radicals (see radical initiation). These radicals transform the substrate into a new radical which enters into the propagation cycle. In the propagation stage, the radical structure increases in complexity ( $R\cdot \rightarrow R_2\cdot$ ). At one point, the formation of the product causes the generation of a new radical R which allows the propagation of the radical chain. Any radical-radical reaction is called termination and is undesirable because the radical chain is stopped. In order to avoid these termination events, low concentrations of radical are required and thus small quantities of initiator are used. Stoichiometric radical systems (non-chain processes) also exist (reduction with  $SmI_2$ ).<sup>46</sup>

The majority of radical chain reactions operates following these three events: initiation, propagation and termination. The three most important elementary steps in the propagation stage are: radical substitution, addition and  $\beta$ -elimination (Figure II.4). They are characterized by the formation of a new bond with the concomitant generation of a new radical. Most of the radical substitution reactions occur at the halogen of a C-X bond or at a hydrogen of C-H bond and these reactions are called  $S_H2$  (substitution, homolytic, bimolecular). The addition of a radical to a double bond is a thermodynamically favoured process because a new  $\sigma$  bond is formed at the

expense of a weaker  $\pi$ -bond. The reverse reaction is called the  $\beta$ -elimination. These two reactions are in equilibrium and the displacement of this equilibrium is related to the stability of the species.



The reactivity of a radical in a reaction is measured by the kinetic constant and is strongly influenced by energetic, structural and orbital factors. The Arrhenius equation links the rate constant ( $k$ ) to the activation energy ( $E_a$ ) and is described by Equation 2.1.

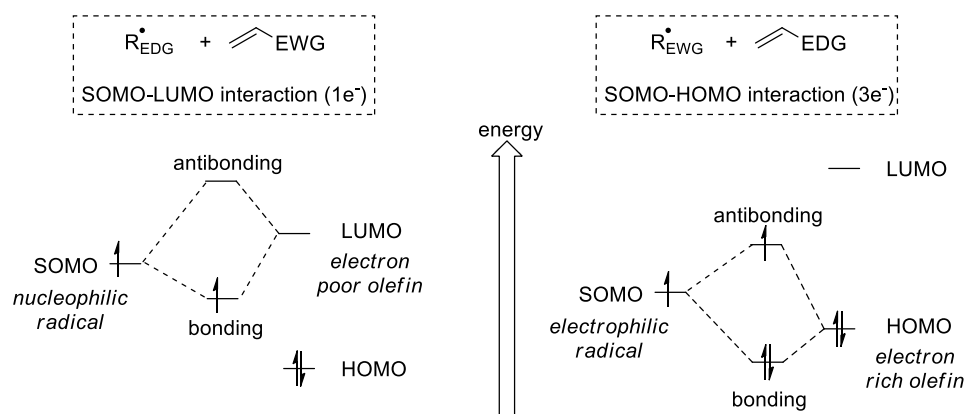
$$k = A \exp \frac{-E_a}{RT} \quad (2.1)$$

where  $A$  is a pre-exponential factor,  $T$  is the temperature (K) and  $R$  is the universal gas constant.

From an energetic point of view, radical additions on unsaturated systems are usually exothermic and their activation energy are usually low (early transition states). The radical additions are then under kinetic control (for a carbon radical). According to the Hammond postulate and the Bell-Evans-Polanyi principle (rate of a reaction is affected by the enthalpy), the more exothermic a reaction is, the lower the activation energy is and thus the closer the structure of the transition state to the reactant.

Another important criterion to consider for the reactivity of a radical is the matching of polarity between the radical and its partner. Indeed, the transition state of a radical reaction can be described by some limit forms involving partial charges. Complementary polarities will enhance the reactivity. In a radical addition reaction, an electrophilic radical will react faster with an electron rich alkene whereas a nucleophilic radical will react faster with an electron deficient alkene (polarity matched). The reverse reaction profile (polarity mismatched) leads to slow kinetics. The consideration of the frontier molecular orbitals (FMO) is helpful to explain this phenomenon (Figure II.5). Let's consider the reaction of a carbon-centered radical with the  $\pi$ -system of an alkene. The SOMO (single occupied molecular orbital) of the radical possesses an energy between the HOMO (highest occupied molecular orbital) and the LUMO (lowest unoccupied molecular orbital) of the alkene. With a nucleophilic radical (higher SOMO) and an electron poor alkene (lower LUMO), the SOMO-LUMO interaction prevails because they are close in energy. In contrast, with an electrophilic radical and an electron rich alkene, the SOMO-

HOMO interaction dominates. In both cases, the interaction results in a gain of energy. The concept of polarity is also explained in the section of radical reaction (see below).

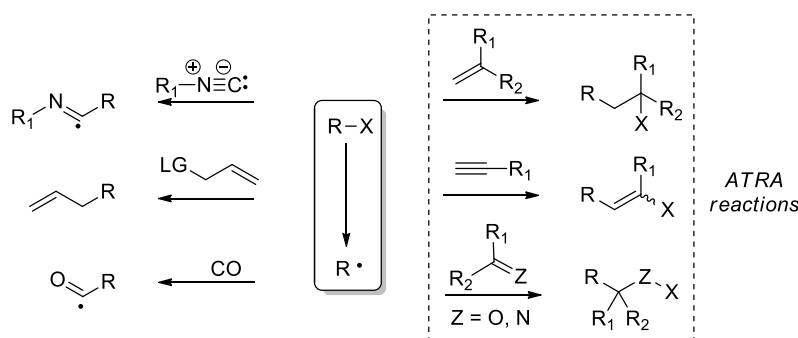


**Figure II.5.** Polar effect explained by FMO considerations.

## 2.4. Radical reactions

### 2.4.1. Radical additions on unsaturated systems

Scheme II.1 illustrates free-radical additions onto different unsaturated substrates (carbon-carbon or carbon-heteroatom multiple bonds). Appropriate substrates are alkenes, alkynes, carbon monoxide, isonitriles, allyl groups, ketones, imines, oximes etc. Among them, the atom transfer radical addition reactions (ATRA) have been widely used.<sup>47</sup>



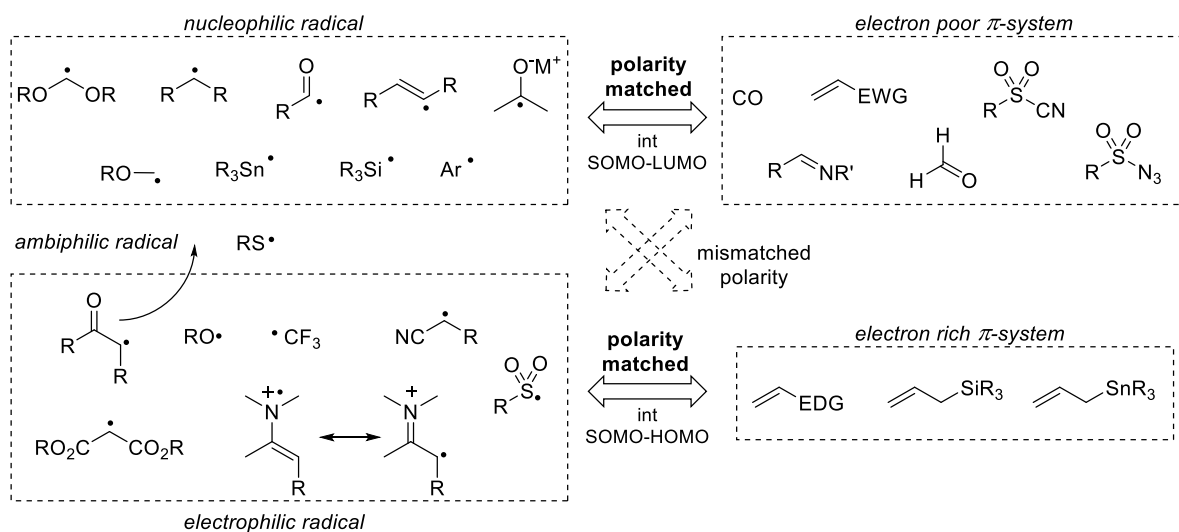
**Scheme II.1.** Radical additions on different unsaturated systems.<sup>47</sup>

The polar effect allows predicting which radical reactions will be favoured. Concerning radical additions, Figure II.6 describes some nucleophilic/electrophilic radicals and their electron poor/rich  $\pi$ -system partners. The matching of the polarity involves a faster reaction. However, this does not mean that the reaction between a nucleophilic radical and an electron rich olefin is not

<sup>47</sup> H. Subramanian, Y. Landais and M. P. Sibi *Radical Addition Reactions*. In: Gary A. Molander and Paul Knochel (eds.), *Comprehensive Organic Synthesis*, 2nd edition, Vol 4, Oxford: Elsevier; **2014**. pp. 699-741.

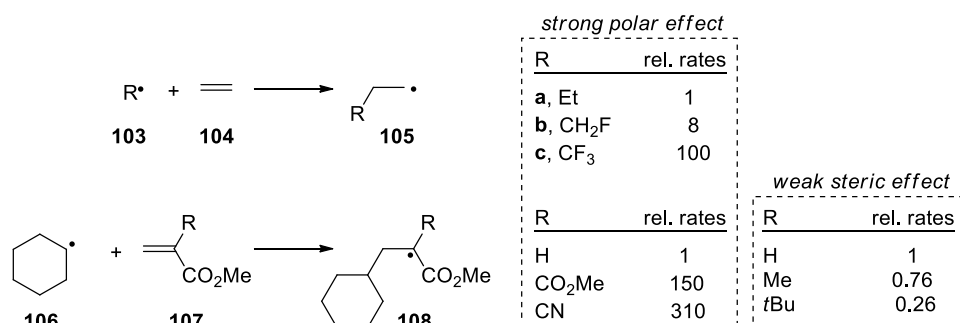


possible. It will occur but at a slower rate.<sup>48</sup> The consideration of the polar effect is of particular interest in the design of a chemoselective radical reaction.



**Figure II.6.** Matching of the polarity between radical species and unsaturated systems.<sup>48</sup>

As an illustration, Figure II.7 describes two opposite cases. The first one shows that trifluoromethyl radical **103c** (electrophilic radical) reacts 100-fold faster with ethylene **104** (electron rich alkene) compared to ethyl radical **103a** (nucleophilic radical).<sup>49</sup> The second example displays the addition of a cyclohexyl radical **106** to an acrylate moiety **107**.<sup>50</sup> A huge enhancement of the reaction rate is observed when a nitrile is placed instead of a hydrogen. This substrate modification increases the electrophilicity by lowering the LUMO orbital. Concerning the steric hindrance, it has only a minor consequence on the reaction rate. However, it has a strong influence on the regioselectivity. The radical addition reactions occur at the less-hindered position and are therefore regioselective.



**Figure II.7.** Relative rates of radical additions to unsaturated systems.<sup>49,50</sup>

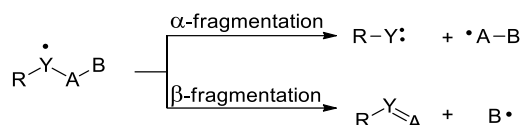
<sup>48</sup> E. Godineau, Y. Landais, *Chem. Eur. J.* **2009**, *15*, 3044-3055.

<sup>49</sup> J. M. Tedder, J. C. Walton, *Acc. Chem. Res.* **1976**, *9*, 183-191.

<sup>50</sup> B. Giese, *Ang. Chem. Int. Ed.* **1983**, *22*, 753-764.

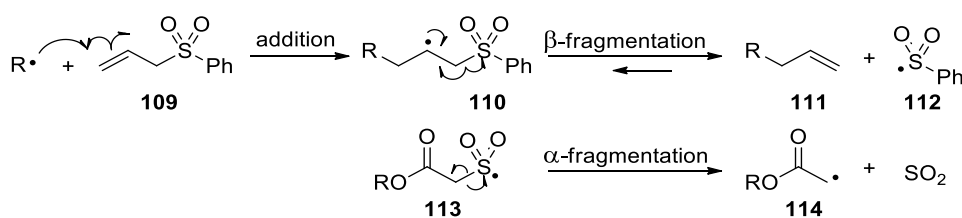
### 2.4.2. Radical fragmentations

The radical fragmentation reaction is the reverse reaction of an addition reaction. The  $\alpha$ - and  $\beta$ -fragmentation are described in Scheme II.2. They are usually endothermic and the increase of entropy is the driving force for these reactions. In order to favour a  $\beta$ -fragmentation, a strong  $\pi$ -bond has to be formed and a weak  $\sigma$ -bond has to be broken (in opposition with the radical addition reactions). The weak  $\sigma$ -bonds typically involved in  $\beta$ -fragmentation are carbon-heteroatom bonds such as C-SR, C-SO<sub>2</sub>R, C-Br, C-I and C-SnR<sub>3</sub>.<sup>51</sup>



**Scheme II.2.** Radical fragmentation reactions.

Scheme II.3 describes two examples of these types of fragmentation. In the case of a  $\beta$ -fragmentation, the weak C-SO<sub>2</sub> bond favours the fragmentation of **110** but it may be reversible. In the second case, the  $\alpha$ -fragmentation (also called  $\alpha$ -scission) is irreversible because gaseous SO<sub>2</sub> and a new stable radical **114** are formed. The liberation of a gas (SO<sub>2</sub>) increases the entropy.



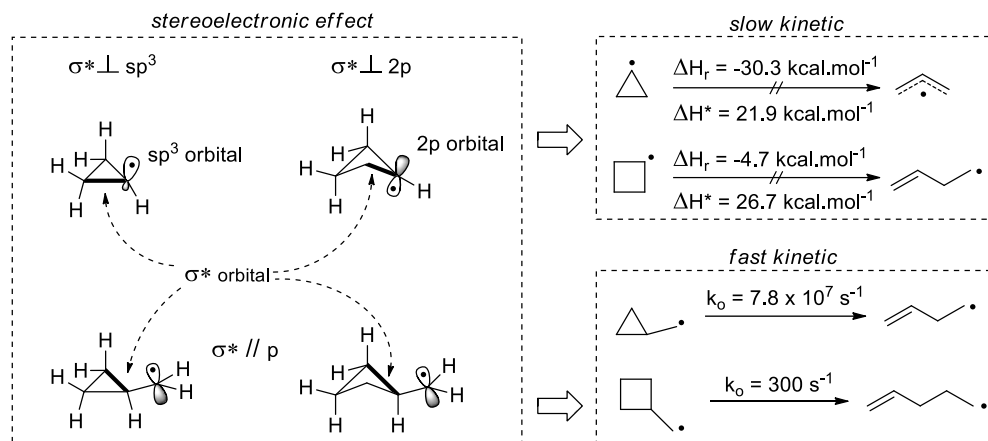
**Scheme II.3.** Examples of  $\alpha$ - and  $\beta$ -fragmentations.

### 2.4.3. Radical ring-opening reactions

Ring-opening reactions correspond to an intramolecular  $\beta$ -fragmentation. These reactions are explained by the ring strain, the stereoelectronic effects and the stability of the formed radical. The ring-opening reactions of small ring systems, like cyclopropanes and cyclobutanes, are generally exothermic because ring strain is released during the reaction. The stereoelectronic effects can explain why the ring-opening reaction of a cyclopropyl or cyclobutyl radical is a very slow process whereas the ring-opening reaction of cyclopropylmethyl or cyclobutylmethyl radical is by far much faster (Figure II.8). Even though the ring-opening reaction of a cyclopropyl or a cyclobutyl radical is thermodynamically favoured, the reaction does not happen because the

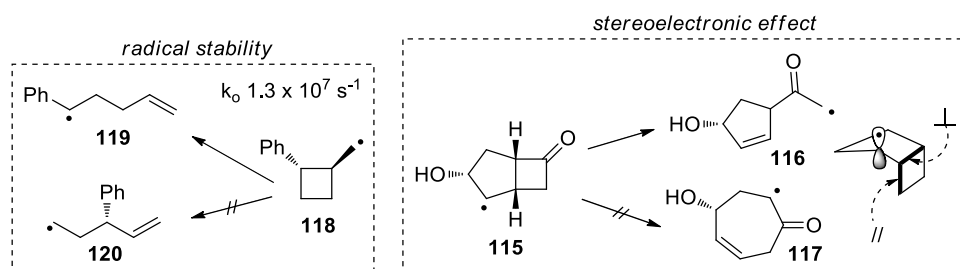
<sup>51</sup> M. P. Bertrand, C. Ferreri, Sulfur-Centered Radicals. In *Radicals in Organic Synthesis*. Wiley-VCH Verlag GmbH, 2001, pp. 485-504.

activation energy is too high.<sup>52</sup> The orbital bearing the radical is perpendicular to the  $\sigma^*$  anti-bonding orbital. On the opposite, for the cyclopropyl- or cyclobutylmethyl radical, the p orbital is parallel to the  $\sigma^*$  anti-bonding orbital. Only small activation energy is required to allow this transformation. In addition, the rate constant for the ring-opening reaction is higher for the cyclopropane than for the cyclobutane ring.<sup>53,54</sup>



**Figure II.8.** Stereoelectronic considerations for the ring-opening of small ring systems (rate constant at 20°C).<sup>53,54</sup>

Stereoelectronic considerations are also useful to predict the selectivity of a ring-opening reaction (Scheme II.4, right). For instance, the ring-opening reaction of bicyclo[3.2.0]heptane **115** did not give the ring expansion to **117** because the  $\sigma$  bond ( $\sigma^*$  orbital) is perpendicular to the p orbital of the radical.<sup>55</sup> When stereoelectronic effects are not critical, then the stability of the formed radical becomes the principal factor for the selectivity. For instance, the ring-opening reaction of cyclobutylbenzene methyl radical **118** occurs towards the more stable benzylic radical **119** (Scheme II.4, left).<sup>54</sup>



**Scheme II.4.** Examples of ring-opening reactions.<sup>54,55</sup>

<sup>52</sup> (a) B. Sirjean, P.-A. Glaude, M. F. Ruiz-Lopez, R. Fournet, *Journal of Physical Chemistry A* **2008**, *112*, 11598-11610; (b) S. Olivella, A. Sole, J. M. Bofill, *J. Am. Chem. Soc.* **1990**, *112*, 2160-2167; (c) A. S. Gordon, S. R. Smith, C. M. Drew, *J. Chem. Phys.* **1962**, *36*, 824-829.

<sup>53</sup> (a) K. U. Ingold, B. Maillard, J. C. Walton, *J. Chem. Soc., Perkin Trans. 2* **1981**, 970-974; (b) M. Newcomb, A. G. Glenn, *J. Am. Chem. Soc.* **1989**, *111*, 275-277; (c) J. C. Walton, *J. Chem. Soc., Perkin Trans. 2* **1989**, 173-177.

<sup>54</sup> M. Newcomb In *Radical Kinetics and Clocks*, John Wiley & Sons Ltd., **2012**, pp. 9.

<sup>55</sup> D. C. Horwell, A. I. Morrell, E. Roberts, *Tetrahedron Letters* **1995**, *36*, 459-460.

Finally, the stability of the formed radical has also an influence on the rate of the ring opening reaction. The more stable the radical is, the faster the reaction. Table II.3 shows this trend and displays a list of kinetic constants for the ring-opening of substituted cyclopropanes **121**.<sup>56</sup>

X	$k$ (s <sup>-1</sup> )	X	$k$ (s <sup>-1</sup> )
H	$7 \times 10^7$	CO <sub>2</sub> Et	$7 \times 10^{10}$
Me	$1 \times 10^8$	Ph	$1.5 \times 10^{11}$
OMe	$1 \times 10^9$		

**Table II.3.** List of kinetic constants for the ring-opening reaction of cyclopropylcarbiny radicals.<sup>56</sup>

## 2.5. Tin-mediated radical chain reactions

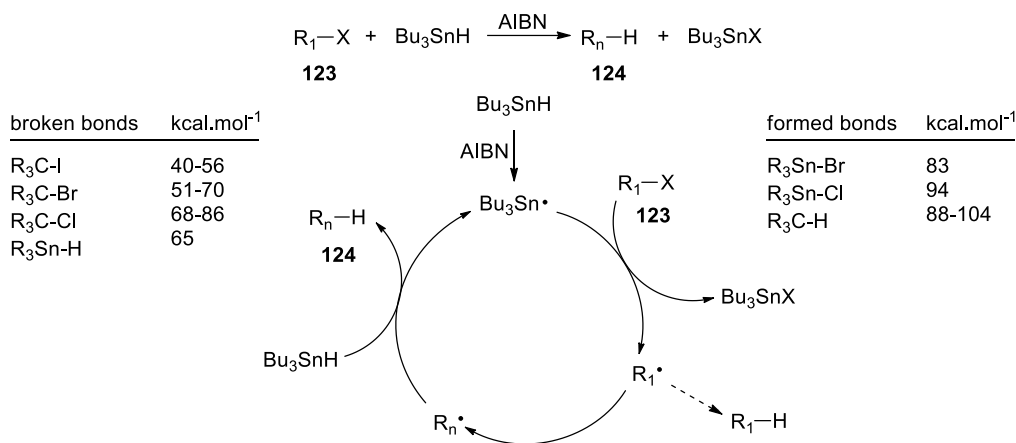
As explained before, the use of radical initiators is required to produce radicals that enter into the propagation cycle. Even if the initiator is added in a sub-stoichiometric amount, this is not a catalyst because its degradation is irreversible. Some reactions do not need an additional reagent for a complete conversion of the precursor into the product. However, many reactions need an additional reagent called a radical mediator. A mediator is a reagent involved in the conversion of the reagent by sustaining the radical chain. The most popular mediators were so far tri-*n*-butyltin hydride and bis(tri-*n*-butyltin). Some representative radical chain reactions employing tin as radical mediator are described below.

### 2.5.1. Hydrogen transfer reactions

Tri-*n*-butyltin hydride (*n*-Bu<sub>3</sub>SnH) has been widely used in hydrogen transfer reactions. A typical reductive dehalogenation and its mechanism are depicted in Figure II.10. Regarding the bond dissociation energies of the broken and formed bonds, this reaction is thermodynamically favoured. Upon initiation, the hydrogen abstraction of *n*-Bu<sub>3</sub>SnH lead to tributyltin radical. The latter enters into the propagation cycle and abstracts the halogen of **123** generating a carbon-centered radical R<sub>1</sub>. This radical can be directly reduced by *n*-Bu<sub>3</sub>SnH or can be transformed to another radical R<sub>n</sub>, which is then subjected to the hydrogen transfer reaction leading to alkane **124**. A new tributyltin radical is formed which sustains the radical chain. The organohalides **123** are

<sup>56</sup> M. Newcomb In *Radical Kinetics and Clocks*, John Wiley & Sons Ltd., **2012**, pp. 16.

not the only compatible precursors in this reaction. Phenylsulfides or selenides are also good candidates. Finally, the alcohols and carboxylic acids can also serve as precursors and can be reduced indirectly via their thionocarbonyl and thiohydroxamate derivatives respectively. These reactions correspond to the famous Barton-McCombie deoxygenation and Barton decarboxylation.<sup>57</sup>



**Figure II.10.** Typical hydrogen transfer reactions and mechanism with Bu<sub>3</sub>SnH.

For toxicity reasons, alternatives to stannanes have been proposed, including silanes (and amongst them tris(trimethylsilyl)silane (TTMSH),<sup>58</sup> one of the most successful reagent), germanes and boranes. Table II.4 compares the ability of stannanes and silanes in a hydrogen transfer reaction regarding the bond dissociation energies. Triphenyltin hydride and diphenyltin dihydride are among the most reactive stannanes. For silanes, the halogen abstraction is faster for silyl radicals but the hydrogen transfer is limited due to the stronger Si-H bond. For this reason, triethylsilane is not a good hydrogen donor in radical chemistry because the hydrogen transfer reaction is slow. However, the TTMSH possesses a sufficiently weak Si-H bond and has shown a broad application in hydrogen atom transfer reactions.<sup>59</sup>

Stannanes	BDE (kcal.mol <sup>-1</sup> )	silane	BDE (kcal.mol <sup>-1</sup> )
<i>n</i> -Bu <sub>3</sub> Sn-H	74	Et <sub>3</sub> Si-H	95
Me <sub>3</sub> Sn-H	77	Ph <sub>2</sub> Si-H <sub>2</sub>	90
Ph <sub>3</sub> Sn-H	70	TTMS-H	84

**Table II.4.** Bond dissociation energies of some hydrogen donor.<sup>60</sup>

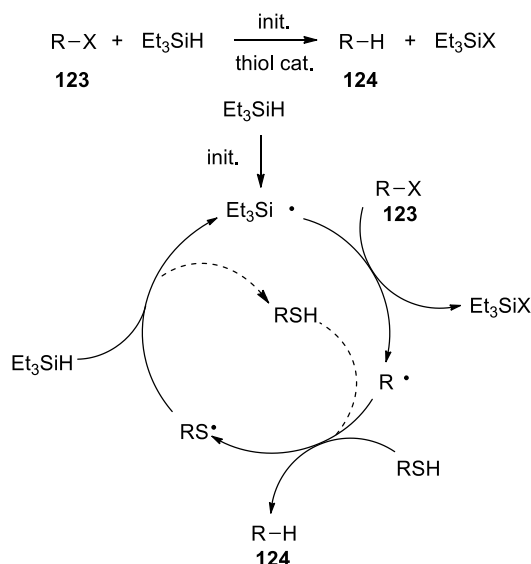
<sup>57</sup> (a) D. H. R. Barton, S. W. McCombie, *J. Chem. Soc., Perkin Trans. 1* **1975**, 1574-1585; (b) D. H. R. Barton, D. Crich, W. B. Motherwell, *J. Chem. Soc., Chem. Commun.* **1983**, 939-941.

<sup>58</sup> C. Chatgililoglu, C. Ferreri, Y. Landais, V. I. Timokhin, *Chem. Rev.* **2018**, *118*, 6516-6572.

<sup>59</sup> C. Chatgililoglu, J. Lalevée, *Molecules* **2012**, *17*, 527.

<sup>60</sup> Y. R. Luo, *Comprehensive Handbook of Chemical Bond Energies*, CRC Press, Boca Raton, FL, **2007**.

In order to apply  $\text{Et}_3\text{SiH}$  in radical chemistry (and avoid the expensive TTMSH), Roberts and co-workers developed the polarity reversal catalysis.<sup>61</sup> Silanes being electron rich hydrogen donors, the reduction of a nucleophilic alkyl radical is not favoured due to a mismatched polarity. The addition of a catalytic amount of thiol, acting as a protic polarity reversal catalyst, enjoyed the benefit from favourable polar effects. The slow reaction of the carbon-centered radical with  $\text{Et}_3\text{SiH}$  is thus replaced by two fast reactions (Figure II.11).



**Figure II.11.** Mechanism of the polarity reversal catalysis.<sup>46</sup>

### 2.5.2. Atom transfer reactions

The first example of the atom transfer radical addition was reported by Kharasch (Figure II.12).<sup>62</sup> Since this discovery, other ATRA reactions have been developed, including examples by Curran and Oshima,<sup>63</sup> as well as metal (Cu)-mediated ATRA processes.<sup>64</sup> They used electrophilic precursors such as iodomalonate **127** and  $\alpha$ -bromo carbonyl compound **130** with electron rich olefins (**128** and **131**). These ATRA reactions do not always require the use of tin reagents like bis(tributyltin). In the example of Curran, bis(tributyltin) is used in a sub-stoichiometric amount and serves as the initiator. Photolysis of the latter generates tributyltin radicals which abstract the iodine atom. Due to the very weak C-I bond of iodomalonate **127**, the iodine transfer reaction is very efficient.

<sup>61</sup> (a) S. J. Cole, J. N. Kirwan, B. P. Roberts, C. R. Willis, *J. Chem. Soc., Perkin Trans. 1* **1991**, 103-112; (b) B. P. Roberts, *Chem. Soc. Rev.* **1999**, 28, 25-35.

<sup>62</sup> M. S. Kharasch, E. V. Jensen, W. H. Urry, *Science* **1945**, 102, 128.

<sup>63</sup> (a) D. P. Curran, M. H. Chen, E. Spletzer, C. M. Seong, C. T. Chang, *J. Am. Chem. Soc.* **1989**, 111, 8872-8878; (b) H. Yorimitsu, H. Shinokubo, S. Matsubara, K. Oshima, K. Omoto, H. Fujimoto, *J. Org. Chem.* **2001**, 66, 7776-7785.

<sup>64</sup> Selected examples of ATRA reactions with metals (Cu, Fe): (a) F. Minisci, *Acc. Chem. Res.* **1975**, 8, 165-171; (b) M. Mitani, I. Kato, K. Koyama, *J. Am. Chem. Soc.* **1983**, 105, 6719-6721; (c) T. Rawner, E. Lutsker, C. A. Kaiser, O. Reiser, *ACS Catal.* **2018**, 8, 3950-3956.

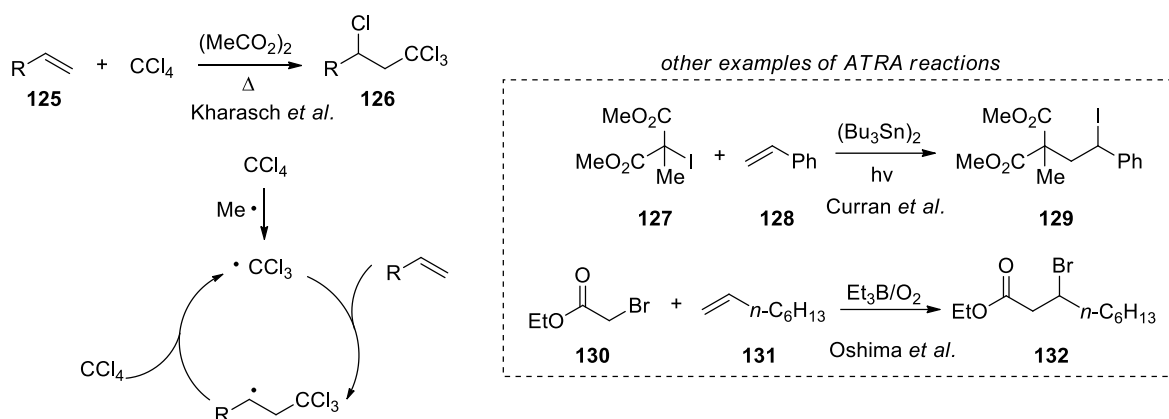


Figure II.12. Mechanism of the Kharasch reaction and other ATRA examples.<sup>62,63</sup>

### 2.5.3. Group transfer reactions

The overall group transfer reaction is a substitution of a group through a stepwise addition-elimination process. Among the group transfer radical reactions, the allyl group transfer was discovered in 1973 with the allyltrimethyltin reagent.<sup>65</sup> Ten years later, Keck and co-workers exemplified this reaction (known as Keck allylation) with the allyltributyltin reagent **133a**, one of the most popular reagents for allylations.<sup>66</sup> A general picture of the allyl transfer reaction is given in Figure II.13. The mechanism starts by the addition of the initiator-based radical onto the allylstannane **133**, followed by elimination of tributyltin radical, which enters into the propagation cycle. Abstraction of the halogen of **123** followed by the addition of the corresponding carbon-centered radical onto the allylstannane **133** and subsequent  $\beta$ -fragmentation furnish the allylation product **134** with regeneration of the tributyltin radical. The similar methallylation is also possible ( $Z = \text{Me}$  or  $\text{CO}_2\text{R}$ ).

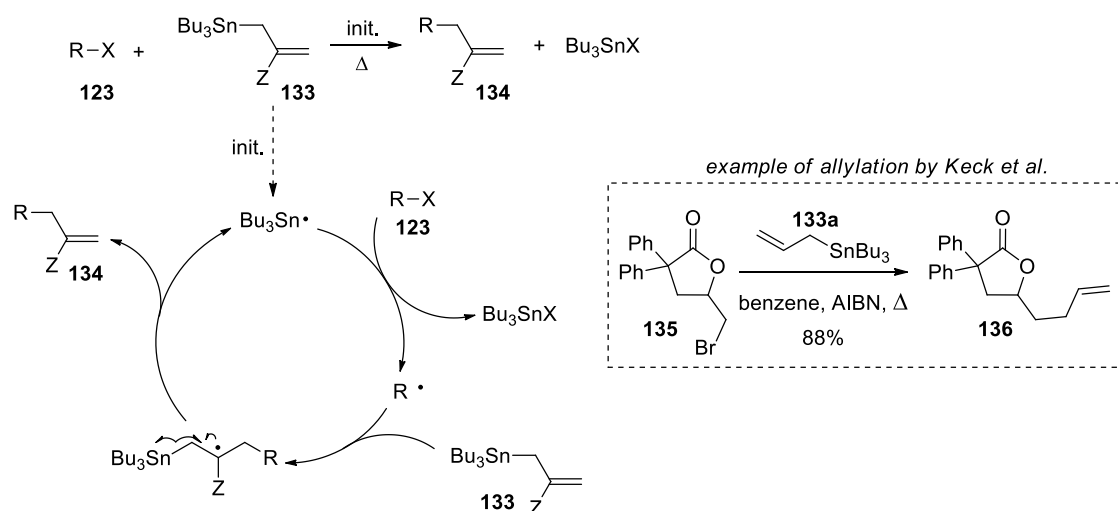


Figure II.13. Mechanism of the allyl transfer reaction.<sup>46</sup>

<sup>65</sup> M. Kosugi, K. Kurino, K. Takayama, T. Migita, *J. Organomet. Chem.* **1973**, 56, C11-C13.

<sup>66</sup> G. E. Keck, E. J. Enholm, J. B. Yates, M. R. Wiley, *Tetrahedron* **1985**, 41, 4079-4094.

To close this section, another important group transfer reaction is the xanthate transfer addition developed by Zard and co-workers. This xanthate chemistry has demonstrated broad synthetic utility.<sup>67</sup>

## 2.6. Sulfonyl derivatives in tin-mediated and tin-free reactions

In this section, the importance of sulfonyl derivatives in the development of multicomponent reactions and tin-free reactions will be discussed.

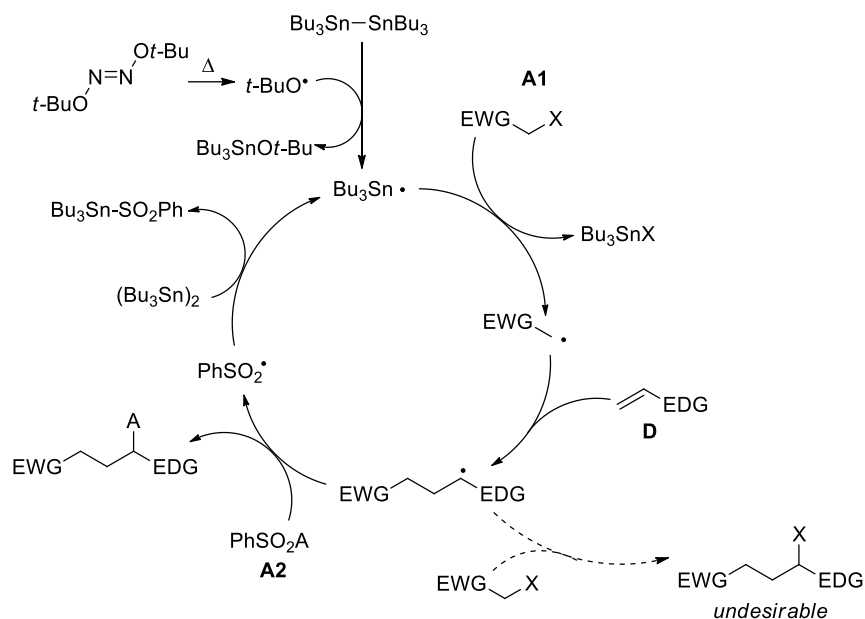
We have seen that the atom transfer radical additions (ATRA) are efficient reactions to functionalize unsaturated systems. These two-components reactions are however limited to the formation of one carbon-carbon bond and one carbon-heteroatom bond. The development of radical multicomponent reactions has facilitated the formation of two carbon-carbon bonds in one operation. By using disubstituted olefins, an all-carbon quaternary stereocenter is formed such that structurally complex architectures can be attained very rapidly. To realise a three-components process, the radical formed after the addition reaction onto the alkene backbone must react faster with an additional reagent (the third component) than the halogen precursor. The challenge is then to find a carbon reagent reactive enough to avoid the formation of the halogen transfer product. Due to their high electrophilicity and their efficient  $\beta$ -fragmentation, the unsaturated sulfonyl derivatives are reagents of choice in these radical multi-components reactions.<sup>68</sup> In the case of an Acceptor-Donor-Acceptor three-component system (ADA), the third component must be a very good acceptor to disfavour the halogen transfer reaction. The mechanism of a typical tin-mediated ADA-three-components radical reaction is shown in Figure II.14. The radical precursor **A1** (acceptor) is subjected to halogen or xanthate abstraction after initiation with DTBHN. The electrophilic radical then adds to the electron rich olefin **D** (donor) generating a new nucleophilic radical. The latter reacts with an electrophilic sulfonyl derivative **A2** (acceptor) to give the functionalized product after  $\beta$ -fragmentation. The reaction of the sulfonyl radical with bis(tributyltin) produces a tributyltin radical which propagates the radical chain.

---

<sup>67</sup> B. Quiclet-Sire, S. Z. Zard, *Chimia* **2012**, 66, 404-412.

<sup>68</sup> (a) V. I. Timokhin, S. Gastaldi, M. P. Bertrand, C. Chatgililoglu, *J. Org. Chem.* **2003**, 68, 3532-3537; (b) C. Chatgililoglu, O. Mozziconacci, M. Tamba, K. Bobrowski, G. Kciuk, M. P. Bertrand, S. Gastaldi, V. I. Timokhin, *J. Phys. Chem. A* **2012**, 116, 7623-7628. (c) B. Ovidia, F. Robert, Y. Landais, *Chimia* **2016**, 70, 34-42.

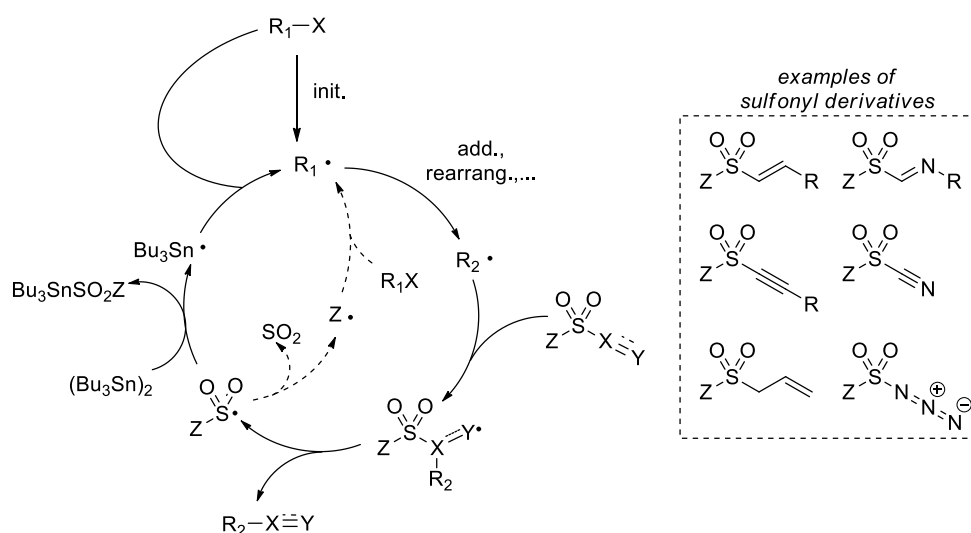




**Figure II.14.** Mechanism of a tin mediated ADA three-components reaction.

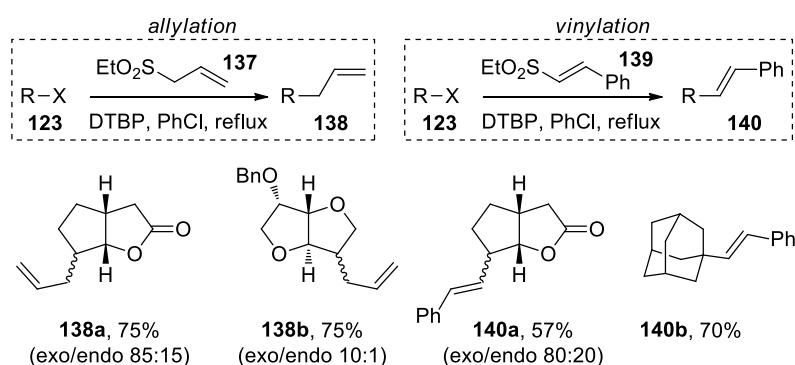
Although tin reagents are efficient mediators in radical chemistry, their replacement is still relevant due to their perceived toxicity and the difficulties to remove tin residues during purifications.<sup>69</sup> In this context, the sulfonyl derivatives are also particularly well-suited because the sulfonyl radical is prone to  $\alpha$ -scission. While the phenylsulfonyl radical is too stable to undergo  $\alpha$ -scission, the fragmentation of an alkylsulfonyl radical is thermodynamically possible to give a new carbon-centered radical which can propagate the radical chain. The  $\alpha$ -scission closes the propagation cycle and avoids the use of tin mediators as it is described in Figure II.15. Based on this mechanism, the diversity of unsaturated sulfonyl derivatives allowed the development of alkynylation, alkenylation, oximation, allylation, cyanation and azidation reactions. The tin-mediated or the tin-free versions of these reactions are discussed below.

<sup>69</sup> E. Le Grogneec, J.-M. Chretien, F. Zammattio, J.-P. Quintard, *Chem. Rev.* **2015**, *115*, 10207-10260.



**Figure II.15.** General mechanism involving sulfonyl derivatives.

This concept was introduced, twenty years ago, by Zard *et al.* for the allylation and vinylation reactions of alkyl iodides.<sup>70</sup> The fragmentation of ethylallylsulfone **137** and ethylvinylsulfone **139** leads to the formation of an ethyl radical which abstracts the iodide of **123** and allows to sustain the radical chain. Some allylation products **138** and vinylation products **140** are described in Scheme II.5.



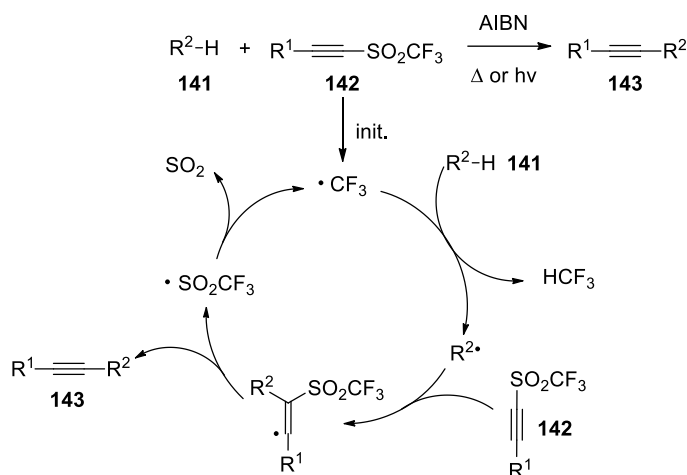
**Scheme II.5.** Radical allylation and vinylation reactions of alkyl iodides by Zard.<sup>70</sup>

Similarly, the alkynylation reaction of C-H bond was developed by Fuchs *et al.*<sup>71</sup> In this study, alkynyltriflone (alkynyl trifluoromethyl sulfone) derivatives **142** were used as radical traps (Figure II.16). Trifluoromethyl radical, formed upon initiation, abstracts the hydrogen atom of the alkane **141** leading to a nucleophilic radical which reacts with the alkynyltriflone **142**.  $\beta$ -Fragmentation of the alkenyl radical furnishes the coupling product **143** and an unstable sulfonyl radical. The latter decomposes through  $\alpha$ -scission to give sulfur dioxide and the trifluoromethyl radical, sustaining the radical chain. These conditions allowed functionalizing poorly reactive

<sup>70</sup> (a) B. Quiclet-Sire, S. Z. Zard, *J. Am. Chem. Soc.* **1996**, *118*, 1209-1210; (b) F. Le Guyader, B. Quiclet-Sire, S. Seguin, S. Z. Zard, *J. Am. Chem. Soc.* **1997**, *119*, 7410-7411; (c) F. Bertrand, B. Quiclet-Sire, S. Z. Zard, *Angew. Chem. Int. Ed.* **1999**, *38*, 1943-1946.

<sup>71</sup> J. Gong, P. L. Fuchs, *J. Am. Chem. Soc.* **1996**, *118*, 4486-4487.

alkanes such as cyclohexane, cycloheptane, norbornane and adamantane. This strategy was then extended to the alkenylation and allylation of alkanes with vinyl- and allyltriflones respectively.<sup>72</sup>

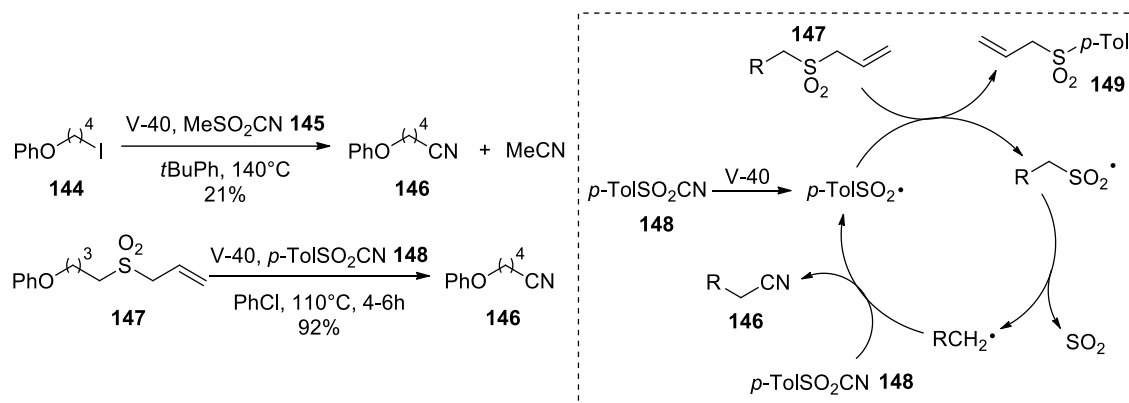


**Figure II.16.** Mechanism of the alkylation of C-H bonds by Fuchs.<sup>71</sup>

The same desulfonylation strategy was attempted by Kim *et al.* for the cyanation of alkyl iodide **144** using methylsulfonyl cyanide **145**.<sup>73</sup> After dissociation of sulfonyl cyanide with V-40, the fragmentation of the sulfonyl radical at high temperature provides a methyl radical. Instead of abstracting the iodine atom, the methyl radical prefers to react with methylsulfonyl cyanide **145** to give acetonitrile as the major product (Scheme II.6). The cyanation product **146** was obtained in low yield. Although alkyl allyl sulfones were used as allylating agents by Zard, they have been used as radical precursors by Kim for the generation of primary alkyl radicals under tin-free conditions. By using alkyl allyl sulfone **147** as starting material and *p*-toluenesulfonyl cyanide **148**, the product of cyanation **146** was obtained with an excellent yield (92% *vs* 21%). The mechanism starts by the dissociation of *p*-toluenesulfonyl cyanide **148**, generating a sulfonyl radical which reacts with the allyl sulfone **147** to produce an alkyl sulfonyl radical as well as *p*-tolyl allylsulfone **149**. The addition of an alkyl radical to an allylsulfone being relatively slow, after SO<sub>2</sub> extrusion, the alkyl radical reacts with *p*-toluenesulfonyl cyanide **148** to give the nitrile product **146** along with the *p*-toluenesulfonyl radical which sustains the radical chain.

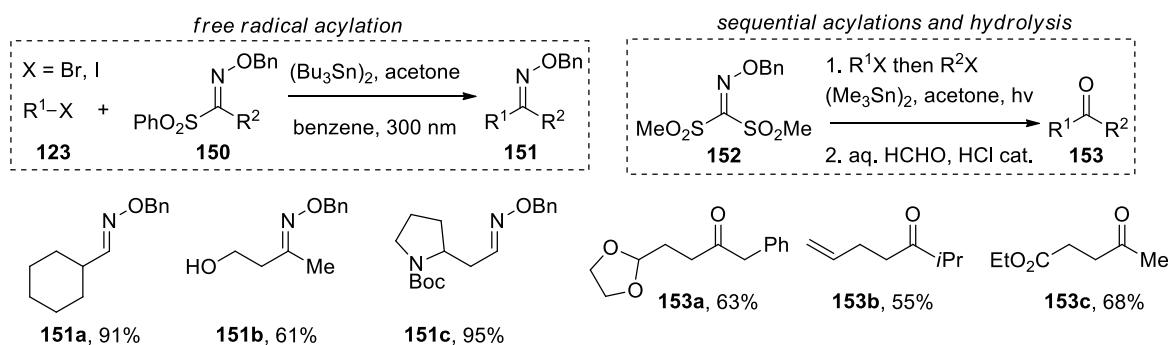
<sup>72</sup> (a) J. Xiang, P. L. Fuchs, *J. Am. Chem. Soc.* **1996**, *118*, 11986-11987; (b) J. Xiang, W. Jiang, P. L. Fuchs, *Tetrahedron Lett.* **1997**, *38*, 6635-6638; (c) J. Xiang, J. Everts, A. Rivkin, D. P. Curran, P. L. Fuchs, *Tetrahedron Lett.* **1998**, *39*, 4163-4166.

<sup>73</sup> S. Kim, C. J. Lim, *Ang. Chem. Int. Ed.* **2002**, *41*, 3265-3267.



**Scheme II.6.** Tin-free radical cyanation reactions from alkyl allyl sulfones by Kim.<sup>73</sup>

The use of sulfonyl oxime ethers **150** and **152** as radical acceptors was introduced by Kim and co-workers for the development of a free radical acylation approach.<sup>74</sup> The oxime ethers **151** were obtained in excellent yields. An application to the synthesis of ketones **153** was achieved with **152** through sequential radical acylations from alkyl iodides followed by hydrolysis (Scheme II.7).<sup>75</sup>



**Scheme II.7.** Free radical acylation of alkyl halide by Kim.<sup>74,75</sup>

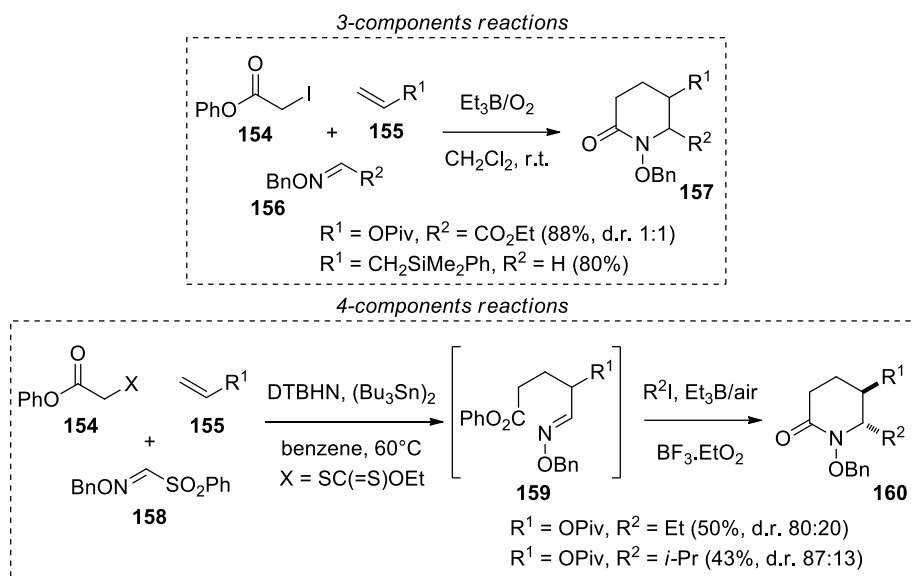
Based on these studies, efficient three-components radical processes were developed by Landais and co-workers. The carbo-oximation reaction of olefins was formally developed in multicomponent radical reactions from oxime ethers **156** (3-MCR) for the synthesis of substituted piperidinones **157**. These lactams were also produced from sulfonyl oxime ether **158** using a 4-MCR.<sup>76</sup> Some examples are described in Scheme II.8. For the three-components reaction, triethylborane was used both as initiator and Lewis acid to mediate the lactamization. For the four-components reactions, instead of triethylborane, bis(tributyltin) was used to sustain the radical chain. The use of sulfonyloxime **158** involved the formation of a new unactivated oxime **159** after  $\beta$ -fragmentation of the  $\text{PhSO}_2$  radical. The subsequent radical functionalization of this new oxime

<sup>74</sup> S. Kim, I. Y. Lee, J.-Y. Yoon, D. H. Oh, *J. Am. Chem. Soc.* **1996**, *118*, 5138-5139.

<sup>75</sup> S. Kim, J.-Y. Yoon, *J. Am. Chem. Soc.* **1997**, *119*, 5982-5983.

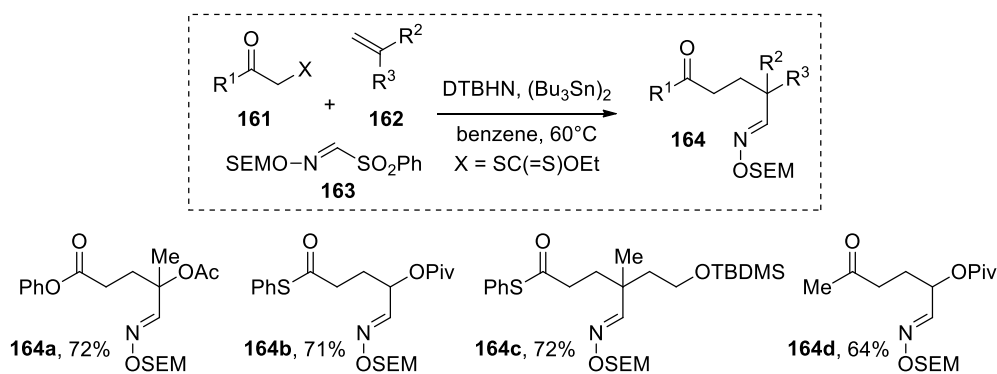
<sup>76</sup> E. Godineau, Y. Landais, *J. Am. Chem. Soc.* **2007**, *129*, 12662-12663.

led to the 4-MCR product **160**. These products were obtained with a moderate overall yield and moderate to good diastereocontrol, the *trans*-product being formed selectively.



**Scheme II.8.** Synthesis of functionalized piperidinones through a carboximation process.<sup>76</sup>

The free radical carbo-oximation of olefins **162** was then described by our group and a broad diversification of the carbo-oximation products was reported, thanks to the development of a new SEM-protected sulfonyloxime **163** (Scheme II.9).<sup>77</sup> The oxime products **164** were usually obtained in good yields.



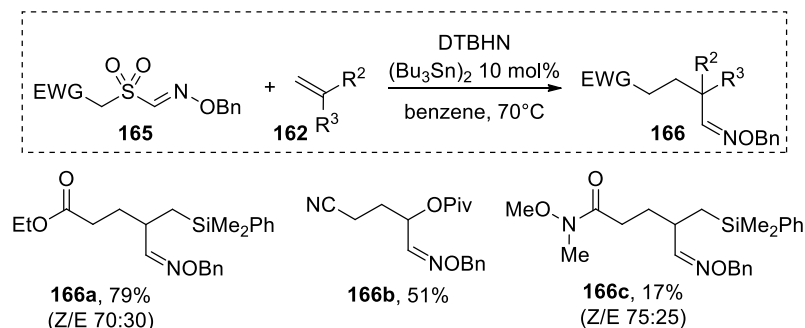
**Scheme II.9.** Carbo-oximation of olefins by Landais.<sup>77</sup>

Attempts at developing a tin-free carbo-oximation using **165** was a little bit tricky (Scheme II.10).<sup>78</sup> Indeed, after an intensive screening of initiators, the reaction yield did not increase as desired. Surprisingly, DTBHN was found to be the best initiator although it forms electrophilic radicals. The presence of a sub-stoichiometric amount of bis(tributyltin) allowed to reach good yields for the model compound **166a** which suggests that the radical chains are relatively short.

<sup>77</sup> Y. Landais, F. Robert, E. Godineau, L. Huet, N. Likhite, *Tetrahedron* **2013**, 69, 10073-10080.

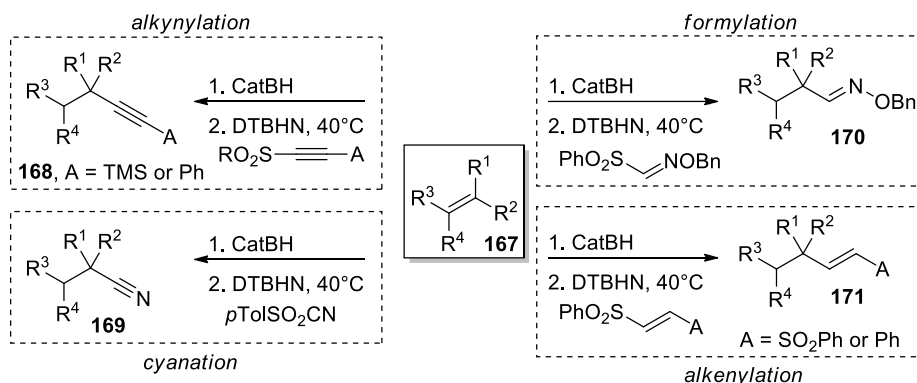
<sup>78</sup> B. Ovadia, F. Robert, Y. Landais, *Org. Lett.* **2015**, 17, 1958-1961.

The reaction scope is however quite narrow and the yields are moderate (**166b**) to low (**166c**). Interestingly, the initiation was found to start by the hydrogen abstraction at the benzylic center of **165**, followed by successive fragmentations, which is consistent with the use of DTBHN and the formation of benzaldehyde as a side-product.



**Scheme II.10.** Approach to a tin-free version of the carbo-oximation of olefins.<sup>78</sup>

Radical alkynylation, alkenylation, formylation and even cyanation reactions of alkyl boranes were also described by Renaud *et al.* using sulfonyl derivatives as radical acceptors. The boranes were synthesized *in situ* through the hydroboration of alkenes **167**.<sup>79</sup> The general reaction is displayed in Scheme II.11. After the hydroboration, the *B*-alkylcatecholborane was treated with the sulfone derivative and di-*tert*-butylhyponitrite furnishing the desired products **168-171** in good yields.



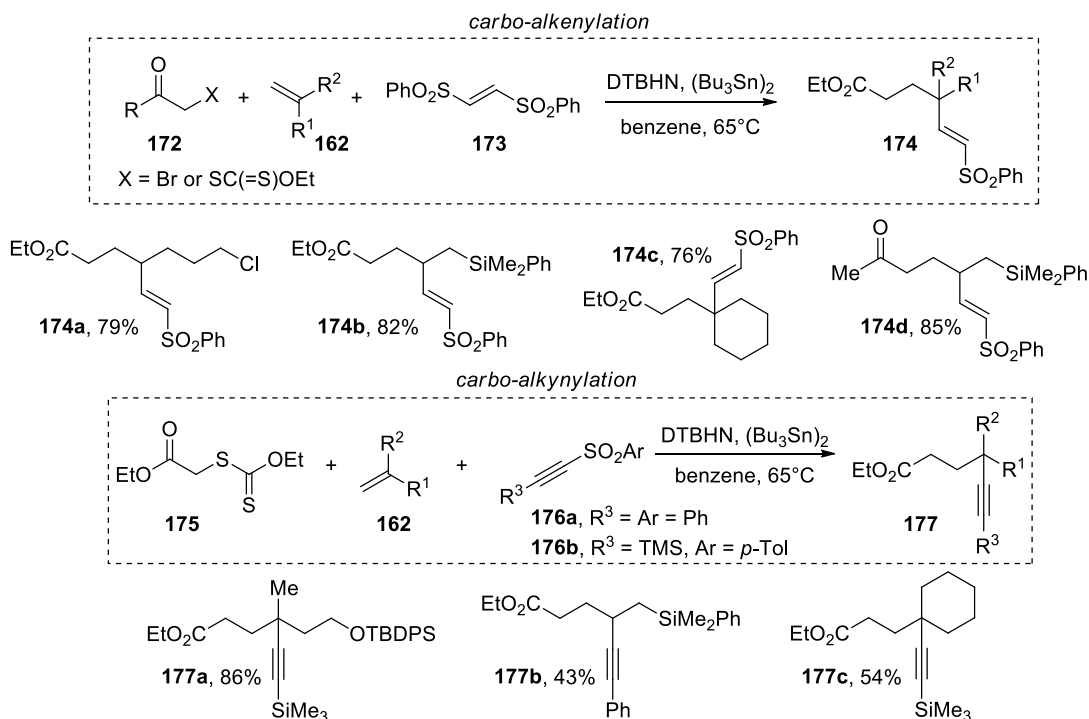
**Scheme II.11.** Alkynylation, alkenylation, formylation and cyanation of boranes by Renaud.<sup>79</sup>

Three-components carbo-alkenylations and -alkynylation of olefins were then described by Landais *et al.*<sup>80</sup> These processes nicely complement the carbo-oximation reaction since two carbon-based functional groups are introduced across the olefin backbone. Good to excellent yields were obtained for the carbo-alkenylation reaction using bisphenylsulfone **173** as the acceptor. The scope of this reaction is broad and significant examples (*e.g.* **174a-d**) are depicted in Scheme II.12. Various radical precursors **172** can be used (bromide and xanthate) as well as

<sup>79</sup> A.-P. Schaffner, V. Darmency, P. Renaud, *Ang. Chem. Int. Ed.* **2006**, *45*, 5847-5849.

<sup>80</sup> V. Liautard, F. Robert, Y. Landais, *Org. Lett.* **2011**, *13*, 2658-2661.

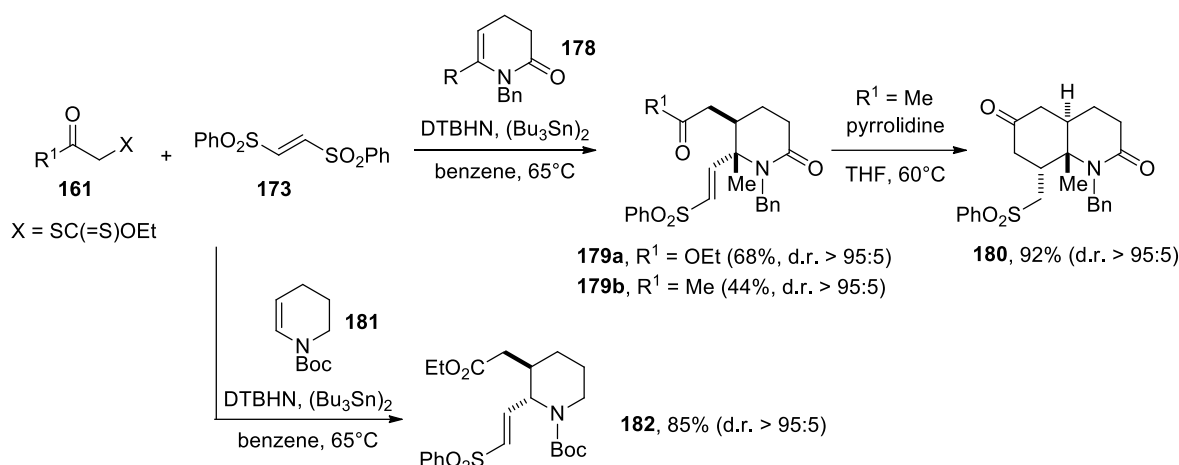
different carbonyl compounds (ketone, nitrile, malonate, amide). For the carbo-alkynylation, alkynylsulfones **176a** and **176b** were used. The yields were slightly better with alkynylsulfone **176b** bearing the trimethylsilyl group. This observation was explained by the polarization of the alkyne triple bond. It appeared that the carbon center in  $\alpha$ - to the sulfone in ((phenylethynyl)sulfonyl)benzene showed a partial negative charge according the Mulliken population analysis.



**Scheme II.12.** Carbo-alkynylation and alkenylation of olefins by Landais *et al.*<sup>80</sup>

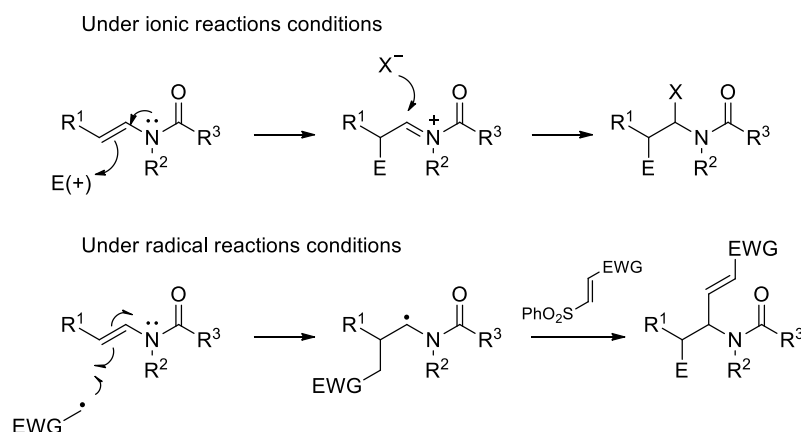
The carbo-alkenylation was extended to enamides and ene-carbamates.<sup>81</sup> Using enamide **178**, the corresponding lactames **179** were obtained with excellent diastereomeric ratio (Scheme II.13). Furthermore, **179b** was converted into a building block **180** which might be suitable for the synthesis of alkaloids of the lycopodium family. The functionalized Boc-protected piperidine **182** was also produced from ene-carbamate **181** with a good yield and a good diastereocontrol.

<sup>81</sup> C. Poittevin, V. Liautard, R. Beniazza, F. Robert, Y. Landais, *Org. Lett.* **2013**, *15*, 2814-2817.



**Scheme II.13.** Application of the carbo-alkenylation to enamides and ene-carbamates.<sup>81</sup>

It is important to notice that the radical functionalization of enamide (and ene-carbamate) affords complementary substrates to that formed through ionic conditions (Scheme II.14). Under radical conditions, two electrophilic reagents are added across the enamide olefin backbone, whereas under ionic condition, an electrophile then a nucleophile are added.



**Scheme II.14.** Reactivity of enamides under ionic or radical conditions.

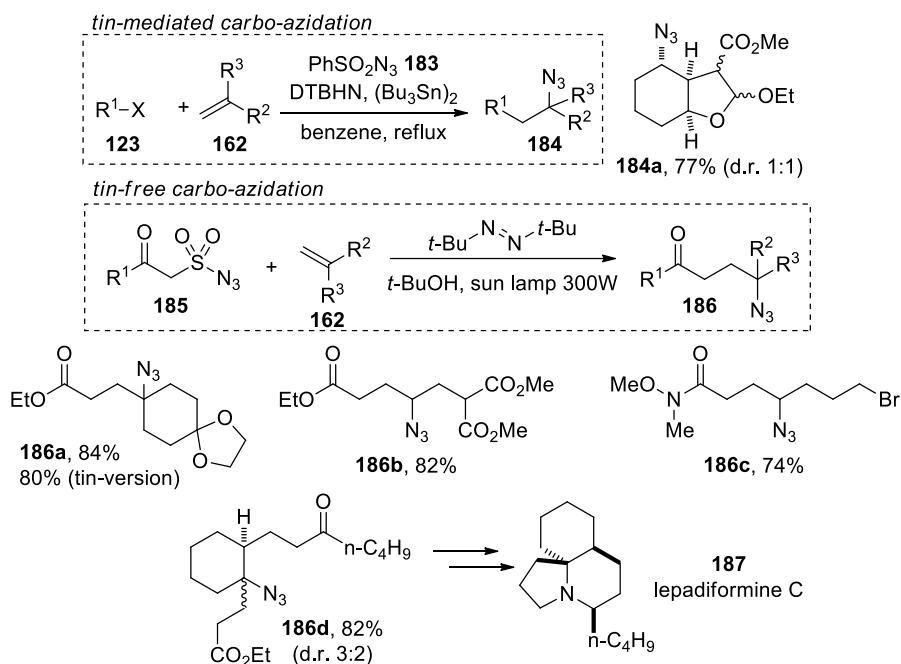
The azidation of alkyl radicals was first reported by Renaud and co-workers using ethyl and phenylsulfonyl azide **183** as radical trap.<sup>82</sup> The carbo-azidation reaction of olefins **162** was then applied.<sup>83</sup> Compound **184a** is a significant example of this reaction (Scheme II.15). In 2010, a two-components tin-free version was developed based on a desulfonylative azidation process.<sup>84</sup> The reagent **185** contains both the electrophilic carbon radical and the azidating agent and allows to sustain the radical chain through desulfonylation. This atom-economical carbo-azidation showed broad scope and the products **186** were obtained in excellent yields. Furthermore, this methodology was applied to a very short synthesis of lepadiformine C **187**.

<sup>82</sup> C. Ollivier, P. Renaud, *J. Am. Chem. Soc.* **2001**, *123*, 4717-4727.

<sup>83</sup> P. Renaud, C. Ollivier, P. Panchaud, *Angew. Chem. Int. Ed.* **2002**, *41*, 3460-3462.

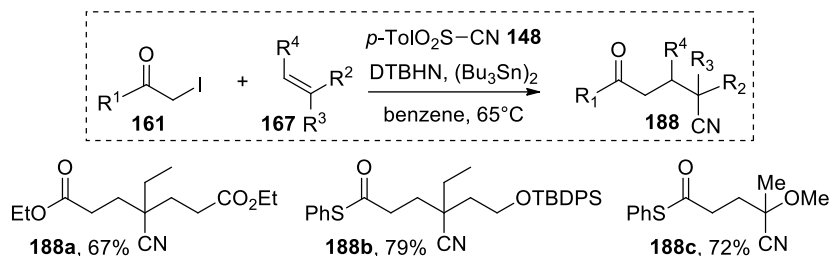
<sup>84</sup> K. Weidner, A. Giroult, P. Panchaud, P. Renaud, *J. Am. Chem. Soc.* **2010**, *132*, 17511-17515.





**Scheme II.15.** Tin-mediated and tin-free carbo-azidation of olefins by Renaud.<sup>83,84</sup>

Recently, Landais and co-workers developed an efficient three-components carbo-cyanation reaction of olefins **167** using the commercially available tosyl cyanide **148** (Scheme II.16).<sup>85</sup> Nitrile-functionalized all-carbon quaternary centers were produced in good yields as illustrated by compounds **188a-c**.



**Scheme II.16.** Free-radical carbocyanation of olefins by Landais.<sup>85</sup>

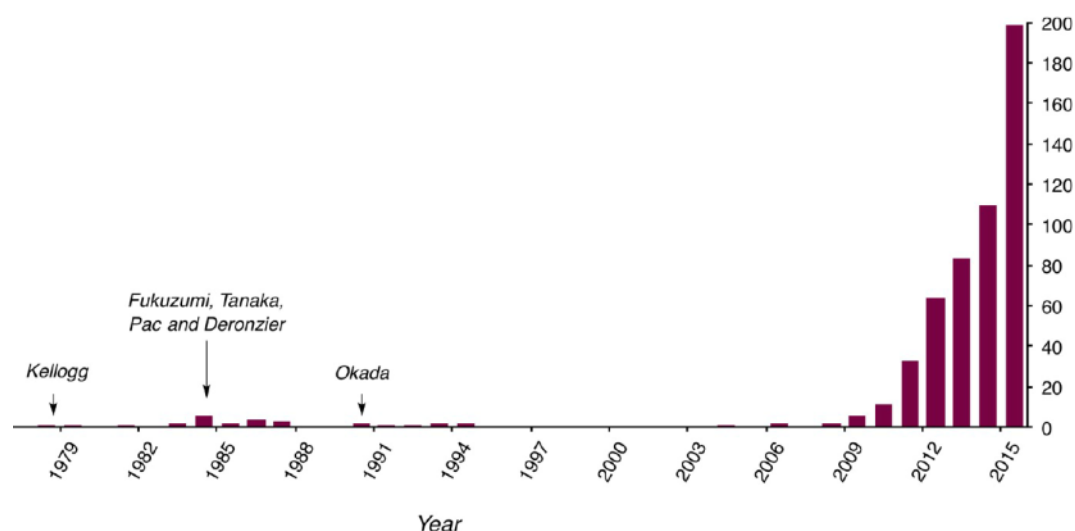
<sup>85</sup> H. Hassan, V. Pirenne, M. Wissing, C. Khiar, A. Hussain, F. Robert, Y. Landais, *Chem. Eur. J.* **2017**, *23*, 4651-4658.

### 3. Photoredox catalysis

#### 3.1. Introduction

Recently, photoredox catalysis has emerged as a very useful and powerful method in radical chemistry because the reactive radical intermediates are generated under very mild conditions. In photoredox catalysis, the unstable initiators and sometimes toxic mediators (tin reagents) used in classical radical chemistry are replaced by visible light irradiation of bench-stable metal complexes or organic dyes. The production of radicals in photoredox systems usually occurs at room temperature compared to the classical initiators which require high temperatures. These mild conditions are particularly interesting for the design of stereoselective transformations.

In the field of organic synthesis, photoredox catalysis has attracted a growing interest in recent years. Although the first applications in synthesis were described in 1978 by Kellogg and in 1984 by Deronzier, it is only since 2008 that the potential of photocatalysis in organic synthesis was recognised. The number of published papers in the field of photoredox catalysis has indeed increased considerably since 2008 (Figure II.17).<sup>86</sup>



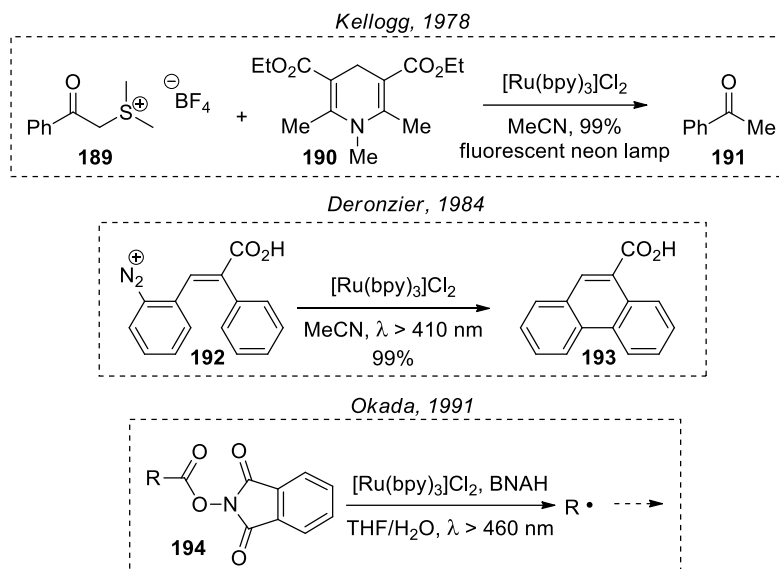
**Figure II.17.** Articles published per year in the field of organic photoredox catalysis.<sup>86</sup>

The well-known tris(2,2'-bipyridyl)ruthenium(II) chloride catalyst,  $[\text{Ru}(\text{bpy})_3]\text{Cl}_2$ , has been used in the first applications of organic photoredox catalysis. Kellogg and co-workers reported, in their seminal work, the reductive desulfurization of sulfonium salt **189** into ketone **191** using 1,4-dihydropyridine **190** as reducing agent (Scheme II.17).<sup>87</sup> They observed that the addition of a catalytic amount of  $[\text{Ru}(\text{bpy})_3]\text{Cl}_2$  could accelerate the reaction. Then, Deronzier *et al.* described the visible light mediated oxidation of benzyl alcohols to aldehydes using  $[\text{Ru}(\text{bpy})_3]\text{Cl}_2$

<sup>86</sup> M. H. Shaw, J. Twilton, D. W. C. MacMillan, *J. Org. Chem.* **2016**, *81*, 6898-6926.

<sup>87</sup> D. M. Hedstrand, W. H. Kruijzinga, R. M. Kellogg, *Tetrahedron Letters* **1978**, *19*, 1255-1258.

and an aryldiazonium salt as oxidant.<sup>88</sup> They also described later that the Pschorr reaction of diazonium **192** can also be catalyzed by the same metal complex generating a phenanthrene product **193**.<sup>89</sup> In 1991, Okada described the generation of alkyl radicals from *N*-(acyloxy)phthalimides **194** through a reductive decarboxylation process.<sup>90</sup> Here, the single electron reduction of phthalimide from the reducing Ru(I) complex initiated the fragmentation. These reports described for the first time the activation of small molecules by photoredox catalyst. Unfortunately, the real interest of photoredox catalysis in organic synthesis only began some twenty years later.



**Scheme II.17.** Pioneering studies in photoredox catalysis (BNAH = 1-benzyl-1,4-dihydronicotinamide).<sup>87,89,90</sup>

In 2008, Yoon described that  $[\text{Ru}(\text{bpy})_3]\text{Cl}_2$  was able to promote intramolecular [2+2] cycloadditions of enone **195** to cyclobutane **196** under visible light irradiation (Scheme II.18).<sup>91</sup> Then, the potential of photoredox system in radical chemistry was explored more thoroughly by MacMillan and Stephenson. Enantioselective  $\alpha$ -alkylation of aldehydes was developed by the group of MacMillan using a dual organo- and photoredox catalysis.<sup>92</sup> In this reaction, alkyl bromide **198** is reduced into an electrophilic radical reacting then with a chiral enamine (formed *in situ* from aldehyde **197**) in an enantioselective fashion leading to **199**. Similarly, Stephenson and co-workers reported the tin-free reductive dehalogenation of benzylic halide **200** to **201** using  $[\text{Ru}(\text{bpy})_3]\text{Cl}_2$  and an amine as the hydrogen donor under visible light irradiation.<sup>93</sup>

<sup>88</sup> H. Cano-Yelo, A. Deronzier, *Tetrahedron Lett.* **1984**, 25, 5517-5520.

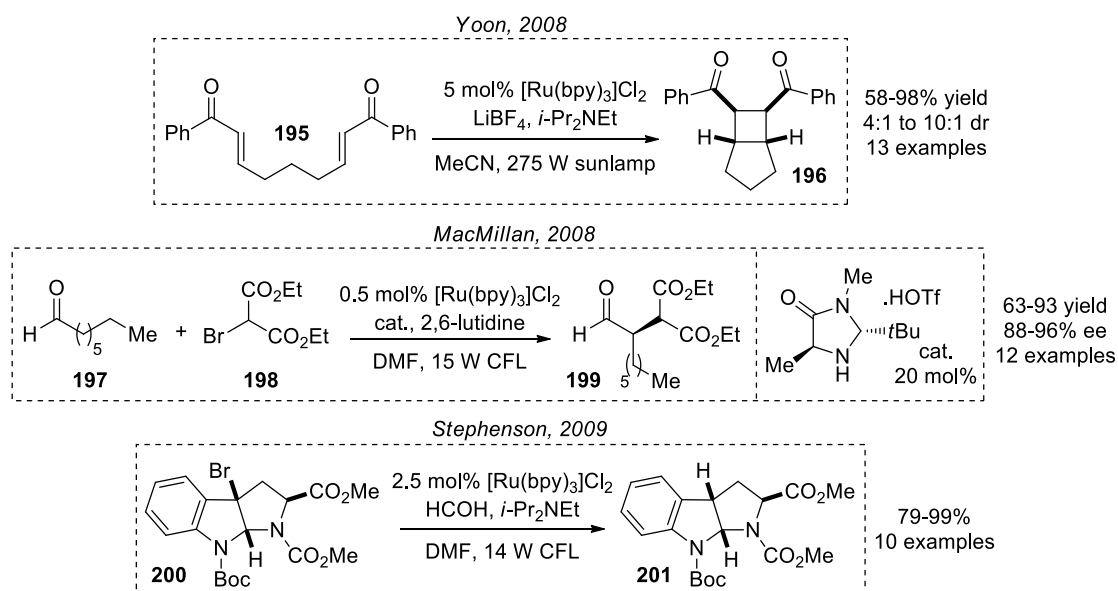
<sup>89</sup> H. Cano-Yelo, A. Deronzier, *J. Chem. Soc., Perkin Trans. 2* **1984**, 1093-1098.

<sup>90</sup> K. Okada, K. Okamoto, N. Morita, K. Okubo, M. Oda, *J. Am. Chem. Soc.* **1991**, 113, 9401-9402.

<sup>91</sup> M. A. Ischay, M. E. Anzovino, J. Du, T. P. Yoon, *J. Am. Chem. Soc.* **2008**, 130, 12886-12887.

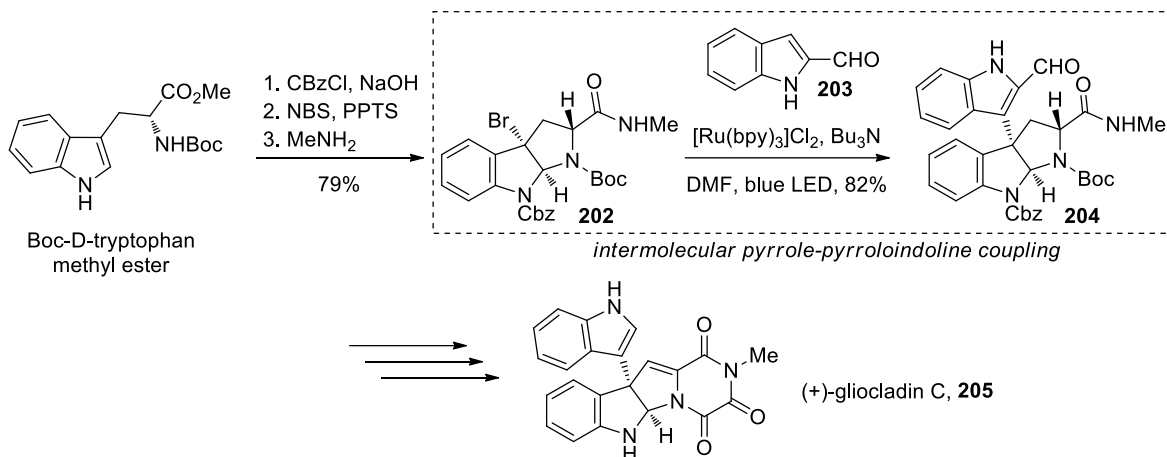
<sup>92</sup> D. A. Nicewicz, D. W. C. MacMillan, *Science* **2008**, 322, 77-80.

<sup>93</sup> J. M. R. Narayanam, J. W. Tucker, C. R. J. Stephenson, *J. Am. Chem. Soc.* **2009**, 131, 8756-8757.



**Scheme II.18.** Renaissance of photoredox catalysis.<sup>91,92,93</sup>

Visible light photoredox catalysis has become an essential part of free radical chemistry and its utility in organic synthesis for the construction of carbon-carbon bond is currently blooming.<sup>94</sup> For instance, the total synthesis of (+)-gliocladin C **205** was achieved by Stephenson and co-workers using a visible light photoredox-catalyzed coupling reaction between pyrroloindoline **202** and the indole motif **203** furnishing **204**, the structural core of the natural product (Scheme II.19).<sup>95</sup>



**Scheme II.19.** Application of photoredox catalysis in natural product synthesis.

<sup>94</sup> D. Staveness, I. Bosque, C. R. J. Stephenson, *Acc. Chem. Res.* **2016**, *49*, 2295-2306.

<sup>95</sup> L. Furst, J. M. R. Narayanam, C. R. J. Stephenson, *Angew. Chem. Int. Ed.* **2011**, *50*, 9655-9659.

### 3.2. Basic concepts of photoredox catalysis

#### 3.2.1. Nature and absorption of light

The light is an electromagnetic radiation which is characterized by a wavelength ( $\lambda$ ), a frequency ( $\nu$ ) and a velocity. These parameters are related by Equation 2.2.

$$\lambda\nu = c \quad (2.2)$$

The velocity of light in vacuum is a constant ( $c = 2.998 \times 10^8 \text{ m}\cdot\text{s}^{-1}$ ). The wavelength (in nm) and the frequency (in Hz) can have different values. The electromagnetic spectrum is composed by different radiations ranging from  $\gamma$ -rays to radio waves (Figure II.18). The wavelength (or frequency) defines the nature of the radiation.

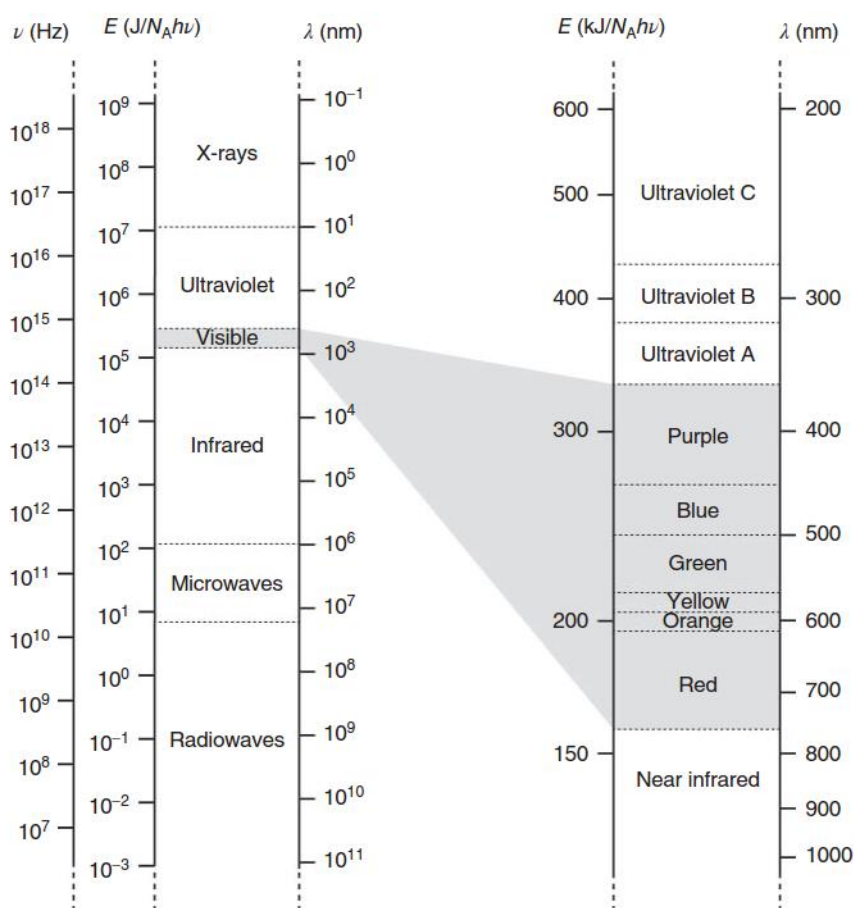


Figure II.18. Electromagnetic spectrum.<sup>96</sup>

According to the wave-particle duality (quantum theory), an electromagnetic radiation can also be seen as a particle called a photon. A beam of radiation is then considered as a flux of

<sup>96</sup> V. Balzani, P. Ceroni, A. Juris, *Photochemistry and Photophysics. Concepts, Research, Applications*, 2014, Wiley-VCH, Weinheim.

photons (or quanta). Each photon is characterized by a frequency (frequency of the radiation) and its energy is defined by Equation 2.3.

$$E = h\nu = h\frac{c}{\lambda} \quad (2.3)$$

In this equation,  $h$  is Planck's constant ( $6.63 \times 10^{-34}$ J.s). The most energetic photons/radiations (high frequencies) are  $\gamma$ -rays and X-rays, whereas radio waves are less energetic (low frequencies). Photochemistry uses a small region of the electromagnetic spectrum, namely light from 200 to 1000 nm. This includes the near-UV region, the visible light and the near infrared radiation (see Figure II.18). These electromagnetic radiations possess a suitable energy to provoke the electronic excitation of a molecule.

If a photon of an appropriate energy interacts with a molecule, the molecule, initially in its ground state, is promoted to an electronically excited state. This phenomenon is called excitation and causes a perturbation in the electronic structure of the molecule. After excitation, the electronic distribution differs from the ground state. For that reason, the excited state possesses different chemical and physical properties from those of the ground-state molecule and can be considered as a new chemical species. The excitation of a molecule  $A$  is generally written as Equation 2.4.



In this expression,  $A$  is the ground state molecule,  $h\nu$  is the absorbed photon and  $A^*$  refers to the electronically excited state. From this equation, it is clear that after excitation,  $A^*$  possesses a greater electronic energy compared to  $A$ . Typically, using light ranging from 200 to 1000 nm, molecule  $A$  receives a quanta of energy between  $9.95 \times 10^{-19}$  and  $1.99 \times 10^{-19}$  J, which corresponds to 599 kJ and 120 kJ for one mole. These values correspond to the bond dissociation energies of some typical carbon-heteroatom or even carbon-hydrogen bonds. This extra energy is then significant for chemical transformations.<sup>96</sup>

The absorption spectrum of compound  $A$  gives important information concerning the energy of the light absorbed. The absorbance of a species is defined by the Beer-Lambert law (Equation 2.5) which describes the absorption of monochromatic light by a substance dissolved in a transparent medium.

$$I = I_0 \times 10^{-\varepsilon bc} \text{ or } A = \log\left(\frac{I_0}{I}\right) = \varepsilon bc \quad (2.5)$$

In this expression,  $I$  is the intensity of the transmitted light,  $I_0$  is the intensity of the incident light,  $A$  is the absorbance,  $\varepsilon$  is the molar absorption coefficient ( $\text{M}^{-1} \cdot \text{cm}^{-1}$ ),  $b$  is the optical path (cm) and  $c$  is the solution concentration (M).

### 3.2.2. Jablonski-Perrin diagram

The Jablonski-Perrin diagram is an energy diagram illustrating the various deactivations of excited states (Figure II.19). The thick horizontal lines of Figure II.19 correspond to the electronic states while the thin horizontal lines represent the vibrational levels. Rotational levels are not indicated. The vertical order shows the relative energies between these levels. For simplicity, only the first excited states are shown. The straight arrows correspond to the absorption or emission of a photon whereas the wavy arrows represent radiationless transitions. The  $S_0 \rightarrow T_n$  transition is forbidden because of the spin selection rule.<sup>96</sup>

The absorption of light by a molecule provokes an  $S_0 \rightarrow S_n$  electronic transition, which promotes the molecule to an excited state ( $S_1, S_2, S_n$ ) possessing a high vibrational level (Franck-Condon state). Vibrational relaxation (v.r.) of the molecule will disperse this additional vibrational energy, eventually leading to the population of  $S_1$  (Kasha's rule). Deactivation of the excited state occurs through radiationless transitions between isoenergetic levels of different electronic states. During these transitions, the system maintains its initial energy. If the spin multiplicities are equal between the states, these transitions are called internal conversion (i.c.). If they are different, they are termed intersystem crossing (i.s.c.). Internal conversions are for example the  $S_n \rightarrow S_1$  and  $T_n \rightarrow T_1$  transitions and are extremely fast (picosecond region) except for  $S_1 \rightarrow S_0$  due to the large energy gap. An example of intersystem crossing is the  $S_1 \rightarrow T_1$  transition. These transitions are slower than internal conversion and are accelerated by spin-orbit coupling. Transitions such as  $S_1 \rightarrow S_0$  and  $T_1 \rightarrow S_0$  can also occur through radiationless deactivation at a much slower rate.

The deactivation of an excited state to the ground state through the emission of a photon is a radiative deactivation. Here, the energy of the excited state is released by the emission of a quanta of light. The reverse Equation 2.4 illustrates this phenomenon. The emitted photon can come from two types of transition. A spin-allowed emission resulting from the  $S_1 \rightarrow S_0$  transition is defined as fluorescence, whereas phosphorescence corresponds to a spin-forbidden emission ( $T_1 \rightarrow S_0$ ). Due to vibrational and solvent relaxation, the frequency of the emitted photon will be smaller than that absorbed photon (Stokes shift).<sup>96</sup>

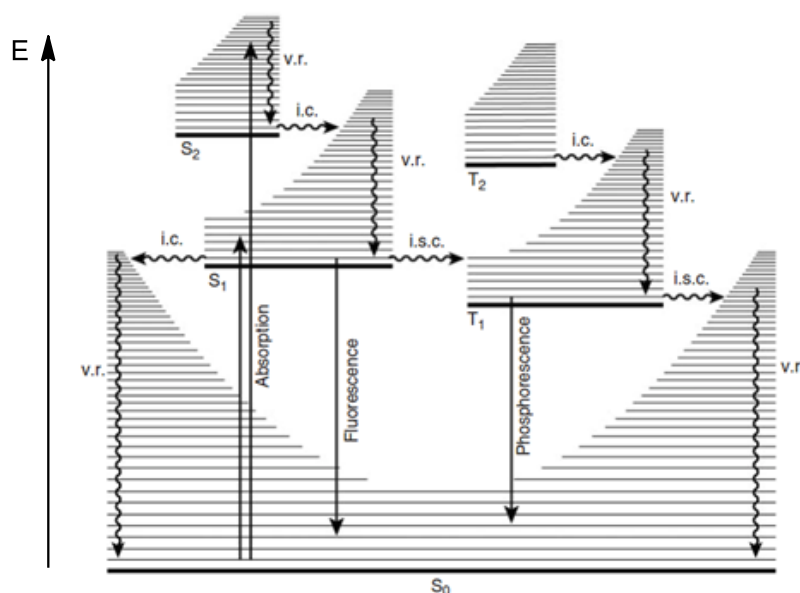


Figure II.19. Jablonski-Perrin diagram.<sup>96</sup>

### 3.2.3. Quantum yield and excited-state lifetime

Excited states ( $A^*$ ) are reactive species and will return to the ground state in a short period of time through different deactivation processes. These processes are summarized in Figure II.20. Deactivation can occur through a unimolecular process (rate constant  $k_p$ ), radiative ( $k_r$ ) and non-radiative ( $k_{nr}$ ) physical processes. In photo-physical processes, the original molecule is recovered in its ground state. The main photo-physical deactivations are emission of light (fluorescence or phosphorescence) and heat dissipation. In the case of photochemical deactivations (uni- or bi-molecular processes), another species is formed.<sup>64</sup>

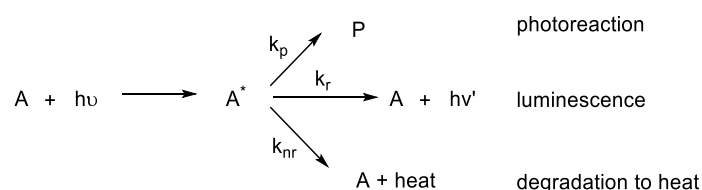


Figure II.20. Deactivation modes of an excited state.<sup>96</sup>

Since the origin of deactivation processes of an excited state arises from the absorption of a photon, it is reasonable to define the quantum yield of an event using Equation 2.6.

$$\Phi_i = \frac{\text{number of molecule undergoing that event}}{\text{number of photons absorbed by the reactant}} \quad (2.6)$$



Considering that a competition between these deactivation processes occurs and that the concentration of excited state is low, a steady state approximation for  $[A^*]$  is valid. The lifetime  $\tau(A^*)$  can therefore be described according Equation 2.7.<sup>96</sup>

$$\tau(A^*) = \frac{1}{k_p+k_r+k_{nr}} = \frac{1}{\sum_j k_j} \quad (2.7)$$

Each deactivation has a probability which is related to its relative rate. The efficiency of each deactivation process can be defined using Equation 2.8. The efficiency of a process is related to the quantum yield and ranges between 0 and 1.<sup>96</sup>

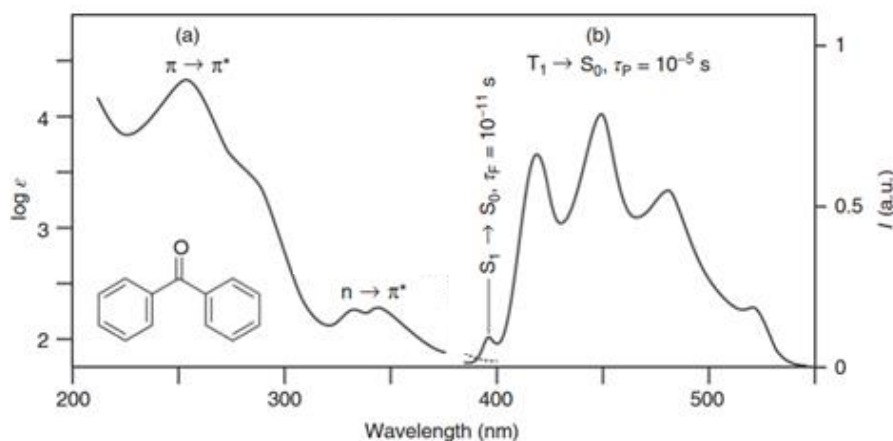
$$\eta_i(A^*) = \frac{k_i}{\sum_j k_j} = k_i \tau(A^*) = \Phi_i \quad (2.8)$$

Equation 2.8 has a considerable importance because the rate constant of a process can be determined by the measurement of the quantum yield and the excited state lifetime. The quantum yield measurement will be discussed in more detail later.

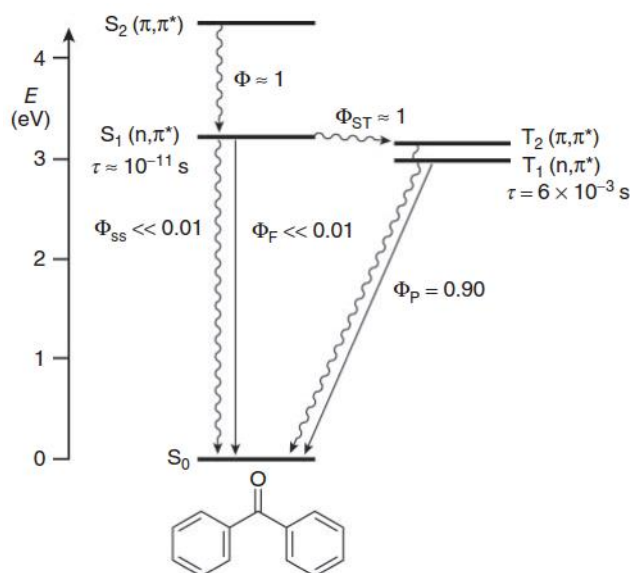
### 3.2.4. Excited state reactivity

In order to illustrate the Jablonski diagram and the reactivity of excited states, two simple molecules, ethene and benzophenone, will be considered here. As mentioned before, the excited state of a molecule possesses not only additional energy but exhibits also a different electronic distribution than the ground state. Therefore, each excited state is characterized by different properties and different reactivities.

Benzophenone absorbs light in the near-UV region and its absorption profile is presented in Figure II.21. The major absorption band with a maximum around 250 nm corresponds to a  $\pi$ - $\pi^*$  transition while the absorption band at 350 nm matches with a symmetry forbidden  $n$ - $\pi^*$  transition. The  $\pi$ - $\pi^*$  transition promotes benzophenone to a  $S_2(\pi$ - $\pi^*)$  excited state which gives the  $S_1(n$ - $\pi^*)$  excited state after relaxation. Concerning the emission profile, the strong emission band corresponds to the  $T_1(n, \pi^*) \rightarrow S_0$  transition (phosphorescence). The fluorescence, defined by the  $S_1(n, \pi^*) \rightarrow S_0$  transition, is almost absent considering the very weak band at 400 nm. Benzophenone is indeed characterized by a strong phosphorescence ( $\Phi_p = 0.9$ ) because the deactivation of  $S_1(n$ - $\pi^*)$  through intersystem crossing is very efficient thanks to strong spin-orbit coupling. The  $T_1(n$ - $\pi^*)$  excited state is reached upon relaxation of  $T_2$  after the intersystem crossing of  $S_1(n$ - $\pi^*)$  to  $T_2(\pi$ - $\pi^*)$ , which is a forbidden process. The Jablonski diagram in Figure II.22 summarizes this discussion.<sup>64</sup>



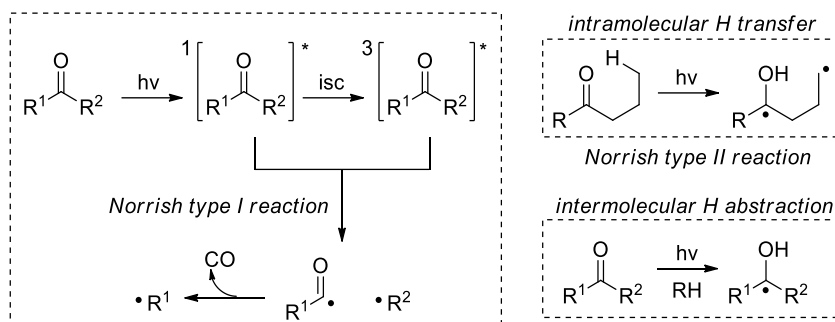
**Figure II.21.** (a) absorption spectrum, (b) emission spectrum of benzophenone in cyclohexane at room temperature.<sup>96</sup>



**Figure II.22.** Jablonski diagram of benzophenone.<sup>96</sup>

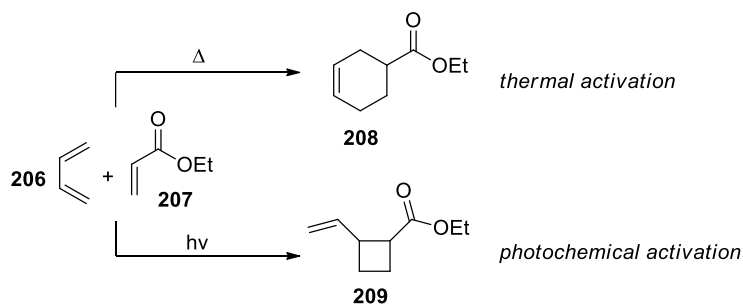
Due to the fast intersystem crossing, the reactive excited state of carbonyl compounds are usually the  $T_1(n-\pi^*)$ , especially for aryl ketones. The typical reactions of ketones in their triplet excited state are the Norrish reactions (type I or II) and intermolecular hydrogen abstraction (Scheme II.20). The homolytic cleavage of the  $\alpha$ -bond of a ketone corresponds to the Norrish type I reaction and is often followed by decarbonylation. This reaction is obviously favoured when stable benzylic or tert-butyl radicals are formed. Ketones possessing a  $\gamma$ -hydrogen can lead to the formation of a 1,4-biradical through a photoinduced intramolecular 1,5-hydrogen atom abstraction. This is the Norrish type II reaction which is an intramolecular hydrogen abstraction.<sup>97</sup>

<sup>97</sup> P. Klán and J. Wirz *Photochemistry of Organic Compounds: from Concepts to Practice*, 2009, John Wiley & Sons, Ltd, Chichester.



**Scheme II.20.** Typical reactions of ketones in their excited state.<sup>97</sup>

The ethene molecule can be considered as a model system for the reactivity of alkenes in their excited state. Upon irradiation by light, ethene absorbs a photon which cause a  $\pi\text{-}\pi^*$  transition and leads to a  $S_1(\pi\text{-}\pi^*)$  excited state. This excited state is characterized by the cleavage of the C-C  $\pi$ -bond. As a result, the geometry of the double bond is lost and cis-trans isomerization can occur.<sup>98</sup> The intersystem crossing ( $S_1 \rightarrow T_1$ ) is usually slow because spin-orbit coupling is small and the singlet and triplet level are not close in energy. The reactivity of alkenes in their excited state is illustrated by the pericyclic reactions (photocycloaddition, electrocyclicization and sigmatropic rearrangement). The example in Scheme II.21 describes the cycloaddition of butadiene **206** with ethyl acrylate **207**. The thermally induced cycloaddition provides the cyclohexene product **208** while the photocycloaddition gives the four-membered ring **209**. This illustrates once again the difference in reactivity between the ground state and the corresponding excited state.

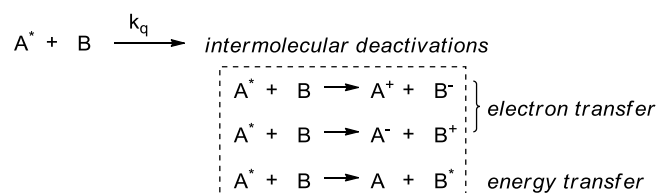


**Scheme II.21.** Cycloaddition of butadiene and ethyl acrylate under thermal or photochemical activation.<sup>98</sup>

<sup>98</sup> J. B. Metternich, R. Gilmour, *Synlett* **2016**, 27, 2541-2552.

### 3.3. Deactivation by bimolecular processes

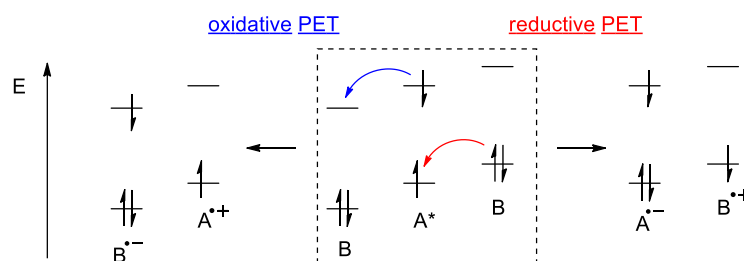
The deactivation of an excited state can occur in an intermolecular manner through a chemical reaction. Let us consider the reaction of an excited state  $A^*$  with a molecule B. If the lifetime of  $A^*$  is sufficiently long, then interaction with B can happen and lead to an intermolecular deactivation of  $A^*$ . There are four main types of interaction leading to deactivation: (i) collisional deactivation; (ii) chemical reaction; (iii) electron transfer process (ET) and (iv) energy transfer process. The deactivations through electron transfer and energy transfer are summarized in Figure II.23. An electron transfer process implies an oxidation or a reduction of A (as well as B) while an excited state  $B^*$  is formed after an energy transfer process. After the interaction with B, the excited state  $A^*$  is said to be quenched and B is the quencher.<sup>64</sup>



**Figure II.23.** Intra- and intermolecular deactivation.<sup>96</sup>

#### 3.3.1. Photoinduced electron transfer (PET)

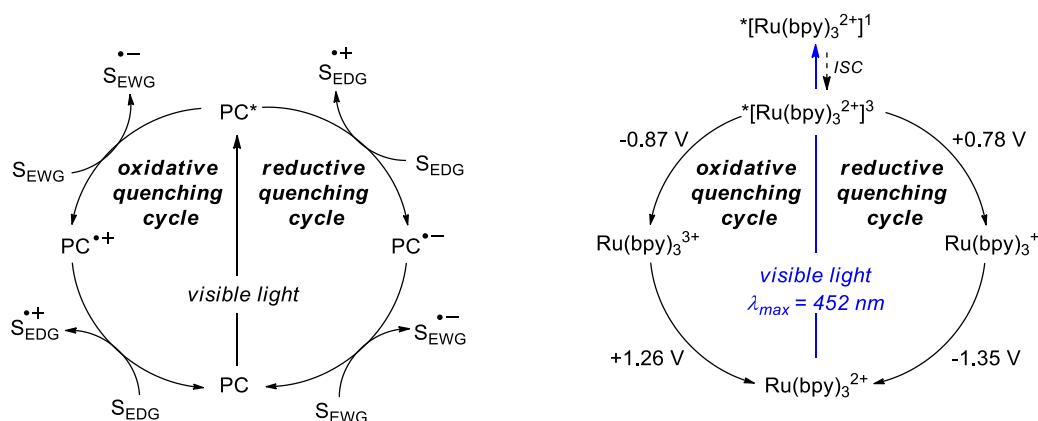
The excited state  $A^*$  has a smaller ionization potential and a higher electron affinity than the ground state, making it both a better oxidant and reductant and interact with B *via* a photoinduced electron transfer. This is illustrated in Figure II.24. This electron transfer would be endergonic for the ground state molecule.



**Figure II.24.** Illustration of oxidative and reductive PET.

Let us consider a photocatalyst, PC: upon excitation with visible light, the photocatalyst is promoted to an excited state. The reductive and oxidative quenching cycles are depicted in Figure II.25. In each quenching cycles, donation and reception of electron make the photocatalyst both an oxidant and a reductant in the same reaction vessel. The feasibility of these redox reactions is governed by the reduction potentials of each catalytic species. As an illustration, the reductive and

oxidative quenching cycles as well as the reduction potentials are given in Figure II.25 for the most well-known photocatalyst, the tris(2,2'-bipyridine)ruthenium(II) complex.<sup>99</sup>



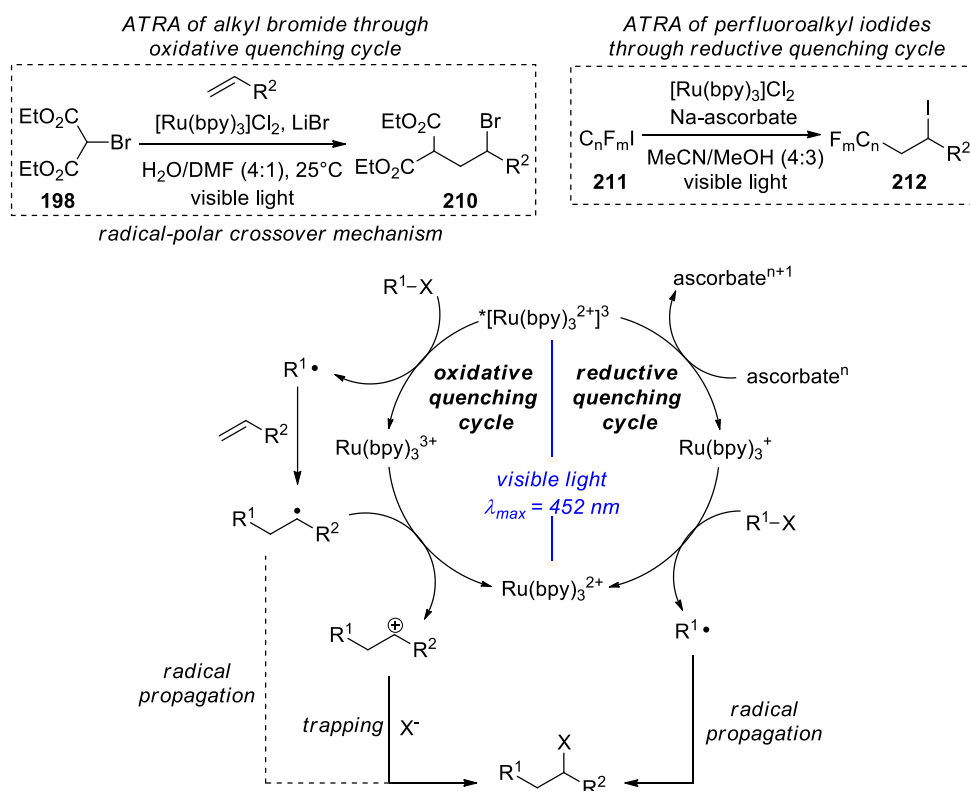
**Figure II.25.** Reductive and oxidative quenching cycle of a photocatalyst (left), detailed example for  $[\text{Ru}(\text{bpy})_3]\text{Cl}_2$  (right).<sup>99</sup>

### 3.3.2. Illustration of PET

The ability of a photocatalyst to enter either in a reductive or an oxidative quenching cycle was illustrated by Stephenson with the ATRA reaction of haloalkanes onto alkenes and alkynes using the tris(2,2'-bipyridine)ruthenium(II) complex.<sup>100</sup> Depending on the reaction parameters, the triplet excited state of  $[\text{Ru}(\text{bpy})_3^{2+}]$  is either reduced or oxidized (Figure II.26). In the oxidative quenching cycle, the activated halogenated substrate **198** is reduced to an electrophilic radical which adds onto the olefin. The new nucleophilic radical may be oxidized by the photocatalyst to form a carbocation which closes the catalytic cycle. The ATRA product **210** either comes from the trapping of the carbocation with a halide or from the propagation of the radical chain. They proposed the radical-polar crossover mechanism although for certain substrates, the radical chain propagation is still effective. In the reductive quenching cycle, the ascorbate acts as an electron donor and quenches the triplet excited state of  $[\text{Ru}(\text{bpy})_3^{2+}]$ . The reduced catalyst  $[\text{Ru}(\text{bpy})_3^+]$ , which possesses a strong reduction potential, converts the perfluoroalkyl iodide **211** into a radical. Then, the ATRA product **212** is obtained through a radical chain mechanism.

<sup>99</sup> J. W. Tucker, C. R. J. Stephenson, *J. Org. Chem.* **2012**, *77*, 1617-1622.

<sup>100</sup> C.-J. Wallentin, J. D. Nguyen, P. Finkbeiner, C. R. J. Stephenson, *J. Am. Chem. Soc.* **2012**, *134*, 8875-8884.



**Figure II.26.** Illustration of oxidative (left) and reductive (right) quenching cycle in ATRA reactions with  $[\text{Ru}(\text{bpy})_3]\text{Cl}_2$ .<sup>100</sup>

### 3.3.3. Thermodynamic of PET

From the example above, it is obvious that the knowledge of the reduction potentials of both the photocatalyst and the substrate is of an importance in the conception of a thermodynamically favoured transformation involving photoinduced electron transfer.

The free energy of a single electron transfer is described by Equation 2.9. In this equation,  $F$  is the Faraday constant ( $23.061 \text{ kcalV}^{-1}\text{mol}^{-1}$ ),  $E_{red}$  and  $E_{ox}$  are the ground state redox potentials for species **A** and **D** describing the half reduction reaction for each species.  $E_{red}$  corresponds to the reduction potential of an acceptor **A** and is also written as  $E_{1/2}(\text{A}/\text{A}^{\bullet-})$  describing the single electron reduction according the half reaction  $\text{A} \rightarrow \text{A}^{\bullet-}$ .  $E_{ox}$  refers to the oxidation potential of a donor **D**, also written as  $E_{1/2}(\text{D}^{\bullet+}/\text{D})$  and is defined by the half reduction reaction  $\text{D}^{\bullet+} \rightarrow \text{D}$ .<sup>101</sup>

$$\Delta G_{ET} = -F(E_{red} - E_{ox}) = -F[E_{1/2}(\text{A}/\text{A}^{\bullet-}) - E_{1/2}(\text{D}^{\bullet+}/\text{D})] \quad (2.9)$$

The free energy of a photoinduced electron transfer process is given by Equation 2.10 in which  $w$  is an electrostatic work term and  $E_{0,0}$  is the excited state energy for a given catalyst. The  $w$  term is usually omitted because the correction of  $w$  to  $\Delta G_{PET}$  is relatively small.

$$\Delta G_{PET} = -F[E_{ox}(\text{D}^{\bullet+}/\text{D}) - E_{red}(\text{A}/\text{A}^{\bullet-})] - w - E_{0,0} \quad (2.10)$$

<sup>101</sup> N. A. Romero, D. A. Nicewicz, *Chem. Rev.* **2016**, 116, 10075-10166.

This equation is particularly useful in the selection of an appropriate photoredox catalyst for a desired transformation. For simplicity reasons, we will consider thereafter the Equations 2.11 and 2.12 in the case of an oxidant and reductant photocatalyst **cat**\* respectively. In Equation 2.11,  $E_{red}^*$  is positive for a photoredox catalyst acting as an excited state oxidant and must be more positive than  $E_{ox}$  to allow the photoinduced oxidation of the substrate **sub**. In the same way,  $E_{ox}^*$  is negative for a photoredox catalyst acting as an excited state reductant and must be more negative than  $E_{red}$  of substrate **sub** for a thermodynamically favoured PET.<sup>101</sup>

$$\Delta G_{PET} = -F[E_{red}^*(\mathbf{cat}^*/\mathbf{cat}^{\bullet-}) - E_{ox}(\mathbf{sub}^{\bullet+}/\mathbf{sub})] \quad (2.11)$$

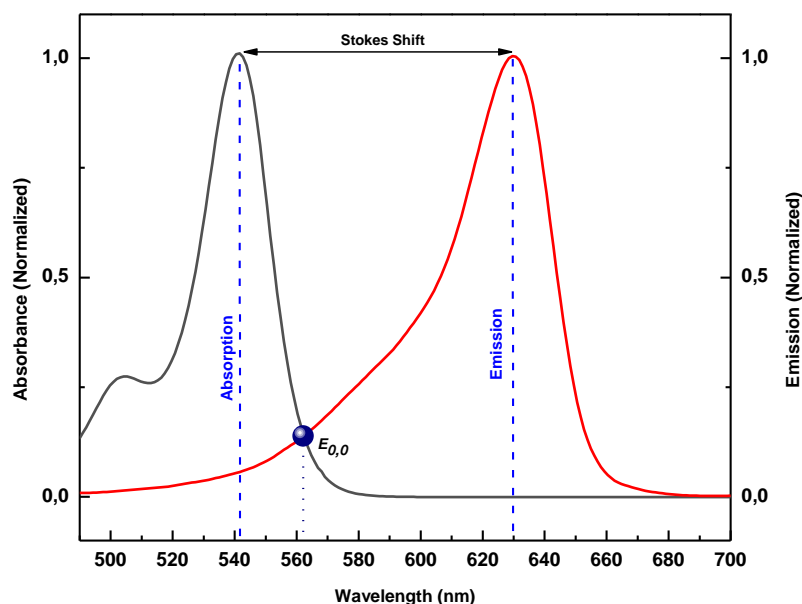
$$\Delta G_{PET} = -F[E_{red}(\mathbf{sub}/\mathbf{sub}^{\bullet-}) - E_{ox}^*(\mathbf{cat}^{\bullet+}/\mathbf{cat}^*)] \quad (2.12)$$

The reduction potential of an excited state **cat**\* is related to its ground state reduction potentials and to the zero-zero excitation energy (in eV) and can be estimated using Equations 2.13 and 2.14.<sup>101</sup>

$$E_{red}^*(\mathbf{cat}^*/\mathbf{cat}^{\bullet-}) = E_{red}(\mathbf{cat}/\mathbf{cat}^{\bullet-}) + E_{0,0} \quad (2.13)$$

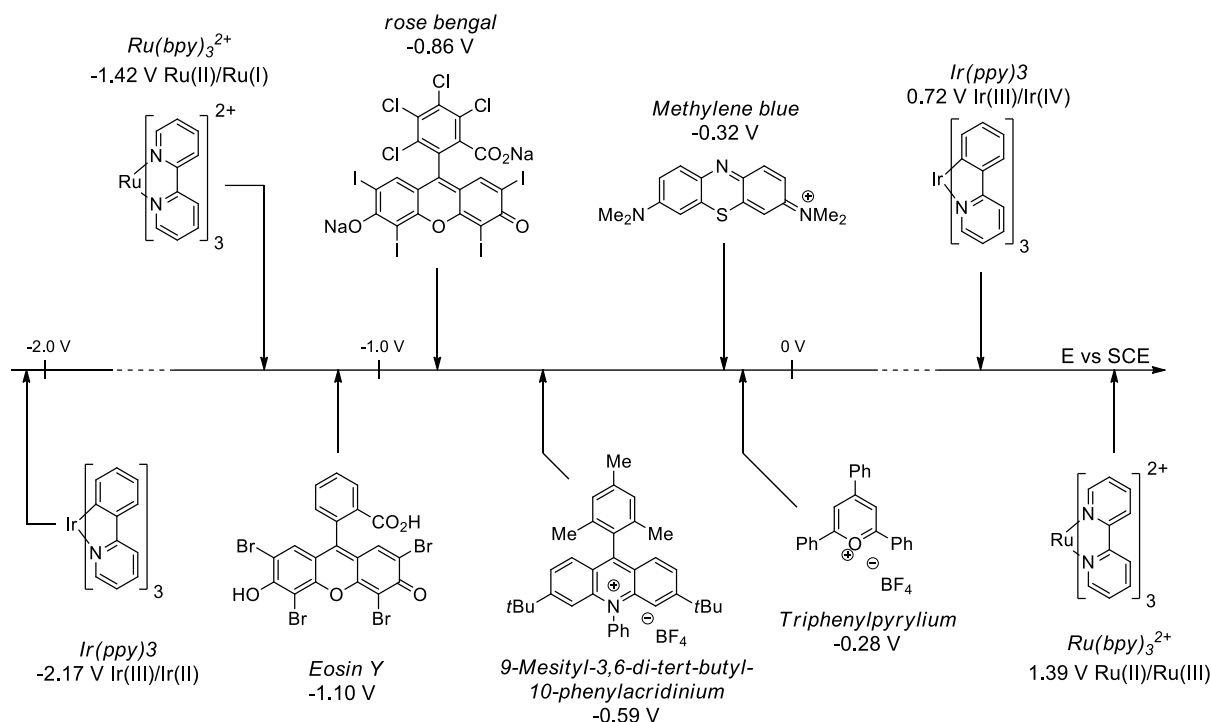
$$E_{ox}^*(\mathbf{cat}^{\bullet+}/\mathbf{cat}^*) = E_{ox}(\mathbf{cat}^{\bullet+}/\mathbf{cat}) - E_{0,0} \quad (2.14)$$

The term  $E_{0,0}$  corresponds to the electronic spectroscopic energy of the excited state catalyst. For a singlet excited state, the term  $E_{0,0}^{S_1}$  refers to the energy of the transition between the lowest energy vibrational state ( $v = 0$ ) of  $S_1$  to  $v = 0$  of  $S_0$ . The  $E_{0,0}$  is usually estimated by the intersection of the absorbance and emission spectra (Figure II.27).



**Figure II.27.** Estimation of the zero-zero excitation energy of an excited state.

The reduction potentials of the ground state photocatalyst are usually measured by cyclic voltammetry (CV) and some of the most common photoredox catalysts are listed in Figure II.28.<sup>102</sup>



**Figure II.28.** Reduction potentials of some common photoredox catalysts measured by CV.<sup>102</sup>

### 3.3.4. Energy transfer

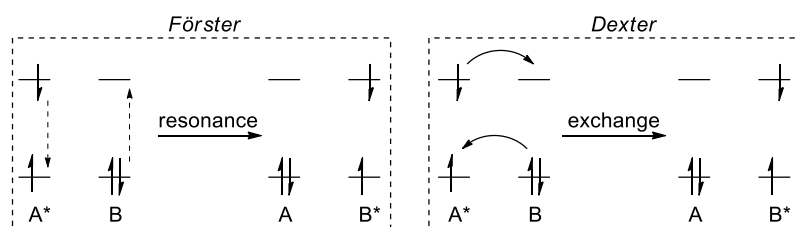
The deactivation of  $A^*$  can occur by interaction of a quencher ( $B$ ) through an energy transfer process. This phenomenon is represented by the Equation 2.15. The excited state  $B^*$  can then undergo radiative or non-radiative deactivation (luminescence or reaction).



Energy transfer is favoured if the energy of  $B^* < A^*$ . Trivial energy transfer occurs through a radiative process in which emission of a photon by  $A^*$  is absorbed by  $B$ . In non-trivial energy transfer illustrated in Figure II.29, the excited state undergoes resonant energy transfer (Förster mechanism), or electron exchange energy transfer (Dexter mechanism).<sup>96</sup>

<sup>102</sup> H. G. Roth, N. A. Romero, D. A. Nicewicz, *Synlett* **2016**, 27, 714-723.

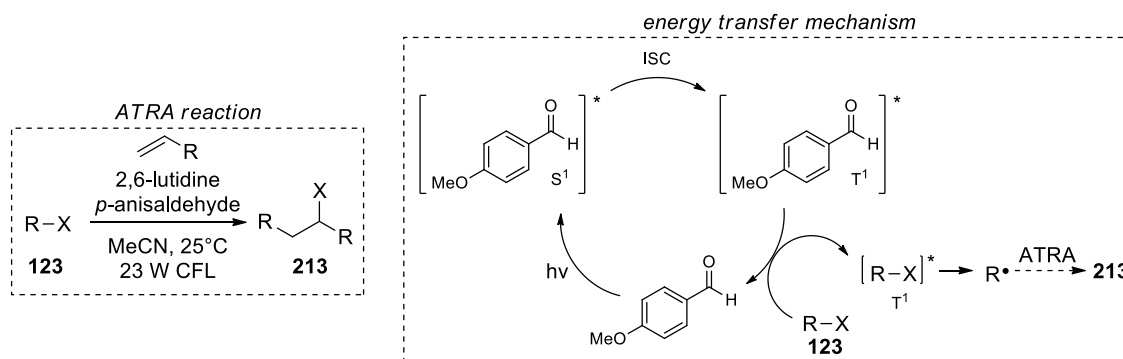




**Figure II.29.** Representative scheme of a resonant energy transfer and an electron exchange energy transfer.<sup>96</sup>

### 3.3.5. Illustration of energy transfer process

An example illustrating the energy transfer in organic synthesis is given in Figure II.30. A mechanism through energy transfer was recently proposed by Melchiorre and co-workers for the photocatalyzed atom transfer radical addition of alkyl halides **123** onto olefins.<sup>103</sup> Visible light irradiation (near UV region) promotes *p*-anisaldehyde to a singlet excited state which after intersystem crossing gives the triplet state. The latter brings the alkyl halide **123** to a triplet excited state through an energy transfer mechanism. This excitation causes a homolytic cleavage of the C-X bond which affords a carbon-centered radical. The bond dissociation energies of the alkyl halides used in this ATRA methodology are around 260-300 kJ.mol<sup>-1</sup>. These values are similar to the energy of the triplet excited state of *p*-anisaldehyde (300 kJ.mol<sup>-1</sup>), which is consistent with an energy transfer mechanism. Furthermore, the model reaction was completely inhibited in presence of triplet quenchers and was also insensitive to solvent polarity.



**Figure II.30.** Illustration of an energy transfer mechanism in ATRA reactions.<sup>103</sup>

<sup>103</sup> E. Arceo, E. Montroni, P. Melchiorre, *Angew. Chem. Int. Ed.* **2014**, 53, 12064-12068.

### 3.3.6. Stern-Volmer equation

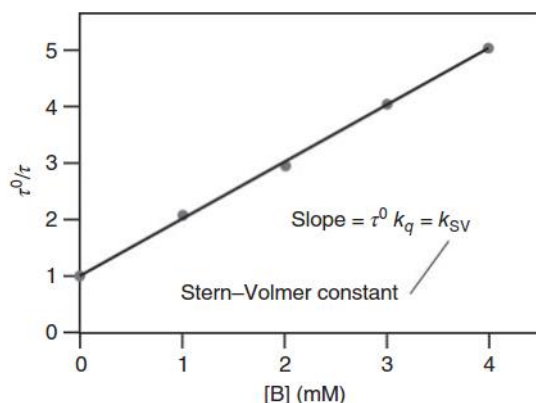
The kinetic analysis of an intermolecular deactivation or bimolecular quenching is described by the Stern-Volmer equation (Equation 2.15).<sup>96</sup>

$$\frac{\tau^0}{\tau} = 1 + \tau^0 k_q [B] \quad (2.15)$$

In this expression, the term  $k_q$  represents the rate constant of the quenching,  $\tau^0$  is the lifetime of  $A^*$  in the absence of  $B$  (the quencher) and  $\tau$  represents the lifetime of  $A^*$  in the presence of  $B$  (Equation 2.16). The product  $\tau^0 k_q$  is called the Stern-Volmer constant ( $K_{SV}$ ).

$$\tau = \frac{1}{(k_p + k_r + k_{nr} + k_q[B])} \quad (2.16)$$

By plotting the ratio  $\tau^0/\tau$  (or  $I^0/I$ ) as a function of the concentration of  $B$ , a straight line is obtained in which the slope corresponds to the Stern-Volmer constant,  $K_{SV}$  (Figure II.31). Therefore, the measurement of the lifetime or fluorescence intensity of  $A^*$  as a function of  $[B]$  allows the determination of the Stern-Volmer constant.<sup>96</sup>



**Figure II.31.** A Stern-Volmer plot.<sup>96</sup>

Practically, the quenching of the fluorescence intensity is usually measured. The term  $\tau^0/\tau$  is replaced by the emission intensity ratio ( $I^0/I$ ). The Stern-Volmer equation becomes Equation 2.17.

$$\frac{I^0}{I} = 1 + K_{SV} [B] \quad (2.17)$$

When  $k_q \approx k_{diff}$ , the quenching process is said to be diffusion-limited (dynamic quenching). Here, the resulting deactivation is caused by a collision between the quencher and the fluorophore during the excited state lifetime. When  $k_q > k_{diff}$ , the quenching may result from an interaction between the quencher and the fluorophore before the excitation process (static quenching, not discussed here).

### 3.3.7. Quantum yield for a photochemical reaction

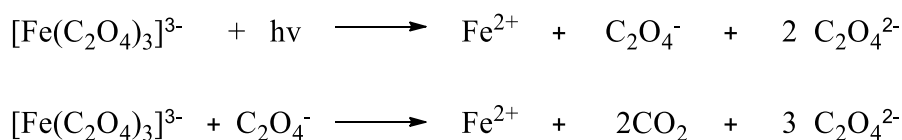
The quantum yield was already defined in Equation 2.6 for a general deactivation process. For a photochemical reaction, the quantum yield becomes the ratio between the number of molecules of products formed in unit of time and the number of photons absorbed in unit of time (Equation 2.18).<sup>64</sup>

$$\Phi = \frac{n_{\text{product/s}}}{n_{\text{photons abs/s}}} \quad (2.18)$$

Practically, the quantum yield of a typical reaction is determined by irradiating monochromatic light for a given time. To simplify the analysis, the absorbance of the solution must be high. In such a way, the absorbed light is assumed to be equal to the incident light. In order to avoid problems arising from secondary reactions, the measurement of the quantum yield is usually limited to a conversion below 10%.

The number of incident photons is measured using an actinometer or an energy meter whereas the number of formed products is measured by an analytical technique. The quantum yield measurement is generally determined by measuring the change in concentration of the product according to time. By using a GC-MS apparatus, the change of the product concentration is measured according to time, such that the quantum yield is given by plotting the product concentration as a function of absorbed photons.

A chemical actinometer is a reference substance undergoing a photochemical reaction with a known quantum yield. Since the quantum yield is known, this photochemical reaction can be used for the determination of the number of absorbed photons. Among chemical actinometers, potassium ferrioxalate is the most reliable for UV and visible light (<420 nm). When an aqueous solution of  $\text{K}_3[\text{Fe}(\text{C}_2\text{O}_4)_3]$  is irradiated, a decomposition into  $\text{CO}_2$  occurs (Scheme II.22). Two  $\text{Fe}^{2+}$  ions are formed for each decomposition of  $[\text{Fe}(\text{C}_2\text{O}_4)_3]^{3-}$ . The quantity of  $\text{Fe}^{2+}$  ions formed during the irradiation is determined by adding phenanthroline which forms the coloured complex  $[\text{Fe}(\text{phen})_3]^{2+}$ . This complex has a maximum of absorbance at  $\lambda=510$  nm ( $\epsilon = 11100 \text{ M}^{-1}\text{cm}^{-1}$ ). By using a UV-visible spectrometer and the Beer-Lambert law, the quantity of  $\text{Fe}^{2+}$  is easily obtained. It is important to notice that the quantum yield of  $\text{Fe}^{2+}$  formation is wavelength dependent (for example the quantum yield is 1,25 at 254 nm and 1,11 at 436 nm).



**Scheme II.22.** Decomposition of  $\text{K}_3[\text{Fe}(\text{C}_2\text{O}_4)_3]$  under visible light irradiation.<sup>96</sup>

When the light of irradiation is above 420 nm, the determination of the photon flux by potassium ferrioxalate is not appropriate. An energy-meter equipped with a calibrated detector can be used to determine the number of incident photons on the reaction vessel.

### 3.4. Photoredox activation of sulfonyl groups

The activation of a sulfonyl group by photoredox catalysis is a mild way to form a sulfonyl radical or a carbon-centered radical (through  $\alpha$ -scission). The commonly used sulfonyl precursors in this field are either electron acceptors (sulfonyl halides, tri/difluoromethylsulfones, thiosulfones, sulfonyl selenides...) or electron donors (sulfinates). The photoredox activation of these sulfonyl precursors has been successfully applied in organic synthesis and the following section will introduce the most important examples over the past 10 years.<sup>104</sup> The proposed photocatalytic mechanisms as well as the synthetic applications will be discussed. The photoredox-based strategies involving sulfur dioxide or its surrogate DABSO were also reported for the synthesis of sulfone-containing compounds but the sulfone moiety rarely intervenes in the photocatalytic cycle and will not be discussed in this chapter.<sup>105</sup>

#### 3.4.1. Sulfonyl selenides as sulfonyl precursors

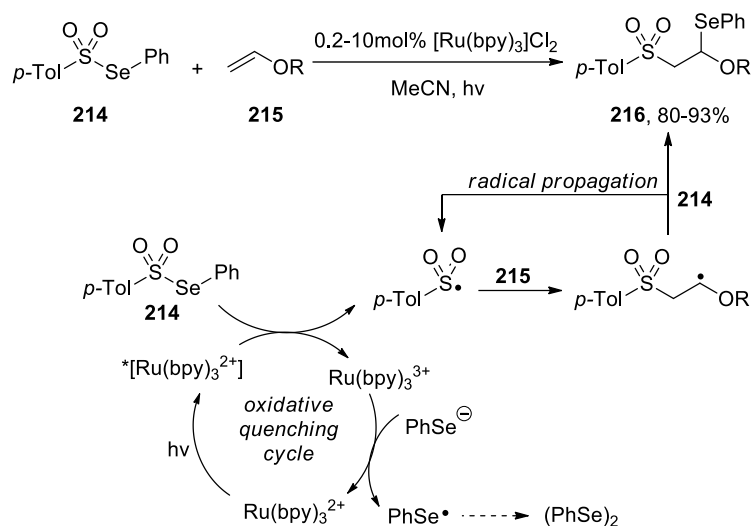
The Ru(bpy)<sub>3</sub>Cl<sub>2</sub>-mediated addition of Se-phenyl areneselenosulfonate **214** to electron rich olefins **215** was described by Barton (Scheme II.23).<sup>106</sup> According to the authors, the tris(2,2'-bipyridine)ruthenium(II) complex acts as a SET initiator. After excitation of this complex with visible light, the *p*-tolueneselenosulfonate **214** is reduced by single electron transfer, furnishing the sulfonyl radical and the corresponding selenide. Then, a radical chain mechanism leads to the ATRA product **216**. Due to the isolation of diphenyldiselenide as a by-product, they hypothesized that the selenide anion could reduce the Ru(bpy)<sub>3</sub><sup>3+</sup> complex to give back the photocatalyst in its ground state.

---

<sup>104</sup> J. Zhu, W.-C. Yang, X.-d. Wang, L. Wu, *Adv. Synth. Catal.* **2017**, *360*, 386-400.

<sup>105</sup> (a) T. Liu, Y. Li, L. Lai, J. Cheng, J. Sun, J. Wu, *Org. Lett.* **2018**, *20*, 3605-3608; (b) N.-W. Liu, S. Liang, G. Manolikakes, *Adv. Synth. Catal.* **2017**, *359*, 1308-1319

<sup>106</sup> D. H. R. Barton, M. A. Csiba, J. C. Jaszberenyi, *Tetrahedron Lett.* **1994**, *35*, 2869-2872.



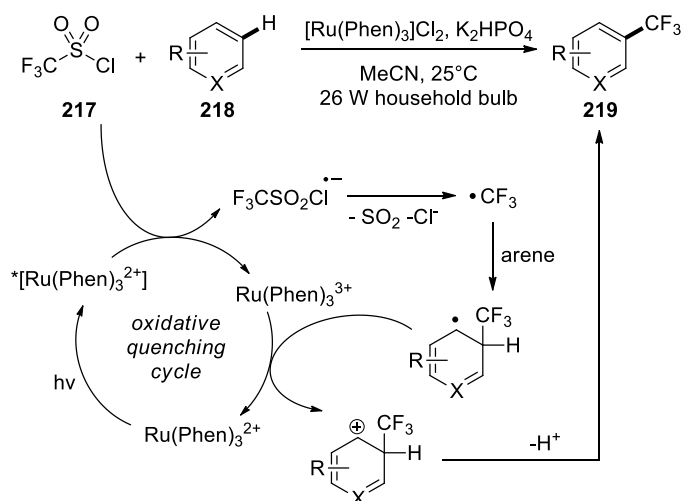
**Scheme II.23.** Addition of Se-phenyl areneselenosulfonates to olefins as described by Barton.<sup>106</sup>

### 3.4.2. Sulfonyl chlorides as sulfonyl precursor

The trifluoromethylsulfonyl chloride is a widely used sulfonyl precursor in photoredox catalysis. The cleavage of the trifluoromethylsulfonyl chloride and perfluoroalkanesulfonyl chlorides catalyzed by  $[\text{Ru}(\text{PPh}_3)_2]\text{Cl}_2$  was first demonstrated by Kamigata and co-workers in perfluoroalkylation of alkenes.<sup>107</sup> Triflyl chloride **217** was then used by MacMillan in the photoredox-catalyzed trifluoromethylation of arenes and heteroarenes **218** (Scheme II.24).<sup>108</sup> The photoinduced electron transfer from the reductant excited state  $^*\text{Ru}(\text{Phen})_3^{2+}$  ( $-0.9$  V vs SCE) to triflyl chloride ( $-0.81$  V) generates a radical anion, which directly collapses to give the trifluoromethyl radical along with sulfur dioxide and the chloride anion. The  $\text{CF}_3$  radical then adds to the most electron-rich position of the arene to give a cyclohexadienyl-type radical ( $-0.1$  V vs SCE). A second SET event reduces the strongly oxidizing  $\text{Ru}^{3+}$  photocatalyst ( $+1.31$  V vs SCE) and gives rise to the formation of a carbocation with the regeneration of the ground state photocatalyst. Deprotonation by a base and rearomatization furnishes the trifluoromethylated arene **219**.

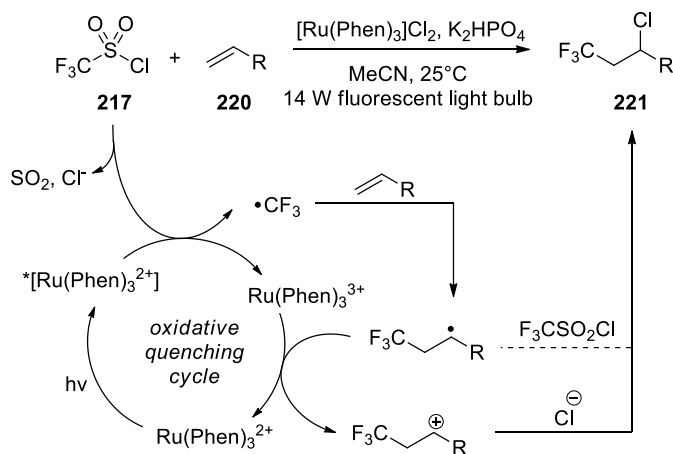
<sup>107</sup> (a) N. Kamigata, T. Fukushima, M. Yoshida, *J. Chem. Soc., Chem. Commun.* **1989**, 1559-1560; (b) N. Kamigata, T. Fukushima, Y. Terakawa, M. Yoshida, H. Sawada, *J. Chem. Soc., Perkin Trans. 1* **1991**, 627-633.

<sup>108</sup> D. A. Nagib, D. W. C. MacMillan, *Nature* **2011**, *480*, 224-228.



**Scheme II.24.** Trifluoromethylation of arenes and heteroarenes by MacMillan.<sup>108</sup>

In sharp contrast to the study of MacMillan, the chlorotrifluoromethylation of alkenes **220** was reported later by Han *et al.* from triflyl chloride **217** using  $\text{Ru}(\text{Phen})_3\text{Cl}_2$  as the photocatalyst (Scheme II.25).<sup>109</sup> The mechanism is similar to that proposed by MacMillan. After the addition of  $\text{CF}_3$  radical to the olefin backbone, the new radical is oxidized by  $\text{Ru}(\text{Phen})_3^{3+}$ , leading to the photocatalyst in its ground-state and to the corresponding carbocation. The latter is trapped by the chloride anion to give the chlorotrifluoromethylated product **221**. According to the authors, the radical chain propagation is not the main pathway for the product formation. Applications of this methodology to alkynes was published later.<sup>110</sup>



**Scheme II.25.** Chlorotrifluoromethylation of alkenes by Jung and Han.<sup>109</sup>

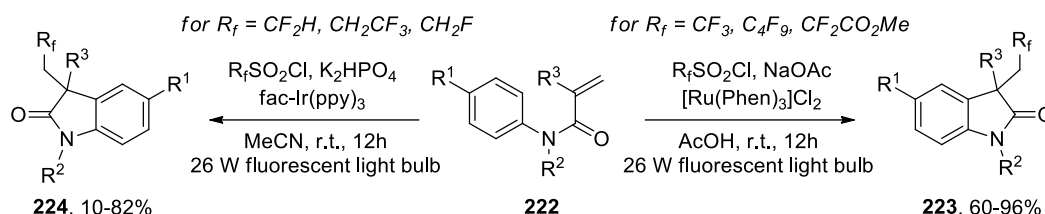
A similar mechanism was proposed by Dolbier for the photoredox-catalyzed tandem radical cyclization of *N*-arylacrylamides **222** (Scheme II.26).<sup>111</sup> Different fluorinated alkyl radicals were formed from the corresponding sulfonyl chlorides  $\text{R}_f\text{SO}_2\text{Cl}$  through photoinduced electron

<sup>109</sup> S. H. Oh, Y. R. Malpani, N. Ha, Y.-S. Jung, S. B. Han, *Org. Lett.* **2014**, *16*, 1310-1313.

<sup>110</sup> H. S. Han, Y. J. Lee, Y.-S. Jung, S. B. Han, *Org. Lett.* **2017**, *19*, 1962-1965.

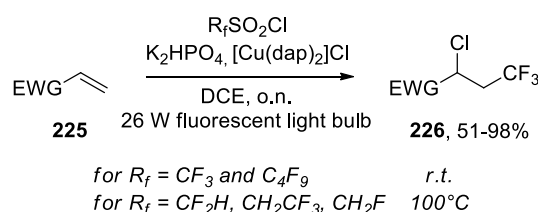
<sup>111</sup> X.-J. Tang, C. S. Thomason, W. R. Dolbier, Jr., *Org. Lett.* **2014**, *16*, 4594-4597.

transfer and SO<sub>2</sub> extrusion. Using Ru(Phen)<sub>3</sub>Cl<sub>2</sub>, the yields were good to excellent for products **223** (R<sub>f</sub> = CF<sub>3</sub>, C<sub>4</sub>F<sub>9</sub> and CF<sub>2</sub>CO<sub>2</sub>Me) but the same photocatalyst was not effective for CF<sub>2</sub>H, CH<sub>2</sub>CF<sub>3</sub> and CH<sub>2</sub>F sulfonyl chlorides. The use of a more reducing photocatalyst, fac-Ir(ppy)<sub>3</sub>, gave moderate to good yields for the cyclized products **224** (R<sub>f</sub> = CF<sub>2</sub>H, CH<sub>2</sub>CF<sub>3</sub>). Lower yields were however obtained for CH<sub>2</sub>F alkyl group. The CH<sub>2</sub>F sulfonyl chloride is indeed more difficult to reduce.



**Scheme II.26.** Photoredox-catalyzed tandem radical cyclization of *N*-arylacrylamides by Dolbier.<sup>111</sup>

Dolbier *et al.* also reported the Cu-catalyzed atom transfer radical addition of fluoroalkylsulfonyl chloride onto electron-deficient alkenes **225** under visible light irradiation (Scheme II.27).<sup>112</sup> Here, the selection of [Cu(dap)<sub>2</sub>]Cl as a photocatalyst was ideal both for the initiation and the propagation of the ATRA reaction with electron-deficient alkenes. This catalyst possesses strong reductive property in its excited state (−1.42 vs SCE in MeCN) as well as a good chloride transfer propensity which circumvents the unfavoured chlorine abstraction by the electrophilic radical. Hard to reduce substrates required higher temperatures.



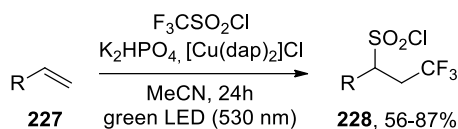
**Scheme II.27.** Cu-catalyzed ATRA reactions of fluoroalkylsulfonyl chloride on electron-deficient alkenes by Dolbier.<sup>112</sup>

Interestingly, the same year Reiser *et al.* reported an unprecedented trifluoromethylchlorosulfonylation of alkenes **227** with the same photocatalyst, [Cu(dap)<sub>2</sub>]Cl (Scheme II.28).<sup>113</sup> They observed that no desulfonylation occurred with [Cu(dap)<sub>2</sub>]Cl leading to products **228**. Others catalysts such as Ru(bpy)<sub>3</sub>Cl<sub>2</sub>, [Ir(ppy)<sub>2</sub>(dtbbpy)]PF<sub>6</sub> or eosin Y gave the trifluoromethylation product showing the unique property of [Cu(dap)<sub>2</sub>]Cl. They proposed an

<sup>112</sup> X.-J. Tang, W. R. Dolbier, Jr., *Angew. Chem. Int. Ed.* **2015**, *54*, 4246-4249.

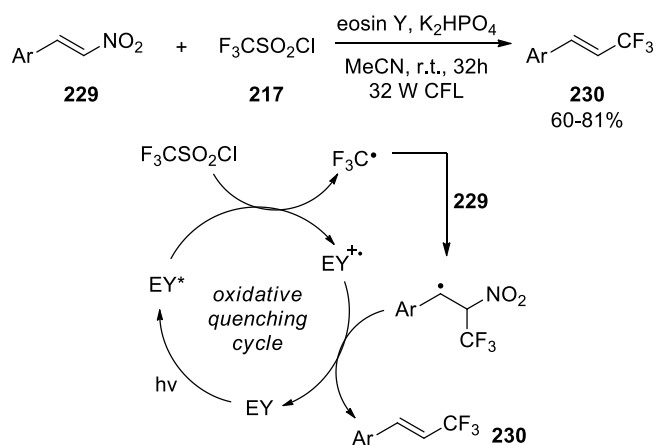
<sup>113</sup> D. B. Bagal, G. Kachkovskiy, M. Knorn, T. Rawner, B. M. Bhanage, O. Reiser, *Angew. Chem. Int. Ed.* **2015**, *54*, 6999-7002.

inner-sphere mechanism in which the  $[\text{Cu}(\text{dap})_2]\text{Cl}$  catalyst is involved in the SET event as well as in the bond forming process by coordinating the two coupling partners.



**Scheme II.28.**  $[\text{Cu}(\text{dap})_2]\text{Cl}$ -mediated trifluoromethylchlorosulfonylation of alkenes by Reiser.<sup>113</sup>

The trifluoromethylation of  $\beta$ -nitroalkenes **229** was also described using eosin-Y as the photoredox organocatalyst (Scheme II.29).<sup>114</sup> The authors proposed an oxidative quenching mechanism in which the excited state of eosin is quenched by triflyl chloride **217**, generating the radical cation  $\text{EY}^{+\bullet}$  and the  $\text{CF}_3$  radical. Curiously, they confirmed this PET event through the Stern-Volmer fluorescence quenching experiments, although they invoked the triplet excited state of eosin Y in their mechanism. After the addition of the trifluoromethyl radical to  $\beta$ -nitroalkene, the trifluoromethylalkene **230** is formed either by oxidation of the benzylic radical which closes the catalytic cycle or through  $\beta$ -elimination of  $\text{NO}_2$ .



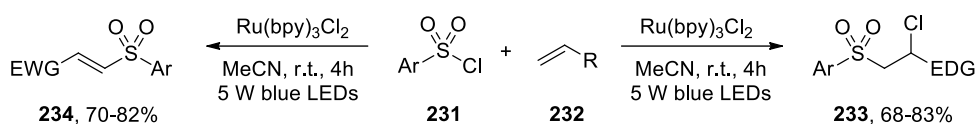
**Scheme II.29.** Eosin-mediated trifluoromethylation of  $\beta$ -nitroalkenes.<sup>114</sup>

Although Stephenson *et al.* already used the tosyl chloride in the photoredox-catalyzed sulfonylchlorination of styrene,<sup>100</sup> a recent paper exemplified this ATRA reaction with arylsulfonyl chlorides **231** and alkenes **232** (Scheme II.30).<sup>115</sup> The ATRA products **233** were only obtained with electron-poor aryl groups. The synthesis of vinyl sulfones **234** was also accomplished with electron-deficient alkenes.

<sup>114</sup> S. P. Midya, J. Rana, T. Abraham, B. Aswin, E. Balaraman, *Chem. Comm.* **2017**, 53, 6760-6763.

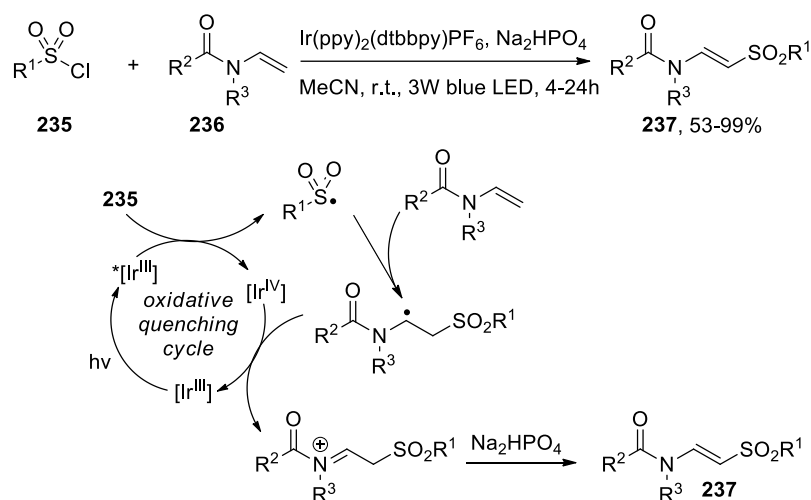
<sup>115</sup> T.-f. Niu, D. Lin, L.-s. Xue, D.-y. Jiang, B.-q. Ni, *Synlett* **2018**, 29, 364-368.





**Scheme II.30.** Sulfonyl chlorides in photoredox-catalyzed sulfonylation of alkenes.<sup>115</sup>

The synthesis of  $\beta$ -amido vinylsulfones **237** through photoredox-catalyzed sulfonylation of enamides **236** was reported by Yu (Scheme II.31).<sup>116</sup> Under visible light irradiation, the iridium photocatalyst is promoted to an excited state which is quenched by the sulfonyl chloride **235** to give the sulfonyl radical. The latter adds onto the unsaturated system of the enamide providing an amido radical which is oxidized by Ir(IV) complex to give *N*-acyliminium cation and the initial Ir(III) photocatalyst. Deprotonation gives the amido vinylsulfone **237**.

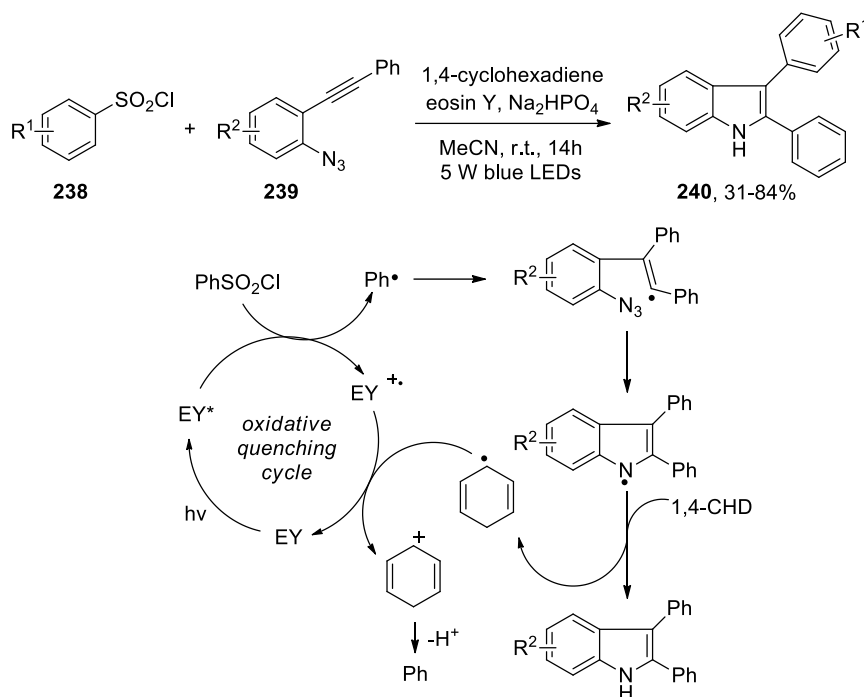


**Scheme II.31.** Synthesis of  $\beta$ -amido vinylsulfones by Yu.<sup>116</sup>

More surprisingly, under visible light irradiation the organic dye eosin-Y was used as a reductant to convert arylsulfonyl chlorides **238** into the corresponding aryl radicals (Scheme II.32).<sup>117</sup> The addition of the latter onto alkynes **239** followed by intramolecular cyclization gives the corresponding 2,3-diaryl-substituted indoles **240**. The authors did not comment on the formation of aryl radicals through desulfonylation which is known to be very slow at room temperature.

<sup>116</sup> H. Jiang, X. Chen, Y. Zhang, S. Yu, *Adv. Synth. Catal.* **2013**, 355, 809-813.

<sup>117</sup> L. Gu, C. Jin, W. Wang, Y. He, G. Yang, G. Li, *Chem. Commun.* **2017**, 53, 4203-4206.

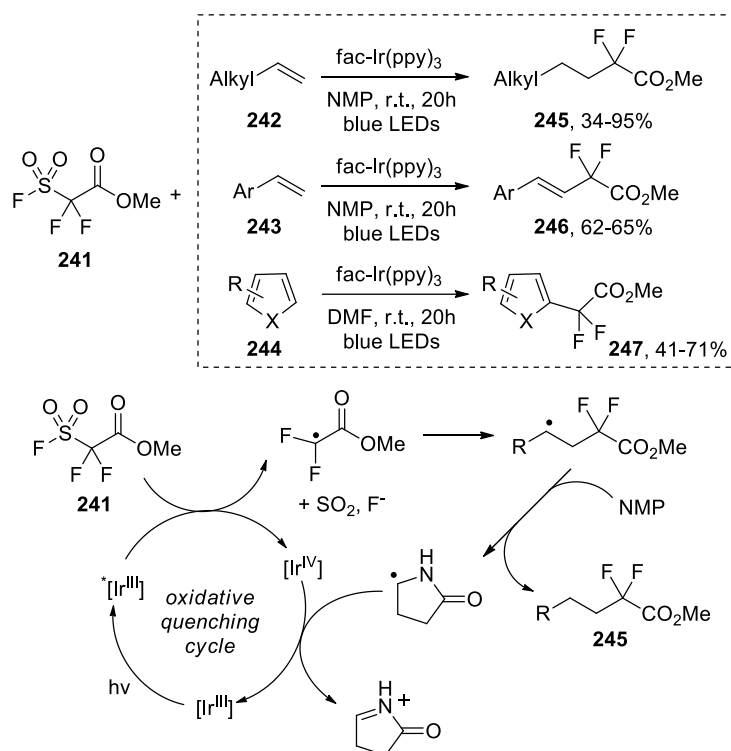


**Scheme II.32.** Synthesis of 2,3-diaryl-substituted indoles reported by Gu.<sup>117</sup>

### 3.4.3. Sulfonyl fluorides as sulfonyl precursor

The activation of sulfonyl fluorides with photoredox catalyst has also been reported.<sup>118</sup> Here, methyl fluorosulfonyldifluoroacetate **241** was reduced through photoinduced electron transfer from <sup>\*</sup>fac-Ir<sup>III</sup>(ppy)<sub>3</sub> to give an electrophilic radical which was further transformed after its addition onto unsaturated systems **242-244** (Scheme II.33). For aliphatic alkenes **242**, the new nucleophilic radical abstracts a hydrogen from NMP to give **245**, whereas for styrenyl alkenes **243** and heteroarenes **244** the new radical is oxidized by fac-Ir<sup>IV</sup>(ppy)<sub>3</sub> to give the final product **246-247** and the initial fac-Ir<sup>III</sup>(ppy)<sub>3</sub> photocatalyst.

<sup>118</sup> W. Yu, X.-H. Xu, F.-L. Qing, *Org. Lett.* **2016**, *18*, 5130-5133.

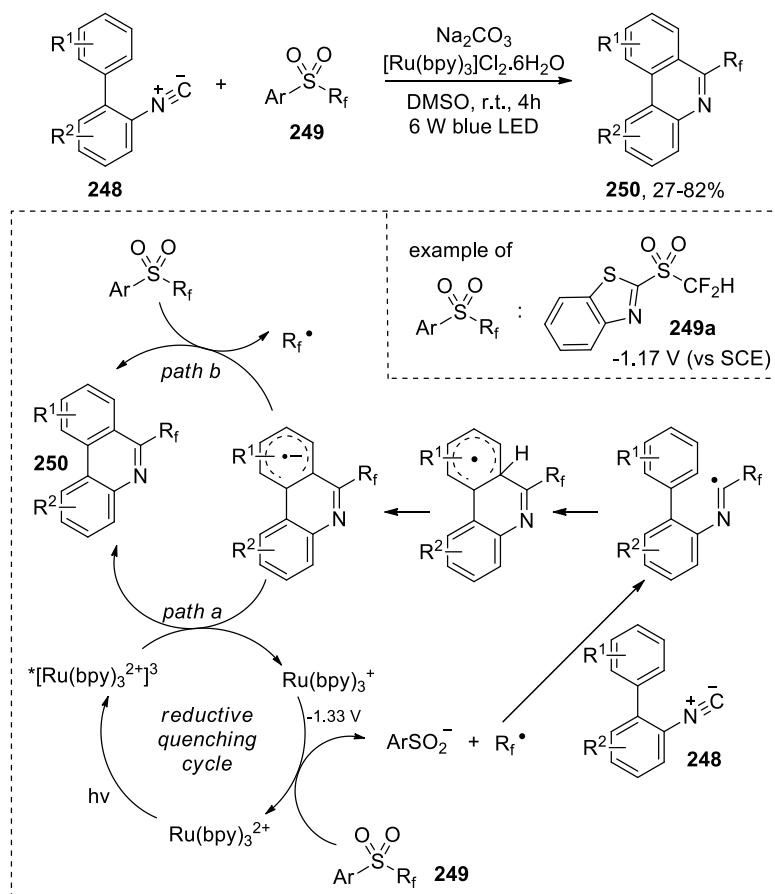


**Scheme II.33.** Methyl fluorosulfonyldifluoroacetate as a  $\text{CF}_2\text{CO}_2\text{R}$  radical source.<sup>118</sup>

### 3.4.4. Aryl sulfones as sulfonyl precursor

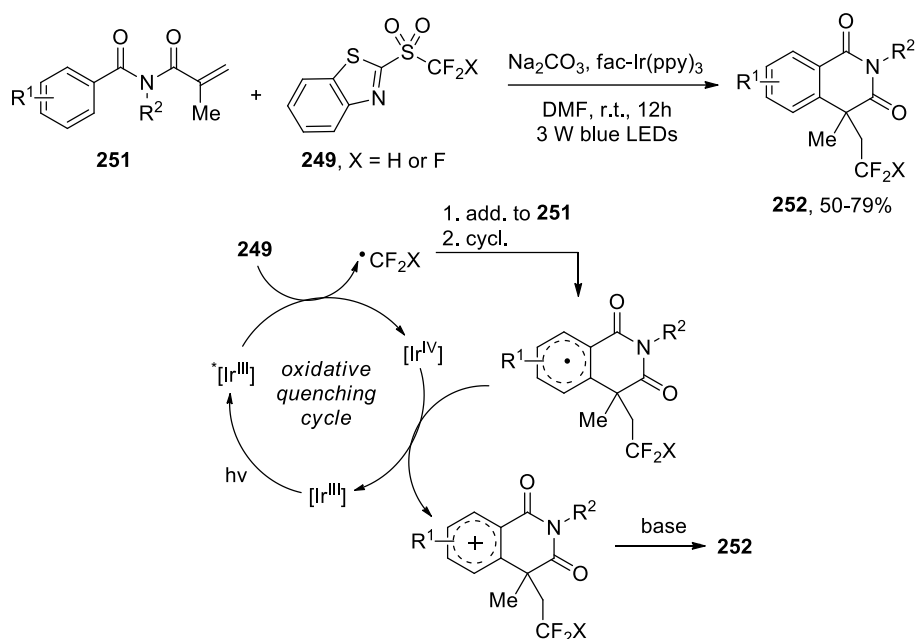
The photoredox-catalyzed radical fluoroalkylation of isonitriles **248** was described by Hu and co-workers using  $[\text{Ru}(\text{bpy})_3]\text{Cl}_2$  starting from aryl alkylfluorinated sulfones **249** (Scheme II.34).<sup>119</sup> The originality of this methodology comes from the fact the  $\text{R}_f\text{-SO}_2$  bond is broken under photoredox conditions. The fluorinated alkyl radicals in the previous studies were generated from the sulfonyl chloride after SET event and  $\text{SO}_2$  extrusion. Based on electrochemical data, the authors proposed a reductive quenching cycle in which the reductant  $\text{Ru}(\text{bpy})_3^+$ , initially formed from the quenching of  $^*\text{Ru}(\text{bpy})_3^{2+}$  by carbonate ion (not shown), gives an electron to the aryl sulfone **249**. This SET event results in the cleavage of the  $\text{R}_f\text{-SO}_2$  bond leading to the sulfinate and the fluorinated alkyl radical. Addition of the latter to the isonitrile **248** followed by intramolecular radical cyclization of the imidoyl radical and deprotonation furnishes a radical anion, finally oxidized by  $^*\text{Ru}(\text{bpy})_3^{2+}$  to give the product **250**.

<sup>119</sup> J. Rong, L. Deng, P. Tan, C. Ni, Y. Gu, J. Hu, *Angew. Chem. Int. Ed.* **2016**, *55*, 2743-2747.

Scheme II.34. radical fluoroalkylation of isonitrile by Hu.<sup>119</sup>

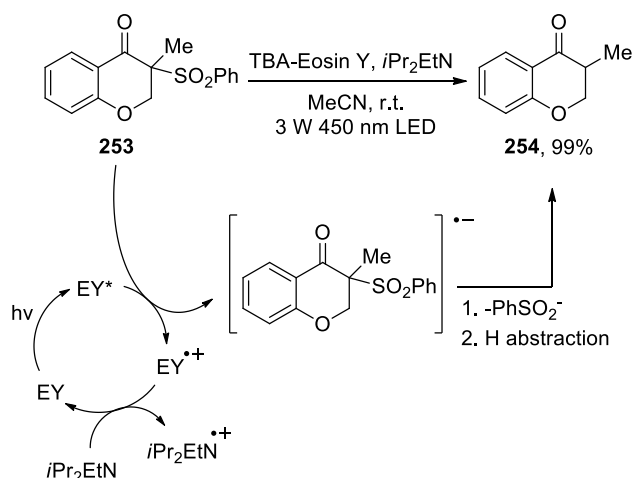
These reagents were also used in other photoredox processes for the trifluoro- and difluoromethylation of *N*-methacryloyl benzamides **251** leading to isoquinolinediones **252** (Scheme II.35).<sup>120</sup> Here, an oxidative quenching cycle mechanism was proposed. However, no mechanistic studies were undertaken to support this mechanism.

<sup>120</sup> G. Zou, X. Wang, *Org. Biomol. Chem.* **2017**, *15*, 8748-8754.



**Scheme II.35.** Trifluoro- and difluoromethylation of *N*-methacryloyl benzamides.<sup>120</sup>

The desulfonylation of  $\beta$ -arylketosulfones was accomplished *via* an oxidative quenching cycle mechanism with the organic dye eosin-Y (Scheme II.36).<sup>121</sup> The quenching of the excited state  $^*\text{EY}$  by the  $\beta$ -arylketosulfone **253** was demonstrated by laser flash photolysis. In these mechanistic investigations, the authors observed the characteristic absorption band (460 nm) of the radical cation of eosin when the  $\beta$ -arylketosulfone was introduced into the solution. By adding a large excess of Hünig base, the radical anion of eosin was observed but no quenching of the latter was found in presence of the  $\beta$ -arylketosulfone. This result suggests that the electron transfer from  $^*\text{EY}$  to the sulfone is not favourable. The photoinduced electron transfer from  $^*\text{EY}$  to the  $\beta$ -arylketosulfone provides a radical-anion which undergoes a desulfonylation reaction. The radical thus formed abstracts a hydrogen to give the final product **254**.

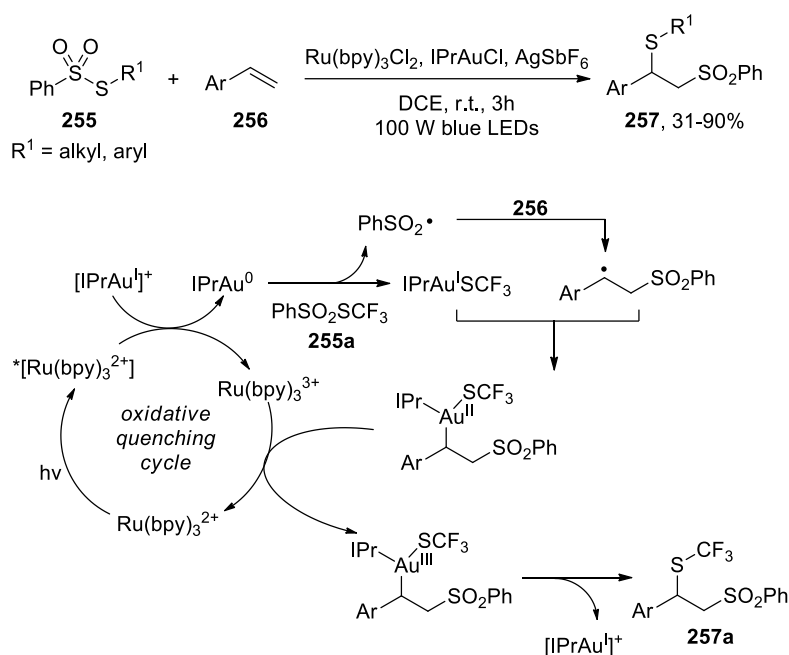


**Scheme II.36.** Desulfonylation of  $\beta$ -arylketosulfones by Liu and Wu.<sup>121</sup>

<sup>121</sup> D.-T. Yang, Q.-Y. Meng, J.-J. Zhong, M. Xiang, Q. Liu, L.-Z. Wu, *Eur. J. Org. Chem.* **2013**, 2013, 7528-7532.

### 3.4.5. Thiosulfone as sulfonyl precursor

The indirect activation of thiosulfones **255** through a dual gold and photoredox catalysis was used for the thiosulfonylation of styrene-type olefins **256** (Scheme II.37).<sup>122</sup> The trifluoromethylthio group as well as other functionalized alkylthio groups can be inserted onto the olefin backbone. Concerning the mechanism, the cationic gold species ( $\text{IPrAu}^{\text{I}}$ ) is reduced by the excited state  $^*[\text{Ru}(\text{bpy})_3]^{2+}$  to give the active  $\text{IPrAu}^0$  catalyst. This photoinduced electron transfer was supported by electrochemical data, Stern-Volmer fluorescence quenching as well as transient absorption spectroscopy. On the basis of this result, the authors proposed the following mechanism (Scheme II.36): the reaction between the reductive  $\text{IPrAu}^0$  species and the thiosulfone **255a** provides the sulfonyl radical and  $\text{IPrAu}^{\text{I}}\text{SCF}_3$ . After the addition of the sulfonyl radical onto alkene **256**, the newly formed radical oxidizes the  $\text{IPrAu}^{\text{I}}\text{SCF}_3$  into an  $[\text{Au}^{\text{II}}]$  intermediate, which is further oxidized into  $[\text{Au}^{\text{III}}]$  by the  $[\text{Ru}(\text{bpy})_3]^{3+}$ , eventually regenerating the  $\text{Ru}^{\text{II}}$  photocatalyst. The final product **257a** is obtained through a reductive elimination process which regenerates the co-catalyst  $\text{IPrAu}^{\text{I}}$ .



**Scheme II.37.** Thiosulfonylation of alkenes through a dual gold and photoredox catalysis.<sup>122</sup>

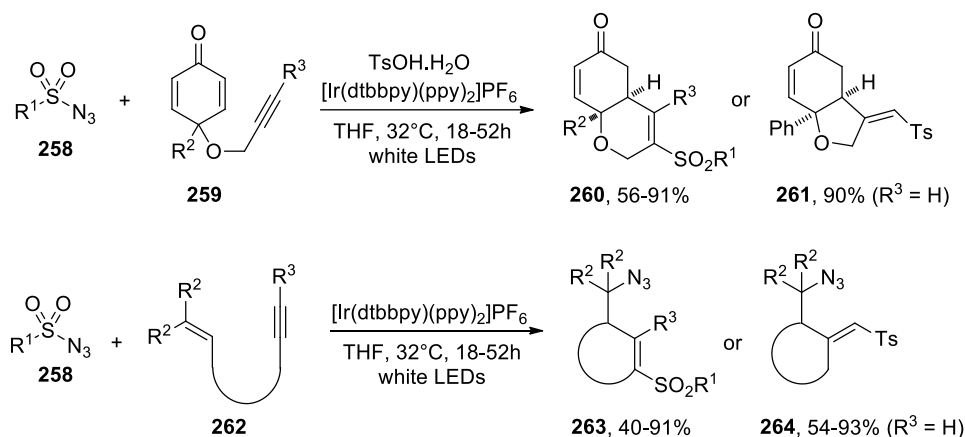
### 3.4.6. Sulfonyl azide as sulfonyl precursor

The generation of sulfonyl radicals from sulfonyl azides **258** using an iridium photocatalyst was reported in the sulfonylative cyclization of alkynes **259** and in the azidosulfonylative cyclization of enynes **262** (Scheme II.38).<sup>123</sup> These processes were strongly affected by the

<sup>122</sup> H. Li, C. Shan, C.-H. Tung, Z. Xu, *Chem. Sci.* **2017**, *8*, 2610-2615.

<sup>123</sup> S. Zhu, A. Pathigoolla, G. Lowe, D. A. Walsh, M. Cooper, W. Lewis, H. W. Lam, *Chem. Eur. J.* **2017**, *23*, 17598-17604.

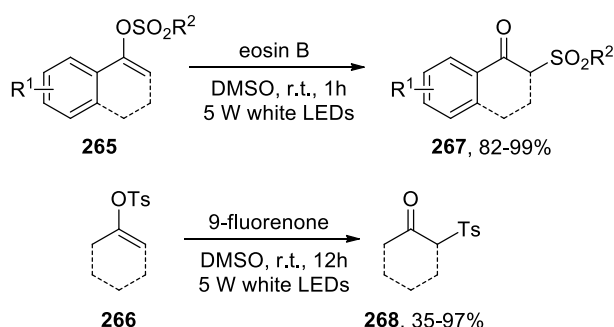
presence of THF. Both reactions are explained by a radical chain mechanism. For the sulfonylative cyclization, THF acts as the hydrogen donor. Concerning the initiation, the high reduction potential of sulfonyl azide ( $\text{TsN}_3$ ,  $-1.22 \text{ V vs SCE}$ ) rules out the possibility of a PET process ( $^*\text{Ir}^{\text{III/IV}}$ ,  $-0.96 \text{ V vs SCE}$ ). An energy transfer mechanism was invoked to produce a sulfonyl nitrene which then abstracts a hydrogen of THF, triggering the radical chain mechanism.



**Scheme II.38.** Sulfonylative and azidosulfonylative cyclization of enynes by Lam.<sup>123</sup>

### 3.4.7. Sulfonates as sulfonyl precursor

Recently, vinyl tosylates **265** and **266** were shown to undergo a rearrangement to  $\beta$ -ketosulfones **267** and **268** under photoredox conditions using eosin-B and 9-fluorenone respectively (Scheme II.39).<sup>124</sup> Based on DFT calculations, the authors proposed a mechanism relying on an energy transfer mechanism, followed by an homolytic cleavage of the O-SO<sub>2</sub> bond. Then, a radical chain mechanism delivers the final compound.



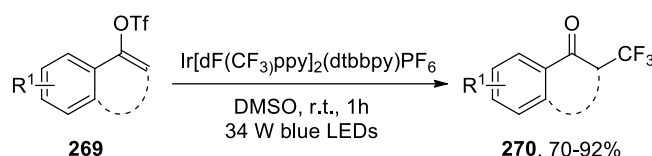
**Scheme II.39.** Rearrangement of vinyl tosylates into  $\beta$ -ketosulfones.<sup>124</sup>

Similarly, a trifluoromethyl migration was also described from enol triflates **269** through an energy transfer mechanism (Scheme II.40).<sup>125</sup> The energy transfer from the excited state of the iridium complex to the enol triflate would consist in an initiation step and result in a rapid bond

<sup>124</sup> L. Xie, X. Zhen, S. Huang, X. Su, M. Lin, Y. Li, *Green Chem.* **2017**, *19*, 3530-3534.

<sup>125</sup> S. Liu, J. Jie, J. Yu, X. Yang, *Adv. Synth. Catal.* **2018**, *360*, 267-271.

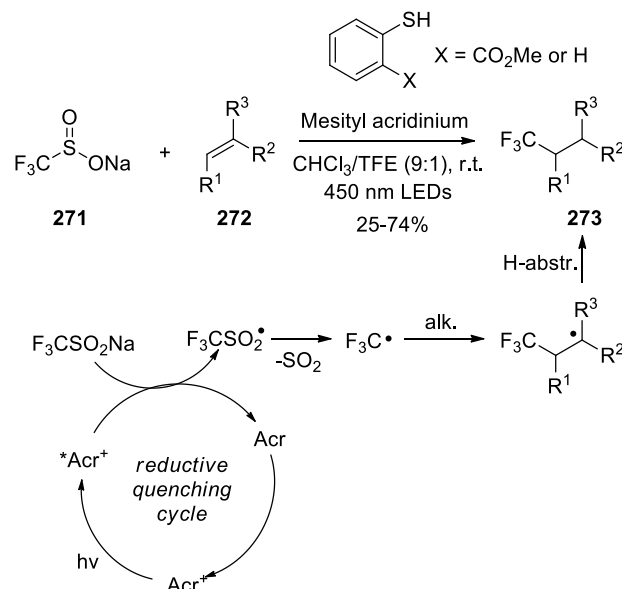
dissociation and SO<sub>2</sub> extrusion with the release of the CF<sub>3</sub> radical. Then, a radical chain process would deliver the  $\alpha$ -trifluoromethylated ketone **270**. This proposed mechanism is not supported by experimental or theoretical evidences.



**Scheme II.40.** Rearrangement of enol triflates to  $\alpha$ -trifluoromethylated ketones.<sup>125</sup>

### 3.4.8. Sulfinates and sulfinic acids as sulfonyl precursor

The hydrotrifluoromethylation of alkenes **272** was described by Nicewicz with mesityl acridinium as the photoredox catalyst using the Langlois reagent **271** (Scheme II.41).<sup>126</sup> PET from the sulfinate salt to the excited state of the acridinium catalyst lead to the formation of the trifluoromethyl radical after extrusion of SO<sub>2</sub>. This electrophilic radical then adds to the olefin backbone. In the case of aliphatic alkenes, methyl thiosalicylate was used as the hydrogen donor in substoichiometric amount, while in the case of styrenyl substrate, thiophenol was used in a stoichiometric amount. The authors also mentioned that the hydrogen abstraction might occur from the trifluoroethanol and several pathways were proposed for the mechanism (not shown).



**Scheme II.41.** Hydrotrifluoromethylation of alkenes by Nicewicz.<sup>126</sup>

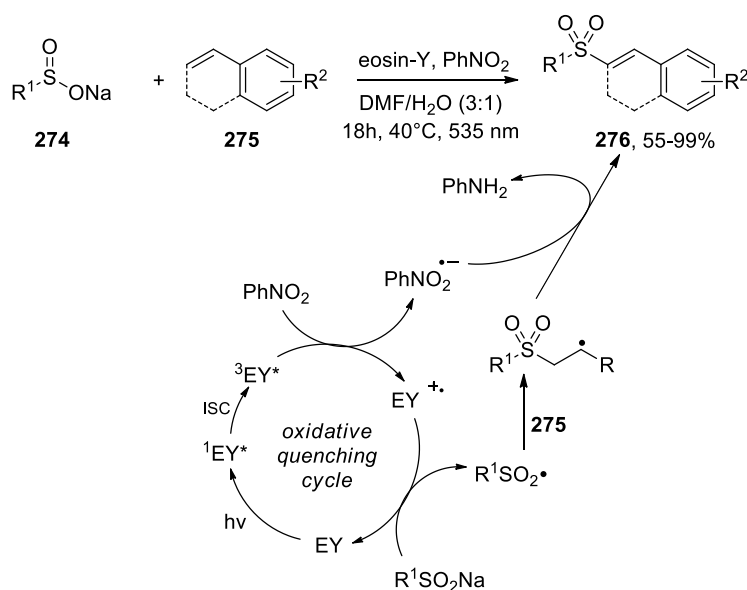
The synthesis of vinyl sulfones **276** from aryl sulfinates **274** with eosin-Y as the photocatalyst was described by König and co-workers (Scheme II.42).<sup>127</sup> Further improvements

<sup>126</sup> D. J. Wilger, N. J. Gesmundo, D. A. Nicewicz, *Chem. Sci.* **2013**, 4, 3160-3165.

<sup>127</sup> A. U. Meyer, S. Jaeger, D. Prasad Hari, B. Koenig, *Adv. Synth. Catal.* **2015**, 357, 2050-2054.

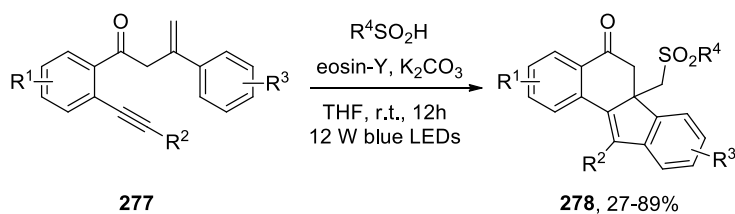


of the sulfinate scope was accomplished later with the determination of the mechanism.<sup>128</sup> Both the oxidative and reductive quenching cycle were thermodynamically possible and transient spectroscopy finally revealed that the triplet excited state of eosin-Y was quenched by nitrobenzene to give the radical cation of eosin-Y. The latter is then able to oxidize the sulfinate into a sulfonyl radical, regenerating eosin-Y in its ground-state. After the addition of the sulfonyl radical to the alkene moiety, the radical anion of nitrobenzene abstracts a hydrogen to give the vinyl sulfone **276**.



**Scheme II.42.** Synthesis of vinyl sulfones by König.<sup>128</sup>

The EY-mediated synthesis of sulfone-containing benzo[a]fluoren-5-ones **278** has been developed through the radical bicyclization of 1,7-enynes **277** (6-*exo*-dig and 5-*endo*-trig, Scheme II.43).<sup>129</sup> This radical-triggered cyclization starts by the formation of the sulfonyl radical from the corresponding sulfinate (formed *in situ* by deprotonation of sulfinic acid). The authors proposed a reductive quenching cycle for the mechanism in which the sulfinate reduces <sup>\*</sup>EY into the corresponding radical anion.

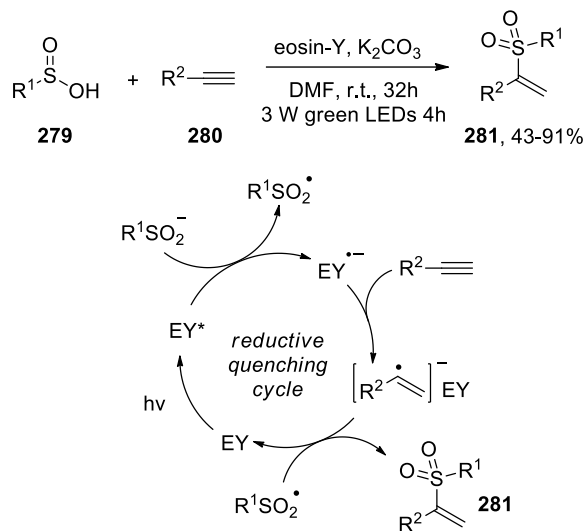


**Scheme II.43.** Synthesis of sulfone-containing benzo[a]fluoren-5-ones by Jiang.<sup>129</sup>

<sup>128</sup> A. U. Meyer, K. Strakova, T. Slanina, B. Koenig, *Chem. Eur. J.* **2016**, *22*, 8694-8699.

<sup>129</sup> M.-H. Huang, Y.-L. Zhu, W.-J. Hao, A.-F. Wang, D.-C. Wang, F. Liu, P. Wei, S.-J. Tu, B. Jiang, *Adv. Synth. Catal.* **2017**, *359*, 2229-2234.

Eosin-Y and sulfinic acids **279** were also used by Lei and co-workers in the Markovnikov addition of sulfonyl radical to terminal alkynes **280** (Scheme II.44).<sup>130</sup> This radical addition is unprecedented because the anti-Markovnikov selectivity is usually observed. EPR experiments suggested that mixed radical species might be involved in the radical pathway. Based on this observation, a radical cross-coupling process was proposed to explain the Markovnikov selectivity. Hence, oxidation of the sulfinate into a sulfonyl radical furnishes the eosin radical-anion, which reacts then with the alkyne moiety to give a vinyl radical. The Markovnikov vinyl sulfone **281** is obtained through the radical cross-coupling and proton transfer.

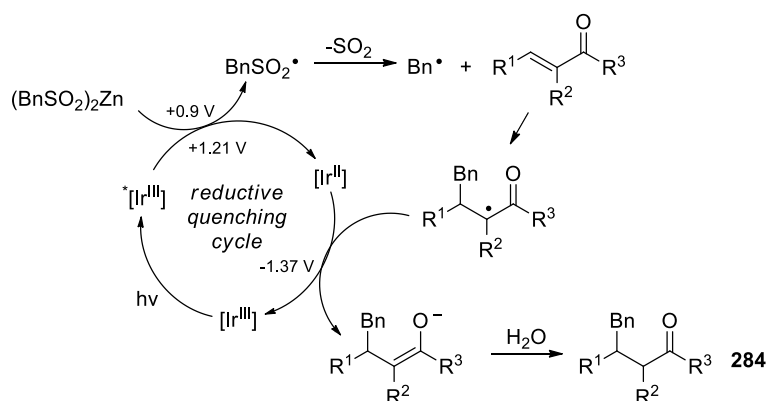
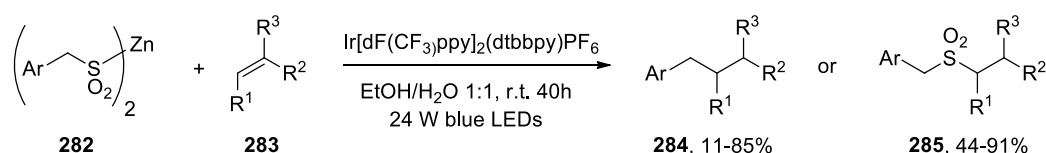


**Scheme II.44.** Markovnikov addition of sulfonyl radical to terminal alkynes.<sup>130</sup>

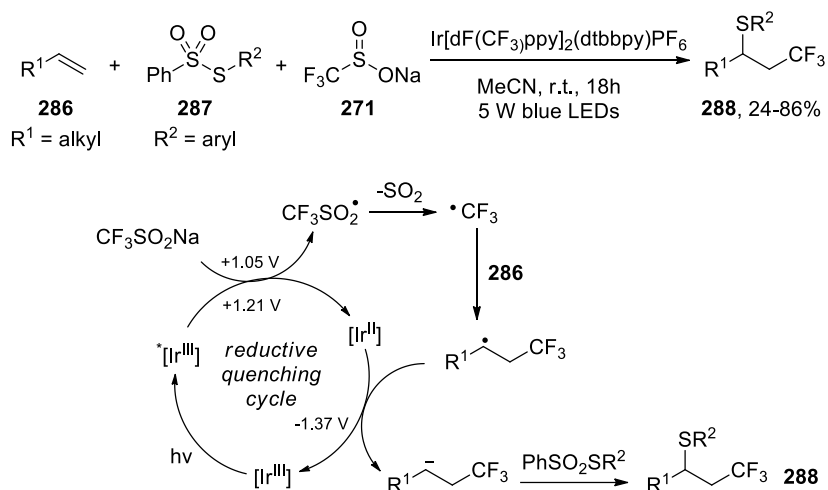
The photocatalytic radical benzylation of electron-deficient alkenes **283** from zinc-sulfonates **282** was also reported (Scheme II.45).<sup>131</sup> Under visible light irradiation, the excited state <sup>\*</sup>Ir[dF(CF<sub>3</sub>)ppy]<sub>2</sub>(dtbbpy)PF<sub>6</sub> is a strong oxidant and converts the zinc-sulfinate into the corresponding sulfonyl radical which undergoes desulfonylation to form a stable benzylic radical. The addition of this radical to a Michael acceptor gives a new radical intermediate, which is then reduced by the [Ir<sup>II</sup>] complex. The obtained enolate is protonated with H<sub>2</sub>O to give the final compound **284**. The mechanism is supported by electrochemical data and Stern-Volmer quenching experiments. With strong electrophilic Michael acceptors, the sulfone derivatives **285** were formed by nucleophilic addition of zinc-sulfonates.

<sup>130</sup> H. Wang, Q. Lu, C.-W. Chiang, Y. Luo, J. Zhou, G. Wang, A. Lei, *Angew. Chem. Int. Ed.* **2017**, *56*, 595-599.

<sup>131</sup> A. Gualandi, D. Mazzarella, A. Ortega-Martínez, L. Mengozzi, F. Calcinelli, E. Matteucci, F. Monti, N. Armaroli, L. Sambri, P. G. Cozzi, *ACS Catal.* **2017**, *7*, 5357-5362.

Scheme II.45. Radical benzylation of electron-deficient alkenes.<sup>131</sup>

The thiotrifluoromethylation of terminal alkenes **286** was accomplished from the Langlois reagent **271** and benzenesulfonothioates **287** (Scheme II.46).<sup>132</sup> The proposed mechanism involves a reductive quenching cycle and is similar to the previous mechanism using zinc-sulfinate. Due to the high oxidation potential of the Langlois reagent, a strong oxidant photocatalyst such as <sup>\*</sup>Ir[dF(CF<sub>3</sub>)ppy]<sub>2</sub>(dtbbpy)PF<sub>6</sub> is required. The high reductive ability of the corresponding [Ir<sup>II</sup>] complex was also required to reduce the new radical into a carbanion, which was finally trapped by the electrophilic thiosulfone to give the thiotrifluoromethylated product **288**.

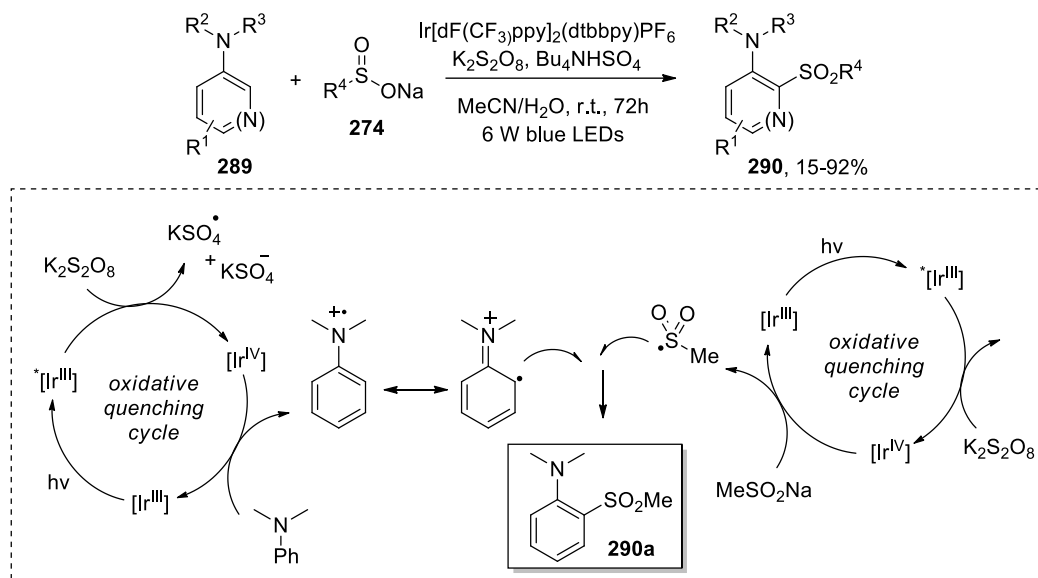
Scheme II.46. Thiotrifluoromethylation of terminal alkenes by Song.<sup>132</sup>

The photoredox-catalyzed sulfonylation of anilines **289** from sodium sulfonates **274** was reported by Willis and co-workers (Scheme II.47).<sup>133</sup> For large scale synthesis, the expensive

<sup>132</sup> W. Kong, H. An, Q. Song, *Chem. Comm.* **2017**, 53, 8968-8971.

<sup>133</sup> T. C. Johnson, B. L. Elbert, A. J. M. Farley, T. W. Gorman, C. Genicot, B. Lallemand, P. Pasau, J. Flasz, J. L. Castro, M. MacCoss, D. J. Dixon, R. S. Paton, C. J. Schofield, M. D. Smith, M. C. Willis, *Chem. Sci.* **2018**, 9, 629-633.

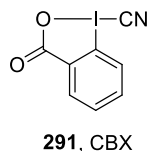
$\text{Ir}[\text{dF}(\text{CF}_3)\text{ppy}]_2(\text{dtbbpy})\text{PF}_6$  photocatalyst may be replaced by the 9-mesityl-10-methylacridinium salt. Importantly, the late stage sulfonylation of drug candidates bearing different functionalities was achieved. Although the mechanistic investigation is still ongoing, they proposed two oxidative quenching cycles forming the sulfonyl radical and the radical cation of aniline which coupled to give the final product **290a**.



**Scheme II.47.** Sulfonylation of aniline by Willis.<sup>133</sup>

### 3.5. Photoredox-catalyzed cyanation reactions

The most common cyanating agents used in photoredox catalysis are tosyl cyanide (TsCN), trimethylsilyl cyanide (TMSCN) and cyanobenziodoxolone **291** (Figure II.32). These radical traps usually react with reactive radical species formed through photoredox activation. Their by-products are sometimes involved in the photocatalytic cycle. Only a few recent examples will be mentioned here.

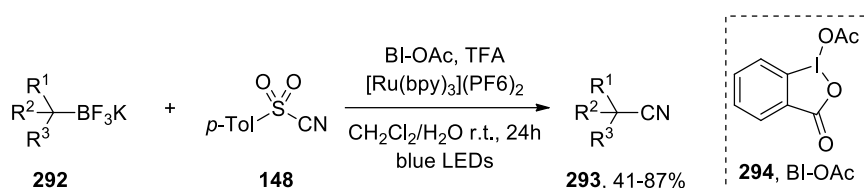


**Figure II.32.** Structure of cyanobenziodoxolone.

The photoredox-catalyzed deboronative cyanation was described by Xu and co-workers using alkyltrifluoroborates **292** as starting materials and tosyl cyanide **148** as the cyanating agent (Scheme II.48).<sup>134</sup> The authors assumed that the alkyl radical was formed through a SET event and

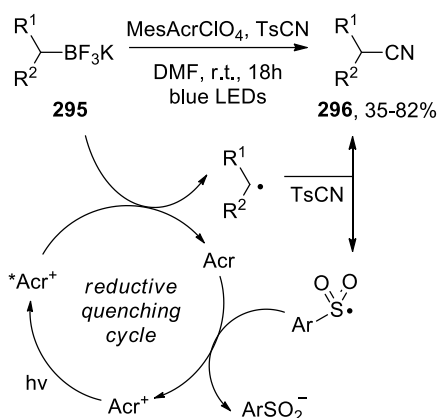
<sup>134</sup> J.-J. Dai, W.-M. Zhang, Y.-J. Shu, Y.-Y. Sun, J. Xu, Y.-S. Feng, H.-J. Xu, *Chem. Commun.* **2016**, 52, 6793-6796.

then trapped by tosyl cyanide furnishing the nitrile product **293**. A stoichiometric amount of oxidant **294** was needed to close the photocatalytic cycle. The role of TFA is not well understood.



**Scheme II.48.** Photoredox-catalyzed deboronative cyanation of alkyltrifluoroborates by Xu.<sup>134</sup>

The cyanation of alkyltrifluoroborates **295** was also described by Molander *et al.* using the mesitylacridinium organophotocatalyst and TsCN (Scheme II.49).<sup>135</sup> The proposed mechanism involves the reductive quenching of the acridinium excited state by the alkyltrifluoroborate, generating the alkyl radical. The trapping of the latter by tosyl cyanide affords the cyanation product **296** and the sulfonyl radical is reduced into a sulfinate by the reduced form of acridinium. Here the sulfonyl reagent acts as a radical trap and as an oxidant. The involvement of the sulfonyl radical in the photocatalytic cycle was also shown by MacMillan *et al.* in their studies related to the photoredox  $\alpha$ -vinylation of  $\alpha$ -amino acids and *N*-aryl amines.<sup>136</sup>



**Scheme II.49.** Photo-organocatalyzed deboronative cyanation by Molander.<sup>135</sup>

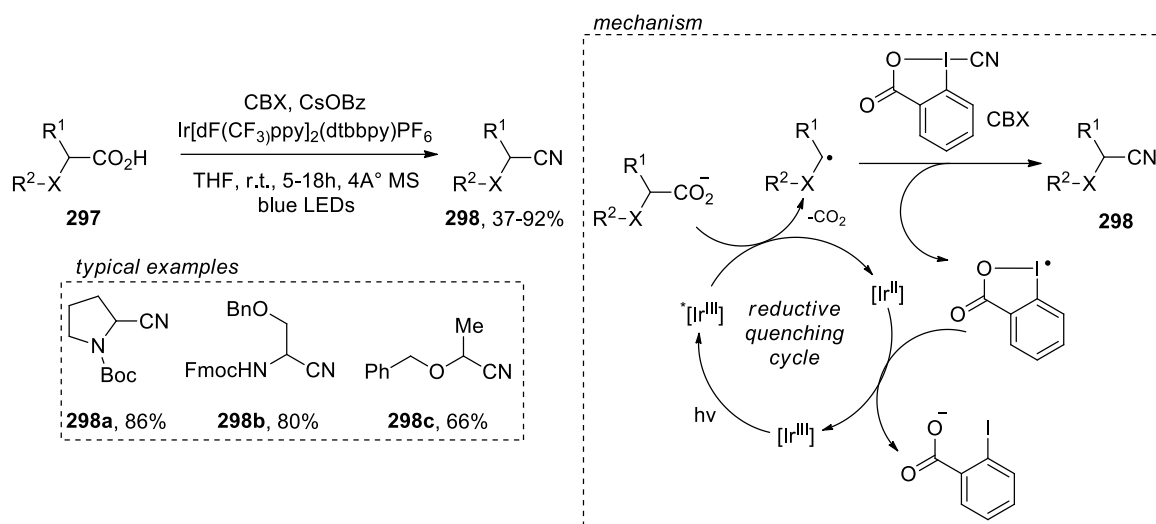
The decarboxylative cyanation of carboxylic acids **297** using cyanobenziodoxolone (CBX) was developed by Waser and co-workers (Scheme II.50).<sup>137</sup> Natural or non-natural amino acids or  $\alpha$ -oxy acids were converted into the corresponding nitriles **298** with good yields. The photocatalytic mechanism involves the reductive quenching of  $^*[\text{Ir}^{\text{III}}]$  by the *in-situ* formed carboxylate. This SET event furnishes a carboxyl radical which undergoes a decarboxylation. The newly formed carbon-centered radical reacts with the hypervalent iodine reagent to give the

<sup>135</sup> D. R. Heitz, K. Rizwan, G. A. Molander, *J. Org. Chem.* **2016**, *81*, 7308-7313.

<sup>136</sup> A. Noble, D. W. C. MacMillan, *J. Am. Chem. Soc.* **2014**, *136*, 11602-11605.

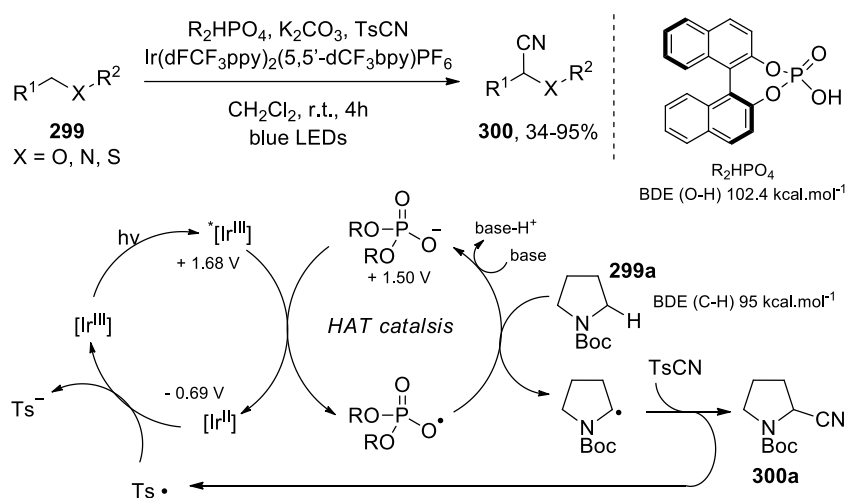
<sup>137</sup> F. Le Vaillant, M. D. Wodrich, J. Waser, *Chem. Sci.* **2017**, *8*, 1790-1800.

cyanation product and the iodine-centered radical. The photocatalytic cycle may finally be closed by the reduction of this iodine radical by the strongly reducing  $[\text{Ir}^{\text{II}}]$  species.



**Scheme II.50.** Photoredox-catalyzed decarboxylative cyanation of carboxylic acids using cyanobenziodoxolones by Waser.<sup>137</sup>

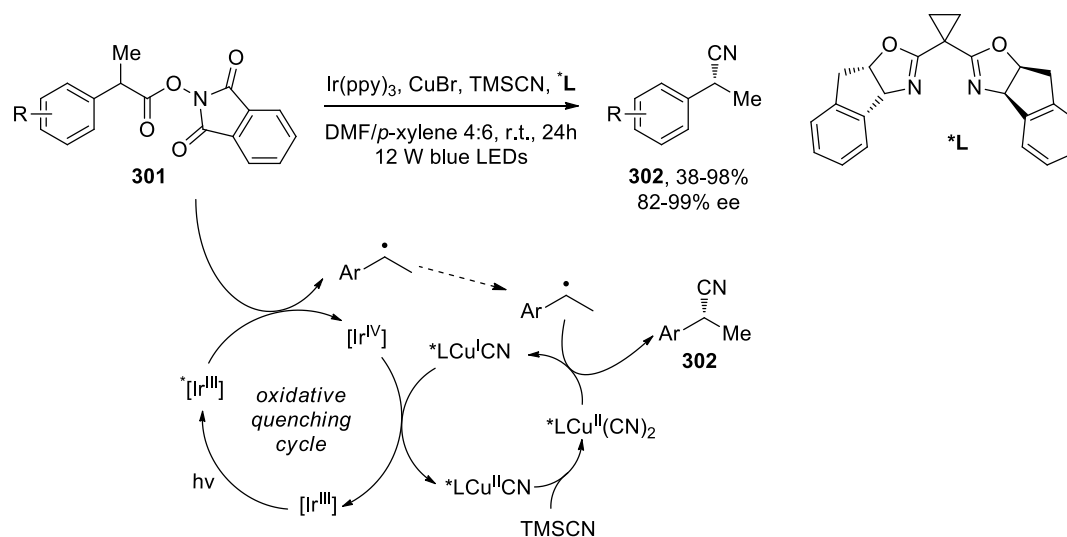
Similar cyanation products **300** were also obtained through a photoredox-catalyzed  $\text{C}(\text{sp}^3)\text{-H}$  cyanation and hydrogen transfer catalysis (Scheme II.51).<sup>138</sup> The photo-oxidation of the phosphate salt by the strong oxidative  $^*[\text{Ir}^{\text{III}}]$  catalyst produces a phosphate radical which acts as a hydrogen-atom-transfer catalyst. Hydrogen abstraction of **299a** furnishes a nucleophilic radical which is trapped by tosyl cyanide to give the cyanation product **300a**. The sulfonyl radical is then reduced into a sulfinate by the  $[\text{Ir}^{\text{II}}]$  complex, regenerating the photocatalyst in its ground state. The reductive quenching of  $^*[\text{Ir}^{\text{III}}]$  catalyst by the phosphate salt was demonstrated by fluorescence quenching experiments.



**Scheme II.51.** Photoredox-catalyzed  $\text{C}(\text{sp}^3)\text{-H}$  cyanation by Kanai.<sup>138</sup>

<sup>138</sup> T. Wakaki, K. Sakai, T. Enomoto, M. Kondo, S. Masaoka, K. Oisaki, M. Kanai, *Chem. - Eur. J.* **2018**, *24*, 8051-8055.

Recently, the enantioselective decarboxylative cyanation was accomplished by means of a cooperative photoredox catalysis and copper catalysis (Scheme II.52).<sup>139</sup> *N*-hydroxy-phthalimides **301** were used as starting materials. The proposed mechanism is based on an oxidative quenching cycle reducing the NHP ester **301** into a benzylic radical. The [Ir<sup>IV</sup>] catalyst is then able to oxidize the copper catalyst into an active [Cu<sup>II</sup>] species, which reacts with the benzylic radical to give the enantioenriched cyanation product **302**. This work was inspired from previous developed enantioselective cyanation of benzylic C-H bonds via copper-catalysis radical relay.<sup>140</sup> A similar enantioselective three-components cyanation of styrene was also reported.<sup>141</sup>



**Scheme II.52.** Enantioselective decarboxylative cyanation of *N*-hydroxy-phthalimides.<sup>139</sup>

<sup>139</sup> D. Wang, N. Zhu, P. Chen, Z. Lin, G. Liu, *J. Am. Chem. Soc.* **2017**, *139*, 15632-15635

<sup>140</sup> W. Zhang, F. Wang, S. D. McCann, D. Wang, P. Chen, S. S. Stahl, G. Liu, *Science* **2016**, *353*, 1014-1018.

<sup>141</sup> W. Sha, L. Deng, S. Ni, H. Mei, J. Han, Y. Pan, *ACS Catal.* **2018**, *8*, 7489-7494.

#### **4. Conclusions**

In this chapter, an overview of radical chemistry was proposed from concepts to more recently published works. Both the traditional radical initiation and the photoredox catalysis furnish a reactive radical intermediate, which is further elaborated into a more complex functionalized substrate. The photoredox catalysis produces this radical intermediate by irradiating selectively a photocatalyst whereas the thermolysis implies to heat the all reaction vessel at high temperatures. The photoredox activation with visible light thus offers very mild conditions and high stereoselectivities can be attained in radical processes. Furthermore, the catalytic nature of photoredox systems circumvent the use of radical mediators. In classical radical chemistry, toxic tin-mediators in stoichiometric amount are often needed to sustain the radical chain. Otherwise, the ability of alkylsulfonyl derivatives to form new carbon-centered radical has been used in the development of tin-free radical reactions. In a broader sense, the sulfonyl derivatives have shown enormous synthetic utility in radical chemistry as well as in photoredox catalysis. They are excellent radical traps and their redox properties make them good acceptors to undergo a SET event leading to a new radical species. As illustrated in this chapter, the combination of sulfonyl precursors and radical chemistry (classical and photoredox catalysis) offers many synthetic opportunities for the organic chemist, which will be discussed along this manuscript.





# Chapter III

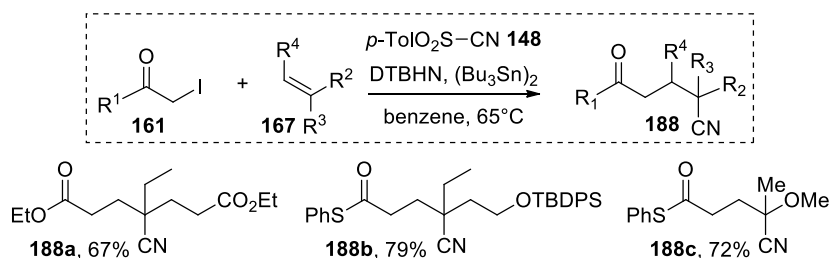
## Development of tin-free radical methodologies



## Chapter III : Development of tin-free radical methodologies

### 1. Introduction

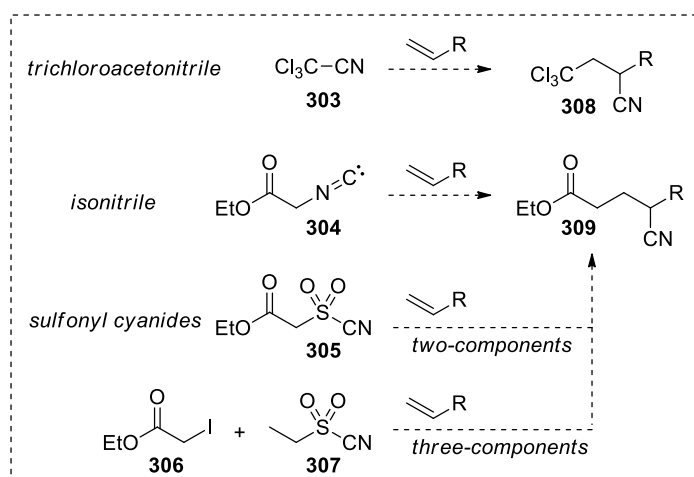
The incorporation of a cyano group on a carbon chain is of great importance for the synthesis of nitrile-containing molecules such as alkaloids. Nitriles are also useful synthetic intermediates, as a result of the versatility of this functional group. Various compounds are accessible from nitriles through hydrolysis, reduction and nucleophilic addition.<sup>142</sup> During our studies directed towards the total synthesis of leucophyllidine as well as the research on the functionalization of olefins, the free-radical carbo-cyanation of olefins was recently developed by our group (Scheme III.1).<sup>85</sup> Even if this method showed a broad scope and excellent yields, the use of bis(tributyltin) is the major drawback and a tin-free version would nicely complement this reaction.



**Scheme III.1.** Free-radical carbo-cyanation of olefins by Landais.<sup>85</sup>

In the following section, specific nitrile-based radical traps will be considered for the development of a tin-free radical carbo-cyanation. The appropriate cyanating agent must be a good radical trap as well as a source of alkyl radicals required for the propagation of the radical chain without the need of a tin mediator. Among them, trichloroacetonitrile **303**, isonitrile **304** and sulfonyl cyanide **305** were envisioned for a tin-free two-components carbo-cyanation reaction (Scheme III.2). As an alternative, a three-components carbo-cyanation with ethylsulfonyl cyanide **307** was also proposed. The strategies based on isonitriles and sulfonyl-cyanides will provide an identical product **309** than the tin-mediated carbo-cyanation. For the two-components carbo-cyanation based on sulfonyl cyanide **305**, both radical initiation and photoredox catalysis will be examined.

<sup>142</sup> S. Patai, Z. Rappoport, *The Chemistry of the Cyano Group*, John Wiley and Sons Ltd 1970.



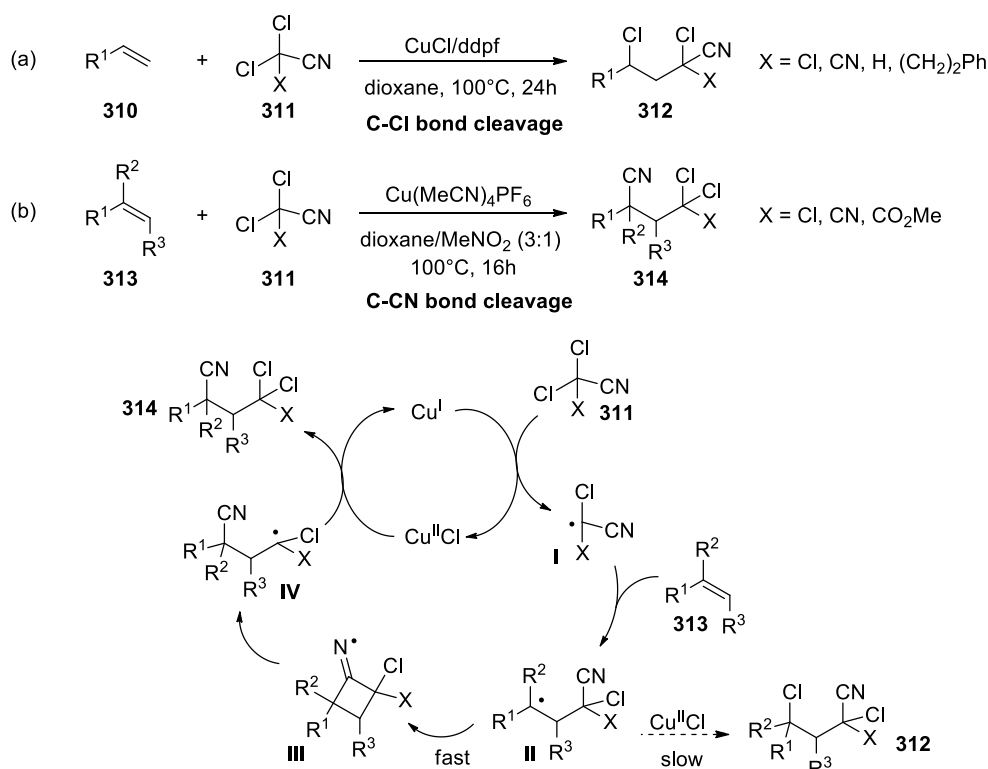
**Scheme III.2.** Envisioned strategies for the development of a tin-free carbo-cyanation.

The last section will be devoted to the photoredox activation of sulfonyl cyanides and the functionalization of olefins by a photoredox-catalyzed sulfonyl-cyanation reaction.

## 2. Carbo-cyanation using trichloroacetone nitrile as radical trap

Due to the bond dissociation energy of the C-CN bond, trichloroacetone nitrile is not an excellent radical trap but it has been used in copper-catalyzed radical reactions. Inoue and co-workers used trichloroacetone nitrile in copper-catalyzed functionalization of olefins **310** (Scheme III.3, a). In this ATRA reaction, a chloromethylcyanide moiety and a chloride were introduced regioselectively onto the olefin backbone using a catalytic amount of CuCl and 1,10-bis(diphenylphosphino)ferrocene. Interestingly, when a trisubstituted olefin **313** was used, the copper-catalyzed carbo-cyanation was observed meaning that the C-CN bond was cleaved (Scheme III.3, b).<sup>143</sup> These carbo-cyanation products **314** were obtained *via* an intramolecular nitrile transfer step. The proposed mechanism starts by the formation of the carbon radical **I** via the C-Cl bond cleavage of **311** catalyzed by the Cu<sup>I</sup> species. Addition of this electrophilic radical to the electron-rich olefin furnishes a new radical **II**, which reacts with the nitrile in an intramolecular fashion to give an iminyl radical **III**. Ring-opening of the strained cyclobutane delivers a more stabilized radical **IV** which reacts with Cu<sup>II</sup>Cl to give the final product **314** and the initial Cu<sup>I</sup> catalyst.

<sup>143</sup> S. Kamijo, S. Yokosaka, M. Inoue, *Tetrahedron Lett.* **2012**, 53, 4324-4327.



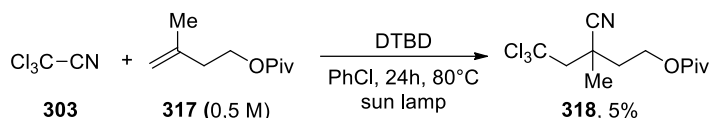
**Scheme III.3.** Trichloroacetonitrile in radical functionalization of olefins by Inoue.<sup>143</sup>

In the Inoue's conditions, the carbo-cyanation of monosubstituted olefins is not possible because the C-CN bond is not cleaved directly. By using a nucleophilic radical initiator, the formation of the trichloromethyl radical from trichloroacetonitrile **303** should be feasible *via* the radical attack onto the nitrile, followed by the fragmentation of the iminyl radical. To test this hypothesis, V-40 and DTBD were used to trigger the ATRA reaction, allowing a functionalization of a monosubstituted olefin such as **315** with a trichloromethyl moiety and a nitrile in a regioselective manner (Table III.1). Although partial conversion was observed, the product **316** was not separable from several side products even after several column chromatography. This problem was similar with more reactive olefins such as vinyl pivalate. In the case of cyclopropenes, no reaction occurred and application of these Cu-catalyzed conditions to cyclopropenes gave only traces of the product.

Entry	Init.	equiv.	[ <b>315</b> ] (M)	$T$ ( $^\circ\text{C}$ )	Time (h)	<sup>[b]</sup> Conv. (%)
1	V-40	3x0,1	0,25	120	5	30
2 <sup>[a]</sup>	DTBD	0,5	0,5	80	24	37
3 <sup>[a]</sup>	DTBD	0,5	1	80	15	40

**Table III.1.** Preliminary experiments for the carbo-cyanation of olefins using  $Cl_3CN$  ([a] under sunlamp irradiation, [b] NMR conversion).

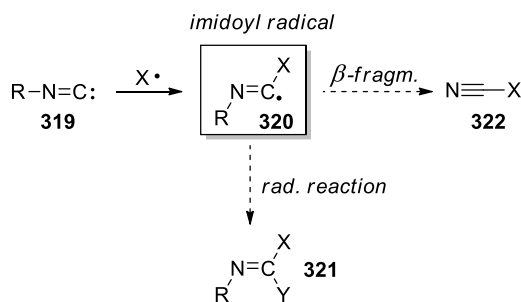
The pure carbo-cyanation product **318** was however isolated with disubstituted olefin **317** which allowed a full characterization of this compound (Scheme III.4). Although the nitrile fragmentation is a possible pathway for the initiation, a mechanism through chlorine abstraction cannot be ruled out. Due to purification problems and the very low yield of this carbo-cyanation reaction, this strategy was abandoned.



**Scheme III.4.** Carbo-cyanation of a disubstituted olefin with  $\text{Cl}_3\text{CN}$ .

### 3. Carbo-cyanation using isonitriles as radical traps

Isonitriles are very efficient radical traps. They behave like a geminal acceptor/donor synthon towards radical species.<sup>144</sup> It means that, in a radical addition to isonitrile, the new formed radical is localized on the carbon atom where the addition occurred (Scheme III.5). The addition of a radical to isonitrile **319** generates an imidoyl radical **320** which can be used in successive radical reactions leading to the general structure **321**. Isonitriles have effectively been used as radical acceptors in radical cascade reactions for the synthesis of nitrogen containing heterocycles.<sup>145</sup>



**Scheme III.5.** Radical chemistry of isonitriles.

Depending on the nature of the R group, the imidoyl radical **320** can also undergo a  $\beta$ -fragmentation, giving rise to the formation of a nitrile **322** (Scheme III.5). The first radical isomerization of isonitrile to nitrile was reported by Pritchard and Shaw using a sub-stoichiometric amount of di-*tert*-butyl peroxide.<sup>146</sup> Röchardt *et al.* established later the radical chain mechanism of this isonitrile-nitrile rearrangement.<sup>147</sup> The tin-mediated radical reduction of isonitrile was

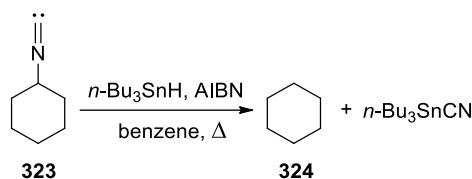
<sup>144</sup> D. P. Curran, H. Liu, *J. Am. Chem. Soc.* **1991**, *113*, 2127-2132.

<sup>145</sup> B. Zhang, A. Studer, *Chem. Soc. Rev.* **2015**, *44*, 3505-3521.

<sup>146</sup> D. H. Shaw, H. O. Pritchard, *Can. J. Chem.* **1967**, *45*, 2749-2754.

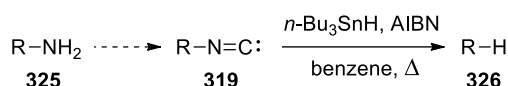
<sup>147</sup> M. Meier, C. Röchardt, *Tetrahedron Lett.* **1983**, *24*, 4671-4674.

described by Saegusa *et al.* through an addition/elimination sequence (Scheme III.6).<sup>148</sup> In this reaction, alkyl isonitriles such as **323** were reduced into the corresponding alkane **324** in the presence of tri-*n*-butyltin hydride using AIBN or di-*tert*-butyl peroxide as initiator.



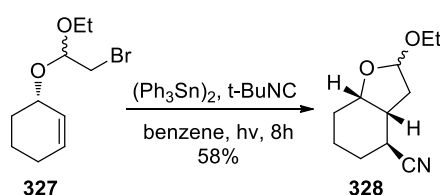
**Scheme III.6.** Tin-mediated reduction of cyclohexyl isonitrile by Saegusa.<sup>148</sup>

The ability of isonitriles to undergo an addition/elimination sequence was first recognized by Barton as a synthetic potential for deamination reactions.<sup>149</sup> The conversion of an amine compound **325** into an isonitrile **319**, followed by tin-mediated reduction furnished the corresponding alkane product **326** (Scheme III.7).



**Scheme III.7.** Deamination method through the radical reduction of isonitriles by Barton.<sup>149</sup>

The fragmentation of isonitriles has also been used in radical cyanation reactions for the synthesis of more complex nitriles. For instance, *tert*-butyl isonitrile was used by Stork *et al.* as a radical trap to produce **328** after the radical cyclization reaction of bromide **327** (Scheme III.8).<sup>150</sup> Here, the radical arising from the cyclization is trapped by *tert*-butyl isonitrile, making this compound a radical cyanating reagent. However, considerable amounts of *t*-BuNC has to be used (*ca.* 20 equiv.).



**Scheme III.8.** Radical formation of nitrile **328** via isocyanide trapping by Stork.<sup>150</sup>

On the basis of these studies, we reasoned that isonitrile **304** should be a good radical trap as well as a source of alkyl radicals and would sustain the radical chain without the need for a tin-mediator (Scheme III.9). Under radical conditions, the fragmentation of **304** should afford a stable electrophilic radical **I** which would add to an electron-rich alkene. The new nucleophilic radical

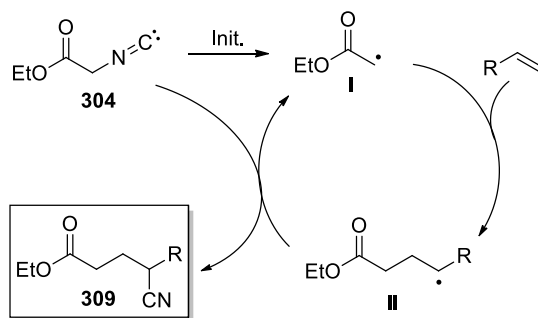
<sup>148</sup> T. Saegusa, S. Kobayashi, Y. Ito, N. Yasuda, *J. Am. Chem. Soc.* **1968**, *90*, 4182-4182.

<sup>149</sup> D. H. R. Barton, G. Bringmann, G. Lamotte, W. B. Motherwell, R. S. H. Motherwell, A. E. A. Porter, *J. Chem. Soc., Perkin Trans. 1* **1980**, 2657-2664.

<sup>150</sup> G. Stork, P. M. Sher, *J. Am. Chem. Soc.* **1983**, *105*, 6765-6766.

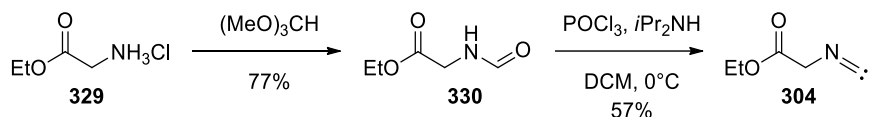


**II** would react with the starting material to give the carbo-cyanation product **309** along with the electrophilic radical **I**, propagating the radical chain.



**Scheme III.9.** Proposed mechanism for the carbo-cyanation of olefins with isocyanides.

To test this hypothesis, the desired isocyanide was synthesized according literature protocol from glycine ethyl ester hydrochloride **329** (Scheme III.10).<sup>151</sup> Formylation of the amine, followed by the dehydration of the formamide **330**, using a standard procedure, provided the desired isocyanide **304**.



**Scheme III.10.** Synthesis of the isocyanide.<sup>151</sup>

We first tried the carbo-cyanation on 1-octene using an excess of isocyanide (Table III.2). Although di-*tert*-butyl peroxide did not give any conversion, V-40 gave traces of the desired product **309a** (entry 1-2). Ethyl 2-cyanoacetate **331** was isolated as a side product and likely results from the reaction between the electrophilic radical **I** and the isocyanide. This is in sharp contrast with the radical isomerization of isocyanide discussed previously. The large excess of isocyanide is partially responsible for the formation of this side product. Decreasing the excess of **304** to 2 equivalents gave 13% yield (entry 2 vs 3). Similar yields were obtained with di-*tert*-butyl diazene (entry 4-5).

<sup>151</sup> (a) R. Obrecht, R. Herrmann, I. Ugi, *Synthesis* **1985**, 1985, 400-402; (b) T. Matsuo, A. Hayashi, M. Abe, T. Matsuda, Y. Hisaeda, T. Hayashi, *J. Am. Chem. Soc.* **2009**, *131*, 15124-15125.

CCOC(=O)CN=C + C=CCCCCCC >> CCOC(=O)CCCC(C#N)C + CCOC(=O)CC#N

Entry	<b>304</b> (equiv.)	Initiator	Equiv.	Time (h)	Yield (%)
1	10	DTBP	0.2	2	0
2	10	V-40	4x0.1	4	traces
3	2	V-40	0.1	2	13
4 <sup>[a,b]</sup>	2	DTBD	0.5	2	6
5 <sup>[b]</sup>	2	DTBD	0.5	24	9

**Table III.2.** Screening of initiator for the carbo-cyanation reaction using isonitrile **304** ([a] in *t*BuOH, [b] under sunlamp irradiation).

In order to disfavour the formation of **331**, an excess of 1-octene was used (Table III.3). The use of peroxides as initiator (DTBP, DCP, DLP) was definitely not appropriate for this reaction (entry 1-3). The maximum yield was obtained with DTBD and V-40 (21%, entry 4 and 7). DTBHN and AIBN also furnished the product **309a** but in lower yields (entry 5-6). The addition of a sub-stoichiometric amount of sulfonyl cyanides in the reaction mixture did not increase the yield (entry 8-9). Considering the result of the table below, the carbo-cyanation from isonitrile **304** is illusive. The formation of ethyl 2-cyanoacetate **331** is unavoidable and is a consequence of a polarity issue. Once the electrophilic radical is formed, it prefers to react with the more electron-rich isonitrile than with the alkene. To counterbalance the reactivity of the electrophilic radical towards the isonitrile, other more reactive unsaturated systems like alkyne and cyclopropene were also tried but these were not successful.

Entry	Initiator	Equiv.	Additives	T (°C)	Time	Yield (%)
1	DTBP	1	-	120	4	n.d.
2	DCP	1	-	120	2	n.d.
3	DLP	2x0.1	-	80	4	0
4 <sup>[a]</sup>	DTBD	0.5	-	-	5	21
5	DTBHN	2x0.1	(Bu <sub>3</sub> Sn) <sub>2</sub>	70	4	17
6	AIBN	5x0.1	-	80	5	13
7	V-40	2x0.1	-	120	2,2	21
8	V-40	1x0.1	<i>p</i> TolSO <sub>2</sub> CN	120	2	traces
9 <sup>[a]</sup>	DTBD	0.5	EtSO <sub>2</sub> CN	-	4.5	0

**Table III.3.** Optimization of the carbo-cyanation using isonitrile **304** (for additives: 0.1 equiv. of (Bu<sub>3</sub>Sn)<sub>2</sub> and 0.5 equiv of RSO<sub>2</sub>CN were used, [a] under sunlamp irradiation).

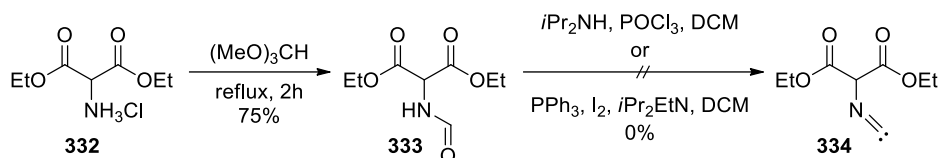
Activation of the isonitrile by metal coordination should enhance the electrophilicity of the carbon. Isonitriles have been used in transition-metal catalyzed reactions.<sup>152</sup> They have excellent ligation properties with metals and this coordination activates the carbon center toward nucleophilic attack. Based on these studies, the introduction of a transition metal in our carbo-cyanation reaction should enhance the reactivity of the electrophilic radical towards the alkene. Several transition metals were added in the reaction medium but none of them allow obtaining the carbo-cyanation product **309a** in satisfying yield (maximum 10%). The following metals were tried without any success: Yb(OTf)<sub>3</sub>, AgSbF<sub>6</sub>, Cu(OTf)<sub>2</sub>, CuI, Cu<sub>2</sub>O, CoCl<sub>2</sub>, MgBr<sub>2</sub>.Et<sub>2</sub>O, Zn(OTf)<sub>2</sub>, Al(OTf)<sub>3</sub>, LiBr, Sc(OTf)<sub>3</sub>, Pd/C, Co(acac)<sub>2</sub>, Pd(acac)<sub>2</sub>, Pd(PPh<sub>3</sub>)<sub>4</sub>. The coordination of isonitrile to a metal center is apparently not adequate for radical reactions.

A substrate modification should also allow to counterbalance the unfavoured polarity. An isonitrile on a malonate should be more electrophilic and therefore would allow a cleaner reaction. However, the synthesis of isonitrile **334** is not reported in the literature. Only solid-supported syntheses have been described.<sup>153</sup> Unfortunately, the classical conditions for dehydration of

<sup>152</sup> (a) S. Chakrabarty, S. Choudhary, A. Doshi, F.-Q. Liu, R. Mohan, M. P. Ravindra, D. Shah, X. Yang, F. F. Fleming, *Adv. Synth. Catal.* **2014**, 356, 2135-2196; (b) T. Vlaar, E. Ruijter, B. U. W. Maes, R. V. A. Orru, *Angew. Chem. Int. Ed.* **2013**, 52, 7084-7097.

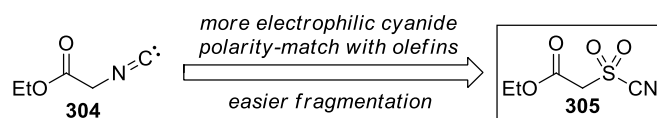
<sup>153</sup> (a) D. Launay, S. Booth, I. Clemens, A. Merritt, M. Bradley, *Tetrahedron Lett.* **2002**, 43, 7201-7203; (b) S. Crosignani, D. Launay, B. Linclau, M. Bradley, *Mol. Diversity* **2003**, 7, 203-210.

formamide **333** did not furnish isonitrile **334** (Scheme III.11).<sup>154</sup> It is assumed that the acidic proton of the malonate **333** might cause problems in this reaction.



**Scheme III.11.** Attempt of classical dehydration for the synthesis of isonitrile **334**.

In view of this results, the two-components carbo-cyanation process using isonitrile **304** might be difficult to achieve. At first glance, isocyanide **304** appeared as a good radical trap as well as a source of electrophilic radical through fragmentation of the C-N bond. Unfortunately, the trapping of both electrophilic and nucleophilic radicals impedes a clean propagation of the radical chain and causes side reactions. In contrast, the sulfonyl cyanide **305** should possess the appropriate polarity and act as an efficient radical trap as well as a source of alkyl radical to propagate the radical chain for the tin-free carbo-cyanation reaction (Figure III.1).



**Figure III.1.** Comparison of isonitrile **304** and sulfonyl cyanide **305**.

## 4. Carbo-cyanation using sulfonyl cyanides as radical traps

### 4.1. Sulfonyl cyanides as electrophiles

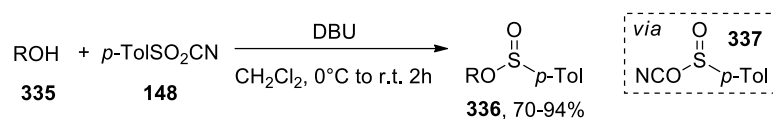
The *para*-toluenesulfonyl cyanide, or tosyl cyanide, has been used as dipolarophile in 1,3-dipolar cycloaddition and as dienophile in Diels-Alder reactions.<sup>155</sup> The tosyl cyanide is also characterized by an activated cyano group. The activation by the sulfone makes the carbon of the nitrile a high electrophilic position. The displacement of the nitrile by nucleophilic addition was described by Van Leusen.<sup>156</sup> The reaction between tosyl cyanide and several nucleophiles proceeds smoothly at room temperature. For instance, organometallics, amines or thiols react with tosyl cyanide in a few minutes, generating the corresponding nitrile products and *para*-toluenesulfinate. Similarly, Barton observed that sulfonyl cyanides (tosyl and mesyl) react with alcohol **335** in

<sup>154</sup> X. Wang, Q.-G. Wang, Q.-L. Luo, *Synthesis* **2015**, 47, 49-54.

<sup>155</sup> (a) A. M. Van Leusen, J. C. Jagt, *Tetrahedron Lett.* **1970**, 971-973; (b) J. C. Jagt, A. M. Van Leusen, *J. Org. Chem.* **1974**, 39, 564-566.

<sup>156</sup> A. M. Van Leusen, J. C. Jagt, *Tetrahedron Lett.* **1970**, 967-970.

presence of DBU to give the corresponding sulfinate esters **336** (Scheme III.12).<sup>157</sup> The addition of DBU on sulfonyl cyanides would induce a rearrangement to form a highly reactive sulfinylcyanate **337** which would react with the alcohol.

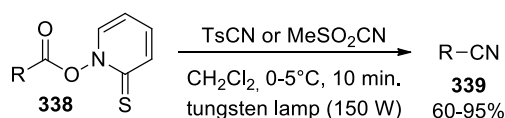


**Scheme III.12.** O-Sulfonylation of alcohols with sulfonyl cyanides and DBU by Barton.<sup>157</sup>

## 4.2. Sulfonyl cyanides as radical traps

The electrophilicity of the nitrile on sulfonyl cyanides and their ability to undergo radical fragmentations make them excellent radical traps. The use of sulfonyl derivatives as radical traps has been already discussed in the previous chapter (see: 2.6. Sulfonyl derivatives in tin-mediated and tin-free reactions) in which radical cyanations using tosyl cyanide were discussed. Let us now consider two additional examples here.

Nitrile compounds **339** have been synthesized by Barton through the reaction of tosyl or mesyl cyanide with carbon radicals generated from acyl derivatives **338** (Scheme III.13).<sup>158</sup> In this reaction, the carbon radical is trapped by the sulfonyl cyanide generating a sulfonyl radical which sustains the radical chain by attacking the Barton ester. The yields are higher with mesyl cyanide as compared to tosyl cyanide.



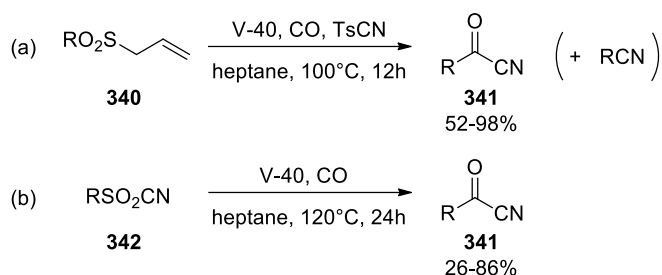
**Scheme III.13.** Reaction of sulfonyl cyanides with carbon radicals by Barton.<sup>158</sup>

Sulfonyl cyanides were also used as radical traps by Kim and co-workers in radical carbonylation.<sup>159</sup> Aliphatic acyl cyanides **341** were first synthesized through a tin-free radical cyano-carbonylation using alkyl allyl sulfone **340**, tosyl cyanide and carbon monoxide (Scheme III.14, a). Upon initiation with V-40, followed by  $\beta$ -fragmentation, the C-centered radical thus generated adds to CO and the newly formed alkenyl radical is trapped by tosyl cyanide. A two-components approach (Scheme III.14, b) was also developed by synthesizing alkylsulfonyl cyanides **342** which fragment at high temperature.

<sup>157</sup> D. H. R. Barton, J. C. Jaszberenyi, E. A. Theodorakis, *Tetrahedron Lett.* **1991**, 32, 2585-2588.

<sup>158</sup> D. H. R. Barton, J. C. Jaszberenyi, E. A. Theodorakis, *Tetrahedron Lett.* **1991**, 32, 3321-3324.

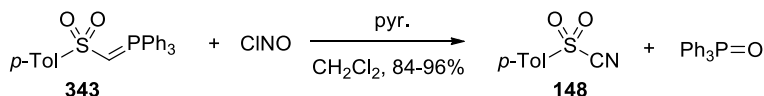
<sup>159</sup> (a) S. Kim, C. H. Cho, S. Kim, Y. Uenoyama, I. Ryu, *Synlett* **2005**, 3160-3162; (b) S. Kim, K.-C. Lim, S. Kim, *Chem. - Asian J.* **2008**, 3, 1692-1701.



**Scheme III.14.** Carbonylation reactions using sulfonyl cyanides by Kim.<sup>159</sup>

### 4.3. Reported methods for the synthesis of sulfonyl cyanides

Tosyl cyanide is the only commercially available sulfonyl cyanide. After a rapid survey in the literature, it appears that sulfonyl cyanides are difficult to prepare in a safe manner and under mild conditions. The first synthesis of *para*-toluenesulfonyl cyanide was reported by Van Leusen.<sup>160</sup> In this report, the sulfonyl-phosphorane **343** reacts with nitrosyl chloride in the presence of pyridine to give the tosyl cyanide **148** (Scheme III.15).



**Scheme III.15.** First synthesis of tosyl cyanide by Van Leusen.<sup>160</sup>

One year later, Cox and Ghosh described a more general method relying on the alkylation of a sulfinate with cyanogen chloride.<sup>161</sup> Different aromatic sulfonyl cyanides were synthesized in good yields. The methylsulfonyl cyanide was however found to be unstable at room temperature after several hours. This methodology was also described in Organic Syntheses in which the synthesis of alkylsulfonyl cyanide was reported.<sup>162</sup> The authors from these two reports made interesting remarks. First, attempt at replacing cyanogen chloride by the bromide analogue gave the sulfonyl bromide instead of the sulfonyl cyanide. Secondly, they observed that sodium sulfite and sodium hydrogen carbonate provoked the degradation of the sulfonyl cyanide (*vide infra*).

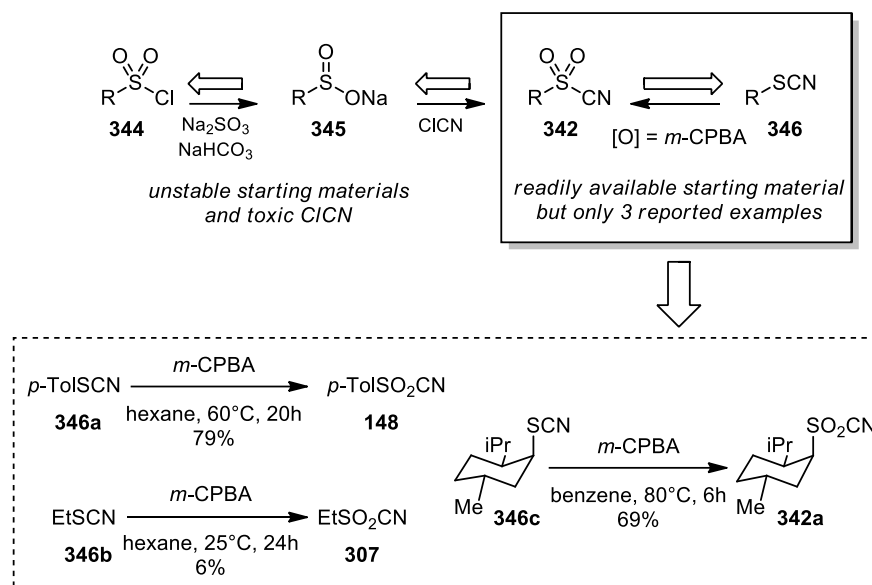
From this literature survey, it appears that the alkylation of sulfinate **345** by cyanogen chloride is the most general and straightforward method for the synthesis of alkylsulfonyl cyanides **342** (Scheme III.16). This procedure was indeed used by Kim for the preparation of alkylsulfonyl cyanides involved in the carbonylation reaction (*vide supra*, Scheme III.14). However, the high toxicity of gaseous cyanogen chloride which is not anymore delivered by chemical suppliers, and

<sup>160</sup> A. M. Van Leusen, A. J. W. Iedema, J. Strating, *Chem. Commun.* **1968**, 440-441.

<sup>161</sup> J. M. Cox, R. Ghosh, *Tetrahedron Letters* **1969**, 10, 3351-3352.

<sup>162</sup> (a) M. S. A. Vrijland, *Org. Synth.* **1977**, 57, 88-92; (b) S. Kim, K.-C. Lim, S. Kim, *Chem. Asian J.* **2008**, 3, 1692-1701.

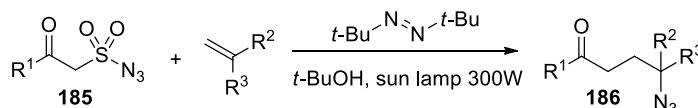
the instability of sulfinates and sulfonyl chlorides prompted us to develop an alternative method. The oxidation of a readily available thiocyanate **346** would constitute a reliable and safer synthetic method to access these compounds. However, only three examples are reported in the literature using *m*-CPBA as an oxidant. Among them, only the *para*-toluene thiocyanate **346a** and the menthol-derived thiocyanate **346c** showed good yields for the corresponding sulfonyl cyanides (Scheme III.16). The oxidation of ethyl thiocyanate **346b** seems to be complicated, the yield being considerably low.<sup>163</sup>



**Scheme III.16.** Synthesis of sulfonyl cyanides by alkylation of sulfinates with cyanogen chloride and reported oxidations of thiocyanates to sulfonyl cyanides.<sup>163</sup>

#### 4.4. Development of a new method for the synthesis of sulfonyl cyanides

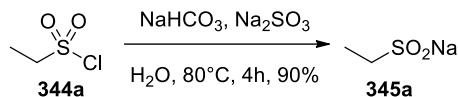
Our motivation to synthesize these compounds was important because the literature survey on the sulfonyl derivatives (see: 2.6. Sulfonyl derivatives in tin-mediated and tin-free reaction) strongly supported our strategy for the two-components carbo-cyanation based on sulfonyl cyanides. As a reminder, Renaud *et al.* developed a similar two-components tin-free carbo-azidation (Scheme III.17), where the sulfonyl azide **185** was subject to a fragmentation to give the electrophilic radical which allowed to sustain the radical chain.<sup>84</sup>



**Scheme III.17.** Tin-free carbo-azidation of olefins by Renaud.<sup>84</sup>

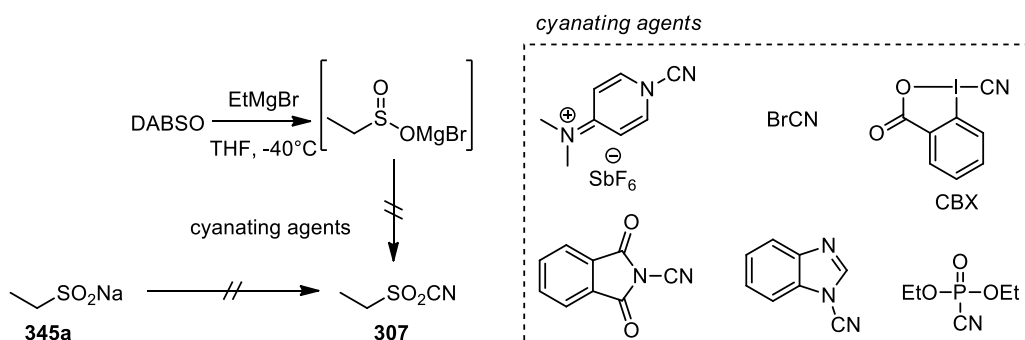
<sup>163</sup> (a) R. G. Pews, F. P. Corson, *J. Chem. Soc. D* **1969**, 0, 1187; (b) J. M. Blanco, O. Caamano, F. Fernandez, G. Gomez, C. Lopez, *Tetrahedron: Asymmetry* **1992**, 3, 749-752.

The first attempts to oxidize thiocyanates with *m*-CPBA were not successful and we decided to find an alternative to ClCN for the alkylation of sulfinates. For that, ethyl sulfinatate **345a** was synthesized from the corresponding sulfonyl chloride **344a** (Scheme III.18).<sup>164</sup> The sulfinatate was also formed *in situ* through the addition of ethyl magnesium bromide to DABSO.<sup>165</sup>



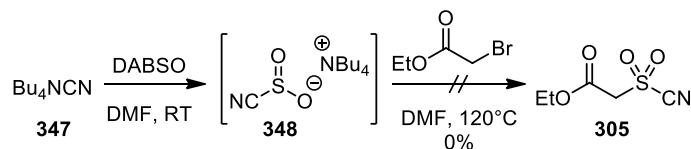
**Scheme III.18.** Synthesis of sodium ethylsulfinatate.<sup>164</sup>

Attempt at replacing ClCN by other cyanating agents (cyanogen bromide, CBX, *N*-cyanophthalimide,<sup>166</sup> diethyl cyanophosphonate, *N*-cyanobenzimidazole,<sup>166</sup> *N*-cyano-4-(*N,N*-dimethylamino)pyridinium hexafluoroantimonate<sup>166</sup>) for the alkylation of sulfinatate salts all failed (Scheme III.19).



**Scheme III.19.** Attempt at alkylating sodium ethylsulfinatate with various cyanating agents.

In order to avoid the manipulation of cyanating agent, we proposed to reverse the strategy according to literature precedent.<sup>167</sup> The addition of cyanide anion **347** to DABSO should furnish the corresponding cyanosulfinatate **348**. The latter could then be alkylated by ethyl 2-bromoacetate. However, the desired sulfonyl cyanide **305** was not observed (Scheme III.20).



**Scheme III.20.** Attempt at alkylating a cyanosulfinatate.

Considering these results, we went back to the oxidation of thiocyanates. Even though preliminary experiments were not successful, we decided to apply the oxidative conditions of

<sup>164</sup> A. U. Meyer, K. Strakova, T. Slanina, B. Koenig, *Chem. Eur. J.* **2016**, *22*, 8694-8699.

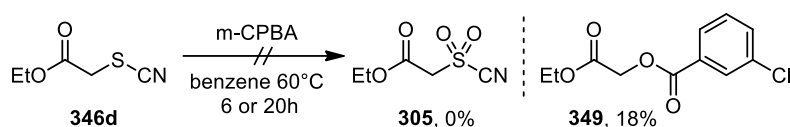
<sup>165</sup> A. S. Deeming, C. J. Russell, A. J. Hennessy, M. C. Willis, *Org. Lett.* **2014**, *16*, 150-153.

<sup>166</sup> P. Anbarasan, H. Neumann, M. Beller, *Chem. Eur. J.* **2010**, *16*, 4725-4728.

<sup>167</sup> (a) A. Kornath, O. Blecher, *Z. Anorg. Chem.* **2002**, *628*, 625-631; (b) A. S. Deeming, C. J. Russell, A. J. Hennessy, M. C. Willis, *Org. Lett.* **2014**, *16*, 150-153.

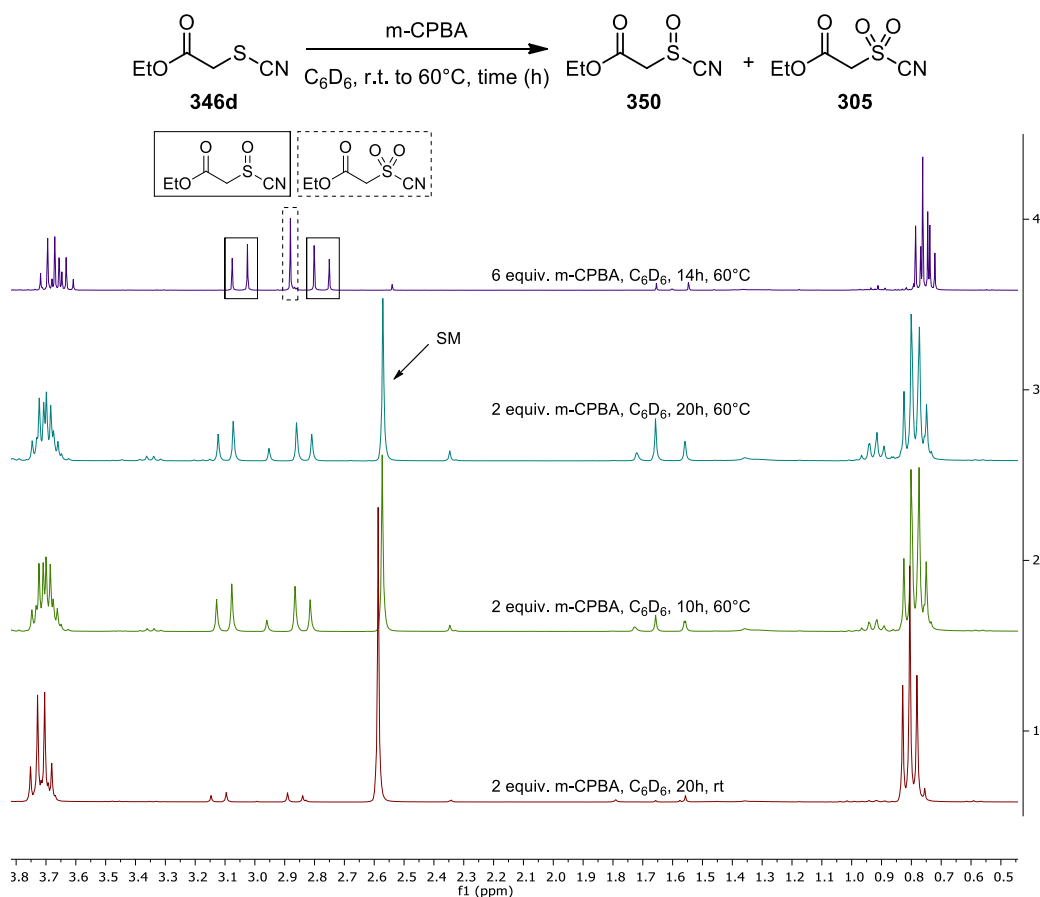


Blanco *et al.* (menthol-derived thiocyanate) on our substrate **346d** and to analyse this reaction more in depth. The desired sulfonyl cyanide **305** was not observed in the crude  $^1\text{H}$  NMR but the side product **349** was isolated in 18% yield after column chromatography (Scheme III.21).



**Scheme III.21.** Application of oxidative conditions of Blanco *et al.*

In order to check that this side product might result from the aqueous work-up (aqueous solution of  $\text{NaHCO}_3$  and  $\text{NaHSO}_3$ ), the reaction was repeated in benzene- $d_6$  and was monitored by  $^1\text{H}$  NMR (Figure III.2). At room temperature, almost no reaction occurred with 2 equivalents of *m*-CPBA. Increasing the temperature to  $60^\circ\text{C}$  gave two sets of doublets ( $\delta = 2.78$  and  $3.05$  ppm) corresponding to the formation of the chiral sulfinyl cyanide **350**. The  $^1\text{H}$  NMR spectrum also showed the presence of a singlet ( $\delta = 2.88$  ppm) corresponding to the desired sulfonyl cyanide **305**. Full conversion of thiocyanate **346d** was observed after 14 hours at  $60^\circ\text{C}$  using 6 equivalents of *m*-CPBA to give a mixture of sulfinyl and sulfonyl cyanide. This NMR monitoring confirms that the oxidation of thiocyanate **346d** occurred cleanly but the work-up might be responsible for the formation of **349**.



**Figure III.2.** NMR monitoring of the oxidation of thiocyanate **346d** with *m*-CPBA.

We therefore envisioned to develop an alternative and more appropriate work-up. Treating the reaction mixture with an aqueous solution of NaHCO<sub>3</sub> at room temperature or at 0°C led to a complete degradation of the sulfinyl as well as the sulfonyl cyanide and the side product **349** was again recovered. Column chromatography on silica, oven-dried silica, neutral alumina or basic alumina caused the degradation of the sulfonyl cyanide. Crystallization of *m*-CPBA in ether or pentane/ether mixture was also not successful to obtain the pure mixture of sulfinyl/sulfonyl cyanide.

Other water-soluble oxidants were then screened for this reaction. A similar screening of oxidants for the oxidation of thiocyanates in sulfinyl cyanides was already performed by Van Leusen, but *m*-CPBA was considered at that time to be the best oxidant for this transformation.<sup>168</sup> In our assays of oxidative conditions (Table III.4), potassium permanganate supported on MnO<sub>2</sub> or MnO<sub>2</sub> alone furnished the thiocyanate hydrolysis product **351** (entry 1-2). No conversion was observed with *in situ* generated dimethyldioxirane (entry 3-4). But to our delight, the desired sulfonyl cyanide **305** was formed with 32% yield with *in situ* generated trifluoroperacetic acid (entry 5-6).

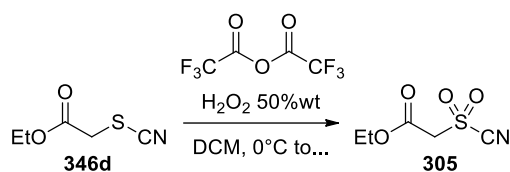
Entry	Oxidant	Equiv.	Solvent	<i>T</i> (C°)	Time (h)	Product
1	KMnO <sub>4</sub> /MnO <sub>2</sub>	-	CH <sub>2</sub> Cl <sub>2</sub>	rt	5	 <b>351</b>
2	MnO <sub>2</sub>	2	CH <sub>2</sub> Cl <sub>2</sub>	rt	14	
3	oxone	50	dry acetone	rt	14	-
4	oxone	50	acetone/H <sub>2</sub> O	60	6	-
5 <sup>[a]</sup>		6.5	CH <sub>2</sub> Cl <sub>2</sub>	rt	2	<b>305 + 350</b>
6 <sup>[a]</sup>		6.5	CH <sub>2</sub> Cl <sub>2</sub>	rt	7	<b>305 (32%)</b>

**Table III.4.** Screening of oxidants for the oxidation of thiocyanate ([a] trifluoroperacetic acid generated *in situ* from trifluoroacetic anhydride and hydrogen peroxide).

Unfortunately, this result was not reproducible with a fresh bottle of trifluoroacetic anhydride and an optimization was therefore carried out in order to obtain a more reliable method. From Table III.5, we can conclude that (i) an excess of anhydride is not required (entry 1-4 vs 5) (ii) full conversion to sulfone required at least 5 eq. of peracid, reflux conditions and long reaction time (entry 9 vs 6-8) (iii) excess of peracid and/or too long reaction time gave the formation of side products. These side products can be removed easily by washing the organic phase with water and brine several times. The optimized conditions (entry 9) furnished the sulfonyl cyanide **305**

<sup>168</sup> M. A. Boerma-Markerink, J. C. Jagt, H. Meyer, J. Wildeman, A. M. Van Leusen, *Synth. Commun.* **1975**, *5*, 147-154.

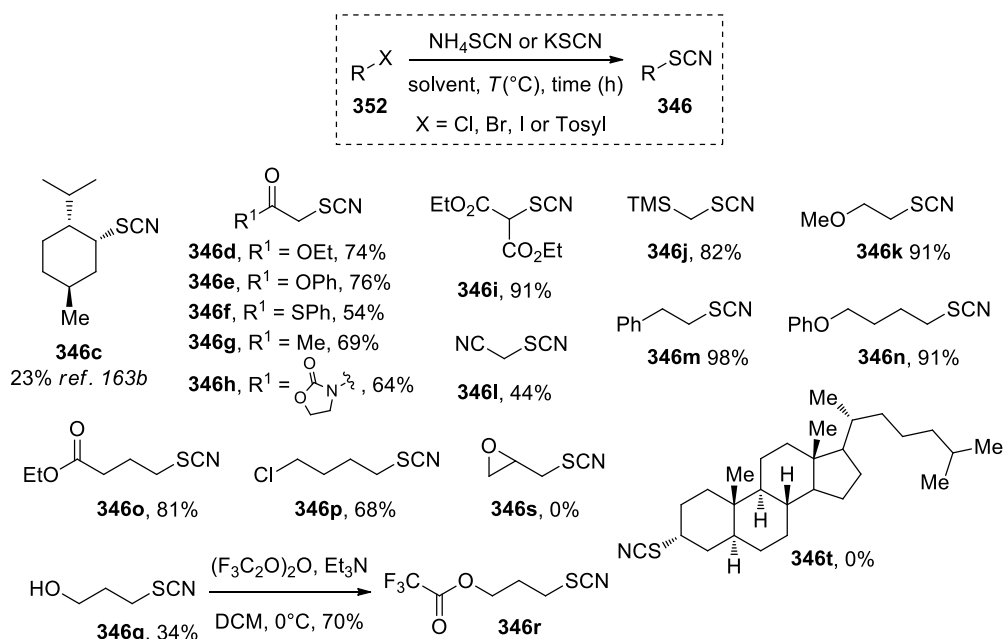
with a good crude yield (~70%). The crude product is pure after the aqueous work-up and do not require further purifications. A  $^{19}\text{F}$  NMR of the crude product was realized in order to check the possible presence of residual trifluoroperacetic acid or trifluoroacetic acid.



Entry	$^{[a]}\text{H}_2\text{O}_2$ (eq.)	Anhydride (eq.)	$T$ ( $^\circ\text{C}$ )	Time (h)	SO/SO <sub>2</sub> /byproduct NMR ratio	Crude yield (%)
1	13	23	r.t.	20	Degradation	-
2	13	23	r.t.	6	80:20:0	-
3	13	20	r.t.	7	60:40:0	-
4	7	12	r.t.	4	80:20:0	-
5	5	5	r.t.	15	56:44:0	-
6	5	5	40	16	20:80:0	-
7	10	10	30	60	0:77:23	-
8	7,5	7,5	35	18	30:70:0	-
9	10	10	40	16	5:95:0	68-75

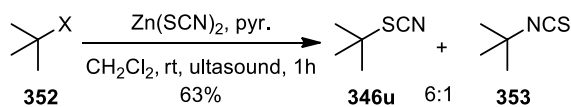
**Table III.5.** Optimization of the oxidation of thiocyanate ([a] H<sub>2</sub>O<sub>2</sub> 50%wt was used).

In order to show the generality of this oxidation, a list of thiocyanates **346** was synthesized according to literature procedures (Scheme III.22). The simplest thiocyanates were synthesized from the corresponding halides or tosylates **352** through nucleophilic substitution with potassium or ammonium thiocyanate. The experimental details (solvent, temperature, reaction time) are furnished in the experimental part.

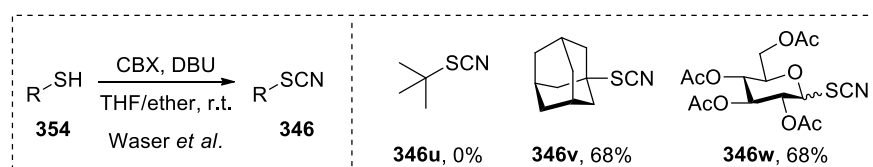


Scheme III.22. Synthesis of thiocyanates.

The synthesis of *tert*-butyl thiocyanate **346u** was tried several times but failed (Scheme III.23). Its synthesis is described based on an ultrasound-assisted nucleophilic substitution reaction of *t*-butyl halide **352** with titanium and zinc thiocyanate.<sup>169</sup> However, these conditions led to a mixture of thiocyanate **346u** and isothiocyanate **353** and were not successful in our laboratory.

Scheme III.23. Reported synthesis of *tert*-butyl thiocyanate.<sup>169</sup>

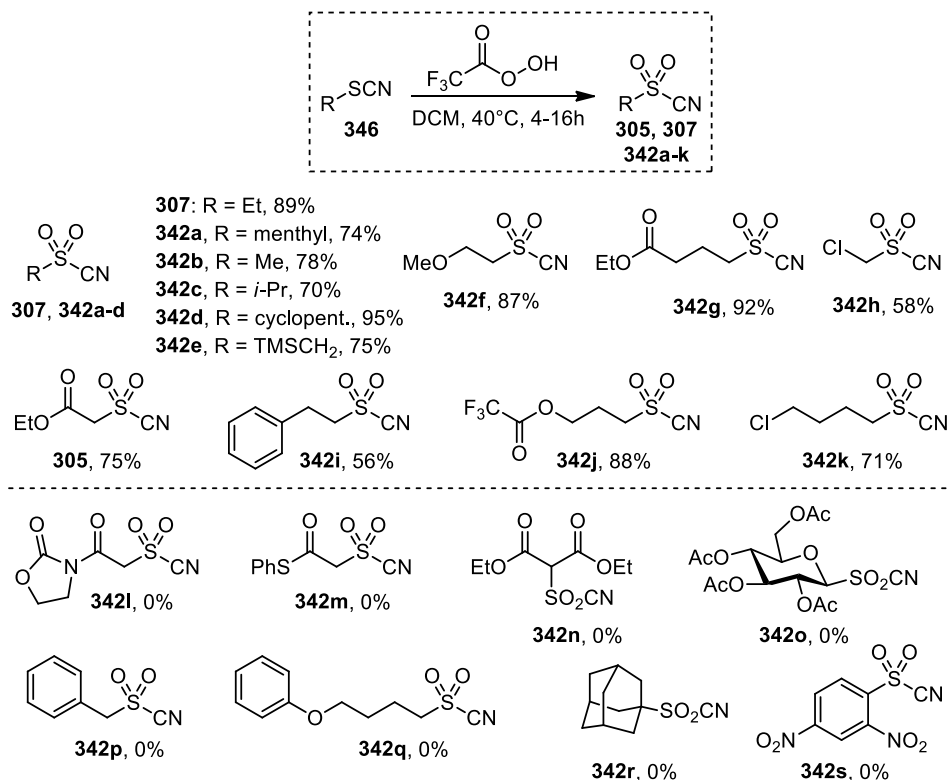
A more general method for the synthesis of thiocyanates from thiols **354** was described by Waser using CBX as the cyanating agent (Scheme III.24).<sup>170</sup> This method was used for the synthesis of adamantyl thiocyanate **346v** and thiocyanate **346w**. Although thiocyanate **346u** was not synthesized in their study, their protocol was applied to *tert*-butyl mercaptan but again we were not able to obtain the product. This might be a consequence of the volatility of the product.

Scheme III.24. Synthesis of thiocyanate from thiol described by Waser.<sup>170</sup>

<sup>169</sup> B. K. Bettadaiah, K. N. Gurudutt, P. Srinivas, *Synth. Commun.* **2003**, *33*, 2293-2299.

<sup>170</sup> R. Frei, T. Courant, M. D. Wodrich, J. Waser, *Chem. Eur. J.* **2015**, *21*, 2662-2668.

The synthesized thiocyanates **346** were tested in our oxidative conditions (Scheme III.25). Our oxidation is compatible with alkyl chains, functionalized alkyl groups such as ester, methoxy, chloride, trifluoroacetate and simple aryl groups (**342f-k**). Sulfonyl cyanide **342e** is very unstable likely due to the presence of the TMS group and decomposition occurred in 24 hours leading to the formation of methylsulfonyl cyanide **342b**. Due to the rather harsh oxidative conditions, this method do not tolerate more sensitive functional groups such as oxazolidinone, thioester, malonate, aryl ethers and adamantyl thiocyanate (**342l-s**). The prepared sulfonyl cyanides can be stored for months in the freezer without decomposition.



Scheme III.25. Scope of the oxidation of thiocyanates in sulfonyl cyanides.

## 4.5. Development of a tin-free carbo-cyanation with sulfonyl cyanides

### 4.5.1. Two-components approach

Having sulfonyl cyanide **305** in hand, different initiators were screened for the two-components carbo-cyanation using allylsilane **355** as the model olefin (Table III.6). Di-*tert*-butyl peroxide (DTBP) in chlorobenzene at  $120^\circ\text{C}$  gave only traces of the nitrile product **309b** (entry 1). Although di-*tert*-butyl diazene (DTBD) was not efficient under thermal activation (entry 2), the irradiation of the reaction mixture with a sunlamp provided **309b** with 58% yield (entry 3).

Dilauroyl peroxide gave a low yield (entry 4) whereas DTBHN and AIBN as well as Et<sub>3</sub>B gave a yield around 50% (entry 5-7). In the absence of initiator, no reaction occurred (entry 8). Although DTBD was the best initiator at that moment AIBN was retained for the following experiments.

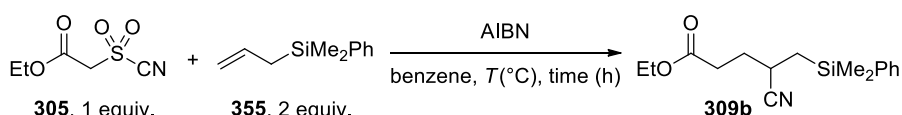
CCOC(=O)C=CSC#N + C=CC[Si](C)(C)Ph  $\xrightarrow[\text{benzene, } T(^{\circ}\text{C}), \text{ time (h)}]{\text{initiator}}$  CCOC(=O)CC(C#N)C[Si](C)(C)Ph

**305**, 1 equiv.                      **355**, 2 equiv.                      **309b**

Entry	Initiator	Equiv.	Time (h)	T (°C)	Yield (%)
1 <sup>[a]</sup>	DTBP	3×0.1	6	120	traces
2	DTBD	3×0.1	6	80	n.r.
3 <sup>[b]</sup>	DTBD	0.5	6	-	58
4	DLP	3×0.1	6	80	32
5	DTBHN	3×0.1	4,5	65	49
6	AIBN	3×0.1	6	80	47
7	Et <sub>3</sub> B(hex)/O <sub>2</sub>	2	5	r.t.	50
8	-	-	14	65	n.r.

**Table III.6.** Screening of initiator for the carbo-cyanation reaction using **305** ([a] in chlorobenzene, [b] under sunlamp irradiation).

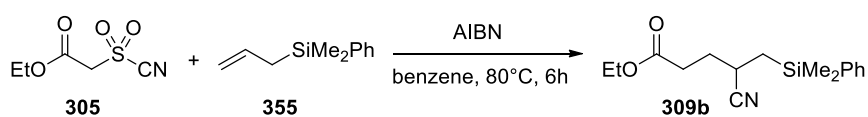
The amount of AIBN was then optimized (Table III.7). Successive additions of small amounts of AIBN did not allow to increase the yield above 60% (entry 1-3). Addition of a larger amount of AIBN (0.25 to 1 equiv.) at lower temperature for a longer period of time led to the same result (entry 4-7). Good yields were obtained with substantial quantities of the initiator (entry 8-9).



Entry	AIBN (equiv.)	Time (h)	T (°C)	Yield (%)
1	4×0.05	8	80	34
2	4×0.1	8	80	51
3	5×0.1	20	80	55
4	0.25	14	65	57
5	0.5	14	65	58
6	0.75	14	65	57
7	1	14	65	62
8	2	14	65	74
9	3×0.25	6	80	75 (65) <sup>[a]</sup>

**Table III.7.** Optimization of the AIBN quantities ([a] yield obtained with sunlamp irradiation).

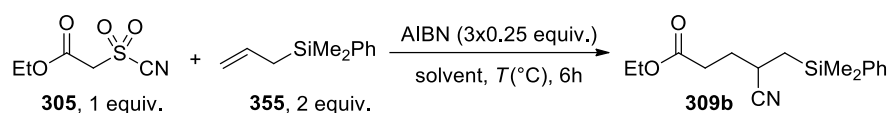
The stoichiometry of the reagents was then analysed (Table III.8). An excess of sulfonyl cyanide did not provide the product in good yields (entry 1-4). The addition of a sub-stoichiometric amount of bis(tributyltin) has no impact on the reaction yield (entry 2). In contrast, an excess of the alkene is crucial to obtain a full conversion and a good yield (entry 5-6). The best conditions were already shown in the precedent table.



Entry	355 <sup>[a]</sup>	305 <sup>[a]</sup>	AIBN <sup>[a]</sup>	(Bu <sub>3</sub> Sn) <sub>2</sub> <sup>[a]</sup>	Yield (%)
1	1	1,5	3×0.2	-	40 (45) <sup>[b]</sup>
2	1	1,5	3×0.2	0,1	45
3	1	2	3×0.2	-	52
4	1	1	3×0.25	-	57
5	2	1	3×0.25	-	75
6	4	1	3×0.25	-	75

**Table III.8.** Optimization of the stoichiometry ([a] amount in equiv., [b] sunlamp irradiation)

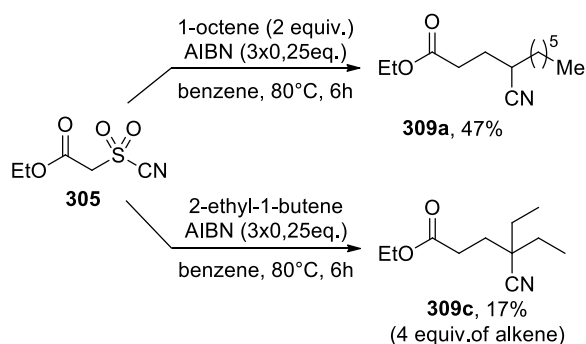
Other solvents were also screened (Table III.9), but benzene remained the more appropriate solvent (entry 1).



Entry	$T$ (°C)	Solvent	Yield (%)
1	80	benzene	75
2	80	<i>t</i> -BuOH	18
3	80	cyclohexane	53
4	80	DCE	46
5	120	chlorobenzene	45

Table III.9. Solvent screening.

The conditions of entry 1 were thus considered as optimal and were applied to 1-octene and 2-ethyl-1-butene in order to validate the scope of the process (Scheme III.26). Unfortunately, less than 50% yield was obtained for **309a** and only traces were obtained for **309c** (17% with 4 equivalents). The reasons of this huge drop in yield were attributed to the use of AIBN as initiator and to the temperature. This is indeed unusual to use such large amount of initiator and AIBN was thus considered as the major problem.



Scheme III.26. Application of the optimal conditions to 1-octene and 2-ethyl-1-butene

We went back to the screening of initiators using 1-octene as the olefin which is less reactive than allylsilane **355**. Triethylborane, DTBHN, and DTBD which gave the best results with allylsilane **355** did not allow to reach yields above 50% for **309a** (Table III.10, entry 1-4). Fortunately, successive additions (3 x 0.25 equiv.) of V40 provided the carbo-cyanation product **309a** in 67% yield (entry 5).



Entry	Initiator	Equiv.	$T$ ( $^{\circ}\text{C}$ )	Time (h)	Yield (%)
1	AIBN	3×0.25	80	6	47
2	Et <sub>3</sub> B (hex)	2	rt	7	29
3	DTBHN	3×0.25	65	4,5	49
4	DTBD (hv)	0,5	<80	7	39
5 <sup>[a]</sup>	V-40	3×0.25	120	6	67

**Table III.10.** Screening of initiators with 1-octene ([a] in chlorobenzene).

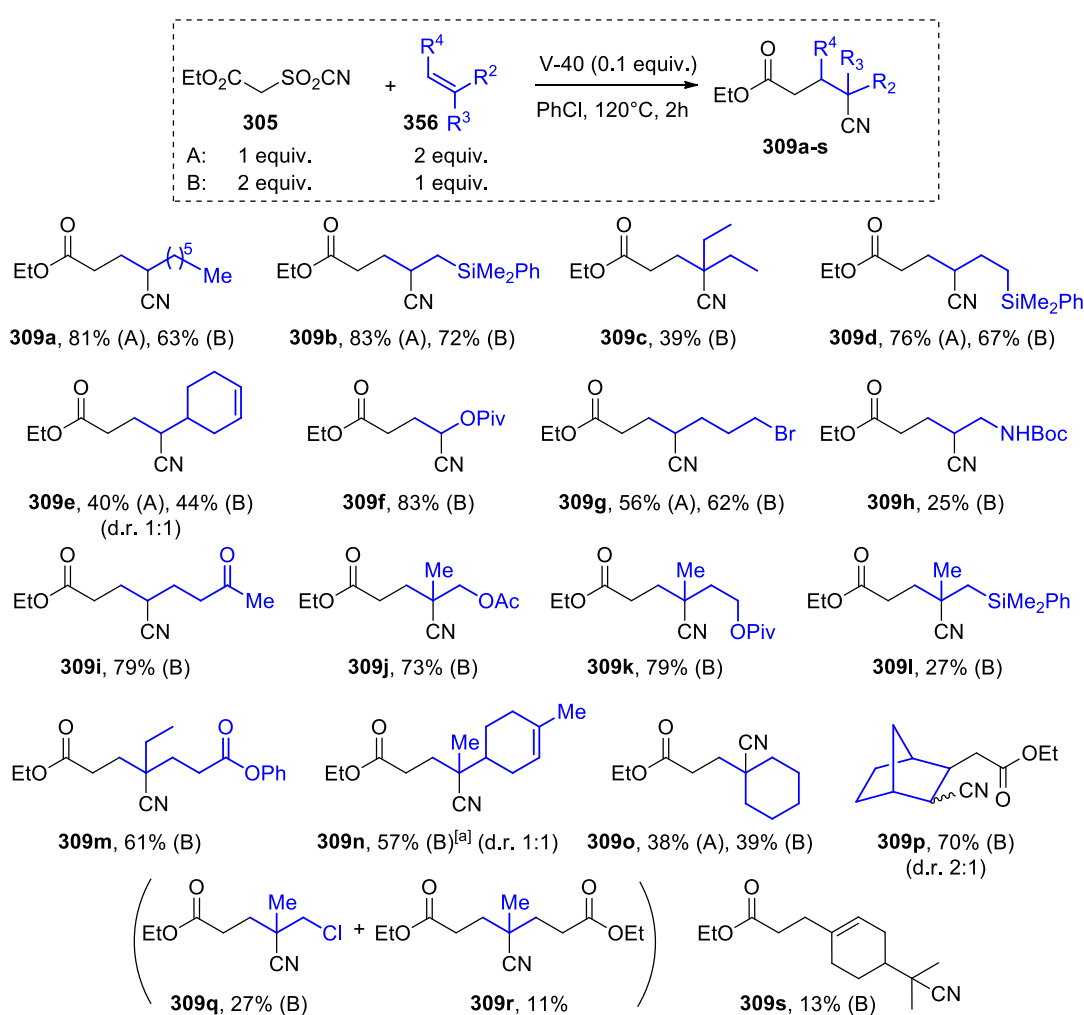
Finally, the amount of V-40 and the reaction time were optimized (Table III.11). Actually, the reaction required only 2 hours to be completed, which also improved the yield of the reaction (entry 2-4). The quantity of the initiator can be diminished up to 0.1 equivalent, furnishing the product **309a** with 81% yield (entry 4-6). Successive additions of small amounts of V-40 did not improve the yield (entry 7-8).

Entry	V-40 (equiv.)	Time (h)	Yield (%)
1	3×0.25	6	67
2	0.5	6	53
3	0.5	4	58
4	0.5	2	80
5	0.3	2	79
<b>6</b>	<b>0.1</b>	<b>2</b>	<b>81</b>
7	2×0.1	2	75
8	2×0.05	2	75

**Table III.11.** Optimization of the V-40 quantities and the reaction time.

These optimal conditions (entry 6, Table III.11) were then applied to a series of olefins. For some olefins, the stoichiometry was reversed (1 equiv. of olefin and 2 equiv. of **305**). This allowed to obtain a full conversion when disubstituted olefins were used. This feature is also an advantage when complex olefins are used and require several steps for their preparation. The reaction scope is presented in Scheme III.27.<sup>85</sup> The tin-free carbo-cyanation reaction is efficient

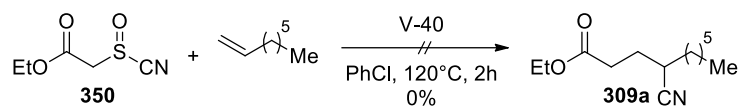
with mono- and disubstituted olefins, affording the corresponding nitriles **309** in moderate to good yields. This reaction also tolerates functional groups such as silane, ester (**309m**), acetate (**309j**), halogen (**309g**), ketone (**309i**) and internal olefin (**309e** and **309n**). The yield drops dramatically with acid-sensitive functional groups like *N*-allyl carbamate (**309h**) which might result from acidification of the reaction mixture due to the release of SO<sub>2</sub> in the medium. Importantly, using disubstituted olefins, a nitrile-functionalised all-carbon quaternary center is produced (**309j-o**). Although the desired nitrile **309q** was obtained in low yield with β-methallyl chloride, this olefin also acts as an allylating agent. Indeed, after addition of the electrophilic radical on β-methallyl chloride, a new olefin is formed which reacts further to give the compound **309r**, isolated as a side product from the reaction mixture. Our attempts at improving this transformation using methallyl bromide or methallyl sulfone met with failure.



**Scheme III.27.** Scope of the tin-free two-component carbo-cyanation ([a] 2x0.1 equiv of V-40).<sup>85</sup>

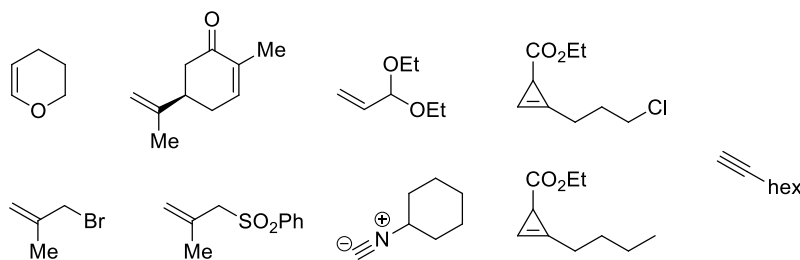
To verify whether sulfinyl cyanide **350** could fragment under these conditions, the synthesis of this compound was achieved through our oxidation method with only one equivalent

of trifluoroacetic acid. The optimal conditions for the carbo-cyanation (Table III.11, entry 6) were used with the sulfinyl cyanide **350** but the product **309a** was not formed (Scheme III.28).



**Scheme III.28.** Possible fragmentation of sulfinyl cyanide **350**.

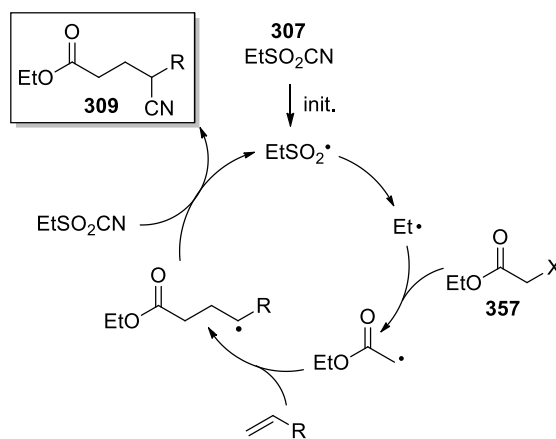
The Scheme III.29 presents the olefins which gave no conversion or complex mixture in the two-components carbo-cyanation reaction.



**Scheme III.29.** Olefins not compatible with the tin-free carbo-cyanation.

#### 4.5.2. Three-components approach

Since the scope of our thiocyanate oxidation is limited by the harsh reaction conditions, a tin-free three-components carbo-cyanation would circumvent the synthesis of others complex sulfonyl cyanides. The combination of a simple radical precursor, an alkene and an alkylsulfonyl cyanide should normally provide the nitrile product **309** according to the following mechanism (Scheme III.30). After initiation of ethylsulfonyl cyanide **307**, the  $\alpha$ -scission of the sulfonyl radical would furnish the ethyl radical, abstracting the halogen atom of **357** to give the electrophilic radical. Addition of the latter to the alkene followed by the trapping of the new formed radical would provide the nitrile product **309** along with the sulfonyl radical sustaining the radical chain.



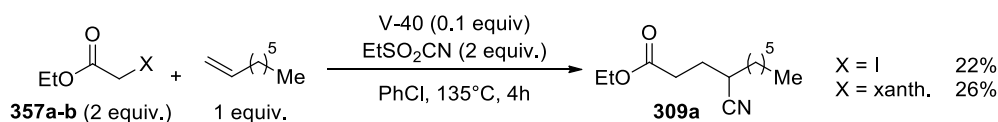
**Scheme III.30.** Proposed mechanism for the tin-free three-components carbo-cyanation.

This strategy was attempted with  $\alpha$ -iodoethylacetate **357a** as the radical precursor (Table III.12). When AIBN was used at 80°C or 120°C, the nitrile product **309b** was isolated in low yield (entry 1-2). Actually, the formation of the product is mainly due to the abstraction of the iodine atom by AIBN which is present in large quantities. Indeed, no reaction occurred when V-40 was used at 120°C (entry 3). In this case, no desulfonylation occurred impeding the formation of ethyl radical required for the iodine abstraction.

Initiator	equiv.	Solvent	T (°C)	Yield (%)
AIBN	3×0.25	benzene	80	27
AIBN	3×0.25	PhCl	120	18
V-40	0.1	PhCl	120	0

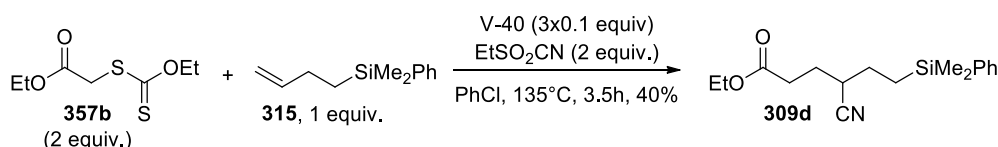
**Table III.12.** Preliminary experiments for the tin-free three-components carbo-cyanation.

In order to favour the sulfone extrusion and the formation of ethyl radical, the temperature was increased to 135°C. After 4 hours, 22% of the carbo-cyanation product **309a** was obtained with 1-octene (Scheme III.31). A similar yield was obtained for the xanthate precursor **357b**.



**Scheme III.31.** Tin-free three-components carbo-cyanation at higher temperature.

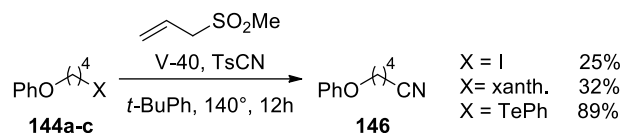
By using alkene **315** and three successive addition of V-40, the nitrile product **309d** was obtained with 40% yield (Scheme III.32).



**Scheme III.32.** Tin-free three-components carbo-cyanation at higher temperature.

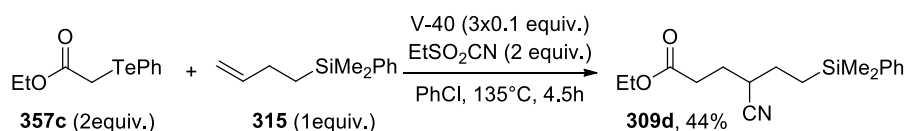
During these experiments, the atom transfer product was always formed but was not separable from the starting material. Another side reaction that might compete with the radical chain propagation is the addition of ethyl radical to the sulfonyl cyanide instead of the desired abstraction. This was observed by Kim and co-workers during their study on the cyanation of alkyl radicals (Scheme III.33). By using a telluride precursor **144c** instead of an iodo or a xanthate

precursor, they could prevent the addition of the methyl radical on the sulfonyl cyanide and favour the abstraction of the telluride precursor.<sup>171</sup> Abstraction of a telluride group by a primary C-centered radical is faster than the abstraction of an iodine atom or a xanthate group as well as the addition of this radical to the sulfonyl cyanide. This allowed the sustainability of the radical chain and higher yields were obtained for **146**.



**Scheme III.33.** Comparison of cyanation reactions from different radical precursors by Kim.<sup>171</sup>

In our case, the yield from the telluride precursor was unfortunately more or less the same than this obtained with the xanthate (Scheme III.34). Furthermore, the alkene **315** was not totally consumed even after 14 hours. The optimization of this reaction was not pursued.



**Scheme III.34.** Three-components carbo-cyanation with phenyl telluride as radical precursor.

## 5. Photoredox activation of sulfonyl cyanides

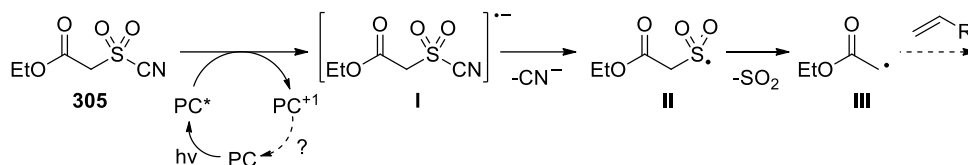
As discussed in Chapter II, the activation of a sulfonyl derivative through photoredox catalysis generates a sulfonyl radical under very mild conditions. Considering the literature survey in Chapter II (see Photoredox activation of sulfonyl groups), we hypothesized that photoredox catalysis could constitute a new mode of initiation for the sulfonyl cyanides leading to a sulfonyl radical and a cyanide anion. When we started our investigations on the photocatalyzed sulfonyl-cyanation and carbo-cyanation, the photoredox activation of sulfonyl cyanides was not reported.

### 5.1. Efforts towards a photoredox-catalyzed carbo-cyanation

We envisioned that the reduction of sulfonyl cyanide **305** through photoredox catalysis should furnish an unstable sulfonyl radical **II** which would rapidly undergo a desulfonylation at room temperature to provide the electrophilic radical **III** (Scheme III.35). The carbo-cyanation

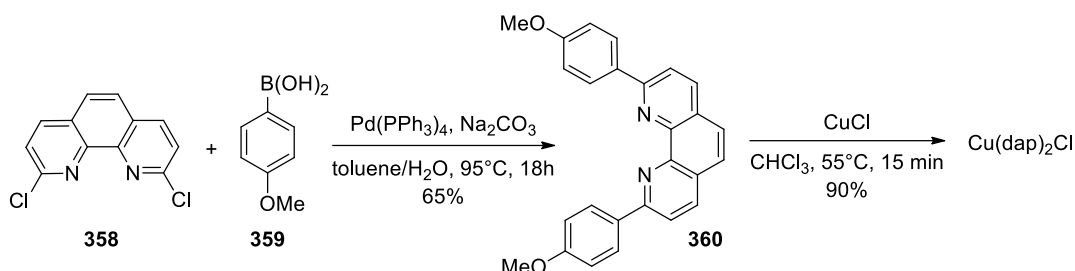
<sup>171</sup> S. Kim, H.-J. Song, *Synlett* **2002**, 2110-2112.

product would then be obtained either by a radical chain mechanism or through a radical-polar crossover pathway.



**Scheme III.35.** Hypothesis for the photoredox activation of sulfonyl cyanide **305**.

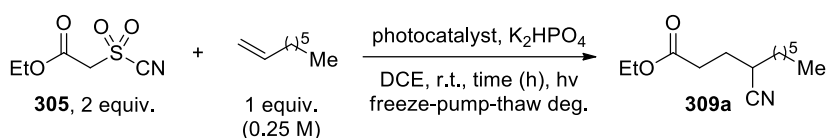
Before starting the screening of photocatalysts for this transformation, we synthesized one of them, *i.e.* Cu(dap)<sub>2</sub>Cl which is not commercially available. The synthesis of Cu(dap)<sub>2</sub>Cl was achieved according a literature procedure (Scheme III.36).<sup>172</sup> The “dap” ligand **360** (dap = 2,9-bis(*para*-anisyl)-1,10-phenanthroline) was synthesized from 2,9-dichloro-1,10-phenanthroline **358** through a Suzuki coupling with 4-methoxyboronic acid **359**. Complexation with CuCl provided the desired copper-photocatalyst.



**Scheme III.36.** Synthesis of Cu(dap)<sub>2</sub>Cl.<sup>172</sup>

Since the reduction potentials of sulfonyl cyanides were not described in the literature, our investigations started by the screening of different reductive photocatalysts (Table III.13). The carbo-cyanation reaction was carried out using 1-octene (0.25 M) and K<sub>2</sub>HPO<sub>4</sub> as an additive in dichloroethane at room temperature in the absence of oxygen. The use of (Ru(bpy)<sub>3</sub>)Cl<sub>2</sub> or [Ir(dtbbpy)(ppy)<sub>2</sub>PF<sub>6</sub> under visible light irradiation gave only traces of the nitrile product **309a** (entry 1-2). Low yield was obtained with Cu(dap)<sub>2</sub>Cl (entry 3). Modification of the light source and the catalyst loading increased the yield up to 36% (entry 4-6). A similar yield was obtained with the organic dye eosin-Y under blue-LED irradiation (entry 7). The same reaction in acetonitrile furnished the product with only 5% (entry 8) and no reaction was observed when the concentration of alkene was decreased to 0.125 M (entry 9). Finally, a moderate yield (52%) was obtained with the strongly reducing fac-Ir(ppy)<sub>3</sub> catalyst under blue-LED irradiation (entry 10).

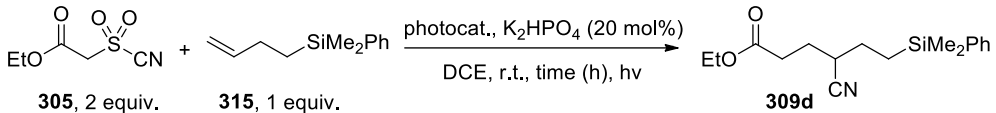
<sup>172</sup> M. Pirtsch, S. Paria, T. Matsuno, H. Isobe, O. Reiser, *Chem. Eur. J.* **2012**, *18*, 7336-7340.



Entry	Light	Photocatalyst	mol%	K <sub>2</sub> HPO <sub>4</sub> (eq.)	Time (h)	Yield (%)
1 <sup>[a]</sup>	FLB	(Ru(bpy) <sub>3</sub> )Cl <sub>2</sub> ·6H <sub>2</sub> O	1	1	23	<5
2 <sup>[a]</sup>	FLB	[Ir(dtbbpy)(ppy) <sub>2</sub> ]PF <sub>6</sub>	1	1	23	5
3 <sup>[a]</sup>	FLB	Cu(dap) <sub>2</sub> Cl	0.5	0.2	18	16
4	FLB	Cu(dap) <sub>2</sub> Cl	1	0.2	62	21
5	CFL	Cu(dap) <sub>2</sub> Cl	1	0.2	62	25
6	LED	Cu(dap) <sub>2</sub> Cl	1	0.2	62	36
7	LED	eosin-Y	1	0.2	62	36
8 <sup>[b]</sup>	LED	eosin-Y	1	0.2	62	5
9 <sup>[c]</sup>	LED	eosin-Y	1	0.2	62	0
10	LED	Fac[Ir(ppy) <sub>3</sub> ]	1	0.2	62	52

**Table III.13.** Screening of photocatalyst for the carbo-cyanation ([a] Na<sub>2</sub>HPO<sub>4</sub> was used; [b] in acetonitrile; [c] 0.125 M of alkene was used; FLB = Fluorescent Light Bulb 23W; CFL = Compact Fluorescent Lamp 15W; LED = blue).

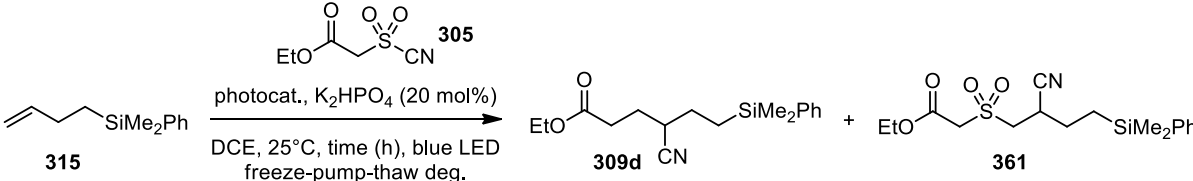
The optimization was continued using alkene **315** in order to have more information about the conversion (Table III.14). The best photocatalysts from the above table were used with alkene **315** but lower yields were obtained as compared to 1-octene. Curiously, the irradiation of eosin-Y with green LED led to no conversion (entry 1). Under blue-LED irradiation, **309d** was formed with almost 20% yield but only 30% conversion was reached after 70 hours of irradiation (entry 2). Using DMF as a solvent instead of DCE slightly improved the yield (entry 3). The presence of oxygen completely inhibited the reactivity (entry 4). Increasing the amount of eosin-Y strongly decreased the yield (entry 5), in contrast with the result obtained by increasing the concentration of alkene (entry 6). Although the conversion with eosin-Y did not attain 40%, full conversion was obtained with fac-Ir(ppy)<sub>3</sub> but only 28% of the nitrile product **309d** was recovered after column chromatography.



Entry	LED	Photocat.	mol%	[ <b>315</b> ] (M)	Time (h)	Conv. (%)	Yield (%)
1	green	eosin-Y	2	0.25	62	0	0
2	blue	eosin-Y	2	0.25	70	30	19
3 <sup>[a]</sup>	blue	eosin-Y	2	0.25	62	-	36
4 <sup>[b]</sup>	blue	eosin-Y	2	0.25	70	0	0
5	blue	eosin-Y	5	0.25	70	<15	traces
6	blue	eosin-Y	5	0.5	70	35	17
7	blue	Fac[Ir(ppy) <sub>3</sub> ]	1	0.25	92	100	28

**Table III.14.** Optimization of the photocatalyzed carbo-cyanation ([a] anhydrous DMF was used instead of DCE; [b] the reaction mixture was not degassed and placed under an O<sub>2</sub> atmosphere).

During this optimization, we observed the formation of a side product which was identified after isolation as **361**, the product of a sulfonyl-cyanation reaction (Table III.15).

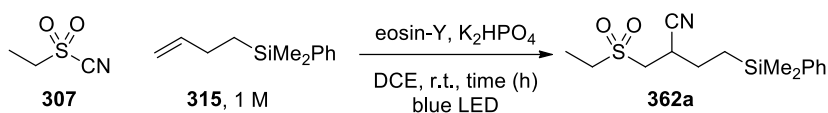


Entry	Photocat.	mol%	[ <b>315</b> ] (M)	Time (h)	<b>309d</b> (%)	<b>361</b> (%)
1	eosin-Y	2	1	40	14	13
2	fac[Ir(ppy) <sub>3</sub> ]	1	0.25	92	28	9

**Table III.15.** Percentage of carbo-cyanation and sulfonyl-cyanation product.

The formation of **361** suggests that the sulfonyl-cyanation reaction would be favoured if alkylsulfonyl cyanides, which are not prone to desulfonylation, were used. This hypothesis was confirmed using ethylsulfonyl cyanide **307** (Table III.16). In dichloroethane, the product **362a** was formed with 81% yield after 112 hours at room temperature (entry 2).





Entry	Time (h)	Conversion (%)	Yield (%)
1	24	60	53
1	112	90	81

**Table III.16.** First attempts of sulfonyl-cyanation of olefins.

## 5.2. Development of a photoredox-catalyzed sulfonyl-cyanation

On the basis of the above results, the photoredox-catalyzed sulfonyl-cyanation was investigated. This reaction would constitute a new method for the synthesis of  $\beta$ -sulfonyl nitriles **362** which might be good starting materials for the synthesis of bioactive sulfones (Figure III.3). Sulfones are an important subclass of organic compounds with diverse biological activities such as anti-inflammatory, antimicrobial, anticancer, anti-HIV and antimalarial.<sup>173</sup> Among the structures presented in Figure III.3, molecule **363** is a candidate for the treatment of Alzheimer's disease.<sup>174</sup> Bicalutamide, **364**, is commonly used as anti-androgen for men with prostate cancer.<sup>175</sup> The hydroxamic acid **365** is a metalloproteinase inhibitor and acts as an anti-inflammatory agent.<sup>176</sup> The last compound **366** shows anticonvulsant activity for epilepsy.<sup>177</sup> Besides pharmaceutical and agrochemical activities, sulfones also serve as key synthetic intermediates<sup>178</sup> for the construction of important building blocks in the total synthesis of natural products.<sup>179</sup>

<sup>173</sup> I. Ahmad, Shagufta, *Int. J. Pharm. Pharm. Sci.*, **2015**, *7*, 19-27.

<sup>174</sup> V. John, M. Maillard, B. Jagodzinska, J. P. Beck, A. Gailunas, L. Fang, J. Sealy, R. Tenbrink, J. Freskos, J. Mickelson, L. Samala, R. Hom, *PCT Int. Appl.* **2003**, WO/2003/040096 A2 20030515.

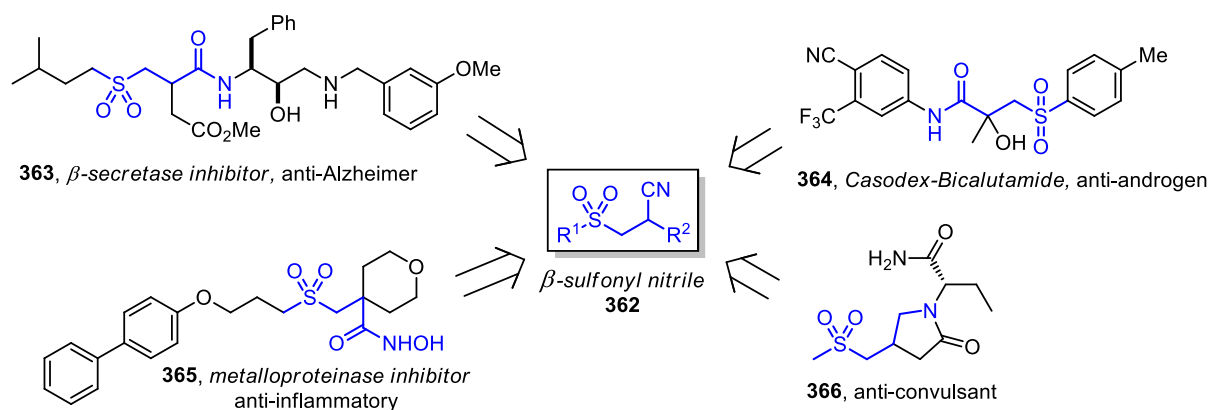
<sup>175</sup> F. Labrie, *Nat. Rev. Urol.*, **2015**, *12*, 132-133.

<sup>176</sup> J. G. Montana, A. D. Baxter, D. A. Owen, R. J. Watson, *PCT Int. Appl.*, **1999**, WO/1999/040080 A1 19990812.

<sup>177</sup> B. E. Kenda, B. Lallemand, A. Matagne, P. Michel, P. Pasau, P. Talaga, *PCT Int. Appl.*, **2001**, WO 2001062726 A2 20010830.

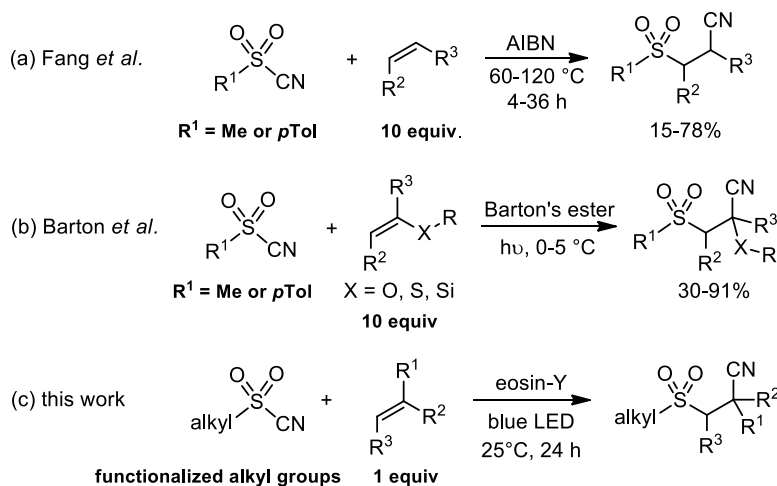
<sup>178</sup> Simpkins, N. S. *Sulphones in Organic Synthesis*, Tetrahedron Organic Chemistry Series, Eds Baldwin, J. E., Magnus, P. D. Pergamon Press, 1993, Vol. 10.

<sup>179</sup> (a) D. A. Evans, P. H. Carter, E. M. Carreira, J. A. Prunet, A. B. Charette and M. Lautens, *Angew. Chem. Int. Ed.*, **1998**, *37*, 2354-2359; (b) J. J. Caldwell, D. Craig, *Angew. Chem. Int. Ed.*, **2007**, *46*, 2631-2634.



**Figure III.3.** Examples of bioactive sulfones.

The sulfonyl-cyanation reaction of olefins was described 30 years ago. In 1987, Fang and Chen reported the sulfonyl-cyanation of unsaturated hydrocarbons by using AIBN as an initiator at 80°C (Scheme III.37, a).<sup>180</sup> The synthesis of  $\beta$ -sulfonyl nitriles was also accomplished by Barton and co-workers in 1992 by visible light photolysis of the Barton's ester at 0-5°C (Scheme III.37, b).<sup>181</sup> However, both processes required considerable excess of olefins (10 equiv.) and are limited to mesyl and tosyl cyanide. Moreover, the Barton's sulfonyl-cyanation is restricted to electron-rich olefins. In the case of Fang conditions, desulfonylation might be a competitive reaction if more substituted alkyl sulfonyl cyanides were used due to the high temperature conditions. In order to improve these methodologies, it was decided developing a sulfonyl-cyanation with functionalized alkylsulfonyl cyanides, only one equivalent of olefin and a cheap organic dye as a photocatalyst (Scheme III.37, c).<sup>182</sup>



**Scheme III.37.** Reported sulfonyl-cyanation and our plan.<sup>180-182</sup>

<sup>180</sup> J. M. Fang and M. Y. Chen, *Tetrahedron Lett.*, 1987, **28**, 2853-2856.

<sup>181</sup> D. H. R. Barton, J. C. Jaszberenyi and E. A. Theodorakis, *Tetrahedron*, 1992, **48**, 2613-2626.

<sup>182</sup> V. Pirenne, G. Kurtay, S. Voci, L. Bouffier, N. Sojic, F. Robert, D. M. Bassani, Y. Landais, *Org. Lett.* **2018**, *20*, 4521-4525.

## 5.2.1. Optimisation and scope of the sulfonyl-cyanation reaction

Ethylsulfonyl cyanide **307** and 4-dimethyl(phenyl)silylbut-1-ene **315** were used as model substrates to set up the optimal reaction conditions. Different photocatalysts were chosen for their respective redox properties and to our delight, the formation of the  $\beta$ -sulfonyl nitrile product **362a** occurred with good yields for all of them (Table III.17). Although Cu(dap)<sub>2</sub>Cl and fac[Ir(ppy)<sub>3</sub>] photocatalysts gave moderate and excellent yields respectively (entry 1-2), we were stimulated to carry out this reaction in a metal-free manner. We thus turned our attention toward cheaper organic dyes such as rose Bengal and eosin-Y. Compared to rose Bengal (entry 3), an excellent yield was obtained with eosin-Y under green light irradiation (entry 4). The yield slightly diminished when K<sub>2</sub>HPO<sub>4</sub> was introduced as an additive (entry 5). Under blue light irradiation, the yield decreased considerably (entry 6), but the addition of K<sub>2</sub>HPO<sub>4</sub> in a sub-stoichiometric amount furnished the product in almost quantitative yield (entry 7). When the reaction was performed in the dark, only partial conversion was observed (entry 8). The product was not formed when the reaction mixture was irradiated without eosin-Y and K<sub>2</sub>HPO<sub>4</sub> (entry 9), suggesting that the light alone cannot initiate the radical reaction. Hence, the combination of eosin-Y, K<sub>2</sub>HPO<sub>4</sub> and blue light irradiation is required to obtain full conversion.

CCS(=O)C#N + C=CCCSi(C)C1=CC=CC=C1  $\xrightarrow[\text{DMF (1 M), r.t., 24h, visible light}]{\text{photocat. (2mol\%)}}$  CCS(=O)CC(C#N)CCSi(C)C1=CC=CC=C1

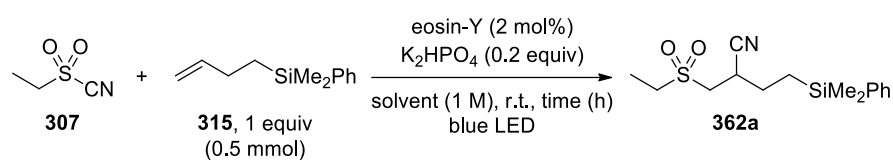
**307**, 2 equiv      **315**, 1 equiv (0.5 mmol)      **362a**

Entry	Photocat.	LED	Additives <sup>[a]</sup>	Conv. (%)	Yield (%)
1	Cu(dap) <sub>2</sub> Cl	green	-	62	59
2	Fac[Ir(ppy) <sub>3</sub> ]	white	-	100	88
3	rose bengal	green	-	80	61
4	eosin-Y	green	-	100	85
5	eosin-Y	green	K <sub>2</sub> HPO <sub>4</sub>	100	75
6	eosin-Y	blue	-	-	30
7	eosin-Y	blue	K <sub>2</sub> HPO <sub>4</sub>	100	98
8	eosin-Y	-	K <sub>2</sub> HPO <sub>4</sub>	25	-
9	-	blue	-	0	-

**Table III.17.** Screening of photocatalysts and additives for the sulfonyl-cyanation reaction using **307** ([a] 0.2 equiv. of K<sub>2</sub>HPO<sub>4</sub> was used).

Then, the stoichiometry of sulfonyl cyanide **307** was reduced to 1.5 equivalent, leading to a quantitative yield (Table III.18, entry 2). With only one equivalent of the sulfonyl cyanide, the

yield decreased considerably (entry 3). A larger amount of eosin-Y did not influence the reaction time and a lower yield was obtained (entry 4). Very small loading of eosin-Y (0.01 mol%) still furnished the product in 68% yield after longer reaction times (entry 5). The optimal conditions (entry 2) were applied to 1 mmol of olefin without affecting the reaction time (entry 6). Finally, other polar solvents such as acetone, acetonitrile or *i*-propanol were also effective for this reaction (entry 7-9). The presence of oxygen was also found to be detrimental to the formation of **362a** (entry 10).



Entry	<b>307</b> (eq.)	Solvent	Time (h)	Yield (%)
1	2	DMF	20	98
2	1.5	DMF	18	quant
3	1	DMF	18	68
4 <sup>[a]</sup>	1.5	DMF	20	86
5 <sup>[b]</sup>	1.5	DMF	148	68
<b>6<sup>[c]</sup></b>	<b>1.5</b>	<b>DMF</b>	<b>20</b>	<b>quant</b>
7	1.5	Acetone	19	94
8	1.5	ACN	19	97
9	1.5	<i>i</i> -PrOH	23	86
10 <sup>[d]</sup>	1.5	DMF	20	48

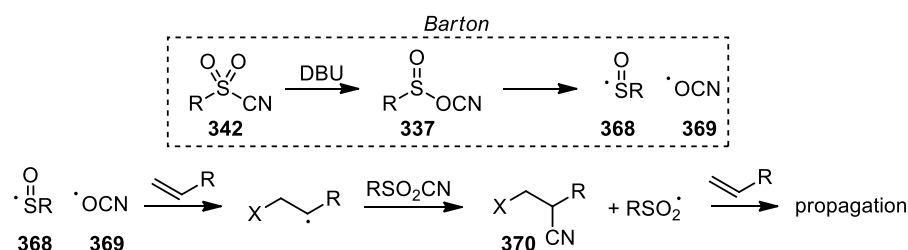
**Table III.18.** Optimization of the reaction conditions for the sulfonyl-cyanation ([a] 10 mol% of eosin-Y, [b] 0.01 mol% of eosin-Y, [c] 1 mmol of alkene, [d] no degassing was realized).

Several control experiments were accomplished regarding the role of  $K_2HPO_4$  (Table III.19). Interestingly, when eosin-Y was omitted, the reaction still works but in low yield (entry 1). More surprisingly, increasing the amount of  $K_2HPO_4$  to 1 equivalent under day light gave 43% of the sulfonyl nitrile **362a** (entry 2). The yield was not improved by using 2 equivalents of the sulfonyl cyanide (entry 3). These results were difficult to reproduce, which might be explained by the weak solubility of  $K_2HPO_4$  in DMF. When the same reaction was carried out in a dark room, only thiosulfone **367** was produced, the formation of **362a** was not observed (entry 4).

Entry	hv	K <sub>2</sub> HPO <sub>4</sub> (eq.)	Time (h)	Conv. (%)	362a (%)	367 (%)
1	LED	0.2	20	38	29	-
2	day	1	17	47	43	-
3 <sup>[a]</sup>	day	1	24	30	20	-
4 <sup>[b]</sup>	-	1	24	0	-	16

**Table III.19.** Control experiments ([a] 2 equiv. of EtSO<sub>2</sub>CN, [b] no light).

Thiosulfone **367** was also produced when a more soluble phosphate salt (NBu<sub>4</sub>H<sub>2</sub>PO<sub>4</sub>) or DBU were added in catalytic amounts. The formation of thiosulfone was already observed by Barton and co-workers in the *O*-sulfonylation of alcohols with *p*-TsCN or MeSO<sub>2</sub>CN and DBU.<sup>157</sup> In this report, they proposed that a sulfinyl cyanate intermediate **137** was formed (Scheme III.38). The weak S-O single bond in this species may undergo homolytic cleavage to afford sulfinyl and cyanate radicals (**368** and **369**). These electrophilic radicals should be able to initiate a radical group transfer process with olefins, albeit poorly efficient. It is believed that similarly to observations by Barton *et al.*, generation of sulfinyl cyanate species occurs which then initiates the radical process as depicted in Scheme III.38.

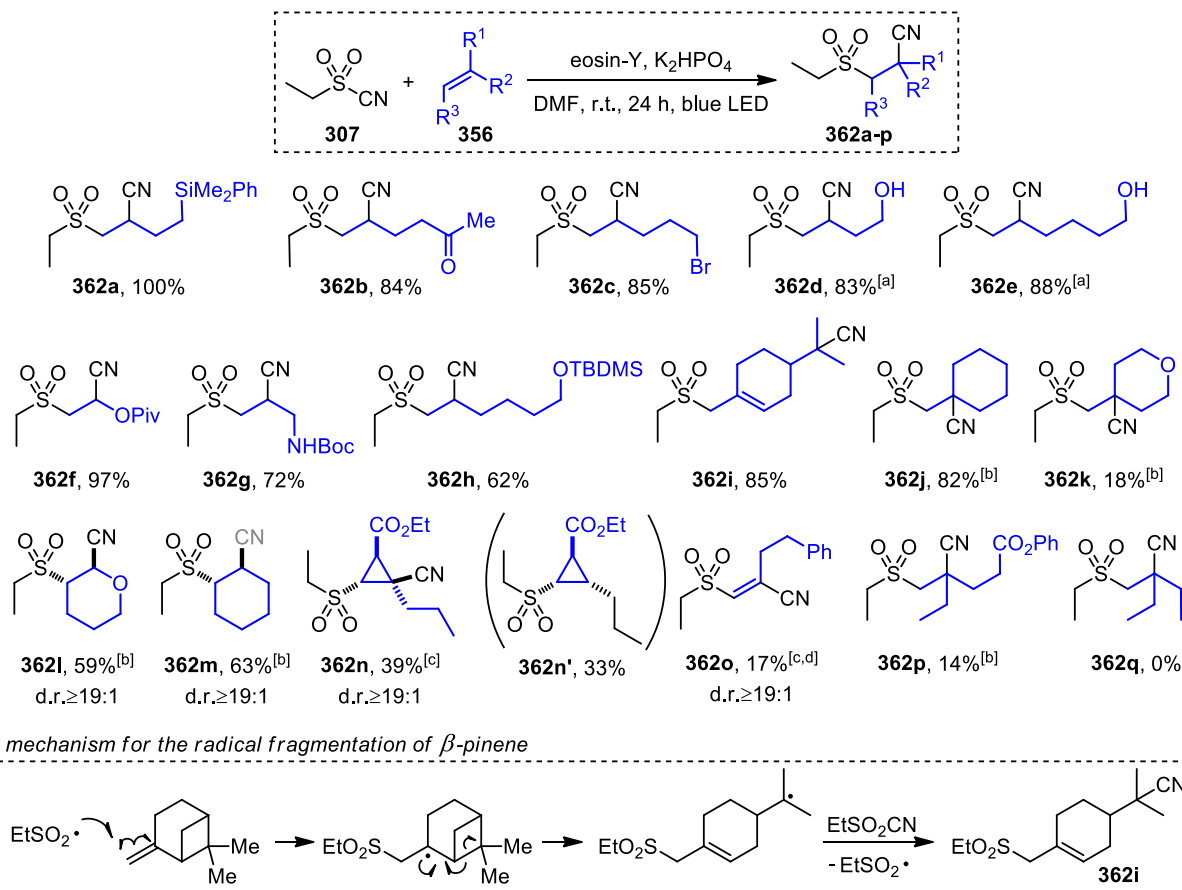


**Scheme III.38.** Proposed mechanism for the sulfonyl-cyanation in the absence of eosin-Y.

The optimized reaction conditions (Table III.18, entry 6) were then applied to a range of olefins using ethylsulfonyl cyanide **307** (Scheme III.39). The eosin-mediated sulfonyl-cyanation showed high-yielding events and a broad applicability to functionalized mono- and di-substituted olefins as well as internal alkenes. Reaction with  $\beta$ -pinene gave the desired alkylsulfonyl nitrile **362i** in good yield, the ring-opening of the  $\beta$ -pinene 4-membered ring indicating the radical nature of this process.<sup>183</sup> The radical mechanism of the  $\beta$ -pinene fragmentation is given in Scheme III.39. The sulfonyl-cyanation proceeds well also with methylenecyclohexane providing the product **362j** in good yield. Lower yields were however obtained with 4-methylenetetrahydro-2H-pyran (**362k**)

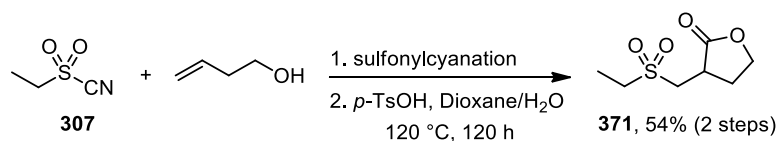
<sup>183</sup> D. M. Oldroyd, G. S. Fisher, L. A. Goldblatt, *J. Am. Chem. Soc.* **1950**, *72*, 2407.

and no product was found with 2-ethyl-1-butene (**362q**). Usually, when a disubstituted olefin was used, an excess of the sulfonyl cyanide could counterbalance the reversibility of the sulfonyl radical addition. Excellent yields were obtained with mono-substituted olefins bearing ketone, bromide, ester, carbamate and silyl protecting groups (**362a-h**).



**Scheme III.39.** Scope of olefins ([a] yield included the corresponding imidate, [b] 3 equiv. of  $EtSO_2CN$  was used, [c] acetone as a solvent, [d] from 4-Phenyl-1-butyne).<sup>182</sup>

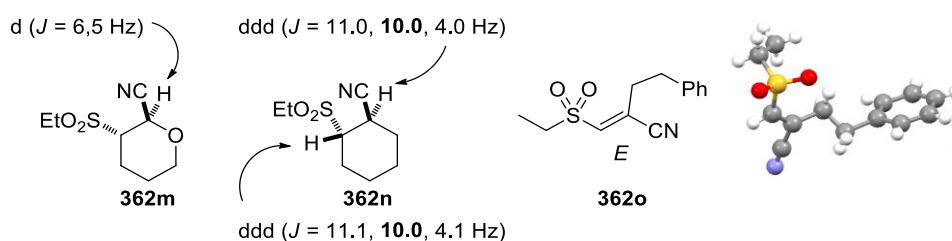
With olefins bearing a free-alcohol, the  $\beta$ -sulfonylnitrile products **362d** and **362e** were isolated with the corresponding imidate as an inseparable mixture. Treatment of the crude mixture with *p*-TsOH led to the alkylsulfonyl lactone **371** in satisfactory yields for two steps (Scheme III.40). Under acidic conditions, the cyclic imidate is hydrolyzed into the corresponding lactone. The same reaction with 5-hexen-1-ol met with failure.



**Scheme III.40.** Synthesis of an alkylsulfonyl lactone through a sulfonyl-cyanation/hydrolysis sequence.<sup>182</sup>

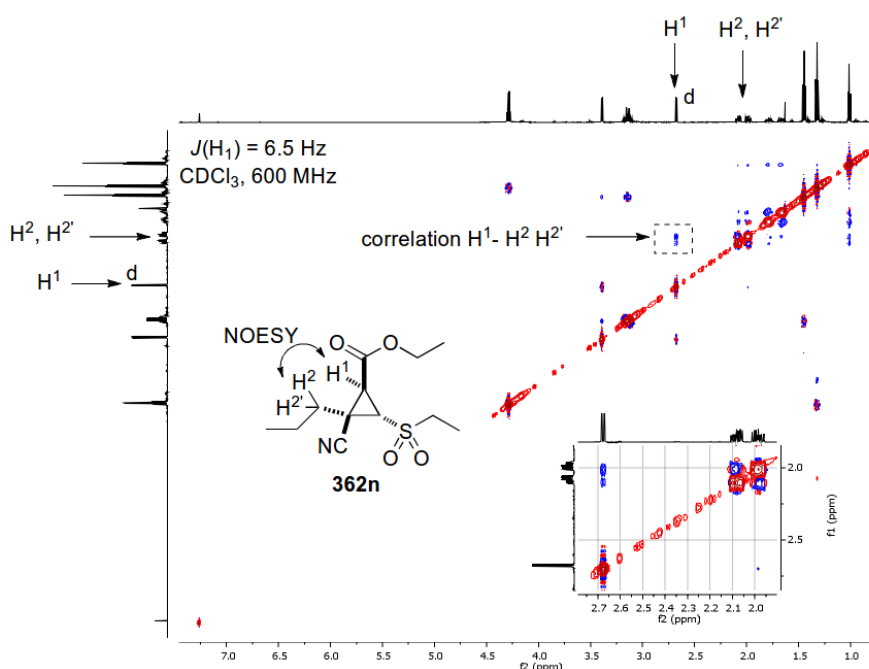
When cyclic olefins were used, the *trans* product was obtained as the major isomer (**362l-n**, Scheme III.39). Moderate yields were obtained with 3,4-dihydro-2H-pyran, cyclohexene and cyclopropene. For cyclopropene and alkyne, acetone was used as a solvent instead of DMF because the corresponding cyclopropyl and alkenyl radicals are less prone to hydrogen abstraction in that solvent. Indeed, when the sulfonyl-cyanation was tried on cyclopropene in DMF, only the cyclopropane **362n'** was isolated in 33% yield. The *trans*-stereoselectivity was also found for alkynes although the yield was really low (**362o**). In contrast, no diastereoselectivity was obtained by Fang and co-workers when their sulfonyl-cyanation was applied to alkynes.<sup>180</sup>

The relative configurations of compound **362m** and **362n** were identified according to the NMR coupling constants which are consistent with a *trans* relative configuration and the *E* geometry of **362o** was demonstrated through X-ray crystal structure analysis (Figure III.4).



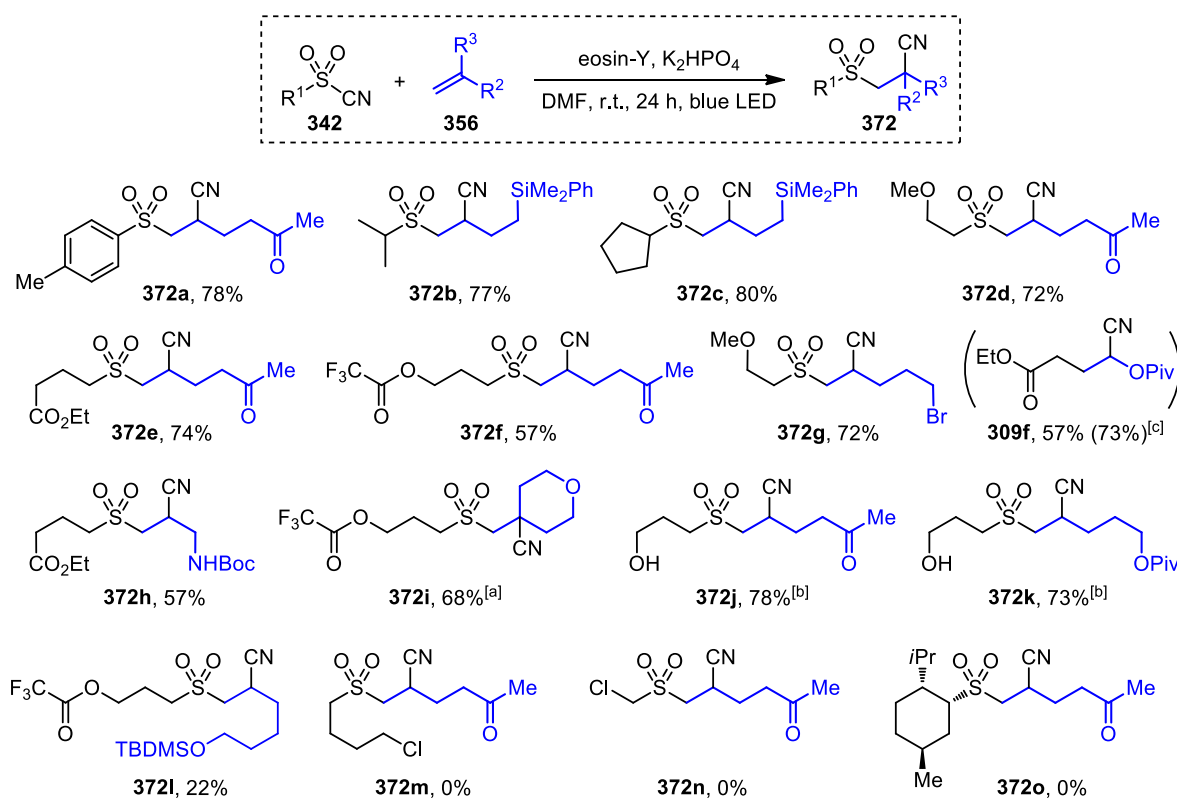
**Figure III.4.** NMR coupling constant and X-ray crystal structure of **362o**.

For cyclopropane **362n**, the coupling constant of H<sup>1</sup> (6.5 Hz) suggests that the addition of the sulfonyl radical to cyclopropene occurred in an *anti* relationship with the ester moiety. Nuclear Overhauser effect (nOe) also established the *cis* relationship between the H<sup>1</sup> and the propyl group (Figure III.5). Hence, the sulfonyl group and the nitrile are *trans*-configured demonstrating once again the *trans* selectivity for the sulfonyl-cyanation on cyclic olefins.



**Figure III.5.** NOESY experiment of cyclopropane **362n**.

The optimized conditions were also applied to a series of sulfonyl cyanides prepared above (Scheme III.41). Overall, the sulfonyl-cyanation reaction showed moderate to good yields and is compatible with sulfonyl cyanides bearing simple alkyl groups, ester, ether, trifluoroacetate and aromatic groups. The commercially available tosyl cyanide gave the desired product **372a** in good yields. No desulfonylation was observed under the reaction conditions with secondary alkyl sulfonyl cyanides (**372b** and **372c**). Reaction of sulfonyl cyanide **342j** with 5-hexen-2-one and 4-methylenetetrahydro-2H-pyran gave the trifluoroacetate products **372f** and **372i** respectively, when purification was carried out through silica gel. Purification using neutral alumina furnished directly the corresponding free alcohols **372j** and **372k**. Interestingly, the product of carbocyanation **309f** was obtained with sulfonyl cyanide **305** even if a very reactive olefin was used in excess. The SO<sub>2</sub> extrusion occurs very rapidly even at room temperature due to the formation of a stabilized C-centered radical. Other sulfonyl cyanides bearing chloride or more complex alkyl group (menthyl) led to inconclusive results (**372l-n**).

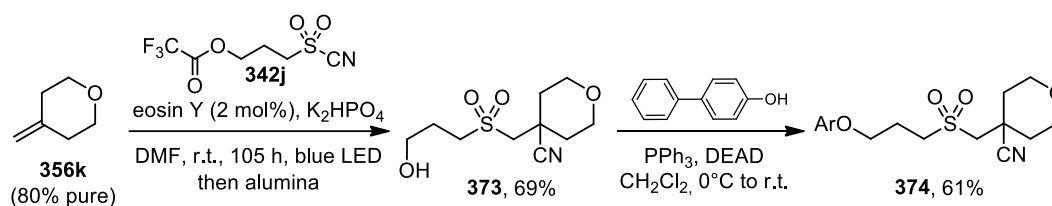


**Scheme III.41.** Scope of alkylsulfonyl cyanides ([a] 4.4 equiv. of RSO<sub>2</sub>CN, [b] column on neutral alumina, [c] 5 equiv. of vinyl pivalate).<sup>182</sup>



## 5.2.2. Application to the total synthesis of a bioactive sulfone

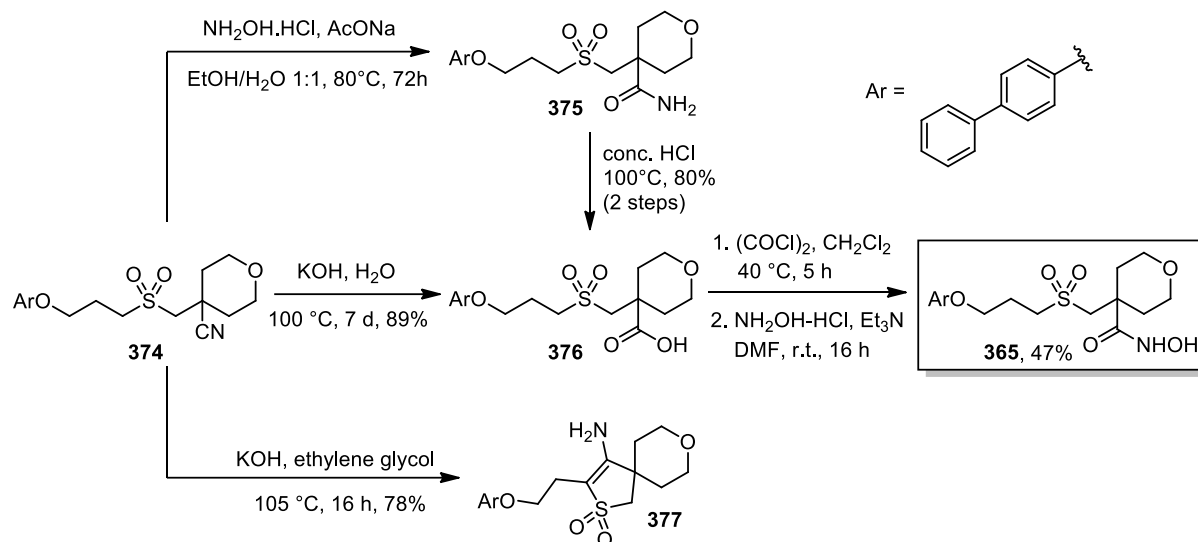
The utility of this methodology was illustrated by the synthesis of a bioactive sulfone. The total synthesis of metalloproteinase inhibitor **365** was engaged by applying the sulfonyl-cyanation with sulfonyl cyanide **342j** and olefin **356k** (Scheme III.42). The corresponding alcohol **373** was obtained in 69% yield after the deprotection of the trifluoroacetate on alumina. The alcohol was then converted into the aryl ether **374** in 61% yield through a Mitsunobu reaction. Copper-catalyzed etherifications were also tried for this C-O bond forming reaction but these trials remained unsuccessful.<sup>184</sup> This two-steps sequence furnished directly the carbon structure of the target.



**Scheme III.42.** Preparation of the precursor for the synthesis of the metalloproteinase inhibitor **365**.

The direct conversion of the nitrile into the hydroxamic acid **365** with hydroxylammonium hydrochloride in an EtOH/H<sub>2</sub>O mixture was tried but only the amide **375** was recovered (Scheme III.43). The latter was treated under acidic conditions furnishing the corresponding acid **376** in good yields. The direct nitrile hydrolysis was more tedious. The hydrolysis under harsh acidic conditions (conc. HCl or conc. H<sub>2</sub>SO<sub>4</sub>) led to a complex mixture. Using KOH in ethylene glycol, led to the unexpected formation of the cyclic enamine **377** in good yield. This product likely results from the deprotonation  $\alpha$ - to the sulfone followed by nucleophilic addition of the resulting carbanion onto the nitrile. Finally, the carboxylic acid **376** was obtained in one step in 89% yield by refluxing the nitrile in a KOH aqueous solution. Transformation of the acid **376** into the hydroxamic acid **365** using carbonyl diimidazole led to no conversion. Moderate yield of **365** was however obtained when the acid was converted into the acyl chloride using oxalyl chloride followed by nucleophilic addition of hydroxylamine.

<sup>184</sup> J. Niu, P. Guo, J. Kang, Z. Li, J. Xu, S. Hu, *J. Org. Chem.* **2009**, *74*, 5075-5078.



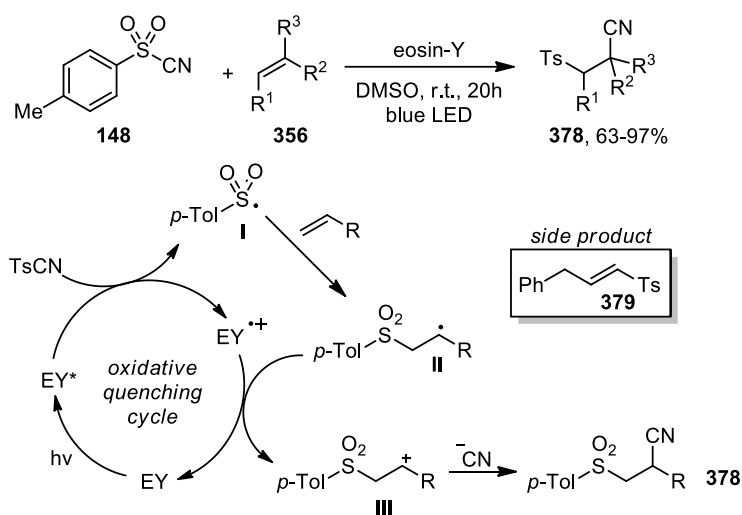
**Scheme III.43.** Conversion of the nitrile to the hydroxamic acid.<sup>182</sup>

Overall, the eosin-mediated sulfonyl-cyanation of olefins showed a good functional groups tolerance and broad scopes, producing the  $\beta$ -sulfonyl nitriles in good yields. Useful synthetic intermediates were obtained as shown by the synthesis of **365** in a limited number of steps.

### 5.2.3. Mechanistic investigations

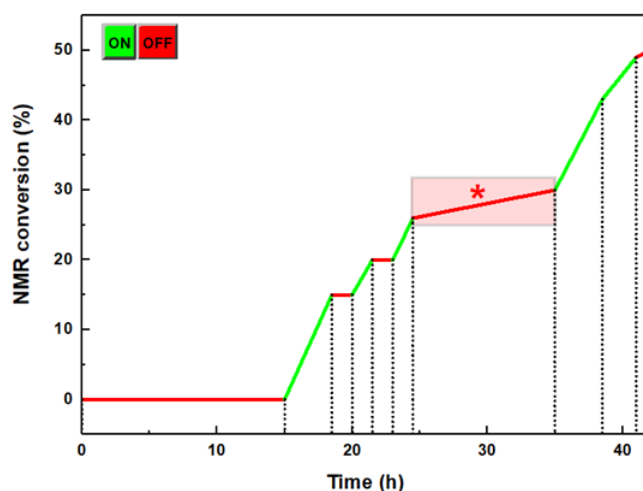
When we started to investigate the mechanism of this reaction, a report by Sun and co-workers appeared on the sulfonyl-cyanation using tosyl cyanide as the commercially available sulfonyl cyanide (Scheme III.44).<sup>185</sup> In their study, they proposed a mechanism invoking an oxidative quenching cycle in which eosin-Y undergoes a photoinduced electron transfer leading to the formation of the sulfonyl radical **I**. The latter adds to the olefin and the new C-centered radical **II** is oxidized to a carbocation **III** by the semi-oxidized form of eosin. The trapping of the carbocation by a cyanide anion finally provides the sulfonyl-nitrile product **378**. The isolation of an elimination product **379** (5%) confirmed the radical-polar crossover mechanism and rules out directly a radical chain process.

<sup>185</sup> J. Sun, P. Li, L. Guo, F. Yu, Y.-P. He, L. Chu, *Chem. Comm.* **2018**, 54, 3162–3165.



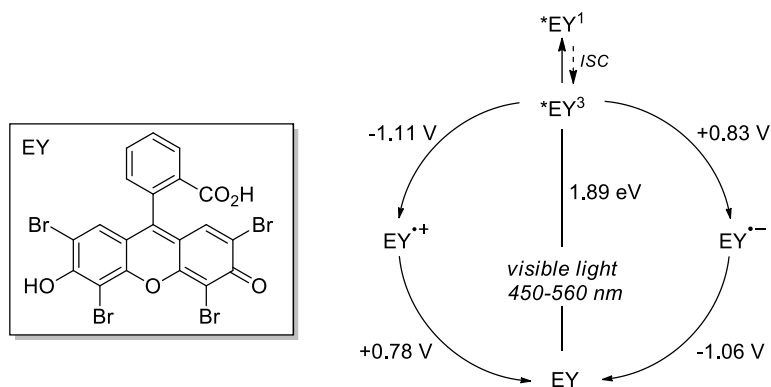
**Scheme III.44.** Mechanism of the photoredox-catalyzed sulfonyl-cyanation as proposed by Sun and co-workers.<sup>185</sup>

Although this radical-polar crossover mechanism might be feasible, we observed that the radical chain is operative but very inefficient. Light ON-OFF experiments were carried out using our model reaction over 50h period and the conversion was monitored by <sup>1</sup>H NMR (Figure III.6). The reaction starts by irradiating the mixture with blue LED but stops when the light was switched off. However, for longer dark periods (10 hours), it can be observed that the reaction continues, albeit slowly, suggesting an inefficient radical chain process. The same reaction in presence of 2 equivalents of TEMPO did not provide any traces of sulfonyl-nitrile product **362a** confirming the radical nature of this transformation.



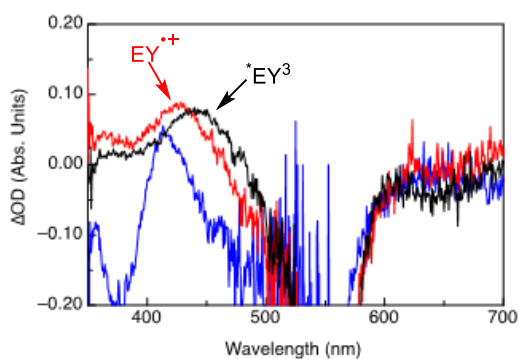
**Figure III.6.** Light ON-OFF experiment.<sup>182</sup>

The properties of eosin-Y are well documented.<sup>186</sup> After irradiation with visible light, eosin-Y possesses a short-lived singlet excited state, which undergoes a rapid intersystem crossing to a long-lived triplet excited state. Eosin-Y has been used as a photoredox catalyst in useful organic reactions and can enter either in an oxidative or reductive quenching cycle depending on the nature of the substrate.<sup>187</sup> The Figure III.7 shows the structure of eosin-Y and the quenching cycles in which reduction potentials are indicated.



**Figure III.7.** Structure and photocatalytic cycle of eosin-Y.

In order to shed light on the mechanism proposed by Sun and co-workers, time-resolved absorption experiments were performed by Dr. Dario Bassani (ISM, NEO group). Upon laser excitation on a DMF solution of eosin-Y in the presence of ethylsulfonfyl cyanide, the formation of a transient species appeared, which possesses a transition at 420 nm (Figure III.8, red curve). This species corresponds to the radical cation,  $EY^{*+}$ . In the absence of ethylsulfonfyl cyanide, only the triplet excited state  $*EY^3$  was observed which shows a transient absorption at 440 nm (Figure III.8, black curve). At first glance, these results seemed to agree with the mechanism proposed by Sun.

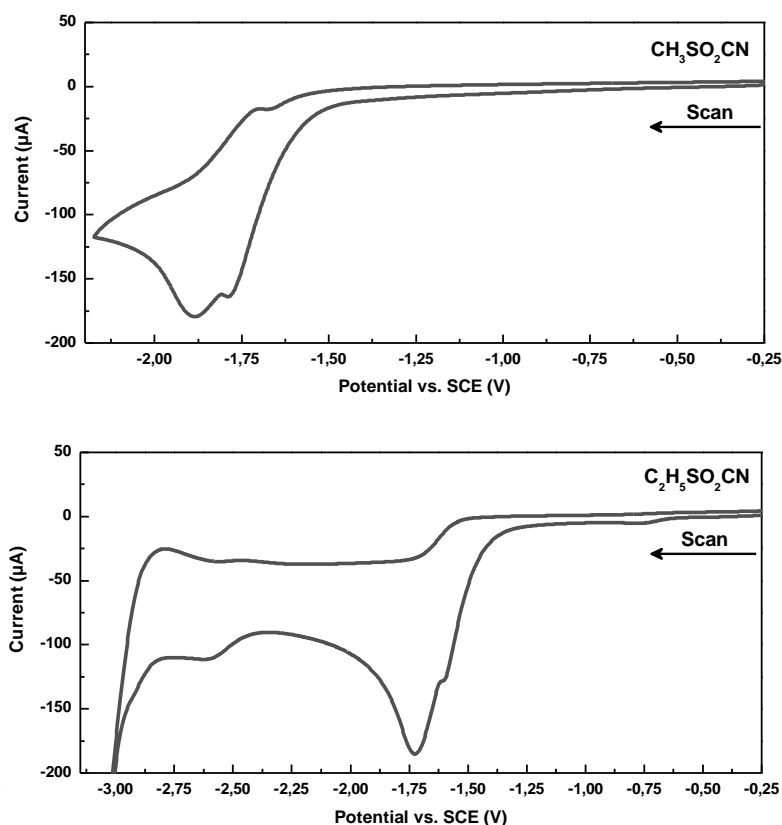


**Figure III.8.** Time-resolved absorption spectra of EY solutions in aerated DMF, collected 100 ns after laser excitation at 532 nm (8.5 nm pulse). Black curve: EY alone. Red curve: solution of EY containing **307** (3 mM). The concentration of EY was adjusted to obtain an absorbance of 1.4 at 532 nm. Blue curve: solution of EY containing EY-Me (1 mM).<sup>182</sup>

<sup>186</sup> M. Majek, F. Filace, A. J. v. Wangelin, *Beilstein J. Org. Chem.* **2014**, *10*, 981-989.

<sup>187</sup> D. P. Hari, B. König, *Chem. Comm.* **2014**, *50*, 6688-6699.

Since the electrochemical data of sulfonyl cyanides were rare in the literature (only the redox potential was described for  $\text{PhSO}_2\text{CN}$  but the measurement was performed using a Hg cathode),<sup>188</sup> the reduction potentials of alkylsulfonyl cyanide were investigated by cyclic voltammetry. These experiments were performed by Dr. Gülbin Kurtay, a post-doctoral associate working in our group. The cyclic voltammograms of methyl- and ethylsulfonyl cyanide (**342b** and **307**) are presented in Figure III.9 and were found to be irreversible. *Alkyl*sulfonyl cyanides exhibit highly negative reduction potentials and should thus be difficult to reduce.



**Figure III.9.** Cyclic voltammograms of methyl and ethylsulfonyl cyanide (experiments were carried out at  $25 \pm 0.5$  °C using a glassy carbon working electrode, a Pt-wire counter-electrode, and Ag as a pseudo-reference electrode, 10 mM  $\text{RSO}_2\text{CN}$  in 0.1M  $\text{TBAPF}_6/\text{DMF}$ ,  $\nu = 100$  mV/s).<sup>182</sup>

The reduction potentials of some sulfonyl cyanides and other substrates are listed in Table III.20. The values of sulfonyl cyanides are controversial because it suggests that the direct electron transfer from  $^*\text{EY}^3$  to  $\text{RSO}_2\text{CN}$  is thermodynamically not favoured for *alkyl*sulfonyl cyanides whereas transient spectroscopy suggests the opposite. The free energy of a photo-induced electron transfer from  $^*\text{EY}^3$  to some selected substrates were calculated (Table III.20) according Equation 2.12.

<sup>188</sup> D. Van der Meer, A. Spaans, H. Thijssse, *Recl. Trav. Chim. Pays-Bas* **1974**, 93, 7-11.

$$\Delta G_{PET} = -F[E_{red}(\mathbf{sub}/\mathbf{sub}^{\bullet-}) - E_{ox}^*(\mathbf{EY}^{\bullet+}/\mathbf{EY}^*)] \quad (2.12)$$

In this equation,  $E_{ox}^*(\mathbf{EY}^{\bullet+}/\mathbf{EY}^*)$  has a value of -1.11V. The free energies listed in Table III.20 confirmed that the direct PET is indeed thermodynamically unfavoured for alkylsulfonyl cyanides. Comparison may be made with  $\text{CF}_3\text{SO}_2\text{Cl}$  which is known to be reduced by  ${}^*\text{EY}^3$ .<sup>114</sup> The reduction potential of thiosulfone **367** was also measured and found to be even more negative ruling out the PET event to this substrate. Even though the electrochemical data obtained by Sun and co-workers on TsCN ( $E_{red} = -0.78\text{V vs SCE}$ ) suggests a slightly exothermic PET from  ${}^*\text{EY}^3$  (slightly endothermic with our data), the highly negative reduction potentials of *alkylsulfonyl cyanides* ruled out the direct PET from  ${}^*\text{EY}^3$  and a more complex mechanism must be invoked.

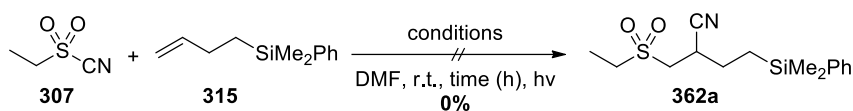
Substrates	$E_{red}$ (V vs SCE)	$\Delta G_{PET}$ (kcal.mol <sup>-1</sup> )
MeSO <sub>2</sub> CN	-1.88	+17.7
EtSO <sub>2</sub> CN	-1.72	+14.1
TsCN	-1.34 (-0.78) <sup>185</sup>	+5.3 (-7.6)
EtSO <sub>2</sub> SEt	-2.64	+35.3
CF <sub>3</sub> SO <sub>2</sub> Cl	-0.81	-6.9

**Table III.20.** Reduction potentials of some sulfonyl cyanides and thiosulfone **367**.<sup>182</sup>

Under our reaction conditions (1.5 M of **307**), the singlet excited state  ${}^*\text{EY}^1$  might be intercepted. The reduction potential of  ${}^*\text{EY}^1$  is estimated to be greater than  ${}^*\text{EY}^3$  which would favour the PET event. To verify whether the PET occurs from the singlet manifold, the fluorescence lifetime of eosin-Y was measured. Similar values were obtained for  ${}^*\text{EY}^1$  in Argon-sparged DMF solutions ( $\tau = 4.14$  ns) and under the conditions used for the synthetic procedures (*i.e.* 1M **307** and  $\text{K}_2\text{HPO}_4$ ,  $\tau = 3.95$  ns). Therefore, sulfonyl cyanides cannot be involved in the quenching of  ${}^*\text{EY}^1$ . In agreement with this result, no sulfonyl-cyanation product was obtained when eosin-Y was replaced by 9,10-dimethoxy-anthracene (DMA) which is characterized by a long-lived singlet excited state (14.3 ns in heptane)<sup>189</sup> (Scheme III.45). Furthermore, upon excitation by light (360-400 nm), the singlet excited state of DMA possesses a higher reduction potential (-2.0 V vs SCE) than the excited state of eosin-Y. Although these photophysical features favour a PET event from  ${}^*\text{DMA}^1$  to  $\text{RSO}_2\text{CN}$ , the reaction did not happen. Similarly, the presence of ferrocene, an efficient triplet quencher of eosin-Y,<sup>190</sup> in our typical reaction conditions, completely inhibited the reactivity as no products were observed (Scheme III.45). These results exclude definitely the participation of  ${}^*\text{EY}^1$  in our reaction.

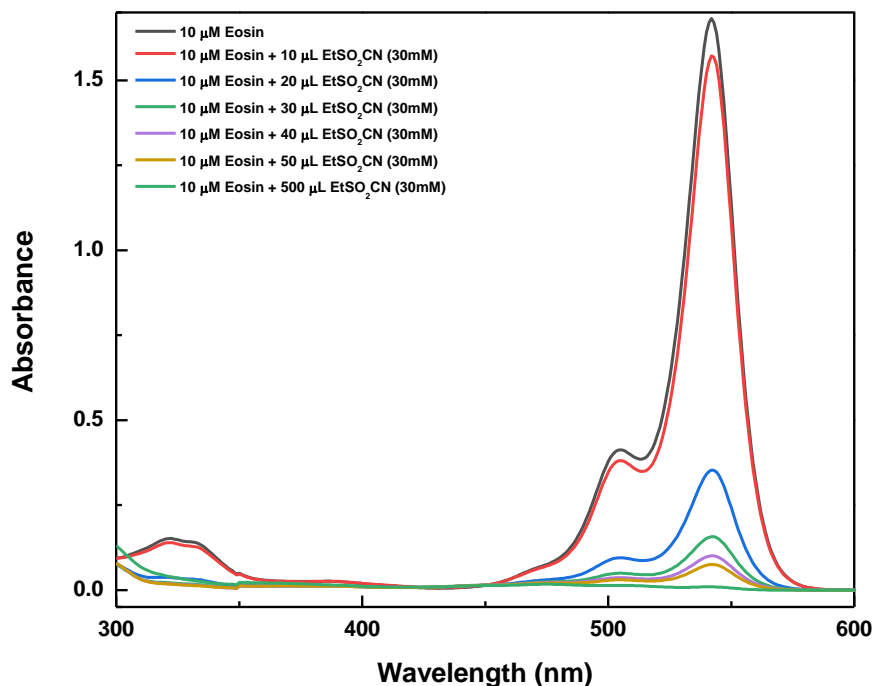
<sup>189</sup> (a) E. Hasegawa, S. Takizawa, T. Seida, A. Yamaguchi, N. Yamaguchi, N. Chiba, T. Takahashi, H. Ikeda and K. Akiyama, *Tetrahedron*, 2006, **62**, 6581-6588; (b) H. Dreeskamp and J. Pabst, *Chem. Phys. Lett.*, 1979, **61**, 262-265.

<sup>190</sup> M. Kikuchi, K. Kikuchi and H. Kokubun, *Bull. Chem. Soc. Jpn.*, 1974, **47**, 1331-1333.



**Scheme III.45.** Control experiments ruling out the involvement of  ${}^*EY^1$ .

Further information aroused from UV-visible studies realized together with Dr. Kurtay and Dr. Dario Bassani. Eosin-Y absorbs strongly in the green region and shows a maximum of absorbance at 544 nm in a DMF solution. Although the sulfonyl cyanides do not absorb in this region, a fast discoloration appeared when ethylsulfonyl cyanide was added to a solution of eosin-Y in DMF. The absorbance of eosin-Y decreases considerably after several consecutive additions of a 30 mM solution of EtSO<sub>2</sub>CN to a 10 μM eosin solution in DMF (Figure III.10). This ground-state bleaching was also confirmed with tosyl cyanide.

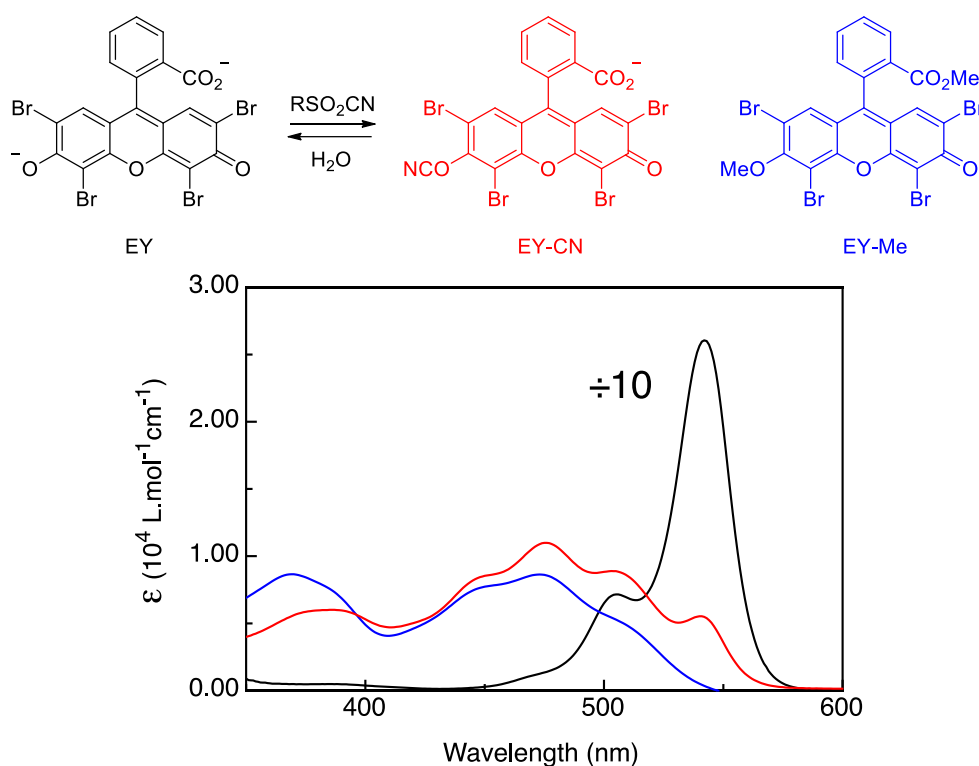


**Figure III.10.** UV-visible spectra of eosin-Y (10μM) after successive additions of a 30 mM solution of **307**.<sup>182</sup>

The NMR analysis of a mixture of eosin-Y and ethylsulfonyl cyanide did not reveal any weak or through-space interactions as reported recently by Lakhdar and co-workers with eosin-Y and pyridinium salts.<sup>191</sup> However, we were alerted by a possible *O*-alkylation of eosin-Y, which might be at the origin of this discoloration. Enlargement of the UV-visible absorption spectrum revealed that this bleaching was accompanied by the appearance of a new absorption profile with

<sup>191</sup> V. Quint, F. Morlet-Savary, J.-F. Lohier, J. Lavee, A.-C. Gaumont, S. Lakhdar, *J. Am. Chem. Soc.* **2016**, *138*, 7436-7441.

$\lambda_{\max} = 475$  nm (Figure III.11, red curve). This new absorption band between 410 and 520 nm corresponds to a xanthene-type dye in which the push-pull character is interrupted. We assigned this new species to a cyanated derivative of eosin-Y (EY-CN) based on reported absorption profiles of substituted eosin derivatives.<sup>192</sup> The formation of EY-CN likely arises from the cyanation of the EY dianion in the presence of sulfonyl cyanide which is in large excess, as compared to the catalytic amount of EY. The sulfonyl cyanides are also excellent electrophiles and as mentioned above, tosyl cyanide has been used in the cyanation of nucleophiles such as phenoxide.<sup>156</sup> To verify this hypothesis, *O*-methylated eosin (EY-Me) was prepared by the alkylation of eosin-Y using (trimethylsilyl)diazomethane (see experimental part). The absorption profile of EY-Me strongly resembles to EY-CN which supports our hypothesis (Figure III.11, blue curve).

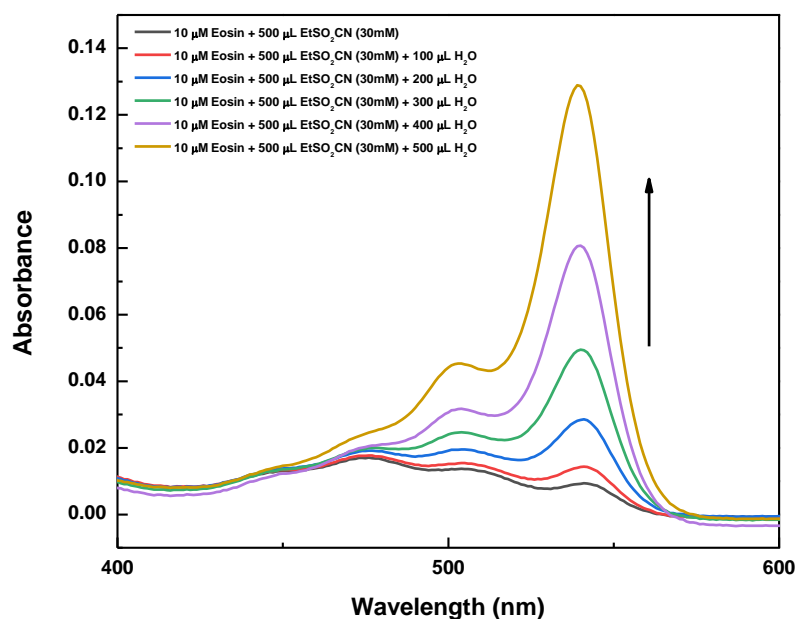


**Figure III.11.** Top: proposed structure of the adduct formed between EY and  $\text{RSO}_2\text{CN}$  (EY-CN). Bottom: Electronic absorption spectrum of EY in DMF (black curve, divided by 10) and of the *O*-methylated derivative (EY-Me, blue curve). The red curve shows the absorption spectrum of the EY-CN adduct obtained by the addition of 10 mM **307** to a 20  $\mu\text{M}$  solution of EY.<sup>182</sup>

Furthermore, in the presence of water, hydrolysis of the adduct EY-CN occurred rapidly releasing EY. Several additions of water to a solution containing eosin-Y and ethylsulfonyl cyanide are sufficient to regenerate EY (Figure III.12). Addition of  $\text{K}_2\text{HPO}_4$ , which might contain traces of water, led to the same observation.

<sup>192</sup> F. Amat-Guerri, M. M. C. López-González, R. Martínez-Utrilla, R. Sastre, *Dyes and Pigments* **1990**, 12, 249-272.





**Figure III.12.** UV-visible spectra of a solution of eosin and EtSO<sub>2</sub>CN after successive additions of water.<sup>182</sup>

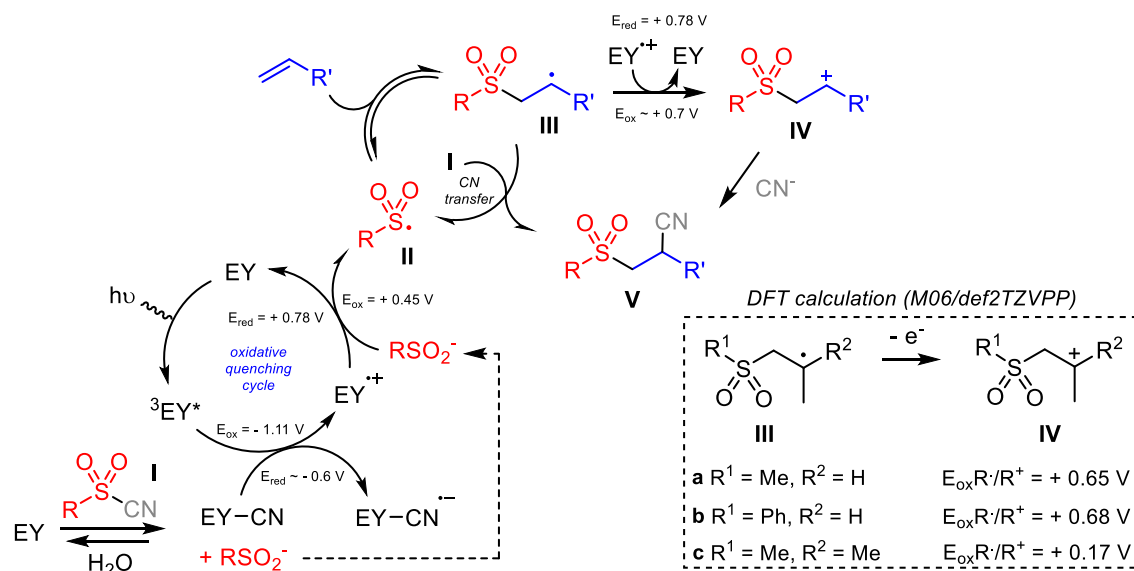
Under the reaction conditions, the proportion of EY-CN was estimated from the UV-visible absorption spectrum to be *ca.* 75%, indicating that EY is not the only photo-active dye. Moreover, the absorption profile of the EY-CN adduct matches well with the emission of the light source (blue LED) and the latter could be the photo-active catalyst. In order to verify this hypothesis, the reaction model was performed using monochromatic irradiation at 436 nm where EY does not absorb. No conversion was observed in this case. When EY was replaced by EY-Me, only partial conversion was observed. These results suggest that EY-CN is not, or only weakly, photoactive. In sharp contrast, the absence of sulfonyl-cyanation reaction with the sulfonyl cyanide **305** and **342h** can be explained by the total bleaching of EY. The presence of electron-withdrawing groups enhances the electrophilicity of the nitrile and eosin-Y is completely converted into the photo-inactive EY-CN adduct.

Although the EY-CN adduct was not found to be photo-active, its concentration is sufficiently high to undergo a bimolecular reaction with <sup>\*</sup>EY<sup>3</sup>. This hypothesis was confirmed when transient spectroscopy was conducted on DMF solutions of EY in the presence of EY-Me. The formation of a transient species absorbing at 416 nm was observed (Figure III.8, blue curve) which strongly resembles to the radical cation EY<sup>+•</sup> (red curve). The transient absorption of <sup>\*</sup>EY<sup>3</sup> was not observed. To verify that this photoinduced electron transfer is thermodynamically favoured, the reduction potential of EY-Me was determined by cyclic voltammetry. The *O*-methylated eosin-Y possesses a reversible reduction peak at -0.65 V *vs* SCE (EY-Me/EY-Me<sup>-•</sup>). This value suggests an exothermic oxidative PET from <sup>\*</sup>EY<sup>3</sup> to EY-Me ( $\Delta G_{\text{PET}} = -F \cdot (-0.65 + 1.11) = -10.6$  kcal/mol). Based on this result, we assumed that a PET occurred between <sup>\*</sup>EY<sup>3</sup> and EY-CN.

On the basis of these observations, we proposed the mechanism depicted in Figure III.13. In the presence of sulfonyl cyanide **I**, EY is partially converted into the cyanate derivative EY-CN releasing a sulfinate anion. The oxidation of sulfinites by EY<sup>+</sup> in sulfonyl radicals was shown recently by König and co-worker.<sup>128</sup> Hence, <sup>3</sup>EY\* undergoes an oxidative PET with EY-CN furnishing the radical cation of EY. The latter oxidizes the sulfinate into the corresponding sulfonyl radical regenerating the ground-state photocatalyst. Reversible addition of the sulfonyl radical **II** to the alkene generates a new C-centered radical **III**. Reaction of the latter with **I** in a nitrile transfer process provides the β-sulfonyl nitrile **V**. Alternatively, as proposed by Sun, the radical **III** might also be oxidized by EY<sup>+</sup> to form a carbocation **IV** which is eventually trapped by a cyanide anion to form **V**. Several oxidation potentials of β-sulfonyl radicals were estimated through DFT calculations (Figure III.13). These values suggest that the oxidation of the β-sulfonyl radicals is only slightly exergonic for monosubstituted olefins. For instance, in case *a*, the free energy was found to be -3.0 kcal/mol according Equation 2.9 where  $E_{1/2}(R^+/R^\bullet) = 0.65$  V.

$$\Delta G_{ET} = -F[E_{1/2}(EY^{*+}/EY) - E_{1/2}(R^+/R^\bullet)] \quad (2.9)$$

In contrast, this SET is favoured with disubstituted olefins (case *c*,  $\Delta G_{ET} = -14.1$  kcal.mol) while the sulfonyl-cyanation reaction with 1,1-disubstituted olefins afforded the product in low yield. Our control experiments in which water and *i*-propanol were added in the reaction medium did not reveal the formation of any elimination products, alcohols or ethers and thus rule out the involvement of a carbocation **IV**. It is also important to remind that the light switch ON-OFF experiment supports a radical chain mechanism.

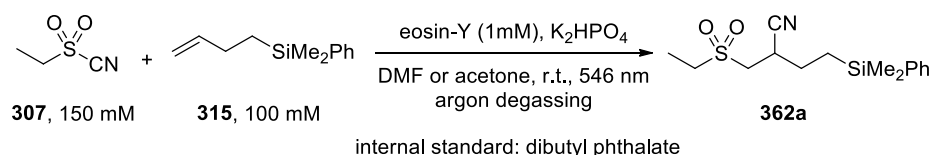


**Figure III.13.** Proposed mechanism and oxidation potentials of β-sulfonyl radicals.<sup>182</sup>

Quantum yields for the formation of **V** measured in DMF and acetone upon monochromatic excitation at 546 nm led respectively to values of  $\Phi_{\text{DMF}} = 0.2$  and  $\Phi_{\text{Acetone}} = 1.17$  (*vide infra*). These values are also in agreement with a moderately efficient radical chain considering that the

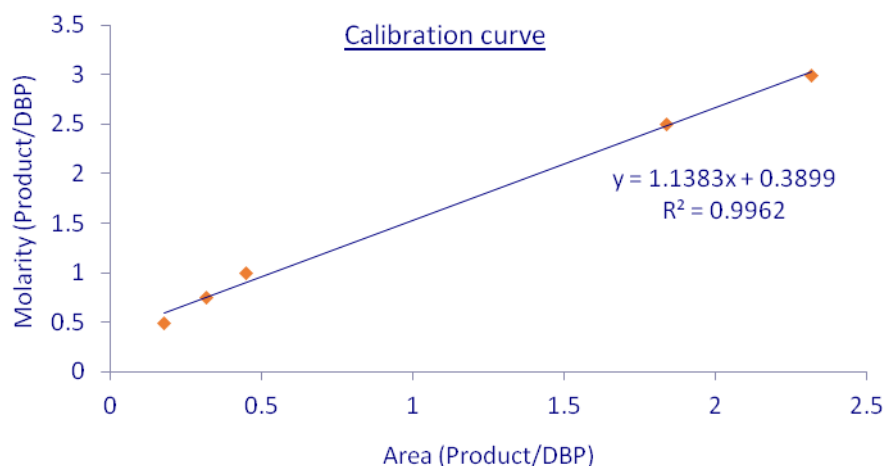
intersystem crossing efficiency of EY is less than unity ( $\Phi_{ISC} = 0.32$  in methanol).<sup>193</sup> This mechanism thus reconciles UV-vis experiments, redox potential measured through cyclic voltammetry and our own observations. It also shows that the direct electron-transfer proposed by Sun *et al.* is either unlikely or operative only with arylsulfonyl cyanides. It is noteworthy that these studies finally provide a new pathway in reactions using eosin-Y as a photocatalyst, invoking its temporary conversion into a redox-active species.

The measurement of the quantum yield for the model reaction was accomplished by Dr. Gülbin Kurtay (Scheme III.46). The quantum yield was measured with a GC-MS apparatus using dibutyl phthalate (DBP) as an internal standard, DMF or acetone as the solvent and a monochromatic light at 546 nm. The use of DMF for the quantum yield measurement is not ideal because it has to be evaporated before the injection in the GC-MS. Compared to DMF, acetone is more convenient but, in that case, we observed a fast bleaching after 30 minutes of irradiation.



**Scheme III.46.** Model reaction for the measurement of the quantum yield.

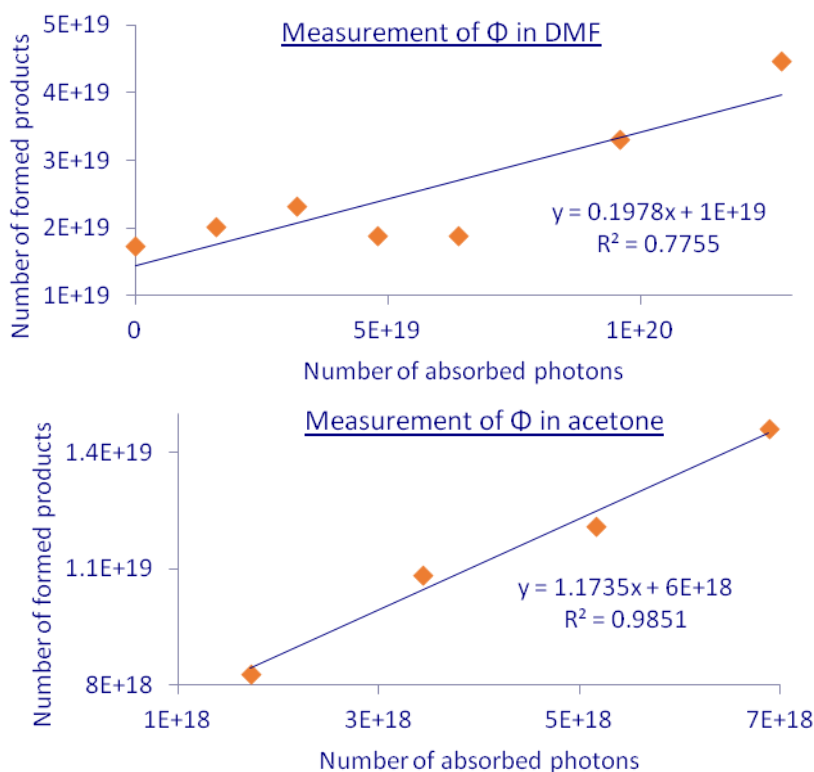
A five-point calibration curve (Figure III.14) was first established to demonstrate the linearity between the molarity and peak area ratios of the DBP and the desired product. The simple linear regression was used to obtain the equation ( $y=1.1383x + 0.3899$ ) and the correlation coefficient was found to be 0.9962. Normally, any calibration curve should cross the zero point. The calibration was repeated several times in different solvents but this problem was not circumvented.



**Figure III.14.** Calibration curve (measurement in acetone).<sup>182</sup>

<sup>193</sup> T. Shen, Z.-G. Zhao, Q. Yu, H.-J. Xu, *J. Photochem. Photobiol., A: Chem.* **1989**, 47, 203-212.

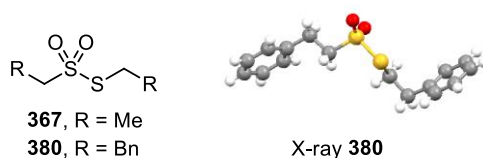
Having the calibration curve, the concentration of the formed product was monitored according the time for a 2 hours period. The quantum yield ( $\Phi$ ) of the model reaction was determined by plotting the number of formed molecules against the number of absorbed photons (Figure III.15). The slope of the obtained line corresponds to the quantum yield. The number of formed molecules was obtained from the measured concentrations using the Avogadro number and considering the dilution factor.



**Figure III.15.** Measurement of quantum yield in DMF and acetone (Top: measurement in DMF at irradiation times 0–30–60–90–120–180–240 minutes, flux of photons =  $8.88 \times 10^{15} \text{s}^{-1}$ . Bottom: measurement in acetone at irradiation times 10–20–30–45 minutes, flux of photons =  $2.87 \times 10^{15} \text{s}^{-1}$ ).<sup>182</sup>

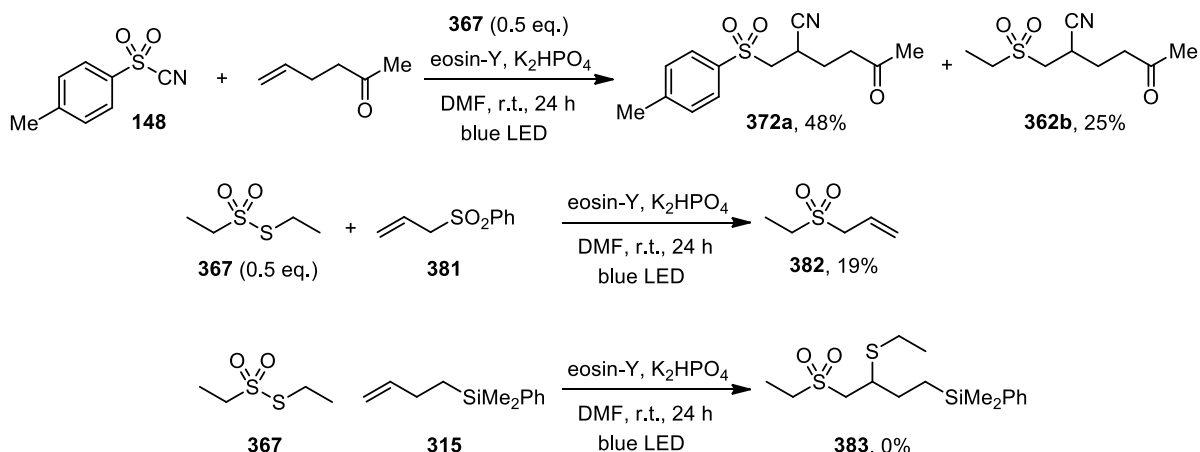
During our study on the sulfonyl-cyanation, thiosulfones **367** and **380** were isolated as side products (Figure III.16). The sulfonyl-cyanation with sulfonyl cyanide **342i** did not produce the desired sulfonyl-nitrile but led to the formation of thiosulfone **380**. Similarly, thiosulfone **367** was isolated and observed several times in the crude  $^1\text{H}$  NMR spectrum when the sulfonyl-cyanation was tried with less reactive olefins. The formation of these thiosulfones has been described through disproportionation from sulfonyl radicals although the exact mechanism still remains unclear.<sup>194</sup>

<sup>194</sup> (a) J. L. Kice, N. E. Pawlowski, *J. Am. Chem. Soc.* **1964**, *86*, 4898-4904; (b) M. Kobayashi, K. Tanaka, H. Minato, *Bull. Chem. Soc. Jpn.* **1972**, *45*, 2906-2909; (c) C. M. M. da Silva Correa, W. A. Waters, *J. Chem. Soc., C.* **1968**, 1872. (d) G. Rouquet, F. Robert, R. Méreau, F. Castet, P. Renaud, Y Landais, *Chem. Eur. J.* **2012**, *18*, 940.



**Figure III.16.** Identification of thiosulfones **367** and **380** as side products of the sulfonylcyanation reaction.<sup>182</sup>

The initial question concerning these thiosulfones was the role of these compounds. They might be only side products as they can be intermediates or be involved in the mechanism. We found that thiosulfones act as a source of sulfonyl radicals. This is suggested by the control experiments presented in Scheme III.47. The addition of thiosulfone **367** in a typical sulfonylcyanation reaction with tosyl cyanide **148** led to a mixture of two  $\beta$ -sulfonyl nitrile products **372a** and **362b** in a 2:1 ratio. In addition, when our reaction conditions were applied to a mixture of thiosulfone **367** and phenyl allylsulfone **381**, the corresponding ethyl allylsulfone **382** was obtained in 19% yield. The sulfonyl-thiolation reaction was tested but led to no conversion although the reaction of C-centered radicals on activated thiosulfones was reported.<sup>195</sup> As expected, the cyanation of C-centered radicals is faster than the thiolation.

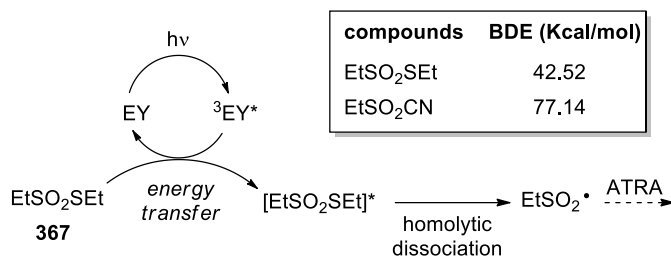


**Scheme III.47.** Role of thiosulfones in the sulfonyl cyanation process.<sup>182</sup>

Thiosulfone **367** possesses a highly negative reduction potential ( $-2.64$  V vs SCE, Table III.20), which excludes its possible reduction by  ${}^*\text{EY}^3$  into a sulfonyl radical. However, the bond dissociation energies for thiosulfones **367** were computed by DFT and found to be particularly low compared to ethylsulfonyl cyanide. A control experiment excludes also the possibility of a homolytic dissociation of the  $\text{O}_2\text{S}-\text{S}$  bond under visible light irradiation. However, the BDE value of thiosulfone **367** is quite close to the energy level of  ${}^*\text{EY}^3$  ( $1.89$  eV  $\approx 43.6$  kcal/mol) and sensitized homolytic dissociation of thiosulfone would be energetically possible to form the

<sup>195</sup> (a) T. Billard, B. R. Langlois, *Tetrahedron* **1999**, *55*, 8065-8074; (b) P. Carta, N. Puljic, C. Robert, A.-L. Dhimane, C. Ollivier, L. Fensterbank, E. Lacote, M. Malacria, *Tetrahedron* **2008**, *64*, 11865-11875; (c) D. Zhu, X. Shao, X. Hong, L. Lu, Q. Shen, *Angew. Chem. Int. Ed.* **2016**, *55*, 15807-15811.

corresponding sulfonyl radical (Figure III.11). Even if thiosulfones accumulate in the medium, they could thus provide sulfonyl radicals capable of propagating the radical chain.



**Figure III.17.** Proposed mechanism for the sensitization of thiosulfone and calculated BDE values for EtSO<sub>2</sub>CN and thiosulfone **367** (6-311++G(2d,p) basis set).

### 5.3. Activation of sulfonyl cyanides through sensitization

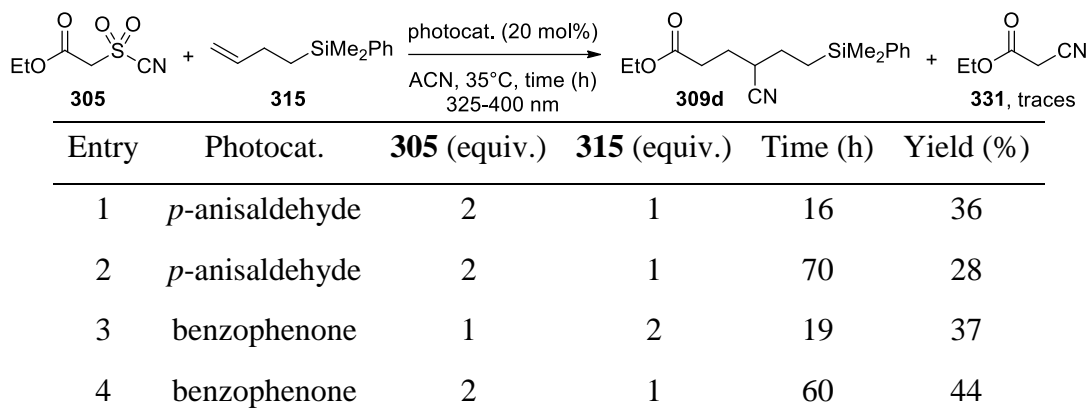
It was anticipated that a photocatalyst possessing a higher triplet energy level would be able to provoke the sensitization of sulfonyl cyanides resulting in a homolytic dissociation of the O<sub>2</sub>S-CN bond. Benzophenone and *p*-anisaldehyde were selected because their high triplet energy levels (around 70 kcal/mol) are in the range of the bond dissociation energies of sulfonyl cyanides. Using a CFL lamp as the light source and *p*-anisaldehyde, the product of sulfonyl-cyanation **362a** was isolated in 38% along with unreacted alkene (Table III.21, entry 1). Full conversion and very good yields (entry 2) were obtained with UV-A irradiation (325-400 nm). The yield obtained with benzophenone was slightly lower (entry 3). Further works will be required to demonstrate that *p*-anisaldehyde is capable of sensitizing the sulfonyl-cyanides by an energy transfer mechanism.

Entry	Sensitizer	Lamp	Time (h)	<i>T</i> (°C)	Yield (%)
1	<i>p</i> -anisaldehyde	CFL <sup>[a]</sup>	21	25	38
2	<i>p</i> -anisaldehyde	UV-A <sup>[b]</sup>	27	35	89
3	benzophenone	UV-A <sup>[b]</sup>	27	35	71

**Table III.21:** Application of *p*-anisaldehyde and benzophenone to our model reaction ([a] CFL 23W, [b] 325-400 nm).

Encouraged by these results, we wondered if the carbo-cyanation reaction would be possible using benzophenone or *p*-anisaldehyde. As a reminder, by using the optimal condition of the sulfonyl-cyanation reaction with the sulfonyl cyanide **305**, only the product of carbo-cyanation was obtained when vinyl pivalate was used. The complete bleaching of eosin-Y by **305** did not

allow to apply these conditions to others olefins. This issue was partially circumvented by using benzophenone and *p*-anisaldehyde (Table III.22). The carbo-cyanation product **309d** was obtained in 36% yield using *p*-anisaldehyde after 16 hours (entry 1). Increasing the reaction time led to a lower yield (entry 2). The yield slightly increased with benzophenone (entry 3-4). During these experiments, traces of the cyanoester product **331** was formed. Our efforts to increase the yield beyond 50% were not successful.



**Table III.22.** Optimization of the photocatalyzed carbo-cyanation.

Considering these results, the photocatalyzed carbo-cyanation should be difficult to achieve. The release of sulfur dioxide renders the medium slightly acidic which might cause some degradations. In contrast to the carbo-cyanation with V-40, the reflux conditions partially remove SO<sub>2</sub> from the medium, which is not the case in the photocatalyzed reactions occurring at room temperature.

## 6. Conclusions

In this chapter, classical radical methodologies and photoredox-catalyzed reactions have been investigated. Sulfonyl cyanides, synthesized through a new oxidation of thiocyanates, were activated successfully with radical initiators as well as photoredox catalysts for the functionalization of olefins and have shown to be excellent radical traps. The development of an original sulfonyl cyanide acting both as radical trap and as a source of alkyl radicals allowed to develop a tin-free carbo-cyanation occurring through a desulfonylative process. Here, 1,1'-azobis(cyanocyclohexane) was the best initiator to promote this reaction. Our efforts to develop a photocatalyzed carbo-cyanation was however less fruitful, with yields reaching a maximum of 50%. We then turned our attention to the investigation of a photoredox-catalyzed sulfonyl-cyanation. This reaction was developed under metal-free conditions, using eosin-Y as a cheap organic dye furnishing the corresponding  $\beta$ -sulfonyl nitriles in excellent yields and with a good functional groups tolerance. The utility of this methodology was illustrated by the synthesis of a bioactive sulfone in a limited number of steps. The mechanism was shown to occur *via* a photoinduced electron transfer to a cyanated derivative of eosin-Y, formed *in situ* in presence of sulfonyl cyanides. This PET event leads to the radical cation of eosin-Y which oxidizes a sulfinate into a sulfonyl radical regenerating the ground-state photocatalyst. This mechanism circumvents the thermodynamically unfavoured direct electron transfer from the triplet excited state of eosin-Y to alkylsulfonyl cyanides. The proposed mechanism is supported by electrochemical data, transient spectroscopy and UV-visible studies. We also found that other photocatalysts such as benzophenone and *p*-anisaldehyde were able to promote the sulfonyl-cyanation and carbo-cyanation reactions using near-UV light.





## Chapter IV

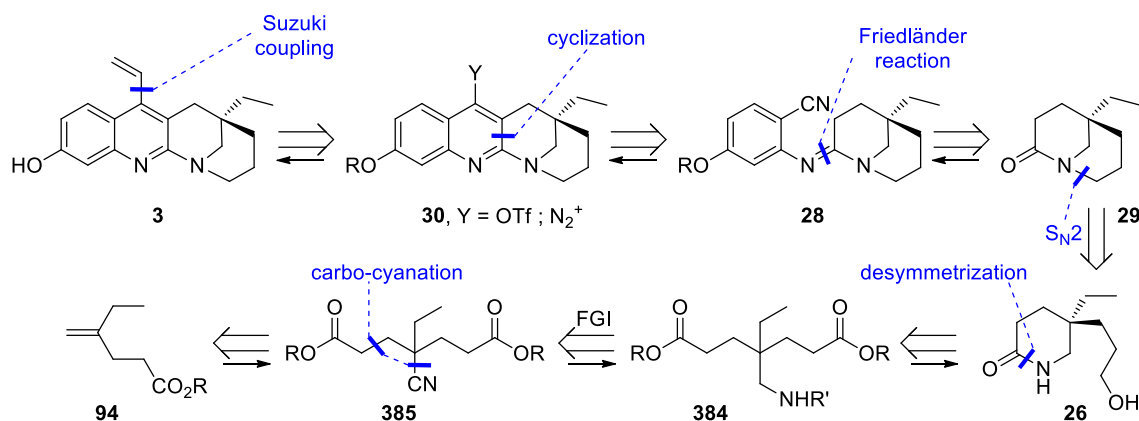
# Enantioselective approaches for the total synthesis of eucophylline



## Chapter IV : Enantioselective approaches for the total synthesis of eucophylline

### 1. Desymmetrization strategy

As a reminder, the racemic synthesis was already developed in our laboratories using a carbo-oximation reaction, installing all the required functional groups for the preparation of the bicyclic lactam **29**. In order to develop an enantioselective approach for this bicyclic amide, an enantioselective carbo-oximation or carbo-cyanation would obviously be the ideal tactic, but also a little bit risky and time-consuming. From the retrosynthetic analysis depicted in Figure IV.1, one can notice the symmetry elements contained in compound **384** and **385**. As an alternative to an enantioselective carbo-cyanation, the desymmetrization of amine **384** through intramolecular amidation would furnish an enantioenriched cyclic amide **26**. This strategy appeared well-suited because the prochiral diester **384** is easily attainable through the previously developed tin-mediated or tin-free carbo-cyanation of olefin **94**. The activation of the esters with a chiral acid should induce a differentiation between these two enantiotopic groups. Our initial idea was to desymmetrize **384** through an amidation reaction in the presence of a chiral phosphoric acid, which would result in an enantioenriched all-carbon quaternary stereocenter.

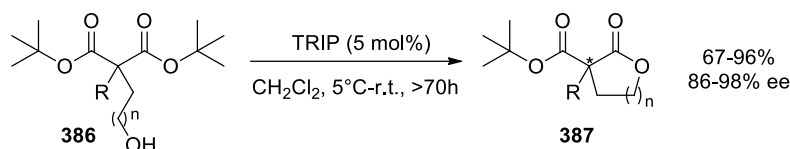


**Figure IV.1.** Retrosynthesis of eucophylline using a desymmetrization strategy.

#### 1.1. Reported desymmetrization of diester compounds

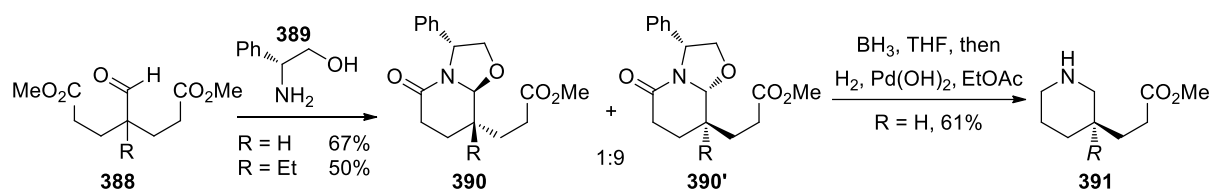
The desymmetrization of prochiral diesters with chiral phosphoric acids is well documented through lactonization. As an example, Petersen and Wilent reported the enantioselective synthesis of lactones **387** from prochiral di-*tert*-butyl diesters **386** using TRIP as

the chiral phosphoric acid (Scheme IV.1).<sup>196</sup> Excellent yield and enantioselectivities were obtained after long reaction times.



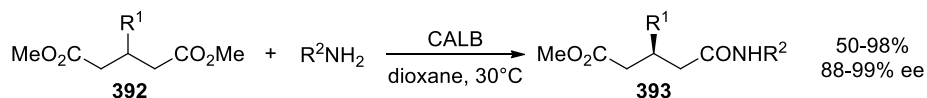
**Scheme IV.1.** Desymmetrizing lactonization of prochiral diesters.<sup>196</sup>

The desymmetrization of the prochiral aldehyde **388** through a cyclodehydration using (*R*)-phenylglycinol **389** as a chiral auxiliary was also described and furnished a 1:9 mixture of two diastereoisomers **390** and **390'** (Scheme IV.2).<sup>197</sup> Structurally similar to our targeted bicyclic amide **29**, the enantiopure 3-piperidine-propionate **391** was then obtained after reduction of the amide and removal of the chiral auxiliary.



**Scheme IV.2.** Prochiral diester desymmetrization by cyclodehydration with (*R*)-phenylglycinol.<sup>197</sup>

The desymmetrization of glutarate derivatives **392** has also been described using enzymatic aminolysis providing the monoamide product **393** (Scheme IV.3).<sup>198</sup> The lipase B from *Candida antarctica* (CAL-B) is known to catalyse the amide bond formation from esters in organic solvents. Yields and enantioselectivities are however highly substrate dependent.



**Scheme IV.3.** Intermolecular desymmetrization of prochiral diester by enzymatic aminolysis.<sup>198</sup>

The only example of desymmetrization through amidation using chiral phosphoric acid was described recently by Kawasaki and co-workers in their study on the asymmetric total synthesis of (-)-leuconoxine (Scheme IV.4).<sup>199</sup> The desymmetrization of compound **394** occurred

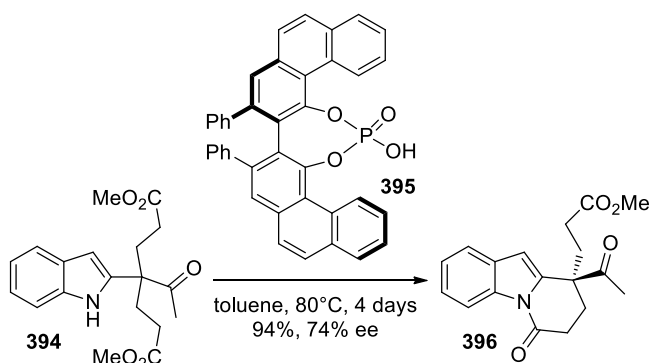
<sup>196</sup> J. Wilent, K. S. Petersen, *J. Org. Chem.* **2014**, *79*, 2303-2307.

<sup>197</sup> M. Amat, M. Canto, N. Llor, V. Ponzio, M. Perez, J. Bosch, *Angew. Chem. Int. Ed.* **2002**, *41*, 335-338.

<sup>198</sup> M. Lopez-Garcia, I. Alfonso, V. Gotor, *Tetrahedron: Asymm.* **2003**, *14*, 603-609.

<sup>199</sup> K. Higuchi, S. Suzuki, R. Ueda, N. Oshima, E. Kobayashi, M. Tayu, T. Kawasaki, *Org. Lett.* **2015**, *17*, 154-157.

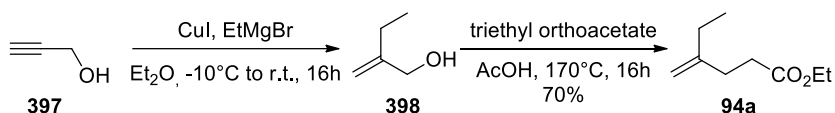
smoothly through amidation of indole in the presence of chiral phosphoric acids. The best enantioselectivities were obtained with VAPOL (**395**).



**Scheme IV.4.** Reported chiral phosphoric acid catalyzed desymmetrization of a prochiral diester.<sup>199</sup>

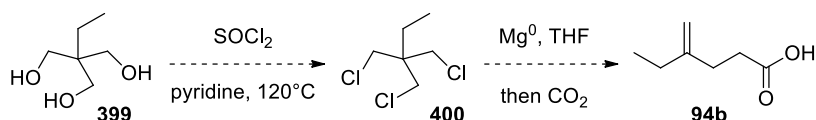
## 1.2. Synthesis of the starting materials

The alkene **94a**, required for the carbo-cyanation, was synthesized according a literature procedure in two steps by a carbocupration of prop-2-yn-1-ol **397**, followed by a Johnson-Claisen rearrangement of allyl alcohol **398** (Scheme IV.5).



**Scheme IV.5.** Synthesis of the starting alkene.

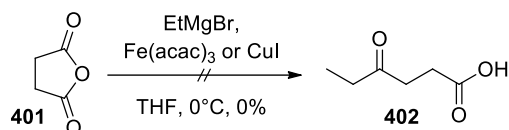
In order to play with the nature of the ester, a more general synthesis was also developed for the corresponding carboxylic acid **94b**. Among the reported method for the synthesis of this acid, the rearrangement of the trichloride **400** with magnesium was already tried in the lab but the yields were not reproducible in our hands (Scheme IV.6).<sup>200</sup>



**Scheme IV.6.** Synthesis of the starting alkene from **399**.<sup>200</sup>

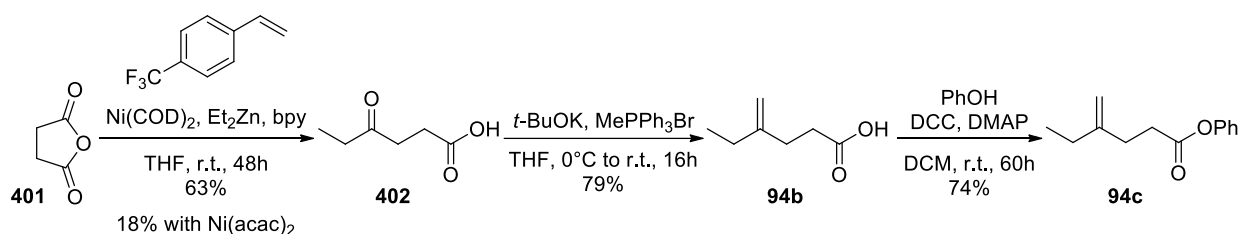
<sup>200</sup> (a) E. L. McCaffery, S. W. Shalaby, *J. Organomet. Chem.* **1967**, *8*, 17-27; (b) A. Biechy, S. Z. Zard, *Org. Lett.* **2009**, *11*, 2800-2803.

Addition of Grignard reagents onto succinic anhydride **401** in presence of iron (III) or CuI is also reported,<sup>201</sup> but the application of this strategy with ethylmagnesium bromide did not provide the corresponding acid **402** (Scheme IV.7). A second addition of EtMgBr on the ketone of the product might be responsible for the difficulty to obtain the pure keto-acid **402**.



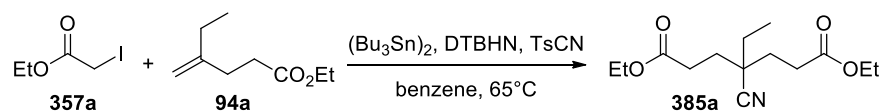
**Scheme IV.7.** Addition of EtMgBr on succinic anhydride.

Finally, the desired acid **94b** was obtained in 2 steps starting from a Nickel-catalysed cross-coupling<sup>202</sup> of succinic anhydride with the diethylzinc reagent followed by a Wittig reaction (Scheme IV.8). The phenyl ester **94c** was then synthesized through a classical esterification.



**Scheme IV.8.** Synthesis of the starting alkene **94b**.

Prochiral compounds were then synthesized by the tin-mediated carbo-cyanation reaction with ethyl iodoacetate as a radical precursor (at that time the tin-free carbo-cyanation was not yet developed). A rapid optimization of the reaction was accomplished with alkene **94a** furnishing the symmetric product **385a** in 67% yield (Table IV.1, entry 1-3).



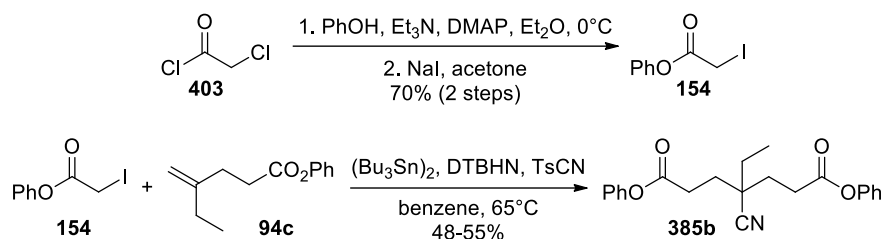
Entry	DTBHN (equiv.)	TsCN (equiv.)	<b>94a</b> (equiv.)	Yield (%)
1	3×0,1	1.5	2	58
2	4×0,1	1.5	4	62
3	4×0,1	2	4	67

**Table IV.1.** Optimization of the carbo-cyanation reaction for **385a**.

<sup>201</sup> (a) A. Chatupheeraphat, D. Soorukram, C. Kuhakarn, P. Tuchinda, V. Reutrakul, C. Pakawatchai, S. Saithong, M. Pohmakotr, *Eur. J. Org. Chem.* **2013**, 2013, 6844-6858; (b) M. Barberis, J. Perez-Prieto, *Tetrahedron Lett.* **2003**, 44, 6683-6685.

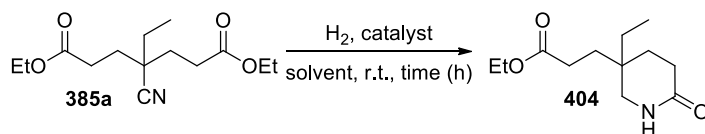
<sup>202</sup> E. A. Bercot, T. Rovis, *J. Am. Chem. Soc.* **2005**, 127, 247-254.

Similarly, the prochiral compound **385b** was obtained with ~50%, using the same conditions (Scheme IV.9). The radical precursor **154** was synthesized in a two-steps sequence from standard procedures.



**Scheme IV.9.** Synthesis of prochiral compound **385c**.

Appropriate conditions for the nitrile reduction were then investigated. The reduction using  $\text{NaBH}_4/\text{CoCl}_2$  or  $\text{NaBH}_4/\text{Co}_2\text{B}^{203}$  were tested but the corresponding amide **404** was never obtained in a clean manner. Hydrogenation was then examined using platinum (IV) oxide under a positive pressure of hydrogen but no conversion was observed (Table IV.2, entry 1-2). Using Raney nickel, the lactam **404** was obtained with 73% yield after 60 hours under a positive pressure of hydrogen of 21 bars (entry 3). A higher pressure of hydrogen led to the decomposition of **404** (entry 4).



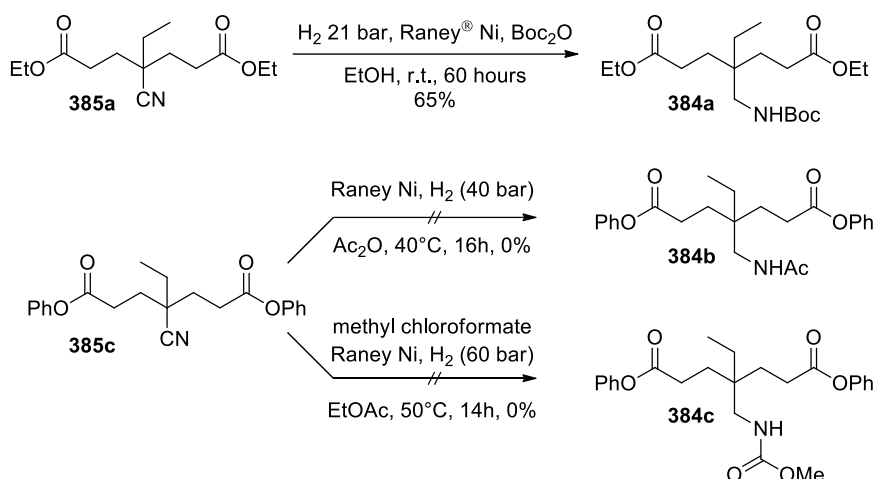
Entry	Catalyst	H <sub>2</sub> (bar)	Solvent	Time (h)	Yield (%)
1	PtO <sub>2</sub>	1	EtOH/CHCl <sub>3</sub> 5:1	48	-
2	PtO <sub>2</sub>	25	EtOH/CHCl <sub>3</sub> 5:1	48	-
3	Raney Ni	21	EtOH	60	73
4	Raney Ni	50	EtOH	60	0

**Table IV.2.** Optimization of the reduction of nitrile **385a**.

Having found the appropriate conditions for the reduction of the nitrile, these conditions were then used in the presence of Boc anhydride to convert nitrile **385a** into the Boc-protected amine **384a** before the amine cyclization (Scheme IV.10). The symmetric product **384a** was obtained in moderate yield. With nitrile **385c**, our attempts to trap the corresponding amine after hydrogenation with less acid-sensitive protecting groups were unsuccessful. The prochiral phenyl ester **384b** and **384c** were not obtained.

<sup>203</sup> (a) S. W. Heinzman, B. Ganem, *J. Am. Chem. Soc.* **1982**, *104*, 6801-6802; (b) S. Gemma, G. Campiani, S. Butini, E. Morelli, P. Minetti, O. Tinti, V. Nacci, *Tetrahedron* **2002**, *58*, 3689-3692.





Scheme IV.10. Synthesis of the prochiral protected amine.

### 1.3. Preliminary experiments of the desymmetrization strategy

With the prochiral compound **384a** in hand, the desymmetrization was tested even if the Boc protecting group may be cleaved under acidic conditions. As expected, most of the acids provoked the deprotection of the Boc which is followed by the formation of lactam **404** (Table IV.3, entry 1-4). Using (R)-(-)-1,1'-Binaphthyl-2,2'-diyl hydrogenophosphate, no conversion was observed after 16 hours at 80°C but traces of **404** and **405** were detected under reflux for 96 hours (entry 5-6). Due to the very small amount of **405** recovered after column chromatography, this product was not characterized. Prolonged heating of the starting material gave no conversion (entry 7).

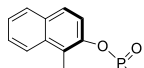
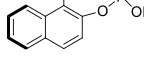
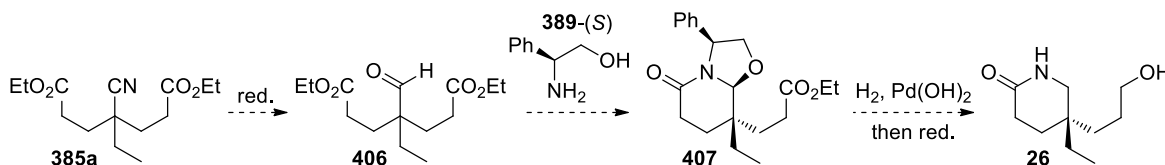
Entry	Reagent	equiv.	$T$ (°C)	Time (h)	Product	Yield (%)
1 <sup>[a]</sup>	Al(OTf) <sub>3</sub>	0.2	80	16	<b>404</b>	n.d.
2	AlMe <sub>3</sub>	4	-78 to -20	6	<b>404</b>	n.d.
3	AlMe <sub>3</sub>	3	-78	6	-	-
4	(+)-CSA	0.1	110	96	<b>404</b>	n.d.
5		0.2	80	16	-	-
6		0.1	110	96	<b>405+404</b>	n.d.
7	-	-	110	72	-	-

Table IV.3. Screening of acid for the lactam formation([a] acetonitrile as a solvent).

In view of these results, the Boc-protected amine is, as expected, not adequate for this enantioselective acid-mediated cyclization. Although chiral phosphoric acids might be appropriate for this desymmetrizing amidation, the high temperature will not allow reaching excellent enantioselectivities. Further work will be required for the design of the starting material as well as on the screening of several chiral phosphoric acids.

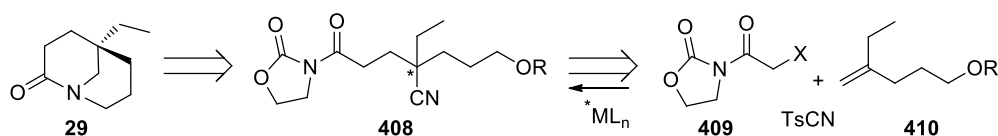
The application of the Amat's desymmetrization with aldehyde **406** would be a good option for the enantioselective total synthesis of eucophylline because intermediate **26** would be rapidly obtained (Scheme IV.11). This strategy was however not tried because of time restriction.



**Scheme IV.11.** Application of the Amat's desymmetrization to our substrate.

## 2. Efforts towards an enantioselective 3-components carbo-cyanation

As mentioned in the desymmetrization strategy, the development of an enantioselective carbo-cyanation of olefins is extremely challenging. We hypothesized that the carbo-cyanation reaction of oxazolidinone **409** as a radical precursor in presence of a chiral metal complex should lead to an enantioenriched nitrile product **408** (Figure IV.2). Hydrogenation of the latter followed by  $S_N2$  reaction would provide the enantioenriched bicyclic lactam **29**.

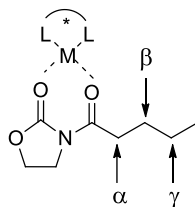


**Figure IV.2.** Retrosynthesis of eucophylline using an enantioselective carbo-cyanation.

### 2.1. Short introduction on enantioselective radical reactions

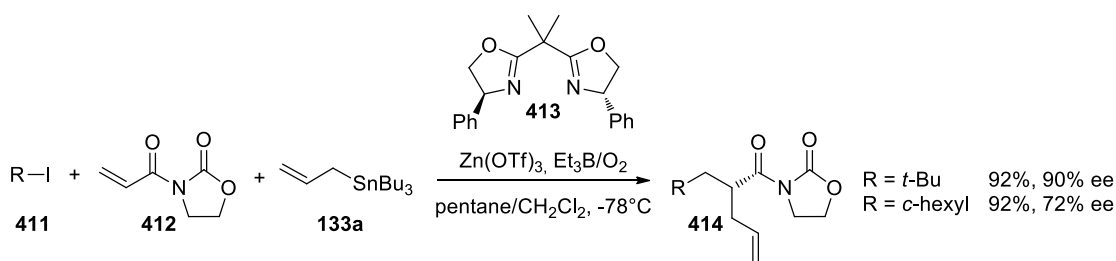
Enantioselective radical transformations are very challenging. However, the enantioselective additions of carbon-centered radical to enone have been well investigated. The enantioselective introduction of alkyl groups to  $\alpha$  or  $\beta$  position of an oxazolidinone (Figure IV.3)

was largely described by Sibi and Porter.<sup>204</sup> This was accomplished through the conjugated addition of an alkyl radical to acryloyloxazolidin-2-ones in the presence of a suitable chiral metal complex. Some examples are described below. In contrast, no functionalization has been reported so far at the  $\gamma$  position which might be too far away from the chiral center.



**Figure IV.3.** Enantioselective functionalization at different positions of the oxazolidinone.

Porter and co-workers reported a catalytic enantioselective free-radical carbon-carbon bond forming reaction through the addition of alkyl radicals to enone **412**, followed by an allyl transfer reaction (Scheme IV.12).<sup>205</sup> The use of chiral bis(oxazoline) ligand **413** with zinc triflate and triethylborane as an initiator provides allylated products **414** in excellent yields and good enantioselectivities. The enantioselectivity is governed by the fact that this radical reaction propagates well at room temperature, but the chain propagation does not occur at low temperature. The complexation of acryloyloxazolidin-2-one **412** with the metal complex enhances the reactivity of the chiral amidyl radical towards the allyl transfer reagent **133a** at low temperature and allows reaching good enantiomeric ratio.



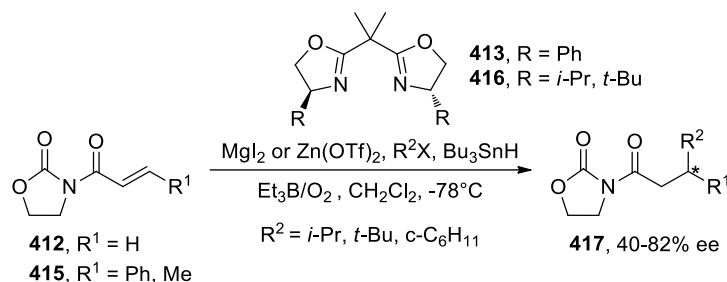
**Scheme IV.12.** Catalytic enantioselective radical allyl transfer reaction by Porter.<sup>205</sup>

Then, Sibi and Porter described an enantioselective radical conjugated addition to acryloyloxazolidin-2-ones **412** and **415** (Scheme IV.13).<sup>206</sup> Under complexation with a chiral Lewis acid, the alkene radical trap undergoes an enantioselective attack of an alkyl radical at the  $\beta$  position. The combination of magnesium or zinc Lewis acids with bis(oxazoline) ligands (**413** or **416**) in a stoichiometric amount furnished the conjugated addition product **417** with moderate enantioselectivities. The enantioselectivities decreased when catalytic amounts of the chiral complex were used.

<sup>204</sup> (a) M. P. Sibi, N. A. Porter, *Acc. Chem. Res.* **1999**, *32*, 163-171; (b) M. P. Sibi, S. Manyem, J. Zimmerman, *Chem. Rev.* **2003**, *103*, 3263-3295.

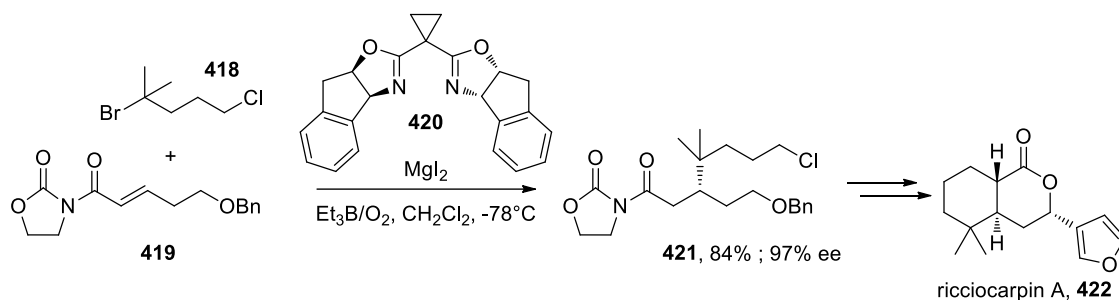
<sup>205</sup> J. H. Wu, R. Radinov, N. A. Porter, *J. Am. Chem. Soc.* **1995**, *117*, 11029-11030.

<sup>206</sup> M. P. Sibi, J. Ji, J. H. Wu, S. Guertler, N. A. Porter, *J. Am. Chem. Soc.* **1996**, *118*, 9200-9201.



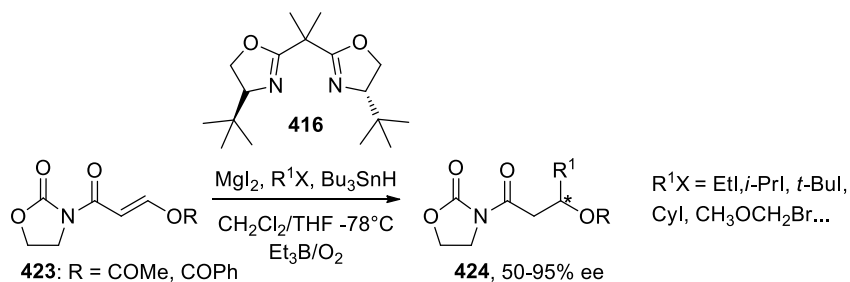
**Scheme IV.13.** Enantioselective radical conjugated additions by Sibi and Porter.<sup>206</sup>

This enantioselective radical reaction was applied to the total synthesis of ricciocarpin A, **422**, a sesquiterpene lactone (Scheme IV.14).<sup>207</sup>



**Scheme IV.14.** Application of the enantioselective radical conjugated addition to the total synthesis of ricciocarpin A by Sibi.<sup>207</sup>

The enantioselective conjugated radical addition was also applied to  $\beta$ -acyloxyamides **423** providing an aldol acetate product **424** (Scheme IV.15).<sup>208</sup> Again, the presence of a Lewis acid improved the reactivity of the alkyl radical towards the acyloxyamide and good enantioselectivities were only obtained with stoichiometric amounts of the chiral Lewis acid.



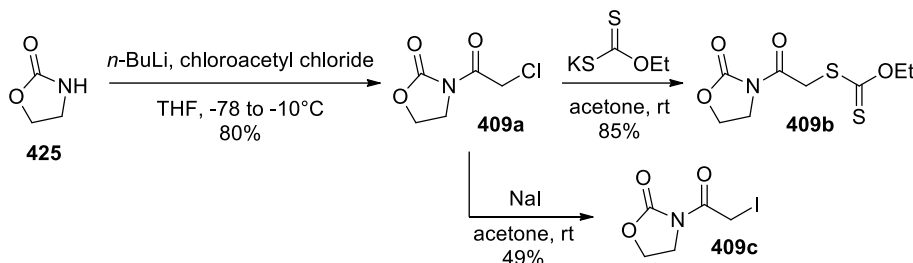
**Scheme IV.15.** Enantioselective radical conjugated additions to  $\beta$ -acyloxyenoates by Sibi.<sup>208</sup>

<sup>207</sup> M. P. Sibi, L. He, *Org. Lett.* **2004**, *6*, 1749-1752.

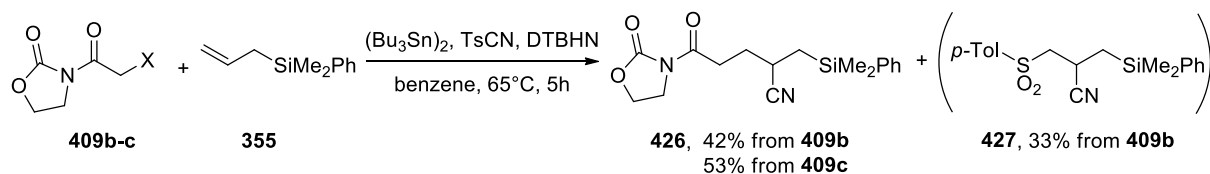
<sup>208</sup> M. P. Sibi, J. Zimmerman, T. Rheault, *Angew. Chem. Int. Ed.* **2003**, *42*, 4521-4523.

## 2.2. Preliminary attempts at enantioselective carbo-cyanation

The radical precursors for the enantioselective carbo-cyanation were synthesized according literature procedures.<sup>209</sup> The xanthate **409b** and the iodide **409c** were formed from the corresponding chloride **409a** by a S<sub>N</sub>2 reaction (Scheme IV.16).

Scheme IV.16. Synthesis of radical precursors.<sup>209</sup>

The tin-mediated carbo-cyanation reaction was then applied to allylsilane **355** as a model alkene furnishing the nitrile product **426** with moderate yield (Scheme IV.17). In addition to the tin residues, the purification of the carbo-cyanation product is tedious due to the similar polarity of the atom transfer product. The product of sulfonyl-cyanation reaction **427** was also formed in significant amount. The formation of this product results from the reversible addition of the sulfonyl radical onto the olefin backbone, followed by the trapping of the formed radical by *p*-tosyl cyanide.

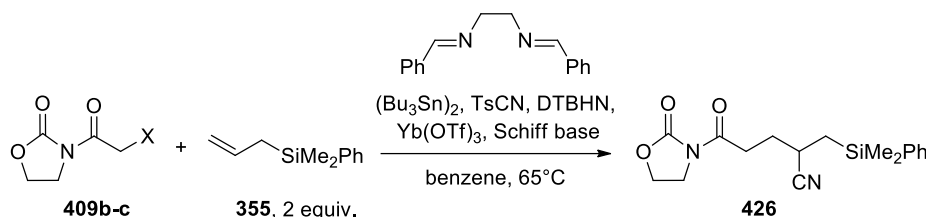


Scheme IV.17. Racemic tin-mediated carbo-cyanation.

In order to achieve this reaction at a lower temperature regime for enantioselectivity reasons, the system Et<sub>3</sub>B/O<sub>2</sub> was tested, but no conversion was observed. The DTBHN was thus kept as the optimal initiator even though it requires a high temperature. Aiming at developing an enantioselective version of this carbo-cyanation reaction, the addition of ytterbium triflate and a Schiff base were first studied. The introduction of this metal complex was well tolerated but the enhancement of the reactivity was not really observed (Table IV.4). For the iodide **409c**, the addition of 1 mol% of Yb(OTf)<sub>3</sub> led to a similar yield. With 1 equivalent, only two additions of DTBHN were needed to obtain full conversion but a lower yield was obtained (entry 3). With a stoichiometric amount of Lewis acid, the atom transfer radical addition might be favoured,

<sup>209</sup> (a) M. C. Willis, G. A. Cutting, V. J. D. Piccio, M. J. Durbin, M. P. John, *Angew. Chem. Int. Ed.* **2005**, *44*, 1543-1545; (b) E. Bacque, F. Pautrat, S. Z. Zard, *Chem. Commun.* **2002**, 2312-2313; (c) G. Lapointe, K. Schenk, P. Renaud, *Org. Lett.* **2011**, *13*, 4774-4777.

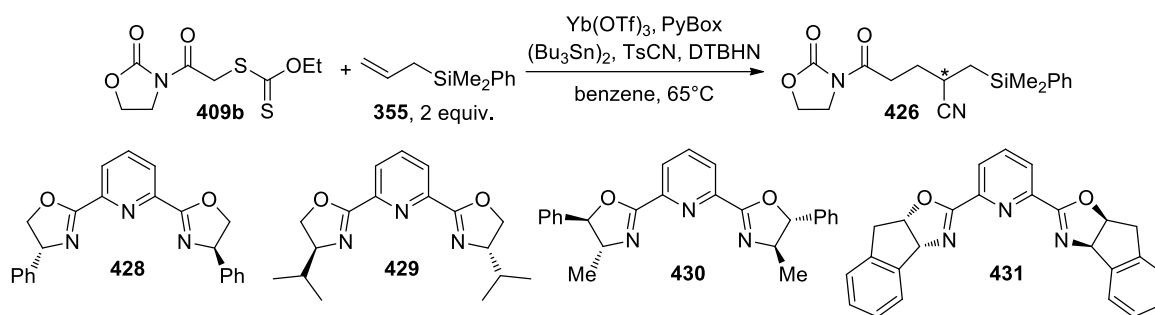
decreasing the amount of product **426**. The addition of a Schiff base, acting as a non-chiral ligand, is also well tolerated (entry 4). These observations were also true for the xanthate precursor **409b** (entry 5-8).



Entry	<b>409</b>	DTBHN (equiv.)	Yb(OTf) <sub>3</sub> (mol%)	Schiff base (mol%)	Yield (%)
1	<b>c</b>	3×0.1	-	-	53
2	<b>c</b>	3×0.1	1	-	51
3	<b>c</b>	2×0.1	1	-	29
4	<b>c</b>	4×0.1	1.6	3.6	55
5	<b>b</b>	3×0.1	-	-	42
6	<b>b</b>	3×0.1	1	-	44
7	<b>b</b>	2×0.1	1	-	46
8	<b>b</b>	4×0.1	1.6	1.6	52

**Table IV.4.** Influence of Yb(OTf)<sub>3</sub> and Schiff base on the carbo-cyanation reaction.

Then, the influence of some chiral ligands on the enantioselectivity was analyzed. The carbo-cyanation was tried with different pyridine bis(oxazoline) ligands in combination with ytterbium triflate (Table IV.5). Under these conditions, the radical precursor **409b** was not fully consumed even if the amount of DTBHN was increased up to four successive additions. Only PyBox **428** gave a full conversion but a very low yield (entry 1). Considering the absence of enantioselectivity for this reaction (entry 1-4), this strategy was not pursued.

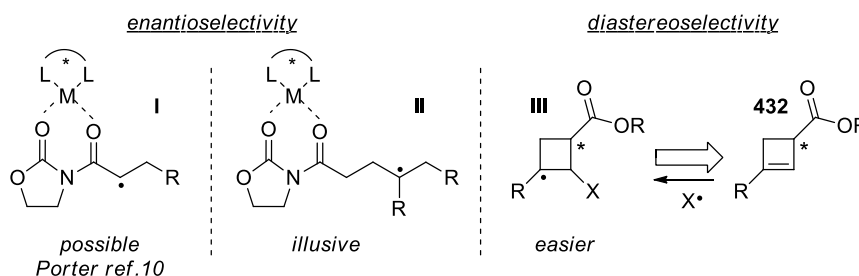


Entry	PyBox	DTBHN (eq.)	Conv. (%)	Yield (%)	ee (%)
1	<b>428</b>	4×0.1	100	26	0
2	<b>429</b>	4×0.1	Not complete	n.d.	0
3	<b>430</b>	4×0.1	Not complete	n.d.	0
4	<b>431</b>	4×0.1	Not complete	n.d.	0

**Table IV.5.** Influence of PyBox on the enantioselectivity of the carbo-cyanation (1.6 mol% of chiral metal complex).

### 3. Synthesis and study on the reactivity of a new cyclobutene motif

While the development of enantioselective radical additions is complicated by low predictability and often by substrate dependence, diastereoselective radical additions can be performed by substrate-controlled or chiral auxiliary-controlled approaches.<sup>210</sup> Furthermore, the control of the relative stereochemistry is easier in cyclic substrates than in their acyclic counterparts. In comparison with the example of Porter (radical **I**, Figure IV.4), the enantioselective functionalization of the chiral radical **II** located at the  $\gamma$  position is illusive because of the multiple conformations of this substrate. In order to develop a stereoselective transformation at the  $\gamma$  position of a carbonyl, the control of relative configurations in cyclic radical **III** would be easier as the approach of the reagent is controlled by the neighbouring substituents in a constrained system. Radical **III** is the result of a radical addition on a chiral cyclobutene **432** acting as a chiral radical trap. This radical reaction would lead to 1,2-stereoselection.



**Figure IV.4.** Discussion of the stereoselection at the  $\gamma$  position of a carbonyl.

<sup>210</sup> H. Subramanian, Y. Landais and M. P. Sibi *Radical Addition Reactions*. In: G. A. Molander and P. Knochel (eds.), *Comprehensive Organic Synthesis*, 2nd edition, Vol 4, Oxford: Elsevier, **2014**, pp. 699-741.

Based on the above discussion on the diastereoselection relying on a chiral cyclobutyl radical, a retrosynthesis of eucophylline was first proposed based on a diastereoselective carbocyanation of chiral cyclobutene **92** (Figure IV.5). As mentioned in the introduction, the synthesis of eucophylline from this cyclobutene is challenging, as there is no report in the literature for the enantioselective synthesis of this strained olefin which is also known to be weakly reactive. In addition to the control of the diastereoselectivity, an appropriate ring-opening reaction from the corresponding cyclobutane would require intensive studies.

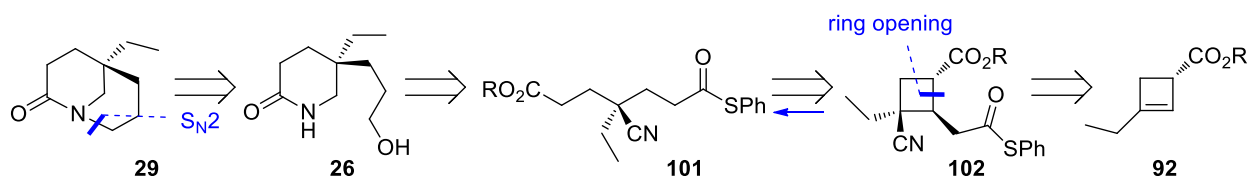


Figure IV.5. Initial retrosynthesis of bicyclic lactam **29**.

### 3.1. Short description of small ring systems

Small-ring systems serve as useful intermediates for the stereoselective elaboration of more complex structural motifs. Their inherent ring strain is used in chemical reactions such as ring expansions or ring-opening reactions leading to new cyclic and acyclic substrates. In this context, the cyclopropane ring has been widely studied compared to its four-membered ring equivalent.<sup>211</sup> Three-membered rings are easily obtained from cyclopropanation of alkenes and alkynes, which has shown broad scope with enantioselective versions and has been applied in total synthesis of natural products.<sup>212</sup> Although recent progresses have been made for the enantioselective synthesis of cyclobutanes, basically through [2+2] cycloadditions, there is still a need for the synthesis of enantioenriched cyclobutenes.<sup>213</sup> The functionalization of these strained double bonds is indeed an alternative synthetic pathway, leading to pertinent cyclopropane/butane motifs. Here, the work of Marek and co-workers on the diastereoselective carbometallation of cyclopropenes **433** has shown broad scope, furnishing alkyl-substituted cyclopropanes **435** bearing an all-carbon quaternary

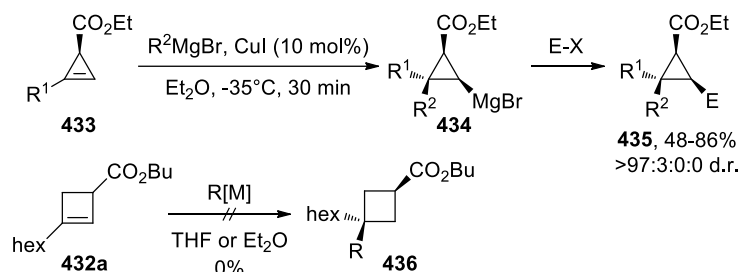
<sup>211</sup> (a) M. A. Cavitt, L. H. Phun, S. France, *Chem. Soc. Rev.* **2014**, *43*, 804-818; (b) F. de Nanteuil, F. De Simone, R. Frei, F. Benfatti, E. Serrano, J. Waser, *Chem. Comm.* **2014**, *50*, 10912-10928; (c) N. Cramer, in *Comprehensive Organic Synthesis II (Second Edition)* (Ed.: P. Knochel), Elsevier, Amsterdam, **2014**, pp. 1077-1105; (d) J. C. Namyslo, D. E. Kaufmann, *Chem. Rev.* **2003**, *103*, 1485-1538; (e) T. Seiser, T. Saget, N. Tran Duc, N. Cramer, *Angew. Chem. Int. Ed.* **2011**, *50*, 7740-7752; (f) L. Wang, Y. Tang, *Isr. J. Chem.* **2016**, *56*, 463-475; (g) M. J. Campbell, J. S. Johnson, A. T. Parsons, P. D. Pohlhaus, S. D. Sanders, *J. Org. Chem.* **2010**, *75*, 6317-6325.

<sup>212</sup> (a) H. Lebel, J.-F. Marcoux, C. Molinaro, A. B. Charette, *Chem. Rev.* **2003**, *103*, 977-1050; (b) C. Ebner, E. M. Carreira, *Chem. Rev.* **2017**, *117*, 11651-11679.

<sup>213</sup> (a) S. Poplata, A. Tröster, Y.-Q. Zou, T. Bach, *Chem. Rev.* **2016**, *116*, 9748-9815; (b) A. Misale, S. Niyomchon, N. Maulide, *Acc. Chem. Res.* **2016**, *49*, 2444-2458; (c) Y. Xu, L. Conner Michael, M. K. Brown, *Angew. Chem. Int. Ed.* **2015**, *54*, 11918-11928.

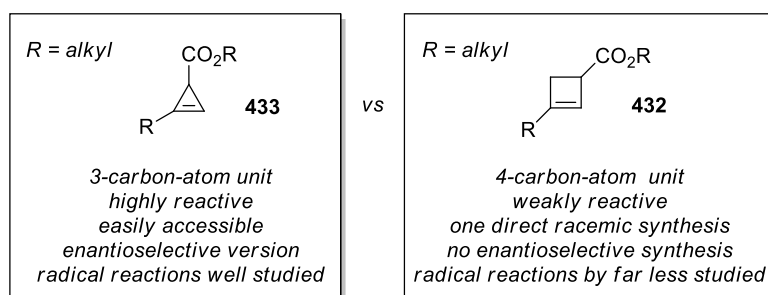


stereocenter with excellent diastereomeric ratio (Scheme IV.18).<sup>214</sup> However, its extension to cyclobutene **432a** was not successful due to the difference in ring-strain energy released during the carbometallation reaction. This first example already illustrates that the behaviour of cyclobutenes cannot be correlated to cyclopropenes. Although similar, they have inherent reactivities.



**Scheme IV.18.** Carbometallation of cyclopropenes and cyclobutenes by Marek.<sup>214</sup>

Similarly, the low reactivity of cyclobutenes is also observed towards radical species. This four-membered ring has a similar reactivity than a cyclohexene ring. Consequently, radical additions to cyclobutenes require highly electrophilic radicals. After the radical addition, the cyclobutyl radical (located in a p orbital) is also less reactive than the cyclopropyl radical (located in a  $sp^3$  orbital), the latter often considered as a “nervous” radical. This difference in reactivity is in sharp contrast with the C-H bond dissociation energies (cyclobutane: 96.5 kcal/mol vs cyclopropane: 106.3 kcal/mol).<sup>215</sup> A comparison of cyclopropene **433** and cyclobutene **432** is given in Figure IV.6. Although cyclopropene **433** is easy to reach through enantioselective cyclopropenation of alkyne, there is no general method for the enantioselective synthesis of cyclobutene **432**. Only one racemic synthesis was reported for such compounds (*vide infra*). Hence, compared to the asymmetric synthesis of eburnan fragment from cyclopropene, the asymmetric synthesis of eucophylline from cyclobutene is by far much more challenging.



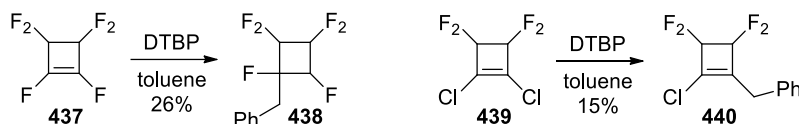
**Figure IV.6.** Comparison of cyclopropene and cyclobutene.

<sup>214</sup> D. Didier, P.-O. Delaye, M. Simaan, B. Island, G. Eppe, H. Eijsberg, A. Kleiner, P. Knochel, I. Marek, *Chem. Eur. J.* **2014**, *20*, 1038-1048.

<sup>215</sup> Y. Feng, L. Liu, J.-T. Wang, S.-W. Zhao, Q.-X. Guo, *J. Org. Chem.* **2004**, *69*, 3129-3138.

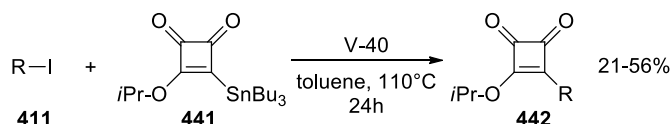
## 3.2. Reported radical additions to cyclobutenes

The radical functionalization of cyclobutene is barely documented. Only few reports on radical additions to cyclobutene have been published. The addition of benzylic radical to hexafluorocyclobutene **437** and 1,2-dichlorotetrafluorocyclobutene **439** was first described by Muramatsu *et al.* (Scheme IV.19).<sup>216</sup>



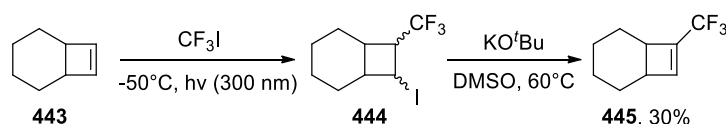
**Scheme IV.19.** Addition of benzylic radical to hexafluorocyclobutene by Muramatsu.<sup>216</sup>

The addition of alkyl radicals to cyclobutenyl stannane **441** was described by Kinney, providing the alkyl substituted cyclobutenediones **442** in moderate yields (Scheme IV.20).<sup>217</sup>



**Scheme IV.20.** Addition of alkyl radicals to cyclobutenyl stannane by Kinney.<sup>217</sup>

The photochemical addition of trifluoromethyl iodide to bicyclo[4.2.0]oct-7-ene **443** was reported by Leigh and co-workers (Scheme IV.21).<sup>218</sup> Elimination of the iodide **444** furnished a new cyclobutene ring **445**.



**Scheme IV.21.** Photochemical addition of trifluoromethyl iodide on cyclobutene.<sup>218</sup>

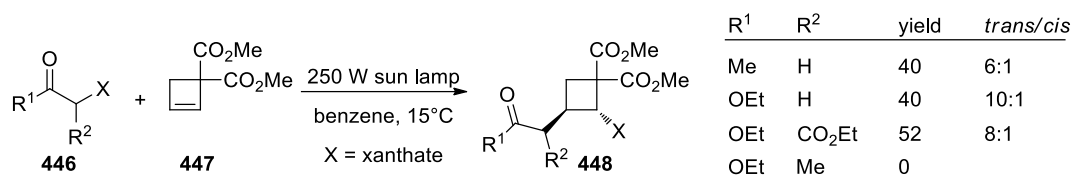
More interestingly, ATRA reactions on cyclopropenes and cyclobutene **447** with xanthate precursors have been described by Saičić but the yields are moderate and the scope is very narrow (Scheme IV.22).<sup>219</sup> The yield slightly improved with more electrophilic radicals (malonyl) and the diastereoselectivity is favoured for the *trans* product.

<sup>216</sup> H. Kimoto, H. Muramatsu, K. Inukai, *Bull. Chem. Soc. Jpn.* **1977**, *50*, 2815-2816.

<sup>217</sup> W. A. Kinney, *Tetrahedron Lett.* **1993**, *34*, 2715-2718.

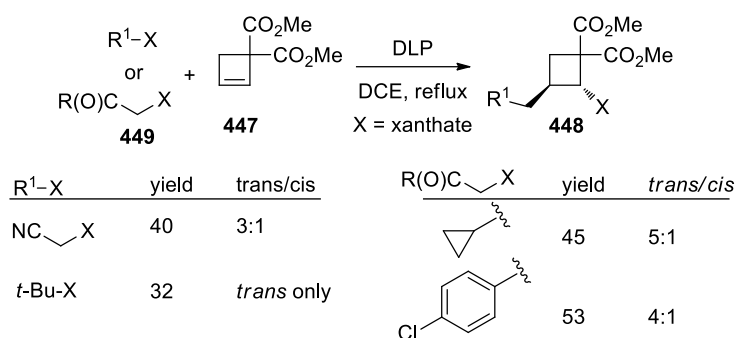
<sup>218</sup> W. J. Leigh, K. Zheng, N. Nguyen, N. H. Werstiuk, J. Ma, *J. Am. Chem. Soc.* **1991**, *113*, 4993-4999.

<sup>219</sup> Z. Ferjančić, Ž. Čeković, R. N. Saičić, *Tetrahedron Lett.* **2000**, *41*, 2979-2982.



**Scheme IV.22.** ATRA reactions on cyclopropene and cyclobutene by Saičić.<sup>219</sup>

The same xanthate transfer radical chemistry on cyclobutene **447** and other strained olefins (cyclopropenes and azetines) has also been published the same year by Zard and co-workers.<sup>220</sup> The Scheme IV.23 described the results obtained for the cyclobutene ring. Same conclusions than the Saičić's work can be made. Moderate yields and a *trans*-diastereoselectivity were observed.



**Scheme IV.23.** ATRA reactions on cyclobutenes by Zard.<sup>220</sup>

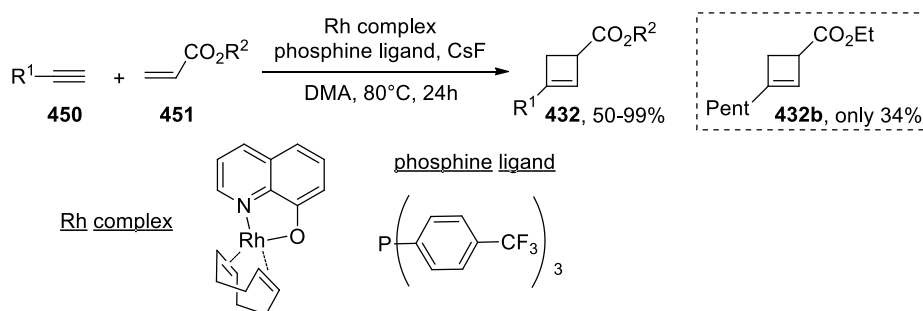
As a conclusion for this section, the cyclobutene ring has been scarcely used in radical addition reactions which might be due to the limited availability of this strained olefin and to its low reactivity towards radical species. Nevertheless, the *trans*-selective ATRA reaction to cyclobutenes (described above) would make this transformation even more interesting if an optically pure cyclobutene was used.

### 3.3. Development of an enantioselective synthesis of cyclobutene

To the best of our knowledge, only one report describes a direct synthesis of cyclobutene **432** by a rhodium-catalyzed intermolecular [2+2] cycloaddition of terminal alkynes **450** with electron-deficient alkenes **451** (Scheme IV.24).<sup>221</sup> Although this is a racemic synthesis and the rhodium catalyst has to be prepared (2 steps from [RhCl(cod)]<sub>2</sub>), this methodology constitutes a good starting point for preliminary experiments. However, attempts at reproducing this reaction led to tedious purifications and very poor yields. For instance, as described in Scheme IV.24, only 34% yield was obtained for **432b** (compared to the reported 99% with 1-octyne).

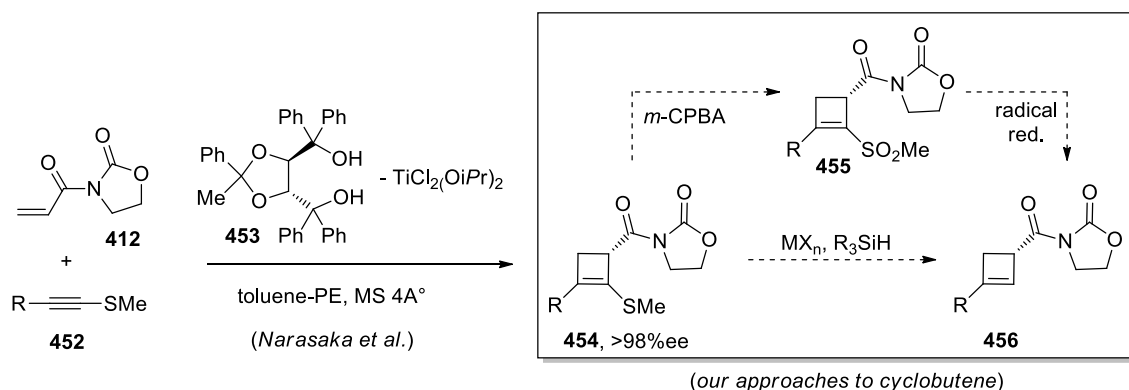
<sup>220</sup> N. Legrand, B. Quiclet-Sire, S. Z. Zard, *Tetrahedron Lett.* **2000**, *41*, 9815-9818.

<sup>221</sup> K. Sakai, T. Kochi, F. Kakiuchi, *Org. Lett.* **2013**, *15*, 1024-1027.



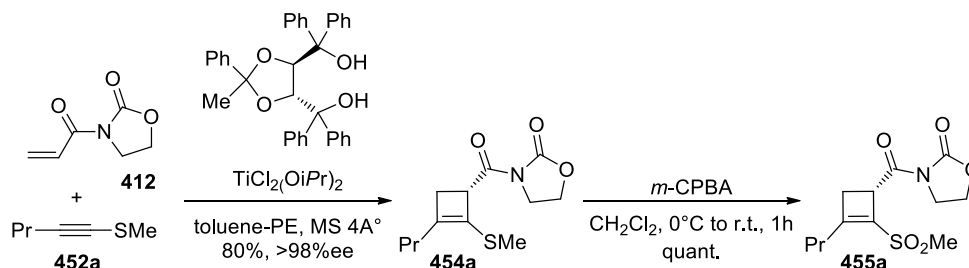
**Scheme IV.24.** Rhodium-catalysed intermolecular [2+2] cycloaddition of terminal alkynes with electron-deficient alkenes.<sup>221</sup>

Considering the high cost of the rhodium catalyst and the lack of enantioselective synthesis for this substrate, we proposed a two-steps sequence, inspired by the work of Narasaka and co-workers on the asymmetric [2+2] cycloaddition reaction between  $\alpha,\beta$ -unsaturated acid derivatives and alkynyl sulfides **452** catalyzed by a chiral titanium reagent **453**.<sup>222</sup> A reduction of the corresponding cyclobutenyl sulfide **454** through a direct desulfurization or indirect desulfonation should then furnish the corresponding cyclobutene **456** (Scheme IV.25).



**Scheme IV.25.** Our approach to the enantioselective synthesis of cyclobutene **456**.

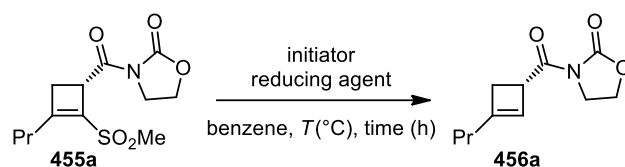
The reduction of the vinyl sulfone **455** was first studied. As a model compound, the cyclobutenyl sulfide **454a** was synthesized with a propyl chain. Oxidation of the latter with *m*-CPBA gave the desired vinyl sulfone **455a** in quantitative yield (Scheme IV.26).



**Scheme IV.26.** Preparation of vinyl sulfone **455**.

<sup>222</sup> Y. Hayashi, K. Narasaka, *Chem. Lett.* **1990**, 1295-1298.

The reduction of alkenyl sulfone is well established.<sup>223</sup> The reduction of vinyl sulfone **455a** was first attempted with typical conditions for desulfonylation (Mg in MeOH or sodium dithionite) but no conversion was observed. We then turned our attention to tin-mediated radical reductions. Using AIBN as initiator and tributyltin hydride as the reducing agent, the desired cyclobutene **456a** was formed in 15% yield (Table IV.6, entry 1). Decreasing the reaction time and the amount of tributyltin hydride furnished the product with 30% yield (entry 2). A maximum yield of 50% was obtained when tributyltin hydride was added portion-wise every 1.5 hours (entry 3). During these experiments, we observed that degradation of cyclobutene **456a** occurred. Indeed, when the reaction was scaled up to 1.8 mmol (entry 4), only 27% of **456a** was recovered. In order to minimize the degradation of the cyclobutene, other reducing agents such as TTMSH (entry 5) and other initiators (DLP and V-40, entry 6-7) were tried but the yields below 30% were obtained. Due to the difficulties to optimize this reaction, the most direct desulfurization was then engaged.



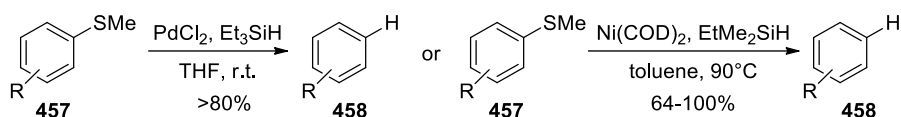
Entry <sup>[a]</sup>	Red. Agent	Equiv.	Initiator	Equiv.	T (°C)	Time (h)	Yield (%)
1	Bu <sub>3</sub> SnH	1+5×0.5	AIBN	6×0.1	80	24	15
2	Bu <sub>3</sub> SnH	1.5	AIBN	5×0.1	80	14	30
3	Bu <sub>3</sub> SnH	6×0.5	AIBN	6×0.1	80	9	51
4 <sup>[b]</sup>	Bu <sub>3</sub> SnH	6×0.5	AIBN	6×0.1	80	9	27
5	TTMSH	1.5	AIBN	6×0.1	70	7	0
6	Bu <sub>3</sub> SnH	1+4×0.5	DLP <sup>[c]</sup>	5×0.1	80	5	0
7	Bu <sub>3</sub> SnH	1.5	V-40 <sup>[c]</sup>	6×0.1	120	7	30

**Table IV.6.** Optimization for the radical desulfonylation ([a] 0.2 mmol of vinyl sulfone, Bu<sub>3</sub>SnH and AIBN were added every 1.5h, [b] 1.8 mmol of vinylsulfone, [c] addition of DLP and V-40 every hour).

The desulfurization is well established with aromatic sulfides **457** using palladium or nickel catalysts and trialkylsilane as a reducing agent.<sup>224</sup> The Scheme IV.27 illustrates two examples of desulfurization using palladium dichloride or nickel(0) catalyst.

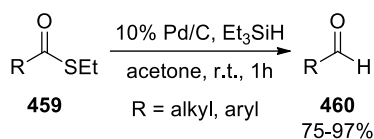
<sup>223</sup> D. A. Alonso, C. N. Ájera, in *Org. React.*, John Wiley & Sons, Inc., **2004**.

<sup>224</sup> (a) T. Matsumura, T. Niwa, M. Nakada, *Tetrahedron Lett.* **2012**, 53, 4313-4316; (b) N. Barbero, R. Martin, *Org. Lett.* **2012**, 14, 796-799; (c) S. Becker, Y. Fort, P. Caubere, *J. Org. Chem.* **1990**, 55, 6194-6198.



**Scheme IV.27.** Reported desulfurization of aromatic sulfides.<sup>224</sup>

We anticipated that these conditions could be applied to vinyl sulfides. Initial attempts on our cyclobutenyl sulfide **454a** using Raney-nickel or deactivated Raney-nickel<sup>225</sup> gave very low conversions or degradation. Slightly better conversions were obtained with Ni[COD]<sub>2</sub> but its instability toward moisture and air led us to try other metals. Our reaction design is inspired from the Fukuyama reduction of thioesters **459** (Scheme IV.28).<sup>226</sup>



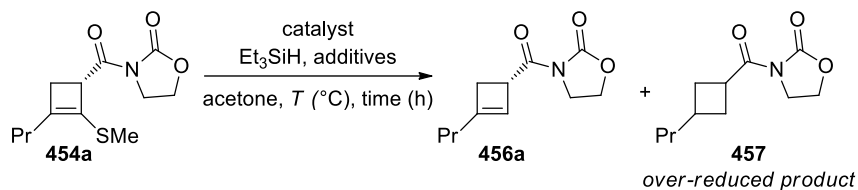
**Scheme IV.28.** Fukuyama's reduction of thioester.<sup>226</sup>

Under the Fukuyama's conditions, the thioester is reduced into an aldehyde in the presence of palladium on charcoal and triethylsilane. Application of these conditions to our substrate led to a full conversion (Table IV.7 entry 1). The purification of the crude mixture led to an inseparable mixture of two compounds. The minor compound was cyclobutene **456a** and we hypothesized that the major compound was the over-reduced product **457**. Palladium chloride and Pd(acac)<sub>2</sub> led to the same result (entry 2-3) and no conversion was observed with PdCl<sub>2</sub>(PEt<sub>3</sub>)<sub>2</sub> (entry 4). It is important to notice that sulfide **454a**, cyclobutene **456a** and **457** are not separable by column chromatography impeding the characterization of compound **457**. A fine-tuned catalyst had thus to be found. This catalyst should be reactive enough to allow for a full conversion, but not reactive towards the alkene moiety to avoid the over-reduction. Lindlar's catalyst, known to reduce alkynes into alkenes, in combination with Et<sub>3</sub>SiH furnished the desired product with moderate conversion but without the over-reduced product (entry 5). The same reaction using 1 equivalent or successive addition of Lindlar's catalyst did not increase further the conversion (entry 6-7). By using an excess of this catalyst (10 equiv.) under reflux conditions for 2 hours, the conversion was complete, furnishing cyclobutene **456a** as the major product but contaminated by **457** (entry 8). The same mixture was obtained at room temperature (entry 9). The addition of a sacrificial alkene was crucial to obtain **456a** without contaminations. Although traces of **457** were still observed under reflux conditions in the presence of 1-octene (entry 10), a full conversion without over-reduction was

<sup>225</sup> G. B. Spero, A. V. McIntosh, Jr., R. H. Levin, *J. Am. Chem. Soc.* **1948**, *70*, 1907-1910; (b) A. V. McIntosh, Jr., A. M. Searcy, E. M. Meinzer, R. H. Levin, *J. Am. Chem. Soc.* **1949**, *71*, 3317-3320.

<sup>226</sup> T. Fukuyama, S. C. Lin, L. Li, *J. Am. Chem. Soc.* **1990**, *112*, 7050-7051.

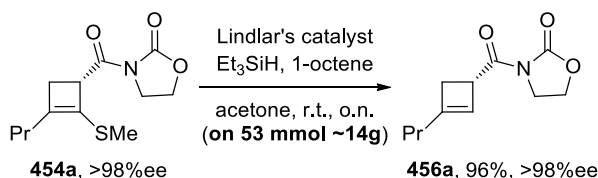
obtained at room temperature (entry 11). Similar conditions were used by Evans and co-workers in the reduction of thioester substrate containing unsaturated moiety.<sup>227</sup>



Entry	Pd cat.	Equiv.	Et <sub>3</sub> SiH (equiv.)	T (°C)	Time (h)	Solvent	Conv. <sup>[b]</sup> (%)	Over-reduction
1	Pd/C	0.1	3	r.t.	0.5	Acetone	100	+
2 <sup>[a]</sup>	PdCl <sub>2</sub>	0.1	5	reflux	14	THF	100	+
3	Pd(acac) <sub>2</sub>	0.1	5	reflux	14	THF	100	+
4	PdCl <sub>2</sub> (PEt <sub>3</sub> ) <sub>2</sub>	0.1	5	reflux	6	THF	0	/
5	Lindlar	0.2	10	reflux	14	Acetone	50	-
6	Lindlar	1	10	reflux	14	Acetone	50	-
7	Lindlar	5×0.05	10	reflux	14	Acetone	26	-
8	Lindlar	10	10	reflux	2	Acetone	100	+
9	Lindlar	10	10	r.t.	2	Acetone	100	+
10 <sup>[a]</sup>	Lindlar	10	10	reflux	2	Acetone	100	+
<b>11<sup>[a]</sup></b>	<b>Lindlar</b>	<b>10</b>	<b>10</b>	<b>r.t.</b>	<b>2</b>	<b>Acetone</b>	<b>100</b>	<b>-</b>

**Table IV.7.** Optimization table for the direct desulfurization of cyclobutenyl thioether ([a] with 5 equiv. of 1-octene, [b] NMR based-ratio).

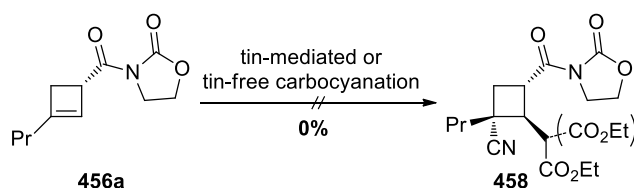
The optimal conditions (entry 11, Table IV.7) were applied to 53 mmol of **454a** furnishing cyclobutene **456a** in an excellent yield, an excellent purity and without racemization (Scheme IV.29). This large-scale synthesis and the reaction scope (not shown here, work of Iman Traboulsi, 1<sup>st</sup> PhD student) have also demonstrated the robustness and the reliability of this method. This two-steps sequence provides an easy enantioselective access to a new type of cyclobutene which are not described so far in the literature.



**Scheme IV.29.** Scale up of the desulfurization.

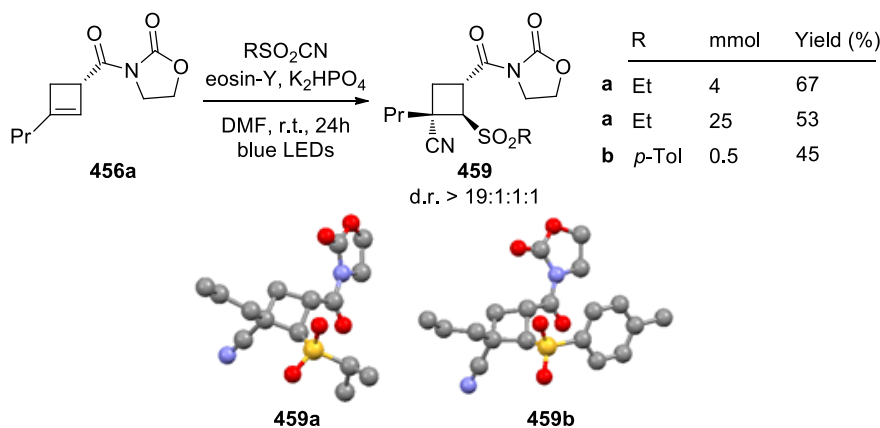
<sup>227</sup> (a) D. A. Evans, W. C. Black, *J. Am. Chem. Soc.* **1993**, *115*, 4497-4513; (b) D. A. Evans, B. W. Trotter, B. Cote, P. J. Coleman, *Angew. Chem. Int. Ed.* **1998**, *36*, 2741-2744.

To test the reactivity of this new cyclobutene ring, the carbo-cyanation was tried on this substrate. Unfortunately, none of the developed carbo-cyanation procedures furnished the desired product **458** even when a more electrophilic malonyl radical was used (Scheme IV.30).



**Scheme IV.30.** Application of the carbo-cyanation reactions to the cyclobutene ring.

Consistent with the low reactivity of the cyclobutene ring, the application of our eosin-mediated sulfonyl-cyanation furnished the *trans* product **459** as the major isomer with a good yield for ethylsulfonyl cyanide and a moderate yield for tosyl cyanide (Scheme IV.31). The difference in reactivity between mesyl and tosyl cyanide was already observed by Barton.<sup>158</sup> The relative configurations of the products **459a-b** were unambiguously assigned through X-ray diffraction analysis. The addition of the sulfonyl radical occurs in an *anti* fashion with the oxazolidinone followed by the usually observed *trans*-stereoselectivity for the sulfonyl-cyanation reaction. The stereoselectivity of these two elementary steps is perfectly controlled since only one isomer has been observed among the fourth possible diastereoisomers.

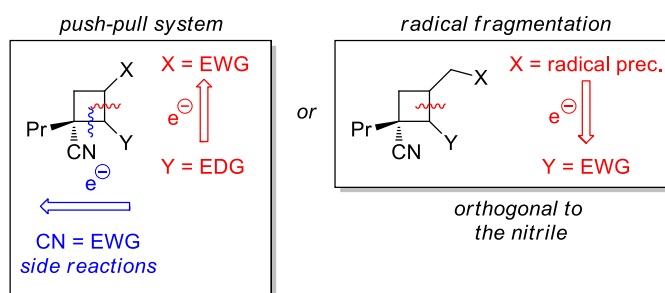


**Scheme IV.31.** Sulfonyl-cyanation reaction on cyclobutene and X-ray crystal structures.



#### 4. Development of a cyclobutane ring-opening reaction

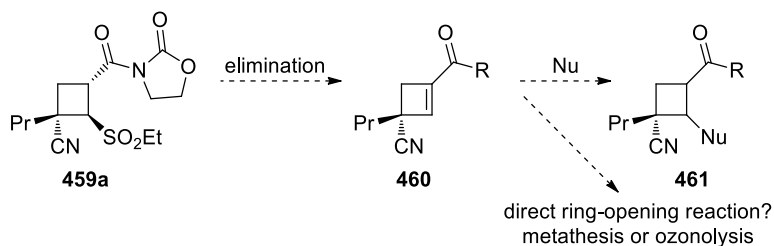
With an adequate reaction in hand to install the nitrile on the cyclobutene in a totally stereocontrolled manner, the second challenge was to develop an efficient ring-opening reaction. Various push-pull systems and radical precursors were envisioned for a metal-catalysed ring opening reaction or a radical fragmentation (Figure IV.7). The presence of the nitrile on the cyclobutane ring makes the situation more complex because it is an electron-withdrawing group, which may act as a second “pull” substituent. Indeed, in the push-pull system strategy, the presence of two “pull” (*X* and CN) substituents implies two possible ring opening reactions. In contrast, the proposed radical fragmentation is orthogonal to the nitrile and might be less problematic.



**Figure IV.7.** Strategies for the cyclobutane ring-opening

##### 4.1. Sulfone elimination

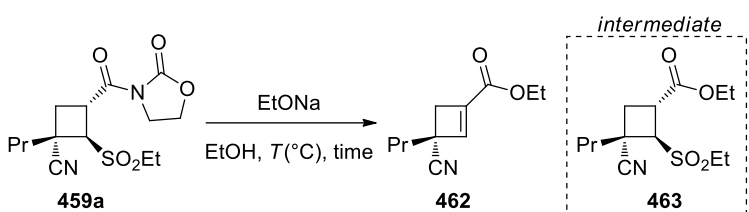
In order to prepare the push-pull precursors, it was anticipated to eliminate first the sulfone through a  $E1_{CB}$  elimination process, affording a new optically pure cyclobutene carboxylate **460**, which could be used either for further functionalization such as 1,4-addition or directly for the ring-opening reaction (Scheme IV.32).



**Scheme IV.32.** Synthetic plan involving the sulfone elimination and subsequent transformations.

The elimination of the sulfone was however not so straightforward and an optimization was required. After the screening of different bases (DMAP, DBU, basic alumina, EtONa, *t*-BuOK, NaH), the elimination product was identified in the crude  $^1H$  NMR when the reaction was performed with sodium ethoxide, potassium *tert*-butoxide and sodium hydride. Even though complex mixtures were obtained in these attempts, the optimization was pursued with sodium

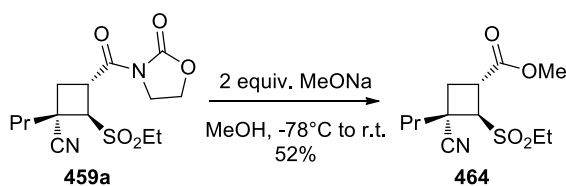
ethoxide. From Table IV.8, it can be noticed that an excess of sodium ethoxide, long reaction time and high temperatures provoke the degradation of product **462** (entry 1-2). The elimination reaction occurs between 0°C and room temperature and by using only one equivalent of EtONa, the  $\beta$ -sulfonyl ester **463** was also isolated (entry 3). The evaporation of ethanol under reduced pressure, before work-up, led to the decomposition of **462** (entry 4). A moderate yield was finally obtained when the reaction was diluted with dichloromethane and quenched with an aqueous solution of NaHCO<sub>3</sub> (entry 5). Good reproducibility and good yields were attained when the reaction was performed in a stepwise manner (entry 6). At -78°C, the oxazolidinone is first converted to **463** and then the sulfone elimination occurs smoothly between 0°C and room temperature. Almost 70% yield can be obtained using 1 mmol of cyclobutane **459a** (entry 7). The scaling-up of this reaction was however a little bit tricky.



Entry	EtONa (eq.)	T (°C)	Time (min)	Work-up	Yield (%)
1	8	80	24h	Evap. then HCl 1M	0
2	2	25	120	Celite filtration	traces
3	1	0	2	Evap. then HCl 1M	39
4	1+1	-40 to 20	10	Evap. then HCl 1M	0
5	2	-40 to 20	15	DCM + NaHCO <sub>3</sub>	52
6	1+1	-78 to 20	30	DCM + NaHCO <sub>3</sub>	67
7 <sup>[a]</sup>	2	-78 to 20	30	DCM + NaHCO <sub>3</sub>	69

**Table IV.8.** Optimization for the sulfone elimination with EtONa ([a] scale up 1 mmol of cyclobutene).

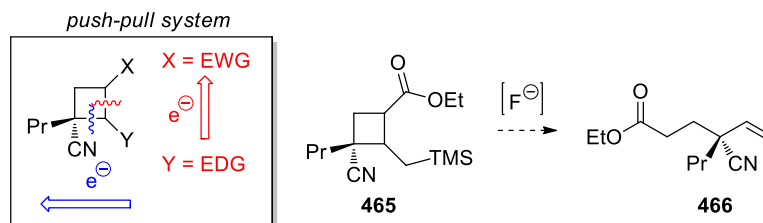
Interestingly, under similar reaction conditions, but using sodium methoxide instead of sodium ethoxide, no elimination occurred even with two equivalents of base (Scheme IV.33). Only the product of trans-esterification **464** was recovered.



**Scheme IV.33.** Attempt at replacing EtONa by MeONa during the sulfone elimination.

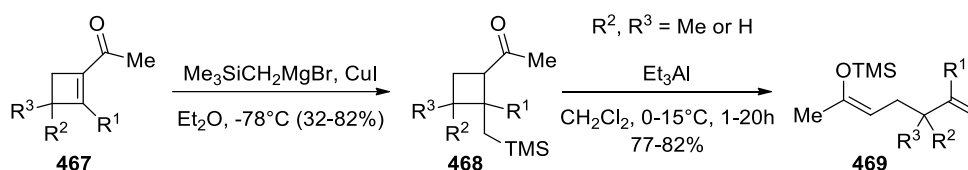
## 4.2. TMS-promoted ring opening reaction

The initial strategy for the ring-opening reaction involved the activation of a silyl group with a fluoride anion (Scheme IV.34).<sup>228</sup> Although the selectivity of the ring-opening reaction of **465** might be difficult, some hard Lewis acids such as  $\text{CeF}_3$  and  $\text{MgF}_2$  could activate the ester and favour the ring opening reaction in this direction through a cyclic transition state.



**Scheme IV.34.** Initial strategy for the cyclobutane ring-opening reaction.

Ring-opening reactions of similar cyclobutanes **468** have been reported by Takeda and co-workers (Scheme IV.35).<sup>229</sup> In this transformation, triethylaluminium was used as a catalyst. The authors proposed that the migration of the trimethylsilyl group occurs *via* a chair-like transition state explaining the obtained geometry of the silyl enol ethers **469**.



**Scheme IV.35.** Triethylaluminium-catalysed ring opening reaction of 1-acetyl-2-[(trimethylsilyl)-methyl]cyclobutanes.<sup>229</sup>

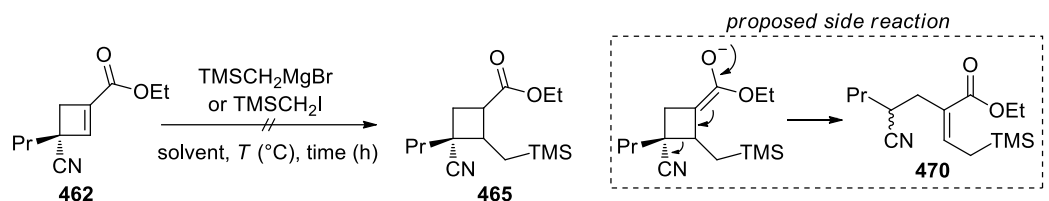
Encouraged by this report, the precursor for this reaction could be obtained from cyclobutene carboxylate **462** through 1,4-addition of a cuprate reagent. Although conjugated additions on cyclobutene carboxylate are well described,<sup>230</sup> this reaction appeared very difficult on our substrate, leading to a very complex mixture (Table IV.9, entry 1). After several purifications of the crude mixture, a side product was isolated, which might be **470** resulting from a ring-opening reaction after the conjugated addition (see below). However, this remains to be confirmed as we were unable to fully characterize this compound, due to a contamination with several inseparable by-products. The  $^1\text{H}$  NMR spectrum and the HRMS analysis support our hypothesis. In order to disfavour this side reaction,  $\text{TMSCl}$  was added in the reaction medium to

<sup>228</sup> K. T. Mead, J. Lu, *Tetrahedron Lett.* **1994**, 35, 8947-8950.

<sup>229</sup> T. Fujiwara, A. Suda, T. Takeda, *Chem. Lett.* **1991**, 1619-1622.

<sup>230</sup> (a) I. Fleming, M. Rowley, *Tetrahedron* **1986**, 42, 3181-3198; (b) T. Fujiwara, T. Takeda, *Tetrahedron Lett.* **1990**, 31, 6027-6030; (c) M. S. Dowling, C. D. Vanderwal, *J. Org. Chem.* **2010**, 75, 6908-6922 (d) Y.-J. Chen, T.-J. Hu, C.-G. Feng, G.-Q. Lin, *Chem. Comm.* **2015**, 51, 8773-8776.

trap the enolate into the corresponding silyl enol ether, but the same observations were made (entry 2-3). No conversion was observed under conjugate radical addition (entry 4). The conjugate addition on cyclobutene carboxylate **462** was thus abandoned and the strategy of TMS-promoted ring-opening reaction was not pursued.

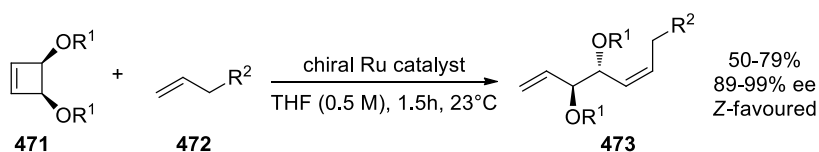


Entry	Reagent	Additives	solvent	$T$ (°C)	Time (h)	Conv. (%)	Yield (%)
1	CuBr.SMe <sub>2</sub>	-	THF	-78	1	100	0
2	CuBr.SMe <sub>2</sub>	TMSCl	THF	-78	1	100	0
3	CuCN	TMSCl	THF	-78	1	100	0
4	Bu <sub>3</sub> SnH, AIBN	-	benzene	80	16	0	-

**Table IV.9.** Reagents screening for the functionalization of **462** by 1,4-addition.

### 4.3. Ring-opening reaction from cyclobutene carboxylate

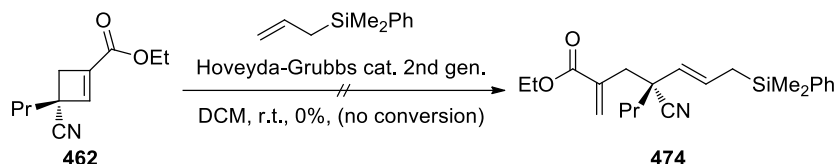
The ring-opening metathesis reaction is well described on cyclobutene but not on cyclobutene carboxylate.<sup>231</sup> As an elegant example, Grubbs and Hartung described the desymmetrization of *meso*-cyclobutenes **471** by an asymmetric ring-opening/cross-metathesis (AROCM), providing the enantioenriched 1,2-*anti*-diols products **473**, the enantioenrichment for the *Z*-isomer being higher than the minor *E*-isomer (Scheme IV.36).



**Scheme IV.36.** Synthesis of 1,2-*anti*-diols through a asymmetric ring-opening/cross-methathesis from cyclobutene by Grubbs.<sup>231</sup>

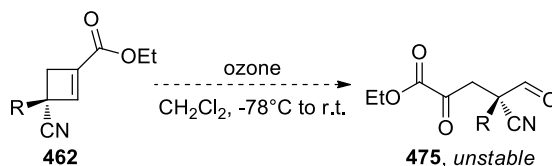
<sup>231</sup> (a) J.-C. Han, C.-C. Li, *Chem. Rec.* **2017**, *17*, 499-517; (b) J. Hartung, R. H. Grubbs, *Angew. Chem. Int. Ed.* **2014**, *53*, 3885-3888; (c) M. Commandeur, C. Commandeur, M. D. Paolis, A. J. F. Edmunds, P. Maienfisch, L. Ghosez, *Tetrahedron Lett.* **2009**, *50*, 3359-3362.

The ring-opening metathesis polymerization (ROMP) is in contrast well documented with achiral cyclobutene carboxylates.<sup>232</sup> It was thus envisioned that our cyclobutene carboxylate **462** could be opened through a ring-opening cross-metathesis reaction. The reaction was tested with the Hoveyda-Grubbs catalyst (2<sup>nd</sup> generation) and a simple olefin but no conversion was observed (Scheme IV.37). The optimization of this reaction was not studied further, but substrate modifications and the screening of other catalysts might allow this cyclobutene ring-opening.



**Scheme IV.37.** Attempt to perform a ring-opening metathesis on cyclobutene **462**.

As an alternative to the metathesis reaction, preliminary experiments using ozonolysis have shown encouraging results (Scheme IV.38). The keto-ester aldehyde **475** formed after treatment of the ozonide with Me<sub>2</sub>S, is however unstable and appropriate conditions are currently examined, as this synthon would be a valuable intermediate for the synthesis of eucophylline and eburnamine.

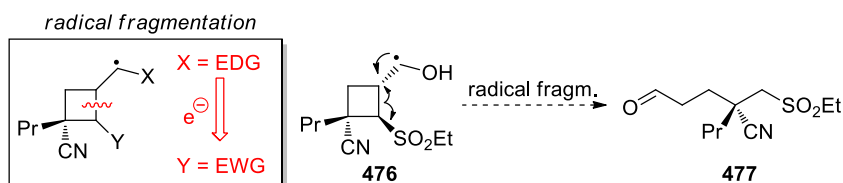


**Scheme IV.38.** Attempt to perform a ring-opening through ozonolysis.

#### 4.4. Radical fragmentation from an alcohol precursor

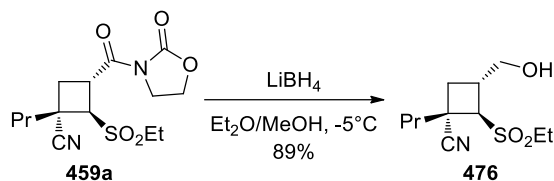
Due to the difficulties encountered in the push-pull system strategy, we decided to investigate precursors suitable for a radical fragmentation. A radical generated  $\alpha$ - to the X group (Scheme IV.39), would initiate a ring-fragmentation favoured by the electron-withdrawing character of the Y group. In the case of the sulfonyl-alcohol precursor **476**, the formation of a stable radical  $\alpha$ - to the sulfone would constitute a valuable driving force. This ring-opening reaction would furnish the aldehyde-sulfone **477** as final product.

<sup>232</sup> (a) L. Tan, K. A. Parker, N. S. Sampson, *Macromolecules* **2014**, *47*, 6572-6579; (b) K. S. Lee, T.-L. Choi, *Org. Lett.* **2011**, *13*, 3908-3911; (c) A. Song, K. A. Parker, N. S. Sampson, *Org. Lett.* **2010**, *12*, 3729-3731; (d) A. Song, K. A. Parker, N. S. Sampson, *J. Am. Chem. Soc.* **2009**, *131*, 3444-3445.



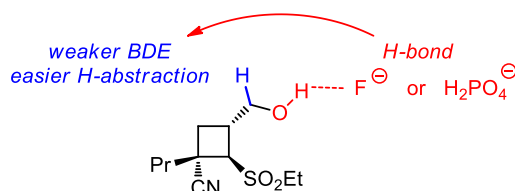
**Scheme IV.39.** Cyclobutane-ring opening reaction from an alcohol precursor.

The alcohol precursor **476** was first selected because it is easily obtained through reduction of the sulfonyl-cyanation product **459a** with excellent yield (Scheme IV.40).



**Scheme IV.40.** Reduction of the oxazolidinone **459a** into alcohol **476**.

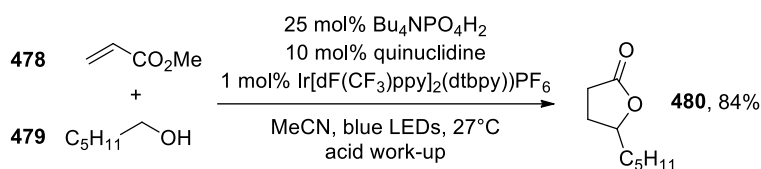
The abstraction of a hydrogen atom  $\alpha$ - to an alcohol is actually not favoured because the bond dissociation energy is too high (92 kcal/mol for EtOH). However, hydrogen abstraction becomes possible when the alcohol is coordinated to a suitable hydrogen-bond acceptor. The H-bond increases the  $n\text{-}\sigma^*$  delocalization of the lone pair of oxygen and consequently reduces the C-H bond strength. An electrophilic radical should then be able to abstract the hydrogen atom. This is illustrated for the cyclobutylmethyl alcohol precursor **476** in Figure IV.8.



**Figure IV.8.** Effect of a H-bond onto the H-abstraction.

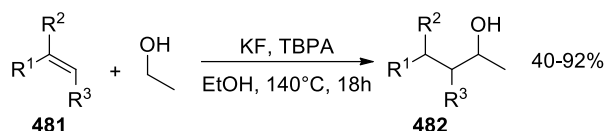
This concept was used by MacMillan and co-workers in photocatalyzed hydrogen-bond assisted C-H activation, using a tetra-*n*-butylammonium phosphate salt as the hydrogen-bond acceptor (Scheme IV.41).<sup>233</sup> This methodology relies on the cooperation of three distinct catalyst: a photoredox catalyst, a hydrogen-atom-transfer (HAT) catalyst and a hydrogen-bonding catalyst. After the hydrogen abstraction of **479**, the nucleophilic addition of  $\alpha$ -oxy radical to acrylate **478** is followed by lactonization. Impressive selectivity for the C-H activation of alcohols were obtained even if weaker  $\alpha$ -oxy C-H bonds (ether, silyl ether) were present in the molecule.

<sup>233</sup> J. L. Jeffrey, J. A. Terrett, D. W. C. MacMillan, *Science* **2015**, 349, 1532.



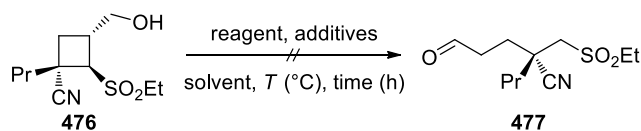
**Scheme IV.41.** Alcohol addition to methyl acrylate through H-bond assisted C-H activation.<sup>233</sup>

Other examples include the use of potassium fluoride in the radical addition of simple alcohols to unactivated olefins **481** (Scheme IV.42).<sup>234</sup> The use of alcohol as a solvent is one of the major drawback of this reaction.



**Scheme IV.42.** H-bonding-promoted radical addition of simple alcohols to unactivated alkenes.<sup>234</sup>

These conditions were applied to our substrate **476** but were unsuccessful (Table IV.10). Using potassium fluoride and dicumyl peroxide as initiator, no conversion was observed (entry 1) but a complex mixture was obtained with *tert*-butyl peroxide (entry 2). The conditions of MacMillan were also not successful (entry 3).



Entry	Reagent	Additives	solvent	<i>T</i> (°C)	Time (h)	Conv. (%)
1	DCP	KF	DMF	130	16	0
2	( <i>t</i> BuO) <sub>2</sub>	KF	<i>t</i> -BuOH	140	16	compl. mix.
3	[Ir] + quinuclidine	Bu <sub>4</sub> NH <sub>2</sub> PO <sub>4</sub>	ACN	r.t.	24	0

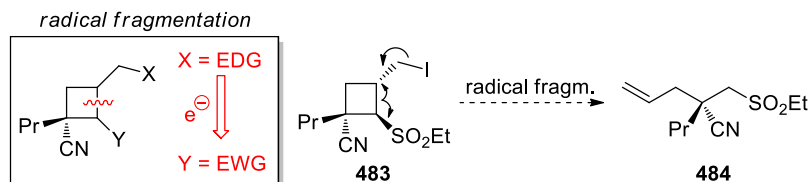
**Table IV.10.** Screening of some reaction conditions ([Ir] = (Ir[dF(CF<sub>3</sub>)ppy]<sub>2</sub>(dtbbpy))PF<sub>6</sub>).

Considering our failure with the alcohol precursor, the corresponding iodide appeared as a viable alternative to study this radical fragmentation. The abstraction of an iodine atom is indeed much easier than a hydrogen  $\alpha$ - to an alcohol and is also well documented.

<sup>234</sup> Y. Tian, Z.-Q. Liu, *Green Chem.* **2017**, *19*, 5230-5235.

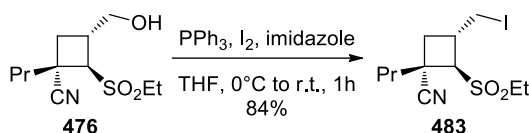
## 4.5. Radical fragmentation from an iodide precursor

The abstraction of the iodine atom of cyclobutane precursor **483** will produce an unstable methyl radical, which will induce the same radical fragmentation to form a new stable radical  $\alpha$ - to the sulfone. Terminal alkene **484** would be the product of this radical fragmentation and should be useful for further transformations (Scheme IV.43).



**Scheme IV.43.** Cyclobutane-ring opening reaction from an iodide precursor.

The iodide precursor **483** was synthesized from the alcohol **476** through an Appel reaction with an excellent yield (Scheme IV.44).



**Scheme IV.44.** Synthesis of iodide precursor **483**.

In order to trap the radical  $\alpha$ - to the sulfone after the ring-opening reaction, vinyloxy-trimethylsilane was introduced in the reaction medium. During our optimization, instead of the expected product **486**, the reduced opened-product **484** and the reduced cyclobutane **485** were isolated as an inseparable mixture using AIBN and TTMSH (Table IV.11, entry 1). Using triethylborane as initiator, only the reduced cyclobutane **485** was formed (entry 2). In order to avoid these competitive reductions, the reversal polarity catalysis was applied to our reaction model. Thus, TTMSH was replaced by  $\text{Et}_3\text{SiH}$  and 1-adamantanethiol, but no reaction was observed when AIBN or DLP were used as initiators (entry 3-4). Photoredox-catalysed reductions have also been tried. The photoredox-mediated radical reductive deiodination conditions of Stephenson were tested, but the same competitive reductions were observed (entry 5-6).<sup>235</sup> Considering these results, we reasoned that an alkene such as vinyloxytris(trimethylsilyl)silane instead of vinyloxy-trimethylsilane would avoid the use of a reducing agent and prevent the reduction of radical intermediates. Unfortunately, no conversion was observed (entry 7). Due to these competitive reductions of radical intermediates, this strategy was not pushed forward.

<sup>235</sup> J. D. Nguyen, E. M. D'Amato, J. M. R. Narayanam, C. R. J. Stephenson, *Nat. Chem.* **2012**, *4*, 854.



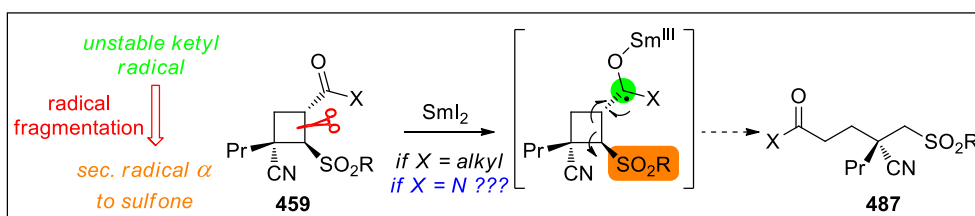
Entry	Init.	Red.	<i>T</i> (°C)	Solvent	Time (h)	Product
1	AIBN	TTMSH <sup>[a]</sup>	100	PhCl	2	<b>484 + 485</b>
2	Et <sub>3</sub> B/O <sub>2</sub>	TTMSH	20	DCM	3	<b>485</b>
3	AIBN	Et <sub>3</sub> SiH/RSH <sup>[b]</sup>	80	cyclohex.	16	-
4	DLP	Et <sub>3</sub> SiH/RSH <sup>[b]</sup>	100	PhCl	6	-
5	fac[Ir(ppy) <sub>3</sub> ]/hv <sup>[c]</sup>	Et <sub>3</sub> N/HE	25	ACN	24	<b>484 + 485</b>
6	Ir cat. <sup>[d]</sup> /hv <sup>[c]</sup>	DIPEA	25	ACN	42	<b>484 + 485</b>
7 <sup>[e]</sup>	AIBN	-	100	PhCl	16	-

**Table IV.11.** Optimization of the reaction conditions ([a] addition with syringe pump, [b] RSH = 1-adamantanethiol, [c] hv = blue LED, [d] Ir cat. = Ir(dtbbpy)(ppy)(PF<sub>6</sub>), [e] vinyloxytris(trimethylsilyl)silane was used).

#### 4.6. SmI<sub>2</sub>-ring opening processes

Following the same guideline than for the above ring-opening reaction, a ketyl-type radical should engage in the same radical fragmentation than the alcohol or iodide precursors. This strategy, illustrated in Scheme IV.45, maintains the carbonyl of the oxazolidinone and do not require synthetic modifications of the sulfonyl-cyanation product. It was hypothesized that a ketyl-type radical could be formed directly from *N*-Acyl oxazolidinone **459**. The generation of this reactive species could be carried out using samarium diiodide. The so-called Kagan's reagent is a powerful reducing agent and is the reagent of choice to generate ketyl radicals from ketones (X = C), and more generally from carbonyl derivatives, by single electron transfer.<sup>236</sup> The introduction of a ketyl-type radical from amides or *N*-Acyl oxazolidinone (X = N) is more difficult and less documented. However, the reducing power of SmI<sub>2</sub> (approximately -1.41 V for a SmI<sub>2</sub> solution in THF) can be tuned by adding additives (water, alcohol, HMPA or amine) in the reaction medium, such that the reduction potential can reach -1.9 V (through addition of 500 equiv. of water or alcohol).

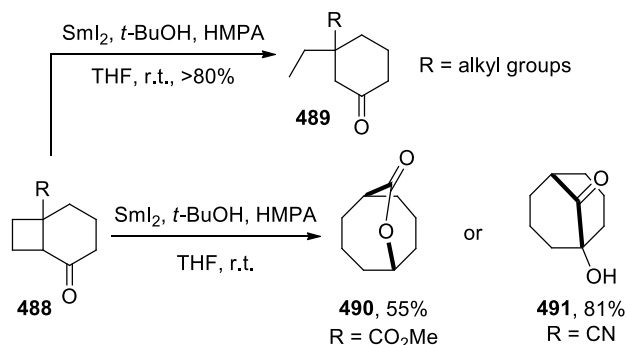
<sup>236</sup> (a) P. Girard, J. L. Namy, H. B. Kagan, *J. Am. Chem. Soc.* **1980**, *102*, 2693-2698; (b) S. C. Coote, R. A. Flowers, II, T. Skrydstrup, D. J. Procter, *Organic Synthesis Using Samarium Diiodide*, John Wiley & Sons Ltd., **2012**, p1-52.



**Scheme IV.45.** Radical fragmentation through a ketyl-type radical.

#### 4.6.1. Reported ring-opening reactions and reductions using $\text{SmI}_2$

The  $\text{SmI}_2$ -promoted radical ring-opening of bicyclo[4.2.0]octan-2-ones **488** has been successfully accomplished using *t*-BuOH and HMPA as additives (Scheme IV.46).<sup>237</sup> This reaction converts alkyl substituted bicyclo[4.2.0]octan-2-ones to the cyclohexanone products **489** through the cleavage of the external cyclobutane bond. The presence of an electron-withdrawing groups such as nitrile, ester or a phenyl derivative was found to reverse the selectivity towards the formation of eight-membered ring products exclusively (*e.g.* **490** and **491**). While the authors did not rationalize this selectivity, stereoelectronic considerations and the stability of the formed radicals may be invoked (see chapter II).

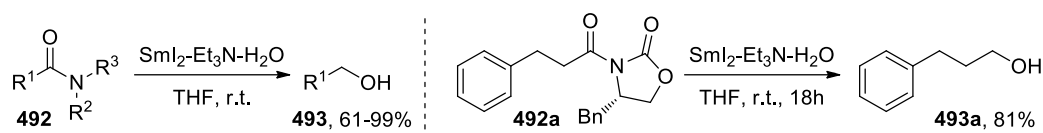


**Scheme IV.46.** Radical ring-opening reaction of bicyclo[4.2.0]octan-2-ones promoted by  $\text{SmI}_2$ .<sup>237</sup>

By tuning the reduction potential of  $\text{SmI}_2$  with additives, Procter and co-workers successfully produced a ketyl-type radical from unactivated amides **492**. The combination of  $\text{SmI}_2$ -amine- $\text{H}_2\text{O}$  has been used in the chemoselective reduction of primary, secondary and tertiary amides into alcohols **493** (Scheme IV.47).<sup>238</sup> In this reaction, the C-N bond is cleaved in contrast to the usual reductions of amides in which the C-O bond is broken. As an example of their reaction scope, *N*-Acyl oxazolidinone derivative **492a** was reduced in alcohol **493a** with an excellent yield. Hence, in presence of additives, samarium diiodide is able to produce a ketyl-type radical from *N*-Acyl oxazolidinone.

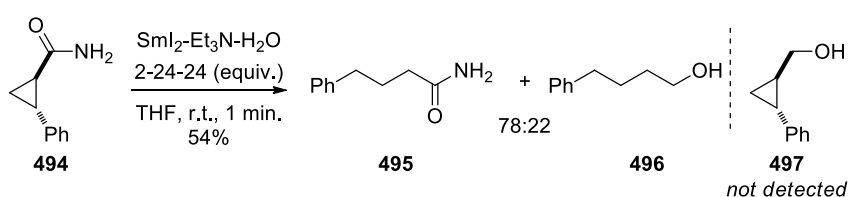
<sup>237</sup> K. Kakiuchi, K. Minato, K. Tsutsumi, T. Morimoto, H. Kurosawa, *Tetrahedron Lett.* **2003**, *44*, 1963-1966.

<sup>238</sup> M. Szostak, M. Spain, A. J. Eberhart, D. J. Procter, *J. Am. Chem. Soc.* **2014**, *136*, 2268-2271.



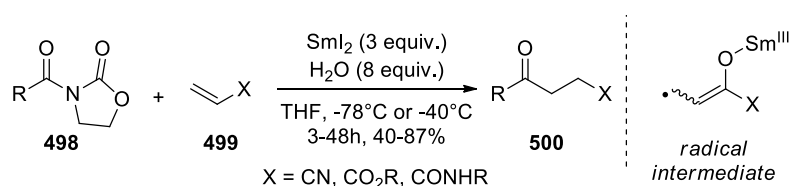
**Scheme IV.47.** Reduction of amides to alcohol using  $\text{SmI}_2$ .<sup>238</sup>

To gain insight into the reaction mechanism, they applied the reductive conditions to the *trans*-cyclopropane **494** used as a radical clock (Scheme IV.48). A rapid ring opening reaction was observed to give acyclic amide **495** and alcohol **496**, suggesting a mechanism involving a ketyl-type radical. The cyclopropyl carbinol **497** was not detected. An interesting additional control experiment using only the couple  $\text{SmI}_2\text{-H}_2\text{O}$  (no triethylamine) produced only the acyclic amide **495** without further reduction to alcohol **496**.



**Scheme IV.48.** Control experiments suggesting a ketyl-type radical intermediate.<sup>238</sup>

Skrydstrup and co-workers have also used water as an additive in the  $\text{SmI}_2$ -promoted radical addition of *N*-Acyl oxazolidinones **498** to acrylates, acrylamides and acrylonitriles (Scheme IV.49).<sup>239</sup> Although they initially proposed a mechanism involving a metallated ketyl radical anion intermediate, they corrected the mechanism in a second report and proposed an initial reduction of the acrylate/acrylamide into a radical-anion, followed by intermolecular alkyl radical addition to carbonyl of the *N*-acyl oxazolidinone.<sup>240</sup>



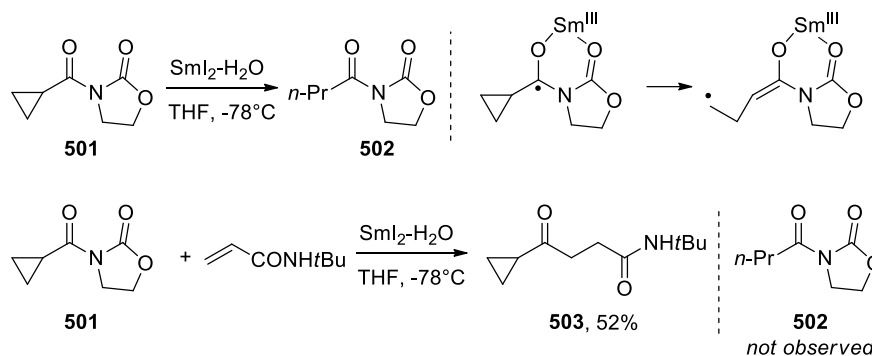
**Scheme IV.49.** Radical addition of *N*-acyl oxazolidinones to acrylamides and acrylates promoted by  $\text{SmI}_2\text{-H}_2\text{O}$ .<sup>239</sup>

During their mechanistic investigations, they designed a control experiment in which a ring-opening reaction of cyclopropane **501** could occur (Scheme IV.50). Even though they observed the opened product **502** suggesting a metallated ketyl radical anion intermediate, the

<sup>239</sup> C. M. Jensen, K. B. Lindsay, R. H. Taaning, J. Karaffa, A. M. Hansen, T. Skrydstrup, *J. Am. Chem. Soc.* **2005**, *127*, 6544-6545.

<sup>240</sup> A. M. Hansen, K. B. Lindsay, P. K. S. Antharjanam, J. Karaffa, K. Daasbjerg, R. A. Flowers, II, T. Skrydstrup, *J. Am. Chem. Soc.* **2006**, *128*, 9616-9617.

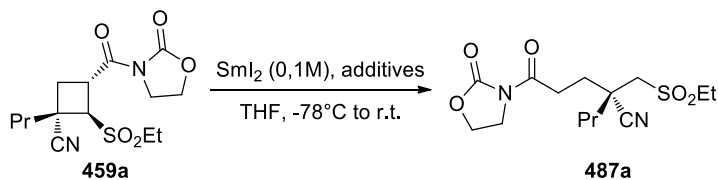
reaction was very slow and most of the starting material was recovered. In agreement with this result, the reduction potential of the cyclopropyl derivative **501** was measured and found to be extremely negative ( $E_{red} = -2.8$  V vs SCE,  $1\text{V}\cdot\text{s}^{-1}$  in THF). In the presence of an acrylamide, the cyclopropane ring-opening reaction was not observed and only the product **503** was obtained in 52% yield ruling out the ketyl-type intermediate.



**Scheme IV.50.** Mechanistic investigations for the intermolecular radical carbonyl addition promoted by  $\text{SmI}_2$ .<sup>240</sup>

#### 4.6.2. $\text{SmI}_2$ -promoted ring-opening of cyclobutane

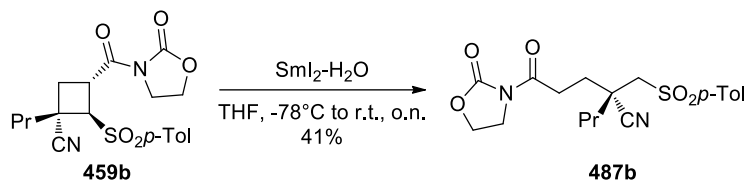
On the basis of these results, the cyclobutane ring-opening reaction promoted by  $\text{SmI}_2$  was investigated (Table IV.12). Without any additives, only traces of the opened product **487a** were observed on the crude  $^1\text{H}$  NMR spectrum. The addition of *tert*-butanol or HMPA did not provide the desired product (entry 2-3). We found that the  $\text{SmI}_2$ - $\text{H}_2\text{O}$  couple was the most adequate for this ring-opening reaction. Only 22 % was obtained with 3 equivalents of  $\text{SmI}_2$  (entry 4) but a larger excess gave a satisfactory yield (entry 5).



Entry	$\text{SmI}_2$ (eq.)	Additives	Equiv.	Time (h)	Yield (%)
1	5	-	-	16	traces
2	5	<i>t</i> -BuOH	10	16	0
3	5	HMPA	10	16	0
4	3	$\text{H}_2\text{O}$	6	5	22
5	11	$\text{H}_2\text{O}$	10	16	63

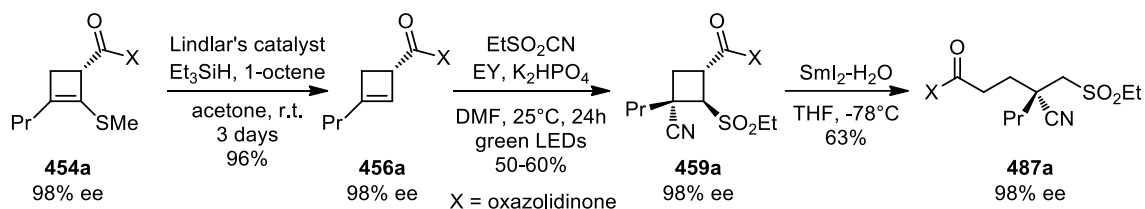
**Table IV.12.** Optimization of the cyclobutane ring-opening reaction promoted by  $\text{SmI}_2$ .

These optimal conditions were also applied to tosyl cyclobutane **459b** furnishing the opened product **487b** in moderate yield (Scheme IV.51). The crude product was contaminated by others side products which were not identified. The arylsulfones are indeed more sensitive than alkylsulfones to  $\text{SmI}_2$  reduction which could explain this lower yield. Due to the strong electron-withdrawing nature of sulfones, the aromatic moiety of arylsulfones acts as an electron acceptor and they are more prone to reductive desulfonation through single electron transfer (SET). In the presence of water, samarium diiodide is even more reductive and SET could occur to the *p*-toluenesulfonyl group leading to a desulfonation or side reactions.



**Scheme IV.51.**  $\text{SmI}_2$ -promoted ring-opening reaction of tosyl cyclobutane **459b**.

Having found a suitable ring-opening reaction, racemic substrates were synthesized in order to verify that no racemization occurred. The enantioselectivities were measured for each substrate from **454a** to **487a** and found to be greater than 98% (Scheme IV.52). Overall, a short and efficient synthetic sequence leading to an enantioenriched nitrile-functionalized all-carbon quaternary stereocenter was developed.

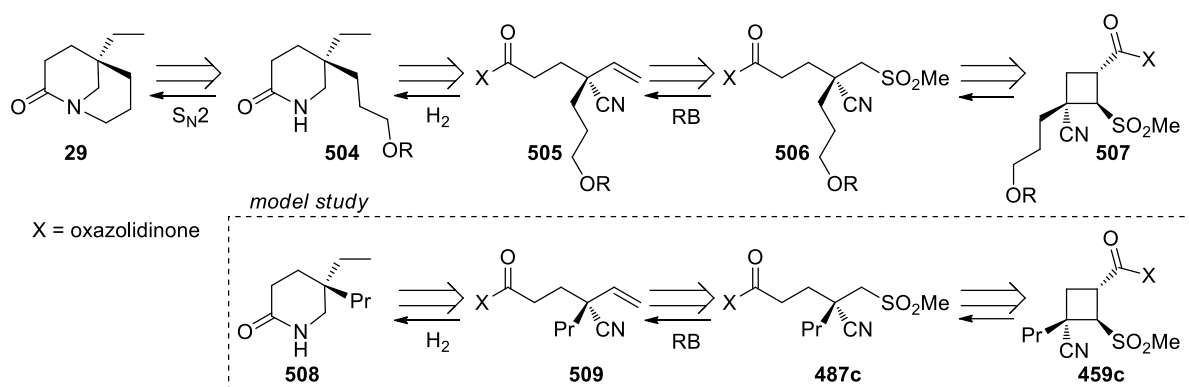


**Scheme IV.52.** Evaluation of the enantiospecificity of the sequence.

Our effort to trap the radical  $\alpha$ - to the sulfone by several unsaturated moiety (vinyl ethers, acrylates and benzaldehyde) remained unsuccessful. Only the opened product **487a** was recovered.

## 5. Total synthesis of eucophylline: model study

Considering the synthetic sequence described above, our initial retrosynthesis of eucophylline based on a carbo-cyanation of cyclobutene was thus modified. The retrosynthesis presented in Figure IV.9 relies on a Ramberg-Bäcklund (RB) reaction converting the methyl sulfone into a vinyl moiety. After the formation of the bicyclic lactam **29**, the free amide **504** would arise from a hydrogenation of the allylic nitrile **505**, the product of a RB reaction. The methyl sulfone **506** would be accessible through our synthetic sequence from methylsulfonyl cyanide. The RB reaction on such substrates will be examined through a model study using **459c**.



**Figure IV.9.** Second retrosynthesis and model study.

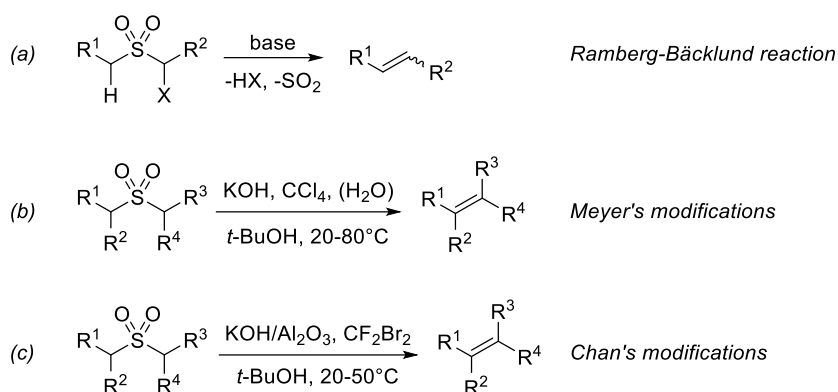
### 5.1. The Ramberg-Bäcklund reaction

The RB reaction is a base-mediated conversion of an  $\alpha$ -halosulfone into an alkene (Scheme IV.53, a). This transformation has shown synthetic utility and was reviewed exhaustively by Taylor.<sup>241</sup> Due to the possible difficulties encountered in the preparation of  $\alpha$ -halosulfones, Meyer and co-workers described a one-pot procedure which converts directly a dialkyl sulfone into an alkene through an *in situ* formation of the  $\alpha$ -halosulfone (Scheme IV.53, b).<sup>242</sup> This is known as the Meyer's modifications and is the most widely used variant of the RB reaction. Another one-pot conversion of sulfones into alkenes was developed by Chan and co-workers using alumina-supported potassium hydroxide and difluorodibromomethane as the halogenating agent (Scheme IV.53, c).<sup>243</sup> For these one-pot procedures, the RB reaction occurs usually at room temperature with activated substrates and at higher temperatures for alkyl sulfones.

<sup>241</sup> R. J. K. Taylor and G. Casy in *The Ramberg-Bäcklund Reaction*, John Wiley & Sons, Inc., **2004**.

<sup>242</sup> C. Y. Meyers, A. M. Malte, W. S. Matthews, *J. Am. Chem. Soc.* **1969**, *91*, 7510-7512.

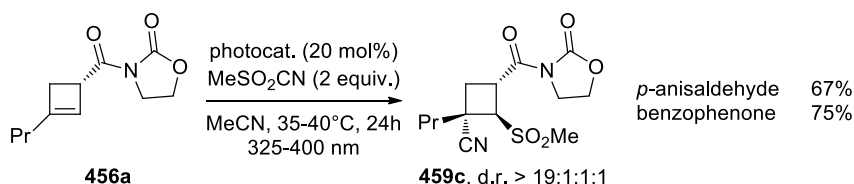
<sup>243</sup> T.-L. Chan, S. Fong, Y. Li, T.-O. Man, C.-D. Poon, *J. Chem. Soc., Chem. Commun.* **1994**, 1771-1772.



**Scheme IV.53.** The Ramberg-Bäcklund reaction and the Meyer and Chan's modifications.<sup>241</sup>

## 5.2. Synthesis of precursors

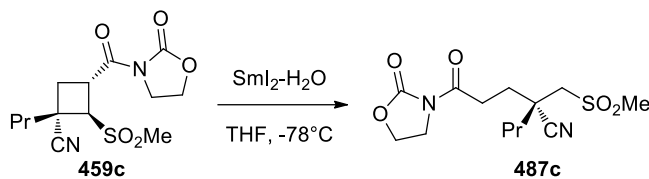
The sulfonyl-cyanation using *p*-anisaldehyde and benzophenone were applied to the model cyclobutene **456a** with methanesulfonyl cyanide furnishing the *trans*-product **459c** in good yields and excellent diastereoselectivity (Scheme IV.54). At the end of the reaction, no work-up is needed. Acetonitrile is evaporated and the crude product is purified through crystallisation and/or column chromatography. Even though the yield is slightly better with benzophenone, *p*-anisaldehyde was preferred as purification is easier.



**Scheme IV.54.** Application of *p*-anisaldehyde and benzophenone to the sulfonyl-cyanation reaction of cyclobutene.

The application of the developed  $\text{SmI}_2$ -promoted ring fragmentation to the cyclobutylmethyl sulfone **459c** gave a disappointing yield of 25% for the opened product **487c** (Table IV.13, entry 1). The methyl sulfone is apparently more sensitive to the  $\text{SmI}_2$ -reduction as compared to the ethylsulfone. The optimization of this reaction with **459c** required huge efforts. It is important to notice that the ratio between  $\text{SmI}_2$  and water as well as the temperature are responsible for the degradation of the final product. Leaving the reaction at room temperature or using an excess of water result in a very complex mixture and a yield below 30%. The reaction is fast and proceeds in less than 1 hour at  $-78^\circ\text{C}$  when sufficient  $\text{SmI}_2$  is used. The addition of  $\text{SmI}_2$  using a syringe pump did not lead to a cleaner reaction. Considering these observations, a short optimization was performed as depicted in Table below. Maintaining the temperature at  $-78^\circ\text{C}$  led

to a recovery of the starting material and a yield based on recovered starting material. Using 6 equivalents of distilled water afforded the open product in 40%, even if an excess or higher concentration of  $\text{SmI}_2$  was used (entry 2 to 3). Increasing the reaction time gave similar yields (entry 4). Excess of water (100 equiv.) led to a full degradation of the product even though the temperature was maintained at  $-78^\circ\text{C}$  (entry 5). A 1:2 ratio between  $\text{SmI}_2$ - $\text{H}_2\text{O}$  did not allow increasing the conversion (entry 6 vs 3). However, a 1:3 ratio increased the yield up to 53% (entry 7). Finally, the reaction was even cleaner when the amount of  $\text{SmI}_2$ - $\text{H}_2\text{O}$  was decreased (entry 8) and the appropriate conditions were found, providing the opened-product **487c** with a 73% yield.



Entry <sup>[a]</sup>	$\text{SmI}_2$ (equiv.)	conc. (M)	$\text{H}_2\text{O}$ (equiv.)	Time (h)	Yield (brsm) (%)
1 <sup>[b]</sup>	11	0.1	10	16	25
2	2.5	0.1	6	2	39 (68)
3	6	1	6	5	42 (63)
4	6	0.2	6	19	42 (67)
5	6	0.2	100	2	Compl. mix.
6	6	0.175	12	2	43 (59)
7	6	0.175	18	5	53
8	4	0.16	12	1	73

**Table IV.13.** Re-optimization of the  $\text{SmI}_2$ -promoted ring fragmentation with **459c** ([a] 0.2 mmol of SM was used, [b]  $-78^\circ\text{C}$  to room temperature).

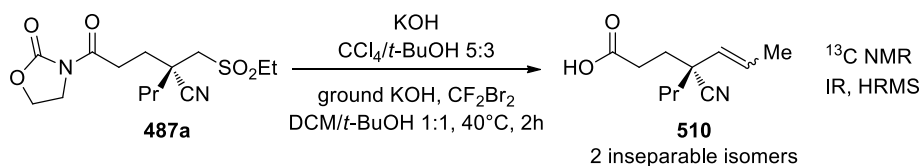
After this second optimization, the substrate scope of this reaction was investigated showing satisfactory to good yields (not shown, work of Iman Traboulsi, 1<sup>st</sup> year PhD student). Our motivation to perform this radical fragmentation with the methyl sulfone was high because the Ramberg-Bäcklund reaction was predicted to be suitable for the synthesis of eucophylline.

### 5.3. Application of the Ramberg-Bäcklund reaction

The Meyer's variant was first tried on ethylsulfone **487a**. The crude  $^1\text{H-NMR}$  was complex but showed typical alkene signal (Scheme IV.55) and the loss of the oxazolidinone moiety. The use of dibromodifluoromethane gave a partial conversion after 2 hours, leading to an inseparable mixture of two major isomers. Full conversion was obtained by heating the reaction mixture to  $40^\circ\text{C}$ . The purification of these acids was tried several times but did not succeed due to the similar



polarity of these compounds. Although this inseparable mixture did not allow us to obtain clean characterizations, the  $^{13}\text{C}$ -NMR, IR and HRMS analysis were consistent with the RB product **510**.



**Scheme IV.55.** Preliminary experiments with ethylsulfone **487a**.

During these preliminary experiments, the formation of highly polar compounds was observed on TLC but never identified. Under the RB conditions, the nitrile might be hydrolysed or undergo an intramolecular nucleophilic attack of the carbanion  $\alpha$ - to the sulfone. To avoid these possible side reactions, the RB reaction was planned after the reduction of the nitrile. Hence, the lactam **511** was synthesised through hydrogenation or reduction of the nitrile **487c** (Table IV.14). Amide **511** was formed in low yields using *in situ* formed nickel boride (entry 1).<sup>244</sup> An excess of sodium borohydride and shorter reaction times gave moderate yield (entry 2). Hydrogenation using Raney Nickel gave a similar yield (entry 3). It is worth noticing that due to the high polarity of compound **511**, a small amount is lost on silica gel during purification. Finally, the yield was slightly improved when the column chromatography was carried out with neutralised silica gel (entry 4).

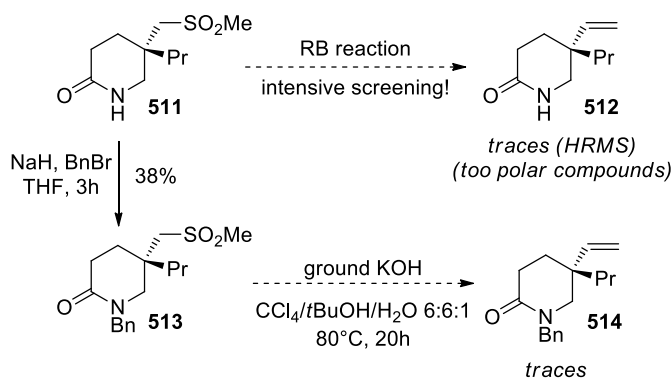
Entry	Red.	Equiv.	catalyst	Time (h)	Yield (%)
1	NaBH <sub>4</sub>	2	NiCl <sub>2</sub> .6H <sub>2</sub> O	16	27
2	NaBH <sub>4</sub>	3	NiCl <sub>2</sub> .6H <sub>2</sub> O	3	55
3	H <sub>2</sub> (25 bar)	-	Raney Ni	16	53
4 <sup>[a]</sup>	H <sub>2</sub> (25 bar)	-	Raney Ni	60	63

**Table IV.14.** Synthesis of the lactam through reduction of the nitrile ([a] the product was purified on column with neutralized silica (Et<sub>3</sub>N/acetone)).

The RB reaction with **511** appeared extremely clean according to TLC, but unfortunately a full conversion was never obtained (Scheme IV.56). Furthermore, the manipulation of such polar compound is also extremely complicated. Most of the starting material and the product were lost in the aqueous layer during the treatment of the reaction using the Meyer's conditions (KOH/CCl<sub>4</sub>/t-BuOH/H<sub>2</sub>O). For that reason, alumina-supported potassium hydroxide was used but

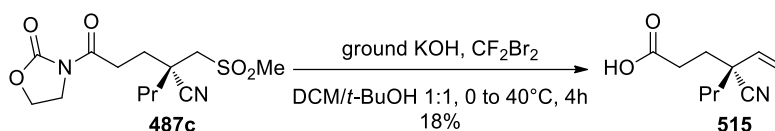
<sup>244</sup> S. Caddick, D. B. Judd, A. K. d. K. Lewis, M. T. Reich, M. R. V. Williams, *Tetrahedron* **2003**, 59, 5417-5423.

in that case the reaction was even slower and the filtration on Celite caused also an important loss of both the starting material and product. This loss of material was also noticed during the purification of the crude product on silica gel. For each reaction, 25 mg of the starting material was used which offered at the end less than 1 mg of product. However, these traces allowed us confirming the formation of product **512** through HRMS analysis. Our attempt to circumvent this solubility problem by protecting the amide **511** with a benzyl group was also unsuccessful (Scheme IV.56).



**Scheme IV.56.** Ramberg-Bäcklund reaction at different steps of the synthesis.

Finally, an application of the RB reaction to the acyclic methylsulfone **487c** gave the desired terminal alkene **515** in only 18% yield (Scheme IV.57). Although the product was obtained in low yield, these preliminary experiments were encouraging and we decided to start the total synthesis.



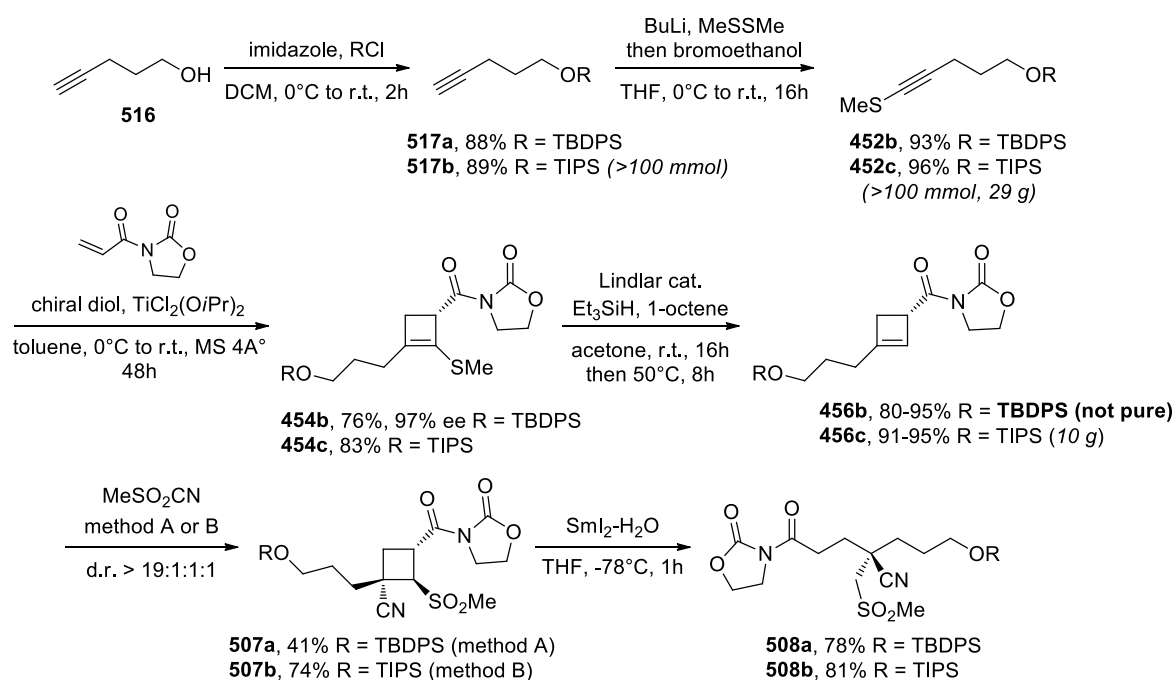
**Scheme IV.57.** Ramberg-Bäcklund with methyl sulfone **487c**.

## 6. Approach to eucophylline through a Ramberg-Bäcklund reaction

### 6.1. Synthesis of precursors

The cyclobutene required for the enantioselective total synthesis of eucophylline was synthesized following the procedure depicted in Scheme IV.58. The synthesis starts from pentyn-1-ol, protected with a TBDPS group. The alkynyl sulfide **452b** was synthesized in excellent yield through the deprotonation of the terminal alkyne **517a**, followed by addition of dimethyl

disulfide.<sup>245</sup> Application of the Narasaka [2+2]-cycloaddition afforded the cyclobutenyl sulfide **454b** in 76% yield, and a high enantiomeric ratio. Reduction of the vinyl sulfide using our procedure gave the desired cyclobutene **456b** contaminated by several inseparable side products. The indicated yield corresponds to this mixture. Modifications of the initial conditions of the reduction were introduced, but the final product was always contaminated by other side products. It was anticipated that the TBDPS protecting group was at the origin of the formation of side products in this reaction. The second major problem was the sulfonyl-cyanation reaction. The application of the eosin-mediated sulfonyl-cyanation to this mixture furnished the corresponding cyclobutane **507a** in low yield, the sulfonyl-cyanation with *p*-anisaldehyde being unknown at that time. Finally, by synthesizing the corresponding TIPS-protected alcohol **517b** and by using *p*-anisaldehyde as the sulfonyl-cyanation photocatalyst, we obtained a reliable synthetic sequence showing excellent yields. Furthermore, each step of this sequence could be run on gram scale. Better results were obtained for the reduction of the cyclobutenyl sulfide **454c** bearing a TIPS protecting group, which occurred without any formation of side products.



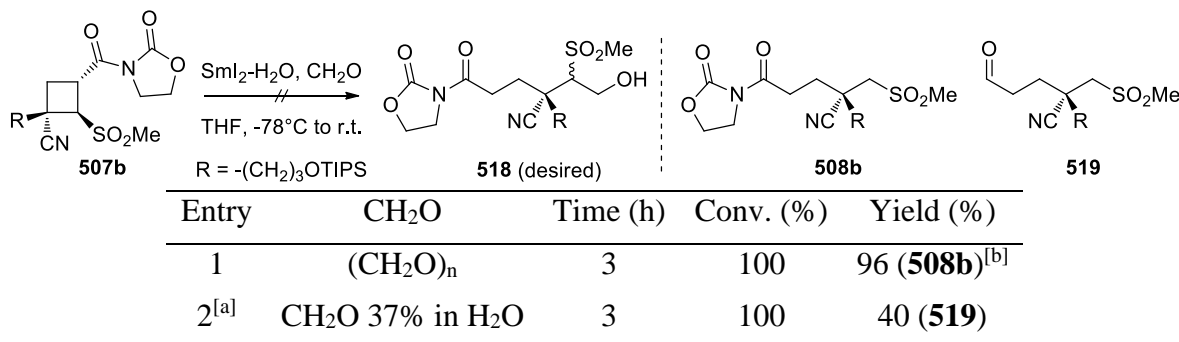
**Scheme IV.58.** Application of the cyclobutene methodology to the total synthesis of eucophylline (method A: eosin Y,  $\text{K}_2\text{HPO}_4$ , acetone,  $25^\circ\text{C}$ , 60h, green LED; method B: *p*-anisaldehyde, ACN,  $35^\circ\text{C}$ , 22h, 325-400 nm).

Before to investigate the RB reaction, we tried one more time to trap the radical after the  $\text{SmI}_2$  ring-opening reaction with formaldehyde. This trapping would lead to a  $\beta$ -hydroxy sulfone **518** which could then be transformed into a terminal alkene through a Julia olefination.<sup>246</sup>

<sup>245</sup> L. Hu, Q. Gui, X. Chen, Z. Tan, G. Zhu, *J. Org. Chem.* **2016**, *81*, 4861-4868.

<sup>246</sup> (a) B. Achmatowicz, E. Baranowska, A. R. Daniewski, J. Pankowski, J. Wicha, *Tetrahedron* **1988**, *44*, 4989-4998; (b) J. L. Acena, O. Arjona, M. Leon, J. Plumet, *Tetrahedron Lett.* **1996**, *37*, 8957-8960.

Formaldehyde is very electrophilic and is known to behave as a radical trap. Indeed, radical additions to formaldehyde using paraformaldehyde and aqueous formaldehyde have been reported by Ryu *et al.*<sup>247</sup> When paraformaldehyde was added after the SmI<sub>2</sub>-promoted ring fragmentation, only the opened product **508b** was obtained (Table IV.15, entry 1). With aqueous formaldehyde as an additive, the aldehyde **519** was unexpectedly formed in moderate yields when the temperature was increased to room temperature. As a reminder, similar reductions of *N*-Acyl oxazolidinone was described by Procter using the combination of SmI<sub>2</sub>-Et<sub>3</sub>N-H<sub>2</sub>O. During these experiments, the desired product **518** was never observed.

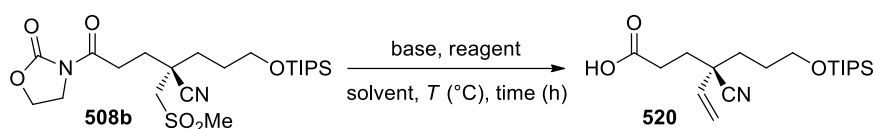


**Table IV.15.** Addition of formaldehyde in the SmI<sub>2</sub> ring-opening reaction ([a] no additional water was added; [b] crude yield).

## 6.2. Optimization of the Ramberg-Bäcklund reaction

The Ramberg-Bäcklund reaction was thus investigated with methyl sulfone **508b**. Several conditions were tried (Table IV.16), but unfortunately, after huge efforts, the maximum yield did not reach more than 21%. Very low yields were obtained using an excess of milled potassium hydroxide and dibromodifluoromethane (entry 1-2). Attempt at replacing the volatile CF<sub>2</sub>Br<sub>2</sub> by carbon tetrachloride or hexachloroethane gave no conversion even at high temperature (entry 3-4). Other bases such as LiOH or *t*-BuOK in combination with CF<sub>2</sub>Br<sub>2</sub> or *N*-bromosuccinimide did not provide the RB product (entry 5-6). Finally, the best yield was obtained when the conditions of entry 1 were repeated with water as an additive (entry 7). The addition of a phase transfer catalyst did not improve the yield (entry 8). Using alumina-supported potassium hydroxide and CF<sub>2</sub>Br<sub>2</sub>, a similar yield was obtained (entry 9). Other halogenating agents (*e.g.* C<sub>2</sub>Br<sub>2</sub>Cl<sub>4</sub>) were also tried with KOH/Al<sub>2</sub>O<sub>3</sub> but did not provide **520**.

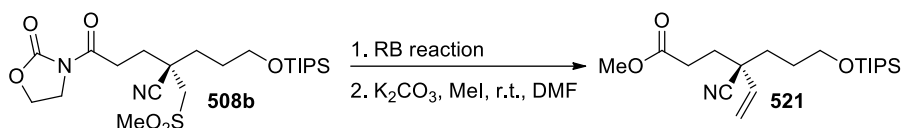
<sup>247</sup> (a) T. Kawamoto, T. Fukuyama, I. Ryu, *J. Am. Chem. Soc.* **2012**, *134*, 875-877; (b) T. Kawamoto, I. Ryu, *Chimia* **2012**, *66*, 372-376.



Entry	Base (eq.)	Reagent <sup>[a]</sup>	Solvent	Time (h)	T (°C)	Yield (%)
1	KOH (22)	CF <sub>2</sub> Br <sub>2</sub>	DCM/ <i>t</i> BuOH 1:1	1	r.t.	<14
2	KOH (5)	CF <sub>2</sub> Br <sub>2</sub>	DCM/ <i>t</i> BuOH 1:1	1	r.t.	8
3	KOH (3)	-	CCl <sub>4</sub> / <i>t</i> BuOH 1:1	8	60	0
4	KOH (3)	C <sub>2</sub> Cl <sub>6</sub>	DCM/ <i>t</i> BuOH 1:1	8	60	0
5	LiOH/ <i>t</i> BuOK	CF <sub>2</sub> Br <sub>2</sub>	THF/H <sub>2</sub> O 5:1	8	r.t.	0
6	LiOH/ <i>t</i> BuOK	NBS	THF/H <sub>2</sub> O 5:1	8	r.t.	0
7 <sup>[b]</sup>	KOH (22)	CF <sub>2</sub> Br <sub>2</sub>	DCM/ <i>t</i> BuOH/H <sub>2</sub> O	24	40	21
8 <sup>[b,c]</sup>	KOH (22)	CF <sub>2</sub> Br <sub>2</sub>	DCM/ <i>t</i> BuOH/H <sub>2</sub> O	48	r.t.	21
9	KOH/Al <sub>2</sub> O <sub>3</sub>	CF <sub>2</sub> Br <sub>2</sub>	DCM/ <i>t</i> BuOH 1:1	18	40	18

**Table IV.16.** Optimization of the Ramberg-Bäcklund reaction ([a] 20 equiv. of CF<sub>2</sub>Br<sub>2</sub>, 1 equiv. of C<sub>2</sub>Cl<sub>6</sub> and 5 equiv. of NBS was used; [b] DCM/*t*BuOH/H<sub>2</sub>O 1:1:0,2; [c] aliquat 336 as additive).

To verify whether the acid might be lost during the column chromatography, the optimal conditions were repeated, followed by an esterification. Yields of **521** for this two-steps sequence did not reach more than 10% (Table IV.17, entry 1-3). Even though the allylic nitrile **521** was the precursor required for the total synthesis of eucophylline, the very low yield did not allow us to continue the synthesis.



Entry	Base	Reagent	Solvent	Time (h)	T (°C)	Yield (%)
1	KOH	CF <sub>2</sub> Br <sub>2</sub>	DCM/ <i>t</i> BuOH/H <sub>2</sub> O	24	40	10
2	KOH/Al <sub>2</sub> O <sub>3</sub>	-	CCl <sub>4</sub> / <i>t</i> BuOH	20	80	9
3	KOH/Al <sub>2</sub> O <sub>3</sub>	-	CCl <sub>4</sub> / <i>t</i> BuOH	60	80	13

**Table IV.17.** Yields after optimized Ramberg-Bäcklund reaction and esterification.

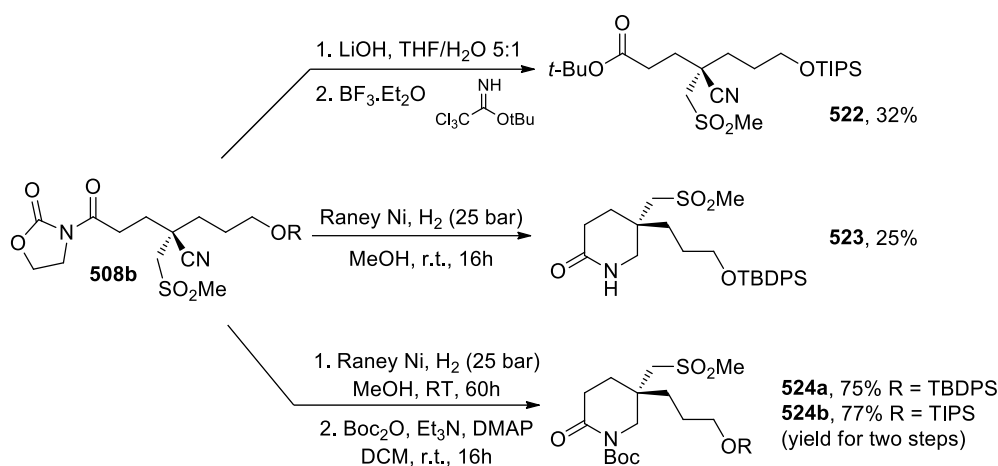
The RB reaction being compatible with ester<sup>248</sup>, Boc-protected amine<sup>249</sup> and other functional groups,<sup>250</sup> other precursors for the RB reaction were also tried. The *t*-Butyl ester **522**

<sup>248</sup> (a) Z. X. Guo, M. J. Schaeffer, R. J. K. Taylor, *J. Chem. Soc., Chem. Commun.* **1993**, 874-875; (b) L. J. Baird, M. S. M. Timmer, P. H. Teesdale-Spittle, J. E. Harvey, *J. Org. Chem.* **2009**, *74*, 2271-2277.

<sup>249</sup> N. Aguilar, A. Moyano, M. A. Pericas, A. Riera, *Tetrahedron Lett.* **1999**, *40*, 3917-3920.

<sup>250</sup> (a) S. P. Chavan, P. N. Chavan, R. G. Gonnade, *RSC Adv.* **2014**, *4*, 62281-62284; (b) K. C. Nicolaou, Y.-P. Sun, H. Korman, D. Sarlah, *Angew. Chem. Int. Ed.* **2010**, *49*, 5875-5878.

and the Boc-protected lactam **524** were synthesized in two steps from the oxazolidinone **508** (Scheme IV.59). Hydrolysis of the oxazolidinone, followed by esterification using *tert*-Butyl 2,2,2-trichloroacetimidate under acidic conditions provided the *tert*-butyl ester **522** in low yield. Hydrogenation of the nitrile furnished the lactam **523** in very low yield, which may be explained by the manipulation and purification of this very polar compound. When the crude hydrogenation reaction mixture was directly used in the Boc protection, Boc-protected lactams **524a** and **524b** were obtained in good overall yields in two steps.



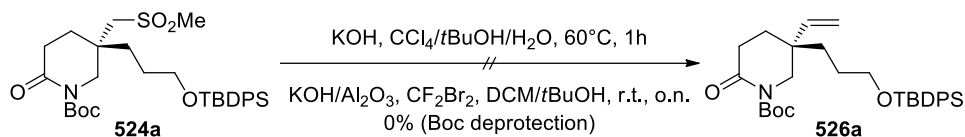
**Scheme IV.59.** Synthesis of precursors for the RB reaction.

The RB reaction was first tried on the *t*-Butyl ester **522** (Table IV.18), but results were disappointing. In order to avoid the hydrolysis of the *t*-Butyl ester, milled KOH was not used. Potassium *tert*-butoxide, in large excess, in combination with  $\text{CF}_2\text{Br}_2$  gave a complex mixture and only traces of the alkene product **525** were detected (entry 1). Only decomposition of the starting material was observed. With alumina-supported potassium hydroxide in the presence of  $\text{CF}_2\text{Br}_2$  or carbon tetrachloride, no conversion was observed (entry 2-3).

Entry	Base	Reagent	Solvent	Time (h)	$T$ ( $^{\circ}\text{C}$ )	Yield (%)
1 <sup>[a]</sup>	<i>t</i> -BuOK	$\text{CF}_2\text{Br}_2$	DCM	6	r.t.	traces
2	KOH/ $\text{Al}_2\text{O}_3$	$\text{CF}_2\text{Br}_2$	DCM/ <i>t</i> BuOH	60	r.t.	0
3	KOH/ $\text{Al}_2\text{O}_3$	-	$\text{CCl}_4$ / <i>t</i> BuOH	20	80	0

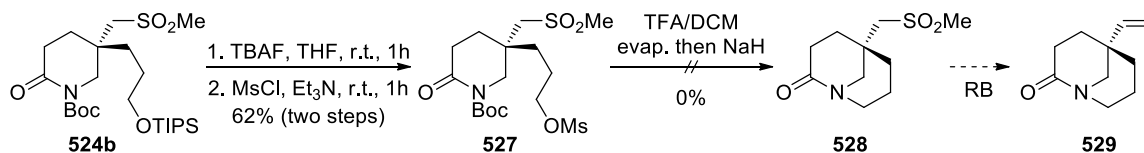
**Table IV.18.** Ramberg-Bäcklund reaction with a *tert*-butyl ester precursor ([a] 12 equiv. of *t*-BuOK and 20 equiv. of  $\text{CF}_2\text{Br}_2$  were used).

As already observed with model compound, the nitrile is not compatible with the RB reaction conditions. Even though the RB reaction was described with Boc-protected amine, the result on the Boc-protected lactam **524a** gave, as expected, only the Boc deprotection (Scheme IV.60).



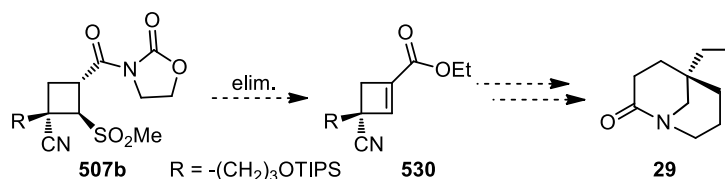
**Scheme IV.60.** Ramberg-Bäcklund reaction with a Boc-protected amide precursor

As a last strategy, we envisioned to perform the RB reaction, later in the synthesis, on the bicyclic lactam **528**. The latter should be less sensitive to basic conditions. The TIPS protecting group of **524b** was thus cleaved using TBAF, furnishing the free alcohol, which was directly converted into the mesylate **527** in satisfactory yield over two steps (Scheme IV.61). The addition of a third polar functional group (sulfonate) on the molecule renders the manipulation and purification even more tedious. The Boc was deprotected using TFA and after evaporation of the reaction mixture, the cyclization was tried several times using sodium hydride. Unfortunately, the bicyclic lactam **528** was not formed and the crude mixture included several unidentified side products.



**Scheme IV.61.** Strategy based on a late Ramberg-Bäcklund reaction.

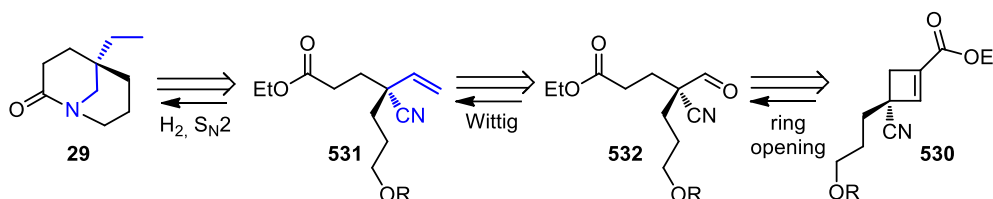
Considering the above results on the RB reaction, this strategy was not pursued. Furthermore, we learned that the manipulation of sulfone compounds is a major issue and is even worst for sulfone-containing lactams. The aqueous treatment and the subsequent purification provoke a considerable loss of material, although precautions are taken (neutralized silica gel). For these reasons, the development of a synthetic sequence from cyclobutene carboxylate **530** was preferred because the sulfone is directly removed after the sulfonyl-cyanation reaction (Scheme IV.62).



**Scheme IV.62.** Synthesis of bicyclic lactam **29** from a cyclobutene carboxylate.

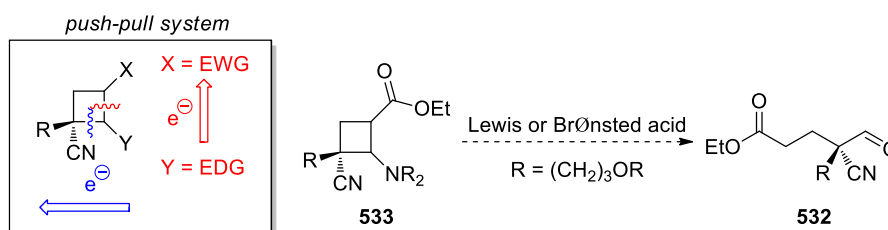
## 7. Approach to eucophylline through an aminocyclobutane

A third retrosynthesis was proposed, based on the preparation of optically pure cyclobutene carboxylate **530**, a potent building block for the enantioselective synthesis of eucophylline (Figure IV.10). The bicyclic lactam **29** would arise from the hydrogenation of the allylic cyanide **531**, followed by a nucleophilic substitution. The terminal alkene of **531** would result from a Wittig reaction from aldehyde **532**, itself formed through a ring-opening reaction on cyclobutene carboxylate **530**. The conjugated addition of a suitable amine to the cyclobutene carboxylate followed by activation of the push-pull system should lead to the corresponding aldehyde **532**.



**Figure IV.10.** Retrosynthesis based on a ring-opening reaction of cyclobutene carboxylate **530**.

The strategy relying on the activation of a donor-acceptor aminocyclobutane such as **533** is presented in Scheme IV.63. The activation of the ester functional group with a Lewis or a Brønsted acid should deliver the opened product **532** after hydrolysis of the formed iminium. As mentioned before for the strategy based on a push-pull system, the nitrile may behave as a second “pull” substituent and cause side reactions. The use of oxophilic acid should favour the ring-opening reaction for the vertical push-pull system. Even though this strategy was not previously examined through a model study, this approach was directly investigated for the total synthesis having large quantities of precursor.



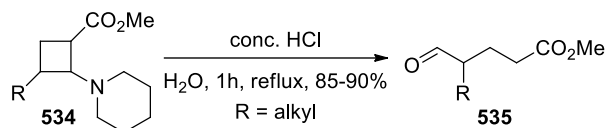
**Scheme IV.63.** Ring-opening reaction of an amino-cyclobutane under acid catalysis.

### 7.1. Reported ring-opening reactions of aminocyclobutanes

The ring-opening reactions of donor-acceptor aminocyclobutane have been less developed compared to the cyclopropane. The ring-opening cyclization of donor-acceptor cyclopropane was reviewed by France and later by Wang.<sup>211a,f</sup> Cyclization and annulation reactions of nitrogen-substituted cyclopropanes have been revised by the group of Waser.<sup>211b</sup>

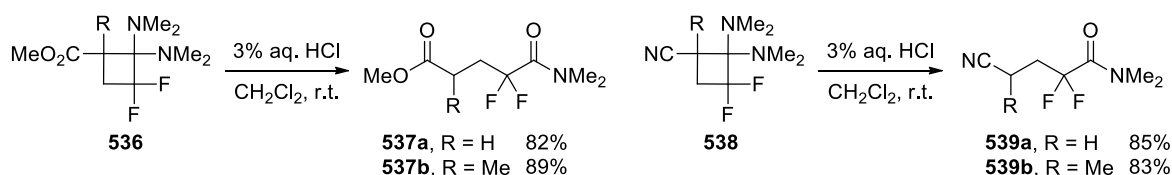


After a brief literature search, our strategy seemed viable. Indeed, a similar ring-opening reaction of aminocyclobutane **534** was already studied by Fleming and Ware in 1988 during their approach to the synthesis of Ebelactone A.<sup>251</sup> The opened product **535** was obtained in excellent yield under acidic conditions (Scheme IV.64).



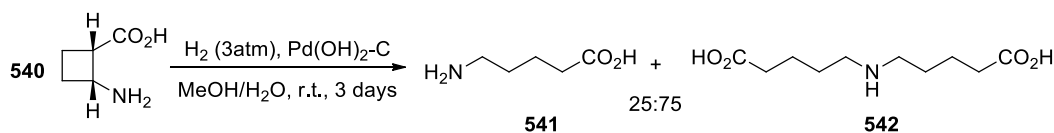
**Scheme IV.64.** Ring-opening reaction of aminocyclobutane under acidic conditions.<sup>251</sup>

Simple ring-opening reactions of aminocyclobutanes **536** and **538** under mild conditions was also described (Scheme IV.65).<sup>252</sup> Here the push-pull system is doubly activated by an aminal moiety, rendering these cyclobutanes extremely sensitive to moisture. Only 3% aqueous HCl was thus needed to obtain the acyclic compounds **537** and **539** as compared with the reflux condition of aminocyclobutane **535**.



**Scheme IV.65.** Ring-opening reaction of aminocyclobutane through hydrolysis.<sup>252</sup>

Aitken and co-workers studied the stability of the cyclobutane  $\beta$ -aminoacid skeleton. They observed that the constrained  $\beta$ -aminoacid **540** easily undergoes a ring opening reaction under hydrogenation conditions (Scheme IV.66).<sup>253</sup> The facile formation of these compounds was rationalized by the *in situ* generation of an iminium intermediate, which is then reduced into the corresponding amines **541** and **542** under hydrogenation conditions.



**Scheme IV.66.** Studies on the stability of cyclobutane  $\beta$ -aminoacids.<sup>253</sup>

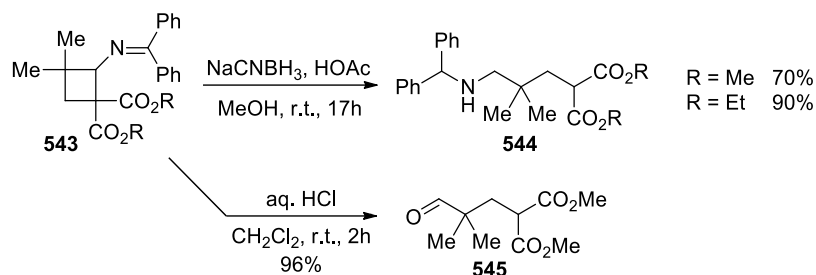
During their efforts to access new  $\beta$ -aminocyclobutane dicarboxylic acid derivatives, the group of Kimpe noticed that cyclobutane **543** is highly unstable under reductive or acidic

<sup>251</sup> A. C. Ware, Approaches to Carbons 6-14 of Ebelactone A, using silicon. **1988**, PhD Thesis, University of Cambridge.

<sup>252</sup> Y. Xu, W. R. Dolbier, Jr., *J. Org. Chem.* **1997**, 62, 6503-6506.

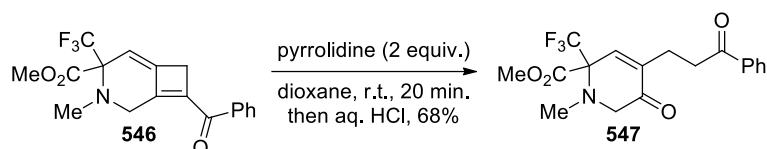
<sup>253</sup> D. J. Aitken, C. Gauzy, E. Pereira, *Tetrahedron Lett.* **2004**, 45, 2359-2361.

conditions leading to the corresponding opened product **544** or **545** (Scheme IV.67).<sup>254</sup> The presence of two geminal ester functions strongly activates the push-pull system.



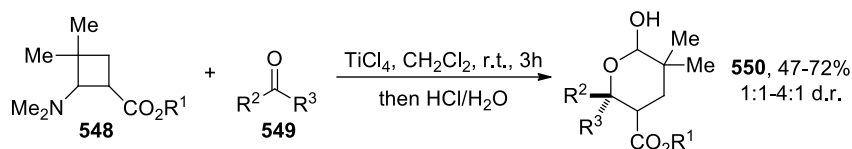
**Scheme IV.67.** High instability of aminocyclobutane bearing two geminal ester functions.<sup>254</sup>

Osipov and co-workers examined the properties of the bicyclo[4.2.0]octa-1,6-diene **546** and unexpectedly found that this structure undergoes, in a few minutes, a four-membered ring-opening reaction in the presence of a secondary amine, affording 1,5-diketone **547** (Scheme IV.68).<sup>255</sup> The DA aminocyclobutane formed *in situ* through 1,4-addition of the amine is responsible for this ring-opening reaction.



**Scheme IV.68.** Ring opening reaction of a bicyclo[4.2.0]octa-1,6-diene substrate in the presence of a secondary amine.<sup>255</sup>

Pioneering work on annulation reactions was accomplished by Saigo and co-workers who reported a [4+2] annulation reaction of 2-(dimethylamino)cyclobutanecarboxylic esters **548** with carbonyl compounds **549** (Scheme IV.69).<sup>256</sup> In the presence of titanium (IV) chloride, the DA aminocyclobutane **548** undergoes a ring-opening reaction with the carbonyl compound to give the lactol **550**.



**Scheme IV.69.** [4+2] annulation between aminocyclobutane and carbonyl compounds.<sup>256</sup>

In 2016, radical [4+2] annulations of aminocyclobutane under photoredox activation have also been reported by Zheng and co-workers (Scheme IV.70).<sup>257</sup> This work was an application of

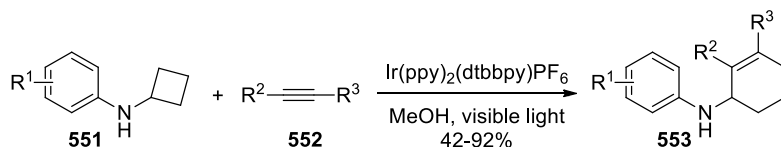
<sup>254</sup> T. Meiresonne, S. Mangelinckx, N. De Kimpe, *Org. Biomol. Chem.* **2011**, *9*, 7085-7091.

<sup>255</sup> A. K. Mailyan, A. S. Peregudov, P. H. Dixneuf, C. Bruneau, S. N. Osipov, *J. Org. Chem.* **2012**, *77*, 8518-8526.

<sup>256</sup> S. Shimada, K. Saigo, H. Nakamura, M. Hasegawa, *Chem. Lett.* **1991**, 1149-1152.

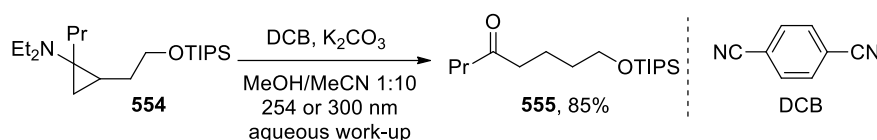
<sup>257</sup> S. A. Morris, J. Wang, N. Zheng, *Acc. Chem. Res.* **2016**, *49*, 1957-1968.

the photoredox catalysis previously developed on cyclopropylanilines. The oxidation of the amine into a radical cation induces a ring fragmentation of the cyclopropane or cyclobutane. Here, cyclobutylanilines **551** undergoes [4+2] annulations with alkynes to give the corresponding cyclohexene products **553**.



**Scheme IV.70.** Radical [4+2] annulation of aminocyclobutane under visible light.<sup>257</sup>

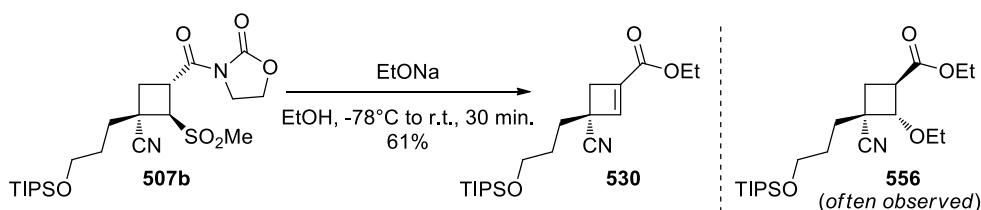
The radical ring fragmentation of aminocyclopropanes has been well studied. The ring-opening reaction of tertiary aminocyclopropane **554** through photooxidation was already reported in 1997 (Scheme IV.71).<sup>258</sup> Similar radical fragmentations have been described using ceric ammonium nitrate (CAN).<sup>259</sup>



**Scheme IV.71.** Radical ring fragmentation of aminocyclopropane.<sup>258</sup>

## 7.2. Synthesis of our aminocyclobutane precursor

The cyclobutene carboxylate **530** was obtained in a satisfactory yield through the sulfone elimination, using the conditions optimized for the model compound (Scheme IV.72). When the sulfone elimination was left for a longer period of time at room temperature, the cyclobutene carboxylate was isolated along with 22% of side product **556**. We considered this compound as a potential push-pull system (*vide infra*).

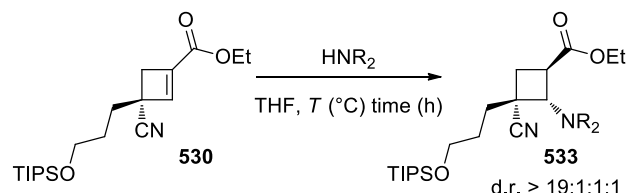


**Scheme IV.72.** Synthesis of cyclobutene carboxylate **530**.

<sup>258</sup> J. Lee, J. S. U, S. C. Blackstock, J. K. Cha, *J. Am. Chem. Soc.* **1997**, *119*, 10241-10242.

<sup>259</sup> Y. Takemoto, S. Yamagata, S.-i. Furuse, C. Iwata, *Chem. Comm.* **1998**, 651-652.

We thus envisioned the preparation of nitrogenated analogues of **556**, through a similar conjugate addition. Several amines were thus screened for the conjugated addition (Table IV.19). Pyrrolidine gave directly the *trans* aminocyclobutane **533** as the major diastereoisomer with excellent yield and excellent diastereoselectivity (entry 1). Cyclohexylamine gave a very low conversion (entry 2). Other amines such as aniline, hexamethyldisilazane (HMDS) or LiHMDS did not give any reaction (entry 3-5). The 1,4-addition of pyrrolidine being really efficient, the screening of amines was not continued.

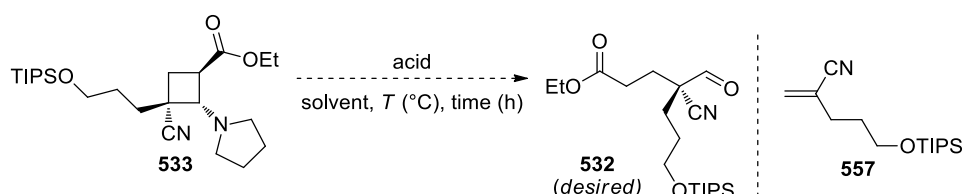


Entry	Amine	Equiv.	<i>T</i> (°C)	Time (h)	Yield (%)
1	pyrrolidine	4	reflux	3	91
2	cyclohexylamine	8	reflux	6	n.d. <sup>[a]</sup>
3	aniline	4	r.t.	16	n.r.
4	HMDS	2	reflux	16	n.r.
5	LiHMDS	1	-78 to r.t.	16	n.r.

**Table IV.19.** Synthesis of donor-acceptor aminocyclobutane through 1,4-addition of amines to cyclobutene carboxylate ([a] low conversion).

### 7.3. Attempts for the ring-opening reaction of aminocyclobutane

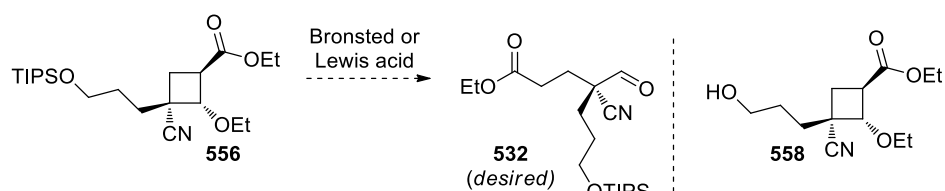
Having the donor-acceptor aminocyclobutane in hand, different acidic conditions were screened (Table IV.20). The behavior of aminocyclobutane **533** was first examined under Brønsted acid conditions and was found to be stable in a 1M aqueous solution of HCl. Using a 3M HCl solution at room temperature or at reflux, no ring-opening reaction was observed (entry 2-3). Only a partial deprotection of the TIPS was detected. However, the stirring of aminocyclobutane **533** in the presence of trifluoroacetic acid or acetic acid led to a complex mixture (entry 4-5). Some Lewis acids were then screened. Among the oxophilic Lewis acid, no reaction was observed with TMSCl, BF<sub>3</sub>.Et<sub>2</sub>O and MgBr<sub>2</sub> (entry 6-8), but full conversion was observed with trimethylsilyl trifluoromethanesulfonate (entry 9). The purification of this complex mixture did not allow the isolation of identified products. The use of transition metals such as Sc(OTf)<sub>3</sub> gave no reaction at room temperature (entry 10) but others such as TiCl<sub>4</sub>, Ca(OTf)<sub>2</sub> and In(OTf)<sub>3</sub> gave unsaturated nitrile **557** (entry 13-15). This product might result from a retro [2+2]-cycloaddition reaction. The yield of **557** with indium triflate was considerably high under reflux conditions (entry 13).



Entry	Acid	Solvent	<i>T</i> (°C)	Time (h)	Obs.
1	HCl 1M	-	r.t.	1	n.r.
2	HCl 3M	-	100	0.5	n.r.
3	HCl 3M	-	r.t.	2	n.r.
4	CF <sub>3</sub> CO <sub>2</sub> H	CH <sub>2</sub> Cl <sub>2</sub>	r.t.	2	compl. mix.
5	-	AcOH/H <sub>2</sub> O	100	1	compl. mix.
6	TMSCl	THF	r.t.	3	n.r.
7	BF <sub>3</sub> .Et <sub>2</sub> O	THF	r.t.	0.5	n.r.
8	MgBr <sub>2</sub> .Et <sub>2</sub> O	CH <sub>2</sub> Cl <sub>2</sub>	r.t.	60	n.r.
9	TMSOTf	THF	r.t.	1	compl. mix.
10	Sc(OTf) <sub>3</sub>	H <sub>2</sub> O	r.t.	24	n.r.
11	TiCl <sub>4</sub>	CH <sub>2</sub> Cl <sub>2</sub>	r.t.	1	<b>557</b>
12	Ca(OTf) <sub>2</sub>	EtOH	reflux	60	<b>557</b> (44%)
13	In(OTf) <sub>3</sub>	EtOH	reflux	60	<b>557</b> (76%)

**Table IV.20.** Screening of acids for the ring-opening reaction of amino-cyclobutane **533**.

Although the electron-donating character of an ether group is weaker than an amine, the ring-opening reaction was also tried with the oxycyclobutane **556** (Table IV.21). Strong Brønsted acids such as formic acid and *p*-toluenesulfonic acid gave only **558**, the TIPS being cleaved under these acidic conditions (entry 1-2) and no reaction was observed with Ca(OTf)<sub>2</sub> (entry 3).



Entry	Acid	Solvent	<i>T</i> (°C)	Time (h)	Product	Yield (%)
1	Formic acid	-	r.t.	4	<b>558</b>	n.d.
2	TsOH.H <sub>2</sub> O	EtOH	reflux	16	<b>558</b>	49
3	Ca(OTf) <sub>2</sub>	EtOH	reflux	48	-	n.r.

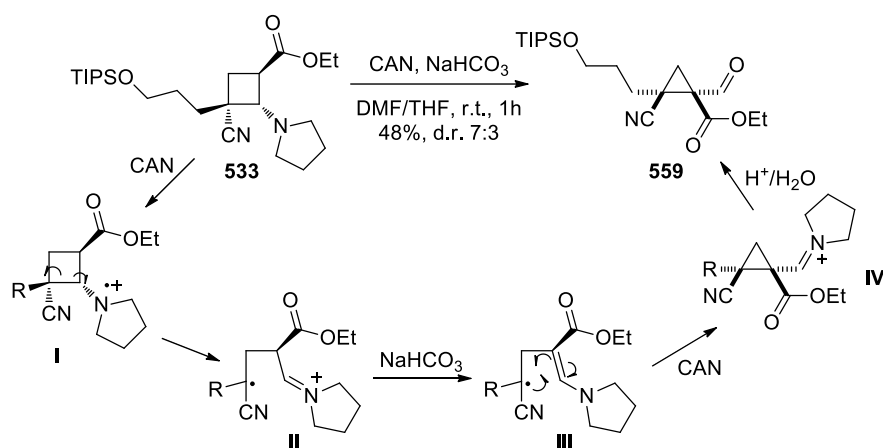
**Table IV.21.** Screening of some acids for the ring-opening reaction of oxycyclobutane.

Since the acid-catalyzed ring-opening reaction was unsuccessful, we envisioned a radical-mediated ring-opening reaction. Single electron oxidizing agent should oxidize the amine moiety into a radical cation, which would trigger the ring-opening process. Hydrolysis of the iminium should then provide the corresponding aldehyde. This strategy was first tested with ceric ammonium nitrate (CAN) and then with different photocatalysts, but the desired product was never obtained. The various conditions we have tested are reported in Table IV.22. To our surprise, when the aminocyclobutane **533** was treated with CAN in DMF, full conversion was observed after 1 hour and the crude <sup>1</sup>H NMR spectrum showed the presence of two diastereoisomers (entry 1). These products were identified after a full characterization by (1D and 2D) <sup>1</sup>H and <sup>13</sup>C NMR and correspond to cyclopropane **559**. The yield of **559** was increased to 48% when the reaction was carried out in a DMF/THF mixture (entry 2). The same reaction in EtOH or acetonitrile gave a complex mixture (entry 3-4). In order to activate the ester function and direct the radical fragmentation toward the desired product, calcium triflate was added in the reaction medium but the cyclopropane was still observed (entry 5). Then, various photocatalysts, known to oxidize amines into radical-cations, were screened. Dicyanobenzene and Ru(bpy)<sub>3</sub>Cl<sub>2</sub>·6H<sub>2</sub>O did not give any conversion (entry 6-7), but Ir[dF(CF<sub>3</sub>)ppy]<sub>2</sub>(dtbpy))PF<sub>6</sub> led to a clean formation of a product which was unstable on silica gel. The crude <sup>1</sup>H-NMR did not show the presence of an aldehyde and was composed of the starting material in majority and a non-identified product. The conversion of this reaction was always limited to 50% and the product was never identified from the complex crude <sup>1</sup>H-NMR.

Entry	Oxidant	hv	Additives	Solvent	Time (h)	Conv. (%)	Yield (%)
1	CAN	-	NaHCO <sub>3</sub>	DMF	1	100	25 ( <b>559</b> )
2	CAN	-	NaHCO <sub>3</sub>	DMF/THF	1	100	48 ( <b>559</b> )
3	CAN	-	K <sub>2</sub> CO <sub>3</sub>	EtOH	4	100	0
4	CAN	-	-	ACN	2	100	0
5	CAN	-	Ca(OTf) <sub>2</sub>	DMF/THF	1	n.d.	<b>559</b>
6	DCB <sup>[a]</sup>	UV-A	-	ACN/MeOH	16	0	-
7	Ru cat.	LED	-	ACN/H <sub>2</sub> O	24	0	-
8	Ir cat.	LED	-	ACN	20	50	0 <sup>[b]</sup>
9	Ir cat.	LED	-	ACN/H <sub>2</sub> O	20	50	0 <sup>[b]</sup>
10	Ir cat.	LED	Ca(OTf) <sub>2</sub>	ACN	60	50	0 <sup>[b]</sup>

**Table IV.22.** Screening of oxidants for the radical-mediated ring-opening reaction ([a] at 40°C, [b] degradation on column, Ir cat. = (Ir[dF(CF<sub>3</sub>)ppy]<sub>2</sub>(dtbpy))PF<sub>6</sub>, DCB = dicyanobenzene, Ru cat. = Ru(bpy)<sub>3</sub>Cl<sub>2</sub>·6H<sub>2</sub>O, LED = blue).

The formation of cyclopropane **559** may be rationalized invoking a radical ring contraction, in which the undesired C-C bond is broken. A mechanism is proposed in Scheme IV.73. Oxidation of the aminocyclobutane **533** by CAN results in the formation of a radical cation **I**. The latter undergoes a radical ring-opening reaction leading to a stabilized radical **II**  $\alpha$ - to the nitrile. The deprotonation  $\alpha$  to the ester provides an enamine intermediate **III**, which reacts intramolecularly with the electrophilic radical. The formed cyclopropane ring is further oxidized by CAN to give an iminium **IV** which is hydrolysed to afford the final product **559**. This radical fragmentation/ring-contraction sequence is favoured by the electron-withdrawing character of the nitrile located on a quaternary center, and thus leading to a tertiary radical species.



**Scheme IV.73.** Proposed mechanism for the ring contraction of the aminocyclobutane.

Since the presence of the nitrile on the cyclobutane impedes the desired ring-opening reaction, it would be interesting to test this reaction after the reduction of the nitrile and the protection of the corresponding amine. This could however not be performed due to a lack of time.

## 8. Conclusions

In this chapter, radical additions to a new optically pure cyclobutene ring has been investigated. This strained olefin was synthesized on gram scale through a new desulfurization of cyclobutenyl sulfides prepared using the Narasaka asymmetric [2+2] cycloaddition.<sup>222</sup> This cyclobutene ring was found to be weakly reactive towards electrophilic radical species. The addition of sulfonyl radicals to cyclobutene gave the corresponding cyclobutyl radical which was efficiently trapped by the sulfonyl cyanide, furnishing a functionalized cyclobutane ring with good yields and excellent diastereoselectivities. This sulfonyl-cyanation reaction was thus ideal to incorporate the nitrile in a fully enantio- and diastereocontrolled manner.

Further studies on the elaboration of the cyclobutane ring were not so straightforward due to the presence of the nitrile. Although our attempts to open the cyclobutane ring using a push-pull system strategy were not successful, an efficient radical fragmentation promoted by  $\text{SmI}_2$  was developed leading to an enantioenriched nitrile, bearing a functionalised all-carbon quaternary stereocenter. Among the advantages of this ring-opening reaction, no substrate modifications are needed after the sulfonyl-cyanation reaction. The formation of an alkyl sulfone is however the major drawback of this reaction. All our efforts to remove the sulfone moiety after the ring-opening reaction remained unsuccessful.



Concerning the total synthesis of eucophylline, the conversion of the methylsulfone into a terminal alkene, through a Ramberg-Bäcklund reaction, gave the desired product but the low efficiency of this process did not allow us to pursue the synthesis using this route. The total synthesis of eucophylline from an enantioenriched cyclobutene carboxylate was preferred because the sulfone moiety is rapidly eliminated in this case, thus avoiding the manipulation of very polar compound. Although the total synthesis has not yet been accomplished, the ring-opening reaction of cyclobutene carboxylate is still under examination in our laboratories.

## Chapter V

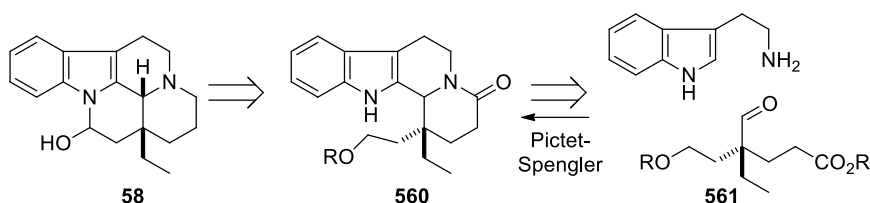
Efforts towards the total synthesis of  
(+/-) eburnamine



## Chapter V : Efforts towards the total synthesis of (+/-) eburnamine

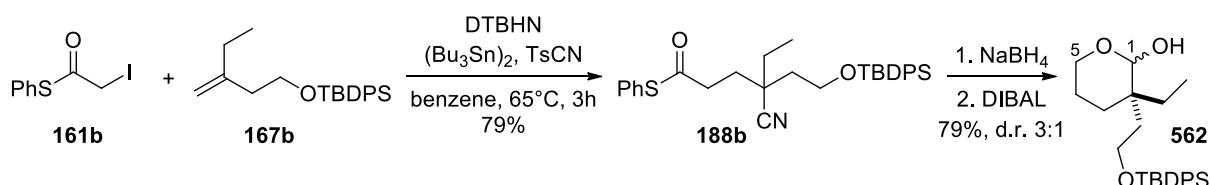
### 1. Previous studies on the racemic total synthesis of eburnamine

The racemic total synthesis of eburnamine has already been studied by a former PhD student.<sup>260</sup> The initial retrosynthesis was based on a Pictet-Spengler approach using aldehyde **561** (Figure V.1). Under acidic conditions, the condensation of tryptamine with aldehyde **561** should form **560**, the tetracyclic core of eburnamine. Unfortunately, the Pictet-Spengler reaction with aldehyde **561** did not give any conversion in the presence of acetic or trifluoroacetic acid.



**Figure V.1.** Retrosynthesis of eburnamine through a Pictet-Spengler approach.

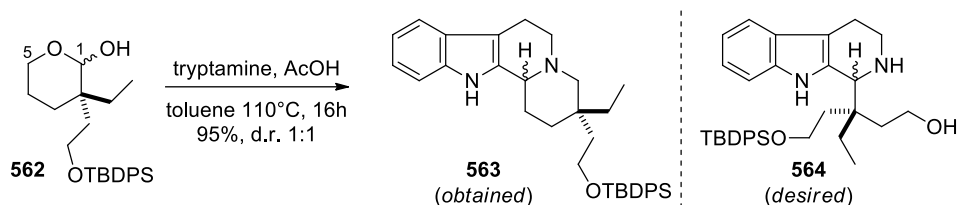
The Pictet-Spengler reaction was then tried on a different substrate. The lactol **562**, acting as a masked aldehyde, was synthesized in three steps (Scheme V.1). The tin-mediated carbonylation reaction furnished the desired nitrile **188b** in good yield from thioester **161b**. Then, reduction of the latter into an alcohol, followed by reduction of the nitrile, gave the lactol in 79% yield over two steps.



**Scheme V.1.** Synthesis of lactol **562**.<sup>260</sup>

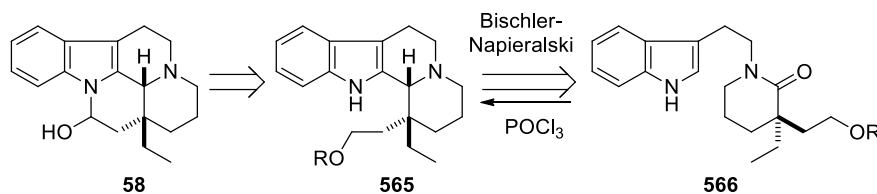
The lactol **562** was first treated with tryptamine under acidic conditions in dichloromethane at room temperature, but the Pictet-Spengler product **564** was not observed. Surprisingly, under reflux conditions, the unexpected tetracyclic core **563** was obtained instead, with an excellent yield (Scheme V.2). X-ray diffraction analysis of a crystalline sample of **563** revealed that, the position of the quaternary stereocenter had shifted. Indeed, the Pictet-Spengler reaction occurred at the C-5 position instead of C-1. Two possible pathways may explain the formation of this unexpected compound. A route involving an azomethine ylide intermediate or an intramolecular hydride transfer, both being consistent and supported by DFT calculations, was proposed.<sup>260</sup>

<sup>260</sup> H. Hassan, *Total synthesis of eucophylline, a free-radical approach towards total synthesis of cytotoxic leucophyllidine* (doctoral dissertation), University of Bordeaux, **2016**.



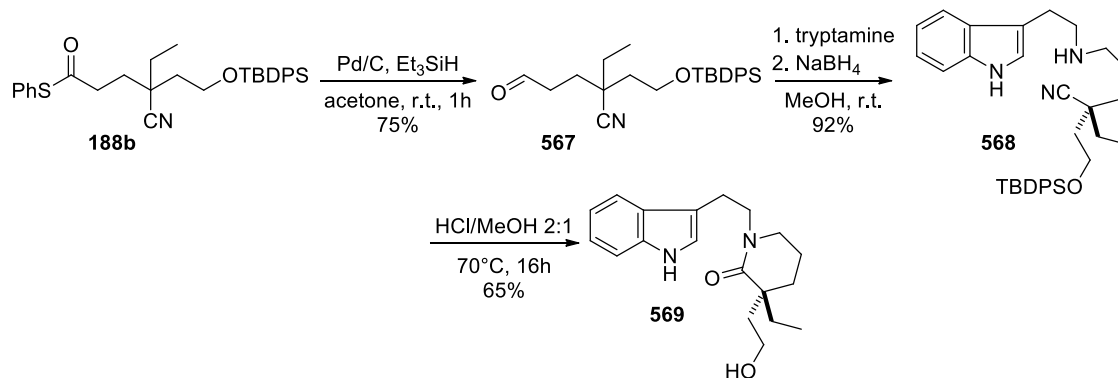
**Scheme V.2.** Synthesis of the eburnan fragment through a Pictet-Spengler approach.<sup>260</sup>

Thus, another retrosynthesis was proposed relying on a Bischler-Napieralski reaction often used for the synthesis of this family of alkaloids (Figure V.2). The treatment of lactam **566** with phosphoryl chloride should lead to the formation of the tetracyclic core of eburnamine **565**.



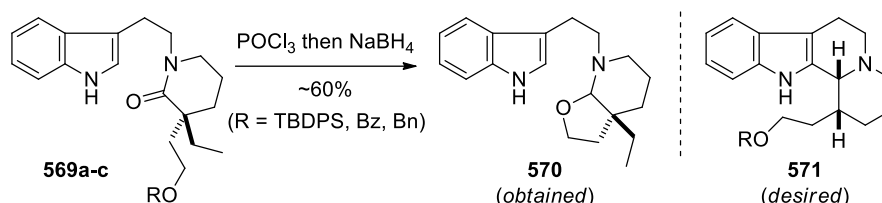
**Figure V.2.** Retrosynthesis of eburnamine through a Bischler-Napieralski approach.

The thioester **188b** was reduced selectively through the Fukuyama reduction and the resulting aldehyde **567** engaged in a reductive amination, furnishing the amino-nitrile **568** in excellent yield (Scheme V.3). Harsh acidic conditions provided the desired lactam **569**. These conditions also cleaved the silyl ether protecting group.



**Scheme V.3.** Synthesis of the lactam precursor.<sup>260</sup>

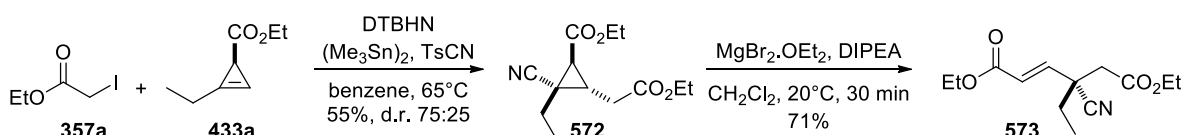
With lactam **569** in hand, the Bischler-Napieralski reaction was then tried with different protected alcohols (**569a-c**) but the hemi-aminal **570** was always obtained as the major product (Scheme V.4). Under highly acidic conditions, as in POCl<sub>3</sub>-mediated cyclizations, any protecting groups were cleaved, releasing the free alcohol. The *in situ* formed chloro-iminium is then directly trapped by the alcohol.



**Scheme V.4.** Application of Bischler-Napieralski conditions to lactam **569**.<sup>260</sup>

## 2. Previous studies on the enantioselective synthesis of eburnamine

As mentioned in Chapter I, the enantioselective synthesis of eburnan was proposed from a chiral cyclopropene. The application of the carbo-cyanation reaction on chiral cyclopropenes would install the nitrile with a good stereocontrol and a suitable ring-opening reaction would form the desired quaternary stereocenter with good enantiopurity. Before starting the enantioselective total synthesis of eburnamine, this methodology was developed on model substrates by a post-doctoral associate.<sup>261</sup> As an example, the Scheme V.5 illustrates this methodology using the adequate cyclopropene for the enantioselective total synthesis of eburnamine. The tin-mediated carbo-cyanation of cyclopropane **433a** occurred in presence of bis(trimethyltin) and tosyl cyanide with moderate yield and diastereoselectivity. Activation of ester **572** with magnesium bromide, followed by deprotonation of the acidic proton provided the opened product **573** in good yield. This diastereoselective two-steps sequence gives access to an acyclic substrate possessing all the required functionalities for the synthesis of eburnan.



**Scheme V.5.** Development of a diastereoselective carbo-cyanation of cyclopropene.<sup>261</sup>

## 3. Proposed retrosynthesis of eburnamine

Based on these studies, the enantioselective synthesis of eburnamine was proposed starting from a carbo-cyanation of cyclopropene **100** and a Bischler-Napieralski reaction. The retrosynthesis is depicted on Figure V.3. In order to study the transformation of aminonitrile **96** into lactam **72**, the racemic synthesis was first investigated. The disubstituted olefin **93a** was

<sup>261</sup> N. S. Dange, F. Robert, Y. Landais, *Org. Lett.* **2016**, *18*, 6156-6159.

selected as a starting building block by analogy to cyclopropene **100**, but also because this approach would directly provide the lactam **72**, already used in a Bischler-Napieralski reaction by Schlessinger.<sup>25</sup> Our route to eburnamine would thus constitute a formal synthesis of eburnamone.

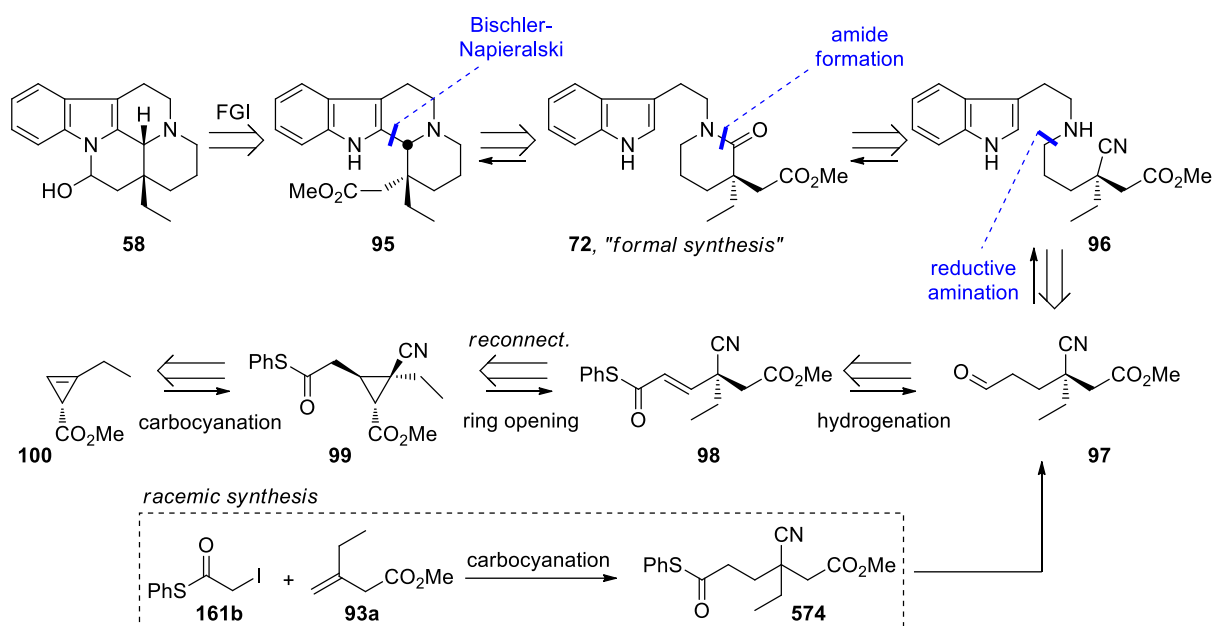
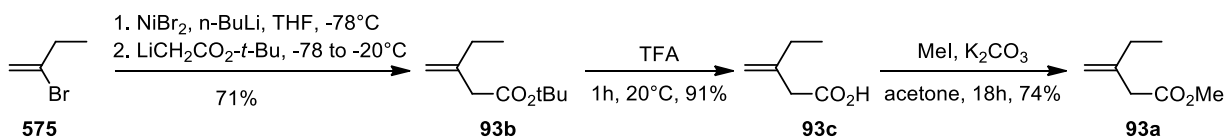


Figure V.3. Retrosynthesis of eburnamine from cyclopropene **100**.

#### 4. Synthesis of alkene **93a**

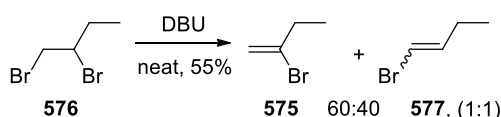
The synthesis of olefin **93a** was described in three steps from the vinyl bromide **575** through a nickel-catalyzed coupling of a lithium enolate (Scheme V.6).<sup>262</sup> The hydrolysis of the *tert*-butyl ester **93b** followed by an esterification provided the methyl ester **93a** in good yields.



Scheme V.6. Reported synthesis of alkene.<sup>262</sup>

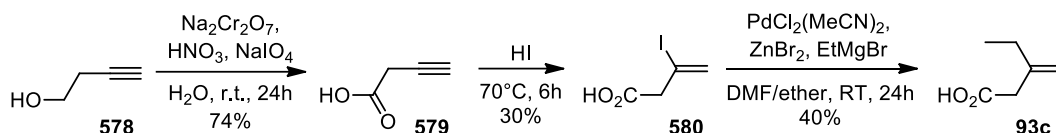
Although this synthesis is relatively short, the vinyl bromide precursor **575** is not commercially available. Its synthesis was described through the elimination of 1,2-dibromobutane **576**. However, this elimination, using DBU as a base, led to a mixture of two inseparable regioisomers (Scheme V.7) and we were not able to repeat the above synthesis using the mixture of vinyl bromides **575** and **577**.

<sup>262</sup> S. G. Alcock, J. E. Baldwin, R. Bohlmann, L. M. Harwood, J. I. Seeman, *J. Org. Chem.* **1985**, *50*, 3526-3535.



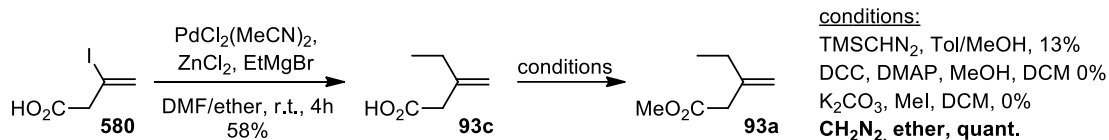
**Scheme V.7.** Elimination of 1,2-dibromobutane.<sup>262</sup>

Another synthetic plan was then envisioned. The synthesis of the corresponding acid **93c** was also reported through a palladium-catalyzed cross-coupling of 3-iodobut-3-enoic acid **580** with organometallic reagents.<sup>263</sup> The vinyl iodide **580** was synthesized in two steps from 3-butyn-1-ol **578** (Scheme V.8). First, the gram-scale oxidation of 3-butyn-1-ol furnished the carboxylic acid **579**.<sup>264</sup> After hydroiodation of the latter, the desired vinyl iodide **580** was obtained in low yield, in contrast with that claimed in the paper, which might result from a tedious purification of this compound through crystallization. Application of the cross-coupling conditions provided the desired olefin **93c** in low yield (40%). It is noteworthy that no conversion was observed when this reaction was repeated on 8 grams.



**Scheme V.8.** Synthesis of the acid **93c** from reported literature procedure.<sup>263,264</sup>

By using  $\text{ZnCl}_2$  (1M in  $\text{Et}_2\text{O}$ ) instead of zinc bromide, the yield of the cross-coupling process increased up to 58% (39% on 24 mmol, Scheme V.9). Esterification of the acid with TMS-diazomethane, standard esterification methods or iodomethane were unsuccessful, due to the volatility of the product. Esterification was thus performed using diazomethane, synthesized from *N*-methyl-*N*-nitrosourea (see experimental part), using conditions that do not require a work-up or the use of high boiling point solvents. With this method, quantitative yield of methyl ester **93a** was obtained.



**Scheme V.9.** Synthesis of the starting alkene.

<sup>263</sup> M. Abarbri, J.-L. Parrain, M. Kitamura, R. Noyori, A. Duchene, *J. Org. Chem.* **2000**, *65*, 7475-7478.

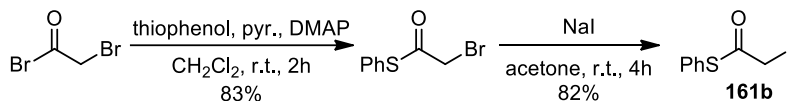
<sup>264</sup> A. Abbas, B. Xing, T.-P. Loh, *Angew. Chem. Int. Ed.* **2014**, *53*, 7491-7494.



## 5. Efforts towards the total synthesis of racemic eburnamine

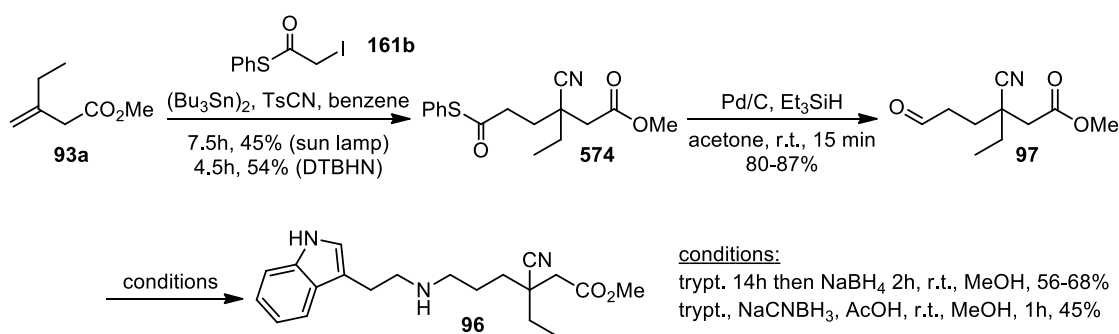
### 5.1. Synthesis of the aminonitrile precursor

With the alkene in hand, the radical precursor for the carbo-cyanation reaction was prepared from standard procedures (Scheme V.10).<sup>265</sup>



**Scheme V.10.** Synthesis of the radical precursor.<sup>265</sup>

The aminonitrile **96** was prepared in three steps (Scheme V.11). The three-components carbo-cyanation was applied to the disubstituted olefins **93a** to give the nitrile product **574** with a maximum yield of 54%. Both initiation with DTBHN or irradiation with sunlamp can be used. The reduction of the thioester using the Fukuyama conditions gave the desired aldehyde **97**, which was coupled with tryptamine through a reductive amination to give **96** in moderate to good yields.



**Scheme V.11.** Synthesis of the aminonitrile precursor.

### 5.2. Reported activation of nitriles towards nucleophilic additions

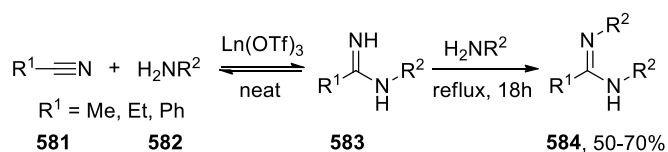
Unactivated nitriles and especially nitriles on quaternary center are often weakly reactive towards nucleophilic additions. They are usually activated by strong acids but the harsh acidic conditions are not always compatible with most functional groups. The activation of nitriles with transition metals is an alternative. Organonitriles can be activated by coordination of a metal center and undergo a wide range of reactions.<sup>266</sup> For instance, the reduction of nitriles has been described

<sup>265</sup> N. Truong, S. J. Sauer, C. Seraphin-Hatcher, D. M. Coltart, *Org. Biomol. Chem.* **2016**, *14*, 7864-7868.

<sup>266</sup> V. Y. Kukushkin, A. J. L. Pombeiro, *Chem. Rev.* **2002**, *102*, 1771-1802.

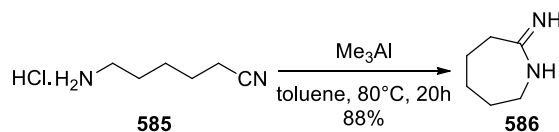
with sodium borohydride or hydrogen in the presence of cobalt or nickel.<sup>267</sup> Transition metal-catalyzed hydrations using copper<sup>268</sup> or palladium<sup>269</sup> have also been reported. The following paragraph discusses the important amidation and reductive amination reactions through the activation of nitriles with metal salts.

The activation of nitriles with lanthanides was shown by Forsberg and co-workers in the reaction of amines **582** with nitriles **581**.<sup>270</sup> Thus, various anhydrous lanthanide(III) trifluoromethanesulfonates (1-10 mol%) catalyzed the reaction of amines with nitriles to give *N,N'*-disubstituted amidines **584** (Scheme V.12). An ytterbium amide complex was used more recently for the synthesis of *N*-Arylamidines.<sup>271</sup>



**Scheme V.12.** Activation of nitrile with lanthanides.<sup>270</sup>

The direct conversion of nitriles into amidines was also described by Garigipati using alkylchloroaluminum amides (generated from trimethylaluminum and ammonium chloride).<sup>272</sup> The treatment of amine hydrochloride such as **585** with trimethylaluminium furnished the 7-membered cyclic amidine **586** (Scheme V.13).



**Scheme V.13.** Synthesis of cyclic amidine using alkylchloroaluminum amides.<sup>272</sup>

Amidines **589** were also synthesized through a copper(I)-induced addition of amines to unactivated nitriles **587** (Scheme V.14).<sup>273</sup> However, most of these examples used acetonitrile as solvent and stoichiometric amount of copper is needed.

<sup>267</sup> (a) S. W. Heinzman, B. Ganem, *J. Am. Chem. Soc.* **1982**, *104*, 6801-6802; (b) S. Caddick, D. B. Judd, A. K. d. K. Lewis, M. T. Reich, M. R. V. Williams, *Tetrahedron* **2003**, *59*, 5417-5423; (c) M. G. Banwell, M. T. Jones, T. A. Reekie, B. D. Schwartz, S. H. Tan, L. V. White, *Org. Biomol. Chem.* **2014**, *12*, 7433-7444.

<sup>268</sup> Z. Li, L. Wang, X. Zhou, *Adv. Synth. Catal.* **2012**, *354*, 584-588.

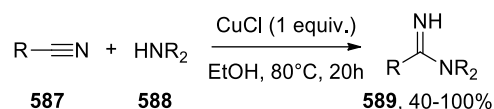
<sup>269</sup> S. Zhang, H. Xu, C. Lou, A. M. Senan, Z. Chen, G. Yin, *Eur. J. Org. Chem.* **2017**, *2017*, 1870-1875.

<sup>270</sup> J. H. Forsberg, V. T. Spaziano, T. M. Balasubramanian, G. K. Liu, S. A. Kinsley, C. A. Duckworth, J. J. Poteruca, P. S. Brown, J. L. Miller, *J. Org. Chem.* **1987**, *52*, 1017-1021.

<sup>271</sup> J. Wang, F. Xu, T. Cai, Q. Shen, *Org. Lett.* **2008**, *10*, 445-448.

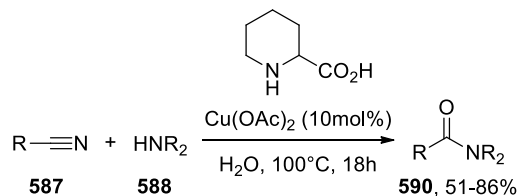
<sup>272</sup> R. S. Garigipati, *Tetrahedron Lett.* **1990**, *31*, 1969-1972.

<sup>273</sup> G. Rousselet, P. Capdevielle, M. Maumy, *Tetrahedron Lett.* **1993**, *34*, 6395-6398.



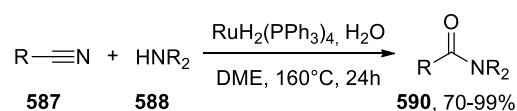
**Scheme V.14.** Copper-induced addition of amines to unactivated nitriles.<sup>273</sup>

Similarly, the synthesis of amides **590** was also accomplished through the activation of nitriles by using catalytic amounts of copper salt in water at high temperature (Scheme V.15).<sup>274</sup> Again, most of the example are benzylic nitriles, acetonitrile and aromatic nitriles.



**Scheme V.15.** Preparation of amides by copper-catalyzed reaction between amines and nitriles.<sup>274</sup>

An efficient condensation of nitriles with amines was developed by Murahashi and co-workers using a ruthenium catalyst in the presence of two equivalents of water (Scheme V.16).<sup>275</sup> This reaction is compatible with alkyl nitriles and intramolecular versions have been used for the synthesis of piperidinones. This ruthenium catalyst was also used for the hydration of nitriles and condensation of nitriles with alcohols.<sup>276</sup> Other platinum complexes were also shown to be able to catalyze amidation reactions of unactivated nitriles.<sup>277</sup>



**Scheme V.16.** Ruthenium-catalyzed amidation of nitriles with amines.<sup>275</sup>

Some organoboron compounds were described to activate nitriles. The boron-catalyzed silylative reduction of alkyl nitrile to primary amines **592** has been developed by Chang and co-workers (Scheme V.17).<sup>278</sup> Using tris(pentafluorophenyl)borane and diethylsilane, nitriles were converted into primary amines after hydrolysis. The *tert*-butyl nitrile was also reduced in excellent yield. Interestingly, when the bulkier triethylsilane was used, the *N*-silylimines **593** were formed in high yields but were not stable on silica gel.

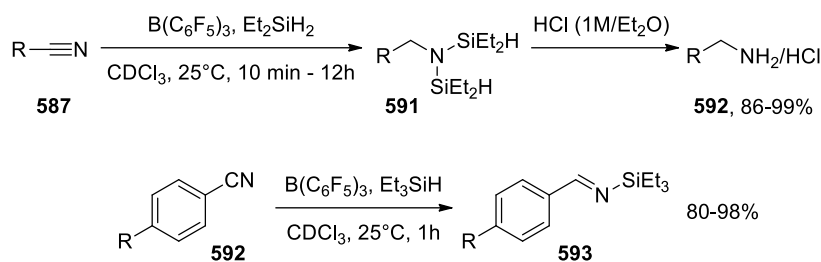
<sup>274</sup> X. Li, Z. Li, H. Deng, X. Zhou, *Tetrahedron Lett.* **2013**, *54*, 2212-2216.

<sup>275</sup> S. Murahashi, T. Naota, E. Saito, *J. Am. Chem. Soc.* **1986**, *108*, 7846-7847.

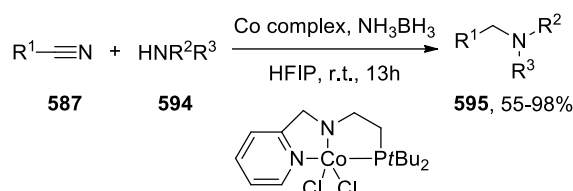
<sup>276</sup> S.-I. Murahashi, T. Naota, *Bull. Chem. Soc. Jpn.* **1996**, *69*, 1805-1824.

<sup>277</sup> C. J. Copley, M. Van den Heuvel, A. Abbadi, J. G. De Vries, *Tetrahedron Lett.* **2000**, *41*, 2467-2470.

<sup>278</sup> N. Gandhamsetty, J. Jeong, J. Park, S. Park, S. Chang, *J. Org. Chem.* **2015**, *80*, 7281-7287.

Scheme V.17. Boron-catalyzed silylative reduction of nitriles.<sup>278</sup>

Recently, the synthesis of amines through a cobalt-catalyzed transfer hydrogenation of nitriles was developed by Liu and Zhou.<sup>279</sup> This reaction uses a well-defined cobalt catalyst and ammonia borane as the hydrogen source. This cobalt catalyst was also found to be reactive towards alkyl nitriles and a cobalt-catalyzed reductive amination of nitriles **587** was developed providing unsymmetrical secondary amines **595** (Scheme V.18).

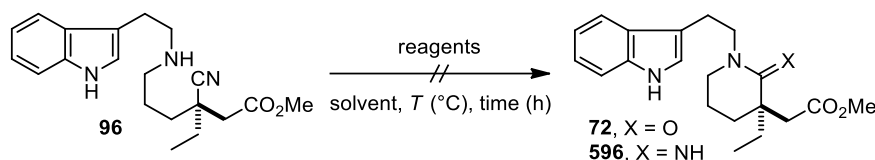
Scheme V.18. Cobalt-catalyzed reductive amination of nitriles.<sup>279</sup>

### 5.3. Attempt at cyclizing aminonitrile precursor

Based on the literature survey described above, several conditions were tried for the cyclization of aminonitrile **96** into the corresponding amidine **596** or amide **72** (Table V.1). First, treatment of aminonitrile **96** with sodium methoxide under reflux conditions led to no reaction (entry 1). These conditions were however used for the conversion of a pre-organized aminonitrile into amidine by Lounasmaa in the total synthesis of (+/-) deethyleburnamone.<sup>280</sup> In contrast, using harsh acidic conditions, a complex mixture was obtained (entry 2). Other conditions involving copper salts were tried but were also unsuccessful (entry 3-4). Platinum salts such as  $\text{PtCl}_2$  was tested, but the amidine formation was not observed (entry 5). The application of the ruthenium-catalyzed amidation of Murahashi to our substrate **96** was unsuccessful, leading to a complex mixture (entry 6).

<sup>279</sup> Z. Shao, S. Fu, M. Wei, S. Zhou, Q. Liu, *Angew. Chem. Int. Ed.* **2016**, *55*, 14653-14657.

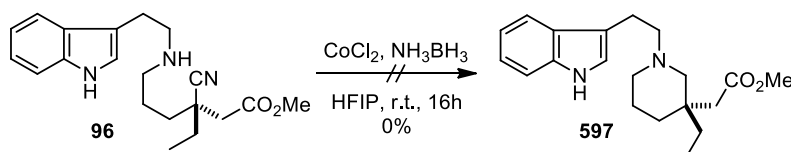
<sup>280</sup> M. Lounasmaa, D. D. Belle, A. Tolvanen, *Heterocycles* **1999**, *51*, 1125-1130.



Entry	Reagent	Additives	Solvent	$T$ ( $^\circ\text{C}$ )	Time (h)	Yield (%)	Obsv.
1	NaOMe	-	MeOH	65	16	0	n.r.
2	HCl	-	MeOH	65	20	0	compl. mix.
3	Cu(OAc) <sub>2</sub>	Proline	H <sub>2</sub> O	100	16	0	n.r.
4	CuBr	-	EtOH	80	16	0	n.r.
5	PtCl <sub>2</sub>	-	DCM	r.t.	16	0	n.r.
6	[PPh <sub>3</sub> ] <sub>4</sub> RuH <sub>2</sub>	H <sub>2</sub> O	DME	160	72	0	compl. mix.

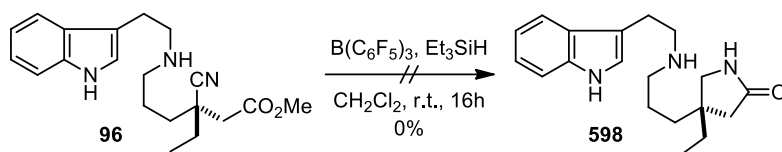
**Table V.1.** Screening of conditions for the cyclisation of **96**.

To test the reactivity of nitrile **96** towards reductive amination, the cobalt-catalyzed reductive amination described above was attempted with cobalt(II) chloride as a catalyst (Scheme V.19). Again, no conversion was observed.



**Scheme V.19.** Application of the cobalt-catalyzed reductive amination according to Zhou.<sup>279</sup>

The boron-catalyzed silylative reduction of alkyl nitriles to primary amines was also tested on our substrate **96** but failed (Scheme V.20).

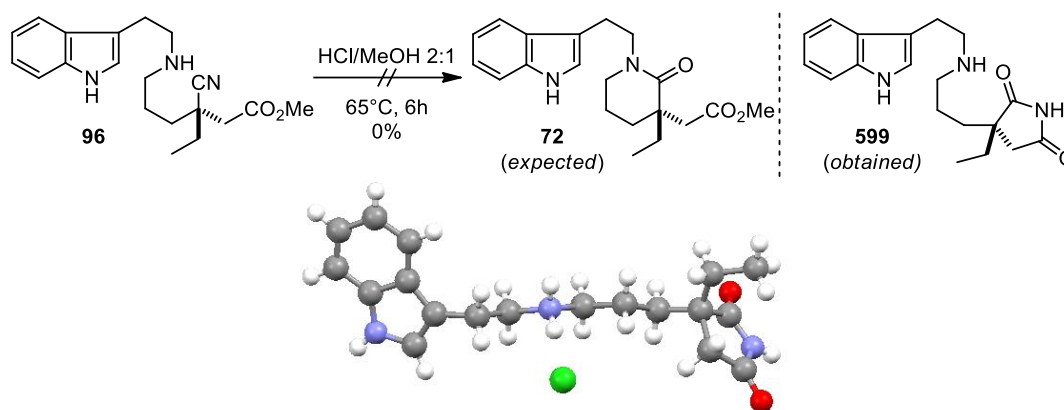


**Scheme V.20.** Application of the boron-catalyzed silylative reduction according to Chang.<sup>278</sup>

All these experiments suggest that the nitrile on a quaternary stereocenter is weakly reactive towards nucleophilic addition. The absence of conversion using transition metals might result from the steric hindrance caused by the presence of a quaternary center  $\alpha$ - to the nitrile.

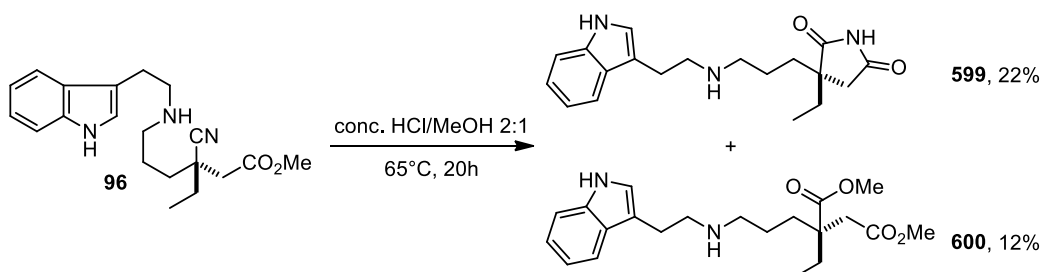
## 5.4. Amidation of aminonitrile precursor using harsh acidic conditions

Although the acid-mediated cyclization (HCl/MeOH) did not give the expected lactam (Scheme V.21), we observed that most of the organic material was lost during the aqueous work-up of the reaction. Evaporation of water and extraction of the solid residue furnished a crude product which was purified. From this purification, a major compound was isolated and was finally identified as succinimide **599** through X-ray diffraction studies and mass spectrometry. The succinimide **599** results from the hydrolysis of the nitrile into an amide followed by cyclization with the ester.



**Scheme V.21.** Attempted amidation of **96** using harsh acidic conditions and X-ray crystal structure of succinimide.

The same reaction was repeated on a larger scale and for a longer reaction time (Scheme V.22). Succinimide **599** was isolated with another minor compound which was identified as the diester **600**. This suggests that the hydrolysis of the nitrile to amide occurred first, leading directly to the formation of the succinimide. Longer reaction times favor the formation of the diester **600**. It is hypothesized that prolonged heating of aminonitrile **96** should lead to the desired lactam. Due to time restriction, we were not able to test this hypothesis.



**Scheme V.22.** Attempted amidation of **96** using harsh acidic conditions for a longer reaction time.

## **6. Conclusions**

Even though racemic total synthesis of eburnamine was not the main objective of this thesis, an advanced aminonitrile intermediate has been synthesized in a limited number of steps using the three-components carbo-cyanation process as a key step. The intramolecular addition of the amine onto the nitrile was expected to afford a lactam, known to be an intermediate in the synthesis of eburnamonine. All our attempts to activate the nitrile with transition metals to promote this reaction were unsuccessful. These disappointing results were rationalized by the steric hindrance close to the electrophilic position. Encouraging results were however obtained using harsh acidic conditions. Once appropriate conditions will be found for the lactam formation, the enantioselective synthesis of eburnamine will be developed using the carbo-cyanation of cyclopropenes.

## **Conclusions and Perspectives**





# Conclusions and Perspectives

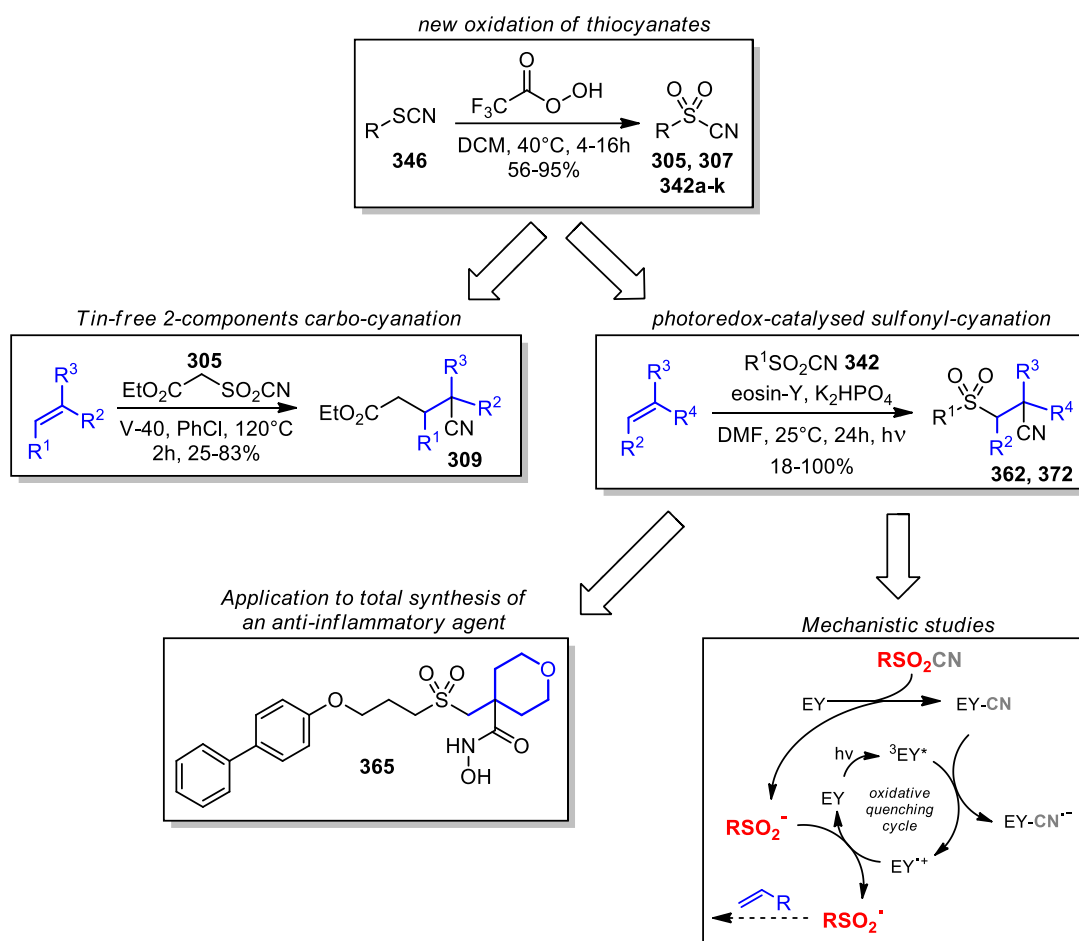
## 1. Conclusions

The first part of this thesis was devoted to the development of tin-free radical methodologies aiming at introducing a nitrile onto an olefin backbone. For this purpose, alkylsulfonyl cyanides were used and have shown an excellent radical trapping ability. These cyanating agents were prepared through a new thiocyanate oxidation, which circumvent traditional methods, consisting in the alkylation of sulfinates using the highly toxic cyanogen chloride. Figure VI.1 presents a summary of the developed methodologies using these alkylsulfonyl cyanides.

The behavior of  $\beta$ -ester sulfonyl cyanide **305**, which acts both as a radical trap and as a source of alkyl radicals, was suitable for the development of a desulfonylative carbo-cyanation avoiding the use of tin mediators. This tin-free two-components reaction occurs in the presence of 1,1'-Azobis(cyanocyclohexane) as an initiator under reflux conditions. Along this transformation, two carbon-carbon bonds are formed introducing a nitrile and an ester function regioselectively on an unsaturated carbon chain. Nitriles **309** are obtained in generally good yields and various functional groups are compatible. It is worth mentioning that nitrile-functionalized all-carbon quaternary centers are produced when disubstituted olefins are used.

The photoredox activation of sulfonyl-cyanides was also investigated. Although the development of a photoredox-catalyzed carbo-cyanation was complicated, the easier sulfonyl-cyanation reaction was studied in depth. This reaction was shown to occur in the presence of the organic dye eosin-Y under visible light irradiation. Compared to the previous studies on the sulfonyl-cyanation reaction,<sup>185</sup> our procedure uses *alkylsulfonyl cyanides* **342** under very mild conditions producing  $\beta$ -sulfonyl nitriles **362** and **372** in excellent yields. The reaction scope is very broad regarding the olefins as well as the sulfonyl-cyanides. Furthermore, the utility of this process was demonstrated by the synthesis of a bioactive sulfone in a limited number of steps.

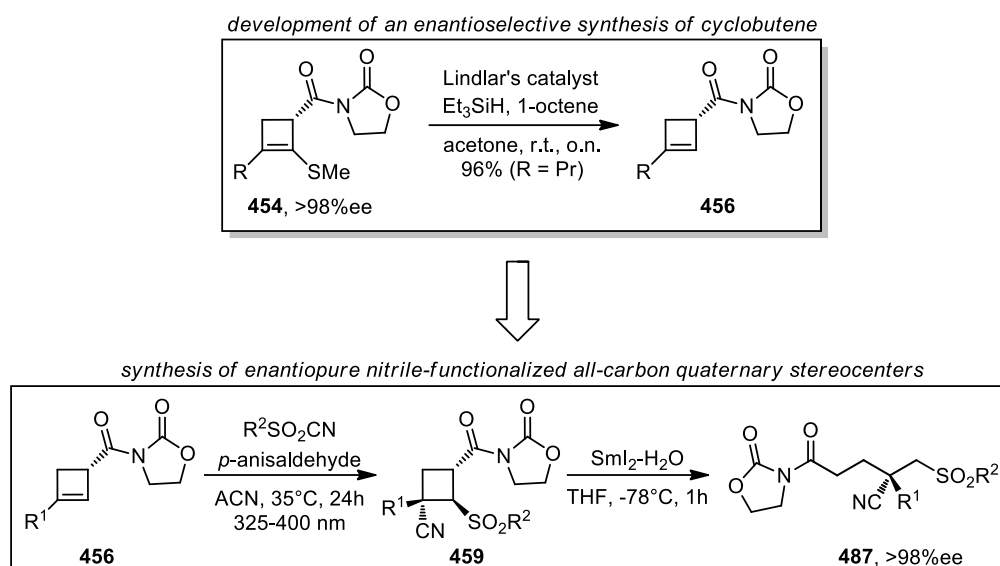
An important study was also conducted regarding the photocatalytic cycle of this reaction. The mechanism was shown to occur *via* a photoinduced electron transfer to a cyanate derivative of eosin-Y, formed *in situ* in the presence of sulfonyl cyanides. This PET event leads to the radical cation of eosin-Y, which oxidizes a sulfinate anion into a sulfonyl radical regenerating the ground-state photocatalyst. This mechanism circumvents the thermodynamically unfavoured direct PET from the triplet excited state of eosin-Y to alkylsulfonyl cyanides. These studies finally provide a new pathway in reactions using eosin-Y as a photocatalyst, invoking its temporary conversion into a redox-active species.



**Figure VI.1.** Summary of the methodologies developed with sulfonyl cyanides.

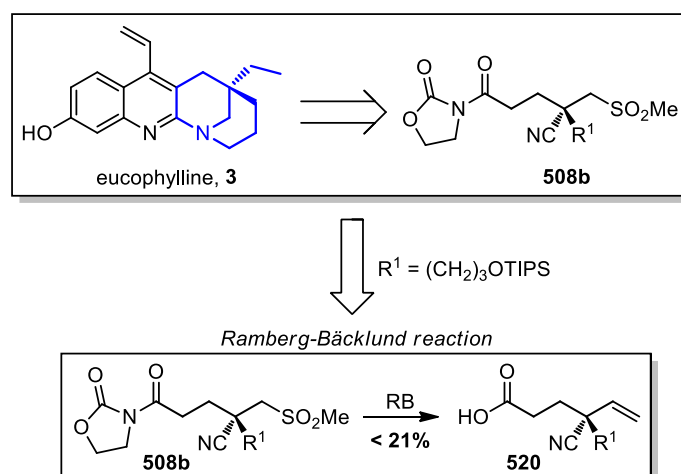
In order to introduce a nitrile onto an unsaturated carbon chain in a stereocontrolled manner, we started to investigate the radical additions on a chiral cyclobutene motif. These strained olefins are known to be poorly reactive towards radical species and few methods describe their enantioselective preparation. Thus, the stereoselective incorporation of a nitrile onto the cyclobutene ring was very challenging. Inspired by the research work of Narasaka,<sup>222</sup> a very efficient enantioselective synthesis of cyclobutenes was first developed. The desired cyclobutene **456** was produced in gram scale and with almost quantitative yields through a desulfurization process (Figure VI.2).

The eosin-mediated sulfonyl-cyanation reaction was successfully applied to this cyclobutene ring furnishing a functionalized cyclobutane **459** with excellent diastereoselectivities. During our investigations on cyclobutenes, we also found that *p*-anisaldehyde and benzophenone were very efficient photocatalysts to promote the sulfonyl-cyanation with better yields than eosin-Y. Ring-opening reaction of the cyclobutane through SmI<sub>2</sub>-promoted radical fragmentation furnished the opened product **487** directly after the sulfonyl-cyanation. This short two-step sequence can be seen as an enantioselective version of the sulfonyl-cyanation of olefins since an optically pure β-sulfonyl nitrile is produced.



**Figure VI.2.** Application of the sulfonyl-cyanation to chiral cyclobutenes.

During our study on the enantioselective total synthesis of eucophylline (the south fragment of leucophyllidine), we proposed to use the previously developed synthetic sequence and to convert methylsulfone **508b** into a terminal olefin through a Ramberg-Bäcklund reaction (Figure VI.3). This would give an ideal precursor for the total synthesis of eucophylline. Although the desired product **520** was obtained, the very low yield of this transformation did not allow us to pursue the total synthesis using this route.



**Figure VI.3.** Efforts towards the enantioselective synthesis of eucophylline through a Ramberg-Bäcklund reaction.

The total synthesis of eucophylline from an enantioenriched cyclobutene carboxylate was preferred because the sulfone moiety is rapidly eliminated in this case, thus avoiding the manipulation of very polar compounds (Figure VI.4). Different ring-opening reactions were envisioned from cyclobutene carboxylate **530**. First, an interesting donor-acceptor amino-cyclobutane **533** was synthesized by the conjugate addition of pyrrolidine to the cyclobutene

carboxylate. Activation of this push-pull system by Brønsted or Lewis acid would lead to a ring opening reaction. Unfortunately, our attempts to open the cyclobutane in the direction of the ester all failed under acidic conditions. Interestingly, when the CAN-mediated radical fragmentation was tried, a ring-contraction was observed leading to diastereomeric cyclopropanes **559**. The difficulties to achieve the desired ring-opening reaction were rationalized by the presence of the nitrile on the cyclobutane ring, initiating a second ring-opening reaction.

Finally, encouraging results were obtained during our attempt to open the cyclobutene carboxylate through an ozonolysis reaction. The obtained  $\alpha$ -ketoester-aldehyde **475** being unstable, we are currently looking for appropriate conditions to functionalize it further.

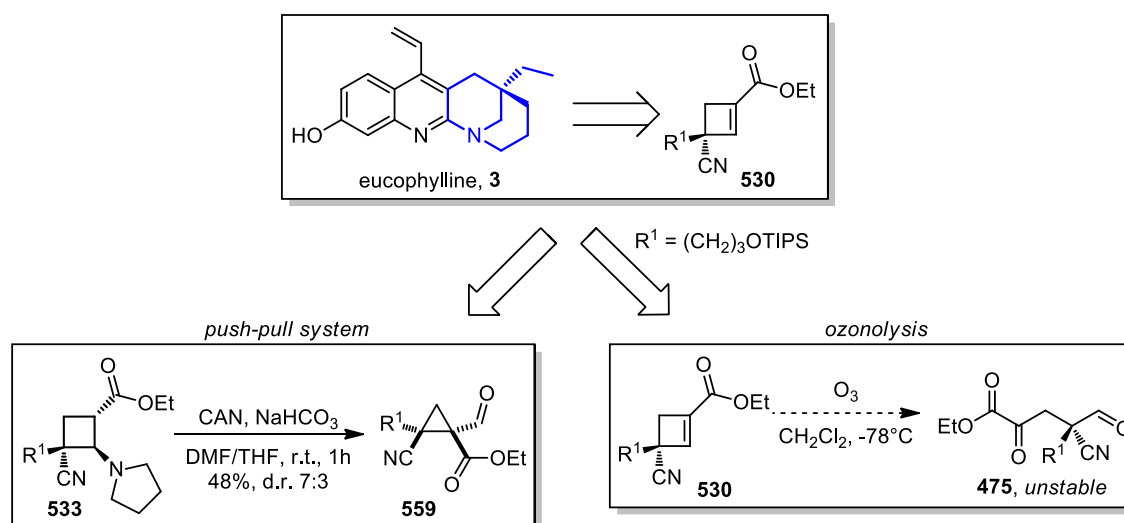
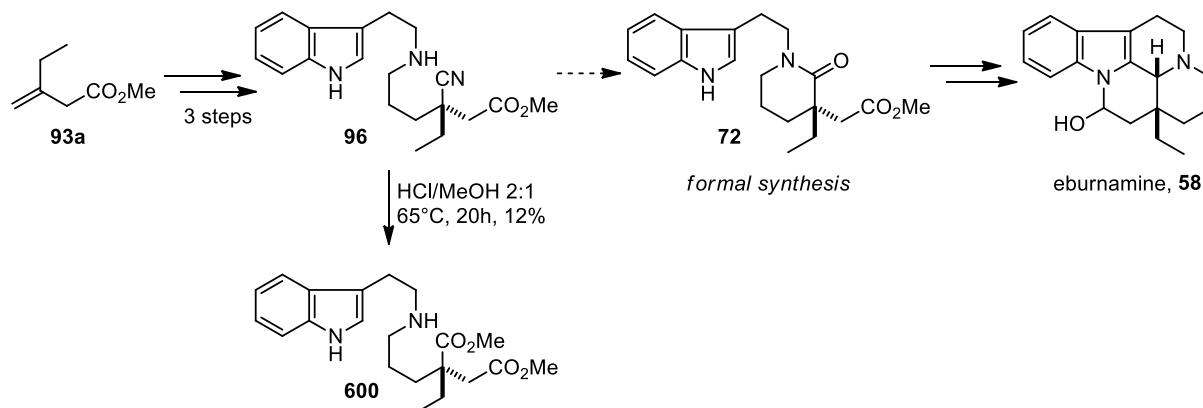


Figure VI.4. Ring opening reaction from cyclobutene carboxylate.

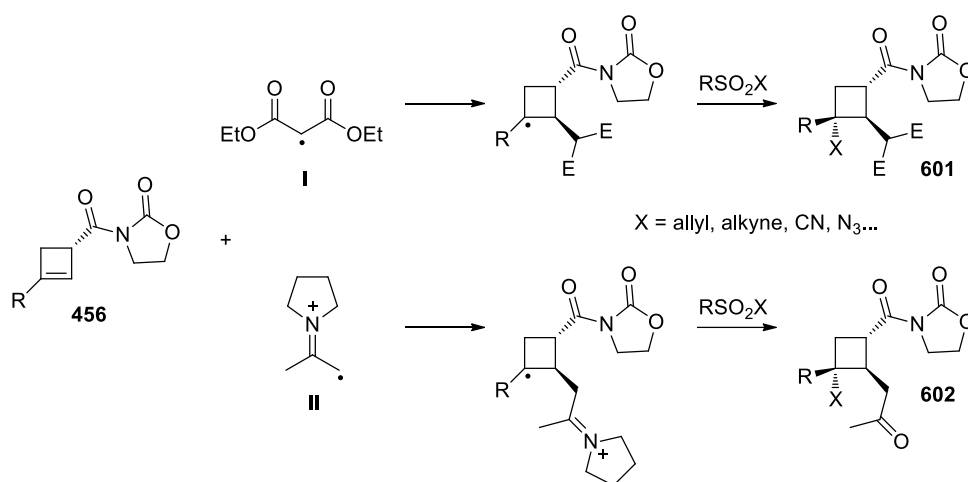
Concerning the racemic synthesis of the eburnan fragment of leucophyllidine, an advanced intermediate was prepared using the tin-mediated carbo-cyanation as a key step (Scheme VI.1). The amino-nitrile **96** was prepared in three steps from the disubstituted olefin **93a**. Cyclization of this amino-nitrile to lactam **72** still remains unsuccessful at the moment but interesting results were obtained using harsh acidic conditions. The difficulties encountered to realize this cyclization might result from the steric hindrance of the quaternary center  $\alpha$ - to the nitrile.



Scheme VI.1. Efforts towards the racemic total synthesis of eburnamine.

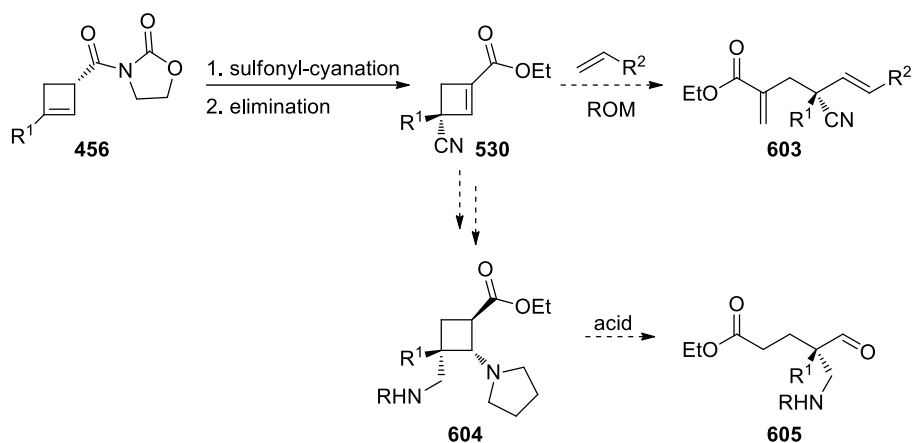
## 2. Perspectives

Having developed a robust method for the enantioselective synthesis of new cyclobutene motifs, it opens new perspectives regarding the radical functionalization of these strained olefins. In order to develop a carbo-functionalization of cyclobutene, a malonyl radical **I** or a radical cation from enamine **II** could be electrophilic enough to counterbalance the low reactivity of the cyclobutene ring **456** (Scheme VI.2). The reaction of the cyclobutyl radical with carbon radical traps would lead to a new functionalized cyclobutene such as **601** or **602**, which could then be opened through the SmI<sub>2</sub>-promoted radical fragmentation. This two steps procedure would give an enantioselective access to a variety of substrates having functionalized all-carbon quaternary stereocenter.



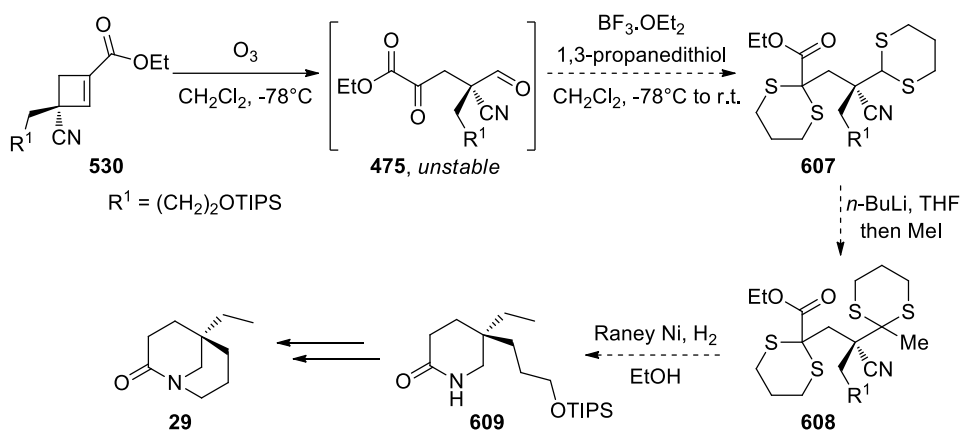
**Scheme VI.2.** Envisioned electrophilic radicals for a carbo-functionalization of cyclobutenes.

The optically pure cyclobutene carboxylate **530** is also a valuable precursor for the total synthesis of alkaloids and it would be interesting to study the chemistry behind this new entity (Scheme VI.3). It is moreover readily available through a two-steps sequence from cyclobutene. In addition to the ozonolysis reaction, other ring-opening reactions should be further examined such as the metathesis reaction. The ring-opening reaction of a donor-acceptor amino-cyclobutane **604** possessing a protected amine should also be investigated.



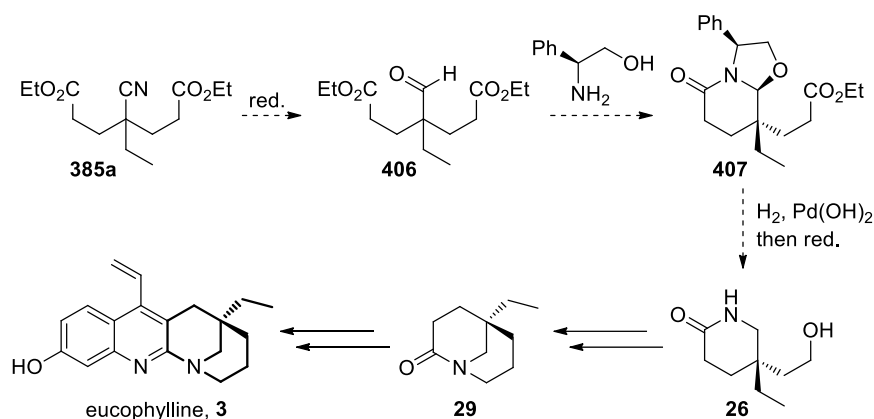
**Scheme VI.3.** Further examination of the ring-opening reaction of cyclobutene carboxylate **530**.

In order to complete the enantioselective total synthesis of eucophylline from the cyclobutene carboxylate **530**, an adequate ring-opening reaction is still required. However, encouraging results were obtained through an ozonolysis reaction producing the  $\beta$ -keto ester **475** which is unfortunately unstable on silica gel. Appropriate conditions are currently examined to convert the aldehyde and the  $\beta$ -keto ester of **475** into 1,3-dithianes in one-pot operation. These functional group transformations would be particularly well-suited for the elaboration of the bicyclic lactam **29** as depicted in Scheme VI.4.



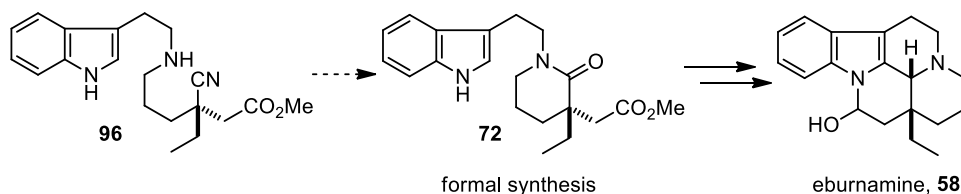
**Scheme VI.4.** Enantioselective synthesis of eucophylline through ozonolysis of cyclobutene carboxylate **530**.

The desymmetrization of prochiral diester compounds, accessible through free-radical carbo-cyanation, is still an alternative approach for the enantioselective synthesis of eucophylline (Scheme VI.5). As mentioned in chapter IV, the Amat's conditions should be further analyzed.<sup>197</sup> Even though the chemoselective reduction of the hindered nitrile **385a** might be difficult, the cyclodehydration of the prochiral aldehyde **406** using (*S*)-phenylglycinol as a chiral auxiliary would lead to an optically pure lactam **26** after the removal of the chiral auxiliary. The bicyclic lactam **29** would then be attained in a straightforward manner.



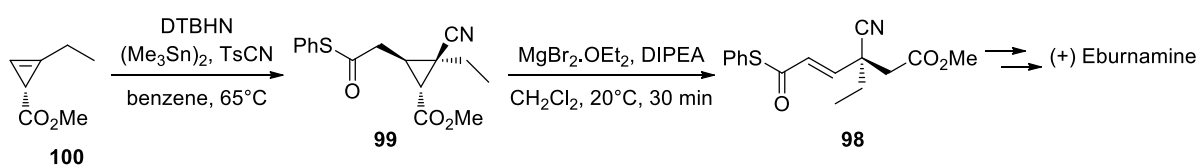
**Scheme VI.5.** Enantioselective synthesis of eucophylline through a desymmetrization strategy.

For the racemic synthesis of eburnamine, adequate conditions are still required for the cyclization of the amino-nitrile **96** into the desired lactam **72** which is a common precursor for the synthesis of eburnamonine (Scheme VI.6).



**Scheme VI.6.** Racemic synthesis of eburnamine.

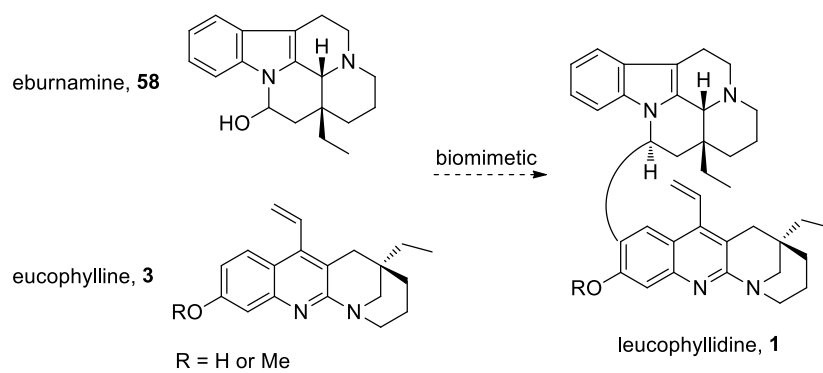
Once the racemic synthesis will be established for the eburnan fragment, the carbocyanation of cyclopropene **100** will be applied to the total synthesis of (+)-eburnamine (Scheme VI.6).



**Scheme VI.7.** Enantioselective synthesis of eburnamine through the carbocyanation of cyclopropene.

Finally, after the elaboration of eucophylline **3** and eburnamine **58**, the union of these two fragments will provide leucophyllidine **1** (Scheme VI.8). Although a Mannich-type coupling was proposed for this dimerization, the preliminary studies of Pandey and co-workers did not provide the correct regioisomer under acidic condition.<sup>19</sup> This suggests that a more complex mechanism is operating and that some efforts are still required to understand the mechanism of this dimerization.





**Scheme VI.8.** Synthesis of leucophyllidine through a biomimetic coupling.

# **Experimental Part**



# Experimental Part

## 1. General informations

Reactions needing an inert atmosphere were carried out under argon. The solvents were dried over activated alumina columns on MBRAUN Solvent Purification System (SPS-800) unless otherwise noted. Ethanol was distilled and dried over molecular sieves (3A). For DMF, typical anhydrous dimethylformamide was purchased from chemical suppliers (Aldrich or Acros Organics). The calculated experimental yields refer to chromatographically and spectroscopically (<sup>1</sup>H-NMR) homogeneous materials unless otherwise stated. All reagent-grade chemicals were obtained from commercial suppliers and were used as received unless otherwise stated. Photochemical reactions were performed with commercial LEDs (7W, 12V, 500 mA), sunlamp (OSRAM ULTRA-VITALUX, E27/ES, 300W) and a RPR-200 Photochemical Reactor (Model RPR-200, 110/227 volts, 50/60 Hz, operating temp 35-40°C) with UV-A light (RPR3000A Black Light Blue, 8W, 12 inches and tube fluorescent Lumiere Noire 8w/08 BLB 370nm). <sup>1</sup>H NMR and <sup>13</sup>C NMR were recorded at room temperature on various spectrometers: a Bruker Avance 300 (<sup>1</sup>H: 300 MHz, <sup>13</sup>C: 75 MHz) and a Bruker Avance 600 (<sup>1</sup>H: 600 MHz, <sup>13</sup>C: 150 MHz) using CDCl<sub>3</sub> as internal reference unless otherwise indicated. The chemical shifts ( $\delta$ ) and coupling constants ( $J$ ) are expressed in ppm and Hz respectively. The following abbreviations were used to explain the multiplicities: br = broad, s = singlet, d = doublet, t = triplet, td = triplet of doublet, q = quartet, dd = doublet of doublet, ddd = doublet of doublet of doublet, m = multiplet, quint = quintuplet, hex = sextuplet, hept = heptuplet. Compounds were described as mixtures when it was not possible, in our hands, to separate both compounds. FT-IR spectra were recorded on a Perkin-Elmer Spectrum 100 using a KBr disc or pellet. The mass spectrometric measurements were performed at the CESAMO technical center in the Institute of Molecular Sciences (ISM) or at the CRMPO platform of Rennes University (for RSO<sub>2</sub>CN). High-resolution mass spectra (HRMS) were recorded with a Waters Q-TOF 2 spectrometer in the electrospray ionization (ESI) mode unless otherwise noted. Melting points were not corrected and determined by using a Stuart Scientific SMP3 apparatus. Analytical thin layer chromatography was performed using silica gel 60 F254 pre-coated plates (Merck) with visualization by ultraviolet light, potassium permanganate or vanillin. Flash chromatography was performed on silica gel (0.043-0.063 mm) with ethyl acetate (EtOAc) and cyclohexane as eluents unless otherwise indicated. The enantiomeric excess measurements were performed on a Jasco LC-NetII/ADC HPLC using a CHIRALPAK IA column (4.6 mm $\Phi$  x 250 mmL, particle size 5 $\mu$ m).

The X-Ray structure analysis measurements were run at the CESAMO technical center or at the IECB (Institut Européen de Chimie et Biologie). X-ray analyses were carried out<sup>281</sup> on a FR-X Rigaku diffractometer with rotating anode and monochromatic Cu-K $\alpha$  radiation ( $\lambda$ = 1.54184 Å) and a Dectris Pilatus 200K detector for compound pivi837. Other X-ray analyses were carried out on a Rigaku R-axis MM007 instrument with a Cu rotating anode ( $\lambda$ = 1.54187 Å) and an image plate as detector for compound liro075. Data reduction was performed with CrysAlisPro<sup>282</sup> or CrystalClear<sup>1</sup>, respectively. The structures were solved by direct methods and refined using Shelx

<sup>281</sup> Crystal Clear Software, Version 2.1 43b (2013), Rigaku-MS Corporation, Tokyo, Japan.

<sup>282</sup> CrysAlis PRO Software, Version 171.38.43 (2015). Rigaku Oxford Diffraction, Yarnton, England.

2014 suite of programs<sup>283</sup> in the integrated WinGX system.<sup>284</sup> The positions of the H atoms were deduced from coordinates of the non-H atoms and confirmed by Fourier synthesis. The non-H atoms were refined with anisotropic temperature parameters. H atoms were included for structure factor calculations but not refined. The program Mercury<sup>285</sup> was used for analysis and drawing figures.

UV–vis absorption spectra were measured on a Cary 100 Scan UV–vis spectrophotometer (Varian, USA), using quartz cuvette (3.500  $\mu$ L, 10 mm light path, Hellma 110-QS) in the 300–600 nm spectral range, in steps of 1 nm.

The reduction potentials of alkyl(or aryl)sulfonyl cyanide derivatives and methylated eosin (EY-Me) were determined by using cyclic voltammetry. The corresponding experiments were conducted on a  $\mu$ AUTOLAB TYPE II potentiostat/galvanostat coupled to the General Purpose Electrochemical Systems (GPES, v.4.9 software; Serial No: AUT72173) (Eco Chemie BV, Utrecht, The Netherlands). The voltammograms were recorded in a Faraday cage and at a temperature of  $25\pm 0.5$  °C. Reaction set-up was degassed using highly pure nitrogen gas bubbling for at least 15 min and the nitrogen atmosphere was kept over the solution during the measurement. The working electrode (WE) was a glassy carbon electrode ( $\phi$ : 2 mm<sup>2</sup>), the counter electrode (CE) was a platinum wire, and a silver wire was used as the pseudo-reference electrode (pseudo-RE). Prior to each measurement, the GCE was polished over the micro cloth PSA (2, 7/8", PN:40-7212, Buehler) with 0.3  $\mu$ m alumina particles on a polishing machine (Metaserv 2000, Buehler). After polishing, the electrode was thoroughly rinsed with UHQ water and ethanol in an ultrasonic bath, respectively. The voltammograms were obtained with a scan rate of 100 mV/s (unless otherwise stated) by using freshly prepared 0.1 M TBAPF<sub>6</sub>/DMF solution.

The time-resolved absorption experiments were done in aerated solutions using a pump – probe setup at right angle excitation equipped with a frequency - doubled Nd-YAG laser (BMI, 532 nm, 8 ns pulses, 34 mJ/pulse) as an excitation source. An intensified CCD (Andor Technologies Instaspec V) was used to collect spectral information at specific delay times.

Photoreaction quantum yields were determined upon excitation at 546 nm on an optical bench equipped with a 150 W Hg-Xe lamp and a monochromator. Samples were sparged with Ar and stirred throughout the irradiation. The incident light intensity was determined using an energy meter (Thor Labs PM100A) equipped with a S170C detector calibrated over the 350 – 1100 nm range. The results from the energy meter were compared to those obtained using a ferrioxalate chemical actinometer for excitation at 365 nm (0.006 M solution,  $F = 1.21$ ) and found to differ by < 5% at this wavelength.

---

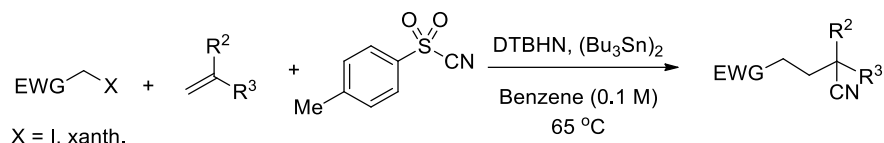
<sup>283</sup> G.M. Sheldrick, *Acta Cryst.*, **2008**, A64, 112-122.

<sup>284</sup> L.J. Farrugia, *J. Appl. Cryst.*, **1999**, 32, 837-838.

<sup>285</sup> C.F. Macrae, et al., *J. Appl. Cryst.*, **2008**, 41, 466-470.

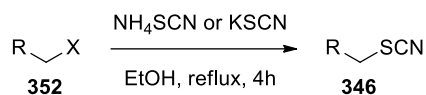
## 2. General procedures

### General Procedure (A) for the tin-mediated carbo-cyanation



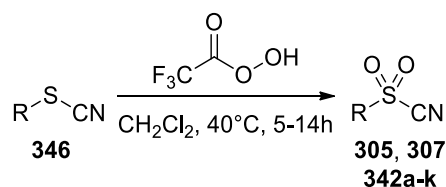
To a solution of radical precursor (1.0 eq.) in dry benzene (0.1 M) were added olefin (2.0 or 4.0 eq.), *p*-toluenesulfonyl cyanide (2.0 eq.) and bis(tributyl)tin (1.5 eq.). The reaction mixture was degassed for 20 minutes by argon sparging and the reaction was initiated by adding DTBHN (0.1 eq.). The reaction mixture was then stirred for 1.5 h at 65°C. DTBHN (0.1 eq.) was added every 1.5 hours. After the indicated time (3 or 4 additions of DTBHN), the mixture was concentrated under reduced pressure and the crude product was purified by flash chromatography.

### General procedure (B) for the preparation of thiocyanates



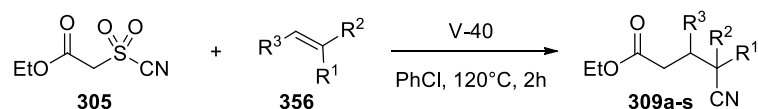
To a solution of ammonium thiocyanate or potassium thiocyanate (1.2 eq.) in EtOH was added alkyl halide (1.0 eq.). The reaction mixture was heated to reflux for 4 or 16 hours. Then, the reaction was allowed to reach room temperature and the solid residues were filtered off and washed with dichloromethane, the washings being added to the filtrate. The pooled liquids were washed with water, brine, dried over MgSO<sub>4</sub> and concentrated under reduced pressure. The obtained crude product was then purified by flash chromatography using silica gel.

### General procedure (C) for the oxidation of thiocyanates



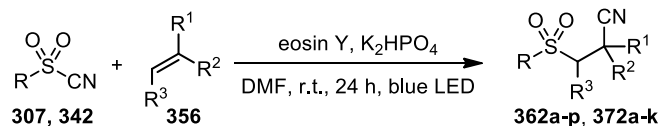
Hydrogen peroxide (50 wt.% solution in water, 10 eq.) was added dropwise at 0°C to a solution of trifluoroacetic anhydride (10 eq.) in dichloromethane in a two-necked round bottom flask equipped with a condenser and a glass cap. After being stirred for 40 minutes at 0°C, the thiocyanate (1.0 eq.) was added dropwise without any dilution and the reaction mixture was stirred at 40°C for 5 or 14 hours. At 0°C, the reaction was quenched with water. The aqueous layer was extracted with dichloromethane and the combined organic layers were washed with water and brine, dried over MgSO<sub>4</sub> and concentrated under reduced pressure. The obtained colourless crude sulfonyl cyanide was pure enough and was used directly without any purification. These compounds can be stored at -20°C for months.

### General procedure (D) for the tin-free carbo-cyanation reaction



In a sealed tube, sulfonyl cyanide **305** (2.0 eq.) and alkene (1.0 eq.) were diluted in distilled chlorobenzene. The mixture was degassed for 15 minutes by argon sparging and 1,1'-Azobis(cyclohexanecarbonitrile) (0.1 eq.) was added in one portion. The tube was tightly closed and the reaction mixture was stirred at 120°C for 2 hours. The chlorobenzene was partially evaporated under reduced pressure and the crude product was directly purified by flash chromatography using silica gel.

### General procedure (E) for the sulfonyl-cyanation reaction



Under ambient atmosphere, a 5 mL cylindrical vial equipped with a stirrer was charged with eosin Y (2 mol%), K<sub>2</sub>HPO<sub>4</sub> (0.2 eq.), alkene (1.0 eq.) and dry DMF. The vial was closed and the mixture was stirred 2 minutes for homogenisation. The mixture was degassed 3 times by the freeze-pump-thaw procedure or by argon sparging (30 min). Then, the sulfonyl cyanide (1.5 eq.) was added and the reaction mixture was stirred at 25°C for 24 hours while being irradiated with commercially available blue LEDs (the vial being placed at a distance of 4 cm of the LEDs). Then, the reaction mixture was diluted with EtOAc and 1M HCl aqueous solution. The aqueous layer was extracted with EtOAc and the combined organic layers were washed with 1M HCl aqueous solution and brine, dried over MgSO<sub>4</sub> and concentrated under reduced pressure. The obtained crude product was then purified by flash chromatography using silica gel.

### Typical procedure for the preparation of a 0.1 M solution of SmI<sub>2</sub>

Diiodoethane was diluted in Et<sub>2</sub>O and the organic layer was washed with an aqueous saturated solution of sodium thiosulfate (3 times) and brine, dried over MgSO<sub>4</sub> and concentrated under reduced pressure to give a white solid. Samarium powder (Strem, 1.5 eq.) was dried under vacuo and purged with argon (3 times). Then, freshly washed diiodoethane (1 eq., see above) was introduced and the flask was backfilled with argon (3 times). The stirring was started at medium speed while THF was introduced at room temperature or at 0°C for scaling up the process. The heterogenous solution was then stirred for 3-5 hours at room temperature and the stirring was stopped for 30 minutes allowing the reaction to settle. This solution was used directly.

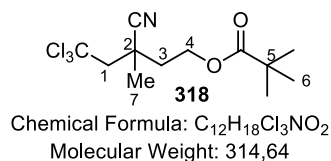
### Typical procedure for the preparation of diazomethane

Under a well-ventilated fume hood and in a specific glassware of distillation, *N*-methyl-*N*-nitrosourea<sup>286</sup> (8.0 eq.) was diluted in a mixture of Et<sub>2</sub>O/H<sub>2</sub>O 2:1. At 0°C was added a KOH aqueous solution (12 eq.). Diazomethane was generated in situ, distilled at 40°C and transferred (by distillation) to the acid (1.0 eq.) diluted in Et<sub>2</sub>O. The completion of the reaction is observed when a yellow colour appeared in the reaction flask. The excess of diazomethane is quenched by adding a solution of acetic acid in Et<sub>2</sub>O. The solvent was then evaporated under reduced pressure to afford the corresponding methyl ester.

<sup>286</sup> Prepared from: Z. Huang, X. Huang, B. Li, C. Mou, S. Yang, B.-A. Song, Y. R. Chi, *J. Am. Chem. Soc.* **2016**, *138*, 7524-7527.

### 3. Experimental part: Chapter III

#### 5,5,5-trichloro-3-cyano-3-methylpentyl pivalate (**318**)



3-methylbut-3-en-1-yl pivalate<sup>287</sup> **317** (85 mg, 0.5 mmol, 1.0 eq.) and trichloroacetonitrile (144 mg, 1.0 mmol, 2.0 eq.) were diluted in 1 mL of distilled chlorobenzene and the mixture was degassed by argon sparging for 20 minutes. DTBD (47  $\mu$ L, 0.25 mmol, 0.5 eq.) was added and the reaction mixture was stirred for 24 hours while being irradiated with a sun lamp. The solvent was evaporated and the crude product was purified by flash chromatography (cyclohexane/EtOAc 95:5) to afford **318** as colourless oil (8 mg, 5%)

**Rf** = 0.55 (cyclohexane/EtOAc 4:1).

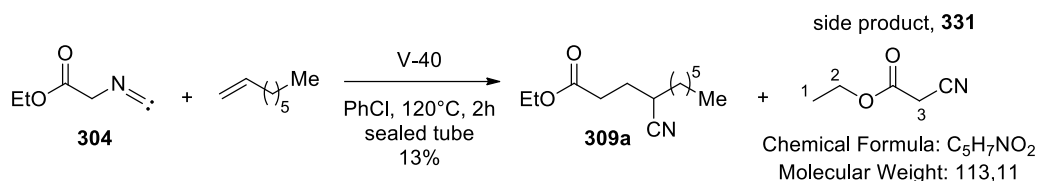
**IR** (film, KBr)  $\nu_{\max}$  (cm<sup>-1</sup>) = 2961, 2927, 2872, 2855, 2246, 1729, 1480, 1461, 1282, 1150.

**<sup>1</sup>H NMR** (300 MHz, CDCl<sub>3</sub>):  $\delta$  (ppm) = 4.35 (t,  $J$  = 6.3 Hz, 2H, H-4), 3.21 (d,  $J$  = 15.8 Hz, 1H, H-1a), 3.12 (d,  $J$  = 15.8 Hz, 1H, H-1b), 2.40 – 2.21 (m, 2H, H-3), 1.87 (s, 3H, H-7), 1.21 (s, 9H, H-6).

**<sup>13</sup>C NMR** (75 MHz, CDCl<sub>3</sub>):  $\delta$  (ppm) = 178.4 (Piv), 115.5 (CN), 67.5 (CCl<sub>3</sub>/C-2), 65.1 (CCl<sub>3</sub>/C-2), 60.8 (C-4), 59.2 (C-1), 43.6 (C-3), 38.8 (C-5), 30.2 (C-7), 27.3 (C-6).

**HRMS** (ESI): [M+Na]<sup>+</sup> C<sub>12</sub>H<sub>18</sub>Cl<sub>3</sub>NO<sub>2</sub>Na: calcd. 336.0295, found 336.0299.

#### Ethyl 2-cyanoacetate (**331**)



In a sealed tube, isonitrile **304** (114 mg, 1.0 mmol, 2.0 eq.) and 1-octene (78  $\mu$ l, 0.5 mmol, 1.0 eq.) were diluted in 4 ml of dry chlorobenzene and the mixture was degassed by argon sparging for 15 minutes. Then, V-40 (12 mg, 0.05 mmol, 0.1 eq.) was added and the reaction mixture was stirred at 120°C for 2 hours. Chlorobenzene was then partially evaporated and the crude mixture was directly purified by flash chromatography (cyclohexane/EtOAc 95:5) to afford the nitrile product **309a** as colourless oil (14.5 mg, 13%, characterization see below) and the cyano ester **331** as a colourless oil (5 mg, 4%).

**Rf** = 0.37 (cyclohexane/EtOAc 4:1).

**<sup>1</sup>H NMR** (300 MHz, CDCl<sub>3</sub>):  $\delta$  (ppm) = 4.28 (q,  $J$  = 7.2 Hz, 2H), 3.45 (s, 2H), 1.33 (t,  $J$  = 7.2 Hz, 3H).

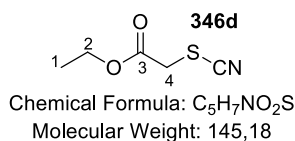
The obtained <sup>1</sup>H NMR spectrum is identical with the commercially available ethyl cyanoacetate.

<sup>287</sup> A. G. Talybov, *Azerb. Khim. Zh.* **2006**, 162-164.



### 3.1. Preparation of thiocyanates

#### Ethyl 2-thiocyanatoacetate (**346d**)



According to the general procedure **B** from ethyl 2-bromoacetate (15.1 g, 90.4 mmol, 1.0 eq.), NH<sub>4</sub>SCN (8.3 g, 108.5 mmol, 1.2 eq.) in EtOH (50 mL) for 16h. The crude product was purified by flash chromatography (cyclohexane/EtOAc 85:15) to afford **346d** as colourless oil (11.9 g, 74%).

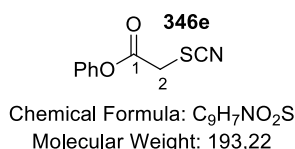
**Rf** = 0.3 (cyclohexane/EtOAc 4/1).

<sup>1</sup>H NMR (300 MHz, CDCl<sub>3</sub>): δ (ppm) = 4.29 (q, *J* = 7.1 Hz, 2H, H-2), 3.77 (s, 2H, H-4), 1.33 (t, *J* = 7.1 Hz, 3H, H-1).

<sup>13</sup>C NMR (75 MHz, CDCl<sub>3</sub>): δ (ppm) = 166.2 (C-3), 110.8 (CN), 62.9 (C-2), 35.0 (C-4), 14.1 (C-1).

The <sup>1</sup>H and <sup>13</sup>C NMR data are in good agreement with those reported in the literature.<sup>288</sup>

#### Phenyl 2-thiocyanatoacetate (**346e**)



According to the general procedure **B** from phenyl 2-bromoacetate<sup>305</sup> (5.0 g, 21.8 mmol, 1.0 eq.), NH<sub>4</sub>SCN (1.99 g, 26.2 mmol, 1.2 eq.) at 80°C in ACN (50 mL) for 3 hours. The crude product was purified by flash column chromatography (cyclohexane/EtOAc 90:10) to afford **346e** as yellow oil (3.2 g, 76%).

**Rf** = 0,39 (cyclohexane/EtOAc 9:1).

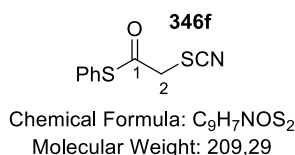
**IR** (film, KBr)  $\nu_{\text{max}}$  (cm<sup>-1</sup>) = 3063, 2941, 2160, 1760, 1591, 1493, 1297, 1191, 1163, 1139.

<sup>1</sup>H NMR (300 MHz, CDCl<sub>3</sub>): δ (ppm) = 7.46 – 7.38 (m, 2H, Ph), 7.33 – 7.27 (m, 1H, Ph), 7.18 – 7.13 (m, 2H, Ph), 4.00 (s, 2H, H-2).

<sup>13</sup>C NMR (75 MHz, CDCl<sub>3</sub>): δ (ppm) = 165.0 (C-2), 150.2 (Ph), 129.8 (Ph), 126.7 (Ph), 121.1 (Ph), 110.5 (CN), 35.0 (C-2).

**HRMS** (EI): [M]<sup>+</sup> C<sub>9</sub>H<sub>7</sub>NO<sub>2</sub>S: calcd. 193.01975, found 193.02020.

#### S-phenyl 2-thiocyanatoethanethioate (**346f**)



According to the general procedure **B** from S-phenyl 2-bromoethanethioate<sup>289</sup> (0.95 g, 4.1 mmol, 1.0 eq.), NH<sub>4</sub>SCN (0.395 g, 5.2 mmol, 1.2 eq.) at 80°C in toluene (10 mL) for 60 hours. The crude

<sup>288</sup> J. Li, J.-j. Cao, J.-f. Wei, X.-y. Shi, L.-h. Zhang, J.-j. Feng, Z.-g. Chen, *Eur. J. Org. Chem.* **2011**, 229-233.

<sup>289</sup> Prepared from: R. J. Alfie, N. Truong, J. M. Yost, D. M. Coltart, *Tetrahedron Lett.* **2017**, 58, 185-189.

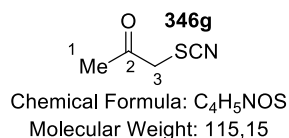
product was purified by flash column chromatography (cyclohexane/EtOAc 92:8) to afford **346f** as yellow oil (0.47 g, 54%).

**Rf** = 0.28 (cyclohexane/EtOAc 4:1).

**<sup>1</sup>H NMR** (300 MHz, CDCl<sub>3</sub>): δ (ppm) = 7.46 (s, 5H, Ph), 3.98 (s, 2H, H-2).

**<sup>13</sup>C NMR** (75 MHz, CDCl<sub>3</sub>): δ (ppm) = 190.3 (C-1), 134.5 (Ph), 130.3 (Ph), 129.6 (Ph), 125.8 (Ph), 110.5 (CN), 42.0 (C-2).

### 1-thiocyanatopropan-2-one (**346g**)



According to the general procedure **B** from 1-chloropropan-2-one (4.3 mL, 54 mmol, 1.0 eq.), NH<sub>4</sub>SCN (4.9 g, 65 mmol, 1.2 eq.) at 40°C in EtOH (20 mL) for 16 hours. The crude product was purified by flash column chromatography (cyclohexane/EtOAc 85:15) to afford **346g** as yellow oil (4.4 g, 69%).

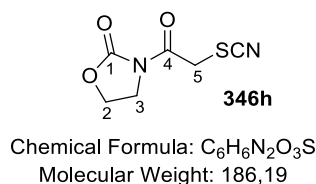
**Rf** = 0,17 (cyclohexane/EtOAc 4:1).

**<sup>1</sup>H NMR** (300 MHz, CDCl<sub>3</sub>): δ (ppm) = 4.04 (s, 2H, H-3), 2.35 (s, 3H, H-1).

**<sup>13</sup>C NMR** (75 MHz, CDCl<sub>3</sub>): δ (ppm) = 198.9 (C-2), 111.5 (CN), 44.4 (C-3), 28.5 (C-1).

**HRMS** (EI): [M]<sup>+</sup> C<sub>4</sub>H<sub>5</sub>NOS: calcd. 115.00918, found 115.00950.

### 3-(2-thiocyanatoacetyl)oxazolidin-2-one (**346h**)



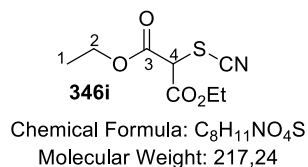
According to the general procedure **B** from phenyl 3-(2-iodoacetyl)oxazolidin-2-one (1.08 g, 4.2 mmol, 1.0 eq.), NH<sub>4</sub>SCN (0.39 g, 5.1 mmol, 1.2 eq.) at 80°C in EtOH (25 mL) for 30 minutes. The crude product was purified by flash column chromatography (cyclohexane/EtOAc 80:20) to afford **346h** as yellow oil (0.47 g, 64%).

**Rf** = 0,25 (cyclohexane/EtOAc 2:1).

**<sup>1</sup>H NMR** (300 MHz, CDCl<sub>3</sub>): δ (ppm) = 4.55 – 4.48 (m, 2H, H-2), 4.39 (s, 2H, H-5), 4.12 – 4.05 (m, 2H, H-3).

**<sup>13</sup>C NMR** (75 MHz, CDCl<sub>3</sub>): δ (ppm) = 165.4 (C-4), 153.5 (C-1), 111.2 (CN), 63.0 (C-2), 42.5 (C-3), 37.3 (C-5).

### Diethyl 2-thiocyanatomalonate (**346i**)



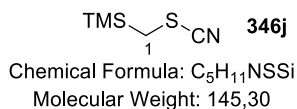
According to the general procedure **B** from (5 g, 21 mmol, 1.0 eq.), NH<sub>4</sub>SCN (2.4 g, 25 mmol, 1.2 eq.) at room temperature in EtOH (20 mL) for 30 minutes. The crude product **346i** was pure enough without further purification (yellow oil, 4.1 g, 91%).

**Rf** = 0.21 (cyclohexane/EtOAc 4:1).

**<sup>1</sup>H NMR** (300 MHz, CDCl<sub>3</sub>): δ (ppm) = 4.69 (s, 1H, H-4), 4.34 (q, *J* = 7.1 Hz, 4H, H-2), 1.34 (t, *J* = 7.1 Hz, 6H, H-1).

The <sup>1</sup>H data are in good agreement with those reported in the literature.<sup>290</sup>

### Trimethyl(thiocyanatomethyl)silane (**346j**)



According to the general procedure **B** from (chloromethyl)trimethylsilane (500 mg, 4.1 mmol, 1.0 eq.), NH<sub>4</sub>SCN (372 mg, 4.9 mmol, 1.2 eq.) in EtOH (5 mL) for 16h. The obtained colourless crude product **346j** (485 g, 82%) was pure enough and was used directly without further purification.

**Rf** = 0.8 (cyclohexane/EtOAc 4/1).

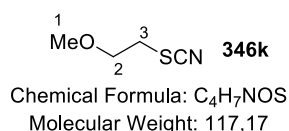
**IR** (film, KBr) *v*<sub>max</sub> (cm<sup>-1</sup>) = 2958, 2902, 2151, 1392, 1253, 850.

**<sup>1</sup>H NMR** (300 MHz, CDCl<sub>3</sub>): δ (ppm) = 2.30 (s, 2H, H-1), 0.18 (s, 9H, TMS).

**<sup>13</sup>C NMR** (75 MHz, CDCl<sub>3</sub>): δ (ppm) = 114.6 (CN), 18.9 (C-1), -2.0 (TMS).

**HRMS** (EI): [M]<sup>+</sup> C<sub>5</sub>H<sub>11</sub>NSSi: calcd. 145.03815, found 145.03851.

### 1-methoxy-2-thiocyanatoethane (**346k**)



According to the general procedure **B** from 1-bromo-2-methoxyethane (3 mL, 32 mmol, 1.0 eq.), NH<sub>4</sub>SCN (2.9 g, 38.3 mmol, 1.2 eq.) in EtOH (15 mL). The crude product was pure enough without any further purification to afford **346k** as yellow oil (3.4 g, 91%).

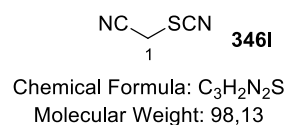
**Rf** = 0,43 (cyclohexane/EtOAc 4:1).

**IR** (film, KBr) *v*<sub>max</sub> (cm<sup>-1</sup>) = 2991, 2934, 2889, 2831, 2155, 1120, 1097, 995.

**<sup>1</sup>H NMR** (300 MHz, CDCl<sub>3</sub>): δ (ppm) = 3.73 (td, *J* = 5.8, 1.3 Hz, 2H, H-2), 3.42 (d, *J* = 1.5 Hz, 3H, H-1), 3.15 (td, *J* = 5.9, 1.4 Hz, 2H, H-3).

**<sup>13</sup>C NMR** (75 MHz, CDCl<sub>3</sub>): δ (ppm) = 112.1 (CN), 70.0 (C-2), 58.9 (C-1), 33.7 (C-3).

### 2-thiocyanatoacetonitrile (**346l**)



According to the general procedure **B** from chloroacetonitrile (5.0 g, 66 mmol, 1.0 eq.), NH<sub>4</sub>SCN (6.1 g, 79 mmol, 1.2 eq.) at 70°C in EtOH (50 mL) for 16 hours. The crude product was purified by flash column chromatography (cyclohexane/EtOAc 80:20) to afford **346l** as yellow oil (2.9 g, 44%).

**Rf** = 0.70 (cyclohexane/EtOAc 4:1).

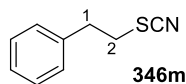
**<sup>1</sup>H NMR** (300 MHz, CDCl<sub>3</sub>): δ (ppm) = 3.78 (s, 2H, H-1).

**<sup>13</sup>C NMR** (75 MHz, CDCl<sub>3</sub>): δ (ppm) = 113.7 (SCN), 108.9 (CN), 19.2 (C-1).

**LRMS** (EI): [M]<sup>+</sup> C<sub>3</sub>H<sub>2</sub>N<sub>2</sub>S<sup>+</sup>: found 98.0.

<sup>290</sup> O. Prakash, H. Kaur, H. Batra, N. Rani, S. P. Singh, R. M. Moriarty, *J. Org. Chem.* **2001**, 66, 2019-2023.

### (2-thiocyanatoethyl)benzene (346m)



Chemical Formula: C<sub>9</sub>H<sub>9</sub>NS  
Molecular Weight: 163,24

According to the general procedure **B** from (2-bromoethyl)benzene (3 g, 16.2 mmol, 1.0 eq.), NH<sub>4</sub>SCN (1.48 g, 19.5 mmol, 1.2 eq.) in EtOH (5 mL) for 4h. The crude product was purified by flash chromatography (cyclohexane/EtOAc 95:5) to afford **346m** as colourless oil (2.58 g, 98%). **R<sub>f</sub>** = 0,67 (cyclohexane/EtOAc 2:1).

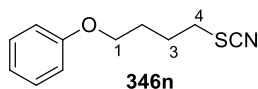
**IR** (film, KBr)  $\nu_{\max}$  (cm<sup>-1</sup>) = 3086, 3063, 3029, 2940, 2854, 2153, 1497, 1457, 752, 701.

**<sup>1</sup>H NMR** (300 MHz, CDCl<sub>3</sub>):  $\delta$  (ppm) = 7.39 – 7.27 (m, 3H, Ph), 7.26 – 7.20 (m, 2H, Ph), 3.24 – 3.07 (m, 4H, H-1 + H-2).

**<sup>13</sup>C NMR** (75 MHz, CDCl<sub>3</sub>):  $\delta$  (ppm) = 137.7 (Ph), 128.9 (Ph), 128.7 (Ph), 127.3 (Ph), 112.2 (CN), 36.1 (C-1/2), 35.2 (C-1/2).

The <sup>1</sup>H and <sup>13</sup>C NMR data are in good agreement with those reported in the literature.<sup>291</sup>

### (4-thiocyanatobutoxy)benzene (346n)



Chemical Formula: C<sub>11</sub>H<sub>13</sub>NOS  
Molecular Weight: 207,29

According to the general procedure **B** from (4-bromobutoxy)benzene (3 g, 13.1 mmol, 1.0 eq.), NH<sub>4</sub>SCN (1.2 g, 15.7 mmol, 1.2 eq.) in EtOH (15 mL) for 14 hours. The crude product **346n** was pure enough and was used directly without further purification (2.48 g, 91%).

**R<sub>f</sub>** = 0,41 (cyclohexane/EtOAc 4:1).

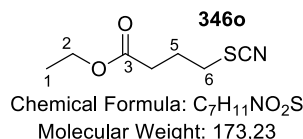
**IR** (film, KBr)  $\nu_{\max}$  (cm<sup>-1</sup>) = 3038, 2943, 2871, 2153, 1599, 1586, 1495, 1472, 1242, 754.

**<sup>1</sup>H NMR** (300 MHz, CDCl<sub>3</sub>):  $\delta$  (ppm) = 7.34 – 7.25 (m, 2H, Ph), 7.00 – 6.85 (m, 3H, Ph), 4.02 (t, *J* = 5.8 Hz, 2H, H-1), 3.09 – 3.01 (m, 2H, H-4), 2.13 – 1.89 (m, 4H, H-2/3).

**<sup>13</sup>C NMR** (75 MHz, CDCl<sub>3</sub>):  $\delta$  (ppm) = 158.6 (Ph), 129.5 (Ph), 120.9 (Ph), 114.4 (Ph), 112.2 (CN), 66.7 (C-1), 33.8 (C-4), 27.5 (C-2/3), 27.0 (C-2/3).

**HRMS** (ESI): [M+Na]<sup>+</sup> C<sub>11</sub>H<sub>13</sub>NOSNa: calcd. 230.0610, found 230.0613.

### Ethyl 4-thiocyanatobutanoate (346o)



Chemical Formula: C<sub>7</sub>H<sub>11</sub>NO<sub>2</sub>S  
Molecular Weight: 173,23

According to the general procedure **B** from ethyl 4-bromobutanoate (3 g, 15.4 mmol, 1.0 eq.), NH<sub>4</sub>SCN (1.4 g, 18.5 mmol, 1.2 eq.) in EtOH (5 mL) for 4h. The crude product was purified by flash chromatography (cyclohexane/EtOAc 85:15) to afford **346o** as colourless oil (2.17 g, 81%). **R<sub>f</sub>** = 0,53 (cyclohexane/EtOAc 2:1).

**IR** (film, KBr)  $\nu_{\max}$  (cm<sup>-1</sup>) = 2983, 2939, 2874, 2154, 1731, 1446, 1420, 1376, 1316, 1205, 1146.

<sup>291</sup> A. R. Kiasat, M. Fallah-Mehrjardi, *Bull. Korean Chem. Soc.* **2008**, 29, 2346-2348.

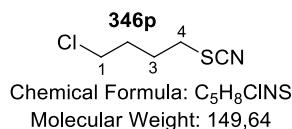
**<sup>1</sup>H NMR** (300 MHz, CDCl<sub>3</sub>): δ (ppm) = 4.16 (q, *J* = 7.1 Hz, 2H, H-2), 3.04 (t, *J* = 7.1 Hz, 2H, H-6), 2.51 (t, *J* = 6.9 Hz, 2H, H-4), 2.25 – 2.06 (m, 2H, H-5), 1.27 (t, *J* = 7.1 Hz, 3H, H-1).

**<sup>13</sup>C NMR** (75 MHz, CDCl<sub>3</sub>): δ (ppm) = 172.0, 111.8, 60.7, 33.1, 31.8, 25.0, 14.1.

172.0 (C-3), 111.8 (CN), 60.7 (C-2), 33.1 (C-4/5), 31.8 (C-4/5), 25.0 (C-5), 14.1 (C-1).

**HRMS** (ESI): [M+Na]<sup>+</sup> C<sub>7</sub>H<sub>11</sub>NO<sub>2</sub>SNa: calcd. 196.0403, found 196.0408.

### 1-chloro-4-thiocyanatobutane (**346p**)



According to a slightly modified procedure from **B**, 1-chloro-4-iodobutane (1 mL, 8.17 mmol, 1.0 eq.), NH<sub>4</sub>SCN (0.62 g, 8.17 mmol, 1.0 eq.) in acetone (10 mL). The reaction mixture was stirred at room temperature for 24 hours. The crude product was purified by flash chromatography (cyclohexane / EtOAc 95:5) to afford **346p** as colourless oil (827 mg, 68%).

**Rf** = 0,50 (cyclohexane/EtOAc 4:1).

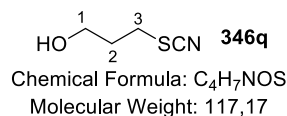
**IR** (film, KBr)  $\nu_{\max}$  (cm<sup>-1</sup>) = 2958, 2868, 2153, 1447, 1320, 1287, 1260, 1024, 799.

**<sup>1</sup>H NMR** (300 MHz, CDCl<sub>3</sub>): δ (ppm) = 3.59 (t, *J* = 6.1 Hz, 2H, H-1), 3.00 (t, *J* = 6.9 Hz, 2H, H-4), 2.10 – 1.88 (m, 4H, H-2, H-3).

**<sup>13</sup>C NMR** (75 MHz, CDCl<sub>3</sub>): δ (ppm) = 112.0 (CN), 43.9 (C-1), 33.2 (C-4), 30.5 (C-2/3), 27.2 (C-2/3).

**LRMS** (EI): [M]<sup>+</sup> C<sub>5</sub>H<sub>8</sub>CINS<sup>+</sup>: calcd. 149.01, found 149.00.

### 3-thiocyanatopropan-1-ol (**346q**)



According to the general procedure **B** from 3-chloro-1-propanol (11.3 g, 120 mmol, 1.0 eq.), KSCN (23.3 g, 239mmol, 2 eq.) in EtOH (50mL) for 20h. The crude product was purified by flash column chromatography (cyclohexane/EtOAc 70:30) to afford **346q** as yellow oil (4,8 g, 34%).

**Rf** = 0.38 (cyclohexane/EtOAc 2:1).

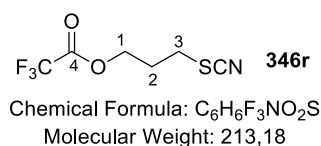
**IR** (film, KBr)  $\nu_{\max}$  (cm<sup>-1</sup>) = 3396, 2946, 2884, 2155, 1642, 1427, 1265, 1052.

**<sup>1</sup>H NMR** (300 MHz, CDCl<sub>3</sub>): δ (ppm) = 3.88 – 3.79 (m, 2H, H-1), 3.12 (t, *J* = 7.0 Hz, 2H, H-3), 2.14 – 2.02 (m, 2H, H-2).

**<sup>13</sup>C NMR** (75 MHz, CDCl<sub>3</sub>): δ (ppm) = 112.7 (CN), 59.4 (C-1), 32.2 (C-3), 30.7 (C-2).

The <sup>1</sup>H and <sup>13</sup>C NMR data are in good agreement with those reported in literature.<sup>292</sup>

### 3-thiocyanatopropyl 2,2,2-trifluoroacetate (**346r**)



To a stirred solution of 3-thiocyanatopropan-1-ol **346q** (2 g, 17.1 mmol, 1 eq.) and triethylamine (2.95 mL, 22.2 mmol, 1.3 eq.) in dry dichloromethane (10 mL) was added dropwise trifluoroacetic

<sup>292</sup> R. Loeser, S. Fischer, A. Hiller, M. Koeckerling, U. Funke, A. Maisonial, P. Brust, J. Steinbach, *Beilstein J. Org. Chem.* **2013**, 9, 1002-1011.

anhydride (3 mL, 21.3 mmol, 1.25 eq.) at 0°C. The reaction mixture was then stirred at room temperature for 15 minutes. At 0°C, the reaction was quenched with water. The aqueous layer was extracted with dichloromethane and the combined organic layers were washed with water and brine, dried over MgSO<sub>4</sub> and concentrated under reduced pressure. The crude product was purified by flash column chromatography (cyclohexane/EtOAc 96:4) to afford **346r** as a colourless oil (2.54 g, 70%).

**Rf** = 0,25 (cyclohexane/EtOAc 4:1).

**IR** (film, KBr)  $\nu_{\max}$  (cm<sup>-1</sup>) = 2968, 2157, 1788, 1404, 1362, 1347, 1223, 1159.

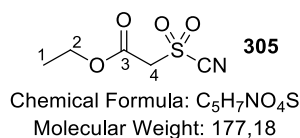
**<sup>1</sup>H NMR** (300 MHz, CDCl<sub>3</sub>):  $\delta$  (ppm) = 4.49 (t, *J* = 5.9 Hz, 2H, H-1), 3.04 (t, *J* = 7.0 Hz, 2H, H-3), 2.34 – 2.23 (m, 2H, H-2).

**<sup>13</sup>C NMR** (75 MHz, CDCl<sub>3</sub>):  $\delta$  (ppm) = 157.2 (q, *J* = 42.7 Hz, C-4), 114.4 (d, *J* = 285.4 Hz, , CF<sub>3</sub>), 111.4 (CN), 65.1 (C-1), 30.0 (C-3), 28.5 (C-2).

**HRMS** (CI): [M+Na]<sup>+</sup> C<sub>6</sub>H<sub>6</sub>F<sub>3</sub>NO<sub>2</sub>SNa: calcd. 214.01496, found 214.01398.

### 3.2. Preparation of sulfonyl cyanides

#### Ethyl 2-(cyanosulfonyl)acetate (**305**)



According to the general procedure **C** from ethyl 2-thiocyanoacetate **346d** (4 g, 27.6 mmol, 1.0 eq.), hydrogen peroxide (50 wt% solution in water, 9.4 g, 276 mmol, 10 eq.), trifluoroacetic anhydride (39 mL, 276 mmol, 10 eq.) in dichloromethane (90 mL) for 14 hours. Crude yield (3.6 g, 75%).

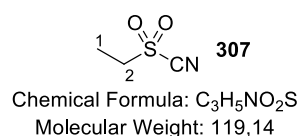
**IR** (film, KBr)  $\nu_{\max}$  (cm<sup>-1</sup>) = 2987, 2934, 2194, 1743 1468, 1447, 1386, 1172.

**<sup>1</sup>H NMR** (300 MHz, C<sub>6</sub>D<sub>6</sub>):  $\delta$  (ppm) = 3.63 (q, *J* = 7.1 Hz, 2H, H-2), 2.82 (s, 2H, H-4), 0.74 (t, *J* = 7.1 Hz, 3H, H-1).

**<sup>13</sup>C NMR** (75 MHz, C<sub>6</sub>D<sub>6</sub>):  $\delta$  (ppm) = 159.4 (C-3), 112.8 (CN), 63.3 (C-2), 60.0 (C-4), 13.5 (C-1).

**HRMS** (ESI): [M+Na]<sup>+</sup> C<sub>5</sub>H<sub>7</sub>NO<sub>4</sub>SNa: calcd. 199.9988, found 199.9987.

#### Ethanesulfonyl cyanide (**307**)



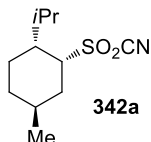
According to the general procedure **C** from ethyl thiocyanate (3 g, 34 mmol, 1.0 eq.), hydrogen peroxide (50 wt% solution in water, 11.7 g, 340 mmol, 10 eq.), trifluoroacetic anhydride (49 mL, 340 mmol, 10 eq.) in dichloromethane (60 mL) for 5 hours. Crude yield (3.6 g, 89%).

**IR** (film, KBr)  $\nu_{\max}$  (cm<sup>-1</sup>) = 2977, 2927, 2192, 1456, 1367, 1167.

**<sup>1</sup>H NMR** (300 MHz, C<sub>6</sub>D<sub>6</sub>):  $\delta$  (ppm) = 1.96 (q, *J* = 7.4 Hz, 2H, H-2), 0.55 (t, *J* = 7.4 Hz, 3H, H-1).

**<sup>13</sup>C NMR** (75 MHz, C<sub>6</sub>D<sub>6</sub>):  $\delta$  (ppm) = 113.0 (CN), 52.1 (C-2), 6.5 (C-1).

### (1R,2R,5S)-2-isopropyl-5-methylcyclohexane-1-sulfonyl cyanide (342a)



Chemical Formula: C<sub>11</sub>H<sub>19</sub>NO<sub>2</sub>S  
Molecular Weight: 229,34

According to the general procedure **C** from thiocyanate<sup>4</sup> **346c** (100 mg, 0.5 mmol, 1.0 eq.), hydrogen peroxide (50 wt% solution in water, 0.144 mL, 5 mmol, 10 eq.), trifluoroacetic anhydride (0.716 mL, 5 mmol, 10 eq.) in dichloromethane (5 mL). Crude yield (85 mg, 74%).

**IR** (film, KBr)  $\nu_{\max}$  (cm<sup>-1</sup>) = 2958, 2930, 2873, 2184, 1784, 1730, 1457, 1362, 1163.

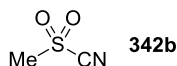
**<sup>1</sup>H NMR** (300 MHz, C<sub>6</sub>D<sub>6</sub>):  $\delta$  (ppm) = 3.88 – 3.82 (m, 1H), 2.61 – 2.50 (m, 1H), 2.16 – 1.39 (m, 6H), 1.11 (d, *J* = 6.4 Hz, 3H), 0.97 (t, *J* = 6.6 Hz, 6H), 1.08 – 0.90 (m, 2H).

**<sup>13</sup>C NMR** (75 MHz, C<sub>6</sub>D<sub>6</sub>):  $\delta$  (ppm) = 113.6, 67.2, 49.0, 35.7, 34.6, 29.5, 26.5, 25.2, 22.2, 22.1, 21.6.

**HRMS** (ASAP): [M-2H+Na] C<sub>11</sub>H<sub>17</sub>NO<sub>2</sub>NaS: calcd. 250.0883, found 250.0884.

The <sup>1</sup>H NMR data are in good agreement with those reported in literature.<sup>293</sup>

### Methanesulfonyl cyanide (342b)



Chemical Formula: C<sub>2</sub>H<sub>3</sub>NO<sub>2</sub>S  
Molecular Weight: 105,12

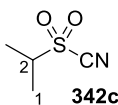
According to the general procedure **C** from methyl thiocyanate (1 mL, 14.4 mmol, 1.0 eq.), hydrogen peroxide (50 wt% solution in water, 4.9 g, 144 mmol, 10 eq.), trifluoroacetic anhydride (20.3 mL, 144 mmol, 10 eq.) in dichloromethane (40 mL) for 5 hours. Crude yield (1.18 g, 78%).

**IR** (film, KBr)  $\nu_{\max}$  (cm<sup>-1</sup>) = 2928, 2195, 1366, 1327, 1172, 967, 772.

**<sup>1</sup>H NMR** (300 MHz, CDCl<sub>3</sub>):  $\delta$  (ppm) = 3.44 (s, 3H, Me).

**<sup>13</sup>C NMR** (75 MHz, C<sub>6</sub>D<sub>6</sub>):  $\delta$  (ppm) = 113.9 (CN), 44.6 (Me).

### Propane-2-sulfonyl cyanide (342c)



Chemical Formula: C<sub>4</sub>H<sub>7</sub>NO<sub>2</sub>S  
Molecular Weight: 133,17

According to the general procedure **C** from isopropyl thiocyanate (948 mg, 9.37 mmol, 1.0 eq.), hydrogen peroxide (50 wt% solution in water, 3.18 g, 93.7 mmol, 10 eq.), trifluoroacetic anhydride (13.2 mL, 93.7 mmol, 10 eq.) in dichloromethane (20 mL) for 5 hours. Crude yield (873 mg, 70%).

**IR** (film, KBr)  $\nu_{\max}$  (cm<sup>-1</sup>) = 2988, 2190, 1464, 1364, 1266, 1176, 1153, 1060, 707.

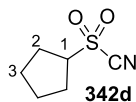
**<sup>1</sup>H NMR** (300 MHz, C<sub>6</sub>D<sub>6</sub>):  $\delta$  (ppm) = 2.34 (hept, *J* = 6.8 Hz, 1H, H-2), 0.80 (d, *J* = 6.9 Hz, 6H, H-1).

**<sup>13</sup>C NMR** (75 MHz, C<sub>6</sub>D<sub>6</sub>):  $\delta$  (ppm) = 112.3 (CN), 58.6 (C-2), 14.3 (C-1).

**HRMS** (ASAP): [M-H]<sup>-</sup> C<sub>4</sub>H<sub>6</sub>NO<sub>2</sub>S: calcd. 132.0125, found 132.0124.

<sup>293</sup> J. M. Blanco, O. Caamano, F. Fernandez, G. Gomez, C. Lopez, *Tetrahedron: Asymm.* **1992**, 3, 749-752.

## Cyclopentanesulfonyl cyanide (342d)



Chemical Formula: C<sub>6</sub>H<sub>9</sub>NO<sub>2</sub>S  
Molecular Weight: 159,21

According to the general procedure **C** from cyclopentyl thiocyanate (500 mg, 3.93 mmol, 1.0 eq.), hydrogen peroxide (50 wt% solution in water, 1.1 mL, 39.3 mmol, 10 eq.), trifluoroacetic anhydride (5.6 mL, 39.3 mmol, 10 eq.) in dichloromethane (10 mL) for 5 hours. Crude yield (594 mg, 95%).

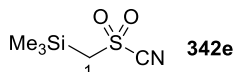
**IR** film, KBr)  $\nu_{\max}$  (cm<sup>-1</sup>) = 2967, 2878, 2188, 1366, 1165.

**<sup>1</sup>H NMR** (300 MHz, CDCl<sub>3</sub>):  $\delta$  (ppm) = 3.76 (p,  $J$  = 7.8 Hz, 1H, H-1), 2.21 (m, 4H, H-2), 1.97 – 1.69 (m, 4H, H-3)).

**<sup>13</sup>C NMR** (75 MHz, CDCl<sub>3</sub>):  $\delta$  (ppm) = 112.6 (CN), 67.1 (C-1), 27.1 (C-2/3), 25.9 (C-2/3).

**HRMS** (ASAP): [M-H]<sup>-</sup> C<sub>6</sub>H<sub>8</sub>NO<sub>2</sub>S: calcd. 158.0281, found 158.0279.

## (trimethylsilyl)methanesulfonyl cyanide (342e)



Chemical Formula: C<sub>5</sub>H<sub>11</sub>NO<sub>2</sub>SSi  
Molecular Weight: 177,30

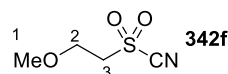
According to the general procedure **C** from trimethyl(thiocyanatomethyl)silane **346j** (44 mg, 0.3 mmol, 1.0 eq.), hydrogen peroxide (50 wt% solution in water, 0.085 mL, 3 mmol, 10 eq.), trifluoroacetic anhydride (0.42 mL, 3 mmol, 10 eq.) in dichloromethane (3 mL) for 4 hours. Crude yield (40 mg, 75%). The colourless crude product was directly characterized after the aqueous work-up and was then stored at -20°C.

**IR** (film, KBr)  $\nu_{\max}$  (cm<sup>-1</sup>) = 2973, 2919, 2188, 1364, 1257, 1172, 854, 796.

**<sup>1</sup>H NMR** (300 MHz, C<sub>6</sub>D<sub>6</sub>):  $\delta$  (ppm) = 1.86 (s, 2H, H-1), -0.15 (s, 9H, TMS).

**<sup>13</sup>C NMR** (75 MHz, C<sub>6</sub>D<sub>6</sub>):  $\delta$  (ppm) = 115.5 (CN), 49.8 (C-1), -1.1 (TMS).

## 2-methoxyethanesulfonyl cyanide (342f)



Chemical Formula: C<sub>4</sub>H<sub>7</sub>NO<sub>3</sub>S  
Molecular Weight: 149,17

According to the general procedure **C** from thiocyanate **346k** (1.5 g, 12.8 mmol, 1.0 eq.), hydrogen peroxide (50 wt% solution in water, 4.35 g, 128 mmol, 10 eq.), trifluoroacetic anhydride (18 mL, 128 mmol, 10 eq.) in dichloromethane (40 mL) for 5h. Crude yield (1.67g, 87%).

**IR** (film, KBr)  $\nu_{\max}$  (cm<sup>-1</sup>) = 2986, 2932, 2840, 2192, 1477, 1457, 1374, 1176, 1161, 1119, 1091, 990, 731.

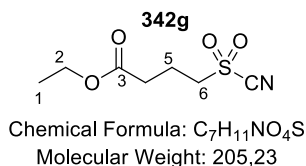
**<sup>1</sup>H NMR** (300 MHz, C<sub>6</sub>D<sub>6</sub>):  $\delta$  (ppm) = 3.97 – 3.91 (m, 2H, H-2), 3.65 – 3.60 (m, 2H, H-3), 3.45 (s, 3H, H-1).

**<sup>13</sup>C NMR** (75 MHz, C<sub>6</sub>D<sub>6</sub>):  $\delta$  (ppm) = 113.2 (CN), 65.1 (C-2), 59.5 (C-1), 58.5 (C-3).

**HRMS** (ASAP): [M-H]<sup>-</sup> C<sub>4</sub>H<sub>6</sub>NO<sub>3</sub>S: calcd. 148.0074, found. 148.0074.



## Ethyl 4-(cyanosulfonyl)butanoate (342g)



According to the general procedure **C** from thiocyanate **346o** (1.0 g, 5.8 mmol, 1.0 eq.), hydrogen peroxide (50 wt% solution in water, 1.96 g, 58 mmol, 10 eq.), trifluoroacetic anhydride (8.2 mL, 58 mmol, 10 eq.) in dichloromethane (20 mL) for 5 hours. Crude yield (1.09 g, 92%).

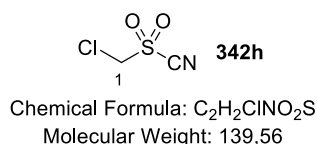
**IR** (film, KBr)  $\nu_{\max}$  (cm<sup>-1</sup>) = 2985, 2921, 2878, 2191, 1730, 1448, 1419, 1376, 1294, 1246, 1198, 1169.

**<sup>1</sup>H NMR** (300 MHz, C<sub>6</sub>D<sub>6</sub>):  $\delta$  (ppm) = 4.18 (q,  $J$  = 7.1 Hz, 2H, H-2), 3.63 – 3.52 (m, 2H, H-6), 2.59 (t,  $J$  = 6.7 Hz, 2H, H-4), 2.36 – 2.22 (m, 2H, H-5), 1.28 (t,  $J$  = 7.1 Hz, 3H, H-1).

**<sup>13</sup>C NMR** (75 MHz, C<sub>6</sub>D<sub>6</sub>):  $\delta$  (ppm) = 171.4 (C-3), 112.4 (CN), 61.0 (C-2), 56.9 (C-6), 31.0 (C-4), 17.8 (C-5), 14.0 (C-1).

**HRMS** (ESI): [M+Na]<sup>+</sup> C<sub>7</sub>H<sub>11</sub>NO<sub>4</sub>SNa: calcd. 228.0301, found 228.0301.

## Chloromethanesulfonyl cyanide (342h)



According to the general procedure **C** from chloromethyl thiocyanate (0.78 mL, 9.9 mmol, 1.0 eq.), hydrogen peroxide (50 wt% solution in water, 2.84 mL, 99 mmol, 10 eq.), trifluoroacetic anhydride (14.1 mL, 99 mmol, 10 eq.) in dichloromethane (40 mL) for 22h. The crude was submitted once again in the same oxidation reaction to reach full conversion. Crude yield after two consecutive oxidations (717 mg, 71%, contaminated by traces of sulfoxyde).

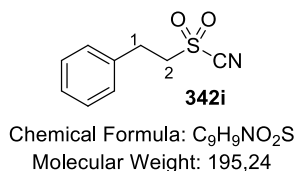
**IR** (film, KBr)  $\nu_{\max}$  (cm<sup>-1</sup>) = 3011, 2942, 2195, 1389, 1174, 748.

**<sup>1</sup>H NMR** (300 MHz, CDCl<sub>3</sub>):  $\delta$  (ppm) = 4.81 (s, 2H, H-1).

**<sup>13</sup>C NMR** (75 MHz, CDCl<sub>3</sub>):  $\delta$  (ppm) = 110.5 (CN), 59.8 (C-1).

**HRMS** (ESI): [M-H]<sup>-</sup> C<sub>2</sub>HNO<sub>2</sub><sup>35</sup>ClS: calcd. 137.9422, found 137.9420.

## 2-phenylethanesulfonyl cyanide (342i)



According to the general procedure **C** from (2-thiocyanatoethyl)benzene **346m** (1.0 g, 6.13 mmol, 1.0 eq.), hydrogen peroxide (50 wt% solution in water, 1.74 mL, 61.3 mmol, 10 eq.), trifluoroacetic anhydride (8.7 mL, 61.3 mmol, 10 eq.) in dichloromethane (20 mL) for 5 hours. Crude yield (676 mg, 56%).

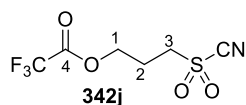
**IR** (film, KBr)  $\nu_{\max}$  (cm<sup>-1</sup>) = 3089, 3065, 3032, 2962, 2918, 2190, 1775, 1659, 1498, 1456, 1374, 1169.

**<sup>1</sup>H NMR** (300 MHz, CDCl<sub>3</sub>):  $\delta$  (ppm) = 7.42 – 7.20 (m, 5H, Ph), 3.70 – 3.61 (m, 2H, H-2), 3.32 – 3.23 (m, 2H, H-1).

$^{13}\text{C}$  NMR (75 MHz,  $\text{CDCl}_3$ ):  $\delta$  (ppm) = 134.9 (Ph), 129.4 (Ph), 128.6 (Ph), 128.0 (Ph), 112.5 (CN), 59.6 (C-2), 28.5 (C-1).

HRMS (ASAP):  $[\text{M}+\text{H}]^+$   $\text{C}_9\text{H}_{10}\text{NO}_2\text{S}$ : calcd. 196.0427, found 196.0429.

### 3-(cyanosulfonyl)propyl 2,2,2-trifluoroacetate (342j)



Chemical Formula:  $\text{C}_6\text{H}_6\text{F}_3\text{NO}_4\text{S}$   
Molecular Weight: 245,18

According to the general procedure **C** from thiocyanate **346r** (2.2 g, 10.6 mmol, 1.0 eq.), hydrogen peroxide (50 wt% solution in water, 3.6 g, 106 mmol, 10 eq.), trifluoroacetic anhydride (15 mL, 106 mmol, 10 eq.) in dichloromethane (30 mL). Crude yield (2.3 g, 88%).

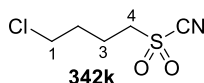
IR (film, KBr)  $\nu_{\text{max}}$  ( $\text{cm}^{-1}$ ) = 2978, 2927, 2193, 1789, 1371, 1224, 1159, 1007, 775, 732.

$^1\text{H}$  NMR (300 MHz,  $\text{C}_6\text{D}_6$ ):  $\delta$  (ppm) = 4.51 (t,  $J$  = 6.0 Hz, 2H, H-1), 3.59 – 3.52 (m, 2H, H-3), 2.50 – 2.38 (m, 2H, H-2).

$^{13}\text{C}$  NMR (75 MHz,  $\text{C}_6\text{D}_6$ ):  $\delta$  (ppm) = 157.1 (q,  $J$  = 43.1 Hz, C-4), 114.4 (q,  $J$  = 285.3 Hz,  $\text{CF}_3$ ), 112.2 (CN), 64.4 (C-1), 54.8 (C-3), 21.7 (C-2).

HRMS (ASAP):  $[\text{M}-\text{H}]^-$   $\text{C}_6\text{H}_5\text{F}_3\text{NO}_4\text{S}$ : calcd. 243.9897, found 243.99.

### 4-chlorobutane-1-sulfonyl cyanide (342k)



Chemical Formula:  $\text{C}_5\text{H}_8\text{ClNO}_2\text{S}$   
Molecular Weight: 181,64

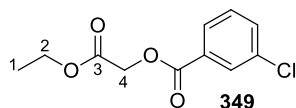
According to the general procedure **C** from thiocyanate **346p** (827 mg, 5.53 mmol, 1.0 eq.), hydrogen peroxide (50 wt% solution in water, 1.88 g, 55.3 mmol, 10 eq.), trifluoroacetic anhydride (7.8 mL, 55.3 mmol, 10 eq.) in dichloromethane (20 mL) for 6 hours. The crude was submitted once again in the same oxidation reaction to reach full conversion. Crude yield after two consecutive oxidations (717 mg, 71%, contaminated by traces of sulfoxide).

IR (film, KBr)  $\nu_{\text{max}}$  ( $\text{cm}^{-1}$ ) = 2963, 2917, 2876, 2191, 1452, 1372, 1167.

$^1\text{H}$  NMR (300 MHz,  $\text{CDCl}_3$ ):  $\delta$  (ppm) = 3.64 – 3.56 (m, 2H, H-1), 3.50 – 3.42 (m, 2H, H-4), 2.23 – 2.10 (m, 2H, H-2/3), 2.06 – 1.93 (m, 2H, H-2/3).

$^{13}\text{C}$  NMR (75 MHz,  $\text{CDCl}_3$ ):  $\delta$  (ppm) = 112.5 (CN), 57.6 (C-4), 43.5 (C-1), 30.1 (C-2/3), 20.0 (C-2/3).

### 2-ethoxy-2-oxoethyl 3-chlorobenzoate (349)



Chemical Formula:  $\text{C}_{11}\text{H}_{11}\text{ClO}_4$   
Molecular Weight: 242,66

In a 100 mL two-necked RBF equipped with a condenser, thiocyanate **346d** (2.0 g, 13.8 mmol, 1.0 eq.) was diluted in 50 mL of dry benzene and *m*-CPBA (16.6 g, 96 mmol, 7.0 eq.) was added. The reaction mixture was stirred at 60°C for 60 hours. At room temperature, the reaction was treated with a saturated aqueous solution of  $\text{NaHSO}_3$  and the aqueous layer was extracted with dichloromethane (3 times). The combined organic layers were washed with a saturated aqueous

solution of NaHCO<sub>3</sub>, water and brine, dried over MgSO<sub>4</sub> and concentrated under reduced pressure. The obtained crude product was then purified by flash chromatography (cyclohexane/EtOAc 95:5) to afford **349** as colourless oil (13 mg, 18%).

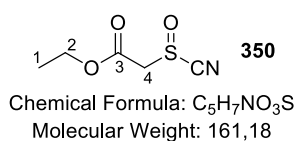
**Rf** = 0.54 (cyclohexane/EtOAc 4:1).

**<sup>1</sup>H NMR** (300 MHz, CDCl<sub>3</sub>): δ (ppm) = 8.12 – 8.09 (m, 1H, Ar), 8.03 – 7.99 (m, 1H, Ar), 7.59 (ddd, *J* = 8.0, 2.2, 1.1 Hz, 1H, Ar), 7.43 (td, *J* = 7.9, 0.5 Hz, 1H, Ar), 4.87 (s, 2H, H-4), 4.29 (q, *J* = 7.2 Hz, 2H, H-2), 1.33 (t, *J* = 7.2 Hz, 3H, H-1).

**<sup>13</sup>C NMR** (75 MHz, CDCl<sub>3</sub>): δ (ppm) = 167.7 (C-3), 164.9 (C-5), 134.8 (Ar), 133.6 (Ar), 131.0 (Ar), 130.1 (Ar), 129.9 (Ar), 128.2 (Ar), 61.7 (C-2), 61.5 (C-4), 14.3 (C-1).

**LRMS** (ESI): [M+Na]<sup>+</sup> C<sub>11</sub>H<sub>11</sub>ClO<sub>4</sub>Na: found 265.0.

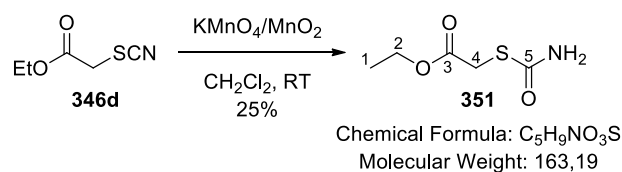
### Ethyl 2-(cyanosulfinyl)acetate (**350**)



According to the general procedure **C** from ethyl 2-thiocyanoacetate **346d** (500 mg, 3.4 mmol, 1.0 eq.), hydrogen peroxide (50 wt% solution in water, 0.2 ml, 6.9 mmol, 2 eq.), trifluoroacetic anhydride (0.97 ml, 6.9 mmol, 2 eq.) in dichloromethane (5 mL) for 3 hours. A mixture of sulfinyl cyanide and thiocyanate in an 8:2 ratio was obtained. Crude yield (356 mg, 65%).

**<sup>1</sup>H NMR** (300 MHz, C<sub>6</sub>D<sub>6</sub>): δ (ppm) = 3.67 (q, *J* = 7.1 Hz, 2H, H-2), 3.00 (d, *J* = 15.2 Hz, 1H, H-4a), 2.73 (d, *J* = 15.2 Hz, 1H, H-4b), 0.76 (t, *J* = 7.1 Hz, 3H, H-1).

### Ethyl 2-(carbamoylthio)acetate (**351**)



An identical protocol from literature was followed.<sup>294</sup>

In a 50 mL two-necked RBF, KMnO<sub>4</sub>/MnO<sub>2</sub> (4.0 g) was added in small portions to a solution of thiocyanate **346d** (280 mg, 1.9 mmol, 1.0 eq.) in 25 mL of dry dichloromethane. The reaction mixture was vigorously stirred at room temperature for 5 hours. The heterogenous solution was filtered off through a celite pad and the filter cake was rinsed with dichloromethane. The filtrate was evaporated under reduced pressure. The crude product was purified by flash chromatography (cyclohexane/EtOAc 75:25) to afford **351** as colourless oil (82 mg, 25%). These oxidative conditions did not give the expected sulfonyl cyanide but the carbamothioate as the major product.

**Rf** = 0.31 (cyclohexane/EtOAc 2:1).

**IR** (film, KBr)  $\nu_{\max}$  (cm<sup>-1</sup>) = 3316, 2984, 2933, 1682, 1466, 1368, 1300.

**<sup>1</sup>H NMR** (300 MHz, C<sub>6</sub>D<sub>6</sub>): δ (ppm) = 5.53 (br s, 2H, NH<sub>2</sub>), 4.21 (q, *J* = 7.2 Hz, 2H, H-2), 3.72 (s, 2H, H-4), 1.28 (t, *J* = 7.2 Hz, 3H, H-1).

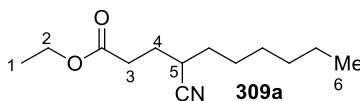
**<sup>13</sup>C NMR** (75 MHz, C<sub>6</sub>D<sub>6</sub>): δ (ppm) = 169.6 (C-3), 167.7 (C-5), 62.0 (C-2), 32.4 (C-4), 14.1 (C-1).

**HRMS** (ESI): [M+Na]<sup>+</sup> C<sub>5</sub>H<sub>9</sub>NO<sub>3</sub>SNa: calcd. 186.0195, found 186.0193.

<sup>294</sup> A. Shaabani, P. Mirzaei, S. Naderi, D. G. Lee, *Tetrahedron* **2014**, *60*, 11415-11420.

### 3.3. Tin-free two-components carbo-cyanation of olefins

#### Ethyl 4-cyanodecanoate (**309a**)



Chemical Formula: C<sub>13</sub>H<sub>23</sub>NO<sub>2</sub>  
Molecular Weight: 225,33

According to the general procedure **D** from sulfonyl cyanide **305** (354 mg, 2.0 mmol, 2.0 eq.), 1-octene (112 mg, 1.0 mmol, 1.0 eq.), 1,1'-Azobis(cyclohexanecarbonitrile) (24 mg, 0.1 mmol, 0.1 eq.) in chlorobenzene (7.0 mL). The crude product was purified by flash chromatography (cyclohexane/EtOAc 95:5) to afford **309a** as colourless oil (143 mg, 63%).

**Rf** = 0.60 (cyclohexane/EtOAc 4:1).

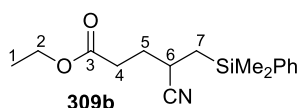
**IR** (film, KBr)  $\nu_{\max}$  (cm<sup>-1</sup>) = 2931, 2860, 2237, 1735, 1458, 1378, 1250, 1183.

**<sup>1</sup>H NMR** (300 MHz, CDCl<sub>3</sub>):  $\delta$  (ppm) = 4.14 (q,  $J$  = 7.1 Hz, 2H, H-2), 2.64 (m, 1H, H-5), 2.56 – 2.39 (m, 2H, H-3), 2.02 – 1.76 (m, 2H, H-4), 1.73 – 1.17 (m, 13H, CH<sub>2</sub> + H-1), 0.87 (m, 3H, H-6).

**<sup>13</sup>C NMR** (75 MHz, CDCl<sub>3</sub>):  $\delta$  (ppm) = 172.4 (CO<sub>2</sub>Et), 121.7 (CN), 60.8 (C-2), 32.3, 31.6, 31.6, 31.1 (C-5), 28.8, 27.5 (C-4), 27.1, 22.6, 14.3 (C-1/C-6), 14.1 (C-1/C-6).

**HRMS** (ESI): [M+Na]<sup>+</sup> C<sub>13</sub>H<sub>23</sub>NO<sub>2</sub>Na: calcd. 248.1621, found 248.1610.

#### Ethyl 4-cyano-5-(dimethyl(phenyl)silyl)pentanoate (**309b**)



Chemical Formula: C<sub>16</sub>H<sub>23</sub>NO<sub>2</sub>Si  
Molecular Weight: 289,44

According to the general procedure **D** from sulfonyl cyanide **305** (354 mg, 2.0 mmol, 2.0 eq.), allyldimethyl(phenyl)silane (176 mg, 1.0 mmol, 1.0 eq.), 1,1'-Azobis(cyclohexanecarbonitrile) (24 mg, 0.1 mmol, 0.1 eq.) in chlorobenzene (7.0 mL). The crude product was purified by flash chromatography (cyclohexane/EtOAc 95:5) to afford **309b** as colourless oil (212 mg, 72%).

**Rf** = 0.46 (cyclohexane/EtOAc 4:1).

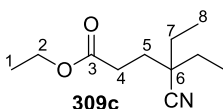
**IR** (film, KBr)  $\nu_{\max}$  (cm<sup>-1</sup>) = 3050, 2958, 2236, 1734, 1252, 1211, 1180, 1114, 838.

**<sup>1</sup>H NMR** (300 MHz, CDCl<sub>3</sub>):  $\delta$  (ppm) = 7.56 – 7.46 (m, 2H, Ph), 7.43 – 7.34 (m, 3H, Ph), 4.11 (q,  $J$  = 7.1 Hz, 2H, H-2), 2.63 (m, 1H, H-6), 2.56 – 2.34 (m, 2H, H-4), 2.01 – 1.75 (m, 2H, H-5), 1.33 – 0.97 (m, 5H, H-7 + H-1), 0.44 (s, 3H, SiMe<sub>2</sub>), 0.40 (s, 3H, SiMe<sub>2</sub>).

**<sup>13</sup>C NMR** (75 MHz, CDCl<sub>3</sub>):  $\delta$  (ppm) = 172.3 (C-3), 137.3 (Ph<sub>quatern.</sub>), 133.6 (Ph), 129.6 (Ph), 128.2 (Ph), 122.6 (CN), 60.8 (C-2), 31.6 (C-4), 30.9 (C-5), 26.6 (C-6), 20.0 (C-7), 14.3 (C-1), -2.3 (SiMe<sub>2</sub>), -3.0 (SiMe<sub>2</sub>).

**HRMS** (ESI): [M+Na]<sup>+</sup> C<sub>16</sub>H<sub>23</sub>NO<sub>2</sub>SiNa: calcd. 312.1390, found 312.1394.

#### Ethyl 4-cyano-4-ethylhexanoate (**309c**)



Chemical Formula: C<sub>11</sub>H<sub>19</sub>NO<sub>2</sub>  
Molecular Weight: 197,27

According to the general procedure **D** from sulfonyl cyanide **305** (354 mg, 2.0 mmol, 2.0 eq.), 2-ethyl-1-butene (0,12 mL, 1.0 mmol, 1.0 eq.), 1,1'-Azobis(cyclohexanecarbonitrile) (24 mg, 0.1 mmol, 0.1 eq.) in chlorobenzene (7.0 mL). The crude product was purified by flash chromatography (cyclohexane/EtOAc 95:5) to afford **309c** as colourless oil (76 mg, 39%).

**Rf** = 0.34 (cyclohexane/EtOAc 4:1).

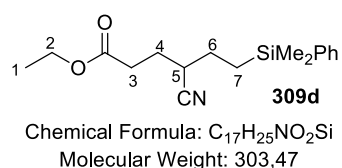
**IR** (film, KBr)  $\nu_{\max}$  (cm<sup>-1</sup>) = 2974, 2941, 2883, 2231, 1737, 1461, 1190.

**<sup>1</sup>H NMR** (300 MHz, CDCl<sub>3</sub>):  $\delta$  (ppm) = 4.15 (q,  $J$  = 7.1 Hz, 2H, H-2), 2.53 – 2.34 (m, 2H, H-4), 1.91 (m, 1H, H-5), 1.62 (q,  $J$  = 7.5 Hz, 4H, H-7), 1.27 (t,  $J$  = 7.1 Hz, 3H, H-1), 1.02 (t,  $J$  = 7.5 Hz, 6H, H-8).

**<sup>13</sup>C NMR** (75 MHz, CDCl<sub>3</sub>):  $\delta$  (ppm) = 172.7 (C-3), 123.3 (CN), 60.9 (C-2), 41.3 (C-6), 30.3 (C-5), 29.8 (C-4), 28.5 (C-7), 14.3 (C-1), 8.7 (C-8).

**HRMS** (ESI): [M+Na]<sup>+</sup> C<sub>11</sub>H<sub>19</sub>NO<sub>2</sub>Na: calcd. 220.1308, found 220.1302.

#### Ethyl 4-cyano-6-(dimethyl(phenyl)silyl)hexanoate (**309d**)



According to the general procedure **D** from sulfonyl cyanide **305** (106 mg, 0.6 mmol, 2.0 eq.), but-3-en-1-yl(dimethyl(phenyl)silane<sup>295</sup> (58 mg, 0.3 mmol, 1.0 eq.), 1,1'-Azobis(cyclohexanecarbonitrile) (7 mg, 0.03 mmol, 0.1 eq.)) in chlorobenzene (2.0 mL). The crude product was purified by flash chromatography (cyclohexane/EtOAc 95:5) to afford **309d** as colourless oil (62 mg, 67%).

**Rf** = 0.39 (cyclohexane/EtOAc 4/1).

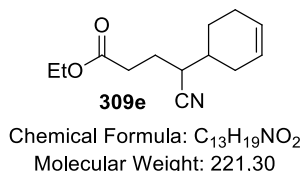
**IR** (film, KBr)  $\nu_{\max}$  (cm<sup>-1</sup>) = 3069, 3049, 2980, 2938, 2955, 2237, 1733.

**<sup>1</sup>H NMR** (300 MHz, CDCl<sub>3</sub>):  $\delta$  (ppm) = 7.53 – 7.45 (m, 2H, Ph), 7.40 – 7.34 (m, 3H, Ph), 4.14 (q,  $J$  = 7.2 Hz, 2H, H-2), 2.68 – 2.53 (m, 1H, H-5), 2.53 – 2.35 (m, 2H, H-3), 2.01 – 1.74 (m, 2H, H-4), 1.68 – 1.51 (m, 2H, H-6), 1.26 (t,  $J$  = 7.1 Hz, 3H, H-1), 1.13 – 0.75 (m, 2H, H-7), 0.30 (s, 6H, SiMe<sub>2</sub>Ph).

**<sup>13</sup>C NMR** (75 MHz, CDCl<sub>3</sub>):  $\delta$  (ppm) = 172.3 (CO<sub>2</sub>Et), 138.1 (Ph), 133.6 (Ph), 129.3 (Ph), 128.0 (Ph), 121.7 (CN), 60.8 (C-2), 34.4 (C-5), 31.6 (C-3), 27.2 (C-4 or 6), 27.0 (C-4 or 6), 14.3 (C-1), 13.5 (C-7), -3.2 (SiMe<sub>2</sub>Ph).

**HRMS** (ESI): [M+Na]<sup>+</sup> C<sub>17</sub>H<sub>25</sub>NO<sub>2</sub>SiNa: calcd. 326.1546, found 326.1547.

#### Ethyl 4-cyano-4-(cyclohex-3-en-1-yl)butanoate (**309e**)



According to the general procedure **D** from sulfonyl cyanide **305** (354 mg, 2.0 mmol, 2.0 eq.), 4-vinyl-1-cyclohexene (0,13 mL, 1.0 mmol, 1.0 eq.), 1,1'-Azobis(cyclohexanecarbonitrile) (24 mg, 0.1 mmol, 0.1 eq.) in chlorobenzene (7.0 mL). The crude product was purified by flash

<sup>295</sup> Prepared from: R. J. Smith, M. Pietzsch, T. Waniek, C. Syldatk, S. Bienz, *Tetrahedron: Asymm.* **2001**, *12*, 157-165.

chromatography (cyclohexane/EtOAc 95:5) to afford **309e** as a 1:1 mixture of inseparable diastereomers (97 mg, 44%).

**Rf** = 0.47 (cyclohexane/EtOAc 4:1).

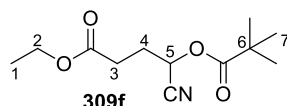
**IR** (film, KBr)  $\nu_{\max}$  (cm<sup>-1</sup>) = 3027, 2981, 2924, 2841, 2237, 1733, 1654, 1191, 1164.

**<sup>1</sup>H NMR** (300 MHz, CDCl<sub>3</sub>):  $\delta$  (ppm) = 5.66 (m, 4H), 4.14 (q,  $J$  = 7.1 Hz, 4H), 2.77 – 2.34 (m, 6H), 2.31 – 1.71 (m, 16H), 1.49 (m, 2H), 1.25 (t,  $J$  = 7.1 Hz, 6H).

**<sup>13</sup>C NMR** (75 MHz, CDCl<sub>3</sub>):  $\delta$  (ppm) = 172.3, 127.3, 127.0, 125.1, 125.0, 120.7, 120.6, 60.8, 37.0, 36.8, 35.8, 35.5, 31.8, 29.8, 28.4, 27.1, 25.9, 25.0, 25.0, 24.9, 24.9, 14.3.

**HRMS** (ESI): [M+Na]<sup>+</sup> C<sub>13</sub>H<sub>19</sub>NO<sub>2</sub>Na: calcd. 244.1308, found 244.1307.

#### Ethyl 4-cyano-4-(pivaloyloxy)butanoate (**309f**)



Chemical Formula: C<sub>12</sub>H<sub>19</sub>NO<sub>4</sub>  
Molecular Weight: 241.28

**Protocol 1:** according to the general procedure **D** from sulfonyl cyanide **305** (354 mg, 2.0 mmol, 2.0 eq.), vinyl pivalate (0.15 mL, 1.0 mmol, 1.0 eq.), 1,1'-Azobis(cyclohexanecarbonitrile) (24 mg, 0.1 mmol, 0.1 eq.) in chlorobenzene (7.0 mL). The crude product was purified by flash chromatography (cyclohexane/EtOAc 90:10) to afford **309f** as a colourless oil (201 mg, 83%).

**Protocol 2:** according to the general procedure **E** from sulfonyl cyanide **305** (177 mg, 1.0 mmol, 1.0 eq.), vinyl pivalate (0.74 mL, 5.0 mmol, 5 eq.), eosin Y (13 mg, 0.02 mmol, 2 mol%) and K<sub>2</sub>HPO<sub>4</sub> (35 mg, 0.2 mmol, 0.2 eq.) in DMF (1.0 mL) for 24 hours. The crude product was purified by flash chromatography (cyclohexane/EtOAc 90:10) to afford **309f** as colourless oil (175 mg, 73%).

**Rf** = 0.49 (cyclohexane/EtOAc 4:1).

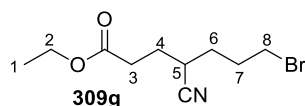
**IR** (film, KBr)  $\nu_{\max}$  (cm<sup>-1</sup>) = 2979, 2940, 2911, 2876, 2250, 1741, 1276, 1183, 1133.

**<sup>1</sup>H NMR** (300 MHz, CDCl<sub>3</sub>):  $\delta$  (ppm) = 5.41 (t,  $J$  = 6.6 Hz, 1H, H-5), 4.17 (q,  $J$  = 7.1 Hz, 2H, H-2), 2.53 (m, 2H, H-3), 2.34 – 2.17 (m, 2H, H-4), 1.26 (m, 12H, H-1 + H-7).

**<sup>13</sup>C NMR** (75 MHz, CDCl<sub>3</sub>):  $\delta$  (ppm) = 176.5 (CO<sub>2</sub>R), 171.4 (CO<sub>2</sub>R), 116.6 (CN), 61.1 (C-2), 60.1 (C-5), 38.9 (C-6), 29.2 (C-3), 27.6 (C-4), 26.9 (C-7), 14.2 (C-1).

**HRMS** (ESI): [M+Na]<sup>+</sup> C<sub>12</sub>H<sub>19</sub>NO<sub>4</sub>Na: calcd. 264.1206, found 264.1214.

#### Ethyl 7-bromo-4-cyanoheptanoate (**309g**)



Chemical Formula: C<sub>10</sub>H<sub>16</sub>BrNO<sub>2</sub>  
Molecular Weight: 262.14

According to the general procedure **D** from sulfonyl cyanide **305** (354 mg, 2.0 mmol, 2.0 eq.), 5-bromo-1-pentene (149 mg, 1.0 mmol, 1.0 eq.), 1,1'-Azobis(cyclohexanecarbonitrile) (24 mg, 0.1 mmol, 0.1 eq.) in chlorobenzene (7.0 mL). The crude product was purified by flash chromatography (cyclohexane/EtOAc 90:10) to afford **309g** as colourless oil (163 mg, 62%).

**Rf** = 0.57 (cyclohexane/EtOAc 2:1).

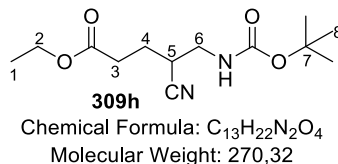
**IR** (film, KBr)  $\nu_{\max}$  (cm<sup>-1</sup>) = 2965, 2981, 2938, 2871, 2238, 1732, 1378, 1252, 1184, 1030.

**<sup>1</sup>H NMR** (300 MHz, CDCl<sub>3</sub>): δ (ppm) = 4.16 (q, *J* = 7.1 Hz, 2H, H-2), 3.45 (t, *J* = 6.3 Hz, 2H, H-8), 2.81 – 2.64 (m, 1H, H-5), 2.63 – 2.40 (m, 2H, H-3), 2.28 – 1.67 (m, 4H, H-6 + H-7), 1.27 (t, *J* = 7.1 Hz, 3H, H-1).

**<sup>13</sup>C NMR** (75 MHz, CDCl<sub>3</sub>): δ (ppm) = 172.2 (CO<sub>2</sub>Et), 121.1 (CN), 60.9 (C-2), 32.4 (C-8), 31.5 (C-3), 30.8 (C-4/6/7), 30.4 (C-5), 29.9 (C-4/6/7), 27.4 (C-4/6/7), 14.3 (C-1).

**HRMS** (ESI): [M+Na]<sup>+</sup> C<sub>10</sub>H<sub>16</sub><sup>79</sup>BrNO<sub>2</sub>Na: calcd. 284.0257, found 284.0262.

### Ethyl 5-((tert-butoxycarbonyl)amino)-4-cyanopentanoate (**309h**)



According to the general procedure **D** from sulfonyl cyanide **305** (354 mg, 2.0 mmol, 2.0 eq.), *tert*-butyl-*N*-allylcarbamate (158 mg, 1.0 mmol, 1.0 eq.), 1,1'-Azobis(cyclohexanecarbonitrile) (24 mg, 0.1 mmol, 0.1 eq.) in chlorobenzene (7.0 mL). The crude product was purified by flash chromatography (cyclohexane/EtOAc 75:25) to afford **309h** as colourless oil (68 mg, 25%).

**R<sub>f</sub>** = 0.29 (cyclohexane/EtOAc 2:1).

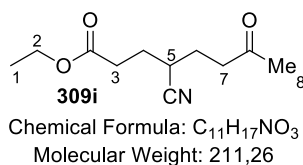
**IR** (film, KBr)  $\nu_{\max}$  (cm<sup>-1</sup>) = 3372, 2980, 2937, 2242, 1714, 1519, 1368, 1274, 1252, 1170.

**<sup>1</sup>H NMR** (300 MHz, CDCl<sub>3</sub>): δ (ppm) = 4.94 (br s, 1H, NHBoc), 4.15 (q, *J* = 7.1 Hz, 2H, H-2), 3.37 (m, 2H, H-6), 2.95 (m, 1H, H-5), 2.70 – 2.37 (m, 2H, H-3), 2.13 – 1.74 (m, 2H, H-4), 1.45 (s, 9H, H-8), 1.27 (t, *J* = 7.1 Hz, 3H, H-1).

**<sup>13</sup>C NMR** (75 MHz, CDCl<sub>3</sub>): δ (ppm) = 172.1 (CO<sub>2</sub>Et), 155.8 (Boc), 120.4 (CN), 80.2 (C-7), 60.9 (C-2), 41.9 (C-6), 32.4 (C-5), 31.3 (C-3), 28.3 (C-8), 24.6 (C-4), 14.2 (C-1).

**HRMS** (ESI): [M+Na]<sup>+</sup> C<sub>13</sub>H<sub>22</sub>N<sub>2</sub>O<sub>4</sub>Na: calcd. 293.1471, found 293.1460.

### Ethyl 4-cyano-7-oxooctanoate (**309i**)



According to the general procedure **D** from sulfonyl cyanide **305** (354 mg, 2.0 mmol, 2.0 eq.), 5-hexen-2-one (117 μL, 1.0 mmol, 1.0 eq.), 1,1'-Azobis(cyclohexanecarbonitrile) (24 mg, 0.1 mmol, 0.1 eq.) in chlorobenzene (7.0 mL). The crude product was purified by flash chromatography (cyclohexane/EtOAc 80:20) to afford **309i** as colourless oil (189 mg, 79%).

**R<sub>f</sub>** = 0.32 (cyclohexane/EtOAc 2:1).

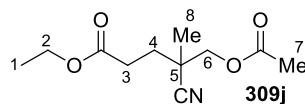
**IR** (film, KBr)  $\nu_{\max}$  (cm<sup>-1</sup>) = 2983, 2940, 2238, 1732, 1374, 1168.

**<sup>1</sup>H NMR** (300 MHz, CDCl<sub>3</sub>): δ (ppm) = 4.15 (q, *J* = 7.1 Hz, 2H, H-2), 2.86 – 2.63 (m, 3H, H-5 + H-7), 2.63 – 2.38 (m, 2H, H-3), 2.18 (s, 3H, H-8), 2.06 – 1.68 (m, 4H, H-4 + H-6), 1.27 (t, *J* = 7.2 Hz, 3H, H-1).

**<sup>13</sup>C NMR** (75 MHz, CDCl<sub>3</sub>): δ (ppm) = 206.7 (CO), 172.1 (CO<sub>2</sub>Et), 121.1 (CN), 60.9 (C-2), 40.4 (C-7), 31.5 (C-3), 30.3 (C-5), 30.1 (C-8), 27.5 (C-4/6), 25.9 (C-4/6), 14.2 (C-1).

**HRMS** (ESI): [M+Na]<sup>+</sup> C<sub>11</sub>H<sub>17</sub>NO<sub>3</sub>Na: calcd. 234.1100, found 234.1092.

### Ethyl 5-acetoxy-4-cyano-4-methylpentanoate (**309j**)



Chemical Formula: C<sub>11</sub>H<sub>17</sub>NO<sub>4</sub>  
Molecular Weight: 227,26

According to the general procedure **D** from sulfonyl cyanide **305** (354 mg, 2.0 mmol, 2.0 eq.), 2-methylallyl acetate (119 mg, 1.0 mmol, 1.0 eq.), 1,1'-Azobis(cyclohexanecarbonitrile) (24 mg, 0.1 mmol, 0.1 eq.) in chlorobenzene (7.0 mL). The crude product was purified by flash chromatography (cyclohexane/EtOAc 85:15) to afford **309j** as colourless oil (173 mg, 73%).

**Rf** = 0.36 (cyclohexane/EtOAc 2:1).

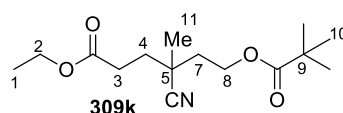
**IR** (film, KBr)  $\nu_{\max}$  (cm<sup>-1</sup>) = 2985, 2941, 2239, 1747, 1378, 1233, 1199, 1048.

**<sup>1</sup>H NMR** (300 MHz, CDCl<sub>3</sub>):  $\delta$  (ppm) = 4.16 (q, *J* = 7.1 Hz, 2H, H-2), 4.07 (s, 2H, H-6), 2.66 – 2.45 (m, 2H, H-3), 2.14 (s, 3H, H-7), 2.12 – 2.01 (m, 1H, H-4a), 1.96 – 1.78 (m, 1H, H-4b), 1.38 (s, 3H, H-8), 1.27 (t, *J* = 7.1 Hz, 3H, H-1).

**<sup>13</sup>C NMR** (75 MHz, CDCl<sub>3</sub>):  $\delta$  (ppm) = 172.0 (CO<sub>2</sub>R), 170.2 (CO<sub>2</sub>R), 121.3 (CN), 67.6 (C-6), 60.9 (C-2), 36.6 (C-5), 31.1 (C-4), 29.8 (C-3), 21.3 (C-8), 20.6 (C-7), 14.2 (C-1).

**HRMS** (ESI): [M+Na]<sup>+</sup> C<sub>11</sub>H<sub>17</sub>NO<sub>4</sub>Na: calcd. 250.1049, found 250.1051.

### Ethyl 4-cyano-4-methyl-6-(pivaloyloxy)hexanoate (**309k**)



Chemical Formula: C<sub>15</sub>H<sub>25</sub>NO<sub>4</sub>  
Molecular Weight: 283,36

According to the general procedure **D** from sulfonyl cyanide **305** (354 mg, 2.0 mmol, 2.0 eq.), 3-methylbut-3-en-1-yl pivalate<sup>287</sup> (170 mg, 1.0 mmol, 1.0 eq.), 1,1'-Azobis(cyclohexanecarbonitrile) (24 mg, 0.1 mmol, 0.1 eq.) in chlorobenzene (7.0 mL). The crude product was purified by flash chromatography (cyclohexane/EtOAc 90:10) to afford **309k** as colourless oil (189 mg, 79%).

**Rf** = 0.47 (cyclohexane/EtOAc 4:1).

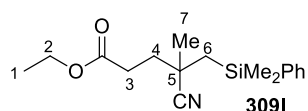
**IR** (film, KBr)  $\nu_{\max}$  (cm<sup>-1</sup>) = 2978, 2938, 2875, 2234, 1732, 1481, 1284, 1191, 1154.

**<sup>1</sup>H NMR** (300 MHz, CDCl<sub>3</sub>):  $\delta$  (ppm) = 4.26 (t, *J* = 6.5 Hz, 2H, H-8), 4.16 (q, *J* = 7.1 Hz, 2H, H-2), 2.59 – 2.40 (m, 2H, H-3), 2.13 – 1.79 (m, 4H, H-4 + H-7), 1.38 (s, 3H, H-11), 1.27 (t, *J* = 7.1 Hz, 3H, H-1), 1.21 (s, 9H, H-10).

**<sup>13</sup>C NMR** (75 MHz, CDCl<sub>3</sub>):  $\delta$  (ppm) = 178.4 (CO<sub>2</sub>*t*Bu), 172.2 (CO<sub>2</sub>Et), 122.9 (CN), 60.9 (C-2), 60.5 (C-8), 38.7 (C-5), 37.7 (C-4 ou C-7), 34.8 (C-9), 34.5 (C-4 ou C-7), 30.1 (C-3), 27.2 (C-10), 24.0 (C-11), 14.2 (C-1).

**HRMS** (ESI): [M+Na]<sup>+</sup> C<sub>15</sub>H<sub>25</sub>NO<sub>4</sub>Na: calcd. 306.1675, found 306.1663.

### Ethyl 4-cyano-5-(dimethyl(phenyl)silyl)-4-methylpentanoate (**309l**)



Chemical Formula: C<sub>17</sub>H<sub>25</sub>NO<sub>2</sub>Si  
Molecular Weight: 303,47



According to the general procedure **D** from sulfonyl cyanide **305** (354 mg, 2.0 mmol, 2.0 eq.), dimethyl(2-methylallyl)(phenyl)silane (190 mg, 1.0 mmol, 1.0 eq.), 1,1'-Azobis(cyclohexanecarbonitrile) (24 mg, 0.1 mmol, 0.1 eq.) in chlorobenzene (7.0 mL). The crude product was purified by flash chromatography (cyclohexane/EtOAc 95:5) to afford **309l** as colourless oil (51 mg, 27%).

**Rf** = 0.44 (cyclohexane/EtOAc 4:1).

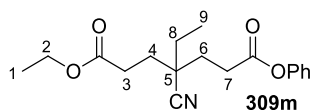
**IR** (film, KBr)  $\nu_{\max}$  (cm<sup>-1</sup>) = 3070, 3049, 2978, 2958, 2938, 2232, 1736, 1300, 1252, 1184, 1113.

**<sup>1</sup>H NMR** (300 MHz, CDCl<sub>3</sub>):  $\delta$  (ppm) = 7.53 (m, 2H, Ph), 7.37 (m, 3H, Ph), 4.12 (q, *J* = 7.1 Hz, 2H), 2.55 – 2.34 (m, 2H, H-3), 1.99 – 1.72 (m, 2H, H-4), 1.37 – 1.03 (m, 8H, H-1 + H-6 + H-7), 0.48 (s, 3H, SiMe<sub>2</sub>Ph), 0.45 (s, 3H, SiMe<sub>2</sub>Ph).

**<sup>13</sup>C NMR** (75 MHz, CDCl<sub>3</sub>):  $\delta$  (ppm) = 172.5 (CO<sub>2</sub>Et), 138.3 (Ph), 133.6 (Ph), 129.5 (Ph), 128.2 (Ph), 124.6 (CN), 60.8 (C-2), 37.8 (C-4), 34.2 (C-5), 30.5 (C-3), 28.3 (C-6), 27.0 (C-7), 14.3 (C-1), -1.5 (SiMe<sub>2</sub>Ph), -1.6 (SiMe<sub>2</sub>Ph).

**HRMS** (ESI): [M+Na]<sup>+</sup> C<sub>17</sub>H<sub>25</sub>NO<sub>2</sub>SiNa: calcd. 326,1546, found 326,1539.

### 1-Ethyl 7-phenyl 4-cyano-4-ethylheptanedioate (**309m**)



Chemical Formula: C<sub>18</sub>H<sub>23</sub>NO<sub>4</sub>  
Molecular Weight: 317,38

According to the general procedure **D** from sulfonyl cyanide **305** (100 mg, 0.56 mmol, 2.0 eq), alkene **94c** (58 mg, 0.28 mmol, 1.0 eq.), 1,1'-Azobis(cyclohexanecarbonitrile) (7 mg, 0.03 mmol, 0.1 eq.) in chlorobenzene (2.0 mL). The crude product was purified by flash chromatography (cyclohexane/EtOAc 90:10) to afford **309m** as colourless oil (54 mg, 61%).

**Rf** = 0.48 (cyclohexane/EtOAc 2:1).

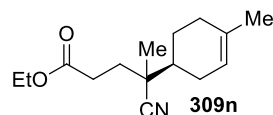
**IR** (film, KBr)  $\nu_{\max}$  (cm<sup>-1</sup>) = 3065, 2977, 2941, 2883, 2232, 1759, 1733, 1194, 1164, 1142.

**<sup>1</sup>H NMR** (300 MHz, CDCl<sub>3</sub>):  $\delta$  (ppm) = 7.47 – 7.32 (m, 2H, Ph), 7.26 (m, 1H, Ph), 7.09 (m, 2H, Ph), 4.17 (q, *J* = 7.1 Hz, 2H, H-2), 2.82 – 2.65 (m, 2H, H-3), 2.57 – 2.44 (m, 2H, H-7), 2.09 – 1.91 (m, 4H, H-4 + H-6), 1.70 (q, *J* = 7.5 Hz, 2H, H-8), 1.28 (t, *J* = 7.1 Hz, 3H, H-1), 1.09 (t, *J* = 7.5 Hz, 3H, H-9).

**<sup>13</sup>C NMR** (75 MHz, CDCl<sub>3</sub>):  $\delta$  (ppm) = 172.3 (CO<sub>2</sub>R), 170.9 (CO<sub>2</sub>R), 150.6 (Ph), 129.6 (Ph), 126.1 (Ph), 122.3 (CN), 121.5 (Ph), 61.0 (C-2), 40.4 (C-5), 30.6 (C-4/6), 30.4 (C-4/6), 29.8 (C-3/7), 29.7 (C-3/7), 29.0 (C-8), 14.3 (C-1), 8.7 (C-9).

**HRMS** (ESI): [M+Na]<sup>+</sup> C<sub>18</sub>H<sub>23</sub>NO<sub>4</sub>Na: calcd. 340.1519, found 340.1509.

### Ethyl 4-cyano-4-((S)-4-methylcyclohex-3-en-1-yl)pentanoate (**309n**)



Chemical Formula: C<sub>15</sub>H<sub>23</sub>NO<sub>2</sub>  
Molecular Weight: 249,35

According to the general procedure **D** from sulfonyl cyanide **305** (354 mg, 2.0 mmol, 2.0 eq.), (S)-(-)-Limonen (0.16 mL, 1.0 mmol, 1.0 eq.), 1,1'-Azobis(cyclohexanecarbonitrile) (24 mg, 0.1 mmol, 0.1 eq.) in chlorobenzene (7.0 mL) were stirred for 1.5 hours at 120°. A second portion of 1,1'-Azobis(cyclohexanecarbonitrile) (24 mg, 0.1 mmol, 0.1 eq.) was added and the reaction was

stirred at 120°C for another 1.5 hours. The crude product was purified by flash chromatography (cyclohexane/EtOAc 95:15) to afford **309n** as a mixture of inseparable diastereomers (142 mg, 57%, d.r. 1:1).

**Rf** = 0.5 (cyclohexane/EtOAc 4:1).

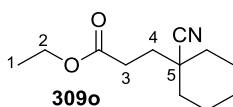
**IR** (film, KBr)  $\nu_{\max}$  (cm<sup>-1</sup>) = 2980, 2965, 2927, 2839, 2231, 1736, 1447, 1189.

**<sup>1</sup>H NMR** (300 MHz, CDCl<sub>3</sub>):  $\delta$  (ppm) = 5.35 (s, 2H), 4.14 (q,  $J$  = 7.1 Hz, 4H), 2.58 – 2.39 (m, 4H), 2.28 – 1.58 (m, 22H), 1.42 (m, 2H), 1.31-1.20 (m, 12H).

**<sup>13</sup>C NMR** (75 MHz, CDCl<sub>3</sub>):  $\delta$  (ppm) = 172.64, 172.63, 134.37, 134.12, 123.49, 123.36, 119.61, 119.36, 60.87, 40.88, 40.55, 39.96, 39.85, 31.86, 31.37, 30.71, 30.67, 30.17, 27.38, 26.30, 25.05, 24.14, 23.28, 23.27, 20.99, 20.36, 14.29.

**HRMS** (ESI): [M+Na]<sup>+</sup> C<sub>15</sub>H<sub>23</sub>NO<sub>2</sub>Na: calcd. 272.1621, found 272.1619.

### Ethyl 3-(1-cyanocyclohexyl)propanoate (**309o**)



Chemical Formula: C<sub>12</sub>H<sub>19</sub>NO<sub>2</sub>  
Molecular Weight: 209,28

According to the general procedure **D** from sulfonyl cyanide **305** (354 mg, 2.0 mmol, 2.0 eq.), methylenecyclohexane (0.12 mL, 1.0 mmol, 1.0 eq.), 1,1'-Azobis(cyclohexanecarbonitrile) (24 mg, 0.1 mmol, 0.1 eq.) in chlorobenzene (7.0 mL). The crude product was purified by flash chromatography (cyclohexane/EtOAc 95:5) to afford **309o** as colourless oil (82 mg, 39%).

**Rf** = 0.3 (cyclohexane/EtOAc 4:1).

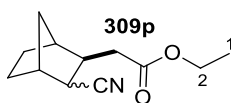
**IR** (film, KBr)  $\nu_{\max}$  (cm<sup>-1</sup>) = 2937, 2861, 2231, 1736, 1190.

**<sup>1</sup>H NMR** (300 MHz, CDCl<sub>3</sub>):  $\delta$  (ppm) = 4.12 (q,  $J$  = 7.1 Hz, 2H, H-2), 2.58 – 2.40 (m, 2H, H-3), 2.36 – 1.46 (m, 15H).

**<sup>13</sup>C NMR** (75 MHz, CDCl<sub>3</sub>):  $\delta$  (ppm) = 172.7 (CO<sub>2</sub>Et), 123.0 (CN), 60.8 (C-2), 38.6 (C-5), 36.5 (Cy), 35.6 (C-4), 35.2 (Cy), 29.7 (C-3), 25.4 (Cy), 23.1 (Cy), 22.7 (Cy), 14.3 (C-1).

**HRMS** (ESI): [M+Na]<sup>+</sup> C<sub>12</sub>H<sub>19</sub>NO<sub>2</sub>Na: calcd. 232.1308, found 232.1314.

### Ethyl 2-((1S,2R,3S,4R)-3-cyanobicyclo[2.2.1]heptan-2-yl)acetate (**309p**)



Chemical Formula: C<sub>12</sub>H<sub>17</sub>NO<sub>2</sub>  
Molecular Weight: 207,27

According to the general procedure **D** from sulfonyl cyanide **305** (354 mg, 2.0 mmol, 2.0 eq.), 2-norbornen (94 mg, 1.0 mmol, 1.0 eq.), 1,1'-Azobis(cyclohexanecarbonitrile) (24 mg, 0.1 mmol, 0.1 eq.) in chlorobenzene (7.0 mL). The crude product was purified by flash chromatography (cyclohexane/EtOAc 90:10) to afford **309p** as separable diastereomers (145 mg, 70%, d.r. 2:1).

#### First Diastereomer:

**Rf** = 0.37 (cyclohexane/EtOAc 4:1).

**IR** (film, KBr)  $\nu_{\max}$  (cm<sup>-1</sup>) = 2960, 2877, 2235, 1741, 1182.

**<sup>1</sup>H NMR** (300 MHz, CDCl<sub>3</sub>):  $\delta$  (ppm) = 4.16 (qd,  $J$  = 7.1, 3.2 Hz, 2H, H-2), 2.70 (dd,  $J$  = 8.7, 1.8 Hz, 1H), 2.64 – 2.40 (m, 3H), 2.31 – 2.08 (m, 2H), 1.81 – 1.51 (m, 3H), 1.38 – 1.22 (m, 6H).

<sup>13</sup>C NMR (75 MHz, CDCl<sub>3</sub>): δ (ppm) = 172.2 (CO<sub>2</sub>Et), 120.4 (CN), 60.8, 42.8, 41.2, 40.2, 37.8, 37.7, 34.8, 29.4, 27.8, 14.3.

HRMS (ESI): [M+Na]<sup>+</sup> C<sub>12</sub>H<sub>17</sub>NO<sub>2</sub>Na: calcd. 230.1151, found 230.1146.

Second Diastereomer:

R<sub>f</sub> = 0.34 (cyclohexane/EtOAc 4:1).

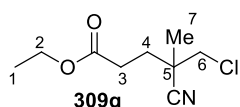
IR (film, KBr) ν<sub>max</sub> (cm<sup>-1</sup>) = 2961, 2880, 2236, 1733, 1178.

<sup>1</sup>H NMR (300 MHz, CDCl<sub>3</sub>): δ (ppm) = 4.17 (q, *J* = 7.1 Hz, 2H, H-2), 2.53 (m, 1H), 2.45 – 2.06 (m, 5H), 1.86 – 1.50 (m, 3H), 1.46 – 1.34 (m, 3H), 1.29 (t, *J* = 7.1 Hz, 3H, H-1).

<sup>13</sup>C NMR (75 MHz, CDCl<sub>3</sub>): δ (ppm) = 171.4 (CO<sub>2</sub>Et), 121.8 (CN), 60.9, 44.8, 41.5, 40.6, 40.1, 37.9, 35.9, 29.2, 24.2, 14.3.

HRMS (ESI): [M+Na]<sup>+</sup> C<sub>12</sub>H<sub>17</sub>NO<sub>2</sub>Na: calcd. 230.1151, found 230.1141.

**Ethyl 5-chloro-4-cyano-4-methylpentanoate (309q)**



Chemical Formula: C<sub>9</sub>H<sub>14</sub>ClNO<sub>2</sub>  
Molecular Weight: 203,67

According to the general procedure **D** from sulfonyl cyanide **305** (354 mg, 2.0 mmol, 2.0 eq.), 3-chloro-2-methylprop-1-ene (98 μL, 1.0 mmol, 1.0 eq.), 1,1'-Azobis(cyclohexanecarbonitrile) (24 mg, 0.1 mmol, 0.1 eq.) in chlorobenzene (7.0 mL). The crude product was purified by flash chromatography (cyclohexane/EtOAc 90:10) to afford **309q** as colourless oil (55 mg, 27%).

R<sub>f</sub> = 0.5 (cyclohexane/EtOAc 2:1).

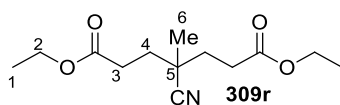
IR (film, KBr) ν<sub>max</sub> (cm<sup>-1</sup>) = 2985, 2941, 2876, 2240, 1732, 1464, 1380, 1308, 1193.

<sup>1</sup>H NMR (300 MHz, CDCl<sub>3</sub>): δ (ppm) = 4.17 (q, *J* = 7.1 Hz, 2H, H-2), 3.61 (d, *J* = 11.3 Hz, 1H, H-6a), 3.55 (d, *J* = 11.3 Hz, 1H, H-6b), 2.63 – 2.43 (m, 2H, H-3), 2.23 – 2.07 (m, 1H, H-4a), 2.02 – 1.85 (m, 1H, H-4b), 1.46 (s, 3H, H-7), 1.28 (t, *J* = 7.1 Hz, 3H, H-1).

<sup>13</sup>C NMR (75 MHz, CDCl<sub>3</sub>): δ (ppm) = 171.8 (CO<sub>2</sub>Et), 121.0 (CN), 61.0 (C-2), 49.3 (C-6), 38.7 (C-5), 31.8 (C-4), 29.9 (C-3), 22.3 (C-7), 14.2 (C-1).

HRMS (ESI): [M+Na]<sup>+</sup> C<sub>9</sub>H<sub>14</sub><sup>35</sup>ClNO<sub>2</sub>Na: calcd. 226.0605, found 226.0599.

**Diethyl 4-cyano-4-methylheptanedioate (309r)**



Chemical Formula: C<sub>13</sub>H<sub>21</sub>NO<sub>4</sub>  
Molecular Weight: 255,31

Isolated as a side-product in the previous reaction. It is a colourless oil (29 mg, 11%).

R<sub>f</sub> = 0.47 (cyclohexane/EtOAc 2:1).

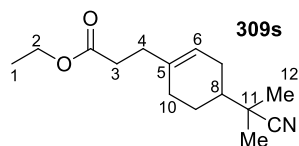
IR (film, KBr) ν<sub>max</sub> (cm<sup>-1</sup>) = 2983, 2939, 2873, 2233, 1735, 1465, 1377, 1302, 1189.

<sup>1</sup>H NMR (300 MHz, CDCl<sub>3</sub>): δ (ppm) = 4.15 (q, *J* = 7.1 Hz, 4H, H-2), 2.59 – 2.45 (m, 4H, H-3), 2.09 – 1.78 (m, 4H, H-4), 1.33 (s, 3H, H-6), 1.27 (t, *J* = 7.1 Hz, 6H, H-1).

<sup>13</sup>C NMR (75 MHz, CDCl<sub>3</sub>): δ (ppm) = 172.2 (CO<sub>2</sub>Et), 122.8 (CN), 60.9 (C-2), 35.9 (C-5), 34.1 (C-4), 30.1 (C-3), 23.6 (C-6), 14.3 (C-1).

HRMS (ESI): [M+Na]<sup>+</sup> C<sub>13</sub>H<sub>21</sub>NO<sub>4</sub>Na: calcd. 278.1362, found 278.1353.

### Ethyl 3-(4-(2-cyanopropan-2-yl)cyclohex-1-en-1-yl)propanoate (**309s**)



Chemical Formula: C<sub>15</sub>H<sub>23</sub>NO<sub>2</sub>  
Molecular Weight: 249,35

According to the general procedure **D** from sulfonyl cyanide **305** (354 mg, 2.0 mmol, 2.0 eq.), 1S-(-)-β-Pinene (157 μL, 1.0 mmol, 1.0 eq.), 1,1'-Azobis(cyclohexanecarbonitrile) (24 mg, 0.1 mmol, 0.1 eq.) in chlorobenzene (7.0 mL). The crude product was purified by flash chromatography (cyclohexane/EtOAc 95:5) to afford **309s** as colourless oil (31 mg, 13%).

**Rf** = 0.42 (cyclohexane/EtOAc 4:1).

**IR** (film, KBr)  $\nu_{\max}$  (cm<sup>-1</sup>) = 2977, 2925, 2232, 1733, 1370, 1173.

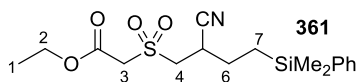
**<sup>1</sup>H NMR** (300 MHz, CDCl<sub>3</sub>):  $\delta$  (ppm) = 5.40 (m, 1H, H-6), 4.13 (q, *J* = 7.1 Hz, 2H, H-2), 2.46 – 2.34 (m, 2H, H-3), 2.29 (m, 2H, H-4), 2.23 – 1.82 (m, 6H, H-7 + H-9 + H-10), 1.60 – 1.37 (m, 1H, H-8), 1.35 (s, 3H, H-12a), 1.32 (s, 3H, H-12b), 1.25 (t, *J* = 7.1 Hz, 3H, H-1).

**<sup>13</sup>C NMR** (75 MHz, CDCl<sub>3</sub>):  $\delta$  (ppm) = 173.5 (CO<sub>2</sub>Et), 136.3 (C-5), 124.7 (CN), 120.1 (C-6), 60.4 (C-2), 42.2 (C-8), 36.0 (C-11), 32.9 (C-3), 32.4 (C-4), 28.9 (Cy), 27.2 (Cy), 24.8 (C-12a), 24.7 (Cy), 24.2 (C-12b), 14.4 (C-1).

**HRMS** (ESI): [M+Na]<sup>+</sup> C<sub>15</sub>H<sub>23</sub>NO<sub>2</sub>Na: calcd. 272,1621, found 272,1621.

### 3.4. Photoredox-catalysed sulfonyl-cyanation of olefins

#### Ethyl 2-((2-cyano-4-(dimethyl(phenyl)silyl)butyl)sulfonyl)acetate (**361**)



Chemical Formula: C<sub>17</sub>H<sub>25</sub>NO<sub>4</sub>SSi  
Molecular Weight: 367,54

But-3-en-1-yl dimethyl(phenyl)silane<sup>295</sup> (105 mg, 0.5 mmol, 1.0 eq.), fac[Ir(ppy)<sub>3</sub>] (3.3 mg, 5 μmol, 1 mol%), sulfonyl cyanide **305** (177 mg, 1.0 mmol, 1.8 eq.), and K<sub>2</sub>HPO<sub>4</sub> (17 mg, 0.1 mmol, 0.2 eq.) were diluted in dry DCE (2.0 mL) and the mixture was degassed by the freeze-pump-thaw procedure (3 times). The reaction mixture was stirred at room temperature while being irradiated with blue LEDs for 92 hours. The reaction was then diluted with dichloromethane and water. The aqueous layer was extracted with dichloromethane. The combined organic layers were washed with water and brine, dried over MgSO<sub>4</sub> and concentrated under reduced pressure. The obtained crude product was then purified by flash chromatography (cyclohexane/EtOAc 80:20) to afford **361** as colourless oil (17 mg, 10%).

**Rf** = 0,2 (Cyclohexane/EtOAc 4:1).

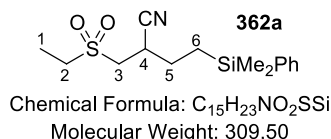
**IR** (film, KBr)  $\nu_{\max}$  (cm<sup>-1</sup>) = 3060, 2929, 2854, 2245, 1738, 1328, 1265, 1251, 1113, 735.

**<sup>1</sup>H NMR** (300 MHz, CDCl<sub>3</sub>):  $\delta$  (ppm) = 7.52 – 7.46 (m, 2H, Ph), 7.41 – 7.35 (m, 3H, Ph), 4.28 (q, *J* = 7.2 Hz, 2H, H-2), 4.19 (d, *J* = 15.3 Hz, 1H, H-3a), 3.98 (dd, *J* = 15.3, 1.1 Hz, 1H, H-3b), 3.84 (dd, *J* = 14.2, 8.8 Hz, 1H, H-4a), 3.31 – 3.14 (m, 2H, H-4b + H-5), 1.84 – 1.70 (m, 2H, H-6), 1.32 (t, *J* = 7.2 Hz, 3H, H-1), 1.11 – 0.81 (m, 2H, H-7), 0.32 (s, 6H, SiMe<sub>2</sub>).

**<sup>13</sup>C NMR** (75 MHz, CDCl<sub>3</sub>):  $\delta$  (ppm) = 163.0 (CO<sub>2</sub>Et), 137.5 (Ph), 133.6 (Ph), 129.5 (Ph), 128.2 (Ph), 119.5 (CN), 63.1 (C-2), 58.3, 54.1, 29.3, 27.4, 14.1, 13.3, -3.2 (SiMe<sub>2</sub>), -3.2 (SiMe<sub>2</sub>).

**HRMS** (ESI): [M+Na]<sup>+</sup> C<sub>17</sub>H<sub>25</sub>NO<sub>4</sub>SSiNa: calcd. 390.1166, found 390.1167.

#### 4-((dimethyl(phenyl)silyl)-2-((ethylsulfonyl)methyl)butanenitrile (362a)



According to the general procedure **E** from ethanesulfonyl cyanide **307** (178 mg, 1.5 mmol, 1.5 eq.), but-3-en-1-yl(dimethyl(phenyl)silane<sup>295</sup> (191 mg, 1.0 mmol, 1.0 eq.), eosin Y (13 mg, 0.02 mmol, 2 mol%) and K<sub>2</sub>HPO<sub>4</sub> (35 mg, 0.2 mmol, 0.2 eq.) in DMF (1.0 mL) for 24 hours. The crude product was purified by flash chromatography (cyclohexane/EtOAc 80:20) to afford **362a** as colourless oil (310 mg, 100%).

**Rf** = 0.33 (cyclohexane/EtOAc 2:1).

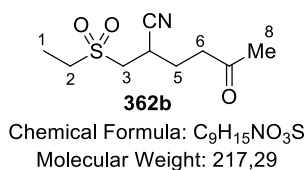
**IR** (film, KBr)  $\nu_{\max}$  (cm<sup>-1</sup>) = 3069, 2952, 2926, 2243, 1454, 1427, 1314, 1276, 1250, 1133.

**<sup>1</sup>H NMR** (300 MHz, CDCl<sub>3</sub>):  $\delta$  (ppm) = 7.64 – 7.47 (m, 2H, Ph), 7.47 – 7.29 (m, 3H, Ph), 3.34 (dd, *J* = 14.1, 8.9 Hz, 1H, H-3a), 3.24 – 3.06 (m, 3H, H-4 + H-2), 3.00 (dd, *J* = 14.1, 4.3 Hz, 1H, H-3b), 1.91 – 1.62 (m, 2H, H-5), 1.41 (t, *J* = 7.5 Hz, 3H, H-1), 1.12 – 0.79 (m, 2H, H-6), 0.32 (s, 6H, SiMe<sub>2</sub>).

**<sup>13</sup>C NMR** (75 MHz, CDCl<sub>3</sub>):  $\delta$  (ppm) = 137.5 (Ph), 133.5 (Ph), 129.4 (Ph), 128.1 (Ph), 119.8 (CN), 52.8 (C-3), 48.5 (C-2), 29.2 (C-4), 27.4 (C-5), 13.2 (C-6), 6.6 (C-1), -3.3 (SiMe<sub>2</sub>).

**HRMS** (ESI): [M+Na]<sup>+</sup> C<sub>15</sub>H<sub>23</sub>NO<sub>2</sub>SSiNa: calcd. 332.1111, found 332.1105.

#### 2-((ethylsulfonyl)methyl)-5-oxohexanenitrile (362b)



According to the general procedure **E** from ethanesulfonyl cyanide **307** (178 mg, 1.5 mmol, 1.5 eq.), 5-hexen-1-one (0.116 mL, 1.0 mmol, 1.0 eq.), eosin Y (13 mg, 0.02 mmol, 2 mol%) and K<sub>2</sub>HPO<sub>4</sub> (35 mg, 0.2 mmol, 0.2 eq.) in DMF (1.0 mL) for 24 hours. The crude product was purified by flash chromatography (cyclohexane/EtOAc 60:40) to afford **362b** as white solid (182 mg, 84%).

**Rf** = 0.2 (cyclohexane/EtOAc 2:3).

**m.p.** = 74-76°C (pentane/EtOAc).

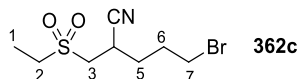
**IR** (film, KBr)  $\nu_{\max}$  (cm<sup>-1</sup>) = 2986, 2943, 2243, 1711, 1455, 1416, 1376, 1308, 1278, 1237, 1171, 1131.

**<sup>1</sup>H NMR** (300 MHz, CDCl<sub>3</sub>):  $\delta$  (ppm) = 3.43 – 3.27 (m, 2H, H-3a + H-4), 3.23 – 3.02 (m, 3H, H-2 + H-3b), 2.87 – 2.62 (m, 2H, H-6), 2.21 (s, 3H, H-8), 2.19-2.09 (m, 1H, H-5a), 2.04-1.91 (m, 1H, H-5b), 1.45 (t, *J* = 7.5 Hz, 3H, H-1).

**<sup>13</sup>C NMR** (75 MHz, CDCl<sub>3</sub>):  $\delta$  (ppm) = 206.4 (C-7), 119.4 (CN), 52.9 (C-3), 48.4 (C-2), 39.8 (C-6), 30.0 (C-8), 25.8 (C-5), 25.2 (C-4), 6.4 (C-1).

**HRMS** (ESI): [M+Na]<sup>+</sup> C<sub>9</sub>H<sub>15</sub>NO<sub>3</sub>SNa: calcd. 240.0665, found 240.0671.

### 5-bromo-2-((ethylsulfonyl)methyl)pentanenitrile (**362c**)



Chemical Formula: C<sub>8</sub>H<sub>14</sub>BrNO<sub>2</sub>S  
Molecular Weight: 268,17

According to the general procedure **E** from ethanesulfonyl cyanide **307** (178 mg, 1.5 mmol, 1.5 eq.), 5-bromo-1-pentene (0.118 mL, 1.0 mmol, 1.0 eq.), eosin Y (13 mg, 0.02 mmol, 2 mol%) and K<sub>2</sub>HPO<sub>4</sub> (35 mg, 0.2 mmol, 0.2 eq.) in DMF (1.0 mL) for 24 hours. The crude product was purified by flash chromatography (cyclohexane/EtOAc 1:1) to afford **362c** as colourless oil (228 mg, 85%). **R<sub>f</sub>** = 0.32 (cyclohexane/EtOAc 2:1).

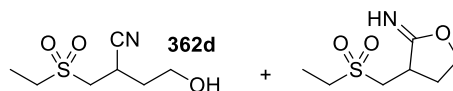
**IR** (film, KBr)  $\nu_{\max}$  (cm<sup>-1</sup>) = 2926, 2853, 2244 1454, 1409, 1309, 1276, 1238, 1131.

**<sup>1</sup>H NMR** (300 MHz, CDCl<sub>3</sub>):  $\delta$  (ppm) = 3.52 – 3.25 (m, 4H, H-3a, H-4, H-7), 3.17 (q, *J* = 7.4 Hz, 2H, H-2), 3.07 (dd, *J* = 13.6, 4.5 Hz, 1H, H-3b), 2.28 – 1.83 (m, 4H, H-5, H-6), 1.46 (t, *J* = 7.5 Hz, 4H, H-1).

**<sup>13</sup>C NMR** (75 MHz, CDCl<sub>3</sub>):  $\delta$  (ppm) = 119.3 (CN), 52.8 (C-3), 48.7 (C-2), 31.9 (C-7), 30.7 (C-5/C-6), 29.6 (C-5/C-6), 25.4 (C-4), 6.5 (C-1).

**HRMS** (ESI): [M+Na]<sup>+</sup> C<sub>8</sub>H<sub>14</sub>BrNO<sub>2</sub>SNa: calcd. 291.9800, found 291.9804.

### 2-((ethylsulfonyl)methyl)-4-hydroxybutanenitrile (**362d**)



Chemical Formula: C<sub>7</sub>H<sub>13</sub>NO<sub>3</sub>S  
Molecular Weight: 191,25

According to the general procedure **E** from ethanesulfonyl cyanide **307** (178 mg, 1.5 mmol, 1.5 eq.), 3-buten-1-ol (0.086 mL, 1.0 mmol, 1.0 eq.), Eosin Y (13 mg, 0.02 mmol, 2 mol%) and K<sub>2</sub>HPO<sub>4</sub> (35 mg, 0.2 mmol, 0.2 eq.) in DMF (1.0 mL) for 24 hours. No acidic work up was accomplished due to the solubility of the desired product in water. DMF was evaporated and the crude product was purified by flash chromatography (EtOAc) to afford the desired alcohol **362d** and the corresponding imidate as inseparable mixture (159 mg, 83% for the mixture).

**R<sub>f</sub>** = 0,31 (EtOAc).

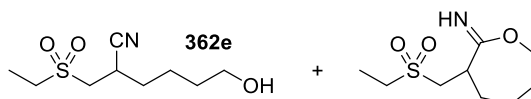
**IR** (film, KBr)  $\nu_{\max}$  (cm<sup>-1</sup>) = 3466, 2981, 2941, 2887, 2246, 1638, 1457, 1411, 1306, 1235, 1129, 1049, 800.

**<sup>1</sup>H NMR** (300 MHz, CDCl<sub>3</sub>):  $\delta$  (ppm) = 4.33 – 4.22 (m, 0.4H), 3.92 (s, 1.5H), 3.62 – 3.37 (m, 1.9H), 3.28 – 3.06 (m, 3H), 2.92 – 2.74 (m, 0.5H), 2.12 – 2.02 (m, 1.5H), 1.51 – 1.40 (m, 3H), 1.28 (t, *J* = 7.6 Hz, 0.7H).

**<sup>13</sup>C NMR** (75 MHz, CDCl<sub>3</sub>):  $\delta$  (ppm) = 119.81, 119.12, 119.02, 75.32, 65.85, 64.85, 64.48, 58.64, 52.59, 52.15, 52.14, 50.70, 50.57, 49.12, 48.59, 48.51, 48.43, 34.17, 32.18, 32.05, 22.96, 22.90, 6.37, 5.14, 5.11.

**HRMS** (heat nebulizer): [M+H]<sup>+</sup> C<sub>7</sub>H<sub>14</sub>NO<sub>3</sub>S: calcd. 192.0688, found 192.0693.

### 2-((ethylsulfonyl)methyl)-6-hydroxyhexanenitrile (**362e**)



Chemical Formula: C<sub>9</sub>H<sub>17</sub>NO<sub>3</sub>S  
Molecular Weight: 219,30

According to the general procedure **E** from ethanesulfonyl cyanide **307** (178 mg, 1.5 mmol, 1.5 eq.), 5-hexen-1-ol (0.12 mL, 1.0 mmol, 1.0 eq.), eosin Y (13 mg, 0.02 mmol, 2 mol%) and K<sub>2</sub>HPO<sub>4</sub> (35 mg, 0.2 mmol, 0.2 eq.) in DMF (1.0 mL) for 24 hours. No acidic work up was accomplished due to the solubility of the desired product in water. DMF was evaporated and the crude product was purified by flash chromatography (EtOAc) to afford the desired alcohol **362e** and the corresponding imidate as inseparable mixture (194 mg, 88% for the mixture).

**Rf** = 0,35 (EtOAc).

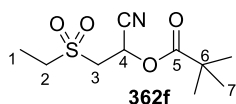
**IR** (film, KBr)  $\nu_{\max}$  (cm<sup>-1</sup>) = 3482, 2940, 2877, 2244, 2189, 1641, 1459, 1307, 1279, 1129.

**<sup>1</sup>H NMR** (300 MHz, CDCl<sub>3</sub>):  $\delta$  (ppm) = 4.15 – 3.98 (m, 2.7H), 3.69 (t, *J* = 5.8 Hz, 2H), 3.38 (dd, *J* = 13.8, 8.3 Hz, 2.6H), 3.33 – 3.22 (m, 2.3H), 3.16 (q, *J* = 7.5 Hz, 4.7H), 3.06 (dd, *J* = 13.8, 4.4 Hz, 2.5H), 2.74 (q, *J* = 7.6 Hz, 2.6H), 1.91 – 1.52 (m, 16H), 1.45 (t, *J* = 7.5 Hz, 7H), 1.26 (t, *J* = 7.6 Hz, 4H).

**<sup>13</sup>C NMR** (75 MHz, CDCl<sub>3</sub>):  $\delta$  (ppm) = 119.75, 119.56, 119.53, 67.85, 67.82, 61.92, 52.95, 52.92, 52.89, 50.73, 48.66, 48.61, 31.84, 31.60, 31.55, 31.52, 29.23, 26.08, 26.03, 25.99, 23.17, 23.13, 23.06, 6.55, 5.35.

**HRMS** (heat nebuliser): [M+H] C<sub>9</sub>H<sub>18</sub>NO<sub>3</sub>S: calcd. 220.1002, found 220.1004.

### 1-cyano-2-(ethylsulfonyl)ethyl pivalate (**362f**)



Chemical Formula: C<sub>10</sub>H<sub>17</sub>NO<sub>4</sub>S  
Molecular Weight: 247,31

According to the general procedure **E** from ethanesulfonyl cyanide **307** (178 mg, 1.5 mmol, 1.5 eq.), vinyl pivalate (0.148 mL, 1.0 mmol, 1.0 eq), eosin Y (13 mg, 0.02 mmol, 2 mol%) and K<sub>2</sub>HPO<sub>4</sub> (35 mg, 0.2 mmol, 0.2 eq.) in DMF (1.0 mL) for 24h. The crude product was purified by flash chromatography (cyclohexane/EtOAc 1:1) to afford **362f** as white solid (240 mg, 97%).

**Rf** = 0.66 (cyclohexane/EtOAc 1 :2).

**m. p.** = 66-70°C (pentane/EtOAc).

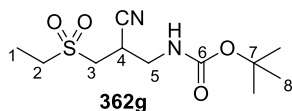
**IR** (film, KBr)  $\nu_{\max}$  (cm<sup>-1</sup>) = 2980, 2943, 2879, 1749, 1481, 1461, 1311, 1278, 1137, 1120, 1036.

**<sup>1</sup>H NMR** (300 MHz, CDCl<sub>3</sub>):  $\delta$  (ppm) = 5.78 (dd, *J* = 8.4, 4.7 Hz, 1H, H-4), 3.63 (dd, *J* = 14.9, 8.4 Hz, 1H, H-3a), 3.51 (dd, *J* = 14.9, 4.7 Hz, 1H, H-3b), 3.13 (q, *J* = 7.5 Hz, 2H, H-2), 1.46 (t, *J* = 7.5 Hz, 3H, H-1), 1.26 (s, 9H, H-7).

**<sup>13</sup>C NMR** (75 MHz, CDCl<sub>3</sub>):  $\delta$  (ppm) = 176.0 (C-5), 114.9 (CN), 55.9 (C-4), 52.5 (C-3), 49.4 (C-2), 38.8 (C-6), 26.8 (C-7), 6.5 (C-1).

**HRMS** (ESI): [M+Na]<sup>+</sup> C<sub>10</sub>H<sub>17</sub>NO<sub>4</sub>SNa: calcd. 270.0771, found 270.0761.

### Tert-butyl (2-cyano-3-(ethylsulfonyl)propyl)carbamate (**362g**)



Chemical Formula: C<sub>11</sub>H<sub>20</sub>N<sub>2</sub>O<sub>4</sub>S  
Molecular Weight: 276,35

According to the general procedure **E** from ethanesulfonyl cyanide **307** (178 mg, 1.5 mmol, 1.5 eq.), *tert*-butyl *N*-allylcarbamate (160 mg, 1.0 mmol, 1.0 eq.), eosin Y (13 mg, 0.02 mmol, 2 mol%) and K<sub>2</sub>HPO<sub>4</sub> (35 mg, 0.2 mmol, 0.2 eq.) in DMF (1.0 mL). The crude product was purified by flash chromatography (cyclohexane/EtOAc 1:1) to afford **362g** as white solid (200 mg, 72%).

**Rf** = 0.17 (cyclohexane/EtOAc 1 :1).

**m. p.** = 125-128°C (pentane/EtOAc)

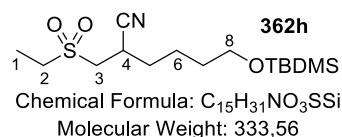
**IR** (film, KBr)  $\nu_{\max}$  (cm<sup>-1</sup>) = 3354, 2969, 2246, 1701, 1523, 1367, 1260, 1165, 1128, 1092, 1034.

**<sup>1</sup>H NMR** (300 MHz, DMSO-d<sub>6</sub>):  $\delta$  (ppm) = 7.31 (t, *J* = 5.4 Hz, 1H, N-H), 3.64 (dd, *J* = 15.2, 10.0 Hz, 1H, H-3a), 3.47 – 3.26 (m, 4H, H-3b, H-4, H-5), 3.19 (q, *J* = 7.4 Hz, 2H, H-2), 1.40 (s, 9H, H-8), 1.24 (t, *J* = 7.4 Hz, 3H, H-1).

**<sup>13</sup>C NMR** (75 MHz, DMSO-d<sub>6</sub>):  $\delta$  (ppm) = 155.6 (C-6), 119.1 (CN), 78.5 (C-7), 49.5 (C-3), 47.3 (C-2), 41.2 (C-5), 28.1 (C-8), 26.1 (C-4), 6.1 (C-1).

**HRMS** (ESI): [M+Na]<sup>+</sup> C<sub>11</sub>H<sub>20</sub>N<sub>2</sub>O<sub>4</sub>SSiNa: calcd. 299.1036, found 299.1044.

### 6-((tert-butyl dimethylsilyl)oxy)-2-((ethylsulfonyl)methyl)hexanenitrile (**362h**)



According to the general procedure **E** from ethanesulfonyl cyanide **307** (178 mg, 1.5 mmol, 1.5 eq.), tert-butyl(hex-5-en-1-yloxy)dimethylsilane<sup>296</sup> (216 mg, 1.0 mmol, 1.0 eq.), eosin Y (13 mg, 0.02 mmol, 2 mol%) and K<sub>2</sub>HPO<sub>4</sub> (35 mg, 0.2 mmol, 0.2 eq.) in DMF (1.0 mL) for 24 hours. The crude product was purified by flash chromatography (cyclohexane/EtOAc 80:20) to afford **362h** as colourless oil (208 mg, 62%).

**Rf** = 0.23 (cyclohexane/EtOAc 2:1).

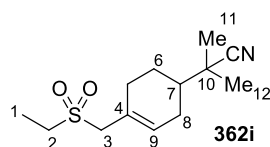
**IR** (film, KBr)  $\nu_{\max}$  (cm<sup>-1</sup>) = 2951, 2932, 2859, 2886, 2244, 1472, 1462, 1312, 1279, 1255, 1130, 1101.

**<sup>1</sup>H NMR** (300 MHz, CDCl<sub>3</sub>):  $\delta$  (ppm) = 3.64 – 3.58 (m, 2H, H-8), 3.37 (dd, *J* = 14.1, 8.7 Hz, 1H, H-3a), 3.28 – 3.19 (m, 1H, H-4), 3.14 (q, *J* = 7.6 Hz, 2H, H-2), 3.02 (dd, *J* = 14.1, 4.5 Hz, 1H, H-2b), 1.85 – 1.49 (m, 6H, H-5/6/7), 1.42 (t, *J* = 7.5 Hz, 3H, H-1), 0.87 (s, 9H, Si*t*Bu), 0.03 (s, 6H, SiMe<sub>2</sub>).

**<sup>13</sup>C NMR** (75 MHz, CDCl<sub>3</sub>):  $\delta$  (ppm) = 119.7 (CN), 62.5 (C-8), 53.3 (C-3), 48.7 (C-2), 32.1 (C-5/6/7), 31.9 (C-5/6/7), 26.4 (C-4), 26.0 (*t*Bu), 23.4 (C-5/6/7), 18.4 (C<sub>quatern</sub>, *t*Bu), 6.6 (C-1), -5.2 (SiMe<sub>2</sub>).

**HRMS** (ESI): [M+Na]<sup>+</sup> C<sub>15</sub>H<sub>31</sub>NO<sub>3</sub>SSiNa: calcd. 356.1686, found 356.1689.

### 2-(4-((ethylsulfonyl)methyl)cyclohex-3-en-1-yl)-2-methylpropanenitrile (**362i**)



According to the general procedure **E** from ethanesulfonyl cyanide **307** (178 mg, 1.5 mmol, 1.5 eq.), (1*S*)-(-)- $\beta$  pinene (0.157 mL, 1.0 mmol, 1.0 eq.), eosin Y (13 mg, 0.02 mmol, 2 mol%) and K<sub>2</sub>HPO<sub>4</sub> (35 mg, 0.2 mmol, 0.2 eq.) in DMF (1.0 mL) for 24 hours. The crude product was purified by flash chromatography (cyclohexane/EtOAc 2:1) to afford **362i** as white solid (218 mg, 85%).

**Rf** = 0.33 (cyclohexane/EtOAc 1 :1).

<sup>296</sup> Synthesised from: L. Balas, J. Bertrand-Michel, F. Viars, J. Faugere, C. Lefort, S. Caspar-Bauguil, D. Langin, T. Durand, *Org. Biomol. Chem.* **2016**, *14*, 9012-9020.



**m. p.** = 78-82 (pentane/EtOAc).

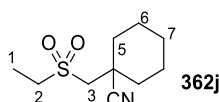
**IR** (film, KBr)  $\nu_{\max}$  (cm<sup>-1</sup>) = 2978, 2926, 2231, 1459, 1307, 1277, 1131, 1115.

**<sup>1</sup>H NMR** (300 MHz, CDCl<sub>3</sub>):  $\delta$  (ppm) = 5.79 (m, 1H, H-9), 3.58 (s, 2H, H-3), 2.96 (q,  $J$  = 7.5 Hz, 2H, H-2), 2.43 – 2.18 (m, 3H), 2.11 – 1.87 (m, 2H), 1.54 (m, 1H), 1.47 – 1.17 (m, 10H).

**<sup>13</sup>C NMR** (75 MHz, CDCl<sub>3</sub>):  $\delta$  (ppm) = 130.4 (C-9), 126.9 (C-4), 124.2 (CN), 59.9 (C-3), 45.9 (C-2), 41.4 (C-7), 35.8 (C-10), 29.2, 27.7, 24.5 (C-11), 24.3 (C-12), 24.2, 6.6 (C-1).

**HRMS** (ESI): [M+Na]<sup>+</sup> C<sub>13</sub>H<sub>21</sub>NO<sub>2</sub>SNa: calcd. 278.1185, found 278.1184.

### 1-((ethylsulfonyl)methyl)cyclohexanecarbonitrile (**362j**)



Chemical Formula: C<sub>10</sub>H<sub>17</sub>NO<sub>2</sub>S  
Molecular Weight: 215,31

According to the general procedure **E** from ethanesulfonyl cyanide **307** (357 mg, 3 mmol, 3. eq.), methylenecyclohexane (0.12 mL, 1.0 mmol, 1.0 eq.), eosin Y (13 mg, 0.02 mmol, 2 mol%) and K<sub>2</sub>HPO<sub>4</sub> (35 mg, 0.2 mmol, 0.2 eq.) in DMF (1.0 mL) for 24 hours. The crude product was purified by flash chromatography (cyclohexane/EtOAc 2:1) to afford **362j** as yellow oil (176 mg, 82%).

**Rf** = 0.3 (cyclohexane/EtOAc 1:1).

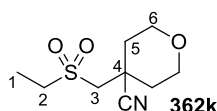
**IR** (film, KBr)  $\nu_{\max}$  (cm<sup>-1</sup>) = 2934, 2861, 2236, 1453, 1316, 1269, 1131, 795.

**<sup>1</sup>H NMR** (300 MHz, CDCl<sub>3</sub>):  $\delta$  (ppm) = 3.24 – 3.11 (m, 4H, H-2, H-3), 2.37 – 2.17 (m, 2H, H-5a), 1.82 – 1.45 (m, 6H), 1.41 (t,  $J$  = 7.5 Hz, 3H, H-1), 1.34 – 1.11 (m, 2H)

**<sup>13</sup>C NMR** (75 MHz, CDCl<sub>3</sub>):  $\delta$  (ppm) = 121.1 (CN), 59.5 (C-3), 49.7 (C-2), 36.6 (C-4), 35.6 (C-5), 24.7 (C-7), 22.6 (C-6), 6.6 (C-1).

**HRMS** (ESI): [M+Na]<sup>+</sup> C<sub>10</sub>H<sub>17</sub>NO<sub>2</sub>SNa: calcd. 238.0872, found 238.0870.

### 4-((ethylsulfonyl)methyl)tetrahydro-2H-pyran-4-carbonitrile (**362k**)



Chemical Formula: C<sub>9</sub>H<sub>15</sub>NO<sub>3</sub>S  
Molecular Weight: 217,29

According to a slightly modified protocol from the general procedure **E**: ethanesulfonyl cyanide **307** (356 mg, 3 mmol, 3.0 eq.), alkene<sup>297</sup> (98 mg, 1.0 mmol, 1.0 eq.), eosin Y (13 mg, 0.02 mmol, 2 mol%) and K<sub>2</sub>HPO<sub>4</sub> (35 mg, 0.2 mmol, 0.2 eq.) in DMF (1.0 mL) for 24 hours. The crude product was purified by flash chromatography (cyclohexane/EtOAc 1:2) to afford **362k** as white solid (39 mg, 18%).

**Rf** = 0.29 (EtOAc).

**m. p.** = 80-85 (pentane/EtOAc).

**IR** (film, KBr)  $\nu_{\max}$  (cm<sup>-1</sup>) = 2974, 2932, 2859, 2240, 1449, 1312, 1243, 1164, 1135, 1113, 1102, 855.

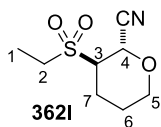
**<sup>1</sup>H NMR** (300 MHz, CDCl<sub>3</sub>):  $\delta$  (ppm) = 4.02 – 3.93 (m, 2H, H-6a), 3.75 (td,  $J$  = 12.4, 2.0 Hz, 2H, H-6b), 3.25 – 3.15 (m, 4H, H-2, H-3), 2.23 – 2.14 (m, 2H, H-5a), 1.91 – 1.79 (m, 2H, H-5b), 1.44 (t,  $J$  = 7.5 Hz, 3H, H-1).

<sup>297</sup> Synthesised from: M. Vishe, R. Hrdina, L. Guenee, C. Besnard, J. Lacour, *Adv. Synth. Catal.* **2013**, 355, 3161-3169.

$^{13}\text{C}$  NMR (75 MHz, DMSO- $d_6$ ):  $\delta$  (ppm) = 120.2 (CN), 64.1 (C-6), 59.2 (C-3), 49.9 (C-2), 35.3 (C-5), 34.4 (C-4), 6.7 (C-1).

HRMS (ESI):  $[\text{M}+\text{Na}]^+$   $\text{C}_9\text{H}_{15}\text{NO}_3\text{SNa}$ : calcd. 240.0664, found 240.0672.

### 3-(ethylsulfonyl)tetrahydro-2H-pyran-2-carbonitrile (362l)



Chemical Formula:  $\text{C}_8\text{H}_{13}\text{NO}_3\text{S}$   
Molecular Weight: 203,26

According to the general procedure **E** from ethanesulfonyl cyanide **307** (357 mg, 3 mmol, 3.0 eq.), 3,4-dihydro-2H-pyran (0.091 mL, 1.0 mmol, 1.0 eq), eosin Y (13 mg, 0.02 mmol, 2 mol%) and  $\text{K}_2\text{HPO}_4$  (35 mg, 0.2 mmol, 0.2 eq.) in DMF (1.0 mL) for 24 hours. The crude product was purified by flash chromatography (cyclohexane/EtOAc 2:1) to afford **362l** as yellow oil (121 mg, 59%, d.r. $\geq$ 19:1).

Rf = 0.39 (cyclohexane/EtOAc 1:1).

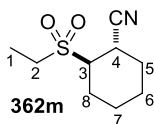
IR (film, KBr)  $\nu_{\text{max}}$  ( $\text{cm}^{-1}$ ) = 2935, 2868, 1454, 1310, 1283, 1135, 1096, 1078.

$^1\text{H}$  NMR (300 MHz,  $\text{CDCl}_3$ ):  $\delta$  (ppm) = 4.87 (d,  $J$  = 6.5 Hz, 1H, H-4), 4.08 – 3.90 (m, 1H, H-5a), 3.66 (ddd,  $J$  = 11.7, 8.0, 3.5 Hz, 1H, H-5b), 3.33 – 3.10 (m, 3H, H-2, H-3), 2.44 – 2.28 (m, 1H, H-7a), 2.16 – 1.93 (m, 2H, H-7b, H-6a), 1.78 – 1.57 (m, 1H, H-6b), 1.43 (t,  $J$  = 7.5 Hz, 3H, H-1).

$^{13}\text{C}$  NMR (75 MHz,  $\text{CDCl}_3$ ):  $\delta$  (ppm) = 116.2 (CN), 66.7 (C-5), 64.3 (C-4), 58.1 (C-3), 48.1 (C-2), 22.4 (C-6), 20.8 (C-7), 6.2 (C-1).

HRMS (ESI):  $[\text{M}+\text{Na}]^+$   $\text{C}_8\text{H}_{13}\text{NO}_3\text{SNa}$ : calcd. 226.0508, found 226.0505.

### 2-(ethylsulfonyl)cyclohexanecarbonitrile (362m)



Chemical Formula:  $\text{C}_9\text{H}_{15}\text{NO}_2\text{S}$   
Molecular Weight: 201,29

According to a slightly modified protocol from the general procedure **E**: ethanesulfonyl cyanide **307** (356 mg, 3 mmol, 3.0 eq.), cyclohexene (0.10 mL, 1.0 mmol, 1.0 eq.), eosin Y (13 mg, 0.02 mmol, 2 mol%) and  $\text{K}_2\text{HPO}_4$  (35 mg, 0.2 mmol, 0.2 eq.) in DMF (1.0 mL) for 72 hours. The crude product was purified by flash chromatography (cyclohexane/EtOAc 70:30) to afford **362m** as colourless oil (126 mg, 63%).

Rf = 0,37 (cyclohexane/EtOAc 1:1)

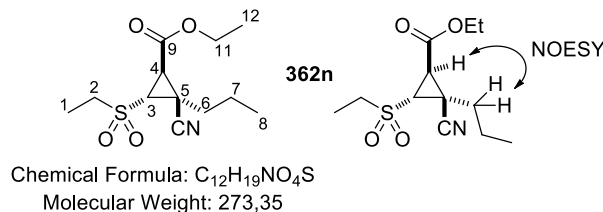
IR (film, KBr)  $\nu_{\text{max}}$  ( $\text{cm}^{-1}$ ) = 2942, 2865, 2243, 1451, 1305, 1266, 1235, 1132, 1100, 1042.

$^1\text{H}$  NMR (300 MHz,  $\text{CDCl}_3$ ):  $\delta$  (ppm) = 3.23 (q,  $J$  = 7.5 Hz, 2H, H-2), 3.12 (ddd,  $J$  = 11.1, 10.0, 4.1 Hz, 1H, H-3), 2.95 (ddd,  $J$  = 11.0, 10.0, 4.0 Hz, 1H, H-4), 2.33 – 2.22 (m, 2H), 2.02 – 1.48 (m, 4H), 1.41 (m, 5H).

$^{13}\text{C}$  NMR (75 MHz,  $\text{CDCl}_3$ ):  $\delta$  (ppm) = 120.6 (CN), 59.6 (C-3), 47.8 (C-2), 29.7 ( $\text{CH}_2$ ), 28.6 (C-4), 23.6 ( $\text{CH}_2$ ), 23.6 ( $\text{CH}_2$ ), 23.4 ( $\text{CH}_2$ ), 6.4 (C-1).

HRMS (ESI):  $[\text{M}+\text{Na}]^+$   $\text{C}_9\text{H}_{15}\text{NO}_2\text{SNa}$ : calcd. 225.0715, found 224.0707.

## Ethyl 2-cyano-3-(ethylsulfonyl)-2-propylcyclopropanecarboxylate (**362n**)



According to a slightly modified protocol from the general procedure **E**: ethanesulfonyl cyanide **307** (178 mg, 1.5 mmol, 1.5 eq.), cyclopropene<sup>298</sup> (153 mg, 1.0 mmol, 1.0 eq.), eosin Y (13 mg, 0.02 mmol, 2 mol%) and K<sub>2</sub>HPO<sub>4</sub> (35 mg, 0.2 mmol, 0.2 eq.) in acetone (1.0 ml) for 70 hours. The crude product was purified by flash chromatography (cyclohexane/EtOAc 80:20) to afford **362n** as yellow oil (105 mg, 39%).

**Rf** = 0.39 (cyclohexane/EtOAc 2:1).

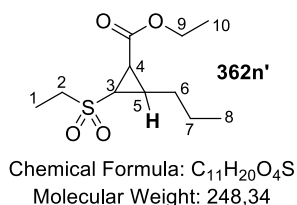
**IR** (film, KBr)  $\nu_{\max}$  (cm<sup>-1</sup>) = 2965, 2934, 2876, 2242, 1735, 1462, 1420, 1321, 1233, 1196, 1139.

**<sup>1</sup>H NMR** (300 MHz, CDCl<sub>3</sub>):  $\delta$  (ppm) = 4.28 (q,  $J$  = 7.1 Hz, 2H, H-11), 3.39 (d,  $J$  = 6.5 Hz, 1H, H-3), 3.14 (qd,  $J$  = 7.5, 4.0 Hz, 2H, H-2), 2.67 (d,  $J$  = 6.5 Hz, 1H, H-4), 2.16 – 1.91 (m, 2H, H-6), 1.86 – 1.56 (m, 2H, H-7), 1.44 (t,  $J$  = 7.5 Hz, 3H, H-1), 1.32 (t,  $J$  = 7.2 Hz, 3H, H-12), 1.01 (t,  $J$  = 7.3 Hz, 3H, H-8).

**<sup>13</sup>C NMR** (75 MHz, CDCl<sub>3</sub>):  $\delta$  (ppm) = 165.9 (C-9), 116.5 (CN), 62.9 (C-11), 50.3 (C-2), 44.0 (C-3), 31.5 (C-4), 30.6 (C-6), 25.8 (C-5), 21.1 (C-7), 14.2 (C-12), 13.4 (C-8), 6.8 (C-1).

**HRMS** (ESI): [M+Na]<sup>+</sup> C<sub>12</sub>H<sub>19</sub>NO<sub>4</sub>SNa: calcd. 296.0927, found 296.0929.

## Ethyl 2-(ethylsulfonyl)-3-propylcyclopropanecarboxylate (**362n'**)



According to the general procedure **E** from ethanesulfonyl cyanide **307** (178 mg, 1.5 mmol, 1.5 eq.), cyclopropene<sup>298</sup> (153 mg, 1.0 mmol, 1.0 eq.), eosin Y (13 mg, 0.02 mmol, 2 mol%) and K<sub>2</sub>HPO<sub>4</sub> (35 mg, 0.2 mmol, 0.2 eq.) in DMF (1.0 mL). The crude product was purified by flash chromatography (cyclohexane/EtOAc 75:25) to afford **362n'** as colourless oil (82 mg, 33%).

**Rf** = 0.27 (cyclohexane/EtOAc 2:1).

**IR** (film, KBr)  $\nu_{\max}$  (cm<sup>-1</sup>) = 3034, 2962, 2935, 2874, 1728, 1460, 1378, 1313, 1281, 1222, 1188, 1134.

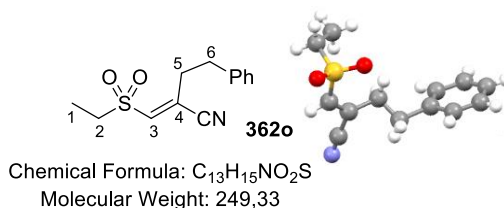
**<sup>1</sup>H NMR** (300 MHz, CDCl<sub>3</sub>):  $\delta$  (ppm) = 4.15 (q,  $J$  = 7.1 Hz, 2H, H-9), 3.02 (q,  $J$  = 7.5 Hz, 2H, H-2), 2.81 (dd,  $J$  = 6.0, 4.8 Hz, 1H, H-3), 2.42 (dd,  $J$  = 10.2, 4.8 Hz, 1H, H-4), 2.04 – 1.91 (m, 1H, H-5), 1.88 – 1.47 (m, 3H, H-6, H-7a), 1.38 (m, 4H, H-7b, H-1), 1.25 (t,  $J$  = 7.1 Hz, 3H, H-10), 0.90 (t,  $J$  = 7.3 Hz, 3H, H-8).

**<sup>13</sup>C NMR** (75 MHz, CDCl<sub>3</sub>):  $\delta$  (ppm) = 168.7 (CO<sub>2</sub>Et), 61.5 (C-9), 48.3 (C-2), 40.7 (C-3), 27.3 (C-6), 25.6 (C-5), 24.5 (C-4), 22.3 (C-7), 14.2 (C-10), 13.6 (C-8), 6.9 (C-1).

**HRMS** (ESI): [M+Na]<sup>+</sup> C<sub>11</sub>H<sub>20</sub>O<sub>4</sub>SNa: calcd. 271.0975, found 271.0980.

<sup>298</sup> Synthesised from: Y. Lou, M. Horikawa, R. A. Kloster, N. A. Hawryluk, E. J. Corey, *J. Am. Chem. Soc.* **2004**, *126*, 8916-8918.

## 2-((ethylsulfonyl)methylene)-4-phenylbutanenitrile (**362o**)



According to the general procedure **E** from ethanesulfonyl cyanide **307** (178 mg, 1.5 mmol, 1.5 eq.), 4-phenyl-1-butyne (0.14 mL, 1.0 mmol, 1.0 eq.), eosin Y (13 mg, 0.02 mmol, 2 mol%) and K<sub>2</sub>HPO<sub>4</sub> (35 mg, 0.2 mmol, 0.2 eq.) in acetone (1.0 mL) for 24 hours. The crude product was purified by flash chromatography (cyclohexane/EtOAc 80:20) to afford **362o** as white solid (42 mg, 17%).

**Rf** = 0.57 (cyclohexane/EtOAc 2:1).

**IR** (film, KBr)  $\nu_{\max}$  (cm<sup>-1</sup>) = 3034, 2979, 2931, 2864, 2226, 1603, 1454, 1310, 1137.

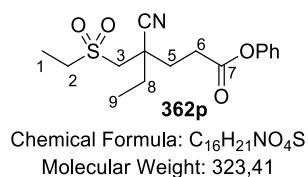
**<sup>1</sup>H NMR** (300 MHz, CDCl<sub>3</sub>):  $\delta$  (ppm) = 7.37 – 7.20 (m, 5H, Ph), 6.78 (t, 1H, H-3), 3.14 (m, 2H, H-5), 2.99 (m, 2H-H-6), 2.71 (q, *J* = 7.5 Hz, 2H, H-2), 1.21 (t, *J* = 7.5 Hz, 3H, H-1).

**<sup>13</sup>C NMR** (75 MHz, CDCl<sub>3</sub>):  $\delta$  (ppm) = 140.2 (C-3), 138.8 (C-4), 130.6 (Ph), 128.8 (Ph), 128.9 (Ph), 127.0 (Ph), 116.2 (CN), 50.1 (C-2), 34.0 (C-5), 31.4 (C-6), 6.6 (C-1).

**HRMS** (FD): [M]<sup>+</sup> C<sub>13</sub>H<sub>15</sub>NO<sub>2</sub>SNa: calcd. 249.08255, found 249.07310.

**X-Ray crystallography**: the crystal suitable for X-ray-measurement was obtained by evaporation in EtOAc.

## Phenyl 4-cyano-4-((ethylsulfonyl)methyl)hexanoate (**362p**)



According to a slightly modified protocol from the general procedure **E**: ethanesulfonyl cyanide **307** (357 mg, 3.0 mmol, 3.0 eq.), alkene<sup>299</sup> (207 mg, 1.0 mmol, 1.0 eq.), eosin Y (13 mg, 0.02 mmol, 2 mol%) and K<sub>2</sub>HPO<sub>4</sub> (35 mg, 0.2 mmol, 0.2 eq.) in DMF (1.0 mL) for 64 hours. The crude product was purified by flash chromatography (cyclohexane/EtOAc 70:30) to afford **362p** as colourless oil (45 mg, 14%).

**Rf** = 0.32 (cyclohexane/EtOAc 1:1).

**IR** (film, KBr)  $\nu_{\max}$  (cm<sup>-1</sup>) = 3066, 3044, 2977, 2943, 2884, 2237, 1756, 1592, 1494, 1456, 1314, 1195, 1164, 1134.

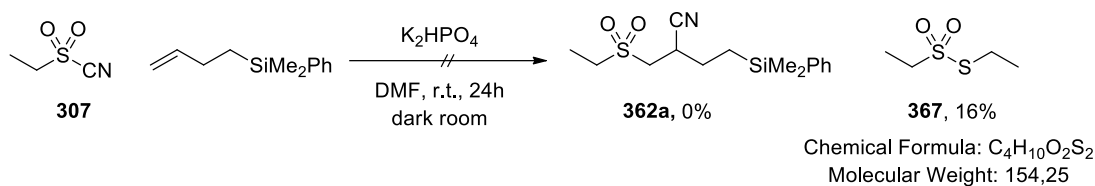
**<sup>1</sup>H NMR** (300 MHz, CDCl<sub>3</sub>):  $\delta$  (ppm) = 7.43 – 7.33 (m, 2H, Ph), 7.28 – 7.19 (m, 1H, Ph), 7.13 – 7.06 (m, 2H, Ph), 3.26 (m, 2H, H-3), 3.15 (q, *J* = 7.5 Hz, 2H, H-2), 2.93 – 2.72 (m, 2H, H-6), 2.56 – 2.40 (m, 1H, H-5a), 2.40 – 2.25 (m, 1H, H-5b), 2.18 – 1.88 (m, 2H, H-8), 1.43 (t, *J* = 7.5 Hz, 3H, H-1), 1.16 (t, *J* = 7.4 Hz, 3H, H-9).

**<sup>13</sup>C NMR** (75 MHz, CDCl<sub>3</sub>):  $\delta$  (ppm) = 170.5 (C-7), 150.6 (Ph), 129.6 (Ph), 126.2 (Ph), 121.5 (Ph), 120.6 (CN), 54.5 (C-3), 50.1 (C-2), 39.6 (C-4), 30.7 (C-5), 30.0 (C-6/C-8), 29.7 (C-6/C-8), 9.0 (C-9), 6.7 (C-1).

**HRMS** (ESI): [M+Na]<sup>+</sup> C<sub>16</sub>H<sub>21</sub>NO<sub>4</sub>SNa: calcd. 346.1084, found 346.1078.

<sup>299</sup> Synthesised from: H. Hassan, V. Pirenne, M. Wissing, C. Khiar, A. Hussain, F. Robert, Y. Landais, *Chem. Eur. J.* **2017**, *23*, 4651-4658.

### S-ethyl ethanesulfonothioate (367)



A 10 mL round bottom flask equipped with a stirrer was charged with but-3-en-1-yltrimethyl(phenyl)silane (95 mg, 0.5 mmol, 1.0 eq.), K<sub>2</sub>HPO<sub>4</sub> (87 mg, 0.5 mmol, 1.0 eq.) and dry DMF (0.5 mL). The mixture was degassed 3 times by the freeze-pump-thaw procedure. Then, the sulfonyl cyanide EtSO<sub>2</sub>CN (89 mg, 0.75 mmol, 1.5 eq.) was added and the reaction mixture was stirred at room temperature for 24 hours in the absence of light (the flask was protected by an aluminium paper). After this time, the reaction mixture was diluted with EtOAc and 1M HCl aqueous solution. The aqueous layer was extracted with EtOAc and the combined organic layers were washed with 1M HCl aqueous solution and brine, dried over MgSO<sub>4</sub> and concentrated under reduced pressure. The obtained crude product was then purified by flash chromatography using silica gel (cyclohexane/EtOAc 70:30). Thiosulfonate **367** was isolated with 16% yield.

**Rf** = 0,61 (cyclohexane/EtOAc 1:1).

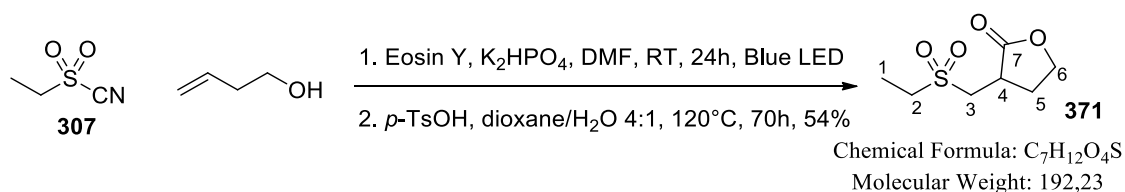
**IR** (film, KBr)  $\nu_{\max}$  (cm<sup>-1</sup>) = 2977, 2936, 2877, 1452, 1319, 1274, 1127, 1043, 777, 708.

**<sup>1</sup>H NMR** (300 MHz, CDCl<sub>3</sub>):  $\delta$  (ppm) = 3.33 (q, *J* = 7.4 Hz, 2H), 3.16 (q, *J* = 7.4 Hz, 2H), 1.48 (t, 3H, *J* = 7.4 Hz), 1.43 (t, 3H, *J* = 7.4 Hz).

**<sup>13</sup>C NMR** (75 MHz, CDCl<sub>3</sub>):  $\delta$  (ppm) = 57.27, 30.78, 15.31, 8.50.

The NMR spectra are in good agreement with reported literature data.<sup>300</sup>

### 3-((ethylsulfonyl)methyl)dihydrofuran-2(3H)-one (371)



According to the general procedure **E** from ethanesulfonyl cyanide **307** (178 mg, 1.5 mmol, 1.5 eq.), 3-buten-1-ol (0.086 mL, 1.0 mmol, 1.0 eq.), eosin Y (13 mg, 0.02 mmol, 2 mol%) and K<sub>2</sub>HPO<sub>4</sub> (35 mg, 0.2 mmol, 0.2 eq.) in DMF (1.0 mL). After 24 hours of blue LED irradiations, DMF was evaporated and the obtained crude product was diluted in a mixture of dioxane/H<sub>2</sub>O 4:1. After adding *p*-TsOH (1.37 g, 5 mmol, 5 eq.), the reaction mixture was stirred in a sealed tube at 120°C for 120 hours. Then at room temperature, a saturated aqueous solution of NaHCO<sub>3</sub> was added dropwise. The aqueous layer was extracted with EtOAc and the combined organic layers were washed with water and brine, dried over MgSO<sub>4</sub> and concentrated under reduced pressure. The obtained crude product was then purified by flash chromatography (EtOAc) to afford **371** as white solid (103 mg, 54% for two consecutive steps)

**Rf** = 0.55 (EtOAc).

**m.p.** = 93-97°C (pentane/EtOAc).

**IR** (film, KBr)  $\nu_{\max}$  (cm<sup>-1</sup>) = 2982, 2933, 1767, 1380, 1308, 1279, 1204, 1153, 1131, 1020.

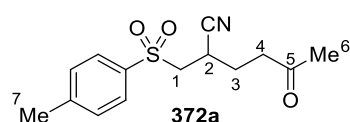
<sup>300</sup> Y. Zheng, F.-L. Qing, Y. Huang, X.-H. Xu, *Adv. Synth. Catal.* **2016**, 358, 3477-3481.

**<sup>1</sup>H NMR** (300 MHz, CDCl<sub>3</sub>): δ (ppm) = 4.42 (td, *J* = 9.0, 1.4 Hz, 1H, H-6a), 4.24 (ddd, *J* = 11.0, 9.2, 6.1 Hz, 1H, H-6b), 3.56 (dd, *J* = 13.7, 2.9 Hz, 1H, H-3a), 3.23 – 3.11 (m, 1H, H-4), 3.07 (q, *J* = 7.5 Hz, 2H, H-2), 2.96 (dd, *J* = 13.7, 10.5 Hz, 1H, H-3b), 2.79 – 2.65 (m, 1H, H-5a), 2.29 – 2.11 (m, 1H, H-5b), 1.39 (t, *J* = 7.5 Hz, 3H, H-1).

**<sup>13</sup>C NMR** (75 MHz, CDCl<sub>3</sub>): δ (ppm) = 176.7 (C-7), 67.2 (C-6), 52.0 (C-3), 48.6 (C-2), 34.0 (C-4), 29.3 (C-5), 6.7 (C-1).

**HRMS** (ESI): [M+Na]<sup>+</sup> C<sub>7</sub>H<sub>12</sub>O<sub>4</sub>SNa: calcd. 215.0349, found 215.0347.

#### 5-oxo-2-(tosylmethyl)hexanenitrile (**372a**)



Chemical Formula: C<sub>14</sub>H<sub>17</sub>NO<sub>3</sub>S  
Molecular Weight: 279,35

According to the general procedure **E** from *p*-toluenesulfonyl cyanide (272 mg, 1.5 mmol, 1.5 eq.), 5-hexen-1-one (0.117 mL, 1.0 mmol, 1.0 eq.), eosin Y (13 mg, 0.02 mmol, 2 mol%) and K<sub>2</sub>HPO<sub>4</sub> (35 mg, 0.2 mmol, 0.2 eq.) in DMF (1.0 mL) for 24 hours. The crude product was purified by flash chromatography (cyclohexane/EtOAc 1:1) to afford **372a** as white solid (219 mg, 78%).

**R<sub>f</sub>** = 0.41 (cyclohexane/EtOAc 1:1).

**m. p.** = 125-128°C (pentane/EtOAc).

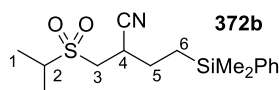
**IR** (film, KBr)  $\nu_{\max}$  (cm<sup>-1</sup>) = 3052, 2983, 2930, 2243, 1712, 1597, 1427, 1407, 1374, 1359, 1305, 1289, 1145, 1087.

**<sup>1</sup>H NMR** (300 MHz, CDCl<sub>3</sub>): δ (ppm) = 7.80 (d, *J* = 8.3 Hz, 2H, Ph), 7.38 (d, *J* = 9.0 Hz, 2H, Ph), 3.49 – 3.37 (m, 1H, H-1a), 3.27 – 3.15 (m, 2H, H-1b, H-2), 2.76 – 2.55 (m, 2H, H-4), 2.44 (s, 3H, H-7), 2.14 (s, 3H, H-6), 2.13 – 2.00 (m, 1H, H-3a), 1.94 – 1.77 (m, 1H, H-3b).

**<sup>13</sup>C NMR** (75 MHz, CDCl<sub>3</sub>): δ (ppm) = 206.2 (C-5), 145.8 (Ph), 135.27 (Ph), 130.3 (Ph), 128.3 (Ph), 118.8 (CN), 57.2 (C-1), 39.8 (C-4), 30.0 (C-6), 25.9 (C-3), 25.8 (C-2), 21.8 (C-7).

**HRMS** (ESI): [M+Na]<sup>+</sup> C<sub>14</sub>H<sub>17</sub>NO<sub>3</sub>SNa: calcd. 302.0821, found 302.0867.

#### 4-(dimethyl(phenyl)silyl)-2-((isopropylsulfonyl)methyl)butanenitrile (**372b**)



Chemical Formula: C<sub>16</sub>H<sub>25</sub>NO<sub>2</sub>SSi  
Molecular Weight: 323,53

According to the general procedure **E** from isopropanesulfonyl cyanide **342c** (200 mg, 1.5 mmol, 1.5 eq.), but-3-en-1-yl(dimethyl(phenyl)silane<sup>296</sup> (190 mg, 1.0 mmol, 1.0 eq.), eosin Y (13 mg, 0.02 mmol, 2 mol%) and K<sub>2</sub>HPO<sub>4</sub> (35 mg, 0.2 mmol, 0.2 eq.) in DMF (1.0 mL) for 24 hours. The crude product was purified by flash chromatography (cyclohexane/EtOAc 75:25) to afford **372b** as colourless oil (248 mg, 77%).

**R<sub>f</sub>** = 0.43 (cyclohexane/EtOAc 2:1).

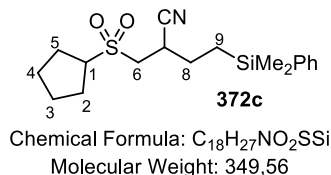
**IR** (film, KBr)  $\nu_{\max}$  (cm<sup>-1</sup>) = 3069, 3048, 2983, 2950, 2809, 2243, 1466, 1427, 1314, 1260, 1251, 1173, 1124, 838, 824.

**<sup>1</sup>H NMR** (300 MHz, CDCl<sub>3</sub>): δ (ppm) = 7.55 – 7.43 (m, 2H, Ph), 7.41 – 7.34 (m, 3H, Ph), 3.34 (dd, *J* = 13.8, 8.3 Hz, 1H, H-3a), 3.28 – 3.15 (m, 2H, H-2, H-4), 2.95 (dd, *J* = 13.8, 4.8 Hz, 1H, H-3b), 1.92 – 1.58 (m, 2H, H-5), 1.42 (s, 3H, H-1), 1.39 (s, 3H, H-1), 1.05 (td, *J* = 13.2, 12.5, 4.9 Hz, 1H, H-7a), 0.96 – 0.82 (m, 1H, H-7b), 0.32 (s, 6H, SiMe<sub>2</sub>).

<sup>13</sup>C NMR (75 MHz, CDCl<sub>3</sub>): δ (ppm) = 137.6 (Ph), 133.6 (Ph), 129.4 (Ph), 128.1 (Ph), 119.8 (CN), 54.2 (C-2), 50.2 (C-3), 28.9 (C-4), 27.5 (C-5), 16.0 (C-1), 14.5 (C-6), 13.2 (C-1'), -3.2 (SiMe<sub>2</sub>), -3.3 (SiMe<sub>2</sub>).

HRMS (ESI): [M+Na]<sup>+</sup> C<sub>16</sub>H<sub>25</sub>NO<sub>2</sub>SSiNa: calcd. 346.1268, found 346.1261.

### 2-((cyclopentylsulfonyl)methyl)-4-(dimethyl(phenyl)silyl)butanenitrile (**372c**)



According to the general procedure **E** from cyclopentane sulfonyl cyanide **342d** (239 mg, 1.5 mmol, 1.5 eq.), but-3-en-1-yl dimethyl(phenyl)silane<sup>10</sup> (190 mg, 1.0 mmol, 1.0 eq.), eosin Y (13 mg, 0.02 mmol, 2 mol%) and K<sub>2</sub>HPO<sub>4</sub> (35 mg, 0.2 mmol, 0.2 eq.) in DMF (1.0 mL) for 24 hours. The crude product was purified by flash chromatography (cyclohexane/EtOAc 80:20) to afford **372c** as colourless oil (281 mg, 80%).

R<sub>f</sub> = 0,43 (cyclohexane/EtOAc 2:1).

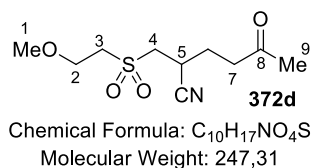
IR (film, KBr) ν<sub>max</sub> (cm<sup>-1</sup>) = 3069, 3048, 2956, 2873, 2243, 1448, 1427, 1303, 1250, 1122, 838, 824.

<sup>1</sup>H NMR (300 MHz, CDCl<sub>3</sub>): δ (ppm) = 7.54 – 7.46 (m, 2H, Ph), 7.40 – 7.34 (m, 3H, Ph), 3.57 – 3.44 (m, 1H, H-1), 3.32 (dd, *J* = 13.7, 8.6 Hz, 1H, H-6a), 3.26 – 3.15 (m, 1H, H-7), 2.99 (dd, *J* = 13.7, 4.4 Hz, 1H, H-6b), 2.21 – 1.93 (m, 4H), 1.90 – 1.59 (m, 6H), 1.12 – 0.82 (m, 2H, H-9), 0.32 (s, 6H, SiMe<sub>2</sub>).

<sup>13</sup>C NMR (75 MHz, CDCl<sub>3</sub>): δ (ppm) = 137.5 (Ph), 133.4 (Ph), 129.2 (Ph), 127.9 (Ph), 119.8 (CN), 61.9 (C-1), 52.2 (C-6), 28.9 (C-7), 27.3 (CH<sub>2</sub>), 27.3 (CH<sub>2</sub>), 26.1 (CH<sub>2</sub>), 25.99 (CH<sub>2</sub>), 25.97 (CH<sub>2</sub>), 13.0 (C-9), -3.4 (SiMe<sub>2</sub>).

HRMS (ESI): [M+Na]<sup>+</sup> C<sub>18</sub>H<sub>27</sub>NO<sub>2</sub>SSiNa: calcd. 372.1424, found 372.1429.

### 2-(((2-methoxyethyl)sulfonyl)methyl)-5-oxohexanenitrile (**372d**)



According to the general procedure **E** from sulfonyl cyanide **342f** (224 mg, 1.5 mmol, 1.5 eq.), 5-hexen-1-one (0.117 mL, 1.0 mmol, 1.0 eq.), eosin Y (13 mg, 0.02 mmol, 2 mol%) and K<sub>2</sub>HPO<sub>4</sub> (35 mg, 0.2 mmol, 0.2 eq.) in DMF (1.0 mL) for 24 hours. The crude product was purified by flash chromatography (cyclohexane/EtOAc 1:2) to afford **372d** as yellow oil (177 mg, 72%).

R<sub>f</sub> = 0.58 (EtOAc).

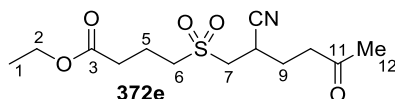
IR (film, KBr) ν<sub>max</sub> (cm<sup>-1</sup>) = 2990, 2932, 2244, 1713, 1375, 1317, 1292, 1170, 1127, 1114.

<sup>1</sup>H NMR (300 MHz, CDCl<sub>3</sub>): δ (ppm) = 3.86 – 3.70 (m, 2H, H-2), 3.53 (dd, *J* = 13.9, 7.9 Hz, 1H, H-4a), 3.43 – 3.11 (m, 7H, H-1, H-3, H-4b, H-5), 2.80 – 2.59 (m, 2H, H-7), 2.16 (s, 3H, H-9), 2.15 – 1.99 (m, 1H, H-6a), 1.97 – 1.81 (m, 1H, H-6b).

<sup>13</sup>C NMR (75 MHz, CDCl<sub>3</sub>): δ (ppm) = 206.3 (C-8), 119.4 (CN), 66.1 (C-2), 59.2 (C-1), 56.1 (C-4), 54.6 (C-3), 39.9 (C-7), 30.0 (C-9), 25.9 (C-6), 25.3 (C-5).

HRMS (ESI): [M+Na]<sup>+</sup> C<sub>10</sub>H<sub>17</sub>NO<sub>4</sub>SNa: calcd. 270.0771, found 270.0776.

### Ethyl 4-((2-cyano-5-oxohexyl)sulfonyl)butanoate (**372e**)



Chemical Formula: C<sub>13</sub>H<sub>21</sub>NO<sub>5</sub>S  
Molecular Weight: 303,37

According to the general procedure **E** from sulfonyl cyanide **342g** (308 mg, 1.5 mmol, 1.5 eq.), 5-hexen-1-one (0.117 mL, 1.0 mmol, 1.0 eq.), eosin Y (13 mg, 0.02 mmol, 2 mol%) and K<sub>2</sub>HPO<sub>4</sub> (35 mg, 0.2 mmol, 0.2 eq.) in DMF (1.0 mL) for 24 hours. The crude product was purified by flash chromatography (cyclohexane/EtOAc 40:60) to afford **372e** as white solid (226 mg, 74%).

**Rf** = 0.34 (cyclohexane/EtOAc 1 :2).

**m. p.** = 69-73°C (pentane/EtOAc).

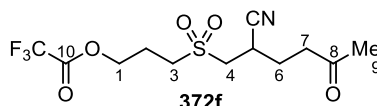
**IR** (film, KBr)  $\nu_{\max}$  (cm<sup>-1</sup>) = 2984, 2939, 2244, 1722, 1376, 1310, 1296, 1262, 1243, 1192, 1125, 1026.

**<sup>1</sup>H NMR** (300 MHz, CDCl<sub>3</sub>):  $\delta$  (ppm) = 4.09 (q, *J* = 7.1 Hz, 2H, H-2), 3.40 (dd, *J* = 13.7, 8.7 Hz, 1H, H-7a), 3.29 (tt, *J* = 9.5, 4.7 Hz, 1H, H-8), 3.22 – 3.09 (m, 3H, H-7b, H-6), 2.79 – 2.58 (m, 2H, H-10), 2.47 (t, *J* = 7.0 Hz, 2H, H-4), 2.18 – 1.80 (m, 7H, H-5, H-9, H-12), 1.21 (t, *J* = 7.1 Hz, 3H, H-1).

**<sup>13</sup>C NMR** (75 MHz, CDCl<sub>3</sub>):  $\delta$  (ppm) = 206.3 (C-11), 172.0 (C-3), 119.3 (CN), 60.8 (C-2), 53.7 (C-7), 52.9 (C-6), 39.9 (C-10), 32.0 (C-4), 30.0 (C-12), 25.8 (C-5/9), 25.3 (C-8), 17.5 (C-5/9), 14.2 (C-1).

**HRMS** (ESI): [M+Na]<sup>+</sup> C<sub>13</sub>H<sub>21</sub>NO<sub>5</sub>SNa: calcd. 326.1033, found 326.1034.

### 3-((2-cyano-5-oxohexyl)sulfonyl)propyl 2,2,2-trifluoroacetate (**372f**)



Chemical Formula: C<sub>12</sub>H<sub>16</sub>F<sub>3</sub>NO<sub>5</sub>S  
Molecular Weight: 343,32

According to the general procedure **E** from sulfonyl cyanide **342f** (368 mg, 1.5 mmol, 1.5 eq.), 5-hexen-1-one (0.117 mL, 1.0 mmol, 1.0 eq.), eosin Y (13 mg, 0.02 mmol, 2 mol%) and K<sub>2</sub>HPO<sub>4</sub> (35 mg, 0.2 mmol, 0.2 eq.) in DMF (1.0 mL) for 24 hours. The crude product was purified by flash chromatography (cyclohexane/EtOAc 40:60) to afford **372f** as colourless oil (194 mg, 57%).

**Rf** = 0.40 (cyclohexane/EtOAc 1:1).

**IR** (film, KBr)  $\nu_{\max}$  (cm<sup>-1</sup>) = 2940, 2246, 1787, 1714, 1350, 1315, 1222, 1163.

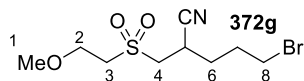
**<sup>1</sup>H NMR** (300 MHz, CDCl<sub>3</sub>):  $\delta$  (ppm) = 4.49 (t, *J* = 6.2 Hz, 2H), 3.44 (dd, *J* = 13.7, 8.8 Hz, 1H), 3.32 (dq, *J* = 8.9, 4.2 Hz, 2H), 3.28 – 3.15 (m, 3H), 2.71 (td, *J* = 7.3, 2.6 Hz, 3H), 2.38 – 2.25 (m, 2H), 2.16 (s, 3H), 2.14 – 1.84 (m, 2H).

**<sup>13</sup>C NMR** (75 MHz, CDCl<sub>3</sub>):  $\delta$  (ppm) = 206.5 (C-8), 157.2 (q, *J* = 42.6 Hz, C-10), 119.4 (CN), 114.4 (q, *J* = 285.5 Hz, CF<sub>3</sub>), 65.7 (C-1), 54.3 (C-4), 50.3 (C-3), 39.8 (C-7), 30.0 (C-9), 25.8 (C-6), 25.3 (C-5), 21.0 (C-2).

**HRMS** (ESI): [M+Na-COCF<sub>3</sub>]<sup>+</sup> C<sub>10</sub>H<sub>17</sub>NO<sub>4</sub>SNa: calcd. 270.0771, found 270.0776.



### 5-bromo-2-(((2-methoxyethyl)sulfonyl)methyl)pentanenitrile (372g)



Chemical Formula: C<sub>9</sub>H<sub>16</sub>BrNO<sub>3</sub>S  
Molecular Weight: 298,20

According to the general procedure **E** from sulfonyl cyanide **342f** (224 mg, 1.5 mmol, 1.5 eq.), 5-bromo-1-pentene (0.118 mL, 1.0 mmol, 1.0 eq.), eosin Y (13 mg, 0.02 mmol, 2 mol%) and K<sub>2</sub>HPO<sub>4</sub> (35 mg, 0.2 mmol, 0.2 eq.) in DMF (1.0 mL) for 24 hours. The crude product was purified by flash chromatography (cyclohexane/EtOAc 1:1) to afford **372g** as colourless oil (214 mg, 72%). **R<sub>f</sub>** = 0.44 (cyclohexane/EtOAc 2:1).

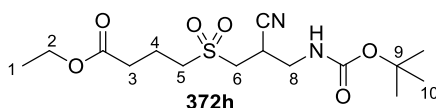
**IR** (film, KBr)  $\nu_{\max}$  (cm<sup>-1</sup>) = 2988, 2934, 2834, 2244, 1452, 1389, 1317, 1292, 1114.

**<sup>1</sup>H NMR** (300 MHz, CDCl<sub>3</sub>):  $\delta$  (ppm) = 3.89 – 3.75 (m, 2H), 3.70 – 3.55 (m, 1H), 3.49 – 3.42 (m, 2H), 3.41 – 3.17 (m, 7H), 2.23 – 1.84 (m, 4H).

**<sup>13</sup>C NMR** (75 MHz, CDCl<sub>3</sub>):  $\delta$  (ppm) = 119.3 (CN), 66.2, 59.3 (C-1), 56.1, 55.0, 31.9, 30.8, 29.7, 25.5 (C-5).

**HRMS** (ESI): [M+Na]<sup>+</sup> C<sub>9</sub>H<sub>16</sub>BrNO<sub>3</sub>SNa: calcd. 319.9926, found 319.9923.

### Ethyl 4-((3-((tert-butoxycarbonyl)amino)-2-cyanopropyl)sulfonyl)butanoate (372h)



Chemical Formula: C<sub>15</sub>H<sub>26</sub>N<sub>2</sub>O<sub>6</sub>S  
Molecular Weight: 362,44

According to the general procedure **E** from sulfonyl cyanide **342g** (308 mg, 1.5 mmol, 1.5 eq.), *tert*-butyl *N*-allylcarbamate (157 mg, 1.0 mmol, 1.0 eq.), eosin Y (13 mg, 0.02 mmol, 2 mol%) and K<sub>2</sub>HPO<sub>4</sub> (35 mg, 0.2 mmol, 0.2 eq.) in DMF (1.0 mL) for 24 hours. The crude product was purified by flash chromatography (cyclohexane/EtOAc 60:40) to afford **372h** as white solid (205 mg, 56%).

**R<sub>f</sub>** = 0.40 (cyclohexane/EtOAc 2:1).

**m. p.** = 94-98°C (pentane/EtOAc).

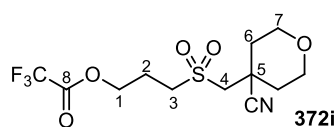
**IR** (film, KBr)  $\nu_{\max}$  (cm<sup>-1</sup>) = 3373, 2981, 2937, 2247, 1716, 1519, 1368, 1277, 1252, 1168, 1126.

**<sup>1</sup>H NMR** (300 MHz, CDCl<sub>3</sub>):  $\delta$  (ppm) = 5.41 (s, 1H, N-H), 4.11 (q, *J* = 7.1 Hz, 2H, H-2), 3.58 – 3.13 (m, 7H, H-5/6/7/8), 2.49 (t, *J* = 7.0 Hz, 2H, H-3), 2.20 – 2.06 (m, 2H, H-4), 1.41 (s, 9H, Boc), 1.22 (t, *J* = 7.1 Hz, 3H, H-1).

**<sup>13</sup>C NMR** (75 MHz, CDCl<sub>3</sub>):  $\delta$  (ppm) = 172.1 (CO<sub>2</sub>Et), 155.9 (Boc), 118.7 (CN), 80.5 (C-9), 60.9 (C-2), 53.0 (C-5), 51.3 (C-6), 41.7 (C-8), 32.1 (C-3), 28.3 (C-10), 27.5 (C-7), 17.5 (C-4), 14.2 (C-1).

**HRMS** (ESI): [M+Na]<sup>+</sup> C<sub>15</sub>H<sub>26</sub>N<sub>2</sub>O<sub>6</sub>SNa: calcd. 385.1403, found 385.1419.

### 3-(((4-cyanotetrahydro-2H-pyran-4-yl)methyl)sulfonyl)propyl 2,2,2-trifluoroacetate (372i)



Chemical Formula: C<sub>12</sub>H<sub>16</sub>F<sub>3</sub>NO<sub>5</sub>S  
Molecular Weight: 343,32

According to the general procedure **E** from sulfonyl cyanide **342j** (1.09 g, 4.4 mmol, 4.4 eq.), 4-methylenetetrahydro-2H-pyran<sup>297</sup> (98 mg, 1.0 mmol, 1.0 eq.), eosin Y (13 mg, 0.02 mmol, 2 mol%) and K<sub>2</sub>HPO<sub>4</sub> (35 mg, 0.2 mmol, 0.2 eq.) in DMF (1.0 mL) for 105 hours. The crude product was purified by flash chromatography (cyclohexane/EtOAc 30:70) to afford **372i** as colourless oil (232 mg, 68%).

**Rf** = 0.23 (EtOAc).

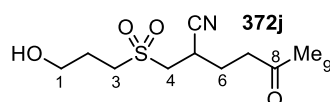
**IR** (film, KBr)  $\nu_{\max}$  (cm<sup>-1</sup>) = 2973, 2934, 2862, 2239, 1787, 1350, 1321, 1306, 1222, 1164, 1137, 856.

**<sup>1</sup>H NMR** (300 MHz, CDCl<sub>3</sub>):  $\delta$  (ppm) = 4.54 (t, *J* = 6.2 Hz, 2H, H-1), 4.00 (dd, *J* = 13.9, 3.5 Hz, 2H, H-7), 3.76 (td, *J* = 12.4, 1.9 Hz, 2H, H-7), 3.37 – 3.29 (m, 2H, H-3), 3.26 (s, 2H, H-4), 2.45 – 2.33 (m, 2H, H-2), 2.20 (dd, *J* = 13.6, 1.9 Hz, 2H, H-6), 1.85 (td, *J* = 12.9, 12.1, 4.5 Hz, 2H, H-6).

**<sup>13</sup>C NMR** (75 MHz, CDCl<sub>3</sub>):  $\delta$  (ppm) = 157.2 (q, *J* = 42.6 Hz, COCF<sub>3</sub>), 120.2 (CN), 114.4 (q, *J* = 285.5 Hz, CF<sub>3</sub>), 65.7 (C-1), 63.9 (C-7), 59.9 (C-4), 51.4 (C-3), 35.0 (C-6), 34.2 (C-5), 20.9 (C-2).

**HRMS** (ESI): [M+Na]<sup>+</sup> C<sub>12</sub>H<sub>16</sub>F<sub>3</sub>NO<sub>5</sub>SNa: calcd. 366.0593, found 366.0602.

### 2-(((3-hydroxypropyl)sulfonyl)methyl)-5-oxohexanenitrile (**372j**)



Chemical Formula: C<sub>10</sub>H<sub>17</sub>NO<sub>4</sub>S  
Molecular Weight: 247,31

According to the general procedure **E** from sulfonyl cyanide **342j** (368 mg, 1.5 mmol, 1.5 eq.), 5-hexen-1-one (0.117 mL, 1.0 mmol, 1.0 eq.), eosin Y (13 mg, 0.02 mmol, 2 mol%) and K<sub>2</sub>HPO<sub>4</sub> (35 mg, 0.2 mmol, 0.2 eq.) in DMF (1.0 mL) for 24 hours. The crude product was purified by flash chromatography on neutral alumina (DCM/MeOH 8:2) to afford **372j** as white solid (192 mg, 78%).

**m. p.** = 51-55 °C (pentane/EtOAc).

**Rf** = 0.28 (EtOAc).

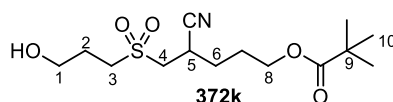
**IR** (film, KBr)  $\nu_{\max}$  (cm<sup>-1</sup>) = 3444, 2940, 2245, 1711, 1413, 1376, 1359, 1301, 1171, 1126, 1058.

**<sup>1</sup>H NMR** (300 MHz, CDCl<sub>3</sub>):  $\delta$  (ppm) = 3.82 (q, *J* = 5.6 Hz, 2H, H-1), 3.49 – 3.25 (m, 4H, H-3 + H4a + H-5), 3.20 – 3.10 (m, 1H, H-4b), 2.79 – 2.70 (m, 2H, H-7), 2.21 (s, 3H, H-9), 2.19 – 2.08 (m, 2H, H-2), 2.03 – 1.89 (m, 1H, H-6a), 1.79 – 1.70 (m, 1H, H-6b).

**<sup>13</sup>C NMR** (75 MHz, CDCl<sub>3</sub>):  $\delta$  (ppm) = 207.1 (C-8), 119.6 (CN), 60.1 (C-1), 53.6 (C-4), 51.0 (C-3), 39.9 (C-7), 30.1 (C-9), 25.8 (C-6), 25.1 (C-5), 24.8 (C-2).

**HRMS** (ESI): [M+Na]<sup>+</sup> C<sub>10</sub>H<sub>17</sub>NO<sub>4</sub>SNa: calcd. 270.0771, found 270.0765.

### 4-cyano-5-(((3-hydroxypropyl)sulfonyl)pentyl) pivalate (**372k**)



Chemical Formula: C<sub>14</sub>H<sub>25</sub>NO<sub>5</sub>S  
Molecular Weight: 319,42

According to the general procedure **E** from sulfonyl cyanide **342j** (368 mg, 1.5 mmol, 1.5 eq.), alkene<sup>301</sup> (170 mg, 1.0 mmol, 1.0 eq.), eosin Y (13 mg, 0.02 mmol, 2 mol%) and K<sub>2</sub>HPO<sub>4</sub> (35 mg, 0.2 mmol, 0.2 eq.) in DMF (1.0 mL) for 24 hours. The crude product was purified by flash

<sup>301</sup> Prepared from: W. B. Reid, J. J. Spillane, S. B. Krause, D. A. Watson, *J. Am. Chem. Soc.* **2016**, *138*, 5539-5542.

chromatography on neutral alumina (DCM/MeOH 98:2) to afford **372k** as a colourless oil (233 mg, 73%).

**Rf** = 0.43 (EtOAc).

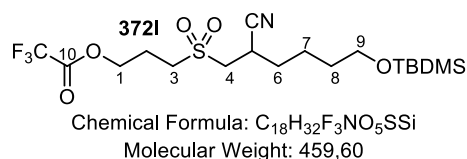
**IR** (film, KBr)  $\nu_{\max}$  (cm<sup>-1</sup>) = 3483, 2969, 2938, 2876, 2245, 1721, 1481, 1289, 1162, 1128, 1058.

**<sup>1</sup>H NMR** (300 MHz, CDCl<sub>3</sub>):  $\delta$  (ppm) = 4.22 – 4.05 (m, 2H, H-8), 3.82 (t, *J* = 5.8 Hz, 2H, H-1), 3.45 (dd, *J* = 13.9, 8.1 Hz, 1H, H-4a), 3.39 – 3.24 (m, 3H, H-3 + H-5), 3.11 (dd, *J* = 13.9, 5.0 Hz, 1H, H-4b), 2.20 – 2.07 (m, 2H, H-2), 2.01 – 1.78 (m, 4H, H-6 + H-7), 1.21 (s, 9H, H-10).

**<sup>13</sup>C NMR** (75 MHz, CDCl<sub>3</sub>):  $\delta$  (ppm) = 178.7 (Piv), 119.5 (CN), 63.0 (C-8), 60.2 (C-1), 53.9 (C-4), 51.3 (C-3), 38.8 (C-9), 29.0 (C-7/8), 27.2 (C-10), 26.1 (C-7/8), 25.9 (C-5), 24.9 (C-2).

**HRMS** (HN): [M+H]<sup>+</sup> C<sub>14</sub>H<sub>25</sub>NO<sub>5</sub>S: calcd. 320.1526, found 320.1528.

### 3-(((tert-butyldimethylsilyloxy)-2-cyanoethyl)sulfonyl)propyl 2,2,2-trifluoroacetate (**372l**)



According to the general procedure **E** from sulfonyl cyanide **342j** (368 mg, 1.5 mmol, 1.5 eq.), tert-butyl(hex-5-en-1-yloxy)dimethylsilane (172 mg, 1.0 mmol, 1.0 eq.), eosin Y (13 mg, 0.02 mmol, 2 mol%) and K<sub>2</sub>HPO<sub>4</sub> (35 mg, 0.2 mmol, 0.2 eq.) in DMF (1.0 mL) for 24 hours. The crude product was purified by flash chromatography (cyclohexane/EtOAc 70:30) to afford **372l** as colourless oil (99 mg, 22%).

**Rf** = 0.47 (cyclohexane/EtOAc 1:1).

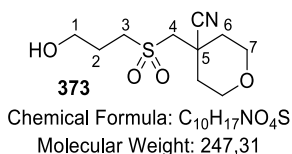
**IR** (film, KBr)  $\nu_{\max}$  (cm<sup>-1</sup>) = 2934, 2860, 2245, 1788, 1406, 1348, 1320, 1223, 1163, 837.

**<sup>1</sup>H NMR** (300 MHz, CDCl<sub>3</sub>):  $\delta$  (ppm) = 4.50 (t, *J* = 6.1 Hz, 2H, H-1), 3.62 (t, *J* = 5.7 Hz, 2H, H-9), 3.42 (dd, *J* = 14.2, 9.1 Hz, 1H, H-4a), 3.29 – 3.19 (m, 3H, H-3 + H-5), 3.09 (dd, *J* = 14.2, 4.3 Hz, 1H, H-4b), 2.41 – 2.29 (m, 2H, H-2), 1.85 – 1.49 (m, 6H, H-6 + H-7 + H-8), 0.87 (s, 9H, Si*t*Bu), 0.03 (s, 6H, SiMe<sub>2</sub>).

**<sup>13</sup>C NMR** (75 MHz, CDCl<sub>3</sub>):  $\delta$  (ppm) = 156.9 (q, *J* = 42.7 Hz, C-10), 120.2 (CN), 117.3 (q, *J* = 142.7 Hz, CF<sub>3</sub>), 65.6 (C-1), 62.5 (C-9), 54.7 (C-4), 50.4 (C-3), 32.1 (CH<sub>2</sub>), 31.8 (CH<sub>2</sub>), 26.4 (C-5), 26.0 (Si*t*Bu), 23.4 (CH<sub>2</sub>), 21.1 (C-2), 18.4 (C<sub>quatern</sub> Si*t*Bu), -5.3 (SiMe<sub>2</sub>).

**HRMS** (ESI): [M+Na-COCF<sub>3</sub>]<sup>+</sup> C<sub>16</sub>H<sub>32</sub>NO<sub>4</sub>SSiNa: calcd. 386.1792, found 386.1786.

### 4-(((3-hydroxypropyl)sulfonyl)methyl)tetrahydro-2H-pyran-4-carbonitrile (**373**)



According to the general procedure **E** from sulfonyl cyanide **342j** (1.24 g, 5 mmol, 5 eq.), 4-methylenetetrahydro-2H-pyran<sup>297</sup> (98 mg, 1.0 mmol, 1.0 eq.), eosin Y (13 mg, 0.02 mmol, 2 mol%) and K<sub>2</sub>HPO<sub>4</sub> (35 mg, 0.2 mmol, 0.2 eq.) in DMF (1.0 mL) for 90 hours. The crude product was purified by flash chromatography on neutral alumina (DCM/MeOH 97:3) to afford **373** as a white solid (170 mg, 69%).

**m.p.** = 83-87°C (pentane/EtOAc).

**Rf** = 0.15 (EtOAc).

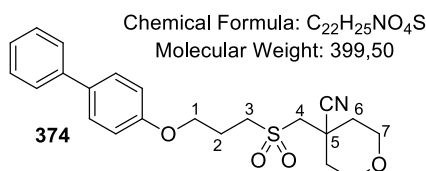
**IR** (film, KBr)  $\nu_{\max}$  (cm<sup>-1</sup>) = 3432, 2966, 2932, 2863, 2239, 1445, 1395, 1305, 1244, 1132, 1101, 1059, 1035.

**<sup>1</sup>H NMR** (300 MHz, CDCl<sub>3</sub>): δ (ppm) = 3.99 (dd, *J* = 12.3, 4.2 Hz, 2H, H-7a), 3.88 – 3.67 (m, 4H, H-7b + H-1), 3.39 – 3.32 (m, 2H, H-3), 3.27 (s, 2H, H-4), 2.25 – 2.09 (m, 4H, H-2 + H-6a), 1.94 – 1.80 (m, 2H, H-6a), 1.66 (t, *J* = 5.1 Hz, 1H, OH).

**<sup>13</sup>C NMR** (75 MHz, CDCl<sub>3</sub>): δ (ppm) = 121.3 (CN), 64.5 (C-7), 60.3 (C-1), 59.4 (C-4), 53.2 (C-3), 35.5 (C-6), 34.8 (C-5), 25.6 (C-2).

**HRMS** (ESI): [M+Na]<sup>+</sup> C<sub>10</sub>H<sub>17</sub>NO<sub>4</sub>SNa: calcd. 270.0770, found 270.0774.

#### 4-(((3-([1,1'-biphenyl]-4-yloxy)propyl)sulfonyl)methyl)tetrahydro-2H-pyran-4-carbonitrile (**374**)



A 10 mL two-necked round bottom flask was charged with alcohol **373** (337 mg, 1.36 mmol, 1.0 eq.), triphenylphosphine (429 mg, 1.64 mmol, 1.2 eq.) and 4-phenylphenol (255 mg, 1.1 mmol). The solids were flushed with argon and diluted in 2 mL of dry THF. DEAD (0.26 mL, 1.64 mmol, 1.2 eq.) was added dropwise at 0°C and then the reaction mixture was allowed to reach room temperature and was stirred for 12 hours. The solvent was evaporated and the crude product was purified directly by flash chromatography (cyclohexane/EtOAc 50:50) to afford **374** as white solid (333 mg, 61%)

**m.p.** = 150-154°C (pentane/EtOAc)

**R<sub>f</sub>** = 0.4 (EtOAc).

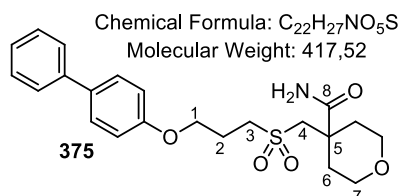
**IR** (film, KBr)  $\nu_{\max}$  (cm<sup>-1</sup>) = 3025, 2968, 2925, 2867, 2242, 1518, 1480, 1328, 1245, 1133, 1112, 1032, 762.

**<sup>1</sup>H NMR** (300 MHz, CDCl<sub>3</sub>): δ (ppm) = δ = 7.57 – 7.50 (m, 4H, H<sub>Ar</sub>), 7.46 – 7.38 (m, 2H, H<sub>Ar</sub>), 7.35 – 7.25 (m, 1H, H<sub>Ar</sub>), 7.00 – 6.92 (m, 2H, H<sub>Ar</sub>), 4.16 (t, *J* = 5.8 Hz, 2H, H-1), 4.02 – 3.93 (m, 2H, H-7a), 3.76 (td, *J* = 12.3, 1.9 Hz, 2H, H-7b), 3.47 – 3.40 (m, 2H, H-3), 3.27 (s, 2H, H-4), 2.45 – 2.33 (m, 2H, H-2), 2.18 (dd, *J* = 13.6, 1.8 Hz, 2H, H-6a), 1.85 (ddd, *J* = 13.7, 12.1, 4.5 Hz, 2H, H-6b).

**<sup>13</sup>C NMR** (75 MHz, CDCl<sub>3</sub>): δ (ppm) = 157.9 (Ar), 140.7 (Ar), 134.5 (Ar), 128.9 (Ar), 128.4 (Ar), 126.9 (Ar), 126.8 (Ar), 120.2 (CN), 114.9 (Ar), 65.5 (C-1), 64.1 (C-7), 60.3 (C-4), 52.5 (C-3), 35.3 (C-6), 34.5 (C-5), 22.3 (C-2).

**HRMS** (ESI): [M+Na]<sup>+</sup> C<sub>22</sub>H<sub>25</sub>NO<sub>4</sub>SNa: calcd. 422.1396, found 422.1405.

#### 4-(((3-([1,1'-biphenyl]-4-yloxy)propyl)sulfonyl)methyl)tetrahydro-2H-pyran-4-carboxamide (**375**)



NH<sub>2</sub>OH. HCl (113 mg, 1.8 mmol, 20 eq.) and AcONa (150 mg, 1.8 mmol, 20 eq.) was added sequentially to a stirred solution of cyanide **374** (36 mg, 0.09 mmol, 1 eq.) diluted in a mixture of EtOH/H<sub>2</sub>O 1:1 (4 mL). The reaction mixture was stirred at 80°C for 60 hours. Then, the reaction mixture was allowed to reach room temperature and the solvents were evaporated under reduced pressure. The crude was directly purified by flash chromatography (DCM/MeOH 98:2) to afford **375** as a white solid (35 mg, 89%)

**m.p.** = 64-68°C (pentane/EtOAc).

**R<sub>f</sub>** = 0.31 (DCM/MeOH 95:5)

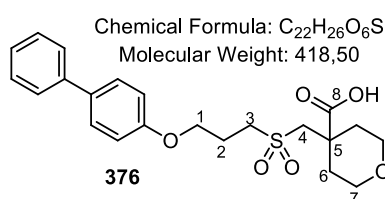
**IR** (film, KBr)  $\nu_{\max}$  (cm<sup>-1</sup>) = 3360, 3033, 2958, 2869, 1672, 1608, 1519, 1487, 1288, 1269, 1244, 1134, 764.

**<sup>1</sup>H NMR** (300 MHz, CDCl<sub>3</sub>):  $\delta$  (ppm) = 7.57 – 7.50 (m, 4H, H<sub>aro</sub>), 7.42 (t, *J* = 7.5 Hz, 2H, H<sub>aro</sub>), 7.34 – 7.27 (m, 1H, H<sub>aro</sub>), 6.96 (d, *J* = 8.8 Hz, 2H, H<sub>aro</sub>), 4.14 (t, *J* = 5.7 Hz, 2H, H-1), 3.77 (m, 4H, H-7), 3.50 (s, 2H, H-4), 3.31 – 3.23 (m, 2H, H-3), 2.40 – 2.28 (m, 2H, H-2), 2.22 – 2.10 (m, 2H, H-6a), 2.01 – 1.90 (m, 2H, H-6b), 1.55 (br s, 2H, NH<sub>2</sub>).

**<sup>13</sup>C NMR** (150 MHz, CDCl<sub>3</sub>):  $\delta$  (ppm) = 176.2 (C-8), 158.0 (Ar), 140.7 (Ar), 134.4 (Ar), 128.9 (Ar), 128.4 (Ar), 126.9 (Ar), 126.8 (Ar), 114.9 (Ar), 65.6 (C-1), 64.1 (C-7), 58.5 (C-4), 52.7 (C-3), 43.3 (C-5), 33.9 (C-6), 22.4 (C-2).

**HRMS** (ESI): [M+Na]<sup>+</sup> C<sub>22</sub>H<sub>27</sub>NO<sub>5</sub>SNa: calcd. 440.1502, found 440.1497.

#### 4-(((3-([1,1'-biphenyl]-4-yloxy)propyl)sulfonyl)methyl)tetrahydro-2H-pyran-4-carboxylic acid (**376**)



KOH (720 mg, 12.8 mmol, 58 eq.) was added to a solution of cyanide **374** (88 mg, 0.22 mmol, 1 eq.) diluted in 8 mL of water. The reaction mixture was heated to 100°C and was stirred for one week. At 0°C, the mixture was acidified with a 1M HCl aqueous solution. The acid layer was extracted with EtOAc. The combined organic layers were washed with brine, dried over MgSO<sub>4</sub> and concentrated under reduced pressure. The crude product was pure enough to afford **376** as white solid (82 mg, 89%).

**m.p.** = 166-170°C (DCM/MeOH).

**R<sub>f</sub>** = 0.22 (DCM/MeOH 9:1).

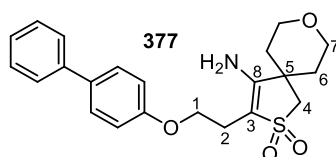
**IR** (film, KBr)  $\nu_{\max}$  (cm<sup>-1</sup>) = 3408, 3029, 2918, 2724, 2569, 1718, 1608, 1509, 1486, 1306, 1293, 1240, 1159, 1127, 763.

**<sup>1</sup>H NMR** (300 MHz, DMSO):  $\delta$  (ppm) = 7.64 – 7.57 (m, 4H, H<sub>Ar</sub>), 7.46 – 7.39 (m, 2H, H<sub>Ar</sub>), 7.34 – 7.27 (m, 1H, H<sub>Ar</sub>), 7.03 (d, *J* = 8.8 Hz, 2H, H<sub>Ar</sub>), 4.13 (t, *J* = 6.2 Hz, 2H, H-1), 3.74 – 3.65 (m, 2H, H-7a), 3.60 (s, 2H, H-4), 3.57 – 3.45 (m, 2H, H-7b), 3.30 – 3.22 (m, 2H, H-3), 2.21 – 2.10 (m, 2H, H-2), 2.05 – 1.94 (m, 2H, H-6a), 1.79 – 1.66 (m, 2H, H-6b).

**<sup>13</sup>C NMR** (75 MHz, DMSO):  $\delta$  (ppm) = 174.7 (C-8), 157.9 (Ar), 139.8 (Ar), 132.8 (Ar), 128.9 (Ar), 127.8 (Ar), 126.7 (Ar), 126.2 (Ar), 115.0 (Ar), 65.6 (C-1), 63.3 (C-7), 58.1 (C-4), 51.5 (C-3), 41.8 (C-5), 33.0 (C-6), 21.6 (C-2).

**HRMS** (ESI): [M+Na]<sup>+</sup> C<sub>22</sub>H<sub>26</sub>O<sub>6</sub>SNa: calcd. 441.1342, found 441.1331.

#### 3-(2-([1,1'-biphenyl]-4-yloxy)ethyl)-4-amino-8-oxa-2-thiaspiro[4.5]dec-3-ene 2,2-dioxide (**377**)



Chemical Formula: C<sub>22</sub>H<sub>25</sub>NO<sub>4</sub>S  
Molecular Weight: 399,50

KOH (70 mg, 1.25 mmol, 5 eq.) was added to a solution of cyanide **374** (98.7 mg, 0.25 mmol, 1 eq.) diluted in 2 mL of ethylene glycol. The reaction mixture was heated to 105°C and was stirred for 16 hours. At room temperature, the mixture was diluted with DCM and water. The basic layer was extracted with DCM. The combined organic layers were washed with brine, dried over MgSO<sub>4</sub> and concentrated under reduced pressure. The crude product was pure enough to afford **377** as white solid (82 mg, 78%).

**m.p.** = 191-193°C (DCM/MeOH).

**R<sub>f</sub>** = 0.46 (DCM/MeOH 9:1).

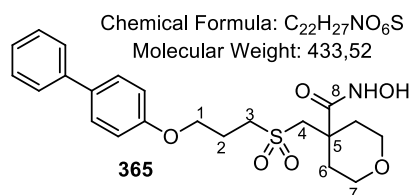
**IR** (film, KBr)  $\nu_{\text{max}}$  (cm<sup>-1</sup>) = 3436, 3360, 3245, 3031, 2951, 2860, 1651, 1609, 1518, 1486, 1267, 1245, 1160, 1096.

**<sup>1</sup>H NMR** (300 MHz, DMSO+D<sub>2</sub>O):  $\delta$  (ppm) = 7.63 – 7.56 (m, 4H, H<sub>Ar</sub>), 7.42 (t, *J* = 7.6 Hz, 2H, H<sub>Ar</sub>), 7.33 – 7.25 (m, 1H, H<sub>Ar</sub>), 7.00 (d, *J* = 8.8 Hz, 2H, H<sub>Ar</sub>), 4.03 (t, *J* = 7.7 Hz, 2H, H-1), 3.81 (dd, *J* = 11.7, 4.2 Hz, 2H, H-7a), 3.44 (m, 4H, H-7b + H-4), 2.66 (t, *J* = 7.7 Hz, 2H, H-2), 2.22 – 2.06 (m, 2H, H-6a), 1.35 (d, *J* = 13.1 Hz, 2H, H-6b).

**<sup>13</sup>C NMR** (75 MHz, DMSO+D<sub>2</sub>O):  $\delta$  (ppm) = 158.1 (C-8), 157.2 (C<sub>Ar</sub>, quatern.), 139.9 (C<sub>Ar</sub>, quatern.), 132.7 (C<sub>Ar</sub>, quatern.), 129.0 (C<sub>Ar</sub>), 127.9 (C<sub>Ar</sub>), 126.8 (C<sub>Ar</sub>), 126.3 (C<sub>Ar</sub>), 115.0 (C<sub>Ar</sub>), 97.9 (C-3), 65.8 (C-1), 63.7 (C-7), 56.6 (C-4), 41.5 (C-5), 33.5 (C-6), 21.1 (C-2).

**HRMS** (ESI): [M+Na]<sup>+</sup> C<sub>22</sub>H<sub>25</sub>NO<sub>4</sub>SNa: calcd. 422.1396, found 422.1386.

#### 4-(((3-([1,1'-biphenyl]-4-yloxy)propyl)sulfonyl)methyl)-N-hydroxytetrahydro-2H-pyran-4-carboxamide (**365**)



#### Preparation of the acyl chloride:

The acid **376** (30.6 mg, 0.073 mmol, 1 eq.) was introduced in a 10 mL two-necked round bottom flask containing activated molecular sieves 4A°. The flask was purged with argon and 2 mL of dry dichloromethane were introduced. At room temperature, oxalyl chloride (45  $\mu$ L, 0.51 mmol, 7 eq.) was added dropwise and the reaction mixture was refluxed for one hour. The addition of oxalyl chloride (45  $\mu$ L, 0.51 mmol, 7 eq.) was repeated and the stirring was continued at reflux for two hours. Then dichloromethane was evaporated under reduced pressure at room temperature and the obtained solid was dissolved in 1 mL of dry DCM. The evaporation was repeated. The obtained solid was kept under argon.

In a separated flask, NH<sub>2</sub>OH.HCl (30.5 mg, 0.44 mmol, 6 eq.) diluted in 2 mL of dry DMF was treated with distilled Et<sub>3</sub>N (0.12 mL, 0.88 mmol, 12 eq.). The reaction mixture was stirred at room temperature for 30 minutes and was then cooled to 0°C. To this solution was added the acyl chloride dissolved in a minimum amount of dry DCM. The reaction mixture was stirred at RT for 16 hours. Then at room temperature, a 1M HCl aqueous solution was added dropwise. The aqueous layer was extracted with EtOAc and the combined organic layers were washed with water and brine, dried over MgSO<sub>4</sub> and concentrated under reduced pressure. The obtained crude product was then purified by flash chromatography (DCM/MeOH 98:2) to afford **365** as white solid (15 mg, 47%).

**m.p.** = 160-164°C (DCM/MeOH).

**R<sub>f</sub>** = 0.50 (DCM/MeOH 9:1).

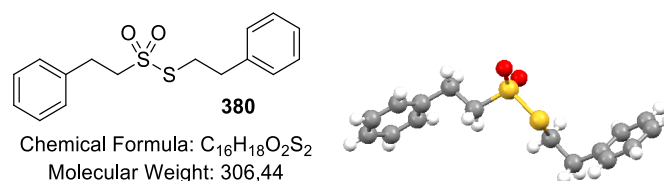
**IR** (KBr pellet)  $\nu_{\max}$  (cm<sup>-1</sup>) = 3244, 3032, 2927, 2871, 1651, 1609, 1519, 1487, 1290, 1269, 1245, 1134, 1102, 1037.

**<sup>1</sup>H NMR** (300 MHz, CDCl<sub>3</sub>):  $\delta$  (ppm) = 7.55 – 7.46 (m, 4H, H<sub>Ar</sub>), 7.40 (t,  $J$  = 7.5 Hz, 2H, H<sub>Ar</sub>), 7.34 – 7.27 (m, 1H, H<sub>Ar</sub>), 6.94 (d,  $J$  = 8.7 Hz, 2H, H<sub>Ar</sub>), 4.08 (t,  $J$  = 5.7 Hz, 2H, H-1), 3.81 – 3.63 (m, 4H, H-7), 3.46 (s, 2H, H-4), 3.27 – 3.20 (m, 2H, H-3), 2.35 – 2.14 (m, 4H, H-2 + H-6a), 1.97 – 1.84 (m, 2H, H-6b).

**<sup>13</sup>C NMR** (150 MHz, DMSO):  $\delta$  (ppm) = 169.3 (C-8), 157.9 (Ar), 139.8 (Ar), 132.8 (Ar), 128.9 (Ar), 127.8 (Ar), 126.7 (Ar), 126.2 (Ar), 115.0 (Ar), 65.6 (C-1), 63.4 (C-7), 57.9 (C-4), 51.2 (C-3), 41.5 (C-5), 32.9 (C-6), 21.7 (C-2).

**HRMS** (ESI): [M+Na]<sup>+</sup> C<sub>22</sub>H<sub>27</sub>NO<sub>6</sub>SNa: calcd. 456.1451, found 456.1457.

### S-phenethyl 2-phenylethanesulfonothioate (**380**)



According to the general procedure **E** from sulfonyl cyanide **342i** (293 mg, 1.5 mmol, 1.5 eq.), 5-hexen-1-one (0.117 mL, 1.0 mmol, 1.0 eq.), eosin Y (13 mg, 0.02 mmol, 2 mol%) and K<sub>2</sub>HPO<sub>4</sub> (35 mg, 0.2 mmol, 0.2 eq.) in DMF (1.0 mL) for 24 hours. The crude product was purified by flash chromatography (cyclohexane/EtOAc 95:5) to afford **380** as a crystalline solid (87 mg, 19%).

**m.p.** = 52-56°C (pentane/EtOAc).

**R<sub>f</sub>** = 0.72 (cyclohexane/EtOAc 2:1).

**IR** (film, KBr)  $\nu_{\max}$  (cm<sup>-1</sup>) = 3086, 3062, 3005, 3028, 2928, 2854, 1603, 1497, 1455, 1319, 1125, 753, 698.

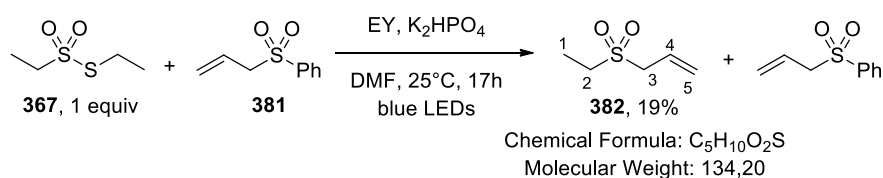
**<sup>1</sup>H NMR** (300 MHz, CDCl<sub>3</sub>):  $\delta$  (ppm) = 7.36 – 7.13 (m, 10H), 3.46 – 3.37 (m, 4H), 3.19 – 3.11 (m, 2H), 3.06 (t,  $J$  = 7.5 Hz, 2H).

**<sup>13</sup>C NMR** (75 MHz, CDCl<sub>3</sub>):  $\delta$  (ppm) = 138.62, 137.02, 128.97, 128.82 (2C), 128.55, 127.19, 127.14, 63.69, 37.72, 36.14, 29.64.

**HRMS** (ESI): [M+Na]<sup>+</sup> C<sub>16</sub>H<sub>18</sub>O<sub>2</sub>S<sub>2</sub>Na: calcd. 329.0640, found 329.0651.

**X-Ray crystallography**: the crystal suitable for X-ray-measurement was obtained by diffusion (pentane/EtOAc).

### 3-(ethylsulfonyl)prop-1-ene (**382**)



A 5 mL cylindrical vial equipped with a stirrer was charged with Eosin Y (6.5 mg, 0.01 mmol, 2 mol%), K<sub>2</sub>HPO<sub>4</sub> (17 mg, 0.1 mmol, 0.2 eq.), phenyl allyl sulfone (0.153 mL, 1 mmol, 2.0 eq.), S-ethyl ethanesulfonothioate **367** (77 mg, 0.5 mmol, 1 eq.) and dry DMF (1 mL). The vial was closed and the mixture was stirred 2 minutes for homogenisation. The mixture was degassed 3 times by the freeze-pump-thaw procedure. Then, the reaction mixture was stirred at 25°C for 17 hours while being irradiated with commercial blue LEDs. After this time, the reaction mixture was diluted with EtOAc and 1M HCl aqueous solution. The aqueous layer was extracted with EtOAc and the combined organic layers were washed with 1M HCl aqueous solution and brine, dried over MgSO<sub>4</sub>

and concentrated under reduced pressure. The obtained crude product was then purified by flash chromatography using silica gel (cyclohexane/EtOAc 65:35) to afford the desired ethyl allyl sulfone **382** (12.6 mg, 19%).

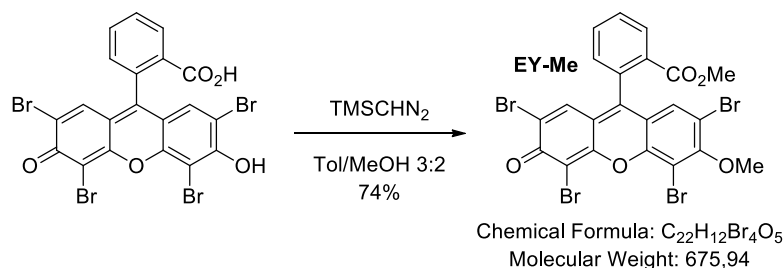
**Rf** = 0.32 (cyclohexane/EtOAc 1:1).

**IR** (film, KBr)  $\nu_{\max}$  ( $\text{cm}^{-1}$ ) = 2955, 2917, 2849, 1740, 1311, 113.

**$^1\text{H}$  NMR** (300 MHz,  $\text{CDCl}_3$ ):  $\delta$  (ppm) = 6.03 – 5.86 (m, 1H, H-4), 5.52 – 5.40 (m, 2H, H-5), 3.70 (d,  $J$  = 7.4 Hz, 2H, H-3), 2.99 (q,  $J$  = 7.5 Hz, 2H, H-2), 1.38 (t,  $J$  = 7.5 Hz, 3H, H-1).

**$^{13}\text{C}$  NMR** (75 MHz,  $\text{CDCl}_3$ ):  $\delta$  (ppm) = 125.3 (C-4), 124.6 (C-5), 57.0 (C-3), 45.7 (C-2), 6.6 (C-1).

### Methylated eosin-Y (EY-Me)



Methylated eosin-Y was synthesized according a slightly modified procedure described in the literature.<sup>302</sup>  $^1\text{H}$  and  $^{13}\text{C}$  NMR data are in good agreement with those reported.

**Rf** = 0.45 (DCM / EtOAc 9:1).

**$^1\text{H}$ -NMR** (300 MHz,  $\text{CDCl}_3$ ):  $\delta$  (ppm) = 8.38 – 8.31 (m, 1H), 7.80 (ddd,  $J$  = 9.1, 7.2, 1.6 Hz, 2H), 7.32 – 7.28 (m, 1H), 7.26 (s, 1H), 7.10 (s, 1H), 4.02 (s, 3H), 3.75 (s, 3H).

**$^{13}\text{C}$ -NMR** (75 MHz,  $\text{CDCl}_3$ ):  $\delta$  (ppm) = 172.4, 165.3, 158.7, 154.4, 149.5, 148.8, 133.6, 133.3, 131.9, 130.9, 130.6, 130.5, 130.1, 129.9, 127.5, 119.9, 119.8, 114.5, 108.4, 102.7, 61.4, 52.9.

**HRMS** (ESI):  $[\text{M}+\text{Na}]^+$   $\text{C}_{22}\text{H}_{12}\text{Br}_4\text{O}_5\text{Na}$ : calcd. 694.7310, found 694.7321.

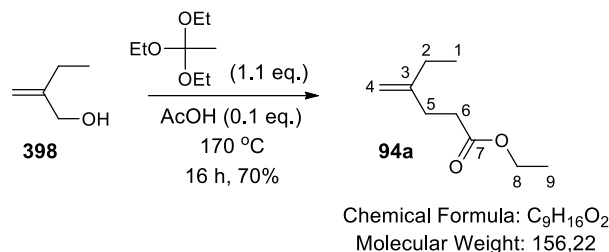
<sup>302</sup> F. Amat-Guerri, M. M. C. López-González, R. Martínez-Utrilla, R. Sastre, *Dyes and Pigments*, **1990**, *12*, 249.



## 4. Experimental part: Chapter IV

### 4.1. Desymmetrization strategy

#### Ethyl 4-methylenehexanoate (**94a**)



In a two necked RBF equipped with a Dean Stark apparatus connected with a reflux condenser, a solution of alcohol **398**<sup>303</sup> (2.65 g, 30.84 mmol, 1 eq.), triethyl-orthoacetate (6.21 mL, 33.92 mmol, 1.1 eq.) and acetic acid (0.17 mL, 3.084 mmol, 0.1 eq.) were added. The reaction mixture was refluxed at 170°C for 12h. The solvent was evaporated under reduced pressure and the crude material was purified by flash chromatography (PE/EtOAc 98:2). The olefin **94a** was obtained as colourless oil (3.360 g, 70%).

**Rf** = 0.52 (Pentane/Et<sub>2</sub>O 98/2).

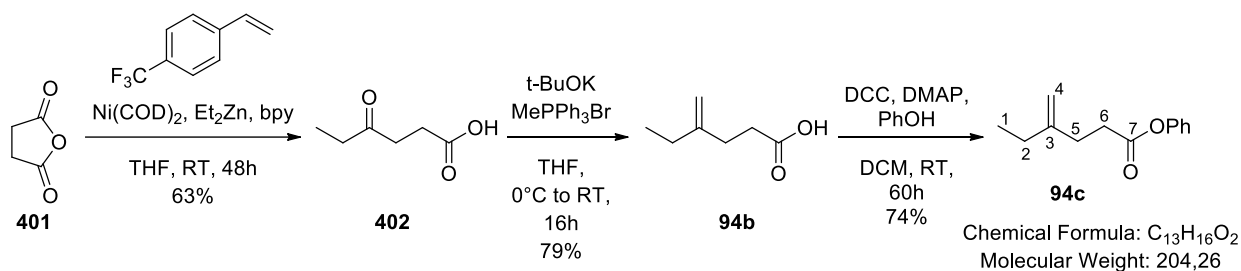
**IR** (film, KBr)  $\nu_{\max}$  (cm<sup>-1</sup>) = 3253, 2976, 2928, 2856, 1730, 1621, 1457, 1261, 1091.

**<sup>1</sup>H NMR** (CDCl<sub>3</sub>, 300 MHz):  $\delta$  (ppm) = 4.74-4.68 (m, 2H, H-4), 4.11 (q, 2H, *J* = 7.2 Hz, H-8), 2.46-2.30 (m, 4H, H-5 + H-6), 2.02 (q, 2H, *J* = 7.5 Hz, H-2), 1.24 (t, 3H, *J* = 7.2 Hz, H-9), 1.02 (t, 3H, *J* = 7.5 Hz, H-1).

**<sup>13</sup>C NMR** (CDCl<sub>3</sub>, 75 MHz):  $\delta$  (ppm) = 173.3 (C-7), 149.7 (C-3), 107.9 (C-4), 60.2 (C-8), 32.7 (C-6), 31.1 (C-5), 28.8 (C-2), 14.2 (C-9), 12.3 (C-1).

**HRMS** (ESI): [M+H]<sup>+</sup> C<sub>9</sub>H<sub>17</sub>O<sub>2</sub>: calcd. 156.11503, found 156.11532.

#### Phenyl 4-methylenehexanoate (**94c**)



The alkene **94c** was obtained in 3 steps starting from a Nickel catalysed cross-coupling<sup>304</sup> of succinic anhydride with the diethylzinc reagent followed by a Wittig reaction and an esterification. For the Nickel catalysed cross-coupling reaction, a slightly modified protocol was used compared to this reported in the literature.

A dried 500 mL two-necked RBF was charged with Ni(COD)<sub>2</sub> (248 mg, 0.9 mmol, 0.01 eq.) and 2,2'-dipyridyl (bpy, 169 mg, 1.1 mmol, 0.012 eq.) in a glove box. Upon removal of the glove box, 200 mL of THF was introduced and the solution was stirred 15 minutes at room temperature. The

<sup>303</sup> (a) J. G. Duboudin, B. J. Jousseume, *Organomet. Chem.* **1979**, 168, 1–11; (b) F. Barile, M. Bassetti, A. D'Annibale, R. Gerometta, M. Palazzi, *Eur. J. Org. Chem.* **2011**, 32, 6519–6526.

<sup>304</sup> E. A. Bercot, T. Rovis, *J. Am. Chem. Soc.* **2005**, 127, 247–254.

solution was then cooled to 0°C and 4-(trifluoromethyl)styrene (310 mg, 1.8 mmol, 0.02 eq.) followed by diethylzinc (1.0M solution in hexane, 100 mL, 100 mmol, 1.11 eq.) were added. Then succinic anhydride (9.1 g, 90.1 mmol, 1.0 eq.) was introduced in small portions. The mixture was stirred at room temperature for 48 hours. The reaction was quenched with 1M HCl (aq.). The aqueous layer was extract with EtOAc. The combined organic layers were extracted with saturated aqueous solution of Na<sub>2</sub>CO<sub>3</sub> and the obtained basic layers were acidified to pH = 1. The acidified layer was extracted with EtOAc and the combined organic extracts were washed with brine, dried over MgSO<sub>4</sub>, filtered, and concentrated under reduced pressure. The crude product **402** (7.4 g, 63%) was obtained as a yellow oil and was directly used in the Wittig reaction:

To a stirred suspension of MePPh<sub>3</sub>Br (61.2 g, 171 mmol, 3.0 eq.) in 500 mL of dry THF was added *t*-BuOK (32 g, 285 mmol, 5.0 eq.) in small portions at 0°C. The reaction mixture was stirred 1 hour at RT and **402** (7.4 g, 57 mmol, 1.0 eq.) diluted in 20 mL of THF was added dropwise. After being stirred overnight at RT, the THF was evaporated and the crude was treated with a 1M NaOH aqueous solution. The aqueous layer was washed with DCM and acidified to pH 1. The acidic aqueous layer was then extracted with EtOAc. The combined organic layers were directly dried over MgSO<sub>4</sub>, filtered, and concentrated under reduced pressure. The crude product **94c** (5.8 g, 79%) was directly used in the esterification reaction:

To a stirred solution of **94b** (5.6 g, 44 mmol, 1.0 eq.), DCC (9.9 g, 48 mmol, 1.1 eq.) and DMAP (1.1 g, 8.8 mmol, 0.2 eq.) in 70 mL of dry DCM was added PhOH (4.9 g, 52 mmol, 1.2 eq.) diluted in 10 mL of DCM. The reaction mixture was stirred at RT for 60 h. The solvent was evaporated under reduced pressure. The residues were diluted in EtOAc and filtered through a celite pad. After evaporation of EtOAc, the crude product was purified by flash chromatography (cyclohexane/EtOAc 97:3) to afford **94c** as a colourless oil (6.6 g, 74%, 36% over 3 steps).

**R<sub>f</sub>** = 0.78 (cyclohexane/EtOAc 4:1).

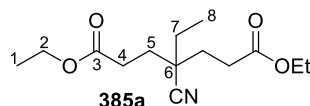
**IR** (film, KBr)  $\nu_{\max}$  (cm<sup>-1</sup>) = 3077, 3044, 2966, 22934, 1761, 1647, 1493, 1197, 1163, 1131.

**<sup>1</sup>H NMR** (300 MHz, CDCl<sub>3</sub>):  $\delta$  (ppm) = 7.44 – 7.32 (m, 2H, Ph), 7.24 (m, 1H, Ph), 7.12 – 7.02 (m, 2H, Ph), 4.87 – 4.77 (m, 2H, H-4), 2.78 – 2.66 (m, 2H, H-6), 2.55 – 2.43 (m, 2H, H-5), 2.10 (q, *J* = 7.6 Hz, 2H, H-2), 1.07 (t, *J* = 7.4 Hz, 3H, H-1).

**<sup>13</sup>C NMR** (75 MHz, CDCl<sub>3</sub>):  $\delta$  (ppm) = 172.0 (C-7), 150.8 (C-3/Ph), 149.5 (C-3/Ph), 129.5 (Ph), 125.9 (Ph), 121.7 (Ph), 108.6 (C-4), 33.0 (C-6), 31.2 (C-5), 29.0 (C-2), 12.5 (C-1).

**HRMS** (CI): [M+H]<sup>+</sup> C<sub>13</sub>H<sub>16</sub>O<sub>2</sub>: calcd. 205.1231, found 205.1231.

### Diethyl 4-cyano-4-ethylheptanedioate (**385a**)



**385a** CN  
Chemical Formula: C<sub>14</sub>H<sub>23</sub>NO<sub>4</sub>  
Molecular Weight: 269,34

According to the general procedure **A** from ethyl iodoacetate (0.05 mL, 0.42 mmol, 1.0 eq.), alkene **94a** (264 mg, 1.7 mmol, 4.0 eq.), tosyl cyanide (153 mg, 0.84 mmol, 2.0 eq.), bis(tributyl)tin (0.32 mL, 0.63 mmol, 1.5 eq.) and DTBHN (4x7 mg, 4x0.04 mmol, 4x0.1 eq.) in dry benzene (4.0 mL). The crude product was purified by flash chromatography (cyclohexane/EtOAc 85:15) to afford **385a** as colourless oil (76 mg, 67%).

**R<sub>f</sub>** = 0,28 (cyclohexane/EtOAc 3:1).

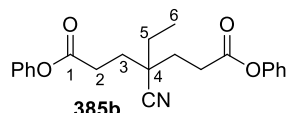
**IR** (film, KBr)  $\nu_{\max}$  (cm<sup>-1</sup>) = 2978, 2941, 2232, 1733, 1463, 1379, 1304, 1188, 1028.

**<sup>1</sup>H NMR** (300 MHz, CDCl<sub>3</sub>): δ (ppm) = 4.15 (q, *J* = 7.1 Hz, 4H, H-2), 2.51 – 2.42 (m, 4H, H-4), 2.02 – 1.77 (m, 4H, H-5), 1.63 (q, *J* = 7.5 Hz, 2H, H-7), 1.27 (t, *J* = 7.1 Hz, 6H, H-1), 1.04 (t, *J* = 7.5 Hz, 3H, H-8).

**<sup>13</sup>C NMR** (75 MHz, CDCl<sub>3</sub>): δ (ppm) = 172.2 (C-3), 122.3 (CN), 60.9 (C-2), 40.2 (C-6), 30.4 (C-5), 29.6 (C-4), 28.8 (C-7), 14.2 (C-1), 8.6 (C-8).

**HRMS** (ESI): [M+Na]<sup>+</sup> C<sub>14</sub>H<sub>23</sub>NO<sub>4</sub>Na: calcd. 292.1519, found 292.1517.

#### Diphenyl 4-cyano-4-ethylheptanedioate (**385b**)



Chemical Formula: C<sub>22</sub>H<sub>23</sub>NO<sub>4</sub>  
Molecular Weight: 365,42

According to the general procedure **A** from phenyl iodoacetate<sup>305</sup> (100 mg, 0.38 mmol, 1.0 eq.), alkene **94c** (312 mg, 1.5 mmol, 4.0 eq.), tosyl cyanide (138 mg, 0.76 mmol, 2.0 eq.), bis(tributyl)tin (0.29 mL, 0.57 mmol, 1.5 eq.) and DTBHN (4x7 mg, 4x0.04 mmol, 4x0.1 eq.) in dry benzene (4.0 mL). The crude product was purified by two successive flash chromatographies (cyclohexane/EtOAc 90:10 then toluene/EtOAc 97:3) to afford **385b** as colourless oil (66 mg, 48%).

**R<sub>f</sub>** = 0.31 (cyclohexane/EtOAc 4:1).

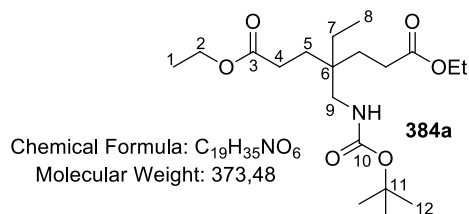
**IR** (film, KBr)  $\nu_{\max}$  (cm<sup>-1</sup>) = 3044, 3069, 2972, 2940, 2232, 1756, 1493, 1196, 1164, 1142.

**<sup>1</sup>H NMR** (300 MHz, CDCl<sub>3</sub>): δ (ppm) = 7.43 – 7.35 (m, 4H, Ph), 7.29 – 7.21 (m, 2H, Ph), 7.13 – 7.07 (m, 4H, Ph), 2.85 – 2.74 (m, 4H, H-2), 2.14 – 2.05 (m, 4H, H-3), 1.75 (q, *J* = 7.4 Hz, 2H, H-5), 1.12 (t, *J* = 7.4 Hz, 3H, H-6).

**<sup>13</sup>C NMR** (75 MHz, CDCl<sub>3</sub>): δ (ppm) = 170.9 (C-1), 150.6 (Ph<sub>quatern.</sub>), 129.6 (Ph), 126.1 (Ph), 122.3 (CN), 121.5 (Ph), 40.5 (C-4), 30.5 (C-3), 29.9 (C-2), 29.1 (C-5), 8.8 (C-6).

**HRMS** (ESI): [M+Na]<sup>+</sup> C<sub>22</sub>H<sub>23</sub>NO<sub>4</sub>Na<sup>+</sup>: calcd. 388,1519, found 388,1526.

#### Diethyl 4-(((tert-butoxycarbonyl)amino)methyl)-4-ethylheptanedioate (**384a**)



Chemical Formula: C<sub>19</sub>H<sub>35</sub>NO<sub>6</sub>  
Molecular Weight: 373,48

In a 25 mL RBF, nitrile **385a** (300 mg, 1.1 mmol, 1.0 eq.) and Boc<sub>2</sub>O (437 mg, 2 mmol, 1.8 eq.) were diluted in 9 mL of EtOH. Raney Nickel (50% slurry in H<sub>2</sub>O, 200 mg) was introduced to the reaction flask. The reaction mixture was stirred at 60°C under a positive pressure of H<sub>2</sub> (41 bar) for 60 hours and was then filtered off through a celite pad. The filter cake was rinsed with EtOAc and the filtrate was concentrated under reduced pressure. The crude product was purified by flash chromatography (cyclohexane/EtOAc 80:20) to afford **384a** as colourless oil (293 mg, 71%).

**R<sub>f</sub>** = 0,58 (cyclohexane/EtOAc 2:1).

**IR** (film, KBr)  $\nu_{\max}$  (cm<sup>-1</sup>) = 3388, 2976, 2936, 1732, 1716, 1520, 1366, 1271, 1248, 1173.

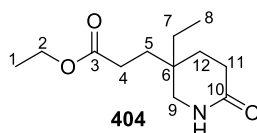
<sup>305</sup> Prepared from: E. Godineau, C. Schäfer, Y. Landais, *Org. Lett.* **2006**, *8*, 4871–4874.

**<sup>1</sup>H NMR** (300 MHz, CDCl<sub>3</sub>): δ (ppm) = 4.72 (s, 1H, NH), 4.12 (q, *J* = 7.1 Hz, 4H, H-2), 2.94 (d, *J* = 6.6 Hz, 2H, H-9), 2.36 – 2.14 (m, 4H, H-4), 1.55 – 1.48 (m, 4H, H-5), 1.43 (s, 9H, H-12), 1.29 – 1.15 (m, 8H, H-1 + H-7), 0.82 (t, *J* = 7.5 Hz, 3H, H-8).

**<sup>13</sup>C NMR** (75 MHz, CDCl<sub>3</sub>): δ (ppm) = 174.0 (C-3), 156.1 (C-10), 79.2 (C-11), 60.5 (C-2), 44.2 (C-9), 38.6 (C-6), 28.5 (C-4/5/12), 28.35 (C-4/5/12), 28.32 (C-4/5/12), 26.2 (C-7), 14.2 (C-1), 7.3 (C-8).

**HRMS** (ESI): [M+Na]<sup>+</sup> C<sub>19</sub>H<sub>35</sub>NO<sub>6</sub>Na: calcd. 396,2356, found 396,2339.

### Ethyl 3-(3-ethyl-6-oxopiperidin-3-yl)propanoate (**404**)



Chemical Formula: C<sub>12</sub>H<sub>21</sub>NO<sub>3</sub>  
Molecular Weight: 227,30

In a 25 mL RBF, nitrile **385a** (40 mg, 0.15 mmol, 1.0 eq.) was diluted in 3 mL of EtOH. Raney Nickel (50% slurry in H<sub>2</sub>O, 100 mg) was introduced to the reaction flask. The reaction mixture was stirred under a positive pressure of H<sub>2</sub> (21 bar) for 48 hours and was then filtered off through a celite pad. The filter cake was rinsed with EtOAc and the filtrate was concentrated under reduced pressure. The crude product was purified by flash chromatography (DCM/MeOH 95:5) to afford **404** as white solid (25 mg, 73%).

**R<sub>f</sub>** = 0,56 (DCM/MeOH 9:1).

**m. p.** = 70-74°C (DCM/MeOH).

**IR** (film, KBr)  $\nu_{\text{max}}$  (cm<sup>-1</sup>) = 3229, 2963, 2938, 2875, 1732, 1665.

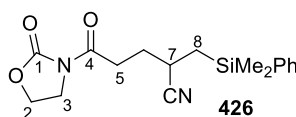
**<sup>1</sup>H NMR** (300 MHz, CDCl<sub>3</sub>): δ (ppm) = 6.71 (br s, 1H, NH), 4.10 (q, *J* = 7.1 Hz, 2H, H-2), 3.01 (d, *J* = 2.6 Hz, 2H, H-9), 2.31 (t, *J* = 7.0 Hz, 2H, H-4), 2.24 – 2.16 (m, 2H, H-11), 1.73 – 1.56 (m, 4H, H-5 + H-12), 1.45 – 1.28 (m, 2H, H-7), 1.23 (t, *J* = 7.1 Hz, 3H, H-1), 0.82 (t, *J* = 7.5 Hz, 3H, H-8).

**<sup>13</sup>C NMR** (75 MHz, CDCl<sub>3</sub>): δ (ppm) = 173.4 (C-3/10), 172.4 (C-3/10), 60.6 (C-2), 50.7 (C-9), 33.6 (C-6), 29.6 (C-5), 28.8 (C-12), 28.6 (C-11), 27.8 (C-4), 26.4 (C-7), 14.2 (C-1), 7.4 (C-8).

**HRMS** (ESI): [M+Na]<sup>+</sup> C<sub>12</sub>H<sub>21</sub>NO<sub>3</sub>Na: calcd. 250,1413, found 250,1418.

## 4.2. Efforts towards an enantioselective 3-components carbo-cyanation

### 2-((dimethyl(phenyl)silyl)methyl)-5-oxo-5-(2-oxooxazolidin-3-yl)pentanenitrile (**426**)



Chemical Formula: C<sub>17</sub>H<sub>22</sub>N<sub>2</sub>O<sub>3</sub>Si  
Molecular Weight: 330,45

According to the general procedure **A** from xanthate **409b**<sup>306</sup> (101 mg, 0.4 mmol, 1.0 eq.), allylsilane (141 mg, 0.8 mmol, 2.0 eq.), tosyl cyanide (145 mg, 0.8 mmol, 2.0 eq.), bis(tributyl)tin (0.3 mL, 0.6 mmol, 1.5 eq.) and DTBHN (3x7 mg, 3x0.1 mmol, 3x0.1 eq.) in dry benzene (4.0

<sup>306</sup> Synthesized according to: (a) M. C. Willis, G. A. Cutting, V. J. D. Piccio, M. J. Durbin, M. P. John, *Angew. Chem. Int. Ed.* **2005**, *44*, 1543-1545; (b) E. Bacque, F. Pautrat, S. Z. Zard, *Chem. Commun.* **2002**, 2312-2313.

mL). The crude product was purified by flash chromatography (cyclohexane/EtOAc 80:20) to afford **426** as colourless oil (57 mg, 42%).

**Rf** = 0,18 (cyclohexane/EtOAc 2:1).

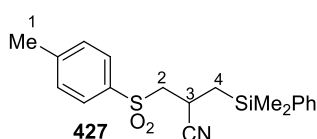
**IR** (film, KBr)  $\nu_{\max}$  (cm<sup>-1</sup>) = 3070, 2958, 2236, 1779, 1698, 1391, 113, 1040, 838.

**<sup>1</sup>H NMR** (300 MHz, CDCl<sub>3</sub>):  $\delta$  (ppm) = 7.56 – 7.47 (m, 2H, Ph), 7.42 – 7.34 (m, 3H, Ph), 4.48 – 4.36 (m, 2H, H-2), 4.05 – 3.93 (m, 2H, H-3), 3.06 (td,  $J$  = 7.2, 3.4 Hz, 2H, H-5), 2.75 – 2.62 (m, 1H, H-7), 1.98 – 1.85 (m, 2H, H-6), 1.31 – 1.19 (m, 1H, H-8a), 1.08 (dd,  $J$  = 14.8, 5.8 Hz, 1H, H-8b), 0.44 (s, 3H, SiMe<sub>2</sub>), 0.40 (s, 3H, SiMe<sub>2</sub>).

**<sup>13</sup>C NMR** (75 MHz, CDCl<sub>3</sub>):  $\delta$  (ppm) = 171.9 (C-4), 153.5 (C-1), 137.3 (CH<sub>ar</sub>), 133.6 (CH<sub>ar</sub>), 129.5 (CH<sub>ar</sub>), 128.1 (CH<sub>ar</sub>), 122.7 (CN), 62.3 (C-2), 42.5 (C-3), 32.6 (C-5), 30.2 (C-6), 26.5 (C-7), 20.0 (C-8), -2.3 (SiMe), -3.1 (SiMe).

**HRMS** (ESI): [M+Na]<sup>+</sup> C<sub>17</sub>H<sub>22</sub>N<sub>2</sub>O<sub>3</sub>SiNa: calcd. 353.1325, found 353.1338.

### 3-(dimethyl(phenyl)silyl)-2-(tosylmethyl)propanenitrile (**427**)



Chemical Formula: C<sub>19</sub>H<sub>23</sub>NO<sub>2</sub>SSi  
Molecular Weight: 357,54

This  $\beta$ -sulfonyl nitrile **427** was obtained as a side product of the carbocyanation reaction (33%, see protocol above).

**Rf** = 0,61 (cyclohexane/EtOAc 2:1).

**IR** (film, KBr)  $\nu_{\max}$  (cm<sup>-1</sup>) = 3069, 3049, 2955, 2926, 2242, 1597, 1427, 1322, 1303, 1149, 837.

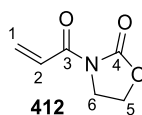
**<sup>1</sup>H NMR** (600 MHz, CDCl<sub>3</sub>):  $\delta$  (ppm) =  $\delta$  = 7.68 (d,  $J$  = 8.3 Hz, 2H, Tol), 7.51 – 7.49 (m, 2H, Ph), 7.44 – 7.37 (m, 3H, Ph), 7.35 – 7.32 (m, 2H, tol), 3.35 (dd,  $J$  = 14.4, 7.4 Hz, 1H, H-2a), 3.11 (dd,  $J$  = 14.4, 5.7 Hz, 1H, H-2b), 3.05 – 2.99 (m, 1H, H-3), 2.45 (s, 3H, H-1), 1.34 (dd,  $J$  = 14.8, 5.3 Hz, 1H, H-4a), 1.29 – 1.24 (m, 1H, H-4b), 0.44 (s, 3H, SiMe<sub>2</sub>), 0.40 (s, 3H, SiMe<sub>2</sub>).

**<sup>13</sup>C NMR** (150 MHz, CDCl<sub>3</sub>):  $\delta$  (ppm) = 145.7 (Ar), 136.4 (Ar), 135.4 (Ar), 133.8 (Ar), 130.3 (Ar), 129.9 (Ar), 128.4 (Ar), 128.3 (Ar), 120.4 (CN), 59.9 (C-1), 22.6 (C-3), 21.9 (C-1), 20.3 (C-4), -2.4 (SiMe<sub>2</sub>), -3.2 (SiMe<sub>2</sub>).

**HRMS** (ESI): [M+Na]<sup>+</sup> C<sub>19</sub>H<sub>23</sub>NO<sub>2</sub>SSiNa: calcd. 380.1135, found 380.1122.

## 4.3. Cyclobutene methodology

### 3-acryloyloxazolidin-2-one<sup>307</sup> (**412**)



Chemical Formula: C<sub>6</sub>H<sub>7</sub>NO<sub>3</sub>  
Molecular Weight: 141,12

In a 1L RBF, triethylamine (23 mL, 172 mmol, 1.0 eq.) and acryloyl chloride (14 mL, 172 mmol, 1.0 eq.) were added at 0°C to acrylic acid (11.8 mL, 172 mmol, 1.0 eq.) diluted in 500 mL of ethyl acetate. The reaction mixture was then stirred at room temperature for 1 hour and filtered off. The

<sup>307</sup> D. A. Evans, S. J. Miller, T. Lectka, P. von Matt, *J. Am. Chem. Soc.* **1999**, *121*, 7559-7573.

filter cake was washed 3 times with ethyl acetate. The filtrate was concentrated under reduced pressure to give the crude anhydride which was used directly in the next step.

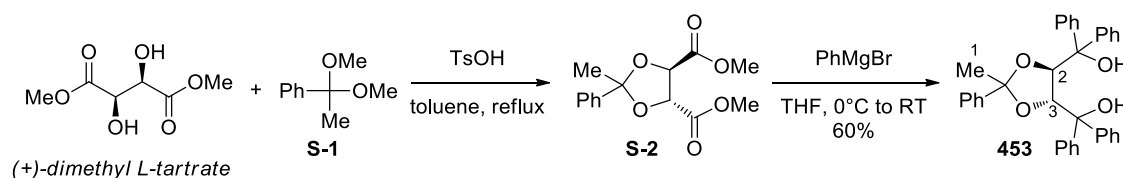
To a suspension of 2-oxazolidinone (12 g, 138 mmol, 1.0 eq.) and LiCl (7.3 g, 172 mmol, 1.25 eq.) in 500 mL of dry THF was added triethylamine (23 mL, 172 mmol, 1.25 eq.) at 0°C. Then, the crude anhydride diluted in 20 mL of THF was introduced and the reaction mixture was stirred at room temperature for 16 hours. The reaction was quenched with a 1M HCl aqueous solution and the aqueous layer was extracted with ethyl acetate (3 times). The combined organic layers were washed with a saturated aqueous solution of NaHCO<sub>3</sub> and brine, dried over MgSO<sub>4</sub> and concentrated under reduced pressure. The crude product **412** was pure enough without further purification (17.3 g, 89%).

**Rf** = 0.49 (cyclohexane/EtOAc 1:1).

<sup>1</sup>H NMR (300 MHz, CDCl<sub>3</sub>): δ (ppm) = 7.50 (dd, *J* = 17.0, 10.5 Hz, 1H, H-1a), 6.57 (dd, *J* = 17.0, 1.8 Hz, 1H, H-1b), 5.91 (dd, *J* = 10.5, 1.8 Hz, 1H, H-2), 4.49 – 4.41 (m, 2H, H-5), 4.13 – 4.05 (m, 2H, H-6).

The NMR data are in good agreement with those reported in the literature.

**((4R,5R)-2-methyl-2-phenyl-1,3-dioxolane-4,5-diyl)bis(diphenylmethanol)**<sup>308</sup> (**453**)



**Prereration of dimethylacetal (S-1):** acetophenone (20 mL, 170 mmol, 1.0 eq.) and trimethyl orthoformate (28 mL, 255 mmol, 1.5 eq.) were diluted in 40 mL of dry MeOH and TsOH (3.2 g, 17 mmol, 0.1 eq.) was added. The reaction mixture was stirred at 65°C for 60 hours. The reaction mixture was quenched at room temperature by adding solid Na<sub>2</sub>CO<sub>3</sub> and was stirred for an additional hour. Then, water was added. The aqueous layer was extracted with ether (3 times) and the combined organic layers were washed with water and brine, dried over MgSO<sub>4</sub> and concentrated under reduced pressure. The crude acetal was used directly in the next step.

**Dioxolane formation (S-2):** The crude acetal (0.93 g, 5.6 mmol, 1.0 eq.), dimethyl L-tartrate (1.0 g, 5.6 mmol, 1.0 eq.) and TsOH (107 mg, 0.56 mmol, 0.1 eq.) were diluted in 20 mL of dry toluene. The mixture was refluxed with a Dean-Stark apparatus for 17 hours. The reaction mixture was quenched with a saturated aqueous solution of NaHCO<sub>3</sub>. The aqueous layer was extracted with ethyl acetate (3 times) and the combined organic layers were washed with water and brine, dried over MgSO<sub>4</sub> and concentrated under reduced pressure. The obtained crude product was purified by flash chromatography (cyclohexane/EtOAc 80:20) to afford **S-2** as yellow oil (0.94 g, 60%).

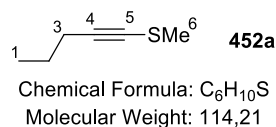
**Addition of Grignard reagent:** The dioxolane **S-2** (2.78 g, 9.9 mmol, 1.0 eq.) was diluted in 100 mL of dry THF and PhMgBr (3.0 M in Et<sub>2</sub>O, 16.6 mL, 49.7 mmol, 5.0 eq.) was added at 0°C. The reaction mixture was then stirred at room temperature for 20 hours and quenched with a saturated aqueous solution of NH<sub>4</sub>Cl. The aqueous layer was extracted with ethyl acetate (3 times) and the combined organic layers were washed with water and brine, dried over MgSO<sub>4</sub> and concentrated under reduced pressure. The obtained crude product was purified by flash chromatography (cyclohexane/EtOAc 85:15) to afford **453** as beige solid (3.15 g, 60%).

**Rf** = 0.5 (cyclohexane/EtOAc 4:1).

<sup>308</sup> K. Narasaka, N. Iwasawa, M. Inoue, T. Yamada, M. Nakashima, J. Sugimori, *J. Am. Chem. Soc.* **1989**, *111*, 5340-5345.

**<sup>1</sup>H NMR** (300 MHz, CDCl<sub>3</sub>): δ (ppm) = 7.58 – 7.05 (m, 25H, Ph), 5.19 (d, *J* = 5.5 Hz, 1H, H-2), 5.10 (d, *J* = 5.5 Hz, 1H, H-3), 2.40 – 2.35 (br s, 1H, OH), 2.24 (br s, 1H, OH), 1.34 (s, 3H, H-1). The NMR data are in good agreement with those reported in the literature.

#### Methyl(pent-1-yn-1-yl)sulfane (452a)



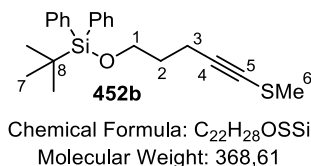
In a dried 250mL two-necked RBF, 1-pentyne (6.9 g, 0.10 mol, 1.25 eq.) was diluted in 100mL of anhydrous THF and *n*-BuLi (2.5 M in THF, 34.4 mL, 86 mmol, 1.06 eq.) was added dropwise at 0°C. The reaction mixture was stirred for 1 hour at 0°C and dimethyl disulfide (7.6 g, 81 mmol, 1.0 eq.) was then added. The mixture was then stirred for 3 hours at room temperature and quenched with 2-bromoethanol (7.2 mL, 0.10 mol, 1.25 eq.). The stirring was pursued for 1 hours and water was added. The aqueous layer was extracted with ether (3 times) and the combined organic layers were washed with water and brine, dried over MgSO<sub>4</sub> and concentrated under reduced pressure. The obtained crude product was then purified by flash chromatography (pentane) to afford **452a** as colourless oil (7.7 g, 84%).

**R<sub>f</sub>** = 0.73 (pentane).

**<sup>1</sup>H NMR** (300 MHz, CDCl<sub>3</sub>): δ (ppm) = 2.35 (s, 3H, H-6), 2.26 (t, *J* = 7.0 Hz, 2H, H-3), 1.61 – 1.44 (m, 2H, H-2), 0.97 (t, *J* = 7.4 Hz, 3H, H-1).

**<sup>13</sup>C NMR** (75 MHz, CDCl<sub>3</sub>): δ (ppm) = 93.2 (C-5), 70.0 (C-4), 22.2 (C-3), 22.1 (C-2), 19.4 (C-6), 13.5 (C-1).

#### tert-butyl((5-(methylthio)pent-4-yn-1-yl)oxy)diphenylsilane (452b)



In a dried 500 mL two-necked RBF, TBDPS-protected pentyn-1-ol<sup>309</sup> **517a** (6.7 g, 20.8 mmol, 1.0 eq.) was diluted in 200 mL of anhydrous THF and *n*-BuLi (2.25 in hexane, 9.7 mL, 21.8 mmol, 1.05 eq.) was added dropwise at 0°C. The reaction mixture was stirred for 1 hour at 0°C and dimethyl disulfide (1.88 mL, 20.8 mmol, 1.0 eq.) was then added. The mixture was then stirred for 3 hours at reflux and quenched at room temperature with 2-bromoethanol (1.6 mL, 22.9 mmol, 1.1 eq.). The stirring was pursued for 1 hour and water was added. The aqueous layer was extracted with ether (3 times) and the combined organic layers were washed with water and brine, dried over MgSO<sub>4</sub> and concentrated under reduced pressure. The obtained crude product was then purified by flash chromatography (cyclohexane/EtOAc 95:5) to afford **452b** as colourless oil (7.1 g, 93%).

**R<sub>f</sub>** = 0.83 (cyclohexane/EtOAc 4:1).

**IR** (film, KBr)  $\nu_{\max}$  (cm<sup>-1</sup>) = 3070, 3049, 2953, 2929, 2894, 2857, 1427, 1109, 1066, 823, 738, 701, 505.

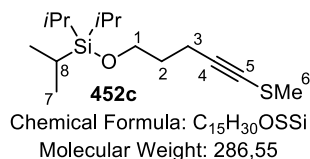
**<sup>1</sup>H NMR** (300 MHz, CDCl<sub>3</sub>): δ (ppm) = 7.70 – 7.64 (m, 4H, Ph), 7.44 – 7.35 (m, 6H, Ph), 3.73 (t, *J* = 6.0 Hz, 2H, H-1), 2.45 (t, *J* = 7.1 Hz, 2H, H-3), 2.32 (s, 3H, H-6), 1.81 – 1.71 (m, 2H, H-2), 1.05 (s, 9H, H-7).

<sup>309</sup> Prepared from: D. J. Clausen, S. Wan, P. E. Floreancig, *Angew. Chem. Int. Ed.* **2011**, *50*, 5178-5181.

$^{13}\text{C}$  NMR (75 MHz,  $\text{CDCl}_3$ ):  $\delta$  (ppm) = 135.7 (Ph), 133.9 (Ph), 129.7 (Ph), 127.8 (Ph), 92.8 (C-5), 70.3 (C-4), 62.4 (C-1), 31.7 (2C, C-2, C-8), 27.0 (C-7), 19.4 (C-6), 16.7 (C-3).

HRMS (ESI):  $[\text{M}+\text{Na}]^+$   $\text{C}_{22}\text{H}_{28}\text{OSSiNa}$ : calcd. 391.1522, found 391.1529.

### triisopropyl((5-(methylthio)pent-4-yn-1-yl)oxy)silane (**452c**)



In a dried 500 mL two-necked RBF, TIPS-protected pentyn-1-ol<sup>310</sup> **517b** (25.2 g, 105 mmol, 1.0 eq.) was diluted in 500 mL of anhydrous THF and *n*-BuLi (2.5 in hexane, 44 mL, 110 mmol, 1.05 eq.) was added dropwise at 0°C. The reaction mixture was stirred for 1 hour at 0°C and dimethyl disulfide (9.5 mL, 105 mmol, 1.0 eq.) was then added. The mixture was then stirred for 16 hours at room temperature and quenched with 2-bromoethanol (8.2 mL, 115 mmol, 1.1 eq.). The stirring was pursued for 1 hour and water was added. The aqueous layer was extracted with ether (3 times) and the combined organic layers were washed with water and brine, dried over  $\text{MgSO}_4$  and concentrated under reduced pressure. The obtained crude product was then purified by flash chromatography (cyclohexane/EtOAc 95:5) to afford **452c** as colourless oil (29 g, 96%).

Rf = 0.85 (cyclohexane/EtOAc 4:1).

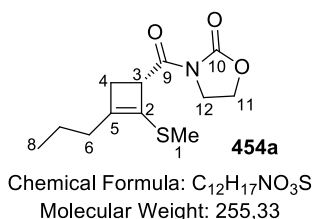
IR (film, KBr)  $\nu_{\text{max}}$  ( $\text{cm}^{-1}$ ) = 2943, 2866, 1463, 1108, 1066, 1012, 882, 681.

$^1\text{H}$  NMR (300 MHz,  $\text{CDCl}_3$ ):  $\delta$  (ppm) = 3.76 (t,  $J$  = 6.0 Hz, 2H, H-1), 2.41 (t,  $J$  = 7.1 Hz, 2H, H-3), 2.35 (s, 3H, H-6), 1.80 – 1.68 (m, 2H, H-2), 1.10 – 1.00 (m, 21H, H-7/8).

$^{13}\text{C}$  NMR (75 MHz,  $\text{CDCl}_3$ ):  $\delta$  (ppm) = 93.1 (C-5), 70.1 (C-4), 61.9 (C-1), 32.1 (C-2), 19.4 (C-6), 18.1 (C-7), 16.7 (C-3), 12.1 (C-8).

HRMS (ESI):  $[\text{M}+\text{Na}]^+$   $\text{C}_{15}\text{H}_{30}\text{OSSiNa}$ : calcd. 309.1678, found 309.1688.

### (*R*)-3-(2-(methylthio)-3-propylcyclobut-2-enecarbonyl)oxazolidin-2-one (**454a**)



In a 100mL two-necked RBF  $\text{TiCl}_2(\text{O}i\text{Pr})_2$  (0.92 g, 3.9 mmol, 0.1 eq.) was dried under vacuo for 20 minutes and flushed with argon 3 times. Chiral diol **453** (2.27 g, 4.3 mmol, 0.11 eq.) was added and 40 mL of dry toluene was introduced. The mixture was stirred overnight at room temperature. This solution was transferred to a pre-dried 1L two-necked RBF containing activated molecular sieves 4A° (1g). The mixture was cooled to 0°C and 3-acryloyloxazolidin-2-one **412** (5.5 g, 39 mmol, 1.0 eq.) was added in small portions. Then, alkynyl thioether **452a** (6.8 g, 60 mmol, 1.5 eq.) diluted in a minimum amount of toluene was added slowly. The reaction was stirred for 60 hours at room temperature. The reaction mixture was filtered off through a celite pad and quenched with a saturated aqueous solution of  $\text{NaHCO}_3$ . The aqueous layer was extracted with dichloromethane (3 times) and the combined organic layers were washed with a saturated aqueous solution of Rochelle salt and brine, dried over  $\text{MgSO}_4$  and concentrated under reduced pressure. The obtained

<sup>310</sup> Prepared from: S. D. Holmbo, N. A. Godfrey, J. J. Hirner, S. V. Pronin, *J. Am. Chem. Soc.* **2016**, *138*, 12316-12319.



crude product was then purified by flash chromatography (pentane/EtOAc 80:20 to 50:50) to afford **454a** as beige solid (8.0 g, 80%, 99.5% ee).

**Rf** = 0.7 (pentane/EtOAc 50:50).

**m. p.** = 59-63°C (pentane/EtOAc).

**IR** (film, KBr)  $\nu_{\max}$  (cm<sup>-1</sup>) = 2959, 2923, 2835, 1789, 1770, 1679, 1383, 1368, 1260, 1218, 1198.

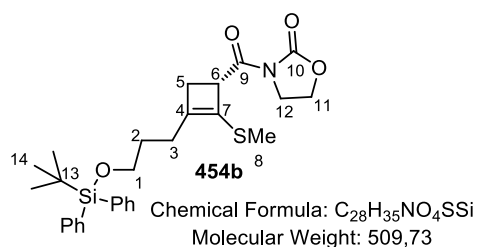
**<sup>1</sup>H NMR** (300 MHz, CDCl<sub>3</sub>):  $\delta$  (ppm) = 4.78 – 4.69 (m, 1H, H-3), 4.49 – 4.37 (m, 2H, H-11), 4.11 – 3.99 (m, 2H, H-12), 2.77 (ddt,  $J$  = 12.7, 4.9, 1.2 Hz, 1H, H-4a), 2.57 – 2.46 (m, 1H, H-4b), 2.24 (s, 3H, H-1), 2.22 – 2.10 (m, 2H, H-6), 1.57 – 1.41 (m, 2H, H-6), 0.93 (t,  $J$  = 7.3 Hz, 3H, H-8).

**<sup>13</sup>C NMR** (75 MHz, CDCl<sub>3</sub>):  $\delta$  (ppm) = 173.0 (C-9), 153.6 (C-5/10), 151.1 (C-5/10), 129.3 (C-2), 62.4 (C-11), 44.8 (C-3), 42.8 (C-12), 33.7 (C-4), 31.0 (C-6), 20.2 (C-7), 15.9 (C-1), 14.1 (C-8).

**HRMS** (ESI): [M+Na]<sup>+</sup> C<sub>12</sub>H<sub>17</sub>NO<sub>3</sub>SSiNa: calcd. 278.0821, found 278.0811.

**[ $\alpha$ ]<sup>25</sup><sub>D</sub>** = +50.55 (c = 0.21, CHCl<sub>3</sub>).

**(R)-3-(3-(3-((tert-butyl)dimethylsilyloxy)propyl)-2-(methylthio)cyclobut-2-enecarbonyl)oxazolidin-2-one (454b)**



In a 100 mL two-necked RBF TiCl<sub>2</sub>(OiPr)<sub>2</sub> (0.118 g, 0.5 mmol, 0.1 eq.) was dried under vacuo for 20 minutes and flushed with argon 3 times. Chiral diol (0.29 g, 0.55 mmol, 0.11 eq.) was added and 5 mL of dry toluene was introduced. The mixture was stirred overnight at room temperature. This solution was transferred to a pre-dried 100 mL two-necked RBF containing activated molecular sieves 4A° (0.2 g) and diluted in 30 mL of dry toluene. The mixture was cooled to 0°C and 3-acryloyloxazolidin-2-one (0.7 g, 5 mmol, 1.0 eq.) was added in small portions. Then, alkynylthioether **452b** (3.7 g, 10 mmol, 2 eq.) diluted in 10 mL of toluene was added slowly. The reaction was stirred for 60 hours at room temperature. The reaction mixture was then filtered off through a celite pad and quenched with a saturated aqueous solution of NaHCO<sub>3</sub>. The aqueous layer was extracted with dichloromethane (3 times) and the combined organic layers were washed with a saturated aqueous solution of Rochelle salt and brine, dried over MgSO<sub>4</sub> and concentrated under reduced pressure. The obtained crude product was then purified by flash chromatography (cyclohexane/EtOAc 80:20) to afford **454b** as colourless oil (1.93 g, 76%, 97% e.e.).

**Rf** = 0.55 (cyclohexane/EtOAc 1:1).

**IR** (film, KBr)  $\nu_{\max}$  (cm<sup>-1</sup>) = 3070, 3047, 2928, 2857, 1780, 1695, 1427, 1386, 1361, 1251, 1224, 1198, 1107, 703.

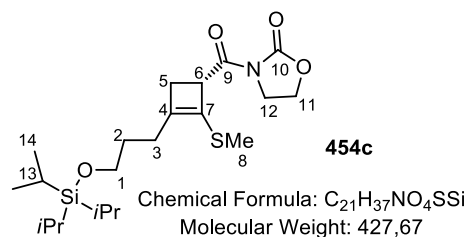
**<sup>1</sup>H NMR** (300 MHz, CDCl<sub>3</sub>):  $\delta$  (ppm) = 7.69 – 7.64 (m, 4H, Ph), 7.43 – 7.34 (m, 6H, Ph), 4.72 – 4.67 (m, 1H, H-6), 4.47 – 4.40 (m, 2H, H-11), 4.08 – 4.00 (m, 2H, H-12), 3.67 (t,  $J$  = 6.3 Hz, 2H, H-1), 2.73 (dd,  $J$  = 12.7, 4.9 Hz, 1H, H-5a), 2.51 – 2.43 (m, 1H, H-5b), 2.34 – 2.24 (m, 2H, H-3), 2.22 (s, 3H, H-8), 1.78 – 1.65 (m, 2H, H-2), 1.05 (s, 9H, H-14).

**<sup>13</sup>C NMR** (75 MHz, CDCl<sub>3</sub>):  $\delta$  (ppm) = 172.8 (C-9), 153.5 (C-4/10), 150.1 (C-4/10), 135.7 (Ph), 134.0 (Ph), 129.7 (Ph), 129.4 (C-7), 127.7 (Ph), 63.5 (C-1), 62.4 (C-11), 44.7 (C-6), 42.7 (C-12), 33.8 (C-5), 29.8 (C-2), 27.0 (C-14), 25.5 (C-3), 19.3 (C-13), 15.7 (C-8).

**HRMS** (ESI):  $[M+Na]^+$   $C_{28}H_{35}NO_4SSiNa$ : calcd. 532.1948, found 532.1964.

$[\alpha]^{25}_D = +19.72$  ( $c = 0.18$ ,  $CHCl_3$ ).

**(R)-3-(2-(methylthio)-3-(3-(triisopropylsilyloxy)propyl)cyclobut-2-enecarbonyl)oxazolidin-2-one (454c)**



In a 100 mL two-necked RBF,  $TiCl_2(OiPr)_2$  (0.54 g, 2.3 mmol, 0.1 eq.) was dried under vacuo for 20 minutes and purged with argon 3 times. Chiral diol (1.3 g, 2.5 mmol, 0.11 eq.) was added and 20 mL of dry toluene was introduced. The mixture was stirred overnight at room temperature. This solution was transferred to a pre-dried 500 mL two-necked RBF containing activated molecular sieves 4A° (1 g) and diluted with 200 mL of dry toluene. The mixture was cooled to 0°C and 3-acryloyloxazolidin-2-one (3.2 g, 23 mmol, 1.0 eq.) was added in small portions. Then, alkynylthioether **452c** (13 g, 46 mmol, 2 eq.) diluted in 10 mL of toluene was added slowly. The reaction was stirred for 48 hours at room temperature. The reaction mixture was then filtered off through a celite pad and quenched with a saturated aqueous solution of  $NaHCO_3$ . The aqueous layer was extracted with dichloromethane (3 times) and the combined organic layers were washed with a saturated aqueous solution of Rochelle salt and brine, dried over  $MgSO_4$  and concentrated under reduced pressure. The obtained crude product was then purified by flash chromatography (cyclohexane/EtOAc 80:20) to afford **454c** as colourless oil (8.1 g, 83%).

**Rf** = 0.69 (cyclohexane/EtOAc 1:1).

**IR** (film, KBr)  $\nu_{max}$  ( $cm^{-1}$ ) = 2942, 2865, 1782, 1696, 1463, 1386, 1362, 1251, 1225, 1105.

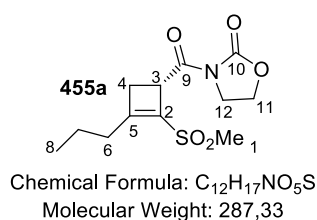
**$^1H$  NMR** (300 MHz,  $CDCl_3$ ):  $\delta$  (ppm) = 4.75 – 4.69 (m, 1H, H-6), 4.47 – 4.40 (m, 2H, H-11), 4.08 – 4.01 (m, 2H, H-12), 3.70 (t,  $J = 6.3$  Hz, 2H, H-1), 2.83 – 2.74 (m, 1H, H-5a), 2.57 – 2.48 (m, 1H, H-5b), 2.33 – 2.23 (m, 5H, H-3, H-8), 1.77 – 1.64 (m, 2H, H-2), 1.12 – 0.97 (m, 21H, H-12/13).

**$^{13}C$  NMR** (75 MHz,  $CDCl_3$ ):  $\delta$  (ppm) = 172.9 (C-9), 153.6 (C-4/10), 150.4 (C-4/10), 129.3 (C-7), 63.0 (C-1), 62.4 (C-11), 44.8 (C-6), 42.8 (C-12), 33.8 (C-5), 30.3 (C-2), 25.5 (C-3), 18.12 (C-14), 15.8 (C-8), 12.1 (C-13).

**HRMS** (ESI):  $[M+Na]^+$   $C_{21}H_{37}NO_4SSiNa$ : calcd. 450.2104, found 450.2118.

$[\alpha]^{25}_D = +38.74$  ( $c = 0.21$ ,  $CHCl_3$ ).

**(R)-3-(2-(methylsulfonyl)-3-propylcyclobut-2-enecarbonyl)oxazolidin-2-one (455a)**



In a 25 mL two-necked RBF, cyclobutene **454a** (63 mg, 0.25 mmol, 1.0 eq.) was diluted in dry dichloromethane (5 mL). The mixture was cooled to 0°C and *m*-CPBA (123 mg, 0.55 mmol, 2.2 eq.) was added. The mixture was stirred for 1 hour at room temperature and then quenched with a saturated aqueous solution of  $NaHCO_3$ . The aqueous layer was extracted with EtOAc and the

combined organic layers were washed with brine, dried over Na<sub>2</sub>SO<sub>4</sub>, filtered, and concentrated under reduced pressure. If necessary the product was purified by flash chromatography on silica gel (pentane/EtOAc 70:30), to afford the desired sulfone **455a** as white crystals (72 mg, quantitative yield).

**Rf** = 0.30 (pentane/EtOAc 1:1)

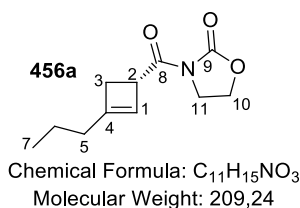
**IR** (film, KBr)  $\nu_{\max}$  (cm<sup>-1</sup>) = 3435, 1776, 1690, 1389, 1299.

**<sup>1</sup>H NMR** (300 MHz, CDCl<sub>3</sub>):  $\delta$  (ppm) = 4.96 – 4.91 (m, 1H, H-3), 4.50 – 4.42 (m, 2H, H-11), 4.08 – 4.01 (m, 2H, H-12), 3.11 (s, 3H, H-1), 2.88 (dd, *J* = 14.7, 4.7 Hz, 1H, H-4a), 2.80 – 2.69 (m, 1H, H-4b), 2.53 (br t, *J* = 7.6 Hz, 2H, H-6), 1.63 – 1.49 (m, 2H, H-7), 0.97 (t, *J* = 7.4 Hz, 3H, H-8).

**<sup>13</sup>C NMR** (75 MHz, CDCl<sub>3</sub>):  $\delta$  (ppm) = 170.9 (C-9), 166.0 (C-10), 153.8 (C-2), 133.2 (C-5), 62.7 (C-11), 44.2 (C-3), 43.4 (C-1), 42.6 (C-12), 33.2 (C-4), 30.9 (C-6), 20.0 (C-7), 14.0 (C-8).

**HRMS** (ESI): [M+Na]<sup>+</sup> C<sub>12</sub>H<sub>17</sub>NO<sub>5</sub>SNa: calcd. 310.07196, found 310.07163

### (S)-3-(3-propylcyclobut-2-enecarbonyl)oxazolidin-2-one (**456a**)



In a 1L two-necked RBF, cyclobutenyl thioether **454a** (13.7 g, 53.5 mmol, 1.0 eq.) and 1-octene (42 mL, 268 mmol, 5.0 eq.) were diluted in 500 mL of dry acetone. Lindlar catalyst (5% on calcium carbonate poisoned with Lead, 25 g, 235 mmol, 4.4 eq.) was introduced in small portions and freshly distilled Et<sub>3</sub>SiH (85 mL, 535 mmol, 10 eq.) was then added slowly at room temperature. The reaction mixture was stirred at room temperature for 3 days and was filtered off through a celite pad (Lindlar catalyst being recycled). The filtrate was concentrated under reduced pressure and the obtained crude product was purified by flash chromatography (PE/EtOAc 70:30) to afford **456a** as colourless oil (10.8 g, 96%, 98% ee).

**Rf** = 0.67 (pentane/EtOAc 70:30).

**IR** (film, KBr)  $\nu_{\max}$  (cm<sup>-1</sup>) = 2959, 2928, 2872, 1780, 1694, 1387, 1361, 1258, 1225.

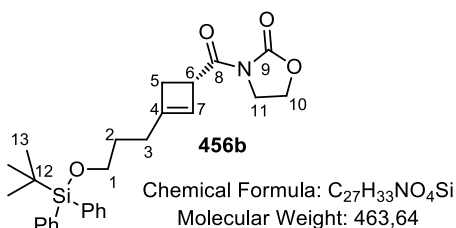
**<sup>1</sup>H NMR** (300 MHz, CDCl<sub>3</sub>):  $\delta$  (ppm) = 5.80 – 5.78 (m, 1H, H-1), 4.46 – 4.38 (m, 2H, H-10), 4.36 – 4.30 (m, 1H, H-2), 4.06 – 3.98 (m, 2H, H-11), 2.81 – 2.73 (m, 1H, H-3a), 2.70 – 2.62 (m, 1H, H-3b), 2.08 – 1.98 (m, 2H, H-5), 1.55 – 1.40 (m, 2H, H-6), 0.92 (t, *J* = 7.4 Hz, 3H, H-7).

**<sup>13</sup>C NMR** (75 MHz, CDCl<sub>3</sub>):  $\delta$  (ppm) = 173.8 (C-8), 153.5 (C-4/9), 152.9 (C-4/9), 125.2 (C-1), 62.4 (C-10), 42.7 (C-2), 42.6 (C-11), 34.8 (C-3), 33.0 (C-5), 19.8 (C-6), 14.0 (C-7).

**HRMS** (ESI): [M+Na]<sup>+</sup> C<sub>11</sub>H<sub>15</sub>NO<sub>3</sub>Na: calcd. 232.0944, found 232.0947.

[ $\alpha$ ]<sup>25</sup><sub>D</sub> = -66.0 (c = 0.25, CHCl<sub>3</sub>).

### (S)-3-(3-(3-((tert-butyl)diphenylsilyloxy)propyl)cyclobut-2-enecarbonyl)oxazolidin-2-one (**456b**)



In a 500 mL two-necked RBF, cyclobutenyl thioether **454b** (1.93 g, 3.8 mmol, 1.0 eq.) and 1-octene (5.9 mL, 38 mmol, 10 eq.) were diluted in 350 mL of dry acetone. Lindlar catalyst (5% on

calcium carbonate poisoned with Lead, 4 g, 38 mmol, 10 eq.) was introduced in small portions and freshly distilled Et<sub>3</sub>SiH (6 mL, 38 mmol, 10 eq.) was then added slowly at room temperature. The reaction mixture was stirred at room temperature for 16 hours and was filtered off through a celite pad (Lindlar catalyst being recycled). The filtrate was concentrated under reduced pressure and the obtained crude product was purified by flash chromatography (PE/EtOAc 70:30 to 50:50) to afford **456b** (contaminated by unidentified side product) as colourless oil (1.38 g, 80%).

**Rf** = 0.32 (PE/EtOAc 4:1).

**IR** (film, KBr)  $\nu_{\max}$  (cm<sup>-1</sup>) = 3070, 3050, 2930, 2857, 1783, 1696, 1386, 1361, 1258, 1125, 1109, 703.

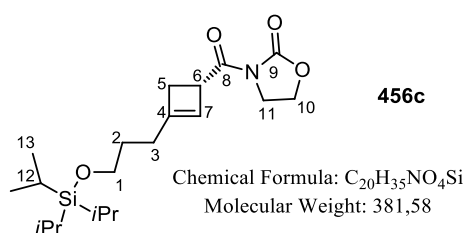
**<sup>1</sup>H NMR** (300 MHz, CDCl<sub>3</sub>):  $\delta$  (ppm) = 7.69 – 7.62 (m, 4H, Ph), 7.44 – 7.34 (m, 6H, Ph), 5.77 – 5.74 (m, 1H, H-7), 4.46 – 4.38 (m, 2H, H-10), 4.33 – 4.28 (m, 1H, H-6), 4.05 – 3.98 (m, 2H, H-11), 3.67 (t, *J* = 6.3 Hz, 2H, H-1), 2.79 – 2.70 (m, 1H, H-5a), 2.68 – 2.61 (m, 1H, H-5b), 2.15 (m, 2H, H-3), 1.78 – 1.65 (m, 2H, H-2), 1.04 (s, 9H, H-13).

**<sup>13</sup>C NMR** (75 MHz, CDCl<sub>3</sub>):  $\delta$  (ppm) = 173.7 (C-8), 153.4 (C-4), 152.5 (C-9), 135.7 (Ph), 134.0 (Ph), 129.6 (Ph), 127.7 (Ph), 125.3 (C-7), 63.4 (C-1), 62.4 (C-10), 42.7 (C-6), 42.6 (C-11), 34.8 (C-5), 29.4 (C-2), 27.3 (C-3), 27.0 (C-13), 19.3 (C-12).

**HRMS** (ESI): [M+Na]<sup>+</sup> C<sub>27</sub>H<sub>33</sub>NO<sub>4</sub>SiNa: calcd. 486.2071, found 486.2075.

[ $\alpha$ ]<sub>D</sub><sup>25</sup> = -24.64 (c = 0.2, CHCl<sub>3</sub>).

**(S)-3-(3-(3-((triisopropylsilyloxy)propyl)cyclobut-2-enecarbonyl)oxazolidin-2-one (456c)**



In a 1L two-necked RBF, cyclobutenyl thioether **454c** (12.2 g, 28.5 mmol, 1.0 eq.) and 1-octene (22 mL, 142 mmol, 10 eq.) were diluted in 750 mL of dry acetone. Lindlar catalyst (5% on calcium carbonate poisoned with Lead, 30 g, 285 mmol, 10 eq.) was introduced in small portions and freshly distilled Et<sub>3</sub>SiH (45 mL, 285 mmol, 10 eq.) was then added slowly at room temperature. The reaction mixture was stirred at 60°C for 14 hours and was filtered off through a celite pad (Lindlar catalyst being recycled). The filtrate was concentrated under reduced pressure and the obtained crude product was purified by flash chromatography (cyclohexane/EtOAc 70:30) to afford **456c** as colourless oil (10.5 g, 97%).

**Rf** = 0.56 (cyclohexane/EtOAc 1:1).

**IR** (film, KBr)  $\nu_{\max}$  (cm<sup>-1</sup>) = 2942, 2866, 1784, 1696, 1464, 1386, 1361, 1226, 1106.

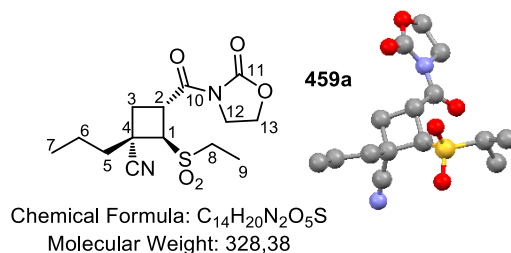
**<sup>1</sup>H NMR** (300 MHz, CDCl<sub>3</sub>):  $\delta$  (ppm) = 5.80 (m, 1H, H-7), 4.47 – 4.38 (m, 2H, H-10), 4.35 – 4.30 (m, 1H, H-6), 4.05 – 3.98 (m, 2H, H-11), 3.70 (t, *J* = 6.3 Hz, 2H, H-1), 2.78 (dd, *J* = 13.3, 4.5 Hz, 1H, H-5a), 2.67 (dd, *J* = 13.3, 1.9 Hz, 1H, H-5b), 2.20 – 2.09 (m, 2H, H-3), 1.75 – 1.63 (m, 2H, H-2), 1.12 – 0.97 (m, 21H, H12 + H-13).

**<sup>13</sup>C NMR** (75 MHz, CDCl<sub>3</sub>):  $\delta$  (ppm) = 173.7 (C-8), 153.4 (C-4/9), 152.6 (C-4/9), 125.2 (C-7), 62.9 (C-1), 62.4 (C-10), 42.7 (C-6), 42.6 (C-11), 3.79 (C-5), 29.8 (C-2), 27.3 (C-3), 18.1 (C-13), 12.1 (C-12).

**HRMS** (ESI): [M+Na]<sup>+</sup> C<sub>20</sub>H<sub>35</sub>NO<sub>4</sub>SiNa: calcd. 404.2227, found 404.2226.

[ $\alpha$ ]<sub>D</sub><sup>25</sup> = -30.52 (c = 0.22, CHCl<sub>3</sub>).

**(1S,2R,3R)-2-(ethylsulfonyl)-3-(2-oxooxazolidine-3-carbonyl)-1-propylcyclobutanecarbonitrile (459a)**



**Protocol 1:** according to the general procedure **E** from ethanesulfonyl cyanide **307** (5.7 g, 47.8 mmol, 2.0 eq.), cyclobutene **456a** (5.0 g, 23.9 mmol, 1.0 eq.), eosin Y (310 mg, 0.48 mmol, 2 mol%) and K<sub>2</sub>HPO<sub>4</sub> (833 mg, 4.8 mmol, 0.2 eq.) in DMF (25 mL) for 60 hours. The crude product was purified by flash chromatography (cyclohexane/EtOAc 1:1) to afford **459a** as white solid (3.7 g, 47%, d.r. ≥ 19:1:1:1).

**Protocol 2:** In a sealed tube, cyclobutene **456a** (208 mg, 0.99 mmol, 1.0 eq.) was diluted in 1 mL of acetonitrile. Ethanesulfonyl cyanide **307** (209 mg, 2 mmol, 2 eq.) and benzophenone (36 mg, 0.2 mmol, 0.2 eq.) were introduced and the mixture was degassed 3 times by the freeze-pump-thaw method. The reaction mixture was stirred at 35°C for 22 hours while being irradiated with UV light (325-400 nm). The solvent was then evaporated and the crude was crystallised in a minimum amount of EtOAc furnishing 160 mg of the desired product (51%). The pool liquids were evaporated and the crude was purified by flash chromatography (DCM/EtOAc 75:25) to afford **459a** as white solid (74 mg, 24%, 75% overall yield).

**R<sub>f</sub>** = 0.38 (cyclohexane/EtOAc 1:1).

**m. p.** = 132-136 (EtOAc).

**IR** (film, KBr)  $\nu_{\max}$  (cm<sup>-1</sup>) = 2966, 2877, 2237, 1782, 1691, 1468, 1391, 1317, 1286, 1229, 1130, 1041.

**<sup>1</sup>H NMR** (300 MHz, CDCl<sub>3</sub>):  $\delta$  (ppm) = 4.59 (d, *J* = 9.9 Hz, 1H, H-1), 4.48 (dd, *J* = 8.5, 7.8 Hz, 2H, H-13), 4.44 (q, *J* = 9.8 Hz, 1H, H-2), 4.05 – 4.01 (m, 2H, H-12), 3.05 – 2.98 (m, 1H, H-8a), 2.96 – 2.86 (m, 1H, H-8b), 2.83 – 2.78 (m, 1H, H-3a), 2.44 (ddd, *J* = 11.4, 9.5, 1.5 Hz, 1H, H-3b), 2.33 – 2.25 (m, 1H, H-5a), 2.10 (ddd, *J* = 13.9, 12.1, 4.6 Hz, 1H, H-5b), 1.60 – 1.43 (m, 2H, H-6), 1.41 (t, *J* = 7.5 Hz, 3H, H-9), 1.03 (t, *J* = 7.3 Hz, 3H, H-7).

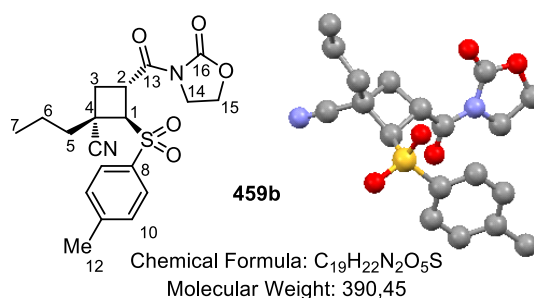
**<sup>13</sup>C NMR** (75 MHz, CDCl<sub>3</sub>):  $\delta$  (ppm) = 170.1 (C-10), 152.9 (C-11), 121.3 (CN), 62.9 (C-13), 57.5 (C-1), 48.9 (C-8), 42.5 (C-12), 38.4 (C-2), 36.1 (C-4), 33.3 (C-3/5), 33.0 (C-3/5), 18.7 (C-6), 13.9 (C-7), 6.2 (C-9).

**HRMS** (ESI): [M+Na]<sup>+</sup> C<sub>14</sub>H<sub>20</sub>N<sub>2</sub>O<sub>5</sub>SNa: calcd. 351.0981, found 351.0985.

[ $\alpha$ ]<sup>25</sup><sub>D</sub> = +97.71 (c = 0.3, CHCl<sub>3</sub>).

**X-Ray crystallography:** the crystal suitable for X-ray-measurement was obtained by evaporation in EtOAc.

**(1S)-3-(2-oxooxazolidine-3-carbonyl)-1-propyl-2-tosylcyclobutanecarbonitrile (459b)**



According to the general procedure **E** from tosyl cyanide (173 mg, 0.97 mmol, 2.0 eq.), cyclobutene **456a** (100 mg, 0.48 mmol, 1.0 eq.), eosin Y (6.2 mg, 9.6  $\mu$ mol, 2 mol%) and  $K_2HPO_4$  (16.6 mg, 0.096 mmol, 0.2 eq.) in DMF (0.5 mL) for 24 hours. The crude product was purified by flash chromatography (cyclohexane/EtOAc 1:1) to afford **459b** as white solid (84 mg, 45%, d.r.  $\geq$  19:1:1:1).

**Rf** = 0,26 (cyclohexane/EtOAc 1:1).

**m. p.** = 175-179°C (EtOAc).

**IR** (film, KBr)  $\nu_{max}$  ( $cm^{-1}$ ) = 2964, 2932, 2875, 2236, 1781, 1697, 1391, 1320, 1285, 1226, 1150, 1040, 733, 669.

**$^1H$  NMR** (300 MHz,  $CDCl_3$ ):  $\delta$  (ppm) = 7.77 (d,  $J$  = 8.3 Hz, 2H, H-9), 7.36 (d,  $J$  = 9.0 Hz, 2H, H-10), 4.70 (d,  $J$  = 9.4 Hz, 1H, H-1), 4.67 – 4.55 (m, 1H, H-2), 4.47 – 4.39 (m, 2H, H-15), 3.97 – 3.77 (m, 2H, H-14), 2.75 (dd,  $J$  = 11.6, 9.8 Hz, 1H, H-3a), 2.46 (s, 3H, H-12), 2.37 (dd,  $J$  = 11.7, 8.7 Hz, 1H, H-3b), 2.28 – 2.19 (m, 2H, H-5), 1.63 – 1.36 (m, 2H, H-6), 1.06 (t,  $J$  = 7.3 Hz, 3H, H-7).

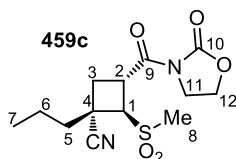
**$^{13}C$  NMR** (75 MHz,  $CDCl_3$ ):  $\delta$  (ppm) = 169.2 (C-13), 153.0 (C-16), 145.7 (C-8/11), 135.5 (C-8/11), 130.2 (C-9/10), 128.3 (C-9/10), 121.2 (CN), 62.7 (C-15), 61.0 (C-1), 42.4 (C-14), 37.0 (C-2), 36.4 (C-4), 33.3 (C-3/5), 33.2 (C-3/5), 21.8 (C-12), 18.6 (C-6), 13.9 (C-7).

**HRMS** (ESI):  $[M+Na]^+$   $C_{19}H_{22}N_2O_5SNa$ : calcd. 413.1141, found 413.1127.

$[\alpha]^{25}_D = +57.25$  ( $c$  = 0.25,  $CHCl_3$ ).

**X-Ray crystallography**: the crystal suitable for X-ray-measurement was obtained by evaporation in EtOAc.

**(1S,2R,3R)-2-(methylsulfonyl)-3-(2-oxooxazolidine-3-carbonyl)-1-propylcyclobutanecarbonitrile (459c)**



Chemical Formula:  $C_{13}H_{18}N_2O_5S$   
Molecular Weight: 314,36

**Protocol 1**: According to the general procedure **E** from methanesulfonyl cyanide **342b** (1.0 g, 10 mmol, 2.0 eq.), cyclobutene **456a** (1.05 g, 5.0 mmol, 1.0 eq.), eosin Y (65 mg, 0.1 mmol, 2 mol%) and  $K_2HPO_4$  (174 mg, 1.0 mmol, 0.2 eq.) in DMF (5 mL) for 5 days. The crude product was purified by flash chromatography (cyclohexane/EtOAc 1:1) to afford **459c** as white solid (0.76 g, 48%, d.r.  $\geq$  19:1:1:1).

**Protocol 2**: In a sealed tube, cyclobutene **456a** (213 mg, 1.02 mmol, 1.0 eq.) was diluted in 1 mL of acetonitrile. methylsulfonyl cyanide **342b** (209 mg, 2 mmol, 2 eq.) and benzophenone (36 mg, 0.2 mmol, 0.2 eq.) were introduced and the mixture was degassed 3 times by the freeze-pump-thaw method. The reaction mixture was stirred at 35°C for 22 hours while being irradiated with UV light (325-400 nm). The solvent was then evaporated and the crude product was purified by flash chromatography (DCM/EtOAc 75:25) to afford **459c** as white solid (240 mg, 75%).

**Rf** = 0.45 (DCM/EtOAc 1:1).

**m. p.** = 66-70 (EtOAc).

**IR** (film, KBr)  $\nu_{max}$  ( $cm^{-1}$ ) = 2964, 2932, 2876, 2237, 1782, 1691, 1391, 1315, 1287, 1228, 1146, 1133, 1040, 759.

**$^1H$  NMR** (300 MHz,  $CDCl_3$ ):  $\delta$  (ppm) = 4.64 (d,  $J$  = 9.8 Hz, 1H, H-1), 4.52 – 4.36 (m, 3H, H-2 + H-12), 4.07 – 3.99 (m, 2H, H-11), 2.92 (s, 3H, H-8), 2.87 – 2.73 (m, 1H, H-3a), 2.46 (ddd,  $J$  =

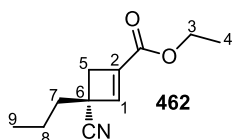
11.4, 9.6, 1.4 Hz, 1H, H-3b), 2.32 – 2.01 (m, 2H, H-5), 1.65 – 1.35 (m, 2H, H-6), 1.02 (t,  $J = 7.3$  Hz, 3H, H-7).

$^{13}\text{C}$  NMR (75 MHz,  $\text{CDCl}_3$ ):  $\delta$  (ppm) = 170.0 (C-9), 153.0 (C-10), 121.3 (CN), 63.0 (C-12), 59.7 (C-1), 42.50 (C-8), 42.46 (C-11), 38.7 (C-2), 35.9 (C-4), 33.1 (C-3), 32.8 (C-5), 18.6 (C-6), 13.9 (C-7).

HRMS (ESI):  $[\text{M}+\text{Na}]^+ \text{C}_{13}\text{H}_{18}\text{N}_2\text{O}_5\text{SNa}^+$  : calcd. 337.0828, found 337.0833.

$[\alpha]^{25}_{\text{D}} = +89.21$  ( $c = 0.27$ ,  $\text{CHCl}_3$ ).

### (R)-ethyl 3-cyano-3-propylcyclobut-1-enecarboxylate (462)



Chemical Formula:  $\text{C}_{11}\text{H}_{15}\text{NO}_2$   
Molecular Weight: 193,24

To a stirred mixture of cyclobutane **459a** (344 mg, 1.05 mmol, 1.0 eq.) in 30 mL of dry EtOH was added at  $-78^\circ\text{C}$  EtONa (143 mg, 2.1 mmol, 2.0 eq.) in one portion. The reaction mixture was stirred 10 minutes at  $-78^\circ\text{C}$  and was then allowed to reach first  $0^\circ\text{C}$  and then room temperature. The stirring was pursued until a homogenous solution appeared (10 minutes). The reaction mixture was then diluted with dichloromethane and with a saturated aqueous solution of  $\text{NaHCO}_3$ . The aqueous layer was extracted with dichloromethane (3 times) and the combined organic layers were washed with water and brine, dried over  $\text{MgSO}_4$  and concentrated under reduced pressure. The obtained crude product was then purified by flash chromatography (cyclohexane/EtOAc 95:5) to afford **462** as colourless oil (139 mg, 69%).

$\text{Rf} = 0.61$  (cyclohexane/EtOAc 1:1).

IR (film, KBr)  $\nu_{\text{max}}$  ( $\text{cm}^{-1}$ ) = 2964, 2938, 2876, 2234, 1725, 1620, 1465, 1370, 1321, 1282, 1233, 1153, 1096.

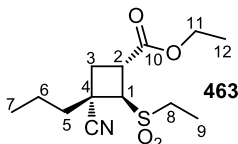
$^1\text{H}$  NMR (300 MHz,  $\text{CDCl}_3$ ):  $\delta$  (ppm) = 6.72 (s, 1H, H-1), 4.22 (q,  $J = 7.1$  Hz, 2H, H-3), 3.18 (d,  $J = 13.8$  Hz, 1H, H-5a), 2.74 (d,  $J = 13.7$  Hz, 1H, H-5b), 1.81 – 1.73 (m, 2H, H-7), 1.65 – 1.50 (m, 2H, H-8), 1.30 (t,  $J = 7.1$  Hz, 3H, H-4), 1.00 (t,  $J = 7.3$  Hz, 3H, H-9).

$^{13}\text{C}$  NMR (75 MHz,  $\text{CDCl}_3$ ):  $\delta$  (ppm) = 161.6 ( $\text{CO}_2\text{Et}$ ), 143.5 (C-1), 140.3 (C-2), 120.5 (CN), 61.1 (C-3), 40.8 (C-5), 38.9 (C-6), 38.3 (C-7), 19.8 (C-8), 14.3 (C-4), 14.0 (C-9).

HRMS (ESI):  $[\text{M}+\text{Na}]^+ \text{C}_{11}\text{H}_{15}\text{NO}_2\text{Na}$ : calcd. 216.0995, found 216.0986.

$[\alpha]^{25}_{\text{D}} = +64.76$  ( $c = 0.22$ ,  $\text{CHCl}_3$ ).

### (1R,2R,3S)-ethyl 3-cyano-2-(ethylsulfonyl)-3-propylcyclobutanecarboxylate (463)



Chemical Formula:  $\text{C}_{13}\text{H}_{21}\text{NO}_4\text{S}$   
Molecular Weight: 287,38

In a 25 mL two-necked RBF, cyclobutane **459a** (130 mg, 0.40 mmol, 1.0 eq.) was diluted in 2 mL of distilled EtOH. EtONa (30 mg, 0.44 mmol, 1.1 eq.) was added at room temperature and the reaction mixture was stirred under reflux for 2 hours. The reaction was quenched with a 1M HCl aqueous solution and the aqueous layer was extracted with ethyl acetate (3 times). The combined organic layers were washed with water and brine, dried over  $\text{MgSO}_4$  and concentrated under

reduced pressure. The crude product was purified by flash chromatography (cyclohexane/EtOAc 80:20) to afford **463** as white solid (55 mg, 48%).

**Rf** = 0.23 (cyclohexane/EtOAc 4:1).

**m. p.** = 117-121 (EtOAc).

**IR** (film, KBr)  $\nu_{\max}$  ( $\text{cm}^{-1}$ ) = 2967, 2877, 2238, 1732, 1460, 1379, 1316, 1238, 1212, 1141, 1128.

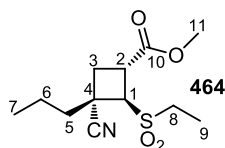
**$^1\text{H}$  NMR** (300 MHz,  $\text{CDCl}_3$ ):  $\delta$  (ppm) = 4.28 (d,  $J$  = 9.6 Hz, 1H, H-1), 4.21 (q,  $J$  = 7.1 Hz, 2H, H-11), 3.64 (q,  $J$  = 9.7 Hz, 1H, H-2), 3.15 – 2.90 (m, 2H, H-8), 2.69 – 2.46 (m, 2H, H-3), 2.37 – 2.23 (m, 1H, H-5a), 2.05 (ddd,  $J$  = 13.9, 11.9, 4.7 Hz, 1H, H-5b), 1.66 – 1.43 (m, 2H, H-6), 1.39 (t,  $J$  = 7.5 Hz, 3H, H-9), 1.28 (t,  $J$  = 7.1 Hz, 3H, H-12), 1.02 (t,  $J$  = 7.3 Hz, 3H, H-7).

**$^{13}\text{C}$  NMR** (75 MHz,  $\text{CDCl}_3$ ):  $\delta$  (ppm) = 170.9 (C-10), 121.0 (CN), 62.2 (C-11), 59.3 (C-1), 48.6 (C-8), 37.0 (C-2), 35.9 (C-4), 32.9 (C-3/5), 32.0 (C-3/5), 18.6 (C-6), 14.2 (C-7), 13.9 (C-12), 6.2 (C-9).

**HRMS** (ESI):  $[\text{M}+\text{Na}]^+$   $\text{C}_{13}\text{H}_{21}\text{NO}_4\text{SNa}$ : calcd. 310.1084, found 310.1077.

$[\alpha]^{25}_{\text{D}}$  = +21.27 ( $c$  = 0.18,  $\text{CHCl}_3$ ).

### (1R,2R,3S)-methyl 3-cyano-2-(ethylsulfonyl)-3-propylcyclobutanecarboxylate (**464**)



Chemical Formula:  $\text{C}_{12}\text{H}_{19}\text{NO}_4\text{S}$   
Molecular Weight: 273.35

In a 50 mL two-necked RBF, MeONa (132 mg, 2.44 mmol, 2. eq.) was purged with argon several times and then diluted in 35 mL of dry MeOH. The mixture was cooled to  $-78^\circ\text{C}$  and cyclobutane **459a** (400 mg, 1.22 mmol, 1.0 eq.) was added in small portions. The reaction mixture was then allowed to reach room temperature and the stirring was continued for 30 minutes. The mixture was then diluted with dichloromethane and with a saturated aqueous solution of  $\text{NaHCO}_3$ . The aqueous layer was extracted with dichloromethane (3 times) and the combined organic layers were washed with water and brine, dried over  $\text{MgSO}_4$  and concentrated under reduced pressure. The obtained crude product was then purified by crystallisation (cyclohexane/EtOAc) to afford **464** as white solid (173 mg, 52%).

**Rf** = 0.4 (cyclohexane/EtOAc 1:1).

**m. p.** = 140-144 (EtOAc).

**IR** (film, KBr)  $\nu_{\max}$  ( $\text{cm}^{-1}$ ) = 2963, 2877, 2237, 1737, 1458, 1438, 1316, 1280, 1242, 1142, 1128.

**$^1\text{H}$  NMR** (300 MHz,  $\text{CDCl}_3$ ):  $\delta$  (ppm) = 4.29 (d,  $J$  = 9.6 Hz, 1H, H-1), 3.78 (s, 3H, H-11), 3.68 (q,  $J$  = 9.7 Hz, 1H, H-2), 3.15 – 2.93 (m, 2H, H-8), 2.70 – 2.48 (m, 2H, H-3), 2.38 – 2.24 (m, 1H, H-5a), 2.14 – 1.99 (m, 1H, 5b), 1.67 – 1.45 (m, 2H, H-6), 1.41 (t,  $J$  = 7.5 Hz, 3H, H-9), 1.04 (t,  $J$  = 7.3 Hz, 3H, H-7).

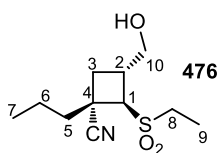
**$^{13}\text{C}$  NMR** (75 MHz,  $\text{CDCl}_3$ ):  $\delta$  (ppm) = 171.4 (C-10), 121.0 (CN), 59.4 (C-1), 53.0 (C-11), 48.6 (C-8), 36.8 (C-2), 36.0 (C-4), 32.9 (C-5), 32.0 (C-3), 18.6 (C-8), 13.9 (C-7), 6.1 (C-9).

**HRMS** (ESI):  $[\text{M}+\text{Na}]^+$   $\text{C}_{12}\text{H}_{19}\text{NO}_4\text{SNa}$ : calcd. 296.0927, found 296.0932.

$[\alpha]^{25}_{\text{D}}$  = +16.35 ( $c$  = 0.27,  $\text{CHCl}_3$ ).

### (1S,2R,3R)-2-(ethylsulfonyl)-3-(hydroxymethyl)-1-propylcyclobutanecarbonitrile (**476**)





Chemical Formula: C<sub>11</sub>H<sub>19</sub>NO<sub>3</sub>S  
Molecular Weight: 245,34

In a 50 mL two-necked RBF, cyclobutane **459a** (1.03 g, 3.04 mmol, 1.0 eq.) was diluted in 24 mL of a 5:1 mixture of Et<sub>2</sub>O/MeOH. At -5°C, LiBH<sub>4</sub> (93 mg, 4.26 mmol, 1.4 eq.) was added and the reaction mixture was allowed to reach room temperature and stirred for 4 hours. 1M HCl aqueous solution was added dropwise and the aqueous layer was extracted with ethyl acetate (3 times). The combined organic layers were washed with water and brine, dried over MgSO<sub>4</sub> and concentrated under reduced pressure. The crude product was pure enough without further purification to afford **476** as colourless oil (706 mg, 94%).

**Rf** = 0,6 (cyclohexane/EtOAc 1:1).

**IR** (film, KBr)  $\nu_{\max}$  (cm<sup>-1</sup>) = 3503, 2963, 2939, 2876, 2235, 1459, 1311, 1283, 1234, 1128, 1047.

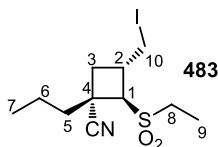
**<sup>1</sup>H NMR** (300 MHz, CDCl<sub>3</sub>):  $\delta$  (ppm) = 4.04 (d, *J* = 9.2 Hz, 1H, H-1), 3.82 (dd, *J* = 11.3, 4.0 Hz, 1H, H-10a), 3.69 (dd, *J* = 11.3, 6.0 Hz, 1H, H-10b), 3.22 – 3.10 (m, 1H, H-2), 3.05 (qd, *J* = 7.5, 1.7 Hz, 2H, H-8), 2.38 (dd, *J* = 11.4, 9.4 Hz, 1H, H-4a), 2.25 (dd, *J* = 11.4, 9.4 Hz, 1H, H-4b), 2.15 – 2.06 (m, 2H, H-5), 1.84 (brs, 1H, OH), 1.63 – 1.36 (m, 5H, H-6 + H-9), 1.04 (t, *J* = 7.3 Hz, 3H, H-7).

**<sup>13</sup>C NMR** (75 MHz, CDCl<sub>3</sub>):  $\delta$  (ppm) = 121.9 (CN), 62.5 (C-10), 60.0 (C-1), 48.2 (C-8), 36.0 (C-4), 35.8 (C-2), 33.3 (C-5), 30.2 (C-3), 18.5 (C-6), 14.0 (C-7), 6.0 (C-9).

**HRMS** (ESI): [M+Na]<sup>+</sup> C<sub>11</sub>H<sub>19</sub>NO<sub>3</sub>SNa: calcd. 268.0977, found 268.0985.

**[ $\alpha$ ]<sup>25</sup><sub>D</sub>** = -22.19 (c = 0.24, CHCl<sub>3</sub>).

### (1S,2R,3S)-2-(ethylsulfonyl)-3-(iodomethyl)-1-propylcyclobutanecarbonitrile (**483**)



Chemical Formula: C<sub>11</sub>H<sub>18</sub>INO<sub>2</sub>S  
Molecular Weight: 355,24

In a 50 mL two-necked RBF, alcohol **476** (640 mg, 2.6 mmol, 1.0 eq.), triphenylphosphine (1,03 g, 3.9 mmol, 1.5 eq.) and imidazole (213 mg, 3.1 mmol, 1.2 eq.) were diluted in 26 mL of dry THF. At 0°C was added I<sub>2</sub> (1.3 g, 5.2 mmol, 2.0 eq.) in one portion. The reaction mixture was allowed to reach room temperature and was stirred for 2 hours. Then, a saturated aqueous solution of Na<sub>2</sub>S<sub>2</sub>O<sub>3</sub> was added. The aqueous layer was extracted with dichloromethane (3 times). The combined organic layers were washed with a saturated aqueous solution of Na<sub>2</sub>S<sub>2</sub>O<sub>3</sub> and brine, dried over MgSO<sub>4</sub> and concentrated under reduced pressure. The crude product was purified by flash chromatography (cyclohexane/EtOAc 60:40) to afford **483** as white solid (771 mg, 83%).

**Rf** = 0,67 (cyclohexane/EtOAc 1:1).

**m. p.** = 110-114 (EtOAc).

**IR** (film, KBr)  $\nu_{\max}$  (cm<sup>-1</sup>) = 2963, 2874, 2235, 1457, 1314, 1285, 1234, 1188, 1132, 1043.

**<sup>1</sup>H NMR** (300 MHz, CDCl<sub>3</sub>):  $\delta$  (ppm) = 3.81 (d, *J* = 9.2 Hz, 1H, H-1), 3.52 (dd, *J* = 10.4, 4.4 Hz, 1H, H-10a), 3.32 (dd, *J* = 10.4, 8.0 Hz, 1H, H-10b), 3.12 – 2.95 (m, 3H, H-2 + H-8), 2.36 (dd, *J* =

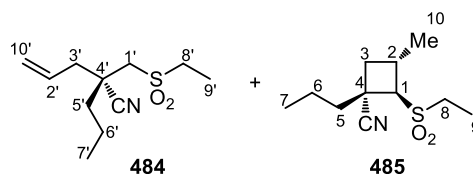
11.6, 8.9 Hz, 1H, H-3a), 2.23 (dd,  $J = 11.6, 9.3$  Hz, 1H, H-3b), 2.08 – 1.99 (m, 2H, H-5), 1.61 – 1.35 (m, 5H, H-6 + H-9), 1.02 (t,  $J = 7.3$  Hz, 3H, H-7).

$^{13}\text{C}$  NMR (75 MHz,  $\text{CDCl}_3$ ):  $\delta$  (ppm) = 121.4 (CN), 63.5 (C-1), 48.7 (C-8), 36.0 (C-3), 35.1 (C-4), 34.9 (C-2), 33.4 (C-5), 18.5 (C-6), 13.9 (C-7), 9.1 (C-10), 6.2 (C-9).

HRMS (ESI):  $[\text{M}+\text{Na}]^+$   $\text{C}_{11}\text{H}_{18}\text{INO}_2\text{SNa}$ : calcd. 377.9995, found 377.9992.

$[\alpha]^{25}_{\text{D}} = +40.98$  ( $c = 0.15$ ,  $\text{CHCl}_3$ ).

### (S)-2-((ethylsulfonyl)methyl)-2-propylpent-4-enitrile (484)



Chemical Formula:  $\text{C}_{11}\text{H}_{19}\text{NO}_2\text{S}$   
Molecular Weight: 229,34

The opened product **484** was isolated as a mixture with cyclobutane **485** (protocol see below).

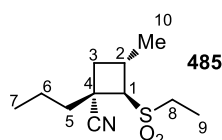
$R_f = 0.35$  (cyclohexane/EtOAc 2:1).

$^1\text{H}$  NMR (300 MHz,  $\text{CDCl}_3$ ):  $\delta$  (ppm) = 5.94 – 5.78 (m, 1H, H-2'), 5.36 – 5.27 (m, 2H, H-10'), 3.64 (d,  $J = 9.5$  Hz, 1H, H-1), 3.24 – 3.10 (m, 4H, H-1' + H-8'), 3.10 – 2.88 (m, 3H, H-2 + H-8), 2.67 (dd,  $J = 7.4, 1.3$  Hz, 2H, H-3'), 2.40 (dd,  $J = 11.4, 9.0$  Hz, 1H, H-3a), 2.18 – 2.02 (m, 3H, H-3b + H-5), 1.96 (m, 1H, H-6a'), 1.78 (m, 1H, H-6b'), 1.65 – 1.47 (m, 2H, H-6), 1.47 – 1.39 (m, 6H, H-9 + H-9'), 1.32 (d,  $J = 6.6$  Hz, 3H, H-10), 1.06 – 0.97 (m, 6H, H-7 + H-7').

$^{13}\text{C}$  NMR (75 MHz,  $\text{CDCl}_3$ ):  $\delta$  (ppm) = 130.7 (C-2'), 122.2 (C-10'), 122.1 (CN), 121.0 (CN'), 65.1 (C-1), 54.9 (C-1'), 50.0 (C-8'), 48.6 (C-8), 40.3 (C-3'/C-5'), 39.1 (C-4'), 38.3 (C-3'/C-5'), 36.4 (C-3), 36.1 (C-4), 33.1 (C-5), 29.2 (C-2), 20.5 (C-10), 18.6 (C-6), 18.1 (C-6'), 14.03 (C-7'), 13.97 (C-7), 6.8 (C-9'), 6.2 (C-9).

HRMS (ESI):  $[\text{M}+\text{Na}]^+$   $\text{C}_{11}\text{H}_{19}\text{NO}_2\text{SNa}$ : calcd. 252.1028, found 252.1036.

### (1S,2R,3S)-2-(ethylsulfonyl)-3-methyl-1-propylcyclobutanecarbonitrile (485)



Chemical Formula:  $\text{C}_{11}\text{H}_{19}\text{NO}_2\text{S}$   
Molecular Weight: 229,34

In a 10 mL two-necked RBF, iodide **483** (57 mg, 0.16 mmol, 1.0 eq.) and vinyloxytrimethylsilane (29  $\mu\text{L}$ , 0.19 mmol, 1.2 eq.) were diluted in 3 mL of distilled chlorobenzene. The mixture was degassed for 10 minutes by argon sparging and AIBN (2.8 mg, 0.016 mmol, 0.1 eq.) was added in one portion. A degassed solution of TTMSH (54  $\mu\text{L}$ , 0.18 mmol, 1.1 eq.) diluted in 0.5 mL of chlorobenzene was added dropwise (syringe pump, 0.5 mL/45 minutes) at 80°C. Then, the reaction mixture was stirred at 80°C and AIBN (2x0.1 eq.) was then added every hour for 2 hours. The solvent was evaporated and the crude was directly purified by column chromatography (cyclohexane/EtOAc 90:10 to 85:15) to afford **485** as colourless oil (7.4 mg, 20%)

$R_f = 0.39$  (cyclohexane/EtOAc 2:1).

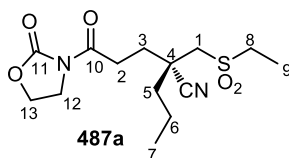
IR (film, KBr)  $\nu_{\text{max}}$  ( $\text{cm}^{-1}$ ) = 2964, 2875, 2233, 1457, 1314, 1287, 1234, 1131, 1046, 708.

**<sup>1</sup>H NMR** (300 MHz, CDCl<sub>3</sub>): δ (ppm) = 3.64 (d, *J* = 9.5 Hz, 1H, H-1), 3.11 – 3.01 (m, 1H, H-2), 2.95 (q, *J* = 7.5 Hz, 2H, H-8), 2.40 (dd, *J* = 11.3, 9.0 Hz, 1H, H-3a), 2.16 – 2.02 (m, 3H, H-3b + H-5), 1.44 (m, 5H, H-6 + H-9), 1.32 (d, *J* = 6.7 Hz, 3H, H-10), 1.02 (t, *J* = 7.3 Hz, 3H, H-7).

**<sup>13</sup>C NMR** (75 MHz, CDCl<sub>3</sub>): δ (ppm) = 122.1 (CN), 65.1 (C-1), 48.6 (C-8), 36.5 (C-3), 36.1 (C-4), 33.1 (C-5), 29.2 (C-2), 20.5 (C-10), 18.6 (C-6), 14.0 (C-7), 6.2 (C-9).

**HRMS** (ESI): [M+Na]<sup>+</sup> C<sub>11</sub>H<sub>19</sub>NO<sub>2</sub>SNa: calcd. 252.1028, found 252.1033.

**(S)-2-((ethylsulfonyl)methyl)-5-oxo-5-(2-oxooxazolidin-3-yl)-2-propylpentanenitrile (487a)**



Chemical Formula: C<sub>14</sub>H<sub>22</sub>N<sub>2</sub>O<sub>5</sub>S  
Molecular Weight: 330,40

To a solution of cyclobutane **459a** (58.6 mg, 0.18 mmol, 1.0 eq.) in 2 mL of dry THF and distilled H<sub>2</sub>O (33 μL, 1.8 mmol, 10 eq.) was added dropwise at -78°C a 0.1 M solution of SmI<sub>2</sub> (20 mL, 2.0 mmol, 11 eq.). The reaction mixture was stirred at -78°C for 4 hours and was then allowed to reach room temperature overnight. The mixture was diluted with 1M HCl aqueous solution and the aqueous layer was extracted with ethyl acetate (3 times). The combined organic layers were washed with a saturated aqueous solution of Na<sub>2</sub>S<sub>2</sub>O<sub>3</sub>, a saturated aqueous solution of Rochelle salts and brine, dried over MgSO<sub>4</sub> and concentrated under reduced pressure. The crude product was purified by flash chromatography (cyclohexane/EtOAc 1:2) to afford **487a** as highly viscous yellow oil (37 mg, 63%).

**R<sub>f</sub>** = 0.53 (EtOAc).

**IR** (film, KBr) ν<sub>max</sub> (cm<sup>-1</sup>) = 2966, 2937, 2877, 2237, 1777, 1699, 1392, 1365, 1313, 1134, 1041.

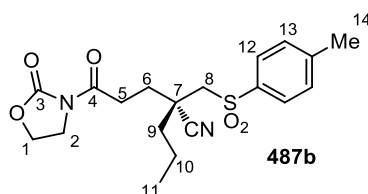
**<sup>1</sup>H NMR** (600 MHz, CDCl<sub>3</sub>): δ (ppm) = 4.42 (t, *J* = 8.1 Hz, 2H, H-13), 4.01 (t, *J* = 8.1 Hz, 2H, H-12), 3.33 – 3.26 (m, 2H, H-1), 3.16 – 3.10 (m, 4H, H-2, H-8), 2.39 – 2.26 (m, 2H, H-3), 2.02 – 1.95 (m, 1H, H-5a), 1.89 – 1.81 (m, 1H, H-5b), 1.58 – 1.50 (m, 2H, H-6), 1.41 (t, *J* = 7.5 Hz, 3H, H-9), 0.99 (t, *J* = 7.3 Hz, 3H, H-7).

**<sup>13</sup>C NMR** (150 MHz, CDCl<sub>3</sub>): δ (ppm) = 171.4 (C-10), 153.8 (C-11), 120.9 (CN), 62.4 (C-13), 54.3 (C-1), 50.1 (C-8), 42.6 (C-12), 39.0 (C-4), 38.6 (C-5), 30.7 (C-2, C-3), 18.1 (C-6), 13.9 (C-7), 6.6 (C-9).

**HRMS** (ESI): [M+Na]<sup>+</sup> C<sub>14</sub>H<sub>22</sub>N<sub>2</sub>O<sub>5</sub>SNa: calcd. 353.1142, found 353.1145.

[α]<sub>D</sub><sup>25</sup> = -0.56 (c = 0.24, CHCl<sub>3</sub>).

**(S)-5-oxo-5-(2-oxooxazolidin-3-yl)-2-propyl-2-(tosylmethyl)pentanenitrile (487b)**



Chemical Formula: C<sub>19</sub>H<sub>24</sub>N<sub>2</sub>O<sub>5</sub>S  
Molecular Weight: 392,47

To a solution of cyclobutane **459b** (60 mg, 0.15 mmol, 1.0 eq.) in 2 mL of dry THF and distilled H<sub>2</sub>O (28 μL, 1.54 mmol, 10 eq.) was added dropwise at -78°C a 0.1 M solution of SmI<sub>2</sub> (7.7 mL, 0.77 mmol, 5 eq.). The reaction mixture was stirred at -78°C for 4 hours and was then allowed to

reach room temperature overnight. The mixture was diluted with 1M HCl aqueous solution and the aqueous layer was extracted with ethyl acetate (3 times). The combined organic layers were washed with a saturated aqueous solution of Na<sub>2</sub>S<sub>2</sub>O<sub>3</sub>, a saturated aqueous solution of Rochelle salts and brine, dried over MgSO<sub>4</sub> and concentrated under reduced pressure. The crude product was purified by flash chromatography (cyclohexane/EtOAc 2:3) to afford **487b** as highly viscous yellow oil (25 mg, 41%).

**Rf** = 0.50 (EtOAc).

**IR** (film, KBr)  $\nu_{\max}$  (cm<sup>-1</sup>) = 2965, 2932, 2875, 2254, 2237, 1778, 1699, 1597, 1453, 1391, 1320, 1305, 1225, 1149 1086, 1040.

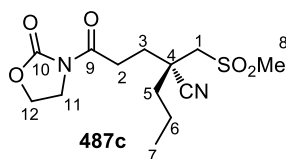
**<sup>1</sup>H NMR** (300 MHz, CDCl<sub>3</sub>):  $\delta$  (ppm) = 7.82 (d, *J* = 8.3 Hz, 2H, Tol), 7.38 (d, *J* = 8.0 Hz, 2H, Tol), 4.43 (t, *J* = 8.1 Hz, 2H, H-1), 4.03 (t, *J* = 8.1 Hz, 2H, H-2), 3.45 – 3.30 (m, 2H, H-8), 3.21 – 3.11 (m, 2H, H-5), 2.45 (s, 3H, H-12), 2.35 (m, 2H, H-6), 2.09 – 1.95 (m, 1H, H-9a), 1.92 – 1.80 (m, 1H, H-9b), 1.61 – 1.45 (m, 2H, H-10), 0.98 (t, *J* = 7.2 Hz, 3H, H-11).

**<sup>13</sup>C NMR** (75 MHz, CDCl<sub>3</sub>):  $\delta$  (ppm) = 171.5 (C-4), 153.7 (C-3), 145.6 (Tol), 137.3 (Tol), 130.3 (Tol), 128.1 (Tol), 120.5 (CN), 62.4 (C-2), 58.5 (C-8), 42.6 (C-1), 39.7 (C-7), 38.7 (C-9), 30.8 (C-5/6), 30.7 (C-5/6), 21.8 (C-12), 18.2 (C-10), 13.9 (C-11).

**HRMS** (ESI): [M+Na]<sup>+</sup> C<sub>19</sub>H<sub>24</sub>N<sub>2</sub>O<sub>5</sub>SNa: calcd. 415.1298, found 415.1283.

**[ $\alpha$ ]<sup>25</sup><sub>D</sub>** = +18.82 (c = 0.15, CHCl<sub>3</sub>).

**(S)-2-((methylsulfonyl)methyl)-5-oxo-5-(2-oxooxazolidin-3-yl)-2-propylpentanenitrile (487c)**



Chemical Formula: C<sub>13</sub>H<sub>20</sub>N<sub>2</sub>O<sub>5</sub>S  
Molecular Weight: 316.37

A 0.16 M solution of SmI<sub>2</sub> (5.3 mL, 0.84 mmol, 4 eq.) was added dropwise at -78°C to a stirred solution of cyclobutane **459c** (66.4 mg, 0.21 mmol, 1.0 eq.) diluted in 2 mL of dry THF and distilled water (46  $\mu$ L, 2.5 mmol, 12 eq.). The reaction mixture was stirred at -78°C for 1 hour and was quenched at this temperature by bubbling air until the blue colour disappeared. The mixture was diluted with dichloromethane and 1M HCl aqueous solution. The aqueous layer was extracted with dichloromethane (3 times). The combined organic layers were washed with a saturated aqueous solution of Na<sub>2</sub>S<sub>2</sub>O<sub>3</sub>, a saturated aqueous solution of Rochelle salts and brine, dried over MgSO<sub>4</sub> and concentrated under reduced pressure. The crude product was purified by flash chromatography (DCM/EtOAc 75:25) to afford **487c** as highly viscous yellow oil (48 mg, 73%).

**Rf** = 0.16 (DCM/EtOAc 75:25).

**IR** (film, KBr)  $\nu_{\max}$  (cm<sup>-1</sup>) = 2966, 2933, 2876, 2237, 1777, 1697, 1391, 1365, 1311, 1226, 1138, 1040, 761.

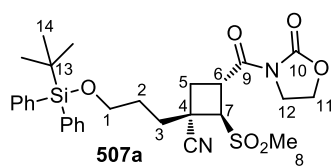
**<sup>1</sup>H NMR** (300 MHz, CDCl<sub>3</sub>):  $\delta$  (ppm) = 4.42 (t, *J* = 8.1 Hz, 2H, H-12), 4.00 (t, *J* = 8.1 Hz, 2H, H-11), 3.36 (s, 2H, H-1), 3.11 (t, *J* = 7.9 Hz, 2H, H-2), 3.06 (s, 3H, H-8), 2.39 – 2.18 (m, 2H, H-3), 2.02 – 1.74 (m, 2H, H-5), 1.60 – 1.45 (m, 2H, H-6), 0.98 (t, *J* = 7.2 Hz, 3H, H-7).

**<sup>13</sup>C NMR** (75 MHz, CDCl<sub>3</sub>):  $\delta$  (ppm) = 171.4 (C-9), 153.8 (C-10), 120.9 (CN), 62.4 (C-12), 57.3 (C-1), 43.5 (C-8), 42.6 (C-11), 38.9 (C-4), 38.5 (C-5), 30.6 (C-2/3), 30.5 (C-2/3), 17.9 (C-6), 13.9 (C-7).

**HRMS** (ESI): [M+Na]<sup>+</sup> C<sub>13</sub>H<sub>20</sub>N<sub>2</sub>O<sub>5</sub>SNa: calcd. 339.0985, found 339.0988.

**[ $\alpha$ ]<sup>25</sup><sub>D</sub>** = -11.24 (c = 0.25, CHCl<sub>3</sub>).

**(1S,2R,3R)-1-(3-((tert-butyldiphenylsilyl)oxy)propyl)-2-(methylsulfonyl)-3-(2-oxooxazolidine-3-carbonyl)cyclobutanecarbonitrile (507a)**



Chemical Formula:  $C_{29}H_{36}N_2O_6SSi$   
Molecular Weight: 568,76

According to the general procedure **E** from methanesulfonyl cyanide **342b** (0.59 g, 5.6 mmol, 2.0 eq.), cyclobutene **456b** (1.3 g, 2.8 mmol, 1.0 eq.), eosin Y (36 mg, 56  $\mu$ mol, 2 mol%) and  $K_2HPO_4$  (98 mg, 0.56 mmol, 0.2 eq.) in acetone (3 mL) for 60 hours. The crude product was purified by flash chromatography (DCM/EtOAc 95:5) to afford **507a** as white solid (0.66 g, 41%, d.r.  $\geq$  19:1:1:1).

**Rf** = 0.56 (DCM/EtOAc 1:1).

**m. p.** = 73-77°C (EtOAc).

**IR** (film, KBr)  $\nu_{max}$  ( $cm^{-1}$ ) = 3071, 3048, 3014, 2956, 2930, 2892, 2858, 2238, 1786, 1692, 1389, 1316, 1282, 1132, 1111, 704.

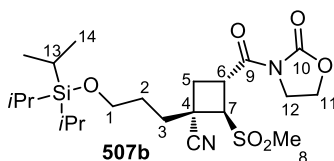
**$^1H$  NMR** (300 MHz,  $CDCl_3$ ):  $\delta$  (ppm) = 7.70 – 7.65 (m, 4H, Ph), 7.44 – 7.36 (m, 6H, Ph), 4.62 (d,  $J$  = 9.8 Hz, 1H, H-7), 4.55 – 4.39 (m, 3H, H-6 + H-11), 4.10 – 4.01 (m, 2H, H-12), 3.79 – 3.67 (m, 2H, H-1), 2.92 (s, 3H, H-8), 2.87 – 2.78 (m, 1H, H-5a), 2.50 – 2.21 (m, 3H, H-5b + H-3), 1.89 – 1.59 (m, 2H, H-2), 1.06 (s, 9H, H-14).

**$^{13}C$  NMR** (75 MHz,  $CDCl_3$ ):  $\delta$  (ppm) = 170.0 (C-9), 152.8 (C-10), 135.68 (Ph), 135.66 (Ph), 133.7 (Ph), 133.6 (Ph), 129.8 (Ph), 127.8 (Ph), 121.1 (CN), 62.94 (C-1/11), 62.85 (C-1/11), 59.7 (C-7), 42.50 (C-8), 42.45 (C-12), 38.6 (C-6), 35.8 (C-4), 33.1 (C-5), 28.3 (C-2), 27.7 (C-3), 27.0 (C-14), 19.2 (C-13).

**HRMS** (ESI):  $[M+Na]^+ C_{29}H_{36}N_2O_6SSiNa^+$ : calcd. 591.1955, found 591.1954.

$[\alpha]^{25}_D = +58.87$  ( $c$  = 0.21,  $CHCl_3$ ).

**(1S,2R,3R)-2-(methylsulfonyl)-3-(2-oxooxazolidine-3-carbonyl)-1-(3-((triisopropylsilyl)oxy)propyl)cyclobutanecarbonitrile (507b)**



Chemical Formula:  $C_{22}H_{38}N_2O_6SSi$   
Molecular Weight: 486,70

Cyclobutene **456c** (1.92 g, 5 mmol, 1.0 eq.) was diluted in 5 mL of acetonitrile.  $MeSO_2CN$  (0.79 g, 7.5 mmol, 1.5 eq.) and *p*-anisaldehyde (0.12 mL, 1.0 mmol, 0.2 eq.) were introduced and the mixture was degassed 3 times by the freeze-pump-thaw method. The reaction mixture was stirred at 35°C for 22 hours while being irradiated with UV light (325-400 nm). The solvent was then evaporated and the crude was purified by flash chromatography (DCM/EtOAc 90:10) to afford **507b** as colourless oil (1.8 g, 73%, d.r.  $>$  19:1:1:1).

**Rf** = 0.62 (DCM/EtOAc 1:1).

**m. p.** = 60-65°C (EtOAc).

**IR** (film, KBr)  $\nu_{max}$  ( $cm^{-1}$ ) = 2943, 2892, 2866, 2238, 1787, 1693, 1463, 1390, 1283, 1227, 1133, 1113.

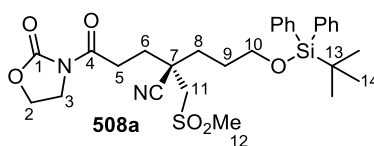
**<sup>1</sup>H NMR** (300 MHz, CDCl<sub>3</sub>): δ (ppm) = 4.62 (d, *J* = 9.7 Hz, 1H, H-7), 4.54 – 4.40 (m, 3H, H-11 + H-6), 4.10 – 4.01 (m, 2H, H-12), 3.85 – 3.72 (m, 2H, H-1), 2.93 (s, 3H, H-8), 2.91 – 2.81 (m, 1H, H-5a), 2.51 – 2.16 (m, 3H, H-5b + H-3), 1.89 – 1.59 (m, 2H, H-2), 1.16 – 0.97 (m, 21H, H-13 + H-14).

**<sup>13</sup>C NMR** (150 MHz, CDCl<sub>3</sub>): δ (ppm) = 170.0 (C-9), 152.9 (C-10), 121.2 (CN), 63.0 (C-11), 62.3 (C-1), 59.7 (C-7), 42.5 (C-12 + C-8), 38.6 (C-6), 35.8 (C-4), 33.2 (C-5), 28.8 (C-2), 27.6 (C-3), 18.1 (C-14), 12.0 (C-13).

**HRMS** (ESI): [M+Na]<sup>+</sup> C<sub>22</sub>H<sub>38</sub>N<sub>2</sub>O<sub>6</sub>SSiNa: calcd. 509.2123, found 509.2126.

[α]<sup>25</sup><sub>D</sub> = +60.5 (c = 0.22, CHCl<sub>3</sub>).

**(S)-2-(3-((tert-butyl-diphenylsilyloxy)propyl)-2-((methylsulfonyl)methyl)-5-oxo-5-(2-oxooxazolidin-3-yl)pentanenitrile (508a)**



Chemical Formula: C<sub>29</sub>H<sub>38</sub>N<sub>2</sub>O<sub>6</sub>SSi  
Molecular Weight: 570.77

A 0.16 M solution of SmI<sub>2</sub> (29 mL, 4.6 mmol, 4 eq.) was added dropwise at -78°C to a stirred solution of cyclobutane **507a** (639 mg, 1.15 mmol, 1.0 eq.) diluted in 6 mL of dry THF and distilled water (0.25 mL, 13.8 mmol, 12 eq.). The reaction mixture was stirred at -78°C for 1 hour and was quenched at this temperature by bubbling air until the blue colour disappeared. The mixture was diluted with dichloromethane and 1M HCl aqueous solution. The aqueous layer was extracted with dichloromethane (3 times). The combined organic layers were washed with a saturated aqueous solution of Na<sub>2</sub>S<sub>2</sub>O<sub>3</sub>, a saturated aqueous solution of Rochelle salts and brine, dried over MgSO<sub>4</sub> and concentrated under reduced pressure. The crude product was purified by flash chromatography (DCM/EtOAc 75:25) to afford **508a** as yellow solid (498 mg, 78%).

R<sub>f</sub> = 0.47 (DCM/EtOAc 1:1).

m. p. = 55-65°C (EtOAc).

**IR** (film, KBr) ν<sub>max</sub> (cm<sup>-1</sup>) = 3070, 2931, 2858, 2240, 1778, 1700, 1390, 1312, 1139, 1111, 704.

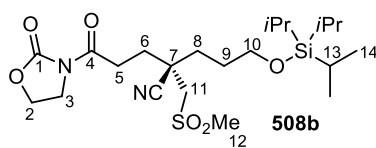
**<sup>1</sup>H NMR** (300 MHz, CDCl<sub>3</sub>): δ (ppm) = 7.69 – 7.62 (m, 4H, Ph), 7.47 – 7.35 (m, 6H, Ph), 4.43 (t, *J* = 8.1 Hz, 2H, H-2), 4.03 (t, *J* = 8.1 Hz, 2H, H-3), 3.72 (t, *J* = 5.9 Hz, 2H, H-10), 3.33 (m, 2H, H-11), 3.15 (t, *J* = 7.8 Hz, 2H, H-5), 3.07 (s, 3H, H-12), 2.44 – 2.24 (m, 2H, H-6), 2.18 – 1.90 (m, 2H, H-9), 1.82 – 1.68 (m, 2H, H-8), 1.05 (s, 9H, H-14).

**<sup>13</sup>C NMR** (75 MHz, CDCl<sub>3</sub>): δ (ppm) = 171.3 (C-4), 153.7 (C-1), 135.6 (Ph), 133.6 (Ph), 129.8 (Ph), 127.8 (Ph), 120.7 (CN), 62.9 (C-10), 62.4 (C-2), 57.4 (C-11), 43.5 (C-12), 42.6 (C-3), 38.7 (C-7), 33.2 (C-9), 30.6 (C-5/6), 30.5 (C-5/6), 27.6 (C-8), 26.9 (C-14), 19.2 (C-13).

**HRMS** (ESI): [M+Na]<sup>+</sup> C<sub>29</sub>H<sub>38</sub>N<sub>2</sub>O<sub>6</sub>SSiNa: calcd. 593.2112, found 593.2109.

[α]<sup>25</sup><sub>D</sub> = -4.32 (c = 0.17, CHCl<sub>3</sub>).

**(S)-2-((methylsulfonyl)methyl)-5-oxo-5-(2-oxooxazolidin-3-yl)-2-(3-((triisopropylsilyloxy)propyl)pentanenitrile (508b)**



Chemical Formula: C<sub>22</sub>H<sub>40</sub>N<sub>2</sub>O<sub>6</sub>SSi  
Molecular Weight: 488,71

A 0.32 M solution of SmI<sub>2</sub> (86 mL, 28 mmol, 5 eq.) was added dropwise at -78°C to a stirred solution of cyclobutane **507b** (2.7 g, 5.6 mmol, 1.0 eq.) diluted in 80 mL of dry THF and distilled water (1.2 mL, 66 mmol, 12 eq.). The reaction mixture was stirred at -78°C for 1 hour and was quenched at this temperature by bubbling air until the blue colour disappeared. The mixture was diluted with dichloromethane and 1M HCl aqueous solution. The aqueous layer was extracted with dichloromethane (3 times). The combined organic layers were washed with a saturated aqueous solution of Na<sub>2</sub>S<sub>2</sub>O<sub>3</sub>, a saturated aqueous solution of Rochelle salts and brine, dried over MgSO<sub>4</sub> and concentrated under reduced pressure. The crude product was purified by flash chromatography (DCM/EtOAc 80:20) to afford **508b** as viscous oil (2.2 g, 81%).

R<sub>f</sub> = 0.43 (DCM/EtOAc 1:1).

IR (film, KBr) ν<sub>max</sub> (cm<sup>-1</sup>) = 2942, 2866, 2891, 2238, 1778, 1699, 1462, 1390, 1312, 1226, 1139, 1109.

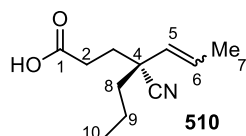
<sup>1</sup>H NMR (300 MHz, CDCl<sub>3</sub>): δ (ppm) = 4.48 – 4.39 (m, 2H, H-2), 4.07 – 3.99 (m, 2H, H-3), 3.75 (t, *J* = 5.9 Hz, 2H, H-10), 3.37 (m, 2H, H-11), 3.16 (t, *J* = 7.8 Hz, 2H, H-5), 3.08 (s, 3H, H-12), 2.45 – 2.25 (m, 2H, H-6), 2.17 – 1.93 (m, 2H, H-8), 1.82 – 1.69 (m, 2H, H-9), 1.10 – 0.99 (m, 21H, H-13 + H-14).

<sup>13</sup>C NMR (75 MHz, CDCl<sub>3</sub>): δ (ppm) = 171.4 (C-4), 153.7 (C-1), 120.7 (CN), 62.4 (C-2), 62.4 (C-10), 57.6 (C-11), 43.6 (C-12), 42.7 (C-3), 38.8 (C-7), 33.3 (C-8), 30.61 (C-5/6), 30.58 (C-5/6), 28.1 (C-9), 18.1 (C-14), 12.0 (C-13).

HRMS (ESI): [M+Na]<sup>+</sup> C<sub>22</sub>H<sub>40</sub>N<sub>2</sub>O<sub>6</sub>SSiNa: calcd. 511.2268, found 511.2272.

[α]<sub>D</sub><sup>25</sup> = 2.41 (c = 0.31, CHCl<sub>3</sub>).

**(R)-4-cyano-4-propylhept-5-enoic acid (510)**



Chemical Formula: C<sub>11</sub>H<sub>17</sub>NO<sub>2</sub>  
Molecular Weight: 195,26

In a 10 mL RBF, nitrile **487a** (47 mg, 0.18mmol, 1.0 eq.) was diluted in a 1:1 mixture of DCM/*t*BuOH (2 mL). At 0°C, ground KOH (100 mg, 1.8 mmol, 10 eq.) and CF<sub>2</sub>Br<sub>2</sub> (0.4 mL, 4.3 mmol, 24 eq.) were added. The reaction mixture was stirred at room temperature for 4 hours at 40°C. The reaction was quenched with 1M HCl aqueous solution and the aqueous layer was extracted with EtOAc (3 times). The combined organic layers were washed with brine, dried over MgSO<sub>4</sub> and concentrated under reduced pressure. The obtained crude product was then purified by flash chromatography (cyclohexane/EtOAc 80:20) to afford **510** as a mixture of inseparable isomers (9.4 mg, 26%).

Characterization for the major diastereomer:

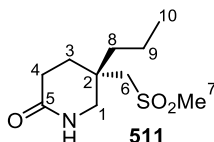
**R<sub>f</sub>** = 0.39 (EtOAc).

**IR** (film, KBr)  $\nu_{\text{max}}$  (cm<sup>-1</sup>) = 3200 (broad), 3028, 2962, 2934, 2875, 2237, 1712.

**<sup>13</sup>C NMR** (75 MHz, CDCl<sub>3</sub>):  $\delta$  (ppm) = 177.7 (C-1), 129.2 (C-6), 125.4 (C-5), 119.6 (CN), 50.2 (C-4), 40.3 (CH<sub>2</sub>), 32.8 (CH<sub>2</sub>), 29.8 (CH<sub>2</sub>), 18.4 (CH<sub>2</sub>), 17.3 (C-7), 13.8 (C-10).

**HRMS** (ESI): [M-H]<sup>-</sup> C<sub>11</sub>H<sub>16</sub>NO<sub>2</sub>: calcd. 194.1186, found 194.1189.

**(S)-5-((methylsulfonyl)methyl)-5-propylpiperidin-2-one (511)**



Chemical Formula: C<sub>10</sub>H<sub>19</sub>NO<sub>3</sub>S  
Molecular Weight: 233.33

**Protocol 1:** In a 10 mL two-necked RBF, nitrile **487c** (59 mg, 0.19 mmol, 1.0 eq.) was diluted in 2 mL of dry MeOH. The mixture was cooled down to 0°C and NiCl<sub>2</sub>·6H<sub>2</sub>O (44 mg, 0.19 mmol, 1.0 eq.) was introduced. Then, NaBH<sub>4</sub> (21 mg, 0.56 mmol, 3.0 eq.) was added and the reaction mixture was stirred 3 hours at room temperature. The solvent was evaporated and the residues were diluted in dichloromethane and filtered off through a celite pad (minimum amount of celite!). The filter cake was rinsed with dichloromethane (5 times) and the filtrate was concentrated under reduced pressure. The crude product was purified by flash chromatography (DCM/MeOH 96:4) to afford **511** as white solid (24 mg, 55%).

**Protocol 2:** In a 25 mL RBF, nitrile **487c** (184 mg, 0.58 mmol, 1.0 eq.) was diluted in 5 mL of MeOH. Raney Nickel (50% slurry in H<sub>2</sub>O, 500 mg) was washed 3 times with MeOH and was introduced to the reaction flask. The reaction mixture was stirred under a positive pressure of H<sub>2</sub> (30 bar) for 32 hours and was then filtered off through a celite pad. The filter cake was rinsed with MeOH (5 times) and the filtrate was concentrated under reduced pressure. The residues were diluted in dichloromethane, dried over MgSO<sub>4</sub> and concentrated under reduced pressure. The crude product was purified by flash chromatography (DCM/MeOH 96:4) to afford **511** as white solid (85 mg, 63%).

**R<sub>f</sub>** = 0.53 (DCM/MeOH 9:1).

**m. p.** = 134-138°C (DCM).

**IR** (film, KBr)  $\nu_{\text{max}}$  (cm<sup>-1</sup>) = 3321, 2960, 2934, 2873, 1659, 1297, 1133.

**<sup>1</sup>H NMR** (300 MHz, CDCl<sub>3</sub>):  $\delta$  (ppm) = 6.33 (br s, 1H, N-H), 3.51 (d, *J* = 12.5 Hz, 1H, H-1a), 3.31 – 3.09 (m, 3H, H-1b + H-6), 2.95 (s, 3H, H-7), 2.56 – 2.33 (m, 2H, H-4), 2.12 – 1.98 (m, 1H, H-3a), 1.85 – 1.66 (m, 3H, H-3b + H-8), 1.43 – 1.28 (m, 2H, H-9), 0.96 (t, *J* = 7.2 Hz, 3H, H-10).

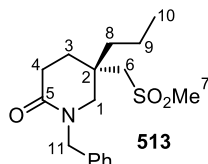
**<sup>13</sup>C NMR** (75 MHz, CDCl<sub>3</sub>):  $\delta$  (ppm) = 171.7 (C-5), 56.3 (C-6), 50.9 (C-1), 44.2 (C-7), 37.4 (C-8), 36.5 (C-2), 30.7 (C-3), 27.8 (C-4), 16.8 (C-9), 14.5 (C-10).

**HRMS** (ESI): [M+H]<sup>+</sup> C<sub>10</sub>H<sub>20</sub>NO<sub>3</sub>S: calcd. 234.1158, found 234.1160.

**[ $\alpha$ ]<sub>D</sub><sup>25</sup>** = -11.17 (c = 0.32, CHCl<sub>3</sub>).



### (S)-1-benzyl-5-((methylsulfonyl)methyl)-5-propylpiperidin-2-one (513)



Chemical Formula: C<sub>17</sub>H<sub>25</sub>NO<sub>3</sub>S  
Molecular Weight: 323,45

In a 10 mL two-necked RBF, lactam **511** (43 mg, 0.18 mmol, 1.0 eq.) was diluted in 4 mL of dry THF. Sodium hydride (60% dispersion in mineral oil, 7.7 mg, 0.19 mmol, 1.05 eq.) was added at 0°C and the reaction mixture was stirred at room temperature for 2 hours. Then, benzyl bromide (24 μL, 0.2 mmol, 1.1 eq.) was added and the stirring was pursued for 3 hours. The reaction was treated with water and the aqueous layer was extracted with EtOAc (3 times). The combined organic layers were washed with water and brine, dried over MgSO<sub>4</sub> and concentrated under reduced pressure. The obtained crude product was then purified by flash chromatography (DCM/MeOH 97:3) to afford **513** as highly viscous oil (23 mg, 38%).

R<sub>f</sub> = 0.71 (DCM/MeOH 9:1).

IR (film, KBr) ν<sub>max</sub> (cm<sup>-1</sup>) = 3027, 2989, 2930, 2872, 1637, 1495, 1301, 1135, 704.

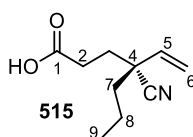
<sup>1</sup>H NMR (300 MHz, CDCl<sub>3</sub>): δ (ppm) = 7.37 – 7.27 (m, 5H, Ph), 4.74 (d, *J* = 14.4 Hz, 1H, H-11a), 4.43 (d, *J* = 14.4 Hz, 1H, H-11b), 3.43 (dd, *J* = 12.6, 1.4 Hz, 1H, H-1a), 3.15 (d, *J* = 12.6 Hz, 1H, H-1b), 3.03 (d, *J* = 14.0 Hz, 1H, H-6a), 2.94 (d, *J* = 14.0 Hz, 1H, H-6b), 2.84 (s, 3H, H-7), 2.57 – 2.48 (m, 2H, H-4), 2.09 – 1.97 (m, 1H, H-3a), 1.85 – 1.73 (m, 1H, H-3b), 1.66 – 1.56 (m, 2H, H-8), 1.35 – 1.12 (m, 2H, H-9), 0.89 (t, *J* = 7.2 Hz, 3H, H-10).

<sup>13</sup>C NMR (75 MHz, CDCl<sub>3</sub>): δ (ppm) = 169.0 (C-5), 137.0 (Ph), 128.7 (Ph), 128.5 (Ph), 127.7 (Ph), 56.9 (C-6), 55.5 (C-1), 50.5 (C-11), 44.1 (C-7), 37.2 (C-2 + C-8), 30.9 (C-3), 28.4 (C-2), 16.6 (C-9), 14.4 (C-10).

HRMS (ESI): [M+Na]<sup>+</sup> C<sub>17</sub>H<sub>25</sub>NO<sub>3</sub>SNa: calcd. 346.1447, found 346.1444.

[α]<sub>D</sub><sup>25</sup> = -2.04 (c = 0.19, CHCl<sub>3</sub>).

### (R)-4-cyano-4-vinylheptanoic acid (515)



Chemical Formula: C<sub>10</sub>H<sub>15</sub>NO<sub>2</sub>  
Molecular Weight: 181,23

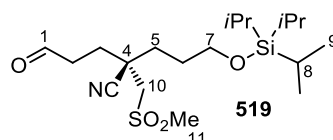
In a 10 mL RBF, nitrile **487c** (26 mg, 0.082 mmol, 1.0 eq.) was diluted in a 1:1 mixture of DCM/*t*BuOH (1 mL). At 0°C, ground KOH (23 mg, 0.41 mmol, 5 eq.) and CF<sub>2</sub>Br<sub>2</sub> (75 μL, 0.82 mmol, 10 eq.) were added. The reaction mixture was stirred at 40°C for 16 hours. The reaction was quenched with 1M HCl aqueous solution and the aqueous layer was extracted with EtOAc (3 times). The combined organic layers were washed with brine, dried over MgSO<sub>4</sub> and concentrated under reduced pressure. The obtained crude product was then purified by flash chromatography (DCM/MeOH 98:2) to afford **515** as colourless oil (2.7 mg, 18%).

R<sub>f</sub> = 0.38 (EtOAc).

IR (film, KBr) ν<sub>max</sub> (cm<sup>-1</sup>) = 3220 (broad), 2963, 2936, 2876, 2238, 1712.

**<sup>1</sup>H NMR** (300 MHz, CDCl<sub>3</sub>): δ (ppm) = 5.52 (dd, *J* = 16.5, 1.8 Hz, 1H, H-6a), 5.47 – 5.37 (m, 1H, H-5), 5.33 (dd, *J* = 9.4, 1.8 Hz, 1H, H-6b), 2.62 – 2.40 (m, 2H, H-2), 2.16 – 2.03 (m, 2H), 1.92 – 1.64 (m, 2H), 1.57 – 1.39 (m, 2H), 0.95 (t, *J* = 7.2 Hz, 3H, H-9).  
**<sup>13</sup>C NMR** (75 MHz, CDCl<sub>3</sub>): δ (ppm) = 177.0 (C-1), 136.1 (C-5), 120.6 (CN), 118.2 (C-6), 45.9, 41.2, 33.3, 29.8, 18.5, 14.0 (C-9).

**(S)-2-((methylsulfonyl)methyl)-5-oxo-2-(3-((triisopropylsilyl)oxy)propyl)pentanenitrile (519)**



Chemical Formula: C<sub>19</sub>H<sub>37</sub>NO<sub>4</sub>SSi  
 Molecular Weight: 403,65

A 0.13 M solution of SmI<sub>2</sub> (10.3 mL, 1.3 mmol, 5 eq.) was added dropwise at -78°C to a stirred solution of cyclobutane **507b** (132 mg, 0.27 mmol, 1.0 eq.) and formaldehyde (37% in H<sub>2</sub>O, 0.22 mL, 8.1 mmol, 30 eq.) diluted in 2.5 mL of dry THF. The reaction mixture was stirred at -78°C for 3 hours and was quenched at this temperature by bubbling air until the blue colour disappeared. The mixture was diluted with dichloromethane and 1M HCl aqueous solution. The aqueous layer was extracted with dichloromethane (3 times). The combined organic layers were washed with a saturated aqueous solution of Na<sub>2</sub>S<sub>2</sub>O<sub>3</sub>, a saturated aqueous solution of Rochelle salts and brine, dried over MgSO<sub>4</sub> and concentrated under reduced pressure. The crude product was purified by flash chromatography (DCM/MeOH 96:4) to afford **519** as colourless oil (44 mg, 40%).

**R<sub>f</sub>** = 0.37 (DCM/MeOH 95:05).

**IR** (film, KBr)  $\nu_{\max}$  (cm<sup>-1</sup>) = 2942, 2891, 2866, 2237, 1726, 1462, 1311, 1136, 1104, 882, 681.

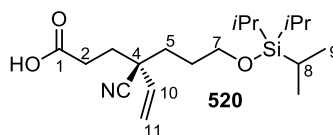
**<sup>1</sup>H NMR** (300 MHz, CDCl<sub>3</sub>): δ (ppm) = 9.80 (s, 1H, H-1), 3.73 (t, *J* = 5.8 Hz, 2H, H-7), 3.29 (d, *J* = 7.6 Hz, 2H, H-10), 3.08 (s, 3H, H-11), 2.74 (t, *J* = 7.8 Hz, 2H, H-2), 2.43 – 2.10 (m, 2H, H-3), 2.08 – 1.89 (m, 2H, H-5), 1.80 – 1.63 (m, 2H, H-6), 1.13 – 0.94 (m, 24H, H8 + H-9).

**<sup>13</sup>C NMR** (75 MHz, CDCl<sub>3</sub>): δ (ppm) = 199.3 (C-1), 120.7 (CN), 62.2 (C-7), 58.2 (C-10), 43.6 (C-11), 39.0 (C-2), 38.5 (C-4), 33.1 (C-5/6), 28.2 (C-3), 27.8 (C-5/6), 18.1 (C-9), 12.0 (C-8).

**HRMS** (ESI): [M+MeOH+Na]<sup>+</sup> C<sub>20</sub>H<sub>41</sub>NO<sub>5</sub>SSiNa: calcd. 458.2366, found 458.2371.

[ $\alpha$ ]<sub>D</sub><sup>25</sup> = -12.33 (c = 0.3, CHCl<sub>3</sub>).

**(R)-4-cyano-7-((triisopropylsilyl)oxy)-4-vinylheptanoic acid (520)**



Chemical Formula: C<sub>19</sub>H<sub>35</sub>NO<sub>3</sub>Si  
 Molecular Weight: 353,57

In a 10 mL RBF, nitrile **508b** (57 mg, 0.12 mmol, 1.0 eq.) was diluted in a 1:1:0.2 mixture of DCM/*t*BuOH/H<sub>2</sub>O (2.2 mL). At 0°C, ground KOH (144 mg, 2.6 mmol, 22 eq.) and CF<sub>2</sub>Br<sub>2</sub> (0.2 mL, 1.2 mmol, 20 eq.) were added. The reaction mixture was stirred at room temperature for 20 hours and at 40°C for 4 hours. The reaction was quenched with 1M HCl aqueous solution and the aqueous layer was extracted with EtOAc (3 times). The combined organic layers were washed with brine, dried over MgSO<sub>4</sub> and concentrated under reduced pressure. The obtained crude product was then purified by flash chromatography (DCM/MeOH 98:2) to afford **520** as colourless oil (8.8 mg, 21%).

**Rf** = 0.43 (DCM/MeOH 9:1).

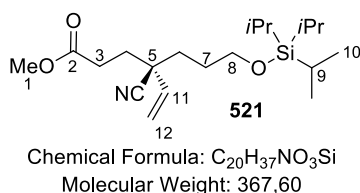
**IR** (film, KBr)  $\nu_{\max}$  (cm<sup>-1</sup>) = 3200 (broad), 2944, 2892, 2867, 2238, 1716, 1462, 1104.

**<sup>1</sup>H NMR** (600 MHz, CDCl<sub>3</sub>):  $\delta$  (ppm) = 5.52 (dd,  $J$  = 17.0, 0.6 Hz, 1H, H-11a), 5.47 – 5.39 (m, 1H, H-10), 5.35 (dd,  $J$  = 10.0, 0.6 Hz, 1H, H-11b), 3.75 – 3.68 (m, 2H, H-7), 2.56 (ddd,  $J$  = 16.7, 11.0, 5.6 Hz, 1H, H-2a), 2.51 – 2.45 (m, 1H, H-2b), 2.11 (ddd,  $J$  = 14.0, 10.8, 5.5 Hz, 1H, H-3a), 1.94 – 1.80 (m, 2H, H-3b + H-5a), 1.76 – 1.61 (m, 3H, H-5b + H-6), 1.13 – 1.00 (m, 21H, H-8 + H-9).

**<sup>13</sup>C NMR** (150 MHz, CDCl<sub>3</sub>):  $\delta$  (ppm) = 177.2 (C-1), 136.0 (C-10), 120.5 (CN), 118.4 (C-11), 62.6 (C-7), 45.7 (C-4), 35.7 (C-5), 33.4 (C-3), 29.8 (C-2), 28.7 (C-6), 18.2 (C-9), 12.1 (C-8).

**HRMS** (ESI): [M+Na]<sup>+</sup> C<sub>19</sub>H<sub>35</sub>NO<sub>3</sub>SiNa: calcd. 376.2278, found 376.2278.

**(R)-methyl 4-cyano-7-((triisopropylsilyloxy)-4-vinylheptanoate (521)**



In a 10 mL RBF, nitrile **508b** (33 mg, 0.07 mmol, 1.0 eq.) was diluted in a 1:1:0.2 mixture of DCM/*t*BuOH/H<sub>2</sub>O (2.2 mL). At 0°C, ground KOH (83 mg, 1.48 mmol, 22 eq.) and CF<sub>2</sub>Br<sub>2</sub> (0.12 mL, 1.35 mmol, 20 eq.) were added. The reaction mixture was stirred at room temperature for 36 hours. The reaction was quenched with 1M HCl aqueous solution and the aqueous layer was extracted with EtOAc (3 times). The combined organic layers were washed with brine, dried over MgSO<sub>4</sub> and concentrated under reduced pressure. The obtained crude product was then diluted in 1.5 mL of dry DMF. Potassium carbonate (19 mg, 0.14 mmol, 2.0 eq.) and iodomethane (17  $\mu$ L, 0.28 mmol, 4.0 eq.) were added and the reaction mixture was stirred for 16 hours at room temperature. The reaction was quenched with 1M HCl aqueous solution and the aqueous layer was extracted with EtOAc (3 times). The combined organic layers were washed with water and brine, dried over MgSO<sub>4</sub> and concentrated under reduced pressure. The obtained crude product was then purified by flash chromatography (cyclohexane/EtOAc 95:5) to afford **521** as colourless oil (2.4 mg, 10%).

**Rf** = 0,85 (cyclohexane/EtOAc 3:2).

**IR** (film, KBr)  $\nu_{\max}$  (cm<sup>-1</sup>) = 2946, 2866, 2237, 1742, 1462, 1104, 882, 682.

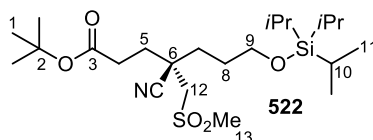
**<sup>1</sup>H NMR** (300 MHz, CDCl<sub>3</sub>):  $\delta$  (ppm) = 5.51 (dd,  $J$  = 16.6, 1.9 Hz, 1H, H-12a), 5.46-5.37 (m, 1H, H-11), 5.32 (dd,  $J$  = 9.3, 1.9 Hz, 1H, H-12b), 3.73-3.69 (m, 2H, H-8), 3.68 (s, 3H, H-1), 2.52-2.41 (m, 2H, H-3), 2.15-2.05 (m, 1H, H-4a), 1.94-1.83 (m, 2H, H-4b + H-6a), 1.72-1.64 (m, 3H, H-6b + H-7), 1.06-1.04 (m, 21H, H-9 + H-10).

**<sup>13</sup>C NMR** (75 MHz, CDCl<sub>3</sub>):  $\delta$  (ppm) = 173.0 (C-2), 136.2 (C-11), 120.6 (CN), 118.1 (C-12), 62.6 (C-8), 51.9 (C-1), 45.7 (C-5), 35.7 (C-6), 33.7 (C-4), 30.1 (C-3), 28.6 (C-7), 18.1 (C-10), 12.0 (C-9).

**HRMS** (ESI): [M+Na]<sup>+</sup> C<sub>20</sub>H<sub>37</sub>NO<sub>3</sub>SiNa: calcd. 390.2434, found 390.2448.

**[ $\alpha$ ]<sup>25</sup><sub>D</sub>** = - 17.68 (c = 0.053, CHCl<sub>3</sub>).

**(S)-tert-butyl 4-cyano-4-((methylsulfonyl)methyl)-7-((triisopropylsilyloxy)heptanoate (522)**



Chemical Formula:  $C_{23}H_{45}NO_5SSi$   
Molecular Weight: 475,76

In a 50 ml RBF, oxazolidinone **508b** (674 mg, 1.38 mmol, 1.0 eq.) was diluted in 25 mL of a 5:1 mixture of THF/H<sub>2</sub>O. Lithium hydroxide (66 mg, 2.8 mmol, 2.0 eq.) was added and the reaction mixture was stirred at room temperature for 2 hours. The reaction was quenched with 1M HCl aqueous solution and the aqueous layer was extracted with EtOAc (3 times). The combined organic layers were washed with brine, dried over MgSO<sub>4</sub> and concentrated under reduced pressure. The obtained crude was then diluted in 10 mL of dry DCM and *tert*-butyl 2,2,2-trichloroacetamide (1.2 g, 5.5 mmol, 4.0 eq.) was added at 0°C. After the addition of a catalytic amount of BF<sub>3</sub>.Et<sub>2</sub>O (17  $\mu$ l, 0.14 mmol, 0.1 eq.), the reaction mixture was allowed to reach room temperature and stirred for 2 hours. The reaction was treated with a saturated aqueous solution of NaHCO<sub>3</sub> and the aqueous layer was extracted with EtOAc (3 times). The combined organic layers were washed with water and brine, dried over MgSO<sub>4</sub> and concentrated under reduced pressure. The crude product was purified by flash chromatography (cyclohexane/EtOAc 75:25) to afford **522** as colourless oil (213 mg, 32%).

**Rf** = 0.46 (cyclohexane/EtOAc 2:1)

**IR** (film, KBr)  $\nu_{max}$  (cm<sup>-1</sup>) = 2942, 2867, 2892, 1728, 1462, 1368, 1313, 1148, 1103.

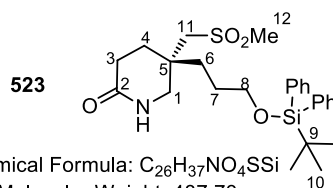
**<sup>1</sup>H NMR** (300 MHz, CDCl<sub>3</sub>):  $\delta$  (ppm) = 3.74 (t, *J* = 5.8 Hz, 2H, H-9), 3.27 (s, 2H, H-12), 3.09 (s, 3H, H-13), 2.47 (t, *J* = 8.1 Hz, 2H, H-4), 2.33 – 1.92 (m, 4H, H-5 + H7), 1.77 – 1.64 (m, 2H, H-8), 1.45 (s, 9H, H-1), 1.08 – 1.01 (m, 24H, H-10/11).

**<sup>13</sup>C NMR** (150 MHz, CDCl<sub>3</sub>):  $\delta$  (ppm) = 171.0 (C-3), 120.8 (CN), 81.4 (C-2), 62.3 (C-9), 58.6 (C-12), 43.5 (C-13), 38.5 (C-6), 32.6 (C-5/7), 31.2 (C-5/7), 30.6 (C-3), 28.2 (C-1), 27.8 (C-8), 18.2 (C-11), 12.0 (C-10).

**HRMS** (ESI): [M+Na]<sup>+</sup> C<sub>23</sub>H<sub>45</sub>NO<sub>5</sub>SSiNa: calcd. 498.2679, found 498.2665.

**$[\alpha]^{25}_D$**  = -8.18 (c = 0.18, CHCl<sub>3</sub>).

**(S)-5-(3-((tert-butyl) diphenylsilyloxy)propyl)-5-((methylsulfonyl)methyl)piperidin-2-one (523)**



Chemical Formula:  $C_{26}H_{37}NO_4SSi$   
Molecular Weight: 487,73

In a 25 mL RBF, nitrile **508a** (90 mg, 0.16 mmol, 1.0 eq.) was diluted in 5 mL of MeOH. Raney Nickel (50% slurry in H<sub>2</sub>O, 550 mg) was washed 3 times with MeOH and was introduced to the reaction flask. The reaction mixture was stirred under a positive pressure of H<sub>2</sub> (25 bar) for 16 hours and was then filtered off through a celite pad. The filter cake was rinsed with MeOH (5 times) and the filtrate was concentrated under reduced pressure. The residues were diluted in dichloromethane, dried over MgSO<sub>4</sub> and concentrated under reduced pressure. The crude product was purified by flash chromatography (DCM/MeOH 95:5) to afford **523** as white solid (19.5 mg, 25%).

**Rf** = 0.31 (DCM/MeOH 9:1).

**m. p.** = 137-141°C (DCM/MeOH).

**IR** (film, KBr)  $\nu_{\max}$  (cm<sup>-1</sup>) = 3268, 3071, 3049, 2954, 2931, 2859, 1664, 1305, 1135, 1110, 733, 704.

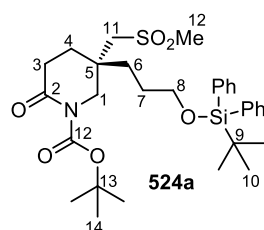
**<sup>1</sup>H NMR** (600 MHz, CDCl<sub>3</sub>):  $\delta$  (ppm) = 7.67 – 7.62 (m, 4H, Ph), 7.42 (m 2H, Ph), 7.41 – 7.36 (m, 4H, Ph), 6.21 (br s, 1H, N-H), 3.73 – 3.66 (m, 2H, H-8), 3.50 (d,  $J$  = 12.4 Hz, 1H, H-1a), 3.21 (d,  $J$  = 12.5 Hz, 1H, H-1b), 3.15 (d,  $J$  = 14.2 Hz, 1H, H-11a), 3.11 (d,  $J$  = 14.2 Hz, 1H, H-11b), 2.92 (s, 3H, H-12), 2.49 – 2.34 (m, 2H, H-3), 2.07 – 2.00 (m, 1H, H-4a), 1.86 – 1.70 (m, 3H, H-4b + H-6), 1.63 – 1.53 (m, 2H, H-7), 1.05 (s, 9H, H-10).

**<sup>13</sup>C NMR** (150 MHz, CDCl<sub>3</sub>):  $\delta$  (ppm) = 171.4 (C-2), 135.7 (Ph), 133.9 (Ph), 129.8 (Ph), 127.8 (Ph), 63.8 (C-8), 56.5 (C-11), 50.9 (C-1), 44.3 (C-12), 36.3 (C-5), 31.3 (C-6), 30.7 (C-4), 27.8 (C-3), 27.0 (C-10), 26.7 (C-7), 19.3 (C-9).

**HRMS** (ESI): [M+Na]<sup>+</sup> C<sub>26</sub>H<sub>37</sub>NO<sub>4</sub>SSiNa: calcd. 510.2104, found 510.2115.

**[ $\alpha$ ]<sup>25</sup><sub>D</sub>** = -11.87 (c = 0.28, CHCl<sub>3</sub>).

**(S)-tert-butyl 5-(3-((tert-butyl)phenylsilyloxy)propyl)-5-((methylsulfonyl)methyl)-2-oxopiperidine-1-carboxylate (524a)**



Chemical Formula: C<sub>31</sub>H<sub>45</sub>NO<sub>6</sub>SSi  
Molecular Weight: 587,84

In a 25 mL RBF, nitrile **508a** (455 mg, 0.8 mmol, 1.0 eq.) was diluted in 15 mL of MeOH. Raney Nickel (50% slurry in H<sub>2</sub>O, 1.8 g) was washed 3 times with MeOH and was introduced to the reaction flask. The reaction mixture was stirred under a positive pressure of H<sub>2</sub> (25 bar) for 72 hours and was then filtered off through a filter paper. The filter cake was rinsed with MeOH (5 times) and the filtrate was concentrated under reduced pressure. The residues were diluted in dichloromethane, dried over MgSO<sub>4</sub> and concentrated under reduced pressure. The crude was then diluted in 10 mL of dry dichloromethane. DMAP (10 mg, 0.08 mmol, 0.1 eq.) and Boc<sub>2</sub>O (384 mg, 1.76 mmol, 2.2 eq.) were introduced. Then, Et<sub>3</sub>N (0.23 mL, 1.68 mmol, 2.1 eq.) was added dropwise and the reaction mixture was stirred at room temperature for 16 hours. The reaction was quenched with a saturated aqueous solution of NH<sub>4</sub>Cl and the aqueous layer was extracted with dichloromethane (3 times). The combined organic layers were washed with water and brine, dried over MgSO<sub>4</sub> and concentrated under reduced pressure. The obtained crude product was then purified by flash chromatography (DCM/EtOAc 80:20) to afford **524a** as white solid (350 mg, 75% for two steps).

**R<sub>f</sub>** = 0.41 (DCM/EtOAc 1:1).

**m. p.** = 58-62°C (EtOAc).

**IR** (film, KBr)  $\nu_{\max}$  (cm<sup>-1</sup>) = 3071, 2931, 2858, 1768, 1718, 1306, 1367, 1251, 1142, 1110, 704.

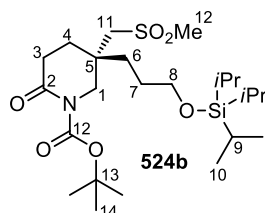
**<sup>1</sup>H NMR** (300 MHz, CDCl<sub>3</sub>):  $\delta$  (ppm) = 7.67 – 7.62 (m, 4H, Ph), 7.46 – 7.34 (m, 6H, Ph), 3.94 (d,  $J$  = 13.5 Hz, 1H, H-1a), 3.68 (t,  $J$  = 6.2 Hz, 2H, H-8), 3.55 (d,  $J$  = 13.5 Hz, 1H, H-1b), 3.15 – 3.03 (m, 2H, H-11), 2.92 (s, 3H, H-12), 2.69 – 2.40 (m, 2H, H-3), 2.19 – 2.07 (m, 1H, H-4a), 1.86 – 1.55 (m, 5H, H-4b, H-6, H-7), 1.52 (s, 9H, H-14), 1.04 (s, 9H, H-10).

$^{13}\text{C}$  NMR (75 MHz,  $\text{CDCl}_3$ ):  $\delta$  (ppm) = 171.0 (C-2), 152.0 (C-12), 135.5 (Ph), 133.7 (Ph), 129.7 (Ph), 127.7 (Ph), 83.3 (C-13), 63.7 (C-8), 57.8 (C-11), 52.4 (C-1), 44.1 (C-12), 37.3 (C-5), 32.9 (C-6), 31.9 (C-3), 30.2 (C-4), 27.9 (C-14), 26.9 (C-10), 26.6 (C-7), 19.2 (C-9).

**HRMS** (ESI):  $[\text{M}+\text{Na}]^+$   $\text{C}_{31}\text{H}_{45}\text{NO}_6\text{SSiNa}$ : calcd. 610.2629, found 610.2640.

$[\alpha]^{25}_{\text{D}} = -5.33$  ( $c = 0.21$ ,  $\text{CHCl}_3$ ).

**(S)-tert-butyl 5-((methylsulfonyl)methyl)-2-oxo-5-(3-((triisopropylsilyloxy)propyl)piperidine-1-carboxylate (524b)**



Chemical Formula:  $\text{C}_{24}\text{H}_{47}\text{NO}_6\text{SSi}$   
Molecular Weight: 505,78

In a 25 mL RBF, nitrile **508b** (1.04 g, 2.1 mmol, 1.0 eq.) was diluted in 15 mL of MeOH. Raney Nickel (50% slurry in  $\text{H}_2\text{O}$ , 1.9 g) was washed 3 times with MeOH and was introduced to the reaction flask. The reaction mixture was stirred under a positive pressure of  $\text{H}_2$  (25 bar) for 60 hours and was then filtered off through a celite pad (minimum of celite!). The filter cake was rinsed with MeOH (5 times) and the filtrate was concentrated under reduced pressure. The residues were diluted in dichloromethane, dried over  $\text{MgSO}_4$  and concentrated under reduced pressure. The crude was then diluted in 40 mL of dry dichloromethane. DMAP (26 mg, 0.21 mmol, 0.1 eq.) and  $\text{Boc}_2\text{O}$  (1.86 g, 8.5 mmol, 4 eq.) were introduced. Then,  $\text{Et}_3\text{N}$  (1.2 mL, 8.5 mmol, 4 eq.) was added dropwise and the reaction mixture was stirred at room temperature for 24 hours. The reaction was quenched with a saturated aqueous solution of  $\text{NH}_4\text{Cl}$  and the aqueous layer was extracted with dichloromethane (3 times). The combined organic layers were washed with water and brine, dried over  $\text{MgSO}_4$  and concentrated under reduced pressure. The obtained crude product was then purified by flash chromatography (DCM/EtOAc 80:20) to afford **524b** as white solid (829 mg, 77% for two steps).

**Rf** = 0.55 (DCM/EtOAc 1:1).

**m. p.** = 79-83°C (EtOAc).

**IR** (film, KBr)  $\nu_{\text{max}}$  ( $\text{cm}^{-1}$ ) = 2942, 2892, 2866, 1769, 1719, 1461, 1368, 1306, 1250, 1143, 1105.

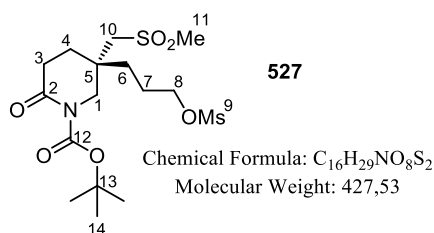
$^1\text{H}$  NMR (300 MHz,  $\text{CDCl}_3$ ):  $\delta$  (ppm) = 3.94 (d,  $J = 13.6$  Hz, 1H, H-1a), 3.69 (t,  $J = 6.2$  Hz, 2H, H-8), 3.59 (d,  $J = 13.7$  Hz, 1H, H-1b), 3.19 – 3.07 (m, 2H, H-11), 2.95 (s, 3H, H-12), 2.67 – 2.42 (m, 2H, H-3), 2.20 – 2.08 (m, 1H, H-4a), 1.87 – 1.55 (m, 5H, H-4b, H-6, H-7), 1.51 (s, 9H, H-14), 1.10 – 0.97 (m, 21H, H-9, H-10).

$^{13}\text{C}$  NMR (75 MHz,  $\text{CDCl}_3$ ):  $\delta$  (ppm) = 171.1 (C-2), 152.2 (C-12), 83.6 (C-13), 63.2 (C-8), 58.1 (C-11), 52.7 (C-1), 44.3 (C-12), 37.6 (C-5), 33.1 (C-6/7), 32.1 (C-3), 30.5 (C-4), 28.1 (C-14), 27.2 (C-6/7), 18.1 (C-10), 12.0 (C-9).

**HRMS** (ESI):  $[\text{M}+\text{Na}]^+$   $\text{C}_{24}\text{H}_{47}\text{NO}_6\text{SSiNa}$ : calcd. 528.2785, found 528.2791.

$[\alpha]^{25}_{\text{D}} = -6.30$  ( $c = 0.23$ ,  $\text{CHCl}_3$ ).

**(S)-tert-butyl 5-((methylsulfonyl)methyl)-5-(3-((methylsulfonyl)oxy)propyl)-2-oxopiperidine-1-carboxylate (527)**



In a 50 mL two-necked RBF, Boc-protected amide **524b** (90 mg, 0.18 mmol, 1.0 eq.) was diluted in 2 mL of dry THF and TBAF (1M in THF, 0.21 mL, 0.21 mmol, 1.2 eq.) was added dropwise at room temperature. The reaction mixture was stirred for 30 minutes and was treated with water. The aqueous layer was extracted with EtOAc (3 times). The combined organic layers were washed with water and brine, dried over MgSO<sub>4</sub> and concentrated under reduced pressure. The obtained crude was then diluted in 2 mL of dry dichloromethane. Distilled MsCl (0.018 mL, 0.23 mmol, 1.3 eq.) and Et<sub>3</sub>N (0.32 mL, 0.23 mmol, 1.3 eq.) were added and the reaction mixture was stirred for 1 hour at room temperature. The reaction was quenched with a saturated aqueous solution of NH<sub>4</sub>Cl and the aqueous layer was extracted with EtOAc (3 times). The combined organic layers were washed with water and brine, dried over MgSO<sub>4</sub> and concentrated under reduced pressure. The obtained crude product was then purified by flash chromatography (DCM/EtOAc 80:20) to afford **527** as viscous yellow oil (47 mg, 68% for two steps).

R<sub>f</sub> = 0.28 (DCM/MeOH 95:5).

IR (film, KBr)  $\nu_{\max}$  (cm<sup>-1</sup>) = 2978, 2936, 1767, 1717, 1350, 1301, 1252, 1173, 1140, 968.

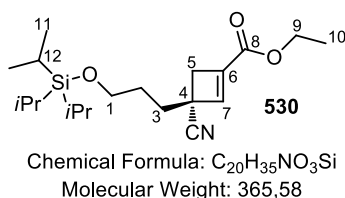
<sup>1</sup>H NMR (300 MHz, CDCl<sub>3</sub>):  $\delta$  (ppm) = 4.30 – 4.23 (m, 2H, H-8), 3.95 (dd, *J* = 13.7, 0.9 Hz, 1H, H-1a), 3.57 (d, *J* = 13.7 Hz, 1H, H-1b), 3.13 (d, *J* = 4.6 Hz, 1H, H-10), 3.02 (s, 3H, H-9), 2.96 (s, 3H, H-11), 2.67 – 2.46 (m, 2H, H-3), 2.20 – 2.08 (m, 1H, H-4a), 1.91 – 1.74 (m, 5H, H-4b + H-6 + H-7), 1.53 (s, 9H, H-14).

<sup>13</sup>C NMR (75 MHz, CDCl<sub>3</sub>):  $\delta$  (ppm) = 170.8 (C-2), 152.1 (C-12), 83.8 (C-13), 69.7 (C-8), 57.1 (C-10), 52.6 (C-1), 44.2 (C-11), 37.54 (C-5), 37.47 (C-9), 32.4 (C-6), 31.8 (C-3), 30.7 (C-4), 28.0 (C-14), 23.8 (C-7).

HRMS (ESI): [M+Na]<sup>+</sup> C<sub>16</sub>H<sub>29</sub>NO<sub>8</sub>S<sub>2</sub>Na: calcd. 450.1226, found 450.1236.

[ $\alpha$ ]<sub>D</sub><sup>25</sup> = -4.75 (c = 0.44, CHCl<sub>3</sub>).

**(R)-ethyl 3-cyano-3-(3-((triisopropylsilyl)oxy)propyl)cyclobut-1-enecarboxylate (530)**



To a stirred mixture of cyclobutane **507b** (72 mg, 0.15 mmol, 1.0 eq.) in 5 mL of distilled EtOH was added at -78°C EtONa (20 mg, 0.29 mmol, 2.0 eq.) in one portion. The reaction mixture was stirred 10 minutes at -78°C and was then allowed to reach first 0°C and then room temperature. The stirring was pursued until a homogenous solution appeared (10 minutes). The reaction mixture was then diluted with dichloromethane and with a saturated aqueous solution of NaHCO<sub>3</sub>. The aqueous layer was extracted with dichloromethane (3 times) and the combined organic layers were washed with water and brine, dried over MgSO<sub>4</sub> and concentrated under reduced pressure. The

obtained crude product was then purified by flash chromatography (cyclohexane/EtOAc 95:5) to afford **530** as colourless oil (33 mg, 61%).

**R<sub>f</sub>** = 0.63 (cyclohexane/EtOAc 2:1).

**IR** (film, KBr)  $\nu_{\max}$  (cm<sup>-1</sup>) = 3079, 2943, 2893, 2866, 2235, 1728, 1619, 1464, 1320, 1147, 1106.

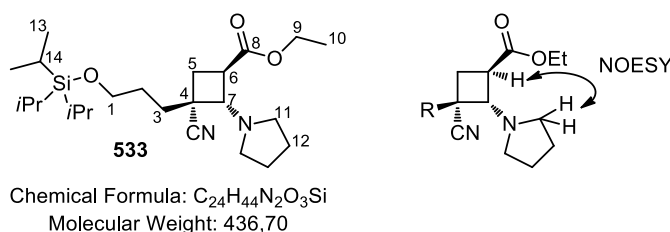
**<sup>1</sup>H NMR** (300 MHz, CDCl<sub>3</sub>):  $\delta$  (ppm) = 6.73 (s, 1H, H-7), 4.22 (q,  $J$  = 7.1 Hz, 2H, H-9), 3.74 (t,  $J$  = 5.8 Hz, 2H, H-1), 3.18 (d,  $J$  = 13.7 Hz, 1H, H-5a), 2.76 (d,  $J$  = 13.7 Hz, 1H, H-5b), 1.96 – 1.87 (m, 2H, H-3), 1.81 – 1.70 (m, 2H, H-2), 1.30 (t,  $J$  = 7.1 Hz, 2H, H-10), 1.10 – 0.98 (m, 21H, H-11/12).

**<sup>13</sup>C NMR** (75 MHz, CDCl<sub>3</sub>):  $\delta$  (ppm) = 161.6 (C-8), 143.5 (C-7), 140.3 (C-6), 120.4 (CN), 62.4 (C-1), 61.1 (C-9), 40.7 (C-5), 38.7 (C-4), 32.9 (C-3), 29.7 (C-2), 18.1 (C-11), 14.3 (C-10), 12.1 (C-12).

**HRMS** (ESI): [M+Na]<sup>+</sup> C<sub>20</sub>H<sub>35</sub>NO<sub>3</sub>SiNa: calcd. 388.2278, found 388.2273.

[ $\alpha$ ]<sub>D</sub><sup>25</sup> = 11.29 (c = 0.2133, CHCl<sub>3</sub>).

**(1R,2S,3R)-ethyl 3-cyano-2-(pyrrolidin-1-yl)-3-(3-((triisopropylsilyloxy)propyl)cyclobutanecarboxylate (533)**



In a 25 mL two-necked RBF, cyclobutene carboxylate **530** (345 mg, 0.94 mmol, 1.0 eq.) was diluted in 10 mL of THF and pyrrolidine (0.32 mL, 3.8 mmol, 4.0 eq.) was added. The reaction mixture was stirred under reflux for 3 hours. The mixture was cooled down to room temperature and the solvent was evaporated. The obtained crude product was then purified by flash chromatography (cyclohexane/EtOAc 90:10) to afford **533** as colourless oil (377 mg, 91%, d.r.  $\geq$  19:1:1:1).

**R<sub>f</sub>** = 0.35 (cyclohexane/EtOAc 4:1).

**IR** (film, KBr)  $\nu_{\max}$  (cm<sup>-1</sup>) = 2945, 2893, 2866, 2234, 1733, 1463, 1202, 1105.

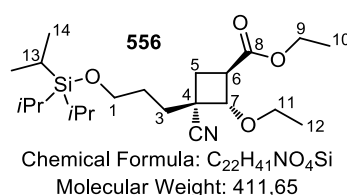
**<sup>1</sup>H NMR** (600 MHz, CDCl<sub>3</sub>):  $\delta$  (ppm) = 4.20 – 4.10 (m, 2H, H-9), 3.74 – 3.69 (m, 2H, H-1), 3.22 (q,  $J$  = 9.6 Hz, 1H, H-6), 2.95 (d,  $J$  = 8.4 Hz, 1H, H-7), 2.62 – 2.51 (m, 4H, H-11), 2.04 (dd,  $J$  = 11.5, 10.2 Hz, 1H, H-5a), 1.94 (dd,  $J$  = 11.5, 9.1 Hz, 1H, H-5b), 1.83 – 1.77 (m, 4H, H-12), 1.77 – 1.57 (m, 4H, H-2 + H-3), 1.25 (t,  $J$  = 7.1 Hz, 3H, H-10), 1.12 – 0.96 (m, 21H, H-13 + H-14).

**<sup>13</sup>C NMR** (150 MHz, CDCl<sub>3</sub>):  $\delta$  (ppm) = 173.0 (C-8), 122.2 (CN), 69.6 (C-7), 62.6 (C-1), 61.1 (C-9), 51.5 (C-11), 40.4 (C-4), 40.3 (C-6), 35.2 (C-5), 30.2 (C-2/3), 28.5 (C-2/3), 23.6 (C-12), 18.2 (C-13), 14.3 (C-10), 12.1 (C-14).

**HRMS** (APCI): [M+H]<sup>+</sup> C<sub>24</sub>H<sub>45</sub>N<sub>2</sub>O<sub>3</sub>Si: calcd. 437.3193, found 437.3199.

[ $\alpha$ ]<sub>D</sub><sup>25</sup> = -27.02 (c = 0.2667, CHCl<sub>3</sub>).

**(1R,2S,3S)-ethyl 3-cyano-2-ethoxy-3-(3-((triisopropylsilyloxy)propyl)cyclobutanecarboxylate (556)**





The product **556** was observed when the elimination reaction was scaled up on ~5 mmol (leading to 22% of this side product) or when the reaction was stirred at room temperature for a long period of time.

**Rf** = 0.58 (cyclohexane/EtOAc 4:1).

**IR** (film, KBr)  $\nu_{\max}$  (cm<sup>-1</sup>) = 2943, 2893, 2867, 2235, 1733, 1463, 1379, 1257, 1199, 1108.

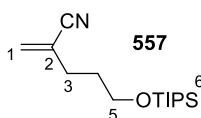
**<sup>1</sup>H NMR** (300 MHz, CDCl<sub>3</sub>):  $\delta$  (ppm) = 4.17 (qd,  $J$  = 7.1, 0.9 Hz, 2H, H-9), 3.88 (d,  $J$  = 7.7 Hz, 1H, H-7), 3.72 (t,  $J$  = 5.8 Hz, 2H, H-1), 3.58 (q,  $J$  = 7.0 Hz, 2H, H-11), 3.21 (td,  $J$  = 10.0, 7.7 Hz, 1H, H-6), 2.50 (ddd,  $J$  = 11.6, 9.8, 0.6 Hz, 1H, H-5a), 2.00 – 1.58 (m, 5H, H-5b + H-2 + H-3), 1.31 – 1.19 (m, 6H, H-10 + H-12), 1.12 – 0.96 (m, 21H, H-13 + H-14).

**<sup>13</sup>C NMR** (75 MHz, CDCl<sub>3</sub>):  $\delta$  (ppm) = 172.3 (C-8), 121.0 (CN), 79.9 (C-7), 65.4 (C-11), 62.4 (C-1), 61.2 (C-9), 43.4 (C-6), 42.8 (C-4), 34.4 (C-2/3), 28.8 (C-2/3), 28.1 (C-5), 18.1 (C-14), 15.1 (C-10/12), 14.3 (C-10/12), 12.1 (C-13).

**HRMS** (ESI): [M+Na]<sup>+</sup> C<sub>22</sub>H<sub>41</sub>NO<sub>4</sub>SiNa: calcd. 434.2697, found 434.2700.

$[\alpha]^{25}_{\text{D}}$  = -39.48 ( $c$  = 0.2, CHCl<sub>3</sub>).

### 2-methylene-5-((triisopropylsilyloxy)pentanenitrile (**557**))



Chemical Formula: C<sub>15</sub>H<sub>29</sub>NOSi  
Molecular Weight: 267.48

In a 10 mL RBF, aminocyclobutane **533** (44 mg, 0.1 mmol, 1.0 eq.) was diluted in 1 mL of EtOH and Ca(OTf)<sub>2</sub> (5.5 mg, 0.016 mmol, 16 mol%) was added. The reaction mixture was stirred under reflux for 48 hours. The reaction mixture was treated at room temperature with water. The aqueous layer was extracted with dichloromethane (3 times) and the combined organic layers were washed with water and brine, dried over MgSO<sub>4</sub> and concentrated under reduced pressure. The obtained crude product was then purified by flash chromatography (cyclohexane/EtOAc 95:5) to afford **557** (12 mg, 44%).

**Rf** = 0.7 (cyclohexane/EtOAc 2:1).

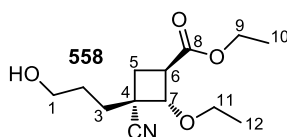
**IR** (film, KBr)  $\nu_{\max}$  (cm<sup>-1</sup>) = 2943, 2893, 2866, 2224, 1463, 1108.

**<sup>1</sup>H NMR** (300 MHz, CDCl<sub>3</sub>):  $\delta$  (ppm) = 5.86 – 5.84 (m, 1H, H-1a), 5.74 – 5.72 (m, 1H, H-1b), 3.72 (t,  $J$  = 5.9 Hz, 2H, H-5), 2.39 (t,  $J$  = 7.6 Hz, 2H, H-3), 1.84 – 1.71 (m, 2H, H-4), 1.14 – 0.96 (m, 21H, H-6 + H-7).

**<sup>13</sup>C NMR** (75 MHz, CDCl<sub>3</sub>):  $\delta$  (ppm) = 130.5 (C-1), 123.1 (C-2/CN), 118.9 (C-2/CN), 61.7 (C-5), 31.3 (C-3), 30.8 (C-4), 18.1 (C-7), 12.1 (C-6).

**HRMS** (ESI): [M+Na]<sup>+</sup> C<sub>15</sub>H<sub>29</sub>NOSiNa: calcd. 290.1910, found 290.1913.

### (1R,2S,3S)-ethyl 3-cyano-2-ethoxy-3-(3-hydroxypropyl)cyclobutanecarboxylate (**558**)



Chemical Formula: C<sub>13</sub>H<sub>21</sub>NO<sub>4</sub>  
Molecular Weight: 255.31

In a 25 mL RBF, cyclobutane **556** (25.5 mg, 0.06 mmol, 1.0 eq.) was diluted in 1 mL of EtOH and TsOH.H<sub>2</sub>O (6 mg, 0.32 mmol, 0.5 eq.) was added. The reaction mixture was stirred under reflux for 16 hours and treated at room temperature with water. The aqueous layer was extracted with

EtOAc (3 times) and the combined organic layers were washed with water and brine, dried over MgSO<sub>4</sub> and concentrated under reduced pressure. The obtained crude product was then purified by flash chromatography (cyclohexane/EtOAc 50:50) to afford **558** as colourless oil (7.7 mg, 49%).

**R<sub>f</sub>** = 0.17 (cyclohexane/EtOAc 4:1).

**IR** (film, KBr)  $\nu_{\text{max}}$  (cm<sup>-1</sup>) = 3462, 2980, 2938, 2878, 2236, 1729, 1449, 1376, 1202, 1135, 1049.

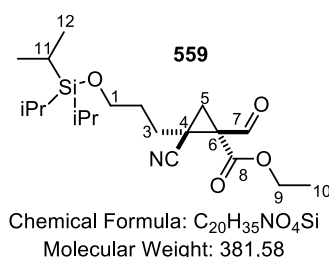
**<sup>1</sup>H NMR** (300 MHz, CDCl<sub>3</sub>):  $\delta$  (ppm) = 4.16 (qd,  $J$  = 7.1, 1.1 Hz, 2H, H-9), 3.89 (d,  $J$  = 7.7 Hz, 1H, H-7), 3.70 (br t,  $J$  = 5.8 Hz, 2H, H-1), 3.58 (q,  $J$  = 7.0 Hz, 2H, H-11), 3.21 (td,  $J$  = 10.0, 7.7 Hz, 1H, H-6), 2.50 (ddd,  $J$  = 11.7, 9.8, 0.8 Hz, 1H, H5a), 2.02 – 1.64 (m, 5H, H-5b + H-2 + H-3), 1.43 (br s, 1H, OH), 1.31 – 1.19 (m, 6H, H-10 + H-12).

**<sup>13</sup>C NMR** (75 MHz, CDCl<sub>3</sub>):  $\delta$  (ppm) = 172.4 (C-8), 121.0 (CN), 79.9 (C-7), 65.5 (C-11), 62.0 (C-1), 61.3 (C-9), 43.4 (C-6), 42.8 (C-4), 34.3 (C-2/3), 28.4 (C-2/3), 28.1 (C-5), 15.2 (C-10/12), 14.3 (C-10/12).

**HRMS** (APCI): [M+H]<sup>+</sup> C<sub>13</sub>H<sub>22</sub>NO<sub>4</sub><sup>+</sup>: calcd. 256.1543, found 256.1552.

[ $\alpha$ ]<sub>D</sub><sup>25</sup> = -44.64 (c = 0.32, CHCl<sub>3</sub>).

#### Ethyl 2-cyano-1-formyl-2-(3-((triisopropylsilyloxy)propyl)cyclopropanecarboxylate (**559**)



In a 10 mL two-necked RBF, aminocyclobutane **533** (65 mg, 0.15 mmol, 1.0 eq.) was diluted in 2 mL of a 1:1 mixture of DMF/THF. NaHCO<sub>3</sub> (62 mg, 0.74 mmol, 5.0 eq.) and CAN (408 mg, 0.74 mmol, 5.0 eq.) were added at room temperature. The reaction showed full conversion after 30 minutes and was treated with a 0.1M HCl aqueous solution. The aqueous layer was extracted with Et<sub>2</sub>O (3 times) and the combined organic layers were washed with water and brine, dried over MgSO<sub>4</sub> and concentrated under reduced pressure. The obtained crude product was then purified by flash chromatography (cyclohexane/EtOAc 95:5) to afford **559** as two separable diastereoisomers (47% overall yield, d.r.  $\geq$  7:3).

Minor diastereoisomer (7.6 mg, 13%)

**R<sub>f</sub>** = 0.44 (cyclohexane/EtOAc 4:1).

**IR** (film, KBr)  $\nu_{\text{max}}$  (cm<sup>-1</sup>) = 2942, 2862, 2892, 2238, 1719, 1463, 1369, 1308, 1229, 1106.

**<sup>1</sup>H NMR** (600 MHz, CDCl<sub>3</sub>):  $\delta$  (ppm) = 10.25 (s, 1H, H-7), 4.39 (qd,  $J$  = 7.1, 1.2 Hz, 2H, H-9), 3.68 (m, 2H, H-1), 2.23 (d,  $J$  = 5.2 Hz, 1H, H-5a), 1.98 (d,  $J$  = 5.2 Hz, 1H, H-5b), 1.90 (ddd,  $J$  = 14.0, 10.6, 5.1 Hz, 1H, H-3a), 1.86 – 1.78 (m, 1H, H-2a), 1.67 (ddd,  $J$  = 14.0, 10.4, 4.9 Hz, 1H, H-3b), 1.63 – 1.54 (m, 1H, H-2b), 1.38 (t,  $J$  = 7.1 Hz, 3H, H-10), 1.12 – 1.01 (m, 21H, H-11 + H-12).

**<sup>13</sup>C NMR** (150 MHz, CDCl<sub>3</sub>):  $\delta$  (ppm) = 193.8 (C-7), 167.0 (C-8), 118.1 (CN), 63.0 (C-9), 61.8 (C-1), 42.2 (C-4), 31.3 (C-6), 31.2 (C-3), 25.8 (C-2), 23.4 (C-5), 18.1 (C-12), 14.3 (C-10), 12.1 (C-11).

**HRMS** (ESI): [M+MeOH+Na]<sup>+</sup> C<sub>21</sub>H<sub>39</sub>NO<sub>5</sub>SiNa: calcd. 436.2490, found 436.2505.

Major diastereoisomer (7.6 mg, 34%)

**R<sub>f</sub>** = 0.27 (cyclohexane/EtOAc 4:1).

**IR** (film, KBr)  $\nu_{\max}$  (cm<sup>-1</sup>) = 2942, 2866, 2892, 2239, 1718, 1463, 1370, 1299, 1257, 1178, 1155, 1105.

**<sup>1</sup>H NMR** (600 MHz, CDCl<sub>3</sub>):  $\delta$  (ppm) = 10.10 (s, 1H, H-7), 4.43 – 4.25 (m, 2H, H-9), 3.76 – 3.70 (m, 2H, H-1), 2.22 (d,  $J$  = 5.2 Hz, 1H, H-5a), 1.94 (d,  $J$  = 5.2 Hz, 1H, H-5b), 1.92 – 1.70 (m, 4H, H-2 + H-3), 1.36 (t,  $J$  = 7.1 Hz, 3H, H-9), 1.14 – 0.98 (m, 21H, H-11 + H-12).

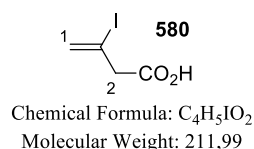
**<sup>13</sup>C NMR** (150 MHz, CDCl<sub>3</sub>):  $\delta$  (ppm) = 193.1 (C-7), 166.1 (C-8), 117.4 (CN), 62.9 (C-9), 61.9 (C-1), 43.6 (C-4), 30.5 (C-2/3), 29.8 (C-6), 27.7 (C-2/3), 23.9 (C-5), 18.1 (C-12), 14.3 (C-10), 12.0 (C-11).

**HRMS** (ESI): [M+MeOH+H]<sup>+</sup> C<sub>21</sub>H<sub>40</sub>NO<sub>5</sub>Si: calcd. 414.2670, found 414.2669.

$[\alpha]^{25}_{\text{D}}$  = 0.61 (c = 0.4, CHCl<sub>3</sub>).

## 5. Experimental part: Chapter V

### 3-iodobut-3-enoic acid<sup>311</sup> (**580**)

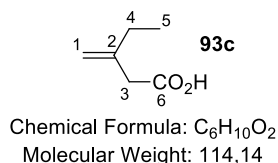


In a 25 mL RBF equipped with a reflux condenser, but-3-ynoic acid<sup>312</sup> **579** (3.6 g, 42 mmol, 1.0 eq.) was diluted in iodhydric acid (HI 57% in H<sub>2</sub>O, 8.2 mL, 47 mmol, 1.5 eq.) and the mixture was stirred at 70°C for 14 hours. The mixture was cooled down to 0°C and solid NaHCO<sub>3</sub> was added until a pH7 was reached. Then, conc. HCl was added to reach pH1 and the acidic aqueous layer was extracted with Et<sub>2</sub>O (3 times). The combined organic layers were dried over MgSO<sub>4</sub> and concentrated under reduced pressure. The obtained crude product was then purified by flash chromatography (PE/Et<sub>2</sub>O 90:10) to afford **580** (2.7 g, 30%).

**<sup>1</sup>H NMR** (300 MHz, CDCl<sub>3</sub>):  $\delta$  (ppm) = 6.25 (m, 1H, H-1a), 5.97 (d,  $J$  = 1.8 Hz, 1H, H-1b), 3.64 (d,  $J$  = 1.2 Hz, 2H, H-2).

The <sup>1</sup>H NMR data are in excellent agreement with those reported in the literature.

### 3-methylenepentanoic acid (**93c**)



In a 250 mL two-necked RBF, EtMgBr (3M in Et<sub>2</sub>O, 26 mL, 78 mmol, 3.2 eq.) was added dropwise at -50°C to a stirred solution of ZnCl<sub>2</sub> (1M in Et<sub>2</sub>O, 75 mL, 75 mmol, 3.1 eq.). The mixture was stirred 1 hours at -50°C and was then allowed to reach room temperature. The stirring was pursued for 5 hours. Then at 0°C, 100 mL of anhydrous DMF were added slowly. Vinyl iodide **580** (5.1 g, 24 mmol, 1.0 eq.) was then added in small portions. PdCl<sub>2</sub>(ACN)<sub>2</sub> (0.3 g, 1.2 mmol, 0.05 eq.) was introduced and the reaction mixture was stirred for 16 hours at room temperature. The reaction was quenched by adding a 1M HCl aqueous solution at 0°C. The aqueous layer was extracted with

<sup>311</sup> M. Abarbri, J.-L. Parrain, M. Kitamura, R. Noyori, A. Duchene, *J. Org. Chem.* **2000**, *65*, 7475-7478.

<sup>312</sup> But-3-ynoic acid was prepared from the oxidation of 3-butyne-1-ol on gram scale (~10g): A. Abbas, B. Xing, T.-P. Loh, *Angew. Chem. Int. Ed.* **2014**, *53*, 7491-7494.

Et<sub>2</sub>O (3 times). The combined organic layers were then extracted with a 1M NaOH aqueous solution (3 times). The aqueous layers were acidified to pH1 and finally extracted with Et<sub>2</sub>O (3 times). The combined organic layers were dried over MgSO<sub>4</sub> and concentrated under reduced pressure. The obtained crude product was then purified by flash chromatography (cyclohexane/EtOAc 95:5) to afford **93c** (1.1 g, 39%).

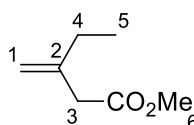
R<sub>f</sub> = 0.29 (cyclohexane/EtOAc 2:1).

IR (film, KBr)  $\nu_{\max}$  (cm<sup>-1</sup>) = 3230, 3086, 2970, 2939, 2679, 1712, 1651, 1409, 1293, 1220, 900.

<sup>1</sup>H NMR (300 MHz, CDCl<sub>3</sub>):  $\delta$  (ppm) = 4.98 – 4.96 (m, 1H, H-1a), 4.95 – 4.93 (m, 1H, H-1b), 3.11 (s, 2H, H-3), 2.15 (q, *J* = 7.4 Hz, 2H, H-4), 1.07 (t, *J* = 7.4 Hz, 3H, H-5).

<sup>13</sup>C NMR (75 MHz, CDCl<sub>3</sub>):  $\delta$  (ppm) = 178.5 (C-6), 143.5 (C-2), 113.1 (C-1), 42.0 (C-3), 28.8 (C-4), 12.1 (C-5).

### Methyl 3-methylenepentanoate (**93a**)



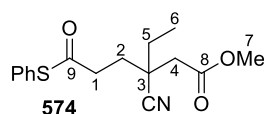
Chemical Formula: C<sub>7</sub>H<sub>12</sub>O<sub>2</sub>

Molecular Weight: 128,17

In a specific glassware equipped with a condenser, *N*-methyl-*N*-nitrosourea (7.2 g, 70 mmol, 8.0 eq.) was diluted in 40 mL of Et<sub>2</sub>O and 20 mL of water. At 0°C was added a KOH aqueous solution (6 g in 20 mL of H<sub>2</sub>O, 105 mmol, 12 eq.). Diazomethane was generated in situ, distilled at 40°C and transferred (by distillation) to the acid **93c** (1.0 g, 8.7 mmol, 1.0 eq.) diluted 40 mL of Et<sub>2</sub>O. The completion of the reaction is reached when a yellow colour appeared in the reaction flask. The excess of diazomethane is quenched by adding a solution of acetic acid in Et<sub>2</sub>O. The solvent was then evaporated carefully at room temperature under reduce pressure (volatile!!!) to afford **93a** as a colourless oil (quantitative).

<sup>1</sup>H NMR (300 MHz, CDCl<sub>3</sub>):  $\delta$  (ppm) = 4.94 – 4.87 (m, 2H, H-1), 3.69 (s, 3H, H-6), 3.06 (s, 2H, H-3), 2.21 – 2.02 (q, 2H, H-4), 1.05 (t, *J* = 7.4 Hz, 3H, H-5).

### Methyl 3-cyano-3-ethyl-6-oxo-6-(phenylthio)hexanoate (**574**)



Chemical Formula: C<sub>16</sub>H<sub>19</sub>NO<sub>3</sub>S

Molecular Weight: 305,39

Protocol 1: according to the general procedure **A** from *S*-phenyl 2-iodoethanethioate<sup>313</sup> (100 mg, 0.36 mmol, 1.0 eq.), alkene **93a** (92 mg, 0.72 mmol, 2 eq.), tosyl cyanide (130 mg, 0.72 mmol, 2.0 eq.), bis(tributyl)tin (0.27 mL, 0.54 mmol, 1.5 eq.) and DTBHN (3x6 mg, 3x0.04 mmol, 3x0.1 eq.) in dry benzene (4.0 mL). The crude product was purified by two successive flash chromatographies (cyclohexane/EtOAc 90:10 then toluene/EtOAc 98:2) to afford **574** as colourless oil (59 mg, 54%).

Protocol 2: In a 10 mL two-necked RBF, *S*-phenyl 2-iodoethanethioate (100 mg, 0.36 mmol, 1.0 eq.), alkene **93a** (92 mg, 0.72 mmol, 2 eq.), tosyl cyanide (130 mg, 0.72 mmol, 2.0 eq.) and bis(tributyl)tin (0.27 mL, 0.54 mmol, 1.5 eq.) were diluted in 4 mL of dry benzene and the mixture was degassed by argon sparging for 20 minutes. The reaction mixture was stirred for 4 hours while

<sup>313</sup> Synthesized according to: N. Truong, S. J. Sauer, C. Seraphin-Hatcher, D. M. Coltart, *Org. Biomol. Chem.* **2016**, *14*, 7864-7868.

being irradiated with a sun lamp. The solvent was evaporated and the crude product was purified by two successive flash chromatographies (cyclohexane/EtOAc 90:10 then toluene/EtOAc 98:2) to afford **574** as colourless oil (50 mg, 45%).

**Rf** = 0.31 (cyclohexane/EtOAc 4:1).

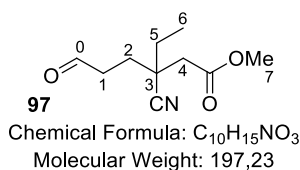
**IR** (film, KBr)  $\nu_{\max}$  (cm<sup>-1</sup>) = 2952, 2236, 1739, 1705, 1440, 1361, 1274, 1198, 984, 748.

**<sup>1</sup>H NMR** (300 MHz, CDCl<sub>3</sub>):  $\delta$  (ppm) = 7.41 (s, 5H, SPh), 3.73 (s, 3H, H-7), 2.92 – 2.83 (m, 2H, H-1), 2.62 (d, *J* = 1.1 Hz, 2H, H-4), 2.16 – 2.07 (m, 2H, H-2), 1.77 (q, *J* = 7.5 Hz, 2H, H-5), 1.08 (t, *J* = 7.4 Hz, 2H, H-6).

**<sup>13</sup>C NMR** (75 MHz, CDCl<sub>3</sub>):  $\delta$  (ppm) = 195.9 (C-9), 169.2 (C-8), 134.6 (Ph), 129.7 (Ph), 129.4 (Ph), 127.2 (Ph), 121.6 (CN), 52.2 (C-7), 39.4 (C-4), 39.0 (C-3), 39.0 (C-1), 31.2 (C-2), 29.7 (C-5), 9.0 (C-6).

**HRMS** (ESI): [M+Na]<sup>+</sup> C<sub>16</sub>H<sub>19</sub>NO<sub>3</sub>Na: calcd. 328.0977, found 328.0973.

### Methyl 3-cyano-3-ethyl-6-oxohexanoate (**97**)



In a dried 10 mL two-necked RBF, thioester **574** (115 mg, 0.38 mmol, 1.0 eq.) was diluted in 3 mL of dry acetone. Pd/C (2mg, 0.019 mmol, 0.05 eq.) was introduced and the flask was flushed with argon. Then, freshly distilled Et<sub>3</sub>SiH (0.18 mL, 1.13 mmol, 3.0 eq.) was added at room temperature. The reaction mixture was stirred for 1 hour and filtered off through a celite pad and the filter cake was rinsed with EtOAc. The filtrate was evaporated under reduced pressure and the crude product was purified by flash chromatography (cyclohexane/EtOAc 60/40) to afford **97** as colourless oil (60 mg, 80%).

**Rf** = 0.24 (cyclohexane/EtOAc 4:1).

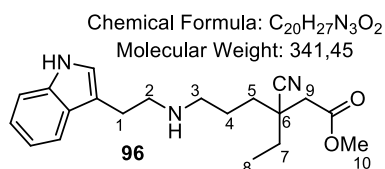
**IR** (film, KBr)  $\nu_{\max}$  (cm<sup>-1</sup>) = 2955, 2924, 2852, 2733, 2235, 1738, 1438, 1361, 1199.

**<sup>1</sup>H NMR** (300 MHz, CDCl<sub>3</sub>):  $\delta$  (ppm) = 9.83 (s, 1H, H-0), 3.73 (s, 3H, H-7), 2.76 – 2.67 (m, 2H, H-1), 2.62 (d, *J* = 1.8 Hz, 2H, H-4), 2.14 – 1.95 (m, 2H, H-2), 1.77 (q, *J* = 7.4 Hz, 2H, H-5), 1.09 (t, *J* = 7.4 Hz, 3H, H-6).

**<sup>13</sup>C NMR** (75 MHz, CDCl<sub>3</sub>):  $\delta$  (ppm) = 199.8 (C-0), 169.3 (CO<sub>2</sub>Me), 121.8 (CN), 52.2 (C-7), 39.5 (C-1/4), 39.4 (C-1/4), 39.0 (C-3), 29.8 (C-5), 28.2 (C-2), 9.0 (C-6).

**HRMS** (ESI): [M+Na]<sup>+</sup> C<sub>10</sub>H<sub>15</sub>NO<sub>3</sub>Na: calcd. 220.0944, found 220.0942.

### Methyl 6-((2-(1H-indol-3-yl)ethyl)amino)-3-cyano-3-ethylhexanoate (**96**)



In a 10 mL two-necked RBF, aldehyde **97** (77 mg, 0.39 mmol, 1.0 eq.) was diluted in 1 mL of dry MeOH and a solution of tryptamine (69 mg, 0.43 mmol, 1.1 eq.) in 1 mL of MeOH was added. The reaction mixture was stirred at room temperature for 16 hours and cooled at 0°C. NaBH<sub>4</sub> (29 mg, 0.78 mmol, 2.0 eq.) was added in one portion and the reaction mixture was allowed to reach room temperature. The stirring was continued for 1 hour. The solvent was evaporated under reduced pressure and the residues were diluted in EtOAc and treated with a saturated aqueous

solution of NaHCO<sub>3</sub>. The aqueous layer was extracted with EtOAc and the combined organic layers were washed with water and brine, dried over MgSO<sub>4</sub> and concentrated under reduced pressure. The obtained crude product was then purified by flash chromatography (DCM/MeOH 90:10) to afford **96** (87 mg, 65%).

**R<sub>f</sub>** = 0.35 (DCM/MeOH 9:1).

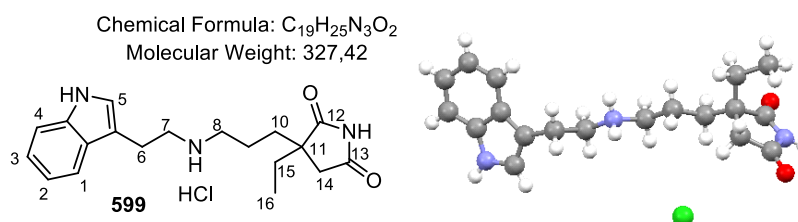
**IR** (film, KBr)  $\nu_{\text{max}}$  (cm<sup>-1</sup>) = 3406, 3218, 3054, 2952, 2881, 2453, 2236, 1738, 1619, 1557, 1456, 1436, 1409, 1340, 1208.

**<sup>1</sup>H NMR** (300 MHz, CDCl<sub>3</sub>):  $\delta$  (ppm) = 8.64 (s, 1H, N-H), 7.59 (d, *J* = 7.8 Hz, 1H, H<sub>indole</sub>), 7.36 (d, *J* = 8.1 Hz, 1H, H<sub>indole</sub>), 7.24 – 7.02 (m, 3H, H<sub>indole</sub>), 6.15 (s, 1H, N-H), 3.68 (s, 3H, H-10), 3.06 (m, 4H, H-1 + H-2), 2.78 – 2.69 (m, 2H, H-3), 2.51 (s, 2H, H-9), 1.75 – 1.57 (m, 6H, H-4 + H-5 + H-7), 0.98 (t, *J* = 7.4 Hz, 3H, H-8).

**<sup>13</sup>C NMR** (75 MHz, CDCl<sub>3</sub>):  $\delta$  (ppm) = 169.7 (CO<sub>2</sub>Me), 136.6, 127.2, 122.8, 122.3, 122.2, 119.5, 118.7, 112.2, 111.5, 52.1 (C-10), 48.8 (C-2/3), 48.4 (C-2/3), 39.3 (C-6), 39.2 (C-9), 33.5 (CH<sub>2</sub>), 29.5 (CH<sub>2</sub>), 24.3 (CH<sub>2</sub>), 23.5 (CH<sub>2</sub>), 8.9 (C-8).

**HRMS** (ESI): [M+H]<sup>+</sup> C<sub>20</sub>H<sub>28</sub>N<sub>3</sub>O<sub>2</sub>: calcd. 342.2176, found 342.2172.

### 3-(3-((2-(1H-indol-3-yl)ethyl)amino)propyl)-3-ethylpyrrolidine-2,5-dione (**599**)



In a 10 mL sealed tube, amino nitrile **96** (116 mg, 0.34 mmol, 1.0 eq.) was diluted in 2 mL of MeOH and HCl (37%, 2 mL) was added dropwise. The sealed tube was closed and the reaction mixture was stirred at 65°C for 20 hours. At room temperature, the mixture was neutralised with a saturated aqueous solution of NaHCO<sub>3</sub> and the solvents were evaporated under reduced pressure. The solid residues were diluted in a mixture of DCM/MeOH 9:1 and the mixture was filtered off, the filter cake being washed several times. The filtrate was then dried over MgSO<sub>4</sub> and concentrated under reduced pressure. The obtained crude product was then purified by flash chromatography (DCM/MeOH 90:10 to 80:20) to afford **599** as white solid (25 mg, 22%).

**R<sub>f</sub>** = 0.53 (DCM/MeOH 8:2).

**m. p.** = 97-101°C (DCM/MeOH).

**IR** (film, KBr)  $\nu_{\text{max}}$  (cm<sup>-1</sup>) = 3284, 3163, 3056, 2963, 2875, 2811, 2451, 1775, 1714, 1455, 1354, 1329.

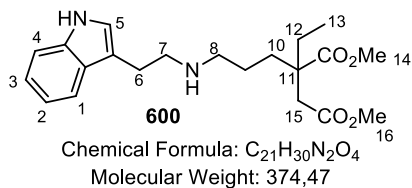
**<sup>1</sup>H NMR** (300 MHz, MeOD):  $\delta$  (ppm) = 7.53 (d, *J* = 7.6 Hz, 1H, H-1/4), 7.32 (d, *J* = 8.0 Hz, 1H, H-1/4), 7.12 (s, 1H, H-5), 7.10 – 6.95 (m, 2H, H-2 + H-3), 3.20 – 3.04 (m, 2H, H-6 + H-7), 2.87 (t, *J* = 7.2 Hz, 2H, H-8), 2.51 (s, 2H, H-14), 1.73 – 1.43 (m, 6H, H-9 + H-10 + H-15), 0.83 (t, *J* = 7.5 Hz, 3H, H-16).

**<sup>13</sup>C NMR** (75 MHz, MeOD):  $\delta$  (ppm) = 185.1 (C-12/13), 179.4 (C-12/13), 138.2 (Ind.), 128.2 (Ind.), 124.2 (Ind.), 122.7 (Ind.), 120.0 (Ind.), 119.0 (Ind.), 112.5 (Ind.), 110.6 (Ind.), 50.2 (C-11), 49.5 (C-7), 49.0 (C-8), 39.7 (C-14), 34.3 (C-9/10), 30.6 (C-9/10), 23.8 (C-6), 22.6 (C-15), 8.7 (C-16).

**HRMS** (ESI): [M+H]<sup>+</sup> C<sub>19</sub>H<sub>26</sub>N<sub>3</sub>O<sub>2</sub>: calcd. 328.2019 found 328.2030.

**X-Ray crystallography:** the crystal suitable for X-ray-measurement was obtained by diffusion (DCM/MeOH).

**dimethyl 2-(3-((2-(1H-indol-3-yl)ethyl)amino)propyl)-2-ethylsuccinate (600)**



The same protocol than **599** was followed. The obtained crude product was then purified by flash chromatography (DCM/MeOH 90:10 to 80:20) to afford **600** as yellow oil (15 mg, 12%).

**R<sub>f</sub>** = 0.68 (DCM/MeOH 8:2).

**IR** (film, KBr)  $\nu_{\text{max}}$  (cm<sup>-1</sup>) = 3362, 2953, 2790, 1725, 1602, 1458, 1435, 1340, 1230, 1199.

**<sup>1</sup>H NMR** (300 MHz, CDCl<sub>3</sub>):  $\delta$  (ppm) = 7.50 – 7.45 (m, 1H, H<sub>indole</sub>), 7.28 – 7.25 (m, 1H, H<sub>indole</sub>), 7.07 (s, 1H, H<sub>indole</sub>), 7.05 – 6.91 (m, 2H, H<sub>indole</sub>), 3.57 (s, 3H, H-14/16), 3.52 (s, 3H, H-14/16), 3.18 – 3.11 (m, 2H, H-7), 3.07 – 2.99 (m, 2H, H-6), 2.84 (t, *J* = 7.5 Hz, 2H, H-8), 2.58 (d, *J* = 15.9 Hz, 1H, H-15a), 2.51 (d, *J* = 15.9 Hz, 1H, H-15b), 1.65 – 1.37 (m, 6H, H-9 + H-10 + H-12), 0.72 (t, *J* = 7.5 Hz, 3H, H-13).

**<sup>13</sup>C NMR** (75 MHz, CDCl<sub>3</sub>):  $\delta$  (ppm) = 177.2 (CO<sub>2</sub>Me), 173.1 (CO<sub>2</sub>Me), 138.3 (Ind.), 128.2 (Ind.), 124.1 (Ind.), 122.7 (Ind.), 120.0 (Ind.), 118.9 (Ind.), 112.5 (Ind.), 110.5 (Ind.), 52.5 (C-14/16), 52.1 (C-14/16), 49.5 (C-7/8), 49.2 (C-7/8), 49.0 (C-11), 39.3 (C-15), 32.1 (CH<sub>2</sub>), 29.2 (CH<sub>2</sub>), 23.7 (C-6), 22.5 (CH<sub>2</sub>), 8.7 (C-13).

**HRMS** (ESI): [M+H]<sup>+</sup> C<sub>21</sub>H<sub>31</sub>N<sub>2</sub>O<sub>4</sub>: calcd. 375.2278 found 375.227

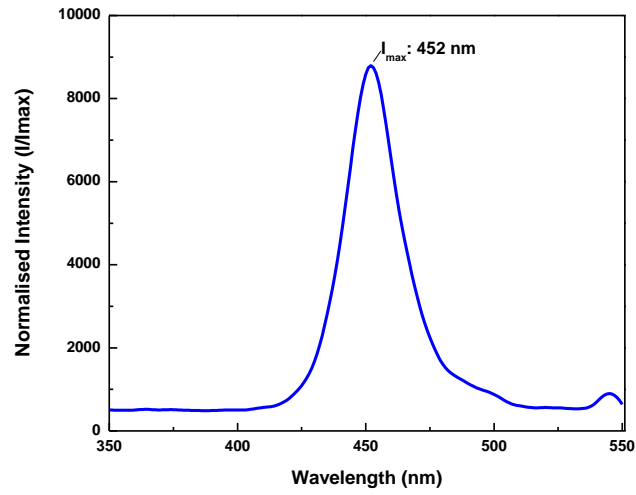
# **Annex**



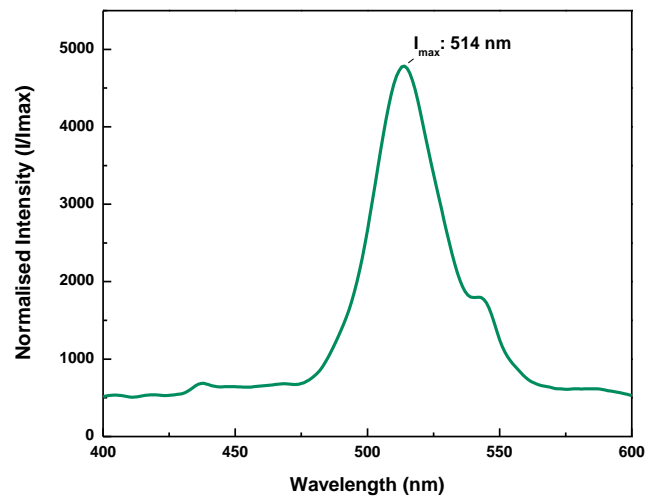


# Annex

## 1. Emission profile of the LEDs

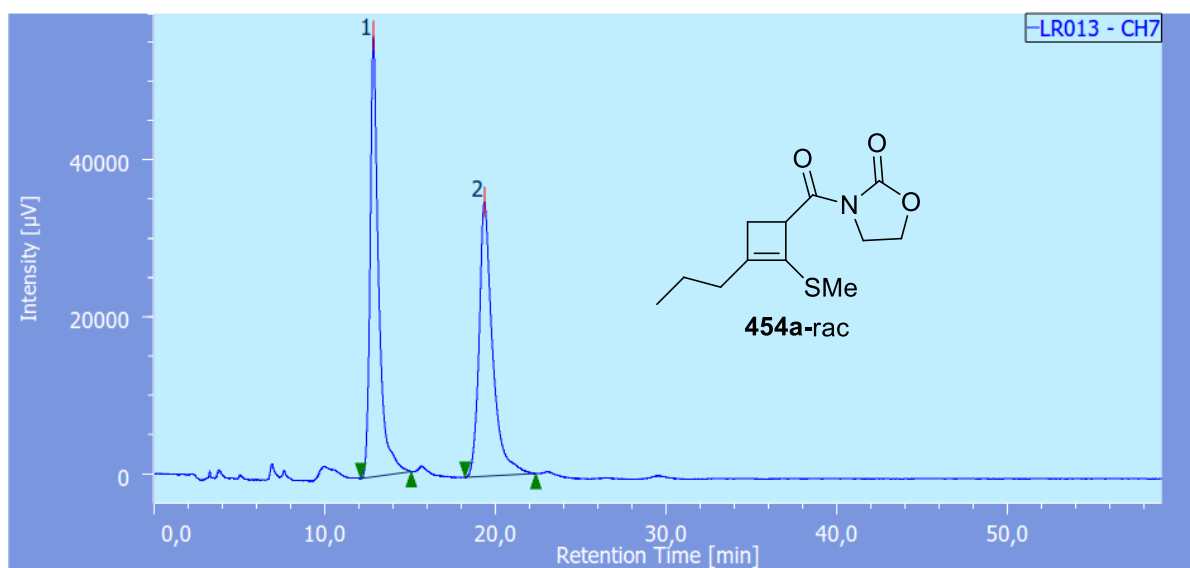


**Figure S1.** The emission spectrum of the blue LEDs.



**Figure S2.** The emission spectrum of the green LEDs.

## 2. Enantiomeric excess measurements



### Chromatogram Information

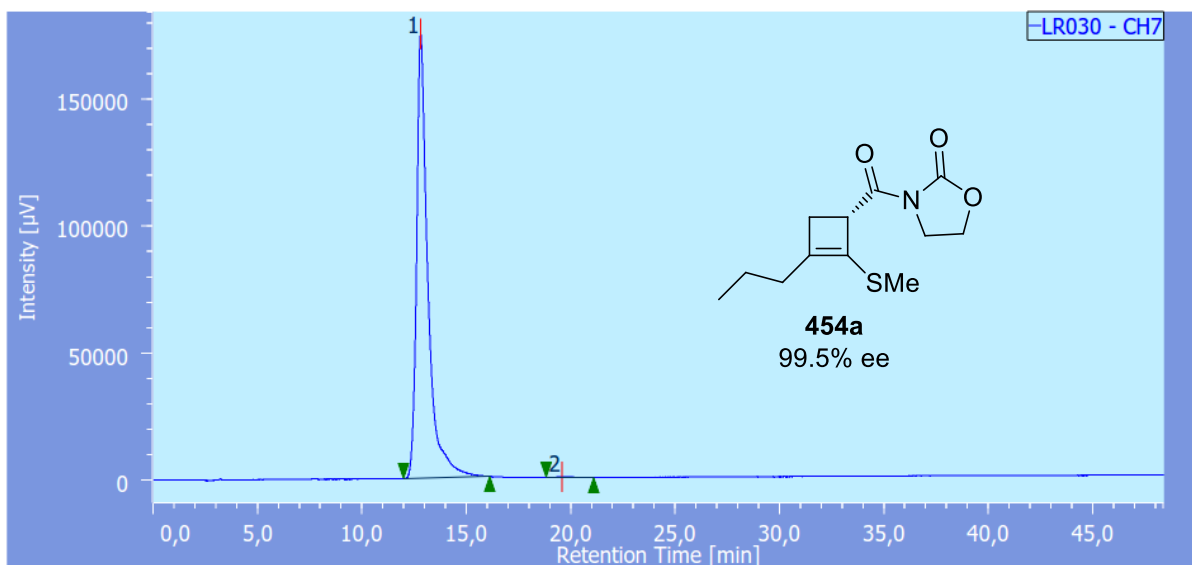
User Name Administrator  
 Date Modified 06/02/2018 16:55:02  
 Description  
 HPLC System Name Orga  
 Injection Date 14/03/2017 16:31:23  
 Volume 20,00 [µL]  
 Sample Number 4  
 Project Name Test  
 Acquisition Time 59,0 [min]  
 Acquisition Sequence LR013-Racemic6-90-Hx-10-EtOH  
 Control Method 90A-Hx 10B-EtOH 60Min  
 Peak ID Table  
 Calibration Method  
 Additional Information

### Channel & Peak Information Table

Chromatogram Name LR013-CH7  
 Sample Name  
 Channel Name 257,0nm  
 Sampling Interval 100 [msec]  
 Peak Method NSD (Manual)

Formula  
 Decision

#	Peak Name	CH	tR [min]	Area [µV·sec]	Height [µV]	Area%	Height%	Quantity	NTP	Resolution	Symmetry Factor	Warning
1	Unknown	7	12,842	1952723	56080	50,556	61,640	N/A	4220	6,318	1,686	
2	Unknown	7	19,342	1909791	34901	49,444	38,360	N/A	3696	N/A	1,502	



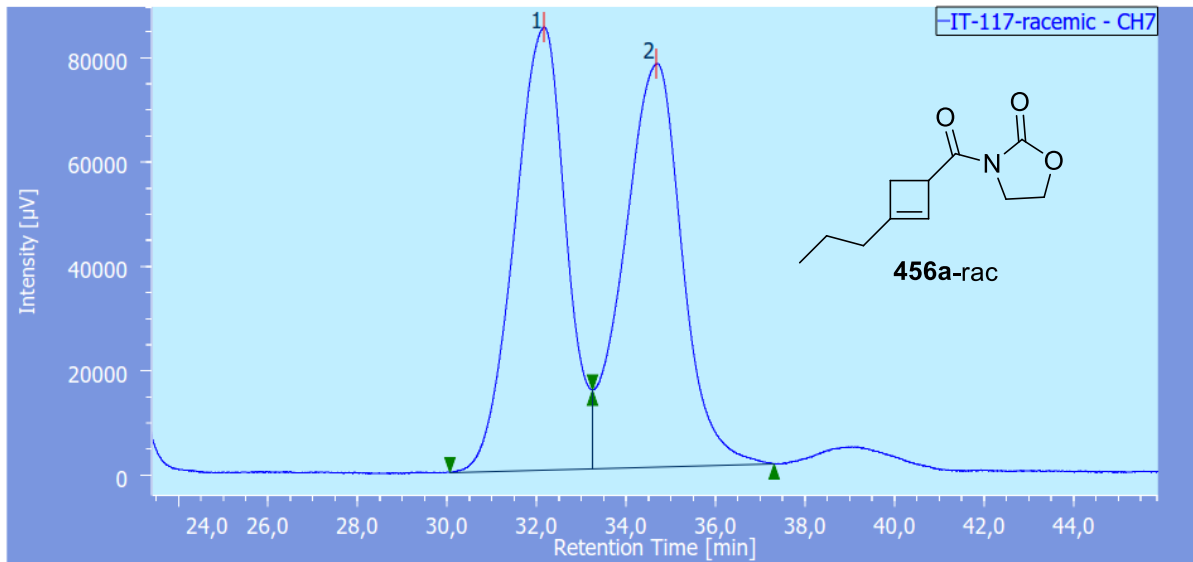
#### Chromatogram Information

User Name Administrator  
 Date Modified 08/03/2018 17:23:37  
 Description  
 HPLC System Name Orga  
 Injection Date 15/03/2017 14:21:22  
 Volume 20,00 [ $\mu\text{L}$ ]  
 Sample Number 5  
 Project Name Test  
 Acquisition Time 59,0 [min]  
 Acquisition Sequence LR030-Enantio1-90-Hx-10-EtOH  
 Control Method 90A-Hx 10B-EtOH 60Min  
 Peak ID Table  
 Calibration Method  
 Additional Information

#### Channel & Peak Information Table

Chromatogram Name LR030-CH7  
 Sample Name  
 Channel Name 257,0nm  
 Sampling Interval 100 [msec]  
 Peak Method IT (Manual)  
 Formula  
 Decision

#	Peak Name	CH	tR [min]	Area [ $\mu\text{V}\cdot\text{sec}$ ]	Height [ $\mu\text{V}$ ]	Area%	Height%	Quantity	NTP	Resolution	Symmetry Factor	Warning
1	Unknown	7	12,807	6584686	174826	99,779	99,800	N/A	3612	6,836	1,812	
2	Unknown	7	19,565	14573	351	0,221	0,200	N/A	4796	N/A	1,675	



**Chromatogram Information**

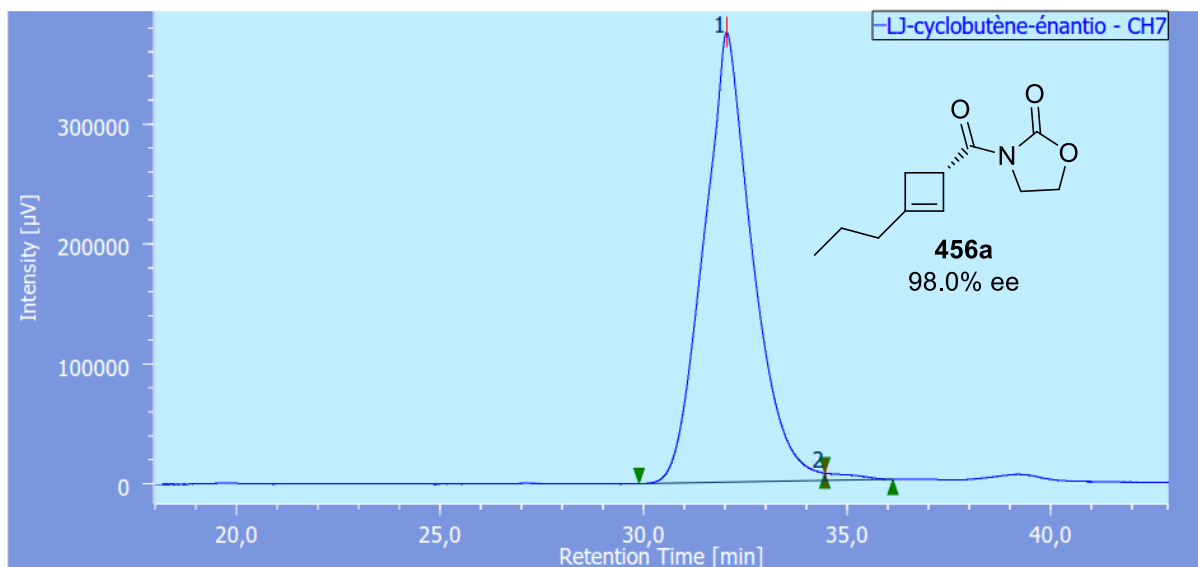
User Name Administrator  
 Date Modified 20/02/2018 17:52:54  
 Description  
 HPLC System Name Orga  
 Injection Date 20/02/2018 15:27:25  
 Volume 20,00 [µL]  
 Sample Number 36  
 Project Name Test  
 Acquisition Time 59,0 [min]  
 Acquisition Sequence IT-117-Rac1-90-Hx-10-EtOH 1 mL-min 20° C IA  
 Control Method 90A-Hx 10D-EtOH 60Min-1ml-min 20° C  
 Peak ID Table  
 Calibration Method  
 Additional Information

**Channel & Peak Information Table**

Chromatogram Name IT-117-racemic-CH7  
 Sample Name  
 Channel Name 211,0nm  
 Sampling Interval 100 [msec]  
 Peak Method IT (Manual)

Formula  
 Decision

#	Peak Name	CH	tR [min]	Area [µV·sec]	Height [µV]	Area%	Height%	Quantity	NTP	Resolution	Symmetry Factor	Warning
1	Unknown	7	32.163	6779831	84809	49,142	52,346	N/A	3759	1,128	N/A	
2	Unknown	7	34.662	7016581	77207	50,858	47,654	N/A	3506	N/A	N/A	



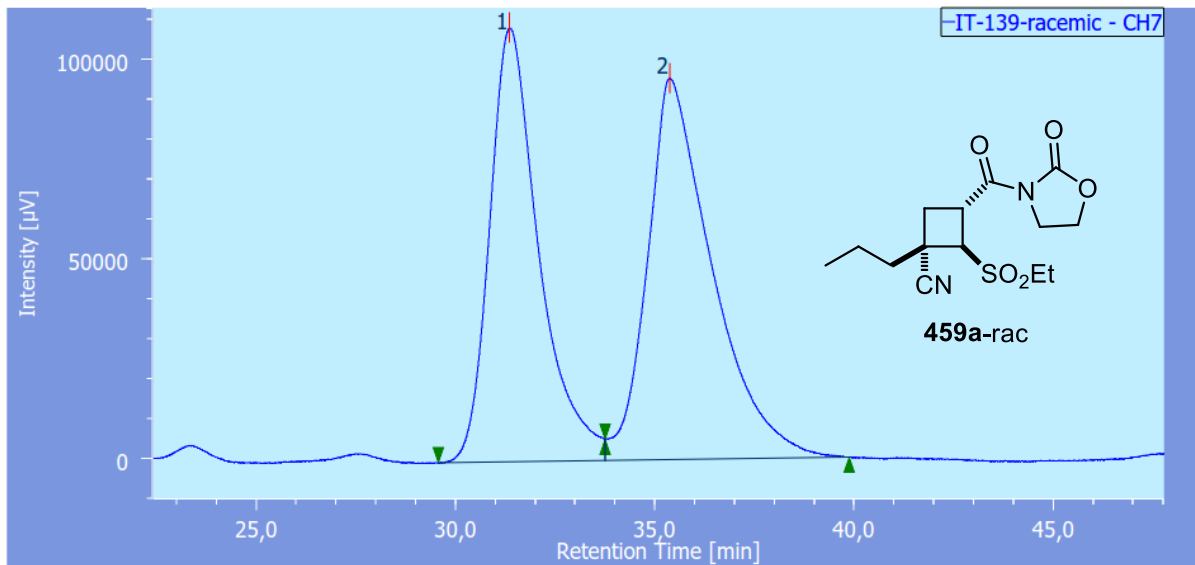
Chromatogram Information

User Name Administrator  
 Date Modified 20/02/2018 17:52:50  
 Description  
 HPLC System Name Orga  
 Injection Date 20/02/2018 17:09:48  
 Volume 20,00 [µL]  
 Sample Number 38  
 Project Name Test  
 Acquisition Time 59,0 [min]  
 Acquisition Sequence LJ-cyclobutène-chiral-90-Hx-10-EtOH 1 mL-min 20° C IA  
 Control Method 90A-Hx 10D-EtOH 60Min-1ml-min 20° C  
 Peak ID Table  
 Calibration Method  
 Additional Information

Channel & Peak Information Table

Chromatogram Name LJ-cyclobutène-énantio-CH7  
 Sample Name  
 Channel Name 211,0nm  
 Sampling Interval 100 [msec]  
 Peak Method IT (Manual)  
 Formula  
 Decision

#	Peak Name	CH	tR [min]	Area [µV·sec]	Height [µV]	Area%	Height%	Quantity	NTP	Resolution	Symmetry Factor	Warning
1	Unknown	7	32.032	31300193	375013	99,030	98,377	N/A	3597	N/A	1,151	
2	Unknown	7	34.455	306544	6189	0,970	1,623	N/A	N/A	N/A	N/A	



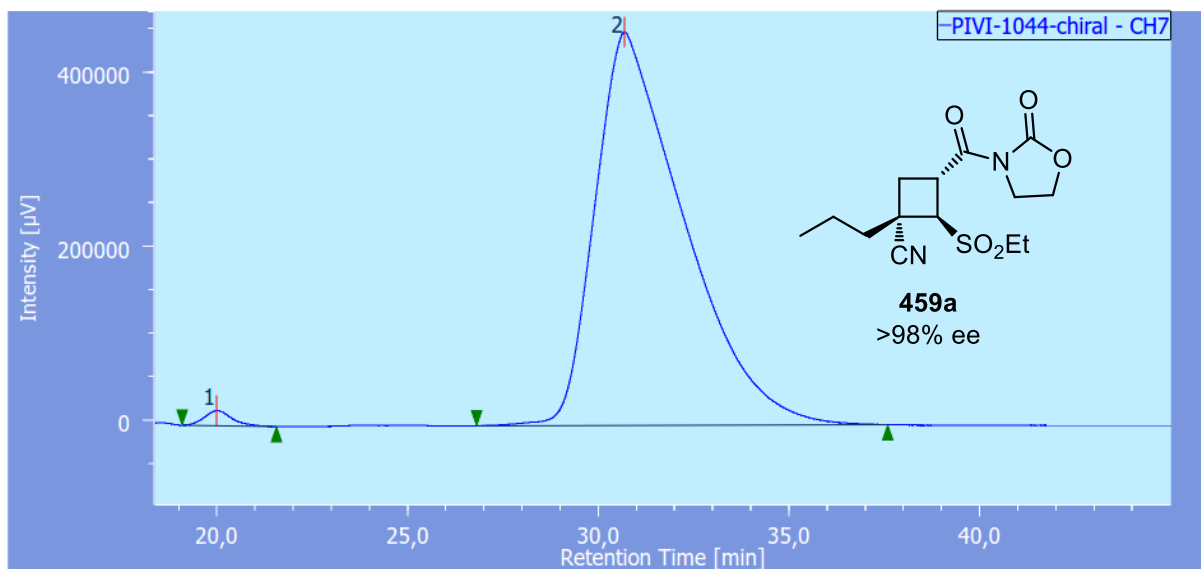
**Chromatogram Information**

User Name Administrator  
 Date Modified 07/03/2018 17:39:56  
 Description  
 HPLC System Name Orga  
 Injection Date 07/03/2018 16:49:19  
 Volume 20,00 [µL]  
 Sample Number 1  
 Project Name Test  
 Acquisition Time 59,0 [min]  
 Acquisition Sequence IT-139-Rac-75-Hx-25-EtOH 1mL-min 20° C IA  
 Control Method 75A-Hx 25D-EtOH 60Min-1ml-min 20° C  
 Peak ID Table  
 Calibration Method  
 Additional Information

**Channel & Peak Information Table**

Chromatogram Name IT-139-racemic-CH7  
 Sample Name  
 Channel Name 209.0nm  
 Sampling Interval 100 [msec]  
 Peak Method IT (Manual)  
 Formula  
 Decision

#	Peak Name	CH	tR [min]	Area [µV·sec]	Height [µV]	Area%	Height%	Quantity	NTP	Resolution	Symmetry Factor	Warning
1	Unknown	7	31,352	9325166	108593	46,409	53,208	N/A	3516	1,638	1,579	
2	Unknown	7	35,368	10768180	95500	53,591	46,792	N/A	2548	N/A	N/A	



**Chromatogram Information**

User Name Administrator  
 Date Modified 09/03/2018 17:39:52  
 Description  
 HPLC System Name Orga  
 Injection Date 09/03/2018 16:50:11  
 Volume 20,00 [µL]  
 Sample Number 4  
 Project Name Test  
 Acquisition Time 59,0 [min]  
 Acquisition Sequence PIVI-1044-Chiral-100-EtOH 1mL-min 20° C IA  
 Control Method 100D-EtOH 60Min-1ml-min 20° C  
 Peak ID Table  
 Calibration Method  
 Additional Information

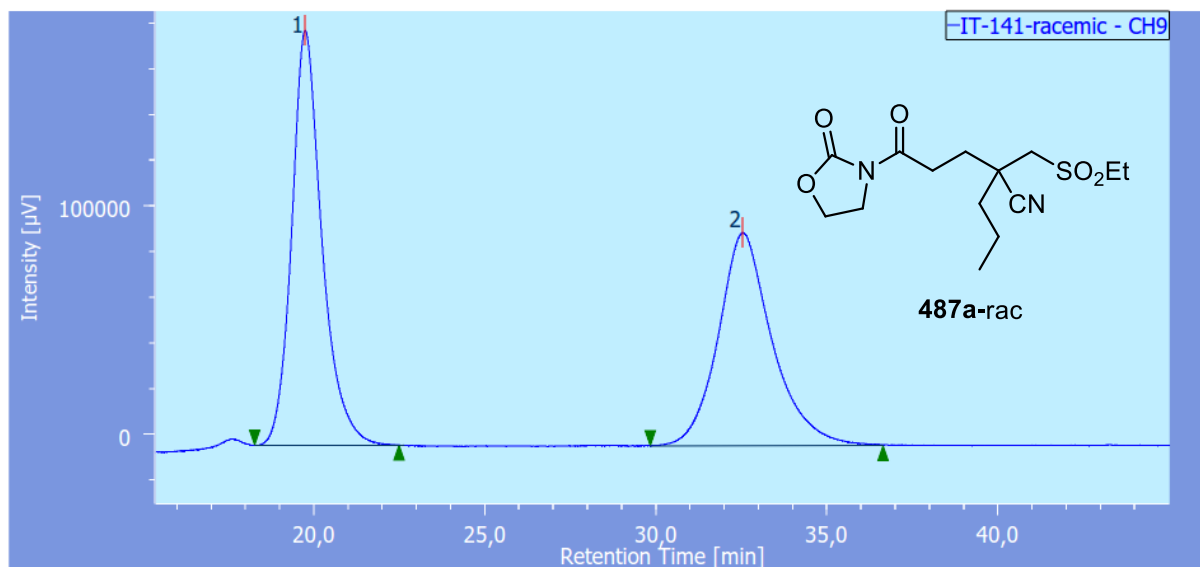
**Channel & Peak Information Table**

Chromatogram Name PIVI-1044-chiral-CH7  
 Sample Name  
 Channel Name 209,0nm  
 Sampling Interval 100 [msec]  
 Peak Method IT (Manual)

Formula  
 Decision

#	Peak Name	CH	tR [min]	Area [µV·sec]	Height [µV]	Area%	Height%	Quantity	NTP	Resolution	Symmetry Factor	Warning
1	Unknown	7	19,993	883550	17508	1,191	3,731	N/A	3986	3,897	1,243	
2	Unknown	7	30,678	73306223	451811	98,809	96,269	N/A	841	N/A	1,738	





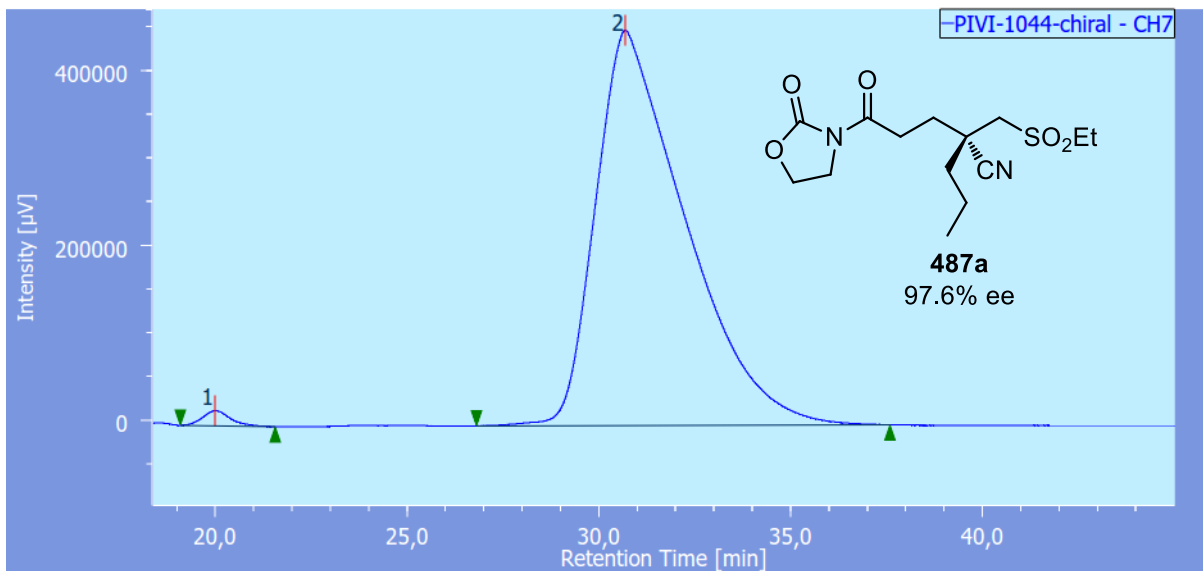
#### Chromatogram Information

User Name Administrator  
 Date Modified 09/03/2018 16:25:28  
 Description  
 HPLC System Name Orga  
 Injection Date 09/03/2018 15:26:25  
 Volume 20,00 [µL]  
 Sample Number 3  
 Project Name Test  
 Acquisition Time 59,0 [min]  
 Acquisition Sequence IT-141-Rac-100-EtOH 1mL-min 20° C IA  
 Control Method 100D-EtOH 60Min-1ml-min 20° C  
 Peak ID Table  
 Calibration Method  
 Additional Information

#### Channel & Peak Information Table

Chromatogram Name IT-141-racemic-CH9  
 Sample Name  
 Channel Name 208,3nm  
 Sampling Interval 100 [msec]  
 Peak Method IT (Manual)  
 Formula  
 Decision

#	Peak Name	CH	tR [min]	Area [µV·sec]	Height [µV]	Area%	Height%	Quantity	NTP	Resolution	Symmetry Factor	Warning
1	Unknown	9	19,748	11182181	181591	52,316	66,089	N/A	2722	6,114	1,240	
2	Unknown	9	32,528	10192269	93177	47,684	33,911	N/A	2362	N/A	1,200	



#### Chromatogram Information

User Name Administrator  
 Date Modified 09/03/2018 17:39:52  
 Description  
 HPLC System Name Orga  
 Injection Date 09/03/2018 16:50:11  
 Volume 20.00 [µL]  
 Sample Number 4  
 Project Name Test  
 Acquisition Time 59.0 [min]  
 Acquisition Sequence PIVI-1044-Chiral-100-EtOH 1mL-min 20° C IA  
 Control Method 100D-EtOH 60Min-1ml-min 20° C  
 Peak ID Table  
 Calibration Method  
 Additional Information

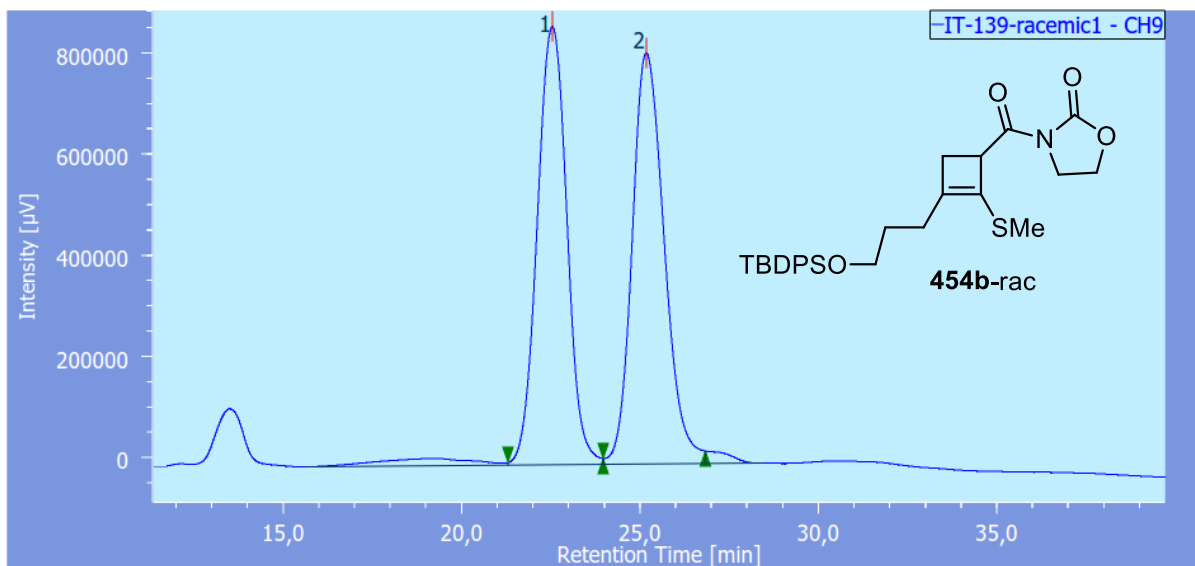
#### Channel & Peak Information Table

Chromatogram Name PIVI-1044-chiral-CH7  
 Sample Name  
 Channel Name 209.0nm  
 Sampling Interval 100 [msec]  
 Peak Method IT (Manual)

#### Formula

#### Decision

#	Peak Name	CH	tR [min]	Area [µV-sec]	Height [µV]	Area%	Height%	Quantity	NTP	Resolution	Symmetry Factor	Warning
1	Unknown	7	19.993	883550	17508	1.191	3.731	N/A	3986	3.897	1.243	
2	Unknown	7	30.678	73306223	451811	98.809	96.269	N/A	841	N/A	1.738	



**Chromatogram Information**

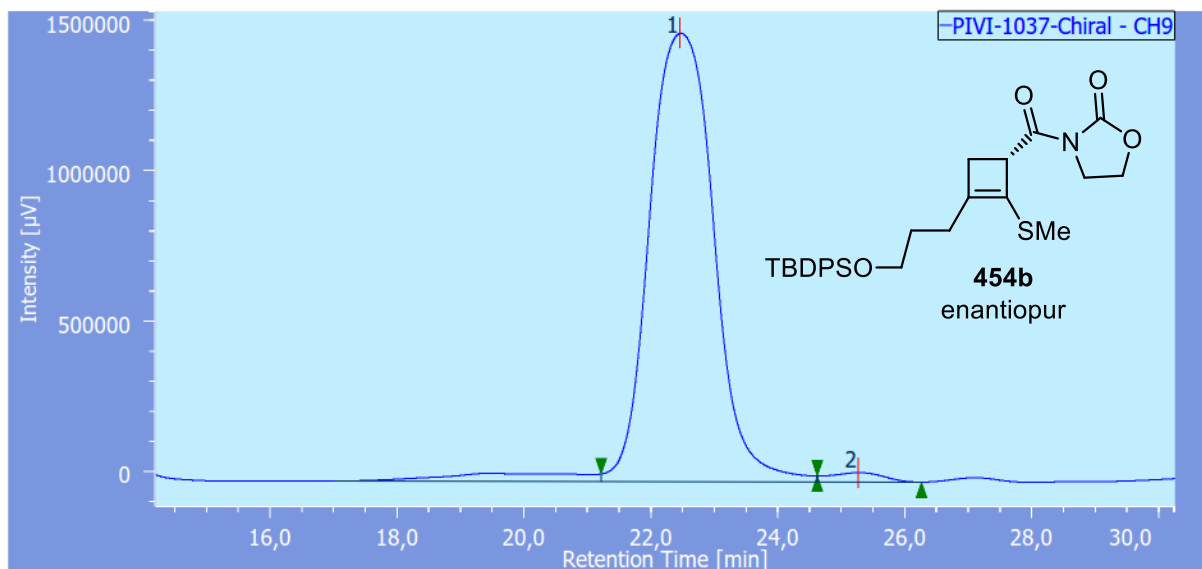
User Name Administrator  
 Date Modified 14/03/2018 12:09:23  
 Description  
 HPLC System Name Orga  
 Injection Date 14/03/2018 11:27:23  
 Volume 20.00 [µL]  
 Sample Number 6  
 Project Name Test  
 Acquisition Time 59.0 [min]  
 Acquisition Sequence PIVI-1032f1-Rac1-95-Hx-5-EtOH 0.5mL-min 20° C IA  
 Control Method 95A-Hx 5D-EtOH 60Min-0.5ml-min 20° C  
 Peak ID Table  
 Calibration Method  
 Additional Information

**Channel & Peak Information Table**

Chromatogram Name IT-139-racemic1-CH9  
 Sample Name  
 Channel Name 212,2nm  
 Sampling Interval 100 [msec]  
 Peak Method IT (Manual)

Formula  
 Decision

#	Peak Name	CH	tR [min]	Area [µV·sec]	Height [µV]	Area%	Height%	Quantity	NTP	Resolution	Symmetry Factor	Warning
1	Unknown	9	22,538	50001586	865799	49,580	51,595	N/A	3462	1,672	1,026	
2	Unknown	9	25,170	50849270	812285	50,420	48,405	N/A	3847	N/A	1,231	



#### Chromatogram Information

User Name Administrator  
 Date Modified 14/03/2018 15:35:49  
 Description  
 HPLC System Name Orga  
 Injection Date 14/03/2018 15:05:28  
 Volume 20,00 [µL]  
 Sample Number 7  
 Project Name Test  
 Acquisition Time 59,0 [min]  
 Acquisition Sequence PIVI-1037f1-Chiral-95-Hx-5-EtOH 0.5mL-min 20° C IA  
 Control Method 95A-Hx 5D-EtOH 60Min-0.5ml-min 20° C  
 Peak ID Table  
 Calibration Method  
 Additional Information

#### Channel & Peak Information Table

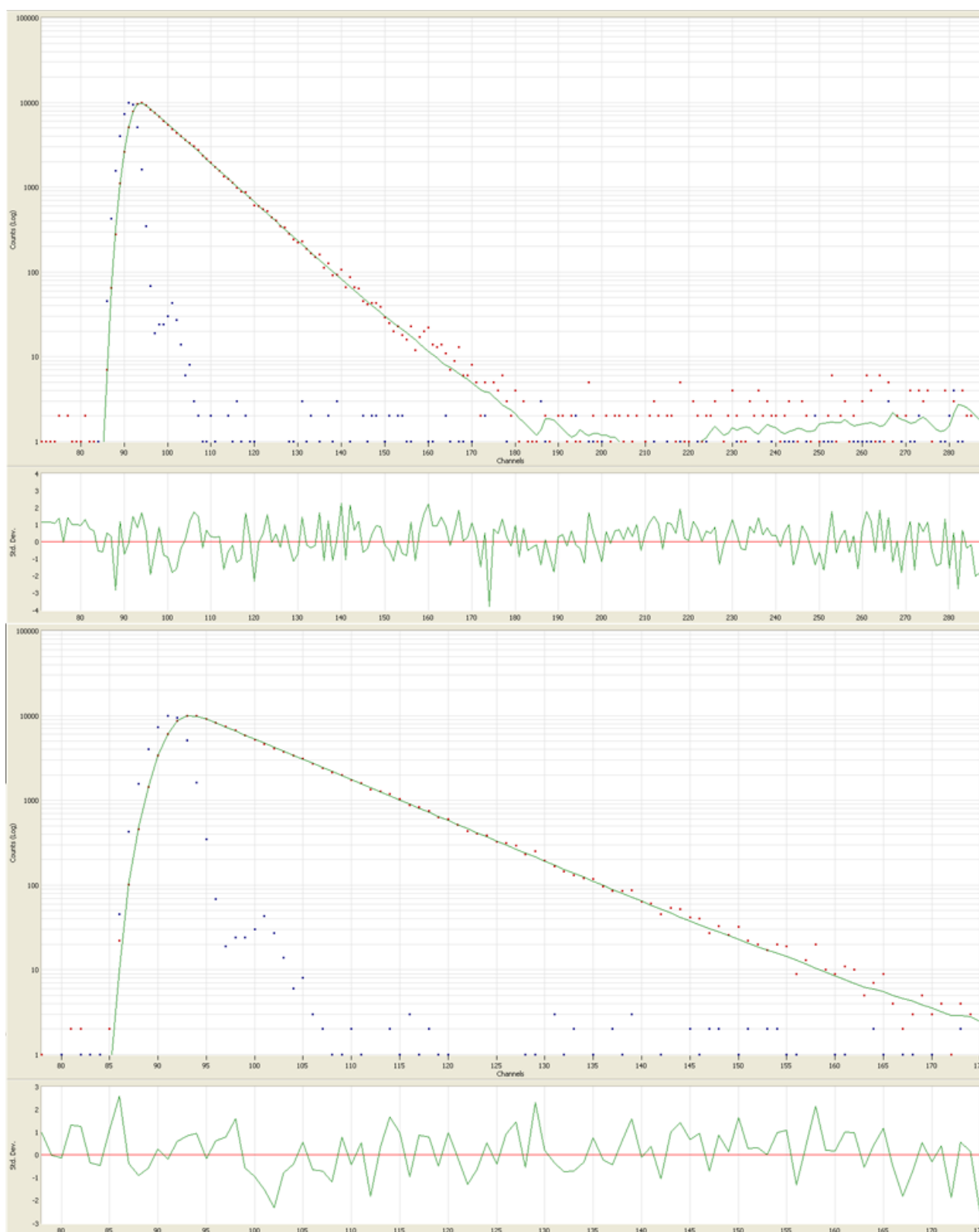
Chromatogram Name PIVI-1037-Chiral-CH9  
 Sample Name  
 Channel Name 212,2nm  
 Sampling Interval 100 [msec]  
 Peak Method IT (Manual)

Formula  
Decision

#	Peak Name	CH	tR [min]	Area [µV-sec]	Height [µV]	Area%	Height%	Quantity	NTP	Resolution	Symmetry Factor	Warning
1	Unknown	9	22,452	104498387	1489548	98,284	97,950	N/A	2328	N/A	1,135	
2	Unknown	9	25,257	1824633	31175	1,716	2,050	N/A	N/A	N/A	N/A	

### 3. Fluorescence lifetime

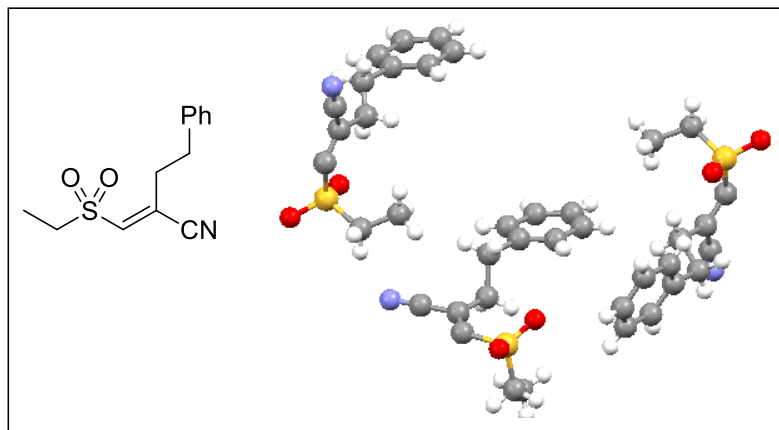
Fluorescence decay profiles were collected at 570 nm using the single photon counting technique on a Horiba Jobin-Yvon Fluorolog 211 instrument using a 560-nm pulsed LED excitation source operated at 1 MHz and a cooled Hamamatsu 6158 single photon counting photomultiplier. The data was deconvoluted from the IRF using a mono-exponential function and the goodness-of-fit judged by the  $\chi^2$  parameter, randomness of the residuals, and Durbin-Watson (D-W) test statistic (**Figure S1**). Samples were purged of oxygen by sparging with argon prior to measurements. A sample of EY (10  $\mu$ M) in DMF gave a lifetime of 4.14 ns ( $\chi^2 = 1.14$ , D-W = 1.8). A solution of EY (20 mM) in a solution of DMF containing **307** (1.5 M) and K<sub>2</sub>HPO<sub>4</sub> (0.2 M) gave  $t = 3.95$  ns ( $\chi^2 = 1.02$ , D-W = 1.7).



**Figure S1:** Fluorescence decay of a degassed solution of EY (10  $\mu$ M) in DMF and best fit according to a mono-exponential decay (top), and of EY (20 mM) in a solution of DMF containing **307** (1.5 M) and K<sub>2</sub>HPO<sub>4</sub> (0.2 M) and best fit according to a mono-exponential decay (bottom).

## 4. Crystallographic data

### 2-((Ethylsulfonyl)methylene)-4-phenylbutanenitrile (362o)



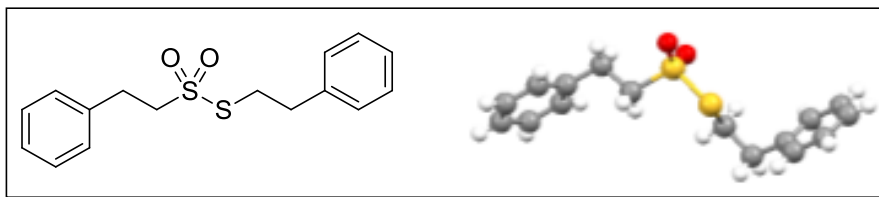
Empirical Formula	$C_{39}H_{45}N_3O_6S_3$
Formula Weight	747.96
Temperature	150(2) K
Wavelength	0.71073 Å
Crystal system, space group	Monoclinic, P 21
Unit cell dimensions	$a = 15.4082(18)$ Å $\alpha = 90$ deg. $b = 5.4329(6)$ Å $\beta = 105.046(13)$ deg. $c = 23.686(3)$ Å $\gamma = 90$ deg.
Volume	$1914.8(4)$ Å <sup>3</sup>
Z, Calculated density	2, 1.297 Mg/m <sup>3</sup>
Absorption coefficient	$0.243$ mm <sup>-1</sup>
F(000)	792
Crystal size	0.300 x 0.120 x 0.020 mm
Theta range for data collection	1.781 to 25.350 deg.
Limiting indices	$-18 \leq h \leq 18$ , $-6 \leq k \leq 6$ , $-28 \leq l \leq 28$
Reflections collected / unique	31074 / 7009 [R(int) = 0.1404]
Completeness to theta = 25.242	99.6 %
Max. and min. transmission	1.00000 and 0.76259
Refinement method	Full-matrix least-squares on F <sup>2</sup>
Data / restraints / parameters	7009 / 1 / 463
Goodness-of-fit on F <sup>2</sup>	1.035
Final R indices [I > 2σ(I)]	R1 = 0.0947, wR2 = 0.2198
R indices (all data)	R1 = 0.1470, wR2 = 0.2548
Absolute structure parameter	0.15(11)

Largest diff. peak and hole 1.231 and -0.483 e.A<sup>-3</sup>

CCDC number CCDC 1848239

S-

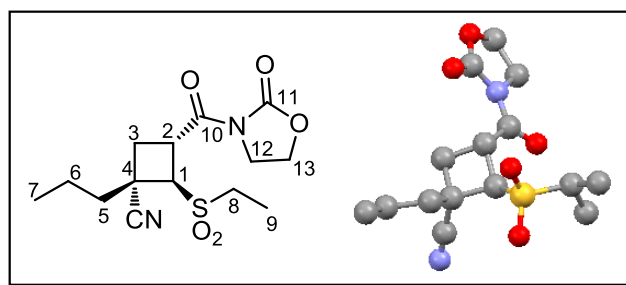
**Phenethyl 2-phenylethanesulfonothioate (380)**



Empirical Formula	C <sub>16</sub> H <sub>18</sub> O <sub>2</sub> S <sub>2</sub>
Formula Weight	306.42
Temperature	120(2) K
Wavelength	0.71073 Å
Crystal system, space group	Monoclinic, P 21/n
Unit cell dimensions	a = 16.4982(16) Å    alpha = 90 deg. b = 5.0535(5) Å    beta = 102.573(3) deg. c = 18.7168(18) Å    gamma = 90 deg.
Volume	1523.1(3) Å <sup>3</sup>
Z, Calculated density	4, 1.336 Mg/m <sup>3</sup>
Absorption coefficient	0.348 mm <sup>-1</sup>
F(000)	648
Crystal size	0.140 x 0.130 x 0.060 mm
Theta range for data collection	1.493 to 28.192 deg.
Limiting indices	-21 ≤ h ≤ 21, -6 ≤ k ≤ 6, -24 ≤ l ≤ 24
Reflections collected / unique	19410 / 3630 [R(int) = 0.0511]
Completeness to theta = 25.242	99.9 %
Refinement method	Full-matrix least-squares on F <sup>2</sup>
Data / restraints / parameters	3630 / 0 / 181
Goodness-of-fit on F <sup>2</sup>	1.016
Final R indices [I > 2σ(I)]	R1 = 0.0464, wR2 = 0.1100
R indices (all data)	R1 = 0.0675, wR2 = 0.1198
Largest diff. peak and hole	0.366 and -0.364 e.A <sup>-3</sup>
CCDC number	CCDC 1848236

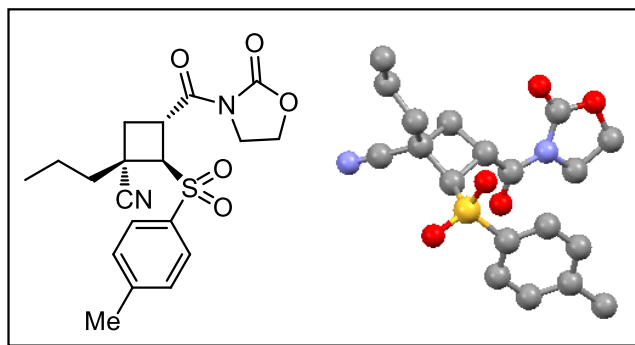


**(1S,2R,3R)-2-(ethylsulfonyl)-3-(2-oxooxazolidine-3-carbonyl)-1-propylcyclobutanecarbonitrile (459a)**



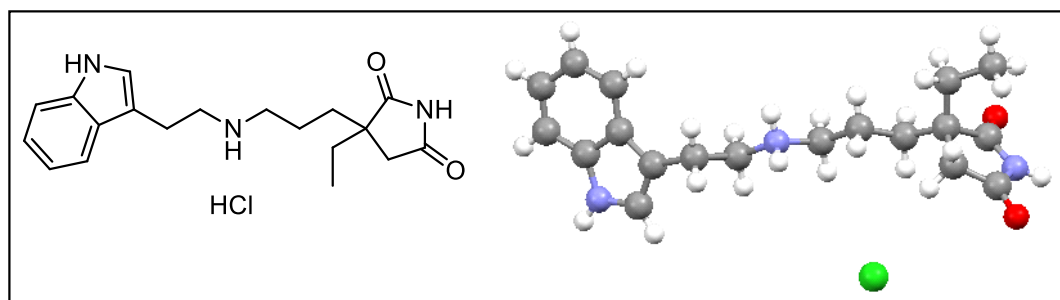
Identification code	liro075	
Empirical formula	C <sub>14</sub> H <sub>20</sub> N <sub>2</sub> O <sub>5</sub> S	
Formula weight	328.38	
Temperature	263(2) K	
Wavelength	1.54187 Å	
Crystal system	Trigonal	
Space group	P3 <sub>1</sub>	
Unit cell dimensions	a = 10.06090(10) Å b = 10.06090(10) Å c = 13.9734(9) Å	alpha = 90°. beta = 90°. gamma = 120°.
Volume	1224.92(8) Å <sup>3</sup>	
Z	3	
Density (calculated)	1.335 Mg/m <sup>3</sup>	
Absorption coefficient	1.986 mm <sup>-1</sup>	
F(000)	522	
Crystal size	0.200 x 0.150 x 0.080 mm <sup>3</sup>	
Theta range for data collection	5.076 to 72.000°	
Index ranges	-10 ≤ h ≤ 11, -12 ≤ k ≤ 12, -16 ≤ l ≤ 17	
Reflections collected	11203	
Independent reflections	3123 [R(int) = 0.0234]	
Completeness to theta = 67.687°	100.0 %	
Absorption correction	Semi-empirical from equivalents	
Max. and min. transmission	1.000 and 0.844	
Refinement method	Full-matrix least-squares on F <sup>2</sup>	
Data / restraints / parameters	3123 / 1 / 213	
Goodness-of-fit on F <sup>2</sup>	1.017	
Final R indices [I > 2σ(I)]	R1 = 0.0294, wR2 = 0.0722	
R indices (all data)	R1 = 0.0330, wR2 = 0.0798	
Absolute structure parameter	0.007(4)	
Extinction coefficient	0.0165(11)	
Largest diff. peak and hole	0.141 and -0.126 e.Å <sup>-3</sup>	
CCDC Number		

**(1S)-3-(2-oxooxazolidine-3-carbonyl)-1-propyl-2-tosylcyclobutanecarbonitrile (459b)**



Empirical Formula	C <sub>19</sub> H <sub>22</sub> N <sub>2</sub> O <sub>5</sub> S
Formula Weight	390.44
Temperature	150(2) K
Wavelength	0.71073 Å
Crystal system, space group	Orthorhombic, P 21 21 21
Unit cell dimensions	a = 8.6866(5) Å      alpha = 90 deg. b = 11.3713(5) Å      beta = 90 deg. c = 18.9830(11) Å      gamma = 90 deg.
Volume	1875.10(17) Å <sup>3</sup>
Z, Calculated density	4, 1.383 Mg/m <sup>3</sup>
Absorption coefficient	0.206 mm <sup>-1</sup>
F(000)	824
Crystal size	0.450 x 0.190 x 0.050 mm
Theta range for data collection	2.088 to 26.407 deg.
Limiting indices	-10 ≤ h ≤ 10, -14 ≤ k ≤ 12, -23 ≤ l ≤ 23
Reflections collected / unique	9546 / 3827 [R(int) = 0.0379]
Completeness to theta = 25.242	99.5 %
Refinement method	Full-matrix least-squares on F <sup>2</sup>
Data / restraints / parameters	3827 / 0 / 246
Goodness-of-fit on F <sup>2</sup>	1.002
Final R indices [I > 2σ(I)]	R1 = 0.0464, wR2 = 0.1100
R indices (all data)	R1 = 0.0390, wR2 = 0.0839
Largest diff. peak and hole	0.286 and -0.301 e.Å <sup>-3</sup>
CCDC number	

**3-(3-((2-(1H-indol-3-yl)ethyl)amino)propyl)-3-ethylpyrrolidine-2,5-dione (599)**



Identification code	pivi-837-f2	
Empirical formula	C <sub>19</sub> H <sub>26</sub> Cl N <sub>3</sub> O <sub>2</sub>	
Formula weight	363.88	
Temperature	113(2) K	
Wavelength	1.54184 Å	
Crystal system	Monoclinic	
Space group	Cc	
Unit cell dimensions	a = 9.6573(3) Å	α = 90°.
	b = 20.4929(7) Å	β = 101.722(3)°.
	c = 9.9043(4) Å	γ = 90°.
Volume	1919.24(12) Å <sup>3</sup>	
Z	4	
Density (calculated)	1.259 Mg/m <sup>3</sup>	
Absorption coefficient	1.895 mm <sup>-1</sup>	
F(000)	776	
Crystal size	0.100 x 0.080 x 0.040 mm <sup>3</sup>	
Theta range for data collection	7.495 to 68.213°.	
Index ranges	-8 ≤ h ≤ 11, -24 ≤ k ≤ 24, -10 ≤ l ≤ 11	
Reflections collected	6923	
Independent reflections	2536 [R(int) = 0.0218]	
Completeness to theta = 67.684°	98.5 %	
Absorption correction	Semi-empirical from equivalents	
Max. and min. transmission	1.00000 and 0.79460	
Refinement method	Full-matrix least-squares on F <sup>2</sup>	
Data / restraints / parameters	2536 / 2 / 226	
Goodness-of-fit on F <sup>2</sup>	1.092	
Final R indices [I > 2σ(I)]	R1 = 0.0734, wR2 = 0.1915	
R indices (all data)	R1 = 0.0771, wR2 = 0.1948	
Absolute structure parameter	0.531(13)	
Extinction coefficient	n/a	
Largest diff. peak and hole	0.565 and -0.367 e.Å <sup>-3</sup>	
CCDC Number		



## **Nouvelles additions radicalaires de cyanures d'alkylsulfonyle sur des oléfines non-activées.**

### **Approches énantiosélectives à la synthèse totale de la leucophyllidine.**

#### **Résumé :**

Dans le cadre de la synthèse totale de la leucophyllidine, un alcaloïde bis-indolique, des réactions de carbo- et sulfonyl-cyanation radicalaires sans étain ont été développées. Les cyanures de sulfonyle  $\text{RSO}_2\text{CN}$ , préparés à partir des thiocyanates correspondant par une nouvelle méthode d'oxydation, sont utilisés comme pièges radicalaires. Ces réactifs fragmentent en présence d'initiateur thermique (carbo-cyanation) ou par le biais de la catalyse photoredox (sulfonyl-cyanation). Dans ce dernier cas, une étude mécanistique approfondie sur le cycle photo-catalytique a été accomplie. Ces méthodologies introduisent un nitrile sur une chaîne carbonée insaturée par voie radicalaire, fournissant des intermédiaires avancés pour la synthèse totale d'alcaloïdes. Pour la synthèse asymétrique de l'eucophylline, le fragment sud de la leucophyllidine, la sulfonyl-cyanation de cyclobutènes énantioenrichis a montré d'excellentes diastéréosélectivités. Différentes stratégies d'ouverture de cycle ont ensuite été examinées.

**Mots clés :** synthèse organique, méthodologies radicalaires sans étain, catalyse photoredox, synthèse totale, produits naturels, cyclobutène, cyanures de sulfonyle.

---

## **New radical additions of alkylsulfonyl cyanides onto unactivated olefins.**

### **Enantioselective approaches towards the total synthesis of leucophyllidine**

#### **Abstract :**

During our efforts directed toward the total synthesis of leucophyllidine, a bis-indole alkaloid, the tin-free radical carbo-cyanation and sulfonyl-cyanation of olefins were developed. The sulfonyl cyanides, acting as radical traps, were synthesized through a new oxidation of the corresponding thiocyanate. These reagents were found to fragment under thermal initiation (carbo-cyanation) or using the photoredox catalysis (sulfonyl-cyanation). A thorough mechanistic study was accomplished for the sulfonyl-cyanation. These methodologies install a nitrile onto an olefin backbone, furnishing advanced intermediates for the total synthesis of alkaloids. For the asymmetric synthesis of eucophylline, the south fragment of leucophyllidine, the sulfonyl-cyanation of optically pure cyclobutenes showed excellent diastereoselectivities. Different ring-opening reactions of the corresponding cyclobutane were then examined.

**Keywords :** organic synthesis, tin-free radical methodologies, photoredox catalysis, total synthesis, natural products, cyclobutene, sulfonyl cyanides.

---

**Institut des Sciences Moléculaire (ISM)**  
**Groupe de synthèse organique et substances naturelles (ORGA)**  
Université de Bordeaux – CNRS UMR 5255  
351 cours de la Libération, F-33405 Talence  
France