



**HAL**  
open science

# Diversity and phylogeography of Southern Ocean sea stars (Asteroidea)

Camille Moreau

► **To cite this version:**

Camille Moreau. Diversity and phylogeography of Southern Ocean sea stars (Asteroidea). Biodiversity and Ecology. Université Bourgogne Franche-Comté; Université libre de Bruxelles (1970-..), 2019. English. NNT : 2019UBFCK061 . tel-02489002

**HAL Id: tel-02489002**

**<https://theses.hal.science/tel-02489002>**

Submitted on 24 Feb 2020

**HAL** is a multi-disciplinary open access archive for the deposit and dissemination of scientific research documents, whether they are published or not. The documents may come from teaching and research institutions in France or abroad, or from public or private research centers.

L'archive ouverte pluridisciplinaire **HAL**, est destinée au dépôt et à la diffusion de documents scientifiques de niveau recherche, publiés ou non, émanant des établissements d'enseignement et de recherche français ou étrangers, des laboratoires publics ou privés.



FACULTÉ  
DES SCIENCES

UNIVERSITÉ LIBRE DE BRUXELLES

UBFC

UNIVERSITÉ  
BOURGOGNE FRANCHE-COMTÉ

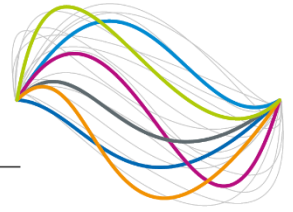

## Diversity and phylogeography of Southern Ocean sea stars (Asteroidea)

**Thesis submitted by Camille MOREAU**

in fulfilment of the requirements of the PhD Degree in science (ULB - “Docteur en Science”) and in life science (UBFC – “Docteur en Science de la vie”) Academic year 2018-2019

Supervisors: Professor Bruno Danis (Université Libre de Bruxelles)

Laboratoire de Biologie Marine

And Dr. Thomas Saucède (Université Bourgogne Franche-Comté)

Biogéosciences



BIOGÉOSCIENCES



# Diversity and phylogeography of Southern Ocean sea stars (Asteroidea)

Camille MOREAU

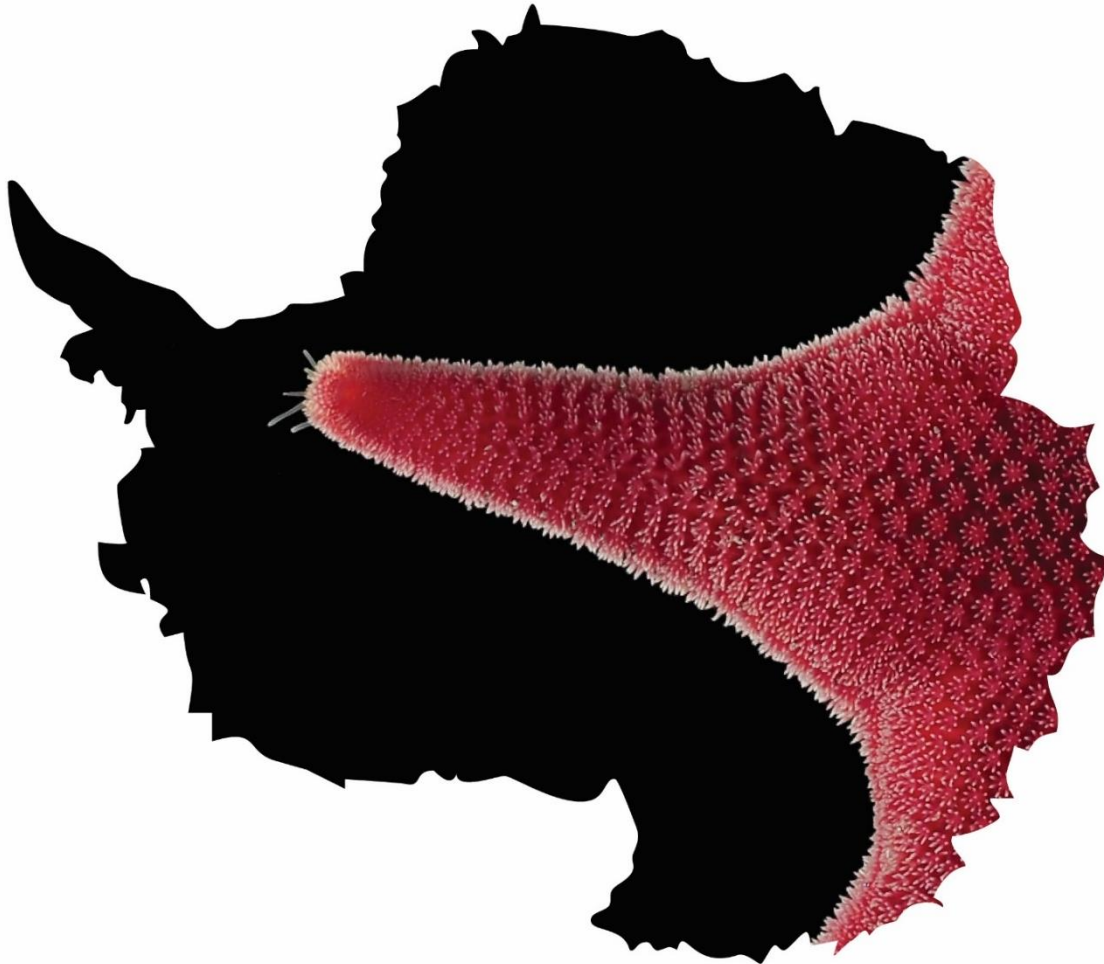

## Thesis committee:

Mr. Mardulyn Patrick	Professeur, ULB	Président
Mr. Van De Putte Anton	Professeur Associé, IRSNB	Rapporteur
Mr. Poulin Elie	Professeur, Université du Chili	Rapporteur
Mr. Rigaud Thierry	Directeur de Recherche, UBFC	Examineur
Mr. Saucède Thomas	Maître de Conférences, UBFC	Directeur de thèse
Mr. Danis Bruno	Professeur, ULB	Co-directeur de thèse

## Avant-propos

Ce doctorat s'inscrit dans le cadre d'une cotutelle entre les universités de Dijon et Bruxelles et m'aura ainsi permis d'élargir mon réseau au sein de la communauté scientifique tout en étendant mes horizons scientifiques. C'est tout d'abord grâce au programme vERSO (Ecosystem Responses to global change : a multiscale approach in the Southern Ocean) que ce travail a été possible, mais aussi grâce aux collaborations construites avant et pendant ce travail. Cette thèse a aussi été l'occasion de continuer à aller travailler sur le terrain des hautes latitudes à plusieurs reprises pour collecter les échantillons et rencontrer de nouveaux collègues. Par le biais de ces trois missions de recherches et des nombreuses conférences auxquelles j'ai activement participé à travers le monde, j'ai beaucoup appris, tant scientifiquement qu'humainement.

## Remerciements

Lorsque vient le temps de faire un bilan et de remercier toutes les personnes ayant accompagné ce projet, je ne peux que réaliser que la thèse est le fruit de nombreuses interactions et d'un travail en équipe. Ce travail est l'aboutissement d'un cheminement depuis mon entrée à l'université et l'initiation aux environnements sous-marin et austraux. Il me revient donc de remercier ces différentes personnes en espérant ne pas en oublier.

Je remercie en premier lieu le laboratoire de Biologie Marine et son directeur Philippe Dubois de m'avoir accueilli et d'avoir facilité mon intégration au sein de l'ULB dans un lieu et un environnement qui étaient nouveaux pour moi.

Je tiens ensuite à remercier Bruno Danis, mon promoteur, qui a cru et s'est investi dans la mise en place de ce projet de thèse. Tu m'auras laissé beaucoup de liberté et toujours soutenu pour me permettre de participer aux missions de terrain et conférences à travers le monde. C'est, je crois, l'un des plaisirs de tout scientifique que d'avoir la chance de partir en expéditions, et lorsque celles-ci se déroulent en Antarctique ou Terre de Feu, ces souvenirs sont d'autant plus mémorables.

Je souhaite remercier Thomas Saucède, mon directeur de thèse à l'Université Bourgogne Franche-Comté de Dijon. Tu auras su me pousser, dans le calme et la sagesse qui te caractérisent, à toujours aller plus loin dans la réflexion et l'intégration de nouvelles méthodes

pour aborder mon sujet tout en développant une vue d'ensemble, perfectionnant ainsi le résultat final de la thèse.

J'ai une pensée particulière pour les personnes qui ont pris part à la genèse de mon cursus et ma carrière. Merci à Marc Eléaume et Nadia Améziane de m'avoir proposé mon premier stage en relation avec l'Océan Austral et d'avoir contribué à faire grandir ma passion pour les hautes latitudes. A massive "thank you" to Katrin Linse. You gave me the opportunity to join the British Antarctic Survey and to take part in my first cruise in Antarctica. It is during this scientific voyage that I met and bound with great scientists and friends who were and still are inspirations for my career. Thank you Cheps, Bec, Jack, Grace and Nina for always being here I needed it, whether for scientific or personal advices, you are part of my life as my Cambridge family and much more. Thank you, Huw, for your support, putting me in contact with Bruno, inviting me around the South Orkney and always pushing to help early career scientists to be part of the community, in the field or during conferences. Many thanks to Dave for including me in his team, whether it is about cycling or science, you are a model of wisdom and it is always pleasant to learn by your side. Finally, a special thanks to Oli and Rachel with whom I shared great moments before and during the PhD and hopefully many more are to come.

Ma reconnaissance se dirige également vers les membres du laboratoire de Biologie Marine, techniciens et étudiants qui auront rendu la thèse un peu plus sympathique une fois par leur aide et leurs conseils. Je remercie ainsi Phil pour son énergie débordante et son aide d'une grande valeur, dans et en dehors des travaux scientifiques. Merci Mathieu pour ton assistance plus que précieuse en laboratoire qui m'aura permis d'aller au bout de mes analyses. Shukraan Saloua pour toutes les pauses café et ta propension à toujours trouver une solution aux problèmes. Auré et Mishal merci d'avoir accompagné mon parcours à Bruxelles avec la bienveillance et la bonne humeur qui vous caractérise. Merci Antonio pour n'avoir jamais refusé de me donner un coup de main pendant la thèse. Un grand merci aussi à Marine et Mathilde qui auront apporté un vent de fraîcheur et de légumes dans le laboratoire pendant ma dernière année de travail. Merci Clément et Laurence pour votre aide technique et administrative.

Je remercie également les programmes et instituts qui ont apporté leur soutien au cours de la thèse, me permettant de mener à bien expériences et travaux de terrain : les programmes rECTO et vERSO financés par le Belgian Science Policy Office, le Museum National d'Histoire

Naturelle de Paris, le laboratoire Biogéosciences, le programme Ant-ERA et le FRIA (Fonds pour la formation à la Recherche dans l'Industrie et l'Agriculture, FNRS).

C'est aussi grâce aux nombreuses personnes et interactions à travers nos différentes collaborations que cette thèse a été menée à bien et notamment Arnaud Brayard du laboratoire Biogéosciences, Elie Poulin et Karine Gérard au Chili, Stefano Schiaparelli de Gênes, Franz et Henrik de la KU Leuven, Patrick Mardulyn et Chantal De Ridder de mon comité d'accompagnement à l'ULB.

Les soutiens viennent aussi évidemment de l'entourage extra-professionnel et sur ce point je souhaite remercier mes amis du handball avec lesquels j'ai partagé énormément de bons moments qui m'auront permis de mettre de côté la science et de donner de l'importance à d'autres choses. Un grand merci Simon, Quentin, Philipp, Melissa, Lena, Mélanie, Ana, Natalita et tous les autres.

Je voudrais aussi remercier les membres de mon jury d'évaluation, Thierry Rigaud et Anton Van De Putte pour leur relecture ainsi que les conseils apportés sur mon manuscrit de thèse.

Je remercie également ma famille qui m'a toujours soutenu dans mes projets et aidé à les mener à bien même dans les moments difficiles. En me laissant tout au long de ma vie la liberté de faire ce qui me plaisait j'ai pu réaliser mes rêves et atteindre les objectifs que je voulais. Merci maman, papa, Guillaume et Lise.

Merci aussi à mes amis en Bretagne, je n'ai malheureusement plus énormément d'occasion de venir vous rendre visite. Je sais cependant que je peux toujours compter sur vous quand je rentre dans notre beau pays. Merci Alix, Christophe, Valentin et Vincent.

J'ai une pensée particulière pour Margot, tu as été présente et as su me soutenir, dans les moments compliqués, avant et pendant la mise en place de ce projet sans jamais économiser ton énergie pour me conforter dans mes choix. Merci pour tout.

Merci Charlène d'y avoir partagé ton inépouissable énergie et de m'y avoir supporté dans le bureau. Merci pour ton aide, notamment sur « R » et lors de nos longues conversations sur la modélo et la génétique. Il était bon d'avoir une compatriote à mes côtés dans le labo.

Sarah, je te remercie énormément pour tout ce que tu m'as apporté lors des baisses de moral mais aussi lorsque tout allait au mieux. Tu m'as fait découvrir beaucoup de belles choses à

Bruxelles et en Belgique. C'est en partie grâce à toi si j'ai réussi et je t'en suis très reconnaissant.

Et enfin peut-être le meilleur, mais en tous les cas le plus touffu pour la fin. Je parle, BIEN SUR, de mon bel ami le Belge, docteur Quentin Jossart. Toujours calme et réfléchi, c'est pas Zizou mais c'est un vrai atout de t'avoir et de t'avoir eu dans le bureau et en dehors au cours de toutes ces années. Toutes ces heures à discuter, jouer au foot, perdre notre temps m'auront beaucoup apporté. Je n'oublie évidemment pas de faire un petit clin d'œil à sa concubine Sophie qui a supporté toutes nos idioties en gardant le sourire. Merci à vous.

# Scientific communications during the PhD

## Publications

- **PhD thesis research**

- **Moreau, C.**, Jossart, Q., Danis, B., Eléaume, M., Christiansen, H., Guillaumot, C., & Saucède, T. The atypical and overlooked diversity of Southern Ocean sea stars (Asteroidea). (Submitted. Zoological Journal of the Linnean Society)
  - **Chapter 3**
- **Moreau, C.**, Danis, B., Jossart, Q., Eléaume, M., Sands, C., Achaz, G., Agüera, A., & Saucède, T. (2019) Is reproductive strategy a key factor in understanding the evolutionary history of Southern Ocean Asteroidea (Echinodermata)? Ecology and Evolution, 9(15), 8465-8478, doi/10.1002/ece3.5280.
  - **Chapter 2**
- **Moreau, C.**, Mah, C., Agüera, A., Améziane, N., Barnes, D., Crokaert, G., Eléaume, M., Griffiths, H., Guillaumot, C., Hemery, L., Jażdżewska, A., Jossart, Q., Laptikhovsky, V., Linse, K., Neill, K., Sands, C., Saucède, T., Schiaparelli, S., Siciński, J., Vasset, N., & Danis B. (2018). Antarctic and sub-Antarctic Asteroidea database. ZooKeys, (747), 141-156, doi: 10.3897/zookeys.747.22751.
  - **Occurrence data used for all PhD analyses**
- **Moreau, C.**, Saucède, T., Jossart, Q., Agüera, A., Brayard, A., & Danis, B. (2017). Reproductive strategy as a piece of the biogeographic puzzle: a case study using Antarctic sea stars (Echinodermata, Asteroidea). Journal of Biogeography, 44(4), 848-860, doi.org/10.1111/jbi.12965.
  - **Chapter 1**
- **Moreau, C.**, Agüera, A., Jossart, Q., & Danis, B. (2015). Southern Ocean Asteroidea: a proposed update for the Register of Antarctic Marine Species. Biodiversity data journal, (3), e7062, doi: 10.3897/BDJ.3.e7062.
  - **Southern Ocean species list update used for diversity reassessment**

- **Other research projects**

- **RECTO/VERSO**

- Jossart, Q., **Moreau C.**, Danis, B., & Kochzius, M. Integrative taxonomy reveals both cryptic and overestimated diversity in an Antarctic sea star family (Pterasteridae). (in prep. Deep Sea Research Part II: Topical Studies in Oceanography)
- Christiansen, H., Heindler, F.M., Hellemans, B., Jossart, Q., Pasotti, F., Robert, R., Verheye, M., Danis, B., Kochzius, M., Leliaert, F., **Moreau, C.**, Patel, T., Van de Putte, A., Vanreusel, A., Volckaert, F., & Schön, I. Facilitating Southern Ocean population genomics of non-model species: optimized experimental design for reduced representation sequencing. (in prep. Molecular Ecology Resources)



- Guillaumot, C., Artois, J., Saucède, T., Demoustier, L., **Moreau, C.**, Eléaume, M., Agüera, A., & Danis, B. (2019). Broad-scale species distribution models applied to data-poor areas. *Progress in Oceanography*, 175, 198-207.
- Agüera, A., Collard, M., Jossart, Q., **Moreau, C.**, & Danis, B. (2015). Parameter estimations of dynamic energy budget (DEB) model over the life history of a key Antarctic species: the Antarctic sea star *Odontaster validus* Koehler, 1906. *PLoS one*, 10(10), e0140078.
- Jossart, Q., **Moreau, C.**, Agüera, A., De Broyer, C. & Danis, B. (2015). The Register of Antarctic Marine Species (RAMS): a ten-year appraisal. *ZooKeys*, 524, 137-145.

### ○ **Antarctic Seabed Carbon Capture Change**

- Gogarty, B., Bax, N., Barnes, D., Sands, C., **Moreau, C.**, Held, C., Paulsen, M., McGee, J., and Haward, M. Protecting Antarctic blue carbon: as marine ice retreats can the law fill the gap? In: McDonald, J., McGee, J., and Barnes, R. (eds). *Research Handbook on Climate Change, Oceans and Coasts*. Edward & Elgar. Accepted
- Bax, N., Gogarty, B., McGee, J., Sands, C., Downey, R., Haward, M., **Moreau, C.**, Held, C., Paulsen, M., Moreno, B., & Barnes, D. Protecting Antarctic blue carbon: as marine ice retreats, can law fill the gap? (*Nature Sustainability*). Submitted.
- Bax, N., Moreno, B., **Moreau, C.**, Barnes, C., Paulsen, M., Held, C., Downey, R., Sands, C., & Souster, T. (2019) Carbon storage by Kerguelen zoobenthos as a negative feedback on climate change. In: Welsford, D., Dell, J., and Duhamel, G. (Eds). *The Kerguelen Plateau: marine ecosystem and fisheries. Proceedings of the Second Symposium*. Australian Antarctic Division, Kingston, Tasmania, Australia, 119-123. ISBN: 978-1-876934-30-9.

### ○ **Other international collaborations**

- Martin, A., Trouslard, E., Hautecoeur, M., Blettery, J., **Moreau, C.**, Saucède, T., Amézière, N., Duhamel, G., & Eléaume, M. (2019) Benthic ecoregionalisation and conservation issues in the french exclusive economic zone of kerguelen. In: Welsford, D., Dell, J., and Duhamel, G. (Eds). *The Kerguelen Plateau: marine ecosystem and fisheries. Proceedings of the Second Symposium*. Australian Antarctic Division, Kingston, Tasmania, Australia, 279-303. ISBN: 978-1-876934-30-9.
- Brasier, M.J., Grant, S.M., Trathan, P.N., Allcock, L., Ashford, O., Blagbrough, H., Brandt, A., Danis, B., Downey, R., Eléaume, Enderlein, P., M., Ghiglione, C., Hogg, O., Linse, K., Mackenzie, M., **Moreau, C.**, Robinson, L.F., Rodriguez, E., Spiridonov, V., Tate, A., Taylor, M., Waller, C., Wiklund, H., & Griffiths, H. (2018). Benthic biodiversity in the South Orkney Islands Southern Shelf Marine Protected Area. *Biodiversity*, 1-15.
- Saucède, T., Griffiths, H., **Moreau, C.**, Jackson, J. A., Sands, C., Downey, R., Reed, A., Mackenzie, M., Geissler, P., & Linse, K. (2015). East Weddell Sea echinoids from the JR275 expedition. *ZooKeys*, (504), 1-10.

# Oral presentations

- **Moreau, C.\***, Danis, B., Eléaume, M., Saucède, T., Christiansen, H., Guillaumot, C., Downey, R., & Jossart, Q. Asteroid diversity: a view from the Southern Ocean. 10th European Conference on Echinoderms, Moscow, Russia, 09/2019.
- **Moreau, C.\***, Saucède, T., Jossart, Q., Agüera, A., Brayard, A., & Danis, B. Estrategia reproductiva como pieza del rompecabezas biogeográfico: un estudio de caso utilizando estrellas de mar antárticas (Echinodermata, Asteroidea). IX Congreso Latinoamericano de Ciencia Antártica, Punta Arenas, Chile, 10/2017.
- **Moreau, C.\***, Saucède, T., Jossart, Q., Agüera, A., Brayard, A., & Danis, B. Reproductive strategy as a piece of the biogeographic puzzle: a case study using Antarctic sea stars (Echinodermata, Asteroidea). XXXIV Scientific Committee on Antarctic Research, Kuala Lumpur, Malaysia, 08/2016.
- **Moreau, C.\***, Saucède, T., Jossart, Q., Agüera, A., Brayard, A., & Danis, B. Reproductive strategy as a piece of the biogeographic puzzle: a case study using Antarctic sea stars (Echinodermata, Asteroidea). VERSO mini-symposium, Brussels, Belgium, 08/2016.
- **Moreau, C.\***, Saucède, T., & Danis, B. Reproductive strategy as a piece of the biogeographic puzzle: a case study using Antarctic sea stars (Echinodermata, Asteroidea). Centre Interuniversitaire de Biologie Marine, Mons, Belgium, 04/2016.
- **Moreau, C.\***, Jossart, Q., Agüera, A., & Danis, B. Analysis of Southern Ocean Asteroidea (Echinodermata) biogeography based on open source data. Empowering Biodiversity Research, Brussels, Belgium, 05/2015.
- Barnes, D.K.\*, Bax, N., Downey, R., Held, C., **Moreau, C.**, Moreno, B., Paulsen, M. & Sands, C.J. Climate and the Magnitude of Blue Carbon Storage by Circumpolar Shelf Benthos. POLAR2018 SCAR/IASC Open Science Conference, Davos, Switzerland, 06/2018.
- Le Bourg, B.\*, Blanchard, A., Danis, B., Jossart, Q., Lepoint, G., **Moreau, C.**, & Michel, L. Feeding ecology of sea stars of the Southern Ocean: possible influence of sea ice on trophic niche partitioning. 16th International Echinoderm Conference, Nagoya, Japan, 06/2018.
- Barnes, D.K.\*, Sands, C.J, Moreno, B., Munoz-Ramirez, C., Downey, R., Held, C., Paulsen, M., **Moreau, C.**, Bax, N. and Morley, S. Climate impact on blue carbon potential of sub-polar continental shelf seabeds. IX Congreso Latinoamericano de Ciencia Antártica, Punta Arenas, Chile, 10/2017.
- Jossart, Q.\*, Danis, B., **Moreau, C.**, & Pernet, P. Antarctic sea stars: a prototype identification key for the Odontasteridae family. Scientific Committee on Antarctic Research, XII Biology Symposium, Leuven, Belgium, 07/2017.

- Brasier, M.J.\*, Griffiths, H., Grant, S.M., Trathan, P.N., Allcock, L., Ashford, O., Blagbrough, H., Brandt, A., Danis, B., Downey, R., Eléaume, Enderlein, P., M., Ghiglione, C., Hogg, O., Linse, K., Mackenzie, M., **Moreau, C.**, Robinson, L.F., Rodriguez, E., Spiridonov, V., Tate, A., Taylor, M., Waller, C., & Wiklund, H. SO-AntEco: Contributing information and scientific advice to the CCAMLR South Orkney Islands MPA review. Scientific Committee on Antarctic Research, XII Biology Symposium, Leuven, Belgium, 07/2017.
- Schiaparelli, S.\*, Chiara, A.M., Cecchetto, M., Danis, B., Fassio, G., Guzzi, A., Jossart, Q., Modica, M.V., **Moreau, C.**, & Oliverio, M. Inventory completeness and accuracy of taxonomic determination: outcomes of a large scale barcoding effort of echinoderms in Terra Nova Bay (Antarctica, Ross Sea). Scientific Committee on Antarctic Research, XII Biology Symposium, Leuven, Belgium, 07/2017.
- Sands C.J.\*, Barnes, D. K., Downey, R., **Moreau, C.**, Griffiths, H., Linse, K., & Martín-Ledo, R. A pragmatic approach to the assessment of South Georgia benthic diversity reveals a unique and vulnerable assemblage. Scientific Committee on Antarctic Research, XII Biology Symposium, Leuven, Belgium, 07/2017.
- Sands, C.J.\*, Downey, R., Held, C., Paulsen, M., Barnes, D.K.A., **Moreau, C.**, Moreno, B., & Bax, N. Towards estimation of blue carbon sink potential of sub-Antarctic continental shelf benthos. Scientific Committee on Antarctic Research, XII Biology Symposium, Leuven, Belgium, 07/2017.
- Le Bourg, B.\*, Blanchard, A., Danis, B., Jossart, Q., Lepoint, G., **Moreau, C.**, & Michel, L. Influence of environmental conditions on trophic niche partitioning among sea stars assemblages. Scientific Committee on Antarctic Research, XII Biology Symposium, Leuven, Belgium, 07/2017.
- Bax, N. \*, Moreno, B., **Moreau, C.**, Barnes, D.K., Paulsen, M., Held, C., Downey, R., & Sands, C.J. How important is carbon storage by southern polar benthos as a negative feedback on climate change? Scientific Committee on Antarctic Research, XII Biology Symposium, Leuven, Belgium, 07/2017.
- Le Bourg, B.\*, Blanchard, A., Danis, B., Lepoint, G., **Moreau, C.**, Jossart, Q., & Michel, L. Feeding ecology of Southern Ocean seastars inferred from stable isotopes ratios. Joint European Stable Isotopes User Group meeting, Ghent, Belgium, 09/2016.

\* Presenting author

# Posters

- **Moreau, C.**, Danis, B., Jossart, Q., Eléaume, M., & Saucède, T. Diversity in Kerguelen Asteroids: a crossroads of faunal influences in the Southern Ocean. 10th European Conference on Echinoderms, Moscow, Russia, 09/2019.
- **Moreau, C.**, Jossart, Q., Saucède, T., Danis, B. Diversity in Kerguelen Asteroids: a crossroads of faunal influences in the Southern Ocean. POLAR2018 SCAR/IASC Open Science Conference, Davos, Switzerland, 06/2018.
- **Moreau, C.**, Jossart, Q., Saucède, T., Achaz, G., Eléaume, M., & Danis, B. Accepted taxonomy versus genetic diversity an approach using Southern Ocean Asteroids. POLAR2018 SCAR/IASC Open Science Conference, Davos, Switzerland, 06/2018.
- **Moreau, C.**, Jossart, Q., Saucède, T., Sands C, Eléaume M, Achaz, G., Bauwens, M., & Danis, B. Sea Stars Comparative Evolutionary Patterns in the Southern Ocean. POLAR2018 SCAR/IASC Open Science Conference, Davos, Switzerland, 06/2018.
- **Moreau, C.**, Jossart, Q., Agüera, A., Pernet, P., & Danis, B. Seastars field guides: a proof of concept for opening more data. XXXIV Scientific Committee on Antarctic Research, Kuala Lumpur, Malaysia, 08/2016.
- Bax, N., Robinson, L., Barnes, D.K., Sands, C.J., Downey, R., Held, C., **Moreau, C.**, Moreno, B., & Paulsen, M. Corals as a Model to Measure Change in Polar Oceans. POLAR2018 SCAR/IASC Open Science Conference, Davos, Switzerland, 06/2018.
- Guillaumot, C., Artois, J., Saucède, T., Demoustier, L., **Moreau, C.**, Eléaume, M., Agüera, A., & Danis, B. Modelled distributions of benthic species of the Southern Ocean in a fast-changing environment. Marine Ecosystem Assessment of the Southern Ocean, Hobart, Australia, 04/2018.
- Jossart, Q., **Moreau, C.**, Danis, B., & Kochzius, M. Depth-differentiation versus depth-refugia hypotheses: a case study in a Southern Ocean sea star. VLIZ Marine Science Day. Bredene, Belgium, 03/2018.

# Cruise reports

- Danis, B., Christiansen, H., Guillaumot, C., Heindler, F., Houston, R., Jossart, Q., Lucas, K., **Moreau, C.**, Pasotti, F., Robert, H., Wallis, B., & Saucède, T. (2019) Report of the Belgica 121 expedition to the West Antarctic Peninsula. 96 pp.
- Griffiths, H., Grant, S.M., Allcock, L., Ashford, O., Blagbrough, H., Brandt, A., Brasier, M.J., Danis, B., Downey, R., Eléaume, Enderlein, P., M., Ghiglione, C., Hogg, O., Linse, K., Mackenzie, M., **Moreau, C.**, Robinson, L.F., Rodriguez, E., Spiridonov, V., Tate, A., Taylor, M., Waller, C., & Wiklund, H. (2016) Report of *RRS James Clark Ross* cruise JR15005. 77 pp.



# Table of content



# **General Introduction.....29**

I.	<u>Antarctica and the Southern Ocean</u> .....	<b>31</b>
a.	<b>Geological &amp; climatic history</b> .....	<b>31</b>
i.	<b>Tectonics and geomorphology</b> .....	<b>31</b>
ii.	<b>Climatic history</b> .....	<b>34</b>
b.	<b>Oceanographic features</b> .....	<b>37</b>
i.	<b>Current system in the Southern Ocean</b> .....	<b>37</b>
ii.	<b>Fronts and zonation</b> .....	<b>39</b>
c.	<b>A changing world</b> .....	<b>41</b>
II.	<u>Origin and evolution of the Antarctic benthos</u> .....	<b>45</b>
a.	<b>Origins: a succession of extinction and recolonisation</b> .....	<b>45</b>
i.	<b>Pre-Cenozoic origins</b> .....	<b>45</b>
ii.	<b>Cenozoic evolution of the Antarctic benthos</b> .....	<b>46</b>
b.	<b>Modern benthic life in the Southern Ocean</b> .....	<b>49</b>
i.	<b>A century of discoveries</b> .....	<b>49</b>
ii.	<b>Particularisms of the benthic fauna</b> .....	<b>50</b>
c.	<b>Biogeography and phylogeography of modern Antarctic benthic faunas</b> ....	<b>52</b>
i.	<b>Distribution of benthic life in the SO</b> .....	<b>53</b>
ii.	<b>Genetic diversity patterns</b> .....	<b>54</b>
iii.	<b>Consequences of reproductive strategies on diversity patterns</b> .....	<b>57</b>
d.	<b>Sea stars in the Southern Ocean</b> .....	<b>58</b>
i.	<b>General view</b> .....	<b>58</b>
ii.	<b>Southern Ocean sea stars</b> .....	<b>60</b>

# **Research objectives .....63**



**Southern Ocean species list update .....67**

Southern Ocean Asteroidea: a proposed update for the Register of Antarctic Marine Species  
.....69

**ABSTRACT .....70**

**INTRODUCTION .....71**

**MATERIALS AND METHODS .....71**

**DATA RESOURCES .....74**

**ANALYSIS .....78**

**DISCUSSION .....79**

**ACKNOWLEDGEMENTS .....80**

**Asteroidea Database .....81**

Antarctic and Sub-Antarctic Asteroidea database .....83

**ABSTRACT .....84**

**INTRODUCTION .....85**

**PROJECT DESCRIPTION .....86**

**ACKNOWLEDGEMENTS .....94**

**Chapter 1 .....95**

Reproductive strategy as a piece of the biogeographic puzzle: a case study using Antarctic sea stars (Echinodermata, Asteroidea) .....97

**ABSTRACT .....98**

**INTRODUCTION .....99**

**MATERIALS AND METHODS .....101**

**Area of interest.....101**

**Data analyses.....101**

**RESULTS .....104**

**Sampling effort, richness patterns and endemism .....104**

**Biogeographic patterns of species .....109**

**Brooders *versus* broadcasters .....111**

**Biogeographic patterns of genera.....111**

**DISCUSSION .....112**

**Main patterns of Southern Ocean asteroid biogeography .....112**

**The importance of reproductive strategies for asteroid biogeography .....114**

**Across taxonomic levels and time-scales .....116**

**CONCLUSIONS .....118**

**ACKNOWLEDGEMENTS .....118**

**Chapter 2 .....119**

Is reproductive strategy a key factor in understanding the evolutionary history of Southern Ocean Asteroidea (Echinodermata)? .....121

**ABSTRACT .....122**

**INTRODUCTION .....123**

**MATERIALS AND METHODS .....125**

**Comprehensive sampling & DNA sequence compilation .....125**

**Phylogenetic reconstruction.....127**

**Species delineation .....128**

**RESULTS .....129**

**Species delineation .....129**

**Phylogenies and divergence time estimates .....131**

**Phylogeographic patterns .....133**

**DISCUSSION .....137**

**Species richness, genetic diversity and taxonomic implications.....137**

**Dispersal capacity and biogeographic patterns .....137**

**The role of past climate change.....140**

**CONCLUSION & FUTURE PROSPECTS .....141**

**ACKNOWLEDGMENTS .....142**

# **Chapter 3 .....145**

The overlooked diversity of Southern Ocean sea stars (Asteroidea) reveals original evolutionary pathways. ....147

**ABSTRACT .....148**

**INTRODUCTION .....149**

**MATERIALS AND METHODS .....151**

**Richness data compilation .....151**

**Genetic data compilation .....152**

**Tree reconstruction.....152**

**RESULTS .....153**

**Sea star taxonomic diversity in the Southern Ocean .....153**

**Latitudinal trends in the Southern Ocean .....156**

**Global phylogenetic exploration .....160**

**Phylogeographic patterns .....161**

**DISCUSSION .....165**

**Spatial and taxonomical diversity in the Southern Ocean .....165**

**Large scale phylogenetic patterns .....167**

**Global barcode library – an asset for future studies .....168**

**CONCLUSION.....169**

**ACKNOWLEDGMENTS .....169**

**General discussion .....171**

- a. Sea star diversity in the Southern Ocean .....174
- b. Distribution and genetic patterns in Southern Ocean sea stars .....181
- c. Biogeographic processes in the Southern Ocean .....183

**Conclusion & Perspectives.....186**

**Appendices .....191**

- Appendix 1 - Chapter 1 .....193
- Appendix 2 - Chapter 2 .....197
- Appendix 3 - Chapter 3 .....205

**References .....223**



# Figures

- Figure 1** Evolution of the Southern Ocean (modified from Crame, 1999; Lawyer & Gahagan, 2003). Paleogeographic reconstructions of the southern continents (south of 30°S) during the Early and Late Cretaceous and during the Early Oligocene. Continental margins and shelves in light beige, continent in dark beige, Antarctica in dark brown. .... 33
- Figure 2** Subglacial topographic reconstruction of the Southern Ocean (compiled using GEMCO, 2014 and BEDMAP2; Fretwell et al., 2013 grids). .... 34
- Figure 3** Global deep-sea oxygen isotope and temperature records during the last 50 Myr (Zachos et al., 2001) showing the Antarctic Cryosphere History (A.C.H.) major geologic (G), climatic (C), oceanographic (O) events. Modified from González-Wevar et al., 2017. .... 36
- Figure 4** Major Southern Ocean circulation features (adapted from Rintoul et al. 2001), showing the Polar and sub-Antarctic Fronts of the Antarctic Circumpolar Current, sub-polar gyres and Antarctic Slope Front (ASF). Background colours show bathymetry. Figure from Post et al., 2014. .... 38
- Figure 5** The globe viewed on a Spilhaus projection; in contrast to conventional projections, this portrays the ocean fringed by land. The global thermohaline circulation is shown in cartoon form, with upper-layer flow in red and lower-layer flow in blue. Figure from Meredith, 2019. .... 38
- Figure 6** A sketch of the Antarctic Circumpolar Current system showing the zonal flow and the meridional overturning circulation and water masses. Antarctica is at the left side. The east–west section displays the isopycnal (same density) and sea surface tilts in relation to submarine ridges, which are necessary to sustain the bottom form stress signatures (see Olbers et al. 2004). The curly arrows at the surface indicate the buoyancy flux; the arrows attached to the isopycnals represent turbulent mixing. An upper cell is formed primarily by northward Ekman transport (horizontal transport of superficial water layers through wind friction) beneath the strong westerly winds and southward transport in the Upper Circumpolar Deep Water (UCDW) layer. The lower cell is driven primarily by formation of dense AABW near the Antarctic continent and inflowing Lower Circumpolar Deep Water (UCDW or NADW). Figure from Olbers and Visbeck (2005), adapted from Speer et al. (2000). .... 39
- Figure 7** Map of the Southern Ocean showing the approximate position of oceanic fronts and associated zones (Figure modified from Knox, 2007 and Orsi et al., 1995). .... 40

- Figure 8** Environmental changes over the industrial period and the 21<sup>st</sup> century for business-as-usual scenario and a stringent emissions scenario consistent with the UNFCCC target of increase in global surface temperature by 2°C. (A to E) Changes in globally averaged (A) Sea surface temperature (SST), (B) sea level, (C) sea surface pH (total pH scale), (D) ocean volume (in % of total ocean volume) with saturation state of calcium carbonate in aragonitic form (Wa) above 1 and above 3, and (E) dissolved oxygen. RCP8.5, red lines; RCP2.6, blue lines. Maps show the 21st century changes in SST (F and G) and in sea surface pH (H and I) for RCP8.5 (top) and RCP2.6 (bottom), respectively. All projected values represent ensemble mean values from the Coupled Model Intercomparison Project 5. Figure from Gattuso et al., 2015. .... 42
- Figure 9** Relationships between changes in the living and non-living nature of the Southern Ocean, depicted in a condensed and simplified way. Arrows indicate directed impact. Interactions between biota and the environment are depicted in red. Links within ecosystem components are only very coarsely considered. Figure from Gutt et al., 2015. For description of individual links see Data S1 in Gutt et al., 2015. .... 42
- Figure 10** Schematic representation of ice sheet balance in Antarctica from 1979 to 2017. Figure by Amanda Montañez, adapted from Rignot et al., 2019. .... 43
- Figure 11** Antarctica and the Southern Ocean in 2070, under ‘low emissions/high action’ (left) and ‘high emissions/low action’ (right) scenarios. Figure from Rintoul et al., 2018. .... 44
- Figure 12** Key stages in the evolution of the Antarctic marine fauna. Seven key events through the Cenozoic era are superimposed on the deep-sea palaeotemperature curve developed by Zachos et al., 2008 and Hansen et al., 2013. It should be noted that shelf-depth palaeotemperatures do not necessarily track those of the deep-sea precisely. The trajectory of Antarctic taxonomic diversity through the Cenozoic is still imperfectly known, but it may not bear any close similarity to either the shallow- or deep-sea palaeotemperature curves. Symbols: ACC, Antarctic Circumpolar Current, K, Cretaceous, Pl., Pliocene, P., Pleistocene .Figure from Crame, 2018. .... 46
- Figure 13** Seasonal variation in the Antarctic sea-ice cover (October and February 2015-2016). NASA Earth Observatory maps by Joshua Stevens, using AMSR2 data supplied by GCOM-W1/JAXA. .... 49
- Figure 14** The rate of description of Southern Ocean species. Figure from Griffiths, 2010. .... 50
- Figure 15** The relative distribution of Southern Ocean (a) benthic sampling intensity (mean = 800 m, median = 4,050 m), (b) pelagic sampling intensity (mean = 120 m, median = 2,950 m) and (c) seafloor area with depth (mean = 3,460 m, median = 4,150 m). Red line indicates the 1000 m depth (shelf break), blue line indicates the 3,000 m depth (abyssal plain). .... 52
- Figure 16** Biogeographic divisions of the Southern Ocean proposed by Hedgpeth (1969). .... 53



- Figure 17** From left to right. Specimens of sea star, sea urchin and brittle star brooding juveniles. Credits: National Museum of Natural History, Smithsonian Institution; P. Bucktrout, British Antarctic Survey and P.J. López-González. .... 58
- Figure 18** Current competing hypothesis of relationships derived from morphological or molecular data for the major sea star's clades (Figure from Feuda & Smith, 2015). .... 59
- Figure 19** Illustration of the Southern Ocean sea stars diversity from the Belgica121 expedition. From top left to bottom right: *Granaster nutrix*, *Labidiaster annulatus*, *Psilaster charcoti*, *Odontaster validus*, *Lysasterias sp.* and *Neosmilaster georgianus*. Photo credits Quentin Jossart..... 62
- Figure 20** Occurrences of RAMS (light grey dots) and Proposed-RAMS (orange dots) sea star species. The Antarctic zone is located below the green line and the Sub-Antarctic zone between the green and dark red lines. The Polar Front (black line) and the Sub-Tropical Front (dashed black line) are also shown..... 72
- Figure 21** Map of the 13,840 asteroid species occurrences available in the present database, within the boundaries of the Southern Ocean (45°S). Projection: South Pole Stereographic. .... 89
- Figure 22** Species richness in the Southern Ocean. The number of asteroid species present in 1° × 1° grid cells are reported using yellow-red colour chart B Sampling effort in the Southern Ocean for the class Asteroidea. The number of sampling station per 1° × 1° grid cell is reported using yellow-red colour chart. Projection: South Pole Stereographic. .... 90
- Figure 23** Map of the Southern Ocean. Area of study (below 45 °S) showing the bioregions: Adélie Land (ALand); Antarctic Peninsula & the South Shetland Is. (AP&SSh); Amundsen & Bellingshausen Sea (AS&BS); Balleny & Scott Is. (Bal&Sco); Bounty & Antipodes Is. (Bount&Ant); Bouvet Is. (Bouv); Campbell & Auckland Is. (Cam&Auc); Crozet Is. (Cro); Davis Sea & Wilkes Land (DS&WL); Falkland Is. (Fal); Heard Is. (Heard); Kerguelen Is. (Ker); Macquarie Is. (Mac); Ob & Lena seamounts (Ob&Lena); Prydz Bay (PBay); Prince Edward & Marion Is. (PEd&Mar); Queen Maud Land & Enderby Land (QML&EL); Ross Sea (Ross); South Argentina (SArg); South Chile (SChi); South Georgia & Shag Rocks (SG&Sha); South Orkney Is. (SOrk); South Sandwich Is. (SSand); Tierra Del Fuego (TdF) and Weddell Sea (WS). Depth of study, between 0 and 1500 m is shown in light grey. Projection: South Pole stereographic. .... 102
- Figure 24** Accumulation curves at the species level of Asteroidea for each investigated bioregion: Adélie Land (ALand); Antarctic Peninsula & the South Shetland Is. (AP&SSh); Amundsen & Bellingshausen Sea (AS&BS); Balleny & Scott Is. (Bal&Sco); Bounty & Antipodes Is. (Bount&Ant); Bouvet Is. (Bouv); Campbell & Auckland Is. (Cam&Auc); Crozet Is. (Cro); Davis Sea & Wilkes Land (DS&WL); Falkland Is. (Fal); Heard Is. (Heard); Kerguelen Is. (Ker); Macquarie Is. (Mac); Ob & Lena seamounts (Ob&Lena); Prydz Bay (PBay); Prince Edward & Marion Is. (PEd&Mar); Queen Maud Land & Enderby Land (QML&EL); Ross Sea (Ross); South Argentina (SArg); South Chile (SChi); South Georgia & Shag Rocks (SG&Sha); South Orkney Is. (SOrk); South Sandwich Is. (SSand); Tierra Del Fuego (TdF) and Weddell Sea (WS). (a) Close-up of the first 250 stations. (b) Complete dataset.....105

**Figure 25** Cluster analyses (average linkage) of the percentage faunal similarity (a), (c), (e) and (g) using the Bray-Curtis index and bootstrapped spanning networks (b), (d), (f) and (h) performed for species and genus level as well as for brooding and broadcasting species for the class Asteroidea among the studied bioregions: Adélie Land (ALand); Antarctic Peninsula & the South Shetland Is. (AP&SSh); Amundsen & Bellingshausen Sea (AS&BS); Balleny & Scott Is. (Bal&Sco); Bounty & Antipodes Is. (Bount&Ant); Bouvet Is. (Bouv); Campbell & Auckland Is. (Cam&Auc); Crozet Is. (Cro); Davis Sea & Wilkes Land (DS&WL); Falkland Is. (Fal); Heard Is. (Heard); Kerguelen Is. (Ker); Macquarie Is. (Mac); Ob & Lena seamounts (Ob&Lena); Prydz Bay (PBay); Prince Edward & Marion Is. (PEd&Mar); Queen Maud Land & Enderby Land (QML&EL); Ross Sea (Ross); South Argentina (SArg); South Chile (SChi); South Georgia & Shag Rocks (SG&Sha); South Orkney Is. (SOrk); South Sandwich Is. (SSand); Tierra Del Fuego (TdF) and Weddell Sea (WS). Links with BSV < 70% correspond to dashed lines, links with BSV < 50% are not shown. Corresponding groups based on the cluster analyses display a similar colour. Green: New Zealand – Red: South America – Orange: Sub-Antarctic Islands – Blue: High Antarctica or East Antarctica – Purple: West Antarctica – Burgundy: Circumpolar Pattern. .... 106

**Figure 26** Non-metric multidimensional scaling map with superimposed minimum spanning tree (partial representation to ease the reading) for the class Asteroidea among the 25 studied bioregions: Adélie Land (ALand); Antarctic Peninsula & the South Shetland Is. (AP&SSh); Amundsen & Bellingshausen Sea (AS&BS); Balleny & Scott Is. (Bal&Sco); Bounty & Antipodes Is. (Bount&Ant); Bouvet Is. (Bouv); Campbell & Auckland Is. (Cam&Auc); Crozet Is. (Cro); Davis Sea & Wilkes Land (DS&WL); Falkland Is. (Fal); Heard Is. (Heard); Kerguelen Is. (Ker); Macquarie Is. (Mac); Ob & Lena seamounts (Ob&Lena); Prydz Bay (PBay); Prince Edward & Marion Is. (PEd&Mar); Queen Maud Land & Enderby Land (QML&EL); Ross Sea (Ross); South Argentina (SArg); South Chile (SChi); South Georgia & Shag Rocks (SG&Sha); South Orkney Is. (SOrk); South Sandwich Is. (SSand); Tierra Del Fuego (TdF) and Weddell Sea (WS). (a) All bioregions. (b) Close-up without AS&BS, Mac, Cam&Auc and Bount&Ant. .... 110

**Figure 27** Maps of the Southern Ocean indicating sample location for each target group (red stars). Sampling locations are labelled: red - South Georgia; pink – South Sandwich Islands; yellow – Bouvet Island; dark blue – Kerguelen Islands; light blue – East Antarctica; light green – Amundsen Sea; orange – Antarctic Peninsula; dark green – Burdwood Bank and purple – Weddell Sea. Projection: South Pole Stereographic. .... 126

**Figure 28** Bayesian chronograms of partitioned COI sequences derived from the brooding (left) and broadcasting (right) groups of interest. The distribution of uncertainty of node placement is indicated around each of the main nodes. Time scale is expressed in millions of years. Posterior probabilities and bootstrap values are provided under main nodes. No value was indicated if bootstrap was less than 45%. Coloured patches indicate sampling locations. Results for each species delineation method are reported as black bars representing the delineated units. .... 131

**Figure 29** Brooders statistical parsimony network indicating genetic relationships with regards to sampling locations. Delineated clades are represented and colour code follows the central map: red - South Georgia; pink – South Sandwich Islands; yellow – Bouvet Island; dark blue – Kerguelen Islands; light blue – East Antarctica; light green – Amundsen Sea; orange – Antarctic Peninsula; dark green – Burdwood Bank and purple – Weddell Sea. Projection: South Pole Stereographic. .... 135

- Figure 30** *Bathybiaster* statistical parsimony network indicating genetic relationships with regards to A) sampling geographic locations and B) sampling depths and Kerguelen Island (shallow and deep). Delineated clades are represented and colour code follows the appended legend. .... 136
- Figure 31** Latitudinal gradients of sea stars' species and genus richness in the Southern Ocean. A.) Occurrence map with location of both quadrants (New Zealand in green and South America in orange) Projection: South Pole stereographic. B.) Entire Southern Ocean. C.) New Zealand Quadrant. D.) South America Quadrant. Histograms for richness, sampling effort and species:genus ratio are presented by 1° latitudinal bands. Accumulation curves are fitted to match with latitude (UGE index – 999 permutations representing a mean random accumulation curve, SObs – recorded richness according to latitude, Jackknife2 – corrected richness based on sampling effort). ..... 155
- Figure 32** (Double page). Bayesian phylogenetic reconstruction of the class Asteroidea based on mtDNA (COI). Nodes posterior probabilities are indicated when superior to 0.5. Coloured squares indicate specimen locations: blue, Southern Ocean; red, outside the Southern Ocean and yellow, from both inside and outside the Southern Ocean. Subgroups used for further analyses are indicated in red (Fully developed tree available in Appendix 3)..... 158
- Figure 33** Characteristic phylogeographic signatures of Southern Ocean sea stars shown as parsimony networks of COI haplotypes coloured according to sampling locations. Species delineation results are presented as red clusters/rectangles for *Rhopiella hirsuta*..... 163
- Figure 34** Accumulation curve of Southern Ocean sea stars occurrences available through time (1872-2014) with indication of major international research programs. Data from Moreau et al., 2018. .... 174
- Figure 35** Number of occurrence records for sea stars (from 1919 to 2019) available from the Ocean Biogeographic Information System..... 178

# Tables

- Table 1** RAMS area of interest. Operational northern limits in the different sector of the Southern Ocean for both the Antarctic zone and the sub-Antarctic zone. .... 73
- Table 2** Breakdown numbers of occurrences, stations and taxonomic entities of Asteroidea for each of the 25 investigated bioregions. NA refers to occurrences found outside of the bioregions of interest. Adélie Land (ALand); Antarctic Peninsula & the South Shetland Is. (AP&SSh); Amundsen & Bellingshausen Sea (AS&BS); Balleny & Scott Is. (Bal&Sco); Bounty & Antipodes Is. (Bount&Ant); Bouvet Is. (Bouv); Campbell & Auckland Is. (Cam&Auc); Crozet Is. (Cro); Davis Sea & Wilkes Land (DS&WL); Falkland Is. (Fal); Heard Is. (Heard); Kerguelen Is. (Ker); Macquarie Is. (Mac); Ob & Lena seamounts (Ob&Lena); Prydz Bay (PBay); Prince Edward & Marion Is. (PEd&Mar); Queen Maud Land & Enderby Land (QML&EL); Ross Sea (Ross); South Argentina (SArg); South Chile (SChi); South Georgia & Shag Rocks (SG&Sha); South Orkney Is. (SOrk); South Sandwich Is. (SSand); Tierra Del Fuego (TdF) and Weddell Sea (WS). .... 108
- Table 3** Results of the Mantel test between BSN structure matrices using the Spearman coefficient.  $r_s$  is the correlation value and p the associated probability. The symbol \* underlines significant values ( $P < 0.05$ ). .... 109
- Table 4** Molecular diversity statistics for each delineated species. Statistics for taxonomic groups with  $n < 25$  are not represented. n: number of sequences.  $\pi$ : nucleotide diversity. H: haplotype diversity. .... 132
- Table 5** Number of species delineated by the different species delineation methods ..... 133
- Table 6** Sea star richness and endemism estimates (in percentage relative to the global richness) inside and outside the Southern Ocean (Compiled from Mah & Blake, 2012; Moreau et al., 2018). .... 154
- Table 7** Investigated families with mention of their environmental settings (from Mah & Blake, 2012) their presence in the Southern Ocean (SO; from Moreau et al., 2018) and whether genetic sequences are available for the Southern Ocean. Ant: Antarctic (i.e. South of the Polar Front  $\sim 60^\circ\text{S}$ ; sub-Ant: sub-Antarctic (i.e. North of the Polar Front and south of the Subtropical Front  $\sim 45^\circ\text{S}$ ). 157
- Table 8** Delineated Southern Ocean species in the six investigated clades, with a note regarding the need for a taxonomic revision. Counts based on available genetic sequences. SO: Southern Ocean. .... 164



# General Introduction



# General Introduction

## I. Antarctica and the Southern Ocean

### a. **Geological & climatic history**

#### i. **Tectonics and geomorphology**

Antarctica is the coldest, driest and most isolated continent on Earth. Its position, centred on the South Pole is the result of a long paleogeographic and tectonic history, dating back to as far as the breakup of the supercontinent Gondwana. Initiated at the very end of the Early Jurassic (~175 Ma), this breakup marks the starting point of what will become the Southern Ocean as we know it today. Within these ~175 Myr, the supercontinent partitioned into seven distinct continental masses: Antarctica, Australia, New Zealand, India, Madagascar (East) and Africa, South America (West) (Knox, 2007). Starting with the initial rifting between West and East Gondwana around 175 Ma, it was not until the Early Cretaceous (130 Ma) that the separation was complete, resulting in the formation of the Weddell Sea and initiating the physical isolation of East Gondwana at high latitudes (Figure 1; Crame, 1999). Around this period, during the Early Cretaceous, rapid northward motion of India started together with the drifting and isolation between Africa and South America (Crame, 1999; McLoughlin, 2001). At the same time Antarctica drifted to its contemporary location and shallow seaways started to emerge between Antarctica and Australia (Lawver & Gahagan, 1998; McLoughlin, 2001). During the Late Cretaceous (80 Ma) New Zealand separated from the Antarctic continent leaving only Tasmania in the East and South America in the West blocking deep water circulation until the end of the Paleogene, ~25 Ma (Crame, 1999). The Cenozoic was a period of dramatic changes with the opening of two key deep ocean gateways: one between Tasmania and Antarctica and the other between South America and Antarctica (Crame, 1999). The former started 64 Ma leading to a complete separation between continental masses by the beginning of the Eocene 50 Ma (Crame, 1999) while the latter led to the disruption of the Weddellian Isthmus and opening of Drake Passage (Reguero et al., 2014), believed to have occurred around 40 Ma with some debate about the accurate dating of the different geologic phases that succeeded between 6 and 41 Ma (Thatje, 2012; Scher & Martin, 2004; Lyle et al., 2007; Barker & Thomas, 2004). These last two events, and particularly the opening of the Drake Passage between Antarctica and South America allowed the circulation of deep circum-



Antarctic waters and onset of the Antarctic Circumpolar Current. These current systems are the main driving forces of the physical and thermal isolation of the Southern Ocean from other water masses (Lagabrielle et al. 2009, Thatje, 2012; Reguero et al., 2014). The onset of the Antarctic Circumpolar Current was associated to a series of climatic and oceanographic changes that play major roles into the distribution and evolution of life in the Southern Ocean.

As a result of its tectonic history, the Southern Ocean is mainly composed of abyssal plains with three deep-water basins surrounding the Antarctic continent (Figure 2; Knox, 2007). The Atlantic-Indian, Indian-Antarctic and Pacific Antarctic basins are partially bounded by a series of ridges, which together with the Kerguelen Plateau and the Scotia Arc tend to restrict or even deflect water circulation from bottom to surface (Figure 2). The Antarctic continental shelf itself has particular geomorphologic features. The enormous pressure exerted by the large mass of ice during ice sheet expansion (isostatic loading), the erosion caused by glacial cycles and iceberg scouring, and the lack of sediment supply from major rivers are at the origin of an over-deepening of the Antarctic continental shelf (Post et al., 2014; Clarke & Johnston, 2003; Huybrechts, 2002). Average depth of the Antarctic continental shelf is about 400 to 700m, representing two to four times the average depth found in other continental shelves in the world (Knox, 2007; Uri et al., 1992; Walsh, 1988). The topographic reconstruction of Antarctic continental mass (i.e. without ice cover; Figure 2) allows to visualise the occurrence of a possible trans-Antarctic seaway that may have opened during periods of ice sheet collapses (Bamber et al., 2009; Pollard & DeConto, 2009) as a result of complex tectonic processes leading to an aborted rift between West and East Antarctic blocks (Fitzgerald, 2002). Both this trans-Antarctic seaway and over-deepening of the Antarctic continental shelf are regarded as conditioning factors of depth and biogeographic distributions of Southern Ocean species (Brey et al., 1996; Barnes & Hillenbrand, 2010; Pierrat et al., 2013; Clarke et al., 2004).

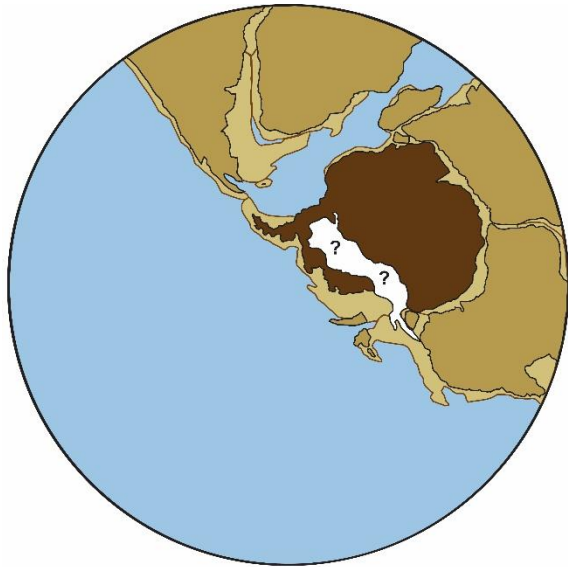

130 Ma - Early Cretaceous

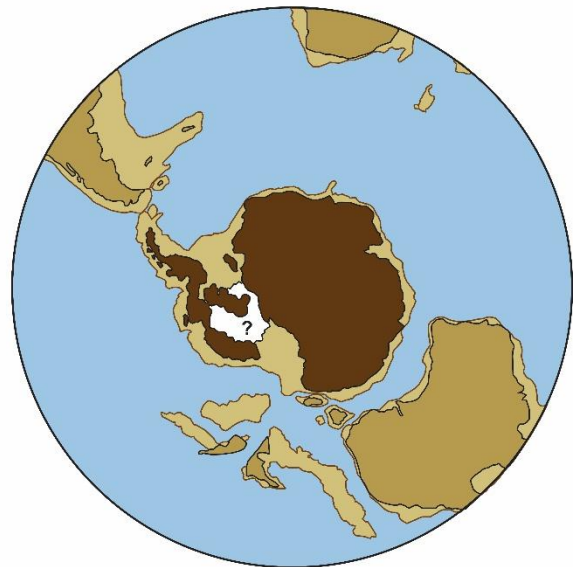

70 Ma - Late Cretaceous

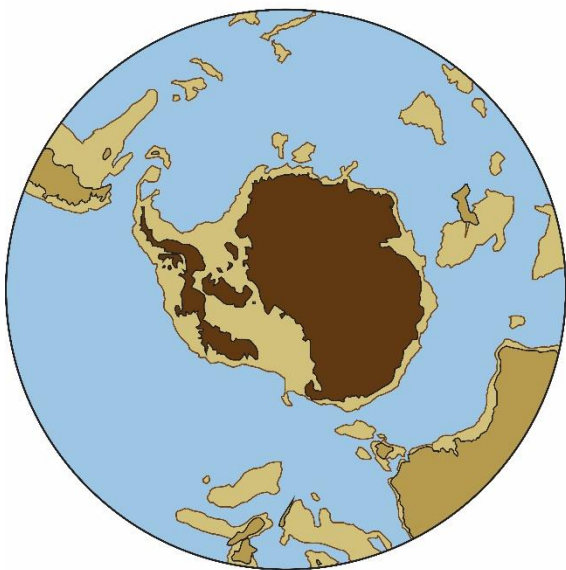

30 Ma - Early Oligocene

Figure 1 Evolution of the Southern Ocean (modified from Crame, 1999; Lawyer & Gahagan, 2003). Paleogeographic reconstructions of the southern continents (south of 30°S) during the Early and Late Cretaceous and during the Early Oligocene. Continental margins and shelves in light beige, continent in dark beige, Antarctica in dark brown.

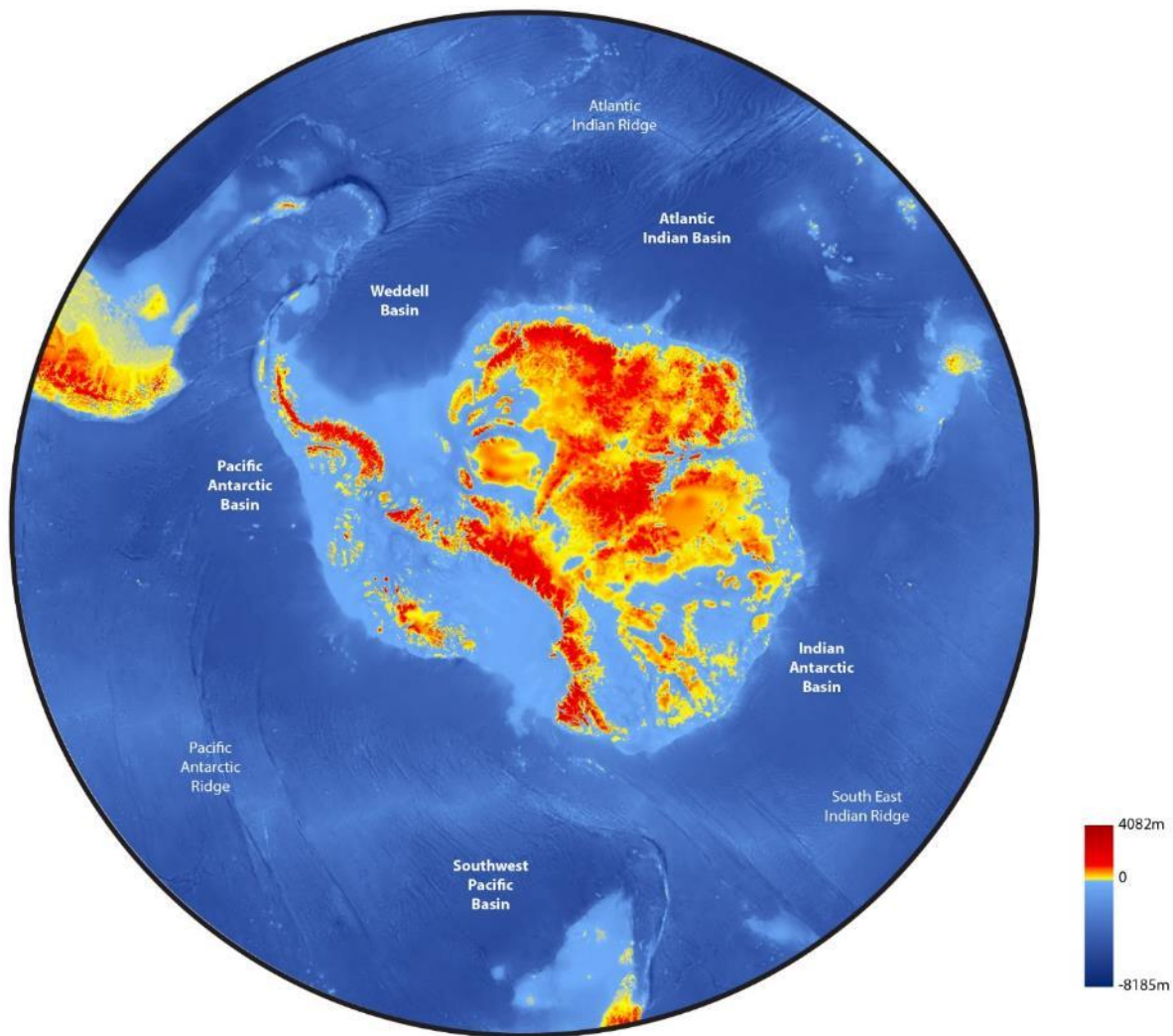

Figure 2 Subglacial topographic reconstruction of the Southern Ocean (compiled using GEBCO, 2014 and BEDMAP2; Fretwell et al., 2013 grids).

### Climatic history

Mean seawater surface temperatures in the Southern Ocean are low compared to other oceans. In the sub-Antarctic, these temperatures range from 4 to 8°C in summer and from 1 to 3°C during winter. Further south, north of the Antarctic region, they range from 1 to 2°C in winter and 3 to 5°C in summer and often reach values as low as about -1.9°C near the continent (See “Fronts and zonation” for the zonal delineation; Knox, 2007; David & Saucède, 2015). These low temperatures are the result of Earth “global cooling” since the Late Mesozoic and the successive climate phases that, from an ice-free world (=Greenhouse global climate/period in the Cretaceous and Paleogene) led to glacial conditions in Antarctica (=Icehouse global climate in the Neogene) (Liu et al., 2009). In Antarctica, its initiation happened around 42 Ma (Doria et al., 2011) and palaeotemperatures suggest a completion in

three distinct steps of around 2-3°C (Figure 3; Crame, 1999; Stott et al., 1990). The onset of the Antarctic Circumpolar Current during the Oligocene (Knox, 2007; Barker et al., 2007; Siebert & Florindo, 2008, Lefebvre et al., 2012) and set-up of the deep ocean circulation reduced southward heat transport (Toggweiler & Bjornsson, 2000; Sijp & England, 2004), and have played an important role in past climate change by increasing the geographic and climatic isolation of Antarctica (See “Oceanographic features” section).

In the Southern Ocean, this global cooling led to the formation and rapid expansion of Antarctic continental ice-sheets with a major influence on the global climate system, notably on the global water cycle by locking up or releasing vast amounts of freshwater, on the radiative budget through the albedo effect and finally on the thermohaline circulation via freshwater discharged by icecap melting or iceberg calving (Eisen et al., 2008). Apart from the Miocene Climatic Optimum that lasted about 15 Myr, temperatures drop continued during the Upper Miocene and accelerated in the Pliocene (5 Ma) until present days to reach the sub-zero values we currently observe in the vicinity of the Antarctic Continent (Zachos et al., 2001). Although the cooling of the Southern Ocean might seem relatively continuous, especially within the last 15 Myr, glacial and interglacial periods, driven by astronomical forcing called the Milankovitch cycles (Berger, 1988) still affect climate and, by extension, the distribution in space and time of Southern Ocean organisms at smaller time scales (several kyr; Clarke & Crame 1989, 1992). Naish et al. (2009) estimated that at least 38 distinct glacial cycles occurred over the last 5 Myr (Plio-Pleistocene glacial cycles). During these glacial-interglacial cycles, the ice sheet expands and retreats, eradicating habitats from the Antarctic continental shelf with tremendous consequences on the fauna (Clarke et al., 1992; Thatje et al., 2005). Molecular and geophysical evidences however suggest that these cycles were not synchronous over the entire continental shelf allowing for ice-free refuges to persist and shelter marine fauna (Hemery et al., 2012; Clarke & Crame, 2010; Shipp et al., 1999; further details in section “Benthos origin and evolution”).

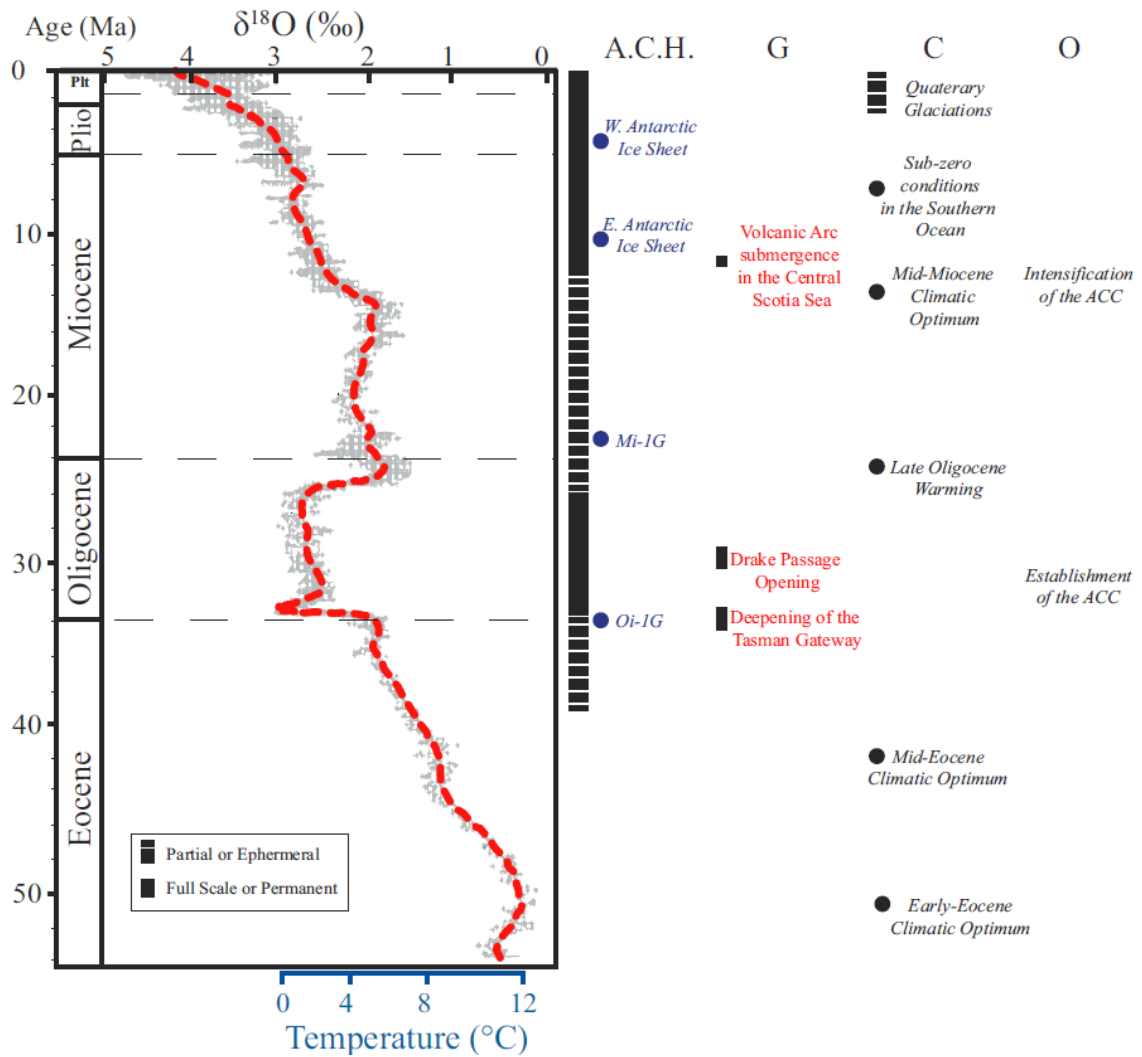

Figure 3 Global deep-sea oxygen isotope and temperature records during the last 50 Myr (Zachos et al., 2001) showing the Antarctic Cryosphere History (A.C.H.) major geologic (G), climatic (C), oceanographic (O) events. Modified from González-Wevar et al., 2017.

## **b. Oceanographic features**

### **i. Current system in the Southern Ocean**

Sea surface currents are mainly the product of stress exerted by the winds on sea surface waters (Gordon, 2001). In the Southern Ocean, strong westerlies (winds blowing eastwards) drive the Antarctic Circumpolar Current (see Rintoul et al., 2001 for a review), the most powerful current on Earth ( $140\text{-}160 \text{ } 10^6 \text{ m}^3/\text{s}$ ). The Antarctic Circumpolar Current flows around the Antarctic Continent with a constriction in the region of the Drake Passage (body of water between Cape Horn and the Antarctic Peninsula) while it reaches over 1,000 km width in the Atlantic sector (Knox, 2007). The strong influence of the Antarctic Circumpolar Current on climate (Cunningham et al., 2003; Griesel et al., 2012), on water masses structure (Sokolov & Rintoul, 2009) and thus on Southern Ocean fauna (Clarke et al., 2005) is no longer to be demonstrated. At higher latitudes, south of  $65^\circ\text{S}$ , easterlies (winds blowing westwards) generate the Antarctic Coastal Current that generally flows along the coastline. Two important indentations in the Ross and Weddell seas are materialised by permanent cyclonic (clockwise) gyres (Figure 4; David & Saucède, 2015; Knox, 2007).

At the scale of the World Ocean, the circumpolar expanse of the Southern Ocean over three major oceanic basins (Atlantic, Pacific and Indian oceans) plays a key role in the global ocean circulation (Figure 5). This interbasin connection via the Antarctic Circumpolar Current sustains a global-scale overturning circulation (Rintoul et al., 2001; Rintoul & Garabato, 2013) with a profound influence on the world's oceans and climate (Carter et al., 2008) notably through the thermohaline circulation (Figure 5; Park et al., 1998; Jacob, 2004). At the surface, wind-driven forcing exerted on water masses creates a northward transport of water (Figure 6). Deep waters follow a same south-north direction, but this transport, feeding the World's ocean with nutrient-rich water masses, is mainly due to variations in water density. At intermediate depths, return flows from the three surrounding basins complete the full cycle of water masses in the overall system (Figure 5 & Figure 6; Sturm, 2004; Carter et al., 2008).

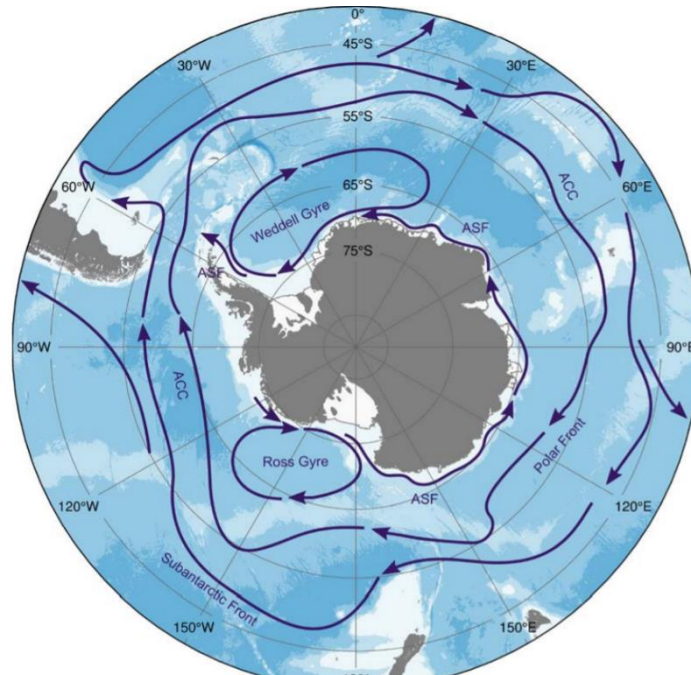

Figure 4 Major Southern Ocean circulation features (adapted from Rintoul et al. 2001), showing the Polar and sub-Antarctic Fronts of the Antarctic Circumpolar Current, sub-polar gyres and Antarctic Slope Front (ASF). Background colours show bathymetry. Figure from Post et al., 2014.

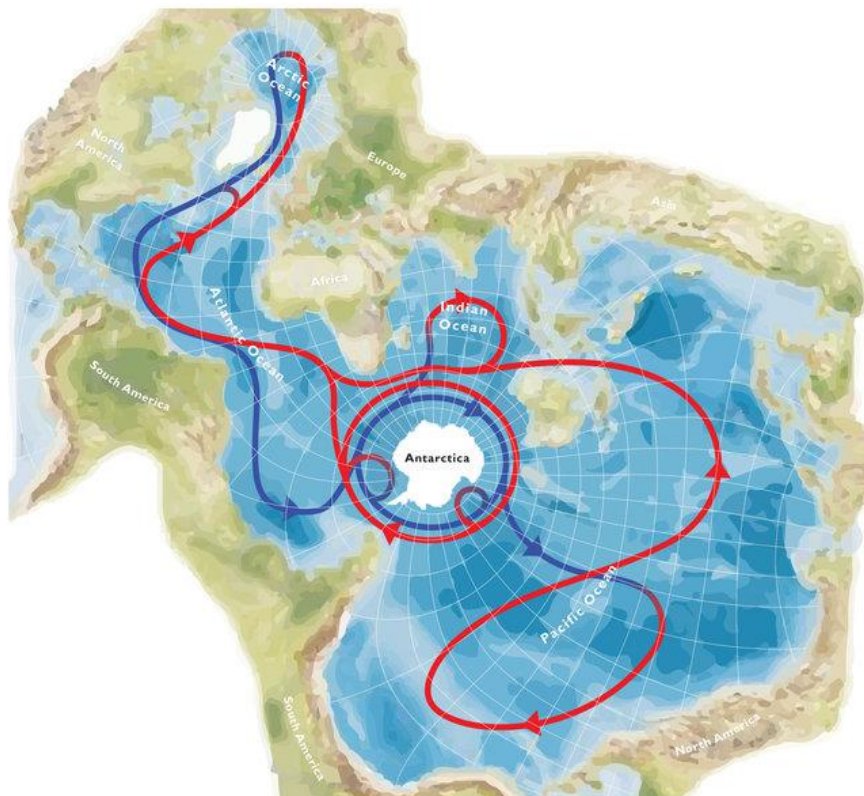

Figure 5 The globe viewed on a Spilhaus projection; in contrast to conventional projections, this portrays the ocean fringed by land. The global thermohaline circulation is shown in cartoon form, with upper-layer flow in red and lower-layer flow in blue. Figure from Meredith, 2019.

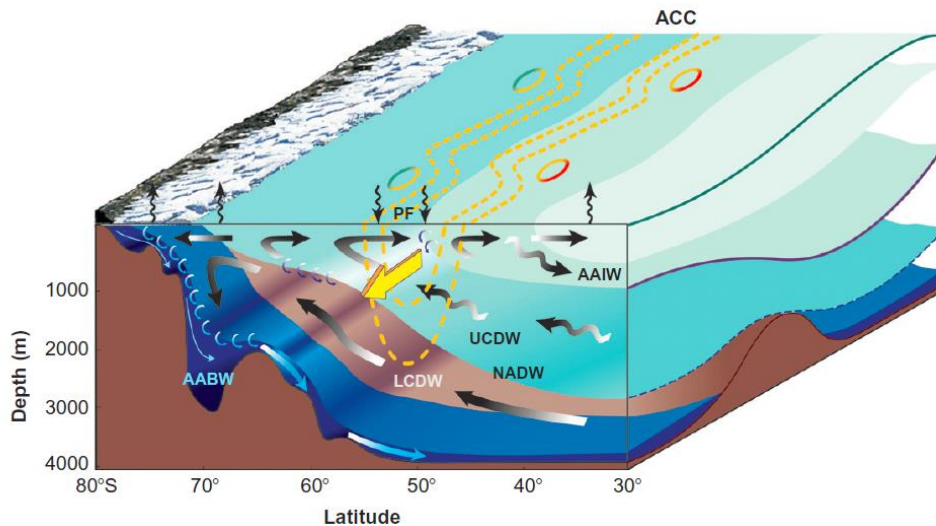

Figure 6 A sketch of the Antarctic Circumpolar Current system showing the zonal flow and the meridional overturning circulation and water masses. Antarctica is at the left side. The east–west section displays the isopycnal (same density) and sea surface tilts in relation to submarine ridges, which are necessary to sustain the bottom form stress signatures (see Olbers et al. 2004). The curly arrows at the surface indicate the buoyancy flux; the arrows attached to the isopycnals represent turbulent mixing. An upper cell is formed primarily by northward Ekman transport (horizontal transport of superficial water layers through wind friction) beneath the strong westerly winds and southward transport in the Upper Circumpolar Deep Water (UCDW) layer. The lower cell is driven primarily by formation of dense AABW near the Antarctic continent and inflowing Lower Circumpolar Deep Water (UCDW or NADW). Figure from Olbers and Visbeck (2005), adapted from Speer et al. (2000).

## ii. Fronts and zonation

Water masses of the Southern Ocean are distributed in accordance with a complex, latitudinal marine front system that was first observed in the early 1930's based on bottle-casts made from the *RRS Discovery* (Deacon, 1937) and then reviewed by Deacon (1982). This frontal system induces a latitudinal zonation of the Southern Ocean comprising four frontal zones and two major regions (Figure 7). From North to South, four main fronts can be characterised by steep gradients (warmer and more saline waters north of each front) in sea-surface temperature and salinity, delimiting water masses with different densities: (1) the subtropical front or subtropical convergence, which delineates the northern boundary of the Southern Ocean and is positioned at around 45°S, materialises the transition between the sub-Antarctic zone and subtropical latitudes (Orsi et al., 1995; Deacon, 1982); (2) the sub-Antarctic front, positioned around 55°S, which delimits the sub-Antarctic Zone to the North and the Polar Frontal Zone to the South (Gordon, 2001); (3) the Polar Front or Antarctic Convergence,



at latitudes of around 60°S, is the most significant front. The Polar Front splits the Southern Ocean into two regions with contrasting climatic and environmental characteristics: the sub-Antarctic to the North and the Antarctic to the South (Knox, 2007); (4) the Antarctic Divergence, in the vicinity of the Antarctic continent, represents the separation between the Antarctic Circumpolar Current and the Antarctic Coastal Current and delimits the Antarctic Zone to the North and the High Antarctic to the South (Figure 7). While these fronts are mainly circumpolar, with the exception of the subtropical front interrupted by South America, their respective latitudinal positions vary with longitude (see Figure 7). The position and permeability of these fronts to marine species dispersal can also vary through time, from seasonal to pluri-millennium time scales. The development of eddies, comparable to current cores crossing the fronts has also been observed (Gordon, 1988). The effect of fronts and eddies on biogeographic patterns is well reported and will be later discussed in this introduction.

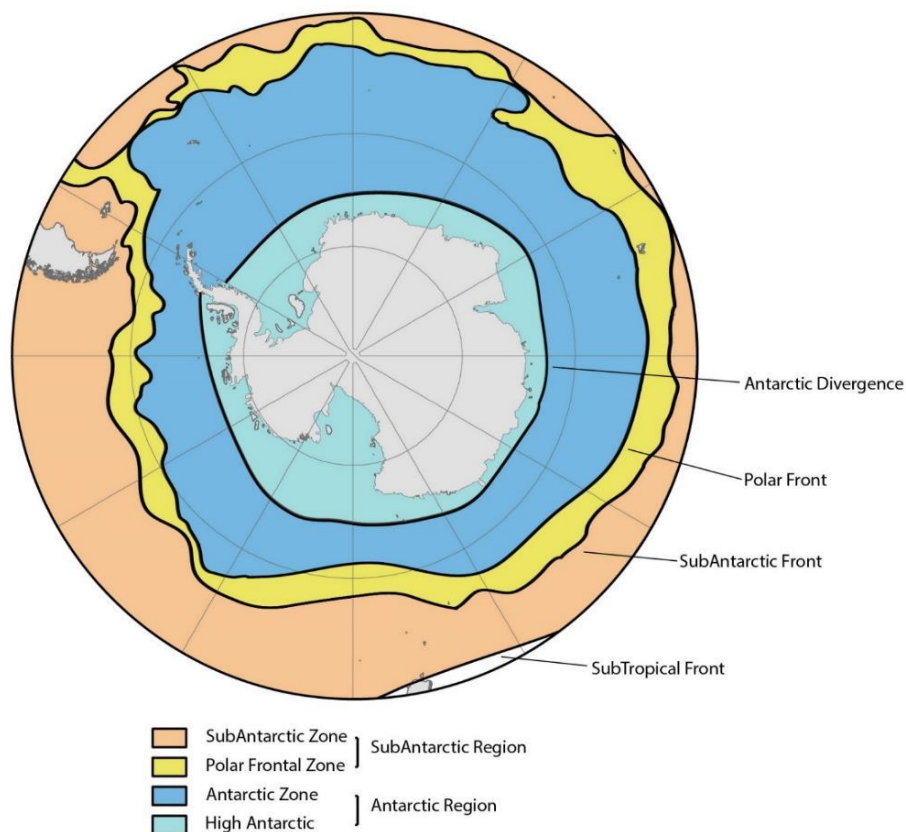

Figure 7 Map of the Southern Ocean showing the approximate position of oceanic fronts and associated zones (Figure modified from Knox, 2007 and Orsi et al., 1995)

### c. A changing world

Since the industrial era, the increase of greenhouse gases released in the atmosphere has driven major environmental changes. Oceans around the world moderate anthropogenic climate change at the cost of profound alterations of their physics, chemistry, ecology, and ecosystem services (Gattuso et al., 2015). Whether at the surface or in deep waters, abiotic parameters such as pH, temperature and oxygen content show profound changes and are expected to follow current trends in the future (see Figure 8). Changes induced by human activities since the industrial era know no boundary and are also affecting the Southern Ocean ecosystems in a significant way (Summerson & Bishop, 2012; Convey, 2001).

Gutt et al. (2015) summarise the relationships between changes in the environment and the potential effect on biotic and abiotic parameters (Figure 9), showing the complexity of interactions within the Southern Ocean. The rise in Earth's global temperature (as observed today) is expected to continue as described in the 5th Intergovernmental Panel on Climate Change report (IPCC, 2015) and many scientific studies (see Rintoul et al., 2018). This is, and will continue to affect habitats and organisms of the Southern Ocean through variations in water temperature, salinity, pH (ocean acidification), current or glacial regimes more rapidly than ever observed (Figure 10; Halanych & Mahon, 2018).

Narratives for the Southern Ocean have been recently presented from the perspective of an observer looking back from 2070 (Rintoul et al., 2018). Under both high and low emissions scenarios, they speculate on future consequences of global change on terrestrial, marine but also in term of human impacts and engagements (see Figure 11). Expected consequences are numerous with notably a rise in air and water temperature of +0.9 to +3°C and +0.7 to +1.9°C respectively, strongly affecting the ice shelf volume and subsequently sea level around the world. Biological communities are not exempted, with an impact on calcification due to ocean acidification, an increase of non-indigenous invasions or profound changes in ecosystems. A more speculative opinion is the incidence of global changes on economic policies for the Southern Ocean, which could lead to an increase in human presence and the use of natural resources (mining, fishing; Figure 11).

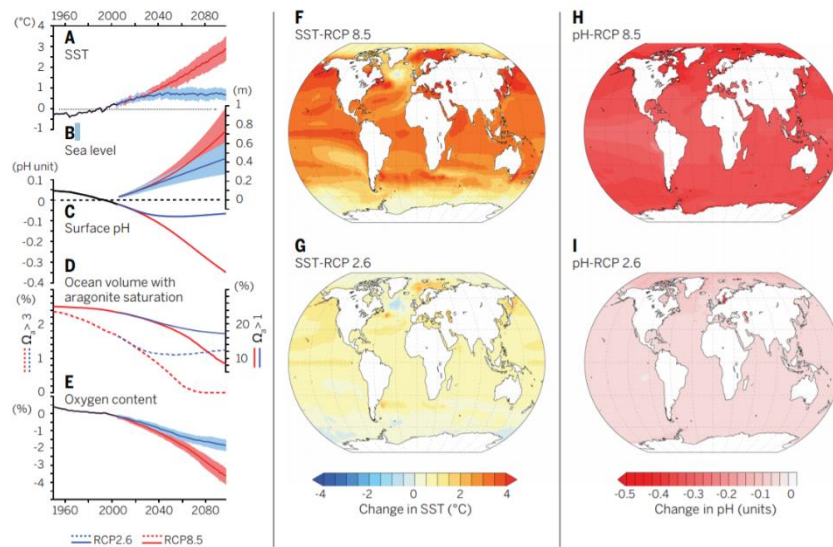

Figure 8 Environmental changes over the industrial period and the 21<sup>st</sup> century for business-as-usual scenario and a stringent emissions scenario consistent with the UNFCCC target of increase in global surface temperature by 2°C. (A to E) Changes in globally averaged (A) Sea surface temperature (SST), (B) sea level, (C) sea surface pH (total pH scale), (D) ocean volume (in % of total ocean volume) with saturation state of calcium carbonate in aragonitic form (W<sub>a</sub>) above 1 and above 3, and (E) dissolved oxygen. RCP8.5, red lines; RCP2.6, blue lines. Maps show the 21st century changes in SST (F and G) and in sea surface pH (H and I) for RCP8.5 (top) and RCP2.6 (bottom), respectively. All projected values represent ensemble mean values from the Coupled Model Intercomparison Project 5. Figure from Gattuso et al., 2015.

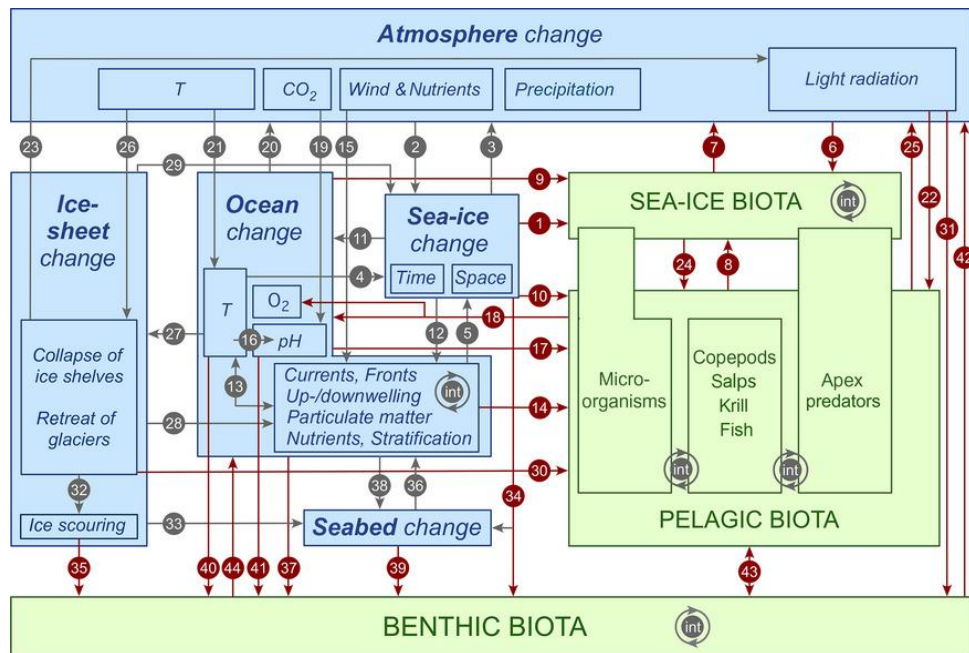

Figure 9 Relationships between changes in the living and non-living nature of the Southern Ocean, depicted in a condensed and simplified way. Arrows indicate directed impact. Interactions between biota and the environment are depicted in red. Links within ecosystem components are only very coarsely considered. Figure from Gutt et al., 2015. For description of individual links see Data S1 in Gutt et al., 2015.

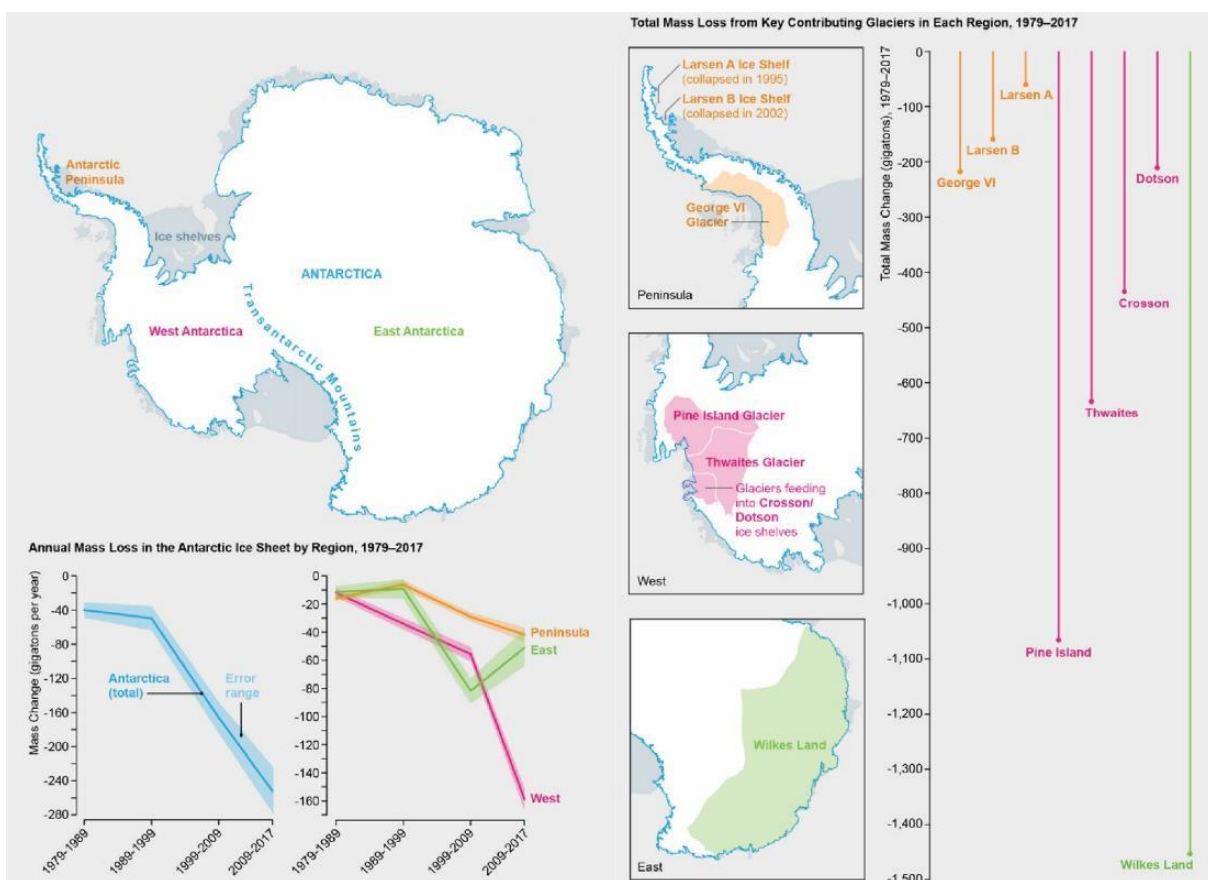

Figure 10 Schematic representation of ice sheet balance in Antarctica from 1979 to 2017. Figure by Amanda Montañez, adapted from Rignot et al., 2019.

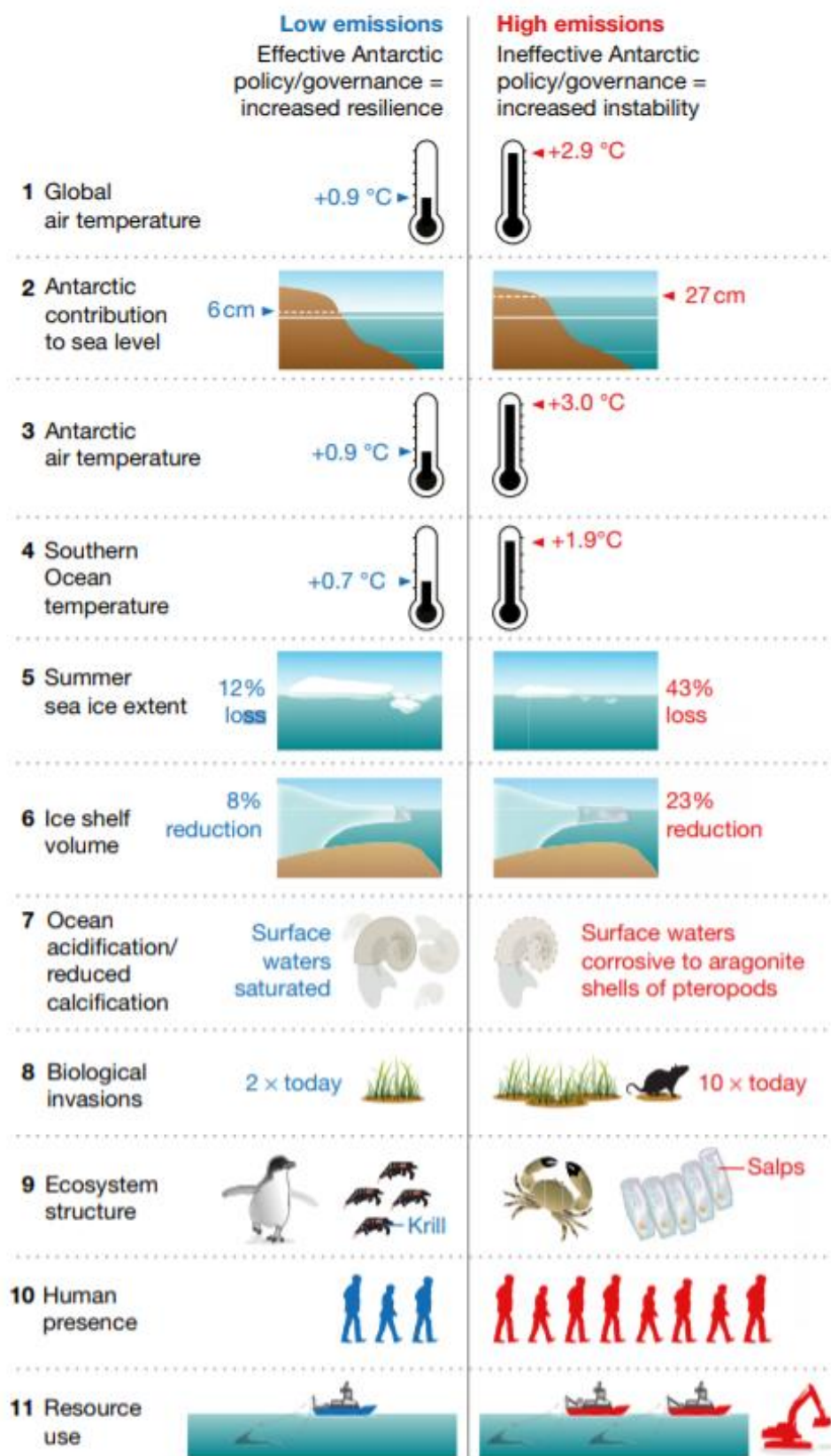

Figure 11 Antarctica and the Southern Ocean in 2070, under ‘low emissions/high action’ (left) and ‘high emissions/low action’ (right) scenarios. Figure from Rintoul et al., 2018.

II. Origin and evolution of the Antarctic benthos

a. **Origins: a succession of extinction and recolonisation**

i. **Pre-Cenozoic origins**

One of the striking features of Southern Ocean benthic communities is its resemblance with Palaeozoic assemblages (~540 to 250 Ma) in which stalked filter-feeders and echinoderms dominated (Dell, 1972; Aronson et al., 1997). It is however now accepted that these Palaeozoic-like characters (i.e. low-predation, filter-feeder communities) do not result from long survival of an old fauna but rather from similarities in ecological conditions (Gili et al., 2006) due to the absence of durophagous species (predators of hard-shelled organisms, Frederich et al., 2002). The possibility that few representatives of the modern benthic fauna in the Southern Ocean could be extremely old and the result of a long and complex history can however not be discounted (Crame, 1994; Crame, 2014). The major issue when trying to estimate the relevance of such old ancestry is the very incomplete marine fossil record (Crame, 1994). Only a small proportion of modern Antarctic groups (i.e. gastropods, asellote isopods, hexactinellid sponges, pycnogonids and gorgonian octocorals) shows scarce but existing evidences of pre-Cenozoic roots (Gili et al., 2006; Taylor & Rogers, 2015; Lins et al., 2012; Crame et al., 2014; Crame, 2018).

The end of the Cretaceous and entrance in the Cenozoic, marked by a mass extinction event (Cretaceous-Paleogene; K-Pi) that took place 66 Ma (Figure 12) is described as a “reset” in the evolution of life on Earth, leading to a fundamental reorganisation of global marine ecosystems and ultimately to the modern faunas’ establishment (Stanley, 2007; Crame, 2018). This transition, although not instantaneous, was rapid and severe (Witts et al., 2016) and initiated a series of evolutionary phases leading to the contemporary fauna (Crame, 2018).

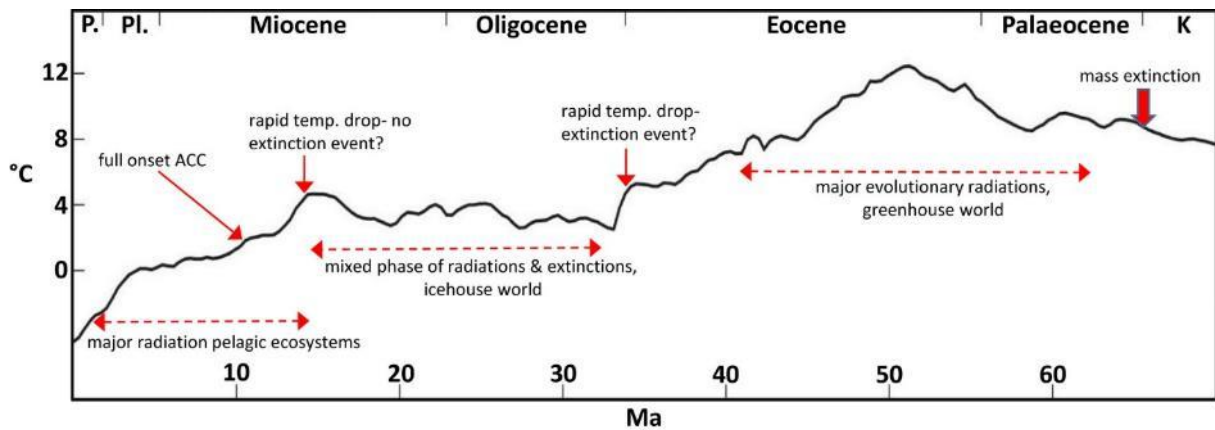

Figure 12 Key stages in the evolution of the Antarctic marine fauna. Seven key events through the Cenozoic era are superimposed on the deep-sea palaeotemperature curve developed by Zachos et al., 2008 and Hansen et al., 2013. It should be noted that shelf-depth palaeotemperatures do not necessarily track those of the deep-sea precisely. The trajectory of Antarctic taxonomic diversity through the Cenozoic is still imperfectly known, but it may not bear any close similarity to either the shallow- or deep-sea palaeotemperature curves. Symbols: ACC, Antarctic Circumpolar Current, K, Cretaceous, Pl., Pliocene, P., Pleistocene. Figure from Crame, 2018.

## ii. Cenozoic evolution of the Antarctic benthos

In his review of key stages in the evolution of the Antarctic marine fauna, Crame (2018) explores in detail the succession of events (Figure 12) that affected benthic and pelagic fauna throughout the Cenozoic era. Although the evolution of Antarctic marine diversity remains largely unknown, a much better picture can now be drawn from integrative paleobiological, molecular and biogeographic studies (coined the macroecological approach by Brown, 1995).

First, the K-P mass extinction was followed by a phase of intense recovery of biodiversity promoted by ecological opportunities and the evolvability of survivors (Crame, 2018). The recovery of biodiversity in the early Cenozoic (Bush & Bambach, 2015) can be traced back within several taxonomic groups (e.g. decapods crustaceans, teleost fish, molluscs, echinoids) through the few fossiliferous formations (e.g., Sobral Formation and La Meseta Formation in Seymour Island) exposed in Antarctica (Zinsmeister 1979, Stilwell et al., 2004; Beu, 2009; Saucède et al., 2013, Crame et al., 2014).

From the Middle Eocene to the Early Oligocene (~45 to 30 Ma), only scarce evidence is available and should be interpreted with care (Crame, 2018). This period coincides with a

major cooling of the Southern Ocean following three phases of 2-3°C drops each (Stott et al., 1990). It is tempting to link a possible Late Eocene extinction event to these environmental changes, but clear evidence is still lacking (Crame, 2018). The physical isolation of Antarctica (see tectonics and geomorphology) being completed at this time together with the onset of glaciation certainly had an effect on the fauna from the Early Oligocene and throughout the Miocene with substantial changes in taxonomic group composition (Aronson et al., 2007). The fossil record is incomplete by nature, but it suggests a significant extinction event at the Eocene-Oligocene boundary (the “break” of Stehlin; Cavalier et al., 1981) followed by a series of phased extinctions and radiations at the Oligocene-Miocene transition (Crame, 2018).

The Middle Miocene marks the last key event in the long evolution of the Antarctic benthos (Figure 12). The intensification of the Antarctic Circumpolar Current, the steep drop in water temperature and the presence of perennial sea-ice cover (Crampton et al., 2016) seem to be concordant with major radiation events in the Southern Ocean benthos (e.g. Strugnell et al., 2008; Janosik et al., 2011). Timings of radiations are however different between taxonomic groups (Verheye et al., 2017; González-Wevar et al., 2017; Dueñas et al., 2016; Barco et al., 2012; Diaz et al., 2011) and may be linked to the dynamics of ice advances and retreats during Pliocene-Pleistocene glacial-interglacial cycles rather than to the Middle Miocene Climatic Transition. This succession of glacial inter-glacial periods, at least 38 during the last 5 Myr (Naish et al., 2009), may have triggered these radiations. The so-called “Antarctic diversity pump” (Clarke & Crame, 1992) resulting from glacial eradications of shelf habitats, subsistence in deep or ice-free isolated refuges followed by recolonisations and migrations in and out of Antarctica has indeed been suggested as a strong driver of species diversification in many genetic studies (e.g. Near et al., 2012; Havermans, 2014; Rogers, 2007).



In summary, the present composition of the Southern Ocean fauna is believed to have several origins:

- **A relict autochthonous fauna** of Gondwanian origin that survived the K-P extinction and the Eocene cooling phase (applicable to the Antarctic and sub-Antarctic fauna).
- **A deep-sea fauna that colonised the Antarctic shelf** from the deep ocean basins and via the deep Antarctic shelf and slope (i.e. Polar Emergence hypothesis) (applicable to the Antarctic and sub-Antarctic zones fauna).
- **A Magellanic component that colonised** via dispersal along the Scotia Arc (applicable to the Antarctic fauna) or dispersal via the Antarctic Circumpolar Current (applicable to the sub-Antarctic fauna).
- **A northern fauna** migrating to the Southern Ocean (applicable to the Antarctic and sub-Antarctic fauna). Either from tropical latitudes (Out of the Tropic scenario) via South American or Indo-West Pacific regions or via deep sea routes.
- ***In situ* diversifications** following all the previously mentioned scenarios. Whether catalysed by geographic isolation in glacial refuges (see section “genetic diversity patterns”), on the many islands surrounding Antarctica or induced by oceanographic (e.g. Antarctic Circumpolar Current) or biological (e.g. reproductive strategy) factors; the uniqueness of current biodiversity is the result of *in situ* evolution.

It is however important to note that these potential origins imply the probable subsequent colonisation via dispersal and/or migration of taxa in and out of their respective zones making the identification of centres of origin rather complicated.

## b. Modern benthic life in the Southern Ocean

### i. A century of discoveries

Being the last to be discovered, regions of the Southern Ocean and Antarctica have only been recently surveyed and remain underexplored for a large part (Clarke & Johnston, 2003; Clarke et al., 2007; Griffiths et al., 2014). The dramatic seasonal variations in sea-ice cover that can double during the austral winter (Figure 13; Zwally et al., 1983; Comiso & Zwally, 1984), extreme weather and sea conditions (e.g. sub-zero temperatures, strong winds), the important depth of the seabed are all limiting factors to marine life investigations. The Heroic Age of Exploration (1895-1922 however witnessed the beginning of systematic and comprehensive scientific sampling in Antarctica starting with the Belgica expedition in 1897-99 and notably including the Discovery and Pourquoi-Pas? research voyages (Figure 14).

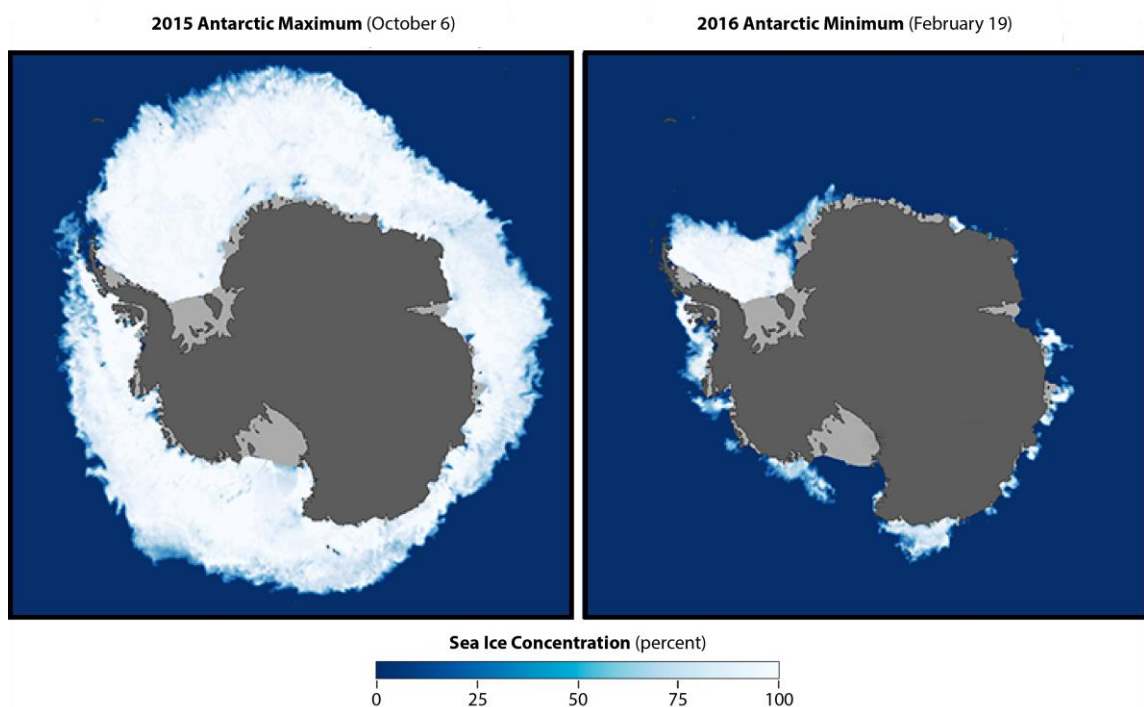

Figure 13 Seasonal variation in the Antarctic sea-ice cover (October and February 2015-2016). NASA Earth Observatory maps by Joshua Stevens, using AMSR2 data supplied by GCOM-W1/JAXA.

Over the last fifty years, the establishment of scientific stations and supply-ship routes have promoted a major increase in the collection of biological samples (Griffiths et al., 2014) and international census projects (Census of Antarctic Marine Life, starting 2005; International Polar Year, 2007-2008) have allowed a better understanding of the Southern Ocean, its unique environments and dynamics.

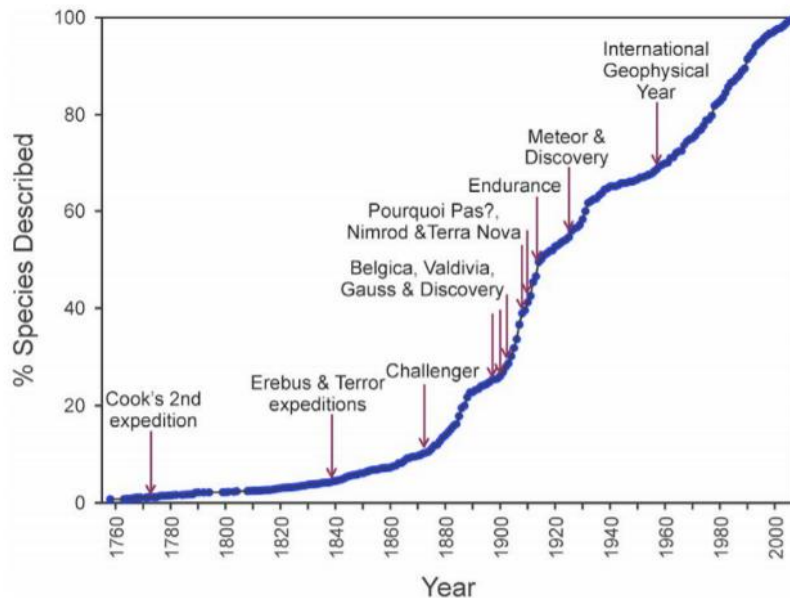

Figure 14 The rate of description of Southern Ocean species. Figure from Griffiths, 2010.

## ii. Particularisms of the benthic fauna

Benthic environmental conditions in the Southern Ocean have traditionally been considered as cold and thermally stable (Post et al., 2014) with seasonal variation in food availability and greater shelf depths in comparison to other oceans (Knox, 2007). Such extreme conditions (water temperatures below 0°C, absence of food intake for months, high impact of iceberg scouring) might appear harsh for life to develop in the Southern Ocean. It is however clear that although communities are very different from other regions, they thrive in these environments despite their apparent harshness (Picken, 1985).

Antarctic benthic organisms are generally described to have unique biological traits such as an important longevity and late maturity, gigantism, slow growth rate. The fauna shows high level of endemism and metabolic adaptations to cold waters (White, 1984; Howe et al., 2004; Knox, 2007, Halanych & Mahon, 2018). Environmental and geographic settings seem to have driven these attributes, especially cold sea water temperatures, and oceanographic and geographic isolation (Pörtner, 2006; Howe et al., 2004).

Another singularity of Southern Ocean benthic fauna is the high incidence of parental care in invertebrates (Poulin et al., 2002; Pearse et al., 2009). For a long time, brooding has been observed (e.g. Thomson, 1876) in higher proportions in the Southern Ocean than in other oceans (Mileikovsky, 1971). The origin of this unusually high number of brooding species with no larval phase in their development is probably to be related to vicariance and allopatric speciation rather than to a consequence of adaptation to freezing conditions (Poulin et al., 2002; Pearse et al., 2009). Two main biogeographic processes at play here lead to the isolation of populations: a persistence in refuges on the continental shelf during Pliocene-Pleistocene glacial maxima (See “genetic diversity patterns”) and/or the transport of propagules to new and remote habitats, especially around the Scotia Arc (Pearse et al., 2009). Brooding has not been without consequence for the evolution, diversity and biogeography of Antarctic fauna. Its significance for understanding phylogeographic relationships between clades is important (e.g. Hoffman et al., 2011; Hellberg et al., 2002) and will be further discussed and investigated for sea stars in the present thesis.

Similarly, the general view of a low marine diversity in the Southern Ocean has been subject to many discussions (Gutt et al., 2004) and was first thought to be due to harsh environmental conditions. Many studies then proved this assumption to be erroneous (Dell, 1972; Arntz et al., 1997; Clarke & Johnston, 2003) albeit varying across taxonomic groups. The macrofauna richness of the Antarctic continental shelf was estimated to exceed 17,000 species (Gutt et al., 2004) when only around 7,600 marine species have been described (data from the Register of Antarctic Marine Species, De Broyer et al., 2019; Jossart et al., 2015). This suggests that diversity is strongly underestimated in the Southern Ocean, which together with a scattered sampling effort (see Figure 15; Griffith et al., 2014) and the increase of molecular data showing the inaccuracy of species richness evaluation (e.g. Janosik et al., 2011; Jossart et al., 2019) suggests diversity levels comparable to temperate and certain tropical non-reef areas (Clarke, 2008).

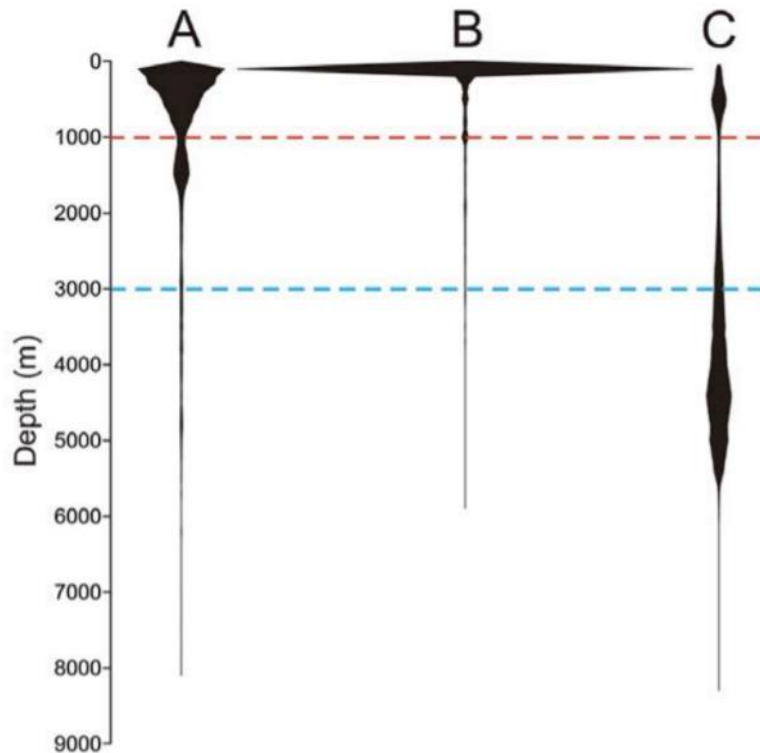

Figure 15 The relative distribution of Southern Ocean (a) benthic sampling intensity (mean = 800 m, median = 4,050 m), (b) pelagic sampling intensity (mean = 120 m, median = 2,950 m) and (c) seafloor area with depth (mean = 3,460 m, median = 4,150 m). Red line indicates the 1000 m depth (shelf break), blue line indicates the 3,000 m depth (abyssal plain).

### c. Biogeography and phylogeography of modern Antarctic benthic faunas

The climatic and tectonic history of the Southern Ocean and the evolution of its benthic fauna, as described in the previous sections, have had major consequences on the present distribution of benthic life. Macroecology has been defined as a research area using quantitative ecology, macroevolution, phylogeography and biogeography in an integrative approach to characterise patterns of species abundance and distribution (Brown 1995, Keith et al., 2012). Using the macroecological approach (to investigate patterns of species distribution and genetic structures in space) allows to untangle the relative importance of the driving factors that underpin the observed patterns.

The biogeographical approach is based on the study of faunal compositions and relationships among bioregions that are, geographical areas characterised by their species assemblages. Studying sea star assemblages will allow to identify faunal similarities among

bioregions and infer their existing or past connectivity while trying to relate them to historical or contemporaneous processes (e.g. onset of the Antarctic Circumpolar Current).

Phylogeographic works, on the other hand, are comparatively new and deal with the analysis of the spatial arrangement of genetic lineages within closely related taxa (Avice, 2009). By taking into account both spatial and temporal dimensions, phylogeography represents a powerful tool to complement the biogeographical approach and is often considered as an extension of it.

### i. Biogeographic regions in the Southern Ocean

First biogeographical studies in the Southern or other oceans were carried out by ichthyologists (Regan, 1914; Nybelin, 1947). Regarding benthic organisms, Knox (1960) and Hedgpeth (1969) undertook pioneering studies on the biogeography of the Southern Ocean. Based on faunal affinities, Hedgpeth (1969) recognised two main regions, the Antarctic and the sub-Antarctic, themselves also subdivided into smaller subregions and districts (see Figure 16).

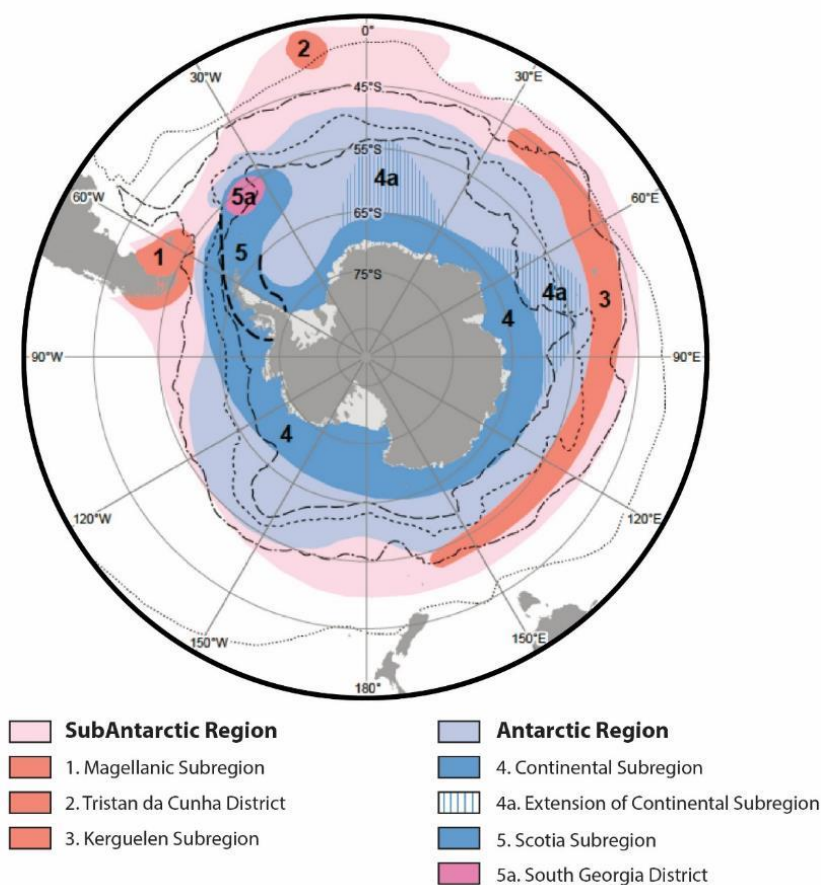

Figure 16 Biogeographic divisions of the Southern Ocean proposed by Hedgpeth (1969).

Since then, several studies have refined these founding works using compiled databases and modern computational statistic tools (e.g. Pierrat et al., 2013). Focusing on individual taxa, these surveys have documented new distribution patterns at smaller scale that are taxon-dependent (e.g. hydroids, Mercado Casares et al., 2017; echinoids, bivalves and gastropods, Pierrat et al., 2013; sea anemones, Rodriguez et al., 2007). Some of the main patterns defined by Hedgpeth (1969), such as the separation between sub-Antarctic and Antarctic regions and the distinctiveness of South Georgia, remain undebated today (De Broyer et al., 2014). Other patterns, such as the unity of the continental subregion have been questioned as they were shown to be highly dependent on the taxa under study (David & Saucède, 2015; De Broyer et al., 2014).

At a very large spatial scale, benthic life usually shows a general pattern of decreasing species richness from the low to the high latitudes, following a well-documented latitudinal gradient of diversity (Lomolino et al., 2017). In the marine realm, there is evidence of an asymmetric distribution of species richness between the poles, with the Southern Ocean being richer than the Arctic because of the relatively young age of the Arctic Ocean isolation (2-3 Myr) (Crame, 2004; Gray, 2001). Longitudinal contrasts are also apparent between the rich areas surrounding New Zealand and the comparatively poorer Magellanic area (David & Saucède, 2015). Recent developments and the popularisation of molecular tools in concert with an increased availability of samples are however bringing new insights on the distribution of life in the Southern Ocean based on quantitative and objective approaches (Held, 2014).

## **ii. Genetic diversity patterns**

One of the main limiting factors of traditional biogeography is its foundation on morphology-based taxonomy that can be subject to mis-interpretations of taxon diversity. Often applied to small taxonomic and geographical entities, genetic tools can be very powerful to infer faunal affinities among localities and taxonomic units. Not only have these tools helped better understand how life is distributed in the Southern Ocean, they also identified and pinpointed the poor knowledge and/or misinterpretation of taxonomic units based on morphological characters only (Held, 2014). One of the first outcomes of the widespread use of molecular tools in the Southern Ocean is the frequent discovery of unrecognised species, which can be defined as cryptic in the absence of a discriminant morphological characters (e.g. Pfenninger & Schwenk, 2007; Brasier et al., 2016; Jossart et al., 2019). The numerous divergent

lineages recently documented in the Southern Ocean are probably the evolutionary consequence of the successive Pliocene-Pleistocene glacial cycles but also to the limited dispersal capacities of certain taxa. Glacial cycles have shaped diversity by vicariance due to the fragmentation of the taxon distribution range during glacial maxima and the survival of small genetic units into refuges (Allcock & Strugnell, 2012). Molecular data obtained from the analysis of contemporary benthic populations have permitted the identification of several types of refuges:

#### **The Deep sea and upper slope**

These refuges have been identified as the main explanation of the apparent extreme eurybathy of many species in the Southern Ocean with many recurrent migration events occurring from shallow to deep environments and back. Although there are molecular evidences suggesting that eurybathy is less prevalent than previously believed, some case-studies still support the deep-sea refugia hypothesis (e.g. Havermans et al., 2011; Arango et al., 2011).

#### **The continental shelf**

Subsistence of populations on the Antarctic continental shelf is probably the most reported type of refuges in the Southern Ocean. Whether resulting from asynchronous ice advances, uncovered areas always free of ice, the permanence of polynyas or natural barriers, many transitional refuges may have sheltered marine fauna locally (David & Saucède, 2015; Allcock & Strugnell, 2012). There are numerous case studies documenting such a process across a wide range of taxa (e.g. echinoids, Díaz et al., 2011; nemertean, Thornhill et al., 2008).

#### **The sub-Antarctic islands**

The last putative glacial refuges in the Southern Ocean correspond to the subsistence of populations around the sub-Antarctic islands including the subsequent colonisation of higher latitudes after the main ice retreats. This type of refugia seems to explain the genetic patterns of some widespread species (e.g. *Promachocrinus kerguelensis*, Hemery et al., 2012). However, the possibility that species now restricted to the high Antarctic region found shelter uniquely on sub-Antarctic islands seems unlikely (Allcock & Strugnell, 2012).



Another strength of molecular analyses resides in its temporal dimension. Based on the “molecular clock” hypothesis, analyses allow to estimate timings of divergence within taxa. This approach is more and more frequently used to date and relate genetic patterns with climatic or tectonic-driven events of vicariance or dispersal. Most recent studies using these tools suggest that radiations recently occurred within the past 5 to 10 Myr, challenging the former idea that present-day patterns mainly result from the much older opening of the Drake Passage and subsequent isolation of Antarctic waters (e.g. Sands et al., 2015; Thornhill et al., 2008; Janosik et al., 2011).

Finally, the last benefit when using genetic data is the delineation of taxonomical units resulting from challenging molecular results. These techniques - often based on a fragment of the sole mitochondrial marker COI (i.e. barcode sequence or Cytochrome c Oxidase subunit I) are based on either tree reconstruction (e.g. GMYC) or genetic distances (e.g. ABGD). They are expected to produce impartial taxonomical units considered as putative species. Nominal species are the working units in a number of studies, far beyond the scope of taxonomy (e.g. species distribution modelling, physiology, biogeography, conservation). It is therefore crucial to use appropriate methods to define robust taxonomic units and ensure relevant scientific outputs. However, there are still many limitations to the use of molecular tools, despite the increasing development of barcode sequences. Introgression, nuclear pseudogenes, lack of representativeness of the whole genome can be problematic. The fact that species delineation methods rely on the concept that intraspecific divergences will be always less marked than interspecific ones (the barcode gap) can also be questionable, especially when taxa have been going through rapid and recent radiations as observed in the Southern Ocean (Allcock & Strugnell, 2012; Monaghan et al., 2006).

Despite these limitations, the development of barcoding has resulted in a substantial contribution to taxonomy, population genetics and molecular phylogenetics (Hajibabaei et al., 2007). There is still a crucial need to increase the number of sampled taxa to better document Antarctic benthic life in space and its evolution through time but also for phylogenetic reconstructions (Hajibabaei et al., 2007). In a period of growing interest in the setting up and management of marine protected areas, accurate and comprehensive barcode libraries should receive more consideration. By providing a reference for specimen identification,

especially for poorly studied taxa, such databases can prevent from misinterpretations of taxonomic data. It is nevertheless evident, that such an effort as to go in concert with morphological identification (i.e. integrative taxonomy approach; Dayrat, 2005).

### **iii. Consequences of reproductive strategies on diversity patterns**

In biogeography and phylogeography, homogeneous distribution patterns are expected to be more likely in species including a pelagic larval stage in their development (i.e. broadcasters) compared to other species without such a stage (i.e. brooders; Held, 2014). Both strategies are well represented in the Southern Ocean with for example, over 50% of brooding species in brittle stars, sea stars (see Figure 17) and sea urchins (David & Saucède, 2015). Because of homogenising factors such as the Antarctic Circumpolar Current (Held, 2014), many early biogeographic works assumed that most Southern Ocean species were circumpolar and structured into a single taxonomic entity (Hedgpeth, 1969; Clarke & Johnston, 1996; Arntz et al., 1994). More recent studies however demonstrate that the relationship between reproduction and population genetic structures is not as evident as previously thought (Halanych & Mahon, 2018). While some broadcasting species display homogeneous genetic patterns on large spatial scale as formerly expected (e.g. Matschiner et al., 2009; González-Wevar et al., 2010), other broadcasters show spatially structured genetic signals (e.g. Hunter & Halanych 2010; Hoffman et al. 2012). Similarly, species with direct development show contrasting genetic structures with either strong (e.g. Hoffman et al., 2011) or weak spatial patterns (e.g. Wilson et al., 2009; Fraser et al., 2013).

Empirical evidences indicate that, although reproductive strategy affects the distribution of Southern Ocean species and the connectivity between populations, other mechanisms can be important (Halanych & Mahon, 2018): 1) The mobility of adults and passive rafting are suspected to promote dispersal; 2) Kelp rafting in the Southern Ocean was shown in sea stars and crustaceans (Waters et al., 2018; Nikula et al., 2010) while rafting on iceberg transporting seafloor debris and invertebrates (gastropods, echinoids) has been observed (Peck, 2018); 3) Anthropogenic debris such as plastics have also been identified as possible dispersal vectors (Barnes 2002, Eriksen et al. 2014).



Figure 17 From left to right. Specimens of sea star, sea urchin and brittle star brooding juveniles. Credits: National Museum of Natural History, Smithsonian Institution; P. Bucktrout, British Antarctic Survey and P.J. López-González.

#### **d. Sea stars in the Southern Ocean**

##### **i. General overview**

The class Asteroidea, commonly referred to as sea stars or starfish, is the second most diverse class within the phylum Echinodermata. With ~1,900 accepted species names (and many more remaining to be described), sea stars are important components of marine ecosystems (Mah & Blake, 2012) and are widely distributed (from the intertidal to more than 6,500 m depth). Sea stars display high ecological diversity (e.g. Jangoux, 1982) and are important in organising benthic marine communities (Menge & Sanford, 2013). Their taxonomic diversity is also high with 38 families and 344 genera (Mah & Blake, 2012). Worldwide diversity patterns of sea stars have been roughly described with the highest species richness found in tropical regions (e.g. Blake, 1990) and a latitudinal diversity gradient decreasing towards the poles with however a lower richness in the Arctic than in the Antarctic (Mah & Blake, 2012). Despite this richness gradient at species level, cold waters of high latitudes harbour a much higher family-level richness (Mah & Blake, 2012).

Generally speaking, sea stars have been used as case studies in numerous biological fields, from benthic community studies (e.g. Gianguzza et al., 2016; Analuddin et al., 2015) to physiological works on the effect of environmental stressors (e.g. Magesky & Pelletier, 2018; Kamyra et al., 2016), parasitology (Takano & Kano, 2014) and immunology (Leclerc, 2015). Despite this interest, the global phylogeny of the class Asteroidea has been controversial for more than 100 years (Lawrence, 2013; Figure 18) and is still subject to discussions, debates and extensive works (Janies et al., 2011; Linchangco et al., 2017). The authors however tend

to agree on the common origin of all modern sea stars: the sub-class Neoasteroidea (Gale, 1987; Blake, 1987). Representatives of the Neoasteroidea are believed to have evolved from a single common ancestor that survived to the Permian-Triassic extinction (Gale, 1987; 2011) and then diversified following an evolutionary pattern common to all five classes echinoderms (Chen & McNamara, 2006; Twitchett & Oji, 2005). Recent fossil findings and phylogenetic results however question this over-simplified interpretation of the post-Palaeozoic diversification of echinoderms (e.g. Villier et al., 2018).

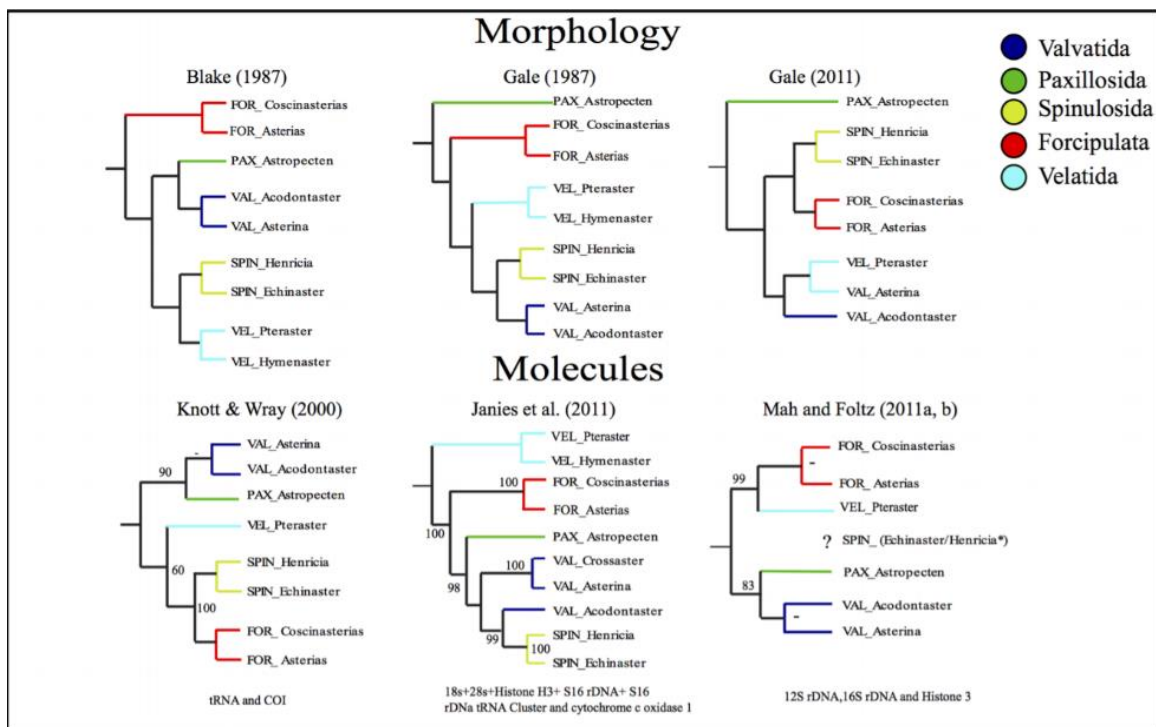

Figure 18 Current competing hypothesis of relationships derived from morphological or molecular data for the major sea star's clades (Figure from Feuda & Smith, 2015).

## ii. Southern Ocean sea stars

In the Southern Ocean, sea stars are also well represented with 12% of the class global species richness recorded in the region (Mah & Blake 2012). Evidences regarding their origin around the Antarctic continent are only scarce but fossils tend to show that Southern Ocean sea stars follow the same general trend as benthic organisms in their evolution (see “Origin and evolution of the Antarctic benthos”). The presence of an extinct asteroid fauna including highly calcified members of Goniasteridae and Oreasteridae (Blake & Aronson, 1998) during the Eocene indicates that no autochthonous sea star fauna survived the cooling of Antarctica while these faunas are still present in other regions. Current phylogenetic evidences argue for a recent diversification in the Southern Ocean and a possible ancestry from adjacent sub-Antarctic regions (Mah & Foltz, 2011a, 2011b; Janosik et al., 2011).

In the Southern Ocean, as in other oceans, sea stars are common benthic organisms found in diverse environments from the intertidal to the abyss (Figure 19; Brandt et al., 2007; Linse et al., 2007a; Mah & Blake, 2012). They have been studied since the late 19th century in the Southern Ocean (e.g. Sladen, 1889) with scientific work documenting their ecological importance to southern ecosystems (McClintock et al., 2008; Mah & Blake, 2012; Lawrence, 2013). However, the vast majority of studies carried out around Antarctica focused on the sole abundant near-shore species *Odontaster validus* (e.g. Janosik et al., 2011; Agüera et al., 2015; Pearse & Bosch, 2002) known for its key position in shallow benthic communities of the Southern Ocean (Dayton 1972; McClintock et al., 2008). *Odontaster validus* has notably been used as a model species in studies on the consequences of global change on Antarctic organisms (e.g. Peck et al., 2008; Gonzalez-Bernat et al., 2013). However, little is known about overall distribution patterns (Danis et al., 2014; Moles et al., 2015), diversity (Mah & Blake, 2012) and evolution of sea stars in the Southern Ocean and even less about the underpinning mechanisms that drive them. The last census of asteroid diversity conducted in the framework of this thesis gives estimates of ~300 species in the Southern Ocean (**Asteroidea Database and species list**) emphasising the potential richness of the Southern Ocean sea stars and their quality as a target group for large scale studies and meta-analyses in diversity, connectivity and distribution studies.

As previously mentioned, sea stars have diverse reproduction modes (e.g. McClintock et al., 2006) and possibly the complete range of this biological function described in the phylum Echinodermata (Naughton & O'Hara, 2009). As for several other benthic groups (e.g. Amphipoda, Echinoidea), brooding, which can take many forms in sea stars (e.g. in the stomach pouch, within brood chambers, on the dorsal surface) seems to occur in an unusually high number of species in the Southern Ocean (Pearse et al., 2009). Broadcasting species are however well represented too, and in contrast with brooding members their offspring can spend more than five months in the water column (Bosch & Pearse, 1990). Such diverging life history traits may have certainly conditioned distribution and diversity patterns along asteroid evolution.

Molecular investigations of the diversity and connectivity between Southern Ocean sea stars are limited but indicate an overlooked diversity in the best studied representative of the class: *Odontaster validus* (Janosik et al., 2011). Another work by Moore et al., 2018 explored phylogeographic patterns in *Glabraster antarctica*, a conspicuous sea star in the Southern Ocean, and confirmed that the species is highly polymorphic but constitutes a single entity as proposed by morphological work (Mah & Foltz, 2014). This does not preclude to the occurrence of strong phylogeographic structures between populations of this species (Moore et al., 2018). Finally, a joint effort in the sampling of *Anasterias suteri* along the shore and on floating kelps in the sub-Antarctic, showed the prevalence of genetic connectivity between geographically distant populations of this brooding species (Waters et al., 2018). At a higher taxonomic level, the phylogeny and evolutionary history of the Asteroidea in the Southern Ocean has also been discussed in several studies (Mah & Foltz, 2011a, 2011b, 2014; Mah et al., 2015). In their comprehensive molecular phylogeny of the superorders Valvatacea and Forcipulatacea, Mah & Foltz (2011a, b) described some diversification processes in several Antarctic and sub-Antarctic families (e.g. Odontasteridae, Antarctic Asteroidea) and a possible ancestry from surrounding regions. They however did not analyse lower taxonomic levels (i.e., genera and species).



Figure 19 Illustration of the Southern Ocean sea stars diversity from the Belgica121 expedition. From top left to bottom right: *Granaster nutrix*, *Labidiaster annulatus*, *Psilaster charcoti*, *Odontaster validus*, *Lysasterias* sp. and *Neosmilaster georgianus*. Photo credits Quentin Jossart.

# Research objectives





# Research objectives

Being the last discovered ocean and despite an intense, coordinated scientific effort over the last decades, biodiversity of the Southern Ocean is still poorly documented and understood. Here, I propose to use sea stars, a common, diverse and important component of Southern Ocean benthic communities as a model taxon to analyse large scale distribution and diversity patterns and their putative evolutionary origin.

**The first objective** of the present work aims at describing and analysing distribution patterns at the scale of the entire Southern Ocean within the whole Asteroidea class. This chapter includes the study of the role of a life history trait on the observed patterns: the reproductive strategy (brooding *versus* broadcasting). I hypothesize that the limited to null ability of species without a pelagic larval phase (i.e. brooders) to disperse will result in noticeable distribution patterns on large spatial and temporal scales. Species with a pelagic phase (i.e. broadcasters) will on the contrary exhibit less structure due to a constant mixing over time. I expect, in this chapter, to show which faunal affinities can be observed among the main bioregions of the Southern Ocean and to deduce which drivers (biotic and abiotic) are influencing these patterns. This biogeographical approach is based on an extensive georeferenced database that includes mention of the respective reproduction strategy (see **Asteroidea Database**).

**The second objective** aims at complementing the first one with an approach based on molecular tools. A phylogeographical approach is used to evaluate the effect of contrasting reproductive strategy (brooding *versus* broadcasting) and the distinct dispersal capacities of species on genetic diversity and structure of Southern Ocean sea stars. Using five genera (three brooding ones and two broadcasting ones), I hypothesize that evolutionary and diversity patterns in brooders will be strongly structured in space and time allowing to pinpoint key events with more accuracy. I then use the construction of time-calibrated phylogenies to determine timings of diversification and the influence of historical events, thus improving our knowledge of asteroid evolutionary history. This chapter is based on the analyses of 1,416 genetic sequences of the mitochondrial markers COI.

**The third** and final chapter is an exploratory approach of the diversity and origin of Southern Ocean sea stars. In chapter 3, the geographical scale is widened at its maximum to explore the roots and evolution of the entire class around the Antarctic continent. I hypothesise that species richness is overlooked and misunderstood in the Southern Ocean due to the origin and evolution of its fauna. This chapter is based on the use of an extensive barcode library compiled from all openly available sequences and the one obtained during this thesis.



# Southern Ocean species list update

Southern Ocean Asteroidea: a proposed update for the Register of  
Antarctic Marine Species



# Southern Ocean species list update

## Southern Ocean Asteroidea: a proposed update for the Register of Antarctic Marine Species

Camille Moreau<sup>1,2\*</sup>, Antonio Agüera<sup>1</sup>, Quentin Jossart<sup>1</sup>, Bruno Danis<sup>1</sup>

<sup>1</sup>Marine Biology Lab, CP160/15 Université Libre de Bruxelles (ULB) 50, B-1050 Brussels, Belgium

<sup>2</sup>UMR CNRS 6282 Biogéosciences, Université de Bourgogne Franche-Comté (UBFC) 6 Boulevard Gabriel, F-21000 Dijon, France

\*Correspondence: Camille Moreau, Université Libre de Bruxelles (ULB) Laboratoire de Biologie Marine, CP160/15 50 Av. F.D. Roosevelt, B-1050 Bruxelles, Belgium.

E-mail: [mr.moreau.camille@gmail.com](mailto:mr.moreau.camille@gmail.com)

Citation: Moreau, C., Agüera, A., Jossart, Q., & Danis, B. (2015). Southern Ocean Asteroidea: a proposed update for the Register of Antarctic Marine Species. *Biodiversity data journal*, (3), e7062, doi: 10.3897/BDJ.3.e7062.

## **ABSTRACT**

### **Background**

The Register of Antarctic Marine Species (RAMS, De Broyer et al. 2015) is the regional component of the World Register of Marine Species (WoRMS Editorial Board 2015) in the Southern Ocean. It has been operating for the last ten years, with a special effort devoted towards its completion after the International Polar Year (IPY) in 2007-2008, in the framework of the Census of Antarctic Marine Life (CAML, 2005 - 2010). Its objective is to offer free and open access to a complete register of all known species living in the Southern Ocean, building a workbench of the present taxonomic knowledge for that region. The Antarctic zone defined by this dynamic and community-based tool has been investigated with a particular interest. The Sub-Antarctic zone was a secondary objective during the establishment of the RAMS and is still lacking the impulse of the scientific community for some taxa.

### **New information**

In the present study, more than 13,000 occurrences records of Asteroidea (Echinodermata) have been compiled within the RAMS area of interest and checked against the RAMS species list of sea stars, using WoRMS Taxon Match tool. Few mismatches (basonym mistakes: i.e. original name misspelled or incorrect) were found within the existing list and 97 unregistered species are actually occurring within the RAMS boundaries. After this update, the number of Asteroidea species was increased by around 50%, now reaching 295 accepted species.

### **Keywords**

Asteroidea, Sea stars, Southern Ocean, RAMS, WoRMS, Register of Antarctic Marine Species, Biodiversity, Checklist

## **INTRODUCTION**

### **The Register of Antarctic Marine Species, RAMS**

RAMS is a collaborative and dynamic information system managing Southern Ocean marine taxon names and related information (De Broyer et al. 2015). The main objective of RAMS is to establish a benchmark of the present taxonomic knowledge of the Southern Ocean biodiversity (De Broyer et al. 2011).

In a recent appraisal of RAMS, Jossart et al. (2015) underscored the number of 10,294 described species of which 8,297 are accepted marine species (viz. checked by taxonomic experts). Among these species, 537 (~6.5%) were reported as accepted species names for echinoderms and 198 (~2.4%) as accepted names for sea star species.

After 10 years of service, RAMS still displays several spatial gaps, especially with regards to species occurring in the sub-Antarctic zone, described as the area below the sub-Tropical front (Deacon 1984, Rintoul 2007) and North of the Polar Front.

In order to complete the taxonomic information for the class Asteroidea, we propose in this work an updated version of the checklist of Southern Ocean sea stars species occurring within the RAMS area of interest.

## **MATERIALS AND METHODS**

### **Area of interest**

As described in De Broyer and Danis (2011) the RAMS area of interest is extending from the coast of the Antarctic continent to the sub-Tropical front. Convenient operational limits have been defined (Table 1; Figure 20), splitting the Southern Ocean into two zones: the Antarctic zone and the sub-Antarctic zone.



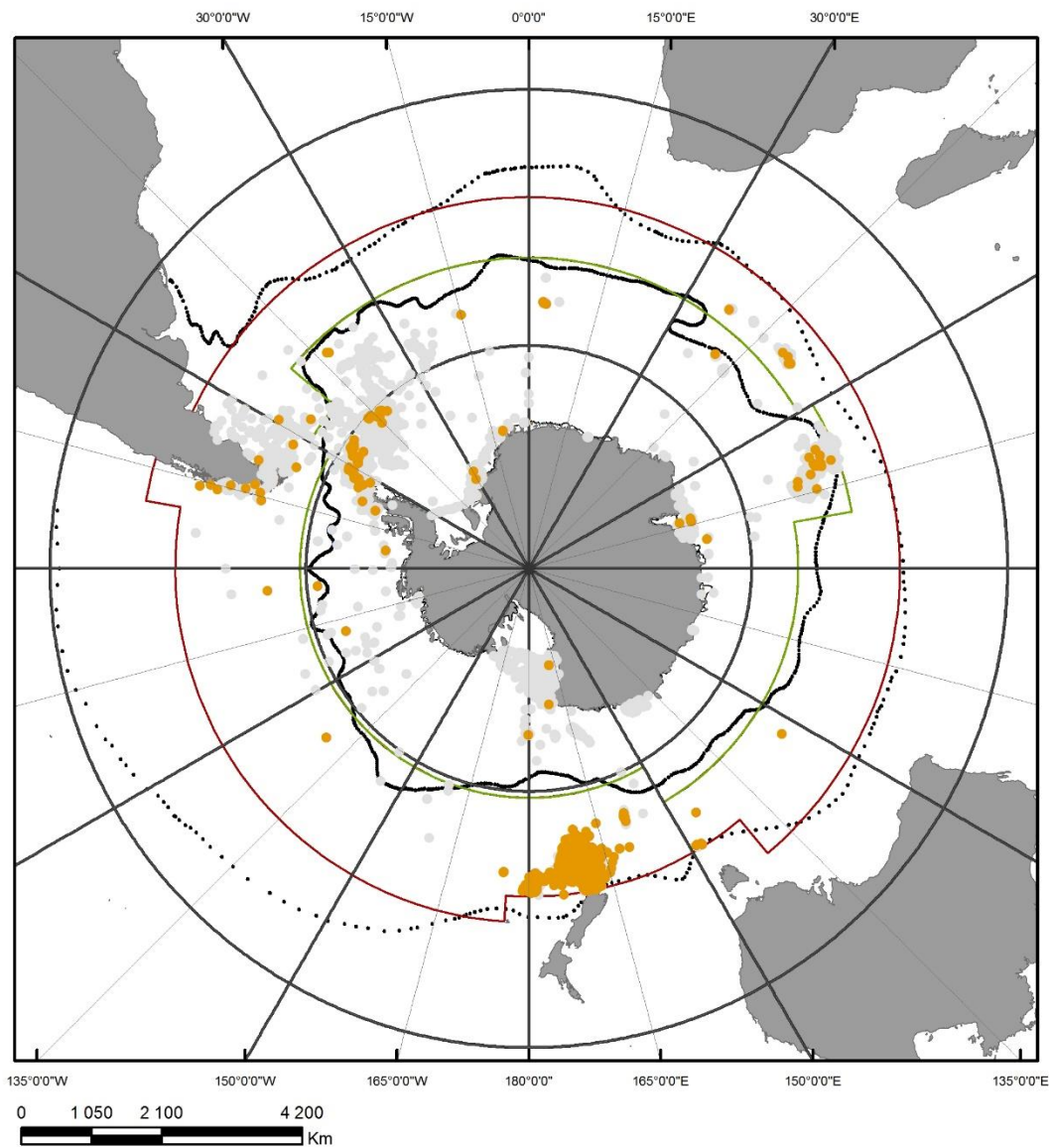

Figure 20 Occurrences of RAMS (light grey dots) and Proposed-RAMS (orange dots) sea star species. The Antarctic zone is located below the green line and the Sub-Antarctic zone between the green and dark red lines. The Polar Front (black line) and the Sub-Tropical Front (dashed black line) are also shown.

Table 1 RAMS area of interest. Operational northern limits in the different sector of the Southern Ocean for both the Antarctic zone and the sub-Antarctic zone.

Sector	Longitude range	Northern limit
<b>Antarctic zone</b>		
South Atlantic Sector	60°W-50°W	57°S
	50°W-30°E	50°S
Indian Sector	30°E-80°E	50°S
	80°E-150°E	55°S
South Pacific Sector	150°E-60°W	60°S
<b>Sub-Antarctic zone</b>		
Atlantic & Indian Sectors	60°W-140°E	43°S
South Pacific Sector	140°E-176°W	48°S
	176°W-80°W	45°S
	80°W-72°W	41°S

### Data collection

More than 13,000 occurrences records were aggregated from different sources including global information systems such as the Ocean Biogeographic Information System (OBIS), the Global Biodiversity Information Facility (GBIF), initiatives such as the Biogeographic Atlas of the Southern Ocean (De Broyer et al. 2014), historic records mined from the literature pertaining to the early exploration of the Southern Ocean (e.g. Sladen 1889), recently published checklists (e.g. Gutt et al. 2014) or unpublished cruise records. Only the specimens identified at a species level, regardless of their depth (shelf, slope, deep-sea) were kept for the preparation of this checklist.

The validity of each species name was controlled using the Taxa Match Tool available in RAMS (<http://www.marinespecies.org/rams/aphia.php?p=match>) and WoRMS (<http://www.marinespecies.org/aphia.php?p=match>) to ensure its validity and presence in the RAMS checklist.

## DATA RESOURCES

### Complete checklist of Southern Ocean Asteroidea

The data underpinning the analyses reported in this paper are deposited at GBIF, the Global Biodiversity Information Facility,

[http://ipt.pensoft.net/resource?r=southern\\_ocean\\_asteroidea&v=1.1](http://ipt.pensoft.net/resource?r=southern_ocean_asteroidea&v=1.1)

### Checklist of RAMS Asteroidea species

*Abyssaster diadematus* (Sladen, 1883); *Abyssaster planus* (Sladen, 1883); *Acodontaster capitatus* (Koehler, 1912); *Acodontaster conspicuus* (Koehler, 1920); *Acodontaster elongatus* (Sladen, 1889); *Acodontaster hodgsoni* (Bell, 1908); *Acodontaster marginatus* (Koehler, 1912); *Adelasterias papillosa* (Koehler, 1906); *Allostichaster capensis* (Perrier, 1875); *Anasterias antarctica* (Lütken, 1857); *Anasterias asterinoides* Perrier, 1875; *Anasterias directa* (Koehler, 1920) *Anasterias mawsoni* (Koehler, 1920); *Anasterias pedicellaris* Koehler, 1923; *Anasterias perrieri* (E. A. Smith, 1876); *Anasterias rupicola* (Verrill, 1876); *Anasterias sphaerulata* (Koehler, 1920); *Anasterias spirabilis* (Bell, 1881); *Anasterias studeri* Perrier, 1891; *Anasterias suteri* (deLoriol, 1894); *Anseropoda antarctica* Fisher, 1940; *Anteliaster australis* Fisher, 1940; *Anteliaster scaber* (E. A. Smith, 1876); *Asterina fimbriata* Perrier, 1875; *Astropecten brasiliensis* Müller & Troschel, 1842; *Bathybiaster loripes* Sladen, 1889; *Belgicella racowitzana* Ludwig, 1903; *Benthopecten pedicifer* (Sladen, 1885); *Caimanaster acutatus* Clark, 1962; *Calyptraster tenuissimus* Bernasconi, 1966; *Calyptraster vitreus* Bernasconi, 1972; *Ceramaster grenadensis* (Perrier, 1881); *Ceramaster patagonicus* (Sladen, 1889); *Cheiraster (Luidiaster) antarcticus* (Koehler, 1907); *Cheiraster (Luidiaster) gerlachei* Ludwig, 1903; *Cheiraster (Luidiaster) hirsutus* (Studer, 1884); *Cheiraster (Luidiaster) planeta* (Sladen, 1889); *Chitonaster cataphractus* Sladen, 1889; *Chitonaster felli* (H.E.S. Clark, 1971); *Chitonaster johannae* Koehler, 1908; *Chondraster elattosis* H.L. Clark, 1923; *Cladaster analogus* Fisher, 1940; *Cosmasterias lurida* (Philippi, 1858); *Crossaster penicillatus* Sladen, 1889; *Cryptasterias brachiata* Koehler, 1923; *Cryptasterias turqueti* (Koehler, 1906); *Ctenodiscus australis* Lütken, 1871; *Ctenodiscus procurator* Sladen, 1889; *Cuenotaster involutus* (Koehler, 1912); *Cycethra frigida* (Koehler, 1917); *Cycethra macquariensis* Koehler, 1920; *Cycethra verrucosa* (Philippi, 1857); *Diplasterias brandti* (Bell, 1881); *Diplasterias brucei* (Koehler, 1908); *Diplasterias*

*kerguelenensis* (Koehler, 1917); *Diplasterias meridionalis* (Perrier, 1875); *Diplasterias octoradiata* (Studer, 1885); *Diplasterias radiata* (Koehler, 1923); *Diplodontias singularis* (Müller & Troschel, 1843); *Diplopteraster clarki* Bernasconi, 1937; *Diplopteraster peregrinator* (Sladen, 1882); *Diplopteraster semireticulatus* (Sladen, 1882); *Diplopteraster verrucosus* (Sladen, 1882); *Dytaster felix* Koehler, 1907; *Echinaster smithi* Ludwig, 1903; *Eremicaster crassus* (Sladen, 1883); *Eremicaster pacificus* (Ludwig, 1905); *Eremicaster vicinus* Ludwig, 1907; *Freyastera tuberculata* (Sladen, 1889); *Freyella attenuata* Sladen, 1889; *Freyella drygalskii* Döderlein, 1927; *Freyella formosa* Korovchinsky, 1976; *Freyella fragilissima* Sladen, 1889; *Freyella giardi* Koehler, 1908; *Freyella heroina* Sladen, 1889; *Freyella mutabila* Korovchinsky, 1976; *Ganeria attenuata* Koehler, 1907; *Ganeria falklandica* Gray, 1847; *Ganeria hahni* Perrier, 1891; *Gaussaster antarcticus* (Sladen, 1889); *Glabraster antarctica* (E. A. Smith, 1876); *Granaster nutrix* (Studer, 1885); *Henricia diffidens* (Koehler, 1923); *Henricia fisheri* A.M. Clark, 1962; *Henricia obesa* (Sladen, 1889); *Henricia pagenstecheri* (Studer, 1885); *Henricia parva* Koehler, 1912; *Henricia praestans* (Sladen, 1889); *Henricia smilax* (Koehler, 1920); *Henricia studeri* Perrier, 1891; *Hippasteria falklandica* Fisher, 1940; *Hippasteria phrygiana* (Parelius, 1768); *Hymenaster caelatus* Sladen, 1882; *Hymenaster campanulatus* Koehler, 1908; *Hymenaster coccinatus* Sladen, 1882; *Hymenaster crucifer* Sladen, 1882; *Hymenaster densus* Koehler, 1908; *Hymenaster edax* Koehler, 1908; *Hymenaster formosus* Sladen, 1882; *Hymenaster fucatus* Koehler, 1908; *Hymenaster graniferus* Sladen, 1882; *Hymenaster latebrosus* Sladen, 1882; *Hymenaster pellucidus* Thomson, 1873; *Hymenaster perspicuus* Ludwig, 1903; *Hymenaster praecoquis* Sladen, 1882; *Hymenaster sacculatus* Sladen, 1882; *Hymenodiscus distincta* (Sladen, 1889); *Hyphalaster inermis* Sladen, 1883; *Hyphalaster scotiae* Koehler, 1907; *Kampylaster incurvatus* Koehler, 1920; *Kenrickaster pedicellaris* A.M. Clark, 1962; *Labidiaster annulatus* Sladen, 1889; *Labidiaster radiosus* Lütken, 1872; *Leptychaster flexuosus* (Koehler, 1920); *Leptychaster kerguelenensis* E. A. Smith, 1876; *Leptychaster magnificus* (Koehler, 1912); *Leptychaster melchiorensis* (Bernasconi, 1969); *Lethasterias australis* Fisher, 1923; *Lonchotaster tartareus* Sladen, 1889; *Lophaster densus* Fisher, 1940; *Lophaster gaini* Koehler, 1912; *Lophaster stellans* Sladen, 1889; *Lophaster tenuis* Koehler, 1920; *Luidia clathrata* (Say, 1825); *Lysasterias adeliae* (Koehler, 1920); *Lysasterias belgicae* (Ludwig, 1903); *Lysasterias chirophora* (Ludwig, 1903); *Lysasterias digitata* A.M. Clark, 1962; *Lysasterias hemiora* Fisher, 1940; *Lysasterias heteractis* Fisher, 1940; *Lysasterias joffrei* (Koehler, 1920); *Lysasterias lactea* (Ludwig, 1903); *Lysasterias perrieri* (Studer, 1885);

*Macroptychaster accrescens* (Koehler, 1920); *Mediaster pedicellaris* (Perrier, 1881); *Mirastrella biradialis* Fisher, 1940; *Neosmilaster georgianus* (Studer, 1885); *Neosmilaster steineni* (Studer, 1885); *Notasterias armata* (Koehler, 1911); *Notasterias bongraini* (Koehler, 1912); *Notasterias candicans* (Ludwig, 1903); *Notasterias haswelli* Koehler, 1920; *Notasterias pedicellaris* (Koehler, 1907); *Notasterias stolophora* Fisher, 1940; *Notioceramus anomalus* Fisher, 1940; *Novodinia novaezelandiae* (H.E.S. Clark, 1962); *Odinella nutrix* Fisher, 1940; *Odontaster meridionalis* (E. A. Smith, 1876); *Odontaster penicillatus* (Philippi, 1870); *Odontaster pusillus* Koehler, 1907; *Odontaster validus* Koehler, 1906; *Paralophaster antarcticus* (Koehler, 1912); *Paralophaster godfroyi* (Koehler, 1912); *Paralophaster lorioli* (Koehler, 1907); *Pectinaster filholi* Perrier, 1885; *Pedicellaster hypernotius* Sladen, 1889; *Pergamaster incertus* (Bell, 1908); *Pergamaster triseriatus* H.E.S. Clark, 1963; *Peribolaster folliculatus* Sladen, 1889; *Peribolaster macleani* Koehler, 1920; *Perknaster antarcticus* (Koehler, 1906); *Perknaster aurantiacus* Koehler, 1912; *Perknaster aurorae* (Koehler, 1920); *Perknaster charcoti* (Koehler, 1912); *Perknaster densus* Sladen, 1889; *Perknaster fuscus* Sladen, 1889; *Perknaster sladeni* (Perrier, 1891); *Persephonaster facetus* (Koehler, 1907); *Poraniopsis echinaster* Perrier, 1891; *Porcellanaster ceruleus* Wyville Thomson, 1877; *Psalidaster mordax* Fisher, 1940; *Pseudarchaster discus* Sladen, 1889; *Psilaster charcoti* (Koehler, 1906); *Pteraster affinis* Smith, 1876; *Pteraster florifer* Koehler, 1920; *Pteraster gibber* (Sladen, 1882); *Pteraster hirsutus* (Sladen, 1882); *Pteraster koehleri* A.M. Clark, 1962; *Pteraster rugatus* Sladen, 1882; *Pteraster spinosissimus* (Sladen, 1882); *Pteraster stellifer* Sladen, 1882; *Radiaster gracilis* (H.L. Clark, 1916); *Remaster gourdoni* Koehler, 1912; *Rhopiella hirsuta* (Koehler, 1920); *Saliasterias brachiata* Koehler, 1920; *Scotiaster inornatus* Koehler, 1907; *Smilasterias clarkailsa* O'Loughlin & O'Hara, 1990; *Smilasterias scalprifera* (Sladen, 1889); *Smilasterias triremis* (Sladen, 1889); *Solaster notophrynus* Downey, 1971; *Solaster regularis* Sladen, 1889; *Styracaster armatus* Sladen, 1883; *Styracaster chuni* Ludwig, 1907; *Styracaster horridus* Sladen, 1883; *Styracaster robustus* Koehler, 1908; *Tremaster mirabilis* Verrill, 1880; *Vemaster sudatlanticus* Bernasconi, 1965; *Zoroaster tenuis* Sladen, 1889

#### **Checklist of Proposed-RAMS Asteroidea species**

*Allostichaster farquhari* McKnight, 2006; *Allostichaster insignis* (Farquhar, 1895); *Allostichaster polyplax* (Muller & Troschel, 1844); *Anasterias laevigata* (Hutton, 1879); *Anthenoides cristatus* (Sladen, 1889); *Astromesites primigenius* (Mortensen, 1925);

*Astropecten polyacanthus* Müller & Troschel, 1842; *Astrostole scabra* (Hutton, 1872); *Benthopecten munidae* H.E.S. Clark, 1969; *Benthopecten pikei* H.E.S. Clark, 1969; *Brisinga chathamica* McKnight, 1973; *Brisingenes multicostata* (Verrill, 1894); *Ceramaster australis* H.E.S. Clark, 2001; *Cheiraster (Cheiraster) otagoensis* Studer, 1883; *Chitonaster trangae* Mah, 2011; *Clavaporania fitchorum* Mah & Foltz, 2014; *Coscinasterias calamaria* (Gray, 1840); *Coscinasterias muricata* Verrill, 1870; *Cosmasterias dyscrita* H.L. Clark, 1916; *Crossaster campbellicus* McKnight, 1973; *Crossaster multispinus* H.L. Clark, 1916; *Diplodontias dilatatus* (Perrier, 1875); *Diplodontias robustus* (Fell, 1953); *Diplopteraster hurleyi* McKnight, 1973; *Dipsacaster magnificus* (H.L. Clark, 1916); *Echinaster farquhari* Benham, 1909; *Eratosaster jenaе* Mah, 2011; *Freyastera benthophila* (Sladen, 1889); *Freyella echinata* Sladen, 1889; *Freyellaster polycnema* (Sladen, 1889); *Fromia monilis* (Perrier, 1869); *Gilbertaster anacanthus* Fisher, 1906; *Henricia aucklandiae* Mortensen, 1925; *Henricia compacta* (Sladen, 1889); *Henricia lukinsii* (Farquhar, 1898); *Henricia ornata* (Perrier, 1869); *Henricia ralphae* Fell, 1958; *Henricia simplex* (Sladen, 1889); *Henricia spinulfera* (E. A. Smith, 1876); *Hymenaster estcourti* McKnight, 1973; *Hymenaster nobilis* Wyville Thomson, 1876; *Hymenodiscus aotearoa* (McKnight, 1973); *Hymenodiscus submembranacea* (Döderlein, 1927); *Hyphalaster giganteus* Macan, 1938; *Lithosoma novaezelandiae* McKnight, 1973; *Luidia porteri* A.H. Clark, 1917; *Mediaster arcuatus* (Sladen, 1889); *Mediaster dawsoni* McKnight, 1973; *Mediaster sladeni* Benham, 1909; *Meridiastra medius* (O'Loughlin, Waters & Roy, 2003); *Meridiastra oriens* (O'Loughlin, Waters & Roy, 2003); *Mimastrella cognata* (Sladen, 1889); *Myxoderma qawashqari* (Moyana & Larrain Prat, 1976); *Odontaster aucklandensis* McKnight, 1973; *Odontaster benhami* (Mortensen, 1925); *Odontaster pearsei* Janosik & Halanych, 2010; *Odontaster roseus* Janosik & Halanych, 2010; *Odontohenricia anarea* O'Hara, 1998; *Odontohenricia endeavouri* Rowe & Albertson, 1988; *Ophidiaster confertus* H.L. Clark, 1916; *Paralophaster hyalinus* H.E.S. Clark, 1970; *Paranepanthia aucklandensis* (Koehler, 1920); *Patiriella regularis* (Verrill, 1867); *Paulasterias tyleri* Mah et al. 2015; *Pectinaster mimicus* (Sladen, 1889); *Pentagonaster pulchellus* Gray, 1840; *Peribolaster lictor* Fell, 1958; *Perissasterias monacantha* McKnight, 1973; *Pillsburiaster aoteanus* (McKnight, 1973); *Pillsburiaster inutilis* McKnight, 2006; *Plutonaster complexus* H.E.S. Clark & D.G. McKnight, 2000; *Plutonaster fragilis* H.E.S. Clark, 1970; *Plutonaster hikurangi* H.E.S. Clark & D.G. McKnight, 2000; *Plutonaster jonathani* H.E.S. Clark & D.G. McKnight, 2000; *Plutonaster knoxi* Fell, 1958; *Plutonaster sirius* A.H. Clark, 1917; *Proserpinaster neozelanicus* (Mortensen, 1925);

*Psilidaster fisheri* McKnight, 2006; *Pseudarchaster garricki* Fell, 1958; *Pseudechinaster rubens* H.E.S. Clark, 1962; *Psilaster acuminatus* Sladen, 1889; *Pteraster bathami* Fell, 1958; *Pteraster robertsoni* McKnight, 1973; *Sclerasterias eustyla* (Sladen, 1889); *Sclerasterias mollis* (Hutton, 1872); *Smilasterias irregularis* H.L. Clark, 1928; *Solaster longoi* Stampanato & Jangoux, 1993; *Solaster torulatus* Sladen, 1889; *Sphaeriodiscus mirabilis* A.M. Clark, 1976; *Stichaster australis* (Verrill, 1871); *Taranuiaster novaezealandiae* McKnight, 1973; *Tarsaster stoichodes* Sladen, 1889; *Zoroaster actinocles* Fisher, 1919; *Zoroaster alternicanthus* McKnight, 2006; *Zoroaster fulgens* Thomson, 1873; *Zoroaster macracantha* H.L. Clark, 1916; *Zoroaster spinulosus* Fisher, 1906

## ANALYSIS

More than 13,000 occurrences records from 295 accepted species have been compiled within the extent of the RAMS area of interest. 198 of these species (67%) were already in the RAMS database and 97 (33%) were new to the system. After this update, the number of Asteroidea species in RAMS will be increased by around 50%.

The seven Orders of the Class Asteroidea are represented in the Southern Ocean. The Valvatida are the most speciose with 8 families, 41 genus and 87 species followed by Forcipulatida (6 families, 30 genus, 78 species), Paxillosida (6 families, 22 genus, 43 species), Velatida (2 families, 6 genus, 37 species), Spinulosida (1 family, 4 genus, 20 species), Brisingida (2 families; 9 genus; 19 species) and Notomyotida (1 family, 4 genus, 2 subgenus, 11 species).

After a careful verification of the RAMS species list for Asteroidea we propose to address the following points. These issues have been taken into account in this paper:

- *Cheiraster (Barbadosaster) echinulatus* and *Stegnaster wesseli* are only described from Central America and should be removed from the RAMS list
- *Spoladaster veneris* is only described from Amsterdam and Saint-Paul Islands which are not part of the RAMS area of interest
- *Anthenoides peircei*, *Astropecten cingulatus*, *Cheiraster (Cheiraster) septus*, *Peltaster placenta*, and *Psilaster herwigi* do not seem to be distributed in the RAMS area of interest

- *Echinaster (Othilia) brasiliensis* is only described from South America and should be removed of the RAMS list
- *Freyella mutabilia* was originally described as *Freyella mutabila* by Korovchinsky (1976)
- *Mimastrella cognata* and *Mirastrella cognata* are source of a problem. Both genera do exist but *Mimastrella cognata* and *Mirastrella biradialis* are the only described species. The genus name being nearly identical, it has led to a mistake. *Mirastrella cognata* is an invalid name and should be deleted from RAMS and WoRMS systems.

Moreover, we recommend the addition of species from our "Proposed-RAMS" checklist (i.e. species not registered in the RAMS list but present in the RAMS area of interest) to RAMS. None of these species are new to science but their austral distribution range was not properly documented (e.g. species from the Campbell Plateau are reported as New-Zealand species but are also present in the Southern Ocean, species from the French sub-Antarctic Islands, etc...). Interestingly, 22 of the 97 "non-RAMS" species are present in the Antarctic zone. Some have been described recently (e.g. *O. roseus* and *O. pearsei* described by Janosik and Halanych (2010); *C. trangae* described by Mah (2011) or *P. tyleri* described by Mah et al. 2015) but have not been added to the RAMS.

A final comment pertains to *Astropecten polyacanthus*, occurring in the RAMS Sub- Antarctic region in a location that is not actually South from the Sub-Tropical Front. This final observation shows that convenient boundaries should be used with care. However, only one species was concerned for a very wide area of interest. *A. polyacanthus* presence in the RAMS checklist should be discussed by the editors from RAMS and WoRMS.

## DISCUSSION

This study highlights the fact that after ten years of effort, the work is still in progress for RAMS. The main objective of covering the Antarctic zone has generally been reached for the class Asteroidea but needs at this point to go through a major update by the editors. Regarding the asteroids, the secondary objective of covering the Sub-Antarctic zone lacked the impulse of the scientific community and we hope that the work presented here will fill the gaps as accurately as possible.



This approach may not bring the same results for all the taxa in the Southern Ocean. Indeed, some charismatic fauna are very well known in the RAMS area of interest (e.g. marine mammals), however, we believe that the knowledge concerning the number of species present in the Southern Ocean waters might be significantly increased.

Only few mistakes were found in the existing RAMS list of Asteroidea and should be fixed soon after getting in contact with the editors. The new updated checklist of Asteroidea species will be available through the RAMS website (<http://www.marinespecies.org/rams>) in early 2016. A way to improve the general system, with the sea stars for model is also in development.

Recent work using genetics on *Odontaster* species (Janosik and Halanych 2010) highlights the fact that diversity might be higher than expected even in well-studied areas. There is also a lack of resources for identification and taxonomic work leading to redundant mistakes. In this context, the creation of a digital library, hotlinked with the RAMS and compiling original descriptions, literature materials and DNA barcoding information for each species will bring the RAMS a step ahead and provide a vital tool for future taxonomic and biogeographic work. Perspectives also include an illustrative determination key using a polytomic approach and the creation of interactive Antarctic Field Guides (<http://afg.biodiversity.aq>) on the <http://www.biodiversity.aq> platform (Van de Putte et al. 2015) in order to help the scientific community with the identification process and to enhance data availability.

We believe that the homogenization of available data for all taxa will result in a better understanding of the Southern Ocean and its biogeography, especially in the Sub-Antarctic zone.

## **ACKNOWLEDGEMENTS**

The work was supported by a "Fonds pour la formation à la Recherche dans l'Industrie et dans l'Agriculture" (FRIA) grants to C. Moreau. This is contribution no.8 to the vERSO project ([www.versoproject.be](http://www.versoproject.be)), funded by the Belgian Science Policy Office (BELSPO, contract n°BR/132/A1/vERSO).

# Asteroidea Database

Antarctic and Sub-Antarctic Asteroidea database



# Asteroidea Database

## Antarctic and Sub-Antarctic Asteroidea database

Camille Moreau<sup>1,2\*</sup>, Christopher Mah<sup>3</sup>, Antonio Agüera<sup>1</sup>, Nadia Améziane<sup>4</sup>, David Barnes<sup>5</sup>,  
Guillaume Crokaert<sup>1</sup>, Marc Eléaume<sup>4,6</sup>, Huw Griffiths<sup>5</sup>, Charlène Guillaumot<sup>1</sup>, Lenaïg G.  
Hemery<sup>6</sup>, Anna Jazdzewska<sup>7</sup>, Quentin Jossart<sup>1,8</sup>, Vladimir Laptikhovskiy<sup>9,10</sup>, Katrin Linse<sup>5</sup>, Kate  
Neill<sup>11</sup>, Chester Sands<sup>5</sup>, Thomas Saucède<sup>2</sup>, Stefano Schiaparelli<sup>12</sup>, Jacek Siciński<sup>7</sup>, Noémie  
Vasset<sup>4,13</sup>, Bruno Danis<sup>1</sup>

<sup>1</sup>Marine Biology Lab, CP160/15 Université Libre de Bruxelles (ULB) 50, B-1050 Brussels, Belgium <sup>2</sup>UMR CNRS 6282 Biogéosciences, Université de Bourgogne Franche-Comté (UBFC) 6 Boulevard Gabriel, F-21000 Dijon, France <sup>3</sup>Department of Invertebrate Zoology, National Museum of Natural History, Smithsonian Institution, Washington, D.C. <sup>4</sup>Muséum National d'Histoire Naturelle, Station de Biologie Marine, Place de la Croix, BP 225 9182 Concarneau Cedex <sup>5</sup>British Antarctic Survey, High Cross, Madingley Rd, Cambridge CB3 0ET, United Kingdom <sup>6</sup>Muséum National d'Histoire Naturelle, Département Origines, UMR7205 ISYEB MNHN-CNRS-UPMC-EPHE, CP51, 57 rue Cuvier, 75231 Paris Cedex 05, France <sup>7</sup>University of Lodz, Faculty of Biology and Environmental Protection, Department of Invertebrate Zoology and Hydrobiology, Laboratory of Polar Biology and Oceanobiology. 12/16 Banacha st., 90-237 Lodz, Poland <sup>8</sup>Marine Biology, Vrije Universiteit Brussel (VUB), Pleinlaan 2, 1050 Brussels, Belgium <sup>9</sup>Centre for Environment, Fisheries and Aquaculture Science, Pakefield Road, Lowestoft NR33 0HT, United Kingdom <sup>10</sup>Shallow Marine Surveys Group, P.O. Box 598, Stanley FIQQ 1ZZ, Falkland Islands <sup>11</sup>National Institute of Water and Atmospheric Research, Coasts and Oceans Centre, 301 Evans Bay Parade, Wellington, New Zealand <sup>12</sup>Dipartimento di Scienze della Terra, dell'Ambiente e della Vita (DISTAV), Università di Genova, C.so Europa 26, Genova I-16132 Italy <sup>13</sup>Noémie Vasset has been central in compiling all POKER 2 samples, among other things, while she was at the MNHN. She passed away August 22, 2016

\*Correspondence: Camille Moreau, Université Libre de Bruxelles (ULB) Laboratoire de Biologie Marine, CP160/15 50 Av. F.D. Roosevelt, B-1050 Bruxelles, Belgium.

E-mail: [mr.moreau.camille@gmail.com](mailto:mr.moreau.camille@gmail.com)

Citation: Moreau, C., Mah, C., Agüera, A., Améziane, N., Barnes, D., Crokaert, G., Eléaume, M., Griffiths, H., Guillaumot, C., Hemery, L., Jazdzewska, A., Jossart, Q., Laptikhovskiy, V., Linse, K., Neill, K., Sands, C., Saucède, T., Schiaparelli, S., Siciński, J., Vasset, N., & Danis B. (2018). Antarctic and sub-Antarctic Asteroidea database. *ZooKeys*, (747), 141-156, doi: 10.3897/zookeys.747.22751.



## **ABSTRACT**

The present dataset is a compilation of georeferenced occurrences of asteroids (Echinodermata: Asteroidea) in the Southern Ocean. Occurrence data south of 45°S latitude were mined from various sources together with information regarding the taxonomy, the sampling source and sampling sites when available. Records from 1872 to 2016 were thoroughly checked to ensure the quality of a dataset that reaches a total of 13,840 occurrences from 4,580 unique sampling events. Information regarding the reproductive strategy (brooders vs. broadcasters) of 63 species is also made available. This dataset represents the most exhaustive occurrence database on Antarctic and Sub-Antarctic asteroids.

## **Keywords**

Antarctic, Asteroidea, presence-only data, Southern Ocean, Sub-Antarctic

## INTRODUCTION

Mapping and understanding life diversity are major issues for the community of biologists and ecologists who focus on the Southern Ocean. For several years, many initiatives such as the International Polar Year, the Census of Antarctic Marine Life (CAML 2005–2010), the Scientific Committee on Antarctic Research: Marine Biodiversity Information Network (SCAR MarBIN, [www.biodiversity.aq](http://www.biodiversity.aq)) or the Biogeographic Atlas of the Southern Ocean (De Broyer et al., 2014) have also gathered information from distinct and transversal scientific domains to provide new multidisciplinary insights in the study of the Southern Ocean marine ecosystems, linking biogeographic, phylogeographic, physiological, oceanographic, and biogeochemistry data. Such programs have established the most exhaustive and accurate inventories of scientific data ever, since the first historical researches of James Cook in 1772–1775 in the region, and have provided open source information systems (e.g., Register of Antarctic Marine Species, De Broyer and Danis, 2010; Global Biodiversity Information Facility, <http://www.gbif.org>; Ocean Biogeographic Information System <http://www.iobis.org/>; Van de Putte et al., 2015, <http://www.biodiversity.aq>).

This extensive assessment was pursued by major improvements in methodologies and data analyses. Improvement of dataset completeness and resolution facilitates modelling approaches (Gutt et al., 2012) that provide interesting tools to better understand distribution patterns in this poorly documented part of the world.

Among benthic taxonomic groups, Asteroidea (Echinodermata) are well represented in the Southern Ocean with 12% of the global species richness present in the region (Mah and Blake, 2012). Around 300 species (Moreau et al., 2015) were reported at all depths including some potential keystone species in benthic communities (McClintock et al., 1988, 2008). As for many taxonomic groups, adaptations of invertebrates to the polar conditions of the Southern Ocean environments have been widely reported (Peck, 2002, 2016) and have led to unique biological traits and life-strategies as well as high levels of endemism in the region (Chown et al., 2015). In particular, reproductive strategies are diversified in the Southern Ocean with a distinction between brooding and broadcasting species (Poulin et al., 2002; Pearse et al., 2009). In asteroids, the two distinct reproductive strategies strongly drive species distribution patterns and the biogeography of the class in the Southern Ocean (Moreau et al., 2017).

The present dataset is a compilation of georeferenced occurrences, at species level, for the whole class Asteroidea in the Southern Ocean. Records from 1872 to 2016 have been gathered

from various open source databases. Data collected during recent and unpublished campaigns were also added including records from literature, reaching a total of 13,840 occurrences from 4,580 unique sampling events. This dataset represents the most exhaustive database on Antarctic and Sub-Antarctic asteroids.

## PROJECT DESCRIPTION

**Project title:** Antarctic and Sub-Antarctic Asteroidea database

**Personnel:** Camille Moreau, Charlène Guillaumot, Quentin Jossart, Antonio Agüera, Guillaume Crokaert, Marc Eléaume, Thomas Saucède, Katrin Linse, Huw Griffiths, Chester Sands, David Barnes, Vladimir Laptikhovsky, Anna Jażdżewska, Jacek Siciński, Noémie Vasset, Lenaig G. Hemery, Christopher Mah, Nadia Améziane, Stefano Schiaparelli, Bruno Danis

**Funding:** The work was supported by a “Fonds pour la formation à la Recherche dans l’Industrie et l’Agriculture” (FRIA) grants to C. Moreau. This is contribution no. 16 to the vERSO project (<http://www.versoproject.be>), funded by the Belgian Science Policy Office (BELSPO, contract n°BR/132/A1/vERSO). This is contribution to the IPEV programs n°1124 REVOLTA and n°1044 PROTEKER and to team SAMBA of the Biogeosciences laboratory.

**Study area descriptions / descriptor:** This study focuses on the Antarctic and Sub-Antarctic regions located at latitudes south of 45°S. The Southern Ocean is a vast region characterised by the paucity of its scientific data (Griffiths, 2010; Griffiths et al., 2011) and available collections are the compilation of several historical campaigns. The objective of this work is to integrate the most complete database of species occurrences for the class Asteroidea in the described geographic extent.

**Design description:** The compilation of occurrence data of asteroid species over the extent of the Southern Ocean was realised by gathering data available from various biodiversity information systems (OBIS, GBIF, biodiversity.aq, PANGAEA <https://www.pangaea.de/>) as well as published literature, including original manuscripts (e.g., Gutt et al., 2014; Moles et al., 2015), data papers and cruise reports. Compiled occurrences were complemented with data from personal communications of unpublished works and museums registered collections. This extensive dataset was developed to describe distribution patterns in the Southern Ocean as well as faunal affinities among 25 Antarctic and Sub-Antarctic bioregions (see Moreau et al., 2017). Several analytical methods such as Bootstrap Spanning

Network, non-metrical multidimensional scaling (nMDS) and clustering contributed to highlight the importance of the reproductive strategy on the contemporary observed distribution patterns. The importance of environmental parameters such as influence of Antarctic Circumpolar Current, the influence of the Polar Front, the presence of gyres or the geographic distance among locations has also been emphasised. This dataset helped to better describe the different biogeographic patterns within asteroids, which are overall congruent with other taxa and differs according to species reproductive strategy. This suggests a differential influence of dispersal capabilities on species distribution patterns. Analyses at genus levels also revealed the underlying legacy of past oceanographic and geodynamic processes in present-day patterns such as the existence of a trans-Antarctic pathway that split the Antarctic continent into two entities in the past. The detailed results are available from Moreau et al., (2017).

**Data description:** Asteroids are common invertebrates of Antarctic benthic communities considering the relative high species richness of the group in the region with regards to the world total diversity (Danis et al., 2014). They play a significant ecological role in Antarctic ecosystems, including in trophic networks (most species being predators) (Dayton, 1972; Lawrence, 2013). The present dataset, that focuses on regions located at latitudes higher than 45°S, compiles 28 families out of the 39 known worldwide (Mah, 2017) with 13,840 occurrences gathered from various sources. The time coverage of the collection starts in 1872 with the HMS Challenger expedition and ends in 2016 with sampled collected during the *RRS James Clark Ross* JR15005 SO-AntEco cruise.

Associated to occurrence data, depth, relative position to the Polar Front, taxonomic information and bioregion were implemented when available. Depth data were extracted from [www.gebco.net](http://www.gebco.net). Information regarding the reproductive strategy (brooding or broadcasting) of 63 species out of the 299 described was included in the database. Corresponding bioregions of the observed occurrences were specified following Moreau et al., 2017. A significant part of the specimens is deposited in various institutions: e.g., National Museum of Natural History (NMNH), Museum national d'Histoire naturelle (MNHN), Museo Nazionale dell'Antartide (MNA), Université Libre de Bruxelles (ULB), Museo Argentino de Ciencias Naturales (MACN), National Institute of Water and Atmospheric Research (NIWA).

**Quality control description:** Data are available at species level. Nomenclature was thoroughly checked using the Taxon Match Tool implemented in the World Register of Marine



Species (WoRMS Editorial Board, 2016), to delete all potential discrepancies and update the taxonomy determination. All replicates originating from overlapping origins as well as errors regarding the georeferencing, species synonymy, or misspelling were removed. Most of the occurrences additions originating from recent campaigns were identified by Christopher Mah and Camille Moreau.

## **Taxonomic coverage**

### **General taxonomic coverage description**

The present dataset is the most exhaustive and up-to-date list of available occurrences for the class Asteroidea (Echinodermata), in the entire Southern Ocean. This collection provides information about the occurrence of 28 asteroid families, 118 genera, and 299 species. Occurrence distribution is illustrated on Figure 1.

Species richness in the different regions of the Southern Ocean was estimated based on  $1^\circ \times 1^\circ$  grid cell resolution (Figure 2A). Maximum richness (55 species per cell) was found along the Western Antarctic Peninsula. High richness values were also reported in the Weddell Sea as well as in Sub-Antarctic Islands (Kerguelen, Crozet, Marion, and South Georgia Islands). Richness distribution needs to be interpreted carefully considering the patchy and uneven sampling effort of past oceanographic cruises carried out in the Southern Ocean (Figure 2B). Indeed, considerable parts of the Southern Ocean present a crucial lack of sampling. In the context of this study, richness values and sampling effort present a significant positive correlation in space (Pearson  $r = 0.52$ ,  $p < 0.001$ ) indicating the need to extend the development of this unique synthesis work and to strengthen the effort for other taxonomic groups.

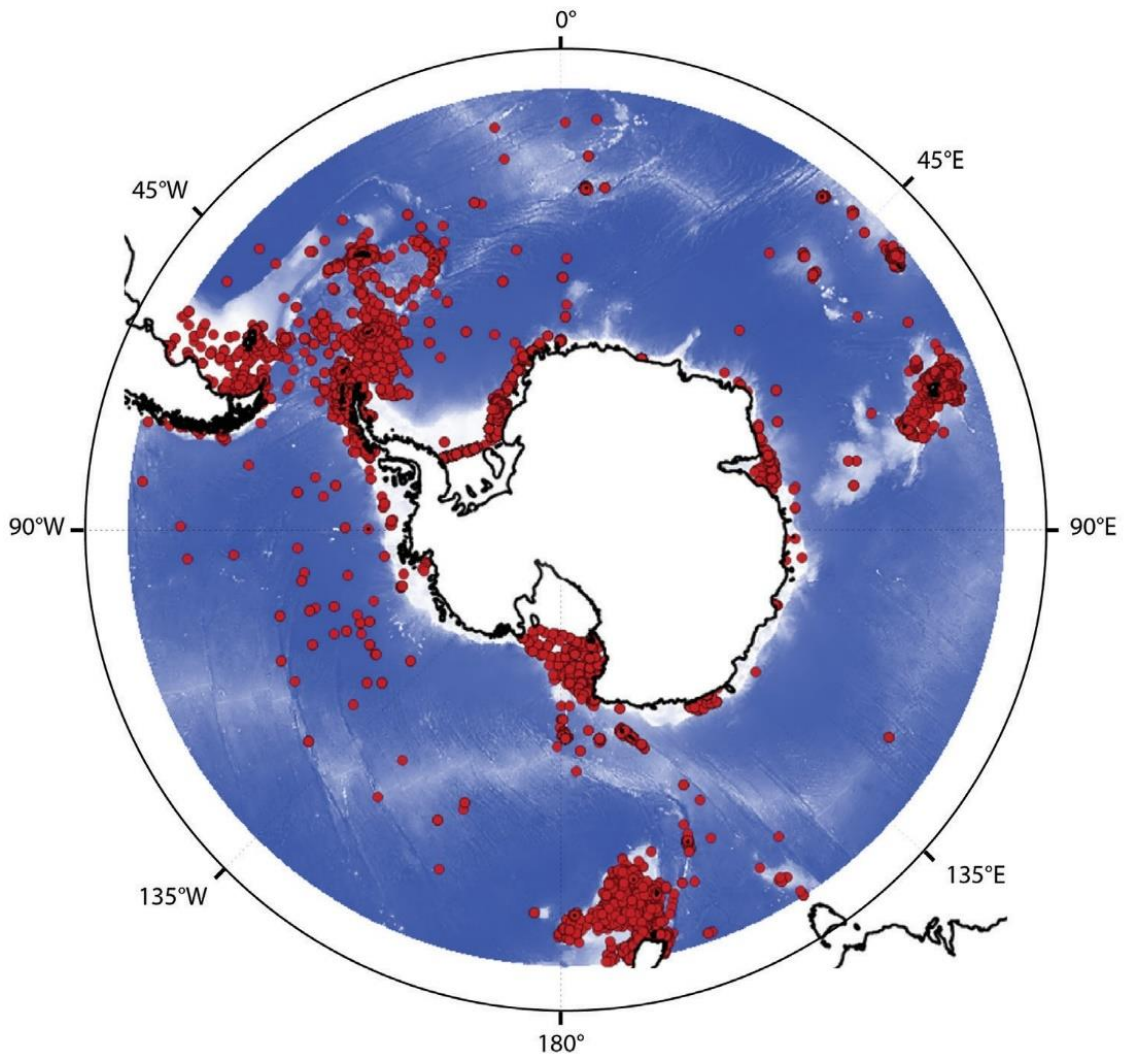

Figure 21 Map of the 13,840 asteroid species occurrences available in the present database, within the boundaries of the Southern Ocean (45°S). Projection: South Pole Stereographic.

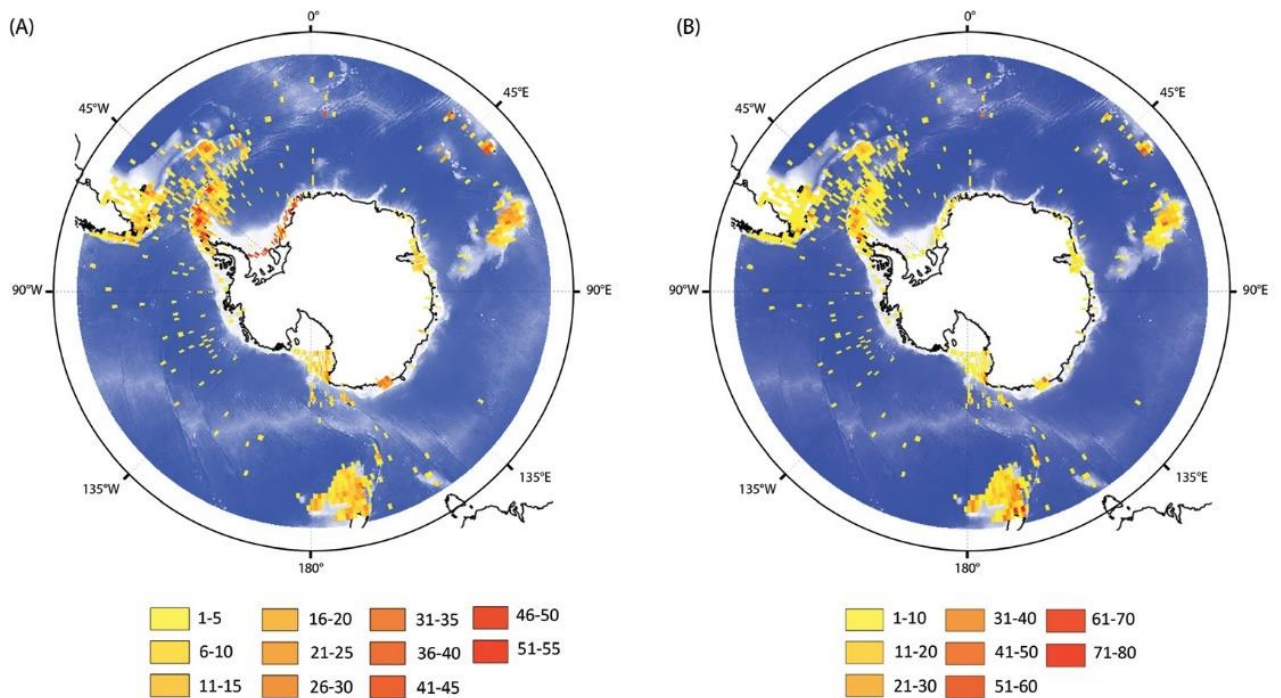

Figure 22 Species richness in the Southern Ocean. The number of asteroid species present in  $1^\circ \times 1^\circ$  grid cells are reported using yellow-red colour chart B Sampling effort in the Southern Ocean for the class Asterozoa. The number of sampling station per  $1^\circ \times 1^\circ$  grid cell is reported using yellow-red colour chart. Projection: South Pole Stereographic.

**Phylum:** Echinodermata

**Class:** Asterozoa

**Order:** Brisingida, Forcipulatida, Notomyotida, Paxillosida, Spinulosida, Valvatida, Velatida

**Family:** Acanthasteridae, Asteroidea, Asterinidae, Astropectinidae, Benthoplectinidae, Brisingidae, Ctenodiscidae, Echinasteridae, Freyellidae, Ganeriidae, Goniasteridae, Heliasteridae, Korethrasteridae, Leilasteridae, Luidiidae, Myxasteridae, Odontasteridae, Ophidiasteridae, Paulasteriidae, Pedicellasteridae, Poraniidae, Porcellanasteridae, Pseudarchasteridae, Pterasteridae, Radiasteridae, Solasteridae, Stichasteridae, Zoroasteridae.

**Genus:** *Abyssaster*, *Acanthaster*, *Acodontaster*, *Adelasterias*, *Allostichaster*, *Anasterias*, *Anseropoda*, *Anteliaster*, *Anthenoides*, *Asterina*, *Asthenactis*, *Astromesites*, *Astropecten*, *Arostole*, *Bathybiaster*, *Belgicella*, *Benthopecten*, *Brisinga*, *Brisingenes*, *Caimanaster*, *Calyptraster*, *Ceramaster*, *Cheiraster*, *Chitonaster*, *Chondraster*, *Cladaster*, *Clavaporania*, *Coscinasterias*, *Cosmasterias*, *Crossaster*, *Cryptasterias*, *Ctenodiscus*, *Cuenotaster*, *Cycethra*, *Diplasterias*, *Diplodontias*, *Diplopteraster*, *Dipsacaster*, *Dytaster*, *Echinaster*, *Eratosaster*, *Eremicaster*, *Freyastera*, *Freyella*, *Freyellaster*, *Fromia*, *Ganeria*, *Gaussaster*, *Gilbertaster*,

*Glabraster, Granaster, Henricia, Hippasteria, Hymenaster, Hymenodiscus, Hyphalaster, Kampylaster, Kenrickaster, Labidiaster, Leptychaster, Lethasterias, Lithosoma, Lonchotaster, Lophaster, Luidia, Lysasterias, Macroptychaster, Mediaster, Meridiastra, Mimastrella, Mirastrella, Myxoderma, Neosmilaster, Notasterias, Notioceramus, Novodinia, Odinella, Odontaster, Odontohenricia, Ophidiaster, Paralophaster, Paranepanthia, Patiriella, Paulasterias, Pectinaster, Pedicellaster, Pentagonaster, Pergamaster, Peribolaster, Perissasterias, Perknaster, Persephonaster, Pillsburiaster, Plutonaster, Poraniopsis, Porcellanaster, Proserpinaster, Psalidaster, Pseudarchaster, Pseudechinaster, Psilaster, Pteraster, Radiaster, Remaster, Rhopiella, Saliasterias, Sclerasterias, Scotiaster, Smilasterias, Solaster, Sphaeriodiscus, Stichaster, Styracaster, Taranuiaster, Tarsaster, Tremaster, Vemaster, Zoroaster.*

**Species:** *Abyssaster diadematus, Abyssaster planus, Acanthaster planci, Acodontaster capitatus, Acodontaster conspicuus, Acodontaster elongatus, Acodontaster hodgsoni, Acodontaster marginatus, Adelasterias papillosa, Allostichaster capensis, Allostichaster farquhari, Allostichaster insignis, Allostichaster polyplax, Anasterias antarctica, Anasterias asterinoides, Anasterias directa, Anasterias laevigata, Anasterias mawsoni, Anasterias pedicellaris, Anasterias perrieri, Anasterias rupicola, Anasterias sphaerulata, Anasterias spirabilis, Anasterias studeri, Anasterias suteri, Anseropoda antarctica, Anteliaster australis, Anteliaster scaber, Anthenoides cristatus, Asterina fimbriata, Asthenactis australis, Astromesites primigenius, Astropecten brasiliensis, Astrostole scabra, Bathybiaster loripes, Belgicella racowitzana, Benthopecten munidae, Benthopecten pedicifer, Benthopecten pikei, Brisinga chathamica, Brisingenes multicostata, Caimanaster acutus, Calyptraster tenuissimus, Calyptraster vitreus, Ceramaster australis, Ceramaster grenadensis, Ceramaster patagonicus, Cheiraster (Cheiraster) otagoensis, Cheiraster (Luidiaster) antarcticus, Cheiraster (Luidiaster) gerlachei, Cheiraster (Luidiaster) hirsutus, Cheiraster (Luidiaster) planeta, Chitonaster cataphractus, Chitonaster felli, Chitonaster johanna, Chitonaster trangae, Chondraster elattosis, Cladaster analogus, Clavaporania fitchorum, Coscinasterias calamaria, Coscinasterias muricata, Cosmasterias dyscrita, Cosmasterias lurida, Crossaster campbellicus, Crossaster multispinus, Crossaster penicillatus, Cryptasterias brachiata, Cryptasterias turqueti, Ctenodiscus australis, Ctenodiscus procurator, Cuenotaster involutus, Cycethra frigida, Cycethra macquariensis, Cycethra verrucosa, Diplasterias brandti, Diplasterias brucei,*

*Diplasterias kerguelenensis, Diplasterias meridionalis, Diplasterias octoradiata, Diplasterias radiata, Diplodontias dilatatus, Diplodontias robustus, Diplodontias singularis, Diplopteraster clarki, Diplopteraster hurleyi, Diplopteraster otagoensis, Diplopteraster peregrinator, Diplopteraster semireticulatus, Diplopteraster verrucosus, Dipsacaster magnificus, Dytaster felix, Echinaster farquhari, Echinaster smithi, Eratosaster jenae, Eremicaster crassus, Eremicaster pacificus, Eremicaster vicinus, Freyastera benthophila, Freyastera tuberculata, Freyella attenuata, Freyella drygalskii, Freyella echinata, Freyella formosa, Freyella fragilissima, Freyella giardi, Freyella heroina, Freyella mutabilia, Freyellaster polycnema, Fromia monilis, Ganeria attenuata, Ganeria falklandica, Ganeria hahni, Gaussaster antarcticus, Gilbertaster anacanthus, Glabraster antarctica, Granaster nutrix, Henricia aucklandiae, Henricia compacta, Henricia diffidens, Henricia fisheri, Henricia lukinsii, Henricia obesa, Henricia ornata, Henricia pagenstecheri, Henricia parva, Henricia praestans, Henricia ralphae, Henricia simplex, Henricia smilax, Henricia spinulfera, Henricia studeri, Hippasteria falklandica, Hippasteria phrygiana, Hymenaster caelatus, Hymenaster campanulatus, Hymenaster carnosus, Hymenaster coccinatus, Hymenaster crucifer, Hymenaster densus, Hymenaster edax, Hymenaster estcourti, Hymenaster formosus, Hymenaster fucatus, Hymenaster graniferus, Hymenaster latebrosus, Hymenaster nobilis, Hymenaster pellucidus, Hymenaster perspicuus, Hymenaster praecoquis, Hymenaster pullatus, Hymenaster sacculatus, Hymenodiscus aotearoa, Hymenodiscus distincta, Hymenodiscus submembranacea, Hyphalaster giganteus, Hyphalaster inermis, Hyphalaster scotiae, Kampylaster incurvatus, Kenrickaster pedicellaris, Labidiaster annulatus, Labidiaster radiosus, Leptychaster flexuosus, Leptychaster kerguelenensis, Leptychaster magnificus, Leptychaster melchiorensis, Lethasterias australis, Lithosoma novaezelandiae, Lonchotaster tartareus, Lophaster densus, Lophaster gaini, Lophaster stellans, Lophaster tenuis, Luidia clathrata, Luidia porteri, Lysasterias adeliae, Lysasterias belgicae, Lysasterias chirophora, Lysasterias digitata, Lysasterias hemiora, Lysasterias heteractis, Lysasterias joffrei, Lysasterias lactea, Lysasterias perrieri, Macroptychaster accrescens, Mediaster arcuatus, Mediaster dawsoni, Mediaster pedicellaris, Mediaster sladeni, Meridiastra medius, Meridiastra oriens, Mimastrella cognata, Mirastrella biradialis, Myxoderma qawashqari, Neosmilaster georgianus, Neosmilaster steineni, Notasterias armata, Notasterias bongraini, Notasterias candicans, Notasterias haswelli, Notasterias pedicellaris, Notasterias stolophora, Notioceramus anomalus, Novodinia novaezelandiae, Odinella nutrix, Odontaster aucklandensis, Odontaster benhami, Odontaster*

*meridionalis*, *Odontaster pearsei*, *Odontaster penicillatus*, *Odontaster pusillus*, *Odontaster roseus*, *Odontaster validus*, *Odontohenricia anarea*, *Odontohenricia endeavouri*, *Ophidiaster confertus*, *Paralophaster antarcticus*, *Paralophaster godfroyi*, *Paralophaster hyalinus*, *Paralophaster lorioli*, *Paranepanthia aucklandensis*, *Patiriella regularis*, *Paulasterias tyleri*, *Pectinaster filholi*, *Pectinaster mimicus*, *Pedicellaster hypernotius*, *Pentagonaster pulchellus*, *Pergamaster incertus*, *Pergamaster triseriatus*, *Peribolaster folliculatus*, *Peribolaster lictor*, *Peribolaster macleani*, *Perissasterias monacantha*, *Perknaster antarcticus*, *Perknaster aurantiacus*, *Perknaster aurorae*, *Perknaster charcoti*, *Perknaster densus*, *Perknaster fuscus*, *Perknaster sladeni*, *Persephonaster facetus*, *Pillsburiaster aoteanus*, *Pillsburiaster indutilis*, *Plutonaster complexus*, *Plutonaster fragilis*, *Plutonaster hikurangi*, *Plutonaster jonathani*, *Plutonaster knoxi*, *Plutonaster sirius*, *Poraniopsis echinaster*, *Porcellanaster ceruleus*, *Proserpinaster neozelanicus*, *Psalidaster fisheri*, *Psalidaster mordax*, *Pseudarchaster discus*, *Pseudarchaster garricki*, *Pseudechinaster rubens*, *Psilaster acuminatus*, *Psilaster charcoti*, *Pteraster affinis*, *Pteraster bathami*, *Pteraster florifer*, *Pteraster gibber*, *Pteraster hirsutus*, *Pteraster koehleri*, *Pteraster robertsoni*, *Pteraster rugatus*, *Pteraster spinosissimus*, *Pteraster stellifer*, *Radiaster gracilis*, *Remaster gourdoni*, *Rhopiella hirsuta*, *Saliasterias brachiata*, *Sclerasterias eustyla*, *Sclerasterias mollis*, *Scotiaster inornatus*, *Smilasterias clarkailsa*, *Smilasterias irregularis*, *Smilasterias scalprifera*, *Smilasterias triremis*, *Solaster longoi*, *Solaster notophrynus*, *Solaster regularis*, *Solaster torulatus*, *Sphaeriodiscus mirabilis*, *Stichaster australis*, *Styracaster armatus*, *Styracaster chuni*, *Styracaster horridus*, *Styracaster robustus*, *Taranuiaster novaezealandiae*, *Tarsaster stoichodes*, *Tremaster mirabilis*, *Vemaster sudatlanticus*, *Zoroaster actinocles*, *Zoroaster alternicanthus*, *Zoroaster fulgens*, *Zoroaster macracantha*, *Zoroaster spinulosus*, *Zoroaster tenuis*.

**Spatial coverage:** Southern Ocean: from 45°S to higher latitudes

**Temporal coverage:** 1872: HMS Challenger to 2016: JR15005.

**Dataset:** Asteroid occurrences available in the Southern Ocean from 1872 to 2016, collected during different campaigns and gathered from different deposit resources.

**Object name:** Antarctic and Sub-Antarctic Asteroidea Database

**Character encoding:** UTF/8

**Format name:** Darwin Core Archive Format

**Format version:** 1.4

**Distribution:** [http://ipt.biodiversity.aq/resource?r=asteroidea\\_southern\\_ocean](http://ipt.biodiversity.aq/resource?r=asteroidea_southern_ocean)

**Publication date of data:**

**Language:** English

**Metadata language:** English

**Date of metadata creation:**

**Hierarchy level:** Dataset

## **ACKNOWLEDGEMENTS**

This work was supported by a “Fonds pour la formation à la Recherche dans l’Industrie et l’Agriculture” (FRIA) grants to C. Moreau. C. Mah was funded by MNHN invited researcher grants (2013, 2014, 2015, 2016). This is contribution no. 16 to the vERSO project ([www.versoproject.be](http://www.versoproject.be)), funded by the Belgian Science Policy Office (BELSPO, contract n°BR/132/A1/vERSO). This is contribution to the IPEV programs n°1124 REVOLTA and n°1044 PROTEKER and to team SAMBA of the Biogeosciences laboratory. We are grateful to the crew and participants of all the cruises and research programs involved in the capture of the samples included in this dataset: POKER 2, REVOLTA 1 & 2, CEAMARC, JR144, JR179, JR230, JR262, JR275, JR287, JR15005. We also thank the following institutions: California Academy of Sciences, Alfred Wegener Institute, Helmholtz Centre for Polar and Marine Research, Shallow Marine Surveys Group, University of Lodz, Muséum national d’Histoire naturelle and University of Genoa, NIWA (National Institute of Water and Atmospheric Research) Invertebrate Collection.

# Chapter 1

Reproductive strategy as a piece of the biogeographic puzzle: a case study using Antarctic sea stars (Echinodermata, Asteroidea)





# Chapter 1

## Reproductive strategy as a piece of the biogeographic puzzle: a case study using Antarctic sea stars (Echinodermata, Asteroidea)

Camille Moreau<sup>1,2\*</sup>, Thomas Saucède<sup>2</sup>, Quentin Jossart<sup>1</sup>, Antonio Agüera<sup>1</sup>, Arnaud Brayard<sup>2</sup>,  
and Bruno Danis<sup>1</sup>

<sup>1</sup>Marine Biology Lab, CP160/15 Université Libre de Bruxelles (ULB) 50, avenue FD Roosevelt B-1050 Brussels, Belgium.

<sup>2</sup>UMR CNRS 6282 Biogéosciences, Université de Bourgogne Franche-Comté (UBFC) 6, boulevard Gabriel F-21000 Dijon, France.

\*Correspondence: Camille Moreau, Université Libre de Bruxelles (ULB) Laboratoire de Biologie Marine, CP160/15 50 Av. F.D. Roosevelt, B-1050 Bruxelles, Belgium

E-mail: [mr.moreau.camille@gmail.com](mailto:mr.moreau.camille@gmail.com)

Short running head: Biogeography of Antarctic sea stars

Citation: Moreau, C., Saucède, T., Jossart, Q., Agüera, A., Brayard, A., & Danis, B. (2017). Reproductive strategy as a piece of the biogeographic puzzle: a case study using Antarctic sea stars (Echinodermata, Asteroidea). *Journal of Biogeography*, 44(4), 848-860, [doi.org/10.1111/jbi.12965](https://doi.org/10.1111/jbi.12965).

## **ABSTRACT**

**Aim** To describe and analyse asteroid biogeographic patterns in the Southern Ocean and test whether reproductive strategy (brooder versus broadcaster) can explain distribution patterns at the scale of the entire class. We hypothesise that brooding and broadcasting species display different biogeographic patterns.

**Location** Southern Ocean, south of 45 °S.

**Methods** Over 14,000 asteroid occurrences are analysed using bootstrapped spanning network (BSN), non-metrical multidimensional scaling (nMDS) and clustering to uncover the spatial structure of faunal similarities among 25 bioregions.

**Results** Main biogeographic patterns are congruent with previous works based on other taxa and highlight the isolation of New Zealand, the high richness in the Scotia Arc area particularly of brooding species, an East/West Antarctic differentiation, and the faunal affinities between South America and sub-Antarctic Islands. Asteroids show lower endemism levels than previously reported with 29% of species occurring in Antarctica only. In particular, asteroids from Tierra del Fuego showed affinities with those of West Antarctica at the species level, suggesting a recent mixing of assemblages. Biogeographic patterns are highly linked to reproductive strategy. Patterns also differ according to the taxonomic level, revealing the underlying role of historical factors.

**Main conclusions** Patterns of sea star biogeography are consistent with results obtained for other marine groups and are strongly linked to reproductive strategy.

**Keywords** Antarctica, benthos, biogeographic barrier, Echinodermata, invertebrate, regionalisation, reproductive mode, sea stars, Southern Ocean

## INTRODUCTION

The Southern Ocean *sensu lato*, as defined by oceanographers, includes the marine area south of the Subtropical Front (STF) (Longhurst, 2007; Rintoul, 2007; Post et al. 2014). In the framework of large-scale biogeographic studies of marine benthic life, the Southern Ocean is generally divided into four major geographic entities (i.e. provinces): the Magellanic Plateau, represented by the southern tip of South America (South Chile, South Argentina, Tierra Del Fuego and the Malvinas/Falkland Islands); Southern New Zealand, represented by the Campbell Plateau; the sub-Antarctic area, located between the STF in the north and the Polar Front in the south, which is mainly composed of abyssal plains and several igneous Islands (e.g. Crozet archipelago, Kerguelen and Heard Islands); and the Antarctic province, defined as the region south of the Polar Front (Griffiths et al., 2009). The Antarctic province is one of the most remote places on Earth, despite representing c. 11% of the global continental shelf surface, and surrounded by the Southern Ocean which surface accounts for c. 8% of all the world's oceans (Griffiths, 2010; Ingels et al., 2012). Each of these provinces can then be divided into smaller entities, defined as bioregions (cf. Hedgpeth, 1969).

The long-term faunal connections within and among these four provinces cannot be explained by a “one-size fits-all” biogeographic theory. Indeed, biogeographic patterns appear to be dependent upon the taxon investigated (e.g. Barnes & Griffiths, 2007 for Bryozoa; Griffiths et al., 2009 for Mollusca and Bryozoa; Downey et al., 2012 for Porifera). All large-scale studies on biogeographic patterns of the Southern Ocean benthic life indicate that oceanographic and historical factors have played a significant role in the current patterns (Linse et al., 2006; Barnes & Griffiths, 2007; Downey et al., 2012; Pierrat et al., 2013). Oceanographic features which are unique to the Southern Ocean, such as the Polar Front, act as a barrier between polar and sub-Antarctic water masses. Both water masses show contrasting physico-chemical properties, and the Polar Front creates a steep gradient in temperature and salinity (Venables et al., 2012). Geomorphological features, such as a “belt” of abyssal basins surrounding the Antarctic continent, have resulted in the biogeographic isolation of the Antarctic shelf, especially the benthos (see Clarke et al., 2005). The combined impacts of surface currents, the environmental characteristics of the Southern Ocean and the long-term gradual cooling and past glacial–interglacial cycles occurring during the Plio-Pleistocene have driven biogeographic patterns (González-Wevar et al., 2012; Strugnell et al.,

2012). The development of the Antarctic Circumpolar Current during the Eocene/Oligocene has and continues to play a major role in the circum-Antarctic structure of environmental and biotic patterns by initiating a fast, clockwise transport of water, dispersing propagules around the entire Antarctic continent (Pearse et al., 2009; Pierrat et al., 2013; David & Saucède, 2015).

Regional-scale processes may also shape biogeographic patterns. For instance, the Polar Front has “marine corridors” connecting distinct regions (Clarke et al., 2005; Barnes & Clarke, 2011). Other oceanographic features, such as regional-scale eddies, island archipelagos, seamounts or refugia during glacial cycles may also have influenced the distribution of benthic species (e.g. Barnes & Kuklinski, 2010). Despite this permeability, benthic fauna living south of the Polar Front are highly adapted to polar environmental conditions (e.g. McClintock, 1994; Peck et al., 2006) and interactions among all the factors mentioned above have resulted in apparently high levels of endemism in many benthic taxa of the Southern Ocean. The recent Biogeographic Atlas of the Southern Ocean (De Broyer et al., 2014, and chapters herein) estimates 57% endemism for bivalves, 79% for gastropods, 64% for pycnogonids, 87% for isopods, 81% for tanaids, 51% for ascidians and 80% for cumaceans.

Sea stars (Asteroidea, Echinodermata) are common organisms living on the Antarctic seafloor with specimens found in diverse environments (Brandt et al., 2007; Linse et al., 2007a; Mah & Blake, 2012). High latitude asteroids have been studied since the late 19th century in the Southern Ocean (e.g. Sladen, 1889) with hundreds of species recorded (latest checklist in Moreau et al., 2015) and frequent checklists (e.g. Moles et al., 2015). Moreover, there is a particularly high proportion of brooding sea stars in the Southern Ocean (Poulin et al., 2002; Pearse et al., 2009). Despite the potential importance of asteroids as ecosystem structuring agents (Mah & Blake, 2012; Lawrence, 2013), very few studies have assessed the overall distribution pattern of Southern Ocean asteroid diversity (Danis et al., 2014; Moles et al., 2015) and the relative importance of each driving factor involved in the observed patterns has not yet been addressed.

In a recent update of the Register of Antarctic Marine species (RAMS), Moreau et al. (2015) reported a total of 295 species, representing more than 15% of the nearly 1,900 extant species of asteroids (Mah & Blake, 2012). Initiatives such as RAMS and the World Register of Marine Species (WoRMS Editorial Board, 2015) enable the use of global data systems [e.g. Ocean Biogeographic Information System (OBIS – <http://www.iobis.org/>), Global Biodiversity Information Facility (GBIF – <http://www.gbif.org/>)] to compile hundreds of thousands

georeferenced data entries (Costello et al., 2013; Jossart et al., 2015). Such extensive datasets can be used to address key biological questions, such as the origin and the structure of asteroid biogeographic patterns in the Southern Ocean.

The objectives of this work were to describe and analyse asteroid biogeographic patterns in the Southern Ocean and test whether reproductive strategy (brooder versus broadcaster) can explain distribution patterns. Specifically, we hypothesise that the contrasting ability of asteroids to disperse (short range for brooders and long range for broadcasters) will generate contrasting biogeographic patterns.

## **MATERIALS AND METHODS**

### **Area of interest**

The geographic area investigated in this study focuses on the Southern Ocean, at latitudes higher than 45°S (Figure 23). The Southern Ocean was then subdivided into the following 25 bioregions based on several recent biogeographic studies (Linse et al., 2006; Clarke et al., 2007; Spalding et al., 2007; Pierrat et al., 2013; De Broyer & Jazdzewska, 2014) and to take into account all occurrences data available for the Southern Ocean asteroids (see Figure 23): Adélie Land (ALand); Antarctic Peninsula & the South Shetland Is. (AP&SSh); Amundsen & Bellingshausen Sea (AS&BS); Balleny & Scott Is. (Bal&Sco); Bounty & Antipodes Is. (Bount&Ant); Bouvet Is. (Bouv); Campbell & Auckland Is. (Cam&Auc); Crozet Is. (Cro); Davis Sea & Wilkes Land (DS&WL); Falkland Is. (Fal); Heard Is. (Heard); Kerguelen Is. (Ker); Macquarie Is. (Mac); Ob & Lena seamounts (Ob&Lena); Prydz Bay (PBay); Prince Edward & Marion Is. (PEd&Mar); Queen Maud Land & Enderby Land (QML&EL); Ross Sea (Ross); South Argentina (SArg); South Chile (SChi); South Georgia & Shag Rocks (SG&Sha); South Orkney Is. (SOrk); South Sandwich Is. (SSand); Tierra Del Fuego (TdF) and Weddell Sea (WS).

### **Data analyses**

Cleaned data (See Appendix 1) were compiled into a matrix providing information for each species on the bioregion and depth of occurrence. The dataset was used in its entirety for richness analyses. For biogeographic analyses, occurrences from depths lower than 1,500 m (abyssal domain and beyond) were excluded to only focus on shelf areas and on the upper

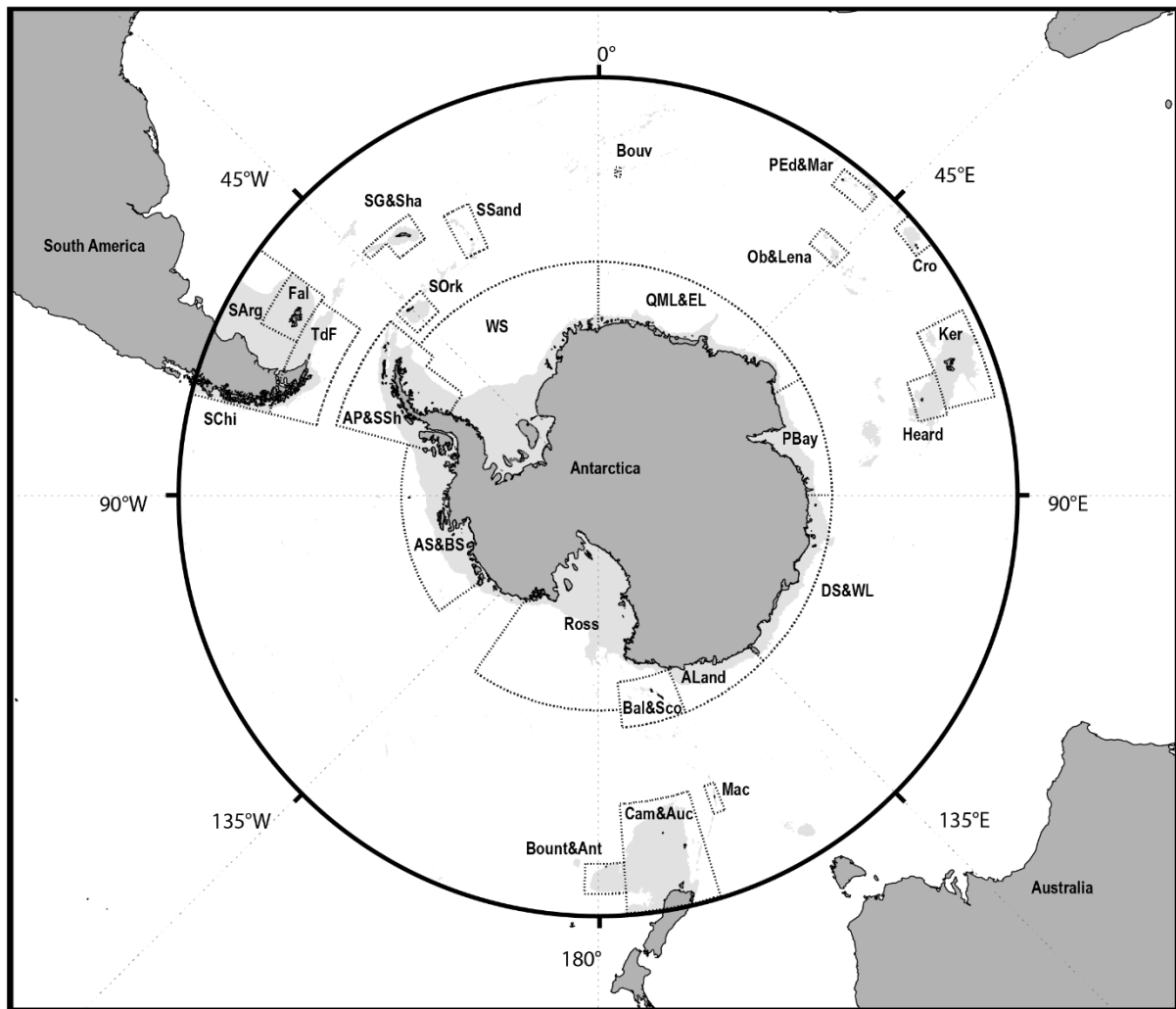

Figure 23 Map of the Southern Ocean. Area of study (below 45 °S) showing the bioregions: Adélie Land (ALand); Antarctic Peninsula & the South Shetland Is. (AP&SSh); Amundsen & Bellingshausen Sea (AS&BS); Balleny & Scott Is. (Bal&Sco); Bounty & Antipodes Is. (Bount&Ant); Bouvet Is. (Bouv); Campbell & Auckland Is. (Cam&Auc); Crozet Is. (Cro); Davis Sea & Wilkes Land (DS&WL); Falkland Is. (Fal); Heard Is. (Heard); Kerguelen Is. (Ker); Macquarie Is. (Mac); Ob & Lena seamounts (Ob&Lena); Prydz Bay (PBay); Prince Edward & Marion Is. (PEd&Mar); Queen Maud Land & Enderby Land (QML&EL); Ross Sea (Ross); South Argentina (SArg); South Chile (SCh); South Georgia & Shag Rocks (SG&Sha); South Orkney Is. (SOrk); South Sandwich Is. (SSand); Tierra Del Fuego (TdF) and Weddell Sea (WS). Depth of study, between 0 and 1500 m is shown in light grey. Projection: South Pole stereographic.

slope. This depth range also includes shallow canyons and troughs. The main changes in faunal communities of the Southern Ocean occur at around 1,500 m depth, deeper than elsewhere in the world's oceans (Brandt et al., 2014). Bathymetric data were compiled using the GEBCO (2014) grid ([www.gebco.net](http://www.gebco.net)). Analyses were performed at the genus and species levels. At the species level, brooding and broadcasting species were also investigated separately to test our

working hypothesis (see Appendix 1 for sources regarding the reproductive strategy). Species accumulation curves were calculated to test the consistency of richness estimation using PRIMER 6 (Clarke & Gorley, 2006) with a focus on the first 250 stations (Figure 24a).

Three complementary approaches were used to quantitatively investigate faunal similarities between the 25 bioregions. Two multivariate analyses, non-metrical multidimensional scaling (nMDS) and clustering, were carried out using PRIMER 6 (Clarke & Gorley, 2006) and the Bray-Curtis coefficient (Bray & Curtis, 1957). A similarity percentage (SP) is given by the cluster analyses to measure similarities among bioregions or groups of bioregions. We also used the bootstrap spanning network (BSN) procedure to visualise non-metric inter-assemblages similarity structure as a connected network. BSN allows the simultaneous identification of partially or totally nested patterns as well as gradational linear or reticulated biogeographic structures (see detailed description in Brayard et al., 2007, 2009). These three methods can be used to identify transitional areas between bioregions and groups of bioregions in term of faunal similarities.

A dissimilarity matrix was calculated using the Bray-Curtis coefficient (Bray & Curtis, 1957). Following the BSN procedure (see Brayard et al., 2007), similarity relationships were displayed as a connected network directly superimposed on geographic maps. Nodes of the network represent studied bioregions and the robustness of each BSN link between nodes was evaluated by bootstrap replications (10,000 replicates were computed here). A bootstrap support values (BSV: i.e. a confidence interval) is obtained for each link between bioregions (see Brayard et al., 2007, 2009 for details). When superimposed on geographic maps, the BSN provides an intuitive visualisation, as well as a quantitative appraisal of faunal exchange pathways and biogeographic structures. BSNs were created with the software BSN 1.0 (Brayard et al., 2007) and visualisations were created in PAJEK 1.07 (Batagelj & Mrvar, 2005). In order to quantitatively compare BSN among different taxonomic levels and reproductive strategies, we built a triangular matrix by multiplying the BSV between bioregions for each of our four studied situations (genus level, species level, brooding and broadcasting species). When two or more pathways were possible in the BSN, we kept the smallest value in order to reflect the highest similarity relationship. The bioregions Bount&Ant, Cam&Auc, AS&BS and Mac were removed from correlation analyses because they were rarely connected to other bioregions in the BSN analyses. A Mantel test using the Spearman coefficient was used to



measure correlations between the BSN structures. Finally, endemism levels of asteroid species were analysed by comparing the Southern Ocean area dataset and the OBIS/GBIF occurrences for the rest of the world. Endemism within each bioregion was also quantified.

## RESULTS

### Sampling effort, richness patterns and endemism

There are clear differences in sampling effort intensity among the bioregions, ranging from 16 stations for both Queen Maud Land & Enderby Land (QML&EL) and Ob & Lena seamounts (Ob&Lena) to 993 stations for Campbell and Auckland Is. (Cam&Auc) (Table 2). Similar patterns can be observed for the number of occurrences [from 45 in the Davis Sea & Wilkes Land (DS&WL) to 2,259 in the Weddell Sea (WS)] and the richness at any taxonomic level (the number of orders, families, genera and species ranges from 4 to 7, 9 to 20, 14 to 61, 20 to 128 respectively). Species accumulation curves for each bioregion (Figure 24a, b) indicate that bioregions Cam&Auc, Ker and Ross are the only ones reaching an asymptote and that many species remain to be discovered in the Southern Ocean regardless of the location. The steepest curves, reflecting potential high species richness, are all found in the area between South America and the Antarctic Continent (TdF, SG&Sha, SSand, SOrk, AP&SSh and WS). Our final dataset contained 14,005 occurrence records, accounting for 4,512 stations. All seven orders of the class Asteroidea were represented, including 299 species assigned to 28 families and 118 genera (Table 2).

Of the 299 species in the dataset, 196 (c. 66%) also occur south of the Polar Front and 123 species (c. 41%) have distributions that also extend north of the STF. Thus, a total of 176 species (c. 59%) occur exclusively south of the STF and are endemic to the Southern Ocean. Among the 196 species found south of the Polar Front, 56 are restricted to the Antarctic zone (c. 29% endemism). In our dataset, 66 species (c. 22%) are only found around southern New Zealand and the adjacent regions (Chatham Islands, Tasmania), but not in any other region of the Southern Ocean. At the scale of a bioregion endemism is low, varying from zero to four endemic species.

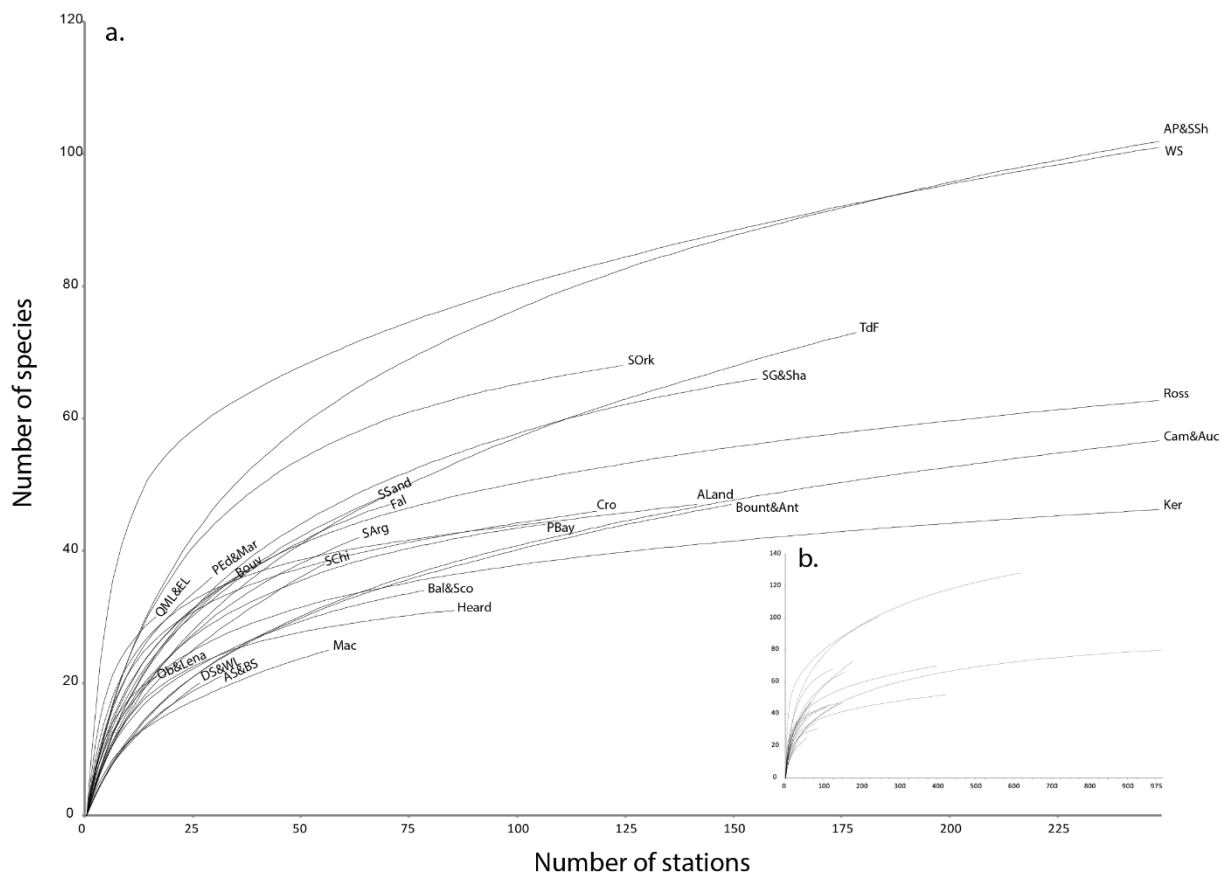
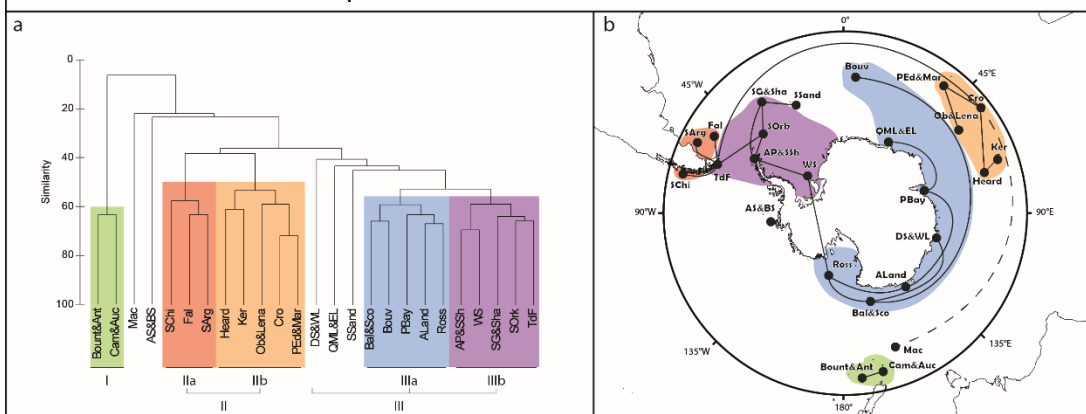

Figure 24 Accumulation curves at the species level of Asteroidea for each investigated bioregion: Adélie Land (ALand); Antarctic Peninsula & the South Shetland Is. (AP&SSh); Amundsen & Bellingshausen Sea (AS&BS); Balleny & Scott Is. (Bal&Sco); Bounty & Antipodes Is. (Bount&Ant); Bouvet Is. (Bouv); Campbell & Auckland Is. (Cam&Auc); Crozet Is. (Cro); Davis Sea & Wilkes Land (DS&WL); Falkland Is. (Fal); Heard Is. (Heard); Kerguelen Is. (Ker); Macquarie Is. (Mac); Ob & Lena seamounts (Ob&Lena); Prydz Bay (PBay); Prince Edward & Marion Is. (PEd&Mar); Queen Maud Land & Enderby Land (QML&EL); Ross Sea (Ross); South Argentina (SArg); South Chile (SChl); South Georgia & Shag Rocks (SG&Sha); South Orkney Is. (SOrk); South Sandwich Is. (SSand); Tierra Del Fuego (TdF) and Weddell Sea (WS). (a) Close-up of the first 250 stations. (b) Complete dataset.

Figure 25 Cluster analyses (average linkage) of the percentage faunal similarity (a), (c), (e) and (g) using the Bray-Curtis index and bootstrapped spanning networks (b), (d), (f) and (h) performed for species and genus level as well as for brooding and broadcasting species for the class Asteroidea among the studied bioregions: Adélie Land (ALand); Antarctic Peninsula & the South Shetland Is. (AP&SSh); Amundsen & Bellingshausen Sea (AS&BS); Balleny & Scott Is. (Bal&Sco); Bounty & Antipodes Is. (Bount&Ant); Bouvet Is. (Bouv); Campbell & Auckland Is. (Cam&Auc); Crozet Is. (Cro); Davis Sea & Wilkes Land (DS&WL); Falkland Is. (Fal); Heard Is. (Heard); Kerguelen Is. (Ker); Macquarie Is. (Mac); Ob & Lena seamounts (Ob&Lena); Prydz Bay (PBay); Prince Edward & Marion Is. (PEd&Mar); Queen Maud Land & Enderby Land (QML&EL); Ross Sea (Ross); South Argentina (SArg); South Chile (SChi); South Georgia & Shag Rocks (SG&Sha); South Orkney Is. (SOrk); South Sandwich Is. (SSand); Tierra Del Fuego (TdF) and Weddell Sea (WS). Links with BSV < 70% correspond to dashed lines, links with BSV < 50% are not shown. Corresponding groups based on the cluster analyses display a similar colour. Green: New Zealand – Red: South America – Orange: Sub-Antarctic Islands – Blue: High Antarctica or East Antarctica – Purple: West Antarctica – Burgundy: Circumpolar Pattern.

### Species level (1500m restriction)



### Genus level (1500m restriction)

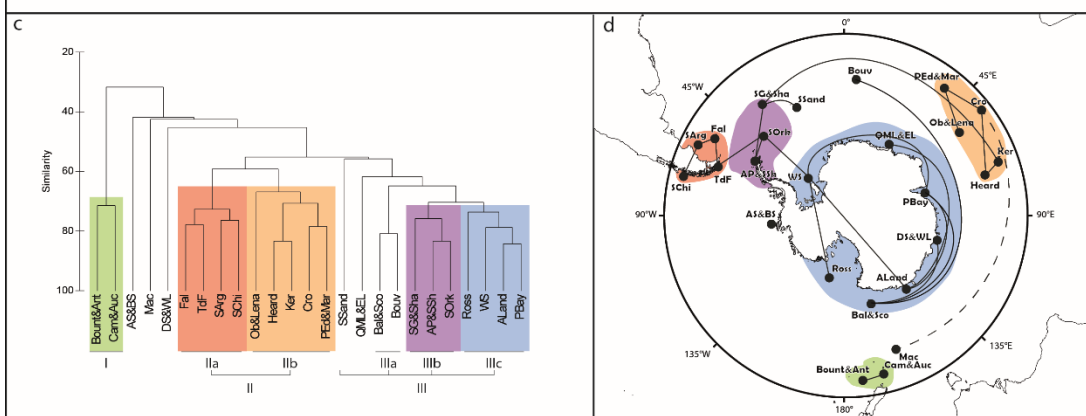

### Brooding species (1500m restriction)

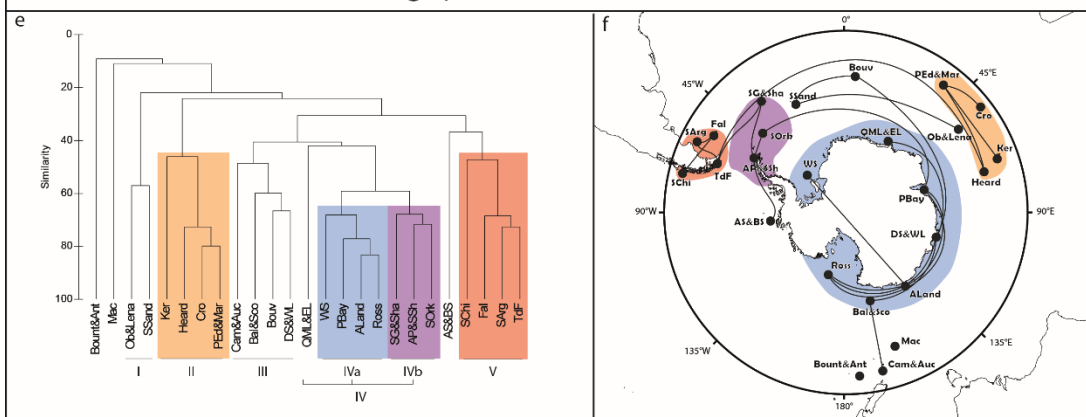

### Broadcasting species (1500m restriction)

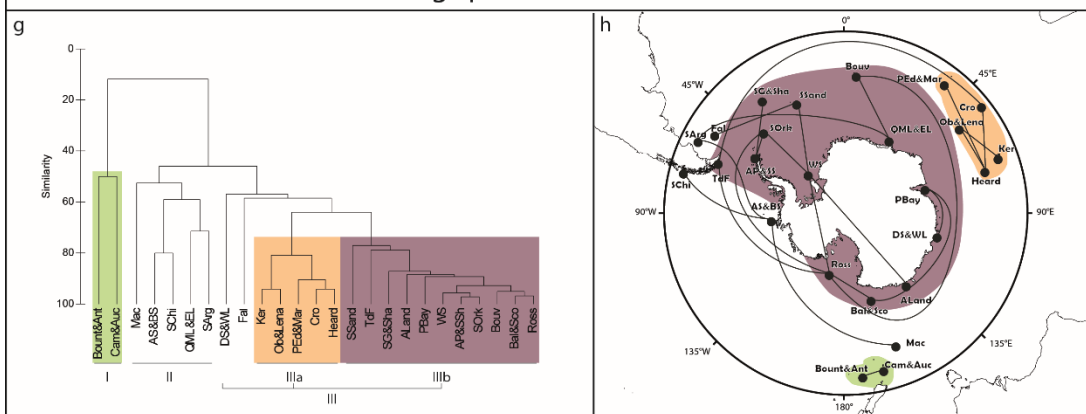

Table 2 Breakdown numbers of occurrences, stations and taxonomic entities of Asteroidea for each of the 25 investigated bioregions. NA refers to occurrences found outside of the bioregions of interest. Adélie Land (ALand); Antarctic Peninsula & the South Shetland Is. (AP&SSh); Amundsen & Bellingshausen Sea (AS&BS); Balleny & Scott Is. (Bal&Sco); Bounty & Antipodes Is. (Bount&Ant); Bouvet Is. (Bouv); Campbell & Auckland Is. (Cam&Auc); Crozet Is. (Cro); Davis Sea & Wilkes Land (DS&WL); Falkland Is. (Fal); Heard Is. (Heard); Kerguelen Is. (Ker); Macquarie Is. (Mac); Ob & Lena seamounts (Ob&Lena); Prydz Bay (PBay); Prince Edward & Marion Is. (PEd&Mar); Queen Maud Land & Enderby Land (QML&EL); Ross Sea (Ross); South Argentina (SArg); South Chile (SChi); South Georgia & Shag Rocks (SG&Sha); South Orkney Is. (SOrk); South Sandwich Is. (SSand); Tierra Del Fuego (TdF) and Weddell Sea (WS).

Bioregion	n of occurrences	n of species	n of known brooding species	n of known broadcasting species	n of genera	n of families	n of orders	n of stations
ALand	694	47	12	14	30	15	7	141
AP&SSh	2042	128	25	18	61	20	7	618
AS&BS	49	21	7	4	16	9	6	31
Bal&Sco	202	34	4	15	28	15	6	78
Bount&Ant	245	47	1	2	35	14	7	149
Bouv	128	36	6	15	24	10	5	35
Cam&Auc	1586	80	3	6	53	19	7	993
Cro	489	46	5	9	27	15	5	118
DS&WL	45	20	6	7	14	9	4	26
Fal	232	47	8	9	31	17	6	70
Heard	223	31	6	8	20	14	6	85
Ker	1477	52	12	9	31	16	6	422
Mac	141	25	5	2	16	13	5	56
NA	673	126	NA	NA	73	24	7	234
Ob&Lena	68	21	2	8	15	12	5	16
PBay	284	44	10	13	31	15	7	106
PEd&Mar	106	36	5	7	25	14	5	29
QML&EL	111	30	5	9	21	11	6	16
Ross	1257	70	12	16	42	18	6	398
SArg	154	42	9	5	27	15	7	63
SChi	131	38	3	6	30	18	6	55
SG&Sha	405	66	17	16	43	19	7	155
SOrk	421	68	14	17	45	19	7	124
SSand	174	48	5	11	34	17	6	68
TdF	409	73	13	12	49	19	7	178
WS	2259	101	13	16	51	18	7	248
Southern Ocean	14005	299	37	22	118	28	7	4512

Table 3 Results of the Mantel test between BSN structure matrices using the Spearman coefficient.  $r_s$  is the correlation value and  $p$  the associated probability. The symbol \* underlines significant values ( $P < 0.05$ ).

Situation	$r_s$	$P$
Brooders vs Broadcasters	0.296	0.067
Brooders vs Genus	0.641*	0.0002
Broadcasters vs Genus	0.444*	0.0142
Genus vs Species	0.728*	0.0001

### Biogeographic patterns of species

Bioregions are structured into three major groups (Figure 25a, b): (I) the New Zealand province, composed of Bount&Ant and Cam&Auc bioregions (SP = 6% only with the closest bioregions); (II) South America and the sub-Antarctic Islands (SChi, SArg, Fal, Heard, Ker, Ob&Lena, Cro, PEd&Mar), and is separated from the third group at SP = 36%; and (III) Antarctic bioregions (Bal&Sco, Bouv, PBay, Aland, Ross, AP&SSh, WS, SG&Sha, SOrk, SSand, QML&EL, DS&WL and TdF). Cluster analyses indicate that groups II and III can be subdivided into smaller geographic entities: South America (IIa) and the sub-Antarctic Islands (IIb) (SP = 38%), East Antarctica (bioregions east of the prime meridian, including Ross) (IIIa) and West Antarctica (bioregions west of the prime meridian) (IIIb) (SP = 52%) respectively. Potential faunal connections among these entities are highlighted by the BSN analysis (See Appendix 1 for BSV) (Figure 25b). East and West Antarctica are well connected to each other through a particularly strong link between the Weddell (WS) and Ross Seas (BSV = 100%), however no link between WS and the closest other bioregions of East Antarctica is observed. West Antarctica and South America are connected to each other through TdF (BSV = 99.9%). South America shows a strong link with the sub-Antarctic Islands (BSV = 99.8%). Within the sub-Antarctic group, the link is weak (BSV = 63%) between Macquarie and other sub-Antarctic Islands.

The nMDS analysis allows visualising similarities among bioregions with a low stress value (0.08). The minimum spanning tree (MST) plotted on the graph indicates the shortest path between bioregions (Figure 26a, b) and confirms that bioregions from New Zealand are well differentiated from others. Two other bioregions, AS&BS and Mac, are also well

discriminated. Other bioregions (Figure 26b) are plotted together following a north–south differentiation: sub-Antarctic and South American bioregions on one side, Antarctic bioregions and the Scotia Arc on the other, with the exception of Tierra del Fuego that shows affinities with Antarctic bioregions (note the shortest path between TdF and SOrk).

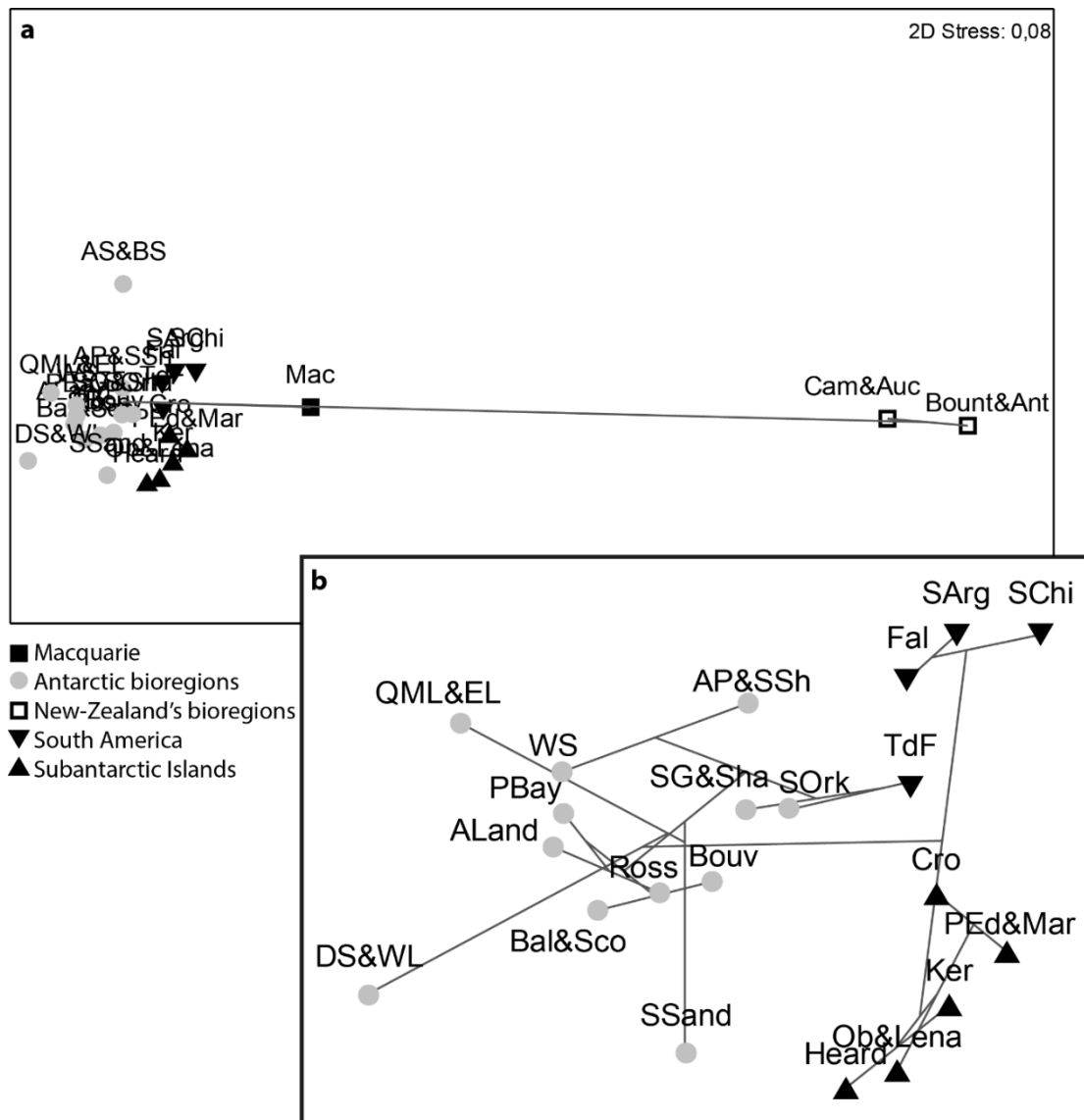

Figure 26 Non-metric multidimensional scaling map with superimposed minimum spanning tree (partial representation to ease the reading) for the class Asterozoidea among the 25 studied bioregions: Adélie Land (ALand); Antarctic Peninsula & the South Shetland Is. (AP&SSh); Amundsen & Bellingshausen Sea (AS&BS); Balleny & Scott Is. (Bal&Sco); Bounty & Antipodes Is. (Bount&Ant); Bouvet Is. (Bouv); Campbell & Auckland Is. (Cam&Auc); Crozet Is. (Cro); Davis Sea & Wilkes Land (DS&WL); Falkland Is. (Fal); Heard Is. (Heard); Kerguelen Is. (Ker); Macquarie Is. (Mac); Ob & Lena seamounts (Ob&Lena); Prydz Bay (PBay); Prince Edward & Marion Is. (PEd&Mar); Queen Maud Land & Enderby Land (QML&EL); Ross Sea (Ross); South Argentina (SArg); South Chile (SChi); South Georgia & Shag Rocks (SG&Sha); South Orkney Is. (SOrk); South Sandwich Is. (SSand); Tierra Del Fuego (TdF) and Weddell Sea (WS).

(a) All bioregions. (b) Close-up without AS&BS, Mac, Cam&Auc and Bount&Ant.

## Brooders *versus* broadcasters

Information about reproductive strategies was available for 59 species with occurrence data shallower than 1,500 m: 37 brooding species (accounting for 2,403 occurrences) and 22 broadcasting species (4,608 occurrences). Cluster analysis of brooding species (Figure 25e) indicates five groups: (I) Ob & Lena seamounts (Ob&Lena) and the South Sandwich Island (SSand) (SP = 22% with the remaining groups); (II) sub-Antarctic Islands (Ker, Heard, Cro and PEd&Mar) (SP = 24% with the remaining groups); (III), four New Zealand, sub-Antarctic and Antarctic bioregions (Cam&Auc, Bal&Sco, Bouv and DS&WL); (IV) eight Antarctic bioregions (SP = 40% between group III and IV) differ from the fifth group; and (V) South American bioregions (SChi, Fal, SArg and TdF) at SP = 30%. The Antarctic group is subdivided into two subgroups: high Antarctica (IVa) (WS, PBay, Aland and Ross) and West Antarctica (IVb) (SG&Sha, AP&SSh and SOrk) (SP = 59%). BSN connections (Figure 25f) indicate the occurrence of a link between New Zealand and Balleny & Scott Is. (Bal&Sco) (BSV = 86%) as well as strong affinities among all bioregions of the high Antarctica (continental Antarctica excluding the Antarctic peninsula). South America is strongly linked to the West Antarctica to the south and the sub-Antarctic Islands to the east through South Georgia & Shag Rocks (SG&Sha) (BSV = 98.5% and 85.7% respectively).

Faunal affinities for broadcasting species (Figure 25g) show higher similarity values than brooders, except for New Zealand (I) which is isolated at 12% of SP. A second group (II) formed by Antarctic (AS&BS, QML&EL) and South American bioregions (SChi and SArg) is distinguished from the remaining bioregions (III) (SP = 46%) structured into two subgroups (SP = 64%): the sub-Antarctic Islands (IIIa) and Antarctic bioregions with TdF (IIIb). The BSN network for broadcasting species (Figure 25h) highlights the isolation of New Zealand from Southern Ocean bioregions. Sub-Antarctic Islands are all strongly linked to each other and to South America through Tierra del Fuego (TdF) (BSV = 98.8%). Brooder and broadcaster networks (Table 3) were not correlated ( $r_s = 0.296$ ;  $P = 0.067$ ).

## Biogeographic patterns of genera

At genus level, bioregions are structured in three distinct geographic groups (Figure 25c, d): (I) New Zealand (SP = 32%), (II) South America (including TdF) and the sub-Antarctic



Islands together, separated from a last group composed of (III) Antarctic bioregions (SP = 55%). At regional scale, group II can be split into two smaller entities: South America (IIa) and the sub-Antarctic Islands (IIb) (SP = 59%). The structure of Antarctic bioregions follows a more complex pattern of three distinct subgroups (SP = 65 to 70%): Antarctic Islands (IIIa) (Bal&Sco and Bouv), West Antarctic bioregions (IIIb) (SG&Sha, AP&SSh and SOrk) and high Antarctica (IIIc) (Ross, WS, ALand and PBay). BSN connections among these subgroups (Figure 25d) highlight the isolation of New Zealand from other bioregions of the Southern Ocean and in contrast, strong links between Antarctic bioregions. Bioregions of South America are linked to West Antarctic through the South Orkney bioregion (BSV = 98.2%). Sub-Antarctic Islands are connected to West Antarctica through South Georgia & Shag Rocks (Sg&Sha; BSV = 86%) to the west and to Macquarie Island (BSV = 66%) to the east. A strong circumpolar connection is present without the gap observed at species level between the Weddell Sea (WS) and the closest other bioregions of East Antarctica (BSV = 99.4%) Figure 25d). There is a significant correlation (Table 3) between genus and species networks ( $r_s = 0.728$ ;  $P < 0.0005$ ), between genus and brooder networks ( $r_s = 0.641$ ;  $P = 0.0005$ ), and a moderate but significant correlation between the genus and broadcaster networks ( $r_s = 0.444$ ;  $P = 0.0142$ ).

## DISCUSSION

### Main patterns of Southern Ocean asteroid biogeography

At species level, high levels of endemism reflect the isolation of marine biogeographic units due to oceanographic barriers to dispersal or environmental filters. We found low values of endemism for each bioregion when considered in isolation in contrast to the high levels of endemism for the Southern Ocean (59%) and Antarctic region (29%). These levels are similar to those previously reported for the Southern Ocean (Moles et al., 2015) and high compared to other regions, possibly due to the ancient isolation of the Southern Ocean by the Antarctic Circumpolar Current front system associated to speciation and radiation events within Antarctic waters (Watling & Thurston, 1989; Lecointre et al., 2013; De Broyer & Jazdzewska, 2014).

Our quantitative analyses highlighted the relatively weak biogeographic connectivity of New Zealand to Southern Ocean bioregions at all taxonomic levels and reproductive

strategies. The influence of New Zealand cold temperate fauna on its southernmost areas is shown by the high level of endemism observed within and around New Zealand waters. The uniqueness of the New Zealand's benthic fauna compared to the rest of the Southern Ocean benthos has been demonstrated in many studies on diverse taxa (e.g. molluscs: Linse et al., 2006; bryozoans: Barnes & Griffiths, 2007; and echinoids: Pierrat et al., 2013).

The faunal affinities between East Antarctica and the Macquarie Island suggest that faunal connections may occur through the southern Macquarie ridge, as demonstrated for other echinoderms (asteroids and ophiuroids) (O'Hara, 1998; O'Hara et al., 2013). An additional link was observed between Macquarie and the sub-Antarctic islands, supporting a pattern already established for echinoderms (asteroids, ophiuroids and holothuroids: O'Hara, 1998). Passive transport of adults and juveniles by kelp rafting may explain this affinity (Edgar, 1987) as well as a long-distance transport of larvae.

Distribution patterns of asteroids are strongly structured within the Southern Ocean. Antarctic and sub-Antarctic provinces are well differentiated from each other with bioregions of East and West Antarctica grouped together to the south, bioregions of South America and the sub-Antarctic Islands to the north. Asteroid distribution is therefore strongly structured according to latitude. This may be a result of the Polar Front acting as a biogeographic barrier to the dispersal of asteroids leading to distinct species assemblages between the two provinces. Northern bioregions are clustered together following an additional, longitudinal segregation between South American bioregions to the west and sub-Antarctic islands to the east.

The role of the Polar Front as a barrier to gene flow between Antarctic and sub-Antarctic benthic fauna has been frequently discussed (Clarke et al., 2005; Fraser et al., 2012), although it can be relatively permeable to certain species (Convey et al., 2009; Sands et al., 2015; Fraser et al., 2016). This is supported by the BSN analyses where there is no obvious faunal connection between the sub-Antarctic and Antarctic bioregions, but through the Scotia Arc bioregions. This last area constitutes a potential gateway to Antarctica for northern fauna, as demonstrated in previous research (e.g. IBMANT: Arntz, 2005). Explanations for this include the role of mesoscale eddies (Glorioso et al., 2005; Chown et al., 2015) and stepping-stone dispersal through islands of the Scotia Arc (e.g. Tatiàn et al., 2005; Fortes & Absalão, 2011). Our results also show faunal affinities between Magellanic and sub-Antarctic assemblages,

supporting previous studies on sponges (Downey et al., 2012), molluscs (Griffiths et al., 2009) and echinoids (Pierrat et al., 2013). This pattern is probably driven by the westward flowing Antarctic Circumpolar Current allowing long-distance dispersal of propagules (see Waters, 2008 for discussion).

West and East Antarctica bioregions are well differentiated from each other, confirming previous studies (e.g. Griffiths et al., 2009; Pierrat et al., 2013; De Broyer & Jazdzewska, 2014). Here, the geological/glacial history of Antarctica can be invoked as a possible cause as the Weddell, Amundsen and Ross Seas may have been connected by a trans-Antarctic seaway (Lawver & Gahagan, 2003; Pollard & DeConto, 2009) that separated East Antarctica from continental fragments of West Antarctica (Linse et al., 2006; Pierrat et al., 2013). Molecular studies partially support this hypothesis (Strugnell et al., 2012), although data from East Antarctica are needed for confirmation. The east–west pattern may also have originated from the contrasting environmental conditions that prevail between East and West Antarctica (David & Saucède, 2015). The affinity of asteroid faunas between Tierra del Fuego and West Antarctic bioregions is a novel result, highlighting the importance of connections between South America and Antarctica.

West Antarctica is surprisingly rich in asteroid species, even when compared to other well-sampled areas (Table 2; Figure 24). As previously discussed (Barnes, 2005; Barnes et al., 2006; Linse et al., 2007b), this can be accounted for by the Antarctic Circumpolar Current hypothesis (see Pearse et al., 2009) that suggests that recurrent (but sporadic) transport of brooding species by the Antarctic Circumpolar Current caused their establishment in the Scotia Arc region. The hypothesis predicts the “existence of many species in clades of varied divergence times, at a wide range of depths, but with highest diversity downstream of the Drake Passage (passage between Cape Horn and the Antarctic peninsula), in the Scotia Arc and Weddell Sea” (Pearse et al., 2009). Here, the high number of brooding species and strong species:genus ratio in the Scotia Arc area supports this hypothesis.

### **The importance of reproductive strategies for asteroid biogeography**

Pappalardo & Fernández (2014) recently reported a poleward increasing number of direct developers in crustaceans and molluscs. They linked this to low temperatures and food

availability in the highest latitudes, emphasising the importance of life-history traits such as larval development in determining patterns of species richness in marine taxa. The high number of brooding asteroid species in the Southern Ocean can also be explained by vicariance and allopatry, and not solely as a consequence of adaptation (Poulin et al., 2002; Pearse et al., 2009).

The ecological uniqueness of the New Zealand asteroid fauna can be explained by the geographic position of New Zealand, which limits faunal exchange and larval dispersal to the south. Surprisingly, with only three brooding species reported in New Zealand waters (among which two are found in the Antarctic region), our results show a connection with East Antarctica (Figure 25f). This weak link might be an artefact due to the very small number of species, but could also reflect an existing relationship such as that proposed for cheilostomatid bryozoa (Griffiths et al., 2009).

The diversity of asteroids from the sub-Antarctic Islands region appears to have been shaped by a complex evolutionary history. Here, reproductive strategy significantly contributes to our understanding of large-scale distribution patterns. Asteroids of the sub-Antarctic Islands show fewer affinities with South American species than with those of both West and East Antarctic regions. The low capacity of brooders to disperse over large distances (around 7,000 km between South America and the sub-Antarctic Islands) partly explains this delineation, given the absence of stepping stones between the sub-Antarctic Islands. In contrast, the high dispersal capacity of broadcasters reduces the impact of geographic isolation on faunal exchange between provinces. In summary, an original fauna evolved in situ around the islands, with some species arriving from South America and others from the Antarctic region. This scenario explains the interrelationships of the fauna of Tierra del Fuego (Figure 25h), which is highly influenced by both South America and the West Antarctic region. Only brooding species show a clear structuring of Antarctic bioregions. In contrast, broadcasting species show weak spatial structure with a clear circumpolar continuity and no distinct biogeographic boundary.

More information is required to fully understand the role of reproductive strategy in asteroid biogeography. Larval ecology of sea stars in the Southern Ocean takes a variety of different forms (Bosch & Pearse, 1990), with planktonic (planktotrophic or lecithotrophic) larvae for broadcasters. The pelagic larval duration may also vary among species, up to 165

days for *Odontaster validus* (Bosch & Pearse, 1990) which allows a huge potential for long-distance dispersal. Brooding biology also varies with some broods developing within suboral maternal brood chambers and others beginning their development in the stomach pouch (McClintock et al., 2006). Broods can be carried for several months before releasing a fully developed juvenile. So far there has been little research on species in the Southern Ocean (Agüera et al., 2015), and most of these focus on near-shore shallow-water species. Overall, brooders account for low fecundity, high survival and a limited dispersal capacity. On the contrary, broadcasters have a high fecundity and a low survival rate of their larvae. Another potentially important (and understudied) factor is variation in habitat suitability for larvae along the dispersal routes. Such suitability depends on many factors including diet of larvae, the dynamics of planktonic life (Byrne et al., 2016), substrate availability and biotic interactions (i.e. competition). New modelling techniques based on experimental data (Dynamic Energy Budget – Functional Trait and Distribution Models) are starting to produce insights into these mechanisms, and can even generate predictive scenarios of migration or invasion (e.g. Byrne et al., 2016).

### **Across taxonomic levels and time-scales**

Analysing biogeographic patterns at high taxonomic levels can bring insights about upstream patterns of distribution and, in particular, the legacy of past processes for present-day biogeography (Pierrat et al., 2013). Our genus-level analysis revealed that some Southern Ocean distribution patterns are ancient and probably linked to major processes that occurred in the past. For instance, the Antarctic versus sub-Antarctic pattern is probably due to the long history of isolation of Antarctic waters. The setting up of the Polar Front and of the Antarctic Circumpolar Current in the early Oligocene (30 Ma BP) (Lawver & Gahagan, 2003; Lawver et al., 2014) and of other biogeographic barriers resulting from past geological activity were accompanied by vicariant processes. However, the use of molecular markers is needed to build robust phylogenies and increase the accuracy of divergence times between clades to infer the potential impact of past geological events on the evolution of the fauna. For example, González-Wevar et al. (2012) used the COI marker in various taxa (*Sterechinus*, *Nacella* and *Yoldia*) to demonstrate that the barrier between Antarctic and sub-Antarctic areas formed 3.7 to 5 Mya. This barrier reflects the recent impact of Plio-Pleistocene glaciations more than the

ancient oceanographic history of the Antarctic Circumpolar Current. Janosik et al. (2011) drew a similar conclusion using data on asteroids, and proposed that mixing was still possible during the Last Glacial Maximum (21,000 years ago) due to changing and moving boundaries of the Polar Front. In contrast, the molecular phylogeny of the sea star superorder Valvatacea (Mah & Foltz, 2011a) suggests a possible ancestry of the Antarctic fauna from the adjacent sub-Antarctic regions and a diversification of the

Antarctic Asteroidea associated with the isolation of the Southern Ocean fauna and the formation of the Antarctic Circumpolar Current. Another molecular study on the asteroid superorder Forcipulatacea (Mah & Foltz, 2011b) also supports the hypothesis of diversification of Antarctic clades when the Antarctic Circumpolar Current first started to flow.

At the generic level, the circum East Antarctic versus West Antarctic pattern can be accounted for by the existence of a past trans-Antarctic pathway linking the Weddell and Ross seas (Linse et al., 2006; Pierrat et al., 2013). The closure of this pathway and the existence of the Weddell Sea Gyre might explain the absence of strong faunal similarities between the Weddell Sea and the close bioregions of East Antarctic at the species level (Linse et al., 2006; Pierrat et al., 2013). Finally, in contrast to the species-level analysis, dissimilarities between the asteroid genera of Tierra del Fuego and the West Antarctic region might reflect the recent mixing of species between South America and West Antarctica.

Surprisingly, the biogeographic patterns shown for brooding species are very similar to those of all asteroid genera. New Zealand apart, the two patterns fit almost perfectly and are statistically the most similar to each other (Table 3). This may simply illustrate the conservative biogeographic patterns of brooders compared to broadcasters that are able to disperse over long distances, which is supported by the circumpolar patterns shown in many species (35% of the species found south of the Polar Front in this study) from many taxonomic groups. Such an ability to disperse may also explain the counter-intuitive presence of multiple lineages of certain circumpolar broadcasting species at the same locations (see Hemery et al., 2012). If broadcasting species were isolated into refugia during glacial maxima, their populations may have evolved independently and merged again after conditions warmed to form the current biogeographic patterns.

## CONCLUSIONS

The biogeographic patterns observed for sea stars in the Southern Ocean are consistent with those of other taxonomic groups. Our result highlights the important role of reproductive strategy to understand large-scale spatial patterns of faunal distribution of asteroids. We therefore recommend that, whenever possible, reproductive strategy should be taken into account in large-scale biogeographic studies. Finally, more effort is needed to fill data shortfalls and to date the diverse origins of biogeographic patterns in the Southern Ocean. Using molecular tools in studies of asteroid species with contrasted reproductive strategies should bring new insights and help to gain a comprehensive understanding of historical legacy on present-day biogeography of the Southern Ocean.

## ACKNOWLEDGEMENTS

The authors thank Dr. Gilles Escarguel (Lyon) for his help with the BSN procedure as well as Rachel Downey and Dr. David Barnes for helpful comments on an early manuscript. Marc Eléaume, Christopher Mah, Vladimir Laptikhovsky and Anna Jażdżewska for their data and identification contributions. Prof. Richard Ladle for the help he offered in the last steps of the submission process. The work was supported by a “Fonds pour la formation à la Recherche dans l’Industrie et l’Agriculture” (FRIA) grants to C. Moreau. This is contribution no. 13 to the vERSO project ([www.versoproject.be](http://www.versoproject.be)), funded by the Belgian Science Police Office (BELSPO, contract n°BR/132/A1/vERSO) and a contribution to team BioME of the Biogéosciences laboratory.

## SUPPORTING INFORMATION

### Appendix 1

- Data source and quality control for Southern Ocean Asteroidea
- Bootstrap Spanning Values for each Bootstrap Spanning Network

# Chapter 2

Is reproductive strategy a key factor in understanding the evolutionary history of Southern Ocean Asterozoa (Echinodermata)?





## Chapter 2

Is reproductive strategy a key factor in understanding the evolutionary history of Southern Ocean Asteroidea (Echinodermata)?

Camille Moreau<sup>1,2\*</sup>, Bruno Danis<sup>1</sup>, Quentin Jossart<sup>1,3</sup>, Marc Eléaume<sup>4</sup>, Chester Sands<sup>5</sup>,  
Guillaume Achaz<sup>4,6</sup>, Antonio Agüera<sup>1</sup>, and Thomas Saucède<sup>2</sup>

<sup>1</sup>Marine Biology Lab, CP160/15 Université Libre de Bruxelles (ULB) 50, B-1050 Brussels, Belgium

<sup>2</sup>UMR CNRS 6282 Biogéosciences, Université de Bourgogne Franche-Comté (UBFC) 6, F-21000 Dijon, France

<sup>3</sup>Marine Biology, Vrije Universiteit Brussel (VUB), Pleinlaan 2, 1050 Brussels, Belgium

<sup>4</sup>Institut de Systématique, Evolution, Biodiversité (ISYEB), Muséum national d'Histoire naturelle, CNRS, Sorbonne Université, EPHE, 57 rue Cuvier, 75005 Paris, France

<sup>5</sup>Natural Environment Research Council, British Antarctic Survey, Cambridge, UK

<sup>6</sup>Centre Interdisciplinaire de Recherche en Biologie (CIRB), CNRS, INSERM, Collège de France, Paris, France

\*Correspondence: Camille Moreau, Université Libre de Bruxelles (ULB) Laboratoire de Biologie Marine, CP160/15 50 Av. F.D. Roosevelt, B-1050 Bruxelles, Belgium.

E-mail: mr.moreau.camille@gmail.com

Short running head: Phylogeography of Southern Ocean sea stars

Citation: Moreau, C., Danis, B., Jossart, Q., Eléaume, M., Sands, C., Achaz, G., Agüera, A., & Saucède, T. (2019) Is reproductive strategy a key factor in understanding the evolutionary history of Southern Ocean Asteroidea (Echinodermata)? *Ecology and Evolution*, 9(15), 8465-8478, doi/10.1002/ece3.5280.

## ABSTRACT

Life traits such as reproductive strategy can be determining factors of species evolutionary history and explain the resulting diversity patterns. This can be investigated using phylogeographic analyses of genetic units. In this work, the genetic structure of five asteroid genera with contrasting reproductive strategies (brooding: *Diplasterias*, *Notasterias* and *Lysasterias* versus broadcasting: *Psilaster* and *Bathybiaster*) was investigated in the Southern Ocean. Over 1,400 mtDNA cytochrome C oxidase subunit I (COI) sequences were analysed using five species delineation methods (ABGD, ASAP, mPTP, sGMYC and mGMYC), two phylogenetic reconstructions (ML and BA), and molecular clock calibrations, in order to examine the weight of reproductive strategy in the observed differences among phylogeographic patterns. We hypothesised that brooding species would show higher levels of genetic diversity and species richness along with a clearer geographic structuring than broadcasting species. In contrast, genetic diversity and species richness were not found to be significantly different between brooders and broadcasters, but broadcasters are less spatially structured than brooders supporting our initial hypothesis and suggesting more complex evolutionary histories associated to this reproductive strategy. Broadcasters' phylogeography can be explained by different scenarios including deep-sea colonisation routes, bipolarity or cosmopolitanism, and sub-Antarctic emergence for the genus *Bathybiaster*; Antarctic- New Zealand faunal exchanges across the Polar Front for the genus *Psilaster*. Brooders' phylogeography could support the previously formulated hypothesis of a past trans-Antarctic seaway established between the Ross and the Weddell seas during the Plio-Pleistocene. Our results also show, for the first time, that the Weddell Sea is populated by a mixed asteroid fauna originating from both the East and West Antarctic.

## Keywords

Antarctica, Asteroidea, bipolarity, brooding, Echinodermata, invertebrate, thermohaline expressway, trans-Antarctic seaway, emergence

## INTRODUCTION

The diversity of marine life in the Southern Ocean has long been underestimated and many taxa could be overlooked or misidentified due to the reliance on systematics based solely on morphological characters (Gutt et al., 2004; Clarke, 2008). The growing awareness of these issues and the lack of representative sampling (Griffiths et al., 2014), have prompted Antarctic marine biologists to undertake a series of comprehensive census surveys covering a wide range of taxa in the last two decades. International efforts such as the International Polar Year (IPY 2007-2008) and the Census of Antarctic Marine Life (CAML 2005-2010) have been the launching pads for a better assessment of Southern Ocean biodiversity and its underlying ecological processes. Recent studies that have applied molecular techniques to these Southern Ocean specimens, exploring diversity, systematics, and phylogeography, have significantly increased our understanding of Antarctic benthic ecosystems (e.g. Sands et al., 2015). These international Southern Ocean sampling expeditions have achieved several major objectives, such as the creation of a baseline census of biodiversity (De Broyer & Danis, 2011; Griffiths et al., 2011), proposing how evolution has been influenced by the regional geological, climatic, and oceanographic histories (e.g. Fraser et al., 2009, González-Wevar et al., 2018), and disentangling phylogeographic patterns at lower taxonomic levels to better understand relationships among populations and species on a case by case strategy (e.g. Brasier et al., 2017; Dömel et al., 2017). This extensive work led to the discovery and the description of many new species (e.g. Janosik & Halanych, 2010; d'Udekem d'Acoz & Verheye, 2017). More importantly, these studies show the frequent discordance existing between traditional (morphology based) and molecular (DNA based) methods for assessing species diversity (e.g. Dömel et al., 2017; Janosik et al., 2011). Cryptic speciation is a documented source of species diversity underestimation, but it is not the only one. A recent study on the most studied sea star species in the Southern Ocean, *Odontaster validus*, Peck et al. (2018) showed that polymorphism in some morphological characters could lead to misidentification of this frequently encountered species. Incorrect taxonomic assignments due to the lack of clear identification keys (Allcock & Griffiths 2014), descriptions of nominal species based on distribution only (Diaz et al. 2011, Saucède et al., 2015), descriptions based on juvenile specimens (Roberts et al. 2014) or on deteriorated specimens due to inappropriate

conservation practices, are all common limitations in meaningful biodiversity assessments (Meyer, 2016).

Processes that have and continue to drive complex diversity patterns in the Southern Ocean are far from being fully understood, but the role of certain drivers has been demonstrated in a number of molecular studies. Processes can be extrinsic (e.g. paleogeographic, climatic, oceanographic) or intrinsic (life history traits) (Allcock & Strugnell, 2012; Thatje, 2012), and their combined effects cumulative, making identification of explanatory processes a difficult endeavour. Life history traits such as reproductive strategies have been proven to shape the genetic structure of species in contrasting ways (Modica et al., 2017). Most marine benthic organisms show low to zero mobility during the adult stage. The dispersal capacity of larvae is thus expected to condition population genetic structure (Bowen et al., 2006; Purcell et al., 2006). Larval development (e.g. planktotrophic, lecithotrophic), parental care (brooders versus broadcasters) and pelagic larval duration (from days to several months; Selkoe & Toonen, 2011), are intrinsic factors that can combine with extrinsic factors, such as oceanographic currents or geological history, to determine the population genetic structure (e.g. Hoffman et al., 2011, Jossart et al., 2017).

As a consequence of their high diversity and differentiated functional roles, benthic invertebrates have been the subject of many studies on genetic diversity and connectivity (see Riesgo et al., 2015 for a review). Sea stars (Asteroidea, Echinodermata) represent a diversified, abundant and common ecological group in Southern Ocean benthic habitats (Jossart et al., 2015). To date, around 300 species have been recorded from the Southern Ocean (Moreau et al., 2015; Moreau et al., 2018) but it is likely that many more remain to be described. Recent studies based on species morphological identification tried to disentangle distribution patterns and biogeographic relationships in sea stars at the scale of the entire Southern Ocean (Moles et al., 2015; Moreau et al., 2017). These studies described the spatial structure of asteroid assemblages and stressed the major influence of life history traits, among which reproductive strategy appeared to have the most notable effect (Moreau et al., 2017).

Few molecular studies have been performed on Southern Ocean asteroids and they are nearly exclusively focused on the common *Odontaster* genus (Janosik & Hallanych, 2010; Janosik et al., 2011). The phylogeny and evolutionary history of the Asteroidea in the Southern Ocean has, however, been discussed in several studies (Mah & Foltz, 2011a, 2011b, 2014; Mah

et al., 2015). In their comprehensive studies on the molecular phylogeny of the superorders Valvatacea and Forcipulatacea, Mah & Foltz (2011a, b) describe some diversification processes in several Antarctic and sub-Antarctic families (e.g. Odontasteridae, Antarctic Asteroiidae) but they did not analyse the lower taxonomic levels (i.e., genera and species).

Brooders and broadcasters have contrasting dispersal capabilities (low range dispersal in brooders vs high range in broadcasters) and brooding taxa are usually hypothesised to display 1) higher genetic diversity, 2) greater species richness and 3) more genetic differentiation through space than broadcasters (e.g. Modica et al., 2017; Purcell et al., 2006). In the present study, we tested these assumptions by investigating the genetic diversity and the phylogeography of five widely distributed asteroid genera across the Southern Ocean. We selected genera with contrasting reproductive strategies in two distinct clades: the three brooding genera *Diplasterias*, *Lysasterias*, and *Notasterias* in the monophyletic family Asteroiidae (Foltz et al., 2007; Mah & Foltz, 2011b), and the two broadcasting genera *Psilaster* and *Bathybiaster* in a monophyletic group of the family Astropectinidae (Mah & Foltz 2011a, Bosch & Pearse, 1990).

## **MATERIALS AND METHODS**

### **Comprehensive sampling & DNA sequence compilation**

Studied specimens were sampled during several expeditions in the Southern Ocean (Figure 27; Appendix 2), all were preserved in 96% ethanol or frozen, and identified at species or genus level (either by Christopher Mah or Camille Moreau). Genomic DNA was extracted using either a salting-out protocol (modified from Sunnucks & Hales, 1996, with larger volumes and incubation at 70°C for 10 minutes to inhibit protein activity after digestion) or QIAGEN DNeasy extraction kits. A fragment (612 nucleotides) of the mitochondrial gene cytochrome c oxidase subunit I (COI) was then amplified using the specific forward primer LCOech1aF1 for the class Asterozoa and the universal HCO2198 Reverse primer (Folmer et al., 1994). COI sequences amplified using the same primers were also obtained through The Barcode of Life Data System (BOLD, Ratnasingham & Hebert, 2007) in both public and private datasets, accounting for 460 of the 1,416 sequences analysed in this study (Appendix 2). As

the Astropectinidae genera are also recorded outside the Southern Ocean (under different nominal species), all available sequences for these from outside the Southern Ocean were included within this study (Appendix 2). Reverse and forward sequences were edited and assembled using CodonCode Aligner v6.0.2 and translated using the echinoderm mitochondrial genetic code to ensure the absence of a stop codon. Sequences were aligned using the MUSCLE alignment process (Edgar, 2004). Base compositional heterogeneity was examined using match-paired tests for symmetry (Ababneh et al., 2006) in SeqVis v1.5 (Ho et al., 2006).

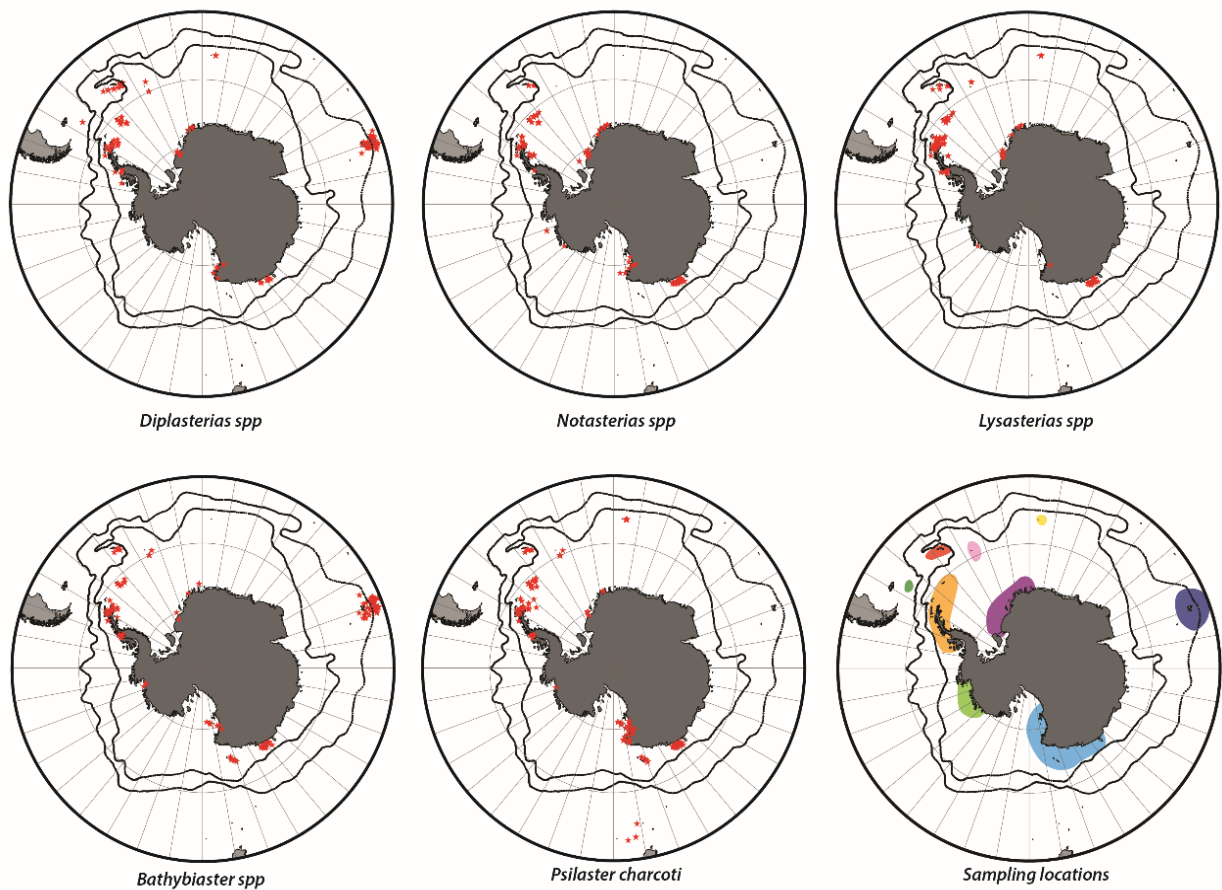

Figure 27 Maps of the Southern Ocean indicating sample location for each target group (red stars). Sampling locations are labelled: red - South Georgia; pink – South Sandwich Islands; yellow – Bouvet Island; dark blue – Kerguelen Islands; light blue – East Antarctica; light green – Amundsen Sea; orange – Antarctic Peninsula; dark green – Burdwood Bank and purple – Weddell Sea. Projection: South Pole Stereographic.

## Phylogenetic reconstruction

Due to relatively high genetic distances, phylogenetic relationships were reconstructed independently within the Asteroiidae and the Astropectinidae. *Coscinasterias muricata* and *Thrissacanthias penicillatus* were used as outgroups respectively, following previous phylogenetic studies (Mah & Foltz, 2011a, 2011b). Maximum Likelihood (ML) and Bayesian Analyses (BA) were used to construct the trees using only unique haplotypes. ML reconstructions were generated using a codon partitioned model and the GTR+G substitution model in RAxML v 8.1.2 (Stamatakis, 2014) through the RAxMLGUI interface (Silvestro & Michalak, 2012). To assess branch support, 10 runs were realised with 1,000 thorough bootstraps each. The PartitionFinder v2 software (Lanfear et al., 2016) was used for the BA reconstructions on the CIPRES Science Gateway (Miller et al., 2010) to select for best-fit partitioning schemes and models of evolution. An XML file was created with BEAUti v1.8.4 (Drummond et al., 2012) using a partition for each codon position as specified by PartitionFinder v2, a strict clock model with a lognormal prior for “clock.rate” such that the median reflected a universal divergence time of echinoderm COI of 3.1 to 3.5% per Myr (McCartney et al., 2000), a Markov chain Monte Carlo run of 20 x 10<sup>6</sup> generations sampling every 1000 trees and a Yule process speciation prior. The XML file was used through the software BEAST v1.8.4 on the CIPRES Science Gateway (Miller et al., 2010) to reconstruct time-calibrated trees. Tracer v1.6 allowed us to ensure an appropriate effective sampling size (ESS > 200) as recommended by the software documentation. TreeAnnotator v1.8.4 calculated a consensus tree which was visualised using FigTree v1.4.3 (<http://tree.bio.ed.ac.uk/software/figtree/>).



## Species delineation

Several single-locus methods of species delineation were used to delineate and explore diversity among the studied genera. Two of these methods, the Generalized Mixed Yule Coalescent (GMYC – Pons et al., 2006; Fujisawa & Barraclough, 2013) and the multi-rate Poisson Tree Processes (mPTP - Kapli et al., 2017) are tree-based methods requiring an ultrametric tree for the former and a maximum likelihood tree for the latter. Both single (sGMYC) and multiple-threshold (mGMYC) models were investigated using the R package SPLITS (Ezard et al. 2009) and the ultrametric tree was obtained using BEAST during the phylogenetic reconstruction. The online webservice (available at <http://mptp.h-its.org>) was used for mPTP with the ML tree constructed using RAxML. We also performed a distance-based analysis using the Automatic Barcode Gap Discovery (ABGD – Puillandre et al., 2012) on the online server (<http://wwwabi.snv.jussieu.fr/public/abgd/abgdweb.html>) with default settings for the prior range (0.001, 0.1), K80 corrected distances and a value of 1.5 for the relative gap width (X). We also used the newly developed ASAP method (<http://wwwabi.snv.jussieu.fr/public/asap/>; Puillandre et al., in prep.) with default settings and K80 corrected distances. For subsequent analyses we have selected the method giving the smallest number of delineated entities as recommended to avoid false interpretation (Carstens et al., 2013). All molecular diversity indexes were calculated using the DNAsp v6 software (Rozas et al., 2017) for each previously delineated species. Differences in haplotype and nucleotide diversity between brooders and broadcasters were tested using a Wilcoxon-Mann-Whitney test (R Core Team, 2018). Only calculations for sample sizes  $\geq 25$  individuals, were discussed as suggested by Goodall-Copestake et al. (2012). Intra and inter-specific genetic distances within each genus were calculated using MEGA v7.0.18 (Kumar et al., 2016) and the Kimura 2-parameter model. Haplotype networks were generated using a TCS network method (Clement et al., 2002) inferred in the software PopART (<http://popart.otago.ac.nz>). The genus *Psilaster* being recovered as polyphyletic, we focus on the Southern Ocean nominal species *Psilaster charcoti*.

## RESULTS

In total, 1,416 sequences of 612bp were included in the analyses (Appendix 2; Table 4; Figure 27), varying from 224 for *Lysasterias* to 318 for *Notasterias*. No stop codons nor significant evidence for base heterogeneity were observed.

### Species delineation

Species delineation applied to all genera show contrasting results dependent upon the method applied (Figure 28; Figure 29; Figure 30; Table 5). Overall, the mGMYP method delineated the highest number of entities (79), while mPTP was the most conservative (19). Following a conservative approach, we based our work on the following delineated entities: two for *Bathybiaster*, three for *Diplasterias* and *Notasterias* and four for *P. charcoti* and *Lysasterias*. These results are in line with haplotype networks and phylogenetic groupings (Figure 28; Figure 29; Figure 30; Appendix 2). Among the brooding entities, only one matches with an identified morphological species: *Diplasterias meridionalis*. In broadcasters, one delineated entity of the genus *Bathybiaster* comprises specimens from the Arctic identified as *Bathybiaster vexillifer* and *Psilaster andromeda*.

Genetic diversity of the delineated entities ranged from 0.00160 (*P. charcoti* - clade 3) to 0.01547 (*Diplasterias* sp2) for nucleotide diversity and from 0.394 (*P. charcoti* - clade 3) to 0.924 (*P. charcoti* - clade 1) for haplotype diversity (Table 4). The number of segregating sites varied from 11 (*D. meridionalis*) to 50 (*P. charcoti* - clade 1). Mean intraspecific distances varied from 0.16% (*P. charcoti* - clade 3) to 1.6% for *Diplasterias* sp2 (Table 4) while inter-specific distances ranged from 2% between clades 2 and 3 (*P. charcoti*) to 6.8% between *Lysasterias* sp1 and *Lysasterias* sp4 (Appendix 2).

Haplotype and nucleotide diversity are not significantly different between brooders and broadcasters (Wilcoxon-Mann-Whitney tests; p-values: 0.1709 and 0.9433, respectively).

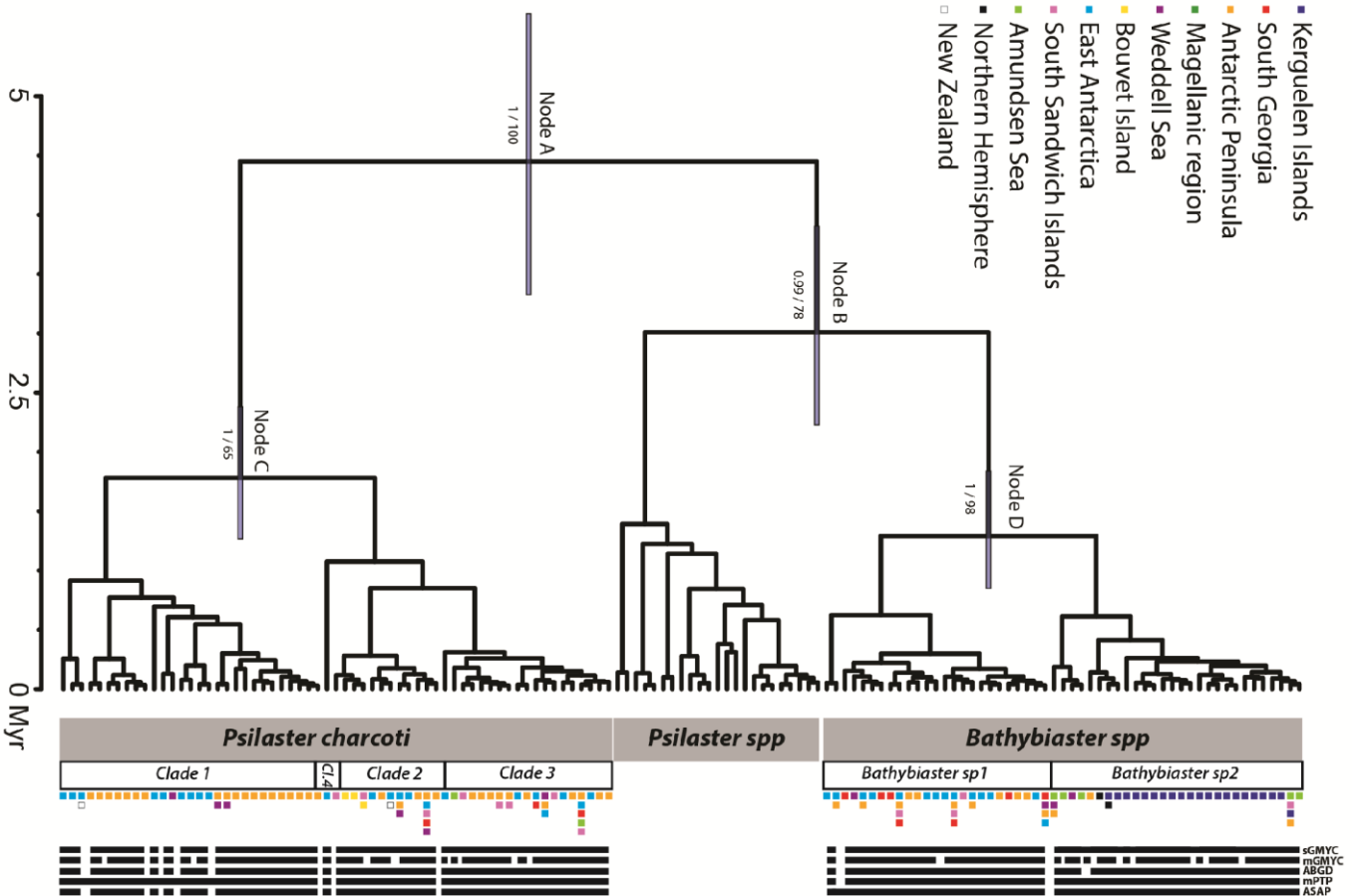
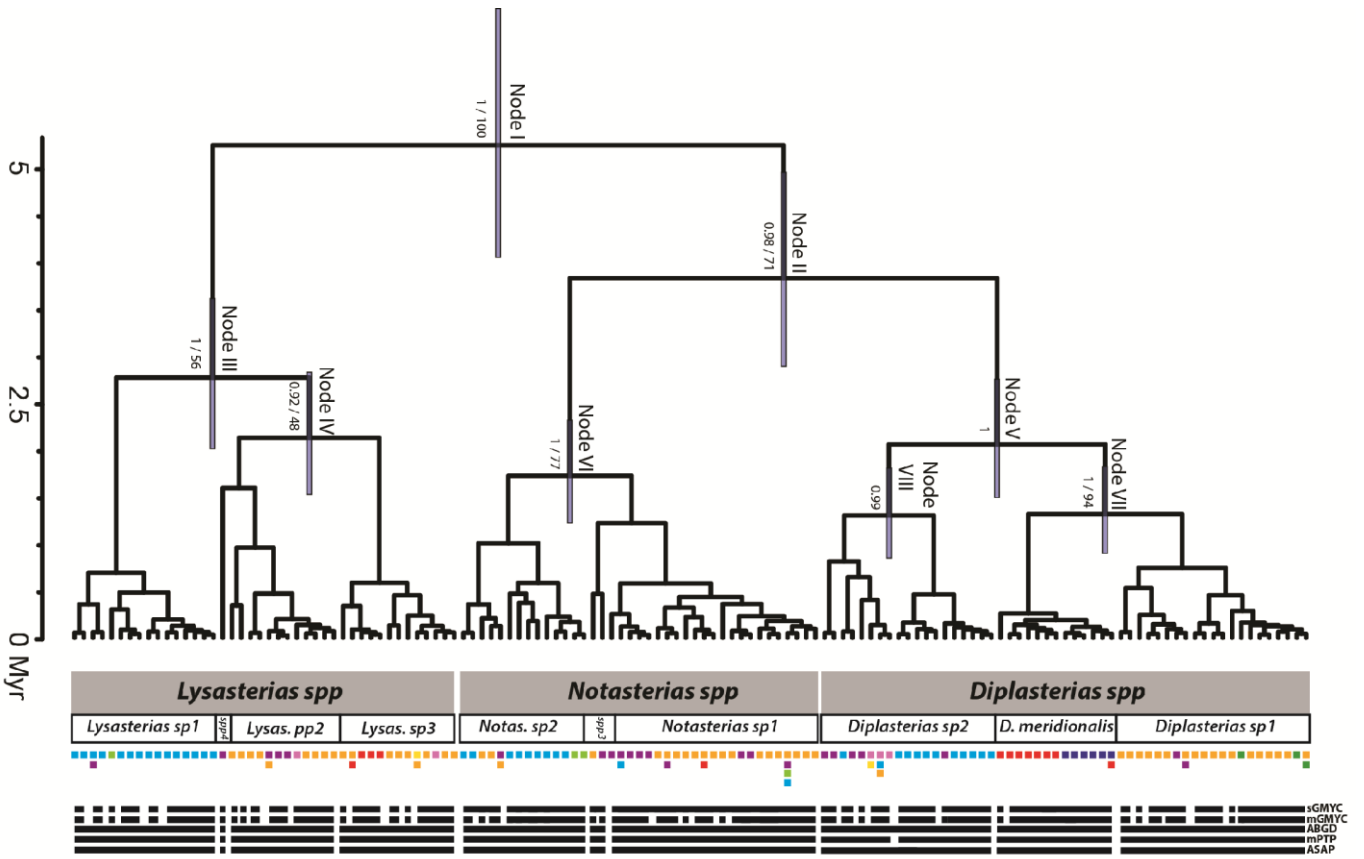

## Phylogenies and divergence time estimates

In total, 578 sequences in broadcasters and 838 in brooders were used for ML and BA reconstructions. Both methods give congruent results for broadcasters with similar taxonomic groupings and high node supports (Figure 28). Node support was higher using the BA method for brooders. Branching patterns were however identical in all reconstructions.

The monophyly of the genus *Psilaster* is not supported by our analysis but Southern Ocean *Psilaster* representatives are monophyletic (i.e. the nominal species *P. charcoti*). The genus *Bathybiaster* is monophyletic and includes specimens from the Southern Ocean and from the Northern Hemisphere (Figure 28). *Psilaster* specimens collected outside the Southern Ocean (*Psilaster acuminatus* from New Zealand and Australia, *Psilaster andromeda* from Sweden and *Psilaster pectinatus* from the Arctic Ocean) are retrieved as monophyletic in a sister clade to *Bathybiaster*. The monophyly of each brooding genus is supported but one sub-clade only matches with the morphological taxonomy: the species *D. meridionalis*. All other sub-clades are composed of

specimens belonging to distinct morphospecies questioning current taxonomy at the species level.

Divergence time estimates suggest numerous divergence events both in brooders and broadcasters over the last 5 Myr and particularly, over the last 2.5 Myr (Figure 28). Results also indicate that members of the Asteroiidae under study diverged from its Pan-tropical outgroup around 21 Myr ago (Appendix 2). Main divergence events (Figure 28; Appendix 2) in *P. charcoti* and *Bathybiaster* occurred around  $1.6 \pm 0.8$  Myr ago (Node C and D in Figure 28). In brooders, divergence time estimates (Figure 28; Appendix 2) between East Antarctic sub-clades and those of the Antarctic Peninsula all fall within the same time range of  $2.1 \pm 1.2$  Ma (Nodes III, V and VI in Figure 28). This is also in line with the time range computed for broadcasters.

Figure 28 Bayesian chronograms of partitioned COI sequences derived from the brooding (left) and broadcasting (right) groups of interest. The distribution of uncertainty of node placement is indicated around each of the main nodes. Time scale is expressed in millions of years. Posterior probabilities and bootstrap values are provided under main nodes. No value was indicated if bootstrap was less than 45%. Coloured patches indicate sampling locations. Results for each species delineation method are reported as black bars representing the delineated units.

Table 4 Molecular diversity statistics for each delineated species. Statistics for taxonomic groups with n<25 are not represented. n: number of sequences.  $\pi$ : nucleotide diversity. H: haplotype diversity.

Taxonomic group		n	$\pi$	n of haplotype	H	Segregating sites	Mean intraspecific distance
Brooders	<i>Lysasterias</i> sp1	81	0.01000 $\pm$ 0.00062	16	0.831 $\pm$ 0.027	25	0.0103 $\pm$ 0.0069
	<i>Lysasterias</i> sp2	78	0.01146 $\pm$ 0.00093	12	0.840 $\pm$ 0.019	26	0.0118 $\pm$ 0.0092
	<i>Lysasterias</i> sp3	56	0.00825 $\pm$ 0.00095	13	0.765 $\pm$ 0.055	21	0.0085 $\pm$ 0.0073
	<i>Notasterias</i> sp1	236	0.00561 $\pm$ 0.00032	23	0.733 $\pm$ 0.027	31	0.0057 $\pm$ 0.0044
	<i>Notasterias</i> sp2	80	0.01108 $\pm$ 0.00109	14	0.718 $\pm$ 0.037	31	0.0114 $\pm$ 0.0096
	<i>Diplasterias</i> sp1	105	0.01262 $\pm$ 0.00030	21	0.909 $\pm$ 0.013	32	0.0130 $\pm$ 0.0069
	<i>Diplasterias</i> sp2	116	0.01547 $\pm$ 0.00097	19	0.849 $\pm$ 0.021	36	0.0161 $\pm$ 0.0123
	<i>Diplasterias meridionalis</i>	75	0.00239 $\pm$ 0.00023	13	0.777 $\pm$ 0.031	11	0.0024 $\pm$ 0.0019
Broadcasters	<i>Bathybiaster</i> sp1	133	0.00347 $\pm$ 0.00042	25	0.790 $\pm$ 0.023	29	0.0035 $\pm$ 0.0039
	<i>Bathybiaster</i> sp2	110	0.00557 $\pm$ 0.00054	28	0.835 $\pm$ 0.026	34	0.0057 $\pm$ 0.0051
	<i>Psilaster charcoti</i> clade1	92	0.01457 $\pm$ 0.00069	29	0.924 $\pm$ 0.015	50	0.0151 $\pm$ 0.0085
	<i>Psilaster charcoti</i> clade2	55	0.00272 $\pm$ 0.00028	12	0.734 $\pm$ 0.052	12	0.0027 $\pm$ 0.0020
	<i>Psilaster charcoti</i> clade3	148	0.00160 $\pm$ 0.00026	19	0.394 $\pm$ 0.052	17	0.0016 $\pm$ 0.0025

Table 5 Number of species delineated by the different species delineation methods

Taxonomic group		ABGD	sGMYC	mGMYC	mPTP	ASAP
Brooders	<i>Lysasterias</i>	4	17	17	4	4
	<i>Diplasterias</i>	3	14	15	4	3
	<i>Notasterias</i>	3	4	18	3	3
Broadcasters	<i>Psilaster charcoti</i>	9	9	17	4	9
	<i>Bathyiaster</i>	4	3	12	3	2
Total		27	47	79	19	30

### Phylogeographic patterns

All brooders display clear geographical patterns, with a distinction between the East Antarctic and the Antarctic Peninsula (Figure 28; Figure 29; Appendix 2). In *Diplasterias*, *D. meridionalis* displays a specific distribution as it is shared between South Georgia and the Kerguelen Plateau. *Diplasterias* sp1, includes specimens from the Antarctic Peninsula along with five specimens from the Magellanic region and five from the Weddell Sea. The last sub-clade (*Diplasterias* sp2) is mainly composed of specimens from the East Antarctic among which seven specimens from the Weddell Sea, 14 from the South Sandwich Islands, four from Bouvet Island and one from the South Orkney Islands. For *Notasterias*, (Table 5; Figure 28; Figure 29; Appendix 2) one sub-clade (*Notasterias* sp1) mainly contains specimens from the Antarctic Peninsula and the Weddell Sea in addition with one sample from the Amundsen Sea, seven from South Georgia and five from East Antarctica. Specimens belonging to the second sub-clade (*Notasterias* sp2) are mainly from East Antarctica (66 specimens) along with two from the Amundsen Sea, four from the Antarctic Peninsula and five from the Weddell Sea. The remaining sub-clade (*Notasterias* sp3) only contains two deep-sea specimens from the Scotia Arc (3,800m) and the Weddell Sea (2,100m). Within the genus *Lysasterias*, (Table 5; Figure 28; Figure 29; Appendix 2) the first entity (*Lysasterias* sp1) nearly exclusively contains specimens from East Antarctica with one from the Weddell Sea. The second entity (*Lysasterias* sp2) mainly contains specimens from the Antarctic Peninsula together with one specimen from the South Sandwich Islands and nine from the Weddell Sea. The third entity is mainly composed

of specimens from the Antarctic Peninsula together with nine specimens from South Georgia, three from Bouvet Island and two from the South Sandwich Islands. Finally, the last entity (*Lysasterias* sp4) is composed of nine specimens and is endemic to the Weddell Sea.

Broadcasters show contrasting biogeographic patterns. *P. charcoti* displays a complex haplotype network with sub-clade 4 endemic to Adélie Land and the three others circumpolar in distribution with two of them containing specimens collected off New Zealand (Appendix 2). Sub-clades of the genus *Bathybiaster* are mainly differentiated according to depth: *Bathybiaster* sp1 gathers specimens from the Antarctic shelf and the shallows of the Scotia Arc, along with a deep specimen from the South Sandwich Islands (Figure 30; Appendix 2). *Bathybiaster* sp2 is composed of representatives from the Antarctic slope, deep troughs, and canyons along with all specimens from the Kerguelen plateau and slope (Figure 30; Appendix 2).

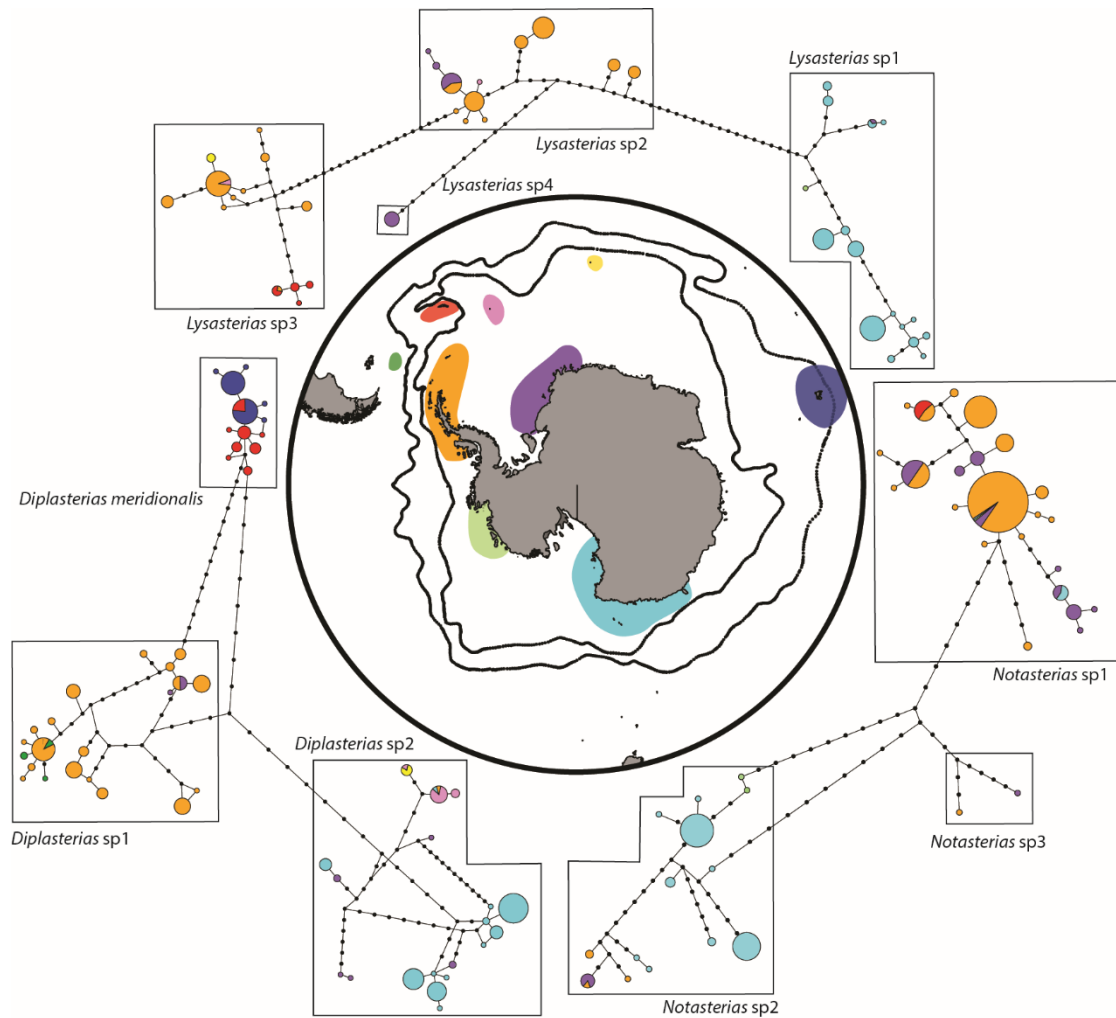

Figure 29 Brooders statistical parsimony network indicating genetic relationships with regards to sampling locations. Delineated clades are represented and colour code follows the central map: red - South Georgia; pink – South Sandwich Islands; yellow – Bouvet Island; dark blue – Kerguelen Islands; light blue – East Antarctica; light green – Amundsen Sea; orange – Antarctic Peninsula; dark green – Burdwood Bank and purple – Weddell Sea. Projection: South Pole Stereographic.



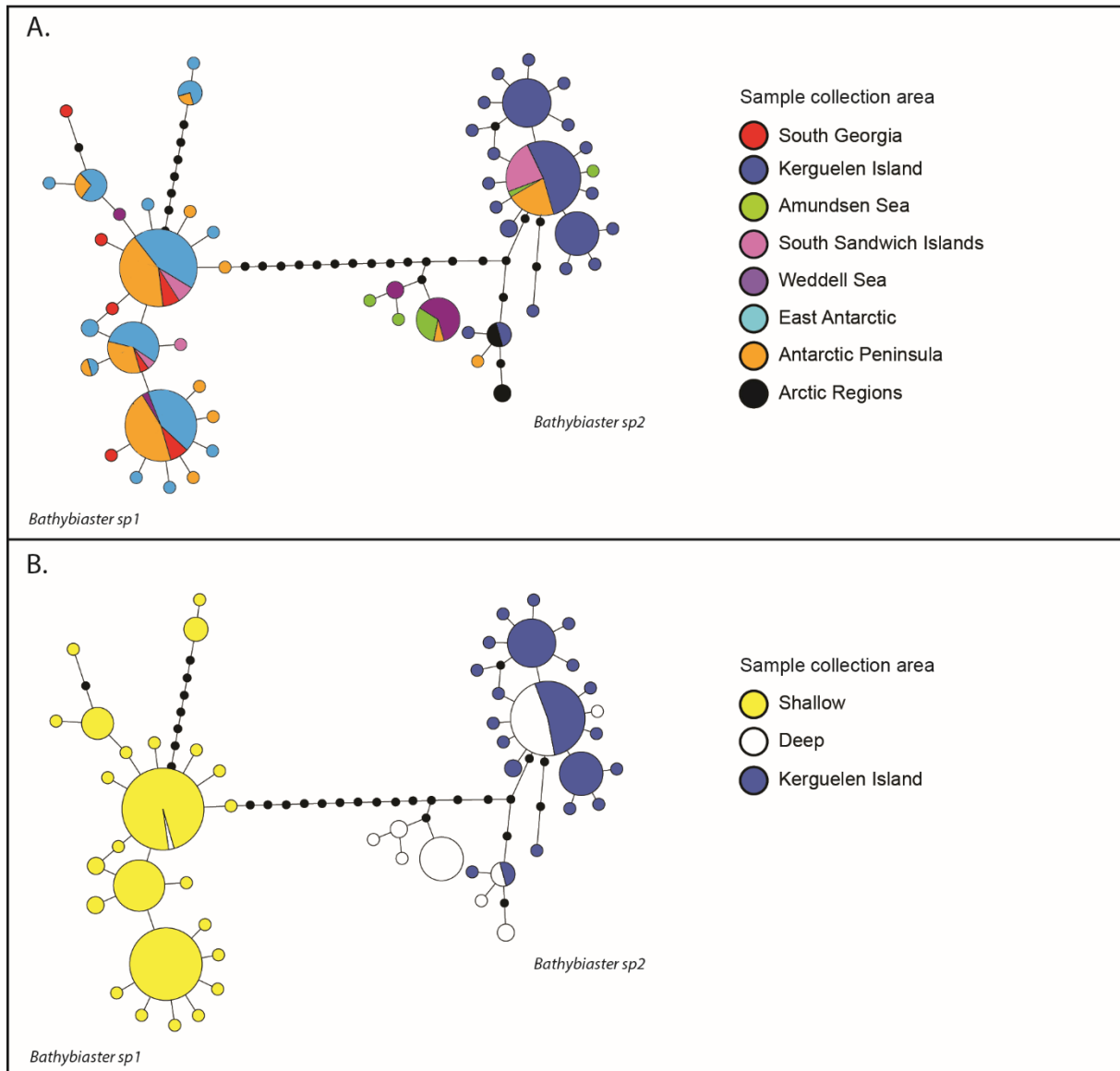

Figure 30 *Bathybiaster* statistical parsimony network indicating genetic relationships with regards to A) sampling geographic locations and B) sampling depths and Kerguelen Island (shallow and deep). Delineated clades are represented and colour code follows the appended legend.

## **DISCUSSION**

### **Species richness, genetic diversity and taxonomic implications**

We found that genetic diversity did not significantly differ between brooders and broadcasters. This may reflect the presence of species complexes, related to recurrent disturbances. Recent glacial and interglacial cycles could have promoted high rates of differentiation in Southern Ocean species (O'Hara et al., 2019), regardless of their dispersal capabilities. Discordances between the different delineation methods were detected in all groups. This had already been highlighted in recent studies (Kekkonen et al., 2015; Blair & Bryson, 2017) and great care should be taken when interpreting the results, as further investigations are needed. At best, these methods should be considered as a first step towards subsequent and more integrative taxonomic works (Kekkonen et al., 2015) and therefore, a conservative approach is recommended (Carstens et al., 2013). Genetic diversity among the delineated species falls into the range of intra-specific values obtained in other taxa for COI mtDNA (Goodall-Copestake et al. 2012), supporting this approach. Similarly, the measured inter-specific (2-6.8%) distances are within the range obtained in previous studies for sea stars (Janosik et al., 2011; Foltz et al., 2013). DNA barcoding has proven to be an efficient method to differentiate echinoderm species (Ward et al., 2008) with ~98% of the 191 studied species being distinguished based on their COI barcodes. Rapid diversification can however make intra- and inter-species genetic distances difficult to interpret using species delineation methods. The clear discrepancy between current taxonomy and our results emphasises the urgent need for a complete reassessment of Southern Ocean asteroid taxonomy based on multiple genes and an integrative taxonomic approach at both species and genus levels.

### **Dispersal capacity and biogeographic patterns**

Several mechanisms have been proposed to account for the unusually high proportion of brooding species in the Southern Ocean and the evolutionary success of Antarctic brooders is now widely recognised within the community of Antarctic biologists (Poulin et al., 2002). While adaptation to polar environmental conditions is not considered a determining mechanism (Poulin et al., 2002; Pearse et al., 2009), reproductive strategy has been hypothesised as the main factor structuring the evolution and the diversity of Southern Ocean

benthic life (e.g. Raupach et al., 2010; Thatje, 2012). Whether they are based on morphology (e.g. Moreau et al., 2017) or genetic markers (e.g. Hoffman et al., 2011), most studies agree that biogeographic structures are more pronounced in brooders than in broadcasters due to contrasting dispersal capacities.

Most of the results obtained in the present study are in line with this expected biogeographic pattern, with the prevalence of clear spatial structures in brooders. This is in agreement with our previous work describing the Southern Ocean asteroid biogeographic patterns and demonstrating the importance of life history traits to understanding the structure of spatial distributions (Moreau et al. 2017). Our results support the differentiation of species between the Antarctic Peninsula and the East Antarctic. The past collapse of the West Antarctic Ice Sheet (Bamber et al., 2009; Pollard & DeConto, 2009) and the putative existence of a subsequent trans-Antarctic seaway separating the West and the East Antarctic have been proposed as possible mechanisms leading to such patterns (Barnes & Hillenbrand, 2010; Pierrat et al., 2013; Linse et al., 2006). The role of the Weddell Sea Gyre (Linse et al., 2006), environmental dissimilarities, and contrasting glacial histories have also been proposed as possible explanations (Anderson et al., 2002). Interestingly, in brooding genera, haplotypes of specimens from the Weddell Sea are present in both the East Antarctic and the Antarctic Peninsula clades. Recent faunal exchanges between the two regions could explain the occurrence in the Weddell Sea of a mixed fauna of East Antarctic and Antarctic Peninsula origin as the Weddell Sea is located in between these two regions.

Divergence dates suggest that a vicariance event occurred ~2 Myr ago, while the last collapse of the West Antarctic ice sheet is hypothesised to have occurred more recently, in the last 1.1 Myr (Pollard & DeConto, 2009; Scherer et al., 2008). This last dating is in line with previous work on Southern Ocean asteroids (Janosik et al., 2011). Contrasting divergence dating between phylogeographic studies is not uncommon and absolute ages should be taken with caution when using a molecular clock (Thomas et al., 2006), given the uncertainties in molecular divergence rates, especially when a single locus is used and when fossil calibrations are not available. However, similar divergence dates were obtained for all brooding genera, which strongly suggests the effect of a common and significant event. Unfortunately, only a few abyssal samples were available for study (only two for the entity *Notasterias* sp3). They are strongly divergent from all other *Notasterias* specimens, suggesting the absence of

population mixing and independent evolution of populations of *Notasterias* on both the continental shelf and in the deep-sea.

In contrast to the marked genetic structures described above, exceptions have been in certain brooders due to the effect of unusual dispersal vectors reported (Cumming et al., 2014; Díaz et al., 2011). This is also the case in this study, as the brooding species *D. meridionalis* shares genetic units between South Georgia and the Kerguelen Islands, which suggests an ongoing connectivity between the two distant regions. This pattern could be explained by kelp rafting via the Antarctic Circumpolar Current, which has previously been found in other Southern Ocean brooding echinoderms (O'Hara, 1998) and taxa such as in isopods and molluscs (Leese et al., 2010, González-Wevar et al., 2018). Kelp rafting was suggested as a viable dispersal vector for shallow-water species living in macro-algal beds (O'Hara, 1998), which is the case of *D. meridionalis*.

Genetic structures in broadcasters under study are quite different from the patterns observed in brooders. The studied broadcasters show circumpolar structures that suggest the prevalence of gene flow across the Southern Ocean promoted by higher larval dispersal capacities. Geographic patterns in *P. charcoti*, with several circumpolar entities, suggest the existence of past refugia during past glacial maxima and subsequent dispersal centres (Hemery et al., 2012). Unfortunately, little is known about asteroid larval biology in the Southern Ocean, apart from a handful of well-studied species (Pearse et al., 1991; Agüera et al., 2015; Peck et al., 2013; Souster et al., 2018). Major differences exist between the genetic structure of *Psilaster* and *Bathybiaster*: (1) clades of *P. charcoti* are found to have a greatly fragmented pattern, potentially as a result of lower dispersal capacity than representatives of *B. loripes* (found at continental shelf depths) but this could also reflect a longer evolutionary history as these clades are older (Figure 28), (2) some specimens of *P. charcoti* occur on both sides of the Polar Front and (3) *Bathybiaster* sp2 shows a potential bipolar distribution (sensu Darling et al., 2000) and likely corresponds to the nominal species *B. vexillifer*. The occurrence of shared haplotypes between the Northern and Southern Hemispheres in *Bathybiaster* sp2 suggests the existence of recent gene flow between the two hemispheres. Morphological

similarities between North American and South African specimens had already been indicated in previous work on the echinoderm fauna of South Africa (Clark, 1923). This could be the result of a deep-sea dispersal route, a scenario coined the “thermohaline expressway” by Strugnell et al. (2008) but a wide, cosmopolitan distribution of the species is probably the most reasonable hypothesis. Unfortunately, no tropical deep-sea samples were available for study. *Bathybiaster* sp2 is recorded on the Kerguelen Plateau around the Kerguelen Islands at shallow depths, giving credit to a possible sub-Antarctic emergence scenario and colonisation of the Kerguelen Plateau from the deep sea (Diaz et al., 2011; Aronson et al., 2007).

Interpretation of the present results is limited by the use of a single mtDNA locus. The observed patterns could be due to mechanisms such as adaptive introgression, demographic disparities or sex-biased asymmetries arising from the sole use of mtDNA (Toews & Brelsford, 2012). Furthermore, if data derived from COI analyses reflect a long-term effect of contrasting dispersal capacities, other fast evolving nuclear markers such as microsatellites or SNPs (RAD-seq data) will be needed in the future to investigate these recent and ongoing processes. Nevertheless, the causal relationship between genetic patterns and dispersal capacities of asteroids, can be linked to past climatic and geological events and give some clues to the upstream drivers of species evolution.

### **The role of past climate change**

The Southern Ocean has been partially isolated for nearly 40 million years since the first opening of the Drake Passage, which led to the onset of the Antarctic Circumpolar Current and subsequent cooling of the ocean when the Antarctic Circumpolar Current intensified. However, isolation of the Southern Ocean was reduced several times during periods of climate warming and the decreasing Antarctic Circumpolar Current intensity (Lagabriele et al., 2009; Dalziel et al., 2013). In a recent review of key stages in the evolution of the Antarctic marine fauna, Crame (2018) emphasises the influence of past climate on the current distribution of modern fauna. At the scale of the Cenozoic (c. 65 Myr), he points out that the succession of several major extinction and radiation events are linked to important drops in sea water temperature. The fossil record of Southern Ocean sea stars is very poor but it suggests that the extinction of an older asteroid fauna was followed by the diversification of the Antarctic

Asteriidae and of other modern Antarctic forcipulataceans (Mah & Foltz, 2011b). The origin of the Antarctic Asteriidae has been dated to 21 Ma in this study, suggesting a diversification of the family starting in the Miocene after the initial opening of the Drake passage (c. 34 Ma) and before the full establishment of the Antarctic Circumpolar Current (c. 14 Ma) (Lawver & Gahagan, 2003). The global phylogeny of Astropectinidae, reconstructed by Mah & Foltz (2011a), does not show any regional pattern, which makes any speculation as to the origin of *Bathybiaster* and *Psilaster* in the Southern Ocean problematic. Our results, however, suggest a recent evolutionary history of broadcasting genera in the Southern Ocean (c. 5 Myr). At a more recent time scale, all the studied groups show a high diversification rate over the last ~2.5 Myr, suggesting that recent climate events could account for these observed patterns. Naish et al. (2009) estimated that at least 38 distinct glacial cycles occurred over the last 5 Myr. These glacial cycles are believed to have been major drivers of species differentiation as hypothesised by the “Antarctic diversity pump” hypothesis (Clarke & Crame, 1989, 1992) and even promoting evolutionary radiations of the benthic fauna (Wilson et al., 2009; Allcock, 2005; Raupach et al., 2007). These major environmental changes could have also resulted in cryptic speciation in brooding species and broadcasting species with limited larval dispersal capabilities, by the maintenance of genetic differentiation at local scales (Thatje, 2012). Finally, the Antarctic Circumpolar Current hypothesis predicts the “existence of many species in clades of varied divergence times, at a wide range of depths, but with highest diversity downstream of the Drake Passage, in the Scotia Arc and Weddell Sea” (sic. Pearse et al., 2009). This hypothesis could explain some of the diversification patterns we have observed in asteroids. Nevertheless, the apparent correlation with past geological and climatic events should be taken with great care due to the lack of fossil records and uncertainties in calibration of the molecular clock also known to be taxon and climate regime dependent (Gillooly et al., 2005).

## CONCLUSION & FUTURE PROSPECTS

The observed genetic patterns of Southern Ocean sea stars highlight the relevance of considering life history traits to understand spatial patterns of genetic diversity. Our results suggest that reproductive strategy could have conditioned the spatial structuring of genetic diversity, but with no apparent effect on the level of genetic diversity. Molecular results also

indicate that an in-depth taxonomic revision of the group is needed based on an integrative taxonomy approach (combining genetic and morphological data). The increasing development of genetic surveys in biodiversity conservation and management plans (Goodall-Copestake et al., 2012) stresses the need for robust estimates of species diversity. Species complexes are frequent in the Southern Ocean (e.g. Hemery et al., 2012) and estimates of species diversity based on morphology can lead to under- or alternatively, overestimating 'true' biological diversity. In that context, multi-locus approaches are essential to detect evolutionary processes within species. Finally, the apparent bipolar or cosmopolitan distribution of the species *B. vexillifer* should be further investigated using additional specimens and multiple molecular markers. This will bring new insights on a potential deep-sea route connecting the two polar oceans and the relevance of biogeographic scenarios such as the thermohaline expressway (Strugnell et al., 2008) and the sub-Antarctic emergence (Diaz et al., 2011). The presence of *B. loripes* on the continental shelf could be the result of a past colonisation from the deep sea (Strugnell et al., 2011), which potentially challenges the established paradigm of an isolated Southern Ocean benthic diversity (Clarke et al., 2004).

## ACKNOWLEDGMENTS

The work was supported by a “Fonds pour la formation à la Recherche dans l’Industrie et l’Agriculture” (FRIA) grant to C. Moreau. This is contribution no. 32 to the vERSO project ([www.rectoversoprojects.be](http://www.rectoversoprojects.be)), funded by the Belgian Science Policy Office (BELSPO, contract n°BR/132/A1/vERSO). The authors thank M. Bauwens, R. Downey, C. Guillaumot and H. Christiansen for their important contribution during key steps of this work. The authors would like to thank all the persons and institutes involved in sharing the samples and sequences analysed in this study as well as research programs that made the collection of samples possible. S. Schiaparelli - University and Museum of Genoa; K. Neill - National Institute of Water and Atmospheric Research; H. Griffiths, D. Barnes and K. Linse - British Antarctic Survey; C. Gallut, N. Améziane, N. Vasset, A. Froger, G. Lecointre and A. Dettai - Museum National d’Histoire Naturelle, Paris; C. Mah - Smithsonian Institution

Programs: PROTEKER (IPEV 1044, French LTER ZATA), POKER 2, REVOLTA (IPEV 1124), CEAMARC, ANTFLOCKS, JR144, JR179, JR230, JR262, JR275, JR287, JR15005, ACE – ASCCC

## **AUTHORS CONTRIBUTION**

C.M., Q.J., B.D. and T.S. conceived and designed the experiments; C.M., Q.J., C.S. and G.A. performed the analyses; C.M., Q.J., A.A., M.E., B.D. and T.S. collected the data; C.M., B.D., Q.J., M.E., C.S., G.A., A.A. and T.S. wrote the manuscript.

## **DATA ACCESSIBILITY**

All data and meta-data used in this study are publicly available on BOLD Systems ([www.boldsystems.org](http://www.boldsystems.org)) under the Dataset code DS-ASTROULB as a compilation of the following projects: SEAST; EAR; DSPEC; CHEC; SOA; SWEMA; TNBA; TCTNB; ODTNB; AIIS; SORK; NZEC and NZECA.





# Chapter 3

Is reproductive strategy a key factor in understanding the evolutionary history of Southern Ocean Asteroidea (Echinodermata)?



# Chapter 3

The overlooked diversity of Southern Ocean sea stars (Asteroidea) reveals original evolutionary pathways.

Camille Moreau<sup>1,2\*</sup>, Quentin Jossart<sup>1,3</sup>, Bruno Danis<sup>1</sup>, Marc Eléaume<sup>4</sup>, Henrik Christiansen<sup>5</sup>,  
Charlène Guillaumot<sup>1,2</sup>, Rachel Downey<sup>6</sup> and Thomas Saucède<sup>2</sup>

<sup>1</sup>Marine Biology Lab, CP160/15 Université Libre de Bruxelles (ULB) 50, B-1050 Brussels, Belgium

<sup>2</sup>UMR CNRS 6282 Biogéosciences, Université de Bourgogne Franche-Comté (UBFC) 6, F-21000 Dijon, France

<sup>3</sup>Marine Biology, Vrije Universiteit Brussel (VUB), Pleinlaan 2, 1050 Brussels, Belgium

<sup>4</sup>Institut de Systématique, Evolution, Biodiversité (ISYEB), Muséum national d'Histoire naturelle, CNRS, Sorbonne Université, EPHE, 57 rue Cuvier, 75005 Paris, France

<sup>5</sup>Laboratory of Biodiversity and Evolutionary Genomics, KU Leuven, Leuven, Belgium

<sup>6</sup>Fenner School of Environment & Society, Australia National University, 46 Sullivans Creek Rd, Canberra, ACT 2601, Australia

\*Correspondence: Camille Moreau, Université Libre de Bruxelles (ULB) Laboratoire de Biologie Marine, CP160/15 50 Av. F.D. Roosevelt, B-1050 Bruxelles, Belgium.

E-mail: [mr.moreau.camille@gmail.com](mailto:mr.moreau.camille@gmail.com)

## **ABSTRACT**

Benthic life in the Southern Ocean features unique life history traits and species assemblages, but the origin and evolution of many of these taxonomical groups is still unclear. Exploring macro-ecological sea star (Asteroidea) diversity patterns through a comprehensive phylogeny based on over 4,400 barcode sequences, we illustrate that the richness of Southern Ocean asteroids has generally been overlooked and misinterpreted. We also demonstrate that the current Southern Ocean sea star diversity mainly emerged from recent diversification. A central evolutionary scenario could explain these signatures through successive invasion and exchange events between the Southern Ocean and adjacent regions with comparable environmental conditions, during periods of rapid environmental change. Finally, we emphasise the importance of employing and endorsing the use of extensive genetic barcode libraries for future biodiversity studies.

## **Keywords**

Antarctica – COI mtDNA – Biodiversity – Echinodermata – Evolution – Phylogeography

## INTRODUCTION

The “Mesozoic Marine Revolution” (*ca.* 250-66 Mya; Vermeij, 1977) has profoundly conditioned the evolution of modern marine benthic fauna and the structure of species interactions within communities. This revolution led to the diversification of durophagous (skeleton-breaking) predators like teleost fish, sharks, rays, predatory molluscs, and decapod crustaceans (Thies & Reif, 1985; Vermeij, 1987; Aronson & Blake, 2001). It drove shallow-water invertebrates into an ecological arms race to rapidly evolve anti-predatory adaptations (e.g. architectural defences; Meyer & Macurda, 1977; Vermeij, 1977; 1987; Roy, 1994). In contrast, other invertebrates, like stalked crinoids and brachiopods did not adapt to new conditions and consequently disappeared from the shallows and currently inhabit deep-sea environments in most modern seas (Wilson, 1999).

Key stages in the evolution of Southern Ocean marine fauna have shaped its unique biological features and life history traits, such as the high prevalence of brooding and the adaptation to sub-zero temperatures (Crame, 2018). Unlike anywhere else in the global ocean, modern Antarctic marine benthic communities comprise of very few durophagous predators, if any (Aronson et al., 2007), conferring the Southern Ocean marine benthos a Palaeozoic-like composition (*ca.* 540-250 Mya; Bowden et al., 2011). However, extant Antarctic fauna is believed to be the result of more recent, Cenozoic (last 66 Myr) in situ diversifications (Clarke et al., 2004). Based on the fossil record of the La Meseta Formation in Seymour Island (Antarctic Peninsula), palaeobiological studies indicate that most shallow-water durophagous predators disappeared from Antarctica at the Eocene-Oligocene transition, an age marked by a sudden drop in sea water temperatures (*ca.* 34 Mya; see for instance Aronson & Blake, 2001). This transition allowed echinoderm-dominated communities to re-flourish in predatorless environments of the Southern Ocean (Stott et al., 1990; Aronson & Blake, 2001; Crame, 2018). There is fossil evidence that asteroid evolution followed this general trend, with local extinction of Southern Ocean taxa at the end of the Eocene, including the highly calcified members of the families Goniasteridae and Oreasteridae (Blake & Aronson, 1998), which currently occur in modern seas outside the Southern Ocean. Nevertheless, our current knowledge of the deep time evolution of sea stars is limited due to the incompleteness of the fossil record (Mah & Blake, 2012).

Sea stars have been used as case studies in numerous biological studies (see in Lawrence, 2013), which have revealed key functions and significant ecological roles performed by many species in marine ecosystems (Paine, 1966; McClintock, 1994; Pratchett, 2001; McClintock et al., 2008). The Southern Ocean is no exception, harbouring a singular marine fauna (David & Saucède, 2015), and with sea stars influencing ecosystems in terms of diversity, abundance and ecological roles (McClintock & Baker, 1997; McClintock et al., 2008; Clarke, 2008).

Contemporary sea stars all belong to the monophyletic sub-class Neoasteroidea (Blake, 1987; Gale, 1987) that diversified after their near complete extinction at the Permian-Triassic boundary (*ca.* 250 Mya; Chen & McNamara, 2006; Twitchett & Oji, 2005). Today, it is the second most diverse class of echinoderms after the Ophiuroidea (~2,100 species), with around 1,900 described species worldwide (WoRMS, 2019). The global diversity of sea stars is believed to be considerably underestimated due to various taxonomic issues and sampling biases (Mah & Blake, 2012; Moreau et al., 2019). In the global ocean, sea star diversity patterns reveal high levels of species richness in tropical regions (e.g. Blake, 1990) and a latitudinal diversity gradient decreasing towards the poles, with lower richness levels recorded in the Arctic compared to the Antarctic (Mah & Blake, 2012). Despite this decreasing species richness gradient towards the poles, the cold polar oceans harbour unusual levels of richness in sea star families (Mah & Blake, 2012).

All seven orders of the class Asteroidea and 75% of known extant families are found in the Southern Ocean (Moreau et al., 2015; 2018). Such a wide taxonomic richness among an entire class is not typical in the Southern Ocean, where long-term biogeographic isolation and extreme environmental conditions have conditioned the specialisation of taxa, especially at high taxonomic levels (i.e. family). For instance, the Southern Ocean ichthyofauna (fish) has been described as “a taxonomically restricted and endemic modern fauna” (Eastman, 2005), and only a fifth of crinoid families are present in the Southern Ocean (Eléaume et al., 2014). The wide taxonomic richness of Southern Ocean sea stars, however, does not preclude their singularity, with 59% of endemic species recorded south of the Subtropical Front and 29% of them south of the Polar Front (Moreau et al., 2017).

Under-sampled marine environments of the Southern Ocean have been subject to renewed biodiversity research efforts since the International Polar Year (IPY 2007-2009) and

the Census of Antarctic Marine Life (CAML 2005-2010), which revealed significant gaps in our knowledge of the Southern Ocean diversity, its origin and evolution (e.g. Clarke et al., 2004, Riesgo et al., 2015). This holds true for sea stars, for which the variety of pathways and processes that shaped their evolution in the Southern Ocean remains unclear. In this study, we analyse the spatial structure of taxonomic and genetic diversity in Southern Ocean sea stars, through the exploration of an extensive phylogeny reconstruction based on over 4,400 barcode sequences. We use a macro-ecological approach to ascertain the origin, evolution and current diversity of Southern Ocean sea stars, assessing the relevance of a recent diversification scenario and challenging the existence of a latitudinal diversity gradient.

## **MATERIALS AND METHODS**

### **Richness data compilation**

We used a combination of global scale and Southern Ocean-centred studies to explore sea star richness across scales (Mah & Blake, 2012, Moreau et al., 2018). The Antarctic and sub-Antarctic Asteroidea database assembled by Moreau et al. (2018) was used to describe the geographic distribution of richness patterns with regards to sampling effort along a latitudinal gradient. Quantification of sampling effort, species and genus richness as well as the species:genus ratio, were calculated at a 1° latitude band resolution (from -45° to -79°) based on taxonomic names from the World Register of Marine Species (WoRMS, 2019). A Spearman correlation was performed to test for dependence between sampling effort and taxonomic richness, both at species and genus level. A detailed comparison of the South American and New Zealand quadrants (Longitudes: -20° to -80° and -160° to 135°, respectively) was used to assess longitudinal effects on the diversity gradients. Species accumulation curves following latitude were calculated along both quadrants with PRIMER 6 (Clarke & Gorley, 2006). The Jackknife2 extrapolator index was used to correct sampling effort and the UGE index (Ugland et al., 2003) was used for a comparison with a random distribution (mean value over 999 permutations).



## Genetic data compilation

DNA barcoding is an effective tool for specimen identification in echinoderms (Ward et al., 2008; Layton et al., 2016) and an asset for resolving the phylogeny at low taxonomical levels, particularly by integrating a large number of specimens (Hajibabaei et al., 2007). DNA sequences of a fragment of the mitochondrial gene cytochrome c subunit I (COI) were compiled from two sources. First, all publicly available sequences from the Barcode of Life Data System (BOLD, Ratnasingham & Hebert, 2007), including the ones previously mined through GenBank (Sayers et al., 2018), for the class Asteroidea were downloaded and compiled without limitations regarding sample location. In addition, new sequences were obtained in our laboratories. Extraction methods were either based on a salting-out protocol (modified from Sunnucks & Hales, 1996 following Moreau et al., 2019) or the QIAGEN DNA Blood and Tissue kit. Amplifications were completed using the echinoderm forward primer LCOech1aF1 and the universal HCO2198 reverse primer (Folmer et al., 1994). Sequence editing and alignment were performed in CodonCode Aligner v6.0.2. All sequences were then translated using the echinoderm mitochondrial genetic code to ensure the absence of stop codons. Sequences were aligned using the MUSCLE alignment process (Edgar, 2004). To maximise species coverage and fragment overlap, we defined a minimum length cut-off of 600 bp.

## Tree reconstruction

Sequences were used for the reconstruction of a global phylogenetic tree based on Bayesian Inference and using unique haplotypes. The PartitionFinder v2 software (Lanfear et al., 2016) was used on the CIPRES Science Gateway (Miller et al., 2010) to select the best-fit model of evolution using a Bayesian information criterion (result: GTR+I+G). The phylogeny was inferred using an XML file created with BEAUti v1.8.4 (Drummond et al., 2012), a strict clock model with a lognormal prior for “clock.rate” such that the median reflected a universal divergence time of echinoderm COI of 3.1 to 3.5% per Myr (McCartney et al., 2000), a MCMC chain of  $10 \times 10^6$  generations sampling every 1,000 trees and a Yule process speciation prior. The XML file was used with the software BEAST v1.8.4 on the CIPRES Science Gateway to reconstruct a time-calibrated tree. TreeAnnotator v1.8.4 calculated a consensus tree that was visualised using FigTree v1.4.3 (<http://tree.bio.ed.ac.uk/software/figtree/>).

In order to reduce mistakes due to spurious identifications and ambiguous or inaccurate phylogenetic assumptions, the phylogenetic tree was constructed using all sequences at once and some members of the class Ophiuroidea (i.e. *Gorgonocephalus arcticus* and *Ophiura albida*) were used as outgroups, as suggested by Linchangco and colleagues (2017). The rarely encountered genus *Xyloplax*, which has an unclear taxonomic status (Janies et al., 2011) was not included in the present work. Six clades from the entire global data set were selected for detailed phylogeographic analyses: Ganeriidae (n=108), Benthoplectinidae (n=168), Odontasteridae (n=319), Pterasteridae (n=164), Solasteridae (n=207) and Echinasteridae (clade *Henricia* + *Rhopiella*; n=156). These clades exhibit the largest available number of sequences, robust phylogenetic groupings, and cover different phylogeographic signatures. Subtrees were extracted from the main phylogenetic tree for specific discussions (see Appendix 3). The ASAP method (<http://www.wabi.snv.jussieu.fr/public/asap>) with default settings and K80 corrected distances was used to delineate species within the six targeted clades. Antarctic Asteroidea (*Diplasterias*, *Notasterias* and *Lysasterias*), Astropectinidae (*Psilaster* and *Bathybiaster*) and Poraniidae (*Glabraster*) have recently been investigated by Moreau et al. (2019) and Moore et al. (2018); results of these studies were included in the present work.

## RESULTS

### Sea star taxonomic diversity in the Southern Ocean

The seven orders of the class Asterozoa are recorded in all investigated areas of the Southern Ocean (Table 6). Out of the 38 existing families, 26 (68%) are present in the Southern Ocean and 24 (63%) south of the Polar Front. A total of 344 genera and 1,892 species of asterozoans have been described worldwide (Mah & Blake, 2012). Out of these, 116 (34%) and 79 (23%) genera are reported in the Southern Ocean and the Antarctic Zone (i.e. south of the Polar Front), respectively. At species level these values range from 294 (16%) in the entire Southern Ocean to 196 (10%) south of the Polar Front. Endemism estimates are lower at higher taxonomic levels with no order nor family being restricted to the Southern Ocean, while 27 genera (23%) and 176 species (60%) exclusively inhabit Southern Ocean waters. South of the Polar Front, endemism decreases to 1 genus (1%) and 56 species (29%). The single endemic genus, *Caimanaster*, being monotypic and recorded by one immature specimen only (Table 6).

Table 6 Sea star richness and endemism estimates (in percentage relative to the global richness) inside and outside the Southern Ocean (Compiled from Mah and Blake 2012, Moreau et al. 2018). \*Antarctic refers to waters south of the Polar Front (ca. 60°S); \*\*Doubtful occurrences were removed in line with a conservative approach. *Luidia clathrata* and *Asthenactis australis* were excluded as the first one is only known from warm shallow waters and the second from a single specimen at the edge of the Southern Ocean.

Taxonomic level	World Ocean		Southern Ocean		Antarctic*	
	n of taxa	n of taxa	n of endemic taxa	n of endemic taxa	n of taxa	n of endemic taxa
Order	7	7 (100%)	0 (0%)	7 (100%)	7 (100%)	0 (0%)
Family	38	26** (68%)	0 (0%)	24 (63%)	24 (63%)	0 (0%)
Genus	344	116 (34%)	27 (23%)	79 (23%)	79 (23%)	1 (1%)
Species	1,892	294 (16%)	176 (60%)	196 (10%)	196 (10%)	56 (29%)

\*Antarctic refers to waters south of the Polar Front (ca. 60°S).

\*\*Doubtful occurrences were removed in line with a conservative approach. *Luidia clathrata* and *Asthenactis australis* were excluded as the first one is only known from warm shallow waters and the second from a single specimen at the edge of the Southern Ocean.

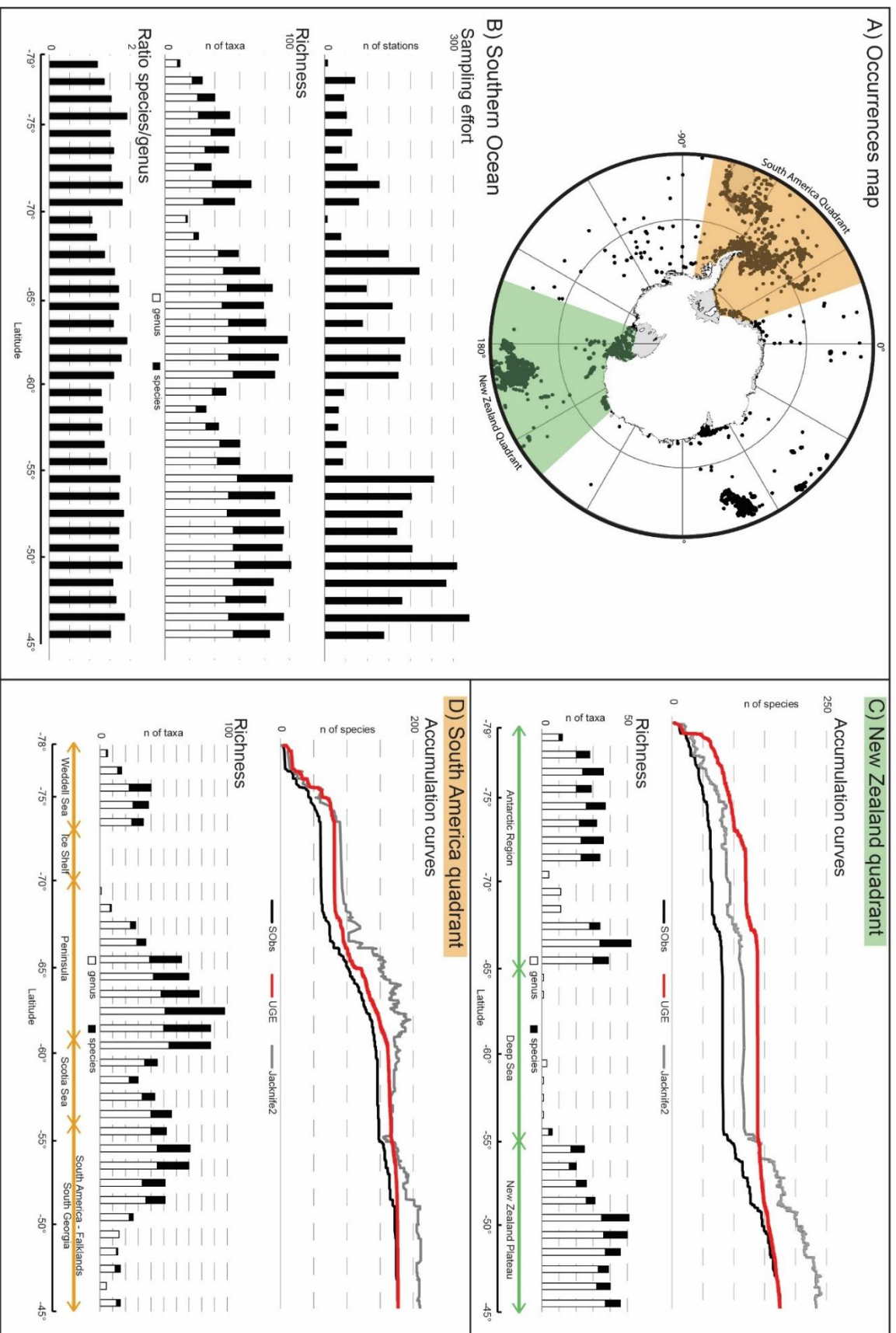

Figure 31 Latitudinal gradients of sea stars' species and genus richness in the Southern Ocean. A.) Occurrence map with location of both quadrants (New Zealand in green and South America in orange) Projection: South Pole stereographic. B.) Entire Southern Ocean. C.) New Zealand Quadrant. D.) South America Quadrant. Histograms for richness, sampling effort and species:genus ratio are presented by 1° latitudinal bands. Accumulation curves are fitted to match with latitude (UGE index – 999 permutations representing a mean random accumulation curve, SObs – recorded richness according to latitude, Jackknife2 – corrected richness based on sampling effort).

## Latitudinal trends in the Southern Ocean

Overall, genus and species richness decrease as latitude increases south of 45°S (Figure 31B) following a pattern that strongly matches sampling effort. The correlation between sampling effort and species and genus richness is highly significant (Spearman's  $r$ ,  $p < 0.005$ ) with  $r_s$  values of 0.82 and 0.75 respectively. Richness decreases sharply in three latitude ranges: -55° to -60°; -68° to -70° and -78° to -79° (Figure 31A and B). These latitudes correspond to undersampled deep-sea basins and the restricted amount of seabed at the higher latitudes in the Southern Ocean. The species:genus ratio remains relatively constant with latitude, with a mean value of  $1.58 \pm 0.23$  (Figure 31B). Under-sampled latitudes, however, also show a marked decrease in the species:genus ratio.

Latitudinal patterns differ between West (South American quadrant) and East (New Zealand quadrant). In the East, species and genus richness follow a bimodal distribution corresponding to the East Antarctic and the New Zealand plateau separated by a deep-sea basin (Figure 31C). In the West, the highest values are recorded in the Antarctic Peninsula (Figure 31D).

Species accumulation curves following latitude show distinct gradients between West and East (Figure 31C and D). In the West, observed values (SObs) approximately follow the random pattern of species accumulation (UGE index), indicating a constant turnover of species with latitude. The curve of extrapolated richness values (Jackknife2 index) predicts potentially greater richness values in the Antarctic Peninsula and South America due to the scarcity of sampling effort in these areas compared to the Scotia Arc and the Weddell Sea (Figure 31D). In the East, observed values (SObs) remain relatively low compared to the random curve (UGE index) showing a marked increase at the latitudes of the New Zealand plateau (Figure 31C) and the presence of a distinct New Zealand fauna. Overall, extrapolated richness values using the Jackknife2 index indicate incomplete sampling effort and a potentially higher richness in both quadrants (Figure 31C and D) as well as in the entire Southern Ocean (Appendix 3).

Table 7 Investigated families with mention of their environmental settings (from Mah and Blake 2012) their presence in the Southern Ocean (SO; from Moreau et al. 2018) and whether genetic sequences are available for the Southern Ocean. Ant: Antarctic (i.e. South of the Polar Front ~-60°; sub-Ant: sub-Antarctic (i.e. North of the Polar Front and south of the Subtropical Front ~-45°). \* from Mah and Blake 2012; \*\* from Moreau et al. 2018.

Superorder	Order	Family	Present in cold or deep-sea waters*	Primarily or only present in cold waters*	Exclusively found in the deep sea *	Recorded in the SO**	Available sequences from the SO in this work
NA	Velatida	Pterasteridae	YES	YES	NO	Ant & sub-Ant	YES
		Korethrasteridae	YES	YES	YES	Ant & sub-Ant	YES
Forcipulatacea	Brisingida	Freyellidae	YES	YES	YES	Ant & sub-Ant	YES
		Brisingidae	YES	YES	YES	Ant & sub-Ant	YES
	Forcipulatida	Asteriidae	YES	NO	NO	Ant & sub-Ant	YES
		Heliasteridae	YES	NO	NO	Ant & sub-Ant	YES
		Pedicellasteridae	YES	YES	YES	Ant & sub-Ant	YES
		Stichasteridae	YES	NO	NO	Ant & sub-Ant	YES
		Zoroasteridae	YES	YES	YES	Ant & sub-Ant	NO
Spinulosacea	Spinulosida	Echinasteridae	YES	NO	NO	Ant & sub-Ant	YES
Valvatacea	Paxillosida	Astropectinidae	YES	YES	NO	Ant & sub-Ant	YES
		Ctenodiscidae	YES	YES	YES	Ant & sub-Ant	NO
		Luidiidae	YES	NO	NO	Doubtful ( <i>L. clathrata</i> )	NO
		Porcellanasteridae	YES	YES	YES	Ant & sub-Ant	YES
		Pseudarchasteridae	YES	YES	NO	Ant & sub-Ant	YES
	Notomyotida	Benthopectinidae	YES	YES	YES	Ant & sub-Ant	YES
	Valvatida	Acanthasteridae	NO	NO	NO	NO	NO
		Archasteridae	NO	NO	NO	NO	NO
		Asterinidae	YES	NO	NO	Ant & sub-Ant	YES
		Asteropseidae	YES	NO	NO	NO	NO
		Ganeriidae	YES	YES	YES	Ant & sub-Ant	YES
		Goniasteridae	YES	YES	YES	Ant & sub-Ant	YES
		Leilasteridae	YES	YES	YES	Only known from Shag Rocks	YES
		Mithrodiidae	NO	NO	NO	NO	NO
		Odontasteridae	YES	YES	NO	Ant & sub-Ant	YES
Oreasteridae		YES	NO	NO	NO	NO	
Poraniidae	YES	YES	NO	Ant & sub-Ant	YES		
Solasteridae	YES	YES	NO	Ant & sub-Ant	YES		

\* from Mah & Blake 2012

\*\* from Moreau et al., 2018

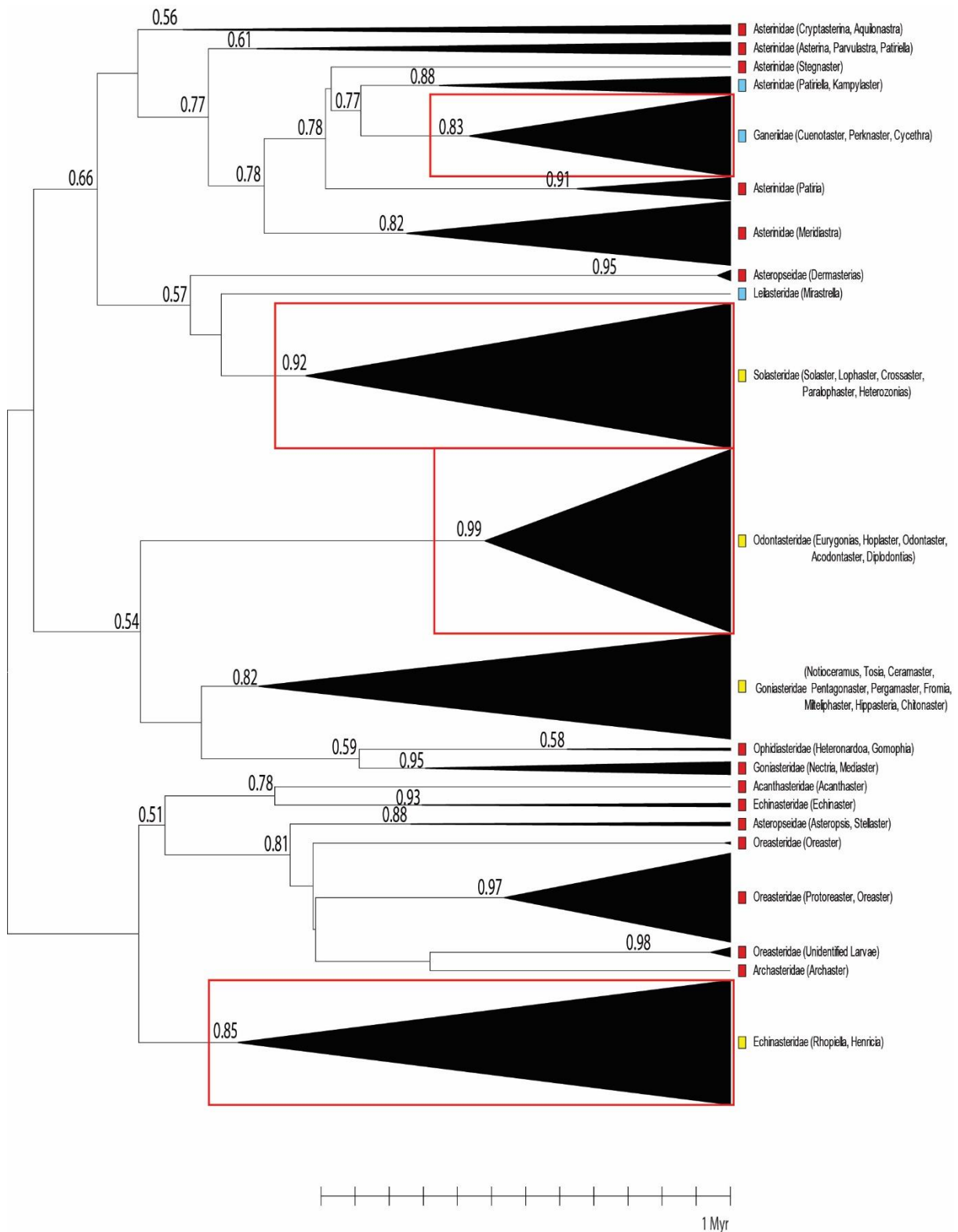
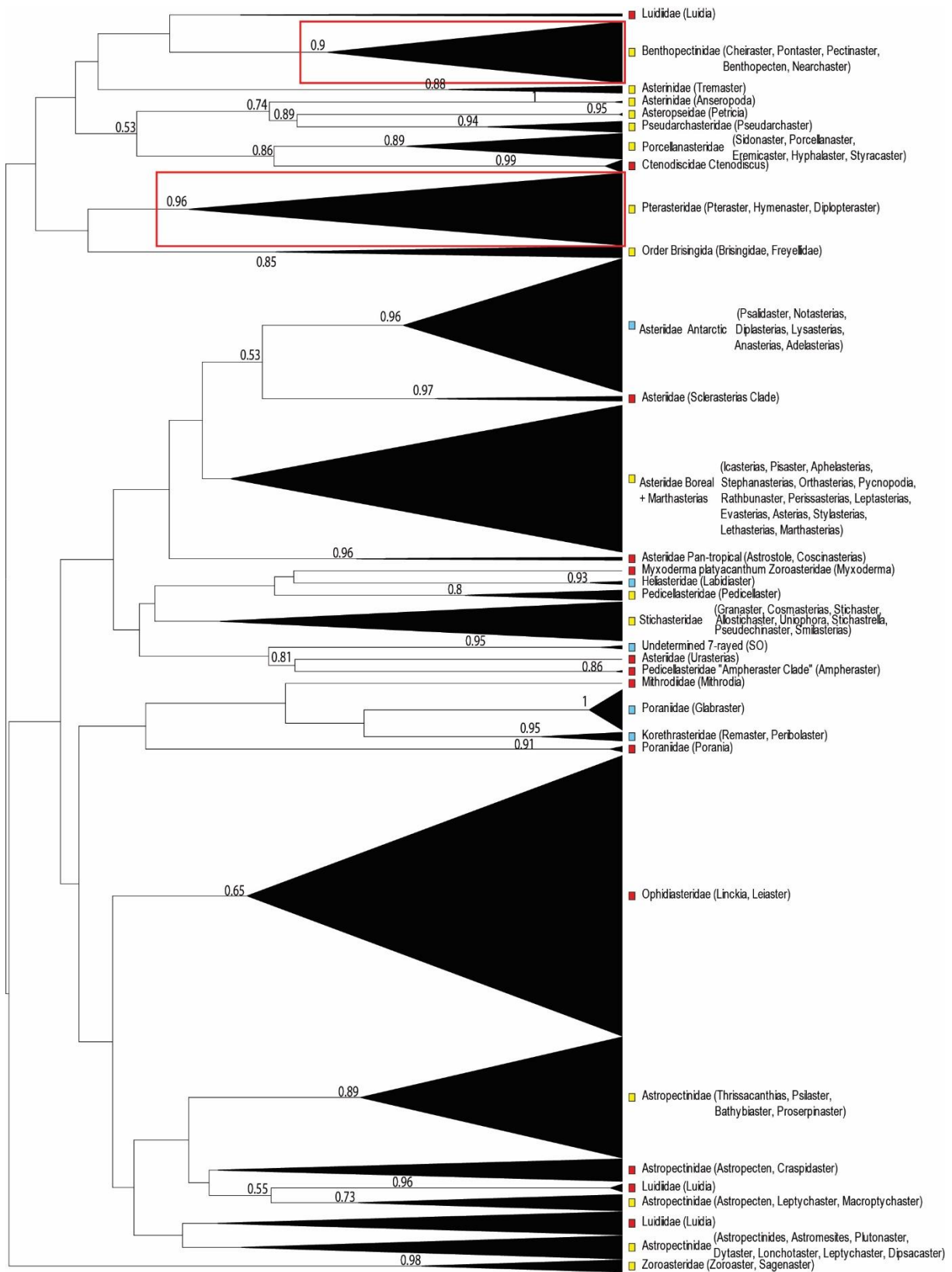

Figure 32 (Double page). Bayesian phylogenetic reconstruction of the class Asterozoa based on mtDNA (COI). Nodes posterior probabilities are indicated when superior to 0.5. Coloured squares indicate specimen locations: blue, Southern Ocean; red, outside the Southern Ocean and yellow, from both inside and outside the Southern Ocean. Subgroups used for further analyses are indicated in red (Fully developed tree available in Appendix 3).





## Global phylogenetic exploration

Genetic data is available for all seven asteroid orders. Out of 38 families described within the class Asteroidea, 28 are represented by at least one sequence and 25 of them have representatives dwelling in deep or cold environments (Table 7 Investigated families with mention of their environmental settings (from Mah and Blake 2012) their presence in the Southern Ocean (SO; from Moreau et al. 2018) and whether genetic sequences are available for the Southern Ocean. Ant: Antarctic (i.e. South of the Polar Front  $\sim$ -60°; sub-Ant: sub-Antarctic (i.e. North of the Polar Front and south of the Subtropical Front  $\sim$ -45°). \* from Mah and Blake 2012; \*\* from Moreau et al. 2018.). Eleven of these 28 investigated families are exclusively found in the deep sea and 17 are primarily or only present in cold environments. Twenty families collected in the Southern Ocean are represented by at least one COI sequence and all but one (Leilasteridae) are found in both Antarctic and sub-Antarctic waters (Table 7 Investigated families with mention of their environmental settings (from Mah and Blake 2012) their presence in the Southern Ocean (SO; from Moreau et al. 2018) and whether genetic sequences are available for the Southern Ocean. Ant: Antarctic (i.e. South of the Polar Front  $\sim$ -60°; sub-Ant: sub-Antarctic (i.e. North of the Polar Front and south of the Subtropical Front  $\sim$ -45°). \* from Mah and Blake 2012; \*\* from Moreau et al. 2018.).

The phylogenetic tree reconstruction included 4,440 sequences (length of at least 600 bp) representing 2,201 unique haplotypes (Figure 32). Alignment is not problematic, and no stop codons are found. Apart from the order Brisingida, no ordinal nor superordinal levels of the accepted sea star taxonomy are retrieved in the reconstructed tree (Figure 32). Ten of the accepted sea star families represented by more than one genus are recovered as monophyletic with good support (e.g. Ganeriidae, Solasteridae, Benthoplectinidae), while others are paraphyletic (e.g. Asterinidae, Oreasteridae, Poraniidae, Astropectinidae) (see Figure 32 for the complete list). Based on the accepted nomenclature of families and delimitation of the Forcipulatacean by Mah and Foltz (2011a), 55 clades are retrieved (Figure 32). Among them, 27 contained sequences from specimens collected in the Southern Ocean. Nineteen of the clades with Southern Ocean representatives also encompassed specimens from outside the Southern Ocean, while eight clades are composed uniquely of Southern Ocean specimens (see Figure 32).

## Phylogeographic patterns

The main phylogeographic patterns observed in this study are illustrated in Figure 33 and detailed below with examples drawn from the six clades of interest and from previous studies with complementing patterns (i.e. *Glabraster*, Moore et al. 2018; *Bathybiaster*, Moreau et al., 2019).

Our results indicate several cases of either cryptic species or unidentified taxa (e.g. genus *Perknaster*, *Acodontaster*, *Henricia*; see Appendix 3). A case in point is the genus *Rhopiella* (endemic to the Southern Ocean) that displays a particularly high level of species richness (Appendix 3). To date, only one species of *Rhopiella* has been described, while 15 clades are delineated here with substantial genetic divergence between them (Figure 33; Table 8).

Spatial affinities with regions surrounding the Antarctic Continent are illustrated by several examples. These affinities exist with New Zealand and notably within the clade ‘*Cheiraster* complex’ (Figure 33) which encompasses 93 specimens identified as either *Cheiraster otagoensis*, *C. gerlachei*, *C. monopedicellaris* or *C. hirsutus*. In the family Benthopectinidae, *Cheiraster* is the sole genus found in the Southern Ocean with two of the delineated clades recorded in Southern Ocean waters (Appendix 3). Members of the species *Lophaster furcilliger* (Solasteridae) also show affinities between Southern Ocean and New Zealand along the Macquarie trench (Figure 33). Similarly, specimens from the Magellanic area present affinities with South Georgia, the Kerguelen Islands (e.g. *Odontaster penicillatus* and *Odontaster sp*; see Figure 33; Appendix 3) and also Antarctic islands like the Balleny Islands (e.g. *Acodontaster sp*; see Figure 33; Appendix 3), following a sub-Antarctic circumpolar pattern. Circumpolarity is also observed in other delineated species, either at the scale of the entire Southern Ocean (e.g. *Glabraster antarctica*, Figure 33) or at finer scale, on the Antarctic shelves (South of 60°S; e.g. *Bathybiaster loripes* and *Cuenotaster involutus*).

The spatial structure found in some of these analyses also indicates depth or geomorphology-related differences, as in the genus *Bathybiaster* (Figure 33) within which *B. loripes* is only found around the Antarctic shelves while *B. vexillifer*, its sister species only occurs in the deep sea, except for the Kerguelen Plateau (Figure 33).

Finally, species with suspected bipolar or cosmopolitan distributions are commonly found within several families (e.g. *Lophaster furcilliger*; *Bathybiaster vexillifer*; *Pteraster* spp; Figure 33; Appendix 3) suggesting recent or ongoing exchange with the northern hemisphere.

Many of the clades explored within this study indicate recent radiations in the Southern Ocean (see Appendix 3). Diversification within both the 'Cheiraster complex' and 'Cheiraster cf. *hirsutus*' clades would have, for example, occurred within the last 2 Myr; whereas the molecular clock analysis indicates that diversification occurred within the last 4 Myr in the 'Paralophaster complex', and within the last 3 Myr within the genus *Perknaster*, *Odontaster* and *Acodontaster* (Appendix 3).

Overall, the phylogenetic analysis highlights many discrepancies between molecular results and current taxonomy based on morphological identifications. Our results show that all six investigated families require systematic revision based on species delineation and morphological identification (see Table 8; Appendix 3). For example, in the species *Odontaster meridionalis*, sequences at our disposal, together with the global phylogenetic tree, suggest that specimens belong to another family. Such identification mismatches are however common in DNA barcoding: specimens could have been either misidentified or samples have been contaminated in former studies (e.g. Janosik et al. 2011; Clades V and VI). Deeper phylogenetic relationships also departed from the accepted taxonomy with the polyphyly of the genera *Solaster*, *Crossaster*, *Lophaster*, *Paralophaster* and *Pteraster*.

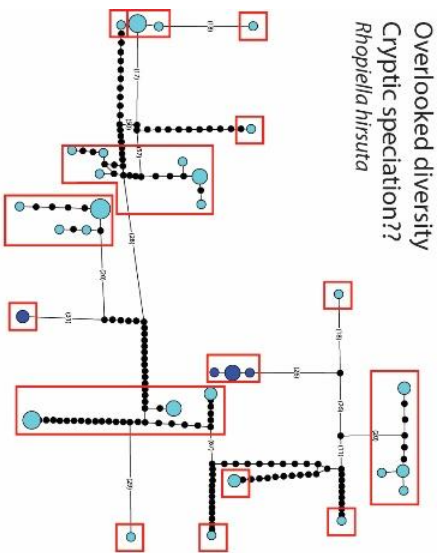

Antarctic New-Zealand Affinities  
*Cheiraster* sp. complex

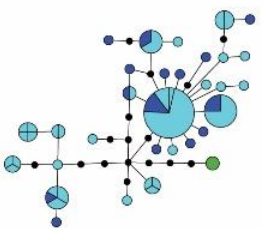

Antarctic / Sub-Antarctic Circumpolar  
*Glabraster antarctica*\*

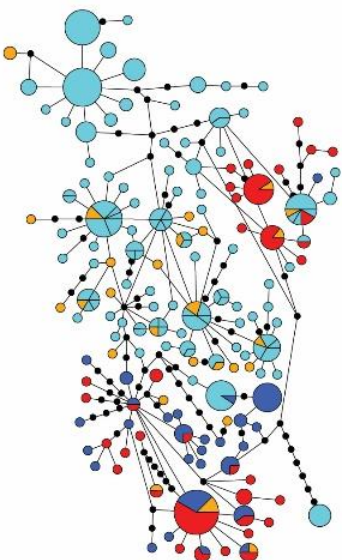

Sub-Antarctic / Magellanic affinities  
*Odontaster penicillatus*

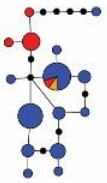

Antarctic & Sub-Antarctic emergence  
*Bathybaster*\*\*

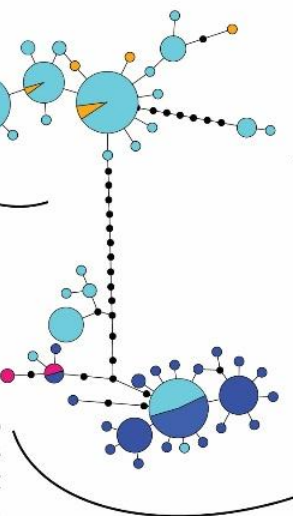

Bipolar / Cosmopolitan species  
*Lophaster furcilliger*

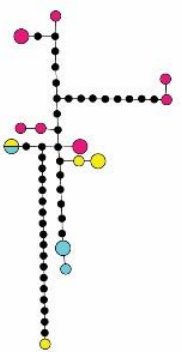

*Acodontaster* sp.

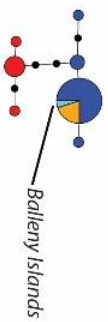

*Bathybaster loripes*  
Antarctic shelf

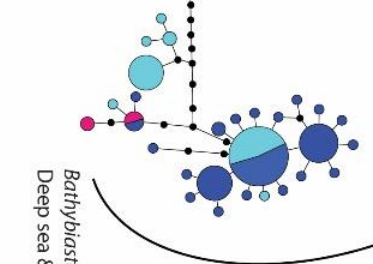

*Bathybaster vexillifer*  
Deep sea & Kerguelen Plateau



Figure 33 Characteristic phylogeographic signatures of Southern Ocean sea stars shown as parsimony networks of COI haplotypes coloured according to sampling locations. Species delineation results are presented as red clusters/rectangles for *Rhopilella hirsuta*.

\* Redrawn using data from this work and from Moore et al. (2018)

\*\* Redrawn from Moreau et al. (2019)

Table 8 Delineated Southern Ocean species in the six investigated clades, with a note regarding the need for a taxonomic revision. Counts based on available genetic sequences. SO: Southern Ocean. \*Specimens from the Kerguelen Plateau also fall into the species *Glabraster antarctica*.

Family	Genus (if found in the SO)	n of delineated species (ASAP)	n of species found in the SO and number of endemic ones	n of species found in the Antarctic and number of endemic ones	Needed systematic revision
Ganeriidae	<i>Cuenotaster</i>	1	1 – 1 (100%)	1 – 1 (100%)	No
	<i>Perknaster</i>	9	9 – 9 (100%)	9 – 7 (78%)	Yes
	<i>Cycethra</i>	2	2 – 2 (100%)	0 – 0 (0%)	Yes
Odontasteridae	<i>Odontaster</i>	8	7 – 6 (75%)	7 – 4 (50%)	Yes
	<i>Diplodontias</i>	2	1 – 1 (50%)	0 – 0 (0%)	No
	<i>Acodontaster</i>	7	7 – 7 (100%)	7 – 6 (86%)	Yes
Benthopectinidae	<i>Cheiraster</i>	4	2 – 1 (25%)	2 – 1 (25%)	Yes
Solasteridae	<i>Solaster</i> - <i>Crossaster</i> - <i>Heterozonias</i>	13	5 – 5 (38%)	3 – 2 (15%)	Yes
	<i>Lophaster</i> - <i>Paralophaster</i>	16	16 – 15 (94%)	15 – 13 (81%)	Yes
Echinasteridae	<i>Henricia</i>	20	2 – 2 (10%)	1 – 1 (5%)	Yes
	<i>Rhopiella</i>	15	15 – 15 (100%)	13 – 13 (87%)	Yes
Pterasteridae	<i>Pteraster</i> & <i>Diplopteraster</i>	14	12 – 6 (43%)	9 – 5 (36%)	Yes
	<i>Hymenaster</i>	13	12 – 11 (85%)	12 – 10 (77%)	Yes
Poraniidae (from Moore et al., 2018)	<i>Glabraster antarctica</i> *	NA	1 – 1 (NA)	1 – 0 (NA)	No
Asteriidae (from Moreau et al., 2019)	<i>Diplasterias</i>	NA	3 – 3 (NA)	3 – 1 (NA)	Yes
	<i>Lysasterias</i>	NA	4 – 4 (NA)	4 – 4 (NA)	Yes
	<i>Notasterias</i>	NA	3 – 3 (NA)	3 – 3 (NA)	Yes
Astropectinidae (From Moreau et al., 2019)	<i>Bathybiaster</i>	NA	2 – 1 (NA)	2 – 1 (NA)	Yes
	<i>Psilaster</i>	NA	4 – 2 (NA)	4 – 2 (NA)	Yes

## DISCUSSION

### Spatial and taxonomical diversity in the Southern Ocean

Uneven sampling effort is one of the main methodological limitations hampering large scale macro-ecological studies in the Southern Ocean and can generate misleading diversity patterns. In our work, spatial patterns of sea star species and genus richness are clearly correlated with sampling effort, as previously demonstrated for molluscs (Clarke et al., 2007). Furthermore, we found no conclusive evidence of a declining latitudinal gradient in species nor genus richness in the entire Southern Ocean, in contrast with other marine groups like gastropods, bivalves, pycnogonids, and echinoids (Clarke et al., 2007; David & Saucède, 2015). The lower number of genera observed south of the Polar Front may reflect reduced sampling effort in this zone, but also the effect on our analysis of the rich and distinct fauna present off southern New Zealand (Moreau et al., 2017).

Although the influence of sampling bias cannot be denied, some contrast in diversity is observed between the South American and New Zealand quadrants. This can be explained by distinct geomorphological features, the South American quadrant offering a continuum of emerged ridges (Scotia Arc), while a deep basin separates New Zealand from Antarctica. The bell-shaped richness pattern obtained from South America to Antarctica could reflect the role of the Antarctic Peninsula and Scotia Arc region as a diversification centre (Linse et al., 2007), promoting speciation by vicariance around the numerous islands of the area. Furthermore, the constant turnover in species composition observed with latitude in the South American quadrant might reflect a mixing of Antarctic and Magellanic faunas favoured by a 'stepping stone' effect along the Arc (Moreau et al., 2017). In contrast, high richness values are observed north and south of the deep-sea basin separating Antarctica from New Zealand with evidence of distinct faunas. This indicates little faunal exchange between the two distant regions.

The relatively constant species:genus ratio measured with latitude suggests a lack of specialisation and/or higher diversification of genera at high latitudes (Krug et al., 2009). This is not in line with species diversification and adaptation patterns reported for other marine groups (see, e.g. for notothenioid fish, Eastman & McCune, 2000; for echinoids, Saucède et al., 2014). Similarly, the wide taxonomic range of Southern Ocean asteroids, here confirmed by both morphological and molecular approaches, supports the hypothesis of continuous and

recent faunal exchange between the Southern Ocean and other adjacent regions. Most of the Southern Ocean families include members widely distributed in cold-water or deep-sea environments elsewhere (Mah & Blake, 2012). As already proposed for holothurians (O’Loughlin et al., 2011), this could indicate that suitable biotic and abiotic conditions have facilitated species exchange between the Southern Ocean and northernmost regions and their local settlement. This could account for the wide diversity and ecological success of asteroids in the Southern Ocean. Such a scenario may also explain the apparent absence of species flocks in Southern Ocean asteroids unlike many other classes of vertebrates and invertebrates (see Lecointre et al., 2013). Altogether, diversity patterns support the hypothesis of the recent colonisation of the Southern Ocean by asteroids that originated in northernmost regions in environments with similar abiotic conditions such as the deep sea (Brandt, 1999).

Morphological and genetic evidence shows that the diversity of Southern Ocean asteroids has been largely overlooked and most families are still in crucial need of taxonomic revision as already emphasised in previous research (e.g. Janosik et al., 2011; Moreau et al., 2019). This is particularly topical and feasible given the recent development of molecular studies (e.g. Layton et al., 2016; Christiansen et al., 2018). Several explanations can account for such a discrepancy between current taxonomy and molecular results. Mainly, 1) the lack of clear identifying tools and resources (e.g. up-to-date, interactive taxonomic keys); 2) the presence of highly polymorphic species (e.g. *Glabraster antarctica*) or, on the contrary, of morphologically very similar species complexes (e.g. *Rhopiella hirsuta*); 3) the subjectivity of identifiers (interpretation of characters, geographic location); and 4) the preservation method/status of specimens that affects morphological identification. Ways to improve the situation include the increased use of integrated taxonomy, including large-scale, standardised DNA barcoding using COI and additional genetic markers, the creation of robust diversity baselines and updated identification keys.

## Large scale phylogenetic patterns

Phylogenetic results suggest that a recent and rapid diversification occurred in most clades of Southern Ocean sea stars, a situation common to other benthic taxa in the Southern Ocean (e.g. ophiuroids, Sands et al., 2015; molluscs, González-Wevar et al., 2017; amphipods, Verheye et al., 2017). These results corroborate recent phylogenomic findings on ophiuroids from the Southern Hemisphere (O’Hara et al., 2019), which challenged the idea that diversification rates are low in polar regions, confirming similar observations found in fishes (Rabosky et al., 2018). Although contemporary asteroid diversity is likely the highest in tropical regions (Mah & Blake, 2012), the dogma that thermal energy promotes diversification is clearly contested by our results. Rapid diversification could also explain the existence of many species complexes that are problematic to taxonomists who rely solely on morphological assessments. The influence of *in situ* environmental disturbance on diversification processes, via the impact of glacial-interglacial cycles, sometimes referred to as the ‘Antarctic diversity pump’ hypothesis (Clarke & Crame, 1989; 1992), may be the main driver of the observed diversity patterns. Other hypotheses could also explain these rapid diversifications, and notably a temporal succession between successful settlement events and divergence processes by vicariance (ACC hypothesis in Pearse et al., 2009).

The suggested faunal affinities between the Southern Ocean and the adjacent regions support the scenarios of recent and recurrent faunal exchanges with South America and New Zealand (Mah & Foltz, 2011b; Moreau et al., 2017). Firstly, the presence of ubiquitous or bipolar clades in deep-sea taxa (e.g. in *Pteraster spp*; *Lophaster furcilliger*; *Bathybiaster vexillifer*; *Bathybiaster loripes*) reinforces the hypothesis of persistence in the deep sea with possible colonisation events of Antarctic shelf environments. In this framework, *B. loripes* could have diverged from its sister species *B. vexillifer* as the result of a polar emergence scenario while within *B. vexillifer*, signs of a more recent sub-Antarctic emergence scenario are detected. Secondly, in shallow waters, potential species exchanges are very likely between the Southern Ocean and other regions: South America and South Atlantic islands (e.g. *Glabraster antarctica*; *Odontaster roseus*), New Zealand (e.g. *Psilaster charcoti*; ‘*Cheiraster* complex’) or both (*Hippasteria phrygiana*; Foltz et al., 2013).

For species endemic to, or mainly distributed in the Southern Ocean, phylogeographic patterns obtained in this study are congruent with previous biogeographic works on sea stars



(Moreau et al., 2017). These patterns include the presence of: 1) affinities of sub-Antarctic species, especially between South America and the Kerguelen Plateau (e.g. *Odontaster penicillatus*; *Cycethra verrucosa*) and often including South Georgia or other Antarctic islands like the Balleny Islands (e.g. *Acodontaster sp1*); 2) circumpolarity of species present on the continental shelf (*Odontaster validus*; *Acodontaster sp2*; *Cuenotaster involutus*; *Bathybiaster loripes*) or the entire Southern Ocean (*Glabraster antarctica*; Moore et al., 2018) and 3) a partition between East and West Antarctic species (*Notasterias spp*; *Lysasterias spp*; *Diplasterias spp*) (Moreau et al., 2019).

### **Global barcode library – an asset for future studies.**

Using mtDNA barcoding only provides a limited amount of information (see Halanych & Mahon, 2018), but this approach has proved useful to gain background knowledge of taxonomy, population genetics and molecular phylogenetics (Hajibabaei et al., 2007). Deep-time relationships among distant taxonomic groups (i.e. between orders) cannot be inferred using COI mtDNA. However, even though the present work did not aim at resolving the global phylogeny of asteroides, using all sequences at once revealed similar topologies as in multi-genes phylogenies (see Mah & Foltz, 2011a, b), at least at the family level. Wrongly associated groupings can result from the lack of representative sampling, taxonomic issues, molecular saturation of COI barcode fragments or misidentifications.

Efficient barcode libraries also help pinpoint: 1) dubious identifications, and 2) target clades for further analysis. There is, however, a crucial need to increase the number of sampled taxa to improve the resolution and correctness of phylogenies and our understanding of Antarctic benthic diversity (Hajibabaei et al., 2007). In a period of growing interest in identifying and managing marine protected areas, accurate and exhaustive barcode libraries can represent a valuable asset for biodiversity assessments and should receive more consideration. For example, Schander and Willassen (2005) showed that reports on North Atlantic marine phyla could only identify two thirds of species with precision. By providing a reference for specimen identification, including juveniles and larvae (Webb et al., 2006), especially for poorly studied taxa, these databases could reduce misleading interpretations of results in several domains of expertise (e.g physiology; modelling).

## CONCLUSION

In the present study, we demonstrate that barcode libraries can be useful to analysing and understanding large-scale marine systems. Our results indicate that significant diversification events occurred recently in many clades of Southern Ocean sea stars and also highlight the important discrepancy between current taxonomy and molecular data. In addition to describing phylogeographic patterns, scenarios were proposed to explain the origin and evolution of Southern Ocean sea stars. The main scenario suggests that successive invasion and exchange events occurred between the Southern Ocean and adjacent regions with comparable environmental conditions, during periods of rapid climate change. To test for the relevance of these proposed scenarios, a significant effort should be made in terms of: 1) sampling effort, especially in deep-sea environments, East Antarctica but also in surrounding areas like South Africa or the south Atlantic islands; 2) valorisation of existing museum collections; 3) use of multi-locus molecular markers; and 4) collaboration between marine biologists working on sea stars worldwide, cooperation between biologists and the repetition of analyses also contributing to improve the accuracy of biodiversity assessments.

## ACKNOWLEDGMENTS

The work was supported by a “Fonds pour la formation à la Recherche dans l’Industrie et l’Agriculture” (FRIA) grant to C. Moreau. This is contribution no. 37 to the vERSO project ([www.rectoversoprojects.be](http://www.rectoversoprojects.be)), funded by the Belgian Science Policy Office (BELSPO, contract n°BR/132/A1/vERSO). The authors would like to thank all the persons and institutes involved in sharing the samples and sequences analysed in this study as well as research programs that made the collection of samples possible. S. Schiaparelli - University and Museum of Genoa; K. Neill - National Institute of Water and Atmospheric Research; H. Griffiths, D. Barnes and K. Linse - British Antarctic Survey; C. Gallut, N. Améziane, N. Vasset, A. Froger, G. Lecointre and A. Dettai - Museum National d’Histoire Naturelle, Paris; C. Mah - Smithsonian Institution

Programs: PROTEKER (IPEV 1044, French LTER ZATA), POKER 2, REVOLTA (IPEV 1124), CEAMARC, ANTFLOCKS, JR144, JR179, JR230, JR262, JR275, JR287, JR15005, ACE – ASCCC



# General discussion



# General discussion

Since its discovery and first explorations of its ecosystems, the Southern Ocean never stopped fascinating explorers and scientists. Despite the ever-growing interest into studying these high latitudes, difficulties to access the southernmost ocean and continent have shaped the relatively poor scientific knowledge of these atypical environments, as underlined by the first Horizon Scan conducted by the Scientific Committee for Antarctic Research (SCAR; Kennicutt et al. 2014, 2015). Recent efforts, notably the Census of Antarctic Marine Life (CAML; Schiaparelli et al., 2013), are adding knowledge to a legacy of 150 years of scientific investigations, allowing major improvements in our understanding of the Southern Ocean. As a consequence, incompleteness in the spatial and temporal cover of biological (see Griffiths et al., 2014; Gutt et al., 2012) and environmental (Post et al., 2014; Trull et al., 2018) records has inevitably decreased over time, but the effect of this biases on macroecological studies persists (e.g. Pierrat et al., 2013; Fabri-Ruiz et al., 2018). During my thesis, a significant effort has been made to compile the results of decades of scientific collaborations under the form of an extensive asteroid occurrence database (Figure 34; Moreau et al., 2018) together with a barcode library, initiated in the CAML framework (Schiaparelli et al., 2013). Despite the improved availability of data, this thesis highlights the importance of sampling bias and the need for more and a better use of data (**Chapters 1, 2 and 3**).

This manuscript also happens at a time when the classic viewpoint about diversity and biogeographic patterns of marine life in the Southern Ocean are more and more often challenged and refined by technological development in term of scientific or operational methods (e.g. Koubbi et al., 2014). Some ideas such as the high levels of endemism seem well founded but other postulations like the circumpolar distribution of most Antarctic species, their Gondwanan origin or the low diversity level of polar communities may well be based on simplistic or incorrect assumptions (Halanych & Mahon, 2018). Refining our understanding of diversity distribution in the Southern Ocean will bring a better knowledge of the drivers at play in the determination of biogeographic patterns.

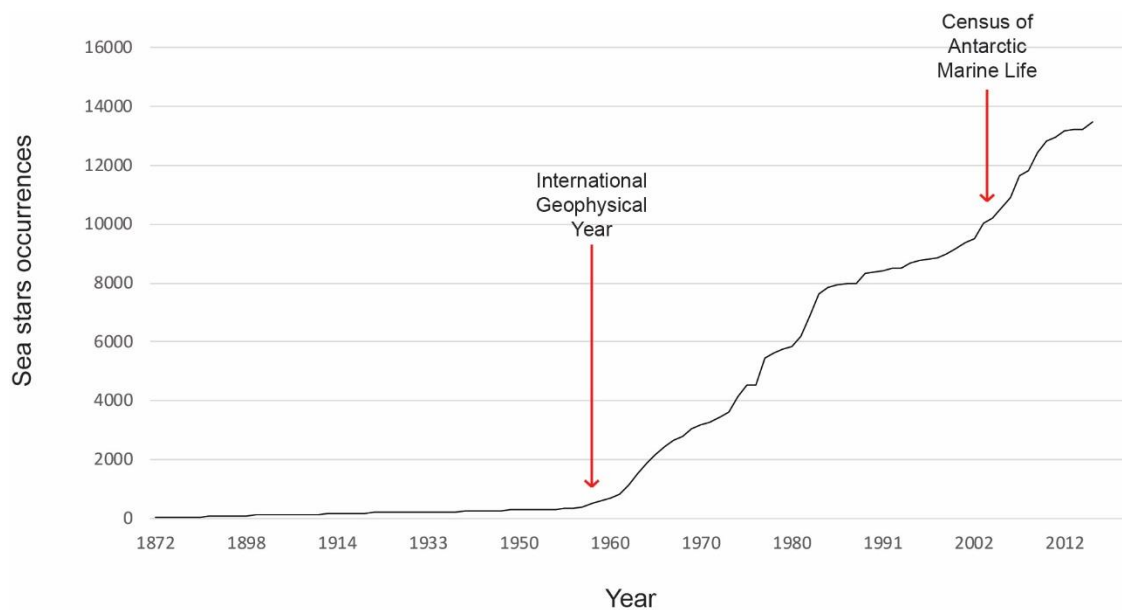

Figure 34 Accumulation curve of Southern Ocean sea stars occurrences available through time (1872-2014) with indication of major international research programs. Data from Moreau et al., 2018.

#### a. Sea star diversity in the Southern Ocean

##### An ill-evaluated diversity

**Morphology-based Taxonomy**, by attributing species names to organisms, is the founding work and usually first approach used for biodiversity studies. As species are often the basal units of ecological studies, accurate identification is essential to carry on robust scientific investigations. One of the main results highlighted by molecular works from **Chapters 2** and **3** is however the obsolete nature of species taxonomy of many Southern Ocean sea star representatives. In nearly all the investigated families, discrepancies were found between morphology-based identifications and results obtained using molecular tools.

Since the earliest descriptions (e.g. Bell, 1881; Sladen, 1889), the taxonomy of sea star genera has been subject to many changes, reappraisals and keeps being reassessed either based on diagnostic morphological characters or using molecular tools (Janosik & Halanych, 2010; Mah & Foltz, 2014; Mah et al., 2014). The studied genera (**Chapter 2**) make no exception. Tedious was the task to differentiate species based on morphological characters but even more tedious is the task to extract a clear diagnosis from the many descriptions, re-

descriptions and synonymies established for each species (e.g. Koehler, 1917, 1920; Bell, 1881; Clark, 1962). The systematics of the broadcasting genera *Bathybiaster* and *Psilaster* have, for example, been subject to discussion for almost a century when in 1923, HL Clark pointed out the morphological similarities between *B. vexillifer* and *B. loripes* in his work on the echinoderm fauna of South Africa (Clark, 1923). Later, Fisher (1940) came to similar conclusions in his Discovery Reports and continued analyses by indicating the close morphological similarity between *Bathybiaster* and *Psilaster* except for *P. charcoti* “the least *Bathybiaster*-like of any *Psilaster*” (Fischer 1940). Mortensen (1927) also doubted whether *Bathybiaster* and *Psilaster* should be assigned to distinct genera (Mortensen, 1927). More recently, Clark and Downey (1992) highlighted the important morphological variations within the genus *Psilaster* (*P. charcoti* excluded) “making clear identification rather complicated” (Clark and Downey 1992). Similarly, the taxonomy of the brooding genera under study has proved to be extremely variable. The first point is a rich synonymy between nominal species of the three genera of interest evidencing important taxonomic issues. In the genus *Notasterias*, the existence of strong morphological variations in diagnostic characters were pointed out by Clark (1962) who also raised doubts about the distinction between *Notasterias stolophora* and *Notasterias armata*. Likewise, he proposed that *Notasterias bongraini* could be a synonym to *Notasterias pedicellaris* and indistinguishable from *N. armata* in dorsal view while diagnostic characters are “not invariable” in ventral view. Similarly, Jangoux & Massin (1986) indicated that *Notasterias candicans* could be closely related to *N. armata*. The genus *Diplasterias* has also been subject to vivid debates. Koehler (1917) questioned the assignment of *Diplasterias spinosa* to the genus *Diplasterias* but described it from a single specimen in bad conservation state. This same year, he described the new species *Diplasterias kerguelensis* based on juveniles, although individuals at this stage can lack species diagnostic characters and therefore belong to an already described species. In 1962, Clark expressed his doubts about the taxonomic difference between *D. brucei* and *D. brandti* and later, Fisher (1940) indicated that a six-rayed *Diplasterias octoradiata* could “give future systematicists something to puzzle over” regarding its resemblance with *D. meridionalis*. Finally, the genus *Lysasterias* makes no exception to the above remarks. Fisher (1930) questioned the validity of the genus diagnostic characters. Later, in 1940, he showed evidence of skeleton degeneration with age certainly leading to character misinterpretation. He also highlighted the polymorphism of *Lysasterias perrieri*, the putative synonymy between *Lysasterias hemiora* and *L. perrieri*, the



similarity between *Lysasterias heteractis* and a *L. perrieri* with eight arms and stressed the critical effect of preservation on species identification.

Similar conclusions might undoubtedly be drawn for other representatives of the Asteroidea when more thorough investigations will be undertaken (see **Chapter 3**). Several factors can be listed to account for taxonomic issues. 1) The lack of clear identifying tools and resources (e.g. interactive taxonomic keys), the identification of species based on their known biogeographic distribution only (Diaz et al., 2011; Saucède et al., 2015), on juveniles (Roberts et al., 2014) or on inappropriately preserved specimens (Meyer, 2016). 2) The focalisation of specialists on restricted geographic areas without considering the surrounding regions and neglecting per consequence the work of other taxonomists. 3) The presence of cryptic species, species complexes or highly polymorphic species making the assessment of diversity based on morphology only rather troublesome.

To overcome the baffling problem of accurate morphology-based identification, several solutions exist but require an important investment in time and money. First, there is a need for a compiling effort of the existing literature describing species synonymy, diagnosis and morphology. Secondly, the creation of a baseline based on barcode DNA sequences would ensure relevant specimens' identification as it has been demonstrated to be a valuable approach for other organisms (Hebert et al., 2003). It is extremely important that both solutions are used in an integrative framework (DeSalle et al., 2005), for example through the development of knowledge bases, by compiling various types of data (e.g. photographs, identification keys, field guides, original descriptions, genetic sequences). In the Southern Ocean, major efforts were made under the umbrella of the Census of Antarctic Marine Life in 2005 and the International Polar Year in 2007-2009 (Grant et al., 2010) to create a baseline using DNA barcoding. Although this work was substantial and represented a great advance in the building of an extensive and efficient barcode library, many efforts are still needed. Other assets of extensive barcode libraries include the characterisation of juveniles or larvae for which only little is known in most species while they have an important role in determining distribution patterns (Heimeier et al., 2010; Janosik et al., 2008; **Chapter 1 and 2**).

**Sampling bias** is another considerable constraint to meaningful assessments of Southern Ocean sea star diversity. Despite significant technological advances since the age of the first pioneers, fieldwork remains very costly, time consuming and challenging today. A more thorough sampling effort is still necessary at the scale of the entire Southern Ocean (Griffiths et al., 2014). The high correlation between sampling effort and species richness as showed in **Chapter 3**; species accumulation curves of **Chapter 1**, which rarely reach the asymptote; and the Jackknife extrapolator index predicting the presence of ~370 species (+32%) in **Chapter 1** and **3** all suggest that our knowledge of Southern Ocean species richness only represents the tip of the iceberg. Unfortunately, and for obvious logistic reasons, areas located far away from scientific research stations and the common routes of research vessels are seldom investigated (Griffiths et al., 2011). Access to biodiversity data on such poorly sampled areas would certainly enhance the quality of analyses and the impact of scientific results. In large-scale studies, this would significantly contribute to filling significant gaps in our understanding of species biogeography. In the absolute, it seems that the quantity and quality of data are lacking for robust and comprehensive studies in the Southern Ocean (Griffiths et al., 2014). However, by taking a closer look at the worldwide distribution of sea star records from the Ocean Biogeographic Information System (OBIS), this assertion is somewhat softened. The surrounding waters of three regions of the world have been clearly more investigated than the rest (*i.e.* North America, western Europe and Indo-Pacific region; Figure 35), but the Southern Ocean has been subject to broad-scale sampling, even if some areas/regions remain poorly sampled. Using whole oceanwide studies could suggest connectivity patterns despite the absence of samples in these regions. Finally, as presented in **Chapters 2** and **3**, the Southern Ocean is not a closed and entirely isolated system and many faunal affinities were highlighted with areas located further north. Unfortunately, very few specimens are available from South America or the southern part of Africa while they could help better delineate broad biogeographic patterns and processes. Similarly, the deep-sea remains poorly studied and findings from this thesis argue for oceanwide relationships (ubiquity or bipolarity) and a key role of deep-sea fauna in the origin and evolution of Antarctic biogeographic patterns (**Chapter 2** and **3**).

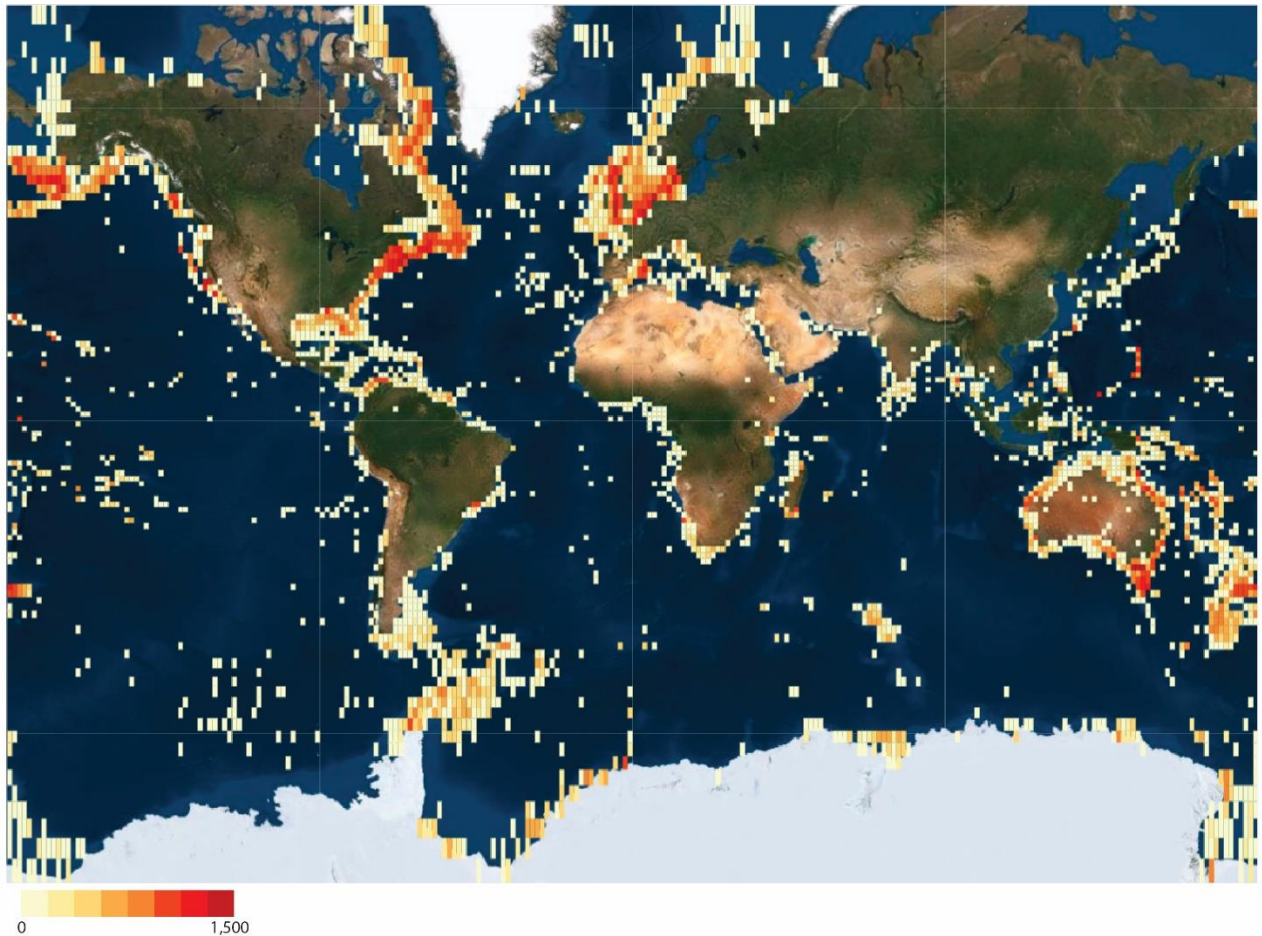

Figure 35 Number of occurrence records for sea stars (from 1919 to 2019) available from the Ocean Biogeographic Information System.

**Easy access to existing samples** and data is the last major methodological issue to overcome. Even if marine biologists studying the Southern Ocean collaborate through an international networking and despite the Antarctic Treaty article III.1.c stating, “Scientific observations and results from Antarctica shall be exchanged and made freely available” (Antarctic Treaty Consultative Parties, 1959), many scientists still remain timorous with the idea of sharing samples and/or data they worked hard to obtain. Furthermore, there is perhaps a profound misunderstanding in the way science is funded in general, with a shift to support more and more applied over fundamental research (Courchamp et al., 2015). Finally, a gap persists between the (high) funds allocated to new fieldwork expeditions (to obtain more samples, to be physically present for political reasons or to communicate about it) and the (low) allocation to process the enormous amount of samples and data generated by these expeditions. At an individual level, scientists should be encouraged to publish or make accessible their existing samples databases which are often more detailed and linked to

various content (photograph, DNA sequence etc...), providing more exhaustive information than expedition reports or occurrences databases.

Following this thought, promoting the use of museum collections would greatly contribute to improving the taxonomy of many taxa. These collections are underused while they should have a fundamental role in biodiversity assessments. Meineke et al. (2018) suggest that specimens deposited in natural history museums have the potential to transform the field of global change biology. They also point out the threats due to budget cuts and other institutional pressures that these resources are subject to.

The obvious solution to that final problem is the promotion and funding of exchanges between experts and institutions to study collections but also the training and recruiting of personnel to process existing samples and policies to finance institutions and allocate more funding to process the samples. Some initiatives, like the European Collections Infrastructure SYNTHESYS, which aims at bringing together 115 museums from 21 countries and promotes access and resources for research users in the natural sciences already exist, but such projects need to be developed and extended.

### **Consequences for the quality of research**

As taxon identification is a prerequisite to many biological studies, spurious identifications are not without consequences for biodiversity studies and inventories, generating taxonomic disagreements within the scientific community. This impacts the quality of diversity assessments and scientific outputs in all ecological studies based on taxonomy with sometimes noxious effects on exploitation (Garcia-Vazquez et al., 2012), conservation or policy management (McGeoch et al., 2012). Ensuring that taxonomy is maintained up to date is particularly important for conservation issues and a wide range of research field, from biogeography to macroecology, species distribution modelling and ecophysiology. Extensive databases like the one used in the present thesis have their own limitations in particular when working at species level. This implies that results presented in **Chapter 1** of the present thesis may need to be supported by improved taxonomy at least at species level, although the genetic study presented in **Chapter 3** tends to partly support them (see section “patterns”).

Similarly, general phylogenies of the class Asteroidea are still not fully reliable. Either based on very few specimens (one per order in Linchangco et al., 2017) or few genetic markers

(three markers and a total length of 1,307 bp in Mah et al., 2010 a and b) these can only reflect little phylogenetic information and might sometimes be misleading. A comparable limitation can be found in the calibration of molecular clocks and the estimation of evolutionary events timings in the Southern Ocean. They are often based on more or less close relatives and mutation rates estimated from other regions (mainly based on mitochondrial markers and the closure of the Isthmus of Panama). Calibration using fossils is an alternative but was not possible in this thesis due to intrinsic issues in sea star fossilisation (incompleteness of the fossil record) and their near absence at high latitudes.

In this framework, the use of advanced molecular tools represents an ideal step forward to address biogeographic issues in the Southern Ocean with accuracy. Results from **Chapters 2** and **3** are here to demonstrate that even the use of a single mitochondrial marker (COI) can answer many questions about the evolution, distribution or diversity of benthic organisms as previously highlighted in other studies (e.g. Hemery et al., 2012; González-Wevar et al., 2017). COI also helps as a basal tool to pinpoint where further investigations are needed like in my work regarding diversity reassessments or faunal affinities. Nevertheless, whether in terms of patterns (endemism, eurybathy, circumpolarity, connectivity) or processes (role of reproductive strategy, timing of radiations, evolutionary history), high-throughput sequencing methods will improve our understanding of Southern Ocean biogeography (Halanych & Mahon, 2018).

Such approaches and methods are still slowly applied to Southern Ocean case studies by the community of Antarctic marine biologists. Only two studies using population genomics on invertebrates is available for the Southern Ocean brittle stars *Ophionotus victoriae* and *Astrotoma agassizii* (Galaska et al., 2017a, 2017b) while this approach holds tremendous potential for understanding the genetic relationships and phylogeography (Reitzel et al., 2013). Applying these molecular methods can be time-consuming, often taxon-specific and the cost of such analyses is particularly high. Altogether, it represents the main limitations to future developments. It is important to note that applying modern methods does not preclude the importance of more traditional morphology-based methods. Both methods will have to be used in concert in the future to enhance diversity assessments.

## **b. Distribution and genetic patterns in Southern Ocean sea stars**

### **Biogeography versus phylogeography**

By characterising the phylogenetic deployment of lineages in the geography, phylogeography represents new developments in biogeographic studies (Arbogast & Kenagy, 2001). In the marine realm, biogeography and phylogeography encompass half a billion years of genetic evolution and the largest habitat on the planet making generalisations arduous, but some are especially robust (Bowen et al., 2016). As postulated at the beginning of this discussion, the Southern Ocean makes no exception when it comes to consider the discrepancies between morphological-based and molecular-based evaluation of diversity, leading to underestimates in the roles of various evolutionary processes (**Chapters 2 and 3**; Arbogast & Kenagy, 2001).

Generally speaking, main biogeographic patterns revealed in **Chapter 1** for sea stars in the Southern Ocean are congruent with previous studies performed on other taxa (echinoids, bivalves, gastropods, Pierrat et al., 2013; amphipods, De Broyer & Jazdzewska, 2014), but these results should be considered carefully. The inconsistencies between morphological and molecular-based identifications highlighted in **Chapters 2 and 3** make the interpretations of biogeographical patterns at the species level not as reliable as previously thought. For example, the mixing between South American and Antarctic sea star faunas along the Scotia Arc is not so obvious. South American species seem to have more affinities with those of South Georgia and the sub-Antarctic islands regardless of the reproductive strategy (**Chapter 2 and 3**). On the contrary, the East-West Antarctic differentiation observed in **Chapter 1** is also highlighted by molecular analysis performed on the brooding genera of **Chapter 2**. Similarly, affinities with New Zealand are confirmed but they seem to be present between species found at deeper depths. Overall, results brought by the global biogeographic analysis are congruent with the phylogeographic analysis. However, the former is based on an extensive database while the latter is more specific and focuses on fewer taxa. In summary, the global investigation of patterns differs from the detailed ones by smoothing the results and building generalities, making a proper comparison of the two approaches rather delicate.

## Diversity patterns

The world ocean covers 71% of Earth's surface and provide 900 times more liveable habitat volume than what is available on land (Costello & Chaudhary, 2017). It appears ideal for studying global scale patterns of life distribution with large, well-connected areas at all latitudes and relatively stable, slow-changing temperatures (Costello & Chaudhary, 2017). Yet, and despite this enormous habitat availability and the fact that life has evolved for a longer time in the sea, only 16% of described species on Earth are marine species (Costello et al., 2013). With the deep sea representing around 60% of the planet's surface, it is clear that no area encompassing such environments should be seen as closed systems. My results, whether obtained from morphological or molecular studies, show that diversity patterns do not always end where the determined boundaries of the studied area do (**Chapter 2** and **3**). Incorporating samples and areas from outside the Southern Ocean has proven to be an asset in **Chapters 2** and **3** and reinforces the idea of a Southern Ocean that is not so isolated even south of the Polar Front (e.g. Clarke et al., 2005).

When integrating molecular approach and the inclusion of surrounding areas, the impact on levels of endemism is straightforward by revealing affinities that were ignored before (**Chapter 2** and **3**). Using only the morphological approach in the **first Chapter**, I showed that levels of endemism were lower than previously estimated even though they remain high (59% in the Southern Ocean and 29% south of the Polar Front). **Chapter 3** comforted this trend and by revealing novel molecular affinities within and beyond the Southern Ocean suggesting that further work will reduce even more the measured endemism.

Finally, and in accordance with a recent study on 65,000 marine species (Chaudhary et al., 2017) I showed that there is no evidence for a diversity gradient decreasing the polewards for sea stars (**Chapter 3**). This general pattern has dominated theoretical discussions and analyses but is based on terrestrial systems where solar energy influx seems to drive diversity (Valentine & Jablonski, 2015) while this is less evident in marine systems. This last point brings an additional argument regarding the underestimated diversity at high latitudes.

### c. Biogeographic processes in the Southern Ocean

The observed patterns of distribution and diversity result from a variety of ecological and evolutionary processes shaping and explaining them (Saucède et al., 2014). Speciation, extinction, adaptation followed by radiation and dispersal all played a role and led to the distinctiveness of Southern Ocean life (Rogers, 2007; Pearse et al., 2009; Krug et al., 2010).

Tectonic and oceanographic factors, through geomorphology (geographic isolation, deep-sea surroundings), and the setting up of marine fronts and currents have notably contributed to the partial isolation and endemism of the Antarctic marine benthos including sea stars (**Chapter 1 and 3**; Marques & Cantero, 2010). On the other hand, the Antarctic Circumpolar and Coastal Currents have played a homogenising role explaining circumpolar distribution patterns at the scale of the entire Southern Ocean or at lower scales (**Chapter 1, 2 and 3**, Moore et al., 2018; Hemery et al., 2012). Endemism has also been reinforced by *in situ* extinction, adaptation and speciation events (see Dayton, 2013) that were conditioned by climatic changes of the Cenozoic. Glacial temperatures clearly promoted the expansion of certain taxa through adaptation and radiation (e.g. glycoproteins in notothenioid fishes) and conversely, the extinction of taxa that did not adapt to the cooling (e.g. durophagous predators). Until now, there is no evidence of adaptive radiation at the origin of Southern Ocean sea stars, and results of this thesis rather suggest an ecological success of the group due to the wide ecological niche of most species (**Chapter 3**). The climatic history of the Southern Ocean can however not only be summarised by the “global Cenozoic cooling”. The 38 Pliocene-Pleistocene glacial cycles that occurred over the last 5 Myr (Naish et al., 2009) also impacted habitats and life in the Southern Ocean. Glacial cycles leading to population fragmentations may have had a tremendous effect on *in situ* diversification by promoting speciation following the “Antarctic diversity pump” hypothesis proposed by Clarke & Crame (1992; **Chapter 2 and 3**) but also probable extinctions (Krug et al., 2009). The numerous and recent diversification events suggested in our time-calibrated phylogeny, leading to species complexes can certainly be explained by these recent glacial cycles (**Chapter 2 and 3**). The hypothetical collapse (Bamber et al., 2009; Pollard & DeConto, 2009) of the West Antarctic ice sheet, allowing a trans-Antarctic passage between East and West Antarctic was also suggested in our analyses as a potential vicariant event explaining disparities between these two regions



(**Chapter 1** and **2**; Barnes & Hillenbrand, 2010; Linse et al., 2006; Pierrat et al., 2013). This passage has already been suggested using microsatellites data in the octopus *Pareledone turqueti* (Strugnell et al., 2012) but remains to be confirmed with more samples from the East Antarctic and other taxonomic groups.

Finally, the reproductive strategy of sea stars in concert with dispersal vectors have been of particular interest all along the thesis to explain diversity patterns. Overall, brooders account for low fecundity, high survival and a limited dispersal capacity. On the contrary, broadcasters have a high fecundity and a low survival rate of their larvae. However, this link is not always straightforward, notably due the various passive and active dispersal vectors at play in the Southern Ocean (see **Chapter 1** and **2**; Held, 2014). I showed, in **Chapters 1** and **2**, the importance of this life history trait on biogeographic and phylogeographic patterns. Its effect in shaping the genetic diversity and species richness has however not been demonstrated (**Chapter 2**). The constant effect of disturbances of glacial cycles over the last 5 Myr, isolating and reducing population effective size, the enormous size of the Southern Ocean and the numerous islands found there, might explain the lack of clear effect on diversity and richness but needs further investigations.

Interestingly, brooding was first considered as an adaptation to cold temperatures (the “Thorson Rule”; Thorson, 1950) and the many observations of this behaviour in the Southern Ocean gave arguments to validate this hypothesis for several decades (Thomson, 1876; Murray, 1885). We can however not deny that many Southern Ocean invertebrates and sea stars display a pelagic phase in their life cycle, raising questions about “Thorson Rule” and the prevalence of brooding behaviour in colder waters. Data regarding ecological traits of asteroid species are sparse but a compiling realised in the framework of my work references 37 asteroid species as brooders against 22 broadcasters (**Chapter 1**). The fact that brooding is by far easier to observe than the release of pelagic larvae (e.g. spawning induction, pelagic sampling) reinforces the idea that this trait is not dominant in Southern Ocean sea stars and cannot be considered as an adaptation to freezing conditions (Poulin et al., 2002).

Conclusion

&

Perspectives



# Conclusion & Perspectives

This thesis had three main objectives: 1) to characterise distribution patterns of Southern Ocean sea stars at wide spatial scale while considering species reproductive strategy, 2) to study the spatial structure of genetic diversity in clades with contrasting reproductive strategies, and 3) to explore a global phylogeny of the entire class to unravel its putative origin and evolution in the Southern Ocean.

The biogeographical approach (**objective 1**) relied on the most extensive database developed for this purpose in the Southern Ocean. It allowed me to show that distribution patterns in Southern Ocean sea stars are consistent with other taxonomic groups, underlying a common history, at least partly, for the Southern Ocean benthos. I also highlighted the role of reproductive strategy in the determination of these patterns, proving that this life history trait does have an influence at a large-scale basis and helps in identifying the underlying processes at play.

Complementing this work using a molecular approach on genera with contrasted reproductive strategies (**objective 2**) brought additional support into the relevance of considering this life history trait in macroecological studies. I showed that reproductive strategy could have conditioned the spatial structure of genetic diversity while not affecting the level of genetic diversity itself. My results also indicate that an in-depth taxonomic revision of the group is fundamentally needed, questioning in the meantime the results from the first objective at species level.

Finally, the analysis of the entire clade class using a barcode library (**objective 3**) helped to demonstrate the efficiency of such molecular tool in studying large-scale marine systems. My results indicate recent diversification events (within the last 5 Myr) together with an important discrepancy between current taxonomy and molecular data, the former being the potential cause of the latter. I also propose a main scenario describing the origin of Southern Ocean sea stars fauna with successive invasions and exchange events between the Southern Ocean and adjacent regions with comparable environmental conditions, during periods of rapid climate change.

The macroecological approach is important to understand how species biogeography was shaped at wide spatial scale and its potential evolution in the future in a fast-changing environment. Overall, my work underlines the need for a more thoughtful use of available data and more comprehensive sampling effort in the Southern Ocean but also in its surrounding regions and especially in the deep sea. Getting a more extended point of view, by sampling novel areas and promoting the use of existing samples, will help understand with higher precision the impact of the evolutionary and ecological processes at play in the Southern Ocean. It will also help to capture with more precision the levels of diversity in the Southern Ocean and refine distribution patterns. Although it is hard to conceive a study at the scale of an entire class and an entire ocean, the use of a few well-targeted species or genera proved to be fruitful. My ambition was to work at these large spatial and taxonomical scales, acknowledging their limits and strengths.

A lot more work remains to be done to fully understand diversity and processes in the Southern Ocean. The advent of high-throughput sequencing methods appears to be a promising solution for this endeavour, but it will require integrative approaches, notably including taxonomic revisions. Future prospects of particular interest include the study of relevant species to answer questions regarding the processes at the origin of the Southern Ocean benthic fauna. In this framework, the genus *Bathybiaster* appears to be a perfect candidate. High-throughput methods could indeed give important insights in processes such as the polar emergence and sub-Antarctic emergence or on patterns like bipolar or cosmopolitan distributions. On the other hand, brooding species seem ideal to study, with these same tools, the existence and role of the potential trans-Antarctic seaway. Finally, an effort is crucially needed to reconcile morphology-based and molecular-based identifications by re-examining the specimens used for original descriptions and by universalising the use of barcode libraries and multi-locus phylogenies to delineate species with more certainty.

## From data mining to archiving

All the data collected, obtained through lab work and used in the framework of this thesis have been deposited into several online, open-source data repositories.

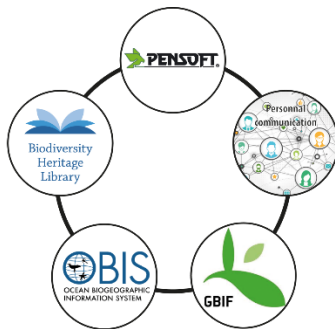

### Data collection

All **occurrence data** were acquired from various sources: specialised information system (OBIS, GBIF, ANTABIF), legacy literature and old cruise reports (Biodiversity Heritage Library), data papers (e.g. Zookeys, Biodiversity Data Journal), collaborations within the scientific community and additions of newly identified specimens. All barcode **genetic sequences** obtained for this thesis either through lab work or from previous private or public datasets available in the Barcode of Life Data System.

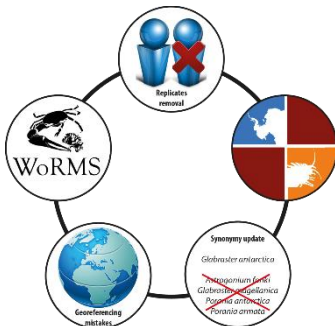

### Data treatment

All **occurrences** were checked individually to ensure quality standards such as: the absence of replicates, a correct georeferencing, an up-to-date nomenclature (using the taxon-match tool implemented in WoRMS). Each occurrence was then associated with a depth (GEBCO) and a bioregion based on their geographic coordinates. Electropherograms of each **genetic sequence** were inspected when available to ensure the quality of the consensus sequences. The absence of stop codon was also ensured

### Data availability

All **occurrences** data are published and openly available through an Integrated Publishing Toolkit ensuring a free access to biodiversity data. All barcode **genetic sequences** are now freely available via the Barcode of Life Data System. These sequences are linked to photographs, identifications and metadata regarding their sampling.

**BOLD**  
SYSTEMS



# Appendices





# Appendix 1

- **Moreau, C.**, Saucède, T., Jossart, Q., Agüera, A., Brayard, A., & Danis, B. (2017). Reproductive strategy as a piece of the biogeographic puzzle: a case study using Antarctic sea stars (Echinodermata, Asteroidea). *Journal of Biogeography*, 44(4), 848-860.  
→ **Chapter 1**

- **Data source and quality control for Southern Ocean Asteroidea**

Data were consolidated using biodiversity information systems (biodiversity.aq, Van de Putte *et al.*, 2016; OBIS, IOC 2016 and through the GBIF data portal) and were complemented with additional data from published literature, including original manuscripts, data papers (e.g. Gutt *et al.*, 2014; Moles *et al.*, 2015), and cruise reports. Additional data were obtained from personal communication with Marc Eléaume, Christopher Mah, Vladimir Laptikhovsky and Anna Jazdzewska. The final working dataset was checked with the WoRMS database (WoRMS Editorial Board, 2015) using the Taxon Match Tool in order to match our data with the most up-to-date taxonomy. The database was cleaned up in order to remove all duplicates due to overlapping origins, georeferencing errors and species synonymy or mis-spelling. Only occurrences for specimens identified at the species level were kept in the working database.

- **References used to build the database**

Available online at <https://onlinelibrary.wiley.com/doi/full/10.1111/jbi.12965>

- **Bootstrap Spanning Values for each BSN**

Species level	BSV
Bouv_Bal&Sco	0,9981
DS&WL_Bal&Sco	0,9332
Heard_Cro	0,9964
Ker_Heard	0,9944
Mac_Cro	0,6308
PBay_ALand	0,9997
PEd&Mar_Cro	1
PEd&Mar_Ob&Lena	0,9889
QML&EL_PBay	0,9337
Ross_ALand	1
Ross_Bal&Sco	0,9972
SG&Sha_AP&SSh	0,9999
SOrk_AP&SSh	1
SOrk_SG&Sha	0,9996
SSand_SG&Sha	0,9818
TdF_Cro	0,9978
TdF_Fal	0,9998
TdF_SArg	0,9999
TdF_SChi	0,9991
TdF_SOrk	0,9999
WS_AP&SSh	1
WS_Ross	1
Bount&Ant_Cam&Auc	1

Genus level	BSV
Ob&Lena_PEd&Mar	0,8639
PEd&Mar_Cro	0,9876
Cro_Heard	0,9409
Heard_Ker	0,9979
Ker_SG&Sha	0,9227
SSand&SG_Sha	0,7099
AP&SSh_SG&Sha	0,9917
AP&SSh_SOrk	0,9998
TdF_SOrk	0,9816
TdF_Fal	0,9899
Fal_SArg	0,9722
SArg_SChi	0,9771
SOrk_WS	0,9961
WS_Ross	0,9805
WS_PBay	0,9937
WS_ALand	0,99350126
PBay_ALand	0,9998
PBay_Bal&Sco	0,9908
Bal&Sco_Bouv	0,9971
DS&WL_Bal&Sco	0,7573
ALand_QML&EL	0,9326
Cro_Mac	0,6624
Bount&Ant_Cam&Auc	1

Brooders	BSV
Cro_PEd&Mar	0,9906
PEd&Mar_Ker	0,7486
PEd&Mar_Heard	0,9808
Heard_TdF	0,8572
TdF_SArg	0,9955
SArg_Fal	0,9836
Fal_SChi	0,8806
TdF_SG&Sha	0,985
SG&Sha_AP&SSh	0,9991
AP&SSh_SOrk	0,9982
SOrk_PBay	0,9962
PBay_ALand	0,9994
WS_ALand	0,9922
ALand_Ross	0,9994
Ross_DS&WL	0,9657
DS&WL_Bal&Sco	0,8993
DS&WL_QML&EL	0,8019
DS&WL_Bouv	0,9411
Bouv_SSand	0,8505
SSand_Ob&Lena	0,9147
Cam&Auc_Bal&Sco	0,8568

Broadcasters	BSV
Ker_Ob&Lena	0,9993
Ob&Lena_Heard	0,987
Heard_PEd&Mar	0,9988
Heard_Cro	0,9998
Cro_TdF	0,9883
TdF_Ross	0,9912
Ross_Bal&Sco	1
Bal&Sco_PBay	0,9993
PBay_DS&WL	0,8269
Ross_Bouv	1
Ross_SOrk	1
SOrk_WS	1
WS_ALand	0,9998
WS_SSand	0,9687
SSand_Fal	0,767
SOrk_AP&SSh	1
AP&SSh_SG&Sha	0,9998
Bouv_QML&EL	0,8828
QML&EL_SArg	0,8376
SArg_AS&BS	0,765
SChi_AS&BS	0,9467
Mac_AS&BS	0,8733
Bount&Ant_Cam&Auc	0,9609

## Appendix 2

- **Moreau, C.**, Danis, B., Jossart, Q., Eléaume, M., Sands, C., Achaz, G., Agüera, A., & Saucède, T. (2019) Is reproductive strategy a key factor in understanding the evolutionary history of Southern Ocean Asteroidea (Echinodermata)? Ecology and Evolution, (Accepted).  
→ **Chapter 2**

- **Metadata associated with barcode sequences**

Available online at <https://onlinelibrary.wiley.com/doi/10.1002/ece3.5280>

- **Statistical Parsimony networks**

Statistical Parsimony network indicating genetic relationships among sampling locations for each genera of interest. Major delineated clades are represented on maps attached to each haplotype network. Inter-specific distance between delineated entities using the K2P model are also presented for each genus.

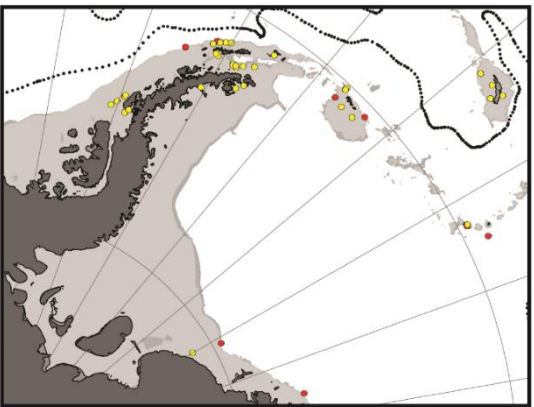
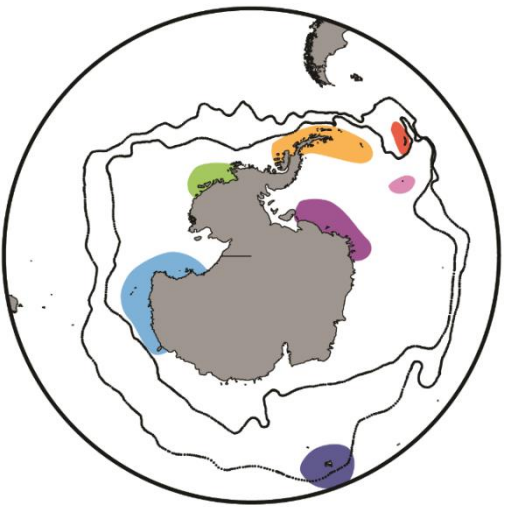

*Bathybiaster* sp1

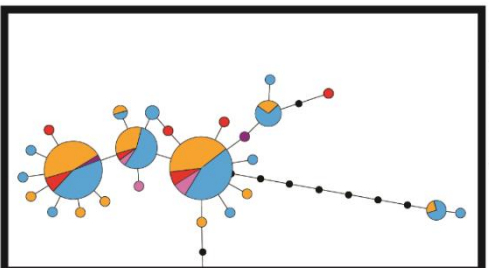

*Bathybiaster* sp2

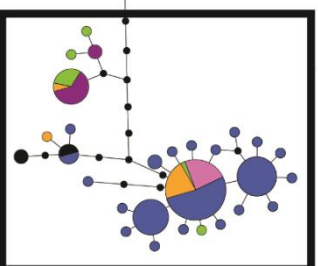

Sample collection area

● Arctic Regions  
○ Refer to the map on the left

Entry 1	Entry 2	Distance
<i>Bathybiaster</i> sp1	<i>Bathybiaster</i> sp2	0.03

Estimated divergence between delineated entities. Conducted using the Kimura 2-parameter model.

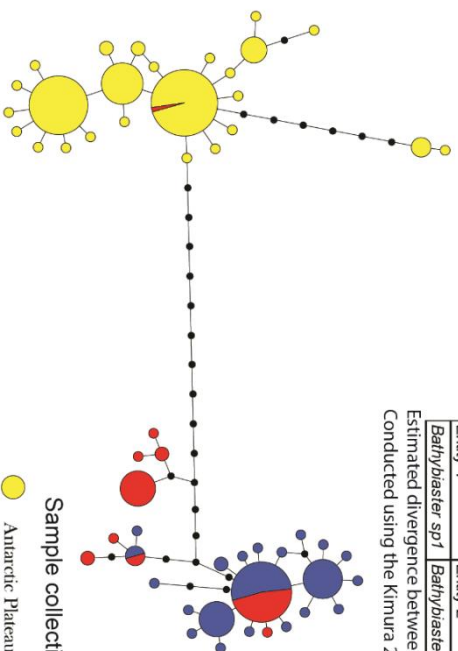

Sample collection particularities

- Antarctic Plateaus
- Antarctic Slopes, canyons and troughs
- Kerguelen Islands



# Appendix *Psilaster charcofi*

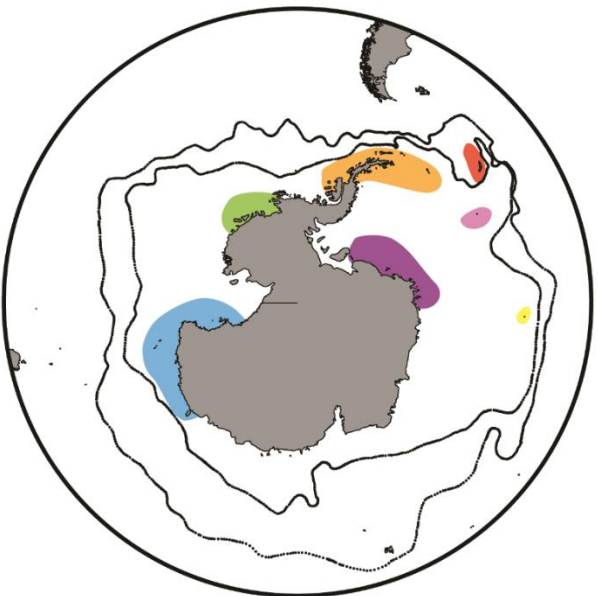

- Sample collection area**
- South Georgia
  - Bouvet Island
  - Amundsen Sea
  - South Sandwich Islands
  - Weddell Sea
  - East Antarctic
  - Antarctic Peninsula
  - New Zealand

Entity 1	Entity 2	Distance
<i>Psilaster charcofi</i> Clade 3	<i>Psilaster charcofi</i> Clade 2	0.02
<i>Psilaster charcofi</i> Clade 3	<i>Psilaster charcofi</i> Clade 1	0.041
<i>Psilaster charcofi</i> Clade 2	<i>Psilaster charcofi</i> Clade 1	0.043
<i>Psilaster charcofi</i> Clade 3	<i>Psilaster charcofi</i> Clade 4	0.032
<i>Psilaster charcofi</i> Clade 2	<i>Psilaster charcofi</i> Clade 4	0.035
<i>Psilaster charcofi</i> Clade 1	<i>Psilaster charcofi</i> Clade 4	0.05

Estimated divergence between delineated entities.  
 Conducted using the Kimura 2-parameter model.

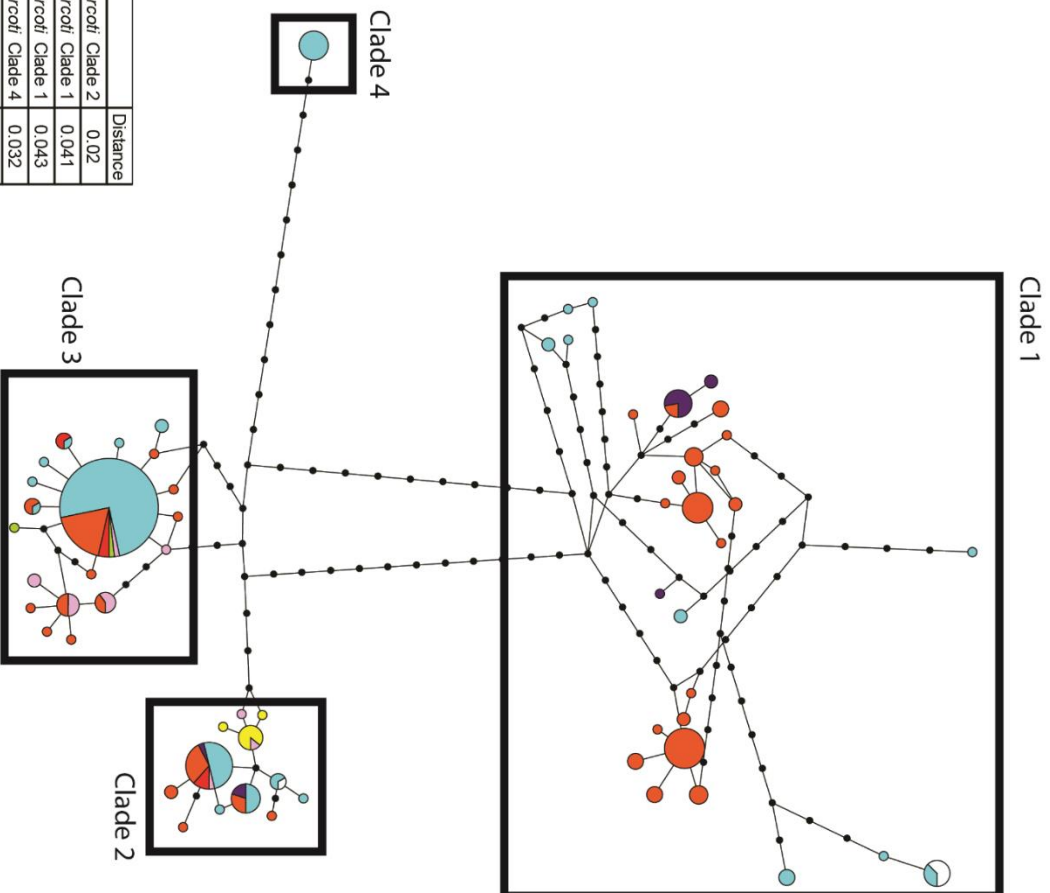

Appendix\_Lysasterias spp

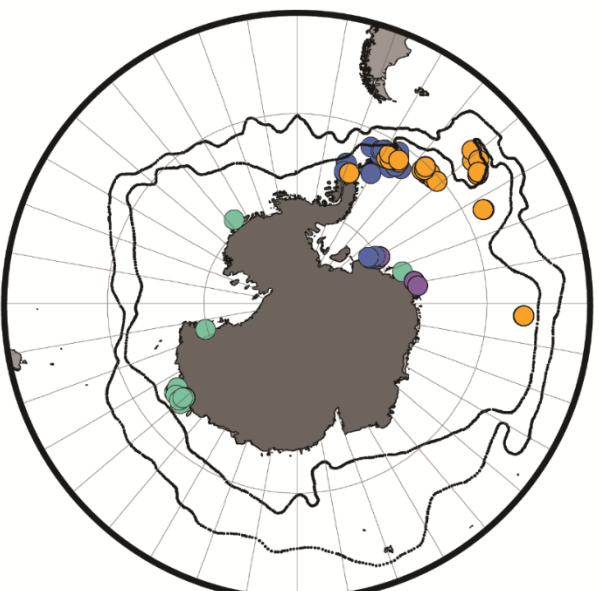
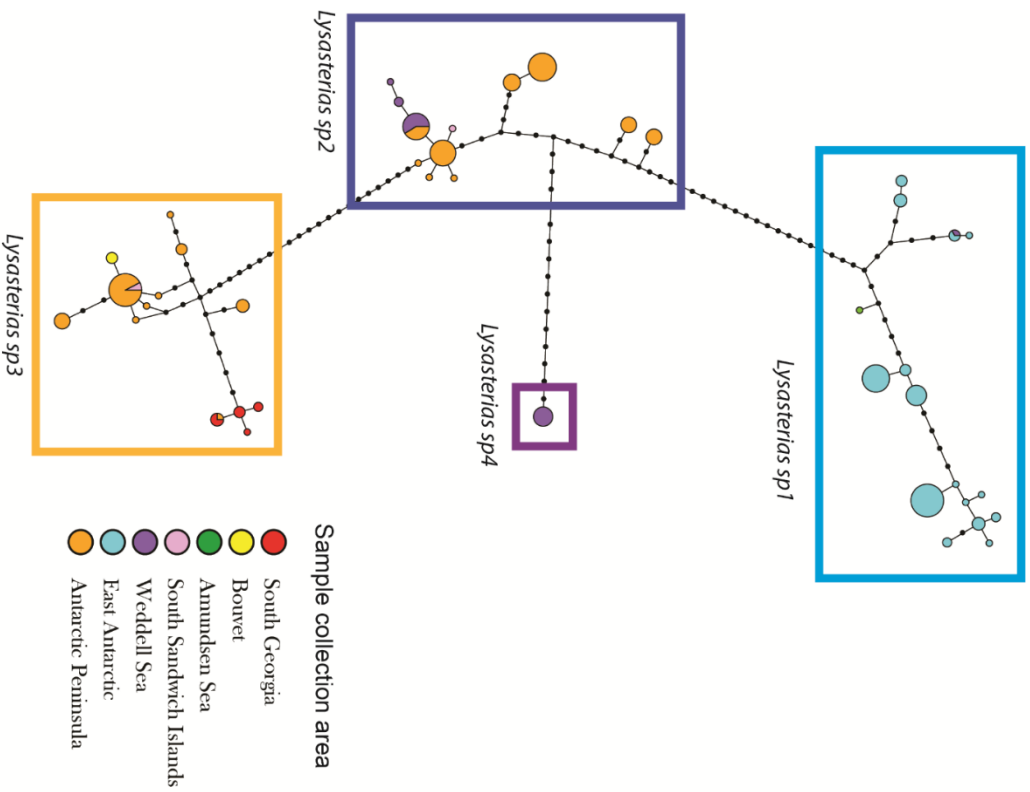

Entity 1	Entity 2	Distance
<i>Lysasterias</i> sp2	<i>Lysasterias</i> sp4	0.04
<i>Lysasterias</i> sp2	<i>Lysasterias</i> sp3	0.052
<i>Lysasterias</i> sp4	<i>Lysasterias</i> sp3	0.053
<i>Lysasterias</i> sp2	<i>Lysasterias</i> sp1	0.059
<i>Lysasterias</i> sp4	<i>Lysasterias</i> sp1	0.068
<i>Lysasterias</i> sp3	<i>Lysasterias</i> sp1	0.066

Estimated divergence between delineated entities.  
 Conducted using the Kimura 2-parameter model.

Appendix\_Notasterias spp

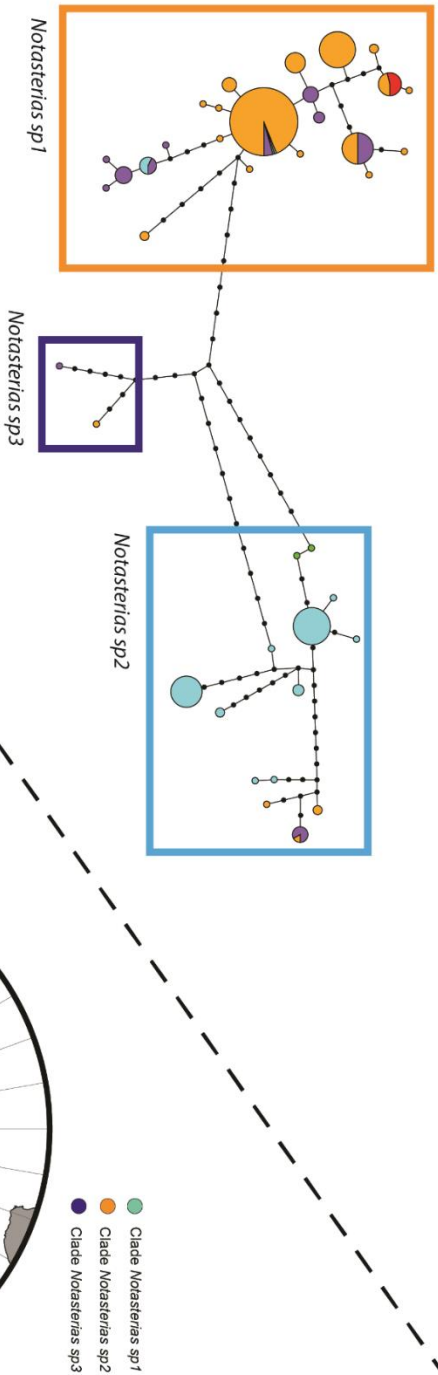

- Sample collection area
- South Georgia
  - Amundsen Sea
  - Weddell Sea
  - East Antarctic
  - Antarctic Peninsula

Entity 1	Entity 2	Distance
<i>Notasterias</i> sp2	<i>Notasterias</i> sp1	0.043
<i>Notasterias</i> sp2	<i>Notasterias</i> sp3	0.034
<i>Notasterias</i> sp1	<i>Notasterias</i> sp3	0.034

Estimated divergence between delineated entities.  
 Conducted using the Kimura 2-parameter model.

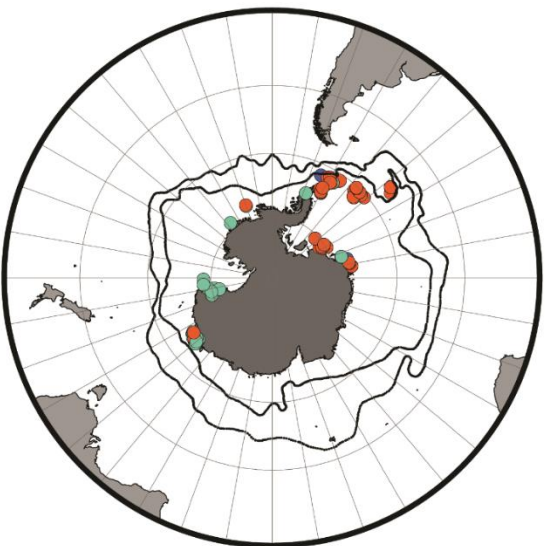

Appendix\_Diplasterias spp

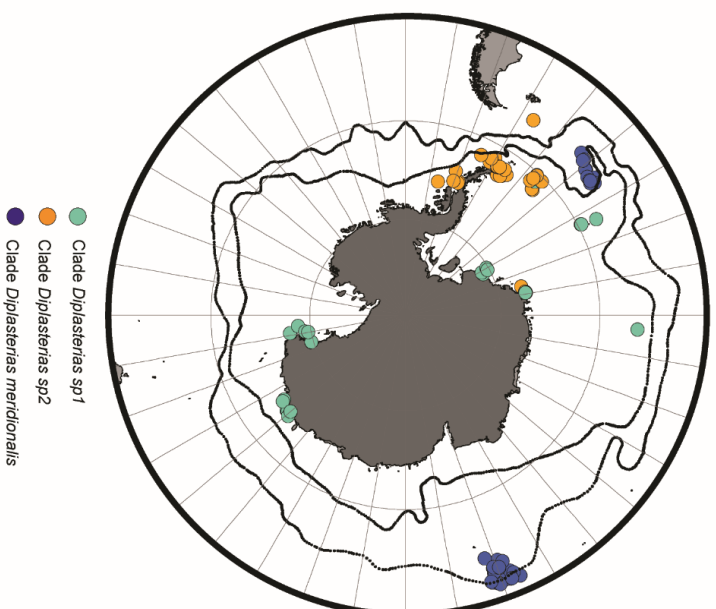
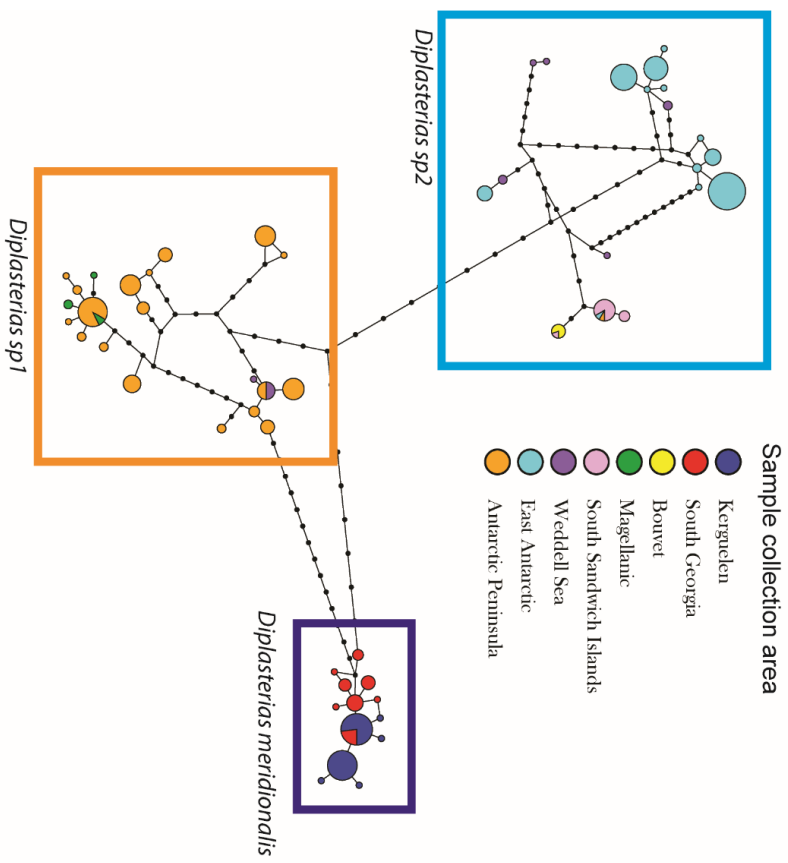

Entity 1	Entity 2	Distance
<i>Diplasterias sp2</i>	<i>Diplasterias sp1</i>	0.046
<i>Diplasterias sp2</i>	<i>Diplasterias sp3</i>	0.05
<i>Diplasterias sp1</i>	<i>Diplasterias sp3</i>	0.039

Estimated divergence between delineated entities.  
 Conducted using the Kimura 2-parameter model.

- Nodes summary statistics for both phylogeny reconstructions

	Node A	Node B	Node C	Node D	Node IV	Node V	Node VI	Node VII	Node VIII
Astropectinidae									
median (Myr)	4.45	3.01	1.78	1.29					
95% HPD interval (Myr)	[3.33, 5.70]	[2.23, 3.91]	[1.27, 2.38]	[0.85, 1.84]					
Asteriidae	Pan-tropical Outgroup	Node I	Node II	Node III	Node IV	Node V	Node VI	Node VII	Node VIII
median (Myr)	20.9	5.24	3.83	2.77	2.13	2.06	1.72	1.31	1.3
95% HPD interval (Myr)	[14.3, 29]	[4.05, 6.69]	[2.89, 4.95]	[2.01, 3.61]	[1.53, 2.83]	[1.49, 2.75]	[1.22, 2.31]	[0.90, 1.82]	[0.85, 1.80]

## Appendix 3

- **Moreau, C.**, Jossart, Q., Danis, B., Eléaume, M., Christiansen, H., Guillaumot, C., Downey, R., & Saucède, T. The overlooked diversity of Southern Ocean sea stars (Asteroidea) reveals original evolutionary pathways. (in prep. Progress in Oceanography)  
→ **Chapter 3**

- **Phylogenetic trees and Statistical Parsimony networks**

Bayesian phylogenetic reconstructions and statistical Parsimony network indicating genetic relationships among sampling locations within the families of interest. Time scale is expressed in millions of years. SO: Southern Ocean; N-Atl: North Atlantic Ocean; N-Pac: North Pacific Ocean; NZ: New Zealand; Arctic: Arctic Ocean; S-Atl: South Atlantic

# Family Pterasteridae

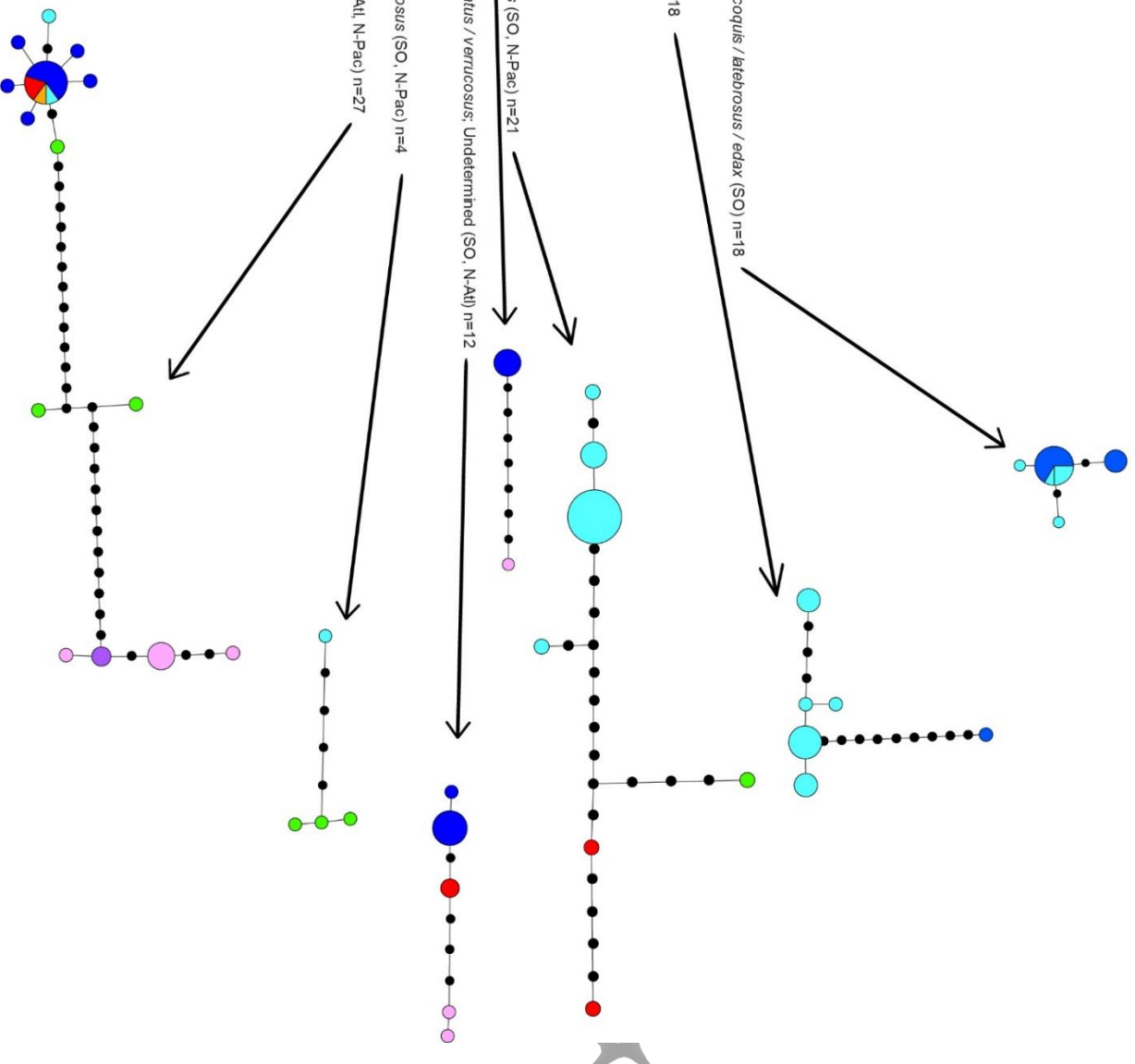
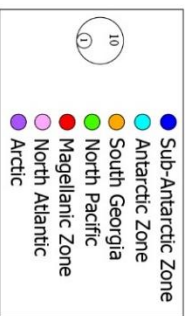
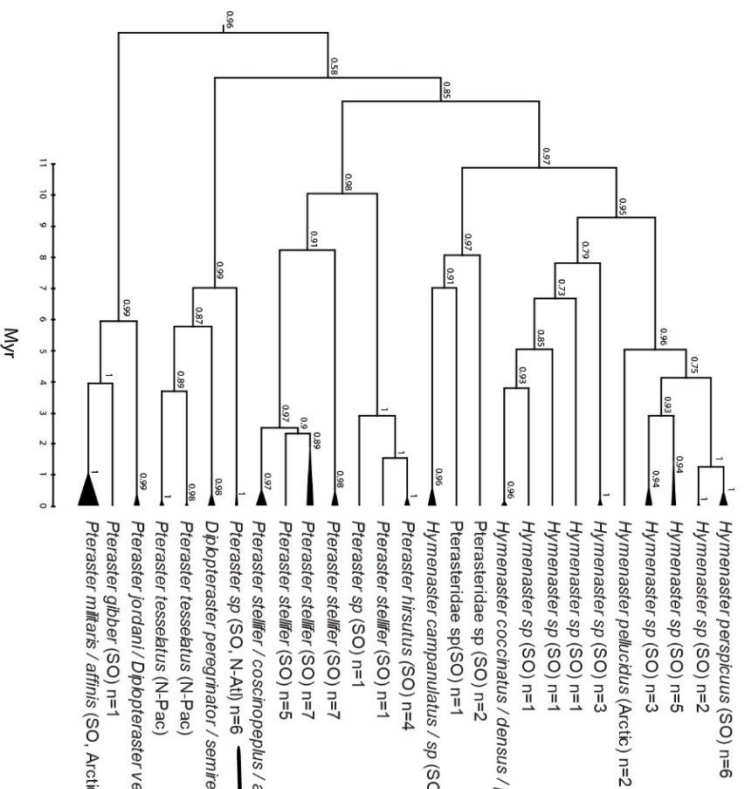



# Family Benthopectinidae

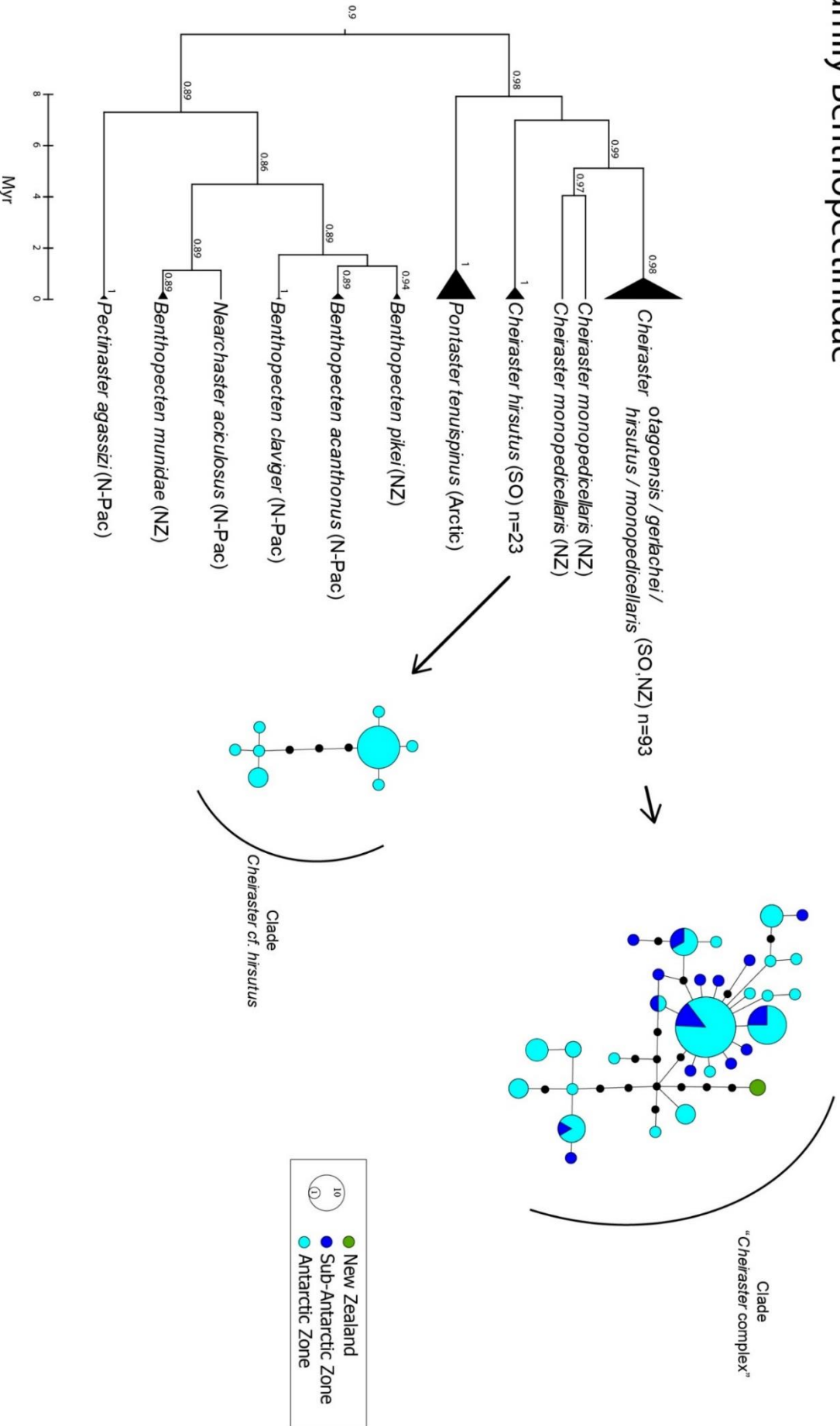

# Family Solasteridae

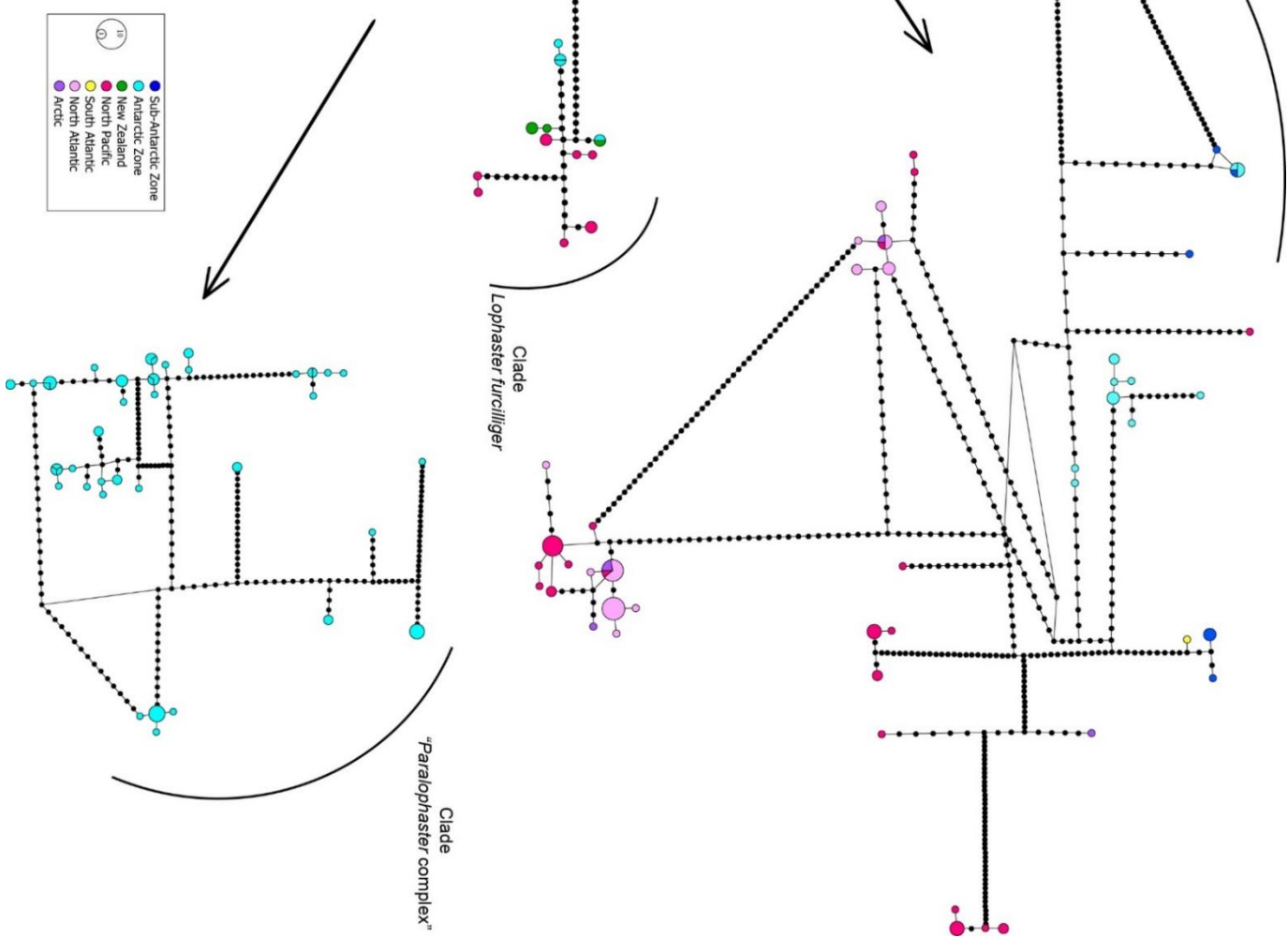
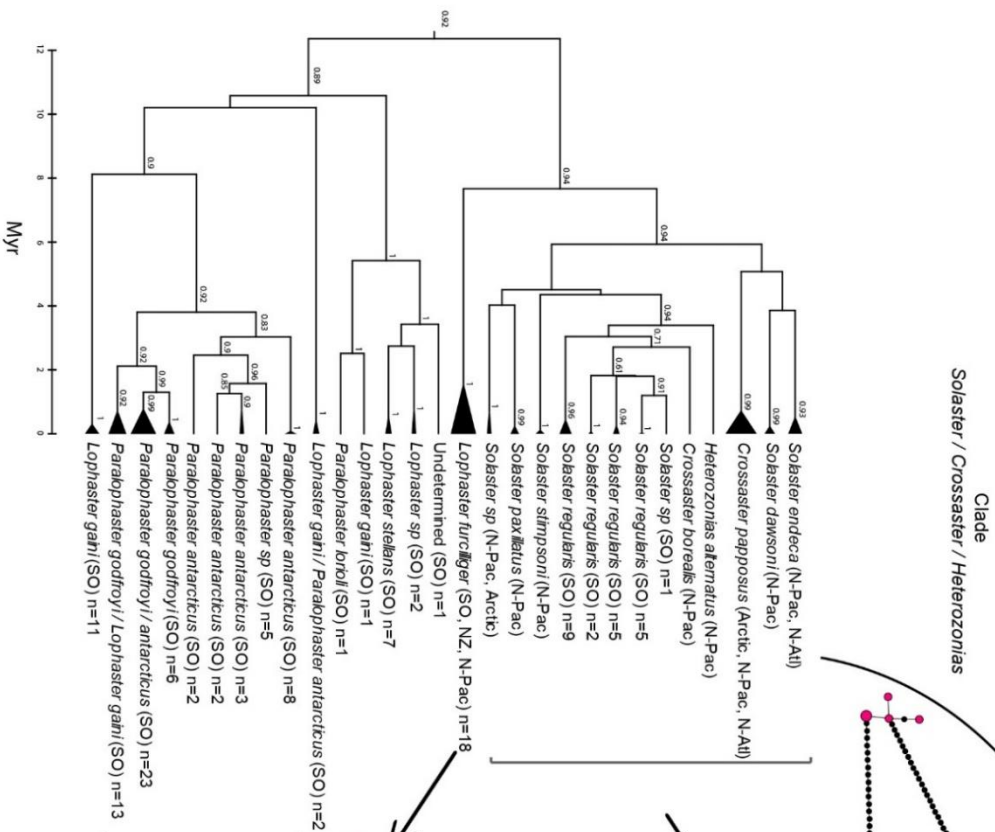

# Family Echinasteridae (Clade *Henricia* + *Rhopiella*)

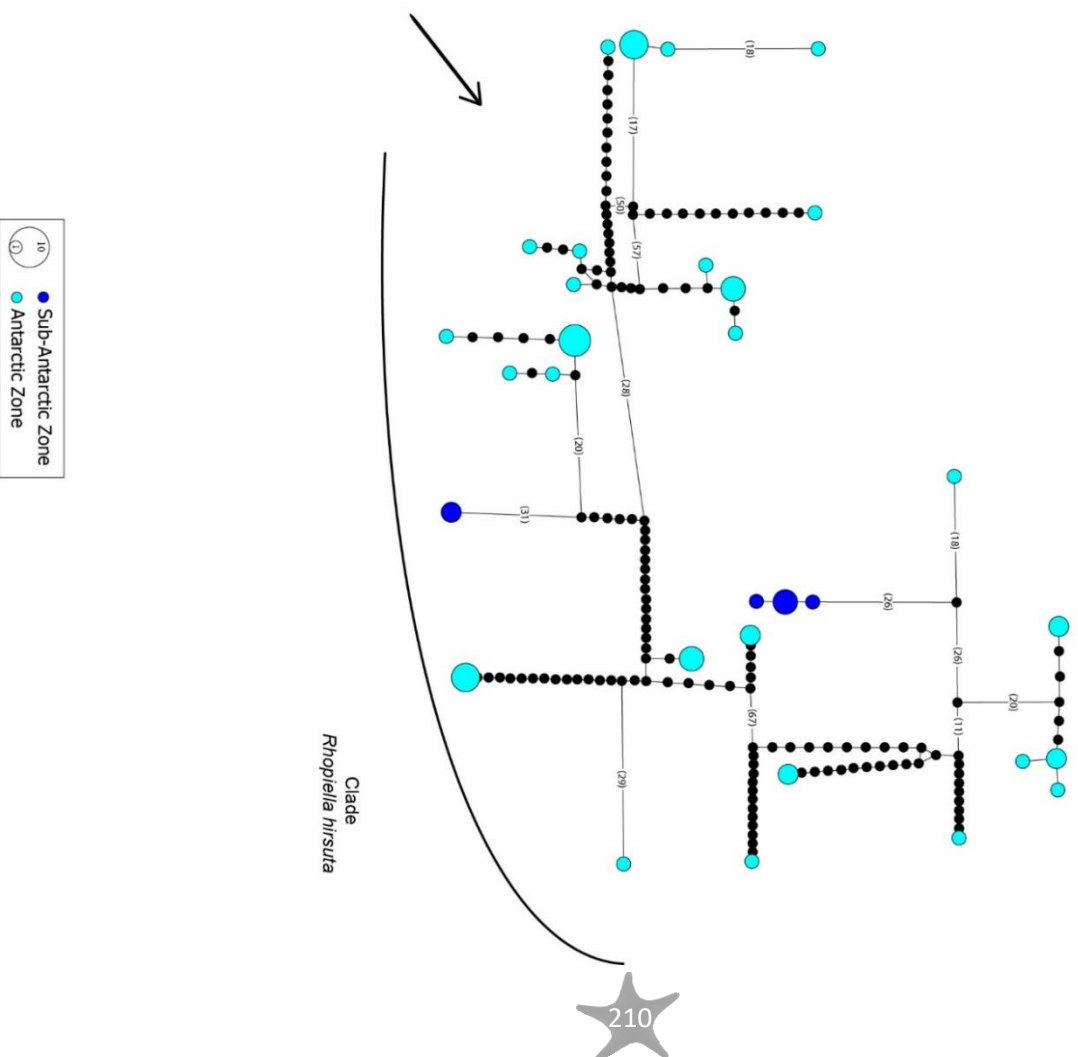
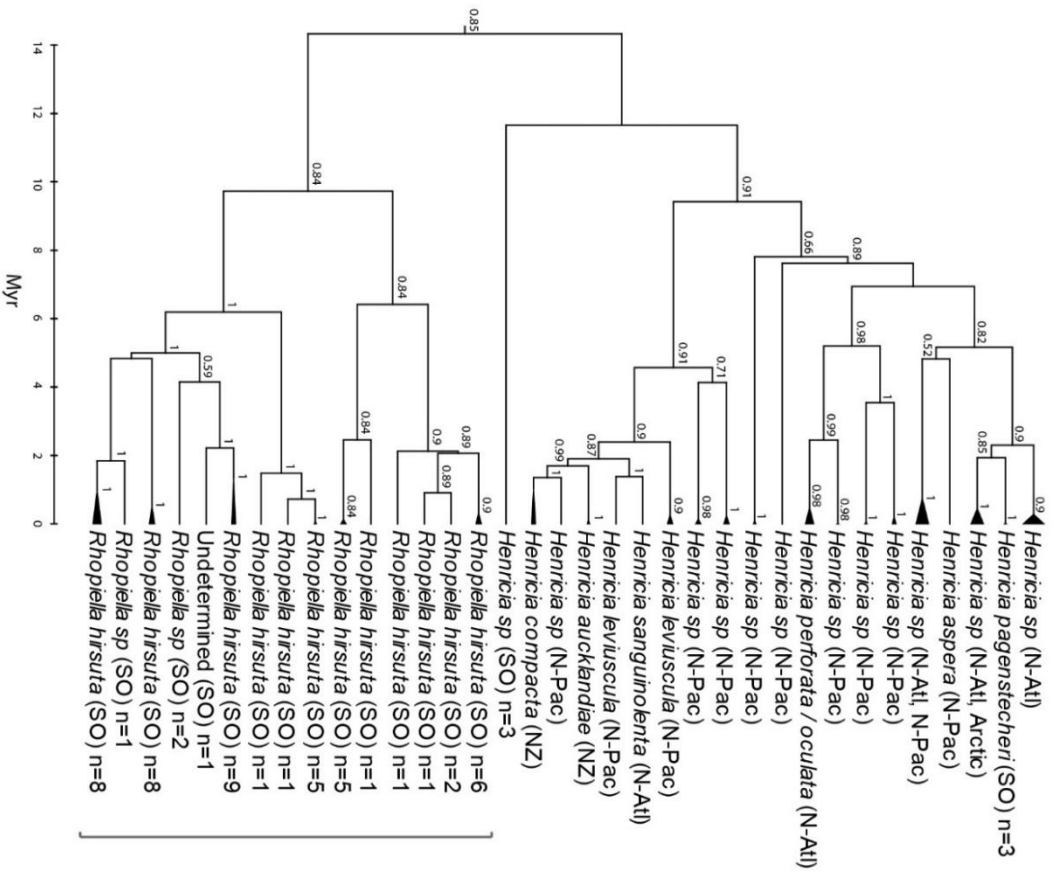

# Family Ganeriidae

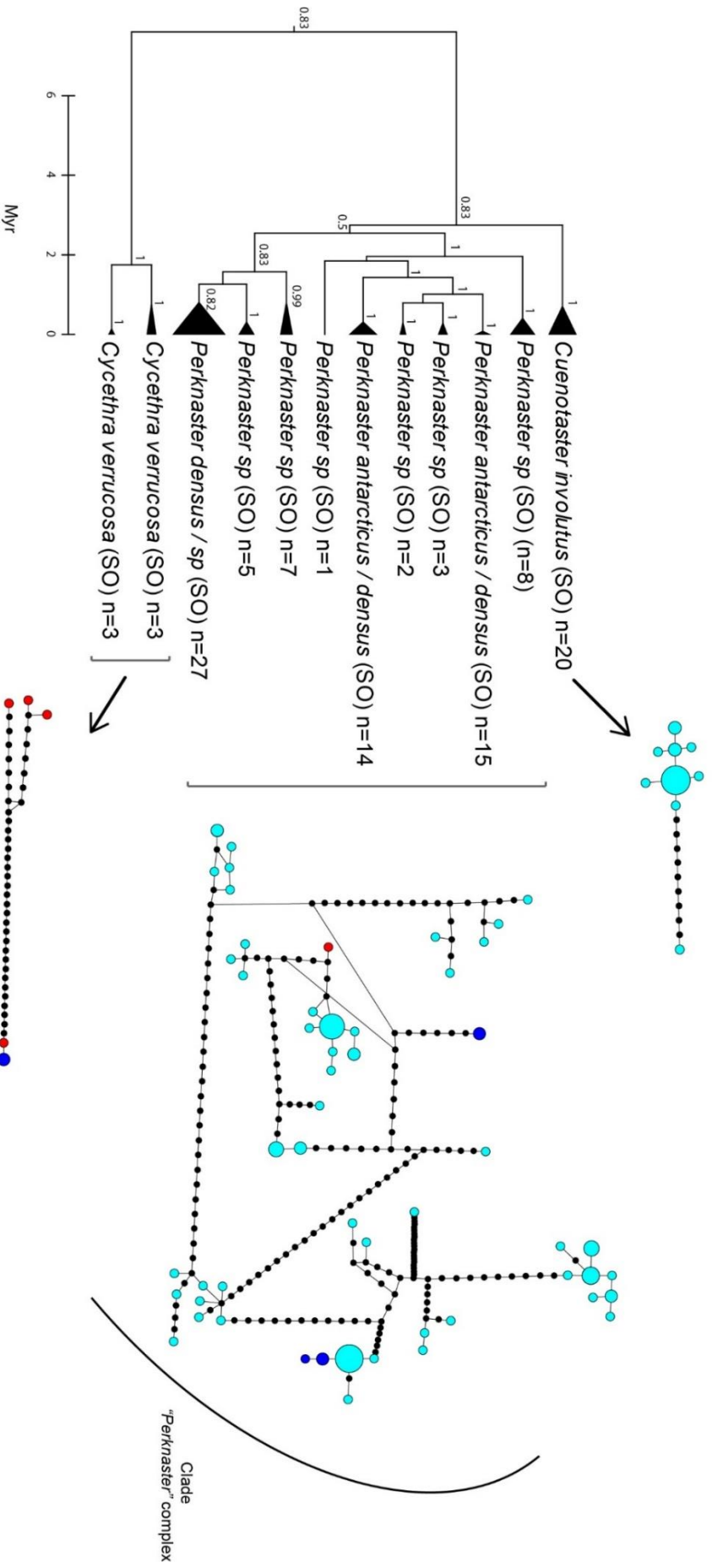

# Family Odontasteridae

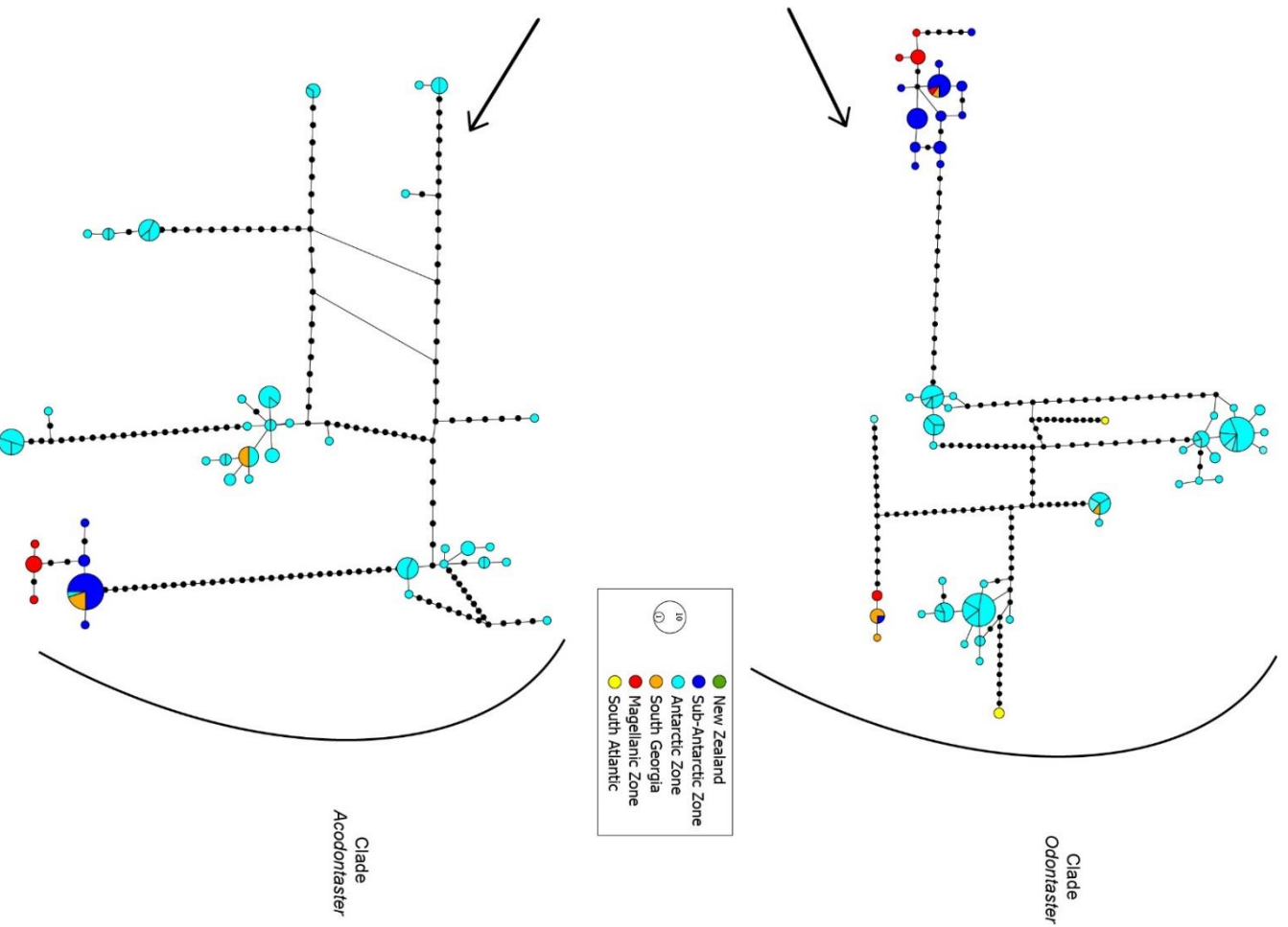
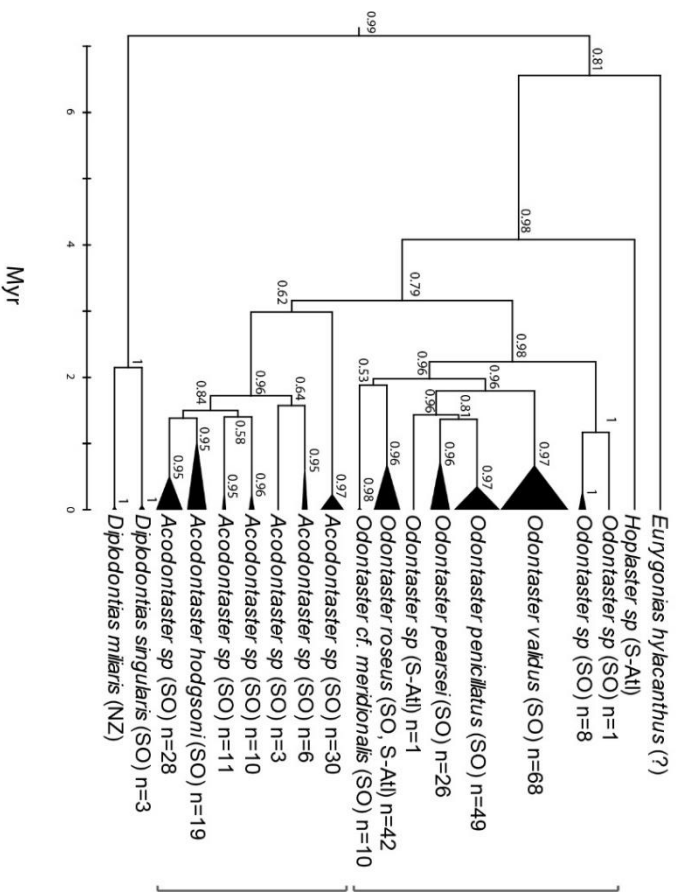

- **Accumulation curves**

Accumulation curves at the species level of Asteroidea for the Southern Ocean fitted to match with latitude (UGE index – 999 permutations representing a random accumulation curve, SObs – recorded richness according to latitude, Jackknife2 – corrected richness based on sampling effort).

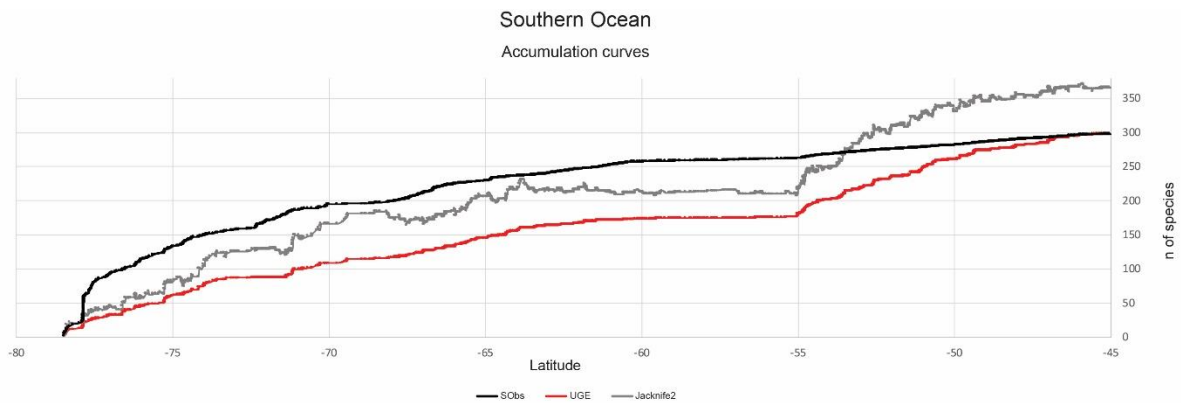

- **Global phylogenetic tree**

Bayesian phylogenetic reconstruction of the class Asteroidea based on mtDNA (COI). Nodes posterior probabilities are indicated when superior to 0.5. Coloured squares indicate specimen locations: blue, Southern Ocean; red, outside the Southern Ocean and yellow, from both inside and outside the Southern Ocean. Subgroups used for further analyses are indicated in red.







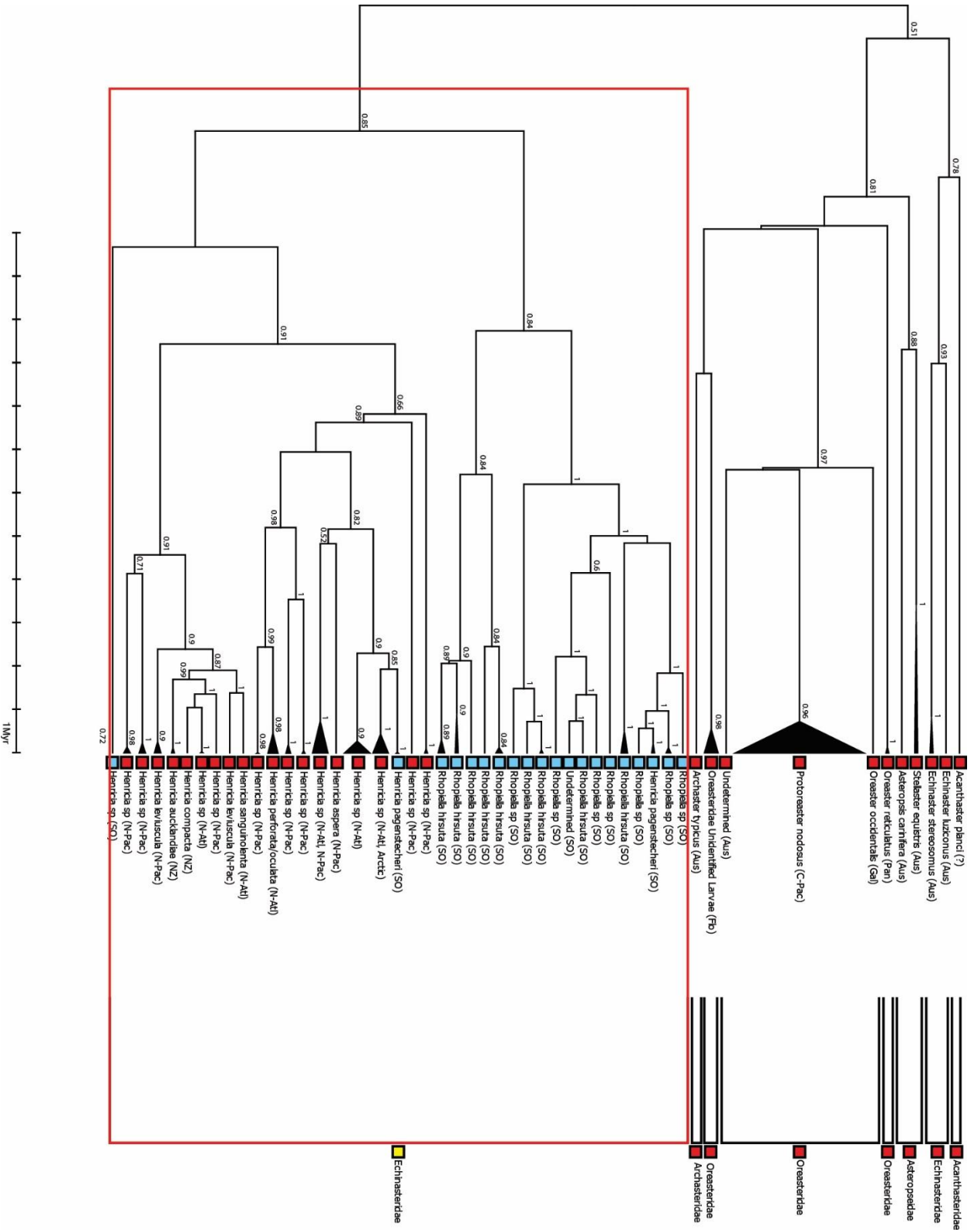

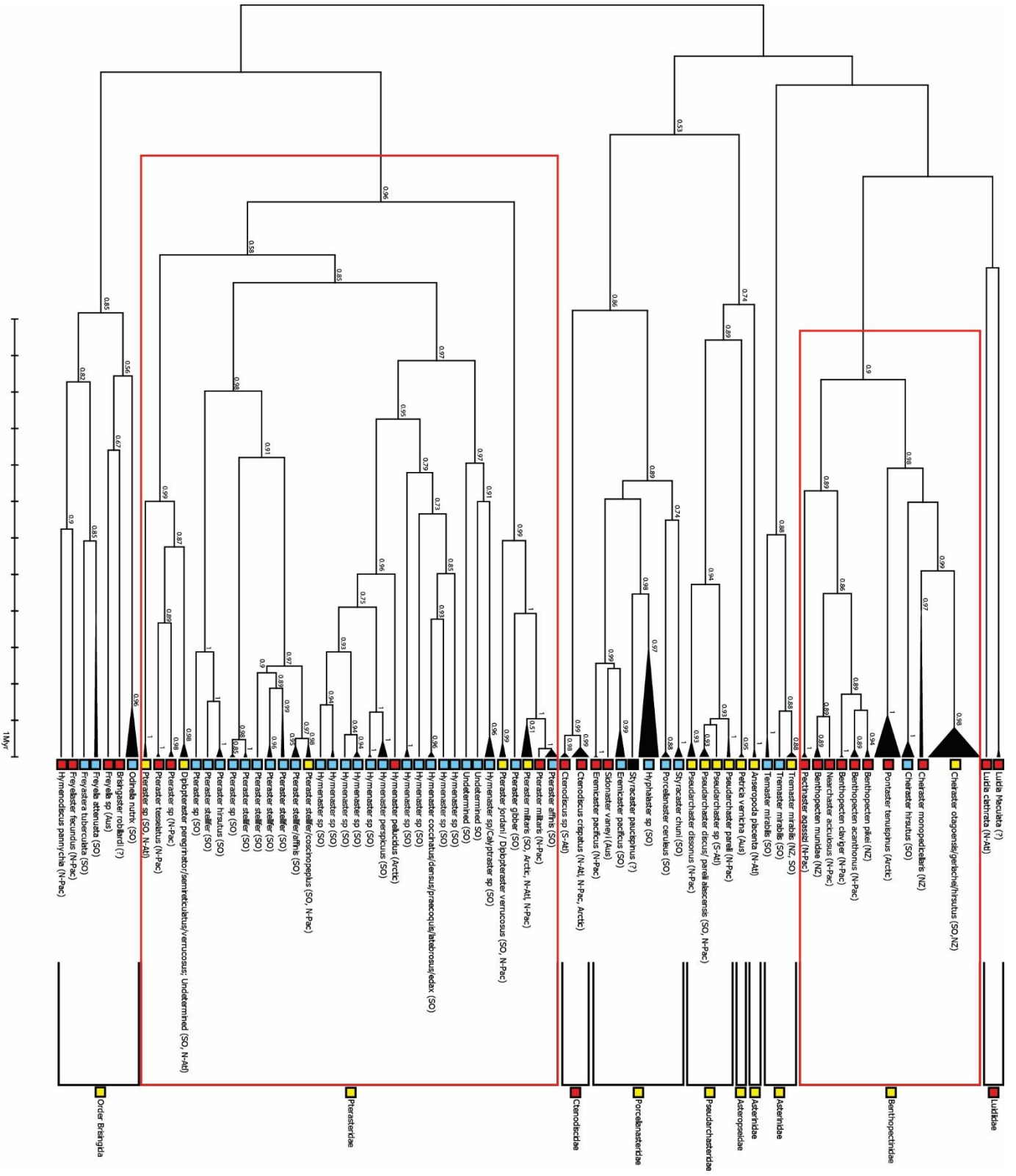

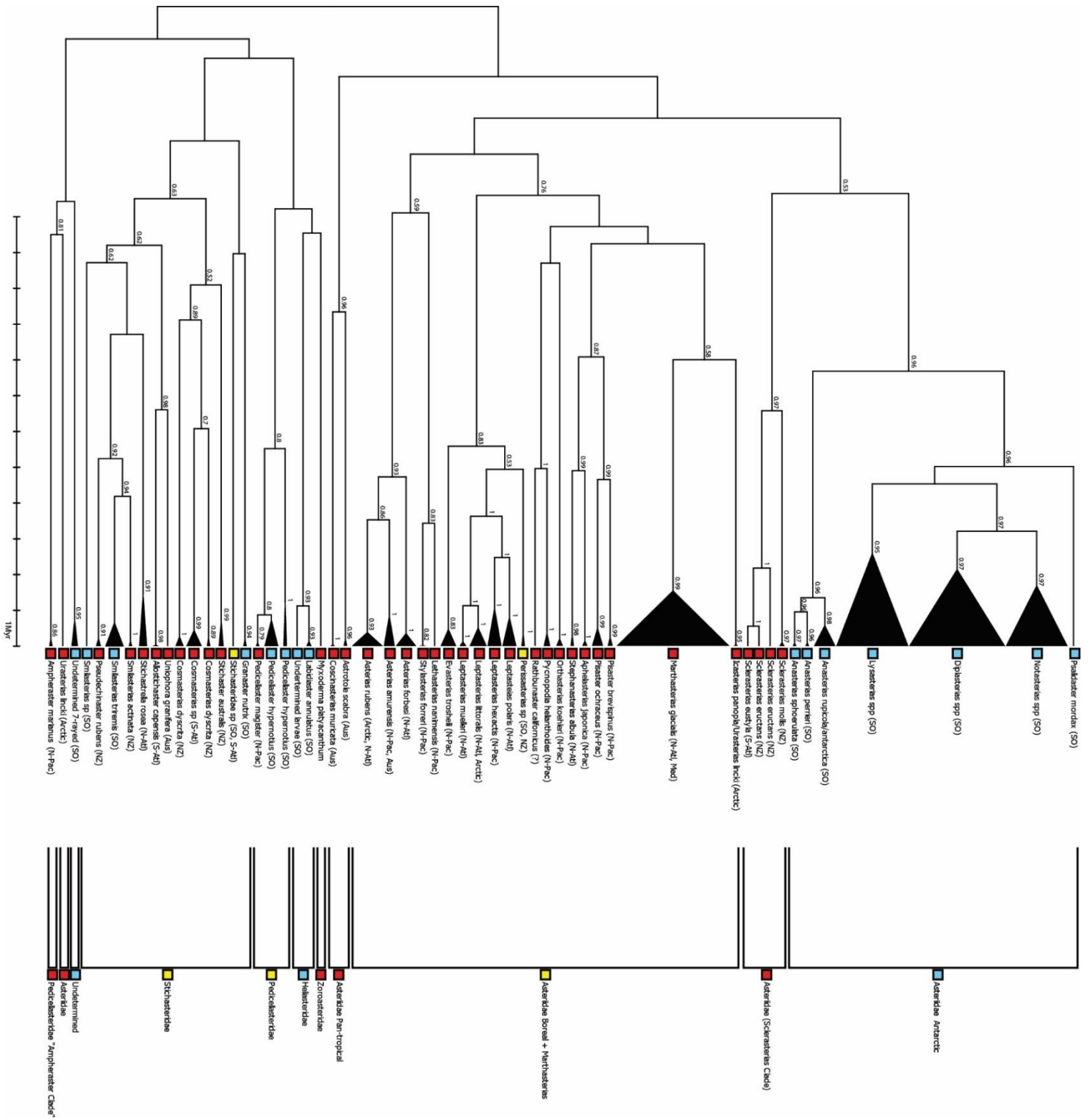

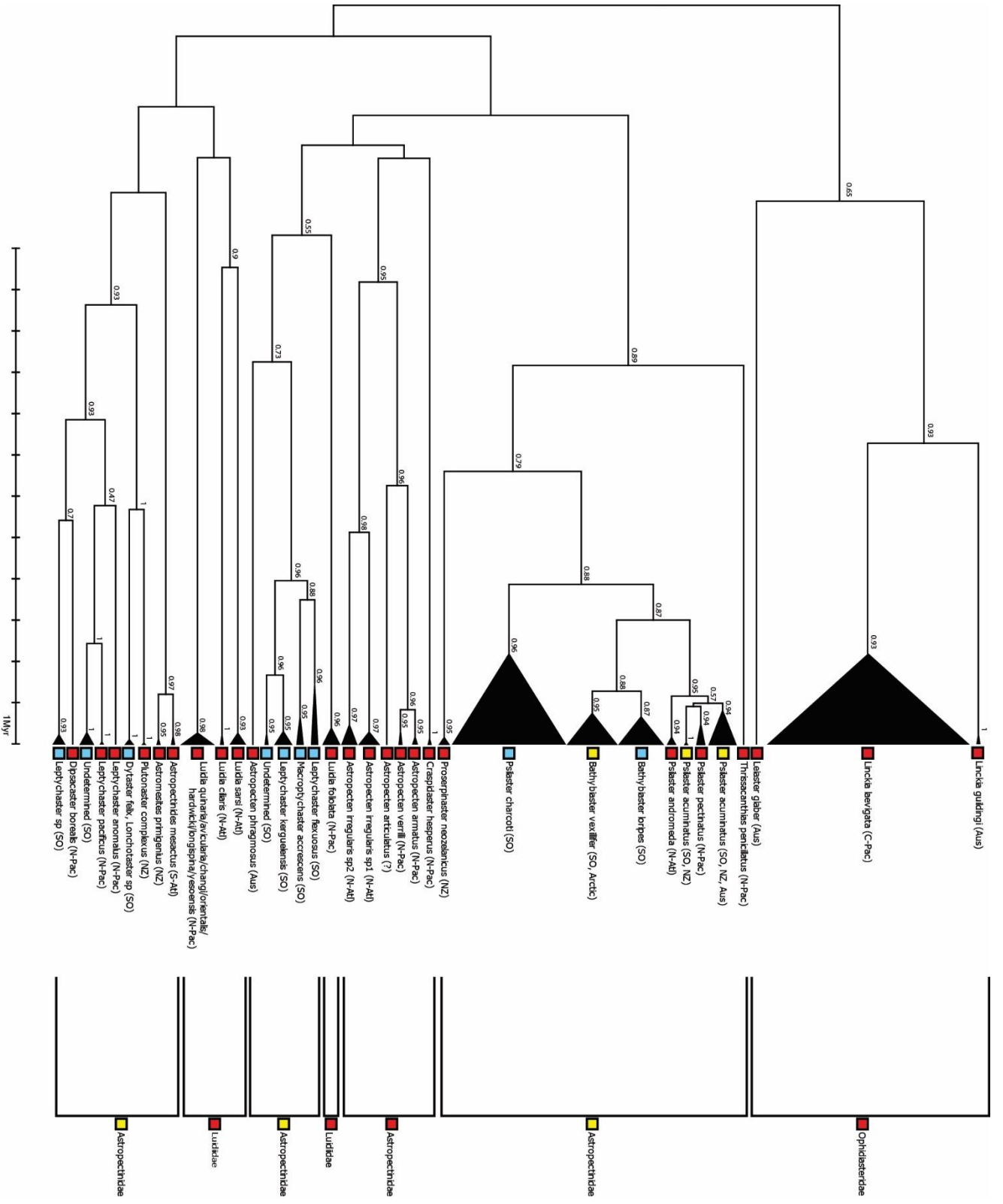

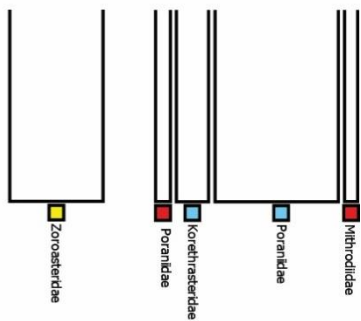
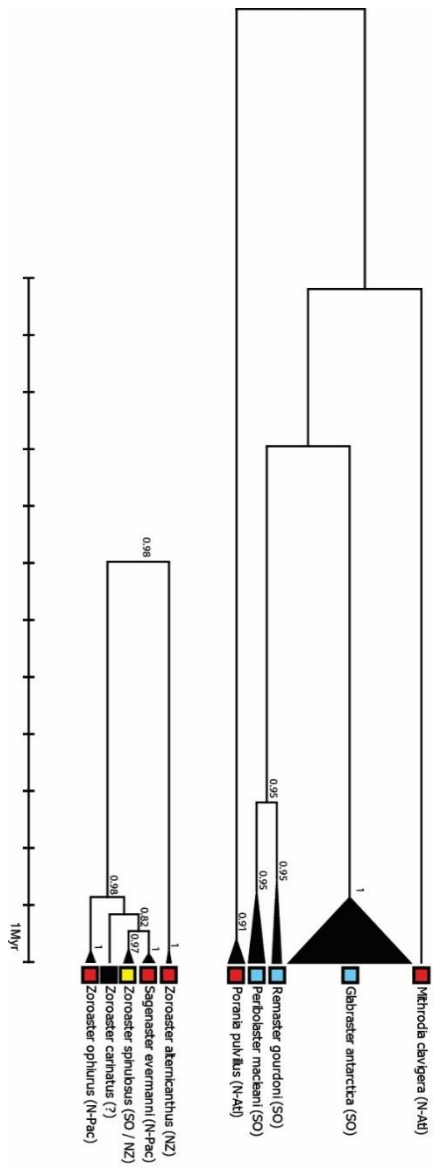



# References





## References

- Ababneh, F., Jermini, L.S., Ma, C., & Robinson, J. (2006). Matched-pairs tests of homogeneity with applications to homologous nucleotide sequences. *Bioinformatics*, 22(10), 1225-1231.
- Agüera, A., Collard, M., Jossart, Q., Moreau, C. & Danis, B. (2015). Parameter estimations of Dynamic Energy Budget (DEB) model over the life history of a key Antarctic species: the Antarctic sea star *Odontaster validus* Koehler, 1906. *PLoS one*, 10, e0140078.
- Allcock, A.L. (2005). On the confusion surrounding *Pareledone charcoti* (Joubin, 1905)(Cephalopoda: Octopodidae): endemic radiation in the Southern Ocean. *Zoological Journal of the Linnean Society*, 143(1), 75-108.
- Allcock, A.L., & Griffiths, H. J. (2014). Bipolarity. *Biogeographic Atlas of the Southern Ocean* (ed. by C. De Broyer, P. Koubbi, H.J. Griffiths, B. Raymond, C. d'Udekem d'Acoz, Van de Putte A., B. Danis, B. David, S. Grant, J. Gutt, C. Held, G. Hosie, F. Huettmann, A. Post and Y. Ropert-Coudert), pp. 510. SCAR, Cambridge.
- Allcock, A.L., & Strugnell, J.M. (2012). Southern Ocean diversity: new paradigms from molecular ecology. *Trends in Ecology & Evolution*, 27(9), 520-528.
- Analuddin, K., Nasaruddin, N., Septiana, A., Sarliyana, W.O., Nurlyati, A., Masa, W., & Rahim, S. (2015). Spatial Pattern in Beta Diversity of Echinoidea and Asteroidea Communities from the Coastal Area of Tomia Island, Wakatobi Marine National Park, Southeast Sulawesi, Indonesia. *BIOTROPIA-The Southeast Asian Journal of Tropical Biology*, 22(1).
- Anderson, J.B., Shipp, S.S., Lowe, A.L., Wellner, J.S., & Mosola, A.B. (2002). The Antarctic Ice Sheet during the Last Glacial Maximum and its subsequent retreat history: a review. *Quaternary Science Reviews*, 21(1-3), 49-70.
- Antarctic Treaty Consultative Parties (1959). *The Antarctic Treaty*.
- Arango, C.P., Soler-Membrives, A., & Miller, K.J. (2011). Genetic differentiation in the circum-Antarctic sea spider *Nymphon australe* (Pycnogonida; Nymphonidae). *Deep Sea Research Part II: Topical Studies in Oceanography*, 58(1-2), 212-219.
- Arbogast, B.S., & Kenagy, G. J. (2001). Comparative phylogeography as an integrative approach to historical biogeography. *Journal of Biogeography*, 28(7), 819-825.
- Arnaud, P. (1964). Echinodermes littoraux de Terre Adélie (holothuries exceptées) et pelecypodes commensaux d'échinides antarctiques (Vol. 258). *Expéditions polaires françaises*.
- Arntz, W.E., Brey, T., Gallardo, V.A. (1994). Antarctic zoobenthos. *Oceanography Marine Biology Annual Review* 32:241–304
- Arntz, W.E., Gutt, J., & Klages, M. (1997). *Antarctic marine biodiversity: an overview. Antarctic communities: species, structure and survival*. Cambridge University Press, Cambridge, 3-14.

- Arntz, W.E. (2005). The Magellan-Antarctic connection: links and frontiers at southern high latitudes. Summary review. *Scientia Marina*, 69, 359.
- Aronson, R.B., Blake, D.B., & Oji, T. (1997). Retrograde community structure in the late Eocene of Antarctica. *Geology*, 25(10), 903-906.
- Aronson, R.B., Thatje, S., Clarke, A., Peck, L.S., Blake, D.B., Wilga, C.D., & Seibel, B.A. (2007). Climate change and invasibility of the Antarctic benthos. *Annual Review of Ecology, Evolution, and Systematics*, 38.
- Aronson, R.B., & Blake, D.B. (2001). Global climate change and the origin of modern benthic communities in Antarctica. *American Zoologist*, 41(1), 27-39.
- Avise, J.C. (2009). Phylogeography: retrospect and prospect. *Journal of biogeography*, 36(1), 3-15.
- Bamber, J.L., Riva, R.E., Vermeersen, B.L., & LeBrocq, A.M. (2009). Reassessment of the potential sea-level rise from a collapse of the West Antarctic Ice Sheet. *science*, 324(5929), 901-903.
- Barco, A., Schiaparelli, S., Houart, R., & Oliverio, M. (2012). Cenozoic evolution of Muricidae (Mollusca, Neogastropoda) in the Southern Ocean, with the description of a new subfamily. *Zoologica Scripta*, 41(6), 596-616.
- Barker, M.F. (1978). Structure of the organs of attachment of brachiolaria larvae of *Stichaster australis* (Verrill) and *Coscinasterias calamaria* (Gray)(Echinodermata: Asteroidea). *Journal of Experimental Marine Biology and Ecology*, 33(1), 1-36.
- Barker, P.F., & Thomas, E. (2004). Origin, signature and palaeoclimatic influence of the Antarctic Circumpolar Current. *Earth-Science Reviews*, 66(1-2), 143-162.
- Barker, P.F., Filippelli, G.M., Florindo, F., Martin, E.E., & Scher, H.D. (2007). Onset and role of the Antarctic Circumpolar Current. *Deep Sea Research Part II: Topical Studies in Oceanography*, 54(21-22), 2388-2398.
- Barnes, D.K. (2002). Biodiversity: invasions by marine life on plastic debris. *Nature*, 416(6883), 808.
- Barnes, D.K., & Brockington, S. (2003). Zoobenthic biodiversity, biomass and abundance at Adelaide Island, Antarctica. *Marine Ecology Progress Series*, 249, 145-155.
- Barnes, D.K. (2005). Changing chain: past, present and future of the Scotia Arc's and Antarctica's shallow benthic communities. *Scientia Marina*, 69, 65-89.
- Barnes, D.K. & Clarke, A. (2011). Antarctic marine biology. *Current Biology*, 21, 451-457.
- Barnes, D.K. & Griffiths, H.J. (2007). Biodiversity and biogeography of southern temperate and polar bryozoans. *Global Ecology and Biogeography*, 17, 84-99.

- Barnes, D.K. & Kuklinski, P. (2010). Bryozoans of the Weddell Sea continental shelf, slope and abyss: did marine life colonize the Antarctic shelf from deep water, outlying islands or in situ refugia following glaciations?. *Journal of Biogeography*, 37,1648-1656.
- Barnes, D.K., Hodgson, D.A., Convey, P., Allen, C.S. & Clarke, A. (2006). Incursion and excursion of Antarctic biota: past, present and future. *Global Ecology and Biogeography*, 15, 121-142.
- Barnes, D.K., & Hillenbrand, C.D. (2010). Faunal evidence for a late Quaternary trans-Antarctic seaway. *Global Change Biology*, 16(12), 3297-3303.
- Batagelj, V. & Mrvar, A. (2005). Pajek (program for analysis and visualization of large network), version 1.07. Distributed by the authors, University of Ljubljana.
- Beckley, L.E., & Branch, G.M. (1992). A quantitative scuba-diving survey of the sublittoral macrobenthos at subantarctic Marion Island. *Polar Biology*, 11(8), 553-563.
- Bell, F.J. (1881). Contributions to the Systematic Arrangement of the Asteroidea. The Species of the genus *Asterias*. In *Proceedings of the Zoological Society of London* 49(3), 492-515. Oxford, UK: Blackwell Publishing Ltd.
- Belman, B.W., & Giese, A.C. (1974). Oxygen consumption of an asteroid and an echinoid from the Antarctic. *The Biological Bulletin*, 146(2), 157-164.
- Benham, W.B. (1909). The echinoderms, other than holothurians, of the subantarctic islands of New Zealand.
- Berger, A. (1988). Milankovitch theory and climate. *Reviews of geophysics*, 26(4), 624-657.
- Beu, A.G. (2009). Before the ice: Biogeography of Antarctic Paleogene molluscan faunas. *Palaeogeography, Palaeoclimatology, Palaeoecology*, 284(3-4), 191-226.
- Blair, C., & Bryson Jr, R.W. (2017). Cryptic diversity and discordance in single-locus species delimitation methods within horned lizards (Phrynosomatidae: *Phrynosoma*). *Molecular ecology resources*, 17(6), 1168-1182.
- Blake, D.B. (1987). A classification and phylogeny of post-Palaeozoic sea stars (Asteroidea: Echinodermata). *Journal of Natural History*, 21(2), 481-528.
- Blake, D.B. (1990). Adaptive zones of the class Asteroidea (Echinodermata). *Bulletin of marine Science*, 46(3), 701-718.
- Blake, D.B., & Aronson, R.B. (1998). Eocene stelleroids (Echinodermata) at Seymour Island, Antarctic Peninsula. *Journal of Paleontology*, 72(2), 339-353.
- Blankley, W.O., & Branch, G.M. (1984). Co-operative prey capture and unusual brooding habits of *Anasterias rupicola* (Verrill)(Asteroidea) at sub-Antarctic Marion Island. *Marine Ecology Progress Series*, 171-176.
- Bosch, I. (1989). Contrasting modes of reproduction in two Antarctic asteroids of the genus *Porania*, with a description of unusual feeding and non-feeding larval types. *The Biological Bulletin*, 177(1), 77-82.

- Bosch, I. & Pearse, J.S. (1990). Developmental types of shallow-water asteroids of McMurdo Sound, Antarctica. *Marine Biology*, 104, 41-46.
- Bosch, I., & Slattery, M. (1999). Costs of extended brood protection in the Antarctic sea star, *Neosmilaster georgianus* (Echinodermata: Asteroidea). *Marine Biology*, 134(3), 449-459.
- Bowden, D.A., Schiaparelli, S., Clark, M.R., & Rickard, G.J. (2011). A lost world? Archaic crinoid-dominated assemblages on an Antarctic seamount. *Deep Sea Research Part II: Topical Studies in Oceanography*, 58(1-2), 119-127.
- Bowen, B.W., Bass, A.L., Muss, A., Carlin, J., & Robertson, D.R. (2006). Phylogeography of two Atlantic squirrelfishes (Family Holocentridae): exploring links between pelagic larval duration and population connectivity. *Marine Biology*, 149(4), 899-913.
- Bowen, B.W., Gaither, M.R., DiBattista, J.D., Iacchei, M., Andrews, K.R., Grant, W.S., ... & Briggs, J.C. (2016). Comparative phylogeography of the ocean planet. *Proceedings of the National Academy of Sciences*, 113(29), 7962-7969.
- Brandt, A. (1992). Origin of Antarctic Isopoda (Crustacea, Malacostraca). *Marine Biology*, 113(3), 415-423.
- Brandt, A. (1999). On the origin and evolution of Antarctic Peracarida (Crustacea, Malacostraca). *Scientia Marina*, 63(S1), 261-274.
- Brandt, A., Gooday, A.J., Brandao, S.N., Brix, S., Brökeland, W., Cedhagen, T., Choudhury, M., Cornelius, N., Danis, B., De Mesel, I. & Diaz, R.J. (2007). First insights into the biodiversity and biogeography of the Southern Ocean deep sea. *Nature*, 447, 307-311.
- Brandt, A., Van de Putte, A., Griffiths, H.J. (2014). Southern Ocean benthic deep-sea biodiversity and biogeography. *Biogeographic Atlas of the Southern Ocean* (ed. by C. De Broyer, C., Koubbi, P., Griffiths, H.J., Raymond, B., d'Udekem d'Acoz, C., Van de Putte, A., Danis, B., David, B., Grant, S., Gutt, J., Held, C., Hosie, G., Huettmann, F., Post, A. & Ropert-Coudert, Y.), pp. 510. SCAR, Cambridge.
- Brey, T., Dahm, C., Gorny, M., Klages, M., Stiller, M., & Arntz, W. E. (1996). Do Antarctic benthic invertebrates show an extended level of eurybathy?. *Antarctic Science*, 8(1), 3-6.
- Brasier, M.J., Wiklund, H., Neal, L., Jeffreys, R., Linse, K., Ruhl, H., & Glover, A.G. (2016). DNA barcoding uncovers cryptic diversity in 50% of deep-sea Antarctic polychaetes. *Royal Society open science*, 3(11), 160432.
- Brasier, M.J., Harle, J., Wiklund, H., Jeffreys, R.M., Linse, K., Ruhl, H.A., & Glover, A.G. (2017). Distributional Patterns of Polychaetes Across the West Antarctic Based on DNA Barcoding and Particle Tracking Analyses. *Frontiers in Marine Science*, 4, 356.
- Bray, J.R. & Curtis, J.T. (1957). An ordination of the upland forest communities of southern Wisconsin. *Ecological Monographs*, 27, 325-349.
- Brayard, A., Escarguel, G. & Bucher, H. (2007). The biogeography of Early Triassic ammonoid faunas: clusters, gradients and networks. *Geobios*, 40, 749-765.

- Brayard, A., Escarguel, G., Bucher, H. & Brühwiler, T. (2009). Smithian and Spathian (Early Triassic) ammonoid assemblages from terranes: paleoceanographic and paleogeographic implications. *Journal of Asian Earth Sciences*, 36, 420–433.
- Brown, J. H. (1995). *Macroecology*. University of Chicago Press.
- Bush, A.M., & Bambach, R.K. (2015). Sustained Mesozoic–Cenozoic diversification of marine Metazoa: A consistent signal from the fossil record. *Geology*, 43(11), 979-982.
- Byrne, M. (2006). Life history diversity and evolution in the Asterinidae. *Integrative and Comparative Biology*, 46(3), 243-254.
- Byrne, M., Gall, M., Wolfe, K., & Agüera, A. (2016). From pole to pole: the potential for the Arctic seastar *Asterias amurensis* to invade a warming Southern Ocean. *Global Change Biology*.
- Carstens, B.C., Pelletier, T.A., Reid, N.M., & Satler, J.D. (2013). How to fail at species delimitation. *Molecular ecology*, 22(17), 4369-4383.
- Carter, L., McCave, I.N., & Williams, M.J. (2008). Circulation and water masses of the Southern Ocean: a review. *Developments in earth and environmental sciences*, 8, 85-114.
- Cavelier, C., Chateauneuf, J. J., Pomerol, C., Rabussier, D., Renard, M., & Vergnaud-Grazzini, C. (1981). The geological events at the Eocene/Oligocene boundary. *Palaeogeography, Palaeoclimatology, Palaeoecology*, 36(3-4), 223-248.
- Chaudhary, C., Saeedi, H., & Costello, M.J. (2017). Marine species richness is bimodal with latitude: A reply to Fernandez and Marques. *Trends in ecology & evolution*, 32(4), 234-237.
- Chen, Z.Q., & McNamara, K.J. (2006). End-Permian extinction and subsequent recovery of the Ophiuroidea (Echinodermata). *Palaeogeography, Palaeoclimatology, Palaeoecology*, 236(3-4), 321-344.
- Cherbonnier G. (1974). Invertébrés de l'infralittoral rocheux dans l'Archipel de Kerguelen. Holothurides et Échinides. Le fascicule 35. Comité national français des recherches ant-arctiques 3: 27–31.
- Chown, S.L., Clarke, A., Fraser, C.I., Cary, S.C., Moon, K.L. & McGeoch, M.A. (2015) The changing form of Antarctic biodiversity. *Nature*, 522, 431-438.
- Christiansen, H., Dettai, A., Heindler, F.M., Collins, M.A., Duhamel, G., Hautecoeur, M., ... & Van de Putte, A.P. (2018). Diversity of Mesopelagic Fishes in the Southern Ocean. A Phylogeographic Perspective Using DNA Barcoding. *Frontiers in Ecology and Evolution*, 6(SEP).
- Clark, A.M. (1962). BANZ Antarctic Research Expedition 1929.1931. Volume IX Asteroidea.
- Clark, A.M., & Downey, M.E. (1992). *Starfishes of the Atlantic (Vol. 3)*. Chapman & Hall.
- Clark, H.L. (1923). *The echinoderm fauna of South Africa*. Trustees of the South African Museums.

- Clarke, A. (2008). Antarctic marine benthic diversity: patterns and processes. *Journal of Experimental Marine Biology and Ecology*, 366(1-2), 48-55.
- Clarke, A., & Crame, J.A. (1989). The origin of the Southern Ocean marine fauna. Geological Society, London, Special Publications, 47(1), 253-268.
- Clarke, A., & Crame, J.A. (1992). The Southern Ocean benthic fauna and climate change: a historical perspective. *Philosophical Transactions of the Royal Society of London B: Biological Sciences*, 338(1285), 299-309.
- Clarke, A., & Crame, J.A. (2010). Evolutionary dynamics at high latitudes: speciation and extinction in polar marine faunas. *Philosophical Transactions of the Royal Society B: Biological Sciences*, 365(1558), 3655-3666.
- Clarke, A., & Johnston, N.M. (2003). Antarctic marine benthic diversity. In *Oceanography and Marine Biology, An Annual Review*, Volume 41 (pp. 55-57). CRC Press.
- Clarke, A., Aronson, R.B., Crame, J.A., Gili, J.M., & Blake, D.B. (2004). Evolution and diversity of the benthic fauna of the Southern Ocean continental shelf. *Antarctic Science*, 16(4), 559-568.
- Clarke, A., Barnes, D.K. & Hodgson, D.A. (2005). How isolated is Antarctica?. *Trends in Ecology & Evolution*, 20, 1-3.
- Clarke, A., Griffiths, H.J., Linse, K., Barnes, D.K. & Crame, J.A. (2007). How well do we know the Antarctic marine fauna? A preliminary study of macroecological and biogeographical patterns in Southern Ocean gastropod and bivalve molluscs. *Diversity and Distributions*, 13, 620-632.
- Clarke, K.R. & Gorley, R.N. (2006). User manual/tutorial. PRIMER-E Ltd., Plymouth, 93.
- Clarke, A., & Johnston, I.A. (1996). Evolution and adaptive radiation of Antarctic fishes. *Trends in Ecology & Evolution*, 11(5), 212-218.
- Clement, M., Snell, Q., Walker, P., Posada, D., & Crandall, K. (2002). TCS: Estimating gene genealogies. *Parallel and Distributed Processing Symposium, International Proceedings*, (2)184.
- Conlan, K.E., Rau, G.H., & Kvitek, R.G. (2006).  $\delta^{13}\text{C}$  and  $\delta^{15}\text{N}$  shifts in benthic invertebrates exposed to sewage from McMurdo Station, Antarctica. *Marine Pollution Bulletin*, 52(12), 1695-1707.
- Convey, P., Stevens, M.I., Hodgson, D.A., Smellie, J.L., Hillenbrand, C.D., Barnes, D.K., Clarke, A., Pugh, P.J., Linse, K. & Cary, S.C. (2009). Exploring biological constraints on the glacial history of Antarctica. *Quaternary Science Reviews*, 28, 3035-3048.
- Convey, P. (2001). Terrestrial ecosystem responses to climate changes in the Antarctic. In "Fingerprints" of Climate Change (pp. 17-42). Springer, Boston, MA.
- Costello, M.J., Bouchet, P., Boxshall, G., Fauchald, K., Gordon, D., Hoeksema, B.W., Poore, G.C.B., van Soest, R.W.M., Stöhr, S., Walter, T.C., Vanhoorne, B., Decock, W. & Appeltans, W.

- (2013). Global coordination and standardisation in marine biodiversity through the World Register of Marine Species (WoRMS) and related databases. *PLoS ONE* 8, e51629.
- Costello, M.J., & Chaudhary, C. (2017). Marine biodiversity, biogeography, deep-sea gradients, and conservation. *Current Biology*, 27(11), R511-R527.
- Courchamp, F., Dunne, J.A., Le Maho, Y., May, R.M., Thébaud, C., & Hochberg, M.E. (2015). Fundamental ecology is fundamental. *Trends in ecology & evolution*, 30(1), 9-16.
- Crame, J.A. (1994). Evolutionary history of Antarctica. In *Antarctic science* (pp. 188-214). Springer, Berlin, Heidelberg.
- Crame J.A. (2004). Pattern and process in marine biogeography: a view from the poles. *Frontiers of biogeography: new directions in the geography of nature* (ed. by Lomolino M.V., Heaney L.R., Sinauer, Sunderland, p.271-291.
- Crame, J.A. (2014). Evolutionary setting. *Biogeographic Atlas of the Southern Ocean* (ed. by C. De Broyer, C., Koubbi, P., Griffiths, H.J., Raymond, B., d'Udekem d'Acoz, C., Van de Putte, A., Danis, B., David, B., Grant, S., Gutt, J., Held, C., Hosie, G., Huettmann, F., Post, A. & Ropert-Coudert, Y.), pp. 510. SCAR, Cambridge.
- Crame, J.A. (2018). Key stages in the evolution of the Antarctic marine fauna. *Journal of Biogeography*, 45(5), 986-994.
- Crame, J.A. (1999). An evolutionary perspective on marine faunal connections between southernmost South America and Antarctica. *Scientia Marina*, 63, 1-14.
- Crame, J.A., Beu, A.G., Ineson, J. R., Francis, J.E., Whittle, R.J., & Bowman, V.C. (2014). The early origin of the Antarctic marine fauna and its evolutionary implications. *PLoS One*, 9(12), e114743.
- Crampton, J.S., Cody, R.D., Levy, R., Harwood, D., McKay, R., & Naish, T.R. (2016). Southern Ocean phytoplankton turnover in response to stepwise Antarctic cooling over the past 15 million years. *Proceedings of the National Academy of Sciences*, 113(25), 6868-6873.
- Cranmer, T.L., Ruhl, H.A., Baldwin, R.J., & Kaufmann, R.S. (2003). Spatial and temporal variation in the abundance, distribution and population structure of epibenthic megafauna in Port Foster, Deception Island. *Deep Sea Research Part II: Topical Studies in Oceanography*, 50(10-11), 1821-1842.
- Crump, R.G. (1971). Annual reproductive cycles in three geographically separated populations of *Patiriella regularis* (Verrill), a common New Zealand asteroid. *Journal of Experimental Marine Biology and Ecology*, 7(2), 137-162.
- Cumming, R.A., Nikula, R., Spencer, H.G., & Waters, J.M. (2014). Transoceanic genetic similarities of kelp-associated sea slug populations: long-distance dispersal via rafting?. *Journal of Biogeography*, 41(12), 2357-2370.



- Cunningham, S.A., Alderson, S.G., King, B.A., & Brandon, M.A. (2003). Transport and variability of the Antarctic circumpolar current in drake passage. *Journal of Geophysical Research: Oceans*, 108(C5).
- Dalziel, I.W.D., Lawver, L.A., Pearce, J.A., Barker, P.F., Hastie, A.R., Barfod, D.N., ... & Davis, M.B. (2013). A potential barrier to deep Antarctic circumpolar flow until the late Miocene?. *Geology*, 41(9), 947-950.
- Danis, B., Griffiths, H.J. & Jangoux, M. (2014). Asteroidea. *Biogeographic Atlas of the Southern Ocean* (ed. by C. De Broyer, C., Koubbi, P., Griffiths, H.J., Raymond, B., d'Udekem d'Acoz, C., Van de Putte, A., Danis, B., David, B., Grant, S., Gutt, J., Held, C., Hosie, G., Huettmann, F., Post, A. & Ropert-Coudert, Y.), pp. 510. SCAR, Cambridge.
- Darling, K.F., Wade, C. M., Stewart, I. A., Kroon, D., Dingle, R., & Brown, A. J. L. (2000). Molecular evidence for genetic mixing of Arctic and Antarctic subpolar populations of planktonic foraminifers. *Nature*, 405(6782), 43.
- David, B. & Saucède, T. (2015). *Biodiversity of the Southern Ocean*, pp. 130. ISTE Press & Elsevier, London.
- Dayrat, B. (2005). Towards integrative taxonomy. *Biological journal of the Linnean society*, 85(3), 407-417.
- Dayton, P.K., Robilliard, G.A., & Paine, R.T. (1970). Benthic faunal zonation as a result of anchor ice at McMurdo Sound, Antarctica. *Antarctic ecology*, 1, 244-258.
- Dayton P.K. (1972). Toward an understanding of community resilience and the potential effects of enrichments to the benthos at McMurdo Sound, Antarctica. *Proceedings of the colloquium on conservation problems in Antarctica* Allen Press Lawrence, Kansas, 81–96.
- Dayton, P.K. (2013). 12 Polar Benthos. *Polar Oceanography: Chemistry, Biology, and Geology*, 631.
- De Broyer, C., Clarke, A., Koubbi, P., Pakhomov, E., Scott, F., Vanden Berghe, E. & Danis, B. (2019). Register of Antarctic Marine Species. Accessed at [www.marinespecies.org/rams](http://www.marinespecies.org/rams)
- De Broyer, C. & Jazdzewska, A. (2014). Biogeographic patterns of Southern Ocean benthic Amphipods. *Biogeographic Atlas of the Southern Ocean* (ed. by De Broyer, C., Koubbi, P., Griffiths, H.J., Raymond, B., d'Udekem d'Acoz, C., Van de Putte, A., Danis, B., David, B., Grant, S., Gutt, J., Held, C., Hosie, G., Huettmann, F., Post, A. & Ropert-Coudert, Y.), pp. 510. SCAR, Cambridge.
- De Broyer, C., & Danis, B. (2011). How many species in the Southern Ocean? Towards a dynamic inventory of the Antarctic marine species. *Deep Sea Research Part II: Topical Studies in Oceanography*, 58(1-2), 5-17.
- De Broyer, C., Koubbi, P., Griffiths, H.J., Raymond, B., d'Udekem d'Acoz, C., Van de Putte, A., Danis, B., David, B., Grant, S., Gutt, J., Held, C., Hosie, G., Huettmann, F., Post, A. & Ropert-Coudert, Y. (2014). *Biogeographic Atlas of the Southern Ocean*. pp. 510. SCAR, Cambridge.

- Deacon, G.E.R. (1937). The hydrology of the Southern Ocean. *Discovery Rep.*, 15, 3-122.
- Deacon, G.E.R. (1982). Physical and biological zonation in the Southern Ocean. *Deep Sea Research Part A. Oceanographic Research Papers*, 29(1), 1-15.
- Dearborn, J.H., Edwards, K.C., & Fratt, D.B. (1991). Diet, feeding behavior, and surface morphology of the multi-armed Antarctic sea star *Labidiaster annulatus* (Echinodermata: Asteroidea). *Marine ecology progress series. Oldendorf*, 77(1), 65-84.
- Dehn, P.F. (1982) The effect of food and temperature on reproduction in *Luidia clathrata* (Asteroidea). *Echinoderms: proceedings of the international, Tampa Bay. Balkema, Rotterdam*, 457–463.
- Dell, R.K. (1972). Antarctic benthos. In *Advances in marine biology* (Vol. 10, pp. 1-216). Academic Press.
- De Moreno, J.E.A., Gerpe, M.S., Moreno, V.J., & Vodopivec, C. (1997). Heavy metals in Antarctic organisms. *Polar Biology*, 17(2), 131-140.
- DeSalle, R., Egan, M.G., & Siddall, M. (2005). The unholy trinity: taxonomy, species delimitation and DNA barcoding. *Philosophical Transactions of the Royal Society B: Biological Sciences*, 360(1462), 1905-1916.
- Desbryères, D., & Guille, A. (1973). La Faune benthique de l'Archipel de Kerguelen. Premières données quantitatives. *Comptes Rendus de l'Académie des Sciences, Paris* 276: 633–636.
- Díaz, A., Féral, J. P., David, B., Saucède, T., & Poulin, E. (2011). Evolutionary pathways among shallow and deep-sea echinoids of the genus *Sterechinus* in the Southern Ocean. *Deep Sea Research Part II: Topical Studies in Oceanography*, 58(1-2), 205-211.
- Dömel, J.S., Melzer, R.R., Harder, A.M., Mahon, A.R., & Leese, F. (2017). Nuclear and mitochondrial gene data support recent radiation within the sea spider species complex *Pallenopsis patagonica*. *Frontiers in Ecology and Evolution*, 4, 139.
- Doria, G., Royer, D.L., Wolfe, A.P., Fox, A., Westgate, J.A., & Beerling, D.J. (2011). Declining atmospheric CO<sub>2</sub> during the late Middle Eocene climate transition. *American Journal of Science*, 311, 63–75.
- Downey, R.V., Griffiths, H.J., Linse, K. & Janussen, D. (2012). Diversity and distribution patterns in high southern latitude sponges. *PLoS One*, 7, e41672.
- Drummond, A.J., Suchard, M.A., Xie, D., & Rambaut, A. (2012). Bayesian phylogenetics with BEAUti and the BEAST 1.7. *Molecular biology and evolution*, 29(8), 1969-1973.
- d'Udekem d'Acoz, C., & Verheye, M.L. (2017). *Epimeria* of the Southern Ocean with notes on their relatives (Crustacea, Amphipoda, Eusiroidea). *European Journal of Taxonomy*, (359).
- Dueñas, L.F., Tracey, D.M., Crawford, A.J., Wilke, T., Alderslade, P., & Sánchez, J.A. (2016). The Antarctic Circumpolar Current as a diversification trigger for deep-sea octocorals. *BMC evolutionary biology*, 16(1), 2.

- Duquesne, S., & Riddle, M. (2002). Biological monitoring of heavy-metal contamination in coastal waters off Casey Station, Windmill Islands, East Antarctica. *Polar Biology*, 25(3), 206-215.
- Eastman, J.T., & McCune, A.R. (2000). Fishes on the Antarctic continental shelf: evolution of a marine species flock?. *Journal of Fish Biology*, 57, 84-102.
- Eastman, J.T. (2005). The nature of the diversity of Antarctic fishes. *Polar biology*, 28(2), 93-107.
- Edgar, G.J. (1987). Dispersal of faunal and oral propagules associated with drifting *Macrocystis pyrifera* plants. *Marine Biology* 95, 599-610
- Edgar, R.C. (2004). MUSCLE: multiple sequence alignment with high accuracy and high throughput. *Nucleic acids research*, 32(5), 1792-1797.
- Eisen, O., Frezzotti, M., Genthon, C., Isaksson, E., Magand, O., Van Den Broeke, M.R., ... & Karlöf, L. (2008). Ground-based measurements of spatial and temporal variability of snow accumulation in East Antarctica. *Reviews of Geophysics*, 46(2).
- Eléaume, M., Hemery, L. G., Roux, M., & Améziane, N. (2014). Southern Ocean crinoids. *Biogeographic atlas of the Southern Ocean* (ed. by C. De Broyer, P. Koubbi, H.J. Griffiths, B. Raymond, C. d'Udekem d'Acoz, Van de Putte A., B. Danis, B. David, S. Grant, J. Gutt, C. Held, G. Hosie, F. Huettmann, A. Post and Y. Ropert-Coudert), pp. 510. SCAR, Cambridge.
- Eriksen, M., Lebreton, L.C., Carson, H.S., Thiel, M., Moore, C. J., Borerro, J.C., ... & Reisser, J. (2014). Plastic pollution in the world's oceans: more than 5 trillion plastic pieces weighing over 250,000 tons afloat at sea. *PloS one*, 9(12), e111913.
- Ezard, T., Fujisawa, T., & Barraclough, T.G. (2009). Splits: species' limits by threshold statistics. *R package version*, 1(11), r29.
- Fabri-Ruiz, S., Danis, B., David, B., & Saucède, T. (2019). Can we generate robust species distribution models at the scale of the Southern Ocean? *Diversity and distributions*, 25(1), 21-37.
- Fell, H.B. (1953). Echinoderms from the Subantarctic islands of New Zealand: Asteroidea, Ophiuroidea, and Echinoidea, *Records Dominion Museum* 2: 73–111.
- Fell, H.B., & Clark HE (1959). *Anareaster*, a new genus of Asteroidea from Antarctica. *Transactions of the Royal Society of New Zealand* 87: 185–187.
- Fernanda, P.A., Clementina, B.C., Javier, C., & Gabriela, M. (2015). Reproduction and oxidative metabolism in the brooding sea star *Anasterias antarctica* (Lütken, 1957). *Journal of experimental marine biology and ecology*, 463, 150-157.
- Feuda, R., & Smith, A.B. (2015). Phylogenetic signal dissection identifies the root of starfishes. *PLoS One*, 10(5), e0123331.
- Fisher, W.K. (1930). Asteroidea of the North Pacific and adjacent waters. Part 3. Forcipulata. *Bulletin of the United States National Museum* (76), 1-356.

- Fisher, W.K. (1940). Asteroidea. *Discovery Reports* (20), 69-306.
- Fitzgerald, P. (2002). Tectonics and landscape evolution of the Antarctic plate since the breakup of Gondwana, with an emphasis on the West Antarctic Rift System and the Transantarctic Mountains. *Royal Society of New Zealand Bulletin*, 35, 453-469.
- Folmer, O., Black, M., Hoeh, W., Lutz, R., & Vrijenhoek, R. (1994). DNA primers for amplification of mitochondrial cytochrome c oxidase subunit I from diverse metazoan invertebrates. *Molecular Marine Biology and Biotechnology*, 3(5), 294-9.
- Foltz, D.W., Bolton, M.T., Kelley, S.P., Kelley, B.D., & Nguyen, A.T. (2007). Combined mitochondrial and nuclear sequences support the monophyly of forcipulatacean sea stars. *Molecular Phylogenetics and Evolution*, 43(2), 627-634.
- Foltz, D.W., Fatland, S. D., Eléaume, M., Markello, K., Howell, K.L., Neill, K., & Mah, C.L. (2013). Global population divergence of the sea star *Hippasteria phrygiana* corresponds to the onset of the last glacial period of the Pleistocene. *Marine Biology*, 160(5), 1285-1296.
- Fortes, R.R. & Absalão, R.S. (2011). Biogeography and connectivity between western South American and Antarctic marine molluscs. *Oecologia Australis*, 15, 111-123.
- Fraser, C.I., Nikula, R., Spencer, H.G., & Waters, J.M. (2009). Kelp genes reveal effects of subantarctic sea ice during the Last Glacial Maximum. *Proceedings of the National Academy of Sciences*, 106(9), 3249-3253.
- Fraser, C.I., Nikula, R., Ruzzante, D.E. & Waters, J.M. (2012) Poleward bound: biological impacts of Southern Hemisphere glaciation. *Trends in ecology & evolution*, 27, 462-471.
- Fraser, C.I., Zuccarello, G.C., Spencer, H.G., Salvatore, L.C., Garcia, G.R., & Waters, J.M. (2013). Genetic affinities between trans-oceanic populations of non-buoyant macroalgae in the high latitudes of the Southern Hemisphere. *PLoS One*, 8(7), e69138.
- Fraser, C.I., Kay, G.M., du Plessis, M. & Ryan, P.G. (2016). Breaking down the barrier: dispersal across the Antarctic Polar Front. *Ecography*, 39, 1-3.
- Frederich, M., Sartoris, F.J., & Pörtner, H.O. (2002). Distribution patterns of decapod crustaceans in polar areas: a result of magnesium regulation? In *Ecological Studies in the Antarctic Sea Ice Zone* (pp. 246-250). Springer, Berlin, Heidelberg.
- Fretwell, P., Pritchard, H.D., Vaughan, D.G., Bamber, J.L., Barrand, N.E., Bell, R., ... & Catania, G.A. (2013). Bedmap2: improved ice bed, surface and thickness datasets for Antarctica.
- Fujisawa, T., & Barraclough, T.G. (2013). Delimiting species using single-locus data and the Generalized Mixed Yule Coalescent approach: a revised method and evaluation on simulated data sets. *Systematic biology*, 62(5), 707-724.
- Galaska, M.P., Sands, C.J., Santos, S.R., Mahon, A.R., & Halanych, K.M. (2017a). Geographic structure in the Southern Ocean circumpolar brittle star *Ophionotus victoriae* (Ophiuridae) revealed from mt DNA and single-nucleotide polymorphism data. *Ecology and evolution*, 7(2), 475-485.

- Galaska, M. P., Sands, C. J., Santos, S. R., Mahon, A. R., & Halanych, K. M. (2017b). Crossing the divide: admixture across the Antarctic polar front revealed by the brittle star *Astrotoma agassizii*. *The Biological Bulletin*, 232(3), 198-211.
- Gale, A.S. (2011). Phylogeny of the neoasteroidea (post-Palaeozoic Asteroidea, Echinodermata). *Special Papers in Palaeontology*, 85, 112.
- Gale, A.S. (1987). Phylogeny and classification of the Asteroidea (Echinodermata). *Zoological Journal of the Linnean Society*, 89(2), 107-132.
- Garcia-Vazquez, E., Machado-Schiaffino, G., Campo, D., & Juanes, F. (2012). Species misidentification in mixed hake fisheries may lead to overexploitation and population bottlenecks. *Fisheries Research*, 114, 52-55.
- Gattuso, J.P., Magnan, A., Billé, R., Cheung, W.W., Howes, E. L., Joos, F., ... & Hoegh-Guldberg, O. (2015). Contrasting futures for ocean and society from different anthropogenic CO<sub>2</sub> emissions scenarios. *Science*, 349(6243), aac4722.
- GEBCO (2014). The GEBCO\_2014 Grid, version 20150318, [www.gebco.net](http://www.gebco.net).
- Gianguzza, P., Di Trapani, F., Bonaviri, C., Agnetta, D., Vizzini, S., & Badalamenti, F. (2016). Size-dependent predation of the mesopredator *Marthasterias glacialis* (L.)(Asteroidea). *Marine biology*, 163(3), 65.
- Gili, J. M., Arntz, W.E., Palanques, A., Orejas, C., Clarke, A., Dayton, P.K., ... & López-González, P.J. (2006). A unique assemblage of epibenthic sessile suspension feeders with archaic features in the high-Antarctic. *Deep Sea Research Part II: Topical Studies in Oceanography*, 53(8-10), 1029-1052.
- Gillies, C.L., Stark, J.S., Johnstone, G.J., & Smith, S.D. (2012). Carbon flow and trophic structure of an Antarctic coastal benthic community as determined by  $\delta^{13}\text{C}$  and  $\delta^{15}\text{N}$ . *Estuarine, Coastal and Shelf Science*, 97, 44-57.
- Gillooly, J.F., Allen, A.P., West, G.B., & Brown, J.H. (2005). The rate of DNA evolution: effects of body size and temperature on the molecular clock. *Proceedings of the National Academy of Sciences*, 102(1), 140-145.
- Glorioso, P.D., Piola, A.R. & Leben, R.R. (2005). Mesoscale eddies in the Subantarctic Front-Southwest Atlantic. *Scientia Marina*, 69, 7-15.
- Gonzalez-Bernat, M.J., Lamare, M., & Barker, M. (2013). Effects of reduced seawater pH on fertilisation, embryogenesis and larval development in the Antarctic seastar *Odontaster validus*. *Polar Biology*, 36(2), 235-247.
- González-Wevar, C.A., Nakano, T., Cañete, J.I., & Poulin, E. (2010). Molecular phylogeny and historical biogeography of *Nacella* (Patellogastropoda: Nacellidae) in the Southern Ocean. *Molecular phylogenetics and evolution*, 56(1), 115-124.

González-Wevar, C.A., Diaz, A., Gerard, K., Cañete, J.I. & Poulin, E. (2012). Divergence time estimations and contrasting patterns of genetic diversity between Antarctic and southern South America benthic invertebrates. *Revista Chilena de Historia Natural*, 85, 445-456.

González-Wevar, C.A., Hüne, M., Segovia, N.I., Nakano, T., Spencer, H.G., Chown, S.L., ... & Poulin, E. (2017). Following the Antarctic Circumpolar Current: patterns and processes in the biogeography of the limpet *Nacella* (Mollusca: Patellogastropoda) across the Southern Ocean. *Journal of biogeography*, 44(4), 861-874.

González-Wevar, C.A., Segovia, N.I., Rosenfeld, S., Ojeda, J., Hüne, M., Naretto, J., ... & Spencer, H.G. (2018). Unexpected absence of island endemics: Long-distance dispersal in higher latitude sub-Antarctic *Siphonaria* (Gastropoda: Euthyneura) species. *Journal of Biogeography*, 45(4), 874-884.

Goodall-Copestake, W.P., Tarling, G.A., & Murphy, E.J. (2012). On the comparison of population-level estimates of haplotype and nucleotide diversity: a case study using the gene *cox1* in animals. *Heredity*, 109(1), 50.

Gordon, A.L. (1988). Spatial and temporal variability within the Southern Ocean. In *Antarctic Ocean and resources variability* (pp. 41-56). Springer, Berlin, Heidelberg.

Gordon, A.L. (2001). Current systems in the Southern Ocean, in *Encyclopedia of Ocean Sciences*, pp. 735–743, Academic Press, doi:10.1006/rwos.2001.0369.

Grant, R.A., Griffiths, H.J., Steinke, D., Wadley, V., & Linse, K. (2011). Antarctic DNA barcoding; a drop in the ocean? *Polar Biology*, 34(5), 775-780.

Gray, J.S. (2001). Antarctic marine benthic biodiversity in a world-wide latitudinal context. *Polar Biology*, 24(9), 633-641.

Griesel, A., Mazloff, M.R., & Gille, S.T. (2012). Mean dynamic topography in the Southern Ocean: evaluating Antarctic Circumpolar Current transport. *Journal of Geophysical Research: Oceans*, 117(C1).

Griffiths, H.J., Barnes, D.K., & Linse, K. (2009). Towards a generalized biogeography of the Southern Ocean benthos. *Journal of Biogeography*, 36, 162-177.

Griffiths, H.J. (2010) Antarctic marine biodiversity – what do we know about the distribution of life in the Southern Ocean? *PLoS One*, 5, p.e11683.

Griffiths, H.J., Danis, B., & Clarke, A. (2011). Quantifying Antarctic marine biodiversity: The SCAR-MarBIN data portal. *Deep Sea Research Part II: Topical Studies in Oceanography*, 58(1-2), 18-29.

Griffiths, H.J., Van de Putte, A. & Danis, B. (2014). Data distribution: Patterns and implications. *Biogeographic atlas of the Southern Ocean* (ed. by C. De Broyer, P. Koubbi, H.J. Griffiths, B. Raymond, C. d'Udekem d'Acoz, Van de Putte A., B. Danis, B. David, S. Grant, J. Gutt, C. Held, G. Hosie, F. Huettmann, A. Post and Y. Ropert-Coudert), pp. 510. SCAR, Cambridge.

Grygier, M.J. (1987). Antarctic records of asteroid-infesting Ascothoracida (Crustacea), including a new genus of Ctenosculidae. *Proceedings of the Biological Society of Washington*, 100(4), 700-712.

Guille, A. (1977). Benthic bionomy of the continental shelf of the Kerguelen Islands: quantitative data on the echinoderms of the Morbihan Gulf. In: Llano GA (Ed.) *Adaptations within Antarctic ecosystems* Smithsonian Institution Washington, DC, 253–262.

Gutt, J., Barratt, I., Domack, E.W., d'Udekem d'Acoz, C., Dimmler, W., Grémare, A., Heilmayer, O., Isla, E., Janussen, D., Jorgensen, E., Kock, K.H., Lehnert, L.S., López-González, P.J., Langner, S., Linse, K., Manjón-Cabeza, M.E., Meißner, M., Montiel, A., Raes, M., Robert, H., Rose, A., Schepisi, E.S., Saucède, T., Scheidat, M., Schenke, H.W., Seiler, J., & Smith, C. (2010). Macroben-thos in surface sediments sampled during POLARSTERN cruise ANT-XXIII/8. [https:// doi.org/10.1594/PANGAEA.718106](https://doi.org/10.1594/PANGAEA.718106), In supplement to: Gutt, J. et al. (2011): Biodiver-sity change after climate-induced ice-shelf collapse in the Antarctic. *Deep Sea Research Part II: Topical Studies in Oceanography* 58(1–2): 74–83.

Gutt, J., Zurell, D., Bracegirdle, T., Cheung, W., Clark, M., Convey, P., ... & Griffiths, H. (2012). Correlative and dynamic species distribution modelling for ecological predictions in the Antarctic: a cross-disciplinary concept. *Polar Research*, 31(1), 11091.

Gutt, J., Sirenko, B.I., Smirnov, I. S., & Arntz, W.E. (2004). How many macrozoobenthic species might inhabit the Antarctic shelf?. *Antarctic Science*, 16(1), 11-16.

Gutt, J., Piepenburg, D., & Voß, J. (2014). Asteroids, ophiuroids and holothurians from the southeastern Weddell Sea (Southern Ocean). *ZooKeys*, (434), 1.

Gutt, J., Bertler, N., Bracegirdle, T.J., Buschmann, A., Comiso, J., Hosie, G., ... & Xavier, J.C. (2015). The Southern Ocean ecosystem under multiple climate change stresses-an integrated circumpolar assessment. *Global Change Biology*, 21(4), 1434-1453.

Hajibabaei, M., Singer, G.A., Hebert, P.D., & Hickey, D.A. (2007). DNA barcoding: how it complements taxonomy, molecular phylogenetics and population genetics. *Trends in Genetics*, 23(4), 167-172.

Halanych, K.M., & Mahon, A.R. (2018). Challenging Dogma Concerning Biogeographic Patterns of Antarctica and the Southern Ocean. *Annual Review of Ecology, Evolution, and Systematics*, 49, 355-378.

Hansen, J., Sato, M., Russell, G., & Kharecha, P. (2013). Climate sensitivity, sea level and atmospheric carbon dioxide. *Philosophical Transactions of the Royal Society A: Mathematical, Physical and Engineering Sciences*, 371(2001), 20120294.

Havermans, C., Nagy, Z.T., Sonet, G., De Broyer, C., & Martin, P. (2011). DNA barcoding reveals new insights into the diversity of Antarctic species of *Orchomene* sensu lato (Crustacea: Amphipoda: Lysianassoidea). *Deep Sea Research Part II: Topical Studies in Oceanography*, 58(1-2), 230-241.

Havermans, C. (2014). Phylogeographic Patterns of the Lysianassoidea (Crustacea: Peracarida: Amphipoda). Biogeographic atlas of the Southern Ocean (ed. by C. De Broyer, P. Koubbi, H.J. Griffiths, B. Raymond, C. d'Udekem d'Acoz, Van de Putte A., B. Danis, B. David, S. Grant, J. Gutt, C. Held, G. Hosie, F. Huettmann, A. Post and Y. Ropert-Coudert), pp. 510. SCAR, Cambridge.

Hebert, P.D., Cywinska, A., Ball, S. L., & Dewaard, J. R. (2003). Biological identifications through DNA barcodes. Proceedings of the Royal Society of London. Series B: Biological Sciences, 270(1512), 313-321.

Hedgpeth, J.W. (1969). Introduction to Antarctic zoogeography. Distribution of selected groups of marine invertebrates in water south of 35°S (ed. by V.C. Bushnell and J.W. Hedgpeth), pp. 1–9. Antarctic Map Folio Series, 11. American Geographical Society, New York.

Heimeier, D., Lavery, S., & Sewell, M. A. (2010). Using DNA barcoding and phylogenetics to identify Antarctic invertebrate larvae: Lessons from a large scale study. Marine genomics, 3(3-4), 165-177.

Held, C. (2014) Phylogeography and population genetics.

Hellberg, M.E., Burton, R.S., Neigel, J.E., & Palumbi, S.R. (2002). Genetic assessment of connectivity among marine populations. Bulletin of marine science, 70(1), 273-290.

Hemery, L.G., Eléaume, M., Roussel, V., Améziane, N., Gallut, C., Steinke, D., Cruaud, C., Couloux, A. & Wilson, N.G. (2012). Comprehensive sampling reveals circumpolarity and sympatry in seven mitochondrial lineages of the Southern Ocean crinoid species *Promachocrinus kerguelensis* (Echinodermata). Molecular Ecology, 21, 2502-2518.

Henderson, J.A., & Lucas, J.S. (1971). Larval development and metamorphosis of *Acanthaster planci* (Asteroidea). Nature, 232(5313), 655.

Ho, J.W., Adams, C.E., Lew, J.B., Matthews, T.J., Ng, C.C., Shahabi-Sirjani, A., ... & Jermini, L.S. (2006). SeqVis: visualization of compositional heterogeneity in large alignments of nucleotides. Bioinformatics, 22(17), 2162-2163.

Hoffman, J.I., Clarke, A., Clark, M.S., Fretwell, P., & Peck, L.S. (2012). Unexpected fine-scale population structure in a broadcast-spawning Antarctic marine mollusc. PLoS One, 7(3), e32415.

Hoffman, J.I., Clarke, A., Linse, K., & Peck, L.S. (2011). Effects of brooding and broadcasting reproductive modes on the population genetic structure of two Antarctic gastropod molluscs. Marine Biology, 158(2), 287-296.

Howe, J.A., Shimmiel, T.M., & Diaz, R. (2004). Deep-water sedimentary environments of the northwestern Weddell Sea and South Sandwich Islands, Antarctica. Deep Sea Research Part II: Topical Studies in Oceanography, 51(14-16), 1489-1514.

Hunter, R.L., & Halanych, K.M. (2010). Phylogeography of the Antarctic planktotrophic brittle star *Ophionotus victoriae* reveals genetic structure inconsistent with early life history. Marine Biology, 157(8), 1693-1704.



Huybrechts, P. (2002). Sea-level changes at the LGM from ice-dynamic reconstructions of the Greenland and Antarctic ice sheets during the glacial cycles. *Quaternary Science Reviews*, 21(1-3), 203-231.

Hyman, L.H. (1955). *The invertebrates: Echinodermata*. McGraw-Hill Book Company, New York, 763 pp.

Ingels, J., Vanreusel, A., Brandt, A., Catarino, A.I., David, B., De Ridder, C., Dubois, P., Gooday, A.J., Martin, P., Pasotti, F. & Robert, H. (2012). Possible effects of global environmental changes on Antarctic benthos: a synthesis across five major taxa. *Ecology and evolution*, 2, 453-485.

IPCC (2015). *Climate change 2014: synthesis report*. 169.

Intergovernmental Oceanographic Commission (IOC) of UNESCO (2015). *The Ocean Biogeographic Information System*. <http://www.iobis.org>

Jacobs, S.S. (2004). Bottom water production and its links with the thermohaline circulation. *Antarctic Science*, 16(4), 427-437.

Jangoux, M. (1982). Food and feeding mechanisms: Asteroidea. *Echinoderm nutrition*, 117-159. Balkema, Rotterdam.

Jangoux, M. & Massin, C. (1986). Catalogue commenté des types d'Echinodermes actuels conservés dans les collections nationales belges. *Bulletin de l'Institut Royal des Sciences Naturelles de Belgique*.

Janies, D.A., Voight, J.R., & Daly, M. (2011). Echinoderm phylogeny including *Xyloplax*, a progenetic asteroid. *Systematic biology*, 60(4), 420-438.

Janosik, A.M., Mahon, A.R., Scheltema, R.S., & Halanych, K.M. (2008). Short Note: Life history of the Antarctic sea star *Labidiaster annulatus* (Asteroidea: Labidiasteridae) revealed by DNA barcoding. *Antarctic Science*, 20(6), 563-564.

Janosik, A.M., & Halanych, K.M. (2010). Unrecognized Antarctic biodiversity: a case study of the genus *Odontaster* (Odontasteridae; Asteroidea). *Integrative and comparative biology*, 50(6), 981-992.

Janosik, A.M., Mahon, A.R. & Halanych, K.M. (2011). Evolutionary history of Southern Ocean *Odontaster* sea star species (Odontasteridae; Asteroidea). *Polar biology*, 34, 575-586.

Jossart, Q., Sands, C.J., & Sewell, M.A. (2019). Dwarf brooder versus giant broadcaster: combining genetic and reproductive data to unravel cryptic diversity in an Antarctic brittle star. *Heredity*.

Jossart, Q., Moreau, C., Agüera, A., De Broyer, C. & Danis, B. (2015). The Register of Antarctic Marine Species (RAMS): a ten-year appraisal. *ZooKeys*, 524, 137-145.

Jossart, Q., De Ridder, C., Lessios, H. A., Bauwens, M., Motreuil, S., Rigaud, T., ... & David, B. (2017). Highly contrasted population genetic structures in a host–parasite pair in the Caribbean Sea. *Ecology and evolution*, 7(22), 9267-9280.

- Kamya, P.Z., Byrne, M., Graba-Landry, A., & Dworjanyn, S.A. (2016). Near-future ocean acidification enhances the feeding rate and development of the herbivorous juveniles of the crown-of-thorns starfish, *Acanthaster planci*. *Coral Reefs*, 35(4), 1241-1251.
- Kapli, P., Lutteropp, S., Zhang, J., Kobert, K., Pavlidis, P., Stamatakis, A., & Flouri, T. (2017). Multi-rate Poisson tree processes for single-locus species delimitation under maximum likelihood and Markov chain Monte Carlo. *Bioinformatics*, 33(11), 1630-1638.
- Keith, S.A., Webb, T.J., Böhning-Gaese, K., Connolly, S.R., Dulvy, N.K., Eigenbrod, F., ... & Isaac, N.J. (2012). What is macroecology? *Biology letters*, 8, 904-906.
- Kekkonen, M., Mutanen, M., Kaila, L., Nieminen, M., & Hebert, P.D. (2015). Delineating species with DNA barcodes: a case of taxon dependent method performance in moths. *PLoS One*, 10(4), e0122481.
- Kennicutt, M.C., Chown, S.L., Cassano, J.J., Liggett, D., Peck, L.S., Massom, R., ... & Allison, I. (2015). A roadmap for Antarctic and Southern Ocean science for the next two decades and beyond. *Antarctic Science*, 27(1), 3-18.
- Kennicutt, M.C., Chown, S.L., Cassano, J.J., Liggett, D., Massom, R., Peck, L.S., ... & Sutherland, W.J. (2014). Polar research: six priorities for Antarctic science. *Nature News*, 512(7512), 23.
- Knox, G.A. (1960). Littoral ecology and biogeography of the southern oceans. *Proc. R. Soc. Lond. B*, 152(949), 577-624.
- Knox, G.A., & Lowry, J.K. (1977). A comparison between the benthos of the Southern Ocean and the North Polar Ocean with special reference to the Amphipoda and the Polychaeta. *Polar oceans*. Arctic Institute of North America, Calgary, 423-462.
- Knox, G.A. (2007). *Biology of the Southern Ocean*. 2nd ed. CRC Press.
- Koehler, R. (1907). Astéries, Ophiures et Echinides recueillis dans les mers australes par la Scotia (1902–1904). *Zoologischer Anzeiger* 32(6): 140–147.
- Koehler, R. (1908). Astéries, Ophiures et Echinides de l'Expédition Antarctique Nationale Écossaise. *Transactions of the Royal Society of Edinburgh* 46: 529–649.
- Koehler, R. (1912). Echinodermes (Astéries, Ophiures et Echinides). Deuxième Expédition Antarctique Française 1908–1910 J. Charcot. Masson et cie, Paris, 1–277.
- Koehler, R. (1917). Echinodermes (Astéries, Ophiures et Echinides) recueillis par M. Rallier du Baty, aux Iles de Kerguelen, en 1913-1914. *Annales de l'institut océanographique*. Monaco, 7(8), 1-82.
- Koehler, R. (1920). Echinodermata: Asteroidea. *Scientific Reports, Australasian Antarctic Expedition (1911-1914)* C8: 1-308.
- Koehler, R. (1923). Astéries et Ophiures. Further zoological results of the Swedish Antarctic Expedition (1901–1903) 1: 1–145.

Korovchinsky, N.M. (1976). New species of abyssal starfishes of the genus *Freyella* (Brisingidae) from the South Atlantic. *Zoologicheskii Zhurnal*, 55(8), 1187-1194.

Koubbi, P., De Broyer, C., Griffiths, H., Raymond, B., D'Udekem d'Acoz, C., Van de Putte, A., ... & Held, C. (2014). Conclusions: Present and Future of Southern Ocean Biogeography. *Biogeographic atlas of the Southern Ocean* (ed. by C. De Broyer, P. Koubbi, H.J. Griffiths, B. Raymond, C. d'Udekem d'Acoz, Van de Putte A., B. Danis, B. David, S. Grant, J. Gutt, C. Held, G. Hosie, F. Huettmann, A. Post and Y. Ropert-Coudert), pp. 510. SCAR, Cambridge.

Krug, A.Z., Jablonski, D., & Valentine, J.W. (2009). Signature of the end-Cretaceous mass extinction in the modern biota. *Science*, 323(5915), 767-771.

Kumar, S., Stecher, G., & Tamura, K. (2016). MEGA7: molecular evolutionary genetics analysis version 7.0 for bigger datasets. *Molecular biology and evolution*, 33(7), 1870-1874.

Lagabrielle, Y., Godd ris, Y., Donnadieu, Y., Malavieille, J., & Suarez, M. (2009). The tectonic history of Drake Passage and its possible impacts on global climate. *Earth and Planetary Science Letters*, 279(3-4), 197-211.

Lagabrielle, Y., Godd ris, Y., Donnadieu, Y., Malavieille, J., & Suarez, M. (2009). The tectonic history of Drake Passage and its possible impacts on global climate. *Earth and Planetary Science Letters*, 279(3), 197-211.

Lanfear, R., Frandsen, P.B., Wright, A.M., Senfeld, T., & Calcott, B. (2016). PartitionFinder 2: new methods for selecting partitioned models of evolution for molecular and morphological phylogenetic analyses. *Molecular Biology and Evolution*, 34(3), 772-773.

Lawrence, J.M., McClintock, J.B., & Guille, A. (1984). Organic level and caloric content of eggs of brooding asteroids and an echinoid (Echinodermata) from Kerguelen (South Indian Ocean). *International Journal of Invertebrate Reproduction and Development*, 7(4), 249-257.

Lawrence, J.M., & McClintock, J.B. (1987). Intertidal invertebrate and algal communities on the rocky shores of the Bay of Morbihan, Kerguelen (South Indian Ocean). *Marine Ecology*, 8(3), 207-220.

Lawrence, J.M. (2013). *Starfish: biology and ecology of the Asteroidea*. pp. 288. Johns Hopkins University Press.

Lawver, L.A., & Gahagan, L.M. (2003). Evolution of Cenozoic seaways in the circum-Antarctic region. *Palaeogeography, Palaeoclimatology, Palaeoecology*, 198(1-2), 11-37.

Lawver, L.A., Gahagan, L.M. & Dalziel, I. (2014). Reconstructions of the Southern Ocean and Antarctic regions. *Biogeographic Atlas of the Southern Ocean* (ed. by C. De Broyer, C., Koubbi, P., Griffiths, H.J., Raymond, B., d'Udekem d'Acoz, C., Van de Putte, A., Danis, B., David, B., Grant, S., Gutt, J., Held, C., Hosie, G., Huettmann, F., Post, A. & Ropert-Coudert, Y.), pp. 510. SCAR, Cambridge.

Lawver, L.A., & Gahagan, L.M. (1998). Opening of Drake Passage and its impact on Cenozoic ocean circulation. *Oxford Monographs on Geology and Geophysics*, 39, 212-226.

- Layton, K.K., Corstorphine, E. A., & Hebert, P. D. (2016). Exploring Canadian echinoderm diversity through DNA barcodes. *PloS one*, 11(11), e0166118.
- Leclerc, M. (2015). Cell-Mediated and Humoral Immune Responses in the Sea-Star *Asterias Rubens* (Echinoderm): Notion of Invertebrate Primitive Antibody. *SAJ Biotechnology*, 2(1), 1.
- Lecointre, G., Améziane, N., Boisselier, M.C., Bonillo, C., Busson, F., Causse, R., ... & d'Acoz, C. D.U. (2013). Is the species flock concept operational? The Antarctic shelf case. *PloS one*, 8(8), e68787.
- Leese, F., Agrawal, S., & Held, C. (2010). Long-distance island hopping without dispersal stages: transportation across major zoogeographic barriers in a Southern Ocean isopod. *Naturwissenschaften*, 97(6), 583-594.
- Lefebvre, V., Donnadiou, Y., Sepulchre, P., Swingedouw, D., & Zhang, Z.S. (2012). Deciphering the role of southern gateways and carbon dioxide on the onset of the Antarctic Circumpolar Current. *Paleoceanography*, 27(4).
- Lieberkind, I. (1926). *Ctenodiscus australis* Lütken. A brood-protecting asteroid. *Vid. Dansk. Nat. Hist. Foren.* 82: 184–196
- Linchangco Jr, G.V., Foltz, D.W., Reid, R., Williams, J., Nodzak, C., Kerr, A.M., ... & Mah, C.L. (2017). The phylogeny of extant starfish (Asteroidea: Echinodermata) including *Xyloplax*, based on comparative transcriptomics. *Molecular phylogenetics and evolution*, 115, 161-170.
- Lins, L.S., Ho, S.Y., Wilson, G.D., & Lo, N. (2012). Evidence for Permo-Triassic colonization of the deep sea by isopods. *Biology Letters*, rsbl20120774.
- Linse, K., Griffiths, H.J., Barnes, D.K. & Clarke, A. (2006). Biodiversity and biogeography of Antarctic and sub-Antarctic mollusca. *Deep Sea Research Part II: Topical Studies in Oceanography*, 53, 985-1008.
- Linse, K., Brandt, A., Bohn, J.M., Danis, B., De Broyer, C., Ebbe, B., Heterier, V., Janussen, D., González, P.J.L., Schüller, M. & Schwabe, E. (2007a). Macro-and megabenthic assemblages in the bathyal and abyssal Weddell Sea (Southern Ocean). *Deep Sea Research Part II: Topical Studies in Oceanography*, 54, 1848-1863.
- Linse, K., Cope, T., Lörz, A.N. & Sands, C. (2007b). Is the Scotia Sea a centre of Antarctic marine diversification? Some evidence of cryptic speciation in the circum-Antarctic bivalve *Lissarca notorcadensis* (Arcoidea: Philobryidae). *Polar Biology*, 30, 1059-1068.
- Liu, Z., Pagani, M., Zinniker, D., DeConto, R., Huber, M., Brinkhuis, H., ... & Pearson, A. (2009). Global cooling during the Eocene-Oligocene climate transition. *Science*, 323(5918), 1187-1190.
- Lomolino, M.V., Riddle, B.R., & Whittaker, R.J. (2017). *Biogeography*.
- Longhurst, A.R. (2007). *Ecological geography of the sea*. Second edition, pp. 542. Academic Press, San Diego.

- Lovell, L.L., & Trego, K.D. (2003). The epibenthic megafaunal and benthic infaunal invertebrates of Port Foster, Deception Island (South Shetland Islands, Antarctica). *Deep Sea Research Part II: Topical Studies in Oceanography*, 50(10-11), 1799-1819.
- Ludwig, H. (1903). Seesterne. Résultats du voyage du S.Y. Belgica en 1897-1898-1899. *Rapports scientifiques*, 1–72.153
- Lyle, M., Gibbs, S., Moore, T.C., & Rea, D.K. (2007). Late Oligocene initiation of the Antarctic circumpolar current: evidence from the South Pacific. *Geology*, 35(8), 691-694.
- MacBride, E.W. (1920) Echinodermata (Part II) and Enteropneusta. Larvae of Echinoderma and Enteropneusta. British Antarctic (Terra Nova) Expedition, 1910. *Natural History Report, Zoology 4*: 83–94.
- Magesky, A., & Pelletier, É. (2018). Molecular Stress Responses against Trace Metal Contamination in Aquatic Invertebrates. In *Heat Shock Proteins and Stress* (pp. 193-265). Springer, Cham.
- Mah, C.L. (2011). Taxonomy of high-latitude Goniasteridae (Subantarctic & Antarctic): one new genus, and three new species with an overview and key to taxa. *Zootaxa*, 2759(1), 1-48.
- Mah, C.L. & Blake, D.B. (2012). Global diversity and phylogeny of the Asteroidea (Echinodermata). *PloS one*, 7, e35644.
- Mah, C.L. & Foltz, D.W. (2011a). Molecular phylogeny of the Valvatacea (Asteroidea: Echinodermata). *Zoological Journal of the Linnean Society*, 161, 769-788.
- Mah, C.L. & Foltz, D.W. (2011b). Molecular phylogeny of the Forcipulatacea (Asteroidea: Echinodermata): systematics and biogeography. *Zoological Journal of the Linnean Society*, 162, 646-660.
- Mah, C.L., & Foltz, D.W. (2014). New taxa and taxonomic revisions to the Poraniidae (Valvatacea; Asteroidea) with comments on feeding biology. *Zootaxa*, 3795(3), 327-372.
- Mah, C.L., Linse, K., Copley, J., Marsh, L., Rogers, A., Clague, D., & Foltz, D. (2015). Description of a new family, new genus, and two new species of deep-sea Forcipulatacea (Asteroidea), including the first known sea star from hydrothermal vent habitats. *Zoological Journal of the Linnean Society*, 174(1), 93-113.
- Marques, A.C., & Cantero, A.L.P. (2010). Areas of endemism in the Antarctic—a case study of the benthic hydrozoan genus *Oswaldella* (Cnidaria, Kirchenpaueriidae). *Journal of Biogeography*, 37(4), 617-623.
- Matschiner, M., Hanel, R., & Salzburger, W. (2009). Gene flow by larval dispersal in the Antarctic notothenioid fish *Gobionotothen gibberifrons*. *Molecular ecology*, 18(12), 2574-2587.
- McCartney, M.A., Keller, G., & Lessios, H.A. (2000). Dispersal barriers in tropical oceans and speciation in Atlantic and eastern Pacific sea urchins of the genus *Echinometra*. *Molecular Ecology*, 9(9), 1391-1400.

- McClintock, J.B., & Pearse, J.S. (1986). Organic and energetic content of eggs and juveniles of antarctic echinoids and asterids with lecithotrophic development. *Comparative Biochemistry and Physiology Part A: Physiology*, 85(2), 341-345.
- McClintock, J.B., Pearse, J.S., & Bosch, I. (1988). Population structure and energetics of the shallow-water Antarctic sea star *Odontaster validus* in contrasting habitats. *Marine Biology*, 99(2), 235-246.
- McClintock, J.B., & Baker, B.J. (1997). A review of the chemical ecology of Antarctic marine invertebrates. *American Zoologist*, 37(4), 329-342.
- McClintock, J.B. (1994). Trophic biology of Antarctic shallow-water echinoderms. *Marine ecology progress series*. Oldendorf, 111, 191-202.
- McClintock, J.B., Baker, B.J., Amsler, C.D., & Barlow, T.L. (2000). Chemotactic tube-foot responses of the spongivorous sea star *Perknaster fuscus* to organic extracts of sponges from McMurdo Sound, Antarctica. *Antarctic Science*, 12(1), 41-46.
- McClintock, J.B., Amsler, M.O., Amsler, C.D. & Baker, B.J. (2006). The biochemical composition, energy content, and chemical antifeedant defenses of the common Antarctic Peninsular sea stars *Granaster nutrix* and *Neosmilaster georgianus*. *Polar Biology*, 29, 615-623.
- McClintock, J.B., Angus, R.A., Ho, C.P., Amsler, C.D., & Baker, B.J. (2008). Intraspecific agonistic arm-fencing behavior in the Antarctic keystone sea star *Odontaster validus* influences prey acquisition. *Marine Ecology Progress Series*, 371, 297-300.
- McClintock, J.B., Angus, R.A., Ho, C., Amsler, C.D., & Baker, B.J. (2008). A laboratory study of behavioral interactions of the Antarctic keystone sea star *Odontaster validus* with three sympatric predatory sea stars. *Marine biology*, 154(6), 1077.
- McGeoch, M.A., Spear, D., Kleynhans, E.J., & Marais, E. (2012). Uncertainty in invasive alien species listing. *Ecological Applications*, 22(3), 959-971.
- McKnight, D.G. (2006). *The Marine Fauna of New Zealand, Echinodermata: Asteroidea (Sea-stars): Order Velatida, Spinulosida, Forcipulatida, Brisingida, with Addenda to Paxilloidea, Valvatida*. Biodiversity Memoirs 120 National Institute of Water and Atmospheric Research, 187 pp.
- McLoughlin, S. (2001). The breakup history of Gondwana and its impact on pre-Cenozoic floristic provincialism. *Australian Journal of Botany*, 49(3), 271-300.
- Meineke, E.K., Davies, T.J., Daru, B.H., & Davis, C.C. (2018). Biological collections for understanding biodiversity in the Anthropocene.
- Menge, B.A., & Sanford, E. (2013). Ecological Role of Sea Stars from Populations. *Starfish: biology and ecology of the Asteroidea*, 67.
- Mercado Casares, B., Soto Àngel, J.J., & Peña Cantero, A.L. (2017). Towards a better understanding of Southern Ocean biogeography: new evidence from benthic hydroids. *Polar Biology*, 40(10), 1975-1988.

- Meredith, M.P. (2019). The global importance of the Southern Ocean, and the key role of its freshwater cycle. *Ocean Challenge*, 23(2), 27-32.
- Meyer, C.L. (2016). Limitations in global information on species occurrences. *Frontiers of Biogeography*, 8(2).
- Meyer, D.L., & Macurda, D.B. (1977). Adaptive radiation of the comatulid crinoids. *Paleobiology*, 3(1), 74-82.
- Mileikovskiy, S.A. (1971). Types of larval development in marine bottom invertebrates, their distribution and ecological significance: a re-evaluation. *Marine Biology*, 10(3), 193-213.
- Miller, M.A., Pfeiffer, W., & Schwartz, T. (2010). Creating the CIPRES Science Gateway for inference of large phylogenetic trees. In *Gateway Computing Environments Workshop (GCE)*, 2010 (pp. 1-8).
- Modica, M.V., Russini, V., Fassio, G., & Oliverio, M. (2017). Do larval types affect genetic connectivity at sea? Testing hypothesis in two sibling marine gastropods with contrasting larval development. *Marine environmental research*, 127, 92-101.
- Moles, J., Figuerola, B., Companyà-Llovet, N., Monleón-Getino, T., Taboada, S. & Avila, C. (2015). Distribution patterns in Antarctic and Subantarctic echinoderms. *Polar Biology*, 38, 799-813.
- Monaghan, M.T., Balke, M., Pons, J., & Vogler, A.P. (2005). Beyond barcodes: complex DNA taxonomy of a South Pacific Island radiation. *Proceedings of the Royal Society B: Biological Sciences*, 273(1588), 887-893.
- Moore, J.M., Carvajal, J.I., Rouse, G.W., & Wilson, N.G. (2018). The Antarctic Circumpolar Current isolates and connects: Structured circumpolarity in the sea star *Glabraster antarctica*. *Ecology and evolution*, 8(21), 10621-10633.
- Moreau, C., Danis, B., Jossart, Q., Eléaume, M., Sands, C., Achaz, G., ... & Saucède, T. (2019). Is reproductive strategy a key factor in understanding the evolutionary history of Southern Ocean Asteroidea (Echinodermata)? *Ecology and Evolution*, 9(15), 8465-8478.
- Moreau, C., Mah, C., Agüera, A., Améziane, N., Barnes, D., Crokaert, G., ... & Jazdzewska, A. (2018). Antarctic and sub-Antarctic Asteroidea database. *ZooKeys*, (747), 141.
- Moreau, C., Agüera, A., Jossart, Q. & Danis, B. (2015). Southern Ocean Asteroidea: a proposed update for the Register of Antarctic Marine Species. *Biodiversity Data Journal*, 3, e7062.
- Moreau, C., Saucède, T., Jossart, Q., Agüera, A., Brayard, A., & Danis, B. (2017). Reproductive strategy as a piece of the biogeographic puzzle: a case study using Antarctic sea stars (Echinodermata, Asteroidea). *Journal of Biogeography*, 44(4), 848-860.
- Mortensen, T. (1927). *Handbook of the Echinoderms of the British Isles*. Oxford University Press.

- Murray, J. (1885). Notes on the reproduction of certain echinoderms from the Southern Ocean. Report on Scientific Research, Voyage H.M.S. Challenger 1873– 1876. Her Majesty's Stationery Office 1, 379–396
- Naish, T., Powell, R., Levy, R., Wilson, G., Scherer, R., Talarico, F., ... & Carter, L. (2009). Obliguity-paced Pliocene West Antarctic ice sheet oscillations. *Nature*, 458(7236), 322.
- Naughton, K.M., & O'Hara, T.D. (2009). A new brooding species of the biscuit star *Tosia* (Echinodermata: Asteroidea: Goniasteridae), distinguished by molecular, morphological and larval characters. *Invertebrate Systematics*, 23(4), 348-366.
- Near, T.J., Dornburg, A., Kuhn, K.L., Eastman, J.T., Pennington, J.N., Patarnello, T., ... & Jones, C.D. (2012). Ancient climate change, antifreeze, and the evolutionary diversification of Antarctic fishes. *Proceedings of the National Academy of Sciences*, 109(9), 3434-3439.
- Nikula, R., Fraser, C.I., Spencer, H.G., & Waters, J.M. (2010). Circumpolar dispersal by rafting in two subantarctic kelp-dwelling crustaceans. *Marine Ecology Progress Series*, 405, 221-230.
- Nybelin, O. (1947). Antarctic fishes. The Scientific Results of the Norwegian Antarctic Expedition, 1927-1928, 26, 1-76.
- O'Hara, T.D. (1998). Origin of Macquarie Island echinoderms. *Polar Biology*, 20, 143-151.
- O'Hara, T.D., Smith, P.J., Mills, V.S., Smirnov, I. & Steinke, D. (2013). Biogeographical and phylogeographical relationships of the bathyal ophiuroid fauna of the Macquarie Ridge, Southern Ocean. *Polar biology*, 36, 321-333.
- O'Hara, T.D., Hugall, A.F., Woolley, S.N., Bribiesca-Contreras, G., & Bax, N.J. (2019). Contrasting processes drive ophiuroid phylodiversity across shallow and deep seafloors. *Nature*, 565(7741), 636.
- O'Loughlin, P.M., Paulay, G., Davey, N., & Michonneau, F. (2011). The Antarctic region as a marine biodiversity hotspot for echinoderms: diversity and diversification of sea cucumbers. *Deep Sea Research Part II: Topical Studies in Oceanography*, 58(1-2), 264-275.
- Olbers, D., & Visbeck, M. (2005). A model of the zonally averaged stratification and overturning in the Southern Ocean. *Journal of physical oceanography*, 35(7), 1190-1205.
- Orsi, A. H., Whitworth, T., & Nowlin Jr, W.D. (1995). On the meridional extent and fronts of the Antarctic Circumpolar Current. *Deep Sea Research Part I: Oceanographic Research Papers*, 42(5), 641-673.
- Pain, S.L., Tyler, P.A., & Gage, J.D. (1982). The reproductive biology of the deep-sea asteroids *Benthopecten simplex* (Perrier), *Pectinaster filholi* Perrier, and *Pontaster tenuispinus* Düben & Koren (Phanerozoia: Benthopectinidae) from the Rockall Trough. *Journal of Experimental Marine Biology and Ecology*, 65(2), 195-211.
- Paine, R.T. (1966). Food web complexity and species diversity. *The American Naturalist*, 100(910), 65-75.



- Pappalardo, P. & Fernández, M. (2014). Mode of larval development as a key factor to explain contrasting effects of temperature on species richness across oceans. *Global ecology and biogeography*, 23, 12-23.
- Park, Y.H., Charriaud, E., & Fieux, M. (1998). Thermohaline structure of the Antarctic surface water/winter water in the Indian sector of the Southern Ocean. *Journal of Marine Systems*, 17(1-4), 5-23.
- Pearse, J.S. (1965). Reproductive periodicities in several contrasting populations of *Odontaster validus* Koehler, a common Antarctic asteroid. *Biology of the Antarctic seas II*, 5, 39-85.
- Pearse, J.S., & Giese, A.C. (1966). The organic constitution of several benthonic invertebrates from McMurdo Sound, Antarctica. *Comparative biochemistry and physiology*, 18(1), 47-57.
- Pearse, J.S., & Bosch, I. (2002). Photoperiodic regulation of gametogenesis in the Antarctic sea star *Odontaster validus* Koehler: evidence for a circannual rhythm modulated by light. *Invertebrate reproduction & development*, 41(1-3), 73-81.
- Pearse, J.S., McClintock, J.B., & Bosch, I. (1991). Reproduction of Antarctic benthic marine invertebrates: tempos, modes, and timing. *American Zoologist*, 31(1), 65-80.
- Pearse, J.S., & Bosch, I. (1994). Brooding in the Antarctic: Östergren had it nearly right. *Echinoderms through time*. Balkema, Rotterdam, 111-120.
- Pearse, J.S., Mooi, R., Lockhart, S.J. & Brandt, A. (2009). Brooding and species diversity in the Southern Ocean: selection for brooders or speciation within brooding clades? *Smithsonian at the poles: contributions to international polar year science* (ed. by Krupnik I., Lang M.A., Miller S.E.) Smithsonian Institution, Washington.
- Peck, L.S. (2002). Ecophysiology of Antarctic marine ectotherms: limits to life. In *Ecological Studies in the Antarctic Sea Ice Zone* (pp. 221-230). Springer, Berlin, Heidelberg.
- Peck, L.S. (2016). A cold limit to adaptation in the sea. *Trends in Ecology & Evolution*, 31(1), 13-26.
- Peck, L.S. (2018). Antarctic marine biodiversity: Adaptations, environments and responses to change. *Oceanography and Marine Biology: an Annual Review*, 56, 105–236.
- Peck, L.S., Webb, K.E., Miller, A., Clark, M.S., & Hill, T. (2008). Temperature limits to activity, feeding and metabolism in the Antarctic starfish *Odontaster validus*. *Marine Ecology Progress Series*, 358, 181-189.
- Peck, L.S., Souster, T., & Clark, M.S. (2013). Juveniles are more resistant to warming than adults in 4 species of Antarctic marine invertebrates. *PLoS One*, 8(6), e66033.
- Peck, L.S., Clark, M.S., & Dunn, N.I. (2018). Morphological variation in taxonomic characters of the Antarctic starfish *Odontaster validus*. *Polar Biology*, 1-7. (7236), 329.
- Peck, L.S., Convey, P. & Barnes, D.K. (2006). Environmental constraints on life histories in Antarctic ecosystems: tempos, timings and predictability. *Biological reviews*, 81, 75-109.

- Pfenninger, M., & Schwenk, K. (2007). Cryptic animal species are homogeneously distributed among taxa and biogeographical regions. *BMC evolutionary biology*, 7(1), 121.
- Picken, G. B. (1985). Marine habitats-benthos. *Key environments Antarctica*, 154-172.
- Pierrat, B., Saucède, T., Brayard, A. & David, B. (2013). Comparative biogeography of echinoids, bivalves and gastropods from the Southern Ocean. *Journal of Biogeography*, 40, 1374-1385.
- Pollard, D. & DeConto, R.M. (2009). Modelling west Antarctic ice sheet growth and collapse through the past five million years. *Nature*, 458, 329–332.
- Pons, J., Barraclough, T.G., Gomez-Zurita, J., Cardoso, A., Duran, D.P., Hazell, S., ... & Vogler, A.P. (2006). Sequence-based species delimitation for the DNA taxonomy of undescribed insects. *Systematic biology*, 55(4), 595-609.
- Pörtner, H.O. (2006). Climate-dependent evolution of Antarctic ectotherms: an integrative analysis. *Deep Sea Research Part II: Topical Studies in Oceanography*, 53(8-10), 1071-1104.
- Post, A.L., Meijers, A.J., Fraser, A.D., Meiners, K.M., Ayers, J., Bindoff, N.L., Griffiths, H.J., Van de Putte, A.P., O'Brien, P.E., Swadling, K.M. & Raymond, B. (2014) Environmental Setting. *Biogeographic Atlas of the Southern Ocean* (ed. by C. De Broyer, C., Koubbi, P., Griffiths, H.J., Raymond, B., d'Udekem d'Acoz, C., Van de Putte, A., Danis, B., David, B., Grant, S., Gutt, J., Held, C., Hosie, G., Huettmann, F., Post, A. & Ropert-Coudert, Y.), pp. 510. SCAR, Cambridge.
- Poulin, E., Palma, A.T. & Féral, J.-P. (2002). Evolutionary versus ecological success in Antarctic benthic invertebrates. *Trends in Ecology & Evolution*, 17, 218–222.
- Pratchett, M.S. (2001). Dynamics of outbreak populations of crown-of-thorns starfish (*Acanthaster planci* L.), and their effects on coral reef ecosystems (Doctoral dissertation, James Cook University).
- Presler, P., & Figielska, E. (1997). New data on the Asteroidea of Admiralty Bay, King George Island, South Shetland Islands. *Polish Polar Research* 18: 107–117.
- Puillandre, N., Lambert, A., Brouillet, S., & Achaz, G. (2012). ABGD, Automatic Barcode Gap Discovery for primary species delimitation. *Molecular ecology*, 21(8), 1864-1877.
- Purcell, J.F., Cowen, R.K., Hughes, C.R., & Williams, D.A. (2006). Weak genetic structure indicates strong dispersal limits: a tale of two coral reef fish. *Proceedings of the Royal Society of London B: Biological Sciences*, 273(1593), 1483-1490.
- R Core Team (2018). R: A language and environment for statistical computing. R Foundation for Statistical Computing, Vienna, Austria. URL <http://www.R-project.org/>.
- Rabosky, D.L., Chang, J., Title, P.O., Cowman, P.F., Sallan, L., Friedman, M., ... & Alfaro, M.E. (2018). An inverse latitudinal gradient in speciation rate for marine fishes. *Nature*, 559(7714), 392.
- Ratnasingham, S., & Hebert, P.D. (2007). BOLD: The Barcode of Life Data System (<http://www.barcodinglife.org>). *Molecular ecology notes*, 7(3), 355-364.

- Raupach, M.J., Malyutina, M., Brandt, A., & Wägele, J.W. (2007). Molecular data reveal a highly diverse species flock within the munnopsoid deep-sea isopod *Betamorpha fusiformis* (Barnard, 1920)(Crustacea: Isopoda: Asellota) in the Southern Ocean. *Deep Sea Research Part II: Topical Studies in Oceanography*, 54(16), 1820-1830.
- Raupach, M.J., Thatje, S., Dambach, J., Rehm, P., Misof, B., & Leese, F. (2010). Genetic homogeneity and circum-Antarctic distribution of two benthic shrimp species of the Southern Ocean, *Chorismus antarcticus* and *Nematocarcinus lanceopes*. *Marine Biology*, 157(8), 1783-1797.
- Regan, C.T. (1914). Fishes. British Antarctic ("Terra Nova"). Expedition 1910, Natural History Report, Zoology, 1, 1-54.
- Reguero, M.A., Gelfo, J.N., López, G.M., Bond, M., Abello, A., Santillana, S.N., & Marensi, S.A. (2014). Final Gondwana breakup: the Paleogene South American native ungulates and the demise of the South America–Antarctica land connection. *Global and Planetary change*, 123, 400-413.
- Reitzel, A.M., Herrera, S., Layden, M.J., Martindale, M.Q., & Shank, T.M. (2013). Going where traditional markers have not gone before: utility of and promise for RAD sequencing in marine invertebrate phylogeography and population genomics. *Molecular ecology*, 22(11), 2953-2970.
- Riesgo, A., Taboada, S., & Avila, C. (2015). Evolutionary patterns in Antarctic marine invertebrates: An update on molecular studies. *Marine genomics*, 23, 1-13.
- Rignot, E., Mouginot, J., Scheuchl, B., van den Broeke, M., van Wessem, M.J., & Morlighem, M. (2019). Four decades of Antarctic Ice Sheet mass balance from 1979–2017. *Proceedings of the National Academy of Sciences*, 116(4), 1095-1103.
- Rintoul, S.R. (2007). Antarctic Circumpolar Current. *Encyclopedia of the Antarctic* (ed. by B. Riffenburgh), pp. 234-239. Taylor & Francis Group, Routledge, New York.
- Rintoul, S.R., & Garabato, A.C.N. (2013). Dynamics of the Southern Ocean circulation. In *International Geophysics* (Vol. 103, pp. 471-492). Academic Press.
- Rintoul, S.R, Hughes, C., & Olbers, D. (2001). The Antarctic circumpolar current system. In *Ocean Circulation and Climate/G*. Siedler, J. Church and J. Gould, eds. New York: Academic Press. p. (pp. 271-302).
- Rintoul, S.R., Chown, S.L., DeConto, R.M., England, M.H., Fricker, H.A., Masson-Delmotte, V., ... & Xavier, J.C. (2018). Choosing the future of Antarctica. *Nature*, 558(7709), 233.
- Roberts, D., Hopcroft, R.R., & Hosie, G.W. (2014). Southern Ocean Pteropods. *Biogeographic Atlas of the Southern Ocean* (ed. by C. De Broyer, P. Koubbi, H.J. Griffiths, B. Raymond, C. d'Udekem d'Acoz, Van de Putte A., B. Danis, B. David, S. Grant, J. Gutt, C. Held, G. Hosie, F. Huettmann, A. Post and Y. Ropert-Coudert), pp. 510. SCAR, Cambridge.
- Rodríguez, E., López-González, P.J., & Gili, J.M. (2007). Biogeography of Antarctic sea anemones (Anthozoa, Actiniaria): What do they tell us about the origin of the Antarctic

benthic fauna?. *Deep Sea Research Part II: Topical Studies in Oceanography*, 54(16-17), 1876-1904.

Rogers, A.D. (2007). Evolution and biodiversity of Antarctic organisms: a molecular perspective. *Philosophical Transactions of the Royal Society of London B: Biological Sciences*, 362(1488), 2191-2214.

Roy, K. (1994). Effects of the Mesozoic Marine Revolution on the taxonomic, morphologic, and biogeographic evolution of a group: aporrhaid gastropods during the Mesozoic. *Paleobiology*, 20(3), 274-296.

Rozas, J., Ferrer-Mata, A., Sánchez-DelBarrio, J.C., Guirao-Rico, S., Librado, P., Ramos-Onsins, S.E., & Sánchez-Gracia, A. (2017). DnaSP 6: DNA sequence polymorphism analysis of large data sets. *Molecular biology and evolution*, 34(12), 3299-3302.

Sands, C.J., O'Hara, T.D., Barnes, D.K. & Martín-Ledo, R. (2015). Against the flow: evidence of multiple recent invasions of warmer continental shelf waters by a Southern Ocean brittle star. *Frontiers in Ecology and Evolution*, 3, 63.

Saucède, T., Díaz, A., Pierrat, B., Sellanes, J., David, B., Féral, J. P., & Poulin, E. (2015). The phylogenetic position and taxonomic status of *Sterechinus bernasconiae* Larrain, 1975 (Echinodermata, Echinoidea), an enigmatic Chilean sea urchin. *Polar Biology*, 38(8), 1223-1237.

Saucède, T., Pierrat, B., Brayard, A., & David, B. (2013). Palaeobiogeography of Austral echinoid faunas: a first quantitative approach. *Geological Society, London, Special Publications*, 381(1), 117-127.

Saucède, T., Pierrat, B., Danis, B. & David, B. (2014). Biogeographic processes in the Southern Ocean. *Biogeographic Atlas of the Southern Ocean* (ed. by C. De Broyer, P. Koubbi, H.J. Griffiths, B. Raymond, C. Udekem d'Acoz, Van de Putte A.P., B. Danis, S. Grant, J. Gutt, C. Held, G. Hosie, F. Heutmann, A. Post and Y. Ropert-Coudert). pp. 456–463. Scientific Committee on Antarctic Research, Cambridge

Sayers, E.W., Cavanaugh, M., Clark, K., Ostell, J., Pruitt, K.D., & Karsch-Mizrachi, I. (2018). GenBank. *Nucleic acids research*, 47(D1), D94-D99.

Schander, C., & Willassen, E. (2005). What can biological barcoding do for marine biology?. *Marine Biology Research*, 1(1), 79-83.

Scher, H.D., & Martin, E.E. (2004). Circulation in the Southern Ocean during the Paleogene inferred from neodymium isotopes. *Earth and Planetary Science Letters*, 228(3), 391-405.

Scherer, R.P., Bohaty, S.M., Dunbar, R.B., Esper, O., Flores, J.A., Gersonde, R., ... & Taviani, M. (2008). Antarctic records of precession-paced insolation-driven warming during early Pleistocene Marine Isotope Stage 31. *Geophysical Research Letters*, 35(3).

Schiaparelli, S., Danis, B., Wadley, V., & Stoddart, D.M. (2013). The Census of Antarctic Marine Life: the first available baseline for Antarctic marine biodiversity. In *Adaptation and Evolution in Marine Environments, Volume 2* (pp. 3-19). Springer, Berlin, Heidelberg.

- Pfenninger, M., & Schwenk, K. (2007). Cryptic animal species are homogeneously distributed among taxa and biogeographical regions. *BMC evolutionary biology*, 7(1), 121.
- Selkoe, K.A., & Toonen, R.J. (2011). Marine connectivity: a new look at pelagic larval duration and genetic metrics of dispersal. *Marine Ecology Progress Series*, 436, 291-305.
- Shilling, F.M., & Manahan, D.T. (1994). Energy metabolism and amino acid transport during early development of Antarctic and temperate echinoderms. *The Biological Bulletin*, 187(3), 398-407.
- Shipp, S., Anderson, J.B., & Domack, E.W. (1999). Seismic signature of the Late Pleistocene fluctuation of the West Antarctic Ice Sheet system in Ross Sea: a new perspective, Part I. *Geological Society of America Bulletin*, 111, 1486-1516.
- Siebert, M.J., & Florindo, F. (2008). Antarctic climate evolution. *Developments in Earth and Environmental Sciences*, 8, 1-11.
- Sijp, W.P., & England, M.H. (2004). Effect of the Drake Passage throughflow on global climate. *Journal of Physical Oceanography*, 34(5), 1254-1266.
- Silva, J.R., & Peck, L. (2000). Induced in vitro phagocytosis of the Antarctic starfish *Odontaster validus* (Koehler 1906) at 0 C. *Polar Biology*, 23(4), 225-230.
- Silvestro, D., & Michalak, I. (2012). raxmlGUI: a graphical front-end for RAxML. *Organisms Diversity & Evolution*, 12(4), 335-337.
- Simpson, R.D. (1982) The reproduction of some echinoderms from Macquarie Island. *Australian Museum Memoirs* 16: 39–52.
- Sladen, W.P. (1882) The Asteroidea of HMS Challenger Expedition. (Preliminary notices). 1. Pterasteridae. *Journal of the Linnean Society of London* 16: 186–246
- Sladen, W.P. (1889). Report on the scientific results of the voyage of HMS Challenger during the years 1873-76. *Zoology*, 30(51), 1-893.
- Slattery, M., & Bosch, I. (1993). Mating behavior of a brooding Antarctic asteroid, *Neosmilaster georgianus*. *Invertebrate reproduction & development*, 24(2), 97-102.
- Smale, D.A., Barnes, D.K., Fraser, K.P., Mann, P.J., & Brown, M.P. (2007). Scavenging in Antarctica: intense variation between sites and seasons in shallow benthic necrophagy. *Journal of Experimental Marine Biology and Ecology*, 349(2), 405-417.
- Sokolov, S., & Rintoul, S.R. (2009). Circumpolar structure and distribution of the Antarctic Circumpolar Current fronts: 1. Mean circumpolar paths. *Journal of Geophysical Research: Oceans*, 114(C11).
- Souster, T.A., Morley, S.A., & Peck, L.S. (2018). Seasonality of oxygen consumption in five common Antarctic benthic marine invertebrates. *Polar Biology*, 41(5), 897-908.
- Spalding, M.D., Fox, H.E., Allen, G.R., Davidson, N., Ferdaña, Z.A., Finlayson, M.A.X., Halpern, B.S., Jorge, M.A., Lombana, A.L., Lourie, S.A., Martin, K.D., McManus, E., Molnar, J., Recchia,

- C.A. & Robertson, J. (2007). Marine ecoregions of the world: a bioregionalization of coastal and shelf areas. *BioScience*, 57, 573-583.
- Speer, K., Rintoul, S.R., & Sloyan, B. (2000). The diabatic Deacon cell. *Journal of physical oceanography*, 30(12), 3212-3222.
- Stamatakis, A. (2014). RAxML version 8: a tool for phylogenetic analysis and post-analysis of large phylogenies. *Bioinformatics*, 30(9), 1312-1313.
- Stanley, S.M. (2007). Memoir 4: an analysis of the history of marine animal diversity. *Paleobiology*, 33(S4), 1-55.
- Stanwell-Smith, D., & Clarke, A. (1998). Seasonality of reproduction in the cushion star *Odontaster validus* at Signy Island, Antarctica. *Marine biology*, 131(3), 479-487.
- Stilwell, J.D., Zinsmeister, W.J., & Oleinik, A. (2004). Early Paleocene mollusks of Antarctica: Systematics, paleoecology and paleobiogeographic significance. Allen Press, Inc.
- Stott, L.D., Kennett, J.P., Shackleton, N.J., & Corfield, R.M. (1990). The evolution of Antarctic surface waters during the Paleogene: Inferences from the stable isotope composition of planktonic foraminifers, ODP Leg 113. Proceedings of the Ocean Drilling Program. Scientific Results, 113, 849-863.
- Strathmann, M.F. (2017). Reproduction and development of marine invertebrates of the northern Pacific coast: data and methods for the study of eggs, embryos, and larvae. University of Washington Press.
- Strugnell, J.M., Watts, P.C., Smith, P.J. & Allcock, A.L. (2012). Persistent genetic signatures of historic climatic events in an Antarctic octopus. *Molecular ecology*, 21, 2775-2787
- Strugnell, J.M., Cherel, Y., Cooke, I.R., Gleadall, I.G., Hochberg, F.G., Ibáñez, C.M., ... & Vecchione, M. (2011). The Southern Ocean: source and sink? *Deep Sea Research Part II: Topical Studies in Oceanography*, 58(1-2), 196-204.
- Strugnell, J.M., Rogers, A.D., Prodöhl, P.A., Collins, M.A., & Allcock, A.L. (2008). The thermohaline expressway: the Southern Ocean as a centre of origin for deep-sea octopuses. *Cladistics*, 24(6), 853-860.
- Sturm, A. (2004). Changes in ocean circulation and carbonate chemistry in the Australian sector of the Southern Ocean during the last 500,000 years (Doctoral dissertation, Christian-Albrechts-Universität).
- Summerson, R., & Bishop, I. (2012). The impact of human activities on wilderness and aesthetic values in Antarctica. *Polar Research*, 31(1), 10858.
- Sunnucks, P., & Hales, D.F. (1996). Numerous transposed sequences of mitochondrial cytochrome oxidase I-II in aphids of the genus *Sitobion* (Hemiptera: Aphididae). *Molecular Biology and Evolution*, 13(3), 510-524.

- Taboada, S., Núñez-Pons, L., & Avila, C. (2013). Feeding repellence of Antarctic and sub-Antarctic benthic invertebrates against the omnivorous sea star *Odontaster validus*. *Polar biology*, 36(1), 13-25.
- Takano, T., & Kano, Y. (2014). Molecular phylogenetic investigations of the relationships of the echinoderm-parasite family Eulimidae within *Hypsogastropoda* (Mollusca). *Molecular Phylogenetics and Evolution*, 79, 258-269.
- Tatiàn, M., Antacli, J.C. & Sahade, R. (2005). Ascidians (Tunicata, Ascidiacea): species distribution along the Scotia Arc. *Scientia Marina*, 69, 205-214.
- Taylor, M.L., & Rogers, A.D. (2015). Evolutionary dynamics of a common sub-Antarctic octocoral family. *Molecular phylogenetics and evolution*, 84, 185-204.
- Thatje, S. (2012). Effects of capability for dispersal on the evolution of diversity in Antarctic benthos.
- Thatje, S., Hillenbrand, C.D., & Larter, R. (2005). On the origin of Antarctic marine benthic community structure. *Trends in Ecology & Evolution*, 20(10), 534-540.
- Thies, D., & Reif, W. (1985). Phylogeny and evolutionary ecology of Mesozoic Neoselachii. *Neues Jahrbuch für Geologie und Paläontologie, Abhandlungen*, 169(3), 333-361.
- Thomas, J.A., Welch, J.J., Woolfit, M., & Bromham, L. (2006). There is no universal molecular clock for invertebrates, but rate variation does not scale with body size. *Proceedings of the National Academy of Sciences*, 103(19), 7366-7371.
- Thomson, C.W. (1876). Notice of some peculiarities on the mode of propagation of certain echinoderms of the southern seas. *Zoological Journal of the Linnean Society* 13(66), 55–79
- Thornhill, D.J., Mahon, A.R., Norenburg, J.L., & Halanych, K.M. (2008). Open-ocean barriers to dispersal: a test case with the Antarctic Polar Front and the ribbon worm *Parborlasia corrugatus* (Nemertea: Lineidae). *Molecular ecology*, 17(23), 5104-5117.
- Thorson, G. (1936). The larval development, growth, and metabolism of arctic marine bottom invertebrates compared with those of other seas (Vol. 100). CA Reitzel.
- Toews, D.P., & Brelsford, A. (2012). The biogeography of mitochondrial and nuclear discordance in animals. *Molecular Ecology*, 21(16), 3907-3930.
- Toggweiler, J.R., & Bjornsson, H. (2000). Drake Passage and palaeoclimate. *Journal of Quaternary Science: Published for the Quaternary Research Association*, 15(4), 319-328.
- Trull, T.W., Passmore, A., Davies, D.M., Smit, T., Berry, K., & Tilbrook, B. (2018). Distribution of planktonic biogenic carbonate organisms in the Southern Ocean south of Australia: a baseline for ocean acidification impact assessment. *Biogeosciences*, 15(1), 31-49.
- Twitchett, R.J., & Oji, T. (2005). Early Triassic recovery of echinoderms. *Comptes Rendus Palevol*, 4(6-7), 531-542.

- Tyler, P.A., Pain, S.L., Gage, J.D., & Billett, D.S.M. (1984). The reproductive biology of deep-sea forcipulate seastars (Asteroidea: Echinodermata) from the NE Atlantic Ocean. *Journal of the Marine Biological Association of the United Kingdom*, 64(3), 587-601.
- Ugland, K.I., Gray, J.S., & Ellingsen, K.E. (2003). The species–accumulation curve and estimation of species richness. *Journal of Animal Ecology*, 72(5), 888-897.
- Uri, S., Rogers, W.P., & Kirkham, R.M. (1992). Modelling the bathymetry of the Antarctic continental shelf. In *Sixth International Symposium on Antarctic Earth Sciences* (pp. 763-771).
- Van de Putte, A., Youdjou, N., Danis, B. (2015) The Antarctic Biodiversity Information Facility. [www.biodiversity.aq](http://www.biodiversity.aq). Accession date: 2015 10 20.
- Valentine, J.W., & Jablonski, D. (2015). A twofold role for global energy gradients in marine biodiversity trends. *Journal of Biogeography*, 42(6), 997-1005.
- Venables, H., Meredith, M.P., Atkinson, A. & Ward, P. (2012). Fronts and habitat zones in the Scotia Sea. *Deep Sea Research Part II: Topical Studies in Oceanography*, 59, 14-24.
- Verheye, M.L., Backeljau, T., & d'Acoz, C.D.U. (2017). Locked in the Icehouse: evolution of an endemic *Epimeria* (Amphipoda, Crustacea) species flock on the Antarctic shelf. *Molecular phylogenetics and evolution*, 114, 14-33.
- Verheye, M.L., Backeljau, T., & d'Acoz, C.D.U. (2016). Looking beneath the tip of the iceberg: diversification of the genus *Epimeria* on the Antarctic shelf (Crustacea, Amphipoda). *Polar Biology*, 39(5), 925-945.
- Vermeij, G.J. (1977). The Mesozoic marine revolution: evidence from snails, predators and grazers. *Paleobiology*, 3(3), 245-258.
- Vermeij, G.J. (1987). The dispersal barrier in the tropical Pacific: implications for molluscan speciation and extinction. *Evolution*, 41(5), 1046-1058.
- Villier, L., Brayard, A., Bylund, K.G., Jenks, J.F., Escarguel, G., Olivier, N., ... & Fara, E. (2018). *Superstesaster promissor* gen. et sp. nov., a new starfish (Echinodermata, Asteroidea) from the Early Triassic of Utah, USA, filling a major gap in the phylogeny of asteroids. *Journal of Systematic Palaeontology*, 16(5), 395-415.
- Walsh, J.J. (1988). *On the nature of continental shelves*. Academic Press, San Diego
- Ward, R.D., Holmes, B.H., & O'Hara, T.D. (2008). DNA barcoding discriminates echinoderm species. *Molecular Ecology Resources*, 8(6), 1202-1211.
- Watling, L. & Thurston, M.H. (1989). Antarctica as an evolutionary incubator: evidence from the cladistic biogeography of the amphipod family Iphimediidae. *Geological Society, London, Special Publications*, 47, 297-313.
- Waters, J.M. (2008). Driven by the West Wind Drift? A synthesis of southern temperate marine biogeography, with new directions for dispersalism. *Journal of Biogeography*, 35, 417-427.



- Waters, J.M., King, T.M., Fraser, C.I., & Garden, C. (2018). Rafting dispersal in a brooding southern sea star (Asteroidea: Anasterias). *Invertebrate Systematics*, 32(2), 253-258.
- Webb, K.E., Barnes, D.K., Clark, M.S., & Bowden, D.A. (2006). DNA barcoding: a molecular tool to identify Antarctic marine larvae. *Deep Sea Research Part II: Topical Studies in Oceanography*, 53(8-10), 1053-1060.
- White, M.G. (1984). Marine benthos. In *Antarctic Ecology*, Vol. 2, ed. R. M. Laws, pp. 421-461. London: Academy Press.
- Wilson, G. (1999). Some of the deep-sea fauna is ancient. *Crustaceana*, 72(8), 1019-1030.
- Wilson, N.G., Schrödl, M., & Halanych, K.M. (2009). Ocean barriers and glaciation: evidence for explosive radiation of mitochondrial lineages in the Antarctic sea slug *Doris kerguelenensis* (Mollusca, Nudibranchia). *Molecular Ecology*, 18(5), 965-984.
- Winkler, M., Fillinger, L., Funke, T., Richter, C., & Laudien, J. (2013) Succession of benthic hard-bottom communities abundance at station Errina2012\_MDD4. <https://doi.org/10.1594/PANGAEA.806083>
- Witts, J.D., Whittle, R.J., Wignall, P.B., Crame, J.A., Francis, J.E., Newton, R.J., & Bowman, V.C. (2016). Macrofossil evidence for a rapid and severe Cretaceous–Paleogene mass extinction in Antarctica. *Nature communications*, 7, 11738.
- WoRMS Editorial Board (2015). World Register of Marine Species. Available from <http://www.marinespecies.org> at VLIZ. Accessed 2015-12-15.
- Zachos, J.C., Pagani, M., Sloan, L., Thomas, E., & Billups, K. (2001). Trends, rhythms, and aberrations in global climate 65 Ma to present. *science*, 292(5517), 686-693.
- Zachos, J.C., Dickens, G.R., & Zeebe, R.E. (2008). An early Cenozoic perspective on greenhouse warming and carbon-cycle dynamics. *Nature*, 451(7176), 279.
- Zinsmeister, W.J. (1979). Biogeographic significance of the late Mesozoic and early Tertiary molluscan faunas of Seymour Island (Antarctic Peninsula) to the final breakup of Gondwanaland (pp. 349-355). Ohio State University, Institute of Polar Studies.
- Zwally, H.J., Comiso, J.C., Parkinson, C.L., Campbell, W.J., & Carsey, F.D. (1983). Antarctic sea ice, 1973-1976: Satellite passive-microwave observations (No. NASA-SP-459). National Aeronautics and Space Administration Washington DC.



**Titre :** Diversité et phylogéographie des astéries (Asteroidea) de l'Océan Austral

**Mots clés :** Biogéographie; Echinodermata; Connectivité; Océan Austral; Phylogéographie

**Résumé :** Comment les espèces sont-elles distribuées sur les fonds marins de l'Océan Austral ? Quels sont les facteurs qui peuvent expliquer leur distribution ? Ces questions, centrales en macroécologie sont d'autant plus pressantes que les régions polaires sont actuellement soumises à de rapides changements environnementaux. L'objectif principal de cette thèse était de décrire et de caractériser les grands patrons de distribution des espèces d'étoiles de mer à l'échelle de l'Océan Austral tout en considérant un trait d'histoire de vie en particulier : la stratégie de reproduction. Dans ma thèse, je teste l'hypothèse que les capacités de dispersion contrastées entre espèces à développement direct (incubantes) et celles à stade larvaire pélagique dans leur développement (dispersantes) induisent des motifs de distribution distincts, permettant ainsi de mettre en évidence un facteur déterminant de leurs distributions. J'ai utilisé à la fois des approches biogéographique (basée sur un jeu de données de 14 000 occurrences) et phylogéographique (pour cinq genres : Diplasterias, Notasterias, Lysasterias, Bathybiaster, Psilaster) à l'échelle de l'Océan Austral et mes résultats montrent que 1) de manière générale, les étoiles de mer présentent les mêmes motifs biogéographiques que ceux déjà mis en évidence chez d'autres groupes d'invertébrés marins benthiques tels que l'isolement de la Nouvelle Zélande, la forte richesse spécifique dans la région de l'Arc de la Scotia chez les espèces incubantes, la différenciation entre les faunes Est et Ouest Antarctiques, et les affinités fauniques entre le sud de l'Amérique du Sud et les îles subantarctiques. Les astéries présentent un niveau d'endémisme moins élevé que précédemment avancé, avec 29% d'espèces endémiques dans la Zone Antarctique seulement. Les patrons de distribution sont fortement influencés par la stratégie de reproduction et diffèrent en fonction du niveau taxonomique considéré, mettant en évidence le rôle sous-jacent de certains facteurs historiques. 2) La stratégie de reproduction ne semble pas affecter les niveaux de diversité génétique ni la richesse spécifique elle-même mais plutôt leur structuration spatiale. L'histoire évolutive des espèces est le résultat de leur stratégie de reproduction. Les patrons phylogéographiques des espèces dispersantes peuvent être expliqués par différents scénarios impliquant des voies de colonisation profondes, de la bipolarité ou du cosmopolitisme, et l'émergence en zone subantarctique pour le genre Bathybiaster ; des échanges fauniques entre Antarctique et Nouvelle Zélande à travers le Front Polaire pour le genre Psilaster. Les motifs présentés par les espèces incubantes suggèrent l'existence d'un passage trans-antarctique précédemment étendu entre les mers de Ross et de Weddell pendant le Plio-Pléistocène. Ces résultats mettent aussi en évidence, pour la première fois, que la Mer de Weddell est peuplée d'un mélange de faunes originaires d'Est et Ouest Antarctique. Enfin, j'utilise une approche exploratoire pour analyser la phylogénie et la phylogéographie de toute la classe des Asteroidea afin de comprendre son origine et son évolution dans l'Océan Austral. Je mets en évidence la variété des chemins évolutifs suivis par les étoiles de mer pour coloniser, se diversifier et évoluer dans l'Océan Austral. Je démontre par la même occasion que leur richesse spécifique n'est pas correctement évaluée dans l'Océan Austral, ce qui est également très certainement le cas aussi dans les autres océans. Je démontre aussi que la diversité des étoiles de mer australes actuelles est en grande partie le résultat de diversifications récentes. L'ensemble de ces résultats m'amène à remettre en question plusieurs grands principes biogéographiques jusqu'ici reconnus pour les faunes de l'Océan Austral, soulignant également la nécessité d'adopter des approches à très large échelle dans ce genre d'étude.

**Title:** Diversity and phylogeography of Southern Ocean sea stars (Asteroidea)

**Keywords:** Biogeography; Echinodermata; Connectivity; Southern Ocean; Phylogeography

**Abstract :** How is life distributed on the Southern Ocean sea floor? How can we explain species distribution patterns, their origin and the underpinning drivers? These questions are central to macroecological studies, especially in regions facing fast environmental changes. The main objective of this thesis was to describe and characterise distribution patterns of sea stars species (Echinodermata: Asteroidea) with regards to reproductive strategy (i.e. brooding versus broadcasting), a key life history trait for species dispersal. I tested whether contrasting dispersal abilities between direct developers (brooders) and species with pelagic larvae in their development (broadcasters) result in distinct diversity and distribution patterns. At the scale of the Southern Ocean, I used both biogeographic (14,000 occurrence records) and phylogeographic approaches (five genera – Diplasterias, Notasterias, Lysasterias, Bathybiaster, Psilaster) to show that 1) biogeographic patterns are highly linked to reproductive strategy but these patterns also vary according to taxonomic levels, revealing the importance of historical factors. 2) Main biogeographic patterns are congruent with results obtained in previous works for other benthic taxa highlighting the prevalence of common biogeographic patterns like: the isolation of New Zealand fauna from the Antarctic, the high richness in the Scotia Arc region (particularly in brooders), the differentiation between East and West Antarctic species, and faunal affinities between southern South America and sub-Antarctic Islands. Overall, asteroids show low endemism levels compared to previously reported values, with 29% of species only occurring in the Antarctic Zone. 3) Phylogeographic patterns indicate that reproductive strategy is not directly related to the levels of genetic diversity nor to species richness but rather to the spatial structure of species distribution. Phylogeographic patterns analysed in broadcasters can be explained by different scenarios including deep-sea colonisation routes, bipolarity or cosmopolitanism, and sub-Antarctic emergence for the genus Bathybiaster; faunal exchanges between the Antarctic and New Zealand across the Polar Front for the genus Psilaster. Phylogeography of brooders support the hypothesis of a past trans-Antarctic seaway established between the Ross and the Weddell seas during the Plio-Pleistocene. These results also show, for the first time, that the Weddell Sea is composed of a mixed asteroid fauna originating from both the East and West Antarctic. Finally, I use an exploratory approach to investigate the phylogeny and phylogeography of the entire class Asteroidea and try to reveal their origin and evolution in the Southern Ocean. I demonstrate that species richness in asteroids has been overlooked and misunderstood in the Southern Ocean and possibly also all around the world. I then argue that modern Southern Ocean sea star fauna result, for the most part, from recent diversifications. These results, altogether, raise questions about commonly accepted principles on biogeographic patterns in the Southern Ocean. This stresses the need for more global and integrative approaches for such studies.