



**HAL**  
open science

# Modeling and Coordination of interconnected microgrids using distributed artificial intelligence approaches

Jin Wei

► **To cite this version:**

Jin Wei. Modeling and Coordination of interconnected microgrids using distributed artificial intelligence approaches. Artificial Intelligence [cs.AI]. Université Bourgogne Franche-Comté, 2019. English. NNT : 2019UBFCA021 . tel-02511243

**HAL Id: tel-02511243**

**<https://theses.hal.science/tel-02511243>**

Submitted on 18 Mar 2020

**HAL** is a multi-disciplinary open access archive for the deposit and dissemination of scientific research documents, whether they are published or not. The documents may come from teaching and research institutions in France or abroad, or from public or private research centers.

L'archive ouverte pluridisciplinaire **HAL**, est destinée au dépôt et à la diffusion de documents scientifiques de niveau recherche, publiés ou non, émanant des établissements d'enseignement et de recherche français ou étrangers, des laboratoires publics ou privés.

**THÈSE DE DOCTORAT DE L'ÉTABLISSEMENT UNIVERSITÉ BOURGOGNE FRANCHE-COMTÉ  
PRÉPARÉE À L'UNIVERSITÉ DE TECHNOLOGIE DE BELFORT-MONTBÉLIARD**

École doctorale n°37  
Sciences Pour l'Ingénieur et Microtechniques

Doctorat d'Informatique

par

**JIN WEI**

**Coordination in Microgrid Networks Using Multi-agent Systems**

Thèse présentée et soutenue à Belfort, le 12 December 2019

Composition du Jury :

WIRA PATRICE	Professeur à l'Université de Haute Alsace	Rapporteur
FONLUPT CYRIL	Professeur à l'Université du Littoral	Rapporteur
IDOUMGHAR LHASSANE	Professeur à l'Université de Haute Alsace	Président du jury
GOUTON PIERRE	Professeur à l'Université de Bourgogne	Examineur
TU XIAOWEI	Professeur à l'Université de Shanghai	Examineur
KOUKAM ABDERRAFIAA	Professeur à l'Université de Technologie de Belfort Montbéliard	Directeur de thèse
ROCHE ROBIN	maître de conférences à l'Université de Technologie de Belfort Montbéliard	Codirecteur de thèse



SPIM

école doctorale sciences pour l'ingénieur et microtechniques



# ABSTRACT

As renewable sources penetrate the current electrical system to relief global warming and energy shortage, microgrid (MG) emerges to reduce the impact of intermittent generation on the utility grid. Additionally, it improves the automation and intelligence of the power grid with plug-and-play characteristics. Inserting more MGs into a distribution network promotes the development of the smart grid. Thus MG networks existing in the power system are in prospect. Coordinating them could gain a system with high reliability, low cost, and strong resistance to electrical faults. Achieving these profits relies on developed technologies of communication, control strategy, and corresponding algorithms.

Dispatching power in distributed MGs while coordinating elements within the individual MG demands a decentralized control system, in which the multi-agent system possesses advantages. It is applied to the MG network for establishing a physically and electrically distributed system. Based on the multi-agent system, this thesis mainly studies the coordination control in the MG network and its modeling. It aims at promoting control performance in terms of efficiency, reliability, economic benefit and scalability. According to the holonic structure, two methods are considered to enable the system scalability, including the coordination with neighboring MGs and within the extensive coordinating area. Then a simulation platform is established to validate the proposed approaches with Python language.

The control strategies for coordination between MGs and their neighbors are proposed to maintain the complete load supply and global security operation while minimizing the generation cost. Centralized control in the coordination group is applied for economic energy management. It uses a Newton-Raphson method to dispatch power among neighboring MGs by simplifying the relationship between MG generation cost and its output power into a quadratic function. An average consensus theorem is adopted to calculate the caused network power flow, and the results are compared with the maximal capacity on the line to keep safe operation. To improve the economic benefits, the approximated relationship between MG output power and the caused generation cost is improved in another strategy. It builds a market for neighboring power trade. Here, the bid is derived from the average generation cost on maximal output. This method maintains the operation privacy of individual MG. Power flow calculation is simplified to be proportional to the angle difference between the two terminations of the connecting line. Both strategies are tested on a 13-node, and 34-node network. Their performance shows that both approaches possess scalability and could economically compensate for the lack of load supply in faulted MG.

For the control strategy with higher reliability and profit, the coordination strategy within a selected extensive area of MGs is proposed. Expanding the coordination area based on neighboring MGs provides more energy sources to the demanded MG. It ensures enough power to compensate imbalance and offers more choices for power dispatching. The selection of the coordination area adopts the distributed evolutionary algorithm programming to the multi-agent system to accelerate the calculation speed. Quadratic programming in Gurobi is used to solve the power dispatching problem. Another ge-

netic algorithm is also adopted to solve the problem of optimal power dispatching with a quadratic generation cost for microturbine. The performance of this strategy is tested, and the results show that it has comprehensive advantages on reliability, scalability, and profit compared with centralized and market methods.

# RÉSUMÉ

À mesure que les sources renouvelables s'intègrent dans le système électrique actuel pour atténuer le réchauffement planétaire et la pénurie d'énergie fossile, les micro-réseaux (MG) émergent comme une solution permettant de réduire l'impact de la production intermittente sur les réseaux publics. En outre, ils permettent d'améliorer l'automatisation et l'intelligence des réseaux avec des caractéristiques plug-and-play. L'intégration d'un plus grand nombre de MG dans un réseau de distribution permettrait d'arriver à un système avec une grande fiabilité, un faible coût, et une forte résilience aux pannes. La réalisation de ces objectifs repose sur des technologies de communication, des stratégies de contrôle et plusieurs types d'algorithmes.

La répartition de la puissance entre MG et la coordination des éléments au sein de chaque MG exige un système de contrôle décentralisé, pour lequel un système multi-agents présentent des avantages. Il est utilisé pour établir un système distribué physiquement et du point de vue de la prise de décision. Basée sur cette approche, cette thèse étudie principalement le contrôle et la coordination d'un réseau de MG. Il vise à permettre une meilleure performance de contrôle en termes d'efficacité, de fiabilité, d'avantages économiques et d'évolutivité. Grâce à une structure holonique, deux méthodes sont étudiées pour permettre l'évolutivité du système. Une plateforme de simulation est établie pour valider les approches proposées avec le langage Python.

Dans une première approche, une stratégie de contrôle pour la coordination entre plusieurs MG voisins est proposée. Elle permet de maintenir la charge complète et la fiabilité de fonctionnement tout en minimisant le coût de production. Le contrôle centralisé dans le groupe de coordination est utilisé pour réaliser le dispatching entre MG et leurs composants. La méthode de Newton-Raphson permet de répartir la puissance entre les MG voisins en simplifiant la relation entre le coût de production des MG et leur puissance de sortie par une fonction quadratique. Un théorème de consensus moyen est adopté pour calculer le flux de puissance qui en résultent sur les différentes lignes, et les résultats sont comparés avec la capacité maximale de chaque ligne pour assurer un fonctionnement sûr. Pour améliorer encore les avantages économiques, l'approximation de la relation entre la puissance de production des MG et le coût de production est améliorée dans une autre stratégie. Elle repose sur un marché de l'électricité entre MG voisins. Ici, les offres sont dérivées du coût moyen de production sur la production maximale. Cette méthode préserve la confidentialité des informations de chaque MG. Le calcul du flux de puissance est simplifié pour être proportionnel à la différence d'angle entre les deux extrémités de la ligne de raccordement. Les deux stratégies sont testées sur des réseaux de 13 et 34 noeuds. Les résultats montrent que les deux approches sont fonctionnelles et pourraient économiquement compenser le manque d'approvisionnement en charge dans des MG défectueux.

Dans une seconde approche, pour encore améliorer la fiabilité et les profits, une stratégie de coordination au sein d'une vaste zone intégrant de multiples MG est proposée. L'élargissement de la zone de coordination fournit plus de moyens de répondre aux be-



soins et annuler le déséquilibre en puissance résultant d'un défaut. La détermination de la zone de coordination repose sur un algorithme évolutionnaire distribué s'appuyant sur système multi-agent pour accélérer la vitesse de calcul. La programmation quadratique dans Gurobi est ensuite utilisée pour résoudre le problème de répartition de puissance. Un autre algorithme génétique est également mis en oeuvre pour résoudre le problème de la répartition optimale de la puissance avec un coût de production quadratique pour la microturbine. La performance de cette stratégie est testée, et les résultats montrent qu'elle présente des avantages sur la fiabilité, l'évolutivité et le profit par rapport aux méthodes centralisées et de marché.

# ACKNOWLEDGEMENTS

I want to express my heartfelt gratitude to all those who have been helping me during the writing of this thesis.

My deepest gratitude goes first and foremost to Professor Abderrafiaa Koukam and Dr. Robin Roche, my supervisors, for their constant encouragement and guidance. They have walked me through all the stages of the writing of this thesis. Without their consistent and illuminating instruction, this thesis could not have reached its present form. I also thank Mr. Fabrice Lauri very much for his kind guiding on computer science.

Secondly, I would like to thank professor Patrice Wira and professor Cyril Fonlupt for accepting to review this thesis and for their valuable comments, despite their very busy schedules. I would also like to thank professor Lhassane Idoumghar, professor Pierre Gouton and professor Xiaowei Tu for accepting to participate in my dissertation committee.

Thirdly, I would like to express my gratitude to the professors and teachers at the Department of CIAD, who have instructed and helped me a lot in the past four years.

My thanks would also go to the China Scholarship Council (CSC), which provides the scholarship to me for finishing this thesis without worrying about expense in life.

Finally, I am extremely grateful to my beloved fiancée, Xin Su. In a country far away from my motherland, his support helps me to overcome difficulties in life and work. Last but not the least, I would like to thank my parents and brother for their thoughtful consideration and great confidence in me all through these years. I also owe my sincere gratitude to my friends and my fellow colleagues. They listen to me and figure out my problems during the difficult course of the thesis.



# CONTENTS

<b>I</b>	<b>Context and Objectives</b>	<b>5</b>
<b>1</b>	<b>Introduction</b>	<b>7</b>
1.1	Context . . . . .	7
1.1.1	Background . . . . .	7
1.1.2	Microgrid Definition . . . . .	10
1.1.3	Microgrid Network . . . . .	14
1.1.4	Multi-agent System . . . . .	16
1.2	Objectives and concerns of this thesis . . . . .	17
1.2.1	Problem Statement . . . . .	17
1.2.2	Coordination with neighboring MGs . . . . .	18
1.2.3	Coordination within extensive MG group . . . . .	19
1.2.4	Simulation studies . . . . .	19
1.3	Outline . . . . .	20
<b>2</b>	<b>Related Works</b>	<b>23</b>
2.1	Coordination with Reconfiguring and Maintaining Microgrid . . . . .	23
2.1.1	Reconfiguring Microgrid . . . . .	24
2.1.2	Maintaining Microgrid . . . . .	25
2.2	Coordination with Centralized and Decentralized control . . . . .	27
2.2.1	Centralized Control . . . . .	27
2.2.2	Decentralized Control . . . . .	28
2.2.3	Multi-agent System Control . . . . .	29
2.3	Conclusion . . . . .	30
<b>II</b>	<b>Contributions</b>	<b>33</b>
<b>3</b>	<b>Modeling And Simulation Platform</b>	<b>35</b>
3.1	Development of Simulation Platform . . . . .	35
3.2	Modeling of MG Network . . . . .	35

3.2.1	MG Network as Complex System . . . . .	35
3.2.2	Multi-agent System . . . . .	37
3.2.2.1	Environment . . . . .	37
3.2.2.2	The Agent . . . . .	38
3.2.3	The MG Network Modeling Based on Multi-agent System . . . . .	39
3.2.3.1	Distributed architecture . . . . .	39
3.2.3.2	Reactivity . . . . .	40
3.2.3.3	Pro-activeness . . . . .	41
3.2.3.4	Social Ability . . . . .	41
3.2.3.5	Modeling of the MG network . . . . .	42
3.2.4	Multi-agent System Controlling the MG Network . . . . .	44
3.2.4.1	Topology . . . . .	44
3.2.4.2	Control Methods and Algorithms . . . . .	46
3.3	Platform Implementation with Python . . . . .	47
3.3.1	Modeling of the Electrical System . . . . .	47
3.3.2	Simulation Platform . . . . .	50
3.3.2.1	Simulation Interface . . . . .	50
3.3.2.2	Simulation Object . . . . .	53
<b>4</b>	<b>Multi-agent Based Coordination with Neighboring Microgrid</b>	<b>57</b>
4.1	Motivation . . . . .	57
4.2	Coordination Problem . . . . .	57
4.3	Elements Model within MG . . . . .	58
4.3.1	Renewable generators . . . . .	58
4.3.1.1	Photovoltaic Generators . . . . .	59
4.3.1.2	Wind Turbine . . . . .	59
4.3.2	Microturbine . . . . .	60
4.3.3	Energy Storage System . . . . .	61
4.4	Microgrid Network Coordination System . . . . .	62
4.4.1	Physical Connection among MGs . . . . .	62
4.4.2	Communication Network in MAS . . . . .	62
4.5	Control Strategy within Individual Microgrid . . . . .	63
4.5.1	Under Normal Condition . . . . .	64
4.5.1.1	Objective and Problem Formulation . . . . .	64
4.5.1.2	Control Process . . . . .	64

4.5.2	Under Fault Condition . . . . .	65
4.5.2.1	Objective and Problem Formulation . . . . .	65
4.5.2.2	Control Process . . . . .	66
4.6	Control Strategy for MG Coordination . . . . .	67
4.6.1	Strategy 1: Centralized Optimal Dispatching in Partial Area . . . . .	67
4.6.1.1	Motivation . . . . .	67
4.6.1.2	Problem Formulation . . . . .	67
4.6.1.3	Control Strategy . . . . .	68
4.6.1.4	Power Flow Algorithm . . . . .	70
4.6.2	Strategy 2: Bidding in the market . . . . .	73
4.6.2.1	Motivation . . . . .	73
4.6.2.2	Problem Formulation . . . . .	74
4.6.2.3	Control Strategy . . . . .	76
4.6.2.4	Power Flow . . . . .	77
4.7	Simulation Results . . . . .	79
4.7.1	Test Multi-agent System and Microgrid Network . . . . .	79
4.7.2	Dispatching Algorithm Comparisons . . . . .	81
4.7.3	Generation Cost Comparison . . . . .	82
4.7.4	Robustness Test . . . . .	82
4.8	Conclusion . . . . .	83
<b>5</b>	<b>Multi-agent based coordination within selected microgrid area</b>	<b>89</b>
5.1	Demand-supply Balance for the Economic Power Dispatching in Network . . . . .	89
5.2	Holonic MAS . . . . .	90
5.3	Control Strategy Process of Proposed Strategy . . . . .	91
5.3.1	Coordination Process . . . . .	91
5.3.2	Coordinating Microgrid Selection . . . . .	94
5.3.3	Power Dispatching . . . . .	95
5.3.4	Distributed Evolutionary Algorithms with Depth-first Search (DFS) . . . . .	96
5.4	Simulation Results . . . . .	97
5.4.1	Case 1 . . . . .	99
5.4.2	Case 2 . . . . .	103
5.4.3	Case 3 . . . . .	106
5.4.4	Impact on Calculation Time and Cost . . . . .	108
5.5	Conclusion . . . . .	109

<b>III Conclusion</b>	<b>111</b>
<b>6 Conclusions</b>	<b>113</b>
6.1 Conclusions on the Proposed Approach . . . . .	113
6.2 Future Work . . . . .	114
6.3 Scientific Production Review . . . . .	114

# NOMENCLATURE

## Acronyms

*AIMMS* advanced integrated multidimensional modeling software

*CA* coordination area

*CS* centralized strategy

*DER* distributed energy resource

*DFS* depth-first search

*DG* distributed generator

*GA* genetic algorithm

*GAMS* general algebraic modeling system

*GAUF* geometric average utility function

*KCL* Kirchhoff's current law

*KVL* Kirchhoff's voltage law

*MAS* multi-agent system

*MG* microgrid

*MGEMS* microgrid energy management system

*MILP* mixed integer linear problem

*MINLP* mixed integer non-linear problem

*MK* market

*MT* micro turbine

*NLP* non-linear problem

*PF* power flow

*PV* photovoltaic generator

*QP* quadratic programming

*SOC* status of charge

*WT* wind turbine



**Indices**

$i$	index for neighboring microgrid
$j$	index for neighboring microgrid
$k$	index for microgrid
$t$	index for time

**Sets**

$\Delta t$	time interval for each time step
$\Delta p_{MG}$	power error between actual and iterative MG output power
$\eta_1^j$	MG cost coefficients for linear items
$\eta_2^j$	MG cost coefficients for quadratic items
$\eta_b^k$	profit gain of buyer indexed $k$
$\eta_s^k$	profit gain of seller indexed $k$
$\mu_{\cos t}^{coordination}$	faulted MG cost on buying enough power from neighbors
$\mu_{\cos t}^{j-i}$	the quantity that the faulted MG paying to the neighbor MG indexed of $j$
$\mu_{\max}^k$	generation cost under maximal volume of generation in $k$ -index MG
$\mu_{\min}^k$	generation cost under maximal volume of load in $k$ -index MG
$\mu_{Bat,\max}^i$	generation cost of battery under MG maximal generation.
$\mu_{MT,\max}^i$	generation cost of MT under MG maximal generation
$\theta$	angle of the MG voltage
$b_{Line}^{i-j}$	susceptance of distribution lines between MGs of $i$ -index and $j$ -index
$g_{Line}^{i-j}$	reactance of distribution lines between MGs of $i$ -index and $j$ -index
$i, j, k$	MG index
$p_{\max,cap}^i$	the power flexibility of $i$ -index MG, upper limit
$p_{\max,in}^k$	maximal volume of input power in $k$ -index MG
$p_{\max,out}^k$	maximal volume of output power in $k$ -index MG
$p_{\min,cap}^i$	the power flexibility of $i$ -index MG, lower limit
$p_{L,equ}^i$	equivalent load of line loss for $i$ -index MG
$p_{Line,cap}^{i-j}$	transmission line's capacity
$p_{Line,loss}^{i-j}$	power loss on lines connecting $i$ -index MG and $j$ -index MG

$P_{Line}^{i-j}$	power flow on the distribution line connecting $j$ -index and $i$ -index MG
$P_{MG, mod}^i$	equivalent power inputting into $i$ -index MG considering the line loss
$P_{MG}^i$	power of $i$ -index MG interacting with network
$P_{MG}^{j-i}$	power volume sold from $i$ -index MG to $j$ -index MG
$r_{Line}^{i-j}$	transmission line's resistance
$s_{MT}^t$	the operating status in the time steps of $t$
$T$	collection of all the MGs in network
$V$	amplitude of the MG voltage
$W$	velocity of wind
$w_{ess}^t$	battery SOC at time step of $t$
$x_{Line}^{i-j}$	impedance of line connecting $i$ -index MG and $j$ -index MG
$\delta^i$	voltage angle of $i$ -index MG
$\eta_{1,MT}$	the cost coefficients of generation corresponding to the linear term
$\eta_{2,MT}$	cost coefficients of generation corresponding to the quadratic term
$\eta_{ch,Bat}$	battery efficiency of charging
$\eta_{disch,Bat}$	battery efficiency of discharging
$\eta_{PV}$	derating factor considering conversion efficiency of PV cells
$\eta_{up,down,MT}$	cost over each change of MT operation status
$\eta_{WT}$	derating factor considering conversion efficiency of WT
$\mu_{cost}$	generation cost of MG
$\mu_{input,net}$	price of power buying from the network
$\mu_{MT}$	total cost generating certain volume of power
$\mu_{output,net}$	price of power selling to the network
$\pi^k$	bid price of assistant $k$ -index MG
$\rho$	air density
$I_{irr}$	density of solar irradiation
$p_L$	value of operating load
$p_{max,L}$	value of the total load
$p_{max\ charge,Bat}$	maximal charging power
$p_{max\ disch\ arg\ e,Bat}$	maximal discharging power

- $P_{command,Bat}$  power command for battery
- $P_{command,MT}$  the command of MG internal control to maintain power balance
- $P_{disch,Bat}, P_{ch,Bat}$  battery discharging/charging power
- $P_{max,MT}$  maximal output of MT
- $P_{max,PV}$  the maximal generation of PV
- $P_{max,WT}$  the maximal generation of WT
- $P_{min,MT}$  minimal output of MT
- $P_{out,Bat}$  battery output
- $P_{out,MT}$  generation of micro turbine
- $P_{out,PV}$  output power of PV
- $P_{out,WT}$  output power of WT
- $P_{req}$  demanding power of faulted MG
- $P_{res}$  supportive power from assistive MGs
- $R_{PV}$  irradiated area of PV cells
- $R_{WT}$  rotor disk area
- $T_L$  collection of load within individual MG
- $T_{Bat}$  collection of battery within individual MG
- $T_{MT}$  collection of micro turbine within individual MG



## CONTEXT AND OBJECTIVES



# INTRODUCTION

## 1.1/ CONTEXT

### 1.1.1/ BACKGROUND

The prosperity of the current industry and technology brings abundant life and convenient tools to human society. However, the increasing consumption of resources and unconscious waste both worsen the earth's environment. As Charles John Huffam Dickens said in the book of [Dickens, 2000], "this is the worst of times, but also the best time," the exploration on energy stimulates creative thoughts and breeds new development under the context in the following:

- 1) Global warming: due to the increasing carbon emission caused by the use of fossil fuel, the global warming problem becomes obvious and starts to influence human life. From the report of NASA, the global land-ocean annual temperature tends to increase since 1974, and until 2016 the annual increment has got to  $0.96^{\circ}\text{C}$  [Aeronautics et al., 2019]. Figure 1.1 from GISS depicts this deterioration, which attracts human beings' attention.

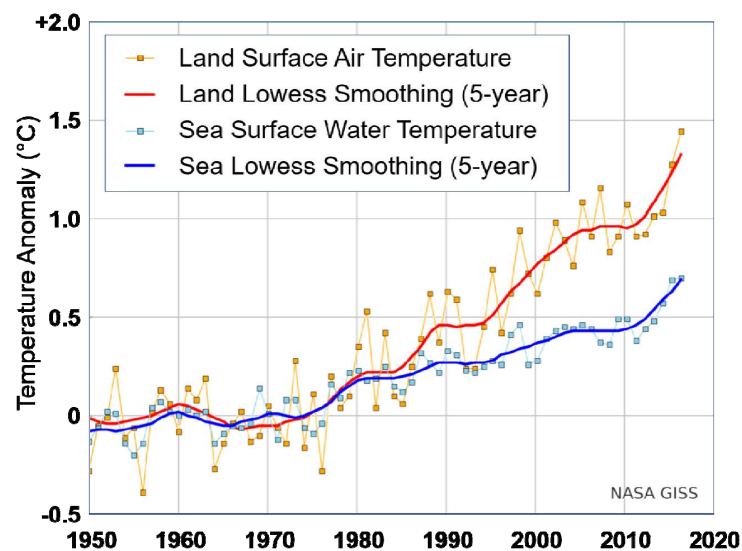

Figure 1.1: Annual mean temperature change for land and ocean. Measured in degree.

- 2) Increase in renewable sources: renewable sources are famous for renewable original energy such as photovoltaic and nuclear generation. This environmental friendly and economical generation penetrates the current electrical power system and sharply increases worldwide. For example, it took a percentage of 16.3% until 2017 in French electricity consumption. The condition is published by the European Environmental Agency, which is shown in figure 1.2 [(EEA), 2019]. However, the generation pulse worsens the power quality and its intermittency also distorts the load prediction in the utility grid. The distributed generation also brings challenges to fault detection.

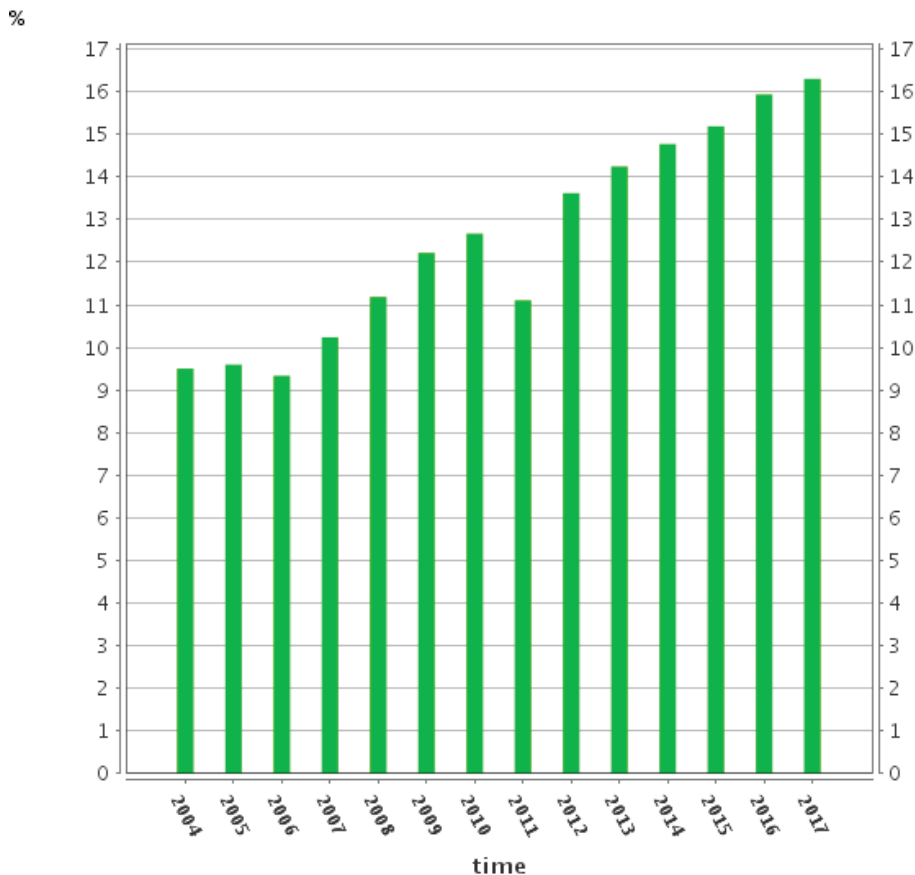

Figure 1.2: Share of renewable energy in gross final energy consumption in France.

- 3) Energy shortage: current human activities rely on fossil fuel more than any other time in history. Over-exploitation and large-scale consumption are exposing human beings under the thread of energy exhaustion. Currently, the danger of energy shortage compels people to exploit new energy sources. According to the figure 1.3 posted in reference [Smil, 2016], the global fossil fuel consumption peaks at 133853.38 TWh in the year of 2017 and the biggest reservation of coal can only last for 114 years under such a speed [Dudley et al., 2015].
- 4) Electricity demand of the remote area: for a particular purpose, some electricity customers are located in a remote area such as a secret military base, island residents, and offshore drilling platform. It is technically difficult and costly to supply such customers by building a transmission system from the primary grid. The visible connection is especially challenging to keep privacy for military usage. Thus an

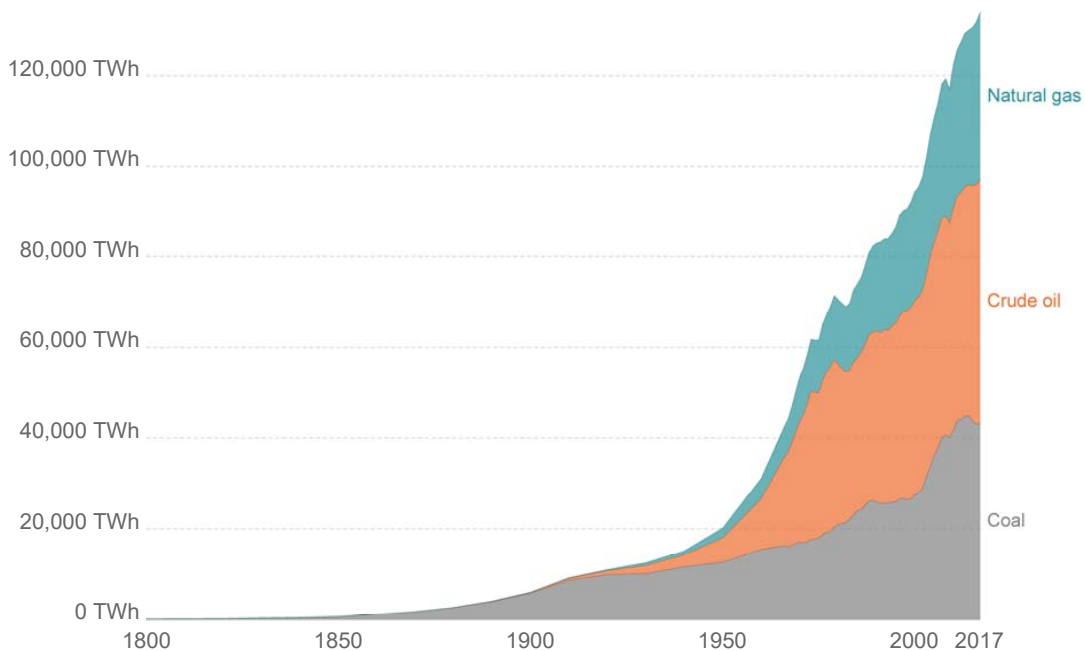

Figure 1.3: Global fossil fuel consumption. Global primary energy consumption by fossil fuel source, measured in terawatt-hours (TWh).

electrically and geographically independent generator-customer system is highly demanded.

- 5) Security operation: the expansion of power systems brings issues in faults detection and recovery. Network interconnection promotes coupling between MGs, which expands the impacts of faults. For example, even a tiny error could cause system collapse. For the utility grid, establishing enough devices to detect and isolate faults is not realistic, given the large scale and corresponding cost. Since 1985, when the first AC system was built, the grid infrastructures have lasted for decades. The aging problems are currently threatening the secure operation [Guarnieri, 2013]. Particularly, aging devices, such as transmission lines, threaten the reliability and efficiency of current emergency solutions.
- 6) Developing technologies in artificial intelligence and electronics: artificial intelligence has participated in every aspect of human activities. Its industrial use highlights by automation and complexity analysis. The development of electronics provides a fast and accurate way to control the high-power system. The combination of both technologies develops the capability of self-control and determination in the power system. Their application in the power grid stimulates creative approaches to optimize the facility operation.
- 7) Smart grid development: with the insertion of digital technology, the current grid is becoming smarter on operation prediction and power dispatching based on the support of communication networks and sensors. It enables the scheduling concept to transform from traditional peer-to-company to current peer-to-peer. The operation of dispatchable generators and distributable loads leads to the issues of optimization on economics, environment, communication, and so on.



### 1.1.2/ MICROGRID DEFINITION

Under the increasing demand for electrical power and the rising deterioration of the environment in the current world, new types of resources are continuously invented and integrated into power systems. Cooperating generators of different characteristics challenge the automatic and intelligent capability of the electrical system. Microgrid (MG) emerges as an effective method by narrowing the controlling system and coordinating the selected types of equipment. Such an architecture shares the control pressure of the main grid. Additionally, it promotes the intelligence and automation of the MG. Due to the growing interests in MG, the agreement on its definition is necessary. The U.S. Department of Energy Microgrid Exchange Group simply defined the MG in the year of 2012 as follows, and an example is shown in figure 1.4 [Ton et al., 2012]:

A microgrid is a group of interconnected loads and distributed energy resources within clearly defined electrical boundaries that acts as a single controllable entity with respect to the grid. A microgrid can connect and disconnect from the grid to enable it to operate in both grid-connected or island mode.

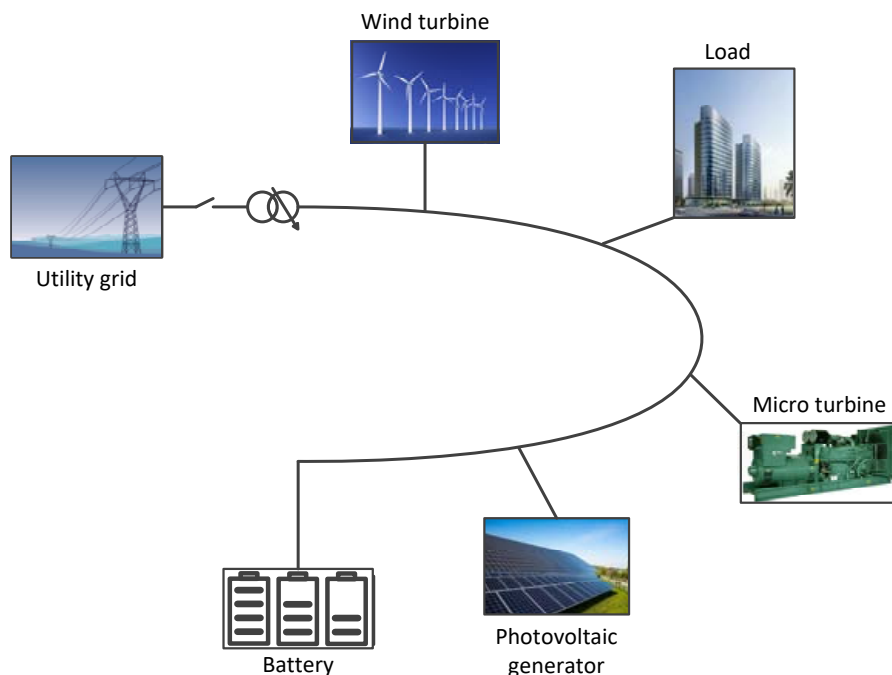

Figure 1.4: An example of MG.

This definition focuses on the isolating operation, and it puts a loose limitation on constituent elements. While another one proposed by CIGRÉ C6.22 Working Group gives a detailed description of the MG in 2015 [Marnay et al., 2015]:

Microgrids are electricity distribution systems containing loads and distributed energy resources, (such as distributed generators (DGs), storage devices, or controllable loads) that can be operated in a controlled, coordinated way either while connected to the main power network or while islanded.

This definition comes along with the qualifiers of MG elements:

Generators cover all sources possible at the scales and within the context of a microgrid, e.g., fossil or biomass-fired small-scale combined heat and power (CHP), photovoltaic modules (PV), small wind turbines, mini-hydro, etc.

Storage Devices include all of electrical, pressure, gravitational, flywheel, and heat storage technologies. While the microgrid concept focuses on a power system, heat storage can be relevant to its operation whenever its existence affects the operation of the microgrid. For example, the availability of heat storage will alter the desirable operating schedule of a CHP system as the electrical and heat loads are decoupled. Similarly, the pre-cooling or heating of buildings will change the load shape of heating ventilation and air conditioning (HVAC) system, and therefore the requirement faced by electricity supply resources.

Controlled loads, such as automatically dimmable lighting or delayed pumping, are particularly important to microgrids simply by their scale. Inevitably in small power systems, load variability will be more extreme than in utility-scale systems. The result is that load control can make a particularly valuable contribution to a microgrid.

Both definitions reveal the main characteristic of MG, which is coordinating its internal elements. The coordination forms an independent energy unit to achieve local demand-supply balance. Based on the internal control, this group can bring profits for both utility grid and interior parts [Ton et al., 2012]. Firstly, it enables the modernization and integration of multiple Smart Grid technologies. Secondly, the integration of distributed and renewable energy sources is enhanced. The increasing generation supplies the MG's load to reduce the load distortion in the utility grid. Besides local generators decrease power loss by supplying loads in short transmission distance. Thirdly, the cooperative method also promotes the participation of customers by demand-side management. Finally, the self-balanced MG supports macro grid and bulk power systems by providing ancillary services, such as compensating intermittent generation.

The MG operates as an ancillary while connecting to the utility grid. It could also be isolated as an independent power unit to avoid the faults impacts from outside or to segregate local errors from the global environment for other parts recovery. The combination of both patterns enables the flexible configuration of the power system connection. It furthermore promotes the transition of the traditional power system to the smart grid. Especially under the increasing insertion of intelligent elements and electronics infrastructures, the utility grid becomes more complicated than ever before. The MG imports the concept of deconstruction to solve the complex issues caused by system expansion. It shows great potential in solving environmental and economic problems. Incentives of expanding MG include: 1) Energy demand from an isolated area. Some electricity users are located in a remote area and have no access to utility grids. They rely on a sustaining power supply for specific applications, such as offshore drilling platforms or military bases on high altitude. 2) The increasing insertion of intermittent renewable generators. Enlarging the share of renewable generation is an effective way to relieve the deteriorating environmental problems due to low carbon emission. In recent years, the falling cost of renewable sources furthermore promotes their widespread establishment. However, the output harmonics from renewable sources lower power quality. Besides its non-dispatchable and

intermittent generation cannot match the load curve, which causes demand-supply imbalance. The low inertia of electronics converters causes rapid change. It breaks the dynamic power balance as traditional bulk generators of low generation ramp cannot follow the fast change [Roche, 2012]. 3) Profitable objective. Distributable loads emerge as intelligent devices to adjust the requirement of consumers. Demand-side management provides a solution for economic power dispatching. For example, peak-load shifting is widely applied to the domestic consumption with electric vehicles, intelligent heating system, and so on. Thus the scheduling method for these loads and energy storage systems is highly demanded. 4) System reliability. The sufficiency of power supplying to customers determines the power system reliability. The lack of energy happens mostly under fault conditions, which could be relieved by inputting the backup sources. However, due to the lack of sensors and breakers, it is almost impractical to detect the accurate location of faults and remove it timely without load shedding. Controlling the faulted system is even more complicated. It could furthermore cause a cascade of failure and extensive power outages because of the network coupling. Thus the electrical connection between elements enlarges the impact of faults and lowers the reliability of the system. For example, the 2003 Italy blackout and Northeast blackout of 2003 cause huge profitable loss and affects the lives of millions of people [Andersson et al., 2005]. Deconstruction of the large scale power system simplifies the problems of failure detection and recovery. The extensive network is separated into multiple independent parts, and the consisting elements coordinate and achieve partial power balance. Hence, this operation could isolate faults and recover all the loads timely [Ross et al., 2011]. 5) Low cost. The expansion of a power system imports longer and more transmission lines. Thus the power loss caused by energy transmission increases. Especially in the system of low or middle voltage level, the loss could be large even if the volume of power flow is not massive. This cost motivates new approaches to supply consumers with power from electrically close sources.

The architecture of the MG reduces the complexity and coupling in the electrical system, but inserting it into the utility grid raises new issues. This power system still demands more reliable, profitable, and flexible solutions to compromise with or even tackle the complicated operating problems. Given the advantages of MG and its wide application, there are hopefully MG networks in the future electrical grid. However, the operation of MG faces challenges which hinder its wide application.

- 1) Weak resistance and reliability under faults. Due to the limited capacity of DGs, the stability depends on the coordination of all the elements, including load curtailment. Such a system lacks sufficient backup sources to rescue sudden outages and tends to shed components for power balance. For example, dispatchable sources could compensate the intermittent output of renewable sources. Thus their outages will cause a system shutdown as the shortage of compensating power breaks the power balance.
- 2) Economic maximization. Even though the demand-supply balance is a priority for the MG, maximizing economic benefits in power dispatching is another control objective. Taking full advantage of the renewable generation is profitable as their original sources are free. However, surplus generation could cause curtailment of renewable generators. It lowers the device use ratio and furthermore weakens its contributions. The control strategy, which sustains the renewable generation, is crucial and imperative.

- 3) The combination of isolation and connection to the grid. Independence from the utility grid enables the supply of the island and remote area. Additionally, the control focuses on the internal elements and optimizes their cooperative behaviors according to the diversified characteristics. Whereas the isolated MG is vulnerable in case of internal faults. Connecting MGs to the network could maintain a reliable load supply, but the intermittent generation causes a demand-supply imbalance in the utility grid. It is beneficial to utilize the advantages of both modes and avoid shortages. Corresponding control strategy for MG is necessary.
- 4) Optimal operation. The optimal service within MG aims at promoting economic profit, environmental benefits, and so on. Based on the prediction of elements operation, it is achieved by optimally dispatching power between various generators and loads. If the loads and generators are distributed and dispatchable, the power dispatching issues will become more complicated due to the increased variables and following constraints. Hence more developed algorithms are required to get a solution.
- 5) Communication efficiency. Ranging from information sharing to coordination control within MGs, the underlying communication network guides each element to achieve common goals. Thus the dynamic and diversified power system demands an efficient communication protocol and topology to maintain stability, timely efficiency, and accuracy.
- 6) Loss reduction. The resistance of distribution lines causes power loss during energy transmission between MGs. Besides the system voltage level also determines the power flow on line. In a large scale of MG network, long-distance and dense connections increase the transmission loss ratio and furthermore reduces the efficiency of power interaction. When the system is a middle-voltage (600V-69kV) or low-voltage (below 600V) level, the share of the transmitted power is further decreased. This problem hinders the scalability of the network. The scalability is a system property to handle a growing amount of work by adding components to the system [Bondi, 2000].
- 7) Calculation pressure. With massive elements underpinning the operation of MG networks, the power dispatching considering load curve and intermittent generation becomes complex, especially when coordinating MGs for multiple objectives. The optimization with a large number of variables usually forms a mixed-integer nonlinear model, which challenges the combination of computation speed and quality of results.
- 8) MG network scalability. A large scale of network imports more elements and complex connections which increases the control complexity. Even though the traditional centralized approaches possess a global view, its reaction delay reduces accuracy and efficiency dramatically. Decentralized methods are widely applied to increase partial automation and intelligence. However, the solution to global optimization is limited due to horizon constraints, especially in an expanding network.

With incentives from advanced technologies and appeals of the electrical participant, the future electrical grid likely includes MG networks, which consists of multiple MGs. An example is shown in figure 1.5. Here, the MG usually contains renewable energy sources (e.g., photovoltaic generators, wind turbines), microturbines, loads and energy

storage systems (e.g., batteries). Due to the dispatchable generators and energy storage system, the MG has limited flexibility in the volume of absorbing and outputting power. Thus it could be treated as a power unit which can behave as a battery.

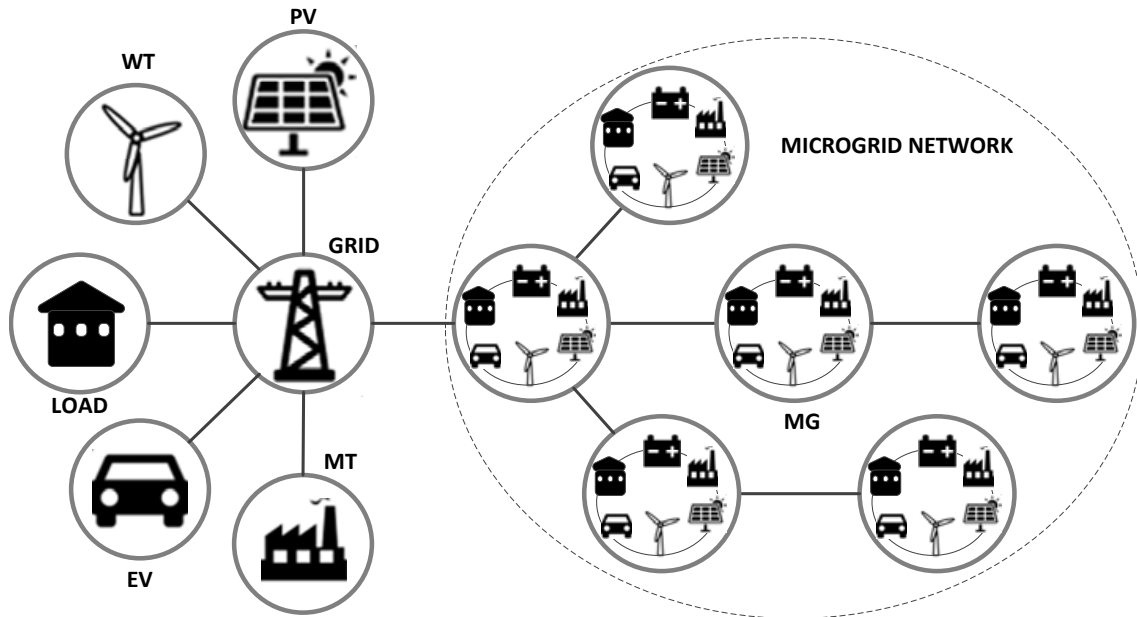

Figure 1.5: Contents of future MG network.

### 1.1.3/ MICROGRID NETWORK

Independent MG maintains self-stability by coordinating internal elements. On one hand, the isolation avoids the impacts from the main grid, such as a system collapse. On the other hand, it consumes the intermittent generation locally to eliminate the distortion to the generation schedule in utility grids. However, due to the limited backup facility, the rescuing method to faults of internal elements (especially generator errors) is unique: load shedding or generator curtailment. It reduces the use of elements and supply stability. Connecting to the grid provides MGs with enough power support, but the intermittent generation disturbs the generation plan and brings interference to the balance of the main grid. Given the advantages of both modes, the faulted MG can be rescued by the supported power from other MGs, while the isolation from the main grid is maintained. This method is available due to plug-in plug-out characteristics, dispatchable generators, and loads. The MG network could be found in areas with densely MGs settled such as a community of domestic MGs and the faulted area restarted by splitting into MG collection. As the coordination and independence coexist, it is more complex than simple elements coordination. Each self-governed MG must participate in the system cooperative actions as an autonomous entity. Problems in MG coordination include:

- 1) Modeling of MG coordination which involves the internal elements and MG behaviors. The coupling between elements and MG operation complexifies the coordination control. The dynamic environment changes elements operation, which further modifies the system status. To maintain the global and individual objectives, MGs coordinate the behavior of components to adjust to the new situation. The mutual

impacts between coordination behaviors and the system performance complex the elements control. Its diagram is demonstrated in figure 1.6. An MG model shows the essential characteristics which are determined by the operation of internal elements cluster. In this thesis, it includes the maximal taking in and sending out power. The devices are operated to satisfy the coordination objective reversely. Thus the lack of methods for decoupling the internal and coordinating control hinders the modeling of the MG network.

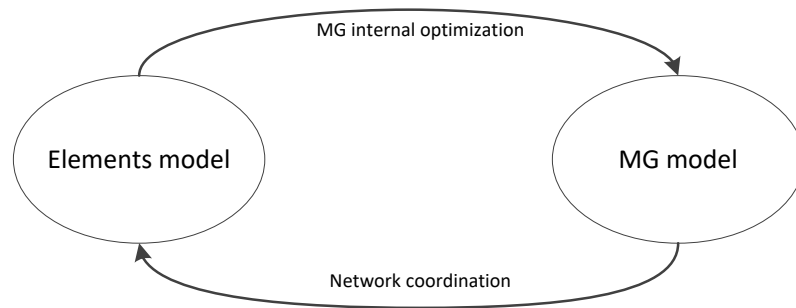

Figure 1.6: Diagram of mutual impacts between MG coordination and operation of internal elements.

- 2) Allocation of MG operation mode (i.e., isolation and connection). As the coordination control sets a common objective to all the participating MGs, the information sharing and optimal calculation among them are essential. However, a large scale of coordinating group delays the time cost in both procedures. Thus the election of connecting to the coordination group or isolation relies on new control strategies and coordination architectures to improve the coordinating efficiency.
- 3) Optimal power dispatching algorithms. With the development of intelligent tools and algorithms, the control is expected to promote the performance of networks in terms of multiple aspects, such as reliability, environmental benefit, and so on. Balancing the weights of several objectives with appropriate algorithms is not easy, especially when some control goals are contradictive. For example, the control for network power balance reduces economic benefits within individual MGs as the assistant MGs generate excessively to supply the faulted MG. Thus the optimal power dispatching algorithms should take full advantage of the distributed network, the MG operating feature and the diversified elements to optimize the system coordination in a comprehensive way.
- 4) Network scalability. The extending system consists of more MGs and more elements. Therefore, it increases communication connections and calculation pressure to the coordination control. The time cost in both procedures could cause reaction delay and even invalidate the control behaviors. Thus the methods adjusted to a wide range of network scales are essential to maintain timely performance, including efficiency, reliability, and timeliness under a dynamic environment.
- 5) Intelligent control for distributed network. In the distributed MG network, centralized methods control the elements collectively to achieve global goals. Promoting the optimization performance of network coordination while maintaining the benefits of individual MGs generates a multiple-objective problem consisting of global and individual goals. A large scale of information connection and calculation are demanded

with the centralized approach. Besides, it has a risk of single-point failure. In the decentralized methods, the coordination problem is split into multiple subtasks, and each of them is addressed separately by distributed intelligence. However, it is time-consuming, power redundant, and energy waste to coordinate all of the MGs for compensating power lack in an individual MG.

- 6) Prevention of transmission overflow. The power flow in MG networks should be limited by the transmission capacity to protect the infrastructure. As it is determined by the power interaction between MGs, the power dispatching problem should consider these constraints. Getting access to all the MG output directly from the assigned agents is not economical, considering the redundancy communication network. Thus establishing an efficient and practical interaction protocol for information sharing is necessary for the power flow calculation. Besides in the control system, how to develop the power flow calculation algorithms to match the distributed system and individual intelligence are the main problems to improve the network security operation.

#### 1.1.4/ MUTI-AGENT SYSTEM

The MG network operates to gain individual MG objectives (e.g., maximizing economic benefits, minimizing emission, and so on) and global goals (e.g., maintaining stability). Elements in the same MG should operate in a coherent and coordinated way. Thus, a control system for individual MG is necessary to save generation costs, maintain device constraints, and achieve global goals. Due to such characteristics of the MG network, the multi-agent system (MAS) is applied as the MG control system. The reference of [Wooldridge et al., 1995] defined the agent as:

An agent is a computer system that is situated in some environment, and that is capable of autonomous action in this environment to meet its design objectives.

Agents are endowed with flexible and autonomous actions, including environment perception, reactions for self-interest, and interaction with each other to gain common objectives. A system consisting of such agents being the only one to act, an environment, objects, relations between all the entities, a set of operations that can be performed by the bodies and the changes of the universe in time and due to these actions, is called multi-agent system [Ferber et al., 1999]. Agents communicate with each other to get global objectives and are intelligent enough to react to the dynamic environment. These advantages match well to the control system as they enable the operation of plug-and-play, active, and distributed approaches. Additionally, they make the system scalable and allows modularity. Overall the characteristics allow the easy and quick adaption of MAS-based control systems to MG networks according to consisting devices, control methods, and size. Based on these factors, new communication topology is stimulated to support the MAS. The research field in intelligent systems is enlarged and furthermore applied to many areas widely, such as the electrical system, telecommunication industry, and so on [Pipattanasomporn et al., 2009][Logenthiran et al., 2011]. The optimization algorithms based on MAS are also proposed to improve the reliability and efficiency of the control. In this thesis, the MG network is an electrical system which consists of multiple MGs.

Coordination among MGs is achieved by agent interaction, and single MG maintains their independence by controlling internal devices. This physically and electrically distributed system is characterized as a complex system which includes multiple entities in interaction, and they operate to provide emergent rescue [Simon, 1996]. Thus the MAS fits the MG network well to promote individual intelligence and global management.

Although the MAS has been widely applied to the power system for device control and energy management, a practical control strategy, which is suitable for the MG network considering scalability and efficiency, is rarely studied. Besides the distributed intelligence of agents has seldom fully used due to the centralized dispatching in power networks. Current research of the MG focuses on internal energy management and the interaction with the utility grid. The power coordination between multiple intelligent micro-power units is neglected. Now the main problem lying in the MG network is how to optimize the power dispatching with the flexibility of the construction.

## 1.2/ OBJECTIVES AND CONCERNS OF THIS THESIS

### 1.2.1/ PROBLEM STATEMENT

**This thesis mainly solves: decentralized optimization for power dispatching in distributed MG networks based on the MAS, considering system scalability and control efficiency.**

The MAS provides a distributed method to operate MGs for individual objectives and coordinate with other MGs for global goals. However, approaches, which match the control system well in terms of MAS topology, intelligence establishment, coordination process, and optimal power dispatching, demand to be further studied. They should meet the control requirement of MG network in terms of stability, the combination of efficiency and scalability, optimal power dispatching and power flow calculation.

Firstly, system stability is a fundamental objective. Due to the limited backup power source, independent MG is not resistant to the faults, especially to outages of generators. MG interconnection allows power assistance between MGs. But the coordination is not entirely reliable to gain sufficient power for all the loads according to different coordination strategies. Load shedding is the most common method to prevent it from voltage collapse and sustain the network system. However, the comfort of consumers is reduced, and the load stability cannot be guaranteed, which hinders its industrial and commercial application. Thus how to take advantage of the MG power interaction and the reserved generation of individual MGs to maintain load and system stability is, therefore, a problem.

Then the open MG network leads to a dynamic construction of the system. The control methods should assort with a wide range of the system scale. Achieving common goals among distributed MGs demands efficient communication protocols for information sharing and advanced calculation algorithms based on the MAS. Given that the MG network is an open system allowing plug-and-play of MGs, its expansion is in expectation as more DGs and users are inserting into it. However, the large scale of intelligent and autonomous MGs with individual goals increases the coordination efficiency due to the increasing communication connections and calculation pressure. How to adjust the algorithms and MAS bilaterally to gain an efficient approach for coordination while maintaining high performance in both small and large scale network is the second problem.



Optimizing the power dispatching is the third issue. To relieve the energy shortage and global warming, renewable and clean sources, such as photovoltaic generators and wind turbines, are widely penetrating the current power system. Their intermittent generation complexifies the optimal scheduling of dispatchable generators in terms of demand-supply balance. Additionally, distributed loads such as batteries of electric vehicles could comply with the scheduling order. Maintaining demand-supply balance with the economically and environmentally optimal operation is the coordination objective both for independent MGs and for the whole network. To this end, controlling dispatchable generators and loads to guarantee the total load supply, compensate and allow the full adoption of the intermittent power is the fundamental solution within individual MGs. However, centralized control to all the network elements is not practical as the communication link to all the parts is time-consuming and such topology could cause single-point failure. The MAS allows distributed power dispatching based on the MG unit, where agents complete the coordination tasks with a decentralized way to reduce the managing elements. But the generation cost and emission increased by the interacting power within MGs are non-linear and discrete, considering internal control and device characteristics. Thus for an MG, how to formulate the relationship between interacting electricity and the optimization objects with more approximate approaches is the essential problem of MG-unit coordination.

Finally, the power flow results from the comprehensive action of global MGs and it influences the network secure operation. The current power system regulates the facility's capacity to maintain the persistence of electrical infrastructures. For the transmission lines, it limits the maximal volume of power flow which is caused by power dispatching among MGs. Hence the calculation of power flow based on MG output should be studied. It is usually solved based on global output information. In the network, the distributed agent gets system information mediately from communication. But the message transmission strongly relies on hardware, scalability, and protocols. It increases control delay and reduces the accuracy of coordination control. Therefore, accurate and timely methods for decentralized power flow calculations are demanded to guarantee secure operation.

To solve these concerns, we initially study the coordination of the faulted MG and its neighboring MGs. A control strategy based on the MAS is proposed for power dispatching among elements within cooperative MGs. To improve the information in the economic benefits, a bidding strategy of individual MGs is proposed for the electricity market. Then the coordination group is extended to a larger scale for more economical operation. The control strategy, consisting of participant MG selection and optimal power dispatching, is proposed. A simulation platform is established in Python to validate the proposed approaches.

### 1.2.2/ COORDINATION WITH NEIGHBORING MGs

The coordination is studied among neighboring MGs, which enables network scalability and minimizes the generation cost. A control strategy for the rescue of elements fault is developed based on the MAS. It includes two stages: economic power dispatching and power flow check. The assistant MGs constitute a new segment centrally controlled by the agent of faulted MG. Here, the method of Lagrange multipliers economically optimizes the power dispatching. The average consensus theorem takes advantage of the neighboring communication between agents to spread data of MG interacting power to the network

and check the violation of caused power flow. Redispatch happens when power flow beyond the capacity of the transmission line. This approach guarantees the reliability of the system and the persistence of total loads during fault periods. However, it mostly shares the micro turbine to the faulted MG and does not take full advantage of the battery to reduce generation cost and emission.

Thus the electricity market is established for power trading between MGs to gain the most economical operation in each MG. A bidding strategy is proposed for MGs to formulate the mathematical relationship between output power and caused cost. The value of electricity price under maximal output multiplying the profit coefficient is assumed as the bidding price as the faulted MG buys the most electricity from the cheapest sellers. Power flow calculation is also improved and well suited to the decentralized intelligence without acknowledge of global information. This strategy saves time delay in gaining global knowledge to improve control efficiency. The economic benefits are also enhanced as the battery and micro turbine are considered in one integrated formulation.

### 1.2.3/ COORDINATION WITHIN EXTENSIVE MG GROUP

In order to further improve economic benefits and maintain control efficiency, the coordination area is extended by importing more adjacent MGs of the previous neighboring group and joining the new neighbors of the enlarged group. The coordination strategy includes two stages: determining cooperative MG group and power dispatching among elements. A distributed evolutionary algorithm is applied to the global agents to share the calculation pressure for selecting optimal coordination group in terms of efficiency, power dispatching calculation, and economic power dispatching. The searching routine is based on the depth-first search. In the second stage, the agent assigned to the faulted MG controls all the elements in the group and solves the power dispatching formulation for maximal economic benefits based on quadratic programming. This approach gets comprehensively good performance in terms of both calculation speed and beneficial results.

### 1.2.4/ SIMULATION STUDIES

In order to validate the proposed control strategies, this thesis develops a simulation platform based on Python programming. It builds the user interface to input the electrical system with graphic tools and data files. Additionally, the model of elements and system operation represents their characteristics and is embedded as the main part of the simulation. Finally, the MAS is simulated as the control entity and each MG is established to an MG for operating control methods. The cases of 12-MG, 13-MG, and 34-MG network are simulated on such a platform. In the 12-MG system, the MG network is connected to the grid to maintain the system voltage. It is applied to validate the control for coordinating neighboring MGs. To validate the scalability of proposed methods, the 13-MG and 34-MG networks are simulated as well.

### 1.3/ OUTLINE

The thesis has six chapters to represent the research of power coordination in the MG network. The first chapter represents the research context and motivations. It shows the urgent demand for a current electrical system to the MG. The highlighted advantages include providing electricity to a remote area, increasing the integration of intermittent energy sources, scheduling various controllable loads to optimize the system operation, and isolating the normal part from an electrical fault. Given the disadvantages of isolated MG, the MG network emerges to improve the resistance to faults, flexibility of individual MG, and preventing the power impact from MGs to the grid.

For promoting the automation and reliability of the MG network, various methodologies are applied and reviewed in chapter 2. The coordinating strategy contains reconfiguring and maintaining the constitution of individual MG. The corresponding control structure is based on the domination among task-solving operators, including centralized and decentralized control.

Thus the research shortage is mainly on the architecture design of an efficient control system and corresponding algorithms. The MAS provides a distributed control method and a modeling methodology for MG networks, in which a holonic MAS emerges as a flexible structure. With problems of designing control architecture and promoting the coordination performance, the requirements on system control are clarified. Finally, the contribution of this thesis is presented from the view of fundamental to application.

Chapter 3 establishes the simulator of MG network with a detailed configuration of elements based on the load data in UTBM, on which the performance of proposed approaches in chapter 3 and 4 are tested. It consists of the simulation of electrical infrastructures and the control system based on the simulation tools presented in this chapter. Designing the MAS model involves the complex MG network into a simple system which enables the control tools of MAS to be applied. Among various agent structures, the holonic MAS is selected due to allowing the flexibility of MG transmission in the coordination, and it provides multiple algorithms to the control. Among the problems hindering the development of MAS, the conflict between global control and self-management stands out. The efficiency of global coordination is improved by treating the MG as a unit, while the internal control is based on the elements operating information. This chapter designs the MAS architecture to the MG network, including the communication network and protocol. It is used to develop the framework of simulators testing the performance of the proposed approaches with Python programming.

Chapter 4 presents two methods to gain a high efficiency on power coordination and resistance to faults for the MG network, under whose framework of negotiation the profit is maximized. The architecture of holonic MAS is designed to gain high efficiency and low redundancy based on the communication network in chapter 2, which dispatches power among neighboring MGs. The infrastructures, including PV, WT, energy storage system, and MT are modeled in this part, and the self-organized control within individual MG minimizes cost. Thus a method of maximizing profit is proposed by simplifying the generation cost of each MG to a quadratic relationship with the output power, as well as a method calculating distributed power flow in the network. The simulation results are compared with another way with centralized control architecture, demonstrating a faster reaction on control. Furthermore, the MG generation cost is completed, considering the generation cost of different sources. An electricity market is established for dispatching

power among MGs, whose bidding principle enhances the accuracy of generation cost than the previous method. The power flow calculation is developed by considering distribution resistance as well. Test results verify its advantages over the first method.

Chapter 5 focuses on the overall performance on efficiency and economic profit of the coordination while keeping the reliability of the network. The architecture of holonic MAS is proposed to allow the flexibility of MG reconfiguration, which enlarges the scale of coordination MGs to gain a more profitable operation. The depth-first search is adopted to avoid communicational redundancy in MAS. For improving the control efficiency, distributed evolutionary algorithm programming is implemented to the coordinating agents for parallel computation. In this part, the simulation results analyze the factors that influence the control efficiency and economic profits. They also show the advantages of the proposed approach by comparing the performances of three other methods.

Chapter 6 concludes the previous work and summarizes the research. This part points out the disadvantages and contributions of the proposed approaches by analyzing the simulation results obtained from chapters 3 and 4. Perspectives on the development of the MG network using MAS are listed.



## RELATED WORKS

In this chapter, the literature about MG energy management is reviewed. As the objectives of power dispatching and constituent elements in MGs are similar to the ones in the main grid, related researches to both areas are concluded as well. The coordination problems are intensely studied in terms of physical structure, control architecture, and optimization algorithms. Keeping the power balance is by adjusting the dispatchable generation and distributed load given that MGs are self-governed. Fault conditions, especially generator outages, break the power balance of MG, which could not be rescued within the isolated unit. Getting support from other MG to regain normal operation improves the generation use ratio and load stability. Besides, the intermittent generation is isolated from the main grid. This conception is achieved with methods mainly including two ways. One is the MG reconfiguration, which means that the components are transferred between MGs to achieve balanced power allocation. The other one is to keep the MG unit and transfer energy by connecting lines to the demanding cluster. As for the tradeoff between optimization area and control complexity in the network, centralized and decentralized methods and algorithms are reviewed. Finally, given the architecture of the MG network, the MAS works well in conjunction with it due to the similarity of functionally and electrically distributed structure.

### 2.1/ COORDINATION WITH RECONFIGURING AND MAINTAINING MICROGRID

As the development of electronics promotes the automation of electrical devices, the feature of plug-and-play enables the flexible elements transfer between MGs. The reconfiguration is essentially to modify the connection of components to form new MGs. It is based on the breakers and backup transmission lines. This method could isolate faults and promote supply stability globally. Studies on system self-healing provide referential methods for the elements reallocation due to their common objectives of self-adequacy, optimization operation, and so on. On the other hand, the flexibility of MG isolation and connection to the system enables the power interaction between them. The approach of maintaining MGs keeps an original construction and only transmits power to support unbalanced MGs by adjusting the output of distributable generators and energy storage systems.

### 2.1.1/ RECONFIGURING MICROGRID

Highly developed electronics technologies and information collection methods promote the intelligence and automation of elements. Thus single items can operate independently and coordinate within a group of devices. With suitable operation for breakers and backup lines, devices could be transferred between MGs and compensate for the power imbalance in the newly formed MG. Due to the limitation of feeder capacity and system voltage, the reconfiguration strategy normally includes 2-stages: the operation for reconstructing MGs, and the limitation of maintenance during power dispatching.

[Yu et al., 2015] proposes a reconfiguration strategy to maintain the crucial load supply when faults happen under the limitation of electrical topology and operational infrastructures. To reduce cost and time delay, the operation number of switches is minimized by connecting with neighboring groups of sufficient energy. [Zidan et al., 2012] adds a new control objective: minimizing the transmission loss. This consideration is achieved by involving the restored loads to the near group directly connected by backup feeder firstly, then the indirectly connected one. However, both approaches optimize the reconfiguration based on the negotiation with neighboring groups and one-by-one message transmission lower the efficiency. Besides, the solution is not unique if the neighbors are connected similarly.

To get the globally optimal solution with combined objectives including load supply, switch operation and line loss, the MINLP problem in [Cavalcante et al., 2015] is approximated to an MILP model considering both active and reactive power balance and limitation on system operation. Another MILP model is presented by adding the operation of DGs [Chen et al., 2015]. The optimization is solved based on the global information collected by consensus theorem. Similar approaches rely on global information collection. Thus the efficiency of the control is reduced. A model is presented to form a new MG to prevent the impacts of faults [Ding et al., 2017]. It is further approximated to a mixed-integer second-order cone programming for simplifying the computational complexity.

To further reduce the calculation pressure and improve control efficiency, intelligence is adapted to the system entity. Considering the three-phase load maximization, a Q-learning method is proposed in [Ghorbani et al., 2015] to endow intelligence to the feeders. They decide their own operations by learning from the previous solutions, which reduces the pressure of real-time information collection. A disadvantage points to the inflexibility of the dynamic system construction. A hybrid structure is presented to combine the partial element control and global perception [Ye et al., 2011]. The Q-learning algorithm is applied to a collection of devices for a goal, which is adjusted based on the network demands. However, this paper does not consider the system operating constraints.

Graph theory is a new concept for the reunion of elements in MG networks. To reduce power loss and improve reliability statistics, The Spanning tree search is to reallocate DGs and storage units for supplying critical loads, while non-critical loads are selected to be energized. The optimization problem for reconfiguration is solved by a linear matrix inequality algorithm [Fang et al., 2019]. In order to minimize the switching operation and the shedding load, [Elkhatib et al., 2015] models the network as a spanning tree, where the MG is a virtual feeder. This method is limited by the radial topology and it also demands a sequential switch operation to avoid a loop.

The probabilistic characteristics of DGs are studied to maximize the active and reactive

self-adequacy of reconfigured MGs. Distributed energy storage resources and distributed reactive sources are both allocated with Tabu search to improve the self-adequacy [Arefifar et al., 2012]. Loads and renewable generation are predicted to make plans for all the faults rescuing in the following one hour [Arefifar et al., 2013a]. The temporary and sustained faults are classified in paper [Arefifar et al., 2013b]. [Baziar et al., 2013] adopts a 2m Point Estimate Method to consider the uncertainties of elements operation. The optimization problem is solved based on  $\theta$ -Particle Swarm algorithm.

Overall, as the switch action causes cost and time delay, the MG reconfiguration focuses on the switch operation to supply the outage area timely and sufficiently. Limited by the radial system structure, the sequence of switching behavior is controlled as well. Backup feeders transmit energy between the newly formed area and its power flow should be restricted within the capacity. Besides, the system voltage drop is another concern referring to connection modification. Thus the priority of this approach is to determine the switch behavior to supply load maximally and efficiently. However, energy management during the load supply is not considered. Especially when there is sufficient power to restore outages, the optimal power dispatching becomes a critical issue to select in candidate solutions.

### 2.1.2/ MAINTAINING MICROGRID

To avoid the caused problems by reconfiguration, the MG feature, which is the flexible transition between isolation and connecting to the utility grid, is fully used for MG coordination to improve the system stability. By treating the MG as an integrated unit, it could behave both as a load or source. A cluster of MGs constitutes an isolated network. The coordination control aims at keeping power balance in the whole system, especially when faults cause power imbalance. Therefore, energy management among MGs is deeply studied.

A bi-level method is applied with the first level for MG negotiation as a distinct entity and the second level for device control within the MG. [Wang et al., 2016a] sets a common point for power interaction between MGs based on their power flexibility (i.e., the maximal output and input power of an MG). To minimize generation costs and satisfy the elements' operation features, MILP is applied to solve the optimization problem for MG internal control. But the power congestion at common point limits sufficient load supply on a large scale of outages. [Wang et al., 2015b] uses the deterministic decomposition algorithm and the concept of progressive hedging to solve the two-stage problem. The operation within the MG is optimized and the penalty is added to the objective function of each MG to maximize load supply and benefits globally. A DC network is established in [Liu et al., 2018] for MG energy exchange except for the AC exchange network. The simplified model for power exchange considering power flow is solved by a distributed algorithm with convergence assurance based on the alternating direction method of multipliers. Still, methods in [Wang et al., 2016a] and [Liu et al., 2018] demand a common bus or point for coordination.

By adding the maintenance cost and main grid trading expense to the economic concern, [Tian et al., 2015] establishes a market for power trade in the MG community. The bidding price of each MG consists of the linear cost model of internal sources, whose non-convexity and nonlinearity are removed based on the piecewise linear functions and logic constraints. This method could cause power trading between self-adequate MGs



for maximizing benefits and it is essentially the markets between generators rather than MGs. The bid for MGs in [Logenthiran et al., 2011] is proposed based on the prediction of facility operation and equal to the maximal value in all possible candidates. The trading price and available power volume are derived from the top point of the generation cost curve without considering system power balance. Besides, it neglects the start-up and shut-down costs. Given the uncertainties of operation, a probabilistic price based unit commitment approach using point estimate method is employed to model their impacts to the MG price [Peik-Herfeh et al., 2013]. For a similar objective, the time-of-use and real-time-pricing demand response programs are applied for the power interactions among MGs, which is solved by a metaheuristic algorithm [Nikmehr et al., 2017].

Considering the relationship between the system voltage and power flow, the droop characteristics are applied to the coordination control. The hierarchical control strategy in [Che et al., 2013] concerns the real-time power coordination to maximize the supply in faulted MG. Droop control for DGs is the primary layer. The secondary level corrects frequency and voltage errors from previous control in the MG controller. The tertiary control manages power interactions between MGs in a distributed system. [Ren et al., 2018] adopts droop control to the power dispatching among MGs. It adjusts voltage volume and frequency of each MG by controlling the output active and reactive power. Even though the adjustment automation and speed are improved greatly, the system stability relies on the communication speed. As for the droop control, DGs in MG risk becoming a current source when the generation changes sharply.

Some elements of special features could improve coordination performance considering power quality. Vanadium redox flow battery is applied in the MGs due to its large capacity and precise SOC detection [Dong et al., 2014]. Its converters apply V/f control in the assistant MGs and maintain the voltage level for both neighboring outages and local elements when the remained capacity is large enough. It also reduces the inrush current during energizing the transformer in fault MG with a capacity no more than two times of generation. Two isolated MGs are connected by a back to back converter to compensate for the power balance for each other during contingencies in [Goyal et al., 2016]. [Moreira et al., 2007] applies droop control between microturbines and batteries to increase the capability of supplying all the loads in faulted MGs.

To compromise the generation cost, heat supply, and the caused emission, the power-sharing schedule is proposed in [Gabbar et al., 2016] with multiple fuel options. Elements in the MGs are scheduled in an all-in-one optimization and it is solved by a genetic algorithm. [Lasseter, 2011] pays attention to the wasted heat during generation. It locates the fuel-based generators near heat loads to match the requirement of both heat and electricity.

[Lv et al., 2016] treats energy utilization as an important factor. To improve it with high power quality, the MG power coordination strategy is explained by an interactive energy game matrix. The formulated optimization problem is solved with a hybrid algorithm of Rough Set Theory–Hierarchical Genetic Algorithm–NSGA-II. The game theory is also applied in a distributed algorithm to reduce the power loss in transmission for coordination [Saad et al., 2011]. The formation of MG groups for energy interaction is optimized based on coalitional game theory.

In order to improve the resiliency of the MG network under emergency conditions, a comprehensive control architecture is proposed [Colson et al., 2011a]. Each MG is self-ordered to supply internal vital loads and then supply the faulted MGs.

The coordination among MGs refers to the process of power dispatching. It includes the generation cost and emission issues during scheduling. Besides various distributed generators show advantages for achieving diversified objectives. Particularly, renewable energy sources provide clear and free energy to relieve fuel consumption. However, the power balance is an issue due to the intermittent generation and dynamic load. Especially during the fault period in MGs, real-time rescue is crucial for the network reliability and load supply stability. This approach considers power dispatching benefits and optimizes it in terms of economic profits, environmental factors, and power loss. However, the restrictions of infrastructure are not considered during power interaction.

## 2.2/ COORDINATION WITH CENTRALIZED AND DECENTRALIZED CONTROL

The control strategies introduced in the last section determine the cooperative behaviors for certain objectives. On the other hand, the control structures provide a platform for the implementation of achievable algorithms. Developed approaches and device allocations are proposed in conjunction with them. Given the complexity of the system and the large scale of the constituent elements, the perception of the whole network for global management and the computational difficulty for the solution are both challenging the control methods. According to the literature, the control structures are divided into centralized and decentralized topology with different advantages respectively.

### 2.2.1/ CENTRALIZED CONTROL

As each change of the electrical devices could cause voltage and power flow change, they can further impact the operation of all the other components. Thus analyzing the network intensively in a centralized controller solves the system problems with a comprehensive view. This structure is widely applied to the control within individual MG. The functions focus on the power dispatching while maintaining the operation constraints, which are similar to the ones in the MG network. Therefore, applications in both areas are included below.

For the centralized MG coordination, an all-in-one optimizing problem for power dispatching is normally formulated with a series of constraints for the operation of the elements. According to its mathematical properties, the solution appropriate algorithms are applied. [Chen et al., 2016] gets a convex optimization problem to minimize the economic cost in terms of generation, emission, and maintenance, which is solved by an interior-point method. Adding the power loss, the objective is formulated by [Faria et al., 2011] a non-linear programming and the Generalized Reduced Gradient (GRG) method is applied to get the solution. Other optimization problems such as MINLP in [Wang et al., 2016b] and MILP in [Moghaddam et al., 2011b] are solved by General Algebraic Modeling Systems. Another solver called Advanced Integrated Multidimensional Modeling Software in CPLEX is adopted for MILP in [Elsied et al., 2015][Morais et al., 2010].

Another centralized structure is applied for supervising the power flow and market operation. Each MG is treated as an integrated entity [Fathi et al., 2013] to trade power in the market. The electricity market is established by the distribution network operator. This operator is a service provider consisting of multiple functional software. These functions

include supervising the power flow and market operation among MGs. Each function is treated as an independent activity and all of the MGs are able to achieve it. To reduce the generation cost and peak-to-average ratio of load, an adaptive scheduling approach is provided. An online stochastic iteration is applied to capture the randomness of the uncertain consumer demand over time. The distribution network operator is also used in [Wang et al., 2015a] for power-balance maintenance and generation cost minimization in the MG network, considering uncertainties of DG outputs. For similar objectives, a distributed market operator is defined in [Parhizi et al., 2015] to set electricity prices and determines the amount of the power exchange between market participators. It collects power information from all the MGs and manages the network power trading.

The MG reconfiguration adopts a centralized structure for determining the switch behaviors and their sequence globally. The paper [Fang et al., 2016] collects the operation condition and characteristics from all the elements to improve the utilization of DGs after splitting the network. A linear matrix inequality approach is applied to optimize the allocation of MGs. [Wang et al., 2015c] reconfigures the MGs during faults to maximize the load supply. The uncertainties of elements and running conditions are collected. According to them, the network optimization problem is formulated as a stochastic process. A scenario reduction method is adopted to get the solution to configure the reunion of all the components.

The controller in a centralized structure gets perception to the whole network and could provide a globally optimal solution. The constraints determine the solution space in one-in-all optimization, which avoids the fitness validation of the results. However, this structure demands communication links between the center and all the devices, and a fast calculation for the solution. These factors reduce the practical value.

### 2.2.2/ DECENTRALIZED CONTROL

Due to the communicational and computational limitations, the system scalability is reduced. As each centralized problem could be decentralized to gain advantages in multiple aspects, the coordination problem is studied with distributed methods. It refers to that partial components accomplish global goals based on local information. Thus the communication and calculation pressure lead to an urgent demand for the exploitation of distributed control strategies. Notably, this structure can further promote the automation and intelligence of each part of the network.

Authors of [Luo et al., 2017] propose a multiple MG coordination control framework which motivates resource sharing among MGs by forming a self-adaptive MG coalition. To simplify the communication network, [Xu et al., 2011] offers a distributed average consensus theorem method for data exploration for each MG to make self-determination for coordination. However, even though communication in both studies is distributed, agents need to discover the complete network information, which is similar to centralized control. The power interaction between the MG network and the main grid is modeled as a bi-level problem [Asimakopoulou et al., 2013]. The lower level determines the power insufficiency by optimizing the internal operation. Then the power requests are made to the upper level where the controller determines the electricity price based on the demand value.

As the decentralized control demands a high level of automation and information discovery to the control entity, the multi-agent system is widely studied and applied as a platform and modeling method for the MG network.

### 2.2.3/ MULTI-AGENT SYSTEM CONTROL

As each MG can operate independently as a power unit, a multi-agent system (MAS) is applied to improve the system automation and intelligence. It will be further introduced in section 3.2.2. Agents can process data in a distributed way. Thus the controller with this ability is robust to single-point-failure. It improves the control speed and scalability. The reliable and profitable operation of the MG network relies on the MAS complementary control methods considering agent interaction and agent self-organization.

Task-sharing is proposed in [Davis et al., 1983]. Herein, agents with multiple tasks get support from less busy agents. It allocates the tasks among agents evenly to promote the efficiency of the system. While [Ephrati et al., 1995] presents a result-sharing strategy. Multiple agents solve the same problem to get a result with high confidence. Distributed planning strategies decide the intention activities of each agent to finish global coordination [Von Martial, 1992]. This thesis studies the optimal operation of the MG network. The problem-solving strategies value reaction time to improve the control accuracy.

Agents in the multi-agent system are autonomous and intelligent enough to achieve self-interest. Therefore, each constituent element can achieve global goals with distributed control. [Elmitwally et al., 2014] establishes three kinds of agents for reconfiguring the electrical groups given the system operation constraints. The load agents check electricity consumers and report the error to the feeder agent, which negotiates with neighbor feeders for load transfer to avoid power congestion or voltage violation. A regulator agent accepts requests from all feeder agents and adjusts the transformer to match the system topology. With similar construction, the MAS is applied to maximize the load supply in MG configuration [Ghorbani et al., 2014]. The feeder agent is endowed with intelligence based on Q-learning algorithm.

A multi-agent system, only including neighboring communication, is designed in the [Solanki et al., 2007] for load maximization. The system consists of switch agents, load agents, and generator agents. Each agent makes queries to the downstream neighboring agents and related proposals are answered and transmitted upstream. With the same communication link and message transmission routine, a two-layer MAS including zone agents and feeder agents is proposed in [Zidan et al., 2012]. Feeder agents negotiate with each other for global information and zone agents monitor the local operation and implement control actions.

Taking advantage of the communication capability of agents, the MAS is applied to model the participants in the electricity market, which could be an MG. Each agent manages the assigned facility for the local goals [Pinto et al., 2011]. To maximize load supply, buying power from DERs to supply unserved loads in MGs has been investigated in [Li et al., 2010] by controlling each element with corresponding agents. A central control agent is applied to summarize the information of all the components to make reconfiguration decisions.

[Zhao et al., 2015] and [Pipattanasomporn et al., 2009] both allocate agents to the electrical facility to enable their predictive capability. Thus, the accuracy of the energy management schedule is improved. Agents control MGs in two layers: coordinating local components and negotiating with other agents [Nunna et al., 2013]. The work in [Logenthiran et al., 2011] establishes a market for power trading between MGs. The assigned agents calculate bids based on the prediction of elements operation cost for each MG.

MG network is a complex system where there exist multiple MGs, and each of them is self-organized by maintaining the supply-demand balance within internal elements. Modeling it with the MAS is to get its outstanding abstractions by analyzing the system from the fundamental items. Based on it, the control framework is provided for the MAS application. Thus theoretical methodologies could support the design of the system with maintaining system complexity [Kinny et al., 1996]. As each agent focuses on the agent behaviors to gain individual and global objectives, the object-oriented approach is widely applied to modeling agents such as Believe-Desire-Intension agent systems [Booch, 2006, Ormandjieva et al., 2015]. It aims at constructing the agent with formulating behaviors to gain the defined individual and global goals. Formal methods provide mathematical basics, such as tools and techniques, to reliably specify and verify the MAS model despite the complexity of the real system [Clarke et al., 1996]. It is especially useful for the system, which includes a large number of agents. Additionally, bounded-rational and categorical approaches are applied to define the behavioral mechanism and to guide the decision-making process of agents and the interaction among them [Le et al., 2008, Ormandjieva et al., 2015]. The former one considers spatial changes, while the latter focuses on interaction semantics among agents in the system without the need for mathematics basics. In conclusion, this dissertation selects formal methods to model the MG system based on its elements in the network. The model of the facility is mathematically modeled according to electrical laws.

## 2.3/ CONCLUSION

Previous studies solve the coordination issues from diverse control strategies with different control structures. Control strategies mainly involve MG reconfiguration and maintaining MGs. Corresponding control structures are divided into centralized and decentralized topology. The control objectives include reducing the reconfiguration delay, increase economic benefits, maintaining system security operation, and so on. The MAS, as a decentralized system with high automation and intelligence individuals, emerges as an adequate method to control the MG network. Selected references for multiple strategies and structures are shown in table 2.1.

Table 2.1: Selected papers on coordination approaches.

Refs.	Strategy	Structure
[Zidan et al., 2012]	MG reconfiguration	decentralized, MAS
[Wang et al., 2015c]	MG reconfiguration	centralized
[Wang et al., 2016a]	maintaining MG	centralized
[Logenthiran et al., 2011]	maintaining MG	decentralized, MAS

However, there are still several problems with which the previous literature does not deal. They can be included in the following:

- 1) How to select the coordinating MG for high reliability of supply and an economic power dispatching scheme simultaneously?
- 2) How to coordinate the MGs with an efficient approach which is not influenced by the extending network scale?

In the next chapter, these issues will be further studied and several solutions to them are presented.

In conclusion, the current literature presents solutions for MG coordination. To improve the efficiency and supply reliability of power coordination, energy compensation and elements transfer are proposed. Corresponding algorithms and network topologies are adopted, for instance, the GA, mixed-integer nonlinear programming, electricity market, minimum spanning tree algorithm, and so on. The control object in a system ranges from elements to individual MG. Supporting communication topologies and control strategies are proposed, such as distributed and centralized control structure. Additionally, consensus theorem and game theory are applied to the computation framework to optimize the control system. The advantages and disadvantages of the coordination approaches are compared thoroughly and listed in table 2.1. As the MG network is geographically and electrically distributed, the MG's automation and intelligence increase the efficiency and supply reliability of achieving individual and global goals. Thus the multi-agent system is adopted in this thesis as the control system.





## CONTRIBUTIONS





# MODELING AND SIMULATION PLATFORM

## 3.1/ DEVELOPMENT OF SIMULATION PLATFORM

In addition to the simulation of fundamental electrical infrastructures, such as transmission lines and diverse facilities, the MAS is also involved in the simulated objects as the control entity. Due to the electrical and physical distributed construction of the MG network, each MG could be functionally independent and cooperative. Hence, the agent concept is imported to simulate individual MG. It depicts the generation/load characteristics, behavioral rules, and cooperative functions as an integrated entity. With quantitative results derived from simulation, the characteristics of the MG network are analyzed and the control performance of proposed approaches for coordination is evaluated.

Currently, popular platforms for the establishment of simulation mainly include Matlab and Python. As a commercial software, the former one provides a simple programming language, a large number of functions and a well-prepared simulation platform based on the default installation of packages, as well as the support from a wide range of scientific community. However, the charging functions, sealing algorithms, and code of no portability raise time and economic cost. While Python, as a programming language, is free with a substantial amount of functions and allows the portability. The easy coding brings Python extensive standard libraries. It is open-source and gives access to the details of the algorithms. Thus, Python is adopted for simulation in this thesis considering the demands for MAS simulation and algorithm development.

To build a functional MG network, electrical devices and the consisting network are modeled based on their features and behaviors. With the mathematical representation and discrete behavioral rules, this physical system could be transferred to a simulation.

## 3.2/ MODELING OF MG NETWORK

### 3.2.1/ MG NETWORK AS COMPLEX SYSTEM

The MG network consists of sources and loads with diverse features. Given the diverse constitutive components for each MG and the various network topology, the power interaction between MGs is complex. To match them for the system supply reliability,

optimal power dispatching for load stability and economic profit is always in the most crucial topics for electrical systems [Borbely et al., 2001]. Until now, load prediction is widely applied to generation scheduling in the steady-status power system. The demand-supply modeling contributes to maintaining the power balance and economic optimization by dispatching power among generators according to the predicted load requirement [Lampropoulos et al., 2010, Mohsenian-Rad et al., 2010]. In traditional power systems, generators are mathematically modeled as voltage sources. The output is load-oriented to keep standard voltage levels according to the Kirchhoff voltage/current laws. For example, the electricity consumption in a city is predicted 24 hours ago and the local generation will follow the prediction the next day [Sauer et al., 1998]. However, the integration of intermittent resources and various dispatchable loads reduce the guidance of load to the generation. Electricity price bidding is influenced by the share of renewable generation, and it is not completely dependent on the load profile anymore. As for the MG network, it consists of multiple MGs which are individually self-organized. The individual MG coordinates internal elements including diversified generators, storages, and loads for self-interest. The power imbalance caused by faults or disturbances highlights the interaction among MGs, and the caused power flow emphasizes the interdependence between single MG and the whole network. Due to the expanding scale of the network and increasing facility with different characteristics, it is difficult to approximate the electrical system to a simple circuit model and analyze it with explicit mathematical expressions, especially under the fault conditions. Rechecking the system to find new modeling methodologies is urgent to study MG networks and solve current practical issues. Concluding its features, they are shown in the following:

- 1) The self-organized MG blocks the interaction between internal elements and the whole network, but their mutual impact exists. Due to the self-organized control, elements are controlled within MGs and the interaction with the network is blocked. However, their mutual impact exists due to electrical interdependence such as voltage and power flow transmission. For example, the generator outages in a faulted MG disorder the voltage frequency in the network and incite the generation increase in other MGs to recover the system. Any change in the network could cause a systematic chain reaction, while internal elements do not know about that.
- 2) The MG network is an open system. Thus the cooperative behaviors of individuals should adjust to the dynamic topology and changing operations of elements. For instance, the plug-and-play MG could join to the network in a random place at any time, and the other MGs should constantly be prepared for the new participant to cooperate with it.
- 3) The system operation has memory on the past operation. The current activity is formed based on the previous status of the components. For example, the battery aging problem collected from the initial start will limit its service time and stop its current operation.
- 4) The network is a non-linear system in which a small disturbance could cause fluctuation on voltage or power flow. The interdependence between elements and system operating status worsens and enlarges the influences on more normal parts in the system.
- 5) There are hierarchical phenomena in the network. Although solving the network problem ultimately relies on the behaviors of elements such as output and load

profile. Other properties could only be studied at a higher level; for instance, the network power flow caused by power transmission among MGs.

- 6) The control system has damping or amplifying feedback loops. For example, the converters of wind turbines apply the PI controller in the voltage control loop to maintain the command value.

Thus the MG network could be regarded as a complex system considering the previous characteristics [Bar-Yam, 2002, Randall, 2011]. As the MAS is electrically and physically distributed and each agent could function independently, this system in conjunction with the MG network provides a matchable structure for establishing the control entity. Thus, the model based on it provides adequate paradigms for system design, simulation, and analysis. A related application of MAS on electricity system backtracks to the year 1994 [Varga et al., 1994], and since then this technology keeps improving its merits and solving power issues. In nowadays, the multi-agent system has been applied widely, which is supported by advanced technologies on communication and automation.

### 3.2.2/ MULTI-AGENT SYSTEM

Consisting of interacting agents and the located environment, the MAS provides the analysis of the autonomous reactions, which is compensatory for the mathematical model [Ferber et al., 1999, Orcutt, 1968]. It provides a paradigm for modeling and controlling the complex system, which is heterogeneous. In the MAS, intelligent agents monitor the dynamic environment and react to it for self-interests or common goals. Changes in the system could be caused by the agent behaviors or outside factors. Reactivity, pro-activeness, and social ability are the main features describing agents [Wooldridge et al., 1995]. They are reflected in the interactions between environment and agents, as shown in figure 3.1. In the following sections, we introduce the basic concepts of the multi-agent system.

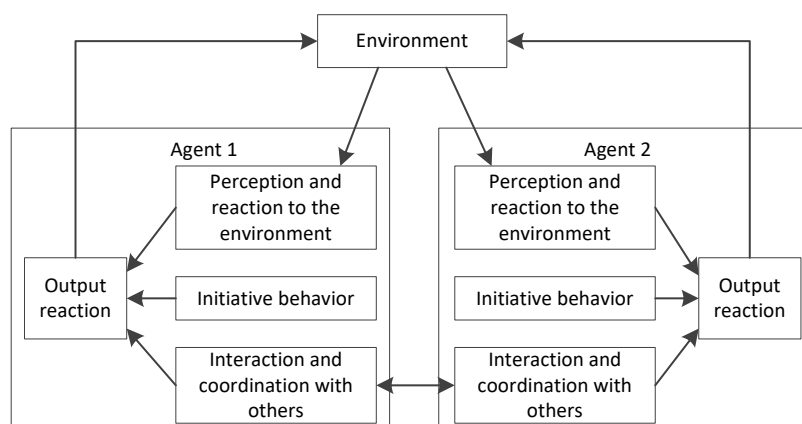

Figure 3.1: Agents and their environment.

#### 3.2.2.1/ ENVIRONMENT

The environment is an important factor influencing the design and architecture of the agent network. It is the controlling and monitoring objects for the agents. For explicit

objectives, agents modify self behaviors for adjusting to the dynamic environment or even influencing it based on the coupling between them. The environment characteristics are normally identified in terms of the following lists [Russell et al., 2016]:

- 1) Perception of the environment. Getting a complete knowledge of the whole environment helps an agent to detect the change in time and even to predict the possible future. However, due to the geographically distributed agents and physical limitation on information-collecting infrastructures, they have difficulties to gain complete, precise, and real-time information to learn about their environment. The lack of percept causes difficulties in the agent reactivity.
- 2) Determinacy of effect. The action of the environment could bring changes. The one, where each action causes a single and fixed result, is called a deterministic environment. On the contrary, certain activity in the environment causes stochastic influence. This environment is non-deterministic and it increases the complexity for designing agents.
- 3) "Memory" of the past scenarios. Memory refers to the dependence of current agent performance on the prior status. If the agent's performance only relies on the current episode of the environment, developing the agent system is simpler as there is no need to predict future scenarios.
- 4) Status of the environment. The static environment is only changed by the stimulation of the agent's action. It is on the contrary with the dynamic one, where a higher process existing outside of the agents runs and modifies the environment. The most common dynamic one is the physical world. Agents have a small influence on such an environment so that the requirement for dealing emergencies is higher than in a static one.
- 5) Continuity of the environment. If the percept and activity of the situation in the environment could be described and quantified by a finite number, it is discrete. Reversely, the continuous one demands a high recognition capability for the agent system.

Identifying the environment in terms of these classifications is helpful for the establishment of the multi-agent system. The agent behaviors and the system architecture should be matched with the situated environment for better performance. Even though the toughest situation is the combination of dynamic, continuous, continuity, non-deterministic, time-varying, and inaccessible features, assumptions and simplifications could reduce the complexity and help to focus on the main researching field.

### 3.2.2.2/ THE AGENT

Before network modeling, individual MGs are the foundation to construct the network. However, the dynamic system takes a functional activity both based on the input and the behaviors of coupling agents. These mutual impacts and random behaviors of agents hinder the modeling which is only based on a single mathematical representation. The agent has advantages in processing dynamic and stochastic systems, especially on modeling decentralized architecture [Borshchev et al., 2004]. Comparing with the other modeling

methods, it represents a new process for dealing with the interactions between distributed entities, as well as individual behaviors. System robustness is also shown in defining the global goals for all the agents. Within a complex environment, the agent's perception and the corresponding reaction have a mutual effect on each other. Establishing a distributed modeling and decentralized control system could provide a capable framework which is detailed to single elements and has a global view simultaneously.

The MAS could be a paradigm of modeling that focuses on the actions of individual agents and the interaction with others. It is characterized by the following factors in the view of practical modeling [Macal et al., 2005]. 1) Identifiability. The standard for identifying the agent should be discrete to distinguish it from the other concept according to clear boundaries. They should include individual characteristics, rules on behavior management, and the ability to make decisions. 2) Behavioral rules. Rules for regulating the agent behavior and chasing goals are established to adjust the system to a dynamic environment and achieve flexible self-operation. 3) Memory. Agents spare data space for storing the past operation and form experience to guide the current behavior. 4) Resources. The resources which the agent models multiply the kind of agents. 5) Decision-making sophistication. Sophisticated decision making is necessary to tackle the inconsistency in the dynamic system. For example, the conflict between global and individual goals needs to be considered and ordered based on the mission priority.

The model and simulation based on the MAS are widely applied in the current complex systems, ranging from abstract models to decision-support models. The former one describes prominent features based on ideal assumptions, and the latter one tackles the practical strategy problems in the real power network. To solve the practical issues, the modeling objects in reality should be analyzed based on the items introduced in this section.

### 3.2.3/ THE MG NETWORK MODELING BASED ON MULTI-AGENT SYSTEM

Given the characteristics of the MG network introduced in section 3.2.1, it could be regarded as a complex system. The MAS emerges as an outstanding paradigm for modeling and controlling it. Similar to agents, the MGs in-network behave with the features including distributed architecture, reactivity, pro-activeness, and social ability. Based on these similarities, current modeling methods with the MAS is reviewed.

#### 3.2.3.1/ DISTRIBUTED ARCHITECTURE

The MGs are geographically distributed and electrically connected, which is much similar to the MAS. To comply with the MG blocks, the MG behaves in 3 manners including self-organization, network negotiation, and bottom-up approach. They cover all the elements operating in the network and provide a clear classification for the control framework.

In the MG network, self-organization refers to the individual behavior of MG. It includes the self-information collection and self-management for achieving individual goals. During this procedure, the MG pays specific attention to the primary constituents. For instance, in each MG, the internal devices coordinate with each other for the power balance and stability of MG cells. Thus, each element is monitored, and all of their behaviors contribute to the MG profit and security.

Electrically connected MGs compose the MG network whose supply reliability relies on the MGs cooperative behaviors. Coordination between MGs emerges as a complementary method to allocate generators between MGs and to improve the utilization of generation. The power interaction makes full use of the network connection to match overload MG with the power-spilling MG. It is dependent on the negotiation among MGs. Especially, when faults occur to the items, the faulted MG cannot maintain the internal power balance and risks load shedding or generation curtailment. Negotiating with other MGs for power support helps to preserve sufficient supply and avoids the disturbance spreading to the utility grid. Additionally, the negotiation between autonomous entities enables new MGs inserting into the network without reconfiguration for the whole system. The characteristic of plug-and-play is profitable for the construction and expansion of the system.

A bottom-up approach is adopted on the management of the MG cluster based on the behaviors of self-organization and negotiation. It is especially helpful to simulate the management process in a complex system where elements are integrated to form a network. Given the clear identification of fundamental infrastructures and its determination on the construction of a higher level, it provides a more reliable and detailed approach than the global model in terms of representing the network. The bottom-up approach is to process components information in each MG to know their functions, operation, investment, and so on. It finally aims at coordinating the monitored elements downward and negotiating the MGs upward initiative and autonomously. As the global and individual goals of each MG may be contradictive on operating infrastructures, identifying the priority of tasks is necessary.

Complexity in modeling the MG network with agents is reduced by distributed information processes and interaction between MGs. With a detailed model of the infrastructure and proper design on coordination behaviors, the operation of MG could be analyzed comprehensively.

### 3.2.3.2/ REACTIVITY

Agent reactivity refers to the actions in environment modification for damping caused impacts on operation status and maintaining objectives. Such activity exists in the MG operation. For example, the load volume and generation are changing according to human activities and the natural environment. The control system of MGs runs to maintain the power balance by coordinating the operation of internal elements and keep the supply-demand equality within the network by negotiation between MGs with the limitation of system security requirements. This characteristic is especially essential for facing emergencies in the network. Faults on elements or distribution lines can cause disturbance on voltage or frequency. Under such a condition, MGs detect the outages and reason the errors to isolate faults and maximize the normal operation of elements based on the information of local infrastructures and the network. In other processes such as fault restoration and consumption of intermittent power, reactivity contributes most to the network autonomy, supply reliability, and flexibility.

Influencing the operation of the MG network, the environment consists of geographical locations, weather, mechanical entities, and human activities. The agent's perception of surroundings could help to predict the operation of components. The environment properties also affect the establishment complexity of agent modeling and control architecture

[Russell et al., 2016]. The MG network environment, consisting of the weather, human activity, and electrical facility, has the following features. 1) Inaccessible. Considering the geographically distributed location, the independent operation of elements and the practical limitation on the communication link, agents could hardly get full, accurate, and the latest information on it. 2) Deterministic. The reaction of the MG network to the environment is assumed to be unique. For example, the discrete behavior of human activity causes single action to the operation of the elements. The generation of renewable sources could be represented by a mathematical function based on environmental factors, such as the PV and WT. 3) Non-episodic. The MG performance relies both on the current environments and the prior status, such as the aging problem of the storage system. 4) Dynamic. The environment is changing even without the operation of agents — for example, load changes along with human activities. During summer, the use of air conditioners demands a higher supply of reactive power, while electrical heater increases the resistive load in winter. 5) Continuous. With the continuous features in the weather such as photovoltaic radiance, the environment has an uncertain and infinite action and perception.

With a complex environment, the agent's knowledge and reaction to it has a mutual effect. Establishing a distributed modeling and control system could provide an adequate frame for controlling single elements and has a global view simultaneously. The reactivity of an individual enables the fast reaction to the environment change, such as compensating for the imbalance in other MGs.

#### 3.2.3.3/ PRO-ACTIVENESS

Each MG has the initiative to achieve global or individual objectives. A single MG behaves under the direction of designed goals. The pro-activeness of MG refers to its capability of achieving goals by finishing certain procedures based on the assumption of system operation. Spending the minimal cost on generation is, for example, a common objective for the network operation. To gain this goal, the procedure includes predicting the load curve in advance and dispatching power within sources according to the prediction to minimize the generation cost. Achieving both steps and finally getting profit results present the pro-activeness. These behaviors are programmed initially and operated during the MG functioning regardless of environmental stimulation. Pro-activeness enables the prediction for possible situations and makes plans or recipes to deal with it. However, in the MG network, i.e., a dynamic environment, the prediction is not entirely accurate being given the practical condition. The error could fail the directed goals. Reactivity could add auxiliary activities to compensate for the unexpected changes from outside and maintains the designed targets.

#### 3.2.3.4/ SOCIAL ABILITY

Negotiation between MGs provides information for the whole network, enables the coordination for achieving global goals, and improves the flexibility of its construction. Due to the geographically distributed location, large constituent elements, and accompanying huge operating information in MGs, it is difficult and costly to get a complete perception timely for each entity. Negotiation helps to transmit the local environment information to remote ones. In this way, global information could be discovered by each MG. The elec-



trical connection combines the operation of all the MGs, and it also determines the global operation. Negotiating with others to schedule optimal behaviors for a global objective is another requirement. Given the non-stability condition in practical applications, negotiation makes the plug-and-play MG easier to be integrated into the network instead of being rejected by the past structure. This characteristic is particularly contributive to network emergencies such as specific faults occurring to the network. According to the communication information, MGs locate the fault and isolate it in a short period to guarantee the system security. Supplying power to unbalanced MGs is another social activity to gain global balance.

### 3.2.3.5/ MODELING OF THE MG NETWORK

As MGs integrate into networks extensively with maintaining self-independence, the complex system needs an adequate method to model it. Operating information in the MG network is detailed into the status of the elements such as the output power of wind turbines. Distributed computation in each MG for individual interests is widely applied and highly developed. These factors enable the MAS to be applied to the MG network. As an autonomous entity in the MG network, the priority of each MG is to maintain the internal balance. Based on stable constituents, system supply reliability is guaranteed. The second task of the entity is to coordinate with faulted ones for maintaining systematic balance. Independence removes communication redundancy and weakens the coupling across MG. Therefore, the scalable paradigm allows the MAS to model and control the distributed network. It furthermore promotes the application of distributed control strategy and related algorithms. For example, the MG could maintain the internal power balance and output energy to keep system stability. Agents get access to global information due to negotiation, which endows the system with advantages of plug-and-play, resilience to the fault, supply reliability, and flexibility. For the MG network, each MG maintains individual balance and keeps power interacting with others for system security, which could be modeled as an agent.

Individual MGs consists of various electrical infrastructures including generations, energy storage system, loads, and lines according to their functions, as shown in figure 3.2. The control objectives determine the element's behaviors and are constrained by facility operating features. For instance, the network power balance relies on the stable operation of elements. Based on the mathematical model for the devices, the activity of the MG network is simulated by the agents.

In recent research on MAS modeling electrical systems, agents describe the element features and guide their operation according to system goals. It tends to represent the functional subparts (e.g. the category of generators) rather than the electrical entity (e.g. a certain wind turbine). Agents in the model are usually divided into three applications in terms of the modeling object: modeling devices in MGs, modeling a cluster of elements and modeling virtual services.

Firstly, the agent models a category of electrical devices. Considering the variety and automation of elements in MGs, coordinating them to promote the performance of the MG and maintain the security operation relies on the negotiation and self-adaptation. Agents represent the operation characteristics of elements such as output limitation of generators and storage status of batteries. Moreover, agent behaviors are described explicitly under the guide of global goals. Such models are widely applied in the supply-

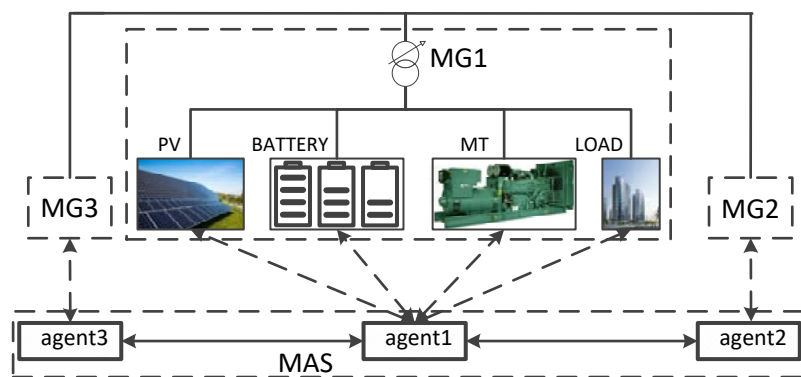

Figure 3.2: An example of MG constitution.

demand balance control. It enables the equipment of load prediction, economic bidding strategies, and so on to promote the performance of MG in terms of profits and balance accuracy [Duan et al., 2008, Kuznetsova et al., 2014, Logenthiran et al., 2008].

Secondly, the agent models a cluster of elements. Forming an independent group by operating a bunch of components cooperatively for supply-demand balance helps to improve the flexibility and avoid one-point failure. For example, the MG is a collection of energy entities and consists of the network. It takes charge of internal coordination among elements and external interactions with the located network, which determines the operation status of the system. Individual and global percept is the foundation for energy management. The agent models the supervisory behaviors, and it designs the reaction to the dynamic environment to represent the control and operation of the MG. The corresponding application includes power trading in electricity markets, MG restoration, and self-healing issues. The agent metaphor extends as an integral representation of collections of goals-oriented entities. For example, agents modeling the MGs as participators in the market represent the bid in the delegate of its power consumption, generation, and corresponding cost based on the features and control methods. The bid finally confirms trading deals by interactions among agents. Comparing with the previous modeling, this one considers the variety of coordination behaviors and gives a clue to the design of cooperative control, especially under the framework of real-time scheduling [Duan et al., 2008, Wang et al., 2011, Colson et al., 2011b].

Thirdly, the agent models virtual services. Ancillary services such as information transmission and control center help to maintain the security operation and improve the system performance in terms of various aspects, including profits, resistance, and flexibility. These virtual services are modeled by agents based on the function-oriented objective. Different from the model of substances in electrical systems, they describe the computational program in controlling the system. The modeling agent is self-activated, condition-triggered, embedded on a host for the context perception to start functioning and demands for the support of other services like communication. An example of an agent modeling data center is widely adopted in the distributed electrical system. It represents the process of data storage and the contents of the data used for global control [Colson et al., 2011b, Zhao et al., 2015].

Apart from the agents' behavior, electrical architectures of the system determine the topology of MAS modeling, which further impacts the following coordination control. The distribution lines both possess electrical features such as resistance and resemble the

path of power flow, which thus enables the power interaction and enlarges elements in coupling. In MAS modeling, such infrastructures are divided into interacting lines and agents resembling devices. Corresponding control algorithms respecting their limitation are further studied to achieve optimization objectives based on the MAS.

### 3.2.4/ MULTI-AGENT SYSTEM CONTROLLING THE MG NETWORK

With electrically and physically distributed MGs in the network, each MG controls components autonomously for individual and global benefits. Interactions between agents provide global information to each agent and enable MG coordination. MG intelligence relies on the control system, which includes the capability of reacting to the dynamic environment and operating following default processes. Agents provide perceptual and reactive functions for MG, which is thus widely applied.

#### 3.2.4.1/ TOPOLOGY

The MAS consists of multiple agents that interact with each other. The communication link forms its structure, based on which the control strategy is designed, and corresponding algorithms are proposed. It furthermore determines behaviors with agents' roles and their mutual affection. The topology of MAS thus affects the performance of data transmission, coordination strategy, and so on [Hayden et al., 1999, Weiss, 1999]. Current topologies suitable for the MAS are described in the following [Horling et al., 2004]:

- 1) Hierarchies. Agents are allocated as a tree structure, and the ones in a higher layer have a wider percept than the ones in a lower layer. Interactions are limited within the connected agents and are forbidden across the branches. Monitoring is bottom-up while control commands flow downwards. Agents are divided into multiple small groups which solve distributed problems. Interactions are thus reduced and independent from the total population of agents. However, the system is fragile or rigid under single-point failure.
- 2) Holarchies. Elements are holons which consist of subordinate entities downstream and could compose other holons upstream. The autonomy degree of each holon is undefined, and holons in the same level interact with each other. The control command flows from superordinate holons to subordinate ones to achieve cooperative goals while keeping individual control on operating internal entities. Apart from the hierarchical topology, it possesses partial autonomy and encapsulated nature. These advantages provide holons sufficient independence, reduce knowledge stress of demander, and cooperation cost on adapting new conditions. The challenge is the selection of appropriate agents in holons.
- 3) Coalitions. The organization is flat, which could be a sub-coalition or overlapping coalition. It forms without distinguishing cooperative and self-interest agents as goals direct and vanishes as missions finish. The coordination between coalition-separate agents only happens to achieve global goals. The least selection of participants brings better rewards and solutions for more complex missions, as well as optimal task allocation among agents. The disadvantages include the difficulty of operating in a dynamic environment; partitioning agents keep interaction and distrust between different kinds of agents.

- 4) Teams. Several cooperative agents consist of a team and coordinate for a sharing goal. Prioritizing the common goal, agents tend to behave consistently and supportively, which endows the system with high resistance to disturbance. Group coordination reduces the difficulty of solving significant problems in individual agents. It can reason the routine of agent interaction for increasing the flexibility of operating in an environment without knowledge and prediction, followed by the advantage of communication augment. The challenges of agents allocation for the high-level problem, a consistent problem during execution, and correction of the team under dynamics mainly hinder its application.
- 5) Congregations. Groups of entities formed by cooperative agents in a flat organization consist of a congregation to gain better performance. Different from the team or holarchy, the congregation exists long-term to tackle multiple various problems. Individual agent behaves rationally to gain itself long-term benefits. Thus, the participation of an agent to a congregation is interest-oriented individually.
- 6) Societies. It has a social construct and exists long. This topology is inherently open for agents to enter and leave freely. It sets structure and order for diverse participants with maintaining the flexibility of interaction arrangement. To coordinate diversified agents and enable their co-existence, certain constraints like universal laws, norms, and conventions, are imposed on the agent behaviors.
- 7) Federations. This topology is composed of multiple groups of agents which are partially controlled by a delegate representing a group. It is identified as the only member that group members could interact with and communicate with the outside. It cooperates with other delegates by driving local agents based on the knowledge of their skills and needs. Such topology could reduce the amount of communication and negotiation for local agents based on the delegate's services.
- 8) Markets. Similar to federations, markets are usually open, and coordinating local agents relies on specific particular individuals. However, participants are competitive and keep self-authority. Agents trade necessary items such as services, tasks, or goods in the market between agents or third parties. The market has grand advantages in allocation and pricing. The expected outcomes are highly guaranteed based on abundant auction protocols. The derivation of bidding price and the determination of auctions' outcome are complicated. Security is another drawback concerning transaction validation, cooperation, and so on. Maintaining the temporal integrity and the complete transaction is essential for the formation.
- 9) Matrix organizations. The agent behaviors are influenced by multiple managers or peers, and they can deduce backward the effects of their activities on multiple entities. Multiple lines of authority enable agents sharing resources for multiple tasks.

Revealing the structure and behavioral fashion is for understanding the operation mechanism to further design agents. An MG network with an increasing scale contains elements of various characteristics. As global control relies on the real-time operating information from all the elements, more communication connections for information collection are demanded, which causes time delay. To coordinate diversified components, more mathematical models are built and increase the polynomial in the problem formulation. Both increments add difficulty to control achievement. Hence a proper topology for organizing

the interaction and activities of the MG can improve the speed of data discovery and simplify the problem formulation. The scalability restricts global network coordination due to transmission loss and time delays during communication. Partial coordination consisting of selected MGs is a solution to improve system stability. This idea is adopted in this dissertation. Corresponding selected agents should aggregate and cooperate for a common objective, while the other agents keep self-control and maintain interaction. To that end, the agents controlling MGs should be able to form a collaborating group voluntarily. Cooperative agents prioritize internal balance and coordinate with other agents to gain the common objective. To maintain the system security, agents in the coordination group should also keep communication with the self-controlled agents outside of the group for monitoring the dynamic system power flow and construction. The holarchies topology endows the holon with partial autonomy and encapsulated nature. Agents with these features can determine how best to satisfy the common objective of the assigned holon. The task decomposition among holons also reduces the knowledge burden of each agent. Thus the holarchies topology fits the partial coordination of the network as the individual autonomy of MG and common goals are combined well. Altogether, this topology allows coordination algorithms to be adopted efficiently for diversified objectives in terms of economic benefits, emission reduction, and so on. System stability and scalability are finally promoted.

Proposed in 1967 by Arthur Koestler, a holon can model a collection of constituent components in the system. It is regarded as an element in a higher layer of the system [Koestler, 1967]. A holonic MAS is applied to the distributed artificial intelligence in [Rodriguez et al., 2006]. An example of the hierarchical architecture is shown in figure 3.3. Part of the agent herein collaborate to form a specific group, and this group behaves as a component of the higher layer. In this research, modeling the MG network with HMAS to represent the mutual affection among agents and the infrastructures are the foundation of network coordination. Then applying HMAS control on the system to import algorithms can furthermore improve the system intelligence and automation. The HMAS in figure 3.3 is applied to the proposed approaches in this thesis and it will be further introduced in chapters 4 and 5.

#### 3.2.4.2/ CONTROL METHODS AND ALGORITHMS

The MAS decentralizes the complex problem in a large electrical system and solves them in a distributed way.

With distributed artificial agents, agent's functions are limited by the information, capability, and expertise. It is nearly impossible to solve a global problem by one agent in a large system. The decentralized control is to coordinate multiple agents to distribute the problem. The solutions to each subtask finally synthesize a global solution. Task-sharing and result-sharing are two common strategies in distributed problem-solving. In the former one, agents pass tasks to the one with fewer tasks to share the calculation stress. In the latter strategy, agents solve problems individually. The identical results, derived from the same context, improve the confidence in correctness, completeness, precision, and timeless [Montgomery et al., 1993, Stankovic et al., 1985].

The algorithms are applied for agents to make optimal decisions. The intelligence endows agents with autonomous activities and identifies their independence. Increasing infrastructures promotes the standard of communication, and the development of com-

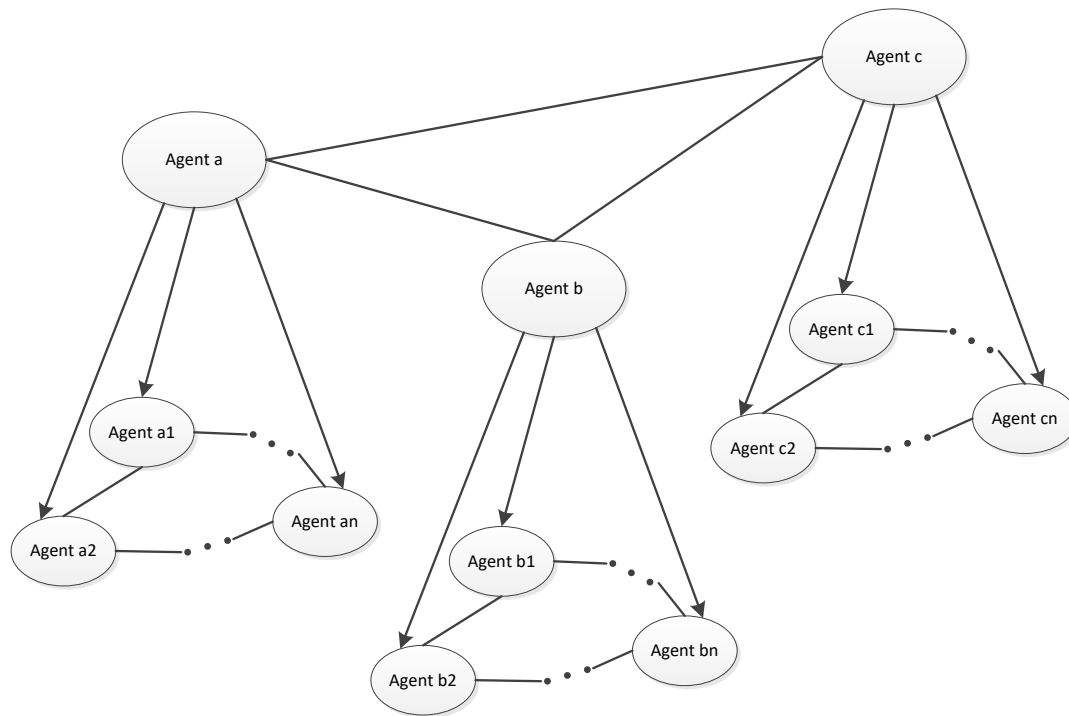

Figure 3.3: HMAS architecture.

puter science supports the negotiation for operative decisions. Both factors motivate improvements in intelligence. Self-interest oriented agents with social capability are widely applied to the cooperative distributed problem-solving. Thus, the design of interaction protocol and strategy in MAS impacts the operating performance. The negotiation protocols can be evaluated from several aspects: social welfare, Pareto efficiency, individual rationality, stability, computational efficiency, distribution efficiency, and communication efficiency. The design of strategy demonstrates the cooperative behavior of agents under the constraints of the protocol. For example, neighboring communication motivates the application of consensus theorem for each agent to explore global information. An interaction protocol is applied to the system to combine agents, while the strategy is unique for each agent to solve particular problems and gain individual goals [Mas-Colell et al., 1995, Maskin, 1983, Sandholm et al., 1996].

### 3.3/ PLATFORM IMPLEMENTATION WITH PYTHON

#### 3.3.1/ MODELING OF THE ELECTRICAL SYSTEM

The simulation imitates the operation of the system, which firstly requires model development. MGs compose the MG network. The distribution lines link them together to form the system architecture and enable the power flow between MGs. Intermittent generation (e.g., wind turbines) and changing loads cause power disturbance in the grid. Dispatchable generators (e.g., micro turbines) compensate for the dynamic power demand cooperatively. Such behaviors are designed according to component characteristics and their

physical connections. Thus, the MAS models the system from a global view, with details of each agent and internal relationships, which reveals the difficulties of the control and directs the available control method for objectives. MAS modeling electrical systems focus on the coordination among multiple components. It includes the agent behavior, electrical and communicational connections which reveal the power coordination and information transmission, respectively.

Electrical elements compose MGs and demand coordination control to maintain power balance within individual MG. These components are encapsulated as an entity of power. Power distribution happens to strengthen network supply reliability when individual MG cannot keep self-stability. Thus models of the MG are divided into two aspects: the elements model representing electrical characteristics and the behavioral model of MGs including the coordination command [Duan et al., 2008].

Line connections between MGs depict the electrical topology and have a limitation on power flow. The impacts of power interaction between MGs to the distribution lines are analyzed. The power flow is calculated based on KVL, KCL, and iterative algorithms. In the system consisting of distributed entities, decentralized power flow calculation is necessary [Stott et al., 2009, Baldick et al., 1999, Kim et al., 1997].

The distributed control of power systems relies on the operating information of electrical constituents. The global goal is derived from collective behaviors of all the elements. In control, the interaction between agents provides network percept and enables command transmission. Thus the communication is designed with high efficiency or informational reliability. Topologies include centralized structure, decentralized, and hierarchical structure based on the process of global data [Jimeno et al., 2011]. The centralized one has an agent that supervises others, while decentralized one lacks data center and transmits information locally. Hierarchical one consists of several layers of agents, in which the agent in a higher layer manages the behaviors of agents in the lower layer.

In this thesis, modeling objects in an MG network includes MGs, electrical connections, and communication structures. Considering the automation and intelligence, individual MG is modeled by the agent-based modeling methods in terms of behavioral features of elements. The model of the network devices is shown in figure 3.4, including the attributes and behaviors of each component. The main components in MGs are mainly divided into three classes in terms of energy metabolism: energy source, load, and energy storage system. Renewable generators (e.g., wind turbines) widely exist in MGs for environmental and economic benefits. The distributable sources, (e.g., fuel cell and the microturbine), are obligatory to compensate for the supply of intermittent generation and fulfill the load. As the power buffer in MGs, storage systems could store and release energy to optimize the power allocation and provide energy support in a fault condition. Herein, batteries are the most common facility currently as the higher energy density than that of superconducting magnetic energy storage and supercapacitors. The energy generation and consumption are collectively managed by an agent within each MG to maintain self-balance. Energy interactions between MGs support the lack of energy and promote the resilience of the system. This process is achieved based on the distribution lines connecting MGs. The physical characteristics and electrical requirements limit power flow, such as the line capacity and voltage standard. Based on the global information, power distribution command is made among agents by negotiation, and the attribute of MGs in the power network is the transmission power.



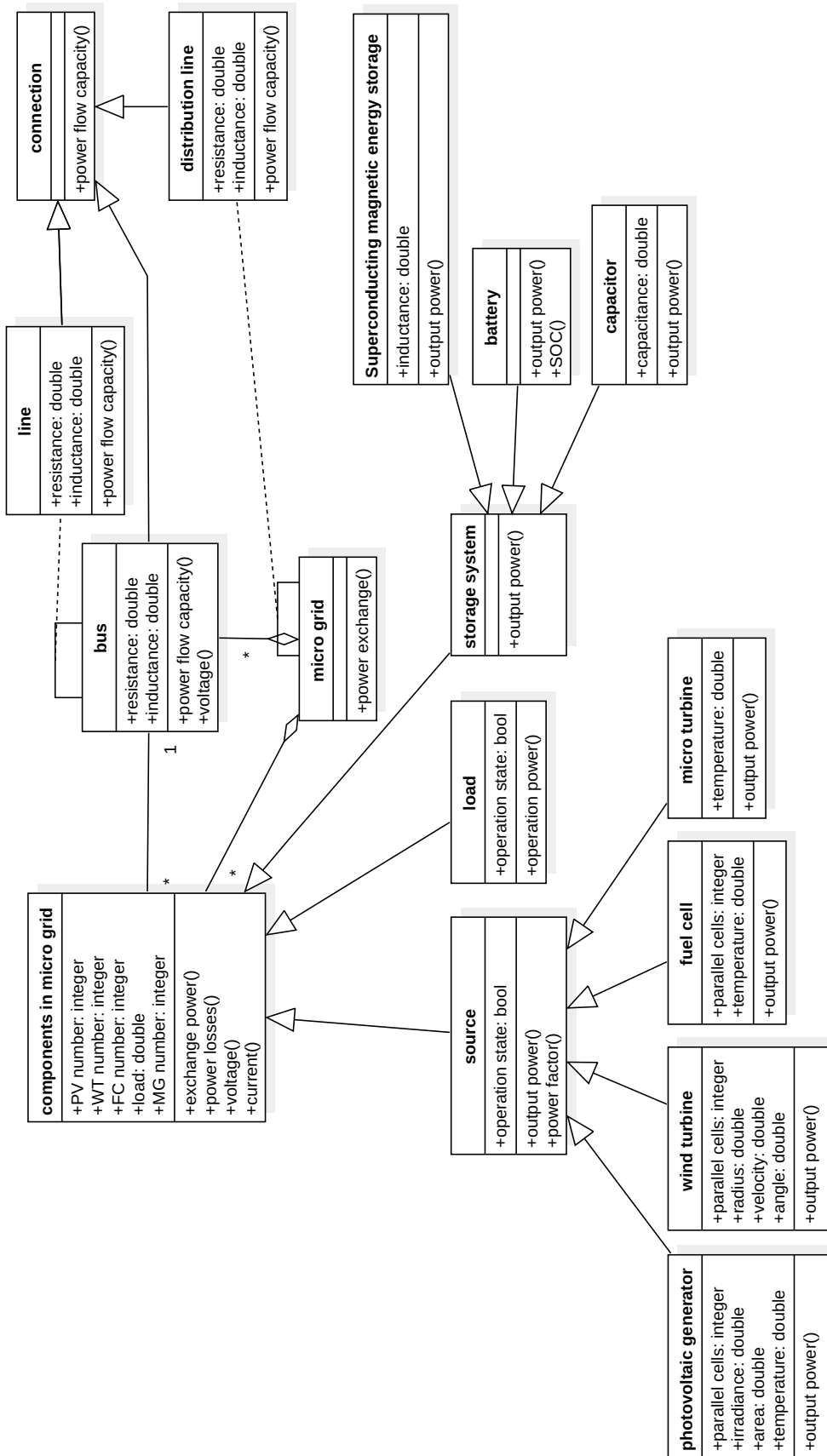

Figure 3.4: Modeling of MG network.



Communications decentralize the system to a cluster of autonomous elements with private information. Its topology is limited by the implementation cost and determines the interaction architecture. The simulation represents the topology and interaction process, as well as efficiency.

### 3.3.2/ SIMULATION PLATFORM

The simulation platform is established with the Python language, which consists of the user interface and simulation space. The user interface is for the simulation parameter input and stores it for running the model. The simulation space is for building an electrical system set by the user, based on the embedded device model. Herein, the electrical system is operated according to the control strategy and related algorithms. The corresponding diagram for the constituent parts in the platform is shown in 3.5. For the simulation in this thesis, the MAS is simulated as a functional coding module. In this dissertation, the 1-phase power system is studied to simplify energy management.

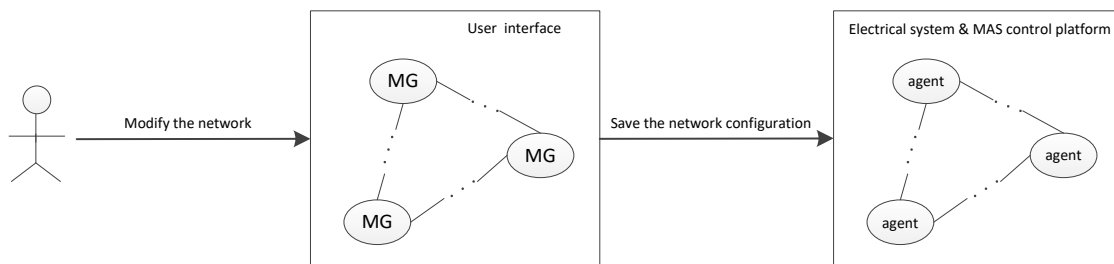

Figure 3.5: Diagram of the simulation software.

#### 3.3.2.1/ SIMULATION INTERFACE

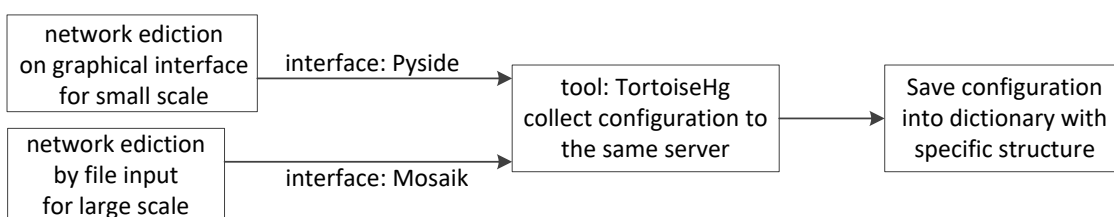

Figure 3.6: Coding architecture of the user interface.

The user interface is applied to input the design of the electrical system by visualized graph or data cluster. For users, they can select the items shown in the toolbar on the graphic interface and connect them directly to build the electrical system, without knowing the mathematical model of devices. For a large network, the numerous configuration data could be input directly by guiding its locating address. Both methods are achieved based on the python packages shown in figure 3.6. The input activity presented in the user interface includes: 1) creating an MG, 2) modifying the number of component elements within MGs, 3) configuring the operation parameters of components, 4) changing the index of MGs, 5) save the created network information. The MG-building information is

translated into data collection with a specific structure. Pyside is adopted as a port for Python programming to the graphic user interface Qt, which enables the graphical input and establishes a visualized electrical system. Software Mercurial applies TortoiseHg to achieve the input integration made in both graphical interfaces and file-reading. The complete system configuration is reorganized with a specific structure and stored in a dictionary for simulating the system.

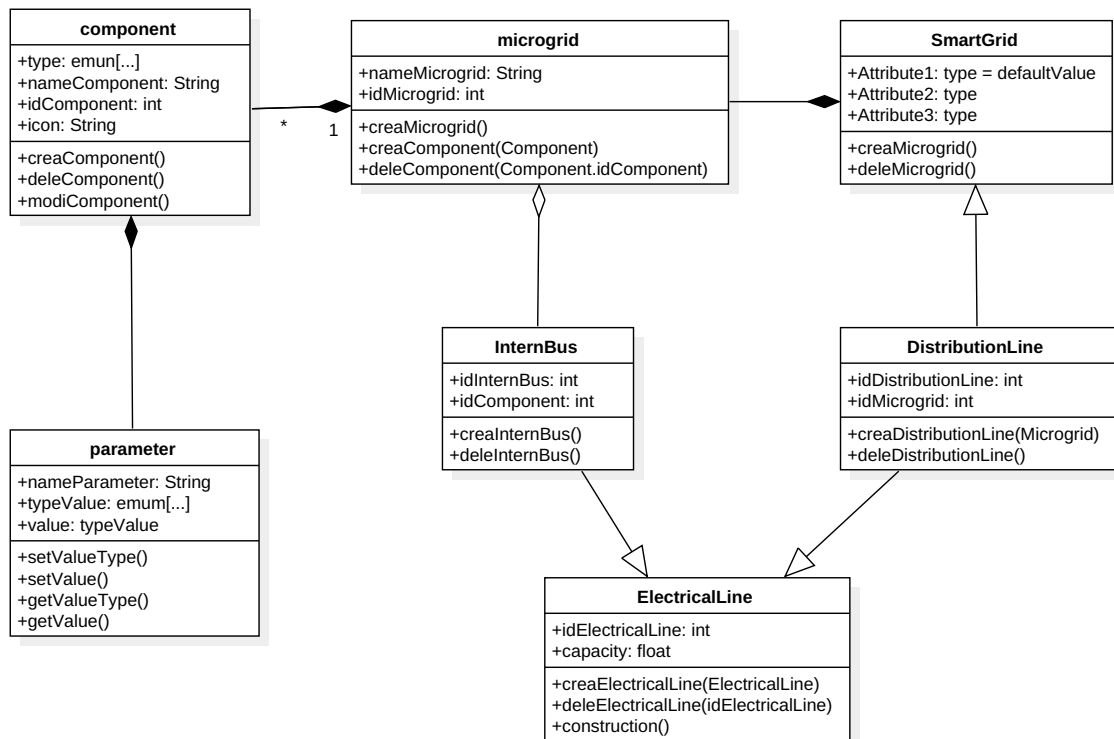
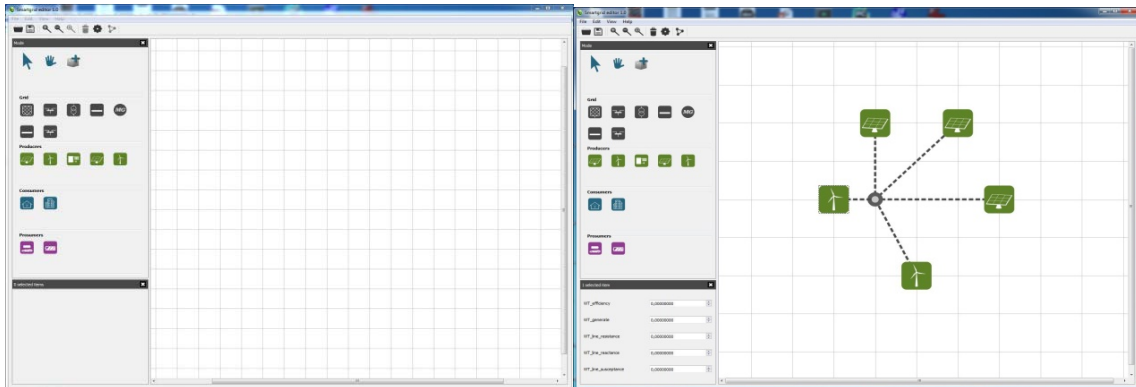

Figure 3.7: Diagram of the models in user interface.

figure 3.7 presents the existent models shown in the toolbar of the user interface. The relationship between them is clarified with linking lines. Editable objects in the interface include MG, smart grid, internal bus, distribution line, electrical line, components, and their parameter. The existent entity demands abstracts to clarify its identity and operations to execute activities including creation, deletion, and modification. Electrical objects in the network are divided into two basic classes, including components and electrical lines in terms of their roles in the electrical system. Components are controllable energy facility which generates, store, and consumes it, while electrical wires are constant elements transmitting power caused by power supply between components. To add all kinds of facilities flexibly, attributes of the facility clarifies the type (e.g., generator, load or storage) and provide the link to a specific icon for the graphical interface. Its feature configuration is settled in the contained class called parameter which provides abstracts to define feature properties and operations to assign them. Apart from standard identification and operation activity, the electrical line also includes a definition for the capacity and service for setting impedance. Two specialized inheriting subclasses including the internal bus and distribution line define the wires inside and outside MGs correspondingly. Multiple components connecting by internal lines form the MG which further consists of MG network with distribution lines. Graphical input starts from MG network creation downwards to

parameter configuration of the component. Such top-down design clarifies the authority of entities in each layer and streamlining missions to gain goals quickly.



(a)

(b)

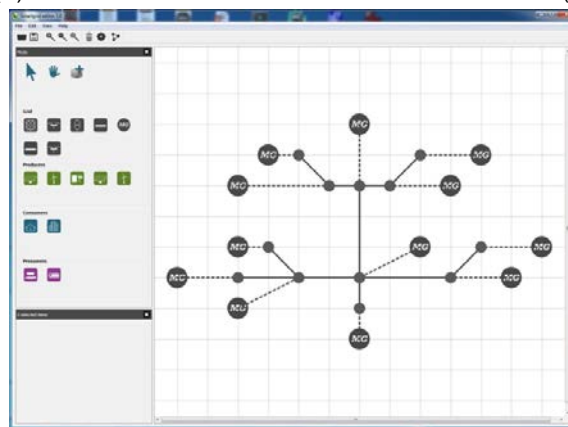

(c)

```

C:\Users\Celine_JU\PyscharnProjects\untitled\venv\Scripts\python.exe "C:/Users/Celine_JU/Desktop/CODE/sg.py"
---Network Management System---
1. Add MG
2. Delete MG
3. Edit MG
4. List MGs
5. Link MGs or Edit MGs
6. Unlink MGs
7. Show Links
8. Save Current Network
9. Load Network
10. Create New Network
0. Exit
Please input your option:

```

(d)

```

1. Add Component
2. Delete Component
3. Edit Component
4. List Components
5. Edit Bus
6. Set Levels
9. Back to Main Menu
Please input your option:

```

(e)

Figure 3.8: The user interface: graphical interface and batch command line.

The user interface is shown in figures 3.8. The graphical initialization interface in 3.8a includes the edition area, toolbar, component library, and activity options. The dialog box appears to set the parameter after selecting an item in 3.8b and a complete MG network is shown graphically in 3.8c. For an extensive system, it is easier to input

the configuration parameters directly from files and generate corresponding simulations. Figure 3.8d and 3.8e show the user interface which could read the parameter file and store the simulation system in the target structure. Modification of the same project on both interfaces is shared and could be shown in the graphic interface.

### 3.3.2.2/ SIMULATION OBJECT

Simulation for the system covers electrical infrastructure operation and the controlling system achieved by software programming. Based on the input configuration and constructed electrical system, the facility is defined, and the MAS topology is the communication link achieved by function classes. This platform provides simulation for both actual and virtual entities which are completely coded in Python. Its architecture is shown in figure 3.9.

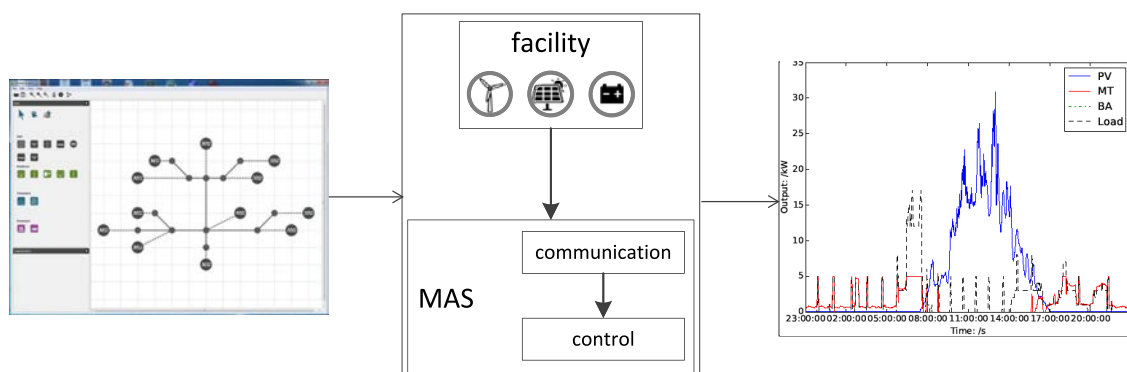

Figure 3.9: Architecture of the Platform Programming.

The abstracts of the network facility include operating parameters and behavior features. A class is identified for inserting control strategies and related algorithms, which is called MAS [Schurr et al., 2005]. The communication between agents is simulated [Genc et al., 2013]. On the simulation platform, models of infrastructures output the operating status in mathematical expression to the MAS system. Simulation on the MAS should include the interaction process between agents and facility control between the agent and the infrastructures. As the central function for agents, the control module collects operating information of facility and other MGs to support optimal decision making comprehensively. In figure 3.9, displaying the simulation results and providing visualized exhibition platform complete the practical function of the platforms, as well as debug tools.

Figure 3.10 shows the programming diagram of the simulation platform. Starting each simulation is by instantiating the classes in the platform and getting the results of running the instantiations. Chapter 3.3.1 introduces that each MG could be modeled as an agent, which includes electrical elements, control systems, and its supporting facility. Thus, the platform is composed of agents and connection lines. Class "agent" is coded with abstracts of the agent's identification and the step interval for the simulation object periodically visiting the configuration of the electrical system. Starting a case of simulation is to instantiate this class with distinct abstracts to model individual MG system. This class inherits from the class of "Agent" in Smart Python Agent Development Environment (SPADE).

For testing cases and control compatibility, the component classes include importing data parts, electrical facility parts, communication parts, control parts, and display parts, as shown in figure 3.8. These parts are for diversifying test cases and control compatibility. The function of inputting MG configuration is a class. It includes architecture and facility operation coefficients. Each of its instantiations corresponds to the setting of an individual MG. Data reading and recognition rely on a Python package called pandas. The facility contains the classes of load, photovoltaic generator, wind turbine, fuel cell, microturbine, and battery in terms of the mathematical model of energy generation and consumption. All the facility begins operation by initiating configuration parameters, stops by turning off it and calculating the energy consumed or generated during running. Their abstracts clarify the facility coefficients in the mathematical model. Being an electrical unit, the MGs calculate the collective characteristics caused by the coordination of elements. The communication process is used for interactions between agents. Its simulation modules are "send" and "receive" classes. The periodic behaviors are subclasses of the "PeriodicBehaviour" of SPADE with the operations of sending and receiving messages. The class of "store" is mainly applied for decoding received messages and providing a buffer for the previous messages. The class of "control" is defined as a cluster of various control algorithms based on the knowledge of the assigned MG and the interaction messages. The control algorithm concerns internal control and network coordination which demands commanding assigned elements and communicating with other agents. Python library provides abundant algorithm packages for simplifying the coding, such as packages of "scipy" and "sopt." The distributed MAS interaction obeys consensus protocol to gain global information for agents. Thus it is defined as a component class of control to provide network information and to simulate new algorithms on consensus theorem. The "distribution lines" mimics wires between MGs. It is defined by the abstracts of conductivity characteristics. The power flow on it is calculated in the behavior of class "control" based on the voltage and power interaction of MG by getting access to the parameters of the line. The package of "PYPOWER" is quoted in this class to optimize the power distribution as well. The class of "log" displays the results derived from the platform in figures and record the log of simulation, which could further help to debug the errors of programming.

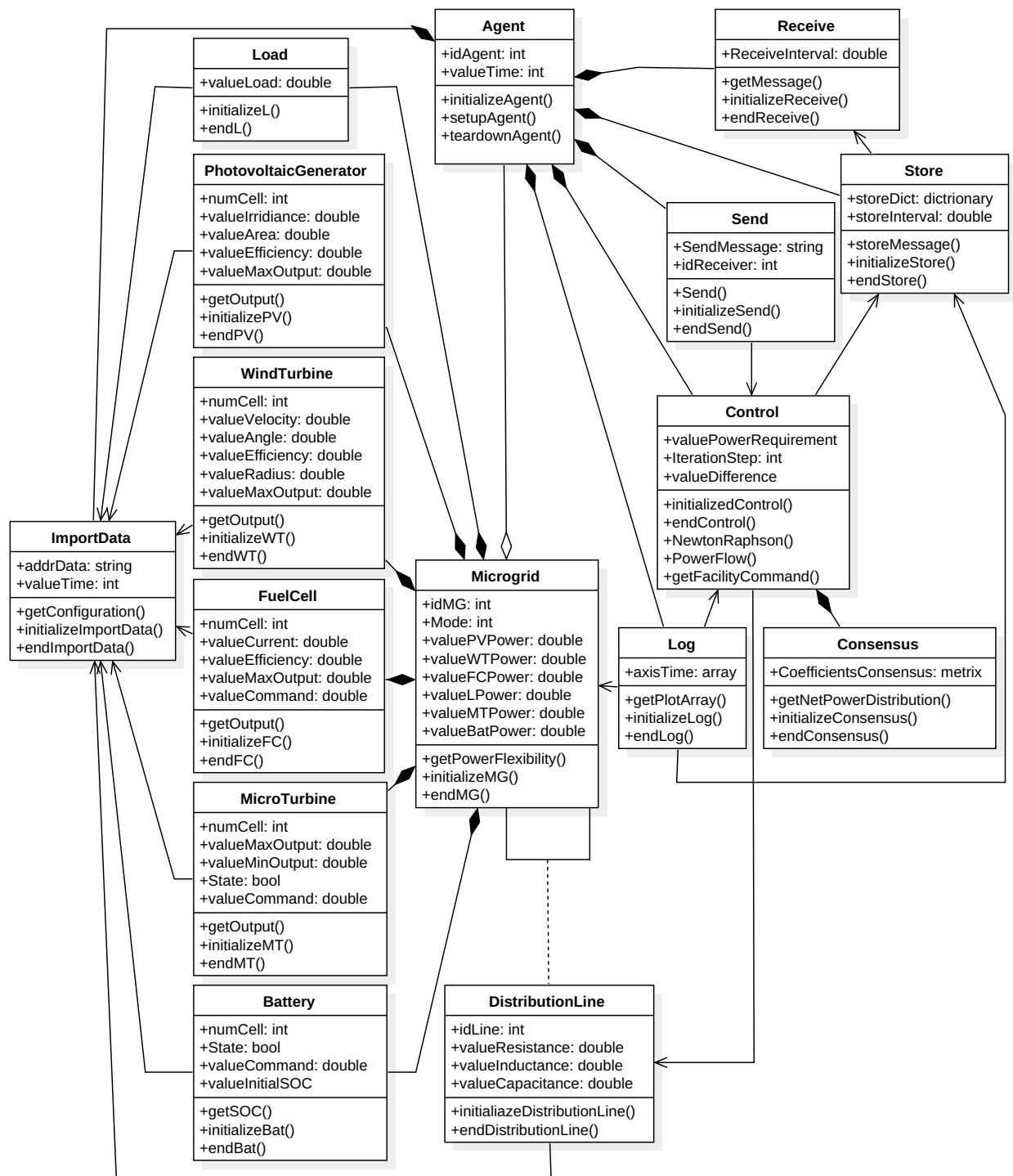

Figure 3.10: Coding diagram of the simulation software including the user interface, electrical system, and MAS.



# MULTI-AGENT BASED COORDINATION WITH NEIGHBORING MICROGRID

## 4.1/ MOTIVATION

MG coordination has been widely applied in the field of self-healing, system restoration, and optimal power scheduling. Due to its capability of flexible connection and isolation from the utility grid, the electrical elements reunion motivates new solutions to the issues in the current autonomous electrical system. As the MAS is applied to the electricity network, the traditional top-down control is generally replaced by more flexible bottom-up approaches. All-in-one optimization involving large amounts of elements fades out as the distributed control provides solutions of high quality considering the practical limitation in terms of information collection, activity delay and calculation pressure.

In the MG network, the distributed control based on the MAS endows automation to each MG for coordination and getting access to the global information. Thus the power dispatching between MGs is triggered by the imbalanced MG and, while participants are selected both by MG initiative intention and global interests. As the load and generation scale within MGs is small, its demanding assistant power could be satisfied only by part of the network. To reduce the communication amount and calculation pressure in reaction, the coordination with neighboring MGs highlights because of the short transmission line between them. Thus, the MAS solves the neighboring coordination by complying with the functional network and embedding appropriate algorithms.

## 4.2/ COORDINATION PROBLEM

In this chapter, we mainly study the coordination between faulted MG and its neighboring MGs. As the power interaction between them involves multiple individual entities consisting of various elements, the cooperative behaviors of MGs and caused impacts to the operation of internal devices are analyzed. To provide assistant power to the faulted MG timely and economically, related problems are presented. 1) How to decide the assistant of MG when multiple neighboring MGs exists. 2) How to dispatch power among elements. 3) How to quantify the impacts of the power interaction to the network power flow, and to reduce the violation of the line capacity. Two coordination strategies based on holon MAS are proposed in this section.



- 1) A centralized control strategy is proposed for the economical and reliable coordination with neighboring MGs, which consists of two stages: the power dispatching process and the caused power flow recheck. The Lagrange multiplier is applied to solve the optimization problem which formulates the power dispatching. An average consensus theorem is applied to explore global information for the distributed power flow calculation and check the capacity violation on line.
- 2) The concept of the electricity market is applied to the second coordination strategy to further improve the economic benefits and the efficiency of decentralized power flow calculation. The electricity price is approximated in the unit of an integrated MG based on the internal optimal control. An improved power flow calculation is proposed by only knowing the neighboring voltage value.

The rest of the chapter consists of the following parts. Section 4.3 models the common devices in a MG. Section 4.4 introduces the MG network, including physical and communicational structures. Section 4.5 describes elements control strategy in each MG and the MG coordination control strategy is clarified in section 4.6. Related simulation results are presented in section 4.7. Finally, section 4.8 concludes this chapter.

### 4.3/ ELEMENTS MODEL WITHIN MG

Thanks to the development of electronics technology, electrical facilities with high autonomy and diverse generation characteristics are widely inserted into the MG. It enables the large-scale application of renewable generators to alleviate environmental problems [Mahmoud et al., 2014]. The variability of elements yet complicates the control and modeling. Cooperating intermittent and controllable energy to supply load stably and flexibly is the prior issue. The economic profit is another interest of study. For investigating the elements' mutual impacts in the same MG, their operations are studied, including device features, behavior, and generation cost. These characteristics compose the facility model. The mathematical representation is simplified to focus on the input-output relationships and economic affections. Thus the calculation is reduced by maintaining the main features of the facility based on reasonable assumptions. Assumptions are made for the system as follows:

- 1) The objective of MG coordination is to minimize generation cost, which is derived by the volume of generated active power. Thus the reactive power is neglected and the power management focuses on the active power dispatching, which determines the voltage frequency. As the reactive power contributes to the voltage amplitude, ignoring it will lose the control to voltage volume. Therefore, the voltage drop on line could not be considered and it will be equivalent to be constant in the network.
- 2) The operation of the system is discretized, considering the nonlinear characteristics of the facility and their dynamic operating behaviors.

#### 4.3.1/ RENEWABLE GENERATORS

Renewable sources are widely adopted in MGs to reduce carbon emission and save fuel costs. The current popular generators are wind turbines and photovoltaic generators.

Operated by electronics converters, they stand out with small inertia to contribute a fast reaction to the environment. However, renewable energy is uncontrollable with intermittent characteristics. Such a facility is operated at the maximal generation to maximize the conversion. The free renewable source such as wind and solar energy has no generation cost by neglecting the small amount of electricity consumption on electronics facility.

#### 4.3.1.1/ PHOTOVOLTAIC GENERATORS

The output characteristic based on the input of solar energy is represented in equation ( 4.1) and equation ( 4.2). It is based on the mathematical model in [Xu et al., 2013] and some simplification is further made according to more assumptions as follows:

- 1) Renewable generators are completely sensible to renewable sources. The generation of threshold to solar irradiation is set as 0, which means that the generator output power since the solar irradiation exists.
- 2) The temperature on the PV cell retains as a constant of the standard value. The assumption neglects the impact of the heat on the generation as the essential environmental factors influencing the generation is represented by the irradiation and the coefficients [Mutoh et al., 2006, Dubey et al., 2013].
- 3) The position and rotation of PV panels are ideal. As mechanical and geographical affections to the generation have no direct link with power management, they are neglectable in the generation.

Thus the output power is proportional to the solar irradiation and limited to the maximal output by the constraints on hardware.

$$p_{out,PV} = R_{PV}I_{irr}\eta_{PV} \quad (4.1)$$

$$p_{out,PV} \leq p_{max,PV} \quad (4.2)$$

Where  $p_{out,PV}$  is the output power of PV,  $R_{PV}$  is the irradiated area of PV cells,  $I_{irr}$  is the density of solar irradiation,  $\eta_{PV}$  is the derating factor considering conversion efficiency.  $p_{max,PV}$  is the maximal generation of PV determined by the hardware of facility.

#### 4.3.1.2/ WIND TURBINE

The generation of the wind turbine is determined by the velocity and angle of the wind. Such a model is a simplified representation derived from the mathematical model in [Fernandez et al., 2006] under steady-status. The based assumptions include:

- 1) The air density is constant. The wind velocity and cut-in angle mainly represent the energy volume.
- 2) The generation of the wind turbine is proportional to the volume of wind input power, which is the product of the angular speed multiplied by the torque caused by wind.
- 3) The conversion efficiency is approximated as a constant determined by the hardware of the wind turbine. Thus the hardware affections on the generation are simplified considering the inertia, leakage flux, mechanical damping, and so on.

The model of wind turbine in equation ( 4.3) represents that the generation is proportional to the velocity of cubic for a certain wind turbine. It has a maximize output limited by facility production as shown in equation ( 4.4).

$$P_{out,WT} = \frac{R_{WT} W^3 \rho}{2} \eta_{WT} \quad (4.3)$$

$$P_{out,WT} \leq P_{max,WT} \quad (4.4)$$

Where  $P_{out,WT}$  is the output power of WT,  $R_{WT}$  is the rotor disk area,  $W$  is the velocity of wind,  $\rho$  is the air density,  $\eta_{WT}$  is the derating factor considering conversion efficiency.  $P_{max,WT}$  is the maximal generation of WT.

#### 4.3.2/ MICROTURBINE

The microturbine usually takes charge of complementing the load demand. The generation is stable and dispatchable. Hence it belongs to the source of MG flexibility. Especially in an isolated MG, it behaves as a voltage source to adjust the demand-supply balance by maintaining bus voltage based on the curves of frequency/active power and phase/reactive power. To simplify the model for power management under stable condition, assumptions of microturbine modeling include:

- 1) The inertia of the microturbine is as small as renewable generators. Thus the ramping volume of output is unlimited to compensate for the output of convertor-controlled sources.
- 2) The time delays over facility control are neglected. The command is achieved immediately to change the operation of the microturbine, without considering the interval between command input and control output.

Thus the output power of the microturbine becomes a variable. It is derived from the formulation of supply-demand balance, as shown in equation ( 4.5). The capacity of the microturbine and its minimal output are shown in the constraints in equation ( 4.6).

$$P_{out,MT} = P_{command,MT} \quad (4.5)$$

$$P_{min,MT} \leq P_{out,MT} \leq P_{max,MT} \quad (4.6)$$

Where  $P_{out,MT}$  is the generation of micro turbine,  $P_{command,MT}$  is the command of MG internal control to maintain power balance,  $P_{min,MT}$  and  $P_{max,MT}$  are the minimal and maximal output of MT respectively.

The generation cost of the microturbine is the fuel expense of fuel, and it directly relies on the value of output, as shown in equation ( 4.7). The start-up and the shut-down cost is included in the price considering the establishment of the stator magnetic field.

$$\mu_{MT} = \eta_{up,down,MT} |s_{MT}^t - s_{MT}^{t-1}| + (\eta_{1,MT} P_{out,MT} + \eta_{2,MT} P_{out,MT}^2) s_{MT}^t \quad (4.7)$$

Where  $\mu_{MT}$  is the total cost generating certain volume of power (i.e.  $p_{out,MT}$ ),  $\eta_{up\_down,MT}$  is the cost over each change of operation status,  $s_{MT}^t$  and  $s_{MT}^{t-1}$  are the operating status in the time steps of t and t-1,  $\eta_{1,MT}$  and  $\eta_{2,MT}$  are the cost coefficients of generation corresponding to the linear term and the quadratic term.

### 4.3.3/ ENERGY STORAGE SYSTEM

The energy storage system behaves as a power buffer in the MG by absorbing or outputting power. Thus it is normally applied to design economic scheduling and serve for emergency rescue. The multiple functions of the storage system come from its bidirectional converters which could be modeled as a current source. Batteries are the most commonly used facility to store energy and provide portable services such as vehicle batteries. Its modeling assumption is that power leakage is neglected. Thus the status of charge (SOC) is changed merely by the charging/discharging operations. The storage facility is operated as equation (4.8) shows. It is constrained by the output and capacity, as shown in equation (4.9) to equation (4.11) [Dufo-Lopez et al., 2007].

$$p_{out,Bat} = p_{command,Bat} = p_{disch,Bat} - p_{ch,Bat} \quad (4.8)$$

$$p_{ch,Bat} \leq p_{max\ charging,Bat}, p_{disch,Bat} \leq p_{max\ discharging,Bat}, p_{ch,Bat} p_{disch,Bat} = 0 \quad (4.9)$$

$$w_{ess}^t = w_{ess}^{t-1} + \eta_{ch,Bat} p_{ch,Bat} \Delta t - \frac{1}{\eta_{disch,Bat}} p_{disch,Bat} \Delta t \quad (4.10)$$

$$w_{ess,min}^t \leq w_{ess}^t \leq w_{ess,max}^t \quad (4.11)$$

Where  $p_{out,Bat}$  is the battery output, which is the difference between discharging power ( $p_{disch,Bat}$ ) and charging power ( $p_{ch,Bat}$ ). It is determined by the system command ( $p_{command,Bat}$ ).  $p_{max\ charging,Bat}$  and  $p_{max\ discharging,Bat}$  are the maximal charging and discharging power,  $w_{ess}^t$  and  $w_{ess}^{t-1}$  are the SOC at time step of t and t-1 respectively.  $\Delta t$  is the time interval for each step.  $\eta_{ch,Bat}$  and  $\eta_{disch,Bat}$  are the efficiency of charging and discharging.

Even though the fuel cost is zero for the battery, the aging limits the maximal charging/discharging cycle. Thus battery at charging or discharging status is consuming the facility itself. Dividing the initial investment by total charging and discharging volume during battery life is the cost for the unit operating power of the battery. The equation is shown in (4.12) [Dufo-Lopez et al., 2007].

$$\mu_{Bat} = \left( \eta_{ch,Bat} p_{ch,Bat} + \frac{1}{\eta_{disch,Bat}} p_{disch,Bat} \right) \frac{\pi_{inv}}{2 \cdot N_{Bat}} s_{Bat}^t \Delta t \quad (4.12)$$

Where  $\mu_{Bat}$  is the battery cost under discharging and charging certain amount of power,  $\pi_{inv}$  is the expense of initial facility investment.  $N_{Bat}$  the maximal charging/discharging cycle during age.  $\eta_{up\_down,Bat}$  is the start-up/shut-down cost of battery.  $s_{Bat}^t$  is the battery operation status at step t.

## 4.4/ MICROGRID NETWORK COORDINATION SYSTEM

Power coordination between MGs involves a set of assistant hardware and software to support the interactive activities ranging from consisting elements to the global system. Electrical connections and communication networks, as the skeleton enabling the coordination, possess specific features impacting the power distribution, interaction objects, and so on. Similarities on the power supply and hardware establishment between both connections provide mutual benefits for their design.

### 4.4.1/ PHYSICAL CONNECTION AMONG MGs

In a system of multiple MGs, as shown in figure 4.1, the internal bus of MG allows bidirectional power flow, and the inner interacting power is transferred on it. It also connects to the distribution system through a transformer for voltage adjustment. The power loss on internal lines is neglected, considering its short distance. Due to the remote distance between MGs, the optimal power flow on distribution lines is calculated to reduce the transmission loss. An assistant facility such as circuit brakes, transformers, and switches are not considered in this thesis to spare less relevant facts and reduce the complexity of the study.

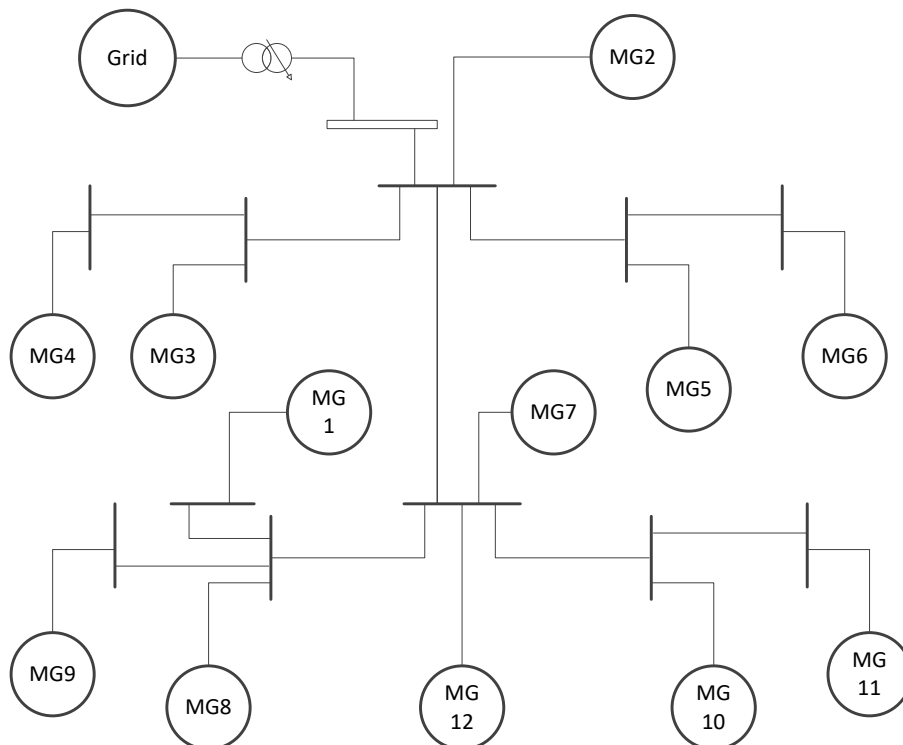

Figure 4.1: An example of the electrical connection in MG network.

### 4.4.2/ COMMUNICATION NETWORK IN MAS

Communication between agents is the fundamental function of MAS enabling interactions to gain external information and distributed control command. The topology and

protocol of message delivery determine control performance, yet limited by the initial economic investment to the establishment of infrastructure. The decentralized control eliminates any central controller to monitor network operation. It demands all the agents to have at least one communicational connection. Such a topology minimizes the redundancy and reduces establishment cost [Petcu et al., 2005]. In practical electricity grids, the communication line is encapsulated in the cable with energy transmission lines [Elkhatib et al., 2015]. Thus the MGs connected by the same lines can interact directly. To take full advantage of the lines and reduce the investment to communicational devices, the neighboring interaction is adopted as shown in figure 4.2. Herein, the communication link exists only between the MGs electrically linked. This topology can avoid information congestion and prevent single-point failure. As each MG is connected to the network electrically, neighboring communication guarantees that the information is sent to every node in the network. Each agent sends messages to neighbors periodically to update the information without being acknowledged. It saves time on having multiple neighbors and spreads data globally in time. Besides, this structure can use powerline communication with limited added cost.

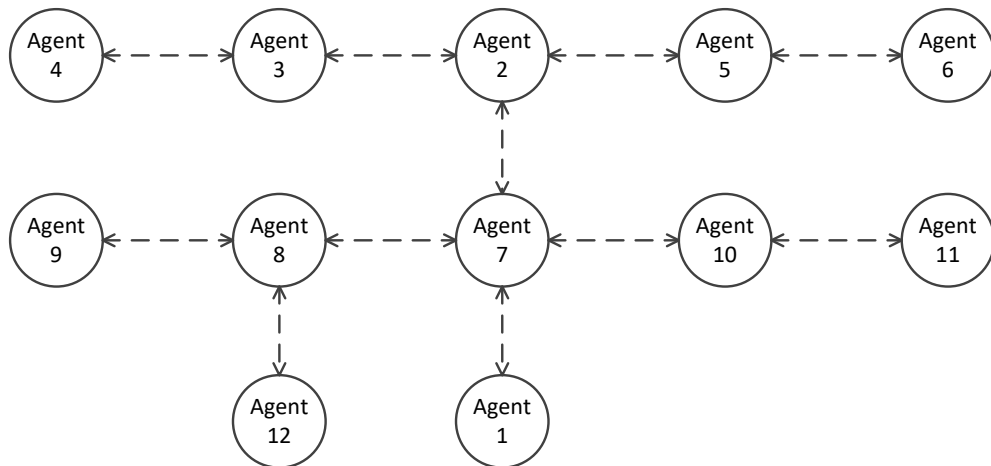

Figure 4.2: Diagram of the communication corresponding to figure 4.1.

#### 4.5/ CONTROL STRATEGY WITHIN INDIVIDUAL MICROGRID

The elements coordination control within individual MG derives from dynamic operation status, including MG coordination and independent control. Thus the economic profits and power balance are both impacted primarily by it. Independent control within MGs is the normal status for profit and efficiency reasons. Internal faults causing power imbalance switches the MGs status to coordination and involves the neighboring MGs for power support. The coordination stops after MGs regain balance, only relying on internal elements. Under both conditions, the control objective is to minimize generation cost to maximize economic benefits, along with the constraints including:

- 1) Maintaining power balance to improve MG supply reliability and resistance.
- 2) Maximizing and guaranteeing the load supply to promote the use ratio of the facility and customer comfort.

- 3) Maximizing the renewable generation to reduce carbon emission and promote the use ratio of the facility. Thus the renewable generators operate at the maximal power point tracking as non-distributable sources.
- 4) Respecting the features and operational constraints of the facility to guarantee the security operation and protect the supply reliability.

#### 4.5.1/ UNDER NORMAL CONDITION

##### 4.5.1.1/ OBJECTIVE AND PROBLEM FORMULATION

As an independent energy unit, the MG could keep internal power balance by elements coordination control. Without intervention from outside, microturbines and batteries take charge of balancing internal power for achieving the objective referred to at the beginning of section 4.5. The output of these facility is the control object, which is formulated as a quadratic constrained programming in equation ( 4.13) to equation ( 4.15). Equation ( 4.13) clarifies the balance between supply and demand. The maximization of load quantity (i.e., meets the demand as well as possible) is shown in equation ( 4.14) and the economic optimization is in equation ( 4.15).

$$\sum P_{out,PV} + \sum P_{out,WT} + \sum P_{out,MT} + \sum P_{disch,Bat} = \sum P_L + \sum P_{ch,Bat} \quad (4.13)$$

$$\sum P_L = \sum p_{max,L} \quad (4.14)$$

$$\min \mu_{cost} = \min \left( \sum \mu_{MT} + \sum \mu_{Bat} \right) \quad (4.15)$$

The constraints of facilities are listed in equation ( 4.1) to equation ( 4.12). Where  $p_L$  is the value of operating load and  $p_{max,L}$  is the value of all the load existing in the MG.  $\mu_{cost}$  is the generation cost of MG.

##### 4.5.1.2/ CONTROL PROCESS

For each independent MG, the optimal control is a periodic behavior and starts from collecting the operation information from each component in every cycle, which is shown in figure 4.3. Based on these data, the power flexibility of MG is defined by the lower and upper limits. The lower limit refers to the difference between generation and load under the condition of distributable generators outputting maximal power as equation ( 4.16) shows. For the upper limit, it corresponds to the condition of minimal MG generation with maximal load, which is shown in equation ( 4.17).  $p_{min,cap}$  is the lower limit gotten in the condition of shutting down microturbines and maximizing the charging power of batteries.  $p_{max,cap}$  is the upper limit corresponding to the maximal output of the microturbine and discharging of batteries. The Facility operation control means the optimization coordination within individual MG. Without power interaction with others, this control aims at self-balance with economic internal power dispatching. Related formulation is presented from equation ( 4.13) to equation ( 4.15).

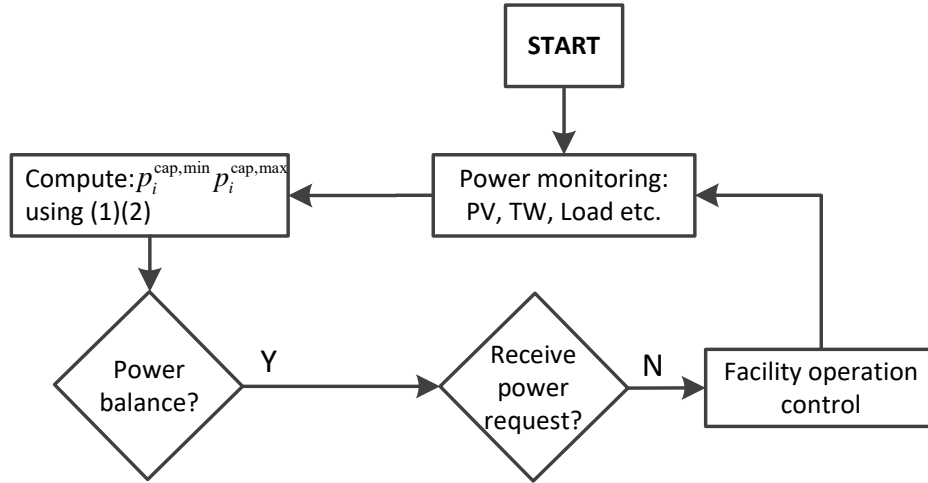

Figure 4.3: Independent control flowchart.

$$P_{\min, cap} = \sum P_{out, PV} + \sum P_{out, WT} - \left( \sum P_L + \sum P_{max\ charge, Bat} \right) \quad (4.16)$$

$$P_{\max, cap} = \sum P_{out, PV} + \sum P_{out, WT} + \sum P_{\max, MT} + \sum P_{\max\ discharge, Bat} - \sum P_L \quad (4.17)$$

## 4.5.2/ UNDER FAULT CONDITION

### 4.5.2.1/ OBJECTIVE AND PROBLEM FORMULATION

The coordination process is stimulated by the loss of balance within individual MG, which is essentially the rescue of multiple element groups to the faulted group. Hence the power interactions happen between the faulted MG and the supporting MGs. Within the faulted MG, minimizing coordination power is the constraint on coordination power, as shown in equation (4.18). The supportive behaviors include energy import ( $P_{input, net}$ ) to supply overload and energy output ( $P_{output, net}$ ) to consume surplus generation, where the value of coordination power is the smaller limit in power flexibility. While the assistant MGs outputs power when the request command is positive and absorbs energy when the command is negative. The power interaction between individual MG and network is unidirectional at each time point as equation (4.20) shows. The power balance in each coordinating MG is maintained, as shown in equation (4.21) and minimizing generation cost is represented in equation (4.22).

$$P_{req} = \min(|P_{\min, cap}|, |P_{\max, cap}|) = \begin{cases} P_{input, net} & P_{\min, cap} > 0 \\ P_{output, net} & P_{\max, cap} < 0 \end{cases} \quad (4.18)$$

$$P_{res} = \begin{cases} P_{output, net} & P_{\max, cap} < 0 \\ -P_{input, net} & P_{\min, cap} > 0 \end{cases} \quad (4.19)$$

$$P_{input, net} P_{output, net} = 0 \quad (4.20)$$



$$\begin{aligned} & \sum P_{out,PV} + \sum P_{out,WT} + \sum P_{out,MT} + \sum P_{disch,Bat} + P_{input,net} \\ & = \sum P_L + \sum P_{ch,Bat} + P_{output,net} \end{aligned} \quad (4.21)$$

$$\min \mu_{cost} = \min \left( \sum \mu_{MT} + \sum \mu_{Bat} + P_{input,net} \mu_{input,net} - P_{output,net} \mu_{output,net} \right) \quad (4.22)$$

Where  $p_{req}$  is the demanding power of faulted MG and  $p_{res}$  is the supportive power from assistive MGs.  $\mu_{input,net}$  and  $\mu_{output,net}$  are the price of power buying from and selling to the network respectively.

#### 4.5.2.2/ CONTROL PROCESS

The internal coordination behavior is to distribute the generation to load under energy intervention from the outside network as figure 4.4 shows. Monitoring the power supply and consumption of all the facilities in MGs firstly, and the power flexibility is calculated in terms of equation (4.16) and equation (4.17), which rely completely on the features and constraints of the local components. Then, the power imbalance is checked to identify the faulted MG. For the balanced MG, they are potential assistant MG, which will finally be selected to supply power for the faulted one. The one without participating coordination will operate according to the control in section 4.5.1. To minimize interacting power with the network, the overload MG maximizes generation and the one with surplus energy maximizes load and battery charging power. In the assistant MG, the facility operation is essentially power dispatching considering the coordinating power with the network. The optimization is formulated from equation (4.18) to equation (4.22), whose results guide the output of distributable generators and storage systems.

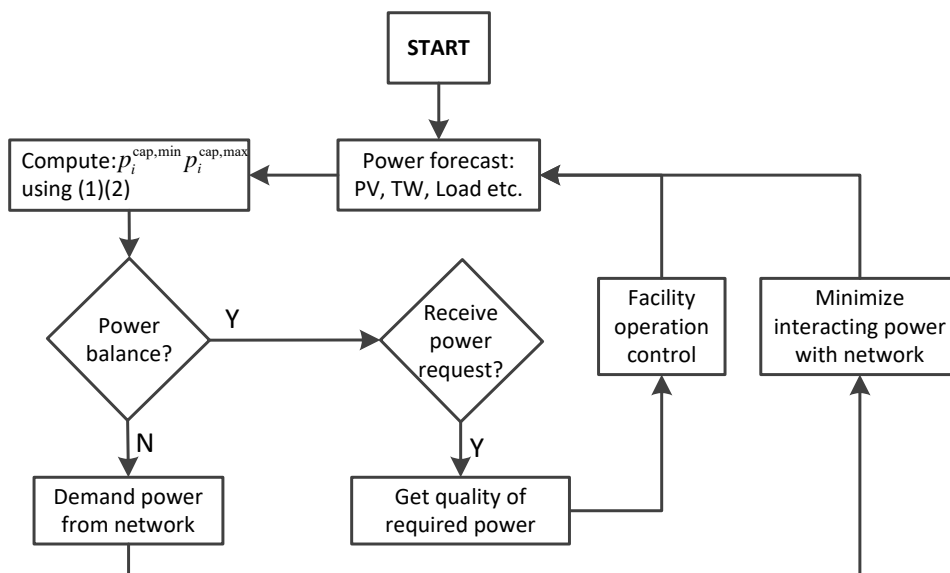

Figure 4.4: Fault control flowchart.

## 4.6/ CONTROL STRATEGY FOR MG COORDINATION

Contingencies or faults cause disturbances in MGs and demand power support from the network to avoid load shedding or generation curtailment. While global coordination helps consolidate the system resistance to fault conditions and improve the efficiency of energy allocation. Its control mainly aims at maintaining power balancing in the horizon of the network to improve the resilience and supply reliability persistently under dynamic conditions including steady status, emergent outages. Maximal economic profit and environmental benefits are to optimize coordination. These global goals guide the process of the interaction and impacting self-control based on the MAS to motivate cooperative behaviors of elements. The power coordination in the network contains two steps: power dispatching among MGs and power flow calculation on distribution wires. Two decentralized methods are proposed in this thesis to optimize coordination: the one-in-all optimization and the market method.

### 4.6.1/ STRATEGY 1: CENTRALIZED OPTIMAL DISPATCHING IN PARTIAL AREA

#### 4.6.1.1/ MOTIVATION

It is not rational to support individual faulted MG by involving all the MGs into coordination considering the network scalability, efficiency, and economic reasons. Establishing coordination groups between faulted MGs and its neighbors tackles the previous problems. The direct communication link and electrical connection help reduce power losses on lines and communication time. Especially, it eliminates the impacts of the network expansion to the complexity of coordination control.

#### 4.6.1.2/ PROBLEM FORMULATION

Under the framework of neighboring coordination, the power is distributed for economic benefit while maintaining the power balance within the network and respecting facility limitations. For simplification objectives, assistant MGs sell energy to the faulted MGs based on the assumptions in the following:

- 1) The electricity price of assistant MG is approximated as the generation cost of the microturbine, which simplifies the economic problem to concentrate on the proposed control strategy. Due to the small inertia and fast ramping up/down output, the battery is used to supply the local load and compensate for the internal intermittent generation. The micro turbine takes charge of assisting neighboring MGs.
- 2) The MG privacy is not considered in this method. The operation information of each assistant MG, including costs, is public to faulted MGs by agents' interaction.

The problem formulation for optimization is shown in equations ( 4.23) to ( 4.27). The economic optimization of coordination is represented in equation ( 4.23), where the cost on each neighboring MG is simplified and shown in equation ( 4.24). The left side of the equation ( 4.25) shows the sum of MGs' interaction power in the network. A positive value means exporting power, while a negative value represents importing power. It should be

equal to the total network line losses shown on the right. The power capacity of the distribution line is demonstrated in equation ( 4.26). Equation ( 4.27) implies that the sum of the power flowing on all lines connecting to a certain MG should be within the limitations of its capacity.

$$\min \mu_{\cos t}^{coordination} = \min \sum_{j \in M_i} \mu_{\cos t}^{j-i} \quad (4.23)$$

$$\mu_{\cos t}^{j-i} = \eta_1^j p_{MG}^{j-i} + \eta_2^j (p_{MG}^{j-i})^2 \quad (4.24)$$

$$\sum_{i \in T} p_{MG}^i = \sum_{i \in T} \sum_{j \in M_i} p_{Line}^{i-j} r_{Line}^{i-j} \quad (4.25)$$

$$p_{Line}^{i-j} \leq p_{Line, cap}^{i-j} \quad (4.26)$$

$$p_{\min, cap}^i \leq \sum_{j \in M_i} p_{Line}^{i-j} \leq p_{\max, cap}^i \quad (4.27)$$

where  $\mu_{\cos t}^{coordination}$  is the faulted MG cost on buying enough power from neighbors and  $\mu_{\cos t}^{j-i}$  is the quantity that the faulted MG paying to the neighbor MG indexed of  $j$ .  $\eta_1^j$  and  $\eta_2^j$  are the cost coefficients for linear and quadratic items respectively.  $p_{MG}^{j-i}$  is the volume of power sold from  $i$ -index MG to  $j$ -index MG.  $p_{MG}^i$  is the power of  $i$ -index MG interacting with network.  $p_{Line}^{i-j}$  are the power flowing on the distribution line connecting  $j$ -index and  $i$ -index MG with  $r_{Line}^{i-j}$  and  $p_{Line, cap}^{i-j}$  as the line's resistance and capacity.  $T$  is the collection of all the MGs in network.  $p_{\min, cap}^i$  and  $p_{\max, cap}^i$  are the power flexibility of  $i$ -index MG.

#### 4.6.1.3/ CONTROL STRATEGY

The MG under imbalance is called "requester," while "responder" refers to the assistant MGs receiving supporting requirements. The requester MG determines the power dispatching schedule for all its neighbors, including the supportive MGs and the bought energy quantity. Such a control architecture is based on the economic optimization demonstrated in equation ( 4.23)-equation ( 4.24) solved by the requester agent. The neighboring MGs hand in the electricity price and its maximal trading volume to the requester to fulfill the power dispatch, which makes the requester a central controller in the coordination group. The capacity of distribution lines limits the power flow coupling with the output of network MGs. It is mathematically analyzed in the following section of 4.6.1.4.2. The calculation on power flow globally demands the perception of the output power of all the MG in-network whose method is introduced explicitly in 4.6.1.4.1. Thus the information transferred between MGs includes the output power and capacity of connecting distribution lines.

According to the previous essential processes, the coordination problem described in equation ( 4.23) to equation ( 4.27) is solved based on the steps shown in figure 4.5. The Newton-Raphson method [Abbasbandy, 2003], which is commonly used for solving the optimization of quadratic problems, is adopted for deriving dispatching solution in

the system. A distributed PF calculation with a consensus theorem is utilized to avoid line capacity violations. Results show the security of the schedule by comparing the line capacity with power flow. The procedure of the PF check will be discussed in detail in the following section. If there is a secure solution, the scheduling process finishes, and the next scheduling step within the MG is run. Otherwise, the schedule fails. If no feasible plan is obtained, this means that some constraints cannot be met and that the stability of the system cannot be ensured. To guarantee the secure operation of the grid, the MG sheds load or curtails renewable power generation. Each responder assists one requester for each coordination cycle. If it receives multiple requests at the same time, a priority order is used. The demands of the most massive value are answered first. Such a procedure continues until the responder's response capacity is reached. The requester then implements the dispatch resulting from the new exchanges.

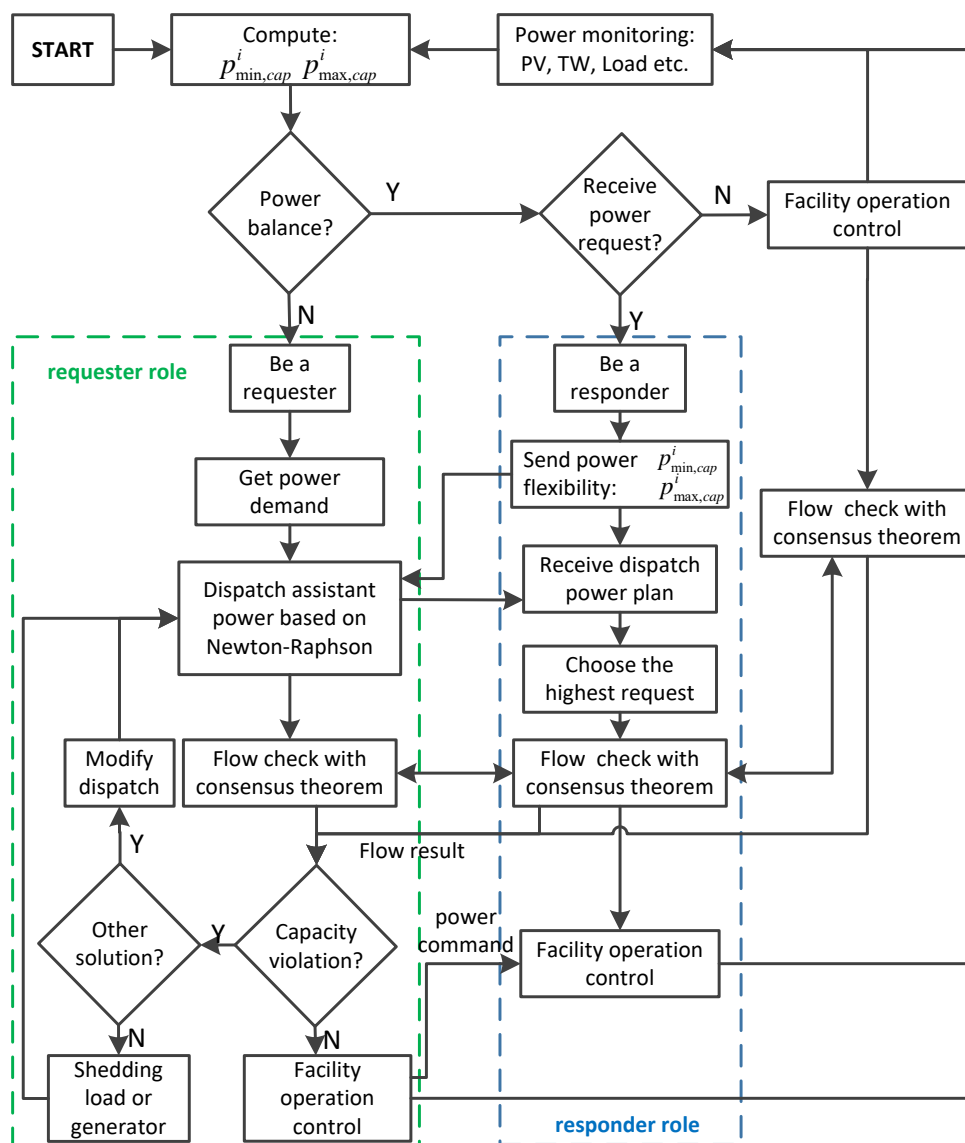

Figure 4.5: Centralized control strategy flowchart.

Figure 4.6 shows an example of messages exchanged during the negotiation process

between two neighboring agents (agent 3 of MG3 is a requester and agent 2 of MG2 is a responder), during the coordination. Based on the facility power forecasts, if MG3 is lacking power or has excess energy, it schedules supportive power demands with its neighbors. Information on the flexibility of the responder is sent to the requester for power dispatching with the Newton Raphson method. Requester MG3 then sends to the corresponding exchange schedule to responder MG2. Based on this, the power flow is calculated in each agent with the consensus theorem. Line capacity constraints are further checked, and the results determine whether the schedule is feasible. If no restriction is violated, the plan is implemented, and a new control cycle starts. Otherwise, the MG3 reduces the interaction power with the MGs which connect or locate nearest with the overload lines, and the reduced assistant power will be compensated by other MGs of lower generation cost.

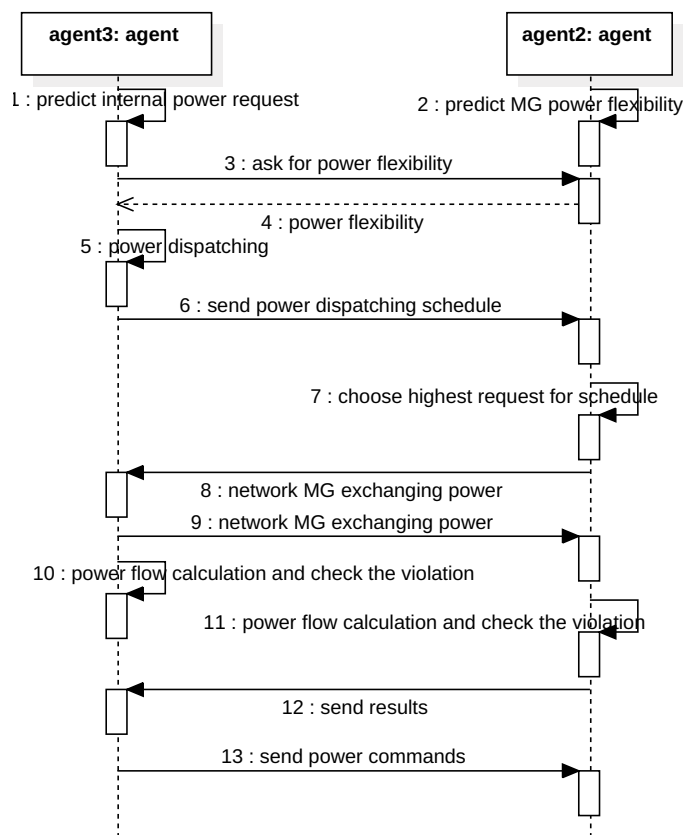

Figure 4.6: Coordinating interaction diagram.

#### 4.6.1.4/ POWER FLOW ALGORITHM

**4.6.1.4.1/ Consensus Algorithm for Distributed MAS** For distributed MG network, power flow during coordination is derived from the output of each MG, and it impacts the security operation given the capacity of distribution lines. A central power flow calculation is not adopted as a central controller is required and it should communicate with all the MGs in the network for global information collection. It is a communicational cost and could cause single-point failure. Besides the information congestion is in expectation when the network scale expands. Thus a decentral-

ized approach is preferred, and it reduces the cost of communication. The neighboring communication topology restrains direct access to global output power. The consensus theorem emerges for distributed MAS perceiving global information in high efficiency. The term of "Consensus" means to accomplish an agreement about a set of interest according to all the agents' status [Yu et al., 2012]. The consensus algorithm (or protocol) defines interaction rule and is used for data exploration. It specifies information exchange between agents and the neighbors in the network [Yu et al., 2012]. Communication protocols based on it depict the interaction process to exchange information between neighboring agents. It is widely applied to the distributed systems including optimal consensus [Shi et al., 2012, Nedic et al., 2010], sampled-data consensus [Qin et al., 2013, Qin et al., 2010, Wang et al., 2012], adaptive consensus [Yu et al., 2012], second-order consensus [Qin et al., 2011a, Qin et al., 2011b, Qin et al., 2012], consensus of generic linear agents [Qin et al., 2014, Yang et al., 2011], and multiple-leader consensus [Peng et al., 2015]. For faster convergence and the higher probability of getting optimum network information, the average consensus theorem is adopted to underpin the communication protocol [Olfati-Saber et al., 2007, Xu et al., 2011, Liu et al., 2016].

Global perception in each agent and the assigned MG is derived by message spreading in neighbor interaction. The collected information could include the volume of output power from all the MGs and their voltage value. They could be used to evaluate the power flow security and even dispatching generation in a global view. Thus the discovery algorithm for network information is represented by equation ( 4.28) to equation ( 4.32). The average consensus algorithm adopted in this thesis develops the convergence speed based on the neighboring information. It corrects the updated value in updating agent iteratively by adding the average errors between it and the values stored in all the adjacent agents. Equation ( 4.28) is the formulation of an MG updating global information based on neighbor messages.

$$x_i^{t+1} = x_i^t + \sum_{j \in N_i} a_{ij} (x_j^t - x_i^t) \quad (4.28)$$

$$X^{t+1} = (I + A) X^t = D X^t \quad (4.29)$$

$$A = \begin{bmatrix} -\sum_{j \in N_1} a_{1j} & \cdots & a_{1n} \\ \vdots & \ddots & \vdots \\ a_{n1} & \cdots & -\sum_{j \in N_n} a_{nj} \end{bmatrix} \quad (4.30)$$

$$X^k = [x_1^k \quad \cdots \quad x_i^k \quad \cdots \quad x_n^k]^T \quad (4.31)$$

$$D = \begin{bmatrix} 1 - \sum_{j \in N_1} a_{1j} & \cdots & a_{1n} \\ \vdots & \ddots & \vdots \\ a_{n1} & \cdots & 1 - \sum_{j \in N_n} a_{nj} \end{bmatrix} \quad (4.32)$$

$$a_{ij} = \begin{cases} \frac{1}{\sum_{N_i} 1 + \sum_{N_j} 1 + \varepsilon} & j \in N_i \\ 1 - \sum_{N_j} \frac{1}{\sum_{N_i} 1 + \sum_{N_j} 1} & j = i \\ 0 & otherwise \end{cases} \quad (4.33)$$

Where  $x$  is the unknown data containing operation information from remote MG, and the  $i$  points to the index of storage agent, which is also the updating agent.  $j$  and  $N_i$  represent the neighboring MG index and neighboring MGs collection to the MG indexed by  $i$  respectively.  $t$  resembles the iteration step before convergence.  $a_{ij}$  is the adaptive coupling gain of error between the data stored in  $j$ -index MG and  $i$ -index MG. The value is constant, and it is derived from equation ( 4.33) under constant topology of communication. Based on equation ( 4.28), the complete system information is discovered by the matrix calculation shown in equation ( 4.29), where  $I$  is the identity matrix, and the other items are further defined in equations equation ( 4.30) to equation ( 4.33).  $N_1$  and  $N_n$  are the neighboring MG collection of 1-index MG and  $n$ -index MG respectively.  $n$  is the scale of the MG network, corresponds to the total MG numbers. The value of adaptive coupling gain for averaging errors determines the stability and adaptivity of the average consensus algorithm. Thus it is represented  $\varepsilon$  is very small and could be neglected in a large complex system.

Agents exchange their operation information with adjacent ones periodically and update their perception to all the MGs after receiving messages from all neighbors. It helps reduce single points of failure in the system, in the hope to reduce the impact of any failure furthermore.

**4.6.1.4.2/ Power Flow Calculation** As the MG network is located in the distribution power system, the connecting lines are short and transmit power with a low voltage level. Thus an improved DC power flow that considers line resistance (instead of reactance) is adopted. The loss on a line  $p_{Line,loss}^{i-j}$  is shown in equation ( 4.34) which is simplified and added onto the value of load at the terminal MGs as shown in equation ( 4.34)-equation ( 4.36) [Hongfu et al., 2014].

$$p_{Line,loss}^{i-j} = (p_{Line}^{i-j})^2 r_{Line}^{i-j} \quad (4.34)$$

$$p_{L,equ}^i = \sum_{j=1, j \in M_i} \frac{p_{Line,loss}^{i-j}}{2} \quad (4.35)$$

$$p_{MG,mod}^i = p_{MG}^i - p_{L,equ}^i \quad (4.36)$$

Where  $p_{Line,loss}^{i-j}$  is the power loss on lines connecting  $i$ -index MG and  $j$ -index MG.  $p_{L,equ}^i$  is the equivalent load of line loss for  $i$ -index MG.  $p_{MG,mod}^i$  is the equivalent power inputting into  $i$ -index MG considering the line loss.

The resulting improved formulation of DC power flow is shown in equation ( 4.37)-equation ( 4.41) [Stott et al., 2009]:

$$\delta = [\delta^1, \delta^2 \dots, \delta^i, \dots, \delta^n]^T \quad (4.37)$$

$$B = \begin{bmatrix} 1 - \sum_{j=2, j \in N_i} b_{1j} & \cdots & b_{1n} \\ \vdots & \ddots & \vdots \\ b_{n1} & \cdots & 1 - \sum_{j=1, j \in N_i, j \neq n} b_{nj} \end{bmatrix} \quad (4.38)$$

$$-P = B\delta \quad (4.39)$$

$$P_{Line}^{i-j} = \frac{\delta^i - \delta^j}{x_{Line}^{i-j}} \quad (4.40)$$

$$P = [P_{MG,mod}^1, P_{MG,mod}^2, \cdots, P_{MG,mod}^i, \cdots, P_{MG,mod}^n]^T \quad (4.41)$$

Where  $\delta^i$  is the voltage angle of  $i$ -index MG.  $x_{Line}^{i-j}$  is the impedance of line connecting  $i$ -index MG and  $j$ -index MG.

## 4.6.2/ STRATEGY 2: BIDDING IN THE MARKET

### 4.6.2.1/ MOTIVATION

The models of MG generation cost and bidding strategy are simplified in the method of section 4.6.1. The quadratic function of price could not reflect the generation cost with multiple renewable generators and batteries. Additionally, even though its communication is distributed, agents need to discover the complete network information, which is similar to centralized control. Thus the model of system demands further complementing and a fully decentralized method for MG coordination has not been proposed yet. In a smart grid made of interconnected MG clusters, decentralized coordination among MGs could be expected to enable MGs to rescue each other to mitigate the impacts of faults. Secondly, it should enable MG clusters to reconfigure whenever relevant (e.g., by changing MG connections). Finally, it must be easily extended to handle a large amount of MGs and hence facilitate DER and local energy integration. Based on these principles, this method has the following contributions:

- 1) A real-time decentralized coordination mechanism between MGs is built. It enables the rescue of an MG by others, which also limits the impact of faults.
- 2) Market power dispatching is applied for dividing assistant power among neighbor MGs to maximize the load supply, energy use, and the MG profits from power trading. The bidding price and volume are determined by the MG control strategy using a genetic algorithm. It aims to minimize the generation cost and carbon dioxide emission, as well as ensure power balance. A more approximate bid model to the MG generation cost is proposed to maximize the economic profit for both sellers and buyers.
- 3) A distributed method is proposed to calculate power flow caused by electricity trading among MGs. Simulation results are compared with the line capacity to ensure secure operation. It helps decrease the communication and calculation burden, especially for large systems.



## 4.6.2.2/ PROBLEM FORMULATION

Based on the neighboring coordination in section 4.6.1, the electricity market is adopted to dispatch the power to solve economic optimization. The faulted MG buys energy from sellers (i.e., neighbor MGs) of the lowest price to a higher price at the volume of maximal output until the summation is equal to the demand quantity. Such an operation is depicted by an example shown in figure 4.7 [Parhizi et al., 2016].

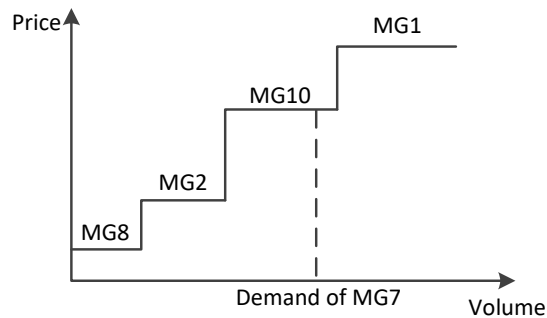

Figure 4.7: An example of power trading in the network in figure 4.7.

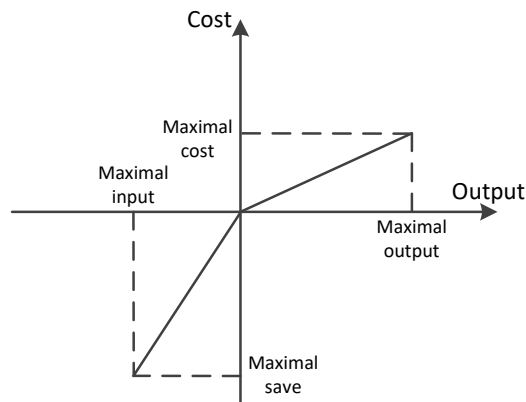

Figure 4.8: The output-cost curve.

As a seller, the neighbor MG makes the bid of selling electricity based on the generation cost, which is minimized by the internal control based on the problem formulation (4.15). A price determination method more approximate to the generation cost of MG is shown in (4.42)-(4.48), which are based on the internal economic optimization coordination within individual MG. It is assumed that the profit is proportional to the cost with a constant ratio parameter. Hence the expense boosted by the neighbor coordination based on MG internal balance control underpins the bid strategy of the assistant MGs. It means that the per-unit cost is obtained by the increased cost dividing the corresponding trading power. The resulted value is usually multiplied by an economic gain for making a profit to get the final bid. However, the coordination-caused expense still cannot be formulated mathematically by a single function of supportive power quantity considering the diverse facility, coordination behaviors, and the previous operation status. It could be approximated to a linear function, as shown in figure 4.8. The origin represents no assistant behavior, and

the terminate point for output resembles the upper limit of MG power flexibility shown in ( 4.17). While for the supportive reaction of absorbing the power, the input-cost line is determined by the origin and the lower limit of MG flexibility. The cost in both kinds of coordination is the increased volume or saved volume comparing with the expense under self-balance. This approximation is equal to the real cost when the MG trades in the maximal power volume. The equations deriving bids are shown in ( 4.42)- ( 4.50) similar to the MG flexibility.

Equation ( 4.42) shows the bid of MG under conditions of exporting and absorbing power. The maximal and minimal generation cost corresponding to the upper and lower limit of MG power flexibility, respectively, are shown in ( 4.43) and ( 4.46). Equations ( 4.44) and ( 4.45) depict the cost of microturbine and battery under maximal MG output by maximizing their generation. On the other hand, the maximal MG input cost is derived by shutting down the microturbine and maximizing the charging power of the battery, whose expense corresponds to ( 4.47) and ( 4.48). The volume of maximal output and input are shown in ( 4.49) and ( 4.50), where the input power is negative, and output power is positive. Network power balance is maintained by the constraint of ( 4.51), which depicts that the summation of all the MGs generation is 0.

$$\pi^k = \begin{cases} \eta_s^k (\mu_{\max}^k - \mu_{self}^k) / P_{\max,out}^k & (P_{MG}^k > 0) \\ \eta_b^k (\mu_{self}^k - \mu_{\min}^k) / P_{\max,in}^k & (P_{MG}^k \leq 0) \end{cases} \quad (4.42)$$

$$\mu_{\max} = \sum_{i \in T_{MT}} (\mu_{MT,\max}^i) + \sum_{i \in T_{Bat}} (\mu_{Bat,\max}^i) \quad (4.43)$$

$$\mu_{MT,\max} = \eta_{up\_down,MT} |1 - s_{MT}^{t-1}| + \eta_{1,MT} P_{\max,MT} + \eta_{2,MT} P_{\max,MT}^2 \quad (4.44)$$

$$\mu_{Bat,\max} = \left( \frac{1}{\eta_{disch,Bat}} P_{\max\ discharge,Bat} \right) \frac{\pi_{inv}}{2 \cdot N_{Bat}} \Delta t \quad (4.45)$$

$$\mu_{\min} = \sum_{i \in T_{MT}} (\mu_{MT,\min}^i) + \sum_{i \in T_{Bat}} (\mu_{Bat,\min}^i) \quad (4.46)$$

$$\mu_{MT,\min} = \eta_{up\_down,MT} |0 - s_{MT}^{t-1}| \quad (4.47)$$

$$\mu_{Bat,\min} = \left( \eta_{ch,Bat} \beta_{ch,Bat} P_{\max\ charge,Bat} \right) \frac{\pi_{inv}}{2 \cdot N_{Bat}} \Delta t \quad (4.48)$$

$$P_{\max,out} = \sum_{i \in T_{WT}} (P_{out,WT}^i) + \sum_{i \in T_{PV}} (P_{out,PV}^i) + \sum_{i \in T_{MT}} (P_{MT,\max}^i) + \sum_{i \in T_{Bat}} (P_{\max\ discharge,Bat}^i) - \sum_{i \in T_L} (P_L^i) \quad (4.49)$$

$$P_{\max,in} = \sum_{i \in T_{WT}} (P_{out,WT}^i) + \sum_{i \in T_{PV}} (P_{out,PV}^i) - \sum_{i \in T_{Bat}} (P_{\max\ charge,Bat}^i) - \sum_{i \in T_L} (P_L^i) \quad (4.50)$$

$$\sum P_{MG}^k = 0 \quad (4.51)$$

Where  $k$  and  $i$  represent the index of MGs and internal elements.  $\pi^k$  is the bid price of assistant MG.  $\eta_s^k$  and  $\eta_b^k$  are the profit gain of the seller.  $\mu_{\max}^k$  and  $\mu_{\min}^k$  are the generation cost under the maximal volume of generation and load.  $\mu_{self}^k$  is the minimal generation cost to maintain internal balance.  $p_{\max,out}^k$  and  $p_{\max,in}^k$  are the maximal volume of output and input power.  $\mu_{MT,\max}^i$  and  $\mu_{Bat,\max}^i$  are the generation cost of the micro turbine and battery under MG maximal generation.  $T_{MT}$ ,  $T_{Bat}$  and  $T_L$  are the collection of the micro turbine, battery, and load within individual MG.

### 4.6.2.3/ CONTROL STRATEGY

In the coordination process, an MG can be a "requester" or a "responder" according to different circumstances. The former one cannot maintain local power balance by itself and therefore needs to be "rescued", while the latter can provide power assistance to requesters.

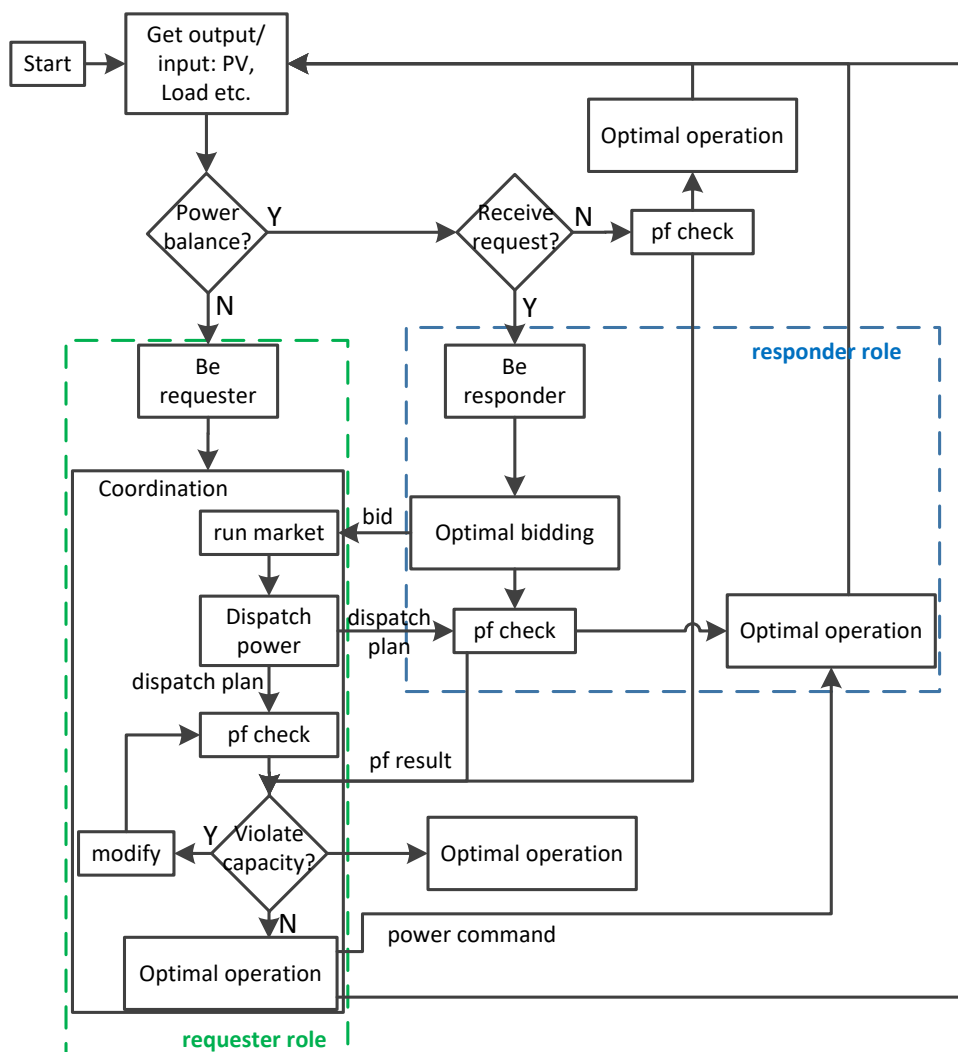

Figure 4.9: Market strategy flowchart.

The other MGs operate to keep maintaining self-balance without power interaction with the network. A flowchart of the coordination mechanism is shown in figure 4.9. In normal conditions, an MG agent controls its facilities to minimize costs according to (4.1)- (4.15). An MG then becomes a requester if its power balance is not met and the neighboring MGs accordingly act as power responders (if they can do so).

Coordination is based on a market established by the requester to trade power with responders for imbalance compensation. The bidding of the responder is determined by (4.42)- (4.45). The requester trades with the MG bidding the lowest price for buying power, and the one with the highest price for selling electricity. The requester thus firstly trades with the MG of the lowest price, as much as it needs. The MG of second-lowest price trade if power is insufficient. Procedures repeat until the imbalance is replenished.

Next, the network power flow is calculated by the agents based on a distributed algorithm (see section 4.6.2.4). The resulting line flow is then compared with line capacity. If capacity violations are detected, the MGs which connect or locate nearest with the overflow line should reduce their trading power and the lacking power is compensated by other MGs of lower generation cost. As the MGs with the lowest prices have provided the most power assistance, the neighboring MGs with higher prices have to compensate this power decrease. Once the dispatching feasibility is verified, the coordination behavior is implemented with (4.1)- (4.12) and (4.18)- (4.22), setting the MG trading power  $p_{MG}^i$  equal to the dispatching command determined in (4.51).

For a responder, it buys electricity from neighboring MGs when the supply is lower than load, and it sells power to the neighbor MGs when there is surplus energy. The bidding price of responders in the market is determined using (4.42).  $\eta_s^k$  is the ratio between the selling price and the cost. The responders' selling price is obtained by multiplying  $\eta_s^k$  (higher than 1 to generate a profit) to the per-unit expense under maximal output. The difference in cost is divided by the difference of generation between the operation under maximal output and the self-balance maintenance under minimum payment. The per-unit expense under maximal output is thus equal to the quotient. Similarly, the responders' buying price is obtained based on the cost and output power under operations of maximal input and the self-balance service at minimum cost. Neighboring MGs send their electricity price and the maximal power volume they can trade to the requester. For trading in the market, a requester buys from the responders with the lowest price. For guaranteeing that assistant power is sufficient, the proposed volume of trading power is set equal to the MG's maximum flexibility. It represents the maximal power the MG can absorb and output. Based on this, the corresponding MG cost can be calculated.

#### 4.6.2.4/ POWER FLOW

As mentioned above, after a dispatching plan having been determined, the resulting power flow should be calculated to check for possible violations of line capacity values. Even though the power flow calculation in section 4.6.1.4.1 does not rely on direct communication with all the MGs, all the agent still needs the global output power to calculate the network power flow. This method takes the computational sources of the MGs outside of the coordination group. Besides, the message content is increasing as the network expands. Therefore, based on the methods described in [Mohammadi et al., 2014, Kersting, 2001], we improve an approximate distributed DC power flow calculation method. It only considers the line resistance (as lines connect-

ing MGs may be short) and calculates the power flow of agent-connected lines. Several assumptions are made to decentralize the power flow calculation:

- 1) The voltage amplitude in the network is equal to the standard per-unit as the reactive power is not discussed in this thesis, and the power is decoupled for active power study.
- 2) The difference of voltage phase between MGs ranges around a small value which enables the linearization of the relationship between angle value and MG output power.

Both assumptions are shown in ( 4.52). The resulting formulation of DC power flow is improved and shown in ( 4.53)-( 4.55) [Mohammadi et al., 2014]:

$$V \approx 1; \quad \sin \theta^{i-j} \approx \theta^{i-j}; \quad \cos \theta^{i-j} \approx 1 \quad (4.52)$$

$$\Delta p_{MG}^{i,t-1} = 0 = p_{MG}^{i,t-1} - V^i \sum_{j \in N_i} V^j (g_{Line}^{i-j} \cos \theta^{i-j,t-1} + b_{Line}^{i-j} \sin \theta^{i-j,t-1}) \quad (4.53)$$

$$\Delta p_{MG}^{i,t-1} = 0 = p_{MG}^{i,t-1} - \sum_{j \in N_i} (g_{Line}^{i-j} + b_{Line}^{i-j} \theta^{i-j,t-1}) \quad (4.54)$$

$$\theta^{i,t} = \theta^{i,t-1} - \gamma (\Delta p^{i,t-1}) \quad (4.55)$$

Where  $V$  and  $\theta$  are the amplitude and phase difference of the MG voltage, which is assumed to be unified and equal to the voltage at the grid connection point.  $\Delta p_{MG}$  is the power error between actual and iterative MG output power. The latter is derived from the voltage angle error. The angle error can be used to correct the voltage angle shown in ( 4.55), where  $\gamma$  is adopted to avoid the divergence of the angle.  $g_{Line}^{i-j}$  and  $b_{Line}^{i-j}$  are the reactance and susceptance of distribution lines between MGs of  $i$ -index and  $j$ -index.

In ( 4.53), the first item and second item on the right side are the MG exchange power and the sum of power flow on the lines which are connected to it. According to Kirchhoff's current law, they are equal to each other. As the voltage angle difference between MGs may be considered negligible (see (4.15)), we obtain ( 4.54). Taking assumptions of ( 4.52) into ( 4.53), we obtain ( 4.54). Within the network, the MG voltage angle is unknown, as it is controlled by the active power command. The voltage angle of reference MG maintains at zero, while the angle of others is initialized at zero. The power flow on lines is finally calculated by ( 4.56):

$$P_{Line}^{i-j} = g_{Line}^{i-j} + b_{Line}^{i-j} (\theta^i - \theta^j) \quad (4.56)$$

The flowchart of the distributed method is shown in figure 4.10. It is a specific instruction for the module of power flow verification ("pf check") in figure 4.9. The requester sends the dispatching plan to responders, and the agents in the network start to calculate the power flow on the lines which are connected with it. The following communication message only includes the sender's voltage angle, which guarantees information privacy for the MG and reduces the complexity of communication. With equations ( 4.55) to ( 4.56), each agent calculates the voltage angle of its assigned MG and further the power flow on the connected lines with ( 4.56). The capacity-check results on all wires are sent back to

the requester to evaluate the dispatching plan for further modification, as shown in figure 4.9. The optimization is achieved by negotiation among MGs. Thus in this chapter, the communication system is assumed to be reliable. The case of communication loss will be further studied in the future.

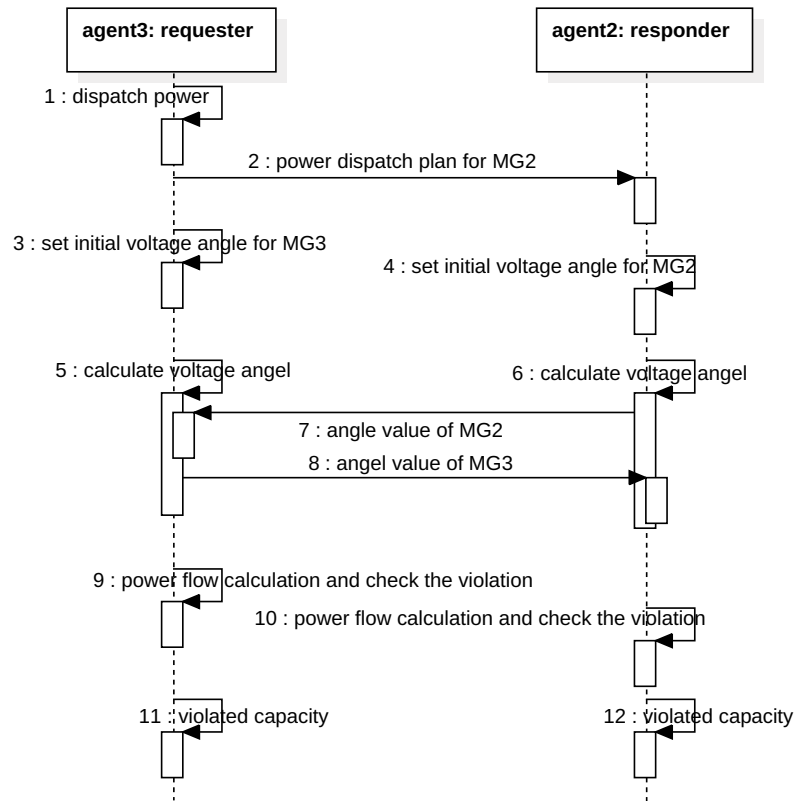

Figure 4.10: Distributed power flow algorithm flowchart.

## 4.7/ SIMULATION RESULTS

The proposed control strategies are tested on the simulation system based on the platform established in chapter 3. Corresponding performance is evaluated on several aspects through several cases. They include the effectiveness of control, economic profit, and the reliability of load supply. The effectiveness of coordination, shedding loads, curtailed generation, and costs are derived from simulation to evaluate the performance of the control.

### 4.7.1/ TEST MULTI-AGENT SYSTEM AND MICROGRID NETWORK

Tests are based on the system of a 13-node system shown in figure 4.1 and the 34-node system according to the paper of [Mohammadi et al., 2014], which also defines the parameters of distribution lines. As the main grid occupies one node and the rest nodes represent the location of MGs, the simulation systems contain 12 MGs and 33 MGs respectively. The architecture of individual MGs is as shown in figure 3.2. Both networks are radial and the MGs are connected like a tree structure. There is no common point

connecting all of the MGs to present the distributed location. The 12-MG network is big enough to contain a neighboring group and the MGs without participating in the coordination. By comparing the control performance in the 12-MG network and the 33-MG network, the system scalability under the proposed control strategy is studied. In the simulation, the battery in MG3 is assumed to be disconnected in the whole day, e.g., for maintenance. Consequently, the imbalance in MG3 includes excess PV generation from 8:00 to 16:00 and surplus load from 6:00 to 7:00. The proposed approaches are applied to the simulation, and their performance is evaluated after the configuration of networks. The components of each MG are shown in table 4.1, where only photovoltaic generator, battery, and microturbine are included. The facility parameters for operation referred to in equations of (4.1) to (4.12) are summarized in tables 4.2 and 4.3. Load information is adapted from the power consumption of an actual building at UBFC, and the profile of solar radiation is collected from the weather in Belfort, France.

Table 4.1: MG facility numbers in the 12-MG system.

MG	MG1	MG2	MG3	MG4	MG5	MG6
PV	5	5	5	5	5	5
Battery	15	15	0	10	15	10
MT	0	0	1	0	0	0
MG	MG7	MG8	MG9	MG10	MG11	MG12
PV	5	5	5	5	5	5
Battery	15	10	15	10	10	10
MT	0	0	0	0	0	0

Table 4.2: MGs facilities rated powers.

Facility	PV	Battery	MT
$P_{max}$ (kW)	8	10	5
$P_{rated}$ (kW)	7.5	9	4.2

Table 4.3: Other parameters.

$\eta_{ch}$	$\eta_{disch}$	$w_{ess,min}$ (kWh)	$\eta_s^k$
0.95	0.95	466.8	1.2
$w_{ess,max}$ (kWh)	$\gamma$	$\Delta t$ (s)	$\eta_b^k$
2100.6	7.5	3.2	0.8

The generation cost defined in partial centralized control for MGs is endowed with the profit parameters shown in table 4.4, where the quadratic function refers to the equation (4.24). Each neighbor MG sends the cost parameters in table 4.4 to the requester and the total cost for buying electricity from responders is minimized for maximizing profit according to the equation (4.23). This problem can then be solved by the Newton-Raphson method to decide the trading power quantity from neighbors.

Another set of parameters for the economic model proposed for market bidding is shown in table 4.5, where the operation cost and shut-down/start-up cost for the distributable generators correspond to the equations of (4.43) to (4.48). The battery has a wide range of output volume as it is limited by maximal charging and discharging. It is assumed to be non-stop as the operation includes non-power interaction, and its cost on shut-

Table 4.4: Electricity price parameters in each MG.

	MG3	MG2	MG4
$\eta_1^{j,i}$ (kW)	1	3.5	6.3
$\eta_2^{j,i}$ (kW)	0.006	0.004	0.009

down/start-up is 0. The generation cost of the microturbine is supposed to be linear to the output volume to simplify the solution to economic optimization. Table 4.5 shows the cost parameters: operation and maintenance (short for OM), startup and shutdown (short for UD).

Table 4.5: Cost parameters. OM: operation and maintenance, UD: startup and shutdown [Moghaddam et al., 2011a].

Generator	ESS OM (cent EUR/kWh)		ESS UD (cent EUR)
Price	0.38		0
Generator	MT OM (cent EUR/kWh)		MT UD (cent EUR)
Price	$\eta_{1,MT}$	$\eta_{2,MT}$	0.96
	0.457	0.10	

#### 4.7.2/ DISPATCHING ALGORITHM COMPARISONS

Two scenarios are considered to validate the effectiveness of the proposed partial coordination strategy on promoting supply reliability and resilience. We use a selfish, self-sufficient control strategy for the reference scenario, where MGs do not coordinate with each other. If the demand and supply of an MG are not balanced, the MG sheds loads with the lowest priority or curtails power generation to maintain power balance. While in the scenario with coordination, the method proposed in this chapter is adopted and evaluated.

For the reference scenario, internal control results of MG3 (which includes no storage) are shown in figure 4.11. The blue line represents the photovoltaic generation. The red curve shows the microturbine output. The operating power of batteries is depicted by the green dash line, where the negative value means charging status and the positive value means discharging status. The output of each component is shown in 4.11a, the lack of power is shown in 4.11b. As there is no MG to absorb the surplus power or supply overload, load and generation shedding are applied to maintain system stability.

With coordinated control, the network operates as a storage unit to compensate MG power imbalances, as shown in figure 4.12. The power outputs of MG2, 3 and 4 are shown in 4.12a. According to figure 4.12b, the sum of the power flowing from MG2 and MG4 to MG3 is equal to the value of the MG3 request. Other MGs do not participate in the coordination, so their outputs are not shown. Coordination is thus achieved among MGs.



### 4.7.3/ GENERATION COST COMPARISON

To validate the economic profit of the proposed market coordination approach, a centralized control strategy in [Wang et al., 2016a] is adopted as the reference strategy. All the self-balanced MGs supply power to compensate for the insufficient power in the network and the trading power quantity is proportional to the MG flexibility. The selling bids of all the MGs are shown in figure 4.13a derived from equation (4.42). The prices of neighbor MGs in the market are demonstrated in figure 4.13b. The neighbors of MG3, i.e., MG2 and MG4, provide the necessary power assistance by bidding competition. During 4:40–6:00, MG3 demands power assistance to the system. The power selling price is determined by (4.42) to (4.50).

Power coordination results are shown in figure 4.14. Based on the price shown in figure 4.13, the proposed coordination strategy motivates MG3 to buy power from MG4, which is shown in figure 4.14b. For the reference strategy from [Faria et al., 2011], the MGs in the network output power as the power demands and the trading results are shown in figure 4.14a. The resulting costs are shown in table 4.6 by multiplying the price and the volume of trading power.

Table 4.6: Requester MG cost in EUR.

	12-MG	33-MG
Market coordination	299.4	299.4
Centralized control	1055.86	1923.43

Numerical results are summarized in table 4.6, which compares the cost of the requester MG controlled by the proposed coordination strategy (market coordination) and the reference strategy (centralized control) in the 12-MG and 33-MG systems. With the reference coordination strategy, the requester MG pays 1055.86 EUR for assistance power, which is significantly larger than 299.4 EUR with the proposed distributed market mechanism. The cost reduction is because the price of neighboring MG power is lower than the average rate of the system. Besides, the cost of facility startup or shutdown decreases when the trading is among fewer MGs. As the number of MGs increases to 33 in the system, the expense of the requester with the reference strategy increases promptly to 1923.43 EUR, which limits the coordination profit and thus decreases the scalability of the method. With the proposed distributed market strategy, the cost of the requester remains at 299.4 EUR. As the profit of the requester MG is guaranteed, and thus the system scalability is improved, the coordination control strategy is therefore profitable and scalable.

### 4.7.4/ ROBUSTNESS TEST

The power supply reliability and quality under fault or emergency conditions reflect the robustness of the control and impact the customer's comfort directly. Thus the system robustness could be evaluated through the volume of facility loss and customer comfort.

Numerical results are summarized in table 4.7, which includes the shed load (SL), the curtailed generation (CG), the trading cost (TC) and the exchanged power (EG) with the network, from the point-of-view of MG3. Results without (0) and with (1) coordination (CO) are compared. Without coordination, MG3 sheds 11.77 kWh of load and 85.28 kWh of generation over the day, as there is no power exchange possibility between MG3 and

the network. The corresponding exchange cost is zero. For the control with coordination, load shedding and curtailments are avoided. As neighbor MGs absorb the excess power of MG3, MG3 can thus generate a profit (i.e., a negative cost). The coordination between MGs helps solve the power imbalance. It improves the system resilience and maximizes the use of renewable energy. As the power demand from MG3 is satisfied by its local resources and the other MGs, the coordination control strategy achieves its objective. A further study on MG coordination with distributed MAS will focus on the comparison with the centralized method, which is lacking flexibility on MG scalability.

Table 4.7: Simulation results.

	SL (kWh)		CG (kWh)		TC (EUR)		EG (kWh)	
	0	1	0	1	0	1	0	1
CO	0	1	0	1	0	1	0	1
MG3	11.77	0	85.28	0	0	-16.74	0	97.05
MG2	0	0	0	0	0	3.834	0	33.17
MG4	0	0	0	0	0	-20.57	0	61.97

## 4.8/ CONCLUSION

This chapter has adopted a concept of partial coordination within the network. Corresponding control strategies are proposed for coordinating power flows among MGs, so that they can provide power support when necessary. One of these approaches combines consensus, power flow, and dispatching algorithms to achieve coordination of the different agents. Preliminary results of simulations with an IEEE 13-node network show that this strategy is feasible on MG coordination for emergency rescue, and can further improve the overall resilience of the system. Another economic control strategy is proposed for dispatching power among MGs to assist imbalanced MGs. The proposed approach establishes the distributed market and applies the decentralized power flow calculation to coordinate the output of MGs. Comparisons of simulation results with a centralized control show that the proposed approach maximizes the profit of the MGs and helps to improve the scalability of the system. Both approaches show that the coordination established between faulted MG and its neighbors could promote the supply reliability and scalability of the network based on the MAS. It increases power sources and loads for individual MG to resist faults and maintains the optimal internal operation. Additionally, the partial coordination group allows the algorithms of power dispatching for multiple objectives, such as economic benefits, environmental reasons, and so on. Simulation results and comparisons with the other control strategy have validated that the coordination strategies could promote reliability of supply without the impacts of system expansion while gaining economic benefits.

Even though the coordination with neighboring MGs improves control scalability, the assistant facility is limited compared with the one of the network scale. The cooperative power dispatching could be more economical with a more massive amount of elements if sources of less cost participate. For example, if the neighboring MGs could not supply sufficient power to the faulted MG, load shedding is unavoidable. Whereas a larger coordination area increases the transmission cost, variable number in the optimization problem, and time delay from communication. Thus a control strategy gaining a comprehensively good performance in terms of efficiency and economic benefits is demanding.

The expansion of coordination groups is necessary, which will be studied in the next chapter.

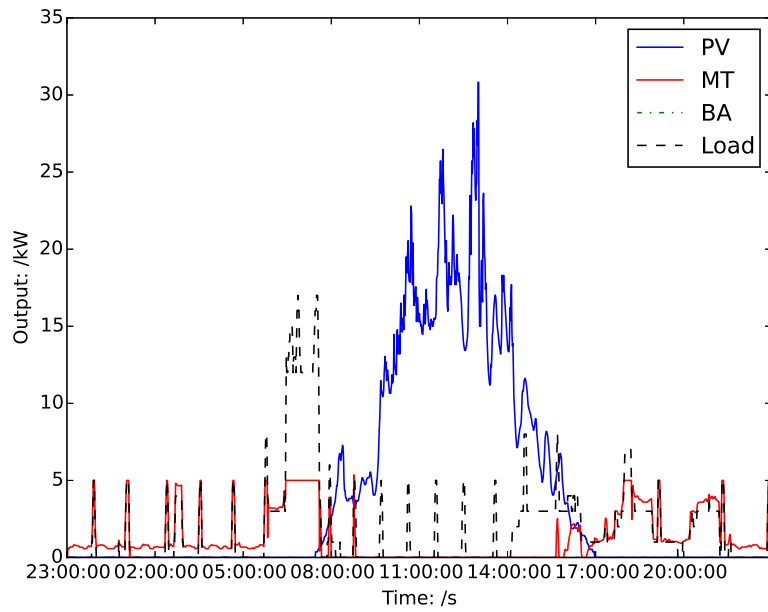

(a) Local resources output.

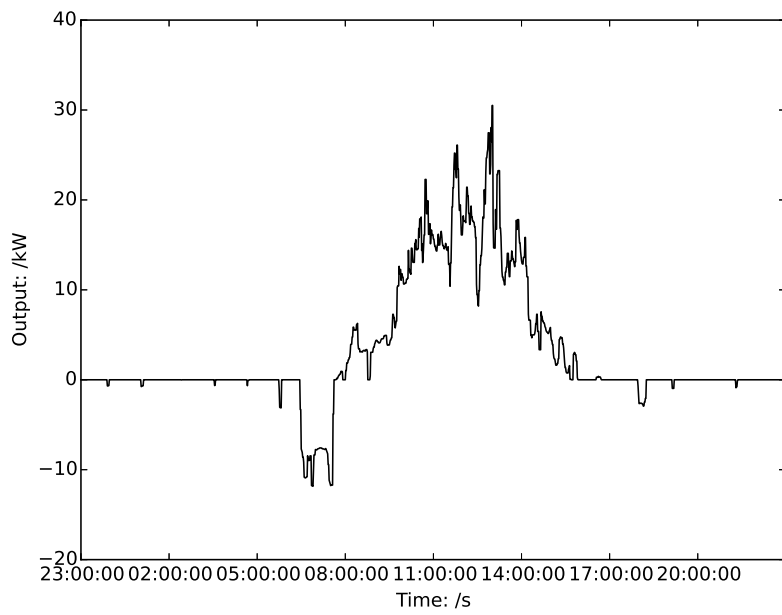

(b) Power deficiency.

Figure 4.11: Bidding prices of the MGs.

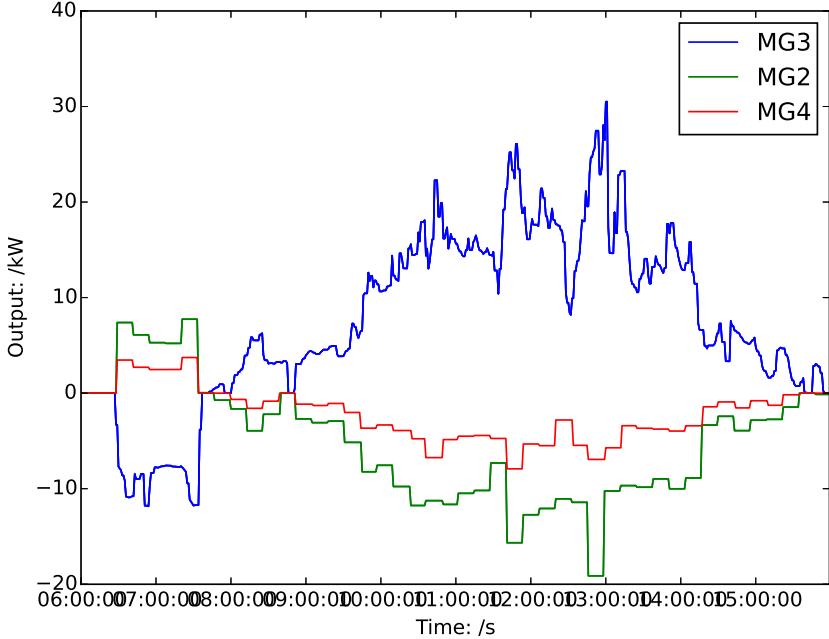

(a) MG coordinating power.

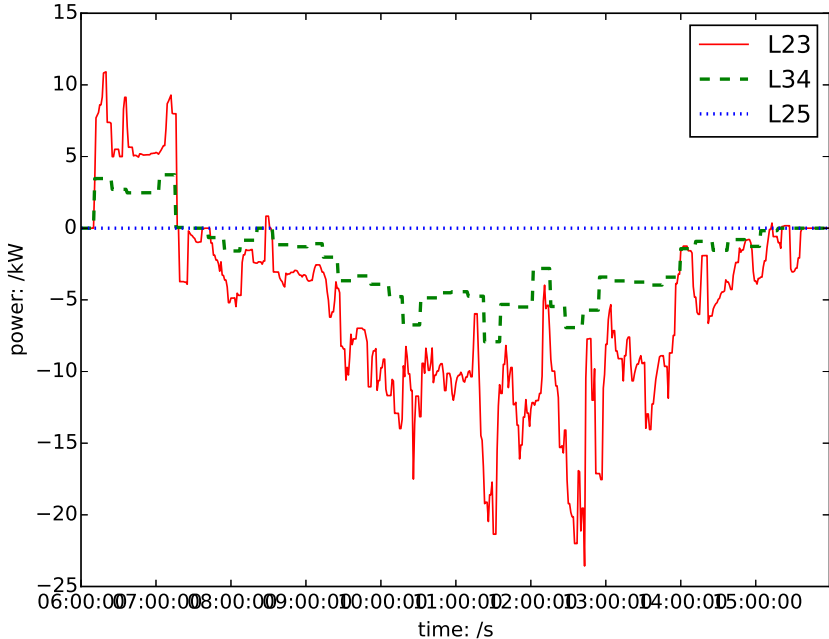

(b) Line power flows.

Figure 4.12: Coordination results for MG3.

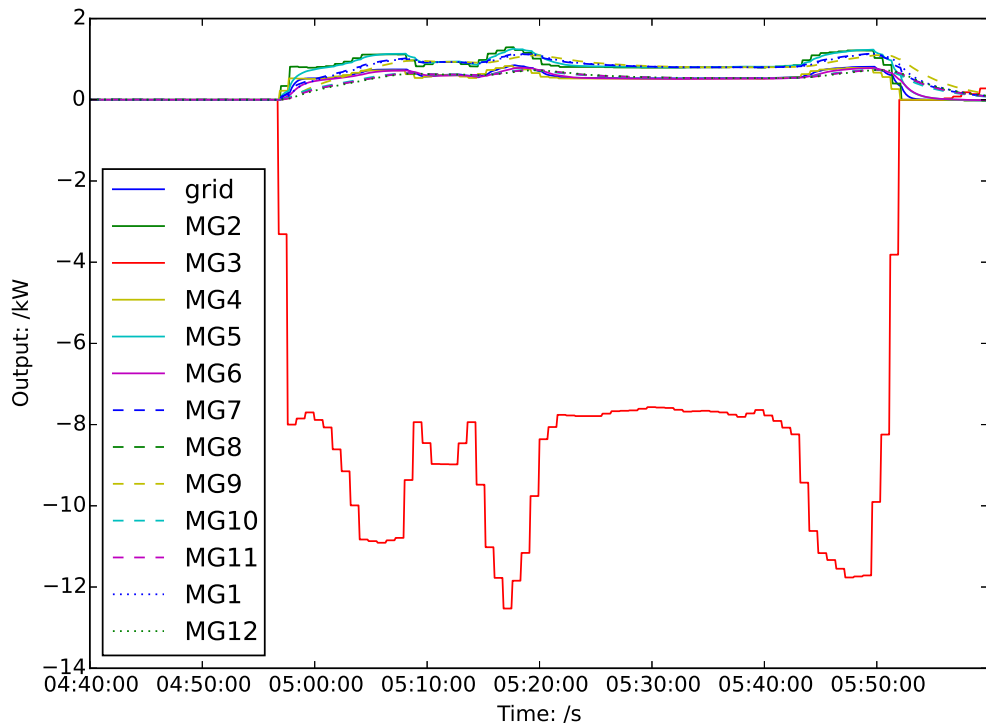

(a) Prices for all MGs.

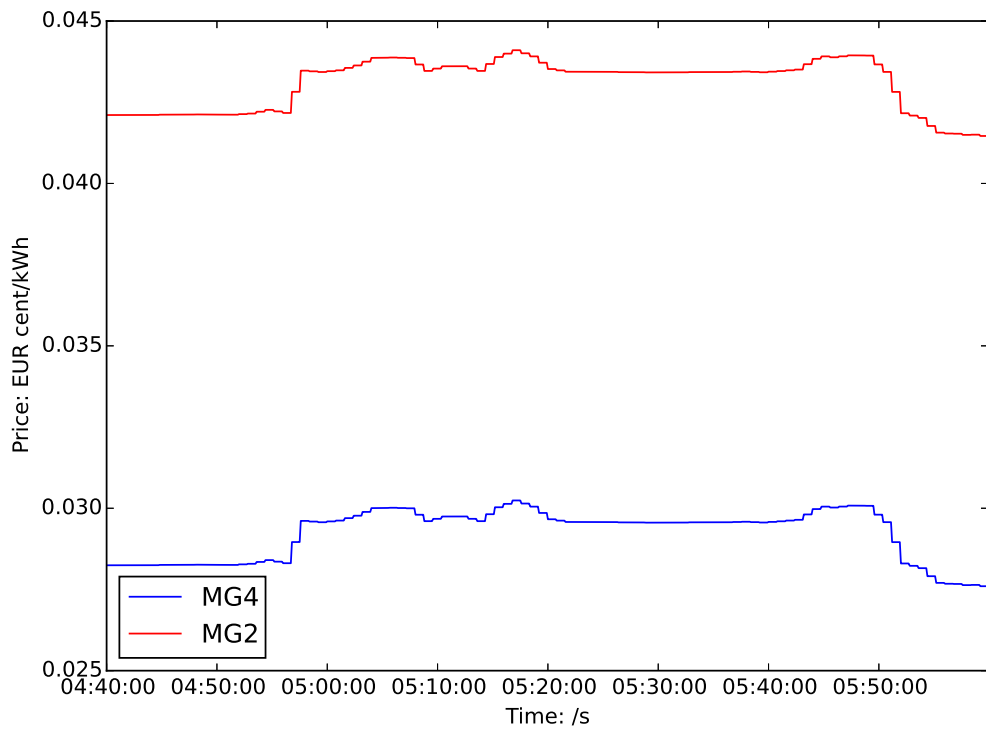

(b) Prices of neighboring MGs.

Figure 4.13: Bidding prices of the MGs.

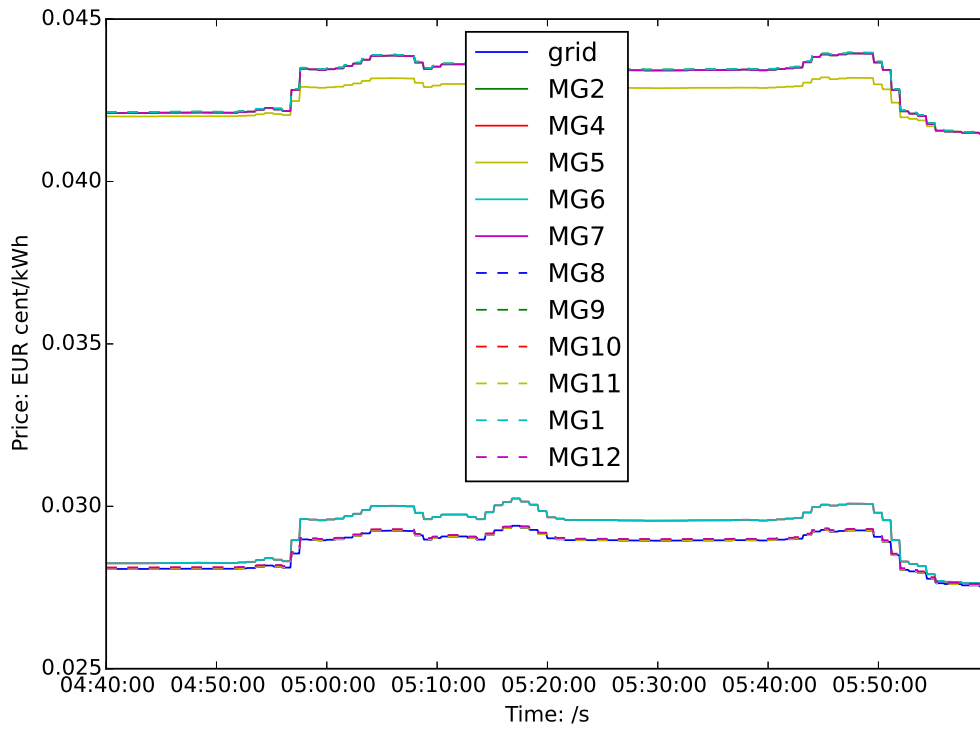

(a) Under centralized control.

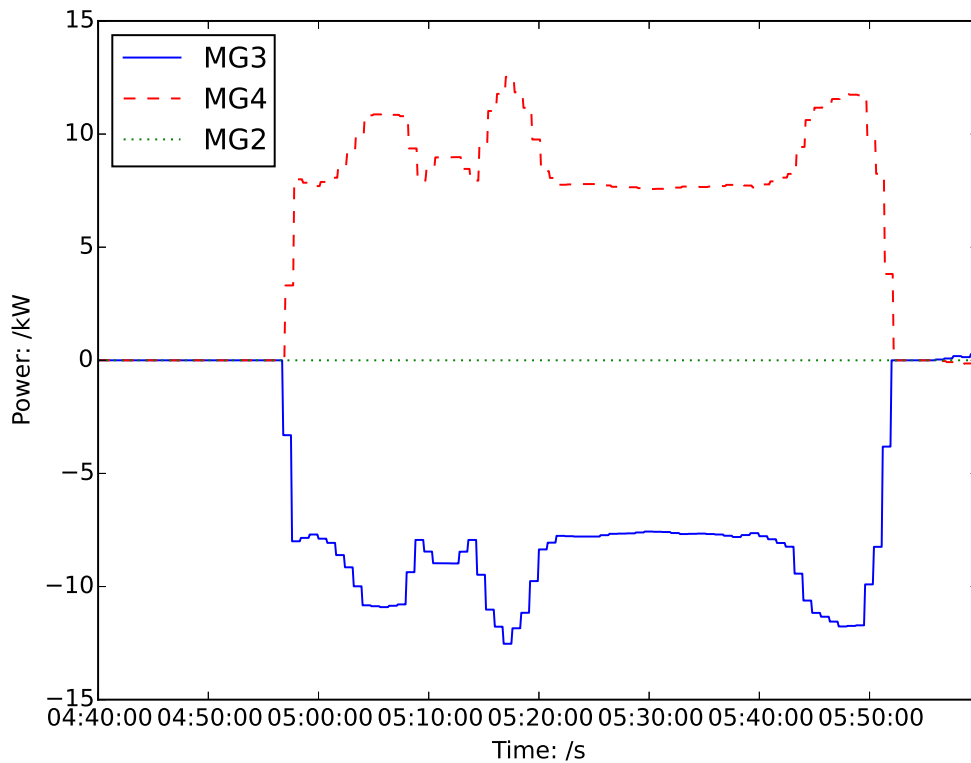

(b) Under decentralized control.

Figure 4.14: Coordination power for MG3.

## MULTI-AGENT BASED COORDINATION WITHIN SELECTED MICROGRID AREA

### 5.1/ DEMAND-SUPPLY BALANCE FOR THE ECONOMIC POWER DISPATCHING IN NETWORK

In chapter 4, approaches for the coordination with neighboring MGs are proposed, which increase the reliability of load supply and generation utilization in an economic way. Additionally, such a partial cooperative area enables the scalability of the network by negotiating merely with the directly connected MGs. However, each MG could provide a low capacity to support load outside after supplying local ones. For the faulted MGs at the terminal of the distribution network, the available assistant energy is even less. Besides, more elements are existing outside the neighbors which could provide more candidate dispatching options economically. On the other hand, more MGs bring more calculation pressure to the computational entity and an increasement in the communication link. They cause longer delays for reaction, which worsens the control efficiency or even disables it. Thus the trade-off between practical achievement and optimization quality is presented for the coordination area selection. To improve the performance of MG coordination in terms of load demand, economic purpose, and emission concern, related problems are listed as follows:

- 1) By what criteria to select the constituent MGs to consist of the coordination area. As the composing MGs contributes to the coordination area according to the functions and capacity of including elements and their share in this area, selecting MGs should consider the individual characteristics and the impacts on the MG group. Formulating both perspectives is necessary.
- 2) How to dispatch power within the coordination area to take full advantage of all the participants. As the MGs are selected by estimating the combination features of all the participated MGs, the power dispatching among MGs should be detailed to the devices level. Related approaches for it relying on the MAS is required.

Based on the MAS and communication connection designed in section 4.4.2, this chapter proposes a distributed control structure for MG network coordination based on MAS to improve the supply reliability, resilience to the faults, scalability, and real-time economic profit. The power assistance is provided by the other MGs to compensate for the power



imbalance within MG. The control structure contains a) selecting MGs to form a coordination area (CA), b) power dispatch among elements in CA. a) delimits an area in which all the MGs provide power assistance to the faulted MG. It minimizes the participation elements with sufficient assistant power for compensating the imbalance, high profit, and low greenhouse gas emission. Based on the neighboring communication, the coordination cluster extends by adding new directly connected MGs iteratively in this chapter. A decentralized evolutionary algorithm is applied based on MAS to accelerate the selection speed. Power dispatching is achieved in CA by controlling internal elements literally. The optimization objective is to minimize generation costs in real-time. The renewable generation possesses the operation priority to reduce carbon emission. The microturbines and energy storage systems are thus controlled to compensate for the power imbalance. The performance of the proposed approach is tested on the simulation of systems consisting of 13 MGs and 34 MGs correspondingly.

## 5.2/ HOLONIC MAS

The holonic MAS represents a hierarchical structure that the agent at a higher level is composed of multiple agents at a lower level [Rodriguez et al., 2006]. In the MG network, the components in the lowest layer of holon are the electrical elements. They form the second holon of MGs, which further aggregate to establish the coordination group. The top layer of a holon is in charge of distributing power among elements to eliminate the imbalance in the faulted MG. Such construction allows the flexibility of coordination group formation in the network. The three levels are thus defined for distinguishing the responsibilities and behavior management. They include social rules describing the interactions among bottom facility, coordinating rules identifying the agreement between holons at the same level, and individual rules stating actions generally undertaken in well-defined situations [Adam et al., 2000].

Coordinating neighboring MGs enlarges the involved facility and increases the power flexibility to enforce the reliability of individual MG. This method avoids the dependency on global information and manages partial MGs during coordination. To further improve the reliability of load supply and find more economic power dispatching alternatives, the coordination group expands by rejoining more MGs. To optimize the economic power dispatching, the control within CA ignores the blocks of MG and coordinates all the internal elements in an all-in-one formulation to reduce the generation cost. This problem is solved centrally by the agent assigned to the faulted MG. Comparing with the coordination which treats the MG as an integrated entity with an approximated feature for the cluster of internal elements, this method considers the characteristics of all the elements individually. The central controller sends the facility operating commands to the assistant agents and they run the elements directly. When a coordination cycle finishes, the CA is dismissed and all the MGs reunion to the optimization group in the next time step if there is still a fault. Agents cooperate with initiative intension and authorize a common controller for the CA dispatching. Such a hierarchical structure could be described by holonic MAS.

Under the holonic structure, the coordination control is divided into two stages: MG selection for the coordination area and power dispatching within this area. Considering the large scale of the candidate CA options, the algorithm for CA optimization is solved by the combinational calculation in all the network agents. Then the power dispatching in CA is

solved by a centralized method.

### 5.3/ CONTROL STRATEGY PROCESS OF PROPOSED STRATEGY

An example MG clustered system based on the IEEE 13-node network is shown in figure 5.1, which contains 13 MGs (MG1 replaces the grid in figure 4.1 to participate in the coordination). An agent is assigned to each MG. The control framework is shown in figure 5.2, where each agent controls the operation of the assigned components and negotiates with neighbor agents. An MG can include distributed energy sources (DERs) and loads. We study the DERs, including PV, WT, MT and battery. The MG studied in this chapter is shown in figure 5.2 (adding WTs to complement the renewable sources of figure 3.2 and the test MG in chapter 4).

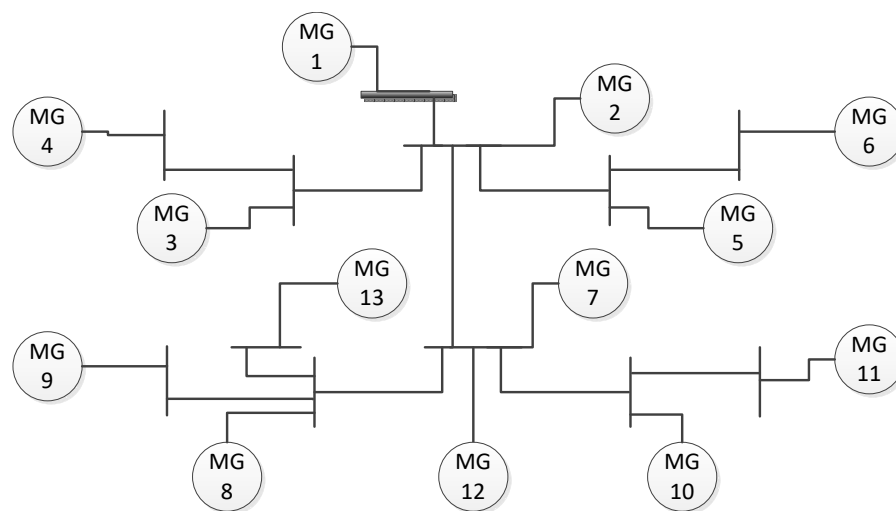

Figure 5.1: Studied 13-MG System.

For the coordination demand, it is assumed that agents can communicate with the neighboring agent (i.e., the assigned MGs are connected physically) in the system. They communicate with each other to store the MG output characteristics in the network. These features include flexibility (i.e., the maximal output and input power of an MG), generation cost, and element numbers. These data are used for selecting CA. It will be further described in section 5.3.2.

#### 5.3.1/ COORDINATION PROCESS

Each agent collects the operation status of their components, including run/stop, load value, and output power. Once the communication connection is established, the approach for power dispatching can be achieved based on the MAS. The optimization objectives include maximizing the profit, minimizing calculation time with low emission in case of faults. The control strategy is shown in figure 5.3. It represents the MG control process with three operations under network faults: keeping self-control, demanding for and providing assistant power.

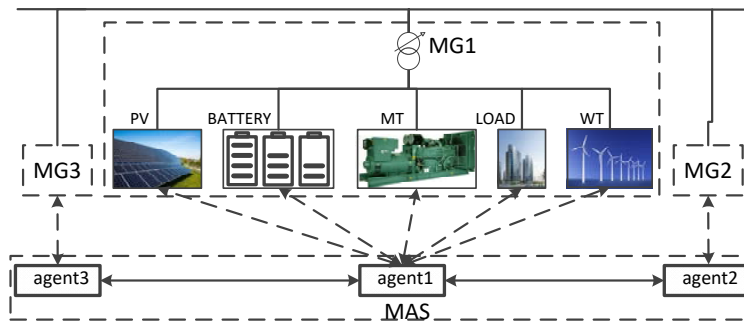

Figure 5.2: Part of the Communication Network for the Studied Network.

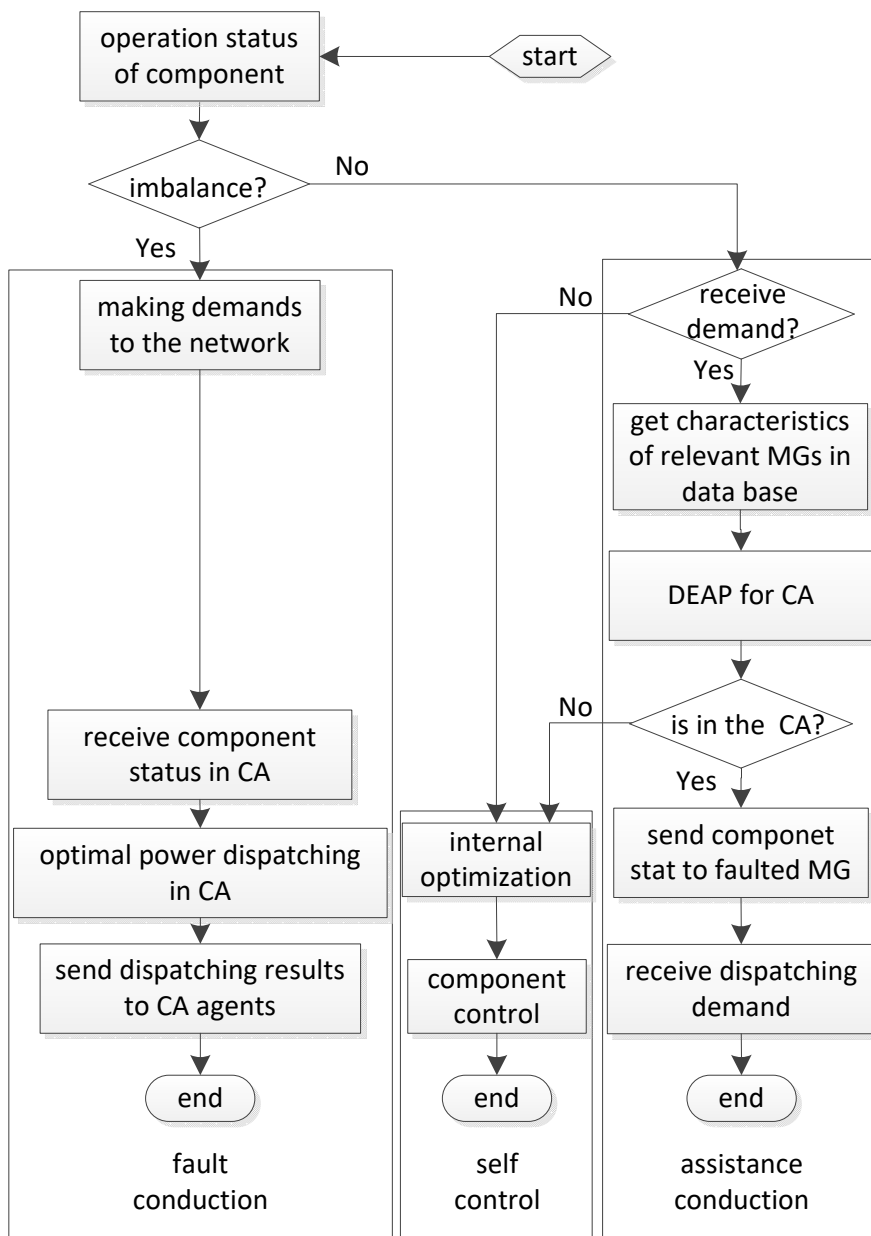

Figure 5.3: The Control Strategy for Cooperation.

When the power imbalance happens in an MG, the assigned agent sends out power demand to the network. Other agents assigned to balanced MGs start to calculate the optimal CA with the distributed evolutionary algorithm programming (DEAP) based on the variables representing MG characteristics [Stypka et al., 2018]. The agent of the database shares the stored information with each agent when the optimization algorithm is achieved. The objective is to find the optimal CA based on equation ( 5.6). The agent evaluates the overall characteristics of the MG groups. With DEAP, every MG agent deals with a subpopulation, and the derived optimal individuals migrate in a constant probability among agents. Once CA is decided, the power dispatching is achieved within it. The agent assigned to the faulted MG collects the internal element's operation status from selected agents, including running/stop status, output power, load value, and the corresponding cost. Based on this, it behaves as the central controller of CA and the internal MGs are reconfigured as a new grid. According to the collected information, the optimal solution for the dispatching is sent to each coordination agent for operating elements. For the MGs without participating coordination, they run the self-optimization control based on ( 5.9) to ( 5.10), and it is solved by quadratic programming in Gurobi.

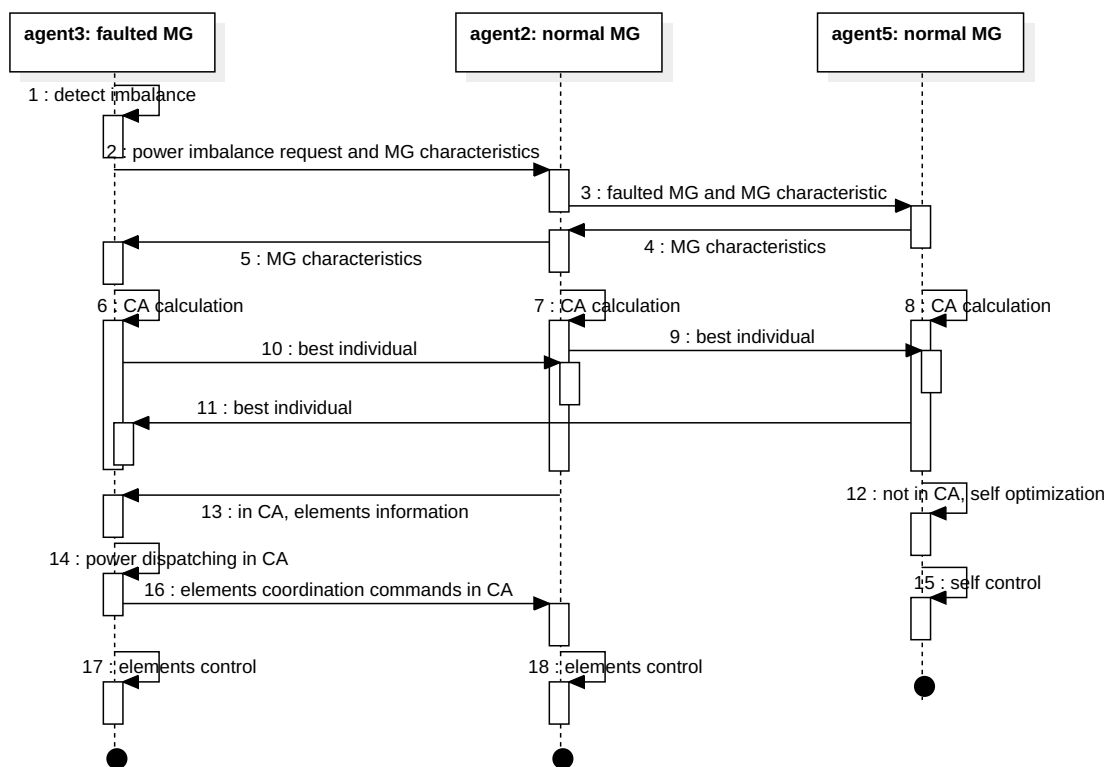

Figure 5.4: The Communication Diagram for Cooperation.

The communication diagram is shown in figure 5.4. To calculate the CA, each agent gain characteristics of other MGs by communicating with neighbor agents based on the average consensus algorithm introduced in paper [Wei et al., 2017]. A distributed evolutionary algorithm is applied in agents, and the best individuals are transferred between agents to get a globally optimal solution. Once the CA is determined, the internal agents communicate for sending elements information to agent3 to solve the optimization problem in equation ( 5.9) and control the operation of components according to the dispatching

solution. Simultaneously the MGs outside of CA operate for internal balance.

### 5.3.2/ COORDINATING MICROGRID SELECTION

MG selection aims at establishing a CA, where all the elements participate in the power dispatching process to maintain balance. All the agents in CA upload operation information of the assigned elements to the faulted agent. The agents which do not participate in it quit negotiating with others to keep the information privacy of the elements in CA. Thus agents between faulted MG and the edge MGs of CA should be included in the coordination area. This construction could prevent them from quitting information exchange and stop the information collection for power dispatching. Power coordination among CA can expand the collaboration components to ensure sufficient power supply. It also provides a faster and profitable solution for power dispatching with importing generators and storage elements. The power dispatching is optimized in CA than in single MG [Nunna et al., 2013]. Additionally, it improves the network scalability by solving the power dispatching under fault in part of the network rather than in the network and isolate the fault in CA. The main objective in the first step is to determine the coordination area possessing minimal generation cost, fast control speed and high use of renewable source. For the group, the formulations, which could approximately reflect the relationships between elements and the optimization objectives, are as follows:

$$r_{MT}^{CA} = \frac{\sum_{i \in T_{MT}^{CA}} p_{MT,max}^i}{\sum_{i \in T_{WT}^{CA}} p_{out,WT}^i + \sum_{i \in T_{PV}^{CA}} p_{out,PV}^i + \sum_{i \in T_{MT}^{CA}} p_{MT,max}^i + \sum_{i \in T_{Bat}^{CA}} p_{maxdisch\ arg\ e, Bat}^i} \quad (5.1)$$

$$c_{average}^{CA} = \frac{\sum_{k \in CA} \mu_{max}^k}{\sum_{i \in T_{WT}^{CA}} p_{out,WT}^i + \sum_{i \in T_{PV}^{CA}} p_{out,PV}^i + \sum_{i \in T_{MT}^{CA}} p_{MT,max}^i + \sum_{i \in T_{Bat}^{CA}} p_{maxdisch\ arg\ e, Bat}^i} \quad (5.2)$$

$$c_{average}^{fault} = \frac{\mu_{max}^{fault}}{\sum_{i \in T_{WT}^{CA}} p_{out,WT}^i + \sum_{i \in T_{PV}^{CA}} p_{out,PV}^i + \sum_{i \in T_{MT}^{CA}} p_{MT,max}^i + \sum_{i \in T_{Bat}^{CA}} p_{maxdisch\ arg\ e, Bat}^i} \quad (5.3)$$

$$r_{cost}^{CA} = \frac{c_{average}^{CA}}{c_{average}^{fault}} \quad (5.4)$$

$$r_{speed}^{CA} = \frac{2^{(N_{MT}^{CA} + N_{Bat}^{CA})}}{2^{(N_{MT}^{Net} + N_{Bat}^{Net})}} \quad (5.5)$$

Where the  $T_{WT}^{CA}$ ,  $T_{PV}^{CA}$ ,  $T_{MT}^{CA}$ ,  $T_{Bat}^{CA}$  are the collections of wind turbine, photovoltaic generator, micro turbine and battery within CA.  $N_{MT}^{CA}$ ,  $N_{Bat}^{CA}$  are the numbers of micro turbine and battery within CA.  $N_{MT}^{Net}$ ,  $N_{Bat}^{Net}$  are the numbers of micro turbine and battery in network.

Formulation ( 5.1) is the ratio of fossil fuel energy to the total energy in CA. The power value corresponds to the maximal output of each power source. Formulation ( 5.2) is the average cost per unit generation under maximal output and ( 5.3) is the average cost per unit generation in faulted MG. Because renewable generators rely on renewable energy,

such as solar and wind, there is no marginal cost. Their start-up and the shut-down cost is zero due to electrical converters. ( 5.4) is applied to evaluate the generation cost per unit of power in CA at each time step. The CA, with a lower value, represents that the generation cost is more profitable. The calculation time is represented in ( 5.5). It influences the time needed to solve the optimal power dispatching problem in CA as the output and operation status (running or stop) of battery and MT are the command variables. Power dispatching applied a genetic algorithm in which the gene corresponds to the operation status of MT. There are combinations. Thus reducing the number of combinations can reduce the searching population of GA and calculation time. This algorithm will be introduced in section 5.3. The optimization formulation in the first step is shown in ( 5.6) with the constraints in ( 5.7) and ( 5.8):

$$\varepsilon = \min(\eta_1^{CA} r_{MT}^{CA} + \eta_2^{CA} r_{cost}^{CA} + \eta_3^{CA} r_{speed}^{CA}) \quad (5.6)$$

s.t.:

$$\eta_1^{CA} + \eta_2^{CA} + \eta_3^{CA} = 1 \quad (5.7)$$

$$\sum_{i \in T_{WT}^{CA}} P_{out,WT}^i + \sum_{i \in T_{PV}^{CA}} P_{out,PV}^i + \sum_{i \in T_{MT}^{CA}} P_{MT,max}^i + \sum_{i \in T_{Bat}^{CA}} P_{maxdisch, arg e, Bat}^i \geq \sum_{i \in T_L^{CA}} P_L^i \quad (5.8)$$

$\eta_1^{CA}$ ,  $\eta_2^{CA}$ ,  $\eta_3^{CA}$  are the weights of each optimization objective correspondingly as shown in ( 5.6) with the values of 0.2, 0.5, 0.3 relatively. Their values are determined according to the priority of the objectives. As the economic power dispatching is the objective for the optimization in the second-stage, it weighs most. The calculation speed comes second because the MG number impacts the scale of the collecting information in the next stage. The share of renewable energy is ranked at last as the intermittent generation cannot comply with the load requirement and the dispatchable resource is necessary for maintaining power balance. Constraint ( 5.8) demonstrates that the sources in CA must supply enough power to the load so that the imbalance caused by fault can be compensated.

### 5.3.3/ POWER DISPATCHING

After the CA is determined, the power dispatching in the area is achieved by the agent of faulted MG. Equation ( 5.5) has a constant value in a certain CA. Renewable generation is the prime source to reduce emission and cost, while MT and batteries operate as auxiliary sources to keep power balance as their stable and controllable output. Thus during the second step of coordination, the control objective is to minimize simply the generation cost by dispatching power among distributable sources. The formulation is shown in ( 5.9) with the constraint in ( 5.10):

$$\mu^{CA} = \min(\mu_{MT}^{CA} + \mu_{Bat}^{CA}) \quad (5.9)$$

s.t.:

$$\sum_{i \in T_{WT}^{CA}} P_{out,WT}^i + \sum_{i \in T_{PV}^{CA}} P_{out,PV}^i + \sum_{i \in T_{MT}^{CA}} P_{out,MT}^i + \sum_{i \in T_{Bat}^{CA}} P_{disch,Bat}^i = \sum_{i \in T_L^{CA}} P_L^i + \sum_{i \in T_{Bat}^{CA}} P_{ch,Bat}^i \quad (5.10)$$

Equation ( 5.9) presents the optimization formulation, which is to minimize generation cost in CA. The first and second items are the costs of all the microturbine and battery in CA. As the main concern of the battery system is the aging depending on fully charging/discharging cycles, the operation cost model is implemented as equation ( 4.12) shown in [Mutoh et al., 2006]. As for the generation cost model of microturbine, it is shown in equation ( 4.7). Equation ( 5.10) is the power balance constraints in CA. The facility constraints ( 4.1) to ( 4.11) in chapter 4 are also included in the constraints for the optimization. As the sufficient supply is guaranteed in constraint ( 5.8) belonging to the previous stage (i.e., CA determination), the power balance is maintained by the power dispatching among distributable sources. This is similar to the MG internal optimization under normal conditions. The difference between both methods is the operation procedure: the dispatching decision is made by the central controller (i.e., agent of faulted MG) and operated by the local agent in CA, while the optimization is solved and achieved all by the assigned agent in individual MG.

#### 5.3.4/ DISTRIBUTED EVOLUTIONARY ALGORITHMS WITH DEPTH-FIRST SEARCH (DFS)

As the scale of CA expands, and the elements involving in the coordination increase abundantly, the calculation pressure resulting from optimizing power dispatching is the main challenge for centralized control. The distributed MAS relies on communication to chase global goals, which is incompatible with the central controller given the single-point failure. Thus a decentralized control method is crucial in reducing the calculation complexity and fulfilling the advantages of distributed agents of high intelligence and automation. With multiple agents existing in the system, DEAP in paper [Stypka et al., 2018] is adopted to reduce calculation pressure and further improve the network scalability. Decentralized optimization among multi-agent system reduces the expensive cost on the computation of large population and the distributed machine is fully used [Sarma et al., 1998, Starkweather et al., 1990, Cantú-Paz, 1998]. Additionally, the limitation on communication and perception to the changing operation of elements is minimized [Stypka et al., 2018, Cantú-Paz, 1998, Arpaia et al., 2014, Agah et al., 1996]. For solving problem ( 5.6) to get CA, DEAP is achieved in system agents synchronically and each agent optimizes the subpopulation in which every individual corresponds to an area formed by connecting MGs. An agent generates subpopulation by assigning the matching MG as an edge of the CA and involving the faulted MG. As figure 5.6 shows, the population in network is shown in ( 5.11).

$$\left[ \begin{array}{cccccccccccc} x & x & x & x & x & x & x & x & x & x & x & x \end{array} \right] \quad (5.11)$$

where 'x' is the gene value which could be 0 or 1, showing outside or inside CA. Its position in the array corresponds to the MG with the same number. The individual is set by assigning 0 or 1 to each x in ( 5.11). For agent 6 (controlling MG6), the subpopulation is limited as ( 5.12):

$$\left[ \begin{array}{cccccccccccc} x & 1 & 1 & x & 1 & 1 & x & x & x & x & x & x \end{array} \right] \quad (5.12)$$

Taking MG6 as the terminal of CA, the MGs between MG3 and MG6 should be involved in CA according to section 4.1. Thus the items corresponding to MG2 and MG5 are as-



signed to 1. The individual is set by assigning values to the left 'x,' whose value represents whether the assigned MG joins the coordination group.

The CA selection is based on the electrical connection. Thus there should be a mathematical formulation to represent the network construction. Agents must identify a potential CA. The DFS is therefore adopted to describe the radial network due to its fast speed in discovering the shortest routine to the faulted MG. As the CA is shaped by the edge MG and faulted MG, the mediate MGs between them are searched by DFS. Starting from an arbitrary MG, it explores the network as far as possible along each branch in the system before backtracking. Based on the graph theory, the network is transferred into a tree with distribution lines as paths, and the vertices are the points where the MGs access to the system. The MGs between edges and faulted MG are found by searching their lowest common ancestor [Korf, 1985].

## 5.4/ SIMULATION RESULTS

Table 5.1: MG elements parameters in 13-MG system.

MG	MG1	MG2	MG3	MG4	MG5	MG6	MG7
PV (cases 1-2)	5	5	5	5	5	5	5
WT (cases 1-2)	5	5	5	5	5	5	5
Battery (cases 1-2)	10	15	0	10	15	10	15
MT (case 1)	0	0	1	0	0	0	0
MT (case 2)	2	2	1	3	1	1	1
$C_{MT}$ (EUR/kW)	0.4562	0.4569	0.4576	0.4583	0.4590	0.4597	0.4604
MG	MG8	MG9	MG10	MG11	MG12	MG13	
PV (cases 1-2)	5	5	5	5	5	5	
WT (cases 1-2)	5	5	5	5	5	5	
Battery (cases 1-2)	10	15	10	10	10	10	
MT (case 1)	0	0	0	0	0	0	
MT (case 2)	2	2	1	1	1	2	
$C_{MT}$ (EUR/kW)	0.4611	0.4618	0.4625	0.4632	0.4639	0.4646	

The proposed approach is tested on 13-MG and 34-MG systems. 13-MG system is shown in figure 4.1 [Dufo-Lopez et al., 2007]. The corresponding facility simulation parameters are summarized in table 5.1 to table 5.3. Python 2.7 is the simulation platform, and it is installed on a desktop under Microsoft Windows 10. The processor is Intel Core i7-4770 3.4GHz 8GB RAM. Load information is adapted from the power consumption of an actual building at UBFC in Belfort, France. The simulation for 24 hours is performed, and the fault happens during 6:25 to 7:25 a.m. to MG3. Its battery suffers an outage and figure 5.5a shows the generation curves under maximal output for each generator, as well as load curve. The total supply within MG3 cannot meet the load demand, and the corresponding lack of power is shown in figure 5.5b. Negative values mean the insufficiency of power.



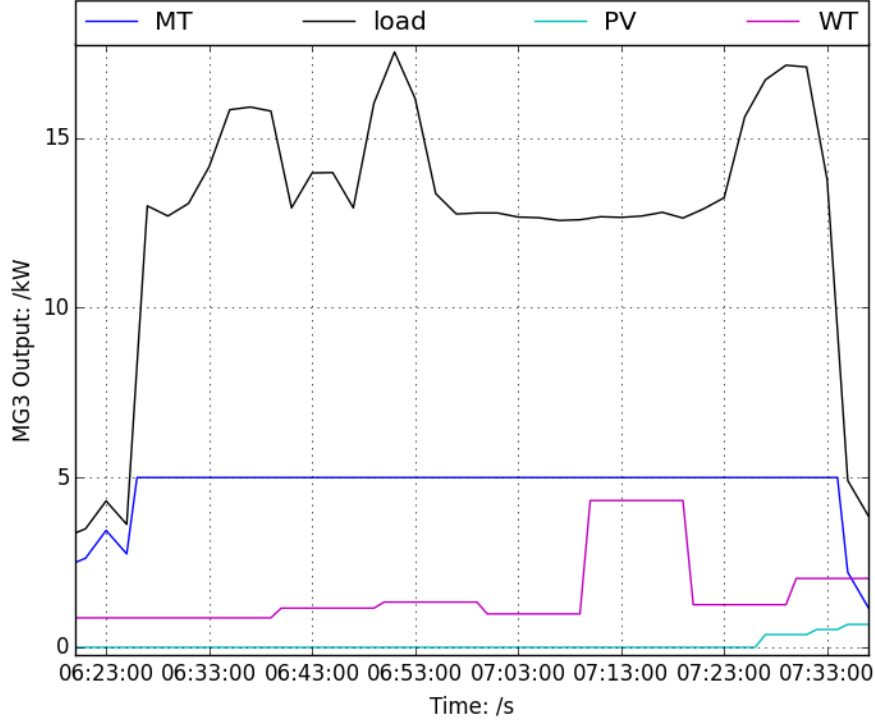

(a) Elements operation status

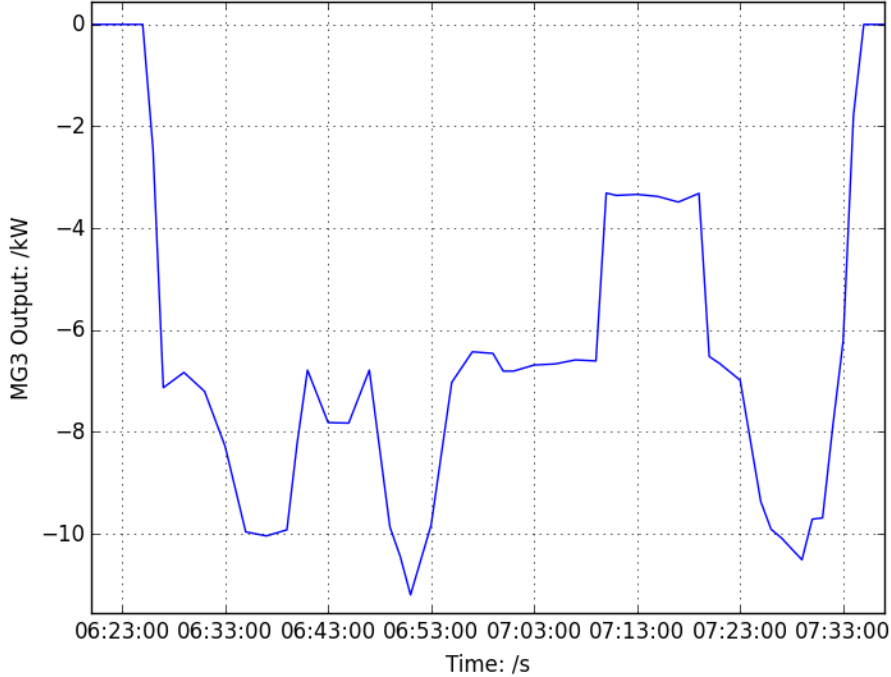

(b) Deficient power of MG3

Figure 5.5: Facility operation status in MG3.

To evaluate the proposed approach, we compare it with centralized control, a market

Table 5.2: Rated power of elements.

Power	PV	Battery	WT	MT
$P_{max}$ (kW)	8	10	10	5
$P_{min}$ (kW)	0	-10	0	0.5

method, and quadratic programming in Gurobi in 3 cases. Case 1 and case 2 both are tested on a 13-MG system. Case 3 is tested on a 34-MG network. Faults in 3 cases happen on MG3 as shown in figure 4.1 and figure 5.13. For simply testing the efficiency of the proposed approach in case 1, only one MT is involved in MG3 as the single dispatchable sources. The other MGs do not include the MT. In case 2, all the MGs include more than one MTs, which is used to show the impacts of the increasing number of MT on the coordination control. The results demonstrate that the generation cost and calculation time of dispatching algorithms are also influenced. In case 3, the MT is involved in each MG, and the network is expanded to 34 MGs to test the scalability of the proposed approach by comparing it with the other 2 cases. The summary of the results in 3 cases is shown in table 5.4.

Table 5.3: Other element parameters.

$\eta_1^{CA}$	$\eta_2^{CA}$	$\eta_3^{CA}$	$V_{ess,max}$
0.3	0.3	4	466.8 kWh
$\pi_{inv}$	$\beta_b$	$N_{bat}$	$\delta_{MT}$
470 EUR/kWh	0.95	2000	0.96 EUR
$V_{ess,min}$	$\Delta t$	$O_{ess,cost}$	
2100.6 kWh	1 s	0.38 EUR/kW	

#### 5.4.1/ CASE 1

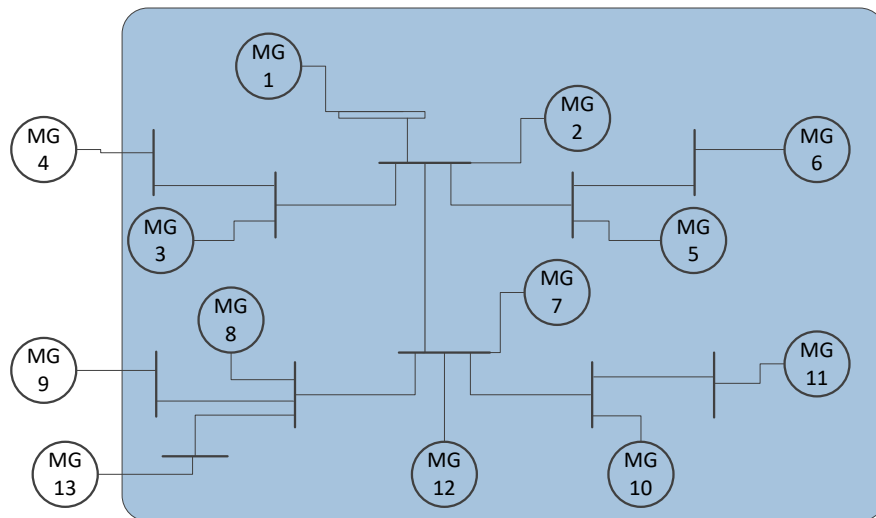
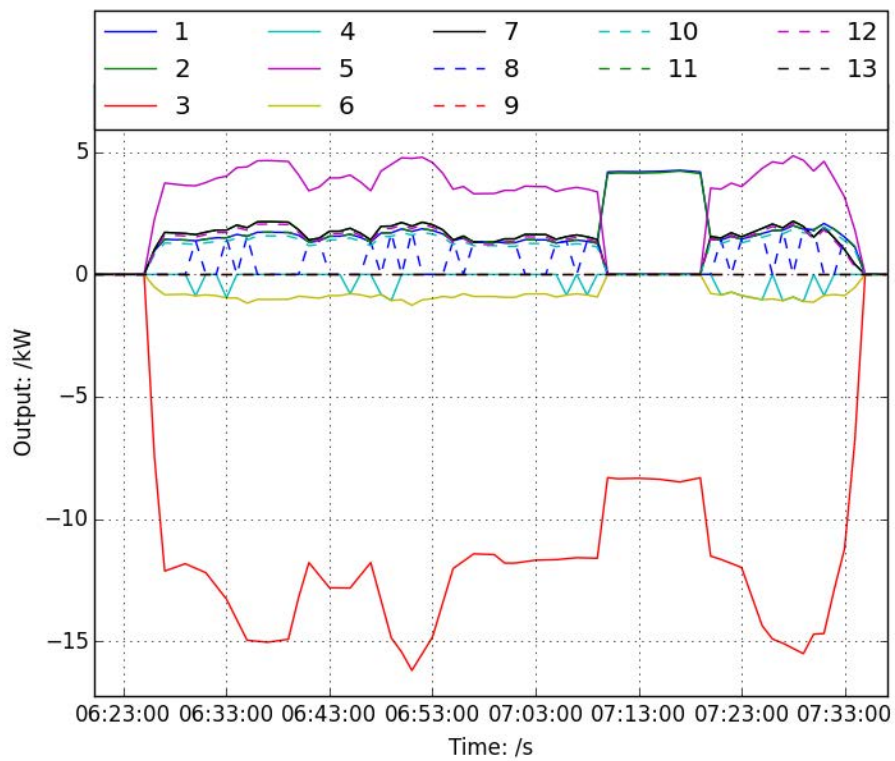

Figure 5.6: Coordination Group Formed in Proposed Approach.

With the proposed approach, the CA formed at 6:58, and it includes 10 MGs in the blue square, as shown in figure 5.6. The comparison algorithm is a centralized method for power dispatching. An agent controls all the elements in the network based on the optimization problem (5.9) to (5.11). A power dispatching in the market is applied as well. It builds an electricity market for MG trading power in the network, where each MG bids its maximal price. It is the average generation cost under the maximal output. The faulted MG buys power from the MG with the lowest price iteratively until the imbalance is compensated [Wei et al., 2018]. Results with different methods are shown in the following. The red curve with a negative value in figures represents the output of MG3. Negative value shows that an MG provides power to compensate for the imbalance.

Figure 5.7a shows the coordination result with the proposed strategy. Herein, the power dispatching is solved by quadratic programming in Gurobi. The CA in this method consists of part of the network. Figure 5.7b shows the power coordination results derived from the centralized-controlled system. Then the trading results in the electricity market for all the MGs are presented in 5.7c. The three methods are short for QP (quadratic programming), CS (centralized strategy), and MK (market). Comparing the input power of MG3 in three figures, the one in figure 5.7c is higher than the one in figure 5.7b by 5kW, which is the maximal output of MT. The total load of MG3 shown in figure 5.5a is supplied by the generation from coordination MG with QP and CS. While with MK, MG3 buys energy from the network to compensate for the internal insufficiency shown in figure 5.5b. The fluctuation of MG output power in figures 5.7a and 5.7c is caused by the change of assistant MG. The renewable generation and the start-up/shut-down of MT change the  $\varepsilon$  of each CA in equation (5.6), as well as the bidding price of each MG. Thus the construction of optimal CA is dynamic and the participants are reselected at each step just before the economical power dispatching. When the previous support MG is replaced by a new one, their interaction power with the network has a fluctuation. Similarly, the switch of trading MG will also cause sharp fluctuations in the new-in and new-out MGs.

The lines depicting generation cost under three approaches are shown in figure 5.9. As the MGs consisting of low-cost generators are included in the CA, its expense has no significant difference with the one gotten from centralized control. They are lower than the cost from the market at a maximum of near 6.25% from 7:10 to 7:20. The extra payment is caused by the MT generation as it spends more than the battery per kW. From the curve of MG3 input power shown in figure 5.7, in the market trading, the faulted MG maximizes the internal generation to minimize the internal insufficiency. Then the remaining demand-supply gap is compensated by trading with the network. MTs spend more than batteries for per unit generation. In this case, MG3 includes one MT which will operate during coordination under market trading, while it stops in the other two methods. Thus the faulted MG costs more with the market method.



(a) with QP.

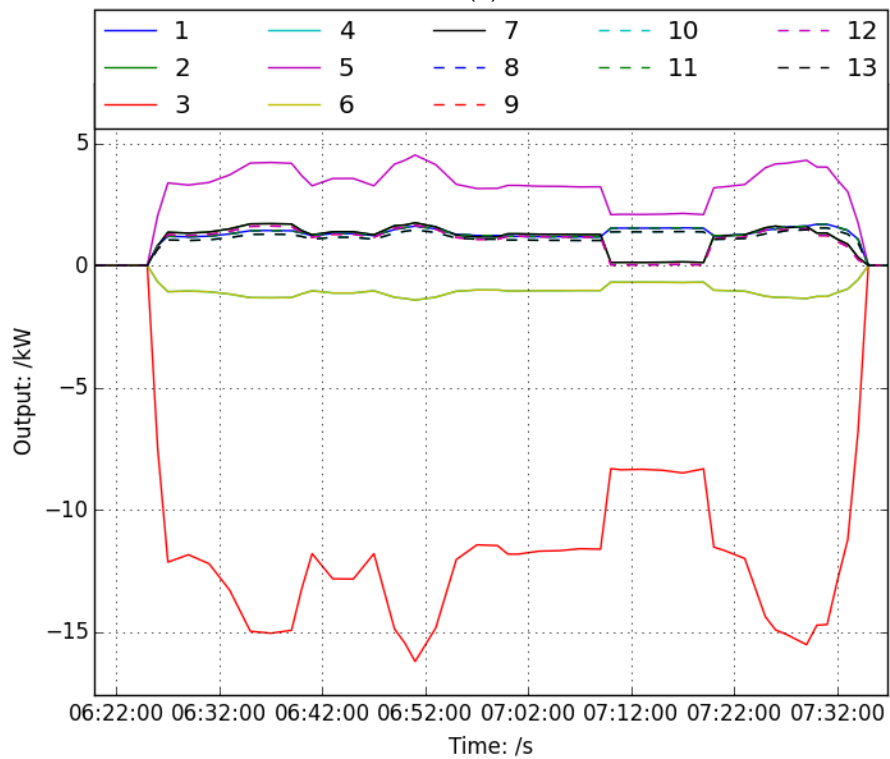

(b) with CS.

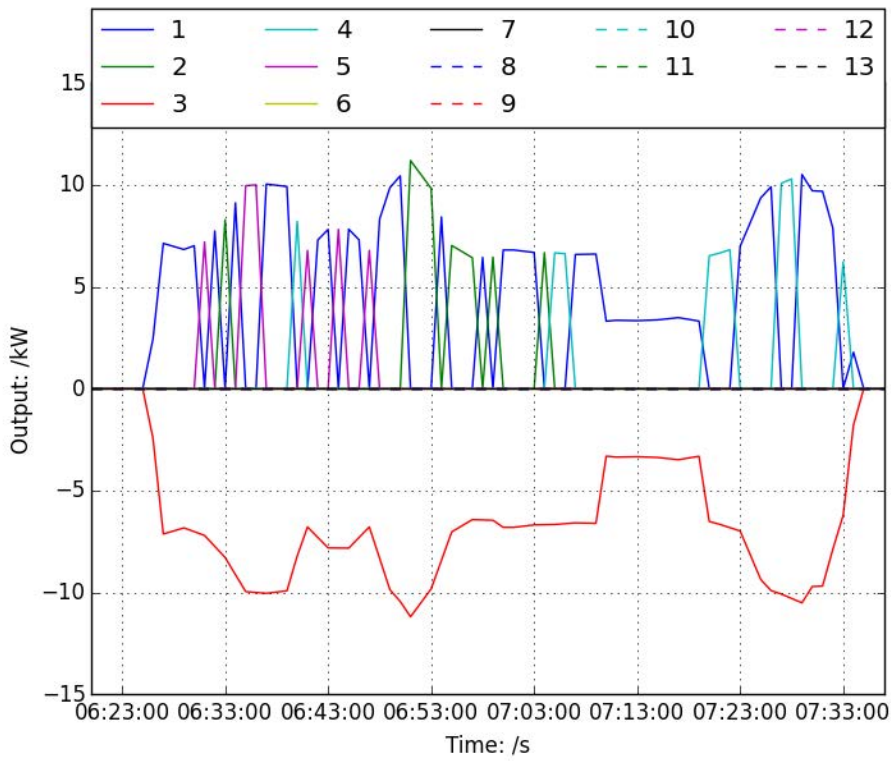

(c) with MK.

Figure 5.7: Power dispatching results among MGs in case 1.

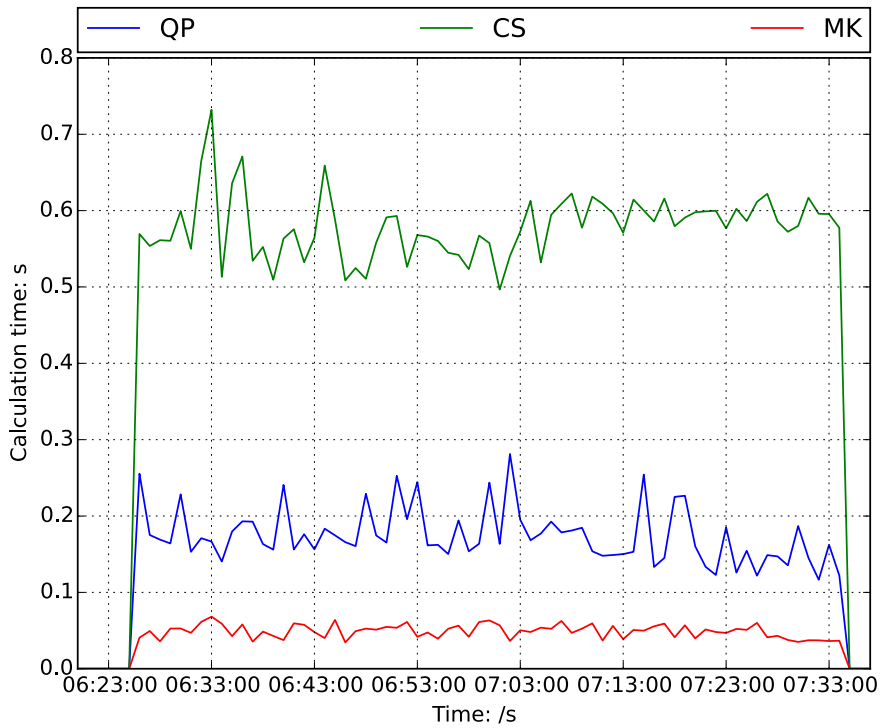

Figure 5.8: Calculation time in case 1

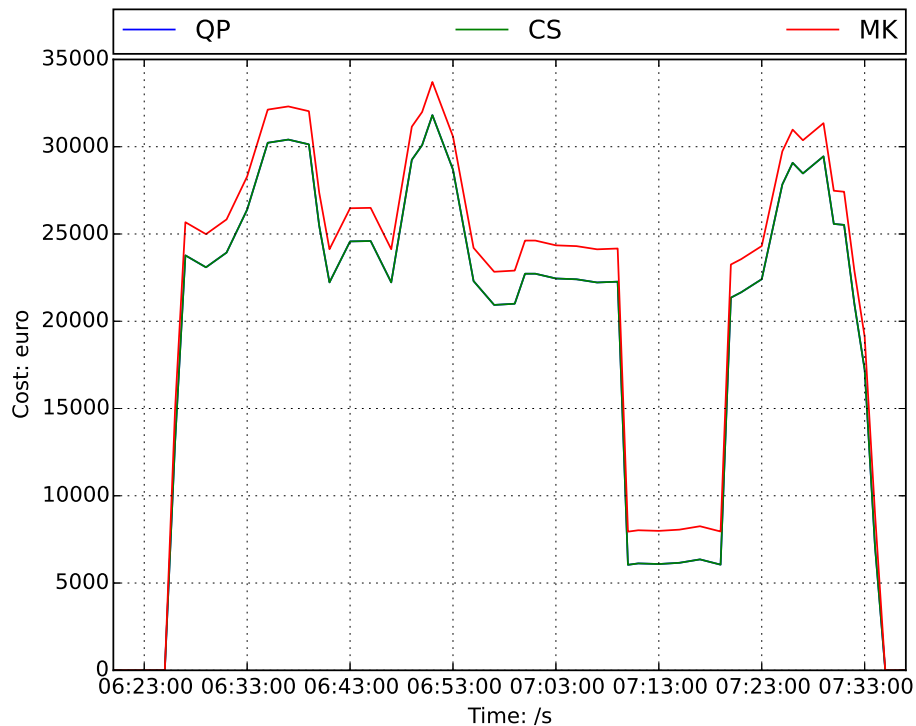

Figure 5.9: Generation cost in network in case 1

#### 5.4.2/ CASE 2

In this case, the performance of the proposed approach is tested on the system in figure 5.2. MGs consist of the components shown in table 5.1 to table 5.3. The faulted MG stays the same with the one in case 1, while the MT number in balanced MGs increases, and this influences the computation time and the quality of the results under different control methods. The coordination results are shown in figure 5.10. With more MT joining into the coordination, the optimal power dispatching problem among MGs becomes more complex as it increases quadratic terms in equation (5.9). The marginal generation cost and on/off cost of MT are larger than the ones of battery. Thus the coordination between elements, within the whole network, tends to select batteries as the supplier for the whole load. The increase of MT causes no modification on the coordination results with a centralized method comparing with figure 5.10b. As the MT number increases, it contributes more to the CA characteristic than the other generation due to the larger capacity. Thus the construction of CA is more stable. Therefore, the interaction power shown in 5.10a for each MG has less fluctuations than the figure 5.7a in case 1. Similarly, the bidding price of the MG is more stable with more MTs. Thus the trading object maintains MG4 and the corresponding volume is shown in figure 5.10c.

Comparing the calculation time for power dispatch, CS spends the longest time at near 0.6s as the increasing MTs, while the market method has the fastest speed at around 0.05s. QP cost nearly 0.2s for each dispatching. As for the cost, it is similar to the one in case 1 as the battery costs less than MT. Thus faulted MG is supplied by the batteries in assistant MGs rather than operating local MTs. With MK, faulted MG operates its internal MT to reduce the buying of electricity from assistant MGs. To sell enough power to MG3,

MG4 with the lowest price operates internal MTs for generation, and this increases more cost than the other two methods.

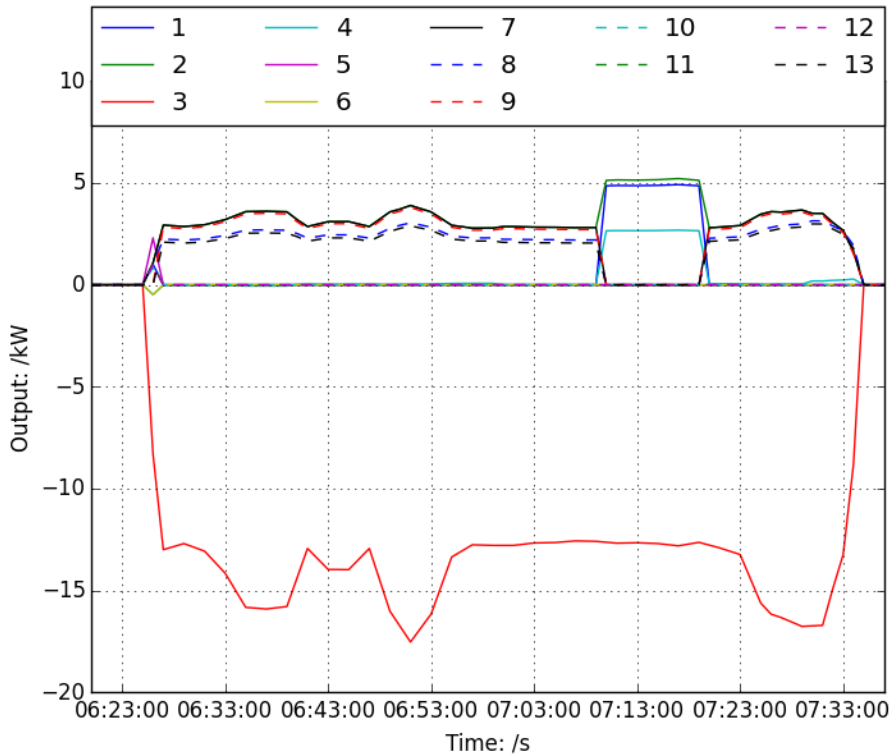

(a) with QP.

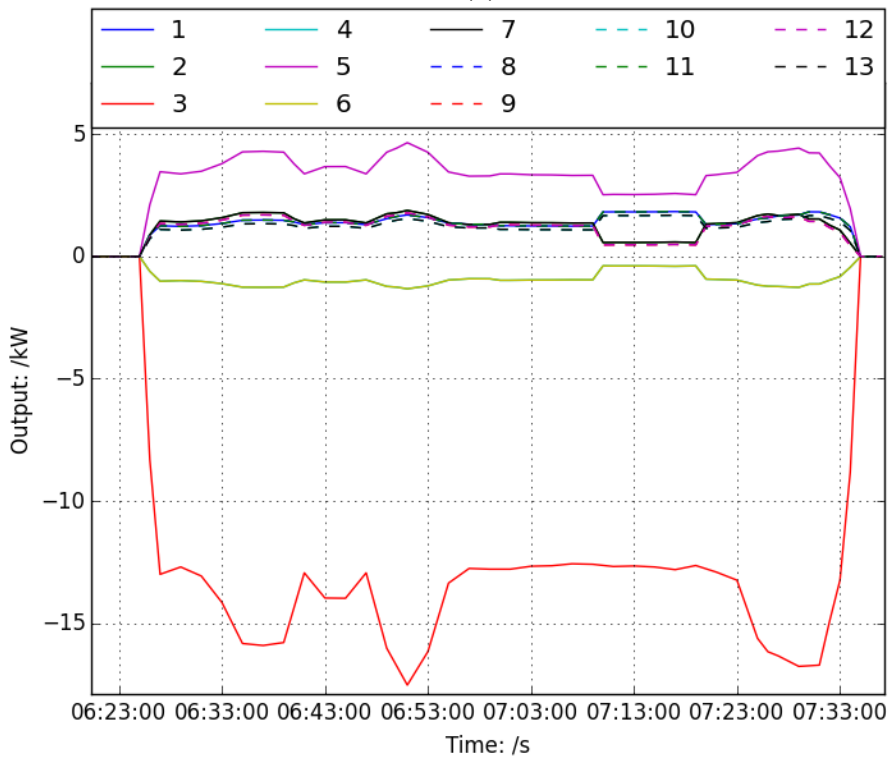

(b) with CS.

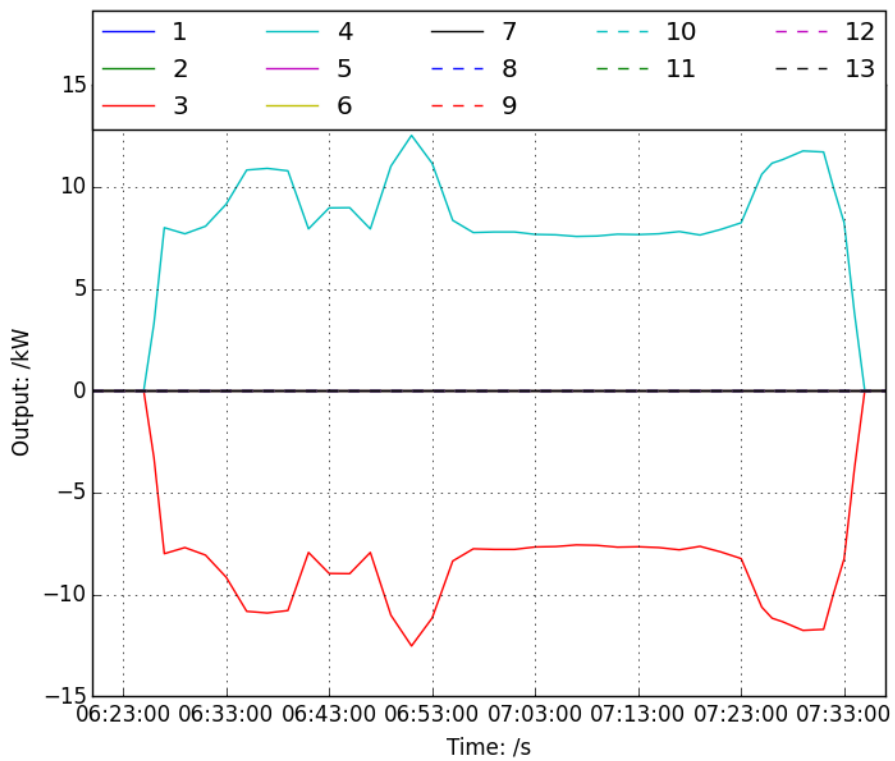

(c) with MK.

Figure 5.10: Power dispatching results among MGs in case 2.

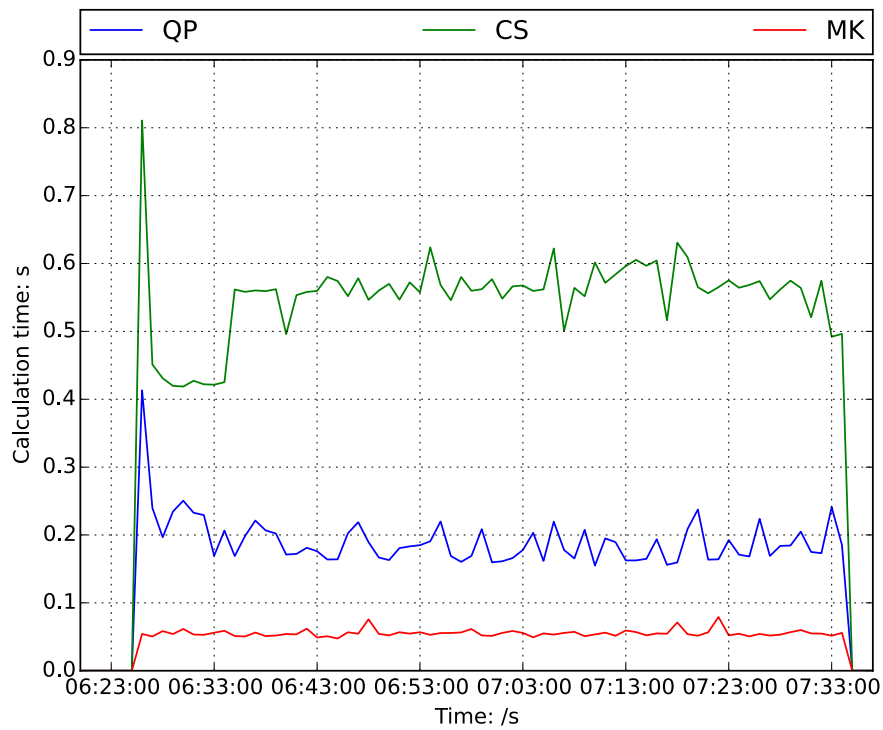

Figure 5.11: Calculation time in case 2



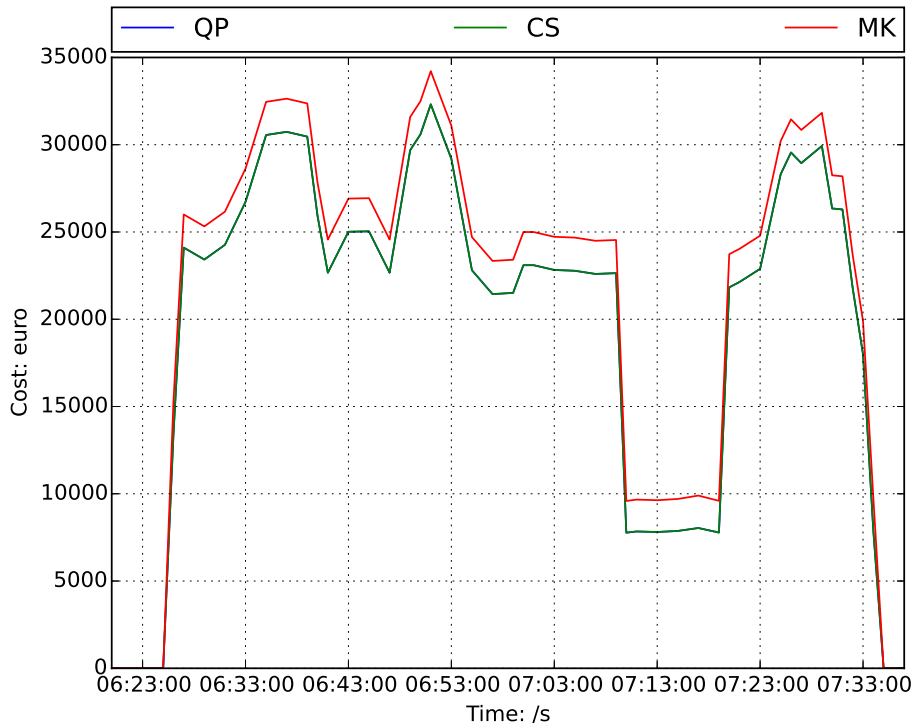

Figure 5.12: Generation cost in network in case 2

### 5.4.3/ CASE 3

The MG number increases in the network. Case 3 tests the control methods on a 34-MG network shown in figure 5.13. Each MG consists of more than one MTs. Hence the scalability of the proposed approach is studied. The constituent elements in MG3 maintain the same.

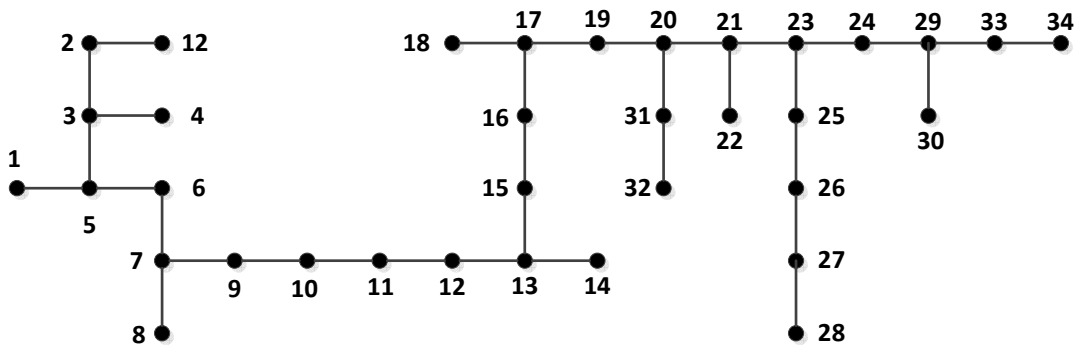

Figure 5.13: Electrical connection of the 34-MG network.

From figure 5.14, centralized control spends the longest time of around 1s to finish the dispatching calculation for all the elements in the network. But the time cost by market trading stays at the shortest time: 0.06s. The calculation with QP is around 0.2s. The time increment is because of the expanding scale of the network and the increasing number

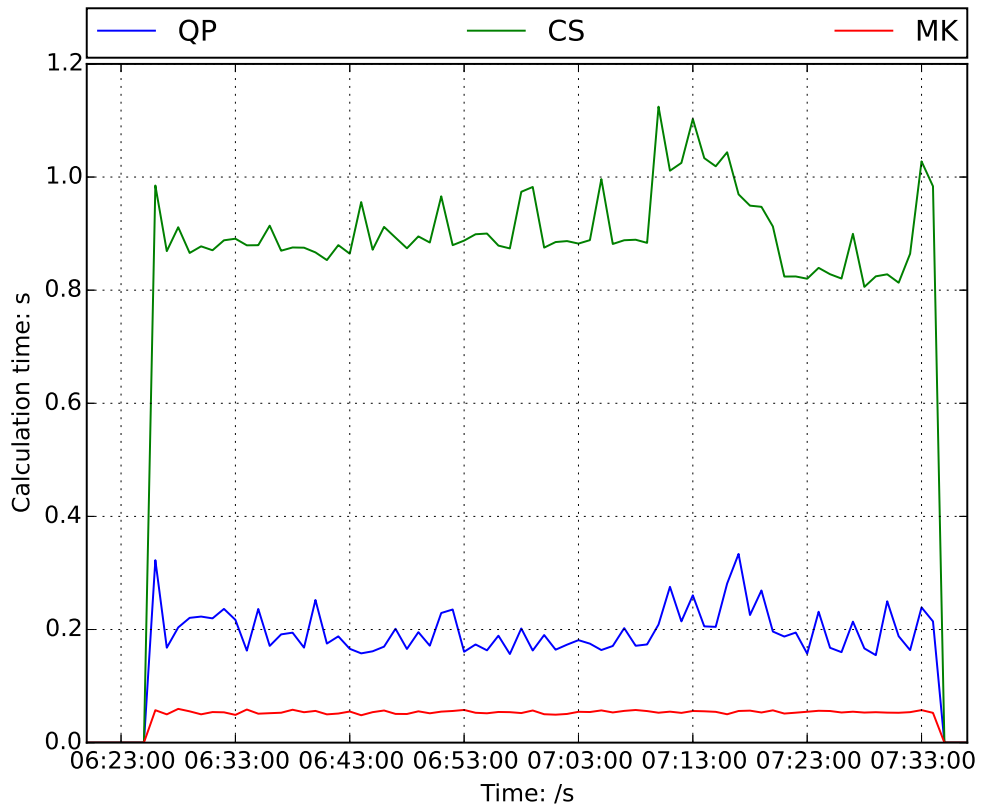

Figure 5.14: Calculation time in case 3



Figure 5.15: Generation cost in network in case 3

of coordination MTs. Regarding figure 5.15, the cost gotten from the market is more than the one from QP and CS.

#### 5.4.4/ IMPACT ON CALCULATION TIME AND COST

The results of cost and time in 3 cases are concluded in table 5.4. Comparing the time gotten from 3 cases, MK has the least calculation time, and QP is in the middle. The CS causes the longest delay is because it controls all elements in the network, while QP is achieved among CA. MK selects several MGs for power trading, which is less than the MGs in CA. Elements increment and network expansion have delayed the calculation time indeed for CS and QP. However, with MK, the control time even falls from 0.0553 to 0.0539 from case 1 to case 3. As power is dispatched among MGs depending on their bids and internal elements which are controlled by the assigned agents. The optimization process is divided into multiple agents. Thus the decentralized algorithm reduces the calculation time of MK and eliminates the impact of scale expansion to the computational time. Summary of results shows that the calculation time with QP changes little by 14.09% from case 1 to case 3. It is much less than the one with CS, which has a sharp increase of 56.38%.

Table 5.4: Summary of calculation time and cost.

	CS		MK	
	time(s)	cost(EUR/h)	time(s)	cost(EUR/h)
case 1	0.5796	27151.11	0.0490	27821.51
case 2	0.5523	27866.34	0.0553	28619.90
case 3	0.9064	67983.14	0.0539	72813.12
	QP			
	time(s)	cost(EUR/h)		
case 1	0.1745	27174.26		
case 2	0.1912	27888.49		
case 3	0.1991	68017.18		

The results are reasonable as the control elements of CS consist of all the devices in 34 MGs. On the other hand, the components controlled by QP are much less than the CS. From the cost, it can be observed that the market spends more than the other three methods. With market trading, elements are controlled by the assigned agent, and its priority control is self-balance. The faulted agent maximizes the local generation to minimize the power buying from other MGs. Thus local MT costs more than the batteries in other MG. For single MG, the power balance is the primary objective. Thus local MT has a priority to the cheaper batteries in other MGs. The simulation shows that the QP spends a much shorter time than CS to solve the power dispatching problem, and the expansion of the system has a small influence on QP. Even though the market method could cost less time, its cost is higher than QP in a relatively significant difference. Thus the quadratic programming with the proposed control strategy can gain a comprehensive better performance on the scalability, profit, and calculation time.

## 5.5/ CONCLUSION

This chapter proposes a distributed control strategy based on MAS for power coordination in the MG network, especially when faults happen and break the balance within single MG. It applies a distributed evolutionary algorithm to form a coordination area firstly and then dispatching power among the internal elements with quadratic programming. Simulation results reveal that the scalability of the system is limited by the control strategy. In return, the number of elements and MGs can influence control performance, including generation cost and calculation time. A market method and a central strategy are applied to the simulation to compare with the proposed control strategy, in which quadratic programming is adopted for solving the power dispatching. Finally, the comparison results show that the proposed control strategy with quadratic programming has a good comprehensive performance on the scalability, profit, and calculation time. This coordination strategy could be applied to the community consisting of smart houses.





## CONCLUSION



## CONCLUSIONS

### 6.1/ CONCLUSIONS ON THE PROPOSED APPROACH

In this dissertation, we focus on the coordination problem in the MG network to improve the reliability of individual MG with an economic dispatching scheme. With the similarity of functionally and physically distributed architecture, the MAS is applied to this system to promote the automation of individual MGs and enable their interaction (section 3). The plug-and-play feature enables the flexible MG coalition for power interaction to compensate for the individual insufficiency. Limited by the communication delay and computational pressure, the partial MG coordination is studied. We solve the power dispatching problems between faulted MG and its neighbors, which is to supply the unbalanced MG economically. MG cooperative behaviors based on MAS are studied, including economical optimization, the approximation of MG integrated features (section 4). For the coordination within the extensive area, we also consider the practical limitation and the scalability of control (section 5).

- First, for the coordination strategy with neighboring MGs, current approaches include MG reconfiguration and maintaining MGs. Reviewing related researches in maintaining MGs, the power dispatching approaches are widely solved by market trading, bi-level strategy and droop control method. In this thesis, the market trading and bi-level method are adopted for economical energy management.
- Then, for the security operation check in the network, the power flow calculation is necessary. The traditional method is the centralized iterative calculation. Based on the communicational agents, a distributed power flow calculation is proposed by adopting an average consensus theorem. To reduce the message scale, a complete distributed calculation method is presented, with only knowing the neighboring voltage frequency.
- Finally, the coordination within the extensive area is studied. We evaluated the performance of both centralized and decentralized control in section 5.4. A combination of both structures is applied to solve this issue. A model for evaluating the comprehensive performance of the integrated cooperative area is defined. A distributed evolutionary algorithm programming is adopted to solve it in a decentralized way. A centralized method is applied to solve the power dispatching problem in the cooperative area.



## 6.2/ FUTURE WORK

Future work will focus on the proposed coordination approaches and their applications. Considering the limited study in the past on the MG network and its complex construction involving abundant elements, future research is diversified and of great interest.

The power flow calculation considering both active and reactive power, as well as voltage limitations, could be added into the problem formulation to improve the system accuracy. The coupling between reactive power and active power influences the line loss. Additionally, the phase and amplitude of the system voltage are standardized. They are determined by the power flow in the network and within MG. Thus the formulation considering reactive power and voltage amplitude is required to make the system more accurate and to increase the stability of system control.

The practical factors in this thesis include communication redundancy, time efficiency, and the probability of communicational failure. They are all related to the communication protocol, and the network scale should be more accurately modeled to represent the impact on system performance. Specifically, these communication characteristics are also impacted by the network scale, whose expansion hinders efficient communication, which further influences the control results.

The market bidding strategy could be more elastic to follow the output cost. As the output cost is derived from the coordination within MG, and it determines the price bidding in the market, the cost varies as the output changes. Thus the bidding strategy proposed in this thesis approximates that the price is proportional to the average cost under maximal output roughly. It is mainly the inaccuracy of price other than the maximal output point that fluctuates profits and even causes benefits loss. Thus penalty could be added to the MG bidding strategy to adjust the price of MG without outputting the maximal volume of power.

Adding distributable or shiftable load, such as electric vehicles and heater, to MG could derive optimal coordination by shifting load. The distributable part leaves flexibility to the generation obeying the user habitat. Such load could also bring economic benefits by peak-shaving.

## 6.3/ SCIENTIFIC PRODUCTION REVIEW

The research in this thesis leads to multiple publications, as shown in the Appendix:

- 1) A control strategy is proposed for the MG network. Individual MG aims to operate independently in normal conditions, and several MGs can support each other in case of contingencies or insufficient generation. Such coordination aims at reducing load shedding and generation curtailment and is achieved by coordinating the output power of MGs. Each MG is equipped with an agent to achieve self-control and to negotiate with other MGs, for example, to request power to its neighbors to support its loads. The Newton-Raphson and consensus methods are used to calculate the output power of each MG. The control strategy is validated using simulations on an IEEE 13-node test feeder [Wei et al., 2017].
- 2) An agent-based decentralized coordination method is designed to improve the re-

silience and flexibility of larger systems. It means that healthy MGs help unhealthy ones (e.g., in the case of insufficient generation). Coordination is expected to eliminate the power imbalance inside MGs, thus limiting the impact for customers and maximizing local production. Decentralized coordination is especially useful as the resulting system is not subject to single points-of-failure. A distributed power flow calculation is used and enables verifying line capacity constraints to ensure the feasibility of the power dispatch resulting from agent interaction. The performance of the approach is tested on a system including 12 MGs and 33 MGs [Wei et al., 2018].



# BIBLIOGRAPHY

- [Abbasbandy, 2003] Abbasbandy, S. (2003). **Improving newton–raphson method for nonlinear equations by modified adomian decomposition method**. *Applied Mathematics and Computation*, 145(2–3):887 – 893.
- [Adam et al., 2000] Adam, E., Mandiau, R., et Kolski, C. (2000). **Homascow: a holonic multi-agent system for cooperative work**. In *Proceedings 11th International Workshop on Database and Expert Systems Applications*, pages 247–253. IEEE.
- [Aeronautics et al., 2019] Aeronautics, N., et (NASA), S. A. (2019). **Giss surface temperature analysis (v4)**. <https://data.giss.nasa.gov/gistemp/graphs/>. Accessed June 1, 2019.
- [Agah et al., 1996] Agah, A., et Bekey, G. A. (1996). **A genetic algorithm-based controller for decentralized multi-agent robotic systems**. In *Proceedings of IEEE International Conference on Evolutionary Computation*, pages 431–436. IEEE.
- [Andersson et al., 2005] Andersson, G., Donalek, P., Farmer, R., Hatziargyriou, N., Kamwa, I., Kundur, P., Martins, N., Paserba, J., Pourbeik, P., Sanchez-Gasca, J., et others (2005). **Causes of the 2003 major grid blackouts in north america and europe, and recommended means to improve system dynamic performance**. *IEEE transactions on Power Systems*, 20(4):1922–1928.
- [Arefifar et al., 2012] Arefifar, S. A., Mohamed, Y. A.-R. I., et El-Fouly, T. H. (2012). **Supply-adequacy-based optimal construction of microgrids in smart distribution systems**. *IEEE transactions on smart grid*, 3(3):1491–1502.
- [Arefifar et al., 2013a] Arefifar, S. A., Mohamed, Y. A.-R. I., et El-Fouly, T. H. (2013a). **Comprehensive operational planning framework for self-healing control actions in smart distribution grids**. *IEEE Transactions on Power Systems*, 28(4):4192–4200.
- [Arefifar et al., 2013b] Arefifar, S. A., Yasser, A.-R. M., et El-Fouly, T. H. (2013b). **Optimum microgrid design for enhancing reliability and supply-security**. *IEEE Transactions on Smart Grid*, 4(3):1567–1575.
- [Arpaia et al., 2014] Arpaia, P., Cimmino, P., Girone, M., Commara, G. L., Maisto, D., Manna, C., et Pezzetti, M. (2014). **Decentralized diagnostics based on a distributed micro-genetic algorithm for transducer networks monitoring large experimental systems**. *Review of Scientific Instruments*, 85(9):095103.
- [Asimakopoulou et al., 2013] Asimakopoulou, G. E., Dimeas, A. L., et Hatziargyriou, N. D. (2013). **Leader-follower strategies for energy management of multi-microgrids**. *IEEE Transactions on Smart Grid*, 4(4):1909–1916.
- [Baldick et al., 1999] Baldick, R., Kim, B. H., Chase, C., et Luo, Y. (1999). **A fast distributed implementation of optimal power flow**. *IEEE Transactions on Power Systems*, 14(3):858–864.

- [Bar-Yam, 2002] Bar-Yam, Y. (2002). **General features of complex systems**. *Encyclopedia of Life Support Systems (EOLSS)*, UNESCO, EOLSS Publishers, Oxford, UK, 1.
- [Baziar et al., 2013] Baziar, A., et Kavousi-Fard, A. (2013). **Considering uncertainty in the optimal energy management of renewable micro-grids including storage devices**. *Renewable Energy*, 59:158–166.
- [Bondi, 2000] Bondi, A. B. (2000). **Characteristics of scalability and their impact on performance**. In *Proceedings of the 2nd international workshop on Software and performance*, pages 195–203.
- [Booch, 2006] Booch, G. (2006). **Object oriented analysis & design with application**. Pearson Education India.
- [Borbely et al., 2001] Borbely, A.-M., et Kreider, J. F. (2001). **Distributed generation: the power paradigm for the new millennium**. CRC press.
- [Borshchev et al., 2004] Borshchev, A., et Filippov, A. (2004). **From system dynamics and discrete event to practical agent based modeling: reasons, techniques, tools**. In *Proceedings of the 22nd international conference of the system dynamics society*, volume 22. Citeseer.
- [Cantú-Paz, 1998] Cantú-Paz, E. (1998). **A survey of parallel genetic algorithms**. *Calculateurs paralleles, reseaux et systems repartis*, 10(2):141–171.
- [Cavalcante et al., 2015] Cavalcante, P. L., López, J. C., Franco, J. F., Rider, M. J., Garcia, A. V., Malveira, M. R., Martins, L. L., et Direito, L. C. M. (2015). **Centralized self-healing scheme for electrical distribution systems**. *IEEE Transactions on Smart Grid*, 7(1):145–155.
- [Che et al., 2013] Che, L., Khodayar, M., et Shahidehpour, M. (2013). **Microgrids for distribution system restoration**. *IEEE Power and Energy Mag.*, 2013.
- [Chen et al., 2015] Chen, C., Wang, J., Qiu, F., et Zhao, D. (2015). **Resilient distribution system by microgrids formation after natural disasters**. *IEEE Transactions on smart grid*, 7(2):958–966.
- [Chen et al., 2016] Chen, J., et Garcia, H. E. (2016). **Economic optimization of operations for hybrid energy systems under variable markets**. *Applied energy*, 177:11–24.
- [Clarke et al., 1996] Clarke, E. M., et Wing, J. M. (1996). **Formal methods: State of the art and future directions**. *ACM Computing Surveys (CSUR)*, 28(4):626–643.
- [Colson et al., 2011a] Colson, C., Nehrir, M., et Gunderson, R. (2011a). **Distributed multi-agent microgrids: a decentralized approach to resilient power system self-healing**. In *2011 4th International Symposium on Resilient Control Systems*, pages 83–88. IEEE.
- [Colson et al., 2011b] Colson, C. M., et Nehrir, M. H. (2011b). **Algorithms for distributed decision-making for multi-agent microgrid power management**. In *2011 IEEE Power and Energy Society General Meeting*, pages 1–8. IEEE.

- [Davis et al., 1983] Davis, R., et Smith, R. G. (1983). **Negotiation as a metaphor for distributed problem solving**. *Artificial intelligence*, 20(1):63–109.
- [Dickens, 2000] Dickens, C. (2000). **A tale of two cities**. Penguin.
- [Ding et al., 2017] Ding, T., Lin, Y., Bie, Z., et Chen, C. (2017). **A resilient microgrid formation strategy for load restoration considering master-slave distributed generators and topology reconfiguration**. *Applied energy*, 199:205–216.
- [Dong et al., 2014] Dong, D., Wang, P., Qin, W., et Han, X. (2014). **Investigation of a microgrid with vanadium redox flow battery storages as a black start source for power system restoration**. In *2014 9th IEEE Conference on Industrial Electronics and Applications*, pages 140–145. IEEE.
- [Duan et al., 2008] Duan, R., et Deconinck, G. (2008). **Agent coordination for supply and demand match in microgrids with auction mechanism**. In *2008 First International Conference on Infrastructure Systems and Services: Building Networks for a Brighter Future (INFRA)*, pages 1–4. IEEE.
- [Dubey et al., 2013] Dubey, S., Sarvaiya, J. N., et Seshadri, B. (2013). **Temperature dependent photovoltaic (pv) efficiency and its effect on pv production in the world—a review**. *Energy Procedia*, 33:311–321.
- [Dudley et al., 2015] Dudley, B., et others (2015). **Bp statistical review of world energy 2016**. London, UK.
- [Dufo-Lopez et al., 2007] Dufo-Lopez, R., Bernal-Agustín, J. L., et Contreras, J. (2007). **Optimization of control strategies for stand-alone renewable energy systems with hydrogen storage**. *Renewable energy*, 32(7):1102–1126.
- [(EEA), 2019] (EEA), E. E. A. (2019). **Share of renewable energy in gross final energy consumption**. [https://ec.europa.eu/eurostat/tgm/table.do?tab=table&init=1&language=en&pcode=t2020\\_31&plugin=1](https://ec.europa.eu/eurostat/tgm/table.do?tab=table&init=1&language=en&pcode=t2020_31&plugin=1). Accessed June 14, 2019.
- [Elkhatib et al., 2015] Elkhatib, M., Ahmed, M., Elshatshat, R., Salama, M., et Shaban, K. B. (2015). **Distribution system restoration based on cooperative multi-agent approach**. In *2015 International Symposium on Smart Electric Distribution Systems and Technologies (EDST)*, pages 42–46. IEEE.
- [Elmitwally et al., 2014] Elmitwally, A., Elsaid, M., Elgamal, M., et Chen, Z. (2014). **A fuzzy-multiagent self-healing scheme for a distribution system with distributed generations**. *IEEE Transactions on Power Systems*, 30(5):2612–2622.
- [Elsied et al., 2015] Elsieid, M., Oukaour, A., Gualous, H., et Hassan, R. (2015). **Energy management and optimization in microgrid system based on green energy**. *Energy*, 84:139–151.
- [Ephrati et al., 1995] Ephrati, E., Pollack, M. E., et Rosenschein, J. S. (1995). **A tractable heuristic that maximizes global utility through local plan combination**. In *ICMAS*, pages 94–101.
- [Fang et al., 2019] Fang, X., et Yang, Q. (2019). **Cooperative energy dispatch for multiple autonomous microgrids with distributed renewable sources and storages**. In *Smart Power Distribution Systems*, pages 127–160. Elsevier.

- [Fang et al., 2016] Fang, X., Yang, Q., Wang, J., et Yan, W. (2016). **Coordinated dispatch in multiple cooperative autonomous islanded microgrids**. *Applied energy*, 162:40–48.
- [Faria et al., 2011] Faria, P., et Vale, Z. (2011). **Demand response in electrical energy supply: An optimal real time pricing approach**. *Energy*, 36(8):5374–5384.
- [Fathi et al., 2013] Fathi, M., et Bevrani, H. (2013). **Adaptive energy consumption scheduling for connected microgrids under demand uncertainty**. *IEEE Transactions on Power Delivery*, 28(3):1576–1583.
- [Ferber et al., 1999] Ferber, J., et Weiss, G. (1999). **Multi-agent systems: an introduction to distributed artificial intelligence**, volume 1. Addison-Wesley Reading.
- [Fernandez et al., 2006] Fernandez, L. M., Saenz, J. R., et Jurado, F. (2006). **Dynamic models of wind farms with fixed speed wind turbines**. *Renewable energy*, 31(8):1203–1230.
- [Gabbar et al., 2016] Gabbar, H. A., et Zidan, A. (2016). **Optimal scheduling of interconnected micro energy grids with multiple fuel options**. *Sustainable Energy, Grids and Networks*, 7:80–89.
- [Genc et al., 2013] Genc, Z., Heidari, F., Oey, M. A., van Splunter, S., et Brazier, F. M. (2013). **Agent-based information infrastructure for disaster management**. In *Intelligent systems for crisis management*, pages 349–355. Springer.
- [Ghorbani et al., 2014] Ghorbani, J., Choudhry, M. A., et Feliachi, A. (2014). **A mas learning framework for power distribution system restoration**. In *2014 IEEE PES T&D Conference and Exposition*, pages 1–6. IEEE.
- [Ghorbani et al., 2015] Ghorbani, M. J., Choudhry, M. A., et Feliachi, A. (2015). **A multi-agent design for power distribution systems automation**. *IEEE Transactions on Smart Grid*, 7(1):329–339.
- [Goyal et al., 2016] Goyal, M., et Ghosh, A. (2016). **Microgrids interconnection to support mutually during any contingency**. *Sustainable Energy, Grids and Networks*, 6:100–108.
- [Guarnieri, 2013] Guarnieri, M. (2013). **The beginning of electric energy transmission: Part two [historical]**. *IEEE Industrial Electronics Magazine*, 7(2):52–59.
- [Hayden et al., 1999] Hayden, S. C., Carrick, C., et Yang, Q. (1999). **A catalog of agent coordination patterns**. In *Proceedings of the third annual conference on Autonomous Agents*, pages 412–413. ACM.
- [Hongfu et al., 2014] Hongfu, W., Xianghong, T., Zhiqiang, Z., Chong, G., Hao, Y., et Shixia, M. (2014). **An improved dc power flow algorithm with consideration of network loss**. In *Power System Technology (POWERCON), 2014 International Conference on*, pages 455–460.
- [Horling et al., 2004] Horling, B., et Lesser, V. (2004). **A survey of multi-agent organizational paradigms**. *The Knowledge engineering review*, 19(4):281–316.



- [Jimeno et al., 2011] Jimeno, J., Anduaga, J., Oyarzabal, J., et de Muro, A. G. (2011). **Architecture of a microgrid energy management system**. *European Transactions on Electrical Power*, 21(2):1142–1158.
- [Kersting, 2001] Kersting, W. H. (2001). **Radial distribution test feeders**. In *2001 IEEE Power Engineering Society Winter Meeting. Conference Proceedings (Cat. No.01CH37194)*, volume 2, pages 908–912 vol.2.
- [Kim et al., 1997] Kim, B. H., et Baldick, R. (1997). **Coarse-grained distributed optimal power flow**. *IEEE Transactions on Power Systems*, 12(2):932–939.
- [Kinny et al., 1996] Kinny, D., et Georgeff, M. (1996). **Modelling and design of multi-agent systems**. In *International Workshop on Agent Theories, Architectures, and Languages*, pages 1–20. Springer.
- [Koestler, 1967] Koestler, A. (1967). **The ghost in the machine. 1990 reprint edition**.
- [Korf, 1985] Korf, R. E. (1985). **Depth-first iterative-deepening: An optimal admissible tree search**. *Artificial intelligence*, 27(1):97–109.
- [Kuznetsova et al., 2014] Kuznetsova, E., Li, Y.-F., Ruiz, C., et Zio, E. (2014). **An integrated framework of agent-based modelling and robust optimization for microgrid energy management**. *Applied Energy*, 129:70–88.
- [Lampropoulos et al., 2010] Lampropoulos, I., Vanalme, G. M., et Kling, W. L. (2010). **A methodology for modeling the behavior of electricity prosumers within the smart grid**. In *2010 IEEE PES Innovative Smart Grid Technologies Conference Europe (ISGT Europe)*, pages 1–8. IEEE.
- [Lasseter, 2011] Lasseter, R. H. (2011). **Smart distribution: Coupled microgrids**. *Proceedings of the IEEE*, 99(6):1074–1082.
- [Le et al., 2008] Le, Q. B., Park, S. J., Vlek, P. L., et Cremers, A. B. (2008). **Land-use dynamic simulator (ludas): A multi-agent system model for simulating spatio-temporal dynamics of coupled human–landscape system. i. structure and theoretical specification**. *Ecological Informatics*, 3(2):135–153.
- [Li et al., 2010] Li, P., Song, B., Wang, W., et Wang, T. (2010). **Multi-agent approach for service restoration of microgrid**. In *Industrial Electronics and Applications (ICIEA), 2010 the 5th IEEE Conference on*, pages 962–966. IEEE.
- [Liu et al., 2016] Liu, Q., Fu, W., Qin, J., Zheng, W. X., et Gao, H. (2016). **Distributed k-means algorithm for sensor networks based on multi-agent consensus theory**. In *2016 IEEE International Conference on Industrial Technology (ICIT)*, pages 2114–2119. IEEE.
- [Liu et al., 2018] Liu, T., Tan, X., Sun, B., Wu, Y., et Tsang, D. H. (2018). **Energy management of cooperative microgrids: A distributed optimization approach**. *International Journal of Electrical Power & Energy Systems*, 96:335–346.
- [Logenthiran et al., 2011] Logenthiran, T., Srinivasan, D., et Khambadkone, A. M. (2011). **Multi-agent system for energy resource scheduling of integrated microgrids in a distributed system**. *Electric Power Systems Research*, 81(1):138–148.



- [Logenthiran et al., 2008] Logenthiran, T., Srinivasan, D., et Wong, D. (2008). **Multi-agent coordination for der in microgrid**. In *2008 IEEE International Conference on Sustainable Energy Technologies*, pages 77–82. IEEE.
- [Luo et al., 2017] Luo, F., Chen, Y., Xu, Z., Liang, G., Zheng, Y., et Qiu, J. (2017). **Multiagent-based cooperative control framework for microgrids' energy imbalance**. *IEEE Transactions on Industrial Informatics*, 13(3):1046–1056.
- [Lv et al., 2016] Lv, T., et Ai, Q. (2016). **Interactive energy management of networked microgrids-based active distribution system considering large-scale integration of renewable energy resources**. *Applied Energy*, 163:408–422.
- [Macal et al., 2005] Macal, C. M., et North, M. J. (2005). **Tutorial on agent-based modeling and simulation**. In *Proceedings of the Winter Simulation Conference, 2005.*, pages 14–pp. IEEE.
- [Mahmoud et al., 2014] Mahmoud, M. S., Hussain, S. A., et Abido, M. A. (2014). **Modeling and control of microgrid: An overview**. *Journal of the Franklin Institute*, 351(5):2822–2859.
- [Marnay et al., 2015] Marnay, C., Chatzivasileiadis, S., Abbey, C., Irvani, R., Joos, G., Lombardi, P., Mancarella, P., et von Appen, J. (2015). **Microgrid evolution roadmap**. In *2015 international symposium on smart electric distribution systems and technologies (EDST)*, pages 139–144. IEEE.
- [Mas-Colell et al., 1995] Mas-Colell, A., Whinston, M. D., Green, J. R., et others (1995). **Microeconomic theory**, volume 1. Oxford university press New York.
- [Maskin, 1983] Maskin, E. (1983). **The theory of implementation in nash equilibrium: A survey**.
- [Moghaddam et al., 2011a] Moghaddam, A. A., Seifi, A., Niknam, T., et Pahlavani, M. R. A. (2011a). **Multi-objective operation management of a renewable mg (micro-grid) with back-up micro-turbine/fuel cell/battery hybrid power source**. *Energy*, 36(11):6490–6507.
- [Moghaddam et al., 2011b] Moghaddam, M. P., Abdollahi, A., et Rashidinejad, M. (2011b). **Flexible demand response programs modeling in competitive electricity markets**. *Applied Energy*, 88(9):3257–3269.
- [Mohammadi et al., 2014] Mohammadi, J., Kar, S., et Hug, G. (2014). **Distributed approach for dc optimal power flow calculations**. *arXiv preprint arXiv:1410.4236*.
- [Mohsenian-Rad et al., 2010] Mohsenian-Rad, A.-H., et Leon-Garcia, A. (2010). **Optimal residential load control with price prediction in real-time electricity pricing environments**. *IEEE Trans. Smart Grid*, 1(2):120–133.
- [Montgomery et al., 1993] Montgomery, T. A., et Durfee, E. H. (1993). **Search reduction in hierarchical distributed problem solving**. *Group Decision and Negotiation*, 2(3):301–317.
- [Morais et al., 2010] Morais, H., Kadar, P., Faria, P., Vale, Z. A., et Khodr, H. (2010). **Optimal scheduling of a renewable micro-grid in an isolated load area using mixed-integer linear programming**. *Renewable Energy*, 35(1):151–156.

- [Moreira et al., 2007] Moreira, C., Resende, F., et Lopes, J. P. (2007). **Using low voltage microgrids for service restoration**. *IEEE Transactions on Power Systems*, 22(1):395–403.
- [Mutoh et al., 2006] Mutoh, N., Ohno, M., et Inoue, T. (2006). **A method for mppt control while searching for parameters corresponding to weather conditions for pv generation systems**. *IEEE Transactions on industrial electronics*, 53(4):1055–1065.
- [Nedic et al., 2010] Nedic, A., Ozdaglar, A., et Parrilo, P. A. (2010). **Constrained consensus and optimization in multi-agent networks**. *IEEE Transactions on Automatic Control*, 55(4):922–938.
- [Nikmehr et al., 2017] Nikmehr, N., Najafi-Ravadanegh, S., et Khodaei, A. (2017). **Probabilistic optimal scheduling of networked microgrids considering time-based demand response programs under uncertainty**. *Applied energy*, 198:267–279.
- [Nunna et al., 2013] Nunna, H. K., et Doolla, S. (2013). **Multiagent-based distributed-energy-resource management for intelligent microgrids**. *IEEE Transactions on Industrial Electronics*, 60(4):1678–1687.
- [Olfati-Saber et al., 2007] Olfati-Saber, R., Fax, J. A., et Murray, R. M. (2007). **Consensus and cooperation in networked multi-agent systems**. *Proceedings of the IEEE*, 95(1):215–233.
- [Orcutt, 1968] Orcutt, G. H. (1968). **Research strategy in modeling economic systems**. *The future of statistics (Academic Press, New York)*, pages 71–95.
- [Ormandjieva et al., 2015] Ormandjieva, O., Bentahar, J., Huang, J., et Kuang, H. (2015). **Modelling multi-agent systems with category theory**. *Procedia Computer Science*, 52:538–545.
- [Parhizi et al., 2015] Parhizi, S., et Khodaei, A. (2015). **Market-based microgrid optimal scheduling**. In *Smart Grid Communications (SmartGridComm), 2015 IEEE International Conference on*, pages 55–60. IEEE.
- [Parhizi et al., 2016] Parhizi, S., Khodaei, A., et Shahidehpour, M. (2016). **Market-based versus price-based microgrid optimal scheduling**. *IEEE Transactions on Smart Grid*, 9(2):615–623.
- [Peik-Herfeh et al., 2013] Peik-Herfeh, M., Seifi, H., et Sheikh-EI-Eslami, M. (2013). **Decision making of a virtual power plant under uncertainties for bidding in a day-ahead market using point estimate method**. *International Journal of Electrical Power & Energy Systems*, 44(1):88–98.
- [Peng et al., 2015] Peng, Z., Wang, D., Shi, Y., Wang, H., et Wang, W. (2015). **Containment control of networked autonomous underwater vehicles with model uncertainty and ocean disturbances guided by multiple leaders**. *Information Sciences*, 316:163–179.
- [Petcu et al., 2005] Petcu, A., et Faltings, B. (2005). **A scalable method for multiagent constraint optimization**. Technical Report.
- [Pinto et al., 2011] Pinto, T., Morais, H., Oliveira, P., Vale, Z., Praça, I., et Ramos, C. (2011). **A new approach for multi-agent coalition formation and management in the scope of electricity markets**. *Energy*, 36(8):5004–5015.

- [Pipattanasomporn et al., 2009] Pipattanasomporn, M., Feroze, H., et Rahman, S. (2009). **Multi-agent systems in a distributed smart grid: Design and implementation**. In *2009 IEEE/PES Power Systems Conference and Exposition*, pages 1–8. IEEE.
- [Qin et al., 2012] Qin, J., et Gao, H. (2012). **A sufficient condition for convergence of sampled-data consensus for double-integrator dynamics with nonuniform and time-varying communication delays**. *IEEE Transactions on Automatic Control*, 57(9):2417–2422.
- [Qin et al., 2014] Qin, J., Gao, H., et Zheng, W. X. (2014). **Exponential synchronization of complex networks of linear systems and nonlinear oscillators: A unified analysis**. *IEEE transactions on neural networks and learning systems*, 26(3):510–521.
- [Qin et al., 2013] Qin, J., Yu, C., et Gao, H. (2013). **Coordination for linear multiagent systems with dynamic interaction topology in the leader-following framework**. *IEEE Transactions on Industrial Electronics*, 61(5):2412–2422.
- [Qin et al., 2010] Qin, J., Zheng, W. X., et Gao, H. (2010). **Sampled-data consensus for multiple agents with discrete second-order dynamics**. In *49th IEEE Conference on Decision and Control (CDC)*, pages 1391–1396. IEEE.
- [Qin et al., 2011a] Qin, J., Zheng, W. X., et Gao, H. (2011a). **Consensus of multiple second-order vehicles with a time-varying reference signal under directed topology**. *Automatica*, 47(9):1983–1991.
- [Qin et al., 2011b] Qin, J., Zheng, W. X., et Gao, H. (2011b). **Coordination of multiple agents with double-integrator dynamics under generalized interaction topologies**. *IEEE Transactions on Systems, Man, and Cybernetics, Part B (Cybernetics)*, 42(1):44–57.
- [Randall, 2011] Randall, A. (2011). **Risk and precaution**. Cambridge University Press.
- [Ren et al., 2018] Ren, L., Qin, Y., Li, Y., Zhang, P., Wang, B., Luh, P. B., Han, S., Orekan, T., et Gong, T. (2018). **Enabling resilient distributed power sharing in networked microgrids through software defined networking**. *Applied Energy*, 210:1251–1265.
- [Roche, 2012] Roche, R. (2012). **Agent-based architectures and algorithms for energy management in smart grids**. PhD thesis, Ph. D. dissertation, Sciences Pour l'Ingénieur et Microtechniques, Institut . . . .
- [Rodriguez et al., 2006] Rodriguez, S., Gaud, N., Hilaire, V., Galland, S., et Koukam, A. (2006). **An analysis and design concept for self-organization in holonic multi-agent systems**. In *International Workshop on Engineering Self-Organising Applications*, pages 15–27. Springer.
- [Ross et al., 2011] Ross, M., Hidalgo, R., Abbey, C., et Joós, G. (2011). **Energy storage system scheduling for an isolated microgrid**. *IET renewable power generation*, 5(2):117–123.
- [Russell et al., 2016] Russell, S. J., et Norvig, P. (2016). **Artificial intelligence: a modern approach**. Malaysia; Pearson Education Limited,.
- [Saad et al., 2011] Saad, W., Han, Z., et Poor, H. V. (2011). **Coalitional game theory for cooperative micro-grid distribution networks**. In *Communications Workshops (ICC), 2011 IEEE International Conference on*, pages 1–5. IEEE.

- [Sandholm et al., 1996] Sandholm, T. W., et Lesser, V. R. (1996). **Negotiation among self-interested computationally limited agents**. PhD thesis, Citeseer.
- [Sarma et al., 1998] Sarma, J. A., et Jong, K. A. (1998). **An analysis of decentralized and spatially distributed genetic algorithms**. Citeseer.
- [Sauer et al., 1998] Sauer, P. W., et Pai, M. A. (1998). **Power system dynamics and stability**, volume 101. Prentice hall Upper Saddle River, NJ.
- [Schurr et al., 2005] Schurr, N., Marecki, J., Tambe, M., Scerri, P., Kasinadhuni, N., et Lewis, J. P. (2005). **The future of disaster response: Humans working with multi-agent teams using defacto**. In *AAAI spring symposium: AI technologies for homeland security*, pages 9–16.
- [Shi et al., 2012] Shi, G., et Johansson, K. H. (2012). **Randomized optimal consensus of multi-agent systems**. *Automatica*, 48(12):3018–3030.
- [Simon, 1996] Simon, H. A. (1996). **The sciences of the artificial**. MIT press.
- [Smil, 2016] Smil, V. (2016). **Energy transitions: global and national perspectives**. ABC-CLIO.
- [Solanki et al., 2007] Solanki, J. M., Khushalani, S., et Schulz, N. N. (2007). **A multi-agent solution to distribution systems restoration**. *IEEE Transactions on Power systems*, 22(3):1026–1034.
- [Stankovic et al., 1985] Stankovic, J. A., Ramamritham, K., et Cheng, S. (1985). **Evaluation of a flexible task scheduling algorithm for distributed hard real-time systems**. *IEEE Transactions on computers*, 100(12):1130–1143.
- [Starkweather et al., 1990] Starkweather, T., Whitley, D., et Mathias, K. (1990). **Optimization using distributed genetic algorithms**. In *International Conference on Parallel Problem Solving from Nature*, pages 176–185. Springer.
- [Stott et al., 2009] Stott, B., Jardim, J., et Alsac, O. (2009). **Dc power flow revisited**. *IEEE Transactions on Power Systems*, 24(3):1290–1300.
- [Stypka et al., 2018] Stypka, J., Turek, W., Byrski, A., Kisiel-Dorohinicki, M., Barwell, A. D., Brown, C., Hammond, K., et Janjic, V. (2018). **The missing link! a new skeleton for evolutionary multi-agent systems in erlang**. *International Journal of Parallel Programming*, 46(1):4–22.
- [Tian et al., 2015] Tian, P., Xiao, X., Wang, K., et Ding, R. (2015). **A hierarchical energy management system based on hierarchical optimization for microgrid community economic operation**. *IEEE Transactions on Smart Grid*, 7(5):2230–2241.
- [Ton et al., 2012] Ton, D. T., et Smith, M. A. (2012). **The us department of energy's microgrid initiative**. *The Electricity Journal*, 25(8):84–94.
- [Varga et al., 1994] Varga, L., Jennings, N. R., et Cockburn, D. (1994). **Integrating intelligent systems into a cooperating community for electricity distribution management**. *Expert Systems with Applications*, 7(4):563–579.
- [Von Martial, 1992] Von Martial, F. (1992). **Coordinating plans of autonomous agents**, volume 2. Springer.

- [Wang et al., 2012] Wang, X., Liu, T., et Qin, J. (2012). **Second-order consensus with unknown dynamics via cyclic-small-gain method**. *IET Control Theory & Applications*, 6(18):2748–2756.
- [Wang et al., 2015a] Wang, Z., Chen, B., Wang, J., Begovic, M. M., et Chen, C. (2015a). **Coordinated energy management of networked microgrids in distribution systems**. *IEEE Transactions on Smart Grid*, 6(1):45–53.
- [Wang et al., 2016a] Wang, Z., Chen, B., Wang, J., et Chen, C. (2016a). **Networked microgrids for self-healing power systems**. *IEEE Transactions on Smart Grid*, 7(1):310–319.
- [Wang et al., 2015b] Wang, Z., Chen, B., Wang, J., et others (2015b). **Decentralized energy management system for networked microgrids in grid-connected and islanded modes**. *IEEE Transactions on Smart Grid*, 7(2):1097–1105.
- [Wang et al., 2016b] Wang, Z., et He, Y. (2016b). **Two-stage optimal demand response with battery energy storage systems**. *IET Generation, Transmission & Distribution*, 10(5):1286–1293.
- [Wang et al., 2015c] Wang, Z., et Wang, J. (2015c). **Self-healing resilient distribution systems based on sectionalization into microgrids**. *IEEE Transactions on Power Systems*, 30(6):3139–3149.
- [Wang et al., 2011] Wang, Z., Yang, R., et Wang, L. (2011). **Intelligent multi-agent control for integrated building and micro-grid systems**. In *ISGT 2011*, pages 1–7. IEEE.
- [Wei et al., 2017] Wei, J., Roche, R., Koukam, A., et Lauri, F. (2017). **Agent and consensus approaches to microgrid coordination for resilience improvement**. In *Proceedings of the 9th International Conference on Management of Digital EcoSystems*, pages 28–34. ACM.
- [Wei et al., 2018] Wei, J., Roche, R., Koukam, A., et Lauri, F. (2018). **Decentralized coordination for mutual rescue in microgrid clusters**. In *2018 IEEE International Energy Conference (ENERGYCON)*, pages 1–6. IEEE.
- [Weiss, 1999] Weiss, G. (1999). **Multiagent systems: a modern approach to distributed artificial intelligence**. MIT press.
- [Wooldridge et al., 1995] Wooldridge, M., et Jennings, N. R. (1995). **Intelligent agents: Theory and practice**. *The knowledge engineering review*, 10(2):115–152.
- [Xu et al., 2013] Xu, L., Ruan, X., Mao, C., Zhang, B., et Luo, Y. (2013). **An improved optimal sizing method for wind-solar-battery hybrid power system**. *IEEE transactions on Sustainable Energy*, 4(3):774–785.
- [Xu et al., 2011] Xu, Y., et Liu, W. (2011). **Novel multiagent based load restoration algorithm for microgrids**. *IEEE Transactions on Smart Grid*, 2(1):152–161.
- [Yang et al., 2011] Yang, T., Roy, S., Wan, Y., et Saberi, A. (2011). **Constructing consensus controllers for networks with identical general linear agents**. *International Journal of Robust and Nonlinear Control*, 21(11):1237–1256.

- [Ye et al., 2011] Ye, D., Zhang, M., et Sutanto, D. (2011). **A hybrid multiagent framework with q-learning for power grid systems restoration.** *IEEE Transactions on Power Systems*, 26(4):2434–2441.
- [Yu et al., 2012] Yu, W., DeLellis, P., Chen, G., Di Bernardo, M., et Kurths, J. (2012). **Distributed adaptive control of synchronization in complex networks.** *IEEE Transactions on Automatic Control*, 57(8):2153–2158.
- [Yu et al., 2015] Yu, W.-Y., Soo, V.-W., et Tsai, M.-S. (2015). **Power distribution system service restoration bases on a committee-based intelligent agent architecture.** *Engineering Applications of Artificial Intelligence*, 41:92–102.
- [Zhao et al., 2015] Zhao, B., Xue, M., Zhang, X., Wang, C., et Zhao, J. (2015). **An mas based energy management system for a stand-alone microgrid at high altitude.** *Applied Energy*, 143:251–261.
- [Zidan et al., 2012] Zidan, A., et El-Saadany, E. F. (2012). **A cooperative multiagent framework for self-healing mechanisms in distribution systems.** *IEEE transactions on smart grid*, 3(3):1525–1539.





# LIST OF FIGURES

1.1	Annual mean temperature change for land and ocean. Measured in degree.	7
1.2	Share of renewable energy in gross final energy consumption in France. . .	8
1.3	Global fossil fuel consumption. Global primary energy consumption by fossil fuel source, measured in terawatt-hours (TWh). . . . .	9
1.4	An example of MG. . . . .	10
1.5	Contents of future MG network. . . . .	14
1.6	Diagram of mutual impacts between MG coordination and operation of internal elements. . . . .	15
3.1	Agents and their environment. . . . .	37
3.2	An example of MG constitution. . . . .	43
3.3	HMAS architecture. . . . .	47
3.4	Modeling of MG network. . . . .	49
3.5	Diagram of the simulation software. . . . .	50
3.6	Coding architecture of the user interface. . . . .	50
3.7	Diagram of the models in user interface. . . . .	51
3.8	The user interface: graphical interface and batch command line. . . . .	52
3.9	Architecture of the Platform Programming. . . . .	53
3.10	Coding diagram of the simulation software including the user interface, electrical system, and MAS. . . . .	55
4.1	An example of the electrical connection in MG network. . . . .	62
4.2	Diagram of the communication corresponding to figure 4.1. . . . .	63
4.3	Independent control flowchart. . . . .	65
4.4	Fault control flowchart. . . . .	66
4.5	Centralized control strategy flowchart. . . . .	69
4.6	Coordinating interaction diagram. . . . .	70
4.7	An example of power trading in the network in figure 4.7. . . . .	74
4.8	The output-cost curve. . . . .	74
4.9	Market strategy flowchart. . . . .	76
4.10	Distributed power flow algorithm flowchart. . . . .	79



4.11 Bidding prices of the MGs. . . . .	85
4.12 Coordination results for MG3. . . . .	86
4.13 Bidding prices of the MGs. . . . .	87
4.14 Coordination power for MG3. . . . .	88
5.1 Studied 13-MG System. . . . .	91
5.2 Part of the Communication Network for the Studied Network. . . . .	92
5.3 The Control Strategy for Cooperation. . . . .	92
5.4 The Communication Diagram for Cooperation. . . . .	93
5.5 Facility operation status in MG3. . . . .	98
5.6 Coordination Group Formed in Proposed Approach. . . . .	99
5.7 Power dispatching results among MGs in case 1. . . . .	102
5.8 Calculation time in case 1 . . . . .	102
5.9 Generation cost in network in case 1 . . . . .	103
5.10 Power dispatching results among MGs in case 2. . . . .	105
5.11 Calculation time in case 2 . . . . .	105
5.12 Generation cost in network in case 2 . . . . .	106
5.13 Electrical connection of the 34-MG network. . . . .	106
5.14 Calculation time in case 3 . . . . .	107
5.15 Generation cost in network in case 3 . . . . .	107

# LIST OF TABLES

2.1	Selected papers on coordination approaches. . . . .	30
4.1	MG facility numbers in the 12-MG system. . . . .	80
4.2	MGs facilities rated powers. . . . .	80
4.3	Other parameters. . . . .	80
4.4	Electricity price parameters in each MG. . . . .	81
4.5	Cost parameters. OM: operation and maintenance, UD: startup and shut-down [Moghaddam et al., 2011a]. . . . .	81
4.6	Requester MG cost in EUR. . . . .	82
4.7	Simulation results. . . . .	83
5.1	MG elements parameters in 13-MG system. . . . .	97
5.2	Rated power of elements. . . . .	99
5.3	Other element parameters. . . . .	99
5.4	Summary of calculation time and cost. . . . .	108



