



**HAL**  
open science

# Analyse et optimisation technico-économiques des nouveaux services de mobilité basés sur l'usage des véhicules autonomes

Jaâfar Berrada

► **To cite this version:**

Jaâfar Berrada. Analyse et optimisation technico-économiques des nouveaux services de mobilité basés sur l'usage des véhicules autonomes. Economies et finances. Université Paris-Est, 2019. Français. NNT : 2019PESC1002 . tel-02513386

**HAL Id: tel-02513386**

**<https://theses.hal.science/tel-02513386>**

Submitted on 20 Mar 2020

**HAL** is a multi-disciplinary open access archive for the deposit and dissemination of scientific research documents, whether they are published or not. The documents may come from teaching and research institutions in France or abroad, or from public or private research centers.

L'archive ouverte pluridisciplinaire **HAL**, est destinée au dépôt et à la diffusion de documents scientifiques de niveau recherche, publiés ou non, émanant des établissements d'enseignement et de recherche français ou étrangers, des laboratoires publics ou privés.

**Thèse de doctorat d'Université Paris-Est**

**Jaâfar BERRADA**

TECHNICAL-ECONOMIC ANALYSIS OF SERVICES BASED ON  
AUTONOMOUS VEHICLES

*Thèse dirigée par Fabien Leurent*

Soutenue le 12 Février 2019

**Jury :**

**Rémi Maniak.** Professeur Ecole Polytechnique (*Rapporteur*)

**Jakob Puchinger.** Professeur Centrale Supélec (*Rapporteur*)

**Patrice Aknin.** Directeur de recherche IRT SystemX (*Examinateur*)

**Zoi Christoforou.** Professeur Université de Patras (*Examinatrice*)

**Goknur Sirin.** Docteur Responsable projets R&D Renault (*Examinatrice*)

**Fabien Leurent.** Professeur ENPC (*Directeur de thèse*)

**Nadège Faul.** Chef de projet VEDECOM (*Co-Encadrante*)



# Dedication

This thesis is dedicated to my first source of inspiration, strength and confidence, to my Dad, without whom nothing in my life would be possible, to my Mom, the reason I am who I am and to my beloved Noussaiba, for her unwavering support and boundless affection.





# Acknowledgements

First and foremost, my deepest gratitude goes to my advisor Prof. Fabien Leurent. Over the last years, he has served as an excellent teacher and mentor, providing guidance, reviewing my work and stretching my abilities. His knowledge, passion and rich curiosity have motivated, and will continue to motivate, my research pursuits. I would also like to extend my gratitude to my supervisor at VEDECOM, Nadège Faul, for her unconditional support of my research project. Her leadership made this thesis an enjoyable work.

Additionally, the help provided by Prof. Ingmar Andreasson invaluable progress this research. Its vision has helped guide the project to its current state, and I am continually grateful to have access to his wisdom. Also, I must particularly thank Shadi Sadeghian for her invaluable contribution to the launch of this research thesis at VEDECOM.

I want also to thank Alexis Poulhès, my colleague at LVMT, for his availability to discuss and advise me to deal with demand simulation issues, Wilco Burghout, for sharing with me its knowledge and experience in developing supply simulation tools, and Zoi Christoforou, for her precious advises and valuable tips throughout my thesis, including to achieve the stated-preference survey. I am sure that we will continue to work together during next years. Thanks also to Nicolas Doucet and Florence Prybyla for their support on demand modelling using PTV VISUM model.

More generally, I would like to thank my colleagues of LVMT, Xavier for the good time we had last years, but also Luc, Cyril, Bachar, Gaële, Mallory, Virginie(s), Sophie, Sandrine(s), Florent, Nicolas, Xioyan, Maylis and many others who had made my past three years so enjoyable. My precious experience has been marked furthermore by the incredible people of VEDECOM: Maxime (1 and 2), Bofei, Toussaint, Tatiana, Abishek, Charlotte, Vincent, Younes, Leurent, Ronan, etc.

To my dear friends: Naoufel, our discussions over these years were instructive. Your ambition, your resolution and your sacrifices for people you care about make of you an exceptional person. Zakaria, Alae and Hamza, I admire you each in such different ways. I can never get enough of discussing with you. Assem, your permanent presence is invaluable. Brahim, Hassan, Ayoub, Abdessamad, Asmaa, Hajar, Hafssa, Sara; all my friends of the association "Les Chaines d'Or", and all others who encouraged me during these years, thank you: I wish you success in your respective projects.

Finally, thank you to my incredible family. My Grandmother, aunts and uncles, thanks for your unconditional support. Si Mohamed and Khadija, thanks for your encouragements. Your unconditional kindness is exceptional. Oumayma and Zaynab, you are wonderful sisters. Thanks for your joyful spirit, your assistance as well as your efforts to make us happy. Hamza, Marwa and Douae, thanks for always believing in me. I admire your energetic and ambitious nature. Keep working and never give up your dreams. My father-in-

law, my mother-in-law, thanks for your unconditional love and for always pushing me to be better. My dad, my mom, and my beloved Noussaiba, I owe you everything. Thank you.

# Abstract

Autonomous Vehicles (AV) are becoming more of a reality, promising beneficial yet potentially disrupting changes to our urban transportation systems. This technology presents the potential to reduce energy consumption and crash occurrences, cut travel costs and minimize urban space occupancy for parking purposes. Yet barriers to implementation and mass-market penetration remain. Economically, the upfront costs in the initial stage will likely lack affordability. Socially, users could be reluctant to change their daily travel routines. Technically, the interactions with the other components of the transportation system remain uncertain. There are other challenges regarding liability, security, ethics and data privacy, too.

This thesis contributes to the ex-ante study of AV-based mobility systems through the identification, design and assessment of upcoming Business Models (BM) articulated around AVs. In particular, it brings about a systemic analysis of “new” mobility services (especially car-sharing, carpooling and ride-sourcing services) in order to identify autonomous taxis (aTaxis) and autonomous shuttles (aTransit) as two of the most relevant forms of services that may enjoy wide spreading. Then, we focus on a service of aTaxis and we put forward a microeconomic model framework to evaluate strategic setups of aTaxis provider. The model framework comprises three levels (operational, tactical and strategic), and integrates three pressure forces (regulation, unit costs and demand preferences). An application is then conducted on a stylized area (Orbicity) and a real urban case (Palaiseau, a city in Paris area).

Simulation results show that automation has the potential to improve both the mobility performances and the economic efficiency of the urban transportation system. Additionally, the density economies of supply and demand are evaluated by controlling both the fleet size and the number of users for a fixed study area. In particular, the framework application on Palaiseau proved that increasing by ten the fleet size of aTaxis involves 1 % more users (+15 passengers) yet 50 % less of profit. A stated-preference survey supports the model framework and suggests that aTaxis will likely be used for short-distance (2 to 5 km) commuting trips by two user profiles: (1) non-motorized young users (less than 30 years old) and (2) motorized active population between 30 and 50 years old.

The thesis takes an interdisciplinary approach combining (1) a qualitative analysis that starts from a review of existing works and adds first a marketing analysis of Business Models based on AVs and second a systemic analysis of an aTaxis service, and (2) a quantitative analysis, situated midway between microeconomics and spatial simulation.

*Keywords:* Autonomous vehicles, Shared Mobility, Business Models, Qualitative bi-diagrams, Microeconomics, Demand modelling

# Contents

Dedication.....	3
Acknowledgements .....	5
Abstract .....	7
Contents .....	1
List of Figures.....	11
List of Tables .....	14
List of Abbreviations .....	<b>Erreur ! Signet non défini.</b>
Introduction .....	15
1. Context: From technology to services .....	15
2. Problem statement .....	21
3. Purpose and Contributions .....	21
4. Approach and Methodology.....	23
5. Overview of the thesis .....	26
References .....	32
Section I. State of the art .....	35
Chapter.1 Modeling Transportation Systems involving Autonomous Vehicles: A State of the Art.....	36
Abstract.....	36
1. Introduction .....	36
2. Spatial models of AV-based services .....	37
3. Socio-economic models of AV development.....	42
4. Impacts of Autonomous Vehicles .....	45
5. Outreach, limitations and some recommendations .....	47
References .....	48
Chapter.2 Shared Mobility services: Review of existing services and findings of spatial and socio-economic models.....	52
Abstract.....	52
1. Introduction .....	52
2. Overview classification of SM services .....	53
3. Overview presentation of existing SM Business Models .....	54
4. Review of models simulating Shared Mobility services .....	68
5. Impacts of SM services: models results and current feedbacks .....	76
6. Summary and recommandations.....	78
References .....	81
appendix: comparison between uber and lyft.....	88
Section II. Exploration of pertinent form(s) of services based on Autonomous Vehicles.....	91
Chapter.3 Between private cars and mass transit: the rise of intermediate modes in the urban setting.....	92
Abstract.....	92
1. Introduction .....	93
2. A typology of urban travel modes .....	94
3. The operator’s standpoint.....	96

4. The user's perspective.....	99
5. The residents' standpoint .....	102
6. Global effects and the community perspective.....	103
7. Conclusion .....	104
References .....	105
Chapter.4 Business Models for services based on Autonomous Vehicles: design and comparison with urban conventional modes and Shared Mobility services.....	107
Abstract.....	107
1. Introduction.....	107
2. Design and classification of BM based on an analysis of pss .....	108
3. Classification based on the category of users and/or the service provider .....	112
4. The impact of AV on B2C Business Models and their integration into a multimodal universe.....	115
5. Conclusion .....	122
References .....	122
Section III. Construction of a microeconomic model for assessment of management strategies with application on Orbicity taxi service .....	123
Chapter.5 Strategic framework for determination and assessment of management decisions for an autonomous taxis business.....	124
Abstract.....	124
1. Introduction.....	124
2. Technical composition and institutional organization of an autonomous for-hire service.....	126
3. Pressure forces.....	129
4. Management decisions setups.....	134
5. Performance indicators.....	136
6. Summary, discussion and next steps.....	138
References .....	140
Chapter.6 From strategic framework to microeconomic model. Mathematical abstraction with a numerical application on Orbicity taxi service.....	143
Abstract.....	143
1. Introduction.....	143
2. Model's architecture .....	144
3. Formulation and model composition .....	149
4. Application case: Orbicity taxi service.....	162
5. Discussion and conclusion.....	178
References .....	180
Appendix.....	182
Section IV. Application case .....	185
Chapter.7 Towards practical implementation of autonomous taxis service: Territorial diagnostic, network design and social acceptance.....	186
Abstract.....	186
1. Introduction.....	186
2. Territorial diagnostic.....	187
3. Service design: transport function and roadway infrastructure.....	196

4. Acceptance of autonomous taxis in palaiseau.....	200
5. Discussion and conclusions .....	211
References .....	212
Appendix: Interview .....	210
Chapter.8 Demand modelling of autonomous shared taxis mixed with scheduled transit with application of the strategic framework on Palaiseau area .....	219
Abstract.....	219
1. Introduction .....	219
2. Demand-supply connection framework.....	220
3. Simulation case study .....	227
4. Conclusion .....	238
References .....	239
Conclusion .....	241
1. Summary.....	241
2. Limitations .....	245
3. Recommendations for future works .....	247
4. Perspectives .....	251

# List of Figures

Figure 1 SAE levels of automation .....	17
Figure 2 Synthesis of literature review.....	48
Figure 3 Models of carsharing services and main impacts findings .....	80
Figure 4 Models of ridesharing services and main impacts findings .....	80
Figure 5 Models of for-hire services and main impacts findings.....	81
Figure 6 Investment costs versus line capacity. ....	96
Figure 7 Investment costs versus supply capacity. ....	99
Figure 8 Operating costs versus average fare. ....	99
Figure 9 Price versus time door-to-door. ....	101
Figure 10 Comfort versus time door-to-door. ....	101
Figure 11 Waiting time versus Access time. ....	101
Figure 12 Real-time flexibility versus physical connectivity. ....	101
Figure 13 Externalities, accessibility and impact of blockage for different services. ...	103
Figure 14 Synthesis of characteristics for planners, operators and users. ....	105
Figure 15 Categories of Business Models applied on vehicles .....	112
Figure 16 Market size versus barriers.....	114
Figure 17 Line capacity versus investment costs.....	118
Figure 18 Supply capacity versus investment costs .....	119
Figure 19 Average fare versus operating costs.....	119
Figure 20 Door-to-door time vs average fare per use .....	120
Figure 21 Door-to-door time versus comfort.....	120
Figure 22 Access time versus waiting time.....	120
Figure 23 Physical connectivity versus real-time flexibility .....	120
Figure 24 Externalities versus accessibility .....	121
Figure 25 Technical components, institutional structure and relations between major stakeholders of an autonomous taxi industry .....	129
Figure 26 Overview of the strategic framework.....	139
Figure 27 Scheme of interrelations (1) between operational, tactical and strategic layers and (2) between strategic layers and pressure forces. ....	146
Figure 28 Scheme of demand-supply equilibrium achieved in the operational layer ..	152
Figure 29 Overview of interrelations between LOS and demand components .....	156
Figure 30 Scheme of the economic equilibrium achieved in the tactical layer as well as relations between tactical and operational layers.....	157
Figure 31 Scheme of the optimization process led by the strategic layer to determine the service commercial positioning .....	160
Figure 32 Results of profit maximization w.r.t demand and AV penetration levels .....	172
Figure 33 Results of welfare maximization w.r.t demand and AV penetration levels...	173
Figure 34 Satellite map of Paris .....	174
Figure 35 Satellite map of Saint-Malo.....	175
Figure 36 Satellite map of Rennes .....	175



Figure 37 Palaiseau City .....	187
Figure 38 Topography altitudes at Palaiseau .....	188
Figure 39 Land use in Palaiseau city (IAU, 2012) .....	189
Figure 40 Population in Palaiseau area (based on (DRIEA, 2010)) .....	190
Figure 41 Density of population in Palaiseau area (based on (DRIEA, 2010)) .....	191
Figure 42 Jobs in Paris Palaiseau area (based on data of (INSEE, 2017)) .....	192
Figure 43 Commuting trips emitted from Palaiseau (based on (DRIEA, 2010)) .....	193
Figure 44 Commuting trips attracted by Palaiseau (based on (DRIEA, 2010)) .....	193
Figure 45 Distribution of public modes subscriptions for users of transit in Palaiseau area .....	194
Figure 46 Three zones representing main sources of emission and attraction in Palaiseau .....	197
Figure 47 Traffic state during peak period in Palaiseau (Tuesday, 09h00), Google Maps .....	198
Figure 48 Traffic state during off-peak period in Palaiseau (Tuesday, 12h00), Google Maps.....	199
Figure 49 Infrastructures of BRT (green) and cars (red) .....	199
Figure 50 Point A requiring civil works .....	200
Figure 51 Point B, with two directions .....	200
Figure 52 Network scheme .....	200
Figure 53 Distribution of respondents during the day.....	202
Figure 54 Distribution of main used modes by respondents according to the interview location.....	203
Figure 55 Distribution of respondents ages by gender.....	204
Figure 56 Socio-professional categories of respondents .....	204
Figure 57 Correlation between the willingness to use the service and the potential frequency of using it .....	205
Figure 58 Relation between users' age and the interest in the service .....	206
Figure 59 Willingness to use the service with respect to gender (women inner circle and men outer circle).....	206
Figure 60 Socio-professional category and potential frequency of using the service..	207
Figure 61 Potential frequency of using the service, a focus on non-active population	207
Figure 62 Travel purpose of aTaxi users .....	208
Figure 63 Travel distances by purpose for aTaxi users .....	208
Figure 64 Frequency of aTaxi use depending on the most used means of transport .	209
Figure 65 Frequency use of aTaxi before and after learning that vehicles are autonomous .....	210
Figure 66 Willingness of ridesharing.....	211
Figure 67 Empty (green) and full (blue) vehicles destined to one of the stations.....	222
Figure 68 VIPSIM output window showing main KPIs and average passenger waiting times at stations .....	223
Figure 69 Overview of the integrated framework: (a) Integration of VIPSIM in the four- step model of VISUM, (b) Feedback loop between VIPSIM and VISUM.....	226
Figure 70 Palaiseau network for autonomous taxis .....	228
Figure 71 Part of public transport demand by iteration number .....	230

Figure 72 Passenger generalized cost for trips to station 1 (Massy-Palaiseau station), grouped by types of origin. ....	231
Figure 73 Variation of hourly demand and profit with respect to aTaxis fleet size.....	233
Figure 74 Variations of ridesharing and empty vehicle kilometers with respect to fleet size .....	233
Figure 75 Profit with respect to fleet size and fare. Zero profit corresponds to BRT profit.....	234
Figure 76 Demand with respect to fleet size and fare. Demand of BRT before implementation of aTaxis is 460. ....	235
Figure 77 Ratio of loaded driven distances with respect to fleet size and fares. ....	235
Figure 78 Emissions with respect to fleet size and fares. ....	236
Figure 79 Impact of demand level and technology on profitability and ratio of loaded driven distances.....	237
Figure 80 Overview of the evolution of the thesis and used approaches .....	243
Figure 81 Price versus door-to-door time considering aTaxis + rapid transit.....	248
Figure 82 Waiting versus access time considering aTaxis + rapid transit.....	248
Figure 83 Feedback loops between VIPSIM and VISUM to deal with two aTaxis services (a) parallel scheme, (b) sequential scheme .....	250

# List of Tables

Table 1 Values of production costs based on literature review.....	44
Table 2 Classification of carsharing services ( <i>Hardt &amp; Bogenberger, 2016</i> ).....	55
Table 3 Pricing structures applied by different providers ( <i>Hardt &amp; Bogenberger, 2016</i> ) .	56
Table 4 Classification of current carpooling providers.....	59
Table 5 Classification of traditional for-hire services.....	64
Table 6 Classification of current for-hire service providers.....	64
Table 7 Technical and economic characteristics of urban travel modes. ....	97
Table 8 Environmental and social characteristics of urban travel modes in the community perspective. ....	104
Table 9 Classification of PSS services into P2P, B2C and B2B Business Models .....	113
Table 10 Characteristics of B2C services .....	115
Table 11 Characteristics of aTaxi and aTransit .....	116
Table 12 Technical and economic characteristics of aTaxi and aTransit services in comparison with urban travel modes.....	117
Table 13 Global effects from the community standpoint .....	121
Table 14 Interests and concerns of major stakeholders of an autonomous taxi industry .....	128
Table 15 Perceived values of level of service from literature review.....	150
Table 16 Performance indicators of the strategic framework .....	161
Table 17 Demand assumption for Orbicity taxis service applied around Paris area .....	165
Table 18 Performance indicators for the maximization profit. Orbicity applied on Paris area. ....	168
Table 19 Results of social welfare maximization and comparison with results of profit maximization.....	169
Table 20 Demand and supply inputs for Saint-Malo, Rennes and Paris.....	177
Table 21 Results of profit maximization for three French cities and two automation scenarios (0% and 100% of fleet) .....	178
Table 22 Results of social welfare maximization for three French cities and two automation scenarios (0% and 100% of fleet).....	178
Table 23 Activity ratios of the Palaiseau population: 2011-2015 evolution .....	190
Table 24 Population and jobs of three zones .....	197
Table 25 Main travel mode used by respondents .....	202
Table 26 Travel characteristics of the sample.....	203
Table 27 BRT technical characteristics.....	227
Table 28 Coefficients of the utility for modes .....	229
Table 29 Mode split between private cars and public modes before and after introducing aTaxi.....	231
Table 30 Performances of two ridesharing strategies .....	237
Table 31 Merits and limits of approaches of the thesis.....	244

# Introduction

## 1. Context: From technology to services

Autonomous Vehicles (AVs), broadly defined, are vehicles used to move passengers or freight with some level of automation that aims to assist or replace human control (Stocker & Shaheen, 2017). They are capable of sensing their surroundings by combining a variety of techniques and sensors, including radar, 3D cameras, light detection and ranging (LIDAR), advanced GPS, odometers and machine vision. Many AV systems are in operation today, mainly in controlled environments: automated metro lines have constituted the main instance since Paris-Orly-Val opened in 1987. On the other hand, hundreds of experiments have been undertaken worldwide to prepare the integration of autonomous cars in public roadways.

### History of vehicle automation and state of practice

Since the beginning of prosperity of the automotive era, the automation of car-driving has attracted specific studies: let us quote the car-to-car communication system using radio waves in Milwaukee during the 1920s (The Milwaukee Sentinel, 1926), the electromagnetic guidance of vehicles in the 1930s and 1940s, or the testing of smart highways by adding magnets to vehicles during the 1950s and 1960s (The Victoria Advocate, 1957). In 1980, Mercedes-Benz and Bundeswehr University Munich created the first autonomous car in the world, enabling to start thinking about legislation adaptation (Davidson & Spinoulas, 2015). Addition impetus was provided by the DARPA Grand Challenges I (2004), II (2005) and III (2007).

Since then, many automakers launched themselves in the quest for the perfect car or autonomous system. As of September 2018, over 45 companies around the world were developing AV technology (CB Insights, 2018), including most major auto manufacturers and many technology companies.

For instance:

- Daimler (Mercedes-Benz owner) and Bosh announced in July 2018 the launch a small fleet of autonomous taxis in California in the second half of 2019 (Bomey, 2018).
- Toyota invested \$1 billion over five years to develop robotics and AI technology (Vincent, 2015).
- In August 2018, Tesla promised to provide full-driving features with the new version of Autopilot V9 (Hawkins, 2018a).
- Last year BMW announced a collaboration with Intel and Mobileye to develop autonomous cars. The official goal is to get “highly and fully automated driving into series production by 2021.” (Walker, 2018)

- In February, Ford announced an investment of \$1 billion in Argo AI<sup>1</sup>. The company plans to combine the expertise of Argo AI with Ford's existing self-driving car efforts to have a "fully autonomous vehicle" coming in 2021 (Korosec, 2018).
- As of July 2018, Waymo had self-driven 13 million kilometers on public roads, today at a rate of 40,000 kilometers per day (Hawkins, 2018b). The company currently has over 600 self-driving Chrysler minivans (Hawkins, 2018b). In addition, they announced in March 2018 (Hawkins, 2018c) and May 2018 (Ohnsman, 2018) a deal with Jaguar Land Rover and Fiat Chrysler respectively for an additional 20,000 electric SUV and 62,000 minivans.
- Last year, Uber entered into a \$300 million joint venture with Volvo to develop next generation autonomous driving cars. Uber CEO, Dara Khosrowshahi, promised to offer passengers the option to ride with automated cars in the first half of 2019 (Pettit, 2018). For now, Uber has tested its AVs on public roads as part of a number of US pilot projects, including Pittsburgh, Tempe, Phoenix and San Francisco (Pettit, 2018).
- The alliance of Renault, Nissan and Mitsubishi plans to release 10 different self-driving cars by 2020. As of September 2018, they proposed 3 models of self-driving cars (JDG, 2018).

### **Levels of automation**

The Society of Automotive Engineers (SAE) has defined six levels of automated functionality (SAE, 2018), ranging from fully manual (Level zero) to full automation (Level five). The classification is based on the degree of driver intervention required rather than the vehicle capabilities. It implies no particular order of market introduction. **Figure 1** presents characteristics of the six levels as proposed by SAE:

---

<sup>1</sup> Argo AI is an artificial intelligence company, based in Pittsburgh in 2017. It aims to tackle AV related applications in computer science, robotics and artificial intelligence (Crunchbase, 2018b).

SAE level	Name	Narrative Definition	Execution of Steering and Acceleration/Deceleration	Monitoring of Driving Environment	Fallback Performance of Dynamic Driving Task	System Capability (Driving Modes)
<b>Human driver monitors the driving environment</b>						
<b>0</b>	<b>No Automation</b>	the full-time performance by the <i>human driver</i> of all aspects of the <i>dynamic driving task</i> , even when enhanced by warning or intervention systems	Human driver	Human driver	Human driver	n/a
<b>1</b>	<b>Driver Assistance</b>	the <i>driving mode</i> -specific execution by a driver assistance system of either steering or acceleration/deceleration using information about the driving environment and with the expectation that the <i>human driver</i> perform all remaining aspects of the <i>dynamic driving task</i>	Human driver and system	Human driver	Human driver	Some driving modes
<b>2</b>	<b>Partial Automation</b>	the <i>driving mode</i> -specific execution by one or more driver assistance systems of both steering and acceleration/deceleration using information about the driving environment and with the expectation that the <i>human driver</i> perform all remaining aspects of the <i>dynamic driving task</i>	<b>System</b>	Human driver	Human driver	Some driving modes
<b>Automated driving system ("system") monitors the driving environment</b>						
<b>3</b>	<b>Conditional Automation</b>	the <i>driving mode</i> -specific performance by an <i>automated driving system</i> of all aspects of the dynamic driving task with the expectation that the <i>human driver</i> will respond appropriately to a <i>request to intervene</i>	System	<b>System</b>	Human driver	Some driving modes
<b>4</b>	<b>High Automation</b>	the <i>driving mode</i> -specific performance by an automated driving system of all aspects of the <i>dynamic driving task</i> , even if a <i>human driver</i> does not respond appropriately to a <i>request to intervene</i>	System	System	<b>System</b>	Some driving modes
<b>5</b>	<b>Full Automation</b>	the full-time performance by an <i>automated driving system</i> of all aspects of the <i>dynamic driving task</i> under all roadway and environmental conditions that can be managed by a <i>human driver</i>	System	System	System	<b>All driving modes</b>

Copyright © 2014 SAE International. The summary table may be freely copied and distributed provided SAE International and J3016 are acknowledged as the source and must be reproduced AS-IS.

**Figure 1 SAE levels of automation**

As of 2018, automakers have reached Level 3, and Level 4 automation has been tested without a human in the driver seat on public roads.

### Lexicology

In this new era of the automobile, "autonomous", "automated", "self-driving" and "driverless" are all terms often used interchangeably to designate the same technology. Culturally they have the same meaning to most people, however, there are slight differences factually.

Autonomous cars are theoretically cars which benefit of an autonomy when making decisions. Thus, a truly autonomous car would act alone and independently. It would decide, without any human, device or entity input, when and where to go. Levinson (2017) stated it as: "A truly autonomous car would decide on destination and route as well as control within the lanes".

Automated cars do not have the level of intelligence or independence to make decisions by themselves. Well-defined instructions of destination and route are stated by the passenger or by the vehicle's owner. Then, automated cars execute these instructions without any intervention of human driver.

Self-driving cars have an autopilot that can temporarily replace the human driver at some stages of the drive. Yet, the “driver” can take the control at any time of the car. In SAE terms, self-driving cars correspond to Level 4 and below.

Driverless cars are capable of analyzing their environment and fully navigating safely without a human in the driver’s seat. They refer to the Level 5 of automation.

As a result, a vehicle with autonomous technology is automated; yet an automated vehicle is not necessarily autonomous. Similarly, driverless cars are self-driving while the converse is not true.

In this thesis, we use the term “autonomous” instead of the term “automated”, even if the latter term is arguably more accurate. This choice is based on a twofold reason: firstly, the term “autonomous” is currently the most widespread, even within the profession, and thus is more familiar to readers. Secondly, we believe that these slight linguistic differences between existing terms will be overcome.

### **Motivations of AV technology development**

There are many reasons for the flurry of interest to AV technology.

Probably one of the most important motivations of developing AV technology is the wide belief that there are major **safety consequences** of motorized vehicles that could be overcome thanks to automation. According to the World Health Organization (WHO), over 3,400 people die on the world’s roads every day and 20 to 50 millions of people are injured or disabled every year (WHO, 2018). The National Highway Traffic Safety Administration (NHTSA) (2008) found that 93 % of crashes in USA between 2005 and 2007 were human caused. Hence, if AVs eliminate all human causes of crashes, accident rates could drop by as much as 90 %.

**Social benefits** include furthermore the potential to increase the trip comfort, enabling people, not obliged to drive the car, to be less stressed and more productive while travelling. Mobility costs would be dramatically lower due to the drastic cut of driving costs. Moreover, accessibility to jobs, education and health care will be improved, especially of those restricted in today’s transport system model, such as elderly and disabled persons, which benefits to the economy at large.

From an **environmental perspective**, automation would likely be combined to an energy transition which promotes electric vehicles based on the sustainable use of renewable energy. Consequently, Autonomous Vehicles would bring in this case dramatic reductions or elimination of air pollution and greenhouse gases from the transport sector, and then improved public health.

Autonomous Vehicles are also expected to involve **systemic changes in urban mobility** and then likely to **reshape cities**. For the past century, the private car has played the major role in structuring cities, expanding their limits and increasing travel speed and comfort. However, the population explosion especially in urban cities has putted tension on already congested urban roadways. Similarly, AVs would enable to manage parking spaces and then decongesting downtown areas because will be able to park themselves. On the other hand, by providing better convenience to passengers, the adoption of AVs is likely to increase car travel (i.e. caused by the switch of people from public transport or the increase of daily trips). Today, planners advocate for reducing congestion and improving urban mobility. In Paris, policymakers want to halve the number of private cars in the city center (Guillot, 2017). In Madrid, they decide to ban in November 2018 all non-resident vehicles, except taxis, public transport, and zero-emission delivery vehicles (Anon., 2018). The mayor of London is aiming for 80 per cent of all trips to be made on foot, by cycle or using public transport by 2041 (Greater London Authority, 2018). Potential benefits of Autonomous Vehicles to contribute to cleaner, safer and more equitable transport system should be considered by planners as well. In addition, the dramatic cut in driving costs should be an additional motivation to make public transportation systems, often unprofitable, financially viable. Consequently, we expect that planners will be highly concerned in the near future by autonomous transportation systems' operators. Probably, their role will change drastically from owning and managing transportation assets to managing autonomous transportation systems' providers to ensure equitable access to autonomous travel modes with high quality of service and low externalities.

On the **economic side**, reduction of transportation costs will induce a significant increase of users' purchasing power. In addition, reclaimed driving hours would result in higher productivity gains for the society. On the other hand, demand of new vehicles will plummet, which could result in total disruption of the car value chain (manufacturers, maintenance companies, insurance companies, etc.), while new categories around autonomous driving will emerge, including mobile apps, special equipment, mobility services, and infrastructure (AT Kearney, 2016). For car manufacturing stakeholders, two adaptation options are conceivable: becoming high-volume assemblers of Autonomous Vehicles, or providers of AV-based services (Kok, et al., 2017). The first option is supported by the fact that since the lifespan of vehicles will pass from about 10 years to 3 years (Zhang, et al., 2015a; Spieser, et al., 2014), their manufacturing while updating the automation technology will be critical to ensure the model's sustainability. The second option is based on the almost unanimous believe that AV-based services will assert themselves among urban travel modes. Goldman Sachs Group Inc. predicts that autonomous taxis will help the Shared Mobility services grow from \$5 billion in revenue today to \$285 billion by 2030 (Phys, 2017). Moreover, without drivers, operating margins could be in the 20 percent range, more than twice what



automakers generate today. In any case, both strategies will be characterized by high levels of competition and with new entrants from other industries.

### **Shared Mobility services and AVs**

Recently, the advent of the internet and then of the smartphone, in terms both of facilities and range of services, have contributed to the development of a sharing economy. The sharing economy is “a developing phenomenon based on renting and borrowing goods and services, rather than owning them” (Shaheen, et al., 2016). There are numerous benefits of the sharing economy, as improving the use efficiency of goods, providing costs saving, strengthening communities, and offering other social and environmental benefits. During the late 2,000s, numerous sharing Business Models emerged, such as peer-to-peer marketplaces (e.g. Airbnb, CouchSurfing...), crowdfunding (e.g. CrowdCube), media sharing (e.g. Spotify, SoundCloud...) and Shared Mobility (e.g. Uber, Zipcar and so on).

Shared Mobility (SM) is the shared use of motor vehicles, bicycles or other low-speed transportation modes, that enable users to obtain short-term access to transportation as needed, rather than requiring ownership (Shaheen, et al., 2016). SM includes carsharing (e.g. Car2Go, Zipcar), carpooling (e.g. UberPOOL, Blablacar), bikesharing and scooter-sharing (e.g. Lime, Bird) and ridesourcing (e.g. Uber, Lyft). SM services have grown rapidly in the world. Some key figures of SM development include for instance:

- car2go vehicles are used by over three million members in 26 locations in Europe, North America and China while over one million members of Zipcar have access to more than 14,000 vehicles in more than 500 cities and towns.
- As of September 2018, Uber have achieved over 10 billion rides while Lyft approaches the 1 billion.
- In September 2018, Lime and Bird, scooter-sharing service providers, have reached 10 million rides in US cities one year after their launch.

Combined to AV technology, SM services may provide even more attractive and sustainable transportation solutions economically, socially and environmentally as well. Numerous small-scale experiments are tested around the world. Uber is partnering with Volvo while Lyft was approached by General Motors in order to test autonomous taxis in public roads. On the other hand, Navya and EasyMile contribute to the research on autonomous shuttles, which were tested in several cities as of the end of 2018.

One of the reasons of this interest to Shared Autonomous Vehicles (SAV) is based on the belief that private AVs might not be affordable for the average customer when first brought to market. In addition, it is conceivable that SAV, unlike private AVs, would probably reduce congestion and GHG emissions, increase accessibility and improve the land use.

## **2. Problem statement**

Automation is becoming more of a reality. In the meantime, it will be necessary to prepare the development of autonomous roadway mobility by anticipating the potential impacts on the spatial organization of cities, on the quality of life of inhabitants and on the local and global economy. In other words, the three pillars of sustainable development are involved. The impacts will depend on the shape of AV-based travel modes to constitute a multimodal universe for the urban mobility, from privately-owned and privately-used AVs to AV-based SM services, the latter including autonomous modes of public transit as well as autonomous taxis and autonomous shuttles. As such, what forms of service deploying Autonomous Vehicles would assert themselves in the urban mobility universe? What would be their benefits both to their customers and their operator? Would they be complementary or competitive with the current transportation supply? How would they affect the operators' businesses, people quality of travel by all modes, the residents' daily life, as well as social and environmental concerns of collectivities?

The analysis of the actual context guided us to observe the particular interest of combining the AV technology with SM. In addition, the majority of experimentations are particularly devoted to exploring impacts of low-capacity SAV, which would strengthen the supply of SM services and then improve the overall mobility and economic performances of the urban transport system. Therefore, SAV based on (1) small to mid-sized vehicles (2-7 seats), known as autonomous taxis or robo-taxis, and (2) large vehicles (10-25 seats), known as autonomous shuttles, capture the attention of academic and industrial research works.

In Palaiseau, France, the implementation by VEDECOM of a service of autonomous taxis in 2019, is one of a series of experimentations that are conducted worldwide. It should make it possible to ask the questions above in a concrete way. Yet, it is required, before that, to determine operational and commercial strategies, including the fleet size, the level of fare, the regulation constraints and so on. To that end, it will be necessary to propose a simulation model that describes the impacts with respect to the service's features from the perspective of each stakeholder. Additionally, the proposed model should be capable of carrying on any type of application sites. As such, what results does it show, in the specific case of Palaiseau, on terms of the economic, social and environmental impacts considering different short, medium and long-term strategies explored by the service provider?

## **3. Purpose and Contributions**

The thesis aims to (1) identify, (2) conceptualize and (3) assess potential Business Models (BM) for urban services based on AV. In particular, this threefold objective consists of:

(1) The identification: brings together previous research works and studies that were conducted to describe and evaluate impacts of AV in particular and of SM services in

general. We put forward a classification of these services according to their technical, economic and social features while considering conventional urban travel modes (transit and private cars). Two business-to-customer (B2C) BM have captured our attention: autonomous taxis and autonomous shuttles. We then focus on autonomous taxis (aTaxis) for the rest of the thesis.

(2) The conceptualization: explores the technical and organizational features of aTaxis service. It describes the main pressure forces of the environment that affect the business. Then, a technical-economic model framework is constructed, which covers operational, tactical and strategic levels of the service management.

(3) The assessment of particular instances of BM: is achieved according to main social actors (stakeholders): operators, users and public authorities. In particular, the performance indicators are mathematically formulated and used to extend the previously defined technical-economic model. An application case on a stylized area (Orbicity) and a real case (Palaiseau, a city in Paris area), explore economic, social and environmental performances of aTaxis.

Concretely, this thesis brings about (1) theoretical contributions by:

- Proposing a literature review of developed simulation models that describe technical and social performances of AV-based services<sup>2</sup>.
- Constructing characteristic diagrams to analyze SM services in a multimodal universe<sup>3</sup>.
- Analyzing qualitatively BM of AV-based services in a multimodal universe<sup>4</sup>.

Additionally, the thesis proposes (2) methodological approaches, by:

- Suggesting a framework to optimize economic strategies of autonomous taxis, based on a systemic analysis.
- Coupling an agent-based model developed by VEDECOM and KTH (VIPSIM), which describes technical features of the supply, and a four-step model, which considers the behavior of the demand<sup>5</sup>.
- Using a stylized urban area proposed by (Leurent, 2017) that describes taxi movements and operational strategies to assess management decisions<sup>6</sup>.

---

<sup>2</sup> Berrada, J. & Leurent, F., 2017. Modeling Transportation Systems involving Autonomous Vehicles: A State of the Art. *Transportation Research Procedia*, Volume 27, pp. 215-221. DOI:10.1016/j.trpro.2017.12.077

<sup>3</sup> Berrada, J., Leurent, F., Lesteven, G. & Boutueil, V., 2017. Between private cars and mass transit: the room for intermediate modes in the urban setting. *Transforming Urban Mobility Conference (Mobil.TUM)*, Munich, Germany, July 4-6

<sup>4</sup> Berrada, J., Christoforou, Z. & Leurent, F., 2017. Which Business Models for Autonomous Vehicles?, *ITS Strasbourg Conference*, Strasbourg, France, June 19-22

<sup>5</sup> Berrada, J., Andreasson, I., Burghout, W. & Leurent, F., 2019. Demand modelling of autonomous shared taxis mixed with scheduled transit. *Proceedings of the 98<sup>th</sup> edition of Transportation Research Board (TRB) Annual meeting*, *Accepted*.

The thesis uses a case-based approach to:

- Suggest a stated-preference survey that explores the acceptancy of autonomous taxis by passengers.
- Analyze the impact of demand density and vehicles' technology on profitability and social welfare<sup>7</sup>.

In parallel, the thesis enables to explore alternative solutions that will not be presented in this manuscript:

- Construction of an agent-based model, which describes the behavior of ridesourcing services by maximizing the utility of vehicles/ drivers<sup>8</sup>.
- Economic assessment of a ridesourcing service in comparison with a service of bus. In particular, the ridesourcing service fare is determined in order to maintain the same level of subsidies provided by public authorities. Results show that for the same fare of buses and ridesourcing, subsidies drops dramatically for ridesourcing<sup>9</sup>.
- Analysis of two assignment strategies: the single-vehicle strategy, where the taxi is only concerned with its own performance and seeks to maximize its utility without consideration for other vehicles in the system; and the dispatching strategy, where vehicles communicate through a dispatcher and collaborate to maximize the utility of all the system. Results of an application on Saclay area found that the dispatcher provides better quality of service and higher economic efficiency<sup>10</sup>.

## 4. Approach and Methodology

This thesis adopts a twofold approach:

- The first one is a **qualitative** approach. It explores Business Models (BM) based on AVs and defines a strategic framework that assesses autonomous taxis services. In particular, it consists of:
  - (a) **A large literature review which explores at the same time:  
+ Modelling transport systems involving Autonomous Vehicles and Shared Mobility services** (carsharing, carpooling and for-hire). This review explores the major approaches

---

<sup>6</sup> Leurent, F. & Berrada, J., 2018. Towards a microeconomic theory of Shared Mobility, Transport Research Arena (TRA), Vienna, Austria, April 16-19

<sup>7</sup> Berrada, J. & Leurent, F., 2017. Density economies and the profitability of demand responsive services.», European Transport Conference (ETC), Barcelona, Spain, October 4-6

<sup>8</sup> Poulhès, A., Berrada, J., 2017. User assignment in a smart vehicles' network: dynamic modelling as an agent-based model., Transport Research Procedia, Volume 27, pp 865-872, DOI:10.1016/j.trpro.2017.12.153

<sup>9</sup> Berrada, J. & Poulhès, A., 2018. Quelle place pour les modes de taxis partagés ? Comparaison économique de différents modes de transport concurrents à l'aide d'une simulation multi-agent, 1ères Rencontres Francophones Transport Mobilité (RFTM), Vaulx-en-Velin, Lyon, June 6-8

<sup>10</sup> Poulhès, A. & Berrada, J., 2018. Single Vehicle Network Versus Dispatcher: User assignment in an agent-based model. Transportmetrica A: Transport Science. *Under review*.

and methodologies of scholars (algorithms, simulation tool, etc.) and brings together their findings, especially obtained economic, social and/ or environmental impacts.

+ **Behavioral studies.** They are based on stated-preference (SP) surveys and revealed-preference (RP) surveys. Most of these surveys define the profile of potential users, their preferences and the possible restraints for using the service.

+ **Microeconomic models.** These models have been developed to analyze performances of taxis service. The analysis of (Wong and Yang, 1998-2017) and more particularly that of (Leurent, 2017) is the basis of our autonomous taxis microeconomic model.

+ **Marketing and strategic studies.** These studies, mostly consulting reports, address different strategic issues, from the prevision of AVs development to the analysis of SM services, passing by the servicizing theory and the shared economy theory.

+ **Official publications,** mainly of OECD and ITF dealing with development issues of AVs and for-hire services.

#### **(b) A marketing analysis of BM based on AVs**

+ To explore BM, this analysis starts from a **product-service system (PSS) analysis**, which enables to classify BM according to the degree of the product/service tangibility. In fact, a BM could be based on the sale of products, on the sale of services or on the sale of the product use.

+ The PSS analysis is then combined with a **classification according to the type of user/provider** and to spatial-temporal constraints.

#### **(c) A systemic analysis**

+ The analysis of BM in a multimodal universe relies on the construction of **characteristic bi-diagrams**, which confront economic, social and environmental indicators while considering the perspective of public authorities, operators, users and residents.

+ The systemic analysis is applied in particular on autonomous taxis. It explores one by one the main technical components of the service, and the major stakeholders that affect directly or indirectly the service production. More globally, it identifies the constraints and pressures that are applied by the service environment.

Then, this analysis classifies the operator's strategies and builds up the structure of a strategic framework that assesses economically, socially and environmentally an aTaxi service.

#### ***Finally, the qualitative approach enables to:***

- Identify approaches and methodologies for supply modelling of AV-based services.
- Understand and assimilate the methodology of building a microeconomic model.
- Compare different kinds of services in the same multimodal universe and according to common indicators.
- Show the interest of studying autonomous taxis and autonomous shuttles.
- Define a strategic framework for autonomous taxis.

- The second approach of the thesis is **quantitative**. It aims to carry forward the findings of the qualitative approach. By focusing on autonomous taxis, it is purported to quantify the impact of strategies introduced previously by the strategic framework. In particular, it combines microeconomics, simulation models and behavioral studies.

**(a) Microeconomics**

Microeconomics enables to express the strategic framework into mathematical problems that could be resolved numerically or analytically. In particular, it defines the supply function and the demand function and then the traffic equilibrium problem. At a tactical level, a cost function and revenues function make up the profit and social welfare functions. The maximization problems of profit and social welfare are furthermore defined and resolved. The regulation issues could also be considered by applying constraints to maximization problems. The constructed microeconomic model is highly inspired from (Leurent, 2017).

As a result, the strategic framework constructed qualitatively give a rise to a microeconomic model, which is general, robust and suitable for different aTaxis implementation cases.

**(b) Spatial simulation models**

The application of the microeconomic model is based on a simulation on Palaiseau (a city in Paris region). The demand is estimated using the VISUM four-step model while the supply is simulated using an agent-based model developed by VEDECOM. By connecting the two models, we analyze mobility performances of the service, but also economic performances and automation strategies. The coupling between the two models is achieved in VISUM, which calls VIPSIM at the mode choice step and in each iteration until the verification of the convergence criterion. The connection is based on a Python program.

On the other hand, the assessment of the microeconomic model is also achieved by using the model of Orbicity that was proposed by Leurent (2018). In particular, the model is used to approach real cases by incorporating French cities data. Then, the optimal supply conditions at tactical (i.e. fleet size and fare level) and strategic (i.e. penetration of automation, demand density) levels are determined in order to maximize the economic and social indicators.

**(c) Territorial and behavioral studies**

Territorial and behavioral studies constitute a major input of the microeconomic model and simulation models as well. The territorial study determines geographic topology of Palaiseau and demographic and socio-professional characteristics of its population. In addition, it explores mobility needs and provides the basis to the design of an aTaxis network.

The behavioral study aims to determine the potential future behavioral response of users to the implementation of an aTaxis service. This study is based on a stated-preference (SP)

survey that was conducted with the population living and/or working/studying in Palaiseau. The study is composed of three parts: firstly, the acceptance of a ridesourcing public mode, then the acceptance of a service of aTaxi, before introducing a set of games that includes different modes in order to explore the main mode choice factors.

**To sum up, the quantitative approach aims to:**

- Construct a microeconomic model for aTaxi based on the strategic framework defined previously.
- Assess the acceptance of an aTaxi service.
- Evaluate the economic, social and environmental impacts of an aTaxi service for a fictive study case and a real territory.

## 5. Overview of the thesis

The thesis is organized into four sections; each one structured in two chapters:

- **Section I. State of the Art.**

This Section presents a state of the art of SM services and services involving Autonomous Vehicles. It is organized into two Chapters:

### **Chapter.1 Modeling Transportation Systems involving Autonomous Vehicles: A State of the Art**

This Chapter reviews the main modeling works on transportation systems involving AVs that were published in the academic literature up to the end of 2017. In particular, it provides some examples of applications and addresses their respective outreach and limitations. The literature review is furthermore organized into two categories of studies:

- Spatial modeling represents (i) in detail the technical specifications, and ii) the spatial features of the area in which the system is implemented.
- Socio-economic modeling addresses the conditions of market penetration and diffusion using mathematical methods with commercial or social orientation.

The Chapter finds that major existing models focus on the supply operations and set-ups without detailing the demand side beyond statistical and spatial description in the form of an origin-destination matrix of trip-flows. The Chapter outlines moreover the need of conducting acceptability studies with the various stakeholders (users but also transport authorities, transit operators, insurance companies, car manufacturers and so on). Since operating costs and commercial revenues cannot be observed for AV-based services as of today, they must be inferred from comparison bases, and simulated by means of an ad hoc model.

Chapter.1 is written in (Berrada and Leurent, 2017).

## **Chapter.2 Shared Mobility services: Review of existing services and findings of spatial and socio-economic models**

This Chapter synthesizes existing literature on definitions and types of SM services that are available at present. It focuses on carsharing, ridesharing and for-hire services and their technical-economic features and socio-economic impacts. Technical-economic features are determined based on the observation of existing providers. Socio-economic impacts derive mainly from scientific studies. They are organized according to two categories of models, similar to those of Chapter.1:

- Spatial models which are mostly agent-based.
- Socio-economic models including marketing analysis, revealed and stated-preferences surveys.

Empirical results indicate that shared modes can provide environmental and social benefits. Moreover, the Chapter identifies the major barriers to development of each service and gives recommendations for the development of Business Models based on AVs. In particular, it outlines that:

- Different kinds of Business Models are possible. Each business model depends on the category of the actor (companies or individuals) and has its own technical and organizational constraints;
- The development of Business Models based on AVs should knocking down technological locks, but also social and psychological barriers. That could be achieved through proposing attractive prices;
- The implementation of AVs should taking into account competition and complementarities with other existing services.

### **• Section II. Exploration of pertinent form(s) of AV-based services**

This Section explores and designs the main Business Models that could emerge for services based on Autonomous Vehicles. It is organized into two Chapters:

## **Chapter.3 Between private cars and mass transit: the rise of intermediate modes in the urban setting**

This Chapter explores in urban settings the potential for Shared Mobility services, which are intermediate modes between public modes and private cars. It put forward characteristic diagrams to depict the range of modal solutions and assess their respective value in several perspectives that pertain respectively to Users, Operators, Planning authorities and Residents. In particular, it investigates the profitability trade-offs between operating costs and commercial revenues, the political trade-offs between modes based of the full array of their environmental, social and economic impacts, the Users' trade-off between quality and price and the Residents' trade-off between accessibility and local environmental externalities.



The main outcome is that there is room available for Shared Mobility services in each of these competitions since in bi-criteria diagrams none of them is dominated by the conventional modes.

Chapter.3 is written in (Berrada et al., 2017).

#### **Chapter.4 Business Models for services based on Autonomous Vehicles with a comparison with urban mobility services**

This Chapter uses a Product-Service-System (PSS) analysis to describe and classify main existing Business Models. The list of PSS Business Models is then crossed with a classification according to the type of the service user/ provider (individual or company). Three categories are then considered: P2P, B2C and B2B.

By focusing on B2C services and by incorporating specific features of AV technology (e.g. no driver required), two main forms of Business Models are identified: aTaxi and aTransit. The first one is based on mid-sized and/or small vehicles, which ensure a door-to-door on-demand service, probably in a limited operating area, and with the option of ridesharing. The second form of service uses larger vehicles, with fixed route service and loosely scheduled or on-demand service.

An analysis of aTaxi and aTransit services in a multimodal universe is achieved by tracing their positions in characteristic bi-diagrams constructed in Chapter.3. The Chapter found out that these new services compete with emergent services and for several attributes, they propose even better performances.

Chapter.4 is based on (Berrada et al., 2017).

#### ***As a result, the Section II:***

- Presents the main conceivable kinds of AV-based Business Models
  - Shows that B2C services are more inclined to assert themselves in the near future
  - Identifies aTaxi and aTransit as two main forms of service to analyze in detail
  - Defines common indicators for urban travel modes (conventional, emergent and future modes)
  - Draws a comparison between these modes using bi-diagrams and considering perspectives of major stakeholders.
- 
- **Section III. Construction of a microeconomic model for assessment of management strategies with application on Orbicity taxi service.**

This Section proposes a strategic framework to assess and optimize economic strategies from the perspective of the provider of an autonomous taxi (aTaxi) service. Then, the strategic framework gives a rise to a microeconomic model which describes the operator's problems mathematically. The Section is organized into two Chapters:

## **Chapter.5 Strategic framework for determination and assessment of management decisions for an autonomous taxis service.**

This Chapter describes technical components of the aTaxi service, specifically main features of vehicles, road infrastructure, stations, dispatcher and operating resources. The analysis of social actors explores interests and powers of the service provider, but also of passengers, public authorities, suppliers of operating supplies and competitors. As a result, three main pressure forces of the service environment are identified: regulation, unit costs of production and demand preferences.

Strategic setups are then introduced to explore main facets of aTaxis service: vehicles' technology to area's properties and assignment strategies. Three levels of operator's decision are considered:

- Strategic decisions define the structure of the activity and its overall direction and commercial positioning.
- Tactical decisions design the technical components of the service in order to optimize operating and economic performances.
- Operational decisions concern regular actions aiming to manage technical components of the service.

These decisions are furthermore assessed using performance indicators, which include from the operator's perspective the profitability and technical efficiency, from users' perspective the quality of service and from regulator's perspective the social welfare and environmental impacts.

## **Chapter.6 From strategic framework to a microeconomic model: Mathematical abstraction and a numerical application on Orbicity taxi service.**

This Chapter proposes a mathematical abstraction of relations that exist between the framework's components. The description of each relation is supported by an explanatory scheme. The mathematical formulation is supported by the literature review.

A numerical application based on Orbicity, a stylized urban area introduced by (Leurent, 2017), enables to evaluate impacts of each model's layer. In Orbicity, taxis are running along the contour with a constant speed and only when requests are emitted. The supply function is described by the availability of vehicles. On the hand, the demand function includes fare and quality of service. It assumes that passengers have same trips preferences and are generated uniformly along the study period.

The profit and social welfare are maximized firstly for Paris area and then with comparison with two other French cities having different demand characteristics. Results show that automation halves the fleet size and the fare and then has significant impacts quality of service and profit as well. On the other hand, the demand density and its sensitivity to the

generalized cost are affecting the service performances. In particular, the comparison between the three cities have shown that bigger cities, often characterized by higher density and greater transport budget of travelers (i.e. Paris in our application case), are attracting more demand and then allowing more profits.

**As a result, the Section III:**

- Defines a strategic framework for managing aTaxis service using a systemic analysis
- In particular, it defines three levels of operator's decisions (operational, tactical and strategic) and three types of pressure forces.
- Constructs a microeconomic model which defines the traffic equilibrium (i.e. supply-demand equilibrium) and the economic equilibrium (i.e. profit maximization) problems.
- Applies the microeconomic model on a stylized urban area by considering demand features of three French cities. It determines the supply conditions (fleet and fare) that maximize the profit and the social welfare.
- Shows the impact of automation and demand features on the operational, economic and social performances of the service.
- Recommends to apply the microeconomic model on a real network.

- **Section IV. Application case.**

This section presents an application case of the model developed in Section III on a real area: Palaiseau, a city in Southwest of Paris region. It is organized into two Chapters:

**Chapter.7 Towards practical implementation of autonomous taxis service: Territorial diagnostic, network design and social acceptance.**

This Chapter introduces Palaiseau through describing the geographic typology, the demographic structure, mobility needs and existing transport supply. In terms of urbanization, the Chapter outlines a heterogeneity (i.e. 31 % of the territory dominated by rural areas), which is confronted to the rapid development since the area is part of the growing French scientific cluster. From sociodemographic perspective, population and jobs are clearly imbalanced. Considering intern mobility performance, we observe that transit modes are competing with private cars (62 % for private cars and 38 % for transit modes). However, we identify the existence of only one BRT line and one bus line that connect the train station to the growing scientific cluster.

Based on results of the territorial diagnostic, the constraints involved by the spatial geography, the demand needs and the existing supply are identified. Then, a network of aTaxis is proposed with the purpose of connecting the main train station in the city to the scientific cluster, while ensuring the feeding in residential areas.

Finally, the Chapter investigates the social acceptance of such a service by conducting a stated-preference survey in Palaiseau. Results suggest that the service would attract mainly two users profiles: (1) non-motorized young users less than 30 years old, and (2) active population between 30 and 50 years old and that is mostly motorized. The service would be used for trips of 2 to 5 km and shared by almost 3/4 of passengers.

### **Chapter.8 Demand modelling of autonomous shared taxis mixed with scheduled transit. Application of the strategic framework on Palaiseau area.**

This Chapter proposes an application of the strategic framework to the city of Palaiseau (Chapter.7) where 60 aTaxis are implemented to replace a BRT service while ensuring moreover a feeding service. It develops a framework for modeling demand and supply interactions for aTaxis mixed with scheduled transit. In particular, it couples a dynamic microscopic supply model for aTaxis (VIPSIM) with a static and macroscopic model for demand (VISUM). Transfers between aTaxis and transit modes are incorporated in a combined utility for public modes. The feedback between these two models reflects the supply-demand equilibrium. It was obtained after 2 to 3 iterations.

Results show that by replacing a line of BRT by an aTaxis network, the level of service of public modes is improved, while operating costs are reduced for reasonable loading rates. In particular, aTaxis would compete with the level of service of the BRT in areas that are served exclusively by aTaxis. At the tactical level, it found that using ten more vehicles involves 1% more of users (+15 passengers) and 50% less of profit (-200€/hour). At the strategic level, a sensitivity analysis with respect to demand density and taxis' automation has ascertained the results of the Orbicity application case.

Chapter.8 is based on (Berrada and al., 2019).

#### ***As a result, the Section IV:***

- Proposes a territorial diagnostic for Palaiseau,
- Designs the network of aTaxis by considering main spatial and transport constraints,
- Conducts a stated-preference survey in Palaiseau and presents the main results,
- Constructs a framework that combines a four-step model (VISUM) and an agent-based model (VIPSIM) and then enables to forecast the demand behavior and in turn the performances of strategies introduced by the technico-economic model.
- Shows the effect of aTaxis on mobility (demand share of public modes, quality of service, etc.), operational (fleet size, loading ratios), economic (fare, profit), social (users' surplus) and environmental performances (emissions).

## References

- Anon., 2018. *Madrid to Extend Its Car Ban to the City Center*. [Online]  
Available at: <http://thenewswheel.com/madrid-to-extend-its-car-ban-to-the-city-center/>  
[Accessed 05 August 2018].
- AT Kearney, 2016. *How Automakers can Survive the Self-Driving Era*, s.l.: A.T. Kearney.
- Berrada, J. & Leurent, F., 2017. *Modeling Transportation Systems involving Autonomous Vehicles: A State of the Art*. Transportation Research Procedia, Volume 27, pp. 215-221. DOI:10.1016/j.trpro.2017.12.077
- Berrada, J., Leurent, F., Lesteven, G. & Boutueil, V., 2017. *Between private cars and mass transit: the room for intermediate modes in the urban setting*. Transforming Urban Mobility Conference (Mobil.TUM), Munich, Germany, July 4-6
- Berrada, J., Christoforou, Z. & Leurent, F., 2017. *Which Business Models for Autonomous Vehicles?*, ITS Strasbourg Conference, Strasbourg, France, June 19-22
- Berrada, J., Andreasson, I., Burghout, W. & Leurent, F., 2019. *Demand modelling of autonomous shared taxis mixed with scheduled transit*. Proceedings of the 98th edition of Transportation Research Board (TRB) Annual meeting
- Bomey, N., 2018. *Daimler's Mercedes-Benz, Bosch to launch self-driving car service in Silicon Valley*. [Online]  
Available at: <https://eu.usatoday.com/story/money/cars/2018/07/10/mercedes-benz-bosch-daimler-self-driving-cars-silicon-valley/771929002/>  
[Accessed 15 October 2018].
- CB Insights, 2018. *46 Corporations Working On Autonomous Vehicles*. [Online]  
Available at: <https://www.cbinsights.com/research/autonomous-driverless-vehicles-corporations-list/>  
[Accessed 15 October 2018].
- Crunchbase, 2018b. *Argo AI*. [Online]  
Available at: <https://www.crunchbase.com/organization/argo-ai#section-overview>  
[Accessed 10 September 2018].
- Davidson, P. & Spinoulas, A., 2015. *Autonomous Vehicles - What Could This Mean For the Future Of Transport?*. Sydney: s.n.
- Greater London Authority, 2018. *Mayor's Transport Strategy*, s.l.: Greater London Authority.
- Guillot, F., 2017. *Paris : le plan d'Hidalgo pour réduire (encore) le nombre de voitures au centre-ville*. [Online]  
Available at: <https://www.lci.fr/societe/paris-le-projet-d-hidalgo-pour-reduire-le-nombre-d-automobilistes-dans-le-centre-ville-2020736.html>  
[Accessed 01 August 2018].
- Hawkins, A., 2018a. *Tesla will start rolling out its 'full self-driving' package in August, Elon Musk says*. [Online]  
Available at: <https://www.theverge.com/2018/6/11/17449076/tesla-autopilot-full-self-driving-elon-musk>  
[Accessed 15 October 2018].
- Hawkins, A., 2018b. *Waymo's autonomous cars have driven 8 million miles on public roads*. [Online]  
Available at: <https://www.theverge.com/2018/7/20/17595968/waymo-self-driving-cars-8-million-miles-testing>  
[Accessed 2018].
- Hawkins, A., 2018c. *Waymo and Jaguar will build up to 20,000 self-driving electric SUVs*. [Online]  
Available at: <https://www.theverge.com/2018/3/27/17165992/waymo-jaguar-i-pace-self-driving-ny-auto-show-2018>  
[Accessed 15 October 2018].
- JDG, 2018. *Renault EZ-ULTIMO : Un véhicule autonome à la demande pour voyager comme dans votre salon*. [Online]  
Available at: <https://www.journaldugeek.com/2018/10/02/renault-ez-ultimo-vehicule-autonome-a-demande-voyager-salon/>  
[Accessed 15 October 2018].
- Kok, I., Zou, S., Gordon, J. & Mercer, B., 2017. *Rethinking Transportation 2020-2030: The Disruption of Transportation and the Collapse of the Internal-Combustion Vehicle and Oil Industries*, s.l.: RethinkX.

- Korosec, K., 2018. *An inside look at Ford's \$1 billion bet on Argo AI*. [Online]  
Available at: <https://www.theverge.com/2017/8/16/16155254/argo-ai-ford-self-driving-car-autonomous>  
[Accessed 10 September 2018].
- Leurent, F., 2017. *Microéconomie d'un service de taxi dans une ville en forme d'anneau*, s.l.: ENPC-LVMT.
- Leurent, F., 2018. *Navettes automobiles dans Orbicity*, s.l.: ENPC - LVMT.
- Levinson, D., 2017. *On the differences between Autonomous, Automated, Self-Driving and Driverless cars*. [Online]  
Available at: <https://transportist.org/2017/06/29/on-the-differences-between-autonomous-automated-self-driving-and-driverless-cars/>  
[Accessed 20 October 2018].
- NHTSA, 2008. *National Motor Vehicle Crash Causation Survey*, s.l.: U.S. Department of Transportation.
- Ohnsman, A., 2018. *Waymo Dramatically Expanding Autonomous Taxi Fleet, Eyes Sales To Individuals*. [Online]  
Available at: <https://www.forbes.com/sites/alanohnsman/2018/05/31/waymo-adding-up-to-62000-minivans-to-robot-fleet-may-supply-tech-for-fca-models/#2e736bde4558>  
[Accessed 16 October 2018].
- Pettit, H., 2018. *Uber's self-driving cars will pick up paying passengers within 18 months, claims CEO Dara Khosrowshahi*. [Online]  
Available at: <https://www.dailymail.co.uk/sciencetech/article-5306305/Uber-plans-self-driving-taxis-roads-18-months.html>  
[Accessed 10 October 2018].
- Phys, 2017. *Investors fuel a multibillion-dollar ride-sharing frenzy*. [Online]  
Available at: <https://phys.org/news/2017-10-investors-fuel-multibillion-dollar-ride-sharing-frenzy.html>  
[Accessed 15 October 2018].
- SAE, 2018. *Taxonomy and Definitions for Terms Related to Driving Automation Systems for On-Road Motor Vehicles*. [Online]  
Available at: [https://www.sae.org/standards/content/j3016\\_201806/](https://www.sae.org/standards/content/j3016_201806/)  
[Accessed 10 September 2018].
- Shaheen, S., Cohen, A. & Zohdy, I., 2016. *Shared Mobility: Current Practices and Guiding Principles*, Washington D.C.: Booz Allen Hamilton Inc..
- Spieser, K. et al., 2014. *Toward a Systematic Approach to the Design and Evaluation of Automated Mobility-on-Demand Systems: A Case Study in Singapore*. *Road Vehicle Automation*, Septembre.
- Stocker, A. & Shaheen, S., 2017. *Shared Automated Vehicles: Review of Business Models*, s.l.: OECD/ITF.
- The Milwaukee Sentinel, 1926. *Phantom Auto' will tour city*. [Online]  
Available at: <https://news.google.com/newspapers?id=unBQAAAAIAAJ&sjid=QQ8EAAAAIAAJ&pg=7304,3766749&hl=fr>  
[Accessed 23 Juillet 2013].
- The Victoria Advocate, 1957. *Power companies build for your new electric living*. [Online]  
Available at: <https://news.google.com/newspapers?nid=861&dat=19570324&id=qtFHAAAAIAAJ&sjid=nn8MAAAAIAAJ&pg=1952,2616834&hl=fr>
- Vincent, J., 2015. *Toyota's \$1 billion AI company will develop self-driving cars and robot helpers*. [Online]  
Available at: <https://www.theverge.com/2015/11/6/9680128/toyota-ai-research-one-billion-funding>  
[Accessed 10 October 2018].
- Walker, J., 2018. *The Self-Driving Car Timeline – Predictions from the Top 11 Global Automakers*. [Online]  
Available at: <https://www.techemergence.com/self-driving-car-timeline-themselves-top-11-automakers/>  
[Accessed 29 October 2018].
- WHO, 2018. *Violence and Injury Prevention*. [Online]  
Available at: [http://www.who.int/violence\\_injury\\_prevention/road\\_traffic/en/](http://www.who.int/violence_injury_prevention/road_traffic/en/)  
[Accessed 10 October 2018].

Zhang, W., Guhathakurta, S., Fang, J. & Zhang, G., 2015a. *The performance and benefits of a shared Autonomous Vehicles based dynamic ridesharing system: an agent*. Washington DC, United States: s.n.

# Section I. State of the art

This section presents a state of the art of Shared Mobility services and services involving Autonomous Vehicles.

It is organized into two Chapters:

- **Chapter.1 Modeling Transportation Systems involving Autonomous Vehicles: A State of the Art.** This Chapter reviews the main modeling works on transportation systems involving AVs that were published in the academic literature up to end of 2017.
- **Chapter.2 Shared Mobility services: Review of existing services and findings of spatial and socio-economic models.** This Chapter synthesizes existing literature that addresses organizational and modelling issues of existing Shared Mobility services as of the end of 2018. It focuses especially on carsharing, ridesharing and for-hire services.



# **Chapter.1 Modeling Transportation Systems involving Autonomous Vehicles: A State of the Art**

## **ABSTRACT**

The emergence of Autonomous Vehicles (AVs) is becoming an unquestionable reality. Several modeling studies investigated their potential impacts with special focus on spatial and/or socio-economic features. Spatial modeling represents (i) in detail the technical specifications of the novel mode, and (ii) the spatial features of the area in which the system is implemented. Most of these models are agent-based. Socio-economic modeling addresses the conditions of market penetration and diffusion using mathematical methods with commercial or social orientation. Furthermore, it investigates investment and operating costs.

This Chapter attempts to summarize the main modeling works on transportation systems involving AVs that were published in the academic literature up to 2018. In addition, we provide some examples of applications and address their respective outreach and limitations. We present recommendations for future developments.

*Keywords:* Autonomous vehicles, new mobility services, spatial modelling, economic modelling

## **1. INTRODUCTION**

### *1.1. Background*

Several experiments have been conducted in last years on Autonomous Vehicles (AVs). Such in-field experiments are mainly intended to test self-driving technology and possibly also the attitudes, use gestures and behaviors of potential users. Yet, up to now there has been no large-scale implementation of AV fleet in a given territory. Prior to that, it is obviously important to deliver safe and reliable technology and to settle a suitable regulatory framework. Even more important, though less obvious, is the requirement to ensure commercial success, i.e. the purchase or hiring of AVs by individual customers or firms, which requires in turn convincing evidence of AV-based services attractiveness within the range of travel solutions that compete to serve mobility purposes. This is why a number of researchers have modelled AV-based services as mobility solutions under particular territorial conditions.

### *1.2. Objective and Method*

This Chapter reviews the main models developed so far, with the aim to summarize their findings and to assess their outreach and limitations. As it turns out, the reviewed models fall into two broad categories depending on their main orientation that can be geographic or socio-economic. Geographic or spatial models focus on technical conditions concerning

service performance, operations and availability in relation to users' needs and alternative solutions. The choice from among alternative solutions indeed leads to economic issues. Models belonging to the socio-economic category put the emphasis on the temporal conditions of AV development: this involves issues of technology readiness, legal framework, demand inclination and adoption, in relation to the production costs of self-driving cars.

### *1.3. Structure of the Chapter*

The rest of the Chapter is organized in four parts. Section 2 reviews models that emphasize spatial conditions: they can be further divided according to whether they are rooted in travel demand needs and choices, or in the dynamic performance of a technical system that links the supply and demand sides. Then, Section 3 addresses socio-economic models, from market penetration to production costs passing by customership issues. Next, Section 4 reports on the evaluation of potential impacts that range from traffic volumes and parking demand to environmental impacts, passing by safety. Lastly, Section 5 discusses the outreach and limitations of the reviewed models and their applications, before proposing some directions for further research.

## **2. SPATIAL MODELS OF AV-BASED SERVICES**

### *2.1. Models rooted in Travel Demand*

Although a lot of research has addressed the objective of AVs, very few have been examined the integration of AVs into travel demand models (Levin, 2015; Burghout, et al., 2015; Auld, et al., 2017; Kloostra & Roorda, 2017).

In 2015, Levin proposed a four-step model dividing demand into classes by value of time and AV ownership. AVs are considered as private vehicles. Mode choice is between parking, repositioning, and transit based on a nested logit model. Static and dynamic assignments showed that using AVs improves the capacity of the intersections but does not reduce significantly the congestion. However, the model focused on the case of fully autonomous privately-owned cars only. Results showed that AVs-motorization will induce less use of transit, suggesting then that parking costs could be a main incentive for transit, yet probably involving more round-trips and in turn increases in congestion and travel times.

Burghout et al. (2015) used the CONTRAM dynamic traffic assignment model to assess benefits of a fleet of Shared Autonomous Vehicles (SAV) replacing private cars commuters in the Stockholm metropolitan area. The results indicated that the SAV system has the potential to provide a high level of service by using 5% of today's private cars and 4% of parking places.

Auld et al. (2017) used a simulation model (POLARIS) which includes an activity-based model (ADAPTS) and a traffic simulation model. Market penetration is controlled on a regional scale by adjusting road capacity. Results showed that capacity and value of time affect significantly vehicle-kilometers travelled (VKT).

Finally, Kloostra and Roorda (2017) assumed that AVs would change road capacity thanks to Autonomous Cruise Control technology (ACC). Then, they modified road links capacities to simulate theoretical increase in throughput enabled by AV driving behavior. They distinguished two types of road links: freeways and arterial streets. A static assignment, using Emme 4, showed that travel time savings could increase by 12 to 21% for a 90% market penetration level while the average trip length would not vary significantly.

### *2.2. Agent-based models*

Agent-based models are an effective tool for the study of innovative urban services, as agents act and react according to the information received in real time. On the other hand, activity models offer improved reproduction of the demand and allow a more realistic analysis of users' mobility. Thus, agent-based models are highly used in literature to describe and analyze operations of AVs.

One of the first studies that have addressed AVs simulation is that of (Burns, et al., 2013). They estimated the utility of Shared Autonomous Vehicles (SAV) for users (waiting time) and operators (cost of production). They considered as variables local specifications, trip length, speed, fleet size and vehicles cost parameters. The model assumed that the vehicle speed is constant and OD trips are uniformly distributed over the study area. The application on three US cities of different sizes Ann Arbor, Babcock Ranch (Florida) and Manhattan (New York) showed that for all scenarios, passengers experience greater convenience with SAVs. Compared to taxicabs, trip fares are lower and waiting times shorter. In addition, economies of scale are reached quickly and costs savings are more important.

In 2015, the International Transport Forum (ITF, 2015) simulated the Shared Mobility in the real network of Lisbon using agent-based models. Mode choice process is based on a rule-based approach. The demand is generated based on the Lisbon Travel Survey. The user groups, especially for new services, are not considered. A trip is generated when a user sends a request. Route choice minimizes travel time by integrating the average speed per section per hour. Sixty stations are spread in the city and three capacities of vehicles are considered (two, five- and eight-seats). One of the most relevant findings of the study indicates that if only 50 % of car travel is carried out by shared self-driving vehicles and the remainder by traditional cars, total vehicle travel will increase between 30 % and 90 %. This holds true irrespective of the availability of high-capacity public transport.

The model of Fagnant and Kockelman (2014) is probably one of the most relevant ones since it constituted a basis for other models developed later (Fagnant & Kockelman, 2015a; Fagnant, et al., 2015b; Fagnant & Kockelman, 2016; Chen, et al., 2016; Boesch, et al., 2016; Loeb, et al., 2018). In fact, they simulated SAVs in Austin (Texas) using an agent-based model (MATSim). SAVs are used by 2 % of the total demand. The city is composed into

traffic zones and each traffic zone is characterized by a factor of attractiveness. All the trips are generated every 5 minutes a day using Poisson distributions. The model is then structured by following four major steps: (1) *SAV location and trip assignment*, which determines which available SAVs are closest to waiting travelers (prioritizing those who have been waiting longest), and then assigning available SAVs to those trips. The assignment is done according to a First-Come First Served (FCFS) order. A vehicle shall be assigned to a customer in an interval of 5 minutes; otherwise the user is put in the waiting list and is considered as a priority in the next simulation. (2) *SAV fleet generation*, which defines the fleet size. In particular, the fleet size is determined by running a SAV "seed" simulation run, in which new SAVs are generated when any traveler has waited for 10 minutes and is still unable to locate an available SAV in 10 minutes away or less. (3) *SAV Movement* is characterized by a vehicle speed equal in a normal hour to 3 times the number of areas. Passengers boarding and alighting last 1 minute. The calculation of the vehicle position is registered every 5 minutes. (4) *SAV relocation*, aims to balance the vehicles distribution ahead of the demand using four relocation strategies. Boesch et al. (2016) largely adopted the assumptions of this model with excluding the relocation policies of AVs. They showed that the relationship between the demand and fleet size is non-linear and the ratio increases as the demand increases.

The comparison between dispatching and relocation strategies was then performed by (Zhu & Kornhauser, 2017; Hörl, 2018; Hyland & Mahmassani, 2018). Zhu et al. (2017) proposed two reactionary local repositioning strategies: the first one considers that when a passenger arrives, only stands with available vehicles that can reach the departure stand before the departure time is considered. The second strategy extends the first one to farther taxi stands if there is no available vehicle that can arrive in time. For the two strategies, the repositioning is performed at the end of the day. The application on New Jersey showed that all of travel demand can be served with a fleet of SAV that is much smaller than the current operating fleet (i.e. one SAV can replace about 6 conventional cars). Hörl (2018) explored the performance of four existing dispatching and rebalancing algorithms that have been used in literature to simulate SAVs. The attractiveness of the service is assessed according to the waiting time and the service fare. The operator influences the service level through dimensioning the fleet size and defining dispatching and rebalancing strategies. For all scenarios, the simulation for the Zurich area found almost same values of waiting time. In addition, AV services appear to be cost-wise highly attractive for car and taxi users, while they are not able to compete with subsidized mass transit. Hyland and Mahmassani (2018) assessed operational performances of six assignment strategies for SAVs with no shared trips (i.e. two simplistic strategies based on FCFS algorithms, and four optimization-based strategies). The results showed that two optimization-based assignment strategies, (1) strategies that allow en-route pickup AVs to be diverted to new traveler requests and (2) strategies that consider en-route drop-off AVs, allow lowest vehicles distances travelled and

travelers waiting times. This observation is valid only for high fleet utilization rates. When fleet utilization is low, operational performances are quietly the same for all strategies. Babicheva et al. (2018) proved by testing different relocation strategies that the best strategy depends on locations of vehicles and passengers. Thus, they propose to combine different strategies depending on the current demand and supply conditions.

On the other hand, few studies have explored issues of dynamic ridesharing. Zhang et al. (2015a; 2015b) reproduced the model of Fagnant with considering users' incomes and Dynamic RideSharing (DRS). Results showed that a DRS can provide more satisfactory level of service compared to a non-shared trips system, in terms of shorter trip delays, more reliable services (especially during peak hours), less Vehicle Kilometers Traveled (VKT) generation, and less trip costs. In addition, DRS may eliminate a significant amount of parking demand for participating households (by 67 %). In 2017, they implemented a parking module in a discrete event simulation with various pricing strategies (Zhang & Guhathakurta, 2017). They found that in the free parking scenario, the parking lots will be more evenly distributed throughout the city. Fagnant and Kockelman (2016) assumed that DRS is applied only if induced extra-time for current riders and new travelers can be tolerated. They found that DRS would reduce VKT by 7 % and the waiting time by 25 %.

By considering that AVs are electric, Fagnant et al. (2015b) found that the average distance travelled per day is greater than that allowed by vehicle range. Chen et al. (2016) developed this model with considering moreover charging stations. The stations are generated in order to allow vehicles to reach the user's origin or destination. The model is simulated for a medium-sized city, for a range of vehicles of 130 km and normal charging stations (4-hour charge). Results indicated that fleet size is sensitive to battery recharge time and vehicle range. Loeb and Kockelman (2018) proposed enhancements to (Chen, et al., 2016) and (Boesch, et al., 2016) by including a more efficient vehicle search algorithm, dynamic ridesharing capabilities and a detailed cost evaluation. It was found that a fleet with lower range and/or charge time did not affect the per-kilometer cost but the fleet was not able to service as many trips each day. Loeb et al. (2018) incorporated more realistic vehicle speeds, and more robust charging strategies that allow still-charging/not-yet-fully-charged vehicles to respond to requests. The application on the network of Austin, Texas, showed that increasing fleet size has a profound effect on response times while vehicle range affects the number of stations.

In regards to the representation of the road network, the majority of studies have considered a grid-based network as abstraction of the real network (Fagnant & Kockelman, 2014; Chen, et al., 2016; Zhang, et al., 2015). More advanced network representations include quasi-dynamic actual road networks with time-dependent, but deterministic travel times (ITF, 2015). Recent research employed dynamic traffic simulation tool such MATSIM (Bischoff & Maciejewski, 2016) or MITSIM (Adnan, et al., 2016; Azevedo, et al., 2016) and a

cell-transmission model (Levin, et al., 2017) to model AVs in a congestible road network. In all of these studies, however, the demand is a fixed input, estimated based on a given penetration rate of AVs.

The number of studies dealing with the connection of AVs with public modes remains limited (ITF, 2015; Vakayil & Samaranayake, 2017). The study of ITF (2015) found that the AV fleet size is influenced by the availability of public transport. In particular, around 18% more SAVs are needed in scenarios without high-capacity public transport, compared to scenarios where SAVs are deployed alongside high-capacity public transport. It follows that without public transport, 5000 additional cars are required and driven kilometers would increase by 13%. Vakayil et al. (2017) proposed a spatially hub-based SAV network model that analyses transfers between AVs and mass transit. The model considered transit frequency, transfer costs and two rebalancing strategies. It proved that an integration between AV and mass transit services leads to reduction in congestion and vehicular emissions. Yu et al. (2017) assessed the potential of using on-demand SAV as the alternative to the low-demand buses to improve the first/last-mile connectivity in a study area in Singapore. The agent-based model is tested for a bus-only scenario and a series of scenarios integrating AV with various fleet sizes. Criteria are defined for each actor. For users, the out-of-vehicle time is evaluated. For transportation services, it is the impact on road traffic. From AV operators' perspective, the profitability is considered. Results are positive if all users accept to share their last-mile rides, with careful selection of the size of AV fleet: lower out-of-vehicle time for the passengers, less occupied road resources than the low-demand buses, and higher possibility to be financially viable.

Probably one of the most complete models cited in literature is SimMobility, under-development by (Spieser, et al., 2014; Azevedo, et al., 2016). It is an integrated agent-based demand and supply model. It comprises three simulation levels: (i) a long-term level that captures land use and economic activity, with special emphasis on accessibility, (ii) a mid-term level that handles agents' activities and travel patterns, and (iii) a short-term level, that simulates movement of agents, operational systems and decisions at a microscopic granularity. The application considers that the vehicle could anticipate the demand to reduce waiting times and to ensure a balance between required vehicles and available vehicles in each area. All existing competing modes (taxis, trains, buses, etc) are considered. The cost of service is assumed about 40 % less than the regular taxi service. The study distinguished between internal trips, external trips and transits. The results highlighted that for 2,400 vehicles and 10 stations, the waiting time is 5 minutes and the number of trips per vehicle is 16 (Azevedo, et al., 2016).

Whereas main agent-based models are rule-based, some others are solving optimization problems for given demand and supply data (Zhang, et al., 2018; Ma, et al., 2017; Gurumurthy & Kockelman, 2018). Zhang et al. (2018) used three successive heuristic

algorithms to examine vehicle ownership reduction potentials after replacing private conventional vehicles by private AVs. They assumed that AVs are shared among household members and optimized vehicle route to determine the origins and destinations times and locations. The application on Atlanta Metropolitan Area showed that more than 18 % of households can reduce vehicles while maintaining their current travel patterns. Ma et al. (2017) proposed to simulate an AV-based service where the operator optimally arranges the AV pickup and drop-off schedule and trip chaining patterns on the basis of a recorded trip demand requests. A linear programming model is suggested to find solutions for AV trip chains under single and multiple service horizons. Gurusurthy et al. (2018) explored DRS matches across different travelers and identify optimum fleet sizes using cellphone-based trip tables of Orlando, Florida. Assuming that the travel patterns do not change significantly in the future, the results suggest on average, one SAV per 22 person-trips is able to serve almost half the region's demand. In addition, 60 % of the single-person trips could be shared with other solo-travelers inducing less than 5 minutes added travel time.

### **3. SOCIO-ECONOMIC MODELS OF AV DEVELOPMENT**

#### *3.1. Market penetration*

In 2012, the IEEE predicted that 75 % of the fleet will be autonomous in 2040 (IEEE, 2012). The French government studied two entry scenarios: a trend-based scenario, in which the deployment is very gradual from 2040; and a breaking scenario where, by 2025, cars can be automated (Janin, et al., 2016). Johnson et al. (2017) predicted that AVs will have the same diffusion shape of color TV, then reaching 50 % US market share in 15 years. According to Litman (2018), it will be at least 2040 before half of all new vehicles are autonomous, 2050 before half of the vehicle fleet is autonomous, and possibly longer due to technical challenges or consumer preferences. Stated-preference surveys in Austin showed that 40 % (Bansal, et al., 2016) to 50 % (Zmud, et al., 2016) of US respondents want to use private AVs for everyday use.

Lavasani et al. (2016) proposed a market penetration model for AV by using a generalized Bass model. Assuming that AVs will become available in 2025, the market of new car sales may reach about 8 million annually in 10 years, and saturation may occur in 35 years assuming a 75 % market size. The sensitivity analysis concluded that the market size strongly impacts adoption rate, while the price of the technology does not seem influencing the diffusion process.

#### *3.2. Potential customers*

In recent years, various surveys investigated the general acceptance of AVs. In terms of age, some studies suggested that SAV will mostly capture the elderly and those with reduced mobility (Rödel, et al., 2014; Schoettle & Sivak, 2014; Schoettle & Sivak, 2015; Fagnant & Kockelman, 2015a). Other studies came to the conclusion that younger people are more

open towards the introduction of AVs (KPMG & CAR, 2012; Power, 2012; Krueger, et al., 2016; Abraham, et al., 2017). In terms of gender, men are more likely to use AV (Piao & McDonald, 2005; Rödel, et al., 2014; Schoettle & Sivak, 2015; Abraham, et al., 2017), but less likely to pay (Lavasani, et al., 2017). Anderson et al. (2014) suggested that non-motorized people would rather be captured by SAV, while Krueger et al. (2016) found that motorization and/or preferences for public transport do not highly affect the attractiveness of AVs. In addition, Krueger et al. (2016) showed that current Shared Mobility users (i.e. carsharing) have a higher probability of choosing SAVs with DRS. Power et al. (2012) and Bansal et al. (2016) noticed that residents of urban areas and people with higher income are more inclined to use AV. According to Kok et al. (2017), the adoption will start in cities and radiate outward to rural areas. Non-adopters will be largely restricted to the most rural areas, where cost and waiting times are likely to be higher. Lavasani et al. (2017) stated that willingness to pay is affected by travel frequency, commuting distance, demand for parking and perception of AV benefits.

### *3.3. Production costs*

Many preceding studies focus on the economics of centrally organized autonomous taxi operator:

- Bansal et al. (2016) suggested a price of 22,000 € in 2025.
- Boston Consulting Group (2015) predicted that in 2025 AV will cost 8,600 €.
- Burns et al. (2013) studied the production costs of AVs spread in three different cities. They estimated capital costs (depreciation, finance, registration and insurance) and operating costs (energy, maintenance and repair, and other costs). They found that capital costs account for 46 % of total costs while operating costs account for the remaining 54 %. In addition, SAVs would cost to customer 0.22 €/km (or 0.9 €/km for electric and small vehicle) instead of 0.88 €/km (for taxis).
- Spieser et al. (2014) estimated the yearly cost of using SAVs in Singapore. For a purchase cost of 13,000 € and a lifespan of SAVs over 2.5 years, SAV costs are 8,500 €/year instead of 10,000 €/year for cars. By integrating the value of time for an average SAVs waiting time of 5.5 minutes, the costs gap is even more significant (4,800 €/year for the AV and 16,000 €/year for cars).
- Fagnant et al. (2016) considered a penetration rate of 1.3 %. The purchase costs are about 60,000 € per AV and the average lifespan 400,000 km (or 7 years). As a result, the SAV costs for user are about 0.55 €/km, which is 3 times less than the taxi fare. For operators, the rate of annual return on investment is around 13 % for a total fleet of 2,118 AVs.
- Chen et al. (2016) found that operating costs of Shared Autonomous Electric Vehicles (SAEV) vary from 0.23 to 0.26 € per occupied kilometer travelled. It follows that SAEVs are price competitive with SAVs when gasoline reaches 1 € to 1.31 € per liter.



- Boesch et al. (2018) considered different scenarios for a study of autonomous public transit cars in Zurich, Switzerland. Ownership costs include depreciation, tax, insurance and interest, and account for 20 % of total costs. Operating costs include cleaning, maintenance and wear, overhead and vehicle operations (e.g., management, HR, fleet-coordination, advertising), fuel, parking and tolls. They account for the remaining 80 %. They argued that shared autonomous rides (self-driving public transit) will probably cost 0.11 – 0.22 € per passenger-kilometer, assuming that they average 3 – 6 passengers.
- Johnson et al. (2017) predicted that SAEV operating costs will decline from 0.46 per kilometer in 2018 to about 0.2 € per kilometer by 2035, less than half of a typical personal car’s total cost of ownership, and slightly less than their operating expenses.
- Kok et al. (2017) predicted an intensive competitive environment, which will lead to a quick transition from human-driven and thermal vehicles to autonomous electric vehicles. In particular, they will benefit of key cost factors, including ten times higher vehicle-utilization rates, 800,000 kilometers vehicle lifetimes (potentially improving to 1.5 million kilometers by 2030), and far lower maintenance, energy, finance and insurance costs. As a result, SAVs will offer lower-cost mobility service, likely four to ten times cheaper per kilometer than buying a new car and two to four times cheaper than operating an existing vehicle in 2021 (Kok, et al., 2017).
- Litman (2018) presented a literature review of production costs of autonomous cars and electric autonomous cars.

**Table 1** presents main findings of the literature review.

**Table 1 Values of production costs based on literature review**

Component	Usage type	Unit cost	Reference
<b>Purchasing vehicles</b>	All types	Required equipment for automation: +5000€ Navigation GPS:+200-600€/year	Litman (2018)
	All types	22,000 € (in 2025)	Bansal et al. (2016)
	All types	8,600 € (in 2025)	(BCG, 2015)
<b>Lifespan</b>	SAV	1 to 3 years	Spieser et al. (2014)
<b>Running costs</b>	SAV	0.22 €/km	Burns et al. (2013)
		0.55 €/km	Fagnant et al. (2016)
	SAEV	0.09 €/km	Burns et al. (2013)
		0.23 – 0.26 €/km	Chen et al. (2016)
		0.19 – 0.46 €/km	Johnson et al. (2017)
		Less than 0.05 €/km	Kok, et al. (2017)
Autonomous public transit	0.11 – 0.22 €/pass.km	Bösch, et al. (2018)	

	cars		
<b>Insurance costs</b>	All types	-50 %	Litman (2018)

#### 4. IMPACTS OF AUTONOMOUS VEHICLES

##### 4.1. Impacts on mobility

The impacts on mobility concern the congestion effect, measured by the number of vehicles on roads and the distance traveled by vehicles:

- Zhang et al. (2018) showed that replacing private conventional cars by private AVs in Atlanta Metropolitan Area would reduce households' motorization by 9.5 %.
- Fagnant et al. (2014; 2015b) found that one SAV would replace 9 to 11 conventional vehicles while inducing 10 % more VKT.
- ITF (2015) emphasized that the substitution of conventional cars by SAV would reduce the total fleet by 90 % and increase the daily utilization of vehicles by 65 %. Hence, the study showed for different rates of market penetration that AVs deployment would increase the VKT.
- Spieser in (2014) indicated that replacing all private cars by SAVs in Singapore would reduce by 2/3 the total fleet of vehicles on roads.
- The application of Levin et al. (2016) on Austin showed a great increase of congestion and travel time, in particular if vehicles' relocation is anticipated.
- Nevertheless, through prearranging AVs trips chains based on recorded demand requests, Ma et al. (2017) proved that one AV can replace about 13 private vehicles or traditional taxis without observing any increase in the VKT incurred by vehicles relocation.
- Zhang et al. (2015a) stated that DRS reduces the fleet size by 5.3 % and empty VKT by 4.8 %.
- Boesch et al. (2016) found that the total vehicle fleet could be significantly reduced (by 90 %) if DRS is allowed and waiting time is over 10 minutes.
- Gurumurthy et al. (2018) showed that 60,000 SAV can meet nearly 50 % of Orlando's 2.8 million single-traveler trips per day.
- According to Chen et al. in (2016), the use of electric vehicles would pass the ratio to only 3.7 of replaced conventional vehicles, with an increase in VKT from 7 to 14 %.
- Loeb et al. (2018) found higher percentage of VKT for SAEV, 19.8 % of which 23 % is for access to charging stations.
- Gucwa (2014) used an activity-based model to investigate the relationships of not shared AVs and road capacity, time value and vehicles operating costs. The study shows that VKT could increase by between 8 and 24 %. Similar studies found that VKT could increase by 3 to 30 % (Childress, et al., 2015) and around 20 % (Zhao & Kockelman, 2017).

Therefore, all modelling studies found that AVs will reduce the number of vehicles on roads while increasing VKT. The level of impact, however, vary from a study to another depending

on their respective context and management strategies (i.e. assignment, relocation, DRS, etc.)

#### *4.2. Impacts on urban parking*

For a market penetration of 2 %, the demand for parking is reduced by about 90 % (Zhang, et al., 2015b). The ITF (2015) found that for the case of 100 % AV, space savings are around 85% to 95%. However, for the case of 50 % of AV, the rate of space savings is insignificant. Fagnant et al. (2015b) suggested that the total parking demand will fall by around 8 vehicle spaces per SAV. In addition, moving the parking from downtown to less dense outlying areas allows for significant savings (Litman, 2012; Fagnant & Kockelman, 2015a). Zhang et al. (2017) suggested that SAV could reduce parking land by 4.5 % in Atlanta at a 5 % market penetration level.

#### *4.3. Impacts on accidents*

More than 90 % of injury accidents are caused by human factors. Li et al. (2016) found that main AVs can save Americans 65 billion Euros each year. In 2014, the cost of road accidents in France stood at 37 billion Euros which 21 billion Euros relating to personal accident (ONISR, 2015). AVs would drastically reduce the frequency of accidents. According to the Insurance Institute for Highway Safety (IIHS), AVs would avoid a 1/3 of accidents (IIHS, 2010).

#### *4.4. Environmental impacts: energy consumption and pollutant emissions*

The environmental impact is estimated on the basis of a Life-Cycle Analysis, which includes vehicle operations (movement, cold start, etc.), but also cars' manufacturing and the construction of related infrastructure (parking, stations, maintenance depots, etc.). Since SAVs would reduce the total vehicle fleet (as cited above), using them would involve significant costs savings. The high use of AV shortens their lifespan to 1.5 – 4 years (Zhang, et al., 2015a; Spieser, et al., 2014), which helps permanent improve of the fleet performances. Currently, the AV technology reduces the energy consumed in acceleration and deceleration by 4 to 10 % (Anderson, et al., 2014). Also, the use of AV reduces by 85 % (Fagnant, et al., 2015b) to 95 % (Zhang, et al., 2015a) emissions induced by cold starts. In addition, sharing vehicles could save more than 4.7 % of energy, GHG, and the pollutants emitted (Zhang, et al., 2015a).

On the other hand, the use of electric vehicles would generate a significant demand for electricity during the peak charging period of the day (53 % of the fleet concurrently charging). Fast charging, although inducing 15 % more in cost, is very effective at demand spreading, with only 8 % of the fleet charging during the peak charging period.

## **5. OUTREACH, LIMITATIONS AND SOME RECOMMENDATIONS**

This brief state of art in modelling transportation systems involving AVs is summarized in **Figure 2**. We observe that major models focus on the supply operations and set-ups without detailing the demand side beyond statistical and spatial description in the form of an origin-destination matrix of trip-flows.

On the supply side, agent-based approaches determine operating conditions, especially the number of required AVs, while optimizing the waiting time and empty VKT. Furthermore, these models permit to reproduce in a realistic, detailed and robust way movements of vehicles considering several strategies. However, studies considering the real network are scarce (ITF, 2015; Adnan, et al., 2016; Anderson, et al., 2014; Azevedo, et al., 2016). Further, urban constraints which determine the locations of stations and their capacities are not considered at all, even in the case of electric vehicles. The combination of fixed stations and free-floating (while respecting the conditions of accessibility (Ciari, et al., 2015)) could reduce waiting time and locating stations in low dense areas (which is also economically attractive). Using dynamic parking cost (relevant to area's configuration and state of congestion) could be explored as well.

Assignment strategies of vehicles to customers should be optimized as well. Indeed, almost all studies are based on a FCFS strategy; a strategy that could be optimized using more sophisticated assignment and relocation algorithms (Babicheva, et al., 2018). In addition, the most of aforementioned models are applied on urban centers of cities. It would be interesting to explore the service potentialities in suburban zones, freeways and around major train stations.

On the demand side, almost all of the studies estimate the AV demand based on market penetration. Studies using real inputs are those exploring full replacement of cars by AVs. In addition, the AVs are not integrated in a multimodal chain. A detailed study of the users' utility of SAV will enable capturing individual preferences while distinguishing between (i) utility of acquiring and/or maintaining and (ii) utility of using AVs. This study is essential since it enables confirming service potential and defining pricing strategies. Its results are used as inputs of economic models and modal choice models. Further, taking into account day-to-day traffic for the year should be explored using activity-based models, while distinguishing between typical weekday, weekend day, holiday or special day events.

On the other hand, to assure AVs sustainability and its dissemination, it is necessary to develop an in-depth knowledge of production costs and demand evolutions in order to promote informed and rational choices. Production costs concern all components involved in transit system operations (track and station elements, vehicles, and staff) that have to be acquired or hired and maintained at acceptable operating conditions. The models of new taxi apps present useful business insights. The yield management used by UBER, LYFT, GrabTaxi... permits to smooth the demand over time.

Moreover, further studies of the acceptability of AVs with the various stakeholders are necessary: mainly users, transport authorities, transit operators, insurance companies and car manufacturers.

Finally, let us outline that these works would highly benefit from detailed data on production costs, as well as on commercial revenue and individual utility of the user and environmental impacts. For an innovative service, some data cannot be observed but must be inferred from comparison bases, and simulated by means of an ad hoc model.

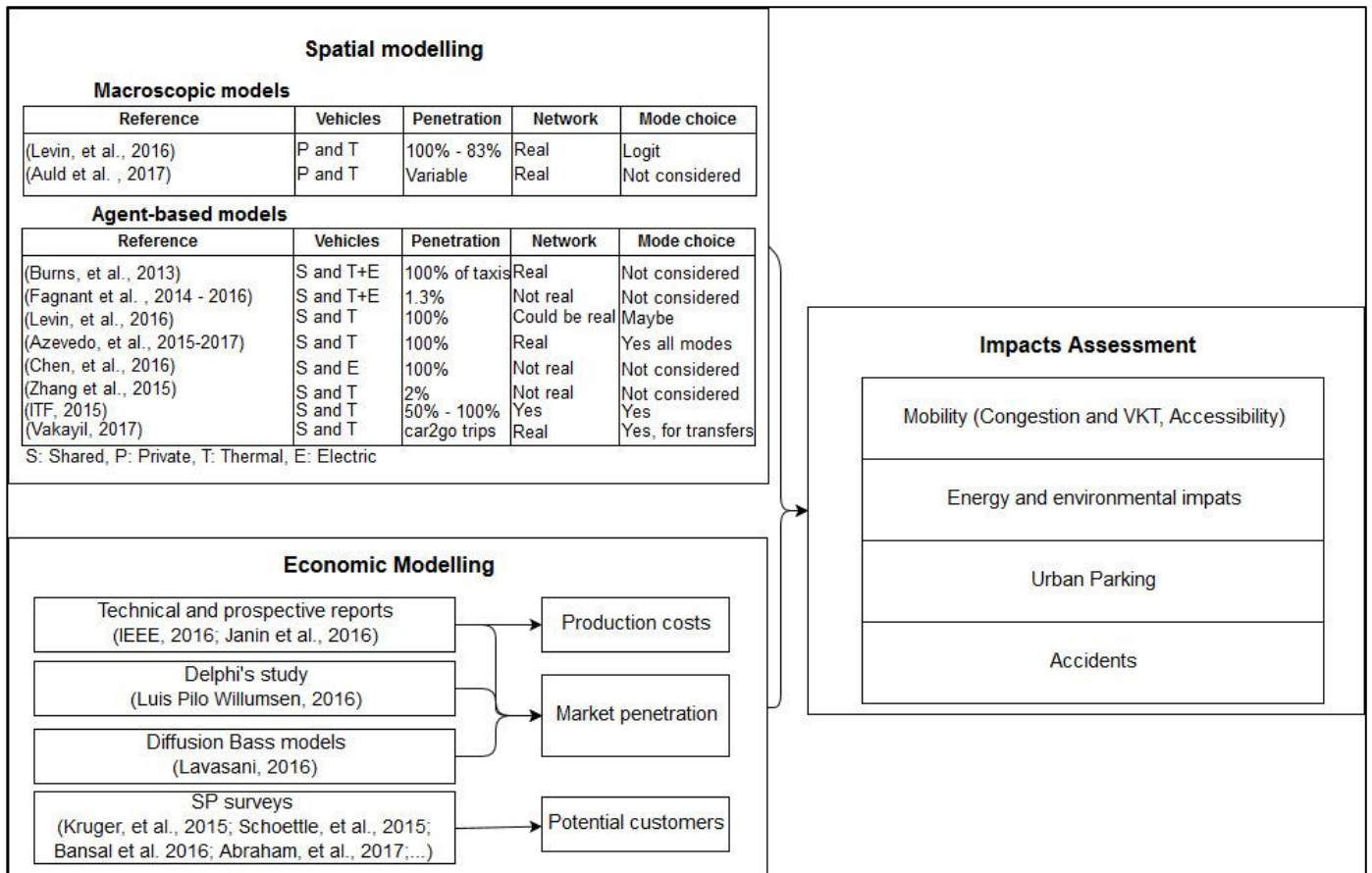

Figure 2 Synthesis of literature review

## REFERENCES

- Abraham, H. et al., 2017. Autonomous Vehicles and alternatives to driving: trust, preferences, and effects of age. *Transportation Research Board 96th Annual Meeting*.
- Adnan, M. et al., 2016. SimMobility: A Multi-Scale Integrated Agent-based Simulation Platform. *Proceedings of the 95th annual meeting of Transportation Research Board*, p. 18.
- Anderson, J. et al., 2014. *Autonomous Vehicle Technology: A Guide for Policymakers*, s.l.: RAND Corporation.
- Auld, J., Sokolov, V. & Stephens, T., 2017. Analysis of the impacts of CAV technologies on travel demand. *Transportation Research Board 96th Annual Meeting*.
- Azevedo, L. C. M. et al., 2016. Microsimulation of Demand and Supply of Autonomous Mobility On-Demand. *Transportation Research Record Journal of the 95th annual meeting of Transportation Research Board*, January.

- Babicheva, T., Burghout, W., Andreasson, I. & Faul, N., 2018. The matching problem of empty vehicle redistribution in autonomous taxi systems. *Procedia Computer Science*, Volume 130, pp. 119-125.
- Bansal, P., Kockelman, K. & Singh, A., 2016. Assessing public opinions of and interest in new vehicle technologies: An Austin perspective. *Transportation Research Part C: Emerging Technologies*, Volume 67, pp. 1-14.
- BCG, 2015. *Revolution in the driver's seat, The road to Autonomous Vehicles*. [En ligne] Available at: [https://www.bcgperspectives.com/content/articles/automotive-12\\_consumer-insight-revolution-drivers-seat-road-autonomous-vehicles/](https://www.bcgperspectives.com/content/articles/automotive-12_consumer-insight-revolution-drivers-seat-road-autonomous-vehicles/) [Accès le March 2017].
- Bischoff, J. & Maciejewski, M., 2016. Simulation of city-wide replacement of private cars with autonomous taxis in Berlin. *Procedia Computer Science*, pp. 237-244.
- Boesch, P., Becker, F., Becker, H. & Axhausen, K. W., 2018. Cost-based analysis of autonomous mobility services. *Transport Policy*, May, Volume 64, pp. 76-91.
- Boesch, P., Ciari, F. & Axhausen, K., 2016. Required Autonomous Vehicle Fleet Sizes to Serve Different Levels of Demand. *Transportation Research Record of Proceeding of the 95th annual meeting of Transportation Research Board*, 2542(4).
- Burghout, W., Rigole, P.-J. J. & Andreasson, I., 2015. Impacts of Shared Autonomous Taxis in a Metropolitan Area.. *Proceedings of the 94th annual meeting of the Transportation Research Board*.
- Burns, L., Jordan, W. & Scarborough, B., 2013. *Transforming Personal Mobility*, New York, United States: The Earth Institute, Columbia University.
- Chen, D., Kockelman, K. & Hanna, J., 2016. Operations of a shared, autonomous, electric vehicle fleet: implications of vehicle & charging infrastructure decisions. *Transportation Research Part A: Policy and Practice*, December, Volume 94, pp. 243-254.
- Childress, S. et al., 2015. Using an Activity-Based Model to explore possible impacts of Automated Vehicles. *Proceedings of 94th Annual Meeting of the Transportation Research Board*.
- Ciari, F., Weis, C. & Balac, M., 2015. Evaluating the influence of carsharing stations' location on potential membership: a Swiss case study. *Euro Journal on Transportation and Logistics*, 17 Mars, pp. 1-25.
- Fagnant, D. & Kockelman, K., 2014. The travel and environmental implications of shared Autonomous Vehicles, using agent-based model scenarios. *Transportation Research Part C: Emerging Technologies*, March, Volume 40, pp. 1-13.
- Fagnant, D. & Kockelman, K., 2015a. Preparing a Nation for Autonomous Vehicles: Opportunities, Barriers and Policy Recommendations. *Transportation Research Part A*, Volume 77, pp. 167-181.
- Fagnant, D. & Kockelman, K., 2016. Dynamic Ride-Sharing and Optimal Fleet Sizing for a System of Shared Autonomous Vehicles in Austin, Texas. *Transportation*, August, 45(1).
- Fagnant, D., Kockelman, K. & Bansal, P., 2015b. Operations of a shared autonomous vehicle fleet for the Austin, Texas Market. *Transportation Research Record Journal of the Transportation Research Board*, 2536(2536), pp. 98-106.
- Gucwa, M., 2014. *Mobility and Energy Impacts of Automated Cars*, s.l.: Stanford University.
- Gurumurthy, K. & Kockelman, K., 2018. Analyzing the dynamic ride-sharing potential for shared autonomous vehicle fleets using cellphone data from Orlando, Florida. *Computers, Environment and Urban Systems*, September, Volume 71, pp. 177-185.
- Hörl, S., 2018. An integrated simulation environment for autonomous mobility on demand in Zurich. *Swiss Transport Research Conference*.
- Hyland, M. & Mahmassani, H., 2018. Dynamic autonomous vehicle fleet operations: Optimization-based strategies to assign AVs to immediate traveler demand requests. *Transportation Research Part C Emerging Technologies*, July, Volume 92, pp. 278-297.
- IEEE, 2012. *Look Ma, No Hands!*. [En ligne] Available at: [http://www.ieee.org/about/news/2012/5september\\_2\\_2012.html](http://www.ieee.org/about/news/2012/5september_2_2012.html)
- IIHS, 2010. New Estimates of Benefits of Crash Avoidance Features on Passenger Vehicles. *Status Report*, Mai 20, Volume 45.
- ITF, 2015. *Urban Mobility System Upgrade: How shared self-driving cars could change city traffic*, Paris: OECD.

- Janin, L., Nemri, M. & Raynard, C., 2016. *La voiture sans chauffeur, bientôt une réalité*, Paris: France Stratégie.
- Johnson, C. & Walker, J., 2017. *Peak Car Ownership: The market opportunity of electric automated mobility services*, s.l.: Rocky Mountain Institute.
- Kloostera, B. & Roorda, M. J., 2017. Fully Autonomous Vehicles: Analyzing transportation network performance and operating scenarios in the Greater Toronto Area. *Transportation Research Board 96th Annual Meeting*.
- Kok, I., Zou, S., Gordon, J. & Mercer, B., 2017. *Rethinking Transportation 2020-2030: The Disruption of Transportation and the Collapse of the Internal-Combustion Vehicle and Oil Industries*, s.l.: RethinkX.
- KPMG & CAR, 2012. *Self-Driving Cars: The Next Revolution*, Ann Arbor: s.n.
- Krueger, R., Rashidi, T. & Rose, J., 2016. Adoption of Shared Autonomous Vehicles - A Hybrid Choice Modeling Approach based on a Stated Choice Survey. *Transportation Research Board 95th Annual Meeting*.
- Lavasani, M., Asgari, H., Jin, X. & Pinjari, A., 2017. Investigating the Willingness to Pay for Autonomous Vehicles and the Likelihood of Residential Relocation. *Transportation Research Board 96th Annual Meeting*.
- Lavasani, M., Jin, X. & Du, Y., 2016. Market Penetration Model for Autonomous Vehicles Based on Previous Technology Adoption Experiences. *Proceeding of the 95th annual meeting of Transportation Research Board*.
- Levin, M., Li, T., Boyles, S. & Kockelman, K., 2017. A general framework for modeling shared Autonomous Vehicles. *Computers, Environment and Urban Systems*, July, Volume 64, pp. 373-383.
- Levin, M. W., 2015. *Integrating Autonomous Vehicle Behavior into Planning Models*, Austin: The University of Texas.
- Li, T. & Kockelman, K., 2016. Valuing the Safety Benefits of Connected and Automated Vehicle Technologies. *Transportation Research Board TRB 95th Annual Meeting*.
- Litman, T., 2012. *Parking Management: Strategies, Evaluation and Planning*, Victoria: Victoria Transport Policy Institute.
- Litman, T., 2018. *Autonomous Vehicle Implementation Predictions: Implications for Transport Planning*, s.l.: Victoria Transport Policy Institute.
- Loeb, B. & Kockelman, K., 2018. Fleet performance & cost evaluation of a shared autonomous electric vehicle (SAEV) Fleet: A case study for Austin, Texas.. *Transportation Research Part A: Policy and Practice*.
- Loeb, B., Kockelman, K. & Liu, J., 2018. Shared autonomous electric vehicle (SAEV) operations across the Austin, Texas network with charging infrastructure decisions. *Transportation Research Part C: Emerging Technologies*, April, pp. 222-233.
- Ma, J., Li, X., Zhou, F. & Hao, W., 2017. Designing optimal autonomous vehicle sharing and reservation systems: A linear programming approach. *Transportation Research Part C: Emerging Technologies*, November, Volume 84, pp. 124-141.
- ONISR, 2015. *La sécurité routière en France : Bilan de l'accidentalité de l'année 2014*, Paris: s.n.
- Piao, J. & McDonald, M., 2005. An assessment of user acceptance of intelligent speed adaptation systems. *Proc. Intelligent Transportation Systems*.
- Power, J., 2012. *Vehicle Owners Show Willingness to Spend on Automotive Infotainment Features*, Westlake Village: s.n.
- Rödel, C., Stadler, S., Meschtscherjakov, A. & Tscheligi, M., 2014. Towards Autonomous Cars: The Effect of Autonomy Levels on Acceptance and User Experience. *Proceedings of the 6th International Conference on Automotive User Interfaces and Interactive Vehicular Applications*, Volume 11.
- Schoettle, B. & Sivak, M., 2014. *A survey of public opinion about autonomous and self-driving vehicles in the U.S., the U.K., and Australia*, s.l.: The University of Michigan Transportation Research Institute.
- Schoettle, B. & Sivak, M., 2015. *Motorists' preferences for different levels of vehicle automation*, s.l.: The University of Michigan Transportation Research Institute.
- Spieser, K. et al., 2014. Toward a Systematic Approach to the Design and Evaluation of Automated Mobility-on-Demand Systems: A Case Study in Singapore. *Road Vehicle Automation*, Septembre.
- Vakayil, A. & Samaranayake, S., 2017. Innovative Applications and Evaluations of Ridesharing and Ridesourcing Services. *Transportation Research Board TRB 96th Annual Meeting*.
- Yu, S., Zhang, H. & Jinhua, Z., 2017. Embedding Autonomous Vehicle Sharing in a Public Transit System: Example of Last-Mile Problem. *Transportation Research Board TRB 96th Annual Meeting*.

*Section I. State of the art*

- Zhang, W. & Guhathakurta, S., 2017. Parking Spaces in the Age of Shared Autonomous Vehicles: How Much Parking Will We Need and Where?. *Transportation Research Board TRB 96th Annual Meeting*.
- Zhang, W., Guhathakurta, S., Fang, J. & Zhang, G., 2015b. *Exploring the Impact of Shared Autonomous Vehicles on Urban Parking Demand: An Agent-Based Simulation Approach*. Cambridge, Massachusetts, United States: s.n.
- Zhang, W., Guhathakurta, S., Fang, J. & Zhang, G., 2015. The performance and benefits of a shared Autonomous Vehicles based dynamic ridesharing system: an agent. *Transportation Research Board TRB 95th Annual Meeting*.
- Zhang, W., Guhathakurta, S. & Khalil, E., 2018. The impact of private Autonomous Vehicles on vehicle ownership and unoccupied VMT generation. *Transportation Research Part C: Emerging Technologies*, May, Volume 90, pp. 156-165.
- Zhao, Y. & Kockelman, K., 2017. Anticipating The Regional Impacts of Connected and Automated Vehicle Travel in Austin, Texas. *Proceedings of the 96th annual meeting of Transportation Research Board*.
- Zhu, S. & Kornhauser, A., 2017. The interplay between fleet size, level-of-service and empty vehicle repositioning strategies in large-scale, shared-ride autonomous taxi mobility-on-demand scenarios. *Transportation Research Board 96th Annual Meeting*.
- Zmud, J., Sener, I. & Wagner, J., 2016. *Consumer Acceptance and Travel Behavior - Impacts of Automated Vehicles*, s.l.: Texas A&M Transportation Institute.



## **Chapter.2 Shared Mobility services: Review of existing services and findings of spatial and socio-economic models**

### **ABSTRACT**

The emergence of artificial intelligence and the widespread dissemination of smartphones have contributed in the last few years to the development of new forms of mobility services: Shared Mobility (SM) services. These recent experiences are full of insights that could support the emergence of services based on Autonomous Vehicles.

This Chapter focuses on carpooling, carsharing and for-hire services. It describes their main technical and economic characteristics and identifies their major barriers to development. Then, the Chapter reviews spatial and statistical models that simulate SM services. Their outcomes in terms of mobility performances and environmental impacts are explored. This analysis enables to draw recommendations for the development of these services, but also to prepare the emergence of AVs.

*Keywords:* Shared Mobility services, spatial and statistical models, impacts assessment

### **1. INTRODUCTION**

#### *1.1. Background*

Shared Mobility (SM), sharing use of a transport mean, is one facet of the sharing economy. It enables users to access to transportation as needed, rather than requiring ownership (Introduction of the thesis). In recent years, the successive advancements in the Internet, social networking and mobile technologies have contributed to the rapid spread of SM services. Economic, environmental and social forces have pushed SM to the mainstream, hence, its impacts on car ownership and urban lifestyles has become a popular topic of discussion.

Convinced that Autonomous Vehicles (AVs) can learn lessons from this growing transportation phenomenon, we consider that it is indispensable to present a state of the art of existing economic, social and technical studies.

#### *1.2. Objective*

This Chapter aims to present a state of art of car-based SM services. We describe main organizational and commercial characteristics of these services and present an overview of main spatial and statistic models proposed in recent years. Finally, we review findings of SM impact studies. We focus on carsharing, ridesharing and for-hire services.

#### *1.3. Method*

The state of the art is organized into two parts. Firstly, a description of organizational and commercial aspects of existing SM services is based on a grey literature: commercial site webs and technical reports, etc. In particular, we focus on carsharing, ridesharing and for-

hire services, and explored their respective organizational forms and pricing structures. A general overview of service providers is furthermore proposed. In a second time, a scientific literature is used to investigate SM services from the perspective of passengers (i.e. sensitivities toward the level of service) and operators (i.e. technical performances of the service).

#### *1.4. Structure*

The rest of the Chapter is organized in four parts. Firstly, we depict an overview classification of Shared Mobility services (§2.). We focus then on carsharing, carpooling and for-hire services and describe their respective objectives, forms, pricing models and Business Models of some major providers (§3.). Main spatial and statistic models that exist up to 2018 are presented (§4.). Finally, we summarize main mobility and environmental impacts (§5.) and suggest recommendations for future developments (§6.).

## **2. OVERVIEW CLASSIFICATION OF SM SERVICES**

Stocker and Shaheen (2017) define three configurations of SM services: (1) Business-to-Consumer services (B2C), (2) Peer-to-Peer services (P2P) and (3) for-hire services.

(1) In B2C services, passengers share time resources by traveling in the same car sequentially. Vehicles are owned/leased and maintained by car fleet managers. Passengers could access vehicles via membership and/or usage fees. B2C services include in particular carsharing, bikesharing, scooter-sharing...

(2) In P2P services, the service provider supervises transactions among individual owners and renters by providing the platform and resources required for the exchange. Vehicles are owned by individuals. The most common form of P2P services is ridesharing or carpooling. In addition, P2P carsharing services are emerging, where privately-owned vehicles are made available for shared use by an individual or member of P2P organization.

(3) For-hire services involve a passenger hiring a driver. Vehicles can be owned by individuals or by a car fleet company. For-hire services include in particular taxis and ridesourcing services. Taxis differ from ridesourcing services since (a) they are regulated by authorities (price and fleet regulation), (b) they may be hailed from streets without online booking in advance and (c) they are charging a fixed fare per kilometer or minute of a trip.

P2P services differ from ridesourcing services in that the trip would have happened regardless of a passenger match. P2P and for-hire services differ from B2C services since passengers share time and space resources by traveling simultaneously.

In the remainder of the Chapter, we focus on carsharing as a B2C service, carpooling as a P2P service and for-hire services. We will not consider P2P carsharing services here. Among companies facilitating this service, a reader can refer to Turo (TURO, 2018) or Getaround (Getaround, 2018).

### 3. OVERVIEW PRESENTATION OF EXISTING SM BUSINESS MODELS

Consider carsharing, carpooling and for-hire services. Thereafter, the Business Models of these services are introduced through describing their main organizational and economic features and presenting the major providers in the international market

#### 3.1. Carsharing

The first attempts to conceive a carsharing system go back to 1970s in France, Amsterdam and England (Wikipedia, 2018). However, the age period for carsharing came in 1980s and first half of 1990s, with continued slow growth in Switzerland and Germany, but also on a smaller scale in Canada, the Netherlands, Sweden, and the United States. Zipcar and car2go were started respectively in 2000 and 2007. Then, carsharing have known a significant growth, passing from 4.5 million members in 2014 to 15 million members in 2016 sharing over 157,000 vehicles (Shaheen, 2018).

##### 3.1.1. Objectives of carsharing

The carsharing is primarily designed for shorter time and shorter distance trips as an extension of the transportation network, providing a public service designed to enhance mobility options (CSA, 2018). Moreover, additional goals of carsharing include:

- (a) to provide an alternative to private car ownership,
- (b) to share investment costs,
- (c) to rationalize the use of private cars
- (d) to reduce private cars externalities.

##### 3.1.2. Organizational forms

A carsharing service is characterized in particular by:

- The design of vehicles: conventional cars or specific design. Some vendors, indeed, propose vehicles with specific design in order to optimize their operational efficiency (e.g. small size vehicles, electric cars...).
- The infrastructure, including roads and cars spots. It depends in general on vehicles design. Cars spots are leased or offered by public authorities.
- The role of dispatcher. In some forms of carsharing, dispatching vehicles is necessary to balance the supply and demand of vehicles.
- The pricing structure: annual subscribing, entry fees... The pricing structure is detailed in §3.1.3.

Four principal forms of carsharing exist. They are differentiable through two main features:

- The first feature describes the possibilities given to pick-up and leave the car. The most common systems are Station-Based (SB) and Free-Floating (FF) services. SB services predetermine cars spots, where they can be picked up and be returned. They usually require a reservation in advance, as well as to state the destination and the trip duration. The main challenge of SB services is parking issues, in particular during peak-periods in high-

attractive zones. In contrast, FF services are not bound to dedicated stations but rather to an operation area. Vehicles can park on-street or on parking areas. They are not necessarily booked in advance and can be opened by a member card straight on the spot.

- The second feature determines if the vehicle should be returned to the starting point of the trip or can be left at a different location at the end of the trip. Two configurations are then possible: Round-Trip (RT) and One-Way (OW) systems. RT systems impose returning the vehicle to the original station or dedicated area. In contrast, OW systems leave it up to users to decide where to leave the vehicle.

By combining these two features, Hardt et al. (2016) propose **Table 2**, which summarizes main existing carsharing services:

**Table 2 Classification of carsharing services (Hardt & Bogenberger, 2016)**

	Station-Based (SB)	Free-Float (FF)
One-way (OW)	<ul style="list-style-type: none"> <li>• Autolib</li> <li>• ScootNetworks</li> <li>• Nextbike, Velib', Hangzhou Public Bicycle, Citi Bike NY, Call a Bike and others</li> </ul>	<ul style="list-style-type: none"> <li>• DriveNow, car2go, JoeCar (Stadtmobil), Auto-Mobile (Communauto)</li> <li>• Soo.me, Jaanu, eMio, CityScoot</li> <li>• Call a Bike</li> </ul>
Round-Trip (RT)	<ul style="list-style-type: none"> <li>• Zipcar, Stadtmobil, Communauto, CiteeCar, Greenwheels, Quicar, Flinkster, Mu by Peugeot</li> <li>• Smaller bike sharing systems</li> </ul>	<ul style="list-style-type: none"> <li>• No service providers known</li> </ul>

### 3.1.3. Pricing structures

Pricing structure is a key of commercial success of carsharing services. It should "be prone to opportunism and deception, and on the other hand capable of transforming by adapting to the needs and requirements of service providers" (Hardt & Bogenberger, 2016). Main pricing structures are:

- Pay per unit: is the most popular technique. The fare is usually calculated per unit of time (per minute, per hour...). Spotcar, in Berlin, is based on a fare per kilometer. For FF services, the cost per time unit decreases when vehicles are parking.
- Pay per month or per year: This structure is prevalent in RT services. By paying per month or per year, the subscriber benefits from fare reductions. Besides the monthly fees, the subscriber is charged fees depending on duration and distance traveled per trip.
- Graduated tariffs: are limiting excessive usage of the service. In addition, they are based on the observation that users with greater usage patterns are usually willing to pay more, resulting in acceptance for higher prices for the service.
- Packages are offering discounts for longer trips. They have to be booked in advance, enabling operators to improve their load planning and reduce the risk of undiscontinued use within the book time period.

- Minimum charges: aim to encourage passengers to use the service during a minimum time given their minimal willingness to pay.
- Static price variation: imposes variations of prices based on time or location, depending on the demand intensity. For instance, some services propose different prices between day and night usages (Stadtmobil in Germany for instance).

An overview of these pricing techniques are presented in **Table 3**, proposed by (Hardt & Bogenberger, 2016).

**Table 3 Pricing structures applied by different providers (Hardt & Bogenberger, 2016)**

	car2go	DriveNow	Stadtmobil	Communauto	Soo.me	Velib'	Call a Bike
<b>Pay per Unit</b>	X	X	X	X	X	X	X
<b>Pay per Month/year</b>			X	X		X	X
<b>Graduated Tariffs</b>						X	
<b>Packages</b>		X	X	X		X	X
<b>Prepaid</b>		X					
<b>Initial free Minutes</b>						X	X
<b>Minimum</b>					X		
<b>Maximum</b>					X		
<b>Static Variation</b>		X	X	X			

#### 3.1.4. Comparison of main carsharing providers

car2go is the market leader of OW-FF carsharing and one of the leading mobility services of Daimler AG. Today, over 14,000 smart and Mercedes-Bens vehicles are used by about three million members in 26 locations in Europe, North America and China (car2go, 2018). Vehicles can be reserved and rented using a mobile app at any time. Passengers are charged by minute, with reduced tariffs for hourly and daily usage. In three European locations, car2go operates 100 % electric fleets with 1,400 vehicles, making car2go one of the biggest electric FF carsharing providers (car2go, 2018).

Zipcar is the market leader of RT-SB carsharing services. From 2013, it is a subsidiary of the American leasing company Avis Budget Group. Zipcar (zipcar overview, 2018) operates in over 500 cities and towns and over 600 universities campuses. Over one million members have access to more than 12,000 vehicles around the world, with over 60 models, including hybrids, pickup trucks, minivans, luxury vehicles... Reservations could be achieved using mobile apps, online or by phone at any time, either immediately or up to a year in advance. Passengers are charged by minute, hour or day; they may pay a monthly or annual membership.

DriveNow is a German carsharing company owned by BMW launched in 2011. It is a OW-FF carsharing service. As of October 2017, it operated over 6,000 BMW vehicles in 9 European countries, attracting more than one million members. Passengers access to the service by using mobile apps. When reserving a car, they are able to check the fuel gauge or the battery's state of charge. Fares are charged by minute depending on the vehicle and business area. In April 2018, BMW and Daimler announced their official intention to combine and expand their carsharing services with the aim to become a leading provider of sustainable mobility services (Drivenow, 2018).

Finally, Autolib, as a monopoly provider of carsharing in Paris since 2008, proposed a station-based service, which operates about 4,000 vehicles and relies on 1,000 stations spread over the French capital (Bouvier, 2018). As of 2017, Autolib accounted about 150,000 subscribers and each vehicle had been rented four times a day (Bouvier, 2018). However, Autolib has announced its closure in July 2018 (latribune, 2018). Among reasons that led to this failure, we can cite:

- The low service reliability: indeed, the number of monthly trips per subscriber has decreased from year to year, proving that clients experience difficulties in using vehicles (availability). After opting for carsharing, they decided to shift to classical travel modes (transit modes or private cars).
- The system is designed for 15 years (Plesse & Bontinck, 2018). It lacks innovation: for instance, relying on using magnetic cards to book and access to vehicles instead of smartphone.
- Vehicles are poorly maintained by users. Consequently, maintenance is complicated and costly (Plesse & Bontinck, 2018).
- The emergence of ridesourcing services had a direct impact on the market share (Plesse & Bontinck, 2018).
- The business model of Autolib was conceived as for a public mode, which incurs losses and is supported by public authorities. Relations with public authorities, however, have been tense over the last years (Quiet, 2018).

#### *3.1.5. Lessons learned*

We conclude from this brief presentation that:

- **The market of carsharing services is growing**

In only one year (2017), car2go increased its number of customers by 30 % to 2.97 million (car2go, 2018). Carsharing has in addition a great potential of a growth across borders of countries and continents.

- **It is an oligopoly, often monopoly, market**

The number of carsharing services that are deployed in the same market is often limited, to two or even three providers. Usually, only one carsharing provider operates.

- **Based on three possible organizational forms**

Three forms of carsharing services exist: (1) Station-Based One-Way, (2) Station-Based Round-Trip and (3) Free-Floating One-Way. The latter form is not constrained by stations and hence, provides more flexibility to users.

- **And using several pricing strategies**

In addition to the organizational aspect, carsharing services are differentiating themselves in the carsharing market by adopting different pricing structures. Moreover, combining different pricing strategies enables to enlarge the market share. For instance, with the introduction of the car2go packages in September 2016, longer rentals became more attractive for users, inducing an increase of the average rental duration by 30 percent.

### *3.2. Ridesharing (carpooling)*

Carpooling is the system whereby two or more users jointly, voluntarily and in an organized manner, use the vehicle belonging to one of them for the purpose of making a common journey.

Even though the term “carpooling” is of the 80s, the concept is a much older. It was born of organizing dynamics of hitchhiking in the 50s (Taxistop in Belgium and Mitfahrzentrale in Germany). In the mid-1970s due to the oil and energy crisis (1973 and 1979), the first employee vanpools were organized at Chrysler and 3M (Oliphant & Amey, 2010). Then, carpooling declined precipitously between the 1970s and the 2000s, being mainly used by students. Recently, the massive use of smartphones and their applications has greatly facilitated the connection between drivers and passengers.

#### *3.2.1. Objectives of carpooling*

Carpooling has different interests for both the user and the community (CTPS, 2018; Commuter Services, 2017; Wikipedia, 2018):

- (a) Increase the loading of vehicles and promote a modal shift from the car,
- (b) Share travel cost between users,
- (c) Reduce congestion and emission of pollutants,
- (d) Streamline the use of passenger cars,
- (e) Improve accessibility, especially for non-motorized people.

Also, companies would benefit from using carpooling:

- (a) Save on parking
- (b) Reduce the cost of company cars
- (c) Improve access conditions for employees: reduce delays, stress, etc.
- (d) Reduce the company's ecological footprint and value its ecological commitments
- (e) Strengthen social cohesion and create a friendly environment.

### 3.2.2. Organizational forms

Carpooling works according to one of these two linking technologies: (a) Manual technologies, based on association, call center, radio ads, etc., and (b) Automated technologies, such as internet, intranet, etc.

Different forms of carpooling can be found: daily or occasional, short or long distance, planned or dynamic or depending on the category of carpoolers (Teal, 1987): carpoolers of the same household, carpoolers contributing to the driving (shared driving between carpoolers) and carpoolers exclusively passengers.

We propose a classification according to two criteria:

- The first criteria is the trip distance. The short-distance carpooling, or urban carpooling, is used for short and regular short trips (i.e. commuting). It can be scheduled or dynamic. The main purpose of short-distance carpooling is to decongest urban roads in rush hours.
- The second criteria concerns the type of carpoolers. We distinguish between individuals on the first hand, excluding members of the same household, and businesses / communities / administrations on the other hand.

**Table 4** presents a non-exhaustive list of existing carpooling services:

**Table 4 Classification of current carpooling providers**

	Particuliers	Entreprises
Short-distance	OuiHop – IDVROOM – Microstop – WazeUp – Carbip – Uber Pool – Zify – MicroStop – Karos – Together We Go (or ToGo) – Ridejoy – Zimride...	Roadz (Chili) – 7ème sens (France) – Covoiturage-Pro (France) – Comovee (France)...
Long-distance	Blablacar – Gomore – Zego – Flic NosFuimos (Chili) – covoiturage-libre – Poolmyride (India)...	

### 3.2.3. Pricing structures

In general, we can distinguish between three possible Business Models:

- The paid model: The matching between drivers and passengers is made in return for payment by one of the two parties or by both parties. This is usually a commission on the total price of the trip.
- The free model: It relies mainly on advertising, donations, etc.



- The mixed model: Combining the two approaches and thus allowing a free or paying relationship, depending on the options offered.

#### **3.2.4. Carpooling providers**

Several carpooling companies exist worldwide. Here, we present some companies that exist as of the end of 2017. We make the distinction between (a) short-distance carpooling service between individuals, (b) short-distance carpooling services for companies and (c) long-distance carpooling service (Blablacar in particular). Thereafter, we present these three categories one by one through citing the main providers.

##### **Short distance carpooling: For individuals**

Short-distance carpooling between individuals, known also as urban carpooling or dynamic ridesharing, relies on ensuring a real-time connection (eventually bargaining) between drivers of personal cars and passengers located en-route.

In France, OuiHop, IDVROOM, Direct Covoiturage, Microstop, WazeUp, Carbip, Karos, Uber Pool ... are among the carpool applications launched recently. For 2 €/month, OuiHop (2018) instantly displays the routes of the cars that pass around the pedestrian in the next minutes. The driver is connected to passengers, without booking upstream or detour. To promote the use of the application, OuiHop offers points to the driver if he is connected. Microstop (2018) adopts the same concept but it is free and connected drivers are rewarded with gas vouchers. The Direct-covoiturage (2016) is moving away from this concept. It identifies itself the possible carpools by proposing the potential passengers to the driver and then returning the confirmation of the driver to the passenger. It is the platform that connects users with an interest in traveling together. Payment is made upstream online. IDVROOM (2018), an application launched by SNCF, offers regular short-distance trips by carpooling, especially from SNCF stations, metro and RER stations, as well as carpooling areas. The reservation can be made upstream and is confirmed by direct negotiation with the driver (departure time, exact place of departure, etc.).

In USA, urban carpooling apps, Ridejoy, Zimride, Getaround and TERO (Konrad, 2015), propose to passengers the best drivers according to their desired routes and schedules. In Asia, a great number of apps is based on social networks. Ridely (2018) connects drivers and passengers without intervening in the price negotiation, leaving the possibility of a free carpool. In the case of no presence of a driver for the required journey, the passenger is informed of the different passengers close to him who share his need. ToGo (CrunchBase, 2018) connects people having a same route by adding them in shared discussion. The group members organize themselves according to their needs and constraints. BeepMe (Slunecnice, 2018) is also a social network of carpoolers who arrange to carpool together according to their needs. Groups of carpoolers are created based on their location/city of residence. They negotiate the time, duration, cost of the journey and way to go.

Despite the large number of urban carpooling services provided across the world, we cannot indicate, as of today and to the best of our knowledge, a successful app which reached a critical mass of users. In USA, Ridejoy (CrunchBase, 2016) and Zimride (CrunchBase, 2016b) have not survived for more than two years (Fehrenbacher, 2013). Getaround and TERO (Konrad, 2015) have quickly reoriented towards "long-term rentals between individuals". In Asia, results are also modest. Two months ago (in October 2018), the navigation app and Alphabet-owned company Waze announced the nationwide rollout of Waze Carpool (Hawkins, 2018), a dedicated carpooling app that is primarily designed to help commuters take advantage of existing rides. Previously, Waze Carpool had only been available in five states and Israel, where Waze was first started (Hawkins, 2018).

### **Short distance carpooling providers: For companies**

The professional carpool services aim to provide companies an alternative mobility solution to the private car for home-to-work commuting and business trips of employees.

The principle is based on an integrated road map, calculating distances, costs, travel time, CO<sub>2</sub> emitted, and identifying partners on the journey. The geographic information tool also integrates public transport facilities (i.e. stations, airports, etc.). Each company tracks, evaluates and manages trips in real time via a personalized website or extranet. The collaborators also have the possibility to locate each other.

One of the first companies proposing a carpooling service for companies in France is Covoiturage.fr, the first version of Blablacar before focusing exclusively on moving individuals. It was offering a carpooling service to IKEA, Renault, Castorama, VINCI, RATP and generated approximately 500,000€ in 2011, or 50 % of its revenues (Elton-Pickford, 2011). Covoiturage-Pro offers service to companies and administrations with less than 500 employees. WayzUp allows a car-to-work carpooling and offers around 50,000 journeys a day on French territory. To create local carpooling networks, WayzUp relies on companies from large business parks, which offer the service to their employees (WayzUp, 2016). In general, 8 out of 10 employees on average find relevant carpoolers (WayzUp, 2016). Comovee offers a carpooling service for businesses and communities. It promotes carpooling between residents of the same city while offering a carpooling solution for local businesses. The size of the community can vary between 2,000 and 1,000,000 inhabitants. Several formulas are proposed: basic (five local companies), smart (twenty local companies) and premium (all local companies). The price can vary from 29 €/month as a basic formula for small agglomeration to 54.2 €/month as a premium formula for a large agglomeration (COMOVEE, 2016b). Comovee for companies exclusively is deployed by INTEL, Air Liquide, P&G, HP, SIEMENS, CITI, PEPSI, etc. (COMOVEE, 2016a).

### **Long distance carpool: Blablacar**

Several long-distance carpooling applications exist: Blablacar, Gomore (Europe), Flic (Germany), Slimride (India), Yatrashare (India), Zego (Italy), Noritomosan (Japan), NosFuimos (Chili), Covoiturage-libre (France), Carlpoolworld...

The world leader in long distance carpooling is the French Blablacar.

As of 2017, Blablacar has 45 million members, with an average of 10 million travelers per quarter and a loading rate of 3 people per vehicle (Blablacar, 2017). In addition, it operates actually in 22 countries (Blablacar, 2017). Launched under the name of Covoiturage.fr by Comuto in 2004, Blablacar succeeded after ten years to establish itself in the French, European and worldwide market. To achieve this, different Business Models had been tested successively: advertising revenue, selling platforms to businesses, connecting with a telephone platform, offering a premium service, collaboration with festivals for an event platform. Finally, Blablacar opted for a business model based on commissions per trip by positioning itself as an intermediary between travel suppliers and potential travelers. In order to reach a critical mass of users, it proposes firstly free trips (in most countries it enters) to quickly acquire the largest number of registrants and then, monetizes its audience.

The contact between drivers and potential travelers is not possible before booking and online payment. This strategy helped reduce the rate of passengers drop-out from 34 % to 4 %. Commissions of Blablacar vary in general between 10 to 15 % of the trip cost per person. The fare is calculated as the sum of fuel and toll charges, which are then divided by 3 people to incorporate loading ratios. The fare is finally increased by a maximum factor of 1.5 (i.e.  $\text{Travel cost} = 1.5 \times (\text{energy cost} + \text{toll}) / 3$ ) (BlaBlaCar, 2016). According to this formula, the driver cannot be in a situation of profit, which is in accordance with the French law (Ministère de la transition écologique et solidaire, 2017).

Finally, Blablacar attempts to diversify its supply by proposing: carpooling for the festivals, Blabladay, Blablatour (tower of France), BlablaDrinks, and BlablaLines to offer for short-distance commuting carpooling.

#### **3.2.5. Lessons learned**

As major lessons learned, we emphasize that:

- **The urban carpooling service experiences difficulties to assert itself**

The urban carpooling apps benefit from low investment and operating costs. In addition, their impact on urban roads congestion is certainly positive. Consequently, several providers attempt to propose a reliable carpooling app, involving an impressive number of apps worldwide. However, there are technical and social challenges that hinders their development, in particular: the service reliability (i.e. punctuality, cancel probability of the

trip in the last minute), the guarantee that the return trip is ensured, privacy, freedom, safety and so on.

- **While other forms of carpooling are beginning to establish themselves**

The success of long-distance carpooling, especially in Europe, is driven by the flexibility that it proposes compared to trains, with often a lower trip cost.

### 3.3. For-hire services

For-hire service first made their apparition on the streets of London and Paris in the first half of the 17<sup>th</sup> century (ITF, 2016). As an innovative transport mean at this time, for-hire services were allowing moving rapidly in those cities without having to support costs of upkeep for horses. These services were a luxury, not affordable for everyone. Then, for-hire services spread and split into two principal categories: (a) street hail market, where passengers hail taxis from the street-side or at taxi stands, and (b) dispatch market, where passengers prearrange their trips by contacting a central dispatcher. The emergence of mobile apps has blurred the lines between these two configurations. Regulators are taken by surprise and sometimes facing violent reactions from taxi drivers and taxi licenses owners. Until today, there is no consensus about the name of these app-based for hire services: in USA, they are called Transportation Network Companies (TNC), in UK, Private-Hire Services (PHV), in Switzerland it is "diffuseur de courses" and in France the term "intermédiaire" encompasses both app-based platforms and traditional telephone call and dispatch centers. In this Chapter, we will use the term ridesourcing to designate these services (Stocker & Shaheen, 2017).

In this section, we present main forms of for-hire services. We do not confront taxis and ridesourcing services. For each service form, main companies operating until 2017 are cited. Pricing strategies are in addition described. Finally, a comparison between elements of Business Models of Uber, Lyft and Sidecar is presented.

#### 3.3.1. Organizational forms

Consider firstly taxis as conventional forms of for-hire services. By observing different taxis configuration around the world, two main features are conceivable:

- The first one is the possibility of ridesharing. In developed countries, taxis represent a luxury service, they are private and do not allow ridesharing. In contrast, in developing countries, taxis, called "collective taxis" are serving several passengers with different destinations simultaneously.
- The second feature is the flexibility of the trip. By definition in developed countries again, taxis are providing a Door-to-Door service (D2D). In some developing countries, however, it is more a form of shuttle with a fixed origin-destination route (Stand-to-Stand S2S). Passengers, knowing taxis' routes, are in general hailing taxis from the street-side or at taxi stands.

**Table 5** presents some of existing taxi systems in the world:

**Table 5 Classification of traditional for-hire services**

	Stand-to-Stand (S2S)	Door-to-Door (D2D)
Private (P)	Rickshaw (India, Japan, China European countries recently), Tuk-Tuk (Thailand, Sri Lanka, Kenya, Algeria, Soudan...)	Taxi (Classical form)
Shared (S)	More than 100 taxi service in Africa and Asia: Grand taxi (Morocco), Dolmuş (Turkey), Service (Lebanon), Machrou' (Egypt), Matatu (Kenya), Treintaxi (Netherlands)...	Taxis in Africa and some Asian countries

Ridesourcing services, driven by the spread of app-based technology, have positioned themselves on at least one of these historic categories.

**Table 6** presents the main companies providing ridesourcing services until 2017, according to the two features defined above.

**Table 6 Classification of current for-hire service providers**

	Stand-to-Stand (S2S)	Door-to-Door (D2D)
Private (P)		Uber, Lyft, Curb, Sidecar, GrabTaxi, Did Kuaidi, OLA, GetTaxi, FlyWheel, Via, Hailo, easy Taxi, LeCab, Haxi
Shared (S)	Bridj, Leap, RidePal, Chariot, Loup, Detecon, CarDekho, Blackline	UberPool, Lyft Line, Sidecar, Split, Haxi

Articulated around smartphone-apps, these services rely on:

- A location based-data, which determines the exact location of drivers and passengers in real-time;
- Algorithms that are based on street addresses or points of interest to estimate the cost ride in advance and depending on the time of day.
- Algorithms that anticipate the requests of passengers and adapt the distribution of drivers in advance.
- An option of rating passengers and drivers which enables to control the quality of service.
- A real-time pricing to balance spatially supply and demand.

### 3.3.2. Pricing structures

Two structures of fares are commonly used in the conventional taxis industry:

- (a) Flat fare, which is fixed for the trip after a bargain between the driver and the passenger,

- (b) Fare per unit, which depends on minutes and/or kilometers traveled in-vehicle. This form is more used by taxis since it is flexible with respect to the network state during the trip. In practice, the fare per unit calculated based on the formula:

$$F_T = F_B + (C_{mn} * t_{mn}) + (C_{km} * d_{km}) + F_r$$

Where:

- $F_B$  : A fixed minimum tariff charged at the beginning of every ride, in attempt to cover costs of short trips;
- $C_{mn} * t_{mn}$  : The cost of the traveled time: where  $C_{mn}$  the cost per minute and  $t_{mn}$  time in minutes;
- $C_{km} * d_{km}$  : The cost of the traveled distance: where  $C_{km}$  the cost per kilometer and  $d_{km}$  the distance in kilometer.
- $F_r$  : An additional fixed tariff is considered for ridesourcing services to cover reservation fees, since they are booked online. It is payed even if the reservation is cancelled by the user.
- Moreover, toll charges are often added to the total fare at the end of trip (Guru, 2016).

In addition, surge pricing (or dynamic pricing) strategy was introduced by Uber to deal with supply-demand imbalance issues observed in peak periods (Uber, 2018). Ridesourcing services, unlike rental car companies, hotels or airlines which frequently use dynamic pricing, are characterized by a dynamic supply. Hence, at the exact time that riders expect more availability (e.g. weekends, night, special events...), drivers would rather not be driving. Uber, and some ridesourcing services, believes that ensuring a reliable and available service at all time is the key factor to increase users' satisfaction, and that their dissatisfaction from being unavailable is worse than their dissatisfaction from surging prices (Gurley, 2014). Cohen et al. (2016) showed through analyzing UberX data in four US cities that surge pricing strategy enabled large users' surplus. The estimation of users' surplus is six times larger than revenues captured by Uber. Bimpikis et al. (2016) highlighted that surge pricing plays an important role in the profitability when the demand pattern is not balanced across the network's locations. Castillo and al. (2018) found that surge pricing can prevent demand from growing beyond supply capacity, hence limiting traffic congestion.

### 3.3.3. Comparison between Uber and Lyft

Uber as a ridesourcing platform leader is the direct evolution of conventional form of taxis. It provides private Door-to-Door (P-D2D) rides. It adapts the service to passengers' willingness to pay, proposing for instance: UberX (UberPop in France) as the cheapest service option (i.e. 4 places), UberXL (i.e. 6 places), UberBlack, as the most expensive service option (i.e. sedan), etc. As of 2018, Uber operates in more than 60 countries and 400 cities (Uber, 2018), hence adapting some characteristics of the service regarding the local legislation and existing competitors. For instance, Uber proposes a service of carpooling in USA and France, UberMOTO in Thailand and India to compete with Tuk-tuk, UberAUTO to compete with rickshaws (UBER, 2015).

Major competitors of Uber in USA are Lyft, Sidecar and Curb (Parnell, 2016). Launched in 2012, Lyft (2018) proposes in US cities, besides the conventional form (P-D2D), the possibility of carpooling (Lyft Line). A more detailed comparison between Business Models of Uber and Lyft is presented in Appendix. In contrast, Curb (2018) proposes an insured service operated by professional taxi drivers. Curb has more than 100,000 drivers and is present in about 60 American cities. Heetch (2018), a French app operating in Europe and Morocco, Careem (2018), in MENA (Middle-East and North-Africa), GrabTaxi (2018), in southeast of Asia, and Didi Kuaidi (Wikipedia, 2018), in China, are adopting the same strategy of Curb.

Shared and Stand-to-Stand services rely often on larger vehicles and are called microtransit by (Stocker & Shaheen, 2017). These types of services have particularly emerged in US cities last years. Chariot, Bridj and Via are among rare such services that survive until 2018. Chariot (2018), launched in 2014 and operating in San Francisco, is based on 15-seat buses that give users the opportunity to "crowdsource" new routes. Twelve routes are ensured by the service as of November 2016. Fares range between 2.5 and 5.5 €. Bridj (2018) is operating in three US cities. Passengers are emitting requests via the app. The dispatcher is then grouping passengers based on their origin location, their route and their destination. The dispatcher then send to passengers their pickup location. According to Bridj, this yields to 22 passengers per vehicle per hour. Fares of Bridj are similar to those of Chariot. Finally, Via (2018) was launched in 2013 and it is deployed in New York City. Their fares are slightly higher than Bridj and Chariot (4 to 6.5 €).

#### *3.3.4. Lessons learned*

The main lessons learned are that:

- **The market of ridesourcing services is "booming"**

The growth of the number of ridesourcing apps worldwide during last years, as well as of the number of drivers and traveled trips of apps leaders shows the great potential of the market.

- **They benefit from great economies of scale**

Ridesourcing services are based on optimizing the matching between passengers and cars owners rather than purchase and managing a fleet of vehicles. Consequently, economies of scale are reached quickly and the service production efficiency is great resulting in cost savings.

- **But depends on the local context**

The expansion of ridesourcing services in different countries, Uber in particular, proved the impact of cultural and institutional aspects on the service success. Regulation, as a key strategy used by public authorities, supports or restricts the service growth.

- **It is an oligopoly market**

The market of ridesourcing is also an oligopoly, because few providers of ridesourcing emerge and compete for the same target demand. The existence of several apps, indeed, enables passengers to affect the fare and the quality of service through choosing the cheapest and more convenient supply.

- **Which asserts itself in the urban universe**

The territory is “shared” between for-hire providers depending on their pricing structure. In fact, ridesourcing services would be more relevant in suburbs while taxis in downtowns (Paper & Shapiro, 2018). Moreover, their price varies in general along the day, being more expensive at nights and during special events.

- **Using sophisticated pricing structure**

Surge pricing is a novel approach of pricing for mobility services. Studies shows that they allow ensuring a stable level of service, and in turn satisfying the service users.

### *3.4.Synthesis*

As a synthesis of this presentation of SM services, we can summarize the main success keys as follows:

- For carsharing services, the access to vehicles and their availability led some providers to propose a Free-Floating service, thus, hindering the constraints of Station-Based forms. The probability of finding an available service near to the departure location is one of the major indicators of the service reliability. On the other hand, pricing strategies are numerous. The choice of the best strategy to adopt is then also a success key.
- For carpooling, the service should reassure drivers and passengers with regards to its reliability. For long-distance carpooling, the cost and the comfort are success keys of the business.
- Concerning for-hire services, they should be adapted to each context. In addition, due to the rude competition, the service must maximize the level of service while proposing competitive prices compared to other services.

The rapid development of ridesourcing services with comparison to the two other services is probably related to psychological barriers: they propose a version 2.0 of taxis, which are known and used at least once by the majority of persons in the world. The carpooling for companies is also the development of a traditional form of organized trips between colleagues of the same company. Carsharing and urban carpooling services, however, are relatively new concepts, that should be rooted progressively in practices and minds of potential users. One method to hinder these barriers is based on reducing fares in order to reach a critical mass of users, without necessarily being a profitable business. Later, the fare could be increased, which could affect negatively the market shares; the objective of being well established in users minds, however, will be reached.



#### 4. REVIEW OF MODELS SIMULATING SHARED MOBILITY SERVICES

Studies modelling SM services adopt in general one of two approaches: (a) a statistic approach, defines sensitivities of passengers toward the service and their mode choice behavior, and (b) a spatial approach, which describes technical performances for a given demand.

##### 4.1. Carsharing

###### **(a) Users' preferences and mode choice behavior**

Several studies have related the service to socio-demographic characteristics of users. Cervero et al. (2006) showed through a survey in San Francisco, that car sharers are young (i.e. between 20 and 40 old), have moderate incomes and are not motorized. Similar results were obtained by Martin and Shaheen (2011). Kim and al. (2003) showed using a web-based survey among participants of Seoul that age and income significantly influenced the sharing behaviors. Becker et al. (2017) considered SB and FF carsharing services operating in the same area, Bassel. They showed that each configuration address different markets. While SB service is adapted to self-employed workers and trips involving using private cars, FF service is used by young males with higher incomes when it helps to save time with respect to other alternatives. Rotaris et al. (2017) focused on carsharing in medium to small size cities. A survey in the Friuli Venezia Giulia region found that car sharers are mostly young, unemployed, and environmentally conscious. In addition, carsharing is generally use for non-commuting and long trips.

Wang et al. (2017) were interested in the distance and purpose of the travel. They conducted a web-based survey in China. They found that trip purpose and trip distance are the most two important influencing factors of carsharing mode choice behavior. In particular, their results showed that carsharing systems should be distributed in central business areas (commuting purpose) and that trip distance interval is 11 to 20 km. Moreover, fares should be competitive.

To estimate the generalized cost, Catalano et al. (2008) developed a random utility model by using data resulting from a stated-preference (SP) survey involving about 500 employees and students in Palermo. They identified as main attributes affecting mode choice of OW-FF carsharing service (i) the travel time and cost, (ii) the parking time, (iii) the number of cars available per household member and (iv) motorization. They found that carsharing is relevant for serving less dense areas (i.e. suburban areas). Yoon et al. (2017) observed through a survey in Beijing that the cost gap between original mode and carsharing have a positive effect for OW trips and a negative effect for RT.

The relation with public transport was explored by Le Vine et al. (2014). They showed through a survey in London that users of OW is about four times larger as users of RT

systems. In addition, OW would be a substitute for public transport, whilst RT a complement.

**(b) Service operating**

The majority of spatial models simulating carsharing services are agent-based models. Probably one of the first attempts to model carsharing systems was that of Ciari et al. (2009 – 2011). They used MATSIM to assess performances of a RT carsharing service in Zurich. They considered different trip's purposes (commuting, leisure, shopping).

In 2015, they investigated the *impact of stations accessibility* on the service attractiveness (Ciari, et al., 2015). They found that the number of subscribers is sensitive to the first mile (from home to station) rather than the last mile (from station to work). Another relevant study exploring the optimization of stations locations and capacities is that of Correia et al. (2012). They investigated the impact of localization of depots on the profitability of an OW service provided in Lisbon. They found through resolving a profit maximization problem that the depots should be in the downtown. In addition, they argued that satisfying all OW carsharing demand will lead to great financial losses.

Several studies have investigated *relocation issues*, in particular for FF systems. Barth and Todd (1999) define three relocation mechanisms based on the available information: (a) a static method to maintain a minimum threshold of available cars at each station; (b) a predictive method based on historical demand; and (c) an exact method based on perfect knowledge on future demand. Predictive relocation problems have been usually solved using optimization methods (Kek, et al., 2009; Febbraro, et al., 2012; Bruglieri, et al., 2014). Weikl et al. (2015) defined a model based on six macro and micro steps (data analysis, relocation inter-macrozones, then inter-microzones, intra-microzones, and lastly regarding the state of charge of batteries, and hence defining next movements of vehicles). An application in Munich showed improvements of vehicles' earnings (by 18 %) and operator's profits (from 4.7 % to 5.8 %). On the other hand, the idle time per trip is reduced by up to 18 %. Hu and Liu (2016) developed a mixed queuing network model to address the reservation policy and road congestion effect in OW carsharing systems. Boyaci et al. (2017) developed simulation framework to make operational decisions related to vehicle relocations and staff allocation. Jorge et al. (2014) combined a mathematical model to determine optimal vehicle relocation, and a discrete-event time-driven simulation model to test performances of relocation policies. They applied the model on the study case of (Correia & Antunes, 2012) and showed that real-time relocation policies can produce significant increases in the profit. In 2015, they incorporated incentives to encourage users to carry out vehicle relocation (Jorge, Molnar, & Correia, 2015).

In regards to pricing issues, Ciari et al. (2015) analyzed the *effects of pricing* by considering five pricing scenarios where fares vary per unit of time and distance with rates that depend on the periods of the day. In addition, they considered RT-SB and RT-FF systems. Results

showed that pricing strategies affect the level of usage, the profile of users, and also the time of trip, the localization of origin and destination points, and the duration of usage.

In addition, few studies proposed to design the service based on a *profit maximization problem*. Huang et al. (2018) resolved a profit maximization problem by including the long-term resource allocation (stations location, station capacity, and fleet size) and the short-term operation strategies (vehicle relocation) simultaneously. They considered that demand is known in advance, dynamic along the day and asymmetrically distributed in space. In addition, the competition with private cars is included through a logit model. An application conducted in Suzhou, China, showed that the profit is maximized when carsharing market reaches 80 %. The pricing is found as the key issue that affects the carsharing system performance. Relocation costs, however, had marginal effects on the profit. Jian et al. (2016) proposed an agent-based model, which includes OW and RT carsharing systems. The demand is assumed static while all conventional modes are considered. The two carsharing systems are provided by the same operator, who aims to maximize its profit. An application in Sydney showed that the fare of OW systems have the most significant impact on the profit. In addition, the profit is maximized when the fare of OW carsharing system is greater by four times than the fare of RT carsharing system.

#### 4.2. *Ridesharing (carpooling)*

##### **(a) Users' preferences and mode choice behavior**

To determine the *profile of carpoolers*, the French Environment & Energy Management Agency, ADEME, conducted a stated preferences survey in France in 2015 (ADEME, 2015a). It found that the most of carpoolers are young, mainly employees (66 %), motorized (85 %) and men (55 %). The survey showed that the principal purpose of carpooling is commuting (80 %) for short trips, while the average in-vehicle distance is 43 km and the access and egress distances are about 12 km. These results confirm earlier findings of Levin (1982) and Cervero et al. (1988) who argued that carpooling is more relevant for longer trips which exceed 30 km. It shows in addition that about 90 % of carpoolers are using their cars to access to the meeting point with drivers. CGDD (2016) focused on long-trips carpooling achieved by Blablacar. It showed that carpoolers are mostly young, employees (53 %) and students (34 %) and having as main trip's purpose to visit a friend (70 %). In contrast with urban carpooling, riders access to the meeting point using mostly public modes.

Experiences showed that the success of carpooling depends on *social factors*. Therefore, several studies attempted to determine which factors are the most critical. For instance, Soltys (2009) considered three types of factors that could affect carpooling: individual factors (costs, motorization, age and gender), spatial factors (access distance to meeting points) and temporal factors (same departure time). A survey in Toronto found that the most common motivations for carpooling were environmental concern and monetary cost.

In addition, the most significant factor was found to involve the localization of meeting point relatively to the place of residence. Commuters are potentially motivated by carpooling with a view to saving time (by using HOV lanes). Lastly, users currently commuting by transit modes were less likely to carpool compared to drivers of private cars. CERTU (2007) argued that 54 % of carpoolers are motivated by sharing the trip's cost, hence confirming findings of (Levin, 1982; Soltys, 2009). ADEME (2015b) analyzed in details potential economies enabled by carpooling in a French context: a reduction of fixed costs by 0.1 €/km, of maintenance costs by 0.12 €/km and of energy costs by 0.11 €/km. Ciari et al. (2012) conducted a large survey with more than 2,000 Swiss participants. The benefits that carpooling is supposed to bring for the environment and the transportation system are considered the most important features. Practical aspects, such as the guarantee that return trip is surely ensured, is found to be the most critical factor. Javid and Raza (2017) conducted a stated preference survey in Lahore City, Pakistan. They found that major constraints of carpooling include practical aspects, relative to punctuality and personal constraints, privacy and freedom of travelers. In addition, passengers may prefer carpooling to private vehicle if the travel cost is reduced significantly, and if this service is comfortable, convenient and safer than private vehicle. Malodia and Singla (2016) analyzed carpoolers' preferences in several cities in India using stated preferences surveys. They considered as influential attributes: walking time to reach the meeting point, waiting time, extra travel time and monetary costs. Results of the survey showed that cost savings and extra travel time are the most significant attributes that affect the carpooling mode choice behavior.

### ***(b) Service operating***

The carpooling problem is formulated as a matching problem between carpoolers (drivers and passengers). There is a huge body of literature that studies optimization problems and computational issues to solve the matching problem using exact (Baldacci, Maniezzo, & Mingozzi, 2004; Xia, Curtin, Li, & Zhao, 2015) and heuristic methods (Calvo, Luigi, Haastруп, & Maniezzo, 2004; Yan & Chen, 2011; Huang, Jiau, & Lin, 2015; Hartman, et al., 2015). However, we focus here on literature investigating how the profile of carpoolers and the pricing strategy affect the matching efficiency.

There is large body of literature that relates the *profile of carpoolers and the matching efficiency*. Cho et al. (2012) proposed an agent-based model where carpoolers define their socio-demographic characteristics (age, gender, revenues...) and preferences (departure time, cost, comfort, desired path...). The probability of successful matching is then estimated. The reputation of carpoolers is also considered and the "robustness" of the social relation between carpoolers is described (same firm, same profile, neighborhood...). Computation performance of the model was evaluated through an application in Belgium cities (Cho, et al., 2013). The application showed furthermore that ridesharing is more adapted in university campuses, where carpooler have similar profiles and preferences. The

model was then developed by (Galland, et al., 2014) in order to investigate more reputation issues.

Di Febbraro et al. (2013) and Dubernet et al. (2013) investigated the matching efficiency *through considering passengers' waiting time*. Di Febbraro et al. (2013) proposed a discrete-event model to optimize matching between drivers and passengers. They defined passengers' tolerance as the difference between desired departure time and real departure time. Then, the problem of matching was to minimize this factor while choosing the shortest-path for traveling and not exceeding vehicles' capacity. The application in Genoa for morning and afternoon peak hours found significant reduction of the match refusals, from about 75 % to 15 %. Dubernet et al. (2013) used an agent-based model to assess the impact of what they called the structural factor: the number of possible matches available to an individual for a given trip. Two main parameters are considered in the model: (1) the time window width, which corresponds to the passengers' tolerance defined by Di Febbraro, and (2) the detour induced by ridesharing. The application on Zurich using MATSIM showed that the effect of structural factor is not significant.

Cici et al. (2015) focused on improving the efficiency of assignment with the objective of minimizing the total travel distance of drivers. They proposed an online ridesharing system containing two modules: the constraint satisfier that includes spatial-temporal constraints of drivers and passengers; and the matching module that explores feasible pairs and determines the best matching. Computational performances of the model are then evaluated.

From the *economic perspective*, Cao et al. (2015) incorporated pricing effects. They proposed a model that allows riders requesting the ridesharing service to indicate the maximum desired price and waiting time. Then, the model computes the price based on the distance of the trip and the detour of the driver and selects the adequate driver within price and temporal constraints. A numerical example is defined in order to evaluate computational performances of the model. Asghari et al. (2016) proposed a pricing model that satisfies both the riders' and drivers' constraints. In particular, the dispatcher assigns riders to drivers based on riders' and drivers' profiles and their itineraries, and the current number of riders in the vehicle. The price of the trip is then determined through considering (1) that drivers receive compensation if the trip is increased by serving more riders, and (2) that riders receive a discount if the trip is longer than the shortest trip between his pick-up and drop-off location. A comparison with literature studies applied on taxis of New York City showed that the proposed framework provides better quality of service, allows shorter trips, increases the number of matchings and improves the overall profit of the platform. Biswas et al. (2017) proposed an optimization model for real-time matching that maximizes profit. They assumed that the decisions of passengers to choose ridesharing depend on the discount offered by the service provider. Two commercial strategies of detour are assessed:

a fixed detour-based discount and a detour-based discount linear of the distance-wise detour. Computational performances are proved using data of taxis in New York City.

#### 4.3. For-hire services

##### **(a) Users' preferences and mode choice behavior**

To determine the *profile of users*, Rayle et al. (2014) conducted a survey to 380 for-hire users in San Francisco. They found that users are mostly young and highly educated than citywide average. In addition, the main purpose of trips was leisure (67 %) while commuting represents only 16 % of trips. A comparison with taxis (Rayle, et al., 2016) showed that users of ridesourcing services are generally younger than frequent taxi users, have higher incomes, have lower car ownership and frequently travel in comparison. Compared to taxis for which the average trips' length is 5 km, ridesourcing trips averaged 6 km. Also, the study showed that ridesourcing wait times (90 % waiting less than 10 minutes regardless of the time of day) is substantially shorter than taxi hail and dispatch wait times (only 35 % waiting less 10minutes on a weekday). Rose and al. (2013) conducted a survey in the Melbourne Metropolitan area and 463 travellers were interviewed. A comparison with other modes (bus, rail, cars...) showed that the access time to taxis was shorter than for all other modes, while the average waiting time was longer. The average travel time was reported as being similar for all modes. The survey showed in addition that riders without the specific requirement to be at their destination at a given time are less inclined to hail a taxi relative to those who stated that they had a deadline to meet.

Recent studies of ridesourcing services relied on *analyzing Uber data rides*. Cohen et al. (2016) used almost 50 million trips performed by UberX in four US cities to estimate the consumer surplus. They found that demand is inelastic, and that the consumer surplus is two times larger than revenues received by drivers and six times greater than the revenue captured by Uber after the driver's share is removed. Paper and Shapiro (2018) used available trip-level data on the pickups of taxis and ridesourcing vehicles (Uber in particular) to study for-hire services in New York City over both space and time. They found that the introduction of Uber to the market has user welfare benefits that vary by a factor of ten from the highest density to least density locations studied. Hence, in highest-density locations, taxi services are more relevant while Uber is increasing the social welfare particularly in less dense areas.

Finally, some studies investigated *factors* affecting for-hire services. Wong et al. (2015) found through a SP survey conducted to 1,242 taxis in China that the access time, the waiting time and the extra-travel time due to congestion are the most significant factors affecting taxis' mode choice behavior. Circella and al. (2017) found that living in urban neighborhood, regional auto-accessibility and public transit availability and quality have the strongest impact on the adoption of ridehailing. In addition, users with higher familiarity with modern technologies and frequent long-distance trips are more inclined to use

ridesourcing. This is also true for users with attitudes towards pro-environmental policies (Alemi, et al., 2017).

**(b) Service operating**

In an attempt to capture the spatial structure of the market, Yang and Wong (1998) developed a model to determine the taxi movements on a given road network for a static customer Origin-Destination (OD) demand pattern. The model minimizes the search time of drivers for a random generation of requests. Later, the model was developed to reflect the best the taxi industry behaviors:

- In 2000, the model was developed (Yang et al., 2000) by introducing a set of variables as taxis availability, taxis utilization, passengers waiting time and taxis' waiting time. Then, the demand-supply equilibrium is formulated.
- Wong et al. (2001) incorporated congestion effects and the customer demand elasticity. Results of a numerical example showed that for small fleets, increasing the number of taxis benefits to users and drivers.
- Yang et al. (2005) estimated congestion externalities due to both occupied and vacant taxi movements. They investigated the monopoly, the social optimum and the stable competitive solutions of cruising taxi services in the presence of congestion externalities by adopting a distance-based and delay-based fare structure. Maximization problems are maximized.
- Yang et al. (2010) proposed a meeting function to describe the search and meeting frictions to reflect spatial particularities.
- Wang et al. (2013) solved the problem of taxi fare optimization in a monopoly market, while simultaneously considering the equilibrium between the social welfare and profit of taxi firms. They found that taxis operating costs affect significantly the equilibrium.
- Wong et al. (2014a) calibrated and validated the logit models based on Global Positioning System (GPS) data from 460 urban taxis to predict the drivers' strategic zonal choice for searching for customers during both peak and off-peak periods. Wong et al. (2014b) extended then the model to consider local customer-search using a cell-based taxi operating network. Results revealed that the taxi drivers' local search is significantly affected by the probability of successfully picking up a passenger along the search route.
- In 2016, the authors integrated mobile technologies and investigated matching efficiency and pricing strategies for e-hailing taxis (2016). They assumed that only one e-hailing platform exist in the market. Then they evaluated quantitatively the impacts of the platform's pricing strategies on the social welfare and the platform's profitability.

On the other hand, several studies considered agent-based models to simulate behaviors and interrelations between drivers and passengers. They are used to assess taxis' relocation strategies (Bailey & Clark, 1992; La Rocca, 2016), booking strategies (Salanova & Estrada, 2015) or drivers' day-to-day learning (Kim, Oh, & Jayakrishnan, 2005).

Concerning assignment and relocation issues:

- Lioris (2010) conducted a discrete-event simulation for collective taxis with both centralised and decentralised management systems. Optimal car itineraries are defined while considering detours. An application on Paris network is used to provide computation performance and the level of service (passengers' waiting times, detours, vehicles' occupancy, passengers' acceptance, etc).
- Seow et al. (2010) developed an agent-based model to automate taxi dispatch in a distributed fashion. A simulation applied in Singapore shows that the proposed system can dispatch taxis with a reduction in customer waiting and empty taxi travel times of up to 33 % and 26 % respectively.
- Nourinejad et al. (2014) suggested an agent-based model for taxi services applying both centralised and decentralised optimisation algorithms. The results indicated greater savings on user costs and on vehicle kilometres travelled (VKT) when multi-passenger rides are allowed.
- Maciejewski et al. (2014) explored collaboration schemes in taxi dispatching between customers, taxi drivers and the dispatcher. They proved that the cooperation between the dispatcher and taxi drivers is indispensable, while the communication between customers and the dispatcher may be compensated by the use of more sophisticated strategies.
- Maciejewski et al. (2015) considered two dispatching strategies: nearest-idle-vehicle and demand-supply balancing. An application on a fleet of over 5000 taxis in Berlin, Germany, showed that the two strategies have comparable performances in terms of average waiting time and travel time when demand is low. However, when the system is overloaded, the second strategy (demand-supply balancing) still efficient with a waiting time below 10 minutes for tripled demand while the waiting time reaches 50 minutes for the first strategy.
- La Rocca (2016) proposed a discrete-event based model to simulate behaviors of electric taxis. In particular, he proposed maximizing taxis revenues and minimizing passengers' waiting time while considering three operational problems: the dispatch, the relocation and the charging of electric taxis. Three assignment strategies are considering: of the nearest idle taxi, of the nearest taxi even if it is not idle (ridesharing allowed), and of the nearest taxi by allowing recalculation and optimization of the dispatch even after assignment (i.e. the taxi has the possibility to change at real-time and en-route its destination if another taxi seems to be better). The author showed that the last strategy can provide a 20 % increase in income relative to the first one.



### **(c) Regulation**

The majority of studies investigating regulation impacts on the taxi industry are based on microeconomic models. Among the first ones and the most known the model proposed by Douglas (1972). He used assumptions about trip cost and waiting time to derive aggregate demand, the structure of production costs and the rationale for fare setting, and showed that for a cooperative configuration to remain in equilibrium, price regulation is required. Douglas' model was then developed to assess the impact of regulation in different markets (De Vany, 1975; Manski & Wright, 1976; Foerster & Gilbert, 1979; Cairns & Liston-Heyes, 1996; Hackner & Nyberg, 1995).

Moore and Balaker (2006) discussed existing economic literature and concluded that most economists who examine taxi deregulation concluded that it is on net beneficial. Of the 28 scientific articles, 19 concluded that deregulation is beneficial, 2 concluded that the results are mixed and 7 concluded that deregulation is harmful.

Regulation aspects are discussed in more detail in Chapter.5.

#### *4.4. Synthesis*

To sum up, models presented above, spatial and statistical as well, attempted to overcome challenges observed in (§3.). In particular:

- For carsharing, studies focused on optimizing stations' locations, on relocation issues of FF and pricing models.
- Carpooling services were modeled through exploring the effects of social factors (i.e. psychologic barriers) on matching efficiency.
- For for-hire services, studies are mostly dealing with dispatching issues in order to increase the level of service. Regulation issues are also investigated. Ridesourcing services are rarely studied, often based on trips data.

## **5. IMPACTS OF SM SERVICES: MODELS RESULTS AND CURRENT FEEDBACKS**

### *5.1. Carsharing*

#### **(a) Impacts on Mobility (congestion and VKT)**

Martin and Shaheen (2011), in collaboration with major carsharing organizations throughout North America, surveyed 9,635 members of a carsharing organization about their travel behavior both during the year before they started carsharing and at the time of the survey. By incorporating distances that would have been driven in the absence of carsharing, VKT dropped by 43 %. On the other hand, car-ownership dropped by 44 % by considering vehicles having been sold or vehicles purchases having been postponed. Millard-Ball and al. (2005) conducted an internet survey amongst 1,340 participants from all major carsharing organizations in the United States and Canada. They found that each shared car replaced about 15 privately owned vehicles in North America. Their results showed moreover that VKT dropped by 37 %. Rydén and Morin (2005) estimated from

surveys amongst carsharing users a reduction in car use in Brussels and Bremen of 28 % and 45 %, respectively. Based on a survey conducted amongst 363 car sharers in Netherlands, Nijland and al. (2017) argued that carsharing reduces the car-ownership by over 30 % amongst car sharers. They showed that shared car mostly replaced a second or third owned car. A second major finding is that carsharing dropped VKT by 15 % to 20 %. After disposing of their car, users were traveling more by train or by using a borrowed or rented car.

***(b) Environmental impacts: energy consumption and pollutant emissions***

By proving that VKT dropped after using carsharing, Rydén and Morin (2005) found that carbon emissions also decreased by 40 % to 50 %. They assumed in addition that shared cars are smaller and more fuel-efficient than conventional cars. Baptista and al. (2014) confirmed these ratios by finding that carsharing in Lisbon, Portugal, would decrease by 35 % or 47 % in terms of energy consumption and 35 % and 65 % for CO<sub>2</sub> emissions, if a shift to hybrid vehicles or to electric vehicles is promoted, respectively. Nijland and al. (2017) found that by using carsharing, CO<sub>2</sub> emissions dropped by only about 15 %. About one third to half of this reduction can be attributed to less car use, the remainder to the lower degree of car ownership. Jung and al. (2018) found, however, that carsharing based on conventional car does not have a significant impact on greenhouse gas emissions.

5.2. *Ridesharing*

At present, there are very few published studies on impacts of ridesharing.

***(a) Impacts on Mobility (congestion and VKT)***

Manzini and al. (2012) showed based on a survey in Italian public institution in Bologna that carpooling between employees enabled saving distance and time by about 27 % and 25 % respectively. CERTU (2007) showed that carpoolers are mostly privately car-owners. Carpooling is then apparently reducing car use significantly. Conversely, carpooling for long distances (e.g. Blablacar) is attracting mostly riders who would have choose train in the absence of carpooling option.

***(b) Environmental impacts: energy consumption and pollutant emissions***

Several surveys showed that carpoolers often associate carpooling with lower environmental impacts (CERTU, 2007; ADEME, 2015a). Seyedabrishami and al. (2012) analyzed results of a SP survey in the Tehran Metropolitan Area (Iran) and estimated that 336.5 million liters annual fuel will be saved if about 50 % of travelers accept carpooling without knowing someone to rideshare. Manzini and al. (2012) deduced from the survey in Bologna that about 2 millions of kilometers could be saved by year; which means saving about 244 tons of CO<sub>2</sub>.

Jacobson and al. (2009) showed USING that adding one additional passenger for every 100 vehicles would reduce annual fuel consumption by 3 – 3.1 billion liters of gasoline per year.

### 5.3. For-hire services

#### **(a) Impacts on Mobility (congestion and VKT)**

A study conducted by Shared-Use Mobility Center (2016) found that the majority of trips made by ridesourcing services occurs between 10 pm and 4 am, when public transit either runs very infrequently or does not run at all. This finding suggests a complementarity effect. Clewlow and Mishra (2017) investigated seven large US metro areas. They showed that ridesourcing services tend to substitute 6 % and 3 % of trips that would have been otherwise made by bus and subway respectively. A review of studies dealing with ridesourcing impacts in US showed that ridesourcing induces reductions in carpool, walk, bike travel, and carsharing (Rodier, 2018). Rayle et al. (2016) found from the SP survey in San Francisco that in the absence of ridesourcing, 39 % of riders would have taken a taxi and 24 % a bus. Only 4% are using ridesourcing as a first-/last-mile trip to and from public transit. On the other hand, 40 % of riders reported that they reduced their driving after the adoption of ridesourcing services (Rayle et al. 2014).

Hena0 (2017) analyzed a SP survey in Denver metropolitan region, USA. They found that ridesourcing increases driven kilometers by 185 %, which have significant implications in terms of congestion and environmental concerns. The congestion reported in New York and San Francisco (CBS SF, 2018) confirms these outcomes, leading New York City to regulate the number of vehicles allowed to pick up riders (New York Times, 2018).

Hall and Krueger (2017) and Chen et al. (2015) quantified the labor welfare impact from Uber's supply model.

#### **(b) Environmental impacts: energy consumption and pollutant emissions**

At present, to the best of our knowledge, there is no study considering environmental issues of ridesourcing. Ridesourcing induces more driven kilometers, more congestion and sometimes less use of public modes. On the other hand, vehicles used for ridesourcing could be more efficient and less polluting than conventional cars.

## 6. SUMMARY AND RECOMMANDATIONS

**Figure 3, Figure 4 and Figure 5** present main references and findings cited in this Chapter for carsharing, ridesharing and for-hiring, respectively.

Empirical evidence indicates that shared modes can provide environmental and social benefits. While studies on carsharing are fairly extensive, with an increasing interest to OW carsharing service, the impacts of capooling are less understood, being mainly based on SP surveys. Models exploring carpooling are in addition focusing on a specific feature of the supply (e.g. price, meeting efficiency, detour, etc.). Concerning for-hire services, an

exhaustive body of studies on taxis exists, exploring vehicles movements, regulation issues, dispatching strategies to meet passengers and so on. However, ridesourcing services are less investigated. Impact assessment studies are consequently practically absent.

Then, further works should explore more the impacts of newer service models and emerging modes, in particular ridesharing and ridesourcing. Other development studies need to be conducted to combine demand studies (i.e. mode choice behavior) with supply studies (i.e. supply management). Furthermore, multimodal integration is a key strategy for improving the level of service of SM services and should be explored. In particular, their integration together into a multimodal urban universe, according to homogenous socio-economic criteria will enable to better understanding existing complementarities between SM services.

Finally, this Chapter draws lessons for the development of Business Models based on AVs:

- Several forms of Business Models are possible. Each business model depends on the category of the actor (companies or individuals) and has its own technical, economic and organizational constraints;
- The development of Business Models based on AVs should knocking down technological locks, but also social and psychological barriers. That could be achieved through proposing attractive prices;
- The implementation of AVs should taking into account competition and complementarities with other existing services.

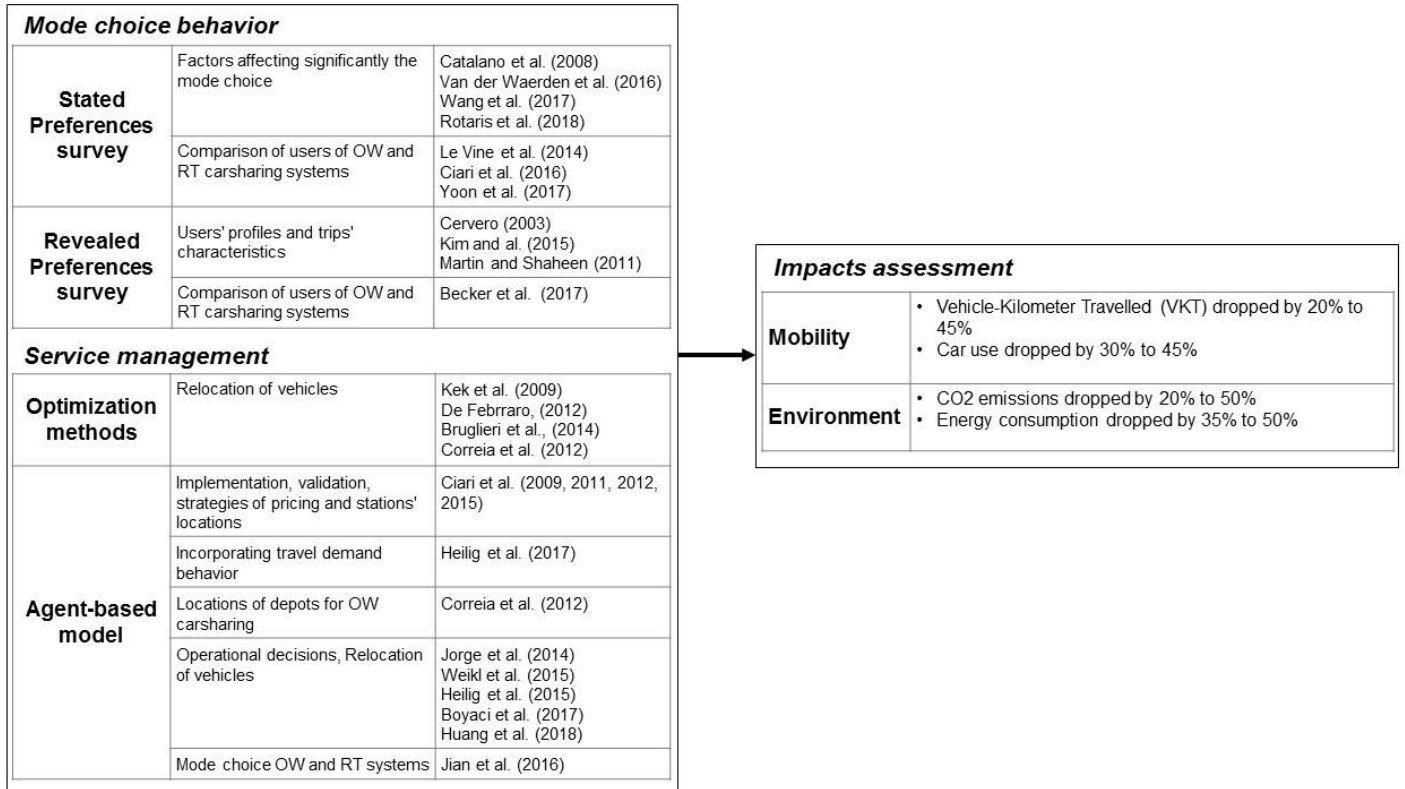

Figure 3 Models of carsharing services and main impacts findings

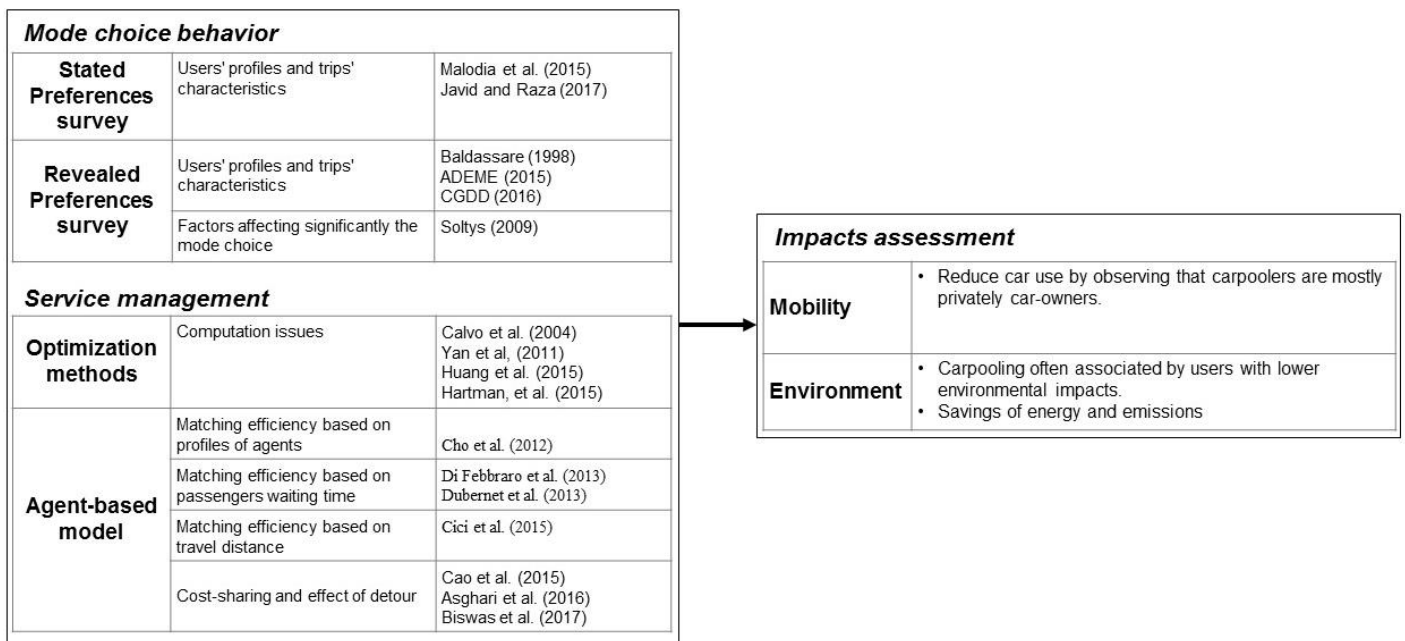

Figure 4 Models of ridesharing services and main impacts findings

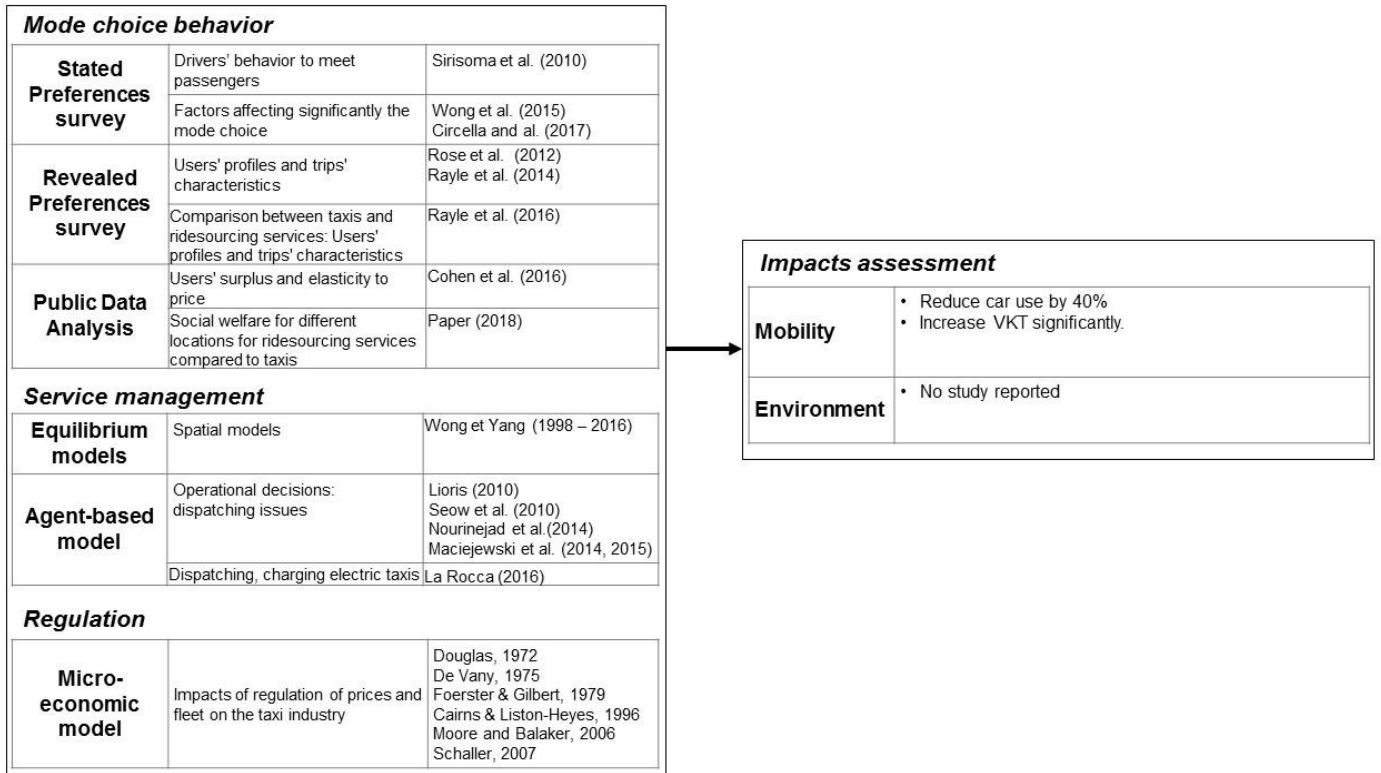

Figure 5 Models of for-hire services and main impacts findings

## REFERENCES

- ADEME, 2015a. Etude Nationale sur le Covoiturage à Courte Distance - Enquête auprès des utilisateurs des aires de covoiturage, s.l.: Agence de l'Environnement et de la Maitrise de l'Energie.
- ADEME, 2015b. Etude Nationale sur le Covoiturage à Courte Distance - Approche méthodologique d'évaluation de l'impact du covoiturage sur les polluants atmosphériques et le CO<sub>2</sub>, s.l.: Agence de l'Environnement et de la Maitrise de l'Energie.
- Alemi, F., Circella, G., Handy, S. L. & Mokhtarian, P. L., 2017. What Influences Travelers to Use Uber? Exploring the Factors Affecting the Adoption of On-Demand Ride Services. Proceedings of the 96th annual meeting of Transportation Research Board, January.
- Asghari, M. et al., 2016. Price-aware Real-time Ride-sharing at Scale -An Auction-based Approach. Proceedings of the 24th ACM SIGSPATIAL International Conference on Advances in Geographic Information Systems, 31 10, Issue 3.
- Bailey, W. & Clark, T., 1992. Taxi management and route control: a systems study and simulation experiment. Proceedings of the 24th conference on Winter simulation, pp. 1217-1222.
- Baldacci, R., Maniezzo, V. & Mingozzi, A., 2004. An exact method for the carpooling problem based on Lagrangean column generation. Operations Research, 52(3), pp. 422-439.
- Baptista, P., Melo, S. & Rolim, C., 2014. Energy, Environmental and Mobility Impacts of Car-sharing Systems. Empirical Results from Lisbon, Portugal. Procedia-Social and Behavioral Sciences, 5 February, Volume 111, pp. 28-37.
- Barth, M. & Todd, M., 1999. Simulation model performance analysis of a multiple station shared vehicle system. Transportation Research Part C, Volume 7, pp. 237-259.

- Becker, H., Ciari, F. & Axhausen, K., 2017. Comparing Carsharing Schemes in Switzerland: User Groups and Usage Patterns. *Transportation Research Part A: Policy and Practice*, March, Volume 97, pp. 17-29.
- Bimpikis, K., Candogan, O. & Saban, D., 2016. *Spatial Pricing in Ride-Sharing Networks*, s.l.: Stanford University.
- Biswas, A. et al., 2017. Impact of Detour-Aware Policies on Maximizing Profit in. 4 May.
- BlaBlaCar, 2016. Calcul du prix d'un trajet en covoiturage. [En ligne]  
Available at: <https://www.blablacar.fr/blablalife/blabla-a-bord/astuces-covoiturage/calcul-prix-trajet-covoiturage>
- Blablacar, 2017. BlaBlaCar en tête du classement Happy Candidates 2017. [En ligne]  
Available at: <https://blog.blablacar.fr/newsroom/news/blablacar-classement-happy-candidates-2017>  
[Accès le 15 August 2018].
- Bouvier, P., 2018. 3 952 véhicules, 154 000 abonnés, 5,7 millions de trajets... Autolib' en chiffres. [En ligne]  
Available at: [https://www.lemonde.fr/entreprises/article/2018/06/21/3-952-vehicules-154-000-abonnes-5-7-millions-de-trajets-autolib-en-chiffres\\_5319193\\_1656994.html](https://www.lemonde.fr/entreprises/article/2018/06/21/3-952-vehicules-154-000-abonnes-5-7-millions-de-trajets-autolib-en-chiffres_5319193_1656994.html)
- Boyaci, B., Zografos, K. & Gerliminis, N., 2017. An integrated optimization-simulation framework for vehicle and person relocations of electric carsharing systems with reservations.. *Transportation Research Part B*, Issue 95, pp. 214-237.
- Bridj, 2018. [En ligne]  
Available at: <https://www.bridj.com/>
- Bruglieri, M., Colorni, A. & Luè, A., 2014. The Vehicle Relocation Problem for the One-way Electric Vehicle Sharing: An Application to the Milan Case. *Procedia - Social and Behavioral Sciences*, Volume 111, pp. 18-27.
- Cairns, R. & Liston-Heyes, C., 1996. Competition and regulation in the taxi industry. *Journal of Public Economics*, Volume 59, pp. 1-15.
- Calvo, R. W., Luigi, F. d., Haastrup, P. & Maniezzo, V., 2004. A distributed geographic information system for the daily car pooling problem. *Computers & Operations Research*, 31(13), p. 2263-2278.
- Cao, B., Alarabi, L., F.Mokbel, M. & Basalamah, A., 2015. SHAREK: A Scalable Dynamic Ride Sharing System. *Proceedings of the 16th IEEE International Conference on Mobile Data Management (MDM)*, June.
- car2go, 2018. Financial year 2017: car2go grows significantly and strengthens its market leadership. [En ligne]  
Available at: [https://www.car2go.com/media/data/germany/microsite-press/files/180111\\_presse-information\\_car2go-grows-significantly-and-strengthens-its-market-leadership.pdf](https://www.car2go.com/media/data/germany/microsite-press/files/180111_presse-information_car2go-grows-significantly-and-strengthens-its-market-leadership.pdf)
- Careem, 2018. [En ligne]  
Available at: <https://www.careem.com/en-ae/>
- Castillo, J., Knoepfle, D. & Weyl, E., 2018. Surge Pricing Solves the Wild Goose Chase. SSRN, 20 March, p. 53.
- Catalano, M., Lo Casto, B. & Migliore, M., 2008. Car sharing demand estimation and urban transport demand modelling using stated preference techniques. *European Transport \ Trasporti Europei*, 40(40), pp. 33-50.
- CBS SF, 2018. Report Links Increased San Francisco Traffic Congestion To Uber, Lyft. [En ligne]  
Available at: <https://sanfrancisco.cbslocal.com/2018/10/16/report-links-increased-san-francisco-traffic-congestion-to-uber-lyft/>
- CERTU, 2007. *Le covoiturage en France et en Europe. Etat des lieux et perspectives.*, France: Ministère de l'Ecologie, du Développement et de l'Aménagement Urbain.
- Cervero, R., Golub, A. & Nee, B., 2006. *San Francisco City CarShare: Longer-Term Travel-Demand and Car Ownership Impacts*, s.l.: Institute of Urban and Regional Development. University of California at Berkeley .
- Cervero, R. & Griesenbeck, B., 1988. Factors influencing commuting choices in suburban labor markets: A case analysis of Pleasanton, California. *Transportation Research Part A*, 22A(3), pp. 151-161.
- CGDD, 2016. *Covoiturage longue distance : état des lieux et potentiel de croissance.* Etudes et documents, Mai, Issue 146.
- Chariot, 2018. [En ligne]  
Available at: <https://www.chariot.com/>
- Chen, M. & Sheldon, M., 2015. *Dynamic Pricing in a Labor Market: Surge Pricing and Flexible Work on the Uber Platform.* Working paper, 11 December.

- Cho, S. et al., 2012. A Conceptual Design of an Agent-based Interaction Model for the Carpooling Application. The 1st International Workshop on Agent-based Mobility, Traffic and Transportation Models, Methodologies and Applications, Volume 10, pp. 801-807.
- Cho, S. et al., 2013. Social Networks in Agent-Based Models for Carpooling. Washington DC: Transportation Research Board.
- Ciari, F. & Axhausen, K. W., 2012. Choosing carpooling or carsharing as a mode: Swiss stated choice experiments. Transportation Research Board Annual meeting.
- Ciari, F., Balac, M. & Balmer, M., 2015. Modelling the effect of different pricing schemes on free-floating carsharing travel demand: a test case for Zurich, Switzerland. *Transportation*, 42(3), pp. 413-433.
- Ciari, F., Weis, C. & Balac, M., 2015. Evaluating the influence of carsharing stations' location on potential membership: a Swiss case study. *EURO Journal on Transportation and Logistics*, Issue 13676.
- Cici, B., Markppoulou, A. & Laoutaris, N., 2015. Designing an On-Line Ride-Sharing System. Proceedings of the 23rd SIGSPATIAL International Conference on Advances in Geographic Information Systems, 03 11, Issue 60.
- Circella, G. & Alemi, F., 2017. The Adoption of Ridehailing and Its Impacts on Travel Demand. [En ligne] Available at: <http://www.demand.ac.uk/wp-content/uploads/2018/01/28-EC1-Circella-Alemi-2017.pdf>
- Clewlow, R. & Mishra, G., 2017. Disruptive Transportation: The Adoption, Utilization, and Impacts of Ride-Hailing in the United States, s.l.: Institute of Transportation Studies- University of California, Davis.
- Cohen, P. et al., 2016. Using Big Data to Estimate Consumer Surplus: The Case of Uber, s.l.: The National Bureau of Research Economy.
- Commuter Services, 2017. Top 5 Benefits of Carpooling. [En ligne] Available at: <https://1800234ride.com/top-5-benefits-of-carpooling/> [Accès le 10 October 2018].
- COMOVEE, 2016a. Comovee entreprises. [En ligne] Available at: <http://www.comovee.fr/entreprise/>
- COMOVEE, 2016b. Comovee, community pricing. [En ligne] Available at: <http://www.comovee.com/community-pricing/>
- Correia, G. H. d. A. & Antunes, A. P., 2012. Optimization approach to depot location and trip selection in one-way carsharing systems. *Transportation Research Part E: Logistics and Transportation Review*, 48(1), p. 233–247.
- CrunchBase, 2016b. Zimride. [En ligne] Available at: <https://www.crunchbase.com/organization/zimride#/entity>
- CrunchBase, 2016. Ridejoy. [En ligne] Available at: <https://www.crunchbase.com/organization/ridejoy#/entity>
- CrunchBase, 2018. Togo Carpool. [En ligne] Available at: <https://www.crunchbase.com/organization/togo-carpool#section-overview>
- CSA, 2018. What is carsharing?. [En ligne] Available at: <https://carsharing.org/what-is-car-sharing/> [Accès le 05 October 2018].
- CTPS, 2018. Goals and Objectives, Boston: Boston Region MPO.
- Curb, 2018. [En ligne] Available at: <https://mobileapp.gocurb.com/>
- De Vany, A., 1975. Capacity Utilization under Alternative Regulatory Restraints: An Analysis of Taxi Markets. *Journal of Political Economy*, 83(1), pp. 83-94.
- Di Febbaro, A., Gattorna, E. & Sacco, N., 2013. Optimizing Dynamic Ridesharing Systems.
- Direct Covoiturage, 2016. Direct Covoiturage, Application de covoiturage dynamique en temps réel. [En ligne] Available at: <http://www.direct-covoiturage.com/>
- Douglas, G., 1972. Price regulation and optimal service standards. *Journal of Transport Economics and Policy*, pp. 116-127.
- Drivenow, 2018. DriveNow and car2go combine to offer extended ride-sharing services. [En ligne] Available at: <https://www.autovistagroup.com/news-and-insights/drivenow-and-car2go-combine-offer->



extended-ride-sharing-services

[Accès le 2018].

Dubernet, T., Rieser-Schüssler, N. & Axhausen, K. W., 2013. Using a Multi-agent Simulation Tool to Estimate the Carpooling Potential. Proceedings of the 92th annual meeting of Transportation Research Board.

Elton-Pickford, 2011. Business Model - Société Comuto, s.l.: s.n.

Febbraro, A., Sacco, N. & SaeedniaM., 2012. One-way carsharing solving the relocation problem.

Transportation Research Record, January, pp. 113-120.

Fehrenbacher, K., 2013. Another failed attempt to make ride sharing work in the U.S., Ridejoy to shut down, s.l.: s.n.

Foerster, J. & Gilbert, G., 1979. Taxicab deregulation: economic consequences and regulatory choices.

Transportation, Volume 8, pp. 371-387.

Galland, S. et al., 2014. Multi-agent simulation of individual mobility behavior in carpooling. Transportation Research part C, Volume 45, pp. 83-98.

Getaround, 2018. Home page. [En ligne]

Available at: <https://www.getaround.com/>

Grab, 2018. [En ligne]

Available at: <https://www.grab.com/sg/>

Gurley, B., 2014. A Deeper Look at Uber's Dynamic Pricing Model. [En ligne]

Available at: <http://abovethecrowd.com/2014/03/11/a-deeper-look-at-ubers-dynamic-pricing-model/>

[Accès le 2018].

Guru, R., 2016. How is My Uber & Lyft Fare Calculated?. [En ligne]

Available at: <https://ride.guru/content/newsroom/how-is-my-uber-fare-calculated>

[Accès le 2018].

Hackner, J. & Nyberg, S., 1995. Deregulating taxi services: a word of caution. Journal of Transport Economics and Policy, 29(2).

Hall, J. & Krueger, A., 2017. An Analysis of the Labor Market for Uber's Driver-Partners in the United States.

IRL Review, 29 June, 71(3), pp. 705-732.

Hardt, C. & Bogenberger, K., 2016. The Price of Shared Vehicles – On current and future Pricing Strategies in Mobility Sharing Systems. Proceedings of the 95th annual meeting of Transportation Research Board.

Hartman, I. B.-A. et al., 2015. Theory and Practice in Large Carpooling Problems. 5th International Conference on Ambient Systems, Networks and Technologies (ANT-2014), Volume 32, pp. 339-347.

Hawkins, A., 2018. Google's Waze is making a big, nationwide bet on carpooling. [En ligne]

Available at: <https://www.theverge.com/2018/10/10/17956496/waze-carpool-expand-nationwide-us-google>

Heetch, 2018. [En ligne]

Available at: <https://www.heetch.com/fr/>

Henao, A., 2017. Impacts Of Ridesourcing – Lyft And Uber – On Transportation Including VMT, Mode Replacement, Parking, And Travel Behavior, s.l.: University of Colorado.

Huang, K., lmeida Correia, G. & An, K., 2018. Solving the station-based one-way carsharing network planning problem with relocations and non-linear demand. Transportation Research Part C: Emerging Technologies, May, Volume 90, pp. 1-17.

Huang, S.-C., Jiau, M.-K. & Lin, C.-H., 2015. A Genetic-Algorithm-Based Approach to Solve Carpool Service Problems in Cloud Computing. IEEE Transactions on Intelligent Transportation Systems, 16(1), pp. 352-364.

Hu, L. & Liu, Y., 2016. Joint design of parking capacities and fleet size for one-way station-based carsharing systems with road congestion constraints. Transportation Research Part B, Volume 93, pp. 268-299.

IDVROOM, 2018. [En ligne]

Available at: <https://www.idvroom.com/>

ITF, 2016. App-Based Ride and Taxi Services. Principles for Regulation., s.l.: OECD.

Jacobson, S. H. & King, D. M., 2009. Fuel saving and ridesharing in the US: Motivations, limitations, and opportunities. Transportation Research Part D Transport and Environment, January, 14(1), pp. 14-21.

Javid, M. et al., 2017. Travelers' attitudes toward carpooling in Lahore: motives and constraints. Journal of Modern Transportation, December, 25(4), pp. 268-278.

- Jian, S., Rey, D. & Dixit, V., 2016. Dynamic Optimal Vehicle Relocation in Carshare Systems. Washington DC, s.n.
- Jorge, D., Correia, G. & Barnhart, C., 2014. Comparing Optimal Relocation Operations With Simulated Relocation Policies in One-Way Carsharing Systems. *IEEE Transactions on Intelligent Transportation*.
- Jorge, D., Molnar, G. & Correia, G., 2015. Trip pricing of one-way station-based carsharing networks with zone and time of day price variations. *Transportation Research Part B*, Volume 81, pp. 461-482.
- Jung, J. & Koo, Y., 2018. Analyzing the Effects of Car Sharing Services on the Reduction of Greenhouse Gas (GHG) Emissions. *Sustainability*, 17 February, Issue 10, p. 539.
- Kek, A., Cheu, R., Meng, Q. & Fung, C., 2009. A decision support system for vehicle relocation operations in carsharing systems. *Transportation Research Part E*, 45(1), pp. 149-158.
- Kim, H., Oh, J. & Jayakrishnan, 2005. Effect of taxi information system on efficiency and quality of taxi services. *Transportation Research Record*, Volume 1903, pp. 96-104.
- Kim, J., Pagliara, F. & Preston, J., 2003. An Analysis of Residential Location Choice Behaviour in Oxfordshire, UK: A Combined Stated Preference Approach. *International Review of Public Administration*, July, 8(1), pp. 103-114.
- Konrad, A., 2015. With \$47 Million And A New Name, Car-Sharing Startup RelayRides Seeks Rebirth. [En ligne] Available at: <http://www.forbes.com/sites/alexkonrad/2015/11/04/with-47-million-and-a-new-name-car-sharing-startup-relayrides-seeks-rebirth/#47335d437c7c>
- La Rocca, C. R., 2016. Algorithmes d'optimisation pour la gestion d'une flotte de taxis électriques, s.l.: HEC Montréal.
- latribune.fr, 2018. Clap de fin pour Autolib': plus dure sera la suite !. [En ligne] Available at: <https://www.latribune.fr/entreprises-finance/services/transport-logistique/clap-de-fin-pour-autolib-plus-dure-sera-la-suite-786700.html> [Accès le 02 November 2018].
- Le Vine, S., Lee-Gosselin, M., Sivakumar, A. & Polak, J., 2014. A new approach to predict the market and impacts of round-trip and point-to-point carsharing systems: Case study of London. *Transportation Research Part D*, Volume 32, pp. 218-229.
- Levin, I., 1982. Measuring Tradeoffs in Carpool Driving Arrangement Preferences. *Transportation*, 11(1), pp. 71-85.
- Lioris, E., 2010. Evaluation et optimisation de systèmes de taxis collectifs en simulation, Paris: CERMICS.
- Lyft, 2018. [En ligne] Available at: <https://www.lyft.com/>
- M. Rose, J. & A. Hensher, D., 2013. Demand for taxi services: New elasticity evidence for a neglected mode. *Transportation*, July, 41(4).
- Maciejewski, M. & Bischoff, J., 2015. Large-scale microscopic simulation of taxi services. *Procedia Computer Science*, Volume 52, pp. 358-364.
- Maciejewski, M. & Nagel, K., 2014. The Influence of Multi-agent Cooperation on the Efficiency of Taxi Dispatching. Conference: International Conference on Parallel Processing and Applied Mathematics, May.
- Malodia, S. & Singla, H., 2016. A study of carpooling behaviour using a stated preference web survey in selected cities of India. *Transportation Planning and Technology*, 39(5), pp. 538-550.
- Manski, C. & Wright, D., 1976. Nature of equilibrium in the market for taxi services. *Transportation Research Record*, pp. 296-306.
- Manzini, R. & Pareschi, A., 2012. A Decision-Support System for the Car Pooling Problem. *Journal of Transportation Technologie*, April, Volume 2, pp. 85-101.
- Martin, E. W. & Shaheen, S. A., 2011. Greenhouse Gas Emission Impacts of Carsharing in North America. *IEEE Transactions on Intelligent Transportation Systems*, 14 July, pp. 1074 - 1086.
- Microstop, 2018. qui sommes nous. [En ligne] Available at: <http://microstop.org/qui-sommes-nous/>
- Milliard-Ball, A. et al., 2005. Car-sharing: Where and how it succeeds, Washington D.C.: Transportation Research Board.

- Ministère de la transition écologique et solidaire, 2017. Le covoiturage en France. [En ligne]  
Available at: <https://www.ecologique-solidaire.gouv.fr/covoiturage-en-france>  
[Accès le 09 November 2017].
- Moore, A. T. & Balaker, T., 2006. Do Economists Reach a Conclusion on Taxi Deregulation?. *Econ Journal Watch*, January, 3(1), pp. 109-132.
- New York Times, 2018. New York Could Become First Major U.S. City to Cap Uber and Similar Vehicles. [En ligne]  
Available at: <https://www.nytimes.com/2018/07/26/nyregion/new-york-city-council-uber-limit.html>
- Nijland, H. & van Meerkerk, J., 2017. Mobility and environmental impacts of car sharing in the Netherlands. *Environmental Innovation and Societal Transitions*, June, Issue 23, pp. 84-91.
- Nourinejad, M. & Roorda, M., 2014. Agent Based Model for Dynamic Ridesharing. Washington DC: Transportation Research Board.
- Oliphant, M. & Amey, A., 2010. Dynamic Ridesharing: Carpooling Meets the Information Age. s.l.:MIT ridesharechoices.
- Ouihop, 2018. Ouihop.com. [En ligne]  
Available at: <https://www.ouihop.com/>
- Paper, J. M. & Shapiro, M. H., 2018. Density of Demand and the Benefit of Uber, s.l.: s.n.
- Parnell, B., 2016. Eight Uber Competitors Reinventing Taxi Apps. [En ligne]  
Available at: <http://www.businessofapps.com/eight-uber-competitors-reinventing-taxi-apps/>
- Plesse, G. & Bontinck, J.-G., 2018. Marie Bolloré : «Mettre fin à Autolib' est une décision aberrante». [En ligne]  
Available at: <http://www.leparisien.fr/info-paris-ile-de-france-oise/transports/marie-bollore-mettre-fin-a-autolib-est-une-decision-aberrante-18-06-2018-7780092.php>
- Quiret, M., 2018. Autolib' : comment Hidalgo a congédié Bolloré. [En ligne]  
Available at: <https://www.lesechos.fr/industrie-services/automobile/0301886576138-autolib-comment-hidalgo-a-congedie-bollore-2189359.php>
- Rayle, L. et al., 2016. Just A Better Taxi? A Survey-Based Comparison of Taxis, Transit, and Ridesourcing Services in San Francisco. *Transport Policy*, Issue 45, pp. 168-178.
- Rayle, L. et al., 2014. App-Based, On-Demand Ride Services: Comparing Taxi and Ridesourcing Trips and User Characteristics in San Francisco. *Transport Policy*.
- Ridely, 2018. [En ligne]  
Available at: <https://ridely.co/>
- Rodier, C., 2018. The Effects of Ride Hailing Services on Travel and Associated Greenhouse Gas Emissions, s.l.: Institute of Transportation Studies, University of California, Davis.
- Rotaris, L. & Danielis, R., 2017. The market potential for carsharing services in small to medium-size towns. *International journal of transport economics*, March, pp. 73-98.
- Rydén, C. & Morin, E., 2005. MOSES Mobility Services for Urban Sustainability, Environmental Assessment, Stockholm: s.n.
- Salanova, J. M. & Estrada, M. A., 2015. Agent Based Modelling for Simulating Taxi Services. *Procedia Computer Science*, Volume 52, pp. 902-907.
- Seow, K. T., Dang, N. H. & Lee, D.-H., 2010. A Collaborative Multiagent Taxi-Dispatch System. *IEEE Transactions on Automation Science and Engineering*, July, 7(3), pp. 607-616.
- Seyedabrishami, S., Mamdoohi, A., Barzegar, A. & Hasanpour, S., 2012. Impact of Carpooling on Fuel Saving in Urban Transportation: Case Study of Tehran. *Procedia - Social and Behavioral Sciences*, October, Volume 54, pp. 323-331.
- Shaheen, S., 2018. Innovative Mobility Carsharing Outlook. Carsharing market overview, analysis and trends, Berkeley: Transportation Sustainability Research Center.
- Shared-use-mobility-center, 2016. Shared-use mobility toolkit for cities, s.l.: USDN.
- Slunecnice, 2018. BeepMe. [En ligne]  
Available at: <https://www.slunecnice.cz/sw/beepme-carpool-rideshare-android/>
- Soltys, A. K., 2009. Toward an Understanding of Carpool Formation and Use, Toronto: University of Toronto.
- Stocker, A. & Shaheen, S., 2017. Shared Automated Vehicles: Review of Business Models, s.l.: OECD/ITF.

- Teal, R., 1987. Carpooling: Who, how and why. *Transportation Research Part A: General*, May, 21(3), pp. 203-214.
- TURO, 2018. home page. [En ligne]  
Available at: <https://turo.com/>
- UBER, 2015. UBER Newsroom. [En ligne]  
Available at: <https://newsroom.uber.com/india/delhi-your-uber-auto-is-arriving-now/>
- Uber, 2018. Cities. [En ligne]  
Available at: <https://www.uber.com/fr/cities/>  
[Accès le 18 November 2018].
- Uber, 2018. How surge works. [En ligne]  
Available at: <https://www.uber.com/fr-MA/drive/partner-app/how-surge-works/>
- Via, 2018. [En ligne]  
Available at: <https://ridewithvia.com/>
- Wang, J., Sun, G. & Hu, X., 2013. A Bi-level Programming Model and Solution Algorithms for Taxi Fare in Taxi Market of China. *Journal of Information and Computational Science*, 10(17), pp. 5787-5803.
- Wang, X., He, F. & Gao, O., 2016. Pricing strategies for e-hailing platform in taxi service. Washington DC., s.n.
- Wang, Y., Yan, X., Zhou, Y. & Xue, Q., 2017. Individuals' Attitudes of Acceptance to Carsharing Mode: A Web-Based Survey in China. *Proceedings of 96th Annual Meeting Transportation Research Board*.
- WayzUp, 2016. WayzUp. [En ligne]  
Available at: <https://www.wayzup.com>
- Weikl, S. & Bogenberger, K., 2015. Integrated Relocation Model for Free-Floating Carsharing Systems. Washington DC, s.n.
- Wikipedia, 2018. Carpooling. [En ligne]  
Available at: <https://en.wikipedia.org/wiki/Carpool>  
[Accès le 20 November 2018].
- Wikipedia, 2018. Carsharing. [En ligne]  
Available at: <https://en.wikipedia.org/wiki/Carsharing#History>  
[Accès le 15 October 2018].
- Wikipedia, 2018. DiDi. [En ligne]  
Available at: <https://en.wikipedia.org/wiki/DiDi>
- Wong, K., Wong, S. & Yang, H., 2001. Modeling urban taxi services in congested road networks with elastic demand. *Transport Research B*, Volume 35, pp. 819-842.
- Wong, R., Szeto, W. & Wong, S., 2014b. A Cell-based Logit-opportunity Taxi Customer-search Model. *Transportation Research Part C*, Volume 48, pp. 84-96.
- Wong, R., Szeto, W. & Wong, S., 2015. Behavior of taxi customers in hailing vacant taxis: A nested logit model for policy analysis. December.
- Wong, R., Szeto, W., Wong, S. & Yang, H., 2014a. Modeling Multi-period Taxi Customer-searching Behavior. *Transportmetrica B*, Volume 2, pp. 40-59.
- Xia, J., Curtin, K. M., Li, W. & Zhao, Y., 2015. A New Model for a Carpool Matching Service. *PLOS One*.
- Yang, H., Cowina, W., Wong, S. & Michael, G., 2010. Equilibria of bilateral taxi-customer searching and meeting on networks. *Transport Research B*, Volume 44, pp. 1067-1083.
- Yang, H., Wing, Y. L., Wong, S. C. & Lo, H. K., 2000. A macroscopic taxi model for passenger demand, taxi utilization and level of services. *Transportation*, Issue 27, pp. 317-340.
- Yang, H. & Wong, S., 1998. A network model of urban taxi services. *Transport Research Part B*, 32(4), pp. 235-246.
- Yang, H., Ye, M., Tang, W. & Wong, S., 2005. Regulating taxi services in the presence of congestion externality. *Transport Research A*, Volume 39, pp. 17-40.
- Yan, S. & Chen, C.-Y., 2011. A model and a solution algorithm for the car pooling problem with pre-matching information. *Computers & Industrial Engineering*, Volume 61, pp. 512-524.
- Yoon, T., R.Cherry, C. & R.Jones, L., 2017. One-way and round-trip carsharing: A stated preference experiment in Beijing. *Transportation Research Part D: Transport and Environment*, June, Volume 53, pp. 102-114.

Zipcar, 2018. zipcar overview. [En ligne]  
Available at: <https://www.zipcar.com/press/overview>

## **APPENDIX: COMPARISON BETWEEN UBER AND LYFT**

While there are other ridesharing apps such as Sidecar and Hailo, Uber and Lyft command the greatest portion of the US market.

First and foremost, Lyft operates in the United States and Ontario, Canada, while Uber extends to major cities in Canada, Mexico, Central America, South America, Europe, the Middle East, Africa, and Asia Pacific. Basically, when abroad, the only option (between these two apps) is likely Uber. Within the U.S., the coverage maps are fairly similar. Uber is available in all 50 states, reaching over 250 total cities. Lyft is currently available in more than 300 cities across all 50 states, as well as Washington, D.C. Lyft accounted for over 375 million rides in 2017 alone, while Uber reached 4 billion rides. Lyft allows customers to reserve a ride up to 7 days in advance in 25 cities, and Uber lets customers schedule a ride up to 30 days in advance in most cities in which it operates.

Both Uber and Lyft rely heavily on location-based data, which means that a good internet connection is needed, either through Wi-Fi or a cellular service. Once the app loads, it will drop a pin on the current location of the client (that can be adjusted if off the mark) or simply enter that address he wants to be picked up from in the text box. Like Google Maps, both Uber and Lyft can work with street addresses or points of interest. So, once the destination is selected, the apps estimate the ride cost based on the chosen service, the time of day, and the proximity of the course. Both Uber and Lyft will also give an estimation of how long it will take for the driver to arrive at the designated pickup spot. Also, both Uber and Lyft show a real-time visual of the driver's progress to the designated location.

Once the ride arrives, if the client is nowhere to be found, Uber and Lyft drivers must wait five minutes before they are allowed to cancel the ride. Uber will begin billing the passenger (per minute) after just two minutes of wait time. With Lyft, the ride automatically starts one minute after the driver arrives.

On the corporate culture side, LYFT stands out by its mustache and the absence of professional drivers; it is more suitable for "classy" reasons. From the very start, Lyft encouraged its passengers to sit next to the driver so that a discussion can be initiated. By contrast, UBER is more like a traditional taxi service, in which the customer relationship is very professional. Its philosophy aligns more closely with the app's livery service origins, meaning most passengers file into the rear seats.

Both Uber and Lyft require credit card information to be stored in the app, so once the client reach the destination, he is free to leave. However, the next time he accesses the Lyft app, he will be asked to rate the driver on a scale of 1 to 5 and offer feedback — and he will also

have a chance to tip him or her. Uber's process is very similar; in-app tipping was added in June, making the process very similar and the app asks for ratings and feedback on the same scale as Lyft. Uber and Lyft drivers also have an opportunity to rate their passengers.

Lyft still had higher overall satisfaction and pay among their drivers compared to Uber, but the gap is narrowing. A majority of Uber drivers were satisfied with Uber's 180 Days of Change campaign, which included new features like a tipping option and a 24/7 phone support line for drivers. Unfortunately, drivers feel strongly that they are underpaid.

In general, the pricing for each app is pretty similar, but there's one more variable that cannot be neglected: surge pricing. Based on location and demand ("heat maps"), both Uber and Lyft will increase a typical ride rate by a certain percentage, Uber calls this situation "Surge" and Lyft calls it "Prime Time." Lyft price increases are usually less than Uber's. Although a rise in prices is justified in certain specific situations, this has been subject to several controversies. Surge and Prime Time pricing have upset taxi drivers and app users alike, with the potential for a \$20 ride turning into one that costs hundreds of dollars. Massive increases in normal fares are not the worst of it, though. During emergency situations such as Hurricane Sandy and a bombing in New York, Uber was slapping Surge rates on people who were attempting to flee dangerous situations (at least briefly). Lyft is not immune to public relations trouble, either. Though the app capped Prime Time increases at 200 percent, the company lifted the ceiling in February 2016, upsetting many users.

In 2015, Uber began to develop self-driving cars. However, Uber is currently engaged in a lawsuit with Alphabet, Google's parent company, over allegations that it did not develop its driverless car technology independently and stole trade secrets from Google's self-driving car spin-off, Waymo. In March 2018, an experimental Uber vehicle, operating in autonomous mode, struck and killed a pedestrian. Uber then stopped testing driverless cars.

In conclusion, it seems that overall Uber and Lyft offer nearly the same service. Both provide convenient, inexpensive transportation in most major areas, and either option is more than sufficient for day-to-day commuting. Nevertheless, Lyft is generally the cheaper option. Not only is Lyft's minimum charge lower, its heat maps are usually smaller as well, meaning the ride will be more economical during peak hours.



# Section II. Exploration of pertinent form(s) of services based on Autonomous Vehicles

This section explores, identifies and designs the main Business Models that could emerge for services based on Autonomous Vehicles.

It is organized into two Chapters:

- **Chapter.3 Between private cars and mass transit: the rise of intermediate modes in the urban setting**

This Chapter explores in urban settings the potential for Shared Mobility services, which are intermediate modes between Public Transit (PT) and Private Cars (PC). We put forward characteristic diagrams to depict the range of modal solutions and assess their respective value in several perspectives that pertain respectively to Users, Operators, Planning authorities and Residents.

- **Chapter.4 Business Models for services based on Autonomous Vehicles: a comparison with urban conventional modes and Shared Mobility services**

In this Chapter, we explore Business Models for services based on autonomous cars. We consider Product-Service-Systems (PSS) to explore and classify main Business Models and, then, deduce those upcoming for AV-based services. Two main forms of Business Models are studied in detail: aTaxi and aTransit. A comparison with conventional urban modes is achieved using diagrams constructed in Chapter 3.



## **Chapter.3 Between private cars and mass transit: the rise of intermediate modes in the urban setting**

### **ABSTRACT**

In the urban settings of developed countries, the Private Car (PC) constitutes by far the main mode of passenger mobility for the trips above some hundred meters, since it is quick, readily available and comfortable, at moderate costs to its users. The main alternative for trips above some kilometers consists in Passenger Transit (PT) modes, from Buses to Commuter trains passing by Bus Rapid Transit (BRT), tramways and metros. Yet bus lines are appropriate in cities of more than several dozen thousand inhabitants, whereas railway lines can be relevant in cities populated at least by several hundred thousand inhabitants. Between PC and PT, cabs operated traditionally make up an alternative limited to a small part of the trips due to relatively high prices and limited availability, thus requiring wait time in addition to service time.

This Chapter is purported to explore the potential for passenger transportation modes intermediate between PT and PC in urban settings. A range of solutions have been developed recently, from individual cabs "à la Uber" to on-demand transport, passing by carsharing "à la Zipcar", shared cars such as Autolib or Car2Go, ridesharing and collective cabs such as Bridj (Chapter.2).

We put forward characteristic diagrams to depict the range of modal solutions and assess their respective value in several perspectives that pertain respectively to Users, Operators, Planning authorities and Residents. To Users, the main criteria are Time, Price and Effort. To Operators the main criteria pertain to unit costs of production and asset productivity. Planners have been accustomed to consider capacity (e.g. measured in passengers per lane per hour) and commercial speed: we provide some revision to give a better account of user attractiveness.

We trace out the influence of local conditions such as traffic density, parking congestion and price, onto the competitive positions of the modes.

This Chapter was presented in the international conference mobil.TUM 2017<sup>11</sup>.

*Keywords:* mobility systems, travel modes, sharing economy, social actors, systems analysis, multicriteria analysis

---

<sup>11</sup> Berrada, J., Leurent, F., Lesteven, G. & Boutueil, V., 2017. Between private cars and mass transit: the room for intermediate modes in the urban setting. Transforming Urban Mobility Conference (Mobil.TUM), Munich, Germany, July 4-6

## **1. INTRODUCTION**

### *1.1. Background*

In developed cities, the major part of the distances travelled by passengers and goods are delivered by two main modes of transportation, namely private cars and mass transit. Recently, the successive advents of the internet and the smartphone, in terms of both facilities and realm of services, have enabled the development of Shared Mobility (SM) services of carsharing, bike-sharing, ridesharing and for-hire (e.g. Uber) that revitalizes the taxi and the car-rental industries. The very rapid pace of smartphone diffusion and web-app development and adoption has laid the technological ground for an upsurge of SM services. Yet such an upsurge also requires profitability on the supply side, and in turn a wide enough demand basis. Furthermore, on-field infrastructural conditions together with legal framework need to be set up.

### *1.2. Objective*

This Chapter is aimed to explore and assess the room for SM services in the multimodal universe of urban mobility for passengers. We abstract SM services into typical modes of travel, of which we identify the specific characteristics that pertain to service provision, on the supply side, to quality of service, on the demand side, and also to a range of external effects on the environment, the society and its economy.

### *1.3. Method and related work*

Based on this qualitative analysis, we build up a theoretical framework to assess the competitiveness of SM modes to conventional modes in the different perspectives that pertain to, respectively, (i) Suppliers, (ii) Users, (iii) Residents, (iv) Public authorities. Our approach is rooted in recent work by (Stocker & Shaheen, 2017) to classify SM services into three kinds and also in the classical work of Vuchic (2007) to classify urban transit modes into three kinds, namely (i) street transit (bus, trolleybus, streetcar), (ii) semi-rapid transit (BRT, LRT) and (iii) rapid transit (Heavy rail), whereas Private vehicles are included for comparison and taxis are considered similar to private vehicles. As basic modal characteristics, Vuchic defined the maximum frequency, vehicle capacity, line capacity, speed, cost, and productive capacity. He proposed three diagrams to analyze the relationship between these characteristics. The first diagram compares capacities (maximum frequency and transit unit capacity) and shows that frequency decreases by going from the private cars (and taxis) to higher-capacity modes, The second diagram assesses operating speed against line capacity: the highest the line capacities, the highest the operating speeds. The third diagram faces investment costs to productive capacity, defined as “the product of speed, affecting primarily passengers, and capacity”. In addition, the last diagram involves secondary axes to show the relation between passenger attraction and the level of service (LOS).

Kim (2009) studied mass transit modes by selecting the right of way (ROW) as major criterion. He split the existing transit modes into three classes: (1) ROW category C, public streets with general traffic, (2) ROW category B, transit ways partially separated from general traffic, and (3) ROW category A, fully separated from general traffic. The relationship between performance (speed, capacity and reliability) and the investment costs per line length exhibits major differences among the categories. Category C has far lower performance than B and A. Also, category A has by far the highest performance and the broadest range of performance values and costs of investment.

Verma and Ramanayya (2015) included also private modes as cars, motorcycle and walking in the comparison. They analyzed the modal performances by showing that the average speed decreases while the accessibility increases by going from the higher-performance modes to walking,

The three abovementioned studies are basically targeted to transportation planners. Yet, from the users' standpoint, the modes are compared and selected on the basis of the quality of service attributes and their prices – cf. e.g. Ortuzar and Willumsen (2014) for standard modeling practice to simulate traffic flows by mode and link, commercial revenues and other impacts. The user perspective is also taken in FDOT (2013), wherein the Level-of-Service (LOS) is taken as the principal criterion to compare driving, walking, biking or riding a bus. The definition of the LOS depends on the mode. For private cars and bikes, it involves the capacity of lanes, the traffic conditions and the limit running speed. For walking, it depends on the state of the sidewalk, its capacity, and the number of pedestrians. Finally, the LOS of bus services depends only on the frequency.

Our own contribution is (i) to gather conventional modes and SM modes in a unified framework, (ii) to articulate different perspectives, one for each "social actor class" from among Suppliers, Users, Residents and Public Authorities, (iii) in each perspective, to assess the room for SM modes on the basis of bi-criteria diagrams that model the comparison of the modes by members of the social actor class.

#### *1.4. Chapter structure*

We first provide a typology of urban travel modes and insert SM modes in the traditional multimodal diagram for transportation planners (Section 2). Then, we develop the multimodal comparison in the perspective of each social actor class: Suppliers (Section 3), Users (Section 4), Residents (Section 5) and Public Authorities (Section 6). To conclude, we provide a synthesis and a discussion (Section 7).

## **2. A TYPOLOGY OF URBAN TRAVEL MODES**

Consider the classification of SM services proposed by (Stocker & Shaheen, 2017) and presented in Chapter.2. The new multimodal universe contains six major classes:

- Rapid transit: heavy rail, metro or underground,
- Semi rapid transit: namely trams and BRT systems,
- Street transit: for buses,
- B2C services: concern the carsharing system,
- P2P services: concern the carpooling system,
- For-Hire: includes ride-sourcing (such as Uber or Lyft...) and taxi services.

The three first classes can be called mass transit modes. We shall also distinguish between taxis, ridesourcing services (noted below RdS) and Private cars (noted below PC) for comparative assessment of modal efficiency and attractiveness to the social actors involved in the urban mobility system: namely, operators, users, residents and public authorities, which command transportation planning. Prior to exploring the characteristics of the generic classes for each actor type, let us adapt the diagrams that were proposed previously for planning purposes. Remind that transportation planners have the mission to design and implement plans and policies to shape urban mobility. The criteria considered in the literature are:

- *Line (per lane) capacity.* It describes the maximum flow of passengers that could be transported per lane in one hour. The line capacity stems from vehicle capacity times service frequency.
- *Investment costs.* Encompass all costs incurred to deliver the service, from initial investment and replacement/renewal of infrastructures and vehicles, up to operations, passing by maintenance. The unit of evaluation is an abstract lane with its own vehicle fleet.

**Figure 6** faces line capacity to investment costs. Rapid transit requires the highest investment, followed by semi-rapid transit and street transit. The investment costs for private cars are those of road construction. Taxis are less costly to the Organizing Authority that recovers revenues from granting licenses. The diagram shows clearly that SM generic classes are competitive. P2P has far lower investment costs and line capacity than have other classes. The B2C services have highest investment costs and line capacity among the SM services. Mass transit modes (street, semi rapid and rapid transit) have by far greater capacity and broader range of values. The private car provides interesting capacities compared to SM services. It is a strong competitor to carsharing in the point of view of planners.

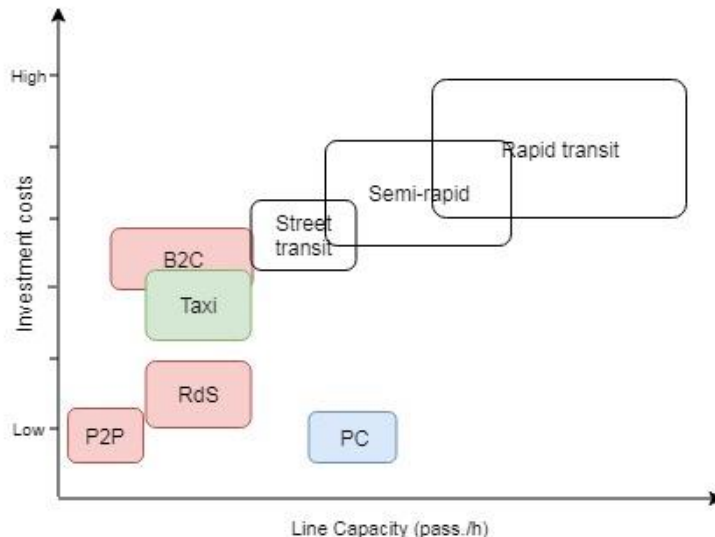

**Figure 6 Investment costs versus line capacity.**

### 3. THE OPERATOR'S STANDPOINT

The operators, or service providers, are interested in the commercial success of their service and also in the technical efficiency of its operating and commercial processes. In particular, their management criteria are oriented toward resource productivity (i.e. cost efficiency) and profitability based on revenues minus costs. Five major characteristics are considered by operators:

- *Investment costs.* Most operators are sensitive to investment costs, especially for SM services that are funded mainly by private companies. In addition, operators are interested to develop the business i.e. to extend its production capacity.
- *Operating costs.* Are associated to the use of resources on a continued basis in order to maintain the production. This involves energy, labor, materials, administration and marketing functions, tax payment etc. The related production unit is one passenger-kilometer.
- *Supply capacity.* Refers to the quantity of output delivered by the operator. It can be measured through either vehicle-kilometers, or passengers transported or passenger-kilometers.
- *Productivity.* Technical resource productivity is described by the ratio of supplied traffic (e.g. seats-kilometers) over operating costs per resource unit such as vehicle or driver. Commercial resource productivity is described by the ratio of commercial revenues (or passenger traffic) over operating costs per resource unit.
- *Revenues.* Revenues depend on the pricing policy and the demand volume. They are commonly averaged over vehicle traffic, yielding unit revenue per vehicle-minute or vehicle-kilometer, as well as over commercial traffic, yielding unit revenue per passenger-minute or passenger-kilometer. There are specific pricing policies to gratify

loyal customers or to enhance revenues, such as: period-long subscriptions, graduated tariffs, packaging, surge prices...

**Table 7** provides the ranges of variation for the basic technical and economic indicators for each modal kind. It shows the relationship between supply capacity and commercial speed. SM services provide greater commercial speed compared to street transit and semi-rapid transit modes.

**Table 7 Technical and economic characteristics of urban travel modes.**

	P2P	RdS	Taxi	B2C	Street transit	Semi rapid	Rapid transit
Capacity of the vehicle (pass/veh)	2 – 5	2 – 5	2 – 5	1 – 5	40 - 120	100 – 750	140 – 2400
Commercial speed (km/h)	20 – 50	20 – 50	20 – 50	20 – 50	15 – 25	20 – 45	30 – 60
Waiting time (mn)	5 – 15	5 – 15	5 – 15	3 – 5	10 – 20	3 – 15	2 – 10
Max Frequency (veh/h)	4 – 12	12 - 20	12 – 20	12 – 20	3 – 6	4 – 20	6 – 30
Average distance per passenger (km) <sup>1</sup>	5 – 15	5 – 15	5 – 15	5 – 15	0.25 – 9	0.35 – 10	1 – 100
Average travel time (mn)	15 – 20	15 – 20	15 – 20	15 – 20	1 – 20	1 – 15	2 – 100
Line capacity (pass/h) <sup>2</sup>	6 – 60	24 – 100	24 – 100	12 – 100	120 – 780	400 – 15,000	840 – 72,000
Supply capacity (pass.km/h) <sup>2</sup>	30 – 900	120 – 1,500	120 – 1,500	60 – 1,500	30 – 7,000	140 – 150,000	840 – 7,200,000
Average fare (€/km)	0.3 – 0.6	1 – 5	2.5 + 1.5	0.2 – 0.6	1– 2	1– 2	0.1 – 1 €/km
Average fare per km (€/km)	0.3 – 0.6	1 – 5	1.5 – 2	0.6 – 0.75	0.2 – 4	0.2 – 3	0.1 – 1
Max revenues (€/h) <sup>2</sup>	10 – 540	120 – 7,500	250 – 2,700	36 – 2,250	30 – 15,000	140 – 300,000	84 – 7,200,000
Investment costs	Very Low	Low - Med	Med	Med-High	Med-High	High	Very High
Operating costs (€/pass.km)	Med	Med	Med-High	High	Low-Med	Low	Low

<sup>1</sup>The average distance per passenger is based on the following assumptions:

- For mass transit modes, the lower limit is the distance between two stations and the upper limit is of the average length of the route.
- For new generic classes, the limits are based on the average travel distance for persons living in Paris region.

<sup>2</sup> Values of supply capacity, productivity and max revenues are not necessarily products for the extreme values of their components because these seldom coincide

The ranges are given on the basis of existing systems. The boundaries of technical and commercial characteristics are neither absolute nor precise limits:

- Investment costs for mass transit modes include costs of infrastructure construction and vehicle fleet purchase. For B2C and some RdS services, the investment costs are restricted to vehicle fleet purchase. Taxis also require license purchasing. P2P services and the majority of RdS services involve only the acquisition and maintenance of an interactive platform to link supply to demand.
- For mass transit modes, operating costs are dominated by the wages of agents, notably drivers. For B2C, the main cost drivers are vehicle maintenance and energy consumption. P2P operating costs are restricted to the utilization of the interactive platform. RdS services add up the operating costs of B2C and P2P, plus drivers' wages.
- Operating costs for P2P and RdS services concern the platform maintenance and development. They include mainly wages. For taxis, costs are of using private cars. The depreciation cost for taxis include furthermore the license depreciation costs. B2C services combine costs of other modes: wages of developer engineers, costs of maintenance vehicles and depreciation costs of vehicles and infrastructure. Mass transit modes benefit of the massification effects. In Paris region, operating costs for rapid transit are around 0.07€/voy.km, semi-rapid transit (tramway) around 0.12 and street transit (bus) between 0.34 and 0.40 (Guéguen-Agenais, 2009).
- Revenues are estimated on the basis of a range of average fare per passenger, per time unit (say minute) or per kilometer travelled. For B2C, membership fees are neglected. Then, the total amount of revenues is equal to the product of unit fare times the average number of passengers carried by the vehicle times the travelled distance.

**Figure 7** relates investment costs to supply capacity, thus reflecting scale effects. As in **Figure 6**, there are important differences among modes. Investment costs increase from P2P to RdS services; then, there is a jump in costs to taxis and B2C services. Maximum productivity increases from P2P to RdS by a factor of 1.5 and to B2C by a factor of 4. Mass transit modes have broad range, stretching from high-productive systems to low-productive. They benefit from their potential of passenger massification. Dotted lines delimit the extreme boundaries of productivity.

**Figure 8** relates operating costs and revenues: the gap represents the service profitability on a unit basis. The hierarchy of modes for operating costs is the same as for investment costs. As concerns profitability, among SM modes RdS is the most promising formula, with the broadest range of potential revenues; P2P yields low revenues and it is no match to other modes. Mass transit modes are quite versatile in terms of costs and revenues; even if their costs are well controlled, they can easily be unprofitable, save for subsidies from the public authorities.

In addition, SM services resort to innovative pricing techniques (annual/ monthly subscription, surge prices...) which are likely to enhance both the revenues and resource productivity.

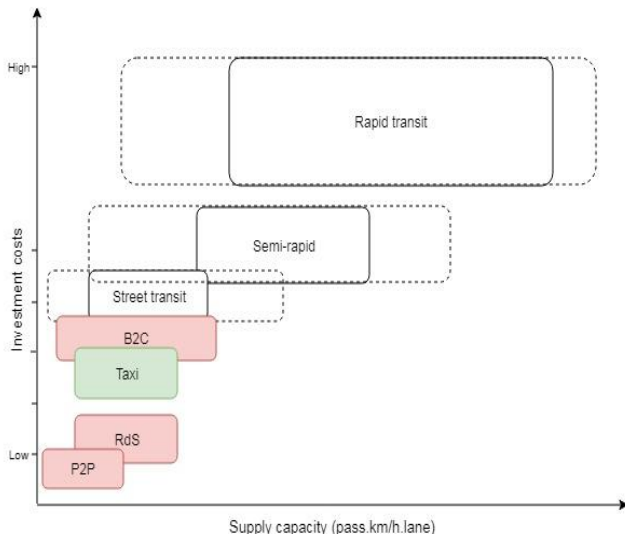

**Figure 7 Investment costs versus supply capacity.**

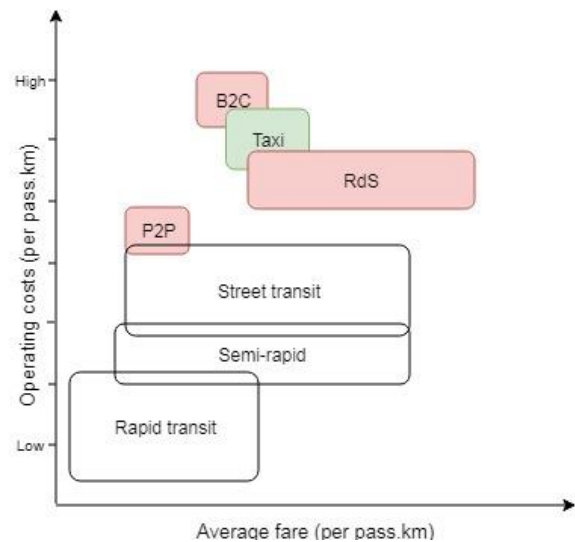

**Figure 8 Operating costs versus average fare.**

#### 4. THE USER'S PERSPECTIVE

Users are concerned by service quality, the tariff and the price-quality ratio. In particular, their criteria include:

- *Price.* For public transit and SM services users, prices are typically membership and/or use fees. As for private car users, they pertain to energy, vehicle maintenance, parking charges and tolls. Prices determine the affordability of travel services. They also depend on usage frequencies, spatial patterns and living/working locations. The costs of using car-based services depend on the in-vehicle time. Thus, they depend on the network state (congestion, weather patterns...) and the path bending with respect to straight line.
- *Door-to-door time.* The door-to-door time is the total time required to reach the destination. It includes access time, waiting time, in-vehicle time and transfer time for the users of the six transit kinds. As for private car users, the door-to-door time encompasses the access time, the in-vehicle time and the parking time. The door-to-door time could be affected by traffic incidents, traffic regulation and weather conditions.
- *Comfort.* The comfort depends on trip type, travel conditions (degree of crowding inside the vehicle, lighting, temperature, air quality, ergonomic factors...) as well as on individual preferences. Travel time spent in public transit can be enjoyable and



productive under specific conditions (Russel, 2012). In general, people prefer to travel alone or with familiar people in a given vehicle rather than with foreign persons. In addition, the perceived travel time in a transit vehicle is twice higher at full loading than under “free flow” conditions (Batarce, et al., 2016).

- *Reliability.* Define system reliability as “the probability that a system will satisfactorily perform the task for which it was designed or intended, for a specified time and in a specified environment” (Weik, 1989). The reliability of mobility services (or travel time reliability) reflects the “probability that a trip can reach the destination within a specific time interval” (Berdica, 2002). In addition, the perceived travel time tends to increase with variability and arrival uncertainty. Unexpected delays are critical factors for activities under strict schedule such as commuting (Hollander, 2006).
- *Access conditions.* The access conditions refer to access time and access distance. They depend on the transport system physical connectivity and the real-time flexibility. Physical connectivity refers to the availability of connections within the transport network, which allow reaching destination rapidly and with less efforts. Among factors affecting the physical connectivity there are density roads, pedestrians paths, and coordination between transit modes. Real-time flexibility involves digital connectivity to supply users with real-time information about the current travel conditions. This enables people for trip planning in real-time, changing route, mode and/or destination depending on the real-time system state.

**Figure 9** and **Figure 10** compare the generic modes in terms of the above-mentioned characteristics. The comparison is qualitative and does not consider real systems values. Dotted lines are used to consider extreme operating conditions (i.e. favorable location of stations, abundant free parking...).

In particular, **Figure 9** relates user costs and door-to-door times. It shows that B2C and RdS services are competitive to mass transit modes in terms of door-to-door time. However, there is a jump in costs from rapid transit to B2C and RdS services. Economies of scale and above all economies of density are key to reduce SM fares and thus, to make them more competitive to mass transit modes. The P2P service competes with semi-rapid transit. The private car makes a first-rate option under efficient speeds and the availability of free parking spaces.

**Figure 10** relates the two criteria of comfort and door-to-door time. RdS services compete with taxis and private cars to provide the best travel comfort. B2C services are far ahead of mass transit systems, whereas P2P competes with them. In this respect also the private car makes a first-rate option under efficient speeds and the availability of free parking spaces.

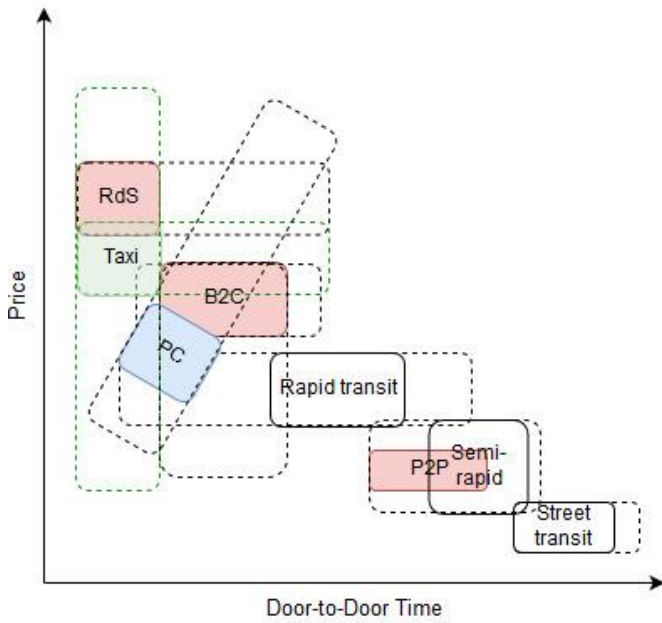

Figure 9 Price versus time door-to-door.

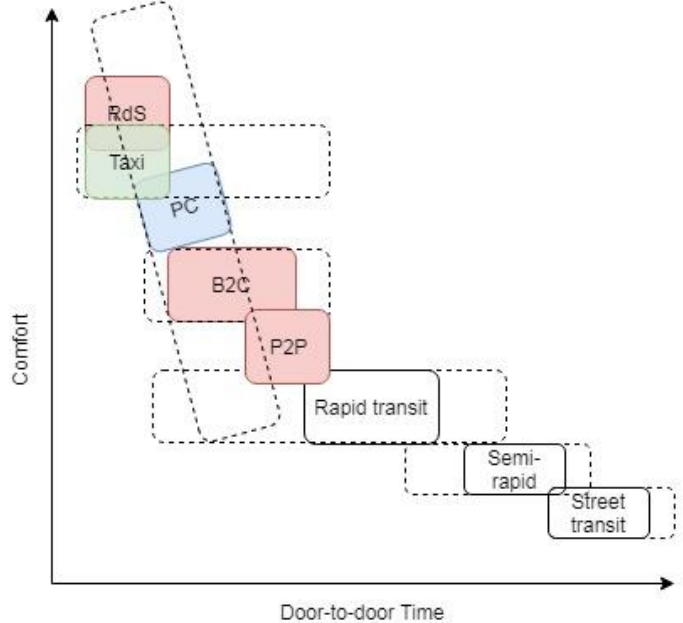

Figure 10 Comfort versus time door-to-door.

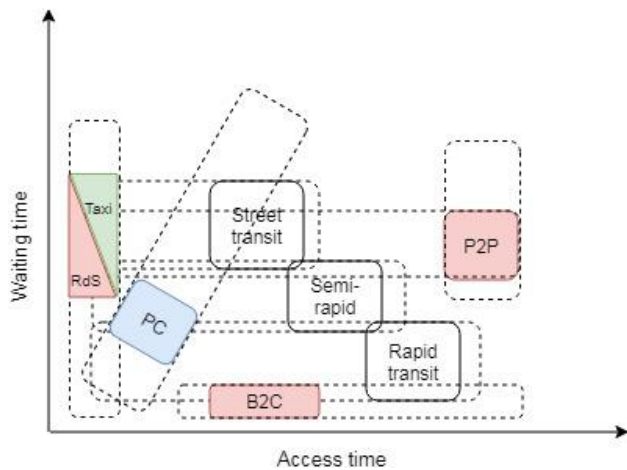

Figure 11 Waiting time versus Access time.

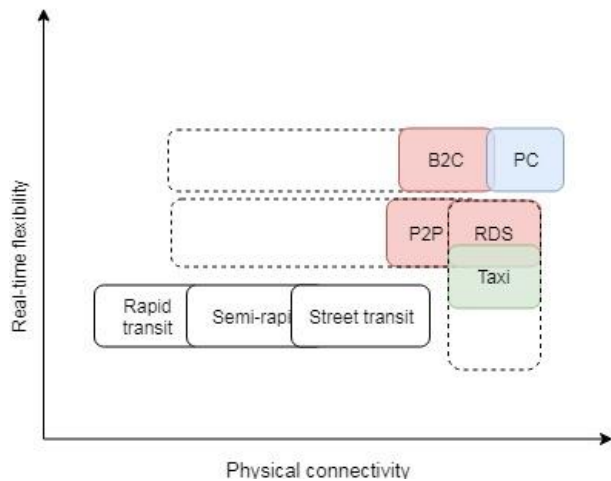

Figure 12 Real-time flexibility versus physical connectivity.

The access conditions are investigated in **Figure 11**. For mass transit modes, the waiting time decreases from street transit to semi rapid, and to rapid transit, while the access time increases. For private cars, the waiting time depends linearly on the access time. They refer to the time required to park the vehicle. Since P2P services require to arrange a meeting point at a meeting time, the waiting time and access time could be very different between individual situations. B2C users have to access to vehicles which are parked. Thus, the access time depends on the density of parking spaces and availability of vehicles. However, the waiting time is in general that of activating and starting the vehicle. Yet for One-Way carsharing, the waiting time could be more important especially in peak hours. Finally, the access conditions of taxis and RdS are the same. The access time is very low while the

waiting time could take several minutes depending on the network state and the nearby availability of taxis.

Accessibility is investigated again in **Figure 12** which deals with physical connectivity and real-time flexibility. Mass transit modes have homogenous flexibility since they are frequently organized and communicated through a single platform. P2P and RdS services provide better physical connectivity and real-time flexibility owing to digital connectivity. Indeed, they provide users the possibility to arrange their plans, to propose routes, to choose the driver and to negotiate the travel cost in real-time. However, once the deal between the driver and the customer is done, the flexibility is restricted. Users of B2C and private cars have the possibility to use real-time traffic information, while driving or riding, to reschedule their desired activities routes.

## **5. THE RESIDENTS' STANDPOINT**

So far we have focused on the supply and demand of mobility services, hence on the economic market of urban mobility. Let us come to the impacts on the environmental, the society and its economy, which constitute market externalities.

Concerning the residents who live in the vicinity of transportation facilities, two features are prominent: accessibility and externalities. On the positive side, accessibility to places and amenities through travel services is important to origin places so that people might avail themselves of the opportunities in destination places, and reciprocally to those destination places in order to extend their catchment areas, eventually up to hinterlands. On the negative side, vehicle traffic generates noise and pollutant emissions, with risks of health troubles and also of injuries in case of accidents. Furthermore, as traffic and parking take place, they reduce the public space available to other activities.

**Figure 13** depicts the respective positions of the urban travel modes in a diagram of accessibility versus externalities. Per unit of passenger traffic, massification reduces the amount of externalities, provided that the transit vehicles carry sufficiently many passengers. Yet, in the absence of access restrictions, the light vehicles yield better accessibility owing to higher service customization.

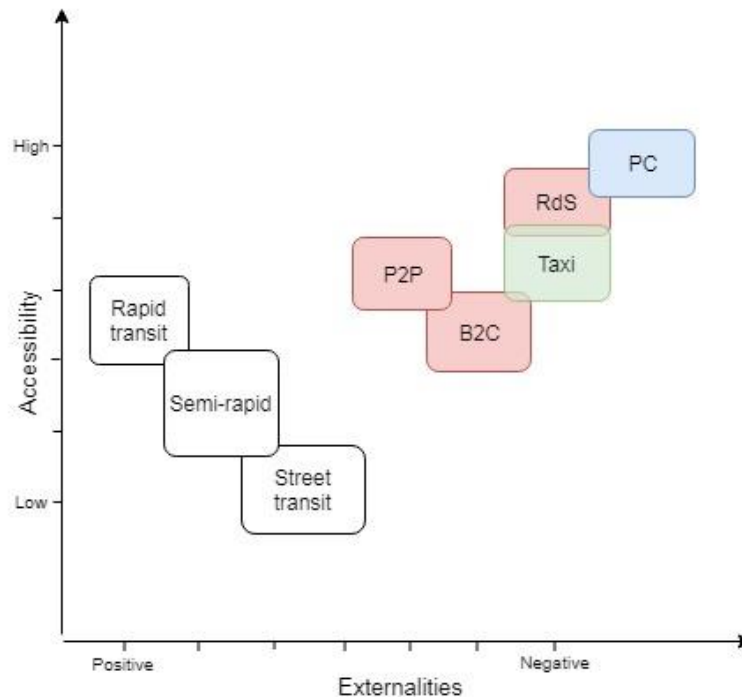

Figure 13 Externalities, accessibility and impact of blockage for different services.

## 6. GLOBAL EFFECTS AND THE COMMUNITY PERSPECTIVE

Local environmental impacts are highly correlated to the local emissions of global environmental impacts: the contribution to global warming due to carbon emissions among others, as well as the depletion of natural resources (materials, energy) and the pollution of natural environments induced by both the use and making of infrastructures and vehicles.

Public authorities are responsible for environmental management and have to take the related impacts into consideration, together with the social and economic impacts. Aside from the economic impacts on supply and demand, a set of related impacts need to be integrated in a broader perspective:

- The quality of transportation services benefits to not only the households but also to firms in their processes of production and distribution.
- The production of transportation services drives the making of infrastructure and vehicles, the production of energy and of typical services (maintenance, insurance, financing). This ripple effect through input-output relationships between productive activities yields multiplying coefficients of typically 3 or 4 for transportation-related flows of value that stem from the end users. All of this leads to wages paid to agents, employers' and employees' contributions to social solidarity, taxes and other contributions paid to the public purse, as well as saving on unemployment benefits (Leurent & Windisch, 2015).
- So there is a twofold effect on social inclusion: first by providing access to jobs and other social opportunities, second by offering specific jobs to people that belong to

the community. This is especially important for the drivers in taxi and ridesourcing services.

- Safety matters concern the passengers and the vehicle drivers as well as the users of the other modes, hence the residents typically as pedestrians. Broadly speaking, the risks are proportional to the flow rate of vehicles and their speed.
- The scarcity of space is a fundamental feature in cities. Congestion on roadways or within transit vehicles are typical consequences. The provision of public space for infrastructures and of access rights for traffic and parking is an in-kind subsidy from public authorities to the suppliers of transportation services.
- Financial subsidies obey to similar reasons. They stem from political trade-offs between the needs and resources of the diverse actors and community members. They can be seen as the collective buying of some kind of “urban subscription” to the mobility services that benefit from them.

**Table 8** assesses the respective performance of our typical modes concerning these features.

**Table 8 Environmental and social characteristics of urban travel modes in the community perspective.**

	P2P	RdS	Taxi	B2C	Street transit	Semi rapid	Rapid transit
<b>Environment issues</b>	Med-High	Med-High	Med-High	Med	Med	Low-Med	Low
<b>Economic induction</b>	Low	Med-High	Med-High	Med	Med	High	Very High
<b>Social inclusion</b>	High	Med-High	Med-High	Med-High	Med	Med	Med
<b>Safety</b>	Med	Med	Med	Med	High	Very High	Very High
<b>Space requirement</b>	Med-High	Med-High	Med	Med-High	Med	Med (Low if underground)	Low if underground

## 7. CONCLUSION

We have analysed SM services in abstract form by featuring out their technical and economic characteristics. We also traced out their position relatively to conventional urban modes (private cars, mass transit) in a series of competitions: from the battle for profitability, to the political trade-offs between modes based of the full array of their environmental, social and economic impacts, passing by the Users’ trade-off between quality and price and the Residents’ trade-off between accessibility and local environmental externalities. The main outcome is that there is room available for SM services in each of these competitions since in our bi-criteria diagrams none of them is dominated by the conventional modes.

Our analysis is primarily qualitative; yet it involves underlying quantitative modelling. The figures pertain to French conditions as of 2015, e.g. those of high and long-standing economic and social development. The conditions in developing countries remain to be addressed specifically; in fact, SM services already hold strong positions in many cities there – thus demonstrating their competitiveness.

As concerns methodology, we have revisited the traditional diagram of planners' trading-off between urban transit modes not only by adapting it, but also by designing alternative diagrams better suited to the diverse social actors that are involved in mobility systems. This makes our systemic analysis a multi-criteria one at two levels: first in the consideration of several social actor classes and their respective viewpoint, second by the inclusion of several criteria in order to compare the set of mobility modes in each actor-related perspective.

Aside from addressing urban settings in developing countries, there are two important topics for further research: first, to include the individual modes such as mono-wheels, scooters or even "bionic boots"; second, the potential effect of self-driving for car-based modes, since this will exert profound influence on driving costs and in turn on service affordability and accessibility.

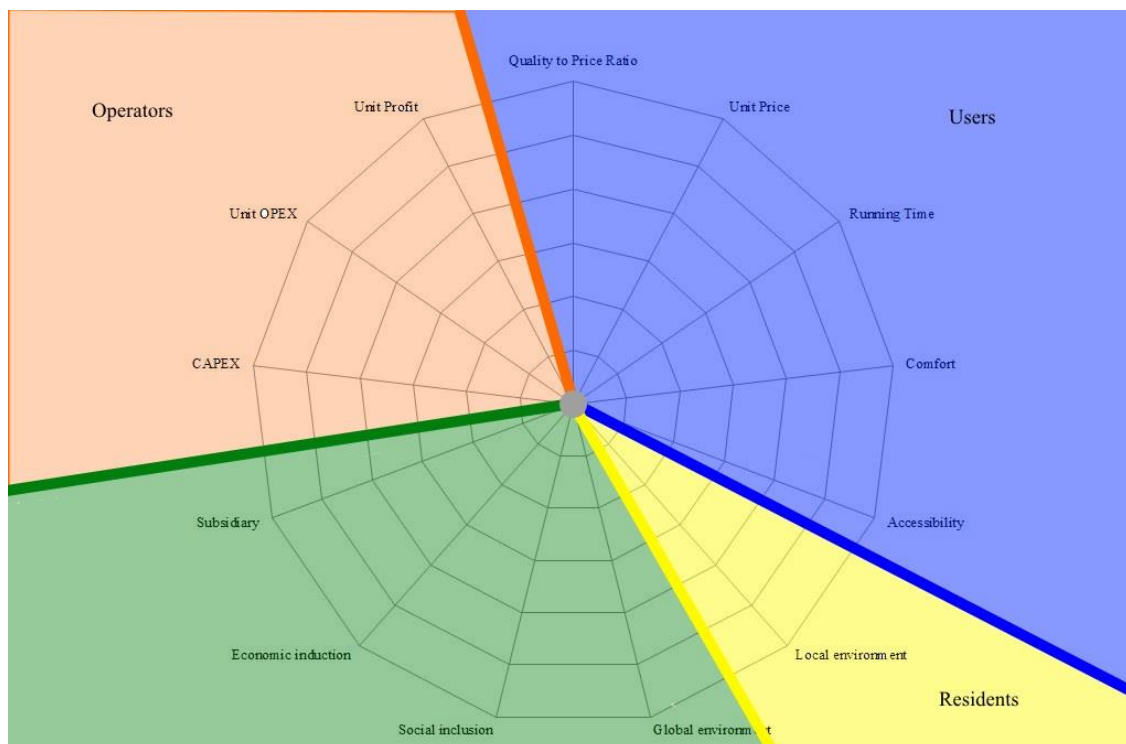

Figure 14 Synthesis of characteristics for planners, operators and users.

## REFERENCES

Batarce, M., Muñoz, J. C. & Ortúzar, J. d. D., 2016. Valuing Crowding in Public Transport: Implications for Cost-benefit Analysis. *Transportation Research Part A*, Volume 91, pp. 358-378.

- Berdica, K., 2002. An introduction to road vulnerability: what has been done, is done and should be done. *Transport Policy*, 9(2).
- Florida Department of Transportation, 2013. *Quality/ Level of Service Handbook*, State of Florida: s.n.
- Guéguen-Agenais, A.-E., 2009. La tarification des déplacements : évaluation de la pertinence d'une évolution tarifaire pour IDF.
- Hollander, Y., 2006. Direct Versus Indirect Models For The Effects Of Unreliability. *Transportation Research Part A*, 40(9), pp. 669-711.
- Kim, T. J., 2009. *Transportation Engineering and Planning*. Oxford: EOLSS Publications.
- Leurent, F. & Windisch, E., 2015. Benefits and costs of electric vehicles for the public finances: An integrated evaluation model based on input-output analysis, with application to France. *Research in Transportation Economics*.
- Russel, M.-L., 2012. *Travel Time Use On Public Transport: What Passengers Do And How It Affects Their Wellbeing*, s.l.: University of Otago.
- Stocker, A. & Shaheen, S., 2017. *Shared Automated Vehicles: Review of Business Models*, s.l.: OECD/ITF.
- Verma, A. & Ramanayya, T., 2015. *Public Transport Planning and Management in Developing Countries*. Boca Raton: CRC Press.
- Vuchic, V. R., 2007. *Urban Transit Systems and Technology*. New Jersey: John Wiley & Sons.
- Weik, M., 1989. *Communications Standard Dictionary*. New York, NY: Van Nostrand Reinhold Co.

## Chapter.4 Business Models for services based on Autonomous Vehicles: design and comparison with urban mobility services

### ABSTRACT

The deployment of Autonomous Vehicles (AVs) will certainly have an impact on the urban universe and on performances of other travel modes. This Chapter aims to explore the main Business Models (BM) that could be developed around AVs. By using a Product-Service-System (PSS) analysis, we determine main kinds of AV-based services. By considering their users and providers types and making the distinction between the individuals and companies, we prove that autonomous taxis (aTaxi) and autonomous transit (aTransit) are the two main forms of services that are expected to emerge.

An analysis based on bi-diagrams proposed in Chapter.3 brings together all travel modes in a multimodal universe and assesses their respective value from the perspective of users, operators, planning authorities and residents.

*Keywords:* Autonomous Vehicles, product-service system, bi-criteria diagrams, social actors, systems analysis

### 1. INTRODUCTION

#### 1.1. Background

Autonomous Vehicles promise many benefits for future mobility. It is expected that full self-driving vehicles will enter the market as an emerging technology in 3 to 10 years (Davidson & Spinoulas, 2015; KPMG & CAR, 2012). They will become a more accepted technology by 15 to 25 years (IEEE, 2012; Litman, 2018; Janin, et al., 2016), and will dominate transportation by 2050 (Litman, 2018; Lavasani, et al., 2016; Stocker & Shaheen, 2017).

All of these growth predictions are driven by the various impacts expected from the deployment of Autonomous Vehicles. Since a real-world deployment of Autonomous Vehicles is still limited, most studies are academic and based on simulation models (Chapter.1). Most of authors seem to believe that using Autonomous Vehicles as shared public service will reduce pollution, energy consumption, congestion and accidents in cities (Chapter.1).

To the best of our knowledge, all previous studies have focused on Autonomous Vehicles as private cars or as transit service. However, different kinds of Business Models have emerged recently for mobility services. In particular, we presented in detail in Chapter.2 and Chapter.3 three different current Business Models of SM: carsharing (B2C), carpooling or ridesharing (P2P) and ridesourcing services.



### *1.2. Objective*

This Chapter endeavors to investigate main Business-to-Customer (B2C) Business Models (BM) that could be developed in relation to Autonomous Vehicles. In particular, it describes major BM that exist in the mobility field, especially BM focusing on product, service or combining products and services. They are then classified into Business-to-Bustomer (B2C), Business-to-Business (B2B) and Peer-to-Peer (P2P) Business Models. By focusing on B2C Business Models and by considering features of Autonomous Vehicles, the analysis found that autonomous taxis (aTaxi) and autonomous shuttles (aTransit) are the two main forms of services that assert themselves in the market. An assessment of aTaxi and aTransit in a multimodal universe is achieved considering the perspective of planners, operators, users and residents as well.

### *1.3. Method*

A Product-Service System (PSS) analysis is applied to cover main Business Models that are/ could be developed around cars. Defined Business Models are then classified according to the type of users and providers: individuals or companies. A focus on Autonomous Vehicles observes main features of conventional cars that evolve. Finally, a qualitative assessment of services based on AVs relies on bi-diagrams that have been constructed in Chapter.3.

### *1.4. Structure*

This Chapter starts by a description of major BM for mobility by using a PSS analysis (§2.). A classification by the type of actors (individuals or companies) follows (§3.). Finally, Business Models for Autonomous Vehicles are deduced and assessed (§4.).

## **2. DESIGN AND CLASSIFICATION OF BM BASED ON AN ANALYSIS OF PSS**

There are three known categories of Business Models:

- Business Models based on the product. The value is mainly in the product content. In particular, it concerns selling pure products.
- Business Models based on the service. The value is mainly in the service content. In particular, it concerns selling pure service.
- Business Models based on the function. The value is mainly in the use of the product or the service. Also known as "Product-service systems PSS".

In the following, each category is described in detail supported by examples related to the mobility field.

### *2.1. Business Models based on the product*

This category of Business Models is built on the production and sale of pure products. The economic profitability depends on the number of units sold and the economic value of the product is its exchange value. After acquiring the product, the customer becomes its exclusive and unique owner, and assumes all expenses related to the product until its end of life. The producer is regarded as a creator of value and the customer as its destructor. Thus, this perspective is based on an economic rationality imposing the maximization of the

production and the consumption of products deliberately deficient. The integration of a logic in line with the issues of sustainable development implies in this case the optimization of the products design so as to lengthen its lifespan.

In this case, Business Models are centered on cars and could be:

- The production and the sale of cars to individuals or operators who provide and manage a car-based service,
- The construction and the sale of equipment(s) and automotive parts, including sensors, batteries, etc.,
- The sale and the installation of charging points if cars are electric,
- The development and the sale of models of dispatching vehicles to public authorities or operators providing a car-based service.

#### 2.2. *Business Models based on the service*

Business Models based on the service provide a technical or intellectual service, which are not subject to a transfer of ownership. They are defined by five main characteristics: (1) intangibility, (2) inventory, they cannot be stored for a future use, (3) inseparability, delivered by the provider at the time of consumption and consumed by the customer at the time of delivery, (4) inconsistency, produced and consumed one and unique time, and (5) involvement, of provider and customer in the service provision. Thus, this category may include several activities, particularly the activities of administration, finance, trade, real estate, transport, education, health, scientific research and social actions. Christopher Lovelock distinguishes four categories of service according to two major criteria (Lovelock, 2014):

- a) Concrete services (medical care, transport of persons ...) or abstract services (teaching, financial activities ...)
- b) Services provided to persons (transport of persons) or goods (freight transport)

Business Models for pure services based on cars may include:

- Transport of persons
- Transport of goods
- Training of planners and service providers
- Promotion and diffusion of car-based services through experimental platforms and through virtual interactive platforms.

#### 2.3. *Business Models based on the function (Product-service systems)*

This category of Business Models is also called "function-oriented Business Models" or "Business Models based on economy of functionality". It is built around optimizing the use of products and services and/or enhancing their function(s). Tukker and Tishner (2006) define product-service systems as "*tangible products and intangibles services designed and combined so that they jointly are capable of fulfilling specific customer needs*". Thus, Product-Service-System focuses on creating a use value that is high, sustainable, and ensuring low-consumption of material and natural resources. According to (Tukker & Tischner, 2006), the PSS concept rests on two pillars:

- a) Considering the final functionality or satisfaction that the user wants to achieve as a starting point of business development.
- b) Elaborating the business that provides this functionality with lower environmental impacts than traditional businesses.

Therefore, the real strength of PSS thinking is that it moves away from existing product concepts, and inherently focuses on the final need or function that should be fulfilled. The economic profitability is then not based on the number of units of the product sold, but rather on the number of functional units that the producer provides to its customers. The producer is oriented towards the optimization of the design of the product so as to maximize its reliability and its operational life. The economic value of the product is its use value, which includes, in addition to its cost price, the operating and maintenance cost, and the end-of-life costs. In this form of Business Models, the producer is a creator of the value, and the consumer a user of the value. The relationship between the two is contractual, aimed at ensuring the product the expected functions, in a sustainable, satisfactory and effective way.

Therefore, the development of Business Models based on the function leads to an acceleration towards more sustainable practices for all the players in society. Various studies have been explored benefits of the migration to this category of Business Models (Roy, 2000; Mont, 2004; Baines, et al., 2007; Beuren, et al., 2013).

Furthermore, most studies make a distinction between three types of PSS:

- The first type concerns *Business Models oriented to products (product-oriented services)*. It revolves around the product sold, providing additional services.
- The second one is *Business Models oriented to use (use-oriented services)*. The product remains at the center of the economic model, but is not sold. The producer owns the product and sells it use to one or more customers.
- The third type is *Business Models oriented to results (results-oriented services)*. In this case, the manufacturer guarantees a result the consumer, regardless of the combination of goods and services.

Furthermore, each type includes Business Models with quite different economic characteristics (Tukker & van Halen, 2003).

#### *Business Models oriented to products (product-oriented services)*

- *Product-related services*. In this case, the provider sells the product, but also additional services required during the use phase of the product. This includes services such as maintenance, repair, supply of additional equipment, exchange of certain components of the product, and taking-back the product in its end-of-life. With respect to Business Models based on the product presented above, it is conceivable in this case:
  - o To provide additional services related to sold vehicles (maintenance contracts, take-back agreements...)

- To provide additional services related to sold automotive parts and equipment (maintenance contracts, supply of consumables...)
- To provide additional services related to models and software (maintenance, development and update versions...)
- *Advice.* In this case, the provider offers all the necessary advice for efficient use of the product sold. This can include providing training sessions, advice on managing vehicles and their equipment, operating of charging points, or using related software.

*Business Models oriented to use (use-oriented services)*

- *Product rental or leasing.* Consumers can access temporarily to the product owned by the provider, who is responsible for maintenance and repair. All products related to vehicles could be rented or leased. This category of business is in full expansion, including in the domain of transport.
- *Product sharing.* The product also remains the property of the provider who ensures its maintenance. The user in this case shares, simultaneously or sequentially, the product with other users. Among the more relevant and recent experiences based on product sharing Business Models, we note the carsharing service (Chapter.2).
- *Product pooling.* It resembles product renting or sharing. However, here there is a simultaneous use of the product.

*Business Models oriented to results (results-oriented services)*

- *Activity management / Outsourcing.* It concerns the management of part(s) of the company activities. Subcontracting activities may include real-time management of a fleet of vehicles, maintenance of charging points, or optimization of the use of parking spaces.
- *Functional results.* The customer and the supplier agree on a functional result in abstract terms, unlike the case of outsourcing. Typically, this can be to ensure that "a minimum number of electric vehicles are charged at any time of the day" or that "a parking space is always available to accommodate vehicles". The supplier is free to combine all products and services to deliver the desired result.

Based on the model of Tukker (2004), **Figure 15** presents a synthesis of these Business Models with some examples for cars.

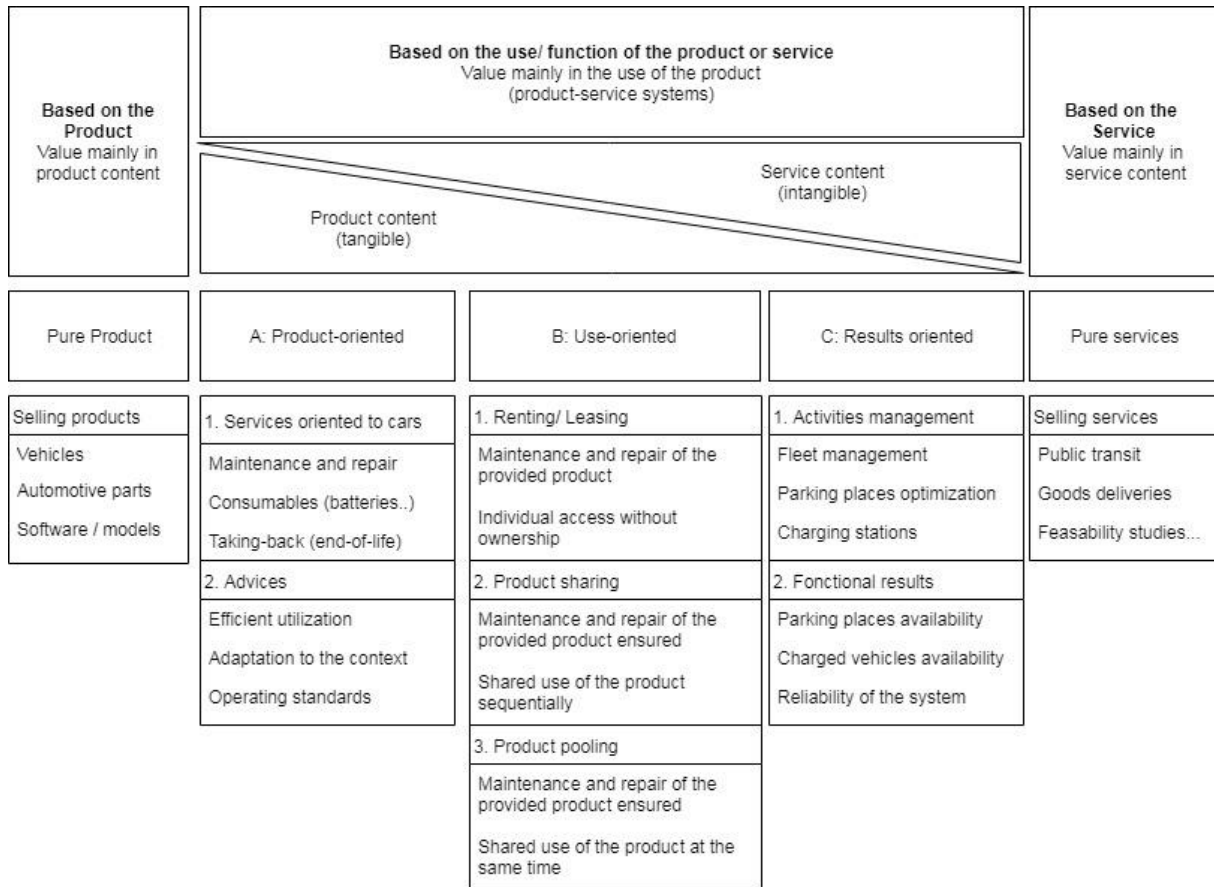

Figure 15 Categories of Business Models applied on vehicles

### 3. CLASSIFICATION BASED ON THE CATEGORY OF USERS AND/OR THE SERVICE PROVIDER

Figure 15 attempted to encompass main Business Models that exist or could emerge in relation with the development of SM services. By focusing in particular on **services**, we retain only Business Models with an important intangibility component, which means: use-oriented services, results oriented services and pure services.

A mobility service involves two main actors: (1) the provider and (2) the user. They could be individuals or companies/ organizations. Consequently, three forms are possible:

- P2P (Person to person): where the provider and the user are individuals. In this case, a third-entity (firm or organization) is generally ensuring the connection between individuals, whether in return for payment or free of charge
- B2C (Business to customer): where the provider is a firm/ organization while users are individuals.
- B2B (Business to Business): where the provider is a firm/organization and users are employees of another firm/organization.

In order to ensure a reliable mobility service to clients (individual or firm), the company should in addition asset on B2B services by invoking other companies, for instance to furnish materials or to manage the fleet...

This classification is quite similar to that used in Chapter.2 and Chapter.3 (Stocker & Shaheen, 2017), whereas B2B services are here also considered. On the other hand, for-hire services are included in B2C services, since the service is provided by a company even if vehicles could be owned by individuals.

**Table 9** confronts services (use-oriented, results oriented and pure services) introduced by **Figure 15** and the classification above by the category of stakeholders (i.e. users and provider).

**Table 9 Classification of PSS services into P2P, B2C and B2B Business Models**

		P2P	B2C	B2B
Use-oriented	Renting/Leasing	X	X	X
	Product sharing	X	X	X
	Product pooling	X		X
Results-oriented	Activities management			X
	Fonctional results			X
Pure service	Selling transport service		X	X

Use-oriented services could be P2P, B2C or B2B services. The most common forms of renting and product sharing are B2C (i.e. car rental companies and carsharing service respectively), while product pooling is mainly a P2P service (i.e. carpooling).

Results oriented services refer, as presented previously, to contracts concluded between companies to ensure a specified result. For instance, it concerns fleet management, system security, energy availability and so on. Consequently, they are by definition B2B services.

Finally, individuals are not allowed to sell a transport service in general. Pure services are regulated by public authorities. Then remaining forms are: (a) B2C, which includes public transit and for-hire services (i.e. taxis and ridesourcing) and (b) B2B, which refers to the transport of company personnel.

In Chapter.2, we found that P2P is facing strong social and psychological barriers compared to other Business Models (B2C, for-hire, B2B carpooling). Moreover, if we consider vehicles' automation, a P2P service would consist in sharing a personal AV with others to take them to their desired destination. However, considering its purchase cost, a personal AV would be, at least in the next few years, a luxury that only rich people can afford. There is thus little prospect that AVs owners will accept to share their car. It follows that the democratization of P2P services based on AVs is related to the vehicles' affordability, then being a social but also economic challenge.

B2C is then a form of service that it is more likely to emerge at a first time, which is testified by the growing number of scientific studies seeking to simulate shared AVs (Chapter.1). On the other hand, B2B services are less constrained than B2C services and relies mainly on gaining companies confidence. However, the market size, in this case, is limited. **Figure 16** confronts from one side difficulties of hindering barriers to the service growing (could also be expressed by time to a successful deployment) and from the other side the potential volume of users (including passengers and providers). Based on **Figure 16**, B2C services can also led to a large-scale breakthrough innovation and a significant evolution of the urban universe and users' behaviors.

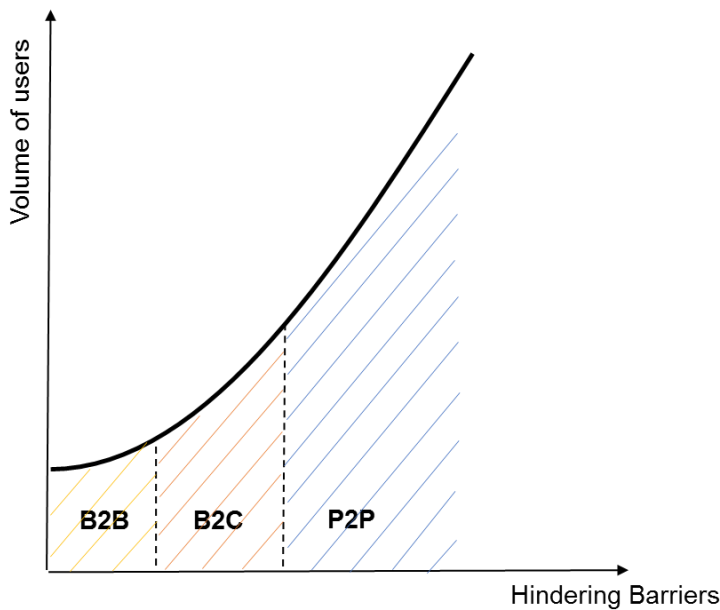

**Figure 16** Market size versus barriers

Thereafter, we focus then on B2C services of **Table 9**:

- Renting/ leasing, where the user access to drive the car according to its needs without any spatial and temporal constraint. The car is rented for at least one day.
- Product sharing, which corresponds to carsharing services, provides to users full flexibility on terms of route choice. The origin and destination are constrained by the operating area. The user has the possibility of sharing its trip depending on vehicles capacity. In general, carsharing services are based on mid-sized (4 to 6 places) and/or small (1 to 2 places) vehicles (Chapter.2).
- Selling transport services, concern (a) for-hire (including taxis and ridesourcing) services and (b) transit modes. (a) For-hire services propose to hail the passenger from its location to its desired destination. The best itinerary is determined by the provider but could also suggested by the rider. The service is ensured in limited geographically but has no temporal limits. Ridesharing is not permitted by taxis and introduced as an option by ridesourcing platforms. (b) Microtransit proposes a

shuttle service, which has a fixed route and fixed stop points. They use large vehicles and impose ridesharing on users.

Main characteristics are synthesized in **Table 10**:

**Table 10 Characteristics of B2C services**

<b>B2C</b>	<b>Renting/Leasing</b>	<b>Product sharing</b>	<b>For-hire</b>	<b>Microtransit</b>
<b>User</b>	Driving Route choice Origin/destination choice	Driving Route choice Origin/destination choice	Origin/destination choice	Origin/destination choice (constrained)
<b>Provider</b>	Maintenance	Maintenance	Driving Route choice Maintenance/repair	Driving Maintenance/repair
<b>Spatial and temporal flexibility</b>	No constraints	Limited area Limited use time	Limited area	Fixed route Fixed schedule or on-demand
<b>Ridesharing</b>	Yes	Yes	Sometimes	Yes
<b>Vehicle size</b>	Mid-sized vehicles	Mid-sized and small vehicles	Mid-sized vehicles	Large vehicles

#### 4. THE IMPACT OF AV ON B2C BUSINESS MODELS AND THEIR INTEGRATION INTO A MULTIMODAL UNIVERSE

Consider now that vehicles are highly or fully automated (SAE level 4 and higher). Thus, they do not require a human intervention to move and to determine the route to destination. In addition, a service based on Autonomous Vehicles would operate, at least in few first years, in limited areas. By removing driving and route choice attributes from the **Table 10** above, renting, product sharing and for-hire services are merged to form one business model, let us name it the aTaxi for autonomous Taxis or autonomous for-hire.

On the other hand, introducing automation would not have significant impact on technical characteristics of microtransit. However, removing driving costs should reduce greatly operating costs (Chapter.1). An autonomous microtransit service will be called aTransit.

**Table 11** summarizes main B2C services based on Autonomous Vehicles:



**Table 11** Characteristics of aTaxi and aTransit

B2C services	aTaxi	aTransit
User	Origin/destination choice	Origin / destination choice (constrained)
Provider	Maintenance/repair	Maintenance / repair
Spatial and temporal flexibility	Limited area Maybe limited use time	Fixed route Fixed schedule or on-demand
Ridesharing	Sometimes	Yes
Vehicle size	Mid-sized and small vehicles	Large vehicles

In order to assess these services in the multimodal universe of urban mobility, let us develop the Chapter.3 by inserting aTaxi and aTransit services.

**Table 12** extends **Table 7** by considering furthermore aTaxis and aTransit services. In particular:

- We assumed that aTaxis and for-hire services have the same technical characteristics: same capacity of vehicles, same commercial speed, same waiting time and travel time.
- aTransit services use larger vehicles (8 to 30 seats). The commercial speed is improved compared to street transit because vehicles are not obliged to stop in all stations. In terms of waiting time, aTransit performances are closer to aTaxi since they are on-demand.
- Investment costs of aTaxis and aTransit services are higher than those of taxis and street transit respectively because of additional related-automation costs.
- On the other hand, aTaxis and aTransit would cut driving costs, so reducing dramatically operating costs, which will involve in turn lower fares.
- Revenues are calculated based on fares and supply capacity (see **Table 7**). In practice, other revenue sources could emerge: as advertising, data monetization, entertainment and product sales.

**Table 12** Technical and economic characteristics of aTaxi and aTransit services in comparison with urban travel modes.

	P2P	RdS	Taxi	B2C	Street transit	aTaxi	aTransit
Capacity of the vehicle (pass/veh)	2 – 5	2 – 5	2 – 5	1 – 5	40 – 120	1 – 7	8 – 30
Commercial speed (km/h)	20 – 50	20 – 50	20 – 50	20 – 50	15 – 25	20 – 50	15 – 40
Waiting time (mn)	5 – 15	5 – 15	5 – 15	3 – 5	10 – 20	3 – 15	3 – 15
Max Frequency (veh/h)	4 – 12	12 – 20	12 – 20	12 – 20	3 – 6	12 – 20	4 – 20
Av. distance per passenger (km)	5 – 15	5 – 15	5 – 15	5 – 15	0.25 – 9	5 – 15	0.25 – 10
Av. travel time (mn)	15 – 20	15 – 20	15 – 20	15 – 20	1 – 20	15 – 20	1 – 15
Line capacity (pass/h) <sup>1</sup>	6 – 60	24 – 100	24 – 100	24 – 100	120 – 780	12 – 140	32 – 600
Supply capacity (pass.km/h) <sup>1</sup>	30 – 900	120 – 1,500	120 – 1,500	120 – 1,500	30 – 7,000	60 – 2,100	8 – 6,000
Average fare (€/km)	0.3 – 0.6 €/km	1 – 5 €/km	2.5 + 1.5 €/km	0.2 – 0.6 €/mn	1 – 2 €/pass	0.2 – 5 €/km	0.2 – 5 €/km
Av. fare per km (€/km)	0.3 – 0.6	1 – 5	1.5 – 2	0.6 – 0.75	0.2 – 4	0.2 – 5	0.2 – 5
Av. fare per trip (€/pass)	1.5 – 9	5 – 75	7.5 – 30	3 – 12	0.05 – 36	2.5 – 75	0.05 – 50
Max revenues (€/h) <sup>1</sup>	10 – 600	20 – 7,500	50 – 3,000	20 – 7,500	1.5 – 30,000	30 – 12,000	1.6 – 30,000
Investment costs	Very Low	Low - Med	Med	Med-High	Med-High	Med – High	Med-High
Operating costs (€/pass.km)	Med	Med	Med-High	High	Low-Med	Med	Low-Med

<sup>1</sup> Values of supply capacity, productivity and max revenues are not necessarily products for the extreme values of their components because these seldom coincide.

Consider again the standpoint of planners, operators and users. The assessment is based on and bi-diagrams defined in Chapter.3, where PC designates private cars, B2C carsharing, for-hire ridesourcing and P2P carpooling. This analysis is qualitative: it is based on range values of **Table 12** and does not consider real systems values.

From planners' standpoint, investment costs are confronted to the line capacity. **Figure 17** shows that aTaxi and aTransit compete strongly with carsharing services and street transit respectively. Private cars, however, remain a better solution since they provide higher capacities for lower investment costs. By reducing investment costs, aTaxi will have the potential to compete with ridesourcing services. Again, rapid and semi-rapid transit modes have greatest investment costs and highest line capacities.

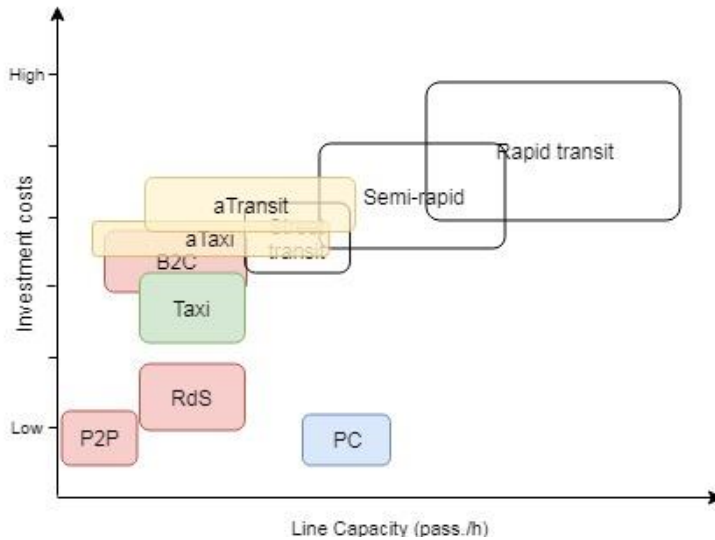

**Figure 17** Line capacity versus investment costs

From operators' standpoint, the productivity is assessed by comparing investment costs against supply capacity (**Figure 18**). The maximum productivity of aTaxi competes with other SM services yet for higher investment costs. aTransit provides almost the same supply capacity of street-transit, penalized by the capacity of vehicles even if the service frequency is improved.

**Figure 19** relates the profitability on a unit basis through facing operating costs and revenues per passenger.km. aTaxi would fill the gap between P2P and for-hire services. They are promising the best formula, with highest ratio between operating costs and potential revenues. On the other hand, aTransit would improve the street transit system by proposing lower operating costs for almost same average fares. However, in the case where it is provided by a private company and the volume of passengers is great, the aTransit service is almost as profitable as aTaxi and for-hire services (**Table 12**).

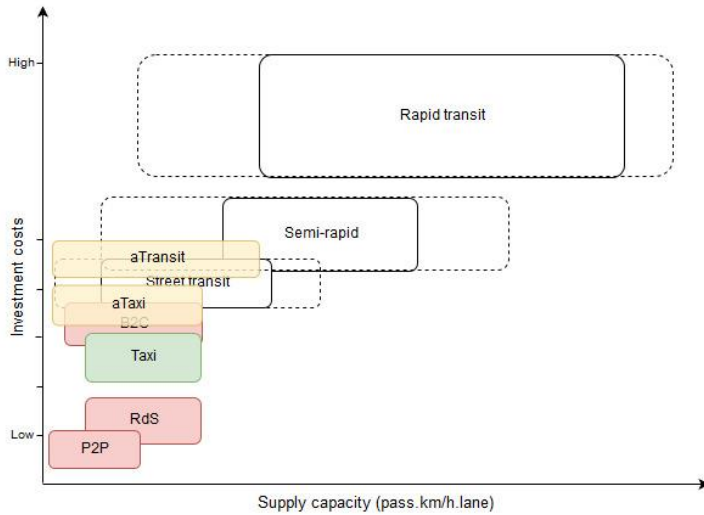

Figure 18 Supply capacity versus investment costs

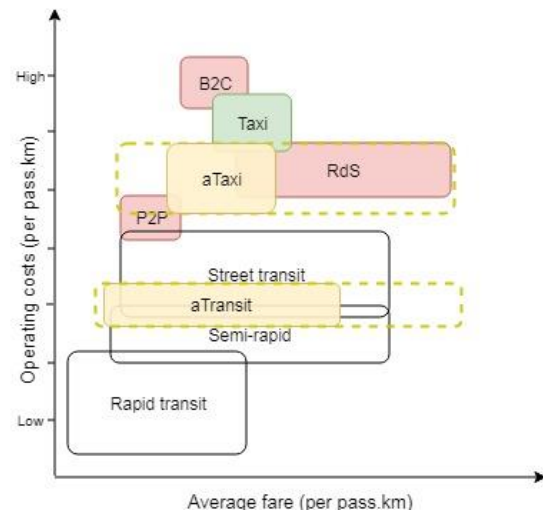

Figure 19 Average fare versus operating costs

From users' standpoint four diagrams are considered to investigate price, door-to-door time, comfort, reliability and access conditions (Chapter.3).

**Figure 20** opposes users' costs and door-to-door time. aTaxis will probably optimize the time of booking, choosing a taxi, and eventually bargaining with the driver before performing the transaction. Then, as shown in **Figure 20**, aTaxis are competitive with for-hire services on terms of door-to-door time. aTransit competes with street transit and semi-rapid systems concerning door-to-door time. In addition, aTaxis and aTransit would benefit from reduction of operating costs, which involves lower fares. Nevertheless, the price could increase greatly to exceed fares of taxis, specifically if the provider relies on a surge pricing strategy.

**Figure 21** relates comfort and door-to-door time. aTaxis compete with ridesourcing in terms of travel comfort (less noise, higher speed, safer, etc.) and aTransit services have the potential to be far ahead of mass transit systems (less intermediate stops, seat probably ensured, less noise, better commercial speed, etc.). Yet the comfort of aTaxis and aTransit depends on the type of vehicle, its brand, its motorization, its capacity and so on. Then, it would be higher for a luxury service, for which fares will be greater.

The access conditions are explored by **Figure 22** and **Figure 23**. aTaxi services combines better performances of for-hire and carsharing services and makes a first rate option with very low walking and waiting times. aTransit services inherit the access time values of street transit. However, waiting time is improved since the user could reserve the vehicle and then manage its time to access to the departure location at the fixed departure time.

**Figure 23** relates real time flexibility and physical connectivity. aTransit and street transit have almost the same performances since routes are fixed and schedules fixed or semi-fixed (sometimes on-demand). aTaxis present same physical connectivity as private cars. They compete with taxis and for-hire services on terms of real-time flexibility since they allow rescheduling routes in real-time and even during the trip.

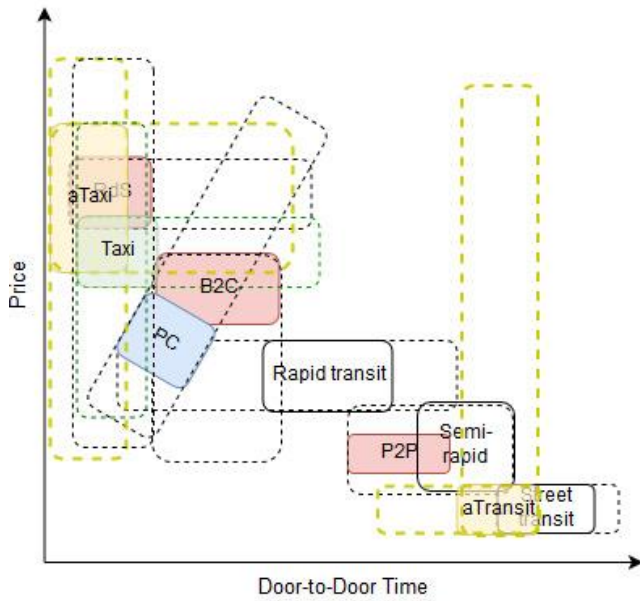

Figure 20 Door-to-door time vs average fare per use

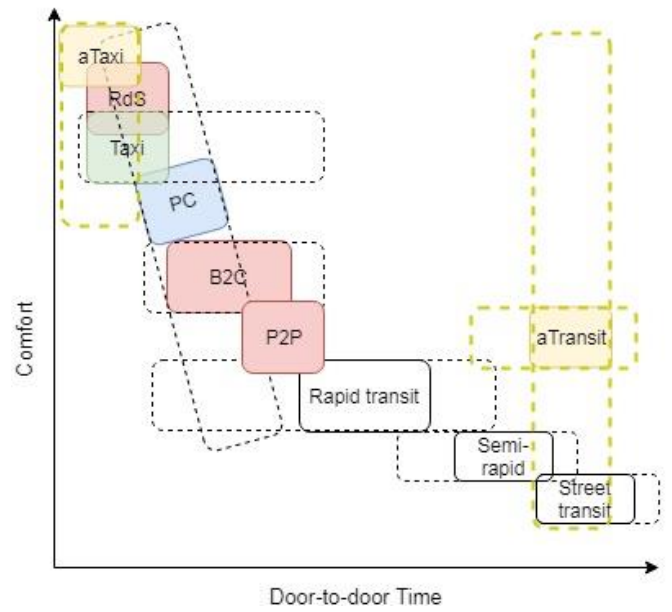

Figure 21 Door-to-door time versus comfort

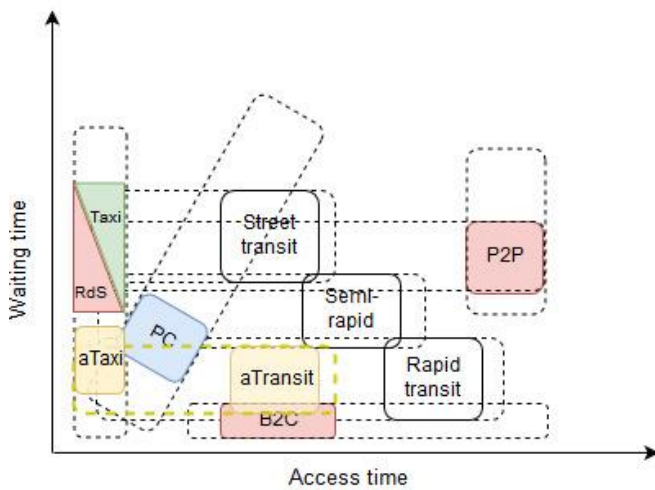

Figure 22 Access time versus waiting time

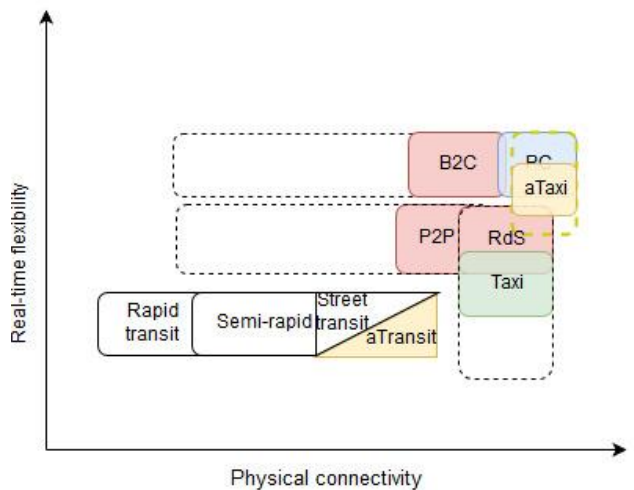
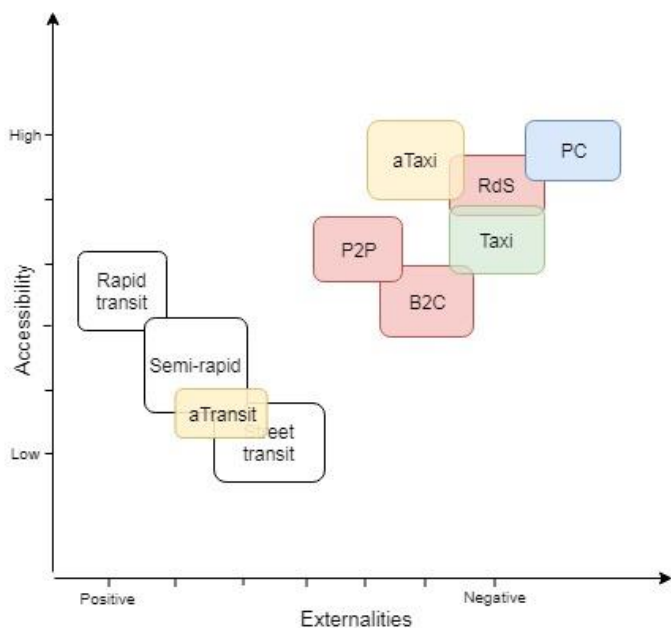

Figure 23 Physical connectivity versus real-time flexibility

Residents are sensitive to accessibility and externalities. aTransit proposes almost the same accessibility level of street-transit systems with slight improvements when aTaxi are not based on stations. They benefit furthermore from being on-demand but remain less effective than semi rapid and rapid transit since their catchment areas are more limited. On terms of externalities, they promise better performances, in particular when they are electric. Similarly, aTaxi emit lower pollutants compared to conventional cars and taxis. On terms of accessibility, they compete strongly with on-demand services as outlined before by **Figure 24**.



**Figure 24 Externalities versus accessibility**

Considering finally the community standpoint, main features are assessed (**Table 13**):

- The impact of automation on jobs is not known up to today. While it is expected to remove manual jobs as driving, several other activities would emerge, especially articulated around software development, IT and security issues.
- The autonomous services would remove barriers of driving, and in turns be accessible to all travelers, including children and older people.
- The presence of on-demand services based on Autonomous Vehicles would increase the productivity of commuters during their trips.
- The automation would lead to significant improvements on terms of safety (Chapter.1).
- Simulation studies showed that using aTaxis will reduce by half to three fourths the number of vehicles on roads (Chapter.1).

**Table 13 Global effects from the community standpoint**

	aTaxis	aTransit	P2P	For-Hire	B2C	Street transit
Environment issues	Med	Low-Med	Med-High	Med-High	Med	Med
Economic induction	Med-High	Med	Low	Med-High	Med	Med
Social inclusion	Med	Med	Med	High	Med-High	Low-Med
Safety	Very High	Very High	Med	Med	Med	Med
Space requirement	Med-High	Med	Med-High	Med-High	Med-High	Med
Subsidies	Med-High	High	Low	Low	Med	Med-High

## **5. CONCLUSION**

The two main B2C forms of mobility services that are expected to emerge are aTaxi and aTransit. The first one is based on mid-sized and/or small vehicles, which ensure a door-to-door on-demand service, probably in a limited operating area, and with the option of ridesharing. The second form of service uses larger vehicles, with fixed route service and loosely scheduled or on-demand service.

We have analyzed aTaxi and aTransit services in a multimodal universe by tracing their positions in diagrams constructed in Chapter.3. We found out that these new services compete with emergent services and for several attributes; they propose even better performances.

Future work should confirm these findings using a quantitative modelling. In addition, two important topics should be considered for future research: first, to consider goods delivering in an urban context using autonomous cars; second, to consider the impact of automation on individual modes (mono-wheels, scooters...), since they are emerging in cities as an important component of mobility-as-a-service (MAAS) solutions. Finally, future studies should expand this Chapter to explore the economic, social and environmental potential and impacts of P2P and B2B mobility services based on self-driving cars.

## **REFERENCES**

- Baines, T., Lightfoot, H., Evans, S. & Wilson, H., 2007. State-of-the-art in product-service systems. Part B: Journal of Engineering Manufacture.
- Beuren, F. H., Ferreira, M. G. G. & Miguel, P. A. C., 2013. Product-service systems: a literature review on integrated products and services. Journal of Cleaner Production, Volume 47, pp. 222-231.
- Davidson, P. & Spinoulas, A., 2015. Autonomous Vehicles - What Could This Mean For the Future Of Transport?. Sydney: s.n.
- IEEE, 2012. Look Ma, No Hands!. [Online]  
Available at: [http://www.ieee.org/about/news/2012/5september\\_2\\_2012.html](http://www.ieee.org/about/news/2012/5september_2_2012.html)
- Janin, L., Nemri, M. & Raynard, C., 2016. La voiture sans chauffeur, bientôt une réalité, Paris: France Stratégie.
- KPMG & CAR, 2012. Self-Driving Cars: The Next Revolution, Ann Arbor: s.n.
- Lavasani, M., Jin, X. & Du, Y., 2016. Market Penetration Model for Autonomous Vehicles Based on Previous Technology Adoption Experiences. Transportation Research Board.
- Litman, T., 2018. Autonomous Vehicle Implementation Predictions: Implications for Transport Planning, s.l.: Victoria Transport Policy Institute.
- Lovelock, C., 2014. Marketing des services. s.l.:Pearson.
- Mont, O., 2004. Product Service-Systems: panacea or myth?, Sweden: Lund University.
- Roy, R., 2000. Sustainable product-service systems. Futures, 32(3-4), pp. 289-299.
- Stocker, A. & Shaheen, S., 2017. Shared Automated Vehicles: Review of Business Models, s.l.: OECD/ITF.
- Tukker, A., 2004. Eight types of product-service system: eight ways to sustainability? Experiences from SusProNet. Business Strategy and the Environment, 13 July, pp. 246-260.
- Tukker, A. & van Halen, C., 2003. Innovation Scan for Product Service Systems, Delft: TNO-STB.
- Tukker, A. & Tischner, U., 2006. Product-services as a research field: past, present and future. Reflections from a decade of research. Journal of Cleaner Production, Volume 14, pp. 1552-1556.

# Section III. Construction of a microeconomic model for assessment of management strategies with application on Orbicity taxi service

This section aims to construct a model to assess and optimize management strategies from the perspective of the provider of an autonomous taxi (aTaxi) service.

It is organized into two Chapters:

- **Chapter.5 Strategic framework for determination and assessment of management decisions for an autonomous taxis business.** This Chapter is based on a systemic analysis to propose an appropriate a strategic framework which covers operational, tactical and strategic decisions of the aTaxi service provider.
- **Chapter.6 From strategic framework to microeconomic model. Mathematical abstraction with a numerical application on Orbicity taxi service.** This Chapter constructs a microeconomic model through describing relations between components of the framework using schemes and mathematical formulas. A numerical application using Orbicity taxi service enables to test the framework.



## **Chapter.5 Strategic framework for determination and assessment of management decisions for an autonomous taxi business**

### **ABSTRACT**

The very rapid pace of smartphone diffusion and web-app development and adoption has laid to the technological ground for an upsurge of for-hire services. Yet, constructing and assessing successful strategies are a prerequisite for the viability and development of these services.

This Chapter constructs a qualitative framework, which enables to explore, describe and assess management decisions of autonomous taxis (aTaxi) service provider. Using a systemic approach, the framework is based on the description of technical components and the investigation of interests and powers of major stakeholders. Then, three pressure forces are identified. Management decisions setups are defined at three levels: Operational, Tactical and Strategic. They attempted to bring together the main aspects of an aTaxi business, starting from vehicles technology, to areas particularities, passing through assignment strategies and regulation issues. Three categories of performance indicators, for Operator, Passengers and Public Authorities, are defined in order to evaluate economic, social and environmental impacts.

*Keywords:* management decisions, strategic framework, systemic approach, Autonomous Vehicles, profitability

### **1. INTRODUCTION**

#### *1.1. Background*

Autonomous taxis (aTaxi) are promising benefits for passengers and operators (Chapter.3 and Chapter.4). Uber, as a leader platform of ridesourcing is restructuring the mobility universe of many developed countries and innovating taxi industries. The company is planning to offer in 2019 the option to ride with an autonomous car. On November 2017, Uber committed to buying 24,000 Volvo SUVs that will be delivered between 2019 and 2021 (see Introduction of the Thesis). This progressive transition is adopted by transit operators and automotive industries, which maintains the competition between different mobility modes (cars, transit and taxis).

Today, Uber is mainly oriented towards cities with similar particularities (e.g. high densities), suggesting that such services have a specified relevant field that ensure their success. In particular, it is crucial to determine relevant areas – given their technical structure and local mobility needs, which are suitable to the operator's supply, including for instance, fleet density, service price and vehicles' comfort... Fails of for-hire services are

usually related to strategic errors: the UK taxi app Hailo suffered in US from social and technological issues (Griffith, 2014) while the American private bus app Leap transit in San Francisco failed to comply with local regulations (Failory, 2017). In general, the failure of taxi apps is linked to a wrong knowledge of expectations of the urban universe major actors (mainly public authorities, users, and residents). In addition, since the implementation of such services often requires huge investment costs, the failure is usually fatal. For aTaxi, the failure is then, quite simply, not admitted. Thus, defining management decisions setups and evaluating them considering the perspective of each actor is a key step to ensure the success of new mobility services.

### *1.2. Objective*

Our objective is to build a strategic framework to describe and explore the main features to setup in the inception, design and implementation of aTaxi services in an urban area. The framework is based on an analysis of major (1) technical components: infrastructure, vehicles, dispatcher and operating supplies, and (2) stakeholders: Public authorities, Users and Suppliers and their relations with the Operator. Competitors are considered through Passengers. Three decision levels are defined in order to encompass most of these stakeholders' concerns while ensuring a performance maximization. They consist in investigating: (1) operational decisions, which concern regular actions aiming to manage technical components of the service such as route choice, (2) tactical decisions, aiming to optimize operating and economic performances, and (3) strategic decisions that describe the technical components of the service for a given environment. Three categories of performance indicators, for Operator, Passengers and Public Authorities, are defined in order to evaluate economic, social and environmental impacts.

### *1.3. Method*

The methodology of this work consists in describing in a first step the main technical components of an aTaxi service. The institutional organization is investigated and the major stakeholders are described depending on their relation to taxis' components. Based on this description, we deduce three pressure forces that are exerted on the Operator and that constraint its strategies. Finally, strategies and performance indicators are introduced. As a result, we built a qualitative model based on a systemic approach, which addresses technical issues of an aTaxi business, social concerns of stakeholders, economic stakes and environmental impacts.

### *1.4. Structure*

In the rest of the Chapter, we first provide a detailed description of technical composition and institutional organization of autonomous taxi industry (§2.). We analyze the major stakeholders according to their respective interests and powers (§2.). Then, we deduce main

pressure forces (§3.) and introduce strategic setups to explore by operators (§4.). Finally, assessment indicators are defined for each stakeholder (§5.).

## **2. TECHNICAL COMPOSITION AND INSTITUTIONAL ORGANIZATION OF AN AUTONOMOUS FOR-HIRE SERVICE**

### *2.1. Technical components*

From the technical standpoint, a for-hire service is the product of a combination between vehicles, infrastructure, dispatcher and operating supplies.

Vehicles allow boarding and transporting users to their destination. They could be shared by different users at the same time or alternatively. The capacity of vehicles determines the maximum number of passengers who are allowed to board. The layout of seats and luggage racks influences the onboard comfort. The form of doors and the ticketing system affect the dwell time (Evans, 2004). The speed of vehicles is constrained by roads speed limits and it is degraded by the congestion. The motorization, thermal or electric, affects the comfort but also purchase costs, operating costs, parking conditions and vehicles availability.

The infrastructure is composed of roads and stations. Roads could be dedicated to taxis or shared with conventional private cars. The autonomous cars are sensitive to their environment. Thus, the vertical and horizontal markings should be managed and maintained by the operator or the public authority. In addition, the road could be used to recharge vehicles by induction. Stations are the points where users access and leave the taxi service. For conventional taxis, every point on the road could be considered as a station. Thus, in general, stations could be fixed (as for a bus service) or not (as for conventional taxis). In the fixed configuration, amenities (e.g. enclosed waiting areas, seating...) could affect greatly the waiting time (Evans, 2004). Stations are also used by users for transfers to another taxi or another mode. Moreover, stations could be used to recharge vehicles if they are electric. Depending on social and environmental impacts of taxis, the parking fees could be more or less high compared to those of conventional cars.

The dispatcher connects vehicles to users. It collects information from (1) users and (2) vehicles. (1) Users emit requests that precise their location, their destinations, their numbers and their desired departure, waiting and arrival time. (2) Vehicles send information concerning their current positions, their loading status and their planned destinations. By combining this two information, the dispatcher communicates to users and vehicles at real-time the service state and the next action to achieve the trip successfully. Two configurations of dispatcher are possible: (i) a decentralized configuration, where each vehicle uses real-time information coming from the dispatcher and decides its own strategy that maximizes its own profit, and (ii) a centralized configuration, where the dispatcher assigns orders to vehicles, by stating their routes, destinations, users to board and standing

times. Vehicles communicate with each other through the dispatcher to avoid unproductive competition, and the profitability of the whole system is maximized.

Finally, operating supplies encompass expenditures of day-to-day operations required to the service production. They include energy costs, access fees to the infrastructure, maintenance costs, insurance... They depend on the fleet size and on the distance travelled by the service – empty and loaded.

## *2.2. Social actors*

Mitchell et al. (1997) introduce the notion of “major stakeholders”. They dictate that an actor is considered as major stakeholder when he has power, defined as “the ability of the power holder to bring about desired outcomes despite resistance from other actors”; legitimacy, defined as “a generalized perception or assumption that the actions of an entity are desirable, proper, or appropriate within some socially constructed system of norms, values, beliefs, and definitions”; and urgency defined as “calling for immediate attention”. As a result, we argue that major stakeholders in an aTaxi industry are Operators, Users, Public Authorities, Competitors and Suppliers. Freeman (1984) has identified the dimensions of power and interest as being significant to determine stakeholders’ impacts on the intended strategic direction. This methodology was applied by Bitsh et al. (2015) to analyze taxi industry stakeholders in Denmark.

**Operators** are the providers of the taxi service. The term “operators” refers to the company (public or private); it includes all internal stakeholders as shareholders and employees. For-hire services are in general structured around booking offices (i.e. for taxis) and e-platforms (i.e. ridesourcing) which distribute customers evenly between drivers. Drivers are obliged to respect the fare imposed by the dispatcher and to provide the same level of service to all passengers. Revenues are shared between drivers and the dispatcher’s manager. However, this distinction is ignored, and drivers are considered internal stakeholders.

Operators do make decisions concerning the fleet size, the dispatcher configuration, the supply area, the assignment and relocation strategies and so on. In addition, they are responsible for maintenance and repair. The main goal of the operator is to earn profit.

**Passengers** are clients of the service. They are sensitive to price and level of service (availability, travel time, comfort...). Their satisfaction is then a key of the service success. However, they have no direct bargaining power but influence the price and quality by choosing competitive services in a basket of provided services. Thus, their power depends on the presence of competitors and their service quality.

**Public authorities** include the government who makes all the laws, rules and regulation and the municipalities, who enforce the law and rules according to providing passengers with an adequate supply. In particular, public authorities dictate maximum tariffs and area constraints in attempt to protect passengers. Depending on countries legislation, they

dictate also the infrastructure access by providing specific licenses, which specifies the technical characteristics of vehicles and the limits of the service area. Considering local social and environmental issues (jobs impact, congestion...), they could regulate also fleet sizes of operators. Through these rules and regulations, authorities are thereby imposing their interests on the operators and influencing their choice of business model.

**Competitors** include providers of urban mobility means who offer similar services to same users. They have the same power of the operator, the same interests, and are subject to the same social and environmental constraints. Porter (1985) defines three generic competitive strategies. (1) In *cost leadership* strategy, the provider sets out to reduce costs compared to other competitors, by achieving economies of scale, proprietary technology, etc. (2) *Differentiation strategy* positions the provider at a particular feature of the level of service and improves it. (3) *Focus strategies* select a segment of clients to serve to the exclusion of others, by adapting price (e.g. premium service) and/or one or some features of the service.

Finally, the taxi business is dependent of its **suppliers**. In an aTaxi industry, suppliers include energy providers, cars manufacturers, automotive parts providers, and so on. They could decide whether to raise price for orders, or to prioritize orders of competitors, which obviously affects operator's profits. Thus, they have a direct impact on quality, price and reputation of the service. On the other hand, they are interested by the sustainability and the profitability of the partnership and are thereby constrained by the competition applied by other suppliers.

To sum up, **Table 14** presents main interests and powers of these stakeholders.

**Table 14 Interests and concerns of major stakeholders of an autonomous taxi industry**

Stakeholders	Interests	Powers
<b>Public Authority</b>	Minimum level of service Social, Economic and Environmental impacts	Regulation of fleet size, tariffs and infrastructure
<b>Operator</b>	Profit	Production and management of the service
<b>Passengers</b>	Price and quality of service	Choosing other modes
<b>Competitors</b>	Profit	Production and management of the service

### 2.3. Relations between technical components and social actors

**Figure 25** summarizes the main interrelations between technical components and social actors. Black blocks refer to stakeholders while grey blocks depict technical components of the service, as presented above (§2.).

The operator exerts a direct influence on the service production through fixing supply conditions, as vehicles technology and dispatching strategies. Eventually, the operator controls also the service infrastructures (e.g. stations and roads as well) through maintaining their performances. In addition, an indirect influence is exerted on operating consumers through negotiating sustainable contracts with suppliers. Public authorities influence directly the infrastructure and indirectly other components through applying regulation policies on the operator and suppliers. Passengers choose the service with the best level of service. Hence, they influence the service components indirectly through opting for competitive services.

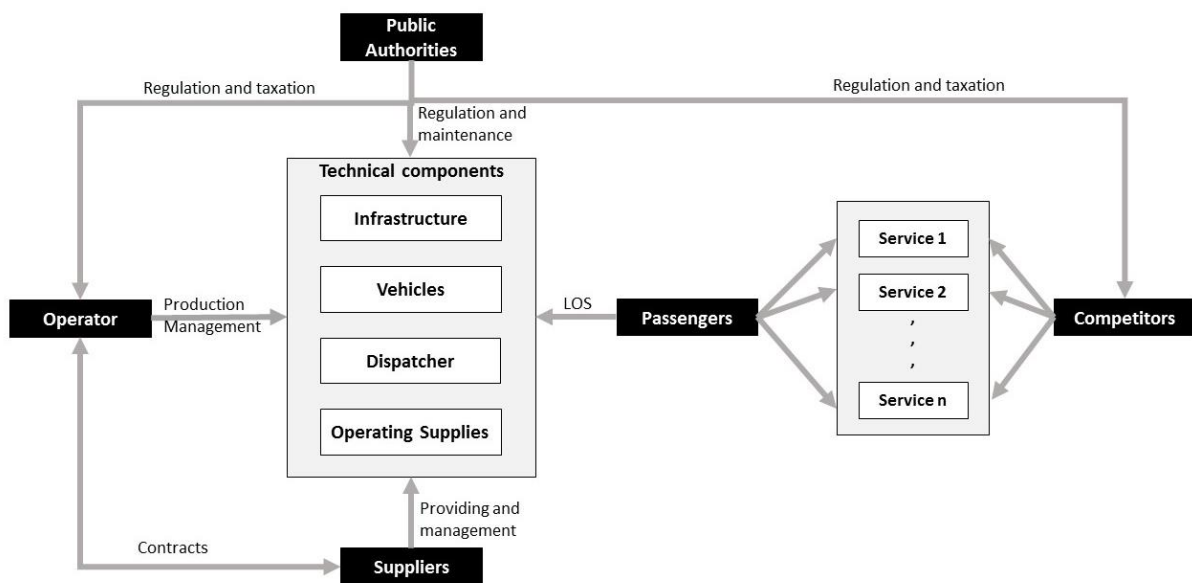

**Figure 25** Technical components, institutional structure and relations between major stakeholders of an autonomous taxi industry

As a result, the service provider is subject to pressure of stakeholders: Public authorities dictate regulation, suppliers control unit costs of production, users and competitors define the fare and the level of service. Hence, three main pressure forces should be considered by the service provider: (1) regulation, (2) demand needs and (3) unit costs of production.

### 3. PRESSURE FORCES

#### 3.1. Regulation

Regulation of taxi services has been studied widely in literature from 70s. Several cities have decided to control entry into the market and set prices (e.g. France, Canada), others have chosen the deregulation option (e.g. Sweden, some US cities) while a third group have opted for a partial regulation (e.g. only entry is regulated as in Norway or only fares are regulated as in Netherlands, Ireland).

Before investigating in more detail the findings of research studies about impacts of regulation, it is worthwhile to recall the definition of regulation as well as its main types.

Regulation is defined by OECD as *“imposition of rules by government, backed by the use of penalties that are intended specifically to modify the economic behavior of individuals and firms in the private sector”* (OECD, 2002). In French, we distinguish between *“réglementation”* and *“régulation”*. The first one is a set of measures (e.g. rules and laws) involving obligations for economic agents, the second one is a mechanism to ensure sustainability and smooth running of an economic and social system. This distinction helps define deregulation as the process of relaxation, reduction or removal of rules and constraints on firms and individuals with the main of foster competition. Different regulatory instruments exist. In taxi industry, three main instruments are used:

(a) Quality regulation. Aims to ensure passengers safety and high levels of customer service. It determines vehicles' standards (age, maintenance, comfort, and motorization), drivers' standards (professional competence, qualification) and operators' standards.

(b) Quantity regulation. It limits the number of taxis on streets and hence the supply in the taxi market. In general, quantity regulation, called also *“entry regulation”* or *“entry control”*, is achieved through a system of licenses. The number of licenses is determined by Public Authorities considering economic performances (incomes of drivers, threats of competition) social issues (public safety, accessibility, passengers protection), and environmental impacts (congestion, pollution).

(c) Price regulation is often annexed to quantity regulation: when entry is restricted, price regulation limits the ability to extract the monopoly rents otherwise available from customers (OECD/ECMT, 2007). Nevertheless, different forms of price regulation are possible: a price set by the regulator, a price structure regulated (e.g. meter) while prices fluctuate freely, or a price controlled completely by the operator but notifying passengers and the regulator.

Other forms of regulations are possible, as regulation of infrastructure, on terms of entry fees and usage charges (Brown, et al., 2006) or even taxation of AVs, in the case where they take people's jobs, in order to fund human services and deal with income inequalities (Kari, 2017).

The main reason behind the persistence of regulation in several countries is the need to compensate for market failures in taxis industry. The major market failure is informational problems (Douglas, 1972; Cairns & Liston-Heyes, 1996). At a given time, there are empty taxis looking for passengers and passengers waiting taxis, not necessarily at same locations. Douglas (1972) argues that, since a driver cannot communicate its charging fare to passengers, the prices generated by a competitive equilibrium are not efficient. In reality, two imbalance configurations exist. The first one is when passengers are abundant and

number of taxis limited. In this case, passengers' uncertainty about taxis availability is high. Also, in the absence of price regulation, if a passenger considers that a taxi fare is too high and rejects it, he has to wait for the next empty taxi, with the hope that it will be cheaper. The additional waiting time increases the generalized cost of the trip. Taxis' operators have then more power over price determination.

The second configuration assumes low-demand and high number of taxis. In this case, passengers have the advantage. However, one reaction of taxis could be to abandon serving the low-demand zone/ during low-demand periods. That induces lower level of service in areas and periods that are judged by taxis as "unprofitable". At the same time, in these areas, general levels of mobility are often lower and the need for using taxi services higher. Cairns and Liston-Heyes (1996) investigated the two configurations by using a simple model of taxi industry and showed that price regulation is necessary for the market equilibrium. To deal with information problems, Yang et al. (2000) used large taxis data to predict some parameters of taxi market performances.

A second market failure is related to the level of service. Given the demand-supply market, taxis are almost certain that they will not hail the same passenger another time. Thus, there are no incentives to provide high level of service to increase loyalty of passengers. The most adopted solution suggests focusing on long-term players, who are able to offer a more efficient service. Short-term players, or "opportunistic", will be more concerned by rapid profit, proposing a reduced quality and creating competition for long-term players (DAF/COMP, 2007). Also, in this case, passengers have no guarantee that the vehicle is safe and the driver is trustworthy. Consequently, in absence of rules and control, passengers could be subject to assaults (Uber, London).

A third market failure is that free entry entails a decrease in the average proportion of paid driven kilometers. However, in reality, increased supply will bring forth additional demand. The "economics of density" ensure that increasing taxi fleet benefit, within a certain range, to drivers and passengers. Frankena and Pautler (1984) outlined that benefits of deregulation would be lower fares, lower operating costs (due to competitive incentives), better level of service (induced by competition), higher incentives to create new market niches and innovative services and finally higher demand for taxi services. Gaunt (1996) showed that after deregulation of the taxi industry in New Zealand, large cities experienced great number of new entrants and significant fare reductions; however, in medium cities the increase of entry was modest and fares reductions minor, and for smaller cities the number of taxis slightly decreases while the fare increases.

Other market failures are related to congestion and pollution issues. Greater numbers of taxis will cruise for passengers, inducing more congestion and pollution. In addition, since they target dense areas, which present for them in general higher "profit probability", the impact will be more critical. Schreiber (1975) considered a social cost that includes congestion and pollution. By imposing low fares for taxis until a free entry scenario, he



argued that fares of taxis are low compared to mass transit. As a result, he found that deregulating market access of taxis would have important negative impact. This approach however, assumes that free entry will induce low taxi fares, which is not immediate as shown above (first market failure). In addition, according to the scenario of Schreiber (high number of taxis and low fares), drivers of private cars could be also encouraged to use taxis, which may reduce congestion and pollution (DAF/COMP, 2007). Reducing congestion was cited as an objective of the 2000 Dutch taxi reform legislation which proposed to ease entry of new taxis and increase taxi use.

Thus, the relevance of regulation is not always evident. In some cases, it could, instead of removing market failures, causing additional distortions in the market. The majority of economic opinions favors free entry to the market (Moore & Balaker, 2006), while almost all studies are agreed that quality should be regulated. With the advent of internet and mobile apps, main market failures disappeared. The major problem of information is already resolved. The quality is also judged by passengers and unsatisfactory drivers are ruled out by the apps' provider. However, there remains several challenges to take up, indeed by the regulator. Ridesourcing apps' operators are growing at an international level, imposing their rules to countries, and creating strong monopolies. They recruit drivers, mainly low skill workers, and share trips commercial revenues with them. However, since they reach a monopoly position in the city, they increase their commissions while drivers are taken as hostages. The same goes for passengers: in a monopoly situation, they will not have a negotiating power anymore in the absence of other apps' providers. Regulation efforts should then focus on protecting drivers and passengers by ensuring the transparency. One solution is to access to data produced by apps' platforms (ITF, 2016). In London, New York City, Sao Paulo and Boston the regulator has already, by law, access to all necessary data (ITF, 2016). Data should be used by regulators to assess the service performances and its impacts on mobility. Fares calculation should be transparent for regulators, and then for passengers, and eventually limited range of prices could be introduced without controlling the surge pricing calculation. Drivers' qualifications and training requirements could be simplified using the mechanism of users' rating. ITF (2016) proposes to introduce a progressive (or proportional) taxation of market share. In New York City, Uber agreed a surcharge on each fare to help fund the local transit services (ITF, 2016).

### *3.2.Demand*

The second main pressure is applied by Passengers, and through them by Competitors. Darbéra (2010), Fels et al. (2012) and Aarhaug (2014) argued that taxi services meet different demand in different cities. They proved that the population density and the city's size have significant effects on the taxi demand. In general, the larger the city and highest its density, the greater the probability for a taxi to find passengers in street. In contrast, in medium and small cities, taxis would better wait at taxi ranks, near train stations or at

airports. The study of Paper and Shapiro (2018) confirms this finding by observing that taxis are relevant in dense areas where they can generate even lower waiting times than Uber's dispatching system. The welfare of Uber's passengers would vary by a factor of ten from the highest density to least dense areas. Based on statistic studies, the impact of demand volume and density is then established by scholars. However, observing the use of taxis in some cities suggest that there are other factors affecting the service: in Paris or London, for instance, taxi use is limited while in New York or Dublin it is a major mode.

In addition to the spatial distribution of demand, two main characteristics should be considered as well: (1) sociodemographic characteristics and (2) demand elasticity to price and level of service.

Elasticities define the sensitivity of passengers to fare and service quality. They vary according to sociodemographic characteristics. However, people have limited money and time to travel, then will respond similarly to changes in their money and time costs (Gonzales, et al., 2008). Consequently, their values could be transferable (Litman, 2017). Schaller (1999) investigated elasticity values of taxi demand in New York City. He found that the elasticity of demand with respect to fares is -0.22, the elasticity of waiting time with respect to fares 0.28 while that of waiting time with respect to the total number of taxis is 1. Booz (2003) used a stated preference survey to estimate cross-elasticities for various costs (fare, waiting time, travel time...), modes (cars, transit, taxi) and trip purposes. He finds that an increase of transit fare by 10 % will reduce transit ridership by 2 % and will increase taxi travel by 0.7 % and car travel by 0.1 %. Cohen et al. (2016) estimated demand elasticities for Uber's service UBERX by using a sample of nearly 50 million consumer sessions from four US cities. They found that price elasticities are -0.4 and -0.6. In addition, the elasticity varies as a function of time of day, user experience or the presence of substitutes.

### *3.3. Unit costs of production*

Unit costs of production or production inputs are often classified according to four-factor inputs (Capital – Labour – Energy – Materials) known as KLEM:

*Capital (K)*: Includes mainly investment costs required to introduce the system into an operational use. Capital costs are observed through two types of reference: academic publications (Zimmerman, 2012; Randal, 2014) and grey literature (Bourget & Labia, 2010; CERTU, 2011; Garcia, 2010).

*Labour (L)*: This variable includes only wages of operating and maintenance workers with excluding administration staff. Drivers' salary structure is based on fixed raw monthly salary to which are added bonus payments pertaining on drivers' performances.

*Energy (E)*: Vehicles' consumption pertains to average speed, braking frequency related to the stations number and road congestion, the motor efficiency, the aerodynamic shape, the size and load of vehicles, the presence of air-conditioning and other parameters related to spatial constraints (slope, bend...).

*Materials and services (M)*: Maintenance costs include wages of maintenance workers, cost of subcontracted maintenance and purchasing/ replacement costs of defective parts.

Typical values of operating costs are presented in **Table 1** (Chapter.1).

#### 4. MANAGEMENT DECISIONS SETUPS

Having analyzed the technical composition and social organization of aTaxi industries (§2.), we deduced the main pressure forces that are applied on the Operator (§3.). Their description based on existing studies enables a sound understanding of the behavior of the service environment. Given that, let now introduce the main management decisions setups of an aTaxi business. Generally, three levels of management decisions exist: Strategic, Tactical and Operational.

+ Strategic decisions define the structure of the activity and overall direction of the business. They describe the technical components of the service for a given environment. Three strategic decisions are identified:

**1) The implementation area.** The Operator determines its commercial positioning. In particular, he defines the service location (e.g. city, country), the targeted segments of population (e.g. high/low incomes, commuters...), the coverage area (e.g. size and density) and the service period (e.g. peak periods, off-peak, night...).

**2) Technology.** The service is based on an intermediation interface (i.e. mobile app). The interface should ensure rapid, reliable and costless connection between passengers and drivers. At vehicles level, two technologies are considered by the Operator: (1) automation and (2) motorization. (1) The level of automation (SAE, 2014) is a critical issue, and unless of a full automation, the driver costs are not imputed. However, savings that could be made on insurance, maintenance costs and energy costs still substantial (**Table 1**). From the standpoint of passengers, Autonomous Vehicles would offer better valorization of travel time, better in-vehicle comfort, shorter waiting time and lower risk of accidents (Fagnant & Kockelman, 2015; Berrada & Leurent, 2017; Littman, 2018). The automation of vehicles will require, in addition, embedding sensors in roads in order to ensure communication between vehicles and infrastructure. (2) Electric cars would reduce energy costs compared to conventional cars (Bösch, et al., 2018). Strategies dealing with charging issues of electric vehicles have been studied for carsharing systems (Bruglieri, et al., 2014; Weikl & Bogenberger, 2015; Boyaci, et al., 2017; Brendel, et al., 2018) and Shared Autonomous Electric Vehicles (Chen, et al., 2016; Loeb, et al., 2018) by several scholars.

**3) Sharing rides.** The Operator decides if rides are privative or shared by passengers. This choice determines the dispatcher's level of complexity, its main functions (e.g. considering loaded vehicles for assignment) and the fleet composition (e.g. vehicles capacity: minibuses, cars). Opting for ridesharing is a decision which controls the form of the service

and defines new business positioning. Several studies simulated ridesharing performances in terms of level of service (Agatz, et al., 2012; Djavadian & Chow, 2017), social welfare (Paraboschi, et al., 2015; Paper & Shapiro, 2018), impacts on employment and drivers profit (Berger, et al., 2017).

These decisions are often long-term, defined for a horizon in 5 to 10 years. They involve concluding agreements with Public Authorities, as well as generation and establishment of a client base. It can also be observed that by taking strategic decisions, the operator answers to the 5W's (Who, What, When, Where and Why): by defining the implementation area, the operator answers to the first, third and fourth question while by defining technology and the form of sharing he answers to the second (e.g. a service provided by autonomous electric minibuses). The response to the question "Why" is the last part of this Chapter, which defines performance indicators.

+ Tactical decisions follow on from strategic decisions and aim to accomplish strategic goals while involving measurable efficiency and/ or quality improvements. These decisions are often medium term, taken for horizons in 1 to 5 years. In fact, they design the technical components of the service in order to optimize operating and economic performances. They include:

**1) Fleet size.** Generally, the greater the number of vehicles, the better the quality of the service and the higher the operating costs. The fleet should then be dimensioned in order to ensure high level of service (e.g. lower waiting time) while maximizing operating efficiency (e.g. empty driven kilometers, number of loaded vehicles...). Since vehicles are used along the day, their lifespan is about 1 to 5 years at the most (Chapter.1). In addition, the fleet could be slightly extended in order to follow the demand growth and its pressures. The fleet is then regularly changing, mostly for a horizon inferior to 5 years.

**2) Fare structure.** Several pricing structures are used by mobility service operators: tariff per trip, per month, per kilometer traveled, per minute, with respect to the supply-demand balance (Chapter.2). However, structures of fares are considered as mid-term decision since they are defined for a period superior to 1 year.

**3) Dispatching strategies.** Two main dispatching strategies are used depending on vehicles state: (1) relocation strategies and (2) assignment strategies. Relocation concerns empty vehicles. It aims to anticipate a potential passenger request. It was simulated by (Song & Earl, 2008; Fagnant & Kockelman, 2014; Fatnassi, et al., 2017; Babicheva, et al., 2018). Assignment strategies of vehicles to passengers are often based on first-come first serve algorithm (FCFS) (Fagnant & Kockelman, 2014; Levin, et al., 2016), longest waiting user (Fagnant & Kockelman, 2014), nearest user (Shen & Lopes, 2015), user with nearest destination, etc.

+ Operational decisions concern regular actions aiming to manage technical components of the service. Their horizon is inferior to 1 year.

**1) Route choice.** It defines movements of vehicles in order to minimize travel time from origin to destination and access time to passengers while considering in real-time the traffic state. The Operator determines at each time step the next movement of taxis as well as their stops.

**2) Operating supplies.** Include energy, maintenance products, insurance costs, etc. Their volume and price are fluctuating along a year. Operating supplies depend on the fleet size and the distance driven by vehicles.

In addition, for electric vehicles, charging strategies should be adjusted depending on the vehicles use, which is dictated by the demand volume.

## 5. PERFORMANCE INDICATORS

As we outlined above, the operator aims to reach the profitability, or at least the viability, of the business through dealing with defined strategic issues. Profitability indicators allow assessing decisions maximizing profit. The operator is also concerned by the optimal use of the business resources, vehicles in particular. Hence, technical efficiency indicators have to be defined as well to evaluate the vehicles utilization.

On the other hand, the business is subject to pressures forces applied by public authorities, Users and Suppliers. They have power to cause the direct failure of the service if it represents a threat to their interests. Then, the operator should consider, furthermore, indicators relative to stakeholders.

Users, and in turn competitors, are affected by the service fare and quality, expressed by waiting time and door-to-door time. Public authorities are concerned by the social surplus which encompasses the total gain of the society (e.g. including operators, users and suppliers). Finally, Suppliers aim to have sustainable revenues over time. Since suppliers revenues constitute a portion of operator's production costs, we will ignore here the distinction between operators and suppliers.

To sum up, Operator's performance and profitability indicators include in particular:

- Operator's standpoint:
  - Profitability indicators. Assess the optimal supply conditions maximizing the profit.
  - Technical efficiency indicators. Reflect the utilization rate of production resources.
- Users' standpoint:
  - Quality of service. Includes the time to serve users.

- Public authorities' standpoint:
  - Volume of passengers.
  - Social surplus, assess the impacts on the society, including Operators and Users.
  - Environmental impacts.

These indicators assess the aTaxi service technically, economically and socially as well. They take into consideration all stakeholders. In addition, they are interdependent; for instance, the service quality is the main indicator for Users, but also an input for technical efficiency indicators and social surplus. In addition, Public Authorities negotiate subsidies as well as terms of regulation based on the quality of service.

In the following, we describe these indicators.

### ***From the Operator standpoint***

#### a) Profitability indicators.

Service profitability determines the optimal supply conditions, mainly on terms of fleet size and tariff structure that maximizes the profit for the provider. The profit is defined as the difference between revenues and costs. Costs depend on the fleet size, the number of served trips and the total driven distance. Revenues are based on the trips' fare paid by the Passengers. They include drivers' earnings and commissions of the dispatcher.

#### b) Technical efficiency indicators

The service production is function of deployed resources, in terms of time and mileage. Hence, we define the time occupancy rate as the time that the taxi is occupied by Passengers. Similarly, the mileage occupancy rate is defined as the occupied driven distance and permits to discern between occupied and vacant mileage.

### ***From Users' standpoint***

#### a) Quality of service

These indicators reflect main features of service quality. They are expressed using the door-to-door time, which incorporates the time of generating a request a vehicle, waiting, boarding, riding and alighting at destination. In particular waiting time and travel time are the most important features. The waiting time reflects the service availability whilst the travel time constitutes generally the longest components of the trip's time. The quality of service increases when the door-to-door time decreases.

### ***From Public Authorities standpoint***

#### a) Volume of passengers

The volume of passengers is measured through the ratio of demand using the service among the total potential market.

b) Social surplus

Social surplus assesses impacts of the service production on society. Society includes users as well as suppliers. Public Authorities aim to maximize benefits for users and suppliers at the same time. At economic and social level, we define the social welfare as the summation of net benefits of users (consumers' surplus) and suppliers (producers' surplus). The consumers' surplus reflects the gain of passengers. It is measured as the difference between the generalized cost of the aTaxi service and the maximal cost that is tolerated by passengers. The supplier surplus corresponds to the profit.

c) Environmental impacts

There is a wide variety of existing externalities indicators, as to consider impacts on pollution, accidents, noise, mode share and congestion, etc. We will focus in this thesis on pollution impacts. They are assessed by assuming fixed emissions ratios per driven kilometer and depend on vehicles' motorization.

## **6. SUMMARY, DISCUSSION AND NEXT STEPS**

This Chapter presented a qualitative framework that describes and assesses main management decisions setups of an aTaxi service. It is based on a systemic approach, which explores technical and institutional composition of the service. Then, it deduces the main social and economic forces that are exerted on the operator. Management decisions setups are defined at three levels: operational, tactical and strategic. Finally, performance indicators are defined from the perspective of each stakeholder. **Figure 26** depicts the general overview of the framework. It shows that decisions are subject to pressure forces. On the other hand, strategic decisions affect pressure forces (e.g. developing technology to circumvent the regulation, choosing an implementation area that reduces transportation costs of materials...).

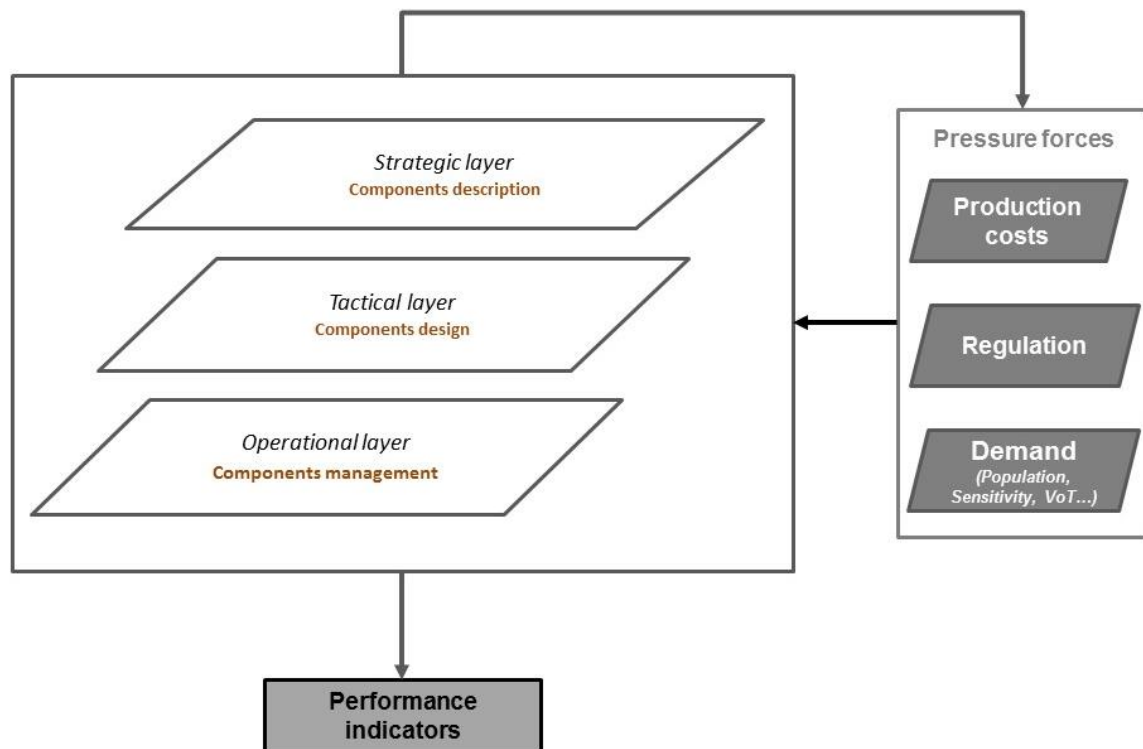

**Figure 26 Overview of the strategic framework**

**Figure 26** is finally close to schemes of economists' management models. The most known and advanced model of simulating taxis is that developed by Wong and Yang between 1998 and 2017 (presented briefly in Chapter.2). In fact, the authors investigated the demand-supply equilibrium through minimizing (a) for taxis the time of searching for a passenger, (b) and for passengers the time to ride a taxi. Additionally, they considered the optimization of profit, social welfare and externalities. The proposed model is then describing in detail the operational and tactical levels of **Figure 26**. Regulation policies are often considered by adjusting the fleet size (i.e. price regulated) and fare (i.e. fleet size fixed). However, there remain some limitations of the model. Firstly, even if Wong et al. (2008) incorporated mode choice in the traffic equilibrium, they included only the choice between taking a taxi or a personal vehicle. Then, the mode choice between taxis and public modes is ignored and the effects of taxis on modal share are not measured. Secondly, all these studies assumed as a common ground that under equilibrium conditions, each vacant taxi travels to the closest and most profitable zone to search for passengers. Thus, each driver makes its decisions individually without taking into account other taxis. In addition, more sophisticated dispatching and relocation strategies are not considered (for instance (Babicheva, et al., 2018)). Another limitation is the assumption that all rides are not shared. Moreover, the impact of automation on the taxi industry is neither explored.



Leurent proposes a technical-economic model to simulate taxis (2017) and shuttles (2018) by considering an urban stylized form. He determines supply conditions (fleet size, fare and access time) that maximize the profit, the social welfare and the second-best scenario. The model is calculated almost analytically based on algorithmic schemes. It could be managed easily using a spreadsheet.

As a development of our strategic framework, relations between decisions levels should be described mathematically (Chapter.6). Since **Figure 26** is very similar to the model framework that was constructed by Leurent (2018), the mathematical abstraction of our framework will be largely based on (Leurent, 2017; 2018). An application on the stylized area proposed by (Leurent, 2017) will permit to assess the model's robustness. On the other hand, the framework is designed to be general and suitable for a wide range of implementation cases. Therefore, a real application case is indispensable to validate the robustness of the framework (Chapter.8).

## REFERENCES

- Aarhaug, J., 2014. Taxis as urban transport, Oslo: Norwegian Centre for Transport Research.
- Agatz, N., Erera, A., Savelsbergh, M. & Wang, X., 2012. Optimization for dynamic ride-sharing: a review. *European Journal of Operational Research*, December, 223(2), pp. 295-303.
- Babicheva, T., Burghout, W., Andreasson, I. & Faul, N., 2018. The matching problem of empty vehicle redistribution in autonomous taxi systems. *Procedia Computer Science*, Volume 130, pp. 119-125.
- Berger, T., Chen, C. & Frey, C., 2017. Drivers of Disruption? Estimating the Uber Effect. [En ligne] Available at: [https://www.oxfordmartin.ox.ac.uk/downloads/academic/Uber\\_Drivers\\_of\\_Disruption.pdf](https://www.oxfordmartin.ox.ac.uk/downloads/academic/Uber_Drivers_of_Disruption.pdf)
- Berrada, J. & Leurent, F., 2017. Modeling Transportation Systems involving Autonomous Vehicles: A State of the Art. *Transportation Research Procedia*, Volume 27, pp. 215-221.
- Bitsch, J., Brochstedt, S., Hjerrild Holm, A. & Knudsen, A., 2015. The role of stakeholders in relation to the business model in the taxi industry. *Proceedings of Pragmatic Constructivism*, 5(1).
- Booz, A. H., 2003. ACT Transport Demand Elasticities Study, s.l.: Canberra Department of Urban Services.
- Bösch, P., Becker, F., Becker, H. & Axhausen, K. W., 2018. Cost-based analysis of autonomous mobility services. *Transport Policy*, May, Volume 64, pp. 76-91.
- Bourget, C. & Labia, P., 2010. Mission de diagnostic et de prospective sur les réseaux de transports urbains de Caen et Nancy, Caen and Nancy: Conseil Général de l'environnement et du Développement Durable.
- Boyaci, B., Zografos, K. G. & Geroliminis, N., 2017. An integrated optimization-simulation framework for vehicle and personnel relocations of electric carsharing systems with reservations. *Transportation Research Part B: Methodological*, Volume 95, pp. 214-237.
- Brendel, A. B. et al., 2018. Improving electric vehicle utilization in carsharing: A framework and simulation of an e-carsharing vehicle utilization management system. *Transportation Research Part D: Transport and Environment*.
- Brown, A., Stern, J., Tenenbaum, B. & Gencer, D., 2006. Handbook for Evaluating Infrastructure Regulatory Systems, Washington DC: The World Bank.
- Bruglieri, M., Colorni, A. & Luè, A., 2014. The Vehicle Relocation Problem for the One-way Electric Vehicle Sharing: An Application to the Milan Case. *Procedia - Social and Behavioral Sciences*, Volume 111, pp. 18-27.
- Cairns, R. & Liston-Heyes, C., 1996. Competition and regulation in the taxi industry. *Journal of Public Economics*, Volume 59, pp. 1-15.
- CERTU, 2011. Les coûts des transports collectifs urbains en site propre - chiffres clés - principaux paramètres. Le point sur - Mobilités et transports, Octobre, p. 18.

- Chen, D., Kockelman, K. & Hanna, J., 2016. Operations of a shared, autonomous, electric vehicle fleet: implications of vehicle & charging infrastructure decisions. *Transportation Research Part A: Policy and Practice*, December, Volume 94, pp. 243-254.
- Cohen, P. et al., 2016. Using Big Data to Estimate Consumer Surplus: The Case of Uber, s.l.: The National Bureau of Research Economy.
- DAF/COMP, 2007. Competitive Restrictions in Legal Professions, s.l.: OECD.
- Darbéra, R., 2010. Taxicab regulation and urban residents' use and perception of taxi services: a survey in eight cities. 12th World Conference on Transport Research.
- Djavadian, S. & Chow, J., 2017. Agent-based day-to-day adjustment process to evaluate dynamic flexible transport service policies. *Transportmetrica B*, 5(3), pp. 286-311.
- Douglas, G., 1972. Price regulation and optimal service standards. *Journal of Transport Economics and Policy*, pp. 116-127.
- Evans, J., 2004. Traveler Response to Transportation System Changes: Chapter 9-Transit Scheduling and frequency, Washington D.C.: Transit Cooperative Research Program.
- Fagnant, D. & Kockelman, K., 2014. The travel and environmental implications of shared Autonomous Vehicles, using agent-based model scenarios. *Transportation Research Part C: Emerging Technologies*, March, Volume 40, pp. 1-13.
- Fagnant, D. & Kockelman, K., 2015. Preparing a Nation for Autonomous Vehicles: Opportunities, Barriers and Policy Recommendations. *Transportation Research Part A*, Volume 77, pp. 167-181.
- Fatnassi, E., Chebbi, O. & Chaouachi, J., 2017. Dealing with the Empty Vehicle Movements in Personal Rapid Transit System with Batteries Constraints in a Dynamic Context. *Journal of Advanced Transportation*.
- Fels, A., 2012. Customers first - service, safety, choice, s.l.: Draft report of the Victorian government taxi inquiry.
- Frankena, M. & Pautler, P., 1984. An Economic Analysis of Taxicab Regulation. Washington, D.C.: Federal Trade Commission.
- Freeman, E. R., 1984. Strategic Management: A Stakeholder Approach. s.l.: Cambridge University Press.
- Garcia, T., 2010. Transit 101: Capital Cost Comparison. [En ligne]  
Available at: <http://www.transitmiami.com/uncategorized/transit-101-capital-cost-comparison>
- Gaunt, C., 1996. The Impact of Taxi Deregulation on Small Urban Areas: Some New Zealand Evidence.. *Transport Policy*, 2(4), pp. 257-262.
- Gonzales, M., Hidalgo, C. & Barabasi, A., 2008. Understanding individual human mobility patterns. *Nature*, 05 June, Volume 453, p. 779-782.
- ITF, 2016. App-Based Ride and Taxi Services. Principles for Regulation., s.l.: OECD.
- Kari, P., 2017. Why robots should pay taxes. [En ligne]  
Available at: <https://www.marketwatch.com/story/why-robots-should-pay-taxes-2017-09-12>
- Levin, M., Li, T., Boyles, S. & Kockelman, K., 2016. A general framework for modeling shared Autonomous Vehicles. Proceeding of the 95th annual meeting of Transportation Research Board.
- Litman, T., 2017. Understanding Transport Demands and Elasticities. How Prices and Other Factors Affect Travel Behavior, s.l.: Victoria Transport Policy Institute.
- Littman, T., 2018. Autonomous Vehicle Implementation Predictions: Implications for Transport Planning, s.l.: Victoria Transport Policy Institute.
- Loeb, B., Kockelman, K. M. & Liu, J., 2018. Shared Autonomous Electric Vehicle (SAEV) operations across the Austin, Texas region, with a focus on charging infrastructure provision and cost calculations. *Transportation Research Part C: Emerging Technologies*, Volume 89, pp. 222-223.
- Mitchell, R., Agle, B. & Wood, D. J., 1997. Toward a Theory of Stakeholder Identification and Salience: Defining the Principle of Who and What Really Counts. *The Academy of Management Review*, 22(4), pp. 853-886.
- Moore, A. T. & Balaker, T., 2006. Do Economists Reach a Conclusion on Taxi Deregulation?. *Econ Journal Watch*, January, 3(1), pp. 109-132.
- OECD/ECMT, 2007. (De) Regulation of the Taxi Industry, Paris: OECD.

- OECD, 2002. Glossary of Statistical Terms. Regulation. [En ligne]  
Available at: <https://stats.oecd.org/glossary/detail.asp?ID=3295>  
[Accès le 15 August 2018].
- Paper, J. M. & Shapiro, M. H., 2018. Density of Demand and the Benefit of Uber, s.l.: s.n.
- Paraboschi, A., Santi, P. & Ratti, C., 2015. Modeling Urban-level Impact of a Shared Taxi Market. *Computers in Urban Planning and Urban Management* .
- Porter, M., 1985. *Competitive Advantage: Creating and Sustaining Superior Performance*. s.l.:Free Press.
- Randal, O., 2014. The Worst of Both. The Rise of High-Cost, Low-Capacity Rail Transit.. *Policy Analysis*, 3 June, Volume 750.
- SAE, 2014. *Taxonomy and Definitions for Terms Related to On-Road Motor Vehicle Automated Driving Systems*, s.l.: s.n.
- Schaller, B., 1999. Elasticities for Taxi Cab Fares and Service Availability. *Transportation*, Volume 26, pp. 283-297.
- Shen, W. & Lopes, C., 2015. Managing Autonomous Mobility on Demand Systems for Better Passenger Experience. *PRIMA 2015: Principles and Practice of Multi-Agent Systems* , pp. 20-35.
- Shreiber, C., 1975. The Economic Reasons for Price and Entry Regulation of Taxicabs. *Journal of Transport Economics and Policy*, 9(3), pp. 268-279.
- Song, D. & Earl, C., 2008. Optimal empty vehicle repositioning and fleet-sizing for two-depot service systems. *European Journal of Operational Research*, 185(2), p. 760-777.
- Weikl, S. & Bogenberger, K., 2015. A practice-ready relocation model for free-floating carsharing systems with electric vehicles – Mesoscopic approach and field trial results. *Transportation Research Part C: Emerging Technologies*, Volume 57, pp. 206-223.
- Yang, H., Wing, Y. L., Wong, S. C. & Lo, H. K., 2000. A macroscopic taxi model for passenger demand, taxi utilization and level of services. *Transportation*, Issue 27, pp. 317-340.
- Zimmerman, S., 2012. The Role of Bus, BRT in integrated Public Transport Networks. *Proceedings of the 92nd annual meeting of Transportation Research Board*.

## **Chapter.6 From strategic framework to microeconomic model. Mathematical abstraction with a numerical application on Orbicity taxi service.**

### **ABSTRACT**

The strategic framework built in Chapter.5 defined three levels of management decisions: operational, tactical and strategic. It proposed furthermore setups of each decision level. Regulation, demand needs and unit costs were identified as three major pressure forces of the external environment.

This Chapter proposes a mathematical abstraction of relations that exist between the framework's components. The aTaxi service is described through its level of service (LOS) performances, which includes the access time, the matching time, the travel time and the service fare. The demand function combined these LOS attributes with user's sensitivity components.

At the operational level, the demand-supply equilibrium problem is described by pointing out the interrelations between demand and supply components. At the tactical level, the profit and social welfare maximization problems with respect to the fleet size and the fare per trip are formulated. At the strategic level, the maximization is performed with respect to the automation technology and implementation area.

A numerical application, based on an idealistic urban area introduced by Leurent (2017; 2018), is proposed to evaluate impacts of each model's layer. The model is proving to be appropriate to assess strategic decisions. It shows that automation and density have significant impacts on quality of service and profit as well. Three French cities (Saint-Malo, Rennes and Paris) having different demand and supply parameters are considered in the numerical application. Results found that larger cities allow better profit and social welfare, while small cities are more affected by the automation.

*Keywords:* mathematical abstraction, framework formulation, stylized urban city, density and technology impacts

### **1. INTRODUCTION**

#### *1.1. Background*

An aTaxi service promises several benefits for Users, Operators and Public Authorities (Chapter.4). In practice, however, its performances depend on the management decisions setups and the pressure of stakeholders (Chapter.5). Recently, several studies have been attempted to simulate operating performances of autonomous taxis services (Chapter.1). Nevertheless, the majority of these models do not include a responsive demand, which

depends on the level of service while considering other available modes. In addition, the optimization of profit and social surplus is rarely considered.

### *1.2. Objective*

The objective of this Chapter is to design, describe and assess a microeconomic model enabling to evaluate management decisions setups of the operator. In particular, it describes mathematically (1) the operational layer, which investigates supply-demand equilibrium and specifies the operating performances, (2) the tactical layer, which determines supply conditions (i.e. fleet, fare...) and (3) the strategic layer, which dictates the commercial and technological positioning. The interrelations between these layers are also described. The demand is responsive. It depends on the level of service while considering alternatives modes. The model reflects the service attractiveness, the operational efficiency, the profitability, the social welfare and environmental impacts. It is territorialized, which enables to consider specific particularities of each study area.

### *1.3. Method*

The mathematical abstraction is based on works of (Leurent, 2017, 2018). For each decision level, inputs and outputs are determined and described using mathematical formulas. Connections between layers are detailed using schemes and mathematical functions. An application based on the framework developed by Leurent (2018) permits to assess the robustness of our model.

### *1.4. Structure*

We first provide a general overview of the microeconomic model (§2.). In particular, we establish model's assumptions and describe objectives of each decision layer. Then, we will present in detail the structure of each layer while considering adjacent layers by using graphics and mathematical formulas (§3). Finally, we present an application case for stylized urban area (§4.).

## **2. MODEL'S ARCHITECTURE**

Consider a service of aTaxis obeying to the following constraints:

- The service is provided in a limited area. Taxis cannot leave it to board more passengers or to take passengers to their destination.
- The service availability is limited by time, in terms of hours or days. Taxis run only during the permitted time slot.
- Vehicles are considered homogeneous: same comfort, same capacity, same brand and same color. Passengers do not differentiate between taxis and consider that all provide exactly the same quality of service in terms of comfort.

- Vehicles' capacity dictates the number of persons that are allowed to board. It is defined by the number of seats. When all seats are occupied, the vehicle cannot accept additional passengers.
- Passengers board and alight from specific points, called stations. They are not allowed to board from other points of the network.
- Taxis are reserved online using mobile apps or specific command apps in stations.

Given these technical constraints, the operator should determine the level of service that will attract passengers while ensuring an operational efficiency and achieving sustainable profitability and maximal social welfare.

The microeconomic model is composed of three layers as presented in Chapter.5:

- Operational layer: describes for a given supply and demand, the technical performances of the service, such as speed, dwell time, ride time.... It confronts demand to the proposed supply in order to assess the volume of attracted demand.
- Tactical layer: determines optimal operating conditions that maximize the profit and the social optimum. We focus in this study on the case of one operator of aTaxis (e.g. no direct competition)
- Strategic layer: investigates opportunities to enhance economic and social performances by defining the commercial and technological positioning.

At the basis of these layers, the demand layer introduces demand characteristics, e.g. population, utility, sensitivities, etc. It dictates how passengers perceive the service.

**Figure 27** depicts the overall scheme of the model. It details the **Figure 26** of Chapter.5 through describing the main interrelations between operational, tactical and strategic layers. It also shows how pressure forces are connected to the model's layers.

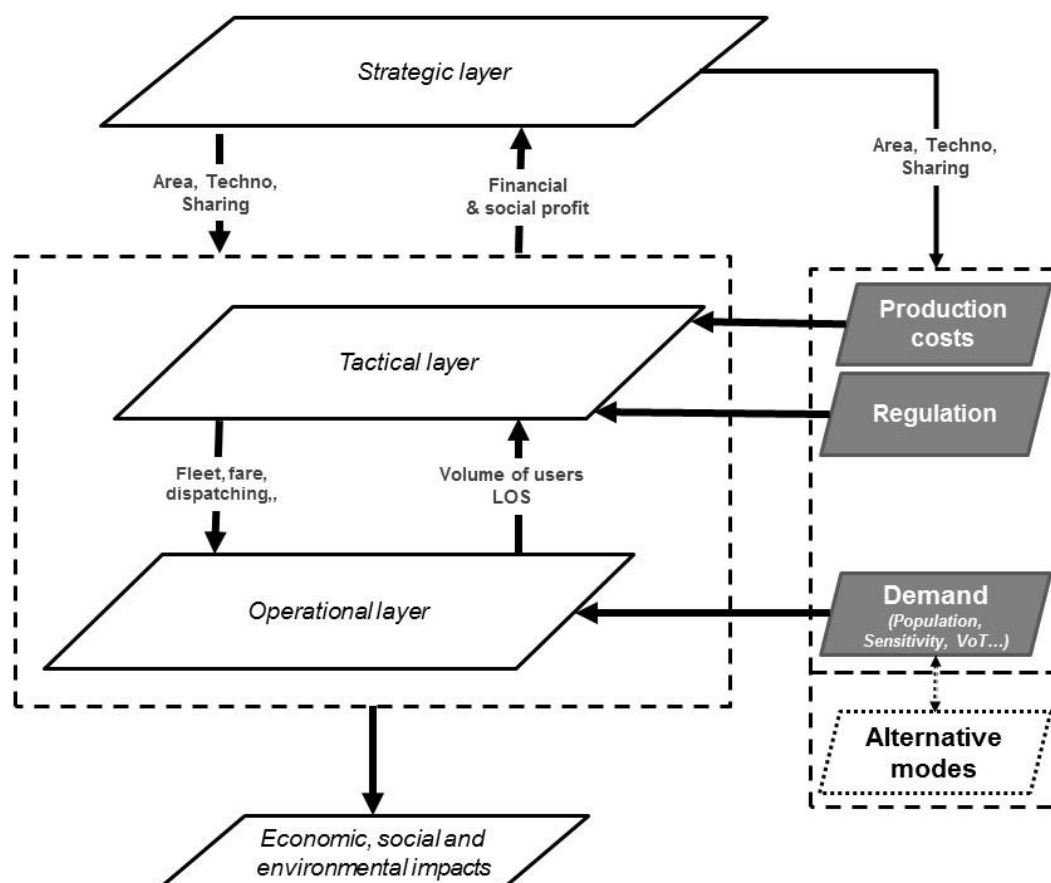

Figure 27 Scheme of interrelations (1) between operational, tactical and strategic layers and (2) between strategic layers and pressure forces.

Thereafter, we present the three layers while describing their connections with pressure forces. Inputs and outputs of each layer are then introduced:

**Operational layer (Supply-demand equilibrium)**

The operational layer describes technical functioning of the service (e.g. access time, waiting time, riding time...) for a given demand parameters and exogenous supply factors.

+ Supply factors are fixed by upper layers. In particular, the fleet size, the fare and ridesharing strategies are dictated by the tactical layer, while vehicles technology, their capacity and the assignment strategies are given by the strategic layer. The level of service (LOS) is expressed using impedances, which include specifically waiting time, in-vehicle time, matching time and intermediate stops.

+ Demand parameters include the total demand volume, the Origin-Destination trips, and the utility function. They are given by the demand component of pressure forces.

By defining how supply varies with respect to demand (§4.1. Operational layer), and how demand is affected by supply (§4.2. Demand function), the demand-supply equilibrium

derives as a solution of a fixed-point problem in demand or impedances (§4.3. Traffic equilibrium). It is obtained when supply and demand functions are satisfied at the same time.

As outputs, demand-supply equilibrium layer provides for fixed supply parameters the volume of users of the service as well as the LOS performances.

#### ***Tactical layer (Economic equilibrium)***

The tactical layer investigates problems of profit maximization and/or social welfare maximization. In addition, it assesses environmental impacts and operational efficiency.

In particular, the tactical layer determines the optimal fare, fleet size and/or ridesharing strategies. That defines the exogenous supply factors, which affect in turn the outputs of the demand-supply equilibrium. The fare, moreover, has a direct effect on the demand through the utility function. Therefore, the optimal fleet, the optimal fare and the optimal ridesharing strategy serve to recalculate the new demand and level of service at the operational level.

At this step, the fare or/and the fleet size could be dictated by the regulator. It is considered in the model through the “regulation” component of pressure forces.

On the other hand, to determine the optimal conditions, the operator should also consider the production costs, including fixed costs of depreciation, drivers’ costs, and mileage costs of running (e.g. energy, maintenance...). Unit costs are fixed by the “unit costs of production” component of pressure forces.

The feedback loop between the operational and tactical layers provides after convergence the economic equilibrium, which corresponds to the optimal operating conditions.

#### ***Strategic layer (Commercial positioning)***

Located at the higher level, the strategic layer defines the commercial position of the service. It reviews the business model in order to optimize economic and socio-economic impacts. In particular, it investigates strategies presented in Chapter.5, which are service area, technology of vehicles and ridesharing options.

In the remainder of this thesis, we will use also the terms “traffic equilibrium” and “demand-supply equilibrium” to appoint the “operational layer”; we will use “economic equilibrium layer” to appoint the “tactical layer” and “commercial positioning” to appoint “strategic layer”.

#### **Notation table**

<i>A</i>	Implementation area
----------	---------------------



$B_T$	Total benefit
$C$	Total production costs
$C_P$	Function of production costs
$D$	Demand function
$E$	Environmental impact
$e$	Energy costs per unit of distance travelled
$e_d$	Pollutants emitted per unit of distance travelled
$F_A$	Supply function of access time
$F_{IVH}$	Supply function of in-vehicle time
$F_m$	Supply function of access time
$F_S$	Supply function of intermediate stops
$g$	Generalized cost
$I$	Investment costs for purchasing vehicles
$i$	Mode index
$l_s$	Lifespan of vehicles
$L_{IVH}$	Travel distance
$m$	Regular maintenance costs per unit of distance travelled
$N$	Fleet size
$o_k$	The occupied mileage
$o_e$	The empty mileage
$o_k^r$	Mileage occupancy rate
$p$	Passenger index
$P_E$	Environmental impacts
$P_O$	Profit of the operator
$P_S$	Social welfare
$P_U$	Users' surplus
$Q$	Demand volume of aTaxis
$Q_0$	Total demand volume (for all available modes)
$R$	Revenues
$RS$	Ridesharing strategy
$r_q$	Ratio of users of aTaxis
$S_{er}$	Intermediate stops
$S_p$	Sharing permission
$t_{IVH}$	The in-vehicle time
$t_A$	The access/ waiting time
$t_m$	The matching time
$t_{OD}$	The door-to-door time
$U_{aT}$	Utility of aTaxis
$U_{ot}$	Utility of available mobility services except aTaxis
$v$	Running speed of taxis
$w$	Costs of drivers' wages
$\alpha_{IVH}$	Sensitivity weight to the in-vehicle time

$\alpha_A$	Sensitivity weight to the access/ waiting time
$\alpha_m$	Sensitivity weight to the matching time
$\tau$	Fare of the service
$\mu_{pr}$	Preference mode

### 3. FORMULATION AND MODEL COMPOSITION

#### 3.1. Pressure forces

##### 3.1.1. Demand parameters

The demand parameters reflect the passengers' sensitivities to the taxi service. They include particularly the fare and LOS performances: the in-vehicle time, the waiting time, the matching time and the mode preference.

##### **Fare**

The fare, measured in Euros, is the price paid by the user to have access rights to use the service. Depending on the market regulation, it is fixed by the regulator in order to protect passengers or by the operator in order to cover fully or partially operating costs.

##### **In-vehicle time**

The in-vehicle time is perceived by drivers of private cars as well as riders of public modes as the most important factor (Wong, et al., 2015; Borja, et al., 2018).

Peruch and al. (1989) found that estimation of travel distance by commuters is equivalent to that reported by taxi drivers. However, taxi drivers perceive travel times shorter (Peruch, et al., 1989; Asif & Vinayak, 2015). Wong et al. (2015) observe that each extra-minute in taxi is perceived as 1.5 minute by the passenger. That because not only it increases the overall time spent in traveling to the destination, but also results in higher travel fare charge as well.

Rietveld and al. (1999) found that commuters admit deliberately or unintentionally a detour factor of about 1.4 to and 1.5 for shorter trips. These detours depend on the average speed of roads and the network's structure (1.2 for fine meshed networks and 1.4 to 1.5 for broad meshed networks). Swoboda (2015) considers for New York City a maximal detour factor for ridesharing of 1.2.

In addition, making detours to pick up carpoolers leads to an increase in travel time of about 10 % (Delucchi, 1998), 15 % (Dubernet, et al., 2013) and 17 % (Rietveld, et al., 1999) compared to solo drivers covering the same distance.

Ciari et al. (2012) found that potential carpoolers seem to prefer to be a passenger rather than a driver.

##### **Waiting time**

Waiting time is also a major parameter with a factor of 1.2 to 1.3 compared to real spent time (Wong, et al., 2015). Wong et al. (2015) show in addition that waiting passengers prefer hailing taxis along the roadside than at taxi stands. The disutility of using taxi stands is found to be similar to that of spending one more minute in taxi search.

Furthermore, waiting time perception depends on specific trip's conditions: carrying heavy luggage, no other public transport mode available to the destination, not familiar with the local road network nearby, and traveling by taxis because of adverse weather (Wong, et al., 2015). Fan et al. (2016) investigated the relationships between bus station/stop amenities and waiting time perceptions. They argued that real-time information alone reduces a transit user's perception of waiting time almost as much as both a bench and a shelter (Fan, et al., 2016). In addition, they indicated a non-linear relationship between reported and observed waiting time variables, and that some amenities (e.g., bench) are more important to longer waits than shorter waits (Fan, et al., 2016). Lagune-Reutler et al. (2016) showed that for waits longer than five minutes, air pollution and traffic awareness increase the overestimation of waiting times, while the presence of mature trees, reduces the waiting time perception and even leads transit users to underestimate the waiting times.

### **Matching time**

To the best of our knowledge, the matching time has not been investigated as a separate factor for services based on mobile apps. That is certainly related to the fact that the matching represents a minor part in the trip time. In high-supply cases, the matching is immediate and the waiting time very short. On the other hand, when taxis supply is insufficient (e.g. low-density areas) or inadequate with passenger expectations (e.g. absence of carpoolers), each additional minute to achieve the matching time would be perceived longer. In this case, also, the waiting time would be longer. Nevertheless, the matching time should not be neglected anymore.

### **Mode preference**

Mode preference factor, named also the modal constant in literature, is used to include all other factors related to LOS (e.g. information, comfort, reliability, etc.) that affect the traveler's behavior. A very few studies have investigated the mode preference factor for taxis. By considering that for-hire services are intermediate modes, with LOS situated between private cars and transit (Wibowo & Chalermpong, 2010; Richter & Keuchel, 2012; Muro-Rodríguez, et al., 2017), the mode preference of taxis would cost in terms of LOS about 0.5 to 2€ less than public modes.

### **Synthesis**

**Table 15** presents values of demand parameters provided by the literature.

## **Table 15 Perceived values of level of service from literature review**

	Perceived value	Reference
<b>Travel time</b>	1 extra-minute = 1.5 minutes	Wong et al. (2015)
<b>Waiting time</b>	1 waiting minute = 1.2 to 1.3 travel minute	Wong et al. (2015)
<b>Detour factor</b>	1.2 (long trips) to 1.5 (short trips)	Rietveld et al. (1999) and Swoboda (2015)
	0.15 of total travel time	Dubernet et al. (2013)
<b>Matching time</b>	<i>Not estimated</i>	
<b>Mode preference</b>	0.5 to 2€ compared to public modes	

### 3.1.2. Unit costs of production

The major components of fixed costs for a for-hire service are depreciation costs of vehicles and drivers' costs. Depreciation costs are function of purchasing costs of vehicles  $I$  and their lifespan  $l_s$ , expressed by unit of time or by unit of distance. On the other hand, drivers' costs are function of wages of drivers per month and the number of drivers required to ensure the service period given their maximal working hours. In fact, fixed costs should also include dispatcher costs, management and supervising costs, etc.

Variable costs, or running costs, are expressed by unit of traveled distance or time. They include specifically energy costs  $e$  and regular maintenance costs  $m$ . Unit energy costs depend on several parameters: the type of energy used (thermal, electric, etc.), vehicles' characteristics and the macroeconomic context. Maintenance costs, on the other hand, incorporate both preventive and corrective maintenance costs and are split among labor costs (i.e. wages of maintenance workers) and unit materials costs. They are in general calculated and introduced by the operator based on the production process.

Consequently, production costs as a function involve depreciation costs, expressed by a combination of  $I$  and  $l_s$ , together with drivers' costs  $w$ , energy costs  $e$  and regular maintenance costs  $m$ .

**Table 1** presents typical values of unit costs of production reported in the literature (Chapter.1).

### 3.1.3. Regulation

Regulation defines production constraints on the operator (Chapter.5). It mainly concerns the fleet size (free entry) or the service fare. In fact, regulation imposes maximization or minimization constraints on fare and/or the fleet size.

Mathematically, maximization problems of performance indicators should incorporate additional constraints.

### 3.2. Management decision layers

#### 3.2.1. Operational layer: Traffic equilibrium

Consider an aTaxis service provided by a fleet of vehicles  $N$  and for a given tariff  $\tau$ . Supply conditions are already fixed by upper layers. The strategic layer also defined the territory, the technology, the pricing structure, the dispatching strategy and so on. The demand is an external layer, which depends on the implementation territory. The objective of this section is to establish relations between the operational layer and upper model's layers. A general overview of these relations is depicted and outputs are described in detail. This layer corresponds to the traffic equilibrium since it seeks the equilibrium of demand (provided by pressure foci) and supply (provided by upper layers).

**Figure 28** presents relations between operational and tactical layers of the model. The operational layer receives as inputs from the demand layer the demand function, and from the tactical layer the fleet, the fare and dispatching strategies. As outputs, the demand-supply equilibrium provides (1) LOS performances and (2) the number of the service.

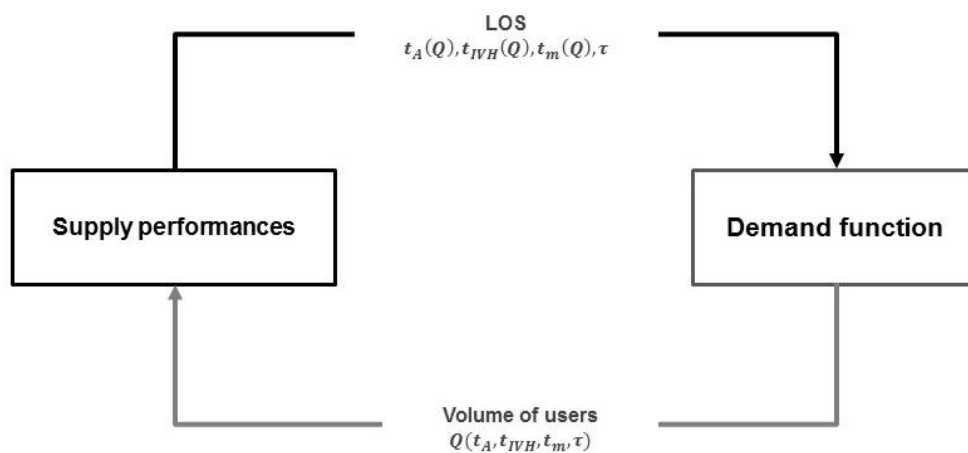

**Figure 28** Scheme of demand-supply equilibrium achieved in the operational layer

In the following, we present mathematical functions of LOS performances and the volume of users:

##### 3.2.1.1. LOS performances

As we presented previously, the main components of LOS are waiting time, in-vehicle time and matching time. We include here furthermore the effect of intermediate stops. Let us investigate all these outputs one by one.

**Access time.** The access time is the most commonly criteria used in literature in order to describe the LOS of taxi services (Douglas, 1972; Yang & Wong, 1998; Wong, et al., 2015). It is also often assumed equal to the waiting time of passengers, considered then as a performance indicator for passengers and providers at the same time.

At any given moment, the access time depends on taxis on streets  $N$ , users of the service  $Q$ , travel time of boarded users  $t_{IVH}$  and eventually their intermediate stops  $S_{er}$  (i.e. noted  $S_{er}$  for en-route stops), the matching time  $t_m$ , taxis running speed  $v$  and the service area  $A$ :

$$t_A = F_A(N, t_{IVH}, Q, v, t_m, S_{er}) \quad (1)$$

**In-vehicle time.** The in-vehicle time,  $t_{IVH}$ , depends on the travelled distance and the commercial speed. The travelled distance is often defined by the demand origin-destination pairs. It is in general greater than the access distance. The commercial speed is affected by congestion, traffic lights and intersections, and acceleration/deceleration required to board or alight passengers (Parthasarathi, et al., 2013). If ridesharing is in addition allowed, additional stops and eventual detours are required to serve more passengers, which would induce longer in-vehicle time for riders in vehicle. The demand volume then has a significant impact on travel time. Similarly, the availability of vehicles enables to avoid intermediate stops so to limit the travel time. Furthermore, if vehicles are electric, then the travel time is also constrained by the status of batteries.

From this short discussion, we could conclude that  $t_{IVH}$  depends – when ridesharing is considered – on commercial speed, travel distance, waiting passengers, available taxis (e.g. with at least one empty seat), access time and the number of intermediate stops. Finally, the travel time could be written:

$$t_{IVH} = F_{IVH}(N, t_A, Q, v, L_{IVH}, S_{er}) \quad (2)$$

**Matching time.** The matching between taxis and passengers could be achieved through street-hailing, at taxi stands or online booking. The last solution offers to passengers the possibility to choose between different providers, on term of pricing and vehicles' availability. We consider here that matching between taxis and passengers is ensured merely by online tools. From passengers' perspective, the matching time includes comparing providers/drivers' prices, their access time, their score assigned by other passengers and their vehicles quality. When taxis are scarce and demand is great, the matching time increases. In addition, if the access time of available taxis is high, a passenger will likely choose the nearest vehicle. If otherwise all taxis are near, the choice will rather be based on the price. In the case of ridesharing (lower trip fare, lower impacts on traffic...), the probability to find available vehicles is lower, the matching time then higher. In the driver's perspective, the matching time depends also on the number of waiting passengers and available taxis. Taxis are choosing passengers depending on their location (access time) and their destination. The matching efficiency and search frictions have been modelled and widely discussed in the literature for traditional taxis (Yang, et al., 2010; Yang & Yang, 2011) however, studies addressing these issues for ridesourcing services are for now very limited (Buchholz, 2018).

By assuming that the matching time is the same for passengers and drivers, it could be written as function of demand (i.e. greater demand involves greater matching time),

available fleet (i.e. greater number of available vehicles involves lower matching time), travel time and intermediate stops (i.e. which reflect vehicles' occupancy) and access time (i.e. higher is the access time, lower is the probability to find near available taxis):

$$t_m = F_m(N, t_A, Q, t_{IVH}, S_{er}) \quad (3)$$

In fact, the matching time would also be affected by the interface ergonomics on terms of simplicity and smoothness, which is not investigated by research studies as of the end of 2018.

**Intermediate stops.** Intermediate stops of loaded vehicles enable to pick-up or drop-off users (e.g. dynamic ridesharing). They could be claimed by passengers waiting en-route or by onboard passengers (e.g. Uber and Lyft option). They aim to reduce waiting time of passengers while increasing vehicles loading. On the other hand, they involve higher travel time, especially when detours are required.

Whatever the objective of intermediate stops, they depend in general on the demand volume and its distribution along the taxi trip, the total distance travelled, available vehicles (e.g. at least one empty seat) and access time (associated for instance to the detour). To sum up, intermediate stops, obey to the following relation:

$$S_{er} = F_S(N, t_A, t_{IVH}, Q) \quad (4)$$

### 3.2.1.2. Demand function

In 3.2.1.1, we exposed the components of the users' sensitivity to LOS of a taxi service. They are summarized into five components: the fare, the travel time, the waiting time, the matching time and finally the mode preference that includes all unknown behavior factors. These sensitivity components, combined with attributes of LOS, constitute the utility function. This function is largely used in the economic literature as a vector of attributes values by means of a scalar. It is expressed in our case as:

$$U_{aT} = \mu_{mp} - \tau - (\alpha_{IVH}t_{IVH} + \alpha_A t_A + \alpha_m t_m) \quad (5)$$

Where  $U_{aT}$  the utility of aTaxis,  $\alpha_{IVH}$ ,  $\alpha_A$  and  $\alpha_m$  are positive weights that correspond to the sensitivity components, also called values of time,  $\mu_{mp}$  a positive constant reflecting the mode preference,  $\tau$ ,  $t_{IVH}$ ,  $t_A$  and  $t_m$  are respectively the trip fare, the in-vehicle time, the waiting time and the matching time. The extra-time induced by a detour and/or additional stop is included in the travel time. Similarly, comfort is generally considered in travel time and waiting time. Consequently, these two penalties are not mentioned in the utility function in order to avoid the risk of double counting or at least overlapping.

The utility function measures the service attractiveness. It also corresponds to the inverse of the generalized cost. In a universe where several services are available, passengers will choose the service which maximizes this utility (i.e. minimize the cost).

The demand function reflects the total volume of the service passengers. It is a function of utilities of services that are available for the passenger. By making the distinction between aTaxi and other modes by respective indices  $aT$  and  $ot$ , the demand of aTaxi could be written:

$$Q = D(U_{aT}, U_{ot}) \quad (6)$$

Or by injecting (Eq.5) in (Eq.6):

$$Q = D(\tau, t_A, t_m, t_{IVH}, U_{ot}) \quad (7)$$

### **3.2.1.3. Traffic equilibrium**

From the analysis of supply and demand sides, it follows that access time, travel time, matching time and demand are all interdependent. **Figure 29** depicts these interrelations: grey elements refer to exogeneous parameters, yellow elements to LOS performances and green ones to demand variable. In addition, green arrows are double-headed while orange ones are not.

The existence of a traffic equilibrium is a priori guaranteed by definition. However, conditions that should be verified to ensure this existence as well as the unicity of this equilibrium, is an issue that depends on the supply and demand models. Consequently, a deep investigation of equilibrium conditions is strongly recommended before computing upper layers. The localization of the operational layer on the basis of the model is indeed mostly motivated by this constraint.

After convergence of supply and demand and reaching the traffic equilibrium, derived outputs include the number of passengers using the service and LOS performances, expressed often by OD impedances and operating performances.



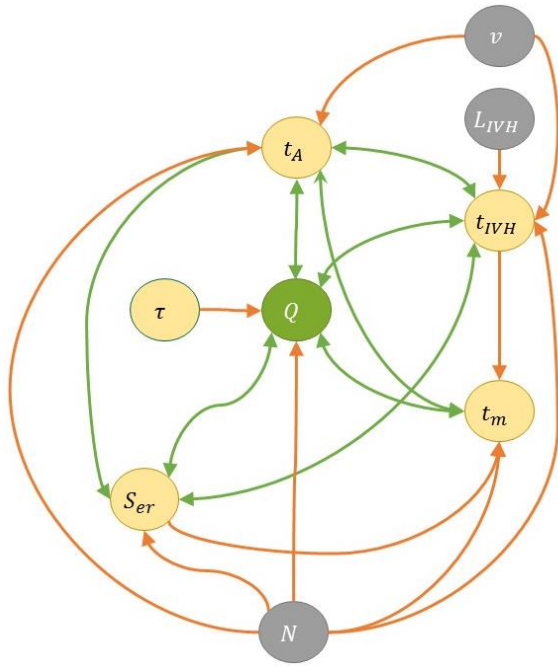

**Figure 29 Overview of interrelations between LOS and demand components**

### 3.2.2. Tactical layer: Economic equilibrium

The tactical layer defines operating processes engaged by the operator with the objective of improving technical efficiency and maximizing profit. In particular, at this level, the operator sets up the fleet size, the fare and dispatching strategies (Chapter.5). The technical efficiency is in addition measured by the time occupancy (Chapter.5).

At this level, strategic setups are fixed: area, technology and form of the service. We present firstly the general overview of relations between the tactical layer and adjacent layers (i.e. strategic and operational). Secondly, economic components (production costs and revenues) are introduced. Then, problems of maximizing profit and social welfare are described.

**Figure 30** presents the scheme of interrelations between the tactical layer and adjacent layers. The tactical layer generates itself three inputs: the fleet size, the fare and dispatching strategies. These inputs are then used in the operational layer to obtain the demand-supply equilibrium. In return, outputs of the operational layer are direct inputs of the tactical layer, which means demand volume and LOS performance. The tactical layer deduces then profit and social welfare and corresponding operating conditions (e.g. optimal fleet, fare and dispatching strategies) as well as operational performances (e.g. loaded driven distances, time occupancy) and environmental impacts (e.g. emissions, energy consumption).

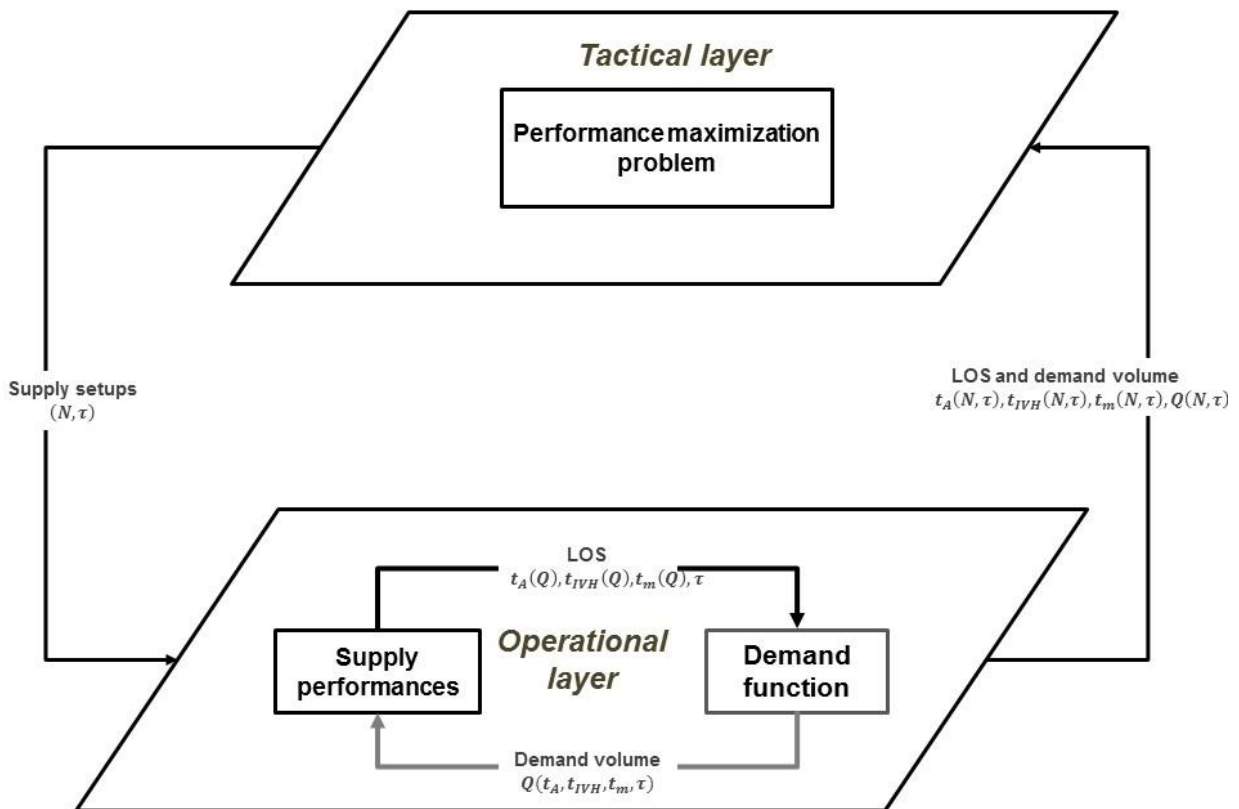

Figure 30 Scheme of the economic equilibrium achieved in the tactical layer as well as relations between tactical and operational layers

### 3.2.2.1. Economic sub-models as components

#### Production costs.

Production costs include in particular fixed costs, or daily costs, and running costs. Typically, fixed costs include depreciation, maintenance of vehicles and infrastructure, drivers' wages, and supervision/ management costs. Vehicles are depreciated over time, regardless of their utilization. Maintenance costs are fees of regular maintenance operations. Drivers' wages obey to the country's legislation. The number of drivers is closely linked to the fleet size. Finally, supervision costs encompass costs of the intermediation platform as well as wages of managers and technical staff. We assume that they are fairly distributed among vehicles and depend only on the operating duration and the number of vehicles. Running costs concern particularly energy costs; they are function of driven kilometers.

Consequently, fixed costs and running costs depend respectively on the number of vehicles and the driven distance. Production costs then could be written as:

$$C = C_P(N, t_A, t_{IVH}) \quad (8)$$

Production costs are considered in particular at the tactical and strategic layers. At the tactical layer, the operator strives to reduce costs by optimizing the utilization of resources. At the strategic layer, the operator determines the technology of vehicles that reduces costs for mid and long-term (from respectively the tactical and strategic perspective). He also determines the service location depending on the availability of suppliers.

### Revenues

Revenues are results of combination between demand and tariffs. They could be expressed as:

$$R = \sum_{p=1}^Q \tau_p \quad (9)$$

Where  $R$  describes commercial revenues,  $\tau_p$  the fare paid by passenger  $p$  and  $Q$  the volume of passengers.

In most economic studies investigating taxi issues, it is assumed that the fare is flat (Douglas, 1972; Wong et al., 1998-2005). Yang et al. (2005) indeed considered a variable taxi fare as a linearly increasing function of travel delay due to congestion but average taxi ride length is assumed to be constant. In 2010, Yang et al. proposed a non-linear fare structure (parabolic function) with a continuously declining charge rate per unit distance (Yang, et al., 2010). They argued that introducing a nonlinear fare will benefit to passengers and taxi drivers, hence improving the total social welfare. The emergence of the concept of surge pricing with Uber has led scholars to investigate its impacts on passengers and social welfare. Hall et al. (2015) found that surge pricing enables to reduce significantly the waiting time. Several application cases in US cities showed that it fosters the supply such that the wait time is almost always fewer than 5 minutes. Paper and Shapiro (2018) combined a spatial model with data of New York City to prove that Uber is increasing the social welfare particularly in less density areas.

#### 3.2.2.2. Profit and social welfare maximization

**The goal of any private operators** is to increase its profits, which amounts to the difference between commercial revenues and production costs:

$$P_o(N, \tau, RS) = R(\tau, Q) - C_P(N, t_A, t_{IVH}) \quad (10)$$

To maximize the profit at a tactical level, the service provider could act on three levers: the fleet size  $N$ , the fare  $\tau$  and the ridesharing strategy  $RS$ . Then, the maximization problem of the profit could be written as:

$$\max_{N, \tau, RS} P_o(N, \tau, RS) = \max_{N, \tau, RS} (R(\tau, Q) - C_P(N, t_A, t_{IVH})) \quad (11)$$

As we have mentioned before, the travel time and the access time are affected by ridesharing strategies. The other parameters as the mode preference could also vary depending on the ridesharing strategy adopted by the operator. We will ignore these effects in this thesis, since specific investigation would require a research project of its own. The maximization problem could be then written:

$$\max_{N,\tau} P_o(N, \tau) = \max_{N,\tau} (R(\tau, Q) - C_p(N, t_A, t_{IVH})) \quad (12)$$

**From the perspective of users**, the gain of passengers is measured as the difference between the current utility of the provided service and the minimal utility that is desired by passengers. If the desired utility is higher than the current utility, then passengers are getting more benefit from using the service. The demand surplus is expressed as the area under the demand curve and above the horizontal line at actual generalized cost. Therefore, it is the definite integral of the demand function with respect to the generalized cost, from the actual generalized cost to any larger cost value:

$$P_u = \int_g^{+\infty} D(g') dg' \quad (13)$$

The problem of users' surplus maximization is then:

$$\max_{N,\tau} P_u(N, \tau) = \int_g^{+\infty} D(g') dg' \quad (14)$$

Finally, **public authorities** are concerned by the total surplus, which covers the surplus of the service provider (i.e. profit) and users' surplus. The total surplus, or the social welfare, is then defined as:

$$P_s = P_o + P_u \quad (15)$$

The maximization problem of the social welfare with respect to the fleet size and the fare is then:

$$\max_{N,\tau} P_s(N, \tau) = \max_{N,\tau} \left( \int_g^{+\infty} D(g') dg' + P_o(N, \tau) \right) \quad (16)$$

### 3.2.3. Strategic layer: Commercial positioning

At the strategic level, the operator makes decisions to enhance the economic and/or social efficiency. Considering optimal tactical setups (which maximizes the technical efficiency), the operator determines the service form, the service area and the technology that maximize the profit, passengers' surplus and the social welfare.

Similarly to the presentation of other layers, we start again by presenting the general overview while describing inputs and outputs of the layer. Then, the profit and social welfare problems are described.

**Figure 31** presents the general overview of relations between the strategic layer and the tactical layer (adjacent layer). The strategic layer has two inputs families: (1) strategic setups (i.e. area, technology and form of the service) and (2) outputs of the tactical layer (i.e. technical efficiency and optimal fleet, fare and dispatching strategies). On the other hand, it provides as outputs the optimal commercial positioning that maximizes the service profitability or its social welfare.

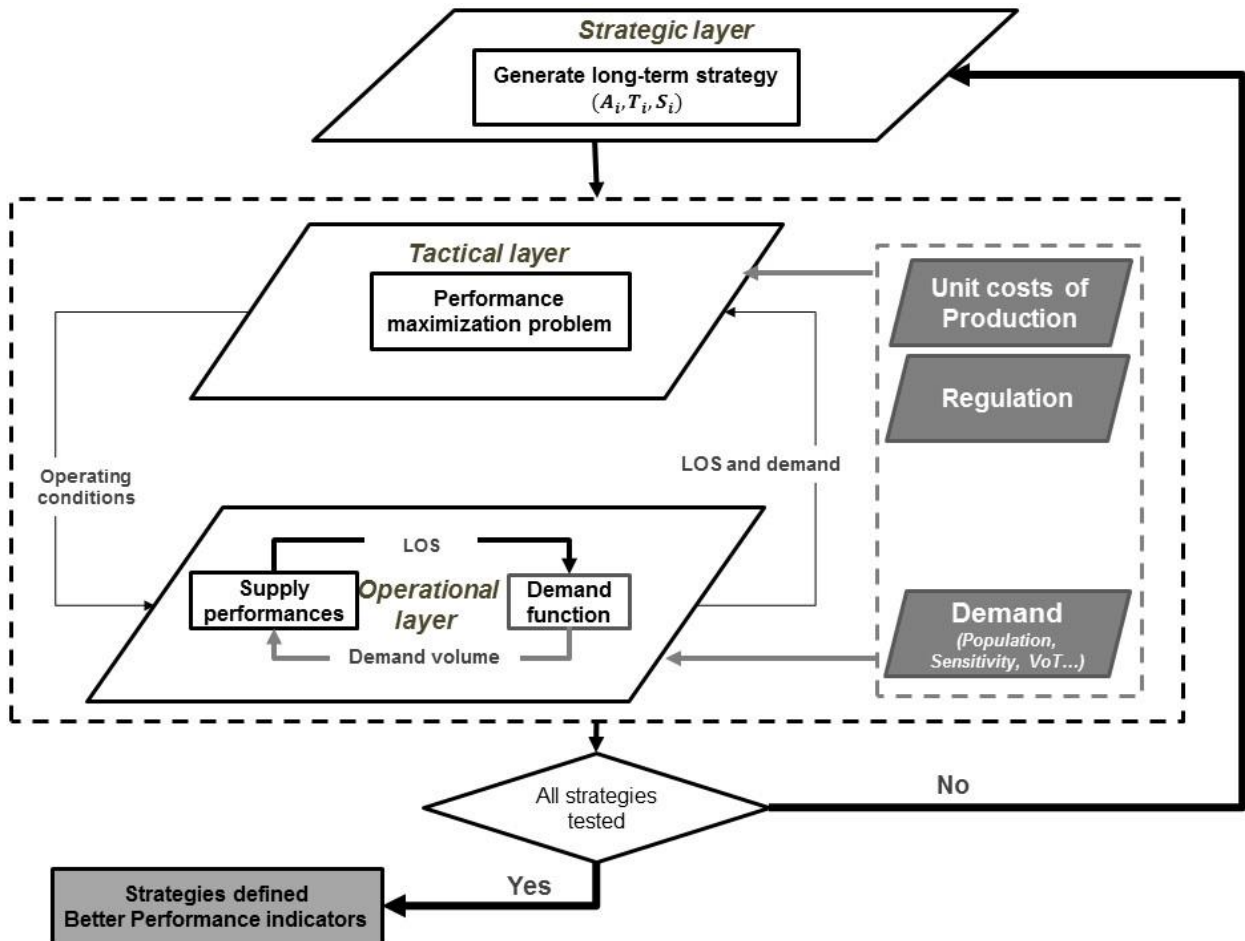

**Figure 31** Scheme of the optimization process led by the strategic layer to determine the service commercial positioning

**Strategic optimization problem**

At the strategic layer, the service provider deals with the same problems that we described for the tactical layer, hence maximizing the profit, the users' surplus and the social welfare. However, the decision factors are now depending of the highest level of hierarchy involving long-term decisions. The maximization problems are then defined with respect to the implementation area, the vehicles' technology and the sharing policy. The equations (Eq.12), (Eq.14) and (Eq.16) are then reformulated as:

$$\max_{A,T,S} P_o(A,T,S) = \max_{A,T,S} (R(\tau, Q) - C_p(N, t_A, t_{IVH}, v)) \quad (17)$$

$$\max_{A,T,S} P_u(A,T,S) = \int_g^{+\infty} D(g') dg' \quad (18)$$

$$\max_{A,T,S} P_s(A,T,S) = \max_{A,T,S} \left( \int_g^{+\infty} D(g') dg' + P_o(A,T,S) \right) \quad (19)$$

### 3.3. Performance indicators

In Chapter.5, we introduced performance indicators by considering the standpoint of the operator, users and the public authority. **Table 16** describes these indicators by providing their definition and their mathematical expression. The notation used in formulas is provided above in §2.

**Table 16 Performance indicators of the strategic framework**

Actor	Indicator	Description	Formulation
<b>Operators</b>	Profit	The financial benefit that is performed when the revenues gained from the production of the service exceed the expenses that are engaged to produce the service.	$P_o = R - C_p$
	Mileage occupancy	The ratio between loaded driven distances and the total driven distance by taxis.	$o_k^r = \frac{o_k}{o_k + o_e}$
<b>Users</b>	Access time	The time between the reservation of the taxi by the passenger and its boarding to the vehicle. It corresponds also to the waiting time.	Obtained from the traffic equilibrium
	Total time	The time between taking the decision to travel and the arrival to the destination. Then it includes the matching time, the	$t_{OD} = t_m + t_{IVH} + t_A$

		waiting time, the travel time and eventually the walking time.	
<b>Public authorities</b>	Volume of users	Refers to the total amount of passengers using the service.  The ratio of actual users on potential users (demand of reference) measures the attracted demand compared to the reference case.	Obtained from the traffic equilibrium  $r_q = Q/Q_0$
	Social welfare	The total benefit induced by the service for all actors that are involved in the service production, mainly users and the service provider	$P_S = \int_g^{+\infty} D(g')dg' + P_0$
	Emissions	The environmental impact corresponds to the amount of pollutants emitted in the area, by all existing modes, due to the modal shift from an existing mode to the taxi service.	$E = \sum e_{d_i}(o_{k_i} + o_{e_i})$

#### 4. APPLICATION CASE: ORBICITY TAXI SERVICE

##### 4.1. Simulation framework

Orbicity is a stylized urban area proposed by Leurent (Leurent, 2017) to simulate technical and economic performances through considering simplifying assumptions of demand and supply features (Leurent, 2017; Leurent & Berrada, 2018). In particular, Orbicity is an urban area in a form of closed loop with a given radius  $r$  where population activities (e.g. housing, jobs, shops...) are located along the city edges. The assumptions of demand and supply are as following:

+ On the demand side, the population activities are distributed uniformly along the city's edges. Demand is elastic to service features and generated along the study period  $H$  according to the ratio  $\lambda = Q/H$ . Passengers have homogeneous behavior. The trip is specified by the angular deviation  $\theta \in [-\pi, \pi]$  between origin and destination.

+ On the supply side, a unique private service is provided by a homogeneous fleet of taxis with same comfort and capacity (i.e. no ridesharing and no competition). Note  $N$  the fleet size. The average commercial speed of taxis is  $v$ . Taxis could stop at each point of the ring (i.e. no stations). In addition, each taxi has one running direction and never changes it. The cab busy times include the ride times, say  $t_{IVH}$  on average per trip, plus the matching time  $t_m$  and the access time, denoted  $t_A$ .

The supply function is defined through the availability function, which corresponds also to the access time function. The access time corresponds to the minimum distance between the current request position and the nearest available taxi. Mathematical developments show that the average access time is function of available taxis and the city area as proved by literature (Yang & Wong, 1998; Yang, et al., 2000; Yang, et al., 2005; Leurent & Berrada, 2018):

$$t_A = \frac{t_0}{k\phi} \quad (20)$$

Where  $t_0$  is the average time to access from a given point to another one, both located on city edges, provided by (Eq.21) for Orbicity,  $k$  the number of available vehicles, provided by the law of Little (Eq.22) and  $\phi$  a positive parameter, considered often equal to 1 in literature.

$$t_0 = \pi r / v \quad (21)$$

$$k = N - (t_A + t_{IVH})Q/H \quad (22)$$

Thus, the availability function depends on fleet size, demand volume and travel time.

$$t_A = \frac{t_0}{(N - Q(t_{IVH} + t_A)/H)} \quad (23)$$

#### 4.2. Pressure forces

##### 4.2.1. Demand properties

**Table 17** presents main demand characteristics by assuming that:

- (1) The service is provided in Paris for 15 hours per day ( $H = 15$ ). The radius of the city is about 5 to 6 km.
- (2) The demand of reference  $Q_0$  corresponds to the trips achieved by travelers of conventional taxis. It is considered homogeneous and set to 50,000 trips per day, all trip purposes included.
- (3) Given the French typical value of time of 12 €/h (Quinet, 2013), weights of the utility function are set to 0.3 €/min:  $\alpha_{IVH} = \alpha_w = \alpha_m = \alpha = 0.3$ . In addition, the mode preference factor is not included in the utility function.
- (4) The travel time assumes that the average distance between random origins and destinations is one fourth of the ring ( $L_{IVH} = \pi r / 2 = 8.9 \cong 9$  km).



- (5) The average speed of taxis in Paris area is about 17 km/h (Dell'Oro, 2014). Hence, the travel time is 30 minutes.
- (6) The generalized cost of reference is that of riding a conventional taxi. It includes the fare and the time costs (including travel time, matching time and waiting time costs).
- The average waiting time of taxis is 15 minutes and taxis are booked through calling booking offices, thus an average matching time of at least 5 minutes.
  - The fare for taxis is composed of the base fare set to 2.6 €, the mileage costs to 1.06 €/km and the cost per minute to 0.54 €/min (El Hassani, 2018).

The generalized cost of reference per trip is the sum of monetary and non-monetary costs, hence equal to:

$$g_0 = (2.6 + 1.06 * 9 + 0.54 * 30) + 0.3 * (30 + 15 + 5) = 43€$$

- (7) For-hire providers, including ridesourcing platforms and taxis' operators, constitute an oligopoly market, where customers have the choice between ridesourcing services and taxis only, and/or eventually aTaxis. Assuming then that for-hire services – that are provided in Orbicity – obey to the structure of the oligopoly market, we admit that they are interdependent. Therefore, the actions of taxis on one side, and ridesourcing platform on the other, affect the market conditions. In particular, these actions could be setting a different price, differentiating products, using loyalty schemes, etc. The oligopoly market suggests in addition that all providers are subject to the same competition laws that are enforced by regulators, which, we admit it, is not the case in reality.

Consequently, we emit the assumption that the demand of ridesourcing services and taxis are elastic and depend on the generalized cost only, then written as:

$$D(g) = Q_0 \left( \frac{g}{g_0} \right)^\epsilon \quad (24)$$

Where  $D$  and  $g$  are respectively the demand volume and the generalized cost for the studied service and  $Q_0$  and  $g_0$  respectively the demand and generalized cost of reference. If conventional taxis are the reference case, then the demand of a ridesourcing service could be expressed as:

$$D(g) = Q_0 \left( \frac{\tau + \alpha(t_{IVH} + t_A + t_m)}{g_0} \right)^\epsilon \quad (25)$$

- (8) For ridesourcing services (e.g. Uber), the waiting and matching times are improved. Assume that the average waiting time is 3 minutes and that the average matching is 2 minutes. In addition, the base fare is 1.2 € while the mileage fare is 1 €/km and the cost per minute equal to 0.3 €/min (El Hassani, 2018).

Hence, the generalized cost per trip is:

$$g = (1.2 + 1.05 * 9 + 0.3 * 30) + 0.3 * (30 + 3 + 2) = 30€$$

- (9) In Paris, the introduction of Uber doubled the total number of for-hire services, allowing the entrance of 20,000 ridesourcing drivers (Pommier, 2018). We then assume that they are attracting almost the same volume of passengers as taxis.

(10) From assumptions (6), (7), (8) and (9), the elasticity to generalized cost is equal to:

$$\epsilon_g = \frac{\Delta Q}{Q} \cdot \frac{g}{\Delta g} = -\frac{1 * 30}{(43 - 30)} = -2.28$$

The elasticity to tariff is then deduced:

$$\epsilon_\tau = \epsilon_g \cdot (\tau/g) = -2.28 * ((1.2 + 1.05 * 9 + 0.3 * 30)/30) = -1.49$$

That suggests that increasing the tariff by 1 % will decrease the demand by 1.5 %. The impact of the generalized cost is even higher, inducing a decrease of 2.28 %. In practice, however, the generalized cost of ridesourcing services depends on the supply-demand balance, since they are using a dynamic pricing to provide the same quality of service along the day. A detailed analysis while considering surge pricing effects would provide more precise values of elasticities.

(11) For the rest of the application case, we will consider that aTaxis are part of this oligopoly market, suggesting same elasticities values to tariff and generalized cost.

**Table 17 Demand assumption for Orbicity taxis service applied around Paris area**

City		Paris
Radius (km)	$R$	5.6
Area (km <sup>2</sup> )	$A$	100
Travel time between two points on the edge (min)	$t_0$	62.0
Demand of reference	$Q_0$	50,000
Travel distance (km)	$L_{IVH}$	9
Speed (km/h)	$v$	17
Travel time (min)	$t_{IVH}$	30.0
Waiting time (min)	$t_A$	3
Matching time (min)	$t_m$	2
Time cost (€)		12.0
Generalized cost of ref (€)	$g_0$	43
Elasticity to generalized cost	$\epsilon_g$	-2.28
Elasticity to price	$\epsilon_\tau$	-1.49

#### 4.2.2. Production costs inputs

##### **Automation technology**

Consider an investment cost of 30,000 € to purchase a conventional taxi with a lifespan of five years; the depreciation cost is then 16 €/day. Drivers' wages in Paris vary between 1,400 €/month and 3,000 €/month depending on the service period (i.e. day or night), their status (i.e. owners of the taxi license) and their operating costs (NKA, 2017). For a ridesourcing service, drivers are often independent entrepreneurs and are paid by the platform according

to their revenues. In absence of data, we expect that the average wage of ridesourcing drivers is higher than for taxis. Assume then that the average wage of drivers is 2,400 €/month, or 80 €/day. Since the maximum workweek is 35 hours, at least three drivers are required for each car. Considering furthermore an increase by 60 % due to taxes, drivers wages would cost finally  $80 \times 3 \times 1.6 = 380$  €/day. The total fixed costs are then for conventional taxis about 400 €/day. Note that we ignore here costs of taxis' licenses, which represents about 78 €/day. Indeed, due to Uber's expansion and such e-hailing services, it is expected that taxis regulation by licenses will be probably revised as a policy system in the near future.

For autonomous cars, we assume that purchasing vehicles costs 20 % more than conventional cars (Chapter.1). On the other hand, Autonomous Vehicles' lifespan will be shorter since they will be used intensively (Chapter.1). For instance, consider taxis realizing trips of 5km as average length with a speed of 20 km/h. Then, for a service period of 15 hours per day, then cars will run about 300 km per day, so more than 100,000 km per year. That reduces the lifespan to 1.5 to 3 years. To sum up, we assume that autonomous cars cost 36,000€ and are fully depreciated in 2 years, then depreciation costs are about 49 €/day. Since driving costs are null, then total fixed costs are set to 49 €/day.

In addition, using autonomous cars would reduce fuel consumption by 10 %.

### **Energy technology**

From the energy perspective, using electric vehicles would increase purchasing costs since costs of batteries are added. We ignore here policies aiming to encourage one technology over another (Heidrich, et al., 2017). Considering that acquiring a battery costs 1000 €/year (Ecomotion, 2018), fixed costs increase slightly by 8 % for autonomous cars and 2 % for non-autonomous cars.

Energy for electric vehicles costs about 18 % of thermal vehicles (Ecomotion, 2018; Boesch, et al., 2018). On the other hand, maintenance for electric vehicles costs only 66 % compared to thermal cars (Palmer, et al., 2018; Ecomotion, 2018). Finally, variable costs of Autonomous Vehicles have a factor of 0.58 compared to conventional vehicles.

For more details about benefits and costs of electric vehicles, a reader may refer to (Leurent & Windisch, 2015) and (Fries, et al., 2017).

#### *4.2.3. Regulation constraints*

Assume that market is unregulated. Impacts of regulation will be assessed in future works.

### *4.3. Simulation results*

#### *4.3.1. Operational layer: Traffic equilibrium*

Orbicity framework assumes that travel time and matching time are fixed. Demand and supply parameters are given by **Table 17**. The matching time is considered equal to 2 minutes, regardless the vehicles' automation technology.

The access time is given by (Eq.23). The demand function is given by the demand layer (Eq.25).

Thus, the traffic equilibrium is deduced through resolving a fixed-point problem in access time (by observing that access time is equal to waiting time). The access time is deduced as:

$$t_A = \frac{N - \lambda(t_{IVH} + t_m)}{2\lambda} \left( 1 - \sqrt{1 - \frac{8\lambda/\beta}{(N - \lambda(t_{IVH} + t_m))^2}} \right) \quad (26)$$

It imposes a condition on the fleet size:

$$N > Q(t_{IVH} + t_m)/H + 2\sqrt{2Q/H\beta} \quad (27)$$

For instance, consider a targeted demand of 50,000 trips per day and a tariff of 10€ (1€ per kilometer). The minimum fleet required is 1,895 vehicles, which ensures the access to travelers in less than one minute.

#### 4.3.2. Tactical layer: Economic equilibrium

Consider that the strategic layer opts for a fleet of non-autonomous cars. In addition, by choosing Paris area, demand constraints are fixed by §4.2.1.

The service is privative and vehicles are running only when a request is emitted, hence the service time is the product of demand volume  $Q$  and busy time ( $t_A + t_{IVH}$ ):

$$C_P(N, Q) = \chi N + c_u(t_A + t_{IVH})Q \quad (28)$$

Where  $\chi$  is fixed costs per vehicle and  $c_u$  running costs per trip and unit of time.

Let us determine optimal fleet size and optimal fare that maximize profit and social welfare.

#### Profit maximization problem

The profit maximization problem (Eq.12) with respect to fleet and fare could be formulated by (Eq.29) and (Eq.30) as:

$$\frac{\partial P_o}{\partial \tau} = Q + \left( \tau - \frac{\partial C_P}{\partial Q} \right) \frac{\partial D}{\partial \tau} = 0 \quad (29)$$

$$\frac{\partial P_o}{\partial t} = \left( \tau - \frac{\partial C_P}{\partial Q} \right) \frac{\partial D}{\partial t} - \frac{\partial C_P}{\partial t} = 0 \quad (30)$$

Given these conditions, the system's resolution is written as an equation in  $g$  (Appendix):

$$g = \frac{\epsilon}{1 + \epsilon} (c_u^+ + \alpha(t_{IVH} + t_m)) + \sqrt{\frac{2\chi(\alpha + \zeta)}{\beta Q_0} \cdot \left(\frac{g_0}{g}\right)^\epsilon} \quad (31)$$

Where:

$$c_u^+ = \frac{\chi(t_{IVH} + t_m)}{H} + c_u t_{IVH} \quad (32)$$

$$\zeta = \frac{\chi}{H} + c_u$$

Given values of demand (§4.2.1) and supply (§4.2.2 and §4.3.1), **Table 18** presents optimal supply conditions (tariff  $\tau^*$ , fleet  $N^*$ ) and corresponding results of supply-demand equilibrium (access time  $t_A^*$  and demand  $Q^*$ ). The performance indicators obtained from profit maximization are the profit for aTaxis operator  $P_p$ , ratio of loaded/empty distances  $o_d$  and the social welfare  $P_s$ .

To evaluate the emissions, we consider that if the volume of the ridesourcing service  $Q$  is inferior to the demand of taxis  $Q_0$ , then  $(Q_0 - Q)$  still using taxis. Conversely, if  $Q$  is superior to  $Q_0$ , we assume that  $(Q - Q_0)$  are originally drivers of personal cars. For vehicles based on the same motorization technology (i.e. all vehicles are thermal), the emissions of taxis and ridesourcing services are similar, since the traveled distances are almost the same. For personal cars, however, additional distances are caused by the research of a parking station. In Paris, the average searching time for parking is set to 3 minutes since drivers have in general access to a parking spot in near to their home and workplace. This corresponds to  $L_{park} = 0.85$  km (i.e. for a speed of 17 km/h). Finally, the ratio of avoided emissions is estimated based on the following formula:

$$E = \begin{cases} \frac{(Q - Q_0)(t_A/v - L_{park})}{Q_0(t_A + t_{IVH})/v} & \text{if } Q > Q_0 \\ 0 & \text{if } Q \leq Q_0 \end{cases} \quad (33)$$

**Table 18** Performance indicators for the maximization profit. Orbicity applied on Paris area.

		Profit Maximization
Supply conditions	Fleet size	1,718
	Fare (€)	34.35
Supply-demand equilibrium	Access time (min)	1.07
	Demand	46,700
Performance indicators	Profit (k€)	919
	Loading rate	96 %
	Social welfare (k€)	2,537
	Emissions (%)	0 %

Results suggest using 1,718 vehicles to serve 93 % of the potential demand for a per trip fare of 34 € (3.8 €/km). In addition, they exhibit great loading performance (96 %). The profit is almost 1,000 k€ per day and social welfare is positive. The emissions are not affected by the service since the overall number of for-hire trips (i.e. taxis + aTaxis) is not affected.

#### Social welfare maximization problem

The social welfare problem (Eq.16) with respect to fleet and fare could be formulated by (Eq.34) and (Eq.35) as:

$$\frac{\partial P_S}{\partial \tau} = \tau - \frac{\partial C_P}{\partial Q} = 0 \quad (34)$$

$$\frac{\partial P_S}{\partial t} = -\alpha Q - \frac{\partial C_P}{\partial t} = 0 \quad (35)$$

Similarly, the problem resolution amount to one equation in the generalized cost only (§Appendix)

$$g = (\zeta + \alpha(t_{IVH} + t_m) + \sqrt{\frac{2\chi(\alpha + c_u^+)}{\beta Q_0} \cdot \left(\frac{g_0}{g}\right)^\epsilon})^\epsilon \quad (36)$$

**Table 19 Results of social welfare maximization and comparison with results of profit maximization**

		Social welfare problem	Compared to profit problem
<b>Supply conditions</b>	Fleet size	2,516	<b>46 %</b>
	Fare (€)	27.5	-20 %
<b>Supply-demand equilibrium</b>	Access time (min)	0.88	-18 %
	Demand	68,870	47 %
<b>Performance indicators</b>	Profit (k€)	887	<b>-3.5 %</b>
	Loading rate	97%	1 %
	Social welfare (k€)	2,900	14 %
	Emissions (%)	-19%	19 %

Compared to results of profit maximization, the level of service is greatly improved (access time by 18 % and fare by 20 %). Hence, more of passengers are attracted by the service (47%). The profit, however, decreases slightly (by 4 %) because of the high number of required vehicles (+46 %). Therefore, even for a better quality of service and higher demand volume, the social welfare, as the sum of operators' profit and users' surplus, is increasing very slightly, by 14 %. Finally, emissions are reduced because aTaxis attract more cars' drivers.

### 4.3.3. Strategic layer

Our model defines three long-term setups: implementation area, technology and sharing rides.

- The main characteristic of Orbicity is the radius. The relation between radius and population along the edges defines the demand density.
- We assume different levels of penetration of Autonomous Vehicles. Thus, for 50% penetration level, 50 % of vehicles are autonomous while the other 50 % are not.
- Finally, sharing rides is not considered since the model Orbicity is designed for privative services.

This part is then focusing on two strategic setups: implementation area and the penetration of automation. It is structured into two parts. Firstly, we investigate the implementation area through controlling the demand density only. That allows assessing density effects on performance indicators. Different levels of penetration are considered at this stage. In a second time, we consider two other implementation areas, Rennes and Saint-Malo, with different densities, different users' sensitivities and different exogenous supply factors. At this stage, we focus on two penetration levels of automation (0 % and 100 %).

#### Impact of demand density and automation penetration

To investigate the impact of density, suppose that the demand of reference is expressed as:

$$Q'_0 = (1 + \gamma)Q_0 \quad (37)$$

Where  $Q_0 = 50,000$ , and  $\gamma$  a constant. For  $\gamma = 0 : Q'_0 = Q_0$ . Since the radius is fixed, the average times  $t_{IVH}$  and  $t_0$  do not vary.

On the other hand, note  $i$  the proportion of autonomous cars in the fleet. The electrification of vehicles is not an option. If we note  $\chi^{NA}$  and  $\chi^{VA}$  fixed costs for Non-Autonomous and Autonomous Vehicles respectively, and  $c_u^{NA}$  and  $c_u^{VA}$  running costs for Non-Autonomous and Autonomous Vehicles respectively, (Eq. 28) becomes:

$$C(N, Q) = ((1 - i)\chi^{NA} + i\chi^{VA})N + ((1 - i)c_u^{NA} + ic_u^{VA})(t_A + t_{IVH})Q \quad (38)$$

By incorporating values of §4.2.2,  $\chi^{VA} = 0.125\chi^{NA}$  and  $c_u^{VA} = 0.58 c_u^{NA}$ , then (Eq.38) could be written as:

$$C(N, Q) = (1 - 0.875i)\chi^{NA}N + (1 - 0.42i)(t_A + t_{IVH})c_u^{NA}Q \quad (39)$$

#### Figure 32

**Figure 32** and **Figure 33** exhibit performance indicators for profit maximization and social welfare maximization respectively, with respect to (1) density for  $\gamma \in [0,1]$  and (2) the level of penetration  $i$ .

Results of profit maximization show that automation involves greater fleet size and lower fares. The fleet size ranges from 1,000 to 10,000 vehicles, while greater sizes are expected for  $\gamma = 1$  and  $i = 1$ . On the other hand, the fare is affected only by  $i$  passing from 16 to 38 € per trip for  $i$  passing from 0 to 1 respectively. In turn, the demand ratio is affected also by  $i$ . aTaxis attract three times more of passengers than conventional taxis (135,000 versus 40,000 passengers). Another important result is that using Autonomous Vehicles improve the operational, economic and social performances.

On the operational side, the loading rate is maximized for 100 % autonomous fleet and higher demand level. Similar finding for the access time, which drops by about 50 % when passing from ( $\gamma = 0$  and  $i = 0$ ) to ( $\gamma = 1$  and  $i = 1$ ).

On the economic side, the profit is positive for all demand levels and rates of technology penetration. The profit increases with  $\gamma$  and  $i$  and is maximal for  $\gamma = 1$  and  $i = 1$ . In particular, for  $\gamma = 1$ , the profit when using a full autonomous fleet is two times higher.

For social performances, the social welfare is found also positive for all demand levels and rates of technology penetration. It is sensitive to the demand level and the automation penetration. In particular, for lowest values of  $\gamma$  ( $\gamma = 0$ ), the social welfare for aTaxis is 1.5 times higher compared to taxis. The ratio is almost 2.5 for  $\gamma = 1$ .

Finally, since aTaxis attract high number of users who shift from driving private cars, then 50 % of emissions are avoided for 100 % autonomous fleet, while non-autonomous cars do not have impact on emissions. Yet, the impact of  $\gamma$  on emissions is not significant.



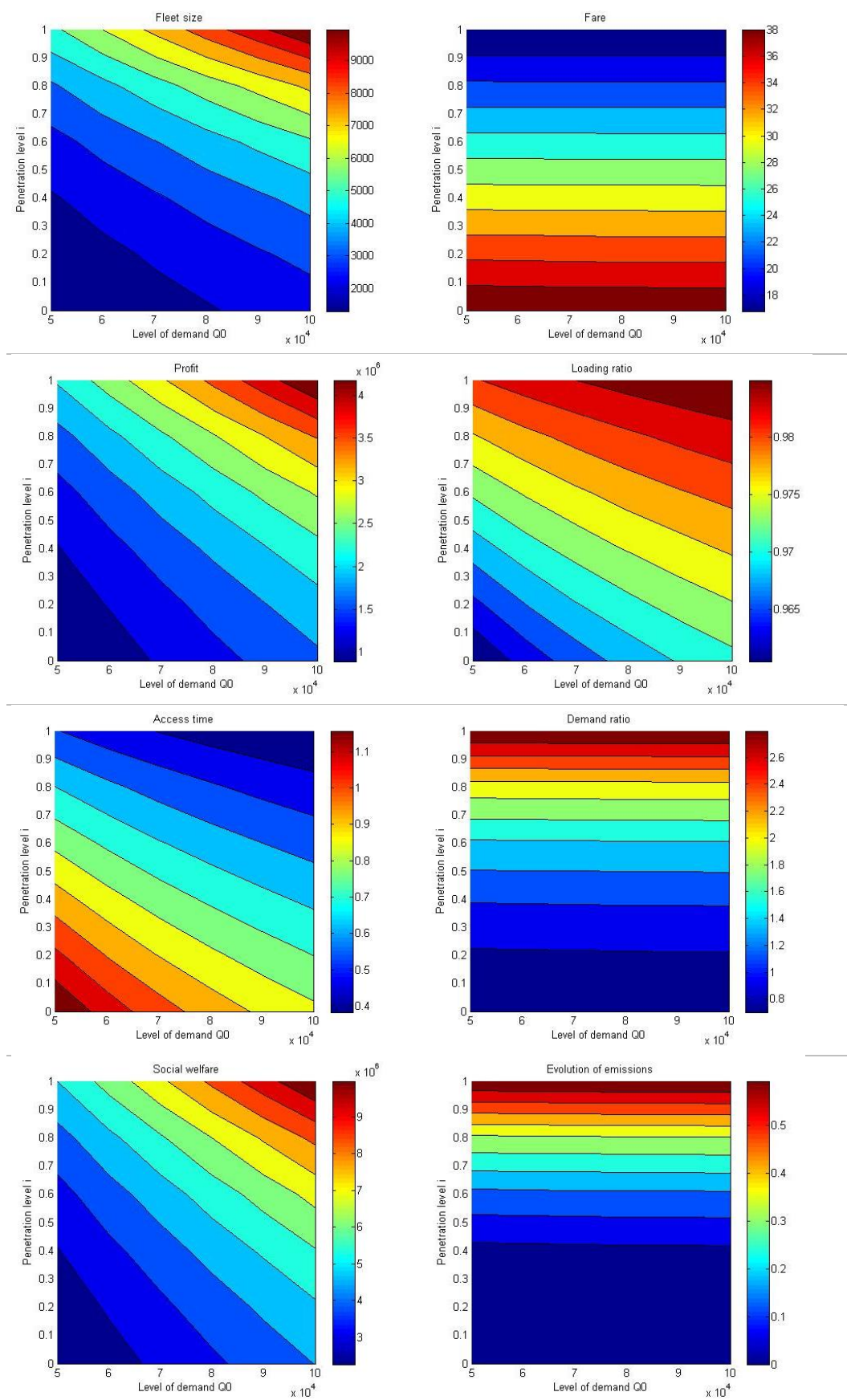

Figure 32 Results of profit maximization w.r.t demand and AV penetration levels

Section III. Construction of a microeconomic model for assessment of management strategies with application on Orbicity taxi service

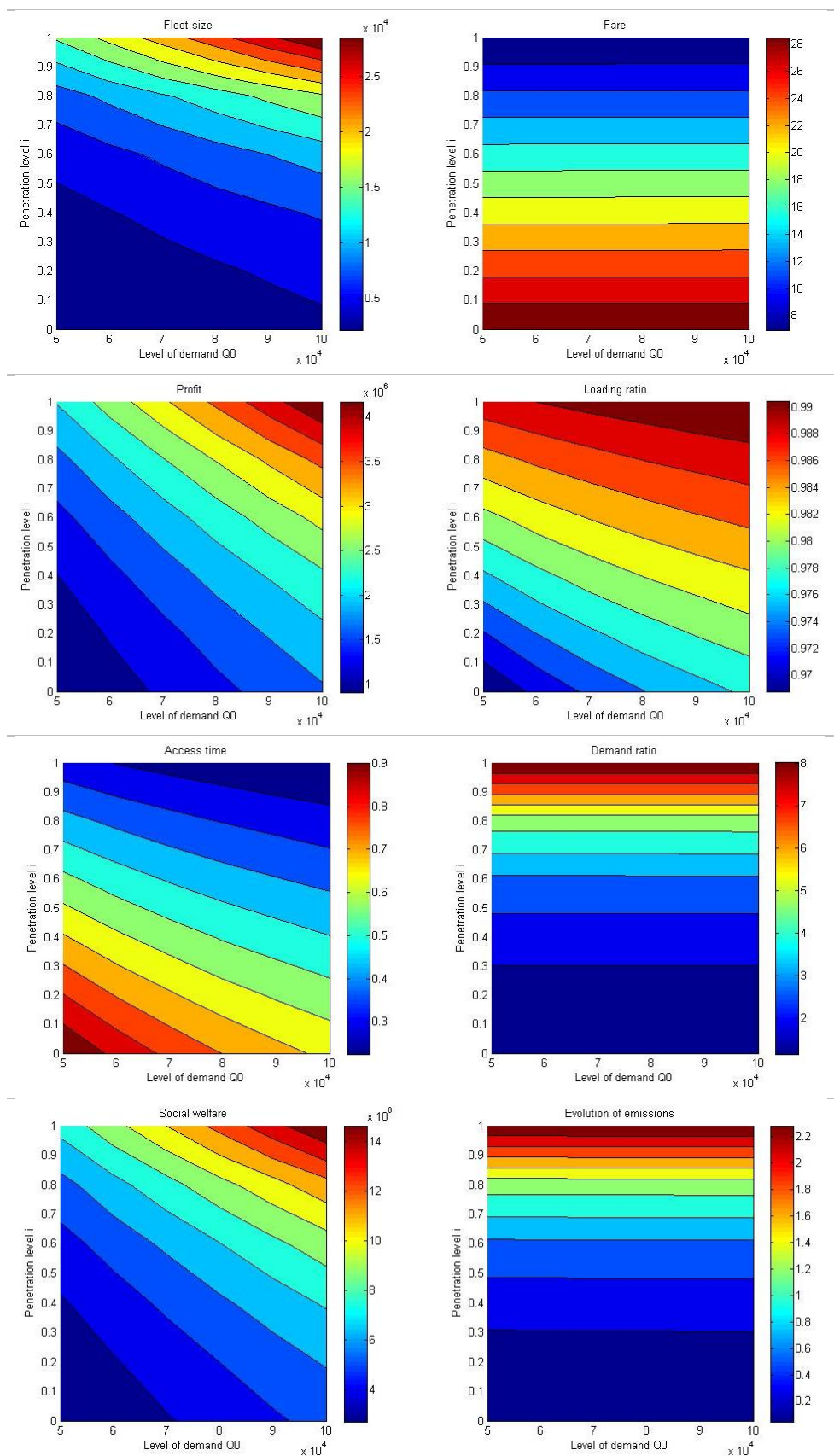

Figure 33 Results of welfare maximization w.r.t demand and AV penetration levels



The indicators of social welfare maximization exhibit the same evolution with respect to  $\gamma$  and  $i$  compared to the profit problem. The social welfare maximization suggests an increase of the fleet size (from 5,000 for  $i = 0$  to 20,000 vehicles for  $i = 1$ ) and a reduction of fares (1 to 3 €/km). In addition, the waiting time is less than 1 minute. As result, the number of passengers is greater compared to profit maximization problem: from 200 % (for  $i = 0$ ) to 800 % of  $Q_0$  (for  $i = 1$ ). In turn, operational performances (i.e. loading ratio), social performances (i.e. welfare) and environmental impacts (i.e. emissions) are also improved.

### Comparison to other cities

Consider two other French cities, Saint-Malo and Rennes. This choice is motivated by our objective of considering French cities which have different sizes and demand and supply composition.

Figure 34, Figure 35 and Figure 36 present satellite maps of respectively Paris, Saint-Malo and Rennes.

Saint-Malo is a small city, with an area of 36 km<sup>2</sup> and a density of 1,280 inhabitants per km<sup>2</sup>. The generalization of a limitation of 30 km/h in urban zones is under process. We consider then that the speed is limited at 30 km/h. The fare of taxis is composed of a base fare of 2.8 €, a mileage cost of 1.62 €/km and a minute cost of 0.43 €/min (Taxis-de-France, 2018).

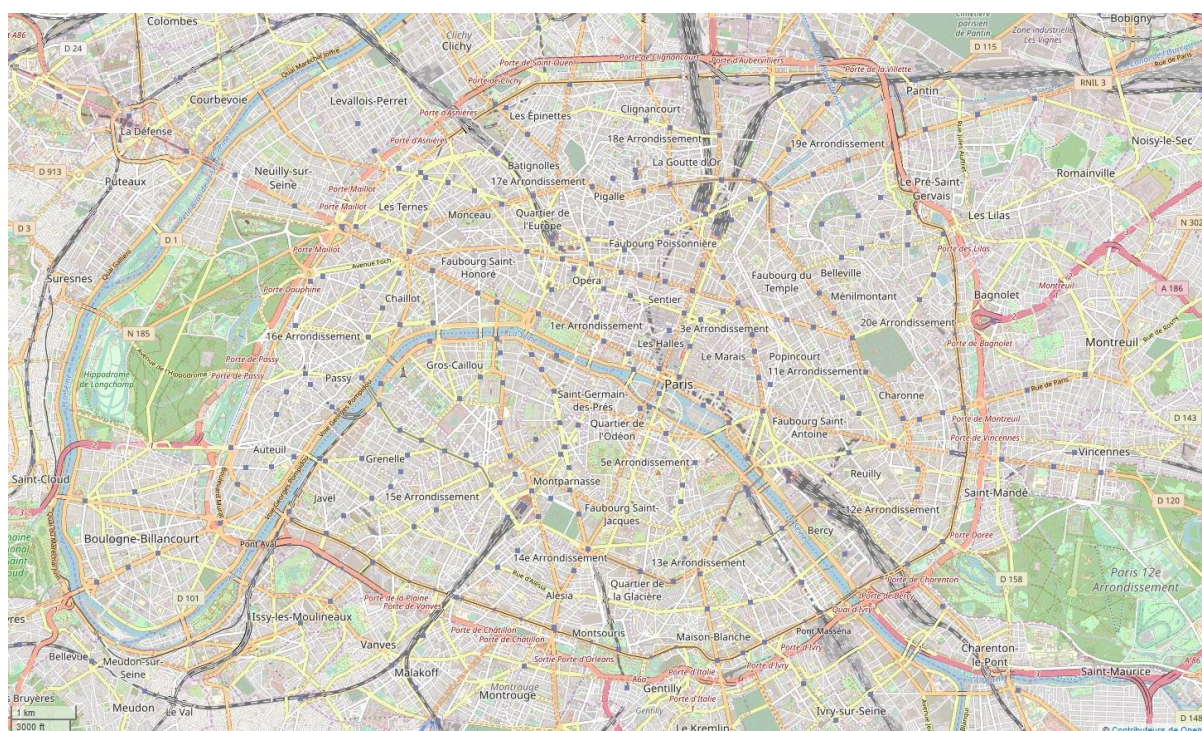

Figure 34 Satellite map of Paris



Section III. Construction of a microeconomic model for assessment of management strategies with application on Orbicity taxi service

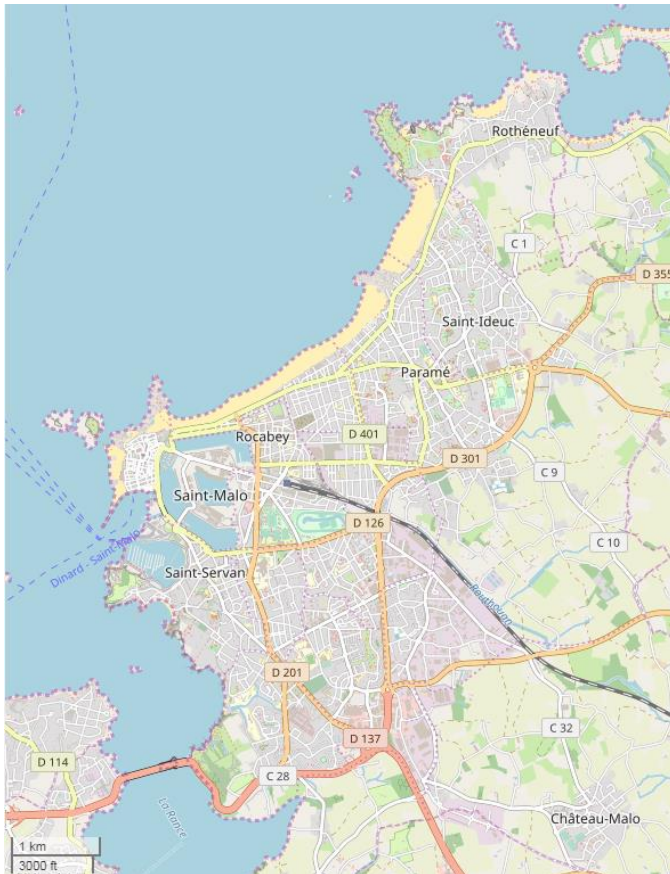

Figure 35 Satellite map of Saint-Malo

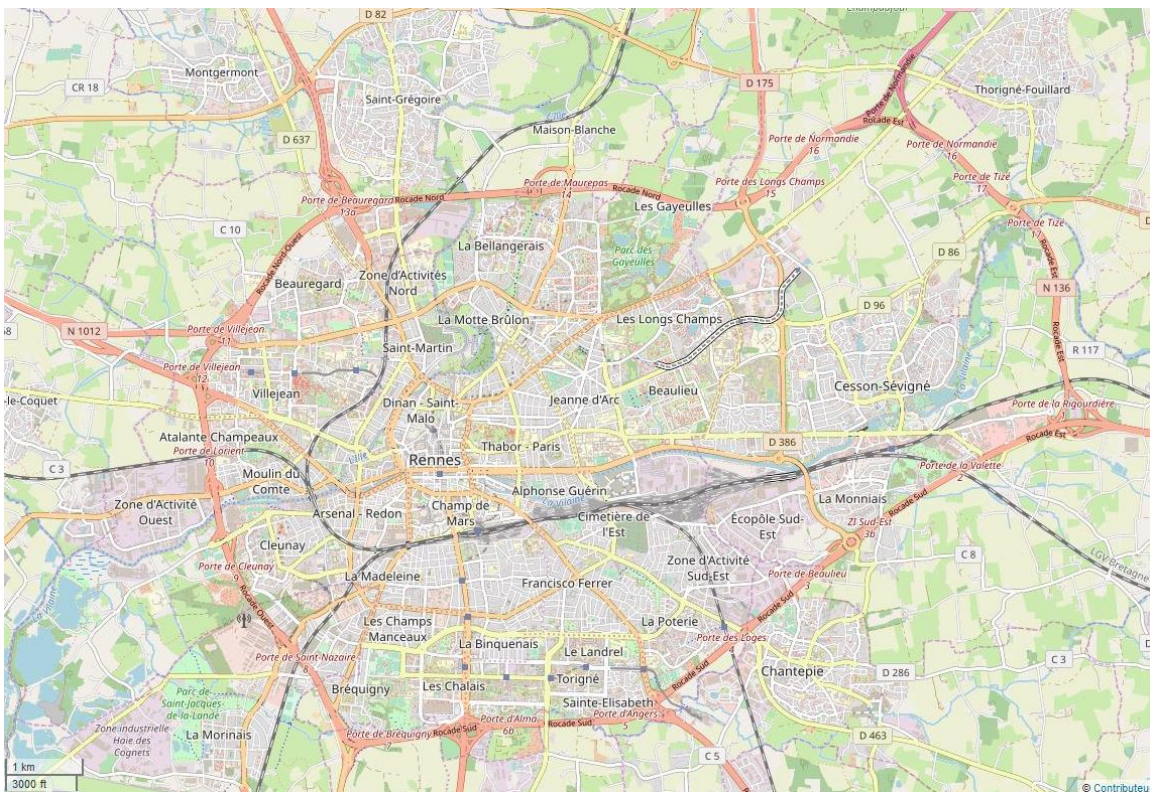

Figure 36 Satellite map of Rennes

Conversely, Rennes is a medium-size city, between Paris and Saint-Malo. Its area is about 50 km<sup>2</sup> and the density is 4,000 inhabitants per km<sup>2</sup>. In the absence of data, we assume that the average running speed in Rennes is 25 km/h, between Paris and Saint-Malo. Since Rennes and Saint-Malo belong to the same department, the tariff is the structure according to the same values: a base fare of 2.8 €, a mileage cost of 1.62 €/km and a minute cost of 0.43 €/min (Taxis-de-France, 2018).

The demand of reference  $Q_0$  is calculated for Saint-Malo and Rennes as proportional to the population. In addition, the average waiting time increases when the population density decreases (Yang & Wong, 1998; Paper & Shapiro, 2018). Since we considered that the average waiting time of a ridesourcing service is 3 minutes in Paris, we assume that in Rennes it is 4 minutes and in Saint-Malo 5 minutes. The elasticity of demand to the generalized cost depends on the population density (De Jong & Van de Riet, 2008; Litman, 2017). Passengers in the least densely populated areas have significantly higher mileages compared to those in the most densely populated areas. We considered until now that drivers in Paris have a price elasticity (i.e. monetary part of the generalized cost) equal to -1.49. For Rennes and Saint-Malo, less densely populated cities, the elasticity is then considered of -1.65 and -1.8 respectively. Elasticities to generalized costs derive from assumption (10) (§4.2.1.). Note that these estimations are emitted here in order to achieve the comparison between cities and assess the impact of strategic decisions on the business activity. Further sensitivity analysis on values of elasticity is required for more rigorous study.

Regarding production costs, we assume that running costs depend on national context and are the same for the three cities. Drivers' wages, however, vary from each French region to another (INSEE, 2016). Highest wages, in Paris, corresponds to 2,400 €/month which involves that fixed costs are equal to 400 €/day. Based on ratios of French region wages (INSEE, 2016), drivers' wages are 1,600 €/month for Saint-Malo and Rennes, so 280 €/day as fixed costs. In the case of autonomous cars, fixed costs do not vary from city to another.

**Table 20** presents demand and supply inputs characteristics for Saint-Malo, Rennes and Paris.

**Table 20 Demand and supply inputs for Saint-Malo, Rennes and Paris**

City		Saint-Malo	Rennes	Paris
Radius (km)	$R$	3.3	4.0	5.6
Area (km <sup>2</sup> )	$A$	35	50	100
Travel time between two points on the edge (min)	$t_0$	21.0	30.0	62.0
Reference demand	$Q_0$	1,000	4,700	50,000
Travel distance (km)	$d_{IVH}$	5.2	6.3	9
Speed (km/h)	$v$	30	25	17
Travel time (min)	$t_{IVH}$	13.5	20.0	30.0
Waiting time (min)	$t_A$	5	4	3
Matching time (min)	$t_m$	2	2	2
Time cost (€)		10.8	11.1	12.0
Generalized cost of ref (€)	$g_0$	23	26	43
Elasticity to generalized cost	$\epsilon_g$	-3.16	-2.72	-2.28
Elasticity to price	$\epsilon_\tau$	-1.8	-1.65	-1.49
Fixed costs (€/veh.day)	$\chi$	280	280	400

Results are presented in **Table 21** and **Table 22**.

**Table 21** shows that highest-density cities attract more passengers, which improves the service efficiency and thus the profit. In addition, in larger cities, where the sensitivity to price is lower, the potential demand is greater and results in higher fares. Automation involves greater fleet sizes (greater 7 times in Paris), then lower access times. The fare is also reduced, and more emissions are avoided.

**Table 22** shows similar evolution in terms of level of service, loading rate of vehicles and demand attracted. The larger is the city, the greater are the profit and the social welfare. Autonomous cars reduce significantly fares and increase dramatically the fleet size. The access time for aTaxi is about 1 minute, which suggests that taxis are always located near to the request, and then involves almost zero empty mileage and 100 % loading ratio. That results in greater profit compared to conventional cars: higher by 1.6, 1.8 and 3 times for Paris, Rennes and Saint-Malo respectively, and greater social welfare: higher by 2.3, 3.2 and 5 times for Paris, Rennes and Saint-Malo respectively. On the other hand, autonomous cars enable to avoid more emissions than conventional taxis, because of the shift of cars' drivers to aTaxi.

**Table 21 Results of profit maximization for three French cities and two automation scenarios (0% and 100% of fleet)**

Profit maximization		Conventional cars			Autonomous cars		
		St-Malo	Rennes	Paris	St-Malo	Rennes	Paris
Supply conditions	Fleet size	11	90	1,718	89	425	9,400
	Fare (€)	23	23.36	34.35	7.22	8.72	11.10
Supply-demand equilibrium	Access time (min)	9	3.36	1	2.5	1.4	0.4
	Demand per day	3,380	2,300	46,700	2,300	11,500	260,000
Performance indicators	Profit (k€/day)	2.6	28	919	12	78	2,400
	Loading rate	77 %	89 %	96 %	92 %	95 %	98 %
	Social welfare (k€/day)	6.8	73	2,537	31	203	6,700
	Emissions (%)	0 %	0 %	0 %	-12 %	-22 %	- 210 %

**Table 22 Results of social welfare maximization for three French cities and two automation scenarios (0% and 100% of fleet)**

Social welfare maximization		Conventional cars			Autonomous cars		
		St-Malo	Rennes	Paris	St-Malo	Rennes	Paris
Supply conditions	Fleet size	17	126	2,516	200	1,000	25,300
	Fare (€)	19	19.3	27.5	3.37	3.61	3.77
Supply-demand equilibrium	Access time (min)	7.35	2.8	0.88	1.7	0.88	0.25
	Demand per day	775	2,800	68,870	5,400	28,000	708,000
Performance indicators	Profit (k€/day)	2.6	27	887	8	50	1,430
	Loading rate	80 %	91 %	97 %	94 %	97 %	99 %
	Social welfare (k€/day)	8.3	84	2,900	41	270	8,900
	Emissions (%)	0 %	0 %	- 19 %	-41 %	-77 %	- 260 %

## 5. DISCUSSION AND CONCLUSION

The Chapter presents a formal expression of the strategic model framework proposed in Chapter.5. The relations between model's layers are described using schemes and formulas while considering pressure forces. The mathematical formulation is supported by the literature review.

The flexibility of the model is tested using a very specific case, Orbicity taxis service. In a circular Orbicity, taxis are running along its edges with a constant speed and only when requests are emitted. The availability of vehicles is described by the access time. The travel time, on the other hand, is assumed as a function of the Orbicity radius. From the demand side, passengers have same travel's preferences and are generated uniformly along the day. The model of Orbicity assesses performances of an on-demand service with fixed itinerary having elliptic or circular form.

The profit and social welfare are maximized firstly for Paris area. They point out the impacts of automation and demand density on the service performances. Orbicity, as an aggregated probabilistic model, helps then investigate the impacts of strategic decisions through considering three French cities having different demand characteristics. Results confirm that automation improves aTaxis performances. In particular, for a given city, the smaller is its size, the greater is the impact of automation. However, the performance indicators are widely better for larger and highest-density cities, regardless whether or not vehicles are autonomous.

This Chapter presents, however, some limitations. At the operational layer, the mode preference factor is critical to capture non-quantitative effects. However, the value of mode preference factor is not known for ridesourcing as emergent service. In addition, the demand-supply equilibrium should be investigated using exact and/or heuristic methods depending on the supply and demand functions. At the tactical layer, costs do not describe in detail dispatching costs. In addition, costs of support functions are ignored. The maximization problem deals furthermore with profit and social welfare. Additional problems deserve to be explored as maximization of occupancy mileage rate, second-optimum problem (i.e. maximizing the social welfare for a positive profit), and the total social welfare, which incorporates costs of externalities in the social welfare. At the strategic layer, additional indicators reflecting the economic and technical performances will improve the model. For instance, the net present value and the rate of return describe respectively the profitability of a projected investment and the profit on an investment over a given period study.

The application case of Orbicity presents also few limitations. Firstly, the demand is generated uniformly and all users have an average travel distance depending on the network size. That affects also the service performances and does not reflect necessarily the real situation. Secondly, the framework does not consider existing modes and their impact on users' choice. In particular, the utility of the service does not include the mode preference. Furthermore, neglecting other modes induces misevaluation of congestion impacts on travel and access time, so a misevaluation of the service quality. Finally, ridesharing is not simulated. The ability to share the trip would increase the service's



performances from the operator's standpoint, but also for public authorities and users. Studies to include ridesharing in Orbicity are underway (Leurent, 2018).

As future developments of the mathematical model, the impact of competition through considering sensitivity of demand to other mobility supply should be measured. In particular, the evolution of demand with respect to the mode preference needs to be investigated through an application on a real case study. The demand evolves with new mobility offers and evolutions of mobility costs. Automations would improve comfort and reduce time lost in transport. That might induce modes changes and increase attractiveness of AVs in comparison with transit modes. Encouraging aTaxis would have in this case negative impacts from the point of view of public authorities. As a result, in addition to social and environmental impacts, public authorities should analyze the origin of demand in order to have an overall picture of the impacts of urban mobility.

For Orbicity model, studies are conducted to include the ridesharing. In addition, transfers between "two Orbicity infrastructures" would permit to analyze coordination between vehicles, complementarities with other modes and simulating door-to-door trips as well.

Finally, an application on a real case study (e.g. real network and real demand data) with a model which describes in detail movements of taxis in interaction with passengers is a fundamental to validate the potential of our framework.

## REFERENCES

- Asif, H. & Vinayak, V. D., 2015. Evaluating Subjective Beliefs of Travel Time of Taxi Drivers. Melbourne, Victoria, Australia, s.n.
- Boesch, P., Becker, F., Becker, H. & Axhausen, K. W., 2018. Cost-based analysis of autonomous mobility services. *Transport Policy*, May, Volume 64, pp. 76-91.
- Borja, A., Barreda, R., dell'Olio, L. & Ibeas, A., 2018. Modelling user perception of taxi service quality. *Transport Policy*, Volume 63, pp. 157-164.
- Buchholz, N., 2018. Spatial Equilibrium, Search Frictions and Efficient Regulation in the Taxi Industry. s.l.:s.n.
- Ciari, F. & Axhausen, K. W., 2012. Choosing carpooling or carsharing as a mode: Swiss stated choice experiments. Transportation Research Board Annual meeting.
- De Jong, G. & Van de Riet, O., 2008. The Driving Factors of Passenger Transport. *European Journal of Transport and Infrastructure Research*, 8(3).
- Dell'Oro, J.-L., 2014. Depuis l'arrivée de Delanoë à Paris, les taxis et les bus circulent beaucoup moins vite. [Online]  
[Accessed 20 August 2018].
- Delucchi, M., 1998. Emissions of Criteria Pollutants, Toxic Air Pollutants, and Greenhouse Gases, from the Use of Alternative Transportation Modes and Fuels, Berkeley: UC Transport.
- Douglas, G., 1972. Price regulation and optimal service standards. *Journal of Transport Economics and Policy*, pp. 116-127.
- Dubernet, T., Rieser-Schüssler, N. & Axhausen, K. W., 2013. Using a Multi-agent Simulation Tool to Estimate the Carpooling Potential. Proceedings of the 92th annual meeting of Transportation Research Board.
- Ecomotion, 2018. Electrique vs Thermique. [Online]  
Available at: <http://eco-motion.fr/content/10-electrique-vs-thermique.html>
- El Hassani, J., 2018. Prix Uber 2018 : tarifs des courses à Paris, Lyon et vers les aéroports. [Online]  
Available at: <https://www.journaldunet.fr/patrimoine/guide-des-finances-personnelles/1209180-prix-uber-2018/>

- Fan, Y., Guthrie, A. & Levinson, D., 2016. Perception of Waiting Time at Transit Stops and Stations. *Transportation Research Part A: Policy and Practice*, Volume 88, pp. 251-264.
- Fries, M. et al., 2017. An Overview of Costs for Vehicle Components, Fuels, Greenhouse Gas Emissions and Total Cost of Ownership, Update 2017, s.l.: UC. Davis.
- Hall, J., Kendrick, C. & Nosko, C., 2015. The effects of Uber's surge pricing: a case study, s.l.: s.n.
- Heidrich, O. et al., 2017. How do cities support electric vehicles and what difference does it make?. *Technological Forecasting and Social Change*, October, Volume 123, pp. 17-23.
- INSEE, 2016. Les salaires dans les régions en 2012. [Online]  
Available at: <https://www.insee.fr/fr/statistiques/2508166>
- Lagune-Reutler, M., Guthrie, A., Fan, Y. & Levinson, D. M., 2016. Transit Riders' Perception of Waiting Time and Stops' Surrounding Environments.. *Transportation Research Board*.
- Leurent, F. & Berrada, J., 2018. Towards a microeconomic theory of For-Hire Services. *Proceedings of 7th Transport Research Arena TRA*.
- Leurent, F. & Windisch, E., 2015. Benefits and costs of electric vehicles for the public finances: An integrated evaluation model based on input-output analysis, with application to France,. *Research in Transportation Economics*.
- Litman, T., 2017. Understanding Transport Demands and Elasticities. How Prices and Other Factors Affect Travel Behavior, s.l.: Victoria Transport Policy Institute.
- Muro-Rodríguez, A. I., Perez-Jiménez, I. R. & Gutiérrez-Broncano, S., 2017. Consumer Behavior in the Choice of Mode of Transport: A Case Study in the Toledo-Madrid Corridor. *Frontiers in Psychology*, Volume 8, p. 1011.
- NKA, 2017. Quel est le salaire d'un chauffeur de taxi à Paris en 2017?. [Online]  
Available at: <https://www.nkaconseils.fr/quel-est-le-salaire-dun-chauffeur-de-taxi-a-paris-en-2017/>
- Palmer, K., Tate, J., Wadud, Z. & Nellthorp, J., 2018. Total cost of ownership and market share for hybrid and electric vehicles in the UK, US and Japan. *Applied Energy*, Volume 209, pp. 108-119.
- Paper, J. M. & Shapiro, M. H., 2018. Density of Demand and the Benefit of Uber, s.l.: s.n.
- Parthasarathi, P., Levinson, D. & Hochmair, H., 2013. Network Structure and Travel Time Perception. *PLoS ONE*, 29 October, p. e77718.
- Peruch, P., Giraudo, M.-D. & Garling, T., 1989. Distance cognition by taxi drivers and the general public. *Journal of Environmental Psychology*, September, 9(3), pp. 233-239.
- Pommier, S., 2018. Les vrais chiffres du marché des VTC et des taxis en France. [Online]  
Available at: [https://lexpansion.lexpress.fr/entreprises/les-vrais-chiffres-du-marche-des-vtc-et-des-taxis-en-france\\_1985813.html](https://lexpansion.lexpress.fr/entreprises/les-vrais-chiffres-du-marche-des-vtc-et-des-taxis-en-france_1985813.html)
- Quinet, E., 2013. L'évaluation socio-économique en période de transition. *Valeurs du temps*, s.l.: France Stratégie. Commissariat général à la stratégie et à la prospective..
- Richter, C. & Keuchel, S., 2012. Modelling Mode Choice in Passenger Transport with Integrated Hierarchical Information Integration. *Journal of Choice Modelling*, 5(1), pp. 1-21.
- Rietveld, P., Zwart, B., van Wee, B. & van den Hoorn, T., 1999. On the relationship between travel time and travel distance of commuters. *The Annals of Regional Science*, 33(3), p. 269-287.
- Swoboda, A. J. T., 2015. *New York City Taxicab Transportation Demand Modeling for the Analysis of Ridesharing and Autonomous Taxi Systems*, s.l.: Princeton University.
- Taxis-de-France, 2018. Les tarifs 2018 des taxis par département. [Online]  
Available at: <https://www.taxis-de-france.com/tarifstaxis.php>
- Wibowo, S. S. & Chalermpong, S., 2010. Characteristics of Mode Choice within Mass Transit Catchments Areas. *Journal of the Eastern Asia Society for Transportation Studies*, Volume 8.
- Wong, R. C. P., Szeto, W. Y. & Wong, S. C., 2015. Behavior of taxi customers in hailing vacant taxis: a nested logit model for policy analysis. *Journal of Advanced Transportation*, Volume 49, p. 867-883.
- Yang, H., Cowina, W., Wong, S. & Michael, G., 2010. Equilibria of bilateral taxi-customer searching and meeting on networks. *Transport Research B*, Volume 44, pp. 1067-1083.
- Yang, H., Fung, C., Wong, K. & Wang, S., 2010. Nonlinear pricing of taxi services. *Transportation Research Part A Policy and Practice*, 44(5), pp. 337-348.

Yang, H., Wing, Y. L., Wong, S. C. & Lo, H. K., 2000. A macroscopic taxi model for passenger demand, taxi utilization and level of services. *Transportation*, Issue 27, pp. 317-340.

Yang, H. & Wong, S., 1998. A network model of urban taxi services. *Transport Research Part B*, 32(4), pp. 235-246.

Yang, H. & Yang, T., 2011. Equilibrium properties of taxi markets with search frictions. *Transportation Research Part B: Methodological*, 45(4), pp. 696-713.

Yang, H., Ye, M., Tang, W. & Wong, S., 2005. Regulating taxi services in the presence of congestion externalities. *Transportation Research Part A*, 39(1), p. 17-40.

## APPENDIX

### 1. Traffic equilibrium for Orbicity taxis service

Consider the equation of service availability:

$$t_A = \frac{t_0}{(N - \lambda(t_{IVH} + t_A))} \quad (1)$$

By noting  $\lambda = Q/H$ .

(Eq.1) could be written:

$$(N - \lambda(t_{IVH} + t_A))t_A = t_0$$

Then a second-degree equation:

$$\lambda t_A^2 + (\lambda t_{IVH} - N)t_A - t_0 = 0 \quad (2)$$

Which admits a solution if and only if the fleet verifies the condition:

$$\lambda t_{IVH} - N < -2\sqrt{\lambda t_0}$$

Or :

$$N > \lambda t_{IVH} + 2\sqrt{\lambda t_0} \quad (3)$$

The solution of (Eq.2) is then given by:

$$t_A = \frac{N - \lambda t_{IVH}}{2\lambda} \left( 1 - \sqrt{1 - \frac{8\lambda/\beta}{(N - \lambda t_{IVH})^2}} \right) \quad (4)$$

### 2. Profit maximization problem for Orbicity taxis service

Since  $N = \lambda(t_{IVH} + t_A) + t_0/t_A$ , optimizing the profit with respect to fleet is also equivalent to optimization with respect to access time. Then, the derivatives of profit with respect to fleet and fare could be expressed by (Eq.1) and (Eq.2):

$$\frac{\partial P_o}{\partial \tau} = Q + \left( \tau - \frac{\partial C_P}{\partial Q} \right) \frac{\partial D}{\partial \tau} = 0 \quad (5)$$

$$\frac{\partial P_o}{\partial t} = \left( \tau - \frac{\partial C_P}{\partial Q} \right) \frac{\partial D}{\partial t} - \frac{\partial C_P}{\partial t} = 0 \quad (6)$$

Since  $C_P(N, Q) = \chi N + c_u(t_A + t_{IVH})Q$ , derivatives of cost are:

$$\frac{\partial C_P}{\partial Q} = \chi \frac{\partial N}{\partial Q} + c_u(t_A + t_{IVH}) = \frac{\chi}{H}(t_A + t_{IVH}) + c_u(t_A + t_{IVH}) = c_u^+ t_A + \zeta \quad (7)$$

$$\frac{\partial C_P}{\partial t} = \chi \frac{\partial N}{\partial t} + Q c_u = \chi \left( \lambda - \frac{t_0}{(t_A)^2} \right) + Q c_u = Q c_u^+ - \chi \frac{t_0}{t_A^2} \quad (8)$$

Where  $c_u^+ = c_u + \chi/H$  and  $\zeta = c_u t_{IVH} + \chi t_{IVH}/H$

Given a demand sensitive to the generalized cost only according to an elastic relation:  $Q = D(g) = Q_0(g/g_0)^\epsilon$  where  $g = \tau + \alpha(t_A + t_{IVH} + t_m)$  then

$$\frac{\partial D}{\partial \tau} = \frac{\partial D}{\partial g} = \frac{\epsilon Q}{g} \quad (9)$$

$$\frac{\partial D}{\partial t} = \alpha \frac{\partial D}{\partial g} = \alpha \frac{\epsilon Q}{g} \quad (10)$$

By combining equations of maximization (Eq.1) and (Eq.2), derivatives of costs (Eq.3) and (Eq.4) and demand variations (Eq.5) and (Eq.6), resolving (Eq.1) and (Eq.2) :

$$\begin{cases} \tau - (c_u^+ t_A + \zeta) = -\frac{Q}{\frac{\partial D}{\partial \tau}} = -\frac{g}{\epsilon} \\ (\tau - (c_u^+ t_A + \zeta)) \alpha \frac{\epsilon Q}{g} = \left( Q c_u^+ - \chi \frac{t_0}{t_A^2} \right) = -\alpha Q \end{cases}$$

Then:

$$\begin{cases} \epsilon \tau - \epsilon (c_u^+ t_A + \zeta) = -(\tau + \alpha(t_A + t_{IVH} + t_m)) \\ \chi \frac{t_0}{Q t_A^2} = c_u^+ + \alpha \end{cases}$$

Or:

$$\begin{cases} (1 + \epsilon) \tau = \epsilon \zeta + (\epsilon c_u^+ - \alpha) t_A - \alpha(t_{IVH} + t_m) \\ \chi \frac{t_0}{Q t_A^2} = c_u^+ + \alpha \end{cases}$$

The optimal fare and access time are then provided by:

$$\begin{cases} \tau = \frac{1}{(1+\epsilon)} (\epsilon\zeta + (\epsilon c_u^+ - \alpha)t_A - \alpha(t_{IVH} + t_m)) \\ t_A = \sqrt{\frac{\chi t_0}{(\alpha + c_u^+)Q}} \end{cases}$$

Finally, the generalized cost is:

$$\begin{aligned} g &= \frac{1}{(1+\epsilon)} (\epsilon\zeta + (\epsilon c_u^+ - \alpha)t_A - \alpha(t_{IVH} + t_m)) + \alpha(t_{IVH} + t_m + t_A) \\ &= \frac{\epsilon\zeta - \alpha(t_{IVH} + t_m)}{(1+\epsilon)} + \alpha(t_{IVH} + t_m) + \left( \alpha + \frac{(\epsilon c_u^+ - \alpha)}{1+\epsilon} \right) \sqrt{\frac{\chi t_0}{(\alpha + c_u^+)Q}} \\ &= \frac{\epsilon}{(1+\epsilon)} \left( \zeta + \alpha(t_{IVH} + t_m) + \sqrt{\frac{\chi(\alpha + c_u^+)t_0}{Q_0} \left( \frac{g_0}{g} \right)^\epsilon} \right) \end{aligned}$$

### 3. Social welfare maximization problem for Orbicity taxis service

The maximization of social welfare with respect to fare and access time is expressed by (Eq.11) and (Eq.12):

$$\frac{\partial P_S}{\partial \tau} = \tau - \frac{\partial C_P}{\partial Q} = 0 \quad (11)$$

$$\frac{\partial P_S}{\partial t} = -\alpha Q - \frac{\partial C_P}{\partial t} = 0 \quad (12)$$

By incorporating (Eq.7) and (Eq.8):

$$\begin{cases} \tau = (c_u^+ t_A + \zeta) \\ \alpha Q = - \left( Q c_u^+ - \chi \frac{t_0}{t_A^2} \right) \end{cases}$$

Or even:

$$\begin{cases} \tau = (c_u^+ t_A + \zeta) \\ t_A = \sqrt{\frac{\chi t_0}{(\alpha + c_u^+)Q}} \end{cases}$$

Finally, the generalized cost is:

$$\begin{aligned} g &= \zeta + \alpha(t_{IVH} + t_m) + (c_u^+ + \alpha) \sqrt{\frac{\chi t_0}{(\alpha + c_u^+)Q}} \\ &= \zeta + \alpha(t_{IVH} + t_m) + \sqrt{\frac{\chi(c_u^+ + \alpha)t_0}{Q_0} \left( \frac{g_0}{g} \right)^\epsilon} \end{aligned}$$

# Section IV. Application case

This section proposes an application case of the microeconomic model developed in Section III.

It is organized into two Chapters:

- **Chapter.7 Towards practical implementation of autonomous taxis service: Territorial diagnostic, network design and social acceptance.** This Chapter describes the application case. It explores the land use, the population composition and jobs distribution. The network of the autonomous taxis service is designed considering geographic, demand and supply constraints. In addition, the social acceptance is assessed using a stated-preference survey.
- **Chapter.8 Demand modelling of autonomous shared taxis mixed with scheduled transit and Application of the strategic framework on Palaiseau area.** The strategic framework is applied on Paris Palaiseau area. A demand framework is developed in order to model aTaxis while considering scheduled transit.

## **Chapter.7 Towards practical implementation of autonomous taxis service: Territorial diagnostic, network design and social acceptance**

### **ABSTRACT**

This Chapter introduces a real case study to assess the framework defined in Section III. This case study is the territory of Saclay, in Palaiseau, Southwest of the Paris region and home to the development of the French scientific cluster.

This Chapter explores the geographic and demographic particularities and provides the diagnostic of the territory. A network of aTaxis is then proposed to connect the main train station in the zone to the scientific cluster, while ensuring the feeding in residential areas. Finally, the Chapter analyses potential uses of aTaxis based on a Stated-Preference (SP) survey. It found that the service will likely be used for short-distance (2 to 5 km) commuting trips by two user profiles: (1) non-motorized young users (less than 30 years old) and (2) motorized active population between 30 and 50 years old.

*Keywords:* Territorial diagnostic, service design, stated-preference survey, acceptance, autonomous taxis

### **1. INTRODUCTION**

#### *1.1. Background*

EVAPS (Eco-Mobility using Autonomous Vehicles in Paris-Saclay Area) is a French project that aims to develop a service of autonomous electric on-demand vehicles. In particular, the project equips roads by technologies that will assist Autonomous Vehicles, and ensures thereafter the infrastructure maintenance and the service management. In addition, EVAPS investigates the acceptability of the service and its performances from the economic, social and environmental perspectives. The project is led by VEDECOM, Renault, Transdev, SystemX and the university Paris-Saclay and will be implemented in Paris Saclay area by 2020.

#### *1.2. Objective*

This Chapter aims (1) to introduce the area of implementation, particularly the geographic typology, the demographic structure, mobility needs and existing transport supply, (2) to design the service of autonomous taxis (aTaxis), based on an exploration of exogenous systems and decisions variables and (3) to assess its acceptance by users on the basis of a stated-preference survey.

### 1.3. Methods

The Chapter combines three methodological approaches. Firstly, an analysis of geographic and sociodemographic characteristics as well as existing transport systems enables to understand the mobility needs of the territory. Then, the aTaxis infrastructure is designed to meet these needs while taking into consideration the main specifications of the EVAPS project. Finally, the acceptance of the service is based on a Stated-Preference (SP) survey that has been conducted with 600 respondents living or working in the area.

### 1.4. Structure

Firstly, we present a territorial diagnostic (§2.), starting from the geographic typology, describing the population and jobs distribution across the area and exploring both mobility practices and available transport supply. Secondly, the infrastructure of the service is designed (§3.). Finally, the design and results of the SP survey are presented (§4.).

## 2. TERRITORIAL DIAGNOSTIC

### 2.1. Overall presentation of the study area

Palaiseau is located around 17 km Southwest from the center of Paris. It is open from the North yet bounded from East by Massy-Palaiseau station, from West by IRT SystemX and EDF Campus and from South by the line RER B.

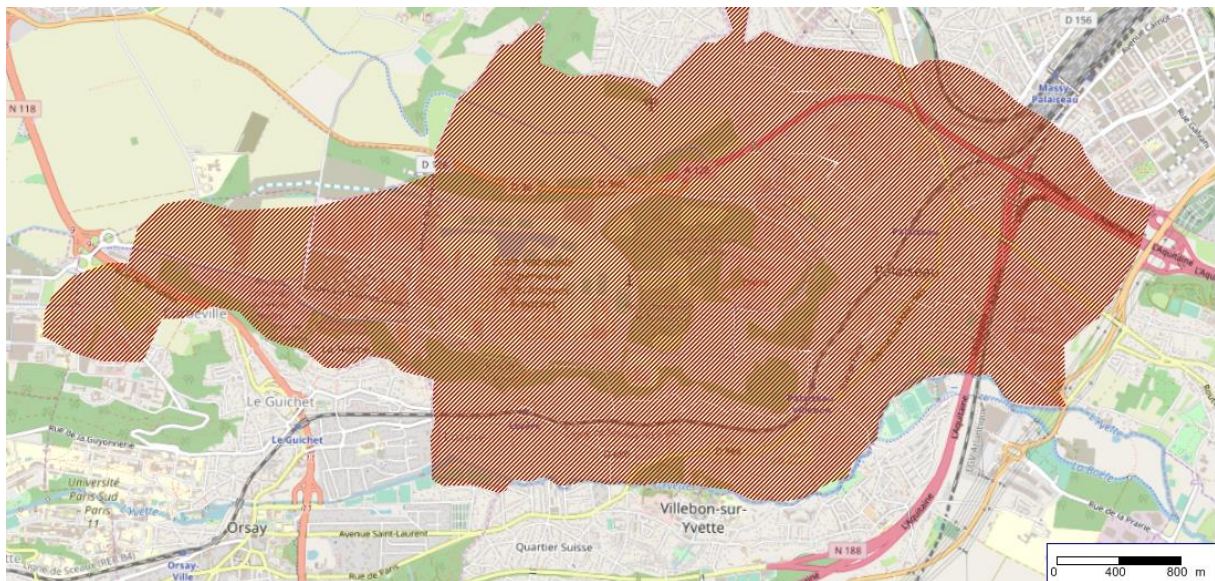

**Figure 37 Palaiseau City**

From the geographic perspective, the study area is characterized by high slopes descending from the North (about 160 m at Ecole Polytechnique) right down to the South (about 60 m at Orsay). The rail-line RER B and the road corridor are located along lower altitudes. Hence,



the topography constrains the implementation of transport systems, mainly those linking North and South.

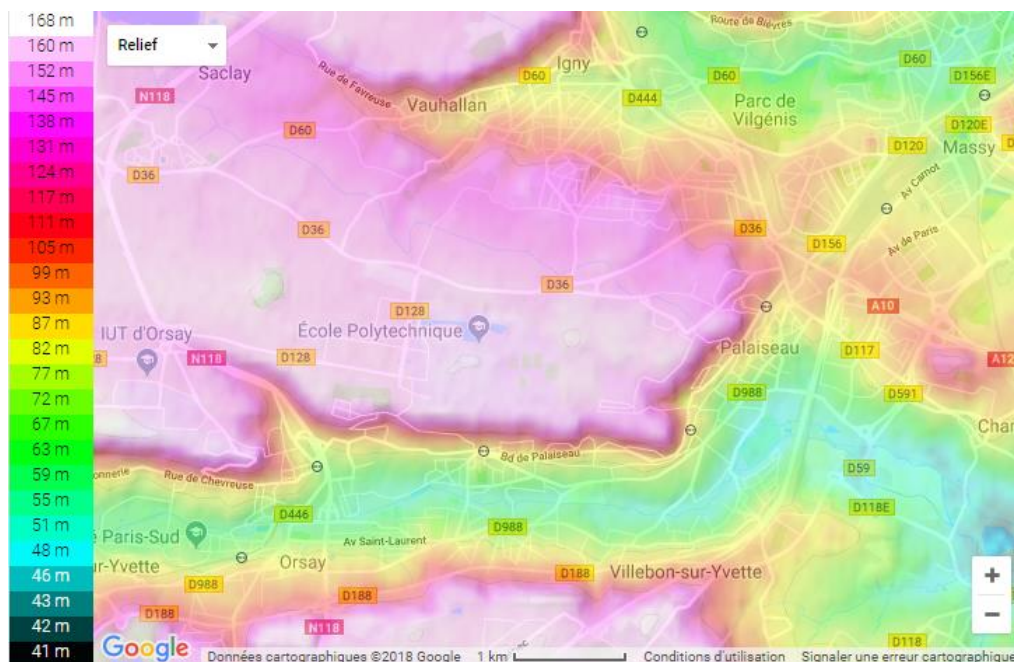
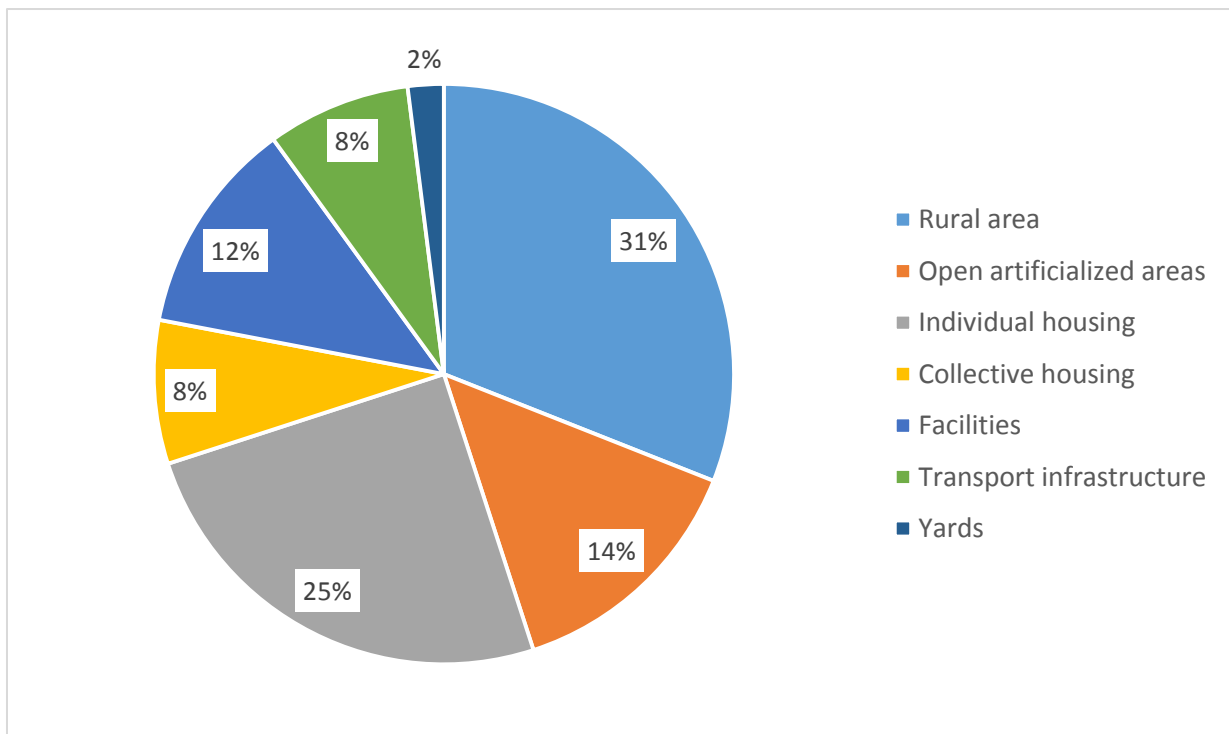

Figure 38 Topography altitudes at Palaiseau

### 2.2. Land use and urbanization

According to land use data (IAU, 2012), the total area is about 1,163.6 ha (i.e. 12km<sup>2</sup>). The pie chart below, based on data from IAU-IDF, represents the detailed distribution of the territory by all types of land use in 2012. The urbanization rate is of 70 %, while 30 % of the area is occupied by forests and agricultural land.



**Figure 39 Land use in Palaiseau city (IAU, 2012)**

### 2.2.1. Population characterization

Palaiseau is home to about 33,114 inhabitants (INSEE, 2018). The distribution of population is heterogeneous: a very high concentration in North-East and South compared to the center. The density of population varies from 2,516 in 2011 to 2,820 inhabitants per km<sup>2</sup> in 2016.

The main socio-economic characteristics of the population include that (INSEE, 2018):

- The distribution of gender is balanced: 52 % of men and 48 % of women (2014).
- The active population is constituted of 24 % of persons aged 15 to 24 years old, 59 % aged 25 to 54 years old and 17 % aged 55 to 64 years old. Note that students of Ecole Polytechnique are included in the active population, since they are employees of the Ministry of Defense.
- Annual births represent about 3.1 times the annual amount of deaths.
- The activity rate is about 74 %. The evolution of activity rates is presented by **Table 23**.
- The high and intermediate professions are occupied by more than 65 % of inhabitants.

**Table 23 Activity ratios of the Palaiseau population: 2011-2015 evolution**

	<b>2015</b>	<b>2011</b>
<b>Population</b>	33,114	30,316
<b>Active population</b>	73.80%	75.50%
Employed	92.30%	92.10%
Unemployed	7.70%	7.90%
<b>Inactive population</b>	26.20%	24.50%
Students	60.90%	57.20%
Retired	21%	25.10%
Others	18.10%	17.70%

The average size of households is 2.4 persons per household (INSEE, 2018). The median revenue per household is about 26,300€. 52.4 % of households are living in Palaiseau for more than 10 years, and 57 % are housings' owners. Households living in Palaiseau for less than 2 years present only 10 % (INSEE, 2018).

**Figure 40** and **Figure 41** depict the distribution of population and density respectively. The distribution is based on IRIS<sup>12</sup> zones.

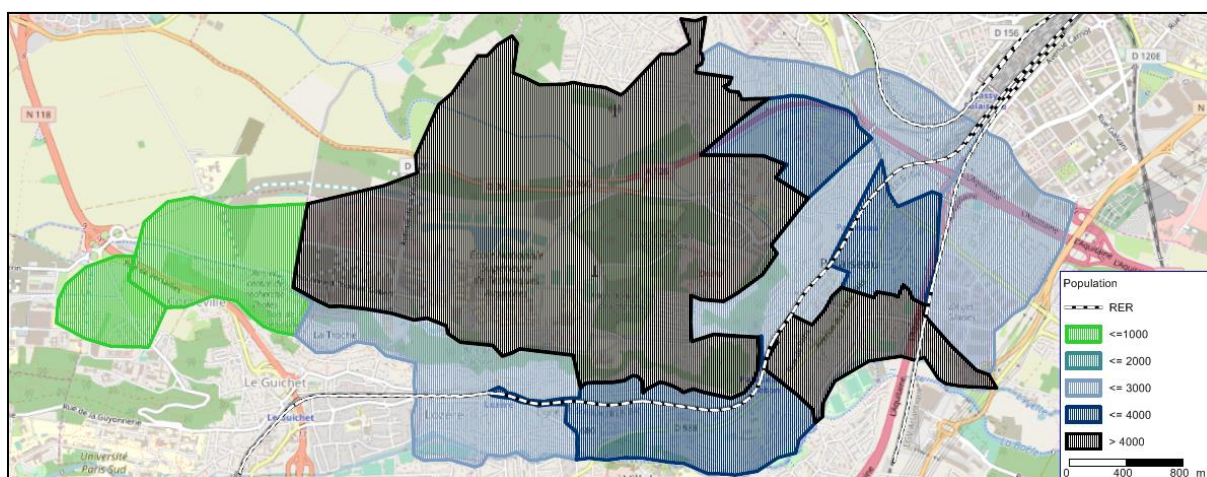

**Figure 40 Population in Palaiseau area (based on (DRIEA, 2010))**

<sup>12</sup> IRIS is a zoning developed by INSEE in 1999. It is the abbreviation of "Grouped Islands for Statistical Information" (i.e. "Ilots Regroupés pour l'Information Statistique"), refer to elementary zones which are home of up to 2000 inhabitants.

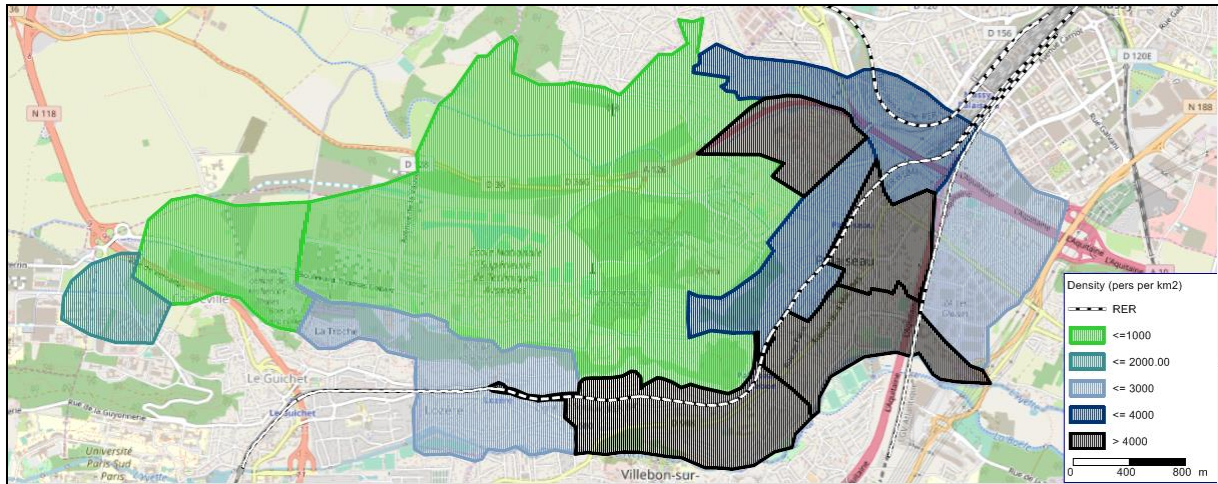

**Figure 41** Density of population in Palaiseau area (based on (DRIEA, 2010))

### 2.2.2. Jobs distribution

As presented above, according to INSEE's data, the active persons represent about 74 % of the total population (INSEE, 2018). The study area provides about 22,565 jobs (INSEE, 2017), occupied mainly by high level professions (39 %) and intermediate professions (26 %). In addition, planned projects as part of the development of the scientific cluster are expected to create at least hundreds of additional jobs opportunities.

We note that the number of provided jobs exceeds the number of active persons. This imbalance between active population and number of jobs would lead to the attraction of persons from other cities of Ile-de-France, accentuated by the out-migration of Palaiseau's inhabitants (75 %).

**Figure 42** depicts the distribution of jobs in Palaiseau by IRIS zone. The majority of jobs is located in the South (more than 4,000 jobs) and near to the Massy-Palaiseau station (more than 2,000 jobs per zone).



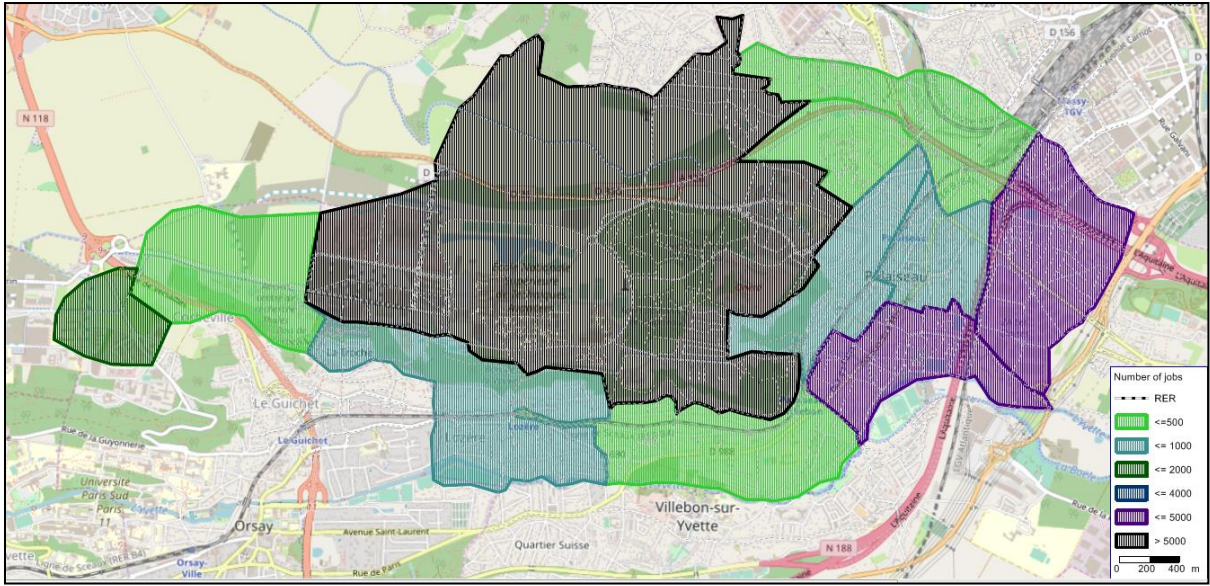

**Figure 42 Jobs in Paris Palaiseau area (based on data of (INSEE, 2017))**

In addition, around the Polytechnic school, in the East of Palaiseau, many labs, companies and universities campus have been implemented from 2014. In particular, the EDF Lab and EDF Campus in 2016, the photovoltaic institute of Ile-de-France in 2017, the National School of Statistic and Economic Administration (ENSAE) in 2017 and the Center of Nanoscience and Nanotechnologies in 2017. In 2018, a residence hotel as well as student residences opened (Van de Maele, 2018).

Other projects are planned for 2019, such as the Mines Telecom Institute, the SIRT A (Atmospheric research observatory of the institute Pierre Simon Laplace), the campus of Agro Paristech, two students’ residences and a parking of 425 places. In 2020, a business incubator (IPHE) will take place and in 2021, the AgroParisTech School and a student residence will be implemented (Van de Maele, 2018).

2.3. *Mobility needs and transport supply*  
 2.3.1. *Mobility needs*

According to a stated-preference survey conducted in Palaiseau by VEDECOM, the number of trips made daily per inhabitant is 3.49 and 3.84 during weekday and weekend respectively (IESEG Conseil, 2018). The traveled distance and trips’ duration are on average about 4 km and 30 minutes for both commuting and leisure trips.

**Figure 43** and **Figure 44** depict the number of trips from/to Palaiseau. They are based on data of 2010 for commuting trips during morning peak hours. Destinations of the most of emitted trips are located in Paris, and especially along the RER B (**Figure 43**). On the other hand, Palaiseau attracts the majority of workers from neighbor cities (**Figure 44**). About two thousands of trips are intern. According to INSEE, 78 % of active inhabitants are working outside of Palaiseau.

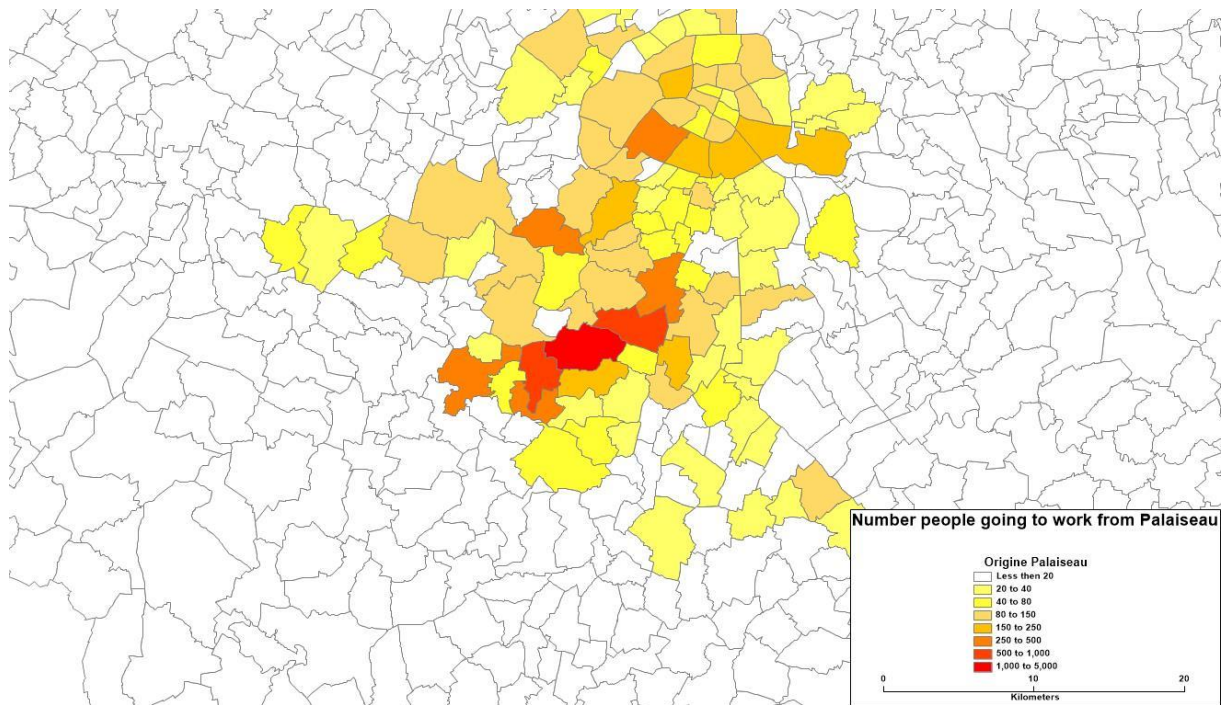

Figure 43 Commuting trips emitted from Palaiseau (based on (DRIEA, 2010))

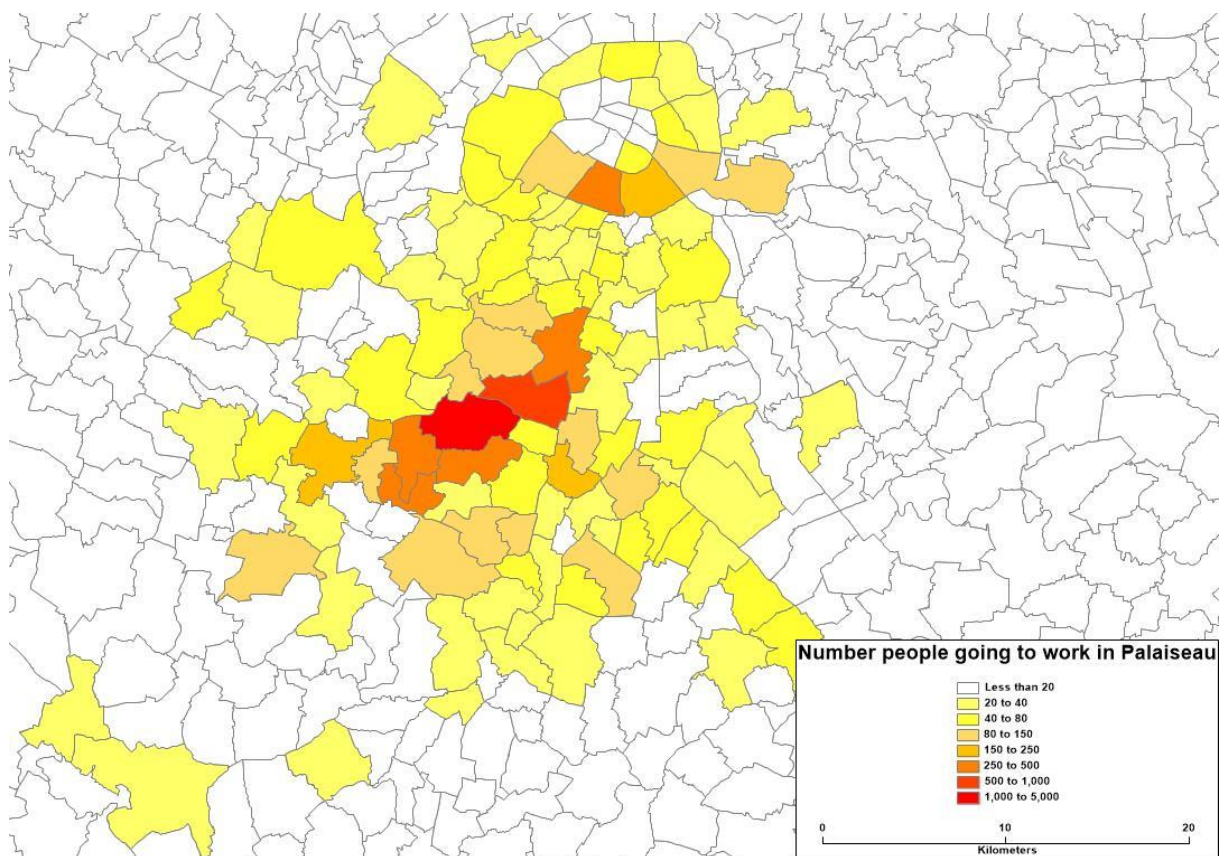
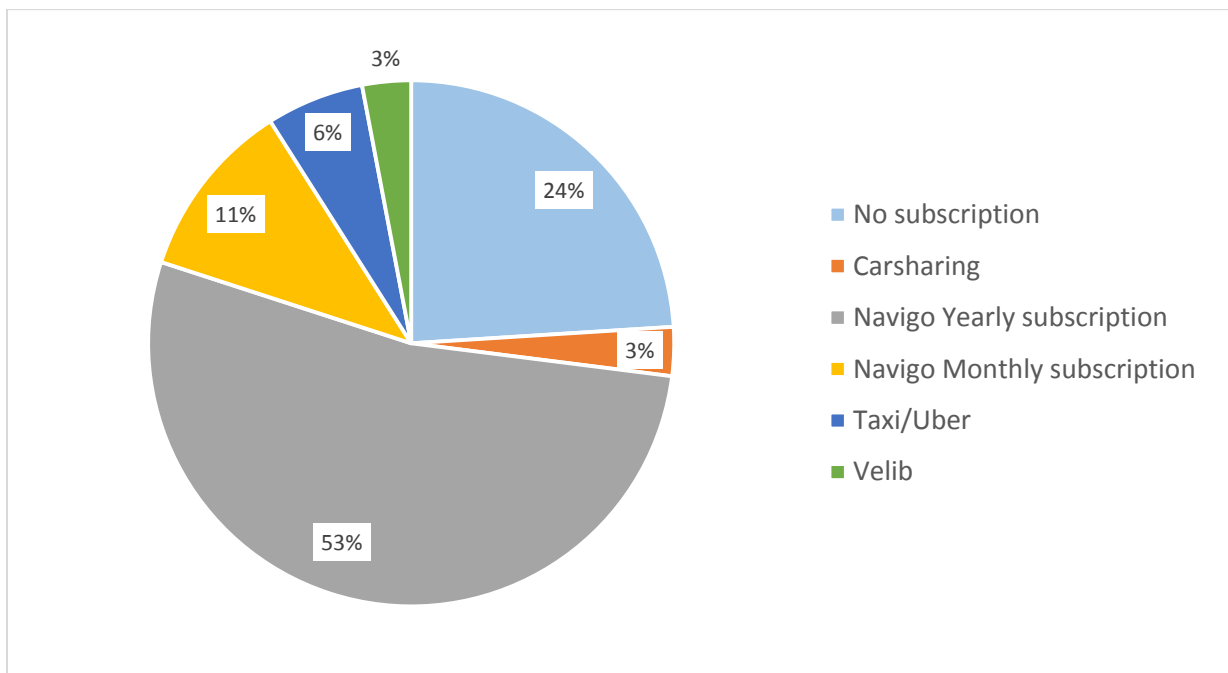

Figure 44 Commuting trips attracted by Palaiseau (based on (DRIEA, 2010))

These figures would evolve, and the outside emissions and attractions would be higher if we consider the current development projects.

Regarding travel modes, 52.5 % of commuters use private cars, 32.2 % transit modes, 7.7 % walk, 3.7 % use two-wheels and 4.4 % do not move (teleworking...). **Figure 45** shows the distribution of public modes subscriptions for transit users (IESEG Conseil, 2018). Considering only motorized modes, 62 % of trips are performed by private cars and 38 % by transit modes, which presents high ratio of public modes compared to French cities (INSEE, 2014). This modal split could be justified by the high quality of service of transit modes: several bus lines, a BRT line and two RER lines serving the territory.



**Figure 45** Distribution of public modes subscriptions for users of transit in Palaiseau area

### 2.3.2. Transport supply

**Road network:** The main entrances to the territory are the A 10 highway on the East side and the N 118 national road on the West side. Since 31 % of the city is occupied by rural and wooded areas, the territory is irrigated by D 36 in the North and D 988 in the South. The total network length is 645.4 km.

**Bus network:** The territory is served by a dozen bus lines: one BRT line is operated by Albatran, four bus lines by Mobicaps, two by RATP and two other lines by Transports Daniel Mayer. Nine lines out of eleven ensure the feeding from the station of Massy-Palaiseau on the territory of study. The BRT line and one bus line connect Massy-Palaiseau station to the scientific cluster while the nine others serve South and North areas.



*Rail network:* Two RER lines define the limits of the territory: the RER B from the South and the RER C from the East, respectively the second and third busiest lines of transport in Ile-de-France. (860,000 (rerb-leblog, 2015) and 550,000 travelers per day (OPENDATA, 2018) for RER B and C respectively).

Four RER B stations serve the South part of the territory: Massy-Palaiseau, Palaiseau, Palaiseau-Villebon and Lozère. The RER C is only accessible via the Massy-Palaiseau station. At weekday peak periods, the schedule (quite complicated due to the complex network of numerous branches) for RER B provides 20 trains per hour, one train every 3 minutes, of which three fourths enter our study area.

Regarding RER C, the numerous stops, the old and fragile infrastructure and the complex network of numerous branches make the Parisian section of the RER C very slow, inefficient and with complicated operating schedule. Hence, the headway of the section serving Massy is 15 minutes at peak.

#### 2.4. *Synthesis*

In conclusion, some points should be emphasized:

- **The heterogeneity of the urbanization**

We observed a discontinuity of the urbanization: Urbanized areas are located along RER lines in the South and the North, while 31 % of the territory is dominated by rural areas.

- **A constrained geographic topology**

The gap between altitudes of urbanized areas in the South and the scientific cluster in the North induces a steep slope, often constraining the implementation of transport systems.

- **The rapid development of the urbanization**

The territory is part of the French scientific cluster. Hence, several projects are under development, which will involve a significant growth of the active population and students on one side, and of the number of jobs on the other side.

- **The imbalance of population and jobs**

Population and jobs are imbalanced: 33,000 inhabitants and 22,000 jobs. In addition, the analysis of incoming and outgoing trips flows shows that Palaiseau attracts/emits few thousands of commuters to/from the Paris region. The projects that are expected in the territory attempt to perform the equilibrium between population and jobs, and in turn to foster intern trips, through combining the implementation of research establishment and the construction of hotel and students' residences.

- **A satisfying quality of service of transit modes for intern trips**

The quality of service of transit modes is competing with private cars concerning intern trips: 62 % of trips are achieved by private cars and 38% by transit modes. In particular, transit modes include ten bus lines, one BRT line and two RER lines. The majority of transit



lines connects the Northeast with the South (i.e. urbanized areas). However, only one BRT line and one bus line are connecting the scientific cluster in the West with other urbanized areas.

### 3. SERVICE DESIGN: TRANSPORT FUNCTION AND ROADWAY INFRASTRUCTURE

#### 3.1. Transport function

The purpose of EVAPS is to link the Massy-Palaiseau station with the Polytechnique campus, which are important sources of trip emission and attraction of our territory, all modes included (car and transit). At the same time, zones that are located between these two points must not be neglected, since they emit the major part of trips using private cars.

On the other hand, we observed that the main bus line linking East (Massy-Palaiseau station) to West (Polytechnique school) is the BRT, which (1) is very effective during peak hours yet underused off-peak, and (2) permits to cross the territory without serving local quarters on-route.

Based on these observations, it follows that aTaxis might play a twofold role: (1) as a crossing system during off-peak hours, which will replace BRT and permits to reach Massy-Palaiseau station and Polytechnique campus as quick as possible, and (2) as a feeder system, allowing serving homes of local inhabitants.

To conclude, we propose to use aTaxis as a complementary service that broads the spectrum of transit modes and improves the overall quality of service.

#### 3.2. Exogenous systems

Exogenous systems belong to the environment of aTaxis. They are uncontrollable and influence the overall performance of the service. In particular, we could distinguish between two major categories of exogenous systems:

- Systems related to demand: include localization of homes, universities and job. By analyzing them, main sources of traffic are detected, but also main unserved zones.
- Systems related to existing supply: concern the existing road and transit infrastructure (including road and stations), but also the state of traffic on routes and junctions per journey period.

##### 3.2.1. Systems related to demand:

As described above, homes are concentrated in the East, near to Massy-Palaiseau station, and in South, along the RER B line. On the other hand, activities (including companies and universities as well) are mainly located in the West, near to Polytechnic campus but also in South, around the RER B line and near to the highway A 10.

That defines three main sources of demand that split the territory (**Figure 46**):

- Zone 1: At the Northeast of Palaiseau. It is bounded from the North by the highway A 126, from the South by the RER B and from the East by the Massy-Palaiseau station. Zone 1 is characterized by high population densities.
- Zone 2: It is located in the West of Palaiseau. It brings together universities, research labs and companies. It attracts the highest number of commuters coming from the outside of Palaiseau.
- Zone 3: It is located along the RER B from the South. It is bounded from the East by the highway A 10. Zone 3 is characterized by high densities of population and jobs.

Table 24 sums up the number of inhabitants and jobs for each zone:

Table 24 Population and jobs of three zones

	Area (km <sup>2</sup> )	Population	Jobs
Zone 1	2.52	12,012	4,656
Zone 2	5.92	5,204	7,876
Zone 3	3.24	13,650	10,034

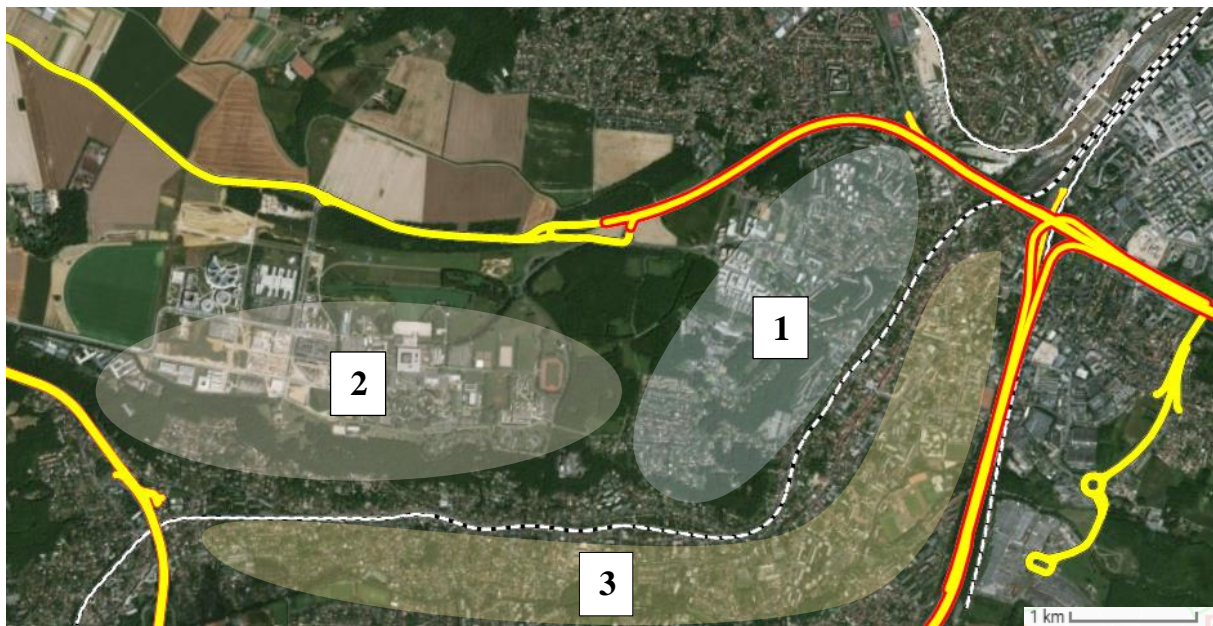

Figure 46 Three zones representing main sources of emission and attraction in Palaiseau

Based on this decomposition, five major OD relations in the territory derive. We ignore intern OD relations in the zone 2, for which all motorized trips are coming from zones 1 or 3. Walking OD trips between students' residences and schools are not considered here.

The largest OD is that linking 1 to 2, while the OD 2 to 3 is avoided because of topography constraints (§1). Going from 3 to 2 and vice-versa requires a detour by 1 or by outside of Palaiseau (through Orsay). Similarly, going from 1 to 2 cannot pass through 3.

### 3.2.2. Systems related to existing supply

As presented before, eleven bus lines are serving the territory, from which just 2 lines are connecting zones 1 to 2 (**Figure 46**). The rest of lines is connecting zones 1 and 3 to Massy - Palaiseau station or zones 1 to 3.

BRT line connecting 1 to 2 benefits from dedicated infrastructure and high-capacity stations. The lanes are used only by buses and taxis, which ensure a high reliability of the service. For other lines, the bus shares with cars the existing road and stops are roadside. A global analysis of local state of traffic using Google maps during peak hours shows that links connecting zones 2 to 3 and crossing 3 are congested (**Figure 47**). During off-peak hours, however, congestion is almost not observed (**Figure 48**).



Figure 47 Traffic state during peak period in Palaiseau (Tuesday, 09h00), Google Maps





**Figure 48** Traffic state during off-peak period in Palaiseau (Tuesday, 12h00), Google Maps

Based on this analysis and considering the motivation to serve Polytechnic Campus, two main scenarios are relevant:

- To connect 1 to 2 directly, with using mainly BRT lines during off-peak hours and nights,
- To connect 1 to 3 and 1 to 2, in order to create a network which serves the maximal volume of users.

Since a Noctilien service connects the zone 3 to Massy-Palaiseau station at night, the first scenario is more relevant to start our study. However, the frequency of Noctilien service is one bus per hour with low loading rates, so limited efficiencies. Future studies could investigate the second network structure.

### 3.3. Design field and decision variables

We selected the first scenario connecting directly zone 1 to 2 with an aTaxi service. To foster complementariness of existing transit modes, we consider that aTaxis are connecting 1 to 2 using the BRT infrastructure, while serving as a feeder mode in zone 1.

Thus, two types of infrastructures are used by aTaxis:

- BRT infrastructure: with segregated lanes, junction priorities, and stations with waiting areas.
- Cars infrastructure: roads are used by buses and cars, and stations are roadside

**Figure 49** shows the two infrastructures.

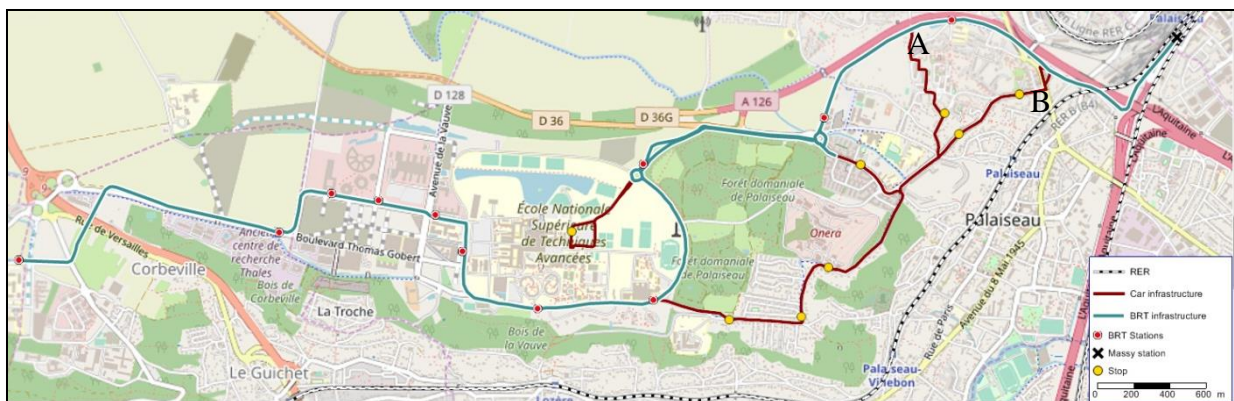

**Figure 49** Infrastructures of BRT (green) and cars (red)

Connecting the two infrastructures requires slight civil works in point A (**Figure 49** and **Figure 50**). In addition, the road is one-way in point B (**Figure 49** and **Figure 51**).



Figure 50 Point A requiring civil works



Figure 51 Point B, with two directions

Finally, locations of stations in zone 1 (i.e. car infrastructure) depend on the distribution of population, then located in highest density points.

### 3.4. Network scheme

As a result of these analysis, the suggested network is presented in **Figure 52**. In zone 1, stations are located near to dense neighborhoods. For zone 2, stations are using BRT stations.

The total length of the roads is 16 km, where about 11 km correspond to the BRT infrastructure and 5 km to car infrastructure. The distance between Massy-Palaiseau station and Polytechnic campus is about 10 km, which corresponds for an average speed of 30 km/h to 20 minutes.

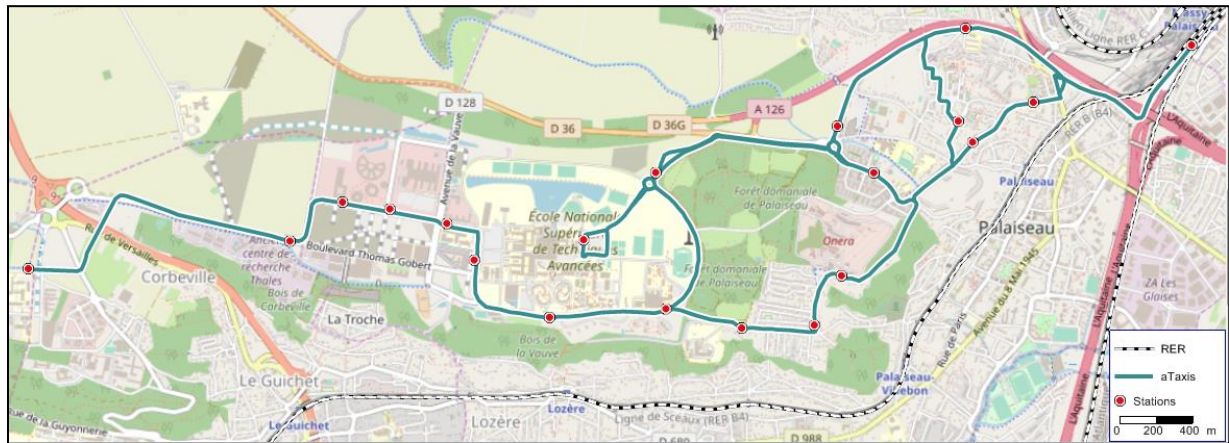

Figure 52 Network scheme

## 4. ACCEPTANCE OF AUTONOMOUS TAXIS IN PALAISEAU

A stated-preference survey was conducted to investigate potential users' acceptance. We hereafter introduce the survey design (§4.1). Then we describe the process of data collection

while presenting the composition of the sample (§4.2). Finally, main findings of the survey are presented (§4.3).

#### *4.1. Survey design*

The survey was designed by (Berrada & Christoforou, 2018) to understand potential users' acceptance of providing an aTaxi service in Palaiseau. The respondents received an explanation that the new service will be launched in 2019 and that their contribution will be used by political decision-makers to define the operating characteristics of the service. The respondents are those who live or have daily/occasional activities in Palaiseau.

Before approaching the respondent, the interviewer records the date and time of the interview and its location, plus the gender and age of the respondent. The interview consists of two parts:

##### **(1) A ridesourcing service.**

The aTaxis service defined above (§2.) is presented without mentioning the word "autonomous". It is presented as an "on-demand service" consisting of a fleet of 20 vehicles of 5 places which provide the service between the Massy-Palaiseau station and the Polytechnic school with a speed of 30 km/h. The network presented in **Figure 52** is presented to the respondents. The service is offered during off-peak hours, when buses have a low frequency. The fare is not mentioned at this stage. In addition, the average waiting time is estimated by passengers and is not stated by the interviewer. The technology of booking is not stated either. Hence, the service could be reserved by a mobile app, in stations or by calling a booking office. Finally, boarding and alighting are possible on the road and in stations.

##### **(2) Shared autonomous taxi service.**

The respondents are informed that the service will be based on Autonomous Vehicles and will use a lane that will be closed to the rest of the traffic except for taxis and buses. Acceptability is then assessed by reiterating the questions asked in the first part.

The interview is presented in Appendix.

#### *4.2. Data collection and sample composition*

The survey was conducted during the month of July 2018 by the IESEG-Conseil (Junior Company at the School of Commerce in Paris and Lille), with 600 people (IESEG Conseil, 2018). After some data cleaning, 567 respondents in total completed the questionnaire in full. **Figure 53** shows the distribution of respondents during the day.

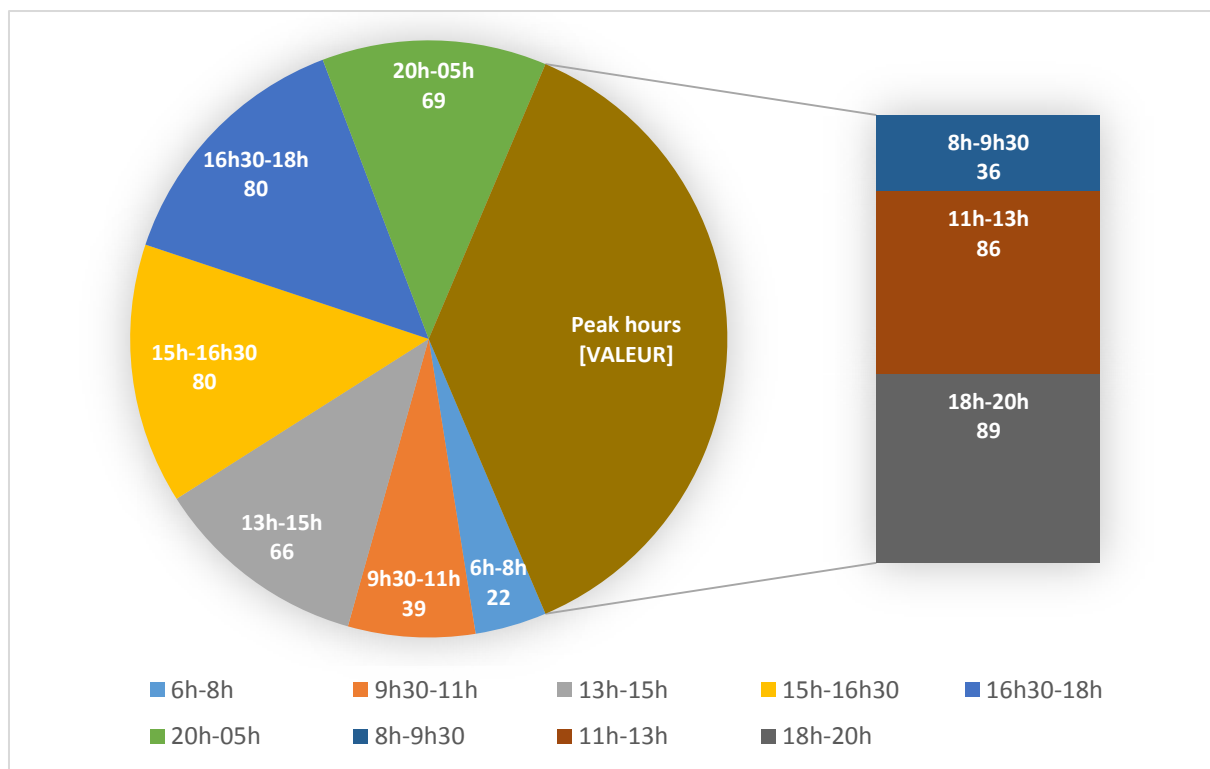

**Figure 53** Distribution of respondents during the day

Respondents were interviewed in three different places:

- On board trains connecting Massy-Palaiseau to Paris in both directions (63 people),
- In the Massy-Palaiseau station (335 people)
- In companies' car parks (202 people).

Hence, the survey focused on trip-makers, with giving higher attention to passengers of mass transit modes. **Table 25** presents the distribution of the main mode used by respondents. It shows that the utilization of public modes and private cars is almost balanced. Soft-modes (i.e. walking and biking) are used as the main travel mode by 15% of respondents. EDP modes, also known as Personal transport means and including skateboards, kick-scooters, hoverboards and so on, are also used, by 1.5 % of respondents.

**Table 25** Main travel mode used by respondents

Transit modes	Private car	Walking	Bike	Scooter	Taxi	Uber	EDP
40.3 %	37.2 %	9.1 %	6.5 %	2.4 %	1.5 %	1.5 %	1.5 %

**Figure 54** relates the main travel mode of respondent with the location of their interview. It shows that 30 % of users of public modes were interviewed in parking of companies. Moreover, 60 % of respondents claiming that their main travel mode is the private car were located in train stations, which suggests that personal cars are used for short-trips: leisure, shopping, taking children to and from school, access to the train station, etc. The comparison between the location of taxi and Uber passengers shows that taxi's users are

mostly located in companies' parks while Uber's users are identified in train stations. That could be linked to the affordability of the service depending on the socio-professional category of respondents.

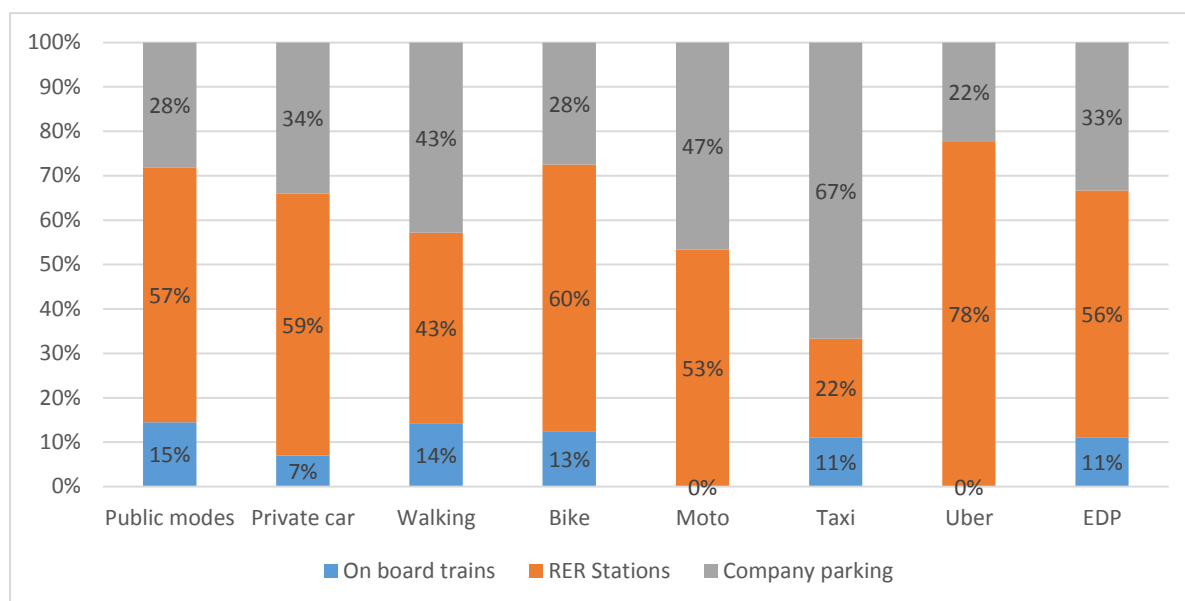

**Figure 54** Distribution of main used modes by respondents according to the interview location

**Table 26** presents the travel distance, the travel time and the average number of trips per day. About 40 % of respondents achieve trips of 3 to 4 km, while around 60 % spend 20 to 40 minutes to reach their place of work or study. In addition, 50 % of respondents achieve less than 3 trips per day and 75 % less than 4 trips.

**Table 26** Travel characteristics of the sample

Average travel distance			Average door-to-door time			Trips per day	
Options	Home-to-Work	Home-to-leisure	Options	Home-to-Work	Home-to-leisure	Options	Ratio
<1 km	6 %	6 %	<10 min	8 %	11 %	2	<b>29 %</b>
1-2 km	12 %	19 %	10-20 min	17 %	20 %	3	<b>23 %</b>
3-4 km	<b>44 %</b>	<b>38 %</b>	20-40 min	<b>57 %</b>	<b>45 %</b>	4	<b>31 %</b>
5-6 km	23 %	20 %	40-60 min	16 %	21 %	5	6 %
>7 km	14 %	17 %	>60 min	3 %	3 %	>5	11 %

Finally, the socio-demographic characteristics of the sample are as following:

- Among the 597 respondents, 51 % were men and 49 % were women. The sample is therefore representative of the population in terms of gender diversity. 88 % of the sample were people in the [18, 50] age band (**Figure 55**).



- The distribution of socio-professional categories is presented in **Figure 56**. Almost 35 % of respondents occupied high-level professions, which is representative of the population (§2.2.1). The ratio of inactive respondents is however over-represented statistically (32 % of respondents versus 26 % for the actual population).

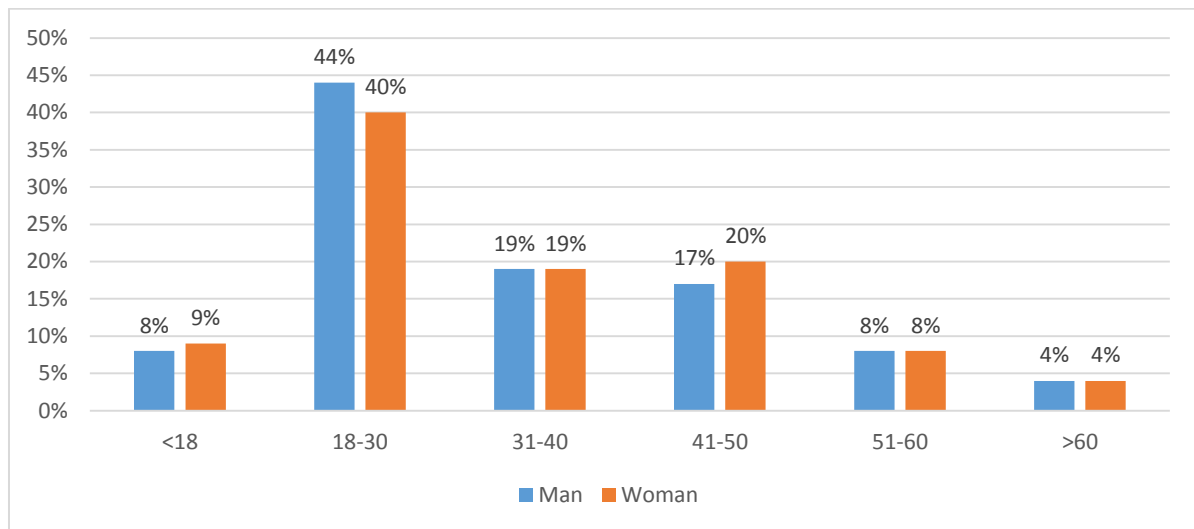

**Figure 55** Distribution of respondents ages by gender

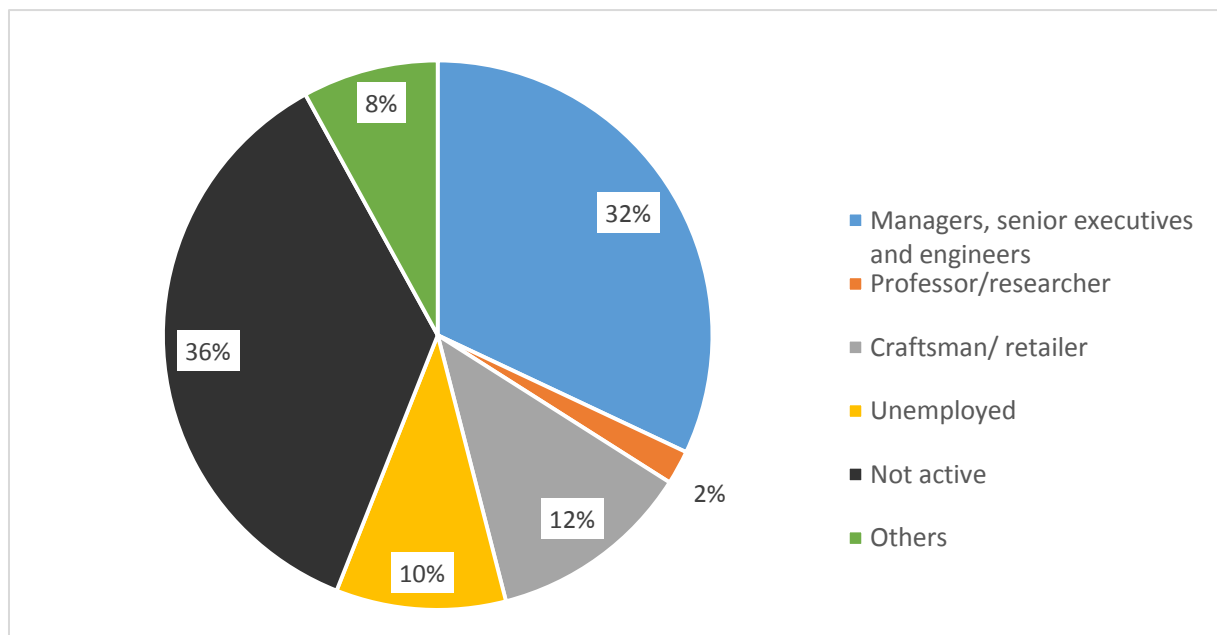

**Figure 56** Socio-professional categories of respondents

### 4.3. Findings

#### 4.3.1. Demographic factors of acceptance

The results of the first part of the interview (i.e. A ridesourcing service) show that:

- 16 % of users are highly interested in using the ridesourcing service (i.e. replying to the question “will you use this service” by: “certainly yes”);
- 34 % are interested (i.e. replying by “probably yes”);
- 27 % are not really interested (i.e. replying “probably no”);
- 23 % are not interested at all (i.e. replying “no”).

**Figure 57** relates the interest in the service and the potential frequency of using the service. 65 % of highly interested respondents would use the service at least 3 to 5 times a week and 93 % of them would use it at least 1 to 2 times a week. For interested respondents, 30 % would use the service at least 3 to 5 times a week while 79 % would use it 1 to 2 times a week. Only 1 % of non-interested respondents would use the service at least 1 to 2 times a week. Finally, we note that regardless the level of interest in the service, 23 % of respondents would use it 3 to 5 times a week and 50 % would use it 1 to 2 times a week.

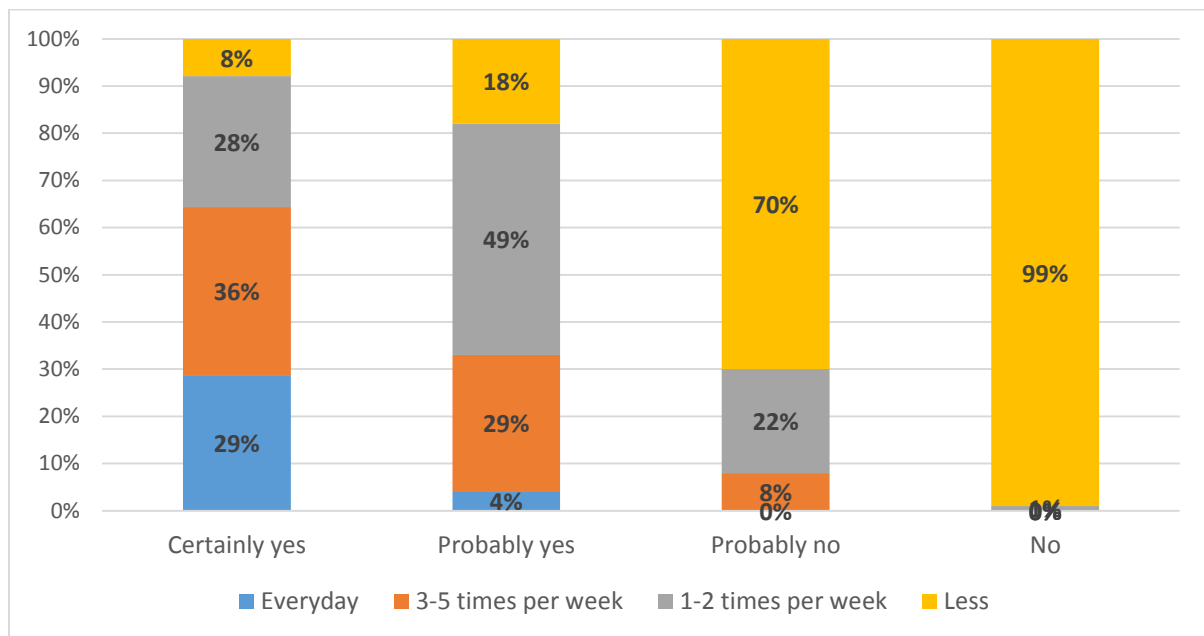

**Figure 57 Correlation between the willingness to use the service and the potential frequency of using it**

**Figure 58** and **Figure 59** relate the age and the gender respectively with the willingness to use the service. They show higher interest among women and younger respondents.

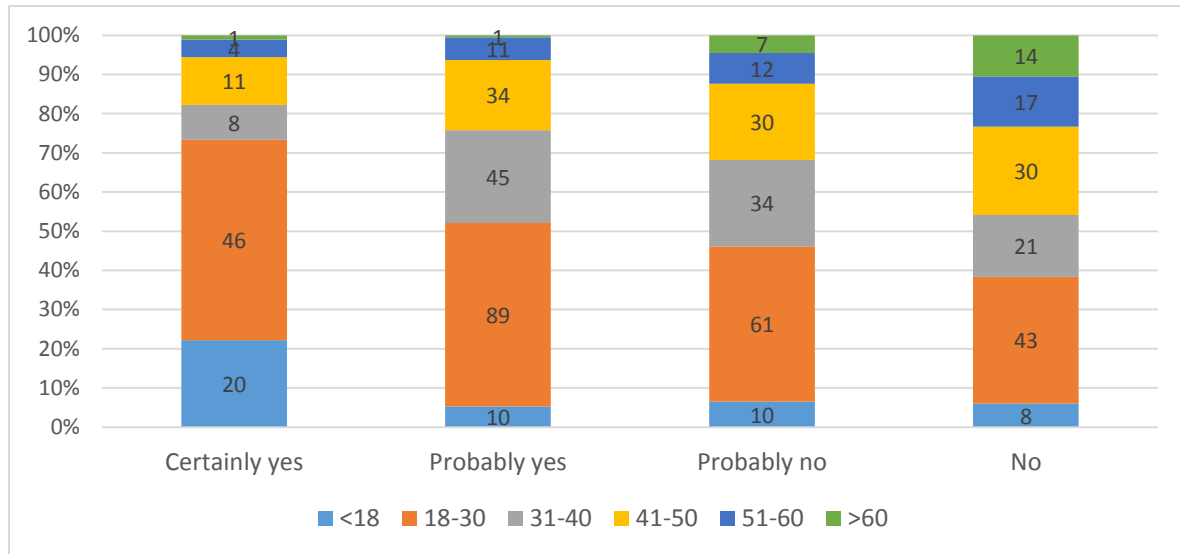

Figure 58 Relation between users' age and the interest in the service

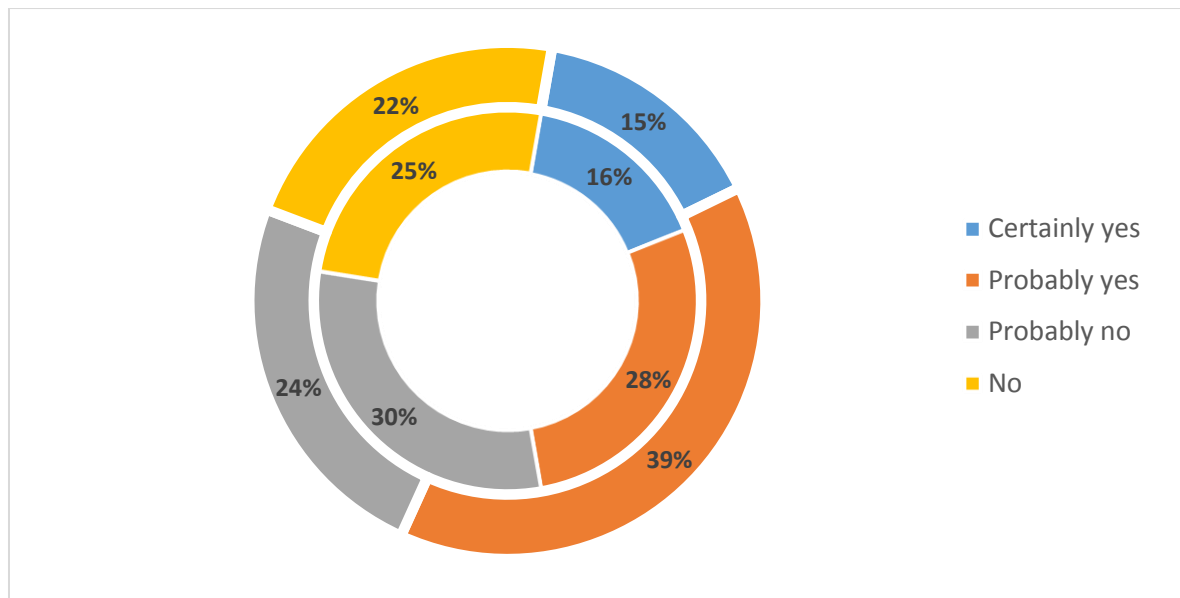
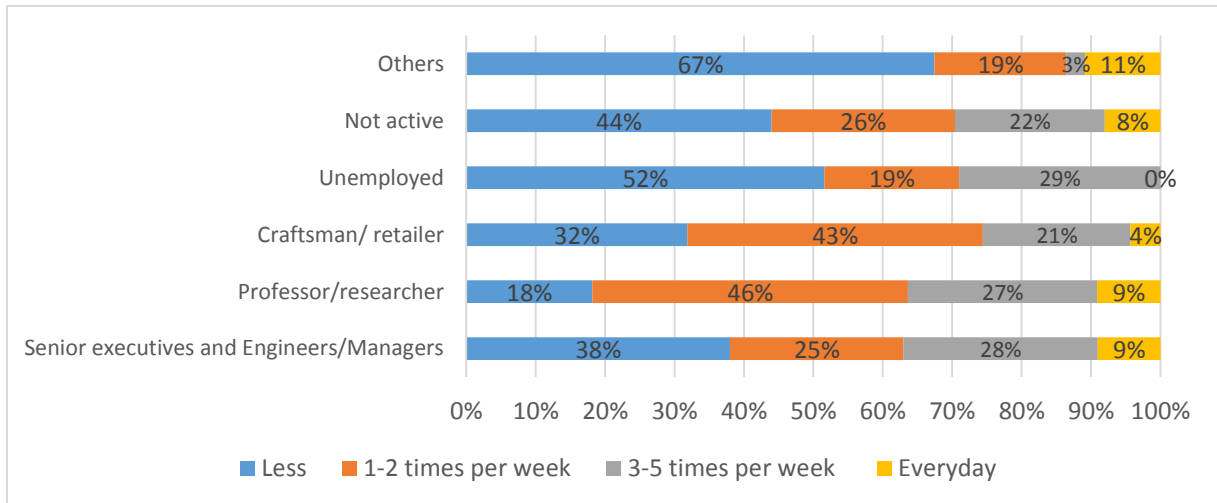

Figure 59 Willingness to use the service with respect to gender (women inner circle and men outer circle)

Regarding the impact of the socio-professional category, and in turn of the revenues, the higher are the revenues, the greater is the probability of using the service more than 3 times per week (Figure 6o). In particular, about 37 % of managers, engineers, professors or senior executives are ready to use the service 3 to 5 times a week.



**Figure 60 Socio-professional category and potential frequency of using the service**

**Figure 61** focuses on the non-active category because it is specifically heterogeneous. While retired respondents are not really interested in the service, the categories "students of high school" and "students of universities" have high probability of using the service more than 3 times a week, with respective ratios of 45.5 % and 31 %. That result confirms the finding of **Figure 58**.

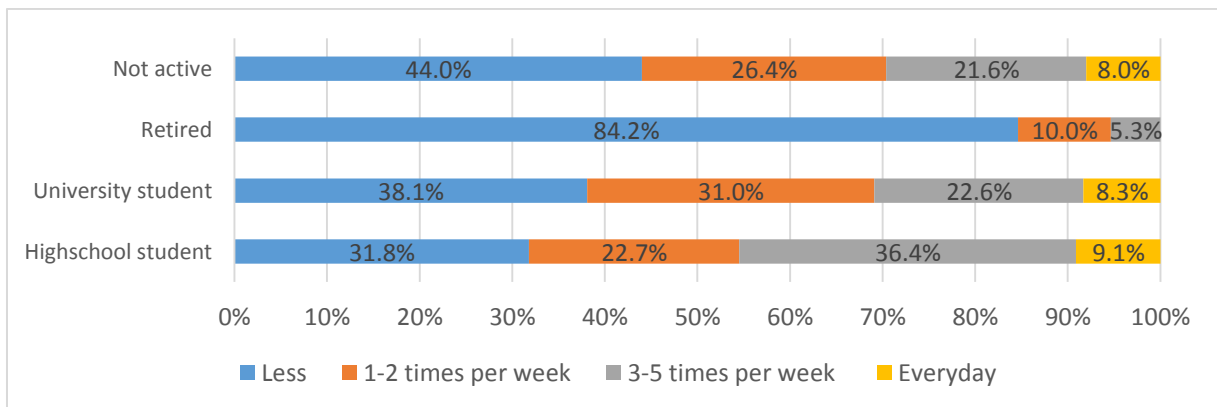

**Figure 61 Potential frequency of using the service, a focus on non-active population**

#### 4.3.2. On travel purpose

Interested people see the ridesourcing service as a means of transportation for business trips. 72 % of the highly interested and 56 % of the interested want to use it mainly for studies and work (**Figure 62**). The less people are interested, and the more they consider the service as an occasional travel option, allowing to do sport /leisure or others. 94 % of not-really interested respondents and 80 % of non-interested want to use it for sports, leisure or others. The answer "others" allowed them mostly to express their disinterest in the service: among the 101 persons having chosen "others" as answer, 70 said that they will not choose the service.

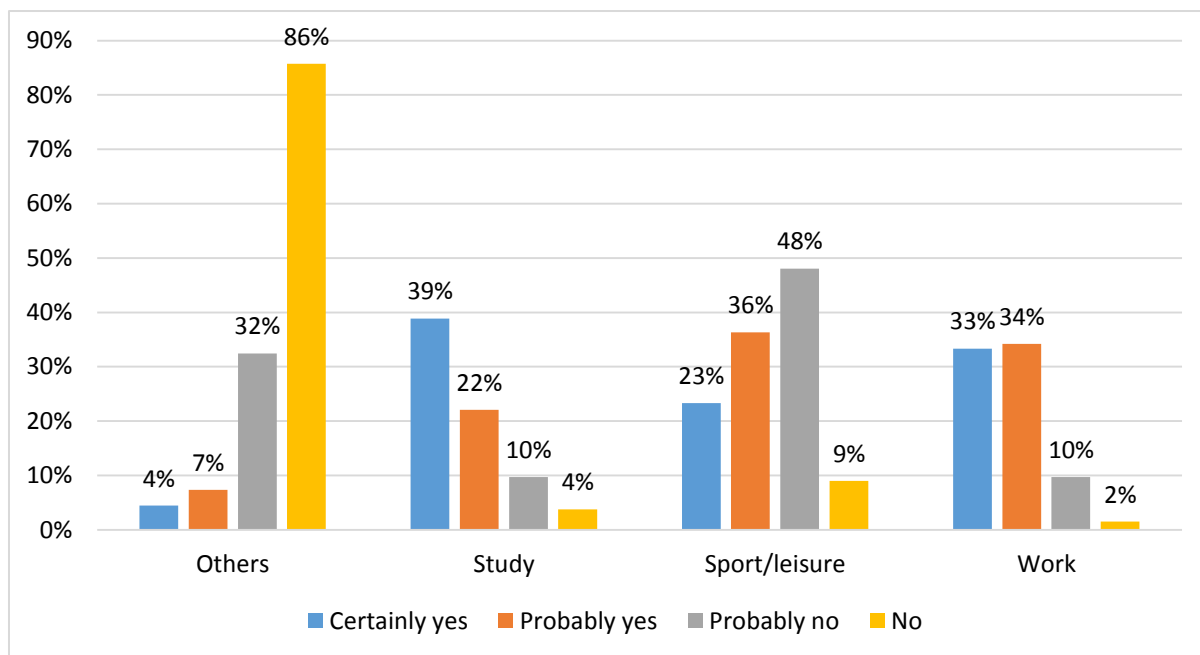

Figure 62 Travel purpose of aTaxis users

#### 4.3.3. On trip distance

Figure 63 depicts the result of the question: "for which purpose will you use this service and for which distance?"

The length of "Home", "Leisure", "Work" and "Other" trips are, for the most part, more than 70 % trips between 2 and 5 km. In particular, the length of "Other" trips are less than 2 km in 86 % of cases. Respondents who responded "Others" were those with low interest in the project.

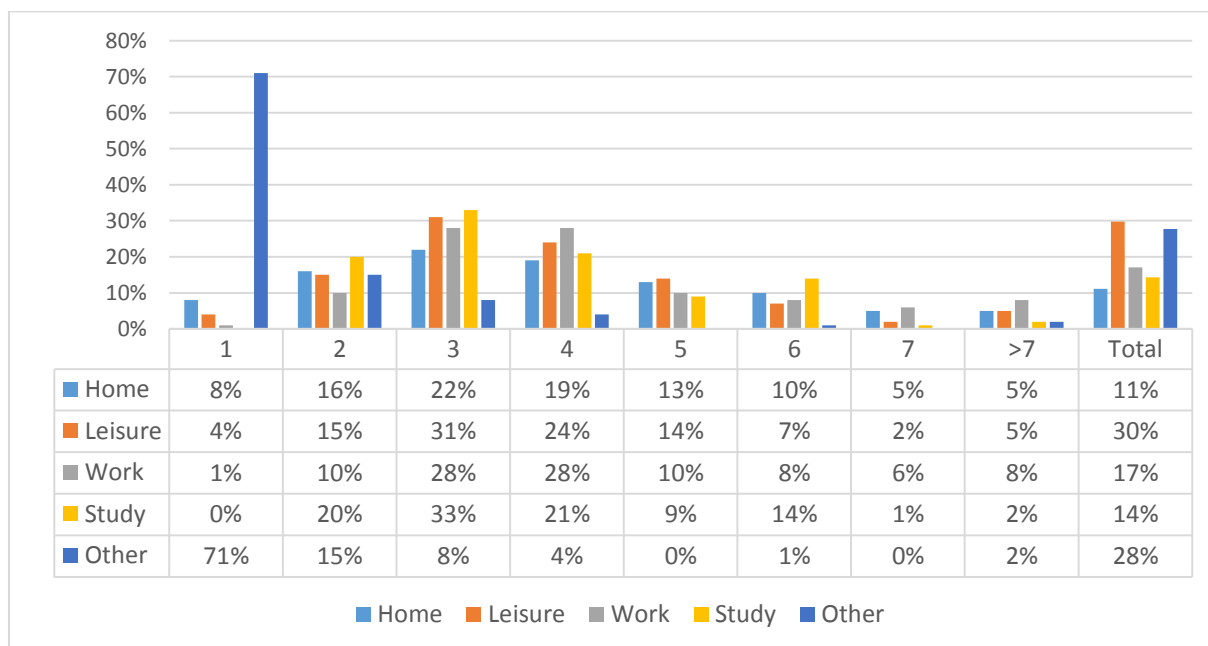

Figure 63 Travel distances by purpose for aTaxis users

#### 4.3.4. Modal influences

The analysis of the user profile (2nd part of the questionnaire) shows that only 13.4 % of respondents do not own any means of transport (including private car, motorcycle, bike, and others).

Even though 45 % of respondents with a car experience some difficulty to park it, the difficulty of parking does not motivate the use of the service.

The analysis of the correlation between the principal mode of transport used by respondents and the use of the service shows that people who most often use an owned motorized vehicle (car or motorcycle) will probably have a frequency of use "greater than 3 times per week" less important than for-hire services (**Figure 64**).

On the other hand, people using Taxi and Uber are more interested than the average (47 % versus 23 %).

People using mainly public transport (representing 39 % of the sample) and walking are on average less interested in a frequency of use "greater than 3 times per week" than the rest of the sample (13 % versus 18 %). That makes the ridesourcing service less competitive to transit modes for daily trips. Yet, the service would be used for occasional trips: 30 % of transit modes users want to use the service 1 to 2 times per week. That results confirm findings of (§2.3) stating that public transit is effective during peak-hours. The ridesourcing service would be attractive during off-peak periods, mainly used for occasional trips.

Finally, people who mainly use the bike or the personal transporter (skateboards, kick scooters, hoverboards, etc.) are the people who have the highest "greater than 3 times a week" use rate (54 % on average for the two categories against 23 % for the entire sample).

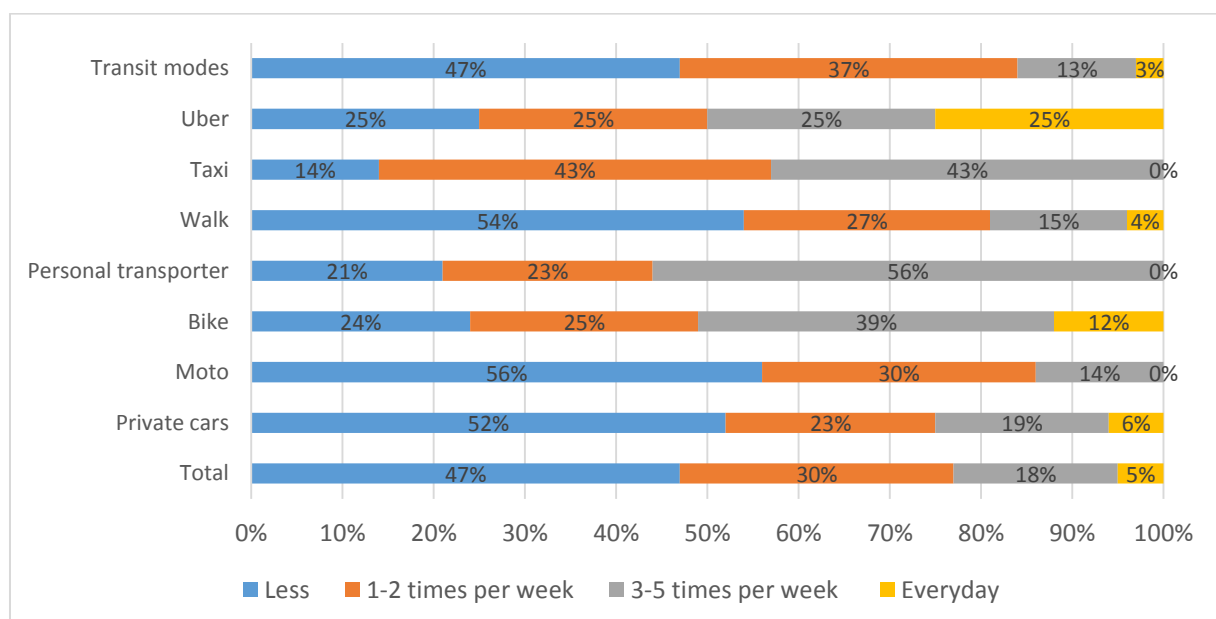
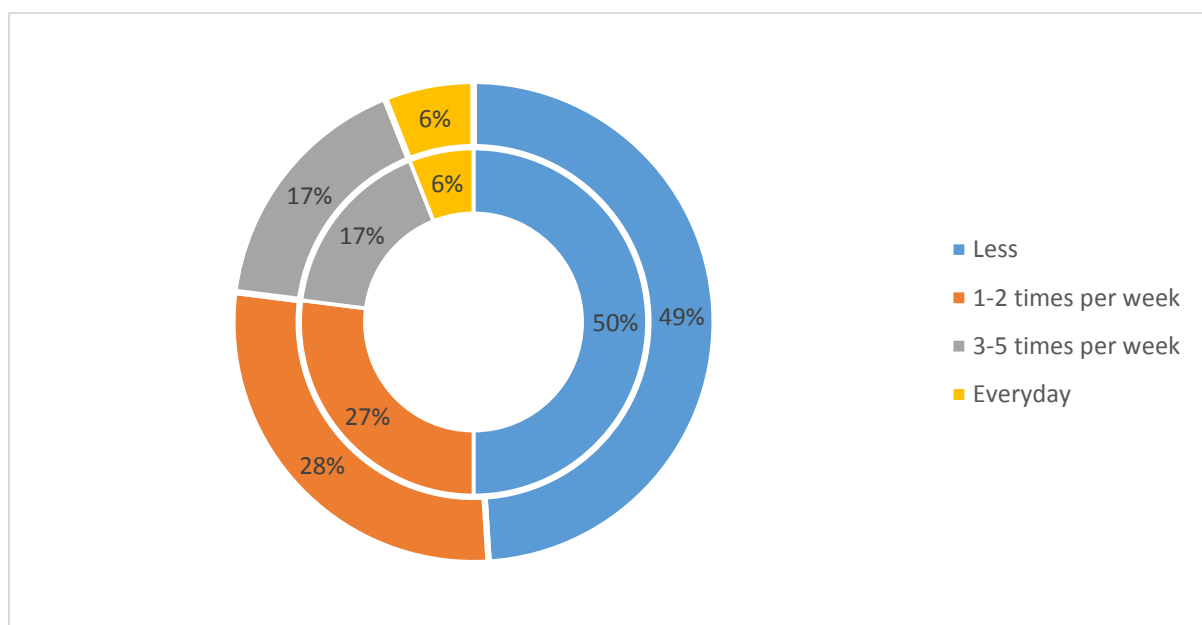

**Figure 64** Frequency of aTaxis use depending on the most used means of transport

#### 4.3.5. Automation technology

In addressing the issue of autonomous cars (§3rd part of the questionnaire), it turned out that 63 % of respondents were not aware of the existence of autonomous vehicle tests in Paris region, while less than one fifth of the respondents had already been in a self-driving car.

On the acceptability side, learning that the vehicles to be used will be autonomous was not a cause for concern (**Figure 65**). There is nevertheless a correlation between the knowledge of the tests with AV and the interest of use. In the same way, people who had already been in an AV are more likely to use this service again.

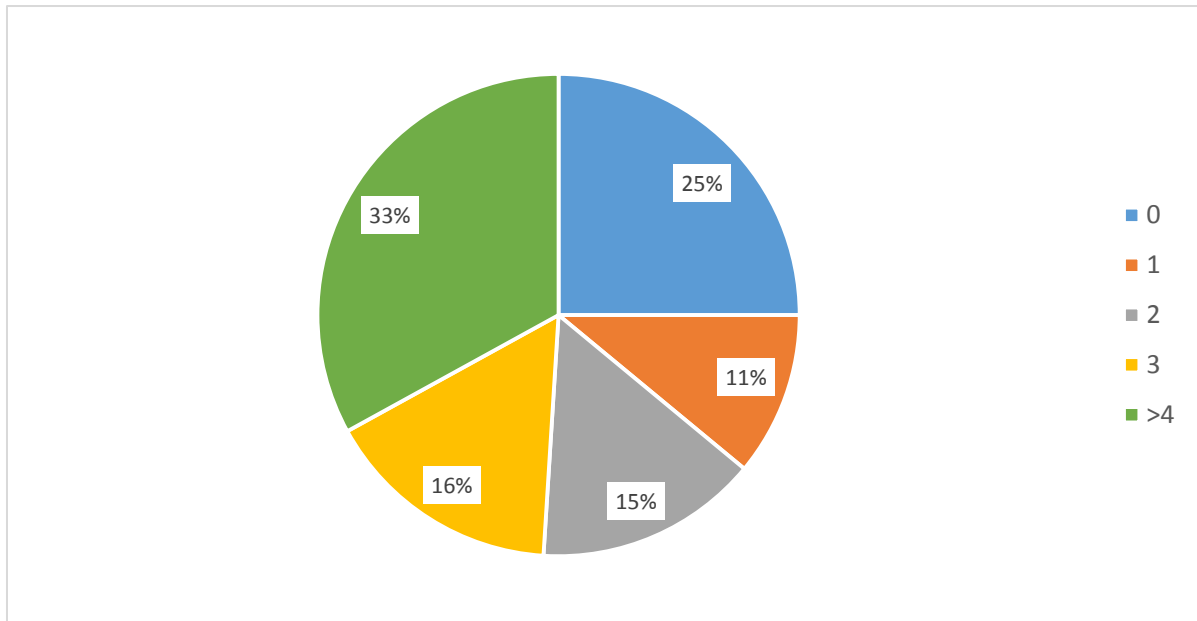

**Figure 65 Frequency use of aTaxis before and after learning that vehicles are autonomous**

The analysis identified a slight decline in trips to work or university in favor of ride to home or other journeys. This decrease is explained by a lack of confidence in the schedules; it is less detrimental to arrive late for his leisure activities rather than his work or his courses, hence the effect of sliding to these trips.

Respondents want to use Autonomous Vehicles over longer distances than before. The most important difference is for people whose patterns are "Other than home and school": some who were reluctant at first seem more inclined to use this service now and for longer periods.

Finally, sharing the vehicle is not a problem for interested people who are willing to share it with two, three, four or even more passengers. However, this is a drag for one fourth of respondents (**Figure 66**).



**Figure 66 Willingness of ridesharing**

## 5. DISCUSSION AND CONCLUSIONS

This Chapter presented a territorial diagnostic and the state of mobility in Paris Palaiseau area. It puts forward a design for the aTaxi service network and explores its acceptance by potential users.

We found that the Palaiseau area is characterized by a heterogeneous distribution of population and jobs. Almost 80 % of inhabitants are working outside of the area while about two quarter are motorized. The transit infrastructure focuses on connecting the area to the Massy-Palaiseau station.

Taking into account demand, supply and geographic constraints, the network of the aTaxi service was designed. The SP survey found that the service should target two users profiles: (1) young users less than 30 years old, which are non-motorized, and (2) active population between 30 and 50 years old and that is mostly motorized. The service would be used for trips of 2 to 5km. Results showed in addition that one fourth of respondents refused to share their rides. Hence, combining private and shared trips should be explored. In this case, private rides would propose higher fares or lower quality of service, which will promote ridesourcing. An analysis of operational, economic and social impacts of such a combined configuration should be subject of future studies. One major limitation of this work, however, is the absence of a statistical adjustment of results according to the actual population. Futur works should also explore mode choice behavior in a context where aTaxi, but also other modes are available. This analysis will assess the impact of travel time, waiting time and trip's fare and will be used to derive the utility of the service. A last part of the SP survey focused on this aspect through proposing a series of games to respondents. The analysis of results, however, remains in progress.



## REFERENCES

- Berrada, J. & Christoforou, Z., 2018. Questionnaire pour l'enquête d'acceptabilité: VEDECOM.
- IAU, 2012. Occupation du sol simplifiée en 2012. [En ligne]  
Available at: <https://geoweb.iau-idf.fr/webapps/mos/pdf/91477.pdf>
- IESEG Conseil, 2018. Enquête d'acceptabilité d'un service de navettes autonomes sur Paris-Saclay, Ile-de-France: IESEG Conseil.
- INSEE, 2014. *Observations Statistiques. Indicateurs & Indices. Les parts modales des déplacements domicile-travail*. [En ligne]  
Available at: <http://www.statistiques.developpement-durable.gouv.fr/indicateurs-indices/f/1830/o/parts-modales-deplacements-domicile-travail.html>  
[Accès le 10 September 2018].
- INSEE, 2017. *Base Siren des entreprises et de leurs établissements (SIREN, SIRET)*. [En ligne]  
Available at: <https://www.data.gouv.fr/fr/datasets/base-sirene-des-entreprises-et-de-leurs-etablissements-siren-siret/>
- INSEE, 2018. Commune de Palaiseau - Dossier complet. [En ligne]  
Available at: <https://www.insee.fr/fr/statistiques/2011101?geo=COM-91477>  
[Accès le 09 September 2018].
- OPENDATA, 2018. Présentation du réseau Transilien. [En ligne]  
Available at: <https://ressources.data.sncf.com/explore/dataset/presentation-reseau-transilien/information/?sort=ligne>  
[Accès le 10 September 2018].
- rerb-leblog, 2015. Fréquentation du RER B: Les grandes tendances. [En ligne]  
Available at: <https://www.rerb-leblog.fr/frequentation-du-rer-b-les-grandes-tendances/>  
[Accès le 2018].
- Van de Maele, P., 2018. Concertation préalable à la modification du dossier de création de la Zone d'aménagement concerté du quartier de l'Ecole Polytechnique. [En ligne]  
Available at: [https://www.epaps.fr/wp-content/uploads/2018/10/Pr%C3%A9sentation-r%C3%A9union-QEP-11-10-18\\_VF.pdf](https://www.epaps.fr/wp-content/uploads/2018/10/Pr%C3%A9sentation-r%C3%A9union-QEP-11-10-18_VF.pdf)

## APPENDIX: INTERVIEW

### Interview

A	Presentation of the service	3 min
B	Transport Profile	1,5 min
C	Automation technology	1,5 min
D	Information personnelle	2 min
<i>Total</i>		8 min

« We are students. We are currently investigating Saclay in 2018. Our goal is to receive advice from future users and report back to decision makers. Would you like to answer our interview knowing that the answers are entirely anonymous? »

### o. Prior Information

To record by the interviewer:

- Number of the interview

- ID of the interviewer
- Date and hour of start / end
- Location (Parking of companies and research institutions or transit modes)
- If transit modes: Train station or on-board trains or both
- Train direction
- Sex of the interviewed person (M-W) et estimation of the age (<18, 18-30, 31-40, 41-50, 51-60, >60)

### A. Presentation of the service

Be careful not to mention the word "autonomous" etc.

A new "transport" on demand system will be set up linking the Massy-Palaiseau station to the Ecole Polytechnique.

It consists of 20 5-seater vehicles that will provide service at a speed of 30 km / h, and will be available at the request of users. The service will be available during off-peak hours, where buses have a low frequency. In particular, the service will be operational during off-peak hours and evening hours during the week and during the weekend.



Map with possible routes.

1. Will you use this service ?

<input type="checkbox"/>	Certainly yes
<input type="checkbox"/>	Probably yes
<input type="checkbox"/>	Probably no
<input type="checkbox"/>	No

2. How often do you will use it?

<input type="checkbox"/>	Everyday
--------------------------	----------

	3-5/week
	1-2/week
	Less

3. What is the purpose ?

	Work
	Study
	Leisure
	Other

4. For which route and approximate distance? **To complete according to the destination**

	To home	Where ?		< 1km
	To work			1-2 km
	To university			3-4 km
	To leisure			5-6 km
	Other			>7 km

5. Currently, for this trip and these schedule

	I use my car
	I ride a taxi
	I take a Uber
	I'm riding a bike
	I walk
	I do not move but I would have liked
	I do not move and do not care
	Other

If car, do you experience some difficulty to park in Saclay? Yes – No

6. Currently, this ride at these times you do it

	Everyday
	3-5/week
	1-2/week
	Less
	Never

## B. Transport Profile

We would now like to know a little more about your daily trips.

1. Do you personally own

	A private car
	A bike
	A motorcycle

	Personal transporter: kick scooter, hoverboard etc
	Other .....

2. Do you have access in your household to a vehicle owned by another family member?

	No
	A private car
	A bike
	A motorcycle
	Personal transporter: kick scooter, hoverboard etc
	Other .....

3. A trip is defined as a trip (even a few meters) between a point of origin (place of work for example) and a point of destination (bakery for example). How much do you spend per day on weekdays and on weekends on average?

On weekdays		On weekends	
	<2		<2
	3-4		3-4
	5-6		5-6
	>6		>6

4. What is your mode of transport?

Main (the most common)		Second option	
	Private car		Private car
	Transit modes		Transit modes
	Walk		Walk
	Bike		Bike
	Motorcycle		Motorcycle
	Personal transporter: kick scooter, hoverboard etc		Personal transporter: kick scooter, hoverboard etc
	Taxi		Taxi
	Uber		Uber
	Other .....		Other .....

5. For your trips, how far do you usually travel?

Home-work/studies		Home-work/studies	
	<1km		<1km
	1-2 km		1-2 km
	3-4 km		3-4 km
	5-6 km		5-6 km
	>7 km		>7 km

6. How much time do you have to travel this door-to-door distance?

Home-work/studies	Home-work/studies
<10 min	<10 min
10-20 min	10-20 min
20-40 min	20-40 min
40-60 min	40-60 min
> 60 min	> 60 min

7. Do you have a subscription?

<input type="checkbox"/>	Navigo Annual subscription
<input type="checkbox"/>	Navigo Monthly subscription
<input type="checkbox"/>	Velib
<input type="checkbox"/>	Taxi ou uber
<input type="checkbox"/>	Car-sharing
<input type="checkbox"/>	Other .....

### C. Automation technology

The new service that will be put in place will use self-driving, driverless vehicles and will use a lane that will be closed to the rest of the traffic with the exception of taxis and buses.



Image of the autonomous vehicle

1. Do you know that this type of vehicle is already in test in the Paris region?

Yes	No
-----	----

2. Have you ever been on an autonomous vehicle?

Yes	No
-----	----

3. Will you use this service?

	As soon as it opens
	1-2 months after
	3-4 months after
	5-6 months after
	Never

4. How often will you use it?

	Everyday
	3-5/week
	1-2/week
	Less

5. What is the purpose?

	Work
	Study
	Leisure
	Other

6. For which route and approximate distance? **To complete according to the destination**

	To home	Where ?		< 1km
	To work			1-2 km
	To university			3-4 km
	To leisure			5-6 km
	Other			>7 km

7. This service can be offered with or without co-travelers. Would you like to share the vehicle with how many people?

	0
	1
	2
	3
	>4

## D. Personal information

### 1. Age range

< 18
19 – 30
31 - 40
41 – 50
51 – 60
61 – 70
71 – 80

### 2. Level of education acquired

Middle School
BAC
BAC+3
BAC+4
BAC+5
>BAC+5

### 3. Socio-professional category

Student of highschool
Student of university
Jobseeker
<b>Professor / Researcher</b>
Senior executive/ manager
Middle level manager
Artisan/ retailer
Retired
Unemployed
Other

If professor / researcher: which discipline? .....

### 4. Do you work in the transport and automotive sector?

Yes	No
-----	----

### 5. Net income class per month.

< 1200 euros
1200 - 2200 euros
2300 – 3200 euros
3300 – 4200 euros
> 4300 euros

## Chapter.8 Demand modelling of autonomous shared taxis mixed with scheduled transit. Application of the strategic framework on Palaiseau area

### ABSTRACT

Autonomous taxis (aTaxis) are promising to restructure the urban mobility universe: dispatching vehicles in roads to minimize congestion, reducing accidents and thus increasing savings of travel time, improving the transit level of service and reducing operating costs of public modes, thus limiting public subsidies (Chapter.1). In Section III, a strategic framework was proposed in order to assess operational, tactical and strategic decisions of a provider of aTaxi service.

This Chapter proposes an application of the strategic framework to the city of Palaiseau (Chapter.7) where aTaxis are implemented to replace a BRT (Bus Rapid Transit) service. It constructs a framework for simulating on-demand aTaxi services, while considering interactions with scheduled transit. In particular, it is coupling an agent-based aTaxi model (VIPSIM) and the four-step VISUM model. Transfers between aTaxis and BRT are considered and a combined utility for public modes is calculated. The convergence between the two models is then performed.

Results of the application case show that, at the operational level, aTaxis improve the demand share of public modes compared to the BRT reference case. A supply management analysis (i.e. tactical level) proved that 20 aTaxis provides high service efficiency and increase the service profitability. In addition, using 10 more vehicles involves 1% more of passengers (+15 passengers) and 50% less of profit (-200€/hour). The sensitivity analysis to the demand volume and the automation technology (i.e. strategic level) confirms that economic performances are higher when demand increases and vehicles are autonomous. The loading ratio reaches its maximum (55%) for a +25% of demand volume.

*Keywords:* Autonomous taxis, on-demand service, demand simulation, mode choice, agent-based model, strategic framework application

### 1. INTRODUCTION

#### 1.1. Background

In Section III, a strategic framework was presented to evaluate an autonomous taxi (aTaxi) service from the technical, economic and environmental perspectives. The application to Orbicity showed that demand density and users' sensitivities have a significant impact on the profit and the social welfare. The introduction of automation enables in addition to



increase the service quality and its profitability as well. The stylized model, nevertheless, assumed several simplifications that do not reflect the real behavior of vehicles and passengers. The operational and tactical levels are therefore not analyzed in detail. On the other hand, most of existing models that have attempted to simulate AVs demand, have considered the case of private AVs that would replace conventional cars (Chapter.1). In addition, major agent-based models focused on the supply operations and set-ups without detailing the demand side beyond statistical and spatial description in the form of an origin-destination matrix of trip-flows.

### *1.2. Objective*

This Chapter proposes an application of the strategic framework (Section III) to the city of Palaiseau (Chapter.7), considering the real demand and the set of available travel modes, transit and private cars. (1) Operational, (2) tactical and (3) strategic decisions are assessed. In particular, (1) technical interactions and/or complementarities between these services (e.g. transfers, feeding...) and the impact on users' mobility (e.g. accessibility, users' costs, modal split...), are firstly determined. (2) At the tactical level, the fleet size and the fare are determined in order to increase profit and social welfare. (3) The impact of automation, demand density and ridesharing strategies on performance indicators are finally evaluated.

### *1.3. Method*

The Chapter proposes a modeling framework that estimates the demand for aTaxi while considering transit modes and private cars as well, in the same territory.

The developed framework has the goal of integrating a dynamic supply model, which simulates performance of on-demand services, into a static demand model, which is dedicated exclusively to scheduled services. In particular, the framework relates VIPSIM, an agent-based model developed by VEDECOM (Babicheva, et al., 2018), and the VISUM four-step model (PTV Group, 2018). The feedback between these two models defines the demand-supply equilibrium. Mobility impacts as well as economic performances of replacing a BRT (Bus Rapid Transit) service with Autonomous Vehicles are evaluated.

### *1.4. Chapter structure*

The Chapter starts by presenting the demand modeling framework, with a brief description of VIPSIM, VISUM and the demand-supply connection scheme (§2.). A detailed description of the four-step model in VISUM and the convergence loop follows. The demand framework is then applied to Paris Palaiseau area in order to investigate its performance, as well as those of the strategic framework (§3.).

## **2. DEMAND-SUPPLY CONNECTION FRAMEWORK**

The demand is modelled with VISUM, a static model that determines the impacts of existing or planned transport supply, which can encompass both the vehicle road network and the scheduled public modes. In particular, the demand can be modelled in VISUM using a four-

step model: (1) Generation of trips, (2) Distribution to destinations, (3) Mode choice and (4) Route assignment. On top of VISUM, a separate agent-based simulation model VIPSIM was developed for the aTaxi system. It simulates movements of vehicles in interaction with passengers. The service performance in terms of passenger waiting time and travel time are among the key outputs generated.

In the following, VIPSIM, an agent-based model for autonomous taxis, is presented. Then, the demand sub-model, the four-step model of VISUM, is presented while outlining main improvements to gather VIPSIM outputs. Finally, the connection between VIPSIM and VISUM is described and the corresponding mathematical problem is formulated.

### *2.1. Supply model: VIPSIM, an agent-based model for autonomous taxis*

VIPSIM (Vedecom Integrated Passenger transport SIMulator) (Babicheva, et al., 2018) is an agent-based microscopic simulation model developed by the VEDECOM institute, which simulates the behavior and performance of a service of shared autonomous taxis.

The vehicle and passenger movements are modeled in detail, as well as operations strategies such as the management of empty vehicles and ride-sharing assignment. An optimization interface allows the evaluation of optimization algorithms minimizing e.g. passenger waiting times, operator costs, empty vehicle mileage, etc.

Empty taxis are redistributed to serve passengers or to anticipate demand, including the arrival of mass public transit vehicles at stations. Depending on the algorithm, they are reserved to nearest users in real-time through a first-come first served (FCFS) algorithm, or use more complicated algorithms that take into account deficits and surpluses of vehicles, based on current and predicted demand (Babicheva, et al., 2018).

When taxis are loaded, they consider ride-sharing passengers along their route with the objective to increase their loading efficiency. They accept passengers, who board and alight in dedicated stations. The stations are located within 400 meters from passengers' origin/destination. Taxis are assumed to run according to a modified Intelligent Driver Model (IDM) (Kesting, et al., 2010) respecting speed limits and interactions with other vehicles.

The main inputs considered in VIPSIM are the passenger demand station-to-station for a given service period, the network infrastructure (roads, stations...) and the number of vehicles. The main outputs are the travel times of trips, passenger waiting times, the number of waiting passengers per station and the empty running times and mileage of vehicles.

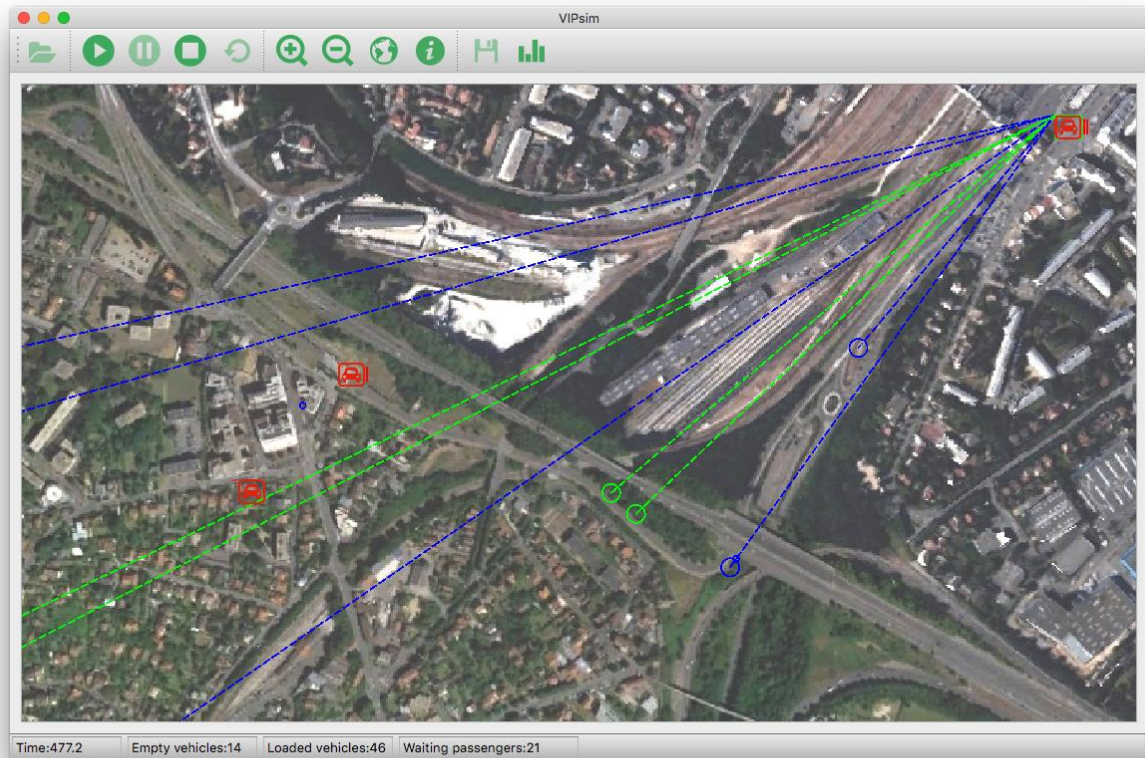

**Figure 67 Empty (green) and full (blue) vehicles destined to one of the stations**

**Figure 67** shows the main simulation model where aTaxis are moving towards a station to pick up waiting passengers. Empty vehicles are shown in green and (partially) loaded vehicles in blue. **Figure 68** shows an example of the main VIPSIM outputs. The main KPIs (Key Performance Indices) are passenger waiting times (average and max), number of passengers served, average passenger and vehicle trip lengths, total kms of loaded and empty vehicle movements, energy consumption, station queue lengths, as well as ridesharing efficiency (number of passengers per loaded vehicle trip). Each output giving rise to a KPI (e.g. average passenger waiting time) can be selected and its details displayed in a graph as well as on the map.

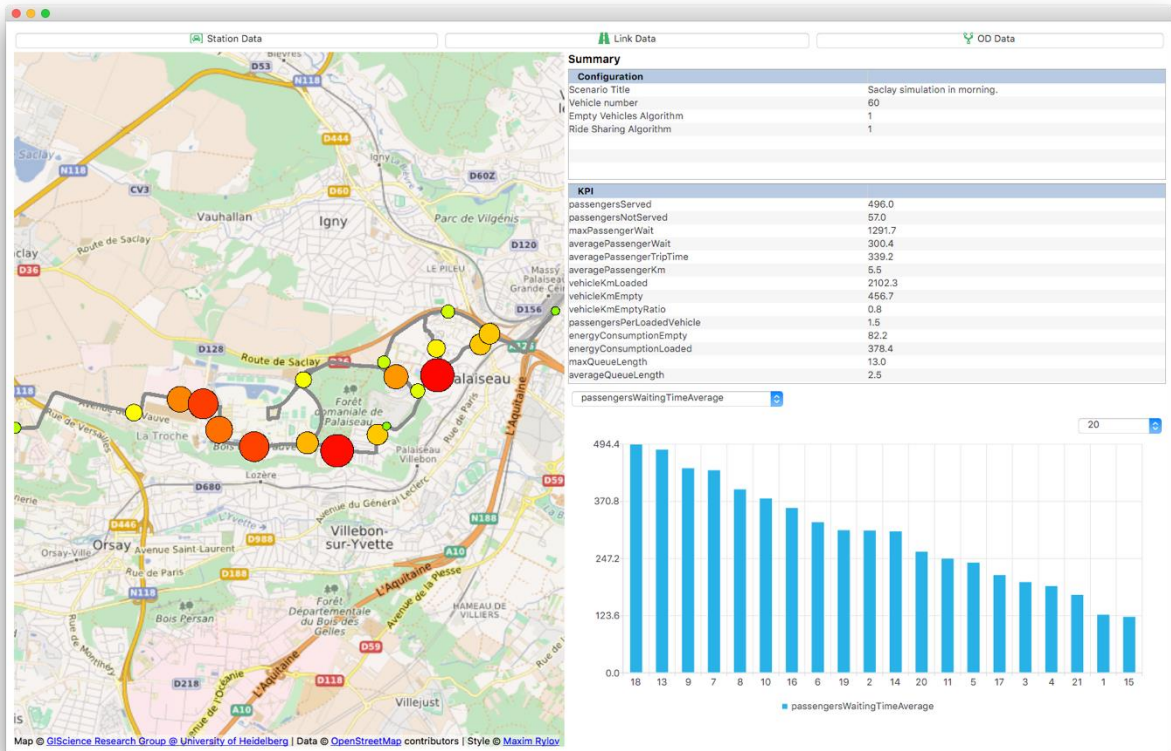

Figure 68 VIPSIM output window showing main KPIs and average passenger waiting times at stations

## 2.2. Demand travel: Four-step model of VISUM

The demand model of VISUM is composed of four sub-models that make up the following sequence: (1) Trip generation, (2) Distribution, (3) Mode choice and (4) Route assignment.

### 2.2.1. Trip generation

The trip generation model estimates for each Traffic Analysis Zone (TAZ) emitted and attracted trips. TAZ are areas of a radius of maximum 400 m around the station. Each train station is considered as an independent TAZ. The centroid of each TAZ is inserted near to the taxi station. Connectors are generated to link the centroid to transit stops and road nodes. Population and jobs for each TAZ are calculated by combining urban characteristics and job address data (INSEE, 2017).

The total amount of internal trips in the city ( $Q_0$ ) is given by data of DRIEA (Regional and Interdepartmental Direction of Equipment and Planning). It is adjusted regarding the evolution of population and jobs in order to approximate actual internal trips. Trip generations and attractions are then obtained using the following equations:

$$E = \frac{E_{tot} P_{TAZ}}{P_{tot}} \quad (1)$$

$$A = \frac{A_{tot}J_{TAZ}}{J_{tot}}$$

Where  $E_{tot}$  and  $A_{tot}$  total generation and attraction respectively, given from surveys of DRIEA,  $P_{TAZ}$  and  $J_{TAZ}$  population and jobs respectively per TAZ and  $P_{tot}$  and  $J_{tot}$  population and jobs for all the study area.

### 2.2.2. Trip distribution

The gravity model computes the trip flows by OD pair zones. They are calculated based on vehicle travel time / transit travel time according to (Eq.2). In particular, the total distribution matrix is calculated as the sum of two distribution matrices: (1) for users of private cars and (2) for users of public modes.

$$F_{ij} = k_{ij}E_iA_j \exp(cU_m(i,j)) \quad (2)$$

Where:  $k_{ij}$  is a normalization factor,  $E_i$  generations by zone,  $A_j$  attractions by zone, and  $U_m(i,j)$  the utility of using a given mode  $m$  between  $i$  and  $j$  (vehicle travel time here),  $c$  is the utility sensitivity parameter.

In particular, we have:  $\sum_j F_{ij} = E_i$  and  $\sum_i F_{ij} = A_j$

### 2.2.3. Mode choice

Two modes are considered: private cars and public transport. aTaxis are considered as a public transport mode. They are integrated with other transit modes (bus, train...) as an additional and complementary public service. In this step, the part of demand using each mode (private cars, public modes and autonomous taxis as well) is determined.

The mode choice multinomial logit model is a discrete logit model using a utility function of each mode. In general, the utility function is expressed as:

$$U_m = \mu^{(m)} - \tau^{(m)} - T^{(m)} = \mu^{(m)} - \tau^{(m)} - (\alpha_{IVH}t_{IVH}^{(m)} + \alpha_A t_A^{(m)}) \quad (3)$$

Wherein  $U$  is the utility of the mode  $m$ ,  $\tau^{(m)}$  the tariff of using  $m$ ,  $T^{(m)}$  the generalized time, as a combination of  $t_{IVH}^{(m)}$  and  $t_A^{(m)}$  resp. the travel time and access time when using the mode  $m$ , and  $\alpha_{IVH}, \alpha_A$  positive coefficients in Euro per unit time.  $\mu^{(m)}$  is a coefficient of the  $m$  mode preference, which reflects unknown impacts of other factors than times and cost (comfort, privacy, flexibility, etc.). Coefficients are determined by approximation or estimated from stated-preference surveys.

The utility of private cars includes running costs  $\alpha_{IVH}t_{IVH}^{(car)}$ . The utility of public transport is a combination of aTaxi utility and conventional public modes utility. In particular, the combined utility is constructed by making the distinction between common ODs and non-common ODs.

*Non-common ODs.* Non-common ODs are ODs which are served only by one mode. In this case, the utility to go from O to D is equal to the utility of the used mode. For public modes, the generalized time is the perceived journey time, which combines travel times, waiting times, access and egress times and transfer times. For aTaxis, the generalized time

combines travel time and waiting time.

*Common ODs.* Common ODs are trips served by combined modes (e.g. aTaxi and bus). The utility of these trips combines AVs utility (travel time and waiting time) until the transfer point, the transfer penalty and then public modes utility (perceived journey time) from the transfer point. Since aTaxis are considered as public transport modes, then the fare of the trip is integrated between AVs and conventional public modes. The preference of the combined mode, furthermore, could be different from the sum of AVs preference and public modes preference. Utility functions are provided later equations (Eq.8) and (Eq.9).

#### 2.2.4. Assignment

The assignment of aTaxis is performed in VIPSIM. Consequently, the assignment of public modes is obtained outside of VISUM. Car assignment is achieved in parallel in VISUM. The assignment impacts travel times which changes the overall trip distribution. Then two loops of assignment are applied in the model as presented in **Figure 6g**: (1) for aTaxis, and (2) for private cars.

#### 2.3. Traffic equilibrium issues

In order to model the demand for aTaxis, VISUM requires the impedance of each mode. For conventional modes (private cars, bus, train...), the impedances are obtained directly from the network and timetables of public modes. For aTaxis (on-demand service), VIPSIM provides the impedance matrix, and thus the utility used for mode choice.

**Figure 6g(a)** shows the general assignment scheme, where VIPSIM is run in the inner loop for the aTaxi assignment (**Figure 6g(b)**). The process stops when the mode choice and trip distribution converge.

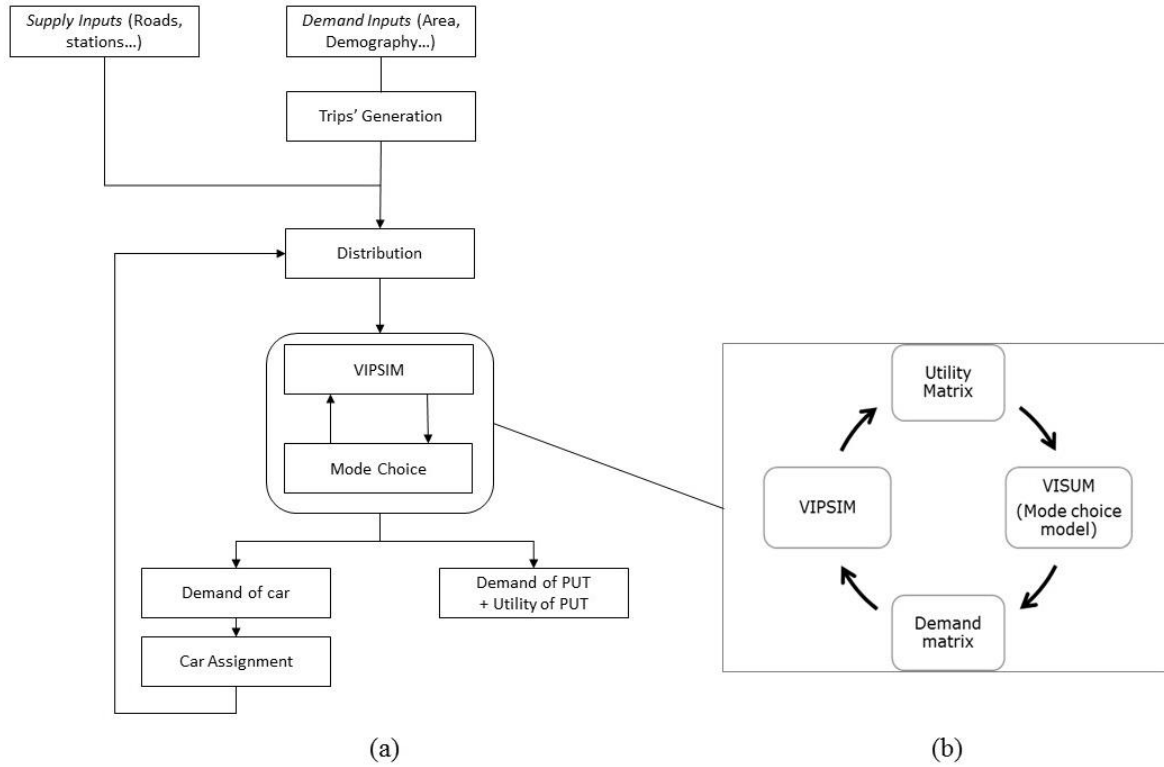

**Figure 69 Overview of the integrated framework: (a) Integration of VIPSIM in the four-step model of VISUM, (b) Feedback loop between VIPSIM and VISUM**

The utility of aTaxis ( $U_{aT}$ ), as a combination of travel times and waiting times (Eq.3), is given by VIPSIM model as a function of demand (Eq.4). The combined utility  $U_{PuT}$  is then provided by (Eq.6) to (Eq.9) by making the distinction between common ODs and non-common ODs. Finally, the demand is calculated considering the combined utility based on a logit model (Eq.5). Hence, the overall system is a fixed-point problem in  $Q$  or  $U_{PuT}$ , that could be summarized through the following equations:

$$U_{aT} = f(Q) \quad (4)$$

$$Q(i, j) = Q_0 \exp(\mu U_{PuT}) / \sum_{i \in \{PuT, Car\}} \exp(\mu U_m) \quad (5)$$

$$U_{PuT}(i, j) = U_{aT}(i, j) \text{ for } (i, j) \in S^{(aT)} \quad (6)$$

$$U_{PuT}(i, j) = U_{Bus}(i, j) \text{ for } (i, j) \in S^{(Bus)} \quad (7)$$

$$U_{PuT}(i, j) = \tau^{(PuT)} + \psi^{(PuT)} + \max_k (T_{aT}(i, k) + T_{Bus}(k, j)) + \Delta T \text{ for } i \in S^{(aT)}, j \in S^{(Bus)}, k \in \bar{S} \quad (8)$$

$$U_{PuT}(i, j) = \tau^{(PuT)} + \psi^{(PuT)} + \max_k (T_{Bus}(i, k) + T_{aT}(k, j)) + \Delta T \text{ for } i \in S^{(Bus)}, j \in S^{(aT)}, k \in \bar{S} \quad (9)$$

Where  $Q_0$  is the total volume of trips,  $\theta$  is the logit parameter,  $\Delta T$  is the transfer penalty.  $S^{(aT)}$ ,  $S^{(Bus)}$  are respectively stations served by aTaxis and buses and  $\bar{S} = S^{(aT)} \cap S^{(Bus)}$ .

The problem is solved using the following program:

**Step 0.** Set an initial value  $Q^{(z)}$ . Let  $z = 0$  and consider that  $Q^{(0)}$  is equal to the total demand resulting from the distribution step.

**Step 1.** Calculate  $t_R^{(z)}$  and  $t_w^{(z)}$  by introducing  $Q^{(z)}$  in VIPSIM

**Step 2.** Update the demand volume in VISUM through running the third step of the model.

**Step 3.** If  $|Q^{(z+1)} - Q^{(z)}| \leq \theta$ , then stop where  $\theta$  is a predetermined convergence tolerance. Otherwise  $z = z + 1$  and return to Step1.

### 3. SIMULATION CASE STUDY

#### 3.1. Case study description

##### 3.1.1. Territory

The model framework is applied to Palaiseau (Chapter.7), a French city located in the Paris metropolitan area, 17 km South from the center of Paris. It is home to about 32 000 inhabitants and provides about 22,000 jobs. The distribution of homes and jobs is heterogeneous. Palaiseau has become an area of interest because it is part of the growing scientific cluster in France, which concentrates universities, graduate schools, research institutes and research labs of companies. The connection to the rest of the urbanized area is mainly ensured by the train line RER B, which traverses Palaiseau along a North-South axis and serves three stations. In particular, the Massy-Palaiseau station is a junction of RER B, RER C and the French high-speed rail line (TGV). Furthermore, it is a hub between train lines and several bus lines, including one BRT line.

##### 3.1.2. Taxi service

A service of aTaxis in Palaiseau is planned to be implemented by 2020. The service is based on a fleet of taxis operating on a selected road network, connecting the Massy-Palaiseau station to universities and research institutes. aTaxis aim to replace the existing service of BRT (Bus rapid transit line) during off-peak hours while providing a feeding service in parallel. The characteristics of BRT are provided by 2010 data of DRIEA (DRIEA, 2010) and presented in **Table 27**.

**Table 27** BRT technical characteristics



Travel time	11min
Length	9.3km
Commercial speed	30km/h
Headway	5min (during Peak Hours) 15min (during Off-Peak Hours)
Number of vehicles	15 (during Peak Hours)
Number of stations	13
Vehicle.km travelled (1 peak hour)	230

The taxi network has a total length of 13 km and includes 21 stations. To each station is associated one Traffic Analysis Zone (TAZ). The fleet is composed of 60 taxis. The average speed of taxis is 50 km/h. which is a function of link speed limits, interactions with other vehicles and entering/ exiting stations. The speed limits in the network vary from 30 km/h to 70 km/h. **Figure 70** shows the overall aTaxis network by making the distinction between BRT network (in green) and additional roads used by aTaxis to improve the feeding service (in red).



**Figure 70 Palaiseau network for autonomous taxis**

### 3.1.3. Demand

The simulation is performed for one morning peak hour and focuses on home-to-work trips. The total volume of trips is based on 2010 data of DRIEA. Trip emissions and attractions are generated by making the distinction between motorized persons, who are able to use private cars and public modes and non-motorized persons for whom public modes are the only option.

For private cars, the perceived travel time is in general over-estimated by more than 50 % (Peer, et al., 2014) depending on the origin-destination length and driving conditions (congestion, traffic lights, intersections...). The mode preference against public modes is set up by default in VISUM to about 2 € for motorized persons. Non-motorized persons prefer using public modes whatever their impedance: thus, they have been given a mode preference of -30 €.

For conventional public modes, the perceived time spent aboard vehicles is generally estimated accurately (Wardman, 2004). However, perceived passenger travel time can increase by as much as 2.5 times in very crowded vehicles (6 standing passengers per m<sup>2</sup>). One waiting minute is perceived as 1.5 (Meunier & Quinet, 2015) to 2.5 (Wardman, 2004) travel minutes. Similarly, one walking minute is equivalent to two travel minutes (Meunier & Quinet, 2015). To sum up, consider factors of 2, 1.5 and 2 resp. for the bus travel time, the waiting time and the walking time.

For taxis, the travel time and waiting time seem to be the most important factors, even more important than fare (Wong, et al., 2015; Borja, et al., 2018). They are perceived resp. with a factor of 1.2 and 1.5 compared to actual spent time. The walking time is perceived as for bus. The mode preference coefficient is assumed to be closer to that of private cars than that of public modes since the service is on demand with guaranteed seating. We assume that it is equal to 1.5 €.

Finally, for public modes (aTaxis and conventional public modes), the fare is assumed of 1.2€ per trip. The transfer time between modes is slightly over-perceived by 20%.

Given the French estimated value of time of 12 €/h for commuting purposes (Quinet, 2013), the utility coefficients are summarized in **Table 28**:

**Table 28 Coefficients of the utility for modes**

	Notation	Car	Bus	aTaxis
Travel time	$\alpha_{IVH}^{(m)}$	0.3	0.4	0.24
Waiting time	$\alpha_A^{(m)}$	0	0.3	0.3
Walking time	$\alpha_w^{(m)}$	0	0.4	0.4
Transfer time	$\alpha_T^{(m)}$	0	0.24	0.24
Fare	$\tau^{(m)}$	0	1.2	1.2
Mode preference (non-motorized)	$\mu^{(m)}$	2	0	1.5
Mode preference (motorized)	$\mu^{(m)}$	-30	0	1.5

### 3.2. Outcomes of Demand-Supply equilibrium (Operational layer)

#### 3.2.1. Equilibrium computation

**Figure 71** shows convergence results between VIPSIM and VISUM. The first iteration corresponds to almost 100 % of demand using public modes. In the next iteration, that passes to 40 %. The convergence is then obtained for about 42 % of the total demand, after seven iterations.

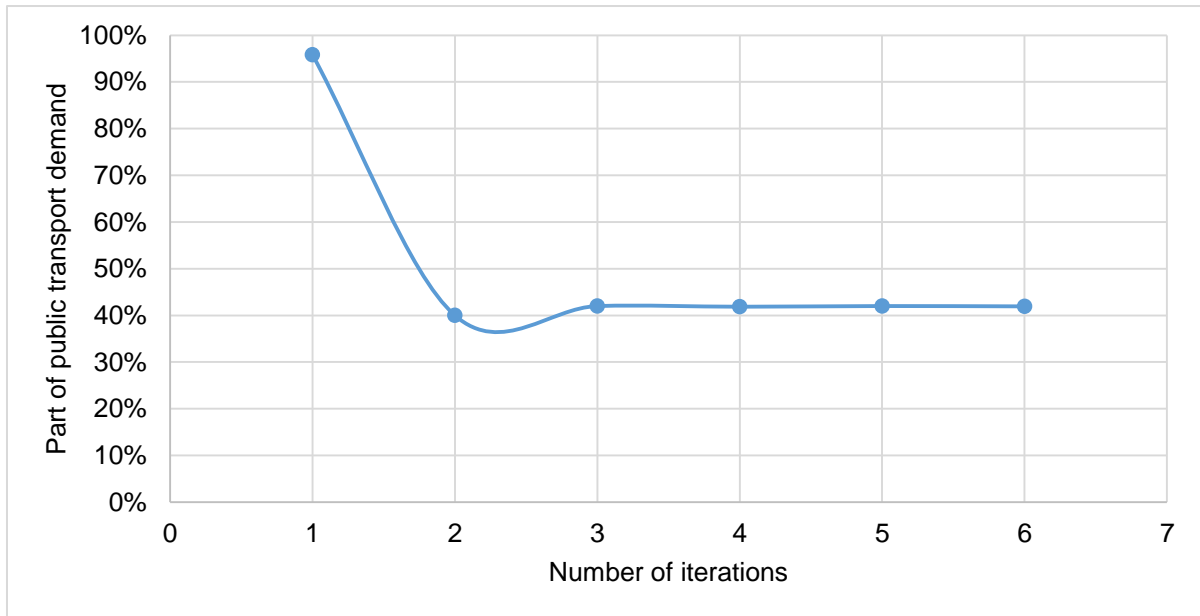

**Figure 71 Part of public transport demand by iteration number**

### 3.2.2. Operational performance

The results presented here are those after reaching convergence (in 3 iterations). The fleet of 60 aTaxis attract 42 % of the total demand, which corresponds to 595 users during the peak hour. The average passenger waiting time is 3 minutes, the maximum is 19 minutes and the 95 % centile is 13 minutes. The average trip time is 3 minutes. The average passenger queue length is 1, but the maximum is 20 passengers. The average passenger trip distance is 4 km, indicating that the aTaxi is mostly attractive for relatively short trips. The total passenger km is 1,350 km, which translates to 22.5 km per vehicle.

The ridesharing is moderately effective at 1.4 passengers per loaded trip, but the empty vehicle trips make up 70 % of the total vehicle km, indicating that a large number of empty vehicles are circulating in the network in anticipation of potential passenger demand. The implemented algorithms do not take into account empty running costs, just minimization of current and anticipated passenger waiting times.

### 3.2.3. Mobility performance

Mobility performance include modal share and quality of service. **Table 29** shows the situation of mode split between cars and public modes before and after introduction of aTaxis. Results show that replacing the BRT by aTaxis ensures about the same modal split, with a slight improvement of about 0.2 % for public modes. Almost 21 % of PuT trips are achieved entirely by aTaxis and about 80 % of trips involve using aTaxis for part of the trip.

**Table 29 Mode split between private cars and public modes before and after introducing aTaxis**

	PUT modes			Motorized modes	
	aTaxis	BUS	aTaxis+BUS	Total PUT	Car
<b>Before</b>	0%	100%	0%	32.8%	67.2%
<b>After</b>	21%	30%	49%	42.0%	58.0%

An analysis for passenger costs of using BRT and aTaxis supports these findings (**Figure 72**). The focus is on all trips aiming to reach station 1, which corresponds to the Massy-Palaiseau station. Three main groups of ODs can be identified:

- (1) Origins that are directly served by the BRT and taxi: aTaxis seem to be more attractive in general.
- (2) Origins that are directly served by aTaxis but indirectly by BRT (involving usage of other bus lines or walking). The results show that for this group aTaxis significantly reduce user costs by an average factor 4.
- (3) Origins that are served by buses only. Trips from these origins involve transfers between BRT/ aTaxis and bus lines. Here, average generalized costs are similar and there is no clear predominance of one system over another.

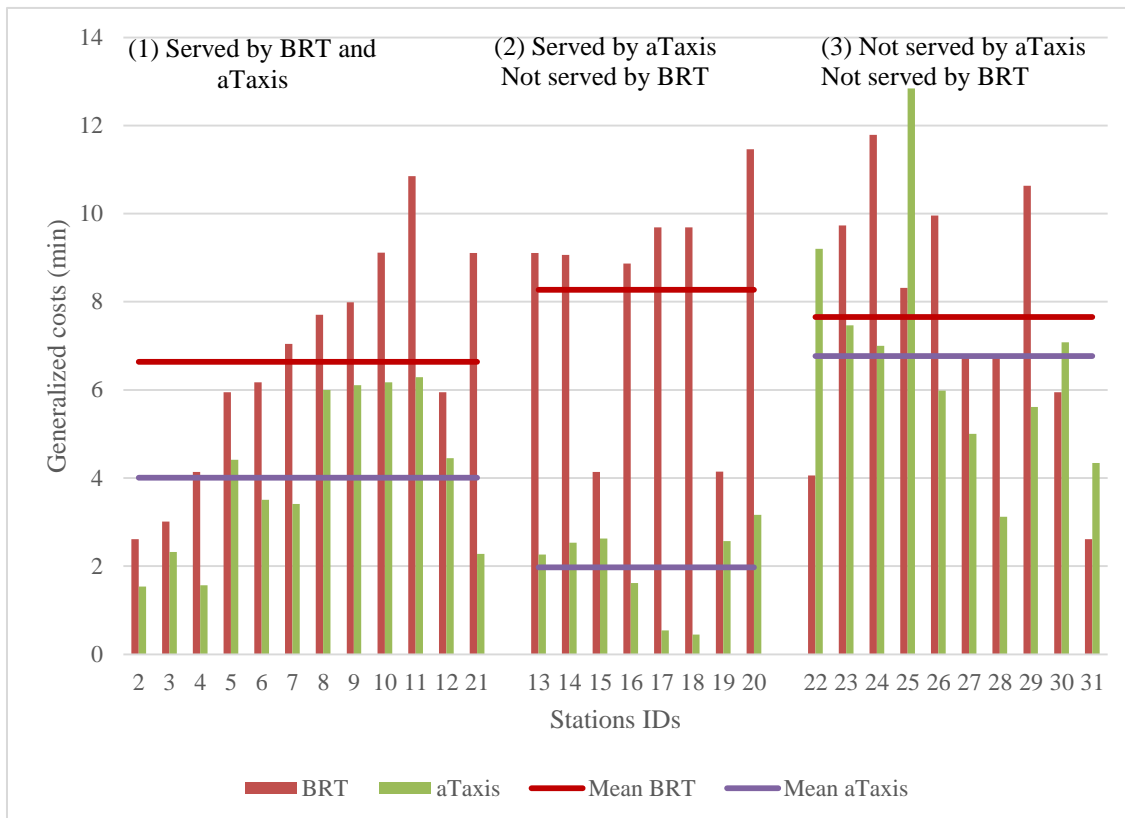

**Figure 72 Passenger generalized cost for trips to station 1 (Massy-Palaiseau station), grouped by types of origin.**

Focusing particularly on trips involving aTaxis (previously BRT), the mode share is 28 % for BRT against 72 % for private cars. The introduction of aTaxis improves the service quality, inducing the evolution of the mode share to 38 % for aTaxis against 62 % for cars.

#### 3.2.4. Costs performance

Costs of purchasing autonomous cars would be higher by 20 % (Boesch, et al., 2018) to 26 % (Owens, 2018) compared to conventional cars. In addition, using autonomous cars would shorten vehicle lifespan to 1.5 to 3 years. Assuming a purchase cost of 36,000 € and a lifespan of 2 years, fixed costs would be, in the absence of drivers' wages, about 50 €/day or 3 €/h. Running costs are expected to decrease by 50 % for insurance (Litman, 2018), and would reduce the energy consumption by about 10 % (Boesch, et al., 2018). Considering the kilometric cost coefficient (PRK), running costs for medium-size vehicles are estimated to 0.4 €/km (Pelletier, 2018).

### 3.3. Application to supply management (Tactical layer)

#### 3.3.1. Impact of fleet size

For public modes, the main priority of the operator is probably the demand maximization, while ensuring the service profitability, or at least its viability. In general, the main factors influencing operator profit are the fleet size, vehicle capacity and pricing. We assume that the capacity of vehicles is fixed, that fares correspond to those of public modes, so 1.2 € per trip, and investigate the impact of fleet size on demand and profit.

**Figure 73** shows the variations of demand and profit with respect to fleet size. For fleets inferior to 25 vehicles, aTaxis are not profitable. Larger vehicle fleets induce more empty kilometers driven and thus higher costs. On the other hand, the demand is barely affected by the fleet size (+1% for +10 vehicles). **Figure 74** investigates the main reasons for this outcome by evaluating ridesharing and empty vehicles traveled. It confirms that 20 vehicles leads to higher ridesharing efficiency (2 passengers per loaded vehicle), and thus higher operating efficiency.

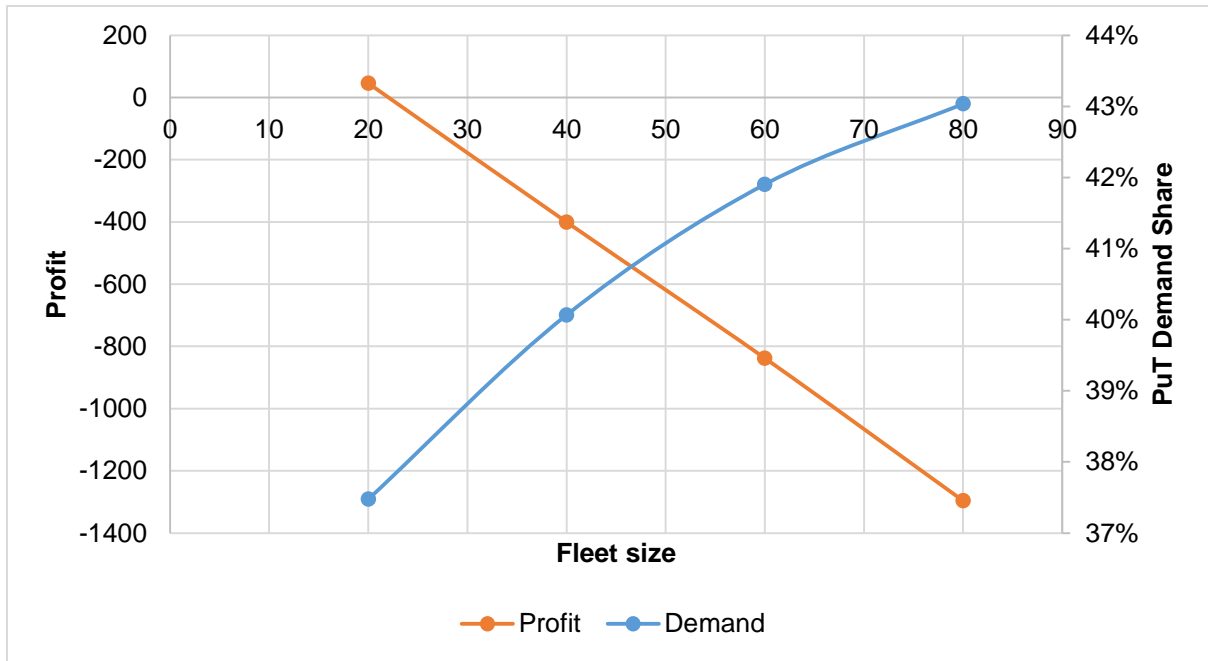

Figure 73 Variation of hourly demand and profit with respect to a Taxis fleet size

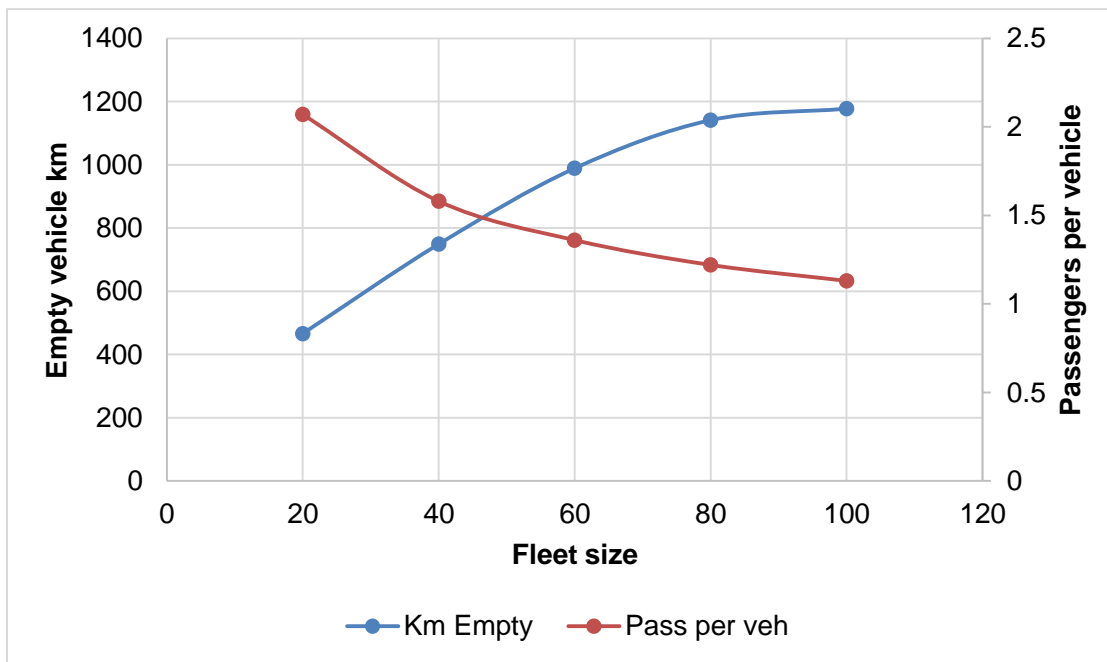

Figure 74 Variations of ridesharing and empty vehicle kilometers with respect to fleet size

### 3.3.2. Impact of fleet size and fare

Consider that fare is not fixed. The operator controls the fleet size and the fare in order to maximize profit or social welfare. **Figure 75** depicts the variation of profit with respect to fleet size and fare. Zero profit, shown by the green cloud, corresponds to the profit of BRT as reference. The greater is the fare, the smaller should be the number of vehicles. The profit

is maximized for the lowest fleet size (20 vehicles) and highest fare (3 € per trip). Operational efficiency, measured by the ratio of loaded driven distances, is maximized for lower number of aTaxis (**Figure 77**). **Figure 76** shows that, on the contrary to profit, the demand is maximized for higher number of vehicles (80 vehicles) and lower tariffs (0.5€ per trip).

**Figure 78** presents emissions compared to BRT scenario with respect to fleet size and fares. Higher fares involve more trips by private cars and then more emissions. On the other hand, increasing the number of vehicles induces larger emissions. Emissions of aTaxis exceed BRT emissions when fares are greater than 2€ and the fleet contains more than 60 vehicles. If aTaxis are in addition electric, the impacts on emissions would be much improved.

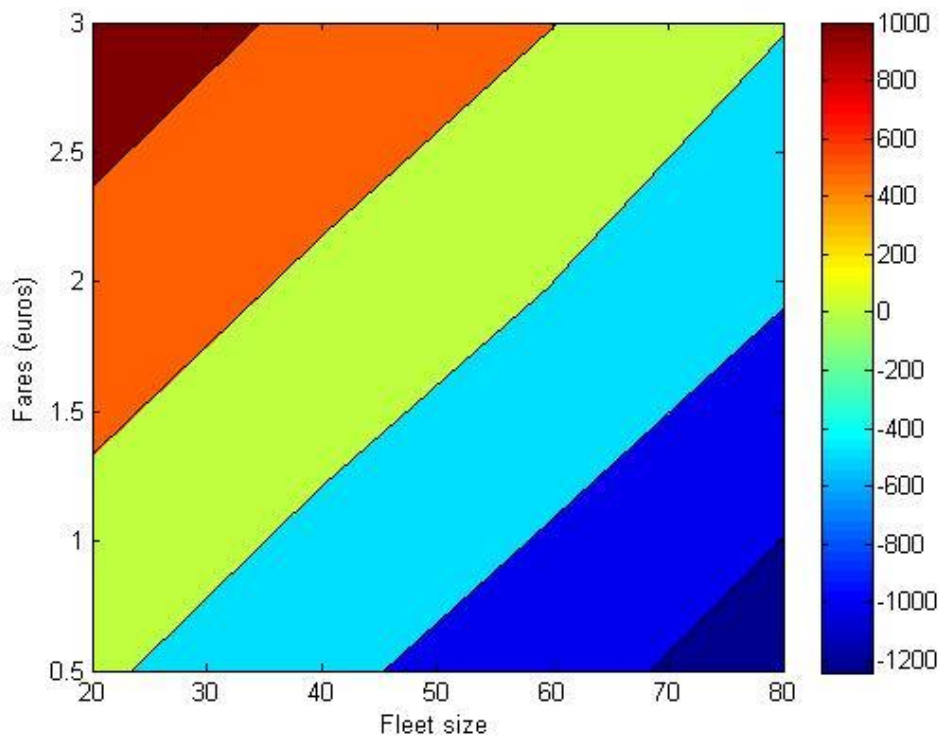

**Figure 75** Profit with respect to fleet size and fare. Zero profit corresponds to BRT profit.

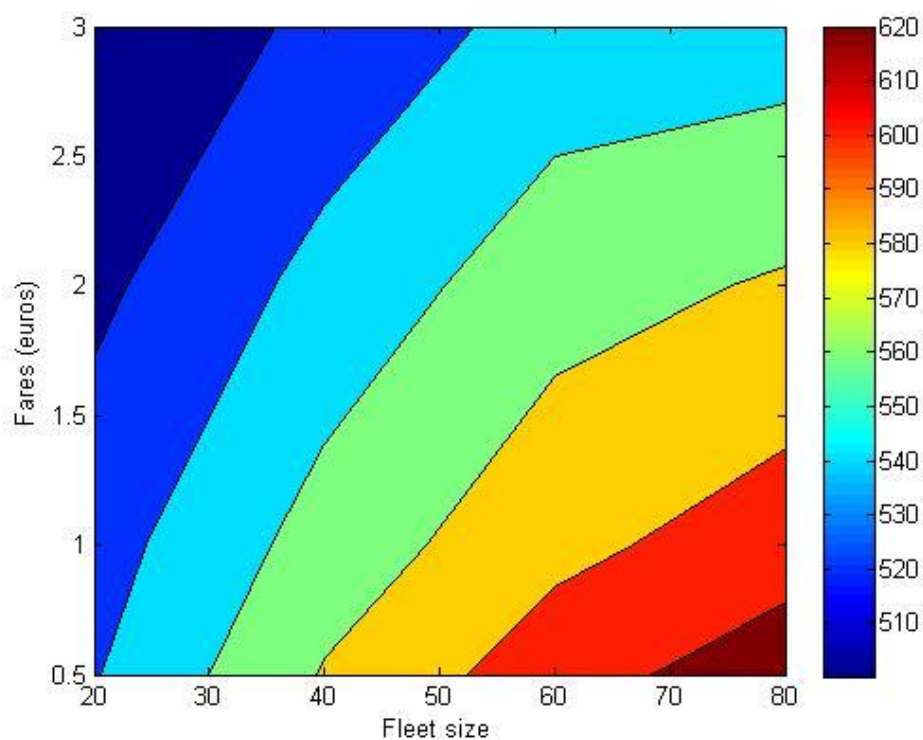

Figure 76 Demand with respect to fleet size and fare. Demand of BRT before implementation of aTaxi is 460.

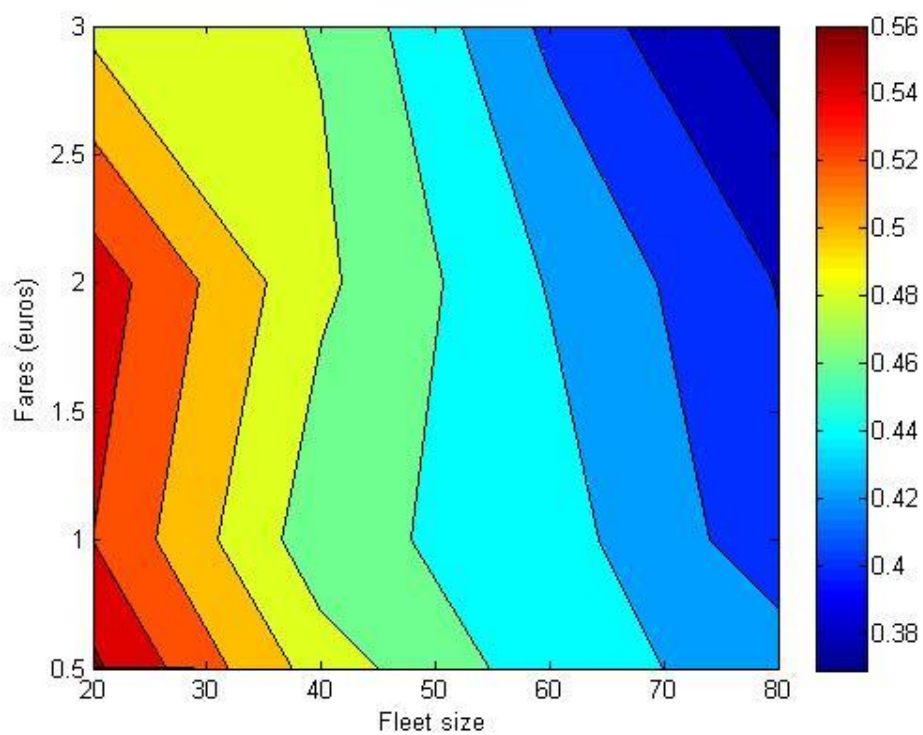

Figure 77 Ratio of loaded driven distances with respect to fleet size and fares.



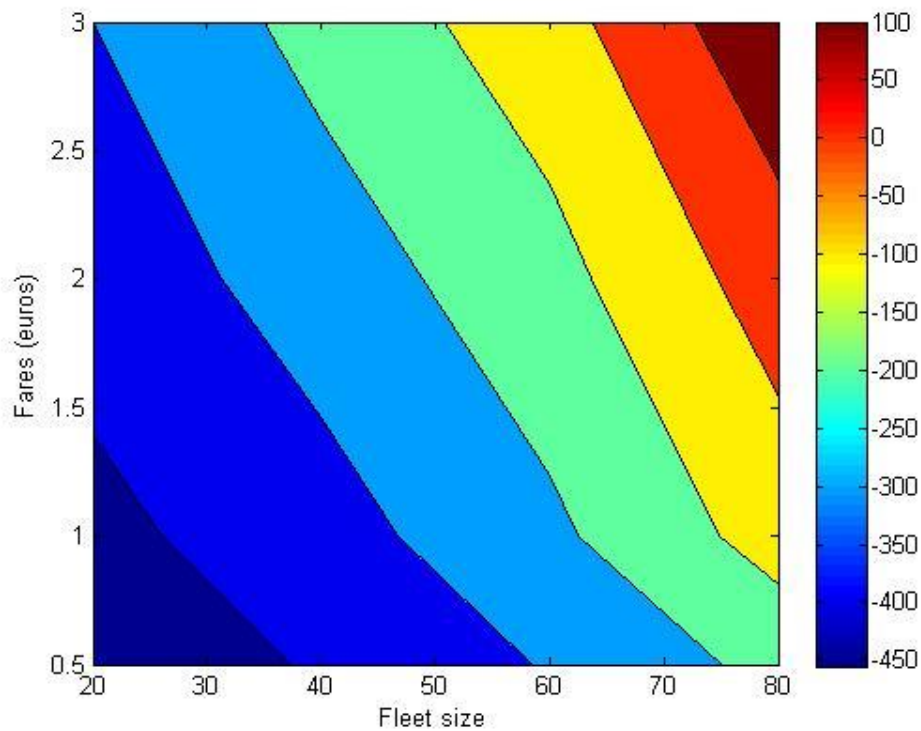

Figure 78 Emissions with respect to fleet size and fares.

### 3.3.3. Impact of assignment strategies

Assume that fleet is fixed at 40 vehicles and fare at 1 € per trip. The impact of assignment strategies was investigated by Babicheva et al. (2018) for a fixed demand. Two assignment strategies were implemented in VIPSIM.

- Simple nearest neighbors (SNN): The nearest empty vehicle is called to the longest waiting passenger in the system.
- Heuristic nearest neighbors (HNN): The nearest empty vehicle is called to the passenger who will be the longest waiting passenger at the moment of pick-up. This method attempts to improve on SNN by taking into account the time it takes for a vehicle to move towards a waiting passenger.

The difference between the SNN and HNN methods can be significant. Consider a long line network with one empty vehicle in one end of this network and two passengers waiting, one at each end of the network. If the SNN algorithm is applied, the vehicle will move towards the currently longest waiting passenger, regardless of how long it takes to get to this passenger. On the other hand, if the HNN is applied, the vehicle will move to the other end of the system because at the moment of its arrival the waiting time of the farthest passenger will be the largest.

**Table 30** shows technical and economic performances for the two assignment strategies. SNN and HNN algorithms present almost the same results in terms of demand, passengers per loaded vehicle and profit.

**Table 30 Performances of two ridesharing strategies**

	PUT demand	PUT demand share	Av. wait time	Ratio loaded km	Total costs	Revenues	Profit (€/hour)	Emissions (compared to BRT)
SNN	568	40.0%	9.2	46.7%	968.8	568.5	-400	-339
HNN	559	39.4%	10.3	45.9%	969.8	559.5	-410	-303

3.4. Commercial and technological positioning (Strategic layer)

Consider a fleet of 40 vehicles and a fare of 1 € per trip. In order to assess the impact of demand density on technical and economic performances, different levels of demand are assumed: from -50 % to +50 % of the base level. **Figure 79** depicts the variation of profit and mileage occupancy (i.e. **Table 16**). As expected, profit and mileage occupancy increase with demand. In particular, the ratio of loaded driven distances reached its maximum (55 %) for demand volume of +25 % of the base level. The loading of taxis, however, increases to exceed 2 passengers. The total driven mileage (empty + loaded trips) is almost the same for all demand scenarios (i.e. about 1,750 km), which induces a quasi-fixed reduction of production costs that is involved by automation from one demand scenario to another. By assuming that aTaxis and conventional taxis are based on same utilities coefficients and are providing the same level of service, then they attract the same number of users.

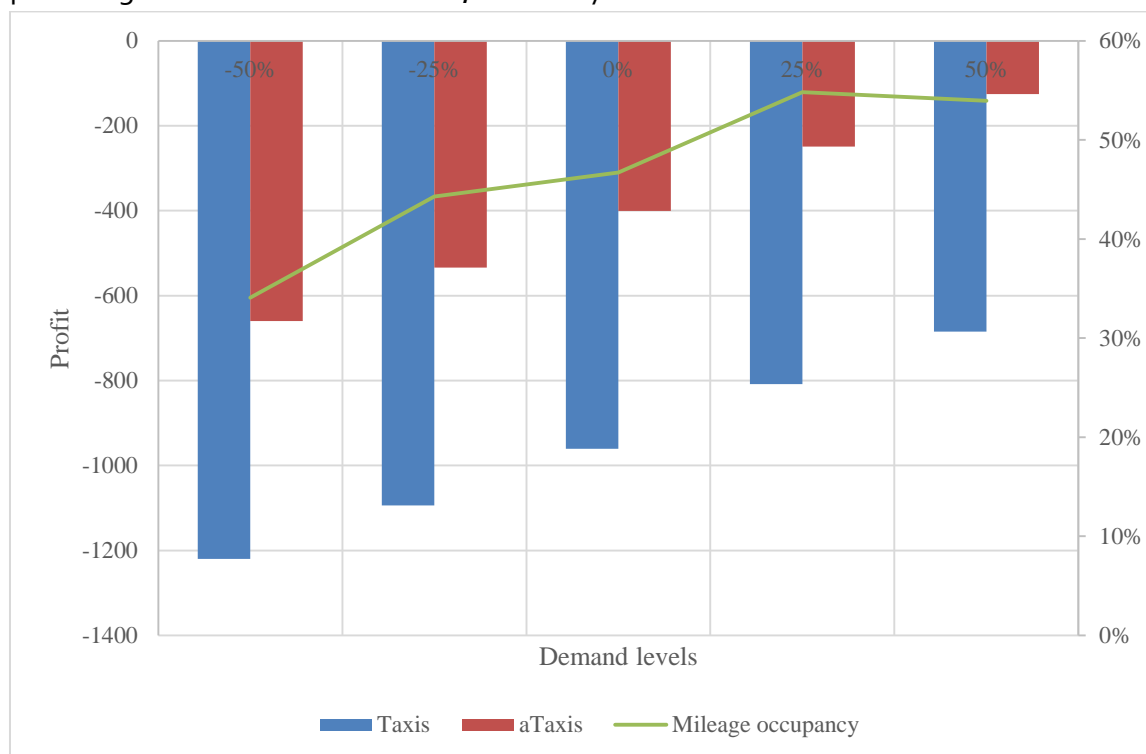

**Figure 79 Impact of demand level and technology on profit and mileage occupancy**

### *3.5. Discussion*

The demand and supply modelling framework is suitable to determine the conditions of traffic equilibrium for a given territory. It is based on a conventional four-step travel demand-forecasting model. The connection with an agent-based model (e.g. VIPSIM) allows modeling an on-demand service using a conventional macroscopic assignment tool (e.g. VISUM). The convergence between the two models is obtained after a limited number of iterations. The proposed framework enables one to assess the impact of implementing new taxi services on the modal split depending on user performances. Further, it has the potential to investigate the efficiency of operational strategies (e.g. fleet size, ridesharing).

There are, however, some limitations to this demand simulation framework. Firstly, the four-step model suffers from a number of drawbacks that are related to the nature of these models (Mladenovic & Trifunovic, 2014). For instance, trips begin and end at a single point in a zone's centroid, workers from households are matched to jobs based on travel time/distance and without considering income and trip purposes. A second issue concerns data availability. Data is required for developing and calibrating the demand model. However, the most recent travel demand survey that has been published as of 2018 is that of 2010. Moreover, data provided by DRIEA is by MODUS zones, which are not adapted to analyze station-to-station trips for a local feeding service (i.e. Palaiseau is composed of two MODUS zones, while we need at least 21 zones). In addition, it concerns only trips performed during morning peak hours. This prevents an analysis of complementarities between autonomous taxis and existing modes, which could alternate along the day depending on the demand volume. Finally, data related to on-demand service do not yet exist and have to be estimated.

Regarding the application case, the simulation was achieved for the case of Palaiseau city, a choice motivated by the EVAPS project led by VEDECOM, which aims to implement a service of autonomous taxis by 2020. This will enable us to validate the model outcomes and calibrate the simulation tool. The simulation scenario also has several limitations. The first limitation is related to the availability of data. Trip generations and attractions are based on old data and projected through observing the evolution of local population and jobs. Moreover, this data corresponds to the peak period and only home-to-work trips. Another limitation of our simulation scenario concerns the utility calculation. We include the mode preference in order to consider security, comfort, attractiveness, but the utility function does not include the access time and walkability, which would be expected to affect the trip cost and then the modal split.

## **4. CONCLUSION**

This Chapter presents a framework for modeling demand and supply interactions for aTaxis mixed with scheduled transit. The framework couples a dynamic microscopic supply model

for aTaxi (VIPSIM) with a static and macroscopic model for demand (VISUM). Consequently, it proposes a solution to model the demand for on-demand services and scheduled modes at the same time. It has in addition the potential to explore the effects of introducing locally (e.g. district level) an on-demand service on the global mode choice (e.g. city or regional level).

The application on a Paris Palaiseau case investigates the replacement of the BRT by 60 aTaxi, running at 50km/h and ensuring feeding shared trips. At the operational level, aTaxi would compete with the level of service of the BRT, specifically in areas that are served exclusively by aTaxi. It follows that the overall demand share for PuT is improved. At the tactical lev

el, increasing ridesharing ratios, and so the economic efficiency of the service, is achieved by reducing the fleet size, which affects in turn the volume of demand negatively. In particular, using ten more vehicles involves 1 % more of users (+15 passengers). Higher fares, on the other hand, induce greater profits while they increase slightly emissions. At a strategic level, automation and demand density involve better quality of service, greater loading ratios and higher profits. The study is focusing only on the peak conditions while aTaxi would likely be more efficient during off-peak times, where Bus offers less frequent service (longer waiting time). Improvements of mobility and economic performances could therefore be greater and more relevant for off-peak times.

Hence, future work should consolidate these findings by considering an analysis during off-peak periods. The realm of supply management should be enlarged to include fare optimization. The latter could involve a tariff by kilometer, as for conventional taxi services, and a dynamic pricing as for for-hire services. In addition, such a service would be regulated in the future. An analysis of impacts of fleet and/or tariff regulation should be relevant. Finally, the estimation of utility coefficients and mode preference constant of such services could be improved through stated-preferences surveys.

## **REFERENCES**

- Babicheva, T., Burghout, W., Andreasson, I. & Faul, N., 2018. The matching problem of empty vehicle redistribution in autonomous taxi systems. *Procedia Computer Science*, Volume 130, pp. 119-125.
- Borja, A., Barreda, R., dell'Olio, L. & Ibeas, A., 2018. Modelling user perception of taxi service quality. *Transport Policy*, Volume 63, pp. 157-164.
- Bösch, P., Becker, F., Becker, H. & Axhausen, K. W., 2018. Cost-based analysis of autonomous mobility services. *Transport Policy*, May, Volume 64, pp. 76-91.
- INSEE, 2017. Base Sirene des entreprises et de leurs établissements (SIREN, SIRET). [En ligne] Available at: <https://www.data.gouv.fr/fr/datasets/base-sirene-des-entreprises-et-de-leurs-etablissements-siren-siret/>
- Kesting, A., Treiber, M. & Helbing, D., 2010. Enhanced Intelligent Driver Model to Access the Impact of Driving Strategies on Traffic Capacity. *Philosophical transactions. Series A, Mathematical, physical, and engineering sciences*, Issue 368, pp. 4585-4605.
- Littman, T., 2018. Autonomous Vehicle Implementation Predictions: Implications for Transport Planning, s.l.: Victoria Transport Policy Institute.
- Meunier, D. & Quinet, E., 2015. Value of Time Estimations in Cost Benefit Analysis: The French Experience.

Transportation Research Procedia, Volume 8, pp. 62-71.

Mladenovic, M. & Trifunovic, A., 2014. The Shortcomings of the Conventional Four Step Travel Demand Forecasting Process. *Journal of Road and Traffic Engineering*, 60(1), pp. 5-12.

Owens, J., 2018. Elon Musk gets the \$35,000 Tesla Model 3 price tag he wanted — but extras cost more. [En ligne]

Available at: <https://www.marketwatch.com/story/elon-musk-gets-the-35000-tesla-model-3-price-tag-he-wanted-but-extras-cost-more-2017-07-29>

Peer, S., Knockaert, J., Koster, P. & Verhoef, E., 2014. Over-reporting vs. overreacting: Commuters' perceptions of travel times. *Transportation Research Part A: Policy and Practice*, November, Volume 69, pp. 476-494.

PTV Group, 2018. PTV Visum. [En ligne]

Available at: <https://www.ptvgroup.com/en/solutions/products/ptv-visum/>

[Accès le 28 July 2018].

Quinet, E., 2013. L'évaluation socio-économique en période de transition. *Valeurs du temps*, s.l.: France Stratégie. Commissariat général à la stratégie et à la prospective..

Spieser, K. et al., 2014. Toward a Systematic Approach to the Design and Evaluation of Automated Mobility-on-Demand Systems: A Case Study in Singapore. *Road Vehicle Automation*, Septembre.

Wardman, M., 2004. Public Transport Values of Time. *Transport Policy*, 11(4), pp. 363-377.

Wong, R. C. P., Szeto, W. Y. & Wong, S. C., 2015. Behavior of taxi customers in hailing vacant taxis: a nested logit model for policy analysis. *Journal of Advanced Transportation*, Volume 49, p. 867–883.

# Conclusion

## 1. Summary

With the advent of AVs and the emergence of Shared Mobility (SM) applications, the urban transportation systems are approaching a potential revolution. The automation technology could reach the level 5 by 2025 and AVs could be a more acceptable technology by 2030 and come to dominate ground transportation by 2050. Several kinds of BM will likely emerge and with no certainty about which will survive. The development of these BM will be guided by the degree of the business tangibility (i.e. service or product), the profile of users and/ or AVs' owners (i.e. preferences, socio-professional category, individual or company, etc.), and the level of involvement of users and operators in the service production. Other aspects such as the technology availability, vehicles size, the service fare will affect the BM performances.

Autonomous Taxis (aTaxis) and Autonomous Transit (aTransit) could be one of the first commercialized services based on AVs. Their popularity is supported by their socio-economic potential yet uncertain impacts of mobility, congestion and environment. On the other hand, other BM (specifically P2P BM), almost absent in scientific research, would be hindered by affordability and acceptability challenges.

By focusing then on aTaxis and aTransit, this thesis investigated their impacts on major stakeholders compared to conventional travel modes and SM services. A systemic analysis explored technical components of aTaxis and external pressure forces of different stakeholders. A framework for aTaxis management is then constructed. It is structured in three layers which cover respectively the operational, tactical and strategic decisions of the service's provider. Also, pressure forces include especially: the regulation, the demand preferences and the unit costs of production. We have shown that these forces depend on the spatial context, and in turn on the strategic decisions. The framework is finally applied to a stylized urban area (Orbicity) and a real territory (Palaiseau).

The application on the Orbicity model of taxi services (Leurent, 2017) considers demand and supply features of three French cities: Paris, Saint-Malo and Rennes. The application found that the demand density but also its elasticity to the generalized cost, affect significantly the fleet size and the service's fare. For the three cases, taxis' automation halves the fleet size and the fare. Consequently, the demand and in turn the access time are greatly improved. The impact on the profit, then positive as well, is greater for small cities in relation terms. The comparison between the three cities showed that larger cities, often with higher densities and greater transport budget of travelers (i.e. Paris in our application case), are attracting more users and then enabling to make more profits. Moreover, since more passengers are transported, the social impact is higher too.

The application case in a real context (Palaiseau) was achieved by coupling the VISUM four-step model with an agent-based model VIPSIM. The feedback loop between these two models is crucial, thereby leading to supply-demand equilibrium. Equilibrium computation was achieved by iteration, also using 2 to 3 iterations. Results have shown that by replacing a line of BRT by an aTaxis network, the level of service is improved, while the operating costs are reduced for reasonable loading rates. The emissions of pollutants, however, increase very slightly. A sensitivity analysis with respect to demand density and taxis' automation has ascertained the results of the Orbicity application case: automation induces more travelers and higher profit. The impact of demand is as well positive, yet characterized beyond a certain level by fixed loading rates and lower increases of profit.

Moreover, over the description of the demand in Palaiseau, we have found from our stated-preferences survey that two users profiles are more inclined to use aTaxis: (1) young users less than 30 years old and non-motorized, and (2) active population between 30 and 50 years old and that is mostly motorized.

The thesis started from a broad qualitative exploration of major potentially upcoming BM to end with a detailed spatial analysis of management decisions for a specific BM. In particular, it mobilizes qualitative and quantitative approaches of different disciplines. **Figure 8o** relates the progress of the thesis and used approaches. The cone on the left shows the evolution from the general to the detail: the range of BM and their analysis are limited progressively. The complementarities between qualitative and quantitative approaches are depicted on the right. In particular, the construction of the strategic framework is based on the combination of the two approaches (systemic analysis and microeconomics).

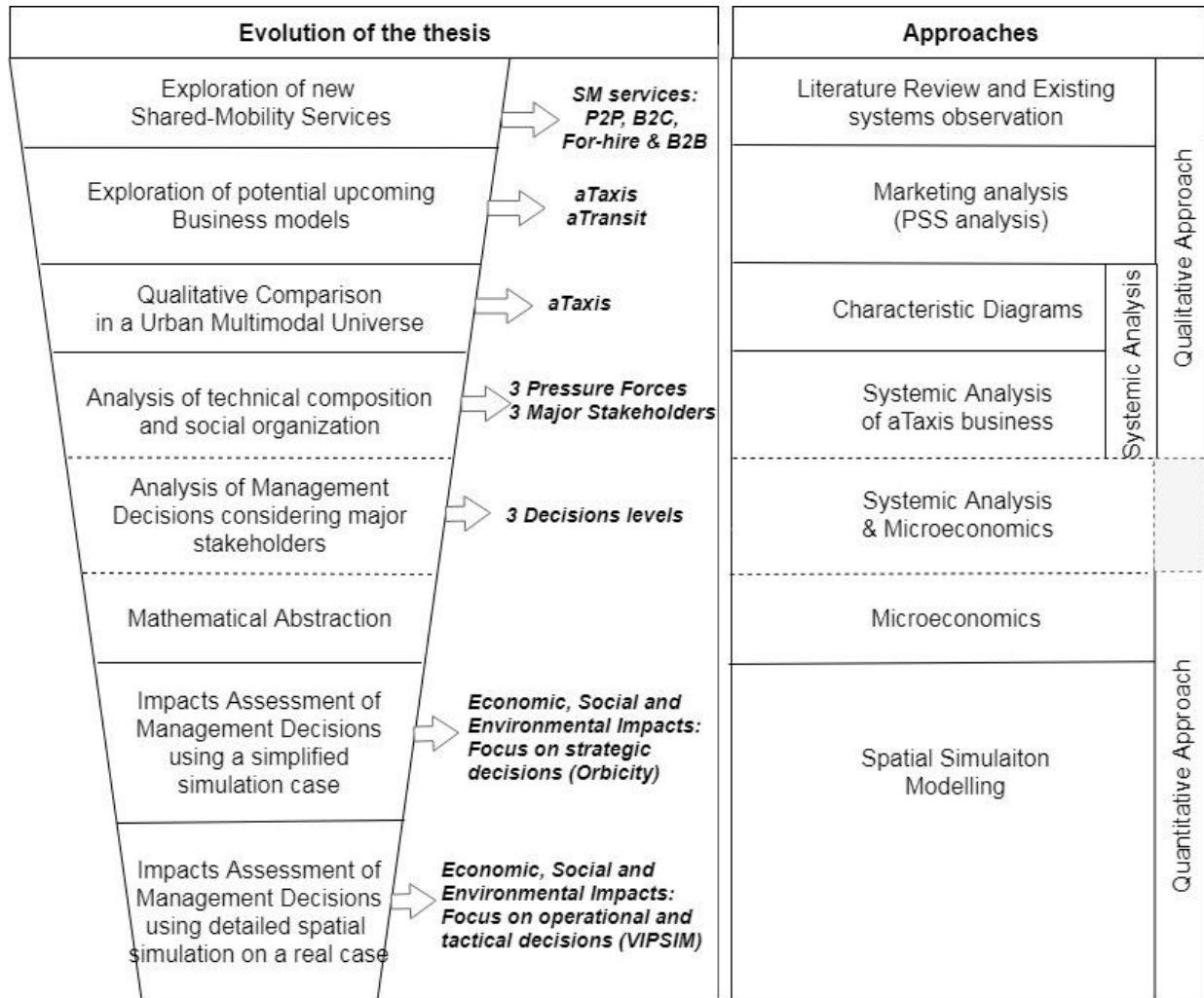

Figure 80 Overview of the progress of the thesis and used approaches

Table 31 confronts merits and limits of the thesis approaches.



Table 31 Merits and limits of approaches of the thesis

Approaches	Merits	Limits
<b>Literature review</b>	- Considers different disciplines and different mobility systems.	- The literature evolves unceasingly and the number of studies is more or less important dependent on the discipline.
<b>Marketing Analysis (PSS)</b>	- Identifies major kinds of Business Models articulated around AVs through combining product and service contents (i.e. PSS analysis)	- Does not permit a quantitative analysis of the service performances.
<b>Systemic Analysis</b>	- Identifies major stakeholders, their interests and the potential impact of service production (i.e. Diagrams). - Simplifies the complexity of the aTaxi system analysis, describes its main technical components and interactions with external environment.	- Diagrams consider wide range of values and need data to be validated.  - Does not enable to analyze in the behavior of the aTaxi system components.
<b>Microeconomics</b>	- The theory of utility enables modeling the choice mode of users. - The economic equilibrium analysis incorporates theories of users' behavior, production costs, and revenues to make proper economic decisions. Hence, it enables to determine the optimal combination of supply inputs (fleet, fare, etc.) that maximizes the profit. - Helps the public authorities fixe policies related to subsidies, taxes, wages levels, etc. on the basis of effects of these factors on the society.	- Considers simple demand and supply representation. - Assumes stability of competition, of public authorities, of operating supplies availability, etc. - Does not allow assessment of the impact on the overall economy.
<b>Spatial simulation</b>	- Describes in detail the behavior of the service actors and their interactions. - Predicts the service performance and estimates its impacts on mobility, society and economy.	- Depends on the quality of inputs: demand and supply inputs. - Should be calibrated. - Does not include all human and social factors (unknown factors).

## 2. Limitations

The thesis, however, is fraught with several limitations.

### *Considering the qualitative analysis*

- Characteristic diagrams

The characteristic diagrams that we have constructed are based on our observation of existing services, and in turn on our own knowledge and perception of their characteristics. By representing each feature using a large range of values, we were able to overcome the particularities of each context. However, this approach involves a loss of accuracy of proposed diagrams. Ideally, they should be based also on numerical data for different urban contexts.

As mentioned in conclusions of Chapter.3 and Chapter.4, soft modes and two-wheel modes are not considered in our classification, yet forming important mobility modes in several developed countries (e.g. Netherlands (60% in Utrecht) and Denmark (62% in Copenhagen)). The emergence of bike-sharing and scooter-sharing testifies also to the necessity of considering these modes in the analysis of a multimodal urban universe.

Our analysis, indeed, has focused on the analysis of each mode compared to others. The existing complementarities are directly deduced by observing, for instance, that rapid transit (i.e. train) is used for high trips lengths while carsharing is relevant for shorter trips. Yet, in reality, we should investigate the issue in more detail by assessing the total trip time for the combined mode carsharing + train. In this case, transfer times will be added, waiting times too, access times and so on. The comparison of combined modes is not an easy task. It depends also on each specific context. Yet, the emerging concept of mobility-as-a-service (MAAS) is underwork and provide an answer to these issues by suggesting an optimal real-time combination of different modes.

- Proposed Business Models

Based on well justified reasons, the thesis chooses to focus on Business-to-Customer services. Considering the particular features of Autonomous Vehicles, two forms of services are selected: aTaxi and aTransit. The main criterion that we considered in our reasoning is the level of involvement of users and operators in the service production.

However, if we consider in addition the capacity of vehicles, aTaxi would contain several forms of services: on-demand shuttles, with a capacity exceeding 10 seats, on-demand mid-sized vehicles, about 5 to 6 seats, and on-demand micro-vehicles, offering a private on-demand service. This classification could be applied as well for aTransit. At first sight, the capacity seems not to be linked to the form of service. However, observe that high capacity vehicles will orientate the business to impose ridesharing and even detour, while mid-sized vehicles would propose ridesharing as an option and small-sized vehicles will be private.

Another criterion that could be considered in the construction of Business Models is the operator's type: private or public. A public operator would propose a service with low fares, or even fares that are integrated in the price of public transit modes. In addition, the proposed service would be designed as a feeding service, ensuring coordination with mass transit modes. A private operator, on the other hand, would have interest in supplying door-to-door trips.

### ***Considering the quantitative approach***

- Economic framework

The economic framework that we proposed in Chapter.5 and Chapter.6 identifies the main strategic components while considering the environment of the service and its main impacts from the standpoint of each stakeholder.

However, like the majority of economic models, the temporal aspect is not integrated in the framework. In reality, production costs are changing depending on the economic context, regulation laws are evolving with socio-economic and sustainability issues and customers' behaviors are in perpetual development. Our framework, in its current form, takes all the economic behaviors as fixed over time. It should be dynamised through opening up to all evolution scenarios, including failure scenarios.

As demonstrated by the mathematical abstraction presented in Chapter.6, relations between demand and supply components are expressed by equations that define the model. Then, the framework depends closely on these inputs, and if they are not valid, then it becomes a case of "GIGO" – Garbage In, Garbage Out".

Finally, as cited in the conclusion of Chapter.6, the mathematical formulation of the tactical and strategic problems focuses on the maximization of the financial profit and the social welfare. However, several other problems could be explored as well. The operator is also interested in the maximization of vehicles' loading or/ and the minimization of empty vehicles kilometers travelled. In addition, the service regulation by public authorities could impose constraints on the fleet, the fare, the quality of service, etc.

- Application case
  - Stylized case: Orbicity

In Chapter.6, we outlined the main limitations of Orbicity. They include:

- The demand is generated uniformly over time and space.
- One mode is available to users. Other modes are considered indirectly using the demand elasticity to generalized cost.
- One and unique strategy of vehicles' assignment is considered (first-come-first-served).
- Vehicles are parking in the absence of demand. Then, relocation strategies of empty vehicles are not included.
- Ridesharing is not permitted.

- Congestion issues are ignored.
  - o Real case: Palaiseau

By coupling VIPSIM and VISUM, we overcame main limitations that we observed in the case of Orbicity. The application case that we presented in Chapter.8, has however some limits:

+ The scale of the example is small. The network is composed of about twenty links and stations. Overall, about 500 persons are served during morning hour peak period, with very short trip lengths (3 minutes, 4 km) and an average aTaxi occupancy at 1.35 passengers per loaded trip.

+ As mentioned above, costs as well as users' preferences evolve over time. They also change from each context to another. A sensitivity analysis on the unit costs of production and the mode choice constants is needed.

+ Users preferences evolve also from one hour to another. It depends, among other factors, on the quality of service of existing mobility supply in the territory. The analysis of the service performances during other periods of the day is then also required.

+ In addition, the consideration of temporal effects involves the analysis of the vehicles' dynamic adaptation of their routes according to their previous experiences. In practice, adaptation is achieved by letting taxis learn from one iteration to the next, also called day-to-day learning.

+ The competition with other existing aTaxis services that are provided in the same territory are not considered. However, it is expected to see the development of different private aTaxis companies competing in same territories.

### **3. Recommendations for future works**

The presentation of limitations enables to mention several recommendations for the qualitative part and the quantitative part as well.

#### ***Considering the qualitative approach***

We have outlined that soft modes and two-wheels modes should be considered in the classification of mobility services since they are more and more present in the urban universe. We also outlined the importance of strengthening characteristic diagrams by using real data of different urban contexts. Finally, we have introduced issues of considering MAAS. We will focus here on the development of three recommendations:

+ The first one is that we have just cited: the integration of mutualized modes (MAAS). Practically, that means to position combined services in characteristic diagrams. For instance, consider a service of aTaxis that ensures the feeding from the origin/ train station to the train station/ destination. The combination of these two modes (aTaxis + rapid transit) is used uniquely for long trips. It involves longer waiting times and lower level of

comfort compared to the case of 100% aTaxis. Thanks to the integrated fare, aTaxis become in this case more affordable. **Figure 81** and **Figure 82** position the service aTaxis + rapid transit with respect to door-to-door time, fare, waiting and access times. For further analysis, the combination of all modes, including soft modes, should be explored and positioned in our diagrams.

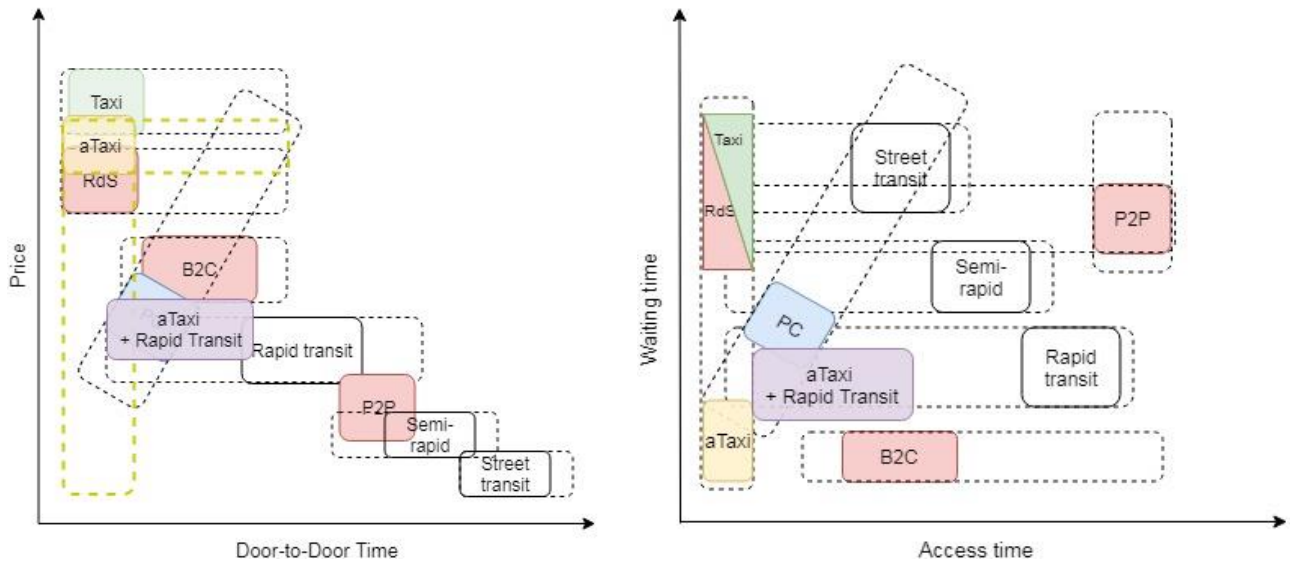

**Figure 81 Price versus door-to-door time considering aTaxis + rapid transit**

**Figure 82 Waiting versus access time considering aTaxis + rapid transit**

+ Our second recommendation is to explore P2P services. From the perspective of the operator, these services are the less expensive. A similar analysis of conventional P2P services while considering specific features of AVs will enable to define P2P Business Models that are articulated around AVs. In addition, the reproduction of the systemic approach of Chapter.5 will allow to construct a framework for these services, which assesses technical, economic and social impacts.

+ The last recommendation is to extend this qualitative analysis to explore the diffusion tendencies of AV-based services by considering management theories as users' learning effects, social policies impacts, etc. The thesis of Nasim Bahari (Bahari, 2015) at VEDECOM explored business models for AV-based systems using a management approach. The combination of these two works is relevant and should be investigated.

**Considering the quantitative approach**

Based on limitations presented above, this thesis will be the basis for future research works and application studies.

+ Temporal effects should be considered in our framework. Practically, the framework could be applied for different scenarios of evolution of demand and production costs. To start, it is possible to simulate the system performances for each scenario and in turn for defined

assumptions of evolution over time. The evolution of usage behaviors could in addition be estimated using SP surveys. Indeed, the SP survey that we have conducted in Palaiseau (Chapter.7) have also raised the question of using aTaxis as soon as they are implemented, after one, two, three, four, five or six months since their implementation. First results are showing that  $\frac{1}{4}$  of persons are ready to use the service as soon as it starts, while about 43% of them would be inclined to use it after 2 months.

By considering temporal aspects, several indicators will be added to the framework, such as the net added value (NAV) and the breakeven and the internal rate of return (IRR).

+ By including temporal effects at an hourly and daily level, day-to-day learning issues could be assessed as well. That enables to propose relocation strategies of empty vehicles to anticipate emitted requests per hour. In addition, by knowing the demand for each hour, the fleet could be adapted by using for instance low capacity vehicles, and in turn low cost vehicles on terms of energy, during low demand periods.

+ We already pointed to the need for a sensitivity analysis on mode choice constants. In addition, we have conducted a SP survey to estimate values of these constants. The analysis of the survey is under development, and the results will be presented and considered in the simulation framework in future works.

+ In the two applications, simple dispatching strategies were considered. However, it would be highly interesting to test strategies that are more sophisticated. We explored two dispatching strategies in (Poulhès and Berrada, 2018), a forthcoming paper. The first strategy assumes that vehicles are independent; each vehicle aims to minimize its own generalized cost. The second strategy considers that vehicles are shared via a dispatcher which seeks to minimize the generalized cost of all the system.

+ To consider competition issues between two services that are provided in the same territory, it is possible to perform in parallel or in two steps the loop between VIPSIM and VISUM. **Figure 83** describes the two convergence mechanisms.

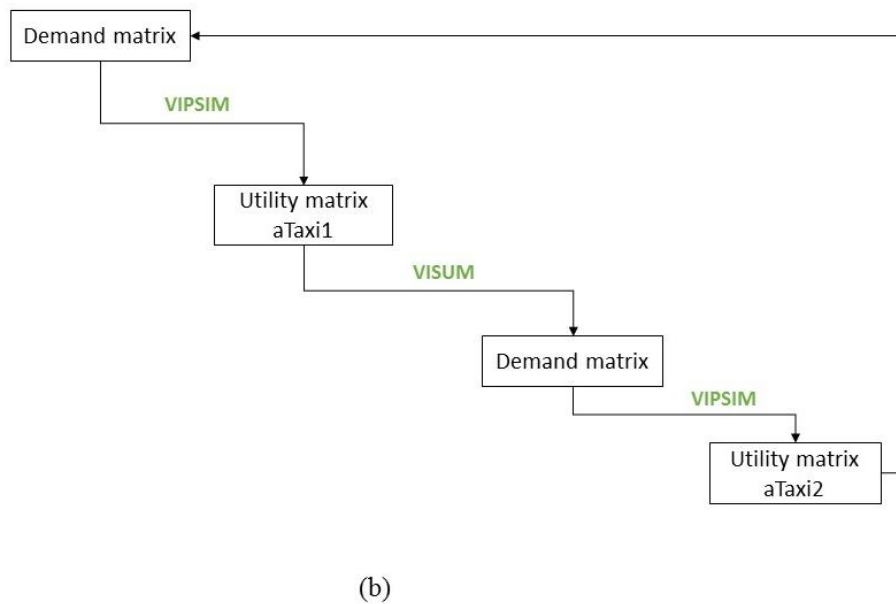
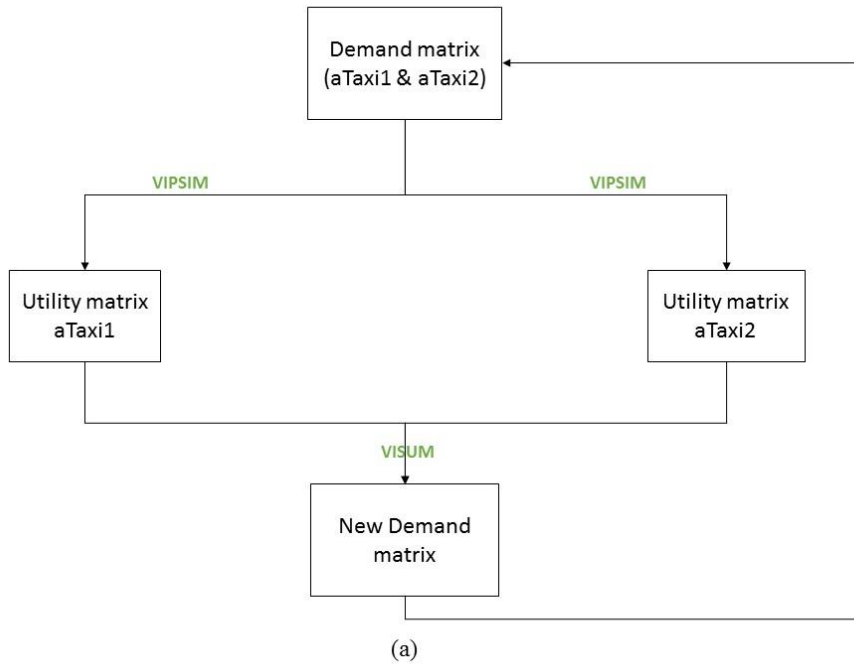

**Figure 83 Feedback loops between VIPSIM and VISUM to deal with two aTaxis services (a) parallel scheme, (b) sequential scheme**

This approach could be extended to include more than two services.

+ Finally, it is highly recommended to apply the framework to a large scale example to explore the effect of a large aTaxis fleet on the mobility performances. In particular for longer commuting trips, aTaxis could compete with transit modes and then, increase the car traffic, potentially inducing more congestion.

## 4. Perspectives

The belief that aTaxis will emerge is more and more widespread. Also, their implementation is just a matter of time. To hinder psychological barriers, aTaxis services will need to reassure users regarding their performances on terms of safety of the technology and the quality of the mobility service (i.e. punctuality, reliability, speed and waiting time between emitting request and riding). Consequently, they will be provided in controlled environment that are characterized by: fixed routes, dedicated or partially dedicated (i.e. shared exclusively with buses and/or taxis) roads and stations, no weather disturbances, dedicated lanes, limited number of passengers, etc.

Thus, we expect that two “use cases” will be deployed at first time: (1) a feeding service of aTaxis in less dense zones, typically rural areas, and (2) a crossing service using highway corridors and connecting different areas. By opting for the first option, the supplier will reduce the operating complexity and will avoid risks related to roads congestion, stations congestion, technical incidents, etc. On the other hand, the second option could be supported by the current highways’ development projects, which aims to implement dedicated bus lanes in highways serving European metropolitan cities (e.g. in Paris region (Plesse, 2018a), Madrid (Odile, et al., 2010)). Both “use cases” will be controlled by planners and operated by incumbent transport operators with cooperation with new entrants from other industries. These use cases, however, will probably be characterized by high empty driven distances and waiting times. Therefore, after proving the technical performances of the aTaxi, it will be necessary to move forward in providing a more flexible service (e.g. not necessarily station-based and with fixed routes) in urban areas with higher demand densities. Therefore, the quality of service (i.e. waiting times) and operational performances (i.e. empty distances) would dramatically be improved and in turn the financial viability and the social welfare.

The knowledge gained from the thesis helps accompanying these future developments by addressing management issues of an aTaxis service. Moreover, it serves as another piece to the puzzle of academic research on AVs. Continued and more developed work on costs structures, users’ acceptance, and competition issues would be valuable to prepare a successful advent of aTaxis. The research in this thesis gleans initial trends of BM based on AVs and performances of aTaxis that are sufficient proof that automation has significant potential in urban cities and by extrapolation on a broader, even regional, scale.

## References

- Bahari, N. 2015. Business models et écosystèmes. Thèse de l'université Paris Saclay.
- Leurent, F., 2017. Microéconomie d'un service de taxi dans une ville en forme d'anneau, s.l.: ENPC-LVMT.
- Odile, H., Brendan, F., Sébastien, R. & François, R., 2010. The European Bus with a High Level of Service (BHLS): Concept and Practice. Built Environment, Volume 36, pp. 307-316.
- Plesse, G., 2018a. Bus et taxis : de nouvelles voies dédiées sur l'A3 et l'A12 d'ici la fin de l'année. [En ligne] Available at: <http://www.leparisien.fr/info-paris-ile-de-france-oise/transports/bus-et-taxis-de-nouvelles-voies-dediees-sur-l-a3-et-l-a12-d-ici-la-fin-de-l-annee-03-09-2018-7875015.php> [Accès le 15 October 2018].



Poulhès, A. & Berrada, J., 2018. Single Vehicle Network Versus Dispatcher: User assignment in an agent-based model. *Transportmetrica A: Transport Science*. *Under review*.



