



HAL
open science

Discovery and implications in the transcriptional regulation of a novel protein variant of the integrin- and amino acid transport-regulator CD98hc

Tomás De Garay Herrera

► **To cite this version:**

Tomás De Garay Herrera. Discovery and implications in the transcriptional regulation of a novel protein variant of the integrin- and amino acid transport-regulator CD98hc. Cell Behavior [q-bio.CB]. CO-MUE Université Côte d'Azur (2015 - 2019), 2019. English. NNT : 2019AZUR4011 . tel-02522910v2

HAL Id: tel-02522910

<https://theses.hal.science/tel-02522910v2>

Submitted on 15 May 2020

HAL is a multi-disciplinary open access archive for the deposit and dissemination of scientific research documents, whether they are published or not. The documents may come from teaching and research institutions in France or abroad, or from public or private research centers.

L'archive ouverte pluridisciplinaire **HAL**, est destinée au dépôt et à la diffusion de documents scientifiques de niveau recherche, publiés ou non, émanant des établissements d'enseignement et de recherche français ou étrangers, des laboratoires publics ou privés.

THÈSE DE DOCTORAT

Découverte et implications dans la régulation transcriptionnelle d'un nouveau variant protéique du régulateur des intégrines et du transport des acides aminés CD98hc

Discovery and implications in the transcriptional regulation of a novel protein variant of the integrin- and amino acid transport-regulator CD98hc

Tomás DE GARAY HERRERA

Institut de Recherche sur le Cancer et le Vieillessement
CNR UMR 7284 – INSERM U1081

**Présentée en vue de l'obtention
du grade de docteur en Sciences
d'Université Côte d'Azur**

Mention : interactions moléculaires et
cellulaires

Dirigée par : Chloé Féral

Soutenu le : 27 Mars 2019

Devant le jury, composé de :

Bruno Antonny, Directeur de Recherche,
Institut de Pharmacologie Moléculaire et
Cellulaire

Ambra Mari, Directeur de Recherche,
Institut NeuroMyoGène

Marta Muzio, Research Director, Ospedale
San Raffaele

Chloé Féral, Directeur de Recherche,
Institut de Recherche sur le Cancer et le
Vieillessement

Découverte et implications dans la régulation transcriptionnelle d'un nouveau variant protéique du régulateur des intégrines et du transport des acides aminés CD98hc

Jury :

Pésident de jury

Bruno Antony, Directeur de Recherche, Institut de Pharmacologie Moléculaire et Cellulaire

Rapporteurs

Ambra Mari, Directeur de Recherche, Institut NeuroMyoGène

Marta Muzio, Research Director, Ospedale San Raffaele

Résumé

La protéine ubiquitaire CD98hc (SLC3A2, 4F2hc), présente chez tous les vertébrés, est impliquée dans un large éventail de processus, tels que l'homéostasie tissulaire, le développement ou la protection contre le stress. Elle constitue la chaîne lourde d'une famille de transporteurs d'acides aminés (SLC7) et est aussi un co-récepteur des intégrines. En régulant la signalisation associée à l'adhésion des intégrines ainsi que le transport des acides aminés, le niveau d'expression de CD98hc contrôle la prolifération cellulaire qui joue un rôle crucial dans l'expansion clonale des lymphocytes, le renouvellement des épithéliums et la tumorigenèse. Le travail présenté dans cette thèse identifie un nouveau variant de la protéine CD98hc. Ce variant est transcrit à partir d'un site d'initiation de la transcription qui se situe en amont du site d'initiation de la transcription canonique. Cette thèse démontre également la capacité promotrice de la région génomique d'environ 1000bp en amont du codon d'initiation alternatif identifié. La combinaison d'analyse de séquence et d'études fonctionnels de la région promotrice alternative, fournit un aperçu des potentiels éléments *cis*-régulateurs gouvernant l'expression du variant alternatif de CD98hc. Cela suggère fortement que la régulation de son expression est différente de celle de la forme canonique. Comprendre cette différence aidera à expliquer la complexité de la régulation des taux d'expression de CD98hc ainsi que la capacité des cellules à moduler ces taux d'expression en fonction de leurs besoins et des signaux fournis, à la fois dans un contexte homéostatique et pathologique. De plus, l'analyse de séquence du variant alternatif de CD98hc ouvre la voie pour la future caractérisation fonctionnelle de cette protéine.

C'est la première fois que le variant protéique alternatif de CD98hc est identifiée, venant ainsi enrichir les connaissances acquises pour une meilleure compréhension des travaux existants et à venir sur CD98hc. L'ensemble de ces travaux contribue donc à la compréhension de cette régulation complexe de l'expression de CD98hc, ainsi que son effet sur la prolifération cellulaire via la signalisation *outside-in* des intégrines et le transport des acides aminés chez les mammifères.

Mots clés

CD98hc, prolifération, intégrine, transporteur des acides aminés, régulation de la transcription, promoteur

Abstract

CD98hc (SLC3A2, 4F2hc) is a ubiquitous protein present in vertebrates and implicated in a wide range of processes such as tissue homeostasis, development or stress protection. It constitutes the heavy chain of a family of amino acid transporters (SLC7) and an integrin co-receptor. By regulating integrin adhesive signaling and amino acid transport, *CD98hc* level of expression controls cell proliferation and has a crucial role in lymphocyte clonal expansion, epithelium renewal, and tumorigenesis. The work in this thesis identifies a novel, alternative CD98hc protein variant conserved in the mammalian *CD98hc* locus. The transcription of this variant initiates from an alternative transcription start site located upstream of the canonical start site. We also demonstrate the promoter capacity of the ≈ 1000 bp 5' flanking genomic region. The combination of sequence analysis and promoter functional assays provides a wide view of the potential *cis*-regulatory elements governing *CD98hc* alternative variant and strongly suggests a different expression regulation as compared to the canonical variant. Understanding this difference will help to explain the complexity of the regulation of *CD98hc* expression levels and the cellular capacity to modulate them according to cellular needs and signals, both in homeostasis and disease. Additionally, sequence analysis of CD98hc alternative protein variant opens the door to a future protein functional characterization. This is the first time CD98hc alternative protein variant is identified, and it enriches the framework for the interpretation of existent and future work on CD98hc. Altogether, it contributes to understanding the complex regulation of *CD98hc* expression, and its effect upon cell proliferation through integrin outside-in signaling and amino acid transport in mammals.

Keywords

CD98hc, proliferation, integrin, amino acid transporter, transcription regulation, promoter

“Cada día tienes la opción de cortar las alas de los demás hablando del miedo y de la incertidumbre, o puedes dejar que tus palabras les empujen hacia sus metas confiando en la capacidad infinita que hay dentro de todo ser humano. Se conoce como efecto Pigmalión y funciona en cualquier momento de nuestras vidas.”

*“Trust can be a potential source of competitive advantage.”
(Rowe and O’Brien, 2002)*

Acknowledgements

Thanks to the jury members for making me the honor of being here.

Here we are, looking backwards from the end of the road. I would not have made it here without many people. This goes to you.

To my parents, for making me who I am today. To Gaia, for being there no matter what. To all my Scout family, for giving me the tools.

To Ramona, Hereroa, Derya, Sanya, Paula, George, Alice, Johan, Marta, Margo, Nadia, Patricia, María... and all the Signalife and IRCAN students, for sharing.

To Laetitia and Laurence. To everybody who supported my work at IRCAN.

To my links to reality, La Cafetera, Carne Cruda.

And finally, to everyone that has been truly supportive and sincere.

Contents

List of figures.....	4
List of abbreviations.....	6
Foreword.....	9
Section 1: Introduction	10
1.1. Generalities about cell growth and CD98hc.....	12
1.2. Adhesive signaling regulates cell proliferation.....	15
1.2.1. The cellular microenvironment: the extracellular matrix.....	15
1.2.1. Integrin-mediated cell adhesion	17
1.2.2. Integrin signaling and cell cycle progression	19
1.2.3. Growth factors and integrin co-regulation	23
1.2.4. Integrin proliferative signaling and tumor development	24
1.2.5. Conclusion	24
1.3. Resource availability and metabolism during proliferation.....	26
1.3.1. Cellular metabolism in proliferation	26
1.3.2. Intracellular energy sensing.....	28
1.3.3. Intracellular nutrient sensing.....	29
1.3.4. mTOR and AMPK as links between nutrient sensing and cellular metabolism	
32	
1.3.5. Nutrient availability signaling during tumor development	34
1.3.6. Conclusion	35
1.4. CD98hc: a signaling integrator	36
1.4.1. Processes tuned by CD98hc	37
1.4.2. CD98hc and cancer	41
1.4.3. Protein interactions	43
1.4.4. Protein three-dimensional structure	48

1.4.5.	CD98hc along evolution	49
1.4.6.	Gene structure	50
1.4.7.	Regulation of gene expression.....	52
1.4.8.	Conclusion	56
1.5.	Time allocation	57
Section 2: Problem statement, scope and aims		59
Section 3: CD98hc alternative promoter regulation		62
3.1.	CD98hc has several alternative variants	63
3.1.1.	Introduction	63
3.1.2.	Results	63
3.1.3.	Discussion.....	69
3.2.	Alternative CD98hc emerged in mammals with a conserved alternative promoter	71
3.2.1.	Introduction	71
3.2.2.	Results	71
3.2.3.	Discussion.....	74
3.3.	The 5'-flanking region of alternative CD98hc contains an alternative promoter with a different regulation	76
3.3.1.	Introduction	76
3.3.2.	Results	77
3.3.1.	Discussion.....	83
3.4.	Materials and methods	86
Section 4: Additional projects.....		93
4.1.	CD98hc canonical and alternative variant functional study.....	95
4.1.1.	Introduction	95
4.1.2.	Results	95



4.1.3. Discussion.....	108
4.2. CD98hc in integrin-mediated mechanosensing	111
4.2.1. Introduction	111
4.2.2. Results	112
4.2.3. Discussion.....	115
4.3. Materials and methods	117
Section 5: General discussion	123
Annex 1: Review article “SLC3A2”	128
Section 6: References	1311

List of figures

Figure 1. Cell cycle	12
Figure 2. Cycling expression cycle	13
Figure 3. ECM-cell interaction	16
Figure 4. Integrin heterodimer combinations.....	18
Figure 5. General integrin bidirectional signaling	20
Figure 6. Integrin adhesive signaling contributes to cell cycle progression	22
Figure 7. Metabolic shift in cellular proliferation	27
Figure 8. AMPK-mediated energy sensing	29
Figure 9. Amino acid-dependent mTORC1 regulation	31
Figure 10. CD98hc implication in vertebrate adaptive immune response	38
Figure 11. CD98hc interaction network	44
Figure 12. Three-dimensional structure of CD98hc.....	49
Figure 13. CCDS CD98hc transcripts.....	51
Figure 14. CD98hc is a ubiquitous protein	53
Figure 15. Transcription regulation at the <i>CD98hc</i> locus.....	55
Figure 16. Time allocation	57
Figure 17. Novel <i>CD98hc</i> long variant is detectable at mRNA and protein level.....	66
Figure 18. <i>CD98hc</i> alternative variant mRNA shows a ubiquitous expression pattern in GTEx data.....	68
Figure 19. <i>CD98hc</i> alternative variant mRNAs relative expression	69
Figure 20. <i>CD98hc</i> alternative variant emerged in mammals.....	72
Figure 21. CD98hc alternative protein variant conservation, potential disorder and interactions	73
Figure 22. Phylogenetic footprinting analysis of human <i>CD98hc</i> (<i>SLC3A2</i>) alternative variant 5' flanking region.....	74
Figure 23. <i>CD98hc</i> has two active promoters with putative differences in TFBS fingerprint	78

Figure 24. Sequence of the CD98hc alternative variant 5' flanking region used in the transcription factor binding site analysis	79
Figure 25. Sequence of the <i>CD98hc</i> canonical variant 5' flanking region used in the transcription factor binding site analysis	80
Figure 26. <i>CD98hc</i> alternative variant 5' flanking region supports transcription initiation ..	82
Figure 27. CD98hc cytosolic tail fusion proteins are not expressed at the required level in <i>Escherichia coli</i>	97
Figure 28. Expression and purification of TAP-tagged CD98hc variants in mammalian cells	99
Figure 29. Expression of FLAG-tagged CD98hc variants in mammalian cells	101
Figure 30. Expression of exogenous CD98hc in CD98hc-null mouse dermal fibroblasts	102
Figure 31. Functional study of CD98hc variants in mouse dermal fibroblasts	104
Figure 32. Endogenous CD98hc is still detectable after Cre recombinase treatment in CD98hc ^{fl/fl} mouse dermal fibroblasts	106
Figure 33. Exogenous CD98hc expression does not change the integrin expression profile of mouse dermal fibroblasts	107
Figure 34. CD98hc ED 3D structure and preliminary results suggest that C330S could have a role in integrin-mediated mechanosensing	112
Figure 35. Expression of CD98hc, but not CD98hc C330S, in CD98hc-null fibroblasts partially rescues cell spreading and growth.....	114
Figure 36. Preliminary data cannot be confirmed because of inconsistent results	115

List of abbreviations

4E-BP: eukaryotic translation initiation factor 4E-binding proteins

AA: amino acid

ACC: acetyl-coenzyme A carboxylase

ADP: adenosine diphosphate

AML: acute myelogenous leukemia

AMP: adenosine monophosphate

AMPK: 5' AMP-activated protein kinase

APC: antigen presenter cells

ATP: adenosine triphosphate

bp: base pair

CAD: carbamoyl-phosphate synthetase 2, aspartate transcarbamylase and dihydroorotase

CAM: cell adhesion molecules

CCDS: Consensus Coding DNA Sequence project

CD: cluster of differentiation

CD98hc: cluster of differentiation 98 heavy chain

Cdc 42: Cell division control protein 42 homolog

CDK: cyclin-dependent kinase

cDNA: complementary DNA

CRISPR: clustered regularly interspaced short palindromic repeats

CRTC2: CREB regulated transcription coactivator 2

CTL: cytotoxic T lymphocyte

Da: Dalton

DNA: deoxyribonucleic acid

ECM: extra cellular matrix

ED: extracellular domain

EGFR: epidermal growth factor receptor

eIF: eukaryotic translation initiation factor

EMSA: electrophoretic mobility shift assay

ES: embryonic stem

FA: focal adhesions

FAK: focal adhesion kinase

FN: fibronectin

FOXO3A: Forkhead box O3A

FRP-1: fusion regulatory protein 1

GAG: glycosaminoglycans

GCN2: general control nonderepressible-2

GDP: guanosine diphosphate

GEF: guanine exchange factor

GF: growth factor

GFR: growth factor receptor

GSH: glutathione

GSK-3 β : glycogen synthase kinase-3 β

GTE_x: genotype-tissue expression

GTP: guanosine triphosphate

hCASK: human calcium/calmodulin-dependent serine kinase	PHA: phytohemagglutinin
hcHAT: heavy chain heteromeric amino acid transporter	PI3K: phosphatidylinositol-3-kinase
HIF-1 α : hypoxia inducible factor 1 α	PKC: protein kinase C
HIV: human immunodeficiency virus	PMA: 4 beta-phorbol 12-myristate 13-acetate
ICAM-1: intercellular adhesion molecule 1	PPAR α : peroxisome proliferator-activated receptor alpha
INF γ : interferon γ	PPP: pentose phosphate pathway
K14: keratin 14	PTEN: phosphatase and tensin homolog
kb: kilo base pair	Rap1: ras-proximate-1
KO: knock out	RNA: ribonucleic acid
KSHV: Kaposi's sarcoma-associated herpesvirus	RNA-seq: RNA sequencing
LAPTM4b: lysosomal-associated transmembrane protein 4b	ROCK: Rho-associated coiled-coil containing protein kinase
LFA-1: lymphocyte function-associated antigen 1	ROS: reactive oxygen species
LPI: lysinuric protein intolerance	S6K: protein S6 kinase
MARCH: membrane associated RING-CH	SH3BP4: SH3 domain-binding protein 4
MCT: monocarboxylate transporter	SIRT1: silent information regulator 1
MEF: mouse embryonic fibroblast	SLC: solute carrier family
miRNA: micro RNA	SP1: specificity protein 1
mRNA: messenger RNA	SREBP: sterol regulatory element binding protein
mTHF: mitochondrial tetrahydrofolate	TCA: tricarboxylic acid
mTOR: mammalian target of rapamycin	TF: transcription factor
NAD: nicotinamide adenine dinucleotide	TFBS: transcription factor binding site
NF- κ B: Nuclear Factor Kappa B	TMD: transmembrane domain
PDGFR: platelet-derived growth factor receptor	tRNA: transfer RNA
	TSC: tuberous sclerosis complex

TSS: transcription start site.

VEGFR: vascular endothelial growth factor

UTR: untranslated region

Foreword

The present thesis report is written to fulfill the graduation requirements of the degree of PhD in Sciences, with mention in molecular and cellular interactions, at the Université Côte d'Azur (Nice, France). In it, I describe my research on understanding the regulation of cell growth and other related cellular processes, through the study of the regulation of the integrin- and amino acid-regulator protein CD98hc.

In the introduction, I summarize the current state of the knowledge regarding the two main CD98hc-regulated processes affecting cell proliferation: integrin-mediated adhesive signaling and intracellular amino acid availability. Then, I expose the available knowledge in regard to CD98hc protein, functions and regulation. Finally, I expose the timely organization of the experimental work along the PhD fellowship. Section 2 exposes the problem statement, scope and aims of the study, while in section 3 I present and discuss the findings of the main research project (currently in preparation for publication) on CD98hc's transcription regulation of an alternative novel protein variant. Section 4 presents two additional, unfinished projects about the possible function of the new CD98hc alternative variant in comparison with the canonical variant and CD98hc's role in integrin-mediated mechanotransduction. I present both positive and negative results and discuss the reasons why these projects were interrupted, the conclusions and possible alternatives. Finally, section 5 includes a general discussion of all the research presented in this report in relation with previous findings and potential future investigations.

The experimental work presented here was performed in the Laboratory of Epithelial Homeostasis and Tumorigenesis at the IRCAN (Nice, France) under the supervision of Dr. Chloé Féral. The approaches we applied to answer the scientific questions did not always yield consistent answers, but my supervisor's and the team's expertise was consequential in effectively directing the research effort to drive the relevant conclusions presented in this report for the research community.

Section 1: Introduction

From unicellular prokaryotes to human beings, cells need to proliferate to sustain life; when and how a cell divides are defined by intracellular and extracellular signals that affect the cell cycle. The precise regulation of this process includes factors like resource availability, environmental conditions, cellular integrity, and, in multicellular organisms, tissue and organ formation, development and homeostasis. The most prominent proliferation regulators are secreted growth factors (GFs) that bind to their correspondent growth factor receptors (GFRs) at the plasma membrane to trigger mitotic signaling cascades. However, they are not alone: proliferation signals are heterogeneous and imbricate in a network of downstream pathways. Cell cycle regulation has a significant complexity, conserved in eukaryotes and probably already present in their common ancestor (Harashima et al., 2013). This fact supports the idea of cells requiring a complex signaling network that seems to increase together with organismal complexity in order to achieve a proper cell cycle regulation.

CD98hc is a ubiquitous signaling integrator protein that promotes cell proliferation both in homeostatic and pathological conditions (Boulter et al., 2013; Cantor and Ginsberg, 2012; Cantor et al., 2009; De La Ballina et al., 2016). Although systems partially analogous are present in other metazoa, CD98hc and its implication in cell proliferation are exclusive to vertebrates (Gabriško and Janeček, 2009; Uinuk-Ool et al., 2002), consistent with a more complex cell cycle regulation in complex organisms. CD98hc regulates integrin adhesive signaling (Feral et al., 2005) and amino acid transport across the plasma membrane (Fotiadis et al., 2013), affecting two major cell cycle regulation systems: (1) cell adhesion to the extracellular matrix (ECM), including integrins as fundamental cell adhesion molecules (CAM) (Kim et al., 2011); (2) and nutrient and energy availability, with particular importance on amino acid regulation of mammalian target of rapamycin (mTOR) (Cargnello et al., 2015). The expression level of CD98hc is susceptible to a number of intracellular and extracellular signals and is closely related to the cell proliferative state.

In this section, I present a revision of the literature about cell proliferation control by the two main processes regulated by CD98hc: integrin adhesive signaling and amino acid availability. Finally, I summarize the state of the art regarding CD98hc, its function, protein partners and expression regulation.

1.1. Generalities about cell growth and CD98hc

Each step of the cell cycle (Fig 1) is strictly regulated by the activity of unique complexes of cyclins and cyclin-dependent kinases (CDKs). Cyclin proteins have a cyclic expression pattern (Fig 2): they are produced and degraded as the cycle progresses. They bind to their partner CDKs and activate their kinase activity, ultimately allowing the progression through the cell cycle.

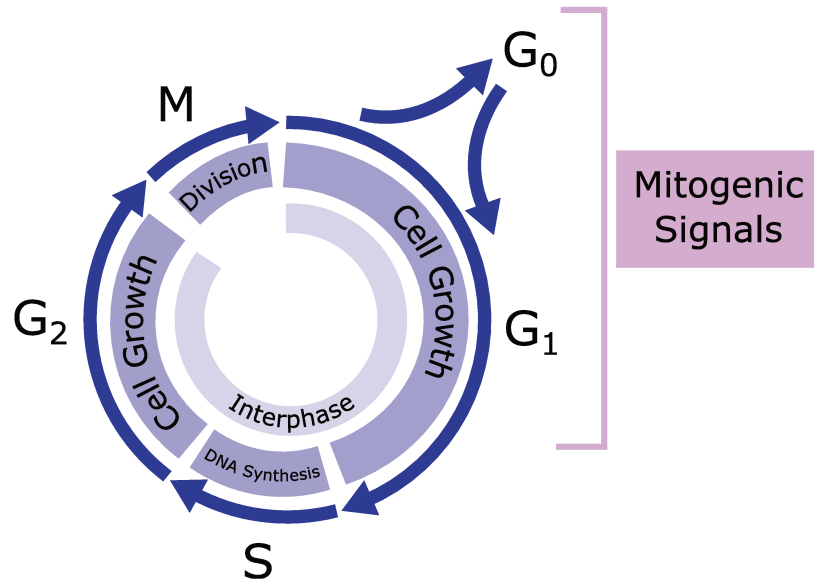

Figure 1. Cell cycle. The cell cycle includes two phases, namely interphase, and mitosis (M). Interphase is, in turn, composed of the gap 1 (G1), the synthesis phase (S) and the gap 2 (G2). Cells are responsive to mitogenic signals only during a part of G1. In their absence or in the presence of quiescence signals, cells can exit the cell cycle to rest in G0 until they are signaled otherwise.

The cell cycle includes two distinct phases, namely interphase and mitotic (M) phase. During the interphase's Gap 1 (G1) the cell grows in size and accumulates the necessary resources for living and proliferating. Only during a window in the early G1 phase are cells responsive to mitogenic environmental signaling (e.g., GF, adhesion). Mitogenic signaling cascades promote the assembly of cyclin D-CDK4 or CDK6 complexes (D-CDK4/6)—depending on the tissue—(Anders et al., 2011; Malumbres and Barbacid, 2009), inducing CDK4/6 kinase activity. Phosphorylation of D-CDK4/6 targets will ultimately liberate transcription factors (TFs) to induce expression of a plethora of genes involved in cell cycle progression, as well as disinhibit Cyclin E-CDK2 complexes (Sherr and Roberts, 2004). After that, the cell enters the synthesis (S) phase to replicate its genetic content (Ma et al., 2000; Okuda et al., 2000). From here on, the cell is no longer sensitive to mitogens and will continue the cell cycle unless it

encounters an internal problem (Orren et al., 1997). E-CDK2 complexes are replaced by A-CDK2 (Koepp et al., 2001; Strohmaier et al., 2001) along the S phase and lead the cell to enter into Gap 2 (G2), the final stage of the interphase. By the end of G2, A-CDK1 will become the major complex. At early mitosis phase, Cyclin A is substituted by Cyclin B (forming B-CDK1 complexes), and finally, degradation of all cyclins (Gavet and Pines, 2010) allows the end of mitosis, chromatid separation, and cytokinesis with the final result of two daughter cells. Along the cycle there are several points to check the correctness of DNA replication and, if necessary, enable correction mechanisms or target the cell for apoptosis if non-reparable genetic damage is found (Orren et al., 1997).

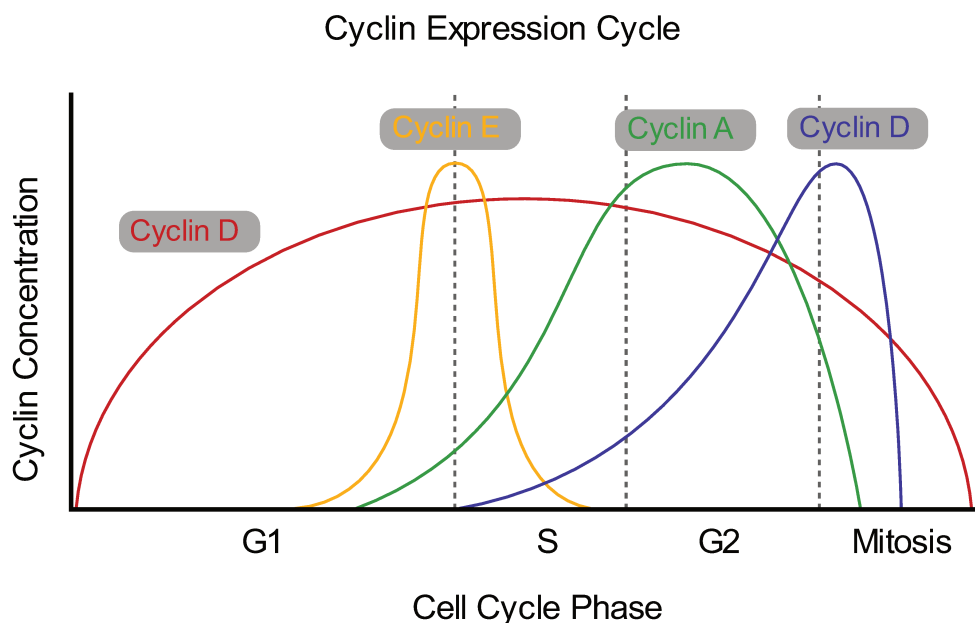

Figure 2. Cyclin expression cycle. Cyclins are expressed cyclically along the cell cycle.

In most tissues, a significant number of cells exit the cell cycle in G1 phase to remain in a quiescent state called G0 (Fig 1), in response to either negative growth signals (growth inhibiting factors, cell-cell contact...) or the absence of the appropriate mitotic signals (growth factors, ECM adhesion...). While in G0 state, cells keep a $2n$ DNA content—DNA is not replicated—, adapt their metabolism, and their morphology—for instance, they stop growing and reduce their total size (Coller, 2007; Coller et al., 2006; Lemons et al., 2010). Quiescence or G0 state is a reversible state and is therefore different from terminal differentiation or senescence, scenarios that imply irreversible growth arrest (Lea et al., 2003; Sachidanandan et al., 2002).

Cell cycle dysregulation can lead to developmental defects (Bolkan et al., 2007; Zhang et al., 2017), immune problems (Balomenos and Martínez-A, 2000; Liao et al., 2016) or, notably, uncontrolled proliferation and tumor formation (Malumbres and Barbacid, 2009). Indeed, cell cycle regulatory proteins are considered attractive targets for cancer therapy and clinical trials are evaluating different approaches to target them (Otto and Sicinski, 2017).

1.2. Adhesive signaling regulates cell proliferation

Cell adhesion to its microenvironment plays, in collaboration with GF signaling, a critical role in regulating cell proliferation. Most non-transformed metazoan cells require ECM adhesion for G1/S phase cell cycle progression, a characteristic known as anchorage-dependent growth. Integrins, as transmembrane receptors for ECM components, trigger signaling cascades necessary for cell cycle progression, ultimately affecting cyclin D expression. Research shows that normal cells, in the absence of ECM attachment or lacking the expression of integrins, undergo cell cycle arrest independently of GF availability (Jeanes et al., 2012; Nikolopoulos et al., 2005; Streuli and Akhtar, 2009; Walker and Assoian, 2005). Adhesive signaling cooperates with GF-activated pathways during the mitogen-sensitivity window in G1 phase. In particular, integrin outside-in signaling after cell-ECM adhesion, a process requiring CD98hc as integrin co-receptor, is necessary for cellular growth in most non-transformed cells, even though it cannot trigger proliferation alone (Moreno-Layseca and Streuli, 2014). On the other hand, anchorage-independent growth is often related to cell transformation and tumor progression (Shin et al., 1975; Stoker et al., 1968).

1.2.1. The cellular microenvironment: the extracellular matrix

Each tissue has a unique ECM composition with different physical and chemical properties but, in general, ECM consists of water and a mesh of molecules secreted by resident cells, including proteoglycans, non-protein-linked glycosaminoglycans (GAGs), and proteins (Järveläinen et al., 2009; Schaefer and Schaefer, 2010). ECM constitutes the cell microenvironment and provides many of the physical properties of tissues and organs. However, ECM has further functions than being the tissue scaffold, including stem cell niche maintenance (Discher et al., 2009; Gattazzo et al., 2014; Pera and Tam, 2010), development (Rozario and DeSimone, 2010) or cancer (Bonnans et al., 2014; Buchheit et al., 2014). Both physical and chemical properties of the ECM act as extracellular cues to trigger specific cell signaling pathways. Hence, ECM affects certain cell behaviors and responses. In turn, cells can remodel the ECM, change its composition and structure, making it a dynamic environment shaped according to cell necessities, rather than a static scaffold (Fig 3). Abnormalities in ECM components give rise to a wide range of disorders, highlighting the importance of the non-cellular component of tissues (Iozzo et al., 2009; Järveläinen et al., 2009).

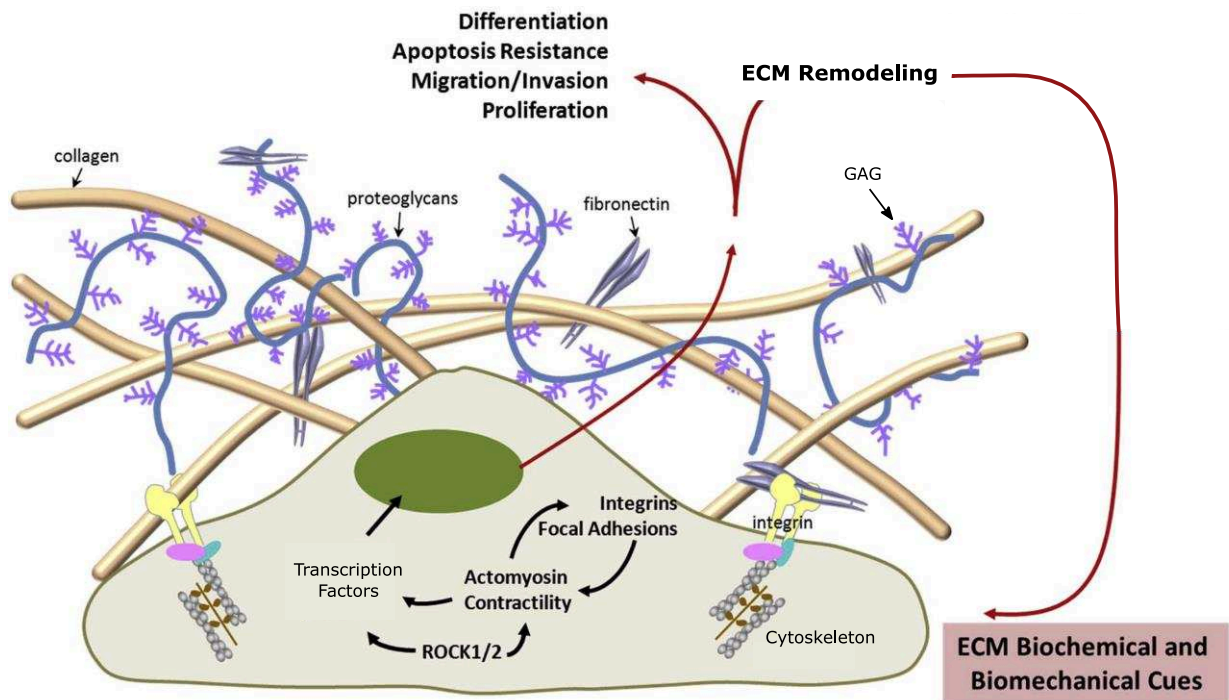

Figure 3. ECM-cell interaction. The extracellular matrix (ECM) is composed of a variety of proteins and carbohydrates including proteoglycans, glycosaminoglycans (GAGs) and proteins such as fibronectin and collagen. Resident cells adhere through cell adhesion receptors such as integrins to connect their cytoskeleton with the ECM transmitting biomechanical and biochemical cues. These signals will trigger a cell response via transcription factors, resulting in ECM remodeling and processes such as differentiation, proliferation, and migration. (Adapted from Thannickal et al., 2014).

1.2.1.1. Composition and structure

ECM components form an interlocking mesh with a variety of macromolecules playing different roles. Proteoglycans—GAG chains covalently linked to a specific protein core, except for hyaluronic acid—fill most of the intercellular space. The vast amount of carbohydrates gives them a net negative charge, able to attract cations (Na^+) to, in turn, retain water molecules. As a result, proteoglycans confer unique properties to the ECM including buffering, hydration, and force-resistance. Additionally, these macromolecules can trap GFs, serving as storage and releasing them under chemical or physical stimuli (Iozzo and Schaefer, 2015; Schaefer and Schaefer, 2010).

Collagen constitutes the primary structural protein of the ECM and the most abundant protein in animals—up to 30% of the total protein mass. Different collagen types are present in ECM of different tissues, but they are all assembled in fibrillar structures with shared fundamental structural properties (Hulmes, 2002). Collagen provides structural support for other ECM components, increases tensile strength, is implicated in tissue development and

harbors cell adhesion (Rozario and DeSimone, 2010). Elastin is the other major ECM structural protein in association with collagen (Kielty et al., 2002). It provides elastic properties to tissues undergoing repeated stretch. Notably, this capacity is limited by elastin's close interaction with collagen proteins (Wise and Weiss, 2009).

Fibronectin (FN) is the principal protein responsible for cell-ECM adhesion and signal transmission, aside from its involvement in directing the organization of the interstitial ECM. It forms a dimer and is usually found binding other proteoglycans or collagen as well as cellular receptors (integrins), thus creating a protein-binding platform (Pankov and Yamada, 2002). FN also allows integrin-mediated translation of mechanical forces into biochemical signals (mechanotransduction) (Fincham et al., 2000; Guilluy et al., 2011; Schiller and Fässler, 2013). It can be stretched by traction forces several times over its resting length, unfolding and exposing cryptic binding sites and producing changes in cellular behavior (Smith et al., 2007). For instance, FN unfolding regulates adhesion and assembly of $\alpha_5\beta_1$ integrins thanks to the exposure of its synergy site, connecting ECM and cytoskeleton mechanics to adhesion-dependent signaling pathways (Friedland et al., 2009). Likewise, other ECM proteins like vitronectin or tenascin can produce pleiotropic effects on cell behavior, regulating processes such as migration or development (Preissner and Seiffert, 1998; Trebault et al., 2007; Tucker and Chiquet-Ehrismann, 2009).

1.2.1. Integrin-mediated cell adhesion

Cells adhesion to the ECM and the surrounding cells is mediated by a number of transmembrane cell adhesion molecules (CAM) such as integrins, selectins or cadherins. Integrins are the principal ECM adhesion receptors and mediate signal transmission through the plasma membrane. They represent a major family of proteins widely expressed in all metazoans (Giancotti and Ruoslahti, 1999) and are implicated in regulating cell proliferation among other processes.

Integrins are heterodimers composed of an α and a β subunit, linked through non-covalent interactions. Each subunit is a type 1, single-pass transmembrane protein with a short intracellular tail, a transmembrane stretch and a long extracellular domain. 18 α subunits and 8 β subunits can heterodimerize, giving rise to 24 possible integrin complexes with different binding specificities (Humphries, 2006; Hynes, 2002) to ECM macromolecules

or, less commonly, to counter-receptors on adjacent cell surfaces (Fig 4). Among the main ECM integrin ligands, we can cite FN (RGD binding), laminin or collagen, although the total integrin ligand array is much more complex and probably not complete to date (Humphries, 2006; Ruoslahti, 1996).

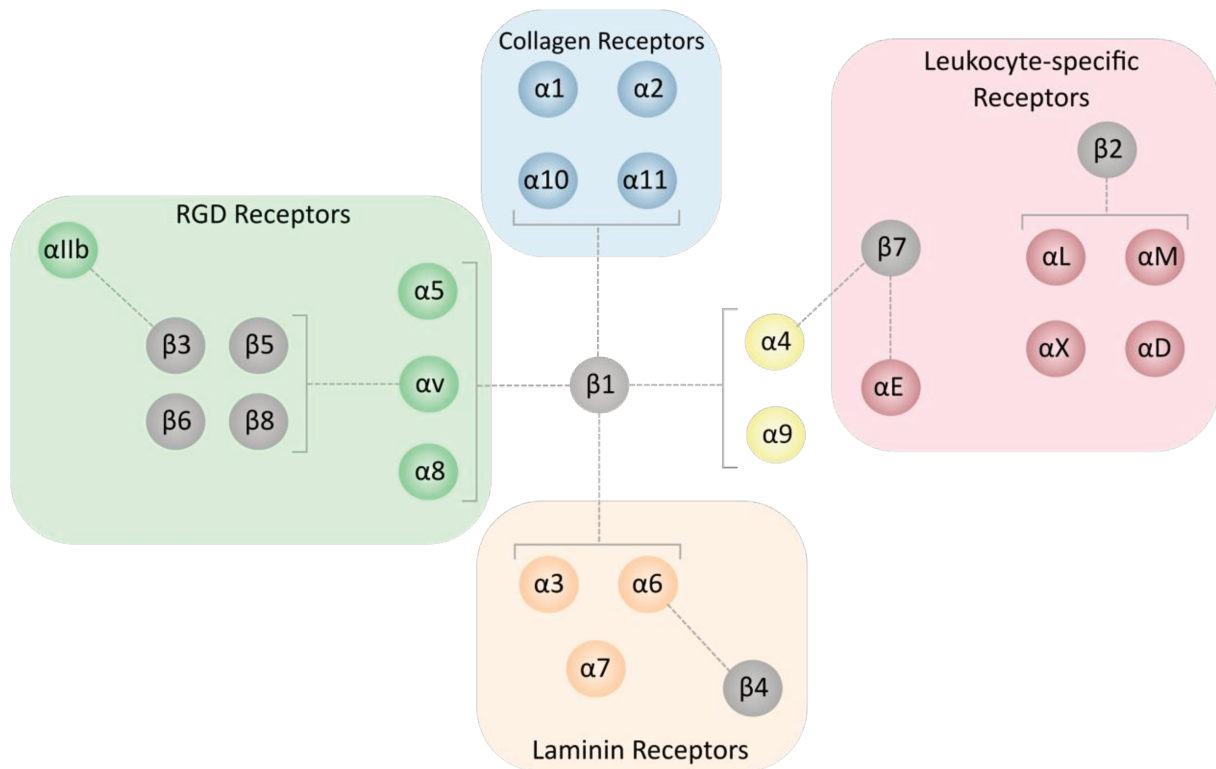

Figure 4. Integrin heterodimer combinations. Integrins are heterodimeric cell adhesion molecules with an α and a β subunit. 18 α and 8 β subunits can be combined in a total of 24 possible heterodimers with different binding capacities. (Adapted from Hynes, 2002).

Integrins represent a two-way signaling street; they can react to cues both intra and extracellularly and produce a change on the opposite side of the plasma membrane to transmit a signal. They play an important role in a wide range of cellular processes such as adhesion, migration, tissues homeostasis and repair, development or host defense (Giancotti and Ruoslahti, 1999; Harburger and Calderwood, 2009). To do that, they bind to ECM components through their extracellular domain and recruit a large number of intracellular proteins. This forms a vast multiprotein complex around their intracellular tail with more than 150 components called the 'adhesome' (Zaidel-Bar et al., 2007).

1.2.2. Integrin signaling and cell cycle progression

Cell cycle progression from G1 to S phase is highly dependent on integrin signaling. Integrin adhesion to the ECM recruits multiprotein complexes to their intracellular tails including adaptor proteins such as talin and paxillin, and enzymes with different activities like small GTPases or the focal adhesion kinase (FAK). These effector proteins trigger downstream signaling cascades that ultimately regulate the level of cyclins, cyclin kinase inhibitors and proliferation-related TF like E2F and c-Jun (Walker and Assoian, 2005). Additionally, integrins are also necessary for spindle alignment during mitosis (LaFlamme et al., 2008; Streuli and Akhtar, 2009). In short, integrin-mediated cell-ECM adhesion is a necessary—although not sufficient—component for cell proliferation in most non-transformed animal cells.

1.2.2.1. Inside-out: activation

Integrin inside-out signaling happens when intracellular stimuli cause extracellular changes. The best example of this signaling type is integrin activation. Although integrin activation is a widespread process regulating, for instance, integrin signaling in platelets and leukocytes in the context of extravasation (Calderwood, 2004; Ginsberg, 2014), it is not clear whether it occurs during homeostasis of static cells in tissues such as the epithelial, neuronal or mesenchymal (Streuli and Akhtar, 2009).

Integrins can be at the plasma membrane in an inactive conformation; this is, in a folded state that drastically limits their ECM-binding ability. Integrin-independent signaling events can, then, occur to trigger integrin activation by recruiting proteins to the integrin intracellular tails. Examples of these signals are selectin adhesion on neutrophils (Green et al., 2004), T-cell receptor activation (Burbach et al., 2007) or platelet binding to exposed collagen (Varga-Szabo et al., 2008) (Fig 5).

Within this process, talin rises as the central required protein for integrin activation (Tadokoro et al., 2003). Aside from regulating integrin affinity, talin provides a physical link between the actin cytoskeleton and integrins. Talin includes a 50-kDa N-terminal FERM domain with a site for integrin β tail high-affinity binding, and a rod domain of 220-kDa that contains multiple binding sites for actin and vinculin (Calderwood et al., 2002; Calderwood et al., 2003; Critchley, 2009). By binding to both integrin β tails and negatively charged phospholipids, (Anthis et al., 2009; Goult et al., 2010; Wegener et al., 2007) talin changes the

tilt angle of β integrin transmembrane domain (Kim et al., 2012a), changing α and β integrin relative positioning. This reorientation results in a conformation with higher exposure of the ligand binding site and therefore higher ligand affinity (Luo et al., 2007; Xia et al., 2004). Talin is required for the regulation of integrin-ligand affinity as documented in cell (Calderwood et al., 1999; Calderwood et al., 2002; Han et al., 2006; Lee et al., 2009; Simonson et al., 2006) and animal models (Haling et al., 2011; Nieswandt et al., 2007; Petrich et al., 2007a; Petrich et al., 2007b). Changes produced by talin and other proteins in the integrin intracellular domains are the key to the activation process. Indeed, removal of integrin intracellular and transmembrane regions results in constitutively active integrins (Mehta et al., 1998), indicating that the missing regions normally limit the activation state of integrins unless bound to intracellular protein complexes.

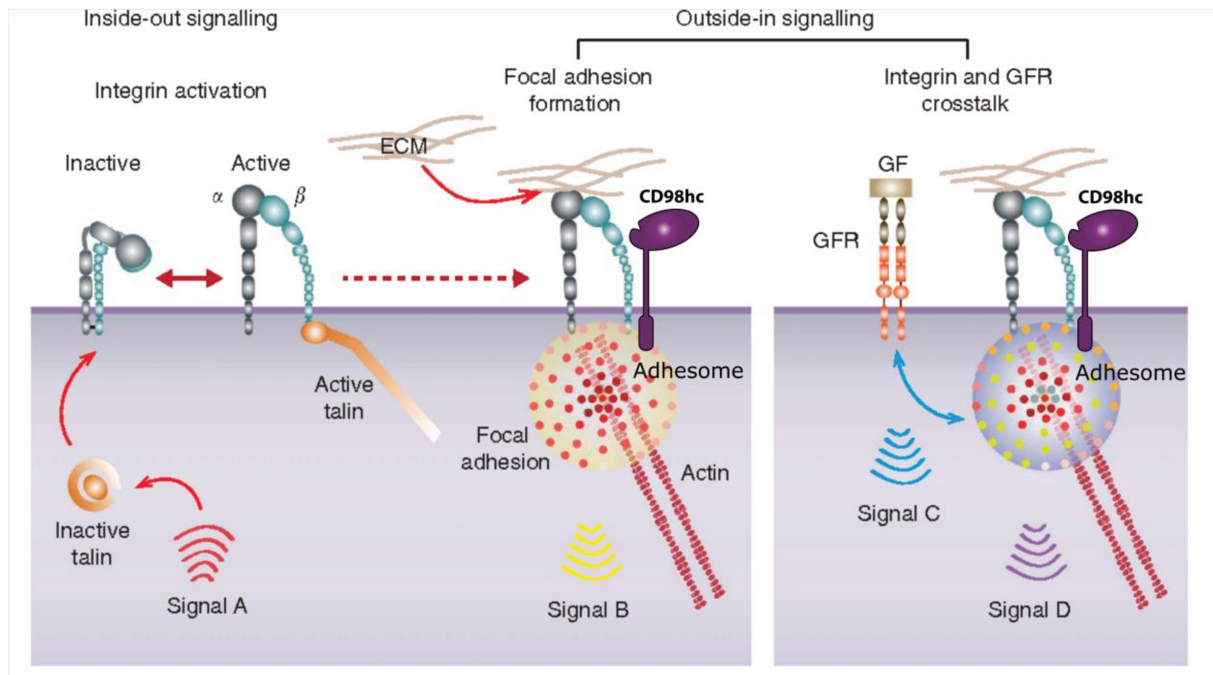

Figure 5. General integrin bidirectional signaling. Intracellular signals (signal A) can trigger a conformational change in integrin heterodimers through talin activation (inside-out signaling). The new conformation provides the receptors with a higher ligand affinity; they start establishing adhesions with the extracellular matrix (ECM) and recruiting adhesome proteins connected to the actin cytoskeleton. This primary adhesion can eventually develop into larger focal adhesions increasing integrin avidity. Once assembled, adhesion complexes will send signals to the cell in a CD98hc-dependent manner, alone or in cooperation with growth factor receptors (GFR) (Outside-in signaling). (Adapted from Hamidi et al., 2016).

Aside from the increase in individual integrin affinity, activation encompasses an avidity increase due to integrin clustering (Ginsberg, 2014; Shattil and Newman, 2004; Shattil et al., 2010), with kindlins recently emerging as major players in the process (Ma et al., 2008a;

Montanez et al., 2008; Moser et al., 2008; Ye et al., 2013). First, ECM-bound integrins cluster into unstable nascent adhesions (Choi et al., 2008) that can, then, mature into dot-like focal complexes. These can in turn progress to larger focal adhesions (FAs), to finally reach the state of streak-like fibrillar adhesions (Geiger et al., 2001). Once integrins are in this high-affinity and high-avidity state, they become efficient at transmitting the large array of intracellular signals collectively known as “outside-in” signaling (Fig 5).

1.2.2.2. Outside-in: intracellular signaling pathways

Extracellular stimuli in the form of integrin binding to ECM components are transmitted through the plasma membrane to cause intracellular changes; this process is known as the integrin “outside-in” signaling. Integrins detect the composition and mechanical properties of their environment and translate this information intracellularly into changes in the cytoskeleton and signaling cascades that affect cell behavior, including cell proliferation. CD98hc acts as a necessary integrin co-receptor for this process (see section 1.4.3.2). Integrin intracellular portion lacks any enzymatic activity, but it is able to recruit a vast number of proteins, including effector proteins and cytoskeletal components, known as the adhesome or adhesion complex (Fig 5) (Legate et al., 2009; Streuli and Akhtar, 2009; Zaidel-Bar et al., 2007).

Integrin-dependent adhesive signaling controls cell cycle progression at the G1/S transition by stabilizing cyclin D and increasing its level, in cooperation with GFR signaling (Le Gall et al., 1998; Radeva et al., 1997; Roovers et al., 1999). This regulation of cyclin D level is the result of the integration of several signaling pathways. Two major pathways contributing to adhesion-dependent cyclin D induction via different complementary mechanisms are AKT and ERK. AKT controls targets such as Forkhead box O3A (FOXO3A) (Zhang et al., 2013), ELK1 (Mut et al., 2012), or mTORC2 (Shanmugasundaram et al., 2013) to allow cell cycle progression, whereas ERK has a partially overlapping list of targets among which we can cite again FOXO3A (Yang et al., 2008) and ELK1 (Mut et al., 2012). The transcription of cyclin-dependent kinase inhibitors (CKIs) p27 or p21 is normally induced by FOXO3A, but this TF is translocated to the cytosol after phosphorylation (Blaess et al., 2004; Li et al., 2005). Additionally, mTORC2 pathway leads to FOXO3A and p27 degradation via the Skp2 component of E3 ubiquitin ligase complex (Shanmugasundaram et al., 2013). Together, both AKT and ERK

activation by phosphorylation are required for cell growth induction after mitogen stimulation (Fig 6) (Dellinger and Brekken, 2011; Fournier et al., 2012; Zhang et al., 2013).

Integrins can trigger AKT activation in an adhesion-dependent manner in many cell types through FAK and its binding to the p85 subunit of phosphatidylinositol-3-kinase (PI3K), or via a Src–vinculin complex (Gera et al., 2004; Gille and Downward, 1999). GFs transiently activate ERK through different effectors, but integrin-dependent adhesion sustains ERK activation during the required period to induce cyclin D expression (Fig 6). Several seemingly redundant integrin-dependent mechanisms for ERK activation exist, involving FAK and Src (Schlaepfer et al., 1994), FAK and p130Cas (Schlaepfer and Hunter, 1997; Schlaepfer et al., 1997), FAK, Ras-proximate-1 (Rap1) and B-Raf (Barberis et al., 2000), Fyn and Shc (Wary et al., 1996; Wary et al., 1998) or p21-activated kinase (Howe and Juliano, 2000; Slack-Davis et al., 2003).

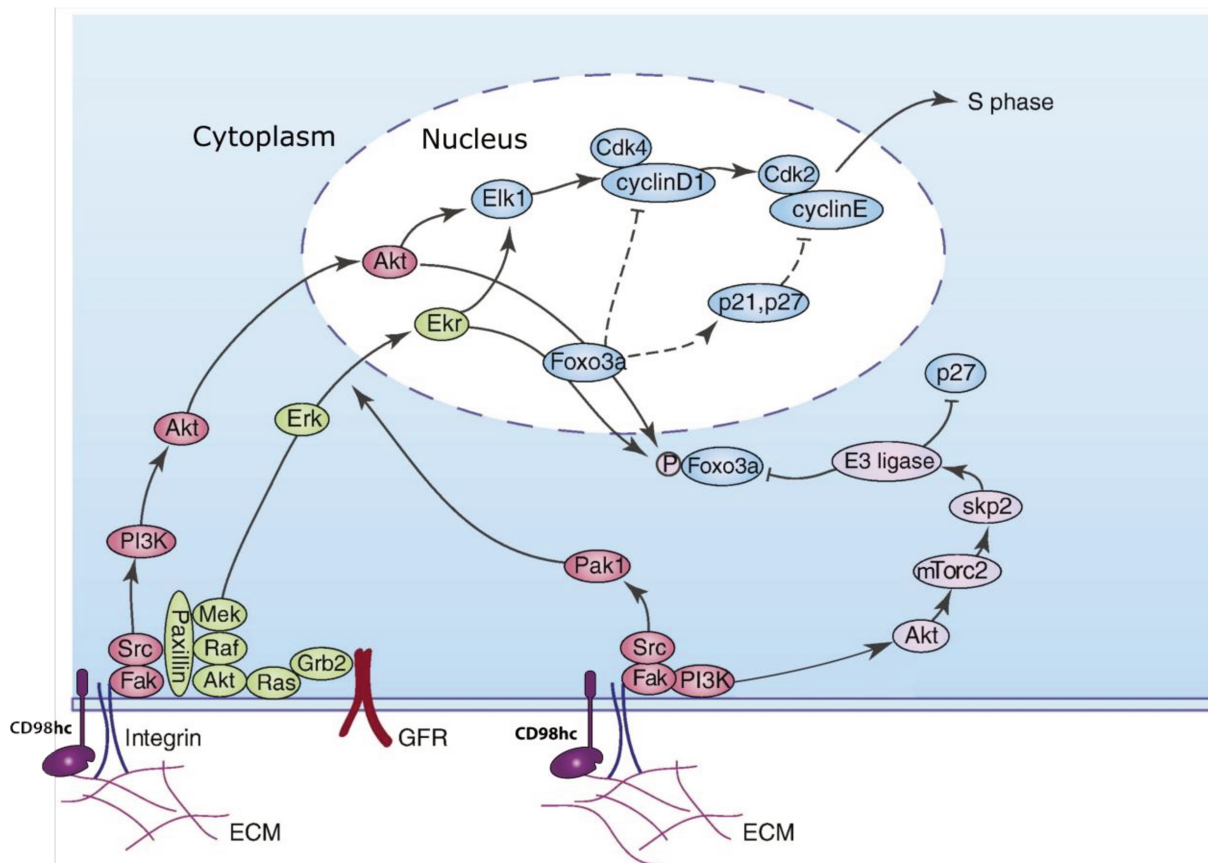

Figure 6. Integrin adhesive signaling contributes to cell cycle progression. Integrin adhesive signaling cooperates with growth factor receptor (GFR) signaling to induce cell cycle progression through several pathways, notably ERK and AKT, by inducing and stabilizing cyclin D. (Adapted from Moreno-Layseca and Streuli, 2014).

Interestingly, the three principal Rho GTPases Rac1, RhoA, and Cell division control protein 42 homolog (Cdc42) are implicated in adhesion-dependent cell cycle regulation (Mack

et al., 2011; Welsh, 2004). Integrins recruit Rac1 to the adhesion macromolecular complexes via the FAK-Src-p130Cas tandem. Once activated, Src phosphorylates p130Cas, which recruits Rac1 to focal adhesions for its activation. Although adhesion proteins such as FAK are involved in linking integrins with AKT and ERK, the detailed mechanisms are not fully resolved.

Integrin adhesive signaling also collaborates in ERK nuclear translocation after phosphorylation (Fig 6) (Nikolopoulos et al., 2005; Streuli and Akhtar, 2009). Since ERK does not contain any classical nuclear localization sequence, it relies on anchoring proteins to regulate nuclear translocation. A study on mouse-derived fibroblasts containing a deletion in the β_1 integrin cytoplasmic tail reported a failure in Rac1 activation and ERK nuclear translocation, although ERK activation was not affected, therefore implicating the small GTPase Rac1 in the process (Hirsch et al., 2002). However, the molecular mechanism of integrin-dependent ERK nuclear translocation remains elusive.

Another Rho GTPase pathway, the RhoA-ROCK (Rho Associated Coiled-Coil Containing Protein Kinase), is involved in stress fiber formation (Leung et al., 1996; Watanabe et al., 1997) and cyclin D expression in mammary epithelial cells and hepatocytes (Hansen and Albrecht, 1999; Liberto et al., 2002). Additionally, ECM's intrinsic physical properties and external forces transmitted through it, deeply affect actin polymerization and adhesion complex assembly through RhoA-mediated mechanosensing, having an impact in cell cycle progression (Dufort et al., 2011; Eyckmans et al., 2011; Guilluy et al., 2011; Walker and Assoian, 2005).

1.2.3. Growth factors and integrin co-regulation

Integrin signaling acts synergistically with GFRs in regulating cell cycle progression (Alam et al., 2007). Signaling triggered by GFRs is partially controlled by integrin-mediated ECM adhesion. Examples of GFRs with signaling activities modulated by integrins include IR (insulin receptor) (Schneller et al., 1997), IGF-1R (type 1 insulin-like growth factor receptor) (Zhang and Yee, 2000); VEGFR (vascular endothelial growth factor receptor) (Ruoslahti, 2002), TGF- β receptor (transforming growth factor beta receptor) (Scaffidi et al., 2004), PDGFR (platelet-derived growth factor- β receptor) (Schneller et al., 1997) and EGFR (epidermal growth factor receptor) (Bill et al., 2004). One mechanism for activating GFRs is through integrin clustering; under this circumstance, dense integrin-GFR complexes can activate GFR in the absence of the corresponding GF (Miyamoto et al., 1996; Moro, 1998). Integrins can also drive GFRs to

lipid microdomains facilitating their activation (Ffrench-Constant and Colognato, 2004), such as $\alpha_6\beta_1$ does with PDGFR in oligodendrocytes and $\alpha_6\beta_4$ with EGFR in keratinocytes (Baron et al., 2003; Gagnoux-Palacios et al., 2003). Indeed, some studies have found a physical association of several integrins with GFRs (Borges et al., 2000; Eliceiri, 2001; Falcioni et al., 1997; Lee and Juliano, 2000; Miyamoto et al., 1996). Since GFRs require the presence of specific integrin subunits for proper signaling and different cell types present different integrin profiles, this 'cellular context' could constitute a cell type-specific determination of the outcome of the GF signals (Alam et al., 2007).

1.2.4. Integrin proliferative signaling and tumor development

Maintaining proliferative signals, becoming anchorage-independent and resisting cell death are all hallmarks of cancer (Hanahan and Weinberg, 2011). Cancer cells acquire the ability for anchorage-independent growth (leading to metastasis in vivo systems) and become resistant to anoikis, an apoptosis type triggered by lack of integrin-mediated adhesion. These two features implicate integrin signaling in invasive cancers (Desgrosellier and Cheresch, 2010; Harburger and Calderwood, 2009; Huck et al., 2010; Lahlou et al., 2007). Additionally, integrin mechanosensing regulates proliferation stimulation by increased ECM stiffness, inducing tumor progression via FAK and PI3K (Levental et al., 2009).

Integrin-mediated cell adhesion can influence tumor-associated cell growth, cell cycle, and survival by increasing the expression of the antiapoptotic TF NF- κ B (Weaver et al., 2002; Zahir et al., 2003), by supporting AKT signaling via PI3K (Chung et al., 2002), by impeding proapoptotic factor production mediated by p53 (Bachelder et al., 1999a; Bachelder et al., 1999b), or by promoting sustained ERK signaling (Gilcrease, 2007; Sun et al., 2014a) among other mechanisms. In short, the dysregulation of integrin-mediated cell cycle and survival control plays a critical role in tumor progression and metastasis, making integrin adhesive signaling an attractive target for anticancer therapy (Desgrosellier and Cheresch, 2010; Raab-Westphal et al., 2017)

1.2.5. Conclusion

The cellular microenvironment provides necessary cues for cell cycle progression by regulating G1/S phase transition via integrin adhesive signaling. The overall process includes a large set of partially overlapping pathways utilized in alternative ways depending on the

cellular ECM microenvironment and the set of proteins (particularly integrin receptors) expressed by each cell type. These differences constitute a proliferation checkpoint, for only the correct combination of ECM conditions and cell adhesion receptors will promote cell cycle progression in response to GF. Signaling pathways implicated in adhesive-mediated cell cycle progression have been extensively studied, including PI3K/AKT cascade, ERK sustained activation and nuclear translocation or RhoA-mediated actin cytoskeleton reorganization. Under many circumstances, these pathways require the integrin co-receptor CD98hc to be activated after integrin-ECM adhesion. Conversely, the composition and functioning of adhesive protein complexes structured around integrin intracellular tails still possess challenges that, once resolved, will deepen our understanding of the process. Increased comprehension of integrin signaling role in cellular proliferation brings attractive opportunities to identify novel therapeutic targets in the treatment of related diseases.

1.3. Resource availability and metabolism during proliferation

Cell growth requires a supply of nutrients and energy to support a metabolic shift towards anabolic processes. Therefore, cell metabolism needs to be coordinated with resource availability during proliferation. This required metabolic change takes place only when nutrient supplies can sustain cell proliferation, it is mediated by mechanisms evolved to sense nutrient availability and it requires mitogenic signaling by GFs and cell adhesion. Extensive research has exposed the 5' AMP-activated protein kinase (AMPK) as a master energy sensor to regulate cellular metabolism based on intracellular energy levels. Furthermore, the target of rapamycin (TOR) integrates amino acid levels and GF signaling to support anabolism during cell proliferation. Thus, metabolic resources are actively implicated in the regulation of cell cycle progression through a variety of mechanisms (Fig 7).

1.3.1. Cellular metabolism in proliferation

Highly proliferative cells increase glucose uptake and inhibit tricarboxylic acid (TCA) cycle carbon circulation, resulting in the production and excretion of high amounts of lactate. This phenomenon, known as the Warburg effect and initially observed in cancer cells (Warburg, 1956), is also found in highly proliferative healthy cells, that switch their metabolism from oxidative phosphorylation to aerobic glycolysis independently of the oxygen availability. This has been observed in multiple cell types such as mouse fibroblasts (Munyon and Merchant, 1959), human and mouse lymphocytes (Hedekov, 1968; Wang et al., 1976), or chicken embryo cells (Steck et al., 1968), suggesting aerobic glycolysis is a common phenomenon in rapidly dividing cells (Lunt and Vander Heiden, 2011). Rather than constituting a strategy to deal with impaired respiratory capacity or hypoxia, research suggests that aerobic glycolysis provides advantages for proliferation, even though it is a less efficient process in generating ATP—2 ATPs per glucose molecule, as compared to a maximum of 36 for oxidative phosphorylation (Nelson and Cox, 2017). Although the full scope of this reason is not clear yet, a considerable amount of research has suggested several explanations.

Proliferating cells have different metabolic requirements than quiescent cells. A cell needs to duplicate all its components prior to mitosis, which poses a high requirement of nutrients, not only as energy but also as building blocks. Aerobic glycolysis provides metabolic intermediates that can be diverted to fuel other anabolic pathways to support the synthesis

of glycerol, ribose or non-essential amino acids, supporting the complex anabolic network in charge of synthesizing all their macromolecular components.

A

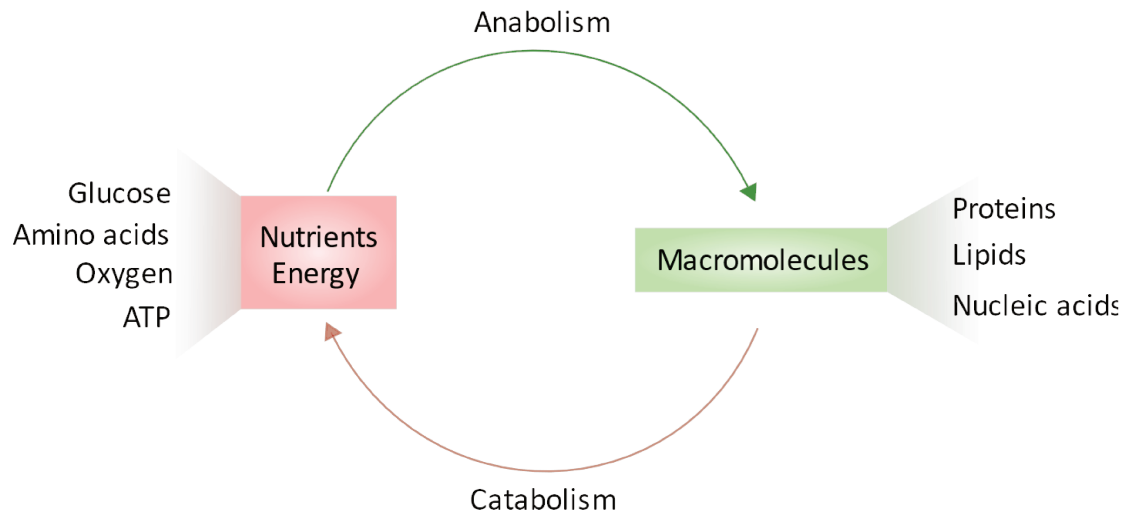

B

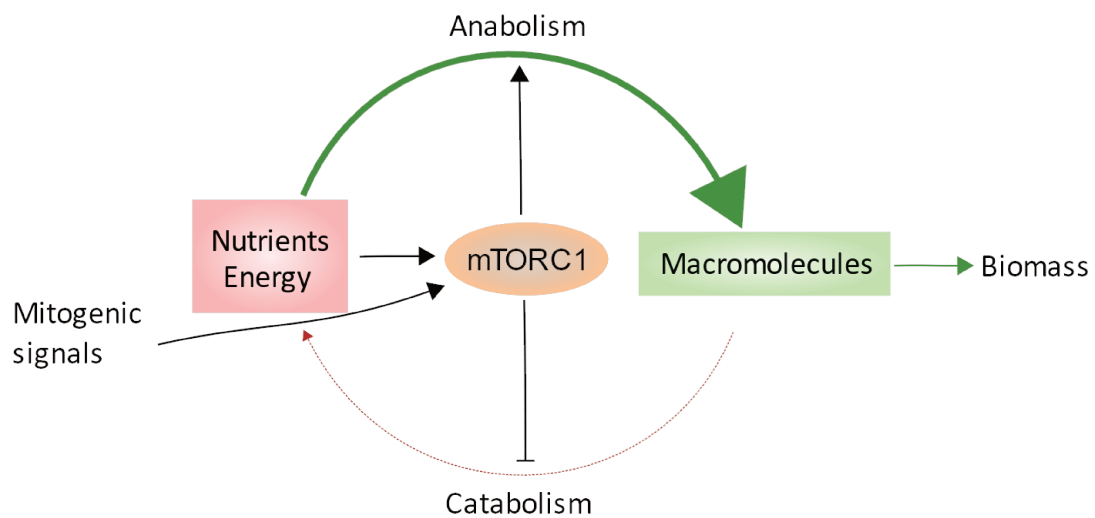

Figure 7. Metabolic shift in cellular proliferation. (A) Under resting conditions, there is a balance between anabolic and catabolic processes to convert nutrients and energy into macromolecules and vice versa. (B) Mitogenic signals trigger a rewiring of metabolites towards anabolic processes via the main metabolic regulator mTORC1, to synthesize the necessary macromolecules for proliferation. (Adapted from Ben-Sahra and Manning, 2017).

Although less efficient, aerobic glycolytic metabolism can produce enough energy to sustain cell proliferation. Inefficient ATP production might be only a problem when nutrients are scarce, and this is not the case for most proliferative cells in multicellular organisms; (Christofk et al., 2008; DeBerardinis et al., 2008). Moreover, proliferation is impeded upon low

energy conditions: if the ATP/ADP ratio is not adequate, sensor systems in the cell will promote cell cycle arrest (Lum et al., 2005; Shaw et al., 2004). Additionally, a portion of the cell's glucose still enters the TCA and undergoes oxidative phosphorylation with high efficiency in ATP production. In fact, data on multiple cell types and tissues show that glycolysis contributes in average only 17% of total ATP production (Zu and Guppy, 2004), although there is a high variation depending on tissues and conditions (0.31%–64%).

1.3.2. Intracellular energy sensing

Cell growth requires a considerable amount of energy to sustain anabolic processes. Although nutrient access is not generally a limiting factor for mammal cells in homeostatic conditions, mechanisms have evolved to detect and ensure proper intracellular energy levels before triggering proliferation. The main chemical readouts to assess intracellular energy levels are the ratios ATP/ADP, ATP/AMP and NAD⁺/NADH (nicotinamide adenine dinucleotide). Cells have developed sensor systems for the constant monitoring of these ratios, allowing them to adapt their metabolism to the growth necessities. AMPK is the principal sensing system in all eukaryotes. It is activated upon energy deficiency conditions—e.g., increased AMP or ADP—to favor catabolic processes over anabolic ones in an effort to recover the energy balance (Hardie et al., 2012). AMPK includes 3 subunits, one catalytic (α) and two regulatory (β and γ), that localize to the plasma membrane thanks to a myristoylation (Mihaylova and Shaw, 2011). AMP, ADP or ATP can directly bind to AMPK through the γ subunit via its adenine nucleotide-binding sites. If the bound nucleotide is AMP or ADP, AMPK undergoes a conformational change leading to enzyme activation via the phosphorylation of a conserved threonine residue in the activation loop by upstream kinases (Hardie, 2011; Oakhill et al., 2011; Xiao et al., 2011). Notably, AMPK activation inhibits mammalian TOR complex 1 (mTORC1) by direct phosphorylation of tuberous sclerosis complex 2 (TSC2) (Inoki et al., 2006) and Raptor (Gwinn et al., 2008) (Fig. 8) (see next section).

In parallel, silent information regulator 1 (SIRT1) acts as a sensor for NAD⁺/NADH to monitor reducing power (Chang and Guarente, 2014). An increase in NAD⁺ levels activates SIRT1. It cooperates with AMPK signaling to switch cell metabolism, inhibiting anabolic processes and favoring catabolic pathways to re-balance the energy status. AMPK and SIRT1 can act synergistically and are able to regulate each other (Ruderman et al., 2010).

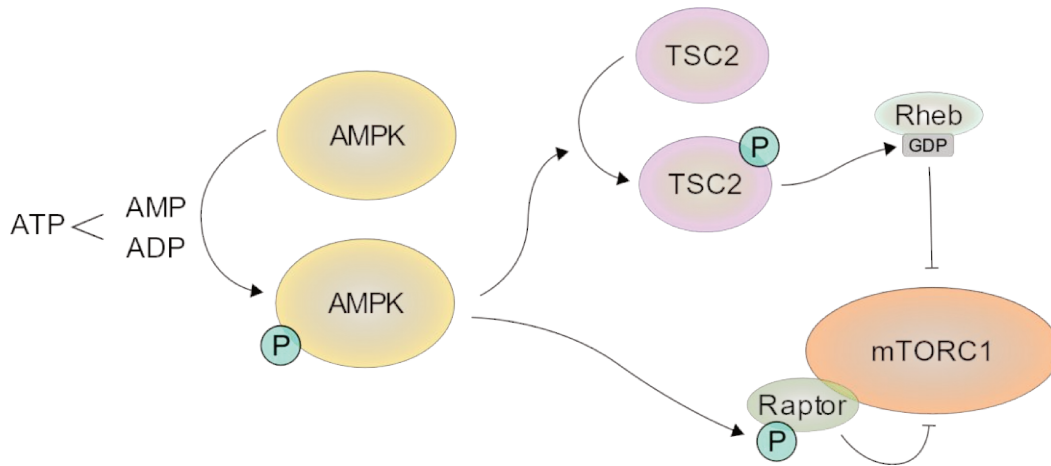

Figure 8. AMPK-mediated energy sensing. When AMP and ADP levels are higher than ATP, AMPK is activated by phosphorylation and it phosphorylates, in turn, TSC2 and Raptor. Phosphorylated TSC2 induces Rheb inactivation by favoring its binding to GDP and therefore the inhibition of mTORC1. Phosphorylation Raptor directly inhibits mTORC1 activity as part of the complex.

1.3.3. Intracellular nutrient sensing

Growing cells need nutrients as building blocks to duplicate all their structures, including membranes (lipids), genetic material (nucleotides) and proteins (amino acids). Among them, amino acids have the most developed sensing machinery; amino acid availability tightly regulates TOR and its downstream signaling in all eukaryotes. Originally identified in yeast and, shortly after, in mammals, the TOR protein is a serine/threonine kinase of around 250 kDa and is inhibited by the drug rapamycin (Koltin et al., 1991; Sabatini et al., 1994). In mammals, it is present in two different complexes: mTORC1 and mTORC2. These two variants differ in the presence of the unique accessory proteins Raptor and Rictor respectively, and develop different functions (Bhaskar and Hay, 2007). The role of mTOR has been deeply studied since its discovery; importantly, it controls cell growth, notably by regulating key proteins for the ribosome biogenesis (Hannan et al., 2003), synthesis of proteins, lipids and nucleotides (Howell et al., 2013) as well as autophagy (Meijer and Codogno, 2004).

mTORC1 is the most studied complex and the only one with a well-characterized amino acid-dependent regulation. Amino acids are necessary (although not sufficient) for mTORC1 activation; a deficiency in amino acids abrogates mTORC1 activation even in the presence of GFs, the primary mTOR pathway activators. Particularly, depletion in essential amino acids leucine and arginine is as efficient as full amino acid deprivation inhibiting mTORC1 (Avruch et al., 2009; Hara et al., 1998). Glutamine metabolism has been implicated in mTORC1 regulation as well (Durán et al., 2012; Van Der Vos and Coffey, 2012) and extracellular leucine

requires glutamine to activate mTORC1 (Nicklin et al., 2009). However, the molecular mechanism underlying this regulation is highly complex and further investigation is still needed to complete our understanding.

The four mammalian Rag proteins A, B, C, and D form functional heterodimers, namely RagA/B-RagC/D (Schürmann et al., 1995; Sekiguchi et al., 2001) and are essential pieces in the amino acid-dependent mTORC1 regulation (Kim et al., 2008a; Sancak et al., 2008). Amino acid presence favors the active form of Rag heterodimers—RagA/B bound to GTP and RagC/D bound to GDP—, that interacts with the mTORC1 subunit Raptor, recruiting the complex to the lysosome membrane, where the Rheb protein can then activate mTOR kinase activity (Fig 9)(Sancak et al., 2008). Rheb is a small GTPase localized at the lysosomal membrane and activated by GF signals via TSC1/TSC2, explaining why amino acid availability is necessary but not sufficient to activate mTORC1; amino acids regulate mTORC1 subcellular localization, influencing Rheb's accessibility to the complex.

Ragulator is another lysosome membrane-associated protein and is responsible for Rag heterodimer activation. Ragulator is, in turn, regulated by intralysosomal amino acid levels via the H⁺ adenosine triphosphatase (v-ATPase) (Zoncu et al., 2011). Other mechanisms implicated in the amino acid-dependent regulation of Rag GTPases are the leucyl-tRNA synthetase, implicated in amino acid sensing (Bonfils et al., 2012; Han et al., 2012), the SH3 domain-binding protein 4 (SH3BP4), that inhibits Rag complex formation under nutrient stress conditions (Kim et al., 2012b), or the Gator1/Gator2 complex, an inhibitor of Rab that is inhibited in a leucine-dependent manner via Sestrin2 (Fig 9) (Kim et al., 2015; Wolfson et al., 2016).

Amino acid transporters have a role to play as well. Recent data describe SLC38A9 as a necessary amino acid transporter at the lysosomal membrane for arginine-dependent mTORC1 activation (Jung et al., 2015; Rebsamen et al., 2015; Wang et al., 2015) and CASTOR1 as cytoplasmic arginine sensor required for arginine depletion to inhibit mTORC1 (Chantranupong et al., 2016). Another amino acid transporter recently related to mTORC1 and cell growth regulation at the lysosome is the heterodimer CD98hc/LAT1 (Milkereit et al., 2015). It transports essential amino acids such as leucine, and it can interact with the lysosomal protein LAPT4b (lysosomal-associated transmembrane protein 4b), increasing lysosomal leucine intake and therefore mTORC1 activation. Additionally, CD98hc/LAT1 plays

an indirect role mediating large neutral amino acid intake at the plasma membrane, its main localization (Fig 9) (Elorza et al., 2012; Hansen et al., 2015).

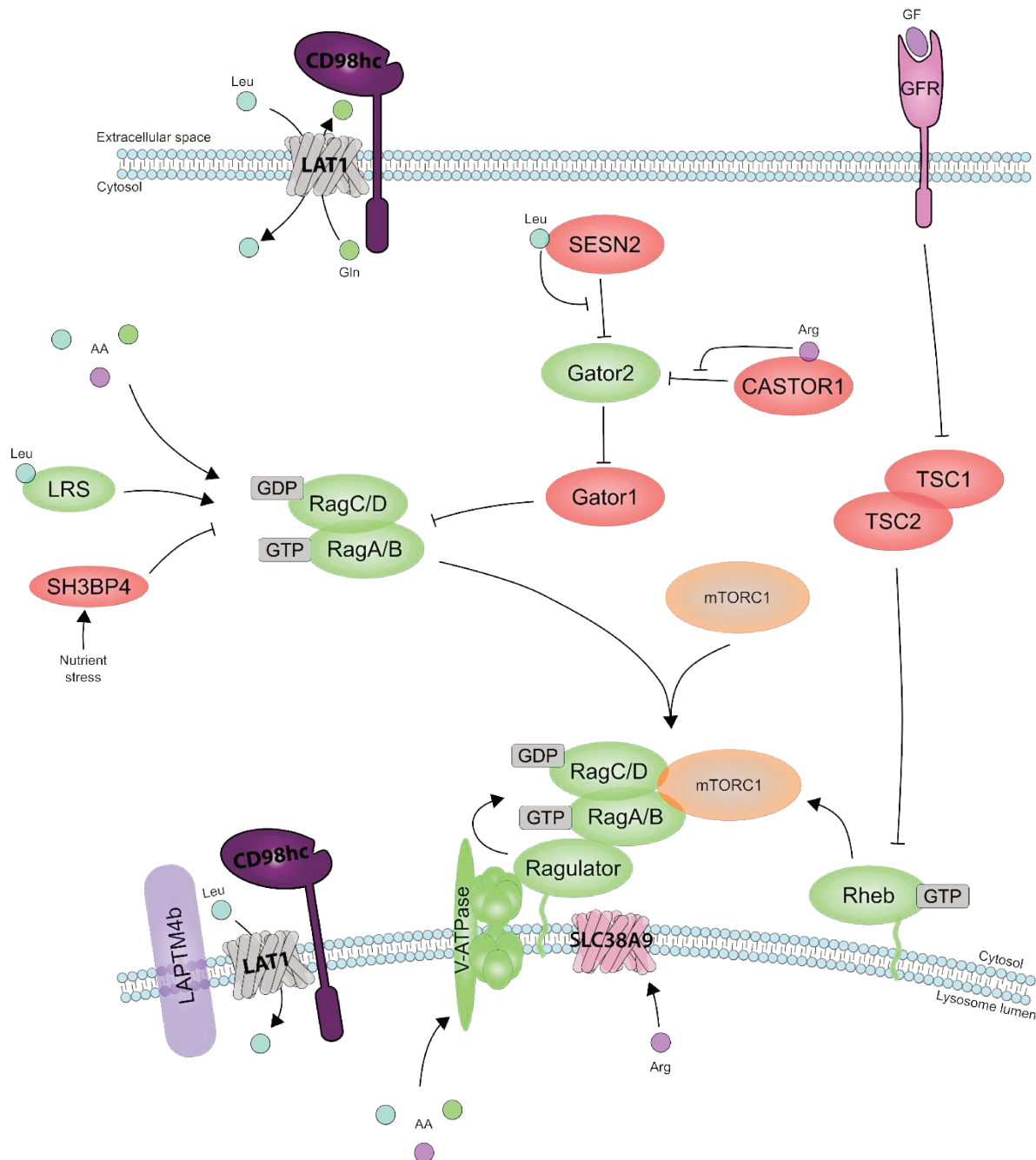

Figure 9. Amino acid-dependent mTORC1 regulation. mTORC1 activators are depicted in green whereas inhibitors are represented in red. Intracellular amino acids promote the activation of Rag heterodimers by several means including leucyl-tRNA synthetase (LRS), CASTOR1 and Sestrin2 (SESN2). Conversely, SH3BP4 inhibits Rag heterodimers upon nutrient stress. Active Rag heterodimers traffic mTORC1 to the lysosomal membrane where Rheb activates it if the proper growth factor receptor (GFR) pathways are activated. Intralysosomal amino acid levels control Rab heterodimer activity as well through the Ragulator protein.

Besides, general control nonderepressible-2 (GCN2) kinase is activated by excess uncharged aminoacyl-tRNA upon amino acid deficiency (Hinnebusch, 2005). GCN2 decreases general translation initiation by phosphorylating eukaryotic translation initiation factor 2-A (eIF2A) and indirectly induces expression of stress-response genes through TFs such as ATF4 (Wek et al., 2006). In short, amino acid deprivation activates GCN2 and inhibits mTORC1 to reduce general protein synthesis. Some data suggest a cross-regulation between these two mechanisms (Novoa et al., 2001; Watanabe et al., 2007).

Finally, as a major metabolic regulator, mTORC1 is also indirectly regulated by AMPK signaling, integrating the cellular nutrient and energy status. Indeed, AMPK represses mTORC1 via TSC2 phosphorylation (Inoki et al., 2003) and Raptor phosphorylation (Gwinn et al., 2008).

1.3.4. mTOR and AMPK as links between nutrient sensing and cellular metabolism

Nutrient sensors mTOR and, to a lower extent, AMPK, maintain cellular homeostasis by acting as major regulators of downstream metabolic pathways. They integrate GF signals and nutrient availability state to regulate metabolic processes such as protein, lipid and nucleic acid synthesis, TCA cycle, glycolysis or oxidative phosphorylation (Dibble and Manning, 2013; Howell et al., 2013). At a glance, AMPK activation switches on catabolic pathways to produce energy while inhibiting ATP-consuming anabolic processes. Conversely, mTORC1 acts under sufficient nutrient availability to promote anabolic pathways through a variety of transcriptional, translational, and post-translational mechanisms, synthesizing the required components for cellular proliferation. The ability of mTORC1 to integrate mitogenic signals with the cell's nutritional and energy status makes it a master metabolic regulator (Dibble and Manning, 2013).

1.3.4.1. Glucose metabolism and energy status

Under mitotic signaling and nutrient availability conditions, mTORC1 promotes the translation of HIF1 α and c-Myc, even in normoxia. As a result, it induces glycolytic enzymes favoring aerobic glycolysis and diverting the glucose-derived carbon flux from the TCA cycle to anabolic pathways to synthesize the necessary building blocks for cell proliferation (Düvel et al., 2010; West et al., 1998).

On the other hand, AMPK and SIRT1 activation under energy restriction conditions promotes ATP production and inhibits anabolism, restricting cell proliferation. Both AMPK and

SIRT1 promote glucose uptake (Xi et al., 2001) and induce glucose oxidative products to enter the TCA cycle by repressing HIF1 α , finally increasing mitochondrial oxidative phosphorylation, while AMPK also promotes mitochondrial biogenesis (Gomes et al., 2013; Hardie, 2011; Lim et al., 2010).

1.3.4.2. Protein synthesis

In the presence of mitogenic signals and GFs, mTORC1 promotes energy-consuming anabolic processes necessary to support cell proliferation; in general, it induces ribosome biogenesis and mRNA translation (Holz et al., 2005; Tcherkezian et al., 2014). mTORC1 phosphorylates the eukaryotic translation initiation factor 4E (eIF4E)-binding proteins (4E-BP1 and 2), promoting eIF4E activity and translation initiation. This can influence global protein synthesis, but mTORC1 specifically controls the translation of a group of mRNAs containing 5'-terminal oligopyrimidine tracts (Jefferies et al., 1994), that encode ribosomal components and other translation-related proteins. Additionally, protein S6 kinase 1 (S6K1) and S6K2 are direct targets of mTORC1 controlling helicase activity (Dorrello et al., 2006; Shahbazian et al., 2006), enhancing translation elongation (Faller et al., 2015; Wang et al., 2001) and regulating some components of the splicing machinery (Ma et al., 2008b).

1.3.4.3. Nucleic acid synthesis

Cell growth demands an increased amount of nucleotides both for the replication of the genetic material and for ribosome biogenesis, given that around 55% of the ribosome is composed of rRNA. Therefore, in proliferating cells, de novo nucleotide synthesis pathways are highly upregulated. mTORC1 induces de novo pyrimidine synthesis via S6K1 and the phosphorylation of the carbamoyl-phosphate synthetase 2, aspartate transcarbamylase, and dihydroorotase (CAD), an enzyme implicated in the first steps of the synthesis process (Ben-Sahra et al., 2013; Robitaille et al., 2013). Activated mTORC1 also enhances de novo purine synthesis via transcriptional induction of several enzymes implicated in the purine synthesis pathway such as glycine and serine synthesis, the mitochondrial tetrahydrofolate (mTHF) pathway or the pentose phosphate pathway (PPP) (Ben-Sahra et al., 2016). Notably, the PPP is the only source of glucose-derived ribose in a cell, and therefore fundamental to the process. Among the two possible PPP branches, mTORC1 enhances the oxidative arm by increasing the glucose-6-phosphate dehydrogenase, a rate-limiting enzyme (Düvel et al.,

2010). This enhances not only ribose production but also NADPH, thus gathering the necessary reducing power for anabolic process.

1.3.4.4. Lipid metabolism

Cell proliferation requires an increase in membrane production both for organelle biogenesis and plasma membrane extension (Menendez and Lupu, 2007). mTORC1 signaling promotes the biogenesis of fatty acids and sterols via increasing the sterol regulatory element binding protein (SREBP) activity, a family of TFs regulating genes involved in lipogenesis (Horton et al., 2002). A number of members of the mTORC1 pathway are involved in this process through different mechanisms, including S6K1 (Li et al., 2011; Owen et al., 2012), lipin1 (Peterson et al., 2011) and CREB regulated transcription coactivator 2 (CRTC2) (Han et al., 2015).

Conversely, AMPK induces fatty acid oxidation via peroxisome proliferator-activated receptor alpha (PPAR α) (Lee et al., 2006) and by inactivating the acetyl-coenzyme A carboxylase (ACC)-2, promoting fatty acid uptake into the mitochondria and favoring mitochondrial metabolism towards fatty acid oxidation (Hardie and Pan, 2002). All this increases β -oxidation and the downstream mitochondrial oxidative phosphorylation, resulting in a high ATP production.

1.3.5. Nutrient availability signaling during tumor development

Evading growth suppressors and deregulating cellular energetics are two well-described hallmarks of cancer (Hanahan and Weinberg, 2011). During cancer-associated dysregulation of cell proliferation, cells acquire the capacity of importing extracellular nutrients independently of GFs and other signaling. Moreover, tumors often accumulate mutations that uncouple the normal regulatory mechanisms upstream of mTORC1 from its downstream metabolic program (Menon and Manning, 2008). This results in an aberrant constitutive mTORC1 signaling, normally mediated by mutations of oncogenes in the AKT and the ERK pathways (Roberts and Der, 2007; Shaw and Cantley, 2006). As a result, mTORC1-mediated proliferative signaling is refractory to suppressor signals, and the metabolic effects described in previous sections divert the cell towards a pro-growth metabolic state. This makes the mTORC1 pathway an attractive target for therapy. Researchers and clinicians are investigating the possibilities of blocking mTOR kinase activity (Feldman et al., 2009; Thoreen et al., 2009;

Yu et al., 2009) or combining mTOR and PI3K kinase activity inhibition (Vilar et al., 2011; Zaytseva et al., 2012) with promising results.

1.3.6. Conclusion

Intracellular metabolite concentrations join GFs and adhesive signaling as part of the signaling network regulating cell cycle progression. This area of research includes many metabolites identified as regulators of signaling cascades, thus participating in the preservation of biosynthetic and energetic balances, with amino acids in a prominent place. The investigation of these signaling cascades and their capacity to modulate the balance between metabolic pathways has been a focus for the scientific community during the last years, although more research is needed to understand these processes fully. mTORC1 rises as the major node for signal integration and pathway cross-regulation, linking growth-promoting signals with the necessary anabolic processes to support cell growth. To fully understand mTORC1 regulation of cell proliferation it is necessary to understand the regulation of intracellular amino acid dynamics, their transport across membranes and its coordination with GF signaling.

1.4. CD98hc: a signaling integrator

Cluster of Differentiation 98 heavy chain (CD98hc, SLC3A2, 4F2hc, FRP-1) is a ubiquitous signaling integrator protein. Its numerous protein-protein interactions—importantly with SLC7 amino acid transporter family and β -integrins—place CD98hc at a molecular hub in the cell signaling network. As a result, it plays a determinant role in a number of cellular processes such as activated T and B cell clonal expansion (Cantor and Ginsberg, 2012; Cantor et al., 2009), inflammation (Yan et al., 2007b), cell survival and migration (Feral et al., 2005), mechanotransduction (Estrach et al., 2014), or angiogenesis (Liao and Cantor, 2016). Most of them rely on the influence of CD98hc on cell proliferation (Boulter et al., 2013; Cantor et al., 2009; De La Ballina et al., 2016). Indeed, highly proliferative cells present an increased expression of CD98hc in physiological (Boulter et al., 2013) and pathological conditions, including cancer (Cantor and Ginsberg, 2012; Henderson et al., 2004; McCracken and Edinger, 2013).

CD98hc was originally discovered as the surface antigen of monoclonal antibody 4F2 in activated lymphocytes (Haynes et al., 1981a). It belongs to the group of heavy chain heteromeric amino acid transporters (hcHATs) together with rBAT (SLC3A1), the other SLC3 family member. Its cDNA, cloned and identified by three groups in the same year (Lumadue et al., 1987; Quackenbush et al., 1987; Teixeira et al., 1987), encodes a 529-amino acid type II transmembrane glycoprotein of 80–85 kDa. It includes an 83-amino acid N-terminal cytoplasmic tail, a 21-amino acid single-pass transmembrane domain (TMD), and a bulky 425-amino acid extracellular domain (CD98hc-ED). Human CD98hc-ED contains 4 glycosylated asparagine residues (positions 264, 280, 323, and 405) (Chen et al., 2009; Jia et al., 2009; Liu et al., 2005; Wollscheid et al., 2009; Zhang et al., 2003); equivalent positions are also glycosylated in the mouse ortholog (Luscher et al., 1985). The mouse (Parmacek et al., 1989), hamster (Fenczik et al., 1997), and rat (Broer et al., 1997) orthologs have also been cloned and present a high sequence identity with the human CD98hc.

It was initially named 4F2hc, and it was later assigned a CD designation number at the Fifth International Workshop and Conference on Human Leukocyte Differentiation Antigens (Lanza et al., 1994). Other used names include Fusion Regulatory Protein 1 (FRP-1) (Ohgimoto et al., 1995) and SLC3A2 (solute carrier family 3 member 2).

1.4.1. Processes tuned by CD98hc

The first proof of CD98hc's importance in vivo was the embryonic lethality of its full-body knockout (E3.5-E9.5), partly due to placentation defect (Tsumura et al., 2003). Later studies used different mouse lines to obtain spatiotemporal CD98hc deletion or overexpression, providing information about the in vivo role of CD98hc in the immune system or epithelial homeostasis (explained below). Although CD98hc is a multifunctional protein, most of its physiological implications rely on its effect on cell proliferation. Highly proliferative cells have an increased CD98hc expression both in physiological (Boulter et al., 2013) and pathological conditions (McCracken and Edinger, 2013). Whereas playing a necessary role in tissue homeostasis, this signal integrator molecule also favors tumor progression and is, in some cases, associated with poor prognosis (Cantor and Ginsberg, 2012; Ip and Sethi, 2016). Altogether, the information present below highlights the pivotal role of CD98hc for correct and efficient cell behavior.

1.4.1.1. Immune response

After its discovery in immune cells, CD98hc was used as an activation early marker for both B and T cells during normal and pathological states (Hafler et al., 1985; Kehrl et al., 1984; Konttinen et al., 1985; Moretta et al., 1981; Patterson et al., 1984). A series of studies showed how CD98hc is required for lymphocyte proliferation during clonal expansion after antigen recognition in an integrin-dependent manner, by using CD98hc conditional KO mouse models. In the case of B cells, clonal expansion and plasma cell formation are impaired upon CD98hc lost in vivo, without perturbing B cell steady-state functions (e.g., B cell basal number, ability to become activated and function as antigen-presenting cell) (Cantor et al., 2009). Regarding T cells, lack of CD98hc drastically reduces clonal expansion, thus impairing a proper immune response. Nevertheless, intrinsic T cell effector functions are not affected (Fig 10) (Cantor et al., 2011). See (Cantor and Ginsberg, 2012) for a detailed review. These characteristics make CD98hc a potential target for autoimmune diseases such as multiple sclerosis (Cantor, 2014) or type 1 diabetes (Lian et al., 2012) as well as allograft acceptance (Liu et al., 2012; Nishio et al., 2016). Increasing evidence relates CD98hc not only to T cell clonal expansion but also Th lymphocyte differentiation. CD98hc deletion increases Treg cell production, that, in turn, inhibits Th1 and CTL (cytotoxic T lymphocyte) proliferation and differentiation (Liu et al., 2012;

Nishio et al., 2016). The molecular mechanism used by CD98hc to control lymphocyte clonal expansion remains yet to be fully elucidated.

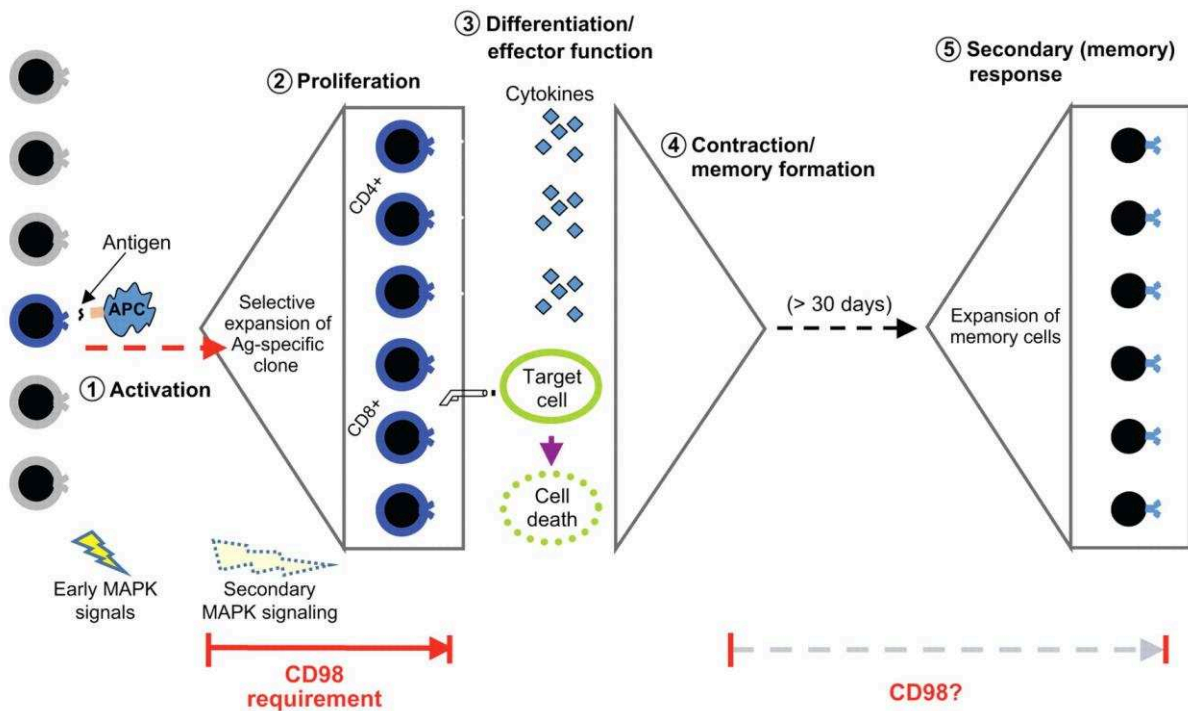

Figure 10. CD98hc implication in vertebrate adaptive immune response. After immune challenge, antigen presenter cells (APC) activate antigen-specific naive T cells specific for the corresponding antigen (in blue). Clonal expansion starts to generate effector CD4+ ‘helper’ cells—secrete cytokines—and CD8+ cytotoxic ‘killer’ T cells. When the immune reaction is finished, a few T cells remain and generate ‘memory’, priming the system for a secondary expansion after re-exposure to the antigen. CD98hc is required for the primary clonal expansion phase but is expendable for antigen recognition, activation and effector functions. The role of CD98hc during a secondary expansion remains unclear. (Cantor and Ginsberg, 2012).

Increasing studies are characterizing the role of CD98hc in inflammation. CD98hc overexpression in intestinal epithelial cells aggravates intestinal inflammation in a colitis mouse model, induces barrier dysfunction, increases cell proliferation and production of pro-inflammatory mediators (Nguyen et al., 2011). On the other hand, CD98hc knockdown or blockage is being evaluated as a possible therapy for chronic inflammatory diseases. In colonic epithelial cells and macrophages, CD98hc reduction results in a lower pro-inflammatory cytokine production both in vivo and in vitro, reducing the severity of colitis (Laroui et al., 2014; Xiao et al., 2014; Xiao et al., 2016).

1.4.1.2. Epithelial homeostasis

Epithelia, including skin and intestine, display a high CD98hc expression in basal layer cells—e.g., proliferative cells—consistently with the high renewal rate required for homeostasis of this type of tissue (Patterson et al., 1984). The role of CD98hc in skin homeostasis was studied *in vivo* using CD98hc^{fl/fl} murine line (Féral et al., 2007) combined with a mouse line displaying inducible Cre recombinase expression under the K14 (keratin 14) promoter, to obtain conditional inducible CD98hc KO mice. Induction of Cre activity in this model results in CD98hc deletion in basal keratinocytes, the proliferative layer of the epithelium. KO animals present impaired skin homeostasis as evidenced by large defects in hair growth and wound healing with substantial proliferation impairment (Boulter et al., 2013). Absence or decrease of CD98hc, either exogenous (KO) or endogenous (aging), results in reduced cell renewal ability.

Molecularly, CD98hc participates in integrin-mediated outside-in adhesive signaling. Interestingly, in homeostatic conditions, neither integrins' affinity nor binding to their ligands are CD98hc dependent (Boulter et al., 2013; Feral et al., 2005). Nevertheless, integrin-mediated cell spreading, as tested in embryonic stem (ES) cells, ES-derived fibroblasts and mouse embryonic fibroblast (MEF) cells on both FN and laminin *in vitro* requires CD98hc-integrin interaction (Feral et al., 2005; Prager et al., 2007). Cell migration and motility studies yield similar results, presenting CD98hc as a crucial modulator of integrin-dependent haptotaxis *in vitro* (Feral et al., 2005; Kabir-Salmani et al., 2008) and in accordance with the *in vivo* results previously mentioned (Boulter et al., 2013). Loss of epidermal CD98hc also impacts ECM structure resulting in a more compliant skin, associated with a decrease in cell proliferation rate. Fibronectin and collagen organization are impacted *in vivo* through reduction of RhoA/ROCK signaling and YAP/TAZ-regulated genes (Estrach et al., 2014). *In vitro* results support this study confirming CD98hc's requirement for integrin-mediated cellular contractility and ECM assembly (Féral et al., 2007). Noteworthy, the sustained *in vivo* activation of RhoA upon CD98hc KO is a result of both RhoGEF (guanine exchange factor) regulation, probably via CD98hc-dependent integrin signaling, and intracellular accumulation of reactive oxygen species (ROS) produced by an impaired amino acid transport (Boulter et al., 2013).

Merlin's group studied the implications of CD98hc in intestinal epithelium using a combination of gain and loss of function in vivo models. CD98hc overexpression in intestinal epithelial cells stimulated cell proliferation and produced barrier dysfunction, as well as increased production of pro-inflammatory cytokines (Nguyen et al., 2011). Although the mechanism is not clear yet, the authors hypothesize it is integrin-mediated.

In summary, CD98hc control of cell proliferation through integrin signaling and nutrient availability seems to be crucial for homeostasis maintenance in fastly renewed tissues such as epithelia. Changes in CD98hc expression are necessary for proper stress response, such as wound healing, but dysregulation can lead to dangerous dysfunctionalities and disease development, particularly tumorigenesis (see section *CD98hc and cancer*).

1.4.1.1. Stress protection

In addition to cell proliferation regulation, CD98hc also impacts cell number by promoting cell survival by providing stress protection. Firstly, CD98hc protects cells from oxidative stress thanks to its role in cystine uptake via the xCT light chain (De La Ballina et al., 2016). The xCT system is also required in vivo for oxidative stress protection (Sato et al., 2005). The transported cystine is converted into L-cysteine, a rate-limiting amino acid in the synthesis of glutathione (GSH), and therefore crucial to control ROS-caused stress (Conrad and Sato, 2012). CD98hc also supports the balance of intracellular amino acid content by governing amino acid transporters expression at the plasma membrane, specially LAT1 and γ^+ LAT2. As a result, CD98hc functions as an integrative node in the cell between ROS handling and low amino acid availability, conferring protection against oxidative and nutritional stresses.

Additionally, CD98hc protects from lack of ECM attachment and anoikis (Feral et al., 2005), and provides the ability to sense and, thus, respond to mechanical stress (Estrach et al., 2014).

1.4.1.2. Host-pathogen interaction

CD98hc plays a notable role in several host-pathogen interaction processes aside from its impact on the vertebrate immune system and inflammatory response. CD98hc was also identified as the Fusion Regulatory Protein 1 (FRP-1) (Ohgimoto et al., 1995) and induces cell fusion in homeostatic processes like monocyte multinucleated giant cell formation (Ohgimoto et al., 1995) or osteoclastogenesis (Mori et al., 2001). This mechanism seems to be hijacked

for virus-induced cell fusion, a common process after viral infection. CD98hc-binding antibodies are capable of regulating human immunodeficiency virus (HIV) gp160-mediated cell fusion or paramyxovirus-induced syncytium cell formation in a β_1 integrin-dependent fashion (Ohgimoto et al., 1996; Ohta et al., 1994; Okamoto et al., 1997; Tsurudome and Ito, 2000). However, stronger evidence and a mechanism to explain CD98hc implication in virus-induced syncytia formation are still to be investigated.

1.4.1.3. Extraembryonic structure formation

The endometrial tissue expresses CD98hc during the implantation window. It is restricted to the cell apical surface and included in tetraspanin-enriched microdomains, and its presence is determinant for endometrial receptivity during the implantation window of the blastocyst (Domínguez et al., 2010). CD98hc is highly expressed in different vertebrate extraembryonic structures as well, including human placenta, and it is implicated in placental cell fusion and syncytiotrophoblast formation (Dalton et al., 2007; Kudo and Boyd, 2000). Additionally, it enhances $\alpha_v\beta_3$ integrin signaling necessary for extravillous trophoblasts to invade the maternal endovascular system (Kabir-Salmani et al., 2008). In zebrafish, CD98hc controls yolk syncytial layer formation an extraembryonic structure of the zebrafish embryo (Takesono et al., 2012). In short, CD98hc is required for proper extraembryonic structure formation.

1.4.2. CD98hc and cancer

CD98hc is highly expressed in many tumor cell types (Bellone et al., 1989; Dixon et al., 1990), as well as some of its associated light chains (McCracken and Edinger, 2013). Increased CD98hc expression correlates with the development, progression, and metastatic potential of tumors (Esteban et al., 1990; Garber et al., 2001; Yoon et al., 2003). In humans, CD98hc expression levels correlate with bad prognosis in many cancers (Cantor and Ginsberg, 2012).

Pioneering in vivo studies identified a role of CD98hc in tumor development. Injection of CD98hc overexpressing fibroblasts produced fibrosarcoma formation (Hara et al., 1999), while CD98hc null mouse ES cells showed a lower teratoma formation capacity than control cells when introduced in athymic and syngeneic mice (Feral et al., 2005). Other mouse models were later used to deepen our knowledge of CD98hc-related tumorigenesis. In vivo data from conditional CD98hc KO mice show that CD98hc increases the stiffness of tumor

microenvironment and amplifies the capacity of cells to respond to matrix rigidity by potentiating integrin role in ECM assembly. ECM stiffening is a common process during tumorigenesis and a positive proliferation signal. Conversely, CD98hc deficiency *in vivo* reduces Ras-induced skin tumorigenesis, and its loss causes tumor regression (Estrach et al., 2014). A mouse model of colitis-associated cancer also provided evidence of CD98hc's role in inducing inflammation-associated tumorigenesis by promoting cell proliferation and enhancing the inflammatory response, possibly through integrin signaling (Nguyen et al., 2011)

Additionally, CD98hc capacity to regulate amino acid transport—and especially light subunits LAT1 and xCT—influences cell proliferation activation (Bulus et al., 2012; Nicklin et al., 2009) and tumorigenesis. CD98hc-dependent amino acid transport is required for cell proliferation regardless of the surrounding environment (De La Ballina et al., 2016). To this respect, the presence and correct functioning of LAT1 is crucial for cancer cell line proliferation (Cormerais et al., 2016). Therefore, both integrin signaling and amino acid transport are partially responsible for CD98hc tumorigenic potential.

Moreover, a recent study demonstrates the capacity of CD98hc to support angiogenesis through VEGFR activation (phosphorylation) in endothelial cells (Liao and Cantor, 2016), opening CD98hc implication in tumorigenesis from a different perspective.

Many studies have tested anti-cancer strategies either inhibiting CD98hc-associated amino acid transport or integrin signaling (Balza et al., 2013; Kim et al., 2008b; Millard et al., 2011; Oda et al., 2010). These strategies have so far yielded promising but limited results.

With the current state of the art, some attempts have already been reported, such as the use of a humanized monoclonal antibody anti-CD98hc for the treatment of acute myelogenous leukemia (AML) in several studies (Bajaj et al., 2016; Bixby et al., 2015; Hayes et al., 2015). CD98hc drives engagement of leukemia cells with their microenvironment, promoting AML propagation and lethality. This antibody has several combined mechanisms of action including antibody-dependent cell death, caspase-dependent apoptosis, lysosomal membrane permeability increase, and amino acid transport decrease. Importantly, authors reported that restoration of the amino acid transport, as well as integrin signaling functions, were needed to obtain a complete rescue of CD98hc null defects in AML development. The study addresses CD98hc dual role in tumorigenesis and tumor progression both through

amino acid transport and integrin signaling regulation, suggesting that targeting CD98hc may be more potent than solely targeting amino acid transporters or upstream adhesive signals. CD98hc constitutes a novel and attractive treatment option that allows targeting at once integrin signaling and nutrient availability. Developing drugs to target such a pivotal signal integrator molecule requires, however, a full understanding of CD98hc action and regulation mechanism.

1.4.3. Protein interactions

CD98hc's importance in the described physiological processes, mainly through the regulation of cell proliferation, is a result of its interaction with different protein partners. No enzymatic or ligand-binding capacity have been reported for CD98hc. Researchers in the field first found and have since focused on studying two CD98hc-interacting proteins, namely β -integrins and SLC7 amino acid transporter family. We now know the key importance of CD98hc in the regulation of integrin outside-in signaling and SLC7-dependent amino acid transport. However, over the years, several studies have highlighted interactions of CD98hc with some additional partners like galectin 3, CD9, CD147, ICAM-1 or hCASK (see section below). This extended interaction network (Fig 11) raises the possibility of CD98hc-containing macromolecular complexes at the plasma membrane being the functional unit to regulate CD98hc-dependent signaling. Although the precise nature of many of these interactions is unknown and functional implications remain, in most of the cases, still to be characterized, we can now picture CD98hc as a hub for a number of cellular signaling pathways, and the link of a potential cross-regulation between them.

1.4.3.1. SLC7: light chain

As mentioned before, CD98hc is one of the hCATs, together with rBAT (SLC3A1). CATs are one of the eleven families involved in amino acid transport across cell membranes in mammals (Bröer and Wagner, 2002) and are composed of a heavy chain acting as a chaperone to traffic the complex to the plasma membrane, and a light chain or catalytic subunit harboring the amino acid transport activity. CD98hc is covalently linked with a light chain through a disulfide bridge at Cys109 (Hemler and Strominger, 1982; Pfeiffer et al., 1998; Torrents et al., 1998), located at the extracellular domain, just four residues away from the transmembrane segment. Each of the six SLC7 light subunits (LAT1, LAT2, γ -LAT1, γ -LAT2, asc1 and xCT) has

amino acid transport activity and confers substrate specificity to the heterodimer (Fotiadis et al., 2013; Kanai et al., 1998; Mastroberardino et al., 1998; Nakamura et al., 1999; Pineda et al., 1999; Torrents et al., 1998). Four amino acid transport systems result from the association of CD98hc and a light chain, covering a broad substrate range including all essential amino acids (Table 1).

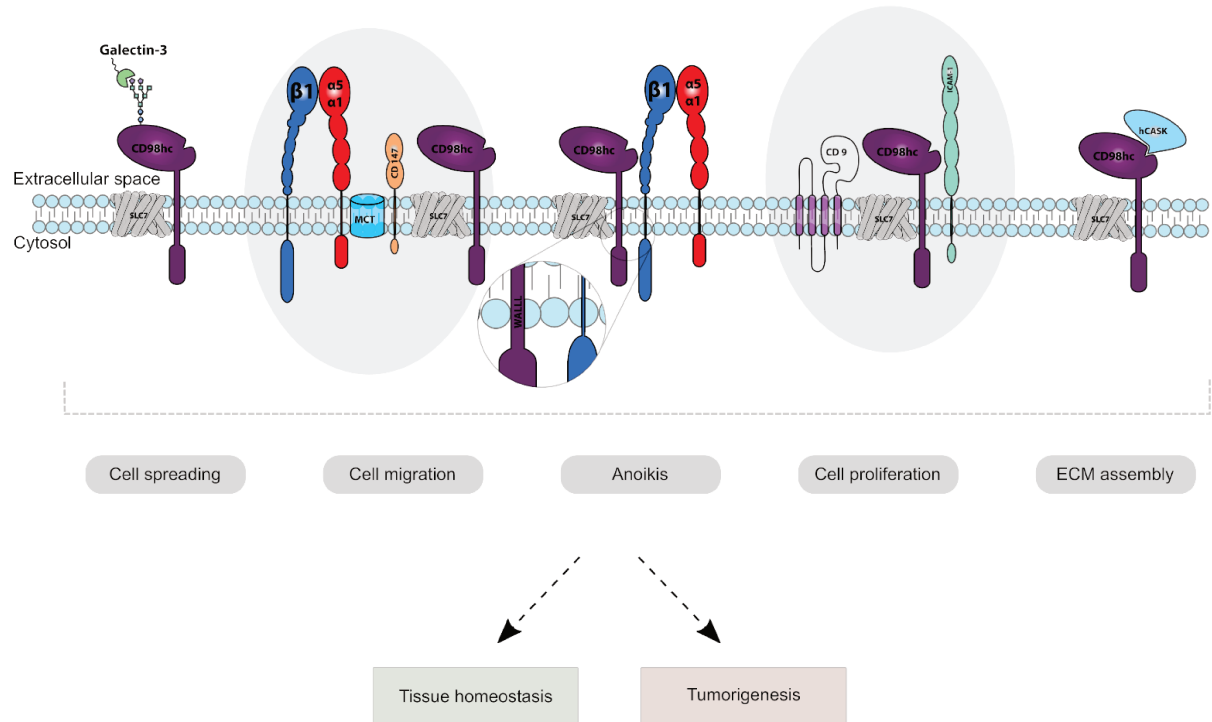

Figure 11. CD98hc interaction network. CD98hc has a wide range of protein-protein interactions described to date. Some of them might give rise to proteins complexes as functional units, as depicted in light blue circular background. Amino acid residues WALLL are crucial for the interaction with β -integrins. (Adapted from de la Ballina, **de Garay** et al., 2018).

CD98hc-associated light chains are non-glycosylated proteins with a 12-TMD topology with intracellular N- and C-termini (Fotiadis et al., 2013). The conserved cysteine residue establishing the di-sulfide bridge with CD98hc at Cys109 is located between TMD3 and TMD4 (Gasol et al., 2004). 3D structure of HATs light chains can be approximated by comparison to those of remote bacterial amino acid/polyamine/organocation (APC) transporters (~20% amino acid sequence identities) (Bartoccioni et al., 2010; Jiménez-Vidal et al., 2004). The functional unit of CD98hc-associated transporters is probably single heterodimers (Fernández et al., 2006). A modeled heterodimer structure predicts the relative positioning of CD98hc-ED and the light chain of the amino acid transporter. 3D reconstruction from negatively stained complexes, docking analysis, and cross-linking experiments rendered the structure of human

CD98hc/LAT2 complex at a 21 Å resolution. CD98hc-ED would be located just above the light chain and interact with its extracellular loops, stabilizing it (Rosell et al., 2014).

Gene name	Protein name	Transport system	Predominant substrates	Tissue, cellular and subcellular distribution	Link to disease
SLC7A5	LAT1	System L Antiporter	Large neutral L-AA, thyroid hormones T3 and T4, L-DOPA, BCH	Brain, ovary, testis, placenta, spleen, colon, blood–brain barrier, fetal liver, activated lymphocytes, tumor cells	Overexpressed in cancer, autism spectrum disorder
SLC7A6	γ^+ LAT2	System γ^+ L Antiporter	Na ⁺ -independent: L-cationic AA Na ⁺ -dependent: large neutral L-AA	Brain, small intestine, testis, parotids, heart, kidney, lung, thymus/basolateral in epithelial cells	
SLC7A7	γ^+ LAT1	System γ^+ L Antiporter	Na ⁺ -independent: L-cationic AA Na ⁺ -dependent: large neutral L-AA	Small intestine, kidney, spleen, leucocytes, placenta, lung/basolateral in epithelial cells	Lysinuric protein intolerance
SLC7A8	LAT2	System L Antiporter	Neutral L-AA, thyroid hormones T3 and T4, L-DOPA, BCH	Small intestine, kidney, lung, heart, spleen, liver, brain, placenta, prostate, ovary, fetal liver, testis, skeletal muscle/basolateral in epithelial cells	
SLC7A10	Asc1	System asc Preferentially antiporter	Small neutral L-AA, D-serine	Brain, CNS, lung, small intestine, heart, placenta, skeletal muscle and kidney	
SLC7A11	xCT	System x _c ⁻ Antiporter	L-cystine (anionic form), L-glutamate	Macrophages, brain, retinal pigment cells, liver, kidney/basolateral in epithelial cells	Overexpressed in cancer, KSHV infection

Table 1: CD98hc-associated amino acid transporters. Adapted from (De La Ballina et al., 2016; Fotiadis et al., 2013)

CD98hc-associated transport systems are involved in several human pathologies. xCT is essential for the Kaposi's sarcoma-associated herpesvirus (KSHV) infection (Veettil et al., 2008). Mutations in LAT1 cause autism spectrum disorders (Tărlungeanu et al., 2016). Mutations in γ^+ LAT1 trigger the aminoaciduria of lysinuric protein intolerance (LPI) (Borsani et al., 1999; Torrents et al., 1999). Finally, both CD98hc and its associated light chains are

implicated in tumorigenesis and considered as a poor prognosis sign in several tumor types (view section *CD98hc and cancer*).

1.4.3.2. Integrins

The first evidence indicating CD98hc's capacity to regulate integrin-mediated signaling was its ability to complement isolated β_1 integrin cytoplasmic domain dominant suppression (Fenczik et al., 1997). This phenomenon occurs in vitro when exogenous overexpression of integrin β_1 cytoplasmic domain blocks integrin activation. Since then, several studies reported subcellular co-localization and co-immunoprecipitation, strongly suggesting a physical interaction between both proteins (Henderson et al., 2004; Kabir-Salmani et al., 2008; Kolesnikova et al., 2001; Merlin et al., 2001; Miyamoto et al., 2003; Rintoul et al., 2002).

Overall, a number of studies have clearly demonstrated that CD98hc cytoplasmic and transmembrane domains (104 aa) regulate integrin signaling (Cai et al., 2005; Fenczik et al., 2001; Feral et al., 2005; Kabir-Salmani et al., 2008), whereas CD98hc-ED (425 aa) is necessary for amino acid transport (De La Ballina et al., 2016; Fenczik et al., 2001). The fundamental approach for locating the CD98hc regions responsible of β integrin and amino acid transporter interaction was based on the use of different chimeras, swapping domains of CD98hc and CD69—another type II transmembrane protein. However, a recent study established a functional link between CD98hc and CD69. In T cells, CD69 associates with the amino acid transporter complex CD98hc/LAT1 regulating its surface expression and the uptake of L-tryptophan (Cibrian et al., 2016). For this reason, although results based on the use of these chimeras were central, a complementary approach will be needed in future studies.

Importantly, amino acid residues 82–86 (WALLL), at the beginning of CD98hc TMD, seem fundamental for CD98hc- β_1 integrin interaction, integrin signaling enhancement, and oncogenic potential (Cai et al., 2005; Henderson et al., 2004). On the integrin side, it is the cytoplasmic domain of β_{1A} and β_3 integrins (but not of β_{1D} or β_7) which interacts with CD98hc (Zent et al., 2000). More recently, β_4 integrins were also shown to bind CD98hc in human keratinocytes (Lemaître et al., 2011).

1.4.3.1. Galectin 3

Galectins are carbohydrate-binding proteins with a high affinity for β galactosides. As the sole chimera-type galectin, Galectin-3 can oligomerize or establish other protein-protein interactions, both intracellularly or in its secreted form. It participates in a wide range of functions in physiological and pathological conditions, including immunity against pathogens, and both acute and chronic inflammation (Díaz-Alvarez and Ortega, 2017; Henderson and Sethi, 2009; Ruvolo, 2016). Secreted galectin-3 binds CD98hc-ED via its glycosylations, at least in immune cells (Dong and Hughes, 1996; Dong and Hughes, 1997). Various functional implications of CD98hc-ED-Galectin-3 interaction have been proposed, including macrophage activation and syncytium formation during placenta development (Dalton et al., 2007), but their mechanism remains to be investigated.

1.4.3.2. Basigin (CD147)

Basigin is a multifunctional type 1 transmembrane glycoprotein that belongs to the immunoglobulin superfamily. It acts as membrane receptor and traffics monocarboxylate transporters (MCTs) to the plasma membrane. It is important in spermatogenesis, vision and other physiological phenomena, and has a significant function in the pathogenesis of numerous diseases, including cancer (Muramatsu, 2016; Xin et al., 2016). Basigin forms a macromolecular complex with CD98hc. It also associates MCTs and integrins to promote the production of matrix metalloproteinases and hyaluronan. This supercomplex is probably playing a critical role in energy metabolism by coordinating the transport of amino acids and lactate (Xu and Hemler, 2005). More recently, basigin was implicated in CD98hc subcellular localization control and protein recycling, thus regulating integrin/CD98hc downstream behaviors (Wu et al., 2015).

1.4.3.3. CD9 (Tetraspanin)

Tetraspanin family proteins contain four transmembrane domains and are involved in many aspects of cell biology and physiology. They interact with other proteins and with other tetraspanins, developing a role in cell membrane compartmentalization (Charrin et al., 2014). CD98hc localizes to tetraspanin-enriched microdomains in the plasma membrane of primary endometrial epithelial cells. There, it interacts with tetraspanin CD9 and possibly other tetraspanins, significantly enhancing mouse endometrial blastocyst adhesion. Thus, CD98hc

seems to be a significant determinant of endometrial receptivity during blastocyst implantation window (Domínguez et al., 2010).

1.4.3.4. ICAM-1

Intercellular Adhesion Molecule 1 (ICAM-1) is the ligand of the lymphocyte function-associated antigen 1 LFA-1, a leukocyte adhesion protein, and it is involved in leukocyte adhesion and transmigration (Long, 2011). It co-immunoprecipitates with CD98hc in epithelial cells. Antibody-mediated cross-linking of both proteins reduces the affinity and increases the capacity of leucine uptake by LAT2 (Liu et al., 2003) Authors suggest that the transport activity changes are the result of direct or indirect phosphorylation of LAT-2. However, further functional studies are needed to elucidate this regulatory process fully. ICAM-1, in turn, can associate with tetraspanin CD9, suggesting the idea of a bigger protein complex (Barreiro et al., 2005).

1.4.3.5. hCASK

CD98hc contains a C-terminal class II PDZ-binding domain (GLLLRFPYAA, amino acids 520–529). In the extracellular space of the intestine's epithelium basolateral domain, it interacts with human calcium/calmodulin-dependent serine kinase (hCASK) (Yan et al., 2007a), a multidomain scaffolding protein with a role in synaptic transmembrane protein anchoring and ion channel trafficking. Implications of this interaction are yet to be elucidated. However, the fact that this domain has been demonstrated to be functional opens the door to explore interactions with other PDZ-binding domain-containing proteins.

1.4.4. Protein three-dimensional structure

CD98hc-ED structure was solved by Palacin's lab after achieving protein crystallization (2.1 Å resolution, PDB: 2DH2). This study provides, to date, the only available three-dimensional atomic structure of an hCHAT (Fort et al., 2007). As expected by sequence similarity and phylogenetic studies (Gabriško and Janeček, 2009; Wells and Hediger, 1992) (see section *CD98hc along evolution*), CD98hc-ED structure resembles that of bacterial α -amylases, including a triose phosphate isomerase (TIM) barrel (α/β)₈ (A-domain) and eight antiparallel β -strands (C-domain). However, CD98hc-ED shows two essential differences with α -amylases. First, CD98hc-ED lacks the B-domain, a region containing calcium-binding sites,

otherwise inserted between the third β -strand and the third α -helix of domain A. Second, CD98hc-ED lacks the three conserved catalytic residues—catalytic triad—of α -amylases, therefore, lacking α -glycosidase activity (Fort et al., 2007).

The available crystallographic 3D structure has the N-terminal position at Cys109, the amino acid residue responsible of the disulfide bridge formation with the amino acid transporter light subunit (SLC7 family), and just four residues apart from the TMD. There is no available information regarding the structure or the relative positioning of the TMD and the intracellular tail. A schematic representation is depicted in figure 12.

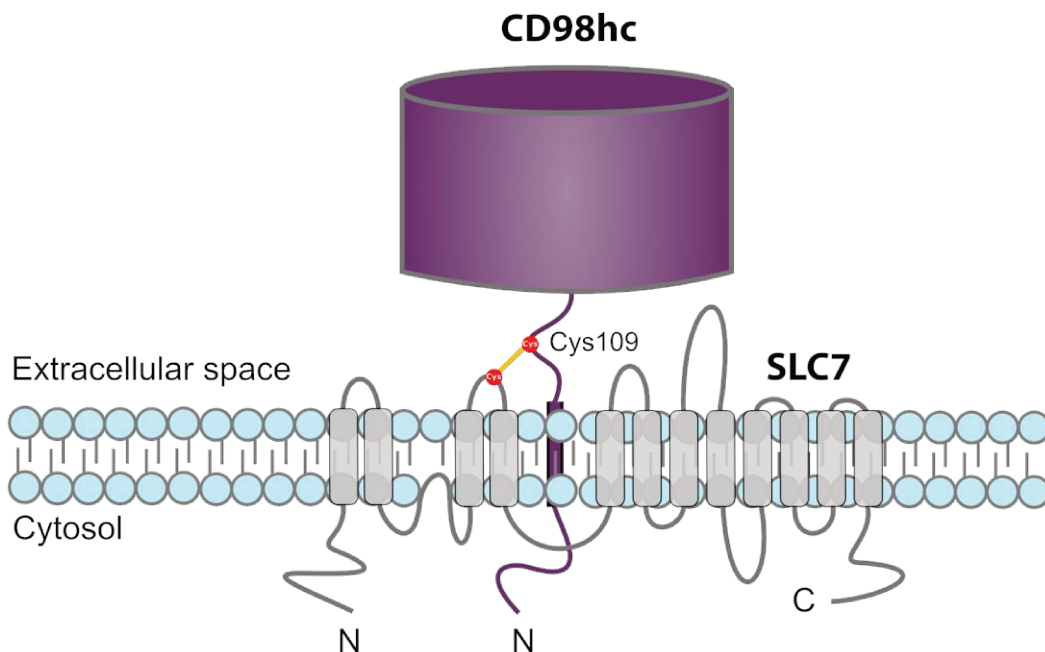

Figure 12. Three-dimensional structure of CD98hc. Schematic representation of CD98hc (4F2hc, in purple) covalently bond to an SLC7 light subunit by a disulfide bond at Cys 109. (Adapted from Fort et al., 2007).

1.4.5. CD98hc along evolution

The SLC3 family of heavy chain heteromeric amino acid transporters (hcHATs) includes CD98hc (SLC3A2) and rBAT (SLC3A1). The C-terminal extracellular domain of hcHATs shares sequence homology with the α -amylase family of proteins (Janecek et al., 1997; MacGregor et al., 2001; Wells and Hediger, 1992). An extensive phylogenetic study (Gabriško and Janeček, 2009) compared 92 hcHAT proteins in different species (representing known rBATs and 4F2hc proteins as well as their putative homologs) and 42 GH13 enzymes (including four GH13-like sequences), the most prominent family of α -amylases. All CD98hcs in the study form their own cluster and respect the taxonomy within it, as do all rBATs.

Authors present two possible alternatives for hcHATs evolutionary appearance: i) one single branching event could have originated an hcHAT ancestor in basal Metazoa, subsequently split into CD98hc and rBAT in chordates; or ii) two independent branching events could have given rise to CD98hc and rBAT independently in basal Metazoa. With the available information, it is impossible to draw the evolutionary picture unequivocally (Gabriško and Janeček, 2009).

The study concludes that hcHATs probably appeared in basal Metazoa. Indeed, hcHATs are present in both bilateral and radial animals. Some invertebrates have an amino acid transporter system analogous to mammalian HAT, like *Drosophila melanogaster* (Reynolds et al., 2009), *Aedes aegypti* (Jin et al., 2003) or schistosomes (Krautz-Peterson et al., 2007). However, functions other than amino acid transport, such as integrin signaling enhancement, have only been found in vertebrates, starting with jawless fish (lampreys) (Uinuk-Ool et al., 2002).

We are only recently starting to understand that adaptive immunity is not restricted to vertebrates. There are examples in other clades, like new mechanisms for the diversification of molecules involved in internal defense in mollusks (Zhang et al., 2004) and echinoderms (Ghosh et al., 2010), or the CRISPR (clustered regularly interspaced short palindromic repeats) system in bacteria and archaea (Mojica et al., 2005). However, it is the feature of clonal expansion that remains unique to vertebrates' adaptive immunity strategy (Boehm and Swann, 2014; Müller et al., 2018). All vertebrates rely on clonal expansion of lymphocytes or lymphocyte-like cells to mount adaptive immune responses, and CD98hc is required for it (Cantor et al., 2009; Cantor et al., 2011). Consistently, well-conserved CD98hc orthologues exist both in jawed and jawless vertebrates and, unlike in invertebrates or other clades, they display a wide array of functions not restricted to amino acid transport (Prager et al., 2007; Uinuk-Ool et al., 2002).

1.4.6. Gene structure

The gene encoding CD98hc human protein (*SLC3A2*) maps to the long arm of chromosome 11 (Francke et al., 1983; Quackenbush et al., 1987). Early studies characterized CD98hc's cDNA as originated from a transcript of 9 exons spanning approximately 8 kb in the

genome (Lumadue et al., 1987; Quackenbush et al., 1987; Teixeira et al., 1987), as confirmed by a later report (Yan et al., 2007b).

Technological developments since the late 1990s have made transcriptomics a widespread discipline (Lowe et al., 2017); over the last years, high throughput sequencing projects worldwide have drastically increased the publicly available genetic information. When querying Ensembl database for *CD98hc* transcripts, four CCDS (Consensus Coding DNA Sequence project) tracks appear along the human genome. 31590.1 is a 9-exon transcript corresponding to the canonical *CD98hc* variant previously reported, the only one identified at a protein level. On the other hand, 31588.1, 31589.1 and 8039.2 start at an upstream alternative transcription start site (TSS) and present alternative splicing of four ~100bp exons located 5' to the region common with the canonical variant (Fig 13). The equivalent is present in the mouse genome except there is only one non-canonical longer transcript with one additional exon instead of four. These potential *CD98hc* alternative transcripts have never been validated by alternative techniques or studied individually, and their biological relevance is unknown. To know whether or not they are translated into a protein and with what functional implications will require further investigation.

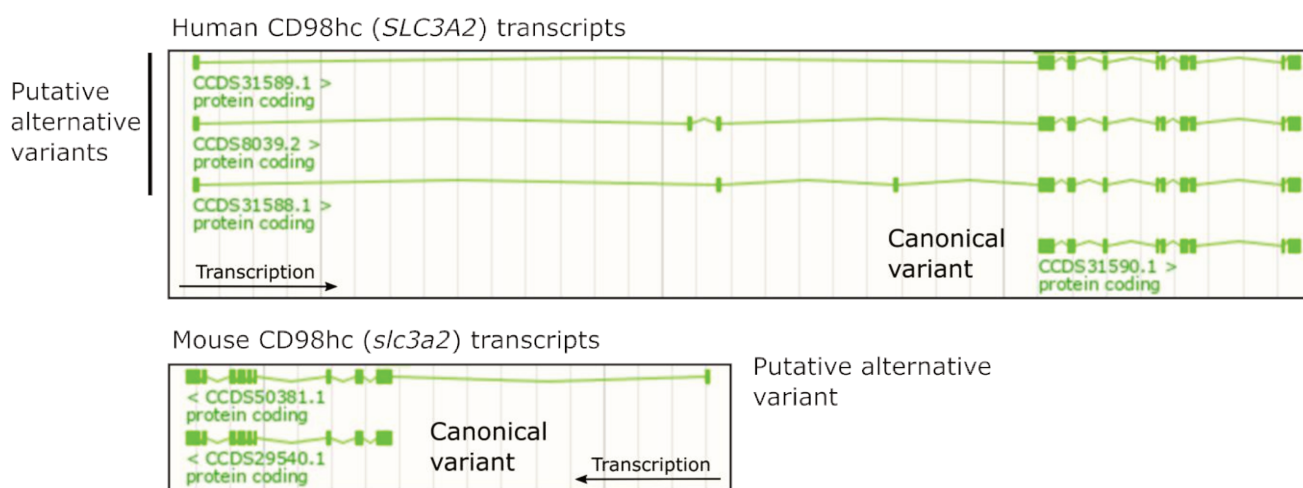

Figure 13. CCDS *CD98hc* transcripts. Image extracted from ENSEMBL genome browser utility showing all CCDS transcripts annotated as *CD98hc*. Both human and mouse loci include *CD98hc* canonical variant and a putative (never detected at a protein level) alternative variant(s).

1.4.7. Regulation of gene expression

CD98hc was firstly identified in immune cells, but it is widely expressed in other tissues. RNA-seq data from the Genotype-Tissue Expression (GTEx) portal show a ubiquitous expression pattern in human tissues (Fig 14). Published reports show CD98hc expression in most established human cell lines and tumor cells (Cantor and Ginsberg, 2012; Devés and Boyd, 2000; Nakamura et al., 1999; Parmacek et al., 1989), making it the only member of SLC3 family showing a ubiquitous distribution. Despite being a ubiquitous protein, CD98hc expression level is highly variable between cell types and conditions. CD98hc is generally upregulated in proliferative cells and profoundly inhibited in quiescent cells. Several studies report upregulation of CD98hc upon stimuli such as inflammation or nutrient deprivation or in pathological conditions such as tumorigenesis. On the other hand, expression decreases with age both in vitro and in vivo (Azzarone et al., 1985; Boulter et al., 2013). Importantly, CD98hc expression regulation during development remains elusive. A study (Parmacek et al., 1989) designed to identify the pattern of *CD98hc* gene expression in neonatal and adult mouse tissues, did not yield a consistent result, i.e., while *CD98hc* expression was increased in neonatal liver as compared to adult liver, the opposite was true for lung. This study suggests a tissue-dependent *CD98hc* regulation, in agreement with the different needs of each tissue along development. *CD98hc* expression has a direct impact on cellular homeostasis, for instance controlling proliferation, and thus requires tight regulation. Despite transcriptional regulation being the first layer of protein expression regulation, there are only a handful of studies assessing it from a mechanistic and molecular point of view, providing a useful but limited understanding of the topic. Here is a summary of the different molecular mechanisms described to regulate *CD98hc* gene expression to date (Fig 15).

CD98hc 5'-flanking sequence (approximately 800bp, depending on the study) displays house-keeping promoter features together with potential inducible promoter elements. The sequence lacks both TATA and CAT boxes. It contains ≈60% of G+C, highly hypomethylated in peripheral blood lymphocyte DNA (Gottesdiener et al., 1988). In silico analysis highlighted the presence of four GC islands, a consensus sequence for binding of a number of ubiquitous TFs. Indeed, two of the identified islands contains functional SP1 binding sites directly impacting *CD98hc* gene expression, as proven through electrophoretic mobility shift assay (EMSA) and gene reporter assay in intestinal Caco2BBE cells (Yan et al., 2007b). Another transcription

factor binding site (TFBS) was described and proved functional, namely NF- κ B. As SP1 functional sites, deletion of NF- κ B binding site decreased promoter activity in a reporter gene assay in intestinal Caco2BBE cells.

Several studies have shown that pro-inflammatory cytokines upregulate *CD98hc* expression in intestinal epithelial cells in vivo (Fais and Pallone, 1989; Nguyen et al., 2010; Yan et al., 2007b). Therefore, SP1 and NF- κ B sites were tested in the context of interferon γ (IFN γ)-mediated inflammation in vitro in Caco2BBE cells, again using a reporter gene assay (dual luciferase system). Results highlight the importance of these TFs not only for *CD98hc* expression in basal conditions but also for *CD98hc* transcription upregulation in an inflammatory context (Yan et al., 2007b). As an additional mechanism, microRNA-7 has been suggested to regulate *CD98hc* expression by directly targeting the 3'-untranslated region (UTR) in Caco2BBE cells in vitro during intestinal differentiation and inflammatory response (Nguyen et al., 2010).

SLC3A2 Gene Expression

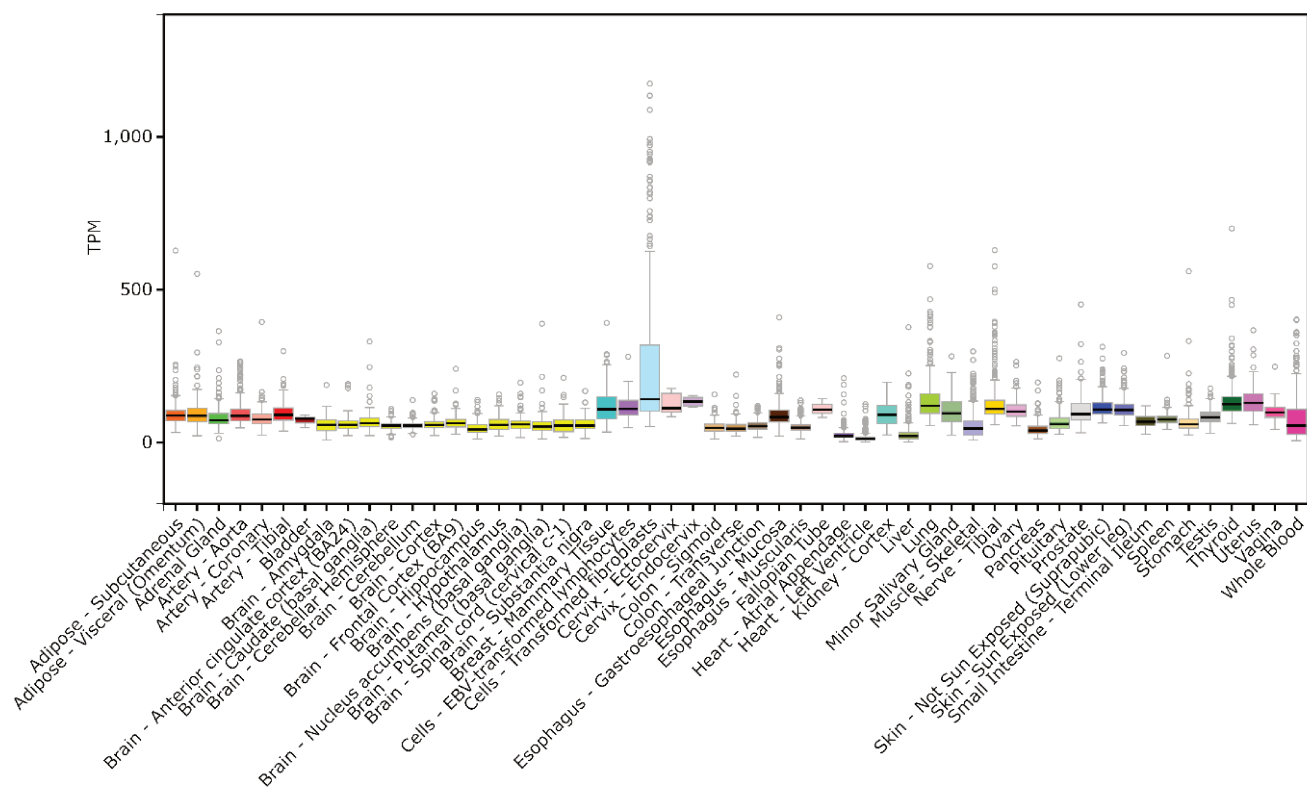

Figure 14. CD98hc is a ubiquitous protein. CD98hc (SLC3A2) expression data extracted from the GTEx portal in human tissues and cells. Expression values are shown in transcripts per million (TPM) and include all gene isoforms. Box plots are shown as median and 25th and 75th percentile; points are displayed as outliers if they are above or below 1.5 times the interquartile range.

Investigators also studied *CD98hc* expression along lymphocyte activation. They observed a distinctly low level of *CD98hc* on the surface of resting lymphocytes, markedly increased after growth stimulation by phytohemagglutinin (PHA), a combination of 4 beta-phorbol 12-myristate 13-acetate (PMA) and ionomycin, or anti-CD3 antibodies (Cotner et al., 1983; Gottesdiener et al., 1988; Haynes et al., 1981b; Lindsten et al., 1988). The increase in *CD98* expression levels in activated T cells compared with quiescent T cells was mediated at the mRNA level, as analyzed by Northern blotting (Nii et al., 2001). Several mechanisms were proposed in this context:

PHA is known to induce the translocation and activation of protein kinase C (PKC) and an increase in intracellular Ca^{++} levels. Indeed, co-stimulation with a PKC activator (PMA) and a calcium ionophore (A23187), resulted in a substantial induction of *CD98hc* in rat and human lymphocytes (Tanaka et al., 1988). Specifically, PMA removes a block to transcription elongation in the region between exon 1 and intron 1 through an unknown mechanism that requires de novo protein synthesis. Authors suggest that PMA, through PKC activation, would induce expression of a third protein capable of removing this block to transcription, therefore increasing *CD98hc* mRNA without increasing transcription initiation rate (Fig 15) (Lindsten et al., 1988; Nii et al., 2001). Ionomycin, another calcium ionophore, acts synergistically with PMA increasing transcription initiation from the same promoter, to produce up to a 60-fold increase in *CD98hc* lymphocyte expression. However, the effects of ionomycin alone are limited.

Additionally, *CD98hc* intron 1 contains a transcriptional enhancer element, active in vitro in a variety of human and mouse cell lines, including lymphocytes. This enhancer element consists of a consensus binding site for the inducible TF AP-1, flanked by binding sites for two unidentified nuclear proteins NF-4FA and NF-4FB (Fig 15). All three motifs, conserved along evolution, are necessary for full enhancer activity in lymphocytes as shown by deletion analysis (Karpinski et al., 1989; Leiden et al., 1989).

CD98hc upregulation upon lymphocyte activation might be kept under control by ubiquitylation by membrane-associated RING-CH (MARCH) ubiquitin ligases, to be able to reduce *CD98hc* surface level, thus limiting T cell proliferation and clonal expansion (Ablack et al., 2015; Eyster et al., 2011).

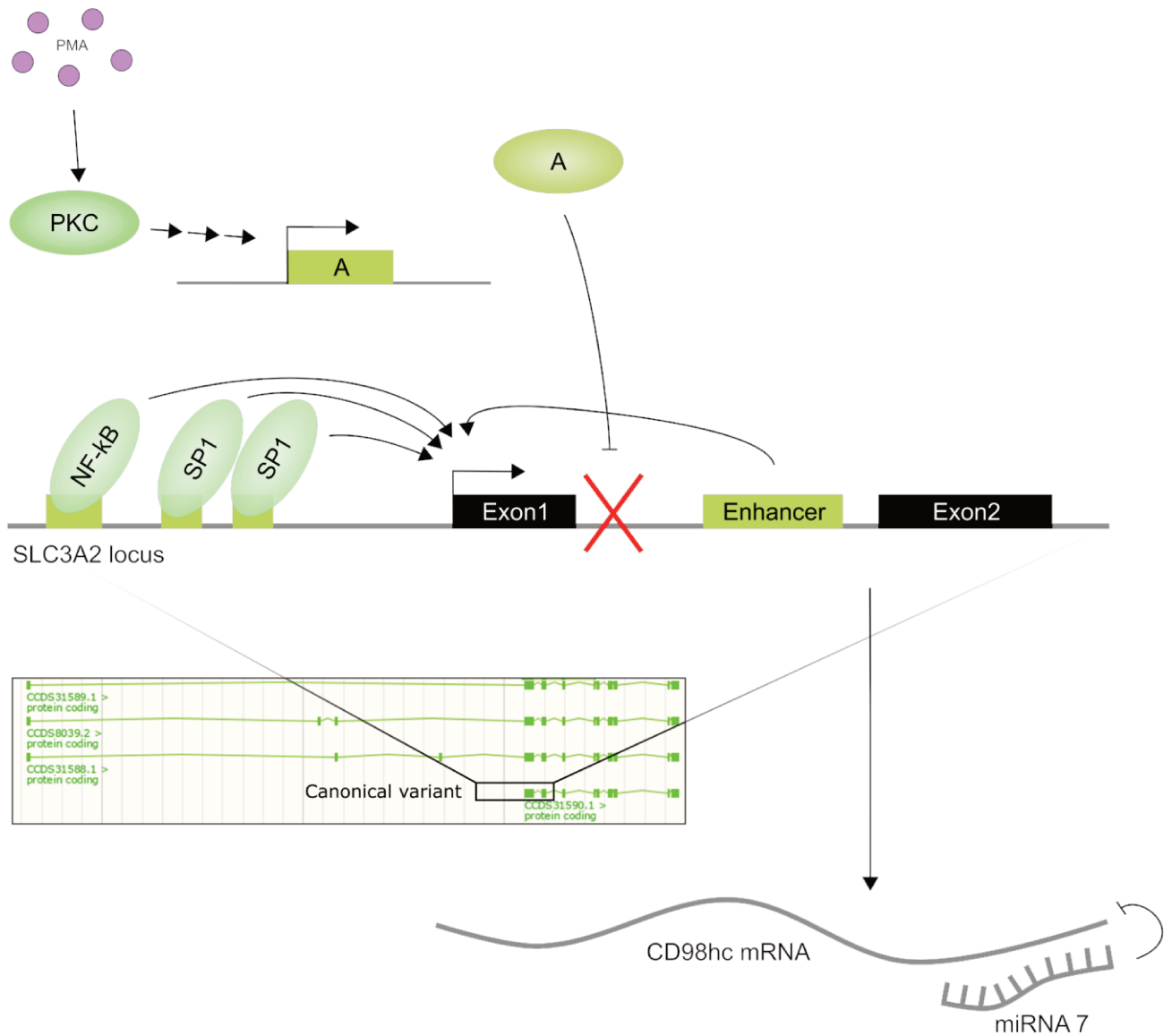

Figure 15. Transcription regulation at the *CD98hc* locus. Transcription factor binding sites at the promoter region (NF-κB and SP1) induce transcription initiation along with the enhancer present in intron 1. PKC activation starts a cascade that lifts the block to transcription between exon1 and intron 1 by a process requiring de novo protein synthesis. *CD98hc* mRNA can be targeted by miRNA 7. All these mechanisms have been described in different experimental models and they might or might not happen simultaneously.

Some attempts have been made to relate the expression of *CD98hc* and light chain amino acid transporters. For instance, *LAT1* also seems to present a transcriptional block downstream of the starting codon; however, it is not reactive to PMA or ionomycin (Nii et al., 2001). Overall, *CD98hc* expression is upregulated whenever the expression of any of the light chains is upregulated as well, consistently with its necessity for light chain trafficking to the plasma membrane. However, results are not homogeneous across experimental systems (Matsuyama et al., 2012; Nii et al., 2001; Padbury et al., 2004; Pineda et al., 1999). Finally,

different light chains have a different tissue and stress-dependent regulation, and *CD98hc* needs to integrate all of them (Fotiadis et al., 2013). Altogether, these data suggest a more complex regulation for *CD98hc* than for the individual light chains.

1.4.8. Conclusion

Research since *CD98hc*'s discovery has highlighted its crucial functionality in signaling integration for cell proliferation and other processes from a molecular and a physiological point of view. The interaction with SLC7 amino acid transporter family and β integrins have been extensively studied and are the two major effector mechanisms of *CD98hc*; however, other partners might also play important roles in *CD98hc* functionality and will require further investigation. Importantly, cell expression level of *CD98hc* is highly variable and depends on extracellular and intracellular signals. Conditions such as nutrient stress, mechanical stress or proliferation signals trigger *CD98hc*'s upregulation, but the molecular mechanisms of *CD98hc* expression regulation remain unknown.

1.5. Time allocation

The current section provides an overview of the time allocation to each different project during the 3.5-years (15th of September 2014 – 14th of March 2018) fellowship I obtained from the Labex Signalife international PhD program. It can be divided in the following parts:

- *Rotations*: From September to December 2014 I performed three 1-month rotations in three laboratories of the program (laboratories of Dr. Gerard Lambeau, Dr. Chloé Féral and Dr. Bruno Antony), as well as the required initial trainings.
- *CD98hc and mechanosensing research project*: I started working as a PhD candidate in Dr. Féral's laboratory in January 2015. This research, described in section 4.2, was discontinued in December 2015 after a mutual agreement between Dr. Féral and I, due to lack of biologically relevant conclusions.
- *CD98hc alternative variant and promoter research project*: On January 2016 I started this project described in section 3.
- *CD98hc alternative protein function research project*: This project, complementary to the previous one, was started on July 2016 and is described in section 4.1.

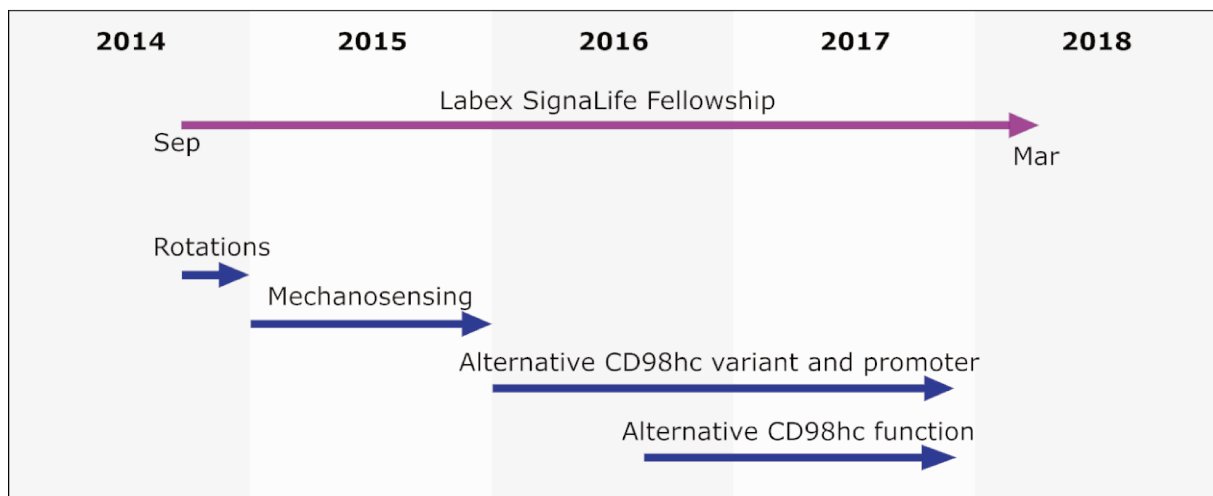

Figure 16. Time allocation. A graphic representation of the time allocation to the different projects during the PhD fellowship time.

Experimental work of the last two projects was stopped on December 2017. At suggestion of the Human Resources department and with the agreement of the Institute's Direction and the Doctoral School, after December 2017 I no longer worked under the supervision of Dr. Féral, even though I remained administratively attached to her group.

The last period, between December 2017 and the 14th of March 2018, was devoted to fulfilling an external evaluation required by the Doctoral School, resulting into the decision of allowing me to enter the regular defense process, write a thesis manuscript and organize the acquired data for a potential scientific publication.

Section 2: Problem statement, scope and aims

Problem statement

CD98hc represents a node for integrin outside-in signaling and amino acid availability, two key factors to regulate cell growth. The literature clearly shows how cell proliferation depends on CD98hc expression levels in many systems. Although CD98hc functions are widely characterized, the molecular mechanisms governing its level of expression under different conditions have not been extensively studied. A clear understanding of CD98hc expression regulation is necessary to comprehend cell growth regulation as well as other CD98hc-mediated cellular processes.

Scope

RNA expression data deposited in public databases suggest the presence of CD98hc alternative transcripts in human and mouse samples. Further evidence is needed to verify the existence of this novel variant, and no study has been conducted yet to assess it at a protein level. Interestingly, if the existence of CD98hc alternative variant is proved, it would imply the existence of an alternative promoter from which transcription of CD98hc alternative variant would initiate—and be regulated. The TSS of CD98hc canonical and putative alternative variants are approximately 25 kb away. Thus, cis-regulatory elements would be most likely different, as it would be the way to integrate transcription regulatory inputs to launch transcription initiation. Therefore, CD98hc canonical and putative alternative variants could have a different transcription regulation, increasing the complexity and versatility of control of its signaling network, including integrin adhesive signaling and amino acid availability. Such an additional regulatory mechanism could have emerged in highly complex organisms such as mammals, helping to fine-tune cell proliferation control.

Aims

In this context, the aims of this thesis are:

1. **To identify potential human CD98hc novel variants at both mRNA and protein level.**
 - a. *To verify the existence of CD98hc alternative transcript(s).* RNA-seq data suggesting *CD98hc* alternative transcripts requires confirmation by different techniques.
 - b. *To detect the possible CD98hc alternative protein variant(s).* More importantly, the translation of those potential alternative mRNAs has

never been addressed, and therefore the existence of CD98hc alternative variant protein is uncertain.

2. To investigate a potential *CD98hc* alternative promoter.

- a. *To assess the transcription initiation capacity of the 5'-flanking DNA region of CD98hc alternative variant.* The existence of *CD98hc* alternative transcripts as deduced from the RNA-seq data would necessarily imply the presence of an alternative promoter to initiate transcription around 25 kb upstream of the canonical TSS.
- b. *To explore the general regulatory features of CD98hc potential alternative promoter.* The long distance between both promoters might imply an independent transcriptional regulation for both *CD98hc* canonical and alternative promoters. A first overview of the possible general regulatory features and an understanding of the promoter structure in comparison with the canonical promoter will provide a deeper insight into this possibility and widen the path to understand the complexity of *CD98hc* regulation better.

Section 3: CD98hc alternative promoter regulation

The results in this section will be the subject of an original research article currently in preparation, to be published in a peer-reviewed journal.

3.1. CD98hc has several alternative variants

3.1.1. Introduction

The study of the proteome becomes an even more complex task when taking into account the abundance of different forms of the same protein called protein isoforms or variants (Stastna and Van Eyk, 2012). Protein variants may be present due to alternative splicing, alternative transcription initiation or termination sites, polymorphisms, post-translational modifications or even from separate genes, such as actin isoforms (Perrin and Ervasti, 2010). Protein variants can have alternative functions, can be implicated in diseases, provide additional functional, transcriptional or post-transcriptional regulation or several of these options at the same time (Buscà et al., 2016; Sjøberg et al., 2017; Steinberg, 2008; Vieler et al., 2018).

A preliminary analysis of high throughput sequencing information deposited in public databases suggests the existence of an upstream *CD98hc* alternative promoter, governing the expression of a novel protein variant in the human genome. If true, this raises the possibility of a different transcriptional regulation for *CD98hc* novel variant, adding unexpected complexity and versatility to *CD98hc* expression regulation in mammals, as well as a potential change in protein function in the novel protein. However, this potential novel variant has never been detected at a protein level. In this chapter, we validated the RNAseq data obtained from public databases to confirm the existence of *CD98hc* alternative transcripts and assessed the existence of CD98hc alternative protein variant(s) in human and mouse models.

3.1.2. Results

3.1.2.1. High throughput sequencing studies suggest the existence of a novel longer CD98hc isoform

We analyzed transcripts from the Consensus Coding DNA Sequence (CCDS) project, a collaborative effort to identify a core set of human and mouse protein coding regions that are

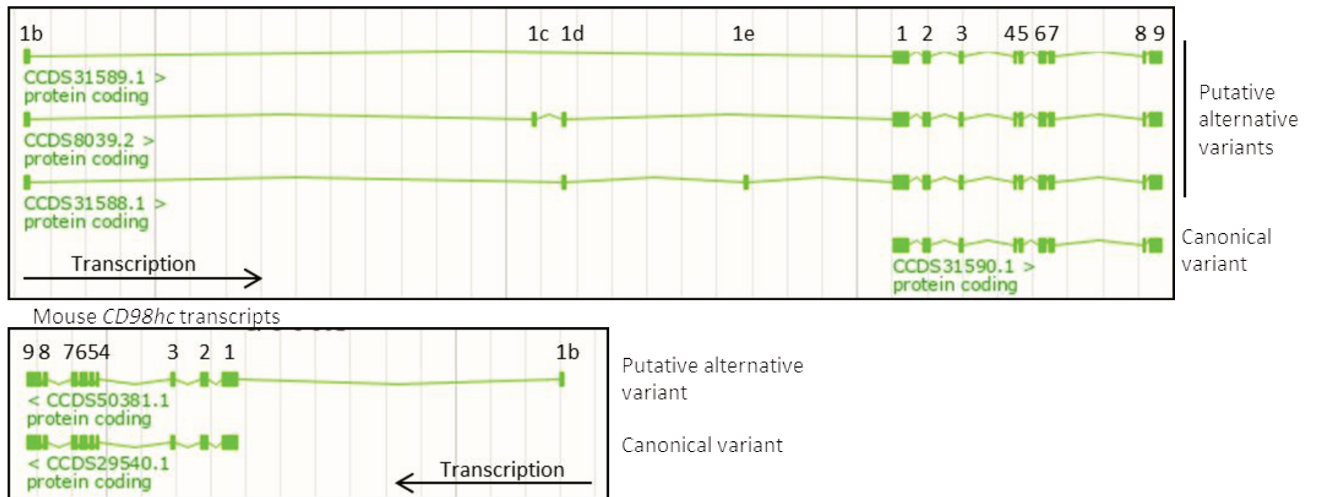
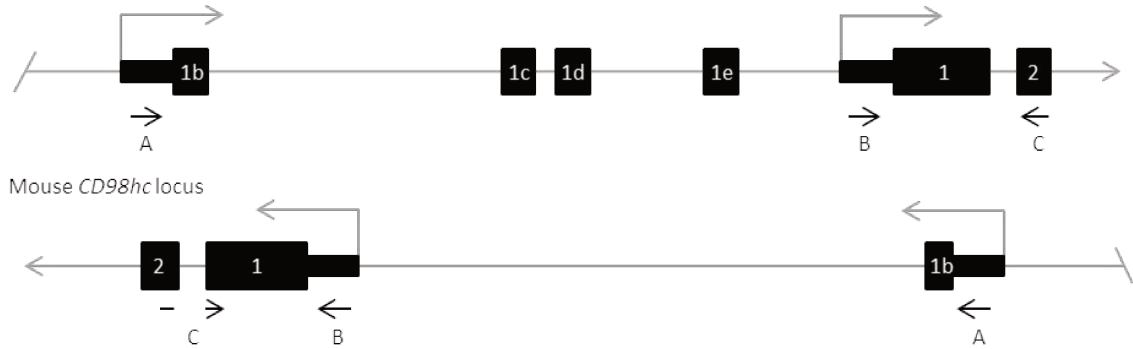
A Human *CD98hc* transcriptsB Human *CD98hc* locus

C

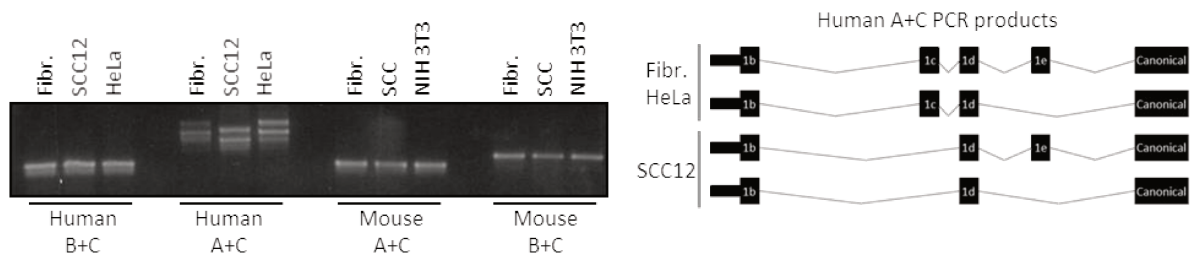

D

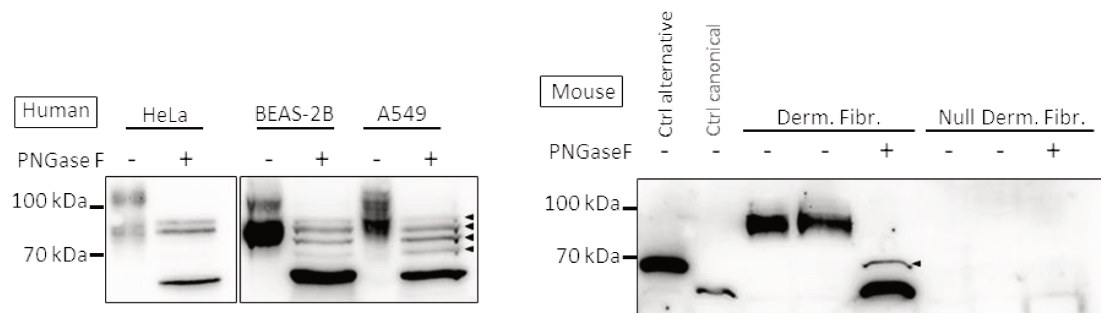

Fig. 17. Novel *CD98hc* long variant is detectable at mRNA and protein level. (A) Human and mouse *CD98hc* transcripts extracted from Ensembl genome browser. All Consensus Coding DNA Sequence (CCDS) project available tracks are shown. Thick regions correspond to exons while lines represent introns. Orientation is indicated by the arrowhead next to each transcript code; note that *CD98hc* has an opposite orientation in the mouse and human loci. (B) Scheme of human and mouse *CD98hc* loci

with PCR primers depicted by black arrows. Thick regions correspond to exons, thin regions to 5'UTR and lines represent introns. (C) PCR band detection of *CD98hc* transcript variants. RNA was extracted from the indicated human or mouse cells grown in vitro, then retro-transcribed into cDNA. PCR was performed using the indicated primers and subjected to electrophoresis in agarose gel. Human alternative variant bands were extracted, purified and subjected to Sanger sequencing. (D) Western blot performed on cell lysates of different human or mouse cell lines after PNGase F enzymatic deglycosylation reaction. Bands corresponding to long alternative CD98hc variants are marked with arrowheads. Lanes 1 and 2 of the right image correspond to in vitro transcribed and translated CD98hc alternative or canonical protein.

consistently annotated across databases and of high quality. We queried Ensembl genome browser utility for *CD98hc* and found four CCDS tracks along the human genome (Fig 17A). 31590.1 is a 9-exon transcript encoding the well-studied canonical CD98hc variant, the only one identified at a protein level. On the other hand, 31588.1, 31589.1 and 8039.2 start at a putative alternative TSS and appear to be the result of alternative splicing of four ~100bp exons located 5' to the region common with the canonical variant. A similar Ensembl query in the mouse genome yields one putative alternative transcript (CCDS50381.1) with an alternative TSS and including only one additional exon. Although genome positioning and exon length indicate this mouse transcript is an ortholog of human alternative transcripts, sequence identity is only significant (43.2%) for the encoded amino acid sequence and not for the DNA sequence. Low identity suggests sequence of exon 1b is not implicated in the selective advantage provided by CD98hc alternative variant. For a more detailed analysis on sequence homology see section 3.2.2.2. In conclusion, a putative CD98hc alternative variant could exist, including one additional exon (1b) in mouse and four (1b, 1c, 1d and 1e) in human.

3.1.2.2. CD98hc alternative longer variant is detectable at both RNA and protein level

To validate *CD98hc* alternative transcript(s) existence, we performed PCR on cDNA samples from a number of human and mouse carcinoma and fibroblast cell lines previously tested in the lab for canonical CD98hc protein expression, as well as cultures established from primary cells. Primers were designed to specifically detect cDNAs originated from only canonical or alternative *CD98hc* mature transcript(s) (Fig 17B). *CD98hc* alternative variant(s) are present in all tested samples, with a difference in splicing variants among human-origin samples (Fig 17C). To further confirm the identity of the different alternative bands present in human samples, we purified and sequenced the electrophoretically separated DNA. Human

fibroblasts and HeLa cell bands correspond to splicing variants containing exons 1b, 1c and 1d (CCDS8039.2) and 1b, 1c, 1d and 1e (not present as a CCDS entry). SCC12 bands correspond to splicing variants containing exons 1b and 1d (not present as a CCDS entry) and 1b, 1d and 1e (CCDS31588.1) (data not shown). Interestingly, as indicated by the location of the splicing acceptor site and confirmed by the sequencing of the electrophoretically separated bands, all alternative transcripts include in their mature forms 5 bp of exon 1 immediately 3' to the canonical start codon. The last positions of all upstream exons 1b, 1c, 1d and 1e is a guanine, completing the two last codons (ggc acc) prior the canonical start codon invariably of the possible alternative splicing. The mouse splicing acceptor at the 5' of exon 1b is in an equivalent position, 5 bp upstream of the canonical start codon. All variants remain in frame independently of the combination of alternative splicing of exons 1c, 1d and 1e.

Numerous RNA transcripts are not translated into a full, mature protein. Hence, we wanted to assess CD98hc alternative variant at a protein level to verify its existence. CD98hc presents four described N-glycosylation sites (Uniprot). Given protein glycosylation heterogenic nature, CD98hc does not migrate as a clearly-defined band when subjected to PAGE electrophoresis. Different predicted CD98hc variants—58, 62, 65, 68 and 71 kDa in size—are thus only distinguishable upon deglycosylation. Using PNGase F enzymatic protein deglycosylation, we were able to detect by Western blot four electrophoretic bands compatible with at least four different CD98hc alternative variants in HeLa, BEAS-2B and A549 human cell line protein extracts (Fig 17D left panel, arrowheads). This finding is consistent with the presence of alternative splicing to generate several human *CD98hc* alternative variant transcripts. As expected, only one electrophoretic band was detected for CD98hc alternative variant on mouse protein samples obtained from immortalized mouse dermal fibroblasts. To confirm the identity of each band, mouse canonical and alternative CD98hc variants were transcribed and translated in vitro, using T7 transcriptase and rabbit reticulocyte extract; their electrophoretic mobility corresponded to that of the previously described bands (Fig 17D). Null dermal fibroblasts under the same conditions yielded no detectable band, confirming the antibody specificity. Taken together, these results strongly support the existence of a novel CD98hc protein variant with an alternative TSS upstream of the canonical TSS.

3.1.2.3. *CD98hc* novel variant's transcript has a ubiquitous (and minority) expression pattern under basal conditions

To assess the *CD98hc* novel variant presence in human tissues and organs and to analyze its expression pattern, we extracted expression data from the Genotype-Tissue Expression (GTEx) project portal (<https://www.gtexportal.org>). Transcript-level quantifications of both canonical (ENST00000338663.7) and alternative (ENST00000535296.1, ENST00000377892.1, ENST00000377891.2, ENST00000377889.2, and ENST00000377890.2) transcripts show a low but consistent presence of *CD98hc* alternative variant in the available human tissues and organs (Fig 18). This finding supports the presence of *CD98hc* alternative transcript not only in *in vitro*-cultured cells but also in human tissue samples. Expression of both variants fluctuate between organs as it is known for total *CD98hc* level, highly dependent on cell type, proliferative state and cellular stress. But analyzing the proportion of *CD98hc* alternative and canonical transcript variants, the former is always lower and represents 3-17% of the total *CD98hc*. The only exception is the cerebellum, where alternative *CD98hc* accounts for up to 27% of total *CD98hc*. From this analysis, we can conclude that *CD98hc* alternative variant has a ubiquitous distribution under basal conditions, always in minority when compared to the canonical variant.

In our cell transcript analysis (Fig 17C), we detected different splicing variants depending on the cell line. Therefore, we wondered whether there was a preferential alternative splicing of intermediate exons 1c, 1d and 1e related to tissue or organ. Analysis of the five most expressed alternative transcripts in relation to total alternative variant expression from the GTEx-extracted data shows how the variant including only intermediate exon 1d is the most common in all datasets (Fig 19). There is no clear differential alternative splicing defined by tissue or organ.

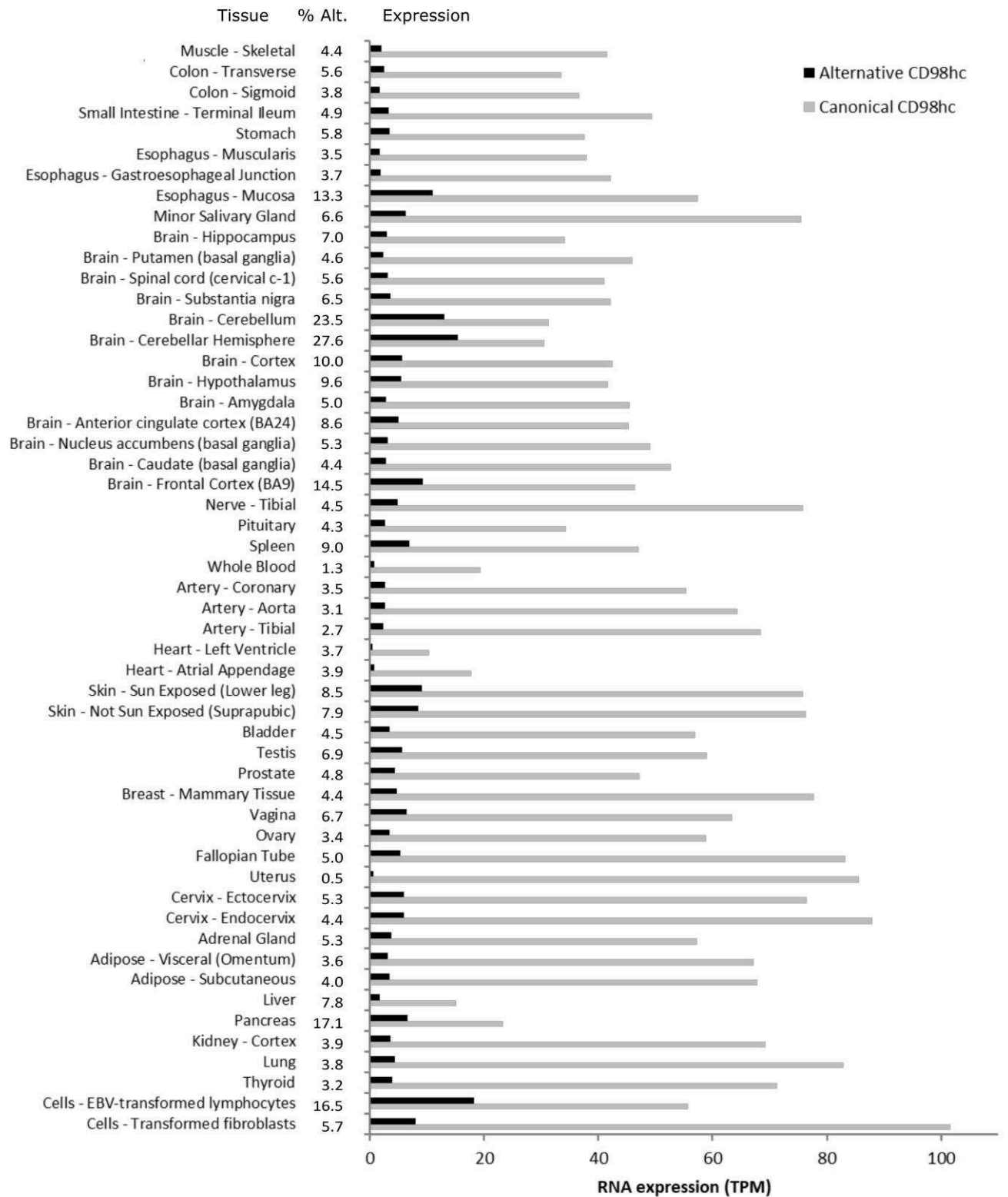

Fig. 18. *CD98hc* alternative variant mRNA shows a ubiquitous expression pattern in GTEx data. Data were extracted from GTEx database. RNA-seq data for *CD98hc* is displayed in Transcripts Per Million (TPM). Percentage of *CD98hc* alternative variant over total *CD98hc* is indicated. *CD98hc* canonical variant (in grey) corresponds to transcript code ENST00000338663.7 whereas alternative variants (in black) correspond to transcript codes ENST00000535296.1, ENST00000377892.1, ENST00000377891.2, ENST00000377889.2, and ENST00000377890.2. Expression of all alternative splicing variants was added together.

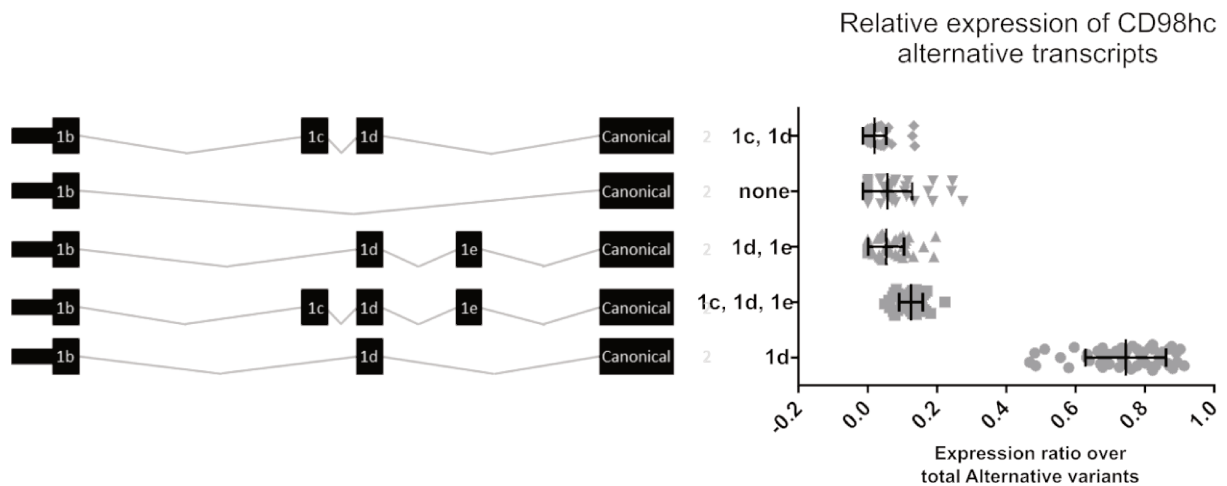

Fig. 19. *CD98hc* alternative variant mRNAs relative expression. Data were extracted from GTEx database. RNA-seq data for each *CD98hc* long variant is displayed as a ratio of the total expression of alternative variants. Each data point represents the value in one tissue or organ. Middle line represents the mean and whiskers indicate the SD.

3.1.3. Discussion

From the data presented in this chapter, it becomes apparent that several *CD98hc* protein variants coexist. To our knowledge, it is the first time this is shown. The small size difference and the heterogeneous glycosylation might account for *CD98hc* alternative variant remaining undetected until now.

CD98hc alternative protein variant was detected (WB) in mouse and human cultured cells, both in well-known cell lines and in-house immortalized primary cells. Furthermore, the consistent presence of *CD98hc* alternative transcripts in all tissues included in the GTEx portal confirms the presence of this variant in human tissues. The particularities of the deglycosylation treatment followed by WB immunodetection used here substantially increased the amount of biological material required, which limited the application of this approach to tissue samples. In the future, the development of variant-specific antibodies will be a valuable asset, allowing direct variant detection in WB and tissue immunolabelling techniques. Nevertheless, all these data combined strongly suggest that *CD98hc* alternative variant can be expressed in humans independently of the tissue type.

Our analysis of GTEx expression data reveals a constant expression proportion of canonical and alternative *CD98hc* variants across human tissues. Only the cerebellum presents a small increase in the proportion of alternative variant. This novel protein isoform could have, therefore, a significant role in this organ and could be the focus of a study in the future by experts in the field. *CD98hc* has been observed to play a role in the central nervous system

via amino acid transport across the brain blood barrier (Duelli et al., 2000; Kageyama et al., 2000) and in glia cells and glioma development (Ogunrinu and Sontheimer, 2010; Polewski et al., 2016), but nothing has been reported with respect to CD98hc and cerebellar cells. CD98hc can transport glutamate, the most important excitatory neurotransmitter in the cerebellum, through the X_c^- system in exchange of cystine. Glutamate uptake plays a crucial role in the maintenance of low extracellular glutamate concentrations, to protect neurons from excitotoxicity. However, cerebellar cells use other channels for glutamate transport like GLAST, GLT-1 (Bergmann glia), EAAT4 and EAAC1 (Purkinje cells) (Takayasu et al., 2009).

The GTEx Dataset has the advantage of being of human origin, homogeneous, comparable and deep enough in its sequencing to differentiate transcript variants of the same gene. Unfortunately, it provides only a static picture of *CD98hc* levels, indifferent to the possible variation along the time axis. The expression of *CD98hc* alternative variant(s) during dynamic processes such as development, aging or disease will require further investigation.

CD98hc is a multifunctional protein, crucial for many tissues and processes and with a complex regulation. This, together with the small difference in alternative *CD98hc* proportion in the analyzed tissues and the fact that it is the first time that this variant is detected, set the focus of the following work on the analysis of the general implications of this discovery rather than confining it to a specific tissue or condition. In this context, it becomes important to understand through what mechanism alternative CD98hc provides a fitness increase that justifies its evolutionary selection.

3.2. Alternative CD98hc emerged in mammals with a conserved alternative promoter

3.2.1. Introduction

Proteins with alternative isoforms or variants can increase the species fitness for a number of reasons. In some cases, they have a functional importance, including a new active or binding site or modifying an existing one. As a result, the implicated exons, residues or motifs tend to be highly conserved, as it happens for PKA C subunit isoforms (Søberg et al., 2017). On the other hand, some protein variants failed to prove a functional difference, as demonstrated in the case of ERK1 alternative splicing of intron 7 in mammals (Buscà et al., 2016). These sequences with no functional relevance evolve neutrally and show a lower conservation. Nevertheless, their presence has been favored by natural selection; therefore, other reasons should explain their emergence such as regulatory implications by the inclusion or change of regulatory features. In particular, recent studies prove the use of alternative TSS as a mechanism present in the majority of human genes, including alternative promoters in about one half of protein-coding genes (Consortium, 2012; Davuluri et al., 2008). On the transcriptional level, alternative TSS and promoters could affect the amplitude of gene expression, result in tissue-specific expression or temporally regulated expression, aside of differences in other regulatory features such as 5'UTR or translation initiation site.

In this chapter, I address the question of *CD98hc* alternative isoform emergence, its conservation and potential 3D structure to assess the possibilities of it playing a relevant role from the protein functionality or regulatory perspective.

3.2.2. Results

3.2.2.1. *CD98hc* alternative variant emerged in mammals

To identify the clades including *CD98hc* alternative variant, we used the tblastn tool to compare the human amino acid sequence of exon 1b (the exon we previously found in human and mouse genomes) with the “nucleotide collection” database. We identified homologous transcripts restricted to the Mammalia class (mammals) (Fig 20), strongly suggesting the emergence of *CD98hc* alternative variant in the mammalian common ancestor. A similar

analysis using the human amino acid sequence of exons 1c, 1d and 1e allowed us to identify homologous transcripts restricted to the Simiiformes infraorder (simians, including New World monkeys, Old World monkeys and Apes, where humans are classified). Thus, *CD98hc* alternative variant probably emerged in mammals with a further exon addition in simians.

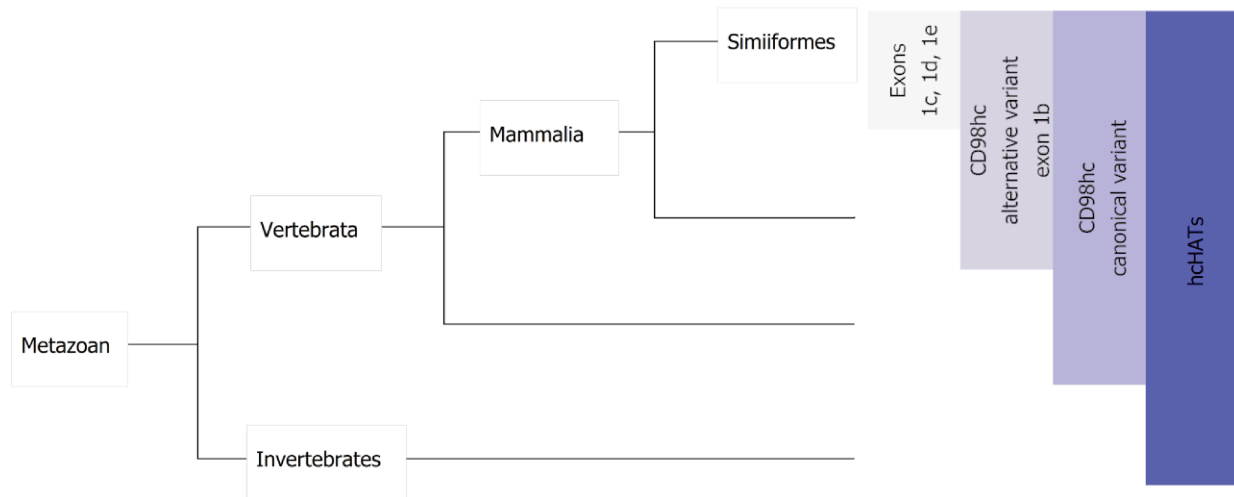

Fig. 20. *CD98hc* alternative variant emerged in mammals. The scheme shows the presence of hcHAT proteins in different clades. hcHATs emerged in metazoan and *CD98hc* canonical variant emerged in Vertebrata (Gabriško and Janeček, 2009). We found orthologs of human *CD98hc* alternative variant exon 1b in the Mammalia class and of exons 1c, 1d and 1e in the Simiiformes infraorder.

3.2.2.2. The N-terminal fragment of *CD98hc* alternative variant is less conserved than the canonical variant and probably unstructured

The N-terminal fragment of *CD98hc* alternative variant could contain a functional domain not present in the canonical variant. To explore this possibility, we next wondered about its conservation and 3D structure, with special interest in exon 1b and 1c, 1d, 1e if present. First, we compared the sequences of 250 orthologs of *CD98hc* alternative variant and scored each residue for conservation using the ConSurf algorithm (minimum score being 0 and maximum 9) (Fig 21). The primary structure of exons 1b, 1c, 1d and 1e is significantly less conserved than the rest of the protein domains. This difference is especially remarkable in the simian-exclusive exons, even though species of this group are less distant.

Then, we analyzed *CD98hc* alternative variant in terms of 3D structure and possible binding to other molecules. No structural or functional motifs were found in exons 1b, 1c, 1d and 1e when comparing alternative *CD98hc* variant to Pfam and Prosite databases. Additionally, analysis for secondary structure and disorder with Phyre² web portal predicts a high disorder degree in the N-terminal region. Finally, we found a consistent high proline

content (between 10% and 25% depending on the species, as compared to an average content of 5-6.3%) (Fig 21) without a conserved proline location. This amino acid residue is highly restrictive in terms of three-dimensional structure. Altogether, this supports the idea of exon 1b (and 1c, 1d, 1e if present) as part of an intracellular tail with no intrinsic three-dimensional structure and it does not suggest any particular function.

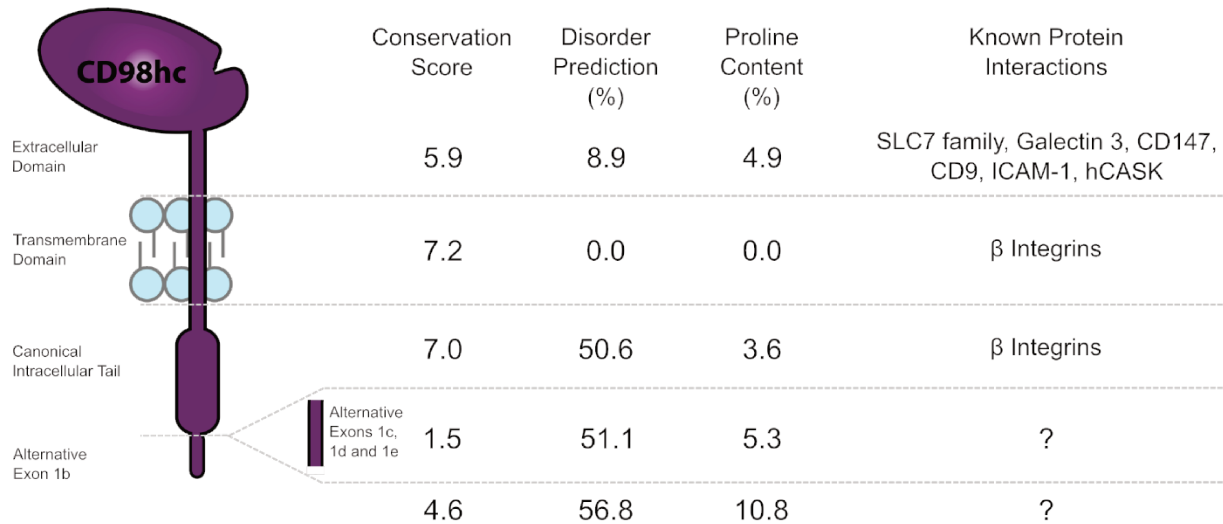

Fig. 21. CD98hc alternative protein variant conservation, potential disorder and interactions. The presented table summarizes key information about human CD98hc alternative protein variant. Conservation scores were calculated using the ConSurf method with a multiple sequence alignment of mammalian CD98hc ortholog predicted proteins on a scale from 0 to 9. The percentage of predicted disordered amino acid residues was calculated using the Phyre² server.

3.2.2.3. The 5'-flanking region of *CD98hc* alternative variant contains three well-conserved regions and may include a bidirectional promoter

To assess the potential importance of the predicted promoter region of *CD98hc* alternative variant, we assessed its conservation and the characteristics of the surrounding sequence. Regulatory non-coding regions tend to accumulate more mutations due to their intrinsic characteristics. Thus, we applied a phylogenetic footprinting analysis using the tool VISTA to assess sequence conservation by comparing sequential overlapping fragments (see materials and methods for a detailed explanation). When comparing the human and mouse sequences up to 1kb 5' to the start codon, three highly conserved regions were detected (Fig 22); one lies in the vicinity of the TSS and the other two further upstream. Interestingly, the 5'UTR is not conserved, reducing the probability of important regulatory mechanisms in this region. Similar results were obtained when comparing the human sequence to rat, cow and dog genomes (data not shown).

Remarkably, the first conserved region is also in the vicinity of the TSS of *SNHG1*, a long non-coding RNA that lies in the opposite orientation. In this context, it is possible for the *CD98hc* alternative variant 5' region to contain a bidirectional promoter, linking the origin of both genes. As *CD98hc*, *SNHG1* is ubiquitously expressed in the GTEx dataset. Moreover, although *SNHG1* is only annotated in the human and mouse genomes, a BLAST analysis of the human *SNHG1* sequence yielded a number of homologous predicted transcripts in different species restricted to the mammalian group, supporting the idea of *SNHG1* and alternative *CD98hc* emerging at once in a mammalian common ancestor.

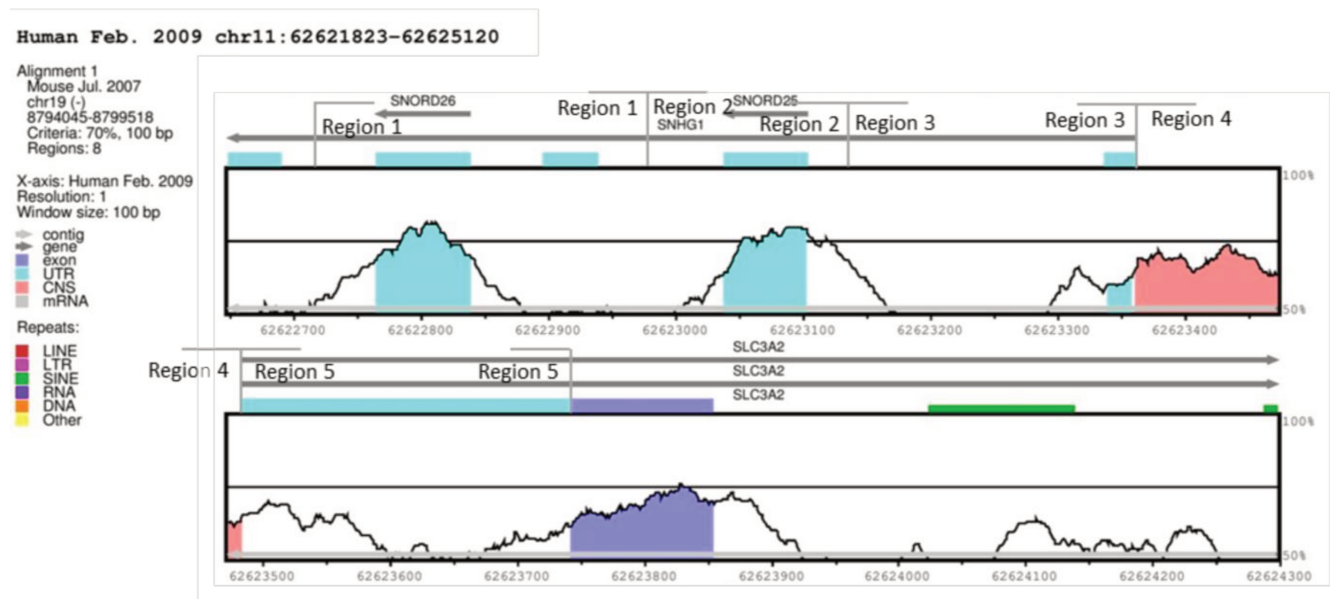

Figure 22. Phylogenetic footprinting analysis of human *CD98hc* (*SLC3A2*) alternative variant 5' flanking region. Regions with more than 70% homology—when compared to mouse sequence—are marked in cyan blue (UTRs, due to the overlap with long non-coding RNA *SNHG1*), pink (non-coding regions) and dark blue (exons). Boundaries of regions 1–5 are indicated for a better comprehension of section 3.3.

3.2.3. Discussion

The small N-terminal cytosolic region that differentiates canonical and alternative *CD98hc* variants (encoded in exons 1b, 1c, 1d and 1e) has no clear associated functionality yet found. *CD98hc*'s functionality as described in the literature is mostly the result of protein-protein interaction through *CD98hc*'s extracellular domain. The only exception is β -integrin interaction: the interphase of *CD98hc*'s transmembrane and cytosolic domains is crucial for it. The intracellular location of *CD98hc* alternative variant N-terminal region makes it improbable for it to participate in any of the known protein-protein interactions. Even in the case of

CD98hc-integrin interaction, the novel fragment's distal location does not suggest a crucial role. Additionally, the poor conservation as compared with the rest of the protein, the lack of intrinsic three-dimensional structure and conserved binding or active domains do not suggest novel interactions or functions. However, we cannot discard a new functionality via a different mechanism such as steric effects. Additionally, although one can expect all canonical CD98hc protein-protein interactions to be reproduced in the alternative variant, this will have to be experimentally proved in the future.

On the other hand, the potential *CD98hc* alternative promoter has three well-conserved regions that could indicate the importance of transcriptional regulation in this novel variant. Moreover, even though the evolutionary origin of *CD98hc* alternative variant is uncertain, one cannot neglect the presence of the long non-coding RNA *SNHG1* TSS at the 3' end of one of those conserved regions. As a result, the putative promoters of both genes have a common region, sharing proximal cis-regulatory elements. The existence of neighboring genes with opposite orientation that share a bidirectional promoter is relatively usual in mammals, accounting for approximately 10% of human protein-coding genes (Collins et al., 2007; Trinklein et al., 2003). Interestingly, the characteristic enrichment of closely located bidirectional pairs of genes in the mammalian genome is less distinct in less complex vertebrates (Franck et al., 2008; Koyanagi et al., 2005). If *CD98hc* alternative promoter is a bidirectional promoter, its evolutionary origin would be linked to *SNHG1*. The probable emergence of both genes in the same ancestral group, as shown by our data, further supports this possibility. From a functional perspective, recent research relates *SNHG1* to tumor progression and cell proliferation in different cancer types (Sahu et al., 2016; Zhang et al., 2016a; Zhang et al., 2016b). However, the first report on *SNHG1* is dated in 2014 and, although publications are growing in the last two years, the lack of information about *SNHG1* regulation and function limits our possible understanding of its role in *CD98hc* alternative variant origin and regulation.

Complex organisms, like mammals, often rely on a very similar proteome as less complex organisms but increase the complexity of protein expression regulation (Levine and Tjian, 2003; Pray, 2008). In this light, the added fitness value of *CD98hc* alternative variant seems to be related to an alternative way of expression regulation via its alternative promoter, adding complexity and versatility to the system.

3.3. The 5'-flanking region of alternative *CD98hc* contains an alternative promoter with a different regulation

3.3.1. Introduction

CD98hc is a multifunctional protein crucial for many cellular processes, as described in Section 1. The ensemble of these processes is dependent on *CD98hc* level and requires a tightly regulated, variable expression kinetic. Changes in *CD98hc* expression occur in heterogeneous time scales (from B and T cell clonal expansion to aging) and cover a wide range of levels from no expression (quiescent cells) to very high levels (highly proliferative cells, tumor cells). Environment adaptation requires *CD98hc* regulation to have high responsiveness to diverse stimuli while homeostasis maintenance compels a tight control to avoid dangerous dysregulations.

Despite the above, *CD98hc* transcription regulation mechanisms have not been extensively studied, limiting our understanding of *CD98hc* gene expression. *CD98hc* cDNA contains 9 exons and originates from a single-copy gene in the long arm of chromosome 11, highly conserved during mammalian evolution (Francke et al., 1983; Quackenbush et al., 1987). Several studies in the late 80s characterized *CD98hc* increase upon PKC activation and intracellular Ca^{++} increase (Lindstein et al., 1989; Tanaka et al., 1988) as well as an enhancer region in intron 1 (Karpinski et al., 1989; Leiden et al., 1989). Finally, 2 independent studies cloned the canonical *CD98hc*'s 5'-flanking DNA region and identified functional sites for SP1 and NF- κ B (Gottesdiener et al., 1988; Yan et al., 2007b), as detailed in Section 1.

The 5' flanking region of *CD98hc* alternative variant seems to contain an alternative promoter. If it is functional, it could be regulated in a different fashion than the canonical promoter, providing an increase in versatility and complexity to the system. Indeed, approximately 50% of human and mouse genes contain alternative TSS and promoters (Davuluri et al., 2008; Forrest et al., 2014; Sun et al., 2014b). Though in some cases alternative TSS usage results in novel proteins, often they generate identical or highly similar open reading frames. However, different TSS have different promoters and therefore different sets of TFs, chromatin states, and epigenetic modifications to regulate protein expression patterns (Mikkelsen et al., 2007; Pal et al., 2011; Rach et al., 2011). In this chapter, I identify for the first

time an alternative promoter in the 5' region of *CD98hc* locus and explore its general regulatory features.

3.3.2. Results

3.3.2.1. Canonical and alternative *CD98hc* have different promoter regions with a different putative transcription factor binding site footprint

We detected several marks associated with active promoters in data from the ENCODE project in the proximity of *CD98hc*'s alternative TSS. These include DNaseI hypersensitivity clusters, histone modifications (H3K4me3, H3K9ac and H3K27ac), predicted active promoter regions by chromatin state segmentation and RNA Polymerase II ChIPSeq peaks (Fig 23A). This suggests the presence of a *CD98hc* alternative promoter approximately 25 kb upstream of the canonical promoter in the human genome. Given the considerable distance between both promoters in the genomic sequence, transcriptional proximal regulatory elements are highly unlikely to overlap. A sequence alignment of a 1 kb region upstream from either start codon, a sequence length commonly used as standard for promoter studies and previously used in the study of *CD98hc* canonical promoter, yields no significant result when using PromoterWise, the EMBL alignment algorithm optimized for promoter sequences (data not shown). The only common features between canonical and alternative variant promoters are the absence of TATA box and the presence of one GC box with an SP1 putative binding site (two in the canonical promoter).

However, non-coding regions and TFBS are often poorly conserved due to a higher mutation tolerance. With the purpose of evaluating the functional similarity between canonical and alternative *CD98hc* promoters, we characterized the putative TFBS of *CD98hc* promoters applying a combined strategy: three different curation methods to minimize the otherwise high false positive rate of TFBS prediction. These methods were based on combining plain TFBS prediction with either additional lines of evidence or interspecies sequence alignment (see materials and methods for a precise description). Our analysis shows that out of the 60 TFBS identified, only 15 are shared between *CD98hc* canonical and alternative promoters (Fig 23B). The only similar region was the aforementioned GC box, a very common motif containing one SP1 binding site known to be functional in *CD98hc* canonical promoter. The full analyzed sequences with all TFBS identified are presented in figures 24 and 25.

Altogether, these results point in the direction of a different TF-mediated promoter regulation for canonical and alternative *CD98hc* promoters, aside from basic ubiquitous TFs.

A

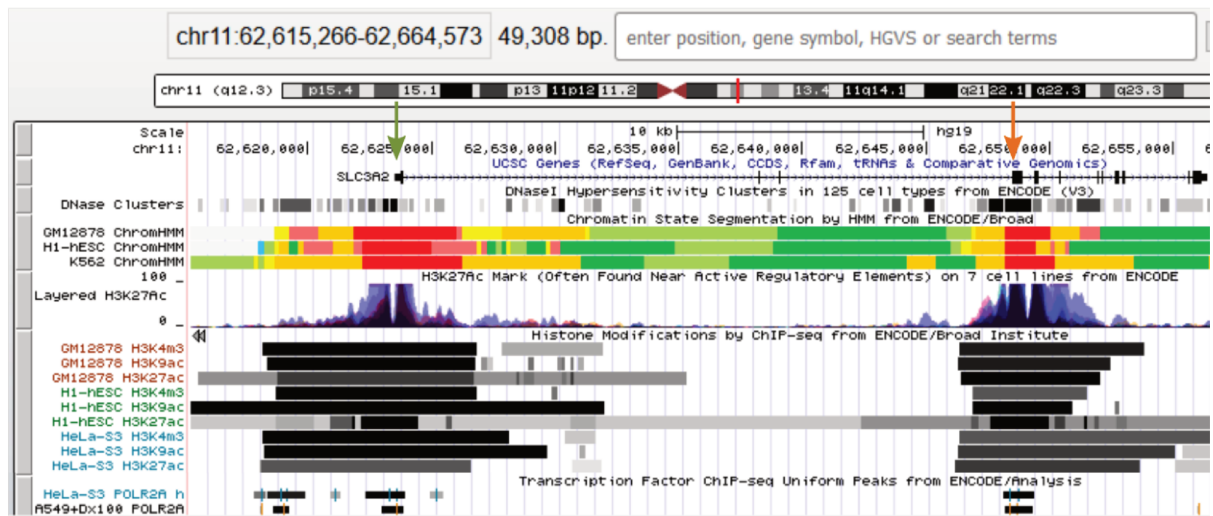

B

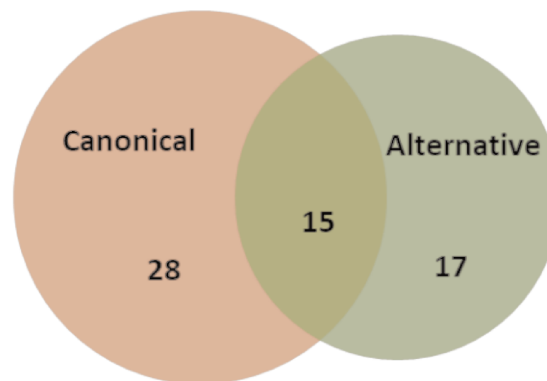

Fig. 23. *CD98hc* has two active promoters with putative differences in TFBS fingerprint. (A) Display of the UCSC genome browser utility. Several features related to active promoters are detected in the proximity of *CD98hc* canonical (orange arrow) and alternative (green arrow) TSS: DNaseI hypersensitivity clusters, “active promoter” chromatin state regions (red bars, as learned by computationally integrating ChIP-seq data for nine factors using a Hidden Markov Model within the ENCODE project), several histone marks associated to active transcription initiation regions and RNA Polymerase II ChIP-seq peaks. (B) Venn diagram representing TFBS found through curated in silico sequence analysis in *CD98hc* canonical (orange) and alternative (green) promoters. Circle size is proportional to the number of TFBS identified. Overlapping region represents TFBS common to both promoters.

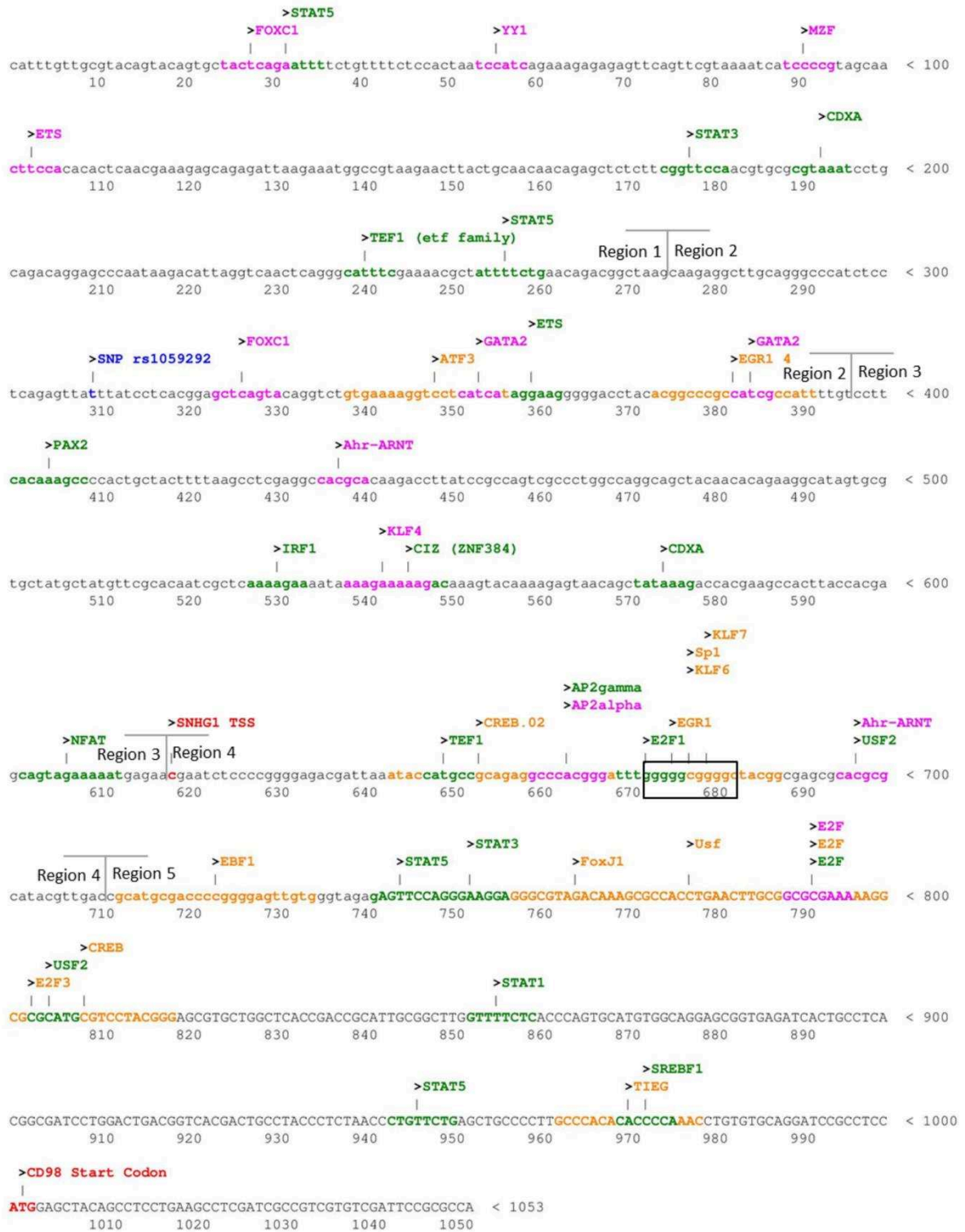

Fig. 24. Sequence of the CD98hc alternative variant 5' flanking region used in the transcription factor binding site analysis. Putative TFBS found along the in silico analysis are depicted in orange (MatInspector), green (MetaAlignment, Transfac) and purple (MetaAlignment, Jaspas). Boundaries of regions 1–5 are indicated. SNP rs1959292, long non-coding RNA SNHG1 transcriptional start site (minus strand), and alternative CD98hc start codon (plus strand) are indicated as well. GC box is depicted in a black rectangle.

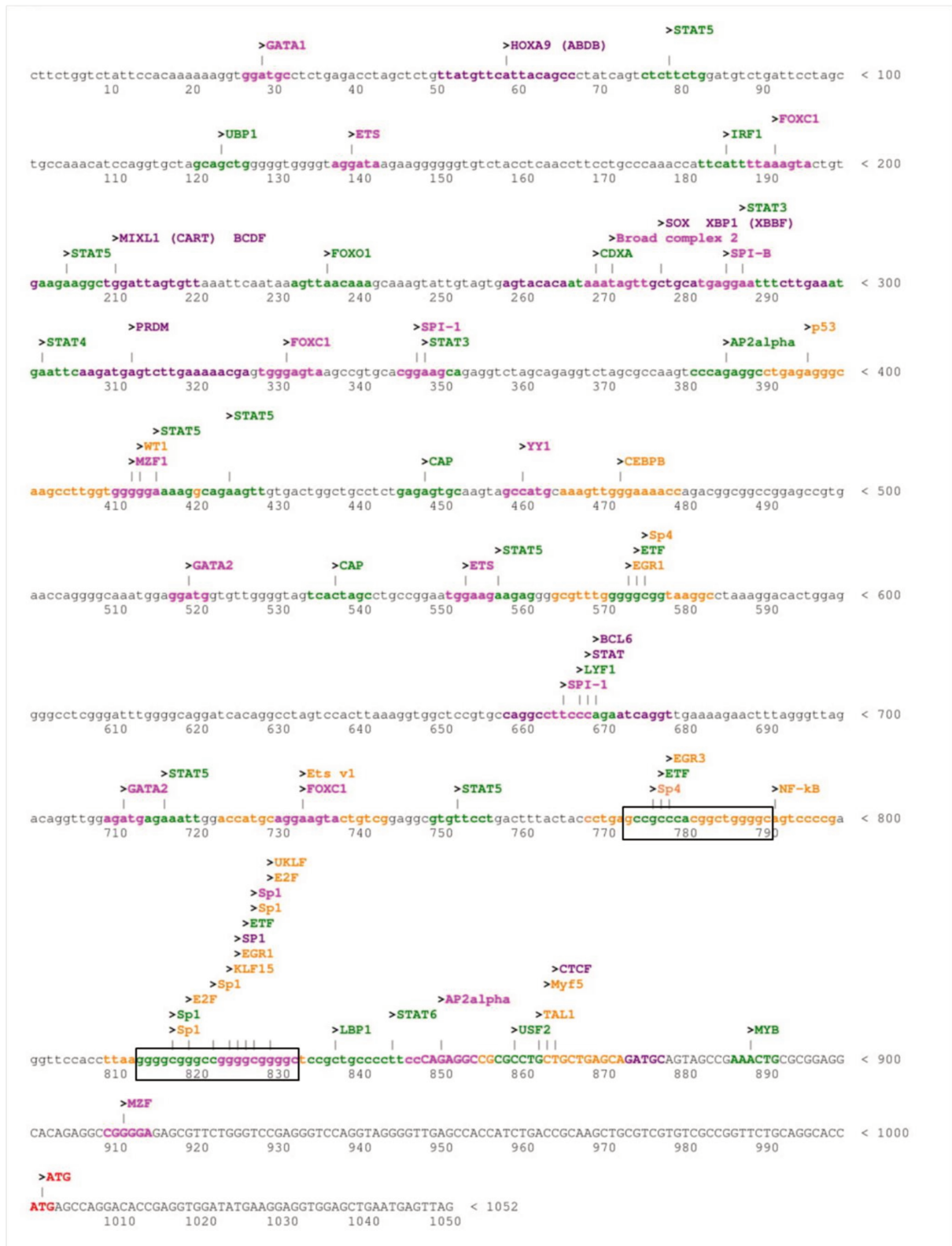

Fig. 25. Sequence of the *CD98hc* canonical variant 5' flanking region used in the transcription factor binding site analysis. Putative TFBS found along the in silico analysis are depicted in orange (MatInspector), dark purple (DiAlign), green (MetaAlignment, Transfac) and light purple

(MetaAlignment, Jaspar). *CD98hc* start codon is indicated in red. GC boxes are depicted in black rectangles.

3.3.2.2. *CD98hc* alternative variant 5'-flanking region presents promoter activity

To assess potential important regions of *CD98hc* alternative promoter, we combined our TFBS analysis with the phylogenetic footprinting study presented in section 3.2. Interestingly, the previously mentioned GC box in *CD98hc* alternative promoter lies on a well-conserved region in the vicinity of the TSS. This together with the fact that the TFBS it contains are general and also found in *CD98hc* canonical promoter suggest this region could harbor necessary basic transcriptional elements.

To test *CD98hc* alternative promoter activity in vitro, we subcloned a 1 kb region upstream of the alternative start codon into pGL3 (Promega), allowing firefly luciferase expression under its control. A plasmid containing renilla luciferase coding sequence under herpes simplex virus thymidine kinase (TK) promoter (pRL-TK) was used for normalization. Luciferase activity was measured 48 h post transfection as a read-out of promoter activity in HeLa cells. We first wondered whether the alternative *CD98hc* 1kb 5'-flanking region (alternative *CD98hc* promoter) had promoter activity. In this experimental system, alternative human *CD98hc* promoter presented the same activity level as the canonical promoter. To confirm these results, we also tested the mouse alternative and canonical promoter regions. Proximal cis-regulatory elements and their interactions with the transcription preinitiation complex are highly conserved between mouse and human (Vierstra et al., 2014; Wilson et al., 2008). In the same system, canonical and alternative mouse *CD98hc* promoters did not present significant differences in activity (Fig 26 A). Transfection efficiency was monitored after protocol optimization by analyzing fluorescence of cells in a control well transfected in parallel with the GFP-mammalian expression plasmid pCDNA3.1(-)/GFP by flow cytometry 48h post transfection. Efficiency was stable and high across experiments (Fig 26 B).

To continue the study of the alternative *CD98hc* promoter region, we divided it into 5 regions according to conservation peaks (from the phylogenetic footprinting, Fig 22) and TFBS clusters (from the in silico TFBS analysis, Fig 23). We performed systematic deletions of the of the 5 regions for a more detailed functional assay, in an approach similar to that previously used to study *CD98hc* canonical promoter (Gottesdiener et al., 1988; Yan et al., 2007b).

Deletion of regions 1, 2 or 3 of alternative promoter produced a 2-fold increase in promoter activity. This effect was accumulative, reaching an increase of 3-fold for deletion 1-2 and 4.5-fold for deletion 1-3. Deletion of region 4, the most conserved one, had an important impact on promoter activity only when activity prior to deletion was high, as seen by the decrease in luciferase activity from deletion 1-3 to deletion 1-4. Finally, region 5 alone was enough to trigger transcription initiation (Fig 26 C).

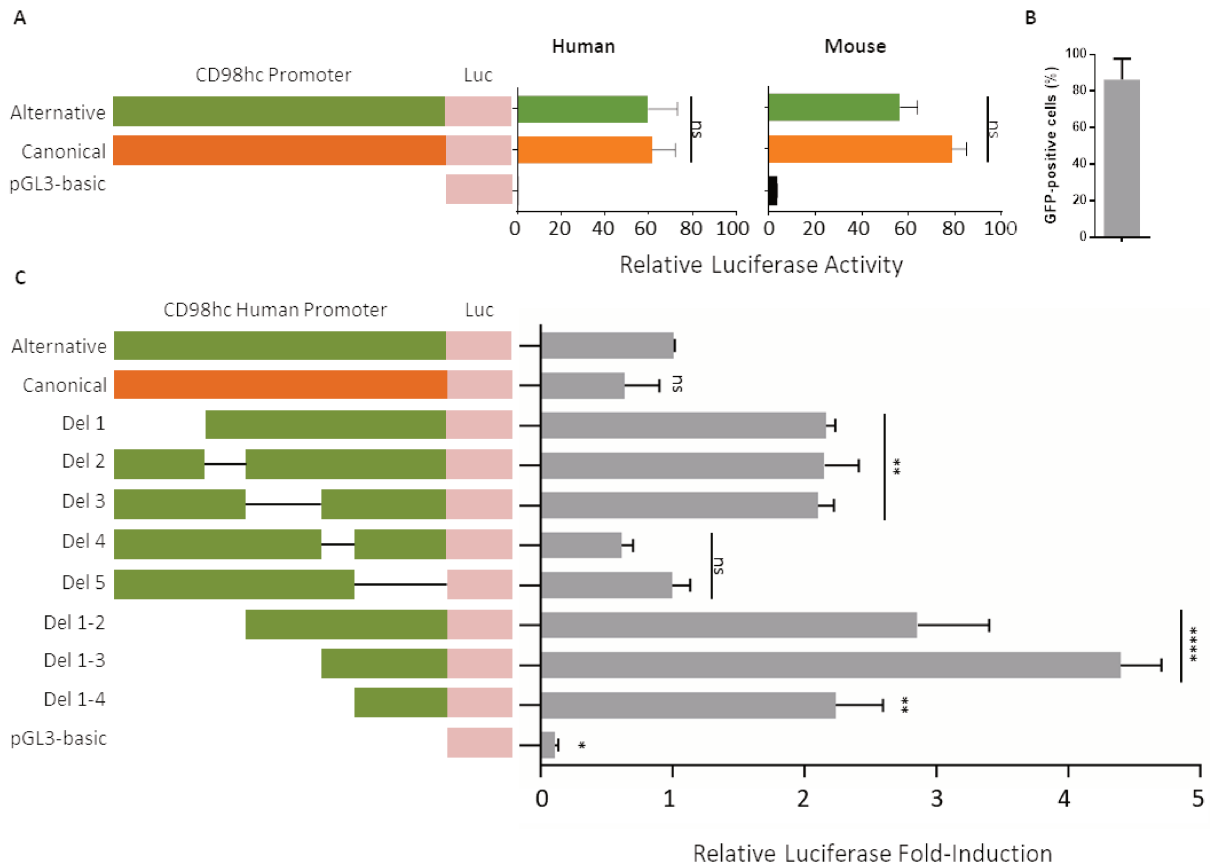

Fig. 26. *CD98hc* alternative variant 5' flanking region supports transcription initiation. HeLa cells were co-transfected with pRL-TK as transfection control and pGL3 including the canonical, alternative or alternative deleted *CD98hc* promoter from human or mouse, as well as pcDNA3.1(-)/GFP. After 48h, cells were harvested, and luciferase activity assessed following Dual Luciferase Assay kit instructions (Promega). (A) Graph shows firefly/renilla luciferase activity ratio. (B) Percentage of GFP-positive cells was evaluated by flow cytometry. (C) Graph shows firefly/renilla luciferase activity ratio normalized to full-length alternative *CD98hc* promoter value. All results are presented as mean \pm SEM of at least 4 independent experiments performed in quadruplicate. * $p < 0.05$, ** $P < 0.01$, and **** $P < 0.0001$ vs. full-length alternative promoter after one-way ANOVA test followed by Dunnett's multiple comparison test.

We can conclude that *CD98hc* alternative variant 5' region has promoter activity in vitro. Regions 1-3 display repressor activity that will have to be further characterized for full

validation. Region 4's conserved common elements are probably important for high-level transcript expression. Finally, region 5 contains the minimal promoter.

3.3.1. Discussion

The complexity of mammalian gene structure is something we are only starting to understand. Evidence now suggests that 20-50% of human genes have alternative promoters as a regulatory mechanism (Davuluri et al., 2008). Although some have been well known for years, the majority of them are yet uncharacterized and contain important clues to transcription regulation.

CD98hc plays a key role in a high diversity of signaling responses. Its expression level is of particular importance; for instance, CD98hc increase will lead to cell proliferation activation in physiological and pathological conditions (Boulter et al., 2013; Cantor and Ginsberg, 2012; McCracken and Edinger, 2013). Thus, one can imagine the relevance of *CD98hc* transcriptional regulation, of which *CD98hc* promoter constitutes the first layer. Here, we demonstrate the existence and functionality of a *CD98hc* alternative promoter, 25 kb upstream of *CD98hc* canonical promoter in the human genome.

Such a dual regulatory system could increase *CD98hc* locus versatility to respond to heterogeneous stimuli while maintaining a tight control to avoid homeostasis dysregulation. Increased responsiveness can translate into a fitness advantage, fixing the additional feature—an alternative promoter—in the mammalian evolutionary line.

From our luciferase assay results on *CD98hc* alternative promoter, we identified fragment 5 as the one containing the minimal promoter. Additionally, there is evidence to suggest important activator elements in fragment 4 and a promoter repressor activity in regions 1-3 in HeLa cells. Interestingly, when two similar studies—on Caco2-BBE colorectal adenocarcinoma cells and Jurkat T cells—were performed on *CD98hc* canonical promoter, progressive promoter truncation did not affect reporter gene level as long as the 330 bp fragment 5' of the start codon was kept (Gottesdiener et al., 1988; Yan et al., 2007b). 1-3 region potential repressor effect, together with differences in TFBS curated prediction, strongly suggests a different regulation of the two *CD98hc* promoters.

Further work is required to confirm and characterize *CD98hc* alternative promoter features. There are several plausible explanations for region 1-3 putative repressor effect.

One possibility is a TF-mediated mechanism. To test it, the TFBS in silico curated analysis presented in this report can be of great value. Some candidates in 1-3 region known to have repressor effects are YY1, involved in differentiation and proliferation (Gordon et al., 2006); MZF1, repressor in non-hematopoietic cells (Hromas et al. 1996); ATF3, related to stress response (Thompson et al., 2009); or KLF4, normally repressor in competition with activator KLF5, involved in the transition between quiescence and proliferation (Dang et al., 2000; Ghaleb et al., 2005). Of those, the first three lie in one of the conserved regions identified by phylogenetic foot printing and ENCODE data includes ChipSeq peaks at least for YY1 in that genomic region.

However, orientation and position effects affecting our luciferase assay results cannot be discarded. It would be interesting to know whether region 1-3 acts as a promoter repressor independently of sequence environment and orientation (e.g., reversed or in the context of a different promoter); we cannot discard a silencer effect of the overall sequence rather than specific sites. Moreover, the potential role of the promoter upstream region (farther than 1 kb upstream from the start codon) is unclear, not to mention all the possible distal regulatory elements present in the genome environment. These factors could be responsible of the difference observed in relative promoter activity—where canonical and alternative promoters have equivalent in vitro activities— as compared to relative mRNA or protein expression— where the canonical variant is always majority. Future studies on the endogenous promoter will shed light on this question.

Finally, it is noteworthy how the 3' end of promoter region 3 coincides with the TSS of the long non-coding RNA *SNHG1*, as described in section 3.2. As a result, region 1-3 spans the 5' end of *SNHG1*. It is not an unusual mechanism for long non-coding RNAs to anneal to their coding sequence in the genome, regulating transcription of neighboring genes (Wang et al., 2008).

On the other hand, several features are potentially common for *CD98hc* canonical and alternative promoters. Firstly, they are both TATA-less and include at least one GC island with one SP1 binding site—three functional SP1 sites in the case of the canonical promoter (Yan et al., 2007b). A transcriptional block in the exon 1-intron 1 region was described as a regulatory mechanism for canonical *CD98hc* transcription (Lindsten et al., 1988). This block would be released upon PMA cellular stimulation and PKC activation, leading to a rapid increase in

CD98hc transcript level. The described mechanism is located in a region common to canonical and alternative *CD98hc* transcripts, thus being a potential co-regulator. These facts could represent a basic common set of activation features, necessary for the expression of all *CD98hc* transcripts. It would allow for a mechanism to inhibit all *CD98hc* transcription when needed, avoiding homeostasis disruption due to *CD98hc* overexpression.

The expression analysis, putative TFBS identification, and general promoter regulation study presented here strongly suggest a different transcriptional regulation for *CD98hc* canonical and alternative promoters. This study opens the door to a future specific characterization of this promoter in CD98hc-dependent cellular processes, and it will help to decipher the complex regulation of this multifunctional protein.

3.4. Materials and methods

3.4.1. Cells

HeLa (human epithelial cervical cancer cells, ATCC number CCL-2TM), NIH3T3 (mouse embryonic fibroblasts, ATCC number CRL-1658) and primary human dermal fibroblasts (foreskin origin, experiments performed at passages 3-10) cells were grown in Dulbecco's modified Eagle's medium (21969-035, Gibco) supplemented with 10% (v/v) fetal bovine serum (FBS) (10270106, Gibco) and 2 mM L-glutamine (25030-024, Gibco). Mouse dermal fibroblasts and mouse squamous cell carcinoma (SCC) cells were grown in DMEM supplemented with 10% v/v FBS, 20 mM HEPES, pH 7.3 (15630-056, Gibco), 100 μ M non-essential amino acids (11140-035, Gibco), 2 mM L-glutamine and 100 μ M 2-mercapto-ethanol (M6250, Sigma). SCC12 cells were cultured in FAD medium (21765, Gibco), supplemented with 10% FBS, 2 mM glutamine, insulin-transferrin-selenium (41400-045, Gibco) and 0.5 μ g/mL hydrocortisone (H-0135, Sigma). A549 (lung carcinoma cells, ATCC number CCL-185) cells were grown in F-12K medium (30-2004, ATCC) supplemented with 10% FBS. BEAS-2B (bronchial epithelial cells, ATCC number CRL-9609) cells were grown in Bronchial Epithelial Cell Growth Medium (BEGM), (CC-3170, Lonza/Clonetics Corporation). All cells were grown at 37°C in a humidified atmosphere containing 5% CO₂.

3.4.2. RNA reverse transcription and polymerase chain reaction

RNA was extracted using RNeasy Mini Kit (74104, Qiagen) following manufacturer's indications. Reverse transcription was performed with 1 μ g of total RNA as template using Superscript II reverse transcriptase (18064, Invitrogen) and anchored oligo (dT)₂₀ (12577011, Invitrogen) following manufacturer's indications. Reverse transcription product was used as template for PCR reaction with taq DNA polymerase mix (M7505, Promega) under manufacturer's recommendations for 35 cycles. Primers A, B or C (table 1) were used as indicated. Samples were finally subjected to electrophoresis in 2% agarose gels at 100V for 1 h, stained with ethidium bromide (E1510, Sigma) and visualized under UV light.

3.4.3. In vitro transcription and translation

1 μ g of pcDNA3.1(-)/mCD98hcCanon or pcDNA3.1(-)/mCD98hcAlt plasmid DNA was used to set up in vitro transcription and translation reactions with TNT T7 coupled reticulocyte

lysate system (L4610, Promega) according to manufacturer's instructions. Briefly, DNA was mixed with T7 RNA polymerase and rabbit reticulocyte lysate and incubated for 90 minutes at 30°C before Western blot analysis.

3.4.4. Plasmid construction

Human genomic DNA was extracted from buccal swabs using DNeasy blood and tissue kit (69504, Qiagen) following manufacturer's instructions. Inserts were obtained by PCR using the following oligonucleotides as primers: hPromLongFmIul and hPromLongRbglII for pGL3-Basic/hCD98hcPromAlt, hPromShortFmIul.2 and hPromShortRbglII.2 for pGL3-Basic/hCD98hcPromCanon, hPromLongRbglII and hPromLongDel1RSmIul for pGL3-Basic/hCD98hcPromAltDel1, hPromLongDel2RS and hPromLongRbglII for pGL3-Basic/hCD98hcPromAltDel1-2, hPromLongDel3RS and hPromLongRbglII for pGL3-Basic/hCD98hcPromAltDel1-3, hPromLongDel4RS and hPromLongRbglII for pGL3-Basic/hCD98hcPromAltDel1-4, hPromLongFmIul and hPromLongDel5LASbglII for pGL3-Basic/hCD98hcPromAltDel5. Mouse genomic DNA was extracted from fibroblasts as before. Inserts were obtained by PCR using the following oligonucleotides as primers: mPromLongFmIul and mPromLongRbglII for pGL3-Basic/mCD98hcPromAlt, and mPromShortFmIul and mPromShortRbglII for pGL3-Basic/mCD98hcPromCan. Inserts were digested with (when indicated in the primer name) Mlul (R0198, New England Biolabs), BglII (R0144, New England Biolabs) and (when nothing indicated in the primer name) Smal (R0141, New England Biolabs) and subsequently subcloned into pGL3-basic vector (E1751, Promega). pGL3-Basic/hCD98hcPromAltDel2, pGL3-Basic/hCD98hcPromAltDel3 and pGL3-Basic/hCD98hcPromAltDel4 were generated subcloning into pGL3-Basic/hCD98hcPromAltDel1-2, pGL3-Basic/hCD98hcPromAltDel1-3 and pGL3-Basic/hCD98hcPromAltDel1-4 inserts obtained by PCR with primers hPromLongFmIul and hPromLongDel2LAS, hPromLongFmIul and hPromLongDel3LAS, and hPromLongFmIul and hPromLongDel4LAS respectively. Restriction enzymes Mlul (R0198, New England Biolabs) and Smal (R0141, New England Biolabs) were used. Human or mouse genomic DNA was used as template in all cases.

pcDNA3.1(-)/mCD98hcCanon and pcDNA3.1(-)/mCD98hcAlt were generated by subcloning PCR-obtained inserts from mouse fibroblast cDNA (extracted as before) after digestion with restriction enzymes NheI (R0131, New England Biolabs) and EcoRI (R0101, New

England Biolabs). Primers used were mCD98hc_short_S_5UTR and mCD98hc_AS_polyA_{signal} or mCD98hc_long_S_5UTR and mCD98hc_AS_polyA_{signal} respectively.

All plasmids were sequenced to control for potential mutations. Sanger sequencing was performed by GATC, Eurofins. Primer sequences can be consulted in table 2. All plasmid DNA used in experiments was purified from *Escherichia coli* TOP10 (C40403, Invitrogen, for pcDNA3.1(-)-derived constructs) or JM109 (L2005, Promega, for pGL3-basic-derived constructs) strains using Plasmid Maxi Kit (12163, Qiagen) following manufacturer instructions.

3.4.5. PNGase F deglycosylation reaction

Pre-confluent cell monolayers were scraped in 10 mM HEPES pH 7.4, 150 mM NaCl, 1% NP-40 0.5% deoxycholate, 0.1 % SDS with EDTA-free protease inhibitors (88666, Thermo Scientific) and put in suspension at approximately 10^7 cells/ml. Cell suspensions were sonicated (3 pulses of 10 seconds) and cleared by centrifugation. After bicinchoninic acid (BCA)-based protein quantification (SK3021, BIO BASIC INC.), 20 µg (for human-origin samples) or 40 µg (for mouse-origin samples) of total protein were subjected to PNGase F (P0704, New England Biolabs) enzymatic deglycosylation reaction at 37°C for 1 h following supplier's instructions.

3.4.6. SDS-PAGE and Western blotting

Protein samples were mixed with reduced Laemmli's sample buffer and heated at 95°C for 5 min. Electrophoresis separation was then performed in 7.5% SDS-PAGE gels. For Western blot analysis, after electrophoresis, proteins were electroblotted onto polyvinylidene difluoride membranes and blocked by incubation with 5% non-fat dry milk in PBS for 30 minutes at RT. Membranes were then probed with primary antibodies (rabbit anti-CD98hc H300 1:1000, Santa Cruz Biotechnology, for human samples, or goat anti-CD98hc N-20 1:200, Santa Cruz Biotechnology, for mouse samples) diluted in blocking solution for 16 h at 4°C. Then, membranes were thoroughly washed with PBS, incubated with goat anti-rabbit IgG horseradish peroxidase conjugate (W4011, Promega) or donkey anti-goat IgG horseradish peroxidase conjugate (PI-9500, Vector Laboratories) diluted 1:10,000 in blocking solution. Immunoreactive bands were detected by ECL Immobilon Western (WBKLS0500, Merck) according to the provided protocol.

3.4.7. Expression data analysis

Expression data were obtained from Genotype-Tissue Expression (GTEx) project portal (<https://www.gtexportal.org>). Transcript-level quantifications for all available human tissues were extracted for transcript numbers ENST00000338663.7 (canonical CD98hc), ENST00000535296.1, ENST00000377892.1, ENST00000377891.2, ENST00000377889.2 and ENST00000377890.2 (alternative CD98hc, different splicing variants).

3.4.8. Phylogenetic footprinting analysis

Sequence comparisons were performed with the Vista platform (<http://genome.lbl.gov/vista/index.shtml>) (Frazer et al., 2004). Mouse and human sequences were compared using a window size of 100 bp and a conservation criterion of 70%.

3.4.9. Protein conservation analysis

Protein conservation scores were obtained using the ConSurf server (Ashkenazy et al., 2010; Ashkenazy et al., 2016; Celniker et al., 2013). The algorithm was provided with a multiple sequence alignment (MSA) for analysis. MSA was performed with COBALT (Papadopoulos and Agarwala, 2007) on 250 CD98hc orthologs obtained after a BLASTP (Johnson et al., 2008) analysis of CD98hc alternative human protein sequence including exons 1b, 1c, 1d and 1e. Each position of the query sequence was assigned a conservation value ranging from 1 (not conserved) to 9 (very well conserved). Presented scores are the average of all positions belonging to each protein domain.

3.4.10. Protein disorder prediction

Protein disorder prediction was performed on the Phyre2 platform (<http://www.sbg.bio.ic.ac.uk/phyre2/html/page.cgi?id=index>) (Kelley et al., 2015) using the alternative human CD98hc amino acid sequence and the normal modeling mode.

3.4.11. Transcription factor binding site search

Input sequence consisted of 1,000 base pairs 5' to the adenine nucleotide of CD98hc (canonical or alternative) start codon. Three different methods were used to identify potentially functional transcription factor binding sites (TFBS). 1) MatInspector (<https://www.genomatix.de/matinspector>) (Cartharius et al., 2005): human CD98hc promoter

sequence was used as input. Results with a matrix simulation score higher than 0.7 and at least 2 additional lines of evidence were considered as positive. Additional lines of evidence include: overlapping with an evolutionarily constrained element, correlating with a ChiP-Seq peak, cocitation of gene and TF within the same sentence of a PubMed abstract and being part of a known promoter module. 2) DiAlign TF (https://www.genomatix.de/online_help/help_dialign/dialign_TF.html): mouse and human promoter sequences were aligned with DiAlign TF package and TFBS were identified within the aligned regions. Threshold T value was set to 0. 3) MetaAlignment (<http://genome.crg.es/software/meta/index.html>) (Blanco et al., 2006): briefly, Meta algorithm was loaded with both mouse and human CD98hc promoter nucleotide sequences to be transformed into TFBS sequences so-called Transcription Factor maps (TF-maps). Finally, TF-maps were aligned and TF within the aligned regions were considered positive. Matrix collections Jaspar or Transfac were used. Mapping threshold quality was set to $T=0.75$. Alignment configuration parameters were set as follows: $\alpha=0.5$, $\lambda=0.1$ and $\mu=0.1$.

3.4.12. Dual luciferase assay

HeLa cells (25,000 cells/well) were cultured in 24-well plates for 24 h. Then, transfection solution was prepared in Opti-MEM (11058-021, Gibco) in a 25 μ l final volume with 300 ng of total DNA (20:1 relevant pGL3:pRL-TK ratio) and 0.9 μ l of FuGene HD (E2311, Promega) (1:3 DNA:Fugene HD ratio), and added in the wells with fresh complete medium. After 48 h, cells were harvested and luciferase activity assessed using the Dual-Luciferase Reporter Assay System (E1910, Promega) as indicated by the supplier on a Centro XS LB960 luminometer (Berthold). Each condition was performed in quadruplicates and at least four independent experiments were done. Values showed in the figure correspond to firefly/renilla activity ratio normalized to full-length CD98hc alternative promoter value. The statistical analysis was carried out using the GraphPad Prism software 6.0 package (GraphPad Software Inc.). A one-way ANOVA test was performed followed by Dunnett's multiple comparisons test between relative luciferase activity of cell lysates transfected with CD98hc full-length alternative promoter construct (pGL3-Basic/hCD98hcPromAlt) and all other conditions. GFP transfection efficacy was evaluated on a flow cytometer (Calibur, BD) with the CellQuestPro software (BD).

Name	Sequence
hPromLongFmlul	CGGGCACGCGTGTGTTTCATCATGGAGTGGTTATCTAC
hPromLongRbglII	CGTGAGATCTGGAGGCGGATCCTGCACAC
hPromShortFmlul.2	TTAATACGCGTACCCTGTGGAGGGAATTCTAG
hPromShortRbglII.2	ATATTAGATCTGGTGCCTGCAGAACCG
hPromLongDel1RSMlul	GGGCACGCGTGCAAGAGGCTTGCAGGGC
hPromLongDel2RS	GGGGTCCTTCACAAAGCCCCACTG
hPromLongDel3RS	GGGCGAATCTCCCCGGGGAG
hPromLongDel4RS	GGGGTTGACCGCATGCGACC
hPromLongDel2LAS	GGGGCTTAGCCGTCTGTTCAG
hPromLongDel3LAS	GGGGACAAAATGGCGATGGC
hPromLongDel4LAS	GGGCGTTCTCATTTTTCTACTGCTC
hPromLongDel5LASBglII	CGTGAGATCTGTCGCATGCGGTCAAC
mPromLongFmlul	CGATCACGCGTCTGAAAAGAGAGCGTACACCCATCC
mPromLongRbglII	GCACAGATCTAGAGATGGATCAACACGCGGC
mPromShortFmlul	CGTACACGCGTGCAAGGTGGTTAAGAGTTAGAACAGGG
mPromShortRbglII	GCACAGATCTGGTGCCTGCAGAAACGGTGACACG
mCD98hc_short_S_5UTR	CTTAGCTAGCGCCGTGTCGTGTCACCGTTTC
mCD98hc_long_S_5UTR	CTTAGCTAGCTCCATACGTTGAGGCGATTTC
mCD98hc_AS_polyAsignal	GAGGCAGGGGTGATGTTTTTATTG
A human	CTTGCCCACACACCCCAAAC
B human	GAGCCACCATCTGACCGCAAG
C human	GGTAATCGAGACGCCCTTCAG

A mouse	CTAAGCCGCGTGTTGATCCATCTC
B mouse	GGATTAGAGCTGCCTCACTGACTACAGG
C mouse	CAAGTACTCCAGATGGCTCTTCAGACC

Table 2 Oligonucleotides.

Section 4: Additional projects

During my PhD fellowship, I developed two additional research projects investigating different aspects of CD98hc. As specified in section 1.5, one of these projects focuses on the comparative function of alternative and canonical CD98hc variants. It is complementary to the main research presented in section 3; however, its state of development is too premature to draw any biological conclusion. The other project addresses CD98hc's role in integrin-mediated mechanosensing and it was suspended due to the lack of conclusive results.

4.1. CD98hc canonical and alternative variant functional study

4.1.1. Introduction

The results presented in section 3 open a complementary line of research concerning the functionality of CD98hc new variants in comparison to the previously studied canonical variant. Some ideas can be drawn from the protein sequence analysis presented previously: the differential N-terminal fragment of alternative CD98hc variant probably lacks intrinsic 3D structure and is unlikely to affect substantially the known CD98hc functions (see Fig 21). CD98hc alternative variant will probably maintain its ED conformation, and therefore the interactions with partners mediated by that domain—all except integrins—will not substantially change. It might not be the same case for CD98hc-integrin interaction; the necessary amino acid residues for this interaction are in the interphase between the TMD and the intracellular tail (positions 82–86 in the canonical variant, WALLL), but the distal part of that intracellular tail might play a role in stabilizing or destabilizing the interaction. CD98hc alternative variant could display a different affinity or a preference for some integrin types, or even a steric impediment for the binding. Finally, all published studies addressing CD98hc binding of partners have been performed on CD98hc canonical variant. The additional fragment of alternative variant could provide ground for the interaction with new partners.

CD98hc exerts its biological functions thanks to its protein partners. Potential new partners or changes in the binding affinity or stability with existing ones could affect CD98hc role in its related cellular processes, such as cell proliferation and survival, spreading or ECM assembly.

The project presented here, complementary to that of section 3, aims at determining whether the N-terminal difference between alternative and canonical variant affects CD98hc partner binding capacity and, as a consequence, its functionality. The results, although necessary for the project progress, are preliminary and do not allow us to fully answer the question posed. This work will be further developed by future lab members.

4.1.2. Results

Being the first study to investigate CD98hc alternative variant function, we decided to use the mouse CD98hc variants for the lower mouse *CD98hc* locus complexity, thanks to the

absence of intermediate exons 1c, 1d and 1e. We developed two complementary lines of research addressing (i) the search of CD98hc variant-specific protein partners and (ii) the study of cellular functions impacted by CD98hc variants.

4.1.2.1. CD98hc alternative variant interactome

To comparatively assess the binding partners of CD98hc canonical and alternative variants, we decided to perform a pull-down assay on mammalian cell protein extracts using CD98hc variants as bait. Given the lack of variant-specific antibodies, we evaluated different protein production and tagging strategies to generate a suitable bait protein.

First, we assessed the production of alternative or canonical intracellular CD98hc tails in *Escherichia coli*, fused in their C-terminus to either GST or poly-histidine (6xHis) tags for subsequent purification (Fig 27 A), in an IPTG-inducible system. Full bacterial lysates were analyzed after incubations of 3 h at 37° C or 16 h at 23° C post IPTG induction. Immunoblotting after SDS-PAGE reveals the presence of at least 3 of the 4 exogenous fusion proteins (Fig 27 B). Conversely, CD98hc canonical 6xHis was not expressed in a sufficient amount for this detection system; being the smallest of the fusion proteins (8.3 kDa), it was probably too small for proper bacterial production and most likely targeted for degradation. Results were the same when analyzing separately the soluble and insoluble fraction of the lysates (data not shown).

The initial amount of bait protein required for a tag-based purification, subsequent pull-down on mammalian protein extracts and final determination of target proteins by mass spectrometry is highly dependent on the biochemistry of the protein itself and its interactions, but it generally ranges the 10^{-4} - 10^{-6} g (micrograms) order of magnitude. Unfortunately, when analyzing bacterial protein extracts by Coomassie blue after SDS-PAGE separation, a technique with a sensitivity of approximately 50-100 ng per band, we were unable to differentiate highly expressed bands compatible with the molecular weights of exogenous fusion proteins, as opposed to the control protein GFP-GST (Fig 27 C). GST-based purification did not succeed in enriching the samples in exogenous protein to the required levels and detection remained only possible by Western blotting. Further optimization could have slightly improved the yield, but it was very unlikely to reach the required levels. With these results, we concluded that the tested strategy was not efficient enough to produce the required exogenous protein quantity.

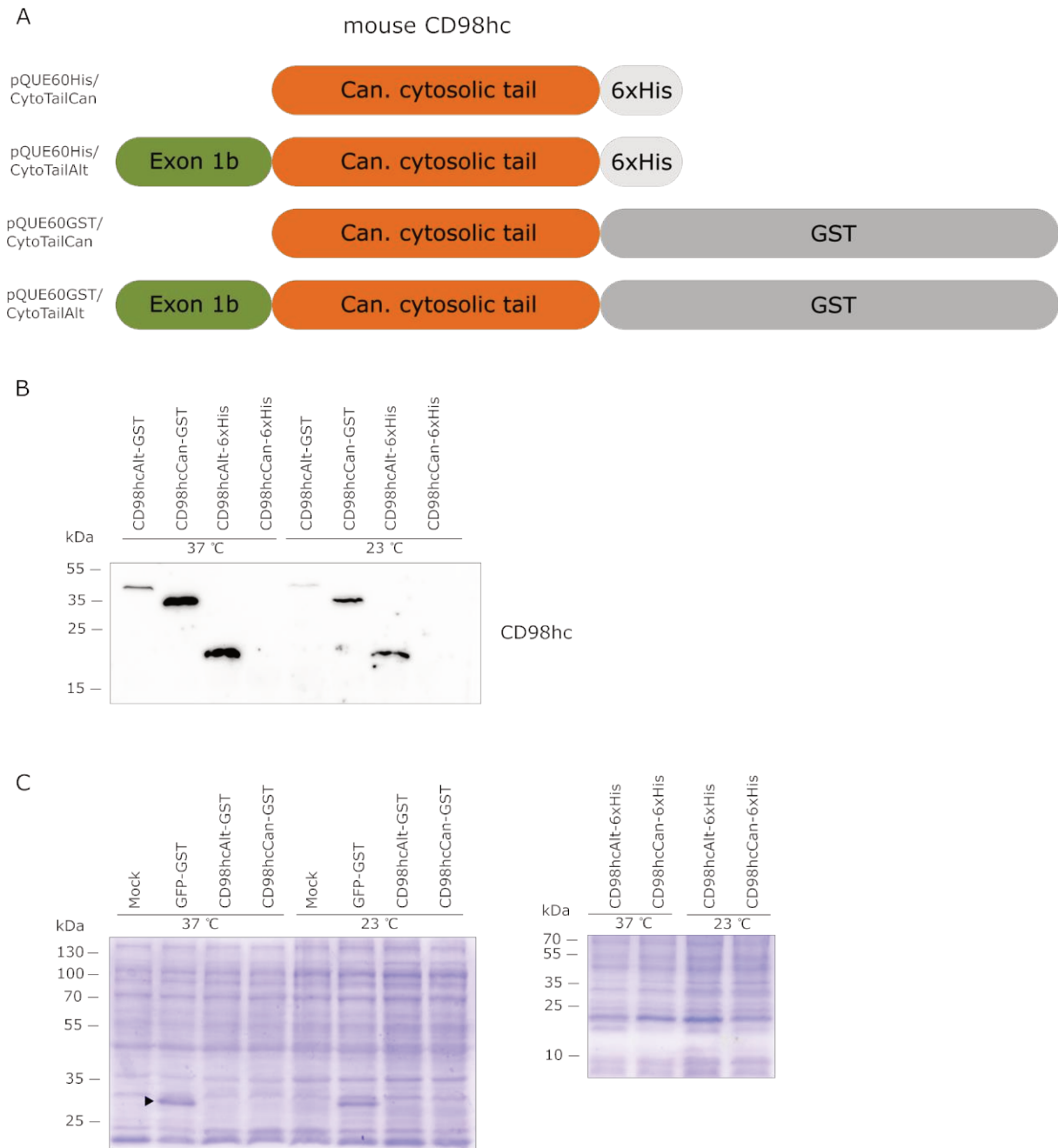

Fig 27. CD98hc cytosolic tail fusion proteins are not expressed at the required level in *Escherichia coli*. (A) Schematic representation of the fusion or tagged proteins. CD98hc's exon 1b is represented in green while the fragment of the intracellular tail common to all variants is represented in orange. Tags are marked grey. (B) Rosetta (BL21 derivatives) *E. coli* cells transformed with expression plasmids of the indicated tagged protein were incubated for the indicated period and temperature after IPTG protein expression induction. Cells were then lysed and subjected to SDS-PAGE and immunodetection with an anti-CD98hc antibody. (C) Samples were obtained as before and subjected to Coomassie blue staining after SDS-PAGE. GFP-GST fusion protein is indicated by an arrowhead.

Although efficient exogenous protein expression is a highly complex process, one of the possible reasons affecting CD98hc fusion protein's expression is the lack of the proper biochemical microenvironment. CD98hc's intracellular tail alone is short, disordered and lacks

the TM domain for stabilization. Therefore, we shifted to a protein expression system in mammalian cells to allow expression of the full protein in the proper membranous environment. In addition, to minimize potential contaminants among CD98hc binding partners, we selected a pull-down strategy based on tandem affinity purification (TAP), a two-step sequential purification process based on two different tags: calmodulin binding peptide (CBP) and protein A domain (Fig 28 A).

HeLa cells were transfected with the corresponding constructs and the exogenous protein expression was confirmed by flow cytometry (Fig 28 B) without cell permeabilization treatment, confirming also the subcellular localization at the plasma membrane. Cells were then lysed to perform TAP on the protein extracts (Fig 28 C). The fusion proteins show the expected electrophoretic mobility and are immunoreactive to antibodies against CD98hc and CBP. Unfortunately, the cleavage by Tobacco Etch Virus (TEV) protease was not efficient enough, leaving the majority of the tagged protein attached to the IgG beads (Fig 28 D, lanes D and F) and unavailable for the second purification step. TEV low efficiency is a rare but known, unpredictable TAP's potential complication, due to protein three-dimensional structure and cleavage site availability. The only effective solution recommended is an increase in protease concentration. Unfortunately, a 5-fold increase in TEV concentration – up to 150 U of TEV, an amount able to cleave 3 mg of target protein in optimal conditions— did not improve cleavage efficiency significantly (Fig 28 E).

The TAP system is designed as a two-step purification to reduce the unspecific proteins in the final product. However, most pull-down approaches include only a single-step purification. Therefore, we wanted to test the product of the first purification step for potential CD98hc binding partners. An SDS-PAGE separation of the purification product and subsequent staining with Coomassie blue (Fig 28 F) yielded a band compatible with the tagged versions of canonical and alternative CD98hc variants respectively, but we found no further differential bands that could account for variant-specific partners. As control, we performed an immunodetection of CDD98hc partners previously described in the literature, such as $\beta 1$ and $\beta 3$ integrins (Fig 28 G). Although antibodies targeting $\beta 1$ and $\beta 3$ integrins yield specific bands when analyzing the full cell lysate, after purification, the bands detected by the α - $\beta 1$ and α - $\beta 3$ antibodies fully overlap with that of TAP-tagged CD98hc, now enriched in the sample. Conversely, we did not observe any overlapping with the endogenous human CD98hc

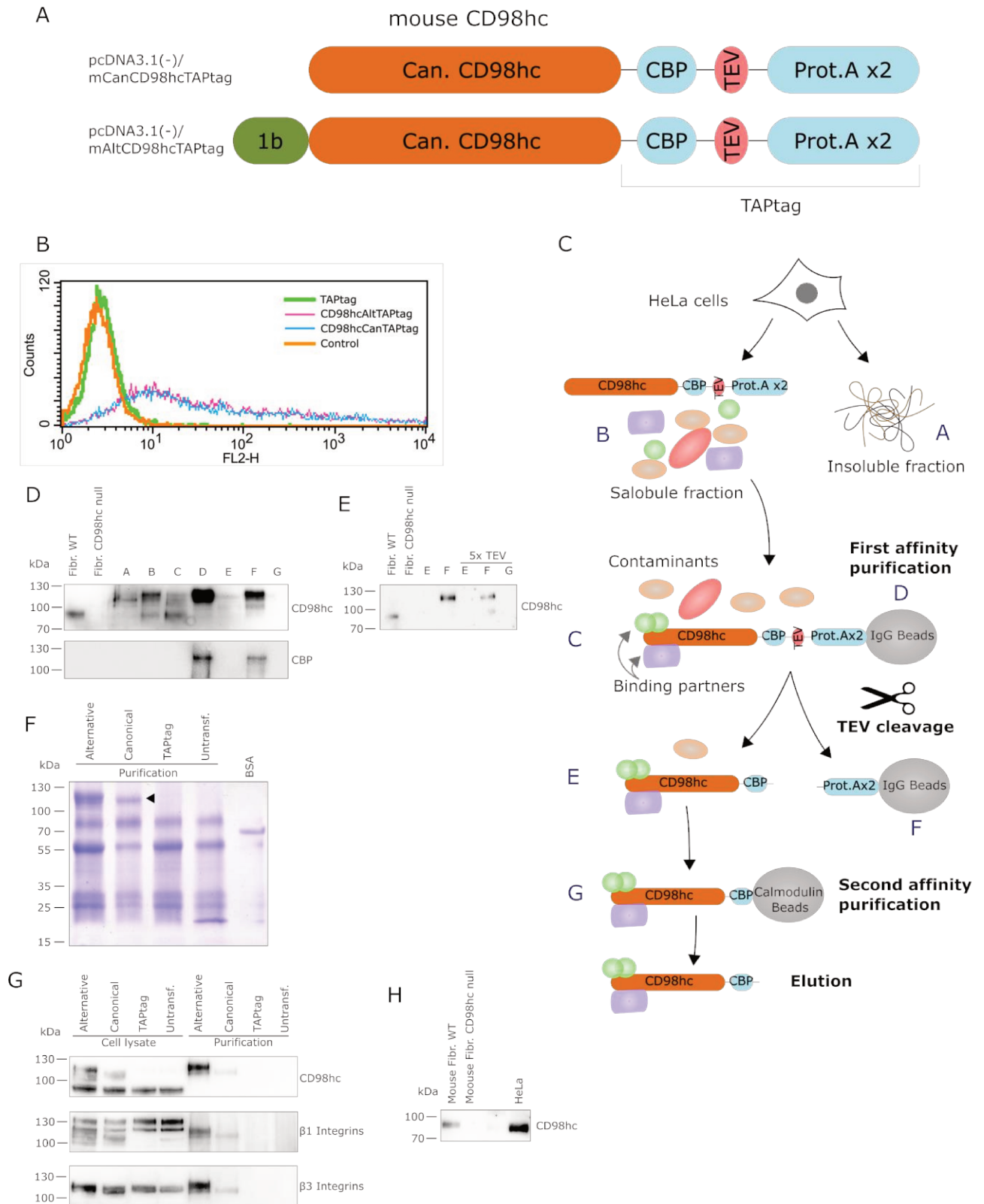

Fig 28. Expression and purification of TAP-tagged CD98hc variants in mammalian cells. (A) Schematic representation of the tagged proteins. CD98hc's exon 1b is represented in green while the fragment of the intracellular tail common to all variants is represented in orange. TAPtag contains Calmodulin Binding Peptide (CBP), Tobacco Etch Virus (TEV) protease cleavage site and protein A domain. (B) Cell cytometry analysis of cell surface expression of mouse CD98hc on HeLa cells. Cells were transfected with expression plasmids of only the TAPtag (green, control), CD98hc alternative (pink) or canonical

(blue) variant. Orange shows a staining with irrelevant IgGs. (C) Schematic representation of the tandem affinity purification process. (D and E) Fractions from the tandem affinity purification were subjected to SDS-PAGE and immunodetection of CD98hc or CBP with 1x or 5x TEV concentration. Results shown correspond to the purification of CD98hc alternative variant tagged protein. (F) Fractions D from the tandem affinity purification were subjected to SDS-PAGE and Coomassie staining. Arrowhead indicates the bands corresponding to CD98hc tagged proteins. HeLa cells expressing only the tag or untransfected were used as control. Last lane contains 100 ng of bovine serum albumin (BSA). (G) Total cell lysates or fractions D from the tandem affinity purification were subjected to SDS-PAGE and immunodetection of CD98hc, $\beta 1$ or $\beta 3$ integrins. All immunodetection reactions were performed sequentially on the same membrane, applying a stripping protocol after each one. (H) Total cell lysates of mouse or human cells were subjected to CD98hc immunodetection after SDS-PAGE.

(lower band) only present in the total lysate and detectable due to the cross-species reactivity of the α -CD98hc antibody (Fig 28 H). This is most likely due to the capacity of the uncleaved protein A domain to bind antibodies nonspecifically during the immunodetection process. As a result, we cannot conclude whether CD98hc alternative variant binds to $\beta 1$ and $\beta 3$ as the canonical variant does.

Even if the impossibility to cleave the Protein A tag prevented us of using this approach to identify variant-specific CD98hc partners, bait protein expression in HeLa cells was significantly more efficient than in the previous bacterial setup. Thus, we decided to maintain this experimental system while changing the TAP by a single-step pull-down strategy based on the FLAG tag (Fig 29 A). First, we evaluated the expression of both canonical or alternative CD98hc variants fused to three repetitions of the FLAG tag at the C-terminus. 48 h post transfection, HeLa cells presented exogenous mouse CD98hc expression at the plasma membrane, as judged by flow cytometry in non-permeabilizing conditions (Fig 29 B). Additionally, FLAG immunodetection after SDS-PAGE yielded bands with the expected electrophoretic mobility, more clearly after deglycosylation of the protein extracts (Fig 29 C). In conclusion, FLAG-tagged CD98hc variants are correctly expressed in HeLa cells at the plasma membrane, at a higher level than previously tested tagged proteins, and do not show significant degradation.

Performing a pulldown assay of FLAG-tagged CD98hc variants in mammalian cells is a future interest of our laboratory to investigate the respective protein partners. The pull-down products could be analyzed by mass spectrometry to identify partners and spot differences between the two CD98hc variants. These results could, then, be confirmed by alternative immunoprecipitations and be further investigated from a functional point of view.

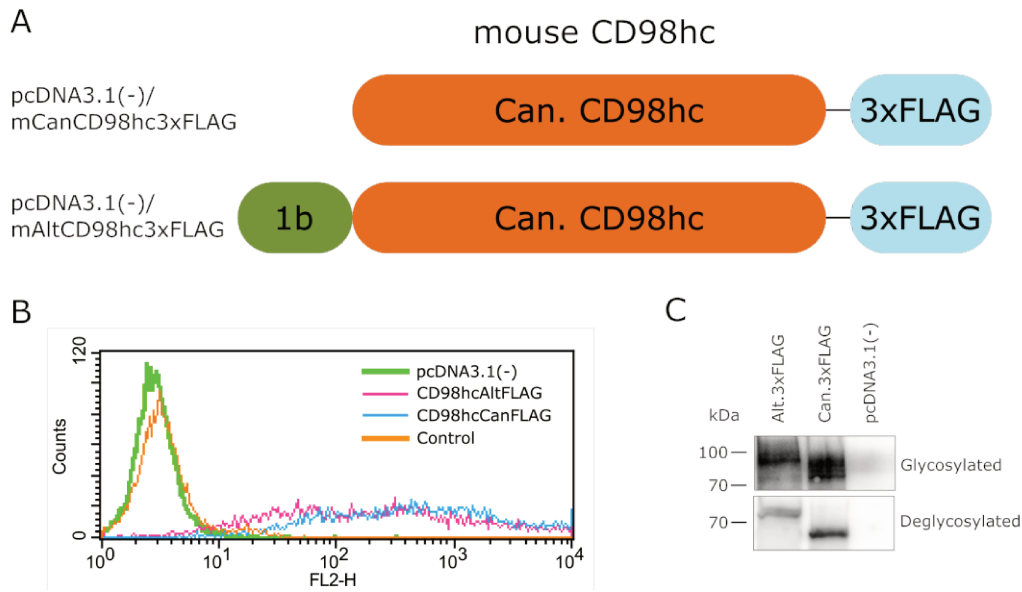

Fig 29. Expression of FLAG-tagged CD98hc variants in mammalian cells. (A) Schematic representation of the tagged proteins. CD98hc's exon 1b is represented in green while the fragment of the intracellular tail common to all variants is represented in orange. 3 copies of the FLAG tag sequence are fused at the C-terminus. (B) Cell cytometry analysis of cell surface expression of mouse CD98hc on HeLa cells. Cells were transfected with expression plasmid empty (green, control), or containing CD98hc alternative (pink) or canonical (blue) variant. Orange shows a staining with irrelevant IgGs. (C) Total cell lysates of transfected HeLa cells were subjected to FLAG immunodetection after SDS-PAGE and, when indicated, PNGaseF deglycosylation treatment.

4.1.2.2. CD98hc alternative variant functional study

To fully understand the implications of CD98hc alternative variant discovery, it is necessary to determine whether canonical and alternative CD98hc variants are implicated in the same cellular functions, in parallel to identifying and comparing their binding partners.

We had previously observed that transfected HeLa cells are able to express exogenous mouse CD98hc with a variety of tags. This is also the case for the untagged protein (Fig 30 A). To perform cellular functional analysis, we introduced alternative or canonical CD98hc variants in mouse dermal fibroblasts isolated and SV-40-immortalized from CD98hc dermal conditional Fsp1-Cre, CD98hc^{fl/fl} KO mice (further referred to as KO or CD98hc-null fibroblasts), and control CD98hc^{fl/fl} littermates (referred to as WT fibroblasts) (Tissot et al., 2018). First, CD98hc-null fibroblasts were stably transfected with pBabe_puro/mCanCD98hc or pBabe_puro/mAltCD98hc and CD98hc expression was detected by Western blot (Fig 30 B) and flow cytometry at the plasma membrane (Fig 30 C). Unfortunately, five weeks after transfection, the fibroblasts showed decreased CD98hc expression even when kept under antibiotic selection (puromycin) (Fig 30 D), probably due to antibiotic resistance acquired

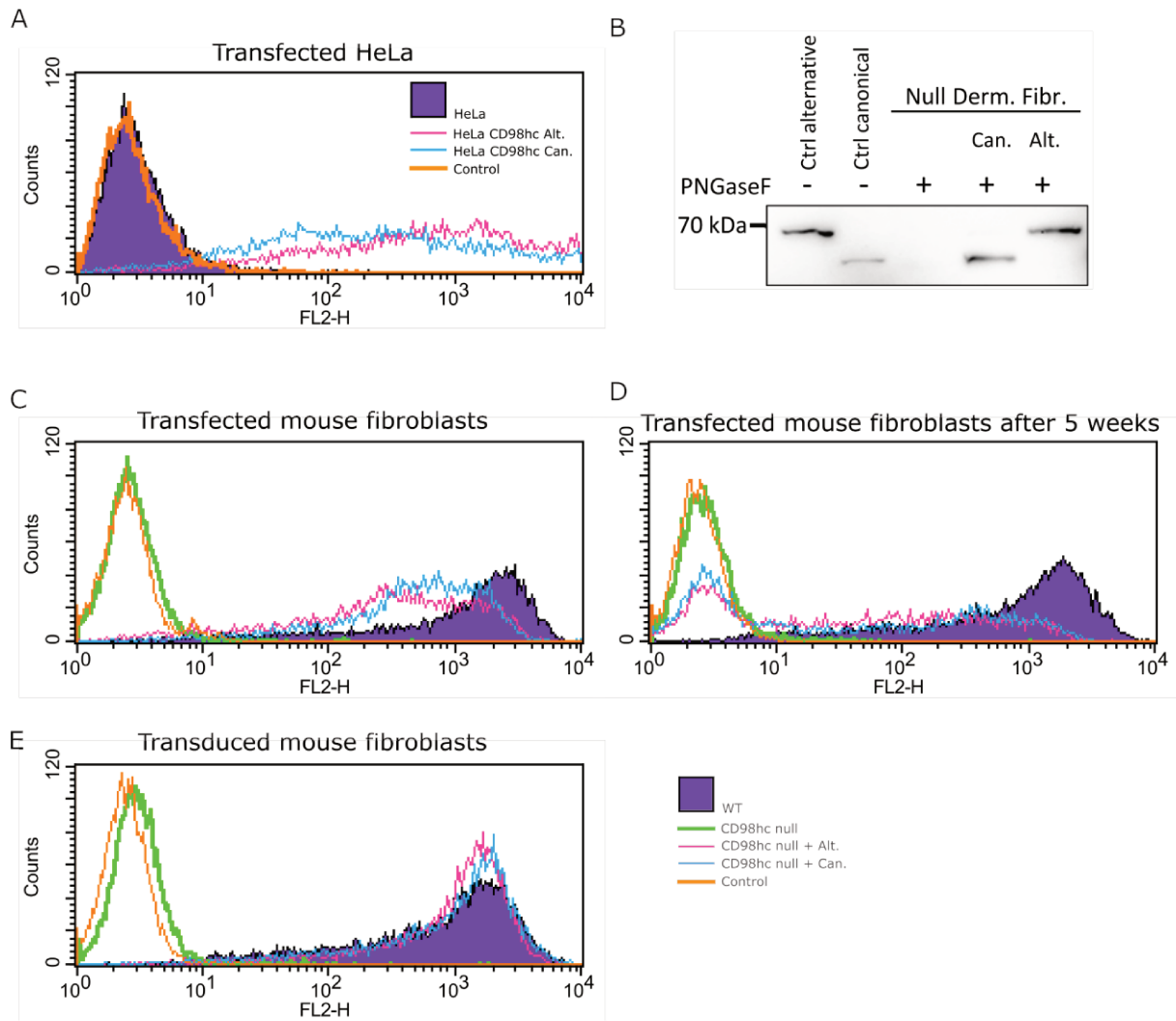

Fig 30. Expression of exogenous CD98hc in CD98hc-null mouse dermal fibroblasts. (A) Cell cytometry analysis of cell surface expression of mouse CD98hc on HeLa cells. Cells were untransfected (solid dark blue, control), or transfected with plasmid containing CD98hc alternative (pink) or canonical (light blue) variant. Orange shows a staining with irrelevant IgGs. (B) Western blot performed on cell lysates of mouse dermal fibroblasts after PNGase F enzymatic deglycosylation reaction. Lanes 1 and 2 correspond to in vitro transcribed and translated CD98hc alternative or canonical protein. (C, D and E) Cell cytometry analysis of cell surface expression of mouse CD98hc on CD98hc-null mouse dermal fibroblasts. Cells were stably transfected (immediately after selection or five weeks after transfection) or transduced with CD98hc alternative (pink) or canonical (light blue) variant. WT fibroblasts were used as control (solid dark blue). Orange shows a staining with irrelevant IgGs.

independently of exogenous CD98hc expression and plasmid loss. To overcome this limitation, we applied virus-mediated genome integration of the CD98hc-expression cassette. CD98hc null dermal fibroblasts were transduced with retroviral vectors and, after antibiotic-selection and amplification of positive cells, CD98hc expression was observed at levels equivalent to the WT cells (Fig 30 E). After this, CD98hc protein expression was monitored frequently to ensure a stable level in the population used for functional experiments. The

same strategy was used to generate WT dermal fibroblasts overexpressing exogenous alternative or canonical CD98hc (data not shown) to evaluate the possibility of a dominant negative effect of one variant over the other.

CD98hc affects both cell proliferation and cell survival. Its ablation results in a dramatic decrease of overall cell growth both in vivo and in vitro (Boulter et al., 2013; Cantor et al., 2009; De La Ballina et al., 2016; Feral et al., 2005). Therefore, we analyzed cell growth in WT, CD98hc-null and reconstituted fibroblasts with canonical or alternative CD98hc. Unexpectedly, there was no significant difference in the growth of all fibroblast populations tested, including CD98hc null (Fig 31 A). These results are in conflict with previous publications (De La Ballina et al., 2016). More importantly, when allowing cells to stay in culture after confluency, all CD98hc-null lines continued growing as opposed to the growth arrest saw in WT cells as an expected result of cell-cell contact inhibition (Fig 31 B). We concluded that CD98hc-null cells have bypassed CD98hc role in cell growth and become refractory to cell-cell contact growth inhibition, probably prior to exogenous *CD98hc* genome integration.

CD98hc ablation produces a dramatic decrease in cell spreading. On the other hand, it has no effect on integrin affinity for their ligands or on cell static adhesion to Fn and Ln (Feral et al., 2005). In parallel to the previous cell growth test, we analyzed cell adhesion and spreading on integrin substrates. We analyzed cell surface of WT and CD98hc-null fibroblasts expressing exogenous canonical or alternative CD98hc during 5 hours after plating on Fn-coated plates. CD98hc-null cells show a minor spreading defect rescued by both CD98hc variants (Fig 31 C). However, this defect is much less important than that described before for mouse ES cells and ES-derived fibroblasts (Fig 31 C, lower panel).

We also wanted to assess cell static adhesion to Fn to confirm that neither of CD98hc variants could affect cell static adhesion. The adaptation of the protocol (Feral et al., 2005) to the experimental system and the available laboratory equipment required the developing of an automated quantification method by direct cell count through the generation of a pipeline with the image analysis software CellProfiler (Fig 31 D, lower panel). Prior to analyzing all the CD98hc-expressing fibroblast populations, we performed a Fn dose-response using WT and CD98hc-null fibroblasts to replicate previously published experiments and compare the Fn saturating concentration (Fig 31 D, upper panel). Cells reached the maximum static adhesion at a Fn concentration of 2.5 µg/ml, as previously described for ES-derived fibroblasts.

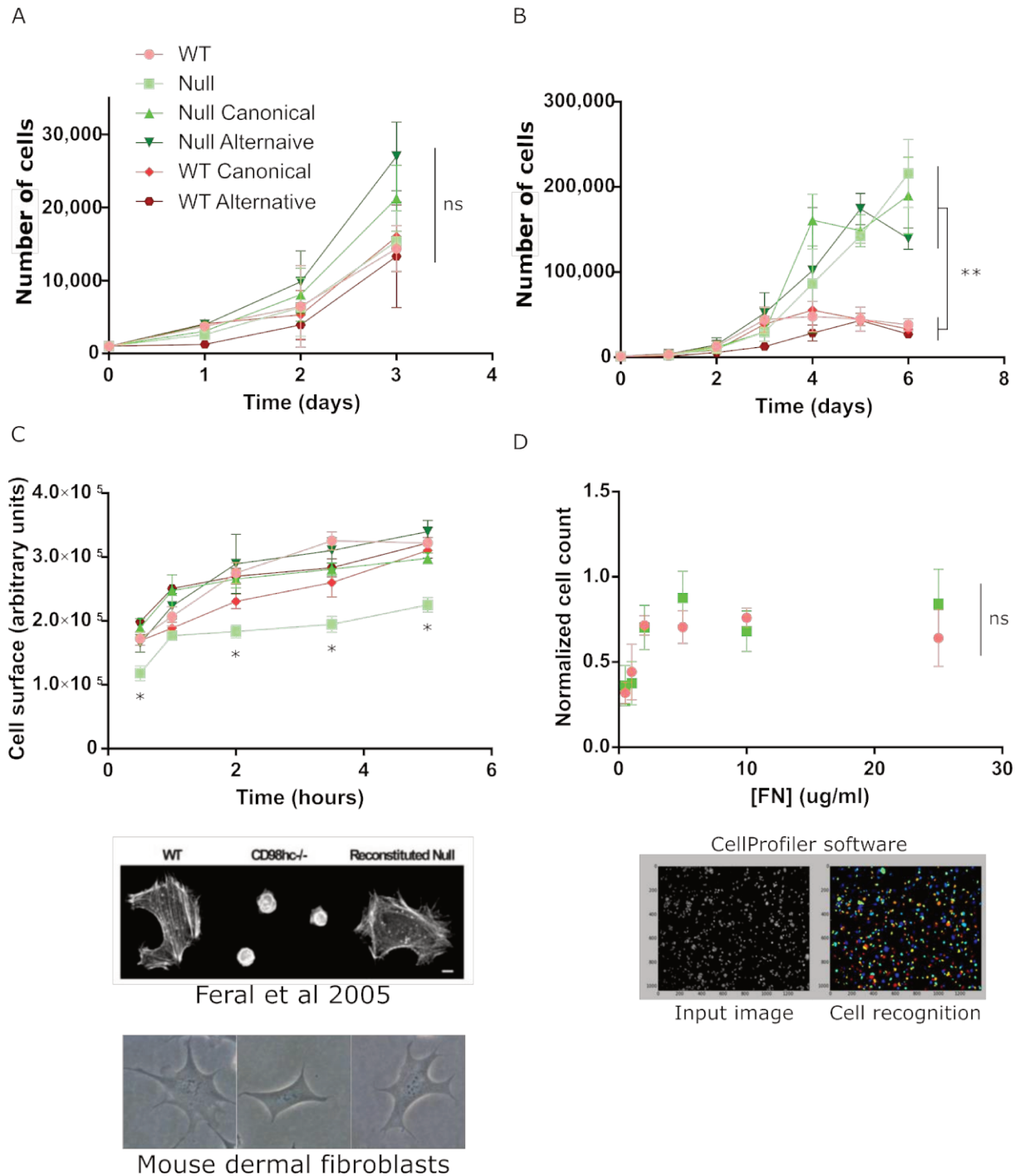

Fig 31. Functional study of CD98hc variants in mouse dermal fibroblasts. WT and CD98hc-null expressing canonical or alternative CD98hc variants when indicated were proliferation were maintained in culture to monitor cell growth compared. The experiment was stopped at pre-confluency (A) or continued for three days after confluency (B). (C, upper panel) Cells were plated on Fn-coated plates and spreading was quantified by cell surface area measurement at the indicated times. (C, lower panel) Comparison of the cell morphology of WT and CD98hc-null cells from Feral et al, 2005, and mouse dermal fibroblasts used in this study. (D, upper panel) Cells were allowed to adhere to Fn-coated plates for 60 minutes at the indicated concentrations. Non-adherent cells were washed off and adherent cells quantified by cell count. (D, lower panel) A representative pictures of the input and output images of the CellProfiler quantification pipeline. Cells are automatically individualized and marked in different colors. Results of all panels are presented as the mean and SD

of at least three independent experiments. * $p < 0.05$ and ** $P < 0.01$, after one-way ANOVA test followed by Dunnett's multiple comparison test (A, B, C) or Student's t-test (D).

The results described above regarding cell growth and spreading were obtained before further adhesion analysis were performed. They clearly show that our CD98hc null fibroblasts do not reproduce the phenotypic deficiencies previously described after CD98hc ablation in different models –including fibroblasts– and they have been able to override CD98hc deficiency. The possible reasons for this are analyzed in the discussion. For this reason, we decided not to further pursue any functional analysis with these cell lines.

KO mouse dermal fibroblasts used in previous experiments underwent CD98hc abrogation in vivo and were then isolated, immortalized and amplified prior to their experimental use. We hypothesized that they adapted to CD98hc absence and overrode its effect during this process. To allow cells to adapt to in vitro culturing conditions before *CD98hc* ablation, we used the WT (or WT expressing exogenous canonical or alternative CD98hc) CD98hc^{fl/fl} mouse dermal fibroblasts. After isolation, immortalization, amplification and, when indicated, integration of exogenous alternative or canonical *CD98hc* expression cassette, we subjected these cells to endogenous *CD98hc* ablation through Cre recombinase protein. For that, cells were transduced with Cre-coding adenoviral vectors. Unfortunately, removal of endogenous CD98hc did not reach the necessary efficiency. After protein deglycosylation treatment, we could still detect endogenous CD98hc in the Cre recombinase-treated cells (Fig 32, arrowhead) at least for the canonical variant. Additionally, when abrogating CD98hc in cells without any exogenous CD98hc expression, CD98hc was still detectable at levels close to normal. The impossibility to eliminate endogenous CD98hc could be explained by an increased CD98hc protein stability, insufficient efficiency of Cre recombinase treatment or a combination of both.

Given the fact that CD98hc KO ES cells and ES-derived fibroblasts consistently present a growth and spreading defect in the literature, we considered the observed effects specific of the population used in this study. Thus, we isolated a new fibroblast population from different individuals of the same mouse model.

CD98hc is not required for integrin expression and its abrogation does not affect integrin expression profile of ES cells or ES-derived fibroblasts. The fibroblast populations used in the previous experiments had been used in the lab for approximately 5 years and had already

been tested to confirm a constant integrin expression profile (data not shown). To confirm the integrin expression pattern of the newly isolated fibroblasts populations, we performed an integrin analysis expression by flow cytometry (Fig 33 B) as well as CD98hc expression (Fig 33 A). Integrin expression remains constant in comparison with WT fibroblasts except for a reduction of integrin $\alpha 6$ in CD98hc-null or null-derived cells. This change is not altered by the expression of exogenous CD98hc canonical or alternative variant.

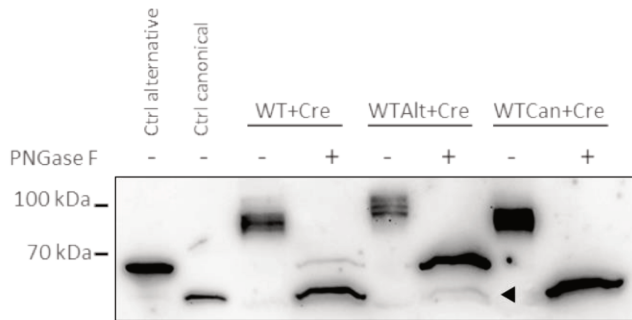

Fig 32. Endogenous CD98hc is still detectable after Cre recombinase treatment in CD98hc^{fl/fl} mouse dermal fibroblasts. Western blot performed on cell lysates of mouse dermal fibroblasts after PNGase F enzymatic deglycosylation reaction. Lanes 1 and 2 correspond to in vitro transcribed and translated CD98hc alternative or canonical protein. Lanes 3-8 correspond to CD98hc^{fl/fl} fibroblasts isolated from the mouse prior to CD98hc ablation (WT), then transduced with canonical or alternative CD98hc and subjected to AdenoCre recombinase treatment.

Finally, to analyze in parallel the spreading and cell growth capacity of the new fibroblast populations, we subjected the cells to impedance-based real time monitoring of cell population surface. In this setup, impedance measurement is proportional to well surface occupied by cells; its increase can be ascribed to adhesion and mainly spreading during the first 8-10 hours, and to cell growth for the remaining period until confluency. As shown in Fig 33 C, CD98hc-null fibroblasts show a small defect in the adhesion and spreading phase – probably due to a spreading defect— but have a growth rate equivalent to that of WT or rescued populations as measured by the function's slope between 10 and 30 hours.

Although these results should be confirmed by individual cell growth and spreading experiments as performed with the previous fibroblast populations, they suggest an equivalent phenotype in terms of cell growth and spreading for the two batches of fibroblast populations.

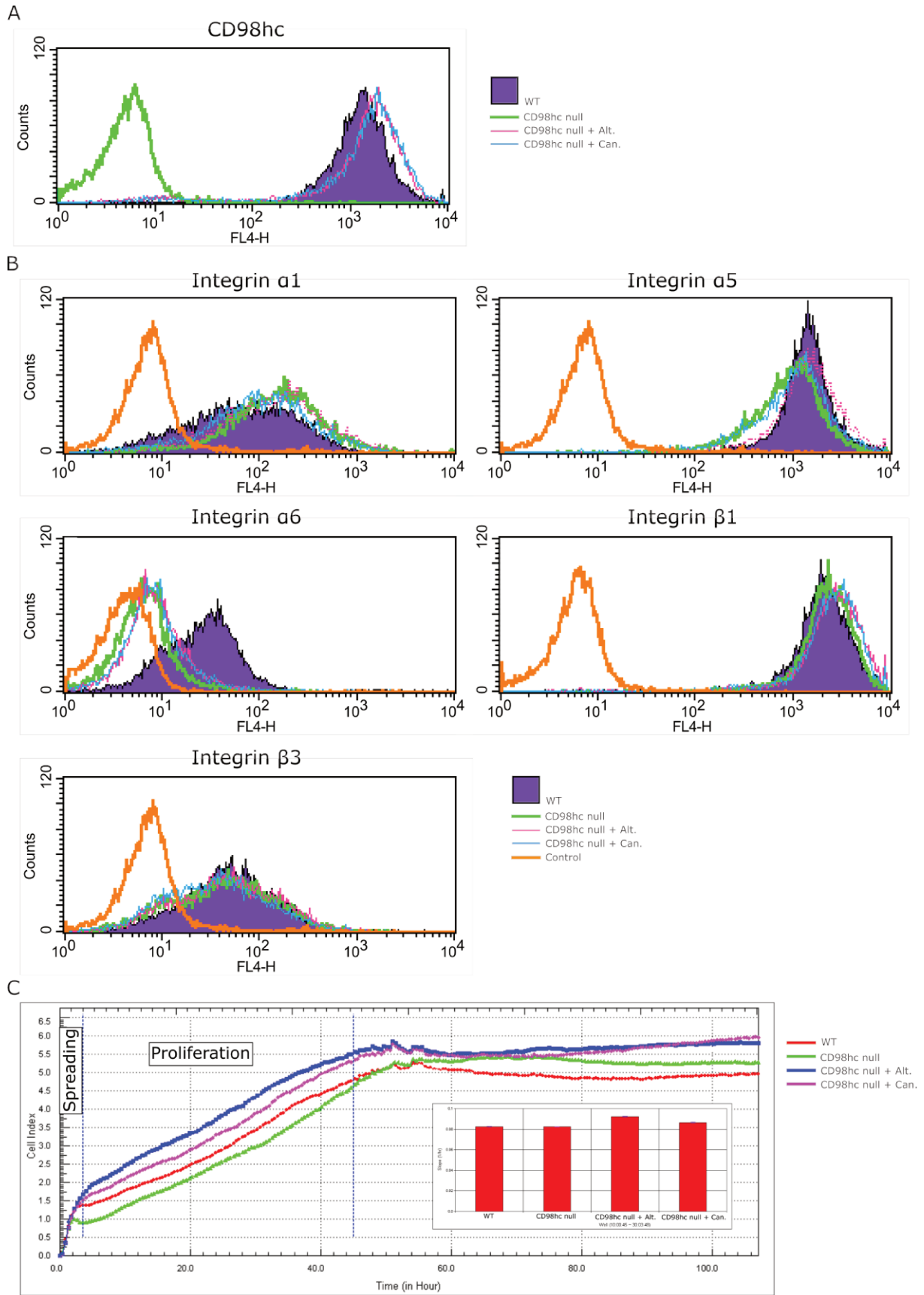

Fig 33. Exogenous CD98hc expression does not change the integrin expression profile of mouse dermal fibroblasts. (A) Cell cytometry analysis of cell surface expression of mouse CD98hc (A) or the

indicated integrin subunit (B) on CD98hc-null mouse dermal fibroblasts. Cells were transduced with CD98hc alternative (pink) or canonical (light blue) variant or not transduced (green). WT fibroblasts were used as control (solid dark blue). Orange shows a staining with irrelevant IgGs. (C) Cells were plated on well with surface electrodes, allowing to record impedance as a readout of surface occupancy along time. CD98hc-null cells (green) were transduced with alternative (blue) or canonical (pink) CD98hc. WT cells were used as control (red). The average slope of the function between 10 and 30 h is displayed in the bar graph.

4.1.3. Discussion

As already mentioned, this is an unfinished project and, as such, does not provide full answers to the original scientific questions. The presented results, however, are relevant for the future development of the research.

The presented CD98hc fusion proteins with FLAG tag have the highest expression in mammalian cells of all the tested options. Also, they allow a one-step, simple pull-down assay with a high-affinity α -FLAG antibody extensively tested in the literature (Gerace and Moazed, 2015). Hence, we can expect that identification of variant-specific CD98hc partners by mass spectrometry could be soon performed using this tool. Conversely, the prior approaches tested to the same end were not suitable and had to be abandoned due to lack of bacterial protein production or inefficient TEV cleavage. The efficiency of these two processes is extremely difficult to predict because they rely on a variety of factors, importantly three-dimensional structure of the fusion proteins and biochemical parameters that change depending on the microenvironment.

Regarding CD98hc variant-specific functionality, we can conclude that our cellular model in its current state is not suitable for the proposed approach. Our results suggest that our *in vitro* CD98hc KO fibroblast model can consistently override CD98hc deficiency to show normal cell growth and absent cell-cell contact inhibition. Cell spreading is partially impeded but to a lower extent than previously described cellular models (Cantor et al., 2009; De La Ballina et al., 2016; Feral et al., 2005). Possible factors contributing to this are discussed below.

Conditions for the maintenance of CD98hc KO cells in culture imply necessary compromises. CD98hc-deficient ES cells or ES-derived fibroblasts generated previously did not survive under standard culture conditions. CD98hc requirement for cell survival is detailed in section 1.4. Importantly, while CD98hc-mediated amino acid transport can be partially compensated via CD98hc-independent transporters, CD98hc is necessary for cystine uptake via the x_c^- system, protecting the cells from ferroptosis. Cystine, a cysteine dimer, is the only

form in which cells can import cysteine in standard culture medium. Cysteine is necessary for protein synthesis and a precursor of GSH, crucial for the maintenance of the redox balance and the protection against ROS. CD98hc-deficient cells require addition of β -Mercaptoethanol to the medium to reduce cystine into cysteine, then imported through CD98hc independent transporters (De La Ballina et al., 2016; Feral et al., 2005). Additionally, cells are immortalized through the expression of SV-40 large antigen and are maintained on stiff plastic plates, a powerful proliferative signal –plastic has around 10^6 kPa as compared to an approximate stiffness of the dermis of 4-8 kPa. As a result, cell immortalization and other proliferative signals, cysteine availability and compensation by CD98hc-independent amino acid transporters partially bypass CD98hc functions and reduce CD98hc-null defective phenotypes.

The presented model is in use in our laboratory in different projects, notably in the deciphering of CD98hc-mediated crosstalk between dermis and epidermis. For this reason, we were interested in characterizing the variant-specific CD98hc functionality in the presented in vitro model to potentiate synergy among different laboratory research lines. However, for the future development of this project and in the light of the results presented in this report, we suggest applying the functional study described here to CD98hc-deficient ES cells or ES-derived fibroblasts characterized in previous publications.

A considerable limitation of the proposed approach lies on the heterogeneity of cell types and conditions upon which CD98hc is expressed and the variety of process for which it is relevant. If CD98hc alternative variant has a differential function, it might only be relevant to a specific subset of those conditions and processes. In our expression analysis of GTEx data (Fig 18), only the cerebellum has a higher (2-3 fold) expression of the alternative CD98hc, suggesting a possible role of this variant in that organ, maybe through amino acid transport.

Unfortunately, we lack expression data under different stimuli or stress conditions; two lines of future research could shed some light in this direction. Firstly, the study of the comparative transcriptional regulation of the two CD98hc variants could identify transcriptional regulators associated with specific cell types or processes. Secondly, comparative investigation of the CD98hc interactome will identify potential differential CD98hc partners for each variant. Altogether, the different lines of research will be complementary in determining the conditions or stimuli upon which CD98hc alternative and

canonical variants perform different tasks and the full versatility of CD98hc as a signal integrator molecule.

CD98hc alternative variant is present only in mammals and includes one additional exon. Furthermore, a subset of mammals, the simians, present not only one but four additional exons with the possibility of alternative splicing (exons 1c, 1d and 1e). Although less conserved, these exons could have a functional meaning as well, increasing the complexity of future studies due to the potential number of different alternative splicing variants. The work presented here has focused on CD98hc alternative variant including only exon 1b due to its conservation along the mammalian clade. The relevance of the multiple alternative variants present in simians will have to be assessed in the future.

The *in vitro* approaches used and proposed here provide advantages such as high capacity to standardize experimental conditions, simplicity of the experimental system and the availability of accessible genetic modification and exogenous protein expression techniques. Nevertheless, *in vivo* studies will eventually be needed to complete our understanding of CD98hc canonical and alternative variants. Variant-specific knockout cell and, eventually, mouse models can be a useful tool for this purpose, but the overlapping of the two variants in the genome poses some difficulties. To disrupt the alternative variant, both exon 1b as well as the start codon and the alternative promoter region, can be targeted for deletion. However, it is highly complicated to individually target the canonical variant in the genome; the only possibility of doing it without disrupting the alternative variant would be by targeting the 5'UTR and the TSS, but this does not guarantee a successful removal of the canonical variant and could affect alternative variant transcription or splicing.

Overall, the work presented in this section highlights important aspects of CD98hc's role in cellular processes, generates research tools, explores the limitations of the proposed approach and paves the way for the future development of a full research project to understand the potential functional differences between CD98hc variants in mammals.

4.2. CD98hc in integrin-mediated mechanosensing

4.2.1. Introduction

The response of individual cells to mechanical forces is of extensive interest in biology, as it affects many characteristics of cell behaviour (Hoffman and Crocker, 2009). The cell's ability to convert an applied physical force into a biochemical signal that induces a cellular response is known as mechanotransduction. It has been identified as a key process for development, cell migration, ECM homeostasis or tumor development among others (Iskratsch et al., 2014; Paluch et al., 2015). Particularly, cells can assess the deformability of its environment using the cytoskeleton contractility to pull on it through adhesion molecules such as integrins. If the ECM generates a force opposing its deformation, it will trigger a cellular signalling cascade. Force application on integrin receptors triggers cytoskeletal rearrangements and adhesion complex growth (Choquet et al., 1997; Matthews et al., 2006; Wang et al., 1993) in a process dependent on RhoA activation (Guilluy et al., 2011). This mechanotransduction process is known as stiffness sensing.

CD98hc has recently been shown to be necessary for integrin-mediated stiffness sensing through RhoA/ROCK signaling in skin both in vivo and in vitro. Its loss compromises ECM stiffness sensing, leads to a marked decrease of matrix rigidity and reduces tumor development. Moreover, CD98hc participates in sensing and generating a stiffer environment, a strong proliferative signal (Estrach et al., 2014).

CD98hc ED three-dimensional structure suggests a high movement capability for helices $\alpha A5$ and $\alpha A6$ as shown by their high b-factor. The cysteine residue at the position 330 (C330), placed behind these two helices and normally not exposed, might become accessible upon force application, thus allowing a protein-protein interaction (Fig 34 A). Preliminary results from our laboratory suggest that C330 plays a crucial role in stiffness sensing: a mutant in which C330 has been substituted by a serine is not able to rescue RhoA activation after 5 minutes of magnetic force application on integrins in mouse dermal fibroblasts, an established readout to assess stiffness sensing (Fig 34 B). We hypothesized that CD98hc might be a mechanosensor itself through a mechanism implicating the exposure of C330 upon force application.

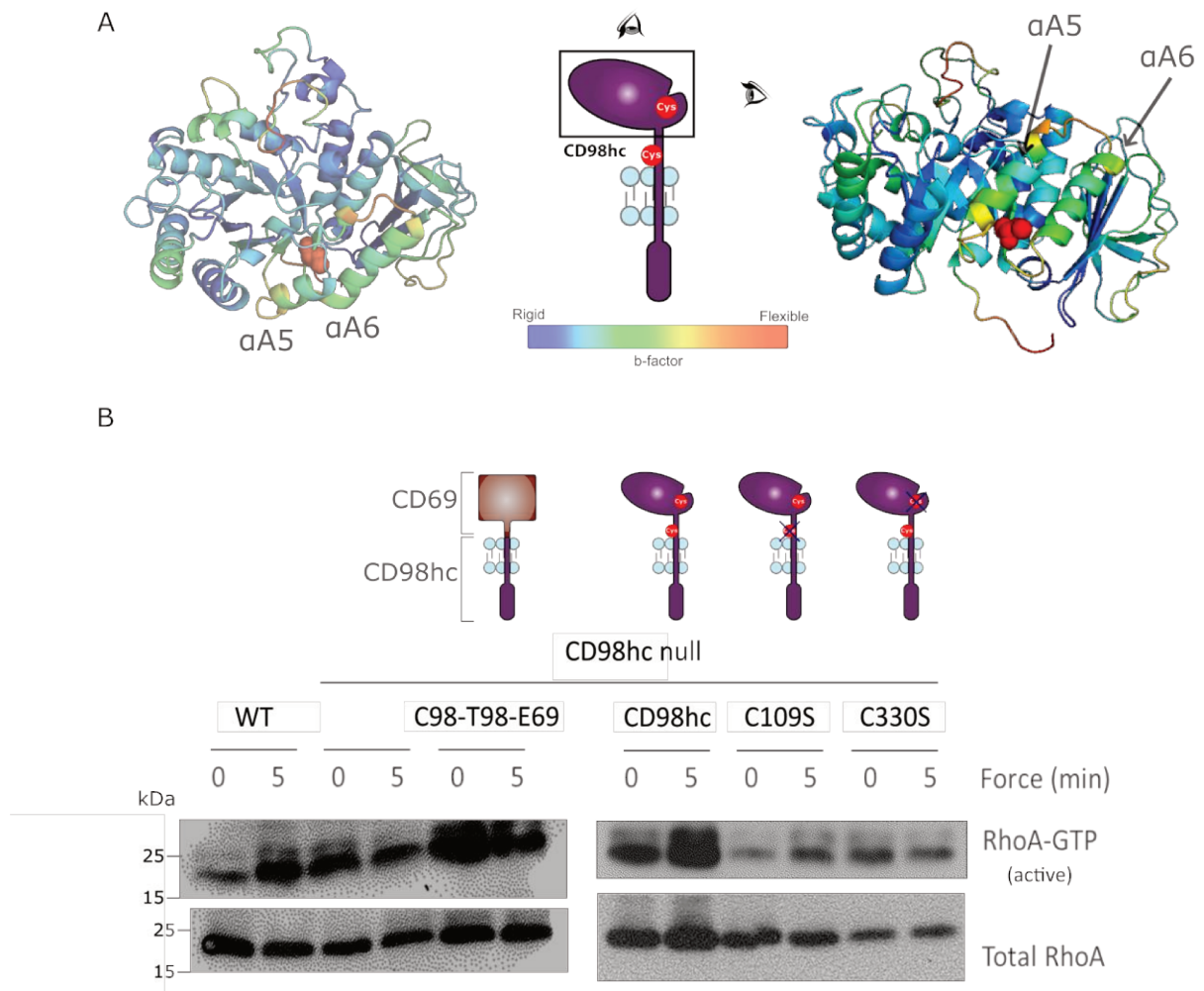

Fig 34. CD98hc ED 3D structure and preliminary results suggest that C330S could have a role in integrin-mediated mechanosensing. (A) CD98hc 3D structure of the ED domain (Fort et al., 2007) from apical (left) and lateral (right) view. Color code represents the b-factor (flexibility). Cysteine 330 is marked in red. Helices α A5 and α A6 are indicated. (B) Immunodetection of GTP-bound RhoA (active) or total RhoA in cell protein extracts after magnetic mechanical force application on integrin receptors. Mouse dermal fibroblasts are WT or CD98hc-null expressing, when indicated, exogenous CD98hc-CD69 chimera protein lacking all CD98hc's ED domain or CD98hc mutants lacking cysteine 109, 330 or both.

Hence, the aims of this project were (i) to understand the molecular mechanism behind the necessity of the C330 for integrin-mediated stiffness sensing and (ii) to assess the CD98hc C330 importance in skin mechanotransduction-related processes.

4.2.2. Results

The information shown in Fig 34 B is the result of a single experiment. Hence, we first wanted to confirm the importance of C330 in integrin-mediated stiffness sensing. Using the previously described in vitro model of CD98hc-deficient mouse dermal fibroblasts, we

introduced human CD98hc cysteine to serine substitution mutants for one or the two existing cysteines (C109S, C330S or Cysless), via retroviral vector-mediated genome integration. All the populations expressed homogenous levels of the corresponding human CD98hc mutant at the plasma membrane as judged by non-permeabilizing flow cytometry (Fig 35 A). General characterization of cell spreading and growth by impedance-based real time monitoring of cell population surface shows how the defect in both the spreading and the growth phase of CD98hc defective cells is partially rescued by genome integration of WT human CD98hc but not by the C330S mutant, in agreement with the participation of stiffness sensing in these two cellular processes (Fig 35 B).

Before any further functional characterization, we wanted to confirm the preliminary experiment presented in the introduction. For that, we used a previously described setup: we applied mechanical forces on integrin receptors using FN-coated paramagnetic beads and monitored RhoA activation. Unfortunately, results under this setup upon expression of the different CD98hc mutants were inconsistent. Firstly, the expected RhoA activation in WT cells and its absence in CD98hc-deficient cells was not present in all the performed experimental replicates (Fig 36 A, B). Also, expression of CD98hc mutant proteins produced inconsistent rescue of RhoA activation across experimental replicates (Fig 36 B). We then analyzed ERK phosphorylation, a pathway component upstream of RhoA activation. Again, results of ERK phosphorylation were inconsistent across experimental replicates. Also, ERK activation did not necessarily correspond with RhoA activation (Fig 36 A, B), although this could be due to insufficient technical robustness or to ERK being upstream of the mechanosensing defect in CD98hc-null cells.

In parallel, to test whether CD98hc C330S mutant had a dominant negative effect on RhoA activation, we overexpressed CD98hc C330S fused to an HA tag in HeLa cells via transfection. Yet again, results were not reproducible. C330S overexpression prevented RhoA activation in some cases while the contrary was also true in different replicates (Fig 36 C). Moreover, general RhoA immunodetection remained suboptimal and ERK or SRC –another upstream pathway component— phosphorylation were not consistently increased upon force application to substitute RhoA activation as experimental readout (Fig 36 D).

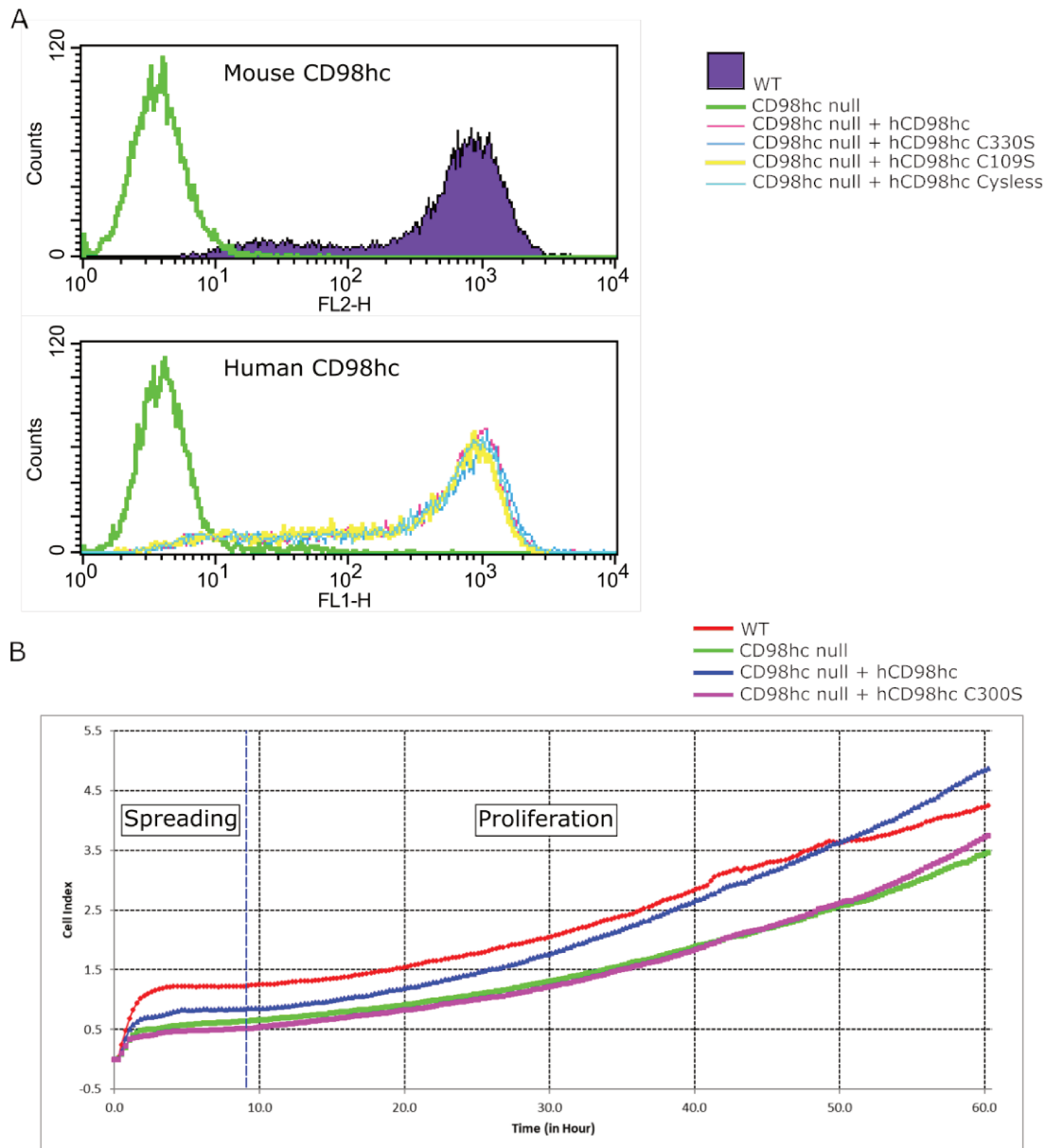

Fig 35. Expression of CD98hc, but not CD98hc C330S, in CD98hc-null fibroblasts partially rescues cell spreading and growth. (A) Cell cytometry analysis of cell surface expression of mouse or human CD98hc on CD98hc-null mouse dermal fibroblasts. Cells were transduced with CD98hc (pink) CD98hc C330S (blue), CD98hc C109S (yellow) or CD98hc cysless (light blue), or not transduced (green). WT fibroblasts were used as control (solid dark blue). (B) Fibroblasts were plated on well with surface electrodes, allowing to record impedance as a readout of surface occupancy along time. CD98hc-null cells (green) were transduced with CD98hc (blue) or CD98hc C330S (pink). WT cells were used as control (red).

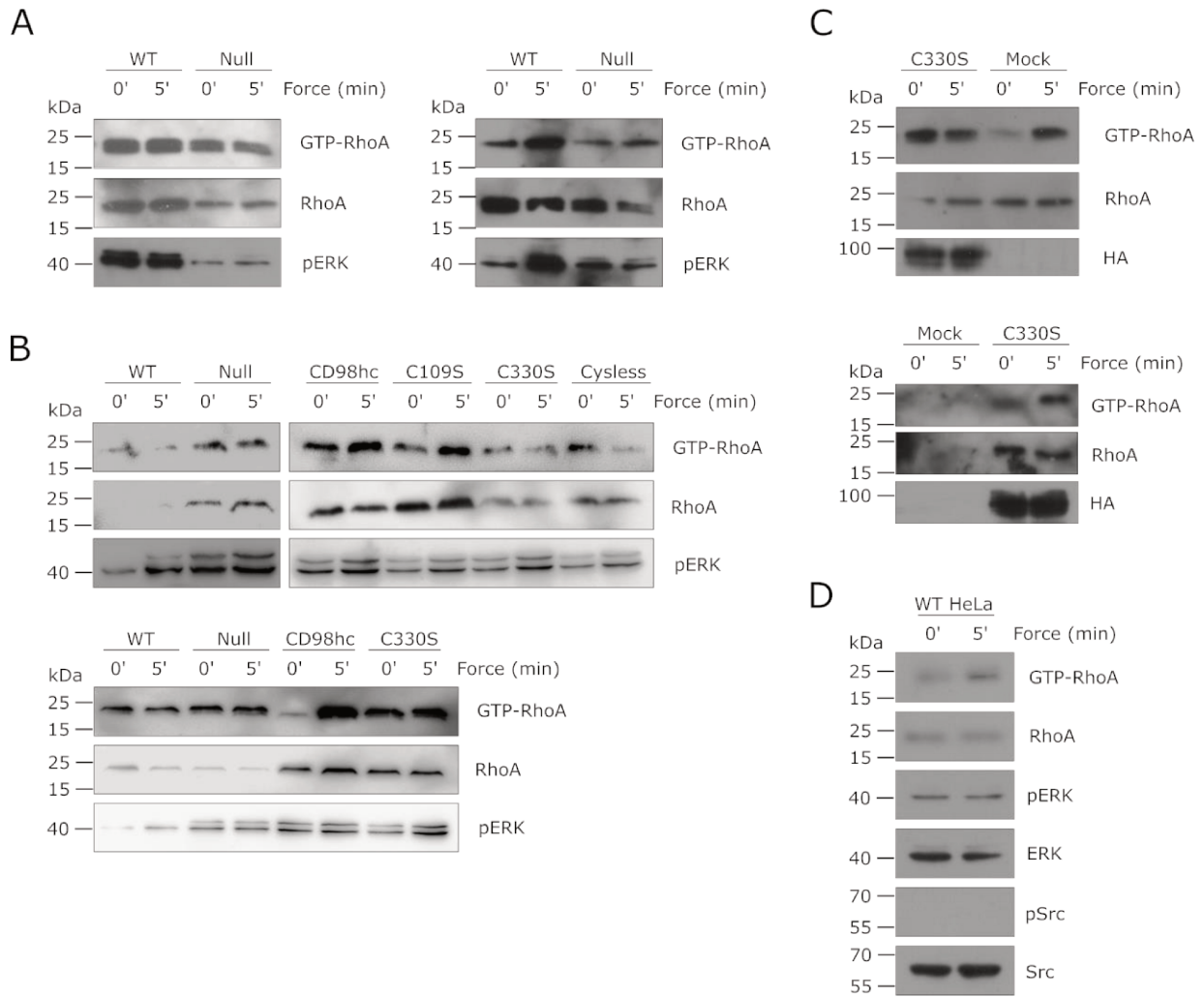

Fig 36. Preliminary data cannot be confirmed because of inconsistent results. Immunodetection upon SDS-PAGE the indicated proteins in fibroblast (A and B) or HeLa cells (C and D) protein extracts after magnetic mechanical force application on integrin receptors. Cells transiently (HeLa) or stably (fibroblasts) expressed the indicated CD98hc mutants. A, B and C present two independent replicates of the same experiment with different results.

4.2.3. Discussion

Despite the promising preliminary data, the inconsistent results obtained repeatedly across experimental replicates did not allow us to conclude in respect to our initial hypothesis. Analysing different pathway components and using different cellular models did not improve the described problems. Unfortunately, alternative techniques for force application at a molecular level in living cells are still limited, although the field is rapidly expanding.

Result inconsistency could be explained by several factors. The experimental model or experimental setup used could be leaving uncontrolled important parameters. CD98hc is implicated in integrin-mediated mechanotransduction (Estrach et al., 2014), but our current

understanding of the process is limited and further exhaustive characterization of the process will help in further understanding the reason behind the limitation of this experimental system. Additionally, there is an agreement in the research community about the high technical complexity of small GTP-bound protein pull-down assays. Given that this research was performed during the first year of my PhD fellowship, my inexperience as researcher probably contributed to result inconsistency.

As a result, GTP-RhoA pull-down assay as the central technique of this research was not robust enough in the applied conditions, compromising the arguments that motivated the initial hypothesis. Therefore, we decided to focus our efforts in other research projects with more consistent evidence supporting their research interest.

Interestingly, the research line led by Dr. Etienne Boulter in our team, originally aimed at identifying what force-based cellular processes required CD98hc, recently discovered the importance of lipid metabolism in integrin-mediated rigidity sensing. This new discovery led them to re-assess the C330 residue under a different hypothesis (Boulter et al., 2018). As opposed to our initial hypothesis, we now know that CD98hc is not a mechanosensor itself, although it is necessary for integrin-mediated mechanosensing and signalling to RhoA. Unexpectedly, CD98hc's C330 residue is required for proper sphingolipid and cholesterol synthesis, acting as a chaperon for the proper folding of the delta-4-desaturase DES2 enzyme. Absence of CD98hc produces disruption of membrane micro-domains or lipid rafts due to lower availability of sphingolipids and cholesterol, resulting in inappropriate spatiotemporal regulation of RhoA GEFs (guanine exchange factors) and defective RhoA activation upon mechanical stimulation.

4.3. Materials and methods

4.3.1. Plasmid construction

pQE60-expression plasmids were generated by subcloning PCR-obtained inserts from mouse fibroblast (extracted as in section 3.4.4) using the indicated primers: primers mCD98hcCytoTailShortF and mCD98hcCytoTailR for plasmids pQE60His/mCytoTailCan and pQE60GST/mCytoTailCan, and primers mCD98hcCytoTailLongF and mCD98hcCytoTailR for plasmids pQE60His/mCytoTailAlt and pQE60GST/mCytoTailAlt, inserted into pQE60His or pQE60GST using NcoI (R0193, New England Biolabs) and BamHI (R0136, New England Biolabs). pQE60His and pQE60GST were a kind gift of Dr. Simona Sacconi and Dr. Dominic Van Essen.

To obtain pcDNA3.1(-)/mCanCD98hcTAPtag and pcDNA3.1(-)/mAltCD98hcTAPtag, versions of pcDNA3.1(-)/mCanCD98hc, pcDNA3.1(-)/mAltCD98hc were generated as described in section 3.4.4 but without stop codons. Then, TAPtag sequence was extracted from pBS/479, (a kind gift from Dr Lawrence Goldfinger) using BamHI (R0136, New England Biolabs) and HindIII (R0104, New England Biolabs), and subcloned into pcDNA3.1(-)/mCanCD98hc, pcDNA3.1(-)/mAltCD98hc or pcDNA3.1(-). pcDNA3.1(-)/mCanCD98hc3xFLAG and pcDNA3.1(-)/mAltCD98hc3xFLAG were obtained by inserting 3xFLAG sequence in pcDNA3.1(-)/mCanCD98hc, pcDNA3.1(-)/mAltCD98hc or pcDNA3.1(-) using BamHI (R0136, New England Biolabs) and HindIII (R0104, New England Biolabs). The insert was obtained by hybridizing oligos 3xFLAGF and 3xFLAGR at a concentration of 50 μ M for 5 minutes at 95° C and posterior slow return to room temperature.

pBabe_puro/mCanCD98hc and pBabe_puro/mAltCD98hc were obtained by inserting into pBabe_puro PCR-obtained DNA fragments as described in section 3.4.4 for pcDNA3.1(-)/mCD98hcCanon and pcDNA3.1(-)/mCD98hcAlt.

Sequences encoding for CD98hc cysteine-mutated versions (C109S, C330S or both together for Cysless), previously described (Boulter et al., 2018), were inserted into pBabe_puro using Sall (R0138, New England Biolabs) and EcoRI (R0101, New England Biolabs) to obtain pBabe_puro/hCD98hc, pBabe_puro/hCD98hcC109S, pBabe_puro/hCD98hcC330S or pBabe_puro/hCD98hcCysless.

All plasmids were sequenced to control for potential mutations. Sanger sequencing was performed by GATC, Eurofins. Oligonucleotide sequences can be consulted in table 3. All

plasmid DNA used in experiments was purified from *Escherichia coli* TOP10 (C40403, Invitrogen) strain using Plasmid Maxi Kit (12163, Qiagen) following manufacturer instructions.

Name	Sequence
mCD98hcCytoTailShortF	AGCCAGGACACCGAAGTGG
mCD98hcCytoTailLongF	GATCCTGAACCTACTGAACACTCC
mCD98hcCytoTailR	GTCTGGATCCTACCTTCAGTAGCTCCTCCTGG
3xFLAGF	GATCCGACTACAAAGACCATGACGGTGATTATAAAGATC ATGACATCGATTACAAGGATGACGATGACAAGTGA
3xFLAGR	AGCTTCACTTGTCATCGTCATCCTTGTAATCGATGTCATGATCTT TATAATCACCGTCATGGTCTTTGTAGTCG

Table 3 Oligonucleotides.

4.3.2. Cells

HeLa (human epithelial cervical cancer cells, ATCC number CCL-2TM) and 293 Phoenix cells (ATCC number CRL-3213) cells were grown in Dulbecco's modified Eagle's medium (21969-035, Gibco) supplemented with 10% (v/v) fetal bovine serum (FBS) (10270106, Gibco) and 2 mM L-glutamine (25030-024, Gibco). Primary mouse dermal fibroblasts were isolated from Fsp1-Cre-CD98hc^{fl/fl} adult skin using enzymatic digestion and immortalized by using pBRSV (ATCC) encoding for the SV40-large T antigen as previously described (Tissot et al., 2018). They were grown in DMEM supplemented with 10% v/v FBS (HyClone), 20 mM Hepes, pH 7.3 (15630-056, Gibco), 100 µM non-essential amino acids (11140-035, Gibco), 2 mM L-glutamine and 100 µM 2-mercapto-ethanol (M6250, Sigma). Stable expression of CD98hc mutants was achieved by transfection of cells with pBabe_puro/mCanCD98hc, pBabe_puro/mAltCD98hc, pBabe_puro/hCD98hc, pBabe_puro/hCD98hcC109S, pBabe_puro/hCD98hcC330S or pBabe_puro/hCD98hcCysless, or by transduction with retroviral vectors produced from the same plasmids in 293 Phoenix packaging cells as described before (Pear et al., 1993) and puromycin (2 µg/ml). All cells were grown at 37°C in a humidified atmosphere containing 5% CO₂.

4.3.3. Protein expression in bacteria

CD98hc-GST or 6xHis proteins were produced in BL21 derivative Rosetta *E. coli*. Bacterial cultures were kept in the exponential grow phase until OD was 0.6 in LB medium with ampicillin (100µg/ml) and chloramphenicol (25µg/ml), then exogenous protein production was induced with IPTG 1 mM. Cells were then kept for either 2 h at 37° C or overnight at 23° C as indicated. Culture samples were then taken, cells isolated by centrifugation and resuspended in Laemli's buffer for SDS-PAGE analysis.

For GST-based purification, cells were disrupted by sonication and incubated with Glutathion Sepharose 4B (GE Healthcare, 17-0756-01) beads as indicated by the manufacturer (for 1 h at 4 C).

4.3.4. Protein expression in mammalian cells

Cells were transfected with plasmids pcDNA3.1(-)/mCanCD98hcTAPtag, pcDNA3.1(-)/mAltCD98hcTAPtag, pcDNA3.1(-)/mCanCD98hc3xFLAG or pcDNA3.1(-)/mAltCD98hc3xFLAG as described in section 3.4.12. 48 h post transfection, TAPtag-based purification was performed as described before (Holowaty et al., 2003). Briefly, a cell extract of 4×10^7 cells was incubated with 50µl of IgG-Sepharose 6 beads (Amersham Biosciences) for 2 h at 4° C, and bound TAP-tagged protein was released by incubation overnight 4° C with 120 units of tobacco etch virus (TEV) protease (Invitrogen). Eluted protein was further purified by incubation with calmodulin-Sepharose 4B for 2 h at 4° C.

4.3.5. SDS-PAGE and Western blotting

Protein samples were mixed with reduced Laemmli's sample buffer and heated at 95°C for 5 min. Electrophoresis separation was then performed in SDS-PAGE gels. For total protein staining, gels were stained with Coomassie R-250 Imperial Protein Stain (24615, Thermo Scientific) as indicated by the manufacturer. For Western blot analysis, after electrophoresis, proteins were electroblotted onto polyvinylidene difluoride membranes and blocked by incubation with 5% non-fat dry milk in PBS for 30 minutes at RT. Membranes were then probed with primary antibodies (goat anti-CD98hc N-20 1:200, Santa Cruz Biotechnology, rabbit anti-calmoduline binding protein epitope tag 1:5000, #07-482 Millipore, rabbit anti-β1 integrin, 1:1000 #AB1952 Millipore, mouse anti-β3 integrin, 1:1000 #611140 BD Biosciences, mouse anti-FLAG M2, 1:2000 #F3165 Sigma-Aldrich) diluted in blocking solution for 16 h at

4°C. Then, membranes were thoroughly washed with PBS, incubated with goat anti-rabbit IgG horseradish peroxidase conjugate (W4011, Promega), goat anti-mouse IgG horseradish peroxidase conjugate (W4021, Promega) or donkey anti-goat IgG horseradish peroxidase conjugate (PI-9500, Vector Laboratories) diluted 1:10,000 in blocking solution. Immunoreactive bands were detected by ECL Immobilon Western (WBKLS0500, Merck) according to the provided protocol.

4.3.6. Flow cytometry analysis

Immunolabelled cells were analysed on a flow cytometer (Calibur, BD) with the CellQuestPro software (BD). Cells were incubated with the primary antibody 1:100 in PBS 0.1% BSA for 1h at 4°C. Cells were then thoroughly washed and, when necessary, incubated with the secondary antibody 1:250 in PBS 0.1% BSA for 1h at 4°C. Primary antibodies used were, Biolegend, hamster anti- α 1 integrin, #555001 BD Biosciences, hamster anti- α 5 integrin, #553350 BD Biosciences, rat anti- α 6 integrin, #563707 BD Biosciences, rat anti- β 1 integrin, #MAB1997, and hamster-anti β 3 integrin, #553344 BD Biosciences, rat anti-mouseCD98hc RL388 coupled with Alexa 647, and hybridoma C13 specific for human CD9hc. Secondary antibodies were Alexa 647-coupled goat anti-hamster (#AB173004 Abcam) and Alexa 647-coupled goat anti-rat (#AB150159 Abcam).

4.3.7. Cell growth

For cell growth assays, cells were seeded at 5×10^4 cells per well in 6-well tissues culture plates with complete DMEM (see above). Cells were counted in triplicates every 24 h using a phase-contrast microscope.

For impedance-based real-time monitoring of cell population surface we used the xCELLigence system. Briefly, the xCELLigence system monitors electrical impedance of culture cells across interdigitated microelectrodes integrated on the bottom of specially designed culture plates. The impedance measurement is proportional the electrode surface occupied by adhering cells. Electrode impedance changes displayed as Cell Index (arbitrary units) were used to adhesion and growth. 5,000 cells were seeded per well at time 0 in E-16 plates (5469830001, Acea Biosciences) and readings were collected every 1 minute for 10 hours and every 5 minutes for the rest of the time. Results are reported as normalized Cell Index (CI).

4.3.8. Adhesion assays

96-well tissue culture plates were coated with Fn (F1141 Sigma) at 0.5, 1, 2.5, 5, 10 or 25 $\mu\text{g/ml}$ overnight at 4°C, then blocked with 2% heat-inactivated BSA (A7906 Sigma). 5×10^3 cells were plated in each well and were allowed to adhere for 60 min at 37°C in triplicates. Nonadherent cells were washed off, adherent cells were fixed and stained with crystal violet. Adherent cells were quantified in bright-field microscopy images with a CellProfiler (Carpenter et al., 2006) customized pipeline.

4.3.9. Spreading assay

24-well tissue culture plates were coated with Fn (F1141 Sigma) at 10 $\mu\text{g/ml}$ overnight at 4°C, then blocked with 2% heat-inactivated BSA (A7906 Sigma). 5×10^4 cells were plated in each well and were imaged with a phase-contrast microscope at 0.5, 1, 2, 3.5 and 5 h in triplicates. Cell surface was then quantified using ImageJ software.

4.3.10. PNGaseF deglycosylation reaction

The reaction was performed as explained in section 3.4.5

4.3.11. Magnetic mechanostimulation and RhoA pulldown

Dynabeads (14203, Invitrogen)s were coated with Fn (F1141Sigma) following manufacturer's protocol. Cells were grown on 10 cm tissue culture dishes for 24 h. Dynabeads were individualized by passing through a 27 G needle and were incubated with the cells for 20 min. Magnetic field was generated by applying a permanent Neodymium magnet on top of the cell monolayer for 5 minutes as previously described (Guilluy et al., 2011) to apply a force of 10 pN per bead.

RhoA activation was tested using a GST-RBD pull-down, as detailed previously (Arthur and Burrige, 2001). Briefly, cells were lysed for 10 min in 25 mM HEPES pH 7.3, 150 mM NaCl, 5 mM MgCl_2 , 0.5% Triton X-100, 0.1% SDS, 10mM NaF, 5 mM dithiothreitol (DTT), and protease inhibitors at 4 °C. Triton-X-100-insoluble material was removed by centrifugation for 10 min at 9500g and the lysates were incubated for 40 min with 50 μg of immobilized GST-RBD at 4 °C. Resulting samples were immunoblotted for RhoA (RhoA-GTP) as well as control whole lysates (total RhoA).

4.3.12. Statistical analysis.

All experiments were performed at least three times. Group comparison was performed using two-tailed unpaired Student's t test. Multiple groups comparison was performed by one-way ANOVA followed by Tukey's multiple comparisons test. All tests were performed using the GrahPad Prism software.

Section 5: General discussion

Mammals are highly complex organisms with a wide range of cell types subjected to a myriad of complex processes such as development, homeostasis or adaptation to external conditions. All the cells in the organism need to be coordinated to perform different and complementary functions at a given time in a tightly controlled manner. For instance, the proliferation and apoptosis rates are crucial all throughout an individual's life. These cell processes are highly reactive to intracellular and extracellular signaling, but their dysregulation can lead to diseases, notably cancer. Yet, all the cell types with different coordinated functional regulations in an organism originate from a single cell and contain identical genetic information.

The estimate of protein-coding gene number in human (20,000-25,000) is lower than the mouse estimate (30,000), similar to *Arabidopsis thaliana* (25,000), not very far from *Drosophila melanogaster* (14,000) and four times *Saccharomyces cerevisiae* (6,000). There is a noteworthy lack of correspondence between genome size and organism phenotypic complexity in the eukaryotic evolutionary line. Thus, other factors account for the increase in organismal complexity, such as a more complex gene expression regulation. In fact, systems governing gene expression, from the transcriptional to the translational level, become more elaborate with the increment in organism complexity (Levine and Tjian, 2003; Pray, 2008).

This context supports the emergence of an alternative *CD98hc* promoter—and therefore an alternative transcription regulatory system—in mammals, as compared to less complex vertebrates. CD98hc is a widely expressed protein with the ability to regulate cellular processes such as proliferation through integrin adhesive signaling and amino acid transport. Hence, it requires a very controlled and cell type-specific regulation to maintain tissue homeostasis without inducing aberrant proliferation. Also, as opposed to its homologs in other clades that are exclusively implicated in amino acid transport, CD98hc has acquired more complex functions in vertebrates. A way to achieve a proper *CD98hc* expression in complex organisms such as mammals, with a wide variety of cell types and processes, is by increasing the complexity of *CD98hc* expression regulation. A locus with multiple promoters has different sets of proximal and distal regulatory elements (5' to the core promoter) and can, therefore, be responsive to a wider range of signals. These regulatory elements normally function not only as direct activators or inhibitors but also as tethering systems to establish contact with enhancers or silencers and the regulatory protein complexes bound to them,

which increases the combinatorial possibilities of gene expression regulators acting in the locus. The emergence of alternative promoters is not a process restricted to *CD98hc*. Alternative promoter usage to generate a complex transcriptional regulation in vertebrates has been identified in numerous loci (Hoppler and Kavanagh, 2007; Landry et al., 2003; Murray-Zmijewski et al., 2006). In this case, our data suggest a common origin of *CD98hc* alternative variant and the long non-coding RNA *SNHG1*. Coregulation or functional interaction between these two genes will have to be further investigated.

This is the first time *CD98hc* is clearly described as a 2-variant protein with two alternative promoters. As such, it opens the way for validation and further characterization of *CD98hc* alternative promoter, transcript(s), and protein variant(s). Of particular interest is the comparative study of *CD98hc* multiple variants to evaluate their implication on different cell-environment signaling or stress responses. Interpretation of previous *CD98hc*-related results in this new context has some limitations that will have to be taken into account for the design of future studies. Until this date, all *CD98hc* variants have been studied together without awareness. Oligonucleotides used as probe or primer to detect *CD98hc* so far, as well as KO or knockdown techniques (siRNAs, genomic KO, etc.) and antibodies with *CD98hc* binding capacity are targeted to the common region of both variants, making it impossible to differentiate among them. Thus, a development of variant-specific tools is now required for a more comprehensive future research. Nevertheless, there are some exceptions where the difference can be made between both variants, like RNA sequencing studies with the necessary depth for transcript variant differentiation, studies based on expression of exogenous *CD98hc* or genome-wide analysis.

The distinction between *CD98hc* alternative and canonical variant and their corresponding promoters presented in this study will help to clarify the terminology and some existent data. There is currently an ambiguity when referring to *CD98hc*: while the *CD98hc* research community normally refers implicitly to the canonical variant, databases such as Uniprot include both canonical and alternative (predicted from RNA-seq studies) variants. These databases are usually the first source of information for researchers not familiar with the *CD98hc* community. Lack of proper labeling and implicit information lead to confusion when talking about *CD98hc* amino acid residue positions or protein domains across studies.

Some confusion arises regarding *CD98hc* promoters as well. Studies focusing on *CD98hc* transcriptional regulation have focused on the canonical promoter. On the other hand, some transcriptional screenings analyzing genome-wide features have described hits in *CD98hc* alternative promoter region, annotated as *CD98hc* predicted promoter in databases and genome browsers. As an example, a recent study found fascin to have a TF role in the nucleus, activating transcription in a number of loci, *CD98hc* among them (Saad et al., 2016). However, the ChIP-seq fascin peak the authors identified does not correspond with *CD98hc* promoter as described in the literature. The result can now be better interpreted knowing that fascin ChIP-seq peak spans *CD98hc* alternative promoter. Another study from 2015 identified the SNP rs1059292 as associated with bad prognosis in non-small cell lung cancer. The researchers ascribed this SNP to a region labeled as “*CD98hc* promoter” and performed promoter functional assays in vitro, to find an increased promoter activity for the variant associated with bad prognosis (Guo et al., 2015). Some confusion arises again in the labeling: rs1059292 locates to *CD98hc* alternative variant promoter and is, therefore, unlikely to affect the canonical promoter activity. The information presented here will help in untangling the nomenclature confusion and will enrich the framework for design and interpretation of future studies in the field.

When analyzing mRNA and protein expression data of both *CD98hc* variants, the translation process has to be considered. Mature alternative and canonical mRNAs only differ in the presence or absence of exons 1b, 1c, 1d and 1e. Being ~100 bp each, the maximum difference is ~400 bp, and is only ~100 bp when just exon 1b exists. Moreover, *CD98hc* alternative variant Kozak sequence is not a strong consensus (gccUccAUGG, as compared to the consensus gccRccAUGG, where R can be either A or G and lower-case letters can vary). It is, therefore, possible for the ribosome to skip the first start codon and continue scanning until the canonical start codon, a process known as leaky scanning. Hence, the canonical *CD98hc* protein could be translated from *CD98hc* alternative mRNA. However, this is only probable for transcripts excluding exons 1c, 1d and 1e, because these exons include additional AUG codons in different frames.

As discussed in section 3.3, *CD98hc* alternative promoter region 5 contains the minimal promoter, region 4 includes a number of core regulatory elements and regions 1, 2 and 3 seem to exert a repressive function. The potential repressive activity of regions 1, 2 and 3 has the

peculiarity of differentiating *CD98hc* canonical and alternative promoters: a similar pattern has never been identified in *CD98hc* canonical promoter when similar studies were performed (Gottesdiener et al., 1988; Yan et al., 2007b). The curated TFBS analysis reported here also suggests a differential regulation between both promoters. These differences are the key to bringing the increase in regulation complexity, and therefore the increased versatility of *CD98hc* expression regulation in complex organisms.

The possible mechanisms to explain this apparent repression could be *SNHG1*-dependent regulation, TFs or DNA structure and are further discussed in section 3.3. A deeper, mechanistic characterization of *CD98hc* alternative promoter regulation will be the focus of future research. Among a number of possible additional questions to continue this line of research, one rises rapidly: is this repression, that seems constitutive, lifted under particular stimuli or circumstances? Removal or inhibition of a constitutive repressor activity in a promoter could represent a mechanism of relatively rapid protein increase under a specific need because all the transcriptional machinery could be already assembled and waiting for blockage removal. Hence, *CD98hc* alternative promoter activity will have to be tested under different cell stimuli or stress conditions. In particular, due to *CD98hc* known expression pattern and function, one could imagine testing promoter activity under the stimulus of different GF or in the presence of different integrin substrates.

In conclusion, this work led to the discovery of a new *CD98hc* protein variant in mammals with multiple splicing variants in simians. Moreover, it identified an alternative promoter governing this novel variant expression. The study of this alternative promoter by functional assays and potential cis-regulatory elements yielded results different than those available for *CD98hc* canonical variant, strongly suggesting a different transcriptional regulation. *CD98hc* alternative variant has a ubiquitous expression pattern and its differential N-terminal portion has no predicted intrinsic 3D structure. Future studies should focus on protein functional analysis and the importance of *CD98hc* alternative variant under the wide variety of *CD98hc*-relevant cell types and stimuli.

Annex 1: Review article “SLC3A2”

The following review article was published as part of the Encyclopedia of Signaling Molecules (Springer, 2018). LB and MP wrote the amino acid transport and structural parts while CF and I wrote the integrin and other partners sections. All authors reviewed the final manuscript.

- human and rat renal cortex Na/P_i cotransport. *Proc Natl Acad Sci U S A*. 1993;90(13):5979–83.
- Marks J, Debnam ES, Unwin RJ. The role of the gastrointestinal tract in phosphate homeostasis in health and chronic kidney disease. *Curr Opin Nephrol Hypertens*. 2013;22(4):481–7.
- Murer H, Hernando N, Forster I, Biber J. Proximal tubular phosphate reabsorption: molecular mechanisms. *Physiol Rev*. 2000;80(4):1373–409.
- Nishimura M, Naito S. Tissue-specific mRNA expression profiles of human solute carrier transporter superfamilies. *Drug Metab Pharmacokinet*. 2008;23(1):22–44.
- Patti M, Forster IC. Correlating charge movements with local conformational changes of a Na⁽⁺⁾-coupled cotransporter. *Biophys J*. 2014;106(8):1618–29.
- Patti M, Fenollar-Ferrer C, Werner A, Forrest LR, Forster IC. Cation interactions and membrane potential induce conformational changes in NaPi-IIb. *Biophys J*. 2016;111(5):973–88.
- Ravera S, Virkki LV, Murer H, Forster IC. Deciphering PiT transport kinetics and substrate specificity using electrophysiology and flux measurements. *Am J Phys Cell Phys*. 2007;293(2):C606–20.
- Schlingmann KP, Ruminiska J, Kaufmann M, Dursun I, Patti M, Kranz B, Pronicka E, Ciara E, Akcay T, Bulus D, Cornelissen EA, Gawlik A, Sikora P, Patzer L, Galiano M, Boyadzhiev V, Dumic M, Vivante A, Kleta R, Dekel B, Levchenko E, Bindels RJ, Rust S, Forster IC, Hernando N, Jones G, Wagner CA, Konrad M. Autosomal-recessive mutations in SLC34A1 encoding sodium-phosphate cotransporter 2A cause idiopathic infantile hypercalcemia. *J Am Soc Nephrol*. 2016;27(2):604–14.
- Uwai Y, Arima R, Takatsu C, Furuta R, Kawasaki T, Nabekura T. Sodium-phosphate cotransporter mediates reabsorption of lithium in rat kidney. *Pharmacol Res*. 2014;87:94–8.
- Vergara-Jaque A, Fenollar-Ferrer C, Kaufmann D, Forrest LR. Repeat-swap homology modeling of secondary active transporters: updated protocol and prediction of elevator-type mechanisms. *Front Pharmacol*. 2015a;6:1–12.
- Vergara-Jaque A, Fenollar-Ferrer C, Mulligan C, Mindell JA, Forrest LR. Family resemblances: a common fold for some dimeric ion-coupled secondary transporters. *J Gen Physiol*. 2015b;146(5):423–34.
- Villa-Belosta R, Sorribas V. Role of rat sodium/phosphate cotransporters in the cell membrane transport of arsenate. *Toxicol Appl Pharmacol*. 2008;232(1):125–34.
- Wagner CA, Rubio-Aliaga I, Biber J, Hernando N. Genetic diseases of renal phosphate handling. *Nephrol Dial Transplant*. 2014;29(Suppl 4):iv45–54.
- Weinstock J. Inhibitors of sodium-dependent phosphate transport. *Expert Opin Ther Pat*. 2004;14(1):3.
- Ye W, Chen C, Gao Y, Zheng ZS, Xu Y, Yun M, Weng HW, Xie D, Ye S, Zhang JX. Overexpression of SLC34A2 is an independent prognostic indicator in bladder cancer and its depletion suppresses tumor growth via decreasing c-Myc expression and transcriptional activity. *Cell Death Dis*. 2017;8(2):e2581.

SLC39A

- ▶ [Zinc Transport in the Pancreatic β-Cell: Roles of ZnT \(SLC30A\) and ZiP \(SLC39A\) Family Members](#)

SLC3A2

Laura R. de La Ballina^{1,2,3}, Tomás de Garay⁴, Chloé C. Féral⁴ and Manuel Palacín^{1,2,5}

¹Institute for Research in Biomedicine (IRB Barcelona), The Barcelona Institute of Science and Technology, Barcelona, Spain

²Department of Biochemistry and Molecular Biology, University of Barcelona, Barcelona, Spain

³Department of Molecular Medicine, Institute of Basic Medical Science, University of Oslo, Oslo, Norway

⁴Université Côte d'Azur, INSERM, CNRS, IRCAN, Nice, France

⁵Spanish Biomedical Research Network in Rare Diseases (CIBERER CB06/07/0100), Barcelona, Spain

Synonyms

4F2hc; 4F2 heavy chain; CD98hc; CD98 heavy chain; FRP-1; Solute carrier family 3 (activators of dibasic and neutral amino acid transport), member 2

Historical Background

The ability of cells to sense, respond, and adapt to their environment is essential for multicellular life. SLC3A2 protein provides cells with the capacity of adjusting to their surroundings by mediating two fundamental molecular functions: amino acid transport and integrin signaling.

SLC3A2 is involved in many cellular processes, such as early activation of T and B cells

(Cantor et al. 2009, 2012), cell fusion (Deves et al. 2000; Takesono et al. 2012), cell survival and migration (Feral et al. 2005), cell proliferation (Cantor et al. 2009; Boulter et al. 2013; de la Ballina et al. 2016), mechanotransduction (Estrach et al. 2014), and angiogenesis (Liao et al. 2016). Thus, SLC3A2 is crucial for responding to different cellular stresses (i.e., oxidative or nutritional stress (de la Ballina et al. 2016), lack of proper cell/ECM attachment (Feral et al. 2005), mechanical stress (Estrach et al. 2014)). Also, SLC3A2 interacts with partners other than amino acid transporters or integrins, forming part of macromolecular complexes (Liu et al. 2003; Xu et al. 2005; Yan et al. 2008) (detailed later). The genetic defect of SLC3A2 results in embryo lethality (Tsumura et al. 2003), and no SLC3A2 mutations have been described so far. Altogether these data highlight the pivotal role of SLC3A2 for a correct and efficient cell behavior.

SLC3A2 constitutes the ancillary protein of six human amino acid transporters (SLC7A5, SLC7A6, SLC7A7, SLC7A8, SLC7A10, and SLC7A11; Fotiadis et al. 2013); it also functions as a coreceptor of β -integrins, amplifying their downstream outside-in signaling (Feral et al. 2005). Interestingly, different domains of SLC3A2 regulate each function, namely, SLC3A2 cytoplasmic and transmembrane domains (105 aa) are responsible for integrin signaling, whereas SLC3A2 ectodomain (SLC3A2-ED, 425 aa) is implicated in amino acid transport (de la Ballina et al. 2016) without affecting integrin signaling (Feral et al. 2005).

Highly proliferative cells overexpress SLC3A2 both in physiological (Boulter et al. 2013) and pathological conditions (McCracken et al. 2013). Thus, whereas playing an important role in keeping homeostasis of healthy tissues, this signal integrator molecule also favors progression of disease, like in cancer, where SLC3A2 expression has been associated with poor prognosis (Cantor et al. 2012; Ip et al. 2016).

SLC3A2 constitutes an attractive therapeutic target for anticancer treatments (Bajaj et al. 2016; Ip et al. 2016). In order to develop drugs that affect SLC3A2-facilitated processes, it

is crucial to understand the mechanisms by which this protein and its multiple partners function.

SLC3A2: Heavy Subunit of Heteromeric Amino Acid Transporters (HATs)

SLC3A2 is part of the heteromeric amino acid transporters (HATs), one of eleven families involved in amino acid transport across cell plasma membrane in mammals (Bröer et al. 2002). HATs constitute the only known example of solute carriers composed by two subunits: i) a heavy subunit (from solute carrier family SLC3) and ii) a light subunit (from solute carrier family SLC7), which are covalently linked together through a disulfide bridge. Human SLC3A2 heterodimerizes with one of six catalytic subunits, which are the actual transporters and confer substrate specificity to the heterodimeric complex (Reig et al. 2002). SLC3A2 traffics the whole transporter to the plasma membrane, where it mediates the corresponding amino acid transport activity. Combinations between SLC3A2 and each of the catalytic subunits render multiple amino acid transport systems, which cover a broad substrate range including all essential amino acids.

SLC3A2 is the only member of the SLC3 family exhibiting a ubiquitous distribution; however, in epithelial cells SLC3A2 is exclusively localized at the basolateral membrane. Such distinct distribution might determine the surface localization of its respective light chains allowing a vectorial amino acid transport in polarized cells. This is particularly relevant in membranes of epithelial cells of the kidney and intestine, where HATs are in charge of the reabsorption and absorption of amino acids filtered from the blood before their excretion and from digested proteins, respectively (Fig.1) (Fotiadis et al. 2013).

SLC3A2 and associated transporters are involved in several human pathologies. SLC3A2, SLC7A5 and SLC7A11 present an increased expression in tumors (being the amino acid transporters overexpressed in most cancer types) (McCracken et al. 2013). Moreover, SLC3A2 expression levels correlate with poor

a Epithelial cell

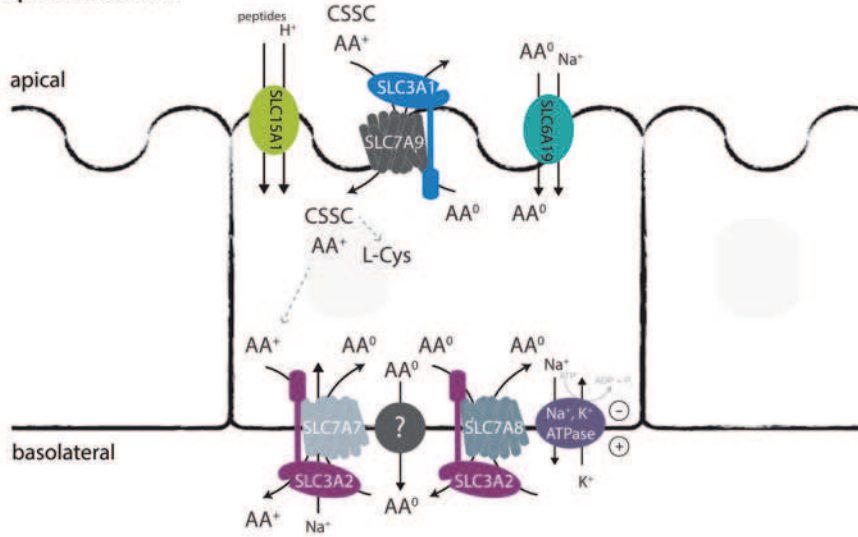

b Non-epithelial cell

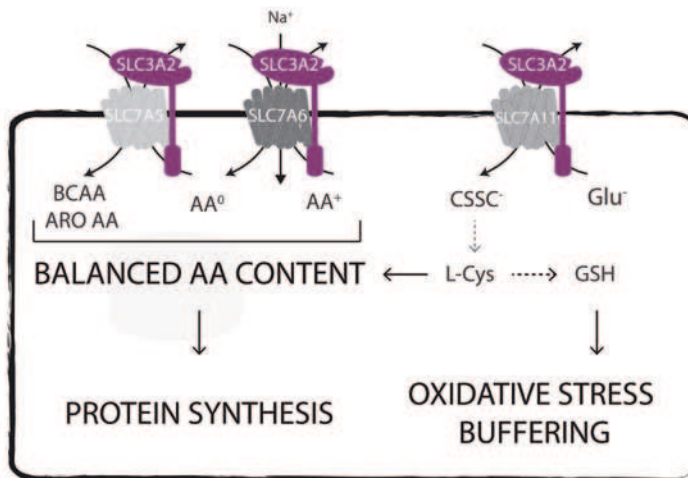

SLC3A2, Fig. 1 Amino acid transport mediated by HATs. (a) Interplay between HATs and other transporters allows vectorial transport of amino acids across epithelia, such as in the small intestine and kidney proximal tubule. Cystine (CSSC) and dibasic amino acids (AA^+) fluxed through epithelial cells are ensured by the presence of distinct transport systems at the apical and basolateral membranes. The apical transport system $b^{0,+}$ (catalyzed by SLC3A1/SLC7A9) mediates influx of AA^+ and CSSC in exchange of neutral amino acids (AA^0), which are accumulated in the cell by the Na^+ -dependent transporter SLC6A19. AA^+ exit the basolateral membrane through system y^+L (catalyzed by SLC3A2/SLC7A7) in exchange of AA^0 and Na^+ ; this is favored by the Na^+ gradient generated by the basolateral Na^+ , K^+ ATPase. The apical small intestine transporter SLC15A1 contributes to the

amino acid pool of the cell by mediating the uptake of di- and tripeptides. Transporters SLC16A10 (aka TAT1, for aromatic amino acids) and SLC43A2 (aka LAT4, for branched-chained amino acids, phenylalanine, and methionine) are candidates for mediating the basolateral efflux of intracellular AA^0 (black circle with question mark). The involvement of SLC3A2/SLC7A8 in this process has also been proposed. (b) In non-epithelial cells HATs SLC3A2/SLC7A5, SLC3A2/SLC7A6, and SLC3A2/SLC7A11 provide cells with a balanced AA content, which allows them to counterbalance oxidative stress (via SLC3A2/SLC7A11 transport, import of CSSC, and its rapid conversion to cysteine (*L-Cys*), which constitutes a rate determining step in the glutathione (*GSH*) synthesis) and to fuel protein synthesis and concomitant cell proliferation

SLC3A2, Table 1 SLC3A2-associated SLC7 L-type amino acid transporters

Gene name	Protein name	Transport system	Substrates	Transport type	Link to disease
SLC7A5	LAT1	System L	Large neutral L-amino acids, thyroid hormones T3 and T4, L-DOPA, BCH	Antiporter. Similar intra- and extracellular selectivity, lower intracellular apparent affinity.	Overexpressed in cancer
SLC7A6	y ⁺ LAT2	System y ⁺ L	<i>Na⁺-independent:</i> L-cationic AA <i>Na⁺-dependent:</i> large neutral L-AA	Antiporter. Preferentially intracellular cationic AA against extracellular neutral AA/Na ⁺	
SLC7A7	y ⁺ LAT1	System y ⁺ L	<i>Na⁺-independent:</i> L-cationic AA <i>Na⁺-dependent:</i> large neutral L-AA	Antiporter. Preferentially intracellular cationic AA against extracellular neutral AA/Na ⁺	LPI
SLC7A8	LAT2	System L	Neutral L-amino acids, thyroid hormone T3, L-DOPA, BCH	Antiporter. Similar intra- and extracellular selectivity, lower intracellular apparent affinity	
SLC7A10	Asc1	System asc	Small neutral L-AA and D-serine	Preferentially antiporter	
SLC7A11	xCT	System x _c ⁻	L-cystine (anionic form) /L-glutamate	Antiporter. Preferentially extracellular cysteine against intracellular glutamate	Overexpressed in cancer/ KSHV infection

AA amino acid

Adapted from Fotiadis et al. (2013)

prognosis in several tumor types. SLC7A5 and SLC7A11 are both considered to be good targets for antitumor therapies, and several inhibitors against these transporters have been designed and tested for reducing tumor proliferation and progression (Ip et al. 2016). Besides their role in cancer, SLC3A2-associated light subunits are also involved in other diseases. Whereas mutations in SLC7A5 cause autism spectrum disorders (Tărlungeanu et al. 2016), SLC7A11 is essential for the Kaposi's sarcoma-associated herpesvirus (KSHV) infection (Veetil et al. 2008). Finally, mutations in SLC7A7 cause lysinuric protein intolerance (LPI) (MIM 222700), a rare aminoaciduria (Torrents et al. 1999; Borsani et al. 1999).

SLC3A2-Associated Amino Acid Transport

Six different catalytic subunits (SLC7A5, SLC7A6, SLC7A7, SLC7A8, SLC7A10, and SLC7A11) require the ancillary protein SLC3A2 to be trafficked to the plasma membrane, where

they yield four different transport activities (L, y⁺L, asc, and x_c⁻). SLC3A2-associated transporters function as Na⁺-independent mainly obligatory antiporters (SLC7A10 can also function as uniporter), meaning that they mediate the translocation of one amino acid across the membrane in exchange to another amino acid being transported in the opposite direction (1:1 stoichiometry). For a detailed review on HATs, see Fotiadis et al. (2013); here, an outline of SLC3A2-associated light subunits and the amino acid transport systems they mediate is presented (Table 1).

System L: SLC7A5 (LAT1) and SLC7A8 (LAT2)

System L is responsible for Na⁺-independent transport of large branched-chain and aromatic neutral amino acids in almost all types of cells. There are four isoforms of system L; two of them, SLC7A5 (LAT1) and SLC7A8 (LAT2), are SLC3A2-associated transporters, whereas the other two, SLC43A1 (LAT3) and SLC43A2 (LAT4), are SLC3A2-independent isoforms.

SLC3A2/SLC7A5 is an obligatory exchanger. The uptake selectivity range of this transporter is relatively broad (large neutral L-amino acids, thyroid hormones T₃ and T₄, L-3,4-dihydroxyphenylalanine (L-DOPA), and 2-aminobicyclo-[2,2,1]-heptane-2-carboxylic acid (BCH)). Because the apparent affinity for extracellular amino acids (in the micromolar range) is 100-fold higher than for intracellular ones, the concentration of intracellular amino acids controls the transport rate. SLC3A2/SLC7A5 does not mediate net uptake of amino acids; instead, this transporter is designed for equilibrating the relative concentrations of different amino acids across a membrane (Fotiadis et al. 2013). Its essential role in the uptake of branched-chain and aromatic amino acids has been recently demonstrated; SLC3A2/SLC7A5 function cannot be compensated for alternative transporters (de la Ballina et al. 2016). SLC3A2/SLC7A5 is also key in mTOR regulation (Nicklin et al. 2009; Cormerais et al. 2016) by providing neutral-branched amino acids to activate mTOR. Recent data show that SLC3A2/SLC7A5 is recruited to the lysosome membrane and mediates Leu uptake into the lysosome, being thus essential for mTOR activation, cell growth, and proliferation (Milkereit et al. 2015). SLC7A5 is expressed in most tested tumors and tumor cell lines.

SLC3A2/SLC7A8 exchanges all neutral amino acids, with the exception of proline, across the membrane in a Na⁺-independent manner and thereby equilibrates their relative concentration. This transporter presents a wider selectivity of neutral amino acids than SLC3A2/SLC7A5, transporting also small ones. Similar to SLC7A5, SLC7A8 also displays a much lower apparent affinity for intracellular amino acids than for extracellular ones (exception for glycine). SLC3A2/SLC7A5 is mainly expressed, but not only, at the basolateral membrane of the proximal kidney tubule and small intestine (Fotiadis et al. 2013).

System y⁺L: SLC7A7 (y⁺LAT1) and SLC7A6 (y⁺LAT2)

System y⁺L mediates the efflux of dibasic amino acids in exchange for, preferably, large neutral

amino acids and Na⁺. The affinity of this system depends on the type of neutral amino acid and the cation concentration present in the medium. SLC7A7 (y⁺LAT1) and SLC7A6 (y⁺LAT2) are the two isoforms responsible for this transport system.

SLC3A2/SLC7A7 catalyzes the transport of dibasic amino acids in the absence of Na⁺ and the uptake of neutral amino acids together with Na⁺, which (as well as protons) increases the affinity for neutral amino acids without altering the maximal velocity of the transporter. Na⁺ is cotransported in a 1:1 stoichiometry with neutral amino acids (Fotiadis et al. 2013). SLC3A2/SLC7A7 presents a basolateral distribution in kidney and small intestine. It participates in the renal reabsorption and intestinal absorption of basic amino acids (lysine, arginine, and ornithine). This transporter is defective in the autosomal recessive disease lysinuric protein intolerance (LPI) characterized by the urinary hyperexcretion and intestinal malabsorption of cationic amino acids (arginine, lysine, and ornithine) (Torrents et al. 1999; Borsani et al. 1999).

SLC3A2/SLC7A6 transport characteristics are very similar to those of SLC3A2/SLC7A7. It also mediates the Na⁺-independent transport of dibasic amino acids and the Na⁺-dependent uptake of neutral amino acids, but it preferentially catalyzes L-arginine efflux in exchange of L-glutamine plus Na⁺ (Bröer et al. 2002). In contrast to SLC7A7, SLC7A6 is widely expressed in epithelial and non-epithelial tissues.

System Asc: SLC7A10 (Asc1)

System asc (alanine-serine-cysteine) is composed by two isoforms: SLC3A2-associated SLC7A10 and SLC7A12, which is associated to a yet unknown heavy subunit. SLC7A12 is present in rodent (e.g., mouse and rat) but not in the human genome.

SLC3A2/SLC7A10 mediates the Na⁺-independent transport of small neutral amino acids such as L-glycine, L-alanine, L-serine, L-threonine, L-cysteine, α-aminoisobutyric acid, and β-alanine. SLC7A10 mRNA is strongly expressed in the human kidney and brain; lower expression appears in the human placenta, heart,

skeletal muscle, lung, liver, and pancreas. Contrary to other members of HATs, SLC3A2/SLC7A10 functions as a preferential (but not obligatory) exchanger, being able to also mediate uniport. SLC7A10 also accepts with a high-affinity D-isomers of small neutral amino acids, in particular D-serine. D-serine plays an important role in the central nervous system where it is required for the activation of the glutamate N-methyl-D-aspartate (NMDA) receptor. Because of this high affinity for D-serine, together with the high levels of expression in brain, SLC7A10 is proposed to play a significant role in D-serine mobilization in the brain (Fotiadis et al. 2013). Moreover, SLC7A10 ablation in mice shows that this transporter controls glycine levels in the central nervous system and is required for glycinergic inhibitory transmission, making it a candidate for hyperekplexia disorders (Safory et al. 2015).

System x_c^- : xCT (SLC7A11)

SLC3A2/SLC7A11 heterodimer is the only isoform of system x_c^- .

This heterodimer catalyzes the Na^+ -independent electroneutral exchange of extracellular anionic cystine for glutamate (1:1 stoichiometry). Because of the low cystine content inside the cells (as it is rapidly reduced to cysteine), the physiological direction of this exchange consists of an exit of glutamate that favors the entrance of cystine. Cystine uptake and reduction are rate limiting for glutathione (GSH) synthesis. SLC7A11 transport directly controls intracellular GSH levels and, therefore, modulates the buffering of reactive oxygen species (ROS). SLC3A2/SLC7A11 activity inactivation leads to ferroptosis, an iron-dependent oxidative (non-apoptotic) death (Dixon et al. 2012). SLC7A11 expression is elevated in cells requiring high GSH synthesis, as native brain and activated macrophages, as well as in most cell culture lines, where oxygen tension is higher than physiological levels. In the brain, SLC3A2/SLC7A11 plays a role in the homeostasis of glutamate levels (Danbolt 2001). SLC7A11 has also been identified as a fusion-entry receptor for Kaposi's sarcoma-associated herpesvirus (KSHV) and

may mediate KSHV entry either in isolation or as part of a complex with other receptors for the virus (Veettil et al. 2008). As SLC7A5, SLC7A11 is also overexpressed in tumors (McCracken et al. 2013).

Structure of SLC3A2 and Heteromeric Amino Acid Transporters

HATs are formed by members of family SLC3 (type II N-glycoproteins with a transmembrane domain and a bulky ectodomain) and family SLC7 (non-glycosylated proteins with 12 transmembrane domains). Heterodimers are bound together by a disulfide bridge. In this section the current structural knowledge of HATs is depicted. A more detailed review on this topic has recently been published (Palacín et al. 2016).

HAT Heavy Subunits

The structure of SLC3A2 ectodomain (SLC3A2-ED; at 2.1 Å resolution, PDB: 2DH2) (Fort et al. 2007) constitutes the only available atomic structure of HATs (Fig. 2).

The SLC3A2-ED structure resembles that of bacterial α -amylases, showing a triose phosphate isomerase (TIM) barrel (α/β)₈ (A-domain) and eight antiparallel β -strands (C-domain). α -Amylases present, inserted between the third β -strand and the third α -helix of domain A, an additional long loop region containing calcium-binding sites (B-domain) (Fort et al. 2007). Despite the sequence identity (25% for A-domain) and structural similarities between SLC3A2 and bacterial α -amylases, the α -glycosidase activity is lost in SLC3A2 (Fort et al. 2007). The N-terminal position of SLC3A2-ED structure corresponds to Cys109, which forms a disulfide bridge with the light subunit and is just four residues away from the putative transmembrane segment. The structure of SLC3A2-ED suggests that the location of the N-terminus imposes strong structural restraints with respect to both the docking of SLC3A2-ED onto the membrane and the interactions with the light subunit in the heterodimer (Fort et al. 2007).

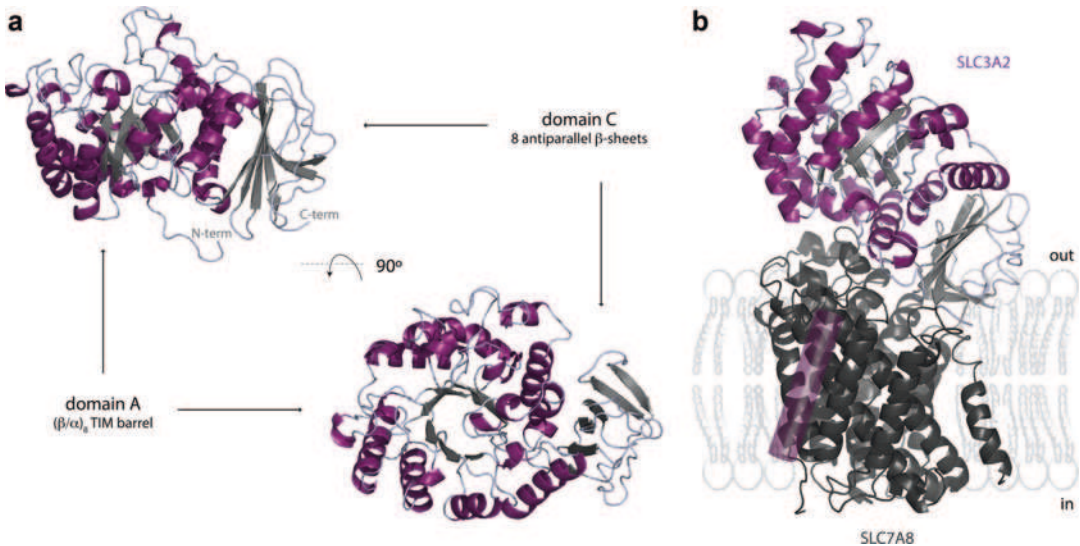

SLC3A2, Fig. 2 Structure of SLC3A2. (a) The SLC3A2-ED structure (PDB: 2DH2; 2.1 Å resolution) can be described in terms of topology and multidomain organization of α -amylases: the so-called A-domain of α -amylases is here a $(\beta/\alpha)_8$ TIM barrel. The C-domain with eight antiparallel β -strands is also present. SLC3A2 lacks a B-domain, present in many α -amylases. (b) Structural model of the heteromeric complex SLC3A2/SLC7A8, generated by combining negative-stained transmission electron microscopy images, docking analysis,

and cross-linking experiments. The long intracellular N-terminus of SLC3A2 is not shown, and the position of the transmembrane domain (shown as a transparent purple cylinder) is a supposition based on compatibility with the establishment of a disulfide bond between SLC3A2 and SLC7A8. Both in a and b, the atomic structure of SLC3A2-ED is represented as a cartoon with α -helices (*in purple*) and β -sheets (*in gray*). The structural model of SLC7A8 is a cartoon in *dark gray*

HAT Catalytic Subunits

Together with their prokaryotic homologous, HAT light subunits form the L-amino acid transporter (LAT) family within the large amino acids, polyamines, and organic cations (APC) superfamily of transporters. The structure of three bacterial APC (non-LAT) transporters has been solved: AdiC (an arginine/arginine exchanger), ApcT (an H^+ -dependent amino acid transporter), and GadC (a glutamate/GABA antiporter). These bacterial APC transporters, despite presenting low amino acid sequence identity with catalytic subunits of human HATs (~ 14 – 20%), constitute their present structural models (Palacín et al. 2016). Despite not having relevant amino acid sequence identity ($\sim 10\%$), all APC-solved structures share the 5 + 5 inverted symmetry motif fold first described for LeuT (a Na^+ -dependent and Cl^- -dependent neurotransmitter transporter). The 5 + 5 inverted repeat fold (or LeuT fold) consists of two-membrane topology repeats of five

transmembrane (TM) domains each related by a pseudo two-fold symmetry axis located in the membrane plane. The two interior pairs of symmetry related helices (TM1/TM6 domains, which are discontinuous and consist of two short α -helices connected by a highly conserved unstructured segment, and TM3/TM8 domains) largely define the central translocation pathway that contains the binding sites for substrate and ions in transporters sharing the 5 + 5 inverted repeat fold. Atomic models of functionally disparate yet structurally related transporter families have provided insight into the principles of an alternating access mechanism in which the transporter undergoes several conformational states required to translocate the substrate across the membrane. During this transition, the transporter keeps the substrate accessible to only one side of the membrane (substrate-binding pocket accessible to extracellular solution “open to out” or to the cytoplasm “open to in”) at a given time by

opening and closing different gates. Upon substrate binding to the open-to-out apo state, the substrate-bound state evolves to an occluded state, where two gates (thick and thin) prevent the diffusion of the substrate to either side of the membrane. Transition to the inward-facing states requires a transient fully occluded symmetrical intermediate. AdiC, ApcT, and GadC have been solved in “open-to-out,” closed intermediate step and “open-to-in” states, respectively. In antiporters, the return to the outward-facing states requires the binding and translocation of a new intracellular substrate that will move the transporter back through all the states but in the opposite direction (Palacín et al. 2016).

As previously mentioned, several SLC3A2-associated transporters (SLC7A5, SLC7A11) are promising targets for the treatment of cancer. Solving the structure of human LATs would be a breakthrough that would allow the design of specific drugs relevant for clinics.

SLC3A2-Mediated Heterodimer Structure

SLC3A2-associated transporters work as single heterodimers (Palacín et al. 2016). Whereas SLC3A2 cytoplasmic and transmembrane domains are important for interactions with β -integrins (Feral et al. 2005), it has been recently demonstrated the importance of the SLC3A2-ED for the function of all SLC3A2-associated transporters expressed in cultured cells (SLC7A5, SLC7A6, and SLC7A11) (Fig. 1) (de la Ballina et al. 2016). This experimental evidence gives support to what was previously predicted from a modeled structure of SLC3A2-containing heterodimers. The structure of human SLC3A2/SLC7A8 was obtained by 3D reconstruction from negatively stained complexes at 21 Å. Such 3D reconstruction, along with docking analysis and cross-linking experiments, showed the relative positioning of heavy and light subunits. Thus, SLC3A2-ED would be located just on top of the catalytic subunit and interact with the extracellular loops of the corresponding associated transporter, stabilizing it (Rosell et al. 2014). In this model, the position of the transmembrane domain of SLC3A2 is not yet known (Fig. 2).

SLC3A2 and Integrins

SLC3A2 was first found to regulate integrin signaling by its ability to complement isolated β_1 cytoplasmic domain dominant suppression (Fenczik et al. 1997), a phenomenon that occurs when overexpression of β_1 cytoplasmic domain blocks integrin activation. Co-immunoprecipitation and subcellular co-localization were also reported, strongly suggesting a physical interaction between SLC3A2 and integrins (Fenczik et al. 1997). Altogether, multiple studies have clearly shown that SLC3A2 cytoplasmic and transmembrane domains (105 aa) are responsible for integrin signaling, whereas SLC3A2 ectodomain (SLC3A2-ED, 425 aa) is implicated in amino acid transport. Each function depends on SLC3A2 contacts with either beta-integrins or amino acid transporter catalytic subunits. One can also raise the possibility that SLC3A2 physical interactions, both with integrins and SLC7 transporter family, could modulate each other. Determining the specific role of each domain of SLC3A2 was based on the use of swapped domain chimeras between SLC3A2 and CD69 – being both type II transmembrane glycoproteins. Although results obtained using this approach were central, Cibrian and coworkers recently established a functional link between these two transmembrane proteins. In T cells, CD69 associates with the amino acid transporter complex SLC3A2/SLC7A5 regulating its surface expression and the uptake of L-tryptophan (Cibrian et al. 2016). Single-point mutants could provide an alternative for analyzing the dual function of SLC3A2. Importantly, amino acid residues 82–86 (WALLL), at the beginning of the transmembrane domain, seem key for SLC3A2 oncogenic activity via its effect downstream of integrins. On the integrin side, it is the cytoplasmic domain of β_{1A} and β_3 integrins (not β_{1D} or β_7) which interacts with SLC3A2 (Zent et al. 2000). More recently, β_4 integrin was also reported to bind SLC3A2 in human keratinocytes (Lemaître et al. 2011).

Processes Tuned by SCL3A2

The dual interaction of SLC3A2, with integrins and transporters, places this protein at the crossroad of a network, providing the context for a

complex cross regulation. SLC3A2 was discovered as a lymphocyte-activating antigen, namely, 4F2, and was reported widely expressed in hematopoietic and lymphoid cells, as well as in all established human tissue culture cells and in most malignant human cells (reviewed in Deves et al. 2000). The first line of evidence of SLC3A2's role *in vivo* resides in the embryonic lethality of its full body knockout (E3.5-E9.5), partly due to placentation defect (Tsumura et al. 2003). SLC3A2 is also a crucial determinant of human endometrial receptivity during the implantation window of the blastocyst (Domínguez et al. 2010). In order to study SLC3A2 function *in vivo*, Feral et al. generated a SLC3A2^{fl/fl} murine line (Féral et al. 2007), which was then combined with multiple Cre recombinase-expressing mouse lines. Specifically, given the SLC3A2 expression pattern, lymphocyte targeting (CD19 promoter) was performed *in vivo*. Ginsberg's lab established that SLC3A2 is a key player in adaptive immunity, via its integrin-signaling portion (Cantor et al. 2009). While it is not a requisite for T- or B-cell compartmentalization, initial activation, or steady-state, SLC3A2 is crucial for clonal expansion after antigen recognition (Cantor et al. 2009, 2012) making it a compelling target for autoimmune diseases.

SLC3A2 is also strongly expressed in epithelia such as the skin and intestine. Spatiotemporal SLC3A2 deletion in mouse basal keratinocytes (K14 promoter) impaired skin homeostasis with major defect in hair growth and wound healing (Boulter et al. 2013). Importantly, this study strongly suggests a key role for SLC3A2 during skin aging. Collagen and fibronectin organization are impacted upon loss of epidermal SLC3A2 *in vivo*, resulting in a more compliant skin through a reduction in RhoA/ROCK signaling and YAP/TAZ target gene expression (Estrach et al. 2014). Concomitantly, integrin-SLC3A2 interaction is also necessary *in vitro* for cellular contractility to exert the necessary force on the matrix to mediate this mechanical assembly process (Féral et al. 2007). SLC3A2 binding to integrins is necessary for proper integrin outside-in signaling (Feral et al. 2005), thus influencing

cellular behavior downstream of integrins (spreading, migration, anoikis). Consequently, SLC3A2 overexpression, such as in transformed or tumor cells, and SLC3A2-activating antibodies enhance integrin signaling (Deves et al. 2000). D. Merlin's laboratory, by generating gain- and loss-of-function genetic mouse models specifically in intestinal epithelial cells (villin promoter), elegantly showed that SLC3A2 expression controls homeostatic and innate immune responses in the gut (Nguyen et al. 2011). SLC3A2 overexpression induced barrier dysfunction and stimulated cell proliferation, as well as production of pro-inflammatory mediators. The authors raise a possible mechanism in which SLC3A2 overexpression would affect integrin signaling in intestinal epithelial cells, disrupting the homeostatic regulation of cell proliferation and survival, which would result in abnormal basal intestinal phenotype and contribute to increased intestinal permeability.

In humans, SLC3A2 overexpression is a marker of bad prognosis for many cancers. Early *in vivo* studies consisting of injecting either overexpressing cells or SLC3A2 null cells in nude mice pointed out a role for this protein in tumor development. Mouse models, either genetic or chemical, completed our understanding by showing that both integrin signaling and amino acid transport are involved in tumorigenesis *in vivo*. In the aforementioned intestine model, the ultimate effect downstream of SLC3A2 overexpression is the induction of tumorigenesis. As mentioned previously, this relates to increased inflammation, which could be integrin dependent (Nguyen et al. 2011). In a Ras-driven skin cancer model, SLC3A2 increased the stiffness of the tumor microenvironment (Estrach et al. 2014). It also amplified the capacity of cells to respond to matrix rigidity, an essential factor in tumor development. Thus, by potentiating integrins role in ECM assembly *in vivo*, SLC3A2 supports tumor progression. A recent study also reported a role for SLC3A2/integrin in angiogenesis through VEGFR activation in endothelial cells (Liao et al. 2016), bringing a novel viewpoint. Notably, SLC3A2 capacity to regulate amino acid transport, and more specifically SLC7A5 and

SLC7A11, participates in proliferation activation and tumorigenic potential (Nicklin et al. 2009; de la Ballina et al. 2016).

A humanized monoclonal antibody anti-SLC3A2 was recently generated and tested from a therapeutic point of view for acute myelogenous leukemia (AML) (Bajaj et al. 2016). SLC3A2 specifically promotes AML propagation and lethality by driving engagement of leukemia cells with their microenvironment. This antibody has several combined mechanisms of action including antibody-dependent cell death, caspase-dependent apoptosis, lysosomal membrane permeability increase, and amino acid transport decrease. Importantly, although the integrin-binding function is critical for the observed effect of SLC3A2 on AML growth, authors reported that more complete rescue of SLC3A2 null defects is only observed following restoration of the amino acid transport as well as integrin signaling functions. This work nails the previously suspected dual role of SLC3A2 in tumorigenesis via integrin and amino acid transporter binding, suggesting that targeting SCL3A2 may be more powerful than solely targeting upstream adhesive signals.

SLC3A2 and Other Partners

In addition to amino acid transporters and β -integrins, several other proteins have been found to interact directly or indirectly with SLC3A2. Specific functions and mechanisms of these interactions remain somewhat elusive. Nonetheless, they could participate in the regulation of SLC3A2-dependent functions, potentially placing SLC3A2 in a complex protein network that requires further functional investigations (Fig. 3).

As such, one of the first partners described was secreted galectin-3, which binds SLC3A2 via its ED glycosylation. Even though this interaction seems implicated in functions as distinct as placental cell fusion and kidney tubulogenesis, its role and mechanisms have not yet been fully revealed. Xu et al. also described the formation of a complex including SLC3A2 and the cell surface protein CD147 (basigin), which promotes production of matrix metalloproteinases and hyaluronan and associates with monocarboxylate transporters (MCTs) and integrins. The formation of this supercomplex was thought to play a critical

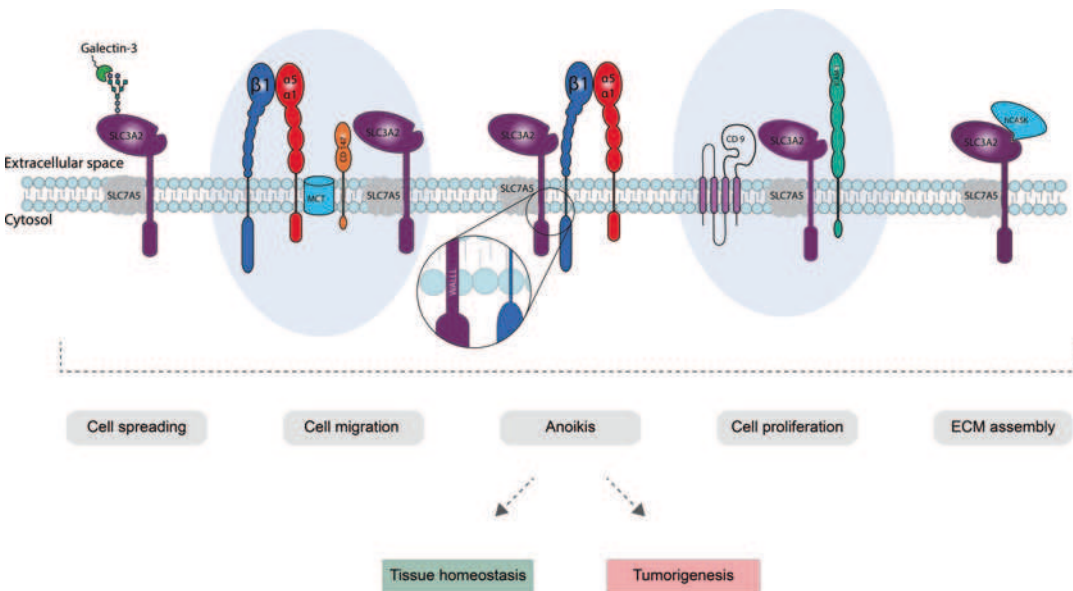

SLC3A2, Fig. 3 SLC3A2 partners. All SLC3A2 known partners (limited to SLC7A5 for amino acid transporters) are depicted. Suggested multiprotein complexes are shaded in blue; nevertheless, data to support one SLC3A2

molecule gathering several partners simultaneously is still missing. Described cellular processes downstream of SLC3A2/partners' interaction are also indicated

role in energy metabolism (Xu et al. 2005). More recently, CD147 was implicated in SLC3A2 redistribution, thus regulating integrin/SLC3A2 downstream behaviors (Yan et al. 2008). Similarly, intercellular adhesion molecule-1 (ICAM-1) co-immunoprecipitates with SLC3A2, and antibody-mediated cross-linking of both proteins conversely affects leucine transport by SLC7A8 (Liu et al. 2003). More specifically, in primary endometrial epithelial cells, SLC3A2 interacts with tetraspanin CD9, within the tetraspanin-enriched microdomains at the plasma membrane, which greatly enhanced mouse blastocyst adhesion (Dominguez et al. 2010). ICAM-1 can also, in turn, associate with CD9, suggesting the idea of macroprotein complex. Finally, thanks to its C-terminal class II PDZ-binding domain (GLLLRFPYAA, amino acids 520–529) protruding into the basolateral extracellular space of the intestine, SLC3A2 was proposed to interact with membrane-associated guanylate kinase hCASK (Yan et al. 2008); the implications of such interaction are yet to be fully elucidated. As mentioned earlier, a macromolecular complex could represent a functional entity capable of controlling SLC3A2-dependent processes, such as amino acid transport activity and/or cell/extracellular matrix adhesion via $\beta 1$ integrin.

The interesting and extended SLC3A2 interaction network places this protein at the crossroad of many cellular processes. Thus, although no enzymatic or ligand-binding capacity has been reported for SLC3A2, one can imagine that it is involved in tuning of a considerable number of cellular processes that may become interdependent.

Summary

SLC3A2 dual function as amino acid transporter and integrin signaling enhancer, make this protein a pivotal signal integrator. Besides, its multiple interactions with partners involved in central cellular processes only reinforce the potential impact of SLC3A2 on the regulation of numerous cell behaviors. For this reason, SLC3A2 constitutes an attractive therapeutic target for the development

of new treatments for diseases such as cancer. However, in order to design specific drugs, information regarding the molecular mechanisms by which SLC3A2 regulates each cellular function and how/whether the different processes mediated by SLC3A2 are regulated and modulate each other is required. Affecting SLC3A2-mediated functions would have a greater effect than separately targeting each of the functions in which it is involved.

References

- Bajaj J, Konuma T, Lytle N, Kwon H, Ablack J, Cantor J, Rizzieri D, Chuah C, Oehler V, Broome E, Ball E, van der Horst E, Ginsberg M, Reya T, et al. CD98-mediated adhesive signaling enables the establishment and propagation of acute myelogenous leukemia. *Cancer Cell*. 2016;30:792–805. doi:10.1016/j.ccell.2016.10.00330.
- Borsani G, Bassi MT, Sperandio MP, De Grandi A, Buoninconti A, Riboni M, Manzoni M, Incerti B, Pepe A, Andria G, Ballabio A, Sebastio G, et al. SLC7A7, encoding a putative permease-related protein, is mutated in patients with lysinuric protein intolerance. *Nat Genet*. 1999;21:297–301. doi:10.1038/681521.
- Boulter E, Estrach S, Errante A, Pons C, Cailleteau L, Tissot F, Meneguzzi G, Féral CC, et al. CD98hc (SLC3A2) regulation of skin homeostasis wanes with age. *J Exp Med*. 2013;210:173–90. doi:10.1084/jem.20121651210.
- Bröer S, Wagner CA, et al. Structure-function relationships of heterodimeric amino acid transporters. *Cell Biochem Biophys*. 2002;36:155–68. doi:10.1385/CBB:36:2-3:15536.
- Cantor J, Browne CD, Ruppert R, Féral CC, Fässler R, Rickert RC, Ginsberg MH, et al. CD98hc facilitates B cell proliferation and adaptive humoral immunity. *Nat Immunol*. 2009;10:412–9. doi:10.1038/ni.171210.
- Cantor JM, Ginsberg MH, et al. CD98 at the crossroads of adaptive immunity and cancer. *J Cell Sci*. 2012;125:1373–82. doi:10.1242/jcs.096040125.
- Cibrian D, Saiz ML, de la Fuente H, Sánchez-Díaz R, Moreno-Gonzalo O, Jorge I, Ferrarini A, Vázquez J, Punzón C, Fresno M, Vicente-Manzanares M, Daudén E, Fernández-Salguero PM, Martín P, Sánchez-Madrid F, et al. CD69 controls the uptake of L-tryptophan through LAT1-CD98 and AhR-dependent secretion of IL-22 in psoriasis. *Nat Immunol*. 2016;17:985–96. doi:10.1038/ni.350417.
- Cormerais Y, Giuliano S, LeFloch R, Front B, Durivault J, Tambutté E, Massard PA, de la Ballina LR, Endou H, Wempe MF, Palacin M, Parks SK, Pouyssegur J, et al. Genetic disruption of the multifunctional CD98/LAT1 complex demonstrates the key role of essential

- amino acid transport in the control of mTORC1 and tumor growth. *Cancer Res.* 2016;76:4481–92. doi:10.1158/0008-5472.CAN-15-337676.
- Danbolt NC. Glutamate uptake. *Prog Neurobiol.* 2001; 65:1–105.
- Deves R, Boyd CAR, et al. Surface antigen CD98 (4F2): not a single membrane protein, but a family of proteins with multiple functions. *J Membr Biol.* 2000; 173:165–77.
- Dixon SJ, Lemberg KM, Lamprecht MR, Skouta R, Zaitsev EM, Gleason CE, Patel DN, Bauer AJ, Cantley AM, Yang WS, Morrison B, Stockwell BR, et al. Ferroptosis: an iron-dependent form of non-apoptotic cell death. *Cell.* 2012;149:1060–72. doi:10.1016/j.cell.2012.03.042149.
- Domínguez F, Simón C, Quiñero A, Ramírez MÁ, González-Muñoz E, Burghardt H, Cervero A, Martínez S, Pellicer A, Palacín M, Sánchez-Madrid F, Yáñez-Mó M, et al. Human endometrial CD98 is essential for blastocyst adhesion. *PLoS One.* 2010;5:e13380. doi:10.1371/journal.pone.00133805.
- Estrach S, Lee SA, Boulter E, Pisano S, Errante A, Tissot FS, Cailleteau L, Pons C, Ginsberg MH, Féral CC, et al. CD98hc (SLC3A2) loss protects against ras-driven tumorigenesis by modulating integrin-mediated mechanotransduction. *Cancer Res.* 2014;74:6878–89. doi:10.1158/0008-5472.CAN-14-057974.
- Fenczik CA, Sethi T, Ramos JW, Hughes PE, Ginsberg MH, et al. Complementation of dominant suppression implicates CD98 in integrin activation. *Nature.* 1997;390:81–5. doi:10.1038/36349390.
- Feral CC, Nishiya N, Fenczik CA, Stuhlmann H, Slepak M, Ginsberg MH, et al. CD98hc (SLC3A2) mediates integrin signaling. *Proc Natl Acad Sci U S A.* 2005;102:355–60. doi:10.1073/pnas.0404852102102.
- Féral CC, Zijlstra A, Tkachenko E, Prager G, Gardel ML, Slepak M, Ginsberg MH, et al. CD98hc (SLC3A2) participates in fibronectin matrix assembly by mediating integrin signaling. *J Cell Biol.* 2007;178:701–11. doi:10.1083/jcb.200705090178.
- Fort J, de la Ballina LR, Burghardt HE, Ferrer-Costa C, Turnay J, Ferrer-Orta C, Usón I, Zorzano A, Fernández-Recio J, Orozco M, Lizarbe MA, Fita I, Palacín M, et al. The structure of human 4F2hc ectodomain provides a model for homodimerization and electrostatic interaction with plasma membrane. *J Biol Chem.* 2007;282:31444–52. doi:10.1074/jbc.M704524200282.
- Fotiadis D, Kanai Y, Palacín M, et al. The SLC3 and SLC7 families of amino acid transporters. *Mol Asp Med.* 2013;34:139–58. doi:10.1016/j.mam.2012.10.00734.
- Ip H, Sethi T, et al. CD98 signals controlling tumorigenesis. *Int J Biochem Cell Biol.* 2016;81:148–50. doi:10.1016/j.biocel.2016.11.00581.
- de la Ballina LR, Cano-Crespo S, González-Muñoz E, Bial S, Estrach S, Cailleteau L, Tissot F, Daniel H, Zorzano A, Ginsberg MH, Palacín M, Féral CC, et al. Amino acid transport associated to cluster of differentiation 98 heavy chain (CD98hc) is at the cross-road of oxidative stress and amino acid availability. *J Biol Chem.* 2016;291:9700–11. doi:10.1074/jbc.M115.704254291.
- Lemaître G, Stella A, Feteira J, Baldeschi C, Vaigot P, Martin MT, Monsarrat B, Waksman G, et al. CD98hc (SLC3A2) is a key regulator of keratinocyte adhesion. *J Dermatol Sci.* 2011;61:169–79. doi:10.1016/j.jdermsci.2010.12.00761.
- Liao Z, Cantor JM, et al. Endothelial cells require CD98 for efficient angiogenesis—brief report. *Arterioscler Thromb Vasc Biol.* 2016;36:2163–6. doi:10.1161/ATVBAHA.116.30835356.
- Liu X, Charrier L, Gewirtz A, Sitaraman S, Merlin D, et al. CD98 and intracellular adhesion molecule I regulate the activity of amino acid transporter LAT-2 in polarized intestinal epithelia. *J Biol Chem.* 2003;278:23672–7. doi:10.1074/jbc.M302777200278.
- McCracken AN, Edinger AL, et al. Nutrient transporters: the Achilles' heel of anabolism. *Trends Endocrinol Metab.* 2013;24:200–8. doi:10.1016/j.tem.2013.01.00224.
- Milkereit R, Persaud A, Vanoaica L, Guetg A, Verrey F, Rotin D, et al. LAPT4b recruits the LAT1-4F2hc Leu transporter to lysosomes and promotes mTORC1 activation. *Nat Commun.* 2015;6:7250. doi:10.1038/ncomms82506.
- Nguyen HT, Dalmasso G, Torkvist L, Halfvarson J, Yan Y, Laroui H, Shmerling D, Tallone T, D'Amato M, Sitaraman SV, Merlin D, et al. CD98 expression modulates intestinal homeostasis, inflammation, and colitis-associated cancer in mice. *J Clin Invest.* 2011;121:1733–47. doi:10.1172/JCI44631121.
- Nicklin P, Bergman P, Zhang B, Triantafellow E, Wang H, Nyfeler B, Yang H, Hild M, Kung C, Wilson C, Myer VE, MacKeigan JP, Porter JA, Wang YK, Cantley LC, Finan PM, Murphy LO, et al. Bidirectional transport of amino acids regulates mTOR and autophagy. *Cell.* 2009;136:521–34. doi:10.1016/j.cell.2008.11.044136.
- Palacín M, Errasti-Murugarren E, Rosell A, et al. Heteromeric amino acid transporters. In search of the molecular bases of transport cycle mechanisms. *Biochem Soc Trans.* 2016;44:745–52. doi:10.1042/BST2015029444.
- Reig N, Chillarón J, Bartoccioni P, Fernández E, Bendahan A, Zorzano A, Kanner B, Palacín M, Bertran J, et al. The light subunit of system b₀(+,) is fully functional in the absence of the heavy subunit. *EMBO J.* 2002;21:4906–14.
- Rosell A, Meury M, Álvarez-Marimón E, Costa M, Pérez-Cano L, Zorzano A, Fernández-Recio J, Palacín M, Fotiadis D, et al. Structural bases for the interaction and stabilization of the human amino acid transporter LAT2 with its ancillary protein 4F2hc. *Proc Natl Acad Sci U S A.* 2014;111:2966–71. doi:10.1073/pnas.13237791111111.
- Safory H, Neame S, Shulman Y, Zubedat S, Radziszewsky I, Rosenberg D, Sason H, Engelder S, Avital A, Hülsmann S, Schiller J,

Wolosker H, et al. The alanine-serine-cysteine-1 (Asc-1) transporter controls glycine levels in the brain and is required for glycinergic inhibitory transmission. *EMBO Rep.* 2015;16:590–8. doi:10.15252/embr.20143956116.

Takesono A, Moger J, Farooq S, Cartwright E, Dawid IB, Wilson SW, Kudoh T. Solute carrier family 3 member 2 (Slc3a2) controls yolk syncytial layer (YSL) formation by regulating microtubule networks in the zebrafish embryo. *Proc Natl Acad Sci U S A.* 2012;109(9):3371–6. doi:10.1073/pnas.1200642109.

Tărlungeanu DC, Deliu E, Dotter CP, Kara M, Janiesch PC, Scalise M, Galluccio M, Tesulov M, Morelli E, Sonmez FM, Bilguvar K, Ohgaki R, Kanai Y, Johansen A, Esharif S, Ben-Omran T, Topcu M, Schlessinger A, Indiveri C, Duncan KE, Caglayan AO, Gunel M, Gleeson JG, Novarino G, et al. Impaired amino acid transport at the blood brain barrier is a cause of autism spectrum disorder. *Cell.* 2016;167:1481–94.e18. doi:10.1016/j.cell.2016.11.013167.

Torrents D, Mykkänen J, Pineda M, Feliubadaló L, Estévez R, de Cid R, Sanjurjo P, Zorzano A, Nunes V, Huoponen K, Reinikainen A, Simell O, Savontaus ML, Aula P, Palacín M, et al. Identification of SLC7A7, encoding y + LAT-1, as the lysinuric protein intolerance gene. *Nat Genet.* 1999;21:293–6. doi:10.1038/680921.

Tsumura H, Suzuki N, Saito H, Kawano M, Otake S, Kozuka Y, Komada H, Tsurudome M, Ito Y, et al. The targeted disruption of the CD98 gene results in embryonic lethality. *Biochem Biophys Res Commun.* 2003;308:847–51.

Veettil MV, Sadagopan S, Sharma-Walia N, Wang FZ, Raghu H, Varga L, Chandran B, et al. Kaposi's sarcoma-associated herpesvirus forms a multi-molecular complex of integrins (alphaVbeta5, alphaVbeta3, and alpha3beta1) and CD98-xCT during infection of human dermal microvascular endothelial cells, and CD98-xCT is essential for the postentry stage of infection. *J Virol.* 2008;82:12126–44. doi:10.1128/JVI.01146-0882.

Xu D, Hemler ME, et al. Metabolic activation-related CD147-CD98 complex. *Mol Cell Proteomics.* 2005;4:1061–71. doi:10.1074/mcp.M400207-MCP2004.

Yan Y, Vasudevan S, Nguyen HT, Merlin D, et al. Intestinal epithelial CD98: an oligomeric and multifunctional protein. *Biochim Biophys Acta.* 2008;1780:1087–92. doi:10.1016/j.bbagen.2008.06.0071780.

Zent R, Fenczik CA, Calderwood DA, Liu S, Dellos M, Ginsberg MH, et al. Class-and splice variant-specific association of CD98 with integrin beta cytoplasmic domains. *J Biol Chem.* 2000;275:5059.

SLC5A7

► [CHT1 \(High-Affinity Choline Transporter\)](#)

Slc6a4

► [5-HTT](#)

SLC9

Meytal Landau

Department of Biology, Technion – Israel Institute of Technology, Haifa, Israel

Synonyms

[Sodium/hydrogen exchanger](#); [Solute carrier family 9](#)

Historical Background

All living cells are critically dependent on homeostatic mechanisms that regulate intracellular pH, Na⁺ content, and, as a result, cell volume. Correspondingly, Na⁺ and H⁺ are among the most prevalent ions in living cells and are essential in cell bioenergetics. In 1974, West and Mitchell discovered sodium proton antiport activity in bacterial cells and suggested that Na⁺/H⁺ antiporter proteins have primary roles in the homeostasis of these cations (West and Mitchell 1974). Since then, sodium proton antiporters have been identified in the cytoplasmic and organelle membranes of almost all cells, including those of plants, animals and microorganisms. Furthermore, increasing numbers of these antiporters are being identified as human drug targets.

The SLC9 gene family encodes Na⁺/H⁺ exchangers (NHEs) in many species from prokaryotes to eukaryotes. In humans, these proteins are associated with the pathophysiology of various diseases. Yet, the most extensively studied

SLC4A7

► [Na⁺/HCO₃⁻ Cotransporter NBCn1](#)

Section 6: References

- Ablack, J. N. G., Metz, P. J., Chang, J. T., Cantor, J. M. and Ginsberg, M. H.** (2015). Ubiquitylation of CD98 limits cell proliferation and clonal expansion. *J. Cell Sci.* **128**, 4273–8.
- Alam, N., Goel, H. L., Zarif, M. J., Butterfield, J. E., Perkins, H. M., Sansoucy, B. G., Sawyer, T. K. and Languino, L. R.** (2007). The integrin—growth factor receptor duet. *J. Cell. Physiol.* **213**, 649–653.
- Anders, L., Ke, N., Hydbring, P., Choi, Y. J., Widlund, H. R., Chick, J. M., Zhai, H., Vidal, M., Gygi, S. P., Braun, P., et al.** (2011). A Systematic Screen for CDK4/6 Substrates Links FOXM1 Phosphorylation to Senescence Suppression in Cancer Cells. *Cancer Cell* **20**, 620–634.
- Anthis, N. J., Wegener, K. L., Ye, F., Kim, C., Goult, B. T., Lowe, E. D., Vakonakis, I., Bate, N., Critchley, D. R., Ginsberg, M. H., et al.** (2009). The structure of an integrin/talin complex reveals the basis of inside-out signal transduction. *EMBO J.* **28**, 3623–3632.
- Arthur, W. T. and Burridge, K.** (2001). RhoA Inactivation by p190RhoGAP Regulates Cell Spreading and Migration by Promoting Membrane Protrusion and Polarity. *Mol. Biol. Cell.*
- Ashkenazy, H., Erez, E., Martz, E., Pupko, T. and Ben-Tal, N.** (2010). ConSurf 2010: Calculating evolutionary conservation in sequence and structure of proteins and nucleic acids. *Nucleic Acids Res.*
- Ashkenazy, H., Abadi, S., Martz, E., Chay, O., Mayrose, I., Pupko, T. and Ben-Tal, N.** (2016). ConSurf 2016: an improved methodology to estimate and visualize evolutionary conservation in macromolecules. *Nucleic Acids Res.*
- Avruch, J., Long, X., Ortiz-Vega, S., Rapley, J., Papageorgiou, A. and Dai, N.** (2009). Amino acid regulation of TOR complex 1. *Am. J. Physiol. Endocrinol. Metab.*
- Azzarone, B., Malpière, Y., Zaech, P., Moretta, L., Fauci, A. and Suarez, H.** (1985). Analysis of the expression of the 4F2 surface antigen in normal and neoplastic fibroblastic human cells of embryonic and adult origin. *Exp. Cell Res.* **159**, 451–462.
- Bachelder, R. E., Marchetti, A., Falcioni, R., Soddu, S. and Mercurio, A. M.** (1999a). Activation of p53 function in carcinoma cells by the alpha6beta4 integrin. *J. Biol. Chem.* **274**, 20733–20737.
- Bachelder, R. E., Ribick, M. J., Marchetti, A., Falcioni, R., Soddu, S., Davis, K. R. and Mercurio, A. M.** (1999b). p53 Inhibits alpha6beta4 integrin survival signaling by promoting the caspase 3-dependent cleavage of AKT/PKB. *J. Cell Biol.* **147**, 1063–1072.
- Bajaj, J., Konuma, T., Lytle, N. K., Kwon, H. Y., Ablack, J. N., Cantor, J. M., Rizzieri, D., Chuah, C., Oehler, V. G., Broome, E. H., et al.** (2016). CD98-Mediated Adhesive Signaling Enables the Establishment and Propagation of Acute Myelogenous Leukemia. *Cancer Cell* **30**, 792–805.
- Balomenos, D. and Martínez-A, C.** (2000). Cell-cycle regulation in immunity, tolerance and autoimmunity. *Immunol. Today* **21**, 551–555.
- Balza, E., Castellani, P., Delfino, L., Truini, M. and Rubartelli, A.** (2013). The pharmacologic inhibition of the xc-antioxidant system improves the antitumor efficacy of COX inhibitors in the in vivo model of 3-MCA tumorigenesis. *Carcinogenesis* **34**, 620–626.
- Barberis, L., Wary, K. K., Fiucci, G., Liu, F., Hirsch, E., Brancaccio, M., Altruda, F., Tarone, G. and Giancotti, F. G.** (2000). Distinct roles of the adaptor protein Shc and focal adhesion kinase in integrin signaling to ERK. *J. Biol. Chem.* **275**, 36532–36540.
- Baron, W., Decker, L., Colognato, H. and Ffrench-Constant, C.** (2003). Regulation of integrin growth factor interactions in oligodendrocytes by lipid raft microdomains. *Curr. Biol.* **13**, 151–155.
- Barreiro, O., Yáñez-Mó, M., Sala-Valdés, M., Gutiérrez-López, M. D., Ovalle, S., Higginbottom, A., Monk, P. N., Cabañas, C. and Sánchez-Madrid, F.** (2005). Endothelial tetraspanin microdomains regulate leukocyte firm adhesion during extravasation. *Blood* **105**, 2852–2861.
- Bartocioni, P., Del Rio, C., Ratera, M., Kowalczyk, L., Baldwin, J. M., Zorzano, A., Quick, M., Baldwin, S. A., Vázquez-Ibar, J. L. and Palacín, M.** (2010). Role of transmembrane domain 8 in substrate selectivity and translocation of SteT, a member of the L-Amino acid Transporter (LAT) family. *J. Biol. Chem.* **285**, 28764–28776.
- Bellone, G., Alloatti, G., Levi, R., Geuna, M., Tetta, C., Peruzzi, L., Letarte, M. and Malavasi, F.** (1989). Identification of a new epitope of the 4F2/44D7 molecular complex present on sarcolemma and isolated cardiac fibers. *Eur. J. Immunol.* **19**, 1–8.

- Ben-Sahra, I. and Manning, B. D.** (2017). mTORC1 signaling and the metabolic control of cell growth. *Curr. Opin. Cell Biol.* **45**, 72–82.
- Ben-Sahra, I., Howell, J. J., Asara, J. M. and Manning, B. D.** (2013). Stimulation of de novo pyrimidine synthesis by growth signaling through mTOR and S6K1. *Science* (80-.).
- Ben-Sahra, I., Hoxhaj, G., Ricoult, S. J. H., Asara, J. M. and Manning, B. D.** (2016). mTORC1 induces purine synthesis through control of the mitochondrial tetrahydrofolate cycle. *Science* (80-.).
- Bhaskar, P. T. and Hay, N.** (2007). The Two TORCs and Akt. *Dev. Cell.*
- Bill, H. M., Knudsen, B., Moores, S. L., Muthuswamy, S. K., Rao, V. R., Brugge, J. S. and Miranti, C. K.** (2004). Epidermal Growth Factor Receptor-Dependent Regulation of Integrin-Mediated Signaling and Cell Cycle Entry in Epithelial Cells. *Mol. Cell. Biol.* **24**, 8586–8599.
- Bixby, D., Wieduwilt, M. J., Akard, L. P., Khoury, H. J., Becker, P. S., Van Der Horst, E. H. and Ho, W.** (2015). A Phase I study of IGN523, a novel Anti-CD98 monoclonal antibody in patients with relapsed or refractory Acute Myeloid Leukemia (AML). *Blood* **126**, 3809.
- Blaess, S., Graus-Porta, D., Belvindrah, R., Radakovits, R., Pons, S., Littlewood-Evans, A., Senften, M., Guo, H., Li, Y., Miner, J. H., et al.** (2004). Beta1-integrins are critical for cerebellar granule cell precursor proliferation. *J. Neurosci.* **24**, 3402–12.
- Blanco, E., Messeguer, X., Smith, T. F. and Guigó, R.** (2006). Transcription factor map alignment of promoter regions. *PLoS Comput. Biol.* **2**, 403–416.
- Boehm, T. and Swann, J. B.** (2014). Origin and Evolution of Adaptive Immunity. *Annu. Rev. Anim. Biosci.* **2**, 259–283.
- Bolkan, B. J., Booker, R., Goldberg, M. L. and Barbash, D. A.** (2007). Developmental and cell cycle progression defects in Drosophila hybrid males. *Genetics* **177**, 2233–2241.
- Bonfils, G., Jaquenoud, M., Bontron, S., Ostrowicz, C., Ungermann, C. and De Virgilio, C.** (2012). Leucyl-tRNA Synthetase Controls TORC1 via the EGO Complex. *Mol. Cell.*
- Bonnans, C., Chou, J. and Werb, Z.** (2014). Remodelling the extracellular matrix in development and disease. *Nat. Rev. Mol. Cell Biol.* **15**, 786–801.
- Borges, E., Jan, Y. and Ruoslahti, E.** (2000). Platelet-derived growth factor receptor beta and vascular endothelial growth factor receptor 2 bind to the beta 3 integrin through its extracellular domain. *J. Biol. Chem.* **275**, 39867–39873.
- Borsani, G., Bassi, M. T., Sperandeo, M. P., De Grandi, A., Buoninconti, A., Riboni, M., Manzoni, M., Incerti, B., Pepe, A., Andria, G., et al.** (1999). SLC7A7, encoding a putative permease-related protein, is mutated in patients with lysinuric protein intolerance. *Nat. Genet.* **21**, 297–301.
- Boulter, E., Estrach, S., Errante, A., Pons, C., Cailleteau, L., Tissot, F., Meneguzzi, G. and Féral, C. C.** (2013). CD98hc (SLC3A2) regulation of skin homeostasis wanes with age. *J. Exp. Med.* **210**, 173–90.
- Boulter, E., Estrach, S., Tissot, F. S., Hennrich, M. L., Tosello, L., Cailleteau, L., de la Ballina, L. R., Pisano, S., Gavin, A. C. and Féral, C. C.** (2018). Cell metabolism regulates integrin mechanosensing via an SLC3A2-dependent sphingolipid biosynthesis pathway. *Nat. Commun.*
- Broer, S., Broer, A. and Hamprecht, B.** (1997). Expression of the surface antigen 4F2hc (CD 98) affects system L-like neutral amino acid transport in mammalian cells. *Amino Acids* **13**, 535–541.
- Bröer, S. and Wagner, C. A.** (2002). Structure – Function Relationships of Heterodimeric Amino Acid Transporters. *Cell Biochem. Biophys.* **36**, 155–168.
- Buchheit, C. L., Weigel, K. J. and Schafer, Z. T.** (2014). Cancer cell survival during detachment from the ECM: multiple barriers to tumour progression. *Nat. Rev. Cancer* **14**, 632–641.
- Bulus, N., Feral, C., Pozzi, A. and Zent, R.** (2012). CD98 increases renal epithelial cell proliferation by activating MAPKs. *PLoS One* **7**,.
- Burbach, B. J., Medeiros, R. B., Mueller, K. L. and Shimizu, Y.** (2007). T-cell receptor signaling to integrins. *Immunol. Rev.* **218**, 65–81.
- Buscà, R., Pouyssegur, J. and Lenormand, P.** (2016). ERK1 and ERK2 Map Kinases: Specific Roles or Functional Redundancy? *Front. Cell Dev. Biol.*
- Cai, S., Bulus, N., Fonseca-Siesser, P. M., Chen, D., Hanks, S. K., Pozzi, A. and Zent, R.** (2005). CD98 modulates integrin beta1 function in polarized epithelial cells. *J. Cell Sci.* **118**, 889–99.

- Calderwood, D. A. (2004). Integrin activation. *J. Cell Sci.* **117**, 657–66.
- Calderwood, D. A., Zent, R., Grant, R., Rees, D. J. G., Hynes, R. O. and Ginsberg, M. H. (1999). The talin head domain binds to integrin β subunit cytoplasmic tails and regulates integrin activation. *J. Biol. Chem.* **274**, 28071–28074.
- Calderwood, D. A., Yan, B., De Pereda, J. M., Alvarez, B. G., Fujioka, Y., Liddington, R. C. and Ginsberg, M. H. (2002). The phosphotyrosine binding-like domain of talin activates integrins. *J. Biol. Chem.* **277**, 21749–21758.
- Calderwood, D. A., Fujioka, Y., de Pereda, J. M., Garcia-Alvarez, B., Nakamoto, T., Margolis, B., McGlade, C. J., Liddington, R. C. and Ginsberg, M. H. (2003). Integrin cytoplasmic domain interactions with phosphotyrosine-binding domains: A structural prototype for diversity in integrin signaling. *Proc. Natl. Acad. Sci.* **100**, 2272–2277.
- Cantor, J. M. (2014). CD98 is a potential target for ablating B cell clonal expansion and autoantibody in multiple sclerosis. *J. Neuroimmunol.* **274**, 230–233.
- Cantor, J. M. and Ginsberg, M. H. (2012). CD98 at the crossroads of adaptive immunity and cancer. *J. Cell Sci.* **125**, 1373–1382.
- Cantor, J., Browne, C. D., Ruppert, R., Féral, C. C., Fässler, R., Rickert, R. C. and Ginsberg, M. H. (2009). CD98hc facilitates B cell proliferation and adaptive humoral immunity. *Nat. Immunol.* **10**, 412–419.
- Cantor, J., Slepak, M., Ege, N., Chang, J. T. and Ginsberg, M. H. (2011). Loss of T cell CD98 H chain specifically ablates T cell clonal expansion and protects from autoimmunity. *J. Immunol.* **187**, 851–60.
- Cargnello, M., Tcherkezian, J. and Roux, P. P. (2015). The expanding role of mTOR in cancer cell growth and proliferation. *Mutagenesis* **30**, 169–176.
- Carpenter, A. E., Jones, T. R., Lamprecht, M. R., Clarke, C., Kang, I. H., Friman, O., Guertin, D. A., Chang, J. H., Lindquist, R. A., Moffat, J., et al. (2006). CellProfiler: image analysis software for identifying and quantifying cell phenotypes. *Genome Biol.* **7**, R100.
- Cartharius, K., Frech, K., Grote, K., Klocke, B., Haltmeier, M., Klingenhoff, A., Frisch, M., Bayerlein, M. and Werner, T. (2005). MatInspector and beyond: Promoter analysis based on transcription factor binding sites. *Bioinformatics* **21**, 2933–2942.
- Celniker, G., Nimrod, G., Ashkenazy, H., Glaser, F., Martz, E., Mayrose, I., Pupko, T. and Ben-Tal, N. (2013). ConSurf: Using evolutionary data to raise testable hypotheses about protein function. *Isr. J. Chem.*
- Chang, H. C. and Guarente, L. (2014). SIRT1 and other sirtuins in metabolism. *Trends Endocrinol. Metab.*
- Chantranupong, L., Scaria, S. M., Saxton, R. A., Gygi, M. P., Shen, K., Wyant, G. A., Wang, T., Harper, J. W., Gygi, S. P. and Sabatini, D. M. (2016). The CASTOR Proteins Are Arginine Sensors for the mTORC1 Pathway. *Cell.*
- Charrin, S., Jouannet, S., Boucheix, C. and Rubinstein, E. (2014). Tetraspanins at a glance. *J. Cell Sci.* **127**, 3641–3648.
- Chen, R., Jiang, X., Sun, D., Han, G., Wang, F., Ye, M., Wang, L. and Zou, H. (2009). Glycoproteomics Analysis of Human Liver Tissue by Combination of Multiple Enzyme Digestion and Hydrazide Chemistry. *J. Proteome Res.* **8**, 651–661.
- Choi, C. K., Vicente-Manzanares, M., Zareno, J., Whitmore, L. A., Mogilner, A. and Horwitz, A. R. (2008). Actin and α -actinin orchestrate the assembly and maturation of nascent adhesions in a myosin II motor-independent manner. *Nat. Cell Biol.* **10**, 1039–1050.
- Choquet, D., Felsenfeld, D. P. and Sheetz, M. P. (1997). Extracellular matrix rigidity causes strengthening of integrin-cytoskeleton linkages. *Cell.*
- Christofk, H. R., Vander Heiden, M. G., Harris, M. H., Ramanathan, A., Gerszten, R. E., Wei, R., Fleming, M. D., Schreiber, S. L. and Cantley, L. C. (2008). The M2 splice isoform of pyruvate kinase is important for cancer metabolism and tumour growth. *Nature* **452**, 230–233.
- Chung, J., Bachelder, R. E., Lipscomb, E. A., Shaw, L. M. and Mercurio, A. M. (2002). Integrin ($\alpha 6\beta 4$) regulation of eIF-4E activity and VEGF translation: A survival mechanism for carcinoma cells. *J. Cell Biol.* **158**, 165–174.
- Cibrian, D., Saiz, M. L., de la Fuente, H., Sánchez-Díaz, R., Moreno-Gonzalo, O., Jorge, I., Ferrarini, A., Vázquez, J., Punzón, C., Fresno, M., et al. (2016). CD69 controls the uptake of L-tryptophan through LAT1-CD98 and AhR-dependent secretion of IL-22 in psoriasis. *Nat. Immunol.* **17**, 985–96.
- Coller, H. A. (2007). What's taking so long? S-phase entry from quiescence versus proliferation. *Nat. Rev. Mol.*

- Cell Biol.* **8**, 667–670.
- Coller, H. A., Sang, L. and Roberts, J. M.** (2006). A new description of cellular quiescence. *PLoS Biol.* **4**, 0329–0349.
- Collins, P. J., Kobayashi, Y., Nguyen, L., Trinklein, N. D. and Myers, R. M.** (2007). The ets-Related Transcription Factor GABP Directs Bidirectional Transcription. *PLoS Genet.* **3**, e208.
- Conrad, M. and Sato, H.** (2012). The oxidative stress-inducible cystine/glutamate antiporter, system x_c⁻: Cystine supplier and beyond. *Amino Acids* **42**, 231–246.
- Consortium, E. P.** (2012). An integrated encyclopedia of DNA elements in the human genome. *Nature* **489**, 57–74.
- Cormerais, Y., Giuliano, S., LeFloch, R., Front, B., Durivault, J., Tambutte, E., Massard, P.-A., De La Ballina, L. R., Endou, H., Wempe, M. F., et al.** (2016). Genetic disruption of the multifunctional CD98/LAT1 complex demonstrates the key role of essential amino acid transport in the control of mTORC1 and tumor growth. *Cancer Res.* **76**, 4481–4492.
- Cotner, T., Williams, J. M., Christenson, L., Shapiro, H. M., Strom, T. B. and Strominger, J.** (1983). Simultaneous flow cytometric analysis of human T cell activation antigen expression and DNA content. *J Exp Med* **157**, 461–472.
- Critchley, D. R.** (2009). Biochemical and Structural Properties of the Integrin- Associated Cytoskeletal Protein Talin. *Annu. Rev. Biophys.* **38**, 235–54.
- Dalton, P., Christian, H. C., Redman, C. W. G., Sargent, I. L. and Boyd, C. A. R.** (2007). Membrane trafficking of CD98 and its ligand galectin 3 in BeWo cells - Implication for placental cell fusion. *FEBS J.* **274**, 2715–2727.
- Dang, D. T., Pevsner, J. and Yang, V. W.** (2000). The biology of the mammalian Kruppel-like family of transcription factors. *Int. J. Biochem. Cell Biol.* **32**, 1103–1121.
- Davuluri, R. V., Suzuki, Y., Sugano, S., Plass, C. and Huang, T. H.-M.** (2008). The functional consequences of alternative promoter use in mammalian genomes. *Trends Genet.* **24**, 167–177.
- de la Ballina, L. R., de Garay, T., Feral, C. and Palacin, M.** (2018). SLC3A2. In *Encyclopedia of Signaling Molecules*, pp. 5022–5034.
- De La Ballina, L. R., Cano-Crespo, S., González-Muñoz, E., Bial, S., Estrach, S., Cailleteau, L., Tissot, F., Daniel, H., Zorzano, A., Ginsberg, M. H., et al.** (2016). Amino acid transport associated to cluster of differentiation 98 heavy chain (CD98HC) is at the cross-road of oxidative stress and amino acid availability. *J. Biol. Chem.* **291**, 9700–9711.
- DeBerardinis, R. J., Lum, J. J., Hatzivassiliou, G. and Thompson, C. B.** (2008). The Biology of Cancer: Metabolic Reprogramming Fuels Cell Growth and Proliferation. *Cell Metab.* **7**, 11–20.
- Dellinger, M. T. and Brekken, R. A.** (2011). Phosphorylation of Akt and ERK1/2 is required for VEGF-A/VEGFR2-induced proliferation and migration of lymphatic endothelium. *PLoS One* **6**,
- Desgrosellier, J. S. and Cheresh, D. A.** (2010). Integrins in cancer: Biological implications and therapeutic opportunities. *Nat. Rev. Cancer* **10**, 9–22.
- Devés, R. and Boyd, C.** (2000). Surface Antigen CD98(4F2): Not a Single Membrane Protein, But a Family of Proteins with Multiple Functions. *J. Membr. Biol.* 165–177.
- Díaz-Alvarez, L. and Ortega, E.** (2017). The Many Roles of Galectin-3, a Multifaceted Molecule, in Innate Immune Responses against Pathogens. *Mediators Inflamm.* **2017**, 9–12.
- Dibble, C. C. and Manning, B. D.** (2013). Signal integration by mTORC1 coordinates nutrient input with biosynthetic output. *Nat. Cell Biol.* **15**, 555–564.
- Discher, D. E., Mooney, D. J. and Zandstra, P. W.** (2009). Growth factors, matrices, and forces combine and control stem cells. *Science* **324**, 1673–7.
- Dixon, W. T., Sikora, L. K. J., Demetrick, D. J. and Martin Jerry, L.** (1990). Isolation and characterization of a heterodimeric surface antigen on human melanoma cells and evidence that it is the 4f2 cell activation/proliferation molecule. *Int. J. Cancer* **45**, 59–68.
- Domínguez, F., Simón, C., Quiñonero, A., Ramírez, M. Á., González-Muñoz, E., Burghardt, H., Cervero, A., Martínez, S., Pellicer, A., Palacín, M., et al.** (2010). Human endometrial CD98 is essential for blastocyst adhesion. *PLoS One* **5**, e13380.
- Dong, S. and Hughes, R. C.** (1996). Galectin-3 stimulates uptake of extracellular Ca²⁺ in human Jurkat T-cells.

- FEBS Lett.* **395**, 165–169.
- Dong, S. and Hughes, R. C.** (1997). Macrophage surface glycoproteins binding to galectin-3 (Mac-2-antigen). *Glycoconj. J.* **14**, 267–274.
- Dorrello, N. V., Peschiaroli, A., Guardavaccaro, D., Colburn, N. H., Sherman, N. E. and Pagano, M.** (2006). S6k1- and β TRCP-mediated degradation of PDCD4 promotes protein translation and cell growth. *Science* (80-).
- Duelli, R., Enerson, B. E., Gerhart, D. Z. and Drewes, L. R.** (2000). Expression of large amino acid transporter LAT1 in rat brain endothelium. *J. Cereb. Blood Flow Metab.*
- Dufort, C. C., Paszek, M. J. and Weaver, V. M.** (2011). Balancing forces: Architectural control of mechanotransduction. *Nat. Rev. Mol. Cell Biol.* **12**, 308–319.
- Durán, R. V., Oppliger, W., Robitaille, A. M., Heiserich, L., Skendaj, R., Gottlieb, E. and Hall, M. N.** (2012). Glutaminolysis Activates Rag-mTORC1 Signaling. *Mol. Cell.*
- Düvel, K., Yecies, J. L., Menon, S., Raman, P., Lipovsky, A. I., Souza, A. L., Triantafellow, E., Ma, Q., Gorski, R., Cleaver, S., et al.** (2010). Activation of a metabolic gene regulatory network downstream of mTOR complex 1. *Mol. Cell.*
- Eliceiri, B. P.** (2001). Integrin and growth factor receptor crosstalk. *Circ. Res.* **89**, 1104–1110.
- Elorza, A., Soro-Arnáiz, I., Meléndez-Rodríguez, F., Rodríguez-Vaello, V., Marsboom, G., de Cárcer, G., Acosta-Iborra, B., Albacete-Albacete, L., Ordóñez, A., Serrano-Oviedo, L., et al.** (2012). HIF2 α Acts as an mTORC1 Activator through the Amino Acid Carrier SLC7A5. *Mol. Cell.*
- Esteban, F., Ruiz-Cabello, F., Concha, A., Ayala, M. P., Delgado, M. and Garrido, F.** (1990). Relationship of 4F2 antigen with local growth and metastatic potential of squamous cell carcinoma of the larynx. *Cancer* **66**, 1493–1498.
- Estrach, S., Lee, S.-A., Boulter, E., Pisano, S., Errante, A., Tissot, F. S., Cailleteau, L., Pons, C., Ginsberg, M. H. and Féral, C. C.** (2014). CD98hc (SLC3A2) loss protects against ras-driven tumorigenesis by modulating integrin-mediated mechanotransduction. *Cancer Res.* **74**, 6878–89.
- Eyckmans, J., Boudou, T., Yu, X. and Chen, C. S.** (2011). A Hitchhiker's Guide to Mechanobiology. *Dev. Cell* **21**, 35–47.
- Eyster, C. A., Cole, N. B., Petersen, S., Viswanathan, K., Früh, K. and Donaldson, J. G.** (2011). MARCH ubiquitin ligases alter the itinerary of clathrin-independent cargo from recycling to degradation. *Mol. Biol. Cell* **22**, 3218–30.
- Fais, S. and Pallone, F.** (1989). Ability of human colonic epithelium to express the 4F2 antigen, the common acute lymphoblastic leukemia antigen, and the transferrin receptor. Studies in inflammatory bowel disease and after in vitro exposure to different stimuli. *Gastroenterology* **97**, 1435–1441.
- Falcioni, R., Antonini, a, Nisticò, P., Di Stefano, S., Crescenzi, M., Natali, P. G. and Sacchi, a** (1997). Alpha 6 beta 4 and alpha 6 beta 1 integrins associate with ErbB-2 in human carcinoma cell lines. *Exp. Cell Res.* **236**, 76–85.
- Faller, W. J., Jackson, T. J., Knight, J. R. P., Ridgway, R. A., Jamieson, T., Karim, S. A., Jones, C., Radulescu, S., Huels, D. J., Myant, K. B., et al.** (2015). mTORC1-mediated translational elongation limits intestinal tumour initiation and growth. *Nature.*
- Feldman, M. E., Apsel, B., Uotila, A., Loewith, R., Knight, Z. A., Ruggero, D. and Shokat, K. M.** (2009). Active-site inhibitors of mTOR target rapamycin-resistant outputs of mTORC1 and mTORC2. *PLoS Biol.*
- Fenczik, C. A., Sethi, T., Ramos, J. W., Hughes, P. E. and Ginsberg, M. H.** (1997). Complementation of dominant suppression implicates CD98 in integrin activation. *Nature* **390**, 81–85.
- Fenczik, C. A., Zent, R., Dellos, M., Calderwood, D. A., Satriano, J., Kelly, C. and Ginsberg, M. H.** (2001). Distinct domains of CD98hc regulate integrins and amino acid transport. *J. Biol. Chem.* **276**, 8746–52.
- Feral, C. C., Nishiya, N., Fenczik, C. A., Stuhlmann, H., Slepak, M. and Ginsberg, M. H.** (2005). CD98hc (SLC3A2) mediates integrin signaling. *Proc. Natl. Acad. Sci. U. S. A.* **102**, 355–360.
- Féral, C. C., Zijlstra, A., Tkachenko, E., Prager, G., Gardel, M. L., Slepak, M. and Ginsberg, M. H.** (2007). CD98hc (SLC3A2) participates in fibronectin matrix assembly by mediating integrin signaling. *J. Cell Biol.* **178**, 701–11.
- Fernández, E., Jiménez-Vidal, M., Calvo, M., Zorzano, A., Tebar, F., Palacín, M. and Chillarón, J.** (2006). The structural and functional units of heteromeric amino acid transporters: The heavy subunit rBAT dictates oligomerization of the heteromeric amino acid transporters. *J. Biol. Chem.* **281**, 26552–26561.

- French-Constant, C. and Colognato, H.** (2004). Integrins: Versatile integrators of extracellular signals. *Trends Cell Biol.* **14**, 678–686.
- Fincham, V. J., James, M., Frame, M. C. and Winder, S. J.** (2000). Active ERK/MAP kinase is targeted to newly forming cell-matrix adhesions by integrin engagement and v-Src. *EMBO J.* **19**, 2911–2923.
- Forrest, A. R. R., Kawaji, H., Rehli, M., Kenneth Baillie, J., de Hoon, M. J. L., Haberle, V., Lassmann, T., Kulakovskiy, I. V., Lizio, M., Itoh, M., et al.** (2014). A promoter-level mammalian expression atlas. *Nature.*
- Fort, J., de la Ballina, L. R., Burghardt, H. E., Ferrer-Costa, C., Turnay, J., Ferrer-Orta, C., Usón, I., Zorzano, A., Fernández-Recio, J., Orozco, M., et al.** (2007). The structure of human 4F2hc ectodomain provides a model for homodimerization and electrostatic interaction with plasma membrane. *J. Biol. Chem.* **282**, 31444–52.
- Fotiadis, D., Kanai, Y. and Palacín, M.** (2013). The SLC3 and SLC7 families of amino acid transporters. *Mol. Aspects Med.* **34**, 139–158.
- Fournier, N. M., Lee, B., Banasr, M., Elsayed, M. and Duman, R. S.** (2012). Vascular endothelial growth factor regulates adult hippocampal cell proliferation through MEK/ERK- and PI3K/Akt-dependent signaling. *Neuropharmacology* **63**, 642–652.
- Franck, E., Hulsen, T., Huynen, M. A., de Jong, W. W., Lubsen, N. H. and Madsen, O.** (2008). Evolution of Closely Linked Gene Pairs in Vertebrate Genomes. *Mol. Biol. Evol.* **25**, 1909–1921.
- Francke, U., Foellmer, B. E. and Haynes, B. F.** (1983). Chromosome mapping of human cell surface molecules: Monoclonal anti-human lymphocyte antibodies 4F2, A3D8, and A1G3 define antigens controlled by different regions of chromosome 11. *Somatic Cell Genet.* **9**, 333–344.
- Frazer, K. A., Pachter, L., Poliakov, A., Rubin, E. M. and Dubchak, I.** (2004). VISTA: Computational tools for comparative genomics. *Nucleic Acids Res.* **32**, 273–279.
- Friedland, J. C., Lee, M. H. and Boettiger, D.** (2009). Mechanically activated integrin switch controls $\alpha 5\beta 1$ function. *Science (80-)*. **323**, 642–644.
- Gabriško, M. and Janeček, Š.** (2009). Looking for the ancestry of the heavy-chain subunits of heteromeric amino acid transporters rBAT and 4F2hc within the GH13 α -amylase family. *FEBS J.* **276**, 7265–7278.
- Gagnoux-Palacios, L., Dans, M., Van't Hof, W., Mariotti, A., Pepe, A., Meneguzzi, G., Resh, M. D. and Giancotti, F. G.** (2003). Compartmentalization of integrin $\alpha 6\beta 4$ signaling in lipid rafts. *J. Cell Biol.* **162**, 1189–1196.
- Garber, M. E., Troyanskaya, O. G., Schluens, K., Petersen, S., Thaesler, Z., Pacyna-Gengelbach, M., van de Rijn, M., Rosen, G. D., Perou, C. M., Whyte, R. I., et al.** (2001). Diversity of gene expression in adenocarcinoma of the lung. *Proc. Natl. Acad. Sci. U. S. A.* **98**, 13784–13789.
- Gasol, E., Jiménez-Vidal, M., Chillarón, J., Zorzano, A. and Palacín, M.** (2004). Membrane topology of System xc- light subunit reveals a re-entrant loop with substrate-restricted accessibility. *J. Biol. Chem.* **279**, 31228–31236.
- Gattazzo, F., Urciuolo, A. and Bonaldo, P.** (2014). Extracellular matrix: A dynamic microenvironment for stem cell niche. *Biochim. Biophys. Acta - Gen. Subj.* **1840**, 2506–2519.
- Gavet, O. and Pines, J.** (2010). Progressive Activation of CyclinB1-Cdk1 Coordinates Entry to Mitosis. *Dev. Cell* **18**, 533–543.
- Geiger, B., Bershadsky, A., Pankov, R. and Yamada, K. M.** (2001). Transmembrane extracellular matrix-cytoskeleton crosstalk. *Nat. Rev. Mol. Cell Biol.* **2**, 793–805.
- Gera, J. F., Mellinghoff, I. K., Shi, Y., Rettig, M. B., Tran, C., Hsu, J. H., Sawyers, C. L. and Lichtenstein, A. K.** (2004). AKT Activity Determines Sensitivity to Mammalian Target of Rapamycin (mTOR) Inhibitors by Regulating Cyclin D1 and c-myc Expression. *J. Biol. Chem.* **279**, 2737–2746.
- Gerace, E. and Moazed, D.** (2015). Affinity Pull-Down of Proteins Using Anti-FLAG M2 Agarose Beads. *Methods Enzymol.*
- Ghaleb, A. M., Nandan, M. O., Chanchevalap, S., Dalton, W. B., Hisamuddin, I. M. and Yang, V. W.** (2005). Krüppel-like factors 4 and 5: the yin and yang regulators of cellular proliferation. *Cell Res.* **15**, 92–6.
- Ghosh, J., Buckley, K. M., Nair, S. V., Raftos, D. A., Miller, C., Majeske, A. J., Hibino, T., Rast, J. P., Roth, M. and Smith, L. C.** (2010). Sp185/333: A novel family of genes and proteins involved in the purple sea urchin immune response. *Dev. Comp. Immunol.* **34**, 235–245.
- Giancotti, F. G. and Ruoslahti, E.** (1999). Integrin Signaling. *Science (80-)*. **285**, 1028–1032.
- Gilcrease, M. Z.** (2007). Integrin signaling in epithelial cells. *Cancer Lett.* **247**, 1–25.

- Gille, H. and Downward, J.** (1999). Multiple Ras effector pathways contribute to G1 cell cycle progression. *J. Biol. Chem.* **274**, 22033–22040.
- Ginsberg, M. H.** (2014). Integrin activation. *BMB Rep.* **47**, 655–9.
- Gomes, A. P., Price, N. L., Ling, A. J. Y., Moslehi, J. J., Montgomery, M. K., Rajman, L., White, J. P., Teodoro, J. S., Wrann, C. D., Hubbard, B. P., et al.** (2013). Declining NAD⁺ induces a pseudohypoxic state disrupting nuclear-mitochondrial communication during aging. *Cell*.
- Gordon, S., Akopyan, G., Garban, H. and Bonavida, B.** (2006). Transcription factor YY1: structure, function, and therapeutic implications in cancer biology. *Oncogene* **25**, 1125–1142.
- Gottesdiener, K. M., Karpinski, B. A., Lindsten, T., Strominger, J. L., Jones, N. H., Thompson, C. B. and Leiden, J. M.** (1988). Isolation and structural characterization of the human 4F2 heavy-chain gene, an inducible gene involved in T-lymphocyte activation. *Mol. Cell. Biol.* **8**, 3809–19.
- Goult, B. T., Bouaouina, M., Elliott, P. R., Bate, N., Patel, B., Gingras, A. R., Grossmann, J. G., Roberts, G. C. K., Calderwood, D. A., Critchley, D. R., et al.** (2010). Structure of a double ubiquitin-like domain in the talin head: A role in integrin activation. *EMBO J.* **29**, 1069–1080.
- Green, C. E., Pearson, D. N., Camphausen, R. T., Staunton, D. E. and Simon, S. I.** (2004). Shear-Dependent Capping of L-Selectin and P-Selectin Glycoprotein Ligand 1 by E-Selectin Signals Activation of High-Avidity 2-Integrin on Neutrophils. *J. Immunol.* **172**, 7780–7790.
- Guilluy, C., Swaminathan, V., Garcia-Mata, R., O'Brien, E. T., Superfine, R. and Burridge, K.** (2011). The Rho GEFs LARG and GEF-H1 regulate the mechanical response to force on integrins. *Nat. Cell Biol.* **13**, 722–7.
- Guo, X., Li, H., Fei, F., Liu, B., Li, X., Yang, H., Chen, Z. and Xing, J.** (2015). Genetic variations in SLC3A2/CD98 gene as prognosis predictors in non-small cell lung cancer. *Mol. Carcinog.* **54 Suppl 1**, E52-60.
- Gwinn, D. M., Shackelford, D. B., Egan, D. F., Mihaylova, M. M., Mery, A., Vasquez, D. S., Turk, B. E. and Shaw, R. J.** (2008). AMPK Phosphorylation of Raptor Mediates a Metabolic Checkpoint. *Mol. Cell*.
- Hafler, D. A., Hemler, M. E., Christenson, L., Williams, J. M., Shapiro, H. M., Strom, T. B., Strominger, J. L. and Weiner, H. L.** (1985). Investigation of in vivo activated T cells in multiple sclerosis and inflammatory central nervous system diseases. *Clin. Immunol. Immunopathol.* **37**, 163–171.
- Haling, J. R., Monkley, S. J., Critchley, D. R. and Petrich, B. G.** (2011). Talin-dependent integrin activation is required for fibrin clot retraction by platelets. *Blood* **117**, 1719–1722.
- Hamidi, H., Pietilä, M. and Ivaska, J.** (2016). The complexity of integrins in cancer and new scopes for therapeutic targeting. *Br. J. Cancer* **115**, 1017–1023.
- Han, J., Lim, C. J., Watanabe, N., Soriani, A., Ratnikov, B., Calderwood, D. A., Puzon-McLaughlin, W., Lafuente, E. M., Boussiotis, V. A., Shattil, S. J., et al.** (2006). Reconstructing and Deconstructing Agonist-Induced Activation of Integrin $\alpha\text{IIb}\beta\text{3}$. *Curr. Biol.* **16**, 1796–1806.
- Han, J. M., Jeong, S. J., Park, M. C., Kim, G., Kwon, N. H., Kim, H. K., Ha, S. H., Ryu, S. H. and Kim, S.** (2012). Leucyl-tRNA synthetase is an intracellular leucine sensor for the mTORC1-signaling pathway. *Cell*.
- Han, J., Li, E., Chen, L., Zhang, Y., Wei, F., Liu, J., Deng, H. and Wang, Y.** (2015). The CREB coactivator CRTC2 controls hepatic lipid metabolism by regulating SREBP1. *Nature*.
- Hanahan, D. and Weinberg, R. A.** (2011). Hallmarks of Cancer: The Next Generation. *Cell* **144**, 646–674.
- Hannan, K. M., Brandenburger, Y., Jenkins, A., Sharkey, K., Cavanaugh, A., Rothblum, L., Moss, T., Poortinga, G., McArthur, G. A., Pearson, R. B., et al.** (2003). mTOR-dependent regulation of ribosomal gene transcription requires S6K1 and is mediated by phosphorylation of the carboxy-terminal activation domain of the nucleolar transcription factor UBF. *Mol. Cell. Biol.*
- Hansen, L. K. and Albrecht, J. H.** (1999). Regulation of the hepatocyte cell cycle by type I collagen matrix: role of cyclin D1. *J. Cell Sci.* **112** (Pt 1, 2971–2981.
- Hansen, C. G., Ng, Y. L. D., Lam, W.-L. M., Plouffe, S. W. and Guan, K.-L.** (2015). The Hippo pathway effectors YAP and TAZ promote cell growth by modulating amino acid signaling to mTORC1. *Cell Res.* **25**, 1299–313.
- Hara, K., Yonezawa, K., Weng, Q. P., Kozlowski, M. T., Belham, C. and Avruch, J.** (1998). Amino acid sufficiency and mTOR regulate p70 S6 kinase and eIF-4E BP1 through a common effector mechanism. *J. Biol. Chem.*
- Hara, K., Kudoh, H., Enomoto, T., Hashimoto, Y. and Masuko, T.** (1999). Malignant transformation of NIH3T3 cells by overexpression of early lymphocyte activation antigen CD98. *Biochem. Biophys. Res. Commun.* **262**, 720–5.

- Harashima, H., Dissmeyer, N. and Schnittger, A.** (2013). Cell cycle control across the eukaryotic kingdom. *Trends Cell Biol.* **23**, 345–356.
- Harburger, D. S. and Calderwood, D. A.** (2009). Integrin signalling at a glance. *J. Cell Sci.* **122**, 159–63.
- Hardie, D. G.** (2011). AMP-activated protein kinase—an energy sensor that regulates all aspects of cell function. *Genes Dev.*
- Hardie, D. G. and Pan, D. a** (2002). Regulation of fatty acid synthesis and oxidation by the AMP-activated protein kinase. *Biochem. Soc. Trans.*
- Hardie, D. G., Ross, F. A. and Hawley, S. A.** (2012). AMPK: A nutrient and energy sensor that maintains energy homeostasis. *Nat. Rev. Mol. Cell Biol.*
- Hayes, G. M., Chinn, L., Cantor, J. M., Cairns, B., Levashova, Z., Tran, H., Velilla, T., Duey, D., Lippincott, J., Zachwieja, J., et al.** (2015). Antitumor activity of an anti-CD98 antibody. *Int. J. Cancer* **137**, 710–720.
- Haynes, B. F., Hemler, M. E., Mann, D. L., Eisenbarth, G. S., Shelhamer, J., Mostowski, H. S., Thomas, C. a, Strominger, J. L. and Fauci, a S.** (1981a). Characterization of a monoclonal antibody (4F2) that binds to human monocytes and to a subset of activated lymphocytes. *J. Immunol.* **126**, 1409–14.
- Haynes, B. F., Hemler, M., Cotner, T., Mann, D. L., Eisenbarth, G. S., Strominger, J. L. and Fauci, A. S.** (1981b). Characterization of a monoclonal antibody (5E9) that defines a human cell surface antigen of cell activation. *J. Immunol.* **127**, 347–351.
- Hedekso, C. J.** (1968). Early Effects of Phytohaemagglutinin on Glucose Metabolism of Normal Human Lymphocytes. *Biochem. J.*
- Hemler, M. E. and Strominger, J. L.** (1982). Characterization of antigen recognized by the monoclonal antibody (4F2): different molecular forms on human T and B lymphoblastoid cell lines. *J Immunol* **129**, 623–628.
- Henderson, N. C. and Sethi, T.** (2009). The regulation of inflammation by galectin-3. *Immunol. Rev.* **230**, 160–171.
- Henderson, N. C., Collis, E. a, Mackinnon, A. C., Simpson, K. J., Haslett, C., Zent, R., Ginsberg, M. and Sethi, T.** (2004). CD98hc (SLC3A2) interaction with beta 1 integrins is required for transformation. *J. Biol. Chem.* **279**, 54731–41.
- Hinnebusch, A. G.** (2005). Translational Regulation of GCN4 and the General Amino Acid Control of Yeast. *Annu. Rev. Microbiol.*
- Hirsch, E., Barberis, L., Brancaccio, M., Azzolino, O., Xu, D., Kyriakis, J. M., Silengo, L., Giancotti, F. G., Tarone, G., Fässler, R., et al.** (2002). Defective Rac-mediated proliferation and survival after targeted mutation of the beta1 integrin cytodomain. *J. Cell Biol.* **157**, 481–92.
- Hoffman, B. D. and Crocker, J. C.** (2009). Cell Mechanics: Dissecting the Physical Responses of Cells to Force. *Annu. Rev. Biomed. Eng.*
- Holowaty, M. N., Zeghouf, M., Wu, H., Tellam, J., Athanasopoulos, V., Greenblatt, J. and Frappier, L.** (2003). Protein profiling with Epstein-Barr nuclear antigen-1 reveals an interaction with the herpesvirus-associated ubiquitin-specific protease HAUSP/USP7. *J. Biol. Chem.* **278**, 29987–29994.
- Holz, M. K., Ballif, B. A., Gygi, S. P. and Blenis, J.** (2005). mTOR and S6K1 mediate assembly of the translation preinitiation complex through dynamic protein interchange and ordered phosphorylation events. *Cell.*
- Hoppler, S. and Kavanagh, C. L.** (2007). Wnt signalling: variety at the core. *J. Cell Sci.* **120**, 385–393.
- Horton, J. D., Goldstein, J. L. and Brown, M. S.** (2002). SREBPs: Transcriptional mediators of lipid homeostasis. In *Cold Spring Harbor Symposia on Quantitative Biology*, .
- Howe, A. K. and Juliano, R. L.** (2000). Regulation of anchorage-dependent signal transduction by protein kinase A and p21-activated kinase. *Nat. Cell Biol.* **2**, 593–600.
- Howell, J. J., Ricoult, S. J. H., Ben-Sahra, I. and Manning, B. D.** (2013). A growing role for mTOR in promoting anabolic metabolism. *Biochem. Soc. Trans.*
- Huck, L., Pontier, S. M., Zuo, D. M. and Muller, W. J.** (2010). 1-integrin is dispensable for the induction of ErbB2 mammary tumors but plays a critical role in the metastatic phase of tumor progression. *Proc. Natl. Acad. Sci.* **107**, 15559–15564.
- Hulmes, D. J. S.** (2002). Building collagen molecules, fibrils, and suprafibrillar structures. In *Journal of Structural Biology*, pp. 2–10.
- Humphries, J. D.** (2006). Integrin ligands at a glance. *J. Cell Sci.* **119**, 3901–3903.

- Hynes, R. O.** (2002). Integrins: Bidirectional, allosteric signaling machines. *Cell* **110**, 673–687.
- Inoki, K., Zhu, T. and Guan, K.-L.** (2003). TSC2 Mediates Cellular Energy Response to Control Cell Growth and Survival. *Cell*.
- Inoki, K., Ouyang, H., Zhu, T., Lindvall, C., Wang, Y., Zhang, X., Yang, Q., Bennett, C., Harada, Y., Stankunas, K., et al.** (2006). TSC2 Integrates Wnt and Energy Signals via a Coordinated Phosphorylation by AMPK and GSK3 to Regulate Cell Growth. *Cell*.
- Iozzo, R. V. and Schaefer, L.** (2015). Proteoglycan form and function: A comprehensive nomenclature of proteoglycans. *Matrix Biol.* **42**, 11–55.
- Iozzo, R. V., Zoeller, J. J. and Nyström, A.** (2009). Basement membrane proteoglycans: Modulators Par Excellence of cancer growth and angiogenesis. *Mol. Cells* **27**, 503–513.
- Ip, H. and Sethi, T.** (2016). CD98 signals controlling tumorigenesis. *Int. J. Biochem. Cell Biol.* **81**, 148–150.
- Iskratsch, T., Wolfenson, H. and Sheetz, M. P.** (2014). Appreciating force and shape — the rise of mechanotransduction in cell biology. *Nat. Rev. Mol. Cell Biol.* **15**, 825–33.
- Janecek, S., Svensson, B. and Henrissat, B.** (1997). Domain evolution in the alpha-amylase family. *J. Mol. Evol.* **45**, 322–331.
- Järveläinen, H., Sainio, A., Koulu, M., Wight, T. N. and Penttinen, R.** (2009). Extracellular matrix molecules: potential targets in pharmacotherapy. *Pharmacol. Rev.* **61**, 198–223.
- Jeanes, A. I., Wang, P., Moreno-Layseca, P., Paul, N., Cheung, J., Tsang, R., Akhtar, N., Foster, F. M., Brennan, K. and Streuli, C. H.** (2012). Specific β -containing integrins exert differential control on proliferation and two-dimensional collective cell migration in mammary epithelial cells. *J. Biol. Chem.* **287**, 24103–24112.
- Jefferies, H. B., Reinhard, C., Kozma, S. C. and Thomas, G.** (1994). Rapamycin selectively represses translation of the “polypyrimidine tract” mRNA family. *Proc. Natl. Acad. Sci.*
- Jia, W., Lu, Z., Fu, Y., Wang, H.-P., Wang, L.-H., Chi, H., Yuan, Z.-F., Zheng, Z.-B., Song, L.-N., Han, H.-H., et al.** (2009). A Strategy for Precise and Large Scale Identification of Core Fucosylated Glycoproteins. *Mol. Cell. Proteomics* **8**, 913–923.
- Jiménez-Vidal, M., Gasol, E., Zorzano, A., Nunes, V., Palacín, M. and Chillarón, J.** (2004). Thiol Modification of Cysteine 327 in the Eighth Transmembrane Domain of the Light Subunit xCT of the Heteromeric Cystine/Glutamate Antiporter Suggests Close Proximity to the Substrate Binding Site/Permeation Pathway. *J. Biol. Chem.* **279**, 11214–11221.
- Jin, X., Aimanova, K., Ross, L. S. and Gill, S. S.** (2003). Identification, functional characterization and expression of a LAT type amino acid transporter from the mosquito *Aedes aegypti*. *Insect Biochem Mol Biol* **33**, 815–827.
- Johnson, M., Zaretskaya, I., Raytselis, Y., Merezhuk, Y., McGinnis, S. and Madden, T. L.** (2008). NCBI BLAST: a better web interface. *Nucleic Acids Res.*
- Jung, J., Genau, H. M. and Behrends, C.** (2015). Amino Acid-Dependent mTORC1 Regulation by the Lysosomal Membrane Protein SLC38A9. *Mol. Cell. Biol.*
- Kabir-Salmani, M., Fukuda, M. N., Kanai-Azuma, M., Ahmed, N., Shiokawa, S., Akimoto, Y., Sakai, K., Nagamori, S., Kanai, Y., Sugihara, K., et al.** (2008). The membrane-spanning domain of CD98 heavy chain promotes $\alpha(v)\beta3$ integrin signals in human extravillous trophoblasts. *Mol. Endocrinol.* **22**, 707–15.
- Kageyama, T., Nakamura, M., Matsuo, A., Yamasaki, Y., Takakura, Y., Hashida, M., Kanai, Y., Naito, M., Tsuruo, T., Minato, N., et al.** (2000). The 4F2hc/LAT1 complex transports L-DOPA across the blood-brain barrier. *Brain Res.*
- Kanai, Y., Segawa, H., Miyamoto, K. I., Uchino, H., Takeda, E. and Endou, H.** (1998). Expression cloning and characterization of a transporter for large neutral amino acids activated by the heavy chain of 4F2 antigen (CD98). *J. Biol. Chem.* **273**, 23629–23632.
- Karpinski, B. A., Yang, L. H., Cacheris, P., Morle, G. D. and Leiden, J. M.** (1989). The first intron of the 4F2 heavy-chain gene contains a transcriptional enhancer element that binds multiple nuclear proteins. *Mol. Cell. Biol.* **9**, 2588–97.
- Kehrl, J. H., Muraguchi, A. and Fauci, S.** (1984). Differential expression of cell activation markers after stimulation of resting human B lymphocytes. *J. Immunol.* **132**, 2857–2861.
- Kelley, L. A., Mezulis, S., Yates, C. M., Wass, M. N. and Sternberg, M. J. E.** (2015). The Phyre2 web portal for protein modeling, prediction and analysis. *Nat. Protoc.* **10**, 845–858.

- Kielty, C. M., Sherratt, M. J. and Shuttleworth, C. A.** (2002). Elastic fibres. *J. Cell Sci.* **115**, 2817–2828.
- Kim, E., Goraksha-Hicks, P., Li, L., Neufeld, T. P. and Guan, K. L.** (2008a). Regulation of TORC1 by Rag GTPases in nutrient response. *Nat. Cell Biol.*
- Kim, C. S., Cho, S.-H., Chun, H. S., Lee, S.-Y., Endou, H., Kanai, Y. and Kim, D. K.** (2008b). BCH, an Inhibitor of System L Amino Acid Transporters, Induces Apoptosis in Cancer Cells. *Biol. Pharm. Bull.* **31**, 1096–1100.
- Kim, S. H., Turnbull, J. and Guimond, S.** (2011). Extracellular matrix and cell signalling: The dynamic cooperation of integrin, proteoglycan and growth factor receptor. *J. Endocrinol.* **209**, 139–151.
- Kim, C., Ye, F., Hu, X. and Ginsberg, M. H.** (2012a). Talin activates integrins by altering the topology of the beta transmembrane domain. *J. Cell Biol.* **197**, 605–611.
- Kim, Y. M., Stone, M., Hwang, T. H., Kim, Y. G., Dunlevy, J. R., Griffin, T. J. and Kim, D. H.** (2012b). SH3BP4 Is a Negative Regulator of Amino Acid-Rag GTPase-mTORC1 Signaling. *Mol. Cell.*
- Kim, J. S., Ro, S.-H., Kim, M., Park, H.-W., Semple, I. A., Park, H., Cho, U.-S., Wang, W., Guan, K.-L., Karin, M., et al.** (2015). Sestrin2 inhibits mTORC1 through modulation of GATOR complexes. *Sci. Rep.* **5**, 9502.
- Koepp, D. M., Schaefer, L. K., Ye, X., Keyomarsi, K., Chu, C., Harper, J. W. and Elledge, S. J.** (2001). Phosphorylation-dependent ubiquitination of cyclin E by the SCFFbw7ubiquitin ligase. *Science (80-.)*. **294**, 173–177.
- Kolesnikova, T. V, Mannion, B. A., Berditchevski, F. and Hemler, M. E.** (2001). Beta1 integrins show specific association with CD98 protein in low density membranes. *BMC Biochem.* **2**, 10.
- Koltin, Y., Faucette, L., Bergsma, D. J., Levy, M. A., Cafferkey, R., Koser, P. L., Johnson, R. K. and Livi, G. P.** (1991). Rapamycin sensitivity in *Saccharomyces cerevisiae* is mediated by a peptidyl-prolyl cis-trans isomerase related to human {FK506-binding} protein. *Mol. Cell. Biol.*
- Kontinen, Y., Bergroth, V. and Nykanen, P.** (1985). Lymphocyte activation in rheumatoid arthritis synovial fluid in vivo. *Scand. J. Immunol.* **22**, 503–507.
- Koyanagi, K. O., Hagiwara, M., Itoh, T., Gojobori, T. and Imanishi, T.** (2005). Comparative genomics of bidirectional gene pairs and its implications for the evolution of a transcriptional regulation system. *Gene* **353**, 169–76.
- Krautz-Peterson, G., Camargo, S., Huggel, K., Verrey, F., Shoemaker, C. B. and Skelly, P. J.** (2007). Amino acid transport in schistosomes: Characterization of the permeaseheavy chain SPM1hc. *J. Biol. Chem.* **282**, 21767–75.
- Kudo, Y. and Boyd, C. A. R.** (2000). Heterodimeric amino acid transporters: Expression of heavy but not light chains of CD98 correlates with induction of amino acid transport systems in human placental trophoblast. *J. Physiol.* **523**, 13–18.
- LaFlamme, S. E., Nieves, B., Colello, D. and Reverte, C. G.** (2008). Integrins as regulators of the mitotic machinery. *Curr. Opin. Cell Biol.* **20**, 576–582.
- Lahlou, H., Sanguin-Gendreau, V., Zuo, D., Cardiff, R. D., McLean, G. W., Frame, M. C. and Muller, W. J.** (2007). Mammary epithelial-specific disruption of the focal adhesion kinase blocks mammary tumor progression. *Proc. Natl. Acad. Sci. U. S. A.* **104**, 20302–7.
- Landry, J.-R., Mager, D. L. and Wilhelm, B. T.** (2003). Complex controls: the role of alternative promoters in mammalian genomes. *Trends Genet.* **19**, 640–648.
- Lanza, F., Moretti, S., Papa, S., Malavasi, F. and Castoldi, G.** (1994). Report on the Fifth International Workshop on Human Leukocyte Differentiation Antigens, Boston, November 3-7, 1993. *Haematologica* **79**, 374–386.
- Laroui, H., Geem, D., Xiao, B., Viennois, E., Rakhya, P., Denning, T. and Merlin, D.** (2014). Targeting intestinal inflammation with CD98 siRNA/PEI-loaded nanoparticles. *Mol. Ther.* **22**, 69–80.
- Le Gall, M., Grall, D., Chambard, J. C., Pouyssegur, J. and Van Obberghen-Schilling, E.** (1998). An anchorage-dependent signal distinct from p42/44 MAP kinase activation is required for cell cycle progression. *Oncogene* **17**, 1271–1277.
- Lea, N. C., Orr, S. J., Stoeber, K., Williams, G. H., Lam, E. W.-F., Ibrahim, M. a a, Mufti, G. J. and Thomas, N. S. B.** (2003). Commitment point during G0-->G1 that controls entry into the cell cycle. *Mol. Cell. Biol.* **23**, 2351–61.
- Lee, J. W. and Juliano, R. L.** (2000). alpha5beta1 integrin protects intestinal epithelial cells from apoptosis through a phosphatidylinositol 3-kinase and protein kinase B-dependent pathway. *Mol. Biol. Cell* **11**, 1973–87.

- Lee, W. J., Kim, M.-S. M., Park, H.-S., Kim, H. S., Jeon, M. J., Oh, K. S., Koh, E. H., Won, J. C., Oh, G. T., Yoon, M., et al. (2006). AMPK activation increases fatty acid oxidation in skeletal muscle by activating PPARalpha and PGC-1. *Biochem. Biophys. Res. Commun.*
- Lee, H. S., Lim, C. J., Puzon-McLaughlin, W., Shattil, S. J. and Ginsberg, M. H. (2009). RIAM activates integrins by linking talin to Ras GTPase membrane-targeting sequences. *J. Biol. Chem.* **284**, 5119–5122.
- Legate, K. R., Wickström, S. A. and Fässler, R. (2009). Genetic and cell biological analysis of integrin outside-in signaling. *Genes Dev.* **23**, 397–418.
- Leiden, J. M., Yang, L. H., Morle, G. D., June, C. H., Lindsten, T., Thompson, C. B. and Karpinski, B. (1989). The 4F2 heavy chain gene: a molecular model of inducible gene expression in human T cells. *J. Autoimmun.* **2 Suppl**, 67–79.
- Lemaître, G., Stella, A., Feteira, J., Baldeschi, C., Vaigot, P., Martin, M. T., Monsarrat, B. and Waksman, G. (2011). CD98hc (SLC3A2) is a key regulator of keratinocyte adhesion. *J. Dermatol. Sci.* **61**, 169–79.
- Lemons, J. M. S., Collier, H. A., Feng, X. J., Bennett, B. D., Legesse-Miller, A., Johnson, E. L., Raitman, I., Pollina, E. A., Rabitz, H. A. and Rabinowitz, J. D. (2010). Quiescent fibroblasts exhibit high metabolic activity. *PLoS Biol.* **8**.
- Leung, T., Chen, X. Q., Manser, E. and Lim, L. (1996). The p160 RhoA-binding kinase ROK alpha is a member of a kinase family and is involved in the reorganization of the cytoskeleton. *Mol. Cell. Biol.* **16**, 5313–27.
- Levental, K. R., Yu, H., Kass, L., Lakins, J. N., Egeblad, M., Erler, J. T., Fong, S. F. T., Csiszar, K., Giaccia, A., Wenginger, W., et al. (2009). Matrix Crosslinking Forces Tumor Progression by Enhancing Integrin Signaling. *Cell* **139**, 891–906.
- Levine, M. and Tjian, R. (2003). Transcription regulation and animal diversity. *Nature* **424**, 147–151.
- Li, N., Zhang, Y., Naylor, M. J., Schatzmann, F., Maurer, F., Wintermantel, T., Schuetz, G., Mueller, U., Streuli, C. H. and Hynes, N. E. (2005). $\beta 1$ integrins regulate mammary gland proliferation and maintain the integrity of mammary alveoli. *EMBO J.* **24**, 1942–1953.
- Li, S., Ogawa, W., Emi, A., Hayashi, K., Senga, Y., Nomura, K., Hara, K., Yu, D. and Kasuga, M. (2011). Role of S6K1 in regulation of SREBP1c expression in the liver. *Biochem. Biophys. Res. Commun.*
- Lian, G., Arimochi, H., Kitamura, A., Nishida, J., Li, S., Kishihara, K., Maekawa, Y. and Yasutomo, K. (2012). Manipulation of CD98 resolves type 1 diabetes in nonobese diabetic mice. *J. Immunol.* **188**, 2227–34.
- Liao, Z. and Cantor, J. M. (2016). Endothelial Cells Require CD98 for Efficient Angiogenesis. *Arterioscler. Thromb. Vasc. Biol.* **36**, 2163–2166.
- Liao, F.-H., Hsiao, W.-Y., Lin, Y.-C., Chan, Y.-C. and Huang, C.-Y. (2016). T cell proliferation and adaptive immune responses are critically regulated by protein phosphatase 4. *Cell Cycle* **15**, 1073–1083.
- Liberto, M., Cobrinik, D. and Minden, A. (2002). Rho regulates p21, cyclin D1, and checkpoint control in mammary epithelial cells. *Oncogene* **21**, 1590–1599.
- Lim, J.-H., Lee, Y.-M., Chun, Y.-S., Chen, J., Kim, J.-E. and Park, J.-W. (2010). Sirtuin 1 modulates cellular responses to hypoxia by deacetylating hypoxia-inducible factor 1alpha. *Mol. Cell.*
- Lindstein, T., June, C. H., Ledbetter, J. A., Stella, G. and Thompson, C. B. (1989). Regulation of lymphokine messenger RNA stability by a surface-mediated T cell activation pathway. *Science (80-)*. **244**, 339–343.
- Lindsten, T., June, C. H., Thompson, C. B. and Leiden, J. M. (1988). Regulation of 4F2 heavy-chain gene expression during normal human T-cell activation can be mediated by multiple distinct molecular mechanisms. *Mol. Cell. Biol.* **8**, 3820–6.
- Liu, X., Charrier, L., Gewirtz, A., Sitaraman, S. and Merlin, D. (2003). CD98 and intracellular adhesion molecule 1 regulate the activity of amino acid transporter LAT-2 in polarized intestinal epithelia. *J. Biol. Chem.* **278**, 23672–23677.
- Liu, T., Qian, W. J., Gritsenko, M. A., Camp, D. G., Monroe, M. E., Moore, R. J. and Smith, R. D. (2005). Human plasma N-glycoproteome analysis by immunoaffinity subtraction, hydrazide chemistry, and mass spectrometry. *J. Proteome Res.* **4**, 2070–2080.
- Liu, Z., Hou, J., Chen, J., Tsumura, H., Ito, M., Ito, Y., Hu, X. and Li, X. K. (2012). Deletion of CD98 heavy chain in T cells results in cardiac allograft acceptance by increasing regulatory T cells. *Transplantation* **93**, 1116–1124.
- Long, E. O. (2011). ICAM-1: Getting a Grip on Leukocyte Adhesion. *J. Immunol.* **186**, 5021–5023.

- Lowe, R., Shirley, N., Bleackley, M., Dolan, S. and Shafee, T.** (2017). Transcriptomics technologies. *PLoS Comput. Biol.* **13**, 1–23.
- Lum, J. J., Bauer, D. E., Kong, M., Harris, M. H., Li, C., Lindsten, T. and Thompson, C. B.** (2005). Growth Factor Regulation of Autophagy and Cell Survival in the Absence of Apoptosis. *Cell* **120**, 237–248.
- Lumadue, J. A., Glick, A. B. and Ruddle, F. H.** (1987). Cloning, sequence analysis, and expression of the large subunit of the human lymphocyte activation antigen 4F2. *Proc. Natl. Acad. Sci. U. S. A.* **84**, 9204–9208.
- Lunt, S. Y. and Vander Heiden, M. G.** (2011). Aerobic Glycolysis: Meeting the Metabolic Requirements of Cell Proliferation. *Annu. Rev. Cell Dev. Biol.*
- Luo, B.-H., Carman, C. V. and Springer, T. A.** (2007). Structural Basis of Integrin Regulation and Signaling. *Annu. Rev. Immunol.* **25**, 619–647.
- Luscher, B., Rousseaux, M., Lees, R., MacDonald, H. R. and Bron, C.** (1985). Cell surface glycoproteins involved in the stimulation of interleukin 1-dependent interleukin 2 production by a subline of EL4 thymoma cells. II. Structure, biosynthesis, and maturation. *J. Immunol.* **135**, 3951–3957.
- Ma, T., Van Tine, B. A., Wei, Y., Garrett, M. D., Nelson, D., Adams, P. D., Wang, J., Qin, J., Chow, L. T. and Harper, J. W.** (2000). Cell cycle-regulated phosphorylation of p220(NPAT) by cyclin E/Cdk2 in Cajal bodies promotes histone gene transcription. *Genes Dev.* **14**, 2298–2313.
- Ma, Y. Q., Qin, J., Wu, C. and Plow, E. F.** (2008a). Kindlin-2 (Mig-2): A co-activator of $\alpha 5 \beta 1$ integrins. *J. Cell Biol.* **181**, 439–446.
- Ma, X. M., Yoon, S. O., Richardson, C. J., Jülich, K. and Blenis, J.** (2008b). SKAR Links Pre-mRNA Splicing to mTOR/S6K1-Mediated Enhanced Translation Efficiency of Spliced mRNAs. *Cell.*
- MacGregor, E. A., Janeček, Š. and Svensson, B.** (2001). Relationship of sequence and structure to specificity in the α -amylase family of enzymes. *Biochim. Biophys. Acta - Protein Struct. Mol. Enzymol.* **1546**, 1–20.
- Mack, N. A., Whalley, H. J., Castillo-Lluva, S. and Malliri, A.** (2011). The diverse roles of Rac signaling in tumorigenesis. *Cell Cycle* **10**, 1571–1581.
- Malumbres, M. and Barbacid, M.** (2009). Cell cycle, CDKs and cancer: A changing paradigm. *Nat. Rev. Cancer* **9**, 153–166.
- Mastroberardino, L., Spindler, B., Pfeiffer, R., Skelly, P. J., Loffing, J., Shoemaker, C. B. and Verrey, F.** (1998). Amino-acid transport by heterodimers of 4F2hc/CD98 and members of a permease family. *Nature* **395**, 288–291.
- Matsuyama, R., Tomi, M., Akanuma, S., Tabuchi, A., Kubo, Y., Tachikawa, M. and Hosoya, K.** (2012). Up-regulation of L-Type Amino Acid Transporter 1 (LAT1) in Cultured Rat Retinal Capillary Endothelial Cells in Response to Glucose Deprivation. *Drug Metab. Pharmacokinet.* **27**, 317–324.
- Matthews, B. D., Overby, D. R., Mannix, R. and Ingber, D. E.** (2006). Cellular adaptation to mechanical stress: role of integrins, Rho, cytoskeletal tension and mechanosensitive ion channels. *J. Cell Sci.* **119**, 508–18.
- McCracken, A. N. and Edinger, A. L.** (2013). Nutrient transporters: The Achilles' heel of anabolism. *Trends Endocrinol. Metab.* **24**, 200–208.
- Mehta, R. J., Diefenbach, B., Brown, A., Cullen, E., Jonczyk, A., Güssow, D., Luckenbach, G. A. and Goodman, S. L.** (1998). Transmembrane-truncated $\alpha 5 \beta 3$ integrin retains high affinity for ligand binding: evidence for an “inside-out” suppressor? *Biochem. J.* **330** (Pt 2), 861–869.
- Meijer, A. J. and Codogno, P.** (2004). Regulation and role of autophagy in mammalian cells. *Int. J. Biochem. Cell Biol.*
- Menendez, J. A. and Lupu, R.** (2007). Fatty acid synthase and the lipogenic phenotype in cancer pathogenesis. *Nat. Rev. Cancer.*
- Menon, S. and Manning, B. D.** (2008). Common corruption of the mTOR signaling network in human tumors. *Oncogene.*
- Merlin, D., Sitaraman, S., Liu, X., Eastburn, K., Sun, J., Kucharzik, T., Lewis, B. and Madara, J. L.** (2001). CD98-mediated Links between Amino Acid Transport and $\beta 1$ Integrin Distribution in Polarized Columnar Epithelia. *J. Biol. Chem.* **276**, 39282–39289.
- Mihaylova, M. M. and Shaw, R. J.** (2011). The AMPK signalling pathway coordinates cell growth, autophagy and metabolism. *Nat. Cell Biol.*
- Mikkelsen, T. S., Ku, M., Jaffe, D. B., Issac, B., Lieberman, E., Giannoukos, G., Alvarez, P., Brockman, W., Kim,**

- T. K., Koche, R. P., et al. (2007). Genome-wide maps of chromatin state in pluripotent and lineage-committed cells. *Nature*.
- Milkereit, R., Persaud, A., Vanoaica, L., Guetg, A., Verrey, F. and Rotin, D. (2015). LAPT4b recruits the LAT1-4F2hc Leu transporter to lysosomes and promotes mTORC1 activation. *Nat. Commun.*
- Millard, M., Odde, S. and Neamati, N. (2011). Integrin Targeted Therapeutics. *Theranostics* **1**, 154–188.
- Miyamoto, S., Teramoto, H., Gutkind, J. S. and Yamada, K. M. (1996). Integrins can collaborate with growth factors for phosphorylation of receptor tyrosine kinases and MAP kinase activation: Roles of integrin aggregation and occupancy of receptors. *J. Cell Biol.* **135**, 1633–1642.
- Miyamoto, Y. J., Mitchell, J. S. and McIntyre, B. W. (2003). Physical association and functional interaction between beta1 integrin and CD98 on human T lymphocytes. *Mol. Immunol.* **39**, 739–51.
- Mojica, F. J. M., Díez-Villaseñor, C., García-Martínez, J. and Soria, E. (2005). Intervening sequences of regularly spaced prokaryotic repeats derive from foreign genetic elements. *J. Mol. Evol.* **60**, 174–182.
- Montanez, E., Ussar, S., Schifferer, M., Bösl, M., Zent, R., Moser, M. and Fässler, R. (2008). Kindlin-2 controls bidirectional signaling of integrins. *Genes Dev.* **22**, 1325–1330.
- Moreno-Layseca, P. and Streuli, C. H. (2014). Signalling pathways linking integrins with cell cycle progression. *Matrix Biol.* **34**, 144–153.
- Moretta, L., Mingari, M. C., Sekaly, P. R., Moretta, A., Chapuis, B. and Cerottini, J. C. (1981). Surface markers of cloned human T cells with various cytolytic activities. *J. Exp. Med.* **154**, 569–574.
- Mori, K., Miyamoto, N., Higuchi, Y., Nanba, K., Ito, M., Tsurudome, M., Nishio, M., Kawano, M., Uchida, A. and Ito, Y. (2001). Cross-talk between RANKL and FRP-1/CD98 Systems: RANKL-mediated osteoclastogenesis is suppressed by an inhibitory anti-CD98 heavy chain mAb and CD98-mediated osteoclastogenesis is suppressed by osteoclastogenesis inhibitory factor. *Cell. Immunol.* **207**, 118–26.
- Moro, L. (1998). Integrins induce activation of EGF receptor: role in MAP kinase induction and adhesion-dependent cell survival. *EMBO J.* **17**, 6622–6632.
- Moser, M., Nieswandt, B., Ussar, S., Pozgajova, M. and Fässler, R. (2008). Kindlin-3 is essential for integrin activation and platelet aggregation. *Nat. Med.* **14**, 325–330.
- Müller, V., de Boer, R. J., Bonhoeffer, S. and Szathmáry, E. (2018). An evolutionary perspective on the systems of adaptive immunity. *Biol. Rev.* **93**, 505–528.
- Munyon, W. H. and Merchant, D. J. (1959). The relation between glucose utilization, lactic acid production and utilization and the growth cycle of L strain fibroblasts. *Exp. Cell Res.*
- Muramatsu, T. (2016). Basigin (CD147), a multifunctional transmembrane glycoprotein with various binding partners. *J. Biochem.* **159**, 481–490.
- Murray-Zmijewski, F., Lane, D. P. and Bourdon, J. C. (2006). p53/p63/p73 isoforms: An orchestra of isoforms to harmonise cell differentiation and response to stress. *Cell Death Differ.* **13**, 962–972.
- Mut, M., Lule, S., Demir, O., Kurnaz, I. A. and Vural, I. (2012). Both mitogen-activated protein kinase (MAPK)/extracellular-signal-regulated kinases (ERK) 1/2 and phosphatidylinositide-3-OH kinase (PI3K)/Akt pathways regulate activation of E-twenty-six (ETS)-like transcription factor 1 (Elk-1) in U138 glioblastoma cells. *Int. J. Biochem. Cell Biol.* **44**, 302–310.
- Nakamura, E., Sato, M., Yang, H., Miyagawa, F., Harasaki, M., Tomita, K., Matsuoka, S., Noma, A., Iwai, K. and Minato, N. (1999). 4F2 (CD98) heavy chain is associated covalently with an amino acid transporter and controls intracellular trafficking and membrane topology of 4F2 heterodimer. *J. Biol. Chem.* **274**, 3009–3016.
- Nelson, D. L. and Cox, M. M. (2017). *Lehninger Principles of Biochemistry*.
- Nguyen, H. T. T., Dalmasso, G., Yan, Y., Laroui, H., Dahan, S., Mayer, L., Sitaraman, S. V. and Merlin, D. (2010). MicroRNA-7 modulates CD98 expression during intestinal epithelial cell differentiation. *J. Biol. Chem.* **285**, 1479–1489.
- Nguyen, H. T. T., Dalmasso, G., Torkvist, L., Halfvarson, J., Yan, Y., Laroui, H., Shmerling, D., Tallone, T., D’Amato, M., Sitaraman, S. V., et al. (2011). CD98 expression modulates intestinal homeostasis, inflammation, and colitis-associated cancer in mice. *J. Clin. Invest.* **121**, 1733–1747.
- Nicklin, P., Bergman, P., Zhang, B., Triantafellow, E., Wang, H., Nyfeler, B., Yang, H., Hild, M., Kung, C., Wilson, C., et al. (2009). Bidirectional Transport of Amino Acids Regulates mTOR and Autophagy. *Cell* **136**, 521–534.

- Nieswandt, B., Moser, M., Pleines, I., Varga-Szabo, D., Monkley, S., Critchley, D. and Fässler, R.** (2007). Loss of talin1 in platelets abrogates integrin activation, platelet aggregation, and thrombus formation in vitro and in vivo. *J. Exp. Med.* **204**, 3113–3118.
- Nii, T., Segawa, H., Taketani, Y., Tani, Y., Ohkido, M., Kishida, S., Ito, M., Endou, H., Kanai, Y., Takeda, E., et al.** (2001). Molecular events involved in up-regulating human Na⁺-independent neutral amino acid transporter LAT1 during T-cell activation. *Biochem. J.* **358**, 693–704.
- Nikolopoulos, S. N., Blaikie, P., Yoshioka, T., Guo, W., Puri, C., Tacchetti, C. and Giancotti, F. G.** (2005). Targeted deletion of the integrin beta4 signaling domain suppresses laminin-5-dependent nuclear entry of mitogen-activated protein kinases and NF-kappaB, causing defects in epidermal growth and migration. *Mol. Cell. Biol.* **25**, 6090–102.
- Nishio, Y., Fujino, M., Cai, S., Kitajima, Y., Saito, T., Tsumura, H., Ito, M., Ito, Y., Nagahara, Y. and Li, X. K.** (2016). Impaired CD98 signaling protects against graft-versus-host disease by increasing regulatory T cells. *Transpl. Immunol.* **35**, 34–39.
- Novoa, I., Zeng, H., Harding, H. P. and Ron, D.** (2001). Feedback inhibition of the unfolded protein response by GADD34-mediated dephosphorylation of eIF2alpha. *J. Cell Biol.*
- Oakhill, J. S., Steel, R., Chen, Z. P., Scott, J. W., Ling, N., Tam, S. and Kemp, B. E.** (2011). AMPK is a direct adenylate charge-regulated protein kinase. *Science* (80-).
- Oda, K., Hosoda, N., Endo, H., Saito, K., Tsuchihara, K., Yamamura, M., Sakata, T., Anzai, N., Wempe, M. F., Kanai, Y., et al.** (2010). L-Type amino acid transporter 1 inhibitors inhibit tumor cell growth. *Cancer Sci.* **101**, 173–179.
- Ogunrinu, T. A. and Sontheimer, H.** (2010). Hypoxia increases the dependence of glioma cells on glutathione. *J. Biol. Chem.*
- Ohgimoto, S., Tabata, N., Suga, S., Nishio, M., Ohta, H., Tsurudome, M., Komada, H., Kawano, M., Watanabe, N. and Ito, Y.** (1995). Molecular characterization of fusion regulatory protein-1 (FRP-1) that induces multinucleated giant cell formation of monocytes and HIV gp160-mediated cell fusion. FRP-1 and 4F2/CD98 are identical molecules. *J. Immunol.* **155**, 3585–92.
- Ohgimoto, S., Tabata, N., Suga, S., Tsurudome, M., Kawano, M., Nishio, M., Okamoto, K., Komada, H., Watanabe, N. and Ito, Y.** (1996). Regulation of human immunodeficiency virus gp160-mediated cell fusion by antibodies against fusion regulatory protein 1. *J Gen Virol* **77** (Pt 11, 2747–2756.
- Ohta, H., Tsurudome, M., Matsumura, H., Koga, Y., Morikawa, S., Kawano, M., Kusugawa, S., Komada, H., Nishio, M. and Ito, Y.** (1994). Molecular and biological characterization of fusion regulatory proteins (FRPs): anti-FRP mAbs induced HIV-mediated cell fusion via an integrin system. *EMBO J.* **13**, 2044–55.
- Okamoto, K., Ohgimoto, S., Nishio, M., Tsurudome, M., Kawano, M., Komada, H., Ito, M., Sakakura, Y. and Ito, Y.** (1997). Paramyxovirus-induced syncytium cell formation is suppressed by a dominant negative fusion regulatory protein-1 (FRP-1)/CD98 mutated construct: an important role of FRP-1 in virus-induced cell fusion. *J. Gen. Virol.* **78** (Pt 4), 775–83.
- Okuda, M., Horn, H. F., Tarapore, P., Tokuyama, Y., Smulian, A. G., Chan, P. K., Knudsen, E. S., Hofmann, I. A., Snyder, J. D., Bove, K. E., et al.** (2000). Nucleophosmin/B23 is a target of CDK2/cyclin E in centrosome duplication. *Cell* **103**, 127–140.
- Orren, D. K., Petersen, L. N. and Bohr, V. a** (1997). Persistent DNA damage inhibits S-phase and G2 progression, and results in apoptosis. *Mol. Biol. Cell* **8**, 1129–1142.
- Otto, T. and Sicinski, P.** (2017). Cell cycle proteins as promising targets in cancer therapy. *Nat. Rev. Cancer* **17**, 93–115.
- Owen, J. L., Zhang, Y., Bae, S.-H., Farooqi, M. S., Liang, G., Hammer, R. E., Goldstein, J. L. and Brown, M. S.** (2012). Insulin stimulation of SREBP-1c processing in transgenic rat hepatocytes requires p70 S6-kinase. *Proc. Natl. Acad. Sci.*
- Padbury, J. F., Diah, S. K., McGonnigal, B., Miller, C., Fugere, C., Kuzniar, M. and Thompson, N. L.** (2004). Transcriptional regulation of the LAT-1/CD98 light chain. *Biochem. Biophys. Res. Commun.* **318**, 529–534.
- Pal, S., Gupta, R., Kim, H., Wickramasinghe, P., Baubet, V., Showe, L. C., Dahmane, N. and Davuluri, R. V.** (2011). Alternative transcription exceeds alternative splicing in generating the transcriptome diversity of cerebellar development. *Genome Res.*
- Paluch, E. K., Nelson, C. M., Biais, N., Fabry, B., Moeller, J., Pruitt, B. L., Wollnik, C., Kudryasheva, G., Rehfeldt,**

- F. and Federle, W.** (2015). Mechanotransduction: use the force(s). *BMC Biol.* **13**, 47.
- Pankov, R. and Yamada, K. M.** (2002). Fibronectin at a glance. *J. Cell Sci.* **115**, 3861–3.
- Papadopoulos, J. S. and Agarwala, R.** (2007). COBALT: Constraint-based alignment tool for multiple protein sequences. *Bioinformatics.*
- Parmacek, M. S., Karpinski, B. a, Gottesdiener, K. M., Thompson, C. B. and Leiden, J. M.** (1989). Structure, expression and regulation of the murine 4F2 heavy chain. *Nucleic Acids Res.* **17**, 1915–1931.
- Patterson, J. A. K., Eisinger, M. and Haynes, B. F.** (1984). Monoclonal antibody 4F2 reactive with basal layer keratinocytes: Studies in the normal and a hyperproliferative state. *J. Invest. Dermatol.* **83**, 210–213.
- Pear, W. S., Nolan, G. P., Scott, M. L. and Baltimore, D.** (1993). Production of high-titer helper-free retroviruses by transient transfection. *Proc. Natl. Acad. Sci.*
- Pera, M. F. and Tam, P. P. L.** (2010). Extrinsic regulation of pluripotent stem cells. *Nature* **465**, 713–720.
- Perrin, B. J. and Ervasti, J. M.** (2010). The actin gene family: Function follows isoform. *Cytoskeleton.*
- Peterson, T. R., Sengupta, S. S., Harris, T. E., Carmack, A. E., Kang, S. A., Balderas, E., Guertin, D. A., Madden, K. L., Carpenter, A. E., Finck, B. N., et al.** (2011). mTOR complex 1 regulates lipin 1 localization to control the srebp pathway. *Cell.*
- Petrich, B. G., Marchese, P., Ruggeri, Z. M., Spiess, S., Weichert, R. A. M., Ye, F., Tiedt, R., Skoda, R. C., Monkley, S. J., Critchley, D. R., et al.** (2007a). Talin is required for integrin-mediated platelet function in hemostasis and thrombosis. *J. Exp. Med.* **204**, 3103–3111.
- Petrich, B. G., Fogelstrand, P., Partridge, A. W., Yousefi, N., Ablooglu, A. J., Shattil, S. J. and Ginsberg, M. H.** (2007b). The antithrombotic potential of selective blockade of talin- dependent integrin alpha IIb beta 3 (platelet GPIIb-IIIa) activation. *J. Clin. Invest.* **117**, 2250–2259.
- Pfeiffer, R., Spindler, B., Loffing, J., Skelly, P. J., Shoemaker, C. B. and Verrey, F.** (1998). Functional heterodimeric amino acid transporters lacking cysteine residues involved in disulfide bond. *FEBS Lett.* **439**, 157–162.
- Pineda, M., Fernández, E., Torrents, D., Estévez, R., López, C., Camps, M., Lloberas, J., Zorzano, A. and Palacín, M.** (1999). Identification of a membrane protein, LAT-2, that co-expresses with 4F2 heavy chain, an L-type amino acid transport activity with broad specificity for small and large zwitterionic amino acids. *J. Biol. Chem.* **274**, 19738–19744.
- Polewski, M. D., Reveron-Thornton, R. F., Cherryholmes, G. A., Marinov, G. K., Cassady, K. and Aboody, K. S.** (2016). Increased Expression of System xc⁻ in Glioblastoma Confers an Altered Metabolic State and Temozolomide Resistance. *Mol. Cancer Res.*
- Prager, G. W., Féral, C. C., Kim, C., Han, J. and Ginsberg, M. H.** (2007). CD98hc (SLC3A2) interaction with the integrin beta subunit cytoplasmic domain mediates adhesive signaling. *J. Biol. Chem.* **282**, 24477–84.
- Pray, L.** (2008). Eukaryotic genome complexity. *Nat. Educ.* **1**, 96.
- Preissner, K. T. and Seiffert, D.** (1998). Role of vitronectin and its receptors in haemostasis and vascular remodeling. *Thromb. Res.* **89**, 1–21.
- Quackenbush, E., Clabby, M., Gottesdiener, K. M., Barbosa, J., Jones, N. H., Strominger, J. L., Speck, S. and Leiden, J. M.** (1987). Molecular cloning of complementary DNAs encoding the heavy chain of the human 4F2 cell-surface antigen: a type II membrane glycoprotein involved in normal and neoplastic cell growth. *Proc. Natl. Acad. Sci. U. S. A.* **84**, 6526–6530.
- Raab-Westphal, S., Marshall, J. F. and Goodman, S. L.** (2017). Integrins as therapeutic targets: Successes and cancers. *Cancers (Basel)*. **9**,
- Rach, E. A., Winter, D. R., Benjamin, A. M., Corcoran, D. L., Ni, T., Zhu, J. and Ohler, U.** (2011). Transcription initiation patterns indicate divergent strategies for gene regulation at the chromatin level. *PLoS Genet.*
- Radeva, G., Petrocelli, T., Behrend, E., Leung-Hagesteijn, C., Filmus, J., Slingerland, J. and Dedhar, S.** (1997). Overexpression of the integrin-linked kinase promotes anchorage-independent cell cycle progression. *J. Biol. Chem.* **272**, 13937–44.
- Rebsamen, M., Pochini, L., Stasyk, T., De Araújo, M. E. G., Galluccio, M., Kandasamy, R. K., Snijder, B., Fauster, A., Rudashevskaya, E. L., Bruckner, M., et al.** (2015). SLC38A9 is a component of the lysosomal amino acid sensing machinery that controls mTORC1. *Nature.*
- Reynolds, B., Roversi, P., Laynes, R., Kazi, S., Boyd, C. A. R. and Goberdhan, D. C. I.** (2009). *Drosophila* expresses a CD98 transporter with an evolutionarily conserved structure and amino acid-transport properties.

Biochem. J. **420**, 363–372.

- Rintoul, R. C., Buttery, R. C., Mackinnon, A. C., Wong, W. S., Mosher, D., Haslett, C. and Sethi, T.** (2002). Cross-linking CD98 promotes integrin-like signaling and anchorage-independent growth. *Mol. Biol. Cell* **13**, 2841–52.
- Roberts, P. J. and Der, C. J.** (2007). Targeting the Raf-MEK-ERK mitogen-activated protein kinase cascade for the treatment of cancer. *Oncogene*.
- Robitaille, A. M., Christen, S., Shimobayashi, M., Cornu, M., Fava, L. L., Moes, S., Prescianotto-Baschong, C., Sauer, U., Jenoe, P. and Hall, M. N.** (2013). Quantitative phosphoproteomics reveal mTORC1 activates de novo pyrimidine synthesis. *Science* (80-).
- Roovers, K., Davey, G., Zhu, X., Bottazzi, M. E. and Assoian, R. K.** (1999). Alpha5beta1 integrin controls cyclin D1 expression by sustaining mitogen-activated protein kinase activity in growth factor-treated cells. *Mol. Biol. Cell* **10**, 3197–3204.
- Rosell, A., Meury, M., Alvarez-Marimon, E., Costa, M., Perez-Cano, L., Zorzano, A., Fernandez-Recio, J., Palacin, M. and Fotiadis, D.** (2014). Structural bases for the interaction and stabilization of the human amino acid transporter LAT2 with its ancillary protein 4F2hc. *Proc. Natl. Acad. Sci.* **111**, 2966–2971.
- Rowe, W. G. and O'Brien, J.** (2002). The role of golem, pygmalion, and galatea effects on opportunistic behavior in the classroom. *J. Manag. Educ.* **26**, 612–628.
- Rozario, T. and DeSimone, D. W.** (2010). The extracellular matrix in development and morphogenesis: A dynamic view. *Dev. Biol.* **341**, 126–140.
- Ruderman, N. B., Julia Xu, X., Nelson, L., Cacicedo, J. M., Saha, A. K., Lan, F. and Ido, Y.** (2010). AMPK and SIRT1: a long-standing partnership? *AJP Endocrinol. Metab.*
- Ruoslahti, E.** (1996). RGD and other recognition sequences for Integrins. *Annu. Rev. Cell Dev. Biol.* **12**, 697–715.
- Ruoslahti, E.** (2002). Specialization of tumor vasculature. *Nat. Rev. Cancer* **2**, 83–90.
- Ruvolo, P. P.** (2016). Galectin 3 as a guardian of the tumor microenvironment. *Biochim. Biophys. Acta - Mol. Cell Res.* **1863**, 427–437.
- Saad, A., Bijian, K., Qiu, D., da Silva, S. D., Marques, M., Chang, C.-H., Nassour, H., Ramotar, D., Damaraju, S., Mackey, J., et al.** (2016). Insights into a novel nuclear function for Fascin in the regulation of the amino-acid transporter SLC3A2. *Sci. Rep.* **6**, 36699.
- Sabatini, D. M., Erdjument-Bromage, H., Lui, M., Tempst, P. and Snyder, S. H.** (1994). RAFT1: A mammalian protein that binds to FKBP12 in a rapamycin-dependent fashion and is homologous to yeast TORs. *Cell*.
- Sachidanandan, C., Sambasivan, R. and Dhawan, J.** (2002). Tristetraprolin and LPS-inducible CXC chemokine are rapidly induced in presumptive satellite cells in response to skeletal muscle injury. *J Cell Sci* **115**, 2701–2712.
- Sahu, D., Hsu, C.-L., Lin, C.-C., Yang, T.-W., Hsu, W.-M., Ho, S.-Y., Juan, H.-F. and Huang, H.-C.** (2016). Co-expression analysis identifies long noncoding RNA SNHG1 as a novel predictor for event-free survival in neuroblastoma. *Oncotarget* **7**, 58022–58037.
- Sancak, Y., Peterson, T. R., Shaul, Y. D., Lindquist, R. A., Thoreen, C. C., Bar-Peled, L. and Sabatini, D. M.** (2008). The rag GTPases bind raptor and mediate amino acid signaling to mTORC1. *Science* (80-).
- Sato, H., Shiya, A., Kimata, M., Maebara, K., Tamba, M., Sakakura, Y., Makino, N., Sugiyama, F., Yagami, K. I., Moriguchi, T., et al.** (2005). Redox imbalance in cystine/glutamate transporter-deficient mice. *J. Biol. Chem.* **280**, 37423–37429.
- Scaffidi, A. K., Petrovic, N., Moodley, Y. P., Fogel-Petrovic, M., Kroeger, K. M., Seeber, R. M., Eidne, K. a, Thompson, P. J. and Knight, D. a** (2004). alpha(v)beta(3) Integrin interacts with the transforming growth factor beta (TGFbeta) type II receptor to potentiate the proliferative effects of TGFbeta1 in living human lung fibroblasts. *J. Biol. Chem.* **279**, 37726–33.
- Schaefer, L. and Schaefer, R. M.** (2010). Proteoglycans: From structural compounds to signaling molecules. *Cell Tissue Res.* **339**, 237–246.
- Schiller, H. B. and Fässler, R.** (2013). Mechanosensitivity and compositional dynamics of cell-matrix adhesions. *EMBO Rep.* **14**, 509–519.
- Schlaepfer, D. D. and Hunter, T.** (1997). Focal adhesion kinase overexpression enhances Ras-dependent integrin signaling to ERK2/mitogen-activated protein kinase through interactions with and activation of c-Src. *J. Biol. Chem.* **272**, 13189–13195.

- Schlaepfer, D. D., Hanks, S. K., Hunter, T. and Geer, P. Van Der** (1994). Integrin-mediated signal transduction linked to Ras pathway by GRB2 binding to focal adhesion kinase. *Nature* **372**, 786–791.
- Schlaepfer, D. D., Broome, M. A. and Hunter, T.** (1997). Fibronectin-stimulated signaling from a focal adhesion kinase-c-Src complex: involvement of the Grb2, p130cas, and Nck adaptor proteins. *Mol Cell Biol* **17**, 1702–1713.
- Schneller, M., Vuori, K. and Ruoslahti, E.** (1997). Alpha v beta 3 integrin associates with activated insulin and PDGF beta receptors and potentiates the biological activity of PDGF. *EMBO J.* **16**, 5600–5607.
- Schürmann, A., Brauers, A., Maßmann, S., Becker, W. and Joost, H. G.** (1995). Cloning of a novel family of mammalian GTP-binding proteins (RagA, RagBs, RagB1) with remote similarity to the Ras-related GTPases. *J. Biol. Chem.*
- Sekiguchi, T., Hirose, E., Nakashima, N., Ii, M. and Nishimoto, T.** (2001). Novel G Proteins, Rag C and Rag D, Interact with GTP-binding Proteins, Rag A and Rag B. *J. Biol. Chem.*
- Shahbazian, D., Roux, P. P., Mieulet, V., Cohen, M. S., Raught, B., Taunton, J., Hershey, J. W. B., Blenis, J., Pende, M. and Sonenberg, N.** (2006). The mTOR/PI3K and MAPK pathways converge on eIF4B to control its phosphorylation and activity. *EMBO J.*
- Shanmugasundaram, K., Block, K., Nayak, B. K., Livi, C. B., Venkatachalam, M. A. and Sudarshan, S.** (2013). PI3K regulation of the SKP-2/p27 axis through mTORC2. *Oncogene* **32**, 2027–2036.
- Shattil, S. J. and Newman, P. J.** (2004). Integrins: Dynamic scaffolds for adhesion and signaling in platelets. *Blood* **104**, 1606–1615.
- Shattil, S. J., Kim, C. and Ginsberg, M. H.** (2010). The final steps of integrin activation: The end game. *Nat. Rev. Mol. Cell Biol.* **11**, 288–300.
- Shaw, R. J. and Cantley, L. C.** (2006). Ras, PI(3)K and mTOR signalling controls tumour cell growth. *Nature.*
- Shaw, R. J., Kosmatka, M., Bardeesy, N., Hurley, R. L., Witters, L. A., DePinho, R. A. and Cantley, L. C.** (2004). The tumor suppressor LKB1 kinase directly activates AMP-activated kinase and regulates apoptosis in response to energy stress. *Proc. Natl. Acad. Sci.* **101**, 3329–3335.
- Sherr, C. J. and Roberts, J. M.** (2004). Living with or without cyclins and cyclin-dependent kinases. *Genes Dev.* **18**, 2699–2711.
- Shin, S. I., Freedman, V. H., Risser, R. and Pollack, R.** (1975). Tumorigenicity of virus-transformed cells in nude mice is correlated specifically with anchorage independent growth in vitro. *Proc. Natl. Acad. Sci. U. S. A.* **72**, 4435–9.
- Simonson, W. T. N., Franco, S. J. and Huttenlocher, A.** (2006). Talin1 Regulates TCR-Mediated LFA-1 Function. *J. Immunol.* **177**, 7707–7714.
- Slack-Davis, J. K., Eblen, S. T., Zecevic, M., Boerner, S. A., Tarcsafalvi, A., Diaz, H. B., Marshall, M. S., Weber, M. J., Parsons, J. T. and Catling, A. D.** (2003). PAK1 phosphorylation of MEK1 regulates fibronectin-stimulated MAPK activation. *J. Cell Biol.* **162**, 281–291.
- Smith, M. L., Gourdon, D., Little, W. C., Kubow, K. E., Eguiluz, R. A., Luna-Morris, S. and Vogel, V.** (2007). Force-induced unfolding of fibronectin in the extracellular matrix of living cells. *PLoS Biol.* **5**, 2243–2254.
- Søberg, K., Moen, L. V., Skålhegg, B. S. and Laerdahl, J. K.** (2017). Evolution of the cAMP-dependent protein kinase (PKA) catalytic subunit isoforms. *PLoS One* **12**, 1–17.
- Stastna, M. and Van Eyk, J. E.** (2012). Analysis of protein isoforms: Can we do it better? *Proteomics.*
- Steck, T. L., Kaufman, S. and Bader, J. P.** (1968). Glycolysis in chick embryo cell cultures transformed by Rous sarcoma virus. *Cancer Res.* **28**, 1611–9.
- Steinberg, S. F.** (2008). Structural Basis of Protein Kinase C Isoform Function. *Physiol. Rev.*
- Stoker, M., O’Neill, C., Berryman, S. and Waxman, V.** (1968). Anchorage and growth regulation in normal and virus-transformed cells. *Int. J. Cancer* **3**, 683–693.
- Streuli, C. H. and Akhtar, N.** (2009). Signal co-operation between integrins and other receptor systems. *Biochem. J.* **418**, 491–506.
- Strohmaier, H., Spruck, C. H., Kaiser, P., Won, K. A., Sangfelt, O. and Reed, S. I.** (2001). Human F-box protein hCdc4 targets cyclin E for proteolysis and is mutated in a breast cancer cell line. *Nature* **413**, 316–322.
- Sun, C. C., Qu, X. J. and Gao, Z. H.** (2014a). Integrins: Players in cancer progression and targets in cancer therapy. *Anticancer. Drugs* **25**, 1107–1121.

- Sun, H., Wu, J., Wickramasinghe, P., Pal, S., Gupta, R. and Davuluri, R. V. (2014b). Genome-wide mapping of RNA Pol-II promoter usage in mouse tissues by ChIP-seq. *Methods Mol. Biol.* **39**, 190–201.
- Tadokoro, S., Shattil, S. J., Eto, K., Tai, V., Liddington, R. C., De Pereda, J. M., Ginsberg, M. H. and Calderwood, D. A. (2003). Talin binding to integrin β tails: A final common step in integrin activation. *Science (80-)*. **302**, 103–106.
- Takayasu, Y., Iino, M., Takatsuru, Y., Tanaka, K. and Ozawa, S. (2009). Functions of glutamate transporters in cerebellar Purkinje cell synapses. *Acta Physiol.*
- Takesono, A., Moger, J., Farooq, S., Cartwright, E., Dawid, I. B., Wilson, S. W. and Kudoh, T. (2012). Solute carrier family 3 member 2 (Slc3a2) controls yolk syncytial layer (YSL) formation by regulating microtubule networks in the zebrafish embryo. *Proc. Natl. Acad. Sci.* **109**, 3371–3376.
- Tanaka, T., Masuko, T. and Chemistry, H. (1988). Appearance of a Proliferation-Associated Human Lymphocytes by Co-Stimulation and Calcium Ionophore Antigen , gp125, on Rat with Phorbol Ester. *J. Biochem.* **649**, 644–649.
- Tărlungeanu, D. C., Deliu, E., Dotter, C. P., Kara, M., Janiesch, P. C., Scalise, M., Galluccio, M., Tesulov, M., Morelli, E., Sonmez, F. M., et al. (2016). Impaired Amino Acid Transport at the Blood Brain Barrier Is a Cause of Autism Spectrum Disorder. *Cell* **167**, 1481–1494.e18.
- Tcherkezian, J., Cargnello, M., Romeo, Y., Huttlin, E. L., Lavoie, G., Gygi, S. P. and Roux, P. P. (2014). Proteomic analysis of cap-dependent translation identifies LARP1 as a key regulator of 5'TOP mRNA translation. *Genes Dev.*
- Teixeira, S., Di Grandi, S. and Kuhn, L. C. (1987). Primary structure of the human 4F2 antigen heavy chain predicts a transmembrane protein with a cytoplasmic NH2 terminus. *J. Biol. Chem.* **262**, 9574–9580.
- Thannickal, V. J., Henke, C. A., Horowitz, J. C., Noble, P. W., Roman, J., Sime, P. J., Zhou, Y., Wells, R. G., White, E. S. and Tschumperlin, D. J. (2014). Matrix biology of idiopathic pulmonary fibrosis. *Am. J. Pathol.* **184**, 1643–51.
- Thompson, M. R., Xu, D. and Williams, B. R. G. (2009). ATF3 transcription factor and its emerging roles in immunity and cancer. *J. Mol. Med.* **87**, 1053–1060.
- Thoreen, C. C., Kang, S. A., Chang, J. W., Liu, Q., Zhang, J., Gao, Y., Reichling, L. J., Sim, T., Sabatini, D. M. and Gray, N. S. (2009). An ATP-competitive mammalian target of rapamycin inhibitor reveals rapamycin-resistant functions of mTORC1. *J. Biol. Chem.*
- Tissot, F. S., Estrach, S., Boulter, E., Cailleteau, L., Seguin, L., Pisano, S., Audebert, S., Croce, O. and Chloé, C. (2018). Dermal fibroblast SLC3A2 deficiency leads to premature aging and loss of epithelial homeostasis. *J. Invest. Dermatol.*
- Torrents, D., Estevez, R., Pineda, M., Fernandez, E., Lloberas, J., Shi, Y.-B., Zorzano, A. and Palacin, M. (1998). Identification and Characterization of a Membrane Protein (γ L Amino Acid Transporter-1) That Associates with 4F2hc to Encode the Amino Acid Transport Activity γ L. A CANDIDATE GENE FOR LYSINURIC PROTEIN INTOLERANCE. *J. Biol. Chem.* **273**, 32437–32445.
- Torrents, D., Mykkänen, J., Pineda, M., Feliubadaló, L., Estévez, R., De Rafael, C., Sanjurjo, P., Zorzano, A., Nunes, V., Huoponen, K., et al. (1999). Identification of SLC7A7, encoding γ -LAT-1, as the lysinuric protein intolerance gene. *Nat. Genet.* **21**, 293–296.
- Trebaul, A., Chan, E. K. and Midwood, K. S. (2007). Regulation of fibroblast migration by tenascin-C. *Biochem. Soc. Trans.* **35**, 695–7.
- Trinklein, N. D., Aldred, S. F., Hartman, S. J., Schroeder, D. I., Otilar, R. P. and Myers, R. M. (2003). An Abundance of Bidirectional Promoters in the Human Genome. *Genome Res.* **14**, 62–66.
- Tsumura, H., Suzuki, N., Saito, H., Kawano, M., Otake, S., Kozuka, Y., Komada, H., Tsurudome, M. and Ito, Y. (2003). The targeted disruption of the CD98 gene results in embryonic lethality. *Biochem. Biophys. Res. Commun.* **308**, 847–851.
- Tsurudome, M. and Ito, Y. (2000). Function of fusion regulatory proteins (FRPs) in immune cells and virus-infected cells. *Crit. Rev. Immunol.* **20**, 167–96.
- Tucker, R. P. and Chiquet-Ehrismann, R. (2009). The regulation of tenascin expression by tissue microenvironments. *Biochim. Biophys. Acta - Mol. Cell Res.* **1793**, 888–892.
- Uinuk-Ool, T., Mayer, W. E., Sato, A., Dongak, R., Cooper, M. D. and Klein, J. (2002). Lamprey lymphocyte-like cells express homologs of genes involved in immunologically relevant activities of mammalian

- lymphocytes. *Proc. Natl. Acad. Sci. U. S. A.* **99**, 14356–14361.
- Van Der Vos, K. E. and Coffey, P. J.** (2012). Glutamine metabolism links growth factor signaling to the regulation of autophagy. *Autophagy*.
- Varga-Szabo, D., Pleines, I. and Nieswandt, B.** (2008). Cell adhesion mechanisms in platelets. *Arterioscler. Thromb. Vasc. Biol.* **28**, 403–413.
- Veettil, M. V., Sadagopan, S., Sharma-Walia, N., Wang, F.-Z., Raghu, H., Varga, L. and Chandran, B.** (2008). Kaposi's Sarcoma-Associated Herpesvirus Forms a Multimolecular Complex of Integrins (V 5, V 3, and 3 1) and CD98-xCT during Infection of Human Dermal Microvascular Endothelial Cells, and CD98-xCT Is Essential for the Postentry Stage of Infection. *J. Virol.* **82**, 12126–12144.
- Vieler, M., Sanyal, S., Vieler, M. and Sanyal, S.** (2018). p53 Isoforms and Their Implications in Cancer. *Cancers (Basel)*. **10**, 288.
- Vierstra, J., Rynes, E., Sandstrom, R., Zhang, M., Canfield, T., Scott Hansen, R., Stehling-Sun, S., Sabo, P. J., Byron, R., Humbert, R., et al.** (2014). Mouse regulatory DNA landscapes reveal global principles of cis-regulatory evolution. *Science (80-)*.
- Vilar, E., Perez-Garcia, J. and Tabernero, J.** (2011). Pushing the Envelope in the mTOR Pathway: The Second Generation of Inhibitors. *Mol. Cancer Ther.*
- Walker, J. L. and Assoian, R. K.** (2005). Integrin-dependent signal transduction regulating cyclin D1 expression and G1 phase cell cycle progression. *Cancer Metastasis Rev* **24**, 383–393.
- Wang, T., Marquardt, C. and Foker, J.** (1976). Aerobic glycolysis during lymphocyte proliferation. *Nature*.
- Wang, N., Butler, J. P. and Ingber, D. E.** (1993). Mechanotransduction across the cell surface and through the cytoskeleton. *Science (80-)*.
- Wang, X., Li, W., Williams, M., Terada, N., Alessi, D. R. and Proud, C. G.** (2001). Regulation of elongation factor 2 kinase by p90RSK1 and p70 S6 kinase. *EMBO J.*
- Wang, X., Arai, S., Song, X., Reichart, D., Du, K., Pascual, G., Tempst, P., Rosenfeld, M. G., Glass, C. K. and Kurokawa, R.** (2008). Induced ncRNAs allosterically modify RNA-binding proteins in cis to inhibit transcription. *Nature* **454**, 126–130.
- Wang, S., Tsun, Z. Y., Wolfson, R. L., Shen, K., Wyant, G. A., Plovianich, M. E., Yuan, E. D., Jones, T. D., Chantranupong, L., Comb, W., et al.** (2015). Lysosomal amino acid transporter SLC38A9 signals arginine sufficiency to mTORC1. *Science (80-)*.
- Warburg, O.** (1956). On the origin of cancer cells. *Science (80-)*. **123**, 309–14.
- Wary, K. K., Mainiero, F., Isakoff, S. J., Marcantonio, E. E. and Giancotti, F. G.** (1996). The adaptor protein Shc couples a class of integrins to the control of cell cycle progression. *Cell* **87**, 733–743.
- Wary, K. K., Mariotti, A., Zurzolo, C. and Giancotti, F. G.** (1998). A requirement for caveolin-1 and associated kinase Fyn in integrin signaling and anchorage-dependent cell growth. *Cell* **94**, 625–634.
- Watanabe, N., Madaule, P., Reid, T., Ishizaki, T., Watanabe, G., Kakizuka, A., Saito, Y., Nakao, K., Jockusch, B. M. and Narumiya, S.** (1997). p140mDia, a mammalian homolog of Drosophila diaphanous, is a target protein for Rho small GTPase and is a ligand for profilin. *EMBO J.* **16**, 3044–3056.
- Watanabe, R., Tambe, Y., Inoue, H., Isono, T., Haneda, M., Isobe, K. I., Kobayashi, T., Hino, O., Okabe, H. and Chano, T.** (2007). GADD34 inhibits mammalian target of rapamycin signaling via tuberous sclerosis complex and controls cell survival under bioenergetic stress. *Int. J. Mol. Med.*
- Weaver, V. M., Lelièvre, S., Lakins, J. N., Chrenek, M. A., Jones, J. C. R., Giancotti, F., Werb, Z. and Bissell, M. J.** (2002). Beta4 integrin-dependent formation of polarized three-dimensional architecture confers resistance to apoptosis in normal and malignant mammary epithelium. *Cancer Cell* **2**, 205–216.
- Wegener, K. L., Partridge, A. W., Han, J., Pickford, A. R., Liddington, R. C., Ginsberg, M. H. and Campbell, I. D.** (2007). Structural Basis of Integrin Activation by Talin. *Cell* **128**, 171–182.
- Wek, R. C., Jiang, H.-Y. and Anthony, T. G.** (2006). Coping with stress: eIF2 kinases and translational control. *Biochem. Soc. Trans.*
- Wells, R. G. and Hediger, M. a** (1992). Cloning of a rat kidney cDNA that stimulates dibasic and neutral amino acid transport and has sequence similarity to glucosidases. *Proc. Natl. Acad. Sci. U. S. A.* **89**, 5596–600.
- Welsh, C. F.** (2004). Rho GTPases as key transducers of proliferative signals in G1cell cycle regulation. *Breast Cancer Res. Treat.* **84**, 33–42.

- West, M. J., Stoneley, M. and Willis, a E.** (1998). Translational induction of the c-myc oncogene via activation of the FRAP/TOR signalling pathway. *Oncogene*.
- Wilson, M. D., Barbosa-Morais, N. L., Schmidt, D., Conboy, C. M., Vanes, L., Tybulewicz, V. L. J., Fisher, E. M. C., Tavaré, S. and Odom, D. T.** (2008). Species-specific transcription in mice carrying human chromosome 21. *Science (80-)*.
- Wise, S. G. and Weiss, A. S.** (2009). Tropoelastin. *Int. J. Biochem. Cell Biol.* **41**, 494–497.
- Wolfson, R. L., Chantranupong, L., Saxton, R. A., Shen, K., Scaria, S. M., Cantor, J. R. and Sabatini, D. M.** (2016). Sestrin2 is a leucine sensor for the mTORC1 pathway. *Science (80-)*. **351**, 43–48.
- Wollscheid, B., Bausch-Fluck, D., Henderson, C., O'Brien, R., Bibel, M., Schiess, R., Aebersold, R. and Watts, J. D.** (2009). Mass-spectrometric identification and relative quantification of N-linked cell surface glycoproteins. *Nat. Biotechnol.* **27**, 378–386.
- Wu, B., Wang, Y., Yang, X.-M., Xu, B.-Q., Feng, F., Wang, B., Liang, Q., Li, Y., Zhou, Y., Jiang, J.-L., et al.** (2015). Basigin-mediated redistribution of CD98 promotes cell spreading and tumorigenicity in hepatocellular carcinoma. *J. Exp. Clin. Cancer Res.* **34**, 110.
- Xi, X., Han, J. and Zhang, J. Z.** (2001). Stimulation of glucose transport by AMP-activated protein kinase via activation of p38 mitogen-activated protein kinase. *J. Biol. Chem.*
- Xia, T., Takagi, J., Collier, B. S., Wang, J. H. and Springer, T. A.** (2004). Structural basis for allostery in integrins and binding to fibrinogen-mimetic therapeutics. *Nature* **432**, 59–67.
- Xiao, B., Sanders, M. J., Underwood, E., Heath, R., Mayer, F. V., Carmena, D., Jing, C., Walker, P. A., Eccleston, J. F., Haire, L. F., et al.** (2011). Structure of mammalian AMPK and its regulation by ADP. *Nature*.
- Xiao, B., Laroui, H., Viennois, E., Ayyadurai, S., Charania, M. A., Zhang, Y., Zhang, Z., Baker, M. T., Zhang, B., Gewirtz, A. T., et al.** (2014). Nanoparticles with surface antibody against CD98 and carrying CD98 small interfering RNA reduce colitis in mice. *Gastroenterology* **146**.
- Xiao, B., Ma, P., Viennois, E. and Merlin, D.** (2016). Urocanic acid-modified chitosan nanoparticles can confer anti-inflammatory effect by delivering CD98 siRNA to macrophages. *Colloids Surfaces B Biointerfaces* **143**, 186–193.
- Xin, X., Zeng, X., Gu, H., Li, M., Tan, H., Jin, Z., Hua, T., Shi, R. and Wang, H.** (2016). CD147/EMMPRIN overexpression and prognosis in cancer: A systematic review and meta-analysis. *Sci. Rep.* **6**, 1–12.
- Xu, D. and Hemler, M. E.** (2005). Metabolic Activation-related CD147-CD98 Complex. *Mol. Cell. Proteomics* **4**, 1061–1071.
- Yan, Y., Vasudevan, S., Nguyen, H., Bork, U., Sitaraman, S. and Merlin, D.** (2007a). Extracellular interaction between hCD98 and the PDZ class II domain of hCASK in intestinal epithelia. *J. Membr. Biol.* **215**, 15–26.
- Yan, Y., Dalmasso, G., Sitaraman, S. and Merlin, D.** (2007b). Characterization of the human intestinal CD98 promoter and its regulation by interferon-gamma. *Am. J. Physiol. Gastrointest. Liver Physiol.* **292**, G535-45.
- Yang, J. Y., Zong, C. S., Xia, W., Yamaguchi, H., Ding, Q., Xie, X., Lang, J. Y., Lai, C. C., Chang, C. J., Huang, W. C., et al.** (2008). ERK promotes tumorigenesis by inhibiting FOXO3a via MDM2-mediated degradation. *Nat. Cell Biol.* **10**, 138–148.
- Ye, F., Petrich, B. G., Anekal, P., Lefort, C. T., Kasirer-Friede, A., Shattil, S. J., Ruppert, R., Moser, M., Fässler, R. and Ginsberg, M. H.** (2013). The mechanism of kindlin-mediated activation of integrin α IIb β 3. *Curr. Biol.* **23**, 2288–2295.
- Yoon, J. H., Kim, Y. B., Kanai, Y., Endou, H. and Kim, D. K.** (2003). Sequential Increases in 4F2hc Expression during DMBA-induced Hamster Buccal Pouch Carcinogenesis. *Anticancer Res.* **23**, 3877–3881.
- Yu, K., Toral-Barza, L., Shi, C., Zhang, W.-G., Lucas, J., Shor, B., Kim, J., Verheijen, J., Curran, K., Malwitz, D. J., et al.** (2009). Biochemical, cellular, and in vivo activity of novel ATP-competitive and selective inhibitors of the mammalian target of rapamycin. *Cancer Res.*
- Zahir, N., Lakins, J. N., Russell, A., Ming, W. Y., Chatterjee, C., Rozenberg, G. I., Marinkovich, M. P. and Weaver, V. M.** (2003). Autocrine laminin-5 ligates α 6 β 4 integrin and activates RAC and NF κ B to mediate anchorage-independent survival of mammary tumors. *J. Cell Biol.* **163**, 1397–1407.
- Zaidel-Bar, R., Itzkovitz, S., Ma'ayan, A., Lyengar, R. and Geiger, B.** (2007). Functional atlas of the integrin adhesome. *Nat. Cell Biol.* **9**, 858–867.
- Zaytseva, Y. Y., Valentino, J. D., Gulhati, P. and Mark Evers, B.** (2012). MTOR inhibitors in cancer therapy. *Cancer Lett.*

- Zent, R., Fenczik, C. A., Calderwood, D. A., Liu, S., Dellos, M. and Ginsberg, M. H.** (2000). Class- and splice variant-specific association of CD98 with integrin β cytoplasmic domains. *J. Biol. Chem.* **275**, 5059–5064.
- Zhang, X. and Yee, D.** (2000). Tyrosine kinase signalling in breast cancer: insulin-like growth factors and their receptors in breast cancer. *Breast Cancer Res.* **2**, 170–5.
- Zhang, H., Li, X. J., Martin, D. B. and Aebersold, R.** (2003). Identification and quantification of N-linked glycoproteins using hydrazide chemistry, stable isotope labeling and mass spectrometry. *Nat Biotechnol* **21**, 660–666.
- Zhang, S. M., Adema, C. M., Kepler, T. B. and Loker, E. S.** (2004). Diversification of Ig superfamily genes in an invertebrate. *Science (80-)*. **305**, 251–254.
- Zhang, S., Huan, W., Wei, H., Shi, J., Fan, J., Zhao, J., Shen, A. and Teng, H.** (2013). FOXO3a/p27^{kip1} expression and essential role after acute spinal cord injury in adult rat. *J. Cell. Biochem.* **114**, 354–365.
- Zhang, H., Zhou, D., Ying, M., Chen, M., Chen, P., Chen, Z. and Zhang, F.** (2016a). Expression of Long Non-Coding RNA (lncRNA) Small Nucleolar RNA Host Gene 1 (SNHG1) Exacerbates Hepatocellular Carcinoma Through Suppressing miR-195. *Med. Sci. Monit.* **22**, 4820–4829.
- Zhang, M., Wang, W., Li, T., Yu, X., Zhu, Y., Ding, F., Li, D. and Yang, T.** (2016b). Long noncoding RNA SNHG1 predicts a poor prognosis and promotes hepatocellular carcinoma tumorigenesis. *Biomed. Pharmacother.* **80**, 73–79.
- Zhang, D., Wang, Y., Lu, P., Wang, P., Yuan, X., Yan, J., Cai, C., Chang, C. P., Zheng, D., Wu, B., et al.** (2017). REST regulates the cell cycle for cardiac development and regeneration. *Nat. Commun.* **8**.
- Zoncu, R., Bar-Peled, L., Efeyan, A., Wang, S., Sancak, Y. and Sabatini, D. M.** (2011). mTORC1 senses lysosomal amino acids through an inside-out mechanism that requires the vacuolar H⁺-ATPase. *Science (80-)*.
- Zu, X. L. and Guppy, M.** (2004). Cancer metabolism: Facts, fantasy, and fiction. *Biochem. Biophys. Res. Commun.*