



HAL
open science

On the dynamic of orientation reversing homeomorphisms of surfaces

Ngoc Diep Tran

► **To cite this version:**

Ngoc Diep Tran. On the dynamic of orientation reversing homeomorphisms of surfaces. Geometric Topology [math.GT]. Université Sorbonne Paris Cité, 2018. English. NNT : 2018USPCD064 . tel-02526891

HAL Id: tel-02526891

<https://theses.hal.science/tel-02526891>

Submitted on 31 Mar 2020

HAL is a multi-disciplinary open access archive for the deposit and dissemination of scientific research documents, whether they are published or not. The documents may come from teaching and research institutions in France or abroad, or from public or private research centers.

L'archive ouverte pluridisciplinaire **HAL**, est destinée au dépôt et à la diffusion de documents scientifiques de niveau recherche, publiés ou non, émanant des établissements d'enseignement et de recherche français ou étrangers, des laboratoires publics ou privés.

UNIVERSITÉ PARIS 13
École Doctorale de l'Institut Galilée
Laboratoire d'Analyse, Géométrie et Applications

THÈSE DE DOCTORAT
présentée pour obtenir le grade de

DOCTEUR EN SCIENCES DE L'UNIVERSITÉ PARIS 13

Discipline : Mathématiques

par

Ngoc Diep TRAN

**Sur la dynamique des homéomorphismes de
surfaces qui renversent l'orientation**

dirigée par **Marc BONINO**

Soutenue à Villetaneuse, le 05 décembre 2018 devant le jury

M.	François Béguin	Université Paris 13, France	Examinateur
M.	Marc Bonino	Université Paris 13, France	Directeur
M.	Sylvain Crovisier	CNRS-Université Paris 11, France	Examinateur
M.	Patrice Le Calvez	Sorbonne Université, France	Rapporteur
Mme.	Sylvie Ruette	Université Paris 11, France	Examinatrice

Rapporteur absent lors de la soutenance

M.	Fábio Armando Tal	Université de São Paulo, Brésil	Rapporteur
----	--------------------------	---------------------------------	------------

Remerciements

Au terme de ce travail, c'est avec émotion que je tiens à remercier tous ceux qui, de près ou de loin, ont contribué à la réalisation de ce projet.

Je tiens en tout premier lieu à adresser mes remerciements les plus sincères à mon directeur, Monsieur Marc Bonino. Je suis très heureux d'avoir travaillé sous sa direction depuis mon master à l'université Paris 13. Je lui suis très reconnaissant de son très grand soutien, de sa très grande disponibilité, et de son attention constante. Je tiens à lui exprimer ma gratitude pour sa patience agréable en comprenant mon français et aussi mon anglais, en m'expliquant des problèmes mathématiques, et en corrigeant soigneusement tous mes travaux. Sa connaissance mathématique et son style de travail vont toujours m'influencer.

Je souhaiterais exprimer ma gratitude à Messieurs Patrice Le Calvez et Fabio Armando Tal pour m'avoir fait l'honneur d'être rapporteurs de cette thèse. Leurs remarques m'ont permis d'envisager mon travail sous un autre angle. Mes remerciements vont également à Messieurs François Béguin et Sylvain Crovisier et à Madame Sylvie Ruette pour avoir accepté de participer à ce jury de thèse.

J'aimerais remercier Monsieur le Professeur Lionel Schwartz pour m'avoir beaucoup aidé dans l'obtention de la bourse d'excellence en Master 2 et de la bourse allocataire en thèse, comme dans mes difficultés en France. Je tiens à dire un énorme merci à Isabelle Barbotin, Jean-Philippe Dru, et Yolande Jimenez pour les démarches administratives ainsi que leur gentillesse.

Je passe ensuite une dédicace spéciale à tous les jeunes gens avec qui j'ai eu le plaisir de partager de très bons moments dans la vie, par exemple, un repas, un gâteau, un café, un sport, un voyage, un karaoké ou une soirée d'amis durant ces quelques années en France, à savoir : *anh chị* Bảo Cúc, Bình, Hiếu, Kiên Thu, Kỳ, Nhật, *chị* Phượng, Thi, Việt Loan, et tous mes amis vietnamiens à l'université Paris 13 comme en France.

Je pense tout particulièrement à *anh* Quang et *anh chị* Cường Mai pour m'avoir beaucoup aidé dès mes premiers jours à Paris, à *anh* Khuê et *anh* Phạm Tuấn pour leurs précieux conseils à l'université Paris 13.

Enfin, les mots les plus simples étant les plus forts, j'adresse toute mon affection à ma famille. Je voudrais également remercier ma petite princesse et mon petit prince, Minh Minh et Nhoong Nhoong. Grâce à leurs sourires, j'ai passé de bons moments et oublié la fatigue, le stress du travail. Je sais que mon absence a été longue et j'espère pouvoir un jour rattraper le retard accumulé.

Tôi xin gửi lời cảm ơn sâu sắc nhất đến ba người mẹ và chị gái của tôi, những người phụ nữ chung thủy nhất cuộc đời tôi, luôn dành cho tôi tình cảm trọn vẹn nhất từ lúc tôi được sinh ra, và giang rộng vòng tay chào đón tôi trở về nhà, cho dù có bất cứ sóng gió nào xảy ra trong cuộc đời này đó cũng là nơi an bình nhất. Tiếp theo, không thể không cảm ơn người phụ nữ của đời tôi, người đã hy sinh vô điều kiện cả tuổi thanh xuân cho tôi mà không một lời kêu ca oán trách và đối với tôi, đó là người phụ nữ kiên cường và dũng cảm nhất, vợ tôi. Xin cảm ơn tất cả người phụ nữ tuyệt vời và quan trọng nhất cuộc đời tôi.

Abstract

On the dynamic of orientation reversing homeomorphisms of surfaces

We first prove that if h is an orientation reversing homeomorphism of the sphere \mathbb{S}^2 without a 2-periodic orbit then the complementary domain of the fixed point set may be foliated with “Brouwer manifolds”. These are 1-dimensional submanifolds (topologically circles, lines or pairs of lines) allowing to define some invariant open sets on which h is conjugated to one of three simple possible models. So, this theorem is a foliated version of a resultat by Bonino asserting that $\mathbb{S}^2 \setminus \text{Fix}(h)$ can be covered with Brouwer manifolds. It also appears as a natural counterpart for orientation reversing homeomorphisms of the Le Calvez’s foliated version of the Brouwer’s plane translation theorem. As an application of this foliation theorem, we next obtain the following result about the fixed point index of the iterates of an orientation reversing local homeomorphism h of \mathbb{R}^2 : as soon as 0 is an isolated fixed point of each iterate h^n ($n \geq 1$), the Poincaré-Lefschetz indices $\text{Ind}(h^{2k-1}, 0)$ and $\text{Ind}(h^{2k}, 0)$ do not depend on the integer $k \geq 1$.

Keywords: Surface homeomorphism · orientation reversal · 2-periodic point · topological foliation · Poincaré-Lefschetz index.

Résumé

Sur la dynamique des homéomorphismes de surfaces qui renversent l'orientation

Nous prouvons d'abord que si h est un homéomorphisme de la sphère \mathbb{S}^2 renversant l'orientation et sans orbite périodique de période minimale 2, alors on peut feuilletter l'ensemble complémentaire des points fixes avec des "variétés de Brouwer". Celles-ci sont des sous-variétés de dimension 1 (topologiquement des cercles, des droites ou des paires de droites) permettant de définir des ouverts invariants sur lesquels h est conjugué à un modèle simple parmi trois possibles. Ce théorème est ainsi une version feuilletée d'un résultat de Bonino affirmant que $\mathbb{S}^2 \setminus \text{Fix}(h)$ peut être recouvert par des variétés de Brouwer. Il apparaît aussi comme un analogue, pour les homéomorphismes renversant l'orientation, de la version feuilletée du théorème de translation plane de Brouwer donnée par Le Calvez. Comme application de ce théorème de feuilletage, on obtient ensuite le résultat suivant sur l'indice de point fixe des itérés d'un homéomorphisme local h de \mathbb{R}^2 renversant l'orientation: dès que 0 est un point fixe isolé de tous les itérés h^n ($n \geq 1$) les valeurs des indices de Poincaré-Lefschetz $\text{Ind}(h^{2k-1}, 0)$ et $\text{Ind}(h^{2k}, 0)$ ne dépendent pas de l'entier $k \geq 1$.

Mots-Clés: Homéomorphisme de surface · renversement de l'orientation · point 2-périodique · feuilletage topologique · indice de Poincaré-Lefschetz.

Contents

Remerciements	i
Abstract	iii
Résumé	v
Contents	vi
1 Introduction	1
1.1 Variations autour du théorème de translation plane	2
1.2 Présentation des résultats et organisation du texte	4
2 Preliminaries	7
2.1 Notations and basic definitions	8
2.2 Brick decompositions	8
3 Brouwer manifolds	11
3.1 Definition	12
3.2 Left and right sides of a Brouwer manifold	12
3.3 Brouwer manifolds without transverse intersection	19
4 Statement of the main results	23
5 Proof of Theorem 4.1	25
5.1 Simplification of the fixed point set	26
5.2 Maximal brick decompositions	27
5.3 Construction of the foliation	46
5.4 Some remarks on the set of Brouwer manifolds \mathcal{P}	103
6 An application of Theorem 4.1	107
6.1 Description of the foliation \mathcal{F} when it has no circle-leaf	109
6.2 Link between the minimal (\mathcal{F}, h) -croissants and the index	122
6.3 Link with Le Calvez equivariant foliations on the annulus	130
6.4 Proof of Theorem 6.2	133

Bibliography

Introduction

Contents

1.1	Variations autour du théorème de translation plane	2
1.1.1	Les versions feuilletées de Le Calvez	3
1.1.2	Un analogue dans le cas renversant l'orientation	3
1.2	Présentation des résultats et organisation du texte	4

1.1 Variations autour du théorème de translation plane

Un outil important pour l'étude de la dynamique des homéomorphismes de surfaces est la théorie de Brouwer qui, de façon générale, explique qu'un homéomorphisme du plan \mathbb{R}^2 préservant l'orientation et sans point fixe a une dynamique très peu récurrente. Un énoncé classique de cette théorie est le théorème de translation plane:

Théorème 1.1. *Soit f un homéomorphisme de \mathbb{R}^2 qui préserve l'orientation et qui n'a pas de point fixe. Alors pour tout point $m \in \mathbb{R}^2$ il existe une droite topologique L passant par m , proprement plongée dans \mathbb{R}^2 , disjointe de son image par f et séparant $f^{-1}(L)$ et $f(L)$ dans \mathbb{R}^2 .*

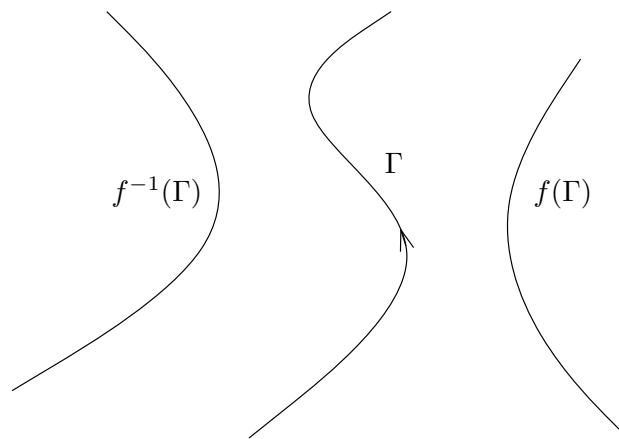

Figure 1.1 – Une droite de Brouwer

On peut se référer à l'article d'origine de Brouwer [Bro12] ou bien à [Gui94, LCS96] pour des preuves plus récentes et plus accessibles. Un homéomorphisme f et une droite topologique L comme dans le théorème précédent sont respectivement appelés un *homéomorphisme de Brouwer* et une *droite de Brouwer* (de f). Ainsi le théorème de translation plane dit que, pour tout homéomorphisme de Brouwer f , on peut recouvrir le plan par des droites de Brouwer. Il peut aussi s'énoncer de façon un peu différente en disant que, sous les mêmes hypothèses pour f , tout point de $m \in \mathbb{R}^2$ est contenu dans un *domaine de translation*, c'est à dire un ouvert connexe, simplement connexe et f -invariant sur lequel f est conjugué à une translation. Plus précisément encore, un domaine de translation est l'image $\varphi(\mathbb{R}^2)$ du plan \mathbb{R}^2 par une application $\varphi : \mathbb{R}^2 \rightarrow \mathbb{R}^2$ continue injective qui envoie chaque verticale $\{x\} \times \mathbb{R}$ sur un fermé de \mathbb{R}^2 .

1.1.1 Les versions feuilletées de Le Calvez

Il est naturel vouloir renforcer le théorème 1.1 en feuilletant (et non pas seulement en recouvrant) le plan \mathbb{R}^2 par des droites de Brouwer. C'est exactement la version feuilletée du théorème de translation plane obtenue dans l'article [LC04].

Théorème 1.2 (Le Calvez, [LC04]). *Soit f un homéomorphisme de Brouwer. Il existe alors un feuilletage topologique orienté \mathcal{F} de \mathbb{R}^2 dont toute feuille est une droite de Brouwer de f .*

Le lecteur notera bien que dans cet énoncé le feuilletage \mathcal{F} n'a aucune raison d'être invariant par f . Ce théorème peut se voir comme une étape vers la version feuilletée équivariante du théorème de translation plane:

Théorème 1.3 (Le Calvez, [LC05]). *Soit G un groupe discret d'homéomorphismes de \mathbb{R}^2 préservant l'orientation, agissant librement et proprement. Soit f un homéomorphisme de Brouwer commutant avec les éléments de G . Il existe alors un feuilletage topologique orienté \mathcal{F} de \mathbb{R}^2 , invariant sous l'action de G , dont toute feuille est une droite de Brouwer de f .*

Dans ce dernier énoncé, f doit être regardé comme un relèvement d'un homéomorphisme \hat{f} de la surface $S = \mathbb{R}^2/G$ isotope à Id_S . Le feuilletage \mathcal{F} se projette alors sur un feuilletage $\hat{\mathcal{F}}$ de S qui est "transverse à la dynamique de \hat{f} ". Ceci constitue un nouvel outil puissant pour l'étude dynamique des homéomorphismes de surfaces (voir par exemple [LC05, LC06b, LC08] ou [LR13]).

1.1.2 Un analogue dans le cas renversant l'orientation

Bien que la littérature sur le sujet soit moins abondante, les homéomorphismes de surfaces renversant l'orientation constituent une classe intéressante de systèmes dynamiques, que l'on ne peut pas comprendre en se contentant "d'élever au carré" pour revenir au cas préservant l'orientation. L'article [Bon04] de Bonino montre cependant qu'il existe de fortes similarités entre les homéomorphismes de Brouwer et les homéomorphismes de la sphère \mathbb{S}^2 qui renversent l'orientation et qui n'ont pas d'orbite périodique de période minimale 2. En particulier le résultat suivant peut se voir comme un analogue du théorème de translation plane.

Théorème 1.4 (Bonino, [Bon04]). *Soit h un homéomorphisme renversant l'orientation de la sphère \mathbb{S}^2 et sans point 2-périodique. Alors, pour tout point $m \in \mathbb{S}^2 \setminus \text{Fix}(h)$, où $\text{Fix}(h)$ est l'ensemble des points fixes de h , il existe une application continue injective $\varphi : \mathcal{O} \rightarrow \mathbb{S}^2 \setminus \text{Fix}(h)$ telle que*

1. \mathcal{O} est \mathbb{R}^2 ou $\{(x, y) \in \mathbb{R}^2 \mid y \neq 0\}$ ou $\mathbb{R}^2 \setminus \{(0, 0)\}$;
2. $m \in \varphi(\mathcal{O})$;
3. Si $\mathcal{O} = \mathbb{R}^2$ ou $\mathcal{O} = \{(x, y) \in \mathbb{R}^2 \mid y \neq 0\}$ alors
 - $h \circ \varphi = \varphi \circ G|_{\mathcal{O}}$ où $G(x, y) = (x + 1, -y)$,
 - pour tout $x \in \mathbb{R}$, $\varphi(\{x\} \times \mathbb{R}) \cap \mathcal{O}$ est un ensemble fermé de $\mathbb{S}^2 \setminus \text{Fix}(h)$;
4. Si $\mathcal{O} = \mathbb{R}^2 \setminus \{(0, 0)\}$ alors
 - $h \circ \varphi = \varphi \circ H|_{\mathcal{O}}$ où $H(x, y) = \frac{1}{2}(x, -y)$.

Dit rapidement, sous les hypothèses de ce dernier résultat, tout point $m \in \mathbb{S}^2 \setminus \text{Fix}(h)$ est contenu dans un ouvert h -invariant $\varphi(\mathcal{O}) \subset \mathbb{S}^2 \setminus \text{Fix}(h)$ où la dynamique de h est celle d'un modèle simple parmi trois possibles. L'ouvert $\mathbb{S}^2 \setminus \text{Fix}(h)$ est ainsi recouvert par trois types de sous-variétés de dimension 1 similaires (bien que plus compliquées) aux droites de Brouwer du théorème de translation plane: il s'agit des ensembles $\varphi(\{x\} \times \mathbb{R}) \cap \mathcal{O}$ lorsque \mathcal{O} est \mathbb{R}^2 ou $\{(x, y) \in \mathbb{R}^2 \mid y \neq 0\}$ et, quand $\mathcal{O} = \mathbb{R}^2 \setminus \{(0, 0)\}$, des ensembles $\varphi(C)$ où C est un cercle euclidien centré sur l'origine $(0, 0)$. Ces sous-variétés sont donc topologiquement des cercles, des droites ou des paires de droites proprement plongées dans $\mathbb{S}^2 \setminus \text{Fix}(h)$. Ces variétés ont un rôle central dans cette thèse et seront appelées *variétés de Brouwer* dans tout le texte.

1.2 Présentation des résultats et organisation du texte

Une question naturelle au vu de ce qui précède est la suivante: existe-t-il une version feuilletée du théorème 1.4, de même que le théorème 1.2 est une version feuilletée du théorème de translation plane ?

Cette question est la première motivation de notre travail. Nous y apportons une réponse positive en prouvant que, pour tout homéomorphisme h comme dans le théorème 1.4, il existe un feuilletage de l'ouvert $\mathbb{S}^2 \setminus \text{Fix}(h)$ par des composantes connexes de variétés de Brouwer (théorème 4.1, Chapitre 4). La preuve de ce résultat est exposée dans le chapitre 5 et s'obtient en combinant les techniques des articles [Bon04] et [LC04]. Nous aurons besoin au préalable de décrire avec précision les variétés de Brouwer, ce qui est fait dans le chapitre 3. En particulier nous verrons comment distinguer naturellement le côté gauche et le côté droit d'une telle variété, en fonction de la dynamique de h . Le court chapitre 2 est consacré aux notations et aux notions de base utilisées tout au long de ce texte.

Nous obtenons aussi, comme première application de notre théorème de feuilletage, un théorème d'indice pour les itérés d'un homéomorphisme (local) h du plan \mathbb{R}^2 qui renverse l'orientation: si l'origine 0 est un point fixe isolé de tous les itérés h^n , alors l'indice de Poincaré-Lefschetz $\text{Ind}(h^n, 0)$ dépend seulement du caractère pair ou

impair de l'entier $n \geq 1$ (théorème 4.2, Chapitre 4). Ce résultat est démontré dans le chapitre 6. La preuve s'appuie sur une analyse du feuilletage \mathcal{F} obtenu en appliquant notre théorème principal à un homéomorphisme de \mathbb{S}^2 ayant seulement deux points fixes ainsi que sur la version feuilletée équivariante du théorème de translation de Brouwer (théorème 1.3 ci-dessus) dans le cas simple où la surface S est un anneau ouvert.

Preliminaries

Contents

2.1	Notations and basic definitions	8
2.2	Brick decompositions	8
2.2.1	First definitions and properties	8
2.2.2	Dynamics on a brick decomposition	9

2.1 Notations and basic definitions

First of all, we give some basic notations. We think of the 2-sphere \mathbb{S}^2 as the one point compactification of \mathbb{R}^2 , that is $\mathbb{S}^2 = \mathbb{R}^2 \cup \{\infty\}$. If Y is a topological space and $X \subset Y$ we write generally $\text{Int}_Y(X)$, $\text{Cl}_Y(X)$ and $\partial_Y(X) = \text{Cl}_Y(X) \setminus \text{Int}_Y(X)$ for respectively the interior, the closure and the frontier of X with respect to Y . For the sake of simplicity we omit the subscript Y when $Y = \mathbb{S}^2$.

A set $X \subset \mathbb{S}^2$ is called a *half-plane*, a *strip*, an *annulus*, a *disc* if it is homeomorphic to, respectively, $[0, +\infty) \times \mathbb{R}$, $[0, 1] \times \mathbb{R}$, $[0, 1] \times \mathbb{S}^1$, the closed unit disc of \mathbb{R}^2 . A *segment* (resp. a *circle*) is a subset of \mathbb{S}^2 homeomorphic to the interval $[0, 1]$ (resp. to the unit circle \mathbb{S}^1). A *Jordan domain* is a connected component of the complementary set of a circle in \mathbb{S}^2 . An *arc* is the image of a continuous map $\alpha : I \rightarrow \mathbb{S}^2$ where $I \subset \mathbb{R}$ is any nonempty interval. Consider now an open subset M of \mathbb{S}^2 . A *line of M* (resp. a *half-line of M*) is a set $X \subset M$ which is homeomorphic to \mathbb{R} (resp. to $[0, +\infty)$) and which is properly embedded in M (that means that X is closed in M).

Let A, B and C be three subsets of a topological space Y . We say that A *separates* B and C in Y if there are two distinct connected components X_1 and X_2 of $Y \setminus A$ such that $B \subset X_1$ and $C \subset X_2$. Note that in this definition we do not assume that B or C is connected.

If Γ is a segment or a line of $M \subset \mathbb{S}^2$ with a provided orientation and if a, b are two points met in this order on Γ , then $[a, b]_\Gamma$ is the sub-segment of Γ from a to b for the chosen orientation of Γ . We also denote $(a, b)_\Gamma = [a, b]_\Gamma \setminus \{a, b\}$ as well as $(a, b]_\Gamma = [a, b]_\Gamma \setminus \{a\}$ and likewise $[a, b)_\Gamma$.

Finally $\text{Fix}(f)$ denotes the fixed point set of any map $f : X \rightarrow Y$ and we write $\sharp(X)$ for the cardinality of any finite set X .

2.2 Brick decompositions

2.2.1 First definitions and properties

The notion of brick decomposition was introduced by Le Calvez and Sauzet in [LCS96, Sau01] and is used in several papers on the dynamics of surface homeomorphisms (e.g. [Bon04], [LC04, LC06b], [LR04]). For completeness we recall here the most basic facts about bricks decompositions, following closely the presentation by Le Calvez in [LC05] or [LC06a].

A *brick decomposition* of a surface M without boundary is given by a one dimensional stratified set $\Sigma \subset M$ with a zero dimensional submanifold V such that any vertex $v \in V$ is locally the endpoint of exactly three edges. An *edge* is the closure in M of a connected component of $\Sigma \setminus V$. It is the image in M of a proper topological

embedding of $[0, 1]$, $[0, +\infty)$, \mathbb{R} or \mathbb{S}^1 . A *brick* is the closure in M of a connected component of $M \setminus \Sigma$. Writing E (resp. B) for the set of edges (resp. bricks) we say that $\mathcal{D} = (V, E, B)$ is a *brick decomposition* of M with skeleton $\Sigma = \Sigma(\mathcal{D})$.

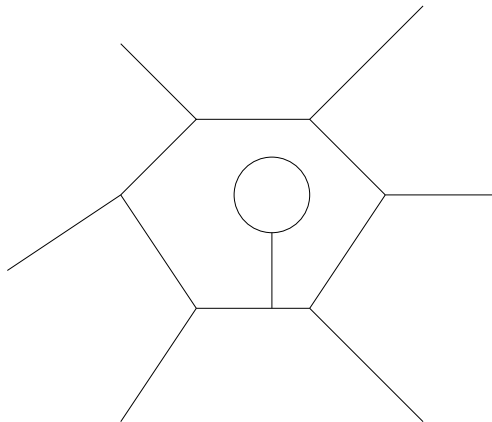

Figure 2.1 – A brick decomposition

Given such a brick decomposition of M , remark that for any $X \subset B$ the union $\bigcup_{\beta \in X} \beta$ is a closed subset of M ; if furthermore $X \notin \{\emptyset, B\}$ then $\bigcup_{\beta \in X} \beta$ is also a surface with boundary and in particular any connected component of $\partial_M(\bigcup_{\beta \in X} \beta)$ is either a circle or a line of M . This is an elementary but important property of brick decompositions. Given $X \subset B$, we will abuse notation slightly and use the same letter X for its “geometric realization” $\bigcup_{\beta \in X} \beta \subset M$, writing $X \subset B$ (resp. $X \subset M$) if we want to insist on the fact that X is regarded as a subset of B (resp. of M). Moreover $X \subset B$ is said to be *connected* if the corresponding set $X \subset M$ is connected; equivalently, for any two bricks β, β' in X , there exists a sequence $(\beta_i)_{0 \leq i \leq n}$ of bricks of X from $\beta_0 = \beta$ to $\beta_n = \beta'$ such that β_i and β_{i+1} are adjacent (that means β_i, β_{i+1} contain a common edge) for every $i \in \{0, \dots, n-1\}$. A *connected component* of $X \subset B$ is defined as a maximal connected set $Y \subset X$; then $Y \subset M$ is a connected component of $X \subset M$ in the usual sense.

Another brick decomposition $\mathcal{D}' = (V', E', B')$ of M is said to be a *subdecomposition* of \mathcal{D} if $\Sigma(\mathcal{D}') \subset \Sigma(\mathcal{D})$; we then write $\mathcal{D}' \subset \mathcal{D}$.

If $B = \sqcup_{i \in I} X_i$ is a partition of B into connected subsets then the set $\bigcup_{i \in I} \partial_M X_i$ is a skeleton of a subdecomposition \mathcal{D}' of \mathcal{D} whose bricks are the X_i 's. Let us say that \mathcal{D} is a *filled* if $\mathcal{D}' = \mathcal{D}$ where \mathcal{D}' is defined by the partition of B into singletons. In other words, \mathcal{D} is filled iff any edge of \mathcal{D} is contained in exactly two bricks of \mathcal{D} .

2.2.2 Dynamics on a brick decomposition

Let M be a surface without boundary endowed with a brick decomposition $\mathcal{D} = (V, E, B)$ and let $h : M \rightarrow M$ be a homeomorphism. We denote $\mathcal{P}(B)$ the set of all the subsets of B . Le Calvez and Sauzet (see e.g. [Sau01], [LC05], [LC06a]) introduced

two natural maps $\varphi : \mathcal{P}(B) \rightarrow \mathcal{P}(B)$ and $\varphi_- : \mathcal{P}(B) \rightarrow \mathcal{P}(B)$ defined by

$$\begin{aligned}\varphi(X) &= \{\beta \in B \mid \text{there exists } \beta' \in X \text{ such that } \beta \cap h(\beta') \neq \emptyset\} \\ &= \{\beta \in B \mid \beta \cap h(X) \neq \emptyset\}.\end{aligned}$$

and

$$\begin{aligned}\varphi_-(X) &= \{\beta \in B \mid \text{there exists } \beta' \in X \text{ such that } \beta \cap h^{-1}(\beta') \neq \emptyset\} \\ &= \{\beta \in B \mid \beta \cap h^{-1}(X) \neq \emptyset\}.\end{aligned}$$

These maps send connected subsets of B onto connected subsets of B . One checks that

$$\varphi\left(\bigcup_{i \in I} X_i\right) = \bigcup_{i \in I} \varphi(X_i), \quad \varphi\left(\bigcap_{i \in I} X_i\right) \subset \bigcap_{i \in I} \varphi(X_i),$$

for any family $(X_i)_{i \in I}$ of subsets of B and of course an analogous property also holds for φ_- .

We call *attractor* any set $X \subset B$ verifying $\varphi(X) \subset X$, which is equivalent to $h(X) \subset \text{Int}(X)$. A *repellor* is a set $X \subset B$ such that $\varphi_-(X) \subset X$; equivalently it is the complement of an attractor. The union or the intersection of a family of attractors (resp. repellors) is itself an attractor (resp. a repellor).

We will explain in Section 5.2 how to use these objects in our framework.

Brouwer manifolds

Contents

3.1	Definition	12
3.2	Left and right sides of a Brouwer manifold	12
3.3	Brouwer manifolds without transverse intersection	19

3.1 Definition

We first recall the main result of [Bon04].

Theorem 3.1. ([Bon04, Theorem 5.1]) *Let h be an orientation reversing homeomorphism of the sphere \mathbb{S}^2 without a 2-periodic point. For any point $m \in \mathbb{S}^2 \setminus \text{Fix}(h)$ there exists a topological embedding (i.e., a continuous one-to-one map) $\varphi : \mathcal{O} \rightarrow \mathbb{S}^2 \setminus \text{Fix}(h)$ such that*

- (i) \mathcal{O} is either \mathbb{R}^2 or $\{(x, y) \in \mathbb{R}^2 \mid y \neq 0\}$ or $\mathbb{R}^2 \setminus \{(0, 0)\}$,
- (ii) $m \in \varphi(\mathcal{O})$,
- (iii) if $\mathcal{O} = \mathbb{R}^2$ or $\mathcal{O} = \{(x, y) \in \mathbb{R}^2 \mid y \neq 0\}$ then
 - $h \circ \varphi = \varphi \circ G|_{\mathcal{O}}$ where $G(x, y) = (x + 1, -y)$,
 - for every $x \in \mathbb{R}$, $\varphi(\{x\} \times \mathbb{R} \cap \mathcal{O})$ is a closed subset of $\mathbb{S}^2 \setminus \text{Fix}(h)$ (we say that φ is a proper embedding),
- (iv) if $\mathcal{O} = \mathbb{R}^2 \setminus \{(0, 0)\}$ then
 - $h \circ \varphi = \varphi \circ H|_{\mathcal{O}}$ where $H(x, y) = \frac{1}{2}(x, -y)$.

For the rest of this Chapter 3 we consider a homeomorphism h as in the above theorem, that means an orientation reversing homeomorphism of \mathbb{S}^2 such that $\text{Fix}(h) = \text{Fix}(h^2)$, and we let $M = \mathbb{S}^2 \setminus \text{Fix}(h)$. We keep the notation of the Theorem 3.1 and we also write $r\mathbb{S}^1$ for the Euclidean circle with center $0 = (0, 0) \in \mathbb{R}^2$ and radius $r > 0$. A set $\varphi(r\mathbb{S}^1)$ in (iv) is said to be a *Brouwer manifold of type 1* of h . A set $\varphi(\{x\} \times \mathbb{R} \cap \mathcal{O})$ in (iii) is named a *Brouwer manifold of type 2* (resp. *type 3*) of h if $\mathcal{O} = \mathbb{R}^2$ (resp. $\mathcal{O} = \{(x, y) \in \mathbb{R}^2 \mid y \neq 0\}$). Brouwer manifolds of type 1, 2 or 3 are commonly called *Brouwer manifolds*. One knows from the invariance of domain that $\varphi(\mathcal{O})$ is an open subset of \mathbb{S}^2 and that φ realizes a homeomorphism from \mathcal{O} onto $\varphi(\mathcal{O}) \subset M$. Consequently a Brouwer manifold of h is a 1-dimensional submanifold of the open set M . Moreover if $\Gamma = \varphi(\{x\} \times (\mathbb{R} \setminus \{0\}))$ is a Brouwer manifold of type 3 then $\Gamma_1 = \varphi(\{x\} \times (0, +\infty))$ and $\Gamma_2 = \varphi(\{x\} \times (-\infty, 0))$ are also closed subsets of M and are the two connected components of Γ . Thus, using the vocabulary from Section 2.1, if Γ_* is either a Brouwer manifold of type 2 or a connected component of a Brouwer manifold of type 3 then Γ_* is a line of M and consequently $\text{Cl}(\Gamma_*) \setminus \Gamma_*$ is a nonempty subset of $\text{Fix}(h)$ with at most two connected components. Observe that $\Gamma \cap h^n(\Gamma) = \emptyset$ for any integer $n \neq 0$ and any Brouwer manifold Γ .

3.2 Left and right sides of a Brouwer manifold

Let Γ be a Brouwer manifold of h . Recall that Γ has at most two connected components and that $h(\Gamma) \cap \Gamma = \emptyset$. We define the *right side* (resp. *the left side*) of Γ , denoted by $R(\Gamma)$ (resp. $L(\Gamma)$) as the closure in M of the union of the connected

components of $M \setminus \Gamma$ which meet $h(\Gamma)$ (resp. $h^{-1}(\Gamma)$).

Proposition 3.1. *Assume that $\text{Fix}(h)$ is either a circle or a totally disconnected set. Then one has the following properties for any Brouwer manifold Γ of h :*

- (i) $L(\Gamma) \cup R(\Gamma) = M$;
- (ii) $L(\Gamma) \cap R(\Gamma) = \Gamma$;
- (iii) $\partial_M L(\Gamma) = \Gamma = \partial_M R(\Gamma)$, $L(\Gamma) = \text{Cl}_M(\text{Int}(L(\Gamma)))$ and $R(\Gamma) = \text{Cl}_M(\text{Int}(R(\Gamma)))$.
Moreover $\text{Int}(L(\Gamma))$ (resp. $\text{Int}(R(\Gamma))$) is the union of the connected components of $M \setminus \Gamma$ which meet $h^{-1}(\Gamma)$ (resp. $h(\Gamma)$);
- (iv) $h(R(\Gamma)) \subset \text{Int}(R(\Gamma))$;
- (v) $h^{-1}(L(\Gamma)) \subset \text{Int}(L(\Gamma))$.

Remark 3.1. *It follows from the results in Section 5.1 below that Proposition 3.1 actually holds true without the assumption on $\text{Fix}(h)$. We write this slightly weaker statement to make the proof easier and because it is enough to get our main result Theorem 4.1.*

Proof. Given a Brouwer manifold Γ of h , the union of the connected components of $M \setminus \Gamma$ meeting $h^{-1}(\Gamma)$ (resp. $h(\Gamma)$) is denoted by U_Γ^* (resp. V_Γ^*) so that $L(\Gamma) = \text{Cl}_M(U_\Gamma^*)$ and $R(\Gamma) = \text{Cl}_M(V_\Gamma^*)$.

We first remark that Properties (i)-(ii) imply (iii). Suppose indeed that (i)-(ii) hold true. If there exists $x \in \Gamma \cap \text{Int}(L(\Gamma))$ then one can consider a neighborhood N of x so small that $N \subset L(\Gamma)$ and (ii) then gives

$$\emptyset \neq V_\Gamma^* \cap N \subset (R(\Gamma) \setminus \Gamma) \cap L(\Gamma) = \emptyset$$

which is absurd. Thus we have $\Gamma \cap \text{Int}(L(\Gamma)) = \emptyset$. The set $M \setminus \Gamma$ is locally connected (as an open subset of \mathbb{S}^2) hence its connected components are open in $M \setminus \Gamma$ and so is U_Γ^* . This implies $\partial_M U_\Gamma^* = L(\Gamma) \setminus U_\Gamma^* \subset \Gamma$ and then $L(\Gamma) \subset \Gamma \sqcup U_\Gamma^* \subset \Gamma \sqcup \text{Int}(L(\Gamma))$ where the symbol \sqcup emphasizes a disjoint union. Using again (ii) one deduces $L(\Gamma) = \Gamma \sqcup \text{Int}(L(\Gamma))$ and $U_\Gamma^* = \text{Int}(L(\Gamma))$. One checks in the same way that $R(\Gamma) = \Gamma \sqcup \text{Int}(R(\Gamma))$ and $V_\Gamma^* = \text{Int}(R(\Gamma))$ which proves (iii).

Observe secondly that if (i)-(ii) and (iv) hold then one has

$$L(\Gamma) = M \setminus \text{Int}(R(\Gamma)) \subset M \setminus h(R(\Gamma)) = h(M \setminus R(\Gamma)) = h(\text{Int}(L(\Gamma)))$$

and (v) follows. Our next task is to prove (i)-(ii) and (iv).

- Assume first that $\text{Fix}(h)$ is totally disconnected.

Case 1. Γ is a Brouwer manifold of type 1.

We have $\Gamma = \varphi(r\mathbb{S}^1)$ for some $r > 0$ and some embedding $\varphi : \mathbb{R}^2 \setminus \{(0,0)\} \rightarrow M$ as described in (iv) of Theorem 3.1. Then Γ is a circle and the Jordan curve theorem tell

us that $\mathbb{S}^2 \setminus \Gamma$ has two connected components U, V with furthermore $\partial U = \partial V = \Gamma$. The segment $\varphi([r/2, 2r] \times \{0\})$ joins $\varphi((r/2, 0)) \in h(\Gamma)$ and $\varphi((2r, 0)) \in h^{-1}(\Gamma)$ and intersects Γ transversely only at the point $\varphi((r, 0))$ therefore Γ separates $h^{-1}(\Gamma)$ and $h(\Gamma)$ in \mathbb{S}^2 , let us say $h^{-1}(\Gamma) \subset U$ and $h(\Gamma) \subset V$. It follows that $h(\text{Cl}(V)) \subset V$ since otherwise the connected set $h(\text{Cl}(V))$ would meet ∂V which implies $h(V) \cap \Gamma \neq \emptyset$ and then contradicts $h^{-1}(\Gamma) \subset U$. According to Lemma 5.2 one has $U_\Gamma^* = U \setminus \text{Fix}(h)$ and $V_\Gamma^* = V \setminus \text{Fix}(h)$ with furthermore $L(\Gamma) = \text{Cl}_M(U_\Gamma^*) = \text{Cl}(U) \setminus \text{Fix}(h)$ and $R(\Gamma) = \text{Cl}_M(V_\Gamma^*) = \text{Cl}(V) \setminus \text{Fix}(h)$. This gives immediately (i)-(ii). Moreover (iv) also holds because

$$h(R(\Gamma)) = h((\text{Cl}(V)) \setminus \text{Fix}(h)) \subset V \setminus \text{Fix}(h) = V_\Gamma^* = \text{Int}(R(\Gamma)).$$

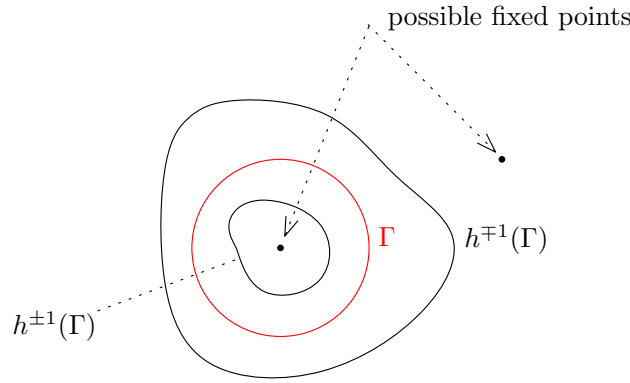

Figure 3.1 – A Brouwer manifold of type 1 and its images by $h^{\pm 1}$

Case 2. Γ is a Brouwer manifold of type 2.

We write $\Gamma = \varphi(\{x\} \times \mathbb{R})$ where φ is an embedding as in (iii) of Theorem 3.1 defined on $\mathcal{O} = \mathbb{R}^2$. We also let

$$\begin{aligned} \gamma_- &= \varphi((x-1, x) \times \{0\}), \\ \gamma_+ &= \varphi((x, x+1) \times \{0\}) = \varphi \circ G((x-1, x) \times \{0\}) = h(\gamma_-), \\ \gamma &= \varphi((x-1, x+1) \times \{0\}) = \gamma_- \cup \{\varphi(x, 0)\} \cup \gamma_+, \end{aligned}$$

where we recall from Theorem 3.1 that $G(x, y) = (x+1, -y)$. We already know that $\text{Cl}(\Gamma) \setminus \Gamma$ is a subset of $\text{Fix}(h)$ containing one or two points. We show now that it actually contains a single point (the following arguments already appear in [Bon04]). Otherwise we have $\text{Cl}(\Gamma) \setminus \Gamma = \{a, b\}$ where a, b are two distinct fixed points of h and the set $C = \text{Cl}(\Gamma \cup h(\Gamma)) = \Gamma \cup h(\Gamma) \cup \{a, b\}$ is a circle disjoint from γ_{\pm} . According to the Jordan curve theorem, $\mathbb{S}^2 \setminus C$ has exactly two connected components, call them V_-, V_+ , and $\partial V_- = \partial V_+ = C$. The segment $\gamma \subset M$ intersects C only at the point $\varphi(x, 0)$ which furthermore is a point of transverse intersection hence C separates the two connected sets $h^{-1}(\Gamma) \cup \gamma_-$ and γ_+ in \mathbb{S}^2 , let us say $h^{-1}(\Gamma) \cup \gamma_- \subset V_-$ and $\gamma_+ \subset V_+$. It follows that

$$\partial h^{-1}(V_+) \cap V_+ = h^{-1}(C) \cap V_+ = h^{-1}(\Gamma) \cap V_+ = \emptyset$$

so we have either $V_+ \subset h^{-1}(V_+)$ or $V_+ \cap h^{-1}(V_+) = \emptyset$. We observe that none of these two situations is possible. The first one implies $\gamma_- \cup \gamma_+ = h^{-1}(\gamma_+) \cup \gamma_+ \subset h^{-1}(V_+)$ which cannot hold because γ intersects $\Gamma \subset h^{-1}(C)$ transversely. Suppose $V_+ \cap h^{-1}(V_+) = \emptyset$. Then we cannot have $\text{Cl}(V_+) \cup h^{-1}(\text{Cl}(V_+)) = \mathbb{S}^2$ since this would imply $h^{-1}(\Gamma) = h(\Gamma)$ which is not possible for a Brouwer manifold. Consequently $\text{Cl}(V_+) \cup h^{-1}(\text{Cl}(V_+))$ is contained in the domain of a single chart of \mathbb{S}^2 and can be represented as in Fig. 3.2. Keeping in mind that a, b are fixed points of h , this contradicts the fact that h reverses the orientation.

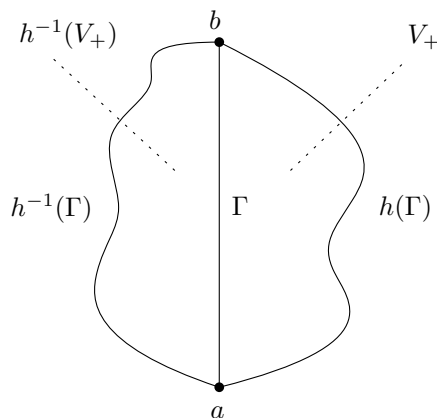

Figure 3.2 – $V_+ \cap h^{-1}(V_+) = \emptyset$ is not possible

Thus we get as announced $\text{Cl}(\Gamma) \setminus \Gamma = \{a\}$ for some $a \in \text{Fix}(h)$ and $\text{Cl}(\Gamma) = \Gamma \cup \{a\}$ is then a circle. Write U, V for the two connected components of $\mathbb{S}^2 \setminus \text{Cl}(\Gamma)$, with $\partial U = \partial V = \text{Cl}(\Gamma)$. The circle $\text{Cl}(\Gamma)$ separates $h^{-1}(\Gamma)$ and $h(\Gamma)$ in \mathbb{S}^2 because the segment $\gamma \subset M$ joins $\varphi(x-1, 0) \in h^{-1}(\Gamma)$ and $\varphi(x+1, 0) \in h(\Gamma)$ and it intersects transversely $\text{Cl}(\Gamma)$ only at the point $\varphi(x, 0)$. Assuming for example $h^{-1}(\Gamma) \subset U$ and $h(\Gamma) \subset V$ one deduces easily that $h(\text{Cl}(V)) \subset V \cup \{a\}$. Properties (i)-(ii) and (iv) now follow from Lemma 5.2 which gives $U_\Gamma^* = U \setminus \text{Fix}(h)$ and $V_\Gamma^* = V \setminus \text{Fix}(h)$ as well as $L(\Gamma) = \text{Cl}_M(U_\Gamma^*) = \text{Cl}(U) \setminus \text{Fix}(h)$ and $R(\Gamma) = \text{Cl}_M(V_\Gamma^*) = \text{Cl}(V) \setminus \text{Fix}(h)$.

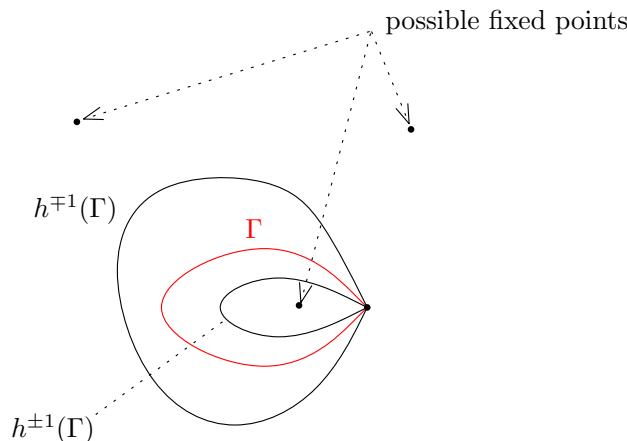

Figure 3.3 – A Brouwer manifold of type 2 and its images by $h^{\pm 1}$

Case 3. Γ is a Brouwer manifold of type 3.

Let us write $\Gamma = \Gamma_1 \sqcup \Gamma_2$ with $\Gamma_i = \varphi(\Delta_i)$ where φ is an embedding as in (iii) of Theorem 3.1 defined on $\mathcal{O} = \mathbb{R}^2 \setminus \{(x, y) \in \mathbb{R}^2 \mid y = 0\}$ and where $\Delta_1 = \{x\} \times (0, +\infty)$ and $\Delta_2 = \{x\} \times (-\infty, 0)$ for some $x \in \mathbb{R}$. Then $h^{\pm 1}(\Gamma_i) = \varphi(G^{\pm 1}(\Delta_i))$ where $G(x, y) = (x + 1, -y)$ ($i \in \{1, 2\}$). Recall that each Γ_i is a line of M so $\text{Cl}(\Gamma_i) \setminus \Gamma_i$ is a subset of $\text{Fix}(h)$ with cardinality one or two. Let us prove that moreover $\text{Cl}(\Gamma_1) \setminus \Gamma_1 = \text{Cl}(\Gamma_2) \setminus \Gamma_2$.

- Assume first that $\text{Cl}(\Gamma_1) \setminus \Gamma_1 = \{a\}$ where $a \in \text{Fix}(h)$. Of course we also have $\text{Cl}(h^{\pm 1}(\Gamma_1)) \setminus h^{\pm 1}(\Gamma_1) = \{a\}$. Using the Schoenflies theorem, one can construct a homeomorphism of \mathbb{S}^2 mapping $h^{-1}(\Gamma_1)$, $h(\Gamma_1)$ and a onto respectively $\{-1\} \times \mathbb{R}$, $\{1\} \times \mathbb{R}$ and ∞ . It follows that $\mathbb{S}^2 \setminus \text{Cl}(h^{-1}(\Gamma_1) \cup h(\Gamma_1)) = \mathbb{S}^2 \setminus (h^{-1}(\Gamma_1) \cup h(\Gamma_1) \cup \{a\})$ has three connected components and only one of them, call it E_0 , has its frontier in \mathbb{S}^2 which meets both $h^{-1}(\Gamma_1)$ and $h(\Gamma_1)$. We have then more precisely $\partial E_0 = h^{-1}(\Gamma_1) \cup h(\Gamma_1) \cup \{a\}$. Consider the domain $B_- = (x - 1, x + 1) \times (-\infty, 0) \subset \mathcal{O}$. Then $\varphi(B_-)$ is a connected subset of M , it is disjoint from $h^{-1}(\Gamma_1) \cup h(\Gamma_1) \cup \{a\}$ and contains Γ_2 . Moreover $h^{\pm 1}(\Gamma_1) \subset \varphi(\text{Cl}_{\mathcal{O}}(B_-)) \subset \text{Cl}(\varphi(B_-))$ so necessarily $\Gamma_2 \subset \varphi(B_-) \subset E_0$. The segment $\varphi([x, x + 2] \times \{-1\}) \subset M$ has endpoints $\varphi((x, -1)) \in E_0$ and $\varphi((x + 2, -1)) \in h^2(E_0)$ and it intersects the circle $\text{Cl}(h(\Gamma_1)) = h(\Gamma_1) \cup \{a\}$ transversely only at the point $\varphi((x + 1, -1))$. Since $h^2(E_0) \cap h(\Gamma_1) = h^2(E_0 \cap h^{-1}(\Gamma_1)) = \emptyset$ it follows that $\text{Cl}(h(\Gamma_1))$ separates the two connected sets E_0 and $h^2(E_0)$ in \mathbb{S}^2 . This shows that E_0 is disjoint from $\text{Fix}(h^2) = \text{Fix}(h)$ and then $\text{Cl}(\Gamma_2) \setminus \Gamma_2 \subset \text{Fix}(h) \cap \text{Cl}(E_0) = \{a\}$ so one also has $\text{Cl}(\Gamma_2) \setminus \Gamma_2 = \{a\}$.

- Assume now $\text{Cl}(\Gamma_1) \setminus \Gamma_1 = \{a, b\}$ where a, b are two distinct fixed points of h . Then $\text{Cl}(h^{-1}(\Gamma_1) \cup h(\Gamma_1)) = h^{-1}(\Gamma_1) \cup h(\Gamma_1) \cup \{a, b\}$ is a circle. The two connected components of $\mathbb{S}^2 \setminus \text{Cl}(h^{-1}(\Gamma_1) \cup h(\Gamma_1))$ given by the Jordan curve theorem are denoted by U, V with for instance $\Gamma_2 \subset U$. The segment $\varphi([x - 3, x] \times \{-1\}) \subset M$ joins $\varphi(x - 3, -1) \in h^{-3}(\Gamma_1)$ and $\varphi(x, -1) \in \Gamma_2$ and it intersects transversely the circle $\text{Cl}(h^{-1}(\Gamma_1) \cup h(\Gamma_1))$ only at the point $\varphi(x - 1, -1)$ so one deduces $h^{-3}(\Gamma_1) \subset V$. A similar argument involving the segment $\varphi([x, x + 2] \times \{-1\})$ shows that $h^2(U) \cap V \neq \emptyset$ and afterwards $h^2(U) \subset V$ because $h^2(U)$ is connected and

$$h^2(U) \cap \partial V = h^2(U \cap (h^{-3}(\Gamma_1) \cup h^{-1}(\Gamma_1) \cup \{a\})) = \emptyset.$$

In particular U is disjoint from $\text{Fix}(h)$ and consequently $\text{Cl}(\Gamma_2) \setminus \Gamma_2 \subset \text{Cl}(U) \cap \text{Fix}(h) = \{a, b\}$. The set $\text{Cl}(\Gamma_2) \setminus \Gamma_2$ cannot be reduced to a single point since the same would be true for $\text{Cl}(\Gamma_1) \setminus \Gamma_1$ (just reverse the roles of Γ_1 and Γ_2 in the previous paragraph) so one gets as expected $\text{Cl}(\Gamma_2) \setminus \Gamma_2 = \{a, b\}$. The continuation of the proof depends on the cardinality of these sets $\text{Cl}(\Gamma_i) \setminus \Gamma_i$.

a) We suppose $\text{Cl}(\Gamma_1) \setminus \Gamma_1 = \text{Cl}(\Gamma_2) \setminus \Gamma_2 = \{a\}$.

Thus $\text{Cl}(\Gamma)$ is the union of the two circles $\text{Cl}(\Gamma_1) = \Gamma_1 \cup \{a\}$ and $\text{Cl}(\Gamma_2) = \Gamma_2 \cup \{a\}$ intersecting only at the point a . Using again the Schoenflies theorem, one can construct a homeomorphism of \mathbb{S}^2 mapping $\text{Cl}(\Gamma)$ onto the “figure eight curve” hence

$\mathbb{S}^2 \setminus \text{Cl}(\Gamma)$ has exactly three connected components U_1, U_2, U_3 as follows: U_1 (resp. U_2) is a connected component of $\mathbb{S}^2 \setminus \text{Cl}(\Gamma_1)$ (resp. $\mathbb{S}^2 \setminus \text{Cl}(\Gamma_2)$) and $U_3 = V_1 \cap V_2$ where V_1 (resp. V_2) denotes the connected component of $\mathbb{S}^2 \setminus \text{Cl}(\Gamma_1)$ (resp. $\mathbb{S}^2 \setminus \text{Cl}(\Gamma_2)$) other than U_1 (resp. U_2). Furthermore $\partial U_i = \text{Cl}(\Gamma_i) = \Gamma_i \cup \{a\}$ for $i \in \{1, 2\}$ and $\partial U_3 = \text{Cl}(\Gamma) = \Gamma \cup \{a\}$. Let us prove there exists $\varepsilon \in \{\pm 1\}$ such that $h^\varepsilon(\text{Cl}(U_i)) \subset U_j \cup \{a\}$, or equivalently $h^\varepsilon(U_i \cup \Gamma_i) \subset U_j$, for any $1 \leq i \neq j \leq 2$ (see Fig. 3.4).

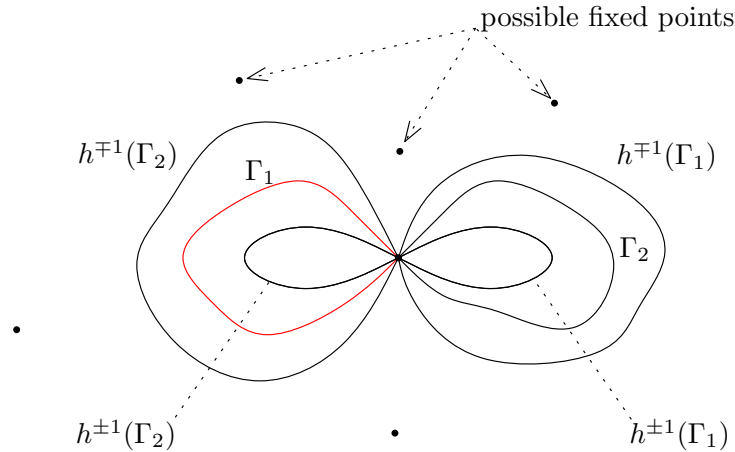

Figure 3.4 – A Brouwer manifold of type 3 and its images by $h^{\pm 1}$ in the subcase (a)

The segment $\varphi([x-1, x+1] \times \{1\}) \subset M$ has one endpoint on $h^{-1}(\Gamma_2)$ and the other on $h(\Gamma_2)$ and it intersects transversely the circle $\text{Cl}(\Gamma_1)$ only at the point $\varphi(x, 1)$ hence $\text{Cl}(\Gamma_1)$ separates $h^{-1}(\Gamma_2)$ and $h(\Gamma_2)$ in \mathbb{S}^2 . One checks similarly that $\text{Cl}(\Gamma_2)$ separates $h^{-1}(\Gamma_1)$ and $h(\Gamma_1)$ in \mathbb{S}^2 . Observe also that $\varphi([x-1, x+1] \times (0, +\infty))$ and $\varphi([x-1, x+1] \times (-\infty, 0))$ are two disjoint connected subsets of M , the first one containing $h^{-1}(\Gamma_2) \cup \Gamma_1 \cup h(\Gamma_2)$ and the latter containing $h^{-1}(\Gamma_1) \cup \Gamma_2 \cup h(\Gamma_1)$. Clearly $\Gamma_1 \subset V_2$ and $\Gamma_2 \subset V_1$ so one deduces $\varphi([x-1, x+1] \times (0, +\infty)) \subset V_2$ and $\varphi([x-1, x+1] \times (-\infty, 0)) \subset V_1$. Combining with the previous separation properties it follows there exists $(\varepsilon_1, \varepsilon_2) \in \{\pm 1\}^2$ such that $h^{\varepsilon_1}(\Gamma_1) \subset U_2$, $h^{-\varepsilon_1}(\Gamma_1) \subset V_2 \cap V_1 = U_3$ and $h^{\varepsilon_2}(\Gamma_2) \subset U_1$, $h^{-\varepsilon_2}(\Gamma_2) \subset V_1 \cap V_2 = U_3$. If $\varepsilon_1 = 1$ and $\varepsilon_2 = -1$ then one has $\Gamma_2 = h(h^{-1}(\Gamma_2)) \subset \text{Cl}(U_3) \cap h(U_1)$ so the open set $h(U_1)$ meets U_3 and afterwards $U_3 \subset h(U_1)$ because of the connectedness of U_3 and because $U_3 \cap \partial h(U_1) = U_3 \cap (h(\Gamma_1) \cup \{a\}) \subset U_3 \cap U_2 = \emptyset$. Thus we have $h(\Gamma_2) \subset U_3 \subset h(U_1)$ so $\Gamma_2 \subset U_1 \cap \text{Cl}(U_2)$ and consequently $U_2 \cap U_1 \neq \emptyset$ which is absurd. One checks in the same way that $\varepsilon_2 = 1 = -\varepsilon_1$ is not possible so we may define $\varepsilon = \varepsilon_1 = \varepsilon_2$. For $i \neq j$ in $\{1, 2\}$ the set $h^\varepsilon(U_i \cup \Gamma_i)$ is connected and $h^\varepsilon(U_i \cup \Gamma_i) \cap \partial U_j = h^\varepsilon(U_i) \cap \Gamma_j \subset h^\varepsilon(U_i \cap U_3) = \emptyset$ hence $h^\varepsilon(U_i \cup \Gamma_i) \subset U_j$ as expected. As a consequence, one gets $\mathbb{S}^2 \setminus (U_3 \cup \{a\}) = U_1 \cup U_2 \cup \Gamma \subset h^{-\varepsilon}(U_1 \cup U_2) = \mathbb{S}^2 \setminus h^{-\varepsilon}(\text{Cl}(U_3))$ so $h^{-\varepsilon}(\text{Cl}(U_3)) \subset U_3 \cup \{a\}$. Properties (i)-(ii) and (iv) now follow since, using again Lemma 5.2, one has

- if $\varepsilon = -1$ then $U_\Gamma^* = (U_1 \cup U_2) \setminus \text{Fix}(h)$, $V_\Gamma^* = U_3 \setminus \text{Fix}(h)$, $L(\Gamma) = \text{Cl}_M(U_\Gamma^*) = \text{Cl}_M(U_1 \setminus \text{Fix}(h)) \cup \text{Cl}_M(U_2 \setminus \text{Fix}(h)) = (\text{Cl}(U_1) \cup \text{Cl}(U_2)) \setminus \text{Fix}(h)$ and $R(\Gamma) = \text{Cl}_M(V_\Gamma^*) =$

$\text{Cl}(U_3) \setminus \text{Fix}(h)$;

- if $\varepsilon = 1$ then $U_\Gamma^* = U_3 \setminus \text{Fix}(h)$, $V_\Gamma^* = (U_1 \cup U_2) \setminus \text{Fix}(h)$, $L(\Gamma) = \text{Cl}_M(U_\Gamma^*) = \text{Cl}(U_3) \setminus \text{Fix}(h)$ and $R(\Gamma) = \text{Cl}_M(V_\Gamma^*) = (\text{Cl}(U_1) \cup \text{Cl}(U_2)) \setminus \text{Fix}(h)$.

b) We now suppose $\text{Cl}(\Gamma_1) \setminus \Gamma_1 = \text{Cl}(\Gamma_2) \setminus \Gamma_2 = \{a, b\}$, $a \neq b$.

Then $\text{Cl}(\Gamma) = \Gamma \cup \{a, b\}$ is a circle and we write U, V for its two complementary domains. In particular $\partial U = \partial V = \Gamma \cup \{a, b\}$. We shall show that there exists $\varepsilon \in \{\pm 1\}$ such that $h^\varepsilon(\text{Cl}(U)) \subset U \cup \{a, b\}$, i.e., $h^\varepsilon(U \cup \Gamma) \subset U$. The circle $\text{Cl}(\Gamma)$ separates $h^{-1}(\Gamma_1)$ and $h(\Gamma_1)$ (resp. $h^{-1}(\Gamma_2)$ and $h(\Gamma_2)$) in \mathbb{S}^2 because the segment $\varphi([x-1, x+1] \times \{-1\}) \subset M$ (resp. the segment $\varphi([x-1, x+1] \times \{1\}) \subset M$) joins $\varphi(x-1, -1) \in h^{-1}(\Gamma_1)$ and $\varphi(x+1, -1) \in h(\Gamma_1)$ (resp. $\varphi(x-1, 1) \in h^{-1}(\Gamma_2)$ and $\varphi(x+1, 1) \in h(\Gamma_2)$) and it intersects transversely $\text{Cl}(\Gamma)$ only at the point $\varphi(x, -1)$ (resp. $\varphi(x, 1)$). Thus for both $i = 1$ and $i = 2$ there exists $\varepsilon_i \in \{\pm 1\}$ such that $h^{\varepsilon_i}(\Gamma_i) \subset U$ and $h^{-\varepsilon_i}(\Gamma_i) \subset V$. Up to conjugacy in \mathbb{S}^2 , one may assume without loss of generality that $\text{Cl}(U)$ is the Euclidean closed unit disc in \mathbb{R}^2 with also $a = (0, -1)$, $b = (0, 1)$, $\Gamma_1 = \partial U \cap ((-\infty, 0) \times \mathbb{R})$, $\Gamma_2 = \partial U \cap ((0, +\infty) \times \mathbb{R})$ and $h^{\varepsilon_1}(\Gamma_1) = \{0\} \times (-1, 1) \subset U$. Thus U is located on the right of Γ_1 oriented from a to b . Since a, b are fixed points of h and since h^{ε_1} reverses the orientation, the set $h^{\varepsilon_1}(U)$ is located on the left of $h^{\varepsilon_1}(\Gamma_1)$ oriented from a to b and then $h^{\varepsilon_1}(U)$ meets the half-disc $D = \text{Cl}(U) \cap ((-\infty, 0) \times \mathbb{R})$. Moreover $\Gamma_1 = h^{\varepsilon_1}(h^{-\varepsilon_1}(\Gamma_1)) \subset D \cap h^{\varepsilon_1}(V)$ hence $\emptyset \neq D \cap \partial h^{\varepsilon_1}(U) = D \cap h^{\varepsilon_1}(\Gamma_2)$ and consequently $h^{\varepsilon_1}(\Gamma_2) \subset D \setminus \Gamma_1 \subset U$ because $\partial D = \Gamma_1 \cup h^{\varepsilon_1}(\Gamma_1) \cup \{a, b\}$ is disjoint from $h^{\varepsilon_1}(\Gamma_2)$. This gives $\varepsilon_2 = \varepsilon_1$ and, letting $\varepsilon = \varepsilon_1 = \varepsilon_2$, one has then $h^\varepsilon(\Gamma) \subset U$ and $h^{-\varepsilon}(\Gamma) \subset V$. One deduces easily that $h^\varepsilon(\text{Cl}(U)) \subset U \cup \{a, b\}$ and also $h^{-\varepsilon}(\text{Cl}(V)) \subset V \cup \{a, b\}$ (see Fig. 3.5).

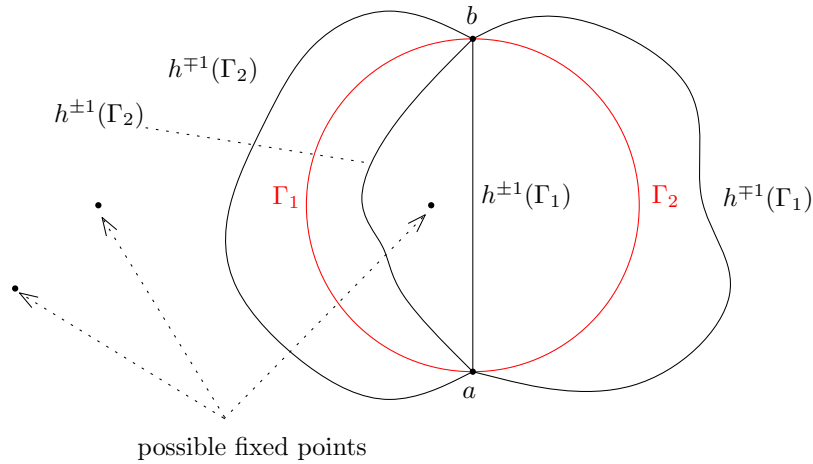

Figure 3.5 – A Brouwer manifold of type 3 and its images by $h^{\pm 1}$ in the subcase (b)

One derive one more time Properties (i)-(ii) and (iv) from Lemma 5.2 which gives $U_\Gamma^* = U \setminus \text{Fix}(h)$, $V_\Gamma^* = V \setminus \text{Fix}(h)$, $L(\Gamma) = \text{Cl}_M(U_\Gamma^*) = \text{Cl}(U) \setminus \text{Fix}(h)$ and $R(\Gamma) = \text{Cl}_M(V_\Gamma^*) = \text{Cl}(V) \setminus \text{Fix}(h)$. This completes the proof when M is connected.

- Assume now that $\text{Fix}(h)$ is a circle.

Then one knows from the Jordan curve Theorem that M has exactly two connected components M_1, M_2 . Moreover $h(M_1) = M_2$ and $h(M_2) = M_1$ because the homeomorphism h reverses the orientation hence only Brouwer manifolds of type 3 can arise. We keep the notations $\Gamma = \Gamma_1 \sqcup \Gamma_2$ as in the third case above. Each M_i is homeomorphic to \mathbb{R}^2 and Γ_i is a line of M_i therefore, by the Jordan curve Theorem, $M_i \setminus \Gamma_i$ has two connected components U_i, V_i with $\partial_{M_i} U_i = \partial_{M_i} V_i = \Gamma_i$. The arc $\varphi([x-1, x+1] \times \{1\}) \subset M_1$ joins $\varphi((x-1, 1)) \in h^{-1}(\Gamma_2)$ and $\varphi((x+1, 1)) \in h(\Gamma_2)$ and it intersects Γ_1 transversely only at the point $\varphi(x, 1)$ thus Γ_1 separates $h^{-1}(\Gamma_2)$ and $h(\Gamma_2)$ in M_1 , let us say $h^{-1}(\Gamma_2) \subset U_1$ and $h(\Gamma_2) \subset V_1$. One obtains likewise $h^{-1}(\Gamma_1) \subset U_2$ and $h(\Gamma_1) \subset V_2$ where U_2, V_2 are the two connected components of $M_2 \setminus \Gamma_2$. One derives from these separation properties that $h(\text{Cl}_{M_i}(V_i)) \subset V_j$ for any $1 \leq i \neq j \leq 2$ and we conclude simply observing that $U_\Gamma^* = U_1 \cup U_2$, $V_\Gamma^* = V_1 \cup V_2$, $L(\Gamma) = \text{Cl}_{M_1}(U_1) \cup \text{Cl}_{M_2}(U_2)$ and $R(\Gamma) = \text{Cl}_{M_1}(V_1) \cup \text{Cl}_{M_2}(V_2)$. \square

Remark 3.2. *A Brouwer manifold of type 2 cannot be a connected component of a Brouwer manifold of type 3. Indeed the proof of Proposition 3.1 shows (at least when $\text{Fix}(h)$ is totally disconnected) that a Brouwer manifold Γ of type 2 separates $h(\Gamma)$ and $h^{-1}(\Gamma)$ in $\mathbb{S}^2 \setminus \text{Fix}(h)$ while this is not true for a connected component Γ of a Brouwer manifold of type 3.*

3.3 Brouwer manifolds without transverse intersection

We say that two Brouwer manifolds Γ and Γ' have no transverse intersection of h if the following two conditions hold:

1. $\Gamma \subset R(\Gamma')$ or $\Gamma \subset L(\Gamma')$,
2. $\Gamma' \subset R(\Gamma)$ or $\Gamma' \subset L(\Gamma)$.

This definition is clearly symmetric with respect to Γ and Γ' . However it is maybe not entirely obvious that (i) and (ii) are equivalent. Let us give a few additional details.

Proposition 3.2. *Assume that $\text{Fix}(h)$ is either a circle or a totally disconnected set. Then two conditions (i) and (ii) are equivalent.*

Remark 3.3. *As for Proposition 3.1 this result is true without the assumption on $\text{Fix}(h)$ but we will need only this weakened version.*

Proof. We first suppose that $\text{Fix}(h)$ is totally disconnected. We keep the notation $U_1, U_2, U_3 = V_1 \cap V_2$ as in the proof of Proposition 3.1 for the connected components of $\mathbb{S}^2 \setminus \text{Cl}(\Gamma)$ when Γ is a Brouwer manifold of type 3 accumulating on a single fixed point. We define similarly $U'_1, U'_2, U'_3 = V'_1 \cap V'_2$ if Γ' is a Brouwer manifold of the same

type. Considering only the topological description of $L(\Gamma)$ and $R(\Gamma)$ given in the proof of Proposition 3.1 for the various types of Brouwer manifolds, it is not difficult to check that if (i) holds true but (ii) does not then one of the three following situations arises:

- (a) Γ (resp. Γ') is a Brouwer manifold of type 2 (resp. type 3) with $\text{Cl}(\Gamma) \setminus \Gamma = \text{Cl}(\Gamma') \setminus \Gamma' = \{a\}$ and the circle $\text{Cl}(\Gamma)$ separates U'_1 and U'_2 in \mathbb{S}^2 (Fig. 3.6 (a));
- (b) Γ and Γ' are Brouwer manifolds of type 3 with $\text{Cl}(\Gamma) \setminus \Gamma = \{a, b\}$, $\text{Cl}(\Gamma') \setminus \Gamma' = \{a\}$ ($a \neq b$) and the circle $\text{Cl}(\Gamma)$ separates U'_1 and U'_2 in \mathbb{S}^2 (Fig. 3.6 (b));
- (c) $\Gamma = \Gamma_1 \sqcup \Gamma_2$ and $\Gamma' = \Gamma'_1 \sqcup \Gamma'_2$ are Brouwer manifolds of type 3 with $\text{Cl}(\Gamma) \setminus \Gamma = \text{Cl}(\Gamma') \setminus \Gamma' = \{a\}$ such that one of the two sets U'_1, U'_2 is contained in U_3 while the other one is contained in U_1 or U_2 (Fig. 3.6 (c)).

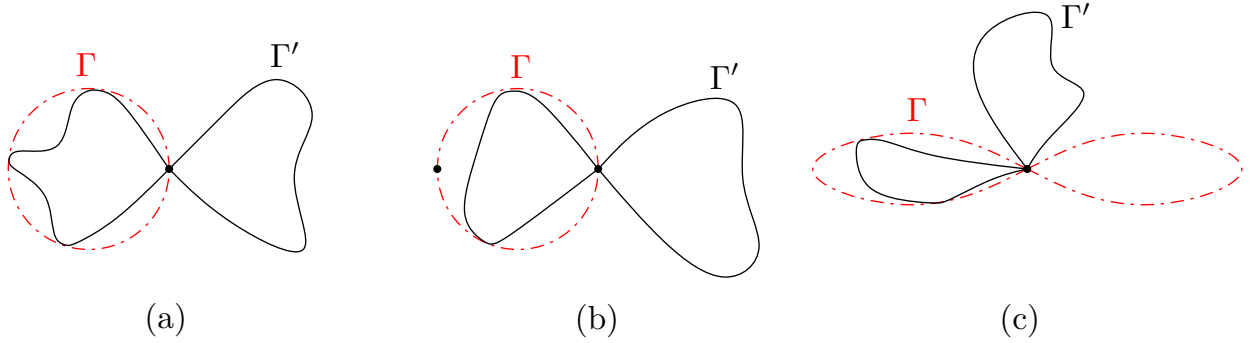

Figure 3.6 – The cases where (i) holds true but (ii) does not

We conclude by showing that (a)-(b)-(c) are actually not possible, due to the dynamics of h . If Γ, Γ' are Brouwer manifolds as in (a) or (b) we know there exists $\varepsilon \in \{\pm 1\}$ and a connected component U of $\mathbb{S}^2 \setminus \text{Cl}(\Gamma)$ such that $h^\varepsilon(U'_i) \subset U'_j$ for any two distinct i, j in $\{1, 2\}$ and $h^\varepsilon(U) \subset U$. Moreover the separation assumption in (a) or (b) allows one to choose $i \neq j$ in $\{1, 2\}$ in such a way that $U'_i \subset U$ and $U'_j \subset \mathbb{S}^2 \setminus \text{Cl}(U)$ hence one obtains $\emptyset \neq h^\varepsilon(U'_i) = h^\varepsilon(U'_i) \cap U'_j \subset h^\varepsilon(U) \cap U'_j \subset U \cap U'_j = \emptyset$ which is absurd. In the situation (c) consider $(\varepsilon, \varepsilon') \in \{\pm 1\}^2$ such that $h^\varepsilon(U_i) \subset U_j$ and $h^{\varepsilon'}(U'_i) \subset U'_j$ for any $i \neq j$ in $\{1, 2\}$. The hypothesis says there exist $i \neq j$ and $k \neq l$ in $\{1, 2\}$ such that $U'_i \subset U_k$ and $U'_j \subset U_3$. If $\varepsilon' = \varepsilon$ then one obtains $\emptyset \neq h^\varepsilon(U'_i) = h^\varepsilon(U'_i) \cap U'_j \subset h^\varepsilon(U_k) \cap U_3 \subset U_l \cap U_3 = \emptyset$ and if $\varepsilon' = -\varepsilon$ then $\emptyset \neq h^{-\varepsilon}(U'_j) = h^{-\varepsilon}(U'_j) \cap U'_i \subset h^{-\varepsilon}(U_3) \cap U_k \subset U_3 \cap U_k = \emptyset$, which proves that (c) cannot hold.

Secondly we suppose that $\text{Fix}(h)$ is a circle. In this case $\Gamma = \Gamma_1 \sqcup \Gamma_2$ and $\Gamma' = \Gamma'_1 \sqcup \Gamma'_2$ are Brouwer manifolds of type 3. We use the same convention as in the proof of Proposition 3.1 for the two connected components U_i, V_i of $M_i \setminus \Gamma_i$ and the connected components of $M_i \setminus \Gamma'_i$ are named U'_i, V'_i analogously ($i \in \{1, 2\}$). Since $\text{Int}(L(\Gamma)) = U_1 \cup U_2$, $\text{Int}(R(\Gamma)) = V_1 \cup V_2$, $\text{Int}(L(\Gamma')) = U'_1 \cup U'_2$ and $\text{Int}(R(\Gamma')) = V'_1 \cup V'_2$ one checks that if (i) holds true but (ii) does not then there exist $i \neq j$ in $\{1, 2\}$ such

that

$$(V_i \subset V'_i \text{ and } U_j \subset V'_j) \quad \text{or} \quad (V_i \subset U'_i \text{ and } U_j \subset U'_j).$$

One gets in first case

$$M_i = h(M_j) = h(\text{Cl}_{M_j}(V_j) \cup U_j) = h(\text{Cl}_{M_j}(V_j)) \cup h(U_j) \subset V_i \cup h(V'_j) \subset V_i \cup V'_i = V'_i$$

and in the second case

$$M_j = h^{-1}(M_i) = h^{-1}(\text{Cl}_{M_i}(U_i) \cup V_i) = h^{-1}(\text{Cl}_{M_i}(U_i)) \cup h^{-1}(V_i) \subset U_j \cup h^{-1}(U'_i) \subset U_j \cup U'_j = U'_j$$

which are two contradictions. \square

Proposition 3.3. *Assume that $\text{Fix}(h)$ is either a circle or a totally disconnected set and let Γ, Γ' be two Brouwer manifolds of h . Then one has*

- 1) $\Gamma \subset R(\Gamma')$ if and only if $R(\Gamma) \subset R(\Gamma')$ or $L(\Gamma) \subset R(\Gamma')$.
- 2) $\Gamma \subset L(\Gamma')$ if and only if $L(\Gamma) \subset L(\Gamma')$ or $R(\Gamma) \subset L(\Gamma')$.

Remark 3.4. *As for Propositions 3.1 and 3.2 this result remains valid without the assumption on $\text{Fix}(h)$.*

Proof. It is enough to show the first assertion, the same arguments proving the second one by reversing the roles of $L(\Gamma)$ and $R(\Gamma)$.

If $\text{Fix}(h)$ is a circle then the result is an easy consequence of Proposition 3.2. Suppose now that $\text{Fix}(h)$ is totally disconnected set and let Γ, Γ' be two Brouwer manifolds such that $\Gamma \subset R(\Gamma')$.

We first consider the case where $\text{Cl}(\Gamma)$ is a circle. Clearly the proposition is true if $\text{Cl}(\Gamma')$ is also a circle. If Γ' is a Brouwer manifold of type 3 with $\text{Cl}(\Gamma') \setminus \Gamma' = \{a\}$ then one also gets the results using the fact that the situations (a) and (b) in the proof of Proposition 3.2 are not possible.

We consider now the case where $\Gamma = \Gamma_1 \sqcup \Gamma_2$ is a Brouwer manifold of type 3 accumulating on a single fixed point $a \in \text{Fix}(h)$. Keeping the same notations as in the proof of Proposition 3.1, it is enough to prove that $\text{Cl}(U_1 \cup U_2) \setminus \{a\} \subset R(\Gamma')$ or $\text{Cl}(U_3) \setminus \text{Fix}(h) \subset R(\Gamma')$.

- Assume that $\text{Cl}(\Gamma')$ is a circle. Then $\mathbb{S}^2 \setminus \text{Cl}(\Gamma')$ has two connected components denoted by U', V' with $R(\Gamma') = \text{Cl}(V') \setminus \text{Fix}(h)$ and $L(\Gamma') = \text{Cl}(U') \setminus \text{Fix}(h)$. For every $i \in \{1, 2\}$ we deduce from $\Gamma \subset R(\Gamma')$ that $\partial U_i \subset \text{Cl}(V')$. This implies either $\text{Cl}(U_i) \subset \text{Cl}(V')$ or $\text{Cl}(U') \subset \text{Cl}(U_i)$. If $\text{Cl}(U_i) \subset \text{Cl}(V')$ for every $i \in \{1, 2\}$ then $\text{Cl}(U_1 \cup U_2) \setminus \{a\} \subset R(\Gamma')$. If there exists $i \in \{1, 2\}$ such that $\text{Cl}(U') \subset \text{Cl}(U_i)$ then $\mathbb{S}^2 \setminus \text{Cl}(U_i) \subset V'$ and hence $U_3 \subset V'$. This implies $\text{Cl}(U_3) \setminus \text{Fix}(h) \subset \text{Cl}(V') \setminus \text{Fix}(h) = R(\Gamma')$.

- Next assume that $\Gamma' = \Gamma'_1 \sqcup \Gamma'_2$ is also a Brouwer manifolds of type 3 accumulating on a single fixed point $b \in \text{Fix}(h)$. As a first case, suppose that $R(\Gamma')$ has two connected components $\text{Cl}(U'_1) \setminus \{b\}$ and $\text{Cl}(U'_2) \setminus \{b\}$. Because $\Gamma \subset R(\Gamma')$ one has $\text{Cl}(\Gamma_1) \subset \text{Cl}(U'_k)$

for some $k \in \{1, 2\}$. This implies either $\text{Cl}(U_1) \subset \text{Cl}(U'_k)$ or $\text{Cl}(V_1) \subset \text{Cl}(U'_k)$. The second inclusion actually does not hold because it implies $U_3 \subset V_1 \subset U'_k$. Defining the integer l so that $\{k, l\} = \{1, 2\}$ one deduces $\emptyset \neq h(U_3) \cap U_3 \subset h(U'_k) \cap U'_k \subset U'_l \cap U'_k = \emptyset$, a contradiction. The first inclusion implies $U_1 \subset U'_k$. Of course one gets likewise $U_2 \subset U'_j$ for some $j \in \{1, 2\}$ (actually $j \neq k$ but and then $a = b$ but it doesn't matter here) and therefore $U_1 \cup U_2 \subset U'_1 \cup U'_2$. This implies $\text{Cl}(U_1 \cup U_2) \setminus \{a\} \subset R(\Gamma')$. As a second case suppose that $R(\Gamma')$ is connected, that means $R(\Gamma') = \text{Cl}(U'_3) \setminus \text{Fix}(h)$. Then one has $\partial U_i \cap U'_k = \emptyset$ for every $i, k \in \{1, 2\}$ hence either $U_i \cap U'_k = \emptyset$ or $U'_k \subset U_i$. Observe that if there exist i, k such that $U'_k \subset U_i$ then also $U'_l \subset U_j$ where $\{i, j\} = \{k, l\} = \{1, 2\}$. Indeed there is $\varepsilon \in \{\pm 1\}$ such that $h^\varepsilon(U_i) \subset U_j$ hence if $U'_k \subset U_i$ one obtains $\emptyset \neq U'_l \cap h^\varepsilon(U'_k) \subset U'_l \cap h^\varepsilon(U_i) \subset U'_l \cap U_j$. This together with $\partial U_j \cap U'_l = \emptyset$ implies $U'_l \subset U_j$.

Consequently one of the two situations occurs.

- One has $U'_1 \cup U'_2 \subset U_1 \cup U_2$ and then $\text{Cl}(U_3) \setminus \text{Fix}(h) \subset R(\Gamma')$.
- Otherwise $U_i \cap U'_k = \emptyset$ for every $i, k \in \{1, 2\}$. It follows that $(U_1 \cup U_2) \cap (U'_1 \cup U'_2) = \emptyset$ hence $U_1 \cup U_2 \subset \text{Cl}(U'_3)$ and finally $\text{Cl}(U_1 \cup U_2) \setminus \text{Fix}(h) \subset R(\Gamma')$.

The proof of the proposition is completed. \square

According to Proposition 3.3, two Brouwer manifolds Γ and Γ' have no transverse intersection iff one of the following four properties is verified

- $R(\Gamma) \subset R(\Gamma')$,
- $L(\Gamma) \subset R(\Gamma')$,
- $R(\Gamma) \subset L(\Gamma')$,
- $L(\Gamma) \subset L(\Gamma')$.

As a remark on our vocabulary, observe that the opposite of the property “ Γ and Γ' have no transverse intersection” does not imply that $\Gamma \cap \Gamma' \neq \emptyset$ because Γ and Γ' are generally not connected. Nevertheless it implies that $\text{Cl}(\Gamma) \cap \text{Cl}(\Gamma') \neq \emptyset$ if furthermore $\text{Fix}(h)$ is assumed to be totally disconnected.

Statement of the main results

Theorem 3.1 says that if h is an orientation reversing homeomorphism of the 2-sphere without a 2-periodic point then one can cover $\mathbb{S}^2 \setminus \text{Fix}(h)$ by Brouwer manifolds of h . Our first goal in this work is to prove a foliated version of Theorem 3.1 similarly as Le Calvez gave a foliated version of the classical Brouwer plane translation theorem (see [LC04]).

Precisely our main result is the following.

Theorem 4.1. *Let $h : \mathbb{S}^2 \rightarrow \mathbb{S}^2$ be an orientation reversing homeomorphism without a 2-periodic point. Then there exists a family $\{\Phi_s\}_{s \in \Lambda}$ of Brouwer manifolds of h such that*

- $\mathbb{S}^2 \setminus \text{Fix}(h) = \bigcup_{s \in \Lambda} \Phi_s$;
- any two $\Phi, \Phi' \in \{\Phi_s\}_{s \in \Lambda}$ have no transverse intersection;
- the set $\{\phi \mid \phi \text{ is a connected component of some } \Phi_s, s \in \Lambda\}$ is the set of leaves of a topological oriented foliation \mathcal{F} of $\mathbb{S}^2 \setminus \text{Fix}(h)$.

Chapter 5 is entirely devoted to the proof of this result. As an application of Theorem 4.1, we prove in Chapter 6 the following result.

Theorem 4.2. *Let U, V be two open neighborhoods of 0 in the plane \mathbb{R}^2 and let $h : U \rightarrow V$ be an orientation reversing homeomorphism such that $\text{Fix}(h) = \text{Fix}(h^2) = \{0\}$. Then the fixed point index $\text{Ind}(h^n, 0)$ is well-defined for every integer $n \neq 0$ (i.e. 0 is an isolated fixed point of h^n) and one has $\text{Ind}(h^{2k-1}, 0) = \text{Ind}(h, 0)$ and $\text{Ind}(h^{2k}, 0) = \text{Ind}(h^2, 0)$ for every integer $k \geq 1$.*

In the above statement, the fact that 0 is an isolated fixed point of h^n for every integer $n \neq 0$ is not new (see [Bon04, Theorem 4.1]) and our interest is in the values of the fixed point index $\text{Ind}(h^n, 0)$. Note that such a result is already contained in the paper [RdPS10] by Del Portal and Salazar assuming some extra properties on the fixed point 0 (see [RdPS10, Main Theorem 2]). It was also known for odd iterates by a paper of Graff and Nowak-Przygodzki ([GNP03]) using entirely different methods.

Proof of Theorem 4.1

Contents

5.1	Simplification of the fixed point set	26
5.2	Maximal brick decompositions	27
5.2.1	Topology of the bricks	29
5.2.2	Orientation of the skeleton	33
5.3	Construction of the foliation	46
5.3.1	Covering the skeleton by Brouwer manifolds	46
5.3.2	Construction of an oriented topological quasi-foliation	54
5.3.3	Construction of an oriented topological foliation	80
5.4	Some remarks on the set of Brouwer manifolds \mathcal{P}	103

Throughout this Chapter 5 we fix once and for all an orientation reversing homeomorphism h of the sphere \mathbb{S}^2 without any 2-periodic point and we keep the notation $M = \mathbb{S}^2 \setminus \text{Fix}(h) = \mathbb{S}^2 \setminus \text{Fix}(h^2)$.

5.1 Simplification of the fixed point set

According to a theorem of Epstein (see [Eps81]), any connected component K of $\text{Fix}(h)$ is either a point or a segment or a circle and in the last two cases h interchanges locally the two sides of K . Combining with the Jordan curve theorem, it follows that one of the two following situations holds:

- The set $\text{Fix}(h)$ is reduced to a circle and M has exactly two connected components which are interchanged by h .
- The set $\text{Fix}(h)$ has only points and segments as connected components; then $\mathbb{S}^2 \setminus K$ is connected for every connected component K of $\text{Fix}(h)$ and this implies that M is also connected (see for example [New61, Chapter V, Theorem 14.3]).

Lemma 5.1. *Suppose that M is connected or, equivalently, that any connected component of $\text{Fix}(h)$ is either a point or a segment. Then there exist an orientation reversing homeomorphism \widehat{h} of \mathbb{S}^2 and a continuous map $\widehat{p} : \mathbb{S}^2 \rightarrow \mathbb{S}^2$ with the following properties:*

1. $\text{Fix}(\widehat{h})$ is totally disconnected and $\text{Fix}(h) = \widehat{p}^{-1}(\text{Fix}(\widehat{h}))$;
2. \widehat{p} maps any two distinct connected components of $\text{Fix}(h)$ onto two distinct points of $\text{Fix}(\widehat{h})$;
3. the restricted map $\widehat{p}|_M : M \rightarrow \mathbb{S}^2 \setminus \text{Fix}(\widehat{h})$ is a conjugacy between the two restricted homeomorphisms $h|_M : M \rightarrow M$ and $\widehat{h}|_{\mathbb{S}^2 \setminus \text{Fix}(\widehat{h})} : \mathbb{S}^2 \setminus \text{Fix}(\widehat{h}) \rightarrow \mathbb{S}^2 \setminus \text{Fix}(\widehat{h})$.

Proof. Consider the topological space \mathcal{S} obtained by identifying each connected component K of $\text{Fix}(h)$ with a single point p_K . Precisely \mathcal{S} denotes the quotient space \mathbb{S}^2 / \sim where \sim is the equivalence relation defined by $x \sim y$ iff $x = y$ or x, y belong to the same connected component of $\text{Fix}(h)$. Writing $p : \mathbb{S}^2 \rightarrow \mathcal{S}$ for the canonical projection, the homeomorphism h induces a map $H : \mathcal{S} \rightarrow \mathcal{S}$ naturally defined by $H \circ p = p \circ h$. One checks that H is a homeomorphism of \mathcal{S} such that $\text{Fix}(h) = p^{-1}(\text{Fix}(H))$. It follows that $p(M) = \mathcal{S} \setminus \text{Fix}(H)$ and the map $p|_M : M \rightarrow \mathcal{S} \setminus \text{Fix}(H)$ is clearly a homeomorphism conjugating the two restricted homeomorphisms $h|_M : M \rightarrow M$ and $H|_{\mathcal{S} \setminus \text{Fix}(H)} : \mathcal{S} \setminus \text{Fix}(H) \rightarrow \mathcal{S} \setminus \text{Fix}(H)$. Observe now that $\text{Fix}(H)$ is totally disconnected. Indeed the compactness of the sphere and the fact that $p^{-1}(\{s\})$ is connected for every $s \in \mathcal{S}$ imply that $p^{-1}(C)$ is connected for every connected set $C \subset \mathcal{S}$ (see for example [Kur68, Chapter 10]). Consequently, if $C \subset \text{Fix}(H)$ is connected then $p^{-1}(C) \subset K$ for some connected component K of $\text{Fix}(h)$ and then $C \subset p(K)$ contains a single point.

Because the connected components of $\text{Fix}(h)$ do not separate \mathbb{S}^2 , a result of Moore ([Moo25, Theorem 25], see also [Kur68, Chapter 10]) tells us that \mathcal{S} and \mathbb{S}^2 are homeomorphic so that one gets the result by letting $\widehat{h} = \psi^{-1} \circ H \circ \psi$ and $\widehat{p} = \psi^{-1} \circ p$ where $\psi : \mathbb{S}^2 \rightarrow \mathcal{S}$ is any homeomorphism between \mathbb{S}^2 and the “abstract sphere” \mathcal{S} . Note that h and \widehat{h} are conjugated on nonempty open subsets of \mathbb{S}^2 hence \widehat{h} also reverses the orientation. \square

Observe that Theorem 4.1 only involves the conjugacy class of the homeomorphism $h|_M : M \rightarrow M$. Hence, replacing h with \widehat{h} , Lemma 5.1 allow us to reduce conveniently to the cases where $\text{Fix}(h)$ is either a circle or a totally disconnected set. This will be assumed from now on.

One may also note that Lemma 5.1 explains Remarks 3.1, 3.3 and 3.4.

We will use repeatedly the following technical result.

Lemma 5.2. *Let F be a totally disconnected closed subset of \mathbb{S}^2 and let X be a closed subset of $\mathbb{S}^2 \setminus F$. If $\{U_i\}_{i \in I}$ is the collection of all the connected components of $\mathbb{S}^2 \setminus \text{Cl}(X)$ then $\{U_i \setminus F\}_{i \in I}$ is the collection of all the connected components of $\mathbb{S}^2 \setminus (F \cup X)$. Moreover $\text{Cl}_{\mathbb{S}^2 \setminus F}(U_i \setminus F) = \text{Cl}(U_i) \setminus F$ for every $i \in I$.*

Proof. Define $U_i^* = U_i \setminus F$ for every $i \in I$. Each U_i is a nonempty open subset of \mathbb{S}^2 and F a closed subset of \mathbb{S}^2 without interior point so U_i^* is also a nonempty open subset of \mathbb{S}^2 and clearly $U_i^* \subset \mathbb{S}^2 \setminus (F \cup X)$. Let us check that U_i^* is connected. Consider a universal covering map $\pi : \mathbb{R}^2 \rightarrow U_i$. The set $\widetilde{F}_i = \pi^{-1}(U_i \cap F)$ is closed in \mathbb{R}^2 and it is easily seen, using the fact that π is a locally one-to-one map, that \widetilde{F}_i is totally disconnected. It follows for example from [New61][Chapter V, Theorem 14.3] that $\mathbb{R}^2 \setminus \widetilde{F}_i$ is connected and then so is $\pi(\mathbb{R}^2 \setminus \widetilde{F}_i) = U_i^*$. Let V_i^* be the connected component of $\mathbb{S}^2 \setminus (F \cup X)$ containing U_i^* . Since X is closed in $\mathbb{S}^2 \setminus F$ one has $\mathbb{S}^2 \setminus (F \cup X) \subset \mathbb{S}^2 \setminus \text{Cl}(X)$ hence $V_i^* \subset U_i$ and consequently $V_i^* \setminus U_i^* \subset (U_i \setminus U_i^*) \cap (\mathbb{S}^2 \setminus F) = \emptyset$ which shows that $V_i^* = U_i^*$ and even better that any connected component of $\mathbb{S}^2 \setminus (F \cup X)$ is equal to some U_i^* . Finally the property $\text{Cl}_{\mathbb{S}^2 \setminus F}(U_i^*) = \text{Cl}(U_i) \setminus F$ is an easy consequence of the closedness of F . \square

5.2 Maximal brick decompositions

We describe here what kind of brick decompositions are useful for our purpose (see Section 2.2 for basic facts on brick decompositions).

Clearly $h(M) = M \neq \emptyset$ and, according to Lefschetz-Hopf Theorem, $M \neq \mathbb{S}^2$. Abusing notation slightly, we also use the letter h for the restricted homeomorphism $h|_M : M \rightarrow M$. A brick decomposition $\mathcal{D} = (V, E, B)$ of M is said to be *adapted to h* if it satisfies the two following properties:

(P₁) : For every brick $\beta \in B$, $h(\beta) \cap \beta = \emptyset = h^2(\beta) \cap \beta$,

(P₂) : For any two bricks $\beta, \beta' \in B$, at most one of the two sets $h(\beta) \cap \beta'$ or $h^{-1}(\beta) \cap \beta'$ is nonempty.

If moreover there is no subdecomposition \mathcal{D}' of \mathcal{D} , $\mathcal{D}' \neq \mathcal{D}$, which is still adapted to h then we say that \mathcal{D} is *maximal*. One constructs easily a brick decomposition \mathcal{D}_0 of M adapted to h and one gets using Zorn Lemma a subdecomposition \mathcal{D} of \mathcal{D}_0 which is maximal.

Lemma 5.3. *Any maximal brick decomposition $\mathcal{D} = (V, E, B)$ of M is filled.*

Proof. Let \mathcal{D}' be the subdecomposition of \mathcal{D} defined by the partition $B = \sqcup_{\beta \in B} \{\beta\}$. Then \mathcal{D}' has the same bricks as \mathcal{D} so it is adapted to h and the maximality of \mathcal{D} implies $\mathcal{D} = \mathcal{D}'$. \square

A key result is the following. This is the same as [Bon04, Lemma 5.9] in a slightly more general context.

Lemma 5.4. *If $\mathcal{D} = (V, E, B)$ is a brick decomposition of M adapted to h then for every $\beta \in B$ we have*

$$\beta \notin \bigcup_{n \geq 1} \varphi^n(\{\beta\}).$$

Proof. Suppose that $\beta \in \bigcup_{n \geq 1} \varphi^n(\{\beta\})$ for some brick $\beta \in B$. In other words there exist an integer $n \geq 1$ and a sequence of bricks $(\beta_i)_{1 \leq i \leq n}$ such that $\beta_1 = \beta$, $h(\beta_i) \cap \beta_{i+1} \neq \emptyset$ for $i = 1, \dots, n-1$ and $h(\beta_n) \cap \beta_1 \neq \emptyset$. Since \mathcal{D} is adapted to h , this is in particular a sequence of bricks satisfying the following four properties (i)-(iii)-(iv'):

- (i) for every $i, j \in \{1, \dots, n\}$, $\beta_i = \beta_j$ or $\text{Int}(\beta_i) \cap \text{Int}(\beta_j) = \emptyset$;
- (iii) for every $i \in \{1, \dots, n\}$, $h(\beta_i) \cap \beta_i = \emptyset = h^2(\beta_i) \cap \beta_i$;
- (iii) for every $i, j \in \{1, \dots, n\}$, β_j meets at most one of the two sets $h(\beta_i)$ or $h^{-1}(\beta_i)$;
- (iv') for every $i \in \{1, \dots, n-1\}$, there exists $k_i \geq 1$ such that $h^{k_i}(\beta_i) \cap \beta_{i+1} \neq \emptyset$, and there exists $k_n \geq 1$ such that $h^{k_n}(\beta_n) \cap \beta_1 \neq \emptyset$.

Let n_0 be the smallest positive integer for which there exists a sequence $(\beta_i)_{1 \leq i \leq n_0}$ of bricks of \mathcal{D} with these properties (i)-(iii)-(iv'). Each β_i is a connected subsurface of \mathbb{S}^2 so one can proceed exactly as in the proof of [Bon04][Lemma 5.4] to construct a sequence $(D'_i)_{1 \leq i \leq n_0}$ of discs such that $D'_i \subset \beta_i$, $D'_i \cap D'_j = \emptyset$ ($0 \leq i \neq j \leq n_0$) and satisfying the following property (iv) slightly stronger than (iv'):

- (iv) for every $i \in \{1, \dots, n_0-1\}$, there exists $k_i \geq 1$ such that $h^{k_i}(D'_i) \cap \text{Int}(D'_{i+1}) \neq \emptyset$, and there exists $k_{n_0} \geq 1$ such that $h^{k_{n_0}}(D'_{n_0}) \cap \text{Int}(D'_1) \neq \emptyset$.

Then $(D'_i)_{1 \leq i \leq n_0}$ is a sequence of discs satisfying the conditions (i)-(iv) in Lemma 5.3 of [Bon04] so h possesses a 2-periodic point, a contradiction. \square

5.2.1 Topology of the bricks

We fix from now on a maximal brick decomposition $\mathcal{D} = (E, V, B)$ of the surface M . If $\text{Fix}(h)$ is a circle then we know that M has exactly two connected components M_1, M_2 which are interchanged by h and we will write $B = B_1 \sqcup B_2$ for the corresponding partition of B .

We begin with a few remarks and notations.

Given $\beta \in B$ and a connected component X of $B \setminus \{\beta\}$ recall that X is closed in M (as an union of bricks of \mathcal{D}). Moreover it is easily seen that if $\text{Fix}(h)$ is totally disconnected (so that M is connected) then $\emptyset \neq \partial_M X \subset \partial_M \beta$ and more precisely that $\partial_M X$ is the union of some connected components of $\partial_M \beta$. If $\text{Fix}(h)$ is a circle and $\beta \in B_i$ then either $X = B_j$ ($1 \leq i \neq j \leq 2$) or X is a connected component of $B_i \setminus \{\beta\}$ whose frontier $\partial_M X = \partial_{M_i} X \neq \emptyset$ is the union of some connected components of $\partial_M \beta = \partial_{M_i} \beta$.

Observe also that there is a 1-to-1 correspondence between the connected components of $B \setminus \{\beta\}$ and those of $M \setminus \beta$: indeed if X is any connected component of $B \setminus \{\beta\}$ then one deduces from $\text{Cl}_M(X) = \text{Cl}_M(\text{Int}(X))$ that $\text{Int}(X)$ is a connected component of $M \setminus \beta$; conversely, if U denotes a connected component of $M \setminus \beta$ then $X = \{b \in B \mid b \cap U \neq \emptyset\}$ is a connected component of $B \setminus \{\beta\}$ and $\text{Int}(X) = U$.

For $k \in \{1, 2\}$ the sets $\varphi_-^k(\{\beta\}) \subset B$ and $\varphi^k(\{\beta\}) \subset B$ are connected and do not contain β (Lemma 5.4) so they are contained in some connected components of $B \setminus \{\beta\}$ denoted respectively by X_β^{-k} and X_β^k . In particular we have $h^k(\beta) \subset \text{Int}(X_\beta^k)$ and $h^{-k}(\beta) \subset \text{Int}(X_\beta^{-k})$. Especially if $\text{Fix}(h)$ is a circle and $\beta \in B_i$ then $X_\beta^{-1} = X_\beta^1 = B_j$ ($1 \leq i \neq j \leq 2$) while X_β^{-2}, X_β^2 are contained in B_i (maybe $X_\beta^{-2} = X_\beta^2$).

Lemma 5.5. *Assume that $\text{Fix}(h)$ is totally disconnected. Given $\beta \in B$ and $k \in \{1, 2\}$, let $Y = B \setminus (X_\beta^k \cup X_\beta^{-k})$. Then we have $h^k(Y) \cap Y = \emptyset$.*

Proof. The connectedness of M together with the fact that Y is the union of $\{\beta\}$ with some connected components of $B \setminus \{\beta\}$ implies that Y is connected, as well as $h^k(Y)$. The latter also intersects X_β^k because $\beta \in Y$. Now one deduces from $h^{-k}(\partial_M X_\beta^k) \subset h^{-k}(\beta) \subset \text{Int}(X_\beta^{-k})$ that $\partial_M X_\beta^k \cap h^k(Y) \subset h^k(\text{Int}(X_\beta^{-k})) \cap h^k(Y) = h^k(\text{Int}(X_\beta^{-k}) \cap Y) = \emptyset$ hence $h^k(Y) \subset \text{Int}(X_\beta^k)$. In particular $h^k(Y)$ is disjoint from Y . \square

Using similar arguments as for Lemma 5.5 one also gets the following lemma. Details are left to the reader.

Lemma 5.6. *Assume that $\text{Fix}(h)$ is a circle. Given $\beta \in B_i$ (with $i \in \{1, 2\}$), let $Z = B_i \setminus (X_\beta^2 \cup X_\beta^{-2})$. Then we have $h^2(Z) \cap Z = \emptyset$.*

Lemma 5.7. *For any brick $\beta \in B$ we have $B \setminus (X_\beta^1 \cup X_\beta^{-1} \cup X_\beta^2 \cup X_\beta^{-2}) = \{\beta\}$.*

Proof. We define $\Omega = B \setminus (X_\beta^1 \cup X_\beta^{-1} \cup X_\beta^2 \cup X_\beta^{-2})$. If $\text{Fix}(h)$ is a circle and $\beta \in B_i$ then $\Omega = B_i \setminus (X_\beta^{-2} \cup X_\beta^2)$ so Ω is a connected subset of B whether $\text{Fix}(h)$ is a circle or a totally disconnected set. Consider the subdecomposition \mathcal{D}' of \mathcal{D} defined by the partition $B = \Omega \sqcup \sqcup_{b \in B \setminus \Omega} \{b\}$; in other words the bricks of \mathcal{D}' are the ones of \mathcal{D} which do not belong to Ω as well as $\Omega \subset M$. Since \mathcal{D} is maximal, it is enough to prove that \mathcal{D}' is adapted to h in order to get $\Omega = \{\beta\}$. Clearly Lemmas 5.5-5.6 imply that $h^i(\Omega) \cap \Omega = \emptyset$ for $i \in \{1, 2\}$ hence \mathcal{D}' satisfies Property (P_1) . If Property (P_2) does not hold true for \mathcal{D}' then there exists $\beta' \in B$ such that $h(\Omega) \cap \beta' \neq \emptyset \neq h^{-1}(\Omega) \cap \beta'$. Remark that necessarily $h(\partial_M \Omega) \cap \beta' = \partial_M h(\Omega) \cap \beta' \neq \emptyset$ since otherwise $\beta' \subset h(\Omega)$ and then $h(\Omega) \cap h^{-1}(\Omega) \neq \emptyset$, which is not possible because $h^2(\Omega) \cap \Omega = \emptyset$. Moreover $\partial_M \Omega \subset \partial_M \beta \subset \beta$ so one obtains $\emptyset \neq h(\partial_M \Omega) \cap \beta' \subset h(\beta) \cap \beta'$. Replacing h with h^{-1} one gets in the same way $h^{-1}(\beta) \cap \beta' \neq \emptyset$. This contradicts the fact that \mathcal{D} satisfies (P_2) . \square

Lemma 5.8. *If $\text{Fix}(h)$ is totally disconnected, then one of the following possibilities holds for any brick $\beta \in B$:*

1. $X_\beta^{-2} = X_\beta^{-1} \neq X_\beta^1 = X_\beta^2$,
2. $X_\beta^{-2} = X_\beta^{-1} = X_\beta^1 = X_\beta^2$,
3. $X_\beta^{-2} = X_\beta^{-1} = X_\beta^1 \neq X_\beta^2$,
4. $X_\beta^{-2} \neq X_\beta^{-1} = X_\beta^1 = X_\beta^2$.

In particular, $B \setminus \{\beta\}$ has at most two connected components.

Proof. We first suppose $X_\beta^1 \neq X_\beta^{-1}$. We have $\partial_M h(X_\beta^1) = h(\partial_M X_\beta^1) \subset h(\beta) \subset \text{Int}(X_\beta^1)$. This together with the connectedness of $M \setminus \text{Int}(X_\beta^1) = B \setminus X_\beta^1$ implies that we have either (a) $h(X_\beta^1) \subset \text{Int}(X_\beta^1)$ or (b) $h(M \setminus X_\beta^1) = M \setminus h(X_\beta^1) \subset \text{Int}(X_\beta^1)$. Case (b) is actually not possible since, using $X_\beta^1 \neq X_\beta^{-1}$, it would implies $\beta = h(h^{-1}(\beta)) \subset h(M \setminus X_\beta^1) \subset \text{Int}(X_\beta^1)$ which is absurd. It follows from (a) that $h^2(\beta) \subset h(X_\beta^1) \subset \text{Int}(X_\beta^1)$ and consequently $X_\beta^1 = X_\beta^2$. The same arguments with h replaced by h^{-1} give $X_\beta^{-1} = X_\beta^{-2}$.

We now suppose $X_\beta^1 = X_\beta^{-1}$ and we let $X_\beta^\pm = X_\beta^1 = X_\beta^{-1}$. We have $h^2(X_\beta^\pm) \cap \text{Int}(X_\beta^2) \neq \emptyset$ because $h^2(\partial_M X_\beta^\pm) \subset h^2(\partial_M \beta) \subset h^2(\beta) \subset \text{Int}(X_\beta^2)$. Since $h^2(X_\beta^\pm)$ is connected, it follows that we have either $h^2(X_\beta^\pm) \subset \text{Int}(X_\beta^2)$ or $\emptyset \neq h^2(X_\beta^\pm) \cap \partial_M X_\beta^2 \subset h^2(X_\beta^\pm) \cap \beta$. In the first case we obtain $h(\beta) = h^2(h^{-1}(\beta)) \subset h^2(X_\beta^\pm) \subset \text{Int}(X_\beta^2)$ so $X_\beta^\pm = X_\beta^2$. In the second case we get $X_\beta^\pm \cap h^{-2}(\beta) \neq \emptyset$ hence $X_\beta^\pm = X_\beta^{-2}$. \square

Proposition 5.1. *Assume that $\text{Fix}(h)$ is totally disconnected. Then any brick $\beta \in B$ is either a disc or an annulus or a half-plane or a strip.*

Proof. First of all, observe that $M \setminus \beta \subset \mathbb{S}^2 \setminus \text{Cl}(\beta)$ because β is closed in M hence each connected component of $M \setminus \beta$ is contained in a connected component of $\mathbb{S}^2 \setminus \text{Cl}(\beta)$. Moreover the fixed point set $\text{Fix}(h)$ has empty interior so any connected component of $\mathbb{S}^2 \setminus \text{Cl}(\beta)$ contains some connected component $\text{Int}(X_\beta^i)$ of $M \setminus \beta$ ($i \in \{\pm 1, \pm 2\}$). If β is compact, it follows from Lemma 5.8 that β is a compact subsurface of \mathbb{S}^2 whose complement $\mathbb{S}^2 \setminus \beta$ has one or two connected components, so that β is a disc or an annulus. We suppose now that β is not compact.

CLAIM 1. *Every connected component of $\partial_M \beta$ is a line of M .*

Proof. Otherwise there is a connected component δ of $\partial_M \beta$ which is a circle. According to the Jordan curve Theorem, the set $\mathbb{S}^2 \setminus \delta$ has exactly two connected components, call them U and V , with $\partial U = \partial V = \delta$. We suppose for example that the connected set $\text{Int}(\beta) \subset \mathbb{S}^2 \setminus \delta$ is contained in U . Then we have $\text{Cl}(\beta) = \text{Cl}(\text{Int}(\beta)) \subset \text{Cl}(U)$ so V is also a connected component of $\mathbb{S}^2 \setminus \text{Cl}(\beta)$ and then there exists $i \in \{\pm 1, \pm 2\}$ such that $\text{Int}(X_\beta^i) \subset V$. Since β is not compact, the set $\text{Cl}(\beta) \setminus \beta \subset \text{Fix}(h) \cap U$ contains at least one point x and one gets

$$x = h^i(x) \in U \cap h^i(\text{Cl}(\beta)) = U \cap \text{Cl}(h^i(\beta)) \subset U \cap \text{Cl}(\text{Int}(X_\beta^i)) \subset U \cap \text{Cl}(V) = \emptyset,$$

a contradiction. □

CLAIM 2. *The set $\partial_M \beta$ has at most two connected components. Furthermore if $\delta \neq \delta'$ are the two connected components of $\partial_M \beta$ then $\text{Cl}(\delta) \setminus \delta = \text{Cl}(\delta') \setminus \delta'$ and this set consists of one or two fixed points of h .*

Proof. The previous claim and the fact that $\text{Fix}(h)$ is totally disconnected tell us that, for any connected component δ of $\partial_M \beta$, the set $\text{Cl}(\delta) \setminus \delta \subset \text{Fix}(h)$ is nonempty and contains at most two points.

Consider now two connected components δ_1, δ_2 of $\partial_M \beta$ and write $\text{Cl}(\delta_i) \setminus \delta_i = \{a_i, b_i\}$ with possibly $a_i = b_i$ ($i \in \{1, 2\}$). We want to prove that $\text{Cl}(\delta_1) \setminus \delta_1 = \text{Cl}(\delta_2) \setminus \delta_2$. It is enough to check that the two situations $a_2 \neq a_1 = b_1$ and $a_2 \neq a_1 \neq b_1 \neq a_2$ are not possible. For the first one, the argument is almost the same as in the proof of Claim 1. Assuming $a_1 = b_1$, the set $C = \text{Cl}(\delta_1) = \delta_1 \cup \{a_1\}$ is a circle so that $\mathbb{S}^2 \setminus C$ has exactly two connected components U, V such that $\partial U = \partial V = C$; one of them, say U , contains the connected set $\text{Int}(\beta) \subset M \setminus \delta_1$. Consequently $\text{Cl}(\beta) = \text{Cl}(\text{Int}(\beta)) \subset \text{Cl}(U)$ hence V is also a connected component of $\mathbb{S}^2 \setminus \text{Cl}(\beta)$ and then $\text{Int}(X_\beta^i) \subset V$ for some $i \in \{\pm 1, \pm 2\}$. If $a_2 \neq a_1$ one obtains

$$a_2 = h^i(a_2) \in (\text{Cl}(\beta) \setminus C) \cap h^i(\text{Cl}(\beta)) \subset U \cap \text{Cl}(h^i(\beta)) \subset U \cap \text{Cl}(\text{Int}(X_\beta^i)) \subset U \cap \text{Cl}(V) = \emptyset$$

which is absurd. Suppose now that a_1, b_1, a_2 are three distinct points. Since $h^{-2}(\beta) \cap \beta = \emptyset$ the set $C_1 = \text{Cl}(h^{-2}(\delta_1) \cup \delta_1) = h^{-2}(\delta_1) \cup \delta_1 \cup \{a_1, b_1\}$ is a circle hence $\mathbb{S}^2 \setminus C_1$ has precisely two connected components U_1, V_1 with C_1 as their common frontier. Since $\text{Int}(\beta)$ is connected and disjoint from C_1 one can assume $\text{Int}(\beta) \subset U_1$ hence $\text{Cl}(\beta) = \text{Cl}(\text{Int}(\beta)) \subset \text{Cl}(U_1)$ and also $a_2 \in \text{Cl}(\beta) \setminus C_1 \subset U_1$. It follows from $a_2 = h^2(a_2) \in \text{Cl}(h^2(\beta))$ that $h^2(\beta)$ meets the open set U_1 and afterwards that $h^2(\delta_1) \subset h^2(\beta) \subset U_1$ because $h^2(\beta)$ is connected and disjoint from $C_1 \subset h^{-2}(\beta) \cup \beta \cup \{a_1, b_1\}$. Define another circle by $C_2 = \delta_1 \cup h^2(\delta_1) \cup \{a_1, b_1\}$ and write U_2, V_2 for the two connected components of $\mathbb{S}^2 \setminus C_2$. One checks with Schoenflies Theorem that one of these two connected components is included in U_1 while the other one contains $V_1 \cup h^{-2}(\delta_1)$, let us say $U_2 \subset U_1$ and $V_1 \cup h^{-2}(\delta_1) \subset V_2$. One deduces from $\delta_1 \subset \text{Cl}(\text{Int}(\beta)) \subset \text{Cl}(U_1)$ and from $\text{Int}(\beta) \cap C_2 = \emptyset$ that $\text{Cl}(\beta) \subset \text{Cl}(U_2)$ hence $a_2 \in \text{Cl}(\beta) \setminus C_2 \subset U_2$. Moreover $a_2 = h^{-2}(a_2) \in \text{Cl}(h^{-2}(\beta))$ so $h^{-2}(\beta)$ intersects both U_2 and V_2 which is not possible due to $h^{-2}(\beta) \cap C_2 \subset h^{-2}(\beta) \cap (\beta \cup h^2(\beta) \cup \{a_1, b_1\}) = \emptyset$.

Finally the fact that $\partial_M \beta$ cannot have three distinct connected components $\delta_1, \delta_2, \delta_3$ follows easily from the connectedness of β and from the equality of the sets $\text{Cl}(\delta_i) \setminus \delta_i$ ($i \in \{1, 2, 3\}$). \square

CLAIM 3. *One has $\text{Cl}(\beta) \cap \text{Fix}(h) = \text{Cl}(\partial_M \beta) \cap \text{Fix}(h)$.*

Proof. If this is not true one can find $x \in \text{Cl}(\beta) \cap \text{Fix}(h)$ with an open disc U containing x and disjoint from $\partial_M \beta$. Clearly $U \cap \text{Fix}(h)$ is a totally disconnected closed subset of U and it follows for example from [New61, Chapter 5, Theorem 14.3] that $U \setminus \text{Fix}(h) = U \cap M$ is connected. Letting $V = U \cap M$ one also has $V \cap \beta = U \cap \beta \neq \emptyset$ and $V \cap \partial_M \beta = U \cap \partial_M \beta = \emptyset$ hence $V \subset \text{Int}(\beta)$. Choosing now another neighbourhood U' of x so small that $U' \cup h(U') \subset U$ one gets

$$\emptyset \neq U' \cap \beta \subset (U \cap h^{-1}(U)) \cap M = V \cap h^{-1}(V) \subset \beta \cap h^{-1}(\beta) = \emptyset,$$

a contradiction. \square

The claims above show that there are only three possible topologies for $\text{Cl}(\beta)$ (see also Fig. 5.1).

- $\text{Cl}(\beta)$ is a disc containing a single fixed point a which moreover belongs to the boundary circle $\partial \text{Cl}(\beta)$. Then $\beta = \text{Cl}(\beta) \setminus \{a\}$ is a half-plane.
- $\text{Cl}(\beta)$ is a disc containing exactly two fixed points a, b and these fixed points lie on the boundary circle $\partial \text{Cl}(\beta)$. Then $\beta = \text{Cl}(\beta) \setminus \{a, b\}$ is a strip.
- $\text{Cl}(\beta)$ is a pinched annulus and the pinching point a is the only fixed point in $\text{Cl}(\beta)$. Then $\beta = \text{Cl}(\beta) \setminus \{a\}$ is a strip.

The proof of Proposition 5.1 is complete. \square

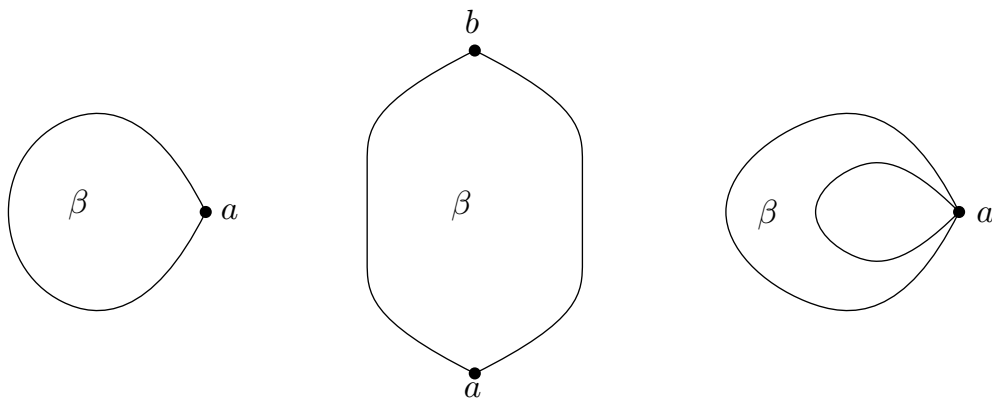
Figure 5.1 – The closure of a noncompact brick β [assuming $\text{Fix}(h)$ totally disconnected]

Proposition 5.2. *Assume that $\text{Fix}(h)$ is a circle. Then any brick $\beta \in B$ is either a disc or a half-plane or a strip.*

Proof. The situation is here similar to the one studied by Le Calvez. For completeness we give a proof directly adapted from the one of [LC05, Proposition 2.6]. We suppose for example $\beta \in B_1$. In this case $X_\beta^1 = X_\beta^{-1} = B_2$ and X_β^{-2}, X_β^2 are also the connected components of $B_1 \setminus \beta$. Since M_1 is homeomorphic to \mathbb{R}^2 and β is closed in M_1 , it is classical that every connected component U of $M_1 \setminus \beta$ has a connected frontier $\partial_{M_1}U = \partial_M U$ contained in $\partial_{M_1}\beta = \partial_M\beta$ (see e.g. [New61, Chapter V, Theorem 14.4]). It follows that $\{\partial_M X_\beta^{-2}, \partial_M X_\beta^2\}$ is also the set of the connected components of $\partial_M\beta$.

Suppose that $\partial_M X_\beta^2$ is a circle. According to the Jordan curve theorem, $M_1 \setminus \partial_M X_\beta^2$ has exactly two connected components U, V , say with $\partial_M U = \partial_M V = \partial_M X_\beta^2$ and $\text{Fix}(h) \subset \partial V$. One has $h^2(\partial_M X_\beta^2) \subset h^2(\beta) \subset \text{Int}(X_\beta^2)$ which implies that $X_\beta^2 = \text{Cl}_M(V)$ since otherwise $X_\beta^2 = \text{Cl}_M(U)$ is a topological disc such that $h^2(X_\beta^2) \subset X_\beta^2$ and the Brouwer fixed point theorem then would give a fixed point point of h^2 in $X_\beta^2 \subset M_1$, a contradiction. In particular one gets $\beta \subset \text{Cl}_M(U)$ so β is compact and $\partial_M X_\beta^{-2}$ is also a circle. Replacing h^2 with h^{-2} , the same argument shows that X_β^{-2} is the connected component V' of $M_1 \setminus \partial_M X_\beta^{-2}$ satisfying $\text{Fix}(h) \subset \partial V'$ hence $X_\beta^2 = X_\beta^{-2}$ and consequently $\beta = U \cup \partial_M X_\beta^2$ is a disc. Of course the same conclusion holds if it is first assumed that $\partial_M X_\beta^{-2}$ is a circle.

Suppose finally that $\partial_M X_\beta^2$ and $\partial_M X_\beta^{-2}$ are lines of M_1 . Then clearly β is a half-plane if $\partial_M X_\beta^2 = \partial_M X_\beta^{-2}$ and β is a strip if $\partial_M X_\beta^2 \neq \partial_M X_\beta^{-2}$. \square

5.2.2 Orientation of the skeleton

Our goal is to endow the skeleton $\Sigma = \Sigma(\mathcal{D})$ with a natural orientation and to study the induced orientation on the boundary of the bricks.

Let us consider an edge $\alpha \in E$ and the two bricks $\beta \neq \beta'$ which are adjacent to α . Because of the maximality of \mathcal{D} , the subdecomposition \mathcal{D}' of \mathcal{D} whose skeleton is

$\Sigma(\mathcal{D}') = \Sigma \setminus \text{Int}_\Sigma(\alpha)$ cannot be adapted to h .

– If \mathcal{D}' does not satisfies Property (P_1) then we have $h^k(\beta \cup \beta') \cap (\beta \cup \beta') \neq \emptyset$ for some $k \in \{1, 2\}$ and consequently $h^k(\beta) \cap \beta' \neq \emptyset$ or $h^k(\beta') \cap \beta \neq \emptyset$;

– If \mathcal{D}' does not satisfies Property (P_2) then there exists $\beta'' \in B$ such that $h(\beta \cup \beta') \cap \beta'' \neq \emptyset \neq h^{-1}(\beta \cup \beta') \cap \beta''$ and we deduce that $h(\beta) \cap \beta'' \neq \emptyset \neq h^{-1}(\beta') \cap \beta''$ or $h(\beta') \cap \beta'' \neq \emptyset \neq h^{-1}(\beta) \cap \beta''$.

Anyway one of the following two possibilities holds:

1. $\beta' \in \varphi(\{\beta\}) \cup \varphi^2(\{\beta\})$,
2. $\beta \in \varphi(\{\beta'\}) \cup \varphi^2(\{\beta'\})$.

As an important consequence of Lemma 5.4, the two situations (i) and (ii) cannot happen simultaneously so we can choose unambiguously the orientation of the edge α in such a way that $r(\alpha) \in \varphi(\{l(\alpha)\}) \cup \varphi^2(\{l(\alpha)\})$ where $r(\alpha)$ (resp. $l(\alpha)$) is the one of the two bricks β, β' which is located on the right (resp. on the left) of α . We also write $v_-(\alpha)$ (resp. $v_+(\alpha)$) for the initial (resp. final) vertex of α if it exists.

Proposition 5.3. *Let $\alpha \in E$ be an edge of \mathcal{D} . Define the attractor associated to $l(\alpha) \in B$ and the repeller associated to $r(\alpha) \in B$ by respectively*

$$\mathcal{A}(l(\alpha)) = \bigcup_{n \geq 0} \varphi^n(\{l(\alpha)\}) \quad \text{and} \quad \mathcal{R}(r(\alpha)) = \bigcup_{n \geq 0} \varphi_-^n(\{r(\alpha)\}).$$

Then $\mathcal{A}(l(\alpha))$ and $\mathcal{R}(r(\alpha))$ have at most two connected components. More precisely either $\mathcal{A}(l(\alpha))$ (resp. $\mathcal{R}(r(\alpha))$) is connected or it has exactly two connected components which are

$$\mathcal{A}_e(l(\alpha)) = \bigcup_{n \geq 0} \varphi^{2n}(\{l(\alpha)\}) \quad \text{and} \quad \mathcal{A}_o(l(\alpha)) = \bigcup_{n \geq 0} \varphi^{2n+1}(\{l(\alpha)\}),$$

$$\text{(resp. } \mathcal{R}_e(r(\alpha)) = \bigcup_{n \geq 0} \varphi_-^{2n}(\{r(\alpha)\}) \quad \text{and} \quad \mathcal{R}_o(r(\alpha)) = \bigcup_{n \geq 0} \varphi_-^{2n+1}(\{r(\alpha)\}),$$

where the subscripts e and o stand for respectively even and odd. The result also hold true for the following sets $\mathcal{A}_(l(\alpha)) = \mathcal{A}(l(\alpha)) \setminus \{l(\alpha)\}$ and $\mathcal{R}_*(r(\alpha)) = \mathcal{R}(r(\alpha)) \setminus \{r(\alpha)\}$.*

Proof. We know that $r(\alpha) \in \varphi(\{l(\alpha)\}) \cup \varphi^2(\{l(\alpha)\})$. If $r(\alpha) \in \varphi(\{l(\alpha)\})$ then $l(\alpha) \cup \varphi(\{l(\alpha)\})$ is connected. Moreover one can write

$$\mathcal{A}(l(\alpha)) = \bigcup_{n \geq 0} \varphi^n(\{l(\alpha)\} \cup \varphi(\{l(\alpha)\}))$$

so $\mathcal{A}(l(\alpha))$ is the union of the connected sets $X_n = \varphi^n(\{l(\alpha)\} \cup \varphi(\{l(\alpha)\}))$ verifying $X_n \cap X_{n+1} \neq \emptyset$ for every $n \geq 0$. It follows that $\mathcal{A}(l(\alpha))$ is connected. Similarly we write $\mathcal{A}_*(l(\alpha)) = \bigcup_{n \geq 1} X_n$, and thus $\mathcal{A}_*(l(\alpha))$ is connected.

If $r(\alpha) \in \varphi^2(\{l(\alpha)\})$ then $l(\alpha) \cup \varphi^2(\{l(\alpha)\})$ is connected and one gets the connectedness of $\mathcal{A}_e(l(\alpha))$ and $\mathcal{A}_o(l(\alpha))$ by writing $\mathcal{A}_e(l(\alpha)) = \bigcup_{n \geq 0} \varphi^{2n}(\{l(\alpha)\} \cup \varphi^2(\{l(\alpha)\}))$ and $\mathcal{A}_o(l(\alpha)) = \bigcup_{n \geq 0} \varphi^{2n+1}(\{l(\alpha)\} \cup \varphi^2(\{l(\alpha)\}))$. In the same way, the set $\mathcal{A}_*(l(\alpha))$ is the union of the following connected sets

$$\bigcup_{n \geq 1} \varphi^{2n}(\{l(\alpha)\} \cup \varphi^2(\{l(\alpha)\})) \quad \text{and} \quad \bigcup_{n \geq 0} \varphi^{2n+1}(\{l(\alpha)\} \cup \varphi^2(\{l(\alpha)\})).$$

The result for $\mathcal{R}(r(\alpha))$ and $\mathcal{R}_*(r(\alpha))$ may be proved similarly. \square

Following Le Calvez ([LC04],[LC05]) we say that a sequence $(\alpha_i)_{i \in I}$ of edges, where I is a nonempty \mathbb{Z} -interval, is *admissible* if $v_+(\alpha_i) = v_-(\alpha_{i+1})$ for every pair $\{i, i+1\} \subset I$ (in particular this holds if $\sharp(I) = 1$). Given such a sequence $(\alpha_i)_{i \in I}$, the arc $\Gamma = \prod_{i \in I} \alpha_i \subset M$ obtained by concatenating the α_i 's is naturally endowed with the orientation which agrees with the one of each α_i ; then Γ is called an *oriented arc* and one defines the *left neighborhood* of Γ by

$$l(\Gamma) = \{l(\alpha_i) \mid i \in I\},$$

and the *right neighborhood* of Γ by

$$r(\Gamma) = \{r(\alpha_i) \mid i \in I\}.$$

For several oriented arcs $\Gamma_1, \dots, \Gamma_n$ one let naturally $l(\Gamma_1 \cup \dots \cup \Gamma_n) = \bigcup_{i=1}^n l(\Gamma_i)$ and $r(\Gamma_1 \cup \dots \cup \Gamma_n) = \bigcup_{i=1}^n r(\Gamma_i)$.

Proposition 5.4. *Suppose that $\beta \in B$ is a disc. Then the circle $\partial_M \beta = \partial \beta$ is the union of two oriented segments*

$$\Gamma = \prod_{i=0}^n \alpha_i \quad \text{and} \quad \Gamma' = \prod_{i=0}^{n'} \alpha'_i$$

where $(\alpha_i)_{0 \leq i \leq n}$ and $(\alpha'_i)_{0 \leq i \leq n'}$ are finite admissible sequences of edges such that $v_-(\alpha_0) = v_-(\alpha'_0)$, $v_+(\alpha_n) = v_+(\alpha'_{n'})$ and $l(\Gamma) = r(\Gamma') = \{\beta\}$. In this case, we denote $v_-(\beta) = v_-(\alpha_0)$ (resp. $v_+(\beta) = v_+(\alpha_n)$) and we say that $v_-(\beta)$ (resp. $v_+(\beta)$) is the initial vertex (resp. the final vertex) of β .

Proof. We first prove that there is at least one edge $\alpha \in E$ such that $l(\alpha) = \beta$. Suppose this is not true, that is $r(\alpha) = \beta$ for every edge $\alpha \subset \partial_M \beta = \partial \beta$. Choose an edge $\alpha_1 \subset \partial \beta$ and define $\beta_1 = l(\alpha_1)$. We know that β belongs to the connected set $\varphi^k(\{\beta_1\}) \subset B$ for some $k \in \{1, 2\}$ hence $\{\beta\} \cup \varphi^k(\{\beta_1\})$ is also connected. Moreover this latter set cannot be reduced to $\{\beta\}$ because $h^k(\alpha_1) = h^k(\beta_1 \cap \beta)$ is disjoint from β so there exists a brick $\beta_2 \in \varphi^k(\{\beta_1\})$ which is adjacent to β . Continuing in the same way, one constructs inductively a sequence of bricks $(\beta_i)_{i \geq 1}$ which are adjacent to β

and such that $\beta_{i+1} \in \varphi(\{\beta_i\}) \cup \varphi^2(\{\beta_i\})$ for every $i \geq 1$. Since there are only finitely many bricks adjacent to β , one has $\beta_{i_1} = \beta_{i_2} \in \bigcup_{n \geq 0} \varphi^n(\{\beta_{i_1}\})$ for some $i_2 > i_1 \geq 1$ which contradicts Lemma 5.4. Replacing φ with φ_- , one proves likewise that there exists at least one edge $\alpha' \subset \partial\beta$ such that $r(\alpha') = \beta$. For later use, let us remark here that the above argument holds for any brick β whose frontier $\partial_M\beta$ contains only finitely many edges.

We end by proving that it is not possible to find two edges α_1, α_2 such that $l(\alpha_1) = l(\alpha_2) = \beta$ and which are separated in $\partial\beta$ by two edges α'_1, α'_2 verifying $r(\alpha'_1) = r(\alpha'_2) = \beta$. Arguing again by contradiction, suppose that such edges exist and then define $\beta_i = r(\alpha_i) \in \varphi(\{\beta\}) \cup \varphi^2(\{\beta\})$ and $\beta'_i = l(\alpha'_i) \in \varphi_-(\{\beta\}) \cup \varphi_-^2(\{\beta\})$ for $i \in \{1, 2\}$. Remark that there is a connected set $X \subset \bigcup_{n \geq 0} \varphi^n(\{\beta\})$ which contains $\{\beta_1, \beta_2\}$. Indeed, if $\beta_i \in \varphi(\{\beta\})$ for some $i \in \{1, 2\}$ then $\{\beta\} \cup \varphi(\{\beta\})$ is connected and we take $X = \varphi(\{\beta\} \cup \varphi(\{\beta\})) = \varphi(\{\beta\}) \cup \varphi^2(\{\beta\})$; otherwise we just let $X = \varphi^2(\{\beta\})$. One checks similarly that $\{\beta'_1, \beta'_2\} \subset X'$ for some connected set $X' \subset \bigcup_{n \geq 0} \varphi_-^n(\{\beta\})$. Choose now two segments γ and γ' lying respectively in $\text{Int}(X)$ and in $\text{Int}(X')$ except for their endpoints, and joining respectively $z_1 \in \text{Int}_\Sigma(\alpha_1)$, $z_2 \in \text{Int}_\Sigma(\alpha_2)$ and $z'_1 \in \text{Int}_\Sigma(\alpha'_1)$, $z'_2 \in \text{Int}_\Sigma(\alpha'_2)$. Since the α'_i 's separate the α_i 's on the circle $\partial\beta$ one can also find two segments $\widehat{\gamma}, \widehat{\gamma}'$ in β whose endpoints are, respectively, z_1, z_2 and z'_1, z'_2 , and which intersect transversely in only one point. According to Lemma 5.4 $\text{Int}(X) \cap \text{Int}(X') = \emptyset$ hence one gets two circles $\gamma \cup \widehat{\gamma}$ and $\gamma' \cup \widehat{\gamma}'$ with a unique point of transverse intersection, which is absurd. \square

Proposition 5.5. *Suppose that $\beta \in B$ is an annulus. Then its two boundary circles may be written $\Gamma = \prod_{i \in I} \alpha_i$ and $\Gamma' = \prod_{i \in I'} \alpha'_i$ where $(\alpha_i)_{i \in I}$ and $(\alpha'_i)_{i \in I'}$ are finite admissible sequences of edges such that $l(\Gamma) = r(\Gamma') = \{\beta\}$.*

Proof. In this case, one knows that the set $\mathbb{S}^2 \setminus \beta$ has two connected components and that the annulus β separates $\text{Int}(X_\beta^2)$ and $\text{Int}(X_\beta^{-2})$ in \mathbb{S}^2 . We will first prove that these two connected components are $X_\beta^1 = X_\beta^2$ and $X_\beta^{-1} = X_\beta^{-2}$. Let us write U, V for these two connected components, say with $\text{Int}(X_\beta^{-2}) \subset U$ and $\text{Int}(X_\beta^2) \subset V$. Arguing by contradiction, we suppose that the situation (4) in Lemma 5.8 holds. Let $D = \beta \cup U$, so that D is a disc whose frontier ∂D is one of the two boundary circles of β . We have $h^{-2}(\beta) \subset h^{-2}(D) \cap \text{Int}(D)$ and then $h^{-2}(D) \subset \text{Int}(D)$ because $D \cap h^2(\partial D) \subset D \cap h^2(\beta) \subset D \cap \text{Int}(X_\beta^2) \subset D \cap V = \emptyset$. According to the Brouwer fixed point theorem one has $\text{Int}(D) \cap \text{Fix}(h^{-2}) \neq \emptyset$ which implies $\text{Int}(h^{-1}(D)) \cap D \neq \emptyset$ because $\text{Fix}(h) = \text{Fix}(h^2)$. Now $X_\beta^{-1} = X_\beta^2$ gives

$$D \cap \partial h^{-1}(D) = D \cap h^{-1}(\partial D) \subset D \cap h^{-1}(\beta) \subset D \cap \text{Int}(X_\beta^{-1}) \subset D \cap V = \emptyset$$

hence $D \subset h^{-1}(D)$ and afterwards $D \subset h^{-1}(D) \subset h^{-2}(D) \subset D$ so that $D = h^{-1}(D)$ and then $\partial D = h^{-1}(\partial D) \subset \beta \cap h^{-1}(\beta) = \emptyset$, which is absurd. Interchanging the roles

of h and h^{-1} , one checks similarly that the situation (3) in Lemma 5.8 cannot occur and consequently that $X_\beta^{-2} = X_\beta^{-1} \neq X_\beta^1 = X_\beta^2$.

Let $\alpha \subset \partial\beta$ be an edge such that $l(\alpha) = \beta$. The brick $r(\alpha)$ is included in a connected component of $B \setminus \{\beta\}$, namely in $X_\beta^1 = X_\beta^2$. Therefore α is contained in $\partial_M X_\beta^1$. Similarly if $r(\alpha) = \beta$ then $\alpha \subset \partial_M X_\beta^{-1}$. \square

Proposition 5.6. *If $\beta \in B$ is a half-plane then its frontier $\partial_M\beta$ is the union of two oriented half-lines Γ and Γ' with the same endpoint $\sigma \in V$. Moreover Γ is the product of the edges satisfying $l(\alpha) = \beta$ and Γ' is the product of the edges satisfying $r(\alpha) = \beta$. The vertex σ is denoted by $v_-(\beta)$ if it is the initial vertex of Γ and Γ' and it is denoted by $v_+(\beta)$ if it is the final vertex of Γ and Γ' .*

Proof. The proof is divided into two parts.

First part. We prove that there exists at least one edge α such that $l(\alpha) = \beta$ and at least one edge α' such that $r(\alpha') = \beta$. This is already known to be true if $\partial_M\beta$ contains only finitely many edges (recall the remark in the proof of Proposition 5.4) so we can suppose

$$\partial_M\beta = \prod_{m < i < l} \alpha_i,$$

where $(\alpha_i)_{m < i < l}$ is an admissible sequence (*i.e.*, for all $m < i < l - 1$ we have $v_+(\alpha_i) = v_-(\alpha_{i+1})$) with $m < 0 < 1 < l$ and moreover $m = -\infty$ or $l = +\infty$. We also define $\sigma_0 = v_+(\alpha_0) = v_-(\alpha_1)$. By contradiction, we suppose that $r(\alpha_i) = \beta$ for every $i \in (m, l)$. Remark that \mathcal{D} is also a maximal brick decomposition of M for h^{-1} and that the orientation induced by h^{-1} of the skeleton is opposite to the one induced by h . Hence, replacing h with h^{-1} , the following arguments also show that one cannot have $\beta = l(\alpha_i)$ for every $i \in (m, l)$. Let us introduce some notation which will allow to deal simultaneously with the case where $\text{Fix}(h)$ is a circle and the case where $\text{Fix}(h)$ is a totally disconnected set.

- Suppose first that $\text{Fix}(h)$ is totally disconnected. Then $\text{Cl}(\beta) \setminus \beta$ consists of a single fixed point p of h and the sets $\text{Cl}(h^i(\beta)) = h^i(\beta) \cup \{p\}$ ($i \in \mathbb{Z}$) are discs intersecting pairwise at p . Using the Schoenflies theorem one can also assume (up to conjugacy) that $p = \infty$ and that the frontiers of the discs $\text{Cl}(h^i(\beta))$, $i \in \{0, \pm 1, \pm 2\}$, form a standard bouquet of 5 circles. It follows that there exists a segment $\gamma \subset \mathbb{S}^2$ linking σ_0 and $h^2(\sigma_0)$, and disjoint from $\bigcup_{i=-2}^2 h^i(\beta)$ except for its endpoints $\sigma_0, h^2(\sigma_0)$. Using Lemma 5.2, it is not difficult to see that one can choose $\gamma \subset M$.

We have two possible cyclic orders around ∞ :

$$\text{Cl}(\beta) < h^{-1}(\text{Cl}(\beta)) < h(\text{Cl}(\beta)) \text{ or } \text{Cl}(\beta) < h(\text{Cl}(\beta)) < h^{-1}(\text{Cl}(\beta)).$$

If $\text{Cl}(\beta) < h^{-1}(\text{Cl}(\beta)) < h(\text{Cl}(\beta))$ then, since h reverses the orientation, we also have $\text{Cl}(\beta) < h^{-2}(\text{Cl}(\beta)) < h^{-1}(\text{Cl}(\beta))$ and $h^2(\text{Cl}(\beta)) < \text{Cl}(\beta) < h(\text{Cl}(\beta))$ so we get (see Fig. 5.2)

$$(\star) \quad \text{Cl}(\beta) < h^{-2}(\text{Cl}(\beta)) < h^{-1}(\text{Cl}(\beta)) < h(\text{Cl}(\beta)) < h^2(\text{Cl}(\beta)).$$

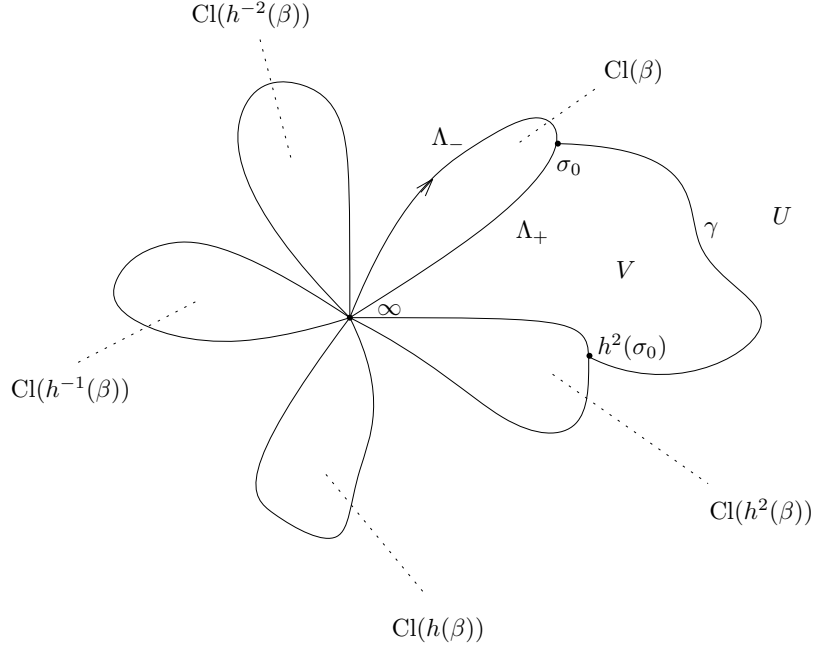

Figure 5.2 – The discs $\text{Cl}(h^i(\beta))$ around ∞ ($-2 \leq i \leq 2$)

If $\text{Cl}(\beta) < h(\text{Cl}(\beta)) < h^{-1}(\text{Cl}(\beta))$ then one gets by the same argument

$$(\star\star) \quad \text{Cl}(\beta) < h^2(\text{Cl}(\beta)) < h(\text{Cl}(\beta)) < h^{-1}(\text{Cl}(\beta)) < h^{-2}(\text{Cl}(\beta))$$

and the picture is the same after interchanging the roles of h and h^{-1} .

Define $D = \mathbb{S}^2 \setminus (\text{Int}(\beta) \cup h^2(\text{Int}(\beta)) \cup \{\infty\}) = \mathbb{R}^2 \setminus (\text{Int}(\beta) \cup h^2(\text{Int}(\beta)))$. Using the Schoenflies theorem, one can check that D is a strip and that $D \setminus \gamma$ has exactly two connected components having γ as their common frontier in D . Observe also that the cyclic order of the $\text{Cl}(h^i(\beta))$'s around ∞ ($-2 \leq i \leq 2$) implies that $h^{-1}(\beta)$ and $h^{-2}(\beta)$ are included in the same connected component of $D \setminus \gamma$. These connected components of $D \setminus \gamma$ are named U, V with the convention $h^{-1}(\beta) \cup h^{-2}(\beta) \subset U$. More precisely note that $h^{-1}(\beta) \cup h^{-2}(\beta)$ is contained in $\text{Int}(U)$ since it is disjoint from $\beta \cup h^2(\beta)$ (see Fig. 5.2).

- Suppose now that $\text{Fix}(h)$ is a circle. Assume for instance that $\beta \subset M_1$. Since M_1 is homeomorphic to \mathbb{R}^2 one can find a segment $\gamma \subset M_1$ joining $\sigma_0 \in \partial_M \beta$ and $h^2(\sigma_0) \in \partial_M h^2(\beta)$ such that γ is disjoint from $\beta \cup h^2(\beta) \cup h^{-2}(\beta)$ except for its endpoints. We let $D = M_1 \setminus (\text{Int}(\beta) \cup h^2(\text{Int}(\beta)))$. As in the case where $\text{Fix}(h)$ is totally disconnected, D is a strip and $D \setminus \gamma$ has two connected components having γ as their common frontier in D ; these connected components are named again U, V with $h^{-2}(\beta) \subset \text{Int}(U)$.

With the previous definitions for D, U and V , the following arguments are valid whether $\text{Fix}(h)$ is a circle or a totally disconnected set. Write $\Lambda_- = \bigcup_{i \leq 0} \alpha_i$ and $\Lambda_+ = \bigcup_{i \geq 1} \alpha_i$. Note that one of the two connected sets $\Lambda_- \setminus \{\sigma_0\}$ or $\Lambda_+ \setminus \{\sigma_0\}$ is contained in U while the other one is contained in V .

(a) We first assume $\Lambda_- \setminus \{\sigma_0\} \subset U$ and $\Lambda_+ \setminus \{\sigma_0\} \subset V$ (in the case where $\text{Fix}(h)$ is totally disconnected, this corresponds to the situation pictured on Fig. 5.2). For each integer $i \in (m, l)$, let us define $\beta_i = l(\alpha_i)$. Then $\beta = r(\alpha_i) \in \varphi(\{\beta_i\}) \cup \varphi^2(\{\beta_i\})$ so one of the following two situations occurs:

$$(*) \beta_i \cap (h^{-1}(\beta) \cup h^{-2}(\beta)) \neq \emptyset,$$

$$(**) \beta_i \cap h^{-1}(\tau_{\beta_i}) \neq \emptyset \text{ and } h^{-1}(\tau_{\beta_i}) \cap h^{-2}(\beta) \neq \emptyset \text{ for some } \tau_{\beta_i} \in B.$$

We denote by BR_* (resp. BR_{**}) the set of the bricks β_i , $1 \leq i < l$, verifying $(*)$ (resp. $(**)$). We let

$$\text{BR} = \text{BR}_* \cup \text{BR}_{**} = \{\beta_i \mid 1 \leq i < l\}.$$

Remark that the set $\{\beta' \in \text{BR} \mid \beta' \not\subset V\}$ is finite. Indeed, for every integer $i \in (m, l)$ one has $\beta \in \varphi(\{\beta_i\}) \cup \varphi^2(\{\beta_i\})$. Therefore one gets with Lemma 5.4 that $\beta_i \cap h^2(\beta) = \emptyset$ and then $\beta_i \subset D$ for every $i \in (m, l)$. If $i \geq 1$ and $\beta_i \not\subset V$ then $\beta_i \cap \gamma \neq \emptyset$. Since γ is a compact subset of M , it intersects only finitely many bricks, which proves the assertion. As a consequence, the set $\text{BR}_* \subset \{\beta' \in \text{BR} \mid \beta' \not\subset V\}$ is also finite.

We shall prove there exists $b \in B$ with the following properties:

- there is a connected subset X of $\mathcal{R}(b)$ such that $h^{-2}(X) \subset \text{Int}(X)$ and moreover X satisfies the following condition (\mathcal{C})
 - if $l < +\infty$ then $\alpha_{l-1} \subset X$,
 - if $l = +\infty$ then $\alpha_i \subset X$ for infinitely many $i \geq 1$;
- there is a connected subset X' of $\mathcal{A}_*(b) = \mathcal{A}(b) \setminus \{b\}$ such that $\beta \in X'$ and $h^2(X') \subset X'$.

Let us explain why this leads to a contradiction. The above properties imply $\beta \cup h^2(\beta) \subset X'$ hence, since $X' \subset B$ is connected, one can find a segment $\omega \subset \text{Int}(X')$ joining a point of $\partial_M \beta$ and a point of $\partial_M h^2(\beta)$ and which is contained in $\text{Int}(D)$ except for its endpoints. Then $D \setminus \omega$ has exactly two connected components Ω_+ and Ω_- and one of them, say Ω_+ , contains the connected set $X \subset M$ because $\omega \cap X \subset \text{Int}(\mathcal{A}_*(b)) \cap \mathcal{R}(b) = \emptyset$. Suppose that $\theta : \mathbb{R} \rightarrow \partial_M \beta$ is a parameterization of $\partial_M \beta$ which agrees with the orientation of $\partial_M \beta$. Define $t_\gamma, t_\omega \in \mathbb{R}$ so that $\theta(t_\gamma) = \gamma \cap \partial_M \beta$, $\theta(t_\omega) = \omega \cap \partial_M \beta$, and let

$$- \Delta_- = \theta((-\infty, \min\{t_\gamma, t_\omega\}));$$

$$- \Delta_0 = \theta([\min\{t_\gamma, t_\omega\}, \max\{t_\gamma, t_\omega\}]);$$

$$- \Delta_+ = \theta((\max\{t_\gamma, t_\omega\}, +\infty)).$$

Thus $\partial_M \beta = \Delta_- \sqcup \Delta_0 \sqcup \Delta_+$ with $\Delta_- \cap \text{Cl}(\Omega_+) = \emptyset$ and $\Delta_+ \cap \text{Cl}(U) = \emptyset$. Similarly the set $\partial_M h^2(\beta)$ is partitioned into three pairwise disjoint connected arcs Δ'_-, Δ'_0 and

Δ'_+ such that $\Delta'_- \cap \text{Cl}(\Omega_+) = \emptyset$, and $\Delta'_+ \cap \text{Cl}(U) = \emptyset$. We write $\{J_i\}_{i \in I}$ for the set of all the connected components of $\text{Int}(\Omega_+) \cap \text{Int}(U)$ (where I is a finite or countable set). Suppose first that $\text{Fix}(h)$ is totally disconnected. Then $\text{Int}(\Omega_+)$ and $\text{Int}(U)$ are two Jordan domains whose boundary circles contain ∞ . Since $(\mathbb{S}^2 \setminus \text{Cl}(\Omega_+)) \cap (\mathbb{S}^2 \setminus \text{Cl}(U)) \neq \emptyset$ (for instance this set contains $\text{Int}(\beta)$) one deduces from a classical result of Kerékjártó (see [dK]) that each J_i is also a Jordan domain with moreover $\partial J_i \subset \partial U \cup \partial \Omega_+ \subset \{\infty\} \cup \partial_M \beta \cup \partial_M h^2(\beta) \cup \gamma \cup \omega$. However $\partial J_i \cap \Delta_- \subset \text{Cl}(\Omega_+) \cap \Delta_- = \emptyset$ and similarly $\partial J_i \cap \Delta_+ = \partial J_i \cap \Delta'_- = \partial J_i \cap \Delta'_+ = \emptyset$. Consequently one has $\partial J_i \subset \Delta_0 \cup \Delta'_0 \cup \omega \cup \gamma$ and then $\infty \notin \text{Cl}(J_i)$. Because of the condition (\mathcal{C}) there exists a sequence $(x_n)_{n \geq 0} \subset X \cap \partial_M \beta$ such that $\lim_{n \rightarrow +\infty} x_n = \infty$ hence also $\lim_{n \rightarrow +\infty} h^{-2}(x_n) = \infty$ and $h^{-2}(x_n) \in h^{-2}(\beta) \subset \text{Int}(U)$. Since $\infty \notin \text{Cl}(J_i)$ for every $i \in I$ one obtains $h^{-2}(x_n) \in \text{Int}(U) \cap \text{Int}(\Omega_-)$ for any large enough n . Therefore we get $h^{-2}(x_n) \in \text{Int}(\Omega_-) \cap h^{-2}(X) \subset \text{Int}(\Omega_-) \cap X \subset \text{Int}(\Omega_-) \cap \Omega_+ = \emptyset$ which gives the expected contradiction. If $\text{Fix}(h)$ is a circle then consider $\text{Int}(\Omega_+)$ and $\text{Int}(U)$ as Jordan domains in the one-point compactification $M_1 \cup \{\infty_1\}$ of M_1 , whose boundary circles contain ∞_1 . The same arguments give again a contradiction.

It remains to prove the existence of the brick $b \in B$ as above. We have to consider the following two cases.

Case 1. $l < +\infty$ or there exists $i \geq 1$ such that $\beta_j = \beta_i$ for infinitely many $j \geq 1$.

We define $k = l - 1$ if $l < +\infty$ and $k = i$ in the second situation. Let α be the edge distinct from α_{k-1} and from α_k such that $\sigma = v_+(\alpha_{k-1}) = v_-(\alpha_k)$ is a vertex of α . Then $b = r(\alpha)$ is a brick as required. Indeed $\{\beta_{k-1}, \beta_k\} = \{l(\alpha), b\}$ is then a connected subset of $\mathcal{R}(b) \subset B$ hence it is contained in a connected component X of $\mathcal{R}(b)$. According to Proposition 5.3, one has $h^{-2}(X) \subset X$. Since $\beta_k \in X$ the set X satisfies the condition (\mathcal{C}) . We also have $b = l(\alpha')$ for some $\alpha' \in \{\alpha_{k-1}, \alpha_k\}$ hence $\beta \in \mathcal{A}_*(b)$. Defining X' to be the connected component of $\mathcal{A}_*(b) \subset B$ containing β , we deduce from Proposition 5.3 that $h^2(X') \subset X'$.

Case 2. $l = +\infty$ and for each $i \geq 1$ one has $\beta_i = \beta_j$ for only finitely many $j \geq 1$.

In particular BR has infinite cardinality and, since $\{\beta' \in \text{BR} \mid \beta' \not\subset V\}$ is finite and contains BR_* , there exists $k_0 \geq 1$ such that $\beta_i \in \text{BR}_{**}$ and $\beta_i \subset V$ for every $i \geq k_0$. For each $\beta' \in \text{BR}_{**}$, we choose a brick $\tau_{\beta'}$ such that $\beta' \cap h^{-1}(\tau_{\beta'}) \neq \emptyset$ and $h^{-1}(\tau_{\beta'}) \cap h^{-2}(\beta) \neq \emptyset$. We then denote $\Theta = \{\tau_{\beta'} \mid \beta' \in \text{BR}_{**}\}$ and, to shorten notation, we write τ_i instead of τ_{β_i} .

For any $i \geq k_0$ we have $h(\tau_i) \cap \beta \neq \emptyset$; it follows from Lemma 5.4 that $h^{-1}(\tau_i) \cap (\beta \cup h^2(\beta)) = \emptyset$ hence $h^{-1}(\tau_i) \subset \text{Int}(D)$. We also deduce from $\beta_i \subset V$ and $h^{-2}(\beta) \subset U$ that $h^{-1}(\tau_i) \cap \gamma \neq \emptyset$, equivalently that $h(\gamma) \cap \tau_i \neq \emptyset$. Since $h(\gamma)$ is a compact subset of M , it intersects only finitely many bricks, which proves that Θ is a finite set.

We define $\Theta_1 = \{\tau \in \Theta \mid h^{-1}(\tau) \text{ meets infinitely many bricks of } \text{BR}_{**}\}$. Observe that Θ_1 is nonempty since BR_{**} is infinite but Θ is finite. Each brick of BR contains only finitely many edges α_j with $j \geq 1$ and for every $\tau \in \Theta \setminus \Theta_1$ the set $h^{-1}(\tau)$ meets

finitely many bricks of BR_{**} so there exists an integer $l_0 \geq k_0$ such that $\beta_i \in \text{BR}_{**}$ and $\tau_i \in \Theta_1$ for every $i \geq l_0$.

We first prove that there are an integer $n \geq l_0$ and a brick $\tau_* \in \Theta_1$ such that $h^{-1}(\tau_*)$ meets both β_n and β_{n+1} . We know there exists a smallest positive integer k such that $h^{-1}(\tau_{l_0}) \cap \beta_{l_0+k} \neq \emptyset$. If $k = 1$, then we are done with $n = l_0$ and $\tau_* = \tau_{l_0}$. Now suppose that $k > 1$. One can construct a circle $\mathcal{C} = \gamma_1 \cup \gamma_2$ where γ_1, γ_2 are segments as follows: γ_1 is a segment in $\partial_M \beta$ from a point $x_1 \in \alpha_{l_0}$ to a point $x_2 \in \alpha_{l_0+k}$; moreover γ_2 is another segment from x_1 to x_2 such that $\gamma_2 \setminus \{x_1, x_2\} \subset \text{Int}(D) \cap (\beta_{l_0} \cup \beta_{l_0+k} \cup h^{-1}(\tau_{l_0}))$ and $\gamma_2 \cap \partial_M h^{-1}(\tau_{l_0}) \subset \beta_{l_0} \cup \beta_{l_0+k}$. Since $\beta_{l_0+1} \cap h^{-1}(\tau_{l_0}) = \emptyset$, there is a connected component W of $\mathbb{S}^2 \setminus \mathcal{C}$ such that $\beta_{l_0+1} \subset \text{Cl}(W)$ and clearly $\Lambda_+ \cap \text{Cl}(W) \subset \bigcup_{i=l_0}^{l_0+k} \alpha_i$. Observe now that all but finitely many $\beta' \in \text{BR}_{**}$ are disjoint from $\text{Cl}(W)$ because $\alpha_i \cap \text{Cl}(W) = \emptyset$ for $i > l_0 + k$ and because the compact set $\mathcal{C} \subset M$ meets only finitely many bricks. Since $\emptyset \neq h^{-1}(\tau_{l_0+1}) \cap \beta_{l_0+1} \subset \text{Cl}(W)$ and $h^{-1}(\tau_{l_0+1}) \cap \beta' \neq \emptyset$ for infinitely many $\beta' \in \text{BR}_{**}$ it follows that necessarily $\emptyset \neq h^{-1}(\tau_{l_0+1}) \cap \mathcal{C} \subset \text{Int}(D) \cap \mathcal{C} \subset \gamma_2$. Recall that $h^{-1}(\tau_{l_0+1}) \cap \text{Int}(h^{-1}(\tau_{l_0})) = \emptyset$ because $\tau_{l_0+1} \neq \tau_{l_0}$ hence $h^{-1}(\tau_{l_0+1}) \cap (\beta_{l_0} \cup \beta_{l_0+k}) \neq \emptyset$ (as a remark, if $\beta_{l_0} = \beta_{l_0+k}$ then one can choose $\gamma_2 \subset \beta_{l_0}$ and one gets more precisely $h^{-1}(\tau_{l_0+1}) \cap \beta_{l_0} \neq \emptyset$). If $h^{-1}(\tau_{l_0+1})$ meets β_{l_0} , then we get the result with $n = l_0$ and $\tau_* = \tau_{l_0+1}$, see Fig. 5.3 right. If not (see Fig. 5.3 left) we apply this argument again replacing $(l_0, l_0 + k)$ with $(l_0 + 1, l_0 + k)$. The process will stop after finitely many steps and we get then an integer n and a brick τ_* as expected.

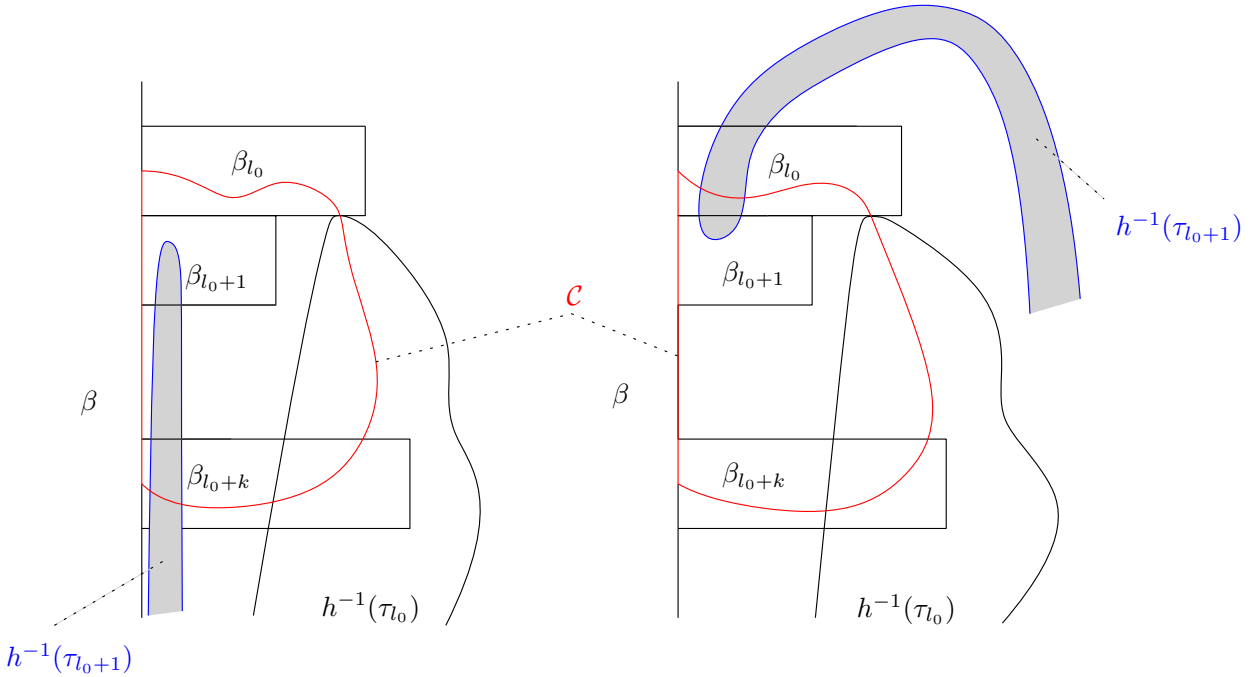

Figure 5.3 – The two ways that $h^{-1}(\tau_{l_0+1})$ can intersect β_{l_0+1}

We end the proof of this second case by checking that $b = \tau_*$ is a brick with the required properties. Since β_n and β_{n+1} are two adjacent bricks, one can define the integers $n_1, n_2 \geq 1$ in such a way that $\{n_1, n_2\} = \{n, n+1\}$ and $\beta_{n_1} \in \varphi_-^k(\{\beta_{n_2}\})$ for some

$k \in \{1, 2\}$. Since furthermore $\beta_{n_2} \in \varphi_-(\{\tau_*\})$ we get $\beta_{n_1} \in \varphi_-^k(\{\beta_{n_2}\}) \subset \varphi_-^{k+1}(\{\tau_*\})$. This implies $\beta_{n_1} \in \varphi_-(\{\tau_*\}) \cap \varphi_-^{k+1}(\{\tau_*\})$ and hence $\varphi_-(\{\tau_*\}) \cup \varphi_-^{k+1}(\{\tau_*\})$ is connected. One checks as in the proof of Proposition 5.3 that the connected component X of $\mathcal{R}_*(\tau_*)$ containing $\varphi_-(\{\tau_*\})$ is either $\mathcal{R}_*(\tau_*)$ or $\bigcup_{n \geq 0} \varphi_-^{2n+1}(\{\tau_*\})$ depending on whether $k = 1$ or $k = 2$. This implies that X is a connected subset of $\mathcal{R}(\tau_*)$ verifying $h^{-2}(X) \subset X$. Moreover $\tau_* \in \Theta_1$ hence $\varphi_-(\{\tau_*\})$ contains infinitely many bricks of BR_{**} and so does X ; this shows that X satisfies the condition (\mathcal{C}) . Observe now that $h(\tau_*) \not\subset \beta$ because otherwise $h^{-1}(\tau_*) \subset h^{-2}(\beta)$ which is impossible because $h^{-1}(\tau_*)$ meets infinitely many bricks $\beta' \in \text{BR}$ while $h^{-2}(\beta) \subset U$ meets only finitely many bricks $\beta' \in \text{BR}$. It follows from $h(\tau_*) \cap \beta \neq \emptyset$ and $h(\tau_*) \not\subset \beta$ that $h(\tau_*) \cap \partial_M \beta \neq \emptyset$ and then $h(\tau_*) \cap \beta_i \neq \emptyset$ for some integer $i \in (m, l)$. Then one has $\beta_i \in \varphi(\{\tau_*\})$. One has moreover $\beta \in \varphi^k(\{\beta_i\})$ for some $k \in \{1, 2\}$ so $\beta \in \varphi^{k+1}(\{\tau_*\})$. Thus we obtain $\beta \in \varphi(\{\tau_*\}) \cap \varphi^{k+1}(\{\tau_*\})$, and consequently $\varphi(\{\tau_*\}) \cup \varphi^{k+1}(\{\tau_*\})$ is connected. Defining X' to be the connected component of $\mathcal{A}_*(\tau_*)$ containing $\varphi(\{\tau_*\})$ we get easily that X' is either $\mathcal{A}_*(\tau_*)$ or $\bigcup_{n \geq 0} \varphi^{2n+1}(\{\tau_*\})$ (depending on whether $k = 1$ or $k = 2$) and consequently $h^2(X') \subset X'$.

(b) We suppose now $\Lambda_- \setminus \{\sigma_0\} \subset V$ and $\Lambda_+ \setminus \{\sigma_0\} \subset U$ (in the case where $\text{Fix}(h)$ is totally disconnected, this corresponds to the situation obtained by switching the roles of h and h^{-1} in Fig. 5.2). By the same argument as above with the edges $(\alpha_i)_{i \geq 1}$ replaced by the edges $(\alpha_i)_{i \leq 0}$, we can prove that there exists a brick $b' \in B$ satisfying the following properties:

- there is a connected subset K of $\mathcal{R}(b')$ such that $h^{-2}(K) \subset K$ and moreover K satisfies the following condition
 - if $m > -\infty$ then $\alpha_{m+1} \subset K$,
 - if $m = -\infty$ then $\alpha_i \subset K$ for infinitely many $i \leq 0$;
- there is a connected subset K' of $\mathcal{A}_*(b')$ such that $\beta \in K'$ and $h^2(K') \subset K'$.

This also gives a contradiction and ends the first part of the proof.

Second part. We now show that two edges $\alpha_1, \alpha_2 \in E$ such that $l(\alpha_1) = l(\alpha_2) = \beta$ cannot be separated in $\partial_M \beta$ by an edge $\alpha' \in E$ verifying $r(\alpha') = \beta$. Arguing by contradiction, suppose there exist α_1, α_2 and α' as above. As in the proof of Proposition 5.4, one checks that $\{r(\alpha_1), r(\alpha_2)\} \subset Z$ where Z is a connected component of $\varphi(\{\beta\}) \cup \varphi^2(\{\beta\})$. We choose two segments γ and γ' joining $z_1 \in \text{Int}_\Sigma(\alpha_1)$, $z_2 \in \text{Int}_\Sigma(\alpha_2)$ which are included in respectively $\text{Int}(Z)$ and $\text{Int}(\beta)$ except for their endpoints. Then $\gamma \cup \gamma' \subset M$ is a circle and moreover $(\gamma \cup \gamma') \cap \partial_M \beta = \{z_1, z_2\}$. We denote by Ω the disc bounded by $\gamma \cup \gamma'$ and containing the segment from z_1 to z_2 in $\partial_M \beta$. One has $\alpha' \subset \varphi_-^k(\{\beta\}) \cap \text{Int}(\Omega)$ for some $k \in \{1, 2\}$ and also $\varphi_-^k(\{\beta\}) \cap \partial \Omega \subset \varphi_-^k(\{\beta\}) \cap \text{Int}(\beta \cup Z) = \emptyset$ because of Lemma 5.4. Consequently we get $h^{-k}(\beta) \subset \varphi_-^k(\{\beta\}) \subset \Omega$ and then

$$\emptyset \neq (\text{Cl}(h^{-k}(\beta)) \setminus h^{-k}(\beta)) \cap \Omega = (\text{Cl}(\beta) \setminus \beta) \cap \Omega = \text{Cl}(\beta) \cap \text{Fix}(h) \cap \Omega = \text{Cl}(\partial_M \beta) \cap \text{Fix}(h) \cap \Omega = \emptyset,$$

a contradiction. This completes the proof of the proposition. \square

Proposition 5.7. *Suppose that $\beta \in B$ is a strip. Then the two connected components of $\partial_M \beta$ may be written $\Gamma = \prod_{i \in I} \alpha_i$ and $\Gamma' = \prod_{i \in I'} \alpha'_i$ where $(\alpha_i)_{i \in I}$ and $(\alpha'_i)_{i \in I'}$ are two admissible sequences of edges such that $l(\Gamma) = r(\Gamma') = \{\beta\}$.*

Proof. The proof is divided into two cases.

Case 1. $\text{Fix}(h)$ is totally disconnected.

We have $\partial_M \beta = \Gamma \sqcup \Gamma'$ where Γ, Γ' are two disjoint lines of M and furthermore $\text{Cl}(\Gamma) \setminus \Gamma = \text{Cl}(\Gamma') \setminus \Gamma' = \{a, b\}$ where a and b are two fixed points of h with possibly $a = b$.

• Assume that $a = b$. Using the notation from Section 5.2.1, Lemma 5.8 tell us that $B \setminus \{\beta\}$ has two connected components, with three possible situations:

- $X_\beta^1 = X_\beta^2 \neq X_\beta^{-1} = X_\beta^{-2}$,
- $X_\beta^2 = X_\beta^\pm \neq X_\beta^{-2}$,
- $X_\beta^{-2} = X_\beta^\pm \neq X_\beta^2$.

We only give the proof for the first two cases, the third one being the same as the second one after replacing h with h^{-1} .

i) Suppose now that $X_\beta^1 = X_\beta^2 \neq X_\beta^{-1} = X_\beta^{-2}$. The argument is similar to the one used when β is an annulus (Proposition 5.5). Let α be any edge such that $l(\alpha) = \beta$. The brick $r(\alpha)$ belongs to a connected component of $B \setminus \{\beta\}$ which contains $\varphi(\{\beta\})$ or $\varphi^2(\{\beta\})$, namely $r(\alpha) \in X_\beta^1$. Therefore α is contained in $\partial_M X_\beta^1$. Similarly if $r(\alpha) = \beta$ then $\alpha \subset \partial_M X_\beta^{-1}$.

ii) Suppose next that $X_\beta^2 = X_\beta^\pm \neq X_\beta^{-2}$. Under the hypotheses, the set $\mathbb{S}^2 \setminus \text{Cl}(\beta)$ has also two connected components, call them U and V such that $\text{Int}(X_\beta^{-2}) \subset U$ and $\text{Int}(X_\beta^2) \subset V$. The set $D = \text{Cl}(\beta) \cup U$ is a disc whose frontier is $\partial_M X_\beta^2 \cup \{a\}$. The next claim is to prove that $D \subset h^2(D)$. It follows from the inclusions $\partial_M h^{-2}(X_\beta^{-2}) = h^{-2}(\partial_M X_\beta^{-2}) \subset h^{-2}(\partial_M \beta) \subset h^{-2}(\beta) \subset X_\beta^{-2}$ and from the connectedness of X_β^{-2} that either $h^{-2}(X_\beta^{-2}) \subset X_\beta^{-2}$ or $M \setminus h^{-2}(X_\beta^{-2}) \subset X_\beta^{-2}$. If $M \setminus h^{-2}(X_\beta^{-2}) \subset X_\beta^{-2}$ it then follows from $X_\beta^\pm \neq X_\beta^{-2}$ that $h^{-1}(\beta) = h^{-2}(h(\beta)) \subset h^{-2}(X_\beta^\pm) \subset h^{-2}(M \setminus X_\beta^{-2}) = M \setminus h^{-2}(X_\beta^{-2}) \subset X_\beta^{-2}$ which is a contradiction. This shows that $h^{-2}(X_\beta^{-2}) \subset X_\beta^{-2}$ and consequently that $D \subset h^2(D)$.

One deduces from $\partial h(D) = h(\partial D) = h(\partial_M X_\beta^2 \cup \{a\}) \subset h(\beta) \cup \{a\} \subset \text{Int}(X_\beta^1) \cup \{a\}$ that $\partial h(D) \subset (\mathbb{S}^2 \setminus D) \cup \{a\}$. Thus one has either $D \subset h(D)$ or $D \cap h(D) = \{a\}$. If $D \subset h(D)$, then we have $h^{-1}(D) \subset D$ hence $h^{-1}(\beta) \subset D$ which contradicts our assumption $X_\beta^{-1} \neq X_\beta^{-2}$. Hence one has necessarily $D \cap h(D) = \{a\}$ or equivalently that $h(D) \cap h^2(D) = \{a\}$. One deduces $h^2(D) \cap h^{-1}(\beta) = \emptyset$ because $h^{-1}(\beta) = h(h^{-2}(\beta)) \subset h(D)$. Even better, we prove now that $h^2(D) \cap \varphi_-(\{\beta\}) = \emptyset$. Otherwise there exists a brick $\beta_1 \in \varphi_-(\{\beta\})$ such that $\beta_1 \cap h^2(D) \neq \emptyset$. We deduce from $h^2(D) \cap h^{-1}(\beta) = \emptyset$

that $\beta_1 \not\subset h^2(D)$. It follows that $\emptyset \neq \beta_1 \cap \partial h^2(D) \subset \beta_1 \cap h^2(\beta)$ which contradicts $\beta_1 \in \varphi_-(\{\beta\})$ by Lemma 5.4.

Let $\alpha \subset \partial_M \beta$ be an edge in E such that $r(\alpha) = \beta$. Then one has $l(\alpha) \in \varphi_-(\{\beta\}) \cup \varphi_-^2(\{\beta\})$. It follows from $\alpha \subset \beta \subset h^2(D)$ that $l(\alpha) \cap h^2(D) \neq \emptyset$. This together with $h^2(D) \cap \varphi_-(\{\beta\}) = \emptyset$ implies that $l(\alpha) \in \varphi_-^2(\{\beta\})$. One concludes that $l(\alpha) \in X_\beta^{-2}$ and hence that $\alpha \subset \partial_M X_\beta^{-2}$. If α is any edge contained $\partial_M \beta$ such that $l(\alpha) = \beta$ then $r(\alpha) \in \varphi(\{\beta\}) \cup \varphi^2(\{\beta\}) \subset X_\beta^1 = X_\beta^2$, consequently $\alpha \subset \partial_M X_\beta^2$.

- Assume now that $a \neq b$.

First we prove that Γ is an oriented line of M . Otherwise we suppose that there exist two edges $\alpha_1, \alpha_2 \in E$ included in Γ such that $l(\alpha_1) = \beta$ and $r(\alpha_2) = \beta$. Since $r(\alpha_1) \in \varphi(\{\beta\}) \cup \varphi^2(\{\beta\})$, we define X to be the connected component of $\varphi(\{\beta\}) \cup \varphi^2(\{\beta\})$ containing $r(\alpha_1)$. Consider a segment η joining a point $w_1 \in \alpha_1$ and a point $w_2 \in \text{Int}(r(\alpha_1))$ such that $\eta \setminus \{w_1\} \subset \text{Int}(r(\alpha_1))$, and thus $\eta \setminus \{w_1\} \subset \text{Int}(X)$. Since $X \cup \{a, b\}$ is connected and contains a, b ; we can join a and b by a segment $\gamma \subset \mathbb{S}^2$ which, except for its endpoints a and b , lies in $\text{Int}(X)$ such that $\gamma \cap \eta = \{w_2\}$, see Fig. 5.4. We deduce from $\beta \cap \text{Int}(X) = \emptyset$ that $\gamma \cup \Gamma$ is a circle. Define Ω the closure of a connected component of $\mathbb{S}^2 \setminus (\gamma \cup \Gamma)$ such that $\eta \subset \Omega$. It is easy to see that $\Omega \cap \beta = \Gamma$. We know that $l(\alpha_2) \in \varphi_-^k(\{\beta\})$ for some $k \in \{1, 2\}$. Moreover, by Lemma 5.4, one has

$$\partial\Omega \cap \text{Int}(\varphi_-^k(\{\beta\})) = (\gamma \cup \Gamma) \cap \text{Int}(\varphi_-^k(\{\beta\})) \subset (\text{Int}(X) \cup \{a, b\} \cup \beta) \cap \text{Int}(\varphi_-^k(\{\beta\})) = \emptyset.$$

As a consequence we get $\partial\Omega \cap \text{Int}(l(\alpha_2)) = \emptyset$, this together with $\text{Int}(l(\alpha_2)) \cap \Omega \neq \emptyset$ (since $\Omega \cap \beta = \Gamma$ and $\alpha_2 \subset \Gamma$) implies that $\text{Int}(l(\alpha_2)) \subset \Omega$. Therefore we get $\emptyset \neq \text{Int}(l(\alpha_2)) \subset \text{Int}(\varphi_-^k(\{\beta\})) \cap \Omega$ consequently $\text{Int}(\varphi_-^k(\{\beta\})) \subset \Omega$ and then $h^{-k}(\beta) \subset \varphi_-^k(\{\beta\}) \subset \Omega$. Thus $\text{Cl}(h^{-k}(\beta))$ joins a and b in Ω . On the other hand, by construction, the segment η separates a and b in Ω . This implies that $h^{-k}(\beta) \cap \eta \neq \emptyset$. In consequence $h^{-k}(\beta) \cap r(\alpha_1) \neq \emptyset$ which contradicts Lemma 5.4, see Fig. 5.4. Therefore we deduce that Γ is an oriented line of M . By the same argument, one gets also that Γ' is an oriented line of M .

Therefore we can write $\Gamma = \prod_{i \in I} \alpha_i$ and $\Gamma' = \prod_{i \in I'} \alpha'_i$ where $(\alpha_i)_{i \in I}$ and $(\alpha'_i)_{i \in I'}$ are two admissible sequences. Now we suppose that $l(\alpha_i) = l(\alpha'_j) = \beta$ for every $i \in I, j \in I'$. Let us fix an edge $\alpha \subset \Gamma$ and an edge $\alpha' \subset \Gamma'$. As in the proof of Proposition 5.4, we can find a connected component Y of $\mathcal{A}(\beta)$ containing $r(\alpha)$ and $r(\alpha')$. We join $z_1 \in \text{Int}_\Sigma(\alpha)$ to $z_2 \in \text{Int}_\Sigma(\alpha')$ by a segment γ (resp. $\hat{\gamma}$) which, except for its endpoints, lies in $\text{Int}(\beta)$ (resp. $\text{Int}(Y)$), and join a to b by a segment γ' (resp. $\hat{\gamma}'$) which, except for its endpoints, lies in $\text{Int}(\beta)$ (resp. $\text{Int}(h^{-1}(\beta))$). One can assume that the two segments γ and γ' intersect transversely in only one point. Thus we get two circles $\gamma \cup \hat{\gamma}$ and $\gamma' \cup \hat{\gamma}'$ with a unique point of transverse intersection, a contradiction. We conclude that $\partial_M \beta = \Gamma \cup \Gamma'$, with $\Gamma = \prod_{i \in I} \alpha_i$ and $\Gamma' = \prod_{i \in I'} \alpha'_i$, where $(\alpha_i)_{i \in I}$ and $(\alpha'_i)_{i \in I'}$ are admissible such that $l(\Gamma) = \{\beta\} = r(\Gamma')$.

Case 2. $\text{Fix}(h)$ is a circle.

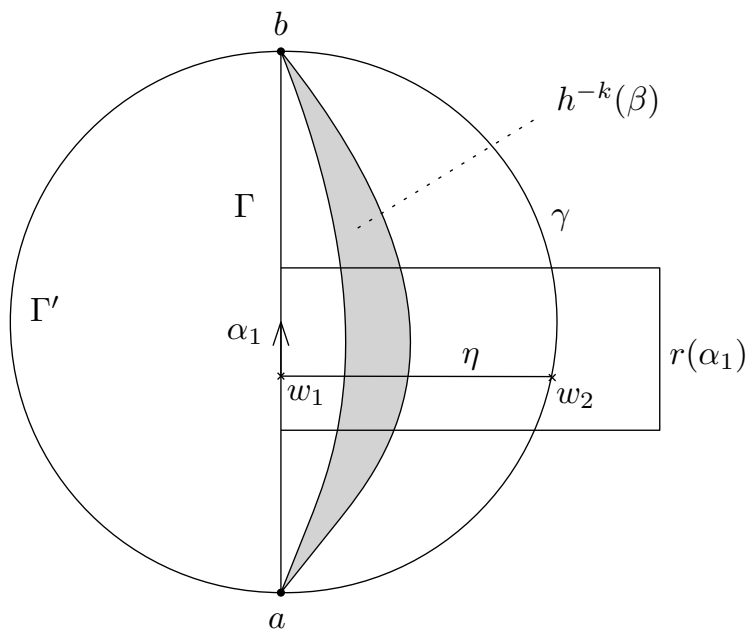
Figure 5.4 – $h^{-k}(\beta) \cap r(\alpha_1) \neq \emptyset$ is impossible

Suppose that $\beta \in B_1$ so that $B_1 \setminus \{\beta\}$ has exactly two connected components, namely X_β^2 and X_β^{-2} . Let α be an edge such that $l(\alpha) = \beta$. The brick $r(\alpha)$ is then contained in the connected component of $B_1 \setminus \{\beta\}$ which contains $\varphi^2(\{\beta\})$, namely X_β^2 . Then α is included in $\partial_M X_\beta^2$. Similarly we also get that if $r(\alpha) = \beta$ then $\alpha \subset \partial_M X_\beta^{-2}$. \square

As an easy consequence of Lemma 5.4, we also have the following proposition.

Proposition 5.8. *No vertex $\sigma \in V$ is the initial vertex or the final vertex of three edges. Consequently any vertex $\sigma \in V$ is the initial vertex or the final vertex of a single brick.*

Proof. Because \mathcal{D} is filled, each vertex σ is adjacent to three distinct edges. Suppose that σ is initial of three edges α_1, α_2 and α_3 indexed so that

$$r(\alpha_1) = l(\alpha_2) = \beta_1, r(\alpha_2) = l(\alpha_3) = \beta_2, r(\alpha_3) = l(\alpha_1) = \beta_3.$$

Thus we deduce immediately that

$$\beta_2 \in \varphi(\{\beta_1\}) \cup \varphi^2(\{\beta_1\}), \beta_3 \in \varphi(\{\beta_2\}) \cup \varphi^2(\{\beta_2\}), \beta_1 \in \varphi(\{\beta_3\}) \cup \varphi^2(\{\beta_3\}).$$

It follows that $\beta_1 \in \bigcup_{n \geq 1} \varphi^n(\{\beta_1\})$. This contradicts Lemma 5.4. \square

5.3 Construction of the foliation

5.3.1 Covering the skeleton by Brouwer manifolds

Recall that $\mathcal{D} = (V, E, B)$ is a maximal brick decomposition of M . Here we construct a set \mathcal{L} of Brouwer manifolds whose union is equal to $\Sigma(\mathcal{D})$. It follows from Lemma 5.4 that the relation \leq_0 defined on B by

$$\beta \leq_0 \beta' \text{ iff } \beta' \in \bigcup_{n \geq 0} \varphi^n(\{\beta\})$$

is antisymmetric. Clearly this relation \leq_0 is also reflexive and transitive hence it is a (partial) order on B . It is a classical consequence of the Zorn Lemma that any order on a given set can be extended to a total order hence we may consider a total order \leq on B extending \leq_0 . Such an order \leq is introduced here as a way to get easily the additional property that any two Brouwer manifolds in the set \mathcal{L} have no transverse intersection. The idea of considering a total order extending the natural dynamical order was already used by Le Calvez to simplify some of the proofs of his foliated versions of the Brouwer plane translation theorem (see [LC06a] or [LC05][Section 3]). We begin with the following simple result.

Proposition 5.9. *For any Brouwer manifold $\Gamma \subset \Sigma$ one has the following properties.*

- 1) *The two sets $R(\Gamma)$ and $L(\Gamma)$ are unions of bricks and do not have any common brick;*
- 2) *$r(\alpha) \subset R(\Gamma)$ and $l(\alpha) \subset L(\Gamma)$ for every edge $\alpha \subset \Gamma$; in other words $l(\Gamma) \subset L(\Gamma)$ and $r(\Gamma) \subset R(\Gamma)$.*

Proof. The first property is a consequence of Items (ii)-(iii) in Proposition 3.1. Thus $R(\Gamma)$ and $L(\Gamma)$ can be seen as two disjoint subsets of B . Consider now an edge $\alpha \subset \Gamma$. Then α is adjacent to two bricks β_1, β_2 and, according to Item (ii) of Proposition 3.1, one can assume $\beta_1 \in R(\Gamma)$ and $\beta_2 \in L(\Gamma)$. Since $h(R(\Gamma)) \subset \text{Int}(R(\Gamma))$ (Item (iv) of Proposition 3.1) we also have $\varphi(\{\beta_1\}) \cup \varphi^2(\{\beta_1\}) \subset \varphi(R(\Gamma)) \cup \varphi^2(R(\Gamma)) \subset R(\Gamma)$. Consequently $\beta_2 \notin \varphi(\{\beta_1\}) \cup \varphi^2(\{\beta_1\})$ and then $\beta_1 \in \varphi(\{\beta_2\}) \cup \varphi^2(\{\beta_2\})$. The definition of the orientation on the skeleton Σ gives $\beta_1 = r(\alpha)$ and $\beta_2 = l(\alpha)$. \square

Proposition 5.10. *For any $\alpha \in E$ there exists a Brouwer manifold $\Gamma(\alpha)$ such that $\alpha \subset \Gamma(\alpha) \subset \Sigma(\mathcal{D})$. Moreover $\Gamma(\alpha)$ and $\Gamma(\alpha')$ have no transverse intersection for every $\alpha, \alpha' \in E$.*

Proof. The proof is divided into two claims.

CLAIM 1. *For any $\alpha \in E$ there exists a Brouwer manifold $\Gamma(\alpha)$ such that $\alpha \subset \Gamma(\alpha) \subset \Sigma(\mathcal{D})$.*

Proof. Given $\alpha \in E$, we define $\beta = r(\alpha)$ and $\mathcal{A}(\beta) = \{\beta' \in B \mid \beta \leq \beta'\}$. It is easily seen that $\mathcal{A}(\beta)$ is an attractor containing $\{\beta\} \cup \varphi(\{\beta\})$ and moreover $l(\alpha) \notin \mathcal{A}(\beta)$ because $\beta \in \varphi(\{l(\alpha)\}) \cup \varphi^2(\{l(\alpha)\})$. Recall from Section 2.2 that $\mathcal{A}(\beta)$ is a closed subset of M and is a surface with boundary. Of course the same holds true for any connected component \mathcal{A}_* of $\mathcal{A}(\beta)$, so that a connected component Γ_* of $\partial_M \mathcal{A}_*$ is either a circle or a line of M ; observe that Γ_* is then also a connected component of $\partial_M \mathcal{A}(\beta)$. We have furthermore $h^n(\mathcal{A}(\beta)) \subset \text{Int}(\mathcal{A}(\beta))$ for every positive integer n which implies $h^n(\Gamma_*) \cap \Gamma_* = \emptyset$ as well as $h^{-n}(\Gamma_*) \cap \mathcal{A}(\beta) = h^{-n}(\Gamma_* \cap h^n(\mathcal{A}(\beta))) = \emptyset$.

Denote by \mathcal{A}_0 and \mathcal{A}_1 the connected components of $\mathcal{A}(\beta)$ such that $\beta \in \mathcal{A}_0$ and $\varphi(\{\beta\}) \subset \mathcal{A}_1$. Since $\alpha = l(\alpha) \cap \beta$ we have $\alpha \subset \partial_M \mathcal{A}_0$ and we define Γ_1 to be the connected component of $\partial_M \mathcal{A}_0$ containing α .

The set $\varphi(\mathcal{A}_0)$ is connected because of the connectedness of \mathcal{A}_0 and contains $\varphi(\{\beta\})$. This together with $\varphi(\mathcal{A}_0) \subset \varphi(\mathcal{A}(\beta)) \subset \mathcal{A}(\beta)$ implies $\varphi(\mathcal{A}_0) \subset \mathcal{A}_1$. According to Propositions 5.4-5.7 there exists an edge $\alpha' \subset \partial_M \beta$ such that $l(\alpha') = \beta$ and we consider $\beta' = r(\alpha')$. Then one has $\beta' \in \varphi^i(\{\beta\})$ for some $i \in \{1, 2\}$. If $i = 2$ (resp. $i = 1$) then $\beta \cup \varphi^2(\{\beta\})$ (resp. $\beta \cup \varphi(\{\beta\}) \cup \varphi^2(\{\beta\})$) is connected. Since these two sets are contained in $\mathcal{A}(\beta)$ we get $\varphi^2(\{\beta\}) \subset \mathcal{A}_0$. Furthermore $\varphi(\mathcal{A}_1)$ is connected, contains $\varphi^2(\{\beta\})$ and satisfies $\varphi(\mathcal{A}_1) \subset \varphi(\mathcal{A}(\beta)) \subset \mathcal{A}(\beta)$ so we deduce $\varphi(\mathcal{A}_1) \subset \mathcal{A}_0$. As a consequence one has $\varphi^2(\mathcal{A}_0) \subset \mathcal{A}_0$ and then $h^2(\mathcal{A}_0) \subset \text{Int}(\mathcal{A}_0)$.

Case 1: Γ_1 is a circle in M .

We denote $\Gamma = \Gamma_1$ and we shall show that Γ is a Brouwer manifold of type 1. We know from the Jordan curve theorem that $\mathbb{S}^2 \setminus \Gamma$ has exactly two connected components W, W' and moreover $\partial W = \partial W' = \Gamma$. One of these two connected components, say W , contains the connected set $\text{Int}(\mathcal{A}_0)$ so that $h^2(\Gamma) \subset h^2(\mathcal{A}_0) \subset \text{Int}(\mathcal{A}_0) \subset W$. We define \mathcal{R}_0 to be the connected component of $B \setminus \mathcal{A}(\beta)$ containing $l(\alpha)$. We have $\text{Int}(l(\alpha)) \subset \text{Int}(\mathcal{R}_0) \cap W'$ and also $\text{Int}(\mathcal{R}_0) \cap \partial W' = \text{Int}(\mathcal{R}_0) \cap \Gamma \subset \text{Int}(\mathcal{R}_0) \cap \mathcal{A}(\beta) = \emptyset$ because \mathcal{R}_0 and $\mathcal{A}(\beta)$ are disjoint in B , which implies that the connected set $\text{Int}(\mathcal{R}_0)$ is contained in W' . We know that $l(\alpha) \in \varphi_-^i(\{\beta\})$ for some $i \in \{1, 2\}$. If $i = 1$ (resp. $i = 2$) then $\varphi_-(\{\beta\}) \cup \varphi_-^2(\{\beta\}) = \varphi_-(\{\beta\}) \cup \varphi_-^2(\{\beta\})$ (resp. $\varphi_-^2(\{\beta\})$) is a connected subset of B containing $l(\alpha)$. Since $\varphi_-(\{\beta\}) \cup \varphi_-^2(\{\beta\}) \subset B \setminus \mathcal{A}(\beta)$ we get anyway $\varphi_-^2(\{\beta\}) \subset \mathcal{R}_0$ and consequently $h^{-2}(\alpha) \subset h^{-2}(\beta) \subset \text{Int}(\mathcal{R}_0) \subset W'$. This together with $h^{-2}(\Gamma) \cap \partial W' = h^{-2}(\Gamma) \cap \Gamma = h^{-2}(\Gamma \cap h^2(\Gamma)) = \emptyset$ implies $h^{-2}(\Gamma) \subset W'$.

Therefore the set Γ separates $h^2(\Gamma)$ and $h^{-2}(\Gamma)$ in \mathbb{S}^2 and we can construct an embedding $\varphi : \mathbb{R}^2 \setminus \{(0, 0)\} \rightarrow M$ showing that Γ is a Brouwer manifold of type 1 as in [Bon04]. The arguments are repeated here only for completeness. Let us consider the disc $D = \text{Cl}(W) = \Gamma \cup W$. Because $h^2(\Gamma) \subset W$ we have either $h^2(D) \subset W$ or $h^2(\mathbb{S}^2 \setminus W) \subset W$ and the latter is actually not possible because $h^{-2}(\partial W) = h^{-2}(\Gamma) \subset \mathbb{S}^2 \setminus W$. According to the Brouwer fixed point Theorem, h^2 possesses a fixed point $z \in W$ and this point is also fixed point of h since h has no 2-periodic point. In particular we have $h(W) \cap W \neq \emptyset$. We now deduce from $h(\Gamma) \cap \Gamma = \emptyset$ that $h(\Gamma) \subset W$.

Otherwise we would have $h(\Gamma) \subset W'$ and consequently

$$W \cap \partial h(W) = W \cap h(\Gamma) = \emptyset,$$

so $W \subset h(W) \subset h^2(W)$ which contradicts $h^2(D) \subset W$. We get similarly $h^{-1}(\Gamma) \subset W'$ replacing h, W with h^{-1}, W' . Hence one has

$$\partial W \cap h(W) = \Gamma \cap h(W) = h(h^{-1}(\Gamma) \cap W) \subset h(W' \cap W) = \emptyset.$$

This together with $W \cap h(W) \neq \emptyset$ implies that $h(W) \subset W$ and even better $h(D) \subset W$ because $h(\Gamma) \subset W$. Defining $\Omega = W \setminus h(D)$, we clearly have $\text{Cl}(\Omega) = \Gamma \cup \Omega \cup h(\Gamma) \subset M$. Let $\varphi : \mathbb{S}^1 \rightarrow \Gamma$ be a homeomorphism. It can be extended to a homeomorphism

$$\varphi : \mathbb{S}^1 \cup H(\mathbb{S}^1) \rightarrow \Gamma \cup h(\Gamma)$$

by defining $\varphi|_{H(\mathbb{S}^1)} = h \circ \varphi \circ H^{-1}|_{H(\mathbb{S}^1)}$. Using suitably the Schoenflies Theorem, one can extend again φ to a homeomorphism from the annulus $A = \{z \in \mathbb{C} \mid 1/2 \leq |z| \leq 1\}$ onto $\text{Cl}(\Omega)$. Finally, for any point $z \in \mathbb{R}^2 \setminus \{(0,0)\}$, there exists a unique $k \in \mathbb{Z}$ such that $z \in H^k(A \setminus \partial^- A)$, where $\partial^- A = \{z \in \mathbb{C} \mid |z| = 1/2\}$, and we define

$$\varphi(z) = h^k \circ \varphi \circ H^{-k}(z) \in h^k(\text{Cl}(\Omega)).$$

One checks that $\varphi : \mathcal{O} = \mathbb{R}^2 \setminus \{(0,0)\} \rightarrow M$ is a well-defined one-to-one continuous map such that $h \circ \varphi = \varphi \circ H|_{\mathcal{O}}$ and $\varphi(\mathcal{O}) = \bigcup_{k \in \mathbb{Z}} h^k(\text{Cl}(\Omega))$. This proves that $\Gamma = \varphi(\mathbb{S}^1)$ is a Brouwer manifold of type 1.

Case 2:

- $\text{Fix}(h)$ is totally disconnected;
- Γ_1 is a line of M such that $\text{Cl}(\Gamma_1) \setminus \Gamma_1 = \{a\} \subset \text{Fix}(h)$;
- the circle $\text{Cl}(\Gamma_1) = \Gamma_1 \cup \{a\}$ separates $h^{-1}(\Gamma_1)$ and $h(\Gamma_1)$ in \mathbb{S}^2 .

Here again the construction of the embedding φ is not difficult and is already present in [Bon04]. We define $\Gamma = \Gamma_1$. Let V_+ be the connected component of $\mathbb{S}^2 \setminus \text{Cl}(\Gamma)$ containing $h(\Gamma)$. Since $h(\Gamma) \subset \partial h(V_+) \cap V_+$ we have $h(V_+) \cap V_+ \neq \emptyset$ and in fact $h(V_+ \cup \Gamma) \subset V_+$ because

$$h(V_+) \cap \partial V_+ = h(V_+) \cap \text{Cl}(\Gamma) = h(V_+) \cap \Gamma = h(V_+ \cap h^{-1}(\Gamma)) = \emptyset.$$

We conclude as follows. Define $\Omega = V_+ \setminus h(\text{Cl}(V_+))$. Obviously $\text{Cl}(\Omega) \setminus \{a\} = \Gamma \cup \Omega \cup h(\Gamma) \subset M$. Using the Schoenflies Theorem, one can construct a homeomorphism

$$\varphi : \{(x, y) \in \mathbb{R}^2 \mid 0 \leq x \leq 1\} \cup \{\infty\} \rightarrow \text{Cl}(\Omega)$$

such that $\varphi(\infty) = a$, $\varphi(\{0\} \times \mathbb{R}) = \Gamma$ and $\forall y \in \mathbb{R}$

$$\varphi(1, y) = h \circ \varphi \circ G^{-1}(1, y) \in h(\Gamma).$$

Now if $k \leq x < k + 1$ ($k \in \mathbb{Z}$) we let

$$\varphi(x, y) = h^k \circ \varphi \circ G^{-k}(x, y) \in h^k(\Gamma \cup \Omega).$$

The map $\varphi : \mathcal{O} = \mathbb{R}^2 \rightarrow M$ defined in this way is a proper topological embedding, with image $\varphi(\mathcal{O}) = \bigcup_{k \in \mathbb{Z}} h^k(\Gamma \cup \Omega)$, such that $h \circ \varphi = \varphi \circ G|_{\mathcal{O}}$. This proves that $\Gamma = \varphi(\{0\} \times \mathbb{R})$ is a Brouwer manifold of type 2.

Case 3:

- $\text{Fix}(h)$ is totally disconnected;
- Γ_1 is a line of M such that $\text{Cl}(\Gamma_1) \setminus \Gamma_1 = \{a\} \subset \text{Fix}(h)$;
- the circle $\text{Cl}(\Gamma_1) = \Gamma_1 \cup \{a\}$ does not separate $h^{-1}(\Gamma_1)$ and $h(\Gamma_1)$ in \mathbb{S}^2 .

We name U, V the two connected components of $\mathbb{S}^2 \setminus \text{Cl}(\Gamma_1)$. They satisfy $\partial U = \partial V = \text{Cl}(\Gamma_1)$ and one of them, say U , contains the connected set $\text{Int}(\mathcal{A}_0)$. One proves similarly as in Case 1 that the circle $\text{Cl}(\Gamma_1)$ separates $h^{-2}(\Gamma_1)$ and $h^2(\Gamma_1)$ in \mathbb{S}^2 and afterwards that $h^2(U \cup \Gamma_1) \subset U$. Let us define $V_+ = U \setminus h^2(\text{Cl}(U))$ which is homeomorphic to $(-1, 1) \times \mathbb{R}$ and satisfies $\partial V_+ = \Gamma_1 \cup h^2(\Gamma_1) \cup \{a\}$. One also has $V_+ \cap h^2(V_+) \subset V_+ \cap h^2(U) = \emptyset$ so $V_+ \subset \mathbb{S}^2 \setminus \text{Fix}(h^2) = \mathbb{S}^2 \setminus \text{Fix}(h) = M$.

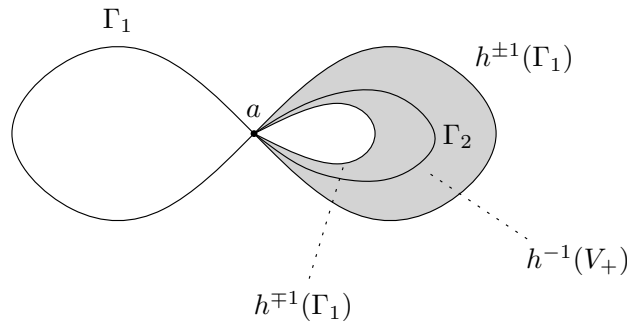

Figure 5.5 – The construction of the line Γ_2

Take two points $x_- \in h^{-1}(\Gamma_1)$ and $x_+ \in h(\Gamma_1)$. Since $h(\Gamma_1) \subset h(\mathcal{A}_0) \subset \text{Int}(\mathcal{A}_1)$ and $h^{-1}(\Gamma_1) \cap \mathcal{A}_1 \subset h^{-1}(\Gamma_1) \cap \mathcal{A}(\beta) = \emptyset$ we can choose two segments γ_-, γ_+ having respectively x_-, x_+ as an endpoint and so small that

$$\gamma_- \setminus \{x_-\} \subset h^{-1}(V_+) \setminus \mathcal{A}_1 \text{ and } \gamma_+ \setminus \{x_+\} \subset h^{-1}(V_+) \cap \text{Int}(\mathcal{A}_1) = \text{Int}_{h^{-1}(V_+)}(h^{-1}(V_+) \cap \mathcal{A}_1).$$

Therefore $\partial_{h^{-1}(V_+)}(h^{-1}(V_+) \cap \mathcal{A}_1) = h^{-1}(V_+) \cap \partial_M \mathcal{A}_1$ separates $\gamma_- \setminus \{x_-\}$ and $\gamma_+ \setminus \{x_+\}$ in $h^{-1}(V_+)$. Moreover $h^{-1}(V_+)$ is homeomorphic to \mathbb{R}^2 and $h^{-1}(V_+) \cap \partial_M \mathcal{A}_1$ is closed in $h^{-1}(V_+)$ so, according for example to [New61, Theorem 14.3], there exists a connected component Γ_2 of $h^{-1}(V_+) \cap \partial_M \mathcal{A}_1$ separating $\gamma_- \setminus \{x_-\}$ and $\gamma_+ \setminus \{x_+\}$ in $h^{-1}(V_+)$. Note that Γ_2 cannot be compact because the images of $\gamma_{\pm} \setminus \{x_{\pm}\}$ under any homeomorphism from $h^{-1}(V_+)$ onto \mathbb{R}^2 are unbounded. Furthermore Γ_2 is also a connected component of $\partial_M \mathcal{A}_1$ because $h^{\pm 1}(\Gamma_1) \cap \partial_M \mathcal{A}_1 = \emptyset$ hence Γ_2 is a line of M (as a remark, such a connected component of $\partial_M \mathcal{A}_1$ separating $\gamma_- \setminus \{x_-\}$ and $\gamma_+ \setminus \{x_+\}$ is unique, due

to the connectedness of \mathcal{A}_1). Since $V_+ \subset M$ one also gets that $\text{Cl}(\Gamma_2) = \Gamma_2 \cup \{a\}$ is a circle. One checks using the Schoenflies theorem that this circle $\text{Cl}(\Gamma_2)$ separates $h^{-1}(\Gamma_1)$ and $h(\Gamma_1)$ in \mathbb{S}^2 , which shows that Γ_1 and Γ_2 are two distinct components of $\partial_M \mathcal{A}(\beta)$ (Fig. 5.5). We now prove that $\Gamma = \Gamma_1 \sqcup \Gamma_2$ is a Brouwer manifold of type 3. We denote in the following

$$\begin{aligned} P_+ &= \{(x, y) \in \mathbb{R}^2 \mid y > 0\}, & P_- &= \{(x, y) \in \mathbb{R}^2 \mid y < 0\}, \\ \delta_1 &= \{(0, y) \in \mathbb{R}^2 \mid y > 0\}, & \delta_2 &= \{(0, y) \in \mathbb{R}^2 \mid y < 0\}, \end{aligned}$$

and τ is the translation of the plane defined by $\tau(x, y) = (x + 1, y)$. Consider the sets $d_1 = \{(x, 1/x) \in \mathbb{R}^2 \mid x > 0\}$, $d_2 = \{(x, -1/x) \in \mathbb{R}^2 \mid x > 0\}$ and write Ω for the domain between d_1 and $\tau^2(d_1)$ in the upper half-plane P_+ . Recall that $G(x, y) = (x + 1, -y)$ so that $G(d_2) = \tau(d_1) \subset \Omega$. Using the Schoenflies Theorem one can construct a homeomorphism

$$\phi : \text{Cl}(\Omega) = \text{Cl}_{\mathbb{R}^2}(\Omega) \cup \{\infty\} \rightarrow \text{Cl}(V_+)$$

such that $\phi(\infty) = a$, $\phi(d_1) = \Gamma_1$, $\phi(G(d_2)) = h(\Gamma_2) \subset V_+$ and $\phi \circ G^2|_{d_1} = h^2 \circ \phi|_{d_1}$. Then we define the map ϕ on the half-plane P_+ by observing that for every $z \in P_+$ there exists a unique even integer $2k \in \mathbb{Z}$ such that $z \in G^{2k}(d_1 \cup \Omega)$, and then defining

$$\phi(z) = h^{2k} \circ \phi \circ G^{-2k}(z) \in h^{2k}(\Gamma_1 \cup V_+).$$

In particular we have at this stage

$$h^2 \circ \phi = \phi \circ G^2|_{P_+}.$$

Next we extend ϕ on P_- by

$$\forall y < 0 \quad \phi(x, y) = h \circ \phi \circ G^{-1}(x, y) \in \bigcup_{k \in \mathbb{Z}} h^{2k+1}(\Gamma_1 \cup V_+).$$

It is easily seen that in this way we have obtained a continuous map

$$\phi : \mathcal{O} = \{(x, y) \in \mathbb{R}^2 \mid y \neq 0\} \rightarrow M$$

satisfying $h \circ \phi = \phi \circ G|_{\mathcal{O}}$ and $\phi(d_i) = \Gamma_i$ for $i \in \{1, 2\}$. Next we consider the homeomorphism $\psi : \mathcal{O} \rightarrow \mathcal{O}$ given by the formula

$$\psi(x, y) = \left(x + \frac{1}{|y|}, y \right).$$

We clearly have $\psi(\delta_i) = d_i$ for every $i \in \{1, 2\}$ and $G \circ \psi = \psi \circ G|_{\mathcal{O}}$. Defining $\varphi = \phi \circ \psi$, we get $h \circ \varphi = \varphi \circ G|_{\mathcal{O}}$ with moreover $\varphi(\delta_1 \sqcup \delta_2) = \phi(d_1) \sqcup \phi(d_2) = \Gamma$ and

$$\text{Cl}(\varphi((\{x\} \times \mathbb{R}) \cap \mathcal{O})) \setminus \varphi((\{x\} \times \mathbb{R}) \cap \mathcal{O}) = \{a\} \subset \text{Fix}(h)$$

for every $x \in \mathbb{R}$, so that $\varphi((\{x\} \times \mathbb{R}) \cap \mathcal{O})$ is a closed subset of M . We conclude by checking that φ is a one-to-one map. Since the circle $\text{Cl}(\Gamma_1)$ does not separates $h^{-1}(\Gamma_1)$ and $h(\Gamma_1)$ in the sphere, we have the following two possibilities.

- i) $h^{-1}(\Gamma_1) \cup h(\Gamma_1) \subset V$. Then $h(\Gamma_1) \subset V$ implies either $h(V) \subset V$ or $h(U) \subset V$ and the first inclusion is actually not possible since it would give $V \subset h^{-1}(V)$ which contradicts $h^{-1}(\Gamma_1) \subset V$. Hence we get $V_+ \cap h(V_+) \subset U \cap h(U) \subset U \cap V = \emptyset$.
- ii) $h^{-1}(\Gamma_1) \cup h(\Gamma_1) \subset U$. Switching the roles of U and V in the above argument, one gets $h(V) \subset U$. Since $V_+ = U \setminus h^2(\text{Cl}(U)) = h^2(V) \setminus \text{Cl}(V)$ one deduces $h^{-2}(V_+) \cap h^{-1}(V_+) \subset V \cap h(V) \subset V \cap U = \emptyset$.

Thus one obtains anyway $V_+ \cap h(V_+) = \emptyset$. According to [Bon04, Lemma 5.2], this together with $V_+ \cap h^2(V_+) = \emptyset$ implies that $h^k(V_+) \cap h^l(V_+) = \emptyset$ for any $k \neq l$. Moreover one has $h^k(\Gamma_1) \cap h^l(\Gamma_1) = \emptyset$ for any $k \neq l$ hence the sets $h^k(\Gamma_1 \cup V_+)$, where $k \in \mathbb{Z}$, are pairwise disjoint. This proves that ϕ is a one-to-one map and this also holds true for $\varphi = \phi \circ \psi$.

Case 4:

- $\text{Fix}(h)$ is totally disconnected;
- Γ_1 is a line of M such that $\text{Cl}(\Gamma_1) \setminus \Gamma_1 = \{a, b\} \subset \text{Fix}(h)$, with $a \neq b$.

Observe that $C = \Gamma_1 \cup h^2(\Gamma_1) \cup \{a, b\}$ is a circle. The two connected components of $\mathbb{S}^2 \setminus C$ are denoted by U, V with for instance $h^{-2}(\Gamma_1) \subset U$. Up to conjugacy in \mathbb{S}^2 , one may assume without loss of generality that $\text{Cl}(V)$ is the Euclidean closed unit disc in \mathbb{R}^2 with also $a = (0, -1)$, $b = (0, 1)$, $\Gamma_1 = \partial V \cap ((-\infty, 0) \times \mathbb{R})$ and $h^2(\Gamma_1) = \partial V \cap ((0, +\infty) \times \mathbb{R})$. Thus V is located on the left of $h^2(\Gamma_1)$ oriented from a to b . Since a, b are fixed points of h and since h^{-2} preserves the orientation, the set $h^{-2}(V)$ is located on the left of Γ_1 oriented from a to b and then $h^{-2}(V) \cap V = \emptyset$ (see Fig. 5.6). Hence one gets $h^2(V) \cap V = \emptyset$.

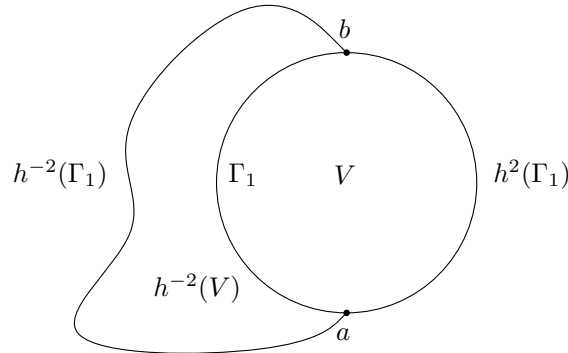

Figure 5.6 – $h^{-2}(V) \cap V = \emptyset$

Since $h^2(\Gamma_1) \subset h^2(\mathcal{A}_0) \subset \text{Int}(\mathcal{A}_0)$ and since \mathcal{A}_0 is arcwise connected, there exists a segment $\gamma \subset \mathcal{A}_0$ from a point of Γ_1 to a point of $h^2(\Gamma_1)$ and which intersects $\Gamma_1 \cup h^2(\Gamma_1)$ only at these endpoints. Then we have either $\gamma \subset \text{Cl}(U)$ or $\gamma \subset \text{Cl}(V)$. If $\gamma \subset \text{Cl}(U)$ then $\gamma \cap h^{-2}(\Gamma_1) \neq \emptyset$ because γ separates a and b in $\text{Cl}(U)$ while $\text{Cl}(h^{-2}(\Gamma_1)) = h^{-2}(\Gamma_1) \cup \{a, b\}$ joins a and b in $\text{Cl}(U)$. This is not possible since $\gamma \cap h^{-2}(\Gamma_1) \subset \mathcal{A}(\beta) \cap h^{-2}(\Gamma_1) = \emptyset$ so we obtain $\gamma \subset \text{Cl}(V)$. Next we show that $h(V) \cap V = \emptyset$ (the following arguments

already appear in [Bon04]). Arguing by contradiction, we suppose that $h(V) \cap V \neq \emptyset$. Remark that the situations $h^{\pm 1}(V) \subset V$ are not possible because $h^2(V) \cap V = \emptyset$ so one has $\emptyset \neq h(V) \cap C = h(V) \cap (\Gamma_1 \cup h^2(\Gamma_1))$ as well as $\emptyset \neq V \cap h(C) = V \cap (h(\Gamma_1) \cup h^3(\Gamma_1))$. Since $h^k(\Gamma_1) \cap h^l(\Gamma_1) \neq \emptyset$ for $k \neq l$ each set Γ_1 and $h^2(\Gamma_1)$ is either disjoint from $h(V)$ or entirely contained in $h(V)$. For the same reason, $h(\Gamma_1)$ and $h^3(\Gamma_1)$ are either disjoint from V or lie entirely in V . If $\Gamma_1 \subset h(V)$ then $h^{-1}(\text{Cl}(\Gamma_1))$ is a connected set joining a and b in $\text{Cl}(V)$ and then, since γ separates a and b in $\text{Cl}(V)$, one obtains

$$\emptyset \neq h^{-1}(\Gamma_1) \cap \gamma = h^{-1}(\Gamma_1 \cap h(\gamma)) \subset h^{-1}((\partial_M \mathcal{A}_0 \cap h(\mathcal{A}_0)) \subset h^{-1}(\partial_M \mathcal{A}(\beta) \cap \text{Int}(\mathcal{A}(\beta))) = \emptyset$$

which is absurd. Thus one gets $\Gamma_1 \cap h(V) = \emptyset$ and $h^2(\Gamma_1) \subset h(V)$. The latter inclusion also gives $h^3(\Gamma_1) \cap V = \emptyset$ since otherwise $h^3(\Gamma_1) \subset V \cap h^2(V) = \emptyset$ and it follows that $h(\Gamma_1) \subset V$, *i.e.*, $h^2(\Gamma_1) \subset h(V)$. Observe that we cannot have $\text{Cl}(V) \cup h(\text{Cl}(V)) = \mathbb{S}^2$ because this would imply $\Gamma_1 \subset h(V)$ and then $h(\Gamma_1) \subset h^2(V) \cap V = \emptyset$. Thus the whole set $\text{Cl}(V) \cup h(\text{Cl}(V))$ is contained in the domain of a single chart of \mathbb{S}^2 . In such a chart the situation is as in Fig. 5.7 and, a and b being fixed points, we obtain a contradiction with the fact that h reverses the orientation. This contradiction tells us that $h(V) \cap V = \emptyset$.

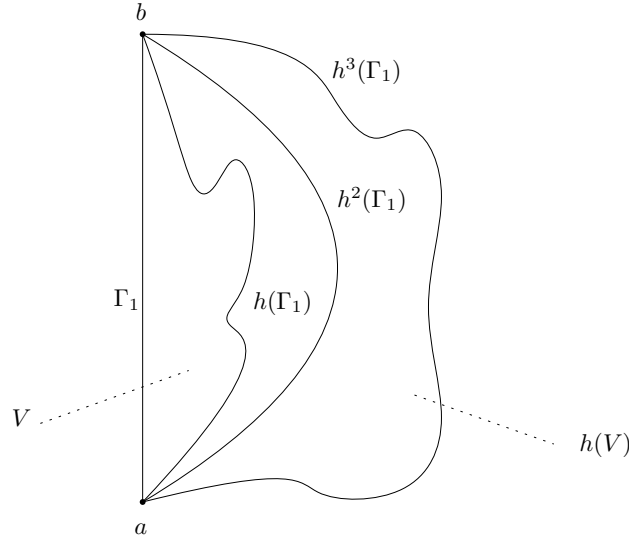

Figure 5.7 – The situation $h(\Gamma_1) \subset V$ is not possible

It follows from $h^{-1}(V) \cap V = \emptyset$ that $h^{-1}(\text{Cl}_M(V)) = h^{-1}(V) \cup h^{-1}(\Gamma_1) \cup h(\Gamma_1) \subset U$. Since $h^{-1}(\Gamma_1) \cap \mathcal{A}_1 = \emptyset$ and $h(\Gamma_1) \subset \text{Int}(\mathcal{A}_1)$ and $V \subset M$, one can find a (unique) connected component Γ_2 of $\partial_M \mathcal{A}_1$ contained in $h^{-1}(V)$ which is a line of M such that $\text{Cl}(\Gamma_2) \setminus \Gamma_2 = \{a, b\}$. The argument is similar to the one of Case 3 and we omit details here. We end by showing that $\Gamma = \Gamma_1 \sqcup \Gamma_2$ is a Brouwer manifold of type 3. We keep the notation $P_+, P_-, \delta_1, \delta_2$ as in Case 3 and we consider the homeomorphism G_1 of $\mathcal{O} = \{(x, y) \in \mathbb{R}^2 \mid y \neq 0\}$ defined by $G_1(x, y) = (x + |y|, -y)$.

Remark that $\psi : \mathcal{O} \rightarrow \mathcal{O}$ defined by $\psi(x, y) = (x|y|, y)$ is a homeomorphism of \mathcal{O} such that $G_1 \circ \psi = \psi \circ G|_{\mathcal{O}}$ with furthermore $\psi|_{\delta_i} = \text{Id}|_{\delta_i}$ for $i \in \{1, 2\}$ and

$$\forall x \in \mathbb{R} \quad \text{Cl}(\psi(\{x\} \times \mathbb{R}) \cap \mathcal{O}) \setminus (\psi(\{x\} \times \mathbb{R}) \cap \mathcal{O}) = \{(0, 0), \infty\}.$$

Denote by Ω the domain in the half-plane P_+ between δ_1 and $G_1^2(\delta_1) = \{(2y, y) \mid y > 0\}$. Clearly $G_1(\delta_2) \subset \Omega$ and using again the Schoenflies Theorem, one can construct a homeomorphism

$$\phi : \text{Cl}(\Omega) \rightarrow \text{Cl}(V)$$

such that $\phi((0, 0)) = a$, $\phi(\infty) = b$, $\phi(\delta_1) = \Gamma_1$, $\phi(G_1(\delta_2)) = h(\Gamma_2)$ and $\phi \circ G_1^2|_{\delta_1} = h^2 \circ \phi|_{\delta_1}$. For every point $z \in P_+$ there exists a unique even integer $2k \in \mathbb{Z}$ such that $z \in G_1^{2k}(\delta_1 \cup \Omega)$, and we set

$$\phi(z) = h^{2k} \circ \phi \circ G_1^{-2k}(z) \in h^{2k}(\Gamma_1 \cup V).$$

We have in this way $h^2 \circ \phi = \phi \circ G_1^2|_{P_+}$. Extending ϕ on P_- by

$$\forall y < 0 \quad \phi(x, y) = h \circ \phi \circ G_1^{-1}(x, y) \in \bigcup_{k \in \mathbb{Z}} h^{2k+1}(\Gamma_1 \cup V),$$

we obtain a continuous map ϕ defined on \mathcal{O} and such that $h \circ \phi = \phi \circ G_1|_{\mathcal{O}}$. Using $h(V) \cap V = \emptyset = h^2(V) \cap V$ and [Bon04, Lemma 5.2] we get that $h^k(\Gamma_1 \cup V) \cap h^l(\Gamma_1 \cup V) = \emptyset$ for $k \neq l$ which ensures that ϕ is a one-to-one map. Next we define $\varphi = \phi \circ \psi : \mathcal{O} \rightarrow M$. We have $h \circ \varphi = \varphi \circ G|_{\mathcal{O}}$ and φ is a one-to-one map because so is ϕ . Moreover one has

$$\forall x \in \mathbb{R} \quad \text{Cl}(\varphi(\{x\} \times \mathbb{R}) \cap \mathcal{O}) \setminus (\varphi(\{x\} \times \mathbb{R}) \cap \mathcal{O}) = \{a, b\} \subset \text{Fix}(h).$$

Hence $\varphi(\{x\} \times \mathbb{R}) \cap \mathcal{O}$ is a closed subset of M for every $x \in \mathbb{R}$. By construction, one has $\Gamma_1 = \phi(\delta_1)$ and $\phi \circ G_1|_{\mathcal{O}} = h \circ \phi$ also gives $\Gamma_2 = \phi(\delta_2)$, which shows that $\Gamma = \phi(\delta_1 \sqcup \delta_2)$ is a Brouwer manifold of h of type 3.

Case 5: $\text{Fix}(h)$ is a circle.

Recall that $M = M_1 \sqcup M_2$. The planes M_1 and M_2 are compactified by adding one point at infinity ∞' . Repeating the argument in Case 3 with a replaced by ∞' , we can find a line Γ_2 of M such that $\Gamma = \Gamma_1 \sqcup \Gamma_2$ is a Brouwer manifold of h of type 3. \square

Therefore for each edge $\alpha \in E$, we have constructed a Brouwer manifold $\Gamma = \Gamma(\alpha) \subset \Sigma(\mathcal{D})$ such that $\alpha \subset \Gamma(\alpha)$.

CLAIM 2. *For every $\alpha, \alpha' \in E$, the two Brouwer manifolds $\Gamma(\alpha), \Gamma(\alpha')$ have no transverse intersection.*

Proof. We keep the notations $\mathcal{A}(r(\alpha)), \mathcal{A}_0$ and \mathcal{A}_1 for the brick $r(\alpha)$ as in the proof of Claim 1, and we define analogously the notations $\mathcal{A}(r(\alpha')), \mathcal{A}'_0$ and \mathcal{A}'_1 for the brick $r(\alpha')$. For simplicity, we write $\Gamma = \Gamma(\alpha)$ and $\Gamma' = \Gamma(\alpha')$. Suppose without loss of generality that $r(\alpha) \leq r(\alpha')$ and then one has $\mathcal{A}(r(\alpha')) \subset \mathcal{A}(r(\alpha))$.

We now prove that \mathcal{A}'_k does not meet both $R(\Gamma)$ and $L(\Gamma)$, considered as subsets of B , for every $k \in \{0, 1\}$. Otherwise there exists an edge $e \subset \Gamma$ such that $l(e) \in \mathcal{A}'_k \cap L(\Gamma)$ because of the connectedness of \mathcal{A}'_k . Moreover it is clear that $l(e) \notin \mathcal{A}(r(\alpha))$. This gives a contradiction because $\mathcal{A}'_k \subset \mathcal{A}(r(\alpha')) \subset \mathcal{A}(r(\alpha))$.

Next we prove that $\mathcal{A}'_0 \cup \mathcal{A}'_1$ is included either in $R(\Gamma)$ or in $L(\Gamma)$, which completes the proof of Claim 2. Otherwise one supposes that $\mathcal{A}'_k \subset R(\Gamma)$ and $\mathcal{A}'_l \subset L(\Gamma)$ where $\{k, l\} = \{0, 1\}$. It follows that

$$\emptyset \neq h(\mathcal{A}'_k) \subset h(R(\Gamma)) \cap \mathcal{A}'_l \subset \text{Int}(R(\Gamma)) \cap L(\Gamma)$$

which contradicts Proposition 3.1. □

The proof of Proposition 5.10 is now completed. □

5.3.2 Construction of an oriented topological quasi-foliation

We first endow the set \mathcal{L}_Σ of all the Brouwer manifolds lying in the skeleton Σ with a natural topology. Let us denote $\mathcal{E} = (E \sqcup \{\infty\})^{\mathbb{Z}} / \delta^1$ where $\delta : (x_j)_{j \in \mathbb{Z}} \mapsto (x_{j+1})_{j \in \mathbb{Z}}$ is the shift map and $\mathcal{M} = \mathcal{E}^2 / \sim$ where \sim is the equivalence relation defined by $(a, b) \sim (b, a)$. Thus \mathcal{M} is nothing but a convenient way to represent the set of all the subsets of \mathcal{E} having cardinality one or two. We now define a map $\Psi : \mathcal{L}_\Sigma \rightarrow \mathcal{M}$ as follows:

- If $\Gamma \subset \Sigma$ is a Brouwer manifold of type 1 then it is a circle and, according to Proposition 5.9, it may be written $\Gamma = \prod_{i \in I} e_i$ where I is a nonempty finite \mathbb{Z} -interval and $(e_i)_{i \in I}$ is an admissible sequence of edges. Then we consider the periodic sequence $X = (x_j)_{j \in \mathbb{Z}} \in E^{\mathbb{Z}}$ defined by $x_j = e_i$ iff $j = i \pmod{\sharp(I)}$ where $\sharp(I)$ is the cardinality of I . Note that the projection \bar{X} of X in \mathcal{E} depends only on Γ and not on the choice of I hence we may define $\Psi(\Gamma)$ as the projection in \mathcal{M} of the pair $(\bar{X}, \bar{X}) \in \mathcal{E}^2$.

- If $\Gamma \subset \Sigma$ is a Brouwer manifold of type 2 then it is a line of M and, using again Proposition 5.9, one has $\Gamma = \prod_{i \in I} e_i$ for some nonempty \mathbb{Z} -interval I and some admissible sequence of edges. Here I may be unbounded from above or/and unbounded from below and we define a sequence $X = (x_j)_{j \in \mathbb{Z}} \in (E \sqcup \{\infty\})^{\mathbb{Z}}$ by $x_j = e_j$ if $j \in I$ and $x_j = \infty$ if $j \in \mathbb{Z} \setminus I$. Here again the projection \bar{X} of X in \mathcal{E} depends only on Γ and we define $\Psi(\Gamma)$ exactly as for a Brouwer manifold of type 1.

- If finally $\Gamma \subset \Sigma$ is a Brouwer manifold of type 3 then its two connected components Γ_1, Γ_2 are two lines of M . Proposition 5.9 ensures that $\Gamma_1 = \prod_{i \in I_1} e_i$ and $\Gamma_2 = \prod_{i \in I_2} e'_i$ where I_1, I_2 are nonempty \mathbb{Z} -intervals and where $(e_i)_{i \in I_1}, (e'_i)_{i \in I_2}$ are two admissible sequences of edges. Then we consider the two sequences $X_1 = (x_j)_{j \in \mathbb{Z}}$ and $X_2 = (x'_j)_{j \in \mathbb{Z}}$ in $(E \sqcup \{\infty\})^{\mathbb{Z}}$ defined by

$$x_j = e_j \quad \text{if } j \in I_1 \text{ and } x_j = \infty \text{ if } j \in \mathbb{Z} \setminus I_1$$

1. The symbol ∞ here is not related to the symbol ∞ used for the one-point compactification $\mathbb{S}^2 = \mathbb{R}^2 \cup \{\infty\}$.

$$x'_j = e'_j \quad \text{if } j \in I_2 \text{ and } x'_j = \infty \text{ if } j \in \mathbb{Z} \setminus I_2.$$

Since the projection $\overline{X_i}$ of X_i in \mathcal{E} does not depend on the choice of I_i ($i \in \{1, 2\}$) we can define $\Psi(\Gamma)$ as the projection in \mathcal{M} of the pair $(\overline{X_1}, \overline{X_2}) \in \mathcal{E}^2$.

One checks that $\Psi : \mathcal{L}_\Sigma \rightarrow \mathcal{M}$ so constructed is a one-to-one map hence \mathcal{L}_Σ may be identified with its image $\Psi(\mathcal{L}_\Sigma) \subset \mathcal{M}$. Now $E \sqcup \{\infty\}$ is equipped with the discrete topology and $(E \sqcup \{\infty\})^\mathbb{Z}$ with the product topology. Then \mathcal{E} , \mathcal{E}^2 and \mathcal{M} are successively endowed with their natural (quotient and product) topologies and \mathcal{L}_Σ is topologized as a subset of \mathcal{M} . This topology on \mathcal{M} is denoted by Top and $\text{Top}|_{\mathcal{X}}$ is the topology it induces on a set $\mathcal{X} \subset \mathcal{M}$.

Proposition 5.10 provides a finite or countable set $\mathcal{L} = \{\Gamma(\alpha)\}_{\alpha \in E} \subset \mathcal{L}_\Sigma$ where $\alpha \subset \Gamma(\alpha)$ for every $\alpha \in E$. We define $\mathcal{L}_\Sigma(\alpha)$ to be the set of all Brouwer manifolds of \mathcal{L}_Σ containing α . We write $\mathcal{L}^* = \text{Cl}_{\mathcal{L}_\Sigma}(\mathcal{L})$ and $\mathcal{L}^*(\alpha) = \mathcal{L}^* \cap \mathcal{L}_\Sigma(\alpha)$. As an important remark, observe that the subset of $\mathcal{L}_\Sigma \times \mathcal{L}_\Sigma$ containing the pairs of Brouwer manifolds having no transverse intersection is closed in $\mathcal{L}_\Sigma \times \mathcal{L}_\Sigma$. Consequently any two Brouwer manifolds of \mathcal{L}^* have no transverse intersection.

Proposition 5.11. *For every $\alpha \in E$, the set $\mathcal{L}^*(\alpha)$ endowed with the topology $\text{Top}|_{\mathcal{L}^*(\alpha)}$ is compact.*

Proof. It is splitted into the following two claims.

CLAIM 1. *For any $\alpha \in E$, there exist finitely many edges $\alpha_1, \dots, \alpha_n \in E \setminus \{\alpha\}$ such that for every Brouwer manifold $\Gamma \in \mathcal{L}^*(\alpha)$ of type 3, the connected component of Γ which does not contain α contains α_i for some $1 \leq i \leq n$.*

Proof. Let $\beta = r(\alpha)$. We know that $\beta = l(\alpha')$ for some $\alpha' \in E$ (Propositions 5.4-5.7) so either $\{\beta\} \cup \varphi(\{\beta\}) \cup \varphi^2(\{\beta\})$ or $\{\beta\} \cup \varphi^2(\{\beta\})$ is connected. Hence we can join a point $x \in \alpha \subset \beta$ and its image $h^2(x) \in h^2(\beta) \subset \varphi^2(\{\beta\})$ by a segment $\gamma \subset \{\beta\} \cup \varphi(\{\beta\}) \cup \varphi^2(\{\beta\})$. The compact set $h^{-1}(\gamma) \subset M$ meets only finitely many edges, which are denoted by $(\alpha_i)_{1 \leq i \leq n}$. Suppose now that $\Gamma = \Gamma_1 \sqcup \Gamma_2 \in \mathcal{L}^*(\alpha)$ is a Brouwer manifold of type 3 with for instance $\alpha \subset \Gamma_1$. According to Item 2) of Proposition 5.9 one has $\beta \in R(\Gamma)$ so, using Proposition 3.1 (iii), one also gets $\gamma \subset R(\Gamma)$. It follows from the description of $R(\Gamma)$ and $L(\Gamma)$ given in the proof of Proposition 3.1 that $\gamma \cap h(\Gamma_2) \neq \emptyset$ or, equivalently, that $h^{-1}(\gamma) \cap \Gamma_2 \neq \emptyset$. Hence Γ_2 contains α_i for some $1 \leq i \leq n$. This completes the proof of the claim. \square

CLAIM 2. *For any $\alpha' \in E$, denote by $\mathcal{S}(\alpha')$ the set of all the sequences $(x_i)_{i \in \mathbb{Z}} \in (E \cup \{\infty\})^\mathbb{Z}$ satisfying $x_0 = \alpha'$ and obtained from a connected Brouwer manifold or from a connected component of a Brouwer manifold of type 3 as explained at the beginning of this Section 5.3.2. Then $\mathcal{S}(\alpha')$ is a compact subset of $(E \cup \{\infty\})^\mathbb{Z}$.*

Proof. For every $e \in E$, there exist at most two edges whose initial vertices are $v_+(e)$ and at most two edges whose final vertices are $v_-(e)$ hence a set $\mathcal{S}(\alpha')$ may be written as a (countable) product of finite subsets of $E \cup \{\infty\}$. \square

According to Claim 1, one has

$$\mathcal{L}^*(\alpha) = \bigcup_{0 \leq i \leq n} \mathcal{L}_i$$

where \mathcal{L}_0 is the set of all the connected Brouwer manifolds in $\mathcal{L}^*(\alpha)$ and, for $1 \leq i \leq n$, \mathcal{L}_i is the set of all the Brouwer manifolds Γ of type 3 in $\mathcal{L}^*(\alpha)$ such that a connected component of Γ contains α and the other one contains α_i . Following Claim 2, each set \mathcal{L}_i is the image by a continuous map of a compact subset of $((E \cup \{\infty\})^{\mathbb{Z}})^2$ hence it is compact and so is $\mathcal{L}^*(\alpha)$. \square

For two Brouwer manifolds Γ and Γ' of h , we write $\Gamma \preceq \Gamma'$ iff $R(\Gamma) \subset R(\Gamma')$. One checks using Proposition 3.1 that \preceq defines an order on the set of all the Brouwer manifolds of h . Firstly we will be interested with the restriction of \preceq to \mathcal{L}^* and to the sets $\mathcal{L}^*(\alpha)$, $\alpha \in E$. One defines naturally the “open intervals” in these ordered sets: given Γ and Γ' in \mathcal{L}^* one lets

$$(\Gamma, \Gamma') = \{\Gamma'' \in \mathcal{L}^* \mid \Gamma \prec \Gamma'' \prec \Gamma'\}, \quad (\leftarrow, \Gamma) = \{\Gamma'' \in \mathcal{L}^* \mid \Gamma'' \prec \Gamma\}$$

and $(\Gamma, \rightarrow) = \{\Gamma'' \in \mathcal{L}^* \mid \Gamma \prec \Gamma''\}$. If furthermore $\{\Gamma, \Gamma'\} \subset \mathcal{L}^*(\alpha)$ for some $\alpha \in E$ then one also defines $(\Gamma, \Gamma')_{\mathcal{L}^*(\alpha)} = (\Gamma, \Gamma') \cap \mathcal{L}^*(\alpha)$ and likewise $(\leftarrow, \Gamma)_{\mathcal{L}^*(\alpha)}$ and $(\Gamma, \rightarrow)_{\mathcal{L}^*(\alpha)}$.

Thought \preceq is not a total order one has the following result.

Lemma 5.9. *Let $\alpha \in E$. The restriction of the order \preceq to $\mathcal{L}^*(\alpha)$ is total.*

Proof. Let Γ, Γ' be two Brouwer manifolds in $\mathcal{L}^*(\alpha)$. Observe that the two sets $R(\Gamma) \cap R(\Gamma')$ and $L(\Gamma) \cap L(\Gamma')$ are nonempty because they contain respectively $r(\alpha)$ and $l(\alpha)$ (Proposition 5.9). Since Γ and Γ' have no intersection transverse, one of the following two inclusions $\Gamma \subset R(\Gamma')$ or $\Gamma \subset L(\Gamma')$ is true.

Suppose first that $\Gamma \subset R(\Gamma')$. According to Proposition 3.3, one has either $R(\Gamma) \subset R(\Gamma')$ or $L(\Gamma) \subset R(\Gamma')$. The second inclusion implies $l(\alpha) \in L(\Gamma) \cap L(\Gamma') \subset R(\Gamma') \cap L(\Gamma')$ which contradicts Item (i) of Proposition 3.1 and the first one gives $\Gamma \preceq \Gamma'$.

Suppose now that $\Gamma \subset L(\Gamma')$. Changing the roles of “the right side” and “the left side” in the above argument, one gets $L(\Gamma) \subset L(\Gamma')$ and then $R(\Gamma') \subset R(\Gamma)$ which shows $\Gamma' \preceq \Gamma$. \square

We denote by $\text{Top}_{\preceq}(\mathcal{L}^*(\alpha))$ the order topology on $\mathcal{L}^*(\alpha)$. The result proved in the next part is the following.

Proposition 5.12. *For every edge $\alpha \in E$, there exists an increasing homeomorphism from the ordered topological space $(\mathcal{L}^*(\alpha), \text{Top}|_{\mathcal{L}^*(\alpha)}, \preceq)$ onto a compact subset of \mathbb{R} . In particular $(\mathcal{L}^*(\alpha), \preceq)$ possesses a smallest and a largest element denoted respectively by Γ_α^- and Γ_α^+ .*

We begin with the following lemma.

Lemma 5.10. *Let $\alpha \in E$. The topology $\text{Top}_{\preceq}(\mathcal{L}^*(\alpha))$ is smaller than the topology $\text{Top}|_{\mathcal{L}^*(\alpha)}$.*

Proof. It is enough to show that the open intervals of the ordered set $(\mathcal{L}^*(\alpha), \preceq)$ belong to the topology $\text{Top}|_{\mathcal{L}^*(\alpha)}$. We write a proof only for a nonempty interval $(\Gamma, \Gamma')_{\mathcal{L}^*(\alpha)}$, similar arguments also hold for intervals $(\leftarrow, \Gamma)_{\mathcal{L}^*(\alpha)}$ and $(\Gamma, \rightarrow)_{\mathcal{L}^*(\alpha)}$. Take $\Gamma'' \in (\Gamma, \Gamma')_{\mathcal{L}^*(\alpha)}$. Since $\Gamma \prec \Gamma''$, there exists an edge $\alpha_1 \subset \Gamma''$ such that $\text{Int}_\Sigma(\alpha_1) \subset \text{Int}(L(\Gamma))$. Likewise $\Gamma'' \prec \Gamma'$ implies that there exists an edge $\alpha_2 \subset \Gamma''$ such that $\text{Int}_\Sigma(\alpha_2) \subset \text{Int}(R(\Gamma'))$. Let $U = \mathcal{L}^*(\alpha) \cap \mathcal{L}_\Sigma(\alpha_1) \cap \mathcal{L}_\Sigma(\alpha_2)$, which is an open neighborhood of Γ'' in $\mathcal{L}^*(\alpha)$ since $\mathcal{L}_\Sigma(\alpha_i)$ is an open subset of \mathcal{L}_Σ for every $i \in \{1, 2\}$. For any $\Upsilon \in U$ we have $\Upsilon \prec \Gamma'$ because $\text{Int}_\Sigma(\alpha_2) \subset \Upsilon \cap \text{Int}(R(\Gamma'))$ and also $\Gamma \prec \Upsilon$ because $\text{Int}_\Sigma(\alpha_1) \subset \Upsilon \cap \text{Int}(L(\Gamma))$. Hence $U \subset (\Gamma, \Gamma')_{\mathcal{L}^*(\alpha)}$ and consequently $(\Gamma, \Gamma')_{\mathcal{L}^*(\alpha)}$ belongs to $\text{Top}|_{\mathcal{L}^*(\alpha)}$. \square

Lemma 5.11. *Let $\alpha \in E$. Then $\mathcal{L}(\alpha)$ is a dense subset of $(\mathcal{L}^*(\alpha), \text{Top}|_{\mathcal{L}^*(\alpha)})$.*

Proof. Let $\Gamma \in \mathcal{L}^*(\alpha) = \mathcal{L}^* \cap \mathcal{L}_\Sigma(\alpha)$. Given a neighborhood N of Γ in $\mathcal{L}^*(\alpha)$, we shall check that $N \cap \mathcal{L}(\alpha) \neq \emptyset$. One has $N = \mathcal{L}^*(\alpha) \cap N'$ where N' is a neighborhood of Γ in \mathcal{L}_Σ . Since $\mathcal{L}_\Sigma(\alpha)$ is also a neighborhood of Γ in \mathcal{L}_Σ one can replace N' with $N' \cap \mathcal{L}_\Sigma(\alpha)$ and assume without loss of generality that $N' \subset \mathcal{L}_\Sigma(\alpha)$. This gives $N \cap \mathcal{L}(\alpha) = N' \cap \mathcal{L}$ and the latter set is nonempty because $\Gamma \in \mathcal{L}^*$. \square

Proof of Proposition 5.12. Since \mathcal{L} is at most countable so is $\mathcal{L}(\alpha)$. Lemmas 5.10-5.11 tell us that $\mathcal{L}(\alpha)$ is a dense subset of $(\mathcal{L}^*(\alpha), \text{Top}_{\preceq}(\mathcal{L}^*(\alpha)))$ so that this topological set is separable.

If Γ, Γ' are two Brouwer manifolds in $\mathcal{L}^*(\alpha)$ such that $\Gamma \prec \Gamma'$ and $(\Gamma, \Gamma')_{\mathcal{L}^*(\alpha)} = \emptyset$ then one says that Γ (resp. Γ') is the *immediate predecessor* (resp. *immediate successor*) of Γ' (resp. Γ). We define S to be the set of all the Brouwer manifolds in $\mathcal{L}^*(\alpha)$ which are the immediate successor of some element of $\mathcal{L}^*(\alpha)$. For $\Gamma \in S$ which is the immediate successor of Γ' , one can choose an edge $\alpha_\Gamma \subset \Gamma$ such that $\text{Int}_\Sigma(\alpha_\Gamma) \subset \text{Int}(L(\Gamma'))$. This provides a map $\chi : S \rightarrow E$, $\chi(\Gamma) = \alpha_\Gamma$ which is one-to-one. Indeed, suppose that $\Gamma_1 \prec \Gamma_2$ in S are such that $\chi(\Gamma_1) = \chi(\Gamma_2)$. Consider the

immediate predecessor Γ'_2 of Γ_2 . One has $\text{Int}_\Sigma(\chi(\Gamma_1)) = \text{Int}_\Sigma(\chi(\Gamma_2)) \subset \Gamma_1 \cap \text{Int}(L(\Gamma'_2))$ which implies $\Gamma'_2 \prec \Gamma_1$ and then $\Gamma'_2 \prec \Gamma_1 \prec \Gamma_2$, a contradiction. Consequently S is at most countable because so is E . One checks similarly that the set of all the Brouwer manifolds in $\mathcal{L}^*(\alpha)$ which are an immediate predecessor is also at most countable. Following [Cat00, Lemma 3], the topological space $(\mathcal{L}^*(\alpha), \text{Top}_\preceq(\mathcal{L}^*(\alpha)))$ is second countable and [Cat00, Theorem II] tells us that there exists an order preserving homeomorphism f from $(\mathcal{L}^*(\alpha), \text{Top}_\preceq(\mathcal{L}^*(\alpha)))$ onto a subspace of \mathbb{R} . By Lemma 5.10, f is also a continuous as a map from $(\mathcal{L}^*(\alpha), \text{Top}|_{\mathcal{L}^*(\alpha)})$ into \mathbb{R} . Recall from Proposition 5.11 that the topological space $(\mathcal{L}^*(\alpha), \text{Top}|_{\mathcal{L}^*(\alpha)})$ is compact therefore one deduces that f is an increasing homeomorphism from $(\mathcal{L}^*(\alpha), \text{Top}|_{\mathcal{L}^*(\alpha)})$ onto its image $f(\mathcal{L}^*(\alpha)) \subset \mathbb{R}$. By the way, this also proves that the topologies $\text{Top}|_{\mathcal{L}^*(\alpha)}$ and $\text{Top}_\preceq(\mathcal{L}^*(\alpha))$ are the same. \square

Following Le Calvez ([LC04]), we say that a Brouwer manifold $\Gamma \in \mathcal{L}^*$ is *isolated from the right* (resp. *from the left*) if there is no sequence $(\Gamma_n)_{n \geq 0}$ in \mathcal{L}^* converging to Γ (for the topology $\text{Top}|_{\mathcal{L}^*}$) and satisfying $\Gamma \prec \Gamma_n$ (resp. $\Gamma_n \prec \Gamma$) for every $n \in \mathbb{N}$.

Lemma 5.12. *Let Γ, Γ' be two Brouwer manifolds of type 3 having a common connected component. Suppose moreover that $\Gamma \preceq \Gamma'$. Then one has*

$$h(R(\Gamma')) \subset \text{Int}(R(\Gamma)) \text{ and } h^{-1}(L(\Gamma)) \subset \text{Int}(L(\Gamma')).$$

Proof. First let us check $h(R(\Gamma')) \subset \text{Int}(R(\Gamma))$. Denote by θ the common connected component of Γ and Γ' . One writes Γ'_1 for the other connected component of Γ' , so that $\Gamma' = \theta \sqcup \Gamma'_1$. Define $S \subset M$ to be the strip with frontier $\partial_M S = \theta \sqcup h^2(\theta)$ such that $S \subset R(\Gamma) \subset R(\Gamma')$. Since Γ' is a Brouwer manifold of type 3 one has $h(\Gamma'_1) \subset \text{Int}(S)$ and therefore $h(\Gamma') = h(\theta) \cup h(\Gamma'_1) \subset h(\Gamma) \cup h(\Gamma'_1) \subset \text{Int}(R(\Gamma))$. Since Γ' is a Brouwer manifold, its image $h(\Gamma')$ is also a Brouwer manifold with $R(h(\Gamma')) = h(R(\Gamma'))$ and $L(h(\Gamma')) = h(L(\Gamma'))$. Then one deduces from Proposition 3.3 that either $h(R(\Gamma')) \subset \text{Int}(R(\Gamma))$ or $h(L(\Gamma')) \subset \text{Int}(R(\Gamma))$. The second inclusion gives $L(\Gamma) \subset h(R(\Gamma'))$. Since $L(\Gamma') \subset L(\Gamma)$ this also implies that

$$L(\Gamma') \subset h(\text{Int}(L(\Gamma'))) \cap h(R(\Gamma')) = h(\text{Int}(L(\Gamma')) \cap R(\Gamma')) = \emptyset,$$

a contradiction which proves the expected inclusion $h(R(\Gamma')) \subset \text{Int}(R(\Gamma))$.

Switching the letters $R(\cdot)$ and $L(\cdot)$, the homeomorphisms h and h^{-1} , the Brouwer manifolds Γ and Γ' one also gets $h^{-1}(L(\Gamma)) \subset \text{Int}(L(\Gamma'))$. \square

Proposition 5.13. *A Brouwer manifold $\Gamma \in \mathcal{L}^*$ is isolated from the right (resp. from the left) if and only if there exists $\alpha \in E$ such that $\Gamma = \Gamma_\alpha^+$ (resp. $\Gamma = \Gamma_\alpha^-$).*

Proof. We only prove the result for Brouwer manifolds isolated from the right, the case of the Brouwer manifolds isolated from the left being similar. For any $\alpha \in E$,

the Brouwer manifold Γ_α^+ is isolated from the right because $\mathcal{L}^*(\alpha)$ is a neighborhood of Γ_α^+ in \mathcal{L}^* . We now prove the converse implication. Consider a Brouwer manifold $\Gamma \in \mathcal{L}^*$. We write $\Gamma = \Gamma_1 \cup \Gamma_2$ with the convention that $\Gamma_1 = \Gamma_2 = \Gamma$ if Γ is connected (*i.e.*, if Γ has type 1 or 2) and Γ_1, Γ_2 are the two connected components of Γ otherwise.

CLAIM 1. *For $i \in \{1, 2\}$, if Γ_i is the union of finitely many edges then Γ_i is a connected component of Γ_α^+ for some edge $\alpha \subset \Gamma_i$.*

Proof. Because Γ_i contains finitely many edges, there exists an edge $\alpha_0 \subset \Gamma_i$ such that there is no edge $\alpha \subset \Gamma_i$ satisfying $\Gamma_\alpha^+ \prec \Gamma_{\alpha_0}^+$. We write

$$\Gamma_i = \prod_{l \leq k \leq m} \alpha_k,$$

where $-\infty < l \leq 0 \leq m < +\infty$. We first prove that $\alpha_k \subset \Gamma_{\alpha_0}^+$ for every $0 \leq k \leq m$. Suppose $m \geq 1$ and let us prove that $\alpha_1 \subset \Gamma_{\alpha_0}^+$. Define α to be the edge different from α_0 and α_1 and possessing $\sigma = v_+(\alpha_0)$ as a vertex. If $v_+(\alpha) = \sigma$ then it is clear that $\alpha_1 \subset \Gamma_{\alpha_0}^+$. Assume that $v_-(\alpha) = \sigma$. One has the following two cases.

- If $r(\alpha_1) = l(\alpha)$ then also $r(\alpha_0) = r(\alpha)$ and one gets $\alpha_1 \subset \Gamma_{\alpha_0}^+$ because otherwise $\alpha \subset \Gamma_{\alpha_0}^+$ and it follows that $\Gamma_{\alpha_0}^+ \prec \Gamma$ in $\mathcal{L}^*(\alpha_0)$ which contradicts the maximality of $\Gamma_{\alpha_0}^+$ in $\mathcal{L}^*(\alpha_0)$.
- If $l(\alpha_1) = r(\alpha)$ then also $l(\alpha_0) = l(\alpha)$ and one gets $\alpha_1 \subset \Gamma_{\alpha_0}^+$ because otherwise $\alpha \subset \Gamma_{\alpha_0}^+$ so $\Gamma_{\alpha_1}^+ \prec \Gamma_{\alpha_0}^+$ which contradicts the hypothesis on α_0 .

Assuming inductively $\alpha_0 \cup \dots \cup \alpha_k \subset \Gamma_{\alpha_0}^+$ for some integer $k \in \{1, \dots, m-1\}$ the same arguments as above give $\alpha_{k+1} \subset \Gamma_{\alpha_0}^+$ and consequently $\alpha_k \subset \Gamma_{\alpha_0}^+$ for every $0 \leq k \leq m$. Similarly one also has $\alpha_k \subset \Gamma_{\alpha_0}^+$ for every $l \leq k \leq 0$ hence one concludes that $\Gamma_i \subset \Gamma_{\alpha_0}^+$. \square

CLAIM 2. *Let $i \in \{1, 2\}$. If for every edge $\alpha \subset \Gamma_i$ the set Γ_i is not a connected component of Γ_α^+ then there exists a sequence $(\gamma_n)_{n \geq 0}$ in \mathcal{L}^* with $\Gamma \prec \gamma_n$ converging to a Brouwer manifold $\gamma \succeq \Gamma$ such that Γ_i is a connected component of γ .*

Proof. It is similar to the one of [LC04, Lemma 3.5]. Claim 1 implies that Γ_i contains infinitely many edges. We write

$$\Gamma_i = \prod_{k \in I} \alpha_k,$$

where I is a \mathbb{Z} -interval with infinite cardinality and $(\alpha_i)_{i \in I}$ is an admissible sequence of edges. First we show that, for every finite \mathbb{Z} -interval $J \subset I$, there exists a Brouwer manifold $\Gamma' \in \mathcal{L}^*$ such that $\Gamma \prec \Gamma'$ and $\prod_{k \in J} \alpha_k \subset \Gamma'$. The proof is by induction on the cardinality p of J . The result is true if $p = 1$ because $\Gamma \prec \Gamma_{\alpha_k}^+$ for every $k \in I$. For any $\{k, k+1\} \subset I$, the Brouwer manifolds $\Gamma_{\alpha_k}^+$ and $\Gamma_{\alpha_{k+1}}^+$ contain respectively α_k and α_{k+1} and satisfy $\Gamma \prec \Gamma_{\alpha_k}^+$, $\Gamma \prec \Gamma_{\alpha_{k+1}}^+$. The vertex $\sigma = v_+(\alpha_k) = v_-(\alpha_{k+1})$ is the endpoint of

a third edge α . If $\sigma = v_-(\alpha)$ then clearly $\alpha_k \subset \Gamma_{\alpha_{k+1}}^+$ and consequently $\Gamma_{\alpha_{k+1}}^+ \preceq \Gamma_{\alpha_k}^+$. If $\sigma = v_+(\alpha)$ then $\alpha_{k+1} \subset \Gamma_{\alpha_k}^+$ so $\Gamma_{\alpha_k}^+ \preceq \Gamma_{\alpha_{k+1}}^+$. Thus $\Gamma_{\alpha_k}^+$ and $\Gamma_{\alpha_{k+1}}^+$ are always comparable and the smallest of these two Brouwer manifolds contains $\alpha_k \cup \alpha_{k+1}$. This proves the assertion for $p = 2$.

Suppose now that the result is true for $p \geq 2$ and consider a \mathbb{Z} -interval $J = \{k, k+1, \dots, k+p\} \subset I$ with cardinality $p+1$. The induction assumption gives a Brouwer manifold $\widehat{\Gamma} \succ \Gamma$ containing $\prod_{k \leq j \leq k+p-1} \alpha_j$ and a Brouwer manifold $\widetilde{\Gamma} \succ \Gamma$ containing $\prod_{k+1 \leq j \leq k+p} \alpha_j$. Then $\widehat{\Gamma}$ and $\widetilde{\Gamma}$ are comparable because they both contain $\prod_{k+1 \leq j \leq k+p-1} \alpha_j$ and, using the fact that they have no transverse intersection, one checks that the smallest of these two Brouwer manifolds contains $\prod_{k \in J} \alpha_j$. This proves the assertion.

Consider now a sequence $(I_n)_{n \geq 0}$ of finite \mathbb{Z} -intervals such that $I_n \subsetneq I_{n+1}$ for every $n \geq 0$ and $\bigcup_{n \geq 0} I_n = I$. The above remark allows to choose for every $n \in \mathbb{N}$ a Brouwer manifold $\gamma_n \in \mathcal{L}^*$ such that $\gamma_n \succ \Gamma$ and $\prod_{k \in I_n} \alpha_k \subset \gamma_n$. Given $q \in I_0$, one has of course $\{\Gamma\} \cup \{\gamma_n\}_{n \in \mathbb{N}} \subset \mathcal{L}^*(\alpha_q)$ and one deduces from Proposition 5.12 that there exists a subsequence $(\gamma_{n_k})_{k \geq 0}$ converging to a Brouwer manifold $\gamma \in \mathcal{L}^*(\alpha_q)$ such that $\Gamma \preceq \gamma$. By construction one has $\Gamma_i \subset \gamma^2$. \square

Recall that a Brouwer manifold of type 2 cannot be a connected component of a Brouwer manifold of type 3 (Remark 3.2). According to Claim 1, if Γ is a connected Brouwer manifold containing finitely many edges then $\Gamma = \Gamma_\alpha^+$ for some $\alpha \subset \Gamma$.

According to Claim 2, if Γ is a Brouwer manifold of type 2 containing infinitely many edges and if $\Gamma \neq \Gamma_\alpha^+$ for every edge $\alpha \subset \Gamma$ then there exists a sequence $(\gamma_n)_{n \geq 0}$ in \mathcal{L}^* converging to Γ with $\Gamma \prec \gamma_n$ for every $n \geq 0$.

It remains to study the case where $\Gamma = \Gamma_1 \sqcup \Gamma_2$ is a Brouwer manifold of type 3. For $i \in \{1, 2\}$, define a Brouwer manifold $\Gamma_i^* \in \mathcal{L}^*$ as follows. If Γ_i is a connected component of Γ_α^+ for some edge $\alpha \subset \Gamma_i$ then let $\Gamma_i^* = \Gamma_\alpha^+$. Otherwise define Γ_i^* to be the Brouwer manifold γ given by Claim 2. Thus one has anyway $\Gamma \preceq \Gamma_i^*$ and Γ_i is a connected component of Γ_i^* . In particular Γ_i^* has type 3.

CLAIM 3. *The two Brouwer manifolds Γ_1^* and Γ_2^* are comparable.*

Proof. Recall that $\Gamma \preceq \Gamma_1^*$ and that these two Brouwer manifolds have one common connected component Γ_1 . According to Lemma 5.12 one has $h(R(\Gamma_1^*)) \subset \text{Int}(R(\Gamma))$.

If $\Gamma_1^* \cap \Gamma_2^*$ contains some edge $\alpha \in E$ then it is already known from Lemma 5.9 that Γ_1^* and Γ_2^* are comparable hence one can assume that $\Gamma_i^* \cap \Gamma_j = \emptyset$ for every $1 \leq i \neq j \leq 2$. It follows from $\Gamma_2 \subset R(\Gamma) \subset R(\Gamma_1^*)$ and $\Gamma_2 \cap \Gamma_1^* = \emptyset$ that $\Gamma_2 \subset \text{Int}(R(\Gamma_1^*))$ and then $\Gamma_2^* \subset R(\Gamma_1^*)$ because Γ_2^* and Γ_1^* have no transverse intersection. According to Proposition 3.3 one has $L(\Gamma_2^*) \subset R(\Gamma_1^*)$ or $R(\Gamma_2^*) \subset R(\Gamma_1^*)$. If $R(\Gamma_2^*) \subset R(\Gamma_1^*)$ then

2. As a remark, the sequence $(\gamma_{n_k})_{k \geq 0}$ may have some other limits in $\mathcal{L}^* \setminus \mathcal{L}^*(\alpha_q)$ because $\mathcal{L}^*(\alpha_q)$ is generally a non closed subset of the non Hausdorff space \mathcal{L}^* . Such a limit $\gamma' \in \mathcal{L}^* \setminus \mathcal{L}^*(\alpha_q)$ is necessarily disjoint from Γ_i .

$\Gamma_2^* \preceq \Gamma_1^*$ and we are done. Suppose now $L(\Gamma_2^*) \subset R(\Gamma_1^*)$. Since $\Gamma \preceq \Gamma_2^*$ one has $R(\Gamma) \subset R(\Gamma_2^*)$ and therefore $L(\Gamma_2^*) \subset R(\Gamma_1^*) \cap L(\Gamma)$. Using $h(R(\Gamma_1^*)) \subset \text{Int}(R(\Gamma))$ one obtains

$$L(\Gamma_2^*) \subset h(L(\Gamma_2^*)) \cap L(\Gamma) \subset h(R(\Gamma_1^*)) \cap L(\Gamma) \subset \text{Int}(R(\Gamma)) \cap L(\Gamma) = \emptyset$$

which is absurd and ends the proof of Claim 3. \square

According to Claim 3 one can suppose $\Gamma \preceq \Gamma_2^* \preceq \Gamma_1^*$. Moreover it follows from $\Gamma_1 \subset \Gamma \cap \Gamma_1^*$ that $\Gamma_1 \subset \Gamma_2^*$ hence $\Gamma = \Gamma_1 \cup \Gamma_2 \subset \Gamma_2^*$. One concludes that $\Gamma = \Gamma_2^*$. The definition of Γ_2^* tell us that if $\Gamma \neq \Gamma_\alpha^+$ for every $\alpha \in E$ then Γ is the limit of a sequence $(\gamma_n)_{n \geq 0}$ in \mathcal{L}^* with $\Gamma \prec \gamma_n$ for every $n \geq 0$. The proof of the proposition is completed. \square

The next two results are already stated and proved in [LC04] in the context of Brouwer homeomorphisms and Brouwer lines. Nevertheless Brouwer manifolds are more complicated than Brouwer lines hence we give the additional arguments needed in our framework.

Proposition 5.14. *For any two edges $\alpha, \alpha' \in E$ we have*

- if $l(\alpha) = l(\alpha')$ then $\Gamma_\alpha^+ = \Gamma_{\alpha'}^+$;
- if $r(\alpha) = r(\alpha')$ then $\Gamma_\alpha^- = \Gamma_{\alpha'}^-$;
- if $l(\alpha) = r(\alpha')$ then $\Gamma_\alpha^+ \prec \Gamma_{\alpha'}^-$ and $(\Gamma_\alpha^+, \Gamma_{\alpha'}^-) = \emptyset$.

Proof. Write $\beta = l(\alpha) = l(\alpha')$. According to Propositions 5.4-5.7, there exists an admissible sequence $(\alpha_i)_{0 \leq i \leq n}$ of edges in $\partial_M \beta$ such that $\alpha_0 = \alpha$, $\alpha_n = \alpha'$ and $l(\alpha_i) = \beta$ for every $i \in \{0, \dots, n\}$. Hence it is enough to prove $\Gamma_{\alpha_i}^+ = \Gamma_{\alpha_{i+1}}^+$ for every given $i \in \{0, \dots, n-1\}$. We name α'' the third edge having $v_+(\alpha_i) = v_-(\alpha_{i+1})$ as a vertex. If $v_-(\alpha'') = v_+(\alpha_i)$ then clearly $\alpha_i \subset \Gamma_{\alpha_{i+1}}^+$ so $\Gamma_{\alpha_{i+1}}^+ \preceq \Gamma_{\alpha_i}^+$. Using Proposition 5.9 one gets $r(\alpha_{i+1}) \subset R(\Gamma_{\alpha_{i+1}}^+) \subset R(\Gamma_{\alpha_i}^+)$ and also $\beta = l(\alpha_{i+1}) = l(\alpha_i) \subset L(\Gamma_{\alpha_i}^+)$. Then it follows from Proposition 3.1 that $\alpha_{i+1} = l(\alpha_{i+1}) \cap r(\alpha_{i+1}) \subset L(\Gamma_{\alpha_i}^+) \cap R(\Gamma_{\alpha_i}^+) = \Gamma_{\alpha_i}^+$ which implies the inverse inequality $\Gamma_{\alpha_i}^+ \preceq \Gamma_{\alpha_{i+1}}^+$. If $v_+(\alpha'') = v_+(\alpha_i)$ then we obtain first $\alpha_{i+1} \subset \Gamma_{\alpha_i}^+$ so $\Gamma_{\alpha_i}^+ \preceq \Gamma_{\alpha_{i+1}}^+$ and one checks the other inequality $\Gamma_{\alpha_{i+1}}^+ \preceq \Gamma_{\alpha_i}^+$ by reversing the roles of α_i, α_{i+1} in the above argument. This proves the first assertion and the second one can be obtained likewise. We now prove the last one. We let $\beta = l(\alpha) = r(\alpha')$. If β is an annulus then one deduces from the two previous assertions that Γ_α^+ and $\Gamma_{\alpha'}^-$ are the two boundary components of β . It follows easily that $\Gamma_\alpha^+ \prec \Gamma_{\alpha'}^-$. If β is a disc or a half-plane then it possesses an initial vertex $v_-(\beta)$ or a final vertex $v_+(\beta)$. We deal only with the first case, the other case being similar. We denote $\sigma = v_-(\beta)$ and α^- the edge such that $v_+(\alpha^-) = \sigma$. Using again the description of $\partial_M \beta$ in Propositions 5.4 and 5.6 as well as the two first assertions, we just have to check $\Gamma_\alpha^+ \prec \Gamma_{\alpha'}^-$ when the edges α, α' and α^- are all adjacent to the vertex σ , so that

$\sigma = v_-(\alpha) = v_-(\alpha') = v_+(\alpha^-)$. Then it is clear that $\alpha^- \subset \Gamma_\alpha^+ \cap \Gamma_{\alpha'}^-$ so Γ_α^+ and $\Gamma_{\alpha'}^-$ are comparable and one deduces from $\beta \in R(\Gamma_{\alpha'}^-) \setminus R(\Gamma_\alpha^+)$ that $\Gamma_\alpha^+ \prec \Gamma_{\alpha'}^-$. We consider now the case where β is a strip. According to Proposition 5.7, one has $\partial_M \beta = \gamma \sqcup \gamma'$ with

$$\gamma = \prod_{i \in I} \alpha_i, \quad \gamma' = \prod_{j \in J} \alpha'_j,$$

where $(\alpha_i)_{i \in I}$ and $(\alpha'_j)_{j \in J}$ are two admissible sequences of edges such that $l(\alpha_i) = r(\alpha'_j) = \beta$ for every $(i, j) \in I \times J$. We know that all the Brouwer manifolds $\Gamma_{\alpha_i}^+$ (resp. $\Gamma_{\alpha'_j}^-$) are equal for $i \in I$ (resp. $j \in J$) so that $\gamma \subset \Gamma_{\alpha_i}^+$ and $\gamma' \subset \Gamma_{\alpha'_j}^-$. According to Proposition 5.9, one has $\gamma \subset \beta \subset R(\Gamma_{\alpha'_j}^-)$ and $\gamma' \subset \beta \subset L(\Gamma_{\alpha_i}^+)$. Remark that γ is disjoint from $\partial_M R(\Gamma_{\alpha'_j}^-) = \Gamma_{\alpha'_j}^-$ since otherwise there exists $i \in I$ such that $\alpha_i \subset \Gamma_{\alpha'_j}^-$ which implies $l(\alpha_i) = \beta \in L(\Gamma_{\alpha'_j}^-) \cap R(\Gamma_{\alpha'_j}^-) = \emptyset$, a contradiction. Thus one obtains more precisely $\gamma \subset \text{Int}(R(\Gamma_{\alpha'_j}^-))$. Similarly $\gamma' \subset \text{Int}(L(\Gamma_{\alpha_i}^+))$ since otherwise one can find $j \in J$ such that $\alpha'_j \subset \partial_M L(\Gamma_{\alpha_i}^+) = \Gamma_{\alpha_i}^+$ which would imply $r(\alpha'_j) = \beta \in R(\Gamma_{\alpha_i}^+) \cap L(\Gamma_{\alpha_i}^+) = \emptyset$. Since $\Gamma_{\alpha_i}^+$ and $\Gamma_{\alpha'_j}^-$ have no transverse intersection, one deduces from $\gamma \subset \text{Int}(R(\Gamma_{\alpha'_j}^-))$ that $\Gamma_{\alpha_i}^+ \subset R(\Gamma_{\alpha'_j}^-)$. Then it follows from Proposition 3.3 that $L(\Gamma_{\alpha_i}^+) \subset R(\Gamma_{\alpha'_j}^-)$ or $R(\Gamma_{\alpha_i}^+) \subset R(\Gamma_{\alpha'_j}^-)$. On the other hand, $\alpha'_j \subset \gamma' \subset \text{Int}(L(\Gamma_{\alpha_i}^+))$ implies $l(\alpha'_j) \in L(\Gamma_{\alpha_i}^+) \cap L(\Gamma_{\alpha'_j}^-)$ which shows that the inclusion $L(\Gamma_{\alpha_i}^+) \subset R(\Gamma_{\alpha'_j}^-)$ is actually not possible. Thus we obtain as expected $R(\Gamma_{\alpha_i}^+) \subset R(\Gamma_{\alpha'_j}^-)$, i.e., $\Gamma_{\alpha_i}^+ \prec \Gamma_{\alpha'_j}^-$.

It remains to show that $(\Gamma_\alpha^+, \Gamma_{\alpha'}^-) = \emptyset$ for any edges α, α' satisfying $l(\alpha) = \beta = r(\alpha')$. Suppose that $\Gamma \in \mathcal{L}^*$ is such that $\Gamma_\alpha^+ \preceq \Gamma \preceq \Gamma_{\alpha'}^-$. According to Proposition 3.1, the brick β belongs either to $L(\Gamma)$ or to $R(\Gamma)$ and $\Gamma \preceq \Gamma_{\alpha'}^-$ also means $L(\Gamma_{\alpha'}^-) \subset L(\Gamma)$. If $\beta \in R(\Gamma)$ then one gets

$$\alpha' = l(\alpha') \cap r(\alpha') = l(\alpha') \cap \beta \subset L(\Gamma_{\alpha'}^-) \cap R(\Gamma) \subset L(\Gamma) \cap R(\Gamma) = \Gamma$$

which implies $\Gamma_{\alpha'}^- \preceq \Gamma$ and afterwards $\Gamma_{\alpha'}^- = \Gamma$. If $\beta \in L(\Gamma)$ then

$$\alpha = l(\alpha) \cap r(\alpha) = \beta \cap r(\alpha) \subset L(\Gamma) \cap R(\Gamma_\alpha^+) \subset L(\Gamma) \cap R(\Gamma) = \Gamma$$

hence $\Gamma \preceq \Gamma_\alpha^+$ and consequently $\Gamma = \Gamma_\alpha^+$. □

For every $\beta \in B$, Proposition 5.14 allows one to define $\Gamma_\beta^+ = \Gamma_{\alpha'}^-$ and $\Gamma_\beta^- = \Gamma_\alpha^+$ where α, α' are any edges such that $r(\alpha') = \beta = l(\alpha)$. One has then $\Gamma_\beta^- \prec \Gamma_\beta^+$ and $(\Gamma_\beta^-, \Gamma_\beta^+) = \emptyset$. According to Propositions 5.4-5.7, there exist two oriented arcs γ_β^- and γ_β^+ such that $\partial_M \beta = \gamma_\beta^- \cup \gamma_\beta^+$ and $l(\gamma_\beta^-) = r(\gamma_\beta^+) = \{\beta\}$. Then we have $\gamma_\beta^- \subset \Gamma_\beta^-$ and $\gamma_\beta^+ \subset \Gamma_\beta^+$. We define an equivalence relation \sim on the set of bricks by

$$\beta \sim \beta' \Leftrightarrow \Gamma_\beta^+ = \Gamma_{\beta'}^+ \text{ and } \Gamma_\beta^- = \Gamma_{\beta'}^-.$$

The equivalence class of $\beta \in B$ is denote by $\widehat{\beta}$.

For later use, observe that two adjacent bricks are not equivalent. Indeed, for every edge $\alpha \in E$, one has

$$\Gamma_{l(\alpha)}^+ \succ \Gamma_{l(\alpha)}^- = \Gamma_{\alpha}^+ \succeq \Gamma_{\alpha}^- = \Gamma_{r(\alpha)}^+.$$

Proposition 5.15. *Let $\beta \in B$. The following three properties are equivalent :*

- i) $\beta' \in \widehat{\beta}$,
- ii) $\beta' \in r(\Gamma_{\beta'}^+) \cap l(\Gamma_{\beta'}^-)$,
- iii) $\beta' \in R(\Gamma_{\beta'}^+) \cap L(\Gamma_{\beta'}^-)$.

Proof. As a first step, one has the following assertion.

CLAIM 1. *The properties i) and ii) are equivalent.*

Proof. If $\beta' \in \widehat{\beta}$ then $\beta' \in r(\Gamma_{\beta'}^+) \cap l(\Gamma_{\beta'}^-) = r(\Gamma_{\beta}^+) \cap l(\Gamma_{\beta}^-)$ hence the implication i) \Rightarrow ii) holds. Let β' be a brick in $r(\Gamma_{\beta}^+) \cap l(\Gamma_{\beta}^-)$. There exist two edges $e_1 \subset \Gamma_{\beta}^+$ and $e_2 \subset \Gamma_{\beta}^-$ such that $\beta' = r(e_1) = l(e_2)$. Then we get

$$\Gamma_{\beta}^- \preceq \Gamma_{e_2}^+ = \Gamma_{\beta'}^- \prec \Gamma_{\beta'}^+ = \Gamma_{e_1}^- \preceq \Gamma_{\beta}^+.$$

According to Proposition 5.14 one has $(\Gamma_{\beta}^-, \Gamma_{\beta}^+) = \emptyset$ so $\Gamma_{\beta}^- = \Gamma_{\beta'}^-$ and $\Gamma_{\beta}^+ = \Gamma_{\beta'}^+$, i.e., $\beta' \in \widehat{\beta}$. The implication ii) \Rightarrow i) is proved. \square

Combining Claim 1 with Proposition 5.9 one gets $\widehat{\beta} = r(\Gamma_{\beta}^+) \cap l(\Gamma_{\beta}^-) \subset R(\Gamma_{\beta}^+) \cap L(\Gamma_{\beta}^-)$ hence it is now enough to prove the converse inclusion $R(\Gamma_{\beta}^+) \cap L(\Gamma_{\beta}^-) \subset \widehat{\beta}$.

We write Γ_1^- (resp. Γ_1^+) for the connected component of Γ_{β}^- (resp. Γ_{β}^+) containing γ_{β}^- (resp. γ_{β}^+). Remember that maybe $\Gamma_1^- = \Gamma_{\beta}^-$ (resp. $\Gamma_1^+ = \Gamma_{\beta}^+$) if Γ_{β}^- (resp. Γ_{β}^+) is connected, i.e., has type 1 or 2.

If β is a disc or a half-plane then β possesses an initial vertex $v_-(\beta)$ and/or a final vertex $v_+(\beta)$ (Propositions 5.4 and 5.6). Assume for instance that β has a final vertex. Then there exists $\alpha_0 \in E$ such that $v_+(\beta) = v_-(\alpha_0)$. Of course $\alpha_0 \subset \Gamma_1^- \cap \Gamma_1^+$ so we can consider the longest admissible sequence of edges beginning with α_0 and containing only edges included in $\Gamma_1^- \cap \Gamma_1^+$. It is convenient to denote this sequence by $(\alpha_i)_{0 \leq i < n}$ with $n \in \mathbb{N} \cup \{+\infty\}$ so that one of the following situations occurs :

- a) $n = +\infty$,
- b) $n < +\infty$ and α_{n-1} has no final vertex,
- c) $n < +\infty$ and α_{n-1} has a final vertex.

In the first two cases, the concatenation $\prod_{0 \leq i < n} \alpha_i$ is a half-line of M so it converges to a fixed point. If (c) holds true then there exist two edges $\alpha_n^- \subset \Gamma_1^-$ and $\alpha_n^+ \subset \Gamma_1^+$ such that $v_+(\alpha_{n-1}) = v_-(\alpha_n^-) = v_-(\alpha_n^+)$ and $r(\alpha_n^+) = l(\alpha_n^-)$. Defining $\beta_1 = r(\alpha_n^+)$ (maybe $\beta_1 = \beta$ when β is a disc), one has then $\beta_1 \in r(\Gamma_{\beta}^+) \cap l(\Gamma_{\beta}^-)$

hence $\beta_1 \sim \beta$ because of Claim 1. This implies $\gamma_{\beta_1}^- \subset \Gamma_1^-$ and $\gamma_{\beta_1}^+ \subset \Gamma_1^+$. Similarly, if β has an initial vertex $v_-(\beta)$ then either there exists a half-line of M emanating from $v_-(\beta)$ and included in $\Gamma_1^- \cap \Gamma_1^+$ or there exists a finite admissible sequence of compact edges $\alpha'_l, \dots, \alpha'_0$ such that $v_+(\alpha'_0) = v_-(\beta)$, $v_-(\alpha'_i) = v_+(\beta_{-i})$ for some brick $\beta_{-1} \sim \beta$ and $\alpha'_i \subset \Gamma_1^- \cap \Gamma_1^+$ for every $i \in \{l, \dots, 0\}$.

Iterating these arguments one finds a sequence $(\beta_i)_{i \in I}$ of pairwise distinct bricks equivalent to β , where I is a \mathbb{Z} -interval containing 0 and $\beta_0 = \beta$, such that

$$\Gamma_1^- = (\Gamma_1^- \cap \Gamma_1^+) \cup \bigcup_{i \in I} \gamma_{\beta_i}^- \quad \text{and} \quad \Gamma_1^+ = (\Gamma_1^- \cap \Gamma_1^+) \cup \bigcup_{i \in I} \gamma_{\beta_i}^+.$$

Note that this writing is still valid when β is a strip with simply $I = \{0\}$, $\Gamma_1^- = \gamma_{\beta}^-$ and $\Gamma_1^+ = \gamma_{\beta}^+$. It is also valid if β is an annulus with $I = \{0\}$, $\Gamma_{\beta}^- = \Gamma_1^- = \gamma_{\beta}^-$ and $\Gamma_{\beta}^+ = \Gamma_1^+ = \gamma_{\beta}^+$. Since $\bigcup_{i \in I} \beta_i$ is closed in M , if M is connected then one has $\text{Cl}(\Gamma_1^-) \setminus \Gamma_1^- = \text{Cl}(\Gamma_1^+) \setminus \Gamma_1^+ \subset \text{Fix}(h)$ which also gives $\text{Cl}(\Gamma_{\beta}^-) \setminus \Gamma_{\beta}^- = \text{Cl}(\Gamma_{\beta}^+) \setminus \Gamma_{\beta}^+$.

It is already known that $\beta_i \in l(\Gamma_1^-) \cap r(\Gamma_1^+) \subset l(\Gamma_{\beta}^-) \cap r(\Gamma_{\beta}^+) \subset L(\Gamma_{\beta}^-) \cap R(\Gamma_{\beta}^+)$ for every $i \in I$. More precisely each singleton $\{\beta_i\}$ is a connected component of $L(\Gamma_{\beta}^-) \cap R(\Gamma_{\beta}^+) \subset B$ because $r(\gamma_{\beta_i}^-) \subset r(\Gamma_{\beta}^-) \subset R(\Gamma_{\beta}^-)$ and $l(\gamma_{\beta_i}^+) \subset l(\Gamma_{\beta}^+) \subset L(\Gamma_{\beta}^+)$ and because, for any $j \in I \setminus \{i\}$, the bricks β_i and β_j are not adjacent. If Γ_{β}^- is not connected (*i.e.*, has type 3) and if Γ_2^- denotes its connected component other than Γ_1^- then one also has $\beta_i \notin l(\Gamma_2^-)$ because $\gamma_{\beta_i}^- \subset \Gamma_1^-$. Defining $R^+ = R(\Gamma_{\beta}^-) \cup \bigcup_{i \in I} \beta_i$, the previous observations together with $\Gamma_{\beta}^- \preceq \Gamma_{\beta}^+$ show that R^+ is a connected subset of $R(\Gamma_{\beta}^+)$ verifying $\partial_M R^+ = \Gamma_1^+ \cup (\Gamma_{\beta}^- \setminus \Gamma_1^-)$ and $\bigcup_{i \in I} \text{Int}_{\Sigma}(\gamma_{\beta_i}^-) \subset \text{Int}(R^+)$ and having the same number (at most two) of connected components as $R(\Gamma_{\beta}^-)$. Precisely, if $R(\Gamma_{\beta}^-)$ has two connected components then they can be named R_1^-, R_2^- with $\Gamma_k^- = \partial_M R_k^-$ and the two connected components of R^+ are $R_1^- \cup \bigcup_{i \in I} \beta_i$ and R_2^- .

If Γ_{β}^- and Γ_{β}^+ are connected then $R(\Gamma_{\beta}^-)$ and $R(\Gamma_{\beta}^+)$ are also connected. One obtains then $\partial_M R^+ = \Gamma_{\beta}^+ = \partial_M R(\Gamma_{\beta}^+)$ which implies $R^+ = R(\Gamma_{\beta}^+)$ and therefore, regarding $R(\Gamma_{\beta}^+)$ and $L(\Gamma_{\beta}^-)$ as subsets of B , one obtains $R(\Gamma_{\beta}^+) \cap L(\Gamma_{\beta}^-) = R(\Gamma_{\beta}^+) \setminus R(\Gamma_{\beta}^-) = \{\beta_i \mid i \in I\} \subset \widehat{\beta}$. This proves the proposition when Γ_{β}^{\pm} are both connected.

CLAIM 2. Γ_{β}^- is connected iff Γ_{β}^+ is connected.

Proof. If $\text{Fix}(h)$ is a circle then all the Brouwer manifolds have type 3. Assume now that $\text{Fix}(h)$ is totally disconnected. Recall that $\text{Cl}(\Gamma_{\beta}^-) \setminus \Gamma_{\beta}^- = \text{Cl}(\Gamma_{\beta}^+) \setminus \Gamma_{\beta}^+ \subset \text{Fix}(h)$. If Γ_{β}^- or Γ_{β}^+ is not connected then this set has cardinality one or two. If it contains two points then Γ_{β}^{\pm} are Brouwer manifolds of type 3. It remains to study the situation where $\text{Cl}(\Gamma_{\beta}^-) \setminus \Gamma_{\beta}^- = \text{Cl}(\Gamma_{\beta}^+) \setminus \Gamma_{\beta}^+$ contains a single point $a \in \text{Fix}(h)$. Under this assumption, the description of the Brouwer manifolds given by the proof of Proposition 3.1 shows that Γ_{β}^- (resp. Γ_{β}^+) is connected iff $L(\Gamma_{\beta}^-)$ and $R(\Gamma_{\beta}^-)$ (resp. $L(\Gamma_{\beta}^+)$ and $R(\Gamma_{\beta}^+)$) are both connected hence one just has to check that $R(\Gamma_{\beta}^-)$ and $R(\Gamma_{\beta}^+)$ are simultaneously connected or not and likewise for $L(\Gamma_{\beta}^{\pm})$. Suppose that $R(\Gamma_{\beta}^+)$ is not connected and name R_1^+, R_2^+ its two connected components with $\Gamma_k^+ =$

$\partial_M R_k^+$. Then $R(\Gamma_\beta^-)$ is also not connected since otherwise, due to $\Gamma_\beta^- \preceq \Gamma_\beta^+$, one can find $i \neq j$ in $\{1, 2\}$ such that $R(\Gamma_\beta^-) \subset R_i^+$ and

$$h(R(\Gamma_\beta^-)) \subset R(\Gamma_\beta^-) \cap h(R_i^+) \subset R_i^+ \cap R_j^+ = \emptyset,$$

a contradiction. Suppose now that $R(\Gamma_\beta^-)$ is not connected. As observed above, $R^+ \subset R(\Gamma_\beta^+)$ also has two connected components which can be written $R_1 = R_1^- \cup \bigcup_{i \in I} \beta_i$ and $R_2 = R_2^-$ where R_1^-, R_2^- are the two connected components of $R(\Gamma_\beta^-)$ with $\Gamma_k^- = \partial_M R_k^-$. One deduces from $\partial_M R_1 = \Gamma_1^+$ that R_1 is also a connected component of $R(\Gamma_\beta^+)$. Moreover $\beta_i \in L(\Gamma_\beta^-)$ for every $i \in I$ hence $R_1 \cap R_2^- = \emptyset$ as subsets of B . Consequently $R(\Gamma_\beta^+)$ possesses a connected component other than R_1 which contains R_2^- . Switching above the roles of $L(\cdot)$ and $R(\cdot)$, of Γ_β^+ and Γ_β^- , of h and h^{-1} one proves likewise that $L(\Gamma_\beta^-)$ is connected iff $L(\Gamma_\beta^+)$ is connected. This ends the proof of Claim 2. \square

According to Claim 2 it remains only to study the case where Γ_β^\pm are Brouwer manifolds of type 3. We write as usual $\Gamma_\beta^- = \Gamma_1^- \sqcup \Gamma_2^-$ and $\Gamma_\beta^+ = \Gamma_1^+ \sqcup \Gamma_2^+$.

Observe that Γ_2^- is disjoint from Γ_1^+ because

$$\Gamma_2^- \cap \Gamma_1^+ = \Gamma_2^- \cap (\Gamma_1^+ \setminus \Gamma_1^-) \subset R(\Gamma_\beta^-) \cap \left(\bigcup_{i \in I} \text{Int}_\Sigma(\gamma_{\beta_i}^+) \right) \subset R(\Gamma_\beta^-) \cap \text{Int}(L(\Gamma_\beta^-)) = \emptyset$$

and likewise

$$\Gamma_2^+ \cap \Gamma_1^- = \Gamma_2^+ \cap (\Gamma_1^- \setminus \Gamma_1^+) \subset L(\Gamma_\beta^+) \cap \left(\bigcup_{i \in I} \text{Int}_\Sigma(\gamma_{\beta_i}^-) \right) \subset L(\Gamma_\beta^+) \cap \text{Int}(R(\Gamma_\beta^+)) = \emptyset.$$

CLAIM 3. *Assume that $\Gamma_2^- \cap \Gamma_2^+ = \emptyset$. Then $l(\Gamma_2^-) = r(\Gamma_2^+)$ and this set is reduced to a single brick $\beta_* \in \widehat{\beta}$ which is a strip with frontier $\partial_M \beta_* = \Gamma_2^- \sqcup \Gamma_2^+$. Moreover one has*

$$L(\Gamma_\beta^-) \cap R(\Gamma_\beta^+) = \{\beta_*\} \sqcup \{\beta_i \mid i \in I\} \subset B.$$

Proof. One also knows that $\Gamma_2^- \cap \Gamma_1^+ = \emptyset$ hence $\Gamma_2^- \subset \text{Int}(R(\Gamma_\beta^+))$. Consider an edge $e \subset \Gamma_2^-$ and let $\beta_* = l(e) \in l(\Gamma_2^-) \subset L(\Gamma_\beta^-)$. Remark that $e \subset \gamma_{\beta_*}^- \cap \Gamma_2^-$ ensures $\beta_* \notin \{\beta_i\}_{i \in I}$.

• As a first step, we show that there is a connected component S of $L(\Gamma_\beta^-) \cap R(\Gamma_\beta^+)$ which is a strip with frontier $\partial_M S = \Gamma_2^- \sqcup \Gamma_2^+$ and which contains β_* and satisfies $S \cap h(S) = \emptyset$. One needs to distinguish the following three cases.

First case : $\text{Fix}(h)$ is totally disconnected and $\text{Cl}(\Gamma_\beta^\pm) \setminus \Gamma_\beta^\pm$ consists of a single point $a \in \text{Fix}(h)$.

Suppose first that $R(\Gamma_\beta^-)$ is not connected. One knows from the proof of Claim 2 that $R(\Gamma_\beta^+)$ is also not connected. Even better, if R_i^- denotes the connected components of $R(\Gamma_\beta^-)$ such that $\partial_M R_i^- = \Gamma_i^-$ then the two connected components of $R(\Gamma_\beta^+)$

may be named R_1^+ and R_2^+ with $R_1^+ = R_1^- \cup \bigcup_{i \in I} \beta_i$ and $R_2^- \subset R_2^+$. Since $R_2^- \cup \{a\}$ and $R_2^+ \cup \{a\}$ are two discs with frontier, respectively, $\Gamma_2^- \cup \{a\}$ and $\Gamma_2^+ \cup \{a\}$, one deduces from the assumption $\Gamma_2^- \cap \Gamma_2^+ = \emptyset$ that the set $S = R_2^+ \setminus \text{Int}(R_2^-) \subset M$ is a strip with frontier $\partial_M S = \Gamma_2^- \sqcup \Gamma_2^+$. It is easily seen that S is a connected component of $L(\Gamma_\beta^-) \cap R(\Gamma_\beta^+)$ such that $\beta_* \subset l(\Gamma_2^-) \cup r(\Gamma_2^+) \subset S$. One also has $h(S) \cap S = \emptyset$ because $h(S) \subset h(R_2^+) \subset \text{Int}(R_1^+)$. Suppose now that $R(\Gamma_\beta^-)$ is connected. Then $L(\Gamma_\beta^-)$ has two connected components as well as $L(\Gamma_\beta^+)$ (see again the proof of Claim 2) and the proof is similar as above: the required strip $S \subset M$ is defined by $S = L_2^- \setminus \text{Int}(L_2^+)$ where L_2^\pm is the connected component of $L(\Gamma_\beta^\pm)$ such that $\partial_M L_2^\pm = \Gamma_2^\pm$, observing that S and $h^{-1}(S)$ are contained in two distinct connected components of $L(\Gamma_\beta^-)$.

Second case : $\text{Fix}(h)$ is totally disconnected and $\text{Cl}(\Gamma_\beta^\pm) \setminus \Gamma_\beta^\pm$ consists of two points $a, b \in \text{Fix}(h)$.

In this case one knows that $R(\Gamma_\beta^-)$ and $R(\Gamma_\beta^+)$ are connected with $D^- \setminus \text{Fix}(h) = R(\Gamma_\beta^-) \subset R(\Gamma_\beta^+) = D^+ \setminus \text{Fix}(h)$ where D^- (resp. D^+) is one of the two discs with frontier $\partial D^- = \Gamma_\beta^- \cup \{a, b\}$ (resp. $\partial D^+ = \Gamma_\beta^+ \cup \{a, b\}$). Clearly one also has $\text{Cl}(R(\Gamma_\beta^-)) = D^- \subset D^+ = \text{Cl}(R(\Gamma_\beta^+))$. Since $\Gamma_2^- \cap \Gamma_2^+ = \emptyset$ one gets $\Gamma_2^- \subset \text{Int}(R(\Gamma_\beta^+)) \subset \text{Int}(D^+)$. It follows that $D^+ = D_1^+ \cup D_2^+$ where D_1^+, D_2^+ are two discs such that $D_1^+ \cap D_2^+ = \Gamma_2^- \cup \{a, b\}$, $\partial D_1^+ = \Gamma_1^+ \cup \{a, b\} \cup \Gamma_2^-$ and $\partial D_2^+ = \Gamma_2^+ \cup \{a, b\} \cup \Gamma_2^-$. Recall that $\Gamma_1^- \cup \bigcup_{i \in I} \beta_i$ is a connected set such that $\Gamma_1^+ \subset \Gamma_1^- \cup \bigcup_{i \in I} \beta_i \subset R(\Gamma_\beta^+)$. It is also disjoint from $\Gamma_2^- \cup \{a, b\}$ because $\Gamma_2^- \cap \beta_i = \Gamma_2^- \cap \partial_M \beta_i \subset (\Gamma_2^- \cap \Gamma_1^+) \cup (\Gamma_2^- \cap \Gamma_1^-) = \emptyset$ for every $i \in I$ hence one deduces that $\Gamma_1^- \cup \bigcup_{i \in I} \beta_i \subset D_1^+$. In particular $\partial D^- \subset D_1^+$ and, since $D^- \subset D^+$, one obtains more precisely $D^- \cup \bigcup_{i \in I} \beta_i \subset D_1^+$ (actually these two sets are equal but we do not use this property). It follows that $D_2^+ \subset D^+ \setminus \text{Int}(D^-)$ hence $l(\Gamma_2^-) \cup r(\Gamma_2^+) \subset D_2^+$. Defining $S = D_2^+ \setminus \{a, b\}$ one gets a strip such that $\beta_* \subset l(\Gamma_2^-) \cup r(\Gamma_2^+) \subset S$ and whose boundary components are Γ_2^\pm . It remains to see that $S \cap h(S) = \emptyset$, which is easily seen to imply that S is a connected component of $L(\Gamma_\beta^-) \cap R(\Gamma_\beta^+)$. Remark that $h(\Gamma_2^-) \subset \text{Int}(R(\Gamma_\beta^-)) \subset \text{Int}(D_1^+)$. Up to conjugacy by a suitable orientation preserving homeomorphism of \mathbb{S}^2 , one may assume that D_1^+ is the Euclidean closed unit disc in \mathbb{R}^2 with $a = (0, -1)$, $b = (0, 1)$, $\Gamma_1^+ = \partial D_1^+ \cap ((-\infty, 0) \times \mathbb{R})$, $\Gamma_2^- = \partial D_1^+ \cap ((0, +\infty) \times \mathbb{R})$ and moreover $h(\Gamma_2^-) = \{0\} \times (-1, 1)$. Because $l(\Gamma_2^-) \subset S \subset \mathbb{S}^2 \setminus \text{Int}(D_1^+)$ the line Γ_2^- is oriented from b to a . Moreover h reverses the orientation hence $h(S)$ lies locally on the right of $h(\Gamma_2^-)$ oriented from $h(b) = b$ to $h(a) = a$. Writing Δ for the left half of D_1^+ , that means for the disc with frontier $\partial \Delta = \Gamma_1^+ \cup \{a, b\} \cup h(\Gamma_2^-)$ and included in D_1^+ , one gets afterwards $h(S) \subset \Delta \setminus (\Gamma_1^+ \cup \{a, b\})$ because $h(S) \cap \Gamma_1^+ = h(S \cap h^{-1}(\Gamma_1^+)) \subset h(D^+ \cap \text{Int}(L(\Gamma_\beta^+))) = \emptyset$. In particular $h(S) \cap S = \emptyset$ (see Fig. 5.8).

Third case : $\text{Fix}(h)$ is a circle.

Suppose for instance $\beta_* \subset M_1$. Working in the one point compactification of M_1 , one checks similarly as in the first case that there is a strip $S \subset M_1$ with frontier $\partial_M S = \Gamma_2^- \sqcup \Gamma_2^+$ which contains $l(\Gamma_2^-) \cup r(\Gamma_2^+)$. Then $h(S) \cap S = \emptyset$ because $h(M_1) = M_2$ and it is easily seen that S is a connected component of $L(\Gamma_\beta^-) \cup R(\Gamma_\beta^+)$.

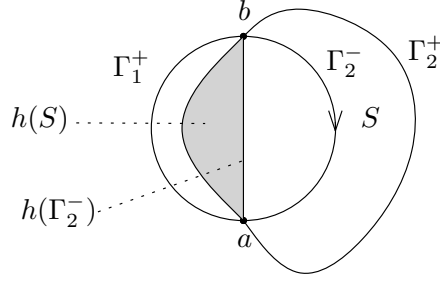
Figure 5.8 – $h(S) \cap S = \emptyset$ [second case]

- As a second step we show that $\beta_* \in r(\Gamma_2^+)$.

Suppose $\beta_* \notin r(\Gamma_2^+)$ and therefore $\beta_* \subset \text{Int}(R(\Gamma_\beta^+))$. According to Propositions 5.4-5.7 there exists $e' \in E$ such that $r(e') = \beta_*$. Since $e \in \Gamma_\beta^-$ one has $\Gamma_\beta^- \preceq \Gamma_e^+ = \Gamma_{\beta_*}^- \prec \Gamma_{\beta_*}^+ = \Gamma_{e'}^- \preceq \Gamma_{e'}^+$ and consequently $R(\Gamma_\beta^-) \subset R(\Gamma_{e'}^+)$, i.e., $L(\Gamma_{e'}^+) \subset L(\Gamma_\beta^-)$. Because $e' \subset \beta_* \subset \text{Int}(R(\Gamma_\beta^+))$ and because $\Gamma_{e'}^+, \Gamma_\beta^+$ have no transverse intersection one knows that $\Gamma_{e'}^+ \subset R(\Gamma_\beta^+)$. Following Proposition 3.3 one has either $R(\Gamma_{e'}^+) \subset R(\Gamma_\beta^+)$ or $L(\Gamma_{e'}^+) \subset R(\Gamma_\beta^+)$. If $R(\Gamma_{e'}^+) \subset R(\Gamma_\beta^+)$ then $\Gamma_\beta^- \prec \Gamma_{e'}^+ \preceq \Gamma_\beta^+$. Furthermore $\Gamma_{e'}^+ \neq \Gamma_\beta^+$ because $e' \not\subset \Gamma_\beta^+$ which contradicts the fact that the \mathcal{L}^* -interval $(\Gamma_\beta^-, \Gamma_\beta^+)$ is empty (Proposition 5.14). If $L(\Gamma_{e'}^+) \subset R(\Gamma_\beta^+)$ then

$$L(\Gamma_{e'}^+) \subset R(\Gamma_\beta^+) \cap L(\Gamma_\beta^-) = S \sqcup \{\beta_i \mid i \in I\} \subset B.$$

One knows that any connected component of $L(\Gamma_{e'}^+)$ intersects its image under h^2 and consequently is included in S because each brick β_i satisfies $h^2(\beta_i) \cap \beta_i = \emptyset$. Hence one obtains $h^{-1}(L(\Gamma_{e'}^+)) \subset L(\Gamma_{e'}^+) \subset S$ which contradicts $h(S) \cap S = \emptyset$.

- We check finally that $S = \{\beta_*\} \subset \widehat{\beta}$.

One has $\beta_* \in l(\Gamma_2^-) \cap r(\Gamma_2^+) \subset l(\Gamma_\beta^-) \cap r(\Gamma_\beta^+)$ hence Claim 1 gives $\beta_* \in \widehat{\beta}$ and then $\gamma_{\beta_*}^- \subset \Gamma_\beta^- = \Gamma_\beta^+$ and $\gamma_{\beta_*}^+ \subset \Gamma_\beta^+ = \Gamma_\beta^-$. More precisely $\gamma_{\beta_*}^- \subset \Gamma_2^-$ because $e \in \gamma_{\beta_*}^- \cap \Gamma_2^-$ and furthermore $\gamma_{\beta_*}^+ \subset \Gamma_2^+$ due to $\beta_* \in r(\Gamma_2^+)$. Afterwards one deduces from $\Gamma_2^- \cap \Gamma_2^+ = \emptyset$ that $\gamma_{\beta_*}^- = \Gamma_2^-$ and $\gamma_{\beta_*}^+ = \Gamma_2^+$, thus proving $S = \beta_* \subset M$.

One can end now the proof of Claim 3. One knows that two distinct equivalent bricks are not adjacent hence $\beta_* \cap \beta_i = \emptyset$ for every $i \in I$ and therefore $R^+ \cup \beta_* = R(\Gamma_\beta^-) \cup \beta_* \cup \bigcup_{i \in I} \beta_i$ is a connected subset of $R(\Gamma_\beta^+)$ satisfying $\partial_M(R^+ \cup \beta_*) = \Gamma_1^+ \sqcup \Gamma_2^+ = \Gamma_\beta^+ = \partial_M R(\Gamma_\beta^+)$. This implies $R^+ \cup \beta_* = R(\Gamma_\beta^+)$ and, as subsets of B , one has then $R(\Gamma_\beta^+) \cap L(\Gamma_\beta^-) = R(\Gamma_\beta^+) \setminus R(\Gamma_\beta^-) = \{\beta_*\} \sqcup \{\beta_i \mid i \in I\}$. Claim 3 is proved. \square

If $\Gamma_2^- \cap \Gamma_2^+ = \emptyset$ Claim 3 gives $R(\Gamma_\beta^+) \cap L(\Gamma_\beta^-) = \{\beta_i \mid i \in I\} \cup \{\beta_*\} \subset \widehat{\beta}$ and we are done. Otherwise $\Gamma_2^- \cap \Gamma_2^+$ contains at least one edge α'_0 . Except if $\alpha'_0 = \Gamma_2^- = \Gamma_2^+$, one finds as for Γ_1^- and Γ_1^+ a sequence $(\beta'_j)_{j \in J}$ of bricks equivalent to β , where J is a non empty \mathbb{Z} -interval, such that

$$\Gamma_2^- = (\Gamma_2^- \cap \Gamma_2^+) \cup \bigcup_{j \in J} \gamma_{\beta'_j}^- \quad \text{and} \quad \Gamma_2^+ = (\Gamma_2^- \cap \Gamma_2^+) \cup \bigcup_{j \in J} \gamma_{\beta'_j}^+.$$

For convenience we also allow $J = \emptyset$ iff $\Gamma_2^- = \Gamma_2^+$ and if this line of M consists of a single edge. Let us define

$$R = R^+ \cup \bigcup_{j \in J} \beta_j = R(\Gamma_\beta^-) \cup \bigcup_{i \in I} \beta_i \cup \bigcup_{j \in J} \beta'_j.$$

Then R has the same number of connected components as $R(\Gamma_\beta^-)$ and $R \subset R(\Gamma_\beta^+)$. Moreover, again because any two distinct bricks of $\widehat{\beta}$ are not adjacent, one has $\partial_M R = \Gamma_\beta^+ = \partial_M R(\Gamma_\beta^+)$. Therefore one gets $R = R(\Gamma_\beta^+)$ and it follows that

$$R(\Gamma_\beta^+) \cap L(\Gamma_\beta^-) = R(\Gamma_\beta^+) \setminus R(\Gamma_\beta^-) = \{\beta_i \mid i \in I\} \cup \{\beta'_j \mid j \in J\} \subset \widehat{\beta}$$

which completes the proof of Proposition 5.15. \square

By definition of the equivalence relation \sim on B one can let $\Gamma_{\widehat{\beta}}^+ = \Gamma_\beta^+$ and $\Gamma_{\widehat{\beta}}^- = \Gamma_\beta^-$ for every $\beta \in B$. The union of common edges of $\Gamma_{\widehat{\beta}}^-$ and $\Gamma_{\widehat{\beta}}^+$ and of the bricks equivalent to β is a closed subset of M denoted by $\mathcal{C}_{\widehat{\beta}}$ and called the *equivalence chain of $\widehat{\beta}$* . Proposition 5.15 tells us that $\mathcal{C}_{\widehat{\beta}}$ has at most two connected components. Precisely $\mathcal{C}_{\widehat{\beta}}$ has as many connected components as $R(\Gamma_{\widehat{\beta}}^-)$ (or $R(\Gamma_{\widehat{\beta}}^+)$).

If β is an annulus then $\mathcal{C}_{\widehat{\beta}} = \beta$ and one has $\Gamma_{\widehat{\beta}}^+ = \gamma_\beta^+$ and $\Gamma_{\widehat{\beta}}^- = \gamma_\beta^-$.

If β is a strip then the connected component of $\mathcal{C}_{\widehat{\beta}}$ containing β is reduced to β and γ_β^- (resp. γ_β^+) is a connected component of $\Gamma_{\widehat{\beta}}^-$ (resp. $\Gamma_{\widehat{\beta}}^+$). If moreover $\mathcal{C}_{\widehat{\beta}}$ is connected then $\mathcal{C}_{\widehat{\beta}} = \beta$ and $\Gamma_{\widehat{\beta}}^- = \gamma_\beta^-$, $\Gamma_{\widehat{\beta}}^+ = \gamma_\beta^+$.

If β is a disc or a half-plane the sets $\Gamma_{\widehat{\beta}}^+$ and $\Gamma_{\widehat{\beta}}^-$ have at least one common edge which contains the final vertex and/or the initial vertex of β if any. Furthermore one has $\gamma_\beta^+ = \Gamma_{\widehat{\beta}}^+ \cap \beta$ and $\gamma_\beta^- = \Gamma_{\widehat{\beta}}^- \cap \beta$.

One foliates now naturally each brick $\beta \in B$ as it is already explained in [LC05, page 40] (except for the case where β is an annulus, which does not appear in [LC05]). Any disc $\beta \in B$ is foliated by a continuous family $(\gamma_\beta^t)_{t \in [-1,1]}$ of segments having endpoints $v_-(\beta), v_+(\beta)$ and intersecting pairwise only at these common endpoints (see Fig. 5.9 or [LC04, page 245]). Any half-plane $\beta \in B$ possessing an initial (resp. a final) vertex $v_-(\beta)$ (resp. $v_+(\beta)$) is foliated by a continuous family $(\gamma_\beta^t)_{t \in [-1,1]}$ of half-lines with endpoint $v_-(\beta)$ (resp. $v_+(\beta)$) and intersecting pairwise only at this common endpoint. Note that in these cases the word ‘‘foliated’’ is used slightly abusively because of the local picture near $v_\pm(\beta)$. Any annulus $\beta \in B$ is foliated by a continuous family $(\gamma_\beta^t)_{t \in [-1,1]}$ of circles and any strip $\beta \in B$ is trivially foliated by a continuous family $(\gamma_\beta^t)_{t \in [-1,1]}$ of lines of M . Whatever is the topology of β , the above parameterizations by t are chosen so that $\gamma_\beta^{-1} = \gamma_\beta^-$ and $\gamma_\beta^1 = \gamma_\beta^+$. Given $\beta \in B$, remark moreover that there is a unique way to orient each γ_β^t so that $(\gamma_\beta^t)_{t \in [-1,1]}$ defines an oriented topological foliation of β compatible with the orientation of $\gamma_\beta^\pm \subset \Sigma$ given by Propositions 5.4-5.7.

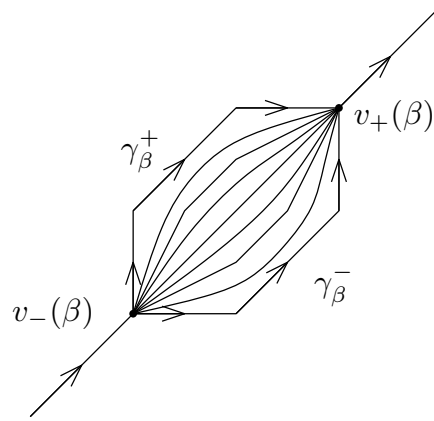
Figure 5.9 – The quasi-foliation in a disc $\beta \in B$.

For every $\beta \in B$, the sets $\Gamma_{\hat{\beta}}^-$ and $\Gamma_{\hat{\beta}}^+$ are Brouwer manifolds of h so we have

$$h(\Gamma_{\hat{\beta}}^-) \subset \text{Int}(R(\Gamma_{\hat{\beta}}^-)) \text{ and } h^{-1}(\Gamma_{\hat{\beta}}^+) \subset \text{Int}(L(\Gamma_{\hat{\beta}}^+)).$$

Then we can also assume that the family $(\gamma_{\beta}^t)_{t \in [-1,1]}$ is chosen in such a way that

$$(\star) \begin{cases} t \in [-1, -1/3] \implies h(\gamma_{\beta}^t) \subset \text{Int}(R(\Gamma_{\hat{\beta}}^-)), \\ t \in [1/3, 1] \implies h^{-1}(\gamma_{\beta}^t) \subset \text{Int}(L(\Gamma_{\hat{\beta}}^+)). \end{cases}$$

As a remark, note that if β is compact (an annulus or a disk) then this assertion follows simply from a suitable parameterization by t . If β is a half-plane or a strip, this also requires a more careful construction of the family $(\gamma_{\beta}^t)_{t \in [-1,1]}$ in the neighborhood of the points of $\text{Cl}(\beta) \setminus \beta \subset \text{Fix}(h)$. Details are left to the reader.

According to [LC04, Lemma 4.1], there exists a family $(\mu_{\beta'})_{\beta' \in \hat{\beta}}$ of increasing homeomorphisms of $[-1,1]$ such that if $\{\beta', \beta''\} \subset \hat{\beta}$ and $\beta' < \beta''$ then $\mu_{\beta''}(1/3) < \mu_{\beta'}(-1/3)$. Clearly if $\hat{\beta} = \{\beta\}$ then one can simply choose $\mu_{\beta} = \text{Id}_{[-1,1]}$. Let us define

$$\Gamma_{\hat{\beta}}^t = \left(\Gamma_{\hat{\beta}}^+ \cap \Gamma_{\hat{\beta}}^- \right) \cup \bigcup_{\beta' \in \hat{\beta}} \gamma_{\beta'}^{\mu_{\beta'}^{-1}(t)}.$$

Remark 5.1. *It is easily seen from the proof of Proposition 5.15 that, given $\beta \in B$, all the sets $\Gamma_{\hat{\beta}}^t$ are homeomorphic ($-1 \leq t \leq 1$). In particular this implies that the Brouwer manifolds $\Gamma_{\hat{\beta}}^- = \Gamma_{\hat{\beta}}^{-1}$ and $\Gamma_{\hat{\beta}}^+ = \Gamma_{\hat{\beta}}^1$ have the same type. Moreover if $\text{Fix}(h)$ is totally disconnected then the set $\text{Cl}(\Gamma_{\hat{\beta}}^t) \setminus \Gamma_{\hat{\beta}}^t$ does not depend on t .*

Lemma 5.13. *Let Γ be a Brouwer manifold of h . Let $\Delta \subset M$ satisfying the following conditions:*

- a) Δ is closed in M and homeomorphic to Γ ;
- b) $\Delta \subset L(\Gamma)$, i.e., $\text{Int}(R(\Gamma)) \subset M \setminus \Delta$;

- c) If $\text{Fix}(h)$ is totally disconnected then $\text{Cl}(\Gamma) \setminus \Gamma = \text{Cl}(\Delta) \setminus \Delta$. If $\text{Fix}(h)$ is a circle (which implies that Γ has type 3) then Δ has a connected component in each connected component M_1, M_2 of M .

We define $\mathfrak{L}(\Delta)$ (resp. $\mathfrak{R}(\Delta)$) to be the closure in M of the union of the connected components of $M \setminus \Delta$ which are disjoint from (resp. which meet) $\text{Int}(R(\Gamma))$. Suppose moreover that

- d) $\mathfrak{L}(\Delta) \cup \mathfrak{R}(\Delta) = M$ and $\mathfrak{L}(\Delta) \cap \mathfrak{R}(\Delta) = \Delta$. Furthermore $\mathfrak{L}(\Delta)$ (resp. $\mathfrak{R}(\Delta)$) has the same number of connected components as $L(\Gamma)$ (resp. $R(\Gamma)$).
- e) Δ satisfies the following Property ($\mathfrak{L} - \mathfrak{R}$) :

$$h^{-1}(\Delta) \subset \text{Int}(\mathfrak{L}(\Delta)) \text{ and } h(\Delta) \subset \text{Int}(\mathfrak{R}(\Delta)).$$

Then Δ is a Brouwer manifold of h with the same type as Γ and furthermore $R(\Gamma) \subset R(\Delta) = \mathfrak{R}(\Delta)$ and $\mathfrak{L}(\Delta) = L(\Delta) \subset L(\Gamma)$.

- Remark 5.2.** i) Suppose that $\text{Fix}(h)$ is totally disconnected. If Γ has type 1 or 2, or has type 3 with $\sharp(\text{Cl}(\Gamma) \setminus \Gamma) = 2$, then $\text{Cl}(\Gamma)$ is a circle and one knows from the proof of Proposition 3.1 that $L(\Gamma) = \text{Cl}_M(U \setminus \text{Fix}(h)) = \text{Cl}(U) \setminus \text{Fix}(h)$ and $R(\Gamma) = \text{Cl}_M(V \setminus \text{Fix}(h)) = \text{Cl}(V) \setminus \text{Fix}(h)$ where U, V are the two connected components of $\mathbb{S}^2 \setminus \text{Cl}(\Gamma)$. Assumptions a), b) and c) then show that $\text{Cl}(\Delta)$ is a circle contained in $\text{Cl}(U)$ hence the connected components of $\mathbb{S}^2 \setminus \text{Cl}(\Delta)$ can be named U', V' with $U' \subset U$ and $V' \subset V$. According again to the proof of Proposition 3.1 one has $\text{Int}(R(\Gamma)) = V \setminus \text{Fix}(h) \subset V' \setminus \text{Fix}(h)$. Combining with Lemma 5.2 one obtains $\mathfrak{L}(\Delta) = \text{Cl}_M(U' \setminus \text{Fix}(h)) = \text{Cl}(U') \setminus \text{Fix}(h)$ and $\mathfrak{R}(\Delta) = \text{Cl}_M(V' \setminus \text{Fix}(h)) = \text{Cl}(V') \setminus \text{Fix}(h)$. One deduces immediately that d) holds true, thus showing that d) is actually a consequence of a), b) and c) in these cases. It is easy to see that the same is true when $\text{Fix}(h)$ is a circle, so that the assumption d) is actually useful only when $\text{Fix}(h)$ is totally disconnected and $\sharp(\text{Cl}(\Gamma) \setminus \Gamma) = 1$.
- ii) Assumption d) also implies $\partial_M \mathfrak{L}(\Delta) = \Delta = \partial_M \mathfrak{R}(\Delta)$ as well as $\mathfrak{L}(\Delta) = \text{Cl}(\text{Int}(\mathfrak{L}(\Delta)))$ and $\mathfrak{R}(\Delta) = \text{Cl}(\text{Int}(\mathfrak{R}(\Delta)))$. Moreover $\text{Int}(\mathfrak{L}(\Delta))$ (resp. $\text{Int}(\mathfrak{R}(\Delta))$) is the union of the connected components of $M \setminus \Delta$ which are disjoint from (resp. which meet) $\text{Int}(R(\Gamma))$. For instance the reader is referred to “(i) + (ii) \Rightarrow (iii)” in the proof of Proposition 3.1.
- iii) Suppose that the four conditions a)-d) hold true and moreover that $h(\mathfrak{R}(\Delta)) \subset \text{Int}(\mathfrak{R}(\Delta))$. Then one has $h(\Delta) \subset h(\mathfrak{R}(\Delta)) \subset \text{Int}(\mathfrak{R}(\Delta))$ and

$$\mathfrak{L}(\Delta) = M \setminus \text{Int}(\mathfrak{R}(\Delta)) \subset M \setminus h(\mathfrak{R}(\Delta)) = h(\text{Int}(\mathfrak{L}(\Delta))).$$

This implies $h^{-1}(\Delta) \subset h^{-1}(\mathfrak{L}(\Delta)) \subset \text{Int}(\mathfrak{L}(\Delta))$ hence Δ satisfies the condition ($\mathfrak{L} - \mathfrak{R}$).

- iv) *The reader should keep in mind that the definition of $\mathfrak{L}(\Delta)$ and $\mathfrak{R}(\Delta)$ also involves Γ although, for simplicity, this does not appear in the notation. The considered Brouwer manifold Γ will be unambiguously specified every time we use Lemma 5.13.*

Proof. We first show that Δ is a Brouwer manifold with the same type as Γ .

- We begin with the case where $\text{Fix}(h)$ is totally disconnected and Γ is a Brouwer manifold of type 1 or 2. Assumptions a)-e) tell us that $\text{Cl}(\Delta)$ is a circle separating $h(\Delta)$ and $h^{-1}(\Delta)$ in \mathbb{S}^2 . One constructs as in Case 1 (resp. Case 2) of Proposition 5.10 a topological embedding $\varphi : \mathcal{O} \rightarrow M$ defined on $\mathcal{O} = \mathbb{R}^2 \setminus \{(0,0)\}$ (resp. $\mathcal{O} = \mathbb{R}^2$) such that $\Delta = \varphi(\mathbb{S}^1)$ (resp. $\Delta = \varphi(\{0\} \times \mathbb{R})$) showing that Δ is a Brouwer manifold of type 1 (resp. type 2).

- Suppose now that $\text{Fix}(h)$ is totally disconnected and Γ is a Brouwer manifold of type 3. Then Δ has two connected components Δ_1 and Δ_2 which are two disjoint lines of M . One needs to study separately the two following situations.

1. *The set $\text{Cl}(\Gamma) \setminus \Gamma$ is reduced to a single point $a \in \text{Fix}(h)$.*

Then $\text{Cl}(\Gamma) = \Gamma \cup \{a\}$ and $\text{Cl}(\Delta) = \Delta \cup \{a\}$ are both homeomorphic to the figure eight curve. It is equivalent to show that Δ is a Brouwer manifold for h or for h^{-1} hence, changing the roles of h and h^{-1} , one may suppose without loss that $R(\Gamma)$ has two connected components R_1 and R_2 . Assumption d) tell us that $\mathfrak{R}(\Delta)$ also has two connected components \mathfrak{R}_1 and \mathfrak{R}_2 . Even better, it is not difficult to deduce from the hypothesis $\Delta \subset L(\Gamma)$ and from $\partial_M \mathfrak{R}(\Delta) = \Delta$ that (possibly after switching the names of \mathfrak{R}_1 and \mathfrak{R}_2) one has $R_i \subset \mathfrak{R}_i$ for every $i \in \{1, 2\}$.

One knows that $h(R_i) \subset R_j$ hence $h(R_i) \subset h(\mathfrak{R}_i) \cap \mathfrak{R}_j$ for every $1 \leq i \neq j \leq 2$. This together with

$$\mathfrak{R}_i \cap h^{-1}(\partial_M \mathfrak{R}_j) \subset \mathfrak{R}_i \cap h^{-1}(\Delta) \subset \mathfrak{R}_i \cap \text{Int}(\mathfrak{L}(\Delta)) = \emptyset$$

implies $h(\mathfrak{R}_i) \subset \text{Int}(\mathfrak{R}_j)$ for every $1 \leq i \neq j \leq 2$ and consequently $h^2(\mathfrak{R}_1) \subset h(\mathfrak{R}_2) \subset \text{Int}(\mathfrak{R}_1)$. We now define $V = \text{Int}(\mathfrak{R}_1) \setminus h^2(\mathfrak{R}_1)$. Then the set V satisfies the following properties:

- $h(\Delta_2) \subset V$,
- $h^2(V) \cap V = \emptyset$ and $h(V) \cap V \subset \mathfrak{R}_2 \cap \mathfrak{R}_1 = \emptyset$.

One constructs as in Case 3 of Proposition 5.10 a topological embedding $\varphi : \mathcal{O} \rightarrow M$ with $\mathcal{O} = \{(x, y) \in \mathbb{R}^2 \mid y \neq 0\}$ and $\Delta = \varphi(\{(\{0\} \times \mathbb{R}) \cap \mathcal{O}\})$ showing that Δ is a Brouwer manifold of type 3.

2. *One has $\text{Cl}(\Gamma) \setminus \Gamma = \{a, b\}$ with $a \neq b$ in $\text{Fix}(h)$.*

Let Δ_1 and Δ_2 be the two connected components of Δ . One knows that $\mathfrak{R}(\Delta) = D \setminus \text{Fix}(h)$ where D is one of the two discs bounded by the circle $\text{Cl}(\Delta) = \Delta \cup \{a, b\}$. According to e), this circle separates $h^{-1}(\Delta)$ and $h(\Delta)$ in \mathbb{S}^2 hence one deduces $h(\Delta) \subset h(D) \subset \text{Int}(D) \cup \{a, b\}$. Let us write \leq for the cyclic order around a naturally induced

by the counterclockwise orientation of \mathbb{S}^2 . Possibly after changing the names of Δ_1 and Δ_2 , the fact that h reverses the orientation implies $\Delta_2 < h(\Delta_1) < h(\Delta_2) < \Delta_1$. Iterating h , one obtains $h^i(D) \subset \text{Int}(h^{i-1}(D)) \cup \{a, b\} \subset \text{Int}(h^2(D)) \cup \{a, b\} \subset \text{Int}(h(D)) \cup \{a, b\} \subset \text{Int}(D) \cup \{a, b\}$ with the following cyclic order around a :

$$\Delta_2 < h(\Delta_1) < h^2(\Delta_2) < h^3(\Delta_1) < h^4(\Delta_2) < h^4(\Delta_1) < h^3(\Delta_2) < h^2(\Delta_1) < h(\Delta_2) < \Delta_1.$$

Then the set $C = \Delta_1 \cup h^2(\Delta_1) \cup \{a, b\}$ is a circle disjoint from $h^{-2}(\Delta_1)$ and one can let W to be the connected component of $\mathbb{S}^2 \setminus C$ which is disjoint from $h^{-2}(\Delta_1)$. Because $C \subset D$ and $h^{-2}(\Delta_1) \cap D = \emptyset$ one gets $W \subset D$ hence $h(W) \cup h^2(W) \subset D$. This together with the cycle order as above implies that $W \cap h(W) = \emptyset = W \cap h^2(W)$ and $h(\Delta_2) \subset W$. As in Case 4 of Proposition 5.10 one can construct now a topological embedding $\varphi : \mathcal{O} \rightarrow M$, where $\mathcal{O} = \{(x, y) \in \mathbb{R}^2 \mid y \neq 0\}$ and $\Delta = \varphi((\{0\} \times \mathbb{R}) \cap \mathcal{O})$ which shows that Δ is a Brouwer manifold of type 3.

- Suppose finally that $\text{Fix}(h)$ is a circle. Then the proof works similarly as in the case where $\text{Fix}(h)$ is totally disconnected and Γ is a Brouwer manifold of type 3 with $\sharp(\text{Cl}(\Gamma) \setminus \Gamma) = 1$. Details are left to the reader.

Thus we proved that Δ is a Brouwer manifold and it remains to explain why $\mathfrak{L}(\Delta) = L(\Delta) \subset L(\Gamma)$ and $\mathfrak{R}(\Delta) = R(\Delta) \supset R(\Gamma)$. Let U (resp. V) be any connected component of $M \setminus \Delta$ meeting $h^{-1}(\Delta)$ (resp. $h(\Delta)$). Recall that each set $\text{Int}(\mathfrak{L}(\Delta))$ and $\text{Int}(\mathfrak{R}(\Delta))$ is the union of some connected components of $M \setminus \Delta$ (see (ii) in Remark 5.2) hence the assumption e) gives $U \subset \text{Int}(\mathfrak{L}(\Delta))$ and $V \subset \text{Int}(\mathfrak{R}(\Delta))$. Using (iii) in Proposition 3.1 one deduces $\text{Int}(L(\Delta)) \subset \text{Int}(\mathfrak{L}(\Delta))$ and $\text{Int}(R(\Delta)) \subset \text{Int}(\mathfrak{R}(\Delta))$ and afterwards $L(\Delta) = \text{Cl}(\text{Int}(L(\Delta))) \subset \text{Cl}(\text{Int}(\mathfrak{L}(\Delta))) = \mathfrak{L}(\Delta)$ and $R(\Delta) = \text{Cl}(\text{Int}(R(\Delta))) \subset \text{Cl}(\text{Int}(\mathfrak{R}(\Delta))) = \mathfrak{R}(\Delta)$. Because $L(\Delta) \cup R(\Delta) = M = \mathfrak{L}(\Delta) \cup \mathfrak{R}(\Delta)$, it follows that $\mathfrak{L}(\Delta) = L(\Delta)$ and $\mathfrak{R}(\Delta) = R(\Delta)$. Item (ii) in Remark 5.2 also gives $\text{Int}(R(\Gamma)) \subset \text{Int}(\mathfrak{R}(\Delta))$ and $R(\Gamma) = \text{Cl}(\text{Int}(R(\Gamma))) \subset \text{Cl}(\text{Int}(\mathfrak{R}(\Delta))) = \mathfrak{R}(\Delta) = R(\Delta)$, which implies $L(\Delta) \subset L(\Gamma)$. This ends the proof of Lemma 5.13. \square

Proposition 5.16. *Let $\beta \in B$. For every $t \in [-1, 1]$ the set $\Gamma_{\hat{\beta}}^t$ is a Brouwer manifold of h with the same type as $\Gamma_{\hat{\beta}}^{\pm}$. Moreover the names $L(\Gamma_{\hat{\beta}}^t)$ and $R(\Gamma_{\hat{\beta}}^t)$ are consistent with the orientation of $\Gamma_{\hat{\beta}}^t$, that means that $L(\Gamma_{\hat{\beta}}^t)$ (resp. $R(\Gamma_{\hat{\beta}}^t)$) lies locally on the left (resp. right) of $\Gamma_{\hat{\beta}}^t$.*

Proof. It is already known that $\Gamma_{\hat{\beta}}^{-1} = \Gamma_{\hat{\beta}}^-$ and $\Gamma_{\hat{\beta}}^1 = \Gamma_{\hat{\beta}}^+$ are two Brouwer manifolds with the same type hence one can assume $t \in (-1, 1)$. For simplicity we write Γ^{\pm} and Γ^t instead of respectively $\Gamma_{\hat{\beta}}^{\pm}$ and $\Gamma_{\hat{\beta}}^t$. One applies Lemma 5.13 to the Brouwer manifold $\Gamma = \Gamma^-$ and to $\Delta = \Gamma^t$. It is not difficult to check that the four conditions

a)-d) in Lemma 5.13 are satisfied. Observe moreover that

$$\mathfrak{R}(\Gamma^t) = R(\Gamma^-) \cup \bigcup_{b \in \widehat{\beta}} \bigcup_{s \in [-1, t]} \gamma_b^{\mu_b^{-1}(s)} \quad \text{and} \quad \mathfrak{L}(\Gamma^t) = L(\Gamma^+) \cup \bigcup_{b \in \widehat{\beta}} \bigcup_{s \in [t, 1]} \gamma_b^{\mu_b^{-1}(s)}.$$

which implies in particular $\partial_M \mathfrak{L}(\Gamma^t) = \Gamma^t = \partial_M \mathfrak{R}(\Gamma^t)$ (this is also known from Remark 5.2).

It remains to prove the so-called Property ($\mathfrak{L} - \mathfrak{R}$) in e) of Lemma 5.13, that means

$$h(\Gamma^t) \subset \text{Int}(\mathfrak{R}(\Gamma^t)) \quad \text{and} \quad h^{-1}(\Gamma^t) \subset \text{Int}(\mathfrak{L}(\Gamma^t)).$$

As a preliminary result, let us observe that $h(\Gamma^t) \cap \Gamma^t = \emptyset$. Indeed $\Gamma^t = (\Gamma^- \cap \Gamma^+) \cup \bigcup_{b \in \widehat{\beta}} \gamma_b^{\mu_b^{-1}(t)}$ and one knows that $h^{-1}(\Gamma^+) \subset \text{Int}(L(\Gamma^+)) \subset \text{Int}(\mathfrak{L}(\Gamma^t))$ and $h(\Gamma^-) \subset \text{Int}(R(\Gamma^-)) \subset \text{Int}(\mathfrak{R}(\Gamma^t))$. Furthermore if $\beta', \beta'' \in \widehat{\beta}$ are such that

$$\emptyset \neq h(\gamma_{\beta''}^{\mu_{\beta''}^{-1}(t)}) \cap \gamma_{\beta'}^{\mu_{\beta'}^{-1}(t)} \subset h(\beta'') \cap \beta'$$

then one gets $\mu_{\beta''}^{-1}(t) > -1/3$ and $\mu_{\beta'}^{-1}(t) < 1/3$ because of the property (\star) for the parameterizations of $(\gamma_{\beta'}^t)_{t \in [-1, 1]}$ and $(\gamma_{\beta''}^t)_{t \in [-1, 1]}$. Equivalently $\mu_{\beta''}(-1/3) < t < \mu_{\beta'}(1/3)$. On the other hand it follows from $h(\beta'') \cap \beta' \neq \emptyset$ that $\beta'' < \beta'$ which contradicts the property of the family $(\mu_{\beta'})_{\beta' \in \widehat{\beta}}$ given by Le Calvez's lemma ([LC04, Lemma 4.1]). One concludes as expected that $h(\Gamma^t) \cap \Gamma^t = \emptyset$ for every $t \in [-1, 1]$.

- We first consider the cases where β is an annulus or a strip satisfying $\mathcal{C}_{\widehat{\beta}} = \beta$ (they are the only situations where $\mathcal{C}_{\widehat{\beta}} = \beta$).

One has then $\Gamma^t \subset \beta$. One knows from Proposition 5.15 that $R(\Gamma^+) = R(\Gamma^-) \cup \beta$ or, equivalently, that $L(\Gamma^-) = L(\Gamma^+) \cup \beta$. Using Items (iv)-(v) of Proposition 3.1 one obtains

$$h(\beta) \subset h(R(\Gamma^+)) \subset R(\Gamma^+) = R(\Gamma^-) \cup \beta \quad \text{and} \quad h^{-1}(\beta) \subset h^{-1}(L(\Gamma^-)) \subset L(\Gamma^-) = L(\Gamma^+) \cup \beta.$$

Recall that $h(\beta) \cap \beta = \emptyset$ hence

$$h(\Gamma^t) \subset h(\beta) \subset R(\Gamma^-) \subset \mathfrak{R}(\Gamma^t) \quad \text{and} \quad h^{-1}(\Gamma^t) \subset h^{-1}(\beta) \subset L(\Gamma^+) \subset \mathfrak{L}(\Gamma^t)$$

and consequently, since $h(\Gamma^t)$ is disjoint from $\Gamma^t = \partial_M \mathfrak{R}(\Gamma^t) = \partial_M \mathfrak{L}(\Gamma^t)$, one gets $h(\Gamma^t) \subset \text{Int}(\mathfrak{R}(\Gamma^t))$ and $h^{-1}(\Gamma^t) \subset \text{Int}(\mathfrak{L}(\Gamma^t))$. This shows that Γ^t satisfies the condition ($\mathfrak{L} - \mathfrak{R}$) and therefore it is a Brouwer manifold of h with the same type as Γ^\pm , that means with type 1 (resp. type 2) if β is an annulus (resp. a strip satisfying $\mathcal{C}_{\widehat{\beta}} = \beta$).

- We exclude from now on the above simple cases, in other words we suppose $\beta \not\subset \mathcal{C}_{\widehat{\beta}}$.

We write Γ_1^\pm for the connected component of Γ^\pm containing γ_β^\pm . As usual Γ_2^\pm denotes the other connected component of Γ^\pm if any and otherwise $\Gamma_2^\pm = \Gamma_1^\pm = \Gamma^\pm$. A similar convention is used for $\Gamma^t = \Gamma_1^t \cup \Gamma_2^t$ with $\gamma_\beta^{\mu_\beta^{-1}(t)} \subset \Gamma_1^t$.

Given $i \in \{1, 2\}$, remark that if Γ_i^- and Γ_i^+ intersect then they have at least one common edge α with also $\alpha \subset \Gamma_i^t$. It follows that

$$h(\alpha) \subset h(\Gamma_i^t) \cap h(\Gamma^-) \subset h(\Gamma_i^t) \cap \text{Int}(R(\Gamma^-)) \subset h(\Gamma_i^t) \cap \text{Int}(\mathfrak{R}(\Gamma^t)).$$

Since $h(\Gamma_i^t) \subset h(\Gamma^t)$ is disjoint from $\Gamma^t = \partial_M \mathfrak{R}(\Gamma^t)$ one deduces that the connected set $h(\Gamma_i^t)$ is included in $\text{Int}(\mathfrak{R}(\Gamma^t))$. Similarly $h^{-1}(\alpha) \subset h^{-1}(\Gamma_i^t) \cap \text{Int}(\mathfrak{L}(\Gamma^t))$ and afterwards $h^{-1}(\Gamma_i^t) \subset \text{Int}(\mathfrak{L}(\Gamma^t))$.

As an immediate consequence of the above remark, the condition $(\mathfrak{L} - \mathfrak{R})$ is satisfied when $\Gamma_i^- \cap \Gamma_i^+ \neq \emptyset$ for every $i \in \{1, 2\}$, in particular when Γ^\pm are connected. Note that Γ^t and Γ^\pm have then the same type because they are homeomorphic.

It remains to consider the situations where Γ^\pm are not connected and $\Gamma_i^+ \cap \Gamma_i^- = \emptyset$ for at least one index $i \in \{1, 2\}$.

First case : $\Gamma_1^- \cap \Gamma_1^+ = \emptyset$ and $\Gamma_2^- \cap \Gamma_2^+ \neq \emptyset$.

In this case, the brick β is a strip containing Γ_1^t with $\partial_M \beta = \gamma_\beta^- \sqcup \gamma_\beta^+ = \Gamma_1^- \sqcup \Gamma_1^+$ and one already knows that $h(\Gamma_2^t) \subset \text{Int}(\mathfrak{R}(\Gamma^t))$ and $h^{-1}(\Gamma_2^t) \subset \text{Int}(\mathfrak{L}(\Gamma^t))$. It is also known that the connected sets $h^\pm(\Gamma_1^t)$ are disjoint from $\partial_M \mathfrak{R}(\Gamma^t) = \Gamma^t = \partial_M \mathfrak{L}(\Gamma^t)$ hence, in order to prove that the condition $(\mathfrak{L} - \mathfrak{R})$ holds, it is enough to show that $h^{-1}(\Gamma_1^t) \cap \mathfrak{L}(\Gamma^t) \neq \emptyset$ and $h(\Gamma_1^t) \cap \mathfrak{R}(\Gamma^t) \neq \emptyset$. One has with Proposition 5.15

$$(*) \quad h(\Gamma_1^t) \subset h(R(\Gamma^+)) \subset R(\Gamma^+) = R(\Gamma^-) \cup \bigcup_{\beta' \in \widehat{\beta}} \beta'.$$

Clearly $h(\Gamma_1^t) \cap \beta \subset h(\beta) \cap \beta = \emptyset$. Let us show that there is no brick $\beta' \in \widehat{\beta} \setminus \{\beta\}$ satisfying $h(\Gamma_1^t) \subset \beta'$. This is certainly true if $\text{Fix}(h)$ is totally disconnected and $\sharp(\text{Cl}(\Gamma^\pm) \setminus \Gamma^\pm) = 2$. Indeed, on one hand $\text{Cl}(h(\Gamma^t)) \setminus h(\Gamma^t) = \text{Cl}(\Gamma^t) \setminus \Gamma^t = \text{Cl}(\Gamma^\pm) \setminus \Gamma^\pm$ and on the other hand one deduces from $\Gamma_2^- \cap \Gamma_2^+ \neq \emptyset$ that every brick $\beta' \in \widehat{\beta} \setminus \{\beta\}$ is either a disc or a half-plane and therefore accumulates on at most one fixed point. Assume now that $\text{Fix}(h)$ is totally disconnected and $\text{Cl}(\Gamma^\pm) \setminus \Gamma^\pm = \{a\}$. Then $\text{Cl}(\Gamma_1^t) = \Gamma_1^t \cup \{a\}$ is a circle and, because $\Gamma_1^t \subset \beta = l(\Gamma_1^-) \cap r(\Gamma_1^+)$, each of both discs D_1, D_2 bounded by $\text{Cl}(\Gamma_1^t)$ contains at least one connected component of $R(\Gamma^-)$ or of $L(\Gamma^+)$. Arguing by contradiction, suppose that $h(\Gamma_1^t) \subset \beta'$ for some brick $\beta' \in \widehat{\beta} \setminus \{\beta\}$ which is necessarily a half-plane accumulating on a . Then for every $i \in \{1, 2\}$ one has $\partial h(D_i) = h(\Gamma_1^t) \cup \{a\} \subset \beta' \cup \{a\} = \text{Cl}(\beta')$. Since $\text{Cl}(\beta')$ is a disc, it follows that there exists $i \in \{1, 2\}$ such that $h(D_i) \subset \text{Cl}(\beta')$. Thus β' contains the h -image of a connected component of $R(\Gamma^-)$ or of $L(\Gamma^+)$ which contradicts $h^2(\beta') \cap \beta' = \emptyset$. If finally $\text{Fix}(h)$ is a circle then one can compactify each connected component M_1, M_2 of M with one point and the same arguments as in the previous situation also work. This proves that in every case $h(\Gamma_1^t) \not\subset \beta'$ for all $\beta' \in \widehat{\beta}$. Recall furthermore that the bricks in $\widehat{\beta}$ are pairwise disjoint hence one deduces from (*) above that $\emptyset \neq h(\Gamma_1^t) \cap R(\Gamma^-) \subset h(\Gamma_1^t) \cap \mathfrak{R}(\Gamma^t)$.

One obtains similarly from

$$(**) \quad h^{-1}(\Gamma_1^t) \subset h^{-1}(L(\Gamma^-)) \subset L(\Gamma^-) = L(\Gamma^+) \cup \bigcup_{\beta' \in \widehat{\beta}} \beta'.$$

that $h^{-1}(\Gamma_1^t) \cap \mathfrak{L}(\Gamma^t) \neq \emptyset$. Thus the condition $(\mathfrak{L} - \mathfrak{R})$ holds true and Γ^t is a Brouwer manifold of type 3.

Second case : $\Gamma_1^- \cap \Gamma_1^+ \neq \emptyset$ and $\Gamma_2^- \cap \Gamma_2^+ = \emptyset$.

One knows that the strip with frontier $\Gamma_2^- \sqcup \Gamma_2^+$ and containing $l(\Gamma_2^-) \cup r(\Gamma_2^+)$ actually consists of a single brick $\beta_* \in \widehat{\beta}$ (see Claim 3 in the proof of Proposition 5.15) hence one reduces to the first case replacing β with β_* .

Third case : One has $\Gamma_i^+ \cap \Gamma_i^- = \emptyset$ for every $i \in \{1, 2\}$.

For convenience we rename $\beta = \beta_1$. Then for every $i \in \{1, 2\}$ there is a brick β_i which is a strip with frontier $\partial_M \beta_i = \gamma_{\beta_i}^- \sqcup \gamma_{\beta_i}^+ = \Gamma_i^- \sqcup \Gamma_i^+$ (for $i = 2$ this requires again Claim 3 in the proof of Proposition 5.15) and one has $\widehat{\beta} = \widehat{\beta}_1 = \widehat{\beta}_2 = \{\beta_1, \beta_2\}$. Let us show that $h(\Gamma_2^t) \subset \text{Int}(\mathfrak{R}(\Gamma^t))$ and $h^{-1}(\Gamma_2^t) \subset \text{Int}(\mathfrak{L}(\Gamma^t))$. Since $h(\Gamma^t)$ is disjoint from $\Gamma^t = \partial_M \mathfrak{L}(\Gamma^t) = \partial_M \mathfrak{R}(\Gamma^t)$, one of the following situations occurs:

1. $h(\Gamma_2^t) \subset \text{Int}(\mathfrak{R}(\Gamma^t))$ and $h^{-1}(\Gamma_2^t) \subset \text{Int}(\mathfrak{L}(\Gamma^t))$,
2. $h(\Gamma_2^t) \subset \text{Int}(\mathfrak{L}(\Gamma^t))$,
3. $h^{-1}(\Gamma_2^t) \subset \text{Int}(\mathfrak{R}(\Gamma^t))$.

Let us prove that actually neither (ii) nor (iii) occurs.

- Suppose first that (ii) holds. For every $i \in \{1, 2\}$ we denote by S_i the strip included in β_i and with frontier $\partial_M S_i = \Gamma_i^t \sqcup \Gamma_i^+$, in other words $S_i = \bigcup_{s \in [t, 1]} \Gamma_i^s$. Note that $S_1 \sqcup S_2 = R(\Gamma^+) \setminus \text{Int}(\mathfrak{R}(\Gamma^t))$ whether $\text{Fix}(h)$ is a circle or a totally disconnected set and, when $\text{Fix}(h)$ is totally disconnected, whether $\text{Cl}(\Gamma^\pm) \setminus \Gamma^\pm$ has cardinality one or two. Our aim is to prove that $h(S_2) \subset \text{Int}(S_1)$ and afterwards it will be shown that this inclusion lead to a contradiction.

Since $\Gamma_2^t \subset \mathfrak{R}(\Gamma^t) \subset R(\Gamma^+)$ one gets $h(\Gamma_2^t) \subset \text{Int}(R(\Gamma^+)) \setminus \mathfrak{R}(\Gamma^t) = \text{Int}(S_1) \sqcup \text{Int}(S_2)$ and more precisely $h(\Gamma_2^t) \subset \text{Int}(S_1)$ because $h(\Gamma_2^t) \cap \text{Int}(S_2) \subset h(\beta_2) \cap \beta_2 = \emptyset$.

◆ Suppose also that $\text{Fix}(h)$ is totally disconnected and $\text{Cl}(\Gamma^\pm) \setminus \Gamma^\pm = \{a, b\}$ with $a \neq b$ in $\text{Fix}(h)$. Recall from the proof of Proposition 3.1 that $R(\Gamma^-) = D^- \setminus \text{Fix}(h)$ where D^- is one of the two discs bounded by the circle $\text{Cl}(\Gamma^-) = \Gamma^- \cup \{a, b\}$ and let $W = \beta_1 \cup D^- \cup \bigcup_{s \in [-1, t]} \Gamma_2^s$. In other words, W is the disc bounded by the circle $\text{Cl}(\Gamma_1^+ \cup \Gamma_2^t) = \Gamma_1^+ \cup \Gamma_2^t \cup \{a, b\}$ and such that $R(\Gamma^-) \subset W$. One knows that $h(\Gamma_2^t) \subset \text{Int}(S_1) \subset \text{Int}(W)$ hence, up to conjugacy by an orientation preserving homeomorphism of \mathbb{S}^2 , one can assume that W is the Euclidean closed unit disc in \mathbb{R}^2 with $a = (0, -1)$, $b = (0, 1)$, $\Gamma_1^+ = \partial W \cap ((-\infty, 0) \times \mathbb{R})$, $\Gamma_2^t = \partial W \cap ((0, +\infty) \times \mathbb{R})$ and $h(\Gamma_2^t) = \{0\} \times (-1, 1)$. By construction, the strip S_2 lies locally on the left of $\Gamma_2^t \subset \partial_M S_2$ and $S_2 \cap W = \Gamma_2^t$ hence Γ_2^t is oriented from b to a . Because h reverses the orientation, $h(S_2)$ lies locally on the right of $h(\Gamma_2^t)$ oriented from

$h(b) = b$ to $h(a) = a$. Since moreover $h(S_2) \cap \Gamma_1^+ \subset \text{Int}(R(\Gamma^+)) \cap \Gamma^+ = \emptyset$ one obtains $h(S_2) \subset W_* \setminus \text{Cl}(\Gamma_1^+)$ where $W_* = \{(x, y) \in W \mid x \leq 0\}$. Furthermore $h(\Gamma_2^t) \subset \text{Int}(S_1)$ separates Γ_1^t and Γ_1^+ in $S_1 \subset W$ and therefore $\Gamma_1^t \subset W \setminus W_*$. It follows that $\text{Int}(W_*) \subset \text{Int}(S_1)$ which implies $h(S_2) \subset \text{Int}(S_1)$ (Fig. 5.10).

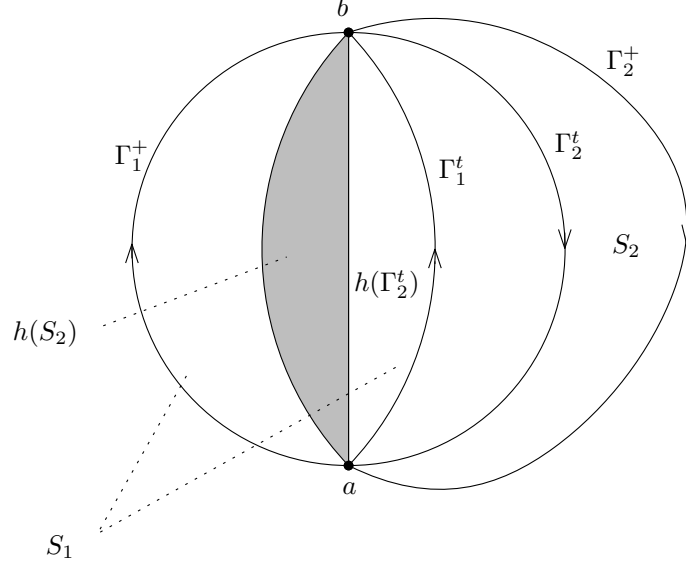

Figure 5.10 – The situation (ii) when $\sharp(\text{Cl}(\Gamma^\pm) \setminus \Gamma^\pm) = 2$

- ◆ Suppose next that $\text{Fix}(h)$ is totally disconnected and that $\sharp(\text{Cl}(\Gamma^\pm) \setminus \Gamma^\pm) = 1$. We first deal with the case where $R(\Gamma^+)$ has two connected components, denoted by R_1^+ and R_2^+ . Then the set $R(\Gamma^-)$ (resp. $\mathfrak{R}(\Gamma^t)$) also has two connected components R_1^- and R_2^- (resp. \mathfrak{R}_1^t and \mathfrak{R}_2^t) which can be numbered so that $R_i^- \subset \mathfrak{R}_i^t \subset R_i^+$ for every $i \in \{1, 2\}$. In this case one has $S_i = R_i^+ \setminus \text{Int}(\mathfrak{R}_i^t)$ for every $i \in \{1, 2\}$. One knows from the proof of Proposition 3.1 that $h(R_i^-) \subset \text{Int}(R_j^-)$ and $h(R_i^+) \subset \text{Int}(R_j^+)$ for every $i \neq j$ in $\{1, 2\}$. One has then $\emptyset \neq h(R_2^-) \subset h(\mathfrak{R}_2^t) \cap R_1^- \subset h(\mathfrak{R}_2^t) \cap \mathfrak{R}_1^t$. This together $\partial_M h(\mathfrak{R}_2^t) \cap \mathfrak{R}_1^t = h(\Gamma_2^t) \cap \mathfrak{R}_1^t \subset \text{Int}(\mathfrak{L}(\Gamma^t)) \cap \mathfrak{R}(\Gamma^t) = \emptyset$ implies $\mathfrak{R}_1^t \subset \text{Int}(h(\mathfrak{R}_2^t))$. Hence one obtains as announced $h(S_2) = h(R_2^+) \setminus \text{Int}(h(\mathfrak{R}_2^t)) \subset \text{Int}(R_1^+) \setminus \mathfrak{R}_1^t = \text{Int}(S_1)$ (Fig 5.11).

Let us study now the case where $L(\Gamma^+)$ has two connected components, denoted by L_1^- and L_2^- . Then $\mathfrak{L}(\Gamma^t)$ (resp. $L(\Gamma^-)$) also has two connected components \mathfrak{L}_1^t and \mathfrak{L}_2^t (resp. L_1^- and L_2^-) with $L_i^+ \subset \mathfrak{L}_i^t \subset L_i^-$ for any $i \in \{1, 2\}$. Recall that $h^{-1}(L_i^-) \subset \text{Int}(L_j^-)$ and $h^{-1}(L_i^+) \subset \text{Int}(L_j^+)$ for $1 \leq i \neq j \leq 2$. In this situation one has $S_i = \mathfrak{L}_i^t \setminus \text{Int}(L_i^+)$. One deduces from $h(\Gamma_2^t) \subset \text{Int}(\mathfrak{L}(\Gamma^t)) = \text{Int}(\mathfrak{L}_1^t) \sqcup \text{Int}(\mathfrak{L}_2^t)$ that $h(\Gamma_2^t) \subset \text{Int}(\mathfrak{L}_1^t)$ since otherwise $h(\Gamma_2^t) \subset \mathfrak{L}_2^t$ and therefore

$$\emptyset \neq h(\Gamma_2^t) \cap \mathfrak{L}_2^t \subset h(L_2^-) \cap L_2^- = h(L_2^- \cap h^{-1}(L_2^-)) \subset h(L_2^- \cap L_1^-) = \emptyset$$

which is absurd. Now $h(\Gamma_2^t) \subset \text{Int}(\mathfrak{L}_1^t)$ implies that $h(\mathfrak{L}_2^t) \subset \text{Int}(\mathfrak{L}_1^t)$ or $M \setminus h(\text{Int}(\mathfrak{L}_2^t)) \subset \text{Int}(\mathfrak{L}_1^t)$. The second inclusion is equivalent to $M \setminus \text{Int}(\mathfrak{L}_2^t) \subset h^{-1}(\text{Int}(\mathfrak{L}_1^t))$

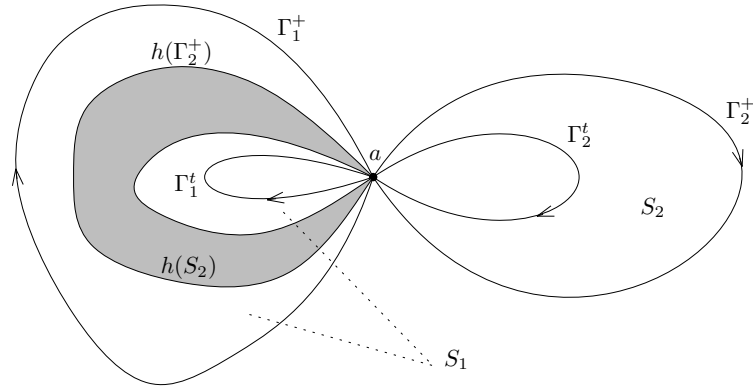

Figure 5.11 – The situation (ii) when $\sharp(\text{Cl}(\Gamma^\pm) \setminus \Gamma^\pm) = 1$ and $R(\Gamma^\pm)$ has two connected components

hence it implies

$$\Gamma_2^- \subset M \setminus \text{Int}(\mathfrak{L}_2^t) \subset h^{-1}(\mathfrak{L}_1^t) \subset h^{-1}(L_1^-) \subset \text{Int}(L_2^-)$$

which is certainly not true. Then one obtains $h(\mathfrak{L}_2^t) \subset \text{Int}(\mathfrak{L}_1^t)$ and it also follows that

$$h(S_2) = h(\mathfrak{L}_2^t) \setminus \text{Int}(h(L_2^+)) \subset \text{Int}(\mathfrak{L}_1^t) \setminus L_1^+ = \text{Int}(S_1).$$

- ◆ If $\text{Fix}(h)$ is a circle then one obtains $h(S_2) \subset \text{Int}(S_1)$ similarly as in the previous case where Γ^\pm accumulate on a single fixed point. Details are left to the reader.

Thus it has been shown that if (ii) holds true then one always has $h(S_2) \subset \text{Int}(S_1)$. Since the foliation \mathcal{F} is trivial in S_2 , there exists a segment $\gamma \subset S_2$ joining a point $x_t \in \Gamma_2^t$ and a point $x_+ \in \Gamma_2^+$ such that $\gamma \setminus \{x_t, x_+\} \subset \text{Int}(S_2)$ and γ intersects the leaf Γ_2^s transversely at only one point for every $s \in (t, 1)$. We also join a point of Γ_1^+ and $h(x_+)$ by a segment γ_1 and a point of Γ_1^t and $h(x_t)$ by a segment γ_2 such that $\gamma^* = \gamma_1 \cup h(\gamma) \cup \gamma_2 \subset S_1$ is a segment. As a remark, $h(\Gamma_2^+)$ and $h(\Gamma_2^t)$ are arranged in $\text{Int}(S_1)$ as pictured on Fig. 5.12, that means that $h(\Gamma_2^+)$ separates Γ_1^+ and $h(\Gamma_2^t)$ in S_1 . This simple property is left to the reader because it is not used in the rest of the proof.

We construct now a continuous map $\psi : \gamma^* \rightarrow \gamma^*$ as follows. For each $m \in \gamma^*$ there exists a unique $s \in [t, 1]$ such that $m \in \Gamma_1^s$. Because the set $\Gamma_2^s \cap \gamma$ consists of a single point, we may define $\psi(m)$ to be the point in $h(\Gamma_2^s \cap \gamma) \subset h(\gamma) \subset \gamma^*$ (see Fig. 5.12). It is not difficult to check that ψ is continuous hence there exists $m \in \gamma^*$ such that $\psi(m) = m$. This implies $h(\Gamma_2^s) \cap \Gamma_1^s \neq \emptyset$ where $m \in \Gamma_1^s$, a contradiction with $h(\Gamma^s) \cap \Gamma^s = \emptyset$. This proves that the situation (ii) cannot occur.

- Suppose now that (iii) holds. Consider the strip $S_i \subset \beta_i$ with frontier $\partial_M S_i = \Gamma_i^- \sqcup \Gamma_i^t$ ($i \in \{1, 2\}$). By switching the letters $R(\cdot)$ and $L(\cdot)$, the letters $\mathfrak{R}(\cdot)$ and $\mathfrak{L}(\cdot)$, the homeomorphisms h and h^{-1} , the same arguments as above arguments give $h^{-1}(S_2) \subset S_1$ (see Figs. 5.13 and 5.14) and then there exists $s \in [-1, t]$ such that $h^{-1}(\Gamma^s) \cap \Gamma^s \neq \emptyset$ which is again a contradiction.

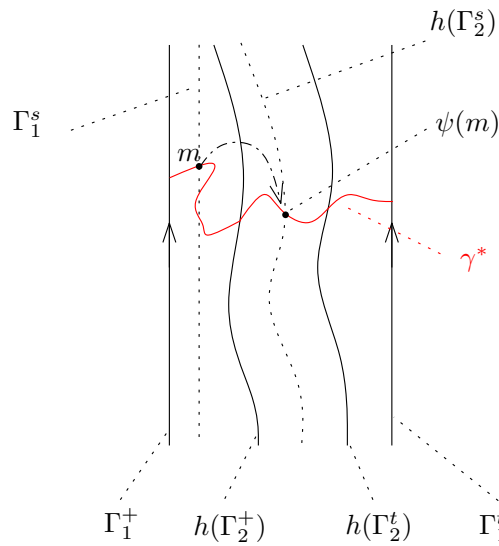

Figure 5.12 – The construction of the map ψ

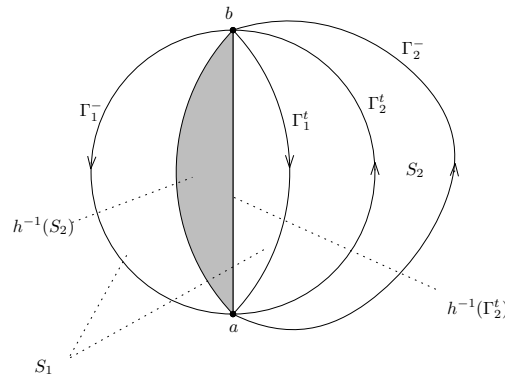

Figure 5.13 – The case $\#(\text{Cl}(\Gamma^\pm) \setminus \Gamma^\pm) = 2$

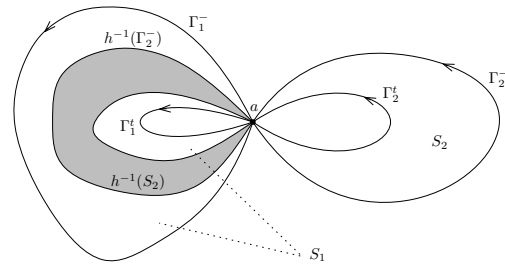

Figure 5.14 – The case $\#(\text{Cl}(\Gamma^\pm) \setminus \Gamma^\pm) = 1$ and the set $L(\Gamma^\pm)$ has two connected components

This proves the property (i), that means $h(\Gamma_2^t) \subset \text{Int}(\mathfrak{R}(\Gamma^t))$ and $h^{-1}(\Gamma_2^t) \subset \text{Int}(\mathfrak{L}(\Gamma^t))$. Clearly the same inclusions are still true with Γ_1^t instead of Γ_2^t which shows that Property $(\mathfrak{L} - \mathfrak{R})$ holds and therefore Γ^t is a Brouwer manifold.

Finally the assertion about the orientation of Γ^t and its two sides $L(\Gamma^t)$ and $R(\Gamma^t)$ is direct consequence of $L(\Gamma^t) = \mathfrak{L}(\Gamma^t)$ and $R(\Gamma^t) = \mathfrak{R}(\Gamma^t)$. This ends the proof of Proposition 5.16. \square

Proposition 5.17. *For every $\beta, \beta' \in B$ and $t, t' \in [-1, 1]$ the two Brouwer manifolds $\Gamma_{\hat{\beta}}^t$ and $\Gamma_{\hat{\beta}'}^{t'}$ have no transverse intersection.*

Proof. The result is clear if $\hat{\beta} = \hat{\beta}'$. Let us consider the case $\hat{\beta} \neq \hat{\beta}'$. Observe first that the two sets $L(\Gamma_{\hat{\beta}}^-)$ and $L(\Gamma_{\hat{\beta}'}^-)$ are disjoint in B iff they are disjoint in M hence we do not need to specify the reference set B or M when we write below that $L(\Gamma_{\hat{\beta}}^-) \cap L(\Gamma_{\hat{\beta}'}^-)$ is empty or not. Similarly for $R(\Gamma_{\hat{\beta}}^-) \cap R(\Gamma_{\hat{\beta}'}^-)$ and $L(\Gamma_{\hat{\beta}}^+) \cap L(\Gamma_{\hat{\beta}'}^+)$ and $R(\Gamma_{\hat{\beta}}^+) \cap R(\Gamma_{\hat{\beta}'}^+)$.

CLAIM 1. *One has*

- $R(\Gamma_{\hat{\beta}}^-) \cap R(\Gamma_{\hat{\beta}'}^-) = \emptyset$ iff $R(\Gamma_{\hat{\beta}}^+) \cap R(\Gamma_{\hat{\beta}'}^+) = \emptyset$,
- $L(\Gamma_{\hat{\beta}}^-) \cap L(\Gamma_{\hat{\beta}'}^-) = \emptyset$ iff $L(\Gamma_{\hat{\beta}}^+) \cap L(\Gamma_{\hat{\beta}'}^+) = \emptyset$.

Proof. We only prove the first assertion since the second one can be obtained in the same way by switching the letters $l(\cdot)$ and $r(\cdot)$, the letters $R(\cdot)$ and $L(\cdot)$ and the symbols $+$ and $-$. If $R(\Gamma_{\hat{\beta}}^+) \cap R(\Gamma_{\hat{\beta}'}^+) = \emptyset$ then also $R(\Gamma_{\hat{\beta}}^-) \cap R(\Gamma_{\hat{\beta}'}^-) = \emptyset$ because $\Gamma_{\hat{\beta}}^- \preceq \Gamma_{\hat{\beta}}^+$ and $\Gamma_{\hat{\beta}'}^- \preceq \Gamma_{\hat{\beta}'}^+$. Conversely, suppose that $R(\Gamma_{\hat{\beta}}^-) \cap R(\Gamma_{\hat{\beta}'}^-) = \emptyset$. Using Proposition 5.15 one gets

$$\begin{aligned} R(\Gamma_{\hat{\beta}}^+) \cap R(\Gamma_{\hat{\beta}'}^+) &= \left((R(\Gamma_{\hat{\beta}}^+) \cap L(\Gamma_{\hat{\beta}}^-)) \cup (R(\Gamma_{\hat{\beta}}^+) \cap R(\Gamma_{\hat{\beta}}^-)) \right) \cap \\ &\quad \left((R(\Gamma_{\hat{\beta}'}^+) \cap L(\Gamma_{\hat{\beta}'}^-)) \cup (R(\Gamma_{\hat{\beta}'}^+) \cap R(\Gamma_{\hat{\beta}'}^-)) \right) \\ &= (\hat{\beta} \cap \hat{\beta}') \cup (\hat{\beta} \cap R(\Gamma_{\hat{\beta}'}^+) \cap R(\Gamma_{\hat{\beta}'}^-)) \cup (\hat{\beta}' \cap R(\Gamma_{\hat{\beta}}^+) \cap R(\Gamma_{\hat{\beta}}^-)) \cup \\ &\quad \cup (R(\Gamma_{\hat{\beta}}^+) \cap R(\Gamma_{\hat{\beta}}^-) \cap R(\Gamma_{\hat{\beta}'}^+) \cap R(\Gamma_{\hat{\beta}'}^-)). \end{aligned}$$

By hypothesis one has $\hat{\beta} \cap \hat{\beta}' = \emptyset = R(\Gamma_{\hat{\beta}}^+) \cap R(\Gamma_{\hat{\beta}}^-) \cap R(\Gamma_{\hat{\beta}'}^+) \cap R(\Gamma_{\hat{\beta}'}^-)$. Using again Proposition 5.15 one also has $\hat{\beta} \cap R(\Gamma_{\hat{\beta}'}^+) \cap R(\Gamma_{\hat{\beta}'}^-) \subset l(\Gamma_{\hat{\beta}}^-) \cap R(\Gamma_{\hat{\beta}'}^-)$ and this latter set is empty (as a subset of B) because otherwise there exists an edge $\alpha \subset \Gamma_{\hat{\beta}}^-$ such that $l(\alpha) \in R(\Gamma_{\hat{\beta}}^-)$ and then $r(\alpha) \in r(\Gamma_{\hat{\beta}}^-) \cap R(\Gamma_{\hat{\beta}'}^-) \subset R(\Gamma_{\hat{\beta}}^-) \cap R(\Gamma_{\hat{\beta}'}^-) = \emptyset$ which is absurd. One gets likewise $\hat{\beta}' \cap R(\Gamma_{\hat{\beta}}^+) \cap R(\Gamma_{\hat{\beta}}^-) \subset l(\Gamma_{\hat{\beta}'}^-) \cap R(\Gamma_{\hat{\beta}}^-) = \emptyset$ which proves $R(\Gamma_{\hat{\beta}}^+) \cap R(\Gamma_{\hat{\beta}'}^+) = \emptyset$. \square

- If $L(\Gamma_{\hat{\beta}}^-) \cap L(\Gamma_{\hat{\beta}'}^-) = \emptyset$ then $\Gamma_{\hat{\beta}}^t \subset L(\Gamma_{\hat{\beta}}^t) \subset L(\Gamma_{\hat{\beta}}^-) \subset R(\Gamma_{\hat{\beta}'}^-) \subset R(\Gamma_{\hat{\beta}'}^{t'})$ hence $\Gamma_{\hat{\beta}}^t$ and $\Gamma_{\hat{\beta}'}^{t'}$ have no transverse intersection.

- If $R(\Gamma_{\hat{\beta}}^-) \cap R(\Gamma_{\hat{\beta}'}^-) = \emptyset$ then by Claim 1 $R(\Gamma_{\hat{\beta}}^+) \cap R(\Gamma_{\hat{\beta}'}^+) = \emptyset$ and therefore $\Gamma_{\hat{\beta}}^t$ and $\Gamma_{\hat{\beta}'}^{t'}$ have no transverse intersection because $\Gamma_{\hat{\beta}}^t \subset R(\Gamma_{\hat{\beta}}^t) \subset R(\Gamma_{\hat{\beta}}^+) \subset L(\Gamma_{\hat{\beta}'}^+) \subset L(\Gamma_{\hat{\beta}'}^{t'})$.

- It remains to study the situation where $R(\Gamma_{\hat{\beta}}^-) \cap R(\Gamma_{\hat{\beta}'}^-) \neq \emptyset$ and $L(\Gamma_{\hat{\beta}}^-) \cap L(\Gamma_{\hat{\beta}'}^-) \neq \emptyset$.

One has the following result.

CLAIM 2. *Suppose that $R(\Gamma_{\hat{\beta}}^-) \cap R(\Gamma_{\hat{\beta}'}^-) \neq \emptyset$ and $L(\Gamma_{\hat{\beta}}^-) \cap L(\Gamma_{\hat{\beta}'}^-) \neq \emptyset$. Then the four Brouwer manifolds $\Gamma_{\hat{\beta}}^-, \Gamma_{\hat{\beta}}^+, \Gamma_{\hat{\beta}'}^-,$ and $\Gamma_{\hat{\beta}'}^+$ are pairwise comparable.*

Proof. - One already knows that $\Gamma_{\hat{\beta}}^- \prec \Gamma_{\hat{\beta}}^+$ and $\Gamma_{\hat{\beta}'}^- \prec \Gamma_{\hat{\beta}'}^+$.

- One also knows that the Brouwer manifolds $\Gamma_{\hat{\beta}}^-$ and $\Gamma_{\hat{\beta}'}^-$ have no transverse intersection. Then combining Proposition 3.3 with our assumption $R(\Gamma_{\hat{\beta}}^-) \cap R(\Gamma_{\hat{\beta}'}^-) \neq \emptyset \neq L(\Gamma_{\hat{\beta}}^-) \cap L(\Gamma_{\hat{\beta}'}^-)$ one obtains that either $R(\Gamma_{\hat{\beta}}^-) \subset R(\Gamma_{\hat{\beta}'}^-)$ or $L(\Gamma_{\hat{\beta}}^-) \subset L(\Gamma_{\hat{\beta}'}^-)$, that means $\Gamma_{\hat{\beta}}^- \preceq \Gamma_{\hat{\beta}'}^-$ or $\Gamma_{\hat{\beta}'}^- \preceq \Gamma_{\hat{\beta}}^-$.
- One has $\emptyset \neq R(\Gamma_{\hat{\beta}}^-) \cap R(\Gamma_{\hat{\beta}'}^-) \subset R(\Gamma_{\hat{\beta}}^-) \cap R(\Gamma_{\hat{\beta}'}^+)$ hence $R(\Gamma_{\hat{\beta}}^-) \not\subset L(\Gamma_{\hat{\beta}'}^+)$ in B and moreover, with Claim 1, $\emptyset \neq L(\Gamma_{\hat{\beta}}^+) \cap L(\Gamma_{\hat{\beta}'}^+) \subset L(\Gamma_{\hat{\beta}}^-) \cap L(\Gamma_{\hat{\beta}'}^+)$ hence $L(\Gamma_{\hat{\beta}}^-) \not\subset R(\Gamma_{\hat{\beta}'}^+)$ in B . Since $\Gamma_{\hat{\beta}}^-$ and $\Gamma_{\hat{\beta}'}^+$ have no transverse intersection, the above observations together with Proposition 3.3 imply that $R(\Gamma_{\hat{\beta}}^-) \subset R(\Gamma_{\hat{\beta}'}^+)$ or $L(\Gamma_{\hat{\beta}}^-) \subset L(\Gamma_{\hat{\beta}'}^+)$, *i.e.*, $\Gamma_{\hat{\beta}}^- \preceq \Gamma_{\hat{\beta}'}^+$ or $\Gamma_{\hat{\beta}'}^+ \preceq \Gamma_{\hat{\beta}}^-$. Reversing the roles of β and β' one checks likewise that $\Gamma_{\hat{\beta}'}^-$ and $\Gamma_{\hat{\beta}}^+$ are comparable.
- Finally $L(\Gamma_{\hat{\beta}}^+) \cap L(\Gamma_{\hat{\beta}'}^+) \neq \emptyset \neq R(\Gamma_{\hat{\beta}}^-) \cap R(\Gamma_{\hat{\beta}'}^-) \subset R(\Gamma_{\hat{\beta}}^+) \cap R(\Gamma_{\hat{\beta}'}^+)$ also imply $L(\Gamma_{\hat{\beta}}^+) \not\subset R(\Gamma_{\hat{\beta}'}^+)$ and $R(\Gamma_{\hat{\beta}}^+) \not\subset L(\Gamma_{\hat{\beta}'}^+)$ in B . Using one more time Proposition 3.3 with the fact that $\Gamma_{\hat{\beta}}^+$ and $\Gamma_{\hat{\beta}'}^+$ have no transverse intersection, one deduces that $R(\Gamma_{\hat{\beta}}^+) \subset R(\Gamma_{\hat{\beta}'}^+)$ or $L(\Gamma_{\hat{\beta}}^+) \subset L(\Gamma_{\hat{\beta}'}^+)$. Equivalently $\Gamma_{\hat{\beta}}^+ \preceq \Gamma_{\hat{\beta}'}^+$ or $\Gamma_{\hat{\beta}'}^+ \preceq \Gamma_{\hat{\beta}}^+$.

This completes the proof of Claim 2. \square

Recall that the \mathcal{L}^* -intervals $(\Gamma_{\hat{\beta}}^-, \Gamma_{\hat{\beta}}^+)$ and $(\Gamma_{\hat{\beta}'}^-, \Gamma_{\hat{\beta}'}^+)$ are empty (Proposition 5.14) hence Claim 2 shows that either $\Gamma_{\hat{\beta}}^+ \preceq \Gamma_{\hat{\beta}'}^-$ or $\Gamma_{\hat{\beta}'}^+ \preceq \Gamma_{\hat{\beta}}^-$. The first inequality implies that $\Gamma_{\hat{\beta}}^t \subset R(\Gamma_{\hat{\beta}}^t) \subset R(\Gamma_{\hat{\beta}}^+) \subset R(\Gamma_{\hat{\beta}'}^-) \subset R(\Gamma_{\hat{\beta}'}^t)$ and then $\Gamma_{\hat{\beta}}^t$ and $\Gamma_{\hat{\beta}'}^t$ have no transverse intersection. The second inequality gives likewise $\Gamma_{\hat{\beta}'}^t \subset R(\Gamma_{\hat{\beta}'}^t)$ hence again $\Gamma_{\hat{\beta}}^t$ and $\Gamma_{\hat{\beta}'}^t$ have no transverse intersection. Proposition 5.17 is proved. \square

At this stage we have built a family $(\Gamma_{\hat{\beta}}^t)_{\beta \in B, t \in [-1, 1]}$ of Brouwer manifolds which have pairwise no transverse intersection and which cover M . Moreover the collection \mathcal{F}_* of all the connected components of these Brouwer manifolds defines an *oriented topological quasi-foliation* of M . Precisely any point $z \notin \Sigma(\mathcal{D})$ belongs to a unique Brouwer manifold $\Gamma_{\hat{\beta}}^t$ and \mathcal{F}_* defines a foliation in the neighborhood of z . A point $z \in \Sigma(\mathcal{D}) \setminus V$ may belong to several $\Gamma_{\hat{\beta}}^t$ but all of them contain the (unique) edge passing through z hence \mathcal{F}_* also defines a foliation in a neighborhood of z . It remains to remove the singularities at the vertices $z \in V$, which is the purpose of the next Section 5.3.3

5.3.3 Construction of an oriented topological foliation

Following Le Calvez ([LC04]), it is possible to desingularize the “quasi-foliation” \mathcal{F}_* above in order to get an oriented topological foliation of M . The modifications to perform are already explained in [LC04] and they are repeated below only for the reader’s convenience; we just add a few details about non compact edges and bricks,

which do not exist in [LC04] (similar variations are also implicit in [LC05]). After performing these perturbations of \mathcal{F}_* we shall show that the obtained foliation \mathcal{F} of M comes from a family of Brouwer manifolds as mentioned in Theorem 4.1.

An edge α is said to be *singular* if $\mathcal{L}^*(\alpha)$ contains a single element; otherwise α is said to be *regular*. We know that there are two types of vertices:

- a vertex of the first type is the initial vertex of two edges and the final vertex of one edge. It is then also the initial vertex of some brick;
- a vertex of the second type is the initial vertex of one edge and the final vertex of two edges. It is then the final vertex of some brick.

For every $\alpha \in E$, we choose a connected and simply connected open neighborhood U_α of α in M verifying $h(U_\alpha) \subset \text{Int}(R(\Gamma_\alpha^-))$ and $h^{-1}(U_\alpha) \subset \text{Int}(L(\Gamma_\alpha^+))$. Thus for every $\Gamma \in \mathcal{L}^*(\alpha)$ we get $h(U_\alpha) \subset \text{Int}(R(\Gamma))$ and $h^{-1}(U_\alpha) \subset \text{Int}(L(\Gamma))$. We can also ask that for any two distinct edges $\alpha, \alpha' \in E$ one has $U_\alpha \cap U_{\alpha'} \neq \emptyset$ iff α and α' are adjacent. Next we choose for every vertex $\sigma \in V$ a connected and simply connected open neighborhood U_σ of σ included in $U_{\alpha_1} \cap U_{\alpha_2} \cap U_{\alpha_3}$, where $\alpha_1, \alpha_2, \alpha_3$ are the edges having σ as an endpoint, such that U_σ meets only the bricks and the edges adjacent to σ .

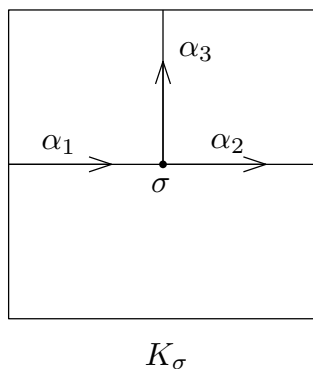

Figure 5.15 – The square $K_\alpha \subset U_\sigma$ for a vertex σ of the first type

• Let σ be a vertex of the first type and consider the edges $(\alpha_i)_{1 \leq i \leq 3}$ such that $\sigma = v_+(\alpha_1) = v_-(\alpha_2) = v_-(\alpha_3)$, $r(\alpha_3) = l(\alpha_2)$. Conjugating h by an orientation preserving homeomorphism, one may suppose that $\sigma = (0, 0)$ and that $K_\sigma = [-1, 1]^2 \subset U_\sigma$ with

- $\alpha_1 \cap K_\sigma = [-1, 0] \times \{0\}$,
- $\alpha_2 \cap K_\sigma = [0, 1] \times \{0\}$,
- $\alpha_3 \cap K_\sigma = \{0\} \times [0, 1]$ (see Fig. 5.15).

The edge α_1 is regular since it is included in at least two manifolds of \mathcal{L}^* , one of them containing α_2 and the other containing α_3 . Remark also that σ is the initial vertex of the brick $\beta = l(\alpha_2) = r(\alpha_3)$.

◆ Suppose that both α_2 and α_3 are regular (see Fig. 5.16). We define three quadrangles T_σ^1 , T_σ^2 and T_σ^3 as follows

- the vertices of T_σ^1 are $(-1, 0)$, $(0, 0)$, $(0, 1/4)$ and $(-1, 1/4)$;
- the vertices of T_σ^2 are $(-1, 1/4)$, $(0, 1/4)$, $(0, 1)$ and $(-1, 1/2)$;
- the vertices of T_σ^3 are $(-1, 1/2)$, $(0, 1)$, $(-1/2, 1)$ and $(-1, 3/4)$.

Next we define the following segments

- $I_+(\alpha_1) = \{-1\} \times [0, 3/4]$, $I_-(\alpha_2) = \{0\} \times [0, 1/4]$, $I_-(\alpha_3) = [-1/2, 0] \times \{1\}$,
- $I_-(\beta) = \{0\} \times [1/4, 1]$ and $I_+^c(\alpha_1) = \{-1\} \times [1/4, 1/2]$.

The segments $I_+(\alpha_1)$, $I_-(\alpha_2)$ and $I_-(\beta)$ are oriented with y increasing and the segment $I_-(\alpha_3)$ is oriented with x decreasing. One foliates the quadrangles T_σ^i , $i \in \{1, 2, 3\}$, by segments oriented with x increasing as follows. The quadrangle T_σ^1 is foliated by the horizontal segments, T_σ^2 by the segments parallel to the oblique segments and finally T_σ^3 by the segments joining $z \in I_+^c(\alpha_1)$ to $\lambda_\sigma(z) \in I_-(\beta)$ where $\lambda_\sigma : I_+^c(\alpha_1) \rightarrow I_-(\beta)$ is an increasing homeomorphism, called a *link homeomorphism*. According to Proposition 5.12 one can construct in each segment $I_-(\alpha_i)$, $i \in \{2, 3\}$, a compact set $\mathcal{L}_-(\alpha_i)$ containing the endpoints of $I_-(\alpha_i)$ which is isomorphic to $\mathcal{L}^*(\alpha_i)$ as an ordered topological space. We denote by $\theta_-(\alpha_i) : \mathcal{L}^*(\alpha_i) \rightarrow \mathcal{L}_-(\alpha_i)$ an increasing isomorphism between these two sets. Transporting $\mathcal{L}_-(\alpha_2) \sqcup \mathcal{L}_-(\alpha_3)$ on $I_+(\alpha_1)$ with the foliation of $T_\sigma^1 \sqcup T_\sigma^3$, one obtains an isomorphism $\theta_+(\alpha_1) : \mathcal{L}^*(\alpha_1) = \mathcal{L}^*(\alpha_2) \sqcup \mathcal{L}^*(\alpha_3) \rightarrow \mathcal{L}_+(\alpha_1)$ with $\mathcal{L}_+(\alpha_1) \subset I_+(\alpha_1)$.

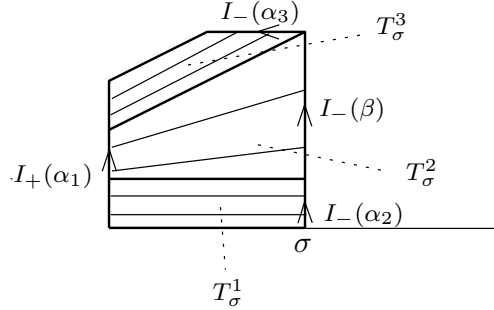

Figure 5.16 – The case where α_2 and α_3 are regular

◆ Suppose that α_2 is regular and α_3 is singular. Then we consider only the two quadrangles T_σ^1 and T_σ^2 with their foliations as above (see Fig. 5.17). We let $I_+(\alpha_1) = \{-1\} \times [0, 1/2]$ which is oriented with y increasing, the segments $I_-(\alpha_2)$ and $I_-(\beta)$ are the same as before and $I_-(\alpha_3)$ is reduced to the point $(0, 1)$. We let $\mathcal{L}_-(\alpha_3) = \{(0, 1)\}$. We construct in $I_-(\alpha_2)$ a closed set $\mathcal{L}_-(\alpha_2)$ containing the endpoints of this segment and which is isomorphic to $\mathcal{L}(\alpha_2)$. Then $\mathcal{L}_-(\alpha_2)$ is transported in $I_+(\alpha_1)$ by the foliation of T_σ^1 which gives, after adding the point $(-1, 1/2)$, a set $\mathcal{L}_+(\alpha_1) \subset I_+(\alpha_1)$ isomorphic to $\mathcal{L}^*(\alpha_1)$.

◆ Suppose now that α_2 is singular and α_3 is regular. Then the quadrangle T_σ^3 and its foliation are the same as in the first case. The quadrangle T_σ^2 has vertices $(-1, 0)$, $(0, 0)$, $(0, 1)$, $(-1, 1/2)$ (see Fig. 5.18). One defines

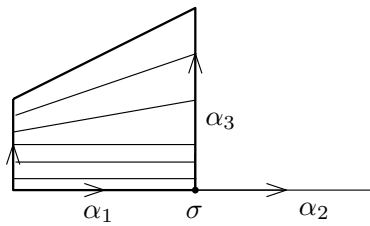

Figure 5.17 – The case where α_2 is regular and α_3 is singular

- $I_+(\alpha_1) = \{-1\} \times [0, 3/4]$,
- $I_-(\alpha_3) = [-1/2, 0] \times \{1\}$,
- $I_-(\beta) = \{0\} \times [0, 1]$.

One lets $I_-(\alpha_2) = \{(0, 0)\} = \mathcal{L}_-(\alpha_2)$ and $\mathcal{L}_-(\alpha_3)$ is a closed subset of $I_-(\alpha_3)$ containing the endpoints of this segment and which is isomorphic to $\mathcal{L}^*(\alpha_3)$. Transporting $\mathcal{L}_-(\alpha_3)$ in $I_+(\alpha_1)$ with the foliation of T_σ^3 and adding the point $(-1, 0)$, one gets a set $\mathcal{L}_+(\alpha_1) \subset I_+(\alpha_1)$ isomorphic to $\mathcal{L}^*(\alpha_1)$.

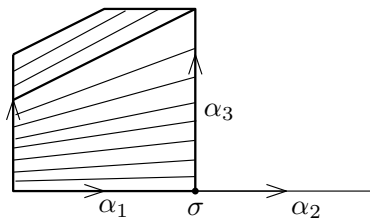

Figure 5.18 – The case where α_2 is singular and α_3 is regular

◆ Suppose finally that both α_2 and α_3 are singular. In this case, we consider only the quadrangle T_σ^2 with vertices $(-1, 0)$, $(0, 0)$, $(0, 1)$ and $(-1, 1/2)$. It is foliated using a link homeomorphism λ_σ (Fig. 5.19). The sets $\mathcal{L}_-(\alpha_2)$ and $\mathcal{L}_-(\alpha_3)$ are reduced to $\{\sigma\} = \{(0, 0)\}$ and $\{(0, 1)\}$ respectively. We have $\mathcal{L}_+(\alpha_1) = \{(-1, 0), (-1, 1/2)\}$. Remark that only two Brouwer manifolds of \mathcal{L}^* contain α_1 .

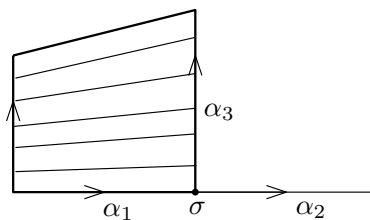

Figure 5.19 – α_2, α_3 are singular

It is also convenient to think of T_σ^1 (resp. T_σ^3) as the emptyset when α_2 (resp. α_3) is singular. This allows to write for instance $\bigcup_{i \in \{1,2,3\}} T_\sigma^i$ in all cases, avoiding a cumbersome discussion about regular/singular edges among α_2 and α_3 .

• Consider now a vertex σ of the second type with the edges $(\alpha_i)_{1 \leq i \leq 3}$ such that $\sigma = v_-(\alpha_1) = v_+(\alpha_2) = v_+(\alpha_3)$, $r(\alpha_3) = l(\alpha_2)$. Remark that σ is the final vertex of

the brick $\beta = l(\alpha_2) = r(\alpha_3)$. As explained in [LC04], similar objects as before may be constructed in this situation. We start from the previous situation and carry out a symmetry with respect to the vertical axis. Let us explain the construction in the case where α_2 and α_3 are regular (see Fig. 5.20). We also suppose that $\sigma = (0, 0)$, $K_\sigma = [-1, 1]^2 \subset U_\sigma$ and

- $\alpha_1 \cap K_\sigma = [0, 1] \times \{0\}$,
- $\alpha_2 \cap K_\sigma = [-1, 0] \times \{0\}$,
- $\alpha_3 \cap K_\sigma = \{0\} \times [0, 1]$.

Note that α_1 is necessarily regular since it lies on at least two manifolds of \mathcal{L}^* , one of them containing α_2 and the other containing α_3 . We define three quadrangles T_σ^1 , T_σ^2 and T_σ^3 as follows

- the vertices of T_σ^1 are $(0, 0)$, $(1, 0)$, $(1, 1/4)$ and $(0, 1/4)$;
- the vertices of T_σ^2 are $(0, 1/4)$, $(1, 1/4)$, $(1, 1/2)$ and $(0, 1)$;
- the vertices of T_σ^3 are $(0, 1)$, $(1, 1/2)$, $(1, 3/4)$ and $(1/2, 1)$.

Next we define the following segments

- $I_-(\alpha_1) = \{1\} \times [0, 3/4]$, $I_+(\alpha_2) = \{0\} \times [0, 1/4]$, $I_+(\alpha_3) = [0, 1/2] \times \{1\}$,
- $I_+(\beta) = \{0\} \times [1/4, 1]$ and $I_-^c(\alpha_1) = \{1\} \times [1/4, 1/2]$.

The segments $I_-(\alpha_1)$, $I_+(\alpha_2)$ and $I_+(\beta)$ are oriented with y increasing and the segment $I_-(\alpha_3)$ is oriented with x increasing. For $i \in \{1, 2, 3\}$, the quadrangle T_σ^i is foliated by some segments oriented with x increasing as follows (see also Fig. 5.20). One foliates T_σ^1 by the horizontal segments, T_σ^3 by the segments parallel to the oblique segments. Finally T_σ^2 is foliated by the segments joining the points $z \in I_+(\beta)$ to $\lambda_\sigma(z) \in I_-^c(\alpha_1)$ where λ_σ is a link homeomorphism from $I_+(\beta)$ onto $I_-^c(\alpha_1)$. For $i \in \{2, 3\}$, one can construct in the segment $I_+(\alpha_i)$ a closed set $\mathcal{L}_+(\alpha_i)$ containing the endpoints of $I_+(\alpha_i)$ which is isomorphic to $\mathcal{L}^*(\alpha_i)$ as an ordered topological space. We denote by $\theta_+(\alpha_i) : \mathcal{L}^*(\alpha_i) \rightarrow \mathcal{L}_+(\alpha_i)$ an increasing isomorphism between these two sets. Transporting $\mathcal{L}_+(\alpha_2) \sqcup \mathcal{L}_+(\alpha_3)$ on $I_-(\alpha_1)$ with the foliation of $T_\sigma^1 \sqcup T_\sigma^3$, we obtain an increasing isomorphism $\theta_-(\alpha_1) : \mathcal{L}^*(\alpha_1) = \mathcal{L}^*(\alpha_2) \sqcup \mathcal{L}^*(\alpha_3) \rightarrow \mathcal{L}_-(\alpha_1)$ where $\mathcal{L}_-(\alpha_1) \subset I_-(\alpha_1)$.

- Consider a regular edge α which is a segment, so that it possesses an initial vertex $v_-(\alpha)$ and a final vertex $v_+(\alpha)$. One constructs a quadrangle $T_\alpha \subset l(\alpha)$ whose frontier consists of $I_-(\alpha) \sqcup I_+(\alpha)$ together with a segment from the upper endpoint of $I_-(\alpha)$ to the one of $I_+(\alpha)$ together with the subsegment of α joining the lower endpoint of $I_-(\alpha)$ with the one of $I_+(\alpha)$. We consider the increasing homeomorphism

$$f_\alpha = \theta_+(\alpha) \circ (\theta_-(\alpha))^{-1} : \mathcal{L}_-(\alpha) \rightarrow \mathcal{L}_+(\alpha)$$

which may be extended to a homeomorphism (again denoted by f_α) from $I_-(\alpha)$ onto $I_+(\alpha)$.

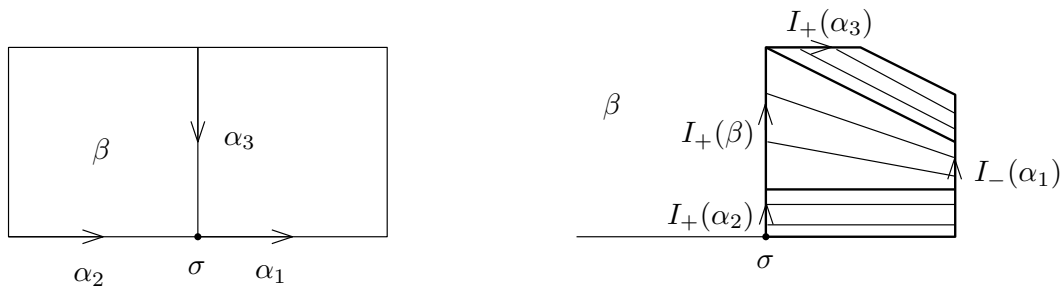

Figure 5.20 – σ is a vertex of the second type and α_2, α_3 are regular

The quadrangle T_α is foliated by oriented segments, each of them beginning at some point $z \in I_-(\alpha)$ and ending at $f_\alpha(z) \in I_+(\alpha)$. We give two examples, the first one is pictured on Fig. 5.21 where $v_-(\alpha)$ is a vertex of the first type and $v_+(\alpha)$ is of the second type; the second example is pictured on Fig. 5.22 where $v_-(\alpha)$ and $v_+(\alpha)$ are vertices of the first type.

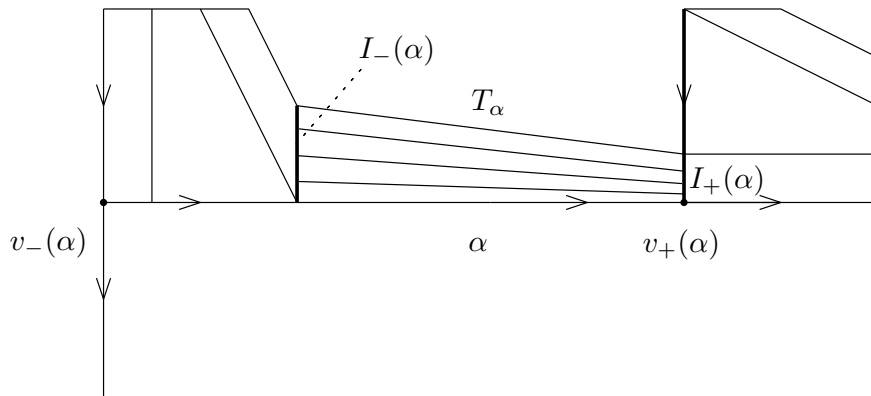

Figure 5.21 – $v_-(\alpha)$ is of the first type and $v_+(\alpha)$ is of the second type

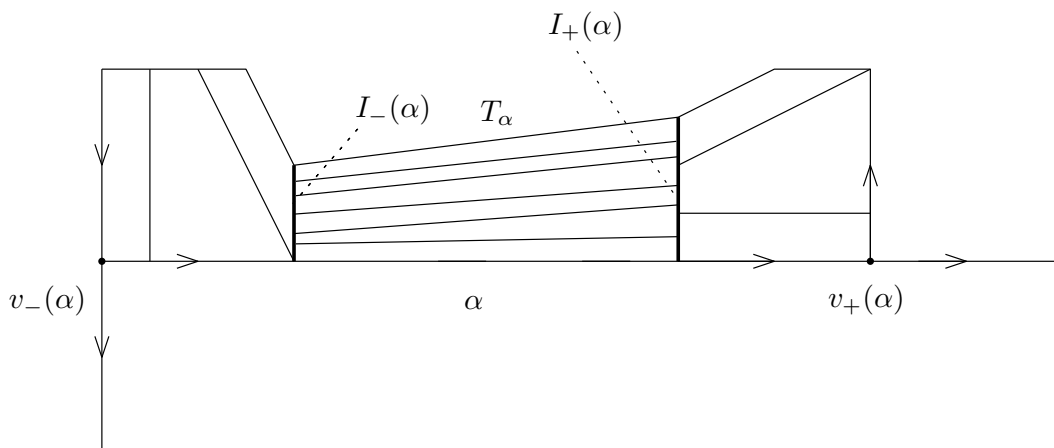

Figure 5.22 – $v_-(\alpha)$ and $v_+(\alpha)$ are of the first type

- If a regular edge α is a half-line of M , so that it possesses only an initial vertex $v_-(\alpha)$ (resp. a final vertex $v_+(\alpha)$) then one choose a half-plane $T_\alpha \subset l(\alpha)$ which is

closed in M and whose frontier $\partial_M T_\alpha$ contains $I_-(\alpha)$ (resp. $I_+(\alpha)$) together with the half-line included in α emanating from the lower endpoint of $I_-(\alpha)$ (resp. $I_+(\alpha)$). Then T_α is foliated by a continuous family of half-lines whose endpoints belong to $I_-(\alpha)$ (resp. to $I_+(\alpha)$) and which are oriented from (resp. towards) their endpoints. Figure 5.23 describes the foliation of T_α in the case where M is connected. In all cases it is supposed that $T_\alpha \subset U_\alpha$.

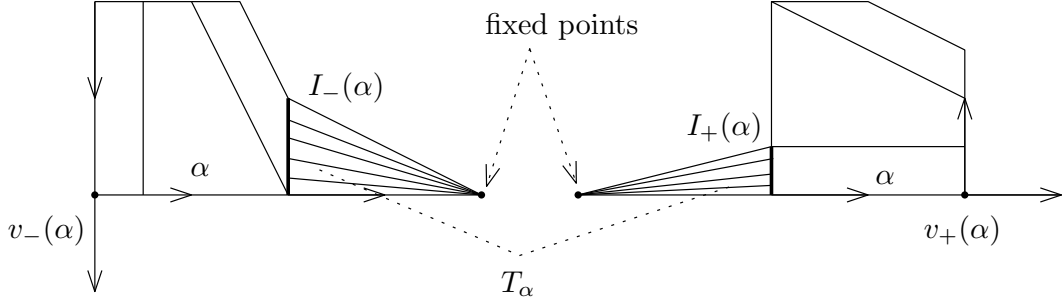

Figure 5.23 – Examples of sets T_α when the edge α is a half-line

The set

$$\left(\bigcup_{\sigma \in V} \bigcup_{i \in \{1,2,3\}} \partial_M T_\sigma^i \right) \cup \left(\bigcup_{\alpha \in E} \partial_M T_\alpha \right) \cup \Sigma(\mathcal{D})$$

is the skeleton of a new brick decomposition \mathcal{D}^* of M whose set of bricks is denoted by B^* . Observe that $T_\sigma^k \in B^*$ and $T_\alpha \in B^*$ for every $\sigma \in V$, $k \in \{1, 2, 3\}$ and $\alpha \in E$. These bricks are foliated as explain above. By construction, every other brick of B^* is included in a brick $\beta \in B$ and every brick $\beta \in B$ contains a single brick of B^* different from the T_σ^k 's and the T_α 's, which is denoted by T_β , (maybe $T_\beta = \beta$ if γ_β^- is reduced to a single edge). More precisely the bricks of B^* included in $\beta \in B$ are

- the brick T_α for every edge α such that $l(\alpha) = \beta$;
- the bricks T_σ^k , $k \in \{1, 2, 3\}$, for every vertex $\sigma \in V$ such that there exist two distinct edges α, α' included in γ_β^- and satisfying $v_+(\alpha) = v_-(\alpha') = \sigma$ (if any);
- the brick T_β , which is always homeomorphic to β .

The T_β 's ($\beta \in B$) are foliated as follows:

- If $\beta \in B$ is a disc then one foliates the brick T_β by a continuous family $(\gamma_\beta^t)_{t \in [-1,1]}$ of oriented segments joining a point of $I_-(\beta)$ and a point of $I_+(\beta)$ (Fig. 5.24).

- If $\beta \in B$ is a half-plane then one foliates the brick T_β by a continuous family $(\gamma_\beta^t)_{t \in [-1,1]}$ of oriented half-lines of M emanating from a point of $I_-(\beta)$ (resp. ending at a point of $I_+(\beta)$) if β admits an initial (resp. a final) vertex (Fig. 5.25). If β is an annulus then one foliates the brick T_β by an family $(\gamma_\beta^t)_{t \in [-1,1]}$ of oriented circles.

- Finally if $\beta \in B$ is a strip then T_β is trivially foliated by a family $(\gamma_\beta^t)_{t \in [-1,1]}$ of oriented lines of M .

Let us emphasize that then these leaves $\gamma_\beta^t \subset T_\beta$ are different from the leaves $\gamma_\beta^t \subset \beta$ considered in Section 5.3.2, except when $T_\beta = \beta$. In the current Section 5.3.3,

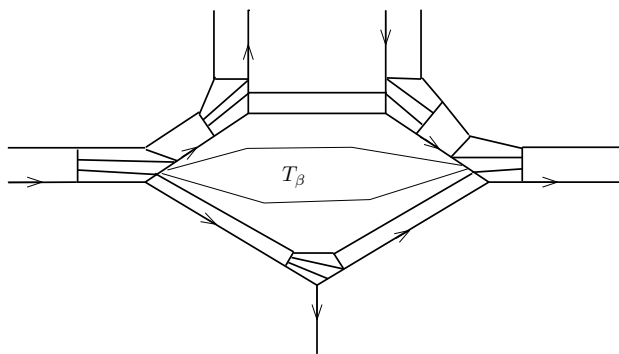
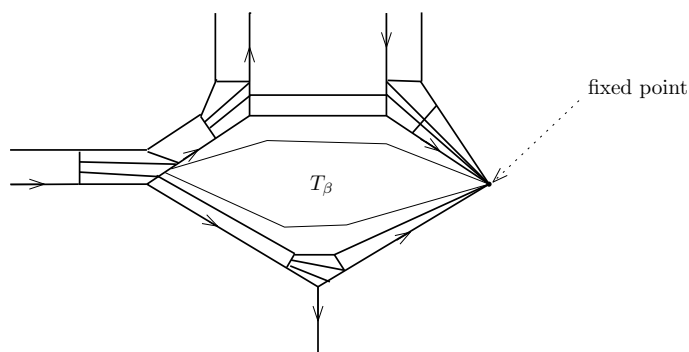
Figure 5.24 – The foliation in T_β when $\beta \in B$ is a discFigure 5.25 – The foliation in T_β when $\beta \in B$ is a half-plane with an initial vertex

the symbol γ_β^t always refers to a leaf of T_β as defined above when $t \in [-1, 1]$. The symbols γ_β^- and γ_β^+ denote as before the subsets of $\partial_M \beta$ given by Propositions 5.4-5.7, so that $\gamma_\beta^- \cup \gamma_\beta^+ = \partial_M \beta$. The parameterization by t of any such family $(\gamma_\beta^t)_{t \in [-1, 1]}$ is chosen coherently with the signs \pm in γ_β^\pm , that means that

$$\gamma_\beta^{-1} \subset \partial_M \left(\bigcup_{\alpha \in E \mid \alpha \subset \gamma_\beta^-} T_\alpha \cup \bigcup_{\sigma} \bigcup_{i \in \{1, 2, 3\}} T_\sigma^i \right) \quad \text{and} \quad \gamma_\beta^1 \subset \gamma_\beta^+$$

where \bigcup_σ denotes here the union over all the vertices $\sigma \in V$ such that there exists two edges $\alpha \neq \alpha'$ in γ_β^- satisfying $v_+(\alpha) = \sigma = v_-(\alpha')$. Moreover the orientation of γ_β^1 is chosen compatibly with the one of $\gamma_\beta^+ \subset \Sigma$ given by Propositions 5.4-5.7, which defines unambiguously the orientation of each leaf $\gamma_\beta^t \subset T_\beta$.

Piecing together the above foliations in the various bricks of B^* one gets an oriented topological foliation \mathcal{F} of M . We introduce now some notation in order to describe conveniently the leaves of \mathcal{F} . We let $A = E \sqcup B$. A sequence $(\varepsilon_i)_{i \in I} \in A^I$, where I is a \mathbb{Z} -interval, is said to be *admissible* if ε_i (resp. ε_{i+1}) has a final (resp. initial) vertex and $v_+(\varepsilon_i) = v_-(\varepsilon_{i+1})$ for every pair $\{i, i+1\} \subset I$.

- If $\varepsilon \in A$ has an initial vertex and a final vertex then any leaf in T_ε originates from some point $z \in I_-(\varepsilon)$ and ends at a point of $I_+(\varepsilon)$ so that it may be concatenated with a (unique) leaf in some quadrangle $T_{v_+(\varepsilon)}^k$ ($k \in \{1, 2, 3\}$) ending at a point $z' \in I_-(\varepsilon')$ for some $\varepsilon' \in A$ such that $v_-(\varepsilon') = v_+(\varepsilon)$. Such a concatenation is

denoted by ξ_ε^z and one gets a continuous one-to-one map

$$\psi_\varepsilon : I_-(\varepsilon) \rightarrow \bigcup_{\{\varepsilon' \in A \mid v_-(\varepsilon') = v_+(\varepsilon)\}} I_-(\varepsilon')$$

by letting $\psi_\varepsilon(z) = z'$.

- If $\varepsilon \in A$ has an initial vertex but no final vertex then we define ξ_ε^z to be the leaf in T_ε originating from $z \in I_-(\varepsilon)$.
- If $\varepsilon \in A$ has a final vertex but no initial vertex then any leaf in T_ε ends at some point of $I_+(\varepsilon)$ and may be concatenated with a (unique) leaf of $T_{v_+(\varepsilon)}^k$ for some $k \in \{1, 2, 3\}$ which ends at a point $z \in I_-(\varepsilon')$ for some $\varepsilon' \in A$ such that $v_+(\varepsilon) = v_-(\varepsilon')$. This concatenation is denoted by ξ_ε^z .

Thus any leaf F of \mathcal{F} may be described in one of the two followings way:

- $F = \gamma_\beta^t \subset T_\beta$ for some $t \in [-1, 1]$ and some $\beta \in B$ which is an annulus or a strip.
- $F = \prod_{i \in I} \xi_{\varepsilon_i}^{z_i}$ where $(\varepsilon_i)_{i \in I}$ is an admissible sequence of at least two elements of A and $(z_i)_{i \in I}$ is a sequence of points in M satisfying some natural connection assumptions which we detail now. If I is unbounded from below then it is simply asked that $z_i \in I_-(\varepsilon_i)$ for every $i \in I$ and $\psi_{\varepsilon_i}(z_i) = z_{i+1}$ for every pair $\{i, i+1\} \subset I$. If I is bounded from below then there are two situations. Letting $i_0 = \min I$, it is first possible that ε_{i_0} has no initial vertex; then it is required that $z_i \in I_-(\varepsilon_i)$ for every $i \in I \setminus \{i_0\}$ and $z_{i_0} = z_{i_0+1}$ and $\psi_{\varepsilon_i}(z_i) = z_{i+1}$ for every pair $\{i, i+1\} \subset I \setminus \{i_0\}$. It is also possible that ε_{i_0} possesses an initial vertex; then I is a finite set, say $I = \{i_0, i_1, \dots, i_k\}$, and one has $z_i \in I_-(\varepsilon_i)$ for every $i \in I$ and $\psi_{\varepsilon_i}(z_i) = z_{i+1}$ for every pair $\{i, i+1\} \subset I$ as well as $\psi_{\varepsilon_{i_k}}(z_{i_k}) = z_{i_0}$, which implies that F is a circle. In this last case, one could also describe F by taking $I = \mathbb{Z}$ and by considering periodic sequences $(\varepsilon_i)_{i \in \mathbb{Z}}$ and $(z_i)_{i \in \mathbb{Z}}$. Nevertheless we adopt here the convention to always use a finite \mathbb{Z} -interval I to describe such a circle F .

Remark 5.3. *In the above notation, it should be observed that*

- i) *One may have a priori $\varepsilon_i = \varepsilon_j$ and $z_i \neq z_j$ for $i \neq j$ in I , that means that a leaf F may intersects a segment $I_-(\varepsilon_i)$ at several points. Nevertheless this situation will not arise for a suitable choice of the homeomorphisms λ_σ .*
- ii) *If I is an infinite set bounded from above then $\varepsilon_{\max I}$ has an initial vertex but no final vertex.*
- iii) *Given a leaf F of \mathcal{F} , the writing $F = \prod_{i \in I} \xi_{\varepsilon_i}^{z_i}$ is generally non unique. Suppose indeed there exists $i \in I$ such that ε_i is a brick with an initial vertex and $z_i = \max I_-(\varepsilon_i)$. We denote α^+ the edge contained in $\gamma_{\varepsilon_i}^+$ such that $v_-(\alpha^+) = v_-(\varepsilon_i)$. Since $\max I_-(\varepsilon_i) = \min I_-(\alpha^+)$ one may also write $F = \prod_{j \in J} \xi_{\varepsilon_j'}^{z_j'}$ with $\varepsilon_i \notin \{\varepsilon_j'\}_{j \in J}$ and $\alpha \in \{\varepsilon_j'\}_{j \in J}$ for every edge $\alpha \subset \gamma_{\varepsilon_i}^+$. One has then $z_j' = \min I_-(\varepsilon_j')$ for every*

$j \in J$ such that ε'_j is an edge included in $\gamma_{\varepsilon_i}^+$. If $\varepsilon_i \in B$ has an initial vertex and $z_i = \min I_-(\varepsilon_i)$ then one can write likewise $F = \prod_{j \in J} \xi_{\varepsilon'_j}^{z'_j}$ where $\varepsilon_i \notin \{\varepsilon'_j\}_{j \in J}$ and $\alpha \in \{\varepsilon'_j\}_{j \in J}$ for every edge $\alpha \subset \gamma_{\varepsilon_i}^-$. Then $z'_j = \max I_-(\varepsilon'_j)$ for every $j \in J$ such that ε'_j is an edge contained in $\gamma_{\varepsilon_i}^-$. If ε_i is a brick with only a final vertex (which implies that I is bounded from below and $i = \min(I)$) similar remarks hold: just replace above the assumption $z_i = \max I_-(\varepsilon_i)$ (resp. $z_i = \min I_-(\varepsilon_i)$) with $z_i = \max I_-(\varepsilon_{i+1})$ (resp. $z_i = \min I_-(\varepsilon_{i+1})$).

As a direct consequence of the construction of the foliation \mathcal{F} in the T_α 's ($\alpha \in E$) and in the T_σ^k 's ($\sigma \in V, k \in \{1, 3\}$) one has the following result.

Proposition 5.18. *Let $\Gamma \in \mathcal{L}^*(\alpha)$ where α is an edge with an initial vertex $v_-(\alpha)$. Define $z = \theta_-(\alpha)(\Gamma)$ and let F be the leaf of \mathcal{F} passing through the point z .*

Then for every edge $\alpha' \in E$ possessing an initial (resp. a final) vertex one has $F \cap I_-(\alpha') = \{\theta_-(\alpha')(\Gamma)\}$ (resp. $F \cap I_+(\alpha') = \{\theta_+(\alpha')(\Gamma)\}$) if α' is included in the same connected component of Γ as α and $F \cap I_-(\alpha') = \emptyset$ (resp. $F \cap I_+(\alpha') = \emptyset$) otherwise.

A similar property holds if α has a final vertex $v_+(\alpha)$, just defining $z = \theta_+(\alpha)(\Gamma)$.

Lemma 5.14. *Let $e \in E$. If e has an initial vertex $v_-(e)$ and if (z_-, z_+) is a connected component of $I_-(e) \setminus \mathcal{L}_-(e)$ then there exists $b \in B$ such such that $z_- = \theta_-(e)(\Gamma_b^-)$ and $z_+ = \theta_-(e)(\Gamma_b^+)$.*

Proof. We know that $z_- = \theta_-(e)(\Gamma)$ and $z_+ = \theta_-(e)(\Gamma')$ where Γ and Γ' are two Brouwer manifolds in $\mathcal{L}^*(e)$ such that $\Gamma \prec \Gamma'$ and $(\Gamma, \Gamma')_{\mathcal{L}^*(e)} = \emptyset$ (this actually implies $(\Gamma, \Gamma') = \emptyset$ but we will not use this fact). Since $\mathcal{L}^*(e)$ is a neighborhood of Γ and Γ' in \mathcal{L}^* , this shows that Γ (resp. Γ') is isolated from the right (resp. from the left). According to Proposition 5.13 there exist two edges α_1, α_2 such that $\Gamma = \Gamma_{\alpha_1}^+$ and $\Gamma' = \Gamma_{\alpha_2}^-$. Letting $b_1 = l(\alpha_1)$ and $b_2 = r(\alpha_2)$ one gets $\Gamma_{b_1}^- = \Gamma \prec \Gamma' = \Gamma_{b_2}^+$ and it remains to prove that $b_1 \sim b_2$.

Let us check that $e \subset \Gamma_{b_2}^-$. Otherwise one has $\text{Int}_\Sigma(e) \subset \text{Int}(L(\Gamma_{b_2}^-))$ because $e \subset \Gamma_{b_2}^+ \succ \Gamma_{b_2}^-$. Moreover $e \subset \Gamma_{b_1}^-$ and $\Gamma_{b_1}^-, \Gamma_{b_2}^-$ have no transverse intersection so $\Gamma_{b_1}^- \subset L(\Gamma_{b_2}^-)$. Then it follows from Proposition 3.3 that $R(\Gamma_{b_1}^-) \subset L(\Gamma_{b_2}^-)$ or $L(\Gamma_{b_1}^-) \subset L(\Gamma_{b_2}^-)$. The first inclusion implies $R(\Gamma_{b_1}^-) \subset R(\Gamma_{b_2}^+) \cap L(\Gamma_{b_2}^-) = \widehat{b}_2$ which is not possible because each connected component of \widehat{b}_2 is a brick (so it is disjoint from its image by h^2) while each connected component of $R(\Gamma_{b_1}^-)$ contains its image by h^2 . The second inclusion gives $\Gamma_{b_2}^- \preceq \Gamma_{b_1}^- \prec \Gamma_{b_2}^+$ hence $\Gamma_{b_2}^- = \Gamma_{b_1}^-$ due to $(\Gamma_{b_2}^-, \Gamma_{b_2}^+) = \emptyset$ (Proposition 5.14 and notation thereafter). This contradicts the assumption $e \not\subset \Gamma_{b_2}^-$. Thus we have proved $e \subset \Gamma_{b_2}^-$ so that $\Gamma_{b_1}^-$ and $\Gamma_{b_2}^-$ are comparable in $\mathcal{L}^*(e)$. Since $(\Gamma_{b_1}^-, \Gamma_{b_2}^+)_{\mathcal{L}^*(e)} = \emptyset$

and $(\Gamma_{b_2}^-, \Gamma_{b_2}^+) = \emptyset$ one obtains $\Gamma_{b_1}^- = \Gamma_{b_2}^-$. One proves similarly that $e \subset \Gamma_{b_1}^+$ and $\Gamma_{b_1}^+ = \Gamma_{b_2}^+$. \square

Let us study more precisely the leaves of \mathcal{F} with the following result.

Proposition 5.19. *Let F be a leaf of \mathcal{F} . Suppose that there is no brick $\beta \in B$ which is an annulus or a strip such that $F = \gamma_\beta^t$ for some $t \in [-1, 1]$.*

Then, for some \mathbb{Z} -interval I with $\sharp(I) \geq 2$, one can write $F = \prod_{i \in I} \xi_{\varepsilon_i}^{z_i}$ in such a way that one of the following two assertions holds.

- i) *Every ε_i is an edge, the set $\prod_{i \in I} \varepsilon_i$ is a connected component of a Brouwer manifold $\Gamma \in \mathcal{L}^*$ and $z_i = \theta_-(\varepsilon_i)(\Gamma) \in \mathcal{L}_-(\varepsilon_i)$ for every ε_i possessing an initial vertex.*
- ii) *The set $\prod_{i \in I} \varepsilon_i$ is a connected component of the equivalence chain $\mathcal{C}_{\widehat{\beta}}$ for some $\beta \in B$ and there is no index $i \in I$ such that $z_i \in \mathcal{L}_-(\varepsilon_i)$. Moreover if $\varepsilon_i \in B$ then F meets the interior of T_{ε_i} , i.e., $\gamma_{\varepsilon_i}^t \subset F$ for some $t \in (-1, 1)$.*

Proof. The assumption tell us that one can write $F = \prod_{i \in I} \xi_{\varepsilon_i}^{z_i}$ where $(\varepsilon_i)_{i \in I}$ is an admissible sequence in $A = E \sqcup B$ and $\sharp(I) \geq 2$. We have the following three cases to consider.

1) First we suppose that $\varepsilon_i \in E$ for every $i \in I$ and moreover that $z_{i_0} \in \mathcal{L}_-(\varepsilon_{i_0})$ for some $i_0 \in I$ such that ε_{i_0} has an initial vertex. According to Proposition 5.18 there exists $\Gamma \in \mathcal{L}^*$ such that $z_i = \theta_-(\varepsilon_i)(\Gamma)$ for every $i \in I$ such that the edge ε_i possesses an initial vertex $v_-(\varepsilon_i)$, that means for every $i \in I$ except maybe for $i = \min I$ if I is bounded from below. In this case $i = \min I > -\infty$, the edge ε_i may have only a final vertex $v_+(\varepsilon_i)$ but Proposition 5.18 also tells us that F intersects $I_+(\varepsilon_i)$ at the point $\theta_+(\varepsilon_i)(\Gamma)$. In particular $\varepsilon_i \subset \Gamma$ for every $i \in I$ so that the concatenation $\Gamma_1 = \prod_{i \in I} \varepsilon_i$ is included in Γ . One knows that Γ_1 is an open subset of Σ (Remark 5.3) and then it is also open in Γ . Moreover Γ_1 is clearly closed in Γ hence it is a connected component of Γ and Property i) holds.

2) Assume now that $\varepsilon_i \in B$ for some $i \in I$. We define $I' \subset I$ to be the set of all these indices. First suppose that for every $i \in I'$ either ε_i has an initial vertex and z_i is an endpoint of the segment $I_-(\varepsilon_i)$ or ε_i only has a final vertex (then $i = \min I > -\infty$) and z_i is an endpoint of $I_-(\varepsilon_{i+1})$. Then one may rewrite $F = \prod_{j \in J} \xi_{\varepsilon'_j}^{z'_j}$ with $\varepsilon'_j \in E$ for every $j \in J$ (see Remark 5.3) and we are reduced to the previous case. Suppose secondly there exists $i_0 \in I'$ such that ε_{i_0} has an initial vertex and z_{i_0} is an interior point of $I_-(\varepsilon_{i_0})$ or such that ε_{i_0} only has a final vertex and z_{i_0} is an interior point of $I_-(\varepsilon_{i_0+1})$. The same arguments as in the proof of [LC04, Proposition 5.2 (ii)] then show that $\prod_{i \in I} \varepsilon_i$ is a connected component of the equivalence chain $\mathcal{C}_{\widehat{\varepsilon_{i_0}}}$ and moreover $\varepsilon_i \in \widehat{\varepsilon_{i_0}}$ and $F \cap \text{Int}(T_{\varepsilon_i}) \neq \emptyset$ for every $i \in I'$. This is the situation described in ii).

3) We finally deal with the case where assumption 1) does not hold true although $\varepsilon_i \in E$ for every $i \in I$. Fixing $i_0 \in I$ such that ε_{i_0} has an initial vertex, one has then $z_{i_0} \in I_-(\varepsilon_{i_0}) \setminus \mathcal{L}_-(\varepsilon_{i_0})$. One can assume without loss that $i_0 = 0 \in I$. Denote by (x_0, y_0) the connected component of $I_-(\varepsilon_0) \setminus \mathcal{L}_-(\varepsilon_0)$ which contains z_0 . Lemma 5.14 tells us that there exists $\beta \in B$ such that $x_0 = \theta_-(\varepsilon_0)(\Gamma_\beta^-)$ and $y_0 = \theta_-(\varepsilon_0)(\Gamma_\beta^+)$. In particular $\varepsilon_0 \subset \Gamma_\beta^- \cap \Gamma_\beta^+$. We also write F_{x_0} and F_{y_0} for the leaves of \mathcal{F} passing through respectively x_0 and y_0 .

Let us check that if $1 \in I$ then $\varepsilon_1 \subset \Gamma_\beta^- \cap \Gamma_\beta^+$. This is obvious if $v_+(\varepsilon_0)$ is a vertex of the second type. Suppose now that $v_+(\varepsilon_0)$ is a vertex of the first type. Then there are $e^-, e^+ \in E$ such that $v_-(e^-) = v_-(e^+) = v_+(\varepsilon_0)$ and $l(e^-) = r(e^+)$. If $e^- \subset \Gamma_\beta^-$ and $e^+ \subset \Gamma_\beta^+$ then one obtains $l(e^-) \sim \beta$ (Proposition 5.15). Letting $b = l(e^-)$ this gives $\Gamma_\beta^- = \Gamma_b^- = \Gamma_{e^-}^+$ and $\Gamma_\beta^+ = \Gamma_b^+ = \Gamma_{e^+}^-$. Recalling Proposition 5.18, one deduces that the oriented segment $\xi_{\varepsilon_0}^{x_0} \subset F_{x_0}$ (resp. $\xi_{\varepsilon_0}^{y_0} \subset F_{y_0}$) ends at $\psi_{\varepsilon_0}(x_0) = \theta_-(e^-)(\Gamma_\beta^-) = \max I_-(e^-) = \min I_-(b)$ (resp. at $\psi_{\varepsilon_0}(y_0) = \theta_-(e^+)(\Gamma_\beta^+) = \min I_-(e^+) = \max I_-(b)$). Since $\psi_{\varepsilon_0} : I_-(\varepsilon_0) \rightarrow \bigcup_{\{\varepsilon \in A, v_-(\varepsilon) = v_+(\varepsilon_0)\}} I_-(\varepsilon)$ is a continuous and one-to-one map, one gets that $z_1 = \psi_{\varepsilon_0}(z_0)$ is an interior point of $I_-(b)$ hence necessarily $\varepsilon_1 = b \in B$, a contradiction. This proves that $e \subset \Gamma_\beta^- \cap \Gamma_\beta^+$ where $e \in \{e^-, e^+\}$. Then the subsegment of $\bigcup_{\{\varepsilon \in A, v_-(\varepsilon) = v_+(\varepsilon_0)\}} I_-(\varepsilon)$ whose endpoints are $x_1 = \psi_{\varepsilon_0}(x_0)$ and $y_1 = \psi_{\varepsilon_0}(y_0)$ is included in $I_-(e)$ and has again $z_1 = \psi_{\varepsilon_0}(z_0)$ as an interior point. This proves that $\varepsilon_1 = e \subset \Gamma_\beta^- \cap \Gamma_\beta^+$. The fact that $x_1 = \theta_-(\varepsilon_1)(\Gamma_\beta^-)$ and $y_1 = \theta_-(\varepsilon_1)(\Gamma_\beta^+)$ allows to continue inductively and to get $\varepsilon_i \subset \Gamma_\beta^- \cap \Gamma_\beta^+$ for every $i \geq 0$ in I .

Since ε_0 has an initial vertex then $-1 \in I$ and ε_{-1} has a final vertex $v_+(\varepsilon_{-1}) = v_-(\varepsilon_0)$. There are two edges α^-, α^+ such that $v_+(\alpha^-) = v_+(\alpha^+) = v_-(\varepsilon_0)$ and $r(\alpha^-) = l(\alpha^+)$. Of course $\varepsilon_{-1} \in \{\alpha^-, \alpha^+\}$ and one checks similarly as above that $\varepsilon_{-1} \subset \Gamma_\beta^- \cap \Gamma_\beta^+$. If $-2 \in I$ (i.e., if ε_{-1} has an initial vertex) then we let $x_{-1} = \theta_-(\varepsilon_{-1})(\Gamma_\beta^-)$ and $y_{-1} = \theta_-(\varepsilon_{-1})(\Gamma_\beta^+)$. Then z_{-1} is an interior point of the subsegment of $I_-(\varepsilon_{-1})$ with endpoints x_{-1}, y_{-1} because $\psi_{\varepsilon_{-1}} : I_-(\varepsilon_{-1}) \rightarrow \bigcup_{\{\varepsilon \in A, v_-(\varepsilon) = v_+(\varepsilon_{-1})\}} I_-(\varepsilon)$ is a continuous one-to-one map and $\psi_{\varepsilon_{-1}}(x_{-1}) = x_0$ and $\psi_{\varepsilon_{-1}}(y_{-1}) = y_0$. An easy induction then gives $\varepsilon_i \subset \Gamma_\beta^- \cap \Gamma_\beta^+$ for every $i \leq -1$ in I . It follows that the concatenation $\prod_{i \in I} \varepsilon_i$ is a connected component of both Γ_β^- and Γ_β^+ which are then necessarily Brouwer manifolds of type 3. Clearly $\prod_{i \in I} \varepsilon_i$ is also a connected component of $\mathcal{C}_{\hat{\beta}}$ and ii) then holds. \square

We denote by $\mathcal{F} \uplus \mathcal{F}$ the set whose elements are either a leaf of \mathcal{F} or the union of two leaves of \mathcal{F} . One constructs a map $\Psi : \mathcal{L}^* \rightarrow \mathcal{F} \uplus \mathcal{F}$ as follows. Consider a Brouwer manifold $\Gamma \in \mathcal{L}^*$ whose connected components are Γ_1 and Γ_2 , where one allows as usual $\Gamma_1 = \Gamma_2 = \Gamma$. For each $k \in \{1, 2\}$ one associates to Γ_k a leaf F_k of \mathcal{F} . If Γ_k is reduced to a single edge then one let $F_k = \Gamma_k$. Otherwise one has

$$\Gamma_k = \prod_{i \in I_k} \alpha_i^k$$

where $(\alpha_i^k)_{i \in I_k}$ is an admissible sequence of edges with $\sharp(I_k) \geq 2$. Let $z_i^k = \theta_-(\alpha_i^k)(\Gamma) \in \mathcal{L}_-(\alpha_i^k)$ for every $i \in I_k$ such that α_i^k possesses an initial vertex (that means for every $i \in I_k$ except maybe for $i = \min I_k$ if I_k is bounded from below). Then, according to Proposition 5.18, there is a leaf F_k of \mathcal{F} passing through every point z_i^k ($i \in I_k$), namely $F_k = \prod_{i \in I_k} \xi_{\alpha_i^k}^{z_i^k}$. Thus we obtain a map $\Psi : \mathcal{L}^* \rightarrow \mathcal{F} \uplus \mathcal{F}$ by letting $\Psi(\Gamma) = F_1 \cup F_2$.

Proposition 5.20. *One has the following properties.*

- 1) *The map $\Psi : \mathcal{L}^* \rightarrow \mathcal{F} \uplus \mathcal{F}$ defined above is a one-to-one map.*
- 2) *For every $\Gamma \in \mathcal{L}^*$, $\Psi(\Gamma)$ is a Brouwer manifold of h with the same type as Γ and satisfies $\Gamma \preceq \Psi(\Gamma)$. Moreover*
 - *$L(\Psi(\Gamma))$ (resp. $R(\Psi(\Gamma))$) lies locally on the left (resp. right) of $\Psi(\Gamma)$;*
 - *if $\text{Fix}(h)$ is totally disconnected then $\text{Cl}(\Psi(\Gamma)) \setminus \Psi(\Gamma) = \text{Cl}(\Gamma) \setminus \Gamma$.*
- 3) *The map Ψ is increasing with respect to the order \preceq on Brouwer manifolds.*

Proof. 1) If Γ, Γ' are two distinct Brouwer manifolds in \mathcal{L}^* then there exists an edge $\alpha \in E$ such that $\alpha \subset \Gamma$ and $\alpha \not\subset \Gamma'$. By construction of the map Ψ one has then $\Psi(\Gamma) \neq \Psi(\Gamma')$.

2) Let $\Gamma \in \mathcal{L}^*$ whose connected components are denoted

$$\Gamma_1 = \prod_{i \in I_1} \alpha_i^1 \quad \text{and} \quad \Gamma_2 = \prod_{i \in I_2} \alpha_i^2$$

where $(\alpha_i^k)_{i \in I_k}$ is an admissible sequence in E ($k \in \{1, 2\}$) and maybe $\Gamma = \Gamma_1 = \Gamma_2$. Write $\Psi(\Gamma) = F_1 \cup F_2$ where F_1, F_2 are two leaves of \mathcal{F} as explained in the definition of Ψ . Remark that $\Psi(\Gamma) = F_1 = F_2$ iff $\Gamma = \Gamma_1 = \Gamma_2$.

As a first step, let us check that $\Psi(\Gamma)$ is closed in M . This is certainly true if Γ is a Brouwer manifold of type 1 because $\Psi(\Gamma)$ is then also a circle. Suppose now that Γ has type 2 or 3. If Γ_k consists of a single edge (*i.e.*, if $\sharp(I_k) = 1$) then $F_k = \Gamma_k$ is closed in M . Otherwise one has $\sharp(I_k) \geq 2$ and, using the notations in the definition of Ψ , one has $F_k = \prod_{i \in I_k} \xi_{\alpha_i^k}^{z_i^k}$. By construction of the foliation \mathcal{F} one also has

$$F_k \subset \bigcup_{i \in I_k} \left(T_{\alpha_i^k} \cup \bigcup_{l \in \{1, 3\}} T_{v_+(\alpha_i^k)}^l \right) \subset l(\Gamma_k).$$

Note that the notation in the first inclusion is slightly abusive since $\alpha_{\max I_k}$ has no final vertex if I_k is bounded from above.

Observe that F_k intersects the segment $I_-(\alpha_i^k)$ at only one point for every $i \in I_k$ such that α_i^k possesses an initial vertex. Indeed, otherwise there exist $i \neq j \in I_k$ such that z_i^k and z_j^k are two distinct points of $I_-(\alpha_i^k)$ which implies that $\alpha_i^k = \alpha_j^k$. This is not possible because Γ_k is a line of M . Hence the intersection of F_k and $T_{\alpha_i^k}$

(resp. $T_{v_+(\alpha_i^k)}^l$) is either empty or a single leaf of $T_{\alpha_i^k}$ (resp. $T_{v_+(\alpha_i^k)}^l$). Therefore F_k does not accumulate on a point of $T_{\alpha_i^k}$ or $T_{v_+(\alpha_i^k)}^k$ which shows that $\Psi(\Gamma)$ is closed in M . If moreover $\text{Fix}(h)$ is totally disconnected then the fact that $\prod_{i \in I_k} \xi_{\alpha_i^k}^{z_i^k} = F^k \subset l(\Gamma_k)$ ($k \in \{1, 2\}$) clearly shows that $\text{Cl}(\Psi(\Gamma)) \setminus \Psi(\Gamma) = \text{Cl}(\Gamma) \setminus \Gamma$.

As a second step, one proves that $\Psi(\Gamma)$ is a Brouwer manifold of h . One uses Lemma 5.13 with the given Brouwer manifold Γ and with $\Delta = \Psi(\Gamma)$. Again it is not difficult to check that the four conditions a)-d) of Lemma 5.13 are satisfied. In the notation of this lemma, one has moreover

$$\mathfrak{R}(\Delta) \subset R(\Gamma) \cup \bigcup_{\{\alpha \in E \mid \alpha \subset \Gamma\}} U_\alpha$$

and therefore

$$h(\mathfrak{R}(\Delta)) \subset h(R(\Gamma)) \cup \bigcup_{\{\alpha \in E \mid \alpha \subset \Gamma\}} h(U_\alpha) \subset \text{Int}(R(\Gamma)) \subset \text{Int}(\mathfrak{R}(\Delta)).$$

According to Item (iii) in Remark 5.2 one obtains that Property $(\mathfrak{L} - \mathfrak{R})$ holds true. Then Lemma 5.13 tell us that Δ is a Brouwer manifold of h with the same type as Γ and moreover $L(\Delta) = \mathfrak{L}(\Delta)$ and $R(\Gamma) \subset R(\Delta) = \mathfrak{R}(\Delta)$. These last two equalities also show that $L(\Delta)$ (resp. $R(\Delta)$) lies locally on the left (resp. right) of Δ as well as $\Gamma \preceq \Delta$.

3) Let $\Gamma \prec \Gamma'$ in \mathcal{L}^* . One writes Γ_1 and Γ_2 (resp. F_1 and F_2) for the connected components of Γ (resp. $\Psi(\Gamma)$) with possibly $\Gamma = \Gamma_1 = \Gamma_2$ and $\Psi(\Gamma) = F_1 = F_2$. One may assume that F_k is associated to Γ_k in the construction of $\Psi(\Gamma)$. One also has $\Psi(\Gamma') = F'_1 \cup F'_2$ with similar conventions.

We first show that $\Psi(\Gamma) \subset R(\Psi(\Gamma'))$. Let $k \in \{1, 2\}$.

- Suppose that Γ_k is reduced to a single edge in E . The definition of Ψ then gives $F_k = \Gamma_k$ and moreover, since $\Gamma \prec \Gamma'$, either Γ_k is included in $\text{Int}(R(\Gamma'))$ or Γ_k is also a connected component of Γ' . One gets anyway $F_k \subset R(\Gamma') \subset R(\Psi(\Gamma'))$.

- Suppose now that Γ_k is the concatenation of at least two edges. Let us write

$$\Gamma_k = \prod_{i \in I_k} \alpha_i^k \quad \text{and} \quad F_k = \prod_{i \in I_k} \xi_{\alpha_i^k}^{z_i^k}$$

as in the definition of Ψ , with $\sharp(I_k) \geq 2$. It is enough to show that $\xi_{\alpha_i^k}^{z_i^k} \subset R(\Psi(\Gamma'))$ for any given $i_k \in I_k$. For short we let $\alpha = \alpha_{i_k}^k$ and $z = z_{i_k}^k$.

- We begin with the case where $\alpha \subset \Gamma'$. Assume moreover that α has an initial vertex, so that $z \in \mathcal{L}_-(\alpha) \subset I_-(\alpha)$. Since $\alpha \subset \Gamma'$ one has $\xi_\alpha^{z'} \subset F'_k$ where $z' = \theta_-(\alpha)(\Gamma') \in \mathcal{L}_-(\alpha)$. Let $X = \bigcup_{i \in \{1, 2, 3\}} T_{v_+(\alpha)}^i$ if α has a final vertex and $X = \emptyset$ otherwise. One knows from Proposition 5.18 that z' is the only point in $\Psi(\Gamma') \cap I_-(\alpha)$ hence $\Psi(\Gamma') \cap (T_\alpha \cup X) = \xi_\alpha^{z'}$. Moreover $z < z'$ in $\mathcal{L}_-(\alpha)$ because $\Gamma \prec \Gamma'$

and therefore ξ_α^z lies between $\xi_\alpha^{z'}$ and α in $T_\alpha \cup X$; more precisely ξ_α^z separates $\xi_\alpha^{z'}$ and $\alpha \cap T_\alpha$ in $T_\alpha \cup X$. It is then clear that ξ_α^z is included in a connected component V of $M \setminus \Psi(\Gamma')$ meeting $\text{Int}(R(\Gamma'))$. Consider the set $\mathfrak{R}(\Psi(\Gamma'))$ obtained when applying Lemma 5.13 to the Brouwer manifold Γ' and $\Delta = \Psi(\Gamma')$. One gets then $\xi_\alpha^z \subset V \subset \mathfrak{R}(\Psi(\Gamma')) = R(\Psi(\Gamma'))$, the last equality being a by-product of the proof of 2) where Γ is replaced with Γ' . If α has no initial vertex (which implies $i_k = \min I_k > -\infty$) then one has $\{z, z'\} \subset \mathcal{L}(\alpha_{i_{k+1}}) \subset I_-(\alpha_{i_{k+1}})$ by definition of ξ_α^z and $\xi_\alpha^{z'}$ but the argument works likewise.

- Next we assume $\alpha \not\subset \Gamma'$. One has then $\text{Int}_\Sigma(\alpha) \subset \text{Int}(R(\Gamma'))$ and one gets $\xi_\alpha^z \subset l(\alpha) \subset R(\Gamma') \subset R(\Psi(\Gamma'))$.

Thus we proved the expected inclusion $\Psi(\Gamma) \subset R(\Psi(\Gamma'))$. It follows from Proposition 3.3 that either $R(\Psi(\Gamma)) \subset R(\Psi(\Gamma'))$ or $L(\Psi(\Gamma)) \subset R(\Psi(\Gamma'))$. Let $\alpha \in E$ be an edge included in Γ' and let $b = l(\alpha) \in L(\Gamma') \subset L(\Gamma)$. By the construction of \mathcal{F} one has $\text{Int}(T_b) \subset \text{Int}(L(\Psi(\Gamma))) \cap \text{Int}(L(\Psi(\Gamma')))$ thus showing that actually $L(\Psi(\Gamma)) \not\subset R(\Psi(\Gamma'))$ and consequently $R(\Psi(\Gamma)) \subset R(\Psi(\Gamma'))$. This completes the proof of Proposition 5.20. \square

Remark 5.4. *The proof of Proposition 5.20 shows that*

$$\Psi(\Gamma) \subset \left(\bigcup_{\alpha \in E} T_\alpha \right) \cup \left(\bigcup_{\sigma \in V} \bigcup_{i \in \{1,3\}} T_\sigma^i \right)$$

for every $\Gamma \in \mathcal{L}^*$ so that $\Psi(\Gamma) \cap \text{Int}(T_b) = \emptyset$ for every $b \in B$. This will allow farther to add new conditions on the families $(\gamma_b^t)_{t \in [-1,1]}$ foliating the bricks $T_b \in B^*$ without altering the truthfulness of this Proposition 5.20.

Let $\widehat{\beta}$ be an equivalence class in B / \sim . Recall that the equivalence chain $\mathcal{C}_{\widehat{\beta}}$ has at most two connected components which we name $\mathcal{C}_{1,\widehat{\beta}}$ and $\mathcal{C}_{2,\widehat{\beta}}$ with maybe $\mathcal{C}_{1,\widehat{\beta}} = \mathcal{C}_{2,\widehat{\beta}} = \mathcal{C}_{\widehat{\beta}}$ and with the convention that $\mathcal{C}_{1,\widehat{\beta}}$ contains at least one brick $\beta \in \widehat{\beta}$. For simplicity we omit the subscript $\widehat{\beta}$ in the following paragraph, so that $\mathcal{C}_{\widehat{\beta}} = \mathcal{C}$ and likewise for its connected components $\mathcal{C}_1, \mathcal{C}_2$. Moreover for every $k \in \{1,2\}$ one can write

$$\mathcal{C}_k = \prod_{i \in I_k} \varepsilon_i^k$$

where $(\varepsilon_i^k)_{i \in I_k}$ is an admissible sequence of pairwise distinct elements in $A = E \sqcup B$.

We also consider the connected components Γ_1^- and Γ_2^- of $\Gamma_{\widehat{\beta}}^-$ with $\gamma_{\widehat{\beta}}^- \subset \Gamma_1^-$ and maybe $\Gamma_1^- = \Gamma_2^- = \Gamma_{\widehat{\beta}}^-$. Similarly one writes $\Gamma_{\widehat{\beta}}^+ = \Gamma_1^+ \cup \Gamma_2^+$ with $\gamma_{\widehat{\beta}}^+ \subset \Gamma_1^+$.

Now let $\Psi(\Gamma_{\widehat{\beta}}^-) = F_1^- \cup F_2^-$ and $\Psi(\Gamma_{\widehat{\beta}}^+) = F_1^+ \cup F_2^+$ where the leaf $F_k^\pm \subset l(\Gamma_k^\pm)$ is associated to Γ_k^\pm in the definition of $\Psi(\Gamma_{\widehat{\beta}}^\pm)$. Recall that $\Gamma_{\widehat{\beta}}^- \prec \Gamma_{\widehat{\beta}}^+$ (see Proposition 5.14 and notations thereafter) hence Proposition 5.20 gives $\Psi(\Gamma_{\widehat{\beta}}^-) \prec \Psi(\Gamma_{\widehat{\beta}}^+)$. One also knows that the four Brouwer manifolds $\Gamma_{\widehat{\beta}}^\pm$ and $\Psi(\Gamma_{\widehat{\beta}}^\pm)$ have the same type. Remark

that the leaves $F_1^- \subset l(\Gamma_1^-)$ and $F_1^+ \subset l(\Gamma_1^+)$ are different because \mathcal{C}_1 contains some brick $\beta \in \widehat{\beta}$ but it is possible that $F_2^- = F_2^+$; precisely this equality holds true iff there is an edge $e \in E$ such that $e = \Gamma_2^- = \Gamma_2^+$.

Let us define $\Omega_{\widehat{\beta}} = R(\Psi(\Gamma_{\widehat{\beta}}^+)) \setminus \text{Int}(R(\Psi(\Gamma_{\widehat{\beta}}^-)))$, which is clearly a closed subset of M . Since $\partial_M R(\Psi(\Gamma_{\widehat{\beta}}^{\pm})) = \Psi(\Gamma_{\widehat{\beta}}^{\pm}) \in \mathcal{F} \sqcup \mathcal{F}$, each set $R(\Psi(\Gamma_{\widehat{\beta}}^{\pm}))$ is saturated by the foliation \mathcal{F} (that means it is the union of some leaves of \mathcal{F}) and then the same is true from $\Omega_{\widehat{\beta}}$. It is also not difficult to see that $\Omega_{\widehat{\beta}}$ possesses one or two connected components. Let us give some additionnal details.

Suppose that $\varepsilon_i^1 \in E$ for some $i \in I_1$, so that ε_i^1 is an edge contained in $\Gamma_1^- \cap \Gamma_1^+$. Note that ε_i^1 has an initial vertex or a final vertex because \mathcal{C}_1 contains some brick $\beta \in \widehat{\beta}$ (actually ε_i^1 has both an initial and a final vertex except maybe if $i = \min I_k > -\infty$ or if $i = \max I_k < +\infty$). If ε_i^1 has an initial vertex then one knows that $\Psi(\Gamma_{\widehat{\beta}}^-)$ (resp. $\Psi(\Gamma_{\widehat{\beta}}^+)$) intersects the segment $I_-(\varepsilon_i^1)$ only at the point $a_i^- = \theta_-(\varepsilon_i^1)(\Gamma_{\widehat{\beta}}^-) \in F_1^-$ (resp. $a_i^+ = \theta_-(\varepsilon_i^1)(\Gamma_{\widehat{\beta}}^+) \in F_1^+$) and $a_i^- < a_i^+$ in $I_-(\varepsilon_i^1)$. The same arguments as in the proof of Item 3) of Proposition 5.20 show that $[a_i^-, a_i^+]_{I_-(\varepsilon_i^1)} \subset \Omega_{\widehat{\beta}}$. If ε_i^1 has a final vertex then $\Psi(\Gamma_{\widehat{\beta}}^-) \cap I_+(\varepsilon_i^1) = \{b_i^-\} \subset F_1^-$ and $\Psi(\Gamma_{\widehat{\beta}}^+) \cap I_+(\varepsilon_i^1) = \{b_i^+\} \subset F_1^+$ with $b_i^- = \theta_+(\varepsilon_i^1)(\Gamma_{\widehat{\beta}}^-) < \theta_+(\varepsilon_i^1)(\Gamma_{\widehat{\beta}}^+) = b_i^+$ in the segment $I_+(\varepsilon_i^1)$ and $[b_i^-, b_i^+]_{I_+(\varepsilon_i^1)} \subset \Omega_{\widehat{\beta}}$.

Consider now $i \in I_1$ such that $\varepsilon_i^1 \in B$. For simplicity we let $b = \varepsilon_i^1$. For any edge $\alpha \in E$ such that $\alpha \subset \gamma_b^-$ one knows that $\Gamma_{\widehat{\beta}}^- = \Gamma_b^- = \Gamma_{\alpha}^+$. If furthermore α possesses an initial (resp. a final) vertex then it follows that the leaf F_1^- passes through the point $\max \mathcal{L}_-(\alpha) = \max I_-(\alpha)$ (resp. $\max \mathcal{L}_+(\alpha) = \max I_+(\alpha)$). In particular if b has an initial (resp. a final) vertex then one can choose α such that $v_-(\alpha) = v_-(b)$ (resp. $v_+(\alpha) = v_+(b)$) which shows that F_1^- contains the point $\max I_-(\alpha) = \min I_-(b)$ (resp. $\max I_+(\alpha) = \min I_+(b)$). Similarly, for any edge $\alpha' \subset \gamma_b^+$ one has $\Gamma_{\widehat{\beta}}^+ = \Gamma_b^+ = \Gamma_{\alpha'}^-$ and one obtains that $\min \mathcal{L}_-(\alpha') = \min I_-(\alpha') \in F_1^+$ (resp. $\min \mathcal{L}_+(\alpha') = \min I_+(\alpha') \in F_1^+$) as soon as α' has an initial (resp. a final) vertex. In particular F_1^+ contains $\max I_-(b)$ or/and $\max I_+(b)$ when b has an initial or/and a final vertex. In all cases one gets $\gamma_b^{-1} \subset F_1^-$ and $\gamma_b^1 \subset F_1^+$. Since moreover $\Psi(\Gamma_{\widehat{\beta}}^{\pm})$ are disjoint from $\text{Int}(T_b)$ (as any Brouwer manifold in $\Psi(\mathcal{L}^*)$) one deduces that $\Omega_{\widehat{\beta}} \cap b = T_b$.

All these intervals $[a_i^-, a_i^+]_{I_-(\varepsilon_i^1)}$ and $[b_i^-, b_i^+]_{I_+(\varepsilon_i^1)}$ where $\varepsilon_i^1 \in E$ as well as the sets $T_{\varepsilon_i^1}$ where $\varepsilon_i^1 \in B$ are contained in the same connected component of $\Omega_{\widehat{\beta}}$, call it $\Omega_{1, \widehat{\beta}}$, because they are pairwise linked by some leaves of \mathcal{F} lying in $\Omega_{\widehat{\beta}}$. It is not difficult to see that $\Omega_{1, \widehat{\beta}}$ is either an annulus or a strip (depending on whether $\Gamma_{\widehat{\beta}}^{\pm}$ are compact or not) with frontier $\partial_M \Omega_{1, \widehat{\beta}} = F_1^- \sqcup F_1^+$. Remark also that all the above segments $[a_i^-, a_i^+]_{I_-(\varepsilon_i^1)}$ and $[b_i^-, b_i^+]_{I_+(\varepsilon_i^1)}$ (when $\varepsilon_i \in E$) as well as the segments $I_{\pm}(\varepsilon_i)$ (when $\varepsilon_i \in B$) define a global cross-section of \mathcal{F} , that means that every leaf of \mathcal{F} cross transversely such a segment. Consequently :

- if $\Omega_{1, \widehat{\beta}}$ is an annulus then it does not contain any Reeb component of \mathcal{F} ;
- if $\Omega_{1, \widehat{\beta}}$ is a strip then, for every leaf $\phi \subset \Omega_{1, \widehat{\beta}}$ and every $i \in I$, the set $\phi \cap T_{\varepsilon_i}$ is

connected, which implies that ϕ a line of M . Moreover $\Omega_{1,\widehat{\beta}}$ is trivially foliated by \mathcal{F} .

Assume now that $\Gamma_{\widehat{\beta}}^{\pm}$ has type 3, so that $\Omega_{\widehat{\beta}}$ has another connected component $\Omega_{2,\widehat{\beta}}$. Remember that maybe $\mathcal{C}_2 = \Gamma_2^- = \Gamma_2^+ = e$ for some edge $e \in E$ which is a line of M . If this situation holds then $F_2^- = \Gamma_2^- = \Gamma_2^+ = F_2^+$ and it follows that $\Omega_{2,\widehat{\beta}} = F_2^{\pm} = \Gamma_2^{\pm}$. In any other situation, the set $\Omega_{2,\widehat{\beta}}$ may be described as $\Omega_{1,\widehat{\beta}}$ above. In particular $\Omega_{2,\widehat{\beta}}$ is then a strip with $\partial_M \Omega_{2,\widehat{\beta}} = F_2^- \sqcup F_2^+$ and $T_b \subset \Omega_{2,\widehat{\beta}}$ for any brick $b \in \widehat{\beta}$ verifying $b \subset \mathcal{C}_2$ (if any).

It is convenient in the following to allow $\Omega_{1,\widehat{\beta}} = \Omega_{2,\widehat{\beta}} = \Omega_{\widehat{\beta}}$ when $\Omega_{\widehat{\beta}}$ is connected, i.e., when the Brouwer manifolds $\Gamma_{\widehat{\beta}}^{\pm}$ have type 1 or 2.

Proposition 5.21. *Let $\widehat{\beta} \neq \widehat{\beta}'$ in B/\sim . Then one has $\text{Int}(\Omega_{\widehat{\beta}}) \cap \Omega_{\widehat{\beta}'} = \emptyset$.*

Proof. Remark that

$$(*) \quad \Omega_{\widehat{\beta}} \subset \bigcup_{b \in \widehat{\beta}} T_b \cup \bigcup_{\alpha \in \Gamma_{\widehat{\beta}}^- \cap \Gamma_{\widehat{\beta}}^+} \left(T_{\alpha} \cup \bigcup_{\sigma=v_{\pm}(\alpha)} T_{\sigma}^i \right)$$

where $\bigcup_{\alpha \in \Gamma_{\widehat{\beta}}^- \cap \Gamma_{\widehat{\beta}}^+}$ denotes the union over all the edges $\alpha \in E$ included in $\Gamma_{\widehat{\beta}}^- \cap \Gamma_{\widehat{\beta}}^+$ and where $\bigcup_{\sigma=v_{\pm}(\alpha)}$ denotes the union over the vertices $\sigma \in V$ belonging to α .

One has likewise

$$(**) \quad \Omega_{\widehat{\beta}'} \subset \bigcup_{b' \in \widehat{\beta}'} T_{b'} \cup \bigcup_{\alpha' \in \Gamma_{\widehat{\beta}'}^- \cap \Gamma_{\widehat{\beta}'}^+} \left(T_{\alpha'} \cup \bigcup_{\sigma'=v_{\pm}(\alpha')} T_{\sigma'}^i \right).$$

Suppose that the result is not true, so that $\text{Int}(\Omega_k) \cap \Omega'_l \neq \emptyset$ where Ω_k (resp. Ω'_l) is a connected component of $\Omega_{\widehat{\beta}}$ (resp. $\Omega_{\widehat{\beta}'}$). Since $\text{Int}(\Omega_{\widehat{\beta}}) \cap \Sigma = \emptyset$ the set Ω'_l is not reduced to a single edge in E hence each set Ω_k and Ω'_l is either an annulus or a strip and therefore $\text{Int}(\Omega_k) \cap \text{Int}(\Omega'_l) \neq \emptyset$. One also denotes by \mathcal{C}_k the connected component of $\mathcal{C}_{\widehat{\beta}}$ corresponding naturally to Ω_k . Precisely, this means that \mathcal{C}_k contains the connected components Γ_k^{\pm} of $\Gamma_{\widehat{\beta}}^{\pm}$ such that $F_k^{\pm} \subset l(\Gamma_k^{\pm})$ where F_k^{\pm} are the leaves in $\partial_M \Omega_k$.

Pick $m \in \text{Int}(\Omega_k) \cap \text{Int}(\Omega'_l)$. Recall that $\text{Int}(\Omega_k)$ and $\text{Int}(\Omega'_l)$ are saturated by \mathcal{F} hence if \mathcal{C}_k contains some brick $b \in \widehat{\beta}$ then the leaf ϕ_m passing through m also contains a point $m' \in \text{Int}(T_b) \cap \text{Int}(\Omega'_l)$. This is not possible because $\text{Int}(T_b)$ is clearly disjoint from all the $T_{b'}$'s and $T_{\alpha'}$'s and $T_{\sigma'}$'s appearing in the above inclusion (**). Consequently \mathcal{C}_k is a common connected component of $\Gamma_{\widehat{\beta}}^-$ and $\Gamma_{\widehat{\beta}}^+$ which may be written $\mathcal{C}_k = \prod_{i \in I} \alpha_i$ where $(\alpha_i)_{i \in I}$ is an admissible sequence in E with $\sharp(I) \geq 2$. In particular there is at least one edge $\alpha \in \{\alpha_i\}_{i \in I}$ having an initial vertex. Reversing the roles of Ω_k and Ω'_l one obtains likewise that there is no brick $b' \in \widehat{\beta}'$ in the connected component \mathcal{C}'_l of $\mathcal{C}_{\widehat{\beta}'}$ corresponding to Ω'_l , so that $\mathcal{C}'_l = \prod_{j \in J} \alpha'_j$ with $\alpha'_j \in E$ for every $j \in J$.

Because ϕ_m also contains a point $m' \in \text{Int}(T_{\alpha}) \cap \text{Int}(\Omega'_l)$ one gets $\alpha \subset \Gamma_{\widehat{\beta}'}^- \cap \Gamma_{\widehat{\beta}'}^+$ hence $\alpha = \alpha'_j$ for some $j \in J$. Consequently the four Brouwer manifolds $\Gamma_{\widehat{\beta}}^{\pm}$ and $\Gamma_{\widehat{\beta}'}^{\pm}$

belong to $\mathcal{L}^*(\alpha)$. One knows that

$$\{z_-\} = I_-(\alpha) \cap \Psi(\Gamma_{\widehat{\beta}}^-), \quad \{z_+\} = I_-(\alpha) \cap \Psi(\Gamma_{\widehat{\beta}}^+),$$

and

$$\{z'_-\} = I_-(\alpha) \cap \Psi(\Gamma_{\widehat{\beta}'}^-), \quad \{z'_+\} = I_-(\alpha) \cap \Psi(\Gamma_{\widehat{\beta}'}^+)$$

where $z_{\pm} = \theta_-(\alpha)(\Gamma_{\widehat{\beta}}^{\pm})$ and $z'_{\pm} = \theta_-(\alpha)(\Gamma_{\widehat{\beta}'}^{\pm})$.

According to Proposition 5.14 one has $(\Gamma_{\widehat{\beta}}^-, \Gamma_{\widehat{\beta}}^+) = \emptyset = (\Gamma_{\widehat{\beta}'}^-, \Gamma_{\widehat{\beta}'}^+)$ hence $(z_-, z_+)_{I_-(\alpha)} \cap (z'_-, z'_+)_{I_-(\alpha)} = \emptyset$. This is absurd since the leaf ϕ_m intersects both $(z_-, z_+)_{I_-(\alpha)}$ and $(z'_-, z'_+)_{I_-(\alpha)}$. \square

Given an equivalence class $\widehat{\beta} \in B/\sim$, our next goal is to choose suitably some link homeomorphisms λ_{σ} and to reparameterize the family $(\gamma_b^t)_{t \in [-1,1]}$ in such a way that all the leaves in $\Omega_{\widehat{\beta}}$ define Brouwer manifolds.

Lemma 5.15. *Let $\widehat{\beta} \in B/\sim$ and consider $\mathcal{C}_{\widehat{\beta}} = \mathcal{C}_{1,\widehat{\beta}} \cup \mathcal{C}_{2,\widehat{\beta}}$ and $\Omega_{\widehat{\beta}} = \Omega_{1,\widehat{\beta}} \cup \Omega_{2,\widehat{\beta}}$ as defined above. Let $k \in \{1,2\}$. The link homeomorphisms λ_{σ} , where $\sigma = v_+(b)$ for some brick $b \in \widehat{\beta}$ with $b \subset \mathcal{C}_k$, may be chosen in such a way that the following property holds true:*

For every leaf $F \subset \Omega_{k,\widehat{\beta}}$ there exists $t \in [-1,1]$ such that

$$\forall b \in \widehat{\beta} \quad b \subset \mathcal{C}_{k,\widehat{\beta}} \implies F \cap T_b = \gamma_b^{\mu_b^{-1}(t)}.$$

Consequently, if $\Gamma_{\widehat{\beta}}^{\pm}$ have type 1 then every leaf included in $\Omega_{k,\widehat{\beta}}$ is a circle.

Proof. Letting again $\mathcal{C}_k = \mathcal{C}_{k,\widehat{\beta}}$, one can write $\mathcal{C}_k = \prod_{i \in I_k} \varepsilon_i^k$ for some admissible sequence $(\varepsilon_i^k)_{i \in I_k}$ of pairwise distinct elements of $A = E \sqcup B$. For simplicity we write ε_i and I instead of, respectively, ε_i^k and I_k . One can also suppose that the sequence $(\varepsilon_i)_{i \in I}$ contains at least one brick since otherwise the result is empty.

If there are several bricks in the sequence $(\varepsilon_i)_{i \in I}$ then there exists $(i,j) \in I^2$ such that $j > i+1$, $\{\varepsilon_i, \varepsilon_j\} \subset B$ and $\varepsilon_l \in E$ for every $l \in \{i+1, \dots, j-1\}$. For $l \in \{i+1, \dots, j-1\}$ we let $z_l^- = \theta_-(\varepsilon_l)(\Gamma_{\widehat{\beta}}^-) \in \mathcal{L}_-(\varepsilon_l)$ and $z_l^+ = \theta_-(\varepsilon_l)(\Gamma_{\widehat{\beta}}^+) \in \mathcal{L}_-(\varepsilon_l)$ and furthermore $z_j^- = \min I_-(\varepsilon_j)$ and $z_j^+ = \max I_-(\varepsilon_j)$. Thus one has

$$\psi_{\varepsilon_l}([z_l^-, z_l^+]_{I_-(\varepsilon_l)}) = [z_{l+1}^-, z_{l+1}^+]_{I_-(\varepsilon_{l+1})}$$

for every $l \in \{i+1, \dots, j-1\}$ and therefore

$$\kappa = \psi_{\varepsilon_{j-1}} \circ \dots \circ \psi_{\varepsilon_{i+1}} \Big|_{I_-^c(\varepsilon_{i+1})} : I_-^c(\varepsilon_{i+1}) \rightarrow I_-(\varepsilon_j)$$

defines an increasing homeomorphism. One chooses the link homeomorphism $\lambda_{v_+(\varepsilon_i)}$ so that, for every $t \in [-1,1]$, it maps the final point of $\gamma_{\varepsilon_i}^{\mu_{\varepsilon_i}^{-1}(t)}$ onto the κ^{-1} -image

of the initial point of $\gamma_{\varepsilon_j}^{\mu_{\varepsilon_j}^{-1}(t)}$. More explicitly, denote by $z_{\varepsilon_i} : [-1, 1] \rightarrow I_+(\varepsilon_i)$ the parametrization of the segment $I_+(\varepsilon_i)$ induced by the family $(\gamma_{\varepsilon_i}^t)_{t \in [-1, 1]}$, that means $\{z_{\varepsilon_i}(t)\} = \gamma_{\varepsilon_i}^t \cap I_+(\varepsilon_i)$ for every $t \in [-1, 1]$. Likewise $z_{\varepsilon_j} : [-1, 1] \rightarrow I_-(\varepsilon_j)$ is the parameterization of $I_-(\varepsilon_j)$ induced by the family $(\gamma_{\varepsilon_j}^t)_{t \in [-1, 1]}$. Then $\kappa^{-1} \circ z_{\varepsilon_j} : [-1, 1] \rightarrow I_-^c(\varepsilon_{i+1})$ is a parameterization of $I_-^c(\varepsilon_{i+1})$ and we define

$$\lambda_{v_+(\varepsilon_i)} = \kappa^{-1} \circ z_{\varepsilon_j} \circ \mu_{\varepsilon_j}^{-1} \circ \mu_{\varepsilon_i} \circ z_{\varepsilon_i}^{-1} : I_+(\varepsilon_i) \rightarrow I_-^c(\varepsilon_{i+1})$$

so that one has $\lambda_{v_+(\varepsilon_i)} \circ z_{\varepsilon_i} \circ \mu_{\varepsilon_i}^{-1} = \kappa^{-1} \circ z_{\varepsilon_j} \circ \mu_{\varepsilon_j}^{-1}$.

After selecting $\lambda_{v_+(\varepsilon_i)}$ for every such pair $(i, j) \in I^2$ (if any), there are two cases to consider.

- If \mathcal{C}_k is not compact (i.e., if $\Gamma_{\hat{\beta}}^{\pm}$ have type 2 or 3) then we are done.

- If \mathcal{C}_k is compact (i.e., if $\Gamma_{\hat{\beta}}^{\pm}$ have type 1) then $\mathcal{C}_{\hat{\beta}} = \mathcal{C}_k$ and moreover $\Omega_{\hat{\beta}} = \Omega_{k, \hat{\beta}}$ is an annulus. In order to prevent spiraling leaves in $\Omega_{\hat{\beta}}$ one needs to choose suitably another link homeomorphism. Clearly I is a finite \mathbb{Z} -interval and $v_+(\varepsilon_{\max I}) = v_-(\varepsilon_{\min I})$. Write $N = \sharp(I)$ and let m (resp. n) be the minimum (resp. the maximum) of the set $\{i \in I \mid \varepsilon_i \in B\}$ (maybe $m = n$). Now extend periodically the sequence $(\varepsilon_i)_{i \in I}$ so that $\varepsilon_i = \varepsilon_{i+N}$ for every $i \in \mathbb{Z}$. Replacing (i, j) with $(n, m + N)$ in the construction above, one gets a link homeomorphism $\lambda_{v_+(\varepsilon_n)}$ which completes the proof of Lemma 5.15. \square

Any vertex $\sigma \in V$ is the final vertex of at most one brick $b \in B$ hence it makes sense to apply Lemma 5.15 simultaneously to different equivalent classes in B / \sim . Consequently we may assume from now on that the conclusion of Lemma 5.15 holds true for every $\hat{\beta} \in B / \sim$.

Given $\hat{\beta} \in B / \sim$ and $k \in \{1, 2\}$, this ensures that the foliation \mathcal{F} restricted to $\Omega_{k, \hat{\beta}}$ defines a continuous family $(\phi_{k, \hat{\beta}}^t)_{t \in [-1, 1]}$ of circles (resp. of lines of M) when $\Gamma_{\hat{\beta}}^{\pm}$ have type 1 (resp. type 2 or 3). The parameterization by t is chosen so that $\phi_{k, \hat{\beta}}^{\pm 1} = F_k^{\pm}$ where F_k^{\pm} is the leaf in $\partial_M \Omega_{k, \hat{\beta}}$ contained in $\Psi(\Gamma_{\hat{\beta}}^{\pm})$. Moreover, writing $\mathcal{C}_{k, \hat{\beta}}$ for the connected component of $\mathcal{C}_{\hat{\beta}}$ corresponding naturally to $\Omega_{k, \hat{\beta}}$ (as explained in the proof of Proposition 5.21), one can ask that

$$\forall t \in [-1, 1] \forall b \in \hat{\beta} \quad : \quad b \subset \mathcal{C}_{k, \hat{\beta}} \implies \phi_{k, \hat{\beta}}^t \cap T_b = \gamma_b^{\mu_b^{-1}(t)}.$$

Recall that if $\Gamma_{\hat{\beta}}^-$ and $\Gamma_{\hat{\beta}}^+$ have a common connected component $e \in E_0$ then $\phi_{2, \hat{\beta}}^t = e = F_2^- = F_2^+$ for every $t \in [-1, 1]$ and this set is a line of M .

For every brick $b \in \hat{\beta}$ one has $\gamma_b^- \subset \Gamma_{\hat{\beta}}^-$ and therefore, since $\Gamma_{\hat{\beta}}^{\pm}$ are two Brouwer manifolds, one gets

$$h(\gamma_b^{-1}) \subset h\left(\bigcup_{\{\alpha \in E \mid \alpha \subset \gamma_b^-\}} U_{\alpha}\right) \subset \text{Int}(R(\Gamma_{\hat{\beta}}^-)) \quad \text{and} \quad h^{-1}(\gamma_b^1) \subset h^{-1}(\Gamma_{\hat{\beta}}^+) \subset \text{Int}(L(\Gamma_{\hat{\beta}}^+)).$$

Then one can construct the family $(\gamma_b^t)_{t \in [-1, 1]}$ foliating T_b in such a way that

- $t \in [-1, -1/3] \implies h(\gamma_b^t) \subset \text{Int}(R(\Gamma_{\hat{\beta}}^-))$,
- $t \in [1/3, 1] \implies h^{-1}(\gamma_b^t) \subset \text{Int}(L(\Gamma_{\hat{\beta}}^+))$.

Now we let $\Phi_{\hat{\beta}}^t = \phi_{1,\hat{\beta}}^t \cup \phi_{2,\hat{\beta}}^t \in \mathcal{F} \uplus \mathcal{F}$ for every $t \in (-1, 1)$ (this is an unambiguous definition due to Proposition 5.21) and $\Phi_{\hat{\beta}}^{\pm 1} = \Psi(\Gamma_{\hat{\beta}}^{\pm})$.

Proposition 5.22. *Let $\hat{\beta} \in B/\sim$. For every $t \in [-1, 1]$ the set $\Phi_{\hat{\beta}}^t$ defined above is a Brouwer manifold of h with the same type as $\Gamma_{\hat{\beta}}^{\pm}$. Moreover $L(\Phi_{\hat{\beta}}^t)$ (resp. $R(\Phi_{\hat{\beta}}^t)$) lies locally on the left (resp. right) of $\Phi_{\hat{\beta}}^t$.*

Proof. It is very similar to the one of Proposition 5.16 and we only mention the needed modifications. For $t = \pm 1$ the result is contained in Proposition 5.20 hence one can assume $t \in (-1, 1)$. For simplicity one writes $\Phi_{\hat{\beta}}^t = \Phi^t = \phi_1^t \cup \phi_2^t$ where ϕ_1^t, ϕ_2^t are the connected components of Φ^t with possibly $\Phi^t = \phi_1^t = \phi_2^t$ and as usual $\mathcal{C}_{\hat{\beta}} = \mathcal{C}_1 \cup \mathcal{C}_2$, $\Gamma_{\hat{\beta}}^{\pm} = \Gamma_1^{\pm} \cup \Gamma_2^{\pm}$ with $\Gamma_k^- \cup \Gamma_k^+ \subset \mathcal{C}_k$ for every $k \in \{1, 2\}$.

We apply Lemma 5.13 to the Brouwer manifold $\Gamma = \Gamma_{\hat{\beta}}^-$ and to the set $\Delta = \Phi^t$. It is easily seen that the properties a)-d) of Lemma 5.13 are true and in particular $\partial_M \mathfrak{L}(\Phi^t) = \Phi^t = \partial_M \mathfrak{R}(\Phi^t)$ (see Remark 5.2). It remains to prove the property ($\mathfrak{L} - \mathfrak{R}$) in e) of Lemma 5.13. As for Proposition 5.16 one needs to prove first that $h(\Phi_{\hat{\beta}}^t) \cap \Phi_{\hat{\beta}}^t = \emptyset$ but the argument is slightly different. One has

$$\Phi_{\hat{\beta}}^t \subset \bigcup_{b \in \hat{\beta}} T_b \cup \bigcup_{\alpha \in \Gamma_{\hat{\beta}}^- \cap \Gamma_{\hat{\beta}}^+} \left(T_{\alpha} \cup \bigcup_{\sigma=v_{\pm}(\alpha)} T_{\sigma}^i \right)$$

where the symbols $\bigcup_{\alpha \in \Gamma_{\hat{\beta}}^- \cap \Gamma_{\hat{\beta}}^+}$ and $\bigcup_{\sigma=v_{\pm}(\alpha)}$ have the same meaning as at the beginning of the proof of Proposition 5.21. It follows that

$$\Phi_{\hat{\beta}}^t \setminus \bigcup_{b \in \hat{\beta}} T_b \subset \bigcup_{\alpha \in \Gamma_{\hat{\beta}}^- \cap \Gamma_{\hat{\beta}}^+} U_{\alpha}$$

and therefore

$$h\left(\Phi_{\hat{\beta}}^t \setminus \bigcup_{b \in \hat{\beta}} T_b\right) \subset \bigcup_{\alpha \in \Gamma_{\hat{\beta}}^-} h(U_{\alpha}) \subset \text{Int}(R(\Gamma_{\hat{\beta}}^-)) \subset \text{Int}(\mathfrak{R}(\Phi^t))$$

which gives

$$h\left(\Phi_{\hat{\beta}}^t \setminus \bigcup_{b \in \hat{\beta}} T_b\right) \cap \Phi_{\hat{\beta}}^t = \emptyset.$$

One also has

$$\Phi_{\hat{\beta}}^t \setminus \bigcup_{b \in \hat{\beta}} T_b \subset \bigcup_{\alpha \in \Gamma_{\hat{\beta}}^- \cap \Gamma_{\hat{\beta}}^+} l(\alpha) \subset L(\Gamma_{\hat{\beta}}^+)$$

hence

$$h^{-1}\left(\Phi_{\widehat{\beta}}^t \setminus \bigcup_{b \in \widehat{\beta}} T_b\right) \cap \bigcup_{b \in \widehat{\beta}} T_b \subset \text{Int}(L(\Gamma_{\widehat{\beta}}^+)) \cap \bigcup_{b \in \widehat{\beta}} b = \emptyset$$

where the last equality follows from Proposition 5.15.

Moreover for every $b \in \widehat{\beta}$ one has

$$\Phi^t \cap T_b = \gamma_b^{\mu_b^{-1}(t)}.$$

Consequently if $h(\Phi^t) \cap \Phi^t \neq \emptyset$ then there exists $b, b' \in \widehat{\beta}$ such that

$$h\left(\gamma_b^{\mu_b^{-1}(t)}\right) \cap \gamma_{b'}^{\mu_{b'}^{-1}(t)} \neq \emptyset$$

and one gets a contradiction as in the proof of Proposition 5.16.

Now one considers the same two situations as in Proposition 5.16.

- Suppose first that $\mathcal{C}_{\widehat{\beta}} = \beta$ for some brick $\beta \in B$.

Then β is either an annulus or a strip, $\widehat{\beta} = \{\beta\}$ and $\Phi^t = \gamma_{\beta}^t \subset T_{\beta} \subset \beta$. The same arguments as in the proof of Proposition 5.16 show that $\Phi^t = \gamma_{\beta}^t$ is a Brouwer manifold of h .

- Assume now that $\mathcal{C}_{\widehat{\beta}}$ is not reduced to a single brick, i.e., $\beta \subsetneq \mathcal{C}_{\widehat{\beta}}$ for every brick $\beta \in \widehat{\beta}$.

Remark that if $\Gamma_i^- \cap \Gamma_i^+ \neq \emptyset$ for some $i \in \{1, 2\}$ then one has

$$h(\phi_i^t) \subset \text{Int}(\mathfrak{R}(\Phi^t)) \quad \text{and} \quad h^{-1}(\phi_i^t) \subset \text{Int}(\mathfrak{L}(\Phi^t))$$

(an analogous remark was used in the proof of Proposition 5.16 with Γ_i^t instead of ϕ_i^t).

Indeed $\Gamma_i^- \cap \Gamma_i^+ \neq \emptyset$ implies $\alpha \subset \Gamma_i^- \cap \Gamma_i^+$ for some edge $\alpha \in E$ and $\emptyset \neq \phi_i^t \cap T_{\alpha} \subset U_{\alpha} \cap l(\alpha)$. Since $\alpha \subset \Gamma_{\widehat{\beta}}^-$ one has $h(U_{\alpha}) \subset \text{Int}(R(\Gamma_{\widehat{\beta}}^-)) \subset \text{Int}(\mathfrak{R}(\Phi^t))$ which gives $h(\phi_i^t) \cap \text{Int}(\mathfrak{R}(\Phi^t)) \neq \emptyset$ and therefore $h(\phi_i^t) \subset \text{Int}(\mathfrak{R}(\Phi^t))$ because $h(\Phi^t) \cap \partial_M \mathfrak{R}(\Phi^t) = h(\Phi^t) \cap \Phi^t = \emptyset$.

On the other hand $\alpha \subset \Gamma_{\widehat{\beta}}^+$ implies $h^{-1}(l(\alpha)) \subset h^{-1}(L(\Gamma_{\widehat{\beta}}^+)) \subset \text{Int}(L(\Gamma_{\widehat{\beta}}^+))$. Note that $L(\Gamma_{\widehat{\beta}}^+) \not\subset \mathfrak{L}(\Phi^t)$ hence the second inclusion to be proved requires a little more work than its analogue in Proposition 5.16. For any edge $e \in \Gamma_{\widehat{\beta}}^-$ one has

$$h^{-1}(l(\alpha)) \cap U_e = h^{-1}(l(\alpha) \cap h(U_e)) \subset h^{-1}(L(\Gamma_{\widehat{\beta}}^-) \cap \text{Int}(R(\Gamma_{\widehat{\beta}}^-))) = \emptyset.$$

Observing furthermore that

$$L(\Gamma_{\widehat{\beta}}^+) \subset \mathfrak{L}(\Phi^t) \cup \bigcup_{\{e \in E \mid e \subset \Gamma_{\widehat{\beta}}^- \cap \Gamma_{\widehat{\beta}}^+\}} U_e$$

one deduces that $h^{-1}(l(\alpha)) \subset \text{Int}(\mathfrak{L}(\Phi^t))$. It follows that $h^{-1}(\phi_i^t) \cap \text{Int}(\mathfrak{L}(\Phi^t)) \neq \emptyset$ and therefore $h^{-1}(\phi_i^t) \subset \text{Int}(\mathfrak{L}(\Phi^t))$ due to $h^{-1}(\Phi^t) \cap \partial_M \mathfrak{L}(\Phi^t) = h^{-1}(\Phi^t) \cap \Phi^t = \emptyset$.

The proof of Proposition 5.22 works now exactly as the one of Proposition 5.16, just replacing Γ_i^t with of ϕ_i^t . \square

Corollary 5.1. *There exists a family \mathcal{P} of Brouwer manifolds of h such that*

- $\mathcal{P} \subset \mathcal{F} \uplus \mathcal{F}$, i.e., the connected components of any $\Phi \in \mathcal{P}$ are leaves of \mathcal{F} ;
- any leaf of \mathcal{F} is a connected component of some $\Phi \in \mathcal{P}$.

Proof. Let

$$\mathcal{P} = \Psi(\mathcal{L}^*) \cup \left\{ \Phi_{\hat{\beta}}^t \right\}_{\hat{\beta} \in B/\sim, t \in [-1,1]} = \Psi(\mathcal{L}^*) \sqcup \left\{ \Phi_{\hat{\beta}}^t \right\}_{\hat{\beta} \in B/\sim, t \in (-1,1)}.$$

Clearly $\mathcal{P} \subset \mathcal{F} \uplus \mathcal{F}$ and Propositions 5.20 and 5.22 tell us that every $\Phi \in \mathcal{P}$ is a Brouwer manifold of h . One also knows from Proposition 5.19 that every leaf of \mathcal{F} is a connected component of such a $\Phi \in \mathcal{P}$ \square

The next task is to prove that any two Brouwer manifolds of \mathcal{P} have no transverse intersection. We begin with the following result.

Lemma 5.16. *Let $\Gamma, \Gamma' \in \mathcal{L}^*$ be such that $R(\Gamma) \subset L(\Gamma')$. Then one has $R(\Psi(\Gamma)) \cap R(\Psi(\Gamma')) = \emptyset$.*

Proof. The hypothesis tell us that $R(\Gamma) \cap R(\Gamma') = \emptyset$ in B . Observe that $\Gamma \cap \Gamma' = \emptyset$ since otherwise $\Gamma \cap \Gamma'$ contains at least one edge $\alpha \in E$ and one obtains $l(\alpha) \cup r(\alpha) \subset L(\Gamma') \cup R(\Gamma) = L(\Gamma')$ which contradicts $\alpha \subset \Gamma' = \partial_M L(\Gamma')$. Thus one gets $R(\Gamma) \cap R(\Gamma') = \emptyset$ in M . Defining

$$\Delta = R(\Gamma) \cup \bigcup_{\{e \in E \mid e \subset \Gamma\}} T_e \cup \bigcup_{\{\sigma \in V \mid \sigma \in \Gamma\}} \bigcup_{i \in \{1,2,3\}} T_{\sigma}^i$$

and

$$\Delta' = R(\Gamma') \cup \bigcup_{\{e \in E \mid e \subset \Gamma'\}} T_e \cup \bigcup_{\{\sigma \in V \mid \sigma \in \Gamma'\}} \bigcup_{i \in \{1,2,3\}} T_{\sigma}^i$$

one has then $\Delta \cap \Delta' = \emptyset$. By the definition of the map Ψ one also has

$$R(\Psi(\Gamma)) \subset \Delta \text{ and } R(\Psi(\Gamma')) \subset \Delta'$$

which implies $R(\Psi(\Gamma)) \cap R(\Psi(\Gamma')) = \emptyset$. \square

Proposition 5.23. *Any two Brouwer manifolds of \mathcal{P} have no transverse intersection.*

Proof. Given $\hat{\beta} \in B/\sim$ and $t, t' \in [-1,1]$, it is clear that $\Phi_{\hat{\beta}}^t \prec \Phi_{\hat{\beta}}^{t'}$ iff $t < t'$; in particular $\Psi(\Gamma_{\hat{\beta}}^-) \prec \Phi_{\hat{\beta}}^t \prec \Psi(\Gamma_{\hat{\beta}}^+)$ when $t \in (-1,1)$. This also implies that $\Phi_{\hat{\beta}}^t$ and $\Phi_{\hat{\beta}}^{t'}$ have no transverse intersection. This simple remark will be repeatedly used in the following.

Consider two Brouwer manifolds Φ and Φ' of \mathcal{P} . According to the definition of \mathcal{P} , one has three cases to consider.

First case : $\{\Phi, \Phi'\} \subset \Psi(\mathcal{L}^*)$.

Then $\Phi = \Psi(\Gamma)$ and $\Phi' = \Psi(\Gamma')$ for some $\Gamma, \Gamma' \in \mathcal{L}^*$. Recall that Γ and Γ' have no transverse intersection (see the paragraph before Proposition 5.11) hence one has either $\Gamma' \subset R(\Gamma)$ or $\Gamma' \subset L(\Gamma)$. According to Proposition 3.3 one of the following four situations holds:

- $R(\Gamma') \subset R(\Gamma)$, *i.e.*, $\Gamma' \preceq \Gamma$; then by Item (3) of Proposition 5.20 one also has $\Phi' \preceq \Phi$.
- $L(\Gamma') \subset R(\Gamma)$; then Item (2) of Proposition 5.20 gives $L(\Phi') \subset L(\Gamma') \subset R(\Gamma) \subset R(\Phi)$.
- $L(\Gamma') \subset L(\Gamma)$, *i.e.*, $\Gamma \preceq \Gamma'$; then using again Item (3) of Proposition 5.20 one gets $\Phi \preceq \Phi'$.
- $R(\Gamma') \subset L(\Gamma)$; then by Lemma 5.16 one has $R(\Phi) \cap R(\Phi') = \emptyset$.

Thus anyway Φ and Φ' have no transverse intersection.

Second case : $\Phi \in \Psi(\mathcal{L}^*)$ and $\Phi' = \Phi_{\hat{\beta}}^t$ for some $\hat{\beta} \in B/\sim$ and some $t \in (-1, 1)$.

Write $\Phi = \Psi(\Gamma)$ where $\Gamma \in \mathcal{L}^*$ and for short let $\Phi^- = \Psi(\Gamma_{\hat{\beta}}^-)$ and $\Phi^+ = \Psi(\Gamma_{\hat{\beta}}^+)$, so that $\Phi^- \prec \Phi' \prec \Phi^+$. If $\Gamma \subset R(\Gamma_{\hat{\beta}}^-)$ or $\Gamma \subset L(\Gamma_{\hat{\beta}}^+)$ then one knows from Proposition 3.3 that one of the following situation arises.

- $R(\Gamma) \subset R(\Gamma_{\hat{\beta}}^-)$, *i.e.*, $\Gamma \preceq \Gamma_{\hat{\beta}}^-$; according to Item (3) of Proposition 5.20 this implies $\Phi \preceq \Phi^- \prec \Phi'$.
- $L(\Gamma) \subset R(\Gamma_{\hat{\beta}}^-)$; using Item (2) of Proposition 5.20 one has then $L(\Phi) \subset L(\Gamma) \subset R(\Gamma_{\hat{\beta}}^-) \subset R(\Phi^-) \subset R(\Phi')$.
- $L(\Gamma) \subset L(\Gamma_{\hat{\beta}}^+)$, *i.e.*, $\Gamma_{\hat{\beta}}^+ \preceq \Gamma$; again by Item (3) of Proposition 5.20 one has $\Phi' \prec \Phi^+ \preceq \Phi$.
- $R(\Gamma) \subset L(\Gamma_{\hat{\beta}}^+)$; according to Lemma 5.16 one also has $R(\Phi) \cap R(\Phi^+) = \emptyset$ and then $R(\Phi) \cap R(\Phi') = \emptyset$ due to $\Phi' \preceq \Phi^+$.

Hence in all these situations the Brouwer manifolds Φ and Φ' have no transverse intersection. We study now the case where $\Gamma \not\subset R(\Gamma_{\hat{\beta}}^-)$ and $\Gamma \not\subset L(\Gamma_{\hat{\beta}}^+)$. Since the Brouwer manifolds in \mathcal{L}^* have pairwise no transverse intersection one has then

$$\Gamma \subset L(\Gamma_{\hat{\beta}}^-) \cap R(\Gamma_{\hat{\beta}}^+) = (\Gamma_{\hat{\beta}}^- \cap \Gamma_{\hat{\beta}}^+) \cup \bigcup_{b \in \hat{\beta}} b.$$

where the latter equality is given by Proposition 5.15. Because $\Gamma \subset \Sigma$ one gets more precisely

$$\Gamma \subset (\Gamma_{\hat{\beta}}^- \cap \Gamma_{\hat{\beta}}^+) \cup \bigcup_{b \in \hat{\beta}} (\gamma_b^- \cup \gamma_b^+).$$

Observe that for every set $\{b, b'\} \subset \hat{\beta}$ one has either $\Gamma \cap \gamma_b^- = \emptyset$ or $\Gamma \cap \gamma_{b'}^+ = \emptyset$ because otherwise one can find two edges $\alpha, \alpha' \in E$ such that $\alpha \subset \Gamma \cap \gamma_b^-$ and $\alpha' \subset \Gamma \cap \gamma_{b'}^+$ and therefore

$$\Gamma \supset \Gamma_{\alpha}^+ = \Gamma_b^- = \Gamma_{\hat{\beta}}^- \prec \Gamma_{\hat{\beta}}^+ = \Gamma_{b'}^+ = \Gamma_{\alpha'}^- \preceq \Gamma$$

which is absurd. Clearly a Brouwer manifold cannot be strictly included in an other one hence one deduces that $\Gamma = \Gamma_{\widehat{\beta}}^-$ or $\Gamma = \Gamma_{\widehat{\beta}}^+$, so that $\Phi = \Phi^- \prec \Phi'$ or $\Phi = \Phi^+ \succ \Phi'$. Again Φ and Φ' have no transverse intersection.

Third case : $\Phi = \Phi_{\widehat{\beta}}^t$ and $\Phi' = \Phi_{\widehat{\beta}'}^{t'}$ for some $\widehat{\beta}, \widehat{\beta}' \in B/\sim$ and some $t, t' \in (-1, 1)$.

The result is contained in the initial remark if $\widehat{\beta} = \widehat{\beta}'$. Assume now that $\widehat{\beta} \neq \widehat{\beta}'$ and pick $\beta \in \widehat{\beta}$ and $\beta' \in \widehat{\beta}'$. According to Proposition 5.15 one has $\beta \in R(\Gamma_{\widehat{\beta}}^-) \cup L(\Gamma_{\widehat{\beta}}^+)$.

Suppose first that $\beta \in R(\Gamma_{\widehat{\beta}}^-)$. If $\beta \in \text{Int}(R(\Gamma_{\widehat{\beta}}^-))$ then $\gamma_{\beta}^- \subset \Gamma_{\widehat{\beta}}^- \cap \text{Int}(R(\Gamma_{\widehat{\beta}'}^-))$ and $\gamma_{\beta}^+ \subset \Gamma_{\widehat{\beta}}^+ \cap \text{Int}(R(\Gamma_{\widehat{\beta}'}^-))$. Since any two Brouwer manifolds in \mathcal{L}^* have no transverse intersection, it follows that $\Gamma_{\widehat{\beta}}^- \cup \Gamma_{\widehat{\beta}}^+ \subset R(\Gamma_{\widehat{\beta}'}^-)$. If $\beta \notin \text{Int}(R(\Gamma_{\widehat{\beta}}^-))$ then there exists an edge $e \subset \partial_M \beta \cap \Gamma_{\widehat{\beta}'}^-$ and necessarily $e \subset \gamma_{\beta}^+$ because $\beta \in R(\Gamma_{\widehat{\beta}}^-)$. This gives $\Gamma_{\widehat{\beta}}^- \prec \Gamma_{\widehat{\beta}}^+ = \Gamma_e^- \preceq \Gamma_{\widehat{\beta}'}^-$ and one gets again $\Gamma_{\widehat{\beta}}^- \cup \Gamma_{\widehat{\beta}}^+ \subset R(\Gamma_{\widehat{\beta}'}^-)$. This together with Proposition 3.3 implies that either $R(\Gamma_{\widehat{\beta}}^+) \subset R(\Gamma_{\widehat{\beta}'}^-)$ or $L(\Gamma_{\widehat{\beta}}^-) \subset R(\Gamma_{\widehat{\beta}'}^-)$. Indeed, otherwise one has $L(\Gamma_{\widehat{\beta}}^+) \subset R(\Gamma_{\widehat{\beta}'}^-)$ and $R(\Gamma_{\widehat{\beta}}^-) \subset R(\Gamma_{\widehat{\beta}'}^-)$ and therefore, using again Proposition 5.15, $\beta' \in L(\Gamma_{\widehat{\beta}'}^-) \subset R(\Gamma_{\widehat{\beta}}^+) \cap L(\Gamma_{\widehat{\beta}}^-) = \widehat{\beta}$, a contradiction. Using one more time Proposition 5.20 one has:

- If $R(\Gamma_{\widehat{\beta}}^+) \subset R(\Gamma_{\widehat{\beta}'}^-)$ then $\Phi \prec \Psi(\Gamma_{\widehat{\beta}}^+) \preceq \Psi(\Gamma_{\widehat{\beta}'}^-) \prec \Phi'$.
- If $L(\Gamma_{\widehat{\beta}}^-) \subset R(\Gamma_{\widehat{\beta}'}^-)$ then $L(\Phi) \subset L(\Psi(\Gamma_{\widehat{\beta}}^-)) \subset L(\Gamma_{\widehat{\beta}}^-) \subset R(\Gamma_{\widehat{\beta}'}^-) \subset R(\Psi(\Gamma_{\widehat{\beta}'}^-)) \subset R(\Phi')$.

Let us consider now the second situation $\beta \in L(\Gamma_{\widehat{\beta}}^+)$. Similarly as above one gets $\Gamma_{\widehat{\beta}}^- \cup \Gamma_{\widehat{\beta}}^+ \subset L(\Gamma_{\widehat{\beta}'}^+)$ and afterwards $R(\Gamma_{\widehat{\beta}}^+) \subset L(\Gamma_{\widehat{\beta}'}^+)$ or $L(\Gamma_{\widehat{\beta}}^-) \subset L(\Gamma_{\widehat{\beta}'}^+)$.

- If $R(\Gamma_{\widehat{\beta}}^+) \subset L(\Gamma_{\widehat{\beta}'}^+)$ then Lemma 5.16 gives $R(\Psi(\Gamma_{\widehat{\beta}}^+)) \cap R(\Psi(\Gamma_{\widehat{\beta}'}^+)) = \emptyset$. Moreover $\Phi \prec \Psi(\Gamma_{\widehat{\beta}}^+)$ and $\Phi' \prec \Psi(\Gamma_{\widehat{\beta}'}^+)$ hence $R(\Phi) \cap R(\Phi') = \emptyset$.
- If $L(\Gamma_{\widehat{\beta}}^-) \subset L(\Gamma_{\widehat{\beta}'}^+)$, i.e., $\Gamma_{\widehat{\beta}}^+ \preceq \Gamma_{\widehat{\beta}'}^-$, then it follows from Item (3) of Proposition 5.20 that $\Phi' \prec \Psi(\Gamma_{\widehat{\beta}'}^+) \preceq \Psi(\Gamma_{\widehat{\beta}}^-) \prec \Phi$.

Hence in all cases Φ and Φ' have no transverse intersection. \square

Therefore we have constructed a family \mathcal{P} of Brouwer manifolds of h satisfying the conditions of Theorem 4.1.

5.4 Some remarks on the set of Brouwer manifolds \mathcal{P}

Of course two distinct Brouwer manifolds Φ, Φ' in \mathcal{P} may intersect. More precisely, observe that $\Phi \cap \Phi' \neq \emptyset$ iff $\Phi \cap \Phi' = \alpha$ where $\alpha \in E$ is an edge which is also a common connected component of $\Gamma_{\widehat{\beta}}^-$ and $\Gamma_{\widehat{\beta}}^+$ for some $\widehat{\beta} \in B/\sim$. Such an edge α is then regular and is a line of M , denote by E_0 the set of such all edges. Moreover the four Brouwer manifolds Φ, Φ' and $\Gamma_{\widehat{\beta}}^{\pm}$ have the same type 3.

Proposition 5.24. *For $\alpha \in E_0$ define $S_\alpha = (R(\Psi(\Gamma_\alpha^+)) \cap L(\Psi(\Gamma_\alpha^-))) \setminus \alpha \subset M$. Then one has the following properties.*

- (1) S_α is a strip with frontier $\partial_M S_\alpha = F^- \sqcup F^+$ where F^-, F^+ are the leaves of \mathcal{F} such that $\alpha \sqcup F^- = \Psi(\Gamma_\alpha^-)$ and $\alpha \sqcup F^+ = \Psi(\Gamma_\alpha^+)$.
- (2) S_α is trivially foliated by \mathcal{F} .
- (3) For every leaf F of \mathcal{F} such that $F \subset \text{Int}(S_\alpha)$, the only Brouwer manifold in \mathcal{P} possessing F as a connected component is $\alpha \sqcup F$. Conversely, if α is a connected component of $\Phi \in \mathcal{P}$ then there exists a leaf F of \mathcal{F} such that $F \subset S_\alpha$ and $\Phi = \alpha \sqcup F$. Consequently, one has $\Psi(\Gamma_\alpha^-) \preceq \Phi \preceq \Psi(\Gamma_\alpha^+)$.
- (4) for any two distinct $\alpha, \alpha' \in E_0$ one has $\text{Int}(S_\alpha) \cap \text{Int}(S_{\alpha'}) = \emptyset$.

Proof. We provide a proof assuming that $\text{Fix}(h)$ is totally disconnected. If $\text{Fix}(h)$ is a circle then one can compactify each connected component M_1, M_2 of M with one point and one obtains the result with minor adaptations of the same arguments.

(1) Write $\text{Cl}(\alpha) \setminus \alpha = \{a, b\} \subset \text{Fix}(h)$ with possibly $a = b$. The definition of E_0 tell us that there exists $\widehat{\beta}_* \in B / \sim$ such that α is a common connected component of the Brouwer manifolds $\Gamma_{\widehat{\beta}_*}^-$ and $\Gamma_{\widehat{\beta}_*}^+$ which have type 3. Consequently $\Gamma_\alpha^- \preceq \Gamma_{\widehat{\beta}_*}^- \prec \Gamma_{\widehat{\beta}_*}^+ \preceq \Gamma_\alpha^+$ and one deduces from Proposition 5.20 that $\Psi(\Gamma_\alpha^-)$ and $\Psi(\Gamma_\alpha^+)$ are two Brouwer manifolds of type 3 such that $\Psi(\Gamma_\alpha^-) \prec \Psi(\Gamma_\alpha^+)$. By the definition of Ψ they also both have α as a connected component. It follows that the set

$$S'_\alpha = (\text{Cl}(R(\Psi(\Gamma_\alpha^+))) \cap \text{Cl}(L(\Psi(\Gamma_\alpha^-)))) \setminus (\{a, b\} \cup \alpha)$$

is a strip in \mathbb{S}^2 having $F^- \sqcup F^+$ as boundary lines and such that $S'_\alpha \subset S_\alpha \cup \text{Fix}(h)$. Now it follows from Lemma 5.12 that

$$h(S_\alpha) \cap S_\alpha \subset h(R(\Psi(\Gamma_\alpha^+))) \cap L(\Psi(\Gamma_\alpha^-)) \subset \text{Int}(R(\Psi(\Gamma_\alpha^-))) \cap L(\Psi(\Gamma_\alpha^-)) = \emptyset.$$

Since $\text{Fix}(h)$ has empty interior this also implies $h(S'_\alpha) \cap S'_\alpha = \emptyset$ so that S'_α is actually contained in M and $S'_\alpha = S_\alpha$.

(2) It is enough to prove that any given leaf F of \mathcal{F} included in $\text{Int}(S_\alpha) = S_\alpha \setminus (F^- \cup F^+)$ separates F^- and F^+ in the strip $S_\alpha \subset M$. Arguing by contradiction, suppose that F^- and F^+ are contained in the same connected component W of $S_\alpha \setminus F \subset M \setminus F$. Then necessarily F accumulates on a single fixed point $a \in \text{Cl}(F^\pm) \setminus F^\pm = \text{Cl}(\alpha) \setminus \alpha$ so that $\text{Cl}(F) = F \cup \{a\}$ is a circle. Lemma 5.2 tell us that $M \setminus F$ has exactly two connected components U and V with for instance $F^- \cup F^+ \subset W \subset U$. Moreover $F \subset \text{Cl}_M(V) \cap \text{Int}(S_\alpha)$ hence $V \cap S_\alpha \neq \emptyset$ and afterwards $V \subset S_\alpha$ because $V \cap \partial_M S_\alpha = V \cap (F^- \cup F^+) = \emptyset$. One knows that there exists at least one Brouwer manifold $\Phi_F \in \mathcal{P}$ possessing F as a connected component (Corollary 5.1). Then there is a connected component V' of $M \setminus \Phi_F$ such that $V' \subset V \subset S_\alpha$. Since $h^i(V') \subset V'$ for

some $i \in \{\pm 2\}$ one deduces that $h^2(S_\alpha) \cap S_\alpha \neq \emptyset$. On the other hand, one gets with Lemma 5.12 that $h^2(R(\Psi(\Gamma_\alpha^+))) \subset h(R(\Psi(\Gamma_\alpha^+))) \subset \text{Int}(R(\Psi(\Gamma_\alpha^-)))$ and therefore

$$h^2(S_\alpha) \cap S_\alpha \subset \text{Int}(R(\Psi(\Gamma_\alpha^-))) \cap L(\Psi(\Gamma_\alpha^-)) = \emptyset,$$

a contradiction.

(3) Let F be a leaf of \mathcal{F} such that $F \subset \text{Int}(S_\alpha)$. First we shall prove that $F \sqcup \alpha$ is a Brouwer manifold of h . It is not difficult to see with (2) above that the Brouwer manifold $\Gamma = \Phi(\Gamma_\alpha^-)$ and the set $\Delta = F \sqcup \alpha$ satisfy the conditions a)-d) of Lemma 5.13. Observe also that $R(\Psi(\Gamma_\alpha^-)) \subset \mathfrak{R}(F \sqcup \alpha) \subset R(\Psi(\Gamma_\alpha^+))$. Then using again Lemma 5.12 one obtains

$$h(F \sqcup \alpha) \subset h(S_\alpha \sqcup \alpha) \subset h(R(\Psi(\Gamma_\alpha^+))) \subset \text{Int}(R(\Psi(\Gamma_\alpha^-))) \subset \mathfrak{R}(F \sqcup \alpha)$$

and

$$h^{-1}(F \sqcup \alpha) \subset h^{-1}(S_\alpha \sqcup \alpha) \subset h^{-1}(L(\Psi(\Gamma_\alpha^-))) \subset \text{Int}(L(\Psi(\Gamma_\alpha^+))) \subset \mathfrak{L}(F \sqcup \alpha).$$

Thus Property ($\mathfrak{L} - \mathfrak{R}$) in Item e) of Lemma 5.13 also holds true and consequently $F \sqcup \alpha$ is a Brouwer manifold of h .

Now consider a Brouwer manifold $\Phi_F \in \mathcal{P}$ containing F . One has $F \subsetneq \Phi_F$, in other words F is not a Brouwer manifold of type 2, because otherwise $\Phi_F = F$ accumulates on only one fixed point (see the proof of Proposition 3.1) and one obtains a contradiction with $h^2(S_\alpha) \cap S_\alpha = \emptyset$ exactly as in the proof of (2). Thus Φ_F has type 3 and we write F' for its connected component other than F . One has $F' \cap S_\alpha = \emptyset$ since otherwise, according to (2), there is a strip $S \subset S_\alpha$ with frontier $\partial_M S = F \sqcup F'$ whose interior intersects both $\text{Int}(R(\Phi_F))$ and $\text{Int}(L(\Phi_F))$, which is not possible because also $F \sqcup F' = \Phi_F = \partial R(\Phi_F) = \partial L(\Phi_F)$. On the other hand, one has $F \subset \text{Int}(S_\alpha) = \text{Int}(R(\Psi(\Gamma_\alpha^+))) \cap \text{Int}(L(\Psi(\Gamma_\alpha^-)))$ and one knows that any two Brouwer manifolds in \mathcal{P} have no transverse intersection (Proposition 5.23) hence one deduces

$$F' \subset \Phi_F \subset R(\Psi(\Gamma_\alpha^+)) \cap L(\Psi(\Gamma_\alpha^-)) = \alpha \sqcup S_\alpha$$

which shows as expected that $F' = \alpha$.

Let $\Phi \in \mathcal{P}$ be a Brouwer manifold possessing α as a connected component. Recall from Remark 3.2 that α cannot be a Brouwer manifold of type 2 hence $\alpha \subsetneq \Phi$. By definition of \mathcal{P} one has either $\Phi \in \Psi(\mathcal{L})$ or there exists $\widehat{b} \in B / \sim$ and $t \in (-1, 1)$ such that $\Phi = \Phi_{\widehat{b}}^t$ and $\Omega_{2, \widehat{b}} = \alpha$. If the first case occurs then $\Phi = \Psi(\Gamma)$ for some $\Gamma \in \mathcal{L}^*$. Clearly $\alpha \subset \Gamma$ hence $\Gamma \in \mathcal{L}^*(\alpha)$ and therefore $\Gamma_\alpha^- \preceq \Gamma \preceq \Gamma_\alpha^+$. According to Item (3) of Proposition 5.20 one obtains $\Psi(\Gamma_\alpha^-) \preceq \Phi \preceq \Psi(\Gamma_\alpha^+)$ which gives $\Phi \setminus \alpha \subset S_\alpha$. If the second case occurs then both Γ_α^- and Γ_α^+ contain α and consequently $\Gamma_\alpha^- \preceq \Gamma_\alpha^- \prec \Gamma_\alpha^+ \preceq \Gamma_\alpha^+$. Combining Item (3) of Proposition 5.20 and the remark at the beginning of the proof of Proposition 5.23 one gets $\Psi(\Gamma_\alpha^-) \prec \Phi \prec \Psi(\Gamma_\alpha^+)$ and it follows again that $\Phi \setminus \alpha \subset S_\alpha$. Since $\Phi \setminus \alpha \neq \emptyset$ one gets as required $\Phi = \alpha \sqcup F$ where F is a leaf of \mathcal{F} included in S_α .

(4) Suppose now that there exists a point $x \in \text{Int}(S_\alpha) \cap \text{Int}(S_{\alpha'}) \neq \emptyset$. Denote by F_x the leaf of \mathcal{F} passing through x . According to Item (3) one obtains that $F_x \sqcup \alpha$ and $F_x \sqcup \alpha'$ are two Brouwer manifolds in \mathcal{P} . Since the strip $S_{\alpha'}$ is trivially foliated by \mathcal{F} , one gets as in the proof of (3) that $\alpha \cap S_{\alpha'} = \emptyset$, i.e., $\alpha \subset \text{Int}(L(\Psi(\Gamma_{\alpha'}^+)) \cup \text{Int}(R(\Psi(\Gamma_{\alpha'}^-)))$. These last two sets are disjoint because $\Psi(\Gamma_{\alpha'}^-) \preceq \Psi(\Gamma_{\alpha'}^+)$ hence one gets either $\alpha \subset \text{Int}(L(\Psi(\Gamma_{\alpha'}^+))$ or $\alpha \subset \text{Int}(R(\Psi(\Gamma_{\alpha'}^-)))$. The first inclusion together with $F_x \subset \text{Int}(S_{\alpha'}) \subset \text{Int}(R(\Psi(\Gamma_{\alpha'}^+)))$ implies a contradiction since $\Psi(\Gamma_{\alpha'}^+)$ and $F_x \sqcup \alpha$ have no transverse intersection as Brouwer manifolds in \mathcal{P} . Similarly the second inclusion also lead to a contradiction because $F_x \subset \text{Int}(S_{\alpha'}) \subset \text{Int}(L(\Psi(\Gamma_{\alpha'}^-)))$ and because $\Psi(\Gamma_{\alpha'}^-) \in \mathcal{P}$ and $F_x \sqcup \alpha \in \mathcal{P}$ have no transverse intersection. \square

An application of Theorem 4.1

Contents

6.1	Description of the foliation \mathcal{F} when it has no circle-leaf	109
6.2	Link between the minimal (\mathcal{F}, h) -croissants and the index	122
6.3	Link with Le Calvez equivariant foliations on the annulus	130
6.4	Proof of Theorem 6.2	133

Our goal in this section is to give some applications of Theorem 4.1 to the fixed point index. Precisely we prove Theorem 4.2 stated in Section 4.

The following statement of Le Roux (see [LR13, Appendix A]) allows to deal conveniently with homeomorphisms of the whole sphere.

Theorem 6.1. *Let $h : U \rightarrow V$ be a homeomorphism between two neighbourhoods U, V of 0 in the plane \mathbb{R}^2 verifying $\text{Fix}(h) = \text{Fix}(h^2) = \{0\}$. Then there exists a homeomorphism H of \mathbb{R}^2 such that $\text{Fix}(H) = \text{Fix}(H^2) = \{0\}$ and $H|_W = h|_W$ for some neighborhood $W \subset U$ of 0 .*

A planar homeomorphism H as in Theorem 6.1 also extends to a homeomorphism of the sphere $\mathbb{S}^2 = \mathbb{R}^2 \cup \{\infty\}$ such that $\text{Fix}(H) = \text{Fix}(H^2) = \{0, \infty\}$ by letting $H(\infty) = \infty$. Moreover the Lefschetz index of an isolated fixed point depends only on the local behavior of the considered map, hence Theorem 4.2 is a direct consequences of Theorem 6.2 below, which shall be proved in this Chapter 6.

Theorem 6.2. *Let h be an orientation reversing homeomorphism of the sphere \mathbb{S}^2 such that $\text{Fix}(h) = \text{Fix}(h^2) = \{0, \infty\}$. Then $\text{Ind}(h^n, 0)$ is well-defined for every integer $n \geq 1$ and one has $\text{Ind}(h^{2k+1}, 0) = \text{Ind}(h, 0)$ and $\text{Ind}(h^{2k}, 0) = \text{Ind}(h^2, 0)$ for every $k \geq 1$.*

Throughout this Chapter 6, we fix once and for all an orientation reversing homeomorphism h of \mathbb{S}^2 such that $\text{Fix}(h) = \text{Fix}(h^2) = \{0, \infty\}$ and a set $\mathcal{P} = \{\Phi_s\}_{s \in \Lambda}$ of Brouwer manifolds of h covering $\mathbb{S}^2 \setminus \{0, \infty\}$ provided by Theorem 4.1.

Thus the sets Φ_s , where $s \in \Lambda$, are Brouwer manifolds of h which have pairwise no transverse intersection and the set $\mathcal{F} = \{\phi \mid \phi \text{ is a connected component of } \Phi_s \text{ for some } s \in \Lambda\}$ defines an oriented topological foliation of $\mathbb{S}^2 \setminus \{0, \infty\}$. In particular every leaf ϕ of \mathcal{F} is either a circle or a line of $\mathbb{S}^2 \setminus \{0, \infty\}$. In the first case, ϕ is called a *circle-leaf*. In the latter case, one has $\emptyset \neq \text{Cl}(\phi) \setminus \phi \subset \{0, \infty\}$ and we say that ϕ is a *petal-leaf at 0* (resp. *at ∞*) if $\text{Cl}(\phi) \setminus \phi = \{0\}$ (resp. $\text{Cl}(\phi) \setminus \phi = \{\infty\}$) and a *line-leaf* if $\text{Cl}(\phi) \setminus \phi = \{0, \infty\}$. In the following, we write ϕ_z for the leaf of \mathcal{F} passing through $z \in \mathbb{S}^2 \setminus \{0, \infty\}$. If ϕ_z is a line of $\mathbb{S}^2 \setminus \{0, \infty\}$ we denote by ϕ_z^+ (resp. ϕ_z^-) the positive (resp. negative) half-leaf in ϕ_z with endpoint z .

We recall some definitions allowing to describe the behaviour of h . Given $i \in \{1, 2\}$, we define following [LR04] an *attracting h^i -petal* at 0 to be a disc $P \subset \mathbb{S}^2$ such that

- $0 \in \partial P$,
- $h^i(P) \subset \text{Int}(P) \cup \{0\}$.

A *repelling h^i -petal* at 0 is an attracting h^{-i} -petal at 0 .

Another useful notion from [LR04] is the following. For $i \in \{1, 2\}$, an *attracting h^i -croissant* is a disc $C \subset \mathbb{S}^2$ verifying

- $\{0, \infty\} \subset \partial C$;
- $h^i(C) \subset \text{Int}(C) \cup \{0, \infty\}$ (Fig. 6.1).

A repelling h^i -croissant is an attracting h^{-i} -croissant.

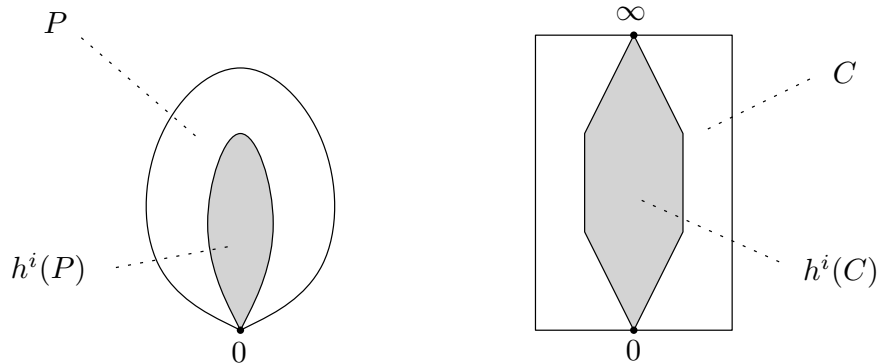

Figure 6.1 – An attracting h^i -petal at 0 and an attracting h^i -croissant

We are mainly interested in this work by croissants and petals bounded by leaves of \mathcal{F} . Precisely we say that a h^i -croissant A (repelling or attracting) is a (\mathcal{F}, h^i) -croissant if $\partial A \setminus \{0, \infty\}$ is the union of two leaves of \mathcal{F} . Similarly, a (\mathcal{F}, h^i) -petal at $a \in \{0, \infty\}$ is a h^i -petal at a such that $\partial P \setminus \{a\}$ is a leaf of \mathcal{F} . A (\mathcal{F}, h^i) -croissant A is said to be *minimal* if there is no (\mathcal{F}, h^i) -croissant A' satisfying $A' \subsetneq A$. For short, we simply use the word \mathcal{F} -croissant (resp. \mathcal{F} -petal) to indicate a set which is a (\mathcal{F}, h^i) -croissant (resp. a (\mathcal{F}, h^i) -petal) for some integer $i \in \{1, 2\}$.

Remark that if $\Phi \in \mathcal{P}$ is a Brouwer manifold of type 3 such that $\text{Cl}(\Phi) \setminus \Phi = \{0, \infty\}$ then $\text{Cl}(R(\Phi)) = R(\Phi) \cup \{0, \infty\}$ and $\text{Cl}(L(\Phi)) = L(\Phi) \cup \{0, \infty\}$ are respectively an attracting and a repelling (\mathcal{F}, h) -croissant.

For any $z \in \mathbb{S}^2 \setminus \{0, \infty\}$, there exist a compact set $K \subset \mathbb{S}^2 \setminus \{0, \infty\}$ containing z in its interior, called *trivializing neighborhood* of z , and an orientation preserving homeomorphism $\psi : K \rightarrow [-1, 1]^2 \subset \mathbb{R}^2$, called *trivialization chart* at z , such that ψ maps the foliation $\mathcal{F}|_K$ induced by \mathcal{F} on K onto the foliation by vertical lines with their upward orientation. The couple (K, ψ) is called a *flow-box* of \mathcal{F} at z . For $t \in [-1, 1]$, the sets $\psi^{-1}(\{t\} \times [-1, 1])$ are named the *local leaves* of \mathcal{F} in K .

6.1 Description of the foliation \mathcal{F} when it has no circle-leaf

Lemma 6.1. *Suppose that $(x_k)_{k \geq 0}$ is a sequence in $\mathbb{S}^2 \setminus \{0, \infty\}$ converging to $a \in \{0, \infty\}$ and such that ϕ_{x_k} is a petal-leaf at $b \in \{0, \infty\} \setminus \{a\}$ for every $k \in \mathbb{N}$. Then the set $\bigcap_{k \in \mathbb{N}} \text{Cl}(\bigcup_{n \geq k} \phi_n)$ contains a line-leaf oriented from 0 to ∞ and a line-leaf oriented from ∞ to 0.*

Proof. The points 0 and ∞ have symmetric roles in this statement hence it is enough to deal with the case $a = \infty$ and $b = 0$. For short we write ϕ_k and ϕ_k^- instead of respectively ϕ_{x_k} and $\phi_{x_k}^-$.

Define $L = \bigcap_{k \in \mathbb{N}} \text{Cl}(\bigcup_{n \geq k} \phi_n^-)$ which is a connected compact set (as a nested intersection of connected compact sets) such that $\{0, \infty\} \subset L$. Let us check that L is saturated by \mathcal{F} , that means that any leaf intersecting L is entirely contained in L . Suppose that ϕ is a leaf of \mathcal{F} and $y \in \phi \cap L$. Consider a trivializing neighborhood V of y . From the definition of L there exists a sequence $(k_i)_{i \geq 0}$ in \mathbb{N} and $y_i \in \phi_{k_i}^-$ such that $\lim_{i \rightarrow +\infty} k_i = +\infty$ and $\lim_{i \rightarrow +\infty} y_i = y$. For i large enough one has $y_i \in V$ and even better the local leaf of \mathcal{F} in V containing y_i lies entirely in $\phi_{k_i}^-$ because $x_k \rightarrow \infty$ as $k \rightarrow +\infty$. It follows that L contains the whole local leaf of \mathcal{F} in V passing through y and consequently $\phi \cap L$ is open in ϕ . Clearly $\phi \cap L$ is also closed in ϕ so $\phi \subset L$, as expected.

Denote by L_0 (resp. L_∞) the union of all the petal-leaves at 0 (resp. at ∞) included in L . Observe that for any two distinct leaves ϕ and ϕ' included in L_0 , the \mathcal{F} -petals P and P' bounded by respectively $\phi \cup \{0\}$ and $\phi' \cup \{0\}$ satisfy $P \cap P' = \{0\}$. Indeed, otherwise one can suppose $\phi \subset \text{Int}(P')$. Since $\phi \subset L$ one has $\phi_k^- \cap \text{Int}(P') \neq \emptyset$ and then $\phi_k \subset \text{Int}(P')$ for infinitely many $k \in \mathbb{N}$, which contradicts the fact that $(x_k)_{k \geq 0}$ converges to ∞ .

CLAIM 1. *Given any point $z \in \mathbb{S}^2 \setminus \{0, \infty\}$ and any trivializing neighborhood V of z , there exist at most two leaves contained in L_0 which meet V .*

Proof. A classical argument from the proof of Poincaré-Bendixson Theorem (see e.g. [PdM82]) tells us that a leaf of \mathcal{F} which accumulates on a single point in $\{0, \infty\}$ intersects V in at most one connected component. Consequently, if ϕ, ϕ' and ϕ'' are three distinct leaves in L_0 intersecting V then each set $\phi \cap V, \phi' \cap V$ and $\phi'' \cap V$ consists of exactly one local leaf of \mathcal{F} in V . Then there exists a segment in V joining two of these leaves, say ϕ and ϕ' , and intersecting the third one ϕ'' transversely in only one point. It follows that the circle $\phi'' \cup \{0\}$ separates ϕ and ϕ' in \mathbb{S}^2 and afterwards that the petal P'' at 0 bounded by $\phi'' \cup \{0\}$ contains one of the two petals P, P' bounded by respectively $\phi \cup \{0\}$ and $\phi' \cup \{0\}$, which is known to be not possible. \square

As a consequence, one gets that $L_0 \cup \{0\}$ is a closed subset of L which does not contains ∞ . Indeed the above Claim clearly shows that $L_0 \cup \{0\}$ is closed in $L \setminus \{\infty\}$ hence one just needs to check that $\infty \notin \text{Cl}(L_0)$. Let D be a disc neighborhood of ∞ so small that $0 \notin D$. There exists a finite open covering $\partial D \subset \text{Int}(V_1) \cup \dots \cup \text{Int}(V_N)$ where each V_i is a trivializing neighborhood of some point in ∂D . According again to Claim 1, only finitely many leaves in L_0 intersect ∂D so there is a smaller disc $D' \subset D$ neighborhood of ∞ which is disjoint from L_0 so that $\infty \notin \text{Cl}(L_0)$.

Reversing the roles of 0 and ∞ one also obtains that $L_\infty \cup \{\infty\}$ is a closed subset of L which does not contain 0. Since L is connected one cannot have a partition $L = (L_0 \cup \{0\}) \sqcup (L_\infty \cup \{\infty\})$ so L contains some line-leaf.

CLAIM 2. Any line-leaf $\phi \subset L$ is oriented from 0 to ∞ .

Proof. Arguing by contradiction we suppose that ϕ is oriented from ∞ to 0. Let $w \in \phi$ and let W be a trivializing neighborhood of w . Since ϕ is a line of $\mathbb{S}^2 \setminus \{0, \infty\}$ one can choose W so small that $\phi \cap W$ consists of a single local leaf of \mathcal{F} in W . Because $w \in L$ one has $\phi_k^- \cap \text{Int}(W) \neq \emptyset$ for infinitely many $k \in \mathbb{N}$. As recalled in the proof of Claim 1, the set $\phi_k \cap W$ is empty or connected and moreover $\lim_{k \rightarrow +\infty} x_k = \infty$. Hence, possibly after replacing $(\phi_k)_{k \geq 0}$ with a suitable subsequence, one can assume that, for $k \geq k_0$, the leaves ϕ_k are pairwise distinct and that the sets $\phi_k^- \cap W$ are local leaves of \mathcal{F} in W located on the same side of $\phi \cap W$ in W , say for instance on the right of $\phi \cap W$, with moreover $\phi_{k+1}^- \cap W$ closer than $\phi_k^- \cap W$ from $\phi \cap W$. Letting $\phi' = \phi_{k_0}$, choose a point $z \in \phi' \cap \text{Int}(W)$ and join z to w with a segment $\eta \subset \text{Int}(W)$ which is transverse to \mathcal{F} . Then $C = \{0\} \cup \phi_z^- \cup \eta \cup \phi_w^+$ is a circle which clearly separates ∞ and x_{k_0} in \mathbb{S}^2 (see Fig. 6.2).

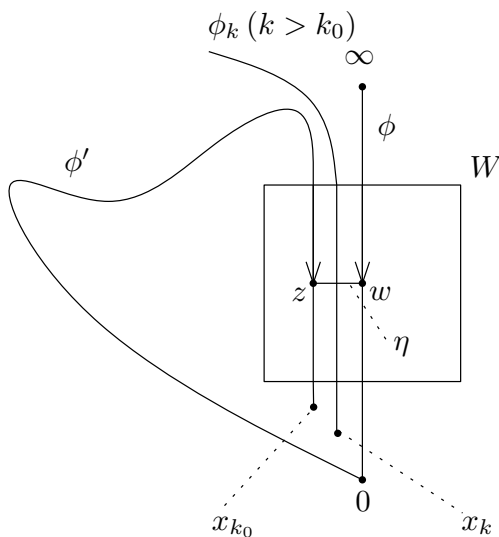

Figure 6.2 – The points x_k for k large enough

Moreover ϕ_k^- intersects η transversely at only one point $z_k \neq x_k$ for every $k > k_0$ and x_k belongs to the same connected component of $\mathbb{S}^2 \setminus C$ as x_{k_0} . This is a contradiction because $x_k \rightarrow \infty$ as $k \rightarrow +\infty$. □

This proves the existence of a leaf-line oriented from 0 to ∞ and contained in $L \subset \bigcap_{k \in \mathbb{N}} \text{Cl}(\bigcup_{n \geq k} \phi_n)$, as expected. One gets similarly the result concerning a leaf-line oriented from ∞ to 0, replacing above L with $L' = \bigcap_{k \in \mathbb{N}} \text{Cl}(\bigcup_{n \geq k} \phi_{x_n}^+)$. □

Proposition 6.1. *The foliation \mathcal{F} contains at least one line-leaf oriented from 0 to ∞ and one line-leaf oriented from ∞ to 0.*

Proof. One can assume that the hypothesis of Lemma 6.1 are not satisfied since otherwise we are done. Hence there exist two disjoint discs V_0, V_∞ neighborhoods of respectively 0, ∞ such that every petal-leaf at ∞ (resp. at 0) is disjoint from V_0 (resp. from V_∞). Observe moreover that it is sufficient to prove the existence of one line-leaf. Indeed any line-leaf ϕ of \mathcal{F} is a connected component of some Brouwer manifold $\Phi = \phi \sqcup \phi' \in \mathcal{P}$ of type 3 and one of the line-leaves ϕ, ϕ' is oriented from 0 to ∞ while the other one is oriented from ∞ to 0.

Arguing by contradiction, let us suppose that \mathcal{F} contains no line-leaf. Choose a segment $\Delta \subset \mathbb{S}^2$ joining 0 to ∞ , oriented from 0 to ∞ , which intersects ∂V_0 (resp. ∂V_∞) at a single point θ_1 (resp. θ_2) and let

$$\Delta_0 = \{x \in [\theta_1, \theta_2]_\Delta \text{ such that } \phi_x \text{ is a petal-leaf at } 0\}.$$

Since \mathcal{F} is assumed to have no circle-leaf one has $\theta_1 \in \Delta_0$. Moreover $\theta_2 \notin \Delta_0$. The compact set $\text{Cl}(\Delta_0) \subset [\theta_1, \theta_2]_\Delta$ possesses a maximum (the segment Δ is naturally ordered by its orientation) which is denoted by θ_* . One has the following two cases.

- First case : $\theta_* \in \Delta_0$. Then $\theta_* < \theta_2$ so there exists a sequence $(x_n)_{n \geq 0}$ in $(\theta_*, \theta_2)_\Delta$ such that $\lim_{n \rightarrow +\infty} x_n = \theta_*$. By the definition of θ_* , the ϕ_{x_n} 's are petal-leaves at ∞ . Since $\phi_{\theta_*} \cap \text{Int}(V_0) \neq \emptyset$ and x_n goes to θ_* as $n \rightarrow \infty$, the leaf ϕ_{x_n} also meets V_0 for n large enough, which contradicts the choice of V_0 .
- Second case : $\theta_* \notin \Delta_0$. In other words, the leaf ϕ_{θ_*} is a petal-leaf at ∞ . Consider a sequence $(z_n)_{n \geq 0}$ in Δ_0 such that $\lim_{n \rightarrow +\infty} z_n = \theta_*$. Since $\phi_{\theta_*} \cap \text{Int}(V_\infty) \neq \emptyset$, one also has $\phi_{z_n} \cap V_\infty \neq \emptyset$ for n large enough, which is another contradiction.

□

Proposition 6.2. *Let ϕ (resp. ϕ') be a line-leaf oriented from 0 to ∞ (resp. from ∞ to 0). Then each disc bounded by the circle $\phi \cup \phi' \cup \{0, \infty\}$ contains at least one minimal (\mathcal{F}, h^2) -croissant.*

Proof. We only deal with the disc D with frontier $\phi \cup \phi' \cup \{0, \infty\}$ which lies locally on the right of ϕ and ϕ' . One proves likewise the result for the other disc bounded by $\phi \cup \phi' \cup \{0, \infty\}$.

Consider a segment Δ with endpoints $x \in \phi$ and $x' \in \phi'$ such that $\Delta \setminus \{x, x'\} \subset \text{Int}(D)$. It is naturally ordered by choosing an orientation, say from x towards x' . We denote by ω the set of all the points in Δ which belong to a line-leaf oriented from 0 to ∞ . Note that $x \in \omega$ and $x' \notin \omega$. Then the compact set $\text{Cl}(\omega) \subset \Delta$ has a maximum $y \in \Delta$ and one has $y = \lim_{n \rightarrow +\infty} x_n$ where $x_n \in \omega$. Then $L = \bigcap_{k \in \mathbb{N}} \text{Cl}(\bigcup_{n \geq k} \phi_{x_n})$ is

clearly a connected compact set satisfying $\{0, \infty\} \subset L \subset D$ and one checks that it is also saturated by \mathcal{F} (the argument is similar to the one in the proof of Lemma 6.1). Since $y = \lim_{n \rightarrow +\infty} x_n$ one gets $y \in L$ and then $\phi_y \subset L \subset D$. Let us prove that ϕ_y is a line-leaf oriented from 0 to ∞ . First suppose that ϕ_y is a petal-leaf at $a \in \{0, \infty\}$ and let V be a trivializing neighborhood of $y' = \max\{\phi_y \cap \Delta\}$. Then $\phi_y \cap V$ consists of a single local leaf of \mathcal{F} in V and $V \setminus \phi_y$ has two connected components V_1 and V_2 . One of them, say V_1 , is contained in the interior of the petal P bounded by $\phi_y \cup \{a\}$ so $V \cap \phi_{x_n} = V_2 \cap \phi_{x_n}$ for every $n \in \mathbb{N}$. One also has $V_1 \cap (y', x']_\Delta = \emptyset$ because $(y', x']_\Delta \cup \phi'$ is connected and disjoint from $\partial P = \phi_y \cup \{a\}$ hence $V \cap (y', x']_\Delta = V_2 \cap (y', x']_\Delta$. Consequently the connected component of $V \cap [y', x']_\Delta$ containing y' is a segment $[y', y'']_\Delta \subset V_2$ with $y'' \in \partial V_2 \setminus \phi_y$. Since $y' \in L$ there exists $n \in \mathbb{N}$ such that ϕ_{x_n} contains a local leaf of \mathcal{F} in V lying between the ones passing through y' and y'' . This implies $\emptyset \neq \phi_{x_n} \cap (y', y'']_\Delta \subset \phi_{x_n} \cap (y, x']_\Delta$ and contradicts the maximality of y . Thus ϕ_y is a line-leaf of \mathcal{F} . Now let V be a trivializing neighborhood of y and fix $n \in \mathbb{N}$ so large that $x_n \in V$. The leaves ϕ_y and ϕ_{x_n} are lines of $\mathbb{S}^2 \setminus \{0, \infty\}$ hence, replacing if necessary V with a smaller trivializing neighborhood of y , one can assume that each set $\phi_y \cap V$ and $\phi_{x_n} \cap V$ consists of only one local leaf of \mathcal{F} in V . If ϕ_y is oriented from ∞ to 0 then of course $\phi_y \neq \phi_{x_n}$ and there exists a segment $\eta \subset V$ from x_n to y which is transverse to \mathcal{F} . Then the set $\phi_{x_n}^- \cup \eta \cup \phi_y^+ \cup \{0\}$ is a circle which is easily seen to separate $\{\infty\}$ and $\phi_{x_n}^+ \setminus \{x_n\}$, which is not possible because $\infty \in \text{Cl}(\phi_{x_n}^+)$. This shows that ϕ_y is oriented from 0 to ∞ .

In particular ϕ_y and ϕ' are two distinct line-leaves so one may define D_1 to be the disc bounded by $\phi_y \cup \phi' \cup \{0, \infty\}$ and such that $D_1 \subset D$. Note that $[y, x']_\Delta \subset D_1$ and define ω' to be the set of all the points in $[y, x']_\Delta$ which belong to some line-leaf oriented from ∞ to 0. Obviously $y \notin \omega'$ and $x' \in \omega'$. The compact set $\text{Cl}(\omega') \subset \Delta$ possesses a minimum $z \in [y, x']_\Delta$ and one proves similarly as above that ϕ_z is a line-leaf contained in D_1 and oriented from ∞ to 0. Notably $\phi_z \neq \phi_y$ hence one may consider the disc C included in D_1 and bounded by $\phi_y \cup \phi_z \cup \{0, \infty\}$.

We prove now that C is a minimal (\mathcal{F}, h^2) -croissant. By the construction there is no line-leaf in $\text{Int}(C)$ hence it is sufficient to show that C is an attracting h^2 -croissant.

We first prove that there exists a sequence $(\phi_n)_{n \geq 0}$ of petal-leaves at $a \in \{0, \infty\}$ such that $\phi_y \cup \phi_z \subset \bigcap_{k \in \mathbb{N}} \text{Cl}(\bigcup_{n \geq k} \phi_n)$ and such that the circle $\phi_n \cup \{a\}$ bounds an attracting (\mathcal{F}, h^2) -petals at a . Using again the fact that $\text{Int}(C)$ contains no line-leaf, one checks as in the proof of Proposition 6.1 that any neighborhood of ∞ meets some petal-leaf at 0 contained in $\text{Int}(C)$ or that any neighborhood of 0 meets some petal-leaf at ∞ contained in $\text{Int}(C)$. Possibly after switching the roles of 0 and ∞ , one may suppose that the first situation holds. This gives a sequence $(x_i)_{i \geq 0}$ in $\text{Int}(C)$ converging to ∞ and such that $\phi_{x_i} \subset \text{Int}(C)$ is a petal-leaf at 0. According to Lemma 6.1 one has $\phi_y \cup \phi_z \subset \bigcap_{j \in \mathbb{N}} \text{Cl}(\bigcup_{i \geq j} \phi_{x_i}) \subset C$. For every $i \in \mathbb{N}$, we define P_i to be the \mathcal{F} -petal at 0 with frontier $\phi_{x_i} \cup \{0\}$. Clearly $P_i \subset \text{Int}(C) \cup \{0\}$. Choose any

point $m \in \phi_y$ and let V be a trivializing neighborhood of m so small that $\phi_y \cap V$ is reduced to a single local leaf of \mathcal{F} in V . Because $m \in \bigcap_{j \in \mathbb{N}} \text{Cl}(\bigcup_{i \geq j} \phi_{x_i})$ there exists a sequence $(i_n)_{n \geq 0}$ in \mathbb{N} converging to $+\infty$ such that $\phi_{x_{i_n}} \cap \text{Int}(V) \neq \emptyset$ for every $n \in \mathbb{N}$. Moreover any leaf ϕ_{x_i} accumulates on only one point in $\{0, \infty\}$ so $\phi_{x_{i_n}} \cap V$ consists of a single local leaf of \mathcal{F} in V for every $n \in \mathbb{N}$. The local leaf $\phi_{x_{i_n}} \cap V \subset \text{Int}(C)$ is located on the right of the local leaf $\phi_y \cap V$ in V because the disc C lies locally on the right of ϕ_y (and ϕ_z). Then the \mathcal{F} -petal P_{i_n} is located on the right of $\phi_{x_{i_n}}$ in V since otherwise $\phi_y \cap P_{i_n} \neq \emptyset$ and afterwards $\phi_y \subset P_{i_n}$ which is absurd because $\infty \in \text{Cl}(\phi_y)$. This implies that P_{i_n} lies locally on the right of $\phi_{x_{i_n}}$ and consequently P_{i_n} is an attracting h^2 -petal. Applying Lemma 6.1 with the sequence $(\phi_{x_{i_n}})_{n \geq 0}$ one also obtains $\phi_y \cup \phi_z \subset \bigcap_{k \in \mathbb{N}} \text{Cl}(\bigcup_{n \geq k} \phi_{x_{i_n}})$. One gets a sequence of petal-leaves as required by letting $\phi_n = \phi_{x_{i_n}}$.

One has notably $h^2(\phi_n) \subset h^2(\text{Int}(C)) \cap h^2(P_n \setminus \{0\}) \subset h^2(\text{Int}(C)) \cap \text{Int}(P_n) \subset h^2(\text{Int}(C)) \cap \text{Int}(C)$ for every $n \in \mathbb{N}$. Observe that any open set $U \subset \mathbb{S}^2$ meeting $h^2(\phi_y \cup \phi_z) \subset \bigcap_{k \in \mathbb{N}} \text{Cl}(\bigcup_{n \geq k} h^2(\phi_n))$ also intersects $h^2(\phi_n)$ for infinitely many $n \in \mathbb{N}$; in particular $U \cap h^2(\text{Int}(C)) \cap \text{Int}(C) \neq \emptyset$. This implies $h^2(\phi_y \cup \phi_z) \subset C$. This also implies $\phi_z \neq h^2(\phi_y)$. Indeed, if this is not true then the two discs C and $h^2(C)$ lie locally on opposite sides of $\phi_z = h^2(\phi_y) \subset \partial C \cap \partial h^2(C)$ because h^2 preserves the orientation and $0, \infty$ are fixed points of h^2 . Hence, given $p \in \phi_z = h^2(\phi_y)$, one can find an open neighborhood U of p such that $U \cap \text{Int}(C) \cap \text{Int}(h^2(C)) = \emptyset$, a contradiction. Furthermore ϕ_y is contained in a Brouwer manifold of h so $h^2(\phi_y) \cap \phi_y = \emptyset$ and consequently $h^2(\phi_y) \cap \text{Int}(C) \neq \emptyset$. One gets likewise $h^2(\phi_z) \cap \text{Int}(C) \neq \emptyset$.

One deduces from $h^2(\phi_y \cup \phi_z) \subset C$ that either $h^2(C) \subset C$ or $h^2(\mathbb{S}^2 \setminus \text{Int}(C)) \subset C$. Let us prove that the latter inclusion actually does not hold. According to the previous paragraph, one can pick $p \in h^2(\phi_y) \cap \text{Int}(C)$ (resp. $p' \in h^2(\phi_z) \cap \text{Int}(C)$). Let U (resp. U') be a connected open neighborhood of p (resp. of p') so small that $U \cup U' \subset C$ and $\text{Cl}(U) \cap h^2(\partial C) = \text{Cl}(U) \cap h^2(\phi_y)$ and $\text{Cl}(U') \cap h^2(\partial C) = \text{Cl}(U') \cap h^2(\phi_z)$. There exists a sequence $(n_k)_{k \geq 0}$ in \mathbb{N} such that $\lim_{k \rightarrow +\infty} n_k = +\infty$ and $\emptyset \neq \phi_{x_{n_k}} \cap h^{-2}(U) \subset \text{Int}(C) \cap h^{-2}(U)$ for every $k \in \mathbb{N}$. Applying Lemma 6.1 with the sequence $(x_{n_k})_{k \geq 0}$ one gets $\phi_z \subset \bigcap_{l \in \mathbb{N}} \text{Cl}(\bigcup_{k \geq l} \phi_{x_{n_k}})$ hence there exists $k \in \mathbb{N}$ such that $\emptyset \neq \phi_{x_{n_k}} \cap U' \subset \text{Int}(C) \cap h^{-2}(U')$. Consequently there exists a connected component V (resp. V') of $\text{Int}(h^2(C)) \cap U$ (resp. of $\text{Int}(h^2(C)) \cap U'$) such that $V \cap h^2(\phi_{x_{n_k}}) \neq \emptyset \neq V' \cap h^2(\phi_{x_{n_k}})$. One has easily $\partial V \subset h^2(\partial C) \cup \partial U$ and moreover $\partial V \cap h^2(\phi_y) = \partial V \cap h^2(\partial C) \neq \emptyset$ because otherwise $V = U \subset \text{Int}(h^2(C))$ which contradicts $p \in U \cap h^2(\phi_y)$. Similarly $\partial V' \subset h^2(\partial C) \cup \partial U'$ with $\partial V' \cap h^2(\phi_z) = \partial V' \cap h^2(\partial C) \neq \emptyset$ so the set $X = V \cup (\partial V \cap h^2(C)) \cup h^2(\phi_{x_{n_k}}) \cup V' \cup (\partial V' \cap h^2(C))$ is a connected subset of $C \cap h^2(C) \setminus \{0, \infty\}$ and meets both $h^2(\phi_y)$ and $h^2(\phi_z)$. It is not difficult to check that if $h^2(\mathbb{S}^2 \setminus \text{Int}(C)) \subset C$ then $h^2(\phi_y)$ and $h^2(\phi_z)$ are contained in two distinct connected components of $(C \cap h^2(C)) \setminus \{0, \infty\}$ which is incompatible with the existence of X above, thus one gets $h^2(C) \subset C$.

It remains to check that $h^2(\phi_y \cup \phi_z) \subset \text{Int}(C)$. This is a consequence of the

fact that h^2 preserves the orientation. Let us give some additional details. It is already known that $h^2(\phi_y \cup \phi_z) \cap (\phi_y \cup \phi_z) = (h^2(\phi_y) \cap \phi_z) \cup (h^2(\phi_z) \cap \phi_y)$. Suppose first that $h^2(\phi_y) \subset \text{Int}(C)$. Thanks to the Schoenflies Theorem, one may assume up to conjugacy that $C = (\mathbb{R} \times [0, +\infty)) \cup \{\infty\}$, $\phi_y = (-\infty, 0) \times \{0\}$, $\phi_z = (0, +\infty) \times \{0\}$ and $h^2(\phi_y) = \{0\} \times (0, +\infty)$. Since h^2 preserves the orientation and has $0, \infty$ as fixed points, the disc $h^2(C)$ lies locally on the right of $h^2(\phi_y)$ oriented from 0 to ∞ so clearly $h^2(\phi_z) \subset h^2(C)$ is disjoint from ϕ_y . One gets similarly $h^2(\phi_y) \cap \phi_z = \emptyset$ if $h^2(\phi_z) \subset \text{Int}(C)$. Suppose finally that $h^2(\phi_y) \cap \phi_z \neq \emptyset \neq h^2(\phi_z) \cap \phi_y$. Choose a segment Δ joining 0 and ∞ such that $\Delta \setminus \{0, \infty\} \subset \text{Int}(h^2(C))$. Up to conjugacy, one may assume that C is an Euclidean disc in the plane \mathbb{R}^2 with Δ as its horizontal diameter. Note that $h^2(\phi_y) \cup \phi_z$ and $h^2(\phi_z) \cup \phi_y$ are two connected subsets of $C \setminus \Delta$ so one of them is included in the upper connected component of $C \setminus \Delta$ and the other one in the lower connected component of $C \setminus \Delta$. Choosing any point $p_0 \in \Delta \setminus \{0, \infty\} \subset \text{Int}(h^2(C)) \subset \text{Int}(C)$, one deduces that, when p moves along ∂C , the winding numbers of the vectors $p - p_0$ and $h^2(p) - p_0$ have opposite values (± 1), which is not possible for the orientation preserving homeomorphism h^2 . \square

Proposition 6.3. *For every $i \in \{1, 2\}$, an attracting (resp. a repelling) minimal (\mathcal{F}, h^i) -croissant lies locally on the right (resp. left) of the two leaves in its frontier.*

Proof. We only consider the case where A is an attracting (\mathcal{F}, h^i) -croissant. Replacing h with h^{-1} , one gets likewise the result for a repelling (\mathcal{F}, h^i) -croissant. Write $\partial A \setminus \{0, \infty\} = \phi_1 \sqcup \phi_2$ where ϕ_1, ϕ_2 are two leaves of \mathcal{F} . There exists a leaf ϕ'_1 of \mathcal{F} such that $\Phi = \phi_1 \sqcup \phi'_1 \in \mathcal{P}$ is a Brouwer manifold of type 3 with $\text{Cl}(\Phi) \setminus \Phi = \{0, \infty\}$ and it is enough to check that $\text{Int}(A) \subset \text{Int}(R(\Phi))$. One has $h^i(\phi_1) \subset \text{Int}(A) \cap \text{Int}(R(\Phi))$ because A is an attracting h^i -croissant. Hence if the above inclusion does not hold then one gets $\emptyset \neq \text{Int}(A) \cap \partial R(\Phi) = \text{Int}(A) \cap \phi'_1$. In particular $\phi'_1 \neq \phi_2$ so $\phi'_1 \cap \partial A = \emptyset$ and then $\phi'_1 \subset \text{Int}(A)$. It follows that one of the two (\mathcal{F}, h^i) -croissants $\text{Cl}(R(\Phi)) = R(\Phi) \cup \{0, \infty\}$ or $\text{Cl}(L(\Phi)) = L(\Phi) \cup \{0, \infty\}$ is strictly contained in A , which contradicts the minimality of A . \square

As an immediate consequence of Propositions 6.1-6.3 one has the following result.

Corollary 6.1. - *There exist at least two minimal (\mathcal{F}, h^2) -croissants.*

- *For any minimal (\mathcal{F}, h^2) -croissant A , there is no line-leaf included in $\text{Int}(A)$.*
- *For any two distinct minimal (\mathcal{F}, h^2) -croissants A, A' , one has $\text{Int}(A) \cap \text{Int}(A') = \emptyset$.*

For any $i \in \{1, 2\}$, we say following [LR04] that an attracting (\mathcal{F}, h^i) -croissant A has *dynamical type* $0 - \infty$ if for every neighborhood V_∞ of ∞ there exists an attracting (\mathcal{F}, h^i) -petal P at 0 such that

- $P \subset A$,

- $P \cap V_\infty \neq \emptyset$.

By reversing the roles of 0 and ∞ , one may also consider an attracting (\mathcal{F}, h^i) -croissant A with dynamical type $\infty - 0$. The dynamical type of a repelling (\mathcal{F}, h^i) -croissant is defined likewise, just asking for the petal P above to be “repelling” instead of “attracting”.

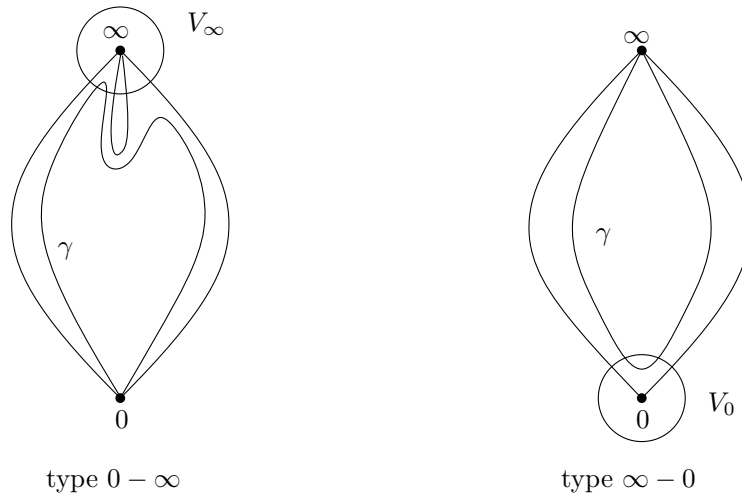

Figure 6.3 – Two dynamical types of croissants

Proposition 6.4. *Any minimal (\mathcal{F}, h^2) -croissant has dynamical type $0 - \infty$ or $\infty - 0$ but not both.*

Proof. We only prove the result concerning an attracting minimal (\mathcal{F}, h^2) -croissant C , the other one being similar. Write $\partial C \setminus \{0, \infty\} = \gamma^- \sqcup \gamma^+$ where $\gamma^- \in \mathcal{F}$ (resp. $\gamma^+ \in \mathcal{F}$) is oriented from 0 to ∞ (resp. from ∞ to 0). Recall from Corollary 6.1 that $\text{Int}(C)$ does not contain any line-leaf of \mathcal{F} hence, with the same argument as in the proof of Proposition 6.1, we get that at least one of the following two situations occurs:

- i) there exists a sequence $(x_n)_{n \geq 0}$ of points in $\text{Int}(C)$ such that $x_n \rightarrow \infty$ as $n \rightarrow +\infty$ and that ϕ_{x_n} is a petal-leaf at 0 for every $n \geq 0$;
- ii) there exists a sequence $(y_m)_{m \geq 0}$ of points in $\text{Int}(C)$ such that $y_m \rightarrow 0$ as $m \rightarrow +\infty$ and that ϕ_{y_m} is a petal-leaf at ∞ for every $m \geq 0$;

Suppose for instance that i) holds true. As in the proof of Proposition 6.2 one obtains a subsequence $(x_{n_k})_{k \geq 0}$ such that

- $x_{n_k} \rightarrow \infty$ as $k \rightarrow +\infty$,
- P_k is an attracting (\mathcal{F}, h^2) -petal at 0 for every k large enough, where P_k is the \mathcal{F} -petal whose frontier is $\phi_{x_{n_k}} \cup \{0\}$.

It implies that C is an attracting (\mathcal{F}, h^2) -croissant with dynamical type $0 - \infty$. If **ii)** holds then one obtains likewise that C is an attracting (\mathcal{F}, h^2) -croissant with dynamical type $\infty - 0$.

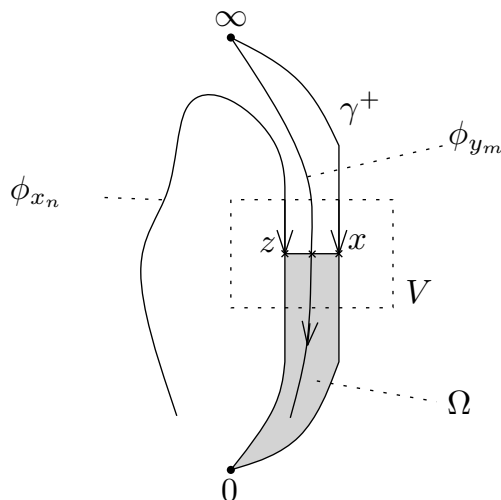

Figure 6.4 – The disc Ω

It remains to prove that the two situations **i)** and **ii)** cannot occur simultaneously. Suppose this is not true. Choose any point $x \in \gamma^+$ and let V be a trivializing neighborhood of x so small that $\gamma^+ \cap V$ is reduced to a single local leaf of \mathcal{F} in V . As in the proof of Proposition 6.2, one can also suppose that $\phi_{x_n} \cap V$ consists of a single local leaf of \mathcal{F} in V for every n large enough. Choose such an integer n . Then pick a point $z \in \phi_{x_n} \cap V$ and join z to x by a segment $\eta \subset V$ which is transverse to the foliation \mathcal{F} . Of course the set

$$\omega = (\gamma^+)_x^+ \cup (\phi_{x_n})_z^+ \cup \eta \cup \{0\}$$

is a circle (see Fig. 6.4) and we define Ω to be the disc bounded by ω and included in C . Observe that $\infty \notin \Omega$. According to Lemma 6.1, one has $\gamma^+ \subset \bigcap_{k \geq 0} \left(\bigcup_{m \geq k} \text{Cl}(\phi_{y_m}) \right)$. Then there exists m large enough such that $\phi_{y_m} \cap \eta \neq \emptyset$. Moreover because ϕ_{y_m} accumulates on only one point in $\{0, \infty\}$ and $\eta \subset V$ is transverse to \mathcal{F} , the leaf ϕ_{y_m} intersects η transversely in only one point, denoted by v . Therefore the half-leaf $(\phi_{y_m})_v^+$ is included in Ω which contradicts $\text{Cl}((\phi_{y_m})_v^+) \setminus (\phi_{y_m})_v^+ = \{\infty\}$ because ϕ_{y_m} is the petal-leaf at ∞ . \square

It is easily seen that there exist only finitely many minimal (\mathcal{F}, h^2) -croissants and we let $\mathcal{A} = \{A_i\}_{1 \leq i \leq m}$ be the set of all these minimal (\mathcal{F}, h^2) -croissants. According to Corollary 6.1 the \mathcal{F} -croissants in \mathcal{A} may be cyclically ordered around 0.

Proposition 6.5. *Assume for convenience that the \mathcal{F} -croissants $A_i \in \mathcal{A}$ are numbered so that a cyclic order around 0 is $A_1 < A_2 < \dots < A_m < A_{m+1} = A_1$ (up to*

circular permutation).

Then we have the following properties.

- i) *For every $1 \leq i \leq m$, one of the two croissants A_i, A_{i+1} is an attracting h^2 -croissant and the other one is a repelling h^2 -croissant. Consequently the number m of minimal (\mathcal{F}, h^2) -croissants is even ($m = 2n$).*
- ii) *If A_i is an attracting (resp. a repelling) h^2 -croissant but is not a h -croissant then there exists a unique attracting (resp. repelling) h^2 -croissant $A_j \neq A_i$ such that $h(A_i) \subset A_j$ and $h(A_j) \subset A_i$ (resp. $h^{-1}(A_i) \subset A_j$ and $h^{-1}(A_j) \subset A_i$).*

Proof. Suppose that A_i and A_{i+1} are two attracting h^2 -croissants. Then there are two leaves $\gamma_i \subset \partial A_i$ and $\gamma_{i+1} \subset \partial A_{i+1}$ and a disc D bounded by $\gamma_i \cup \gamma_{i+1} \cup \{0, \infty\}$ such that

- $D \cap \text{Int}(A_i) = \emptyset = D \cap \text{Int}(A_{i+1})$;
- one has the following cyclic order $A_i < D < A_{i+1}$.

One of the leaves γ_i, γ_{i+1} is oriented from 0 to ∞ and the other one is oriented from ∞ to 0. According to Proposition 6.2 the set D contains a minimal (\mathcal{F}, h^2) -croissant, a contradiction which proves i).

Suppose for instance that A_i is attracting for h^2 but is not a h -croissant. We write γ_i^- and γ_i^+ for the two connected components of $\partial A_i \setminus \{0, \infty\}$ with γ_i^- oriented from 0 to ∞ and γ_i^+ oriented from ∞ to 0. One knows that there exists some Brouwer manifold $\Phi^- = \gamma_i^- \sqcup \gamma^- \in \mathcal{P}$ and $\Phi^+ = \gamma_i^+ \sqcup \gamma^+ \in \mathcal{P}$ possessing respectively γ_i^- and γ_i^+ as a connected component as follows. If there are several possible choices for Φ^- (resp. Φ^+) then one knows from Section 5.4 that $\gamma_i^- = \alpha$ (resp. $\gamma_i^+ = \alpha'$) for some edge $\alpha \in E_0 \subset E$ (resp. $\alpha' \in E_0 \subset E$). If this occurs then, with the notation from Proposition 5.24 in Chapter 5, we choose $\Phi^- = \Psi(\Gamma_\alpha^-)$ (resp. $\Phi^+ = \Psi(\Gamma_{\alpha'}^-)$), in other words we choose γ^- (resp. γ^+) to be the connected component of $\Psi(\Gamma_\alpha^-)$ (resp. $\Psi(\Gamma_{\alpha'}^-)$) other than α (resp. α'). Since A_i is not a h -croissant, the two leaves γ^-, γ_i^+ are distinct as well as the two leaves γ^+, γ_i^- . Moreover $\gamma^- \cap \text{Int}(A_i) = \emptyset$ because of the minimality of A_i hence one deduces $\gamma_i^+ \subset \text{Int}(R(\Phi^-))$ and actually $\Phi^+ \subset R(\Phi^-)$ because Φ^-, Φ^+ have no transverse intersection. One gets similarly $\Phi^- \subset R(\Phi^+)$. It is easy to check that $L(\Phi^-) \subset R(\Phi^+)$ and even better $L(\Phi^-) \subset \text{Int}(R(\Phi^+))$. Then the open set $\text{Int}(R(\Phi^+)) \setminus L(\Phi^-)$ has exactly two connected components U and V with for instance $\text{Cl}(U) = A_i$ and $\text{Cl}(V)$ being a disc with boundary circle $\gamma^+ \cup \gamma^- \cup \{0, \infty\}$. For any $k \in \{1, 2\}$ one has

$$h^k(\text{Int}(R(\Phi^+)) \setminus L(\Phi^-)) \subset \text{Int}(R(\Phi^+)) \setminus L(\Phi^-)$$

and therefore each connected set $h^k(U), h^k(V)$ is contained in either U or V . Since $h^2(A_i) \subset A_i$ one has $h^2(U) \subset U$. According to Proposition 6.2 the disc $D = \text{Cl}(V)$ contains a minimal (\mathcal{F}, h^2) -croissant which implies that $h^2(V) \cap V \neq \emptyset$ and then

$h^2(V) \subset V$. Since the disc D lies locally on the right of γ^- and since h^2 preserves the orientation, the disc $h^2(D)$ also lies locally on the right of $h^2(\gamma^-)$ oriented from ∞ to 0. Similarly $h^2(D)$ lies locally on the right of $h^2(\gamma^+)$ oriented from 0 to ∞ . This together with $h^2(\gamma^-) \cap \gamma^- = \emptyset = h^2(\gamma^+) \cap \gamma^+$ implies $\partial D \cap \partial h^2(D) = \{0, \infty\}$ hence $h^2(D) \subset \text{Int}(D) \cup \{0, \infty\}$, which means that D is an attracting (\mathcal{F}, h^2) -croissant.

Suppose now that $h(U) \subset U$. Then one has $h(\gamma_i^-) \subset \text{Cl}(h(U)) \subset \text{Cl}(U) = A_i$. Moreover one knows that $h(\gamma_i^-) \cap \gamma_i^- = \emptyset$ hence one may consider the disc Ω bounded by the circle $h(\gamma_i^-) \cup \gamma_i^- \cup \{0, \infty\}$ and contained in A_i . The description of Brouwer manifolds provided by the proof of Proposition 3.1 tell us that $h(\gamma^-)$ separates γ_i^- and $h(\gamma_i^-)$ in the disc $\text{Cl}(R(\Phi^-)) = R(\Phi^-) \cup \{0, \infty\}$. Consequently one has $h(\gamma^-) \subset \text{Int}(\Omega) \subset U$ and, since $h(\gamma^-) \subset h(D) = \text{Cl}(h(V))$, one obtains $h(V) \cap U \neq \emptyset$. Then one gets $h(V) \subset U$ and therefore $h^2(V) \subset h(U) \subset U$ which contradicts the fact that $D = \text{Cl}(V)$ is a h^2 -croissant. This proves that actually $h(U) \subset V$ and it follows that also $h(V) \subset U$ since otherwise $h^2(U) \subset h(V) \subset V$ which is not possible because $A_i = \text{Cl}(U)$ is a h^2 -croissant.

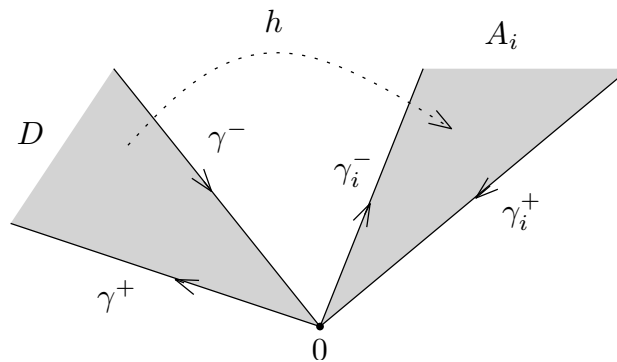

Figure 6.5 – The two attracting minimal (\mathcal{F}, h^2) -croissants

Thus we obtain $h(A_i) \subset D$ and $h(D) \subset A_i$ and it remains to prove that D is minimal among the (\mathcal{F}, h^2) -croissants. If this is not true then $\text{Int}(D) = V$ contains a line-leaf γ . One knows that γ is a connected component of some Brouwer manifold $\Phi = \gamma \sqcup \gamma' \in \mathcal{P}$. Since any two Brouwer manifolds in \mathcal{P} have no transverse intersection one obtains $\gamma' \subset R(\Phi^-) \cap R(\Phi^+) = A_i \cup D$. One has $\gamma' \neq \gamma_i^-$ since otherwise γ_i^- is a connected component of both Φ and Φ^- with furthermore $\Phi \prec \Phi^-$ which contradicts the choice we made for Φ^- (recall Item (3) of Proposition 5.24 in Chapter 5). Similarly $\gamma' \neq \gamma_i^+$ because otherwise Φ and Φ^+ have γ_i^+ as a common connected component and moreover $\Phi \prec \Phi^+$, a contradiction with the choice of Φ^+ . Moreover one has $\gamma' \cap U = \emptyset$ because of the minimality of A_i hence one gets $\gamma' \cap A_i = \emptyset$ and consequently $\gamma' \subset D$. This gives $\Phi \subset D$ and therefore either $L(\Phi)$ or $R(\Phi)$ is included in D . This implies that $\text{Int}(L(\Phi)) \subset h^{-1}(V)$ or $\text{Int}(R(\Phi)) \subset h(V)$ and contradicts now $h(V) \cap V = \emptyset$. \square

Proposition 6.6. *Among the $2n$ minimal (\mathcal{F}, h^2) -croissants, there exist exactly two distinct (\mathcal{F}, h) -croissants.*

Proof. Suppose that $n = 1$ so that we have only two minimal (\mathcal{F}, h^2) -croissants A_1 and A_2 . According to the first item in Proposition 6.5 one of these \mathcal{F} -croissant is h^2 -attracting and the other is h^2 -repelling. Item ii) of Proposition 6.5 then implies that A_1 and A_2 are also two (\mathcal{F}, h) -croissants.

Let us now consider the case $n \geq 2$. For every $i \in \{1, 2, \dots, 2n\}$ one defines $A_i^* = h(A_i) \cap h^{-1}(A_i)$. Observe from Corollary 6.1 and Proposition 6.5 that for every $i \in \{1, \dots, 2n\}$ there exists a unique $j \in \{1, \dots, 2n\}$ such that $A_i^* \subset A_j$. Hence one gets a well-defined map $\zeta : \mathcal{A} \rightarrow \mathcal{A}$ where $\zeta(A_i)$ is the unique $A_j \in \mathcal{A}$ such that $A_i^* \subset A_j$. Proposition 6.5 also gives $\zeta^2 = \text{Id}_{\mathcal{A}}$ (in particular ζ is a one-to-one map) and moreover $A \in \mathcal{A}$ is a fixed point of ζ iff A is also a h -croissant. Remark now that ζ reverses the cyclic order on \mathcal{A} . Indeed, assuming again the cyclic order $A_1 < A_2 < \dots < A_{2n} < A_{2n+1} = A_1$ around 0, one has $h(A_{2n}) < \dots < h(A_2) < h(A_1)$ because h reverses the orientation. Moreover $A_i^* \subset h(A_i)$ for every $i \in \{1, 2, \dots, 2n\}$ so one has the cyclic order $A_{2n}^* < \dots < A_2^* < A_1^*$ and finally $\zeta(A_{2n}) < \dots < \zeta(A_2) < \zeta(A_1)$ with the definition of ζ . This implies that ζ has at most two fixed points so we can suppose $A_1 \neq \zeta(A_1)$ which means that A_1 is not a h -croissant. Thus according to Proposition 6.5 one has $\zeta(A_1) = A_{2k+1}$ for some $k \in \{1, \dots, n\}$. Define $\mathcal{C} = \{A_1, A_2, \dots, A_{2k+1}\}$. This set is naturally endowed with a total order $A_1 < A_2 < \dots < A_{2k+1}$ induced by the cyclic order on \mathcal{A} . It is also invariant by ζ and the restricted map $\zeta|_{\mathcal{C}}$ reverses the restricted order $<$. Since \mathcal{C} has odd cardinality, one deduces that ζ possesses a unique fixed point in \mathcal{C} . Repeating the above argument with $\mathcal{C}' = \{A_{2k+1}, \dots, A_{2n}, A_1\}$ instead of \mathcal{C} , one also obtains that ζ possesses exactly one fixed point in \mathcal{C}' . \square

Proposition 6.7. *Let $A \in \mathcal{A}$ which is also a (\mathcal{F}, h) -croissant. Then we have the following.*

- i) *A is also a minimal (\mathcal{F}, h) -croissant.*
- ii) *A is an attracting (resp. a repelling) (\mathcal{F}, h^2) -croissant iff A is an attracting (resp. a repelling) (\mathcal{F}, h) -croissant.*
- iii) *If A is a (\mathcal{F}, h^2) -croissant with dynamical type $0 - \infty$ then A is also a (\mathcal{F}, h) -croissant with dynamical type $0 - \infty$. Similarly for a (\mathcal{F}, h^2) -croissant with dynamical type $\infty - 0$.*
- iv) *A minimal (\mathcal{F}, h) -croissant cannot have simultaneously the dynamical types $0 - \infty$ and $\infty - 0$.*

Proof. Items i) and ii) are straightforward. Let us prove iii). We suppose for example that A is an attracting minimal (\mathcal{F}, h^2) -croissant with dynamical type $0 - \infty$. All the

other cases can be proved similarly. Then there exists a sequence $(x_n)_{n \geq 0}$ of points in $\text{Int}(A)$ with $\lim_{n \rightarrow +\infty} x_n = \infty$ such that ϕ_{x_n} is a petal-leaf at 0 and moreover the \mathcal{F} -petal P_n bounded by the circle $\phi_{x_n} \cup \{0\}$ is h^2 -attracting. The point here is to see that the P_n 's are actually h -petals (necessarily h -attracting) and not only h^2 -petals, at least for infinitely many of them. To do this it is enough to prove that $h(P_n) \cap \text{Int}(P_n) \neq \emptyset$.

Denote by γ^\pm the two line-leaves of \mathcal{F} included in ∂A with γ^- oriented from 0 to ∞ and γ^+ oriented from ∞ to 0. According to Lemma 6.1 and Corollary 6.1 one gets that

$$\gamma^- \cup \gamma^+ \subset \bigcap_{k \geq 0} \text{Cl} \left(\bigcup_{n \geq k} \phi_{x_n} \right).$$

Take a point $x \in \gamma^-$ and a trivializing neighborhood V_x of x so small that $\gamma^- \cap V_x$ is reduced to a single local leaf of \mathcal{F} in V . Since $x \in \bigcap_{k \geq 0} \text{Cl} \left(\bigcup_{n \geq k} \phi_{x_n} \right)$ there exists a subsequence $(x_{n_i})_{i \geq 0}$ of $(x_n)_{n \geq 0}$ such that $\phi_{x_{n_i}} \cap V_x \neq \emptyset$ for every $i \in \mathbb{N}$. Recall that the set $\phi_{x_{n_i}} \cap V_x$ consists of a single local leaf of \mathcal{F} in V_x because $\phi_{x_{n_i}}$ accumulates only on 0. Applying Lemma 6.1 to the sequence $(x_{n_i})_{i \geq 0}$ one still has

$$\gamma^- \cup \gamma^+ \subset \bigcap_{k \geq 0} \text{Cl} \left(\bigcup_{i \geq k} \phi_{x_{n_i}} \right).$$

Let us remark now that the \mathcal{F} -petals P_{n_i} ($i \in \mathbb{N}$) are pairwise comparable w.r.t. the inclusion. Indeed if $P_{n_i} \neq P_{n_j}$ then one can suppose for instance that the local leaf $\phi_{x_{n_i}} \cap V_x$ is located on the right of $\phi_{x_{n_j}} \cap V_x$ in V_x . Then the \mathcal{F} -petal P_{n_j} contains $\phi_{x_{n_i}} \cap V_x$ because otherwise $\gamma^- \cap V_x \subset P_{n_j}$ and then $\gamma^- \subset P_{n_j}$ which is certainly not true. One deduces that $P_{n_i} \subset P_{n_j}$.

Since $\lim_{i \rightarrow +\infty} x_{n_i} = \infty$ it follows from the previous remark that there exists a subsequence $(x_{m_k})_{k \geq 0}$ of $(x_{n_i})_{i \geq 0}$ such that $P_{m_k} \subset P_{m_{k+1}}$ for every $k \in \mathbb{N}$. Applying again Lemma 6.1 to this sequence $(x_{m_k})_{k \geq 0}$ one gets

$$(*) \quad \gamma^- \cup \gamma^+ \subset \bigcap_{l \geq 0} \text{Cl} \left(\bigcup_{k \geq l} \phi_{x_{m_k}} \right).$$

Since A is an attracting h -croissant one has $h(\gamma^-) \subset \text{Int}(A)$ and $\text{Int}(A) \setminus h(\gamma^-)$ has then exactly two connected components U_1 and U_2 with $\partial U_1 = \gamma^- \cup h(\gamma^-) \cup \{0, \infty\}$ and $\partial U_2 = \gamma^+ \cup h(\gamma^-) \cup \{0, \infty\}$. The inclusion $(*)$ above and the fact that $(P_{m_k})_{k \geq 0}$ is an increasing sequence of \mathcal{F} -petals lying in $\text{Int}(A) \cup \{0\}$ imply that $\text{Int}(P_{m_k}) \cap h(\gamma^-) \neq \emptyset$ for every k large enough, say for $k \geq l$. Choose a point $z \in h(\gamma^-) \cap \text{Int}(P_{m_l})$ and an open neighborhood W of $h^{-1}(z) \in \gamma^-$ so small that $h(W) \subset \text{Int}(P_{m_l})$. Then there exists $l' \geq l$ such that $W \cap \phi_{x_{m_k}} \neq \emptyset$ for every $k \geq l'$ and consequently

$$\forall k \geq l' \quad \emptyset \neq h(W \cap P_{m_k}) \subset \text{Int}(P_{m_l}) \cap h(P_{m_k}) \subset \text{Int}(P_{m_k}) \cap h(P_{m_k})$$

which implies as expected that P_{m_k} is a h -petal.

Remark finally that any minimal (\mathcal{F}, h) -croissant with dynamical type $0-\infty$ (resp. $\infty-0$) is also a minimal (\mathcal{F}, h^2) -croissant with dynamical type $0-\infty$ (resp. $\infty-0$). Then it follows from Proposition 6.4 that a minimal (\mathcal{F}, h) -croissant cannot have simultaneously the dynamical types $0-\infty$ and $\infty-0$ which proves Item **iv**). This ends the proof of Proposition 6.7. \square

6.2 Link between the minimal (\mathcal{F}, h) -croissants and the fixed point index

In this Section we mainly use some techniques from [Bon02] to establish the relationship between the fixed point index $\text{Ind}(h, 0)$ and the nature of the two minimal (\mathcal{F}, h) -croissants provided by Section 6.1. Precisely we shall prove the following result.

Proposition 6.8. *Assume that the foliation \mathcal{F} possesses no circle-leaf. Let p_a (resp. p_r) be the number of attracting (resp. repelling) croissants having dynamical type $0-\infty$ among the two (\mathcal{F}, h) -croissants provided by Proposition 6.6. Let also let q_a (resp. q_r) be the number of attracting (resp. repelling) croissants having dynamical type $\infty-0$ among the same two (\mathcal{F}, h) -croissants. Then one has*

$$\text{Ind}(h, 0) = \frac{p_a + q_r - (p_r + q_a)}{2} \in \{0, \pm 1\}.$$

The next Lemma, which is a precise version of a classical result of Kerékjártó, corresponds to [Bon02, Proposition 3.1] and is proved in the first section of [LCY97]. From now on, any circle in \mathbb{R}^2 is counter-clockwise oriented.

Lemma 6.2 ([LCY97]). *Let D, D' be two Jordan domains containing the point 0 such that $\text{Cl}(D) \cup \text{Cl}(D') \subset \mathbb{R}^2$ and $D \not\subset D' \not\subset D$. Denote by $D \wedge D'$ the connected component of $D \cap D'$ which contains 0 and by $\partial D \wedge \partial D'$ the frontier of $D \wedge D'$.*

(i) *We have a partition*

$$\partial D \wedge \partial D' = ((\partial D \wedge \partial D') \cap \partial D \cap \partial D') \bigcup_{i \in I} \alpha_i \bigcup_{j \in J} \beta_j$$

where

- I, J are non-empty and at most countable sets,
- for every $i \in I$, $\alpha_i = (a_i, b_i)_{\partial D}$ is a connected component of $\partial D \cap D'$,
- for every $j \in J$, $\beta_j = (c_j, d_j)_{\partial D'}$ is a connected component of $\partial D' \cap D$.

(ii) *For every $j \in J$, $D \wedge D'$ is contained in the Jordan domain with frontier $\beta_j \cup [d_j, c_j]_{\partial D}$ and containing 0.*

- (iii) $\partial D \wedge \partial D'$ is a circle.
- (iv) Three points a, b, c of $(\partial D \wedge \partial D') \cap \partial D$ (resp. of $(\partial D \wedge \partial D') \cap \partial D'$) are met in this order on ∂D (resp. on $\partial D'$) iff they are met in the same order on $\partial D \wedge \partial D'$.

Consider a Jordan domain D containing 0 such that $\text{Cl}(D) \subset \mathbb{R}^2$ and define $D' = h^{-1}(D)$. Then D' is also a Jordan domain with $0 \in D'$ and $\text{Cl}(D') \subset \mathbb{R}^2$. Assuming $D \not\subset D' \not\subset D$, one may consider the partition (P) of $\partial D \wedge \partial D'$ and the segments α_i and β_j obtained by applying Lemma 6.2 with these Jordan domains D and D' . Then let ϕ be the inversion in the circle $C = \partial D$. Let $C_j = \text{Cl}(\beta_j) \cup \phi(\text{Cl}(\beta_j))$ and $\Gamma = C \wedge h^{-1}(C)$. Define a map H from $\Gamma \cup \phi(\Gamma)$ to \mathbb{R}^2 by setting

$$H(z) = \begin{cases} h(z) & \text{if } z \in \Gamma, \\ h(\phi(z)) & \text{if } z \in \phi(\Gamma). \end{cases}$$

Following [Bon02] one has the following formula:

$$(*) \quad \text{Ind}(h, 0) + \sum_{j \in J} \text{Ind}(H, C_j) = 1.$$

We consider the two minimal (\mathcal{F}, h) -croissants given by Proposition 6.6, denoted by A_1 and A_2 in the following. The calculation of the index will be divided into the following three cases.

Case 1. Both A_1 and A_2 have dynamical type $0 - \infty$.

Subcase 1 – a. A_1 and A_2 are two attracting (\mathcal{F}, h) -croissants.

Let us show that $\text{Ind}(h, 0) = 1$ in this case. Let $P_i \subset A_i$ be an attracting (\mathcal{F}, h) -petal at 0 for every $i \in \{1, 2\}$. Using the Schoenflies Theorem one can suppose that

- P_1 is the triangle with vertices $0 = (0, 0), (-1, -1)$ and $(-1, 1)$,
- P_2 is the triangle with vertices $0, (1, -1)$ and $(1, 1)$,
- $h^{-1}(P_1)$ is the triangle with vertices $0, (-2, -3)$ and $(-2, 3)$,
- $h^{-1}(P_2)$ is the triangle with vertices $0, (2, -3)$ and $(2, 3)$,

and moreover

- $h^{-1}((1, 0)) = (2, 0), h^{-1}((-1, 0)) = (-2, 0)$,
- $h^{-1}(\{-1\} \times [-1, 1]) = \{-2\} \times [-3, 3]$,
- $h^{-1}(\{1\} \times [-1, 1]) = \{2\} \times [-3, 3]$.

Let C be the rectangle with vertices $(-1, -3), (-1, 3), (1, -3), (1, 3)$ and let D be the Jordan with frontier C containing 0 (Fig. 6.6). We write $D' = h^{-1}(D)$ and $C' = \partial D' = h^{-1}(C)$. We denote by γ_1 (resp. γ_2) the straight segment joining $(-2, -1)$ and $(-1, 0)$ (resp. $(2, -1)$ and $(1, 0)$). For convenience we also let $x_1 = (-1, 0) \in C \cap \partial P_1$ and $x_2 = (1, 0) \in C \cap \partial P_2$. It is not difficult to get the following result, whose proof is left to the reader.

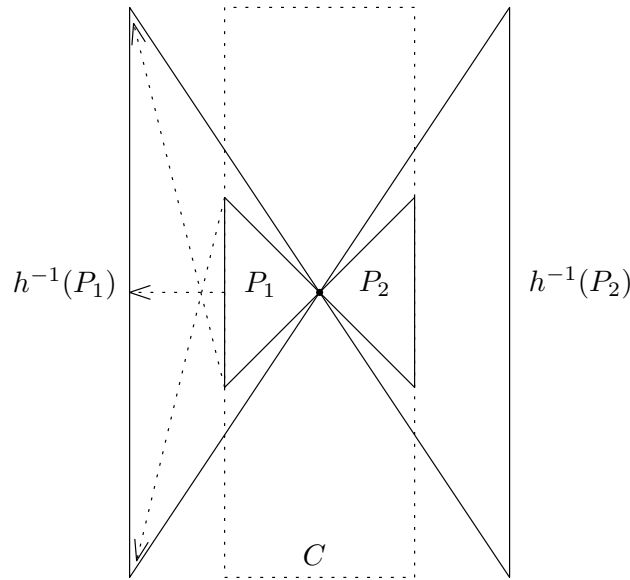
Figure 6.6 – The circle C and the petals P_1, P_2

Lemma 6.3. • *The set*

$$C'' = \gamma_2 \cup ([1, 2] \times \{0\}) \cup [h^{-1}(x_2), h^{-1}(x_1)]_{C'} \cup ([-2, -1] \times \{0\}) \cup \gamma_1 \cup [(-2, -1), (2, -1)]_{C'}$$

is a circle contained in $\text{Cl}(D') \setminus \{0\}$ (Fig. 6.7);

- *The Jordan domain D'' with frontier C'' and containing 0 satisfies $D'' \cap D = D' \cap D$;*
- *For every $x \neq y$ in $C' \cap C''$, the four points x_2, x, y, x_1 are met in this order on C'' (up to circular permutation) iff $h^{-1}(x_2), x, y, h^{-1}(x_1)$ are met in this order on C' .*

If $D \subset D'$ then directly $\text{Ind}(h, 0) = 1$ so one may assume $D \not\subset D'$. One also has $D' \not\subset D$ because $h^{-1}(x_1) \in \text{Cl}(D') \setminus \text{Cl}(D)$ hence one can apply Lemma 6.2 with these two Jordan domains D, D' . Using the notation in Lemma 6.2, one knows from [Bon02, Lemma 3.2] that if $[h(d_j), h(c_j)]_C \cap [c_j, d_j]_C = \emptyset$ then $\text{Ind}(H, C_j) = 0$. According to the formula (*), it is enough to check that $[h(d_j), h(c_j)]_C \cap [c_j, d_j]_C = \emptyset$ for every $j \in J$. By the construction of C one has

$$\text{Cl}(\beta_j) \cap (P_1 \cup P_2) \subset C' \cap (P_1 \cup P_2) = h^{-1}(C \cap h(P_1 \cup P_2)) \subset h^{-1}(C \cap (\text{Int}(P_1) \cup \text{Int}(P_2) \cup \{0\})) = \emptyset.$$

Using moreover item (ii) in Lemma 6.2, one deduces that either $[c_j, d_j]_C \subset (x_1, x_2)_C$ or $[c_j, d_j]_C \subset (x_2, x_1)_C$. We only deal with the second situation because the same argument can be applied to the first one.

Since $\{x_1, x_2, c_j, d_j\} \subset (C \wedge C'') \cap (C \cap C'')$ one knows from item (iv) in Lemma 6.2 that x_2, c_j, d_j, x_1 are also met in this order on C'' . According to Lemma 6.3 the points $h^{-1}(x_2), c_j, d_j, h^{-1}(x_1)$ are met in this order on C' and then $[h(d_j), h(c_j)]_C \subset (x_1, x_2)_C$

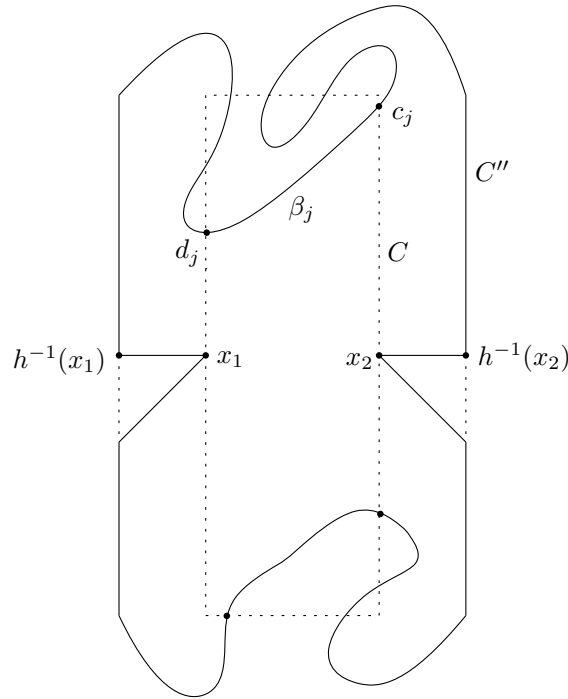

Figure 6.7 – The circles C and C'' in Subcase 1 – a

because h reverses the orientation. This implies as expected $[h(d_j), h(c_j)]_C \cap [c_j, d_j]_C = \emptyset$ and completes the proof of $\text{Ind}(h, 0) = 1$ in this case.

Subcase 1 – b. A_1 and A_2 are two repelling (\mathcal{F}, h) -croissants.

Replacing h with h^{-1} in the previous Subcase 1 – a one has $\text{Ind}(h^{-1}, 0) = 1$ and it follows that $\text{Ind}(h, 0) = -\text{Ind}(h^{-1}, 0) = -1$.

Subcase 1 – c. A_1 is a repelling (\mathcal{F}, h) -croissant and A_2 is an attracting (\mathcal{F}, h) -croissant.

We consider $P_1 \subset A_1$ a repelling (\mathcal{F}, h) -petal at 0 and $P_2 \subset A_2$ an attracting (\mathcal{F}, h) -petal at 0. Using again Schoenflies Theorem one can suppose that

- P_1 is the triangle with vertices $0, (-2, -3)$ and $(-2, 3)$,
- $h(P_2)$ is the triangle with vertices $0, (2, -3)$ and $(2, 3)$,
- $h^{-1}(P_1)$ is the triangle with vertices $0, (-1, -1)$ and $(-1, 1)$,
- P_2 is the triangle with vertices $0, (3, -5)$ and $(3, 5)$,

and moreover

- $h^{-1}([-3, -2] \times \{0\}) = [-2, -1] \times \{0\}$; in particular $h^{-1}((-2, 0)) = (-1, 0)$;
- $h^{-1}(\{-2\} \times [-3, 3]) = \{-1\} \times [-1, 1]$;
- $h^{-1}(\{2\} \times [-3, 3]) = \{3\} \times [-5, 5]$ with $h^{-1}(2, 0) = (3, 0)$.

Let C be the rectangle with vertices $(-2, -5), (-2, 5), (2, -5)$ and $(2, 5)$. We denote by D the Jordan domain containing 0 with frontier C . For convenience we also let $C' = h^{-1}(C)$, $D' = h^{-1}(D)$, $x_1 = (-2, 0) \in \partial P_1$ and $x_2 = (2, 0) \in \partial h(P_2)$.

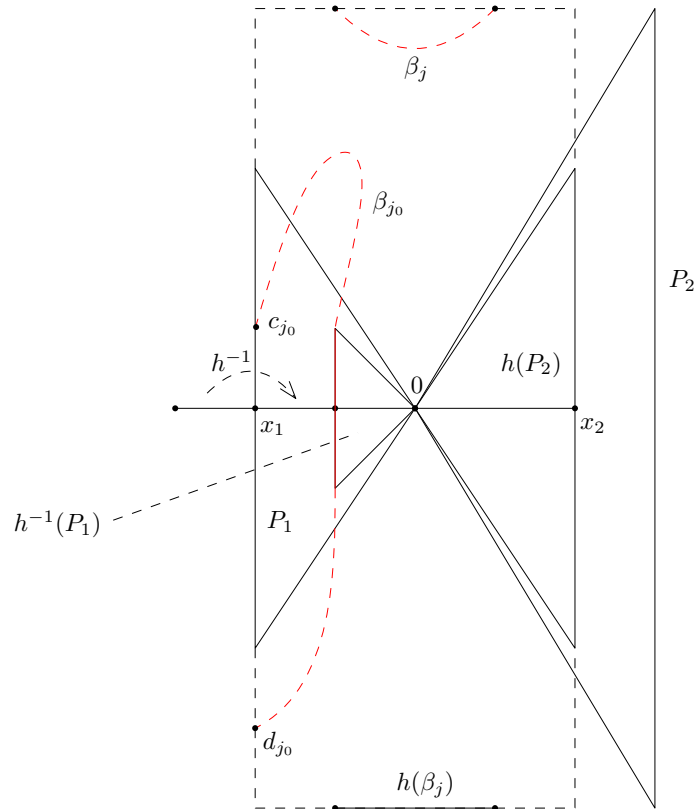
Figure 6.8 – The circle C and some β_j 's in Subcase **1 – c**

Observe that $D \not\subset D' \not\subset D$ because $h^{-1}(x_1) \in D$ and $h^{-1}(x_2) \notin \text{Cl}(D)$ hence Lemma 6.2 applies. Clearly $h^{-1}(x_1) \in \{0\} \times [-1, 1] \subset \beta_{j_0} = (c_{j_0}, d_{j_0})_{C'}$ for some $j_0 \in J$ so $x_1 \in (h(d_{j_0}), h(c_{j_0}))_C$ because h reverses the orientation. On the other hand $h^{-1}(x_2) \in (d_{j_0}, c_{j_0})_{C'}$ because $h^{-1}(x_2) \notin \text{Cl}(D)$ hence $x_2 \in (h(c_{j_0}), h(d_{j_0}))_C$. Since $h^2(P_2) \subset \text{Int}(h(P_2)) \cup \{0\}$ one has $C' \cap h(P_2) = h^{-1}(C \cap h^2(P_2)) = \emptyset$ and then

$$\begin{aligned} C' \cap ([-2, 2] \times \{0\}) &= C' \cap ([-2, -1] \times \{0\}) \\ &= h^{-1}(C \cap ([-3, -2] \times \{0\})) = \{h^{-1}(x_1)\} = \{(-1, 0)\}. \end{aligned}$$

Since D' lies locally on the left of C' , this implies $c_{j_0} \in (x_2, x_1)_C$ and $d_{j_0} \in (x_1, x_2)_C$. It follows that $[c_{j_0}, d_{j_0}]_C \cap [h(d_{j_0}), h(c_{j_0})]_C$ is a non empty connected set and [Bon02, Lemma 3.3] then gives $\text{Ind}(H, C_{j_0}) = 1$. One also gets $\text{Cl}(\beta_j) \cap ([-2, 2] \times \{0\}) = \emptyset$ for every $j \neq j_0$ which, together with Item (ii) in Lemma 6.2, implies that $[c_j, d_j]_C \subset [d_{j_0}, x_2]_C \subset (x_1, x_2)_C$ or $[c_j, d_j]_C \subset (x_2, c_{j_0}]_C \subset (x_2, x_1)_C$.

Similarly as for Subcase **1 – a**, one constructs a circle C'' bounding a Jordan domain D'' such that $x_2 \in C''$, $D \cap D'' = D' \cap D''$ and such that, for any $x \neq y$ in $C' \cap C''$, the points x_2, x, y are met in this order on C'' iff $h^{-1}(x_2), x, y$ are met in this order on C' . Consider $j \in J \setminus \{j_0\}$ and suppose for instance that $[c_j, d_j]_C \subset (x_2, c_{j_0}]_C \subset (x_2, x_1)_C$. We know from item (iv) in Lemma 6.2 that the points $x_2, c_j, d_j, c_{j_0}, d_{j_0}$ are met in this order both on C and on C'' because they all belong to $(C \wedge C'') \cap C \cap C''$ (with possibly $d_j = c_{j_0}$). Consequently $h^{-1}(x_2), c_j, d_j, c_{j_0}, h^{-1}(x_1), d_{j_0}$ are met in this order

on C' and afterwards $[h(d_j), h(c_j)]_C \subset (x_1, x_2)_C$ (see Fig. 6.8). Using again [Bon02, Lemma 3.2] one obtains $\text{Ind}(H, C_j) = 0$ and one gets likewise the same conclusion if $[c_j, d_j]_C \subset [d_{j_0}, x_2]_C \subset (x_1, x_2)_C$. One concludes with the formula (*) that $\text{Ind}(h, 0) = 0$.

Case 2. Both A_1 and A_2 have dynamical type $\infty - 0$.

Recall that $\text{Ind}(h, 0) + \text{Ind}(h, \infty) = 0$ because h reverses the orientation. Replacing 0 with ∞ in the arguments for the first case, we obtain that

- If A_1 and A_2 are two attracting (\mathcal{F}, h) -croissants then $\text{Ind}(h, 0) = -\text{Ind}(h, \infty) = -1$.
- If A_1 is an attracting (\mathcal{F}, h) -croissant and A_2 is a repelling (\mathcal{F}, h) -croissant then $\text{Ind}(h, 0) = -\text{Ind}(h, \infty) = 0$.
- If A_1 and A_2 are two repelling (\mathcal{F}, h) -croissants then $\text{Ind}(h, 0) = -\text{Ind}(h, \infty) = 1$.

Case 3. A_1 has dynamical type $\infty - 0$ and A_2 has dynamical type $0 - \infty$.

It is slightly more complicated than in Case 1 to find a circle C suitable to the computation of $\text{Ind}(h, 0)$. We explain a possible construction in each of the four natural subcases.

Subcase 3 – a. A_1 is a repelling (\mathcal{F}, h) -croissant and A_2 is an attracting (\mathcal{F}, h) -croissant.

Consider a repelling (\mathcal{F}, h) -petal $P_1 \subset A_1$ at ∞ and an attracting (\mathcal{F}, h) -petal $P_2 \subset A_2$ at 0. Up to conjugacy, one may suppose that

- $\partial P_1 \setminus \{\infty\} = \{(x, -x+1) \in \mathbb{R}^2 \mid x \leq -1\} \cup (\{-1\} \times [-2, 2]) \cup \{(x, x-1) \in \mathbb{R}^2 \mid x \leq -1\}$,
- $\partial h^{-1}(P_1) \setminus \{\infty\} = \{(x, -x-1) \in \mathbb{R}^2 \mid x \leq -2\} \cup (\{-2\} \times [-1, 1]) \cup \{(x, x+1) \in \mathbb{R}^2 \mid x \leq -2\}$,
- $[-1, 0] \times \{0\} \subset \text{Int}(A_1)$,
- $h^3(P_2)$ is the triangle with vertices 0, (1, -1) and (1, 1),
- $h^2(P_2)$ is the triangle with vertices 0, (2, -3) and (2, 3),
- $h(P_2)$ is the triangle with vertices 0, (3, -7) and (3, 7),
- $h(A_2) \setminus \{\infty\} = \{(x, y) \in \mathbb{R}^2 \mid x \geq 0, |y| \leq 3x\}$

and moreover

- $h^{-1}(\{-1\} \times [-2, 2]) = \{-2\} \times [-1, 1]$ with $h^{-1}(-1, 0) = (-2, 0)$,
- $h^{-1}(\{1\} \times [-1, 1]) = \{2\} \times [-3, 3]$,
- $h^{-1}(\{2\} \times [-3, 3]) = \{3\} \times [-7, 7]$ with $h^{-1}(2, 0) = (3, 0)$.

Denote $x_1 = (-1, 0) \in \partial P_1$, $x_2 = (2, 0) \in \partial h^2(P_2)$ and $\delta = [-1, 0] \times \{0\}$. Because of the compactness of $h(\delta)$ there exists an Euclidean disc K with center the origin such that $h(\delta) \subset K$. There exist $k_1 < -1 < 2 < k_2$ such that the four points $M = (k_1, -k_1 + 1)$, $N = (k_1, k_1 - 1)$, $P = (k_2, -3k_2)$ and $Q = (k_2, 3k_2)$ all lie in $\mathbb{R}^2 \setminus K$. Then one can join M and Q by a segment $C_+ \subset \{(x, y) \in \mathbb{R}^2 \mid y > 0\}$ such that C_+ is disjoint from

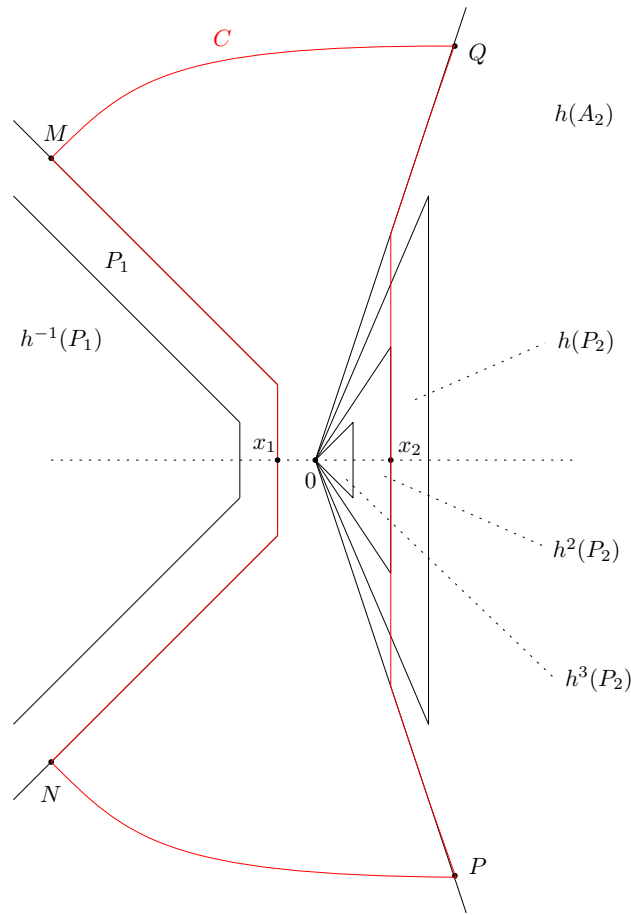
Figure 6.9 – The circle C in Subcase **3 – a**

$P_1 \cup K \cup h(A_2)$ except for the two endpoints M and Q . Similarly one can join N and P by a segment $C_- \subset \{(x, y) \in \mathbb{R}^2 \mid y < 0\}$ such that C_- is disjoint from $P_1 \cup K \cup h(A_2)$ except for its endpoints N and P . Consider now the segment $C_l \subset \partial P_1 \setminus \{\infty\}$ having M, N as endpoints and the segment

$$C_r = \{(x, -3x) \mid 2 \leq x \leq k_2\} \cup (\{2\} \times [-6, 6]) \cup \{(x, 3x) \mid 2 \leq x \leq k_2\} \subset h(A_2)$$

so that $C = C_l \cup C_- \cup C_r \cup C_+$ is a circle (Fig. 6.9) and easily $C \cap (h(\delta) \cup h^3(P_2)) = \emptyset$.

This allows to consider the Jordan domain D with frontier C which contains the connected set $h(\delta \cup h^2(P_2))$. We let again $C' = h^{-1}(C)$ and $D' = h^{-1}(D)$. One has $D' \not\subset D$ because $h^{-1}(x_2) \notin \text{Cl}(D)$. If $D \subset D'$ then $\text{Ind}(h, 0) = 1$. If $D \not\subset D'$ the method used in Subcase **1 – a** also works in the current situation: in the notation of Lemma 6.2, every segment $\text{Cl}(\beta_j) = [c_j, d_j]_{C'}$ is disjoint from the straight segment $[-1, 2] \times \{0\} \subset \delta \cup h^2(P_2)$ joining x_1 and x_2 which implies $[c_j, d_j]_{C'} \subset (x_2, x_1)_C$ or $[c_j, d_j]_{C'} \subset (x_1, x_2)_C$; moreover $\{h^{-1}(x_1), h^{-1}(x_2)\} \cap \text{Cl}(D) = \emptyset$ which allows to check that $\text{Ind}(H, C_j) = 0$ and finally $\text{Ind}(h, 0) = 1$.

Subcase 3 – b. A_1 is an attracting (\mathcal{F}, h) -croissant and A_2 is a repelling (\mathcal{F}, h) -croissant.

Replacing h with h^{-1} in Subcase **3 – a** one gets $\text{Ind}(h, 0) = -\text{Ind}(h^{-1}, 0) = -1$.

Subcase 3 – c. A_1 and A_2 are two attracting (\mathcal{F}, h) -croissants.

Consider an attracting (\mathcal{F}, h) -petal $P_1 \subset A_1$ at ∞ and an attracting (\mathcal{F}, h) -petal $P_2 \subset A_2$ at 0. In this case, one may assume that

- $\partial P_1 \setminus \{\infty\} = \{(x, -x+1) \in \mathbb{R}^2 \mid x \leq -1\} \cup (\{-1\} \times [-2, 2]) \cup \{(x, x-1) \in \mathbb{R}^2 \mid x \leq -1\}$,
- $\partial h(P_1) \setminus \{\infty\} = \{(x, -x-1) \in \mathbb{R}^2 \mid x \leq -2\} \cup (\{-2\} \times [-1, 1]) \cup \{(x, x+1) \in \mathbb{R}^2 \mid x \leq -2\}$,
- P_2 is the triangle with vertices $0, (2, -3)$ and $(2, 3)$,
- $h(P_2)$ is the triangle with vertices $0, (1, -1)$ and $(1, 1)$,
- $A_2 \setminus \{\infty\} = \{(x, y) \in \mathbb{R}^2 \mid x \geq 0, |y| \leq 2x\}$,
- $[-1, 0] \times \{0\} \subset \text{Int}(A_1)$

and moreover

- $h(\{-1\} \times [-2, 2]) = \{-2\} \times [-1, 1]$ with $h(-1, 0) = (-2, 0)$;
- $h(\{2\} \times [-3, 3]) = \{1\} \times [-1, 1]$ with $h(2, 0) = (1, 0)$.

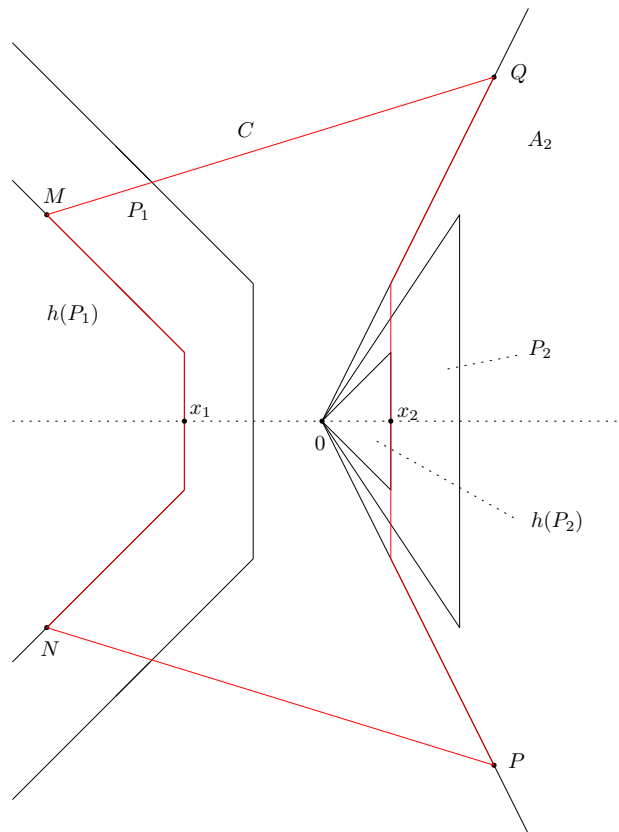

Figure 6.10 – The circle C in Subcase **3 – c**

Denote $x_1 = (-2, 0) \in \partial h(P_1)$, $x_2 = (1, 0) \in \partial h(P_2)$ and $\eta = [-1, 0] \times \{0\}$. Let K be an Euclidean disc with center 0 such that $h(\eta) \subset K$. Let us choose two integers $k_1 < -2 < 1 < k_2$ so large that the four points $M = (k_1, -k_1 - 1)$, $N = (k_1, k_1 + 1)$, $P = (k_2, -2k_2)$ and $Q = (k_2, 2k_2)$ all lie in $\mathbb{R}^2 \setminus K$. Then one can join M and Q by a

segment $C_+ \subset \{(x, y) \in \mathbb{R}^2 \mid y > 0\}$ such that C_+ is disjoint from $h(P_1) \cup K \cup h(A_2)$ except for the two endpoints M and Q . Similarly one can join N and P by a segment $C_- \subset \{(x, y) \in \mathbb{R}^2 \mid y < 0\}$ such that C_- is disjoint from $P_1 \cup K \cup h(A_2)$ except for its endpoints N and P . Consider now the segment $C_l \subset \partial h(P_1) \setminus \{\infty\}$ with endpoints M, N as well as

$$C_r = \{(x, -2x) \mid 1 \leq x \leq k_2\} \cup (\{1\} \times [-2, 2]) \cup \{(x, 2x) \mid 1 \leq x \leq k_2\} \subset A_2$$

so that $C = C_l \cup C_- \cup C_r \cup C_+$ is a circle disjoint from $h(\eta) \setminus \{x_1\}$ (Fig. 6.10). Let D be the Jordan domain with frontier C containing $h(\eta) \setminus \{x_1\}$ and let $C' = h^{-1}(C)$ and $D' = h^{-1}(D)$. Note that $D \not\subset D' \not\subset D$ so Lemma 6.2 applies and the computation of $\text{Ind}(h, 0)$ then continues essentially as for Subcase 1 – c. First there exists $j_0 \in J$ such that $h^{-1}(x_1) \in \{-1\} \times [-2, 2] \subset \beta_{j_0} = (c_{j_0}, d_{j_0})_{C'}$; since $(h(\eta) \cup h^2(P_2)) \cap C = \{x_1\}$, i.e., $(\eta \cup h(P_2)) \cap C' = \{h^{-1}(x_1)\}$, one gets $c_{j_0} \in (x_2, x_1)_C$ and $d_{j_0} \in (x_1, x_2)_C$ and consequently $\text{Ind}(H, C_{j_0}) = 1$. Secondly $(\eta \cup h(P_2)) \cap C' = \{h^{-1}(x_1)\}$ together with the fact that $h^{-1}(x_2) \notin \text{Cl}(D)$ implies $[h(d_j), h(c_j)]_C \cap [c_j, d_j]_C = \emptyset$ for every $j \in J \setminus \{j_0\}$ hence $\text{Ind}(H, C_j) = 0$. One obtains finally $\text{Ind}(h, 0) = 0$.

Subcase 3 – d. A_1 and A_2 are two repelling (\mathcal{F}, h) -croissants.

Replacing h with h^{-1} in the subcase 3 – c one has $\text{Ind}(h, 0) = -\text{Ind}(h^{-1}, 0) = 0$.

The ten columns of the following table (see Table 6.1) summarize the various kinds of minimal (\mathcal{F}, h) -croissants which one can have and they give in each case the value of the fixed point index of 0.

Number of minimal attracting (\mathcal{F}, h) -croissants with dynamical type $0 - \infty$	2	0	1	0	0	0	1	0	0	1
Number of minimal repelling (\mathcal{F}, h) -croissants with dynamical type $0 - \infty$	0	2	1	0	0	0	0	1	1	0
Number of minimal attracting (\mathcal{F}, h) -croissants with dynamical type $\infty - 0$	0	0	0	2	0	1	1	1	0	0
Number of minimal repelling (\mathcal{F}, h) -croissants with dynamical type $\infty - 0$	0	0	0	0	2	1	0	0	1	1
$\text{Ind}(h, 0)$	1	-1	0	-1	1	0	0	-1	0	1

Table 6.1 – The index $\text{Ind}(h, 0)$ according to the nature of A_1 and A_2

This proves the required formula and moreover one gets $\text{Ind}(h, 0) \in \{-1, 0, 1\}$ (as it is already known from [Bon02] in the general case where 0 is simply an isolated fixed point of h).

6.3 Link with Le Calvez equivariant foliations on the annulus

Recall that a fixed point free orientation preserving homeomorphism F of the plane \mathbb{R}^2 is said to be a *Brouwer homeomorphism*. Moreover a line L of \mathbb{R}^2 is named

a *Brouwer line* of F if it separates $F^{-1}(L)$ and $F(L)$ in \mathbb{R}^2 . One has the following powerful result due to Le Calvez.

Theorem 6.3 ([LC05]). *Let G be a discrete group of orientation preserving homeomorphisms of the plane acting freely and properly and let F be a Brouwer homeomorphism commuting with every element of G . Then there exists a topological oriented foliation of the plane, invariant under the action of G , whose leaves are Brouwer lines of F .*

We say that a foliation as in Theorem 6.3 is a *Le Calvez foliation* for F . Let us state the result to be proved in this section.

Proposition 6.9. *Define $f = h^2$ and $M = \mathbb{S}^2 \setminus \{0, \infty\} = \mathbb{R}^2 \setminus \{0\}$ and let $\tilde{\mathcal{F}}$ be the lift of \mathcal{F} to the universal cover \mathbb{R}^2 of M . If \mathcal{F} has no circle-leaf then there exists a lift $\tilde{f} : \mathbb{R}^2 \rightarrow \mathbb{R}^2$ of $f|_M : M \rightarrow M$ to \mathbb{R}^2 such that $\tilde{\mathcal{F}}$ is a Le Calvez foliation of \tilde{f} .*

Proof. We choose the map $\Pi : \mathbb{R}^2 \rightarrow M$ defined in complex notation by $\Pi(x, y) = e^{y+2i\pi x}$ as universal covering map of M . Thus the covering transformations group is $G = \{\tau^k\}_{k \in \mathbb{Z}}$ where $\tau(x, y) = (x + 1, y)$. We also consider the fundamental domain $D = [0, 1) \times \mathbb{R}$.

Note that every lift of $f|_M$ to \mathbb{R}^2 is a Brouwer homeomorphism because $f|_M$ does not have any fixed point and that $\tilde{\mathcal{F}}$ is an G -invariant oriented topological foliation by lines of \mathbb{R}^2 . For any oriented line l of \mathbb{R}^2 , one defines following [LC05] two half-planes $\mathcal{R}(l)$ and $\mathcal{L}(l)$ of \mathbb{R}^2 respectively on the right side and on the left side of l ¹. Precisely $\mathcal{R}(l) = \varphi^{-1}([0, +\infty) \times \mathbb{R})$ and $\mathcal{L}(l) = \varphi^{-1}((-\infty, 0] \times \mathbb{R})$ where φ is any orientation preserving homeomorphism of \mathbb{R}^2 mapping the oriented line l onto the vertical straight line $\{0\} \times \mathbb{R}$ oriented from bottom to top. In particular $\mathcal{R}(l) \cup \mathcal{L}(l) = \mathbb{R}^2$ and $\mathcal{R}(l) \cap \mathcal{L}(l) = l$. Observe that for every lift \tilde{f} of $f|_M$ to \mathbb{R}^2 one has $\tilde{f}(\mathcal{R}(l)) = \mathcal{R}(\tilde{f}(l))$ and $\tilde{f}(\mathcal{L}(l)) = \mathcal{L}(\tilde{f}(l))$ because \tilde{f} preserves the orientation. Moreover it is classical that $f|_M$ and the identity map Id_M are isotopic as homeomorphisms of M , which ensures that \tilde{f} commutes with the covering transformations $\tau^k \in G$.

Let A be a minimal attracting (\mathcal{F}, f) -croissant constructed in Section 6.1. We know from Proposition 6.3 that $\partial A \setminus \{0, \infty\} = \delta \sqcup \delta'$ where δ' (resp. δ) is a line-leaf oriented from 0 to ∞ (resp. from ∞ to 0) and that A lies locally on the right of these two leaves.

Remark that the property to be proved is invariant by conjugacy in the following sense. Let g be a homeomorphism of \mathbb{S}^2 having 0 and ∞ as fixed points and let \tilde{g} be a lift of $g|_M$ to \mathbb{R}^2 . One defines naturally the foliation $g(\mathcal{F})$ of M , image of \mathcal{F} by $g|_M$. Write $\widetilde{g(\mathcal{F})}$ for the lift of $g(\mathcal{F})$ to \mathbb{R}^2 . One has $\widetilde{g(\mathcal{F})} = \tilde{g}(\tilde{\mathcal{F}})$ because $g \circ \Pi = \Pi \circ \tilde{g}$

1. We use the letters $\mathcal{R}(l)$ and $\mathcal{L}(l)$ rather than $R(l)$ and $L(l)$ in order to avoid confusion with $R(\Phi)$ and $L(\Phi)$ as defined previously for a Brouwer manifold $\Phi \subset M$.

hence, given a lift \tilde{f} of $f|_M$, one obtains that $\tilde{\mathcal{F}}$ is a Le Calvez foliation for \tilde{f} iff $\widetilde{g(\mathcal{F})}$ is a Le Calvez foliation for $\tilde{g} \circ \tilde{f} \circ \tilde{g}^{-1}$, this last homeomorphism being of course a lift of $(g \circ f \circ g^{-1})|_M$.

Therefore, replacing f with $g \circ f \circ g^{-1}$ for some suitable homeomorphism g of \mathbb{S}^2 , one can assume without loss that $A = \{0, \infty\} \cup \Pi(\tilde{A})$ where $\tilde{A} = [0, \frac{1}{4}] \times \mathbb{R}$ (i.e., $A = \{\infty\} \cup [0, +\infty)^2$) and

$$f^{-1}(A) = \{0, \infty\} \cup \Pi\left(\left[-\frac{1}{16}, \frac{5}{16}\right] \times \mathbb{R}\right), \quad f(A) = \{0, \infty\} \cup \Pi\left(\left[\frac{1}{16}, \frac{3}{16}\right] \times \mathbb{R}\right).$$

We denote $\tilde{\delta} = \{0\} \times \mathbb{R}$ and $\tilde{\delta}' = \{\frac{1}{4}\} \times \mathbb{R}$ which are two leaves of $\tilde{\mathcal{F}}$ oriented respectively from top to bottom and from bottom to top satisfying $\delta = \Pi(\tilde{\delta}) = [0, +\infty) \times \{0\}$ and $\delta' = \Pi(\tilde{\delta}') = \{0\} \times [0, +\infty)$. Since f preserves the orientation one has moreover

$$f^{-1}(\delta) = \Pi\left(\left\{-\frac{1}{16}\right\} \times \mathbb{R}\right), \quad f^{-1}(\delta') = \Pi\left(\left\{\frac{5}{16}\right\} \times \mathbb{R}\right),$$

$$f(\delta) = \Pi\left(\left\{\frac{1}{16}\right\} \times \mathbb{R}\right), \quad f(\delta') = \Pi\left(\left\{\frac{3}{16}\right\} \times \mathbb{R}\right).$$

Since $f(A) \subset \text{Int}(A)$ there exists a (unique) lift \tilde{f} of $f|_M$ such that $\tilde{f}(\tilde{A}) \subset \text{Int}(\tilde{A})$ and we shall prove that $\tilde{\mathcal{F}}$ is a Le Calvez foliation for \tilde{f} . Since Π is a one-to-one map when restricted to $[-\frac{1}{16}, \frac{1}{16}] \times \mathbb{R}$ one gets $\tilde{f}(\{-\frac{1}{16}\} \times \mathbb{R}) = \tilde{\delta}$ and $\tilde{f}(\tilde{\delta}) = \{-\frac{1}{16}\} \times \mathbb{R}$ which shows that $\tilde{\delta}$ is a Brouwer line of \tilde{f} . One checks similarly that $\tilde{\delta}'$ is a Brouwer line of \tilde{f} with $\tilde{f}(\{\frac{5}{16}\} \times \mathbb{R}) = \tilde{\delta}'$ and $\tilde{f}(\tilde{\delta}') = \{\frac{3}{16}\} \times \mathbb{R}$. Consider now a leaf $\tilde{\phi}$ of $\tilde{\mathcal{F}}$ which projects onto a leaf $\phi = \Pi(\tilde{\phi})$ of \mathcal{F} which is different from δ and δ' . Since $\tilde{\mathcal{F}}$ is G -invariant and since \tilde{f} commutes with the elements of G , one can assume $\tilde{\phi} \subset D \setminus \tilde{\delta}$. Let Φ be a Brouwer manifold in \mathcal{P} having ϕ as a connected component. The foliation \mathcal{F} has no circle-leaf hence Φ has type 2 or 3 ($\Phi = \phi$ in the first case). The description of $R(\Phi)$ and $L(\Phi)$ given in the proof of Proposition 3.1 provides two strips $S_- \subset M$ and $S_+ \subset M$ as follows:

- $\partial_M S_+ = \phi \sqcup f(\phi)$ and $\text{Int}(S_+) \subset \text{Int}(R(\Phi))$,
- $\partial_M S_- = \phi \sqcup f^{-1}(\phi)$ and $\text{Int}(S_-) \subset \text{Int}(L(\Phi))$.

The key observation is that one of the two strips S_{\pm} is disjoint from $\delta \cup \delta' = \partial A \setminus \{0, \infty\}$. This certainly holds if $\text{Cl}(\Phi) \setminus \Phi$ contains a single point $a \in \{0, \infty\}$ (in particular if $\Phi = \phi$ is a Brouwer manifold of type 2) because one of the two discs bounded by $\phi \cup \{a\}$ is disjoint from $\delta \cup \delta'$ and contains either S_- or S_+ . If $\text{Cl}(\Phi) \setminus \Phi = \{0, \infty\}$ then Φ has type 3 has we write ϕ' for the connected component of Φ other than ϕ . Recall that $\text{Int}(A)$ does not contain any line-leaf (Corollary 6.1) hence $\phi \cap A = \emptyset$ and $\phi' \cap \text{Int}(A) = \emptyset$. Therefore there are three situations to consider (see Fig. 6.11 and 6.12).

a) $\phi' \notin \{\delta, \delta'\}$. Then one of the two sets $R(\Phi)$ or $L(\Phi)$ is disjoint from A and the assertion follows.

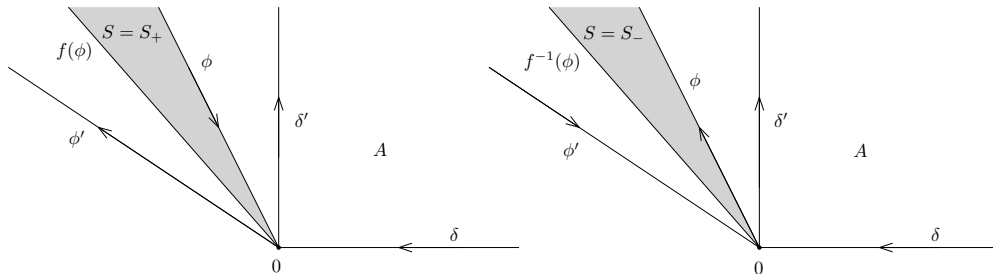

Figure 6.11 – The two possibilities for the situation **a)**

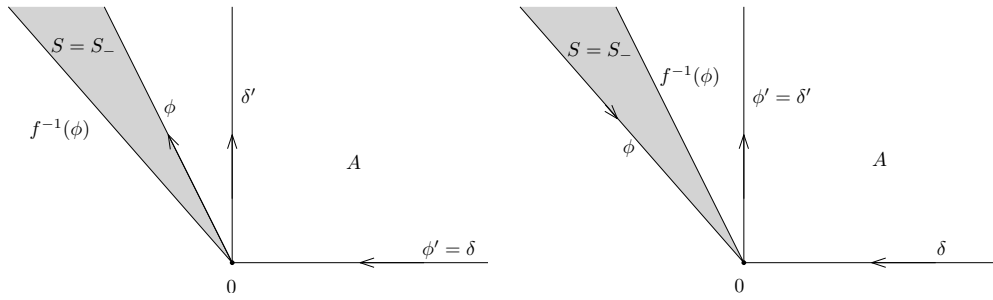

Figure 6.12 – The situations **b)** and **c)**

b) $\phi' = \delta$. Then $L(\Phi) \cap A = \phi'$ and the assertion holds true with S_- .

c) $\phi' = \delta'$. Then again $L(\Phi) \cap A = \phi'$ and the assertion holds true with S_- .

For convenience we write S for the strip among S_{\pm} with the required properties and we let $\varepsilon = -1$ (resp. $\varepsilon = 1$) if $S = S_-$ (resp. if $S = S_+$). There is a unique connected component \tilde{S} of $\Pi^{-1}(S)$ contained in the fundamental domain D and $\Pi|_{\tilde{S}} : \tilde{S} \rightarrow S$ is a homeomorphism, so that $\partial_{\mathbb{R}^2} \tilde{S} = \tilde{\phi} \cup \tilde{\psi}$ where $\tilde{\psi}$ is a connected component of $\Pi^{-1}(f^\varepsilon(\phi))$. One has actually either $\tilde{S} \subset (0, \frac{1}{4}) \times \mathbb{R}$ or $\tilde{S} \subset (\frac{1}{4}, 1) \times \mathbb{R}$ because $S \cap (\delta \cup \delta') = \emptyset$. In the first case one gets $\tilde{S} \cup f^\varepsilon(\tilde{S}) \subset [-\frac{1}{16}, \frac{5}{16}] \times \mathbb{R}$ and in the latter case $\tilde{S} \cup f^\varepsilon(\tilde{S}) \subset [\frac{3}{16}, \frac{17}{16}] \times \mathbb{R}$. The fact that Π is a one-to-one map on these two vertical strips implies that $\tilde{f}^\varepsilon(\tilde{\phi}) = \tilde{\psi}$ in both cases. Since the covering map Π is an orientation reversing local homeomorphism (its Jacobian determinant is $-2\pi e^{2y} < 0$) it follows that if $\varepsilon = 1$ (resp if $\varepsilon = -1$) then $\tilde{S} \subset \mathcal{R}(\tilde{\phi}) \cap \mathcal{L}(\tilde{f}^\varepsilon(\tilde{\phi}))$ (resp. $\tilde{S} \subset \mathcal{L}(\tilde{\phi}) \cap \mathcal{R}(\tilde{f}^\varepsilon(\tilde{\phi}))$). Using the fact that $\mathcal{L}(\tilde{f}^\varepsilon(\tilde{\phi})) = \tilde{f}^\varepsilon(\mathcal{L}(\tilde{\phi}))$ and $\mathcal{R}(\tilde{f}^\varepsilon(\tilde{\phi})) = \tilde{f}^\varepsilon(\mathcal{R}(\tilde{\phi}))$ one deduces that anyway $\tilde{f}(\mathcal{L}(\tilde{\phi})) \subset \text{Int}(\mathcal{L}(\tilde{\phi}))$ and $\tilde{f}^{-1}(\mathcal{R}(\tilde{\phi})) \subset \text{Int}(\mathcal{R}(\tilde{\phi}))$ which proves that $\tilde{\phi}$ is a Brouwer manifold of \tilde{f} . \square

6.4 Proof of Theorem 6.2

- Consider first the case where \mathcal{F} has at least one circle-leaf ϕ . Let D be the disc containing 0 and bounded by ϕ . Then one has either $h(D) \subset \text{Int}(D)$ or $h^{-1}(D) \subset \text{Int}(D)$. In the first (resp. second) case one deduces easily $\text{Ind}(h^{2k-1}, 0) = 1$ (resp. $\text{Ind}(h^{2k-1}, 0) = -1$) for every integer $k \geq 1$ and in both cases $\text{Ind}(h^{2k}, 0) = 1$ for every $k \geq 1$.

- Suppose now that \mathcal{F} has no circle-leaf. Let again $f = h^2$ and $M = \mathbb{S}^2 \setminus \{0, \infty\} = \mathbb{R}^2 \setminus \{0\}$ and consider the lift \tilde{f} of $f|_M$ provided by Proposition 6.9. Fix an integer $k \geq 1$ and for convenience define $g = f^k = h^{2k}$. Of course \tilde{f}^k is a lift of $g|_M$ and $\tilde{\mathcal{F}}$ is also a Le Calvez foliation for \tilde{f}^k because a Brouwer line of \tilde{f} is a Brouwer line of \tilde{f}^k . According to a remark of Le Calvez (see [LC05, page 4]), this implies that for every point $\tilde{z} \in \mathbb{R}^2$ one can choose an oriented arc $\tilde{\gamma}_{\tilde{z}} \subset \mathbb{R}^2$ from \tilde{z} to $\tilde{f}^k(\tilde{z})$ which is negatively² transverse to $\tilde{\mathcal{F}}$. As it is well known, there exists an isotopy $I = (g_t)_{t \in [0,1]}$ on M from $g_0 = \text{Id}_M$ to $g_1 = g|_M$ which is lifted by an isotopy $\tilde{I} = (\tilde{g}_t)_{t \in [0,1]}$ on \mathbb{R}^2 from $\tilde{g}_0 = \text{Id}_{\mathbb{R}^2}$ to $\tilde{g}_1 = \tilde{f}^k$. Indeed choose any isotopy $J = (\varphi_t)_{t \in [0,1]}$ on M from $\varphi_0 = \text{Id}_M$ to $\varphi_1 = g|_M$ and consider a lift $\tilde{J} = (\tilde{\varphi}_t)_{t \in [0,1]}$ of J from $\tilde{\varphi}_0 = \text{Id}_{\mathbb{R}^2}$. Then \tilde{f}^k and $\tilde{\varphi}_1$ are two lifts of $g|_M$ hence, keeping the notation $G = \{\tau^k\}_{k \in \mathbb{Z}}$ as in the proof of Proposition 6.9, one has $\tilde{f}^k = \tau^m \circ \tilde{\varphi}_1$ for some $m \in \mathbb{Z}$. One obtains an isotopy I as expected by letting $g_t = r_t^m \circ \varphi_t$ where r_t is the rotation with center 0 and angle $2\pi t$.

Projecting down the above arcs $\tilde{\gamma}_{\tilde{z}}$ on M , one obtains that the foliation \mathcal{F} is dynamically transverse to the isotopy I , which means that for every $z \in M$ the trajectory $I(z) = \{g_t(z)\}_{t \in [0,1]}$ is homotopic (relative to the endpoints) to an oriented arc $\gamma_z \subset M$ from z to $g(z)$ which is negatively transverse to \mathcal{F} . Then one has the following result which is contained in [LC08].

Proposition 6.10. *In the above notation, one has $\text{Ind}(g, 0) = \text{Ind}(\mathcal{F}, 0)$ where $\text{Ind}(\mathcal{F}, 0)$ is the Poincaré-Hopf index of the foliation \mathcal{F} at the singularity 0.*

More precisely this proposition follows from the proof of [LC08, Proposition 3.5]. Indeed, recall that our foliation \mathcal{F} possesses a line-leaf δ oriented from 0 to ∞ and also a line-leaf δ' oriented from ∞ to 0 hence there is no circle transverse to \mathcal{F} . Thus the arguments in the proof of [LC08, Proposition 3.5] always apply with our assumptions and give $\text{Ind}(g, 0) = \text{Ind}(\mathcal{F}, 0)$ (even if $\text{Ind}(\mathcal{F}, 0) = 1$). Alternatively, Proposition 6.10 may also be obtained from the proof of [LR13, Proposition 4.2.2] which gives $\text{Ind}(g, 0) = \text{Ind}(I, 0) = \text{Ind}(\mathcal{F}, 0)$ where $\text{Ind}(I, 0)$ is the index of the isotopy I as defined in [LR13].

In particular Proposition 6.10 shows that $\text{Ind}(h^{2k}, 0)$ does not depend on the integer $k \geq 1$.

It remains to study the case of the odd iterates h^{2k-1} . Define now $g = h^{2k-1}$ where k is a given positive integer. Remark that a Brouwer manifold of h is also a Brouwer manifold of g hence the notions of \mathcal{F} -petal and \mathcal{F} -croissant introduced for h also make sense for g and all the results in Section 6.1 still hold with g instead of h . For every $i \in \{1, 2\}$, a (\mathcal{F}, h^i) -petal (resp. a (\mathcal{F}, h^i) -croissant) is also a (\mathcal{F}, g^i) -petal (resp. a (\mathcal{F}, g^i) -croissant) with the same attracting or repelling nature for both h^i and g^i .

2. This is a minor difference with [LC05] where the author deals with arcs which are positively transverse to the foliation. It is due to our choice of the covering map Π which locally reverses the orientation so that \tilde{f} maps any leaf $\tilde{\phi}$ of $\tilde{\mathcal{F}}$ “on its left side”, that means in $\text{Int}(\mathcal{L}(\tilde{\phi}))$.

It follows furthermore from Corollary 6.1 that a minimal (\mathcal{F}, h^i) -croissant is also a minimal (\mathcal{F}, g^i) -croissant.

Let A_1, A_2 be the two minimal (\mathcal{F}, h) -croissants of the family \mathcal{A} constructed in Paragraph 6.1. According to the previous remarks, A_1 and A_2 are also two minimal (\mathcal{F}, g) -croissants with the same attracting or repelling feature and the same dynamical type $0 - \infty$ or $\infty - 0$ for h and g . Then the same calculation as in Section 6.2 applies for g instead of h and one concludes that $\text{Ind}(h^{2k-1}, 0)$ does not depend on k .

Bibliography

- [Bon02] Marc Bonino. Lefschetz index for orientation reversing planar homeomorphisms. *Proc. Amer. Math. Soc.*, 130(7):2173–2177 (electronic), 2002.
- [Bon04] Marc Bonino. A Brouwer-like theorem for orientation reversing homeomorphisms of the sphere. *Fund. Math.*, 182(1):1–40, 2004.
- [Bro12] L. E. J. Brouwer. Beweis des ebenen Translationssatzes. *Math. Ann.*, 72(1):37–54, 1912.
- [Cat00] F. S. Cater. On order topologies and the real line. *Real Anal. Exchange*, 25(2):771–779, 1999/00.
- [dK] K. de Kerékjártó. *Topology (I)*. Springer, Berlin, 1923.
- [Eps81] D. B. A. Epstein. Pointwise periodic homeomorphisms. *Proc. London Math. Soc. (3)*, 42(3):415–460, 1981.
- [GNP03] Grzegorz Graff and Piotr Nowak-Przygodzki. Fixed point indices of iterations of planar homeomorphisms. *Topol. Methods Nonlinear Anal.*, 22(1):159–166, 2003.
- [Gui94] Lucien Guillou. Théorème de translation plane de Brouwer et généralisations du théorème de Poincaré-Birkhoff. *Topology*, 33(2):331–351, 1994.
- [Kur68] K. Kuratowski. *Topology. Vol. II*. New edition, revised and augmented. Translated from the French by A. Kirkor. Academic Press, New York-London; Państwowe Wydawnictwo Naukowe Polish Scientific Publishers, Warsaw, 1968.
- [LC04] Patrice Le Calvez. Une version feuilletée du théorème de translation de Brouwer. *Comment. Math. Helv.*, 79(2):229–259, 2004.
- [LC05] Patrice Le Calvez. Une version feuilletée équivariante du théorème de translation de Brouwer. *Publ. Math. Inst. Hautes Études Sci.*, (102):1–98, 2005.
- [LC06a] Patrice Le Calvez. Identity isotopies on surfaces. In *Dynamique des difféomorphismes conservatifs des surfaces: un point de vue topologique*, volume 21 of *Panor. Synthèses*, pages 105–143. Soc. Math. France, Paris, 2006.

- [LC06b] Patrice Le Calvez. Periodic orbits of Hamiltonian homeomorphisms of surfaces. *Duke Math. J.*, 133(1):125–184, 2006.
- [LC08] Patrice Le Calvez. Pourquoi les points périodiques des homéomorphismes du plan tournent-ils autour de certains points fixes? *Ann. Sci. Éc. Norm. Supér. (4)*, 41(1):141–176, 2008.
- [LCS96] Patrice Le Calvez and Alain Sauzet. Une démonstration dynamique du théorème de translation de Brouwer. *Exposition. Math.*, 14(3):277–287, 1996.
- [LCY97] Patrice Le Calvez and Jean-Christophe Yoccoz. Un théorème d’indice pour les homéomorphismes du plan au voisinage d’un point fixe. *Ann. of Math. (2)*, 146(2):241–293, 1997.
- [LR04] Frédéric Le Roux. Homéomorphismes de surfaces: théorèmes de la fleur de Leau-Fatou et de la variété stable. *Astérisque*, (292):vi+210, 2004.
- [LR13] Frédéric Le Roux. L’ensemble de rotation autour d’un point fixe. *Astérisque*, (350):x+109, 2013.
- [Moo25] R. L. Moore. Concerning upper semi-continuous collections of continua. *Trans. Amer. Math. Soc.*, 27(4):416–428, 1925.
- [New61] M. H. A. Newman. *Elements of the topology of plane sets of points*. Second edition, reprinted. Cambridge University Press, New York, 1961.
- [PdM82] Jacob Palis, Jr. and Welington de Melo. *Geometric theory of dynamical systems*. Springer-Verlag, New York-Berlin, 1982. An introduction, Translated from the Portuguese by A. K. Manning.
- [RdPS10] Francisco R. Ruiz del Portal and José M. Salazar. A Poincaré formula for the fixed point indices of the iterates of arbitrary planar homeomorphisms. *Fixed Point Theory Appl.*, pages Art. ID 323069, 31, 2010.
- [Sau01] Alain Sauzet. Application des décompositions libres à l’étude des homéomorphismes de surfaces. *Ph.D. Thesis, Université Paris 13*, 2001.