



HAL
open science

Modulation of sensory processing by direct descending projections from the somatosensory cortex to the spinal dorsal horn

Noémie Frezel

► **To cite this version:**

Noémie Frezel. Modulation of sensory processing by direct descending projections from the somatosensory cortex to the spinal dorsal horn. Neuroscience. Université Paris sciences et lettres; Universität Zürich, 2019. English. NNT : 2019PSLEE018 . tel-02528239

HAL Id: tel-02528239

<https://theses.hal.science/tel-02528239v1>

Submitted on 1 Apr 2020

HAL is a multi-disciplinary open access archive for the deposit and dissemination of scientific research documents, whether they are published or not. The documents may come from teaching and research institutions in France or abroad, or from public or private research centers.

L'archive ouverte pluridisciplinaire **HAL**, est destinée au dépôt et à la diffusion de documents scientifiques de niveau recherche, publiés ou non, émanant des établissements d'enseignement et de recherche français ou étrangers, des laboratoires publics ou privés.



THÈSE DE DOCTORAT
DE L'UNIVERSITÉ PSL

Préparée à l'Ecole Normale Supérieure (IBENS)
Dans le cadre d'une cotutelle avec University of Zürich

**Modulation du traitement sensoriel par des projections descendantes
directes du cortex somatosensoriel vers la moelle épinière**

**Modulation of sensory processing by direct descending projections
from the somatosensory cortex to the spinal dorsal horn**

Soutenue par
Noémie FREZEL
Le 27.09.2019

Ecole doctorale n° 158
Cerveau, cognition, comportement

Spécialité
Neurosciences



Composition du jury :

Présidente du Jury : Esther, STOECKLI, Prof.

Gilles FORTIN, Prof.
Neurosciences Paris-Saclay Institute, France
Rapporteur

Alessandra PIERANI, Prof.
Institut de Psychiatrie et de Neurosciences de Paris et
Institut Imagine, France
Rapporteur

Esther STOECKLI, Prof.
Institute of Molecular Life Sciences, University of Zurich,
Switzerland
Examineur

Camilla BELLONE, Prof.
Neurosciences fondamentales, University of Geneva,
Switzerland
Examineur

Christian, SPECHT, PhD
IBENS, Ecole normale supérieure, France
Directeur de thèse

Hanns Ulrich ZEILHOFER Prof.
Institute of Pharmacology and Toxicology, University of
Zurich, Switzerland
Directeur de thèse

Dissertation

zur

**Erlangung der naturwissenschaftlichen Doktorwürde
(Dr. sc. nat.)**

vorgelegt der

Mathematisch-naturwissenschaftlichen Fakultät

der

Universität Zürich

von

Noémie Frezel

aus

Frankreich

Promotionskommission

Prof. Dr. Esther Stoeckli (Vorsitz)

Prof. Dr. Hanns U. Zeilhofer

Dr. Christian Specht

Prof. Dr. Alessandra Pierani

Prof. Dr. Gilles Fortin

Prof. Dr. Camilla Bellone

Zürich, 2019

TABLE OF CONTENTS

I. Summary	8
II. Resumé.....	9
III. List of Abbreviations.....	10
1 Introduction	11
1.1 The somatosensory and pain circuits.....	12
1.1.1 Primary sensory neurons	12
1.1.2 Laminar organization of the spinal cord.....	14
1.1.3 Projection neurons and ascending pathways	14
1.1.4 Spinal cord interneurons.....	15
1.1.4.1 The gate control theory of pain	15
1.1.4.2 Heterogeneity of spinal cord interneurons: from marker genes to functional cell types	16
1.1.4.3 The mechanosensory dorsal horn	17
1.1.4.4 c-maf expressing spinal interneurons	17
1.1.5 Pathways descending from the brain to the spinal cord	18
1.1.5.1 Descending control of pain by the brainstem	18
1.1.5.2 The cortex and the corticospinal tract.....	18
1.2 Methods to study specific neuron populations and their role in sensory processing.....	22
1.2.1 Mouse lines and genetically defined neuronal populations.....	22
1.2.2 Site-specific and recombinase-based gene expression in mice	22
1.2.3 Adeno-associated viruses	23
1.2.4 Rabies virus for retrograde monosynaptic tracing.....	24
1.2.5 Anterograde trans-synaptic tracing.....	25
1.2.6 Manipulation of neuronal function and behavioral assessment of mice.....	26
1.2.6.1 Manipulation of neuronal function using DREADDs	26
1.2.6.2 Behavioral assessment of sensory processing in mice	26
1.3 References	28
1.4 Aims of the thesis	35
2 RESULTS CHAPTER 1:	36
Characterization of direct descending projections from the somatosensory cortex to the spinal dorsal horn.....	36
2.1 Abstract	36
2.2 Introduction	37
2.3 Methods.....	37
2.3.1 Animals	37
2.3.2 Immunohistochemistry (IHC) and image analysis	38
2.3.3 Intraspinal and cortical virus injections.....	38

2.3.4	Tissue clearing and light sheet imaging	38
2.3.5	Prism implantation and miniscope mounting	39
2.3.6	Behavioral responses to nociceptive stimulation.....	39
2.3.7	Processing of Ca ²⁺ imaging videos.....	40
2.3.8	Experimental design and statistical analysis	40
2.4	Results	42
2.4.1	Labeling of S1-CST neurons by using rAAVs in wild type mice	42
2.4.2	Labeling S1-CST neurons in CCK ^{cre} mice	43
2.4.3	Viral targeting strategies to label S1-CST neurons.	45
2.4.4	Morphology of S1-CST neurons	46
2.4.5	S1-CST neurons receive input from the somatosensory circuit	47
2.4.6	S1-CST neurons make direct synaptic contacts onto spinal interneurons.	48
2.4.6.1	Labeling of CST axons in the spinal cord	48
2.4.6.2	Anterograde transsynaptic tracing with WGA	49
2.4.6.3	Monosynaptic contacts from CST terminals onto spinal interneurons.....	49
2.4.7	Investigation of S1-CST neurons role in sensory processing.....	52
2.4.7.1	Manipulation CST neurons.....	52
2.4.7.2	Recording of S1-CST neurons activity in freely moving mice	54
2.5	Discussion	55
2.6	References	59
3	RESULTS CHAPTER 2:	63
	Characterization of spinal c-maf expressing interneurons	63
3.1	Abstract	63
3.2	Introduction	64
3.3	Methods.....	65
3.3.1	Animals	65
3.3.2	Intraspinal and cortical virus injections.....	65
3.3.3	Immunohistochemistry and image analysis.....	65
3.3.4	In situ hybridization (ISH).....	65
3.3.5	Behavioral analyses	66
3.3.6	Experimental design and statistical analysis	66
3.4	Results	68
3.4.1	Characterization of spinal c-maf ⁺ interneurons	68
3.4.2	Characterization c-maf ^{FN} and c-maf ^{EX} mouse lines.....	69
3.5	Connectivity of c-maf neurons	73
3.5.1	c-maf neurons receive input from primary afferents and the somatosensory cortex.....	73
3.5.2	Output pathways of c-maf neurons in the dorsal spinal cord	74

3.6	Investigation of c-maf neurons role in sensory processing	78
3.6.1	Pharmacogenetic activation of c-maf ^{fEX} neurons.....	78
3.6.2	Manipulation of c-maf ^{fN} neurons.....	78
3.6.2.1	Pharmacogenetic silencing of c-maf ^{fN} neurons in naive mice	78
3.6.2.2	Pharmacogenetic activation of c-maf ^{fN} neurons in naive and neuropathic mice	80
3.7	Discussion	82
3.8	References	85
4	General discussion.....	88
	References	90
5	Acknowledgments.....	93
6	Annexe	94
7	Curriculum vitae.....	95

I. Summary

Noxious stimuli are sensed by specialized sensory neurons of the peripheral nervous system called nociceptors. The nociceptive information is then processed in the spinal cord dorsal horn, which contains local interneurons and projection neurons that send axons to the brain. Supraspinal areas in turn project downwards to the spinal cord where they contribute to the gating of nociceptive signals. Exaggerated and abnormal pain sensitivity is accompanied by alterations in spinal processing and descending pain control systems. The connection between the somatosensory cortex in particular and the spinal cord is conserved in mammals, but very little is known about its role in modulating spinal sensory processing. A major challenge of studying neuronal circuits is to specifically label and target defined groups or subgroups of neurons. Classical approaches include targeting of genetically defined neuronal populations based on the expression of a marker gene. However, this is not always sufficient to define functionally distinct groups of neurons. Here, we describe and used genetic and viral targeting strategies based on the connectivity pattern of the neurons as well as the expression of one or two marker genes. In particular, we used a combination of transgenic mouse lines and intraspinal and cortical injections of recombinant viral vectors to identify and target specific neurons in the cortex and lumbar spinal cord. We identified a population of pyramidal neurons in the somatosensory cortex that project directly to the spinal dorsal horn (S1-CST neurons). These neurons make direct contacts onto c-maf expressing interneurons in the deep dorsal horn which also receive direct inputs from low threshold mechanosensory primary afferents. Additionally, pharmacogenetic manipulation of c-maf neurons led to altered processing of mechanical stimuli.

These results identify two elements of a circuit that integrates descending inputs from the cortex with peripheral sensory signals and contributes to the modulation of somatosensory perception.

II. Résumé

Les stimuli nociceptifs sont détectés par des neurones sensoriels spécialisés du système nerveux périphérique appelés nocicepteurs. L'information nociceptive est ensuite traitée dans la corne dorsale de la moelle épinière, qui contient des interneurons locaux et des neurones de projection qui envoient des axones vers le cerveau. Les aires supra-spinales projettent à leur tour vers la moelle épinière, où elles contribuent à la synchronisation des signaux nociceptifs. Une sensibilité à la douleur exagérée et anormale s'accompagne d'altérations du traitement de l'information dans la moelle épinière dans les systèmes de contrôle descendants de la douleur. La connexion entre le cortex somatosensoriel en particulier et la moelle épinière est conservée chez les mammifères, mais très peu de choses sont connues sur son rôle dans la modulation du traitement sensoriel dans la moelle épinière.

Un défi majeur dans l'étude des circuits neuronaux est de marquer et de cibler spécifiquement des groupes ou sous-groupes définis de neurones. Les approches classiques incluent le ciblage de populations neuronales définies génétiquement, i.e. sur la base de l'expression d'un gène marqueur. Cependant, cela ne suffit pas toujours pour définir des groupes de neurones fonctionnellement distincts. Ici, nous décrivons et utilisons des stratégies de marquage génétiques et virales basées sur la connectivité des neurones ainsi que sur l'expression d'un ou de deux gènes marqueurs. En particulier, nous avons utilisé une combinaison de lignées de souris transgéniques et d'injections intra-spinales et corticales de vecteurs viraux recombinants pour identifier et cibler des neurones spécifiques du cortex et de la moelle épinière lombaire.

Nous avons identifié une population de neurones pyramidaux dans le cortex somatosensoriel qui projettent directement dans la corne dorsale (neurones S1-CST). Ces neurones établissent un contact direct avec les interneurons exprimant c-maf dans la corne dorsale profonde, qui reçoivent également des contacts directs d'afférents primaires mécano-sensoriels à bas seuil. De plus, la manipulation pharmacogénétique des neurones c-maf a entraîné des modifications dans le traitement des stimulations sensorielles mécaniques.

Ces résultats identifient deux éléments d'un circuit qui intègre les informations descendantes du cortex avec des signaux sensoriels périphériques et contribue à la modulation de la perception somatosensorielle.

III. List of Abbreviations

AAV: adeno-associated virus (rAAV: Recombinant AAV)
CCK: cholecystokinin
CNO: clozapine-N-oxide
CNS: central nervous system
CST: corticospinal tract
DREADDs: designer receptor exclusively activated by designer drugs
GCT: gate control theory
GFP: green fluorescent protein (eGFP: enhanced GFP)
HSV: herpes simplex virus
i. p.: intra-peritoneal
LTMR: low-threshold mechanoreceptors
NPY: neuropeptide Y
PKC γ : protein kinase C, γ
PV: parvalbumin
RVM: rostral ventromedial medulla
PAG: periaqueductal grey
PN: projection neurons
S1: primary somatosensory cortex, S1hl: hindlimb area of S1
S1-CST: corticospinal tract originating in S1
SOM: somatostatin
VPL: ventral posterolateral nucleus of the thalamus
WGA: wheat germ agglutinin
WGA-HRP: horseradish peroxidase coupled to WGA

1 Introduction

The International Association for the Study of Pain (IASP) defines pain as “An unpleasant sensory and emotional experience associated with actual or potential tissue damage, or described in terms of such damage”¹. This highlights the very complicated nature of pain: it is a complex and subjective interpretation of nociceptive input, and is therefore highly influenced by past experience, memories, emotions or other cognitive states, as well as by the context.

The ability of an organism to feel acute pain is essential to its survival as it leads to protective behaviors and avoidance of situations that could result in tissue damage and potentially severe or fatal injuries. This is evident from human patients who suffer from a congenital insensitivity to pain due to a mutation in the Nav1.7 sodium channel gene SCN9A². These patients do not feel pain or discomfort upon burn injuries or bone fractures and often die very young of unnoticed and unattended injuries.

Chronic pain is a major cause of disability worldwide, as it affects about 20% of the world’s population³. Unlike acute pain, chronic pain manifests in different symptoms such as spontaneous pain, allodynia and hyperalgesia^{4,5}. Mechanical allodynia is a painful sensation elicited by normally innocuous stimuli such as light touch^{1,5}. It is distinct from hyperalgesia, which is defined as an enhanced sensitivity to normally painful stimuli¹. Whereas hyperalgesia can be protective and part of the physiological healing process after injury, allodynia or other forms of persistent pain do not serve any biological function.

Chronic pain conditions can originate from a variety of causes. One of the most common causes of pain is musculoskeletal pain. It is most often acute (following falls, bones fractures, sprains, joint dislocations, etc.) but can also persist long after an acute injury (back or neck pain and sciatica are very common forms) or be associated with chronic inflammatory conditions (such as rheumatoid arthritis). Other origins of chronic pain include unresolved injuries, cancer, various diseases such as type II diabetes, multiple sclerosis, fibromyalgia, post herpetic neuralgia, but also some medications (such as drugs used for the treatment of cancer), and genetic causes.

Additionally, chronic pain is very often associated with the development of other pathologies including anxiety and depression, and is therefore a very heavy burden for both the affected patients and for society. To this day, several treatment strategies exist to manage acute and chronic pain⁶, including paracetamol (mostly used for mild to moderate pain), non-steroidal anti-inflammatory drugs (NSAIDs, used to reduce inflammation but should only be used for short periods of time), opioids, gabapentinoids or repurposed antidepressants at low doses. Several of these medications however suffer from severe limitations, including huge variability in the patients’ responses to treatments and numerous unwanted side effects. The latter is particularly true for opioid-based treatments. Opioids are widely used drugs for the treatment of chronic pain but their use for chronic non-malignant pain is more and more controversial because of limited evidence supporting their efficacy for long-term treatment of chronic pain and numerous side effects⁷. Severe side effects of opioids are tolerance, addiction, opioid-induced hyperalgesia, bowel dysfunction, suppression of testosterone, cognitive impairment and substance abuse that can lead to addiction or use of other addictive substances. Management of chronic pain therefore remains a serious healthcare problem worldwide.

Understanding the cells and circuits that generate acute or chronic pain is essential to understand the mechanisms and changes that lead to pathological pain. Very briefly, touch and noxious stimuli are sensed in the periphery by specialized primary sensory afferents nerve fibers. Tactile afferents and nociceptors convey the information to the spinal and medullary dorsal horns. At these sites, the

information is processed by a local neuronal network and a relatively low number of projection neurons that send their axons to the brain^{4,8-10}.

The processing of pain in the brain is very complex and dependent on many factors including emotions, memories, cognitive states or mood and health status. The brain areas activated during pain experience, usually referred as the “pain matrix”, are not a static and easily defined anatomical entity, rather they are highly modulated and interacting with each other to form the subjective experience of pain perception¹¹. Additionally, supraspinal structures in the brain send axons to the spinal cord, where their signals are integrated with information from the periphery to control gating of somatosensory input^{4,10}(Fig.1A). In many pathologies this processing can be altered, contributing to hyperalgesia and allodynia.

Previous and ongoing studies in the Zeilhofer laboratory have demonstrated the role of several populations of spinal interneurons^{10,12-15} in the processing of pain (and also itch). These advances have been made possible through development of technological tools to study the pain circuits¹⁶⁻¹⁸ such as the development of genetically modified mouse lines for use in optogenetic and chemogenetic experiments, surgical procedures¹⁸, viral tools^{17,19,20} and imaging procedures.

Below, I describe the general anatomy and cellular structure of the somatosensory and pain circuits. I will focus in particular on the role of the deep spinal dorsal horn in the processing of touch signals and the origins of mechanical allodynia, as well as the anatomy and role of the corticospinal tract (CST) in the modulation of sensory processing. Finally, I describe the methods and tools used to investigate the somatosensory circuits.

1.1 The somatosensory and pain circuits

1.1.1 Primary sensory neurons

Sensory neurons, also called primary afferents, transmit sensory information from the periphery (including the skin and muscles but also joints and internal organs) to the spinal cord and brainstem (Fig.1A). The cell bodies of these sensory neurons are located in the dorsal root or trigeminal ganglia (DRG or TG). Their central branches terminate in the dorsal horn of the spinal cord or brainstem. The organization is similar for the sensory information coming from the face: the trigeminal ganglia contain sensory neuron cell bodies and the trigeminal nuclei are the functional equivalent of the spinal dorsal horns. Different types of nociceptive and non-nociceptive inputs are sensed by different types of primary afferents^{4,21}. The afferents vary in cell body and axon diameter, myelination, and thus conduction velocities, as well as in activation thresholds^{22,23}. The increased knowledge of DRG neuron neurochemistry has allowed the identification of genetically distinct subpopulations, and more recently, single-cell mRNA sequencing led to the identification of eleven DRG neuron classes²⁴.

Nociceptive stimuli are sensed by slowly conducting, unmyelinated C-fibers, a subset of myelinated A δ fibers and ultra-fast A β nociceptors²⁵. Non-nociceptive mechanical stimuli are sensed by thinly myelinated A δ , thickly myelinated A β , and thin unmyelinated, low threshold fibers called C-LTMRs^{3,24}. This heterogeneity permits the detection of a large range of sensory stimuli, including temperatures, chemicals or mechanical stimulation of various intensities and types²². In the skin, A δ and C-fibers terminate in “free nerve endings” in the epidermis or around hair follicles (A δ). Other sensory fibers (A β) in the skin are encapsulated into sensory organs (Meissner, Pacinian and Ruffini corpuscles) or associated with specialized cells (Merkel cells) involved in the detection of mechanosensory stimuli^{22,23}. The central branches of the sensory neurons also terminate in different laminae in the dorsal horn of the

spinal cord (Fig1A, right). A subset of LTMRs also extends collateral branches directly to the dorsal column nuclei through dorsal column pathway²³.

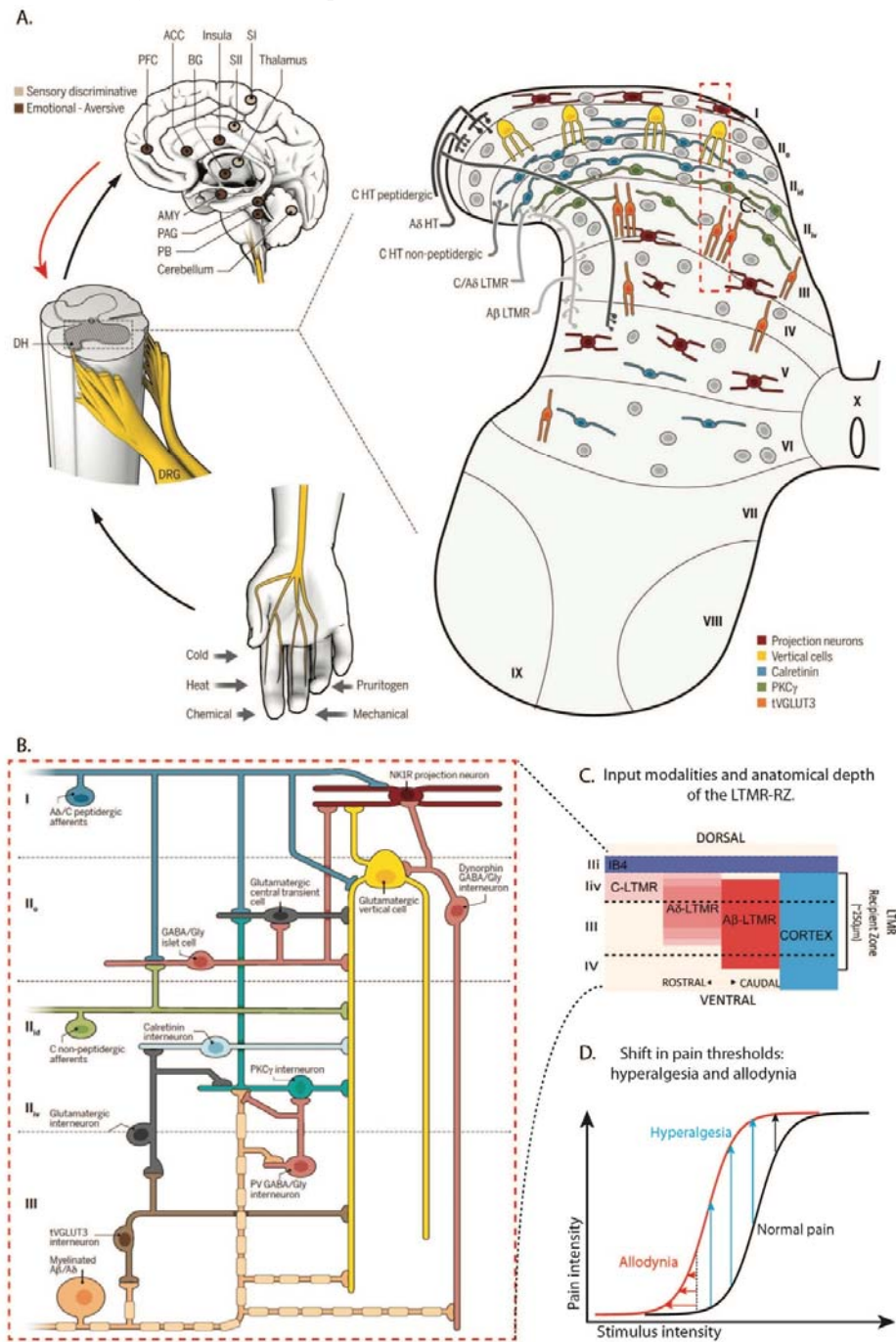

Fig.1: Anatomy of somatosensory circuits. **A.** General organization of the somatosensory system from primary afferents in the skin, to the dorsal root ganglia (DRG), the spinal cord, and the brain. The spinal cord is divided into 10 laminae (I to VI correspond to the dorsal horn, DH) and is composed of numerous neuronal populations (shown in the right panel and in B.)(A and B taken from Peirs & Seal. 2016 (ref.¹⁰), with permission) **B.** Cellular organization of the dorsal horn circuit for pain. **C.** Input modalities and anatomical depth of the LTMR recipient zone: overlap between the LTMR and CST termination areas. (taken from Abraira *et al.* 2017 (ref.²⁶), with permission) **D.** Shift in pain thresholds leading to hyperalgesia and allodynia. ACC: anterior cingulate cortex, SI (II): primary (secondary) somatosensory cortex, PAG: periaqueductal gray, PB: parabrachial nucleus, AMY: amygdala, PFC: prefrontal cortex; BG: basal ganglia.

1.1.2 Laminar organization of the spinal cord.

The spinal cord can be subdivided into 10 distinct laminae²⁷. Laminae I-VI form the dorsal horn, that contains the terminations of primary sensory afferents, interneurons involved in sensory processing (Fig.1A, right; Fig.1B, Fig.2B) and projection neurons. The ventral horn, in contrast, contains neurons involved in motor control. The lamina X contains neurons involved in somatosensory integration, visceral nociception, autonomic regulation and modulation of motor neurons. The laminar organization of the dorsal horn also suggests distinct functional roles of these fibers and of the spinal interneurons. While nociceptive fibers terminate preferentially in the superficial dorsal horn (laminae I and II), non-nociceptive (proprioceptive and mechanosensory) fibers terminate in deeper laminae, mainly III and IV. More precisely, the most superficial lamina (I) contains projection neurons, terminations of peptidergic C nociceptors and A δ fibers as well as inhibitory (GABAergic) and excitatory interneurons. Lamina II contains terminations of peptidergic (II_{outer}) and non-peptidergic (II_{inner}) C fibers, and many interneurons (GABAergic and glycinergic inhibitory neurons and glutamatergic excitatory neurons). The laminae III and IV are innervated mainly by A β and A δ myelinated fibers as well as by C-LTMRs (Fig.1B, C). They also contain many interneurons and some large projection neurons. Lamina V harbors wide dynamic range neurons defined by their responsiveness to both noxious and non-noxious stimuli.

The anatomy and function of the mechanosensory circuits (myelinated afferents and deep dorsal horn interneurons) has traditionally received less attention than the purely nociceptive superficial dorsal horn circuit. However, a growing number of laboratories and studies now focus on this part of the somatosensory circuit^{14,15,23,26,28,29}.

1.1.3 Projection neurons and ascending pathways

The ability of an organism to sense sensory stimuli also depends on the activation of several brain areas. These receive the information from the spinal cord via projection neurons (PNs), mainly located in laminae I (excitable only by nociceptive input) and III-V (wide dynamic range neurons, excitable both by nociceptive and non-nociceptive input) (Fig.2C). PNs represent only a small fraction of spinal neurons (5 to 10% in lamina I) but can also be distinguished based on their morphology and connectivity to various brain areas^{8,9}. Many PNs in lamina I express the neurokinin1 receptor, activated by binding of substance P. They receive input from local interneurons in the spinal cord and also directly from nociceptive C-fibers. They project to various parts of the brain, including the caudal ventrolateral medulla, parabrachial area, periaqueductal grey matter and thalamus (through the spinothalamic tract)³⁰. In the deeper laminae, the two major output pathways are the postsynaptic dorsal column pathway (PSDC) and the spinocervical tract (SCT)^{2,3}. The PSDC, SCT and the direct dorsal column pathway convey touch information to the brain (Fig.2A, C). Marker genes that are expressed exclusively in the PNs are under investigation but not yet known. In the spinal cord white matter, the axons of PNs are assembled into eight ascending tracts targeting different brain areas³¹. In the rodent, the main target area of the PNs is the parabrachial nucleus, but they also project to other areas such as the periaqueductal grey (PAG, through the spinoparabrachial tract), the reticular formation, the hypothalamus and the thalamus (spinothalamic tract)^{4,9}.

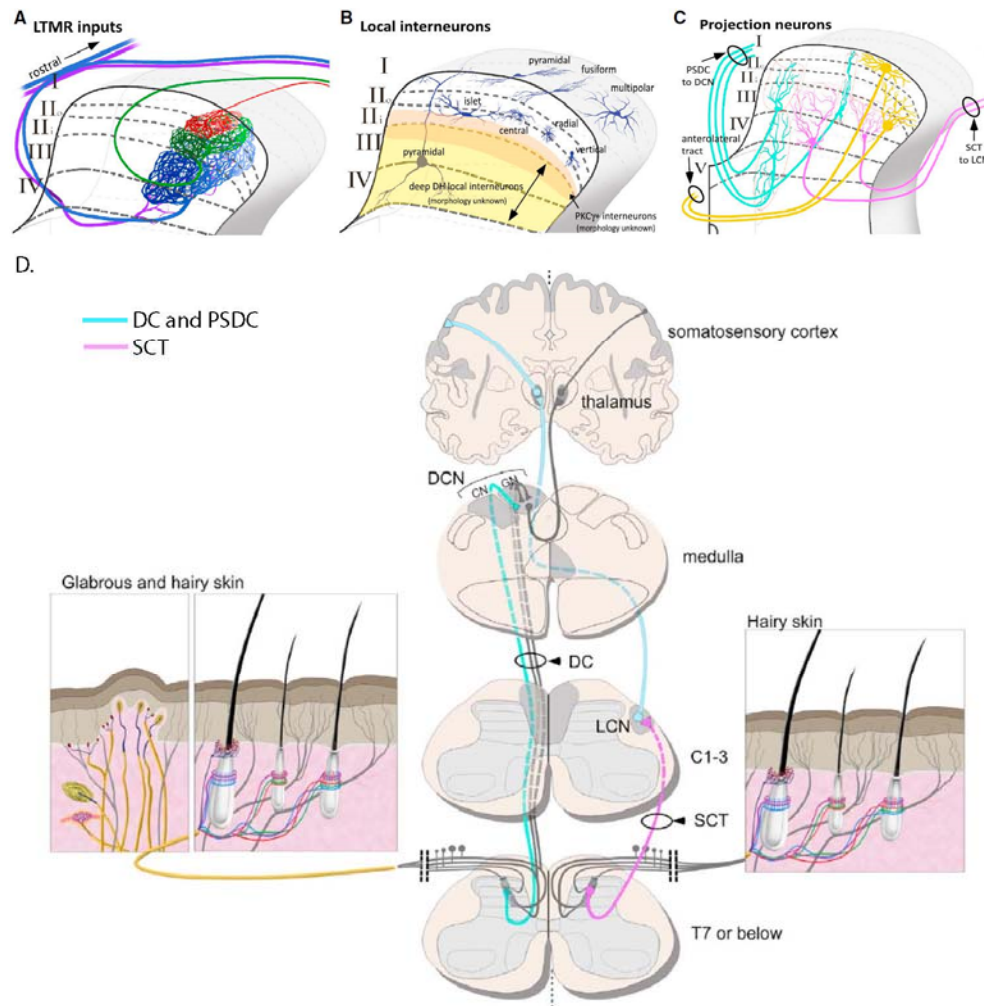

Fig.2: Spinal cord dorsal horn and ascending pathway for the processing of touch. **A.** Central terminations and columnar organization of A β (rapidly and slowly adapting), A δ -, and C-LTMRs. **B.** Locally projecting interneurons in the dorsal horn that carry tactile information out of the spinal cord into brain types: the anterolateral tract system (yellow, pain and temperature, cell bodies in lamina I and III–V), the postsynaptic dorsal column (PSDC; teal) and the spinocervical tract (SCT; pink) neurons (innocuous tactile information, cell bodies in lamina III–V). **C.** Morphology of the direct dorsal column (DC) pathway and the indirect postsynaptic dorsal column (PSDC) and spinocervical tract (SCT) pathways. GN: gracile nucleus, LCN: lateral cervical nucleus (adapted from Abraira *et al.* 2013 (ref.²³), with permission).

1.1.4 Spinal cord interneurons

1.1.4.1 The gate control theory of pain

The gate control theory (GCT) of pain, published by Melzack and Wall in 1965 (ref.³²) (Fig.3), proposed that the transmission of the noxious information from the spinal cord to the brain depends on the balance of large and small afferent fibers that concurrently activate spinal circuits. Whereas input from large afferent fibers “close” the pain gate, small afferent fibers input would “open” it. Melzack and Wall also postulated that supraspinal control systems could regulate the output of the spinal cord. This means that pain is not only a function of the activation intensity of the nociceptive fibers, but rather the result of the integrated activity of a complex circuit located in the superficial dorsal horn of the spinal cord. This also

implies that this circuit can be regulated by the activity of both nociceptive and non-nociceptive afferents, as well as by the activation of supraspinal regions.

Since 1965, the knowledge of the actual complexity of spinal cord circuitry has dramatically increased. Studies from many laboratories have led to the identification of the local inhibitory interneurons that are at the center of the GCT^{8,13,15,33,34}, as well as that of several other excitatory^{14,35,36} and inhibitory^{37,38} interneuron subpopulations and their role in sensory and pain processing.

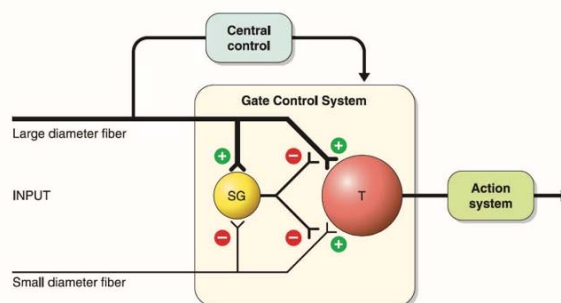

Fig.3: Schematic representation of the gate control theory of pain. In yellow: inhibitory interneurons located in substantia gelatinosa (SG); in red: spinal transmission system (T) to higher CNS areas (adapted from Melzack and Wall, 1965 (ref.³²), with permission).

1.1.4.2 *Heterogeneity of spinal cord interneurons: from marker genes to functional cell types*

In the last few decades, great advances have been made in deciphering the heterogeneity of spinal dorsal horn interneuron classes^{4,8-10,39}. Initially described according to their localization, action potential firing patterns and morphology, they are also now classified based on the expression of marker genes (including transcription factors, enzymes, calcium-binding proteins, membrane transporters and receptors, neurotransmitters and neuropeptides). Recent single-cell mRNA sequencing studies have described in detail the neurochemical heterogeneity of the spinal cord dorsal horn⁴⁰. This classification is very valuable and allows researchers to genetically target specific populations of neurons to study their anatomical and functional characteristics in the sensory circuits, as well as to make sense of their own findings in regard to other laboratories' results.

Models of the dorsal horn circuitry have emerged from many studies on the role of individual interneuron populations and are being refined continuously^{10,14,36} (Fig.1A, right; Fig.1B). It should be noted however that the identification of genetically distinct subtypes of interneurons is complementary to previously used identification methods and not by itself sufficient. Indeed, one goal of research on sensory processing is to identify functional cell types (i.e. one given population that has a clear and defined function and that is distinct from the other populations...). This implies identification of one population of neurons presenting a uniform: 1) gene expression profile, 2) morphology and physiological properties, 3) pattern of connectivity, and 4) role in behavior. Choosing one (or two) marker gene(s), although it has greatly increased our understanding of the spinal circuitry, does usually not recapitulate perfectly all of these characteristics.

Nevertheless, the combination of morphological, electrical, and behavioral experiments together with circuit tracing studies allows us to better understand how sensory information is processed in the spinal cord.

The consequence of this incredibly complex circuit is that the spinal cord dorsal horn is not a simple relay site in the transmission of sensory information from the primary afferents to the brain, but rather the place of extensive processing and integration of various peripheral and supraspinal inputs^{10,26,41}.

1.1.4.3 *The mechanosensory dorsal horn*

Mechanical allodynia is a painful sensation elicited by a stimulation which is not normally painful (in other word, it is pain evoked by the activation of non-nociceptive fibers)^{1,42}. In contrast, hyperalgesia is an enhanced sensitivity to a normally painful stimulation¹ (Fig.1D). In case of injury or inflammation, the heightened pain sensitivity can present an important biological function: to protect one from further injuries. Neuropathic pain originating from nerve damage or chronic metabolic diseases such as diabetes does not have a protective role. The growing number of people affected worldwide by diseases such as diabetes increases the number of patients susceptible to developing chronic neuropathy. Spontaneous pain and mechanical allodynia are major complaints in these patients. The understanding of spinal circuits underlying touch processing in normal and pathological settings, and the understanding of the cellular and molecular basis of the changes occurring in pathological states is therefore crucial for the future development of therapeutic strategies.

In contrast to the superficial laminae (I and II), the deep dorsal horn has only very recently started to be the focus of investigations. The lamina III is the termination area of non-nociceptive myelinated A β and A δ -Low-Threshold Mechanical Receptor fibers (LTMRs) (Fig.1C), and is involved primarily in the processing of touch and proprioception. Recent studies described the cellular architecture of this “mechanosensory dorsal horn”^{14,35,36,38,43,44}. Interneurons marked by the expression of parvalbumin (PV)¹⁵, PKC γ , somatostatin (SOM)³⁶, calretinin¹⁴, cholecystokinin (CCK), or transient expression of vGluT3^{14,36} play an important role in transmission and modulation of touch, mechanical allodynia and mechanical hypersensitivity. Abaira *et al.* identified 11 distinct (7 excitatory and 4 inhibitory) subpopulations of interneurons located in the termination area of LTMRs. These interneurons receive convergent inputs from LTMRs, local interneurons, and corticospinal neurons²⁶. Interestingly, the CST and LTMR termination areas show a large overlap (Fig.1C). Several of the 11 populations identified by Abaira *et al.* correspond to populations that have also been functionally described previously or since then (see above).

These data provide more information on how inhibitory glycinergic interneurons^{13,15} close the gate through feed-forward inhibition of the pain transmission. Studies of PV, PKC γ and transiently vGluT3-expressing neurons also demonstrate the role of these interneuron populations in mechanosensation and the development of mechanical allodynia after injury. Specifically, pharmacogenetic activation of inhibitory PV interneurons leads to higher mechanical thresholds in naïve mice and a reversal of nerve injury-induced mechanical hypersensitivity¹⁵. Activation of the transiently vGluT3-expressing neurons (which partially overlap with PKC γ expressing neurons) leads on the contrary to lower mechanical thresholds and spontaneous mechanical pain¹⁴. These studies also demonstrate how changes in the circuitry of the dorsal horn contribute to the expression of mechanical allodynia in different types of conditions. They also suggest that distinct subtypes of interneurons may be involved in the expression of different types of pain (inflammatory or neuropathic pain)^{10,14}.

1.1.4.4 *c-maf expressing spinal interneurons*

The transcription factor c-maf is expressed in DRG neurons and laminae III/IV neurons of the dorsal spinal cord. In DRG neurons, c-maf is required for the normal development and function of several rapidly adapting mechanoreceptor types⁴⁵. In the spinal cord, it is required for the proper development of laminae III/IV interneurons⁴⁶, in particular for the expression of the *mafa*, *gabrg5*, *cck*, and *rora*

genes. In the postnatal mouse spinal cord, c-maf also overlaps with the expression of these genes. About two thirds of c-maf-expressing neurons are excitatory and one third is inhibitory⁴⁷. Although c-maf is very important for the development of deep dorsal horn interneurons, its expression pattern in the adult spinal cord and the role of c-maf expressing interneurons are largely unknown. Data from single-cell RNA expression suggest that c-maf is expressed in 2 out of 15 populations of glutamatergic neurons and 3 out of 15 populations of GABAergic neurons in the dorsal horn⁴⁰. The excitatory population also corresponds to CCK expressing interneurons.

1.1.5 Pathways descending from the brain to the spinal cord

Descending control of spinal sensory processing originates from many brain regions and plays a critical role in determining the experience of both acute and chronic pain. It is well established that descending control of spinal processing can arise from the hindbrain^{11,48-51}. Very little is known however about descending inputs from the cerebral cortex and the role of the corticospinal tract in sensory processing. In the following paragraphs, I describe the general anatomy of the descending control circuits from the brain to the spinal cord, with a special attention to the CST and its role in modulation of sensory processing.

1.1.5.1 *Descending control of pain by the brainstem*

The main brainstem areas involved in modulation of spinal processing are the rostral ventromedial medulla (RVM), the PAG and the locus coeruleus^{52,53}. These regions exert both inhibitory as well as facilitating effect on nociceptive relay. There is a dynamic balance between the two: shifts in the balance towards greater facilitation might result in central sensitization and the development of secondary hyperalgesia, thus facilitating the transition from acute to chronic pain. One important example of enhanced inhibition of sensory processing on the other hand, is stress-induced analgesia⁵⁴. In the case of extreme stress, hindbrain areas inhibit nociceptive transmission in the spinal cord, leading to a decreased responsiveness to noxious stimuli^{52,54}. Brainstem areas are also influenced by cortical activity to mediate context or emotion-dependent modulation of pain control (reviewed in Tracey *et al.*, 2007¹¹).

1.1.5.2 *The cortex and the corticospinal tract*

1.1.5.2.1 *Cortex and pain*

Brain imaging studies in animals and humans have demonstrated the role of the cortex in processing and perception of pain and some data suggest a modulatory role on pain. In particular, persistent pain has been associated with long-lasting changes of neuronal functions in the pain pathway, in peripheral nociceptors and spinal cord, but also in supraspinal and cortical areas^{11,55-57}.

In humans, five main cortical areas are consistently responding to acute pain stimulation: the anterior cingulate cortex (ACC), the insular cortex (IC), the primary somatosensory cortex (S1), the secondary somatosensory cortex (S2) and the prefrontal cortex (PFC). Although brain imaging in chronic pain patients is more challenging in part due to the heterogeneity of their conditions, it has also been reported that changes occur in EEG activity or structural reorganization of the cortical areas.

Studies in mice and rats have allowed the precise identification of molecules, cells and circuits that are important for somatosensory and pain processing in the cortex (and other brain areas). Although most brain studies in rodents in regard to pain are focused on the ACC (an area important for pain perception and unpleasantness^{55,58}), activity and structural changes have also been shown after nerve injury in S1^{56,57,59,60}. A recent study investigated how neuronal circuitry in S1 is modified and becomes

hyperactive during the development of neuropathic pain⁵⁷. The authors showed an increased excitability of layer 5 pyramidal neurons and of two classes of interneurons, and reduced sensitivity after activation of somatostatin interneurons. Another study showed that activation of parvalbumin positive inhibitory interneurons in S1 enhances nociceptive sensitivity and aversive avoidance behavior⁶⁰. Additionally, strategies to reduce reorganization and hyperexcitability in S1 are beneficial against chronic pain development⁶¹⁻⁶³, but the mechanisms responsible for their effect are not very well known.

1.1.5.2.2 Anatomy of the corticospinal tract

Neurons from the sensorimotor cortex have been described to project directly to the spinal cord via the CST in rodents¹⁹. These terminate mostly in the dorsal horn of the spinal cord at all levels, but the function of this connection remains mostly unknown.

The corticospinal tract originates from several cortical areas, including the sensory and motor cortices, premotor areas and the ACC. Like other cortical output neurons, the corticospinal neurons are pyramidal neurons from the layer 5 of the cortex (Fig.4A). They are large cells with prominent dendritic tufts in the layer 1 and a periodic spatial organization. They receive abundant inputs from multiple cortical cell classes, including layer 2/3 pyramidal neurons and several classes of local inhibitory interneurons⁶⁴. These are generally classified into three broad classes, PV, SOM, and 5HTR3a expressing interneurons and are discriminated based on their morphology and expression of various markers (PV, SOM, CCK, VIP, NPY, see Fig.4B).

The axons of the CST neurons travel through the internal capsule in the forebrain (Fig.4E.1), to enter the cerebral peduncles at the base of the midbrain (Fig.4E.2). They then pass through the brainstem, from the pons to the medulla, and on to form the pyramids, at the base of the medulla. The fiber tracts then decussate as they enter the spinal cord (Fig.4C, E.3). In the rodent, the corticospinal tract is located in the dorsal white matter between the dorsal horns (Fig.4D, E.4), in contrast to primates, where the CST mainly runs through the dorsal aspect of the contralateral lateral column⁶⁶. In the 1980s, a few studies demonstrated the existence of axon terminals from corticospinal neurons in the deeper laminae of the spinal cord (III and IV) and to a lesser extent in laminae I-II¹⁹, using horseradish peroxidase (HRP) or HRP conjugated to the anterograde tracer wheat germ agglutinin (WGA-HRP).

The anatomy of this connection also differs between species, as reviewed by Lemon and Griffith⁶⁷, but an important connection between the primary somatosensory cortex (S1) and the dorsal horn of the spinal cord is found in all mammals. More recently, transgenic reporter mice have been developed where the CST is marked by the expression of fluorescent proteins in populations of forebrain neurons, such as Emx1 positive neurons⁶⁸ or Thy1 positive neurons⁶⁹. The labeling of the CST using these mice is valuable for studying spinal cord injury or CST repair, but they do not allow specific targeting of CST neurons for functional manipulation, as Emx1 and Thy1 are broadly expressed throughout the forebrain^{69,70}.

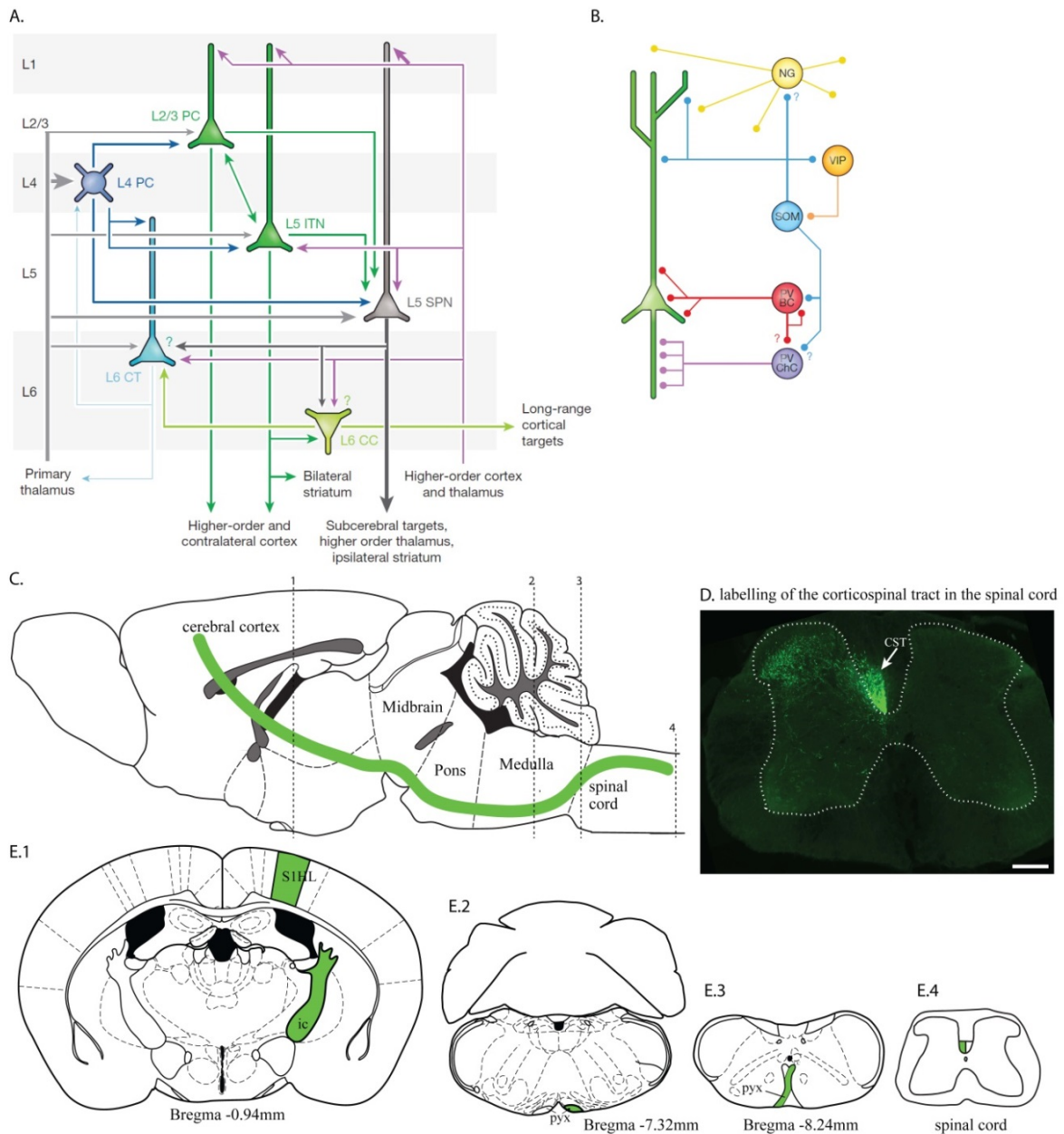

Fig.4: Anatomy of the corticospinal tract (CST). **A.** Canonical connectivity of cortical principal cells. **B.** Current understanding of the synaptic targets of five classes of cortical interneurons, the green neuron represents a principal cell. BC: basket cells, CC: Corticocortical cells, ChC: Chandelier cells, CT: Corticothalamic cells, NG: neurogliaform cells, PC: principal cell, ITN: Intratelencephalic neurons, SPN: Subcerebral projection neurons, VIP, SOM, PV: vasoactive intestinal peptide-, somatostatin- and parvalbumin-expressing cells, respectively (A, B: taken from Harris *et al.* 2013 (ref.⁶⁴), with permission). **C.** Sagittal view of the mouse central nervous system and corticospinal tract (CST, green) (Atlas plates modified from the Mouse brain atlas, Paxinos, 2001 (ref.⁶⁵)). **D.** Labeling of CST fibers in the dorsal funiculus of the spinal cord. **E.** Coronal views of the CST trajectory through the brain. At the junction between the hindbrain and the spinal cord (pyramidal decussation), the majority of CST axons cross the midline and continue their trajectory through the ventral part of the dorsal funiculus within the contralateral half of the spinal cord. Scale bar: 200 μ m. CC: central canal, CST: corticospinal tract, ic: internal capsule, pyx: pyramidal tracts.

1.1.5.2.3 *The role of the CST in modulation of sensory processing*

The function of the corticospinal tract has originally been investigated in primates and cats, and associated mostly to motor control. There is evidence nonetheless that the CST has other functions including gating and selection of spinal reflexes, autonomic functions and importantly, control of spinal nociceptive transmission⁶⁷. The latter has first been attributed to gating of presynaptic inputs from sensory afferents fibers on to spinal interneurons^{71,72}. It is however clear from more recent studies and from our data that CST axons also directly contact dorsal horn spinal interneurons^{26,41}, and are thus likely to have a much more complicated role in modulation of spinal sensory processing.

Several lines of evidence suggest that modulation of the activity of the sensorimotor cortex has an effect on the transmission of nociceptive information or pain perception: electrical stimulation of the sensorimotor cortex attenuates pain perception in humans⁷³ and animals⁶¹, inhibits C fiber-evoked dorsal horn field potentials⁷¹, and activation of cortical interneurons prevents the development of neuropathic pain in mice⁵⁷. Optogenetic stimulation of the CST also evokes postsynaptic responses in the spinal cord⁷⁴. Additionally, S1 has been shown to respond to noxious stimulation as well as to innocuous stimuli in humans and animals. In mice for example, the immediate early gene *c-fos* is upregulated in S1 after hindpaw formalin injection⁷⁵, and hindpaw stimulation evokes activity in S1 in naïve mice or after induction of chronic pain^{55,59}. Chronic pain also increases activation and somatotopic reorganization in S1 by inducing changes in synaptic connectivity⁵⁹ and excitability^{57,60}. These studies suggest a role of S1 in sensory processing, but the precise modulatory effect of the CST neurons themselves is not known.

A recent publication addressed more directly the role of primary somatosensory cortex CST (S1-CST) neurons in spinal sensory processing⁷⁶, showing that they are important for modulation of normal and pathological tactile sensory processing in the spinal cord.

1.1.5.2.4 *Integration of CST and sensory inputs in the lamina III of the spinal cord*

It is interesting to note that all deep dorsal horn interneurons populations described by Abaira *et al.* receive inputs from the CST (ranging from 13 to 18% of the total excitatory input to these interneurons)²⁶ in addition from the LTMR inputs (Fig.1C). This suggests a very important role of the deep dorsal horn interneurons in the integration of sensory and supraspinal inputs.

Observations made using Thy1-GFP (ref.⁶⁹) or Emx1^{cre} (ref.⁶⁸) mouse lines have shown that the axons of corticospinal neurons terminate in the deep dorsal in all segments of the spinal cord. However, these studies were using fluorescent reporter mice and there was a large spread of the terminations that made it difficult to identify specific targets areas for potential subpopulation of CST neurons. Very recently, Ueno *et al.*⁴¹ showed in a more detailed and systematic approach that CST fibers originating in the mouse motor cortex (M1) directly synapse onto premotor interneurons in the intermediate dorsal horn, whereas S1-CST neurons preferentially target lamina III and IV interneurons. Interestingly, they identify the target neurons of S1-CST neurons as vGluT3- and *lmx1β* lineage interneurons. These two observations are very consistent with our own results.

1.2 Methods to study specific neuron populations and their role in sensory processing

1.2.1 Mouse lines and genetically defined neuronal populations.

The use of genetically modified (GM) mouse lines in many fields of biology, especially in neurosciences, has allowed tremendous progress in our understanding of the anatomy and function of neuronal circuits. A great variety of mouse lines are available in many laboratories and commercial facilities, and can also be bred with other lines in order to combine different mutated alleles.

In parallel with the development of GM mouse lines, our knowledge of the neuronal diversity in many areas of the brain, the spinal cord and sensory neurons has grown massively. The preferred approach in many circuit neuroscience studies therefore involves choosing a genetically defined population of neurons, i.e. identified based on the expression of one or several gene(s) by this population. The chosen cells or neurons are then targeted using a mouse line in which expression of fluorescent or functional proteins is under the control of the promoter of the marker gene(s).

Fluorescent proteins used very often are the green fluorescent protein (GFP) or the red fluorescent proteins tdTomato and mCherry. Proteins for functional manipulation of neurons include a wide variety of effectors including chemogenetic receptors (Designer Receptor Exclusively Activated by Designer Drugs, DREADDs), light activated ion channels (channelrhodopsins), or calcium sensors (GCaMPs). Importantly, in the late 1990s, strategies for conditional gene targeting based on cell type-specific expression of site-specific recombinases have been developed.

1.2.2 Site-specific and recombinase-based gene expression in mice

The most commonly used recombinase for cell type-specific control of gene expression is the cre recombinase from the P1 bacteriophage^{77,78}. Other frequently used recombinases are Flp⁷⁹ (from the *Saccharomyces cerevisiae* 2 micron circle plasmid) and Dre⁸⁰ (from the phage D6). These enzymes can be expressed in a chosen neuronal population, i.e., under a specific promoter. They mediate recombination of two homologous sites (loxP, frt or rox for cre, Flp or Dre, respectively) and can be used to ablate or activate the expression of a gene. Gene deletion is done by excising part of the coding sequence flanked by the recognition sites for the recombinase, whereas activation of gene expression can be mediated by the excision of a STOP cassette or by irreversible inversion of a coding sequence in the FLEX system⁸¹(Fig.5A).

The availability of numerous mouse lines expressing these recombinases under cell type-specific promoters provides a large and versatile set of possibilities to label and manipulate targeted neuronal populations. Indeed, crossing these mice with GM mice carrying recombinase-dependent alleles or injecting viruses allows specific expression of the previously mentioned fluorescent or functional proteins. Breeding cre-expressing mice with mice carrying recombinase-dependent alleles will result in labeling of neuronal lineage, i.e., all the cells that have expressed the recombinase(s) at some point during development will be labeled. Conversely, injection of viruses provides a more specific temporal and spatial control of the recombination: the virus can be injected in young or adult mice and in a defined region of the nervous system¹⁸.

Specific cell populations can also be defined by the expression of several genes. We therefore took advantage of the specificity of cre, Flp and Dre for their recognition sites to use them in combination. The recombinase-dependent transgene can for example be preceded by two STOP cassettes, each flanked with target sites of one of the recombinases. The expression will then only occur if the two

STOP cassettes are excised, i.e. if the 2 recombinases are present. A more recent system has been developed where the coding sequence of the transgene is split into double inverted exons separated by introns that contain the recombination sites. This system called “INTRSECT”⁸² requires the presence of two recombinases (Fig.5B). The C_{on}/F_{on} construct requires cre and Flp, whereas the C_{on}/D_{on} construct requires cre and Dre.

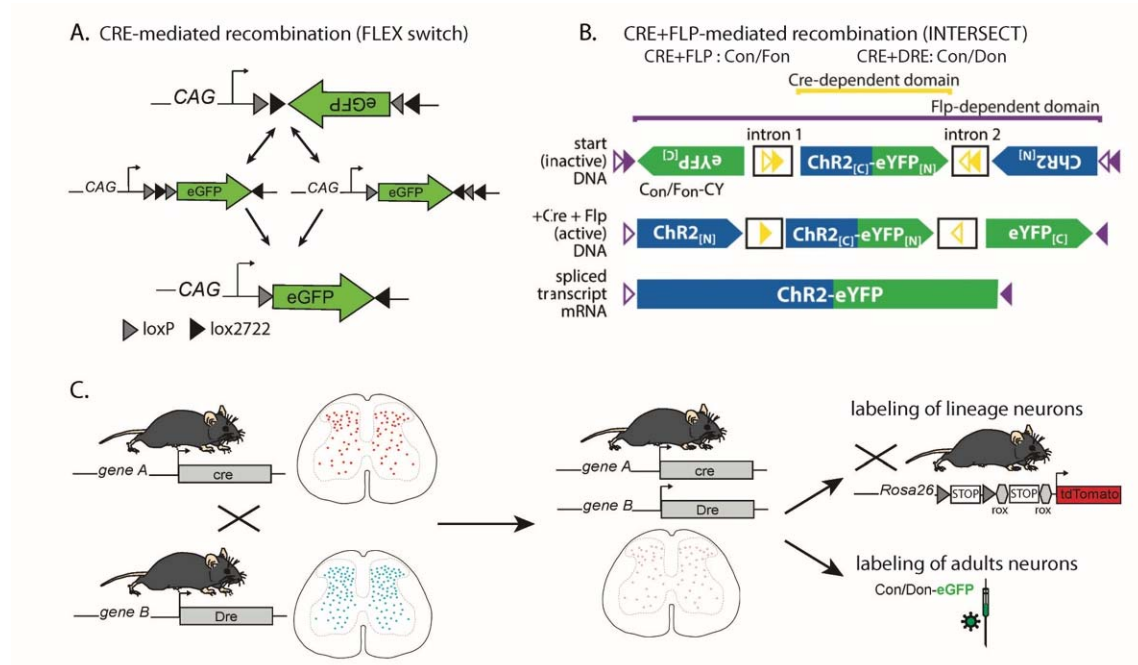

Fig.5: Recombinase-based gene expression and intersectional genetic targeting of neuronal populations in mice. **A.** FLEX switch recombination system for stable inversion in two steps: inversion and excision. loxP and lox2722 are orthogonal recombination sites (adapted from Atasoy *et al* (ref.⁸¹), with permission). **B.** INTRSECT recombination system for double-recombinase-mediated recombination: both recombinases are necessary for all exons of the construct (C_{on}/F_{on}-ChR2-eYFP) to be in the sense direction (taken from Fenno *et al.* 2014 (ref.⁸²), with permission). **C.** Breeding strategy to generate double transgenic mice carrying both a cre and a Dre allele under the promoters of two different genes. These mice can then either be crossed with reporter mice (e.g. Rosa26^{dstdTom}/wt reporter mouse) or injected with viruses that carry recombinases-dependent alleles.

Typically, we perform “intersectional” experiments using mouse lines that express cre under one neuron-specific marker (“gene 1”, Fig.5C) and Dre under another one (“gene 2”, Fig.5C). Similarly to the single recombinase approach, we can then either cross these mice to mice carrying double-recombinase-dependent alleles or inject double-dependent viruses in a selected region of the nervous system, thus targeting expression of the transgene of interest only in the “intersectional” cell population where both recombinases are present (Fig.5C).

1.2.3 Adeno-associated viruses

Adeno-associated viruses (AAVs) are small, non-enveloped, single-strand DNA (ssDNA) viruses. They have linear ssDNA genome of approximately 4.7-kilobases (kb), with two 145 nucleotide-long inverted terminal repeats (ITR) at the termini. The naturally occurring AAVs contain two viral genes between the ITRs: *rep* (replication) and *cap* (capsid), encoding non-structural and structural proteins, respectively. In the recombinant AAVs (rAAVs) used in research, these genes have been replaced with

a selected promoter, the transgene of interest and additional regulatory elements. These viral constructs present a very versatile tool in neuroscience research as they are non-pathogenic, have low immunogenicity, and can be relatively easily produced with high titers. Additionally, they don't integrate in to the genome (or very rarely) but still confer long term-expression of the transgene.

Over the years, the tropism and transduction/intracellular transport efficacy of rAAVs has been improved by directed evolution and pseudotyping (i.e. mixing of a capsid and genome from different viral serotypes). In particular, rAAV2-retro has been modified to maximize retrograde transduction capabilities²⁰. It was shown to efficiently label long-range projections within the brain, but has not been used to label projections from the brain to the spinal cord, that can span over 5-6 cm in the rodent CNS. The choice of the serotype and promoter that drives transgene expression are also important factors to target selective and efficient expression in the desired neuronal region or population, as we have previously shown in our laboratory¹⁸.

In most of the experiments presented here, we chose to target, label and manipulate populations of neurons defined by the expression of one or two genes in the adult (cck, c-maf, SLC6A5 or lmx1b), and have thus opted for the use of recombinant adeno-associated viruses (rAAVs) injections in selected regions of the CNS (lumbar spinal cord¹⁸ or S1 cortex).

1.2.4 Rabies virus for retrograde monosynaptic tracing

The rabies virus is an enveloped, negative single-strand RNA (ssRNA-) virus. Rabies virus has been used to trace neuronal circuits^{19,83} because of its high neurotropism and ability to travel retrogradely and transsynaptically. However, it is also very neurotoxic and will typically travel through multiple synapses⁸⁴. Wickersham *et al.* developed a monosynaptic tracing method using a protein G-deleted variant of the SAD B19 vaccination strain^{85,86}.

Retrograde monosynaptic tracing experiments require a two-step strategy (Fig.6): first, one or two recombinant helper viruses harboring the rabies glycoprotein (G), the TVA receptor (avian tumor receptor A), and sometimes a fluorescent protein, are injected. Their expression defines the starter population. The expression of the helper virus (rAAV.flex.rox.TVA.G) used in the present study is dependent on the presence of both cre and Dre recombinases and thus specifically expressed in the neurons of interest. In a second step, we inject an EnvA (avian sarcoma leucosis virus A envelope glycoprotein)-pseudotyped, G-deficient rabies virus carrying the GFP transgene (EnvA.RV.ΔG.eGFP). TVA expression in cre+Dre+ cells allows entry of the rabies virus in these cell specifically, where it will be complemented with the G protein and be able to replicate. The complemented virus can then cross through the synapse to the presynaptic neurons. If this second order neuron does not express the G protein, the rabies cannot be complemented again, rendering this approach ideal for monosynaptic tracing. If the helper viruse(s) carry fluorescent proteins different from that of the rabies virus, then starter cells can also be distinguished from second order neurons based on this fluorescence.

The rabies virus is thus a very useful tool to map neuronal circuits. However, this technique still has important limitations. Indeed, the virus only labels a fraction of the starter cells and the efficacy of transsynaptic transfer is low. Additionally, replication of the virus in the starter cells and in the retrogradely infected cells is highly cytotoxic and leads to cell death within a few days or weeks, depending on the cell population. Moreover, these two aspects likely vary greatly depending on the chosen neuronal population, making it difficult to reproduce in different CNS regions. Another important limitation in the field of pain research is that some subtypes of DRG neurons (peptidergic sensory neurons and C-LTMRs) are resistant to rabies infection¹⁶. Any attempt to label sensory inputs onto a given spinal interneuron population will thus be biased and lead to under representation of unmyelinated afferents. New strains and variants of rabies viruses and G proteins are currently under

development to address these issues, in particular toxicity. Indeed, functional studies require that the cells can remain healthy for several weeks. Newly developed versions of rabies virus include the condon-optimized glycoprotein oG⁸⁷ (for greater trans-synaptic transfer efficiency), the new rabies strain CVS-N2cΔG⁸⁸, and ΔGL rabies virus⁸⁹, or a “self-inactivating” rabies virus⁹⁰.

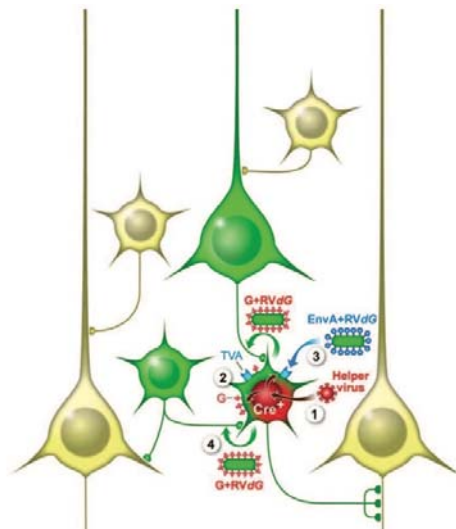

Fig.6: Retrograde monosynaptic tracing with rabies virus. Monosynaptic rabies tracing of inputs to cre expressing starter cells (cre⁺). A recombinase-dependent helper virus is first injected to drive expression of the EnvA receptor, TVA, and rabies glycoprotein (G) in starter cells. A few weeks later the pseudotyped rabies (EnvA + RVdG) is injected. The RVdG is *trans*-complemented by G to produce G+RVdG that spreads trans-synaptically to neurons providing synaptic input to starter cells. The spread of RVdG is monosynaptically restricted because the input cells lack G and G is required for trans-synaptic spread (taken from Callaway *et al.* 2015(ref.¹⁹), with permission).

1.2.5 Anterograde trans-synaptic tracing

Several molecular or genetic approaches are available for anterograde transsynaptic tracing of neuronal circuits, including the use of the plant lectins such as Wheat germ agglutinin (WGA)⁹¹, or viruses such as the herpes simplex virus (HSV)⁹². In contrast to retrograde transsynaptic tracing, there is currently no method available that allows monosynaptic anterograde labeling.

WGA is isolated from the wheat, *Triticum vulgare*, and binds specifically to *N*-acetyl-d-glucosamine and *N*-acetylneuraminic acid (sialic acid) residues, which are present in all neural membranes, and enters the cell through receptor-mediated endocytosis. Once taken up into CNS neurons, it can jump transsynaptically to label postsynaptic neurons. WGA can be injected directly in to the CNS or can be genetically targeted to a specific population by injection of cre-dependent virus⁹¹. However, some studies have shown that WGA is not perfectly unidirectional, but rather can be transported bidirectionally across synapses with preference for the anterograde direction in the CNS^{91,93}.

The natural neuronal tropism and transneuronal spread capacity of the HSV have made it a useful neuronal circuit tracer and the H129 strain in particular displays anterograde transneuronal transmission⁹⁴. In 2011, Lo *et al.*⁹⁵ developed a cre recombinase-dependent, anterograde transneuronal tracer, based on the H129 strain of HSV. This HSV also expresses a red fluorescent protein (H129-tdTomato), making it possible to directly visualize the output neural pathways.

These tools still have important limitations. First, WGA and HSV, as well as other available molecular and genetic anterograde transsynaptic tracers, are not restricted to jumping one synapse, and careful management of time after the injection is necessary to be able to interpret the results. Additionally, the H129 (HSV) causes inflammatory reactions in the CNS, is cytotoxic and leads to neuronal death within only a few days after injection into the CNS. Use of H129-tdTomato for tracing output areas is efficient^{12,92}, but before the neurons die, the expression of certain markers is also affected, making identification of individual labeled cells complicated. For these reasons, it is important to complement anterograde transsynaptic experiments results with other lines of evidence. Recently, a thymidine kinase (TK)-deleted variant of H129 (H129- Δ TK-tdT) was developed and could be a promising approach for monosynaptic anterograde transneuronal labeling⁹⁶.

Another potentially helpful tool is the newly-developed WGA and recombinase (cre, Dre or Flp)-fusion proteins^{97,98}. Indeed, we have mentioned before that genetically targeting subpopulations of neurons is not always sufficient to define a functional cell type. Some populations are better identified based on their connectivity, for example. Being able to drive expression of various effector proteins in a given neuronal population based on its connectivity pattern would thus enable to answer many questions about the function of long range projections like the CST for example. It seems however that the labeling efficacy with this approach is region-dependent⁹⁸, and it still needs to be tested in the corticospinal system.

1.2.6 Manipulation of neuronal function and behavioral assessment of mice

1.2.6.1 Manipulation of neuronal function using DREADDs

Pharmacogenetics (or chemogenetics) is the modulation of genetically defined population of cells by the use of modified receptor proteins (often G-protein coupled receptors, GCPR) that are activated by synthetic ligands. DREADDs are modified GPCRs^{99,100}. The most commonly used are the activating DREADD hM3Dq and the inhibitory DREADD hM4Di. They are derived from human muscarinic acetylcholine receptors that were rendered insensitive to acetylcholine by two point mutations, and respond instead to the synthetic drug clozapine-N-oxide (CNO) (Fig.7A). CNO activates hM3Dq, leading to depolarization and higher neuronal excitability¹⁰¹. Conversely, hM4Di activation by CNO leads to the opening of inwardly rectifying potassium channels and neuronal silencing¹⁰². Compared to cell ablation or permanent silencing, they offer the advantage of a reversible modulation of neuronal activity. The hM3Dq and hM4Di DREADDs are commonly used in pain and sensory processing research to probe the function of genetically targeted neuronal populations¹³⁻¹⁵

1.2.6.2 Behavioral assessment of sensory processing in mice

Animal models of nociception and pain are crucial to understand the processing of pain. Since the 19th century and the invention of the von Frey “hairs” by Maximilian von Frey, a large number of tests and animal models have been developed to study acute and chronic pain states (for review in mice, see Gregory *et al.* 2013(ref.¹⁰³)). Today, many tests exist to assess nociception or pain. They are broadly classified into two categories: reflexive and non-reflexive tests. Disease models include models of inflammatory pain, neuropathic pain, cancer- or medication-induced pain, or other diseases such as diabetes¹⁰³. Widely used models of chronic pain are the subcutaneous injection of zymosan A¹⁰⁴ or Complete Freund’s adjuvant (CFA)¹⁰⁵ to provoke inflammatory pain, injection of formalin¹⁰⁶ and the chronic constriction injury (CCI)¹⁰⁷ and spared nerve injury (SNI)¹⁰⁸ models of neuropathic pain.

In the present project, I used reflexive tests to assess sensitivity to mechanical (using von Frey filaments, brush or pin prick), heat (Hargreaves apparatus), or cold (dry ice) stimulations^{12,13,109}. In the following experiments, behavioral assessment was typically carried out in naïve mice expressing a DREADD receptor in a genetically targeted neurons population, before (baseline) and after injection of CNO, or in combination with chronic pain models¹³(Fig.7B).

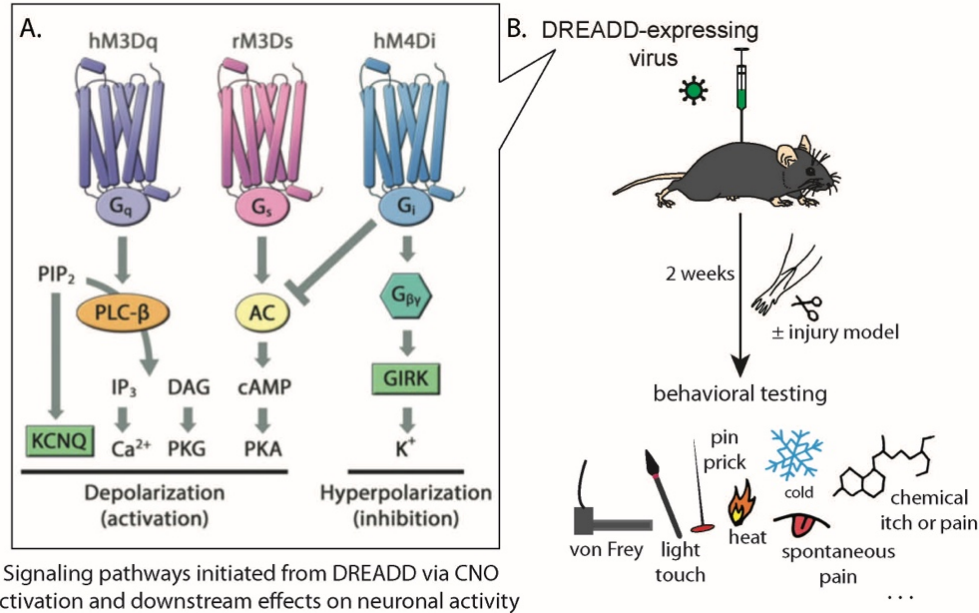

Fig.7: Pharmacogenetic manipulation of neuronal populations and behavioral assessment of mice using DREADDs. **A.** Signaling pathways initiated from DREADD receptors (adapted from Michaelides *et. al*, 2016 (ref.⁹⁹), with permission) after clozapine-N-Oxide (CNO) injection. **B.** A virus carrying the DREADD transgene is injected locally in to the CNS and behavior of the mice in response to various sensory stimuli are tested about 2 weeks later.

1.3 References

- 1 Pain terms: a list with definitions and notes on usage. Recommended by the IASP Subcommittee on Taxonomy. *Pain* **6**, 249 (1979).
- 2 Dib-Hajj, S. D., Yang, Y., Black, J. A. & Waxman, S. G. The Na(V)1.7 sodium channel: from molecule to man. *Nat Rev Neurosci* **14**, 49-62 (2013).
- 3 Gupta, S., Gupta, M., Nath, S. & Hess, G. M. Survey of European pain medicine practice. *Pain Physician* **15**, E983-994 (2012).
- 4 Basbaum, A. I., Bautista, D. M., Scherrer, G. & Julius, D. Cellular and molecular mechanisms of pain. *Cell* **139**, 267-284 (2009).
- 5 Vellucci, R. Heterogeneity of chronic pain. *Clin Drug Investig* **32 Suppl 1**, 3-10 (2012).
- 6 Guidelines, W. S. G. o. P. Scoping WHO Guide non-malignant pain adults. (2008).
- 7 Morrone, L. A., Scuteri, D., Rombola, L., Mizoguchi, H. & Bagetta, G. Opioids Resistance in Chronic Pain Management. *Curr Neuropharmacol* **15**, 444-456 (2017).
- 8 Braz, J., Solorzano, C., Wang, X. & Basbaum, A. I. Transmitting pain and itch messages: a contemporary view of the spinal cord circuits that generate gate control. *Neuron* **82**, 522-536 (2014).
- 9 Todd, A. J. Neuronal circuitry for pain processing in the dorsal horn. *Nat Rev Neurosci* **11**, 823-836 (2010).
- 10 Peirs, C. & Seal, R. P. Neural circuits for pain: Recent advances and current views. *Science* **354**, 578-584 (2016).
- 11 Tracey, I. & Mantyh, P. W. The cerebral signature for pain perception and its modulation. *Neuron* **55**, 377-391 (2007).
- 12 Albisetti, G. W., Pagani, M., Platonova, E., Hosli, L., Johannssen, H. C., Fritschy, J. M., Wildner, H. & Zeilhofer, H. U. Dorsal Horn Gastrin-Releasing Peptide Expressing Neurons Transmit Spinal Itch But Not Pain Signals. *J Neurosci* **39**, 2238-2250 (2019).
- 13 Foster, E., Wildner, H., Tudeau, L., Haueter, S., Ralvenius, W. T., Jegen, M., Johannssen, H., Hosli, L., Haenraets, K., Ghanem, A., Conzelmann, K. K., Bosl, M. & Zeilhofer, H. U. Targeted ablation, silencing, and activation establish glycinergic dorsal horn neurons as key components of a spinal gate for pain and itch. *Neuron* **85**, 1289-1304 (2015).
- 14 Peirs, C., Williams, S. P., Zhao, X., Walsh, C. E., Gedeon, J. Y., Cagle, N. E., Goldring, A. C., Hioki, H., Liu, Z., Marell, P. S. & Seal, R. P. Dorsal Horn Circuits for Persistent Mechanical Pain. *Neuron* **87**, 797-812 (2015).
- 15 Petitjean, H., Pawlowski, S. A., Fraine, S. L., Sharif, B., Hamad, D., Fatima, T., Berg, J., Brown, C. M., Jan, L. Y., Ribeiro-da-Silva, A., Braz, J. M., Basbaum, A. I. & Sharif-Naeini, R. Dorsal Horn Parvalbumin Neurons Are Gate-Keepers of Touch-Evoked Pain after Nerve Injury. *Cell Rep* **13**, 1246-1257 (2015).
- 16 Albisetti, G. W., Ghanem, A., Foster, E., Conzelmann, K. K., Zeilhofer, H. U. & Wildner, H. Identification of Two Classes of Somatosensory Neurons That Display Resistance to Retrograde Infection by Rabies Virus. *J Neurosci* **37**, 10358-10371 (2017).

- 17 Haenraets, K., Foster, E., Johannssen, H., Kandra, V., Frezel, N., Steffen, T., Jaramillo, V., Paterna, J. C., Zeilhofer, H. U. & Wildner, H. Spinal nociceptive circuit analysis with recombinant adeno-associated viruses: the impact of serotypes and promoters. *J Neurochem* **142**, 721-733 (2017).
- 18 Haenraets, K., Albisetti, G. W., Foster, E. & Wildner, H. Adeno-associated Virus-mediated Transgene Expression in Genetically Defined Neurons of the Spinal Cord. *J Vis Exp* (2018).
- 19 Callaway, E. M. & Luo, L. Monosynaptic Circuit Tracing with Glycoprotein-Deleted Rabies Viruses. *J Neurosci* **35**, 8979-8985 (2015).
- 20 Tervo, D. G., Hwang, B. Y., Viswanathan, S., Gaj, T., Lavzin, M., Ritola, K. D., Lindo, S., Michael, S., Kuleshova, E., Ojala, D., Huang, C. C., Gerfen, C. R., Schiller, J., Dudman, J. T., Hantman, A. W., Looger, L. L., Schaffer, D. V. & Karpova, A. Y. A Designer AAV Variant Permits Efficient Retrograde Access to Projection Neurons. *Neuron* **92**, 372-382 (2016).
- 21 Turk, S. M. M. K. I. T. D. *Peripheral Mechanisms of Cutaneous Nociception, Wall & Melzack's Textbook of Pain*. 6th edn, 1-30 (2013).
- 22 Delmas, P., Hao, J. & Rodat-Despoix, L. Molecular mechanisms of mechanotransduction in mammalian sensory neurons. *Nat Rev Neurosci* **12**, 139-153 (2011).
- 23 Abraira, V. E. & Ginty, D. D. The sensory neurons of touch. *Neuron* **79**, 618-639 (2013).
- 24 Usoskin, D., Furlan, A., Islam, S., Abdo, H., Lonnerberg, P., Lou, D., Hjerling-Leffler, J., Haeggstrom, J., Kharchenko, O., Kharchenko, P. V., Linnarsson, S. & Ernfors, P. Unbiased classification of sensory neuron types by large-scale single-cell RNA sequencing. *Nat Neurosci* **18**, 145-153 (2015).
- 25 Djouhri, L. & Lawson, S. N. Abeta-fiber nociceptive primary afferent neurons: a review of incidence and properties in relation to other afferent A-fiber neurons in mammals. *Brain Res Brain Res Rev* **46**, 131-145 (2004).
- 26 Abraira, V. E., Kuehn, E. D., Chirila, A. M., Springel, M. W., Toliver, A. A., Zimmerman, A. L., Orefice, L. L., Boyle, K. A., Bai, L., Song, B. J., Bashista, K. A., O'Neill, T. G., Zhuo, J., Tsan, C., Hoynoski, J., Rutlin, M., Kus, L., Niederkofler, V., Watanabe, M., Dymecki, S. M., Nelson, S. B., Heintz, N., Hughes, D. I. & Ginty, D. D. The Cellular and Synaptic Architecture of the Mechanosensory Dorsal Horn. *Cell* **168**, 295-310 e219 (2017).
- 27 Rexed, B. The cytoarchitectonic organization of The spinal cord in the cat. *Journal of Comparative Neurology* (1952).
- 28 Moehring, F., Halder, P., Seal, R. P. & Stucky, C. L. Uncovering the Cells and Circuits of Touch in Normal and Pathological Settings. *Neuron* **100**, 349-360 (2018).
- 29 Seal, R. P., Wang, X., Guan, Y., Raja, S. N., Woodbury, C. J., Basbaum, A. I. & Edwards, R. H. Injury-induced mechanical hypersensitivity requires C-low threshold mechanoreceptors. *Nature* **462**, 651-655 (2009).
- 30 Todd, A. J. Anatomy of primary afferents and projection neurones in the rat spinal dorsal horn with particular emphasis on substance P and the neurokinin 1 receptor. *Exp Physiol* **87**, 245-249 (2002).
- 31 Watson, C. & Harrison, M. The location of the major ascending and descending spinal cord tracts in all spinal cord segments in the mouse: actual and extrapolated. *Anat Rec (Hoboken)* **295**, 1692-1697 (2012).
- 32 Melzack, R. & Wall, P. D. Pain mechanisms: a new theory. *Science* **150**, 971-979 (1965).

- 33 Zeilhofer, H. U., Wildner, H. & Yevenes, G. E. Fast synaptic inhibition in spinal sensory processing and pain control. *Physiol Rev* **92**, 193-235 (2012).
- 34 Zeilhofer, H. U., Benke, D. & Yevenes, G. E. Chronic pain states: pharmacological strategies to restore diminished inhibitory spinal pain control. *Annu Rev Pharmacol Toxicol* **52**, 111-133 (2012).
- 35 Bourane, S., Grossmann, K. S., Britz, O., Dalet, A., Del Barrio, M. G., Stam, F. J., Garcia-Campmany, L., Koch, S. & Goulding, M. Identification of a spinal circuit for light touch and fine motor control. *Cell* **160**, 503-515 (2015).
- 36 Cheng, L., Duan, B., Huang, T., Zhang, Y., Chen, Y., Britz, O., Garcia-Campmany, L., Ren, X., Vong, L., Lowell, B. B., Goulding, M., Wang, Y. & Ma, Q. Identification of spinal circuits involved in touch-evoked dynamic mechanical pain. *Nature neuroscience* **20**, 804-814 (2017).
- 37 Cui, L., Miao, X., Liang, L., Abdus-Saboor, I., Olson, W., Fleming, M. S., Ma, M., Tao, Y. X. & Luo, W. Identification of Early RET+ Deep Dorsal Spinal Cord Interneurons in Gating Pain. *Neuron* **91**, 1413 (2016).
- 38 Duan, B., Cheng, L., Bourane, S., Britz, O., Padilla, C., Garcia-Campmany, L., Krashes, M., Knowlton, W., Velasquez, T., Ren, X., Ross, S., Lowell, B. B., Wang, Y., Goulding, M. & Ma, Q. Identification of spinal circuits transmitting and gating mechanical pain. *Cell* **159**, 1417-1432 (2014).
- 39 Wildner, H., Das Gupta, R., Brohl, D., Heppenstall, P. A., Zeilhofer, H. U. & Birchmeier, C. Genome-wide expression analysis of Ptf1a- and Ascl1-deficient mice reveals new markers for distinct dorsal horn interneuron populations contributing to nociceptive reflex plasticity. *J Neurosci* **33**, 7299-7307 (2013).
- 40 Haring, M., Zeisel, A., Hochgerner, H., Rinwa, P., Jakobsson, J. E. T., Lonnerberg, P., La Manno, G., Sharma, N., Borgius, L., Kiehn, O., Lagerstrom, M. C., Linnarsson, S. & Ernfors, P. Neuronal atlas of the dorsal horn defines its architecture and links sensory input to transcriptional cell types. *Nature neuroscience* **21**, 869-880 (2018).
- 41 Ueno, M., Nakamura, Y., Li, J., Gu, Z., Niehaus, J., Maezawa, M., Crone, S. A., Goulding, M., Baccei, M. L. & Yoshida, Y. Corticospinal Circuits from the Sensory and Motor Cortices Differentially Regulate Skilled Movements through Distinct Spinal Interneurons. *Cell Rep* **23**, 1286-1300 e1287 (2018).
- 42 Lolignier, S., Eijkelkamp, N. & Wood, J. N. Mechanical allodynia. *Pflugers Arch* **467**, 133-139 (2015).
- 43 Cui, L., Miao, X., Liang, L., Abdus-Saboor, I., Olson, W., Fleming, M. S., Ma, M., Tao, Y. X. & Luo, W. Identification of Early RET+ Deep Dorsal Spinal Cord Interneurons in Gating Pain. *Neuron* **91**, 1137-1153 (2016).
- 44 Sharif-Naeini, R. Contribution of mechanosensitive ion channels to somatosensation. *Prog Mol Biol Transl Sci* **131**, 53-71 (2015).
- 45 Wende, H., Lechner, S. G., Cheret, C., Bourane, S., Kolanczyk, M. E., Pattyn, A., Reuter, K., Munier, F. L., Carroll, P., Lewin, G. R. & Birchmeier, C. The transcription factor c-Maf controls touch receptor development and function. *Science* **335**, 1373-1376 (2012).
- 46 Hu, J., Huang, T., Li, T., Guo, Z. & Cheng, L. c-Maf is required for the development of dorsal horn laminae III/IV neurons and mechanoreceptive DRG axon projections. *J Neurosci* **32**, 5362-5373 (2012).
- 47 Del Barrio, M. G., Bourane, S., Grossmann, K., Schule, R., Britsch, S., O'Leary, D. D. & Goulding, M. A transcription factor code defines nine sensory interneuron subtypes in the mechanosensory area of the spinal cord. *PLoS One* **8**, e77928 (2013).

- 48 Zhuo, M. & Gebhart, G. F. Characterization of descending inhibition and facilitation from the nuclei reticularis gigantocellularis and gigantocellularis pars alpha in the rat. *Pain* **42**, 337-350 (1990).
- 49 Fields, H. L., Bry, J., Hentall, I. & Zorman, G. The activity of neurons in the rostral medulla of the rat during withdrawal from noxious heat. *J Neurosci* **3**, 2545-2552 (1983).
- 50 Marinelli, S., Vaughan, C. W., Schnell, S. A., Wessendorf, M. W. & Christie, M. J. Rostral ventromedial medulla neurons that project to the spinal cord express multiple opioid receptor phenotypes. *J Neurosci* **22**, 10847-10855 (2002).
- 51 Francois, A., Low, S. A., Sypek, E. I., Christensen, A. J., Sotoudeh, C., Beier, K. T., Ramakrishnan, C., Ritola, K. D., Sharif-Naeini, R., Deisseroth, K., Delp, S. L., Malenka, R. C., Luo, L., Hantman, A. W. & Scherrer, G. A Brainstem-Spinal Cord Inhibitory Circuit for Mechanical Pain Modulation by GABA and Enkephalins. *Neuron* **93**, 822-839 e826 (2017).
- 52 Heinricher, M. M., Tavares, I., Leith, J. L. & Lumb, B. M. Descending control of nociception: Specificity, recruitment and plasticity. *Brain Res Rev* **60**, 214-225 (2009).
- 53 Stamford, J. A. Descending control of pain. *Br J Anaesth* **75**, 217-227 (1995).
- 54 Terman, G. W., Shavit, Y., Lewis, J. W., Cannon, J. T. & Liebeskind, J. C. Intrinsic mechanisms of pain inhibition: activation by stress. *Science* **226**, 1270-1277 (1984).
- 55 Zhuo, M. Cortical excitation and chronic pain. *Trends Neurosci* **31**, 199-207 (2008).
- 56 Kim, W., Kim, S. K. & Nabekura, J. Functional and structural plasticity in the primary somatosensory cortex associated with chronic pain. *J Neurochem* **141**, 499-506 (2017).
- 57 Cichon, J., Blanck, T. J. J., Gan, W. B. & Yang, G. Activation of cortical somatostatin interneurons prevents the development of neuropathic pain. *Nat Neurosci* **20**, 1122-1132 (2017).
- 58 Zhuo, M. Contribution of synaptic plasticity in the insular cortex to chronic pain. *Neuroscience* **338**, 220-229 (2016).
- 59 Kim, S. K. & Nabekura, J. Rapid synaptic remodeling in the adult somatosensory cortex following peripheral nerve injury and its association with neuropathic pain. *J Neurosci* **31**, 5477-5482 (2011).
- 60 Tan, L. L., Oswald, M. J., Heintz, C., Retana Romero, O. A., Kaushalya, S. K., Monyer, H. & Kuner, R. Gamma oscillations in somatosensory cortex recruit prefrontal and descending serotonergic pathways in aversion and nociception. *Nat Commun* **10**, 983 (2019).
- 61 Lopes, P. S. S., Campos, A. C. P., Fonoff, E. T., Britto, L. R. G. & Pagano, R. L. Motor cortex and pain control: exploring the descending relay analgesic pathways and spinal nociceptive neurons in healthy conscious rats. *Behav Brain Funct* **15**, 5 (2019).
- 62 Flor, H., Denke, C., Schaefer, M. & Grusser, S. Effect of sensory discrimination training on cortical reorganisation and phantom limb pain. *Lancet* **357**, 1763-1764 (2001).
- 63 De Ridder, D., De Mulder, G., Menovsky, T., Sunaert, S. & Kovacs, S. Electrical stimulation of auditory and somatosensory cortices for treatment of tinnitus and pain. *Prog Brain Res* **166**, 377-388 (2007).
- 64 Harris, K. D. & Mrsic-Flogel, T. D. Cortical connectivity and sensory coding. *Nature* **503**, 51-58 (2013).

- 65 Paxinos, G. Franklin, KBJ. *Mouse Brain Stereotaxic Coordinates*. Vol. 2nd edition (Academic Press, 2001).
- 66 Serradj, N., Agger, S. F. & Hollis, E. R., 2nd. Corticospinal circuit plasticity in motor rehabilitation from spinal cord injury. *Neurosci Lett* **652**, 94-104 (2017).
- 67 Lemon, R. N. & Griffiths, J. Comparing the function of the corticospinal system in different species: organizational differences for motor specialization? *Muscle Nerve* **32**, 261-279 (2005).
- 68 Bareyre, F. M., Kerschensteiner, M., Misgeld, T. & Sanes, J. R. Transgenic labeling of the corticospinal tract for monitoring axonal responses to spinal cord injury. *Nat Med* **11**, 1355-1360 (2005).
- 69 Porrero, C., Rubio-Garrido, P., Avendano, C. & Clasca, F. Mapping of fluorescent protein-expressing neurons and axon pathways in adult and developing Thy1-eYFP-H transgenic mice. *Brain Res* **1345**, 59-72 (2010).
- 70 Zeisel, A., Munoz-Manchado, A. B., Codeluppi, S., Lonnerberg, P., La Manno, G., Jureus, A., Marques, S., Munguba, H., He, L., Betsholtz, C., Rolny, C., Castelo-Branco, G., Hjerling-Leffler, J. & Linnarsson, S. Brain structure. Cell types in the mouse cortex and hippocampus revealed by single-cell RNA-seq. *Science* **347**, 1138-1142 (2015).
- 71 Moreno-Lopez, Y., Perez-Sanchez, J., Martinez-Lorenzana, G., Condes-Lara, M. & Rojas-Piloni, G. Cortical presynaptic control of dorsal horn C-afferents in the rat. *PLoS One* **8**, e69063 (2013).
- 72 Rojas-Piloni, G., Martinez-Lorenzana, G., Condes-Lara, M. & Rodriguez-Jimenez, J. Direct sensorimotor corticospinal modulation of dorsal horn neuronal C-fiber responses in the rat. *Brain Res* **1351**, 104-114 (2010).
- 73 Canavero, S. & Bonicalzi, V. Therapeutic extradural cortical stimulation for central and neuropathic pain: a review. *Clin J Pain* **18**, 48-55 (2002).
- 74 Jayaprakash, N., Wang, Z., Hoeynck, B., Krueger, N., Kramer, A., Balle, E., Wheeler, D. S., Wheeler, R. A. & Blackmore, M. G. Optogenetic Interrogation of Functional Synapse Formation by Corticospinal Tract Axons in the Injured Spinal Cord. *J Neurosci* **36**, 5877-5890 (2016).
- 75 Hartmann, B., Ahmadi, S., Heppenstall, P. A., Lewin, G. R., Schott, C., Borchardt, T., Seeburg, P. H., Zeilhofer, H. U., Sprengel, R. & Kuner, R. The AMPA receptor subunits GluR-A and GluR-B reciprocally modulate spinal synaptic plasticity and inflammatory pain. *Neuron* **44**, 637-650 (2004).
- 76 Liu, Y., Latremoliere, A., Li, X., Zhang, Z., Chen, M., Wang, X., Fang, C., Zhu, J., Alexandre, C., Gao, Z., Chen, B., Ding, X., Zhou, J. Y., Zhang, Y., Chen, C., Wang, K. H., Woolf, C. J. & He, Z. Touch and tactile neuropathic pain sensitivity are set by corticospinal projections. *Nature* **561**, 547-550 (2018).
- 77 Sauer, B. & McDermott, J. DNA recombination with a heterospecific Cre homolog identified from comparison of the pac-c1 regions of P1-related phages. *Nucleic Acids Res* **32**, 6086-6095 (2004).
- 78 Sternberg, N. & Hamilton, D. Bacteriophage P1 site-specific recombination. I. Recombination between loxP sites. *J Mol Biol* **150**, 467-486 (1981).
- 79 Golic, K. G. & Lindquist, S. The FLP recombinase of yeast catalyzes site-specific recombination in the Drosophila genome. *Cell* **59**, 499-509 (1989).

- 80 Anastassiadis, K., Fu, J., Patsch, C., Hu, S., Weidlich, S., Duerschke, K., Buchholz, F., Edenhofer, F. & Stewart, A. F. Dre recombinase, like Cre, is a highly efficient site-specific recombinase in *E. coli*, mammalian cells and mice. *Dis Model Mech* **2**, 508-515 (2009).
- 81 Atasoy, D., Aponte, Y., Su, H. H. & Sternson, S. M. A FLEX switch targets Channelrhodopsin-2 to multiple cell types for imaging and long-range circuit mapping. *J Neurosci* **28**, 7025-7030 (2008).
- 82 Fenno, L. E., Mattis, J., Ramakrishnan, C., Hyun, M., Lee, S. Y., He, M., Tucciarone, J., Selimbeyoglu, A., Berndt, A., Grosenick, L., Zalocusky, K. A., Bernstein, H., Swanson, H., Perry, C., Diester, I., Boyce, F. M., Bass, C. E., Neve, R., Huang, Z. J. & Deisseroth, K. Targeting cells with single vectors using multiple-feature Boolean logic. *Nat Methods* **11**, 763-772 (2014).
- 83 Callaway, E. M. Transneuronal circuit tracing with neurotropic viruses. *Curr Opin Neurobiol* **18**, 617-623 (2008).
- 84 Ugolini, G. Specificity of rabies virus as a transneuronal tracer of motor networks: transfer from hypoglossal motoneurons to connected second-order and higher order central nervous system cell groups. *Journal of Comparative Neurology* (1995).
- 85 Wickersham, I. R., Finke, S., Conzelmann, K. K. & Callaway, E. M. Retrograde neuronal tracing with a deletion-mutant rabies virus. *Nat Methods* **4**, 47-49 (2007).
- 86 Wickersham, I. R., Lyon, D. C., Barnard, R. J., Mori, T., Finke, S., Conzelmann, K. K., Young, J. A. & Callaway, E. M. Monosynaptic restriction of transsynaptic tracing from single, genetically targeted neurons. *Neuron* **53**, 639-647 (2007).
- 87 Kim, E. J., Jacobs, M. W., Ito-Cole, T. & Callaway, E. M. Improved Monosynaptic Neural Circuit Tracing Using Engineered Rabies Virus Glycoproteins. *Cell Rep* **15**, 692-699 (2016).
- 88 Reardon, T. R., Murray, A. J., Turi, G. F., Wirblich, C., Croce, K. R., Schnell, M. J., Jessell, T. M. & Losonczy, A. Rabies Virus CVS-N2c(DeltaG) Strain Enhances Retrograde Synaptic Transfer and Neuronal Viability. *Neuron* **89**, 711-724 (2016).
- 89 Chatterjee, S., Sullivan, H. A., MacLennan, B. J., Xu, R., Hou, Y., Lavin, T. K., Lea, N. E., Michalski, J. E., Babcock, K. R., Dietrich, S., Matthews, G. A., Beyeler, A., Calhoon, G. G., Gloor, G., Whitesell, J. D., Yao, S., Cetin, A., Harris, J. A., Zeng, H., Tye, K. M., Reid, R. C. & Wickersham, I. R. Nontoxic, double-deletion-mutant rabies viral vectors for retrograde targeting of projection neurons. *Nat Neurosci* **21**, 638-646 (2018).
- 90 Ciabatti, E., Gonzalez-Rueda, A., Mariotti, L., Morgese, F. & Tripodi, M. Life-Long Genetic and Functional Access to Neural Circuits Using Self-Inactivating Rabies Virus. *Cell* **170**, 382-392 e314 (2017).
- 91 Braz, J. M., Rico, B. & Basbaum, A. I. Transneuronal tracing of diverse CNS circuits by Cre-mediated induction of wheat germ agglutinin in transgenic mice. *Proc Natl Acad Sci U S A* **99**, 15148-15153 (2002).
- 92 Lo, L. C. & Anderson, D. J. A Cre-Dependent, Anterograde Transsynaptic Viral Tracer for Mapping Output Pathways of Genetically Marked Neurons. *Neuron* **72**, 938-950 (2011).
- 93 Yoshihara, Y., Mizuno, T., Nakahira, M., Kawasaki, M., Watanabe, Y., Kagamiyama, H., Jishage, K., Ueda, O., Suzuki, H., Tabuchi, K., Sawamoto, K., Okano, H., Noda, T. & Mori, K. A genetic approach to visualization of multisynaptic neural pathways using plant lectin transgene. *Neuron* **22**, 33-41 (1999).
- 94 Sun, N., Cassell, M. D. & Perlman, S. Anterograde, transneuronal transport of herpes simplex virus type 1 strain H129 in the murine visual system. *J Virol* **70**, 5405-5413 (1996).

- 95 Lo, A. C., Fung, M. K., Au, C. L., Chan, T. S., Sauer, B., Chung, S. S. & Chung, S. K. Transgenic mice over-expressing endothelin-1 in testis transactivated by a Cre/loxP system showed decreased testicular capillary blood flow. *Transgenic Res* **13**, 119-134 (2004).
- 96 Zeng, W. B., Jiang, H. F., Gang, Y. D., Song, Y. G., Shen, Z. Z., Yang, H., Dong, X., Tian, Y. L., Ni, R. J., Liu, Y. P., Tang, N., Li, X. Y., Jiang, X., Gao, D., Androulakis, M., He, X. B., Xia, H. M., Ming, Y. Z., Lu, Y. M., Zhou, J. N., Zhang, C., Xia, X. S., Shu, Y. S., Zeng, S. Q., Xu, F. Q., Zhao, F. & Luo, M. H. Anterograde monosynaptic transneuronal tracers derived from herpes simplex virus 1 strain H129. *Molecular Neurodegeneration* **12** (2017).
- 97 Gradinaru, V., Zhang, F., Ramakrishnan, C., Mattis, J., Prakash, R., Diester, I., Goshen, I., Thompson, K. R. & Deisseroth, K. Molecular and Cellular Approaches for Diversifying and Extending Optogenetics. *Cell* **141**, 154-165 (2010).
- 98 Libbrecht, S., Van den Haute, C., Malinouskaya, L., Gijssbers, R. & Baekelandt, V. Evaluation of WGA-Cre-dependent topological transgene expression in the rodent brain. *Brain Structure & Function* **222**, 717-733 (2017).
- 99 Michaelides, M. & Hurd, Y. L. in *Neuroscience in the 21st Century* (eds Donald W. Pfaff & Nora D. Volkow) 1-10 (Springer New York, 2016).
- 100 Roth, B. L. DREADDs for Neuroscientists. *Neuron* **89**, 683-694 (2016).
- 101 Alexander, G. M., Rogan, S. C., Abbas, A. I., Armbruster, B. N., Pei, Y., Allen, J. A., Nonneman, R. J., Hartmann, J., Moy, S. S., Nicoletis, M. A., McNamara, J. O. & Roth, B. L. Remote control of neuronal activity in transgenic mice expressing evolved G protein-coupled receptors. *Neuron* **63**, 27-39 (2009).
- 102 Armbruster, B. N., Li, X., Pausch, M. H., Herlitze, S. & Roth, B. L. Evolving the lock to fit the key to create a family of G protein-coupled receptors potently activated by an inert ligand. *Proc Natl Acad Sci U S A* **104**, 5163-5168 (2007).
- 103 Gregory, N. S., Harris, A. L., Robinson, C. R., Dougherty, P. M., Fuchs, P. N. & Sluka, K. A. An overview of animal models of pain: disease models and outcome measures. *J Pain* **14**, 1255-1269 (2013).
- 104 Meller, S. T. & Gebhart, G. F. Intraplantar zymosan as a reliable, quantifiable model of thermal and mechanical hyperalgesia in the rat. *Eur J Pain* **1**, 43-52 (1997).
- 105 Pircio, A. W., Fedele, C. T. & Bierwagen, M. E. A new method for the evaluation of analgesic activity using adjuvant-induced arthritis in the rat. *Eur J Pharmacol* **31**, 207-215 (1975).
- 106 Dubuisson, D. & Dennis, S. G. The formalin test: a quantitative study of the analgesic effects of morphine, meperidine, and brain stem stimulation in rats and cats. *Pain* **4**, 161-174 (1977).
- 107 Bennett, G. J. & Xie, Y. K. A Peripheral Mononeuropathy in Rat That Produces Disorders of Pain Sensation Like Those Seen in Man. *Pain* **33**, 87-107 (1988).
- 108 Decosterd, I. & Woolf, C. J. Spared nerve injury: an animal model of persistent peripheral neuropathic pain. *Pain* **87**, 149-158 (2000).
- 109 Frezel, N., Kratzer, G., Verzar, P., Bürki, J., Weber, F. A. & Zeilhofer, H. U. Does toe clipping for genotyping interfere with later-in-life nociception in mice? *PAIN Reports* **4**, e470 (2019).

1.4 Aims of the thesis

The overarching aim of this thesis was to provide new insights into the neuronal circuitry that is responsible for the processing of touch at the spinal cord level and its modulation by the somatosensory cortex using neurochemical, morphological and functional approaches.

My work is divided into two related research projects that are described as two separate chapters :

Specific aim 1: Understanding of the anatomy and connectivity of corticospinal neurons of the somatosensory cortex.

Specific aim 2: Characterization of a population of spinal interneurons expressing the transcription factor c-maf and definition of their role in the modulation of sensory processing.

2 RESULTS CHAPTER 1:

Characterization of direct descending projections from the somatosensory cortex to the spinal dorsal horn.

2.1 Abstract

Noxious stimuli are sensed by specialized sensory neurons of the peripheral nervous system called nociceptors. The nociceptive information is then processed in the spinal (or medullary) dorsal horn, which contains local interneurons and projection neurons that send axons to the brain. Supraspinal areas in turn send axons down to the spinal cord where they control the gating of nociceptive signals. Exaggerated and abnormal pain sensitivity is accompanied by alterations in such descending pain control systems. Much previous work has focused on the neuronal projections descending from the hindbrain areas, while little is known about the role of projections reaching the spinal cord from the forebrain.

Using rAAV vector based retrograde tracing, we have identified a population of pyramidal neurons in the somatosensory cortex that project directly to the spinal dorsal horn (S1-CST neurons). In order to characterize the connectivity and function of these neurons, we used AAV mediated gene transfer and genetically modified mice expressing cre under the control of a neuron type-specific promoter.

We found that S1-CST neurons receive monosynaptic input from layer 2/3 pyramidal neurons, PV and NPY positive interneurons in the cortex, as well as from thalamic relay sensory neurons that are part of the somatosensory system. We were able to record Ca^{2+} signals in S1-CST neurons in freely behaving mice. We show that the axons of most S1-CST neurons terminate in laminae III and IV of the dorsal horn, where they form direct synaptic contacts onto spinal interneurons. Anterograde tracing with Wheat germ agglutinin (WGA) revealed that about 60% of the spinal target neurons are local inhibitory interneurons.

Taken together, these results show that we can specifically target subsets of CST neurons based on their connectivity and gene expression. CST neurons from S1 receive input from sensory pathways and directly contact spinal interneurons, which are important for the gating of sensory and painful stimuli. They are thus ideally positioned to serve as a corticospinal feedback loop in the control of somatosensation.

2.2 Introduction

Several supraspinal areas project down to the spinal cord where they control the gating of sensory signals. In particular, neurons from several cortical areas, including the primary somatosensory (S1), motor, and pre-motor cortices have been described to project directly to the spinal cord via the corticospinal tract (CST). The CST originates in layer 5 of these cortical areas. The axons then run through the internal capsule to the medulla, where the vast majority decussates at the level of the pyramids to continue into the contralateral spinal cord. In the rodent, the CST is located in the dorsal funiculus in the spinal cord.

The CST has been shown to be involved in the regulation of many motor and sensory functions, such as gating and selection of spinal reflexes, autonomic functions and importantly, control of spinal nociceptive transmission¹. The connection between S1 in particular and the spinal cord is also conserved in mammals. Layer 5 pyramidal neurons and local inhibitory interneurons in S1 show enhanced excitability after nerve injury², and manipulation of inhibitory interneurons leads to modulation of sensory processing^{2,3} in mice. Very little is known however about the function of this specific subset of CST neurons that originates from S1.

Transgenic mouse lines^{4,5} and virus-mediated gene transfer^{6,7} have been used to label CST neurons. These studies showed that the CST axons terminate mainly in the lamina III and IV of the dorsal horn in the spinal cord and contact dorsal horn interneurons^{7,8}. However, in *Emx1* or *Thy1* fluorescent reporter mouse lines, many forebrain neurons are labeled in addition to the CST^{4,5,9}. Similarly, local injection of viruses into S1 leads to labeling of local interneurons and other cortical output neurons but is not specific to CST neurons. In order to specifically manipulate this population of neurons for functional studies, it is crucial to restrict transgene expression to the layer 5 pyramidal neurons in S1 that project to the dorsal horn of the spinal cord (S1-CST neurons).

Recombinant adeno-associated virus (rAAV) vectors are widely used gene delivery systems to study neuronal circuits^{10,11}, because of their ability to efficiently transduce neurons and to lead to long-term gene expression, together with a very low immunogenicity. They allow the expression of a great variety of effector proteins such as fluorescent proteins, pharmacogenetic receptors, bacterial toxins, or optogenetic effector proteins, making them ideal for tracing and manipulating neurons. In addition, the use of rAAV vectors is generally combined with recombinase-dependent transgene expression¹⁰⁻¹³ to enable the manipulation of genetically defined subsets of neurons. rAAVs have previously been used to label long-range projections in the brain¹⁴, but labeling of projections from the brain to the spinal cord has recently become much more efficient through the development of the rAAV2-retro serotype^{14,11}.

Here, we used a combination of viral approaches and transgenic mice to specifically label S1-CST neurons. Our approaches allowed the expression of fluorescent or effector proteins in this population. We demonstrate that S1-CST neurons receive input from sensory circuits and project directly onto interneurons in the dorsal spinal cord, involved in gating of sensory processing¹⁵.

2.3 Methods

2.3.1 Animals

Experiments were performed on 6-12-week-old mice kept at a 12:12 h light/dark cycle. Permissions for experiments have been obtained from the Canton of Zurich (permissions 03/2018, 031/2016, and 063/2016). *c-maf^{cre}* mice are knock-in mice generated by conventional gene targeting in the laboratory of C. Birchmeier (MDC Berlin, Germany). For further details on the genetically modified mice used in this study, see Table 1.

2.3.2 Immunohistochemistry (IHC) and image analysis.

Mice were transcardially perfused with 4% ice-cold paraformaldehyde (in 0.1M sodium phosphate buffer, pH 7.4). Lumbar spinal cord and brain were immediately dissected and post-fixed for 2h with 4% paraformaldehyde (PFA) on ice. Post-fixed tissue was briefly washed with 0.1M sodium phosphate buffer (pH 7.4) and then incubated in 30% sucrose (in PBS) overnight at 4°C for cryoprotection. Cryoprotected tissue was cut at 25 µm or 40 µm (spinal cord or brain, respectively) on a Hyrax C60 Cryostat (Zeiss, Oberkochen, Germany), mounted on superfrost plus glass slides and then incubated with the respective combinations of primary antibodies in 1% donkey serum in phosphate-buffered saline (PBS) over night at 4°C. After brief washes in PBS, sections were incubated with the respective secondary antibodies for 2h at room temperature and briefly rinsed in PBS, before mounting with coverslips and DAKO fluorescent mounting media (Dako, Carpinteria, CA, USA). For the synaptic contact stainings, spinal cord sections were cut at 35 µm and IHC was performed on floating sections using the same reagents and then mounted onto the super frost plus glass slides. All primary antibodies used are listed in the Table 1. Secondary antibodies raised in donkey were purchased from Jackson Immuno-Research (West Grove, PA, USA.).

Z-stacks of fluorescent images were acquired on a Zeiss LSM700 confocal and Zeiss LSM800 Airy Scan microscope (Zeiss, Oberkochen, Germany). Numbers of immunoreactive cells in z-stacks were determined using the ImageJ (NIH, Bethesda, Maryland) Cell Counter plugin (Kurt DeVos, University of Sheffield, Academic Neurology).

2.3.3 Intraspinal and cortical virus injections

Viruses were obtained from the resources indicated in the Table 1, and used as previously described¹¹. Virus injections were made in adult (6-12-week-old) mice anesthetized with 2% isoflurane and immobilized on a motorized stereotaxic frame (David Kopf Instruments, Tujunga, CA, USA and Neurostar, Tübingen, Germany). For intraspinal injections, the vertebral column was fixed using a pair of spinal adaptors and lumbar spinal cord at L4 and L5 was exposed. Injections (3×300 nL) spaced approximately 1mm apart were made at a rate of 50 nL/min with glass micropipettes (tip diameter 30-40 µm) attached to a 10 µL Hamilton syringe. For S1 injections, the head was fixed using head bars, the skull exposed and the following injection coordinates were used: (-1; 1.5; 0.8).

2.3.4 Tissue clearing and light sheet imaging

Mice were anesthetized deeply using pentobarbital and perfused transcardially with 10 mL of artificial cerebrospinal fluid (ACSF containing in mM: 125 NaCl, 2.5 KCl, 1.25 NaH₂PO₄, 25 NaHCO₃, 1 MgCl₂, 2 CaCl₂, 20 glucose equilibrated with 95% O₂, 5% CO₂) at room temperature (RT) followed by 200 mL of RT 4% PFA. The perfusion was performed using a gravity perfusion setup. Brain and spinal cord attached were dissected and incubated in 4% PFA overnight, followed by overnight incubation in 4% acrylamide (161–0140; Bio-Rad) and 0.25% VA-044 (017–19362; Novachem) in PBS at 4°C. They were then incubated for 3 hours at 37°C for acrylamide polymerization, washed overnight at 37°C in clearing solution (200 mM SDS (L3371; Sigma-Aldrich) and 200 mM boric acid (L185094; Sigma-Aldrich), pH 8.5), and electrophoresed in clearing solution using an X-CLARITY Tissue Clearing System (Logos Biosystems) for 8 hours at 1.2 A constant current, temperature <37°C, and 100 rpm pump speed. The samples were incubated in approximately 88% Histodenz (D2158; Sigma-Aldrich) solution in PBS (refractive index adjusted to 1.457) overnight, and mounted for imaging in the same solution. Samples were imaged using a MesoSPIM light sheet microscope¹⁶.

2.3.5 Prism implantation and miniscope mounting

The preparation of the mice for *in vivo* calcium imaging was performed as described previously^{17,18}. Following the same preparation of animals as described above, a small craniotomy was performed over the target area, and superficial tissue (approx. 1 mm) was carefully aspirated to accommodate the prism without compressing neighboring brain tissue. Specifically, a miniature prism attached to a glass coverslip was inserted at the craniotomy site. Prism implantation was performed one week after virus injection. Implanted animals were then given 3-4 weeks to recover before behavioral analysis. The fluorescence was checked in anesthetized mice using a Leica M205 FCA stereomicroscope. The baseplate designed to hold the miniaturized microscope (miniscope) was then mounted on the head of the mice as follows: we built a layer of blue-light curable composite (Pentron, Flow-It N11VI) from the dental cement on the mouse's skull without touching the baseplate, followed by a layer of UV-curable epoxy (Loctite(R) Light-Activated Adhesive #4305) that affixed the baseplate to the composite. For *in vivo* calcium imaging sessions, the miniscope (approx. 5 x 20 mm) was mounted on the animals' head using a small screw to connect it to the baseplate.

2.3.6 Behavioral responses to nociceptive stimulation

Male mice were randomly assigned to CNO (2 mg/kg) or vehicle (control) groups. All behavioral tests were performed by an experimenter blinded to the treatment of the mice. Only one test was performed per day and mouse.

Mechanical sensitivity. Mice were placed in Plexiglas chambers (8 x 8 cm) on an elevated wire grid and allowed to acclimatize for at least 1 hour before testing. Withdrawal thresholds were assessed by stimulation of the hindpaw with an electronic von Frey anesthesiometer (IITC, Woodland Hills, CA). Measurements were taken at 10 min intervals.

Sensitivity to light touch or acute painful stimulation was also tested. Both hindpaws were stimulated alternately and 10 measurements were taken of each hindpaw. For light touch, mice were gently touched (from the bottom of the grid) with a soft paint brush on the plantar surface of the hind paw. For acute painful stimulation, the plantar surface of hindpaws was stimulated with a blunted G26 needle without penetration of skin. For both tests, each response to this stimulation was quantified by a score of 0 or 1 (no evoked movement = 0, walking away or brief paw lifting for ≤ 1 s = 1) and reported as the response frequency (%).

Cold sensitivity. Mice were placed in Plexiglas chambers (8 x 8 cm) on a 5 mm thick borosilicate glass platform and allowed to acclimatize for at least 1 hour before testing¹⁹. A dry ice pellet was applied to the surface of the glass from underneath the paw. Withdrawal thresholds were measured using a stopwatch and a cutoff time of 20 s was set. Measurements were taken at 10 min intervals.

Heat sensitivity (Hargreaves test). Mice were placed in Plexiglas chambers (8 x 8 cm) on a glass surface and allowed to acclimatize for at least 1 hour before testing. A movable infrared generator was placed below the plantar surface of one hindpaw. Withdrawal thresholds were recorded automatically by an electronically controlled commercially available instrument with a built-in timer (Plantar Analgesia Meter, IITC, Woodland Hills, USA) and a cutoff time of 32 s was set. Measurements were taken at 10 min intervals.

Motor coordination (rotarod). Mice were placed onto a rotarod setup (IITC, Woodland Hills, USA). The rod was set to accelerate from 4 to 40 rpm over a period of 300 s. Two training sessions were performed before the latency to fall was measured in 5 test sessions per mouse.

Chronic pain models. Neuropathic pain was studied using the chronic constriction injury (CCI) model. A constriction injury of the left sciatic nerve just proximal to the trifurcation was performed as described previously^{20,21}. Anesthesia was induced and maintained at 2% isoflurane (Provet AG, Lyssach, Switzerland),

combined with oxygen (30%) and ambient air (68%). Before the start of the surgery, mice received 0.2 mg/kg buprenorphine subcutaneously. The sciatic nerve was exposed at the mid-thigh level proximal to the sciatic trifurcation by blunt dissection through the biceps femoris. Three chromic gut ligatures (5/0) were tied loosely around the nerve until a brief twitch in the hindlimb was elicited. The incision was closed in layers. Subacute chemical pain was induced by injecting 20 μ l of a 5% formalin subcutaneously into one hindpaw under a short isoflurane anesthesia²². The number of flinches and the time spent licking are measured in 5 min intervals as a measure nociceptive activation for a total of 60 min starting immediately after formalin injection.

Ca²⁺ imaging procedure. After mounting of the miniscope, mice were placed in Plexiglas chambers (8 x 8 cm) on a raised wire grid and allowed to acclimatize before testing. The behavior of the mouse was observed with a camera, connected to and triggered by the miniscope recording setup. Before sensory stimulation, we measured spontaneous neuronal activity by recording changes in intracellular Ca²⁺ levels for 20 min while the mouse freely moved within the testing box. Then two series of sensory stimulation were applied: von Frey and brush stimulations (as described above). Finally, we injected formalin in the left hindpaw of the mouse and recorded behavior (licking and flinching) simultaneously with Ca²⁺ imaging.

2.3.7 Processing of Ca²⁺ imaging videos

The processing of Ca²⁺ imaging videos was performed as described previously¹⁷, using a custom Matlab protocol written in the laboratory of B.F. Grewe (INI, ETH Zürich, Switzerland). The Ca²⁺ traces were extracted and analyzed using Matlab (MATLAB R2017b, The MathWorks, Inc., Natick, Massachusetts, USA).

2.3.8 Experimental design and statistical analysis

All behavioral experiments were designed to allow comparisons between two groups. Behavioral responses and cells counts are reported as mean \pm SEM. Statistical analysis of behavioral responses was performed as follows: group means of CNO- and vehicle-injected mice were compared using a 2-sided unpaired Student t test (rotarod) or a 2-way repeated measures analysis of variance (ANOVA, all other tests), followed by pairwise comparisons with Sidak adjustment for multiple comparisons (t tests and ANOVA performed with SPSS: IBM Corp. Released 2017. IBM SPSS Statistics for Windows, Version 25.0. Armonk, NY). Numbers of experiments (cells or mice) results of the statistical analysis are provided in the figure legends and Table 2.

Table 1. Materials and reagents

Materials	Resource	Identifier
Mice (shortname)		
C57BL/6J (wild type)	The Jackson Laboratory	IMSR_JAX:000664
C57BL/6.FVB-Tg(Slc6a5-EGFP)13Uze (GlyT2::eGFP)	IPT (Zurich, Switzerland)	MGI:3835459, (Zeilhofer <i>et al.</i> , 2005) ²³
Cck<tm1.1(cre)Zjh>/J (CCK ^{cre})	Jackson Laboratory	(Taniguchi <i>et al.</i> , 2011) ²⁴
c-maf ^{cre/wt}	Dr Carmen Birchmeier	unpublished
C57BL/6-Lmx1b<tm(Dre)Uze (lmx1 ^{βdre/wt})	IPT (Zurich, Switzerland)	unpublished
B6N-Tg(GlyT2-Dre) (GlyT2 ^{Dre/wt})	IPT (Zurich, Switzerland)	unpublished
Viral vectors short name		
rAAV9.CAG.flex.eGFP	Penn Vector Core (Philadelphia, USA)	AV-1-ALL854
SAD.RabiesΔG.eGFP (EnvA) (EnvA.RV.dG.eGFP)	Salk Institute (USA)	Albisetti <i>et al.</i> ²⁵
rAAV2-EF1α-flex-WGA	IPT (Zurich, Switzerland)	unpublished
rAAV-retro/2-hCMV-cre	VVF (Zurich, Switzerland)	v36-retro
rAAV-retro/2-shortCAG-tdTomato	VVF (Zurich, Switzerland)	v131-retro
rAAV-retro/2-hEF1a-DreO	VVF (Zurich, Switzerland)	v127-retro
rAAV-retro/2-shortCAG-dlox-EGFP	VVF (Zurich, Switzerland)	vHW22-retro
rAAV-8/2-hEF1α-D _{on} /C _{on} -mSyp1_mCherry	VVF (Zurich, Switzerland)	vHW51-8
rAAV-8/2-hCMV-cre	VVF (Zurich, Switzerland)	v36-8
rAAV-DJ/2-hEF1α-DreO	VVF (Zurich, Switzerland)	v127-DJ
rAAVDJ-CAG-eGFP	VVF (Zurich, Switzerland)	v24-DJ
rAAV-8/2-hSyn1-roxSTOP-dlox-TVA_2A.RabG	VVF (Zurich, Switzerland)	vHW7-1
rAAV-9/2-hEF1α-D _{on} /C _{on} -eGFP	VVF (Zurich, Switzerland)	vHW18-9
rAAV-9/2-hEF1α-C _{on} /D _{on} -hM3Dq-HAtag	VVF (Zurich, Switzerland)	vHW24-9
rAAV-8/2-hEF1α-C _{on} /D _{on} -hM4Di-mCherry	VVF (Zurich, Switzerland)	vHW23-8
AAV1.CAG.flex.tdTomato.	Penn Vector Core (Philadelphia, USA)	AllenInstitute854
rAAV9-Syn-flex-GCaMP6m	Penn Vector Core (Philadelphia, USA)	100838-AAV9
Antibodies (dilution)		
goat anti-Pax2 (1:400)	R&D Systems (Minneapolis, USA)	AB_10889828
guinea pig anti-Lmx1b (1:10 000)	Dr Carmen Birchmeier	(Muller <i>et al.</i> 2002) ²⁶
chicken anti-GFP (1:1000)	Life Technologies	AB_2534023
rabbit anti-GFP (1:1000)	Molecular Probes	AB_221570
rabbit anti-NeuN (1:1000)	Abcam	AB_10711153
goat anti-WGA (1:2000)	VECTOR laboratories	AS-2024
rabbit anti-WGA (1:2000)	Sigma Aldrich	T4144
rabbit anti-c-maf (1:1000)	Dr Carmen Birchmeier	#40
guinea pig anti-c-maf (1:1000)	Dr Carmen Birchmeier	#2223, #1 final bleed
rabbit anti-PKCg (1:1000)	Santa Cruz	AB_632234
rabbit anti-SOM (1:1000)	Santa Cruz	sc-13099
mouse anti-PV (1:1000)	Swant	235
rabbit anti-NPY (1:1000)	Peninsula Laboratories	T-4069
goat anti-tdTomato (1:1000)	Sicgen	AB8181-200
rabbit anti-HAtag (1:2000)	Bioconcept	3724S
goat anti-c-fos (1:500)	Santa Cruz	sc-52-G

IPT: Institute of Pharmacology and Toxicology, University of Zürich; VVF: Viral Vector Facility (ETH, Zurich)

2.4 Results

2.4.1 Labeling of S1-CST neurons by using rAAVs in wild type mice

First, we tested if intraspinal injection of rAAV vectors would also lead to the transduction of descending axon terminals from supraspinal CNS areas. We injected different serotypes of rAAVs encoding for fluorescent proteins (eGFP or tdTomato) into the lumbar spinal cord of wild type mice, and analyzed eGFP (or tdTomato) expression at supraspinal sites known to provide descending input to neurons of the lumbar spinal cord, such as the rostral ventromedial medulla (RVM) and the primary somatosensory cortex (S1). We found that neurons descending from these areas can be traced from the spinal cord through locally injected rAAV vectors¹¹ (Fig.1A).

Because rAAV viruses typically do not cross synapses, the presence of labeled neurons in several brain areas suggests that these neurons have been labeled by direct transduction of their axon terminals in the spinal cord. In particular, we analyzed expression of fluorescent proteins encoded by different rAAV serotypes, in RVM and in the primary somatosensory cortex (S1). In S1, as expected, the labeled neurons are pyramidal neurons located in the layer 5 of the cortex, consistent with what is known about cortical output neurons. All serotypes tested led to eGFP (or tdTomato) expression in supraspinal sites such as the RVM and S1, but displayed different labeling efficacies. We quantified the number of layer 5 pyramidal neurons labeled in S1 and found that serotypes 6 (63 ± 17 neurons/animal) and 9 (33 ± 12 neurons/animal) displayed the highest efficacy to retrogradely transduce terminals of S1-CST neurons (Fig.1B).

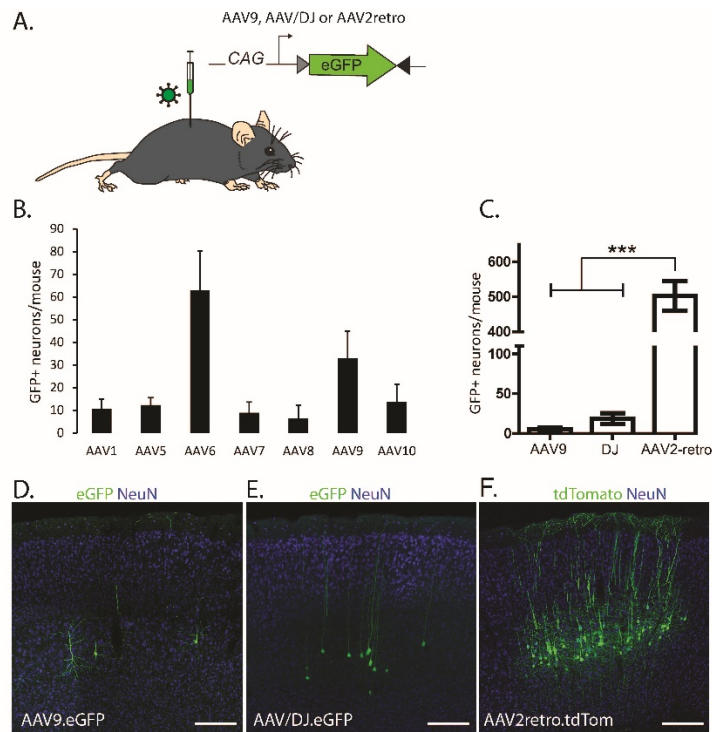

Fig.1: Retrograde transduction of CST neurons by different recombinant adeno-associated virus (rAAV) serotypes. **A.** Injection of rAAVs into the lumbar spinal cord of wild type mice. **B.-C.** Quantification of the number of retrogradely transduced neurons in S1 after intraspinal injection of the indicated serotypes. **D.-F.** Representative example of S1-CST labeling after intraspinal injections of rAAV9 (n=4), rAAV/DJ (n=4) or rAAV2-retro (n=4) serotypes. Scale bars 200μm. Error bars represent \pm SEM, *** $p < 0.001$

We then compared the transduction efficacy of serotype 9 to that of the recently published serotype 2 capsid variant rAAV2-retro¹⁴. We found that rAAV2-retro injection led to an increase of about 25- fold (19 ± 8 vs. 502 ± 42 neurons/animal, respectively, Fig.1C-F) in the number of labeled neurons in S1.

The presence of corticospinal projections from the motor and sensory cortices in the rodent is known^{1,7,8,27}, but these neurons are not very well characterized and little is known about their function. We therefore aimed to investigate in more detail the anatomy of the direct connection between the primary somatosensory cortex and the spinal cord.

2.4.2 Labeling S1-CST neurons in CCK^{cre} mice

Injection of rAAV9.CAG.flex.eGFP into the lumbar spinal cord of CCK^{cre} mice led us to identify a population of layer 5 (L5) pyramidal neurons, which express the marker cholecystokinin (CCK) and project directly onto interneurons in the dorsal spinal cord (Fig.2A). Although CCK is traditionally used as a marker of inhibitory interneurons in the cortex²⁸, it is also expressed in layer 5 pyramidal neurons in the mouse brain⁹. After intraspinal injection of rAAV9.CAG.flex.eGFP, we also observed eGFP+ neurons in a few other brain areas, including the anterior cingulate cortex (ACC) the thalamus and the RVM (Fig.2B). Injection of a cre-dependent rAAV directly into S1 leads to labeling of a larger population of neurons, including pyramidal neurons in the layer 5 and the CCK-expressing inhibitory interneurons (Fig.C-D). Therefore, this labeling strategy can be used to label terminals of CST axons in the spinal cord (Fig.3B) but does not specifically label CST neurons in the cortex.

The CCK^{cre} mouse line provides a good tool to study S1-CST neurons because the expression of the recombinase in these neurons allows the expression of a wide variety of fluorescent or effector proteins, from viruses carrying recombinase-dependent transgenes. However, it was not known whether the CCK-expressing L5 CST neurons represent the majority of the CST neurons in this area or rather only a subset. To address this question, we investigated what is the proportion of all S1-CST neurons that express cre (under the CCK promoter). To this end we co-injected a rAAV2-retro.flex.eGFP and a rAAV2-retro.tdTomato virus into the lumbar spinal cord of CCK^{cre} mice (Fig.2E-F). The eGFP (cre-dependent) will thus be expressed only in cre+ neurons, whereas the tdTomato will label all neurons connected to the injection site (cre-independent). We found that about 70% ($71.5\% \pm 3.1$) of all tdTomato+ S1-CST neurons also expressed eGFP. Conversely, the proportion eGFP+ neurons that expressed tdTomato was very similar ($75.5\% \pm 1.6$). This suggests that virtually all S1-CST neurons expressed cre under the CCK promoter and that S1-CST neurons can be labeled using the CCK^{cre} mouse line.

Fig.2: Labeling S1-CST neurons in CCK^{cre} mice. **A.** Injection of rAAVs encoding for cre-dependent eGFP and cre-independent tdTomato fluorescent proteins into the lumbar spinal cord of CCK^{cre} mice. **B.** Brain areas labeled with eGFP positive neurons after intraspinal injection of rAAV9.flex.eGFP in CCK^{cre} mice. 7N: facial nuclei, ACC: anterior cingulate cortex, MnR: median raphe nucleus, PAG: Periaqueductal grey, S1hl: somatosensory cortex, hindlimb area. **C.** Injection of rAAVs encoding for cre-dependent tdTomato into the S1 cortex of CCK^{cre} mice. **D.** Widespread labeling of cortical neurons with tdTomato (red) after cortical injection (C). **E.-F.** and Quantification and comparison of S1-SCT neurons labeled by cre-dependent GFP (n=4) and cre-independent tdTomato (n=4) fluorescent proteins. Scale bars: 200 μ m, Error bars represent \pm SEM.

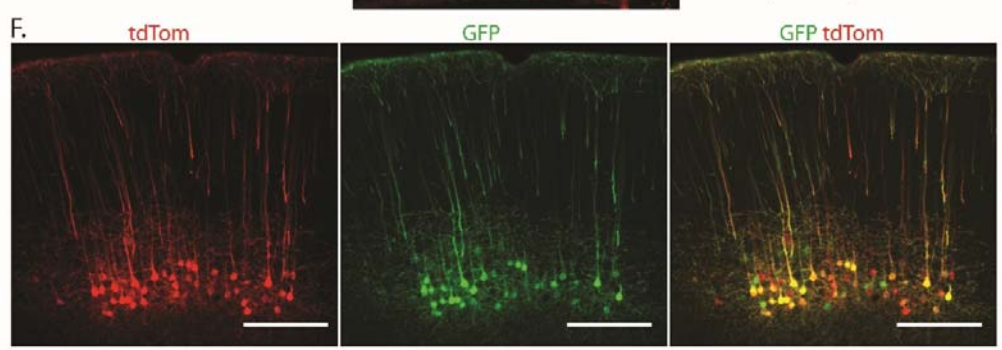
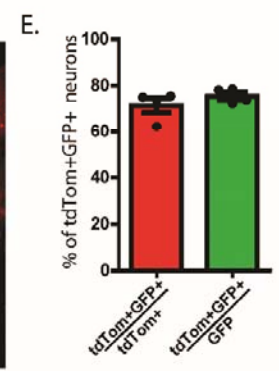
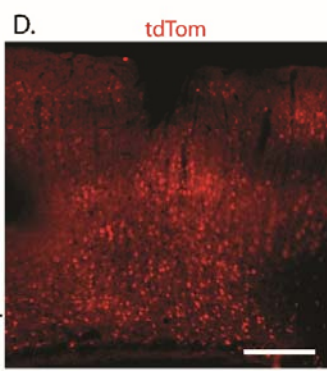
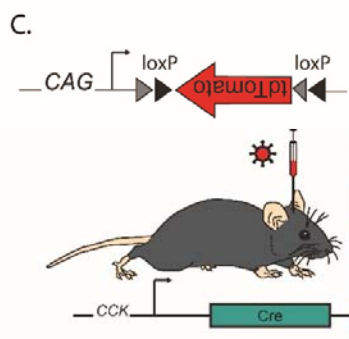
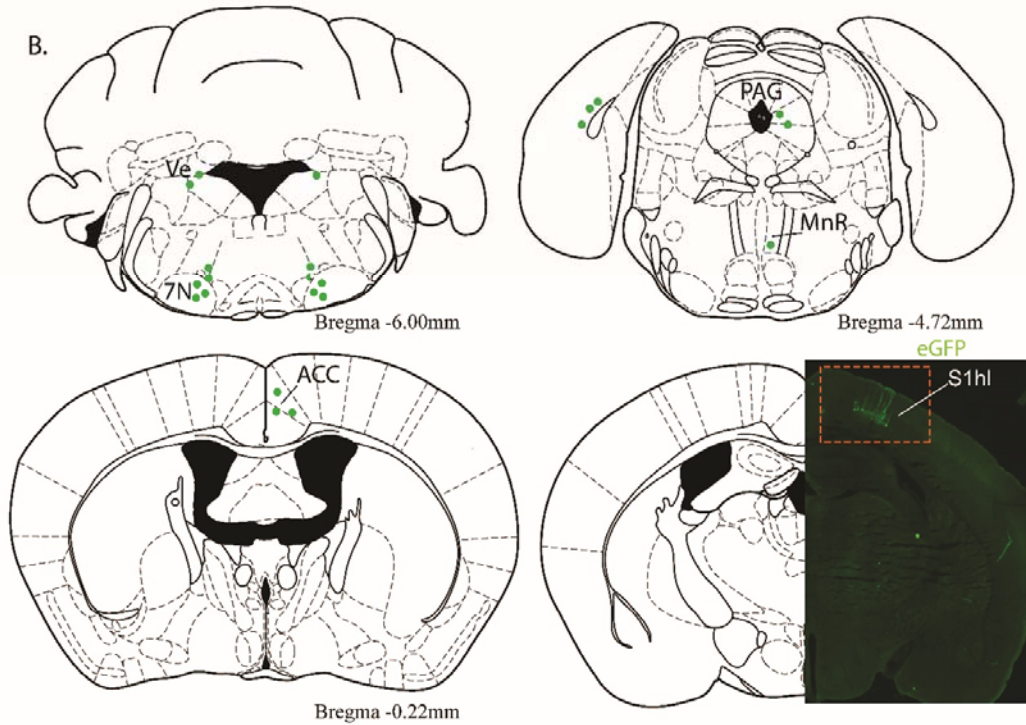
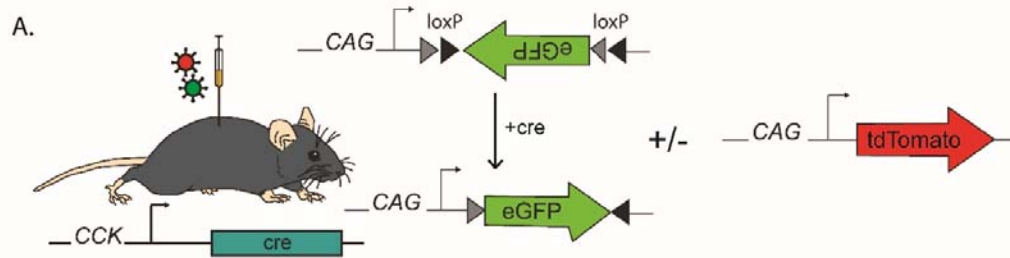

2.4.3 Viral targeting strategies to label S1-CST neurons.

In order to more precisely characterize a given population of neurons identified either genetically or anatomically, we need to be able to target these neurons in a specific and efficient manner.

Two challenges arose: first, the local injection of cre-dependent rAAVs into the S1 cortex would lead to expression of the transgene in neurons different from CST neurons, as CCK is also expressed in inhibitory interneurons in layers 5 and 6, and possibly also in other (non CST) pyramidal neurons of layer 5⁹ (Fig.2D). The use of other driver genes (Thy1, emx1, CAMK2A) was also considered but the markers usually used to label CST axons are not specific to CST neurons, but rather broadly expressed in the forebrain^{4,5,9}. Second, with the intraspinal injection of rAAV viruses, we could specifically label CST neurons in S1 that express the cre under the CCK promoter, but we also labeled neurons in a few other brain areas (Fig.2B), as well as spinal CCK positive interneurons.

We therefore developed an intersectional strategy (Fig.3B. “Intersectional strategy 1”) to specifically target neurons that (1) project from S1 to the spinal cord, and (2) express cre under the CCK promoter. To this end, we injected a rAAV2-retro.Dre into the lumbar spinal cord of CCK^{cre} mice (Fig.3B). The S1-CST neurons (as well as other cre⁺ neurons that are located or project in the spinal cord) thus express both recombinases cre and Dre. We then targeted expression of the desired transgene by local injection in S1 of cre- and Dre-dependent rAAVs. As a proof of principle we demonstrated that this strategy works with the injection in S1 of rAAVs carrying several different transgenes (Fig.3B.1: AAV.C_{on}/D_{on}.GFP; Fig.8A.8: AAV.C_{on}/D_{on}.hM3Dq, AAV.C_{on}/D_{on}.hM4Di (not shown), and AAV.C_{on}/D_{on}.Chr2 (not shown)).

A possible variation of this intersectional strategy (Fig.3C, “Intersectional strategy 2”) is the injection of a rAAV2-retro.cre into the spinal cord of a wild type mouse, followed by the local injection in S1 of a rAAV carrying a cre-dependent transgene. This strategy provided higher labeling efficacy as the intersectional strategy 1 for some transgenes. This is likely due to the requirement of only a single recombination event (by the cre only and not by the cre and the Dre) is necessary for the transgene expression. In the case of S1-CST neurons, as we have shown that cre positive neurons represent the vast majority of the S1-CST population, the intersectional strategies 1 and 2 should label the same population. It is interesting to note, however, that this strategy could be useful in other cases, where a marker gene would only label a subset of the projection neurons.

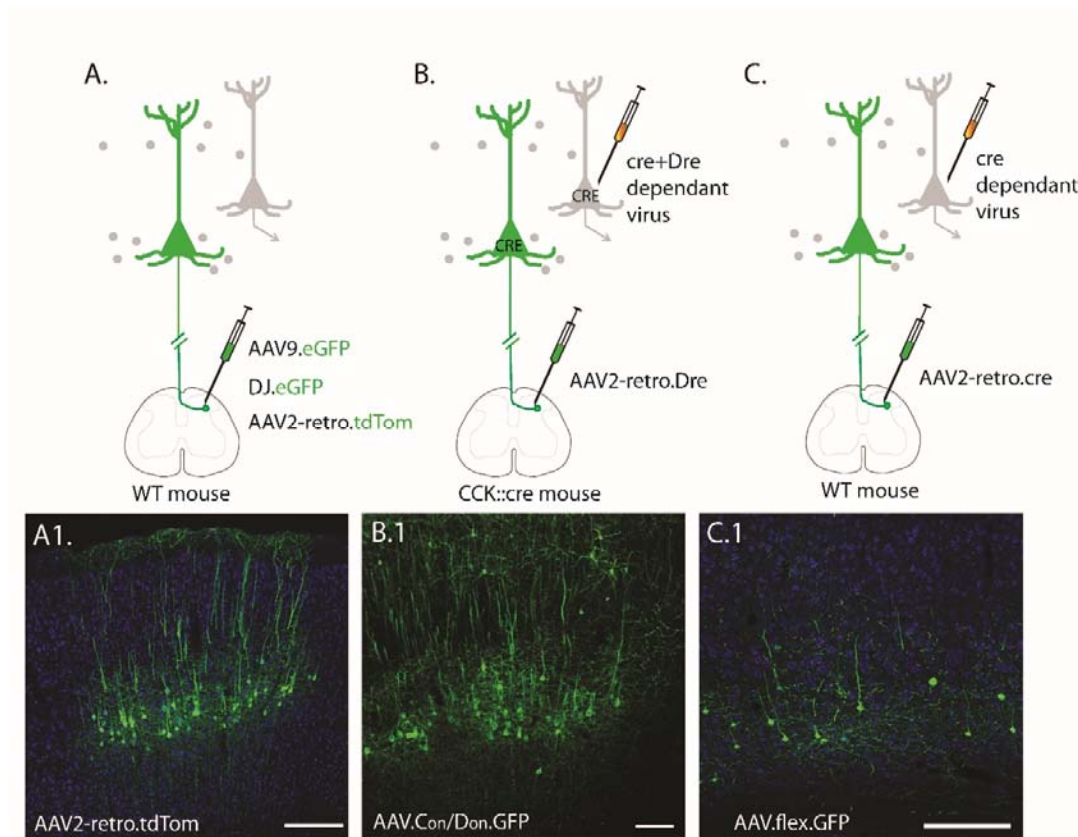

Fig.3: Optimization of the viral targeting strategy to label S1-CST neurons. **A.** Retrograde (axonal) transduction of descending neurons from S1 by different recombinant rAAV serotypes. (A.1: example of S1-CST neurons labeling using the rAAV2-retro serotype). **B.** Intersectional strategy #1: a rAAV2-retro.Dre is injected into the lumbar spinal cord of a CCK^{cre} mouse, followed by a cortical (S1) injection of a cre-and Dre-dependent rAAV (B.1: example with cortical injection of AVV carrying a transgene for GFP). **C.** Intersectional strategy #2: a rAAV2-retro.cre is injected into the lumbar spinal cord of a wild type (WT) mouse, followed by a cortical (S1) injection of a cre-dependent rAAV (C.1: example with cortical injection of rAAV carrying a transgene for GFP). Scale bars: 200 μ m.

2.4.4 Morphology of S1-CST neurons

We have shown that we can specifically label S1-CST neurons that project to the lumbar spinal cord. In order to assess if these neurons project solely to the spinal cord or have collaterals in others regions of the CNS, we performed sparse labeling of S1-CST neurons with eGFP. We then imaged whole cleared brains with light sheet microscopy¹⁶. The vast majority of the axons from labeled S1-CST neurons run from the cortex through the internal capsule and to the midbrain pyramids, following the known trajectory of the CST (Fig.4). We observed collaterals branching from the main tract to two areas (Fig.4B). A small number of axons bifurcated from the internal capsule to terminate in the striatum, and another small group branched off in the midbrain (Fig.4B, inset).

In addition to the anatomy of the CST neurons, understanding their function in somatosensory processing requires the identification the connected cells in the circuit.

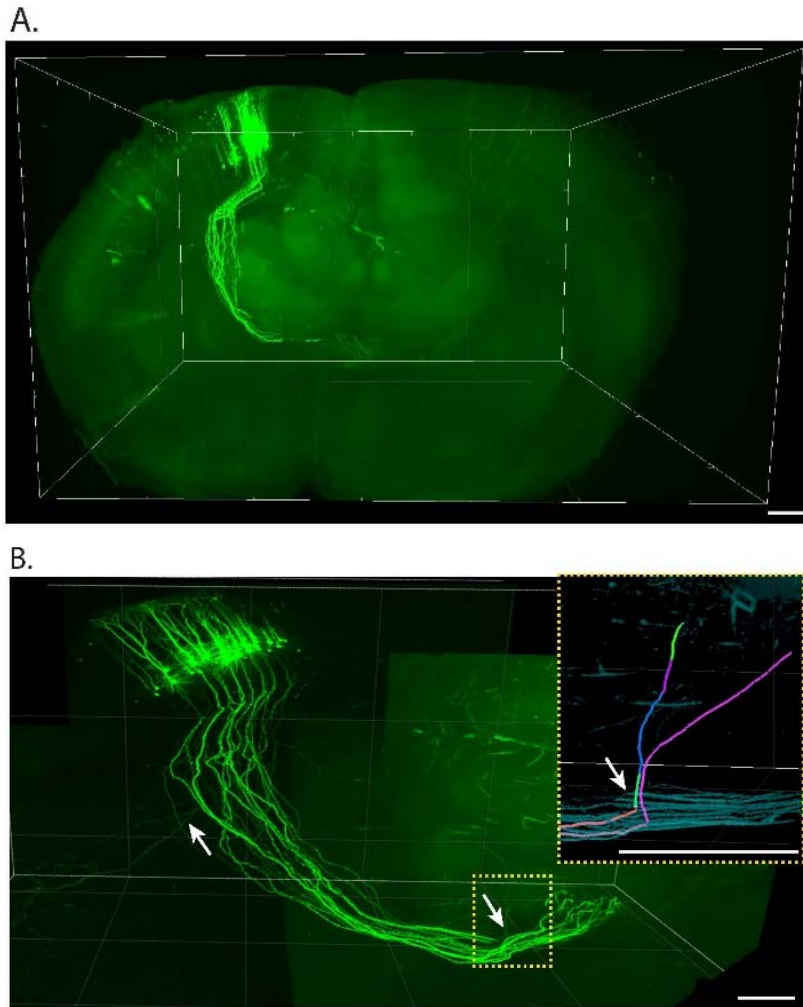

Fig.4: Labeling of the corticospinal tract in CLARITY-cleared brain. A-B. eGFP labeling of S1-CST neurons in a cleared brain, from the front (A) or the side (B). Inset in (B) shows the possible tracing of individual axonal projections. Scale bars: A: 1 mm, and B: 200 μ m.

2.4.5 S1-CST neurons receive input from the somatosensory circuit

The direct connection between the spinal dorsal horn and the somatosensory cortex suggests that S1-CST neurons may be involved in a circuit for sensory processing. We sought to further investigate the precise position of S1-CST neurons in this circuit by tracing their input. To this end, we performed monosynaptic retrograde labeling using rabies virus²⁹ (Fig.5). S1-CST neurons were targeted in CCK^{cre} mice by intraspinal injection of rAAV2-retro.Dre followed by local S1 injection of the helper virus rAAV.flex.rox.TVA.G and the rabies virus EnvA.RV.dG.eGFP. Pyramidal neurons in the layer 5 of all cortical areas are known to receive mainly input from layer 2/3 pyramidal neurons, local interneurons, but also from the thalamus³⁰. As expected, we found eGFP labeling in layer 5 (including the primarily infected S1-CST neurons, Fig.5B-C) and in many pyramidal neurons in layer 2/3. In layer 5, the rabies virus also labeled interneurons that we further characterized with immunohistochemistry (Fig.5E-G). We found co-labeling of eGFP with PV (Parvalbumin), NPY and in very few cases with SOM (somatostatin), three well characterized markers of cortical inhibitory interneurons²⁸. Interestingly, we also found eGFP+ neurons in the ventral posterolateral nucleus (VPL) of the thalamus (Fig.5B; D). The morphology of these cells is representative of thalamocortical relay sensory neurons³¹ and consistent with reports that thalamic neurons can directly

project to layer 5 and 6 cortical neurons³⁰. These thalamic sensory relay neurons are known to receive input from sensory circuits^{32,33}. Overall, these results confirm that CCK-expressing S1-CST neurons are part of a larger sensory circuit loop between the spinal cord and the brain.

2.4.6 S1-CST neurons make direct synaptic contacts onto spinal interneurons.

2.4.6.1 Labeling of CST axons in the spinal cord

Next, we identified the termination area of S1-CST neurons in the lumbar spinal cord (Fig.6). The injection of rAAV1.flex.tdTomato in the hindlimb area of S1 (S1hl) in CCK^{cre} mice led to the labeling of the CST axons in the ventral part of the dorsal white matter column in the spinal cord. Terminals were also visible within the grey matter mainly in the deep dorsal horn (Fig.6B, “CST”), in laminae III and IV. This finding is consistent with previous reports of labeling spinal interneurons targeted by CST neurons^{7,27,34}, showing that tracing from M1 labels terminals mainly in the ventral and intermediate spinal cord, whereas tracing from S1 labels terminals in lamina III and IV of the dorsal horn.

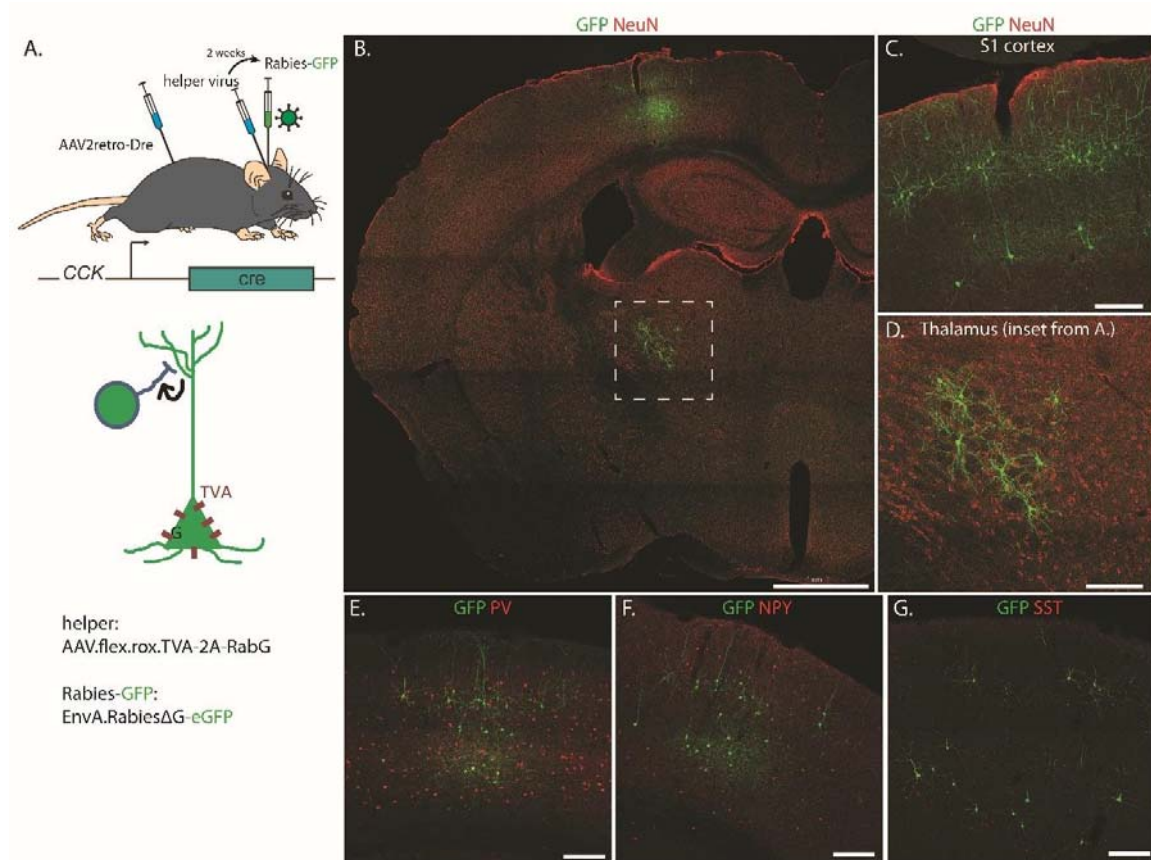

Fig.5: Retrograde monosynaptic tracing of S1-CST neurons with rabies. **A.** A rAAV2retro.Dre is injected in the spinal cord of CCK^{cre} mice, followed by a cre-and-Dre-dependent helper virus (TVA, RabG) in S1 and later the rabies virus in S1. **B.** Overview of the labeled neurons in the brain: S1-CST neurons (starter cells) as well as layer 2/3 pyramidal neurons (also in **C.**), layer 5 inhibitory interneurons (**E-G.**) and thalamic sensory relay neurons (**D.**). Scale bars: **B:** 1 mm; **C-G:** 200 μ m.

The lamina III and IV of the dorsal horn of the spinal cord are known to contain interneurons involved in the processing of touch and proprioceptive information, as well as the termination area of low-threshold mechanosensory fibers (LTMRs)⁸. We therefore decided to identify the spinal neurons that are targeted by S1-CST neurons in this region.

2.4.6.2 *Anterograde transsynaptic tracing with WGA*

We first used wheat germ agglutinin (WGA) to label neurons that are targeted by S1-CST neurons. CCK^{cre} mice were injected with rAAV2.flex.WGA in S1hl. WGA is transported transsynaptically to label the postsynaptic neurons. After 10 days, we detected WGA in the dorsal horn of the lumbar spinal cord (Fig.6C-G). WGA immunoreactivity was mostly found in the deep dorsal horn, in lamina III and IV as expected. In order to identify the neurons that were labeled with WGA, we performed immunocytochemistry against known markers of dorsal horn interneurons populations. Excitatory interneurons in laminae I-III can be labeled using an antibody against *Imx1β*³⁵ (Fig.6C), while inhibitory neurons can be labeled using an antibody against *pax2*³⁵ (Fig.6D) or GlyT2 (glycinergic neurons, Fig.6E)^{15,23}. Other markers were used, such as PKCγ (not shown) and the transcription factor *c-maf* (Fig.6F). We found that about a third of the WGA positive neurons were positive for *Imx1β* ($27.8 \pm 1.3\%$) and two thirds were positive for *pax2* ($56.9 \pm 2.1\%$, n=8) (Fig.6G). About half of all WGA positive neurons were glycinergic ($47.8 \pm 2.8\%$). Notably, we found that more than half of all WGA positive neurons also expressed the transcription factor *c-maf* ($54.8 \pm 3.9\%$). Because *c-maf* is present in a heterogeneous population of spinal interneurons^{36,37}, we determined the proportion of WGA positive neurons that were either *c-maf* positive and inhibitory (*pax2* positive: $21.9 \pm 2.6\%$) or *c-maf* positive and excitatory (*pax2* negative: $27.5 \pm 1.9\%$). We did not find any WGA positive neuron that was also positive for PKCγ (Fig.6G).

These results suggest that S1-CST neurons contact a heterogeneous population of interneurons in the spinal dorsal horn, including a large proportion of glycinergic neurons and *c-maf* expressing neurons.

A more detailed analysis of the spinal *c-maf* expressing neurons is presented in Results Chapter 2.

2.4.6.3 *Monosynaptic contacts from CST terminals onto spinal interneurons*

In order to confirm that CST neurons form synapses onto *c-maf* expressing spinal interneurons, we next used a rAAV encoding for the fusion protein synaptophysin-mCherry to label CST terminals in the spinal cord. Synaptophysin is an integral membrane glycoprotein located at the presynaptic vesicles in neuron terminals. The expression of the fusion protein synaptophysin-mCherry leads to specific labeling of the presynaptic terminals with red mCherry fluorescence. In order to study the synaptic contacts between S1-CST neurons and *c-maf* positive interneurons, we injected a rAAV encoding for the fusion protein synaptophysin-mCherry in S1hl, as well as an eGFP-expressing virus in the lumbar spinal cord to label *c-maf*-expressing interneurons. We performed immunohistochemistry against vGluT1 and homer to further label the terminals of mCherry positive S1-CST neurons, and the post-synaptic area in eGFP+ neurons, respectively. We found numerous examples of contacts between CST terminals (mCherry+vGluT1+) and *c-maf* neurons (eGFP+homer+) (Fig.7). Together with the WGA tracing experiments, these results confirm the presence of direct synaptic contacts between S1-CST neurons and *c-maf* expressing spinal interneurons.

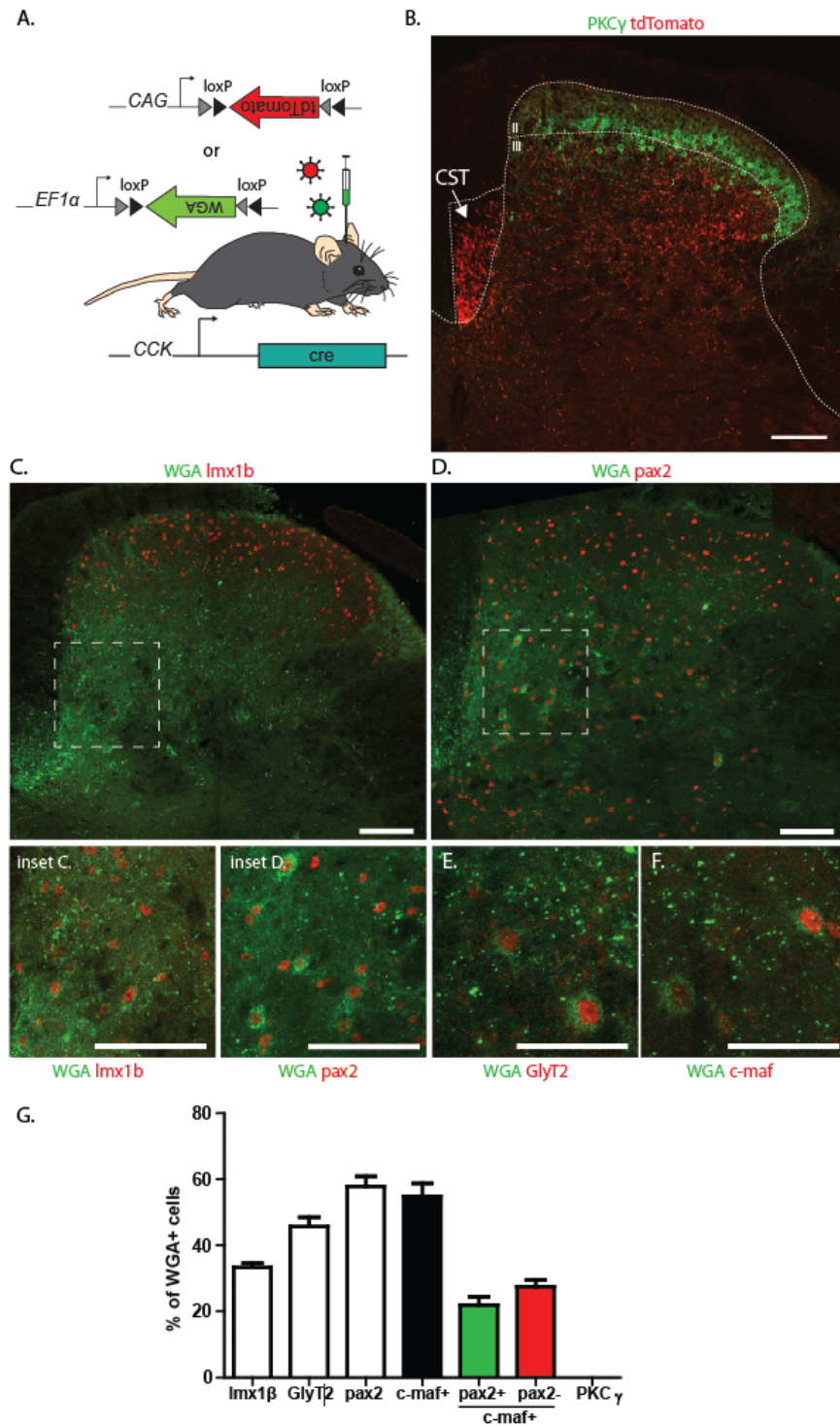

Fig.6: Labeling of the output of S1-CST neurons in the spinal cord. **A.** rAAVs carrying either a cre-dependent tdTomato or WGA transgene are injected in S1hl of CCK^{cre} mice. **B.** Labeling of the CST in the dorsal funiculus of the spinal cord, contralateral to the brain injection site. CST terminals are preferentially located below the laminae II-III border marked by PKC γ immunoreactivity. **C-D.** Co-labeling of WGA positive neurons in the spinal cord with the excitatory marker Imx1 β (**C.** and inset) and the inhibitory marker pax2 (**D.** and inset). WGA positive neurons also express eGFP (**E.**) and the transcription factor c-maf (**F.**). **G.** Quantification of the number of WGA positive neurons that express Imx1 β (n=4, 243 neurons), pax2 (n=8, 391 neurons), GlyT2 (n=3, 275 neurons), c-maf (n=6, 506 neurons) or PKC γ (n=4, 201 neurons). Error bars represent \pm SEM, Scale bars: 100 μ m.

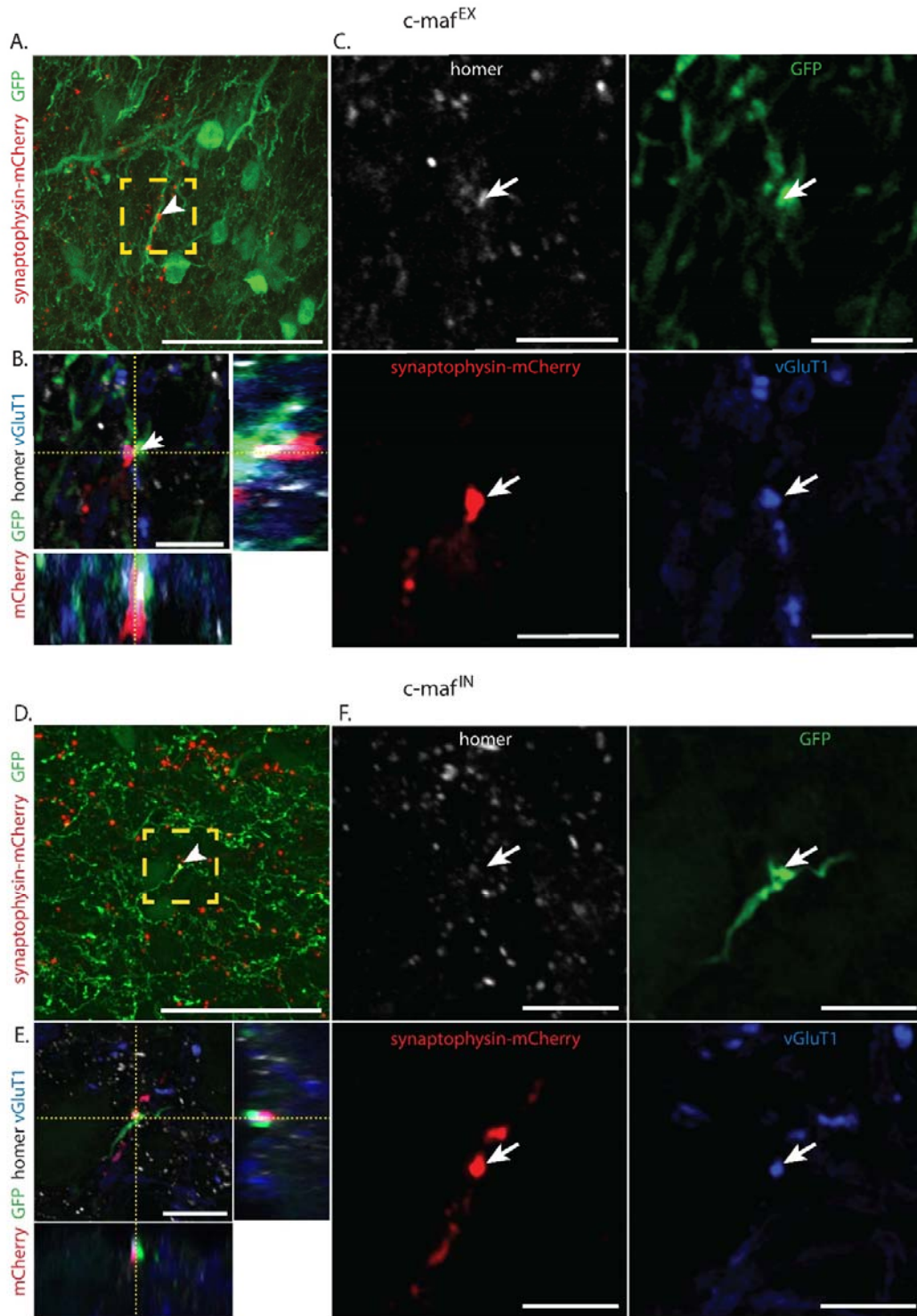

Fig.7: Synaptic contacts by CST neurons onto c-maf expressing spinal interneurons. A-B. Representative examples of synaptic contacts between a CST axon (red, synaptophysin-mCherry) and a GFP-labeled (green) c-maf excitatory (A-C) or inhibitory (D-F) spinal interneuron (n=4 and n=3 mice to label c-maf^{EX} and c-maf^{IN} neurons respectively). A, D. Overview of the mCherry labeled terminals in the vicinity of eGFP expressing neurons. B, E. insets of A and D, respectively, with orthogonal projection views showing the close contacts between mCherry, GFP, homer and vGluT1. The pre- and post-synaptic compartments are also labeled by vGluT1+ (blue) and homer (grey) immunoreactivity, respectively. C, F. Details of B and E, respectively. c-maf^{EX/IN}: c-maf excitatory/inhibitory neurons, respectively. Scale bars: A, D: 50 μ m; B, C, E, F: 5 μ m.

2.4.7 Investigation of S1-CST neurons role in sensory processing

S1-CST neurons directly project to the dorsal horn of the spinal cord, more specifically in lamina III, and to a lesser extent in other laminae. This area is known to be involved in the processing of touch and proprioception. It is also known that under normal conditions, tonic inhibition from glycinergic interneurons located in deeper laminae³⁸⁻⁴⁰ limits activation of the pain pathways by touch-sensitive circuits. Nerve injury can induce changes in these circuits leading to activation of nociceptive pathways⁴¹. Because CST neurons directly contact interneurons in this area, we hypothesized that their activity could influence sensory processing. The conditions under which CST neurons are active are also unknown.

2.4.7.1 Manipulation CST neurons

We sought to investigate the influence of S1 corticospinal neurons on spinal sensory processing. In order to specifically manipulate these neurons, we first targeted them using the previously described intersectional strategy (#1, Fig.3B) in CCK^{cre} mice. DREADDs expression was driven by injection of rAAV2-retro.Dre into the lumbar spinal cord of CCK^{cre} mice, followed by a cortical injection of a rAAV carrying a cre-and Dre-dependent transgene for hM4Di (Fig8.A.1-3) or hM3Dq (Fig8.A.4-7).

We found no differences in sensory thresholds after silencing of S1-CST neurons with hM4Di. We found a significant but very small difference in the response to von Frey (Fig.8A.1) stimulations, and no differences in heat or cold sensitivities (Fig.8A.2-3) in the mice expressing hM3Dq injected with CNO compared to the mice injected with vehicle. hM3Dq-mediated activation of S1-CST neurons had also a very small and not significant effect on the CCI-induced mechanical hypersensitivity (Fig.8A.7). The DREADD receptor expression in S1 was verified by immunostaining against the HA-tag or mCherry, for hM3Dq (Fig.8A.8) and hM4Di (not shown), respectively.

We then silenced S1-CST neurons by injection of rAAV2-retro.cre into the lumbar spinal cord of wild type mice, followed by a cortical (S1) injection of a rAAV carrying a cre-dependent hM4Di (intersectional strategy #2, Fig3, and Fig.8B). We found no differences in the responses to mechanical sensitivities in the mice injected with CNO compared to the mice injected with vehicle. There was a small but significant difference in responses to heat (Fig.8B.2) and cold (Fig.8B.3) stimulations. The amplitude of the difference between the two groups in the cold test however was very small and unlikely to reflect a biologically relevant difference. In the Hargreaves test, the difference was larger but difficult to interpret because the threshold values for the control mice are decreasing over time, while the responses of the CNO injected mice were stable over time. Silencing of S1-CST neurons did not affect motor coordination (Fig.8B.6). In order to investigate the potential effect of silencing CST neurons on chemically-induced hypersensitivity, we next injected formalin subcutaneously into the paw of the mice and assessed spontaneous pain behavior. There were no significant differences in the time spent biting the injected paw or in the number of flinches between CNO and vehicle injected mice (Fig.8B.7-8). hM4Di expression in S1 was verified by immunostaining against mCherry (Fig.8B.9).

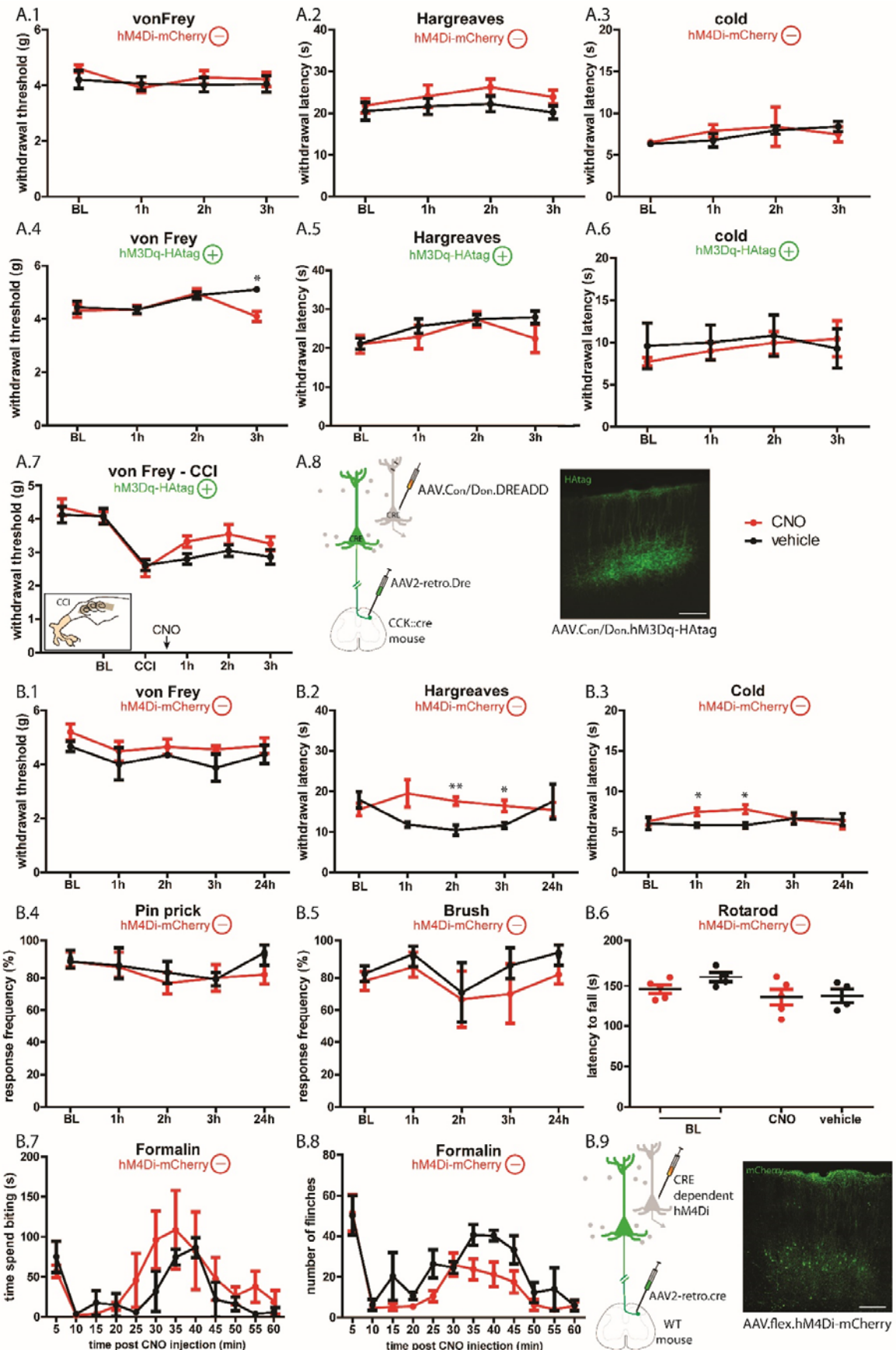

Fig.8: Modulation of S1-CST neurons activity using DREADDs. **A.** DREADD expression was driven by injection of rAAV2retro.Dre into the lumbar spinal cord of CCK^{cre} mice, followed by a cortical (S1) injection of a cre-and Dre-dependent rAAV carrying a transgene for hM4Di (A.1-3, CNO: n=5; vehicle: n=5) or hM3Dq (A.4-7 CNO: n=6; vehicle: n=5) and CCI (A.7 CNO: n=10; vehicle: n=8). **A.1-A.3.** Responses to mechanical (A.1), heat (A.2) and cold (A.3) stimulations after hM4Di-mediated silencing of CST neurons. (von Frey: F (4,54) = 0.675; P = 0.571; Hargreaves: F (4,54) = 0.407; P = 0.748; cold: F (4,54) = 0.501; P = 0.685). **A.4-A.6.** Responses to mechanical (A.4), heat (A.5) and cold (A.6) stimulations after hM3Dq-mediated activation of CST neurons in naïve mice. (von Frey: F (1.782,16.04) = 4.543; P = 0.031, Hargreaves: F (3,27) = 0.872; P = 0.467, cold: F (1.56,14.042) = 1.002; P = 0.372;) **A.7.** Effect of CCK positive S1-CST neurons activation on CCI-induced mechanical hypersensitivity (CNO: n=10; vehicle: n=8, F(2.381,38.097)=1.233, p= 0.072). **A.8.** Labeling of S1-CST neurons expressing hM3Dq-HAtag (green). **B.** DREADDs expression was driven by injection of rAAV2retro.cre into the lumbar spinal cord of wild type mice, followed by a cortical (S1) injection of a cre-dependent rAAV carrying a transgene for hM4Di (CNO: n=5; vehicle: n=4). **B.1-5.** Responses to mechanical (B.1, 4, 5), heat (B.2) and cold (B.3) stimulations after hM4Di-mediated silencing of CST neurons (von Frey: F (2.027,14.191) = 0.131; P = 0.881; pin prick: F(4,28) = 0.511; P = 0.728; brush: F(1.88,13.16) = 0.159; P = 0.843; cold: F(11.295,27.795) = 2.845; P = 0.043, Hargreaves: F(4,28) = 2.926; P = 0.039). **B.6.** No effect of neuronal silencing on gross locomotor activity (rotarod, P = 0.902). **B.7-8.** No effect of neuronal silencing on formalin-induced aversive behaviors (CNO: n=4; vehicle: n=3; flinching: F(11,55) = 0.653; P = 0.775; biting: F(11,55) = 1.07; P = 0.401). **B.8.** Labeling of S1-CST neurons expressing hM4Di-mCherry (green). Error bars represent \pm SEM, * $p < 0.05$ (ANOVA). BL: baseline, horizontal axis: time post CNO injection, scale bars: 200 μ m.

2.4.7.2 Recording of S1-CST neurons activity in freely moving mice

Layer 5 pyramidal neurons are output neurons of the cortex. They receive input from many local interneurons in different layers and are consequently able to accumulate information from an entire cortical column before sending output to sub-cortical areas. The conditions under which layer 5 cortical neurons in the somatosensory cortex become active however, are not precisely known. Here we performed calcium imaging experiments of S1-CST neurons in freely moving mice. We took advantage of a head-mounted miniaturized microscope (miniscope)^{18,42} that allow recording of calcium signals in freely behaving animals. Ca²⁺ sensor (GCaMP6m) expression in CST neurons was driven by intraspinal injection of rAAV2-retro.cre into the lumbar spinal cord of wild type mice, followed by injection of AAV-CAG-flex-GCaMP6m in S1. In order to image the cell bodies of layer 5 neurons, which are located about 800 μ m deep below the surface of the brain, we implanted a small prism lateral to the GCaMP6m labeled neurons (Fig.9A), and the objective of the miniscope was composed of a gradient-index (GRIN) lens. The behaviour of the mouse and time points of sensory stimulations were recorded simultaneously with the Ca²⁺ signals (Fig.9C, D). We were able to detect transient increases in Ca²⁺ signals. We will analyse these events during baseline and sensory stimulations (von Frey, brush, or after injection of formalin) to determine the conditions that lead to activation of S1-CST neurons.

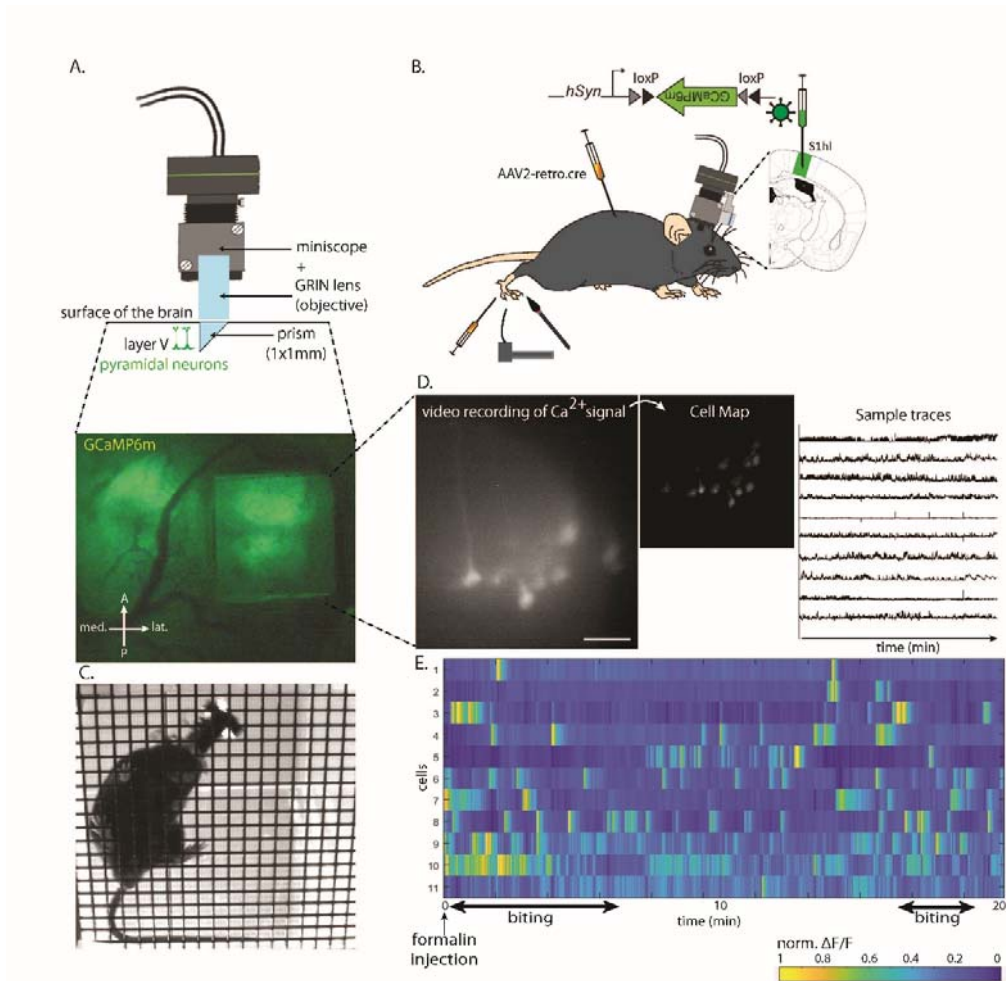

Fig.9: *in vivo* calcium imaging of S1-CST neurons in freely moving mice. **A.** Schematic representation of the miniscope and prism implantation. The prism is placed lateral to the GCaMP6m labeled neurons. **B.** GCaMP6m expression was driven by injection of rAAV2retro.cre into the lumbar spinal cord of wild type mice, followed by a cortical (S1) injection of a cre-dependent rAAV carrying a transgene for GCaMP6m. Stimulations of the hindpaw in GCaMP6m expressing, freely moving mice. **C.** Video recording of mouse behavior during Ca^{2+} imaging. **D.** Example output of the calcium analysis (scale bar: 50 μm). Cell map showing the identified neurons, example traces and alignment of calcium activity to annotated behavior. S1h1: somatosensory cortex.

2.5 Discussion

Identification of genetically defined subpopulations of neurons in the central nervous system has greatly improved our understanding of many neuronal circuits in the past few years. Together with morphology and physiological properties, as well as a better understanding of the connectivity of the studied neurons, these data help researchers to identify functional cell types and decipher their role in physiology and disease.

The corticospinal tract has been extensively studied in physiological experiments in cats and primates, but only recently in mice. It is known that the anatomy of the CST is generally conserved between mammals, and tools have been developed to label CST neurons in the rodent, mainly to study spinal cord injury and repair. The presence in all mammals of a direct connection between neurons in the primary somatosensory cortex and spinal interneurons however suggest that these neurons play an important role in non-pathological conditions as well. Additionally, some studies have shown that CST neurons from the M1 and S1 cortices

preferentially contact distinct populations of spinal interneurons⁷, suggesting distinct roles from these different populations in modulation of spinal processing.

Tools to specifically target CST neurons based on their gene expression pattern and connectivity to a region of the spinal cord are therefore essential to advance our understanding of CST function. The tools available today to target CST neurons include genetically modified mouse lines, and injection of viral vectors into the cortex or the spinal cord. Commonly used mouse lines are the Thy1-GFP lines and mouse lines where transgene expression is driven by the Emx1 promoter (Emx1^{IREScrc} or corresponding fluorescent reporter mouse lines). However, use of these two driver genes results in widespread labeling in the forebrain and is not specific to CST neurons^{4,5,9}. Similarly, cortical injection of rAAVs will result in transduction of many non-CST neurons. Although this can be useful to study spinal cord repair after injury, it is not possible to specifically label or manipulate CST. Until very recently, intraspinal injection of rAAV vectors was also of limited use because of very low transduction very low efficacy. We have shown recently that it is possible to label CST neurons from an intraspinal injection using rAAV2-retro with a more than 20-fold efficacy compared to previously used serotypes.

Here, we took advantage of this new tool and of a different transgenic mouse line, the CCK^{cre} line, to specifically label CST neurons from a defined origin and target region and on the promoter-driven expression of the cre recombinase.

Targeting of specific populations of long-range projections

A direct comparison of several rAAV serotypes revealed that the rAAV2-retro serotype is by far the best available rAAV vector to label long-range projections from the cerebral cortex to the spinal cord. We confirmed that there is a direct connection from pyramidal neurons in the layer 5 of S1 to the lumbar spinal cord. A recent study also found that rAAV2-retro was efficient to label projection neurons from the brain to the cervical spinal cord⁴³ and is a useful tool for gene delivery into long range projecting neurons, in line with our results. We also found that we could label a population of layer 5 CST neurons in S1 by injecting a cre dependent rAAV2-retro into the lumbar spinal cord of CCK^{cre} mice. Our results show that the CST neurons expressing CCK in S1 account for virtually all S1-CST neurons. Indeed, the number of CST neurons in S1 transduced by injection of rAAV2-retro vectors carrying cre-dependent or non-cre-dependent transgenes are similar. This suggests that the use of the CCK^{cre} mouse line is a good tool to target expression of transgenes of interest into CST neurons. However, we also found that a simple intraspinal injection of the virus also leads to labeling of neurons in a few other areas of the brain, in line with previous results¹¹. This strategy can therefore be useful for applications that are targeted locally to S1, such as optogenetic manipulation of S1-CST neurons or recording of Ca²⁺ signals for example. It also has the advantage of only requiring a single virus injection. It cannot however be used to label exclusively CST neurons or a specific subpopulation of them, and tracing or functional experiments using such an approach should be interpreted carefully. If DREADDs are expressed in other descending neurons for example, it is not possible to attribute an observed behavior to one specific group of neurons. Another limitation is that one would need to produce viruses carrying the desired transgene for each individual application.

We have therefore tested two intersectional strategies, using either wild type mice or the CCK^{cre} mouse line that allow us to drive expression of one or two recombinases specifically into S1 neurons that project into the lumbar spinal cord. We show that both strategies allow for a specific and efficient labeling of S1-CST neurons. In contrast to direct labeling from the spinal cord with a single rAAV injection, there is no labeling of any other neurons in the spinal cord or any other brain area. This high specificity is required for chemogenetic manipulation experiments, when the activating drug (CNO in the case of the hm3Dq and hm4Di DREADDs) is injected systemically. Additionally, they can be easily adapted in a laboratory where

various one-or two-recombinase dependent rAAV vectors are already available, without the necessity of further virus design and production.

Importantly, these intersectional viral strategies can be transferred to other model circuits. Although in this case the two approaches label equivalent populations of neurons (because CCK is expressed in virtually all S1-CST neurons), the intersectional strategy #1 would prove essential to label specific long-range projections in regions that contains genetically distinct subpopulations of projection neurons, such as the RVM.

S1-CST neurons in somatosensory circuits

Through specific targeting of S1-CST neurons using these approaches, we confirmed that they form direct synaptic contacts onto dorsal horn spinal interneurons. Retrograde monosynaptic tracing with rabies virus revealed that S1-CST neurons receive direct input not only from layer 2/3 pyramidal neurons (as expected) but also from sensory relay neurons in the VPL of the thalamus. Interestingly, this nucleus receives input from the postsynaptic dorsal column, the direct dorsal column pathway and the spinocervical tract that are known to propagate tactile information from the periphery to the brain³³. In addition, immunostainings against known markers of cortical inhibitory interneurons showed that S1-CST neurons receive input mainly from PV and NPY interneurons and to a lesser extend from SOM neurons.

We identified neuronal targets of S1-CST neurons in the spinal cord. Transsynaptic anterograde tracing with WGA resulted in labeling of neurons in the deeper dorsal horn, consistent with the termination area of CST fibers. About two thirds of the WGA labeled interneurons were inhibitory (pax2 positive) and one third was excitatory (lhx1 β positive). We then confirmed the presence of direct synaptic contacts between S1-CST neurons and spinal interneurons by labeling of the synaptic terminals. These results are consistent with unpublished observations from our laboratory that S1-CST neurons are labeled by monosynaptic retrograde rabies tracing from several spinal interneuron populations. Recent results by Ueno *et al.*⁷ also show that CST neurons from S1 form synaptic contacts onto vGluT3 and lhx1 β lineage interneurons. In contrast to previous studies^{34,43}, here we labeled only lumbar spinal cord projecting CST neurons in S1. Taking advantage of this, we showed that these neurons, although they mainly project through the CST, also send collateral branches to the striatum and the midbrain. Further experiments will allow tracing of these axons more precisely into the brain and exact identification of the target areas. Additionally, advances in tissue clearing and light sheet microscopy imaging, when combined with the described labeling strategies, allow imaging of large samples, such as whole mouse brain and spinal cord attached¹⁶. It is also possible to attain a sufficient spatial resolution to trace single axons in such samples.

Function of S1-CST neurons

Previous studies have shown a role of CST neurons in motor coordination and fine sensory motor transformation^{34,43,44}. However, these studies targeted either the whole corticospinal tract, or CST neurons from the motor cortex. Because CST neurons from S1 neurons directly contact interneurons in the dorsal spinal cord, we hypothesized that their activity could also influence sensory processing. The conditions under which this specific population of CST neurons is active are also unknown. We thus took advantage of our specific labeling strategies to address these questions.

Using either of the intersectional strategies mentioned above (Fig.1), we were not able to detect a clear effect of activating or silencing S1-CST neurons on modulations of sensory processing. Activation of CCK positive S1-CST neurons had no acute effect on heat, cold and mechanical sensitivities. We observed a small difference in von Frey thresholds between 3 and 4 hours after CNO injection, although the strongest behavioral effects are usually apparent around 2 h post injection. This small drop in withdrawal thresholds could be due to the prolonged activation of the neurons, but is also quite small (about 4.1 vs 5.1g) and may not reflect a biologically relevant difference. We did not detect a significant difference in von Frey

thresholds after CNO injection in CCI-injured mice either. It is interesting to note, however, that CCK positive S1-CST neurons that target the dorsal horn of the lumbar spinal cord contact both inhibitory and excitatory interneurons. WGA tracing experiments showed that about 60% of the target neurons are inhibitory (including a large proportion of glycinergic neurons). It would therefore be possible that activation of S1-CST neurons in turn activates inhibitory interneurons, leading to reversal of mechanical allodynia¹⁵. However, since both inhibitory and excitatory interneurons would be activated, it is possible that conflicting events might mask a clear behavioral effect.

Here, the behavioral measurements were performed about 3 weeks after cortical injection of the double-recombinase-dependent DREADDs, which according to other experiments in our laboratory, should allow sufficient time for expression of the receptors. However, we sought to confirm these results by a different method. We therefore silenced S1-CST neurons by injecting a cre-expressing virus in the spinal cord of wild type mice, followed by a cortical injection (in S1) of a cre-dependent hM4Di-expressing virus. This strategy could lead to a faster and higher expression of the receptor because only one recombination event is required. However, although we saw a good expression of hM4Di in S1, we did not observe substantial differences in the behavioral responses of the CNO injected mice in the common somatosensory tests we performed. In contrast, Liu *et al.*³⁸ observed changes in mechanical thresholds after ablation or silencing of S1-CST neurons. This difference could be explained by the different methods used to target CST neurons. Indeed, Liu *et al.* observed impairments of light touch sensitivity after pyramidectomy (in adult mice) or ablation of the CST neurons in very young mice. It is likely that these manipulations would lead to a more severe phenotype than the transient pharmacogenetic silencing of a small subset adults CST neurons that we performed here. We also tested the effect of transient silencing of S1-CST neurons using this method in mice that were injected with formalin and saw no clear effect of CNO injection on their behavior. A further experiment will be to silence S1-CST neurons in mice with neuropathic pain. Other methods to study the role of these neurons include ablation with diphtheria toxin or silencing with tetanus toxin. Considering the heterogeneity of the targeted neurons in the spinal cord, it is also possible that the effect of silencing CST neurons in the adult mouse are more complicated and require a different set of behavioral tests, including fine sensory testing, sensory-motor transformation tests or tests of fine motor control. Because CST neurons in S1 receive input from various brain regions, tests that allow seeing the effect of context, stress or emotional state would also be interesting to perform, although testing some of these modalities is not straightforward in rodents.

The conditions that lead to activation of CST neurons in S1 are also mostly unknown. In parallel to our study, Liu. *et al.* have shown that the amplitude of Ca²⁺ signals is enhanced in S1 layer 5 neuron dendrites upon mechanical stimulation⁴⁴. We have developed a procedure to label and image the cell bodies of S1-CST neurons in layer 5. Further analysis is required to determine the activity pattern of corticospinal neurons associated with encoding of various somatosensory and nociceptive inputs.

Overall, we have demonstrated that we can specifically label CST neurons based on their precise connectivity between one region of the spinal cord and one defined region of the cortex. The CCK^{cre} mouse line provides a useful tool to study these neurons, together with injection of rAAVs in the cortex and spinal cord.

Table 2. ANOVA results and P values for behavioral analysis in Figure 8

mouse line	DREADD	test	n(TG)	n (control)	ANOVA or t test
CCK ^{cre}	hM4Di	von Frey	5	5	F (4,54) = 0.675; P = 0.571
		Cold			F (4,54) = 0.501; P = 0.685
		Hargreaves			F (4,54) = 0.407; P = 0.748
	hM3Dq	von Frey	6	5	F (1.782,16.04) = 4.543; P = 0.031
		Cold			F (1.56,14.042) = 1.002; P = 0.372
		Hargreaves			F (3,27) = 0.872; P = 0.467
CCK ^{cre}	hM3Dq+CCI	von Frey	10	8	F(2.381,38.097)=1.233, P= 0.072
wild type	hM4Di	von Frey	5	4	F (2.027,14.191) = 0.131; P = 0.881
		Cold			F(11.295,27.795) = 2.845
		Hargreaves			F(4,28) = 2.926 ; P = 0.039
		Pin prick			F(4,28) = 0.511; P = 0.728
		Brush			F(1.88,13.16) = 0.159; P = 0.843
		Rotarod BL/1h			0.0988/0.902 (t test)
		Formalin (flinches)			4
	Formalin (biting)			F(11,55) = 1.07; P = 0.401	

2.6 References

- 1 Lemon, R. N. & Griffiths, J. Comparing the function of the corticospinal system in different species: organizational differences for motor specialization? *Muscle Nerve* **32**, 261-279 (2005).
- 2 Cichon, J., Blanck, T. J. J., Gan, W. B. & Yang, G. Activation of cortical somatostatin interneurons prevents the development of neuropathic pain. *Nat Neurosci* **20**, 1122-1132 (2017).
- 3 Tan, L. L., Oswald, M. J., Heintz, C., Retana Romero, O. A., Kaushalya, S. K., Monyer, H. & Kuner, R. Gamma oscillations in somatosensory cortex recruit prefrontal and descending serotonergic pathways in aversion and nociception. *Nat Commun* **10**, 983 (2019).
- 4 Porrero, C., Rubio-Garrido, P., Avendano, C. & Clasca, F. Mapping of fluorescent protein-expressing neurons and axon pathways in adult and developing Thy1-eYFP-H transgenic mice. *Brain Res* **1345**, 59-72 (2010).
- 5 Bareyre, F. M., Kerschensteiner, M., Misgeld, T. & Sanes, J. R. Transgenic labeling of the corticospinal tract for monitoring axonal responses to spinal cord injury. *Nat Med* **11**, 1355-1360 (2005).
- 6 Hutson, T. H., Verhaagen, J., Yanez-Munoz, R. J. & Moon, L. D. Corticospinal tract transduction: a comparison of seven adeno-associated viral vector serotypes and a non-integrating lentiviral vector. *Gene Ther* **19**, 49-60 (2012).
- 7 Ueno, M., Nakamura, Y., Li, J., Gu, Z., Niehaus, J., Maezawa, M., Crone, S. A., Goulding, M., Baccei, M. L. & Yoshida, Y. Corticospinal Circuits from the Sensory and Motor Cortices Differentially Regulate Skilled Movements through Distinct Spinal Interneurons. *Cell reports* **23**, 1286-1300 e1287 (2018).
- 8 Abaira, V. E., Kuehn, E. D., Chirila, A. M., Springel, M. W., Toliver, A. A., Zimmerman, A. L., Orefice, L. L., Boyle, K. A., Bai, L., Song, B. J., Bashista, K. A., O'Neill, T. G., Zhuo, J., Tsan, C., Hoynoski, J., Rutlin, M., Kus, L., Niederkofler, V., Watanabe, M., Dymecki, S. M., Nelson, S. B.,

- Heintz, N., Hughes, D. I. & Ginty, D. D. The Cellular and Synaptic Architecture of the Mechanosensory Dorsal Horn. *Cell* **168**, 295-310 e219 (2017).
- 9 Zeisel, A., Munoz-Manchado, A. B., Codeluppi, S., Lonnerberg, P., La Manno, G., Jureus, A., Marques, S., Munguba, H., He, L., Betsholtz, C., Rolny, C., Castelo-Branco, G., Hjerling-Leffler, J. & Linnarsson, S. Brain structure. Cell types in the mouse cortex and hippocampus revealed by single-cell RNA-seq. *Science* **347**, 1138-1142 (2015).
 - 10 Haenraets, K., Albiseti, G. W., Foster, E. & Wildner, H. Adeno-associated Virus-mediated Transgene Expression in Genetically Defined Neurons of the Spinal Cord. *J Vis Exp* (2018).
 - 11 Haenraets, K., Foster, E., Johannssen, H., Kandra, V., Frezel, N., Steffen, T., Jaramillo, V., Paterna, J. C., Zeilhofer, H. U. & Wildner, H. Spinal nociceptive circuit analysis with recombinant adeno-associated viruses: the impact of serotypes and promoters. *J Neurochem* **142**, 721-733 (2017).
 - 12 Atasoy, D., Aponte, Y., Su, H. H. & Sternson, S. M. A FLEX switch targets Channelrhodopsin-2 to multiple cell types for imaging and long-range circuit mapping. *J Neurosci* **28**, 7025-7030 (2008).
 - 13 Anastassiadis, K., Fu, J., Patsch, C., Hu, S., Weidlich, S., Duerschke, K., Buchholz, F., Edenhofer, F. & Stewart, A. F. Dre recombinase, like Cre, is a highly efficient site-specific recombinase in E. coli, mammalian cells and mice. *Dis Model Mech* **2**, 508-515 (2009).
 - 14 Tervo, D. G., Hwang, B. Y., Viswanathan, S., Gaj, T., Lavzin, M., Ritola, K. D., Lindo, S., Michael, S., Kuleshova, E., Ojala, D., Huang, C. C., Gerfen, C. R., Schiller, J., Dudman, J. T., Hantman, A. W., Looger, L. L., Schaffer, D. V. & Karpova, A. Y. A Designer AAV Variant Permits Efficient Retrograde Access to Projection Neurons. *Neuron* **92**, 372-382 (2016).
 - 15 Foster, E., Wildner, H., Tudeau, L., Haueter, S., Ralvenius, W. T., Jegen, M., Johannssen, H., Hosli, L., Haenraets, K., Ghanem, A., Conzelmann, K. K., Bosl, M. & Zeilhofer, H. U. Targeted ablation, silencing, and activation establish glycinergic dorsal horn neurons as key components of a spinal gate for pain and itch. *Neuron* **85**, 1289-1304 (2015).
 - 16 Voigt, F. F., Kirschenbaum, D., Platonova, E., Pagès, S., Campbell, R. A. A., Kästli, R., Schaettin, M., Egolf, L., van der Bourg, A., Bethge, P., Haenraets, K., Frézel, N., Topilko, T., Perin, P., Hillier, D., Hildebrand, S., Schueth, A., Roebroek, A., Roska, B., Stoeckli, E., Pizzala, R., Renier, N., Zeilhofer, H. U., Karayannis, T., Ziegler, U., Batti, L., Holtmaat, A., Lüscher, C., Aguzzi, A. & Helmchen, F. The mesoSPIM initiative: open-source light-sheet mesoscopes for imaging in cleared tissue. *Biorxiv* (2019).
 - 17 Corder, G., Ahanonu, B., Grewe, B. F., Wang, D., Schnitzer, M. J. & Scherrer, G. An amygdalar neural ensemble that encodes the unpleasantness of pain. *Science* **363**, 276-+ (2019).
 - 18 Grewe, B. F., Grundemann, J., Kitch, L. J., Lecoq, J. A., Parker, J. G., Marshall, J. D., Larkin, M. C., Jercog, P. E., Grenier, F., Li, J. Z., Luthi, A. & Schnitzer, M. J. Neural ensemble dynamics underlying a long-term associative memory. *Nature* **543**, 670-675 (2017).
 - 19 Brenner, D. S., Golden, J. P. & Gereau, R. W. t. A novel behavioral assay for measuring cold sensation in mice. *PLoS One* **7**, e39765 (2012).
 - 20 Bennett, G. J. & Xie, Y. K. A Peripheral Mononeuropathy in Rat That Produces Disorders of Pain Sensation Like Those Seen in Man. *Pain* **33**, 87-107 (1988).
 - 21 Frezel, N., Kratzer, G., Verzar, P., Bürki, J., Weber, F. A. & Zeilhofer, H. U. Does toe clipping for genotyping interfere with later-in-life nociception in mice? *PAIN Reports* **4**, e470 (2019).
 - 22 Dubuisson, D. & Dennis, S. G. The formalin test: a quantitative study of the analgesic effects of morphine, meperidine, and brain stem stimulation in rats and cats. *Pain* **4**, 161-174 (1977).

- 23 Zeilhofer, H. U., Studler, B., Arabadzisz, D., Schweizer, C., Ahmadi, S., Layh, B., Bosl, M. R. & Fritschy, J. M. Glycinergic neurons expressing enhanced green fluorescent protein in bacterial artificial chromosome transgenic mice. *J Comp Neurol* **482**, 123-141 (2005).
- 24 Taniguchi, H., He, M., Wu, P., Kim, S., Paik, R., Sugino, K., Kvitsiani, D., Fu, Y., Lu, J., Lin, Y., Miyoshi, G., Shima, Y., Fishell, G., Nelson, S. B. & Huang, Z. J. A resource of Cre driver lines for genetic targeting of GABAergic neurons in cerebral cortex. *Neuron* **71**, 995-1013 (2011).
- 25 Albisetti, G. W., Ghanem, A., Foster, E., Conzelmann, K. K., Zeilhofer, H. U. & Wildner, H. Identification of Two Classes of Somatosensory Neurons That Display Resistance to Retrograde Infection by Rabies Virus. *J Neurosci* **37**, 10358-10371 (2017).
- 26 Muller, T., Brohmann, H., Pierani, A., Heppenstall, P. A., Lewin, G. R., Jessell, T. M. & Birchmeier, C. The homeodomain factor *lhx1* distinguishes two major programs of neuronal differentiation in the dorsal spinal cord. *Neuron* **34**, 551-562 (2002).
- 27 Kamiyama, T., Kameda, H., Murabe, N., Fukuda, S., Yoshioka, N., Mizukami, H., Ozawa, K. & Sakurai, M. Corticospinal Tract Development and Spinal Cord Innervation Differ between Cervical and Lumbar Targets. *Journal of Neuroscience* **35**, 1181-1191 (2015).
- 28 Xu, X., Roby, K. D. & Callaway, E. M. Immunochemical characterization of inhibitory mouse cortical neurons: three chemically distinct classes of inhibitory cells. *J Comp Neurol* **518**, 389-404 (2010).
- 29 Callaway, E. M. & Luo, L. Monosynaptic Circuit Tracing with Glycoprotein-Deleted Rabies Viruses. *J Neurosci* **35**, 8979-8985 (2015).
- 30 Constantinople, C. M. & Bruno, R. M. Deep cortical layers are activated directly by thalamus. *Science* **340**, 1591-1594 (2013).
- 31 Tlamsa, A. P. & Brumberg, J. C. Organization and morphology of thalamocortical neurons of mouse ventral lateral thalamus. *Somatosens Mot Res* **27**, 34-43 (2010).
- 32 McMahon, S. Koltzenburg. M. Tracey, Dennis Turk, D. *Ascending projection systems, Wall & Melzack's Textbook of Pain*. 6th edn, 187-192 (2013).
- 33 Abraira, V. E. & Ginty, D. D. The sensory neurons of touch. *Neuron* **79**, 618-639 (2013).
- 34 Wang, X., Liu, Y., Li, X., Zhang, Z., Yang, H., Zhang, Y., Williams, P. R., Alwahab, N. S. A., Kapur, K., Yu, B., Chen, M., Ding, H., Gerfen, C. R., Wang, K. H. & He, Z. Deconstruction of Corticospinal Circuits for Goal-Directed Motor Skills. *Cell* **171**, 440-455 e414 (2017).
- 35 Albisetti, G. W., Pagani, M., Platonova, E., Hosli, L., Johannssen, H. C., Fritschy, J. M., Wildner, H. & Zeilhofer, H. U. Dorsal Horn Gastrin-Releasing Peptide Expressing Neurons Transmit Spinal Itch But Not Pain Signals. *J Neurosci* **39**, 2238-2250 (2019).
- 36 Hu, J., Huang, T., Li, T., Guo, Z. & Cheng, L. c-Maf is required for the development of dorsal horn laminae III/IV neurons and mechanoreceptive DRG axon projections. *J Neurosci* **32**, 5362-5373 (2012).
- 37 Del Barrio, M. G., Bourane, S., Grossmann, K., Schule, R., Britsch, S., O'Leary, D. D. & Goulding, M. A transcription factor code defines nine sensory interneuron subtypes in the mechanosensory area of the spinal cord. *PLoS One* **8**, e77928 (2013).
- 38 Zeilhofer, H. U., Benke, D. & Yevenes, G. E. Chronic pain states: pharmacological strategies to restore diminished inhibitory spinal pain control. *Annu Rev Pharmacol Toxicol* **52**, 111-133 (2012).
- 39 Zeilhofer, H. U., Wildner, H. & Yevenes, G. E. Fast synaptic inhibition in spinal sensory processing and pain control. *Physiol Rev* **92**, 193-235 (2012).

- 40 Petitjean, H., Pawlowski, S. A., Fraine, S. L., Sharif, B., Hamad, D., Fatima, T., Berg, J., Brown, C. M., Jan, L. Y., Ribeiro-da-Silva, A., Braz, J. M., Basbaum, A. I. & Sharif-Naeini, R. Dorsal Horn Parvalbumin Neurons Are Gate-Keepers of Touch-Evoked Pain after Nerve Injury. *Cell Rep* **13**, 1246-1257 (2015).
- 41 Torsney, C. & MacDermott, A. B. Disinhibition opens the gate to pathological pain signaling in superficial neurokinin 1 receptor-expressing neurons in rat spinal cord. *J Neurosci* **26**, 1833-1843 (2006).
- 42 Ghosh, K. K., Burns, L. D., Cocker, E. D., Nimmerjahn, A., Ziv, Y., El Gamal, A. & Schnitzer, M. J. Miniaturized integration of a fluorescence microscope. *Nat Methods* **8**, 871-U147 (2011).
- 43 Wang, Z., Maunze, B., Wang, Y., Tsoulfas, P. & Blackmore, M. G. Global Connectivity and Function of Descending Spinal Input Revealed by 3D Microscopy and Retrograde Transduction. *J Neurosci* **38**, 10566-10581 (2018).
- 44 Liu, Y., Latremoliere, A., Li, X., Zhang, Z., Chen, M., Wang, X., Fang, C., Zhu, J., Alexandre, C., Gao, Z., Chen, B., Ding, X., Zhou, J. Y., Zhang, Y., Chen, C., Wang, K. H., Woolf, C. J. & He, Z. Touch and tactile neuropathic pain sensitivity are set by corticospinal projections. *Nature* **561**, 547-550 (2018).

3 RESULTS CHAPTER 2:

Characterization of spinal c-maf expressing interneurons

3.1 Abstract

Interneurons in the deep dorsal horn (laminae III-V) of the spinal cord dorsal horn receive input mainly from non-nociceptive myelinated sensory fibers and are believed to be important for the processing of touch and proprioceptive input. However, the impact of deep dorsal horn interneuron activity on generating noxious sensations is not completely understood. Here, we identified a population of deep dorsal horn neurons characterized by the expression of the transcription factor c-maf that is required for the proper development of laminae III/IV interneurons.

We found that in the adult, c-maf is expressed by a heterogeneous population of dorsal horn interneurons. About a third of c-maf positive neurons are inhibitory and two thirds are excitatory. We used an intersectional genetic targeting approach to study the function of the excitatory and inhibitory subpopulation of c-maf-expressing interneurons in processing of noxious sensory stimuli. We showed that activation of excitatory c-maf neurons or inhibition of inhibitory c-maf neurons leads to mechanical hypersensitivity. Conversely, activation of inhibitory c-maf neurons led to reduced sensory thresholds in response to noxious and light touch stimulations, in naïve and neuropathic pain conditions. We also showed that c-maf positive interneurons receive direct input from both low-threshold mechanical receptors (LTMRs) and corticospinal neurons. We have therefore identified a population of deep dorsal horn interneurons that integrates descending inputs from the cortex as well as peripheral sensory signals to modulate the perception of sensory stimuli.

3.2 Introduction

Mechanical allodynia is a painful sensation elicited by innocuous touch stimuli¹. It is often associated with nerve damage, unresolved injuries or diseases such as diabetes. It affects a growing number of persons worldwide, and it is still very difficult to treat¹. The understanding of spinal circuits underlying touch processing in normal and pathological settings, and of the cellular and molecular basis of the changes occurring in pathological states is therefore crucial for the development of future therapeutic strategies.

The spinal dorsal horn is a major site of integration of information coming from the sensory fibers and supraspinal inputs. It is composed of excitatory and inhibitory interneuron populations that process the sensory information before it is sent to supraspinal sites via a small number of projection neurons present in laminae I and III-IV. The superficial laminae (I-II) of the dorsal spinal horn receive input from temperature-sensing and nociceptive fibers, whereas the deeper laminae (III-IV) are the termination area of fibers transmitting low threshold mechanical information. A main mostly unanswered question is how can innocuous touch become painful in order to evoke allodynia?

A common hypothesis to explain mechanical allodynia is based on the idea that touch responsive, excitatory deep dorsal horn interneurons can engage pain circuits. Under normal conditions (i.e. without insult, injury or disease) the connections between excitatory deep dorsal horn interneurons and pain transmitting neurons in the superficial laminae are silenced by inhibitory interneurons. In the setting of injury however, a reduction of inhibition takes place, allowing touch-sensitive fibers (low-threshold mechanical receptors, LTMRs)^{2,3} to activate nociceptive pathways. Meanwhile, a few studies looking at specific spinal neuron subtypes in the deep dorsal horn have provided some evidence in favor of this idea. Peirs *et al.* identified a population of spinal interneurons that transiently expressed vGluT3 during development and that are important for the expression of mechanical allodynia⁴. Spinal excitatory interneurons expressing CCK⁵ (Zeilhofer laboratory, unpublished), or inhibitory interneurons expressing parvalbumin (PV)⁶, as well as neurons from the *lbx1* lineage^{7,8} have also been shown to play an important role in the transmission of mechanical sensation in normal and pathological conditions.

Additionally, it has recently been shown that numerous neuron populations in the deep dorsal horn receive convergent inputs from LTMRs and from the somatosensory cortex (S1)⁹⁻¹¹, and it has been suggested that mechanical allodynia is impacted by corticospinal modulation. We have also shown that corticospinal neurons from the primary somatosensory cortex (S1) make direct contact onto lamina III interneurons (see Results Chapter 1). A large proportion of these neurons expressed the transcription factor *c-maf*. During development, the transcription factor *c-maf* is required for proper specification of PNS and CNS neurons. In the DRGs, it coordinates the normal development and function of several rapidly adapting mechanoreceptor types¹², and in the spinal cord, it is necessary for the development of laminae III/IV interneurons¹³. However, the role of *c-maf* expressing interneurons in the adult is largely unknown. Despite their potential role as integrators of sensory and corticospinal input, their nature and function has not yet been addressed. We find that *c-maf* expressing spinal interneurons consist of an excitatory and an inhibitory subset. We therefore use intersectional viral targeting strategies to separately label and manipulate inhibitory and excitatory *c-maf* neurons. This enables us to specifically target two subsets of deep dorsal horn interneurons and address their function in processing of noxious information. We show that both populations receive input from corticospinal tract (CST) neurons and from LTMRs and that modulation of the activity of these neurons leads to altered sensory thresholds.

3.3 Methods

3.3.1 Animals

Experiments were performed on 6-12-week old mice kept at a 12:12 h light:dark cycle. Permissions for experiments have been obtained from the Canton of Zurich (permissions 063/2016 and 003/2018). GlyT2::Dre mice are BAC transgenic mice that have been generated in the Zeilhofer laboratory as described previously for the GlyT2::cre and GlyT2::eGFP mice^{14,15}. c-maf^{cre} mice are knock-in mice generated by conventional gene targeting in the laboratory of C. Birchmeier (MDC Berlin, Germany). For further details on the genetically modified mice used in this study, see Table 1.

3.3.2 Intraspinal and cortical virus injections

Viruses were obtained from the resources indicated in the Table 1, as previously described¹⁶. Virus injections were made in adult mice (6-12-week-old) anesthetized with 2% isoflurane and immobilized on a motorized stereotaxic frame (David Kopf Instruments, Tujunga, CA, USA and Neurostar, Tübingen, Germany). For intraspinal injections, the vertebral column was fixed using a pair of spinal adaptors and lumbar spinal cord at L4 and L5 was exposed. Injections (3×300 nL) spaced approximately 1mm apart were made at a rate of 50 nL/min with glass micropipettes (tip diameter 30-40µm) attached to a 10 µL Hamilton syringe. For S1, the head was fixed using head bars, the skull was exposed and the following injection coordinates were used: (-1; 1.5; 0.8).

3.3.3 Immunohistochemistry and image analysis

Mice were transcardially perfused with 4% ice-cold paraformaldehyde (in 0.1 M sodium phosphate buffer, pH 7.4). Lumbar spinal cord and brain were immediately dissected and post-fixed for 2 h with 4% paraformaldehyde on ice. Post-fixed tissue was briefly washed with 0.1 M sodium phosphate buffer (pH 7.4) and then incubated in 30% sucrose (in 0.1 M sodium phosphate buffer, pH 7.4) overnight at 4°C for cryoprotection. Cryoprotected tissue was cut at 18 µm, 25 µm or 40 µm (for DRG, spinal cord or brain, respectively) on a Hyrax C60 Cryostat; Zeiss, Oberkochen, Germany, mounted on superfrost plus glass slides and then incubated with the respective combinations of primary antibodies in 1% donkey serum in phosphate-buffered saline (PBS) over night at 4°C. After brief washes in PBS, sections were incubated with the respective secondary antibodies for 2h at room temperature and briefly rinsed in PBS, before mounting with coverslips and DAKO fluorescent mounting media (Dako, Carpinteria, CA, USA). All primary antibodies used are listed in the Table 1. Secondary antibodies raised in donkey were purchased from Jackson Immuno-Research (West Grove, PA, USA). Z-stacks of IHC and ISH fluorescent images were acquired on a Zeiss LSM700 Pascal confocal microscope and Zeiss LSM800, respectively (Zeiss, Oberkochen, Germany). Numbers of reactive cells in z-stacks were determined using the ImageJ Cell Counter plugin (Kurt De Vos, University of Sheffield, Academic Neurology).

3.3.4 In situ hybridization (ISH)

Spinal tissue used for ISH was dissected from 6-to-12-week-old mice, collected in 1.5 ml Eppendorf tubes, and immediately frozen in liquid nitrogen. Tissue was embedded in NEG50 frozen section medium (Richard-Allen Scientific), cut into 16 µm sections, and hybridized using the probes designed for RNAscope Fluorescent Multiplex ISH listed in Table 1.

3.3.5 Behavioral analyses

Double transgenic male mice (c-maf^{cre/wt}; GlyT2::Dre (c-maf^{dN}) and c-maf^{cre/wt}; lmx1β^{Dre/wt} (c-maf^{EX}), expressing both cre and Dre) were compared to control (cre⁺ only, Dre⁺ only or cre-Dre-) mice, all injected with 2 mg/kg CNO. All behavioral tests were performed by an experimenter blinded to the genotype of the mice. Only one test was performed per day and mouse.

Mechanical sensitivity. Mice were placed in Plexiglas chambers (8 x 8 cm) on an elevated wire grid and allowed to acclimatize for at least 1 hour before testing. Withdrawal thresholds were assessed by stimulation of the hindpaw with an electronic von Frey anesthesiometer (IITC, Woodland Hills, CA). Measurements were taken at 10 min intervals. Sensitivity to light touch or acute painful stimulation was also tested. Both hindpaws were stimulated alternately and 10 measurements were taken of each hindpaw. For light touch, mice were gently touched (from the bottom of the grid) with a soft paint brush on the plantar surface of the hind paw. For acute painful stimulation, the plantar surface of hindpaws was stimulated with a blunted G26 needle without penetration of skin. For both tests, each response to this stimulation was quantified by a score of 0 or 1 (no evoked movement = 0, walking away or brief paw lifting for ≤ 1 s = 1) and reported as the sum of the responses.

Cold sensitivity. Mice were placed in Plexiglas chambers (8 x 8 cm) on a 5 mm thick borosilicate glass platform and allowed to acclimatize for at least 1 hour before testing. A dry ice pellet was applied to the surface of the glass from underneath the paw¹⁷. Withdrawal thresholds were measured using a stopwatch and a cutoff time of 20 s was set. Measurements were taken at 10 min intervals.

Heat sensitivity (Hargreaves test). Mice were placed in Plexiglas chambers (8 x 8 cm) on a glass surface and allowed to acclimatize for at least 1 hour before testing. A movable infrared generator was placed below the plantar surface of one hindpaw. Withdrawal thresholds were recorded automatically by an electronically controlled commercially available instrument with a built-in timer (Plantar Analgesia Meter, IITC, Woodland Hills, USA) and a cutoff time of 32 s was set. Measurements were taken at 10 min intervals.

Chronic Constriction Injury (CCI) model of neuropathic pain. Neuropathic pain was studied using the CCI model. A constriction injury of the left sciatic nerve just proximal to the trifurcation was performed as described previously^{18,19}. Anesthesia was induced and maintained by 2% isoflurane (Provet AG, Lyssach, Switzerland), combined with oxygen (30%) and ambient air (68%). Before the start of the surgery, mice received 0.2 mg/kg buprenorphine subcutaneously. The sciatic nerve was exposed at the mid-thigh level proximal to the sciatic trifurcation by blunt dissection through the biceps femoris. Three chromic gut ligatures (5/0) were tied loosely around the nerve until a brief twitch in the hindlimb was elicited. The incision was closed in layers.

3.3.6 Experimental design and statistical analysis

All behavioral experiments were designed to allow comparisons between two groups: double transgenic (expressing cre and Dre) vs control (expressing cre only, Dre only, or neither) mice. Behavioral responses are reported as mean \pm SEM. Statistical analysis was performed as follows: group means of double transgenic and control mice for all behavioral tests were compared using a 2-sided unpaired Student t test (spontaneous aversive behavior) or a 2-way repeated measures ANOVA, followed by pairwise comparisons with Sidak adjustment for multiple comparisons (t tests and ANOVA performed with SPSS: IBM Corp. Released 2017. IBM SPSS Statistics for Windows, Version 25.0. Armonk, NY: IBM Corp.). Numbers of experiments (cells or mice) and results of the statistical analysis are provided in the figure legends and Table 2.

Table 1. Materials and reagents

Materials	Resource	Identifier
Mice (shortname)		
C57BL/6J (wild type)	Jackson Laboratory	IMSR_JAX:000664
c-maf ^{cre/wt}	Dr Carmen Birchmeier	unpublished
B6;129S-Gt(ROSA)26Sor ^{tm66.1(CAG-tdTomato)Hze/J} (Rosa26 ^{dstdTom/wt})	Jackson Laboratory	
C57BL/6-Lmx1b<m(Dre)Uze (lmx1β ^{dre/wt})	IPT (Zurich, Switzerland)	unpublished
B6N-Tg(GlyT2-dre) (GlyT2 ^{dre/wt})	IPT (Zurich, Switzerland)	unpublished
Viral vectors shorname		
rAAV-9/2-hEF1α-Con/Don-eGFP	VVF	vHW18-9
SAD.RabiesΔG.eGFP (EnvA) (EnvA.RV.dG.eGFP)	Salk Institute (USA)	Albisetti <i>et al.</i> ²⁰
rAAV-8/2-hSyn1-roxSTOP-dlox-TVA_2A.RabG	VVF	vHW7-1
rAAV-9/2-hEF1α-Con/Don-hM3Dq-HAtag	VVF	vHW24-9
rAAV-8/2-hEF1α-Con/Don-hM4Di-mCherry	VVF	vHW23-8
AAV8/2- hEF1α -Con/Don-Syp-mRuby	VVF	vHW25-8
Antibodies (dilution)		
rabbit anti-GFP (1:1000)	Molecular Probes	AB_221570
rabbit anti-PV (1:1000)	Immunostar	24428
rabbit anti-NF200 (1:1000)	Sigma	N4142
rabbit anti-PKCγ (1:1000)	Santa Cruz	AB_632234
rabbit anti-CGRP (1:1000)	Immunostar	AB_572217
goat anti-TrkA (1:200)	R+D Systems	AF1056
goat anti-Pax2 (1:400)	R+D Systems	AB_10889828
goat anti-tdTomato (1:1000)	Siegen	AB8181-200
guinea pig anti-Lmx1b (1:10 000)	Dr Carmen Birchmeier	(Muller <i>et al.</i> 2002) ²¹
guinea pig anti-NeuN (1:1000)	SynapticSystems	AB_2619988
chicken anti-GFP (1:1000)	LifeTechnologies	AB_2534023
AlexaFluor-488-conkey anti-chicken (1:500)	Jackson IR Lab	AB_2340376
AlexaFluor-488-donkey anti-rabbit	Jackson IR Lab	#711-546-152
Cy3-donkey anti-rabbit	Jackson IR Lab	AB_2307443
Cy3-donkey anti-goat	Jackson IR Lab	AB_2340413
DyLight 549-donkey anti-guinea pig	Jackson IR Lab	#706-506-148
AlexaFluor-647-donkey anti-rabbit	Jackson IR Lab	#711-607-003
AlexaFluor-647-donkey anti-guinea pig	Jackson IR Lab	AB_2340477
AlexaFluor-647-donkey anti-goat	Jackson IR Lab	AB_2340437
isolectin IB4	Invitrogen Molecular Probes	132450
RNAScope multiplex FISH probes		
vGluT2	ACD	Mm-Slc17a6-C1
c-maf	ACD	Mm-Maf-C2
CCK	ACD	Mm-CCK-C1
VIAAT (vGAT)	ACD	Mm-Slc32a1-C1
Pvalb (PV)	ACD	Mm-Pvalb-C3

ACD: Advanced Cell Diagnostics

IPT: Institute of Pharmacology and Toxicology, University of Zürich

Jackson IR Lab.: Jackson ImmunoResearch Laboratories

VVF: Viral Vector Facility (ETH, Zurich)

3.4 Results

3.4.1 Characterization of spinal c-maf⁺ interneurons

Very little is known about the identity and the role of c-maf neurons in the dorsal horn. These interneurons comprise both inhibitory and excitatory subpopulations. In order to characterize c-maf neurons in more detail, we performed multiplex *in situ* hybridization using RNAscope on spinal cord sections of adult wild type mice (Fig.1). We found that little more than half of the c-maf positive neurons were excitatory and one third were inhibitory ($52.9 \pm 1.58\%$ expressed vGluT2 and $31.3 \pm 1.55\%$ expressed vGat, Fig.1E-F). These results are consistent with a previous study that reported that about two thirds of spinal c-maf interneurons are excitatory⁸.

Next, we quantified the overlap of the c-maf population with other known markers of deep dorsal horn interneurons, namely CCK (exclusively expressed in excitatory neurons) and PV (expressed in both excitatory and inhibitory neurons) (Fig.1A-F). We found that $24.7 \pm 2.8\%$ of all c-maf positive neurons expressed PV and conversely, $30.7 \pm 4.6\%$ of PV positive neurons expressed c-maf. More precisely, $7.62 \pm 1.3\%$ of the excitatory and $12.7 \pm 0.6\%$ of the inhibitory c-maf neurons also expressed PV. Among the c-maf- and PV-double positive neurons, $63.0 \pm 0.04\%$ were inhibitory and $30.2 \pm 0.03\%$ excitatory neurons. Additionally, we found that $44.5 \pm 2.5\%$ of c-maf positive neurons expressed CCK and conversely, $27.7 \pm 2.1\%$ of CCK positive neurons expressed c-maf. Only very few c-maf positive neurons ($4.90 \pm 1.2\%$) were also positive for both CCK and PV.

This data is in good agreement with recently published single cell sequencing data that indicates a rather selective expression of c-maf in two out of 15 excitatory and three out of 15 inhibitory subpopulations of spinal dorsal horn neurons²². In addition, we found c-maf expression almost exclusively in spinal neurons located in lamina III and deeper. We therefore conclude that the c-maf gene is a suitable driver gene for recombinases in order to enable functional analysis of a selective subset of deep dorsal horn interneurons.

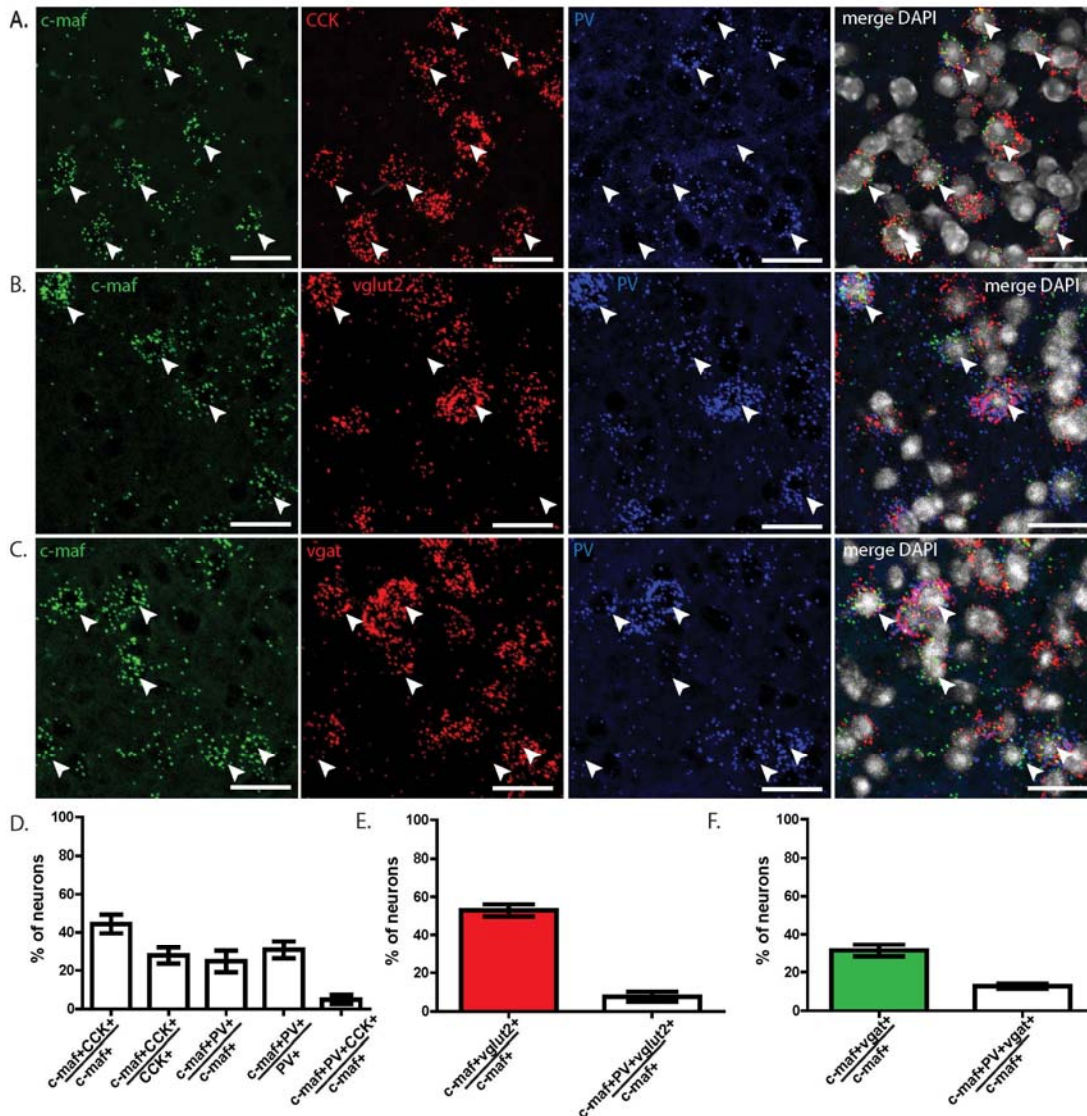

Fig.1: Characterization of spinal c-maf expressing interneurons with RNAscope *in situ* hybridization (ISH). A. Triple ISH showing overlap between c-maf-, CCK- and PV-expressing neurons. B. Triple ISH showing overlap between c-maf-, vGlut2- and PV-expressing neurons. C. Triple ISH showing overlap between c-maf-, vGat- and PV-expressing neurons. D. Quantification of (A). E. Quantification of (B). F. Quantification of (C). n = 4 mice. Scale bars: 20 μm .

3.4.2 Characterization c-maf^{fN} and c-maf^{fEX} mouse lines

We decided to use c-maf^{cre} mice in combination with an intersectional genetic targeting approach to specifically study the function of either excitatory or inhibitory c-maf expressing spinal dorsal horn neurons. We therefore crossed c-maf^{cre/wt} mice (Dr. C. Birchmeier, unpublished) to either Lmx1 β ^{Dre/Dre} mice (Zeilhofer laboratory, unpublished), which express the Dre recombinase specifically in excitatory dorsal horn neurons, or GlyT2::Dre mice (Zeilhofer laboratory, unpublished), which express Dre specifically in glycinergic neurons. We generated two mouse lines: c-maf^{cre/wt}; Lmx1 β ^{Dre/wt} and c-maf^{cre/wt}; GlyT2::Dre, that will be referred to from here on as c-maf^{fEX} and c-maf^{fN} mice, respectively. Using this strategy were able to restrict the reporter gene expression to either excitatory (i.e. Lmx1 β positive: c-

maf^{EX}) or inhibitory (i.e. GlyT2 positive: c-maf^{fN}) c-maf-expressing neurons. Because *lmx1β* and GlyT2 are not expressed in sensory neurons, this strategy also avoids expression of effector proteins in the DRGs. To verify the correct expression of the two recombinases in the spinal cord and absence of expression in DRGs, we crossed these mice further to Rosa26^{dstdTom/wt} reporter mice (Fig.2A). Neurons expressing tdTomato were found in the dorsal spinal cord in both c-maf^{EX}; Rosa26^{dstdTom/wt} and c-maf^{fN}; Rosa26^{dstdTom/wt} (Fig.2B-E), but not in the DRGs (Fig.2F). In c-maf^{EX}; Rosa26^{dstdTom/wt} mice, we observed tdTomato positive satellite cells in the DRGs, suggesting that these express cre and Dre at some time point during development, but not in neurons. Quantification of tdTomato positive cells together with antibodies against either *lmx1β* or *pax2* showed that the expression of the cre and Dre recombinases in both c-maf^{EX} and c-maf^{fN} intersectional mouse lines, is specifically restricted to either excitatory or inhibitory interneurons (Fig2.C and Fig.2E), respectively. In c-maf^{EX}; Rosa26^{dstdTom/wt} mice injected intraspinally with a cre-and Dre-dependent eGFP-reporter AAV (rAAV-hSyn1.C_{on}/D_{on}-eGFP), almost all tdTomato positive (92.0 ± 1.9%) and eGFP positive (92.1 ± 1.3%) neurons were also positive for *lmx1β*. Additionally, 46.2 ± 5.7% of the tdTomato positive cells expressed eGFP and 82.5 ± 2.0% of the eGFP positive cells expressed tdTomato. Similarly, in c-maf^{fN}; Rosa26^{dstdTom/wt} mice injected intraspinally with rAAV-hSyn1.C_{on}/D_{on}-eGFP, almost all tdTomato positive (94.6 ± 0.8%) and eGFP positive (88.7 ± 4.3%) neurons were positive for *pax2*. Additionally, 38.5 ± 10.5% of the tdTomato positive cells expressed eGFP and 73.6 ± 2.9% of the eGFP positive cells expressed tdTomato.

Importantly, when we injected a rAAV-hSyn1.C_{on}/D_{on}-eGFP into the lumbar spinal cord of either c-maf^{EX}; Rosa26^{dstdTom/wt} or c-maf^{fN}; Rosa26^{dstdTom/wt} mice, we detected eGFP positive cells in the lumbar dorsal horn only. No eGFP was found either in the DRGs or the brains of any animal (Fig.2F).

Next we studied the localization of eGFP labeled neurons in c-maf^{EX} and c-maf^{fN} mice (Fig.3). We used CGRP antibody and IB4 to label lamina I/II_o and II_i, respectively²³. PKCγ immunoreactive cells delineate the border between the laminae II and III. We found that most c-maf^{EX} and c-maf^{fN} neurons were located more ventral than IB4 and CGRP immunoreactive layers (Fig.3C, D) and just below the PKCγ cell layer (Fig.3E, F). Most c-maf positive neurons were located in the area containing vGluT1 immunoreactivity, which corresponds to the area of termination of low-threshold cutaneous and proprioceptive myelinated afferents²⁴. Interestingly, very few (4/561 neurons, 4 mice) of the eGFP positive cells expressed PKCγ (Fig.3E, F) in both c-maf^{EX} and c-maf^{fN} mice.

These results demonstrate that intraspinal viral injections of intersectional rAAVs in the adult mouse are well suited to specifically target either excitatory or inhibitory c-maf expressing spinal interneurons.

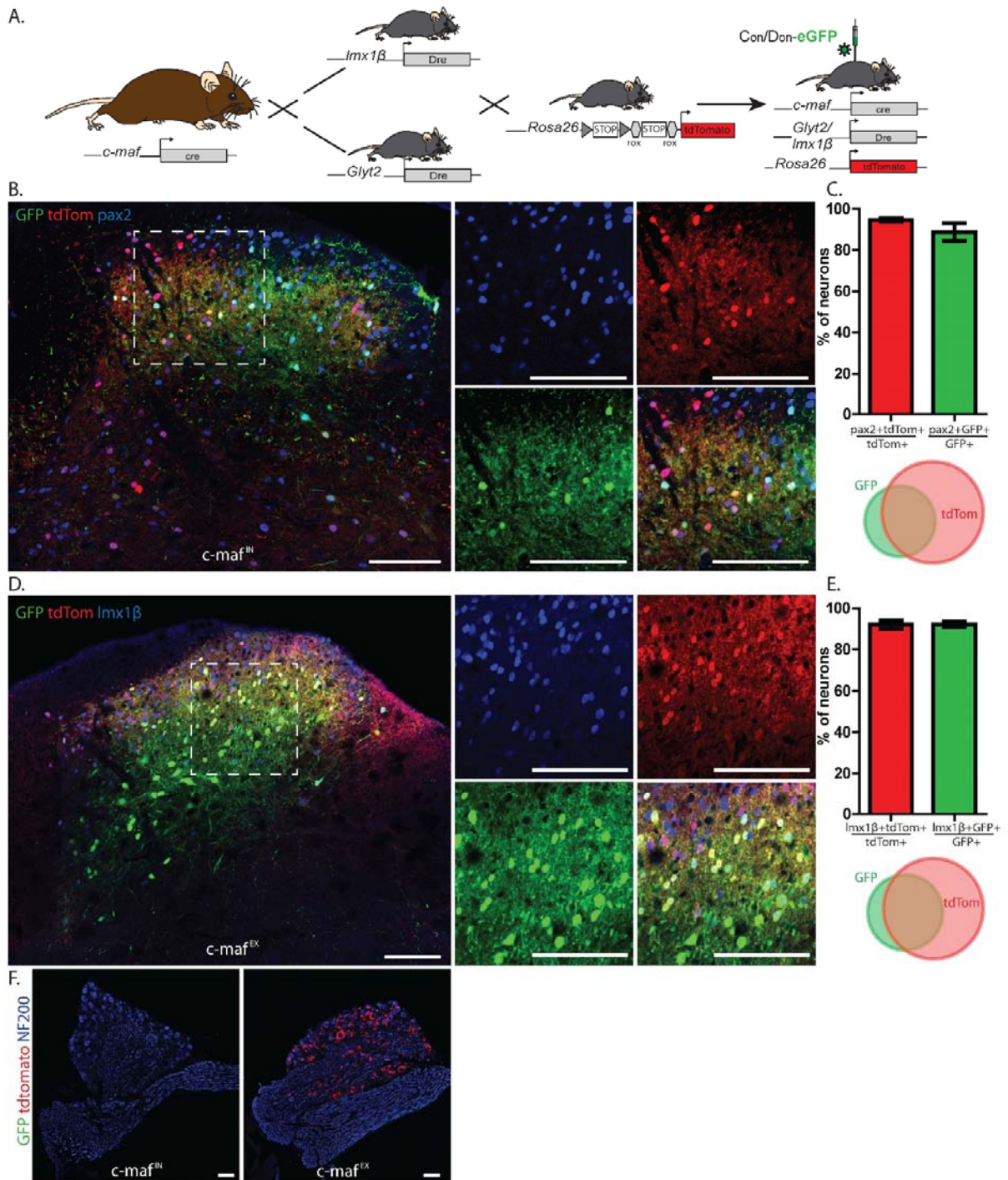

Fig.2: Characterization of *c-maf*^{cre} mice. **A.** Crossing of *c-maf*^{cre} mice to either *GlyT2::Dre* or *lmx1β*^{dre} mice, followed by crossing of both double transgenic lines to *tdTomato* reporter mice, and intraspinal injection of rAAV9.CAG.C_{on}/D_{on}.eGFP. **B.** Immunofluorescence staining on a transversal section of lumbar spinal cord of *c-maf*^{flN}; *Rosa26*^{dstdTom/wt} mice, injected in the spinal cord with a rAAV9.CAG.C_{on}/D_{on}.eGFP virus. **C.** Quantification of the number of *tdTomato*⁺ and *GFP*⁺ neurons positive for *pax2* and overlap between *tdTomato*⁺ and *GFP*⁺ neurons in (B.) **D.** Immunofluorescence staining on a transversal section of lumbar spinal cord of *c-maf*^{EX}; *Rosa26*^{dstdTom/wt} mice, injected in the spinal cord with a rAAV9.CAG.C_{on}/D_{on}.eGFP virus. **E.** Quantification of the number of *tdTomato*⁺ and *GFP*⁺ neurons positive for *pax2* and overlap between *tdTomato*⁺ and *GFP*⁺ neurons in (D.) **F.** Immunofluorescence staining dorsal root ganglia sections in both experiments. Scale bars: 100 μm.

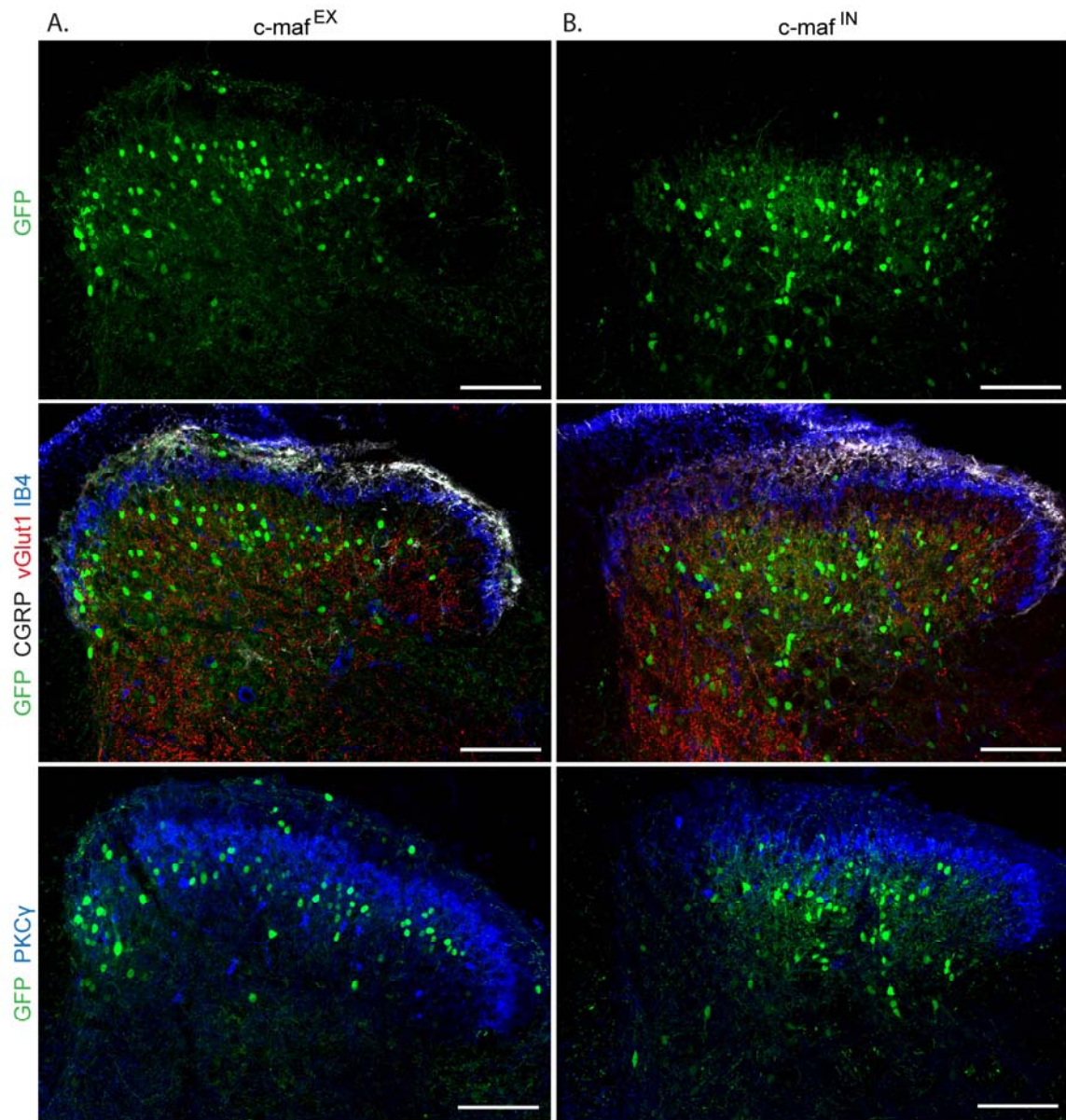

Fig.3: Localization of c-maf expressing interneurons in the dorsal spinal cord. A. B. localization of eGFP labelled neurons after intraspinal injection of rAAV9.CAG.C_{on}/D_{on}-eGFP in c-maf^{EX} or c-maf^{fN} mice. **C-D.** Localization of eGFP labelled neurons relative to CGRP, IB4 and vGluT1. **E-F.** Localization of eGFP labelled neurons relative to PKC γ . Scale bars: 100 μ m.

3.5 Connectivity of c-maf neurons

Next we aimed to describe the connectivity of c-maf positive neurons within sensory circuits in the adult mouse. Results described in Results Chapter 1 have provided evidence that c-maf spinal interneurons receive direct synaptic input from CST neurons residing in the somatosensory cortex.

3.5.1 c-maf neurons receive input from primary afferents and the somatosensory cortex

In order to map neurons presynaptic to dorsal horn c-maf neurons, we used a monosynaptic retrograde tracing rabies virus strategy. Lumbar spinal cord segments of c-maf^{EX} and c-maf^{FN} mice were injected with a helper virus to express the TVA receptor and the rabies G glycoprotein, and four weeks later with an EnvA-pseudotyped, eGFP-expressing rabies virus.

Five days after rabies virus injection, we could find eGFP labeled neurons in lumbar DRGs ipsilateral to the virus injection site and in S1 in both c-maf^{EX} and c-maf^{FN} mice (Fig.4A, D). The presence of eGFP positive layer 5 pyramidal neurons in S1 confirms the direct connection between these S1-CST neurons and spinal c-maf neurons that we have shown previously (Chapter 1).

We also found many eGFP labeled neurons in lumbar DRGs. In order to identify the subtypes of labeled sensory neurons, we performed co-stainings with known markers of sensory neuron classes²⁵. We first found that the vast majority of eGFP+ neurons ($95.0 \pm 3.54\%$ and $86.3 \pm 5.18\%$ of neurons traced from c-maf^{EX} and c-maf^{FN} neurons, respectively) were also positive for NF200, which marks myelinated sensory neurons (Fig.4B, E). Only very few neurons positive for TrkA ($7.50 \pm 6.5\%$ myelinated and $0.75 \pm 0.7\%$ unmyelinated TrkA+ neurons) were traced from c-maf^{EX} neurons. We did not find eGFP co-expressed with either P2X3 or PLXNC1, markers of nonpeptidergic populations. Myelinated ($16.7 \pm 0.3\%$ of eGFP+ cells) and unmyelinated ($2.33 \pm 1.9\%$ of eGFP+ cells) TrkA+ neurons could be traced from c-maf^{FN} neurons.

Because both populations of c-maf neurons seem to be targeted mainly by myelinated afferents, we looked at markers for mechanosensory fibers and proprioceptors. We found that the majority of myelinated eGFP positive neurons presynaptic to c-maf^{FN} neurons expressed PV ($33.7 \pm 8.4\%$), TrkC ($23.3 \pm 10.5\%$) or both ($26.0 \pm 10.0\%$). Similarly, the majority of myelinated eGFP+ positive neurons presynaptic to c-maf^{EX} neurons expressed PV ($40.7 \pm 3.5\%$), TrkC ($44.2 \pm 9.3\%$) or both ($27.9 \pm 4.7\%$) (Fig.4C, F). PV+, TrkC+ and TrkA+ DRG neurons account for approximately 65% of myelinated input neurons presynaptic to c-maf^{EX} neurons. It is likely that the remaining labeled neurons belong to the TrkB+ class of LTMRs. Unfortunately, there is no convincing antibody directed against TrkB available.

According to mRNA-sequencing data of single DRG neurons²⁵, PV labels two populations of proprioceptors (namely NF4 and NF5) in the DRGs. TrkC is expressed at low levels in these two populations, and in higher levels in the NF3 subpopulation of LTMRs. The PV+TrkC+ and PV only immunoreactive neurons therefore represent proprioceptors and TrkC only positive neurons are LTMRs. Altogether, these results suggest that both populations of c-maf expressing neurons receive most input from these three populations of non-noxious sensory fibers. c-maf^{FN} neurons also receive more input from myelinated peptidergic afferents (TrkA positive, PEP2) than c-maf^{EX} neurons.

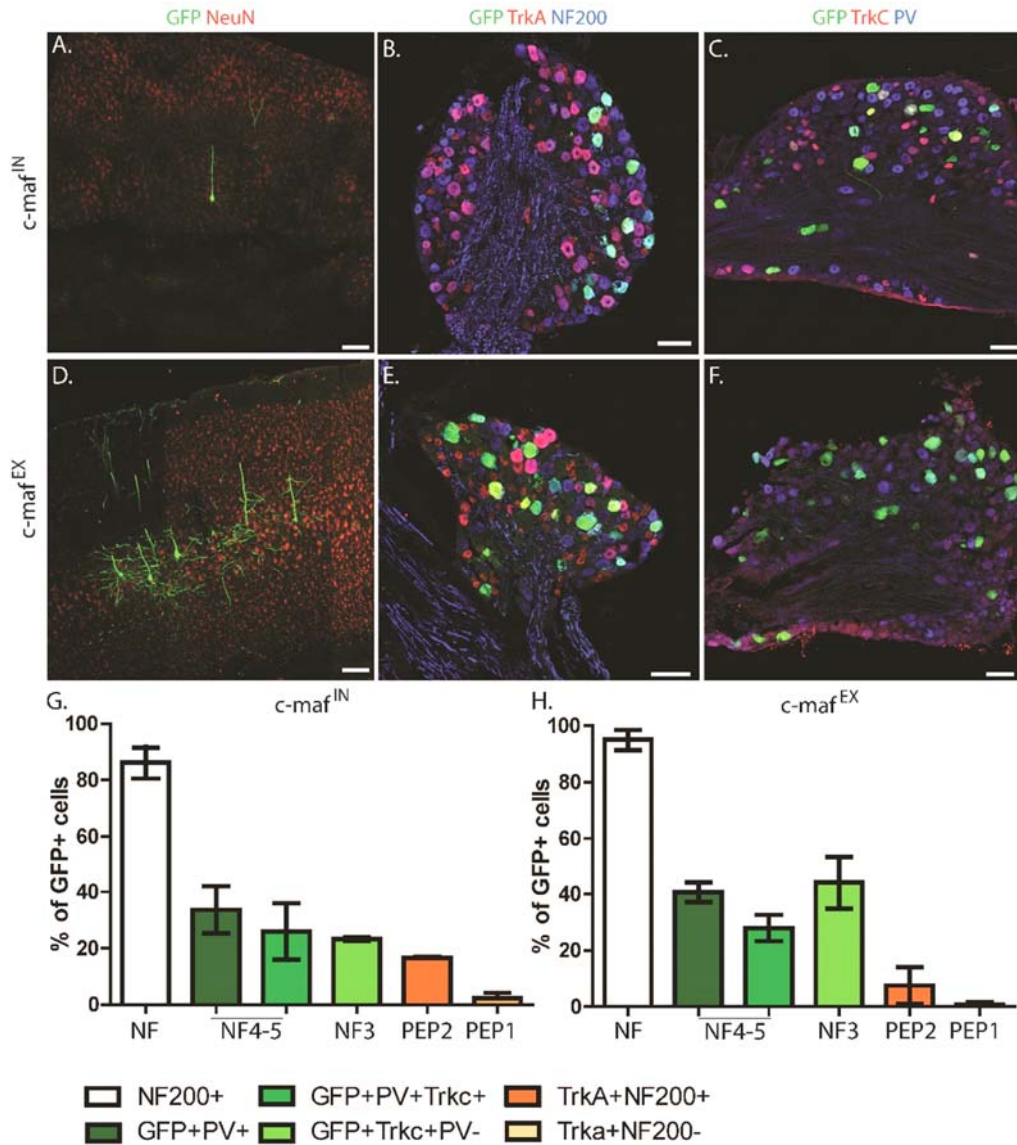

Fig.4: Retrograde rabies virus-based monosynaptic tracing of c-maf neurons. A helper virus (TVA, RabG) was injected in the spinal cord of c-maf^{fN} and c-maf^{EX} mice, followed by injection of the EnvA-pseudotyped rabies virus (EnvA.RV.ΔG.eGFP). **A, D.** Labeling corticospinal neurons in the layer 5 of the somatosensory cortex (S1) in c-maf^{fN} (A) and c-maf^{EX} (D) mice. **B, C, E, F.** Immunofluorescence staining on DRG sections showing overlap between GFP and markers of sensory neurons in c-maf^{fN} (B, C) and c-maf^{EX} (E, F) mice. **G-H.** Quantification of the number of GFP+ DRG neurons positive for NF200, TrkA, PV and TrkC in c-maf^{fN} (G.) and c-maf^{EX} (H.) mice. Scale bars: 100 μm.

3.5.2 Output pathways of c-maf neurons in the dorsal spinal cord

Inhibitory interneurons in the dorsal spinal cord, in particular PV expressing neurons, have been shown to be a source of inhibitory presynaptic input onto myelinated primary afferents²⁶. Since c-maf expressing neurons are located in the same region and show some overlap with PV neurons, we investigated the presence of synaptic contacts between c-maf neurons and vGluT1 positive terminals in the dorsal horn. We injected rAAV-EF1α.C_{on}/D_{on}.synaptophysin-mRuby3 in the lumbar spinal cord of c-maf^{EX} and c-maf^{fN} mice. Injection of this virus leads to expression of a synaptophysin-mRuby fusion protein in cre and Dre double positive neurons. Synaptophysin-mRuby is specifically located at the axon

terminals. The area occupied by synaptic terminals of c-maf^{EX} neurons is mostly located in the deep dorsal horn and extends laterally to the lateral spinal nucleus in c-maf^{EX} mice. Some mRuby fluorescence is also found at the border of laminae II_i and III. Terminals of c-maf^{FN} neurons extends throughout the dorsal horn, is most dense in laminae II_i close to the PKC γ reactive cell layer, and in III-IV, but we also see some terminals in the superficial dorsal horn (Fig.5B).

In both cases, we found many examples of contact between mRuby positive terminals and vGluT1 positive terminals (Fig.5C, D). In c-maf^{EX} mice, $13.4 \pm 3.6\%$ of all synaptophysin-mRuby labeled terminals were found in close proximity to a vGluT1 terminal. In c-maf^{FN} mice, the proportion of synaptophysin-mRuby labeled terminals found in close proximity to a vGluT1 terminal was $24.4 \pm 2.7\%$ (Fig.5E). The majority of mRuby positive terminals that are vGluT1 negative ($84.9 \pm 4.4\%$ and $72.9 \pm 3.7\%$, respectively) are therefore likely to be synapses onto local interneurons.

In order to determine which spinal circuits are engaged by excitatory c-maf neurons in the dorsal horn, we injected CNO in mice expressing the excitatory DREADD hM3Dq in c-maf^{EX} interneurons. After CNO injection, we found a strong increase in the number of c-fos immunoreactive cells in the lumbar dorsal spinal cord (Fig.6A-B). This increase was similar in proportions (about 3-fold) in the superficial and in the deep dorsal horn when we quantified the number of c-fos positive cells relative to the laminae II-III border, visualized by vGluT3 expression (Fig.6C).

These results show that c-maf expressing interneurons likely contact both terminals of LTMRs and local interneurons in the deep dorsal horn. This suggests that they could be involved in integrating and modulating transmission of mechanical information in the spinal cord.

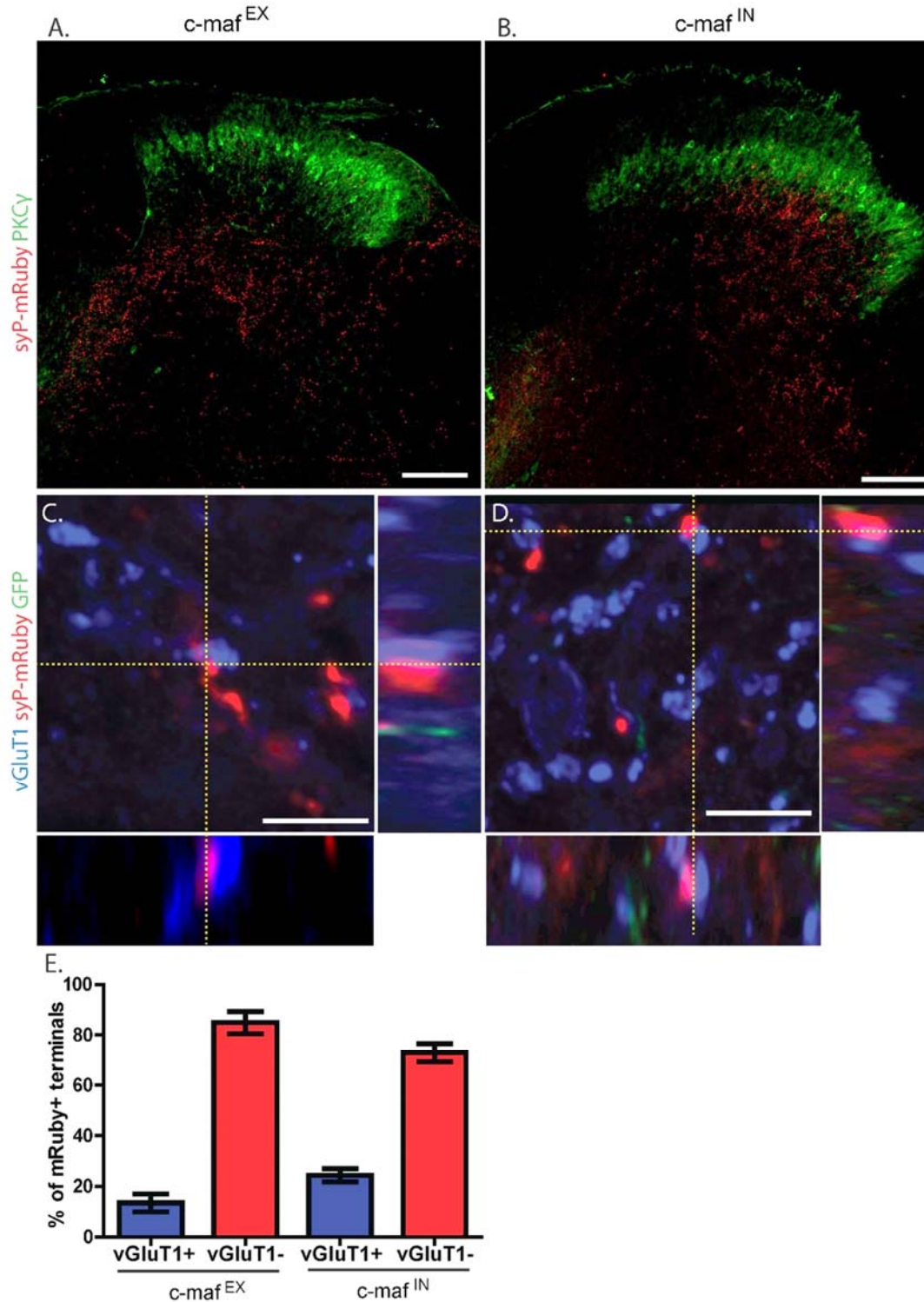

Fig.5: c-maf neurons make axo-axonic contacts onto LTMRs terminals. **A-B.** Localization of synaptophysin-mRuby labeled terminals from $c\text{-maf}^{\text{EX}}$ (A) or $c\text{-maf}^{\text{IN}}$ (B) neurons, relative to the PKC γ immunoreactive layer in the dorsal spinal cord. **C. D.** Representative examples of synaptic contacts between terminals from a $c\text{-maf}^{\text{EX}}$ (C) or $c\text{-maf}^{\text{IN}}$ (D) neuron and vGluT1 positive synapses. **C.** Quantification of the number of mRuby positive terminals contacting vGluT1 positive synapses. ($c\text{-maf}^{\text{EX}}$: n=3, $c\text{-maf}^{\text{IN}}$: n=3). Scale bars: A, B : 100 μm , C-D : 5 μm .

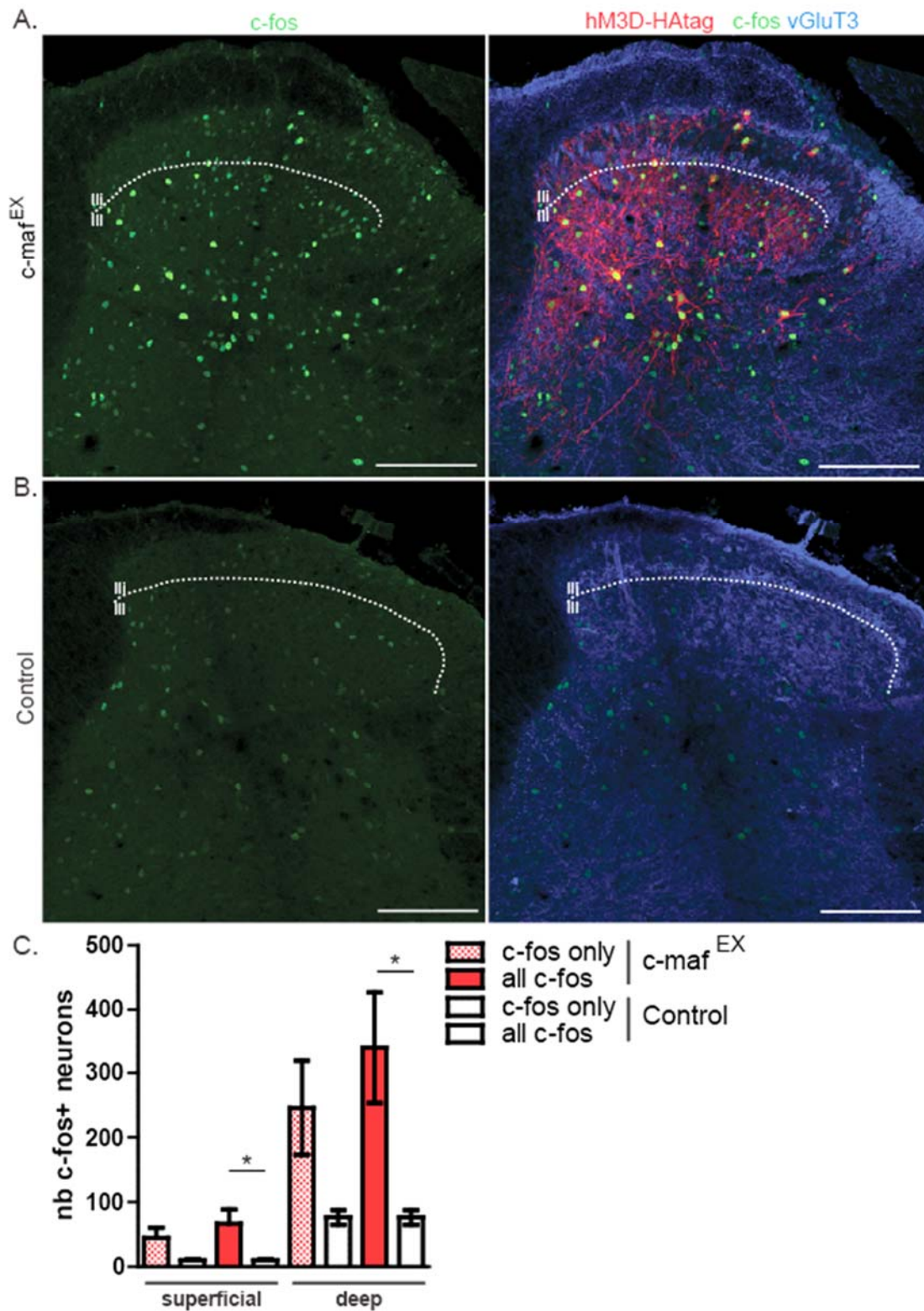

Fig.6: Superficial and deep dorsal horn neurons activated by c-maf^{EX} neurons. hM3Dq expression was driven by injection of rAAV.hsyn.C_{on}/D_{on}.hM3Dq into the lumbar spinal cord of c-maf^{EX} mice. **A-B.** c-fos immunoreactivity after CNO injection in c-maf^{EX} (A, n=4) or control (B, n=4) mice. **C.** Quantification of (A) and (B). Scale bars: 100 μ m. Error: \pm SEM, * p < 0.05 (unpaired Student t test).

3.6 Investigation of c-maf neurons role in sensory processing

c-maf positive spinal interneurons receive excitatory inputs from primary sensory afferent and CST neurons from S1. We therefore tried to understand how activation of c-maf interneurons would affect sensory and nociceptive behaviors.

3.6.1 Pharmacogenetic activation of c-maf^{fEX} neurons

In order to transiently activate c-maf^{fEX} interneurons, we injected an AAV encoding the excitatory DREADD (rAAV.hSyn.C_{on}/D_{on}.hM3Dq) into the lumbar spinal cord of c-maf^{fEX} mice or control mice that do not express either one or the two of the recombinases. The expression of hM3Dq in the spinal cord was verified by immunostaining (Fig.6A). Injection of CNO i.p. led to hypersensitivity to punctate mechanical (Fig.7B) and cold (Fig.6D) stimulations in the c-maf^{fEX} but not in the control mice. No differences were detected for heat sensitivity, noxious pinprick and light dynamic touch stimulations (Fig.7C, E-F). Importantly, c-maf^{fEX} mice displayed strong spontaneous aversive behavior (Fig.6G, licking and biting of the left leg, 256 ± 43s vs 87 ± 21 s) after CNO injection and developed lesions on the left leg that did not appear in the control mice (Fig.7H). This phenotype is similar to what was observed previously upon the ablation of dorsal horn glycinergic interneurons¹⁴.

3.6.2 Manipulation of c-maf^{fN} neurons

3.6.2.1 Pharmacogenetic silencing of c-maf^{fN} neurons in naive mice

in situ hybridization experiments (Fig.1) showed that 14 ± 1% of vGat positive neurons expressed c-maf. We also demonstrated that c-maf neurons overlap with inhibitory PV neurons (Fig.1). c-maf^{fN} neurons therefore likely represent a small subset of glycinergic spinal interneurons. It has been shown previously that ablation of dorsal horn glycinergic (GlyT2 positive) interneurons¹⁴ leads to mechanical, heat, and cold hyperalgesia and well as spontaneous aversive behavior similar to what we observed when activating the excitatory c-maf neurons. We therefore asked if the transient silencing of c-maf^{fN} neurons could lead to a comparable phenotype. We injected a rAAV-hsyn1-C_{on}/D_{on}.hM4Di virus into the lumbar spinal cord of c-maf^{fN} or control mice. Injection of CNO led to hypersensitivity to mechanical stimulation (von Frey test, Fig.8D) in the c-maf^{fN} mice compared to controls. We saw however no differences in responses to heat (Fig.8B), cold (Fig.8C), pin prick (Fig.8E) or brush (Fig.8F) stimulation. We did not observe spontaneous aversive behavior. The effect of silencing this subpopulation of glycinergic neurons is more restricted to mechanical sensitivity.

Fig.7: Transient pharmacogenetic activation of c-maf^{fEX} spinal interneurons **A.** hM3Dq expression was driven by injection of rAAV.hsyn.C_{on}/D_{on}.hM3Dq into the lumbar spinal cord of c-maf^{fEX} and control mice. **B.-F.** Behavioral responses after injection of CNO to mechanical (B, E, F), heat (C), cold (D) stimulations. (c-maf^{fEX}: n=8; control: n=5; von Frey: F(1.47,44) = 6.023; P = 0.017, Hargreaves: F(4,32) = 0.943; P = 0.452, cold: F(4,44) = 9.318; P<0.000, pinprick :F(1.87,44) = 0.189; P = 0.815, brush: F(4,44) = 0.551; P = 0.699). **G.** Spontaneous aversive behavior: licking/biting of the left flank over 20min (c-maf^{fEX}: n=8; control: n=8, P = 0.0032). **H.** Localized hair removal and skin lesions. BL: baseline, horizontal axis: time post CNO injection, error: ± SEM, *p < 0.05; **p < 0.01 (B-F: ANOVA, G: unpaired Student t test).

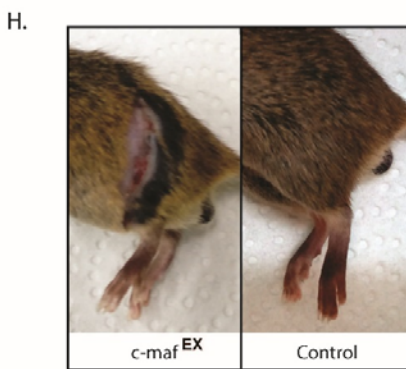
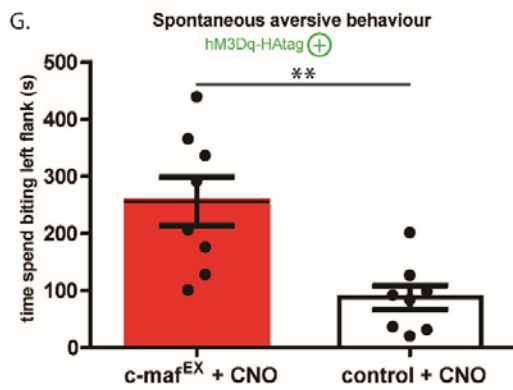
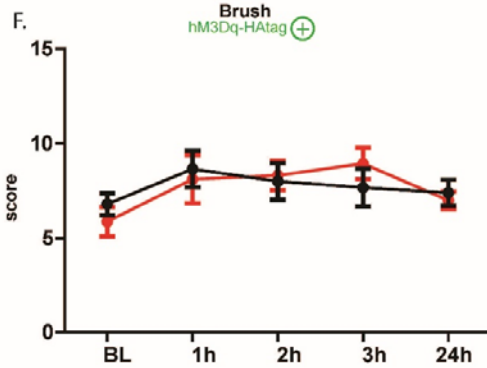
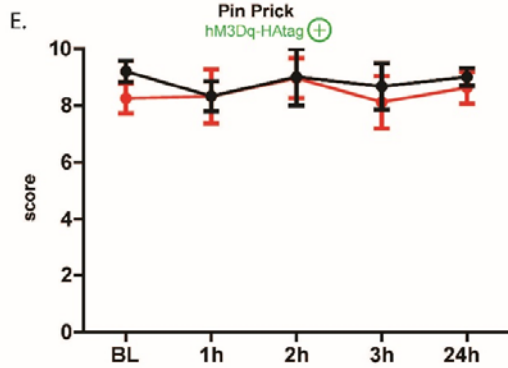
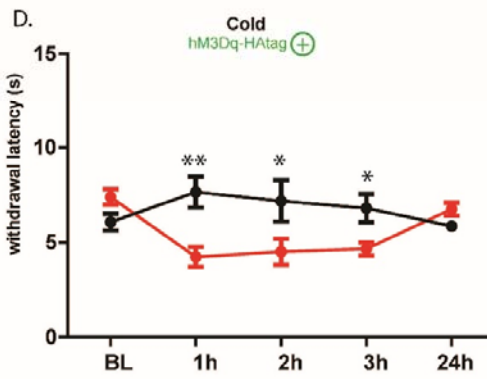
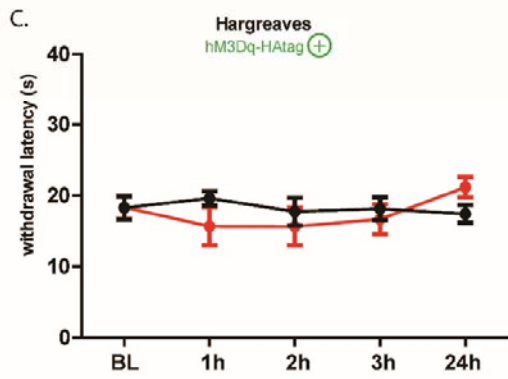
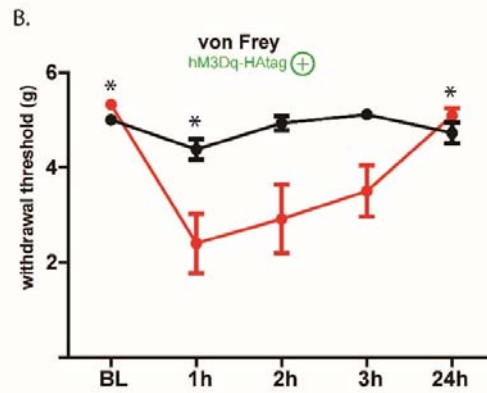
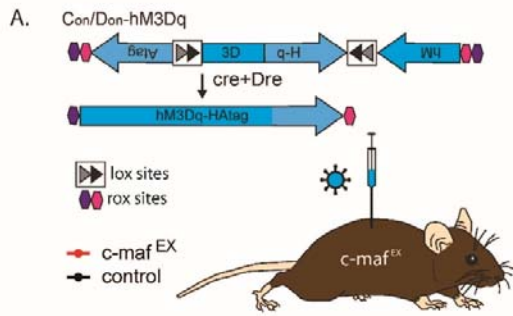

3.6.2.2 Pharmacogenetic activation of c-maf^{fN} neurons in naïve and neuropathic mice

We then tested the effect of activating the c-maf^{fN} neurons in both naïve and neuropathic pain conditions. rAAV.hsyn1.C_{on}/D_{on}.hM3Dq virus was injected into the lumbar spinal cord of c-maf^{fN} and control mice. After CNO injection in naïve mice, we observed a strong loss of sensitivity to noxious stimulation in c-maf^{fN} mice compared to controls (Fig.8J), as well as a reduced sensitivity to light touch and cold stimulations (Fig.8K, H). There were no significant differences in the Hargreaves and von Frey tests (Fig.8B, D).

Nerve injury leads to a loss of the inhibitory tone in the deep dorsal horn²⁷ and enhances the activation of nociceptive pain pathways by LTMRs. We tested if the pharmacogenetic activation of inhibitory c-maf neurons could transiently reverse CCI-induced mechanical hypersensitivity. Seven days after CCI surgery, both c-maf^{fN} and control mice developed the expected hypersensitivity to von Frey stimulation. In c-maf^{fN} mice, CNO had only a small and not significant effect on hypersensitivity to von Frey stimulation (Fig.8L) but led to a reduction in sensitivity to brush stimulation (Fig.8N), as well as a pronounced loss of sensitivity to noxious pin prick (Fig.8M).

Fig.8: Pharmacogenetic modulation of c-maf^{fN} spinal interneurons activity in naïve and CCI mice. **A.** DREADD expression was driven by injection of rAAV.hsyn.C_{on}/D_{on}.hM3Dq or rAAV.hsyn.C_{on}/D_{on}.hM4Di into the lumbar spinal cord of c-maf^{fN} and control mice (c-maf^{fN}: n=5; control: n=5). **B-F.** Behavioral responses after hM4Di-mediated silencing of neurons. Responses to heat (B) cold (C) and mechanical (D-F) stimulation (Hargreaves: F(4,20) = 1.184; P = 0.348, cold: F(4,32) = 0.508; P = 0.730; von Frey F(4,32) = 5.266; P=0.002, pin prick: F(4,32) = 0.277; P = 0.891, brush: F(4,32) = 0.294; P = 0.880). **G-K.** Behavioral responses after hM3Dq-mediated activation of neurons (c-maf^{fN}: n=3; control: n=3, preliminary data). Responses to heat (G) cold (H) and mechanical (I-K) stimulation (Hargreaves: F(4,16) = 2.334; P = 0.100, cold: F(4,16) = 10.847; P = 0.008, von Frey: F(4,16) = 1.793; P = 0.18; pin prick, F(4,16) = 4.058; P=0.019, brush: F(4,16) = 4.058; P = 0.019). **L-N.** Reversal of mechanical hypersensitivity hM3Dq-mediated activation of neurons in CCI injured mice (von Frey: F(2.608,70) = 1.288; P = 0.292, pin prick: F(5,70) = 3.979; P = 0.003, brush: F(5,70) = 2.5; P = 0.038). BL: baseline, horizontal axis: time post CNO injection. Error bars represent ± SEM, *p < 0.05; **p < 0.01 (ANOVA).

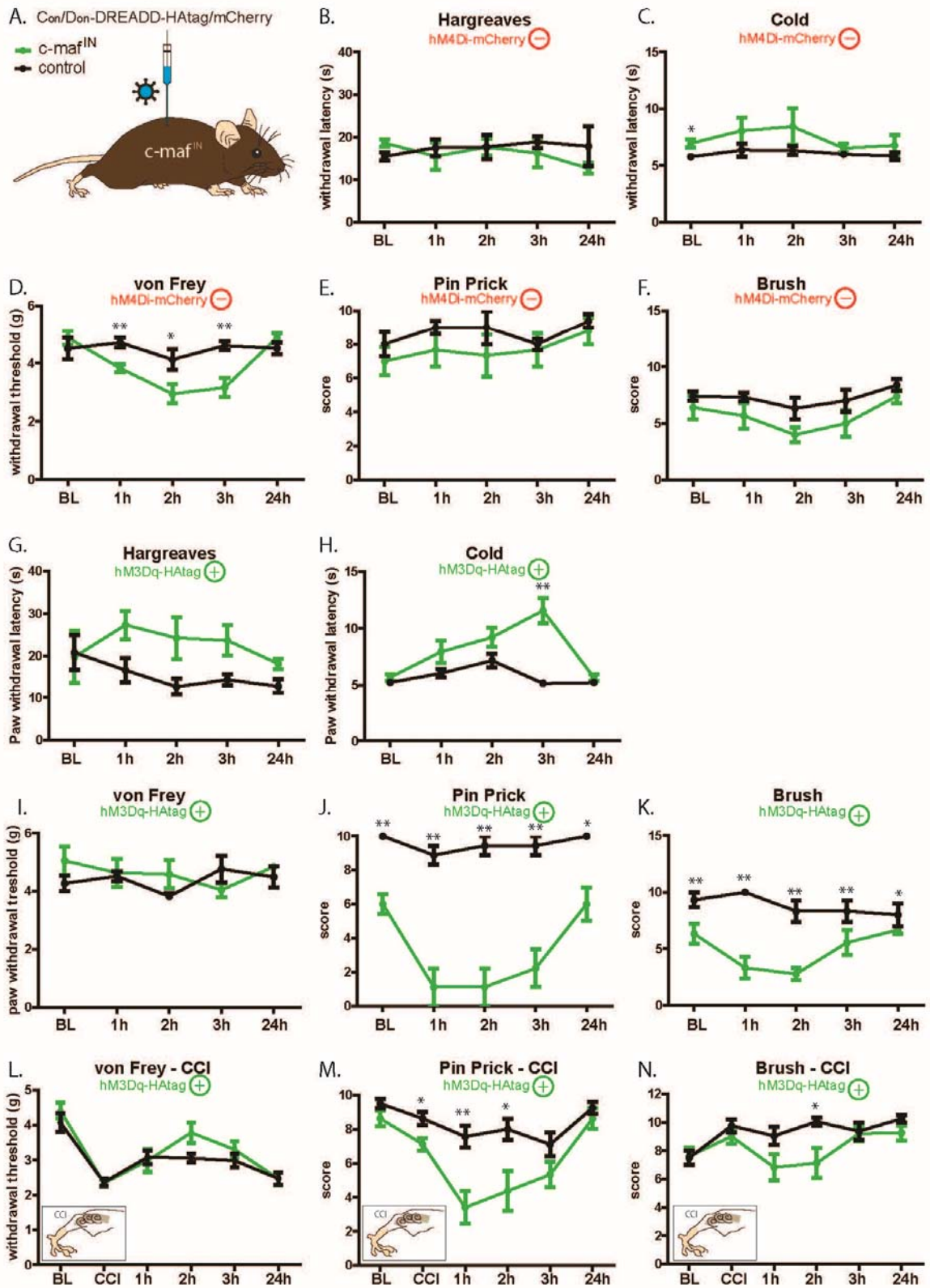

3.7 Discussion

We characterized two subpopulations of c-maf-expressing interneurons located in the deep dorsal horn of the spinal cord. These neurons receive inputs from both supraspinal sites and peripheral sensory fibers. Pharmacogenetic manipulation of these interneurons altered sensory processing.

c-maf expressing spinal interneurons overlap with deep dorsal horn interneuron populations

We first confirmed that about two thirds of c-maf positive interneurons in the dorsal horn are excitatory and one third inhibitory. Multiplex *in situ* hybridization experiments showed that c-maf expression overlaps with that of CCK and PV. In the spinal cord, all CCK positive neurons are excitatory²² (94% of CCK-lineage neurons colocalize with *lmx1β*²⁸), and about 80 to 85% of PV positive neurons are inhibitory (unpublished). Accordingly, only very few (about 5%) c-maf positive neurons were positive for PV and CCK. We also confirmed previous observations from our laboratory that there is virtually no overlap between c-maf and PKC γ ²⁸.

Recently, single-cell RNA sequencing experiments have shown that c-maf is expressed in two subpopulations of CCK-expressing interneurons as well as three (CCK negative) inhibitory interneuron populations, consistent with our findings. Data from the same study also shows an overlap between c-maf and PV in one inhibitory population and between CCK, c-maf and PV in one excitatory interneuron population. There is also evidence that c-maf and CCK are expressed in subsets of ROR α expressing interneurons. The latter have been shown to mediate light touch sensitivity¹¹. Further *in situ* hybridization experiments will help us determine the exact proportion of c-maf neurons expressing ROR α . It is also known from various studies that PV⁶ and CCK^{5,28} interneurons are involved in the processing of mechanical stimuli coming from LTMRs. We therefore aimed to determine the connectivity and functional role of c-maf expressing interneurons within mechanosensory circuits.

Consistent with our current understanding of spinal sensory processing, several studies have shown that silencing or ablation of inhibitory interneuron populations^{6,7,14,29} leads to hypersensitivity to various stimuli whereas silencing or ablation of excitatory interneurons induces higher sensory thresholds^{4,30}. Because c-maf marks a heterogeneous population of neurons, we hypothesized that simultaneous modulation of the both c-maf subpopulations might potentially cancel out, and designed a strategy to separately manipulate inhibitory and excitatory-maf positive interneurons. Crossing of c-maf^{cre/wt} mice with either GlyT2::Dre or *lmx1β*^{dre/wt} mice resulted in specific labeling of these two subpopulations. We therefore used these two intersectional genetic mouse lines to further study the place of c-maf interneurons in spinal circuits. The use of recombinant AAV injections into the lumbar spinal cord³¹ allowed us to specifically target c-maf^{f^N} or c-maf^{f^{EX}} interneurons in adult mice.

c-maf expressing interneurons receive LTMR and cortical inputs

Retrograde monosynaptic tracing using rabies virus resulted in labeling of mainly myelinated primary afferents in the DRGs in both mouse lines. Both excitatory and inhibitory c-maf neurons receive inputs from LTMRs and proprioceptors (NF3, NF4 and NF5 populations in Usoskin *et al.* 2015²⁵). c-maf^{f^{EX}} neurons received relatively more inputs from PV negative (NF3) LTMRs, whereas c-maf^{f^N} neurons received slightly lower input from the NF3-5 populations and more from peptidergic TrkA positive (PEP2) fibers than c-maf^{f^{EX}} neurons. It is important to note that we did not find rabies (eGFP) co-labeling with either P2X3 or PYXNC1, markers of nonpeptidergic populations. This is on the one hand expected as it has previously been demonstrated that nonpeptidergic and C-fiber low-threshold mechanoreceptor neurons are resistant to direct and transsynaptic infection from the spinal cord with rabies virus²⁰. On the other hand, in c-maf^{f^{EX}} or c-maf^{f^N} animals injected with AAV.ConDon.eGFP, little overlap between

the c-maf labeled neurons and markers of peptidergic and nonpeptidergic primary afferent terminals (CGRP and IB4, respectively) was observed. Together our data suggest that c-maf^{EX} as well as c-maf^{FN} receive primarily sensory input from LTMRs and proprioceptors. Additionally, we have shown previously that c-maf positive neurons receive direct input from CST neurons in S1. This is confirmed by the presence of labeled pyramidal neurons in the layer 5 of S1hl in rabies tracing experiment from both populations of c-maf neurons. We have therefore identified a marker gene for a population of deep dorsal horn interneurons that integrate descending inputs from the cortex and peripheral sensory signals for modulation of spinal processing, in addition to those identified previously¹⁰. The precise parameters that lead to activation of some of these neurons over other neurons in various contexts are still unknown.

c-maf expressing interneurons contact other spinal neurons and LTMR presynaptic terminals.

We quantified the number of synaptic terminals of c-maf neurons that were in close proximity to vGluT1 reactive terminals. As expected from the overlap between c-maf^{FN} and PV neurons, we detected numerous contacts between c-maf^{FN} synapses and vGluT1 positive presynaptic terminals. More surprisingly, we also found many of these contacts made by c-maf^{EX} neurons. Although the present experiment does not allow to distinguish between LTMR and CST terminals (all positive for vGluT1), it is likely that a proportion of these contacts correspond to axo-axonic synapses from c-maf neurons onto LTMR terminals²⁶. The majority of labeled synaptic terminals from c-maf neurons were not associated with vGluT1 immunoreactivity. Because they are located rather in the deep dorsal horn, it is likely that most of these synapses contact local interneurons. Indeed, we observed very few terminals of c-maf neurons in the superficial laminae, the termination area of nociceptive fibers.

It is important to note however that the present study does not allow a precise quantification of the number of c-maf neurons terminals contacting LTRMs, as vGluT1 also labels terminals of CST neurons in the dorsal spinal cord. Further experiments will allow us to quantify the proportion of the vGluT1 positive fibers that we observe that correspond to either LTMRs or CST terminals. In addition to providing feedback to myelinated sensory fibers, c-maf interneurons also send information to other spinal neurons, as shown by the 3 to 4-fold increase in c-fos reactive neurons in both the deep and the superficial dorsal horns subsequent to c-maf^{EX} neurons activation.

Modulation of the activity of c-maf neurons leads to altered sensory thresholds.

We have shown that a large proportion of c-maf and PV double-positive neurons is inhibitory. It is likely that these neurons have been targeted in a previous study⁶ that showed that activation of inhibitory PV interneurons leads to higher mechanical thresholds in naïve mice and reversal of nerve injury-induced mechanical hypersensitivity. Surprisingly, we found no effect of activation of c-maf^{FN} neurons on von Frey thresholds, but we did see a strong effect on responses to light touch and noxious pin prick in both naïve and CCI-injured mice. Such differences could be explained by the fact that we target a not fully overlapping and much smaller population of neurons. Here we also silenced c-maf^{FN} neurons, and showed that they are required for static mechanical sensitivity (von Frey). The ablation of spinal glycinergic neurons led to a much broader phenotype, including mechanical, heat, and cold hyperalgesia, as well as spontaneous aversive behavior¹⁴. Here we only saw a difference in mechanical thresholds. This is not surprising because c-maf^{FN} neurons only represent a small subset of all spinal glycinergic neurons.

Conversely, activation of c-maf^{EX} neurons led to a strong reduction of the responses to punctate mechanical stimulation (von Frey) but did not affect responses to light touch or noxious stimulation. Interestingly, we also saw spontaneous aversive behavior and development of lesions very similar to those observed after ablation of glycinergic interneurons¹⁴. We will further study the role of c-maf^{EX}

neurons by pharmacogenetic silencing of these neurons. It will be interesting to compare these results to the selective loss of light touch sensitivity observed after ablation of ROR α neurons¹¹. Indeed, there is overlap between c-maf^{EX} and ROR α neurons and both populations are innervated by LTMRs, but we also show that c-maf^{EX} neurons received proprioceptive input in addition.

The variety of sensory fibers and spinal interneurons populations permits the detection of a large range of sensory stimuli. Functional analysis of selective subsets of deep dorsal horn interneurons will help understanding how activity from the primary afferent fibers, local interneurons and descending projection neurons are integrated to produce an accurate perception of the environment. Using genetic tools to probe the function and connectivity of c-maf expressing interneurons, the present study provides additional elements towards a more comprehensive view of the spinal cord circuitry involved in the processing of tactile and mechanical sensitivity.

Table 2. ANOVA results and P values for behavioral analysis in Figures 6-7

mouse line	DREADD	test	n(TG)	n (control)	ANOVA
c-maf ^{EX}	hM3Dq	von Frey	8	5	F(1,47,44)=6.023; P=0.017
		Cold			F(4,44)=9.318; P<0.000
		Hargreaves			F(4,32)=0.943; P=0.452
		Pin prick			F(1.87,44)=0.189; P=0.815
		Brush			F(4,44)=0.551; P=0.699
		Biting/liking			8
c-maf ^{FN}	hM4Di	von Frey	5	5	F(4,32)=5.266; P=0.002
		Cold			F(4,32)=0.508; P=0.730
		Hargreaves			F(4,20)=1.184; P=0.348
		Pin prick			F(4,32)=0.277; P=0.891
		Brush			F(4,32)=0.294; P=0.880
	hM3Dq	von Frey	3	3	F(4,16)=2.334; P=0.100
		Cold			F(4,16)=10.847; P=0.008
		Hargreaves			F(4,16)=1.793; P=0.18
		Pin prick			F(4,16)=4.058; P=0.019
		Brush			F(4,16)=4.058; P=0.019
	hM3Dq-CCI	von Frey	3	8	F(2,608,70)=1.288; P=0.292
		Pin prick			F(5,70)=3.979; P=0.003
		Brush			F(5,70)=2.5; P=0.038

3.8 References

- 1 Lolignier, S., Eijkelkamp, N. & Wood, J. N. Mechanical allodynia. *Pflugers Arch* **467**, 133-139 (2015).
- 2 Braz, J., Solorzano, C., Wang, X. & Basbaum, A. I. Transmitting pain and itch messages: a contemporary view of the spinal cord circuits that generate gate control. *Neuron* **82**, 522-536 (2014).
- 3 Zeilhofer, H. U., Wildner, H. & Yevenes, G. E. Fast synaptic inhibition in spinal sensory processing and pain control. *Physiol Rev* **92**, 193-235 (2012).
- 4 Peirs, C., Williams, S. P., Zhao, X., Walsh, C. E., Gedeon, J. Y., Cagle, N. E., Goldring, A. C., Hioki, H., Liu, Z., Marell, P. S. & Seal, R. P. Dorsal Horn Circuits for Persistent Mechanical Pain. *Neuron* **87**, 797-812 (2015).
- 5 Liu, Y., Latremoliere, A., Li, X., Zhang, Z., Chen, M., Wang, X., Fang, C., Zhu, J., Alexandre, C., Gao, Z., Chen, B., Ding, X., Zhou, J. Y., Zhang, Y., Chen, C., Wang, K. H., Woolf, C. J. & He, Z. Touch and tactile neuropathic pain sensitivity are set by corticospinal projections. *Nature* **561**, 547-550 (2018).
- 6 Petitjean, H., Pawlowski, S. A., Fraine, S. L., Sharif, B., Hamad, D., Fatima, T., Berg, J., Brown, C. M., Jan, L. Y., Ribeiro-da-Silva, A., Braz, J. M., Basbaum, A. I. & Sharif-Naeini, R. Dorsal Horn Parvalbumin Neurons Are Gate-Keepers of Touch-Evoked Pain after Nerve Injury. *Cell Rep* **13**, 1246-1257 (2015).
- 7 Duan, B., Cheng, L., Bourane, S., Britz, O., Padilla, C., Garcia-Campmany, L., Krashes, M., Knowlton, W., Velasquez, T., Ren, X., Ross, S., Lowell, B. B., Wang, Y., Goulding, M. & Ma, Q. Identification of spinal circuits transmitting and gating mechanical pain. *Cell* **159**, 1417-1432 (2014).
- 8 Del Barrio, M. G., Bourane, S., Grossmann, K., Schule, R., Britsch, S., O'Leary, D. D. & Goulding, M. A transcription factor code defines nine sensory interneuron subtypes in the mechanosensory area of the spinal cord. *PLoS One* **8**, e77928 (2013).
- 9 Ueno, M., Nakamura, Y., Li, J., Gu, Z., Niehaus, J., Maezawa, M., Crone, S. A., Goulding, M., Baccei, M. L. & Yoshida, Y. Corticospinal Circuits from the Sensory and Motor Cortices Differentially Regulate Skilled Movements through Distinct Spinal Interneurons. *Cell Rep* **23**, 1286-1300 e1287 (2018).
- 10 Abaira, V. E., Kuehn, E. D., Chirila, A. M., Springel, M. W., Toliver, A. A., Zimmerman, A. L., Orefice, L. L., Boyle, K. A., Bai, L., Song, B. J., Bashista, K. A., O'Neill, T. G., Zhuo, J., Tsan, C., Hoynoski, J., Rutlin, M., Kus, L., Niederkofler, V., Watanabe, M., Dymecki, S. M., Nelson, S. B., Heintz, N., Hughes, D. I. & Ginty, D. D. The Cellular and Synaptic Architecture of the Mechanosensory Dorsal Horn. *Cell* **168**, 295-310 e219 (2017).
- 11 Bourane, S., Grossmann, K. S., Britz, O., Dalet, A., Del Barrio, M. G., Stam, F. J., Garcia-Campmany, L., Koch, S. & Goulding, M. Identification of a spinal circuit for light touch and fine motor control. *Cell* **160**, 503-515 (2015).
- 12 Wende, H., Lechner, S. G., Cheret, C., Bourane, S., Kolanczyk, M. E., Pattyn, A., Reuter, K., Munier, F. L., Carroll, P., Lewin, G. R. & Birchmeier, C. The transcription factor c-Maf controls touch receptor development and function. *Science* **335**, 1373-1376 (2012).
- 13 Hu, J., Huang, T., Li, T., Guo, Z. & Cheng, L. c-Maf is required for the development of dorsal horn laminae III/IV neurons and mechanoreceptive DRG axon projections. *J Neurosci* **32**, 5362-5373 (2012).

- 14 Foster, E., Wildner, H., Tudeau, L., Haueter, S., Ralvenius, W. T., Jegen, M., Johannssen, H., Hosli, L., Haenraets, K., Ghanem, A., Conzelmann, K. K., Bosl, M. & Zeilhofer, H. U. Targeted ablation, silencing, and activation establish glycinergic dorsal horn neurons as key components of a spinal gate for pain and itch. *Neuron* **85**, 1289-1304 (2015).
- 15 Zeilhofer, H. U., Studler, B., Arabadzisz, D., Schweizer, C., Ahmadi, S., Layh, B., Bosl, M. R. & Fritschy, J. M. Glycinergic neurons expressing enhanced green fluorescent protein in bacterial artificial chromosome transgenic mice. *J Comp Neurol* **482**, 123-141 (2005).
- 16 Haenraets, K., Foster, E., Johannssen, H., Kandra, V., Frezel, N., Steffen, T., Jaramillo, V., Paterna, J. C., Zeilhofer, H. U. & Wildner, H. Spinal nociceptive circuit analysis with recombinant adeno-associated viruses: the impact of serotypes and promoters. *J Neurochem* **142**, 721-733 (2017).
- 17 Brenner, D.S., Golden, J.P. & Gereau, R.W. A novel behavioral assay for measuring cold sensation in mice. *PLoS One* **7**, e39765 (2012).
- 18 Bennett, G. J. & Xie, Y. K. A Peripheral Mononeuropathy in Rat That Produces Disorders of Pain Sensation Like Those Seen in Man. *Pain* **33**, 87-107 (1988).
- 19 Frezel, N., Kratzer, G., Verzar, P., Bürki, J., Weber, F. A. & Zeilhofer, H. U. Does toe clipping for genotyping interfere with later-in-life nociception in mice? *PAIN Reports* **4**, e470 (2019).
- 20 Albisetti, G. W., Ghanem, A., Foster, E., Conzelmann, K. K., Zeilhofer, H. U. & Wildner, H. Identification of Two Classes of Somatosensory Neurons That Display Resistance to Retrograde Infection by Rabies Virus. *J Neurosci* **37**, 10358-10371 (2017).
- 21 Muller, T., Brohmann, H., Pierani, A., Heppenstall, P. A., Lewin, G. R., Jessell, T. M. & Birchmeier, C. The homeodomain factor *lhx1* distinguishes two major programs of neuronal differentiation in the dorsal spinal cord. *Neuron* **34**, 551-562 (2002).
- 22 Haring, M., Zeisel, A., Hochgerner, H., Rinwa, P., Jakobsson, J. E. T., Lonnerberg, P., La Manno, G., Sharma, N., Borgius, L., Kiehn, O., Lagerstrom, M. C., Linnarsson, S. & Ernfors, P. Neuronal atlas of the dorsal horn defines its architecture and links sensory input to transcriptional cell types. *Nat Neurosci* **21**, 869-880 (2018).
- 23 Snider, W. D. & McMahon, S. B. Tackling pain at the source: New ideas about nociceptors. *Neuron* **20**, 629-632 (1998).
- 24 Todd, A. J., Hughes, D. I., Polgar, E., Nagy, G. G., Mackie, M., Ottersen, O. P. & Maxwell, D. J. The expression of vesicular glutamate transporters VGLUT1 and VGLUT2 in neurochemically defined axonal populations in the rat spinal cord with emphasis on the dorsal horn. *Eur J Neurosci* **17**, 13-27 (2003).
- 25 Usoskin, D., Furlan, A., Islam, S., Abdo, H., Lonnerberg, P., Lou, D., Hjerling-Leffler, J., Haeggstrom, J., Kharchenko, O., Kharchenko, P. V., Linnarsson, S. & Ernfors, P. Unbiased classification of sensory neuron types by large-scale single-cell RNA sequencing. *Nat Neurosci* **18**, 145-153 (2015).
- 26 Hughes, D. I., Sikander, S., Kinnon, C. M., Boyle, K. A., Watanabe, M., Callister, R. J. & Graham, B. A. Morphological, neurochemical and electrophysiological features of parvalbumin-expressing cells: a likely source of axo-axonic inputs in the mouse spinal dorsal horn. *Journal of Physiology-London* **590**, 3927-3951 (2012).
- 27 Zeilhofer, H. U., Benke, D. & Yévenes, G. E. Chronic pain states: pharmacological strategies to restore diminished inhibitory spinal pain control. *Annu Rev Pharmacol Toxicol* **52**, 111-133 (2012).
- 28 Haueter, S. PKC γ and CCK expressing neurons in the spinal processing of somatosensory information. *Dissertation. ETH-Zürich. 2016. Nr. 23257* (2016).

- 29 Cheng, L., Duan, B., Huang, T., Zhang, Y., Chen, Y., Britz, O., Garcia-Campmany, L., Ren, X., Vong, L., Lowell, B. B., Goulding, M., Wang, Y. & Ma, Q. Identification of spinal circuits involved in touch-evoked dynamic mechanical pain. *Nat Neurosci* **20**, 804-814 (2017).
- 30 Wang, L., Chen, S. R., Ma, H., Chen, H., Hittelman, W. N. & Pan, H. L. Regulating nociceptive transmission by VGlut2-expressing spinal dorsal horn neurons. *J Neurochem* **147**, 526-540 (2018).
- 31 Haenraets, K., Albisetti, G. W., Foster, E. & Wildner, H. Adeno-associated Virus-mediated Transgene Expression in Genetically Defined Neurons of the Spinal Cord. *J Vis Exp* (2018).

4 General discussion

Specific targeting of selected neuronal populations

In the past years, great advances have been made in the identification of individual spinal cord neuronal populations and their functions. Models of the dorsal horn circuitry have emerged that give us a better understanding of sensory processing in both normal and pathological conditions. Many of these advances relied on the identification of genetically and functionally defined cell types. To be able to study in detail the morphology, physiological properties, connectivity pattern and role in behavior of a given population requires selective targeting of a small group of neurons.

The use of mouse lines expressing recombinases (cre or Dre for example) under a specific promoter is a powerful tool to target gene expression to restricted population of cells. Recombination leads to specificity and amplification of transgene expression in the chosen cell population. Additionally, many different transgenes, and thus effector proteins, can be delivered into the cells by simple injection of viral vectors, without the need for several different mouse lines. We and others have shown that recombinant AAV vectors are ideal tools for gene delivery in such systems. The choice of the AAV serotype and promoter in particular are essential for efficient and correct expression of the desired transgene¹. In contrast to crossing recombinase-expressing mice with mice carrying recombinase-dependent alleles (thus labeling all the cells that have expressed the recombinase at some point during development), injection of viruses leads to temporally and spatially controlled expression of the transgene.

However, the expression a gene is rarely restricted to one functionally defined subpopulation of neurons. It may therefore be necessary to use a second marker gene to more precisely target the population of interest. To this end, we employed intersectional targeting approaches, where a population of neurons is defined by two criteria.

In the spinal cord, we typically use two markers genes with different but overlapping expression patterns. One recombinase (cre) is expressed under the promoter of the first gene, and the second (Dre) under the promoter of the second gene. We also use this intersectional approach to restrict transgene expression to the spinal cord, i.e. avoiding expression in the DRGs and supraspinal sites.

The connectivity pattern of some neuronal populations is also an important parameter in defining functional subtypes. This is true in particular for long-range projection neurons that connect various parts of the CNS. In this case, rather than using markers genes for the intersectional targeting, we have shown that it is possible to target neurons based on their projection area. Targeting neurons by retrograde transduction of the axonal terminals in the projection area has been previously shown to work^{2,3}. Here we demonstrate that the rAAV2-retro serotype is best suited to target long-range projections between the brain and the lumbar spinal cord. Additionally, we propose that we can further define subpopulations of projection neurons based on expression of a marker gene. Here we have studied the connection between the somatosensory cortex and the lumbar spinal cord, but similar principles would apply for other connected areas. In this case, we found that CCK was not a specific marker for a subpopulation of S1-CST neurons. It is possible however that marker genes of CST neuron subpopulations could be identified in the future. A recent gene profiling study in the cortex showed that transcriptional programs reflect axonal target identity⁴. It will be interesting to see if a similar approach applied to corticospinal neurons would lead to identification of specific marker genes. Additionally, this strategy can readily be applied in other model circuits where markers of subpopulations are known. One important example is

the RVM that contains serotonergic, glutamatergic and GABA/glycinergic neurons projecting to the spinal cord.

Integration of proprioceptive and tactile inputs to modulate somatosensation

Sensory integration begins in the spinal cord, before projection neurons propagate this processed information to the brain. All sensory fibers types, although they have very distinct physiological properties, converge onto the dorsal horn. In particular, distinct LTMR subtypes converge onto deep dorsal horn interneurons in a somatotopic and columnar manner⁵. Processing of tactile information by the spinal cord therefore results from a combination of the connectivity pattern of distinct primary fiber subtypes within particular lamina of the dorsal horn, but also from their synapses onto dorsal horn circuit components as well as the cell types and connectivity of the targeted spinal interneurons and projection neurons. Recent advances in classification of deep dorsal horn interneurons and genetic manipulation of these neurons have begun to shine light on the mechanisms of integration and processing of LTMR activity⁶⁻⁹.

Here we provide further evidence that inputs from LTMRs but also from supraspinal areas converge onto deep dorsal horn neurons. These interneurons in turn contact directly or indirectly projection neurons that send touch information to higher brain centers. We and others¹⁰ have also found evidence that deep dorsal horn interneurons also contact LTMR terminals, likely providing feedback to further modulate the information coming from the periphery. Together with other recent studies of the role of various subtypes of interneurons, this supports a model in which the deep dorsal horn serves to integrate non-noxious inputs from the periphery before it is transmitted to higher brain centers. The fact that many of these neurons also receive contacts back from the cortex suggests that they may also play a role in the modulation of somatosensory processing, possibly affecting perception of tactile stimuli, but also of body position and balance (through modulation of proprioception) as well as fine locomotor activity^{6,11,12}.

Characterization of the connection between S1 and the mechanosensory dorsal horn

Here, we have identified populations of neurons in the spinal cord and in the cortex that are important for somatosensory processing. In the spinal cord, we have shown that *c-maf* is a well suited driver gene to manipulate selected subpopulations of interneurons in the deep dorsal horn. Recent mRNA sequencing data also found that *c-maf* is selectively expressed in two excitatory and two inhibitory subpopulations of spinal dorsal horn neurons¹³. Here we show that we can separately target *c-maf*^{f^N} and *c-maf*^{f^{EX}} neurons in adult mice using an intersectional genetic approach. *c-maf*^{f^N} and *c-maf*^{f^{EX}} neurons integrate descending inputs from the cortex as well as peripheral sensory signals and are able to alter sensory processing.

We were also able to identify CST neurons in S1 that make direct synaptic contact onto the *c-maf* neurons. Although it is possible to selectively target a subset of CST neurons based on their projection area, it was however not possible to restrict targeting to those CST neurons that contact *c-maf* expressing neurons (or *vice versa*). Indeed, we show that S1-CST neurons that target the dorsal horn of the lumbar spinal cord contact both inhibitory and excitatory interneurons. The activation of *c-maf*^{f^N} and *c-maf*^{f^{EX}} could in part reflect what happens when they are activated by the excitatory inputs from the CST, but the heterogeneity of the S1-CST target population might explain the fact that we do not detect a clear effect of S1-CST neurons manipulation on classical somatosensory tests.

Outlook on viral tools to study sensory circuits

In order to study in more detail the function of this circuit, we considered the two following approaches.

The first one would be to specifically target effector protein expression selectively to S1-CST neurons that are presynaptic to either c-maf^N or c-maf^{EX} neurons. The advantage of rabies virus tracing is that one can target directly connected cells. The high cytotoxicity of the rabies virus however strongly limits its use for functional applications.

Recently, Ciabatti *et al.* developed a self-inactivating rabies virus (SiR) designed to provide long-term access to neural networks¹⁴. This tool was highly promising because it would allow one to restrict functional manipulation to neurons connected to the chosen starter population. We could therefore selectively drive expression of the Flp recombinase in S1-CST neurons that are presynaptic to either spinal inhibitory or excitatory interneurons. We found however that injection of this SiR virus into the lumbar spinal cord of adult mice lead to the death of primarily infected (starter) cells within 1-2 weeks, and also of the retrogradely labeled CST neurons. This time window would not be compatible with behavioral experiments and cell death would be a severe confounding factor in such experiments. In parallel to our experiments, another group found similar results¹⁵, suggesting that this approach is not feasible. In order to self-inactivate, the SiR expresses a proteasome targeting sequence. According to Matsuyama *et al.*, the selection pressure would favor viruses with mutations in this sequence and thereby compromise the “self-inactivating” capacity. The viral particles that do cross the synapse are the “escape” mutants that cannot self-inactivate and have therefore the same toxicity as classical Δ G rabies viruses.

An alternative approach might be based on anterograde gene transfer to drive expression of effector proteins in spinal interneurons that are directly targeted by S1-CST neurons. Herpes simplex virus (HSV) can be used to label postsynaptic neurons¹⁶. The viral genome can also be modified to carry a transgene of interest, such as fluorescent marker proteins, but neuroinflammation and cytotoxicity make this approach problematic too. On the other hand, WGA is a well suited tool for anterograde transsynaptic tracing in the CNS, but does not allow transgene expression in the traced neurons. The recently developed WGA-cre fusion protein could prove a highly interesting approach to combine the low toxicity and transsynaptic labeling capacities of WGA with the possibility to drive gene expression in connected neurons. The efficacy of this approach to label long range projections such as the corticospinal tract still remains to be determined.

We have tested a recent version of this fusion protein developed in the laboratory of Dr. Shaoyu Ge (Stony Brook University, USA). We have found that injection of an AAV carrying the WGA-cre transgene into the cortex of *ROSA^{Isl1-tdTom}* (tdTomato reporter) mice led to labeling of a very small number of neurons in the spinal cord. It is likely however that expression of cre-dependent transgenes carried by viral vectors is more efficient than expression of transgenes from reporter mice. Further experiments will therefore be carried out to test the efficacy of WGA-cre to recombine a spinally injected cre-dependent viral transgene.

In conclusion, we have shown that deep dorsal horn interneuron populations integrate inputs from the cortex and the periphery to modulate processing of mechanical stimuli. Further studies will be needed to understand how different circuits and activity patterns in the brain and spinal cord that lead to an appropriate behavioral response depending on the environment and internal state of the animal.

References

- 1 Haenraets, K., Albisetti, G. W., Foster, E. & Wildner, H. Adeno-associated Virus-mediated Transgene Expression in Genetically Defined Neurons of the Spinal Cord. *J Vis Exp* (2018).

- 2 Tervo, D. G., Hwang, B. Y., Viswanathan, S., Gaj, T., Lavzin, M., Ritola, K. D., Lindo, S., Michael, S., Kuleshova, E., Ojala, D., Huang, C. C., Gerfen, C. R., Schiller, J., Dudman, J. T., Hantman, A. W., Looger, L. L., Schaffer, D. V. & Karpova, A. Y. A Designer AAV Variant Permits Efficient Retrograde Access to Projection Neurons. *Neuron* **92**, 372-382 (2016).
- 3 Wang, Z., Maunze, B., Wang, Y., Tsoulfas, P. & Blackmore, M. G. Global Connectivity and Function of Descending Spinal Input Revealed by 3D Microscopy and Retrograde Transduction. *J Neurosci* **38**, 10566-10581 (2018).
- 4 Klingler, E., De la Rossa, A., Fievre, S., Devaraju, K., Abe, P. & Jabaudon, D. A Translaminar Genetic Logic for the Circuit Identity of Intracortically Projecting Neurons. *Curr Biol* **29**, 332-339 e335 (2019).
- 5 Abraira, V. E. & Ginty, D. D. The sensory neurons of touch. *Neuron* **79**, 618-639 (2013).
- 6 Bourane, S., Grossmann, K. S., Britz, O., Dalet, A., Del Barrio, M. G., Stam, F. J., Garcia-Campmany, L., Koch, S. & Goulding, M. Identification of a spinal circuit for light touch and fine motor control. *Cell* **160**, 503-515 (2015).
- 7 Cheng, L., Duan, B., Huang, T., Zhang, Y., Chen, Y., Britz, O., Garcia-Campmany, L., Ren, X., Vong, L., Lowell, B. B., Goulding, M., Wang, Y. & Ma, Q. Identification of spinal circuits involved in touch-evoked dynamic mechanical pain. *Nat Neurosci* **20**, 804-814 (2017).
- 8 Peirs, C., Williams, S. P., Zhao, X., Walsh, C. E., Gedeon, J. Y., Cagle, N. E., Goldring, A. C., Hioki, H., Liu, Z., Marell, P. S. & Seal, R. P. Dorsal Horn Circuits for Persistent Mechanical Pain. *Neuron* **87**, 797-812 (2015).
- 9 Abraira, V. E., Kuehn, E. D., Chirila, A. M., Springel, M. W., Toliver, A. A., Zimmerman, A. L., Orefice, L. L., Boyle, K. A., Bai, L., Song, B. J., Bashista, K. A., O'Neill, T. G., Zhuo, J., Tsan, C., Hoynoski, J., Rutlin, M., Kus, L., Niederkofler, V., Watanabe, M., Dymecki, S. M., Nelson, S. B., Heintz, N., Hughes, D. I. & Ginty, D. D. The Cellular and Synaptic Architecture of the Mechanosensory Dorsal Horn. *Cell* **168**, 295-310 e219 (2017).
- 10 Hughes, D. I., Sikander, S., Kinnon, C. M., Boyle, K. A., Watanabe, M., Callister, R. J. & Graham, B. A. Morphological, neurochemical and electrophysiological features of parvalbumin-expressing cells: a likely source of axo-axonic inputs in the mouse spinal dorsal horn. *J Physiol* **590**, 3927-3951 (2012).
- 11 Ueno, M., Nakamura, Y., Li, J., Gu, Z., Niehaus, J., Maezawa, M., Crone, S. A., Goulding, M., Baccei, M. L. & Yoshida, Y. Corticospinal Circuits from the Sensory and Motor Cortices Differentially Regulate Skilled Movements through Distinct Spinal Interneurons. *Cell Rep* **23**, 1286-1300 e1287 (2018).
- 12 Wang, X., Liu, Y., Li, X., Zhang, Z., Yang, H., Zhang, Y., Williams, P. R., Alwahab, N. S. A., Kapur, K., Yu, B., Chen, M., Ding, H., Gerfen, C. R., Wang, K. H. & He, Z. Deconstruction of Corticospinal Circuits for Goal-Directed Motor Skills. *Cell* **171**, 440-455 e414 (2017).
- 13 Haring, M., Zeisel, A., Hochgerner, H., Rinwa, P., Jakobsson, J. E. T., Lonnerberg, P., La Manno, G., Sharma, N., Borgius, L., Kiehn, O., Lagerstrom, M. C., Linnarsson, S. & Ernfors, P. Neuronal atlas of the dorsal horn defines its architecture and links sensory input to transcriptional cell types. *Nat Neurosci* **21**, 869-880 (2018).
- 14 Ciabatti, E., Gonzalez-Rueda, A., Mariotti, L., Morgese, F. & Tripodi, M. Life-Long Genetic and Functional Access to Neural Circuits Using Self-Inactivating Rabies Virus. *Cell* **170**, 382-392 e314 (2017).
- 15 Matsuyama, M., Jin, L., Lavin, T. K., Sullivan, H. A., Hou, Y., Lea, N. E., Pruner, M. T., Dam Ferdínez, M. L. & Wickersham, I. R. Self-inactivating" rabies viruses are just first-generation, ΔG rabies viruses. *bioRxiv* (2019).

- 16 Lo, L. & Anderson, D. J. A Cre-dependent, anterograde transsynaptic viral tracer for mapping output pathways of genetically marked neurons. *Neuron* **72**, 938-950 (2011).

5 Acknowledgments

I would like to thank

All the Jury members for accepting to evaluate my work, in particular Alessandra Pierani and Gilles Fortin for reading this thesis and writing the report. Esther Stöckli and Camilla Bellone for being in my committee.

Uli Zeilhofer for the opportunity to do my PhD in this lab and to stay in Zürich, all the very valuable inputs and support on the projects. Christian Specht and Antoine Triller for supporting me from Paris.

Hendrik Wildner for all the help and advice, constant support in planning and analyzing experiments. The rest of the “minigroup” for daily help in the lab: Karen, Rebecca, Gioele, Robert and the other students who stayed with us, in particular Vinnie and Salome.

Jean-Charles Paterna at the VVF, without whom most of the experiments would not be possible. People from the IPT workshop, the ZMB, the Brain Institute at UZH (hiFo) and the INI for help, support and collaborations.

Everybody in the lab, my colleagues and my friends in the office, and outside of the office.

6 Annexe

Publications during the thesis:

Frezel N, Kratzer G, Verzar P, Bürki J, Weber, FA, Zeilhofer HU. **Does toe clipping for genotyping interfere with later-in-life nociception in mice?** *PAIN Reports* 4, e740 (2019).

Contribution: performed the experiments, analysed data and wrote the manuscript

Voigt FF, Kirschenbaum D, Platonova E, Pagès S, Campbell RAA, Kästli R, Schaettin M, Egolf L, van der Bourg A, Bethge P, Haenraets K, Frezel N, Topilko T, Perin P, Hillier D, Hildebrand S, Schueth A, Roebroeck A, Roska B, Stoeckli E, Pizzala R, Renier N, Zeilhofer HU, Karayannis T, Ziegler u, Batti L, Holtmaat A, Lüscher C, Aguzzi A, Helmchen F. **The mesoSPIM initiative: open-source light-sheet mesoscopes for imaging in cleared tissue.** *Bioarxiv*; under revision at *Nat Methods*.

Contribution: prepared samples for clearing and imaging of whole mouse CNS

Haenraets K, Foster E, Johannssen H, Kandra V, Frezel N, Steffen T, Jaramillo V, Paterna JC, Zeilhofer HU, Wildner H. **Spinal nociceptive circuit analysis with recombinant adeno-associated viruses: the impact of serotypes and promoters.** *J Neurochem* 142, 721-733 (2017).

Contribution: performed and analysed tracing experiments of corticospinal tract neurons.

In preparation:

Frezel N, Hauselmann S, Wildner H, Mateos JM, Ehret B, Dermuzt H, Grewe BF, Zeilhofer HU. Characterization of direct descending projections from the somatosensory cortex to the spinal dorsal horn.

Frezel N, Hauselmann S, Wildner H, Birchmeier C, Zeilhofer HU. Characterization of spinal c-maf expressing deep dorsal horn interneurons involved in the processing of mechanical stimuli.

7 Curriculum vitae

Education

- 2015/2019 **PhD studies** at UZH, Zurich, Switzerland, and IBENS, Paris, France
- 2014/2015 Master's Degree Biologie intégrative, option Neurosciences Cellulaires et Intégrées at UPMC, Paris VI, France.
- 2012/2013 **Agrégation externe Biologie, Génie Biologique BGB**, and Master 2 Formation des Enseignants du Supérieur, ENS Cachan, France.
- 2011/2012 **Master 1 Neurosciences et Signalisation**, ENS Cachan and University of Orsay PARIS XI, France.
- 2010/2011 **Bachelor's Degree in Biology (BGB)**, the ENS Cachan and University of Orsay PARIS XI, France.
- 2008/2010 **Classe Préparatoire aux Grande Ecoles**, section BCPST, Lycée HENRI IV, Paris, France.
- June 2008 **High school graduation** (Baccalaureat), Lycée HENRI IV, Paris, France

Research experience

- 02/ 2015-06/2015 **Internship in neurological Research.** Biologie cellulaire de la synapse, UM1024, IBENS (Paris, France), supervised by Dr. Antoine Triller and Dr. Christian Specht.
Title: Characterization of endocannabinoid expression and their role in glycine receptors diffusion in spinal cord neurons.
- 09/2013-06/2014 **Internship in neurological Research.** Basbaum laboratory, Department of Anatomy, UCSF (California, USA), supervised by Prof. Dr. Allan I. Basbaum.
Title: Use of Viral retrograde and anterograde tracers to map neuronal circuitry involved in pain processing.
- 08/2012 **Internship in neurological Research,** Panum Institute, Faculty of Health Sciences, University of Copenhagen (Denmark), supervised by Prof. Dr. Jens Bo Nielsen.
Title: Effect of antispastic medications baclofen and tizanidine on unloading and stretch reflexes in human soleus and tibialis anterior muscle.
- 06/2011-08/2011 **Internship in neurological Research.** Center for Neuroscience and Regeneration Research, West Haven VA Hospital and Yale University (Connecticut, USA), supervised by Dr. Joel Black.
Title: Role of voltage gated sodium channels in small fiber neuropathies and the generation of pain.
- 09/2010 **Initiation to laboratory research.** INSERM research unit 757, University of Science of Orsay (France), supervised by Dr. Oliver Nüsse and Dr. Sophie Dupre.
Title: Study of NADPH-Oxydase activation in phagocytes.

Grants

2013 - 2014 Grant of the Zellidja Foundation, delivered by the Académie Française
2015 - 2018 CDSN: PhD grant from Ministry of Higher Education and Research (MNSER)

Publications

Frezel N, Kratzer G, Verzar P, Bürki J, Weber, FA, Zeilhofer HU. **Does toe clipping for genotyping interfere with later-in-life nociception in mice?** *PAIN Reports* 4, e740 (2019).

Voigt FF, Kirschenbaum D, Platonova E, Pagès S, Campbell RAA, Kästli R, Schaettin M, Egolf L, van der Bourg A, Bethge P, Haenraets K, Frezel N, Topilko T, Perin P, Hillier D, Hildebrand S, Schueth A, Roebroeck A, Roska B, Stoeckli E, Pizzala R, Renier N, Zeilhofer HU, Karayannis T, Ziegler U, Batti L, Holtmaat A, Lüscher C, Aguzzi A, Helmchen F. **The mesoSPIM initiative: open-source light-sheet mesoscopes for imaging in cleared tissue.** *Nat Methods*, doi:10.1038/s41592-019-0554-0 (2019).

Haenraets K, Foster E, Johannssen H, Kandra V, Frezel N, Steffen T, Jaramillo V, Paterna JC, Zeilhofer HU, Wildner H. **Spinal nociceptive circuit analysis with recombinant adeno-associated viruses: the impact of serotypes and promoters.** *J Neurochem* 142, 721-733 (2017).

Frezel N, Sohet F, Daneman R, Basbaum AI. & Braz JM. **Peripheral and central neuronal ATF3 precedes CD4+ T-cell infiltration in EAE.** *Exp Neurol* 283, 224-234 (2016).

Black JA, Frezel N, Dib-Hajj SD & Waxman SG. **Expression of Nav1.7 in DRG neurons extends from peripheral terminals in the skin to central preterminal branches and terminals in the dorsal horn.** *Mol Pain* 8, 82, (2012).

Conference posters and presentations

27.01.2017: SSN (Swiss society of Neurosciences), Basel, CH

01.02.2019: SSN (Swiss society of Neurosciences), Geneva, CH

03.08.2019: Montreal Conference on pain circuits, Montreal, CA

12.09.2019: ZNZ Symposium, Zürich, CH

RÉSUMÉ

Les stimuli nociceptifs sont détectés par des neurones sensoriels spécialisés du système nerveux périphérique appelés nocicepteurs. L'information nociceptive est ensuite traitée dans la corne dorsale de la moelle épinière, qui contient des interneurons locaux et des neurones de projection qui envoient des axones vers le cerveau. Les aires supra-spinales projettent à leur tour vers la moelle épinière, où elles contribuent à la synchronisation des signaux nociceptifs. Une sensibilité à la douleur exagérée et anormale s'accompagne d'altérations du traitement de l'information dans la moelle épinière dans les systèmes de contrôle descendants de la douleur. La connexion entre le cortex somatosensoriel en particulier et la moelle épinière est conservée chez les mammifères, mais très peu de choses sont connues sur son rôle dans la modulation du traitement sensoriel dans la moelle épinière.

Un défi majeur dans l'étude des circuits neuronaux est de marquer et de cibler spécifiquement des groupes ou sous-groupes définis de neurones. Les approches classiques incluent le ciblage de populations neuronales définies génétiquement, i.e. sur la base de l'expression d'un gène marqueur. Cependant, cela ne suffit pas toujours pour définir des groupes de neurones fonctionnellement distincts. Ici, nous décrivons et utilisons des stratégies de marquage génétiques et viraux basées sur la connectivité des neurones ainsi que sur l'expression d'un ou de deux gènes marqueurs. En particulier, nous avons utilisé une combinaison de lignées de souris transgéniques et d'injections intra-spinales et corticales de vecteurs viraux recombinants pour identifier et cibler des neurones spécifiques du cortex et de la moelle épinière lombaire.

Nous avons identifié une population de neurones pyramidaux dans le cortex somatosensoriel qui projettent directement dans la corne dorsale (neurones S1-CST). Ces neurones établissent un contact direct avec les interneurons exprimant c-maf dans la corne dorsale profonde, qui reçoivent également des contacts directs d'afférents primaires mécano-sensoriels à bas seuil. De plus, la manipulation pharmacogénétique des neurones c-maf a entraîné des modifications dans le traitement des stimulations sensorielles mécaniques.

Ces résultats identifient deux éléments d'un circuit qui intègre les informations descendantes du cortex avec des signaux sensoriels périphériques et contribue à la modulation de la perception somatosensorielle.

MOTS CLÉS

Corticospinal, système sensoriel, corne dorsale, moelle épinière, virus

ABSTRACT

Noxious stimuli are sensed by specialized sensory neurons of the peripheral nervous system called nociceptors. The nociceptive information is then processed in the spinal cord dorsal horn, which contains local interneurons and projection neurons that send axons to the brain. Supraspinal areas in turn project downwards to the spinal cord where they contribute to the gating of nociceptive signals. Exaggerated and abnormal pain sensitivity is accompanied by alterations in spinal processing and descending pain control systems. The connection between the somatosensory cortex in particular and the spinal cord is conserved in mammals, but very little is known about its role in modulating spinal sensory processing.

A major challenge of studying neuronal circuits is to specifically label and target defined groups or subgroups of neurons. Classical approaches include targeting of genetically defined neuronal populations based on the expression of a marker gene. However, this is not always sufficient to define functionally distinct groups of neurons. Here, we describe and used genetic and viral targeting strategies based on the connectivity pattern of the neurons as well as the expression of one or two marker genes. In particular, we used a combination of transgenic mouse lines and intraspinal and cortical injections of recombinant viral vectors to identify and target specific neurons in the cortex and lumbar spinal cord.

We identified a population of pyramidal neurons in the somatosensory cortex that project directly to the spinal dorsal horn (S1-CST neurons). These neurons make direct contacts onto c-maf expressing interneurons in the deep dorsal horn which also receive direct inputs from low threshold mechanosensory primary afferents. Additionally, pharmacogenetic manipulation of c-maf neurons led to altered processing of mechanical stimuli.

These results identify two elements of a circuit that integrates descending inputs from the cortex with peripheral sensory signals and contributes to the modulation of somatosensory perception.

KEYWORDS

Corticospinal tract, sensory system, spinal dorsal horn, viral tracing