



HAL
open science

Microevolution in action: a quantitative case study on natural populations of *Artemia* spp.

Nicolas O. Rode

► **To cite this version:**

Nicolas O. Rode. Microevolution in action: a quantitative case study on natural populations of *Artemia* spp.. Populations and Evolution [q-bio.PE]. Université Montpellier II - Sciences et Techniques du Languedoc, 2012. English. NNT: 2012MON20119 . tel-02544872

HAL Id: tel-02544872

<https://theses.hal.science/tel-02544872>

Submitted on 16 Apr 2020

HAL is a multi-disciplinary open access archive for the deposit and dissemination of scientific research documents, whether they are published or not. The documents may come from teaching and research institutions in France or abroad, or from public or private research centers.

L'archive ouverte pluridisciplinaire **HAL**, est destinée au dépôt et à la diffusion de documents scientifiques de niveau recherche, publiés ou non, émanant des établissements d'enseignement et de recherche français ou étrangers, des laboratoires publics ou privés.

– Université Montpellier II –
Sciences et Techniques du Languedoc

THÈSE

En vue d'obtenir le grade de
Docteur de l'Université Montpellier II

Discipline	Biologie des populations et écologie
École doctorale	Systèmes Intégrés en Biologie, Agronomie, Géosciences, Hydrosociences, et Environnement (SIBAGHE)

présentée et soutenue publiquement par

Nicolas Rode

le 20 juillet 2012

**Microévolution en temps réel : étude
quantitative dans les populations naturelles
d'*Artemia spp.***

Jury

Jacques David	Montpellier SupAgro	Examineur
Dieter Ebert	Université de Bâle	Rapporteur
Michael Lynch	Université de Bloomington	Rapporteur
Thomas Tully	ENS Paris	Examineur
Anne Charmantier	CNRS Montpellier	Directrice de thèse
Thomas Lenormand	CNRS Montpellier	Directeur de thèse

Remerciements

Merci à Anne Charmantier et Thomas Lenormand de m'avoir (en)cadré vaillamment au cours de ces quatre années de thèse, en me donnant une méthode et des bases scientifiques solides, tout en laissant une certaine liberté dans mes thèmes de recherche.

Merci à Jacques David, Dieter Ebert, Michael Lynch et Thomas Tully d'avoir accepté d'évaluer mon travail de thèse et d'avoir fait des suggestions qui amélioreront grandement les articles en cours.

Merci à Patrice David, Guillaume Martin, Yannis Michalakis et Thierry Rigaud pour leur participation à mes comités de thèse. Merci pour vos nombreuses remarques et suggestions. Merci pour votre ouverture d'esprit, j'ai franchement apprécié de pouvoir discuter si librement avec vous et d'aborder des questions variées, allant de la taxonomie des microsporidies à l'adaptation à la température ! Thierry, j'espère que tu me diras ce que ça t'a fait lorsque tu découvriras le nom de *Msp1*...

Merci à Elodie Flaven, Roula Zahab et Adeline Ségard pour votre aide précieuse sur la biologie moléculaire, sur le maintien d'un certain ordre à l'artémarium et pour l'échantillonnage sur le terrain. J'ai particulièrement apprécié de travailler avec vous sur les divers sujets abordés durant ma thèse. J'espère que mon manque d'organisation chronique ne vous aura pas trop gêné.

Merci à Aurélien Fossé, Mandy Thion, Julie Landes et Eva Lievens d'avoir été des stagiaires si endurants ! J'espère ne pas trop vous avoir dégoûté des stat'. Vous m'avez en tout cas permis de clarifier grandement mon esprit sur le sujet.

Merci à Christian Vivares, Luis-Miguel Chevin, Marta Sanchez, Gilbert Van Stappen, Paco Amat et France Dufresne avec qui j'ai beaucoup collaboré pendant ma thèse. Sans vous, je n'aurais jamais fait tout ça !

Merci à Marie-Pierre Dubois, Chantal Debain, Véronique Arnal, Chantal Cazevieille, Frédéric Bakry, Delphine Bonnet, Volker Baecker, Bruno Buatois, David Degueldre et Christianne Boix pour vos conseils et votre aide technique pendant ma thèse.

Merci à Claude Amiel et aux personnels du CREUFOP de Sète pour nous avoir fourni des cultures d'algues.

Merci aux préparateurs du bâtiment 4 à l'UM2 pour votre accueil chaleureux lors des TP.

Merci à Thomas Gout, François Gout et Dino Facca pour nous avoir accueillis sur les salins d'Aigues-Mortes.

Merci aux membres du monde entier de la communauté « *Artemia* » pour avoir partagé beaucoup de leurs échantillons.

Merci aux membres des équipes (feu) ECOGEV, Biométrie et GENEV pour des discussions très stimulantes. Merci notamment à Sylvain Gandon, PAC et Olivier Gimenez.

Merci à Florence, François, Sarah, Roxane, Thomas, Audrey et Michel pour m'avoir donné l'occasion de discuter (souvent) d'autres choses que de travail au CEFÉ.

Merci à mes amis, ma famille et à Clément pour avoir été présents durant ces quatre années intenses. Merci beaucoup d'être venu pour ma soutenance, la réunion pour cette occasion aura été un moment fort qui m'a beaucoup touché !

Enfin, merci à Castorama, pour m'avoir fournis les nombreux matériaux nécessaires à la réalisation de l'expérience sur l'adaptation à la température !

Résumé

Comprendre les processus microévolutifs naturels nécessite de quantifier les principales forces sélectives qui s'exercent sur les populations sauvages. Ces dix dernières années, les études à long terme et l'écologie de la résurrection (utilisant des structures de dormance) ont été les principales approches pour étudier l'évolution des traits d'histoire de vie sur plusieurs générations dans les populations sauvages. Mon travail consiste à comprendre comment des facteurs écologiques simples (p. ex. la température) et des interactions biotiques plus complexes (p. ex. les interactions antagonistes hôte-parasite ou mâle-femelle) façonnent l'évolution. Dans cette optique, j'ai utilisé l'Artémia comme un organisme modèle, en combinant des études sur le terrain et en laboratoire. Premièrement, j'ai étudié l'évolution de la niche thermique suite à un changement d'environnement en utilisant une série temporelle d'œufs de dormance d'une population d'Artémia originaire de marais salants tempérés et introduite dans des marais salants tropicaux dans les années 80. Cette étude montre un taux d'adaptation régulier aux températures tropicales sur plus de 100 générations après l'introduction. Deuxièmement, j'ai utilisé une approche similaire pour étudier l'adaptation entre mâles et femelles dans une autre population naturelle d'Artémia. Cette étude suggère que les conflits sexuels provoquent une dynamique de coévolution fluctuante sur une échelle d'environ 100 générations. Troisièmement, j'ai étudié les impacts de différents parasites (cestodes et microsporidies) sur la compétition entre une espèce d'hôte autochtone asexuée et une espèce d'hôte invasive sexuée. Ces parasites sont spécialistes (d'une espèce ou de certains génotypes d'hôte) et ont de forts effets phénotypiques (castration) et comportementaux (manipulation du comportement d'agrégation). Par conséquent, les parasites jouent un rôle majeur dans la compétition entre les espèces d'hôte autochtone et invasive. Enfin, j'ai réalisé des études de génétique des populations d'Artémia asexuées (diploïdes et polyploïdes) et sexuées proches. Les espèces asexuées diploïdes produisent des mâles rares permettant des événements de reproduction sexuée occasionnels. De plus, l'hybridation d'espèces diploïdes divergentes a donné naissance à au moins trois lignées polyploïdes indépendantes. Le travail de cette thèse illustre la pertinence de combiner des approches d'écologie de la résurrection et de terrain pour étudier la microévolution en milieu naturel.

Mots-clés : expérience de décalage temporel | adaptation à la température | conflits sexuels | interférence parasitaire sur la compétition | manipulation comportementale | asexualité | polyplôidie

Abstract

Getting a comprehensive understanding of microevolution in natural populations requires proper quantification of the important selective forces exerted on these populations. Over the last decade, long-term studies and resurrection-ecology (revival of resting stages) have been the main approaches to study life history trait evolution over many generations in the wild. My work aims at understanding how simple ecological factors (e.g. temperature) and complex interactions between and within species (host-parasite and male-females antagonistic interactions) shape evolutionary processes in natural populations. To this end, I used the brine shrimp *Artemia* as a model system and combined laboratory and field studies. First, I investigated thermal niche evolution with a resurrection ecology approach, using dormant-egg time series from an *Artemia* population introduced from temperate to tropical salterns in the mid-80's. This experiment shows that survival at the high temperatures typical of the new environment increased linearly through time after the introduction, suggesting a sustained rate of adaptation over more than 100 generations. Second, I used the same approach to study adaptation between sexes in another *Artemia* population. I found that sexual conflicts result in fluctuating male-female coevolutionary dynamics *in natura*, over a time scale of ~100 generations. Third, I studied the relative role of one cestode and two microsporidian parasites in mediating the competition between a native asexual host and an invasive bisexual host. I found that all three parasites were either host- or genotype-specific and that the castrating cestode parasite specifically infected the native species, suggesting that this parasite actually played a major role in the competition between native and invasive hosts. Interestingly, all three parasites manipulated the swarming behavior of their host, most likely to increase their transmission. Fourth, I performed population genetic studies of diploid and polyploid *Artemia parthenogenetica* and their Asian bisexual close relatives. Diploid asexual *Artemia* produce rare males and I found indication that these males allow some rare sex in this otherwise parthenogenetic species. In addition, hybridization between divergent *Artemia* species has led to the origin of at least three independent polyploid lineages. This work illustrates the relevance of using a combination of resurrection ecology and field approaches to investigate microevolution *in natura*.

Keywords: time shift experiment | adaptation to temperature | sexual conflicts | parasite-mediated competition | behavioral manipulation | asexuality | polyploidy

Table of contents

Preface	1
Synthesis	
Introduction.....	7
1 Evolution <i>in natura</i> and the two historical approaches to quantify it	10
2 Studying natural selection on focal loci: population genetic approaches.....	18
3 Studying natural selection on focal traits: quantitative genetic approaches.....	23
4 Experimental evolution in the field and resurrection ecology in the laboratory.....	31
5 Highlights of the thesis work.....	36
Articles	
Résumé des articles (French summary of the articles)	63
1 <i>Likelihood</i> , a likelihood approach for fitness and trade-off analyses of censored multi-event individual life-histories.....	73
2 Dynamics of temperature adaptation over 130 generations in a wild population of <i>Artemia franciscana</i>	119
3 Male-female coevolution in the wild: evidence from a time series in <i>Artemia franciscana</i>	149
4 Differential susceptibility to parasites of invasive and native species of <i>Artemia</i> living in sympatry: consequences for the invasion of <i>A. franciscana</i> in the Mediterranean Region.....	213
5 Differential susceptibility of native and invasive <i>Artemia spp.</i> to two microsporidian parasites.....	263
6 Evidence for cestode and microsporidian parasite manipulation of the swarming behaviour of infected brine shrimp (<i>Artemia spp.</i>).....	323
Appendix	
Origin and evolution of asexuality and polyploidy in the <i>Artemia</i> genus.....	381

Preface

Evolution is quite a strange discipline: virtually everyone has a set opinion on it, whereas virtually everyone would not have such an opinion on Philosophy, Physics or Chemistry. One can observe living organisms around and one can get the feeling to understand how the living world functions. At the beginning of my PhD, I actually realized that my knowledge of how evolution might work was (very) limited. I found evolutionary concepts such as natural selection or genetic drift extremely difficult to visualize (compared to mathematical concepts such as a limit or the infinite). I guess this is the reason why my thesis title could have been “What you always wanted to know about *Artemia* without daring to ask?”. Indeed, in response to the complexity of evolutionary concepts, I had a bottom up approach during an important part of my thesis. I focused on some basic knowledge and processes in *Artemia* evolutionary ecology and subsequently used an inductive scheme to generalize phenomena found in *Artemia* to other systems. Fortunately, this incidentally allowed me to get a better understanding of basic evolutionary concepts and to wonder about more general questions. This synthesis represents a further step in this maturing process. In the practice of writing this document, I stepped back and adopted a top-down approach, starting from the definition of evolution and theoretical considerations to review practical methods to

investigate evolution in natural populations. Hence, this PhD will have been a trip from nature to theory and back. Finally, as a foreword to this thesis I will quote the introduction of Vandel's article entitled "La Parthenogenèse géographique" (1928). In his preface, he indeed explained why studying specific (model) organisms allow a better understanding of general biological processes that apply to many other species. The relevance of this quotation is two-fold: first it will delight the native French speakers as it is the only part in French in my thesis (apart from the acknowledgements), and second, it will explain to my family and friends that, while not working on human beings but on small uninteresting animals, we can still find interesting evolutionary patterns and learn more about evolutionary processes which apply to a variety of species. At last, I am also happy that this thesis contributes to Vandel's call for a better understanding of polyploidy in the *Artemia* genus (VANDEL 1940).

La Spanandrie Géographique se rencontre dans les groupes zoologiques les plus variés, et même chez des Végétaux. Il m'a été impossible d'étudier en détail, tous les cas particuliers. La zoologie est, à l'heure actuelle, une science si vaste et si complexe qu'il faut un travail considérable et un temps fort long pour bien connaître un seul groupe animal. Posséder l'anatomie et l'embryologie, connaître la systématique, parcourir la bibliographie, pénétrer le mode de vie, établir les méthodes d'élevage, et mettre au point les méthodes d'investigation histologique sont autant de données que l'on doit acquérir avant d'entreprendre des recherches originales sur un groupe donné, et qui sont indispensables si l'on ne veut faire une œuvre superficielle et sans valeur. C'est pourquoi une étude détaillée de la Spanandrie Géographique, dans chaque groupe zoologique où elle se rencontre, demanderait un labeur énorme.

Mais, heureusement une étude aussi complète n'est pas nécessaire pour dégager le phénomène général qui, seul intéresse le biologiste. D'ailleurs un examen détaillé de tous les cas particuliers ne conduirait souvent qu'à des répétitions inutiles. Je me suis borné à étudier à fond et d'aussi près que possible un cas particulier, choisi parmi les plus favorables et les plus représentatifs. J'ai ensuite groupé autour de ce cas typique, tous les exemples de même ordre, et j'ai essayé de dégager, de l'ensemble de ces faits, les résultats d'ordre général. Les spécialistes compléteront, par la suite, chacun dans les groupes auxquels ils se sont consacrés, les indications sommaires ou fragmentaires que j'ai pu réunir.

(La parthénogenèse géographique, Vandel 1928)

NB : la spanandrie représente la quasi absence de mâles dans une espèce (Marchal 1911). Vandel réutilise le terme au début de son ouvrage pour décrire l'observation de certaines espèces comme le cloporte dont la proportion des deux sexes varie avec la latitude. Vandel a en effet observé que les espèces sexuées (qui possèdent des mâles et des femelles) dominent dans les régions méridionales et que les espèces asexuées (constituées uniquement de femelles parthénogénétiques qui n'ont pas besoin d'être fécondées et ne produisent que des femelles) dominent dans les régions septentrionales. Vandel abandonne plus tard dans son article le nom de spanandrie géographique pour celui de parthénogénèse géographique, d'où le titre. En effet, il considère qu'il ne s'agit pas d'une seule et même espèce dont la proportion de mâles varie avec la latitude, mais bien de deux espèces différentes (sexuée et parthénogénétique) qui ont des répartitions latitudinales différentes.

Part I

Synthesis

Microevolution in action:
a quantitative case study
in natural *Artemia* populations

Introduction

Evolutionary biologists seek to understand the origin and maintenance of biological diversity. The disciplines that make up Evolutionary Biology differ from traditional natural history sciences as being more quantitative and experimental than qualitative and observational. Evolution, as a science, usually focuses on any characteristic that can be transmitted over successive generations (i.e. heritable). Early evolutionary theoreticians identified four factors causing allelic and phenotypic changes in populations: natural selection, genetic drift, migration and mutation (FISHER 1930; HALDANE 1932; WRIGHT 1951). In contrast, ecology, as a science, focuses on the relationships between organisms within and among species and with their environment. The major aim of ecological genetics is to investigate and quantify the main evolutionary forces in natural populations, which has been tackled over the last century with a combination of field and laboratory work (FORD 1964). I had the same aim during my PhD, where I tried to understand and quantify selection pressures acting on individuals in a realistic ecological context. As my thesis, this synthesis deals with the evolution of natural populations and focuses primarily on selective processes. In particular, this synthesis reviews the three methods at hand to investigate evolution by natural selection: population and quantitative genetic approaches, as well as resurrection

ecology (in conjunction with time-shift experiments). Each approach often needs to account for numerous factors to get a comprehensive understanding of the evolutionary process. Although, I did not use all three approaches during my PhD, I believe I tried to get such an integrated view when examining selection in natural populations. The main evolutionary and technical concepts used in this document are provided in Panel 1.

In this synthesis, I first provide a rapid overview of the basic ecological and genetic factors that affect evolution in natural systems. Second, I describe the three main approaches that can be used to investigate evolution *in natura*, I review their respective advantages and drawbacks, underlining how ecological and genetic factors interact and make the study of selection fairly complicated. I finally explain how I have tried to use such an integrated framework during my PhD, when I investigated the role of a multiple of selective factors in the evolution of natural populations.

Panel 1:

Ecological genetics: study of the “adjustment and adaptations of wild populations to their [abiotic and biotic] environment”, “often [requiring] long-continued estimates of the frequency of genes or of characters controlled on a polygenic or multifactorial basis” (Ford 1964).

Microevolution: evolutionary changes within and among populations over a relatively short number of generations (as opposed to macroevolution).

Fitness: expected number of offspring in future generations.

Population genetic approach: study of allele frequency changes over time (characters that have a simple genetic determinism can be directly followed).

Linkage disequilibrium: non-random association between two markers or two genes

Quantitative genetic approach: study of the change in quantitative characters over time (assuming a polygenic determinism of the focal character).

Heritability: proportion of phenotypic variation in a population that is due to genetic differences between individuals.

Selection gradient: covariation between a trait and ‘fitness’ in a population.

Response to selection: change in allele frequency or trait mean due to selective factors (equivalent to evolution in Fig. 1)

Resurrection ecology: comparison of past and contemporary propagules (animal or plant resting stages) that are revived and reared in a common environment.

Time-shift experiment approaches: resurrection ecology study comparing the performance of past and contemporary genotypes reared in past and contemporary common environments.

1 Evolution *in natura* and the two historical approaches to quantify it

1.1 Evolution="environmental factors" X "genetic basis"

Evolution can be defined as an allele frequency change or a mean trait change over (generation) time (bottom panel, Fig. 1). The causes of natural selection are fundamentally environmental. Differential reproduction or survival of individuals with different characters can arise from various abiotic or biotic environmental factors. The abiotic environment of a focal individual can be represented by chemical and physical factors (e.g. temperature, pH, salinity), while the biotic environment of the same individual can be represented by other individuals from the same species and other species (intra- and interspecific competition, predators and parasites (DARWIN 1859; HALDANE 1949, middle-left panel, Fig. 1). Selected traits must vary in the parental generation and be transmitted to the offspring generation for evolution to occur. The majority of traits are genetically determined, but some particular traits (e.g. cultural) can be non-genetically determined (middle-right panel, Fig. 1). Hence, trait-determining factors are those that are passed on to the next generation (middle-right panel, Fig. 1). Understanding their genetic or non-genetic basis and measuring their variation in the parental generation are crucial to the prediction of evolution by natural selection (middle-right panel, Fig. 1).

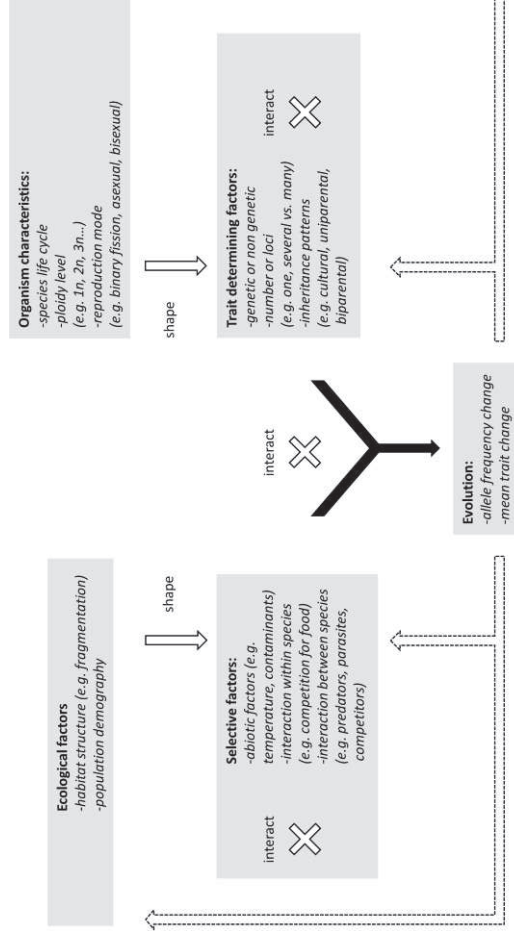

Figure 1: **Evolution as the result of the interactions between selective factors and trait determinism.** The cross and black arrow represent the main interaction between selective factors and trait determinism that result in evolution. Middle-left and right crosses represent the interactions between selective factors and between trait determining factors respectively. Downward arrows represent ecological factors and organism characteristics that interact with selective factors and trait determinism and mitigate the evolutionary response. Upward arrows represent the evolutionary ecological and genetic feedbacks that in turn modify selective factors, trait determinism, ecological factors and organism characteristics.

Natural conditions are always more complicated than laboratory conditions and additional factors need to be taken into account to understand the evolution of wild populations under natural selection. Giving an exhaustive list of these factors is beyond the scope of this synthesis (see ROUGHGARDEN 1979 for a more thorough introduction on this topic). Briefly, regarding selective factors, habitat structure and population demography are important ecological factors as they can influence the importance of migration and genetic drift relative to selection, respectively (top-left panel, Fig. 1). In parallel, when it comes to the trait-determining factors, species life cycle, ploidy level, and mode of reproduction are important factors to consider when examining evolution by natural selection (top-right panel, Fig. 1).

In addition, positive and negative interactions between evolutionary forces are common. For example, negative antagonistic interactions between one or several traits led Darwin (1859) to make a distinction between “sexual” and “natural” selective factors. Indeed, certain traits can be positively selected via reproduction when their bearer have more mating opportunities (e.g. the peacock tail), while being negatively selected via survival when their bearer has increased risk of mortality (e.g. due to predation risk, middle-left box, Fig. 1). Similarly, positive and negative interactions between trait-determining factors are also common (middle-right panel, Fig. 1). Such interactions are well known in

population genetics, where they are called epistasis (interaction among loci) or dominance (interaction within loci in diploid and polyploid species). In addition, pleiotropic interactions (between a locus and different traits) are also common. All the interactions *between* selective factors and *between* trait-determining factors and *between* selective factors and trait-determining factors thus result in evolution, that is allele or mean trait change (bottom panel, Fig. 1). Microevolution is the iteration of such process over several generations. In return, evolutionary-ecological and genetical feedbacks can alter selective factors, ecological factors, trait-determining factors and organism characteristics (upward arrows, Fig. 1).

Evolution by natural selection is a multivariate process and its study is particularly complicated in natural populations, as a virtually infinite number of traits and ecological factors has to be investigated (BLOWS 2007). For example, as phenotypic traits are often functionally or genetically correlated, the change of a single selective factor can often result in the change of very different traits both at the phenotypic and genetic levels (e.g. HOFFMANN and PARSONS 1991). Hence, understanding how a single selective factor can affect different traits can be complicated. Conversely, a mutation arising at a single locus can affect a number of different traits (pleiotropy) that are selected by different forces in potentially different directions. Hence, understanding the

evolutionary fate of a single mutation can be complicated. The challenge for ecological geneticists is to understand the main relationships between selective factors and potentially correlated phenotypic traits, while considering that these traits are controlled by different loci that potentially interact together and with the external environment. Formal theory has greatly helped ecological geneticists in defining which of the different components listed in Figure 1 are relevant to evolution.

Panel 2: The Price equation

The evolutionary change over a time interval of any heritable characteristic (e.g. allele or trait) can be theoretically calculated with the Price Equation (PRICE 1970):

$$\bar{w}\Delta\bar{z} = \text{Cov}(z_i, w_i) + E[w_i\Delta z_i], \quad (1)$$

or with its simplified form disregarding the second term hence assuming that trait average in the offspring do not differ from trait average in the parent(s) (ROBERTSON 1966),

$$\bar{w}\Delta\bar{z} = \text{Cov}(z_i, w_i), \quad (2)$$

where z_i and w_i represent the focal phenotype and number of offspring respectively of any individual (or genotype) i in the population and Δz_i represents the difference between the phenotypic values of the individual and its offspring. \bar{w} and $\Delta\bar{z}$ represent the mean offspring number in the population and the difference between parent and offspring phenotype means. The Price equation is a theorem and does not tell us anything about how evolution might work in natural populations. However, this equation can have a heuristic value, when one questions the biological meaning of the different terms. For example, covariation between a trait and offspring number can be seen as arising from both selection and genetic drift; which brings to light the difference between offspring number and fitness. As most examinations of evolutionary processes can be derived from this equation (FRANK 1995), it also allows to see the link between the different theoretical approaches (RICE 2004).

1.2 Population vs. quantitative genetic approaches

Natural selection has been studied with two general approaches depending on the genetic determinism of the phenotype under study. Population genetics focuses on allele frequencies, whereas quantitative genetics focuses on linear combinations of such allele frequencies (i.e. breeding values, FALCONER 1989). These approaches describe the allele frequency and breeding value change across generations (a process mathematically described by the Price equation of Panel 2). When translated into natural populations, population genetic approaches directly monitor allele frequency through time in natural populations (e.g., CAIN and SHEPPARD 1954; FISHER and FORD 1947; KETTLEWELL 1956; LAMOTTE 1952; WRIGHT and DOBZHANSKY 1946). In contrast, quantitative genetic approaches monitor traits that are assumed to have a polygenic basis for which breeding values can be calculated (FALCONER 1989; LUSH 1947). Computing these breeding values in natural populations is relatively difficult (see below) and early studies focused on mean character changes through time in natural populations as illustrations of evolution in action (BOAG and GRANT 1981; BUMPUS 1899). Although very instructive, the measure of the mean phenotypic response to selection does not inform us on the genetic response to selection. In comparison with population genetics, theoreticians have provided ecological geneticists with quantitative genetics methods to investigate selection in natural populations relatively recently (LANDE 1979; LANDE and ARNOLD 1983). The field of quantitative genetics in natural populations is thus of recent origin (e.g. GRANT and GRANT 1995).

1.3 Population or quantitative genetics, which approach?

A widespread idea is that discrete traits are studied with population genetics, and that continuous traits are studied with quantitative genetics. This idea is valid only if the discrete trait studied is determined by one or few loci and if the continuous trait studied is determined by many loci. However, this idea is wrong when the discrete trait studied is polygenic (e.g. WRIGHT 1934) or when the continuous trait studied is controlled by one or two loci (e.g. EAST 1916). Field biologists that investigate selection in a new species will first go for a set of candidate genes, if the trait they are studying is known to have a simple genetic basis in other species (e.g. melanism gene). The genetic basis can be determined with simple crosses if one or two loci are involved (STEWART 1969), with Quantitative Trait Loci (QTL) mapping if few loci of large effects are involved (GELDERMANN 1975) or with association studies if the loci are numerous (BALDING 2006). If one or two loci are found, their dynamics will be followed by traditional population genetic methods. However, this approach can not apply to a variety of organisms. Field biologists will assume that continuous traits in these organisms have a polygenic basis and will follow the dynamics of these traits with quantitative genetic approaches. Hence, there is a profound asymmetry in the use of population and quantitative genetic

approaches. In particular, the use of the latter approach relies on assumptions that are difficult to test in natural populations.

In the following sections, the relative advantages and drawbacks of these two approaches when applied to the study of selection in natural populations are discussed. Finally, a complementary (rather than an alternative) method is presented (resurrection ecology and time-shift experiments, Panel 1) in chapter 4, which represents a powerful approach to investigate evolution over a large number of generations in natural populations.

2 Studying natural selection on focal loci: population genetic approaches

2.1 Temporal and spatial approaches

Historically, population genetic approaches that followed the dynamics through time of traits with simple genetic determinisms and that could provide accurate measures of selection gradients on these traits have largely prevailed in the literature. For instance, color characters, especially melanism, were extensively studied in the earliest period of population genetics as their Mendelian inheritance was easy to check in the laboratory (e.g. FISHER and FORD 1947; HALDANE 1948; LAMOTTE 1952). Studying Mendelian characters allowed to follow the frequency of the underlying loci directly and to avoid potential confounding factors (such as plasticity). In addition,

the identification of the phenotypic traits controlled by these loci allowed making clear hypotheses regarding the agents of natural selection and to test them with experimental studies both in the field and in the laboratory (e.g. CAIN and SHEPPARD 1954; KETTLEWELL 1956). In addition to these temporal comparisons, spatial comparisons of populations living in contrasted habitats also helped describing how species are locally adapted to their environment. In particular, the study of phenotypic and genetic clines has long been the main argument for the occurrence of evolution under natural selection in wild populations (e.g. BARBER 1965; DADAY 1954; HALDANE 1948; JAIN and BRADSHAW 1966), especially in *Drosophila spp.* where chromosomal latitudinal and altitudinal clines are common (e.g. METTLER *et al.* 1977; WRIGHT and DOBZHANSKY 1946). Both migration and selection shape clines and disentangling these forces require to measure migration independently (e.g. through capture-mark recapture techniques, FORD 1964; or using two loci with a known rate of recombination, LENORMAND *et al.* 1998). Combination of temporal and spatial data on such clines allows measuring temporal change in selection and migration which is relevant to various ecological conditions (or seasonal cline fluctuation, LENORMAND and RAYMOND 2000; e.g. spread of an infection, TURELLI and HOFFMAN 1991). Importantly, even when migration and selection are adequately measured, drift has to be accounted for when investigating temporal or spatial allele

frequency change (e.g. WRIGHT 1948), which is a difficult task in natural populations. A good example of this challenge is the long-standing debate over the relative effect of selection and genetic drift on color polymorphism in the desert plant *Linanthus parryae* that only ended recently (EPLING and DOBZHANSKY 1942; EPLING *et al.* 1960; SCHEMSKE and BIERZYCHUDEK 2001; SCHEMSKE and BIERZYCHUDEK 2007; WRIGHT 1943; WRIGHT 1978). In general, spatial or temporal replicated observations allow ascertaining that allele frequency change is caused by natural selection (or migration). A further step is the comprehensive understanding of the migration or selective forces that shape clines, which requires identifying the selective agents and quantifying the degree to which they predict allele frequency change (e.g. COOK 2003; KETTLEWELL 1956).

2.2 Linkage disequilibrium in asexual and sexual species, advantage and limits

Change of an allele frequency is equivalent to its evolution. Everything else being equal and when mutation, migration and drift can be excluded, an increase in an allele frequency represents a higher fitness for its bearers. However, higher fitness might not be the consequence of selection acting on the focal allele, but other loci linked to this focal allele. Linkage disequilibrium is maximal in asexual species, as all loci are then inherited together. Following temporal clonal frequency changes in large closed populations allows measuring the

genetic response to natural selection without actually knowing the loci or trait(s) involved. This approach is thus particularly useful for the study of natural populations and has been used to address different questions in ecological genetics (host-parasite coevolution, DYBDAHL and LIVELY 1998; e.g. effect of habitat seasonality on the selection of specialist vs. generalist strategies, LYNCH 1983). The same approach can be used in sexual species, provided recombination is low between the selected loci and the marker used. Historically, chromosomal inversions were the first markers used with this purpose (e.g. WRIGHT and DOBZHANSKY 1946). In the last decade, genome-wide association studies have extensively used this approach for the study of human populations (BALDING 2006) and will certainly become the prominent method for the study of natural populations (GUPTA *et al.* 2005).

A further step requires identifying the selected loci. This task is particularly difficult in asexual species and often requires genetic engineering to introduce a candidate allele in different genetic backgrounds to measure its effect on fitness (e.g. DYKHUIZEN and HARTL 1980). Alternatively, mutation induction or knocking out techniques performed in different isogenic backgrounds can allow measuring the particular effect of an allele or a locus on fitness. Unfortunately, these techniques are only available for model organisms in which ecology remains often poorly known. Measuring the fitness effect of a single locus located on a chromosomal inversion is

also a complicated task, as these segments often comprise deleterious mutations with substantial fitness effects (e.g. MULLER 1918; STURTEVANT and MATHER 1938). For sexual species in which controlled breeding is sufficiently easy, traditional mapping approaches (e.g. chromosomal walking) allow finding the locus or the loci under selection (e.g. JORON *et al.* 2011). Finally, even if the focal loci under selection remain unknown experimental tests in the laboratory can allow identifying the selective agents involved in allele frequency changes (e.g. WRIGHT and DOBZHANSKY 1946).

2.3 Example of interaction between selective factors: antagonistic coevolution

Antagonistic coevolution represents a good example of the feedback that evolution can have on the interaction between selective factors and trait determinisms. Indeed, such coevolution results from reciprocal adaptive genetic changes in two evolving entities belonging to different species (e.g. host and parasite) or to the same species (e.g. males and females). Historically, the first evidence of such interactions was discovered in flax plants and their rust fungus pathogen (FLOR 1947). Indeed, both resistance and virulence traits are heritable in this system. A resistance gene in the host interacts with a virulence gene in the pathogen and the outcome of the interaction depends on the combination of alleles at these loci. Gene for gene interactions has been extensively studied in Australian flax/rust natural populations (BURDON 1994). In

addition, ecological factors such as population structure play a prominent role in the antagonistic interaction between the plant and the pathogen (THRALL and BURDON 2003; THRALL *et al.* 2001), resulting in strong local adaptation patterns which give a nice example of the interplay between population structure and trait determinism in both host and parasites (THRALL and BURDON 2002; THRALL and BURDON 2003; THRALL *et al.* 2012).

3 Studying natural selection on focal traits: quantitative genetic approaches

3.1 Response to selection and univariate breeder's equation

Measuring evolution under natural selection on specific traits *in natura* is challenging, and can only be done in some particular situations (see below). Hence early studies of selection in natural populations have mainly inferred selection from cross-sectional studies where differences between cohorts were reported (see ENDLER 1986). For example, reduced whorl variation in juvenile snails compared to adults was interpreted as the result of natural (stabilizing) selection (DI CESNOLA 1907; WELDON 1901).

From the mid-XXth century, Lush (1947) developed an equation that could be used by plant and animal breeders to predict the response to selection in artificial settings:

$$R = h^2S, \quad (3)$$

where R represents the mean change in the selected trait, h^2 and S represent the heritability of and the selection differential on that trait (measured in the parents, see Panel 1). Most early quantitative geneticists focused on artificial selection in the laboratory. Clayton & Robertson (1957; 1957) were among the first to actually test the predictions of the breeder's equation. They selected for increased bristle number with a known selection intensity for several generations and measured the two other parameters from the breeder's equation: the heritability and the response to selection. This allowed them to test both the short (CLAYTON *et al.* 1957) and long-term response to selection (CLAYTON and ROBERTSON 1957). In parallel, field ecological geneticists simply inferred selection from the mean change of traits in natural populations (BOAG and GRANT 1981; BUMPUS 1899; DHONDT *et al.* 1979; HAIRSTON and WALTON 1986) and debated on adequate methods to measure individual fitness in natural populations (e.g. HOWARD 1979, see below). However, selection and the response to selection are distinct evolutionary concepts (FISHER 1930; HALDANE 1954) and change of a trait mean does not necessary result from direct selection on that trait. As for population genetic approaches, linkage disequilibrium

between the loci that determine the trait and other loci under selection can indeed be a confounding factor (among others). Linkage disequilibrium is problematic only when a small number of loci determine an important part of the variation of the trait. Such loci are defined as quantitative trait loci (QTL) and their detection requires fine scale QTL mapping to detect a significant association between these loci and the focal trait (Geldermann 1975). Demonstrating direct selection on a QTL trait requires detecting significant statistical association of QTL with fitness, which usually bias QTL detection towards QTL with large effects (LYNCH and WALSH 1998). As both QTL genotyping and fitness estimations are difficult to perform in natural populations, few studies have investigated the importance of linkage disequilibrium on fitness in natural population (e.g. GRATTEN *et al.* 2008).

3.2 The multivariate breeder's equations

Theoretically, the genetic change of a trait is equal to the genetic covariance between this trait and fitness (Panel 2), whereas according to the univariate breeder's equation it is equal to the product of heritability and selection differential (equation 3). The latter relationship is only valid when the relationship between a phenotypic trait and fitness is not influenced by an environmental factor or a 'hidden trait' that affects both phenotype and fitness (QUELLER 1992; RAUSHER 1992). A possible correction is to consider and measure other traits that might be correlated to the focal trait and could

influence fitness. Historically, Pearson (1903) was the first to develop statistical techniques to measure the genetic response to selection on a set of correlated traits. However, their implementation for the study of natural populations was made possible later with the development of the multivariate breeder's equation and the associated methods to measure multivariate selection in natural populations considering Gaussian and non Gaussian trait distributions (ARNOLD and WADE 1984b; LANDE 1979; LANDE and ARNOLD 1983). The authors made use of datasets on the response to selection (e.g. BUMPUS 1899) to disentangle the effect of direct and indirect selection on the different characters measured (LANDE and ARNOLD 1983) or to identify the fitness components that are the most subject to sexual selection (ARNOLD and WADE 1984a). In addition, knowledge and proper quantification of the environmental factors that likely affect the covariance between phenotypic traits and fitness allow disentangling the relative role of genetic and environmental factors in this covariance (or role of parasites on resemblance between parents and offspring, CHARMANTIER *et al.* 2004; e.g. microevolutionary vs. plastic responses to increased temperature, CHARMANTIER *et al.* 2008).

3.3 The Price equation and the limits of quantitative genetic approaches

However, the number of correlated traits under natural selection is virtually infinite. Hence, the shortcomings mentioned for the univariate breeder's equation because of unmeasured correlated characters are likely to uphold when using the multivariate equation in natural populations. These effects have been suspected to be responsible for the lack of response of heritable traits that are positively correlated to fitness (MERILÄ *et al.* 2001; PRICE *et al.* 1988). Hence, a direct measurement of the additive genetic covariance between the focal trait(s) and fitness allow getting rid of phenotypic confounding factors (e.g. when there is a non-genetical relationship between an environmental factor and either the focal trait or fitness, ETTERTON and SHAW 2001; MORRISSEY *et al.* 2010; RAUSHER 1992). This alternative might be difficult to put in practice as both fitness and genetic covariances are notoriously difficult to estimate. In addition, this approach does not account for the confounding effect of 'hidden traits' or environmental factors that affect the genetic covariance between trait and fitness. Pleiotropic effects of loci that determine both the focal traits and another unknown selected trait are known to be widespread in laboratory studies (MACKAY *et al.* 2009), yet the importance of these effects in natural populations remain to be assessed (ROFF and FAIRBAIRN 2007). Accounting for unknown environmental

effects that are shared between parents and offspring (e.g. because of non random spatial distribution of parents and offspring, STOPHER *et al.* 2012) is another major challenge for quantitative genetic studies in natural populations. For instance, controlling for soil heterogeneity and local offspring dispersal is particularly important in quantitative genetic studies of plant species, as confounding factors such as plasticity are likely to be very important (RAUSHER 1992). In some cases, these non-genetic causes of resemblance can be factored out with experimental manipulation in the field such as transplant experiments (e.g. cross fostering, MERILÄ 1997) (or plant transplantation, ETTERTON and SHAW 2001). Furthermore, addressing the role of migration in natural population with quantitative genetic approaches would require a long-term study at a metapopulation level which is hardly feasible for most organisms used. As phenotypic traits often differ between resident and dispersing individuals (VERHULST *et al.* 1997) such studies would provide very interesting information regarding the evolution of life-history strategies in natural populations. Finally, the role of drift is rarely addressed in quantitative genetic studies of natural populations, although effective population size in wild vertebrate populations might often be substantially low (TINKLE 1965).

3.4 Molecular markers: from pedigree to association studies

An important limitation of the development of quantitative genetic analyses in the 90's was that only incomplete pedigree data was available. Indeed, while a social pedigree is easily obtained through individual monitoring in some birds, amphibian or reptile species, extra-pair paternities can make it a poor surrogate for a genetic pedigree (KRUUK 2004). Furthermore only the maternal pedigree is known in most polyandrous mammal species (e.g. CHEVERUD and DITTUS 1992). The development of codominant molecular markers such as microsatellites has opened new avenues for reconstructing genetic pedigrees, even if parental assignment is rarely 100% in wild populations (KRUUK 2004; PEMBERTON 2008). As the cost of whole-genome sequencing decreases, the number of markers available for pedigree reconstruction will increase and will allow more precise measures of natural selection in small wild population (e.g. BRADLEY and LAWLER 2011). Ultimately, QTL mapping and genome-wide association studies of quantitative traits known to be under selection will likely help quantifying the importance of major QTL in the evolution of natural populations (e.g. JOHNSTON *et al.* 2011). Thus population and quantitative genetic approaches will certainly converge in the future, resolving some of problems inherent to quantitative genetic studies (e.g. pleiotropic effects).

3.5 Measuring fitness in natural populations

The definition of fitness depends upon ecological conditions and there is a long debate history regarding how to calculate fitness (e.g. BROMMER 2000; BROMMER *et al.* 2002; CHARLESWORTH 1994; HOWARD 1979; KOZLOWSKI 1993). Indeed, theoretical models indicate that very different fitness measures are relevant to different ecological conditions (CHARLESWORTH 1994). Most evolutionary biologists use only one of two fitness measures, making implicit assumptions. Indeed, lifetime reproductive success is a good fitness measure assuming a stable population size, whereas the intrinsic rate of increase is a good fitness measure assuming the population is growing (or declining) exponentially (CHARLESWORTH 1994; ROUGHGARDEN 1979). However, both measures require the absence of frequency- or density-dependent selection, an assumption which is hardly testable in natural populations. Even when the relevant fitness measure is known, complete life history data is usually available for only a fraction of the individuals which further complicates fitness estimation. Another important issue in open populations is to account for dispersing individuals, as neither their fitness nor the fitness of their parents can be accurately estimated. Overall, the relevance of fitness measures in the study of a natural population is difficult to assess. A possibility is to calculate heritability and selection gradient estimates and to compute the expected response to selection. If the sample

size is large enough to get accurate estimates and that the assumptions of the breeder's equation are met for the trait studied, the expected and observed responses to selection should be similar grant (GRANT and GRANT 1995).

4 Experimental evolution in the field and resurrection ecology in the laboratory

4.1 From the field to the lab and back

Early ecological geneticists combined both field and laboratory approaches to investigate natural selection in wild populations (FORD 1964). Meanwhile, experimental evolution in the laboratory was developed as a powerful tool to investigate the process of selection (e.g. CLAYTON *et al.* 1957; DALLINGER 1887; L'HÉRITIER 1937 ; L'HÉRITIER and TEISSIER 1933). In the 70's, some ecological geneticists got inspired by such experiments and went back to the field to do experimental evolution *in natura*. They tested specific evolutionary and ecological questions introducing individuals from the same original population in habitats with different selective pressures. Although, they found the expected changes in mean phenotypes (ENDLER 1980; SCHOENER and SCHOENER 1983), comparisons across introduced populations also showed important life-history and morphological changes in relation to the altered selective pressures (LOSOS *et al.* 1997; REZNICK *et al.* 1990). Indication for such adaptation (over ~50-

100 generations) has also been provided over larger time scales by studies that compared populations exposed to contrasted selective pressures, generally following human disturbance (e.g. CARROLL and BOYD 1992; JOHNSTON and SELANDER 1971; LEE 1999; SEELEY 1986). However, few systems allow rearing individuals in common garden experiments to test for the genetic basis of the changes observed (e.g. copepod, LEE and PETERSEN 2002; fish, REZNICK *et al.* 1990). Hence, the main argument for the occurrence of natural selection in these studies is the presence of replicated phenotypic changes (in the expected a priori directions). In addition, the speed of evolutionary changes has only been investigated in one fish system (REZNICK *et al.* 1997), so that overall little is known about the dynamics of evolutionary changes in these experimental systems.

4.2 Temporal genetic differentiation and resurrection ecology

Time and resources are two major limitations of experimental evolution in the field which are shared by population and quantitative genetics approaches. (Human) generation time is indeed one of the major limitations of long-term studies, especially when studying multi-cellular organisms. Indeed, most quantitative long-term studies in natural populations span less than 30 generations of the studied animal (CLUTTON-BROCK and SHELDON 2010). Hence, to date, only short-term

responses to selection can be investigated with these methods.

An interesting alternative is the use of propagules (e.g. plant and animal resting stages) that allow investigating evolution over a larger number of generations. A first approach is to assess temporal genetic differentiation with molecular markers in time series of resting stages collected in populations that are known to have undergone a major change in environmental pressures (e.g. BREDE *et al.* 2009; COUSYN *et al.* 2001; WEIDER *et al.* 1997). A second approach is to revive resting stages in order to compare ancestral and derived traits in a common environment (“resurrection ecology”, e.g. BENNINGTON *et al.* 1991). In addition, resurrection ecology in combination with common garden experiments allows controlling for the potential confounding environmental effects such as plasticity. In addition, resurrection ecology is extremely powerful when individuals from each time point can be reared in different environments that mimic ancestral and contemporary selection pressures (“time-shift experiments”, GABA and EBERT 2009).

Time-shift experiments have been used to investigate the effects of various selective agents (Fig. 1), corresponding to abiotic (e.g. drought, FRANKS *et al.* 2007; temperature, Article 2; contaminants, HAIRSTON *et al.* 1999) and biotic selective factors steiner (e.g. predation, COUSYN *et al.* 2001;

parasites, DECAESTECKER *et al.* 2007; sexual conflicts, Article 3; interspecific competition, STEINER *et al.* 2007).

4.3 The limits of resurrection ecology approaches

The validity of such an approach relies crucially on the assumption that resting stages represent an unbiased fraction of the populations, which might be problematic in permanent habitats where genotypes contribute differentially to resting egg bank (e.g. JANKOWSKI and STRAILE 2003; KELLER and SPAAK 2004). Partial hatching rate can also be problematic if hatching efficiency is correlated to the trait under study. Exact knowledge of the sampling sites is a further problem for resurrection ecology studies using seed and egg banks rather than core samples. Indeed, spatial samples from genetically differentiated subpopulations will result in the confusion of spatial and temporal genetic differentiation. Furthermore, as for population and quantitative genetic approaches, drift and migration are often difficult to rule out. The impossibility to actually observe the population prevents to conduct experimental tests of these factors in the field. Hence, resurrection ecology approaches require a thorough knowledge of the ecological history of the system under study. Alternatively, molecular techniques such as temporal Qst-Fst comparisons could help to rule out the effects of drift or migration.

4.4 Resurrection ecology and fitness measures in the lab

Statistically significant phenotypic change between ancestral and derived genotypes reared in the same environment (common garden experiments) ascertain the genetic basis of phenotypic change, provided confounding factors such as maternal effects can be excluded. When migration is small, genetic drift and selection remain two alternative hypotheses to genetic change. Hence, to further demonstrate that the genetic change of a trait results from natural selection, such a change has to increase the fitness of individuals with the new trait. As for fitness measures in natural populations, accurate fitness estimates in the laboratory are also difficult to obtain if not for the same reasons. This assertion is even more problematic when one wants to use fitness measures in the laboratory as surrogates of fitness in the wild. Indeed the vast majority of environmental factors is unknown or cannot be controlled for in laboratory conditions. In addition absence of important factors that cannot be recreated in the laboratory, can limit the scope of experimental studies. Hence, laboratory studies often assume that fitness differences stem only from one trait in natural conditions and focus on this particular trait in their lab study (e.g. behavior, COUSYN *et al.* 2001; flowering time, FRANKS *et al.* 2007; rate of growth, HAIRSTON *et al.* 1999). Even when different life-history traits are considered (e.g. DECAESTECKER *et al.* 2007; STEINER *et al.* 2007, Article 2,

Article 3), such inference is far from trivial and some assumptions have to be made (e.g. stable population demography). Hence, although resurrection ecology and time-shift approaches allow monitoring evolution over a large number of generations and avoiding environmental residual correlation between trait and fitness, along quantitative genetic approaches, they rely on the correct identification of key traits that are the most likely to have been under selection in natural populations.

5 Highlights of the thesis work

5.1 Ecological genetics of *Artemia* populations

As mentioned above, the purpose of this synthesis is not to review all the literature on natural selection in natural populations, but to explore it with what I think is a top-down way of thinking. So now the trip is over and we are back from theory to nature. What did I learn? Evolution is the product of interactions at different levels (e.g. selection within and between species, genetic architecture); all of which cannot be considered simultaneously, even theoretically. Over the last decade, considerable knowledge has been accumulated on these different levels (e.g. on community, population, physiological or molecular levels). Meanwhile, theory has contributed to identifying which factors were the most relevant (and in which ecological conditions) for the evolution of natural

populations. During my PhD, I worked on several of the above levels and on some of their interactions. In the following paragraph I give a brief overview of the different articles that compose this manuscript. I shall use the term “we” throughout since in my sense all this PhD is a collaborative project. I indicated the relative contribution of the different authors at the end of each unpublished manuscript.

5.1.1 A new statistical method for the analysis of individual life histories (Article 1)

We developed a new statistical method to analyze individual life-histories and obtain relevant fitness estimates. In Article 1, we present this so called ‘Lifelihood’ method which uses continuous survival models to analyze conjointly survival and reproductive parameters using a maximum likelihood framework. The method is well suited for the analysis of individual life history data with censored observation intervals, such as those from laboratory studies. Inference from laboratory fitness estimates to fitness measure in natural populations can be made, which allow accounting for the likely higher extrinsic mortality in natural populations. In addition, provided individual heterogeneity within experimental groups is low, this approach allows analyzing right-censored life-history (where some individuals are not followed until their death). Importantly, as the Lifelihood software uses individual life histories the method allows analyzing different reproduction-survival trade-offs and to distinguish such trade-

offs from actuarial senescence. Hence, this method opens new avenues for fitness estimation in some laboratory experiments and to quantify the complex physiological trade-off between reproduction and survival.

5.1.2 Adaptation pattern to directional and fluctuating selection (Article 2, Article 3)

We used time-shift experiments to investigate selection in response to abiotic (e.g. temperature, Article 2) and biotic factors (i.e. the other sex, Article 3). In Article 2, we investigated thermal niche evolution using dormant-eggs time series from an *Artemia* population introduced from temperate to tropical salterns in the mid-80's. The introduction resulted in an increased temperature from 20-22°C (San Francisco Bay, USA, ancestral population) to 27.5°C-30°C (Vinh Chau, Vietnam, introduced population). This resurrection ecology approach showed that survival at the high temperatures typical of the new environment increased linearly through time after the introduction, which suggests a sustained rate of adaptation over more than 100 generations. Trait directional selection toward high temperatures (27.5-30°C) also resulted in correlated response to selection with increased survival at intermediate temperatures (20-25°C). In contrast, a sharp survival decrease was observed at the lowest temperature (15°C), suggesting pleiotropic effects or the accumulation of deleterious mutation on genes conferring the adaptation to the ancestral environment. The results from this study give some

insights into the rate of adaptation in a natural population under directional selection. In Article 3, we used the same approach to study adaptation between sexes in another *Artemia* population. We hatched past and contemporary cysts samples and mated females from each time point with males either from their past, present or future. The pattern found on survival and reproductive traits was consistent with a scenario of male-female fluctuating coevolution. However, when analyzing the intrinsic rate of increase (combining both survival and reproductive data), the pattern found did not allow disentangling fluctuating from directional coevolution. The likely reason for this is that analyses of reproduction data did not detect a difference between the reproductive output of females mated either with males from their past or males from their future. This difference could also be to the choice of measuring female fitness as the intrinsic rate of increase (e.g. assuming a growing population size). Overall this study shows that sexual conflicts result in male-female coevolutionary dynamics *in natura*, over a time scale of ~100 generations. The results from these time-shift experiments indicate that this approach is a powerful tool to investigate the speed and shape of evolution in response to selection over a large number of generations *in natura*.

5.1.3 Parasite mediated competition (Article 4, Article 5)

We studied the relative role of parasites in mediating the competition between a native asexual host (*Artemia parthenogenetica*) and an invasive bisexual host (*Artemia franciscana*), living in sympatry since 1970. We found that one cestode species (*Flamingolepis liguloides*) and two uncharacterized microsporidian species (*Msp1*, *Msp2*) were very prevalent in this population, with infections generally above 50%. All three parasites were either host- or genotype-specific and the castrating cestode parasite specifically infected the native species, suggesting that this parasite actually played a major role in the competition between native and invasive hosts. In addition, the two microsporidia were also highly host-specific: *Msp1* was more prevalent on the native host, whereas *Msp2* was more prevalent on the invasive host. Interestingly, *Msp1* infected females were less likely to reproduce, suggesting a reproductive cost for both native and invasive hosts. A phylogeographic study of both microsporidia species indicated that *Msp1* was only present in Europe, whereas *Msp2* was present in French and Israeli invaded populations and in American populations (the ancestral range of *A. franciscana*), but was absent from populations where the invasive species was not present, suggesting a potential cointroduction of the *Msp2* parasite with the invader.

5.1.4 Parasite behavioral manipulation (Article 6)

We investigated *Artemia* swarming (i.e. aggregation) and the manipulative role of both cestode and microsporidian parasites in this swarming behavior. We used depth-stratified samples to compare parasite prevalence within and outside swarms. We found that *A. franciscana* males were ten times more likely to be found swarming near the surface than females, which suggested a potential link between reproduction and swarming behavior in this species. The cestode *F. liguloides* is already known to manipulate the surfacing behavior and to increase the red color of its *A. parthenogenetica* host. We found that this parasite was twice more prevalent within swarms than outside swarms and that behavioral manipulation was associated with increased red color. These observations suggest that this cestode might manipulate the swarming behavior of its host in order to increase its transmission to the final host, the greater Flamingo which feed on *Artemia*. Interestingly, cestode infection did not depend on host genotype, whereas one host genotype was more susceptible to cestode manipulation. Some studies suggest that microsporidia can manipulate the surfacing behavior of the *Daphnia* host or the shoaling behavior of their fish host. We investigated both kind of manipulation in the native and invasive hosts and found that *Msp1*- and *Msp2*-infected hosts were respectively six and two times more likely to be swarming near the surface compared to uninfected

hosts. Interestingly, manipulation was not host-specific; however, two *A. parthenogenetica* genotypes were more susceptible to *Msp1*, whereas two other genotypes were more susceptible to *Msp2*. We conducted experimental infections in the laboratory in order to test if microsporidia manipulation could increase transmission, while decreasing the risk of coinfection. We used only the least manipulating parasite, *Msp2*. We used vertical cages in two treatments where we placed infected donor hosts either above or below uninfected recipient hosts and we found that transmission to recipient hosts was more than 80% in the first treatment and below 25% in the second treatment respectively. These results indicate that microsporidia induced surfacing and swarming behavior result in increased parasite transmission.

5.1.5 Multiple origin of asexuality and polyploidy in *Artemia* (Appendix)

We examined how asexuality and polyploidy evolved in the *Artemia* genus. First, we clarified the relationship between diploid and polyploid *Artemia parthenogenetica* and their Asian bisexual close relatives, using mitochondrial phylogenies. We then tested for the presence of rare sex events investigated potential discordances between mitochondrial and nuclear makers. Interestingly, we found than multiple sex events occurred between bisexuals and diploid asexual lineage as well as within diploid asexual lineage, resulting into 'mitochondrial capture' as well as the formation of a new

triploid asexual lineage. Furthermore, tetraploidy evolved at least twice in the genus through the hybridization of divergent bisexual species. Interestingly, rare sex seems also to be present in tetraploid lineages. Finally, the pentaploid lineage mostly likely arose through abnormal segregation in tetraploid females. These results indicate that unsuspected sexual reproduction might be widespread in the different *A. parthenogenetica* lineages.

5.2 Perspectives for field studies and resurrection ecology in *Artemia*

My thesis work hopefully contributes to the demonstration that time-shift experiments in the laboratory and short-term field studies in combination with experiments in the laboratory can provide valuable information regarding the selective pressures that are at work in natural populations. I shall now discuss why *Artemia* could become a 'model organism' and provide valuable information for other species. I detail below two major evolutionary questions for which studies in *Artemia* will be particularly relevant and useful in the future.

5.2.1 Competition between asexual and sexual species

Since Vandel's seminal work (VANDEL 1928; VANDEL 1940, see the Preface section of this thesis), understanding the differential spatial repartition of sexual and asexual species has been a challenge for evolutionary biologists. Hence, sympatric populations where both species are present

represent a rare opportunity to address this question. In addition, as sexual and asexual species often have overlapping niches, studying sympatric populations is relevant to the more general understanding of the coexistence of species with similar niches. The results from the study on the interaction between sympatric *Artemia* and their parasites suggest that these can play an important role in promoting or precluding species coexistence. Host specificity and parasites cost on hosts fitness are the main factors in that respect. Importantly, parasite infection can have both direct and indirect or 'facultative' effects on host fitness. For example, both microsporidia species seem to have a limited effect on host fitness as they mostly require the host to be alive in order to allow transmission. However, the surfacing and swarming behaviors they induced are likely to increase predation by flamingo. But, this indirect fitness cost actually depends on the presence of this predator. In addition, biased sex ratio in *A. franciscana* swarms suggests that such behavior might be related to reproduction and that the parasite exploit this pre-existing behavior. Hence parasites can interact with host reproductive behavior, which has been suggested in some sexually transmitted diseases. Thus, the transmission of such microsporidia during mating remains to be investigated. In addition, the Red Queen hypothesis suggests that sexual rather than asexual reproduction allow escaping parasites more efficiently. As *A. parthenogenetica* can reproduce

occasionally sexually through rare males, one would predict that the frequency of rare males would be correlated to parasite prevalence. This prediction remains to be tested. Furthermore, we found seasonal fluctuations of *A. franciscana* and *A. parthenogenetica*, most likely due to different thermal niches. Studying the effect of this abiotic forcing on parasite specificity would be very interesting, as one would expect temporal host fluctuations to select for lower host specificity. Finally the importance of sexual conflicts in sympatric sexual and asexual populations has rarely been investigated. However, whenever males do not discriminate bisexual from asexual females, mating attempts could result in substantial fitness costs for the female. Preliminary results which are not presented in this thesis suggest that *A. parthenogenetica* females evolved to actually accept more male mate-guarding, which suggests that rejecting rather than accepting male mating attempts might be costly. Although specific to the Artemia system, most of the complex interaction between abiotic environment, parasites and reproduction mode are likely to be widespread in other species.

5.2.2 Antagonistic coevolutions, field studies vs. time-shift experiments

Antagonistic interaction occurs when one partner in an interaction has an interest in manipulating the other partner which has to pay a cost for being manipulated. Such conflict of interest appears to be widespread both between species

through host-parasite interactions and within species through sexual conflicts, and both can lead to antagonistic coevolutions. During my PhD, I attempted to get a better understanding of coevolutionary processes. As a first approach, I tried through experimental tests to directly measure the costs and benefits of manipulation for the *Msp2* parasite. In addition, I took advantage of the asexuality of the host, to investigate genetic variation for susceptibility to infection and manipulation by the different parasites. The results indicate that manipulation is advantageous for the parasites and that there is genetic variation for infection and manipulation in the microsporidian and cestode parasite respectively. Although this is very speculative, this interspecific pattern could correspond to parasite trade-offs between infection and manipulation. Further investigation of a potential infection-manipulation trade-off within at the intraspecific level would be very interesting. In addition, investigation of genetic variation for manipulation in the parasite and of the respective costs of infection and manipulation for the host would allow testing for a genetic basis for coevolution. Investigating the role of sexual conflicts on male-female coevolution would require such approach. The main limitation is that female manipulation by males is likely not just a simple behavioral manipulation and that investigating sexual conflicts would require a more complex experimental quantitative genetic design where both female and male fitness would be

measured. To avoid these shortcomings, time-shift experiments are powerful approaches, as they allow unraveling coevolutionary processes whenever the traits or loci under conflict are unknown. They indeed allow disentangling to a certain extent 'fluctuating' from 'arms race' coevolutionary dynamics, provided relevant and accurate laboratory fitness estimates are available. Ideally, the pattern found could help finding the trait or loci involved in the conflicts. Theoretically, crosses could be made between ancestral and derived genotypes and the fitness of the offspring could be measured under 'ancestral' and 'contemporary' selection pressures in order to find the loci involved in the adaptation, as in QTL mapping and genome-wide association studies. To my knowledge such approaches remain to be tested.

5.3 Major challenges for understanding adaptation in the wild

Molecular techniques have allowed us to reconstruct pedigrees at different evolutionary scales (both macroevolutionary, with the reconstruction of the tree of life and microevolutionary, with the reconstruction of family genealogies). Such techniques will certainly revolutionize the study of evolution in natural populations. Association studies in natural populations will indeed allow the fusion of population and quantitative genetic approaches. However, knowing the loci involved in adaptation is different from understanding the

process of adaptation. Long term studies provide valuable knowledge to understand the different selective forces that shape the evolution of natural populations. In addition, obtaining relevant fitness measures both in laboratory and wild populations will certainly remain a major challenge for evolutionary biologists. For certain laboratory organisms (and for certain wild populations that can be monitored intensively), the Lifelihood approach allows getting an integrated fitness measure, based on individual life histories.

To date, time-shift experiment in plant species remain at its infancy and experiments with long-lived seeds will likely permit to study evolutionary process such as adaptation or speciation over a larger number of generation than in animals, as suggested by the recent regeneration of a 30,000 year old plant (YASHINA *et al.* 2012). Such approach will allow comparing short- and long-term responses to selection and may bridge the gap between micro and macroevolution. Finally, combination of long-term experimental evolution and whole genome sequencing has opened new avenues to identify the loci involved in adaptation (e.g. BARRICK *et al.* 2009; BURKE *et al.* 2010; TENAILLON *et al.* 2012). The combination of time-shift experiment and whole genome sequencing in the future might be a very powerful tool to identify the molecular basis of the adaptation of natural populations. Ultimately, change in the genetic architecture in the course of adaptation could be better understood. Such an understanding of

complex traits determined by a large number of loci would allow using quantitative genetic approaches to make strong predictions regarding the adaptive response of natural populations.

5.4 Applied implications

My work is fundamentally fundamental, but as *Artemia* species are used worldwide for aquaculture and salt production, I shall underline here some potential applications from this thesis. The first would be that we found new microsporidian parasites in most of the populations where *Artemia* is collected to be sold. Although transmission to other animals such as fish is unlikely, people collecting *Artemia* should be aware that microsporidian parasites are very prevalent in natural populations, that transmission is high and that even spores present on unencapsulated cysts could infect new born nauplii. As infected *Artemia* seem to incur some reproductive costs, preventive methods such as cyst decapsulation are important. Second, we developed specific genetic markers that should help to tell *Artemia parthenogenetica* individuals with different ploidy levels apart, which might be of interest for traceability of *Artemia* aquaculture products. Third, from a more sociological point of view, *Artemia* give a good example of the effect of globalization on species distribution. Indeed, *Artemia* is a typical invasive species that is linked with human economical activity. For example, *A. franciscana* was introduced in France in several saltworks on the Atlantic and

Mediterranean coasts in the 70's. Most of these saltworks have now been abandoned, because they were not enough profitable. Conjointly, introduced populations have been thriving and have colonized new saltworks, sometimes replacing native *Artemia* species. The future of this invasive species is likely to depend crucially on land use policies such as the decision of local authorities to pursue salt harvesting as a recreational activity for tourists or to sell the land to real estate investment trusts. Unfortunately, time-shift experiments will not help us to predict this future.

References

- ARNOLD, S. J., and M. J. WADE, 1984a On the measurement of natural and sexual selection: applications. *Evolution* **38**: 720-734.
- ARNOLD, S. J., and M. J. WADE, 1984b On the measurement of natural and sexual selection: theory. *Evolution* **38**: 709-719.
- BALDING, D. J., 2006 A tutorial on statistical methods for population association studies. *Nature Reviews Genetics* **7**: 781-791.
- BARBER, M. N., 1965 Selection in natural populations. *Heredity* **20**: 551-572.
- BARRICK, J. E., D. S. YU, S. H. YOON, H. JEONG, T. K. OH *et al.*, 2009 Genome evolution and adaptation in a long-term experiment with *Escherichia coli*. *Nature* **461**: 1243-1247.
- BENNINGTON, C., J. MCGRAW and M. VAVREK, 1991 Ecological genetic variation in seed banks. II. Phenotypic and genetic differences between young and old subpopulations of *Luzula parviflora*. *The Journal of Ecology*: 627-643.
- BLOWS, M. W., 2007 A tale of two matrices: multivariate approaches in evolutionary biology *Journal of Evolutionary Biology* **20**: 1-8.
- BOAG, P. T., and P. R. GRANT, 1981 Intense natural selection in a population of Darwin's finches (Geospizinae) in the Galapagos. *Science* **214**: 82-85.
- BRADLEY, B. J., and R. R. LAWLER, 2011 Linking genotypes, phenotypes, and fitness in wild primate populations. *Evolutionary Anthropology: Issues, News, and Reviews* **20**: 104-119.
- BREDE, N., C. SANDROCK, D. STRAILE, P. SPAAK, T. JANKOWSKI *et al.*, 2009 The impact of human-made ecological changes on the genetic architecture of *Daphnia* species. *Proceedings of the National Academy of Sciences* **106**: 4758.
- BROMMER, J. E., 2000 The evolution of fitness in life-history theory. *Biological Reviews* **75**: 377-404.
- BROMMER, J. E., J. MERILA and H. KOKKO, 2002 Reproductive timing and individual fitness. *Ecology Letters* **5**: 802-810.
- BUMPUS, H. C., 1899 The elimination of the unfit, as illustrated by the introduced sparrow, *Passer domesticus*. *Biological*

- Lectures, Woods Hole Marine Biological Station **6**: 209-226.
- BURDON, J. J., 1994 The distribution and origin of genes for race-specific resistance to *Melampsora lini* in *Linum marginale*. *Evolution* **48**: 1564-1575.
- BURKE, M. K., J. P. DUNHAM, P. SHAHRESTANI, K. R. THORNTON, M. R. ROSE *et al.*, 2010 Genome-wide analysis of a long-term evolution experiment with *Drosophila*. *Nature* **467**: 587-590.
- CAIN, A. J., and P. M. SHEPPARD, 1954 Natural selection in *Cepaea*. *Genetics* **39**: 89.
- CARROLL, S. P., and C. BOYD, 1992 Host race radiation in the soapberry bug: natural history with the history. *Evolution* **46**: 1052-1069.
- CHARLESWORTH, B., 1994 *Evolution in Age-Structured Populations*. Cambridge University Press, Cambridge, UK.
- CHARMANTIER, A., L. E. B. KRUUK and M. M. LAMBRECHTS, 2004 Parasitism reduces the potential for evolution in a wild bird population. *Evolution* **58**: 203-206.
- CHARMANTIER, A., R. H. MCCLEERY, L. R. COLE, C. M. PERRINS, L. E. B. KRUUK *et al.*, 2008 Adaptive phenotypic plasticity in response to climate change in a wild bird population. *Science* **320**: 800-803.
- CHEVERUD, J. M., and W. P. J. DITTUS, 1992 Primate population studies at Polonnaruwa. II. Heritability of body measurements in a natural population of toque macaques (*Macaca sinica*). *American Journal of Primatology* **27**: 145-154.
- CLAYTON, G., J. MORRIS and A. ROBERTSON, 1957 An experimental check on quantitative genetical theory I. Short-term responses to selection. *Journal of Genetics* **55**: 131-151.
- CLAYTON, G., and A. ROBERTSON, 1957 An experimental check on quantitative genetical theory II. The long-term effects of selection. *Journal of Genetics* **55**: 152-170.
- CLUTTON-BROCK, T., and B. C. SHELDON, 2010 Individuals and populations: the role of long-term, individual-based studies of animals in ecology and evolutionary biology. *Trends in Ecology & Evolution* **25**: 562-573.

- COOK, L. M., 2003 The rise and fall of the carbonaria form of the peppered moth. *The Quarterly review of biology* **78**: 399-417.
- COUSYN, C., L. DE MEESTER, J. COLBOURNE, L. BRENDONCK, D. VERSCHUREN *et al.*, 2001 Rapid, local adaptation of zooplankton behavior to changes in predation pressure in the absence of neutral genetic changes. *Proceedings of the National Academy of Sciences* **98**: 6256.
- DADAY, H., 1954 Gene frequencies in wild populations of *Trifolium repens*. *Heredity* **8**: 377-384.
- DALLINGER, W. H., 1887 The president's address. *Journal of the Royal Microscopical Society* **7**: 185-199.
- DARWIN, C., 1859 *The Origin of Species*. Murray, London.
- DECAESTECKER, E., S. GABA, J. A. M. RAEYMAEKERS, R. STOKS, L. VAN KERCKHOVEN *et al.*, 2007 Host-parasite 'Red Queen' dynamics archived in pond sediment. *Nature* **450**: 870-U816.
- DHONDT, A. A., R. EYCKERMAN and J. HUBLE, 1979 Will Great Tits become little tits? *Biological Journal of the Linnean Society* **11**: 289-294.
- DI CESNOLA, A. P., 1907 A first study of natural selection in *Helix arbustorum* (Helicogena). *Biometrika* **5**: 387-399.
- DYBDAHL, M. F., and C. M. LIVELY, 1998 Host-parasite coevolution: evidence for rare advantage and time-lagged selection in a natural population. *Evolution*: 1057-1066.
- DYKHUIZEN, D., and D. L. HARTL, 1980 Selective neutrality of 6PGD allozymes in *E. coli* and the effects of genetic background. *Genetics* **96**: 801-817.
- EAST, E., 1916 Inheritance in crosses between *Nicotiana Langsdorffii* and *Nicotiana alata*. *Genetics* **1**: 311.
- ENDLER, J. A., 1980 Natural selection on color patterns in *Poecilia reticulata*. *Evolution* **34**: 76-91.
- ENDLER, J. A., 1986 *Natural selection in the wild*. Princeton University Press, Princeton.
- EPLING, C., and T. DOBZHANSKY, 1942 Genetics of natural populations. VI. Microgeographic races in *Linanthus parryae*. *Genetics* **27**: 0317-0332.

- EPLING, C., H. LEWIS and F. M. BALL, 1960 THE BREEDING GROUP AND SEED STORAGE - A STUDY IN POPULATION-DYNAMICS. *Evolution* **14**: 238-255.
- ETTERSON, J. R., and R. G. SHAW, 2001 Constraint to adaptive evolution in response to global warming. *Science* **294**: 151-154.
- FALCONER, D. S., 1989 *Introduction to Quantitative Genetics*. 3rd Ed. Longman Sci. and Tech., Harlow, UK.
- FISHER, R. A., 1930 *The genetical theory of natural selection*. Oxford University Press, Oxford.
- FISHER, S. R. A., and E. B. FORD, 1947 The spread of a gene in natural conditions in a colony of the moth *Panaxia dominula* L. *Heredity* **1**: 143-174.
- FLOR, H., 1947 Inheritance of reaction to rust in flax. *J. Agric. Res* **74**: 241.
- FORD, E. B., 1964 *Ecological genetics*. Methuen, London.
- FRANK, S. A., 1995 George Price's contributions to evolutionary genetics. *Journal of Theoretical Biology* **175**: 373-388.
- FRANKS, S. J., S. SIM and A. E. WEIS, 2007 Rapid evolution of flowering time by an annual plant in response to a climate fluctuation. *Proceedings of the National Academy of Sciences* **104**: 1278.
- GABA, S., and D. EBERT, 2009 Time-Shift Experiments as a Tool to Study Antagonistic Coevolution. *Trends in Ecology & Evolution* **24**: 226-232.
- GELDERMANN, H., 1975 Investigations on inheritance of quantitative characters in animals by gene markers I. Methods. *TAG Theoretical and Applied Genetics* **46**: 319-330.
- GRANT, P. R., and R. B. GRANT, 1995 Predicting microevolutionary responses to directional selection on heritable variation. *Evolution* **49**: 241-251.
- GRATTEN, J., A. WILSON, A. MCRAE, D. BERARDI, P. VISSCHER *et al.*, 2008 A localized negative genetic correlation constrains microevolution of coat color in wild sheep. *Science* **319**: 318-320.
- GUPTA, P. K., S. RUSTGI and P. L. KULWAL, 2005 Linkage disequilibrium and association studies in higher plants: present status and future prospects. *Plant molecular biology* **57**: 461-485.

- HAIRSTON, N. G., W. LAMPERT, C. E. CÁCERES, C. L. HOLTMEIER, L. J. WEIDER *et al.*, 1999 Rapid evolution revealed by dormant eggs. *Nature* **401**: 446.
- HAIRSTON, N. G., and W. E. WALTON, 1986 Rapid evolution of a life history trait. *Proceedings of the National Academy of Sciences* **83**: 4831.
- HALDANE, J. B. S., 1932 *The causes of evolution*. Harper, New York.
- HALDANE, J. B. S., 1948 The theory of a cline. *Journal of Genetics* **48**: 277-284.
- HALDANE, J. B. S., 1949 Disease and evolution. Supplement to *La Ricerca Scientifica* **19**: 68-76.
- HALDANE, J. B. S., 1954 *The biochemistry of genetics*. George Allen & Unwin, London.
- HOFFMANN, A. A., and P. A. PARSONS, 1991 *Evolutionary Genetics and Environmental Stress*. Oxford University Press, Oxford.
- HOWARD, R. D., 1979 Estimating reproductive success in natural populations. *American Naturalist*: 221-231.
- JAIN, S. K., and A. D. BRADSHAW, 1966 Evolutionary divergence among adjacent plant populations. I. The evidence and its theoretical analysis. *Heredity* **21**: 407-441.
- JANKOWSKI, T., and D. STRAILE, 2003 A Comparison of Egg-Bank and Long-Term Plankton Dynamics of Two *Daphnia* Species, *D. hyalina* and *D. galeata*: Potentials and limits of reconstruction. *Limnology and Oceanography* **48**: 1948-1955.
- JOHNSTON, R. F., and R. K. SELANDER, 1971 Evolution in the house sparrow. II. Adaptive differentiation in North American populations. *Evolution*: 1-28.
- JOHNSTON, S. E., J. MCEWAN, N. K. PICKERING, J. W. KIJAS, D. BERARDI *et al.*, 2011 Genome-wide association mapping identifies the genetic basis of discrete and quantitative variation in sexual weaponry in a wild sheep population. *Molecular Ecology*.
- JORON, M., L. FREZAL, R. T. JONES, N. L. CHAMBERLAIN, S. F. LEE *et al.*, 2011 Chromosomal rearrangements maintain a polymorphic supergene controlling butterfly mimicry. *Nature* **477**: 203-U102.

- KELLER, B., and P. SPAAK, 2004 Nonrandom Sexual Reproduction and Diapausing Egg Production in a *Daphnia* Hybrid Species Complex. *Limnology and Oceanography* **49**: 1393-1400.
- KETTLEWELL, H. B. D., 1956 A résumé of investigations on the evolution of melanism in the Lepidoptera. *Proceedings of the Royal Society of London B* **145**: 297-303.
- KOZLOWSKI, J., 1993 Measuring Fitness in Life-History Studies. *Trends in Ecology & Evolution* **8**: 84-85.
- KRUUK, L. E. B., 2004 Estimating genetic parameters in wild populations using the 'animal model'. *Philosophical Transactions of the Royal Society of London B* **359**: 873-890.
- L'HÉRITIER, P., 1937 Etude des variations quantitatives au sein d'une espèce: *Drosophila melanogaster*. *Archives de Zoologie Experimentale et Générale* **78**: 255-356.
- L'HERITIER, P., and G. TEISSIER, 1933 Etude d'une population de *Drosophiles* en équilibre. *CR Acad. Sci. Paris* **197**: 1765--1767.
- LAMOTTE, M., 1952 Le rôle des fluctuations fortuites dans la diversité des populations naturelles de *Cepaea nemoralis* (L.). *Heredity* **6**: 333-343.
- LANDE, R., 1979 Effective deme size during long term evolution estimated from rates of chromosomal rearrangement. *Evolution* **33**: 234-251.
- LANDE, R., and S. J. ARNOLD, 1983 The measurement of selection on correlated characters. *Evolution* **37**: 1210-1226.
- LEE, C. E., 1999 Rapid and repeated invasions of fresh water by the copepod *Eurytemora affinis*. *Evolution*: 1423-1434.
- LEE, C. E., and C. H. PETERSEN, 2002 Genotype-by-environment interaction for salinity tolerance in the freshwater-invading copepod *Eurytemora affinis*. *Physiological and Biochemical Zoology* **75**: 335-344.
- LENORMAND, T., T. GUILLEMAUD, D. BOURGUET and M. RAYMOND, 1998 Evaluating gene flow using selected markers: a case study. *Genetics* **149**: 1383-1392.
- LENORMAND, T., and M. RAYMOND, 2000 Analysis of clines with variable selection and variable migration. *The American Naturalist* **155**: 70-82.

- LOSOS, J. B., K. I. WARHEIT and T. W. SCHOENER, 1997 Adaptive differentiation following experimental island colonization in *Anolis* lizards. *Nature* **387**: 70-73.
- LUSH, J. L., 1947 Family merit and individual merit as bases for selection. Part I. *The American Naturalist* **81**: 241-261.
- LYNCH, M., 1983 Ecological genetics of *Daphnia pulex*. *Evolution*: 358-374.
- LYNCH, M., and B. WALSH, 1998 *Genetics and Analysis of Quantitative Traits*. Sinauer Associates, Inc., Sunderland, Mass.
- MACKAY, T. F. C., E. A. STONE and J. F. AYROLES, 2009 The genetics of quantitative traits: challenges and prospects. *Nature Reviews Genetics* **10**: 565-577.
- MERILÄ, J., 1997 Expression of genetic variation in body size of the collared flycatcher under different environmental conditions. *Evolution* **51**: 526-536.
- MERILÄ, J., B. C. SHELDON and L. E. B. KRUK, 2001 Explaining stasis: microevolutionary studies in natural populations. *Genetica* **112-113**: 199-222.
- METTLER, L., R. VOELKER and T. MUKAI, 1977 Inversion clines in populations of *Drosophila melanogaster*. *Genetics* **87**: 169-176.
- MORRISSEY, M. B., L. E. B. KRUK and A. J. WILSON, 2010 The danger of applying the breeder's equation in observational studies of natural populations. *Journal of Evolutionary Biology* **23**: 2277-2288.
- MULLER, H. J., 1918 Genetic variability, twin hybrids and constant hybrids, in a case of balanced lethal factors. *Genetics* **3**: 422.
- PEARSON, K., 1903 Mathematical contributions to the theory of evolution. XI. On the influence of natural selection on the variability and correlation between organs. *Phil. Trans. Roy. Soc. London A* **200**: 1-66.
- PEMBERTON, J., 2008 Wild pedigrees: the way forward. *Proceedings of the Royal Society B: Biological Sciences* **275**: 613-621.
- PRICE, G., 1970 Selection and covariance. *Nature* **227**: 520-521.

- PRICE, T. D., M. KIRKPATRICK and S. J. ARNOLD, 1988 Directional selection and the evolution of breeding date in birds. *Science* **240**: 798-799.
- QUELLER, D. C., 1992 Quantitative genetics, inclusive fitness, and group selection. *American Naturalist*: 540-558.
- RAUSHER, M. D., 1992 The measurement of selection on quantitative traits: biases due to environmental covariances between traits and fitness. *Evolution* **46**: 616-626.
- REZNICK, D. A., H. BRYGA and J. A. ENDLER, 1990 Experimentally induced life-history evolution in a natural population. *Nature* **346**: 357-359.
- REZNICK, D. N., F. H. SHAW, F. H. RODD and R. G. SHAW, 1997 Evaluation of the rate of evolution in natural populations of Guppies (*Poecilia reticulata*). *Science* **275**: 1934-1937.
- RICE, S. H., 2004 *Evolutionary theory: mathematical and conceptual foundations*. Sinauer Associates, Sunderland, MA.
- ROBERTSON, A., 1966 A Mathematical Model of Culling Process in Dairy Cattle. *Animal Production* **8**: 95-&.
- ROFF, D., and D. FAIRBAIRN, 2007 The evolution of trade-offs: where are we? *Journal of Evolutionary Biology* **20**: 433-447.
- ROUGHGARDEN, J., 1979 *Theory of Population Genetics and Evolutionary Ecology: An Introduction*. Macmillan Publishing Co, New York.
- SCHEMSKE, D. W., and P. BIERZYCHUDEK, 2001 Perspective: Evolution of flower color in the desert annual *Linanthus parryae*: Wright revisited. *Evolution* **55**: 1269-1282.
- SCHEMSKE, D. W., and P. BIERZYCHUDEK, 2007 Spatial differentiation for flower color in the desert annual *Linanthus parryae*: Was Wright right? *Evolution* **61**: 2528-2543.
- SCHOENER, T. W., and A. SCHOENER, 1983 The time to extinction of a colonizing propagule of lizards increases with island area.
- SEELEY, R. H., 1986 Intense natural selection caused a rapid morphological transition in a living marine snail. *Proceedings of the National Academy of Sciences* **83**: 6897.
- STEINER, C. F., C. E. CÁCERES and S. D. P. SMITH, 2007 Resurrecting the ghost of competition past with dormant zooplankton eggs. *The American Naturalist* **169**: 416-422.

- STEWART, J., 1969 Biometrical genetics with one or two loci. I. The choice of a specific genetic model. *Heredity* **24**: 211.
- STOPHER, K. V., C. A. WALLING, A. MORRIS, F. E. GUINNESS, T. H. CLUTTON-BROCK *et al.*, 2012 Shared spatial effects on quantitative genetic parameters: accounting for spatial autocorrelation and home range overlap reduces estimates of heritability in wild red deer. *Evolution*.
- STURTEVANT, A., and K. MATHER, 1938 The interrelations of inversions, heterosis and recombination. *The American Naturalist* **72**: 447-452.
- TENAILLON, O., A. RODRÍGUEZ-VERDUGO, R. L. GAUT, P. McDONALD, A. F. BENNETT *et al.*, 2012 The Molecular Diversity of Adaptive Convergence. *Science* **335**: 457-461.
- THRALL, P. H., and J. J. BURDON, 2002 Evolution of gene-for-gene systems in metapopulations: the effect of spatial scale of host and pathogen dispersal. *Plant Pathology* **51**: 169-184.
- THRALL, P. H., and J. J. BURDON, 2003 Evolution of virulence in a plant host-pathogen metapopulation. *Science* **299**: 1735-1737.
- THRALL, P. H., J. J. BURDON and A. YOUNG, 2001 Variation in resistance and virulence among demes of a plant host-pathogen metapopulation. *Journal of Ecology* **89**: 736-748.
- THRALL, P. H., A. L. LAINE, M. RAVENSDALE, A. NEMRI, P. N. DODDS *et al.*, 2012 Rapid genetic change underpins antagonistic coevolution in a natural host-pathogen metapopulation. *Ecology Letters* **15**: 425-435.
- TINKLE, D. W., 1965 Population structure and effective size of a lizard population. *Evolution*: 569-573.
- TURELLI, M., and A. A. HOFFMAN, 1991 Rapid spread of an inherited incompatibility factor in california *Drosophila*. *Nature* **353**: 440-442.
- VANDEL, A., 1928 La parthénogénèse géographique. Contribution à l'étude biologique et cytologique de la parthénogénèse naturelle. *Bulletin Biologique de la France et de la Belgique* **62**: 164-281.
- VANDEL, A., 1940 La parthénogénèse géographique. IV. Polyploidie et distribution géographique. *Bulletin Biologique de la France et de la Belgique* **74**: 94-100.

- VERHULST, S., C. PERRINS and R. RIDDINGTON, 1997 Natal dispersal of great tits in a patchy environment. *Ecology* **78**: 864-872.
- WEIDER, L. J., W. LAMPERT, M. WESSELS, J. K. COLBOURNE and P. LIMBURG, 1997 Long-term genetic shifts in a microcrustacean egg bank associated with anthropogenic changes in the Lake Constance ecosystem. *Proceedings of the Royal Society of London. Series B: Biological Sciences* **264**: 1613-1618.
- WELDON, W., 1901 A first study of natural selection in *Clausilia laminata* (Montagu). *Biometrika* **1**: 109-124.
- WRIGHT, S., 1934 An analysis of variability in number of digits in an inbred strain of guinea pigs. *Genetics* **19**: 506.
- WRIGHT, S., 1943 Isolation by distance. *Genetics* **28**: 114-138.
- WRIGHT, S., 1948 On the roles of directed and random changes in gene frequency in the genetics of populations. *Evolution*: 279-294.
- WRIGHT, S., 1951 The genetical structure of populations. *Annals of Eugenics* **15**: 323-354.
- WRIGHT, S., 1978 *Evolution and the genetics of populations. IV. Variability within and among natural populations.* . University of Chicago Press, Chicago.
- WRIGHT, S., and T. DOBZHANSKY, 1946 Genetics of natural populations. XII. Experimental reproduction of some of the changes caused by natural selection in certain populations of *Drosophila pseudoobscura*. *Genetics* **31**: 125.
- YASHINA, S., S. GUBIN, S. MAKSIMOVICH, A. YASHINA, E. GAKHOVA *et al.*, 2012 Regeneration of whole fertile plants from 30,000-y-old fruit tissue buried in Siberian permafrost. *Proceedings of the National Academy of Sciences*.

Part II

Articles

Résumé des articles (French summary of the articles)

Dans le contexte d'un impact grandissant de l'homme sur le monde vivant, la vitesse et les mécanismes de l'évolution demeurent des éléments clés pour comprendre les phénomènes d'adaptation. Lors de ma thèse, je me suis intéressé en particulier aux facteurs gouvernant l'évolution à long terme (~ 100 générations) des populations sauvages. Les études à long terme et l'écologie de la résurrection (faisant revivre des structures de dormance) ont été les principales approches pour étudier l'évolution des traits d'histoire de vie sur plusieurs générations dans les populations sauvages. Mon travail consiste à comprendre comment des facteurs écologiques simples (p. ex. la température) et des interactions biotiques plus complexes (p. ex. les interactions antagonistes hôte-parasite ou mâle-femelle) façonnent l'évolution. Dans cette optique, j'ai utilisé l'*Artemia* un petit crustacé halophile vivant dans les marais salants comme un organisme modèle. J'ai cherché à avoir une approche générale et exhaustive, en combinant des études sur le terrain et en laboratoire.

1. Adaptation à la température et coévolution antagoniste entre les sexes

Sélection directionnelle et adaptation à la température

La température est un déterminant majeur de la niche écologique de beaucoup d'organismes, surtout des ectothermes. L'adaptation à la température joue un rôle clef dans les réponses éco-évolutives aux changements climatiques. Comprendre et prédire l'évolution des niches thermiques est primordial. Cependant, la sélection naturelle liée à la température est généralement mesurée sur un faible nombre de générations dans les populations sauvages (souvent moins de 50). Je me suis donc intéressé à l'évolution de la niche thermique suite à un changement d'environnement en utilisant une série temporelle d'œufs de dormance d'une population d'Artémia originaire de marais salants tempérés et introduite dans des marais salants tropicaux dans les années 80. L'introduction a conduit à une augmentation de 20-22°C (Baie de San Francisco, Etats-Unis, population ancestrale) à 27-30°C (Vinh Chau, Vietnam, population introduite). J'ai élevé à 8 températures différentes allant de 15 à 35°C des descendants d'œufs de dormance échantillonnés à différentes dates après l'introduction (0, 2, 8, 11 et 22 ans). Les analyses de la survie des adultes ont montré une augmentation de la survie de 31% aux températures élevées caractéristiques du nouvel environnement après 22 ans (Article 2). En revanche,

la survie des adultes à 15°C a diminué de 94% après 22 ans. Cette étude montre un taux d'adaptation régulier aux températures tropicales au cours des 130 générations après l'introduction. De manière surprenante, cette étude montre aussi que l'adaptation à un nouvel environnement cause une diminution drastique de l'adaptation à l'ancien environnement de la population.

Coévolution mâle-femelle et patrons de sélection

Les conflits sexuels, qui résultent de la divergence d'intérêts évolutifs entre mâles et femelles d'une même espèce, sont très répandus dans la nature. Ces conflits se produisent au sein des espèces où les femelles s'accouplent avec différents mâles au cours de leur vie. D'un point de vue évolutif, un mâle qui fait pondre plus de descendants à la femelle avec qui il s'accouple sera positivement sélectionné. Si cette augmentation de la reproduction précoce de la femelle induit une diminution de sa reproduction plus tard dans sa vie, cette manipulation représente un coût pour la femelle. En conséquence, les conflits sexuels se traduisent souvent par une coévolution antagoniste entre les mâles et femelles où chaque sexe s'adapte constamment à la manipulation ou à la résistance de l'autre sexe. Du fait de sa nature dynamique, ce processus coévolutif est très difficile à démontrer expérimentalement dans la nature. Dans une deuxième étude, j'ai essayé de démontrer l'existence de cette coévolution chez

l'artémie et de caractériser le patron de sélection à l'origine de cette coévolution (sélection directionnelle ou fluctuante). Pour cela, j'ai utilisé des œufs de dormances collectés dans une même population durant trois années différentes, couvrant une période de 23 ans (~160 générations). J'ai fait éclore ces œufs et ai effectué des croisements de femelles de chaque année avec des mâles provenant soit de la même année (mâles contemporains) ou d'années différentes (mâles du passé ou du futur). Les analyses ont montré que la survie et la reproduction des femelles variaient en fonction de l'année d'origine du mâle avec lequel elles étaient accouplées (Article 3). Ces résultats démontrent qu'il existe une coévolution entre les sexes dans cette population. Cependant, la combinaison des données de survie et de reproduction de femelles ne permettait pas de distinguer statistiquement les patrons de coévolution directionnelle et fluctuante. Ainsi, cette étude suggère que les conflits sexuels provoquent une dynamique de coévolution fluctuante sur une échelle d'environ 100 générations dans des conditions naturelles. Par ailleurs, cette étude montre aussi que de telles expériences, dites de « décalage temporel », représentent des outils puissants pour d'étudier la vitesse et la forme du processus coévolutif dans la nature.

2. Interactions hôte-parasite : transmission, virulence et manipulation du comportement des hôtes

*Rôle des parasites dans l'invasion mondiale de l'espèce américaine *Artemia franciscana**

La différence de susceptibilité à des parasites virulents entre hôtes autochtones et introduits est une des principales hypothèses de la biologie de l'invasion afin d'expliquer le succès des espèces introduites. J'ai donc étudié les impacts de différents parasites (cestodes et microsporidies) sur la compétition entre une espèce d'hôte autochtone asexuée (*A. parthenogenetica*) et une espèce d'hôte invasive sexuée (*A. franciscana*), vivant en sympatrie à Aigues-Mortes depuis 1970. La comparaison de la prévalence des cestodes au sein des deux espèces d'*Artemia* a montré que l'espèce autochtone était extrêmement parasitée (prévalence d'environ 70%), contrairement à l'espèce invasive (prévalence d'environ 1,5%, Article 4) Par ailleurs, l'espèce de cestode la plus prévalente (66% des infections) cause une castration des hôtes autochtones infectés, alors qu'elle est complètement absente chez l'espèce invasive (Article 4). Les cestodes réduisent donc drastiquement le potentiel compétitif de l'espèce native par rapport à l'espèce invasive.

Concernant les microsporidies, nous avons découvert et caractérisé deux nouvelles espèces, *Anostracospora rigaudi* (*Microsporidium* sp. 1) et *Enterocytopora artemiae* (*Microsporidium* sp. 2) qui infectent les hôtes natifs et invasifs de manière différente (Article 5) La comparaison de la prévalence au sein des deux espèces d'*Artemia* a en effet montré que l'espèce autochtone était trois fois plus susceptible à l'infection par *A. rigaudi* par rapport à l'espèce invasive. Par ailleurs, *A. rigaudi* diminue fortement la probabilité des femelles de se reproduire et diminue donc fortement le potentiel compétitif de l'espèce autochtone (Article 5). Par conséquent, les parasites jouent un rôle majeur dans la compétition entre les espèces d'*Artemia* autochtone et invasive.

Rôle des parasites dans le comportement d'agrégation de l'Artemia

Les comportements d'agrégations sont observés dans de nombreux groupes d'animaux et de bactéries (p. ex. les insectes, les crustacés, les poissons et les bactéries du genre *Pseudomonas*). Ces comportements sont souvent étudiés avec l'idée qu'ils sont socialement ou sexuellement adaptatifs, c'est à dire qu'ils confèrent un avantage sélectif aux individus agrégés. Peu d'hypothèses alternatives ont été proposées pour expliquer l'existence de tels comportements. Durant ma thèse, j'ai testé l'hypothèse que le comportement d'agrégation

résulte de la manipulation de l'hôte par des parasites. On peut en effet penser que les parasites transmis par contact entre hôtes sains et infectés ont intérêt à manipuler le comportement de leur hôte pour qu'ils se rendent dans des zones de forte densité. De manière similaire, les parasites à cycle indirect peuvent aussi avoir intérêt à manipuler le comportement de leur hôte pour qu'ils se rendent dans des zones de forte densité, si ces zones présentent un taux de prédation par l'hôte final supérieur à celui des zones de faible densité.

Les artémies forment des agrégats d'individus que les hypothèses adaptatives actuelles ont du mal à expliquer. Nous avons donc testé l'hypothèse que ces agrégats résultent soit de la manipulation de parasites à cycle indirect (*F. liguloides*) ou direct (*A. rigaudi* et *E. artemiae*). De manière surprenante, nous avons trouvé que les trois parasites manipulent le comportement de leur hôte. *F. liguloides* induit un comportement d'agrégation chez son hôte (Article 6). De plus, le parasite augmente de manière concourante la couleur rouge de son hôte (Article 6). Une précédente étude a montré que l'augmentation de couleur rouge augmentait le taux de prédation par les oiseaux des hôtes infectés (Sanchez et al 2009). Ces résultats suggèrent que l'association de la manipulation du comportement et de la couleur rouge par *F. liguloides* permet d'augmenter la transmission à l'hôte final (Article 6). Les deux microsporidies induisent aussi un

comportement d'agrégation et elles provoquent aussi une remontée dans la colonne d'eau des hôtes infectés (Article 6). Des expériences complémentaires au laboratoire ont montré qu'un tel comportement permettait d'augmenter les transmissions aux hôtes nageant dans le bas de l'agrégat (Article 6). En effet, ces deux microsporidies parasitent uniquement le tube digestif de l'*Artemia* et les spores sont relargués avec les fèces des individus infectés, avant d'être filtrée et ingérées par de nouveaux hôtes (Article 5). Cette étude montre que la manipulation du comportement est partagée par des espèces de parasites phylogénétiquement éloignées. Il est probable que ce mécanisme soit répandu dans le monde animal et qu'il explique une part importante du comportement d'agrégation.

3. Projets annexes

Développements statistiques

Les approches d'écologie de la résurrection comme celles utilisées dans ma thèse, nécessite d'effectuer des mesures des paramètres de survie et de reproduction de génotypes actuels et passés en laboratoire. Une des difficultés principales de ces approches est d'arriver à combiner ces paramètres afin d'obtenir une estimation réaliste de la valeur sélective de ces génotypes. Pour cela, nous avons développé une nouvelle approche statistique appelée *Lifelihood* et qui permet de combiner des données de survie et reproduction afin d'estimer ces paramètres (Article 1). Nous avons de plus créé un logiciel *Lifelihood* qui sera mis librement à la disposition des chercheurs souhaitant utiliser ce type d'approche.

Evolution de l'asexualité et de la polyploïdie dans le genre Artemia

Comprendre l'évolution du mode de reproduction est fondamental en biologie évolutive. Je me suis donc intéressé à la transition entre reproduction sexuée et reproduction asexuée chez l'*Artemia*. En effet, il existe un grand nombre de populations où, selon la littérature, les femelles se reproduisent exclusivement de manière asexuée, tout en produisant des mâles rares à faible fréquence (~1%). Ces

mâles rares sont considérés comme des « erreurs » évolutives. Durant ma thèse, j'ai réalisé des études de génétique des populations d'*Artemia* asexuées (diploïdes et polyploïdes) et sexuées proches. J'ai montré que les mâles rares produits par les espèces asexuées diploïdes permettent des événements occasionnels de reproduction sexuée. De plus, l'hybridation d'espèces diploïdes divergentes a donné naissance à au moins trois lignées polyploïdes indépendantes (Appendice). Cette étude m'a amené à m'intéresser aux conditions évolutives permettant le maintien de la reproduction sexuée et à entreprendre un post-doctorat sur ce thème.

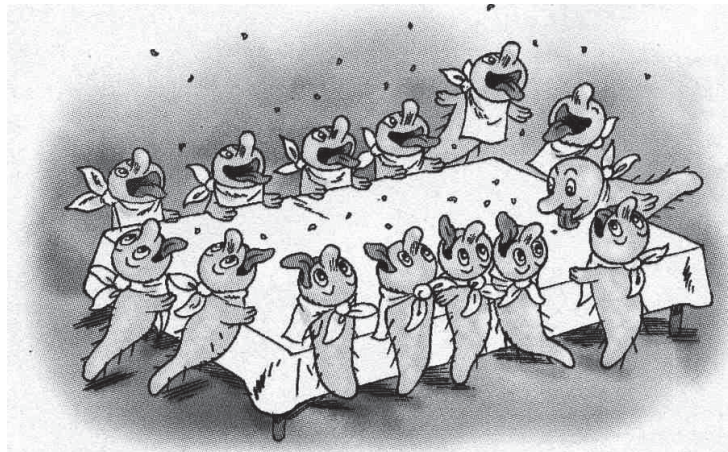

Article 1

Lifelihood, a likelihood approach for fitness and
trade-off analyses of censored multi-event
individual life-histories

Nicolas O. Rode and Thomas Lenormand

In preparation

Abstract

Fitness is a central concept in evolution, yet its computation is complicated in practice. We developed a new program to fit mean individual life history parameters and fitness using a maximum likelihood framework. The main idea is to use life history traits (e.g. age at maturity, age at each reproductive event, number of offspring per reproductive event and survival) either to fit these different life history parameters taking into account the dependency between parameters (e.g. an individual cannot reproduce before being mature) or to fit fitness using all the information in the data directly. The major novelties of this program are: (1) fitting age specific changes of reproductive and survival rates (monotonously or curvilinearly). This modality is particularly useful to test whether the probability of maturing, producing offspring or dying within a time interval increases or decreases with age; (2) measuring phenotypic selection on particular traits with lab fitness estimates that are relevant to fitness in the field; (3) including censored observations. In this case, the precise timing of each life history event is not necessary, only the age interval in which the event occurred is required and the individuals not followed until their death can still be taken into account in the computation of fitness estimates; (4) fitting different life history parameters to different sexes, even if the sex of some individuals is unknown (e.g. when individuals die before sex assignment is possible); (5) fitting trade-offs between reproduction and survival as an increase in mortality rate following each reproductive event. This will allow the independent estimation of reproduction-dependent and reproduction-independent increase in age specific mortality rate.

Keywords: Multiple time failure survival model, Interval censored observations, Right-censored data

Introduction

Fitness comparisons of different groups or genotypes are central for hypothesis testing in evolutionary experiments (ROFF 1992). Two broad methods have been developed to measure fitness (FALCONER and MACKAY 1996). The first is to perform a competition experiment between different genotypes and obtain a direct measure of individual fitness with e.g. the number of offspring or grand-offspring (e.g. KNIGHT and ROBERTSON 1957; SVED 1989). The second consists in measuring a suite of life histories for each genotype independently and combining them to obtain, under some assumptions, an estimation of fitness (e.g. CLUTTON-BROCK *et al.* 1982).

The first method is extremely powerful and has provided the best fitness measures to date (GALLET *et al.* 2012). However, it also presents important limitations. The first obvious limitation is that this type of experiment cannot be performed on all organisms in a reasonable amount of time, space and effort. It is very well suited to microbes, can be used on small organisms (*Drosophila*, *Caenorhabditis* etc.), but is not feasible on large organisms except under very specific conditions (e.g. semi-natural set-ups). In sexual populations with several segregating loci, selective interactions within and among loci have to be taken into account in addition to allelic effects, which can seriously complicate the method. The second limitation is that this

method does not provide the demographic underpinning of the fitness differences and may therefore be less easily extrapolated to other environmental conditions.

The second method is based on the measure of a series of 'fitness-related' traits, which are typically components of individual life histories (e.g. juvenile survival, brood size, lifetime reproductive success, age at maturity etc.). This method is especially useful when applied to long-lived species as it can rely on data collected over a short period of time (one generation) and on any organism whose life history can be individually monitored. There are however three issues with this approach. The first is the difficulty to compute reliable fitness estimates from individual life history data to test for fitness differences between genotypes. The second is that one needs to combine disparate statistical analyses (done for each trait). For instance, survival models are statistically very different from models analyzing offspring number. The third limitation is that the approach often results in performing analyses for the different traits on different subset of individuals. For instance, it is not straightforward to compute life time reproductive success in experiments where some individuals are still alive when observations are stopped (right-censoring). There are plenty of other similar situations where the dataset has to be trimmed to avoid introducing bias, at the cost of losing much information (SHAW *et al.* 2008).

In this paper, we develop an approach to deal with these three types of problems that arise when attempting to estimate individual fitness based on a suite of life-history traits. In a nutshell, the idea is based on a generalized survival model, where the timing of each event in the life history (age at maturity, age at clutch i , age at death) is analyzed as a censored event. Different 'hazard' functions are associated to the different events to encompass a wide variety of possible life histories and each hazard can start accumulating only after some other specified event. In particular the hazard for first clutch accumulates once maturity has been reached and the hazard for clutch i ($i > 1$) accumulates once clutch $i - 1$ has been laid. Finally the probability of a 'clutch event' is given by the product of the probability that this clutch is laid on a given time interval times the probability of observing the number of offspring in that clutch.

This method offers an integrated likelihood framework to address a large number of statistical problems. The three main applications are (1) to analyze different components of life histories in a single step, taking all information and all individuals into account (2) to analyze fitness differences between genotypes/phenotypes using several possible fitness definitions and with extension to analyze fitness functions (e.g. reaction norms), (3) to model interactions (e.g. trade-offs) between life history components such as survival and reproduction as direct changes in hazard functions that can

depend on individual past life history. We will first present the method generally, introducing notations for the data, and deriving the likelihood. We will then illustrate each of this application with simulated data. An accompanying program *Lifelikelihood* can be used to fit the data and the notation used here is parallel with the notation used in the program.

Multi-event survival model

We denote the life history observed for a given individual as an ordered list of events. In a basic female life history there are at least three types of events (1) *maturity*, (2) *reproduction*, (3) *death*. In male life history only the timing of *maturity* and *death* can usually be determined. In most life-history studies, the timing of these events is usually not directly observed, but each event is either observed on the time interval $[t_1, t_2[$ or not observed before the end of the experiment. The latter situation (“right censoring”) can be modeled equivalently by considering ‘occurrence’ on the interval $[t_{\text{end}}, \infty[$, where t_{end} is the date of last observation. Thus all events can be seen as occurring in some time interval. We develop the likelihood in this situation below, but precise data without any censoring can of course be used if available. The fundamental idea is to analyze these events using a generalized ‘survival analysis’. In a standard survival analysis, *death*, is supposed to occur stochastically depending on the amount of ‘hazard’ accumulated since birth (represented by the integral between 0 and any age t in

equation (1) below). The hazard function can take different shapes leading to different distributions of death time (e.g. Exponential, Weibull, Gamma, Log-normal or Gompertz). Similarly, we assume that maturity occurs stochastically depending on the amount of ‘hazard’ accumulated since birth. If *death* occurs before, however, maturity is noted as a right censored event at the time of death (i.e. it is assumed to ‘occur’ on $[t_{\text{death}}, \infty[$). *Reproduction* events are also assumed to occur stochastically depending on the amount of a hazard accumulated since the date of the last clutch (or since maturity for the first *reproduction* event). Importantly, if a female has matured, the likelihood of not observing any *reproduction* event between the last event observed and the last observation of her alive before *death* has to be accounted for. Hence, we add an event for the last + 1 *reproduction* event, which we implicitly assume to ‘occur’ on the interval $[t_{\text{death}}, \infty[$. This new event is right-censored at the time of death, to account for the fact that no clutch has been observed between the last clutch (or maturity if no clutch has been observed after maturity) and death.

We note $\lambda(t)$ the hazard rate at time t , $\Lambda(t)$ the cumulated hazard at time t and $S(t)$ the survival function at time t . The survival function $S(t)$ gives the probability that an event (maturity, reproduction or death) occurs after time t . We have

$$\begin{aligned}\Lambda(t) &= \int_0^t \lambda(x) dx \\ S(t) &= \text{Exp}(-\Lambda(t))\end{aligned}\tag{1}$$

Let us note λ_{mat} , λ_{repro} and λ_{death} the instantaneous hazard functions for the different type of events (and correspondingly S_{mat} , S_{repro} and S_{death} the survival functions). The probability that an event e occurs on the interval $[t_1, t_2]$ is $\text{Prob}(e) = S(t_1) - S(t_2)$ with the appropriate S function depending on the type of event (maturity, reproduction or death). The likelihood of a given life history h is then the product of the probability of each event in this life history:

$$L_h(\text{life history } h|\boldsymbol{\theta}) = \prod_{e \in h} (S(t_{1,e}) - S(t_{2,e})),\tag{2}$$

where $\boldsymbol{\theta}$ is the vector of parameters for all hazard functions used, $t_{1,e}$ and $t_{2,e}$ represent the last age at which the event e was not observed and the first age at which the event e was observed. Fig. 1A provides an example for a particular life history.

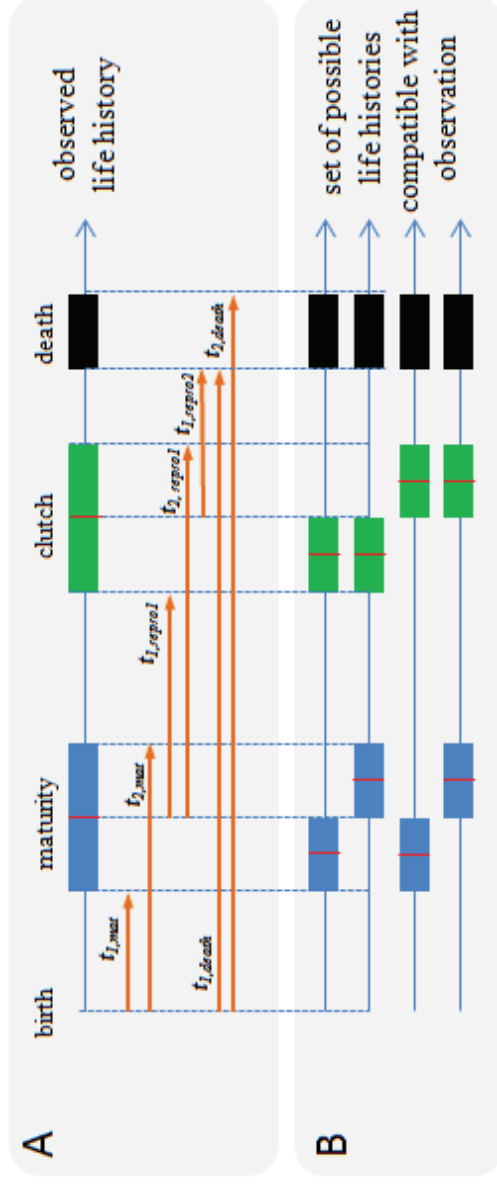

Figure 1. Example of computation. Panel (A) illustrates the data corresponding to a life history with a single clutch and death observed before the end of the observation period. The blue box represents the time interval when maturity is known to occur, the green box, the time interval when the first clutch is laid and the black box the time interval when death occurs. The orange arrows represent the period of hazard accumulation for each event.

Figure 1. (continued)

The likelihood of this particular life history is

$$L_h(\text{life history } h|\theta) = \left(S_{mat}(t_{1,mat}) - S_{mat}(t_{2,mat}) \right) \left(S_{repro}(t_{1,mat}) - S_{repro}(t_{2,mat}) \right) \left(S_{repro}(t_{1,mat}) - S_{repro}(t_{1,mat}) \right) \left(S_{death}(t_{1,death}) - S_{death}(t_{2,death}) \right). \quad (x)$$

Note that the term $S_{repro}(t_{1,mat})$ corresponds to the likelihood of not observing any *reproduction* event between the last *reproduction* event observed and the last observation of the individual alive before *death*. When the intervals of observation are wide compared to the duration of the life history, as illustrated, a large uncertainty is introduced by assuming that the *reproduction* hazard starts accumulating at the median time (in red) within the interval of the previous event. This previous event is maturity for the first clutch (with a start date $(t_{1,mat} + t_{2,mat})/2$) and it is the first clutch for the second clutch (with a start date $(t_{1,mat} + t_{2,mat})/2$). Note that the second clutch is not observed in this life history, but could have stochastically occurred between first clutch and death, which must be accounted for. Since this median time is a very crude measure, it is better to integrate the likelihood over different starting times (each within its own interval). One simple solution to perform this integration is to divide the interval of each event into subintervals. This is illustrated on panel (b) where *maturity* and *reproduction* intervals are divided into two subintervals. The likelihood of each new life history is computed exactly as in panel (a) and the overall likelihood is then summed over these different life histories.

The likelihood of a given dataset is obtained by the product of the likelihood over all individuals. Similar or different hazard functions can be fitted for different groups of individuals for each event type (e.g. if males and females have different survival hazard functions). Computing this likelihood presents two difficulties that we did not mention yet. The first is that the timing of the different events is not precisely known. We only know the time interval in which they occur. This is problematic for *reproduction* events where we need to know the date of the previous event to determine the time at which the *reproduction* hazard starts accumulating. Accounting for this uncertainty is difficult as the proper likelihood would require to chain integrate over all uncertain time within each *reproduction* interval. A simple approximation to this very heavy integration is to take the average time in the interval as the starting date for hazard accumulation to the next event and, to divide intervals of observation of each event in sub-intervals and generate the list of all possible life histories (this set is noted H) that would be compatible with the one that is actually observed (Fig. 1B). The likelihood of an observed individual life history is then the sum of likelihoods of the different life histories in H .

$$L_h(\text{life history } h|\theta) = \sum_{g \in H} L_g(\text{life history } g|\theta), \quad (3)$$

Fig. 1B gives an example of this partitioning and set H . With many sub-intervals, the number of possible life history increases rapidly, but the width of sub-intervals can be chosen such that the total number of life histories does not exceed some threshold. The method described here can be extended to encompass modifications of the basic event types presented above (e.g. metamorphosis in insects) or other types of event (e.g. marriage in humans, larval stages in insects, etc). It can also be useful in other contexts, such as analyzing longitudinal data analysis of individual infection history. Such 'multiple failure time' models have been developed especially in this epidemiological context (FINE and GRAY 1999).

Added event features

Each event may be characterized not only by its timing of occurrence, but also by extra features. In particular, clutch size may itself be recorded and stochastically distributed. Incorporating this information in the likelihood is straightforward as it only requires to multiply the likelihood by the probability to draw a clutch of size x given that it occurred.

One simple approach is to consider that clutch size follows a zero-truncated Poisson distribution, as any clutch observed as at least one offspring.

Noting $P_e(x)$ the probability that the event e extra feature has value x , the likelihood becomes:

$$L_h(\text{life history } h|\theta) = \prod_{e \in h} \left(S(t_{1,e}) - S(t_{2,e}) \right) P_e(x), \quad (2)$$

where θ include the parameters for all hazard functions and the parameter of the zero-truncated Poisson distribution.

Juvenile mortality and partial sex assignment

Many species have bathtub-shape hazard functions where survival hazard is high early in life, then decreases to a plateau and then increases late in life with senescence (e.g. CHOQUET *et al.* 2011). Such curvilinear functions are not accounted for by standard two-parameter survival function such as Weibull or LogNormal. Hence, we modeled the proportion of individuals surviving between birth and a certain age t_{jmort} with a Bernouilli probability P_{jmort} . This age t_{jmort} can be defined by the user and usually correspond to the end of high juvenile mortality period. Hence, when the P_{jmort} parameter is fitted, the probability of surviving the “high mortality” interval $[0, t_{jmort}]$ is: $P_{jmort} S(t_{jmort})$.

In many animal and dioecious plant species, the absence of sexual dimorphism prevents the discrimination of males and females, especially in juveniles. This can be a significant problem when life history parameters related to *maturity* or *death* events differ between sexes. When sex cannot be assigned for some of the individuals, the likelihood

can nevertheless be computed by fitting the sex ratio at birth. Specifically, the probability of the life history of a non-sexed individual is the probability of its life history given that it is female times the probability of being female plus the probability of the life history given it is male times the probability of being a male. This option is available in Likelihood. Hence, differences in male and females life histories can be tested, even for data with partial sex assignment. Fitting different life history parameters to different classes of individuals by taking into account individuals with unknown class (e.g. dominant/subordinates, self-fertilized/outcrossed, etc...) is another potential application of this option.

Input and output

Input files should include one row per individual and should contain all life history information (i.e. observation interval for maturity, reproduction and death). Right-censored individuals (i.e. that either died before maturing or with unknown age of death) should be specified with $t_{2, e} = \text{NA}$. Any text output file can be selected before fitting the data to export the life history parameter estimates as well the log-likelihood associated.

Parameter estimation

We used classical survival distributions such as Weibull, LogNormal and exponential to compute the likelihood of the different life history events. The functions are quite flexible as

they allow monotonous increase (or decrease) with age of event hazard (for the Weibull distribution), as well as increase and decrease with age of the event hazard (for the LogNormal distribution). The exponential distribution with a constant hazard can also be used. The minimum, maximum bounds and starting value of each parameter are user-defined. Parameter estimates are computed by Maximum Likelihood with simulated annealing algorithm. A random number generator with integer seeds (MARSAGLIA *et al.* 1990) is used to explore the likelihood landscape. Annealing schedule can be chosen by modifying the “Metropolis Parameters” in the Custom window. Convergence can be checked by repeating parameter estimation with different starting values, by increasing the number of iterations in of the Metropolis parameters or by using different seeds for the random number generator. Estimate of standard errors are computed using the second-order partial derivatives (*Hessian* matrix) at the maximum.

Fitness reparameterization

Fitness differences among individuals are of primary interest to most evolutionary experimentalists and the definition of fitness depends critically on the characteristics and dynamics of the population studied (BROMMER *et al.* 2002; STEARNS 1992). The intrinsic rate of increase, r , is a good fitness measure in a population with a stable age structures, when

population size is growing (or declining) exponentially. Comparatively, the lifetime reproductive success, LRS (or adjusted LRS, see below), is an appropriate measure when the population is stable. In principle, estimating fitness only require to reparameterize the model in term one of these fitness measures. One simple approach is to reparameterize clutch size as a function of fitness, as this parameter is likely to increase monotonically with fitness. So far, only the LRS based fitness measures are implemented in Lifelihood. Applying the same method for the intrinsic rate of increase would be similar, but would be more computationally intensive as it requires to numerically solve the Euler-Lotka equation to reparameterize the likelihood function.

Inference from fitness differences in the lab to relevant fitness differences in nature is often hampered by possible discrepancies between the lab and field estimates of survival and fecundity. For instance, several sources of extrinsic mortality are likely to be found in a natural situation compared to lab-optimized cultures. To account for such problem, Pekkala (2011) propose the calculation of an adjusted LRS measure taking into account the likely increased extrinsic mortality in nature. Lifelihood allows the computation of such adjusted LRS. The idea is that lab measures allow computing a r_{max} , corresponding to the asymptotic population growth rate in absence of density dependence, predators, parasites, etc.

The adjusted LRS in Lifelihood is defined as:

$$adjLRS = \int_0^{\infty} (1 - S_{mat}(t)) B(t) S_{repro}(t) \exp^{-d t} dt, \quad (3)$$

where d , the discount rate, can be set at any value between 0 and r_{max} . Hence, for $d = 0$, the adjusted LRS equals the LRS and for $d = r_{max}$, the adjusted LRS equals 1 (as defined by the Euler-Lotka equation, LOTKA 1907). The adjusted LRS might be an appropriate fitness measure when the population growth is not dependent upon the genotypes in competition, but this remains to be formally demonstrated. In Lifelihood, the users can choose which demographic conditions would be the most relevant to their system. When this option is selected, the likelihood is reparametrized with the adjusted LRS instead of the number of offspring, which allow the computation of adjusted LRS' standard errors and most importantly allow constraining fitness to be identical among different groups of individuals (for hypothesis testing) or to express fitness as functions of individual covariates.

Goodness of fit

Goodness of fit can be assessed either independently for each event distribution or with a bootstrap-goodness-of-fit method. The first approach is a way to detect the lack of fit of some of the events as in classical goodness of fit approaches (BOLKER 2008; FARAWAY 2006). For instance, the adequacy between

the observed event distribution of each group and the corresponding fitted event distribution can be verified (e.g. for 'survival' models BRADBURN *et al.* 2003). The second approach aims at checking the "overall" goodness of fit of the model and the global absence of violation of model assumptions (i.e. independence of observations, no overdispersion). A large number of datasets are simulated with the same number of individuals as in the observed dataset. They are sampled in distributions corresponding to the parameter best estimates fitted on the observed dataset. These simulated datasets are then analyzed with the same model to obtain the expected distribution of deviances under all the assumptions of the model. The observed deviance is then ranked to compute a P-value determining the proportion of simulated datasets with more extreme deviances. In case of overdispersion, and to avoid overfitting, all deviances can be divided by the coefficient of overdispersion \hat{c} (BURNHAM and ANDERSON 2002). This coefficient can be computed by dividing the observed deviance by the mean deviance of simulated models. Corrected deviances can then be used for model selection (e.g. QAIC and QAICc computation, BURNHAM and ANDERSON 2002).

Estimator properties

In order to investigate potential biases and degree of precision of the different parameters estimated with the Likelihood

method, we simulated different datasets for several scenarios that reasonably reflect the type of data one would be interested in practice: estimation of life history parameters under different experimental conditions, estimation of fitness and estimation of trade-off between reproduction and survival. For each scenario, we simulated 500 datasets (1000 individuals each), using Weibull 'survival' distributions for the three types of events (*maturity*, *reproduction* and *death*) and a zero-truncated Poisson distribution to draw clutch size at each *reproduction* event (see Appendix for simulation details). Estimate bias was consistently low, while estimate precision was high and confidence interval coverage was mostly above 93%. As an example, Figure 2 shows Lifelihood results (relative bias, precision and confidence interval coverage), in a simulated experiment where 50% of the individuals were not followed to death.

Confidence Interval Coverage

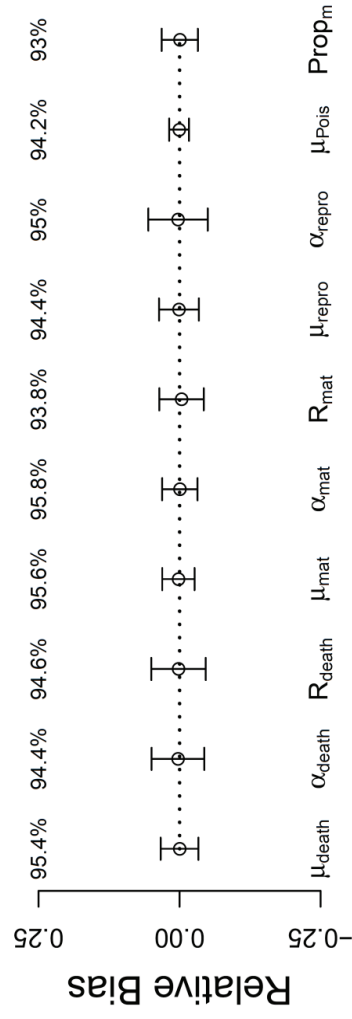

Figure 2. Relative Bias, Precision and Confidence Interval coverage with right-censoring of 50% of the surviving individuals. Points and error bars show relative bias ($\frac{E(\hat{\theta}) - \theta}{\theta}$) and the associated standard deviation (precision, $\sqrt{E[(\hat{\theta} - E[\hat{\theta}])^2]}$). Confidence interval coverage correspond to the proportion of the 500 simulations in which the computed confidence interval ($\hat{\theta} \pm 1.96 \times SE(\hat{\theta})$) actually included the true value θ . Each simulated dataset included 1000 simulated individual life histories. Simulation details are given in appendix. Results were similar when no individual or 25% of individuals were right-censored (data not shown).

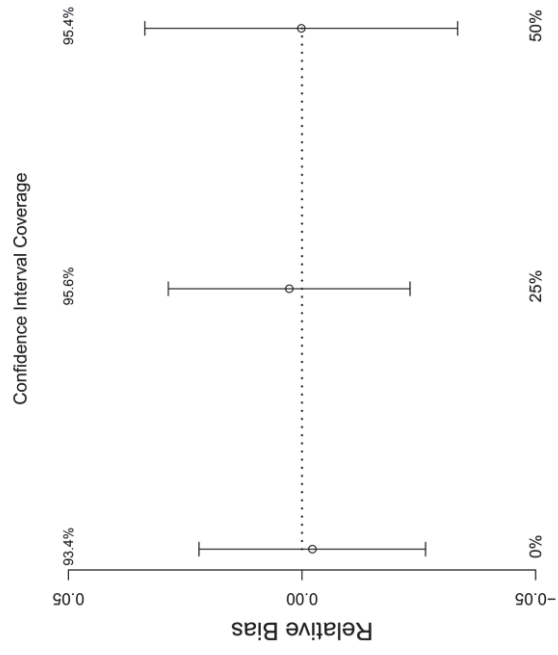

Figure 3. Relative Bias, Precision and Confidence Interval coverage of Weibull scale mortality parameter (μ_{death}) with right-censoring of 0, 25% and 50% of the surviving individuals. See Fig. 2 for the formulae of relative bias and precision computation.

Estimate precision of the Weibull scale parameter (corresponding to female longevity in the absence of senescence) decreased with the percentage of right-censored individuals (Fig. 3). Parameters estimates were also both unbiased and accurate when simulations included partial sex determination (20% individuals with unknown sex, Fig. S1).

Estimate precision of the trade-off parameter (corresponding to the increase of female hazard following each reproduction events) increased with the trade-off parameter used for the simulations (Fig. 4), hence the power to detect such trade-off depend both on the strength of this trade-off and on the number of reproductive events recorded. Estimates of the adjusted LRS setting d to 0 allows calculating the expected LRS even if the life-histories are right censored (Fig. 5). Even with 25% right-censored life histories, adjusted LRS estimates were both precise and unbiased for discount rates spanning the $[0, r_{max}]$ range (Fig. 5).

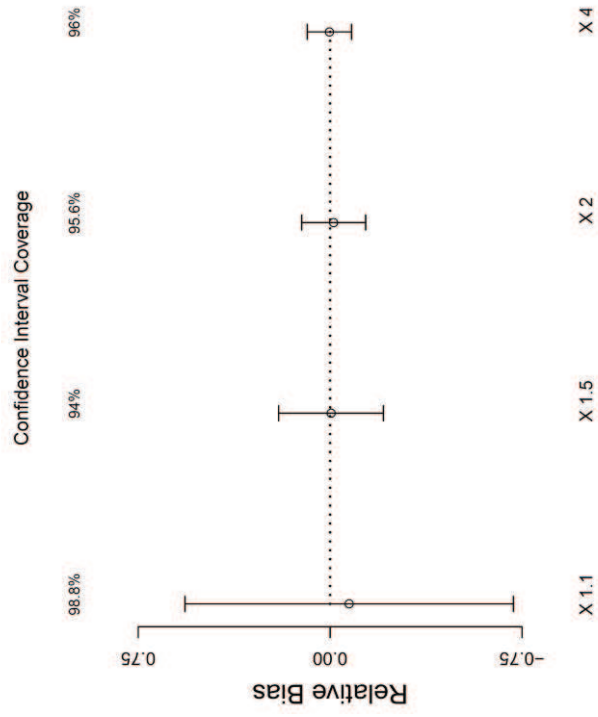

Figure 4. Relative Bias, Precision and Confidence Interval coverage of the reproduction-survival tradeoff parameter. Estimate precision increased with increasing trade-off parameters. See Fig. 2 for the formulae of relative bias and precision computation.

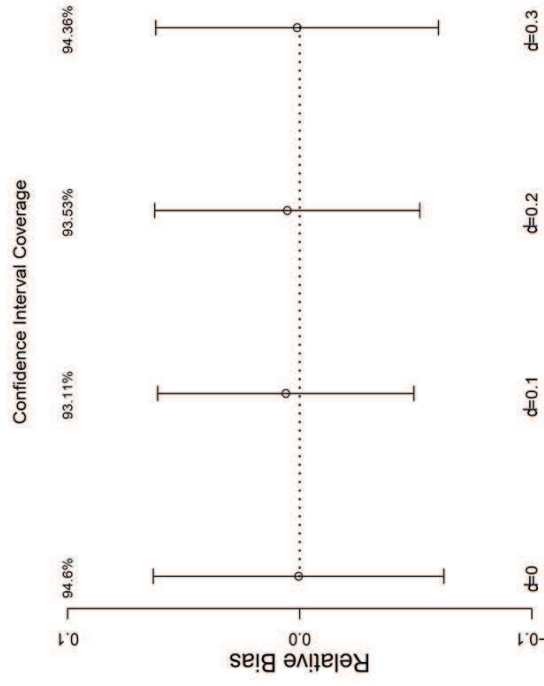

Figure 5. Relative Bias, Precision and Confidence Interval coverage of adjusted LRS with right-censoring of 25% of the surviving individuals. Bottom values of d where chosen in the interval $[0, r_{\max}=0.32]$. Only results of analyses where convergence was reached in the two replicates were included ($n > 450$). See Fig. 2 for the formulae of relative bias and precision computation.

Discussion

Several methods allow modeling time to event data, including multi event survival models, such as competing hazard models (ALLISON 2010a). With the exception of the Aster package (GEYER *et al.* 2007; SHAW *et al.* 2008), these models have never been used for the analysis of individual life histories and fitness. Broadly, survival analyses allow modeling events with either discrete or continuous time (ALLISON 2010a). Discrete time models are most appropriate when event times are truly discrete or when events can happen at any time but are only observed to occur on the same discrete intervals for all individuals (ALLISON 2010a). Continuous time models are most appropriate in other situations, notably when event time are continuous or when events are observed to occur in different discrete intervals for each individuals (ALLISON 2010a). Aster belongs to the first category. It is well suited for organisms whose reproduction systematically occurs in a predictable time interval (e.g. spring for many temperate perennial plants) and when observation in that interval is systematic. Lifelihood approach belongs to the second category. It is well suited for organisms whose reproduction is continuous and not strongly synchronized on predictable external cues (e.g. mice in a laboratory experiment). It is also much more convenient to deal with censoring, especially with individual-specific, and possibly partially overlapping, censoring intervals. For instance

if individual 1 dies in the interval [4, 6], while individual 2 dies in the interval [5, 7], a discrete time model requires to consider the common time interval [4, 7], which loses some information and increases the chance that several events co-occur in the same interval. In contrast, a continuous time model would use each censored interval separately and therefore all the information available. However, whether discrete or continuous, performing integrated analyses of life histories presents five main advantages compared to traditional single event analyses. We discuss them in turn.

(1) Integrated analyses allow accounting for structural dependencies between life history events. Indeed the probability of the occurrence of any event (such as maturity or reproduction, is at a given stage, is conditional on survival to that stage. Dependency to different previous events can also be modeled (e.g. reproduction is conditional on maturity and survival). This is particularly important to correctly model the observed distribution of the data. For example the distribution of observed offspring number for all individuals in a sample depends on the dynamics of all events (maturity, clutch and death) in addition to the time interval of censoring. This can easily lead to complex distributions that cannot be analyzed using standard approaches. Some methods have been devised for this kind of problems (e.g. Zero-Inflated Count distribution to account for the presence of non reproducing individuals, ZEILEIS *et al.* 2008), but they are limited in scope

as (1) they do not distinguish the different biological reasons that may cause e.g. a zero inflation (e.g. death before maturation vs. sterility), (2) they can only model specific deviations of distributions (i.e. zero inflation), and (3) they may be difficult to apply when censoring intervals are not exactly similar for all individuals.

(2) Integrated analyses allow combining survival and reproduction data and to directly estimate fitness with an appropriate model of its sampling error. More traditional approaches either consider each trait separately (which complicates inferences regarding fitness variation) or compute a summary statistics from each life history, which is then analysed either via resampling (e.g. LENSKI and SERVICE 1982; VASSILIEVA and LYNCH 1999) or a standard generalized linear model (e.g. RODE *et al.* 2011). Hierarchical data structure can seriously complicate the use of resampling techniques, while incorrect error structure specification is likely with parametric approaches (see point 1 above). Computing a summary statistics combining several observations also inherently leads to a loss of information and thus statistical power. This problem of performing 'statistics on statistics' is further amplified when the analysis requires a second step. This is a common situation when estimating phenotypic selection gradients (e.g. regression of fitness on environmental or phenotypic individual covariates, SHAW *et al.* 2008). These problems are easily overcome with multi-events analyses

which allow measuring directly from observed data, both phenotypic and correlational selection on several traits.

(3) Integrated analyses allow taking incomplete life histories (e.g. right-censored individuals) into account even when analyzing a fitness measure that requires in principle lifetime information. Traditional approaches would trim incomplete data e.g. when investigating a trait that depends on lifetime information. A first problem is that trimming data leads to loss of information. Indeed, partial life histories can provide valuable information, provided there is little within group heterogeneity in life history parameters. A second problem is that life history data can be incomplete in different ways (e.g. some individuals may have incomplete information for either maturity, reproduction or death), so that the final dataset with complete life histories is very small compared to the overall dataset. Last, trimming the data may bias inferences when exclusion of individual with missing data generates different bias in different groups. For instance excluding live individual at the end of an experiment may more downwardly bias LRS estimates in groups of long-lived individuals than in groups of short lived individuals. This situation of 'selective disappearance' is a common problem in life history analyses, which can be partially addressed using an integrated censored life history analysis. In addition to incomplete life histories, it is possible to account for incomplete individual covariate information in some cases. For instance, as we have shown,

datasets with partial sex assignment can be used to test for differences between male and female life history parameters.

(4) Integrated analyses allow modeling possible trade-offs between life history events. As the whole individual life history is considered, dependency between individual events can be easily modeled, by changing the hazard of an event depending on the actual date of occurrence of another event. This approach offers an avenue to model phenotypic trade-off using the random occurrence of events in different individuals of the same genotype. Controlling for this phenotypic trade-off allows a better distinction of genotypic from phenotypic trade-offs among life histories. A prominent application of this approach would be to distinguish, for different genotypes, reproductive and actuarial senescence from various trade-off involving survival and reproduction.

There are some statistical drawbacks to the use of integrated life history analyses. The first issue is that a large number of parameters need to be considered. High dimensionality of Likelihood models can indeed cause global optimization problems, so that algorithm converges to a local maximum. Importantly, model convergence has to be carefully examined, especially when using the fitness reparameterization option. High dimensionality is also an issue for model selection. For complex life history data, the total number of models can rarely be exhaustively explored. In this case, model selection should be conducted considering only

relevant biological hypotheses. A second issue arises when the same event is repeated within the life history of an individual (e.g. reproduction). Likelihood and aster approaches indeed treat these observations as distinct information. Such repeated observations provide more statistical power (see above) and allow considering unobserved variables that affect reproduction and are constant through time. However, within groups individual heterogeneity may generate statistical dependence between these observations and alter the error structure assumed. Dependence between observations can be accounted for with several methods (ALLISON 2010b). Implementation of individual random effects (frailty in survival models) would for example correct for this potential problem. However, such effects will require integrating over the likelihood function for several parameter assuming a distribution for their within group variation. While possible in principle, it will further increase model dimensionality and algorithm convergence time.

Conclusion

Multi-event survival analyses provide a powerful statistical framework for the study of complex life-history data. Likelihood models differ mainly from Aster models in analyzing continuous rather than discrete time life history data. Dependency between events, accurate fitness and phenotypic selection estimates are the main advantages of Aster and

Lifelihood models. Although Lifelihood currently lack the implementation of intrinsic rate of increase, this software allow computing the adjusted LRS (PEKKALA *et al.* 2011). Such alternative fitness estimate might be relevant when comparing different genotypes in the laboratory to infer their fitness differences in the field. In addition, both Aster and Lifelihood allow testing for life history difference between groups, when incomplete life history data is available. Lifelihood provides a better handling of censored data and account for uncertainties of interval censored observations. Finally, the lifelihood approach open new avenues for the study of time-dependent trade-offs between life history traits. Comparison of models with increased hazard as a function of clutch number or clutch size or increased hazard that decreases with the time after reproduction should give new insights on the physiological links between reproduction and survival.

Acknowledgements

We thank R. Choquet, O. Gimenez, R. Pradel and O. Ronce for discussion. We are also grateful to A. Charmantier for comments on an early draft of this manuscript. We also thank M.C. Quidoz who is in charge of the cluster used for the simulations.

Contribution statement

TL had the idea of the Lifelihood analysis. TL and NOR discussed about the implementation. TL and NOR implemented the program. NOR did the simulations to test the program. TL and NOR wrote the paper.

References

- ALLISON, P. D., 2010a *Survival analysis*. Taylor and Francis, New York.
- ALLISON, P. D., 2010b *Survival analysis using SAS: A practical guide*. SAS publishing.
- BOLKER, B. M., 2008 *Ecological models and data in R*. Princeton Univ Pr.
- BRADBURN, M., T. CLARK, S. LOVE and D. ALTMAN, 2003 Survival Analysis Part III: Multivariate data analysis—choosing a model and assessing its adequacy and fit. *British journal of cancer* **89**: 605.
- BROMMER, J. E., J. MERILA and H. KOKKO, 2002 Reproductive timing and individual fitness. *Ecology Letters* **5**: 802-810.
- BURNHAM, K. P., and D. R. ANDERSON, 2002 *Model Selection and Multi-Model Inference: A Practical Information-Theoretic Approach*. Springer-Verlag, New York.
- CHOQUET, R., A. VIALLEFONT, L. ROUAN, K. GAANOUN and J. M. GAILLARD, 2011 A semi-Markov model to assess reliably survival patterns from birth to death in free-ranging populations. *Methods in Ecology and Evolution* **2**: 383-389.
- CLUTTON-BROCK, T. H., F. E. GUINNESS and S. D. ALBON, 1982 *Red deer: behavior and ecology of two sexes*. University of Chicago Press.

- FALCONER, D. S., and T. F. C. MACKAY, 1996 *Introduction to Quantitative Genetics*. Longman, New York.
- FARAWAY, J. J., 2006 *Extending the linear model with R: generalized linear, mixed effects and nonparametric regression models*. CRC press.
- FINE, J. P., and R. J. GRAY, 1999 A proportional hazards model for the subdistribution of a competing risk. *Journal of the American Statistical Association*: 496-509.
- GALLET, R., T. F. COOPER, S. F. ELENA and T. LENORMAND, 2012 Measuring selection coefficients below 10^{-3} : method, questions, and prospects. *Genetics* **190**: 175-186.
- GEYER, C. J., S. WAGENIUS and R. G. SHAW, 2007 Aster models for life history analysis. *Biometrika* **94**: 415-426.
- KNIGHT, G., and A. ROBERTSON, 1957 Fitness as a measurable character in *Drosophila*. *Genetics* **42**: 524.
- LENSKI, R. E., and P. M. SERVICE, 1982 The statistical analysis of population growth rates calculated from schedules of survivorship and fecundity. *Ecology* **63**: 655-662.
- LOTKA, A. J., 1907 Studies on the mode of growth of material aggregates. *American Journal of Science* **4**: 199.
- MARSAGLIA, G., B. NARASIMHAN and A. ZAMAN, 1990 A random number generator for PC's. *Computer Physics Communications* **60**: 345-349.
- PEKKALA, N., J. S. KOTIAHO and M. PUURTINEN, 2011 Laboratory Relationships between Adult Lifetime Reproductive Success and Fitness Surrogates in a *Drosophila littoralis* Population. *Plos One* **6**: e24560.
- RODE, N. O., A. CHARMANTIER and T. LENORMAND, 2011 Male-Female Coevolution in the Wild: Evidence from a time series in *Artemia franciscana*. *Evolution*.
- ROFF, D. A., 1992 *The evolution of life histories: Theory and analysis*. Chapman and Hall, New York.

- SHAW, R. G., C. J. GEYER, S. WAGENIUS, H. H. HANGELBROEK and J. R. ETTERSON, 2008 Unifying Life-History Analyses for Inference of Fitness and Population Growth. *The American Naturalist* **172**: E35-E47.
- STEARNS, S. C., 1992 *The Evolution of Life Histories*. Oxford University Press, Oxford.
- SVED, J. A., 1989 *The measurement of fitness in Drosophila*. C. A. B. International Wallingford.
- VASSILIEVA, L. L., and M. LYNCH, 1999 The Rate of Spontaneous Mutation for Life-History Traits in *Caenorhabditis elegans*. *Genetics* **151**: 119-129.
- ZEILEIS, A., C. KLEIBER and S. JACKMAN, 2008 Regression models for count data in R. *Journal of Statistical Software* **27**: 1-25.

Article 1

SUPPLEMENTARY MATERIALS

Simulation details

Simulations were performed with the R. software (version 2.14.2). We first determined the sex (*Sex*) of each individual using a Bernoulli distribution with the simulated sex ratio as parameter ($Prop_m$). We then simulated the life history of the individual according to his/her sex (*Sex*=1, female; *Sex*=0, male). We then consider a small interval (e.g. from 0 to dt) where we calculated the probability of occurrence of each event (*maturity*, *reproduction* and *death*) by integrating the event hazards over the small interval dt . We then used a uniform distribution between 0 and 1 to determine if each event occurred (or not) within this interval. The *reproduction* events were conditioned on the time since the occurrence of *maturity* or the previous *reproduction* events. We repeated simulations over successive intervals (i.e. $[0, dt[$; $[dt, 2dt[$; etc...) until death occurred (or alternatively until a certain age t_{cens} at which individuals were right-censored). In simulations aimed at testing Likelihood robustness to partial sex assignment, we determined a

threshold age at which sex could be assigned. Hence, the sex of individuals dying before this age remained unknown. In simulations aimed at testing the statistical power to detect reproduction-survival trade-offs, we incremented female hazard by a small value corresponding to the cost of reproduction multiplied by the number of reproduction events (*trade-off* X number of reproduction events), we then integrated the incremented hazard over the small interval *dt*. Once simulations were completed, we determine the frequency *visit* of the event census. Hence, we determined in which *visit* interval each event occurred and recorded the event as having occurred between the lower bound and upper bound of this interval. As a consequence, several events could happen in the same interval in the simulations. When two *reproduction* events occurred in the same interval, we recorded only one event and added the number of offspring produced during these events.

Simulation parameters

Life history simulations without censoring and complete sex assignment

For each of the 500 datasets, we simulated the life histories of 1000 individuals with the following parameter values:

$dt=0.01$

$visit=0.1$

$\mu_{mat}=10, \alpha_{mat}=2, \mu_{repro}=5, \alpha_{repro}=2, \mu_{death}=15, \alpha_{death}=2,$
 $\mu_{Pois}=15, R_{mat}=0.9, R_{death}=1.1, t_{jmort}= 0$ (which is equivalent to $P_{jmort}=1$, i.e. no early juvenile mortality)

1. Sex was determined with a Bernouilli distribution and survival b

$Sex \sim \text{Bernouilli} (Prop_m)$

2.1. if the individuals was a female we simulated the life history with the following parameters:

$S_{mat} \sim \text{Weibull} (\mu_{mat}, \alpha_{mat})$

$S_{repro} \sim \text{Weibull} (\mu_{repro}, \alpha_{repro})$

$$S_{death} \sim \text{Weibull}(\mu_{death}, \alpha_{death})$$

$$P_e \sim \text{Poisson}(\mu_{Pois})$$

2.2. if the individual was a male we simulated the life history with the following parameters:

$$S_{mat} \sim \text{Weibull}(\mu_{mat} \times R_{mat}, \alpha_{mat})$$

$$S_{death} \sim \text{Weibull}(\mu_{death} \times R_{death}, \alpha_{death})$$

Life history simulations without censoring and partial sex assignment

We used the life history parameters mentioned above to simulate individual life histories, but sex was assigned only to individuals alive at age 8 (~80% of individuals with our parameters).

Life history simulations with right-censoring of 25% and 50% of individuals and complete sex assignment

We used the life history parameters mentioned above to simulate individual life histories, but we disregarded all information after the age 17.6 and

12, corresponding approximately to the 25% and 50% survival quantiles.

Life history simulations with a reproduction-survival female trade-off without censoring

We used the life history parameters mentioned above to simulate individual life histories, but we added a small increment '*tradeoff*' after each female reproductive event. Hence, female hazard depends both on her age and her reproductive history. We used four *tradeoff* value (0.01, 0.05, 0.1, 0.3), which with our life history parameter correspond approximately to multiply female hazard by 1.1, 1.5, 2, 4 (Fig. 4).

Lifelihood analyses

Analyses with censoring or partial sex assignment

In the dataset, each line corresponds to an individual life history. The first event corresponds to sex. Each event in the life history is censored on the interval $]t_{1,e}, t_{2,e}]$. If maturity or death events are not

observed, they are right-censored with $t_{2,e} = t_{inf}$. (i.e. the event occurred in the interval $]t_{1,e}, t_{inf}[$. Sex information can be missing for some of the individuals, in that case, the life-histories of such individuals are included in the likelihood with both male parameters (with a probability equal to the sex ratio) and with female parameters (with a probability equal to one minus de sex-ratio).

Confidence Interval Coverage

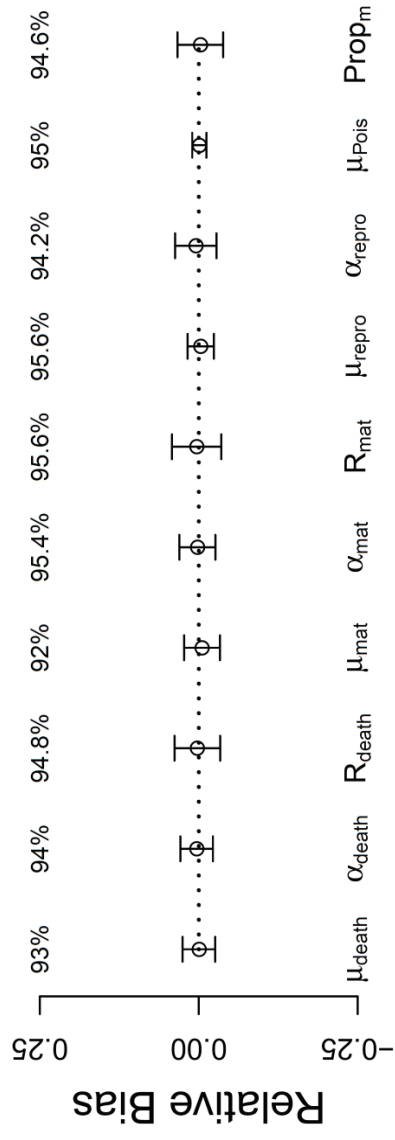

Fig. S1. Relative Bias, Precision and Confidence Interval coverage with partial sex assignment. Each simulated dataset included 1000 simulated individual life histories where sex was assigned only to 80% of the individuals (i.e. those that lived to the age where sex assignment was possible). See Fig. 2 for the formulae of relative bias and precision computation.

Analyses of life history simulations with censoring and complete sex assignment with adjLRS reparametrization

In the analysis aimed at testing the analyses of adjusted LRS, we first calculated the r_{\max} associated with the parameter mentioned above ($r_{\max}=0.3287$). We then reparametrized the adjusted LRS (adjLRS) according to equation (3) and tested four different discount rates comprised between 0 and r_{\max} : $d=0$, $d=0.1$, $d=0.2$, $d=0.3$ (Fig. 5). We used the 500 simulations with the life history parameter presented above without any censoring. For each d , we performed two independent Likelihood analyses. Only analyses with log-likelihoods differing by less than 0.0001 were considered ($n>450$). We then used the life history parameters mentioned above, as well as the d used for each analysis to compute independently the expected adjusted LRS (adjLRS). Bias and confidence interval coverage were calculated with this expected adjLRS.

Article 2

Dynamics of temperature adaptation over 130 generations in a wild population of *Artemia franciscana*

N. O. Rode, A. Charmantier, LM. Chevin, G. Martin, R. Jabbour-Zahab,
N. Van Hoa, G. Van Stappen, & T. Lenormand

In preparation

Foreword:

This paper is not finished. We plan to use the Lifelihood approach and software (Article 1) to provide a comprehensive analysis of all the data at hand and to specifically estimate variation in fitness in the experiment. Thus, the results and discussion should be considered preliminary.

Abstract

Knowledge on thermal niches is central for predicting plastic responses to temperature change in ectotherms. However, little is known about the evolution of these niches in the wild, for which most data is comparative and interspecific. Models predict either a shift in optimal temperature or an increased plasticity (and tolerance) following abrupt environmental change, depending on the amount of genetic variance displayed in adaptive traits and their plasticity. Testing these predictions 'in real time' and under natural selection pressures in the wild requires longitudinal data over many generations, and is hampered by the difficulty to accurately estimate breeding values of plasticity in an uncontrolled environment. "Resurrection ecology" (revival of resting stages) represents a good alternative to overcome these shortcomings. We study adaptation to high temperatures over *ca.* 130 generations *in natura*, by reviving dormant cysts from an *Artemia franciscana* population transferred from temperate to tropical salterns in the mid 1980's. Comparison of a time series of ancestral and derived populations raised in the laboratory at different temperatures allowed measuring the gradual evolution of their thermal tolerance curve. We found that the derived population underwent a continuous survival increase (since its introduction) at high temperatures typical of the new environment and a tremendous decrease of survival at low temperatures typical of the ancestral environment. Our preliminary results indicate that the thermal niche may evolve rapidly in the wild, but that this evolution entails trade-offs between performances at high and low temperatures.

Keywords: Temperature; Resurrection ecology; Thermal niche

General Context

Temperature is one of the major determinants of the abiotic ecological niches of many organisms, especially ectotherms (ANGILLETTA 2009), hence thermal adaptation is thought to play a prominent role in eco-evolutionary responses to current global climate change (DEUTSCH *et al.* 2008; HOFFMANN and SGRÒ 2011; PARMESAN 2006). Understanding and predicting the evolution of the thermal niches is therefore important for both fundamental and applied purposes. However, natural selection is often measured over a small number of generations in natural populations (<50 generations, BELL 2008), except for some well known textbook examples (COOK 2003; LABBÉ *et al.* 2009; SCHEMSKE and BIERZYCHUDEK 2001). This limitation is particularly true for the evolution of thermal niches for which our current view is mostly based on interspecific (DEUTSCH *et al.* 2008) and inter-population (HOFFMANN *et al.* 2003) comparisons. Indeed, most data documenting the dynamics of adaptation over more than 100 generations of thermal niches comes from experimental evolution on microorganisms (BENNETT and LENSKI 1993;

KNIES *et al.* 2006; KNIES *et al.* 2009). While these data are extremely valuable, they cannot be directly transposed to field situations: thermal constraints can largely differ between microbes and multicellular organisms; adaptation to more complex natural conditions may often entail the optimization of a much larger number of traits which can largely impact the response to selection (BARTON and PARTRIDGE 2000). In addition, plasticity appear to play a prominent role in the ability of natural populations to cope with environmental change (e.g. CHARMANTIER *et al.* 2008); however, little is known regarding the evolution and limit of plastic responses in natural populations over longer time scales. Investigating such dynamics requires having access to a population sampled through time, as well as precise knowledge of the selection pressures, in order to get relevant fitness estimates in reference environments for each sample. Such long term studies are highly costly and work-intensive. In contrast, resurrection ecology is a powerful tool to investigate long-term evolution in natural populations (COUSYN *et al.* 2001; DECAESTECKER *et al.* 2007; HAIRSTON *et al.* 1999; KERFOOT

and WEIDER 2004; RODE *et al.* 2011). This approach based on the revival of dormant eggs, allows studying both short- and long-term adaptation of natural populations over typically more than 100 generations, which is otherwise hardly feasible in multicellular organisms in the wild. Furthermore, resurrection ecology combined with time shift experiments allows specifically measuring the temporal pattern of adaptation through time. Finally, non-random distribution of genotypes across environments often prevents to estimate genetic and environmental effects independently in natural settings, which can notoriously bias estimations of genetic variance and genetic change (RAUSHER 1992). Resurrection ecology allows overcoming these shortcomings with the phenotypic measurement of a series of naturally occurring genotypes replicated over a series of controlled environmental conditions.

The invasive crustacean *Artemia franciscana* is an interesting system to investigate the evolution of thermal niche, as it has been introduced multiple times from temperate to tropical salterns in the mid-80's (Vos *et al.* 1982). These introductions have resulted in increased resistance to heat

shock of resting stages (cysts) and adults (CLEGG *et al.* 2000; CLEGG *et al.* 2001) and higher reproductive output at high temperature (KAPPAS *et al.* 2004). Temperature and salinity are the main axes of *Artemia*'s niche; such abiotic factors are easily reproduced in the laboratory, which allows obtaining relevant fitness estimates in controlled experiments (BROWNE and WANIGASEKERA 2000). In addition, *Artemia* species produce dormant eggs that can be hatched after several years and used to test the occurrence of microevolution over a large number of generations (RODE *et al.* 2011). This study was based on a time-shift experiment using times series of dormant *Artemia* eggs collected in an ancestral temperate population (San Francisco Bay, USA) as well as in an introduced tropical population (Vinh Chau, Vietnam). Since the introduction was associated with a strong shift in ambient temperatures (from 20-22°C in California to 27.5-30°C in Vietnam) we tested for a thermal niche evolution based on the analysis of survival, reproduction and trade-offs measured for both the ancestral and the introduced population in a series of temperatures. The general aim was to document the rate of

adaptation in a natural population after a sudden change in environmental conditions.

Methods

Population history and experimental setup

A. franciscana cysts from the San Francisco Bay population have been introduced in Vinh Chau salterns in the Mekong delta (Vietnam) in 1986 for cysts harvesting (ROTHUIS 1987). Mean temperature in San Francisco Bay salterns is about 22°C (min: 3°C, max: 28°C, CARPELAN 1957). In contrast, mean temperature in Vinh Chau is about 27°C (min:22, max: 35°C, VAN HOA 2002). As a consequence, maximal temperature in Vinh Chau is close to the thermal tolerance limit of *A. franciscana* from the ancestral population (37°C, VOS *et al.* 1984). Vinh Chau cysts have been collected every year since the introduction for commercial purposes. Each year, ponds are re-inoculated at the beginning of the dry season (December-January) with cysts stocked in the previous year (VAN HOA 2002). Salinity is controlled in Vinh Chau salt ponds and ranges from 90 to 150g/l (as San Francisco Bay population, (CARPELAN 1957; VAN HOA 2002).

Artemia populations go extinct annually with the flooding of salterns at the beginning of the wet season (May-June).

We took advantage of cyst time series collected from the population of origin, in San Francisco Bay, hereafter 'ancestral' population (1984, 2003, Fig. 1) and from the introduced population in Vinh Chau, hereafter the 'derived' population (1988, 1994, 1997, 2008, Fig. 1). We used cyst samples from the Artemia Reference Center (except for the frozen SFB 1984 sample provided by Dr. J. Clegg). Cyst samples have been kept frozen since their of collection. As all ponds are reinoculated each year with the same stock of cysts from the previous year, confounding temporal and spatial heterogeneities are unlikely.



Figure 1 | Test for the evolution of the thermal niche in the derived population. Sampling dates of the ancestral (San Francisco Bay, SFB, 1984, 2003) and derived populations (Vinh Chau, VC, 1988, 1994, 1997, 2008) are provided on a relative time scale. The red arrow marks the introduction of *Artemia franciscana* from SFB to VC in 1986.

Cysts were hatched at $25\pm 1^{\circ}\text{C}$ (RODE *et al.* 2011). Larvae were kept in 20L tanks with sea water (50g/L) and fed once a week *Dunaliella tertiolecta* algae *ad libitum*. To avoid maternal and environmental effects such as conservation time, we mated males from each population to different females from two strains (San Francisco Bay and Great Salt Lake, mean=13.5 males per population, min=6, max=18, Fig. 2). Crosses were performed in test tubes at $25\pm 1^{\circ}\text{C}$, which is intermediate between the ancestral and derived populations. The presence of nauplii larvae was checked daily and we recovered 2439 F1 nauplii over the first four weeks of the experiment. Sibling F1 nauplii were split into 8 different temperature treatments randomized in two rooms. Each nauplius was isolated in a test tube with a filter bottom to allow the water to flow (mesh size: 120 μm). Tubes were placed in a tray connected to a circuit with a constant water flow and a controlled temperature (15°C , 20°C , 22.5°C , 25°C , 27.5°C , 30°C , 32.5°C , 35°C). We used 6 trays per temperature and 4 temperatures per room (48 trays in total). We provided a constant daily individual amount of algae (*Dunaliella*

tertiolecta, 1.2×10^6 cell/ml). Survival and maturity of F1 juveniles and males were monitored weekly. Mature F1 females were immediately allocated a male (San Francisco Bay strain). Offspring presence and number were monitored twice a week thereafter. Dead males were immediately replaced. The experiment was stopped after 10 weeks (88% of the individuals were dead by then).

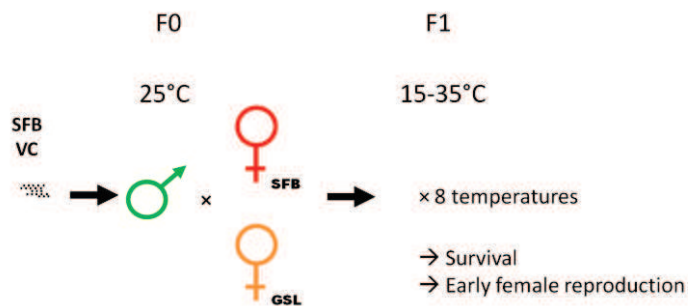

Figure 2 | Crossing scheme for the 6 temporal male populations. F0 males were crossed with F0 females from 2 different strains (VC: Vinh Chau, Vietnam; SFB: San Francisco Bay population, USA; GSL: Great Salt Lake). New born sibling larvae were isolated at eight different temperatures (15°C, 20°C, 22.5°C, 25°C, 27.5°C, 30°C, 32.5°C, 35°C) and their life history recorded. n=2349.

Statistical analyses

Survival was analyzed with a Weibull distribution in the R survival package (THERNEAU *et al.* 2003). Temperature and maternal population of origin (San Francisco Bay vs. Great Salt Lake) were included as fixed factors. We tested for a thermal niche evolution by comparing a saturated model (with an interaction between temperature and male population factors), with an additive model (with temperature factor and male population factor), and a 'steady evolution' model (with an interaction between temperature factor and a covariate representing the time since introduction). Time since introduction was calculated as indicated in Fig. 1. In addition, we hypothesized no thermal niche evolution in the ancestral population, so both SFB samples (1984, 2003) were assigned a time since introduction of 0.

We first calculated the mortality rate for different age classes and for each treatment temperature (Fig. 3). When dead individuals were observed, death was assumed to occur in the middle of the last censoring interval. Mortality rate was calculated as the proportion of individuals dying in 4-day

intervals for each temperature. We found that mortality rate was globally bimodal with an early peak corresponding to high juvenile mortality and a later peak corresponding to senescence. Juvenile mortality rate decreased to a plateau after 21 days. Hence, we performed separate analyses for each period. Survival to day 21 was analyzed with a Bernoulli probability ($n=2439$), whereas survival from day 21 onwards was analyzed with a Weibull distribution ($n=681$). The three individuals that survived more than 21 days in the 35°C treatment were excluded from the latter analysis. Model selection was based on AICc (HURVICH and TSAI 1989).

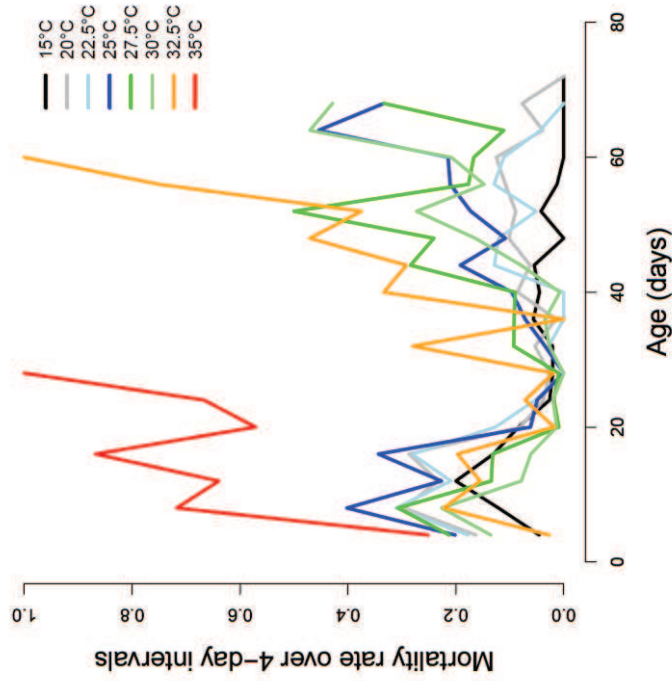

Figure 3 | Increase of mortality rate early and late in life for the 8 different temperature treatments. Mortality rate was calculated as the proportion of individuals dying over 4-day intervals.

Table 1 | Test of gradual thermal niche evolution in mortality before 21 days.

Model	K	logLik	AIC	AICc	Δ AICc	w_i	Parameters
Additive	14	-1081.82	2191.65	2191.82	0	1	Mal Pop +Temp
Saturated	49	-1055.8	2209.6	2211.65	19.83	0	Mal Pop xTemp
'Steady adaptation'	17	-1090.66	2215.32	2215.57	23.75	0	Time xTemp+Temp

'Time' represents the time since introduction covariate. Mal Pop: identity of the male population.

Temp: temperature as discrete factor. K: number of parameters. Δ AICc: AICc difference with the best model. w_i : AICc weights.

Results

Regarding the analysis of mortality in early life, the additive model was the best model for the probability of surviving to age 21 days (Table 1). Hence, the thermal niche of juveniles appeared to depend on both temperature and temporal population samples, but no interaction was found between these effects ($\Delta AICc > 19$, Table 1).

In contrast, the 'steady adaptation' model gave the best fit to the data on survival after age 21 (Table 2). To refine this model further and because the sign of the slope for the temperature \times time since introduction interaction appears to be reversed at 15°C compared to the other temperatures, we further tested for a 'steady adaptation' with two different paces for low and high temperatures. Hence, we fitted two different slopes for the interaction temperature \times time since introduction for 15°C and for temperatures above 15°C, respectively. The best model included this interaction (Table 2). Slope estimates were positive for temperature above 15°C and negative for 15°C, indicating that survival at temperatures above 15°C increased linearly after the introduction, whereas survival at

15°C decreased linearly after the introduction (Fig. 4). However, the magnitude of evolutionary changes was very different: survival decrease was more than two-fold at 15°C, whereas it was small at temperatures above 15°C (Fig. 4). In order to test the significance of these two interactions, we performed models disregarding either of the interaction. However, none of these models gave a better fit for the data ($\Delta AICc > 3$, Table 2). Hence, the survival increase observed at temperatures above 15°C in the Vinh Chau population was well supported.

Table 2 | Test of gradual thermal niche evolution in mortality after 21 days.

Model	K	logLik	AIC	AICc	$\Delta AICc$	w_i	Parameters
Temperature-dependent 'steady adaptation'	17	-974.77	1983.54	1984.46	0	0.83	TimeIntrodxTemp20-32.5° +TimeIntrodxTemp15°C+1
Temperature-dependent 'steady adaptation'	16	-977.51	1987.02	1987.84	3.38	0.15	TimeIntrodxTemp15°C+Te
Temperature-dependent 'steady adaptation'	16	-980.18	1992.36	1993.17	8.72	0.01	TimeIntrodxTemp20-32.5°
Steady adaptation'	22	-974.18	1992.37	1993.9	9.44	0.01	TimeIntrodxTemp+Temp
Additive	20	-978.31	1996.61	1997.88	13.43	0	MalPop +Temp
Saturated	50	-965.24	2030.47	2038.56	54.1	0	MalPop xTemp

Abbreviations as in Table 1.

TimexTemp15°C represents the slope of the time since introduction covariate for the 15°C temperature.

TimexTemp20-32.5°C represents the slope of the time since introduction covariate for the temperatures above 15°C (from 20°C to 32.5°C).

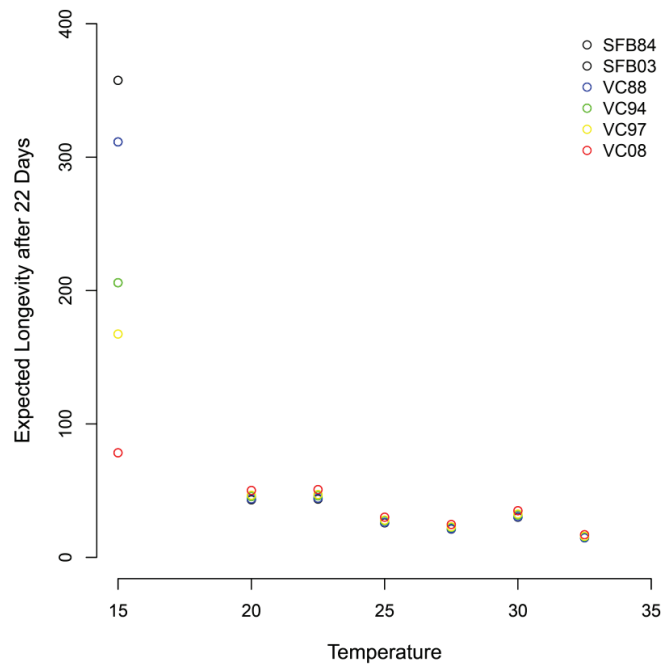

Figure 4 | Decreased survival with time since introduction at 15°C and increased survival with time since introduction at temperatures above 15°C.

Maturity was delayed at low temperatures for males (Fig. 5A) and at both high and low temperatures for females (Fig. 5B). As a consequence, females died without maturing at high temperature (32.5°C, 35°C). Furthermore, only four females from VC 1997 and 2008 reproduced at 30°C.

These preliminary results focused on the analysis of survival across the treatments, will be completed by fitness analyses combining survival and reproductive data, as well as exploration of trade-offs, using the software Lifelihood. Unfortunately, implementing and validating this new approach with a complete model selection was not feasible before the completion of this thesis manuscript.

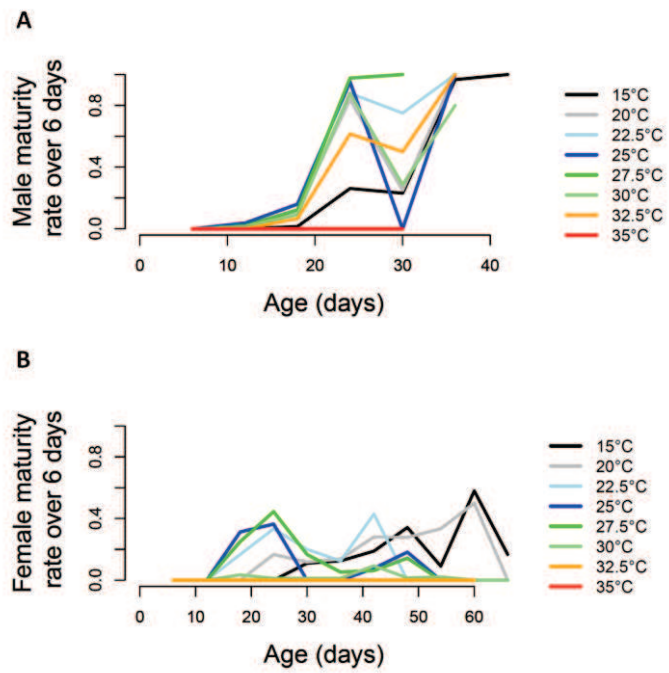

Figure 5 | Delayed maturity rate at low temperatures for males (A) and at both high and low temperatures for females (B). No maturity event was observed at 32.5 or 35°C.

Discussion

Recent theory suggests that a temporary increase of plasticity might play an important role in the adaptation to an abrupt environmental change (LANDE 2009). Most long-term studies on the evolution of thermal tolerance curves have so far compared ancestral and derived populations after typically 10-50 generations in pluricellular organisms (e.g. WHITE *et al.* 1970) and 2000-20,000 generations in unicellular organisms (e.g. BENNETT and LENSKI 1993; MONGOLD *et al.* 1996). Interestingly, these studies suggest that trade-offs are widespread and that adaptation to a new environment often leads to decreased fitness in other environments. Although very informative, these studies can not address the dynamics of thermal niche evolution. To my knowledge, only two studies have investigated the shape and pace of thermal adaptation to a stable environment, but did not find any increase in plasticity as measured by thermal tolerance breadth over 20000 and 200 generations (COOPER *et al.* 2001; KNIES *et al.* 2006).

Our preliminary results suggest an evolutionary change towards adaptation in late-life rather than early-life survival. A

possible explanation is that adults are more susceptible to high temperatures than juveniles because of physiological constraints such as oxygen uptake. In addition, daily temperature fluctuation is common in the derived populations (VAN HOA 2002). As *A. franciscana* is unable to reproduce at high temperatures (e.g. BROWNE and WANIGASEKERA 2000, this study), oviparously produced nauplii are mostly born at low temperatures (e.g. at night). When temperatures gradually increase, nauplii could have the time to get acclimated to increasing temperatures. Such thermal acclimatization has been shown to allow *Daphnia* juveniles to sustain higher temperatures as evidenced in (KIVIVUORI and LAHDES 1996).

Interestingly, we found that directional selection to survive at high temperatures (27.5-30°C) resulted in a correlated response with an increased survival at intermediate temperatures (20°C-25°C). However, we found opposite survival patterns at the lowest temperature (15°C), where survival largely decreased, contrary to higher temperatures (Fig. 4). Two non-mutually exclusive hypotheses could explain these results. First, decreased survival at low temperatures

could be due the pleiotropic effect of genes allowing the increased survival at higher temperatures (e.g. GILCHRIST 1996). Second, decreased survival at low temperatures could be due to the accumulation of deleterious mutations in genes that are no longer selected in the derived populations (e.g. COOPER *et al.* 2001). However, a major caveat of these analyses so far is that survival does not represent fitness and survival and reproduction data should be combined to give more realistic fitness estimates. This work is ongoing, and should be shortly implemented using the Likelihood approach (Article 1). However, as only 4 out of the 15 females that matured at 30°C actually reproduced, computing fitness estimates for the different male populations is not possible for these temperatures. Hence, survival increase at high temperature will most probably remain a good indicator of increased fitness at high temperatures in the Vinh Chau population.

Acknowledgements

We are grateful to J. Clegg for providing the SFB cyst sample. We also thank E. Flaven for technical assistance in the early stage of this project. NOR also thank P. David for statistical advice. Financial support was provided by an ANR grant to AC (ANR-08-JCJC-0041-01), the QuantEvol ERC grant to TL, and a French Ministry of Research fellowship to NR.

Contribution statement

TL and GM conceived the experiment. NOR, AC and TL designed the experiment. NVH and GVS provided the cyst samples. NOR, AC, LMC, RJZ and TL performed the experiment. NOR analyzed the data. NOR, AC, LMC, and TL wrote the manuscript.

References

- ANGILLETTA, M. J., 2009 *Thermal adaptation: a theoretical and empirical synthesis*. Oxford University Press, USA.
- BARTON, N. H., and L. PARTRIDGE, 2000 Limits to natural selection. *BioEssays* **22**: 1075-1084.
- BELL, G., 2008 *Selection: the mechanism of evolution*. Oxford University Press, USA.
- BENNETT, A. F., and R. E. LENSKI, 1993 Evolutionary adaptation to temperature II. Thermal niches of experimental lines of *Escherichia coli*. *Evolution*: 1-12.
- BROWNE, R. A., and G. WANIGASEKERA, 2000 Combined Effects of Salinity and Temperature on Survival and Reproduction of Five Species of *Artemia*. *Journal of Experimental Marine Biology and Ecology* **244**: 29-44.
- CARPELAN, L. H., 1957 Hydrobiology of the Alviso salt ponds. *Ecology* **38**: 375-390.
- CHARMANTIER, A., R. H. MCCLEERY, L. R. COLE, C. M. PERRINS, L. E. B. KRUUK *et al.*, 2008 Adaptive phenotypic plasticity in response to climate change in a wild bird population. *Science* **320**: 800-803.
- CLEGG, J. S., S. A. JACKSON, N. VAN HOA and P. SORGELOOS, 2000 Thermal resistance, developmental rate and heat shock proteins in *Artemia franciscana*, from San Francisco Bay and southern Vietnam. *Journal of Experimental Marine Biology and Ecology* **252**: 85-96.
- CLEGG, J. S., N. VAN HOA and P. SORGELOOS, 2001 Thermal tolerance and heat shock proteins in encysted embryos of *Artemia* from widely different thermal habitats. *Hydrobiologia* **466**: 221-229.
- COOK, L. M., 2003 The rise and fall of the carbonaria form of the peppered moth. *The Quarterly review of biology* **78**: 399-417.
- COOPER, V. S., A. F. BENNETT and R. E. LENSKI, 2001 Evolution of thermal dependence of growth rate of *Escherichia coli* populations during 20,000 generations in a constant environment. *Evolution* **55**: 889-896.
- COUSYN, C., L. DE MEESTER, J. COLBOURNE, L. BRENDONCK, D. VERSCHUREN *et al.*, 2001 Rapid, local adaptation of

- zooplankton behavior to changes in predation pressure in the absence of neutral genetic changes. *Proceedings of the National Academy of Sciences* **98**: 6256.
- DECAESTECKER, E., S. GABA, J. A. M. RAEYMAEKERS, R. STOKS, L. VAN KERCKHOVEN *et al.*, 2007 Host-parasite 'Red Queen' dynamics archived in pond sediment. *Nature* **450**: 870-U816.
- DEUTSCH, C. A., J. J. TEWKSBURY, R. B. HUEY, K. S. SHELDON, C. K. GHALAMBOR *et al.*, 2008 Impacts of climate warming on terrestrial ectotherms across latitude. *Proceedings of the National Academy of Sciences* **105**: 6668.
- GILCHRIST, G. W., 1996 A quantitative genetic analysis of thermal sensitivity in the locomotor performance curve of *Aphidius ervi*. *Evolution*: 1560-1572.
- HAIRSTON, N. G., W. LAMPERT, C. E. CÁCERES, C. L. HOLTMEIER, L. J. WEIDER *et al.*, 1999 Rapid evolution revealed by dormant eggs. *Nature* **401**: 446.
- HOFFMANN, A., R. HALLAS, J. DEAN and M. SCHIFFER, 2003 Low potential for climatic stress adaptation in a rainforest *Drosophila* species. *Science* **301**: 100-102.
- HOFFMANN, A. A., and C. M. SGRÒ, 2011 Climate change and evolutionary adaptation. *Nature* **470**: 479-485.
- HURVICH, C. M., and C. L. TSAI, 1989 Regression and Time-Series Model Selection in Small Samples. *Biometrika* **76**: 297-307.
- KAPPAS, I., T. ABATZOPOULOS, N. VAN HOA, P. SORGEOLOS and J. BEARDMORE, 2004 Genetic and reproductive differentiation of *Artemia franciscana* in a new environment. *Marine Biology* **146**: 103-117.
- KERFOOT, W. C., and L. J. WEIDER, 2004 Experimental paleoecology (resurrection ecology): chasing Van Valen's Red Queen hypothesis. *Limnology and Oceanography*: 1300-1316.
- KIVIVUORI, L. A., and E. O. LAHDES, 1996 How to measure the thermal death of *Daphnia*? A comparison of different heat tests and effects of heat injury. *Journal of thermal Biology* **21**: 305-311.
- KNIES, J. L., R. IZEM, K. L. SUPLER, J. G. KINGSOLVER and C. L. BURCH, 2006 The genetic basis of thermal reaction norm

- evolution in lab and natural phage populations. *PLoS biology* **4**: e201.
- KNIES, J. L., J. G. KINGSOLVER and C. L. BURCH, 2009 Hotter is better and broader: thermal sensitivity of fitness in a population of bacteriophages. *The American Naturalist* **173**: 419-430.
- LABBÉ, P., N. SIDOS, M. RAYMOND and T. LENORMAND, 2009 Resistance gene replacement in the mosquito *Culex pipiens*: fitness estimation from long-term cline series. *Genetics* **182**: 303-312.
- LANDE, R., 2009 Adaptation to an extraordinary environment by evolution of phenotypic plasticity and genetic assimilation. *Journal of Evolutionary Biology* **22**: 1435-1446.
- MONGOLD, J. A., A. F. BENNETT and R. E. LENSKI, 1996 Evolutionary adaptation to temperature. IV. Adaptation of *Escherichia coli* at a niche boundary. *Evolution*: 35-43.
- PARMESAN, C., 2006 Ecological and evolutionary responses to recent climate change. *Annu. Rev. Ecol. Evol. Syst.* **37**: 637-669.
- RAUSHER, M. D., 1992 The measurement of selection on quantitative traits: biases due to environmental covariances between traits and fitness. *Evolution* **46**: 616-626.
- RODE, N. O., A. CHARMANTIER and T. LENORMAND, 2011 Male–Female Coevolution in the Wild: Evidence from a time series in *Artemia franciscana*. *Evolution*.
- ROTHUIS, A., 1987 First report on the activities on the culture of *Artemia salina* and *Macrobrachium rosenbergii* in Can Tho and Vinh Chau in southern Vietnam., pp. 80 pp. in *Dutch Committee for Science and Technology (KWT) and Institute of Agricultural Engineering*, Wageningen, Netherlands.
- SCHEMSKE, D. W., and P. BIERZYCHUDEK, 2001 Perspective: evolution of flower color in the desert annual *Linanthus parryae*: Wright revisited. *Evolution* **55**: 1269-1282.
- THERNEAU, T. M., P. M. GRAMBSCH and V. S. PANKRATZ, 2003 Penalized Survival Models and Frailty. *Journal of Computational and Graphical Statistics* **12**: 156-175.
- VAN HOA, N., 2002 Seasonal farming of the brine shrimp *Artemia franciscana* in artisanal ponds in Vietnam: Effects of temperature and salinity.

- , pp. 184. University of Ghent., Belgium.
- VOS, J., P. LÉGER, P. VANHAECKE and P. SORGELOOS, 1984 Quality evaluation of brine shrimp *Artemia* cysts produced in Asian salt ponds. *Hydrobiologia* **108**: 17-23.
- WHITE, E. B., P. DEBACH and M. J. GARBER, 1970 Artificial selection for genetic adaptation to temperature extremes in *Aphytis ling-nanensis* Compere (Hymenoptera: Aphelinidae). *Hilgardia* **40**: 161-192.

Article 3

Male-female coevolution in the wild: evidence from a time series in *Artemia franciscana*

Nicolas O. Rode, Anne Charmantier, and Thomas Lenormand

As published in Evolution (2011)

Abstract

Sexual conflicts are ubiquitous in nature and are expected to lead to an antagonistic coevolution between the sexes. This coevolutionary process is driven by selection on sexually antagonistic traits that can either be directional or fluctuating. In this study, we used dormant cysts of *Artemia franciscana*, collected in the same population in three different years over a 23-year period (corresponding to ~160 generations in this system), to investigate male-female coevolution in natural conditions over time. We performed a cross experiment study where reproduction of females mated to males from the past, present or future was monitored until death. In agreement with a model of 'fluctuating selection', we found that females survived better and had longer interbrood intervals when mated with their contemporary males compared to when mated with males from the future or the past. However, female weekly and lifetime reproductive successes displayed no differences between contemporary and non-contemporary matings. Finally, the coevolutionary patterns ('arms race dynamics' or 'fluctuating selection dynamics') possibly acting on female relative fitness could not be discriminated. This study is the first direct demonstration that the process of male – female coevolution, previously revealed by experimental evolution in laboratory artificial conditions, can occur in nature on a short evolutionary time scale.

Keywords: Sexual conflicts, time-shift experiment, arms race, fluctuating selection, cyst, resurrection ecology.

Sexual conflict occurs when the fitness optimum of a trait differs between males and females (e.g. Parker 1979). Traits selected in opposite directions in both sexes can result in an “evolutionary chase” (Parker 1979). A large number of species has actually been shown to exhibit antagonistic coevolution between males and females in reproductive behaviour, morphology or physiology (Arnqvist and Rowe 2005a; Holland and Rice 1998). For instance, in polyandrous species each male is selected to maximize his mate’s resource allocation towards its own offspring (since offspring produced later in life are likely to be fathered by other males, Rice 2000). Hence, males may ‘manipulate’ females to increase their short term fecundity. In contrast, females are selected to maximize their lifetime reproductive success and to resist male mating persistence (Rice 2000). Female ‘manipulation’ by males has been exemplified in *Drosophila*, where males increase their own fitness by manipulating the egg-laying rate of their mate at the expense of female survival (Chapman et al. 1995; Chen et al. 1988; Fowler and Partridge 1989). Differences over mating rate optima between sexes have also been found in other insect

species (Arnqvist and Nilsson 2000) and similar conflicts of interests between males and females are in fact ubiquitous in nature (Holland and Rice 1998).

Antagonistic coevolutions are driven by a variety of processes which involve reciprocal adaptive genetic changes between species –e.g. in host-parasite systems (Woolhouse et al. 2002)– or between sexes –in species with sexual conflicts (Arnqvist and Rowe 2005a). Among these processes, arms race dynamics (ARD) and fluctuating selection dynamics (FSD) are usually opposed (Arnqvist and Rowe 2005a; Gandon et al. 2008; Woolhouse et al. 2002). Under arms race selection, the phenotypic traits under conflicts are altered unidirectionally over time. This leads to constant “phenotypic innovations” which occur through the selection of new combinations of alleles or genes. For instance, grasping and anti-grasping structures in male and female water striders are supposed to have evolved under ARD (Arnqvist and Rowe 2002a; Arnqvist and Rowe 2005a). Under fluctuating selection the phenotypic traits under conflicts are oscillating periodically over time. This “phenotypic repetition” occurs either through the recruitment of new alleles

or genes or through frequency changes of pre-existing alleles or genes over time (e.g. through frequency dependent selection). This latter case can lead to a stable polymorphism, for example it is thought to drive the maintenance of female colour polymorphism in damselflies (Andres et al. 2002; Arnqvist and Rowe 2005a).

Sexual conflicts have been intensively investigated over the last decade; yet, studies have mainly focused on insect behaviour and unambiguous experimental data on coevolutionary processes in other taxa remain scarce (Tregenza et al. 2006). Since sexual coevolution is a dynamic process, several authors (e.g. Chapman and Partridge 1996; Rice 1996; Rice 2000) have hypothesized that contemporary conflicts may be hidden by a long history of adaptations and counteradaptations. Several studies have tried to circumvent this problem using two main approaches. First, experimental evolution and genetic manipulation have been used in order to impede the adaptation of one sex to the other (Holland and Rice 1999; Rice 1996). In a study on *Drosophila*, Rice (1996) showed that males could rapidly adapt to a static female phenotype,

when females were prevented from coevolving with males. However, even if such studies show that there is scope for sexual conflicts to occur, they most often involve complex experimental setups that may involve artificial selective conditions. Overall, these experiments cannot inform us on the direction and strength of similar coevolution in natural populations. Second, experiments involving crosses between individuals from different populations have been used to reveal coevolution between sexes. Indeed, males and females living in different populations can express coevolving characters, which follow divergent evolutionary trajectories (Parker and Partridge 1998). In these studies, spatial variation between populations is thought to mirror variation through evolutionary time within a population and, when comparing crosses of females mated to males from different populations (including from their own), females should be more resistant to manipulative traits of males with which they coevolved (Parker and Partridge 1998). Many experiments have been conducted in order to test this prediction (Andres and Arnqvist 2001; Brown and Eady 2001; Nilsson et al. 2002). However, up to now, the results from these studies

are partly inconsistent (Chapman et al. 2003). One inherent problem to this approach is that only pairwise population comparisons can be performed, which in a factorial experiment prevents the combination of the information from all the crosses to infer the coevolutionary process.

Ideally, sexual conflicts should be investigated with a historical perspective (Holland and Rice 1998; Pizzari and Snook 2003), for example studying a population over a large temporal scale (comparing individuals at time t with their ancestors over many generations). However, the model organisms currently used to investigate such conflicts (*Drosophila* and more generally insects) do not allow the comparison of live individuals several generations apart, preventing the direct study of coevolution between sexes. In the last decade, some attempts have been made to study such long term (co-)evolution in host-parasite systems through time-shift experiments (Gaba and Ebert 2009). These experiments compared the proportion of infected hosts when confronted with “past”, “contemporary” and “future” parasites (Buckling and Rainey 2002; Decaestecker et al. 2007). However, the

organisms used in this host-parasite literature reproduce mostly (or totally) asexually, preventing the investigation of male-female coevolution in these systems.

In this paper, we used the brine shrimp (*Artemia franciscana*) to study long term coevolution between sexes in a natural population. The biology of *Artemia*, makes it an ideal model to directly reveal sexual coevolution *in natura*. *Artemia* species reproduce either ovoviviparously or oviparously. The latter mode is favoured by either high salinity, high temperature, low oxygen concentration, food shortage or short photoperiods (Clegg and Trotman 2002; Nambu et al. 2004). In this case, they produce encysted embryos called cysts (Clegg and Trotman 2002), that can be stored at low temperature for long periods of time before hatching and initiating the next generation (Lavens and Sorgeloos 1987). Thus, multi-generational experiments with controlled and synchronized hatching are possible in this species (Reznick 1993).

In this study, we tracked male-female coevolution over a period of 23 years (c.a. 160 generations, see below), using dormant cysts from a wild population of *Artemia franciscana*

from the Great Salt Lake (Utah, USA). More specifically, we used newly produced cysts, collected in three different years (1985, 1996, 2007) in a cross experiment where females were mated either with males from their own or from other years. We measured different life-history traits such as female lifetime survival and reproductive output. We investigated male-female coevolution patterns by testing specific statistical interactions between male and female year effects. Ultimately, we examined whether fluctuating or directional selection is driving male-female coevolution in this species.

Materials and Methods

MODEL SPECIES *ARTEMIA FRANCISCANA*

Artemia species, also known as brine shrimps (Pancrustacea, Banchiopoda, Anostraca), have a worldwide distribution and are found in inland salt lakes, coastal lagoons and solar saltworks (Lenz and Browne 1991). The environment of this hypersaline species can easily be recreated in the laboratory (Lenz and

Browne 1991). In particular, the most wide-spread member of the group, the bisexual *Artemia franciscana* has been the focus of a number of life history studies (Browne 1980; Browne 1982; Browne et al. 1988; Browne et al. 2002; Browne and Wanigasekera 2000; Shirdhankar et al. 2004). In this polyandrous species, mate guarding occurs and male antennae develop into claspers which they use to clasp females during mating (Lochhead 1950). This clasping usually lasts longer than just the time needed for copulation (Wolfe 1973); thus, clasping is probably costly for the female (e.g. in term of foraging activity).

This study was focused on one population of *Artemia franciscana* from the Great Salt Lake (Utah, USA). Dormant cysts sampled in three different years (June 1985, February 1996 and September 2007), spanning a 23-year period, were kept refrigerated at the *Artemia Reference Center* (Ghent, Belgium). Given the high population size ($N_e > 10^9$, Wurtsbaugh and Maciej Gliwicz 2001), the homogeneity of environmental conditions in the South part of the lake (where the cysts were collected) and the mixing effect of winds and currents, we

expect negligible neutral differentiation between our samples. First reproduction appears in late April in this population and mature females' density increases throughout spring and summer to peak in early October (with a shift from 0% to 96% of oviparously reproducing females over this period, Wurtsbaugh and Maciej Gliwicz 2001). Considering an average generation time of 23 days at 15°C (von Hentig 1971), we estimated an average of 7 generations per year over this 6-month period (± 4 generations, based on the data at 10°C and 20°C). Hence, we estimated that our experiment spans approximately 160 generations (± 90 generations).

CULTURE CONDITIONS

Nauplii and adults were reared in concentrated brine water (Thalasea ©, Salins du midi, Aigues-Mortes, France) diluted to a 40 g/L salinity with dechlorinated tap water. Individuals were kept at 25°C ($\pm 1^\circ\text{C}$) under constant fluorescent lighting and fed with *Dunaliella salina* and *D. tertiolecta* algae. These algae were cultured and frozen in the laboratory, and subsequently distributed four times a week after defrosting, providing a daily

individual amount of around 1.6 million cells (about half of the adult maximum ingestion rate, Reeve 1963). Culture medium was replaced weekly. Cyst decapsulation and hatching protocols were modified from Bengston et al (1991). Cysts were sieved on a 120 μ m-mesh, decapsulated with a brief exposure (< 10 min) to a sodium hypochlorite solution (2.6%), and rinsed with fresh water. Decapsulated cysts were incubated in a 5 g/L salinity medium buffered with 2 g/L of NaHCO₃ (pH=8.3). We used cylindroconical hatching containers (3L) where aeration was applied from the bottom with an air-water-lift system. After emergence, first-instar nauplii were placed in large containers (8L) and fed daily. This procedure was performed independently for the three different years of cyst origin.

Before individuals reached sexual maturity, their sex was assigned on the basis of sexual dimorphism (Lochhead 1950). After maturity, single pairs of males and females from the same year were placed in 0.5L pints in order to produce an F1 generation. Each brood of nauplii was isolated from their parents 24h after the first nauplii were observed. Within two weeks after brood isolation, individuals were isolated in test

tubes (2.5x7 cm) in 30 trays containing up to 70 tubes. Tubes had a filter bottom in order to allow the water to flow (mesh size: 120µm). Each brood was identified and each tray contained from one to six families (randomized across years), with no more than nine siblings from a given family. Tray position on the lab shelf was weekly randomised in order to avoid local shelf effects.

EXPERIMENTAL SETTING

The number of families used was balanced across the three years (13 in 1985, 14 in 1996 and 14 in 2007). Female survival and reproduction were monitored individually, while males were randomized within each given year. Hence, when the F1 generation was old enough to be sexed, males from the same year were pooled together in large containers whereas females were kept individually isolated in test tubes. 763 females were followed (281 in 1985, 290 in 1996 and 192 in 2007). Sibling females were assigned to one of three time-shift treatments (*i.e.* male from the past, present, future, see below). All treatments were represented in each family except for two families of low

sample size, and females were paired before their sexual maturity, either with a male of 1985, 1996 or 2007. The three male treatments were equally represented among sibling females on the same tray.

Since all the males used in the experiment did not reach sexual maturity at the same time and in order to average male effect among years, males were replaced once a week during all the term of the experiment, females were then randomly allocated a new male from the same treatment year. Males clasping females could not be removed because of possible harm to them or their mate. Hence some females remained with the same male for consecutive weeks. On average females remained ~8 days with the same male. Dead males were immediately replaced.

Survival (longevity) and reproductive parameters (laying date of consecutive clutches, type of offspring (cysts/nauplii), clutch or brood size) were recorded three times a week for each female until its death (last female died at 203 days).

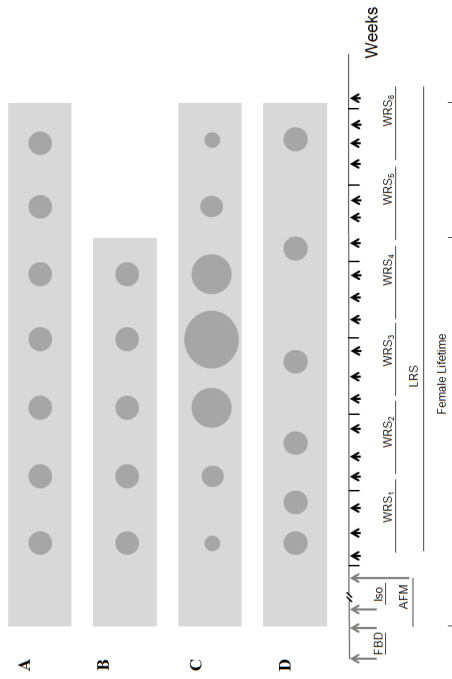

Fig. 1. Schematic illustration of the survival and reproductive traits analysed along with some confounding covariates. Female lifetime reproductive success (LRS) of females B, C and D differs from the reference female A (with constant brood size and interbrood interval) in one trait: survival time (B), weekly reproductive success (WRS, C) and interbrood interval (reproductive rate, D). Tick marks on the horizontal axis represent the weeks after first reproduction. Vertical arrows are observations. Light grey rectangles represent female lifespan. Dark grey circles represent reproductive events and circle size represents brood/clutch size. WRS is the number of offspring produced over a 7-day period. LRS is the sum of WRSs. Female relative fitness could not be represented. FBD: time between the start of the experiment and female birth. AFM: female age when the first male was introduced. Iso: isolation time between brood individualization and first male introduction

Clutch or brood size was estimated based on photographs (repeatability 89% for nauplii and 98% for cysts, repeatability estimations based on Lessells and Boag 1987). Pictures were taken using a Pixelink (PL-A662) high resolution colour camera.

STATISTICAL ANALYSES

We analyse a suite of female life history traits: survival (time to death), lifetime reproductive success (LRS, lifetime number of offspring), weekly reproductive success (WRS, number of offspring in consecutive weeks), reproductive rate (interbrood interval), relative fitness (a combination of those traits that we define below). Male-female coevolution was investigated on the suite of traits illustrated in Fig. 1. A significant interaction term ($\text{FemYr} \times \text{MaYr}$) after accounting for female and male years of origin ($\text{FemYr} + \text{MaYr}$) is an indication of such coevolution. However, simpler models can reach a better compromise between number of parameters and deviance (*i.e.* explanatory power). They are also more insightful, since they allow the inference (and prediction) of specific coevolutionary patterns.

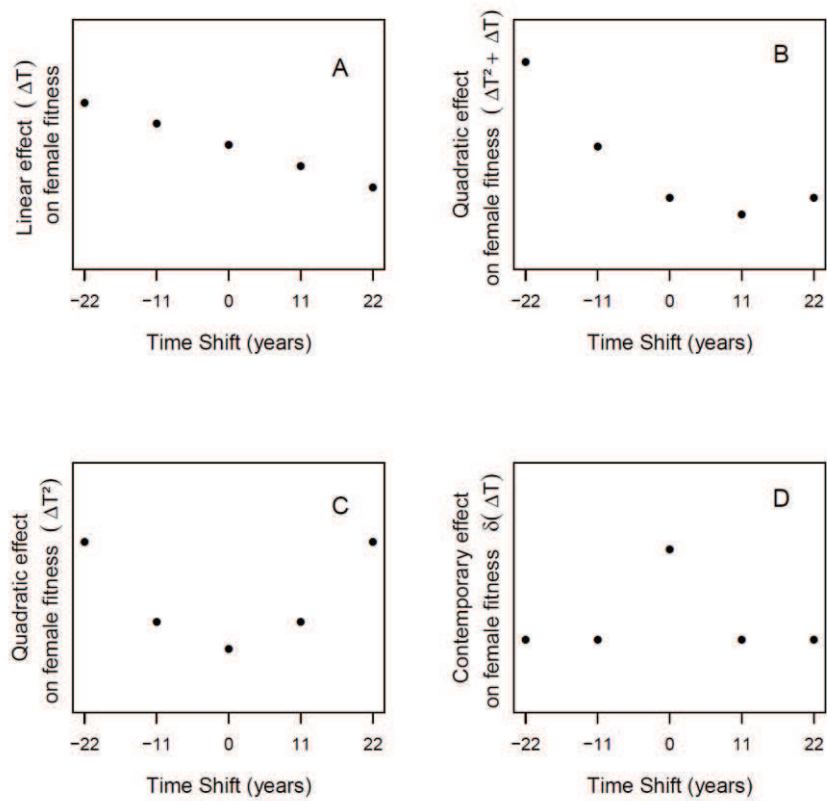

Fig. 2. Expected time-shift effect on female fitness under different coevolutionary processes. Time-shift (ΔT = male year – female year). Male-female coevolution was tested with different interaction shapes. Female fitness under “arms race” selection (ARD model) is altered unidirectionally with time-shift. A. Linear time-shift effect (ΔT). Female fitness under ‘fluctuating selection’ (FSD models) is altered with absolute time-shift. B and C. quadratic effects ($\Delta T^2 + \Delta T$ and ΔT^2), D. different coefficients for contemporary and non contemporary matings ($\delta(\Delta T)$). The experiment comprises different male-female combinations for the different time-shifts (3 for $\Delta T = 0$ year, 2 for $|\Delta T| = 11$ years and 1 for $|\Delta T| = 22$ years).

Hence, we used different functions of time-shift (ΔT = male year – female year) to test specific male-female coevolution patterns (Fig. 2). We directly fitted ΔT for directional effects (e.g. arm race dynamics, hereafter ARD, Fig. 2A) and a combination of ΔT and ΔT^2 , for more complex shapes (e.g. fluctuating selection dynamics FSD, Fig. 2B and 2C). Finally we also used $\delta(\Delta T)$, where $\delta(\cdot)$ stands for the Dirac delta function, to model contemporary *versus* all non-contemporary matings (e.g. rapid fluctuating coevolution, Fig. 2D). It is important to note that the model including ΔT along with male and female year effects is undefined (unlike ΔT^2 , or $\delta(\Delta T)$). Thus, it could only be fitted with either of these variables, which may be problematic if both year effects are large. In addition, a set of potential confounding effects were also included in all the analyses: number of siblings of the focal female (*SibSize*), female birth date (*FBD*), age of female when the first male was introduced (*AFM*), the duration the female spent alone between sibling isolation and male first introduction (*Iso*, see Fig. 1), tray effect (*Tray*), and family effect (*Sib*, included in the analyses as a random effect, unless otherwise stated). All analyses were performed using R (version

2.10.0). We detail below specific models used for each trait. Model selection was based on corrected Akaike's Information Criterion AICc (Hurvich and Tsai 1989). Whenever a model with a function of time-shift provided a better fit than the additive model ($\Delta AICc < 2$), the percentage of the residual deviance (R^2_{Dev}) from the additive model accounted for by this model was calculated (Grosbois et al. 2008; Skalski 1996).

Female survival

Female survival was analysed using the *survival* package in R. This analysis was aimed at testing the effect of male time-shift on female survivorship and focused on the number of days between male introduction and female death. An interval censored model with the age of last observation alive and the age at first observation dead was used (Gómez et al. 2009). A small number of females had unknown date of death or could not be assigned a mate because of male shortage during the experiment. These females (24 and 18 respectively) were right-censored to the last valid observation (*RC* females hereafter). First, the full model was fitted using different survival curves

available in the *survival* package (Weibull, Extreme value, Exponential, Gaussian, Logistic, Lognormal, Loglogistic). Since the Weibull was, by far, the best model ($\Delta AICc \gg 2$ for other models), it was used in all subsequent model selection. The Weibull model allows age specific mortality rate (α) to increase or decrease with age (Crawley 1993), in addition to the fit of the survival function scale (λ). The package allows fitting only one factor to α . We tried either female year or discrete time-shift effects. Family was specified as a random effect (frailty option, Therneau et al. 2003, nesting of family within female year was not possible in this package).

Female Lifetime Reproductive Success

Since female lifetime reproductive success (LRS) was clearly bimodal with many non reproducing females (30%), we analysed separately the probability to reproduce (logistic regression, *lme4* package) and LRS of reproducing females (negative binomial count model with the *glmmADMB* package). In the former, tray and family were specified as random effects. In the latter, the proportion of nauplii (*Prop*) (as opposed to

cysts) was added to the set of variables previously mentioned to control for different costs of cysts versus nauplii production. *RC* females were excluded from these analyses.

Female Weekly Reproductive Success

Female Weekly Reproductive Success (WRS) was computed as the number of offspring (cysts and nauplii) produced per week after the first reproduction. In order to analyse the variation of reproductive effort with age, we regressed WRS on *Time* (number of weeks of reproduction) and $Time^2$ to allow for a possible non linear effect (along with all other covariables mentioned previously). WRS was analyzed with a negative binomial error in the *glmmADMB* package. To account for non independence of consecutive WRS values for a given female, female identity was included as a random effect. Non reproducing females were excluded from this analysis. Only the data to the last valid observation was used for *RC* females.

Female Reproductive Rate

We analysed female interbrood interval following an approach similar to a survival analysis where each reproductive event is

analogous to a death event. This method is equivalent to a study of mortality rate in different populations. Each female here is comparable to a population and the number of clutch/brood corresponds to the number of individuals in each population, hence the different reproduction events are equivalent to the death of an individual. For this analysis, the occurrence of reproduction between *Time* minus one week (*Time* - 1) and *Time* was analysed with an interval censored survival model (Gómez et al. 2009). We used one week intervals to circumvent problems that would occur for smaller or larger time interval. A much larger interval would frequently merge two consecutive reproductive events (they occur on average every 5-10 days in our experiment). On the other hand, a much smaller interval would create a negative correlation between the probabilities of observing a clutch/brood in consecutive intervals, since minimal interbrood interval is ~4 days in *Artemia*. Similarly to our survival analysis, we tried here different 'survival' curves in the *survival* package and the Weibull was the best to fit the data ($\Delta AICc > 2$ for other curves). Only the data to the last valid observation was used for *RC* females.

Female relative fitness

To combine survival and the rate of offspring production in a synthetic measure of fitness, we used the intrinsic rate of increase r which represents the growth rate of a population initiated from a single individual, once the stable age structure has been reached (Charlesworth 1994; Peters et al. 2003; Vassilieva and Lynch 1999). It was computed only for reproducing females, using the WRS data set, as the largest root r of :

$$\int_0^{\infty} e^{-rx} l(x)m(x)dx , \quad (1)$$

where $l(x)m(x)$ is the product of survivorship to and productivity (WRS) at week x . Relative fitness was measured by dividing each female r by the mean r . This variable was analysed with a gamma error using the *stats* package. Family (*Sib*) was included as a fixed effect in the model (this package does not allow random effect specification).

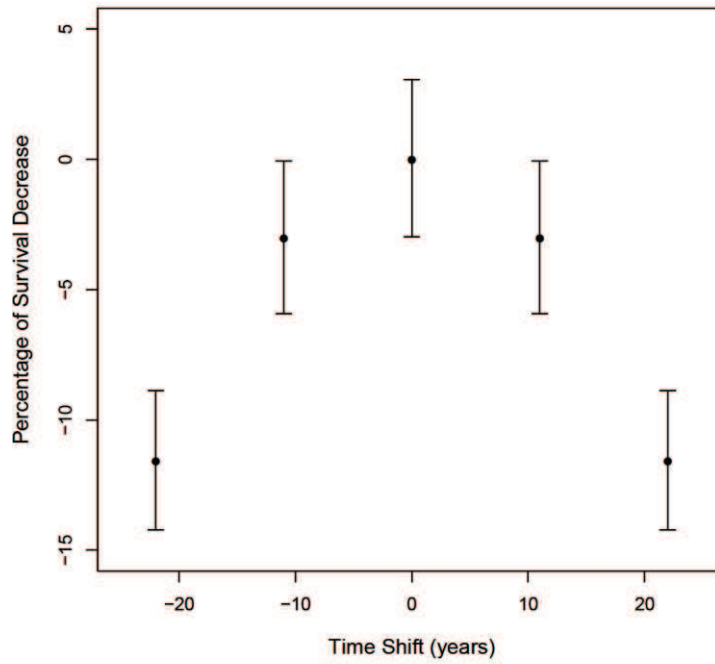

Fig. 3. Fitted effect of time-shift on female survival. The best model indicated a decrease of female survival when mated to non contemporary males. Errors bars denote 95% confidence intervals based on bootstrap values calculated with the standard error of the ΔT^2 coefficient (Table 1). The other best models (with $\Delta AICc < 2$) gave qualitatively similar results.

RESULTS

We investigated whether the life history traits of sibling females differed in the presence of a male from their past, present or future. A vast majority of females (95%) were followed until death and the experiment lasted 203 days. We detail below, for each female trait separately, the results from the best models. In the appendix (Tables S1-S6) all models with AICc differences lower than 10, compared to the best model are presented (Anderson et al. 2001).

Female survival

Average female lifetime after male introduction was 29.6 days (S.D. = 27.2 d, median = 21 d, min = 1 d, max = 158 d, excluding *RC* females). A strong effect of female year of origin was observed during the experiment with increased survival for 2007 females compared to 1985 and 1996 females (Fig. S1). Models including ΔT^2 and $\delta(\Delta T)$ effects (*i.e.* corresponding to gradual or rapid fluctuating selection, FSD) ranked best with ΔAICc lower than two (Table S1). Fitted survival curves were qualitatively equivalent in these models. Estimates from the ΔT^2 model are presented in Table 1. This model

accounted for 94% of the residual deviance between the additive and saturated models (Table S1). The fitted ΔT^2 effect was negative, indicating that overall females survived best when mated with contemporary males (Fig. 3, Fig. S2). According to this model, females with a time-shift of ± 11 and ± 22 years survived on average 3% and 12% less, when compared to those mated with contemporary males. The Weibull model also indicated that, for the three years, female age-specific mortality rate is increasing with age in this species ($\text{Log}(1/\alpha) < 0$, Table 1).

Female lifetime reproductive success (LRS)

The proportion of non-reproducing females was variable across years (0.3, 0.4, 0.06 in females from 1985, 1996 and 2007, respectively). The ΔT , ΔT^2 and additive (*i.e.* male and female effects but no male-female interaction) models fitted best the data on the probability to reproduce ($\Delta\text{AICc} < 2$, Table S2). Thus, we did not detect a clear effect of time-shift on the probability to reproduce. Reproducing females produced 135.3 offspring on average (S.D. = 138.2, median = 86, min = 6, max = 860, excluding *RC* females) over their lifetime. The additive (with female effect only), $\delta(\Delta T)$, ΔT^2 and ΔT models

fitted the LRS data best (Table S3). Thus, again, we did not find any simple coevolutionary pattern. Interestingly, female LRS increased with the proportion of nauplii (Table 2, Table S3), which may suggest either that nauplii are cheaper to produce than cysts or that females in good condition tend to produce more nauplii.

Female Weekly Reproductive Success

Reproducing females produced on average 31.6 offspring per week (S.D. = 26.6, median = 28, min = 0, max = 169) during each week of their lifetime. All best models included a quadratic effect of the number of weeks after first reproduction ($Time + Time^2$, $\Delta AICc < 2$, Table S4). However, complementary analyses showed that this pattern was due to an increase of WRS early in life, followed by a plateau, rather than to true senescence. In addition, some of these models included an effect of time-shift (ΔT^2 or ΔT) on the intercept and/or an interaction between $Time$ or $Time^2$ and a function of time-shift (*i.e.* either ΔT^2 , ΔT or $\delta(\Delta T)$, Table S4). The fitted values of the intercept and the interaction with $Time+Time^2$ of ΔT were negative, whereas those fitted for ΔT^2 and $\delta(\Delta T)$ were positive (data not shown). Moreover, the additive model (without any time-shift term) was

among the best models (Table S4). Thus, we did not detect any consistent effect of time-shift on the age specific weekly reproductive success.

Female Reproductive Rate

The interaction, FSD (ΔT^2 and $\delta(\Delta T)$) and additive models fitted Weibull scale parameter to the reproductive rate data similarly ($\Delta AICc < 2$, Table S5). As for female WRS, we did not detect a consistent effect of time-shift on this parameter. However, all these models fitted different Weibull shapes for contemporary and non contemporary matings, demonstrating a difference in age specific reproductive rate between both treatments (Table S5). The two first best models accounted only for 14% and 10% of the residual deviance between the additive and saturated models (Table S5). Fitted Weibull shape was lower when females were mated to contemporary males, indicating that reproduction rate was lower in this treatment (Fig. 4). In addition, the fitted Weibull shapes were higher than one in both treatments suggesting that, on average, reproduction rate increases with age in this species (both curves from females with contemporary and non contemporary males lie above the curve of a reference female with

constant interbrood interval in Fig. 4). Consequently, the decrease of interbrood interval was sharper when females were mated to non contemporary males (Fig. 4).

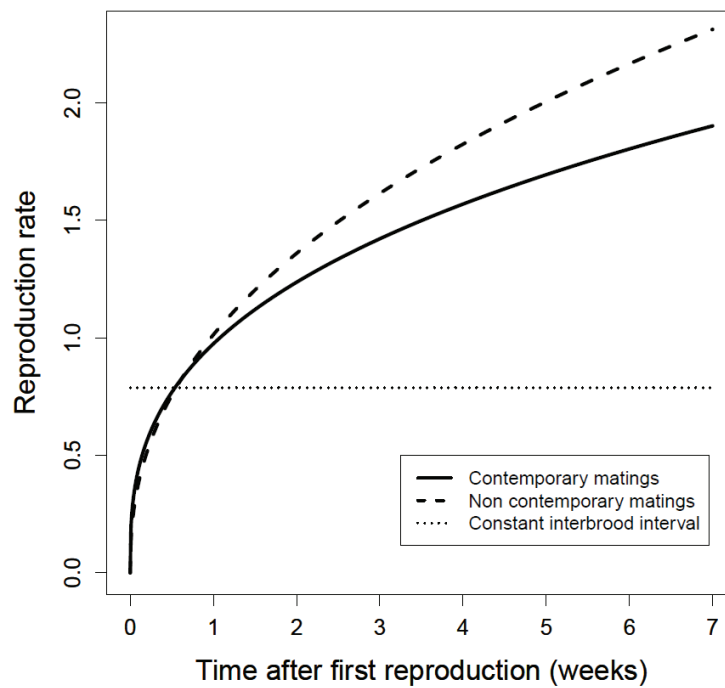

Fig. 4. Comparison of fitted reproductive rate between contemporary and non contemporary matings. The best models suggest that females had a lower egg-laying rate when mated with contemporary males, compared to the females mated with non-contemporary males. Interbrood interval decreases with age for females from both treatments. $\Lambda = 0.79$ (Weibull Scale), $\alpha_{(\delta(\Delta T=0))} = 1.34$, $\alpha_{(\delta(\Delta T \neq 0))} = 1.42$, and $\alpha_{ref} = 1$ (Weibull Shapes).

Relative fitness

Mean female relative fitness was 1 (S.D. = 26.6) and ranged from 0.48 to 2.78. The $\Delta T^2 + \Delta T$ and ΔT models fitted the data best ($\Delta AICc < 2$, Table S6). Both these models indicated that female fitness decreased with time-shift (Fig. 5, Fig. S3). The $\Delta T^2 + \Delta T$ model accounted only for 22% of the residual deviance between the additive and saturated models (Table S6). As a consequence, unambiguous discrimination between ARD and FSD patterns on this trait was not possible.

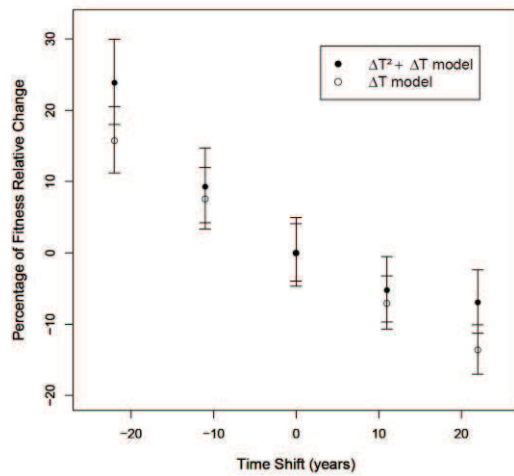

Fig. 5. Fitted fitness relative change compared to contemporary pairs. The $\Delta T^2 + \Delta T$ and ΔT models indicated a decrease of female relative fitness with time-shift. Errors bars denote 95% confidence intervals based on bootstrap values calculated with the standard error of the time-shift coefficients of the models.

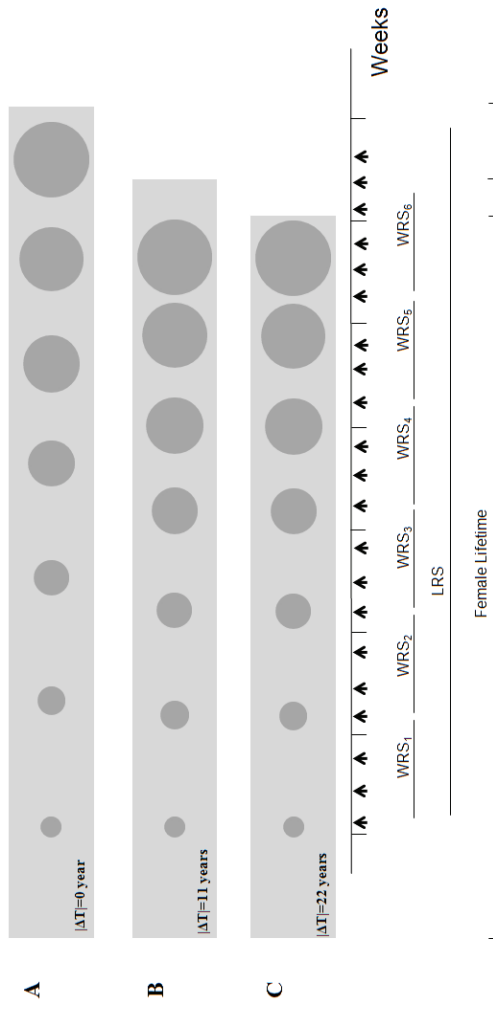

Fig. 6. Schematic illustration of the results from the study. Females survived best when mated to contemporary males (rectangle length in A, B and C). Female lifetime reproductive success did not differ between time-shifts (same number of circles in A, B and C). Female interbrood interval decrease was shallower when females were mated to contemporary males (longer distances between the circles in A, compared to B and C). Note that even if female weekly reproductive successes seem to differ between A and B and C, no difference was found for this trait between time-shifts. Symbols are described in Fig. 1.

Consistency across traits

Figure 6 pictures the main results of the study. Female survival and interbrood interval were affected by ΔT^2 and $\delta(\Delta T)$ respectively, which suggests that these traits are under fluctuating selection (Fig. 6). On the contrary, we did not detect any clear trend on female lifetime and weekly reproductive success (Fig. 6). Unfortunately, the selection pattern on female relative fitness could not be clearly identified.

DISCUSSION

In this study, we investigated male – female coevolution through time using dormant cysts of *Artemia franciscana* collected in the same population in different years (1985, 1996 and 2007). This is the first time sexual conflicts *in natura* are investigated over this time scale (spanning about 160 generations). Interestingly, our results suggest that male-female coevolution occurs in this population. The analyses of survival and reproductive rate patterns are consistent with fluctuating selection, whereas analyses of female relative fitness failed to distinguish arms race from fluctuating selection.

FEMALE YEAR EFFECT ON SURVIVAL AND REPRODUCTION

Our experiment revealed that all life history traits investigated, but one (WRS) showed significant differences across females from different years of origin. Analyses of survival and lifetime reproductive success showed that females from 2007 lived longer and produced more offspring in total than females from 1985 and 1996. Interestingly this effect was not found in the WRS analysis. This discrepancy indicates that the number of offspring per clutch/brood was equivalent across years, although female survival and interbrood interval were different. Thus, these strong year effects could be either due to a genetic change of the population or to different environmental conditions (*e.g.* time of conservation), which would have been passed on to the focal F1 offspring in our experiment through maternal effects. To our knowledge the effect of conservation time on life history traits has never been investigated in *Artemia*. Further investigations rearing several generations in laboratory conditions would help disentangle genetic from environmental factors acting on this strong year-of-origin effect.

SHAPE OF MALE-FEMALE COEVOLUTION IN ARTEMIA

In this study, we found that female survival and reproductive traits followed patterns consistent with male-female coevolution in a wild population of *Artemia franciscana*. Earlier studies have investigated sexual conflicts between species (e.g. Arnqvist and Rowe 2002b) or between populations within species (e.g. Andres and Arnqvist 2001; Brown and Eady 2001; Nilsson et al. 2002), but to our knowledge, this is the first study indicating such a coevolutionary pattern in a natural population over such a time scale.

Different variables were used in order to test alternative coevolutionary scenarios (see Methods). Our results indicated a time-shift effect on some of the traits. Analyses of survival and reproduction patterns indicated FSD scenarios as very likely. Disentangling the FSD from the ARD scenario was however statistically impossible for female relative fitness.

The clearer statistical effects of time-shift concerned female survival and reproductive rate (Fig. 3 and 4). Survival was the highest when females were mated to contemporary males and decreased by 3% and 12% when mated to males with 11 year- and 22 year time-

shifts (Fig. 3). In addition, the decrease of interbrood interval with age was the highest, when females were mated with non contemporary males (Fig. 4). In theory, this time-shift effect on female interbrood interval should translate into an interaction between time-shift and *Time* in the WRS analysis (Fig. 6). However, evidence for such an interaction was mitigated, since the additive model (without any time-shift effect) was amongst the best WRS models (Table S4). We suppose that the effect of time-shift on interbrood interval was too small to be detected in the WRS analysis. In addition, we observed an increase in female WRS over the first 7 weeks following first reproduction, after which WRS plateaus. Finally, we did not find any clear effect of time-shift on female lifetime reproductive success. This result may not be surprising as the increased survival of females mated with contemporary males tended to be counterbalanced by the shallower decrease in interbrood interval. It simply reflects trade-offs between survival and reproduction. Such a trade off as already been shown in *A. franciscana* (Browne 1982). Its presence makes it difficult to determine the primary fitness trait influenced by male behaviour across time-shifts.

Interestingly, we found a decrease in female fitness with increasing absolute time-shift. Indeed, ARD and FSD selection patterns on female relative fitness could not be statistically disentangled (Fig. 5). This result contrasts sharply with those obtained for the other traits (survival, LRS, WRS and reproductive rate), where females with non contemporary males (*i.e.* with positive or negative time-shifts) behaved similarly. Since female relative fitness was computed as a combination of survival and reproduction, we also expected that trait to follow a similar pattern. These differences occur because early reproduction weighs more in the fitness measure than late reproduction (an effect not taken into account in the LRS analysis). Consistent with this explanation, we found an effect of ΔT on WRS's intercept in some of the best models in Table S4. In all cases, the fitted ΔT effects were negative, which indicates that WRS early in life was higher for females with negative time-shifts. Discriminating among directional and fluctuating selection patterns acting on female fitness would require sampling over a wider time scale. This would also allow to ascertain the occurrence of the coevolutionary cycles observed on female survival and interbrood interval and would help to better characterize the dynamics (*e.g.* period

and phase) of these cycles. Nevertheless, although ancient cysts are readily available for such experiments, their hatching remains a challenge.

Furthermore, although our experiments support the hypothesis that female survival and reproduction are affected by males, the underlying mechanisms mediating the male – female interaction remain unknown. Indeed, the persistence of a sexual conflict requires divergent selection on one or several traits involved in the male – female interaction (Rowe and Day 2006). However, finding out which traits generate the conflict is not straightforward. Some hypotheses would be worth considering in our system. In *Artemia franciscana*, amplexus can last from hours to days and females are found in amplexus even when carrying fertilized eggs (Belk 1991). Mate guarding has been shown to be costly for females in many species (see Arnqvist and Rowe 2005b; Jormalainen 1998 for reviews). These costs (*e.g.* decreased foraging activity) are possibly stronger if contemporary males guard their mates more than their counterparts from the past or future. Hence, one explanation for the fluctuating selection pattern would be that in our experiment contemporary males were on average either faster to clasp their mates

and/or better able to secure her. Under this hypothesis, we expect contemporary males to perform better when competing with non-contemporary males. Measuring the fitness advantage of contemporary males over non-contemporary males when competing for fertilization would help confirm that sexual conflicts are driving male-female coevolution in this species.

TIME-SHIFT EXPERIMENTS AND COEVOLUTION PATTERNS

Time-shift experiments are powerful tools to investigate the dynamics of adaptation to changing selection (*e.g.* Hairston et al. 1999), especially antagonistic coevolutions (Gaba and Ebert 2009). Validity of inferences on ancient communities based on dormant eggs using this approach is a major concern for resurrection ecologists (*e.g.* Jankowski and Straile 2003; Keller and Spaak 2004). Such studies usually rely on the hypothesis that dormant eggs represent an unbiased sample of the study population regarding the focal trait. Hatching success of ancient eggs is usually low (*e.g.* Amat et al. 2005; Jankowski and Straile 2003), which is likely to impose selection on dormancy traits such as basal metabolic rate or diapause duration.

Hence, our results rely on the assumption that even if selective hatching would be correlated to sexually antagonistic traits, it would not create the male-female interaction observed here. Although extremely challenging, a formal test of this assumption would be useful.

One conceptual issue in this time-shift experiment is that the model including ΔT along with female and male year effects cannot be mathematically defined. This constraint limits the interpretation of additive effects of female and male years because they cannot be both estimated independently from ΔT effect. However, based on the model selection presented, it appears that the additive male year factor when fitted with ΔT had a persistently weak effect on female life history traits.

In the last decades, experimental evolution with microbes (virus, bacteria, yeast or unicellular algae) has become the main approach for studying adaptation over many generations in the laboratory (see Bell 2008). Although this method is very informative, research on individual life histories using these model organisms remains limited. Resurrection ecology has recently flourished with the use of *Daphnia* as a good multicellular alternative to microbes,

especially in the study of host-parasite coevolution (*e.g.* Decaestecker et al. 2007) and adaptation to a novel environment (*e.g.* Hairston et al. 1999). As we demonstrated in this study, *Artemia* long-lived resting eggs, could well become a valuable resurrection model for the study of sexual selection in natural conditions. Likewise angiosperm dormant seeds might prove to be a good system to study parental conflicts over post-fertilization offspring resource allocation, since this kind of sexual conflicts is likely to be widespread in this group (Cailleau et al. 2010; Friedman 2001).

ACKNOWLEDGMENTS

We thank G. Van Stappen for providing us with the cysts from *Artemia franciscana* and W. A. Wurtsbaugh for the information about *Artemia* population dynamics in the Great Salt Lake. We are grateful to V. Hornsperger, A. Remy, E. Flaven for their help with lab work and to the ECOGEV team, G. Martin, L.-M. Chevin, F. Blanquart and O. Gimenez for their help and comments. We also wish to thank Tracey Chapman and two anonymous reviewers for their comments. Financial support was provided by an ANR grant to AC (ANR-08-JCJC-0041-01), the QuantEvol ERC grant to TL and a French Ministry of Research fellowship to NR.

LITERATURE

- Amat, F., F. Hontoria, O. Ruiz, A. J. Green, M. I. Sanchez, J. Figuerola, and F. Hortas. 2005. The American brine shrimp as an exotic invasive species in the Western Mediterranean. *Biological Invasions* 7:37-47.
- Anderson, D. R., W. A. Link, D. H. Johnson, and K. P. Burnham. 2001. Suggestions for Presenting the Results of Data Analyses. *Journal of Wildlife Management* 65:373-378.
- Andres, J. A., and G. Arnqvist. 2001. Genetic Divergence of the Seminal Signal-Receptor System in Houseflies: the Footprints of Sexually Antagonistic Coevolution? *Proceedings of the Royal Society of London Series B-Biological Sciences* 268:399-405.
- Andres, J. A., R. A. Sanchez-Guillen, and A. C. Rivera. 2002. Evolution of Female Colour Polymorphism in Damselflies: Testing the Hypotheses. *Animal Behaviour* 63:677-685.
- Arnqvist, G., and T. Nilsson. 2000. The Evolution of Polyandry: Multiple Mating and Female Fitness in Insects. *Animal Behaviour* 60:145-164.
- Arnqvist, G., and L. Rowe. 2002a. Antagonistic Coevolution Between the Sexes in a Group of Insects. *Nature* 415:787-789.
- Arnqvist, G., and L. Rowe. 2002b. Correlated Evolution of Male and Female Morphologies in Water Striders. *Evolution* 56:936-947.
- Arnqvist, G., and L. Rowe. 2005a. Concepts and Levels of Sexual conflict. Pp. 216-225 *in* G. Arnqvist and

- L. Rowe, eds. Sexual conflict. Princeton University Press, Princeton.
- Arnqvist, G., and L. Rowe. 2005b. Sexual Conflict after Mating. Pp. 92-155 in G. Arnqvist and L. Rowe, eds. Sexual conflict. Princeton University Press, Princeton.
- Belk, D. 1991. Anostracan Mating Behaviour: a Case of Scramble Competition Polygyny. Pp. 111–125 in R. T. Bauer and J. W. Martin, eds. Crustacean Sexual Biology. Columbia University Press, New York.
- Bell, G. 2008. Experimental Evolution. *Heredity* 100:441-442.
- Bengtson, D. A., P. Léger, and P. Sorgeloss. 1991. Use of *Artemia* as a Food Source for Aquaculture. Pp. 237-253 in R. A. Browne, P. Sorgeloos and C. N. A. Trotman, eds. *Artemia* biology. CRC Press, Boca Raton, Florida.
- Brown, D. V., and P. E. Eady. 2001. Functional Incompatibility Between the Fertilization Systems of Two Allopatric Populations of *Callosobruchus maculatus* (Coleoptera : Bruchidae). *Evolution* 55:2257-2262.
- Browne, R. A. 1980. Reproductive Pattern and Mode in the Brine Shrimp. *Ecology* 61:466-470.
- Browne, R. A. 1982. The Costs of Reproduction in Brine Shrimp. *Ecology* 63:43-47.
- Browne, R. A., L. E. Davis, and S. E. Sallee. 1988. Effects of Temperature and Relative Fitness of Sexual and Asexual Brine Shrimp *Artemia*. *Journal of Experimental Marine Biology and Ecology* 124:1-20.

- Browne, R. A., V. Moller, V. E. Forbes, and M. H. Depledge. 2002. Estimating Genetic and Environmental Components of Variance Using Sexual and Clonal *Artemia*. *Journal of Experimental Marine Biology and Ecology* 267:107-119.
- Browne, R. A., and G. Wanigasekera. 2000. Combined Effects of Salinity and Temperature on Survival and Reproduction of Five Species of *Artemia*. *Journal of Experimental Marine Biology and Ecology* 244:29-44.
- Buckling, A., and P. B. Rainey. 2002. Antagonistic Coevolution Between a Bacterium and a Bacteriophage. *Proceedings of the Royal Society of London Series B-Biological Sciences* 269:931-936.
- Cailleau, A., P. O. Cheptou, and T. Lenormand. 2010. Ploidy and the Evolution of Endosperm of Flowering Plants. *Genetics* 184:439-453.
- Chapman, T., G. Arnqvist, J. Bangham, and L. Rowe. 2003. Sexual Conflict. *Trends in Ecology & Evolution* 18:41-47.
- Chapman, T., L. F. Liddle, J. M. Kalb, M. F. Wolfner, and L. Partridge. 1995. Cost of Mating in *Drosophila melanogaster* Females is Mediated by Male Accessory Gland Products. *Nature* 373:241 - 244.
- Chapman, T., and L. Partridge. 1996. Sexual Conflict as Fuel for Evolution. *Nature* 381:189-190.
- Charlesworth, B. 1994. *Evolution in Age-Structured Populations*. Cambridge University Press, Cambridge, UK.
- Chen, P. S., E. Stumm-Zollinger, T. Aigaki, J. Balmer, M. Bienz, and P. Böhlen. 1988. A Male Accessory

- Gland Peptide That Regulates Reproductive Behavior of Female *D. melanogaster*. *Cell* 54:291-298.
- Clegg, J. S., and C. N. A. Trotman. 2002. Physiological and Biochemical Aspects of *Artemia* Ecology. *Artemia: Basic and Applied Biology* 129-170.
- Crawley, M. J. 1993. *Glim for Ecologists*. Blackwell Scientific Publications, Oxford.
- Decaestecker, E., S. Gaba, J. A. M. Raeymaekers, R. Stoks, L. Van Kerckhoven, D. Ebert, and L. De Meester. 2007. Host-parasite 'Red Queen' dynamics archived in pond sediment. *Nature* 450:870-U16.
- Fowler, K., and L. Partridge. 1989. A cost of mating in female fruit-flies. *Nature* 338:760-761.
- Friedman, W. E. 2001. Developmental and Evolutionary Hypotheses for the Origin of Double Fertilization and Endosperm. *Comptes Rendus De L'Academie Des Sciences Serie III-Sciences De La Vie-Life Sciences* 324:559-567.
- Gaba, S., and D. Ebert. 2009. Time-Shift Experiments as a Tool to Study Antagonistic Coevolution. *Trends in Ecology & Evolution* 24:226-232.
- Gandon, S., A. Buckling, E. Decaestecker, and T. Day. 2008. Host-Parasite Coevolution and Patterns of Adaptation Across Time and Space. *Journal of Evolutionary Biology* 21:1861-1866.
- Gómez, G., M. L. Calle, R. Oller, and K. Langohr. 2009. Tutorial on Methods for Interval-Censored Data and their Implementation in R. *Statistical Modelling* 9:259-297.

- Grosbois, V., O. Gimenez, J. M. Gaillard, R. Pradel, C. Barbraud, J. Clobert, A. P. Moller, and H. Weimerskirch. 2008. Assessing the Impact of Climate Variation on Survival in Vertebrate Populations. *Biological Reviews* 83:357-399.
- Hairston, N. G., W. Lampert, C. E. Caceres, C. L. Holtmeier, L. J. Weider, U. Gaedke, J. M. Fischer, J. A. Fox, and D. M. Post. 1999. Lake Ecosystems - Rapid Evolution Revealed by Dormant Eggs. *Nature* 401:446-446.
- Holland, B., and W. R. Rice. 1998. Perspective: Chase-Away Sexual Selection: Antagonistic Seduction Versus Resistance. *Evolution* 52:1-7.
- Holland, B., and W. R. Rice. 1999. Experimental Removal of Sexual Selection Reverses Intersexual Antagonistic Coevolution and Removes a Reproductive Load. *Proceedings of the National Academy of Sciences of the United States of America* 96:5083-5088.
- Hurvich, C. M., and C. L. Tsai. 1989. Regression and Time-Series Model Selection in Small Samples. *Biometrika* 76:297-307.
- Jankowski, T., and D. Straile. 2003. A Comparison of Egg-Bank and Long-Term Plankton Dynamics of Two *Daphnia* Species, *D. hyalina* and *D. galeata*: Potentials and limits of reconstruction. *Limnology and Oceanography* 48:1948-1955.
- Jormalainen, V. 1998. Precopulatory Mate Guarding in Crustaceans: Male Competitive Strategy and Intersexual Conflict. *Quarterly Review of Biology* 73:275-304.

- Keller, B., and P. Spaak. 2004. Nonrandom Sexual Reproduction and Diapausing Egg Production in a *Daphnia* Hybrid Species Complex. *Limnology and Oceanography* 49:1393-1400.
- Lavens, P., and P. Sorgeloos. 1987. The Cryptobiotic State of *Artemia* Cysts, its Diapause Deactivation and Hatching: a Review. *Artemia* research and its applications: 3. Ecology, culturing, use in aquaculture. Proceedings of the Second International Symposium on the brine shrimp *Artemia*, 27-63.
- Lenz, P. H., and R. A. Browne. 1991. Ecology of *Artemia*. Pp. 237-253 in R. A. Browne, P. Sorgeloos and C. N. A. Trotman, eds. *Artemia* biology. CRC Press, Boca Raton, Florida.
- Lessells, C. M., and P. T. Boag. 1987. Unrepeatable Repeatabilities - a Common Mistake. *Auk* 104:116-121.
- Lochhead, J. H. 1950. *Artemia*. Pp. 394-399 in F. A. J. Brown, ed. *Selected Invertebrates Types*. John Wiley and Sons, New York.
- Nambu, Z., S. Tanaka, and F. Nambu. 2004. Influence of Photoperiod and Temperature on Reproductive Mode in The Brine Shrimp, *Artemia franciscana*. *Journal of Experimental Zoology Part A Comparative Experimental Biology* 301A:542-546.
- Nilsson, T., C. Fricke, and G. Arnqvist. 2002. Patterns of Divergence in the Effects of Mating on Female Reproductive Performance in Flour Beetles. *Evolution* 56:111-120.
- Parker, G. A. 1979. *Sexual Selection and Reproductive Competition in Insects*. Academic, New York.

- Parker, G. A., and L. Partridge. 1998. Sexual Conflict and Speciation. *Philosophical Transactions of the Royal Society of London Series B-Biological Sciences* 353:261-274.
- Peters, A. D., D. L. Halligan, M. C. Whitlock, and P. D. Keightley. 2003. Dominance and Overdominance of Mildly Deleterious Induced Mutations for Fitness Traits in *Caenorhabditis elegans*. *Genetics* 165:589-599.
- Pizzari, T., and R. R. Snook. 2003. Perspective: Sexual conflict and Sexual Selection: Chasing Away Paradigm Shifts. *Evolution* 57:1223-1236.
- Reeve, M. R. 1963. Filter-Feeding of *Artemia* .1. in *Pure Cultures of Plant Cells*. *Journal of Experimental Biology* 40:195-205.
- Reznick, D. 1993. New Model Systems for Studying the Evolutionary Biology of Aging - Crustacea. *Genetica* 91:79-88.
- Rice, W. R. 1996. Sexually Antagonistic Male Adaptation Triggered by Experimental Arrest of Female Evolution. *Nature* 381:232-234.
- Rice, W. R. 2000. Dangerous Liaisons. *Proceedings of the National Academy of Sciences of the United States of America* 97:12953-12955.
- Rowe, L., and T. Day. 2006. Detecting Sexual Conflict and Sexually Antagonistic Coevolution. *Philosophical Transactions of the Royal Society B-Biological Sciences* 361:277-285.
- Shirdhankar, M. M., P. C. Thomas, and S. K. Barve. 2004. Phenotypic Estimates and Heritability Values of *Artemia franciscana*. *Aquaculture Research* 35:35-39.

- Skalski, J. R. 1996. Regression of Abundance Estimates from Mark-Recapture Surveys Against Environmental Covariates. *Canadian Journal of Fisheries and Aquatic Sciences* 53:196-204.
- Therneau, T. M., P. M. Grambsch, and V. S. Pankratz. 2003. Penalized Survival Models and Frailty. *Journal of Computational and Graphical Statistics* 12:156-175.
- Tregenza, T., N. Wedell, and T. Chapman. 2006. Introduction. Sexual Conflict: a New Paradigm? *Philosophical Transactions of the Royal Society B-Biological Sciences* 361:229-234.
- Vassilieva, L. L., and M. Lynch. 1999. The Rate of Spontaneous Mutation for Life-History Traits in *Caenorhabditis elegans*. *Genetics* 151:119-129.
- von Hentig, R. 1971. Influence of Salinity and Temperature on Development, Growth, Reproduction and Energy Budget of *Artemia-Salina*. *Marine Biology* 9:145-182.
- Wolfe, A. F. 1973. Observations on the Clasp Behavior of *Artemia-Salina*. *American Zoologist* 13:1340-1340.
- Woolhouse, M. E. J., J. P. Webster, E. Domingo, B. Charlesworth, and B. R. Levin. 2002. Biological and Biomedical Implications of the Co-evolution of Pathogens and their Hosts. *Nature Genetics* 32:569-577.
- Wurtsbaugh, W. A., and Z. Maciej Gliwicz. 2001. Limnological Control of Brine Shrimp Population Dynamics and Cyst Production in the Great Salt Lake, Utah. *Hydrobiologia* 466:119-132.

Article 3

SUPPLEMENTRAY MATERIALS

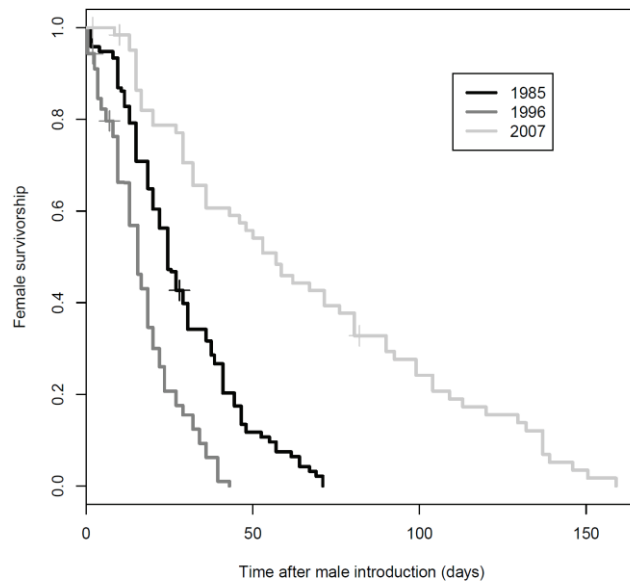

Fig. S1. Proportion of females from the three years alive over time, for females mated with contemporary males only. A differential mortality rate across years was observed. Mortality rate was the highest in females from 1996 and the lowest in females from 2007. Crosses represent censored females.

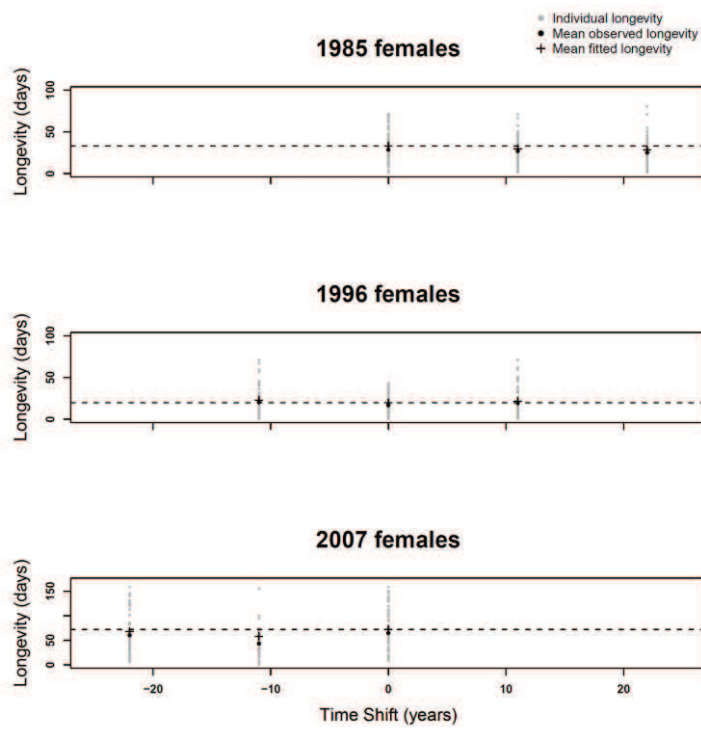

Fig. S2. Comparison of mean observed and fitted longevity of females from 1985, 1996 and 2007. Right-censored females are not included in mean observed longevity calculation, as a consequence observed mean tends to be lower than mean fitted longevity computed with the fully censored data. The horizontal dash lines represent the fitted longevity of females mated with contemporary males. Estimates from the best survival model were used to compute the fitted means (Table1).

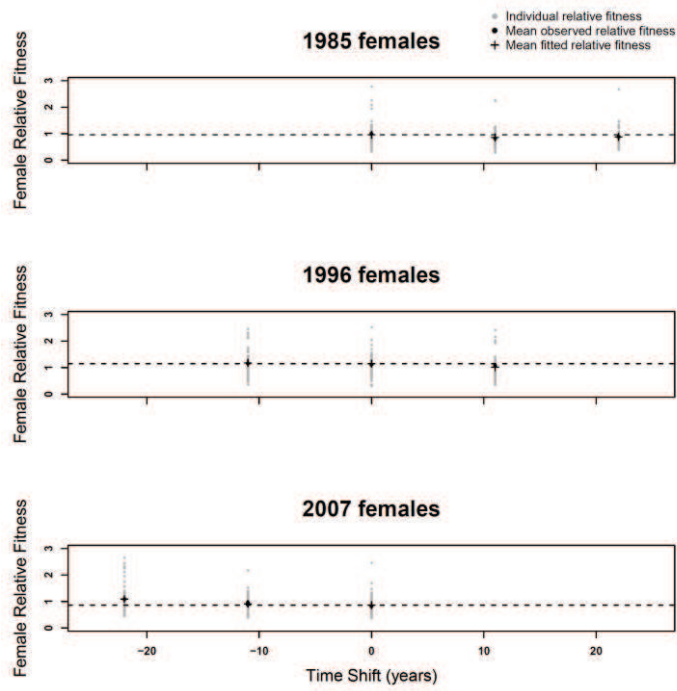

Fig. S3. Comparison of mean observed and fitted relative fitness of females from 1985, 1996 and 2007. The horizontal dash lines represent the fitted relative fitness of females mated with contemporary males. Estimates from the best relative fitness model were used to compute the fitted means.

Table S1. Model selection of female survival models based on AICc. Models are sorted according to their Akaike weight (wi). All models included Tray, FBD, AFM, Iso, SibSize, an interaction SibSize:female year and Sib as a random effect. The different factors fitted on Weibull shape (α) are presented. FSD: Fluctuating Selection Dynamics, ARD: Arms Races Dynamics, M, F: Male year and female year. Other abbreviations are defined in the methods.

Model	K	logLik	AIC	AICc	$\Delta AICc$	Akaike Weight (wi)	Male-Female			R ² Dev
							Effects and Interaction on Weibull Shape	Male-Female Interaction on Weibull Scale	Male-Female Effects on Weibull Scale	
FSD	61.74	-2289.85	4723.17	4734.23	0.00	0.29	$\alpha(F)$	ΔJ^2	M+F	0.94
FSD	59.64	-2302.64	4724.56	4734.86	0.63	0.21	$\alpha(F)$	ΔJ^2	F	
FSD	59.68	-2303.06	4725.47	4735.78	1.55	0.14	$\alpha(F)$	$\delta(\Delta J)$	F	
Additive	60.60	-2302.26	4725.73	4736.38	2.15	0.10	$\alpha(F)$	-	M+F	
FSD	60.58	-2302.50	4726.16	4736.80	2.57	0.08	$\alpha(F)$	$\Delta J^2 + \Delta J$	F	
ARD	59.52	-2303.79	4726.62	4736.87	2.64	0.08	$\alpha(F)$	ΔJ	F	
FSD	61.68	-2301.49	4726.34	4737.38	3.15	0.06	$\alpha(F)$	$\delta(\Delta J)$	M+F	
Interaction	64.61	-2299.69	4728.59	4740.75	6.52	0.01	$\alpha(F)$	M*	M+F	
FSD	59.58	-2305.81	4730.78	4741.05	6.83	0.01	α	ΔJ^2	M+F	
Additive	58.48	-2307.71	4732.38	4742.27	8.04	0.01	α	-	M+F	
FSD	60.54	-2305.63	4732.34	4742.97	8.74	0.00	$\alpha(\delta(\Delta J))$	ΔJ^2	M+F	
Additive	59.45	-2307.32	4733.54	4743.77	9.54	0.00	$\alpha(\delta(\Delta J))$	-	M+F	
FSD	59.52	-2307.27	4733.60	4743.85	9.62	0.00	α	$\delta(\Delta J)$	M+F	

Table S2. Model selection of female probability to lay a clutch/brood at least once in her lifetime based on AICc. All models included *FBD*, *AFM*, *SibSize* as fixed effects and *Tray* and *Sib* as random effects. See Table S1 and methods for abbreviations.

Model	K	logLik	AIC	AICc	$\Delta AICc$	Akaike Weight (wi)	Male-Female Interaction	Male-Female Effects
Additive	10	-347.29	714.58	714.88	0.00	0.33	-	M+F
FSD	11	-347.20	716.40	716.76	1.88	0.13	ΔT^2	M+F
FSD	11	-347.27	716.53	716.90	2.01	0.12	$\delta(\Delta T)$	M+F
ARD	9	-349.44	716.88	717.13	2.24	0.11	ΔT	F
FSD	10	-349.30	718.59	718.89	4.01	0.04	$\Delta T + \Delta T$	F
Additive	8	-351.85	719.70	719.90	5.01	0.03	-	F
FSD	9	-351.74	721.48	721.73	6.84	0.01	ΔT^2	F
Interaction	14	-346.66	721.31	721.89	7.01	0.01	M+F	M+F
FSD	9	-351.85	721.70	721.95	7.06	0.01	$\delta(\Delta T)$	F
ARD	9	-352.72	723.43	723.68	8.79	0.00	ΔT	M

Table S3. Model selection for female lifetime reproductive success based on AICc. All models included the proportion of nauplii and AFM as covariates and *Sib* as a random effect. See Table S1 and methods for abbreviations.

Model	K	logLik	AIC	AICc	Δ AICc	wi	Male-Female Interaction	Male-Female effects
Additive	7	-2379.09	4772.18	4772.45	0.00	0.37	-	F
FSD	8	-2378.87	4773.74	4774.09	1.64	0.16	$\delta(\Delta T)$	F
FSD	8	-2378.93	4773.86	4774.21	1.76	0.15	ΔT^2	F
ARD	8	-2379.04	4774.08	4774.43	1.98	0.14	ΔT	F
FSD	9	-2378.89	4775.78	4776.22	3.77	0.06	$\Delta T^2 + \Delta T$	F
Additive	9	-2378.94	4775.88	4776.32	3.87	0.05	-	M+F
FSD	10	-2378.76	4777.52	4778.06	5.61	0.02	ΔT^2	M+F
ARD	10	-2378.87	4777.74	4778.28	5.83	0.02	ΔT	M+F
FSD	11	-2378.71	4779.42	4780.07	7.62	0.01	$\Delta T^2 + \Delta T$	M+F
Interaction	13	-2376.59	4779.18	4780.08	7.63	0.01	M+F	M+F

Table S4. Model selection of female weekly reproductive success based on AICc. The models included female identity as a random effect and *Tray*, *FBD*, *AFM*, *Iso* and *SibSize* as covariates, unless otherwise stated. Time since first reproduction (*Time*) and its square value (*Time*²) were also included. See Table S1 and methods for other abbreviations.

Model	K	logLik	AIC	AICc	$\Delta AICc$	wi	Time effect	Male-Female Interaction	Male-Female Effects	Effects not included
FSD	36	-8241.16	16554.32	16555.49	0.00	0.1	<i>Time</i> * ΔT * <i>Time</i> ²	-	-	-AFM-FBD
FSD	37	-8240.34	16554.88	16555.92	0.43	0.08	<i>Time</i> * ΔT * <i>Time</i> ²	ΔT	-	-AFM-FBD
ARD	36	-8241.53	16555.06	16556.23	0.74	0.07	<i>Time</i> * ΔT * <i>Time</i> ²	-	-	-AFM-FBD
Additive	36	-8241.64	16555.28	16556.45	0.96	0.06	<i>Time</i> * <i>Time</i> ²	-	-	-AFM
ARD	37	-8240.63	16555.26	16556.50	1.01	0.06	<i>Time</i> * ΔT * <i>Time</i> ²	ΔT^2	-	-AFM-FBD
FSD	37	-8240.84	16555.68	16556.92	1.43	0.05	<i>Time</i> * ΔT * <i>Time</i> ²	ΔT^2	-	-AFM-FBD
FSD	37	-8240.85	16555.70	16556.94	1.45	0.05	<i>Time</i> * <i>Time</i> ² * ΔT^2	ΔT^2	-	-AFM-FBD
Additive	35	-8242.93	16555.86	16556.97	1.48	0.05	<i>Time</i> * <i>Time</i> ²	-	-	-AFM-FBD
ARD	37	-8240.98	16555.96	16557.20	1.71	0.04	<i>Time</i> * <i>Time</i> ² * ΔT	ΔT	-	-AFM-FBD
FSD	36	-8242.02	16556.04	16557.21	1.72	0.04	<i>Time</i> * ΔT * <i>Time</i> ²	-	-	-AFM-FBD
ARD	37	-8241.07	16556.14	16557.38	1.89	0.04	<i>Time</i> * ΔT * <i>Time</i> ²	ΔT	-	-AFM-FBD
FSD	36	-8242.27	16556.54	16557.71	2.22	0.03	<i>Time</i> * <i>Time</i> ² * ΔT	-	-	-AFM-FBD
Additive	36	-8242.53	16557.06	16558.23	2.74	0.02	<i>Time</i> * <i>Time</i> ²	-	-	-FBD
FSD	36	-8242.6	16557.20	16558.37	2.88	0.02	<i>Time</i> * <i>Time</i> ² * ΔT^2	-	-	-AFM-FBD
Additive	37	-8241.62	16557.24	16558.48	2.99	0.02	<i>Time</i> * <i>Time</i> ²	-	-	-

ARD	36	-8242.82	16557.64	16558.81	3.32	0.02	$Time+Time^2*\Delta T$	-	-	-AFM/FBD
FSD	39	-8239.77	16557.54	16558.91	3.42	0.02	$Time+Time^2$	ΔT^2	F	-AFM
FSD	37	-8241.95	16557.90	16559.14	3.65	0.02	$Time*\delta(\Delta T)+Time^2$	$\delta(\Delta T)$	-	-AFM/FBD
FSD	37	-8242	165580	16559.24	3.75	0.02	$Time+Time^2*\delta(\Delta T)$	$\delta(\Delta T)$	-	-AFM/FBD
FSD	39	-8239.99	16557.98	16559.35	3.86	0.01	$Time*\Delta T^2+Time^2$	ΔT^2	-	-
FSD	39	-8240.01	16558.02	16559.39	3.90	0.01	$Time+Time^2*\Delta T^2$	ΔT^2	-	-
Additive	34	-8245.20	16558.40	16559.44	3.95	0.01	Time	-	-	-AFM/FBD
ARD	39	-8240.09	16558.18	16559.55	4.06	0.01	$Time+Time^2*\Delta T$	ΔT	-	-
FSD	39	-8240.15	16558.30	16559.67	4.18	0.01	$Time+Time^2$	ΔT^2	M	-AFM
ARD	39	-8240.16	16558.32	16559.69	4.20	0.01	$Time*\Delta T+Time^2$	ΔT	-	-
ARD	39	-8240.19	16558.38	16559.75	4.26	0.01	$Time+Time^2$	ΔT	M	-AFM
Additive	38	-8241.23	16558.46	16559.76	4.27	0.01	$Time+Time^2$	-	F	-AFM
FSD	36	-8243.44	16558.88	16560.05	4.56	0.01	$Time*\Delta T$	ΔT^2	-	-AFM/FBD
ARD	39	-8240.36	16558.72	16560.09	4.60	0.01	$Time+Time^2$	ΔT	F	-AFM
FSD	39	-8240.56	16559.12	16560.49	5	0.01	$Time+Time^2$	$\delta(\Delta T)$	M	-AFM
Additive	34	-8245.84	16559.68	16560.72	5.23	0.01	Time ²	-	-	-AFM/FBD
FSD	39	-8240.78	16559.56	16560.93	5.44	0.01	$Time*\delta(\Delta T)+Time^2$	$\delta(\Delta T)$	-	-
ARD	36	-8243.92	16559.84	16561.01	5.62	0.01	$Time^2*\Delta T$	ΔT	-	-AFM/FBD

FSD	39	-8240.86	16559.72	16561.09	5.60	0.01	$Time+Time^2 \cdot \delta(\Delta T)$	$\delta(\Delta T)$	-
FSD	36	-8243.99	16559.88	16561.15	5.66	0.01	$Time^2 \cdot \Delta T^2$	ΔT^2	-AFM-FBD
Additive	36	-8244.04	16560.08	16561.25	5.76	0.01	$Time$	-	-
FSD	40	-8239.99	16559.98	16561.42	5.93	0.01	$Time \cdot \Delta T^2 + Time^3 \cdot \Delta T^2$	ΔT^2	-
FSD	39	-8241.06	16560.12	16561.49	6	0	$Time+Time^2$	$\delta(\Delta T)$	F
Additive	36	-8244.27	16560.54	16561.71	6.22	0	$Time+Time^2$	-	-S/bSize
Additive	40	-8240.19	16560.38	16561.52	6.33	0	$Time+Time^2$	-	M+F
Additive	36	-8244.56	16561.12	16562.29	6.80	0	$Time^2$	-	-
FSD	41	-8239.40	16560.80	16562.32	6.83	0	$Time+Time^2$	ΔT^2	M+F
Additive	36	-8244.91	16561.52	16562.99	7.50	0	$Time+Time^2$	-	-Iso
ARD	41	-8239.79	16561.58	16563.10	7.61	0	$Time+Time^2$	ΔT	M+F
FSD	41	-8240.10	16562.20	16563.72	8.23	0	$Time+Time^2$	$\delta(\Delta T)$	M+F
Additive	41	-8240.58	16563.16	16564.88	9.19	0	$Time+Time^2+F$	-	F
Additive	41	-8240.59	16563.18	16564.70	9.21	0	$Time^2+Time^2$	-	F

Table S5. Model selection for female reproductive rate based on AICc. The models included female identity as a random effect and Tray, FBD, AFM, Iso and SibSize as covariates, unless otherwise stated. The last model is included for the calculation of the R²_Dev coefficient. See Table S1 and methods for abbreviations.

Weibull Shape Model	Weibull Scale Model	K	logLik	AIC	AICc	ΔAICc	wi	Male-Female		Effects not Included	R ² _Dev
								Effects and Interaction on Weibull Shape	Effects on Weibull Scale		
FSD	Interaction	248.05	-3495.66	7487.44	7547.27	0.00	0.13	$\alpha(\delta(\Delta T))$	M/F	M+F	0.14
FSD	Interaction	247.82	-3495.97	7487.58	7547.29	0.02	0.13	$\alpha(\delta(\Delta T))$	M/F	M+F	0.10
FSD	FSD	248.77	-3495.37	7488.28	7548.48	1.21	0.07	$\alpha(\delta(\Delta T))$	ΔT^2	M+F	-SibSize
FSD	Interaction	249.52	-3494.46	7487.97	7548.56	1.29	0.07	$\alpha(\delta(\Delta T))$	M/F	M+F	-FBD
FSD	FSD	249.57	-3494.50	7488.14	7548.75	1.48	0.06	$\alpha(\delta(\Delta T))$	$\delta(\Delta T)$	M+F	
FSD	Additive	249.53	-3494.59	7488.23	7548.82	1.55	0.06	$\alpha(\delta(\Delta T))$	-	M+F	
FSD	Interaction	248.80	-3495.57	7488.74	7548.95	1.68	0.06	$\alpha(\delta(\Delta T))$	M/F	M+F	-FBD-SibSize
Additive	Interaction	248.16	-3496.60	7489.51	7549.40	2.13	0.05	$\alpha(M)$	M/F	M+F	
FSD	Interaction	250.08	-3494.24	7488.65	7549.52	2.25	0.04	$\alpha(\Delta T^2)$	M/F	M+F	
FSD	ARD	254.57	-3488.74	7486.62	7549.83	2.56	0.04	$\alpha(\delta(\Delta T))$	ΔT	F	
FSD	Interaction	247.68	-3497.47	7490.30	7549.94	2.67	0.04	$\alpha(\delta(\Delta T))$	M/F	M+F	-Iso
FSD	FSD	254.35	-3489.13	7486.97	7550.07	2.79	0.03	$\alpha(\delta(\Delta T))$	ΔT^2	F	
FSD	FSD	249.55	-3495.25	7489.59	7550.19	2.82	0.03	$\alpha(\delta(\Delta T))$	ΔT^2	M+F	-FBD-SibSize
FSD	FSD	253.49	-3490.31	7487.60	7550.25	2.88	0.03	$\alpha(\delta(\Delta T))$	$\delta(\Delta T)$	F	

FSD	Additive	254.08	-3489.69	7487.55	7550.50	3.23	0.03	$\alpha(\delta(\Delta T))$	-	F
FSD	FSD	250.57	-3494.15	7489.44	7550.56	3.29	0.03	$\alpha(\delta(\Delta T))$	$\delta(\Delta T)$	F+M
FSD	Additive	250.68	-3494.07	7489.51	7550.70	3.43	0.02	$\alpha(\delta(\Delta T))$	-	M+F
FSD	ARD	255.35	-3488.71	7488.11	7551.73	4.46	0.01	$\alpha(\delta(\Delta T))$	ΔT	F
FSD	FSD	254.94	-3489.32	7488.51	7551.91	4.64	0.01	$\alpha(\delta(\Delta T))$	ΔT^2	F
FSD	FSD	254.04	-3490.52	7489.11	7552.04	4.77	0.01	$\alpha(\delta(\Delta T))$	$\delta(\Delta T)$	F
FSD	Additive	254.80	-3489.72	7489.04	7552.37	5.10	0.01	$\alpha(\delta(\Delta T))$	-	F
Additive	Interaction	254.80	-3489.73	7489.05	7552.38	5.11	0.01	$\alpha(F)$	M*F	M+F
ARD	Interaction	253.36	-3492.17	7491.08	7553.66	6.38	0.01	$\alpha(\Delta T)$	M*F	M+F
FSD	Interaction	250.65	-3495.75	7492.80	7553.97	6.70	0.00	$\alpha(\delta(\Delta T))$	M*F	M+F
Interaction	Interaction	258.98	-3490.05	7498.06	7563.61	16.34	0.00	$\alpha(M*F)$	M*F	M+F

Table S6: Model selection of female relative fitness based on AICc. All models included Sib as a fixed effect. See Table S1 and methods for abbreviations.

Model	K	logLik	AIC	AICc	Δ AICc	wi	Male-Female Interaction	Male-Female effects	R ² _Dev
FSD	43	-55.04	196.08	206.17	0.00	0.31	$\Delta T^2 + \Delta T$	F	0.22
ARD	42	-56.33	196.65	206.26	0.09	0.30	ΔT	F	
FSD	44	-54.83	197.65	208.24	2.08	0.11	$\delta(\Delta T)$	M+F	
Additive	43	-56.09	198.17	208.26	2.10	0.11	-	M+F	
FSD	44	-55.01	198.02	208.61	2.45	0.09	ΔT^2	M+F	
Interaction	47	-51.30	196.61	208.77	2.60	0.08	M*F	M+F	

Article 4

Differential susceptibility to parasites of invasive and
native species of *Artemia* living in sympatry:
consequences for the invasion of *A. franciscana*
in the Mediterranean Region

M.I. Sánchez, N.O. Rode, E. Flaven, S. Redón, F. Amat,

G.P. Vasileva, T. Lenormand

As published in Biological Invasions (2012)

Abstract

Elucidating the mechanisms making a successful invader remains a central problem in invasion ecology. There is growing evidence supporting that the outcome of competition between species can be controlled by parasites. However our understanding of how parasites affect the interaction between native and invasive species is very limited. Here we explore the role of parasites as potential agents mediating the competitive exclusion of populations of Mediterranean brine shrimps *Artemia* by the exotic American *A. franciscana*, which is leading in most of the cases to the extinction of native *Artemia* populations. We compared the susceptibility of the invasive species and the native *A. parthenogenetica* to different cestode species using an exceptional case of sympatry in Aigues-Mortes saltern, South of France. The invader *A. franciscana* showed greatly reduced diversity, low prevalence and low burden of cestode larvae compared to its native congener. Infection in *A. parthenogenetica* was associated with high fitness costs. In particular, the most prevalent cestode, *Flamingolepis liguloides* caused castration in *A. parthenogenetica*. The results of this study suggest that the large impact of cestode on the native, but not the invading species, is likely to confer a decisive competitive advantage to the invader. It thus certainly contributes to explain the demographic success of *A. franciscana* in the Mediterranean region.

Keywords: *Artemia parthenogenetica*, *Artemia franciscana*, cestodes, biological invasions

Introduction

Massive transgression of biogeographical barriers and translocation of organisms into new non-natural ranges is a global phenomenon, which is changing the world significantly and permanently. One of the main consequences of this biological exchange is the competitive displacement and extinction of native species by aliens, resulting in a homogenisation of the biota, both at the species and genetic levels. This has led scientists to consider invasions as a main component of the globalisation process, *i.e.* “bioglobalisation” (Petit 2004; Van der Weijden et al. 2007). Non-indigenous species represent a major threat to biodiversity and ecosystem integrity, with extensive ecological and evolutionary consequences (Mooney and Cleland 2001).

Elucidating the mechanisms making an invasive species successful is crucial for a full understanding of the invasion phenomenon and to improve our capacity to predict the outcome of ongoing or future invasions. Despite the intensive research in this field in the last two decades (Kolar and Lodge 2001), it is still not clear whether the invasive ability

of a species resides in a better adaptation toward either abiotic or biotic factors. In the latter case, the key requirement is an asymmetry between native and alien species in their adaptation to native (or alien if they are also co-introduced) preys, parasites or predators (Dunn 2009).

The “Enemy Release Hypothesis” is one of the most accepted arguments to explain the success of invasive species (Keane and Crawley 2002). Evidence in favor of this hypothesis is, however, conflicting (Colautti et al. 2004; Liu et al. 2007). Most biogeographical studies comparing native and introduced populations of a given host show a reduction in enemies in the new invaded area. In contrast, community studies comparing native and invasive species co-occurring within the same habitat often show similar prevalence between native and invasive host species (Colautti et al 2004). However only the latter approach can address the role of parasites in the relative success of invasive versus native species. Importantly, this comparison is best made in a common environment where native and invasive species co-occur.

Brine shrimps *Artemia* spp. (Pancrustacea, Branchiopoda, Anostraca) are considered as keystone species in hypersaline ecosystems, as many species of waterbirds depend on *Artemia* as prey (Britton and Johnson 1987; Sánchez et al. 2006a), and where they represent an important component of the biodiversity (Amat 1983; Lenz and Browne 1991; Amat et al. 1995). The repeated introduction of the American brine shrimp *A. franciscana* has led to a serious decline in native populations of other *Artemia* species. Competitive exclusion has been suggested as a possible mechanism for this decline (Mura et al. 2004; Amat et al. 2005; Green et al. 2005; Amat et al. 2007). In most populations, the invasion of the exotic *A. franciscana* resulted in a complete and rapid eradication of its native congeners.

A different susceptibility to parasites has been hypothesized to explain the invasive success of *A. franciscana* in the Mediterranean region (Georgiev et al. 2007). *Artemia* is the intermediate host of several species of avian cestodes whose transmission depends on predation by waterbirds (see reviews in Georgiev et al. 2005; Vasileva et al. 2009).

Cestode infection in native *Artemia* is associated to spectacular phenotypic alterations (Gabrion et al. 1982; Thiéry et al. 1990; Sánchez et al. 2006b, 2007, 2009a), which considerably reduce host fitness (castration, increased predation, Amat et al. 1991; Sánchez et al. 2009b). In *Artemia*, cestode prevalence varies between species and within species among populations (Thiery et al. 1990; Georgiev et al. 2007). However, there is no direct evidence that these differences of prevalence are due to genetic differences (within or between species) in susceptibility or to different environmental conditions (e.g. water chemistry, final host community). This difficulty is due to the very rare co-occurrence of native and invasive species (Amat et al. 2005). Finally, the virulence, or more broadly, the phenotypic impact of cestodes on invasive *Artemia* is completely unknown.

The main objective of this paper is to evaluate the role of cestode parasites in the success of *A. franciscana* invasion. To do so, we focus on a particular case of sympatry (Aigues Mortes salterns, South of France) between the exotic *A. franciscana* and the native *A. parthenogenetica*. First, we

document the distribution of the different parasites across seasons in both species. Second, we measure the phenotypic impact of the parasites on these species.

Methods

Populations and sampling

Brine shrimps were collected in an industrial saltern in Aigues-Mortes (43°34'N– 4°11'E), South of France. The native *Artemia* population is parthenogenetic (Amat et al. 2005); *A. franciscana* (from San Francisco Bay area) was introduced more than 30 years ago and both species have been coexisting since then. Sampling was carried out 5 times in summer (twice in July, once in August, twice in September) and 2 times in winter (December) throughout 2008. After collecting, living individuals were stocked in the laboratory in a shallow tank 50 (length) × 10 (height) × 30 (width) cm, and provided with food *ad libitum* (*Dunaliella tertiolecta*).

Cestode identification

Individual *Artemia* were randomly sampled from the tank and examined under a stereomicroscope. Species (*A. parthenogenetica* or *A. franciscana*) were assigned according to Hontoria and Amat (1992a, b). Subsequently, each specimen was prepared in a temporary mount and examined under microscope for the presence of metacestode parasites. Identification of cysticercoids was made on the basis of rostellar hooks following Georgiev et al. (2005) and Vasileva et al. (2009). We recorded the effect of infection by measuring colour intensity (pale pink, medium and bright red), reproductive status (castrated, presence of ovocytes, cysts, or developing nauplii) and presence/absence of conspicuous lipid granules.

Analysis of cestode distribution

Cestode prevalence, abundance and intensity of infection were computed following Bush *et al.* (1997). Prevalence is the % of infected individuals of the host population. Abundance is the number of parasites per

individual (both infected and uninfected) of the host population. Intensity is the number of parasites per infected individual of the host population. Prevalence and abundance of each parasite species were analysed using generalized linear models with binomial and Poisson errors, respectively (package stats in R. 11.0). The full model included 'species' (*A. franciscana* and *A. parthenogenetica*) and 'season' (summer vs. winter) as factors, as well as their interaction. Model selection was performed using stepwise regression with χ^2 tests.

In order to determine (1) whether parasites tend to be aggregated in some individuals (instead of being randomly distributed) and (2) whether the presence of parasites from different species is correlated among individuals (instead of being independent), we analysed in details the joint distribution of the two most prevalent parasites (*Flamingolepis liguloides* and *Fimbriarioides tadornae*). Only the data on *A. parthenogenetica* individuals was used, because of the low prevalence of these parasites in *A. franciscana*. We used a bivariate Poisson Log-Normal model (Aitchison and Ho 1989).

In short, noting \mathbf{n} the vector of the number of *F. liguloides* and *F. tadornae* counted in a given individual we have

$$\begin{aligned} \mathbf{n} &\sim \mathcal{P}_2(\exp(\boldsymbol{\lambda})) \\ \boldsymbol{\lambda} &\sim \mathcal{N}_2(\mathbf{m}, \boldsymbol{\Sigma}) \end{aligned} \quad (1)$$

where \mathcal{P}_2 and \mathcal{N}_2 denote bivariate Poisson and Normal distributions, respectively, and where

$$\begin{aligned} \mathbf{m} &= (m_1, m_2) \\ \boldsymbol{\Sigma} &= \begin{pmatrix} \sigma_1^2 & \rho\sigma_1\sigma_2 \\ \rho\sigma_1\sigma_2 & \sigma_2^2 \end{pmatrix}. \end{aligned} \quad (2)$$

With this parameterization, m_1 and m_2 measure prevalence of each species of parasite while σ_1 and σ_2 indicate their degree of aggregation (parasites being more aggregated with larger σ). Finally, ρ measures whether the two species of parasites co-occur more ($\rho > 0$) or less ($\rho < 0$) often within a given individual than randomly. This model was fitted by maximum likelihood using numerical integration in Mathematica (Wolfram 1999). Support limits for estimates were computed within 2 units of Log-likelihood.

Analysis of cestode phenotypic impact

The presence of lipid granules was analysed using a generalized linear model with a binomial error (package stats in R. 11.0). The full model included host species (*A. franciscana* vs. *A. parthenogenetica*), 'season' (summer vs. winter) and 'parasite species' as well as their interactions. *Artemia* colour (pale pink, medium and bright red) and female reproductive status (absence/presence of ovocytes, cysts, nauplii) were analysed similarly (except that a sex effect was fitted for *Artemia* colour), but with a multinomial error (nnet package in R 11.0). Model selection was performed using stepwise regression with χ^2 tests. For the study of colour, only live *Artemia* were used. In order to compare the effect of parasite presence and infection intensity on the presence of lipids, on *Artemia* colour and on female reproductive status, we used AIC criterion since both models were not nested (Burnham and Anderson 2002).

		<i>A. parthenogenetica</i>		<i>A. franciscana</i>	
		Summer <i>n</i> = 303 (60.2%)	Winter <i>n</i> = 9 (3%)	Summer <i>n</i> = 200 (39.8%)	Winter <i>n</i> = 291 (97%)
Total	P%	70.9	66.7	1.5	0.7
	MA	1.40 ± 0.08	1.46 ± 0.60	0.015 ± 0.01	0.007 ± 0.005
	MI	1.97 ± 0.08	2.33 ± 0.715	1.00 ± 0.00	1.11
<i>Flamingolepis liguloides</i>	P%	66.7	66.7	0	0
	MA	1.21 ± 0.07	1.33 ± 0.47	0	0
	MI	1.82 ± 0.08	2.00 ± 0.52	0	0
<i>Flamingolepis flamingo</i>	P%	2.3	11.1	0	0
	MA	0.02 ± 0.01	0.11 ± 0.11	0	0
	MI	1.00 ± 0.0	1.00 ± 0.0	0	0
<i>Fimbriarioides tadomae</i>	P%	7.9	0	0.5	0
	MA	0.13 ± 0.03	0	0.01 ± 0.01	0
	MI	1.62 ± 0.20	0	1.00	0
<i>Wardium stellorae</i>	P%	1.3	0	0	0
	MA	0.01 ± 0.01	0	0	0
	MI	1.00 ± 0.0	0	0	0
<i>Eurycestus avoceti</i>	P%	1.6	11.1	1.0	0.7
	MA	0.02 ± 0.01	0.11 ± 0.11	0.01 ± 0.01	0.007 ± 0.005
	MI	1.0 ± 0.0	1.0 ± 0.0	1.0 ± 0.0	1.0 ± 0.0

Table 1. Prevalence (P%), mean abundance (MA ±SE) and mean intensity (MI ±SE) of metacestodes in *A. parthenogenetica* and *A. franciscana* from Aigues Mortes salterns (South France) in summer (July-August-September) and winter (December) 2008. The percentage of each *Artemia* species present in the community is given in parentheses

Results

Artemia populations

A total of 803 brine shrimps were analysed (503 in summer and 300 in winter). The relative frequency of *A. franciscana* and *A. parthenogenetica* was different between summer and winter ($\chi^2 = 316.1$, $df = 1$, P -value < 0.001). While in summer the native parthenogenetic species was the most abundant (60.2%), *A. franciscana* largely dominated (97%) the winter community (Table 1).

Parasite identification

We found higher diversity of cestode species in *A. parthenogenetica* (5 species) compared to *A. franciscana* (2 species, Table 1). Among the few parasites found in *A. franciscana*, *F. tadornae* has already been reported in this population (Vasileva et al. 2009), but this is the first report of the presence of *E. avoceti* in this population (although it has been reported in Iberian populations, Georgiev et al. 2007). Regarding *A. parthenogenetica*, this is the first description of *F. flamingo*, *E. avoceti* and *W. stellorae* in this population, the

two other parasite species being already reported (see Thiery et al. 1990; Vasileva et al. 2009). Notably, *F. liguloides* was not found in *A. franciscana* while being the most prevalent in *A. parthenogenetica* (Fig. 1).

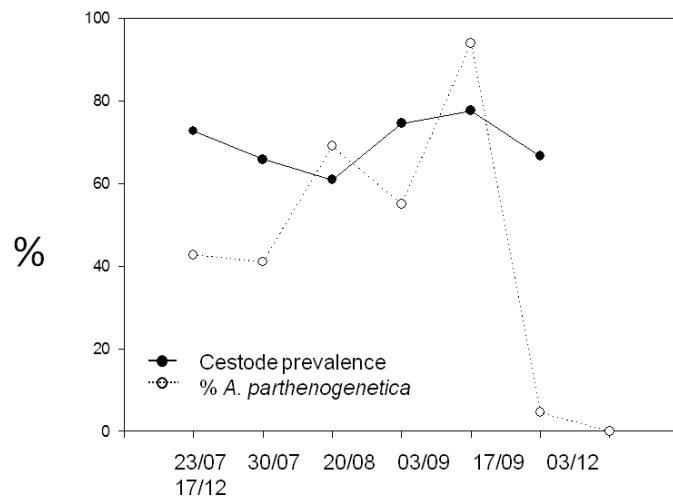

Figure 1. Seasonal prevalence of cestodes in *Artemia parthenogenetica* and proportion of this *Artemia* species in the community, from summer to winter 2008

Parasite distribution

Amongst the individuals analysed, 70.8% of *A. parthenogenetica* and only 1.02% of *A. franciscana* were infected with cysticercoids. We recorded 437 cysticercoids in 312 *A. parthenogenetica* individuals and only 5 in 491 *A. franciscana* individuals. When infected, *A. franciscana* carried only one cysticercoid per host (both in summer and winter) while the maximum intensity for *A. parthenogenetica* was 7 cysticercoids (reached in summer). In winter the maximum intensity for *A. parthenogenetica* was 5 cysticercoids.

For all cestode species, prevalence and abundance were higher in *A. parthenogenetica* than in *A. franciscana* (although not significantly for *E. avoceti*, Table 2). No seasonal effect was found on parasite prevalence and abundance except for *F. tadornae*, which was only present in summer (Table 2).

	Prevalence				Mean Abundance				Mean Intensity			
	Season		Species		Season		Species		Season		Species	
	$\chi^2 =$	P-value	$\chi^2 =$	P-value	$\chi^2 =$	P-value	$\chi^2 =$	P-value	$\chi^2 =$	P-value	$\chi^2 =$	P-value
<i>Flamingolepis liguloides</i>	0.00	ns	521.51	***	0.10	ns	718.47	***	0.10	ns	-	-
<i>Flamingolepis flamingo</i>	1.54	ns	15.25	***	1.47	ns	15.13	***	-	-	-	-
<i>Fimbriarioides tadornae</i>	3.26	o	39.07	***	4.08	*	32.03	***	-	-	0.27	ns
<i>Wardium stellorae</i>	0.24	ns	7.59	**	0.23	ns	7.56	**	-	-	-	-
<i>Eurycestus avoceti</i>	0.24	ns	1.84	ns	0.24	ns	1.82	ns	-	-	-	-

Table 2. Parasite distribution. Effect of species (*A. parthenogenetica* vs. *A. franciscana*) and season (summer vs. winter) on parasite prevalence, mean abundance and mean intensity (ns non significant, ° P < 0.1, * P < 0.05, ** P < 0.01, *** P < 0.001). Mean intensity was analysed only when the number of parasites varied across infected individuals (*i.e.* between summer and winter for *F. liguloides* in *A. parthenogenetica* and in summer for *F. tadornae* in both species).

However, no interaction between host species and season was found for this parasite species ($P > 0.1$). It is important to note that seasonal and species effects are in many cases difficult to clearly disentangle because *A. parthenogenetica* individuals are scarce in winter. Last, the prevalence of *F. tadornae* and *E. avoceti* did not differ between *A. franciscana* males and females (P -value > 0.1).

Mean intensity was analysed only when *Artemia* individuals carried more than one cysticeroid. Only a seasonal effect was tested for *F. liguloides* since it was only found in *A. parthenogenetica*, whereas only a species effect was tested for *F. tadornae* since it was only found in summer. Neither effect was detected (Table 2).

The joint distribution of the two latter species was analysed in more detail within *A. parthenogenetica* (see 'association analysis'). *F. liguloides*, the most prevalent parasite (66% of *A. parthenogenetica* females being infected) exhibited moderate aggregation ($\sigma_1 = 0.51$, support limits 0.33 - 0.67). *F. tadornae*, the less prevalent parasite (8% of *A. parthenogenetica* females being infected), exhibited much

stronger aggregation ($\sigma_2 = 2.05$, support limits 1.4 – 3.0). The presence of the two species is strongly and negatively correlated within individuals but this estimate is very imprecise ($\rho = -0.41$ support limits -0.92 – 0.16).

Pathological effect of infection

Lipid granules

After controlling for direct species and season effects (which are strong), we found that only *F. liguloides* and *F. tadornae* had a significant effect on the presence of lipid granules (Table 3, Figure 2). The probability of having conspicuous lipid granule increased in the presence of *F. liguloides* (in *A. parthenogenetica*), but decreased in presence of *F. tadornae*. The latter effect was not found to be different in *A. parthenogenetica* and *A. franciscana*, but we had no power to discriminate this host x parasite species interaction. The model accounting for the number of both parasites within individuals (instead of simple presence/absence) fitted the data better based on AIC comparison ($\Delta AIC = 8.2$).

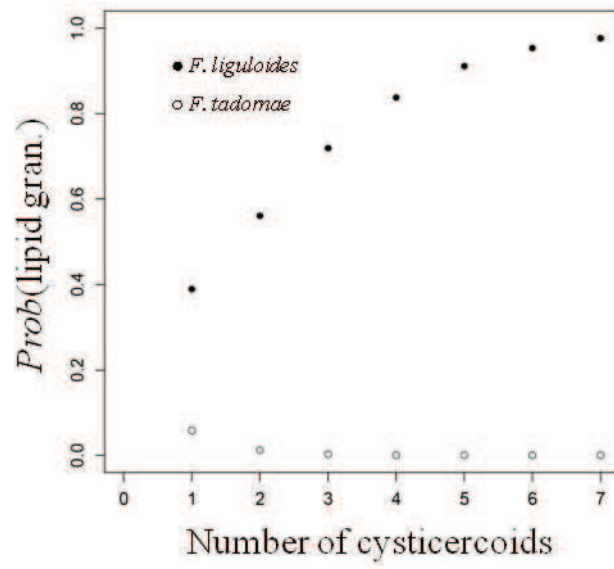

Figure 2. Fitted effects of parasite number on the probability of carrying lipid granules.

	Estimate	SE	P-value
Intercept	-2.10	0.23	
Season (winter)	-0.96	0.37	
Species (AP)	0.96	0.32	
Season (winter) x Species (AP)	-15.67	719.96	*
<i>Flamingolepis liguloides</i>	0.70	0.15	***
<i>Flamingolepis flamingo</i>	-	-	ns
<i>Fimbriarioides tadornae</i>	-1.63	0.69	***
<i>Wardium stellorae</i>	-	-	ns
<i>Eurycestus avoceti</i>	-	-	ns

Table 3. Parasite effect on *Artemia* lipid content. Effect of species (*A. parthenogenetica* vs. *A. franciscana*), season (summer vs. winter) and number of metacestodes on the probability of having lipid granules. Estimates in logit scale. Significance as in Table 2. *F. liguloides* was only present in *A. parthenogenetica*.

	<i>Prob(pink)</i>		<i>Prob(red)</i>		P-value
	Estimate	SE	Estimate	SE	
Intercept	-2.33	0.25	-5.22	1.00	
Season (Winter)	-	-	-	-	ns
Species (AP)	2.12	0.35	3.67	1.04	***
Sex (male)	-1.01	0.41	-14.28	<0.01	*
<i>Flamingolepis liguloides</i>	2.45	0.58	4.55	0.64	***
<i>Flamingolepis flamingo</i>	-3.43	3.59	10.89	103.3	*
<i>Fimbriarioides tadornae</i>	2.96	1.28	3.01	1.34	**
<i>Wardium stellorae</i>	-	-	-	-	ns
<i>Eurycestus avoceti</i>	-	-	-	-	ns

Table 4. Parasite effect on *Artemia* color. Effect of species (*Artemia parthenogenetica* vs. *A. franciscana*), season (summer vs winter) and sex (in *A. franciscana*) metacestode infection on the probability of being pale pink [*Prob(pink)*] or red [*Prob(red)*]. Estimates in logit scale. Significance as in Table 2. *F. liguloides* and *F. flamingo* were only present in *A. parthenogenetica*.

Furthermore, we did not detect any interaction between parasites, so that the antagonistic effects of both parasites directly add up in co-infected individuals.

Colour

After controlling for a direct species effect (which is strong, *A. parthenogenetica* being more red), we found that individuals infected by *F. liguloides*, *F. flamingo* and *F. tadornae* were significantly more red than non infected individuals (Table 4, Figure 3). Again these effects were not found to be different in *A. parthenogenetica* and *A. franciscana*, but we had no power to discriminate these host x parasite species interactions given the very low prevalence (or even absence) of these parasites in *A. franciscana*. The model simply accounting for the presence / absence of parasites within individuals (instead of accounting for the number of parasites within individuals) fitted the data better based on AIC comparison ($\Delta AIC = 34.3$), indicating a threshold effect. Furthermore, we did not detect any interaction between parasites, so that the effects of pairs of parasites directly add up in co-infected individuals.

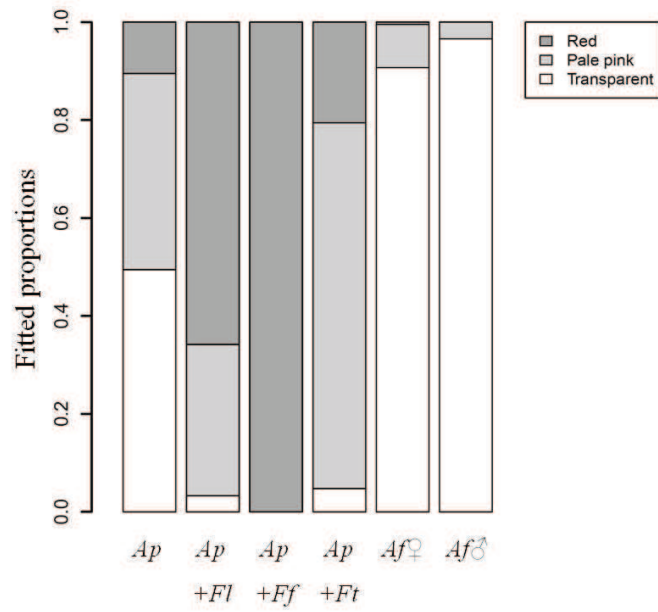

Figure 3. Fitted effects of parasites, sex and species on *Artemia* colour. *Ap*: *A. parthenogenetica*, *Af*: *A. franciscana*, *Fl*: *F. liguloides*, *Ff*: *F. flamingo*, *Ft*: *F. tadornae*.

	Prob(ovocytes)		Prob(cysts)		Prob(embryos)		P-value
	Estimate	SE	Estimate	SE	Estimate	SE	
Intercept	1.32	0.56	1.61	0.55	0.00	0.71	
Species (AP)	-0.45	0.64	-0.76	0.62	-0.92	0.86	
Season (Winter)	13.40	134.6	9.30	134.6	11.42	134.6	
Season (Winter)*Species (AP)	-11.44	134.6	1.66	198.7	-19.7	322.3	***
<i>Flamingolepis liguloides</i>	-4.99	0.66	-31.3	184.9	-3.60	0.86	***
<i>Flamingolepis flamingo</i>	-29.77	<0.01	-23.98	<0.01	-21.9	<0.01	o
<i>Fimbriarioles tadornae</i>	-	-	-	-	-	-	ns
<i>Wardium stellorae</i>	-	-	-	-	-	-	ns
<i>Eurycestus avoceti</i>	-	-	-	-	-	-	ns

Table 5. Parasite effect on *Artemia* reproduction. Effect of species (*A. parthenogenetica* vs. *A. franciscana*), season (summer vs winter), their interaction and metacestode infection on the probability for a female to carry ovocytes, cysts or embryos. Estimates in logit scale. Significance as in Table 2. *F. liguloides* and *F. flamingo* were only present in *A. parthenogenetica*.

Reproductive status

After controlling for direct species and season effects and their interaction (which are strong, Table 5), we found that individuals infected by *F. liguloides* and *F. flamingo* had a lower chance to carry oocytes, embryos or cysts. This effect was significant for *F. liguloides* and marginally significant for *F. flamingo* (Table 5). These effects were very strong and indicate a castrating effect of the parasite: the fitted proportion of non-reproducing infected females was 97.4% and 100%, respectively, compared to 16.3% for non infected *A. parthenogenetica* females (Figure 4). The model accounting for the presence / absence of parasites within individuals (instead of accounting for the number of parasites within individuals) fitted the data better based on AIC comparison ($\Delta AIC = 9.2$), indicating that a single cysticercoid is able to trigger castration. Interaction was found neither between *F. liguloides* and *F. flamingo*, nor between *F. liguloides* and *F. tadornae*, or between host species and *E. avoceti* (all *P*-values > 0.1).

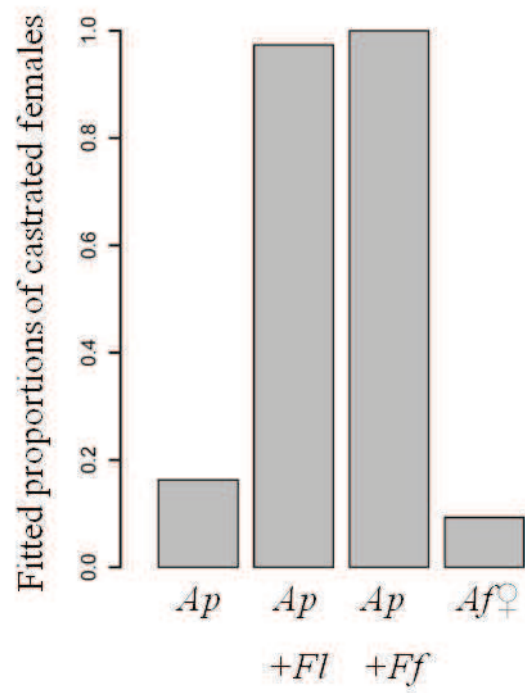

Figure 4. Fitted proportions of castrated females. *Ap*: *A. parthenogenetica*, *Af*: *A. franciscana*, *Fl*: *F. liguloides*, *Ff*: *F. flamingo*.

Discussion

The diminution of the regulation by parasites has been proposed as an important force driving the success of introduced species (Mitchell and Power 2003; Torchin et al. 2003). However, very few studies estimate the real impact of parasites comparing the effect of infection between native and invasive species in the same environment.

A major problem to study the invasion of *A. franciscana* in the field, and an important limitation to accurately estimate the extent parasites have a role in determining the invasion outcome, is the rapid replacement of native *Artemia* populations (Amat et al. 2005). Consequently, mixed communities where both congeneric populations coexist under the same environmental conditions are extremely rare. Comparing sympatric populations exposed to the same environment is particularly relevant when parasites with complex life cycles are involved as their prevalence strongly depends on the presence of the final host which can vary between study areas. Here, we present the first report pointing

out the implication of parasites in the competitive success of the exotic *A. franciscana* in the Mediterranean region by studying an exceptional case of sympatry in South of France. Our results clearly demonstrated strong differences in cestode prevalence and diversity between native and exotic brine shrimps. Similar findings, with values consistently higher in native brine shrimps (*A. parthenogenetica* and *A. salina*) have been previously reported by Georgiev et al. (2007) comparing cestode prevalence in several non-sympatric spatially independent *Artemia* populations. Our field study is relevant to other Mediterranean salterns. In fact, since both *Artemia* species have been co-occurring since the early 70's and still coexist, our case study may represent a situation where the two *Artemia* species have lower demographic differences than elsewhere. Despite this, we find a dramatic difference in the effects of parasites between the two species of *Artemia*, which strongly reinforces the generality of our results.

The major difference between the two *Artemia* species is that *A. parthenogenetica* is heavily infected by *F. liguloides* while *A. franciscana* is not. Since this parasite causes a

severe pathology (castration and colour alteration), it clearly has a large negative demographic effect on *A. parthenogenetica* population. *A. franciscana*, which competes for the same resource in the saltern enjoys thus a large competitive advantage of being free of this enemy. Regarding parasite shared by the two species, we did not detect significant differences in the pathological effects caused by the parasites on the exotic and native hosts. There is however a very limited power to detect those differences given the low parasite prevalence in *A. franciscana*.

Unrelated to the effect of parasites, we found that the native *Artemia* were more red than the invasive one. Prey choice experiments have shown that birds actively select conspicuous red preys (Sánchez et al. 2009b). Thus, this basic difference between *A. parthenogenetica* and *A. franciscana* may also contribute to the success of *A. franciscana* by conferring a lower predation rate relative to *A. parthenogenetica*.

Seasonal distribution of hosts

We observed significant seasonal changes (from summer to winter) in the frequency of the two *Artemia* species. Summer community was dominated by *A. parthenogenetica* and winter community was dominated by *A. franciscana*. Laboratory studies show that temperature strongly affects the biomass and productivity of different *Artemia* species. Bisexual populations (*A. salina* and *A. franciscana*) exhibit high production and hatchability of cysts at low temperatures, while parthenogenetic populations prefer higher temperature (Barata et al. 1995, 1996). These results match well with our observations, suggesting that temperature was the main determinant of the seasonal abundance of the bisexual *A. franciscana* and *A. parthenogenetica* in the field.

Distribution of parasites

Except for *F. tadornae*, which is slightly more prevalent in summer, we were not able to detect significant differences between summer and winter in cestode prevalence (and no species x season interaction either). In addition, *A.*

franciscana was not more infected by parasites in winter when the native host disappears, as could be expected if parasite switch to a non preferred host when the preferred host is absent. Thus, the cyclic extinction of *A. parthenogenetica* in winter probably imposes a demographic crash of cysticeroid populations.

The variability in the ability of the different cestode species to infect *A. franciscana* may be explained in terms of host-parasite coevolutionary history. Parasites which have never been confronted to a given host species may be unable to infect it. In our case, *A. franciscana* has only been present for ca. 40 years in Aigues-Mortes, which may not be enough for host shifts to occur for all cestode species (if it is to occur at all). Interestingly, the main host shift in terms of prevalence documented in Aigues-Mortes (*E. avoceti*) corresponds to a cestode species which is known to infect *A. franciscana* in its native range (Clark 1954, see the Appendix) with closely related final hosts in both ranges (*Recurvirostra americana* and *R. avosetta* in the native and exotic range of *A. franciscana*, respectively). More importantly, the equivalent

prevalence of *E. avoceti* in both species suggests that this parasite is not locally more adapted to its native host. To our knowledge, the other cestode species in our sample are not documented in the native range of *A. franciscana* (see Appendix). In our field survey, we only document an host shift for *E. avoceti*. However, we cannot exclude that other cestodes rarely infect *A. franciscana*. In fact, such host shifts have been reported for the other species (except *W. stellorae*) in Iberian *A. franciscana* populations (Georgiev et al., 2007). It is possible that populations entirely dominated by *A. franciscana* caused stronger selection pressure for host shift, which may explain this pattern.

Effect of the parasites on the hosts

Only infection by *F. liguloides*, *F. flamingo* and *F. tadornae* causes noticeable pathological effects. *F. liguloides* (which is only present in *A. parthenogenetica*) (i) castrates its hosts (ii) slightly increases lipid content, (iii) changes its host colour (toward more red). These effects have already been reported in a Spanish population where *A. franciscana* is

absent (Amat et al. 1991). The effect on reproduction is also documented in *Artemia salina* populations (Amarouayache et al. 2009). Effect (ii) increases with the number of cysticercoids within individuals. *F. tadornae* (i) does not alter reproduction, (ii) strongly decreases lipid content, (iii) changes its host colour (toward more red). Only effect (ii) magnitude increases with the number of cysticercoids within individuals. *F. flamingo* strongly alters its host colour and is also likely to castrate it. These effects have not been previously documented. In co-infected individuals, we did not detect any effect of the combination of parasites. Consequently the phenotype of co-infected individuals only depends on the relative magnitude of the effect of the two parasites. For instance, since *F. tadornae* has a stronger negative effect on lipid content, co-infected individuals with equal number of cysticercoids have lower lipid content than non infected individuals.

These two parasite species tend to exhibit very different levels of aggregation (*F. liguloides* being less aggregated). Aggregation of parasites can be caused by several mechanisms, notably population structure (some area

being more infection-prone) and genetic or phenotypic differences among individuals in the chance to become infected (e.g. older individuals accumulating more parasites, individual already carrying a parasite being more or less infection-prone, some genotypes being resistant to infection etc.). One plausible explanation for the difference in aggregation between the two species in our sample would be that *Artemia* infected by *F. liguloides* are of more similar ages than *Artemia* infected by *F. tadornae*. This would occur if they become infected later and/or if they die earlier. The former is unlikely since *F. liguloides* have smaller eggs (30 x 45 µm, Robert and Gabrion 1991) than *F. tadornae* (60 x 42 µm, Maksimova 1976), which can be ingested by younger/smaller *Artemia* (Redón et al. 2010; for size of particle ingested see Reeve 1963), while the latter may be due to a higher predation on *F. liguloides* infected individuals. (Note that the latter effect does not contradict the observation that, in the laboratory, *F. liguloides* infected *A. parthenogenetica* live longer than non-infected ones, presumably because of an absence of reproduction costs in castrated individuals, Amat et al. 1991).

Both hypotheses are consistent with the negative correlation in the presence of the two parasite species: if *F. tadornae* has milder effect on their host survival, they can accumulate in older *Artemia*, but *Artemia* can grow old only if they do not carry *F. liguloides* parasites. Another simple explanation for the difference in aggregation would involve spatial segregation of the different parasites or of their final host. This hypothesis is less likely since shelducks and flamingos are feeding in the same areas in summer (Britton and Johnson 1987). The last possibility is that groups of *F. tadornae* eggs may sometimes be swollen by *Artemia*. This might be the consequence of the peculiar type of strobila in this species, which posterior part can detach and carry numerous ripe eggs (Maksimova 1976).

Parasite manipulation vs. parasite exploitation

Phenotypic changes associated with cestode infections may be caused either by the direct effect of host exploitation or the indirect benefit of host manipulation on parasite transmission. These two effects are difficult to disentangle and are in fact not necessarily mutually exclusive.

In this study, we see that *F. tadornae*, *F. flamingo* and *F. liguloides* alter their host colour. Red brine shrimp have been shown to be more predated by sandpipers (Sánchez et al. 2009b). In addition, red *Artemia* also tend to swim on the surface where they are very conspicuous to visual predators (Sánchez et al. 2007). Thus, colour alteration has been proposed as a manipulation of the host by the parasite to increase its transmission rate. This explanation may well apply to *F. tadornae*, since shelducks (their final host Vasileva et al. 2009) probably also use visual cues for feeding (Cramp and Simmons 1978; Patterson and Fursen 2009). Its application to *F. liguloides* is less straightforward, since flamingos (their final hosts Georgiev et al. 2005) feed by filtration in the water column (Martin et al. 2005). *Artemia* sometimes form dense swarms (Gulbrandsen 2001), which, when made of red specimens, may be more attractive to flamingos.

In this study, *F. liguloides* castrates and increases lipid content while *F. tadornae* decreases lipid content. Thus, the two parasites have contrasted strategy on the exploitation / manipulation of their host. A simple interpretation is that *F.*

liguloides draws on host resources devoted to reproduction while *F. tadornae* draws on host resources devoted to survival. In this view, the two species differ in their strategy of host exploitation. For *F. liguloides*, this strategy may also correspond to a host manipulation in the sense that, by castrating, the parasite indirectly increases host survival (as shown in the laboratory, Amat et al 1991) and thus the chance of being eventually transmitted. In contrast, for *F. tadornae* there is no indication that host exploitation also alters transmission. Monitoring of *F. tadornae* infected *Artemia* in the laboratory would help clarifying this issue.

In conclusion, the results of this study suggest that the replacement and exclusion of native *Artemia* populations by the invasive species can be partially attributed to a competition mediated by parasites/predators through a differential impact on host fitness. Parasites limit more severely population growth in native than exotic brine shrimps populations (castration by *F. liguloides*). Bird predators might also limit more population growth in native than exotic brine shrimps

populations (the native species being more red). The reduced demographic control by natural enemies (cestodes and birds) suggests that being free of enemy give a decisive competitive advantage to the invader, explaining, at least partially, the speed at which this exotic species replaces the native one.

Acknowledgements

We thank A. Marchand and F. Gout for their help in the field, B. Georgiev and P. Nikolov for checking controversial cestode identification. We also thank A. J. Green and anonymous referees for valuable comments on the manuscript. This work has been supported by the ERC grant Quantevol to T.L.

References

Aitchison J and Ho C (1989) The multivariate Poisson-log normal distribution. *Biometrika* 76:643-653

Amarouayache M, Farid D, Hichem KM (2009) The parasitism of *Flamingolepis liguloides* (Gervais, 1847) (Cestoda, Hymenolepididae) in *Artemia salina* (Crustacea, Branchiopoda) in two saline lakes in Algeria. *Acta Parasitol* 54:330-334

Amat F (1983) Zigogenetical and parthenogenetical *Artemia* in Cadiz sea side salterns. *Mar Ecol Prog Ser* 13:291-293

Amat F, Gozalbo A, Navarro JC, Hontoria F, Varó I (1991) Some aspects of *Artemia* biology affected by cestode parasitism. *Hydrobiologia* 212:39-44

Amat F, Barata C, Hontoria F, Navarro JC, Varó I (1995) Biogeography of the genus *Artemia* (Crustacea, Branchiopoda, Anostraca) in Spain. *Int J Salt Lake Res* 3:175-190

Amat F, Hontoria F, Ruiz O, Green AJ, Sánchez MI, Figuerola J, Hortas F (2005) The American brine shrimp as an exotic invasive species in the western Mediterranean. *Biol Inv* 7:37-47

Amat F, Hontoria F, Navarro JC, Vieira N, Mura G (2007) Biodiversity loss in the genus *Artemia* in the Western Mediterranean Region. *Limnetica* 26 (2):387-404

Barata C, Hontoria F, Amat F (1995) Life history, resting egg formation, and hatching may explain the temporal-geographical distribution of *Artemia* strains in the Mediterranean basin. *Hydrobiologia* 298 (1-3):295-305

Barata C, Hontoria F, Amat F (1996) Estimation of the biomass production of *Artemia* with regard to its use in aquaculture: Temperature and strain effects. *Aquaculture* 142 (3-4):171-189

Britton RH, Johnson AR (1987) An ecological account of a Mediterranean Salina: The Salin de Giraud (Southern France). *Biol Conserv* 42(3):185-230

Burnham KP, Anderson DR (2002) Model selection and multimodel inference: a practical information-theoretic approach. Springer, New York

Bush AO, Lafferty KD, Lotz JM, Shostak AW (1997) Parasitology meets ecology on its own terms: Margolis et al. revisited. *J Parasitol* 83:575–583

Clark DT (1954) A new cyclophyllidian cestode from the Avocet. *J Parasitol* 40:340-346

Colautti RI, Ricciardi A, Grigorovich IA, MacIsaac HJ (2004) Is invasion success explained by the enemy release hypothesis? *Ecol Lett* 7:721–733

Cramps S and Simmons KEL (Eds.) (1977) *The birds of the Western Palearctic*. Vol. 1. Ed. Oxford University Press, Oxford

Dunn AM (2009) Parasites and biological invasions. *Adv Parasitol* 68, pp161-184.

Gabriel C, MacDonald-Crivelli G, Boy V (1982) Dynamique des populations larvaires du cestode *Flamingolepis liguloides* dans une population d'*Artemia* en Camargue. *Acta Oecol* 3:273–293

Georgiev BB, Sánchez MI, Green AJ, Nikolov PN, Vasileva GP, Mavrodieva RS (2005) Cestodes from *Artemia parthenogenetica* (Crustacea, Branchiopoda) in the Odiel Marshes, Spain: a systematic survey. *Acta Parasitol* 50 (2):105-117

Georgiev BB, Sánchez MI, Vasileva GP, Nikolov PN, Green AJ (2007) Cestode parasitism in invasive and native brine shrimps (*Artemia* spp.): can it explain the rapid invasion of *A. franciscana* in the Mediterranean region? *Parasitol Res* 101:1647-1655

Green AJ, Sánchez MI, Amat F, Figuerola J, Hontoria F, Hortas F (2005) Dispersal of invasive and native brine shrimp *Artemia* (Anostraca) via waterbirds. *Limnol Oceanogr* 50:737-742

Gulbrandsen J (2001) *Artemia* Swarming Mechanisms and Suggested Reasons. J Plank Res 23 (7) pp.659-669

Hontoria F, Amat F (1992a) Morphological characterization of adult *Artemia* (Crustacea, Branchiopoda) from different geographical origin. Mediterranean populations. J Plank Res 14(7):949–959

Hontoria F, Amat F (1992b) Morphological characterization of adult *Artemia* (Crustacea, Branchiopoda) from different geographical origin. American populations. J Plank Res 14(10):1461–1471

Keane RM, Crawley MJ (2002) Exotic plant invasions and the enemy release hypothesis. Trends Ecol Evol 17:164–170

Kolar CS, Lodge DM (2001) Progress in invasion biology: predicting invaders. Trends Ecol Evol 16: 199– 204

Lenz PH, Browne RA (1991) Ecology of *Artemia*. *Artemia* Biology. Browne RA, Sorgeloos P and Trotman CNA Boca Raton, Florida, CRC. 10: 237-253

Liu H, Stiling P, Pemberton RW (2007) Does enemy release matter for invasive plants? Evidence from a comparison of insect herbivore damage among invasive, non-invasive and native congeners. Biol Inv 9:773–781

Maksimova AP (1976) A new cestode, *Fimbriarioides tadornae* sp. n., from *Tadorna tadorna* and its development in the intermediate host. Parazitologiya 10:17-24 (In Russian).

Martin GR, Jarrett N, Tovey P, White CR (2005) Visual fields in Flamingos: chick-feeding versus filter-feeding. Naturwissenschaften 92:351-354

Mitchell CE, Power AG (2003) Release of invasive plants from fungal and viral pathogens. Nature 421:625–627

Mooney HA, Cleland EE (2001) The evolutionary impact of invasive species Proceedings of the National Academy of Sciences of the USA 98:5446–5451

Mura G, Amat F, Abatzopoulos TJ, Moscatello S (2004) First record of *Artemia franciscana* in an Italian saltwork. Book of abstracts 35-36. Fifth International Large Branchiopod Symposium. Toodyay. August 2004. Western Australia

Patterson J, Furse C (2009) The Shelduck: A Study in Behavioural Ecology. Cambridge University Press. 288 pag

Petit RJ (2004) Biological invasions at the gene level. Diversity and Distributions 10: 159–165

Redón S, Amat F, Hontoria F, Vasileva GP, Nikolov PN, Georgiev BB (2010) Participation of metanauplii and juvenile individuals of *Artemia parthenogenetica* (Branchiopoda) in the circulation of avian cestodes. Parasitology Research References

Reeve MR (1963) The filter-feeding of *Artemia*. II. In suspensions of various particles. J. Exp Biol 40:207-214

Robert F, Gabrion C (1991) Cestodoses de l'avifaune Camarguaise. Rôle d'*Artemia* (Crustacea, Anostraca) et stratégies de rencontre hôte-parasite. Annales de Parasitologie Humaine et Comparée 66: 226-235

Sánchez MI, Green AJ, Castellanos EM (2006a). Temporal and spatial variation of an aquatic invertebrate community subjected to avian predation at the Odiel salt pans (SW Spain). Arc für Hydrobiol 166:199-223

Sánchez MI, Georgiev BB, Nikolov PN, Vasileva GP, Green AJ (2006b) Red and transparent brine shrimps (*Artemia parthenogenetica*): comparative study of their cestode infections. Parasitol Res 100(1):111-114

Sánchez MI, Georgiev BB, Green AJ (2007) Avian cestodes affect the behaviour of their intermediate host *Artemia parthenogenetica*: an experimental study. *Behav Proc* 74:293-299

Sánchez MI, Thomas F, Perrot-Minnot MJ, Bertrand-Michel J, Biron DG, Missé D (2009a). Neurological and physiological disorders in *Artemia* harboring manipulative cestodes. *J Parasitol* 95(1) : 20-24

Sánchez MI, Hortas F, Figuerola J, Green AJ (2009b) Sandpipers select red brine shrimps rich in carotenoids but also parasites. *Ethology* 115:196-200

Thiéry A, Robert F, Gabrion C (1990) Distribution des populations d'*Artemia* et de leur parasite *Flamingolepis liguloides* (Cestoda, Cyclophyllidea), dans les salins du littoral méditerranéen français. *Can J Zool* 68:2199–2204

Torchin ME, Lafferty KD, Dobson AP, McKenzie VJ, Kuris AM (2003) Introduced species and their missing parasites. *Nature* 421, 628–630

Vasileva GP, Redón S, Amat F, Nikolov PN, Sánchez MI, Lenormand T, Georgiev BB (2009) Records of cysticercoïds of *Fimbriarioïdes tadornae* Maksimova, 1976 and *Branchiopodataenia gvozdevi* (Maksimova, 1988) (Cyclophyllidea, Hymenolepididae) from brine shrimps at the Mediterranean coast of Spain and France, with a key to cestodes from *Artemia* spp. from the Western Mediterranean. *Acta Parasitol* 54(2):143-150

Weijden Van der W, Leewis R, Bol P (2007) Biological globalisation – Bioinvasions and their impacts on nature, the economy and public health. KNNV Publishing, Utrecht, the Netherlands. 223 pp.

Wolfram S (1999) *The Mathematica Book* Ed. 4. Wolfram Media/Cambridge University Press, Cambridge, UK.

Article 4

SUPPLEMENTARY MATERIALS

List of previous records of cestode species found in *Artemia* spp. in Aigues-Mortes

Cestode parasite	Host species	Locality	Source reference
<i>Flamingolepis liguloides</i> (FL) - adult	Phoenicopterus roseus	North-Western Africa	Lüthe (1898)
FL - adult	<i>Phoenicopterus roseus</i>	Czech Republic	Rysavy & Sitko (1995)
FL - adult	<i>Phoenicopterus roseus</i>	Kazakhstan	Maksimova (1989)
FL - cysticercoid	<i>Artemia</i> sp.	Camargue, France	Thiéry et al. (1990); Robert & Gabrion (1991)
FL - cysticercoid	<i>Artemia parthenogenetica</i>	Spain	Georgiev et al. (2005, 2007), Sanchez et al. (2006)
<i>Flamingolepis flamingo</i> (FF) - adult	<i>Phoenicopterus roseus</i>	Camargue, France	Skrjabin (1914)
FF - adult	<i>Phoenicopterus roseus</i>	Kazakhstan	Maksimova (1989)

FF - cysticercoid	<i>Artemia</i> sp.	Camargue, France	Robert & Gabrion (1991)
FF - cysticercoid	<i>Artemia parthenogenetica</i>	Spain	Georgiev et al. (2005)
<i>Fimbrarioioides tadornae</i> (FT) - adult	<i>Tadorna tadorna</i>	Kazakhstan, Ukraine	Maksimova (1976; 1989)
FT - cysticercoid	<i>Artemia parthenogenetica, A. franciscana</i>	Spain	Vasileva et al. (2009)
FT - cysticercoid	<i>A. franciscana</i>	Aignes-Mortes (France)	Vasileva et al. (2009)
Wardium stellorae (WS) - adult	<i>Larus ridibundus</i>	France	Deblock, Biguet & Capron (1960)
WS - adult	<i>Larus genei</i>	Kazakhstan	Maksimova (1986)
WS - cysticercoid	<i>Artemia salina</i>	Kazakhstan	Maksimova (1986)

WS - cysticeroid	<i>Artemia parthenogenetica</i>	Spain	Georgiev et al. (2005)
Eurycestus avoceti (EA) adult	<i>Recurvirostra avosetta</i>	France, Ukraine, Kazakhstan	Baer (1968); Spasskaya & Spassky (1978), Robert & Gabrion (1991), Maksimova (1991)
EA - adult	<i>Recurvirostra americana</i>	USA	Clark (1954)
EA - adult	<i>Himantopus mexicanus</i>	USA	Hinojos & Canaris (1988)
EA - adult	<i>Phoenicopterus roseus</i>	Kazakhstan	Maksimova (1991)
EA - cysticeroid	<i>Artemia parthenogenetica</i>	Spain	Georgiev et al. (2005, 2007); Sanchez et al. (2006)
EA - cysticeroid	<i>Artemia salina</i>	Spain	Georgiev et al. (2007); Maksimova (1991)
EA - cysticeroid	<i>Artemia</i> sp.	France	Robert & Gabrion (1991)
EA - cysticeroid	<i>Artemia franciscana</i>	Portugal, Spain	Georgiev et al. (2007)

References

- Baer JG (1968) *Eurycestus avoceti* Clark, 1954 (Cestode cyclophyllidien) parasite de l'avocette en Camargue. Vie Milieu 19(1) : 189-198
- Deblock S, Biguet J, Capron A (1960) Contribution a l'étude des cestodes de Lari des côtes de France. I. Le genre Hymenolepis. Annales de Parasitologie Humaine et Comparée 35:538-574
- Gabrion C, MacDonald-Crivelli G, Boy V (1982) Dynamique des populations larvaires du cestode *Flamingolepis liguloides* dans une population d'*Artemia* en Camargue. Acta Oecol 3:273-293
- Georgiev BB, Sánchez MI, Green AJ, Nikolov PN, Vasileva GP, Mavrodieva RS (2005) Cestodes from *Artemia parthenogenetica* (Crustacea, Branchiopoda) in the Odiel Marshes, Spain: a systematic survey. Acta Parasitol 50 (2):105-117
- Georgiev BB, Sánchez MI, Vasileva GP, Nikolov PN, Green AJ (2007) Cestode parasitism in invasive and native brine shrimps (*Artemia* spp.): can it explain the rapid invasion of *A. franciscana* in the Mediterranean region? Parasitol Res 101:1647-1655
- Hinojos JG, Canaris AG (1988) Metazoan parasites of *Hymantopus mexicanus* Muller (Aves) from Southwestern Texas, with a checklist of helminth parasites from North America. Journal of Parasitology 74(2):326-331
- Lühe M. (1898). Beitrage zur Helminthenfauna der Berberi. Vorlaufige Mittheilungf über Ergebnisse einer mit Unterstützung der Königlichen Akademie der Wissenschaften im Jahre 1889 ausgeführten Forschungsreise
- Sitzungsberichte der Königlich Preussischen Akademie der Wisseschaften zu Berlin 40:619-628
- Maksimova AP (1986) Morphology and biology of the cestode *Wardium stellorae* (Cestoda, Hymenolepididae). Parazitologiya 20:487-491
- Maksimova AP (1989) Hymenolepid cestodes of aquatic birds in Kazakhstan.Izd. Nauka, Alma-Ata

Maksimova AP (1991) On ecology and biology of *Eurycestis avoceti* (Cestoda, Dilepididae): Parazitologiya 25:73-76

Robert F, Gabrion C (1991) Cestodoses de l'avifaune Camarguaise. Rôle d'*Artemia* (Crustacea, Anostraca) et stratégies de rencontre hôte-parasite. Annales de Parasitologie Humaine et Comparée 66: 226-235

Rysavy B, Sitko J (1995) New findings of tapeworms (Cestoda) of birds from Moravia and synopsis of bird cestodes from Czech Republic. Prorodevedne Prace ustavu Ceskoslovenske Akademie Ved v Brne 29(25):1-66

Sánchez MI, Georgiev BB, Nikolov PN, Vasileva GP, Green AJ (2006) Red and transparent brine shrimps (*Artemia parthenogenetica*): comparative study of their cestode infections. Parasitol Res 100(1):111-114

Skrjabin KI (1914) Beitrag zur Kenntnis einiger Vogelcestoden. Centralblatt für Bakteriologie, Parasitenkunde und Infektionskrankheiten 75:59-83

Spassakaya LP, Spasskii AA (1978) Cestodes of birds in the USSR. Dilepididae of aquatic birds. Izd. Nauka, Moscow

Thiéry A, Robert F, Gabrion C (1990) Distribution des populations d'*Artemia* et de leur parasite *Flamingolepis liguloides* (Cestoda, Cyclophyllidea), dans les salins du littoral méditerranéen français. Can J Zool 68:2199-2204

Vasileva GP, Redón S, Amat F, Nikolov PN, Sánchez MI, Lenormand T, Georgiev BB (2009) Records of cysticercoids of *Fimbriarioides tadornae* Maksimova, 1976 and *Branchiopodactenia gvozdevi* (Maksimova, 1988) (Cyclophyllidea, Hymenolepididae) from brine shrimps at the Mediterranean coast of Spain and France, with a key to cestodes from *Artemia* spp. from the Western Mediterranean. Acta Parasitol 54(2):143-150

Article 5

Differential susceptibility of native and invasive *Artemia spp.* to two microsporidian parasites

Nicolas Olivier Rode, Eva J. P. Lievens, Julie Landes, Elodie Flaven,

Adeline Segard, Roula Jabbour-Zahab,

Christian P. Vivarès & Thomas Lenormand

In preparation

Abstract

Recent evidence suggests that microsporidian parasites can strongly influence the success of biological invasions. We used molecular markers and transmission electron microscopy to characterize two microsporidian parasites, *Microsporidium sp.1* and *Microsporidium sp.2*, infecting both native and invasive *Artemia spp.* in sympatry in Aigues-Mortes salterns (Southern France). Using both experimental and phylogeographic approaches, we found that *Microsporidium sp.1* was native to Europe, whereas *Microsporidium sp. 2* might have been independently introduced with its invasive host *A. franciscana* from the USA to France and Israel. We investigated the role of both microsporidian parasites in mediating the competition between invasive and native hosts in natural populations from Aigues-Mortes. Surprisingly, we found that *Microsporidium sp.1* was more prevalent in its native hosts, whereas *Microsporidium sp. 2* was more prevalent in the invasive host. In addition, infection with *Microsporidium sp.1* caused a strong reduction in female fitness in both host species. Hence the invasive *A. franciscana* is likely to benefit from the higher susceptibility to the virulent *Microsporidium sp.1* of the native *A. parthenogenetica*.

Keywords: Microsporidiosis; Enemy release; Biological invasions; Horizontal transmission

1. Introduction

Parasites have been shown to play a prominent role in determining the success and extent of biological invasions (Dunn 2009). In particular, when the introduced species does not bring its own parasites in the invaded area, it may enjoy a release of parasite burden compared to local competitors, who suffer from their local parasites. This is the “Enemy Release Hypothesis” (Keane & Crawley 2002; Mitchell & Power 2003; Torchin *et al.* 2003). Notwithstanding that such a situation can be very transitory as local parasites may quickly evolve to infect the invading species, this “release” can provide a decisive early advantage to the invading species. Other scenarios are however possible, notably when invading species carry along their own parasites. In this case, the situation favorable to the invader is when the introduced parasites cause a disproportionate harm to the native species.

Parasites may be introduced along with the invasive host (e.g., Tompkins *et al.* 2003), or may already be present in the native host (e.g., Krakau *et al.* 2006). Once present in the invaded system, parasites can influence the success of an

invasion either directly, when they differentially affect introduced and native species, or indirectly, when they modify the interaction between competing host species (Prenter *et al.* 2004).

The effect of parasite transmission strategy on biological invasions is not well understood. In particular, the role of vertically transmitted parasites in biological invasions has rarely been investigated, although they seem less likely to be lost during invasion than horizontally transmitted parasites (Slothouber Galbreath *et al.* 2010). Some species have been shown to alter the long-distance dispersal behaviour of their host (Goodacre *et al.* 2009) or to distort the offspring sex-ratio of infected hosts, enabling rapid invasion of conspecific populations (e.g., Hoffmann *et al.* 2011). In addition, theory predicts some level of horizontal transmission in vertically transmitted parasites to be advantageous (Ironsides *et al.* 2003). Thus, the spread of parasites with mixed-transmission strategies from invasive hosts to related species is possible, and has been suggested in invasive insect species infected with *Wolbachia* symbionts (e.g., Tsutsui *et al.* 2003).

Studies investigating the importance of parasites in mediating invasion success usually rely on 'community' studies (contrasting parasite prevalence in native and invasive species co-occurring within the same habitat), which require an extensive sampling (and a substantial host genetic differentiation) in the original range (Muirhead *et al.* 2008), or on biogeographical studies (comparing parasite prevalence in the native versus introduced habitat, Colautti *et al.* 2004), which require knowledge of the source(s) populations in its original range (Colautti *et al.* 2004). However, some model systems easily allow both knowledge and extensive sampling of source populations.

In the last decades, the New World brine shrimp, *Artemia franciscana* (hereafter *Af*), has been repeatedly introduced in salterns from the Old World where it has led to a serious decline in native populations of *Artemia parthenogenetica* (hereafter *Ap*) and *Artemia salina* (hereafter *As*) (Amat *et al.* 2005; Mura *et al.* 2006; Amat *et al.* 2007). In Southern France, cysts were introduced from 1970 to 1983 from two American populations (San Francisco Bay and Great

Salt Lake, D. Facca, pers. com.). *Artemia* are infected by several different parasites, among which the microsporidia form an important group. Microsporidia are endocellular microparasites related to fungi (James *et al.* 2006) with horizontal, vertical and mixed transmission strategies (Becnel & Johnson 2000). Among the six microsporidian species known to infect *Artemia* species, five have been described in non-invaded European populations (Codreanu 1957; Martinez *et al.* 1993; Martinez *et al.* 1994; Ovcharenko & Wita 2005) and one in a single invaded Brazilian population (Martinez *et al.* 1992) where cysts were introduced from San Francisco Bay (Camara & Castro 1983). Of these parasite species, only *Nosema artemiae* has been described in more than one population (Codreanu 1957; Martinez *et al.* 1993; Martinez *et al.* 1994; Ovcharenko & Wita 2005).

Interestingly, the degree of host specialization is linked to transmission mode and is extremely variable in this taxa, ranging from highly specific, for most vertically transmitted species to highly generalist, for some horizontally transmitted species (e.g. Solter & Maddox 1998; Terry *et al.* 2004; Saito &

Bjornson 2008; Krebs *et al.* 2010; Wilkinson *et al.* 2011; Andreadis *et al.* 2012; Li *et al.* 2012). In addition, microsporidia are known to affect host reproduction both negatively and positively in natural populations, depending on their transmission mode (e.g., Stirnadel & Ebert 1997; Bengtsson & Ebert 1998; Becnel & Johnson 2000; Haine *et al.* 2004; Decaestecker *et al.* 2005; Ryan & Kohler 2010). To our knowledge, experimental infections investigating the mode of transmission of *N. artemiae* (Codreanu 1957, C. Vivares, pers. obs.). The question of the possible co-invasion of microsporidian parasites with their invasive arthropod host has only been addressed recently (e.g., Slothouber Galbreath *et al.* 2004; Wattier *et al.* 2007; Slothouber Galbreath *et al.* 2010; Yang *et al.* 2010), and not much is known about the importance of microsporidia in mediating invasion success.

In this study, we investigated microsporidian infection in the invasive *Af* and the native *Ap* using genus-specific molecular markers. We characterized two new microsporidian species and tested for their potential introduction with the invasive host through (pseudo) vertical transmission by

experimental tests in the laboratory and by contrasting microsporidian polymorphism in invaded and non invaded Old World populations, as well as in New World populations (ancestral range of the invader). Finally, we investigated the phenotypic and fitness effects of both microsporidian parasites on sympatric hosts.

2. Material and methods

2.1. Localisation of microsporidia in infected individuals through PCR tests

We found two uncharacterized microsporidia species (hereafter *Msp1* and *Msp2*) for which we designed specific ribosomal DNA markers (see Supplementary methods for microsporidia investigation and primer design). Since two microsporidian species infecting *Artemia* are cryptic and found only in the intestinal epithelium (Codreanu 1957; Martinez *et al.* 1993), we performed dissections aiming at contrasting microsporidia infection in the digestive tract versus the rest of the body. Hence, we dissected 4 *Msp1*-infected *Ap* females

and 8 *Msp2*-infected individuals (4 *Af* females, 3 *Af* males and 1 *Ap* female) into three parts (digestive tract, adjacent tissue and thoracopods). All parts were PCR-tested for microsporidian infection.

2.2. Transmission Electron Microscopy

To obtain image of microsporidian infections, we used three *Msp1*-infected females and six *Msp1*-infected females. Each female was cut in half: the anterior part was used for PCR testing to confirm the infection status; the posterior part was fixed in 2.5% glutaraldehyde in Sorensen's buffer (0.1M, pH 7.4) and kept overnight at 4°C. Two non infected females were also fixed as a control. Specimens were washed in Sorensen's buffer and post-fixed in the dark for 2 h, in 0.5% osmic acid at room temperature. After washing in three changes of Sorensen's buffer, the specimens were dehydrated in a graded ethanol series (30-100%). They were then embedded in EMbed-812 (Electron Microscopy Sciences, Fort Washington, USA) using an Automated Microwave Tissue Processor for Electronic Microscopy (Leica EM AMW,

Bensheim, Germany). Semi-thin (1µm) and ultra-thin sections (70 nm, Leica-Reichert Ultracut E) were collected at different levels of each block. Semi-thin sections were stained with Toluidine Blue for viewing with a light microscope to identify suitable target areas. Ultra-thin sections of these areas were mounted on uncoated copper grids and were counterstained with uranyl acetate and observed using a Hitachi 7100 transmission electron microscope at the Centre de Ressources en Imagerie Cellulaire (CRIC, Montpellier, France). We examined different tissues (hypoderm, musculature, intestinal epithelium), as well as the haemocoel in each infected individual. Measurements were made using the on-board calibrated measuring software of the TEM.

2.3. Life cycle and transmission mode of Msp1 and Msp2

In order to investigate the possibility of indirect life cycles in *Msp1* and *Msp2*, we tested for their presence in species co-occurring with *Artemia* in Aigues-Mortes salterns by PCR (heterotrichous ciliates n~20, harpacticoida copepods n=6 and *Potamonectes cerisyi* beetles, n=2). Host DNA quality was

checked using universal primers for the COI mitochondrial gene (LCO1490/ HCO2198, Folmer *et al.* 1994).

In order to test for vertical transmission of microsporidia to *Artemia spp.* nauplii, we isolated females from two *Ap* lab strains infected either by *Msp1* (n=6) or *Msp2* (n=6) and wild-caught *Ap* (n=4) and *Af* females (n=9) with unknown infection status. All females were maintained individually (*Ap* females) or with males (*Af* females) in 300mL jars filled with 50 g/L artificial sea water (Instant Ocean, Aquarium Systems, Mentor, Ohio). To prevent any horizontal transmission, the jars were checked twice daily for nauplii and newborn nauplii were immediately transferred into a new medium; the female was killed and preserved in 96% ethanol. 220 nauplii were recovered. To maximize the chance of detecting microsporidian infection, PCR tests were performed on pools of 3 to 5 sibling individuals at different ages (mean=16.4d, min=0d, max=38d). In addition, we investigated the possibility of transovarial or transovum transmission via cysts (i.e. direct transfer of the pathogen within the egg vs. on the egg

surface). As washing of the egg surface is known to prevent transovum transmission (Goertz & Hoch 2008), we performed independent PCR tests on intact and bleach-decapsulated cyst samples. The cysts were collected from two Aigues-Mortes populations with high prevalence of both parasites (Site9, 2010, N43° 32' 25"-E4° 13' 26", Pont l'Abbé, 2011, N43° 32' 40"-E4° 9' 17) and from two American populations in three different years (San Francisco Bay, 1979, 1989, 2005 and the Great Salt Lake 1977, 1989, 2005); we ground 0.1g (~10⁴ embryos) of intact and decapsulated cysts from each sample. For an additional sample from Site9, we also incubated ground cysts with Proteinase K at 56°C overnight and extracted DNA with the Qiagen Blood and Tissue kit following the manufacturer protocol (Qiagen, Hilden, Germany). Since DNA detection of microsporidia is facilitated in early-infection stages compared to spores, we also hatched 0.1g of intact and bleach-decapsulated cysts from Aigues-Mortes, San Francisco Bay and the Great Salt Lake. After one month, we PCR-tested 15 adults per treatment/population combination.

In order to test for horizontal transmission of microsporidia between hosts, we used three infected *Af* lab cultures (infection either by *Msp1*, *Msp2* or both parasite species). All individuals were removed from the first two tanks whereas they were left in the third one. We then introduced uninfected *Ap* hosts in each tank. After three weeks, five *Ap* individuals from each tank were PCR-tested.

2.4. Timing of infection of N. artemiae and Microsporidium sp.

We investigated the timing between microsporidian infection and its subsequent detection by PCR. We focused on the first 48h as infection is known to be detected by PCR six days after infection in both microsporidian species (A. Segard, unpublished). We placed the recipient hosts (40 *Af* males and females and 40 *Ap* females from uninfected lab cultures) in a cage at the bottom of a 10L tank filled with sea water (50g/L, Fig. S1). Infected donors (20 *Af* and 20 *Ap*) from lab cultures infected by *Msp1* and *Msp2* were placed in a cage above the recipient hosts (Fig. S1). Cages were separated by a net (mesh size 0.2mm), allowing the flow of food and

microsporidian spores (Fig. S1). This treatment was replicated twice. Uninfected controls (10 *Af* and 10 *Ap*) were placed in a similar cage, in the absence of infected donors. 1h after donor host introduction, 8 *Ap* and *Af* were respectively sampled and preserved in ethanol, while 50% of the remaining uninfected individuals were placed in new medium in the absence of infected hosts (Fig. S1). Samples were taken at 9h and 48h following donor introduction and preserved in ethanol, except for controls that were only sampled after 48h (Fig. S1). All recipient individuals were then PCR-tested for infection by either *Msp1* or *Msp2*.

2.5. Population screening and phylogenetic analyses

In order to test for the introduction of *Msp1* or *Msp2* along with *Af*, we investigated its presence in wild-caught brine shrimp (*Ap*, *Af*, *As*) from 24 invaded salterns in France and Israel (Table S1), from 9 non-invaded salterns in North Africa, Central Asia and Europe, as well as from 8 salterns in the USA—in the original range of *A. franciscana* (Table S2). All individuals were killed and preserved in 96% ethanol. DNA

from each individual was extracted and screened for microsporidia using V1f/530r primers and the two primer sets designed for this study (see Supplementary methods). DNA quality for the *As* samples was checked using the COI_Fol-F/COI_Fol-R primer set (Muñoz *et al.* 2008a), with the same protocol as microsatellited markers. To investigate DNA polymorphism, positive PCR products amplified with the V1f/530r primers were sequenced as described in the Supplementary methods (6 products from Old World populations and 12 products from New World populations). Sequences were aligned using the ClustalW algorithm in BioEdit v7.0.9 (Hall 2001), and were blasted against GenBank sequences. The closest matches were selected along with already characterized clade-specific microsporidian sequences (Vossbrinck *et al.* 2005). Phylogenetic analyses were performed only on those portions of the sequences that could be unambiguously aligned. We determined the best model for the base frequencies and substitution rates based on AICc using jModelTest 0.1, (TPM3 model with a gamma variation rate among sites, Posada & Crandall 1998; Posada

2008). Maximum likelihood analyses were carried out using Phyml v3.0 (Guindon *et al.* 2010) and robustness of nodes was assessed with 1000 bootstrap replications.

2.6. Msp1 and Msp2 prevalence, phenotypic effects and effect on brooding probability of sympatric females from Aigues-Mortes

Juvenile and adult *Artemia* were sampled with a plankton net in three shallow salterns (depth < 30cm) in Aigues-Mortes in May 2011. Two samples were taken from Site16 and Site17, whereas one sample was taken from Site18 (TableS3). Samples were kept in 10L tanks (salinity 50 g/L, Thalasea, Camargue-Pêche, Grau du Roi, France) and fed *ad libitum* *Dunaliella tertiolecta* algae. Individuals were randomly selected from each sample and their total length was measured to the nearest 0.05mm. Sex, species, the number of infecting cestodes (mostly *Flamingolepis liguloides*) and reproductive status of females (empty brood pouch vs. presence of ovules/embryos) were observed using a binocular. *Ap* females with atrophied or absent brood pouch because of *F. liguloides* infection were considered to be

mature and non-reproducing when they measured more than 0.7mm (which was 0.1mm longer than the smallest reproducing female). In order to investigate the white colour of individuals infected by microsporidia (Codreanu 1957; Martinez *et al.* 1992; Martinez *et al.* 1994), the presence of white spots on the cuticle or the presence of a white digestive tract were also recorded. In order to increase the sample size of *Ap* females not infected with *F. liguloides*, where a potential effect of microsporidian infection on female reproduction could be detected, we discarded two third of the *Af* individuals in each sample, conserving a final sample size of 243 *Af* and 987 *Ap* individuals. Upon observation, individuals were killed and placed in ethanol in 96-well plates and PCR-tested. Microsporidian infection was judged based on band presence on electrophoresis gels.

2.7. Statistical analyses

We used chi-squared tests for independence to investigate microsporidia localisation, differential prevalence of *Msp1* and *Msp2* in *Af* and *Ap* from Aigues-Mortes and to test

for the association between *Msp1* or *Msp2* infection and the observation of white spots on the cuticle or the observation of a white digestive tract (package stats in R 2.14.2). Analysis of female brooding probability was performed using a generalized linear model with a Bernoulli error distribution (package stats in R 2.14.2). Models included host species, presence of *Msp1*, presence of *Msp2*, presence of *F. liguloides*, sample identity (five in total), length, length², the interaction between the three parasite species, the interaction between *Msp1* presence, *Msp2* presence and host species along with each interaction between length and each of the other effect tested. Model selection was based on the corrected Akaike's information criterion (AICc; Hurvich & Tsai 1989).

3. Results

3.1. Localisation of Msp1 in infected individuals

Infection was 100% in the intestinal region for both *Msp1* and *Msp2*, 100% and 29% in the adjacent tissues for both

Msp1 and *Msp2*, respectively and 50% in the thoracopods for both *Msp1* and *Msp2*. After pooling the data on adjacent tissue and thoracopod infection, the probability of *Msp2* infection differed significantly between the digestive tract and the rest of the body ($\chi_1^2=7.89$, $P=0.005$), whereas the probability of *Msp1* infection did not ($\chi_1^2=1.2$, $P=0.27$). Results from Fisher exact tests were similar. Hence, *Msp2* seems to localize specifically to the digestive tract region, whereas *Msp1* appear less tissue-specific.

3.2. Transmission Electron Microscopy

For *Msp1*, different tissues (intestine, musculature and hypoderm), as well as the haemocoel were examined in infected individuals (as checked by PCR), but no microsporidia-like structure could be identified. For *Msp2*, as suspected from PCR localisation, infection was mainly restricted to the enterocytes and nearby cells. Spores were small (0.9-1 μ m) and uninucleate (Fig. 1A). Parasitophorous vesicles with both immature and mature spores seemed to be excreted into the intestinal lumen (Fig. 1B).

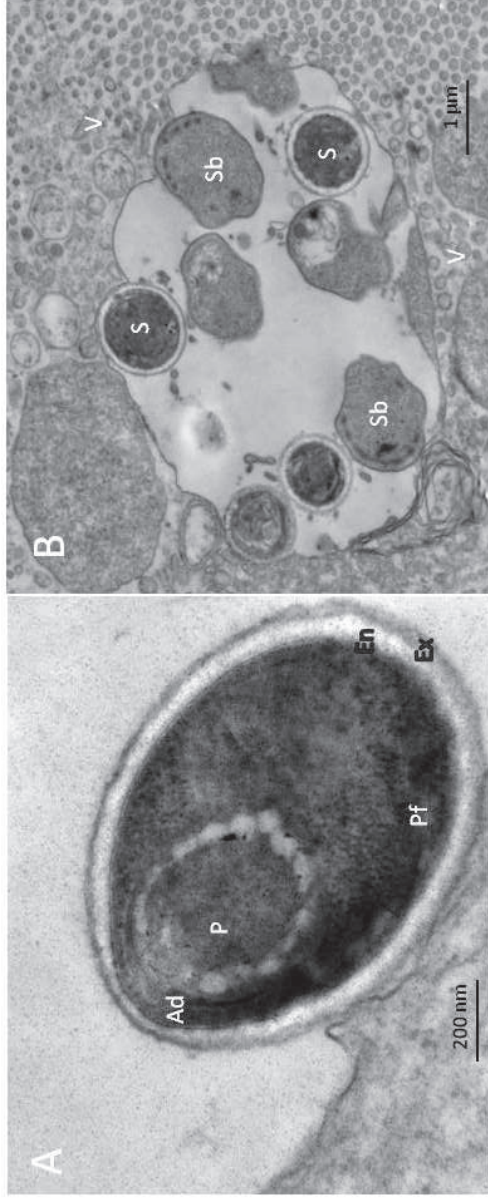

Figure 1. Transmission Electron micrograph of Msp2 showing a maturing spore (A) and the localization of a parasitophorous vesicle (C). (Ad, anchoring disc; En, endospore; Ex, exospore; P, polaroplast; Pf, polar filament; S, spore; Sb, sporoblast; V, intestinal villi).

3.3. Life cycle and transmission mode of *Msp1* and *Msp2*

All tests for infection of species co-occurring with *Artemia* in Aigues-Mortes salterns were negative. Thus both microsporidian species are likely to have direct life cycles and to be specific to the *Artemia* genus.

Among the 25 females used to examine vertical transmission to nauplii, 5 *Ap* females were infected by *Msp1*, 7 *Ap* and 4 *Af* females were infected by *Msp2*, and 9 females (5 *Af* and 4 *Ap*) were not infected. None of the 60 nauplii from the non-infected females were infected and no infection was found among the 32 nauplii of the *Msp1*-infected females. Hence vertical transmission through nauplii is very low or absent in *Msp1* infected females. Only one pool of 3 nauplii among the 128 offspring of the *Msp1*-infected females was positive. The other 7 siblings of the positive nauplii were not infected. As contamination during DNA extraction or horizontal transmission before isolation of the nauplii cannot be excluded, vertical transmission through nauplii is likely to be low or absent in *Msp2*-infected females. In support of this finding, no microsporidian DNA was detected in the (raw and

decapsulated) cysts from San Francisco Bay or Aigues-Mortes and no microsporidian infection was detected in any of the adults hatched from raw and decapsulated cysts from the same populations. Hence, transovum (and transovarial) transmission through cysts is likely to be very low or inexistent in both *Msp1* and *Msp2*.

Three weeks after their introduction into the two tanks that previously contained individuals infected either with *Msp1* or *Msp2*, infection prevalence in *Ap* hosts was 80% and 100% in respectively (n=5 per tank). In the last tank with alive *Msp1* and *Msp2* co-infected *Af* hosts, the prevalence in the *Ap* hosts was 100% and 40% respectively (n=5). Hence, horizontal transmission seems the main route of infection for both *Msp1* and *Msp2*.

3.4. Timing of infection of *Msp1* and *Msp2*.

No *Msp2* infection was detected in the 160 recipient hosts or in the 20 control hosts after two days of exposition to donor hosts. Hence, *Msp2* can only be detected by PCR more than 48h after infection. Two *Ap* recipient hosts infected with *Msp1*

were retrieved at t=1h and one *Ap* control host infected with *Msp1* were retrieved at t=48h. None other *Msp1*-infected host was retrieved from the experiment. *Msp1*-infection probability in the 160 recipients hosts and in the 20 control hosts did not differ (Fisher exact test, $P=0.3$). Subsequent tests of the different lab cultures used to supply the uninfected hosts showed that one culture was infected with *Msp1*. Hence, infection with this parasite is likely to be detected by PCR more than 48h after infection.

3.5. Prevalence and phylogenetic analyses of microsporidia across populations

We performed PCR screening for microsporidian infection on 267 individuals from *Af*-invaded populations from France and Israel (Table S1), on 67 individuals from non-invaded Old World populations, and 86 individuals from American populations (ancestral range, Table S2). Microsporidian prevalence varied widely across populations and infections were only detected in roughly 30% of the populations (defined as geographical units, Table S1-S2). Overall, we found microsporidian infections in four of twelve

invaded French and Israeli populations, one of seven non-invaded Old World populations and three of five American populations. PCR and DNA sequencing of the microsporidian SSU rRNA gene revealed four sets of divergent sequences (hereafter *Msp1*, *Msp2*, *Msp3*, *Msp4*). No polymorphism was found in *Msp1* or *Msp2* although several sequences from different locations were available. *Msp1* was only found in Europe (France and Ukraine, Table S2). *Msp3* and *Msp4* were only found in American populations (Table S2). Interestingly, *Msp2* was the only species found both in American, French and Israeli populations and was absent from non-invaded Old World populations.

Phylogenetic analyses revealed that these sequences are likely to represent different undescribed species from the terresporida clade *sensu* Vossbrinck and Debrunner-Vossbrinck (2005). *Msp1* and *Msp3* appeared to belong to a clade including *Endoreticulatus spp.* and *Vittaforma cornea* (Fig. 1). *Msp2* grouped together with *Nucleospora salmonis* and *Enterocytozoon bieneusi*. *Msp4* was distantly related to the *Msp1*, *Msp2*, *Msp3* clade and grouped with sequences

from *Encephalitozoon* species. As sequences were short, polymorphism was low and most bootstrap supports were lower than 70%.

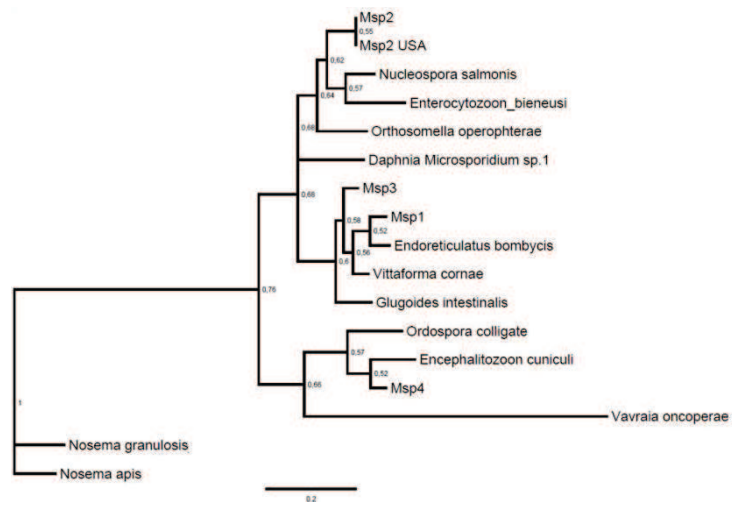

Fig. 2. Phylogenetic tree of microsporidia based on partial SSU rDNA using maximum likelihood, showing the position of the five microsporidian species infecting *Artemia* spp. Bootstrap supports are shown at the base of each node.

3.6. *Msp1 and Msp2 prevalence and phenotypic effects on sympatric hosts from Aigues-Mortes*

The prevalence of *Msp1* in Aigues-Mortes was roughly 60% in *Ap* and 15% in *Af* (Table S1). Hence, *Msp1* seems to be more specific to the former host species ($\chi_1^2=179.59$, $P<10^{-15}$). In contrast, *Msp2* prevalence was roughly 15% and 45% in *Ap* and *Af* respectively (Table S1). Hence, *Msp2* seems to be more specific to the latter host species ($\chi_1^2= 102.77$, $P<10^{-15}$).

Analyzing all the infection data together, neither the observation of white spots on the cuticle, nor the observation of a white digestive tract was associated with *Msp1* or *Msp2* infection ($\chi_3^2= 5.58$, $P=0.13$ for white spots and $\chi_3^2= 1.02$, $P=0.80$ for the white digestive tract). The results were similar when examined using a Fisher exact test.

3.7. *Effect on brooding probability in sympatric female hosts*

For female brooding probability, all best models included *Msp1* and *F. liguloides* infection along with host species, length and sample ($\Delta AICc<2$, Table S2). Both *Msp1* and *F. liguloides* infections had a clear negative impact on female

brooding probability (Table S4, Fig. 3). In contrast, *Msp2* infection was included in only one best model ($\Delta AICc < 2$, Table S4) and although *Msp2* also had a negative impact on female brooding probability in this model, its effect was much smaller (Table S4, Fig. 3). *Ap* females were on average more likely to be reproducing than *Af* females at the time of sampling, and large females were more likely to be reproducing than small ones (Fig. 3). However, none of the best models included an interaction between female species and either *Msp1* or *Msp2* infection ($\Delta AICc > 2$, Table S4), indicating that the effect of microsporidian infection on brooding probability did not differ between host species. In addition, the positive interaction between female length and *Msp1* presence found in some of the best models suggest a 20% decrease in brooding probability in small infected compared to non-infected females (Table S4, Fig. 3), whereas no difference was found in large females (~3% increase in Fig. 3). Again, this decrease in small females did not differ between host species ($\Delta AICc > 2$, Table S4). Finally, the negative interaction found between *Msp1* and *F. liguloides* infections in some of the best models suggests a

greater reproductive cost of the presence of both species in co-infected females (Table S4, Fig. 3).

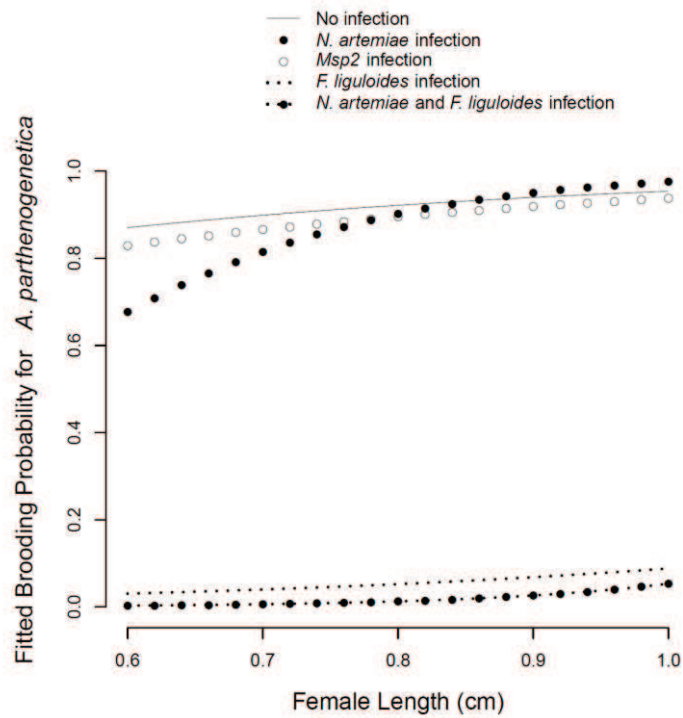

Figure 3. Effect of *Msp1*, *Msp2* and *F. liguloides* infections on *Ap* female brooding probability. The best model including *Msp1* was used to compute the fitted values. Curve shapes were similar for *Af* females, but with lower intercepts.

4. Discussion

Characterization of Msp1 and Msp2 species

We characterized two new microsporidian parasites, *Msp1* and *Msp2* infecting divergent *Af* and *Ap* hosts. We could only image the second species which was not recognizable as any of the known microsporidia species. Infection around the intestinal epithelium was suspected from the dissection experiments and confirmed by electron microscopy, which indicated that *Msp1* preferentially infects the enterocytes and nearby cells. Spores were small (1 μ m) and uninucleate (Fig. 1B). Parasitophorous vesicle, with all developmental stages including immature and mature spores, appeared to be excreted into the intestinal lumen (Fig. 1C). We further characterized *Msp1* elsewhere (Rode et al, in prep), as a more thorough description of its ultrastructure is beyond the scope of this study.

Phenotypic investigation of microsporidian infection in *Artemia spp.* (and other crustacean hosts) has usually relied on the examination of macroscopic white spots through the cuticle (Codreanu 1957; Martinez *et al.* 1992; Martinez *et al.*

1994). As we failed to detect microsporidia in the samples from Odiel (Spain), although they contained some individuals with white spots (Marta Sanchez, pers. com.) and that two microsporidian parasites have been described in this population with frequencies above 25% (Martinez *et al.* 1993), we investigated the phenotypic effect ('white colour') of both microsporidian parasites on their *Artemia* hosts in 1230 individuals collected from natural ponds in Aigues-Mortes. Surprisingly, we did not find any significant association between infection by either parasite and the presence of white spots on the cuticle or of a white digestive tract. Thus, this cue appears not to be an indicator of microsporidian infection in this system. Furthermore, although "white-spot" identification enables the suspicion of infection with *N. artemiae* in *Artemia* populations (Codreanu 1957; Martinez *et al.* 1994), it certainly greatly underestimates parasite prevalence, as vegetative stages cannot be detected. That the determination of microsporidian infection using "white-spot" identification does not appear to be reliable is important, as some virulent viruses can also produce white spots in their

crustacean hosts (Li *et al.* 2003; Escobedo-Bonilla *et al.* 2008). This bias may be even more significant for *Msp2*, for which no obvious outward sign of infection could be detected in infected lab cultures (N. Rode, pers. obs.). Although, the results from our infection timing experiment indicate that spore cannot be detected in the early stages of the infection, PCR assays with specific primers such as those developed in this study seem to be the most accurate method to detect early infections and to estimate accurately microsporidian prevalence in the field. Further microscopic investigations could potentially allow discriminating *Msp1* and *Msp2* based on spore morphology and tissue specificity.

In order to better characterize *Msp1* and *Msp2*, we studied the transmission mode of both parasites and tested for their introduction along with the invasive host. Both *Msp1* and *Msp2* seemed to have direct life cycles with horizontal transmission. Both *Msp1* and *Msp2* appeared to be exclusively horizontally transmitted, given the high rate of horizontal transmission observed in the laboratory (>80%) and the lack of infection detected in nauplii and cysts laid by infected mothers

(although we cannot completely rule out the possibility of a low vertical transmission of *Msp2*).

Origin of Msp1 and Msp2

As we did not detect *Msp1* in the original range of *Af*, thus this species is likely to be native to the Old World. In contrast, *Msp2* occurred in some invaded French and Israeli populations as well as some American populations. Two alternative hypotheses could explain these results. First, *Msp2* could be a specialist parasite preferentially infecting *Af* with a worldwide distribution. Natural dispersal of *Msp2* would occur through water birds, most likely from populations with *Af*, given this species appear more susceptible than *Ap*). Dispersal of viable microsporidian spores by birds has been demonstrated in two *Nosema* species (Higes *et al.* 2008; Valera *et al.* 2011). If this were to be true, we would expect to find *Msp2* in other *Af* populations in the Old World especially French Mediterranean populations as they are all well connected through birds (e.g., Thiéry *et al.* 1990).

An alternative hypothesis is that *Msp1* would have been co-introduced along with its invasive host *Af*. Indeed, we only

found *Msp1* in populations where *Af* is present. In addition, although the short- range introduction between invaded French salterns, likely occurred through water birds, long range introduction from the France to Israeli salterns appeared unlikely. As we did not detect microsporidian DNA in intact or bleached cysts, spore DNA is likely to be particularly difficult to extract in these microsporidian species or alternatively, only a small number of spores could actually remain on cyst surface. Although we did not detect any vertical (transovarial or transovum) transmission through cysts from natural populations (Great Salt Lake, San Francisco Bay, Site 9, Pont l'Abbé), our experiment is likely not commensurable with the historical introduction, as several kilos of cysts ($>10^8$ embryos) were introduced into the Aigues-Mortes salterns (D. Facca, pers. com.), which is also likely for *Af* introduction in Israel. Importantly, the cysts introduced in Aigues-Mortes were not bleached before introduction (F. René, D. Facca, pers. com.), hence the original microbiota on the cysts surface was likely preserved in the introduction. Resistance of spores to desiccation is typically low in aquatic microsporidia (Becnel &

Andreadis 1999); however this may vary across species, as a recent study found roughly 50% infection after 5 weeks of desiccation (Vizoso *et al.* 2005). Hence, low levels of *Msp1*-transmission through dry cysts following its introduction in Aigues-Mortes and Eilat seem plausible.

Parasite-mediated host competition

We investigated the role of both microsporidian parasites in mediating the competition between invasive and native hosts in natural populations. Surprisingly, we found contrasting prevalence patterns of the two microsporidian parasites in the two *Artemia* hosts. In the Aigues-Mortes ponds, *Msp1* was roughly four times more prevalent in the native *Ap*, while *Msp2* was roughly four times more prevalent in the invasive *Af* (Table S3). The latter result appears quite robust, since we found that the higher prevalence of *Msp2* in *Af* was highly significant ($P < 10^{-16}$), without taking into account the larger size (and the likely higher rate of spore ingestion) of *Ap* compared to *Af* (Triantaphyllidis *et al.* 1995, data not shown for this study). The same pattern was found in Salin-de-Giraud, where none of the 17 *A. parthenogenetica* from one sample was

infected, although the parasite was detected in *Af* (Table S1). Hence, although these two parasites are able to infect divergent *Artemia* hosts (30-35 MY divergence, Abreu-Grobois 1987; Baxevanis *et al.* 2006), they appear to be highly host specific. This result is surprising, as few studies have documented the ability of microsporidia to infect divergent hosts in sympatric natural populations (e.g., Shykoff & Schmid-Hempel 1991; Stirnadel & Ebert 1997; Bengtsson & Ebert 1998; Ebert *et al.* 2001; Gillespie 2010) or in lab populations (e.g., Solter & Maddox 1998; Solter *et al.* 2000; Saito & Bjornson 2006; Saito & Bjornson 2008) and high host-specificity seem to be the rule in microsporidian infections (e.g., Solter *et al.* 2000; Porter *et al.* 2007; Andreadis *et al.* 2012). In addition, we looked for differential effects of both parasites on the fitness of females from the invasive and native host species. We focused on the probability of brooding in infected vs. non-infected females. Interestingly, we found a strong negative impact of *Msp1* on this variable, while the negative effect of *Msp1* was smaller and not well supported. Furthermore, *Msp1* detrimental effect tended to be restricted

to small females (Fig. 3). This decrease could be due to old (and consequently large) females becoming parasitized while already carrying eggs, to large females being more able to cope with parasite infection or to the preferential survival of females that can resist the deleterious effects of *Msp1* and reproduce. Further experiments with females of known ages would help to decipher the relative importance of these factors and to further quantify the fitness effects of *Msp1* and *Msp2* infection. Finally, infection by *F. liguloides* negatively impacted female brooding probability, as shown in other studies (Fig. 3, Amat *et al.* 1991; Varó *et al.* 2000; Sánchez *et al.* 2012). Interestingly, the interaction between *Msp1* and *F. liguloides* found in some of the best models suggests a greater reproductive cost of these species in co-infected females. Such increased virulence in co-infected hosts has recently been reported in *Daphnia* parasites (Lohr *et al.* 2010; Ben-Ami *et al.* 2011).

Conclusion

Overall, as we found that the invasive *Af* is four times less likely to be infected by the virulent *Msp1* compared to the native *Ap*, the invasive species consequently pays lower demographic costs in invaded areas where *Msp1* is present. This is further evidence that parasites play an important role in altering the outcome of competition between invasive and native *Artemia* species (Sánchez *et al.* 2012). As *Ap* and *Af* has been coexisting for more than 40 years, the ecological factors balancing the detrimental fitness effects of parasites remain to be determined.

Acknowledgements

The authors are grateful to C. Cazevieuille and C. Sanchez for their technical assistance and help in interpreting data concerning ultrastructural evaluation. We also thank Y. Michalakis, P. Agnew, T. Rigaud and M.-P. Dubois for their advice and help regarding the molecular and microscopic investigations of microsporidiosis. We are indebted to M. Sanchez, C. Mathieu, G. Van Stappen, JP. Rullmann, R.

Jellison, J.Y. Takekawa, AG. Saez, J. Butler, S. Bonnet-Questiau, I. Gallois-Morin, A. Atzeni, G. Martin, P-A. Crochet for providing some of the samples. We also wish to thank T. Pugliano and JL. Kammradt, T. Gout, and F. Gout that assisted in sampling and R. Tkavc for pointing the presence of a microsporidium in Eilat and providing individual samples. Finally, we thank D. Facca, F. René, B. Menu, A. Muller-Feuga, P. Serene, and L. Euzet for their information about the introduction of *A. franciscana* in Southern France.

Contribution statement

EF and TL found the microsporidia. NOR, EJPL, EF, RJZ, TL collected the samples. EJPL and NOR did the measurements. AS and JL tested for vertical transmission. EJPL, EF, AS, JL and RJZ conducted the molecular work. NOR, AS, EF, RJZ and CV tried to image the species by electron microscopy. NOR analyzed the data. EJPL, NOR and TL wrote the paper.

References

- Abreu-Grobois F.A. (1987). *A review of the genetics of Artemia*. Universa Press, Wetteren, Belgium.
- Amat F., Gozalbo A., Navarro J., Hontoria F. & Varó I. (1991). Some aspects of *Artemia* biology affected by cestode parasitism. *Hydrobiologia*, 212, 39-44.
- Amat F., Hontoria F., Navarro J.C., Vieira N. & Mura G. (2007). Biodiversity loss in the genus *Artemia* in the Western Mediterranean Region. *Limnetica*, 26, 387-404.
- Amat F., Hontoria F., Ruiz O., Green A.J., Sanchez M.I., Figuerola J. & Hortas F. (2005). The American brine shrimp as an exotic invasive species in the Western Mediterranean. *Biological Invasions*, 7, 37 - 47.
- Andreadis T.G., Simakova A.V., Vossbrinck C.R., Shepard J.J. & Yurchenko Y.A. (2012). Ultrastructural characterization and comparative phylogenetic analysis of new microsporidia from Siberian mosquitoes: Evidence for coevolution and host switching. *Journal of Invertebrate Pathology*.
- Baker M.D., Vossbrinck C.R., Maddox J.V. & Undeen A.H. (1994). Phylogenetic relationships among *Vairimorpha* and *Nosema* species (Microspora) based on ribosomal RNA sequence data. *Journal of Invertebrate Pathology*, 30, 509–518.
- Baxevanis A.D., Kappas I. & Abatzopoulos T.J. (2006). Molecular phylogenetics and asexuality in the brine shrimp *Artemia*. *Molecular phylogenetics and evolution*, 40, 724 - 738.
- Becnel J.J. & Andreadis T.G. (1999). Microsporidia in insects. *The Microsporidia and microsporidiosis*, 447-501.
- Becnel J.J. & Johnson M.A. (2000). Impact of *Edhazardia aedis* (Microsporidia: Culicosporidae) on a seminatural population of *Aedes aegypti* (Diptera: Culicidae). *Biological Control*, 18, 39-48.
- Ben-Ami F., Rigaud T. & Ebert D. (2011). The expression of virulence during double infections by different parasites with conflicting host exploitation and transmission strategies. *Journal of Evolutionary Biology*.

- Bengtsson J. & Ebert D. (1998). Distributions and impacts of microparasites on *Daphnia* in a rockpool metapopulation. *Oecologia*, 115, 213-221.
- Camara M.R. & Castro E.V. (1983). *Artemia salina* L. (Anostraca): uma opção para a aqüicultura do nordeste do Brasil. *Revta. bras. Zool.*, 1, 145-147.
- Codreanu R. (1957). Sur quatre especes nouvelles de microsporidies parasites de l'*Artemia salina* (L.) de Roumaine. *Annales Des Sciences Naturelles Zoologiques*, 19, 561-572.
- Colautti R.I., Ricciardi A., Grigorovich I.A. & MacIsaac H.J. (2004). Is invasion success explained by the enemy release hypothesis? *Ecol. Lett.*, 7, 721-733.
- Decaestecker E., Declerck S., De Meester L. & Ebert D. (2005). Ecological implications of parasites in natural *Daphnia* populations. *Oecologia*, 144, 382-390.
- Dunn A.M. (2009). Parasites and Biological Invasions. In: *Advances in Parasitology, Vol 68: Natural History of Host-Parasite Interactions*, pp. 161-184.
- Ebert D., Hottinger J.W. & Pajunen V.I. (2001). Temporal and spatial dynamics of parasite richness in a *Daphnia* metapopulation. *Ecology*, 82, 3417-3434.
- Escobedo-Bonilla C., Alday-Sanz V., Wille M., Sorgeloos P., Pensaert M. & Nauwynck H. (2008). A review on the morphology, molecular characterization, morphogenesis and pathogenesis of white spot syndrome virus. *Journal of fish diseases*, 31, 1-18.
- Folmer O., Black M., Hoeh W., Lutz R. & Vrijenhoek R. (1994). DNA primers for amplification of mitochondrial cytochrome c oxidase subunit I from diverse metazoan invertebrates. *Molecular marine biology and biotechnology*, 3, 294-9.
- Gillespie S. (2010). Factors affecting parasite prevalence among wild bumblebees. *Ecological Entomology*, 35, 737-747.
- Goertz D. & Hoch G. (2008). Vertical transmission and overwintering of microsporidia in the gypsy moth, *Lymantria dispar*. *Journal of Invertebrate Pathology*, 99, 43-48.
- Goodacre S.L., Martin O.Y., Bonte D., Hutchings L., Woolley C., Ibrahim K., Thomas C.F.G. & Hewitt G.M. (2009).

- Microbial modification of host long-distance dispersal capacity. *Bmc Biology*, 7.
- Guindon S., Dufayard J.F., Lefort V., Anisimova M., Hordijk W. & Gascuel O. (2010). New algorithms and methods to estimate maximum-likelihood phylogenies: assessing the performance of PhyML 3.0. *Systematic biology*, 59, 307-321.
- Haine E.R., Brondani E., Hume K.D., Perrot-Minnot M.J., Gaillard M. & Rigaud T. (2004). Coexistence of three microsporidia parasites in populations of the freshwater amphipod *Gammarus roeseli*: evidence for vertical transmission and positive effect on reproduction. *International Journal for Parasitology*, 34, 1137-1146.
- Hall T. (2001). BioEdit version 5.0. 6. *North Carolina State University, Department of Microbiology, Raleigh, North Carolina*, 192.
- Higes M., Martín-Hernández R., Garrido-Bailón E., Botías C., García-Palencia P. & Meana A. (2008). Regurgitated pellets of *Merops apiaster* as fomites of infective *Nosema ceranae* (Microsporidia) spores. *Environmental Microbiology*, 10, 1374-1379.
- Hoffmann A.A., Montgomery B.L., Popovici J., Iturbe-Ormaetxe I., Johnson P.H., Muzzi F., Greenfield M., Durkan M., Leong Y.S., Dong Y., Cook H., Axford J., Callahan A.G., Kenny N., Omodei C., McGraw E.A., Ryan P.A., Ritchie S.A., Turelli M. & O'Neill S.L. (2011). Successful establishment of *Wolbachia* in *Aedes* populations to suppress dengue transmission. *Nature*, 476, 454-U107.
- Hurvich C.M. & Tsai C.L. (1989). Regression and Time-Series Model Selection in Small Samples. *Biometrika*, 76, 297-307.
- Ironside J.E., Dunn A.M., Rollinson D. & Smith J.E. (2003). Association with host mitochondrial haplotypes suggests that feminizing microsporidia lack horizontal transmission. *Journal of Evolutionary Biology*, 16, 1077-1083.
- James T.Y., Kauff F., Schoch C.L., Matheny P.B., Hofstetter V., Cox C.J., Celio G., Gueidan C., Fraker E. & Miadlikowska J. (2006). Reconstructing the early evolution of Fungi using a six-gene phylogeny. *Nature*, 443, 818-822.

- Keane R.M. & Crawley M.J. (2002). Exotic plant invasions and the enemy release hypothesis. *Trends in Ecology & Evolution*, 17, 164-170.
- Krakau M., Thielges D.W. & Reise K. (2006). Native parasites adopt introduced bivalves of the North Sea. *Biological Invasions*, 8, 919-925.
- Krebs L., Blank M., Frankowski J. & Bastrop R. (2010). Molecular characterisation of the Microsporidia of the amphipod *Gammarus duebeni* across its natural range revealed hidden diversity, wide-ranging prevalence and potential for co-evolution. *Infection, Genetics and Evolution*, 10, 1027-1038.
- Li J., Chen W., Wu J., Peng W., An J., Schmid-Hempel P. & Schmid-Hempel R. (2012). Diversity of *Nosema* associated with bumblebees (*Bombus* spp.) from China. *International Journal for Parasitology*, 42, 49-61.
- Li Q., Zhang J., Chen Y. & Yang F. (2003). White spot syndrome virus (WSSV) infectivity for *Artemia* at different developmental stages. *Diseases of aquatic organisms*, 57, 261.
- Lohr J.N., Yin M. & Wolinska J. (2010). Prior residency does not always pay off? co-infections in *Daphnia*. *Parasitology*, 137, 1493.
- Martinez M.A., Larsson J.I.R., Amat F. & Vivares C.P. (1994). Cytological Study of *Nosema artemiae* (Codreanu, 1957) Sprague 1977 (Microsporidia, Nosematidae). *Archiv Fur Protistenkunde*, 144, 83-89.
- Martinez M.A., Vivares C.P. & Bouix G. (1993). Ultrastructural-Study of *Endoreticulatus durforti* N-Sp, a New Microsporidian Parasite of the Intestinal Epithelium of *Artemia* (Crustacea, Anostraca). *Journal of Eukaryotic Microbiology*, 40, 677-687.
- Martinez M.A., Vivares C.P., Rocha R.D., Fonseca A.C., Andral B. & Bouix G. (1992). Microsporidiosis on *Artemia* (Crustacea, Anostraca) - Light and Electron-Microscopy of *Vavraia-Anostraca* Sp-Nov (Microsporidia, Pleistophoridae) in the Brazilian Solar Salterns. *Aquaculture*, 107, 229-237.

- Mitchell C.E. & Power A.G. (2003). Release of invasive plants from fungal and viral pathogens. *Nature*, 421, 625-627.
- Muirhead J.R., Gray D.K., Kelly D.W., Ellis S.M., Heath D.D. & Macisaac H.J. (2008). Identifying the source of species invasions: sampling intensity vs. genetic diversity. *Molecular Ecology*, 17, 1020-1035.
- Muñoz J., Gómez A., Green A.J., Figuerola J., Amat F. & Rico C. (2008a). Phylogeography and local endemism of the native Mediterranean brine shrimp *Artemia salina* (Branchiopoda: Anostraca). *Molecular Ecology*, 17, 3160-3177.
- Muñoz J., Green A., Figuerola J., Amat F. & Rico C. (2008b). Characterization of polymorphic microsatellite markers in the brine shrimp *Artemia* (Branchiopoda, Anostraca). *Molecular Ecology Resources*, 9, 547-550.
- Mura G., Kappas I., Baxevanis A.D., Moscatello S., D'Amico Q., Lopez G.M., Hontoria F., Amat F. & Abatzopoulos T.J. (2006). Morphological and molecular data reveal the presence of the invasive *Artemia franciscana* in Margherita di Savoia Salterns (Italy). *International Review of Hydrobiology*, 91, 539-554.
- Ovcharenko M. & Wita I. (2005). The ultrastructural study of *Nosema artemiae* (Codreanu, 1957) (Microsporidia : Nosematidae). *Acta Protozool.*, 44, 33-41.
- Porter S.D., Valles S.M., Davis T.S., Briano J.A., Calcaterra L.A., Oi D.H. & Jenkins R.A. (2007). Host specificity of the microsporidian pathogen *Vairimorpha invictae* at five field sites with infected *Solenopsis invicta* fire ant colonies in northern Argentina. *Florida Entomologist*, 90, 447-452.
- Posada D. (2008). jModelTest: phylogenetic model averaging. *Molecular Biology and Evolution*, 25, 1253-1256.
- Posada D. & Crandall K.A. (1998). MODELTEST: testing the model of DNA substitution. *Bioinformatics*, 14, 817-818.
- Prenter J., MacNeil C., Dick J.T.A. & Dunn A.M. (2004). Roles of parasites in animal invasions. *Trends in Ecology & Evolution*, 19, 385-390.
- Ryan J.A. & Kohler S.L. (2010). Virulence is context-dependent in a vertically transmitted aquatic host-microparasite system. *International Journal for Parasitology*, 40, 1665-1673.

- Saito T. & Bjornson S. (2006). Horizontal transmission of a microsporidium from the convergent lady beetle, *Hippodamia convergens* Guerin-Meneville (Coleoptera : Coccinellidae), to three coccinellid species of Nova Scotia. *Biological Control*, 39, 427-433.
- Saito T. & Bjornson S. (2008). Effects of a microsporidium from the convergent lady beetle, *Hippodamia convergens* Guerin-Meneville (Coleoptera: Coccinellidae), on three non-target coccinellids. *Journal of Invertebrate Pathology*, 99, 294-301.
- Sánchez M., Rode N., Flaven E., Redón S., Amat F., Vasileva G. & Lenormand T. (2012). Differential susceptibility to parasites of invasive and native species of *Artemia* living in sympatry: consequences for the invasion of *A. franciscana* in the Mediterranean region. *Biological Invasions*, 1-11.
- Shykoff J. & Schmid-Hempel P. (1991). Incidence and effects of four parasites in natural populations of bumble bees in Switzerland. *Apidologie*, 22, 117-125.
- Slothouber Galbreath J.G.M., Smith J.E., Becnel J.J., Butlin R.K. & Dunn A.M. (2010). Reduction in post-invasion genetic diversity in *Crangonyx pseudogracilis* (Amphipoda: Crustacea): a genetic bottleneck or the work of hitchhiking vertically transmitted microparasites? *Biological Invasions*, 12, 191-209.
- Slothouber Galbreath J.G.M., Smith J.E., Terry R.S., Becnel J.J. & Dunn A.M. (2004). Invasion success of *Fibrillanosema crangonycis*, n.sp., n.g.: a novel vertically transmitted microsporidian parasite from the invasive amphipod host *Crangonyx pseudogracilis*. *International journal for parasitology*, 34, 235-44.
- Solter L.F. & Maddox J.V. (1998). Physiological host specificity of microsporidia as an indicator of ecological host specificity. *Journal of Invertebrate Pathology*, 71, 207-216.
- Solter L.F., Pilarska D.K. & Vossbrinck C.F. (2000). Host specificity of microsporidia pathogenic to forest Lepidoptera. *Biological Control*, 19, 48-56.
- Stirnadel H.A. & Ebert D. (1997). Prevalence, host specificity and impact on host fecundity of microparasites and epibionts in

- three sympatric *Daphnia* species. *Journal of Animal Ecology*, 66, 212-222.
- Terry R.S., Smith J.E., Sharpe R.G., Rigaud T., Littlewood D.T.J., Ironside J.E., Rollinson D., Bouchon D., MacNeil C., Dick J.T.A. & Dunn A.M. (2004). Widespread vertical transmission and associated host sex-ratio distortion within the eukaryotic phylum Microspora. *Proceedings of the Royal Society of London Series B-Biological Sciences*, 271, 1783-1789.
- Thiéry A., Robert F. & Gabrion C. (1990). Distribution des populations d'*Artemia* et de leur parasite *Flamingolepis liguloides* (Cestode, Cyclophyllidea), dans les salins du littoral méditerranéen français. *Canadian Journal of Zoology*, 68, 2199-2204.
- Tompkins D.M., White A.R. & Boots M. (2003). Ecological replacement of native red squirrels by invasive greys driven by disease. *Ecol. Lett.*, 6, 189-196.
- Torchin M.E., Lafferty K.D., Dobson A.P., McKenzie V.J. & Kuris A.M. (2003). Introduced species and their missing parasites. *Nature*, 421, 628-630.
- Triantaphyllidis G.V., Pouloupoulou K., Abatzopoulos T.J., Pérez C.A.P. & Sorgeloos P. (1995). International study on *Artemia* XLIX. Salinity effects on survival, maturity, growth, biometrics, reproductive and lifespan characteristics of a bisexual and a parthenogenetic population of *Artemia*. *Hydrobiologia*, 302, 215-227.
- Tsutsui N.D., Kauppinen S.N., Oyafuso A.F. & Grosberg R.K. (2003). The distribution and evolutionary history of *Wolbachia* infection in native and introduced populations of the invasive argentine ant (*Linepithema humile*). *Molecular Ecology*, 12, 3057-3068.
- Valera F., Martín-Hernández R. & Higes M. (2011). Evaluation of large-scale dissemination of *Nosema ceranae* spores by European bee-eaters *Merops apiaster*. *Environmental Microbiology Reports*, 3, 47-53.
- Varó I., Taylor A., Navarro J. & Amat F. (2000). Effect of parasitism on respiration rates of adults of different *Artemia* strains from Spain. *Parasitology research*, 86, 772-774.

- Vizoso D.B., Lass S. & Ebert D. (2005). Different mechanisms of transmission of the microsporidium *Octosporea bayeri*: a cocktail of solutions for the problem of parasite permanence. *Parasitology*, 130, 501-509.
- Vossbrinck C.R., Debrunner-Vossbrinck B.A., Lom J., Vávra J., Weiss L. & Bukva V. (2005). Molecular phylogeny of the Microsporidia: ecological, ultrastructural and taxonomic considerations. In: Institute of Parasitology, Academy of Sciences of the Czech Republic, pp. 131-142.
- Wattier R.A., Haine E.R., Beguet J., Martin G., Bollache L., Musko I.B., Platvoet D. & Rigaud T. (2007). No genetic bottleneck or associated microparasite loss in invasive populations of a freshwater amphipod. *Oikos*, 116, 1941-1953.
- Weiss L.M., Zhu X., Cali A., Tanowitz H.B. & Wittner M. (1994). Utility of Microsporidian Ribosomal-Rna in Diagnosis and Phylogeny - a Review. *Folia Parasitol.*, 41, 81-90.
- Wilkinson T.J., Rock J., Whiteley N.M., Ovcharenko M.O. & Ironside J.E. (2011). Genetic diversity of the feminising microsporidian parasite *Dictyocoela*: New insights into host-specificity, sex and phylogeography. *International Journal for Parasitology*, 41, 959-966.
- Yang C.-C., Yu Y.-C., Valles S.M., Oi D.H., Chen Y.-C., Shoemaker D., Wu W.-J. & Shih C.-J. (2010). Loss of microbial (pathogen) infections associated with recent invasions of the red imported fire ant *Solenopsis invicta*. *Biological Invasions*, 12, 3307-3318.

Article 5

SUPPLEMENTARY MATERIALS

Supplementary methods

Design of species specific primers for microsporidia from Aigues-Mortes

To design species-specific primers, we used 125 *A. parthenogenetica* and 135 *A. franciscana* individuals sampled in different the salterns in Aigues-Mortes during summer and winter 2008 for a previous study (Sánchez *et al.* 2012). Adult individuals were preserved in 96% ethanol and dried in 96-well plates at 56°C. DNA was extracted using Extraction Solution (Sigma, Germany, extraction in 30µL at 95°C for 10min, 20°C for 10min, product diluted with 50µL of sterile deionized water). We screened for microsporidian infection via PCR with microsporidia-specific small subunit (SSU) ribosomal DNA primers (V1f/530r, Baker *et al.* 1994; Weiss *et al.* 1994). PCR amplifications were carried out in a total volume of 20 µL containing 2µL of 10X PCR buffer (Eurogentec), 0.5µM of each primer, 1.8mM MgCl₂, 1mM dNTPs (Eurogentec), 1 U of RedGoldStar® *Taq* polymerase (Eurogentec) and 1µl of DNA extract. A negative control (PCR mix alone) was included on each extraction plate. The thermal profile consisted of a 2min initial cycle at 94°C, followed by 35 cycles at 94°C for 30s, 60°C for 1min, and 72°C for 2min, with a

final extension at 72°C for 5min. 5µL of the PCR product was separated by electrophoresis on a 2% agarose gel containing 0.5 µg/ml GelRed™ (Biotium, USA) and visualized under UV light. The quality of the DNA template was checked via an additional PCR on all samples using host microsatellite primers (Apdq02TAIL/EU888845, Af-B10/EU 888838, Muñoz *et al.* 2008b); any negative sample was excluded from the analysis. 62 positive PCR products were sequenced on an ABI prism 3130xl genetic analyser (Applied Biosystems) with an ABI Prism Big Dye Terminator Cycle Sequencing Ready Reaction Kit. Approximately 340bp of SSU rDNA sequence was generated for each parasite isolate; from these we detected two divergent sequences. Specific primer sets were subsequently designed to amplify the two microsporidian sequences, each of which was found in both *Artemia* host species: *Microsporidium sp. 1* (Ty1p2f, 5' GAAAATGTGGCTAAGGGCGC 3' and Ty1p3r, 5'TTTGCCAAGCATTTCATCCTC 3') and *Microsporidium sp. 2* (Ty2p1f, 5' GCGATGATTTGCTCTTGATG 3' and Ty2p3r, 5' AGCACTTGTTTACTGTGCC 3').

Timing of *Msp1* and *Msp2* infection

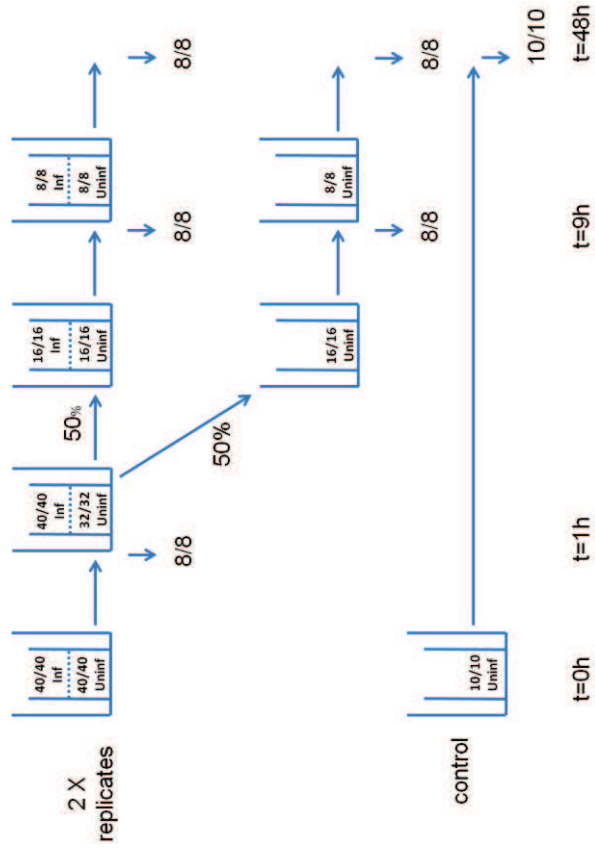

Figure S1 Investigation of the timing of infection of both microsporidian parasites. 40 Af and 40 Ap recipient hosts supposed to be uninfected were placed in a cage at the bottom of a tank. 40 Af and 40 Ap donor hosts infected by *Msp1* and *Msp2* were placed in a cage above the uninfected hosts. Cages were separated by a net (mesh size 0.2mm). 10 Af and 10 Ap supposed to be uninfected were kept isolated as a control. After one hour, 8 recipient hosts of each species were sampled and preserved in ethanol and 50% of the uninfected recipients were immediately placed in a cage in new medium in the absence of infected donor hosts ($t=1h$). Samples were subsequently taken at $t=9h$ and $t=48h$. Vertical arrows indicate the number of Af/ Ap sampled. Individuals in the control were only sampled at the end of the experiment.

Table S1: Prevalence of microsporidia infection in invaded populations from France and Israel.

Sampling Site	Host Species	Microsporidia	Prevalence in Ap (%)	Prevalence in Af (%)	N sampled (Af; Ap)	Latitude-Longitude	Sampling date
Invaded populations							
France							
Saline la Haye; Més basin; Anssérac ^a	Af	-	-	-	0; 16	N47° 24' 55" W2° 25' 2"	15/11/2011
Petite Loire; Noirmoutier ^a	Af	-	-	-	0; 16	N46° 59' 56" W2° 16' 36"	09/05/2011
	Af	-	-	-	0; 16		17/05/2011
	Af	-	-	-	0; 8		21/10/2011
Salin-de-Giraud salterns; Salin-de-Giraud (Saint Genest) b	Ap.	Msp1	42.9	-	7; 0	N43° 21' 48" E4° 42' 45"	20/05/2011
	Ap; Af	Msp1	88.2	100	17; 3		19/10/2011
	Ap; Af	Msp2	0	33	17; 3		19/10/2011
Thau castellas; Marseillan c	Af	-	-	-	0; 8	N43° 20' 38" E3° 34' 10"	14/05/2002
Thau castellas; Marseillan (Site 1) c	Af	-	-	-	0; 15	N43° 20' 40" E3° 34' 13"	31/03/2012
Sète-Villeroiy (Thau L'istel); Sète c	Af	-	-	-	0; 8	N43° 22' 56" E3° 37' 31"	14/05/2002
Sète-Villeroiy (Thau L'istel); Sète (Site 1) c	Ap	-	-	-	15; 0	N43° 22' 51" E3° 37' 23"	31/03/2012
Sète-Villeroiy (Thau L'istel); Sète (Site 2) c	Af	-	-	-	0; 15	N43° 22' 50" E3° 37' 23"	31/03/2012
Berre salterns; Berre l'Etang a	Af	-	-	-	0; 8	N43° 28' 13" E5° 9' 31"	15/05/2002
Berre salterns; Berre l'Etang (Site 1) a	Ap.	-	-	-	10; 0	N43° 28' 48" E5° 8' 26"	16/04/2012
Fos-sur-mer (Fos I) ^a	Af	-	-	-	0; 7	N43° 25' 50" E4° 57' 00"	15/05/2002
Fos-sur-mer (Fos II) ^a	Af	-	-	-	0; 6	N43° 25' 49" E4° 57' 01"	15/05/2002
Pesquiers salterns; Hyères d	Af	-	-	-	2; 6	N43° 3' 50" E6° 8' 43"	15/05/2002
Pesquiers salterns; Hyères (Site 1) d	Af	-	-	-	0; 10	N43° 4' 36" E6° 8' 34"	16/04/2012
Pesquiers salterns; Hyères (Site 2) d	Af	-	-	-	0; 10	N43° 4' 30" E6° 8' 40"	16/04/2012
Pesquiers salterns; Hyères (Site 3) d	Af	-	-	-	0; 10	N43° 4' 29" E6° 8' 40"	16/04/2012
Vieux salins; Hyères (Site 1) a	Af	-	-	-	0; 10	N43° 7' 25" E6° 12' 33"	16/04/2012
Vieux salins; Hyères (Site 2) a	Ap; Af	-	-	-	1; 9	N43° 7' 22" E6° 12' 42"	16/04/2012
Saint Martin salterns; Gruissan b	Ap; Af	Msp2	100	33.3	1; 6	N43° 5' 13" E3° 5' 4"	28/12/2011

Table S1 (continued)

Israel						
<i>Ein Evrona salterns; Eilat (Site 63)</i> ^e	Af	-	-	0:1	N29° 37' 46" E34° 59' 56"	2008
<i>Ein Evrona salterns; Eilat (Site 65)</i> ^e	Af	Msp2	100	0:3	N29° 37' 24" E34° 59' 54"	2008
<i>Eilat salterns; Eilat (Site 104)</i> ^e	Af	Msp2	100	0:1	N29° 34' 9" E34° 58' 5"	2008
<i>Eilat salterns; Eilat (Site 200)</i> ^e	Af	-	-	0:1	N29° 33' 44" E34° 58' 0"	2008
<i>Eilat salterns; Eilat (Site 207)</i> ^e	Af	Msp2	100	0:1	N29° 33' 19" E34° 58' 19"	2008

^a Unknown introduction date.

^b No human introduction, introduction most likely through waterbirds (D. Facca, pers com).

^c Introduction in July 1970 (F. René, pers com).

^d Introduction before 1970 (D. Facca, pers com).

^e Introduction in 1979 (Zmora and Popper 1985, N. Rode, unpublished).

Table S2: Prevalence of microsporidian infections in non-invaded Old World populations and in original New World populations

Sampling Site	Host Species	Microsporidia sp.	Prevalence e (%)	N sampled	Latitude-Longitude	Sampling date
Non Invaded Old World populations						
<i>Germany</i>						
Province of Thuringen, Germany (Unknown)	Ap	-	-	3	Unknown	Unknown
<i>Italy</i>						
Vasche retroritorali, Molentargius Park, Cagliari	As	-	-	8	8N39° 12' 21"-E 9° 9' 24"	12/10/2011
<i>Marroco</i>						
Oualidia	As	-	-	15	15N32° 50' 6"-W8° 54' 11"	20/03/2012
<i>Spain</i>						
Odiel (E13)	Ap	-	-	13	13N37° 15' 17"-W6° 58' 18"	26/07/2011
Odiel (E14)	Ap	-	-	13	13N37° 15' 17"-W6° 58' 22"	26/07/2011
<i>Ukraine</i>						
Ukraine (Unknown)	Ap	Msp4	-	25	4Unknown	1988
Ukraine (Unknown)	Ap	Msp1	-	100	4Unknown	1998
<i>Uzbekistan</i>						
Cape Aktumsuk, Utsyurt, Karakalpakstan,	Ap	-	-	4	4N44° 35' 57"-E58° 17' 56"	2002
Uzbekistan	Ap	-	-	3	3Unknown	2000
Tashkent, Uzbekistan						

Table S2 (continued)
American populations
 USA

Great Salt Lake, USA (Spiral Jetty)	Af	Msp2		18.8	16N41° 26' 16"-W112° 40' 03"	01/10/2011
	Af	Msp4		6.3	16	01/10/2011
Mono Lake, USA	Af	Msp2		31.8	22N37° 59' 27"-W119° 08' 04"	14/10/2010
Alviso Pond, SFB, USA (A22)	Af	-	-		4N37° 29' 03"-W121° 57' 40"	25/03/2008
Alviso Pond, SFB, USA (A23)	Af	-	-		4N37° 28' 31"-W121° 57' 39"	25/03/2008
Eden Landing Pond, SFB, USA (B5C)	Af	-	-		4N37° 34' 21"-W122° 05' 58"	26/03/2008
Eden Landing Pond, SFB, USA (B8X)	Af	Msp3		37.5	8N37° 36' 15"-W122° 07' 05"	20/03/2008
Eden Landing Pond, SFB, USA (B12)	Af	-	-		4N37° 36' 56"-W122° 07' 26"	20/03/2008
Ravenswood Pond, SFB, USA (R1)	Af	-	-		8N37° 29' 56"-W122° 08' 35"	18/03/2008

Table S3: Prevalence of microsporidian infections in the invaded salterns from Aigues-Mortes (France).

Sampling Site	Host Species	Microsporidia	Prevalence in Ap (%)	Prevalence in Af (%)	N sampled (Ap; Af)	Latitude-Longitude	Sampling date
Site 16	Ap, Af	Msp1	60.1	12.7	336; 55	N43° 31' 25"-E4° 10' 37"	25/05/2011
	Ap, Af	Msp2	17	52.7	336; 55		
Site 17	Ap, Af	Msp1	62.4	14.7	404; 95	N43° 31' 26"-E4° 10' 35"	25/05/2011
	Ap, Af	Msp2	14.11	41.1	404; 95		
Site 18	Ap, Af	Msp1	65.2	15.1	247; 93	N43° 30' 51"-E4° 10' 42"	25/05/2011
	Ap, Af	Msp2	15.8	45.2	247; 93		

Introduction with San Francisco Bay cysts in September 1970 and from 1974 to 1979. Introduction with Great Salt Lake cysts in 1979 (F. René and D. Facca, pers com).

Table S4: Analysis of female brooding probability using AICc.

K	logLik	AIC	AICc	$\Delta AICc$	wi	Parameters
11	-224.56	471.11	471.38	0.00	0.11	length*M.sp1+fpresence*M.sp1+species+sample
9	-226.90	471.81	471.99	0.61	0.08	length+fpresence+M.sp1+species+sample
12	-224.12	472.24	472.55	1.17	0.06	M.sp2+length*M.sp1+fpresence*M.sp1+species+sample
10	-226.26	472.52	472.73	1.36	0.06	length*M.sp1+fpresence+species+sample
12	-224.37	472.73	473.04	1.67	0.05	length*M.sp1+fpresence*M.sp1+species*M.sp1+sample
10	-226.43	472.85	473.07	1.69	0.05	length+fpresence*M.sp1+species+sample
10	-226.51	473.01	473.23	1.85	0.05	length+fpresence+species+M.sp1+M.sp2+sample
9	-227.64	473.28	473.46	2.08	0.04	length+fpresence+M.sp2+species+sample
7	-229.70	473.40	473.51	2.14	0.04	length*M.sp1+fpresence*M.sp1+species
5	-231.85	473.70	473.76	2.38	0.03	length+fpresence+species+M.sp1
10	-226.81	473.61	473.83	2.45	0.03	length+fpresence+M.sp1+species*M.sp1+sample
11	-226.80	473.60	473.88	2.49	0.03	length*M.sp1+length*M.sp1.species+fpresence+species+sample
13	-223.80	473.60	473.96	2.59	0.03	M.sp2+length*M.sp1+length*M.sp1.species+fpresence+species+fpresence*M.sp1+sample
11	-225.88	473.76	474.02	2.64	0.03	length+fpresence+length*M.sp1+M.sp2+species+sample
11	-225.88	473.76	474.02	2.64	0.03	M.sp2+length*M.sp1+fpresence+species+sample
11	-226.00	474.00	474.26	2.89	0.03	M.sp2+length+fpresence*M.sp1+species+sample
13	-223.96	473.93	474.29	2.91	0.03	length*M.sp1+fpresence*M.sp1+species*M.sp2+sample
6	-231.14	474.28	474.36	2.99	0.03	length*M.sp1+fpresence+species
6	-231.23	474.47	474.55	3.18	0.02	length+fpresence+M.sp1+M.sp2+species
12	-225.21	474.42	474.73	3.35	0.02	M.sp2+length*M.sp1+length*M.sp1.species+fpresence+species+sample
11	-226.36	474.71	474.97	3.60	0.02	length+length+fpresence+M.sp1+M.sp2+species+M.sp1+M.sp2+sample
11	-226.39	474.78	475.04	3.66	0.02	length+fpresence+M.sp1+species*M.sp2+sample
6	-231.51	475.02	475.10	3.72	0.02	length+fpresence*M.sp1+species
9	-228.60	475.20	475.38	4.00	0.02	length+fpresence+M.sp1+M.sp2+sample

Table S4 (continued)

12	-225.60	475.21	475.52	4.14	0.01	length ² +length+fpresence+length*M.sp1+M.sp2+species+M.sp1+M.sp2+sample
12	-226.33	476.66	476.96	5.59	0.01	length ² +length+fpresence+M.sp1+length*M.sp2+species+M.sp1+M.sp2+sample
13	-225.53	477.07	477.43	6.05	0.01	length ² +length+fpresence+length*M.sp1+length*M.sp2+species+M.sp1+M.sp2+sample
14	-225.10	478.20	478.62	7.24	0.00	length ² +length+fpresence+length*M.sp1+length*M.sp2+species*M.sp1+M.sp2+sample
14	-225.53	478.07	478.48	8.11	0.00	length ² +length+fpresence+length*M.sp1+length*M.sp2+M.sp1+species*M.sp2+sample
16	-223.49	478.99	479.53	8.15	0.00	length*M.sp1+fpresence*M.sp1+species*M.sp1+M.sp2+sample
15	-225.03	480.07	480.55	9.17	0.00	length ² +length+fpresence+length*M.sp1+length*M.sp2+species*M.sp1+species*M.sp2+sample
14	-226.24	480.48	480.90	9.53	0.00	length+fpresence+M.sp1+species*M.sp1+M.sp2+sample

Article 6

Evidence for cestode and microsporidian parasite manipulation of the swarming behaviour of infected brine shrimp (*Artemia spp.*)

Nicolas Olivier Rode,[†] Eva Joanna Patricia Lievens,[†] Elodie Flaven,
Adeline Segard, Roula Jabbour-Zahab, Marta Isabel Sanchez and Thomas
Lenormand

[†]Equal contribution

In preparation

Abstract

Over the course of evolution, parasites have developed a number of different strategies to increase their transmission dependent on their own ecology and on the conflicts of interest imposed by the intra-host community with which they compete. The outcomes of transmission conflicts are especially interesting when one of the co-infectors manipulates the host, as is the case in our study system: the cestode *Flamingolepis liguloides* is a known trophically transmitted manipulator, which co-occurs with two horizontally transmitted microsporidian parasites (*Microsporidium* sp. 1 and *Microsporidium* sp. 2) in brine shrimp of the genus *Artemia* in the Aigues-Mortes salterns, Southern France. We find that both cestodes and microsporidia manipulate their host in favour of swarming. We hypothesize that manipulative microsporidia profit from entering cestode-induced swarms: by inducing swarming themselves, the microsporidia gain access to a high concentration of new hosts. In addition, we found that microsporidia increased the swarming probability of their host near the water surface. Experimental tests with one microsporidium in the laboratory indicated that such manipulation could increase transmission, while decreasing the risk of coinfection. Hence manipulation is adaptive for microsporidia parasites. This study suggests that parasites might play a prominent role in the grouping behaviour of their hosts.

Keywords: Host manipulation, trophic transmission, superinfection, parasite conflicts, *Artemia parthenogenetica*, *Artemia franciscana*, *Flamingolepis liguloides*, Microsporidiosis

INTRODUCTION

Grouping behaviour, the spatial aggregations of individuals, are found in a variety of taxa, including fish, insects, crustaceans and bacteria (e.g., Kennedy 1951; Williams & Schwarzhoff 1978; O'Brien 1988; Ambler 2002; Sumpter 2006). Such behaviours are generally considered to be adaptive (Ambler 2002), but the underlying selective pressures are varied, encompassing: protection against predation (e.g. in fishes, Krause & Godin 1994), access to mates (e.g. in arthropods, Sullivan 1981; Ambler *et al.* 1996), reduced energy expenditure (e.g. in birds, Wiersma & Piersma 1994; in krill, Ritz 2000), and improved foraging in highly aggregated resource distributions (e.g., Foster *et al.* 2001). These behaviours frequently involve an altruistic component, so that grouping individuals are often related. (e.g., Young *et al.* 1994; Fraser *et al.* 2005; Tóth *et al.* 2009). In addition, group behaviour may present individual costs which trade off against the benefits. For instance, swarming may allow finding mates, but increase predation risk in insects (e.g., Gwynne & Bussière 2002; Kemp 2012) and aggregation in tadpoles

decreases predation risk, but reduces food availability (e.g., Spieler & Linsenmair 1999). Overall, while adaptive explanations are often compelling, it is difficult to take the various and potentially detrimental effects of grouping into account.

Intriguingly, one non-adaptive explanation is rarely considered, namely that grouping behaviour result from parasite manipulation. Host behavioural manipulation by infecting parasites is widespread in nature, and serves to increase parasite transmission (Barnard & Behnke 1990; Moore 2002; Poulin 2010). In parasites with direct life cycles, transmission is increased in high hosts densities (e.g., Côté & Poulin 1995). Although it is improbable that parasites could manipulate non-infected hosts into forming a group, an existent grouping behaviour can be reinforced if parasites manipulated infected hosts into actively joining groups (e.g. fish infected with microsporidia are more likely to join shoals, Ward *et al.* 2005). In parasites with indirect life cycles, manipulation can cause grouping more directly, for instance if groups of infected hosts are more likely to be predated by the

final host than isolated infected individuals (e.g. fish infected with trematodes are more likely to be found at the front rather than at the rear of shoals, which likely lead to an increased risk of bird predation, Ward *et al.* 2002).

The parasite manipulation hypothesis is a good candidate to explain swarming behaviour in the brine shrimp genus *Artemia* (Branchiopoda: Anostraca) (Mason 1966). Swarming has been documented in both the bisexual American species *Artemia franciscana* (Garman 1872; Mason 1966; Lenz 1980); hereafter *Af*) and the asexual Old World species *Artemia parthenogenetica* (Sánchez *et al.* 2012; hereafter *Ap*). In nature, swarms (also referred to as 'plumes') vary from 20cm to 2m in diameter (Lenz 1980); they are highly dynamic and fairly short lived (Lenz 1980). No convincing explanation for their occurrence has been proposed to date. First, they appear unrelated to sexual reproduction, at least in the asexual *Ap*. Second, they are probably not related to foraging efficiency, as food availability is not aggregated in this system; at least not at the scale of swarms (brine shrimp consume unicellular algae in the water column). Third, swarms are unlikely to not protect

against predation. Fish predators are absent at salinities above 70 g/l NaCl (Britton & Johnson 1987), where most *Artemia* populations are found (some euryhaline Atherinoformes fishes are found up to 100g/L but not above, Carpelan 1957). The main avian predator in the Old World is the Greater Flamingo (*Phoenicopterus ruber roseus*), which does not capture *Artemia* individually, negating the benefit of grouping. Mason (1966) proposed that swarms are initiated by thermal currents which attract brine shrimp, but there is little evidence for this. Considering the variety of cestode and microsporidian parasites that infect the genus (Ovcharenko & Wita 2005; Sánchez *et al.* 2012), the parasite manipulation hypothesis remains a good candidate in this system.

In this study, we test the parasite manipulation hypothesis in a population of *Artemia* in the Aigues-Mortes salterns in Southern France, where *Af* and *Ap* occur in sympatry (Sánchez *et al.* 2012). In this population, *Artemia* are infected by several parasites, but we focus on the three most prevalent: the cestode *Flamingolepis liguloides* (hereafter *Fl*) infects only *Ap*, one undescribed microsporidium (hereafter

Msp1) infects mostly *Ap*, and another undescribed microsporidium (hereafter *Msp2*) infects mostly *Af*. We examine two main hypotheses: (1) *Fl* causes swarming behaviour. *Fl* has an indirect life cycle, with *Ap* as its intermediate and the Greater Flamingo as its final host (Georgiev *et al.* 2005). This hypothesis implies that *Fl* manipulates infected *Artemia* into forming conspicuous swarms and that Greater Flamingos prey disproportionately upon these swarms. Under this hypothesis, we expect a higher prevalence of *Fl* in swarms. We also expect swarms to consist only of *Ap*, since *Fl* does not infect *Af*. In support of this hypothesis, a preliminary study demonstrated that the prevalence of *Fl* is significantly higher within than outside swarms (N. Rode, unpublished data). In addition, infection with *Fl* is known to cause several phenotypic changes in *Ap*: colour change from pale pink to red (Sánchez *et al.* 2006; Sánchez *et al.* 2007; Sánchez *et al.* 2012), castration (Amat *et al.* 1991; Sánchez *et al.* 2012), longer life span and possibly higher nutritive value (Amat *et al.* 1991), and possibly surfacing behaviour (Sánchez *et al.* 2007). Red colour and surfacing

behaviour may contribute to swarm visibility. However, swarms have been described in two American populations where *Fl* and *Ap* are absent mason (Mason 1966). (2) Microsporidia contribute to swarm formation. Both *Msp1* and *Msp2* have a direct life cycle, and could induce infected individuals to join swarms in order to access the high densities of recipient hosts. Under this hypothesis, we expect a higher prevalence of *Artemia* infected with microsporidia in swarms (with possibly an independent effect of *Msp1* on *Ap* and *Msp2* on *Af*). The strength of this hypothesis is that it accounts for the widespread occurrence of swarms across *Af* and *Ap* populations. Its drawback is that it does not explain why uninfected *Artemia* swarm in the first place.

To test our parasite manipulation hypotheses, we sampled *Artemia* within and outside swarms in five sites to measure their infection status and a suite of parasite-altered traits (size, distance to surface, colour, reproductive status). To account for possible variation in infection and manipulation susceptibility across *Artemia* genotypes, we genotyped a subset of the sampled *Ap* individuals. Prompted by the

collected data, we also investigated the effect of relative depth on the transmission success of microsporidian parasites. Surprisingly, our results indicate strong manipulative effects of all three parasites.

MATERIAL AND METHODS

Sampling

We sampled *Artemia spp.* in five different shallow salterns (depth < 30cm) in May 2011 in Aigues-Mortes (Southern France). The sampling locations were chosen based on the presence of swarming *Artemia*. At each location, we sampled within and outside swarms using mesh nets with a rectangular opening of 7 x 10 cm. To avoid bias due to local heterogeneity in prevalence (see below), we replicated sampling for two distant swarms in Site 16 and Site 17 (Table S1). Cestodes are known to manipulate their hosts into surfacing behaviour (Sánchez *et al.* 2007); to avoid this bias we took depth-stratified samples wherever possible (Table S1). Thus, we use the term 'sample' to refer to *Artemia* captured in the same location, at a certain depth and either inside or outside a

swarm. In the laboratory, the samples were transferred into 10L tanks, provided with additional salt water (salinity 50 g/L, Thalasea, Camargue-Pêche, Grau du Roi, France) and regularly fed with an algal solution.

Characterization of *Artemia* phenotype and infection status

For each of the samples, we described the phenotype and infection status of a random subset of roughly 100 adult brine shrimp (min: 48; max: 227). Characterization occurred in three phases: macroscopic description (including *Fl* infection status), molecular identification of microsporidian infection status, and molecular species confirmation for selected males.

For each individual, we first recorded the species, sex, reproductive status (reproducing or non-reproducing), body length and number of infecting *Fl* cysticercoids using a binocular. For *Ap* females, we were interested in the relationship between infection by *Fl*, colour change and castration, so also we measured the red colour intensity of mature *Ap* females from all samples except sample 2. Individuals were anesthetized with 50% carbonated water and

photographed using the program Camera Control Pro with a Nikon D300S camera. We later imported the photographs into the imaging software ImageJ and measured the relative red intensity of each individual (discounting dark areas: the digestive tract, eyes and any cysts in the brood pouch). Immediately following morphological characterization, all *Ap* and one third of *Af* individuals were killed and conserved in ethanol. We focused our efforts on *Ap* because its susceptibility to both cestode and microsporidian infection allowed us to study the interactions between these parasites.

Second, we used molecular methods to identify the presence of *Msp1* and *Msp2* in the sampled *Artemia*. DNA was extracted from each conserved individual using the HotShot method and subjected to two polymerase chain reactions (PCR), with primers specific to the small subunit ribosomal DNA of *Msp1* and *Msp2* respectively (see Rode et al, Article 5). Infection status was judged based on electrophoresis gels.

Finally, some males were suspected to be rare *Ap* males, based on their large size as compared to *Af* males (as

normally observed in laboratory cultures) and their infection with *Fl*. To ensure correct identification, we verified the species assignment for all males using species-specific microsatellite markers (Muñoz *et al.* 2008). We recovered 10 rare males in total (9 of which were correctly suspected to be *Ap*).

Identification of *Ap* genotype

In order to test for differential susceptibility to parasite infection and manipulation across host genotypes, we genotyped a subset of asexual *Ap*. We randomly selected individuals from the two best depth-stratified sites (Site 17, replicate 2 and Site 18; mean number of individuals per sample = 19, min = 6, max = 32); using replicated populations to avoid confounding factors (e.g. cohort effects due to shared mothers). We genotyped each individual at 12 polymorphic microsatellite loci (see Flaven *et al.*, in prep for details) and calculated the number of mutations between each pair of individual genotypes. Individuals that differed by one mutation (or less) were assigned the same multilocus genotype

(hereafter genotype); all genotypes with a frequency below 8% were pooled in order to increase our statistical power.

Statistical analyses of *Artemia* phenotype & genotype effects'

Our statistical analyses consisted of two main arcs: first, analyses of *Artemia* phenotypic traits to estimate parasite manipulation; second, analyses of swarming and infection probability including *Artemia* genotype effects. All analyses were performed using the stats package in R (R 2.14.2, <http://www.r-project.org/>).

We conducted a first arc of analyses to examine the factors predicting two aspects of the *Artemia* phenotype which we hypothesized to be under the influence of parasites: swarming behaviour and red colouration. First, we used the full dataset of *Artemia* to analyse the probability that a given individual was found swarming, given its sampling location and depth (hereafter the swarming probability). We used generalized linear models (GLMs) with Bernoulli error distributions, and selected the best predictive model using the corrected Akaike Information Criterion (AICc; Hurvich & Tsai

1989) Models included host species, sex, length, distance from the surface, presence of each parasite (*Fl*, *Msp1*, *Msp2*), and all double interactions. We also compared our best models with models including the square distance (distance²) or the number of *Fl* cysticercoids instead of their presence/absence. Importantly, since sampling was non-random and not proportional to *Artemia* density, the interaction between sample and factorial distance from the surface was included in every model. As a second phenotypic trait, we investigated the red colour intensity of *Ap* females using linear models (LM). Models included sex, length, female reproductive status, swarm effect (sampled within or outside swarm), distance from the surface, sample, number of *Fl* cysticercoids and presence of each microsporidian parasite (*Msp1* or *Msp2*), as well as all double interactions between these effects. In order to investigate potential interactions between the different traits affected by parasites, we also included interactions between swarm effect, reproductive status and infection by each of the three parasites. AICc was again used to select the best predictive model.

In the second arc, we used the 187 genotyped *Ap* individuals to clarify the effect of host genotype on swarming probability and infection status. To examine its effect on swarming probability, we used the best model from the previous analysis as a base, from which we tested for significant interactions between genotype and parasite presence (*Fl*, *Msp1* or *Msp2*) and between genotype and the squared distance from the surface. Second, we examined the effect of host genotype on the probability that a sampled individual was infected by *Fl*, *Msp1* or *Msp2*. For each parasite, we constructed a GLM with a Bernoulli error distribution, including the main effects found in the swarming analyses (sex, length, host genotype, the presence of each of the two other parasites, swarm effect, distance from the surface and sample, as well as all double interaction between these effects). From this base model, we tested for differential parasite susceptibility across *Artemia* host genotypes by specifically testing for genotype effects. In addition, we took advantage of this model to test for depth effects in infected non-swarming individuals; this allowed us to investigate effect

of water depth on outside-swarm parasite prevalence (which we could not see in the previous analyses).

Effect of the vertical position of infected individuals on the transmission of *Msp2*

Prompted by depth-dependent effects in our data (see below), we hypothesized that microsporidian transmission is highest when infected hosts are alive and swimming above uninfected hosts. We tested this hypothesis using *Msp2* as a model; we considered *Mps2* to be representative of both microsporidia because of their phylogenetic proximity and similar manipulative effects (see below). We had three treatments, each consisting of 7 *Af* and 9 *Ap* uninfected recipient hosts and 20 *Af* donor hosts from a natural population with high *Msp2* infection prevalence (>80%). To differentiate infection through grazing from infection through spore ingestion in the water column, we placed recipient hosts in cylindrical cages (diameter, 10cm; height, 10cm) at the bottom of a tank that allowed (Treatment A, Fig. S1A) or prevented (Treatment B, Fig. S1B) grazing of detritus and

spores, while donor hosts were placed in a cage above them (Fig. S1A-B). In treatment A and B, dead donor hosts were removed so that spores came only from live hosts. In a third treatment, uninfected recipient hosts were placed in the upper cage whereas donor hosts were placed in the lower cage and not allowed to graze (Treatment C, Fig. S1C). Cages were separated by a net (mesh size 0.2mm); a similar net was used to prevent grazing in treatments A and C. In order to compare spore transmission from living and dead hosts we placed 16 uninfected recipient individuals in a tank with a homogenate of 20 donor hosts (positive control D, Fig. S1D). Finally, we kept 16 uninfected individuals isolated in a tank (negative control E, Fig. S1E). We replicated each treatment four times and each control twice. All recipient hosts were PCR tested for infection after 10 days.

For the statistical analysis of this experiment, we used a GLM with a Bernoulli error distribution. Control E was excluded from the analysis as no infection occurred in the negative control (see below). To control for ingestion heterogeneity among host species and sex, we included host

recipient species and sex in all models. We then compared models including treatment effect, replicates and their interaction. To specifically test for differences in transmission from living vs. dead hosts, we also included a model where infection probability was constrained to be identical in treatment A, B and D. Model selection was based on AICc.

RESULTS

Effect of parasite infection on *Artemia spp.* phenotype

Parasite and depth effects were the strongest factors influencing the swarming probability of both *Ap* and *Af*. All best models included the presence of the three parasites (*Fl*, *Msp1* and *Msp2*, $\Delta\text{AICc} < 2$, Table S2); individuals infected by any of these parasites were more likely to be swarming (Fig. 1). *Msp1* and *Msp2* also had a synergistic effect on the swarming behaviour of coinfecting hosts (Table S2). Importantly, a negative interaction between the presence of each microsporidium and the square distance from the surface was found in all best models, indicating that individuals infected by microsporidia were more likely to be found swarming when

near the surface (Fig. 1). There was a trend towards species-dependence of these effects when infected with *Msp1*, and a much weaker trend towards species-dependence when infected with *Msp2* ($\Delta\text{AICc}=0.17$ and 1.42 respectively, Fig. 1, Table S2). Swarming was independent from depth in *Fl* ($\Delta\text{AICc}=1.97$, Table S2). Large individuals of both *Ap* and *Af* were more likely to be swarming when close to the surface (Fig. 1, Table S2). Surprisingly, males were more likely to swarm, and swarm at the surface, than females (Fig. 1, Table S2). However, as only 10 *Ap* males were sampled, we had low power to investigate the species-dependence of this effect. Finally, *Msp1*-infected males were less likely to swarm than uninfected males (Table S2).

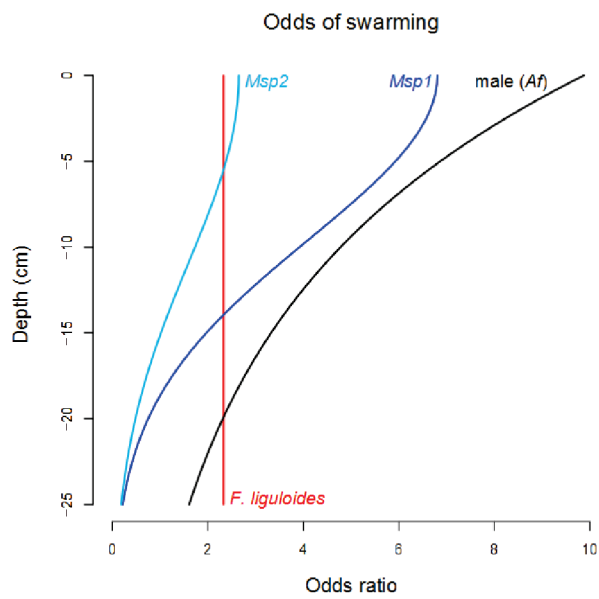

Figure 1 Effect of sex and parasite infection on *Artemia spp.* swarming behaviour. Swarming odd are given compared to an infected *Af* or *Ap* female, as there was no strong difference between the swarming behaviour or both species.

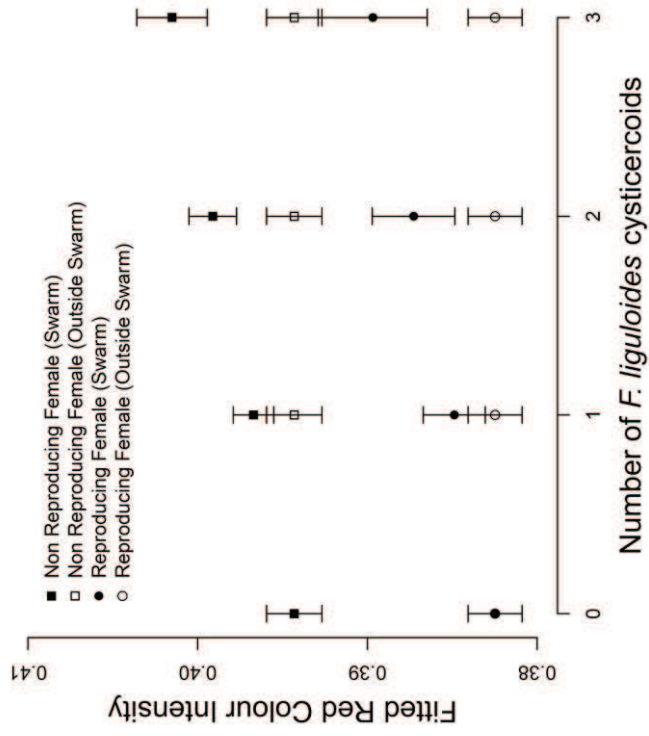

Figure 2 Covariation between number of *F. liguloides* and red colour . Estimates correspond to the red colour intensity of individuals sampled outside the swarm (open symbols) or within the swarm (closed symbols). Error bars represent estimates' 95% confidence intervals. ($R^2=0.34$).

From the analysis of red colouration of *Ap* females, we found an *Fl*-induced covariation between red colour intensity and swarming behaviour of infected individuals. The best models included a positive interaction between swarming effect and *Fl* cysticeroid count, indicating that swarming infected individuals were redder than swarming non-infected individuals (Fig. 2, Table S4). This effect had low support for non-swarming individuals ($\Delta AICc=0.68$, Table S4). Independently of this swarming effect, we found an increased red colour in non-reproducing females (Fig. 2, Table S4). As 96% of these females were infected with *Fl*, which castrates its hosts (Amat *et al.* 1991), the higher red intensity of non-reproducing females is likely an indirect effect of cestode castration and of the subsequent accumulation of carotenoids. Microsporidian infection did not alter the effect of *Fl* on red colour intensity ($\Delta AICc>2$, Table S4). Finally, red colour intensity increased with length.

Effect of host genotype on swarming and infection probability

When *Ap* genotypes were taken into account, we found that host genotype impacted several of the factors predicting swarming probability. The host genotype factor included the 4 most common *Ap* genotypes (A-D) and an additional level pooling the least common genotypes (E). Genotypes A and D had a higher *Fl*-induced swarming propensity than the other genotypes ($\Delta\text{AICc} < 2$, Table S3). Surprisingly, all best models included an interaction between the genotype factor and the distance from the surface ($\Delta\text{AICc} < 2$, Table S3), indicating that swarming propensity varied differently with water depth across genotypes. Correcting for swarming differences across genotypes unravelled an antagonistic interaction between *Fl* and *Msp2* ($\Delta\text{AICc} < 2$, Table S3); coinfecting individuals of all genotypes were less likely to swarm than expected from individuals with single infections ($\Delta\text{AICc} < 2$, Table S3). In contrast, support for the synergistic effect of *Msp1* and *Msp2* coinfection was much lower when taking host genotype into account ($\Delta\text{AICc} = 1$, Table S3).

The susceptibility of an *Ap* individual was only genotype-dependent for infection by the microsporidian parasites. *Msp1* prevalence was lowest in genotypes A and D (Fig. 3, Table S6, Table S7), whereas *Msp2* prevalence was highest in these genotypes (Fig. 3). Infection probability did not differ across genotypes for *FI* ($\Delta\text{AICc}>2$, Table S5).

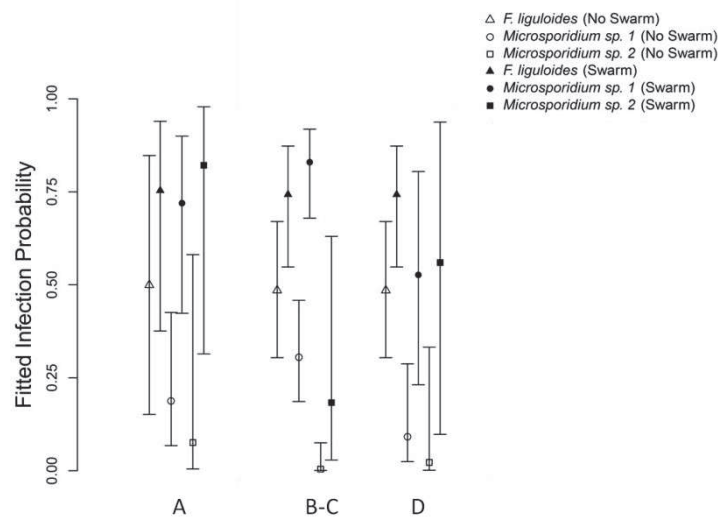

Figure 3 Infection probabilities of the different *Artemia parthenogenetica* genotypes. Fitted estimates were computed from the model with lowest AICc value from the analysis of the probability of infection for each of the three parasites. Estimates correspond to the infection probability of a surfacing individual sampled outside the swarm (open symbols) or within the swarm (closed symbols). Estimates for the least frequent genotypes were similar to those from B and C genotypes. Error bars represent estimates' 95% confidence intervals.

Modelling the infection probability also allowed us to investigate the depth-dependent prevalence of parasites outside the swarm. Surprisingly, *Msp1* and *Msp2* infection increased with the distance from the surface outside swarms, indicating that infected individuals were more likely to be found at the bottom outside swarms (Fig. 4, Table S6, Table S7). A contrasting trend was apparent for *Fl*, with low support ($\Delta AICc=0.6$, Table S5).

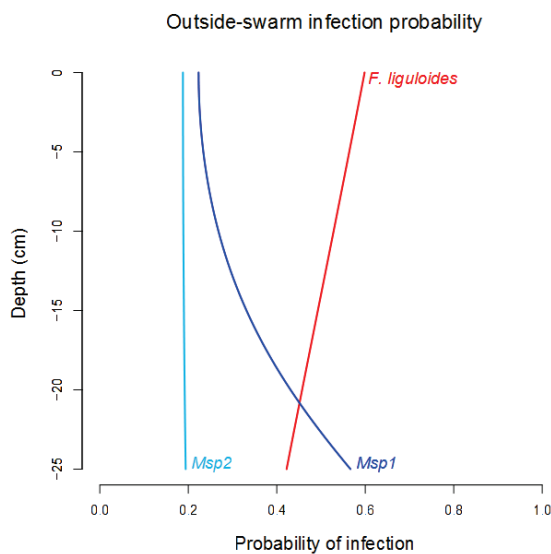

Figure 4 Average parasite infection probability as a function of depth for an individual outside the swarm. Fitted estimates were computed with the average infection probability of the different genotypes with the same model as Fig. 3.

Effect of the vertical position of infected individuals on the transmission of *Msp2*

The vertical position of infected individuals had clear effects on the transmission of microsporidia, as did the infection from live individuals or spores. Observed *Msp2* infection was the highest when uninfected recipient hosts were placed at the bottom of the tank and allowed to graze detritus (92%, treatment A). Infection lowered when individuals were prevented from grazing (81%, treatment B) or fed crushed donor hosts (70%, control D). Infection was the lowest when uninfected hosts were placed above donor hosts (22%, treatment C). None of hosts in the negative control E became infected. The best model fitted a different effect to each treatment (Table S8, Fig. 5); specifying the same transmission probability from living or dead hosts produced a worse fit of the data ($\Delta AICc > 2$, Table S8). Hence, *Msp2* transmission was highest when donor hosts were alive and swimming above recipient hosts.

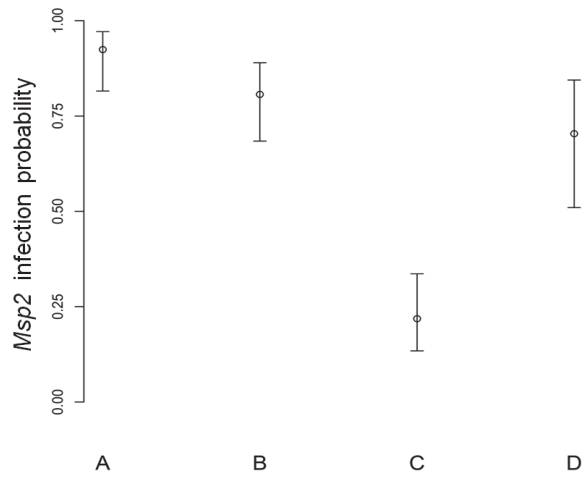

Figure 5 Fitted *Msp2* infection probabilities in the different treatments. No infection was found in treatment E (not represented). Error bars represent estimates' 95% confidence intervals.

DISCUSSION

Parasite manipulation causes *Artemia* swarming

Contrary to our expectation, we found that *Fl*, *Msp1* and *Msp2* are all successful manipulators of host behaviour. Foremost, all three parasite species induce swarming: they were consistently much more prevalent in swarms. Furthermore, we found evidence of suites of manipulations in both the cestode and microsporidian parasites. For *Fl*, the induction of swarming behaviour in female *Ap* was linked to significant increases in red colour intensity: only those individuals which were both infected and swarming had a strong increase in colour intensity. In contrast, the increase in red intensity caused by castration was independent of these linked manipulations. For *Msp1* and *Msp2*, there were strong depth effects in play: the prevalence of parasites was highest close to the surface within swarms and close to the bottom outside swarms. These results indicate two possible ways in which *Msp1* and *Msp2* manipulate their host. First, manipulation could include a swarming and a surfacing

component: when triggered to do one, the infected individuals also do the other. Alternately, the swarming manipulation could be depth-dependent: the parasite induces swarming when the host is near the surface, and avoids swarming when the host is near the bottom.

Other factors affecting swarming probability included sex and body size. In the bisexual *Af* species, males were up to 10 times more likely to swarm than females (decreasing with depth, Fig 1.), which suggests that males actively enter swarms, and thus that swarming might be important for reproduction. This is however obviously not the case for the asexual *Ap*. Large individuals of both *Ap* and *Af* were more likely to be swarming when close to the surface, which may indicate that such individuals actively choose this position or that large individuals are passively sorted by differential swimming speeds.

Advantage of hosts swarming for parasite transmission

Why should *Msp1*, *Msp2* and *FI* cause swarming behaviour? The high density of swarms increases the transmission success of each parasite, but the resultant spatial aggregation between parasites can be expected to impose costs as well. We hypothesize that swarming is a manifestation of transmission/predation/co-infection trade-offs experienced by *FI*, *Msp1* and *Msp2*. Each parasite must balance the benefit of swarming (an increased rate of transmission) with the cost (a higher risk unsuitable predation and co-infection). For each parasite, we expect different factors to affect the outcome of this trade-off.

For *FI*, the relative predation rates of swarming *Artemia* by Greater Flamingo and other avian hosts will determine the costs and benefits of swarm induction by cestodes. Swarming is expected to increase the probability that the intermediate *Ap* host is predated by the Greater Flamingo (unfortunately, the predation rates of swarms have not yet been studied; Fig. 5A). However, swarming may also result in increased predation by unsuitable avian hosts (Fig. 5A), although the degree to which

this occurs remains unclear. Indeed, pecking and filter-feeding birds are likely to exert different predation pressures on swarms: for pecking birds such as waders, catching individual *Artemia* (Sanchez *et al.* 2009) may be difficult at high *Artemia* density (Verkuil *et al.* 2003); filter-feeding birds such as flamingos and shelducks are unlikely to encounter such difficulties.

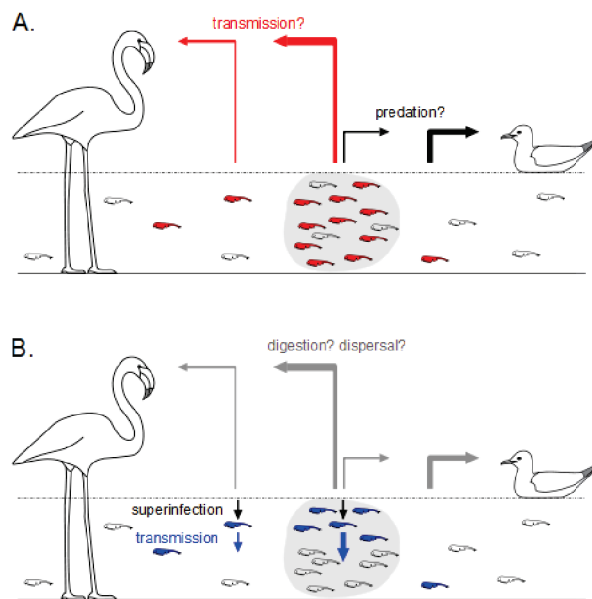

Figure 6 Trade-off between transmission and predation in cestode (A) and microsporidian (B) parasites. Red: *F. liguloides*-infected *Artemia*; Blue: Infection by *Msp1*- or *Msp2*-infected *Artemia*.

An increased transmission of *Msp1* and *Msp2* spores is expected to trade off against the risk of co-infection and predation of their *Artemia* hosts, mediated by the effect of depth on swarming. When hosts are present in dense swarms, spores released by the microsporidium are more likely to be ingested by a new host (Fig. 5B). However, the increased prevalence of microsporidia inside swarms is also likely to be costly: swarm-inducing microsporidia risk multiple infection of their host, and inter- and intraspecific competition could seriously impair the establishment of its spores in a new host. The balance of this transmission/co-infection trade-off will depend on the density of individuals within and outside the swarm, the proportion of uninfected individuals within and outside the swarm, and the effect of co-infection on establishment and persistence. The depth effects we uncovered for both microsporidian parasites may mediate this trade-off. We found that *Artemia* infected with microsporidia were preferentially found swarming at the surface or dispersed at the bottom (Fig. 1, Fig. 3). We hypothesized that these depth effects were caused by an effect of the relative vertical

position of donor and recipient hosts, a hypothesis which we confirmed in our experiment with *Msp2*. By positioning themselves near the surface of the swarm, the parasite ensures that transmission to uninfected hosts swimming below in the water column is high, and the chance of infection from above is low. In contrast, a position at the bottom of the swarm is very disadvantageous: the risk of co-infection is large and the chance of transmission small (Fig. 5B). Although other microsporidian species have been shown to induce surfacing behaviour in their cladoceran hosts (Fels *et al.* 2004; Makrushin 2010), previous studies failed to demonstrate any adaptive value for the parasite (Fels 2006). Besides the risk of co-infection, an increase in levels of avian predation due to swarming may be costly for microsporidian parasites (Fig. 5B), especially given the induction of surfacing behaviour. However, it is unknown how well microsporidian spores survive bird digestive systems: the effect of predation may range from disastrous (fully digested) to beneficial (dispersed into other salterns).

Moreover, because *Fl*, *Msp1* and *Msp2* occur together, intraspecific conflicts of interest will affect the complex transmission/co-infection/predation trade-offs for each species. In an *Fl*-infected host, a superinfecting microsporidium may decrease host survival, so that chances of cestode transmission to the final host are reduced. Hosts of cestode parasites are especially at risk of co-infection by microsporidia, as *Fl* induces swarming but not surfacing behaviour. Thus, hosts may be placed towards the bottom of swarms, where they will intercept many microsporidian spores. Similarly, swarming may be costly for microsporidia when they are the later parasite to infect the host in a sequential co-infection: if the microsporidium is still immature when the cestode is mature and ready for host manipulation, the limited surface-seeking behaviour of *Fl* will expose the host to co-infection with other microsporidian parasites. The great reduction in swarming propensity of individuals infected both by *Fl* and *Msp2* (when taking the vertical segregation of genotypes into account) may be indicative of such conflicts of interest; similar interspecific conflicts over manipulation have

already been found between microsporidian and trematode parasites (Haine *et al.* 2005).

Host genotype influences parasite fitness

Parasite fitness depends on successful infection and manipulation, which may vary with host genotype: genetic variation of infection probability has been extensively studied from both the host and the parasite perspective (e.g., Decaestecker *et al.* 2003; Leung & Poulin 2010). For *Fl*, host genotype affected the parasite's ability to manipulate, but not to infect, their hosts. Host genotype did not affect susceptibility to *Fl*, but *Ap* genotypes A and D were more subject to behavioural manipulation by this parasite: they were more likely to swarm when infected. To our knowledge, these results provide the first evidence of host genetic variation affecting parasite manipulation behaviour.

In contrast to the results for *Fl*, we found that *Artemia* genotype affected the susceptibility to infect but not to manipulation by *Msp1* and *Msp2*. Genotypes A and D were more susceptible to infection by *Msp1* and more resistant to *Msp2*. Once infected, host genotype did not affect the probability of swarming (i.e. the magnitude of microsporidia manipulation). Interestingly, a similar contrasting pattern exists for microsporidian infections in *Ap* and *Af*: *Msp1* preferentially infects *Ap*, whereas *Msp2* preferentially infects *Af* (Rode et al., Article 5). Thus, *Ap* genotypes A and D, *Ap* genotypes B, C, and E, and *Af* are decreasingly susceptible to infection by *Msp1* but increasingly susceptible to infection by *Msp2*. Overall, these results strongly suggest that the two microsporidian species are specialists of different host genotypes, a specialization which extends to the species divide. Importantly, genetic variation for host positioning behaviour as demonstrated by our and other studies (e.g., de Meester 1993) is also likely to influence parasite fitness.

Parasite manipulation of host swarming behaviour is likely to be wide-spread

Our results strongly suggest that parasite manipulation is a major, mostly non-adaptive, cause of *Artemia* swarming. While the role of parasites in swarming behaviour has been evoked in fish (Ward *et al.* 2002; Ward *et al.* 2005) where alternative hypotheses are difficult to exclude, our study indicates that such manipulation may be much more widespread. First, we showed that all parasites that we investigated had an influence on swarming behaviour, although cestodes and microsporidia are phylogenetically very distant and have dissimilar modes of transmission. Furthermore, each microsporidian species was able to induce swarming in both *Af* and *Ap*, which are highly diverged (30-35MY divergence, Abreu-Grobois 1987; Baxevanis *et al.* 2006); this is especially striking given that *Af* has only been introduced recently (Sánchez *et al.* 2012).

CONCLUSION

This study demonstrates that three parasites of the genus *Artemia* manipulate their host into swarming to increase their own transmission: the microsporidia *Msp1* and *Msp2* manipulate both *Ap* and *Af*, while *Fl* infects and manipulates *Ap*. This occurs within a transmission/predation/co-infection trade-off; for example, our experiment demonstrated that the surface-swarming behaviour induced by the microsporidia increases parasite transmission while reducing the likelihood of co-infection. To the best of our knowledge, this is the first conclusive evidence that concurrent induction of surfacing and swarming behaviour can result in increased parasite transmission. Given the swarming behaviour of *Fl*-infected and male hosts, we suggest that microsporidia induce swarming in their hosts in order to profit from the pre-existent swarming behaviour of cestode-infected and mate searching *Artemia*. Finally, we found that *Ap* host genetic variation influenced infection (microsporidian parasites) and manipulation (cestode parasite). Based on our results, we suggest that swarming due to parasite manipulation may be more prevalent than previously assumed.

ACKNOWLEDGEMENTS

The authors are grateful to T. Gout, F. Gout, A.S. Deville, F. Lenne and L.M. Chevin for their help during the sampling. We are also indebted to V. Baecker from the MRI platform for his kind help regarding colour measurements with ImageJ.

CONTRIBUTION STATEMENT

TL and NOR has an idea and tested it in a preliminary sampling with the assistance of EF. EJPL, TL and NOR designed the second sampling. EJPL, RJZ and NOR sampled the individuals. EJPL and NOR did the measurements. EF, EJPL and RJZ did the molecular work. EJPL and NOR analyzed the data. EJPL, TL and NOR wrote the paper.

REFERENCES

- Abreu-Grobois F.A. (1987). *A review of the genetics of Artemia*. Universa Press, Wetteren, Belgium.
- Amat F., Gozalbo A., Navarro J., Hontoria F. & Varó I. (1991). Some aspects of *Artemia* biology affected by cestode parasitism. *Hydrobiologia*, 212, 39-44.
- Ambler J., Broadwater S., Buskey E. & Peterson J. (1996). Mating behaviour in swarms of *Dioithona oculata*. *Zooplankton: Sensory ecology and physiology*. Gordon and Breach, 287-299.
- Ambler J.W. (2002). Zooplankton swarms: characteristics, proximal cues and proposed advantages. *Hydrobiologia*, 480, 155-164.
- Barnard C.J. & Behnke J.M. (1990). *Parasitism and host behaviour*. Taylor & Francis Group.
- Baxevanis A.D., Kappas I. & Abatzopoulos T.J. (2006). Molecular phylogenetics and asexuality in the brine shrimp *Artemia*. *Molecular phylogenetics and evolution*, 40, 724 - 738.
- Britton R. & Johnson A. (1987). An ecological account of a Mediterranean salina: the Salin de Giraud, Camargue (S. France). *Biological Conservation*, 42, 185-230.
- Carpelan L.H. (1957). Hydrobiology of the Alviso salt ponds. *Ecology*, 38, 375-390.
- Côté I.M. & Poulin R. (1995). Parasitism and group size in social animals: a meta-analysis. *Behavioral Ecology*, 6, 159-165.

- de Meester L. (1993). Genotype, fish-mediated chemical, and phototactic behavior in *Daphnia magna*. *Ecology*, 1467-1474.
- Decaestecker E., Vergote A., Ebert D. & de Meester L. (2003). Evidence for strong host clone-parasite species interaction in the daphnia microparasite system. *Evolution*, 57, 784-792.
- Fels D. (2006). Transmission of the microsporidian *Glugoides intestinalis* in relation to spatial structure of the host *Daphnia magna*. *Archiv für Hydrobiologie*, 165, 455-467.
- Fels D., Lee V.A. & Ebert D. (2004). The impact of microparasites on the vertical distribution of *Daphnia magna*. *Archiv für Hydrobiologie*, 161, 65-80.
- Foster E.G., Ritz D.A., Osborn J.E. & Swadling K.M. (2001). Schooling affects the feeding success of Australian salmon (*Arripis trutta*) when preying on mysid swarms (*Paramesopodopsis rufa*). *Journal of Experimental Marine Biology and Ecology*, 261, 93-106.
- Fraser D.J., Duchesne P. & Bernatchez L. (2005). Migratory charr schools exhibit population and kin associations beyond juvenile stages. *Molecular Ecology*, 14, 3133-3146.
- Garman S.W. (1872). The Salt Lake Crustacean. *The American Naturalist* 6, 771-772.
- Georgiev B.B., Sánchez M.I., Green A.J., Nikolov P.N., Vasileva G.P. & Mavrodieva R.S. (2005). Cestodes from *Artemia parthenogenetica* (Crustacea, Branchiopoda) in the Odiel

- Marshes, Spain: A systematic survey of cysticercooids. *Acta Parasitologica*, 50, 105–117.
- Gwynne D.T. & Bussière L.F. (2002). Female mating swarms increase predation risk in a role-reversed dance fly (Diptera: Empididae: *Rhamphomyia longicauda* Loew). *Behaviour*, 1425-1430.
- Haine E.R., Boucansaud K. & Rigaud T. (2005). Conflict between parasites with different transmission strategies infecting an amphipod host. *Proceedings of the Royal Society B: Biological Sciences*, 272, 2505-2510.
- Hurvich C.M. & Tsai C.L. (1989). Regression and Time-Series Model Selection in Small Samples. *Biometrika*, 76, 297-307.
- Kemp D.J. (2012). Costly copulation in the wild: mating increases the risk of parasitoid-mediated death in swarming locusts. *Behavioral Ecology*, 23, 191-194.
- Kennedy J.S. (1951). The migration of the desert locust (*Schistocerca gregaria* Forsk.). I. The behaviour of swarms. II. A theory of long-range migrations. *Philosophical Transactions of the Royal Society of London. Series B, Biological Sciences*, 163-290.
- Krause J. & Godin J.G.J. (1994). Shoal choice in the banded killifish (*Fundulus diaphanus*, Teleostei, Cyprinodontidae): effects of predation risk, fish size, species composition and size of shoals. *Ethology*, 98, 128-136.

- Lenz P.H. (1980). *Ecology of an alkali-adapted variety of Artemia from Mono Lake, Ca.* Universa Press, Wetteren, Belgium
- Leung T. & Poulin R. (2010). Infection success of different trematode genotypes in two alternative intermediate hosts: evidence for intraspecific specialization? *Parasitology*, 137, 321-328.
- Makrushin A.V. (2010). Changes in the behaviour of *Moina macrocopa* (Crustacea: Cladocera) under the influence of *Gurleya sp.* (Microsporidia: Gurleyidae). *Parazitologiya*, 44, 475-477.
- Mason D.T. (1966). Density-current plumes. *Science*, 152, 354-356.
- Moore J. (2002). *Parasites and the behavior of animals*. Oxford University Press, USA.
- Muñoz J., Green A., Figuerola J., Amat F. & Rico C. (2008). Characterization of polymorphic microsatellite markers in the brine shrimp *Artemia* (Branchiopoda, Anostraca). *Molecular Ecology Resources*, 9, 547-550.
- O'Brien D. (1988). Direct observations of clustering (schooling and swarming) behaviour in mysids (Crustacea: Mysidacea). *Marine ecology progress series. Oldendorf*, 42, 235-246.
- Ovcharenko M. & Wita I. (2005). The ultrastructural study of *Nosema artemiae* (Codreanu, 1957) (Microsporidia : Nosematidae). *Acta Protozool.*, 44, 33-41.

- Poulin R. (2010). Parasite Manipulation of Host Behavior: An Update and Frequently Asked Questions. *Advances in the Study of Behavior*, 41, 151-186.
- Ritz D.A. (2000). Is social aggregation in aquatic crustaceans a strategy to conserve energy? *Can. J. Fish. Aquat. Sci.*, 57.
- Sánchez M., Rode N., Flaven E., Redón S., Amat F., Vasileva G. & Lenormand T. (2012). Differential susceptibility to parasites of invasive and native species of *Artemia* living in sympatry: consequences for the invasion of *A. franciscana* in the Mediterranean region. *Biological Invasions*, 1-11.
- Sánchez M.I., Georgiev B., Nikolov P., Vasileva G. & Green A.J. (2006). Red and transparent brine shrimps (*Artemia parthenogenetica*): a comparative study of their cestode infections. *Parasitology research*, 100, 111-114.
- Sánchez M.I., Georgiev B.B. & Green A.J. (2007). Avian cestodes affect the behaviour of their intermediate host *Artemia parthenogenetica*: An experimental study. *Behavioural Processes*, 74, 293-299.
- Sanchez M.I., Hortas F., Figuerola J. & Green A.J. (2009). Sandpipers select red brine shrimps rich in both carotenoids and parasites. *Ethology*, 115, 196-200.
- Spieler M. & Linsenmair K.E. (1999). Aggregation behaviour of *Bufo maculatus* tadpoles as an antipredator mechanism. *Ethology*, 105, 665-686.
- Sullivan R.T. (1981). Insect swarming and mating. *The Florida Entomologist*, 64, 44-65.

- Sumpter D.J.T. (2006). The principles of collective animal behaviour. *Philosophical Transactions of the Royal Society B: Biological Sciences*, 361, 5-22.
- Tóth Z., Bókony V., Lendvai Á.Z., Szabó K., Péntes Z. & Liker A. (2009). Whom do the sparrows follow? The effect of kinship on social preference in house sparrow flocks. *Behavioural Processes*, 82, 173-177.
- Verkuil Y., van der Have T.M., van der Winden J. & Chernichko I.I. (2003). Habitat use and diet selection of northward migrating waders in the Sivash (Ukraine): the use of brine shrimp *Artemia salina* in a variably saline lagoon complex. *Ardea*, 91, 71-83.
- Ward A., Hoare D., Couzin I., Broom M. & Krause J. (2002). The effects of parasitism and body length on positioning within wild fish shoals. *Journal of Animal Ecology*, 71, 10-14.
- Ward A.J.W., Duff A.J., Krause J. & Barber I. (2005). Shoaling behaviour of sticklebacks infected with the microsporidian parasite, *Glugea anomala*. *Environmental biology of fishes*, 72, 155-160.
- Wiersma P. & Piersma T. (1994). Effects of microhabitat, flocking, climate and migratory goal on energy expenditure in the annual cycle of red knots. *Condor*, 257-279.
- Williams F.D. & Schwarzhoff R.H. (1978). Nature of the swarming phenomenon in *Proteus*. *Annual Reviews in Microbiology*, 32, 101-138.

Young S., Watt P.J., Grover J.P. & Thomas D. (1994). The unselfish swarm? *Journal of Animal Ecology*, 611-618.

ARTICLE 6

SUPPLEMENTARY MATERIALS

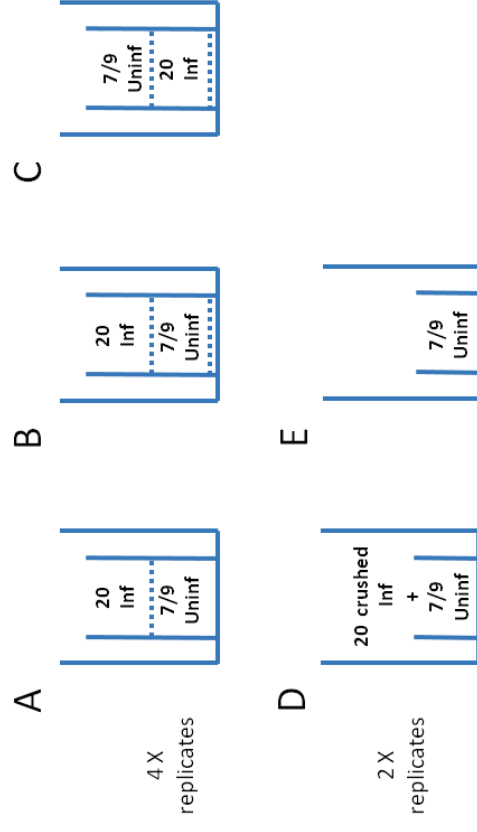

Figure S1: Experimental set up to test the effect of vertical position on *Msp2* infection. Each treatment included 7 *A. franciscana* and 9 *A. parthenogenetica* uninfected recipient hosts and 20 *A. franciscana* donor hosts. In the first two treatments, uninfected individuals were placed in cages at the bottom of the tanks that allowed (A) or prevented them (B) to graze detritus, while infected hosts were placed in a cage on top of them (A and B). In a third treatment, uninfected individuals were placed on top whereas donor hosts were placed at the bottom and not allowed to graze (C). Cages were separated by a net (mesh size 0.2mm). The same number of uninfected individuals was kept with a homogenate of 20 infected individuals (D) or isolated as a control (E). All recipient hosts were PCR tested for infection after 10 days.

Table S1: *F. liguloides*, *Msp1* and *Msp2* prevalence within and outside swarms in Aigues-Mortes salterns.

Sampling Site	Host Species investigated	Depth	<i>F. liguloides</i> Prevalence						<i>Msp1</i> Prevalence						<i>Msp2</i> Prevalence						Sampling date
			Outside Swarm		Within Swarm		Outside Swarm		Within Swarm		Outside Swarm		Within Swarm		Outside Swarm		Within Swarm				
			0	0.67	0	0.72	0	0.38	0	0.24	0	0.33	0	0.33	0.03	0.28	0.71	0.28	0.71	0.28	
Site 16 (Replicate 1)	A. f. A. p.	. .	0	0	0	0	0	0.24	0.33	0.71	0.28	0.71	0.28	0.71	0.28	29	55	158	May 2011 (160g/L)		
Site 16 (Replicate 2)	A. f. A. p.	. .	0	0.48	0	0.57	0.06	0.14	0.31	0.64	0.64	0.64	0.64	0.64	0.64	54	41	41	May 2011 (160g/L)		
Site 17 (Replicate 1)	A. f. A. f. A. f.	-10cm -20cm ² -30cm ²	0	0	0	0	0.2	0.42	0	0.67	0	0.36	0.36	0.36	17	36	35	May 2011 (150g/L)			
Site 17 (Replicate 2)	A. p. A. p. A. p.	-10cm -20cm ² -30cm ²	0.25	0.83	0.67	0.6	0.07	0.71	0.6	0.19	0.19	0.19	0.19	0.19	12	70	69	May 2011 (160g/L)			
Site 17 (Replicate 1)	A. f. A. f. A. f.	-5cm -15cm	0	0	0	0	0.17	0.27	0.25	0.73	0.73	0.73	0.73	0.73	64	23	32	May 2011 (150g/L)			
Site 17 (Replicate 2)	A. p. A. p. A. p.	-5cm -15cm	0.55	0.69	0.27	0.73	0.49	0.76	0.08	0.16	0.16	0.16	0.16	0.16	38	45	45	May 2011 (170g/L)			
Site 18	A. f. A. f. A. f.	-5cm -15cm -25cm	0	0	0	0	0.24	0.22	0.2	0.13	0.13	0.13	0.13	0.13	16	47	54	May 2011 (170g/L)			
Site 18	A. p. A. p. A. p.	-5cm -15cm -25cm	0.48	0.78	0.38	0.87	0.48	0.79	0.05	0.33	0.33	0.33	0.33	0.33	50	50	47	May 2011 (170g/L)			
	A. p.		0.52	0.68	0.48	0.79	0.76	0.42	0.07	0.17	0.17	0.17	0.17	0.17	29	47	54				
	A. p.		0.66	0.76	0.42	0.76	0.42	0.42	0.12	0.08	0.08	0.08	0.08	0.08	21	54	54				

¹: Swarms were in shallow area and could not be sampled at different depth. ²: Swarm in Site 17 (Rep.1) was in very deep water and some depth levels could not be sampled.

Table S2: Model selection of *Artemia* swarming probability.

K	logLik	AIC	AICc	$\Delta AICc$	wi	Parameters
21	-587.67	1217.33	1218.1	0	0.17	f presence+Msp1*distance+Msp2*sex*length*distance+sex*distance+distance*sample
22	-586.71	1217.42	1218.26	0.17	0.16	+species*Msp1*distance ²
22	-587.34	1218.68	1219.52	1.42	0.08	+species*Msp2*distance ²
20	-588.42	1218.85	1219.54	1.44	0.08	-Msp1*Msp2
22	-587.59	1219.18	1220.01	1.92	0.07	+f presence*Msp1
22	-587.59	1219.18	1220.02	1.92	0.07	+f presence*Msp2
22	-587.61	1219.23	1220.07	1.97	0.06	+f presence*distance ²
21	-588.74	1219.48	1220.24	2.14	0.06	+Msp2*distance
20	-589.89	1219.79	1220.48	2.39	0.05	-sex*depth
23	-586.86	1219.71	1220.63	2.53	0.05	-Msp1*species
23	-586.86	1219.73	1220.64	2.54	0.05	-Msp2*species
20	-590.23	1220.45	1221.15	3.05	0.04	length*depth
20	-590.44	1220.88	1221.57	3.48	0.03	-sex*Msp1
21	-589.61	1221.21	1221.98	3.88	0.02	+Msp1*distance
20	-597.76	1235.52	1236.22	18.12	0	-Msp2*distance ²
20	-602.03	1244.06	1244.76	26.66	0	-f presence
20	-616.42	1272.84	1273.54	55.44	0	-Msp1*distance ²

sex: sex; f|presence: presence of *F. iguiloidea*, Msp1: presence of *Microsporidium* sp. 1, Msp2: presence of *Microsporidium* sp. 2; distance: distance from the surface; length: length; species: host species. Model including number of *F. iguiloidea* instead of f|presence gave a worse fit to the data ($\Delta AICc > 10$).

Table S3: Model selection of swarming probability of the different *Artemia parthenogenetica* genotypes.

K	logLik	AIC	AICc	$\Delta AICc$	wi	Parameters
21	-80.59	203.19	208.79	0	0.42	Msp1*f presence+f presence*MLGA_D+distance^2*MLGqt8%+Msp1*distance^2+Msp2*distance^2+distance^2*sample
22	-79.81	203.62	209.79	1	0.25	+Msp1*Msp2
22	-80.01	204.01	210.18	1.4	0.21	+Msp1*f presence
23	-80.5	207.01	213.78	4.99	0.03	+length*distance
20	-84.67	209.34	214.4	5.61	0.03	-Msp:distance^2
20	-84.76	209.52	214.58	5.79	0.02	-Msp2*f presence
20	-84.91	209.82	214.88	6.09	0.02	-Msp1:distance^2
25	-79.42	208.84	216.91	8.12	0.01	+Msp2*MLGqt8%
25	-79.58	209.16	217.24	8.45	0.01	+Msp1*MLGqt8%
19	-90.76	219.53	224.08	15.29	0	-f presence*MLGA_D
17	-95.25	224.51	228.13	19.34	0	-depthSq;MLGqt8%

MLGqt8%: factor with 5 levels corresponding to the 4 genotypes with frequencies above 8% and the other genotypes.

MLGA_D: two-level factor corresponding to genotype A, genotype D and the other genotypes.

See Table 1 for other abbreviations.

Table S4: Model selection of *Artemia parthenogenetica* red intensity.

K	logLik	AIC	AICc	Δ AICc	wi	Parameters
5	2219.09	-4428.18	-4428.1	0	0.31	swarm.fl+length+non repro
6	2219.77	-4427.53	-4427.42	0.68	0.22	+fl
6	2219.18	-4426.36	-4426.25	1.85	0.12	+sex
6	2219.15	-4426.31	-4426.2	1.9	0.12	+Msp2
6	2219.09	-4426.19	-4426.08	2.02	0.11	+Msp1
8	2220.55	-4425.11	-4424.92	3.18	0.06	+fl*Msp2
8	2220.16	-4424.32	-4424.13	3.97	0.04	+fl*Msp1
5	2215.82	-4421.65	-4421.57	6.53	0.01	+swarm.flpresence
5	2215.12	-4420.25	-4420.17	7.93	0.01	-swarm.fl+fl
4	2206.85	-4405.7	-4405.65	22.45	0	-swarm.fl
4	2169.26	-4330.52	-4330.47	97.63	0	-repro
4	2142.46	-4276.93	-4276.88	151.22	0	-length

non repro: two-level factor for non reproductive females and males/reproductive females

Table S5: Model selection of *F. liguloides* infection probability of the different *Artemia parthenogenetica* genotypes.

K	logLik	AIC	AICc	$\Delta AICc$	wi	Parameters
6	-115.31	242.62	243.08	0	0.36	swarm*Msp2+MLGA*swarm
7	-114.53	243.06	243.69	0.6	0.26	+distance
7	-115.16	244.33	244.95	1.87	0.14	+sample
7	-115.29	244.58	245.21	2.13	0.12	+length
9	-113.14	244.29	245.3	2.22	0.12	+MLGfqt8%

Table S6: Model selection of *Msp1* infection probability.

K	logLik	AIC	AICc	$\Delta AICc$	wi	Parameters
7	-105.3	224.59	225.22	0	0.2	MLGA_D+swarm+distance ² +swarm:distance ² +sample
6	-106.97	225.93	226.4	1.18	0.11	-distance
5	-108.37	226.73	227.06	1.84	0.08	-MLGA_D
8	-105.29	226.59	227.4	2.18	0.07	+length
6	-107.54	227.08	227.55	2.33	0.06	-sample
9	-104.94	227.88	228.9	3.68	0.03	+MLGB_C

Table S7: Model selection of *Msp2* infection probability.

K	logLik	AIC	AICc	$\Delta AICc$	wi	Parameters
8	-76.71	169.42	170.23	0	0.54	MLGA_D+swarm+distance ² +swarm.distance ²
10	-75.27	170.55	171.8	1.57	0.25	+MLGB_C
9	-76.56	171.13	172.15	1.92	0.21	+length
5	-89.98	189.96	190.29	20.07	0	-distance ²
6	-89.86	191.72	192.18	21.96	0	-MLGA_D
7	-88.93	191.87	192.49	22.27	0	+sample

Table S8: Model selection of *Msp2* infection probability in the experiment on the effect of infected host vertical position.

K	logLik	AIC	AICc	$\Delta AICc$	wi	Parameters
6	-88.22	188.44	188.88	0	0.74	Treatment+Species+Sex
4	-91.42	190.83	191.04	2.16	0.25	TreatmentABD+Species+Sex
16	-82.49	196.98	199.94	11.06	0	Treatment*Replicate+Species+Sex
3	-128.34	262.68	262.81	73.93	0	Species+Sex

TreatmentABD: same infection probability in treatment A, B and D.

Appendix

Origin and evolution of asexuality and polyploidy in the *Artemia* genus

Nicolas Olivier Rode, France Dufresne, Elodie Flaven, Roula Jabbour-Zahab,
Francisco Amat, Gilbert Van Stappen & Thomas Lenormand

In preparation

General context

To date, the phylogeny of *Artemia* has mostly been investigated using the COI mitochondrial marker and five microsatellites markers. Even if limited, this has proved useful to unravel the phylogenetical relationships among species in the genus (MANIATSI *et al.* 2011; MUÑOZ *et al.* 2008). The phylogeny of the genus is particularly interesting to understand the evolution of parthenogenesis and the evolution of ploidy. Indeed, the genus comprised seven bisexual species (*A. persimilis*, *A. salina*, *A. franciscana*, *A. sinica*, *A. tibetiana*, *A. urmiana* and an uncharacterized species from Kazakhstan, hereafter *A. kaz*) and asexual clones collectively referred to as *A. parthenogenetica*. The latter group is polyphyletic and comprised clones with various ploidy levels as seen on Fig. 1 (next page). The current phylogeny suggests the existence of four *A. parthenogenetica* clades (two diploid taxa, one triploid and one tetraploid taxa). The current analysis is limited for several reasons. First, the *A. kaz* bisexual species was not included in the analysis which is problematic as several diploid clones have been shown to be closely related to this species (MUÑOZ *et al.* 2008). Second, pooled cyst samples were used for flow cytometry analyses, potentially confounding cyst endopolyploidy with population level ploidy variation. Third, the microsatellite markers are few (low discrimination power) and difficult to interpret (null alleles, multiple peaks even in diploids). Fourth, pentaploid taxa were not included.

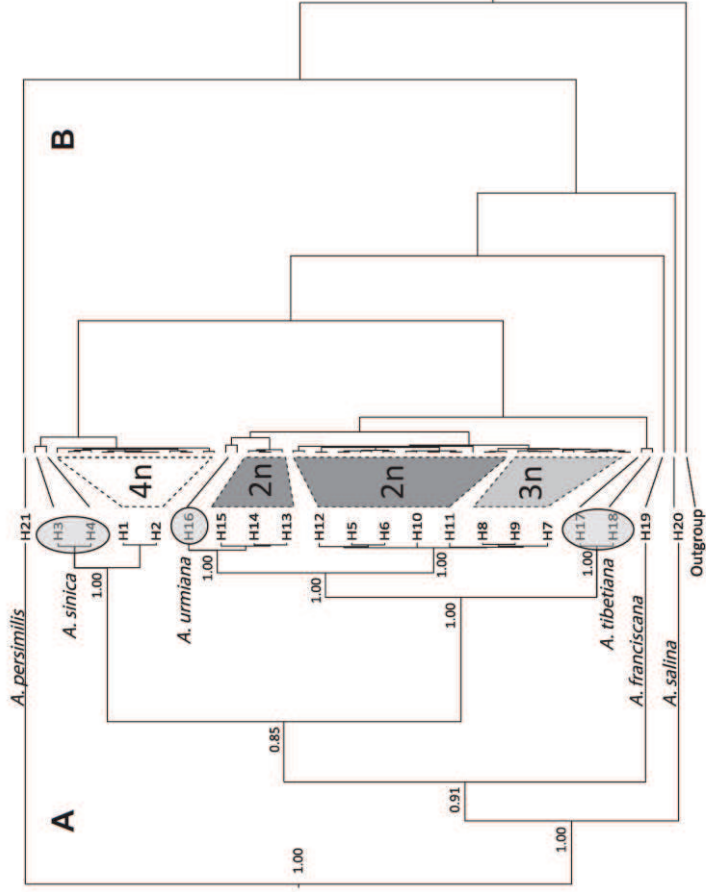

Figure 1: COI phylogenetic tree of the *Artemia* genus with (A) COI haplotypes and (B) COI sequences. Bisexual species are indicated in italics. Diploid, triploid and tetraploid asexual taxa are indicated with shaded area (from Maniatsi et al 2011).

We tried to improve the current phylogeny with different approaches. First, we developed new microsatellites markers in both bisexual and asexual species. This was performed using three microsatellite-enriched banks (on cysts of diploids from the two asexual clades, tetraploids, *A. urmiana* and *A. sinica*). The banks were extremely poor in candidate microsatellite loci and we finally recovered 9 polymorphic markers, that cross amplified most *Artemia* species. These loci were not shared with the most external sexual species compared to the asexual clades (i.e. *A. salina* and *A. franciscana*). Amplification in *A. persimilis* was not tested, but is likely to be low as it is distantly related to the other species in the genus. Second, we used an extensive collection comprising (1) an exhaustive sample of all clades whose ploidy level has been characterized, (2) missing important samples (*A. kaz.*, pentaploids, tetraploids with unknown mitochondrial genotype), (3) an extensive collection of diploid clones from various locations (notably, Southern France, coastal China, Tibet, Spain, Italy, Kazakhstan, Albania, Bulgaria, Ukraine). Third, we used flow cytometry based on individuals (rather than cyst pools) to determine ploidy levels. Fourth, on a set of reference samples, we characterized both genome size and genotypes (nuclear and mitochondrial) from unique individuals. Last, we specifically investigated the origin and fertility of rare males in asexual clones. To do this, we genotyped rare males from field and laboratory monoclonal

populations together with some of their mother/sister genotypes. Then, we performed crosses between five of such rare males and *A. urmiana* sexual females. We isolated F1 female offspring to test their ability to reproduce parthenogenetically and investigate the possible origin of new clones through contagious parthenogenesis.

This phylogenetic work was designed to better understand the origin and evolution of asexuality in the *Artemia* genus. More specifically, we assessed the robustness of previous phylogenies and we tried to determine if new asexual clones originated spontaneously in bisexual species (and which ones), through contagious asexuality (rare 'asexual' males crossed with sexual females), through hybridization between sexual species, or last because of cryptic sex within asexual clones. We used the same approach to investigate the origin of polyploidy as it could occur spontaneously in asexual clones or through hybridization (either with sexual or 'asexual' males).

Results and discussion

We first determined the genome size and mitochondrial genotype (COI marker) of a set of reference individuals from all bisexual and asexual clades with known ploidy level. We also included samples from populations with unknown ploidy level(s) ($n \sim 150$). We also sequenced the mitochondrial COI gene of an additional set of *ca.* 300

individuals from the same and from other populations and built a phylogenetic tree by maximum likelihood, using the PHYML software (GUINDON *et al.* 2010). The estimated genome sizes of major bisexual and asexual clades are given in Table1.

Taxa	Population	Ploidy	<i>n</i>	Genome Size (pg)	SD
<i>A. salina</i>	La Mahala, Spain	2n	11	2.41	0.06
<i>A. franciscana</i>	Great Salt Lake, USA	2n	6	4.20	0.13
<i>A. franciscana</i>	San Francisco Bay, USA	2n	4	3.56	0.04
<i>A. sinica</i>	Yimeng, China	2n	4	4.74	0.12
<i>A. tibetiana</i>	Lagor Co, China	2n	10	6.61	0.18
<i>A. urmiana</i>	Lake Urmia, Iran	2n	6	4.25	0.19
<i>A. kaz.</i>	Kazakhstan	2n	9	4.92	0.14
<i>A. parth. clade mt-urm</i>	France, Italy, Spain, China	2n	29	4.70	0.18
<i>A. parth. clade mt-kaz</i>	France, China, Russia	2n	24	4.77	0.20
<i>A. parth. clade mt-kaz</i>	Turkey, Madagascar, Albania	3n	19	6.97	0.51
<i>A. parth. clade mt-sin</i>	Greece, China, Spain	4n	2	12.49	0.16
<i>A. parth. clade mt-tib</i>	Greece, China, Spain, France, Turkey	4n	22	11.58	1.05
<i>A. parth. clade mt-tib</i>	Bulgaria, Turkey	5n	8	13.56	1.83

Table 1: Genome size of *Artemia* species. The Taxa column indicates the bisexual species or the mitochondrial clade for *A. parthenogenetica* (see Fig.2 and Fig 3 for the mitochondrial and nuclear respective phylogenetic relationships between these taxa). Individual nuclei of somatic tissue were extracted using *Artemia* individuals. Genome size (in pg) was computed using the Nippon Bar rice (0.91 pg) as an internal reference. Ploidy refers to chromosomal counts of reference samples from the literature (except *A. kaz.*). The number of individuals measured is indicated by *n*. SD is the standard deviation of genome size across individuals in a taxon.

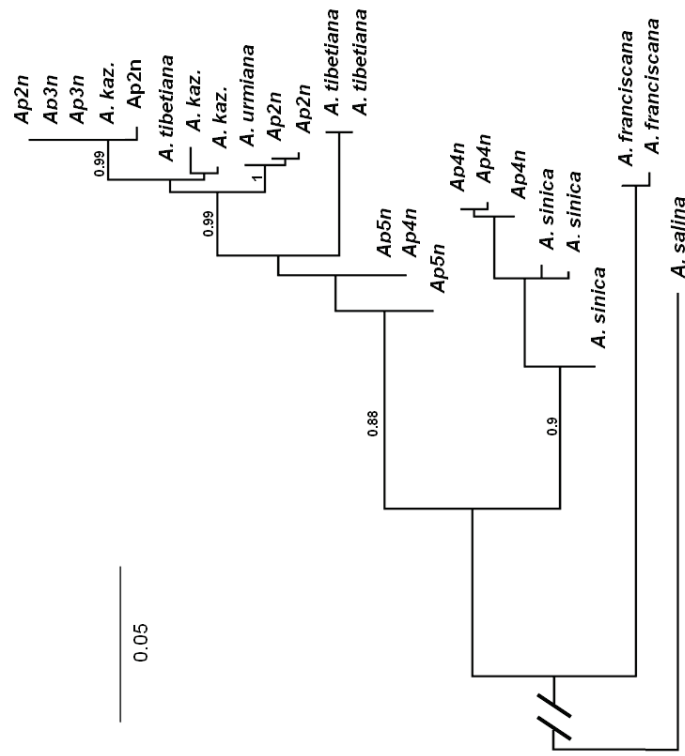

Figure 2: COI phylogenetic relationship between bisexual and asexual clades (*Ap2n*: diploids, *Ap3n*: triploids, *Ap4n*: tetraploids, *Ap5n*: pentaploids). Bootstrap supports (n=500 replications) are given above the branches of relevant bisexual and asexual clades.

The phylogenetic tree was pruned to eliminate redundant sequence information (Fig. 2). Our tree confirmed previous analyses and indicated that the main taxa of the genus are well supported (Fig. 2). The only differences were (1) the addition of a new tetraploid clade, close to *A. tibetiana*, (2) the inclusion of the pentaploid clade, close to *A. tibetiana*, (3) the non ambiguous position of *A. kaz* clade as a sister group to one of the asexual diploid clade and to the asexual triploid clade.

We then used these groups to compute F_{ST} distance based on 12 microsatellite markers, including the nine markers developed for this study and three previously characterized (Munoz et al 2008). We built a minimum spanning tree using these distances (hapstar, Teacher & Griffiths 2010). The results are illustrated in Fig. 3 and summarize both nuclear and mitochondrial information. There are six asexual taxa: the two diploid clades are close to *A. Kaz* but have two different mitochondrial (hereafter, mt) genotypes (one shared with *A. kaz.*, and the other with *A. urmiana* bisexual species). We will denote them *Ap2n_urm* and *Ap2n_kaz*. The triploid clade is between *A. urmiana* and *Ap2n_kaz*. As it has the same mt-genotype as *A. kaz.*, we note it *Ap3n_kaz*. The two tetraploid clades were intermediate between *A. tibetiana*, *A. sinica* and *A. kaz*. While having highly divergent mt genotypes, they were extremely close at the nuclear level. More specifically, when found in the same location, these two taxa were identical for

all loci investigated. However, there was some interpopulation differentiation. Again, we will refer to them as *Ap4n_tib* and *Ap4n_sin* depending on their mt-genotype. Last, the pentaploid clade was close to the tetraploids with a *A. tibetiana* mt-genotype (*Ap5n_tib*). We examine the origin of the different asexual clades in turn.

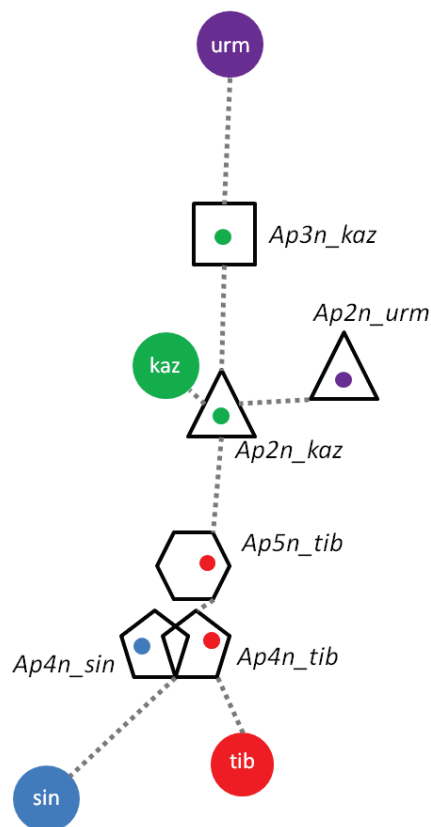

Figure 3: Minimum spanning distance (F_{ST}) network. F_{ST} values were computed using 12 microsatellites loci (including the 9 markers developed for this study and three previously characterized loci). Bisexual individuals were grouped according to their species (colored circles, urm = *A. urmiana*, kaz = *A. kaz.*, sin = *A. sinica*, tib = *A. tibetiana*), while asexual individuals were grouped by ploidy level and mitochondrial genotype (open figures: triangle = 2n, square = 3n, pentagon = 4n, hexagon = 5n). Colored-dots in asexual taxa correspond to the bisexual origin of their mitochondrial genotypes.

The origin of diploids

This analysis revealed many surprising results. There are several possible evolutionary scenarios leading to this pattern. We present here what we think is one of the most parsimonious scenarios. Parthenogenesis occurred *de novo* in *A. kaz.* bisexual species, probably in central Asia. This led to the *Ap2n_kaz* group. Both groups are still very close both at the mt and nuclear levels. Today this *Ap2n_kaz* clade is found worldwide except in America. As observed in the lab and in different field samples, this asexual clade still produces 'rare males'. One of them probably mated with an *A. urmiana* immigrating female (probably in central Asia as well, since *A. urmiana* is now found only in lake Urmia, Northern Iran). This cross introduced the *urmiana* mitochondrial genotype (hereafter, mt-urm) into the *Ap2n_kaz* population and subsequent backcrosses with rare males led to the almost complete introgression of mt-urm into a *Ap2n_kaz* nuclear background leading to *Ap2n_urm*. This pattern is surprising as it implies regular mating between the two diploid asexual mt-clades. Because, we cannot say that the F1 progeny of this initial cross was asexual, it is not entirely clear whether this is a case of 'contagious' asexuality, but it is one option. It is noteworthy that *Ap2n* were described as being sometime automicts, with a modified meiosis with refusion of meiotic products (METALLI and BALLARDIN 1970).

The origin of triploids

Ap2n_kaz was also probably involved in a cross in the other direction (an *A. urmiana* male with a 'parthenogenetic' female). This cross resulted in triploid offspring with *A. kaz* mitochondria. This is *Ap3n_kaz*, which is at intermediate nuclear distance between *A. kaz.* and *A. urmiana*. Thus, this asexual clade probably occurred via hybridization. The absence of further introgression and backcross supports the idea that these triploids are 'truly' asexual (apomicts). It is noteworthy to say that rare males have never been observed in these clones and that they do not produce offspring *via* meiosis (METALLI and BALLARDIN 1970). Here, triploidy results from the fact that the asexual female produced an unreduced egg, which was subsequently fertilized by a haploid sperm.

The origin of tetraploids

The origin of tetraploid probably occurred in eastern Asia. The simplest hypothesis is that crosses between divergent *A. sinica* and *A. tibetiana* resulted in tetraploid clones. These crosses occurred in both directions as we now recover both mt-tib and mt-sin in tetraploids. However, today, when found in sympatry, *Ap4n_tib* and *Ap4n_sin* share the same nuclear background. Moreover this background varies from one population to the other. Hence, local sex between tetraploids is highly probable. This conclusion is inescapable given the nuclear data obtained in three independent populations. However, it is at odds with the fact that no 'rare' males have

ever been described in laboratory populations. We predict that field survey should reveal their existence. The fact that these tetraploids share some nuclear alleles with *A. kaz.* (see their relative position on Fig 3) may indicate that their *tibetiana* ancestor was perhaps closer to these central Asian sexual populations. In these tetraploids, rare sex resulted in patterns of segregation intermediate between auto- and allotetraploidy. Indeed, some microsatellite loci appeared to segregate as diploids while some others segregated with their ancestral homolog. This might be due to the heterogeneity in divergence between *A. sinica* and *A. tibetiana* ancestral chromosomes. Overall, the most likely origin of these asexual tetraploids is hybridization between divergent bisexual species.

The origin of pentaploids

Pentaploids most likely arose as segregational errors in tetraploids. Higher ploidy levels are difficult to tell apart and it remains unclear whether these pentaploids retained their full 5x haploid genome. This scenario would involve frequent independent origin of pentaploidy in tetraploid populations. An alternative hypothesis, is that pentaploids arose from the cross between either *A. kaz.* male or *Ap2n_kaz* 'rare' male with a tetraploid female. As such matings are likely to be rare, this scenario would be more consistent with a single origin of pentaploidy. This second scenario is however less likely, as we did not find evidence of the presence of five different alleles for any of the 12 loci investigated.

'Asexual' males and cyclical parthenogenesis

Rare male fertility has been investigated in crosses with *A. salina* (VENTURA 1963) *A. franciscana* females with contradictory results (BOWEN *et al.* 1978; MACDONALD and BROWNE 1987). Only Bowen recovered F1 offspring from such crosses, but F1 offspring proved not to be parthenogenetic. As *A. salina* and *A. franciscana* are distantly related to *Ap2n* clones, these crosses may not be relevant to the origin of asexuality. Another attempt was made in a cross with *A. urmiana* females, which are much more closely related, but the offspring were sacrificed for genetical investigation (BOWEN *et al.* 1978). Thus, we still do not know whether contagious asexuality is possible in *Artemia*. In fact, very limited genetic information is available to understand the origin and fertility of rare males. In particular, it is important for the scenarios developed above that mitochondrial inheritance is maternal in *Artemia*, that rare males produce reduced gametes and that their offspring can be asexual. Furthermore, diploid *A. parthenogenetica* has been shown to be ZW (STEFANI 1960) and rare males to ZZ (STEFANI 1964). Since *Ap2n* females have been described as reproducing automictically, the origin of rare males may result from segregation of ZW sex chromosome in automictic females. If true, we expect that rare males would show a loss of heterozygosity compared to their mother.

To test these hypotheses, we isolated 12 rare males from field and lab monoclonal *Ap2n_kaz* populations. Their nuclear genotype was exactly identical to the female clones in the same population, which rule out that they originate from ZW meiotic segregation. Next, we investigated whether these 'rare' males could fertilize sexual females and could transmit asexuality genes. To do so, we crossed five *Ap2n_kaz* rare males with *A. urmiana* females. We typed a part of their offspring and determined whether the daughter were able to parthenogenetically reproduce when isolated. These crosses also checked whether mt-inheritance was maternal as most scenarios explained above rely on this assumption. We found that these crosses were fertile. Offspring sex-ratio was close to 1:1. Only a small number of F1 females were able to reproduce asexually. We did not determine whether the non reproducing females were bisexual or sterile (asexual or sexual). The offspring mt genotype was maternal in the three crosses investigated and their nuclear genome was as expected in a F1 hybrids, indicating that rare males have a normal meiosis (in the sense that they produce haploid sperm). Offspring from the F1 parthenogenetically reproducing females were short-lived. Overall, even if these results are still qualitative (in the sense that sample size are low), they all support the scenarios envisioned above. Further investigation should shed light on the trigger of rare sexuality in *Ap2n* and *Ap4n* clones. Rare males are the only 'visible' side of the story

and, even if more challenging, meiotic females remain to be found in these 'clones'. We suspect that as in many other cyclical parthenogenetic species, environmental triggers such as stressful conditions are important for the switch from asexual to sexual reproduction. Diploid and tetraploid *A. parthenogenetica* may thus be considered as cyclical parthenogens, but this cycle may be either long or triggered only rarely in response to extreme conditions.

Conclusions

The lack of exhaustive sampling and the absence of polymorphic markers have greatly hampered the understanding of the origin of asexuality in the *Artemia* genus. This study unravels that asexuality originated multiple times in the genus. Interestingly, all three major mechanisms that are known to lead to asexuality appear to be involved in *Artemia*: spontaneous origin, contagious asexuality through rare males and hybridization. In addition, 'asexual' males seem to play an important evolutionary role in both diploid and tetraploid species. This study contributes to withdraw *Artemia parthenogenetica* from the list of 'ancient asexual scandals' (JUDSON and NORMARK 1996), and revealed that sex is likely to be widespread in the different supposedly 'asexual' species. However, mictic females remain to be found in *Artemia parthenogenetica* and the ecological conditions leading to sexual reproduction remain to be investigated.

Contribution statement

NOR and TL conceived the experiment. FA and GVS provided the samples. NOR and RJZ performed the flow cytometry measurements with the advice of FD. NOR performed the crosses. EF, RJZ and FD genotyped the individuals. NOR and TL analyzed the data and wrote the manuscript.

References

- BOWEN, S. T., J. P. DURKIN, G. STERLING and L. S. CLARK, 1978 *Artemia* hemoglobins: genetic variation in parthenogenetic and zygogenetic populations. *The Biological Bulletin* **155**: 273-287.
- GUINDON, S., J. F. DUFAYARD, V. LEFORT, M. ANISIMOVA, W. HORDIJK *et al.*, 2010 New algorithms and methods to estimate maximum-likelihood phylogenies: assessing the performance of PhyML 3.0. *Systematic biology* **59**: 307-321.
- JUDSON, O. P., and B. B. NORMARK, 1996 Ancient asexual scandals. *Trends in Ecology and Evolution* **11**: 41-46.
- MACDONALD, G. H., and R. BROWNE, 1987 Inheritance and reproductive role of rare males in a parthenogenetic population of the brine shrimp, *Artemia parthenogenetica*. *Genetica* **75**: 47-53.
- MANIATSI, S., A. D. BAXEVANIS, I. KAPPAS, P. DELIGIANNIDIS, A. TRIANTAFYLLIDIS *et al.*, 2011 Is polyploidy a persevering accident or an adaptive evolutionary pattern? The case of the brine shrimp *Artemia*. *Molecular phylogenetics and evolution* **58**: 353-364.
- METALLI, P., and E. BALLARDIN, 1970 Radiobiology of artemia: radiation effects and ploidy. *Current topics in radiation research quarterly*: 181-240.
- MUÑOZ, J., A. GREEN, J. FIGUEROLA, F. AMAT and C. RICO, 2008 Characterization of polymorphic microsatellite

- markers in the brine shrimp *Artemia* (Branchiopoda, Anostraca). *Molecular Ecology Resources* **9**: 547-550.
- STEFANI, R., 1960 L'*Artemia salina* pathenogenetica a Cagliari. *Riv. Biol.* **53**: 463-490.
- STEFANI, R., 1964 The origin of males in parthenogenetic populations of *Artemia salina*. *Riv. Biol.* **57**: 147-162.
- VENTURA, B., 1963 L'amissa tra i biotipi diploide anfigonico e diploide parthenogenetico in *Artemia salina* Leach a la comparsa di maschi in popolazioni partenogenetiche. *Rend. Sem. Facolta Scienze Univ. Cagliari* **33**: 1-15.

Abstract

Getting a comprehensive understanding of microevolution in natural populations requires proper quantification of the important selective forces exerted on these populations. Over the last decade, long-term studies and resurrection-ecology (revival of resting stages) have been the main approaches to study life history trait evolution over many generations in the wild. My work aims at understanding how simple ecological factors (e.g. temperature) and complex interactions between and within species (host-parasite and male-females antagonistic interactions) shape evolutionary processes in natural populations. To this end, I used the brine shrimp *Artemia* as a model system and combined laboratory and field studies. First, I investigated thermal niche evolution with a resurrection ecology approach, using dormant-egg time series from an *Artemia* population introduced from temperate to tropical salterns in the mid-80's. This experiment shows that survival at the high temperatures typical of the new environment increased linearly through time after the introduction, suggesting a sustained rate of adaptation over more than 100 generations. Second, I used the same approach to study adaptation between sexes in another *Artemia* population. I found that sexual conflicts result in fluctuating male-female coevolutionary dynamics *in natura*, over a time scale of ~100 generations. Third, I studied the relative role of one cestode and two microsporidian parasites in mediating the competition between a native asexual host and an invasive bisexual host. I found that all three parasites were either host- or genotype-specific and that the castrating cestode parasite specifically infected the native species, suggesting that this parasite actually played a major role in the competition between native and invasive hosts. Interestingly, all three parasites manipulated the swarming behavior of their host, most likely to increase their transmission. Fourth, I performed population genetic studies of diploid and polyploid *Artemia parthenogenetica* and their Asian bisexual close relatives. Diploid asexual *Artemia* produce rare males and I found indication that these males allow some rare sex in this otherwise parthenogenetic species. In addition, hybridization between divergent *Artemia* species has led to the origin of at least three independent polyploid lineages. This work illustrates the relevance of using a combination of resurrection ecology and field approaches to investigate microevolution *in natura*.

Keywords: time shift experiment | adaptation to temperature | sexual conflicts | parasite-mediated competition | behavioral manipulation | asexuality | polyploidy

Résumé

Comprendre les processus microévolutifs naturels nécessite de quantifier les principales forces sélectives qui s'exercent sur les populations sauvages. Ces dix dernières années, les études à long terme et l'écologie de la résurrection (utilisant des structures de dormance) ont été les principales approches pour étudier l'évolution des traits d'histoire de vie sur plusieurs générations dans les populations sauvages. Mon travail consiste à comprendre comment des facteurs écologiques simples (p. ex. la température) et des interactions biotiques plus complexes (p. ex. les interactions antagonistes hôte-parasite ou mâle-femelle) façonnent l'évolution. Dans cette optique, j'ai utilisé l'Artémia comme un organisme modèle, en combinant des études sur le terrain et en laboratoire. Premièrement, j'ai étudié l'évolution de la niche thermique suite à un changement d'environnement en utilisant une série temporelle d'œufs de dormance d'une population d'Artémia originaire de marais salants tempérés et introduite dans des marais salants tropicaux dans les années 80. Cette étude montre un taux d'adaptation régulier aux températures tropicales sur plus de 100 générations après l'introduction. Deuxièmement, j'ai utilisé une approche similaire pour étudier l'adaptation entre mâles et femelles dans une autre population naturelle d'Artémia. Cette étude suggère que les conflits sexuels provoquent une dynamique de coévolution fluctuante sur une échelle d'environ 100 générations. Troisièmement, j'ai étudié les impacts de différents parasites (cestodes et microsporidies) sur la compétition entre une espèce d'hôte autochtone asexuée et une espèce d'hôte invasive sexuée. Ces parasites sont spécialistes (d'une espèce ou de certains génotypes d'hôte) et ont de forts effets phénotypiques (castration) et comportementaux (manipulation du comportement d'agrégation). Par conséquent, les parasites jouent un rôle majeur dans la compétition entre les espèces d'hôte autochtone et invasive. Enfin, j'ai réalisé des études de génétique des populations d'Artémia asexuées (diploïdes et polyploïdes) et sexuées proches. Les espèces asexuées diploïdes produisent des mâles rares permettant des événements de reproduction sexuée occasionnels. De plus, l'hybridation d'espèces diploïdes divergentes a donné naissance à au moins trois lignées polyploïdes indépendantes. Le travail de cette thèse illustre la pertinence de combiner des approches d'écologie de la résurrection et de terrain pour étudier la microévolution en milieu naturel.

Mots-clés : expérience de décalage temporel | adaptation à la température | conflits sexuels | interférence parasitaire sur la compétition | manipulation comportementale | asexualité | polyplôïdie