



HAL
open science

Molecular interactions between the kelp *saccharina latissima* and algal endophytes

Miriam Bernard

► **To cite this version:**

Miriam Bernard. Molecular interactions between the kelp *saccharina latissima* and algal endophytes. Symbiosis. Sorbonne Université, 2018. English. NNT : 2018SORUS105 . tel-02555205

HAL Id: tel-02555205

<https://theses.hal.science/tel-02555205v1>

Submitted on 27 Apr 2020

HAL is a multi-disciplinary open access archive for the deposit and dissemination of scientific research documents, whether they are published or not. The documents may come from teaching and research institutions in France or abroad, or from public or private research centers.

L'archive ouverte pluridisciplinaire **HAL**, est destinée au dépôt et à la diffusion de documents scientifiques de niveau recherche, publiés ou non, émanant des établissements d'enseignement et de recherche français ou étrangers, des laboratoires publics ou privés.

Sorbonne Université

Ecole doctorale Sciences de la Nature et de l'Homme (ED 227)

Laboratoire de Biologie Intégrative des Modèles Marins UMR 8227

Equipe Biologie des algues et interactions avec l'environnement

Molecular interactions between the kelp *Saccharina latissima* and algal endophytes

Par Miriam Bernard

Thèse de doctorat de Biologie Marine

Dirigée par Catherine Leblanc et Akira F. Peters

Présentée et soutenue publiquement le 07/09/2018

Devant un jury composé de :

| | | |
|-------------------------|--------------------------------|---------------------|
| Dr. Florian Weinberger | Chercheur GEOMAR Kiel | Rapporteur |
| Dr. Sigrid Neuhauser | Chercheur Univ. Innsbruck | Rapportrice |
| Pr. Soizic Prado | Professeur MNHN | Examinatrice |
| Pr. Christophe Destombe | Professeur Sorbonne Université | Représentant UPMC |
| Dr. Catherine Leblanc | Directrice de Recherche | Directrice de thèse |
| Dr. Akira F. Peters | Chercheur Bezhin Rosko | Directeur de thèse |

Acknowledgements

First of all, I would like to thank my supervisors Catherine Leblanc and Akira Peters. You were the two most important persons to contribute to the success of this thesis. Thank you for giving me the opportunity to work on this project and for your guidance and advice over the last three years. It has really been a pleasure to work with you.

I would also like to thank everyone else who has been involved in this work, in particular Sylvie Rousvoal, who not only developed several protocols with me, but also helped to improve my French. Whenever I had problems in the lab you had the ideas to make things work.

Qikun Xing has provided incredible help with the analysis of the RNAseq data. Thank you so much, I would not have been able to finish this project on time without you! Here I would also like to acknowledge the advice and support from Erwan Corre during the transcriptomic analysis.

Thanks also to Laurence Dartevelle for showing me how to handle the kelp cultures and for helping out with the kelp stocks and to Sandrine Boulben for the continuous detective work on the luminometer. I hope it will work forever from now on.

I would also like to thank my co-authors Martina Strittmatter, Pedro Murúa, Svenja Heesch, Ga Youn Cho, Bertrand Jacquemin, Sylvie Rousvoal, Marion Ballenghien, Nadia Collet, Tristan Le Goff and Philippe Potin for their valuable attributions and the friendly collaborations.

Furthermore, I am very grateful for valuable discussions of my work with the members of my thesis committee (thanks also for being spontaneous enough to move the committee meeting to my living room) and with the ABIE team.

A big thank you goes to the ALFFies. You are the best! I really enjoyed all the meetings and also the time we spent together outside of the ALFF meetings, such as a crazy karaoke night in Prague and Sri's wedding in India. Thanks also in particular to Claire Gachon who brought ALFF to life and hosted me twice during my secondments at SAMS. Here I also want to thank everyone else at SAMS for the help during my secondments in Oban.

I would also like to thank Job Schipper at Hortimare and Olavur Gregersen, Urd Grandorf Bak and Nicoline Korsvold at Ocean Rainforest for giving me hands-on experience in kelp aquaculture and for being so welcoming and supportive.

A very special thanks goes to Hetty KleinJan: back then when we met for the first time in Bonn, we didn't know yet what we would get involved in. I am so happy that I had you by my side during these 3 years, not only as a colleague, but as a really good friend.

Of course, I would also like to thank all my other colleagues at the station. In particular Margot Tragin, Zujaila Qui Minet, Svenja Heesch and Martina Strittmatter for being such good companions. Virginie Glippa, I guess that we sometimes might have been a bit too loud when joking around in the lab in three different languages (or the corridor...!), but you made the labwork so much better. Also, I am sure that no other lab in the station is decorated as nicely as ours. Thanks also to the "office girls": Amandine Simeon, Maria Matard, Laure Mignerot and Eugenie Grigorian.

Looking back into the past, this thesis would not have happened without Inka Bartsch and Katharina Zacher: You really aroused my love for kelps and I am incredibly thankful that I had your continuous support even during my PhD.

Zum Schluss möchte ich mich bei meiner Familie und bei Valentin bedanken. Danke, dass ihr immer für mich da seid. Ihr seid meine Helden!

Table of contents

| | |
|---|-----------|
| General Introduction..... | 1 |
| 1. Evolutionary context of studying seaweed interactions | 1 |
| 2. Kelps..... | 2 |
| 2.1 Life cycle and ecological relevance of kelps..... | 2 |
| 2.2. Global seaweed aquaculture and ecological relevance of kelps..... | 4 |
| 3. Pigmented algal endophytes..... | 6 |
| 3.1 Defining algal host-endophyte interactions..... | 6 |
| 3.2 Endophytic red algae..... | 8 |
| 3.3 Endophytic green algae | 9 |
| 3.4 Endophytic brown algae..... | 10 |
| 4. Algal defence reactions against biotic stresses | 13 |
| 4.1 Recognition of the attacker | 13 |
| 4.2 Inducible defence responses..... | 15 |
| 4.2.1 Oxidative burst..... | 15 |
| 4.2.2 Free fatty acids and oxylipins release | 16 |
| 4.2.3 Halogenation..... | 16 |
| 4.2.4 Transcriptomic regulation..... | 17 |
| 4.3 Systemic responses and distance signalling | 20 |
| 5. Thesis project and outline | 20 |
| | |
| Chapter I. Diversity, biogeography and host specificity of kelp endophytes with a focus on the genera <i>Laminariocolax</i> and <i>Laminarionema</i> | 23 |
| 1. Introduction..... | 26 |
| 2. Material and Methods | 28 |
| 2.1 Sampling and isolation of endophytes..... | 28 |
| 2.2 DNA extraction, barcode markers, amplification and sequencing..... | 28 |
| 2.3 Data analysis | 29 |

| | |
|--|-----------|
| 3. Results | 30 |
| 3.1 Molecular systematics | 30 |
| 3.2 Hosts and geographic origin of the isolated strains..... | 34 |
| 3.3 <i>Laminariocolax atlanticus</i> M. Bernard, Strittmatter & A.F. Peters sp. nov..... | 35 |
| 4. Discussion..... | 37 |
| 4.1 Molecular phylogeny of kelp endophytes | 37 |
| 4.2 Species delimitation in <i>Laminariocolax</i> | 39 |
| 4.3 Variability of host specificity | 41 |
| 5. Supplementary Material | 42 |

Chapter II. qPCR-based relative quantification of the brown algal endophyte *Laminarionema elsbetiae* in *Saccharina latissima*: variation and dynamics of host-endophyte interactions

| | |
|--|-----------|
| 1. Introduction..... | 54 |
| 2. Material and Methods | 55 |
| 2.1 In situ algal sampling | 55 |
| 2.2 Monospecific algal cultures | 56 |
| 2.3 DNA extraction | 57 |
| 2.4 qPCR and evaluation of the assay | 58 |
| 2.5 Data analysis | 59 |
| 3. Results | 59 |
| 3.1 Set-up and validation of the qPCR assay | 59 |
| 3.2 Distribution of endophyte filaments along the thallus of <i>S. latissima</i> | 60 |
| 3.3 Infection rates in young kelps | 61 |
| 3.4 Natural infection of laboratory-grown samples in a seaweed farm..... | 62 |
| 3.5 Seasonal variation of relative infection rates | 63 |
| 3.6 Geographic variation of relative infection rates | 64 |
| 3.7 Host specificity..... | 65 |
| 4. Discussion..... | 66 |

| | |
|---|-----------|
| 4.1 A specific and reliable qPCR approach for epidemiological studies | 66 |
| 4.2 Early occurrence of the infection in nature | 67 |
| 4.3 Variation of infection rates..... | 68 |
| 4.4 Host specificity of <i>L. elsbetiae</i> | 69 |
| 5. Supplementary Material | 71 |

Chapter III. A highly prevalent filamentous algal endophyte in natural populations of the sugar kelp *Saccharina latissima* is not detected during cultivation in Northern Brittany

| | |
|--|-----------|
| 1. Introduction..... | 78 |
| 2. Material and methods..... | 79 |
| 2.1 Algal Material | 79 |
| 2.2 Spore release and seeding procedure..... | 79 |
| 2.3 Offshore cultivation..... | 80 |
| 2.4 Sampling | 80 |
| 2.5 DNA extraction | 81 |
| 2.6 qPCR | 82 |
| 3. Results and discussion | 82 |

Chapter IV. Physiological and molecular responses of kelps to an infection by *Laminarionema elsbetiae*, a filamentous brown algal endophyte

| | |
|--|-----------|
| 1. Introduction..... | 90 |
| 2. Material & Methods | 92 |
| 2.1 Biological material | 92 |
| 2.2 Co-cultivation bioassay | 93 |
| 2.3 Extension of the co-cultivation bioassay: preliminary experiments..... | 95 |
| 2.3.1 GG pre-treatment | 95 |
| 2.3.2 Addition of fungal extracts | 96 |
| 2.4 Oxidative response measurement..... | 97 |

| | |
|---|------------|
| 2.5 Transcriptomic analysis..... | 97 |
| 2.5.1 Experimental set-up for transcriptomic analysis..... | 97 |
| 2.5.2 RNA extraction, quality assessment and sequencing..... | 98 |
| 2.5.3 De novo assembly and annotation of the transcriptome | 98 |
| 2.5.4 Identification of differentially expressed (DE) genes | 99 |
| 2.5.5 <i>Laminarionema elsbetiae</i> read analysis | 99 |
| 3. Results | 99 |
| 3.1 The effect of co-cultivation with algal endophytes on kelp growth | 99 |
| 3.2 Preliminary experiments to modify kelp responses towards algal endophytes | 101 |
| 3.2.1 GG pre-treatment | 101 |
| 3.2.2 Addition of fungal extracts | 102 |
| 3.3 Oxidative burst measurement | 104 |
| 3.4 Transcriptomics..... | 105 |
| 3.4.1 General overview of the transcriptomes | 105 |
| 3.4.2 Differentially expressed genes | 107 |
| 3.4.3 Functional annotation of differentially expressed genes..... | 109 |
| 3.4.4 <i>Laminarionema elsbetiae</i> reads | 110 |
| 4. Discussion..... | 113 |
| 4.1 The two kelp species show a different physiological response during the co-cultivation with the endophyte | 113 |
| 4.2 Defense elicitation can modify the physiological response of <i>L. digitata</i> towards the algal endophyte | 115 |
| 4.3 Gene regulation during the first contact with the endophytes differs in the two hosts | 115 |
| 4.4 A complex cross-talk between kelp and endophyte could be involved in host specificity .. | 118 |
| 4.5 Conclusion: first insights into host specificity in kelp-endophyte interactions..... | 120 |
| Conclusions and perspectives | 129 |
| 1. Different molecular and chemical responses of kelps to algal endophytes could be the basis of natural infection patterns | 129 |
| 2. <i>Laminarionema elsbetiae</i> - a kelp pathogen?..... | 132 |

| | |
|--|------------|
| 3. Variation of kelp-endophyte relationships: a complex interaction depending on different abiotic and biotic factors | 132 |
| 4. Future directions for studying kelp-endophyte interactions | 133 |
| References..... | 135 |
| List of abbreviations | 165 |
| Appendix I: Oral presentations..... | 167 |
| Appendix II: Presented posters | 169 |
| Appendix III: <i>Microspongium alariae</i> in <i>Alaria esculenta</i>: a widely-distributed non-parasitic brown algal endophyte that shows cell modifications within its host (Murúa et al. 2018) | 173 |
| Abstract | 189 |
| Résumé..... | 189 |

General Introduction

1. Evolutionary context of studying seaweed interactions

Marine macroalgae – commonly known as seaweeds – are of vital importance for the functioning of coastal ecosystems (Bold & Wynne [1985](#)). Seaweeds are an evolutionary diverse, polyphyletic group with representatives in all three major algal lineages - green (Chlorophyta), red (Rhodophyta) and brown algae (Phaeophyceae, see asterisks Fig. 1A).

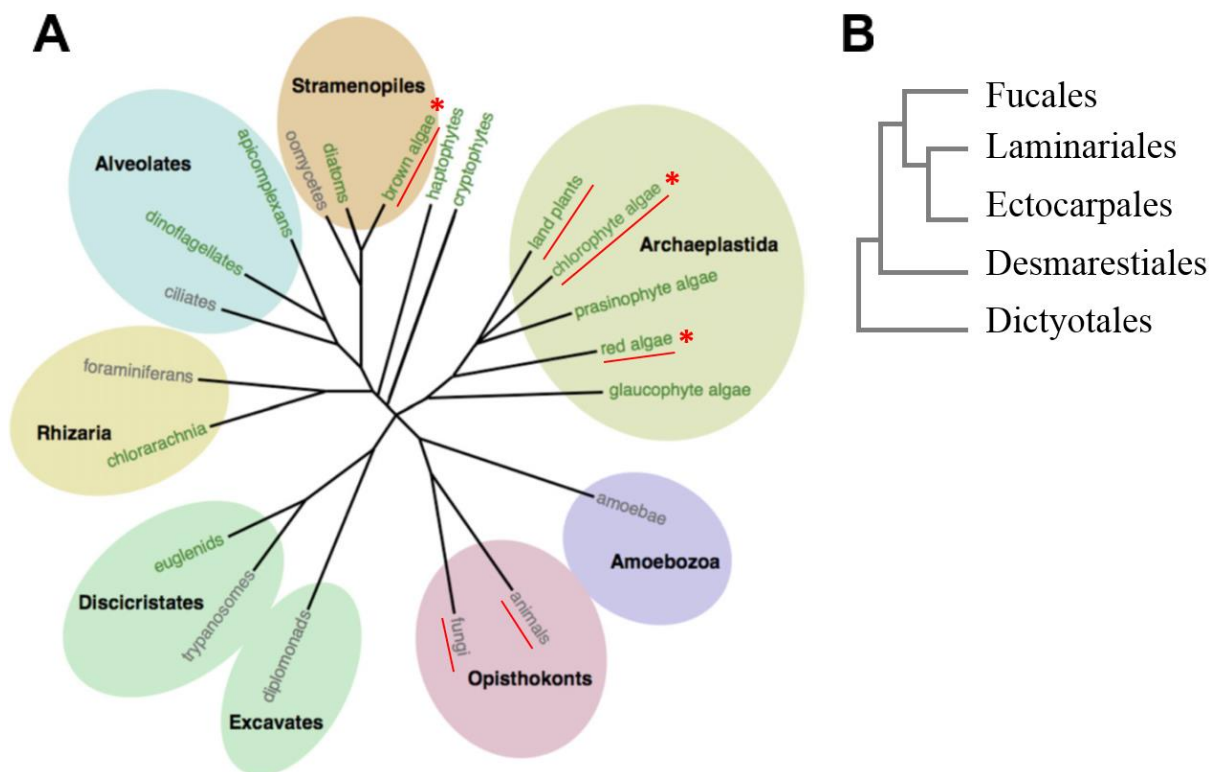

Fig 1: A. Eukaryotic tree of life (edited from Cock & Coelho [2011](#)). Lineages showing complex multicellularity are underlined in red. Lineages containing seaweeds are marked with red asterisks. [Printed with the permission of Oxford University Press] **B.** Relationship of selected brown algal orders (based on Silberfeld et al. [2010](#)). Kelps belong to the Laminariales, the endophytes *Laminariocolax* and *Laminarionema* belong to the Ectocarpales.

Most rocky shore habitats in temperate and northern polar seas are dominated by brown seaweeds of the orders Fucales and Laminariales (Fig. 1B, Dayton [1985](#)). Brown algae are part of the Stramenopiles, a lineage that originated from a secondary endosymbiosis event between an ancestral non-photosynthetic protist and a red alga approximately 1 billion years ago (Baldauf [2003](#)). Since multicellularity has evolved independently from the other multicellular groups in the Phaeophyceae, they provide an ideal basis for comparative studies of evolutionary

processes. For instance, research on the brown algal model *Ectocarpus siliculosus* has contributed to a better understanding of key cellular processes, such as carbon storage and cell wall biosynthesis (Michel et al. [2010a](#); reviewed by Cock & Coelho [2011](#)). The anatomy of brown algae ranges from crusts over filamentous thalli to more complex differentiated tissues (Lobban & Harrison [1994](#)). The largest and morphologically most complex brown seaweeds are found within the order of Laminariales (Fig. 1B) which are commonly known as kelps. Due to their important role in coastal habitats, kelps are involved in various biotic interactions with associated micro- and macroorganisms (reviewed by Leblanc et al. [2011](#) and Potin [2012](#)).

Despite their phylogenetic distance, brown algae have been shown to share certain basic defence mechanisms against biotic stress with the other multicellular eukaryotic lineages (reviewed by Cosse et al. [2007](#)). However, while the molecular and physiological bases of biotic interactions are very well studied in animals and terrestrial plants, brown algae remain poorly understood to a large extent in this regard (reviewed by Brodie et al. [2017](#)). An experimental investigation of biotic interactions in this lineage could provide a better understanding of the underlying biological processes from an evolutionary point of view.

2. Kelps

2.1 Life cycle and ecological relevance of kelps

Kelps are characterized by a complex and strongly heteromorphic, haploid-diploid life cycle consisting of microscopic haploid gametophytes and diploid sporophytes of up to several meters length (Fig. 2). Sporangia develop in areas on the blades of the diploid sporophytes referred to as sori (Bold & Wynne [1985](#)). Within these sporangia, haploid zoospores of 4-8 μm size are formed, which are released under environmentally-controlled mechanisms (Amsler & Neushul [1989a](#)) and dispersed by currents (Dayton [1985](#)). Germinated spores grow into male and female gametophytes and produce motile spermatozooids from antheridia and egg cells from oogonia, respectively. After fertilization, the diploid zygote develops into a macroscopic sporophyte, whereas unfertilized egg cells can grow to haploid parthenosporophytes (Dayton [1985](#)). Due to the large size of the sporophytes, the kelp life cycle is usually completed only partially in laboratory cultures. Cultures can be started from gametophyte stocks or freshly released spores which develop into young sporophytes that can be used for experimentation.

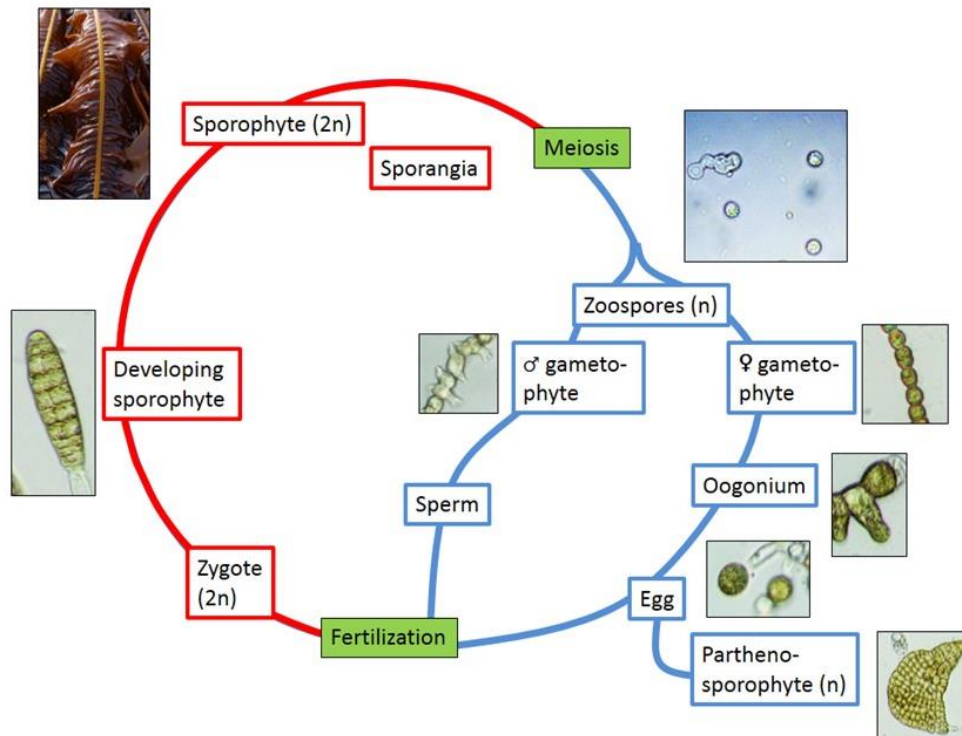

Fig. 2: Life cycle of Laminariales. Red: diploid phase, Blue: haploid phase (Bernard [2014](#)).

Kelps are the major component of rocky intertidal and subtidal habitats (Bold & Wynne [1985](#)). They form vast underwater forests which are among the most diverse and productive ecosystems in the world (Mann [1973](#)). Kelp forests support complex food webs and provide habitats and breeding areas for a variety of animals, such as fish, molluscs, crustaceans and mammals (reviewed by Bartsch et al. [2008](#)). They also play an important role in carbon sequestration (Chung et al. [2013](#)) and significantly affect currents and water flows (Jackson [1983](#)).

The sugar kelp *Saccharina latissima* (Fig. 3A) is a short-lived perennial species with a circumpolar distribution in the Northern hemisphere (Bolton et al. [1983](#)). In Europe, it can be found in cold waters of the high Arctic to temperate regions in northwest Spain and northern Portugal (Ardre [1970](#); Gulliksen et al. [1999](#); Cires Rodriguez & Moliner [2010](#)). Its undivided, characteristically dimpled and wrinkled blade reaches lengths of up to four meters. The common habitats of *S. latissima* are sheltered intertidal pools and the shallow subtidal where it grows with its rhizoid attached to rocks, boulders or large stones (Hanelt [1998](#)).

Laminaria digitata (Fig. 3B), commonly known as oarweed or finger kelp, is a perennial North Atlantic kelp species with a distribution range from Arctic regions to Connecticut and Northern

Spain along American and European coasts, respectively (Miranda [1931](#); Schneider et al. [1979](#); Gulliksen et al. [1999](#)). The blade is split into finger-like segments of up to 2.5 m length with the number of digits varying depending on wave exposure (Lobban & Wynne [1981](#)). *L. digitata* usually forms dense forests in the lower intertidal and shallow subtidal, but occasionally reaches depths of up to 25 m at its northern distribution range (Birkett et al. [1998](#); Cabioc'h et al. [2006](#)).



Fig. 3: A. Sporophytes of *Saccharina latissima* showing the characteristic undivided, wrinkled blade (© Mike Guiry). B. Sporophytes of *Laminaria digitata* with blades split into finger-like segments (© Mike Guiry).

2.2. Global seaweed aquaculture and ecological relevance of kelps

The use of seaweed by humans has a long history. The earliest written record of seaweed used as food in China dates back more than 2500 years (reviewed by Anis et al. [2017](#)) whereas archaeological evidence of algae being collected and used by humans exists even from the Palaeolithic age (Dillehay et al. [2008](#)). Today, the global seaweed aquaculture is rapidly expanding (Buschmann et al. [2017](#)) and the production as well as the associated value have increased exponentially over the last decades (Fig. 4, FAO Food and Agriculture Organization of the United Nations).

Approximately 80 % of the produced biomass is used for human diet. Other applications include the use as fertilizers, animal feed and cosmetic or medical products (McHugh [2003](#); Loureiro et al. [2015](#)). Furthermore, seaweeds have a high potential for the sustainable production of bioethanol and biogas (Adams et al. [2009](#); Mazarrasa et al. [2014](#); reviewed by Chen et al. [2015](#)).

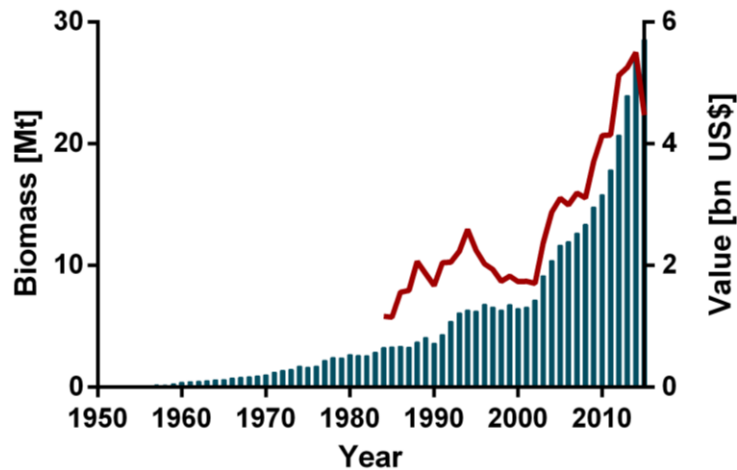

Fig. 4: Seaweed aquaculture biomass (histogram) and value (red curve) over the period from 1950-2015 (data obtained from FAO Food and Agriculture Organization of the United Nations).

S. latissima is the closest European relative to the Asian *S. japonica*, a dominant species in the Asian seaweed industry. It is one of the fastest-growing European kelp species and has a high carbohydrate content (Skjermo et al. [2014](#)). Traditionally, *S. latissima* was collected as a fertilizer in agriculture and as animal feed. Today, the off-shore cultivation of this species in Europe is increasing (Mesnildrey et al. [2012](#); Skjermo et al. [2014](#)) with additional applications in human diet, abalone feeding and as an extract for the cosmetic industry.

Laminaria digitata, on the other hand, is one of the most strongly harvested species in France with 40.000-60.000 tons harvested per year and an annual turn-over of 1.7 to 2.7 million Euro (Mesnildrey et al. [2012](#)). While it has traditionally been harvested as a fertilizer and animal feed, it is now mainly used for alginate production (Chapman & Chapman [1980](#); Mesnildrey et al. [2012](#)).

3. Pigmented algal endophytes

Seaweeds do not only serve as food source or habitats for animals, they also provide a substratum for smaller organisms growing on (epiphytes) or inside of (endophytes) their thalli, such as fungi, oomycetes or filamentous algae of all three macroalgal lineages (Dayton [1985](#); reviewed by Bartsch et al. [2008](#) and Gachon et al. [2010](#)). Algal epiphytes penetrate into the outermost cell layers of the host tissue mainly for mechanical support (Setchell [1918](#)). Algal endophytes, on the other hand, may grow entirely within a host and only reproductive structures are formed at the host surface (Peters [1991](#)). A clear distinction of epi- and endophytes is not always possible because certain species may represent a continuum between an epiphytic and endophytic lifestyle (Peters [2003](#); Gauna & Parodi [2008](#)). Furthermore, pigmented algal endophytes are usually photosynthetically independent from their hosts (Potin [2012](#)) and life stages of such species can also be found outside of their hosts (Küpper et al. [2016](#)). For simplicity, the term endophyte is used in this thesis to describe algae that possess the ability to grow inside of an algal host and penetrate deeper than the cortex.

Endophytic algae have attracted the interest of phycologist mainly due to the fact they occasionally coincide with morphological changes or disease symptoms in their hosts (Apt [1988a](#); Correa et al. [1988](#)), which can also have a direct impact on the economic value of kelps (Yoshida & Akiyama [1979](#)). Despite an increasing interest in this topic due to the economic importance of seaweed aquaculture (Chen [2004](#)), still little is known about the identity, phylogeny and life cycles of pigmented algal endophytes.

3.1 Defining algal host-endophyte interactions

The term endophyte describes an "organism living within a host plant" (greek: éndon = inside; phytón = plant; Womersley [1987](#)) and thus defines the spatial relationship of this interaction. It does, however, not give a further assessment of it as being detrimental, neutral, or beneficial for each partner. The following definitions can be used instead to describe the nature of algal interactions more precisely.

A symbiosis characterizes a close interaction between two different organisms, regardless of the effect they have on each other (Table 1, De Bary [1879](#); Correa [1994](#); Begon [2006](#)). Symbioses can be obligatory, if one or both partners depend on each other, or facultative. As pigmented algal endophytes are usually independent from their host in regard to their nutrition (Peters [1991](#); Correa [1994](#); Gauna & Parodi [2008](#)), they can be referred to as facultative

endosymbionts. Within a symbiosis, the effects of host and symbiont on each other may be either beneficial, innocuous or harmful (Table 1, Correa [1994](#)).

Mutualism describes a relationship between organisms of different species that results in a mutual benefit for each partner (Table 1, Begon [2006](#)). It usually involves the direct exchange of either nutrients or services, such as shelter or transport (Begon [2006](#)).

Commensalism, on the other hand, describes a relationship between two organisms where one partner benefits and the other one is neither significantly harmed nor helped (Table 1, Begon [2006](#)). The commensal may obtain nutrients, shelter, support or locomotion from a host that is unaffected by the former.

Parasitism is a non-mutual relationship between two organisms that is beneficial for one member (the parasite) and harmful for the other (the host, Table 1, Correa [1994](#); Begon [2006](#)). Parasites develop on or in their host and derive at least a part of their nutrition from the host (Begon [2006](#)).

Table 1: Overview on terms used to describe associations between different organisms. n.d. = not defined. + = positive effect. 0 = neutral, no effect. - = negative effect.

| Term | Host | Endophyte |
|--------------|------|-----------|
| Symbiosis | n.d. | n.d. |
| Mutualism | + | + |
| Commensalism | 0 | + |
| Parasitism | - | + |

If the presence of a symbiont has a negative effect on its host, it can be referred to as a pathogen. Pathogens are organisms that cause a disease in their hosts, i. e. an abnormal physiological or developmental condition (Correa [1994](#)).

The following postulates have been formulated by Koch ([1876](#)) as a reference in evaluating causal relationships between diseases and infectious agents (see also Evans [1976](#) for a revision of the Koch's postulates):

1. The putative pathogen must be present in all stages of the disease.
2. The putative pathogen must be isolated from the diseased host and be grown in pure culture.

3. When healthy hosts are infected with the putative pathogen from the pure culture, the specific symptoms of the disease must re-occur.
4. The organism must be re-isolated from the diseased host and correspond to the original putative pathogen.

Although the Koch postulates can be useful to describe pathogenicity of certain organisms, a major constraint is the fact that some pathogens cannot be grown in isolated cultures. These rules therefore have to be adapted according to the studied organisms (Evans [1976](#)).

Natural associations, such as kelp-endophyte interactions, cannot always be clearly labelled with the terms described above as it is often difficult to obtain solid data on the effect of the interaction on either partner. Particular endophyte species may be referred to as pathogens, in cases where evidence proves a harmful effect on the vital functions of the host, like retarded growth, loss of regeneration capacity or severe cellular damage (Yoshida & Akiyama [1979](#); Apt [1988a](#); Correa & McLachlan [1992](#); Correa et al. [1993](#)). A general classification of endophytes as pathogens, however, cannot be made. Instead, host-endophyte pairs have to be studied individually to assess the effects – beneficial or harmful – on each partner.

3.2 Endophytic red algae

Extensive literature exists on parasitic red algae that either possess highly reduced photosynthetic pigments (Kugrens & West [1973](#)), or have lost their coloration entirely (Evans et al. [1973](#), Callow et al. [1979](#)). Pigmented red algal endophytes, on the other hand, which are commonly members of the family Achrochaetiaceae, have received less research attention (Tam et al. [1987](#)). Although red algal endophytes are most often associated with red algal hosts (Fig. 5A), they have also been found infecting brown algae, such as *Desmarestia aculeata* (Fig. 5B, Selivanova & Zhigadlova [2013](#)).

Little is known about the epidemiology of these organisms and macroscopically detectable disease symptoms in infected hosts have only been described for few species. The filamentous endophyte *Rhododrewia porphyrae*, for instance, causes red spots in the economically important red alga *Porphyra*, whereas infections of other hosts, such as the red alga *Pterosiphonia bipinnata*, are usually not associated with macroscopic disease symptoms (Tam et al. [1987](#)).

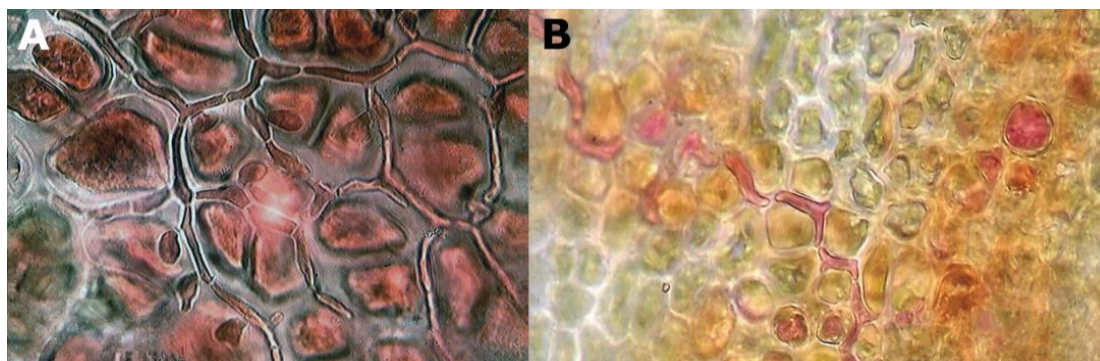

Fig. 5: **A.** Endophytic filaments of *Colaconema endophyticum* in *Membranoptera dimorpha* (source: Selivanova & Zhigadlova [2013](#)). **B.** Endophytic filaments of *Colaconema desmarestiae* in *Desmarestia aculeata* (source: Selivanova & Zhigadlova [2013](#)).

3.3 Endophytic green algae

The green algal genus *Ulvella* (formerly *Acrochaete*) contains several well-studied endophytic filamentous green algae. *Ulvella operculata* and *Ulvella heteroclada*, for instance, are considered as primary pathogens of the sporophytes of *Chondrus crispus*, an economically important rhodophyte (Correa & McLachlan [1994](#)). They do, however, not penetrate beyond the outer cell layers of the gametophyte of *C. crispus* (Correa & McLachlan [1991](#)). Green algal endophytes can have a negative impact on the growth, reproductive output, carrageenan yield, wound healing and regeneration of their host (Correa & McLachlan [1992](#); Faugeron et al. [2000](#)) and facilitate secondary infections by pathogenic bacteria (Correa & McLachlan [1994](#)).

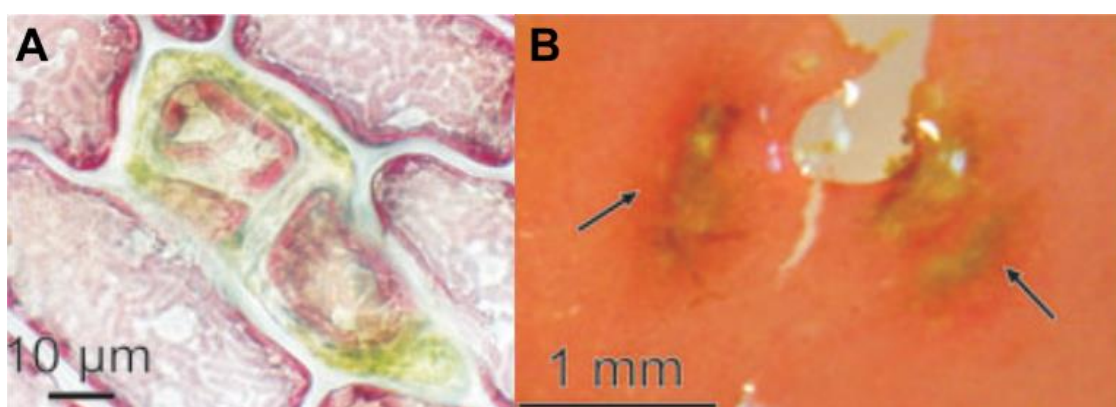

Fig. 6: **A.** The thallus of *Hymenena falklandica* showing green spots (arrows) as a symptom of infection with *Epicladia heterotricha* (source: Gauna & Parodi [2008](#)). [Printed with the permission of John Wiley and Sons] **B.** Thallus of *E. heterotricha* surrounding a cell of the host *H. falklandica* (source: Gauna & Parodi [2008](#)). [Printed with the permission of John Wiley and Sons]

Endophytic green algae can reach a very high prevalence in their host populations. *Epicladia heterotricha*, for instance, has been found infecting 100% of the individuals within a population of its host, the red alga *Hymenena falklandica*, in Argentina (Gauna & Parodi [2008](#)). It grows between the hosts' cells (Fig. 6A) and forms macroscopically visible green spots on its host (Fig. 6B, Gauna & Parodi [2008](#)).

3.4 Endophytic brown algae

Endophytic brown algae are most commonly found in kelps (Andrews [1977](#); Lein et al. [1991](#); Peters and Schaffelke [1996](#); Ellertsdóttir and Peters [1997](#)). They are microscopic, with filamentous thalli, diffuse growth, and usually possess plastids with pyrenoids (Burkhardt & Peters [1998](#)). Most endophytic brown algae are included in the Ectocarpales *sensu lato* due to their morphologically reduced nature and the presence of pedunculated pyrenoids but the phylogenetic relationships are not fully explored and classifications undergo continuous changes (Fig. 1B, Burkhardt & Peters [1998](#)). Limited sampling due to the difficult isolation of these algae from infected hosts has so far prevented a comprehensive revision of the taxonomy of endophytic brown algae.

The most commonly reported genera of kelp endophytes are *Laminariocolax* (Russel [1964](#); Ellertsdóttir & Peters [1997](#); Thomas et al. [2009](#)) and *Laminarionema* (Kawai & Tokuyama [1995](#); Peters & Ellertsdóttir [1996](#); Ellertsdóttir & Peters [1997](#)).

Laminarionema

The genus *Laminarionema* consists currently of only one species, i.e. *Laminarionema elsbetiae*. It has been first described in 1995 infecting *Saccharina japonica* in Japan, but none of the other kelp species in the direct vicinity, such as *Costaria costata* or *Undaria pinnatifida* (Kawai & Tokuyama [1995](#)).

Furthermore, it was found on Helgoland infecting *S. latissima* and – in lower amounts – *Laminaria digitata* (Ellertsdóttir & Peters [1997](#)). In Argentina, *L. elsbetiae* was found not in kelps but in the red alga *Rhodymenia pseudopalmata* (Gauna et al. [2009a](#)).

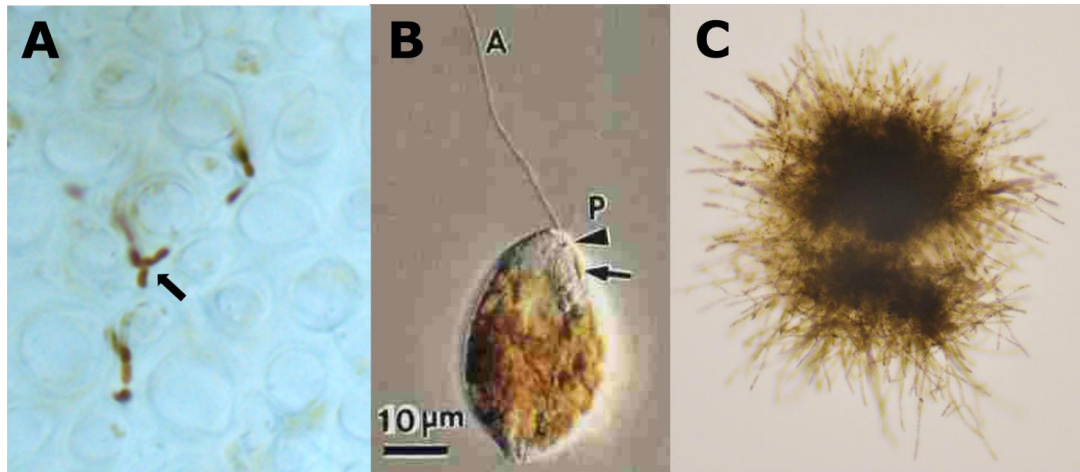

Fig. 7: **A.** Cross section of the blade of *S. latissima*: Vegetative *Laminarionema elsbetiae* filaments (arrow) growing between the host cells. **B.** Released macrospore of *L. elsbetiae* (source: Kawai & Tokuyama [1995](#)). [Printed with the permission of John Wiley and Sons] **C.** *L. elsbetiae* isolate from *S. latissima* in unialgal culture.

Laminarionema elsbetiae is characterised by a strictly endophytic thallus (Fig. 7A), with only phaeophycean hairs emerging from the host. Its large macrosporangia form a single very large macrospore of 23 – 30 µm length, one of the largest flagellated cells in brown algae (Fig. 7B, Kawai & Tokuyama [1995](#); Peters & Ellertsdóttir [1996](#)).

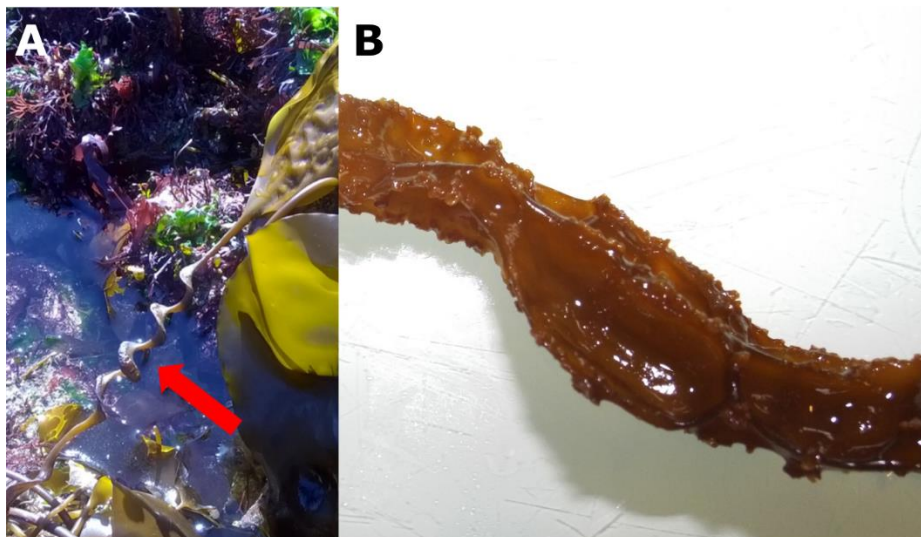

Fig. 8: **A.** Twisted stipe (arrow) of *S. latissima*. **B.** Distorted blade and warts on *S. latissima*, infected with *L. elsbetiae*.

Like other pigmented algal endophytes, it can be isolated from the host tissue and be grown in unialgal culture (Fig. 7C). *Laminarionema elsbetiae* has been associated with the following

disease symptoms: dark spots, twisted stipes (Fig. 8A), wart-like protrusions and degenerated phylloids (Fig. 8B, Peters & Ellertsdóttir [1996](#); Ellertsdóttir & Peters [1997](#)). However, while 93% of individuals in a natural *Saccharina latissima* population on Helgoland were infected with *L. elsbetiae*, only half of the infected kelps showed morphological alterations visible by eye (Peters & Ellertsdóttir [1996](#); Ellertsdóttir & Peters [1997](#)). Thus, the presence of *L. elsbetiae* alone is not causing disease symptoms and it can therefore not generally be described as a pathogen. Other factors, for instance endophyte density or the distribution in the host, may be crucial for the occurrence of disease symptoms (Gauna et al. [2009a](#)).

Laminariocolax

Two endophytic species of the genus *Laminariocolax* have been described to date: *Laminariocolax aecidioides* and *Laminariocolax tomentosoides*.



Fig. 9: **A.** Cross section of the stipe of *L. digitata*: Vegetative *Laminariocolax tomentosoides* filaments (arrow) growing between the host cells. **B.** Distorted blade of *L. digitata* (arrow), infected with *L. tomentosoides*.

L. aecidioides was originally described from Greenland (Rosenvinge [1893](#)) and includes the taxa *L. eckloniae* and *L. macrocystis*, which have formerly been described as distinct species (Peters et al. [2015](#)). It is found in temperate to polar regions worldwide and known to infect a broad range of kelps, including *Ecklonia maxima* (Burkhardt & Peters [1998](#)), *Macrocystis pyrifera* (Peters [1991](#)), *Saccharina sessilis* (Setchell & Gardner [1922](#)) and *Undaria pinnatifida* (Yoshida & Akiyama [1979](#)), but also other brown algal hosts, such as *Fucus vesiculosus*

(Fucales, Nielsen & Gunnarson [2001](#)), *Saccorhiza polyschides* (Tilopteridales, Dixon [1961](#)) and *Himantothallus grandifolius* (Desmarestiales, Peters [2003](#)). *L. aecidioides* has been associated with various disease symptoms in kelps, in particular dark spots (Peters & Schaffelke [1996](#); Gauna et al. [2009b](#)) wart-like protrusions, galls (Lein et al. [1991](#)), crippled thallus (Peters & Schaffelke [1996](#)) and tumours (Thomas et al. [2009](#)). However, similarly to *Laminarionema elsbetiae*, not all infected hosts show disease symptoms (Gauna et al. [2009b](#)). *Laminariocolax aecidioides* can reach a very high prevalence in host populations, infecting up to 100% of the host individuals, as reported for a *S. latissima* population in Kiel (Peters & Schaffelke [1996](#)) and for a population of *Laminaria hyperborea* on the southwestern coast of Norway (Lein et al. [1991](#)).

Laminariocolax tomentosoides is the type species of the genus *Laminariocolax*. It was first described as *Ectocarpus tomentosoides* by Farlow ([1889](#)) infecting *Laminaria* species in Massachusetts (United States). It has been isolated from seaweeds along the North Pacific (Lee [1980](#); Klochkova et al. [2009](#); Lindstrom [2006](#); Liu [2008](#)) and North Atlantic coasts (Russel [1964](#)). In Europe, *Laminariocolax tomentosoides* is most commonly found in *Laminaria digitata* (Fig. 9A, Russel [1964](#); Kornmann & Sahling [1977](#)), but it also infects other brown and red seaweeds, like *Palmaria palmata* (Russel [1964](#)) and *Grateloupia turuturu* (Villalard-Bohnsack & Harlin [2001](#)). Disease symptoms associated with *Laminariocolax tomentosoides* include twisted stipes and fronds (Fig. 9B, Peters [2003](#)). Similar to what has been reported for other endophyte species, the prevalence of *L. tomentosoides* within a host population can be very high (up to 87%, Ellertsdóttir & Peters [1997](#)).

4. Algal defence reactions against biotic stresses

4.1 Recognition of the attacker

In biotic interactions, the key for an effective defence is the early recognition of an attacker in order to stop it before irreversible damage is done (Weinberger [2007](#)). A common feature of innate immunity in eukaryotes is the recognition of exogenous microbe- or pathogen-associated molecular patterns (MAMPs or PAMPs, Nürnberger et al. [2004](#)). MAMPs are highly conserved patterns in the cell envelope or cell wall, which are found only on the attacker, but not on the host itself (Küpper et al. [2006](#); Weinberger [2007](#)).

In addition to MAMPs, algae can also recognize endogenous elicitors that induce defence responses, such as oligosaccharides derived from the degradation of their own cell wall

following a biotic attack (Küpper et al. [2001](#), [2002](#)). Alginate – the main component of the brown algal cell wall - is a linear polymer composed of two different monomers: β -D-mannuronate (M) and α -L-guluronate (G, Fig. 10). They are linked either in homopolymeric guluronate blocks (GG), homopolymeric mannuronate blocks (MM) or alternating mannuronate and guluronate blocks (MG, Fig. 10, Paredes Juárez et al. [2014](#)). Only the guluronate-containing blocks are recognized as endogenous elicitors by *Laminaria digitata*, with GG blocks inducing a much stronger oxidative burst (description see below) than MG blocks. MM blocks and alginate polymers are not recognized by the kelp and thus cannot elicit measurable defence reactions (Küpper et al. [2001](#)).

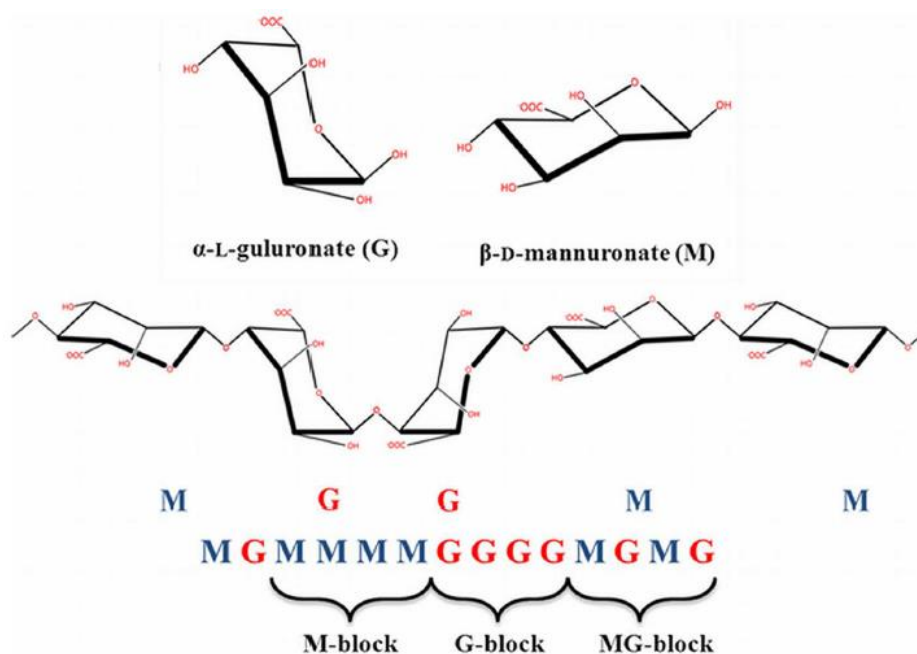

Fig. 10: Chemical structure of alginate. Linear block polymers of β -D-mannuronate (M) and α -L-guluronate (G) with a variation in composition and sequential arrangements (source: Paredes Juárez et al. [2014](#)).

The endophytic green alga *Ulvella operculata* expresses carrageenolytic activity to degrade and penetrate into the cell wall of its host, the red alga *Chondrus crispus* (Bouarab et al. [1999](#)). Similarly, Heesch & Peters ([1999](#)) suggested that the spores of the brown algal endophytes *Laminarionema elsbetiae* and *Laminariocolax aecidioides* penetrate the surface of *S. latissima* by locally dissolving the cell wall using alginolytic enzymes. GG blocks are likely to be released during the interaction with alginolytic organisms and could therefore act as endogenous elicitors during kelp-endophyte interactions.

4.2 Inducible defence responses

4.2.1 Oxidative burst

One of the defence reactions following the perception of exogenous or endogenous elicitors is the oxidative burst, i.e. the massive production of reactive oxygen species (ROS), such as superoxide ions, hydrogen peroxide or hydroxyl radicals, through the activation of plasma membrane-associated NADPH oxidases (Bouarab et al. [1999](#); Küpper et al. [2001](#); Weinberger and Friedlander [2000](#)). The oxidative burst is a component of innate immunity conserved among eukaryotes, from animals to terrestrial plants and marine macroalgae (Halliwell & Gutteridge [2007](#)). It is rapid – in *Laminaria digitata* it was measured 2 to 3 minutes after the addition of GG – and transient, lasting no longer than 30 minutes (Küpper et al. [2001](#)).

In kelp sporophytes, an oxidative burst can be induced either by exogenous or endogenous elicitors: lipopolysaccharides from the cell wall of gram-negative pathogenic bacteria (Küpper et al. [2006](#)) as well as GG derived from its own cell wall (Küpper et al. [2001](#)) induced a strong oxidative burst in *L. digitata*. GG equally induced an oxidative burst in sporophytes of other kelp species, such as *S. latissima*, *L. hyperborea*, *Laminaria ochroleuca* and *Laminaria pallida*, whereas kelp gametophytes generally did not respond to these elicitors (Küpper et al. [2002](#)).

Interestingly, the response to GG seems to be restricted to the sporophytes of Laminariales and Desmarestiales. Other brown algae, like members of the Fucales and Ectocarpales, do not respond to the addition of endogenous elicitors although their cell walls also contain alginate (Küpper et al. [2002](#)).

The released ROS have direct cytotoxic effects that can help to control and suppress the growth of pathogenic bacteria (Weinberger & Friedlander [2000](#); Küpper et al. [2001](#); Küpper et al. [2002](#)). Furthermore, they serve as a signal to induce and mediate the activation of defence genes (Hancock et al. [2001](#); Neill et al. [2002](#)).

In concordance with reports about the importance of H₂O₂ in the systemic acquired resistance of terrestrial plants (Torres et al. [2006](#)), ROS also seem to play an essential role in the resistance of seaweeds against algal endophytes. Sporophytes of the red alga *C. crispus*, which are susceptible to an infection by the green algal endophyte *U. operculata*, released only low amounts of H₂O₂ when challenged with extracts of the endophyte (Bouarab et al. [1999](#)). In contrast, the gametophytes of *C. crispus* – the naturally resistant generation – responded with a strong oxidative burst. In the kelp *L. digitata*, an oxidative burst elicited by GG treatment around 1 week prior to the infection increased the resistance of *L. digitata* against the algal

endophyte *Laminariocolax tomentosoides* (Küpper et al. [2002](#)). The authors hypothesized that ROS induced secondary long-term defence mechanisms in *Laminaria digitata*, including the mediation of cell-wall modifications in order to provide a barrier against penetration by the pathogen (Küpper et al. [2002](#)).

4.2.2 Free fatty acids and oxylipins release

Another common response of eukaryotes following the perception of an attacker is the production of free fatty acids and oxygenated derivatives known as oxylipins (Weinberger [2007](#)). Many inducible defence genes in terrestrial plants are regulated by signalling pathways involving oxylipins, such as jasmonic acid (Dave & Graham [2012](#)). In marine algae, oxylipins are produced from C20 and C18 fatty acids (Gerwick et al. [1999](#)) and are involved in the responses to abiotic and biotic stresses. The red alga *Gracilaria chilensis* releases oxylipins as part of its defence against epiphytes (Lion et al. [2006](#)). Furthermore, oxylipins are essential in the natural resistance of the *C. crispus* gametophyte against the endophyte *U. operculata*, as an inhibition of the oxylipin pathways increased the susceptibility of *C. crispus* gametophytes to the endophyte significantly (Bouarab et al. [2004](#)). Free fatty acids and oxylipins also seem to play an important role in the interactions between kelps and endophytes: Küpper et al. ([2009](#)) showed that a pre-incubation of *L. digitata* with methyl jasmonate, a volatile derivative of jasmonic acid, induced resistance of the kelp against the endophyte *Laminariocolax tomentosoides*.

4.2.3 Halogenation

The emission of iodinated, brominated or chlorinated low-molecular-weight carbon skeletons (volatile halogenated organic compounds, VHOCs) is a rapid, phylum-specific defence response of marine macroalgae (reviewed by Leblanc et al. [2006](#); Cosse et al. [2009](#)). It is well known that marine algae, and kelps in particular, are concentrating halides from the environment. The dry weight of young *L. digitata* sporophytes consists of up to 4.7% of iodine dependent on the tissue, the season and the age of the plant (Ar Gall et al. [2004](#)), whereas red algae are important accumulators of bromine (Saenko et al. [1978](#)). A particular class of peroxidases – vanadium-dependent haloperoxidases (vHPO) – plays a key role in the halogen metabolism of marine algae. They catalyse the oxidation of halides in the presence of H₂O₂. A diffusible halogen intermediate X⁺ is formed that halogenates various organic substrates to

form VHOCs (reviewed by Leblanc et al. [2006](#)). Iodine is mainly accumulated as iodide in kelps, which is considered an important scavenger of H₂O₂ and other ROS that are formed during the oxidative responses (Küpper et al. [2008](#)). VHOCs, on the other hand, are likely to play a direct role in the defence of marine algae against biotic and abiotic stresses (Leblanc et al. [2006](#); La Barre et al. [2010](#)). The production of VHOCs is increased under abiotic stresses, such as high light, UV exposure or temperature stress (Mtolera et al. [1996](#); Abrahamsson et al. [2003](#); Laternus et al. [2004](#)). Furthermore, an upregulation of VHOCs production has been observed as a response of the red algae *Gracilaria sp.* and *C. crispus* to oligosaccharide defence elicitors (Cosse et al. [2007](#); Weinberger et al. [2007a](#)). In *L. digitata*, GG elicitation was followed by the emission of iodine-containing halocarbons and molecular iodine I₂ (Palmer et al. [2005](#); Ball et al. [2010](#); Leigh et al. [2010](#)). Cosse et al. ([2009](#)) furthermore proposed a putative role of vHPOs in oxidative cross-linking of alginates and polyphenols, which leads to cell wall strengthening and mechanical protection against herbivores and pathogens, such as endophytic algae.

4.2.4 Transcriptomic regulation

Regulating the gene expression is a key response of eukaryotes to biotic and abiotic stresses (reviewed by Shinozaki & Yamaguchi-Shinozaki [2007](#) and de Nadal et al. [2011](#)). Insights into an organism's transcriptome - the complete set of transcripts and their quantity - can help to reveal and identify genes that are differentially regulated during specific interactions, such as host-pathogen interactions (reviewed by Westermann et al. [2012](#)). While various technologies have been used over time to measure the gene expression of different organisms, the contemporary two main techniques are the hybridisation of transcripts to an array of probes (microarray technology) and the more recent RNA-sequencing (RNAseq, see the review by Lowe et al. [2017](#) for the development of transcriptomics technologies). In 1995, microarrays were used for the first time to study the gene expression of *Arabidopsis* (Schena et al. [1995](#)). The development of RNAseq followed in 2006 (Bainbridge et al. [2006](#)) and new high-throughput sequencing technologies have since led to a rapid increase in the amount of RNAseq experiments in plant and animal research (reviewed by Lowe et al. [2017](#)).

In seaweeds, on the other hand, there has been a significant delay in the publication of transcriptomic data. Collén et al. ([2007](#)) were the first to perform a microarray-based transcriptomic study on defence mechanisms of *C. crispus*, showing that seaweeds respond to

abiotic stresses with multiple transcriptomic changes. Since then, the amount of publications in this field has increased significantly within the last decade using both microarrays and RNAseq technologies. The biggest part of available literature focusses on transcriptomic responses to abiotic factors (Deng et al. [2012](#); Liu et al. [2014](#); Heinrich et al. [2015](#); Sun et al. [2015](#); Lee et al. [2017](#)) and only few studies have investigated the transcriptomic regulation associated to biotic stresses so far. Recently, a transcriptomic analysis of the brown seaweed *Fucus vesiculosus* showed that only a small amount of genes was up- or downregulated in response to grazing by *Littorina obtusata* after 3 and 12 days (Flöthe et al. [2014](#)). Similarly, Ritter et al. ([2017](#)) found only 0.8% of the totally identified genes of the kelps *Laminaria digitata* and *Lessonia spicata* to be differentially expressed during grazing. Although they presented a set of candidate genes that were specifically induced by grazing, the biological role of these genes remains unclear due to few homologies with known gene functions (Ritter et al. [2017](#)).

When *C. crispus* gametophytes were challenged with cell-free extracts of *U. operculata*, Bouarab et al. ([2004](#)) observed an upregulation of phenylalanine ammonia lyase, an enzyme involved in the biosynthesis of aromatic compounds, which was correlated with an increased resistance against the endophyte. Besides this study, the gene expression of seaweeds upon an infection with algal endophytes has never been studied until now.

However, Cosse et al. ([2009](#)) demonstrated a rapid regulation of the transcriptome of *L. digitata* after GG elicitation, with the maximal numbers of upregulated genes after 6 hours. As GG blocks are likely to be released by kelps during an infection with algal endophytes, gene expression might be similar during these interactions. Certain general transcriptomic responses towards stress were shown to be conserved among eukaryotes, such as antioxidant mechanisms, signalling or the production of antimicrobial secondary compounds, whereas other mechanisms, like the involvement of iodine metabolism in defence responses, appear to be a novel trait among marine algae (Cosse et al. [2009](#)). GG elicitation also induced a number of C5 epimerases which convert MM-rich alginates into GG-rich polysaccharides, thereby potentially strengthening the cell wall as mechanical protection against pathogens (Cosse et al. [2009](#)). Although the transcriptomic responses of kelps towards endogenous elicitors have been described partially, genome-wide transcriptomic response patterns during biotic interactions remain poorly understood.

A schematic overview of the different hypothetically induced defence responses of kelps during interactions with algal endophytes is presented in Fig. 11.

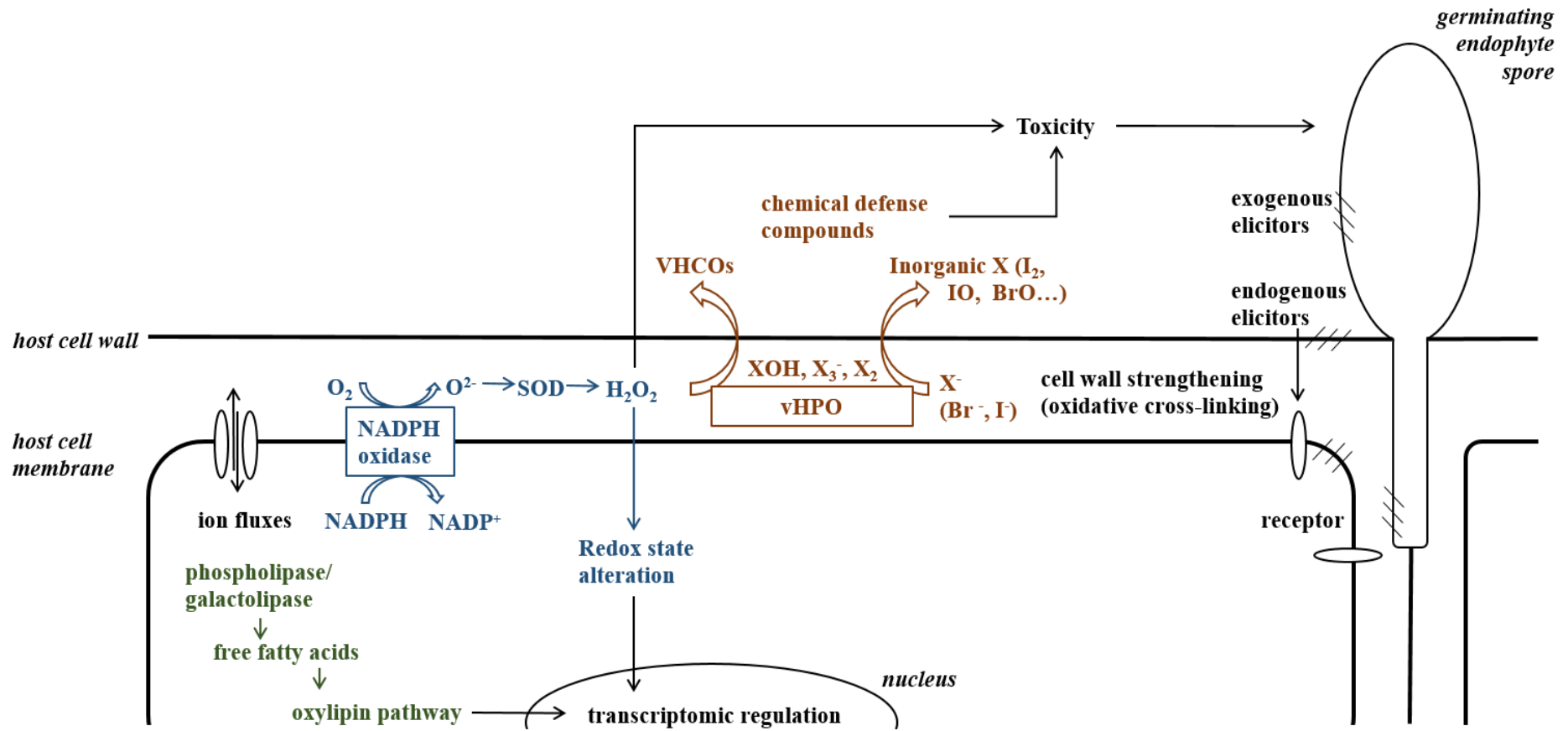

Fig. 11: Scheme of hypothetical pathways induced in kelp –endophyte interactions (based on Cosse et al. 2007). Blue: oxidative burst, green: oxylipin pathway, brown: halogen pathway. SOD = superoxide dismutase, vHPO = vanadium-dependent haloperoxidase, VHCOs = volatile halogenated organic compounds.

4.3 Systemic responses and distance signalling

In animals and plants, in order to restrict the spread of an attacker, defence mechanisms may not only be induced locally, but also in distant tissue that is not challenged directly (reviewed by Boehm [2012](#) and Dempsey & Klessig [2012](#)). These so-called systemic responses have rarely been studied in seaweeds. Potin et al. ([2002](#)) showed that resistance of *C. crispus* against the endophyte *U. operculata* triggered by oligosaccharide elicitation occurred only at the part of the thallus that had been challenged with the oligosaccharides, but not at distant parts. The authors therefore concluded that *C. crispus* is not able to transfer signals internally in order to restrict potential infections (Potin et al. [2002](#)).

On the contrary, when the kelp *L. digitata* was challenged with GG, oxidative responses were not only triggered locally at the site of elicitation, but also at distant parts of the kelp's thallus (Thomas et al. [2014](#)). Using a pharmacological approach the authors showed that – unlike in terrestrial plants – ROS were not involved in the long distance signalling in *L. digitata*. Instead, their results suggested that free fatty acids and their derivatives are translocated through the sieve elements of kelps to distant parts of the thallus where they activate ROS production or are further metabolized to oxylipins (Thomas et al. [2014](#)). The role of systemic responses and distance signalling during kelp-endophyte interactions remains to be studied.

5. Thesis project and outline

This thesis project is part of ALFF (Algal Microbiome: Friends and Foes), a Marie Skłodowska-Curie Initial Training Network funded by the European Union. In the course of the global increase of algal aquaculture, research in applied phycology mainly focuses on yield improvement and engineering bottlenecks or the discovery of new metabolites. A big challenge that has so far been largely understudied, however, is the understanding of the role of microorganisms (the so-called algal microbiome) on algal growth and development which may be beneficial, neutral or harmful. In this context, my thesis focuses on the interactions of kelps with filamentous algal endophytes.

The challenges that remain to be tackled regarding this topic are very diverse. Due to the difficult isolation of the endophytes from their hosts, extensive sampling campaigns are rare. Therefore, not only the phylogeny of these organisms is undergoing continuous changes (Burkhardt & Peters [1998](#), Peters et al. [2015](#)), but also little is known about the biogeographic distributions and host ranges of different endophyte species (see Eggert et al. [2010](#) for a

discussion of these aspects). In addition, important parts of the biology of filamentous endophytic algae have only been studied partially. For instance, while the life cycle of most endophyte species has been described under laboratory conditions (Kawai & Tokuyama [1995](#); Peters & Ellertsdóttir [1996](#); Gauna et al. [2009b](#)), it has rarely been followed in nature (Peters 1991). The endophytes spread via zoospores that are released from plurilocular sporangia on infected host plants (Peters & Ellertsdóttir [1996](#); Heesch & Peters [1999](#)), but spore release by the endophyte has never been followed over the course of a year and it is unclear which mechanisms are causing the spore release in nature. Furthermore, former studies imply that specific relationships between endophytes and kelps exist (Russel [1964](#); Kawai & Tokuyama [1995](#); Ellertsdóttir & Peters [1997](#)), but the molecular bases of host specificity are hardly understood. A local dissolution of the kelp surface by enzymes has been suggested as the mechanisms for invasion by the endophyte spores (Heesch & Peters [1999](#)) – similar to what has been described for the green algal endophyte *U. operculata* (Correa & McLachlan [1994](#)) – but further biochemical and molecular studies are necessary to confirm this hypothesis.

Another important point that remains to be investigated is whether the disease symptoms that are usually co-occurring with the presence of endophytic algae are actually caused by the endophytes, as no experimental proof based on the Koch postulates (Koch [1876](#)) exists. It is also unclear if these disease symptoms could decrease the economic value of cultivated kelps. Unlike a lot of other biotic stressors, such as epiphytes, bryozoans, amphipods or gastropods (Forbord et al. [2012](#); Handå et al. [2013](#); Peteiro & Freire [2013](#); Lüning & Mortensen [2015](#)), the impact of endophytic infections on kelp aquaculture has rarely been investigated (Yoshida & Akiyama [1979](#)),

The lack of a reliable method to quantify endophytic infections makes epidemiological studies and experiments on the variation and dynamics of endophytic infections very difficult. Former epidemiological studies have mainly been based on visual assessments of microscopic sections and the subsequent isolation of endophytic filaments in order to identify them by morphological or molecular characters. However, this approach is not only time-consuming, but also less adapted for an actual quantification.

It is now established that kelps feature innate immunity as other eukaryotic multicellular lineages and that they activate defense responses during biotic attacks (Küpper et al. [2001](#); Küpper et al. [2002](#); Cosse et al. [2009](#); Flöthe et al. [2014](#); Ritter et al. [2017](#)). However, an overall picture of how kelps respond towards endophytic infections on a molecular level is missing.

To obtain a better understanding of kelp-endophyte interactions on a physiological and molecular level, I combined different methodological approaches in my thesis:

In chapter I, I investigated the diversity of endophyte strains isolated from different kelp species in Europe, Chile, Korea and New Zealand by sequencing two unlinked molecular markers. The data allowed not only a revision of the molecular phylogeny of kelp endophytes and a comparison of their biogeographic distribution ranges, but also inferences on specificity of certain kelp-endophyte relationships.

In chapters II+III, I describe a qPCR-based quantitative method to follow spatio-temporal dynamics of endophytic infection patterns of *Laminarionema elsbetiae* in *S. latissima*, using a long-term approach in natural kelp populations (chapter II) and short-term approach in seaweed aquaculture (chapter III). The results also provided new insights into the life cycle of *Laminarionema elsbetiae*.

Chapter IV compares the physiological and molecular responses of two different kelp species to an infection by the endophyte *Laminarionema elsbetiae*. While the endophyte is very common in natural populations of *S. latissima*, it is only occasionally found in *Laminaria digitata*, suggesting that the two kelp species react differently towards the infection. To test this hypothesis, I developed a co-cultivation bioassay to measure the impact of *L. elsbetiae* on the growth of both hosts. Furthermore, large-scale RNA sequencing was used to compare the regulation of the gene expression of both kelp species during the first contact with the endophyte.

Chapter I. Diversity, biogeography and host specificity of kelp endophytes with a focus on the genera *Laminariocolax* and *Laminarionema*

The first important step towards a better understanding of kelp-endophyte interactions is the investigation of the diversity of algal endophytes, not only in order to obtain an overview of the common species, but also to find out whether consistent patterns in the specificity of endophytes towards certain hosts exist. Due to their morphologically reduced nature, filamentous brown algae – which are often found as epi- and endophytes in kelps - are commonly included in the Ectocarpales *sensu lato*. However, their phylogenetic relationships are not fully explored and their classifications underwent continuous changes since the first description of *Laminariocolax* as a kelp endophyte in the late 19th century (Farlow 1889). As species identification based exclusively on morphological characters has turned out to be insufficient, a combination of descriptive data with DNA barcoding has emerged as a well-suited tool to catalogue the diversity and unravel the phylogeny of filamentous brown algal endophytes (Thomas et al. 2009; Peters et al. 2015). In order to obtain DNA of endophytic algae, they have first to be isolated and cultivated in unialgal cultures in a difficult and time-consuming process which has so far prevented a comprehensive revision of the endophyte taxonomy.

The study presented in this chapter included 56 endophyte strains which were isolated from seven different kelp species in Europe, Korea, Chile and New Zealand. They were grown in unialgal cultures until enough material for DNA extraction was available to investigate their molecular diversity by sequencing two independent molecular markers, the mitochondrial 5'-COI and the nuclear ITS1. The new molecular data were combined with published sequences as well as records based on morphological descriptions in order to revise the phylogeny of the identified species. A new species of the genus *Laminariocolax* was described here as *Laminariocolax atlanticus* sp. nov. Using the data, it was also possible to define the global biogeographic distribution ranges of four different endophyte species and to obtain first insights into the specificity of host-endophyte relationships.

Article

Diversity, biogeography and host specificity of kelp endophytes with a focus on the genera *Laminarionema* and *Laminariocolax* (Ectocarpales, Phaeophyceae)

Authors: Miriam Bernard^{1*}, Martina Strittmatter², Pedro Murúa^{2,3}, Svenja Heesch¹, Ga Youn Cho⁴, Catherine Leblanc¹, Akira F. Peters^{5*}

¹ Sorbonne Université, CNRS, UMR 8227, Integrative Biology of Marine Models, Station Biologique de Roscoff, Roscoff, France

² The Scottish Association for Marine Science, Scottish Marine Institute, Culture Collection for Algae and Protozoa, Oban, Argyll, PA37 1QA, Scotland, United Kingdom.

³ Aberdeen Oomycete Laboratory, International Centre for Aquaculture Research and Development, University of Aberdeen, Foresterhill, Aberdeen, AB25 2ZD, Scotland, United Kingdom.

⁴ National Institute of Biological Resources, Incheon 22689, Korea

⁵ Bezhin Rosko, 29250 Santec, France

* Corresponding authors

This chapter is accepted for publication in the European Journal of Phycology

Abstract

Endophytic filamentous brown algae are known to invade stipes and fronds of kelps with potentially negative effects for the hosts. They have simple filamentous thalli and are difficult to identify based on morphology. We investigated the molecular diversity of 56 endophytes isolated from seven different kelp species from Europe, Chile, Korea and New Zealand by sequencing two unlinked molecular markers (5'COI and ITS1). A majority of 49 of the isolated endophytes (88%) belonged to the genera *Laminarionema* and *Laminariocolax*. The endophyte *Laminarionema elsbetiae* was isolated from *Saccharina latissima* and *S. japonica* tissues in Europe and Korea, respectively, showing highly similar sequences in both regions. In contrast, three different species of the genus *Laminariocolax* were identified, the most common of which being *L. aecidioides*, an endophyte with a worldwide distribution and a broad host range. The other two species - *L. tomentosoides* and a species described here as *Laminariocolax atlanticus* sp. nov.- were associated with different kelp species in the Northern hemisphere and the North Atlantic, respectively. Our results suggest that specific host-endophyte patterns could exist locally, as found in kelps in Brittany, where all endophytes isolated from *S. latissima* in Brittany were *L. elsbetiae*, all endophytes isolated from *Laminaria digitata* were *Laminariocolax tomentosoides*, and the two species *L. atlanticus* and *L. aecidioides* both isolated from *Laminaria hyperborea*. However, this pattern was not consistent with the results from other places, like Western Scotland and Helgoland, where the same kelp species are present.

Keywords

Endophytes; kelps; barcoding; 5'COI; ITS1; biogeography; host specificity

1. Introduction

Kelps are essential elements of lower eulittoral and sublittoral zones of rocky shore coastal ecosystems in temperate and northern polar seas (Bartsch et al. [2008](#)). While they serve as food source or habitats for animals, they also provide a substratum for smaller algae growing on (epiphytes) and inside (endophytes) their thalli (Dayton [1985](#); Bartsch et al. [2008](#)). Epiphytes penetrate into the outermost cell layers of the host tissue mainly for mechanical support (Setchell [1918](#)). Endophytes, on the other hand, may grow entirely within a host and only reproductive structures are formed at the host surface (Peters [1991](#)). A clear distinction of epi- and endophytes is not always possible because certain species may represent a continuum between an epiphytic and endophytic lifestyle (Peters [2003](#); Gauna & Parodi [2008](#)). Furthermore, most of these associations are facultative and life stages of such endophytic species may also be found outside of their hosts (Peters et al. [2015](#); Küpper et al. [2016](#)). In this study, we use the term endophyte to describe organisms that possess the ability to penetrate deeper than the cortex and grow inside of an algal host. Infections by filamentous endophytic brown algae have been reported from kelp species worldwide (e.g., Peters [1991](#); Kawai & Tokuyama [1995](#); Ellertsdóttir & Peters [1997](#); Amsler et al. [2009](#); Gauna et al. [2009a+b](#)), with a prevalence of up to 100% of infected individuals within a population (Lein et al. [1991](#)). The presence of endophytes in kelps often coincides with disease symptoms, such as dark spots on fronds, warts or twists of fronds and stipes (Yoshida & Akiyama [1979](#); Apt [1988a](#); Peters & Schaffelke [1996](#); Ellertsdóttir & Peters [1997](#); Thomas et al. [2009](#)). However, not all infected hosts show morphologic changes (Gauna et al. [2009b](#); Bernard et al. [2017](#)), and until now the basic underlying molecular mechanisms of this interaction and the profits or disadvantages for either partner are still unclear.

Endophytes of kelps are in most cases microscopic brown algae, with filamentous thalli, diffuse growth, and plastids with pyrenoids (Burkhardt & Peters [1998](#)). Due to their morphologically reduced nature they are included in the Ectocarpales *sensu lato*, but their phylogenetic relationships are not fully explored, and classifications undergo continuous changes. The species *Laminariocolax aecidioides* (Rosenvinge) A.F.Peters, for instance, was originally classified in the genus *Ectocarpus*, as *E. aecidioides* Rosenvinge ([1893](#)). Later it was assigned to the genera *Phycocelis*, *Myrionema*, *Entonema*, *Gononema* and *Streblonema*, based on different aspects of the endophyte's morphology (Burkhardt & Peters [1998](#)). A molecular systematic study finally classified it in the genus *Laminariocolax* within the Chordariaceae (Burkhardt & Peters [1998](#)). As the description of filamentous endophytic brown algae based

exclusively on morphological characters has turned out to be insufficient, a combination of descriptive data with DNA barcoding emerged as a well-suited method to catalogue the diversity and unravel the phylogeny of this group of organisms (Thomas et al. [2009](#); Peters et al. [2015](#)). However, limited sampling due to the difficult isolation of these algae from infected hosts has so far prevented a comprehensive revision of the endophyte taxonomy. Furthermore, little is known about their biogeographic distributions and host ranges (see Eggert et al. [2010](#) for a discussion of these aspects).

In this study, we isolated 56 endophyte strains from seven different kelp species in Europe, Korea, Chile and New Zealand and investigated their molecular diversity using two independent molecular markers, 5'COI and ITS1. The mitochondrial cytochrome oxidase I locus (5'COI) was proposed as a universal marker for DNA barcoding of animals by Herbert et al. ([2003](#)). It is suitable for species delimitation of various organisms, such as insects (Herbert et al. [2004](#)), zooplankton (Bucklin et al. [2010](#)), but also red algae (Saunders [2005](#); Le Gall & Saunders [2010](#)) and several brown algal groups, such as *Fucus* (Kucera & Saunders [2008](#)), Laminariaceae (McDevit & Saunders [2010](#)), *Sargassum* (Mattoo & Payri [2010](#)), *Desmarestia* (Yang et al. [2014](#)) and Ectocarpales (Peters et al. [2015](#); Montecinos et al. [2017](#)). The internal transcribed spacer 1 (ITS1) is a nuclear marker, separating the 18S and 5.8S subunits of the rDNA. While the 18S subunit is commonly used as a nuclear marker to roughly classify microbial eukaryotes (e.g. Tragin et al. [2016](#)), it is not sufficiently variable to distinguish between different species of brown algae (Saunders & Kraft [1995](#)). The ITS1 region, evolving much faster than the adjacent subunit regions of the rDNA (Baldwin [1992](#); Goff et al. [1994](#)), has therefore been established as a common nuclear marker to distinguish closely related species in the Phaeophyceae (Burkhardt & Peters [1998](#); Kucera & Saunders [2008](#); Kogame et al. [2015](#); Montecinos et al. [2017](#)).

The aims of this paper were to study the molecular phylogeny of the isolated endophytes and to compare their biogeographic distribution ranges based on published and new molecular data as well as on morphological records. Our data also allowed inferences on specific host-endophyte relationships.

2. Material and Methods

2.1 Sampling and isolation of endophytes

Endophytes were isolated from kelp tissue as described by Peters & Ellertsdóttir (1996), with most strains deriving from tissue showing obvious morphological alterations, like dark spots, warts or twists on the kelp fronds and stipes (Eggert et al. 2010). The kelps were usually collected in situ during low tide and one endophyte strain was isolated per host individual. In total, 56 clonal endophyte strains were included in the study (Table S1 in the supplementary material). They were isolated from seven different kelp species: *Laminaria digitata* (Hudson) J.V.Lamouroux, *L. hyperborea* (Gunnerus) Foslie (Brittany, Helgoland), *Saccharina latissima* (L.) C.E.Lane et al. (Brittany, German Baltic and North Sea, Scotland and England), *Saccharina japonica* (Areschoug) C.E.Lane et al. (Korea), *Saccharina nigripes* (J.Agardh) Lontin & G.W.Saunders (Svalbard), *Lessonia berteroana* Montagne (Chile) and *Macrocystis pyrifera* (L.) C.Agardh (New Zealand). Furthermore, a filamentous brown alga (BI-041) isolated from incubated substratum from Baffin Island in the Canadian Arctic (Küpper et al. 2016) has been added to the present study. The endophytes from temperate regions were cultivated at 14°C, Arctic isolates at 4°C, with monthly changes of the culture medium (half-strength Provasoli enrichment, Coelho et al. 2012). Light irradiance was 5 $\mu\text{mol photons s}^{-1} \text{m}^{-2}$ at 12 h light/day.

2.2 DNA extraction, barcode markers, amplification and sequencing

Algal material from actively growing cultures was freeze-dried and ground in a mechanical bead grinder (Tissuelyser II, Qiagen, Germany) twice for 2 min at 30 Hz. DNA was extracted using the Nucleospin Plant II kit (Macherey-Nagel, Germany). The mitochondrial marker (5'COI, primers GazF2 and GazR2, Lane et al. 2007) was PCR-amplified in all samples. Additionally, the nuclear ribosomal marker (ITS1, primers AFP4L and 5.8S1R, Peters & Burkhardt 1998) was amplified in representative isolates (at least one isolate from each locality). The total PCR reaction volume consisted of 20 μL , containing 3 mM MgCl_2 , 5x Green GoTaq Flexi buffer (Promega, US), 1 μL template DNA, primers at 400 nM, 0.2mM dNTP each and 1 unit of GoTaq Flexi Polymerase (Promega, US). An initial 4-min denaturation step at 95°C was followed by 35 cycles of 30 s at 95°C, 30 s at 55°C and 1 min at 72°C and a final extension at 72°C for 10 min. PCR products were commercially Sanger

sequenced using the primers mentioned above and each resulting chromatogram was checked for quality by eye.

2.3 Data analysis

The COI sequences were edited in MEGA7 (Kumar et al. [2016](#)) and aligned by MUSCLE (Edgar [2004](#)). Consensus sequences were compared to published data by NCBI BLAST searches (Altschul et al. [1990](#)), and close matches (>97% of identity) were included in the phylogenetic analyses (Table S2). The kelp species *Laminaria digitata*, *L. hyperborea* and *S. latissima* were used as outgroup. ITS1 sequences were too divergent for common alignment and were therefore aligned separately for *Laminarionema* and *Laminariocolax*.

COI and ITS1 sequences were analysed using the same methods. Maximum likelihood analysis (1000 bootstraps, General Time Reversing Model GTR; henceforth ML) was performed with MEGA7. Bayesian analysis (BI) was performed with Beast 2 (Bouckaert et al. [2014](#)) using the HKY substitution model, default settings for temperature and branch-swapping, 8 million generations and samplings of every 1000 generations. The first 10% of obtained trees were discarded as burn-in. Trees were edited in TreeGraph 2 (Stöver & Müller [2010](#)). Kimura-2-Parameter distances (Kimura [1980](#), henceforth K2P) between and within the resulting clades were calculated in MEGA7. The gap between intraspecific diversity and interspecific diversity for 5'COI sequences of the genus *Laminariocolax* was determined with the web version of Automatic Barcode Gap Discovery (ABGD, Puillandre et al. [2012](#)) using the Jukes-Cantor model with a relative gap width of 1.5 and 10 steps. Prior maximum divergence of intraspecific diversity was set between 0.001 and 0.012. All sequences were submitted to Genbank with the accession numbers MG770493 - MG770548 for 5'COI sequences and MG781159 - MG781176 for ITS1 sequences (Table S1 in the supplementary material).

Distribution maps were constructed in R using the packages mapdata, maps and mapproj (R Development Core Team [2013](#)) based on genetic sequences of endophytes isolated in this study, sequences available in public databases and morphological records obtained from Algaebase (Guiry & Guiry [2017](#)) and published articles.

3. Results

3.1 Molecular systematics

For molecular analyses of the 5'COI region, we constructed an alignment of 77 sequences (Fig. 1), which included 21 reference sequences obtained from public databases and 56 newly determined sequences. The length of the 5'COI alignment used for the phylogenetic analysis was 591 bp. All isolated strains were members of the Ectocarpales. The topology of the 5'COI tree was independent of the phylogenetic reconstruction method used (PhyML or BI). For molecular analyses of the ITS1 region of the genus *Laminarionema*, we used an alignment of six sequences, which included a reference sequence obtained from public databases and five newly determined sequences; the aligned sequences had a length of 278 bp (tree not shown because all sequences were highly similar). For molecular analyses of the ITS1 region of the genus *Laminariocolax*, we used an alignment of 23 sequences (Fig. 2), which included 10 reference sequences obtained from public databases and 13 newly determined sequences. Due to several indels in the alignment, the length of ITS1 and the flanking subunit sequences ranged from 323 to 839 bp. The topology of the *Laminariocolax* ITS1 tree was independent of the method used (PhyML or BI). The choice of setting had a minor impact on the bootstrap/posterior probabilities values, but not on the general topology of the tree. Overall, the phylogenetic analyses of the endophyte strains with the two different markers supported the same clades.

49 of the isolated endophytes (88%) belonged to the genera *Laminarionema* and *Laminariocolax*. Furthermore, seven epi-endophytic species were isolated (Fig. 1), comprising a so far unidentified member of Chordariaceae, a strain of *Hecatonema maculans* (Collins) Sauvageau, two isolates of *Hinckesia hincksiae* (Harvey) P.C.Silva, an unidentified member of Acinetosporaceae, and two isolates of *Ectocarpus fasciculatus* Harvey. In the following, the focus will be on the endophytic genera *Laminarionema* and *Laminariocolax*.

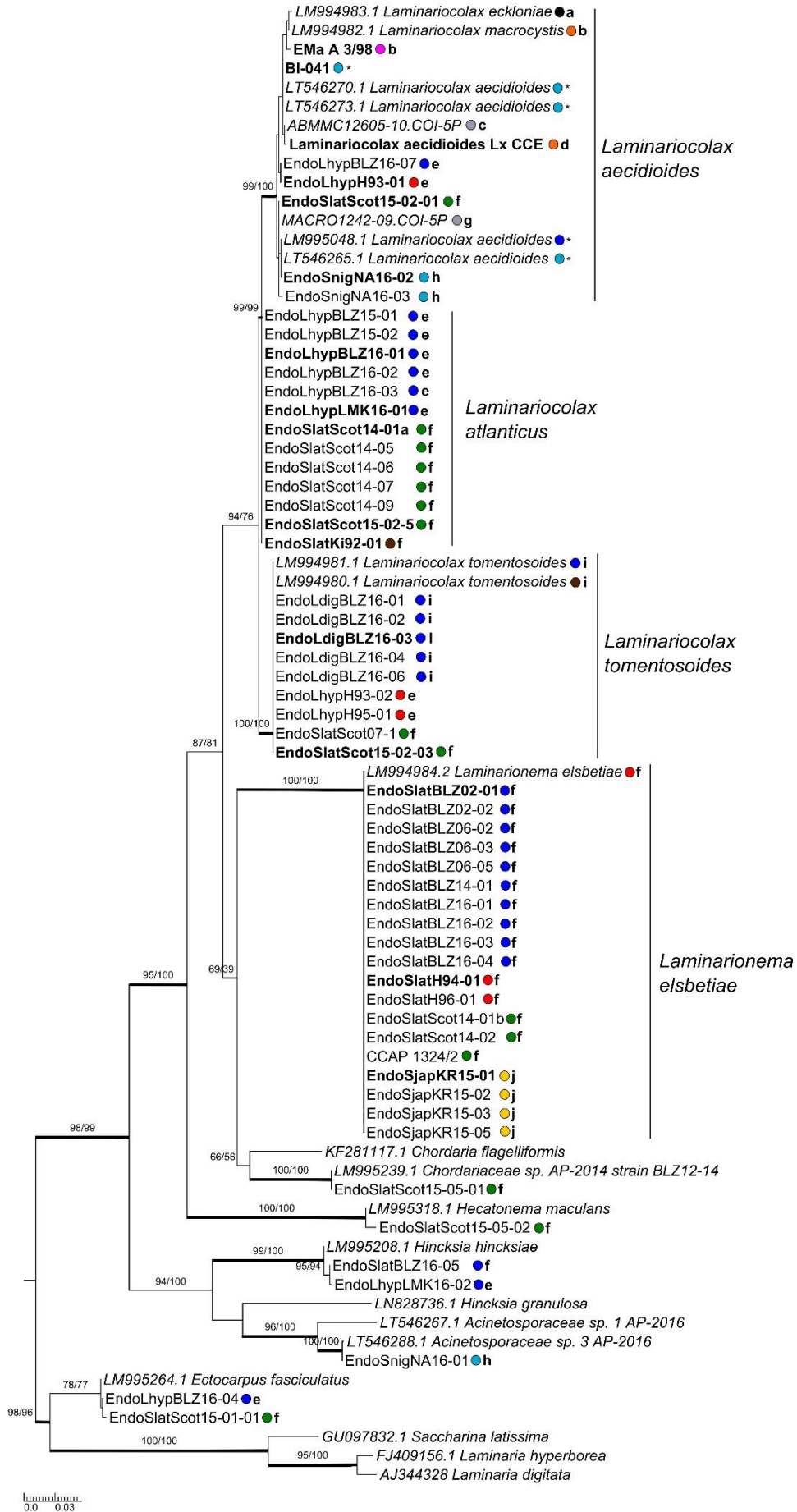

Fig. 1: Phylogenetic tree of 5'COI sequences. Values at nodes indicate bootstrap support obtained by ML/BI analysis. Bootstrap supports >95 in both analyses are indicated by a thicker line. Reference sequences from public databases are printed in italics and using the identities given in the original publications. ITS1 sequences are available for specimens shown in bold. The colours and letters behind the strain names indicate the geographic origin and host species, respectively.

Origins: black = South Africa; orange = Chile; pink = New Zealand; light blue = Arctic; grey = Canadian Pacific coast; dark blue = Brittany; red = Helgoland; green = UK; brown = Kiel, western Baltic; yellow = Korea

Hosts: a = *Ecklonia maxima*; b = *Macrocystis pyrifera*; c = *Saccharina sessilis*; d = *Lessonia berteroana*; e = *Laminaria hyperborea*; f = *Saccharina latissima*; g = *Costaria costata*; h = *Saccharina nigripes*; i = *Laminaria digitata*; j = *Saccharina japonica*; * = grown from incubated substratum.

The genus *Laminarionema* consisted of a single species, i.e. *L. elsbetiae* H.Kawai & Tokuyama. Analysis of 5'COI (Fig. 1) did not show any intraspecific variability, whereas ITS1 sequences showed a low intraspecific variability of 0.6 % (Table 1).

Table 1: Kimura-2-Parameter genetic distances for pairwise comparisons within 5'COI and ITS1 sequences in % \pm SE for *L. aecidioides*, *L. atlanticus*, *L. tomentosoides* and *L. elsbetiae*.

| | d \pm SE (5'COI) | d \pm SE (ITS1) |
|-------------------------------------|--------------------|-------------------|
| <i>Laminariocolax aecidioides</i> | 0.8 \pm 0.01 | 1.1 \pm 0.12 |
| <i>Laminariocolax tomentosoides</i> | 0 | 0 |
| <i>Laminariocolax atlanticus</i> | 0 | 0.3 \pm 0.05 |
| <i>Laminarionema elsbetiae</i> | 0 | 0.6 \pm 0.18 |

The genus *Laminariocolax* consisted of three clades, which were supported statistically by high bootstrap and posterior probability values (Figs 1-2). Three congruent primary partitions were obtained by ABGD analysis of the 5'COI sequences for prior distances ranging from 0.001 to 0.091 (Fig. S1 in the supplementary material). Higher prior distances resulted in one partition only (Fig. S1).

The first clade - *L. aecidioides* - clustered together with published sequences of *L. aecidioides*, *L. eckloniae* A.F.Peters and *L. macrocystis* (A.F.Peters) A.F.Peters. The second group did not have any matches in public databases for 5'COI sequences (Fig. 1). However, it formed a clade with four published sequences labelled as *L. aecidioides* in the ITS1 analysis (Fig. 2). The third clade represented *L. tomentosoides* (Farlow) Kylin.

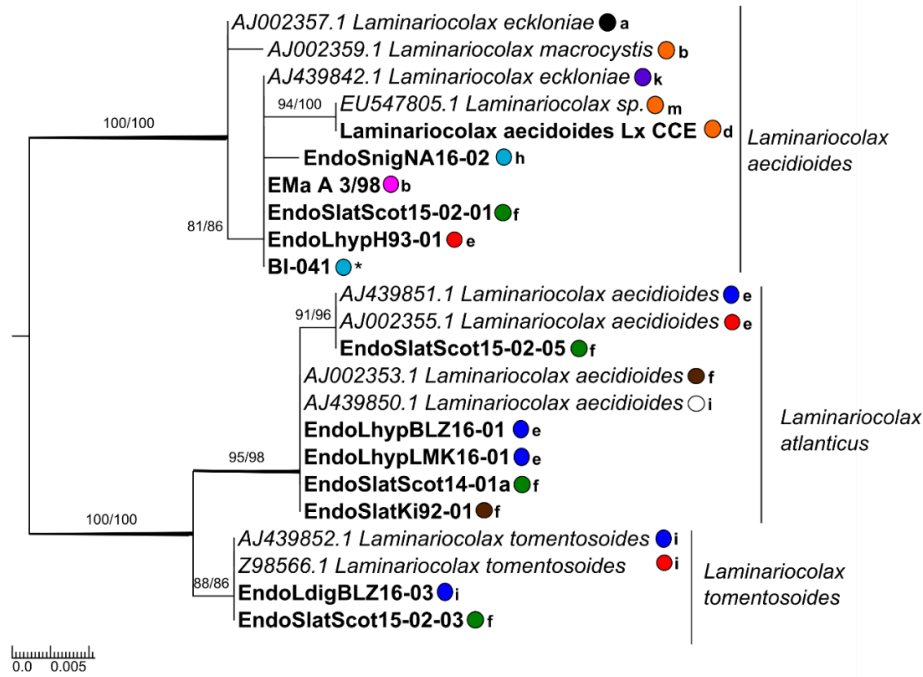

Fig. 2: Phylogenetic tree of ITS1 sequences from strains of the genus *Laminariocolax*. Values at nodes indicate bootstrap support obtained by ML/BI analysis. Bootstrap supports >95 in both analyses are indicated by a thicker line. Reference sequences from public databases are printed in italics and using the identities given in the original publications. Specimens printed in bold are also presented in the 5'COI tree (Fig. 1). The colours and letters behind the strain names indicate the geographic origin and host species, respectively.

Origins: black = South Africa; orange = Chile; purple = Antarctica; light blue = Arctic; pink = New Zealand; green = UK; red = Helgoland; dark blue = Brittany; brown = Kiel, western Baltic; white = US Atlantic coast
 Hosts: a = *Ecklonia maxima*; b = *Macrocystis pyrifera*; d = *Lessonia berteroana*; e = *Laminaria hyperborea*; f = *Saccharina latissima*; h = *Saccharina nigripes*; i = *L. digitata*; k = *Himantothallus grandifolius*; m = *Lessonia nigrescens*; * = grown from incubated substratum.

Interspecific K2P pairwise genetic differences of *Laminariocolax* ranged from 1.4 to 3 % for 5'COI and from 2.6 to 5.8 % for ITS1 (Table 2). Intraspecific K2P pairwise significant differences were 0 to 0.8 % in the 5'COI analysis and 0 to 1.1 % in the ITS1 analysis. They were higher within the *L. aecidioides* clade than in the other clades of the genus *Laminariocolax* (Table 1).

Table 2: Kimura-2-Parameter genetic distances for pairwise comparisons between 5'COI (below diagonal) and ITS1 (above diagonal) sequences in % \pm SE for *Laminariocolax* species.

| | 1. <i>L. aecidioides</i> | 2. <i>L. tomentosoides</i> | 3. <i>L. atlanticus</i> |
|----------------------------|--------------------------|----------------------------|-------------------------|
| 1. <i>L. aecidioides</i> | - | 5.3 \pm 0.15 | 5.8 \pm 0.09 |
| 2. <i>L. tomentosoides</i> | 3 \pm 0.02 | - | 2.6 \pm 0.05 |
| 3. <i>L. atlanticus</i> | 1.8 \pm 0.03 | 1.4 \pm 0 | - |

3.2 Hosts and geographic origin of the isolated strains

Laminarionema elsbetiae was isolated from tissue of *Saccharina latissima* in Scotland, France and Helgoland and from *S. japonica* in Korea (Fig. 4A). A putative distribution along the Northern Hemisphere Atlantic and Pacific coasts is suggested based on molecular records (Fig. 3A).

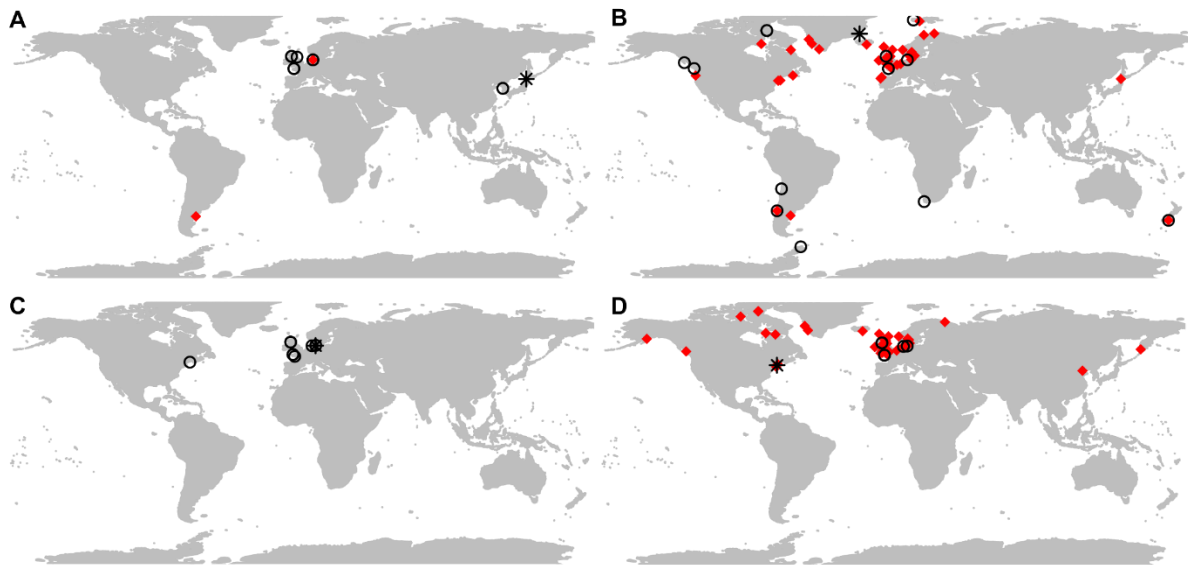

Fig. 3: Biogeographic distribution maps of **A.** *Laminarionema elsbetiae*, **B.** *Laminariocolax aecidioides*, **C.** *Laminariocolax atlanticus*, **D.** *Laminariocolax tomentosoides*. Black circles indicate records based on sequence data (Table S2 in the supplementary material), red diamonds indicate records based on morphological records (Tables S3-S5 in the supplementary material), black asterisks indicate the type localities.

Laminariocolax aecidioides showed the broadest host range of all endophytes included in this study. It was isolated from *Macrocystis pyrifera*, *Lessonia berteroana*, *Laminaria hyperborea*, *S. latissima* and *S. nigripes* (Figs. 1 and 2). Furthermore, it has been cultivated from incubated abiotic substratum (isolate BI-041). In this study, *L. aecidioides* was found in Brittany, Helgoland, Scotland, Svalbard, Baffin Island, New Zealand and Chile (Fig. 3B). Published sequences and records of the species based on morphological identification suggest a worldwide distribution in temperate to polar regions.

The second clade of *Laminariocolax* was isolated from *Laminaria hyperborea* and *S. latissima* (Figs 1+2) in Brittany, Scotland and Kiel. Additionally, ITS1 sequences of strains isolated from *L. hyperborea* in Helgoland and from *L. digitata* in Maine (Fig. 2) are available in public

databases, suggesting a distribution of this species in kelp populations along American and European North Atlantic coasts (Fig. 3D).

Laminariocolax tomentosoides was isolated from *Laminaria digitata*, *L. hyperborea* and *S. latissima* (Figs 1+2) in Brittany, Helgoland and Scotland. Published sequences and records based on morphological identification suggest a distribution of this species along Northern Hemisphere Atlantic and Pacific shores (Fig. 3C).

Based on these results we describe the second clade of *Laminariocolax* as a new species. Its distinction from the sister species (Fig. 4B+C) is shown in Table 3.

3.3 *Laminariocolax atlanticus* M. Bernard, Strittmatter & A.F. Peters sp. nov.

DIAGNOSIS AND DESCRIPTION: Microscopic filamentous thallus, branched, endophytic in the sporophytes of *Laminaria hyperborea*, *L. digitata* and *Saccharina latissima* on North Atlantic coasts, recognized macroscopically as dark spots on the host. Phaeophycean hairs sticking out from host surface. Plurilocular sporangia in groups on the host surface (Fig. 4B), 30-33 µm long (7-8 loculi), 7-9 µm in diameter (values from measurements in field material used for isolation of the authentic strain). Plurilocular sporangia similar in unialgal culture (Fig. 4C). Unilocular sporangia not seen. Vegetative cells 10-20 µm long with several discoid or shortband-shaped plastids (Fig. 4D).

HOLOTYPE: Kiel (western Baltic, Germany); coll. A. F. Peters, 23/11/1992; fixed material of cultivated authentic strain; deposited in the Natural History Museum, Paris, France (MNHN_PC_PC0786150).

ISOTYPE: deposited in the in the Natural History Museum, Paris, France (MNHN_PC_PC0786151) and the Natural History Museum, London, UK (BM000701859).

AUTHENTIC STRAIN: CCAP 1322/3

TYPE LOCALITY: Isolated on 23/11/1992 from plurilocular endophyte infesting a sorus of *Saccharina latissima* collected in Kiel (western Baltic, Germany).

ETYMOLOGY: The name refers to the putative distribution of the species along (North) Atlantic coasts.

HABITAT: Marine, endophytic in kelps, so far isolated from *L. hyperborea*, *L. digitata*, *S. latissima*.

REPRESENTATIVE BARCODES: MG770512 (5'COI) and MG781174 (ITS1)

Table 3: Comparison of *L. tomentosoides* and *L. aecidioides* with the new species *L. atlanticus*: a) Ellertsdóttir & Peters [1997](#); b) Apt [1988a](#); c) Peters [1991](#); d) host information by G. W. Saunders, pers. communication; e) Burkhardt & Peters [1998](#); f) Setchell & Gardner [1922](#); g) Yoshida & Akiyama [1979](#); h) Nielsen & Gunnarson [2001](#); i) Peters [2003](#); j) Dixon [1961](#); k) Kornmann & Sahling [1977](#); l) Russel [1964](#); m) Cotton [1912](#); n) Villalard-Bohnsack & Harlin [2001](#).

| | <i>Laminariocolax aecidioides</i> | <i>Laminariocolax atlanticus</i> | <i>Laminariocolax tomentosoides</i> |
|-------------------------|---|--|--|
| Macroscopic appearance | Dark spots ^a , galls ^b | Dark spots | Dark areas, distorted phylloids, twisted cauloids ^a , felt-like cover on the host ^k |
| Thallus organisation | Sporophyte: microscopic uniseriate branched endophytic filaments; gametophyte: epiphytic uniseriate filaments up to 200 µm in length ^c | Microscopic uniseriate branched filaments | Microscopic, uniseriate branched endophytic filaments and epiphytic uniseriate filaments up to 1 cm in length ^k |
| Hairs | Present ^c | Present | Absent ^l |
| Plastids | Several (2-10), discoid or band-shaped, with pyrenoids ^c | Several, discoid or band-shaped, with pyrenoids | Small number (usually 2), irregularly band-shaped, with pyrenoids ^l |
| Plurilocular sporangia | Uniseriate (both on sporophyte and gametophyte) ^c | Uniseriate | Uniseriate ^l |
| Unilocular Sporangia | Solitary, ovoid ^c | Not observed | Not observed ^l |
| Life history | Diploid-haploid; also, direct replication of both generations by means of spores from plurilocular sporangia or parthenogenesis of gametes of both sexes ^c | Direct | Direct ^l |
| Hosts | Kelps: <i>Costaria costata</i> ^d , <i>Ecklonia maxima</i> ^e , <i>Laminaria hyperborea</i> , <i>L. digitata</i> , <i>Lessonia berteriana</i> , <i>L. nigrescens</i> , <i>M. pyrifer</i> ^c , <i>S. latissima</i> , <i>S. nigripes</i> , <i>S. sessilis</i> ^f , <i>Undaria pinnatifida</i> ^g Other brown algae: <i>Fucus vesiculosus</i> ^h , <i>Himantothallus grandifolius</i> ⁱ , <i>S. polyschides</i> ^j | Kelps: <i>Laminaria hyperborea</i> , <i>L. digitata</i> ^l , <i>S. latissima</i> | Kelps : <i>Alaria esculenta</i> ^l , <i>L. digitata</i> , <i>L. hyperborea</i> , <i>S. latissima</i> Other brown algae: <i>Saccorhiza polyschides</i> ^l , <i>Himantothalia elongata</i> ^m Red algae: <i>Palmaria palmata</i> ^l , <i>Grateloupia turuturu</i> ⁿ |
| Geographic distribution | Worldwide temperate to polar | Temperate North Atlantic | Northern hemisphere temperate to polar, Atlantic and Pacific |

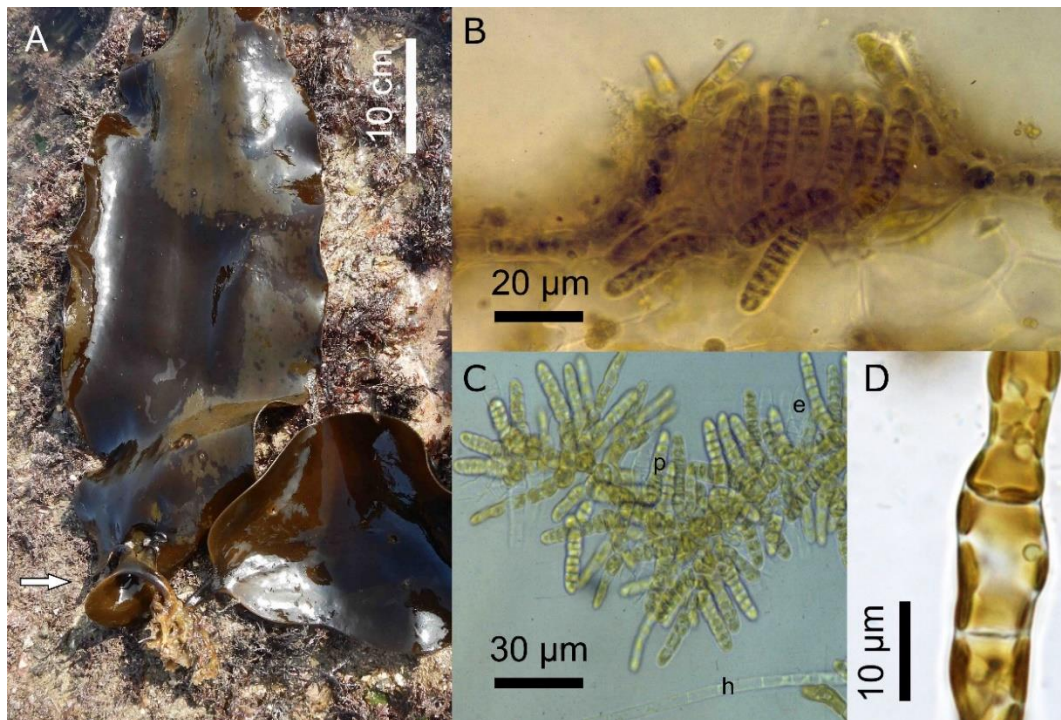

Fig. 4: **A.** *Saccharina japonica* sporophytes from Padori Beach, Taean, Chungnam Province, Korea. The left individual presents symptoms of putative infection by *Laminarionema elsbetiae*, which we isolated from similar individuals: twisted lower part of blade (arrow). The right individual has a regular morphology. **B.** Plurilocular sporangia of *Laminariocolax atlanticus* sp. nov. on the surface of a field sample of *Saccharina latissima* from Kiel, Germany (transverse section). Large cells in lower part of the micrograph belong to the host. **C.** Authentic strain of *L. atlanticus* in culture. h = phaeophycecan hair, p = plurilocular sporangium, e = empty plurilocular sporangium (also published in Eggert et al. [2010](#)). **D.** Authentic strain of *L. atlanticus* in culture. Vegetative cells.

4. Discussion

4.1 Molecular phylogeny of kelp endophytes

In this study we performed a broad sampling of kelp endophytes, isolation into clonal cultures and identification of the strains by means of DNA barcoding. All isolated endophytes were brown algae belonging to the Ectocarpales and 88% to the endophyte genera *Laminarionema* and *Laminariocolax*. The phylogenetic trees obtained using 5'COI and ITS1 sequences were in concordance, and the resolution of the markers was sufficiently variable to distinguish different clades within the genus *Laminariocolax*.

Laminarionema was monospecific with no genetic variability in the 5'COI sequences and low variability in ITS1 sequences despite its geographic separation on Atlantic and Pacific coasts. This raises the question whether the endophyte has been exchanged between the two oceans only recently. While ITS sequences have been used to follow the dispersal of other algal

species, like the invasive green alga *Caulerpa taxifolia* (M.Vahl) C.Agardh (Jousson et al. [1998](#); Schaffelke et al. [2002](#)), the ITS1 data of *Laminarionema* obtained in our study are not sufficiently variable to distinguish European and Asian populations. Additional sampling and more sensitive markers are necessary to further investigate this question. Our isolates represent the first records of this species in Great Britain, France and Korea. Previously, it was only known from the type locality in Northern Japan (Kawai & Tokuyama [1995](#)) and from Helgoland, North Sea, Germany (Peters & Ellertsdóttir [1996](#)). We became aware of *L. elsbetiae* in natural populations of European and Korean *Saccharina* because it was associated with twisting of stipes (Fig. 4A). The symptoms were similar but usually less dramatic than those seen previously in *S. latissima* at Helgoland (Peters & Ellertsdóttir [1996](#)). In *S. japonica*, symptoms like the ones we saw in Korea had not been observed from infected hosts in northern Japan (Kawai & Tokuyama [1995](#)). They were similar to symptoms referred to as “twisted-frond disease” in cultivated *S. japonica* in China (Wu et al. [1983](#)). However, Wu et al. ([1983](#)) detected a mycoplasma-like organism in sections of diseased tissue and regarded it as likely causative agent. In Brittany, presence of *L. elsbetiae* in *S. latissima* often does not cause any obvious morphological changes (Bernard et al. [2017](#)).

There is a surprising morphological record of *L. elsbetiae* infecting *Rhodymenia pseudopalmata* (J.V.Lamouroux) P.C.Silva from Argentina (Gauna et al. [2009a](#)). *L. elsbetiae* has characteristic large zoospores (Kawai & Tokuyama [1995](#); Peters & Ellertsdóttir [1996](#)) and was therefore clearly recognized by Gauna et al. ([2009a](#)). It is possible that the species has been introduced to Argentina with macroalgae like *Undaria pinnatifida* of North-East Asian origin. Re-isolation and sequence data are nevertheless required to confirm the identity of this endophyte, especially since it represents the first record of *L. elsbetiae* from a red algal host and from the southern hemisphere.

Our *Laminariocolax* isolates belonged to three different species, the distinction of which was supported by high bootstrap and posterior probability values and congruent with the primary partitions obtained by the ABGD analysis (Fig. S1). The interspecific K2P pairwise genetic difference between 5'COI sequences of *L. tomentosoides* and *L. atlanticus* sp. nov. (1.4 %) is lower than the general species-level-cut-off of 1.8 % proposed by Peters et al. ([2015](#)) for Ectocarpales. However, the value of 1.8 % must not be regarded as a strict criterion. We think it is required and justified to describe *L. atlanticus* sp. nov. as a separate species because intraspecific variability is absent in the clades of *L. tomentosoides* and *L. atlanticus* for 5'COI and negligible for ITS1. The small genetic distance between *L. tomentosoides* and *L. atlanticus*

sp. nov. suggests that they may have diverged recently, possibly in North Atlantic waters, where their assumed distribution ranges overlap. However, geographically extended sampling is necessary to further support this hypothesis.

4.2 Species delimitation in *Laminariocolax*

The data obtained in this study support the proposition of Peters et al. (2015) to include the previously described species *L. eckloniae* and *L. macrocystis* in *L. aecidioides*. The original description of these taxa as distinct species was based on the occurrence of large indels in ITS1 sequences, geographic separation and occurrence in different hosts (Burkhardt & Peters 1998). However, the importance of indels as phylogenetic markers can easily be overestimated, leading to wrong conclusions (Babteste & Philippe 2002). In fact, indels in *L. aecidioides* affect mainly the first part of the ITS1 region, which shows extreme high variability in Ectocarpales (e.g. Montecinos et al. 2017).

As *L. aecidioides* was originally described from Greenland (Rosenvinge 1893), we decided that the name *L. aecidioides* should be applied to the clade that includes Arctic isolates. Logistic constraints inhibited us from recollecting at the type locality, but the isolates from similar habitats at Svalbard and Baffin Island were used to molecularly define *L. aecidioides*. In our study, *L. aecidioides* was isolated from *Laminaria*, *S. latissima* and *M. pyrifera*, but it is known to infect a broader range of kelps, including *Costaria costata* (C.Agardh) De A.Saunders (host information by G. W. Saunders, pers. communication), *Ecklonia maxima* (Osbeck) Papenfuss (Burkhardt & Peters 1998), *Saccharina sessilis* (C.Agardh) Kuntze (Setchell & Gardner 1922) and *Undaria pinnatifida* (Harvey) Suringar (Yoshida & Akiyama 1979). Additionally, it was found on other brown algal hosts such as *Fucus vesiculosus* L. (Fucales, Nielsen & Gunnarson 2001), *Himantothallus grandifolius* (A.Gepp & E.S.Gepp) Zinova (Desmarestiales, Peters 2003) and *Saccorhiza polyschides* (Lightfoot) Batters (Tilopteridales, Dixon 1961). *L. aecidioides* has previously also been isolated from abiotic substratum at sites where potential hosts were present (Table S2; Peters et al. 2015; Küpper et al. 2016). It is found in temperate to polar regions worldwide, and the adaptation to different hosts and geographic regions could be a possible explanation for the higher intraspecific divergence within this species (Ramel 1998). Additionally, *L. aecidioides* is the only species in the genus in which unilocular sporangia (the possible site of meiosis in brown algae) have been described (Rosenvinge 1893, in the type) and sexuality has actually been observed (Peters 1991), which could be another reason for the larger intraspecific genetic variability (Bengtsson 2003).

The newly described species *L. atlanticus* sp. nov. did not retrieve any matches in public databases for the 5'COI sequences, but formed a clade with 4 ITS1 sequences previously identified as *L. aecidioides* (Peters [2003](#)). The new species has so far been isolated from *Saccharina latissima*, *Laminaria hyperborea*, and *L. digitata* in the North Atlantic. While it is morphologically similar to the sporophyte of *Laminariocolax aecidioides* (Table 3), no unilocular sporangia – which are known to be present in *L. aecidioides* (Rosenvinge [1893](#); Peters [1991](#); Burkhardt & Peters [1998](#)) - have been observed in field material or any of the *L. atlanticus* sp. nov. isolates. The new species is morphologically distinct from *L. tomentosoides* in having generally more plastids per cell and lacking epiphytic assimilatory filaments. It possesses phaeophycean hairs, which have not been reported in *L. tomentosoides* (Table 3; Russel [1964](#); Kornmann & Sahling [1977](#)). However, the presence of phaeophycean hairs may depend on environmental conditions (Pedersen [1984](#)), making them a less reliable classification criterion.

L. tomentosoides was first described as *Ectocarpus tomentosoides* by Farlow ([1889](#)) infecting *Laminaria* species in Massachusetts (United States, see asterisk in Fig. 6B). It is the only *Laminariocolax* species that has been found not only in brown algal hosts, but also in the red algae *Palmaria palmata* (L.) F.Weber & D.Mohr (Russel [1964](#)) and *Grateloupia turuturu* Yamada (Villalard-Bohnsack & Harlin [2001](#)), based on morphological records. Published sequences and our new molecular data confirm the presence of *L. tomentosoides* in the North Atlantic. However, there are several morphological records of *L. tomentosoides* infecting Pacific kelps (Lee [1980](#); Klochkova et al. [2009](#); Lindstrom [2006](#); Liu [2008](#)), and a molecular characterization of Pacific strains is necessary to clarify its actual distribution range.

The morphological species concept has dominated algal systematics for decades but numerous cases of cryptic (= morphologically indistinguishable) species have been revealed by the use of molecular data (De Clerck et al. [2013](#); Peters et al. [2015](#), Montecinos et al. [2017](#)). Consequently, species delimitation based on morphological data can lead to an underestimation of diversity, especially in organisms with a low morphological complexity, such as endophytic brown algae. *L. aecidioides*, *L. atlanticus* sp. nov. and *L. tomentosoides* were observed sympatrically with their distribution ranges overlapping on the European Atlantic coast. Although slight morphological and ecological differences between the *Laminariocolax* species exist, our study stresses the importance of molecular barcoding or related methods (e.g. Bernard et al. [2017](#)) for reliable species identification in endophytic brown algae.

In addition to the three species of *Laminariocolax* included in this study, *L. draparnaldioides* (Noda [1971](#)) has been recorded from Japan (Noda [1971](#); Yoshida et al. [1990](#)), the Russian Far East (Perestenko [1980](#)), and China (Liu [2008](#)). It was found as an epiphyte on *Stephanocystis hakodatensis* (Yendo) Draisma et al., a member of the Fucales. Re-isolation and molecular data are required to confirm its belonging to this genus.

4.3 Variability of host specificity

Host ranges of the endophyte species differed across localities. The strains isolated from kelps in Brittany showed a clear host specificity: all endophytes isolated from *Saccharina latissima* in Brittany were identified as *Laminarionema elsbetiae*, all endophytes isolated from *Laminaria digitata* were identified as *Laminariocolax tomentosoides*, and the two endophytic species *L. atlanticus* sp. nov. and *L. aecidioides* were isolated from *Laminaria hyperborea*. However, this pattern was not consistent with the results from other localities, where the same kelp species are present. According to Ellertsdóttir & Peters ([1997](#)), both *Laminariocolax tomentosoides* and *L. aecidioides* were isolated from *Laminaria hyperborea* at Helgoland. In Scotland, all three species of *Laminariocolax* as well as *Laminarionema elsbetiae* were isolated from *S. latissima*; none of these endophyte species had been described from the Scottish sampling site before.

Electron microscopic observations by Heesch & Peters ([1999](#)) showed that *L. elsbetiae* and *Laminariocolax atlanticus* (described as *L. aecidioides*) infect their hosts by penetration of the host cell wall, suggesting an enzymatic dissolution. However, the underlying molecular mechanism of the infection and kelp responses are still unclear. Differences in the cell wall composition of the host species, for instance in the content of celluloses, hemicelluloses and alginates (Siegel & Siegel [1973](#)), could play an important role in defining specific host-endophyte relationships.

The strains isolated in this study hardly represent the diversity of all endophytic taxa as there was a sampling bias towards species that coincide with morphological changes. However, not all hosts infected with endophytes show morphologic changes (Gauna et al. [2009b](#); Bernard et al. [2017](#)). More complete sampling campaigns, including a broader range of kelp hosts, disease symptom-free hosts, additional sampling sites and advanced identification techniques avoiding time-consuming isolation and cultivation of endophytes (Bernard et al. [2017](#)) are necessary to further investigate specificity in host-endophyte interactions. Moreover, Laminariales are

known to induce specific defence reactions towards biotic attacks, such as oxidative bursts (Küpper et al. 2002) or transcriptional reprogramming (Cosse et al. 2009). Physiological and co-cultivation studies are essential to further investigate the ability of endophyte species to infect different hosts to finally obtain a comprehensive knowledge of this interaction.

Acknowledgements. We would like to thank Inka Bartsch for sampling material of *Saccharina nigripes* from Svalbard, Margot Tragin for providing the basic R script for the creation of the distribution maps, Hiroshi Kawai for sharing the publication by Noda (1971) and Gary Saunders for providing additional information on samples from Canada. This project has received funding from the European Union’s Horizon 2020 research and innovation programme under the Marie Skłodowska-Curie grant agreement N°642575 and by the project IDEALG (France: ANR-10-BTBR-04). MS acknowledges support from the Genomia Fund (project HERDIR). PM was funded by Conicyt (Becas Chile N° 72130422) for PhD studies at the University of Aberdeen, and by the NERC IOF Pump priming (scheme NE/L013223/1) for activities at the Scottish Association for Marine Sciences. SH acknowledges scholarships from the German Academic Exchange Service DAAD and the University of Otago. GYC was supported by the Ministry of Environment of Korea (NIBR201501118).

5. Supplementary Material

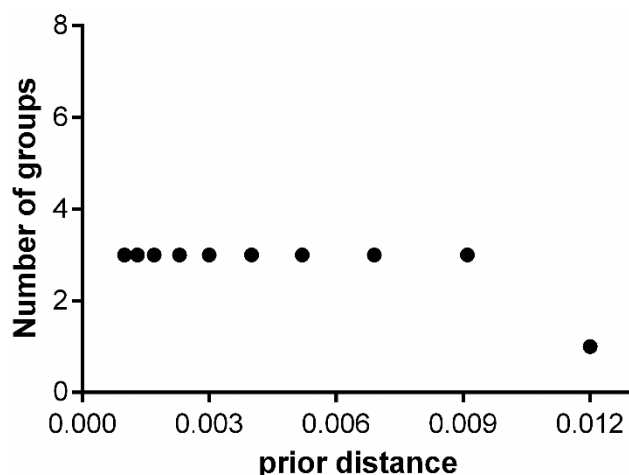

Figure S1: Results of the automatic barcode gap discovery (ABGD) showing the initial primary partitions (i.e. number of groups) for a range of prior maximum divergence of intraspecific diversity.

Partition 1 (N = 16): LM994983.1, LM994982.1, EndoMpyrNZ98-01, BI-041, LT546270.1, LT546273.1, ABMMC12605-10.COI-5P, Laminariocolax aecidioides Lx CCE, EndoLhypBLZ16-07, EndoLhypH93-01, EndoSlatScot15-02-01, MACRO1242-09.COI-5P, LM995048.1, LT546265.1, EndoSni16-02, EndoSni16-03.

Table S1: Collecting information. ¹: representative strain of *L. atlanticus*, original name SaecKi92-5. Culture was also used in Burkhardt & Peters (1998, Table 1, strain 1) and Heesch & Peters (1999) as *L. aecidioides*. *: sequence has been updated.

| ID | Species | Origin | Lat | Long | Host | Sampling year | COI | ITS |
|------------------------------|-----------------------|------------------|--------|--------|----------------------|---------------|----------|----------|
| BI-041 | <i>L. aecidioides</i> | Baffin Island | 72.45 | -79.83 | - | 2009 | MG770494 | MG781169 |
| EndoLhypBLZ16-07 | <i>L. aecidioides</i> | Brittany, France | 48.73 | -4 | <i>L. hyperborea</i> | 2016 | MG770496 | - |
| L. aecidioides Lx CCE | <i>L. aecidioides</i> | Chile | -26.15 | -70.67 | <i>L. berteroa</i> | 2015 | MG770495 | MG781164 |
| EndoLhypH93-01 | <i>L. aecidioides</i> | Helgoland | 54.19 | 7.87 | <i>L. hyperborea</i> | 1993 | MG770497 | MG781168 |
| EMa A 3/98 | <i>L. aecidioides</i> | New Zealand | -45.77 | 170.71 | <i>M. pyrifer</i> | 1998 | MG770493 | MG781166 |
| EndoSlatScot15-2-1 | <i>L. aecidioides</i> | Scotland | 56.46 | -5.44 | <i>S. latissima</i> | 2015 | MG770498 | MG781167 |
| EndoSngNA16-02 | <i>L. aecidioides</i> | Svalbard | 78.99 | 11.57 | <i>S. nigripes</i> | 2016 | MG770499 | MG781165 |
| EndoSngNA16-03 | <i>L. aecidioides</i> | Svalbard | 78.99 | 11.57 | <i>S. nigripes</i> | 2016 | MG770500 | - |
| EndoLhypBLZ15-01 | <i>L. atlanticus</i> | Brittany, France | 48.73 | -4 | <i>L. hyperborea</i> | 2015 | MG770501 | - |
| EndoLhypBLZ15-02 | <i>L. atlanticus</i> | Brittany, France | 48.73 | -4 | <i>L. hyperborea</i> | 2015 | MG770502 | - |
| EndoLhypBLZ16-01 | <i>L. atlanticus</i> | Brittany, France | 48.73 | -4 | <i>L. hyperborea</i> | 2016 | MG770503 | MG781171 |
| EndoSlatKi92-01 ¹ | <i>L. atlanticus</i> | Kiel, Germany | 54.44 | 10.22 | <i>S. latissima</i> | 1992 | MG770512 | MG781174 |
| EndoSlatScot14-01a | <i>L. atlanticus</i> | Scotland | 56.46 | -5.44 | <i>S. latissima</i> | 2014 | MG770507 | MG781173 |
| EndoSlatScot14-05 | <i>L. atlanticus</i> | Scotland | 56.46 | -5.44 | <i>S. latissima</i> | 2014 | MG770508 | - |
| EndoSlatScot14-06 | <i>L. atlanticus</i> | Scotland | 56.46 | -5.44 | <i>S. latissima</i> | 2014 | MG770509 | - |
| EndoSlatScot14-07 | <i>L. atlanticus</i> | Scotland | 56.46 | -5.44 | <i>S. latissima</i> | 2014 | MG770510 | - |
| EndoSlatScot14-09 | <i>L. atlanticus</i> | Scotland | 56.46 | -5.44 | <i>S. latissima</i> | 2014 | MG770511 | - |
| EndoSlatScot15-2-5 | <i>L. atlanticus</i> | Scotland | 56.46 | -5.44 | <i>S. latissima</i> | 2015 | MG770513 | MG781170 |
| EndoLhypBLZ16-02 | <i>L. atlanticus</i> | Brittany, France | 48.73 | -4 | <i>L. hyperborea</i> | 2016 | MG770504 | - |
| EndoLhypBLZ16-03 | <i>L. atlanticus</i> | Brittany, France | 48.73 | -4 | <i>L. hyperborea</i> | 2016 | MG770505 | - |
| EndoLhypLMK16-01 | <i>L. atlanticus</i> | Brittany, France | 47.55 | -2.92 | <i>L. hyperborea</i> | 2016 | MG770506 | MG781172 |
| EndoSlatBLZ02-01 | <i>L. elsbetiae</i> | Brittany, France | 48.73 | -4 | <i>S. latissima</i> | 2002 | MG770523 | MG781159 |
| EndoSlatBLZ02-02 | <i>L. elsbetiae</i> | Brittany, France | 48.73 | -4 | <i>S. latissima</i> | 2002 | MG770524 | - |
| EndoSlatBLZ06-02 | <i>L. elsbetiae</i> | Brittany, France | 48.73 | -4 | <i>S. latissima</i> | 2006 | MG770525 | - |
| EndoSlatBLZ06-03 | <i>L. elsbetiae</i> | Brittany, France | 48.73 | -4 | <i>S. latissima</i> | 2006 | MG770526 | - |

| | | | | | | | | |
|--------------------|-----------------------------|------------------|-------|--------|----------------------|------|------------|----------|
| EndoSlatBLZ06-05 | <i>L. elsbetiae</i> | Brittany, France | 48.73 | -4 | <i>S. latissima</i> | 2006 | MG770527 | - |
| EndoSlatBLZ14-01 | <i>L. elsbetiae</i> | Brittany, France | 48.73 | -4 | <i>S. latissima</i> | 2014 | MG770528 | - |
| EndoSlatBLZ16-01 | <i>L. elsbetiae</i> | Brittany, France | 48.73 | -4 | <i>S. latissima</i> | 2016 | MG770529 | MG781160 |
| EndoSlatBLZ16-02 | <i>L. elsbetiae</i> | Brittany, France | 48.73 | -4 | <i>S. latissima</i> | 2016 | MG770530 | - |
| EndoSlatBLZ16-03 | <i>L. elsbetiae</i> | Brittany, France | 48.73 | -4 | <i>S. latissima</i> | 2016 | MG770531 | - |
| EndoSlatBLZ16-04 | <i>L. elsbetiae</i> | Brittany, France | 48.73 | -4 | <i>S. latissima</i> | 2016 | MG770532 | - |
| CCAP 1324/2 | <i>L. elsbetiae</i> | England | 55.91 | -2.04 | <i>S. latissima</i> | 2008 | MG770537 | MG781162 |
| EndoSlatH94-01 | <i>L. elsbetiae</i> | Helgoland | 54.19 | 7.87 | <i>S. latissima</i> | 1994 | MG770533 | MG781161 |
| LM994984.1* | <i>L. elsbetiae</i> | Helgoland | 54.19 | 7.87 | <i>S. latissima</i> | 1994 | LM994984.1 | - |
| EndoSlatH96-01 | <i>L. elsbetiae</i> | Helgoland | 54.19 | 7.87 | <i>S. latissima</i> | 1996 | MG770534 | - |
| EndoSjapKR15-01 | <i>L. elsbetiae</i> | Korea | 36.43 | 126.32 | <i>S. japonica</i> | 2015 | MG770538 | MG781163 |
| EndoSjapKR15-02 | <i>L. elsbetiae</i> | Korea | 36.43 | 126.32 | <i>S. japonica</i> | 2015 | MG770539 | - |
| EndoSjapKR15-03 | <i>L. elsbetiae</i> | Korea | 36.43 | 126.32 | <i>S. japonica</i> | 2015 | MG770540 | - |
| EndoSjapKR15-05 | <i>L. elsbetiae</i> | Korea | 36.43 | 126.32 | <i>S. japonica</i> | 2015 | MG770541 | - |
| EndoSlatScot14-01b | <i>L. elsbetiae</i> | Scotland | 56.32 | -5.58 | <i>S. latissima</i> | 2014 | MG770535 | - |
| EndoSlatScot14-02 | <i>L. elsbetiae</i> | Scotland | 56.46 | -5.44 | <i>S. latissima</i> | 2014 | MG770536 | - |
| EndoLdigBLZ16-01 | <i>L. tomentosoides</i> | Brittany, France | 48.73 | -4 | <i>L. digitata</i> | 2016 | MG770514 | - |
| EndoLdigBLZ16-02 | <i>L. tomentosoides</i> | Brittany, France | 48.73 | -4 | <i>L. digitata</i> | 2016 | MG770515 | - |
| EndoLdigBLZ16-03 | <i>L. tomentosoides</i> | Brittany, France | 48.73 | -4 | <i>L. digitata</i> | 2016 | MG770516 | MG781175 |
| EndoLdigBLZ16-04 | <i>L. tomentosoides</i> | Brittany, France | 48.73 | -4 | <i>L. digitata</i> | 2016 | MG770517 | - |
| EndoLdigBLZ16-06 | <i>L. tomentosoides</i> | Brittany, France | 48.73 | -4 | <i>L. digitata</i> | 2016 | MG770518 | - |
| EndoLhypH93-02 | <i>L. tomentosoides</i> | Helgoland | 54.19 | 7.87 | <i>L. hyperborea</i> | 1993 | MG770519 | - |
| EndoLhypH95-01 | <i>L. tomentosoides</i> | Helgoland | 54.19 | 7.87 | <i>L. hyperborea</i> | 1995 | MG770520 | - |
| EndoSlatScot07-1 | <i>L. tomentosoides</i> | Scotland | 56.3 | -5.65 | <i>S. latissima</i> | 2007 | MG770521 | - |
| EndoSlatScot15-2-3 | <i>L. tomentosoides</i> | Scotland | 56.46 | -5.44 | <i>S. latissima</i> | 2015 | MG770522 | MG781176 |
| EndoSnigNA16-01 | <i>Acinetosporaceae sp.</i> | Svalbard | 78.99 | 11.57 | <i>S. nigripes</i> | 2016 | MG770546 | - |
| EndoSlatScot15-5-1 | <i>Chordariaceae sp.</i> | Scotland | 56.32 | -5.58 | <i>S. latissima</i> | 2015 | MG770542 | - |
| EndoLhypBLZ16-04 | <i>E. fasciculatus</i> | Brittany, France | 48.73 | -4 | <i>L. hyperborea</i> | 2016 | MG770547 | - |
| EndoSlatScot15-1-1 | <i>E. fasciculatus</i> | Scotland | 56.46 | -5.44 | <i>S. latissima</i> | 2015 | MG770548 | - |

| | | | | | | | | |
|--------------------|-----------------------|------------------|-------|-------|----------------------|------|----------|---|
| EndoSlatScot15-5-2 | <i>Hecatonema sp.</i> | Scotland | 56.32 | -5.58 | <i>S. latissima</i> | 2015 | MG770543 | - |
| EndoLhypLMK16-02 | <i>Hincksia sp.</i> | Brittany, France | 47.55 | -2.92 | <i>L. hyperborea</i> | 2016 | MG770545 | - |
| EndoSlatBLZ16-05 | <i>Hincksia sp.</i> | Brittany, France | 48.73 | -4 | <i>S. latissima</i> | 2016 | MG770544 | - |

Table S2: Sequences obtained from public databases. *: sequence has been updated.

| Database | Accession number | Marker | Species label | Identification | Host |
|----------|------------------|--------|-----------------------------|-------------------------|----------------------|
| GenBank | LM994983.1 | 5'COI | <i>L. eckloniae</i> | <i>L. aecidioides</i> | <i>E. maxima</i> |
| GenBank | LM994982.1 | 5'COI | <i>L. macrocystis</i> | <i>L. aecidioides</i> | <i>M. pyrifer</i> |
| GenBank | LT546265.1 | 5'COI | <i>L. aecidioides</i> | <i>L. aecidioides</i> | Incubated substratum |
| GenBank | LT546270.1 | 5'COI | <i>L. aecidioides</i> | <i>L. aecidioides</i> | Incubated substratum |
| GenBank | LT546273.1 | 5'COI | <i>L. aecidioides</i> | <i>L. aecidioides</i> | Incubated substratum |
| BOLD | ABMMC12605-10 | 5'COI | <i>Ectocarpales</i> | <i>L. aecidioides</i> | <i>S. sessilis</i> |
| BOLD | MACRO1242-09 | 5'COI | <i>Ectocarpales</i> | <i>L. aecidioides</i> | <i>C. costata</i> |
| GenBank | LM995048.1 | 5'COI | <i>L. aecidioides</i> | <i>L. aecidioides</i> | Incubated substratum |
| GenBank | LM994980.1 | 5'COI | <i>L. tomentosoides</i> | <i>L. tomentosoides</i> | <i>L. digitata</i> |
| GenBank | LM994981.1 | 5'COI | <i>L. tomentosoides</i> | <i>L. tomentosoides</i> | <i>L. digitata</i> |
| GenBank | LM994984.1* | 5'COI | <i>L. elsbetiae</i> | <i>L. elsbetiae</i> | <i>S. latissima</i> |
| GenBank | KF281117.1 | 5'COI | <i>C. flagelliformis</i> | - | - |
| GenBank | LM995239.1 | 5'COI | <i>Chordariaceae sp.</i> | - | - |
| GenBank | LM995318.1 | 5'COI | <i>H. maculans</i> | - | - |
| GenBank | LM995208.1 | 5'COI | <i>H. hincksiae</i> | - | - |
| GenBank | LN828736.1 | 5'COI | <i>H. granulosa</i> | - | - |
| GenBank | LT546267.1 | 5'COI | <i>Acinetosporaceae sp.</i> | - | - |
| GenBank | LT546288.1 | 5'COI | <i>Acinetosporaceae sp.</i> | - | - |
| GenBank | LM995264.1 | 5'COI | <i>E. fasciculatus</i> | - | - |
| GenBank | GU097832.1 | 5'COI | <i>S. latissima</i> | - | - |
| GenBank | FJ409156.1 | 5'COI | <i>L. hyperborea</i> | - | - |
| GenBank | AJ344328 | 5'COI | <i>L. digitata</i> | - | - |

| | | | | | |
|---------|------------|------|---------------------------|-------------------------|------------------------|
| GenBank | Z98567 | ITS1 | <i>L. elsbetiae</i> | <i>L. elsbetiae</i> | <i>S. latissima</i> |
| GenBank | AJ439842.1 | ITS1 | <i>L. eckloniae</i> | <i>L. aecidioides</i> | <i>H. grandifolius</i> |
| GenBank | AJ002357.1 | ITS1 | <i>L. eckloniae</i> | <i>L. aecidioides</i> | <i>E. maxima</i> |
| GenBank | AJ002359.1 | ITS1 | <i>L. macrocystis</i> | <i>L. aecidioides</i> | <i>M. pyrifer</i> |
| GenBank | EU547805.1 | ITS1 | <i>Laminariocolax</i> sp. | <i>L. aecidioides</i> | <i>L. nigrescens</i> |
| GenBank | AJ439851.1 | ITS1 | <i>L. aecidioides</i> | <i>L. atlanticus</i> | <i>L. hyperborea</i> |
| GenBank | AJ002355.1 | ITS1 | <i>L. aecidioides</i> | <i>L. atlanticus</i> | <i>L. hyperborea</i> |
| GenBank | AJ002353.1 | ITS1 | <i>L. aecidioides</i> | <i>L. atlanticus</i> | <i>S. latissima</i> |
| GenBank | AJ439850.1 | ITS1 | <i>L. aecidioides</i> | <i>L. atlanticus</i> | <i>L. digitata</i> |
| GenBank | AJ439852.1 | ITS1 | <i>L. tomentosoides</i> | <i>L. tomentosoides</i> | <i>L. digitata</i> |
| GenBank | Z98566.1 | ITS1 | <i>L. tomentosoides</i> | <i>L. tomentosoides</i> | <i>L. digitata</i> |

Table S3: *L. elsbetiae* records used to build Fig. 3A.

| Described as | Location | Host(s) | Reference |
|---------------------|--------------------------|-------------------------|---|
| <i>L. elsbetiae</i> | Muroran (Japan) | <i>S. japonica</i> | Kawai & Tukoyama 1995 |
| <i>L. elsbetiae</i> | Helgoland (Germany) | <i>S. latissima</i> | Peters & Ellertsdóttir 1996 |
| <i>L. elsbetiae</i> | Santa Isabel (Argentina) | <i>R. pseudopalmata</i> | Gauna et al. 2009a |

Table S4: *L. aecidioides* records used to build Fig. 3B.

| Described as | Location | Host(s) | Reference |
|-------------------------------|-------------------------|--|---------------------------------|
| <i>Ectocarpus aecidioides</i> | Kap Tobin (Greenland) | <i>L. longicruris</i> , <i>L. groenlandica</i> | Rosenvinge 1893 |
| | Skibshavn (Greenland) | <i>L. longicruris</i> , <i>L. groenlandica</i> | Rosenvinge 1893 |
| | Holstenborg (Greenland) | <i>L. longicruris</i> , <i>L. groenlandica</i> | Rosenvinge 1893 |
| | Kagsimiut (Greenland) | <i>L. longicruris</i> , <i>L. groenlandica</i> | Rosenvinge 1893 |
| <i>Myrionema aecidioides</i> | Fobes Sound (Canada) | <i>Laminaria</i> | Lee 1980 |
| | Munn Bay (Canada) | <i>Laminaria</i> | Lee 1980 |
| | Guernsey (UK) | <i>S. polyschides</i> | Dixon 1961 |

| | | | |
|-----------------------------------|---------------------------|-------------------------------------|--|
| <i>Entonema aecidioides</i> | Claire Island (Ireland) | - | Cotton 1912 |
| | Island | - | Caram & Jónsson 1972 |
| | Connecticut (US) | - | Schneider et al. 1979 |
| | North Norway | - | Jaasund 1965 |
| <i>Gononema aecidioides</i> | Svalbard | - | Gulliksen et al. 1999 |
| | Faroer Islands | <i>Alaria, Fucus, L. hyperborea</i> | Nielsen & Gunnarsson 2001 |
| | Netherlands | - | Stegenga et al. 1997 |
| | Isla de Arousa (Spain) | <i>U. pinnatifida</i> | Veiga et al. 1997 |
| <i>Laminariocolax aecidioides</i> | California (US) | - | Miller 2012 |
| <i>Gononema aecidioides</i> | Oregon (US) | - | Hansen 1997 |
| <i>Laminariocolax aecidioides</i> | Puerto Madryn (Argentina) | <i>U. pinnatifida</i> | Gauna et al. 2009b |
| | St Andrews (UK) | - | Hardy & Guiry 2003 |
| | Bangor (UK) | - | Hardy & Guiry 2003 |
| | Shetland Islands (UK) | - | Hardy & Guiry 2003 |
| | Galicia (Spain) | - | Peteiro et al. 2013 |
| <i>Laminariocolax macrocystis</i> | New Zealand | - | Harper et al. 2012 |
| <i>Streblonema aecidioides</i> | Kiel (Germany) | <i>S. latissima</i> | Peters & Schaeffelfe 1996 |
| <i>Laminariocolax aecidioides</i> | Isfjorden (Svalbard) | - | Fredriksen et al. 2015 |
| <i>Entonema aecidioides</i> | Eastern Canada | - | South & Cardinal 1970 |
| <i>Gononema aecidioides</i> | Limfjorden (Denmark) | - | Nielsen 2005 |
| <i>Gononema aecidioides</i> | Kattegat (Denmark) | - | Nielsen 2005 |
| <i>Gononema aecidioides</i> | Storebelt (Denmark) | - | Nielsen 2005 |
| <i>Streblonema aecidioides</i> | Rhode Island (US) | - | Wood & Villalard-Bohnsack 1974 |
| <i>Entonema aecidioides</i> | Finkcove (Canada) | - | Edelstein et al. 1973 |
| <i>Streblonema aecidioides</i> | Hganholmen (Norway) | <i>Laminaria</i> | Jaasund 1962 |
| <i>Streblonema aecidioides</i> | Revsbotn (Norway) | <i>Laminaria</i> | Jaasund 1962 |
| <i>Laminariocolax aecidioides</i> | Helgoland (Germany) | - | Ellertsdóttir & Peters 1997 |
| <i>Laminariocolax aecidioides</i> | Japan | - | Yoshida & Akiyama 1979 |
| <i>Laminariocolax macrocystis</i> | Valdivia (Chile) | <i>Macrocystis pyrifera</i> | Peters 1991 |

Table S5: *L. tomentosoides* records used to build Fig. 3D.

| Described as | Location | Host(s) | Reference |
|-------------------------------------|--------------------------------------|----------------------------------|---|
| <i>Ectocarpus tomentosoides</i> | Massachusetts (US) | <i>Laminaria</i> | Farlow 1889 |
| <i>Ectocarpus tomentosoides</i> | Skibshavn (Greenland) | <i>L. longicuris</i> | Rosenvinge 1893 |
| <i>Ectocarpus tomentosoides</i> | Holstensborg (Greenland) | <i>L. longicuris</i> | Rosenvinge 1893 |
| <i>Laminariocolax tomentosoides</i> | Creswall Bay (Canada) | <i>L. longicuris</i> | Lee 1980 |
| <i>Laminariocolax tomentosoides</i> | Fox Island (Canada) | <i>L. longicuris</i> | Lee 1980 |
| <i>Laminariocolax tomentosoides</i> | Cardigan Strait (Canada) | - | Lee 1980 |
| <i>Laminariocolax tomentosoides</i> | Wakeham Bay (Canada) | - | Lee 1980 |
| <i>Laminariocolax tomentosoides</i> | Ivujivik (Canada) | - | Lee 1980 |
| <i>Laminariocolax tomentosoides</i> | Guernsey (UK) | <i>S. polyschides, Laminaria</i> | Dixon 1961 |
| <i>Laminariocolax tomentosoides</i> | Claire Island (Ireland) | <i>Himanthalia, Laminaria</i> | Cotton 1912 |
| <i>Laminariocolax tomentosoides</i> | Iceland | - | Caram & Jónsson 1972 |
| <i>Laminariocolax tomentosoides</i> | Svalbard | - | Gulliksen et al. 1999 |
| <i>Laminariocolax tomentosoides</i> | Faroe Islands | - | Nielsen & Gunnarsson 2001 |
| <i>Laminariocolax tomentosoides</i> | Netherlands | - | Stegenga et al. 1997 |
| <i>Laminariocolax tomentosoides</i> | Scotland | - | Hardy & Guiry 2003 |
| <i>Laminariocolax tomentosoides</i> | Isle of Man (UK) | - | Hardy & Guiry 2003 |
| <i>Laminariocolax tomentosoides</i> | Anglesey (UK) | - | Hardy & Guiry 2003 |
| <i>Laminariocolax tomentosoides</i> | Shetland Island (UK) | - | Hardy & Guiry 2003 |
| <i>Laminariocolax tomentosoides</i> | Western Norway | <i>Laminaria</i> | Jaasund 1965 |
| <i>Laminariocolax tomentosoides</i> | Eastern Canada | - | South & Cardinal 1970 |
| <i>Laminariocolax tomentosoides</i> | Kattegat (Denmark) | - | Nielsen 2005 |
| <i>Laminariocolax tomentosoides</i> | Isle of Samsø (Denmark) | - | Nielsen 2005 |
| <i>Laminariocolax tomentosoides</i> | Little Belt (Denmark) | - | Nielsen 2005 |
| <i>Ectocarpus tomentosoides</i> | Northern Massachusetts to Maine (US) | <i>Laminaria</i> | Taylor 1957 |

| | | | |
|-------------------------------------|-----------------------------|----------------------|--|
| <i>Ectocarpus tomentosoides</i> | North Devon Island (Canada) | <i>Laminaria</i> | Taylor 1957 |
| <i>Laminariocolax tomentosoides</i> | Rhode Island (US) | - | Villalard-Bohnsack & Harlin 2001 |
| <i>Laminariocolax tomentosoides</i> | Helgoland (Germany) | <i>L. hyperborea</i> | Ellertsdóttir & Peters 1997 |
| <i>Laminariocolax tomentosoides</i> | Kiel (Germany) | - | Burkhardt & Peters 1998 |
| <i>Laminariocolax tomentosoides</i> | Murmansk coast (Russia) | <i>L. hyperborea</i> | Mikhaylova & Shtrik 2007 |
| <i>Laminariocolax tomentosoides</i> | Barren Islands (US) | - | Lindstrom 2006 |
| <i>Laminariocolax tomentosoides</i> | Southeast Kamtchatka | - | Klochkova et al. 2009 |
| <i>Laminariocolax tomentosoides</i> | Nuvuk Islands (Canada) | - | Keats et al. 1989 |
| <i>Laminariocolax tomentosoides</i> | Bohai Sea (China) | - | Liu 2008 |

Chapter II. qPCR-based relative quantification of the brown algal endophyte *Laminarionema elsbetiae* in *Saccharina latissima*: variation and dynamics of host-endophyte interactions

In order to investigate the variation and dynamics of kelp-endophyte interactions in nature, a reliable method to quantify endophytic infections is crucial. Until now, epidemiological studies of kelp endophytes have mainly been based on visual assessments of microscopic sections and the subsequent isolation of endophytic filaments in order to identify them by morphological or molecular characters. This approach is not only time-consuming, but the resulting microscopic data are difficult to analyse with statistical methods. To overcome this problem, this chapter presents a highly specific qPCR assay for the detection and quantification of the endophyte *Laminarionema elsbetiae* in its main host *Saccharina latissima*, a kelp-endophyte relationship that has been shown to be very common (see chapter I). After the thorough evaluation of the assay, it was applied to examine the distribution of *L. elsbetiae* filaments along the thallus of *S. latissima* and to study the prevalence of *L. elsbetiae* in different natural populations of *S. latissima*. Furthermore, the assay was applied to detect spores of *L. elsbetiae* in the seawater surrounding a natural *S. latissima* population, which provided new insights into the life cycle of *L. elsbetiae*. Finally, the prevalence of *L. elsbetiae* in different kelp species was compared in order to further assess the specificity of the endophyte.

Article

qPCR-based relative quantification of the brown algal endophyte *Laminarionema elsbetiae* in *Saccharina latissima*: variation and dynamics of host-endophyte interactions

Authors: Miriam Bernard^{1*}, Sylvie Rousvoal¹, Bertrand Jacquemin^{2,3}, Marion Ballenghien², Akira F. Peters⁴, Catherine Leblanc^{1*}

¹ CNRS, UMR 8227, Integrative Biology of Marine Models, Station Biologique de Roscoff, Sorbonne Universités, UPMC Univ. Paris 06, 29680 Roscoff, France

² CNRS, UMI 3614, Evolutionary Biology and Ecology of Algae, Station Biologique de Roscoff, Sorbonne Universités, UPMC Univ. Paris 06, 29680 Roscoff, France

³ Present Address: CEVA, 22610 Pleubian, France

⁴ Bezhin Rosko, 29250 Santec, France

* Corresponding authors

This chapter is published as an article in the Journal of Applied Phycology

DOI: 10.1007/s10811-017-1367-0

Abstract

Morphological changes—such as dark spots, twisted stipes and deformed blades—have been observed in wild and cultivated *Saccharina latissima*. The putative cause for the disease symptoms is the filamentous endophytic brown alga *Laminarionema elsbetiae*, which is known to invade stipes and fronds of its hosts. Little is known about this interaction and its occurrence in the field, although former studies indicated high endophyte prevalence in kelp populations. Previous epidemiological studies on kelp endophytes were mainly based on the examination of microscopic sections, followed by time-consuming isolation and cultivation steps in order to identify the endophyte and a reliable method to quantify endophyte infections was missing. As a novel approach, we established and validated a qPCR assay for relative quantification of the endophyte *L. elsbetiae* within its host *S. latissima*, which allows to examine both, the prevalence of endophytic algae and the severity of infections. The assay was shown to be highly specific and suitable to reliably detect small amounts of endophyte DNA in the host. Using this method, we detected very high endophyte prevalence in the investigated kelp populations, up to 100% in young *S. latissima* sporophytes in Brittany during spring. Furthermore, our results suggest that *Saccharina* sporophytes are infected early in their life and that seasonality and environmental factors have a significant impact on infection rates. In the future, this approach could also be applied to study other host-endophyte pairs using specific primers.

Keywords

Endophytes; *Laminarionema elsbetiae*; kelps; *Saccharina latissima*; quantitative PCR

1. Introduction

The sugar kelp *Saccharina latissima* (Laminariales, Phaeophyceae) is an important primary producer in temperate to cold northern hemisphere coastal ecosystems (Bartsch et al. [2008](#)) and an economically relevant seaweed with high industrial potential (Østgaard et al. [1993](#); Adams et al. [2009](#)). Growing or being cultivated in the sea *S. latissima* is exposed to a high number of potentially harmful organisms such as fungi, bacteria or endophytic algae (Andrews [1977](#); Wu et al. [1983](#); Apt [1988a](#); Potin et al. [2002](#)). Previous studies on the latter reported a high prevalence of filamentous endophytic algae in kelp populations, with up to 100% of infected individuals (Andrews [1977](#); Lein et al. [1991](#); Peters & Schaffelke [1996](#); Schaffelke et al. [1996](#); Ellertsdóttir & Peters [1997](#)). Amongst them is *Laminarionema elsbetiae* (Ectocarpales, Phaeophyceae), a filamentous brown algal endophyte highly prevalent in European wild *S. latissima* populations (Peters & Ellertsdóttir [1996](#); Ellertsdóttir & Peters [1997](#)). It invades stipes and fronds of its host, thereby potentially not only causing morphological changes but even more severe impairment as it has been shown for other filamentous endophytic brown algae (Yoshida and Akiyama [1979](#); Apt [1988a+b](#); Peters & Schaffelke [1996](#); Ellertsdóttir & Peters [1997](#); Thomas et al. [2009](#)). Despite an increasing interest in this topic due to the economic importance of *Saccharina* aquaculture (Chen [2004](#)), little is known about this particular interaction, its prevalence in the field, the natural infection process and variation under different environmental conditions. A considerable drawback is the lack of a common comparable and rapid method to conduct these studies. In particular, there is no reliable technique to quantify endophyte infections, which is crucial to investigate the dynamics of this phenomenon.

Quantitative PCR is a well-established tool for the detection of pathogens in the field of plant-pathogen interactions (Brouwer et al. [2003](#); Gachon et al. [2004](#)) which has lately also been applied for the detection of the pathogenic oomycete *Eurychasma dicksonii* in *Ectocarpus siliculosus* (Gachon et al. [2009](#)). Here, we developed a highly specific qPCR assay that is not only fast and reproducible but also suitable to detect minor amounts of target DNA. This method allows us to examine the prevalence of endophyte infections, i.e. the number of infected thalli in a population, and the severity of infection, i.e. the relative amount of endophyte present in the host tissue. The first aim of this study was to validate this qPCR assay according to recommended guidelines (Bustin et al. [2009](#)). Subsequently, we applied the assay to examine the distribution of filaments of *L. elsbetiae* along the thallus of *S. latissima* and the impact of seasonality and geographic variation on endophyte infection rates in different kelp populations.

The natural infection process was studied by cultivating laboratory-grown *S. latissima* sporophytes in a seaweed farm and comparing their infection rates with those of wild individuals. Finally, the assay was applied to assess the specificity of *L. elsbetiae* towards different kelp species.

2. Material and Methods

2.1 In situ algal sampling

To determine the distribution of endophyte occurrence along the thallus, tissue was punched out (\varnothing 2.8 cm) at four positions on *S. latissima* sporophytes: (1) 50% of the stipe length (piece of 2.8 cm length), (2) 10% of the blade length, (3) 50% of the blade length, and (4) 90% of the blade length. Samples of *S. latissima* were collected in the same location of different populations, i.e. in Northern Brittany (Perharidy near Roscoff; 48.73° N, 4.00° W, N = 10) in March and April 2016, in Southern Brittany (Locmariaquer; 47.55° N, 2.92° W, N = 5) in March 2016, and in Western Scotland (Bridge over the Atlantic; 56.31° N, 5.58° W, N = 5) in April 2016. Additionally, two sections were made next to each punch-out to look for the presence of endophytic filaments using a light microscope.

For the following studies, all samples were taken from the distal part of the blades (i.e. 90% of the blade length) of the kelp sporophytes. The onset of endophyte infections in the field was explored by obtaining infection rates of young *S. latissima* sporophytes with different thallus lengths collected in March 2017 in Northern Brittany (Perharidy; 48.73° N, 4.00° W, N = 10) that were grouped according to the host length: 3–5 cm (N = 6), 6–10 cm (N = 7), 11–15 cm (N = 8), 16–26 cm (N = 4), and > 26 cm (N = 30).

An experimental set-up was used to investigate the impact of natural infection on laboratory-grown sporophytes. Gametophytes descending from spores of *S. latissima* from Perharidy were seeded on collectors in February 2016 by submerging them in 50 mL Falcon tubes overnight. Then, the collectors were transferred to filtered seawater containing half-strength Provasoli enrichment (10 mL solution per L seawater, Provasoli [1968](#)). The young sporophytes were grown in 11°C with 40 $\mu\text{mol photons m}^{-2} \text{ s}^{-1}$ with a light/dark cycle of 8/16 h during the first 20 days and 12/12 h until the end of the experiment. After 68 days, when the sporophytes had reached a length of 2–4 cm, a part of them was transferred to a seaweed farm in vicinity to the wild population (4 km distance) in April 2016 while the rest was maintained in laboratory conditions. In October 2016, infection rates in samples from the individuals cultivated in the

farm (N = 57) were compared to samples collected from the wild population at Perharidy (N = 30) within the same week. The kelps kept in laboratory conditions since April 2016 served as controls (N = 27).

Seasonal variation of endophyte infection rates was examined in *S. latissima* sporophytes collected in March 2016, April 2016, July 2016, September 2016, October 2016, November 2016, December 2016, February 2017 and March 2017 (N = 30, each month) in Perharidy.

Saccharina latissima samples were collected in Southern Brittany in March 2016 (N = 12) and in Western Scotland in April 2016 (N = 30) and compared to the samples collected in Perharidy in March and April 2016 (N = 30, each) to investigate geographic variation of endophyte infection rates.

To explore host specificity of *L. elsbetiae*, tissue was punched out from distal parts of blades in *L. digitata*, *L. hyperborea* and *L. ochroleuca* (N = 10 for each species) collected in March 2017 in Perharidy and compared to the infection rate of *S. latissima* (N = 30). Additionally, 10 L seawater (N = 3) were collected and directly filtered through a 150- μm mesh. Subsequently, the water was filtered through 3- μm polycarbonate filters (Nucleopore Track-Etched Membranes, Whatman, GE Healthcare, USA) with a vacuum pump. The filters were transferred to cryotubes, frozen in liquid nitrogen and kept in -20°C until DNA was extracted.

All samples were collected haphazardly regardless of possible morphological infection symptoms. The punched-out tissue was soaked dry with tissue paper, transferred to silica gel and stored in silica until DNA extraction.

2.2 Monospecific algal cultures

DNA from monospecific algal cultures was used for setting-up and validating the qPCR assay. The cultures of laboratory-grown kelps were started from freshly released spores of mature sporophytes collected at Perharidy. Developing sporophytes were kept in 10 L bottles containing half-strength Provasoli enrichment (10 mL Provasoli solution/L seawater) in 14°C and $\sim 20 \mu\text{mol photons m}^{-2} \text{s}^{-1}$ at 12 h light/day with weekly changes of the culture medium. Cultures of the filamentous brown algal endophyte *L. elsbetiae* were grown from the strain LelsPH14-01 obtained from the Bezhin Rosko culture collection (origin Perharidy, France). Isolation of other algal strains from the order Ectocarpales was performed as described by Peters (1991). Ectocarpales cultures were kept in 14°C and $5 \mu\text{mol photons m}^{-2} \text{s}^{-1}$ at 12 h light/day with monthly changes of the culture medium (half-strength Provasoli enrichment).

The cultured algal material was soaked dry with tissue paper and freeze-dried for DNA extraction.

2.3 DNA extraction

All samples were extracted according to the same protocol to limit differences in extraction yields. The dried algal material was ground in a mechanical bead grinder (Tissuelyser II, Qiagen, Germany) twice for 2 min at 30 Hz. Twenty milligrams of ground material was transferred to a 2-mL Eppendorf tube and used for the following DNA extraction that was adapted after Apt et al. (1995). One millilitre of extraction buffer (100 mM Tris-HCl [pH 7.5], 1.5 M NaCl, 2% CTAB, 50 mM EDTA [pH 8], 50 mM DTT) was added to the ground tissue, and samples were incubated at room temperature on a shaker at 250 rpm for 1 h. One vol of chloroform/isoamyl alcohol (24:1) was added, and the two phases were mixed by vortexing and centrifuged at 10.000 rpm for 15 min. The upper phase was transferred to a new tube and 0.3 vol ethanol was added drop by drop until polysaccharide precipitation was visible, followed by a second chloroform extraction and another centrifugation step at 10.000 rpm for 15 min. The upper phase was transferred onto the filter of the Nucleospin plant II kit (Macherey-Nagel, Germany), and the protocol recommended by the manufacturer was followed from this step onwards with two elution steps of 50 μL .

For DNA extraction from the seawater samples, 1.5 mL of lysis buffer (0.7 M sucrose, 50 mM Tris pH 8, 40 mM EDTA) was added to each filter. One hundred microlitres lysozyme (20 mg mL^{-1}) was added, and samples were shaken at 37°C for 45 min. Twenty microlitres proteinase K (20 mg mL^{-1}) and 100 μL 20% SDS was added, and samples were homogenised by inversion and incubated at 55°C for 1 h. The content was transferred to a new tube and 1 vol phenol-chloroform-isoamyl alcohol (25:24:1) was added; the phases were mixed and then centrifuged for 15 min at 4500 rpm at 4°C. The supernatant was mixed with 1 vol of the binding buffer from the Nucleospin plant II kit (Macherey-Nagel, Germany), and the protocol recommended by the manufacturer was followed from this step onwards with two elution steps of 50 μL .

DNA concentrations were measured with a Qubit Fluorometer (Thermo Fisher, USA) and diluted to 0.05 ng DNA μL^{-1} with autoclaved milliQ-filtered H_2O .

2.4 qPCR and evaluation of the assay

The first primer pair CG64 and CG65 (Gachon et al. [2009](#)) matched the 18S rDNA of all Ectocarpales and Laminariales (72-bp amplicon size) and was used to amplify 18S rDNA from both, host and endophyte DNA. The second primer pair LelsITS1-F2 (TTTCGAGAGCTTTTCGAGAGG) and LelsITS1-R2 (TCTTCACGCCTCTTACATGG) (83-bp amplicon size) was designed to specifically match the partial ITS1 of *Laminarionema elsbetiae*. Specificity of the latter primer pair was tested by blasting the sequence and testing it with the DNA from 10 other brown algae diluted to 0.05 ng DNA μL^{-1} , including algal endophytes from the order Ectocarpales and possible hosts from the order Laminariales (Fig. S1). The qPCR products were run in a 2.5% agarose gel electrophoresis at 100 V for 25 min to check for presence or absence of bands.

Artificial mixtures of host and endophyte DNA were assembled to assess if different amounts of endophyte DNA were detectable reliably. Therefore, 1 ng of DNA from *S. latissima* was mixed with 0.0024, 0.012 g, 0.06 and 0.3 ng of DNA from *L. elsbetiae*.

Standard curves for the CG primer pair were constructed in triplicates with 1:5 serial dilutions of *S. latissima* DNA, extracted from a laboratory-grown sporophyte, ranging from a concentration of 0.5 ng to 6.4×10^{-6} ng. Standard curves for the LelsITS1 primer pair were constructed with 1:2 serial dilutions of *L. elsbetiae* DNA, extracted from the strain LelsPH14-01, ranging from a concentration of 0.375 ng to 1.14×10^{-5} ng.

A total of 2.5 μL LightCycler 480 SYBR Green I Master (2x, Roche Diagnostics, Germany) was mixed with the primers (400 nM), and 2.9 μL of this mix was added to 2.1 μL of diluted DNA (0.05 ng μL^{-1}). Real-time PCR was performed on a LightCycler 480 (Roche Life Science, Germany) in white 384-well plates, sealed with adhesive foil. A 5-min denaturation step at 95°C was followed by 55 cycles of 10 s at 95°C and 15 s at 60°C and 15 s at 72°C. After each run, a dissociation curve was obtained by heating the samples from 65 to 97°C. The dissociation curves indicated a single product for both primer pairs (data not shown). All samples were run in triplicates, as recommended by Pfaffl ([2004](#)), and autoclaved milliQ H₂O was used as negative control. For relative quantification, the differences between the quantification cycles (ΔC_q) obtained by two qPCRs with the different primer pairs run in parallel on the same DNA sample were measured, as by Gachon et al. ([2009](#)). The resulting ΔC_q values correlate negatively to the relative amount of endophyte DNA in the sample.

No relative quantification was performed for the water samples. Only the *L. elsbetiae*-specific primer pair was used in a qPCR reaction, and the final qPCR product was run in a 2.5% agarose gel electrophoresis to check for presence or absence of endophyte DNA.

2.5 Data analysis

Cycle thresholds were calculated with the LightCycler 480 Software (Roche, Germany) and exported to Excel 2013 (Microsoft, USA) where ΔC_q values of each DNA sample were determined. Values are reported as average \pm standard deviation. Graphs of the standard curves were drawn with GraphPad Prism (GraphPad Prism Software, Inc., USA), and the heat map was constructed in R Studio (RStudio, Inc., USA). SPSS (IBM Corp. Released 2013. IBM SPSS Statistics for Windows, Version 22.0. Armonk, NY: IBM Corp.) was used to perform statistical analyses. Normality of the data was tested with the Shapiro-Wilk test and homogeneity of variances with the Levene test. Data with normal distribution and homogeneous variances was analysed with one-way ANOVA. In the case of heterogeneous variances, the non-parametric Kruskal-Wallis test was used.

3. Results

3.1 Set-up and validation of the qPCR assay

The specificity of the endophyte-specific primer pair was verified by blasting the sequence (BLASTN search), and no other species showed 100% identity over the full query. Furthermore, the primers were tested with 10 other brown algal species. Electrophoresis on an agarose gel resulted in no visible bands for any sample except *L. elsbetiae*, suggesting a strong specificity of the primer pair (Fig. S1 in the supplementary material).

Artificial mixtures with the same amount of host DNA and different amounts of endophyte DNA were used to test if varying amounts of *L. elsbetiae* could be detected reliably, even in low concentrations (Fig. S2 in the supplementary material). Similar quantification cycles (C_q) were obtained with the CG primer pair. Since only small amounts of endophyte DNA were added, the total amount of DNA did not change significantly (Fig. S2A in the supplementary material). At the contrary, quantification of the same mixtures with the endophyte-specific primer pair (Fig. S2B in the supplementary material) resulted in different C_q values, showing that the qPCR amplification was sufficiently discriminant to detect different concentrations of total endophyte DNA over the assessed range from 0.0024 to 0.3 ng μL^{-1} total DNA.

Standard curves were drawn for both primer pairs to define the linear dynamic range of stable quantification and to compare the efficiency of amplification. As the efficiency of both primer pairs was similar (88.74% for the CG primer pair and 91.08% for the *Laminarionema* specific primer pair, Fig. S3 in the supplementary material), no efficiency correction was applied. For the primer pair CG64 and CG65, a reliable quantification was possible for cycle numbers between 18 and 29 (Fig. S3A in the supplementary material). C_q values of all samples lay within the range of this standard curve. For the LelsITS1 primer pair, the linear quantification range was between 19 and 32 cycles (Fig. S3B in the supplementary material). Thus, a maximal ΔC_q value of 14 (32–18) was set for stable quantification of *L. elsbetiae* according to the standard curves. Samples with higher C_q values or no endophytes were marked as “undetected”.

3.2 Distribution of endophyte filaments along the thallus of *S. latissima*

To determine the distribution of *L. elsbetiae* along the thallus of *S. latissima*, a relative infection map was established by quantifying relative infection rates at four different positions along the thallus.

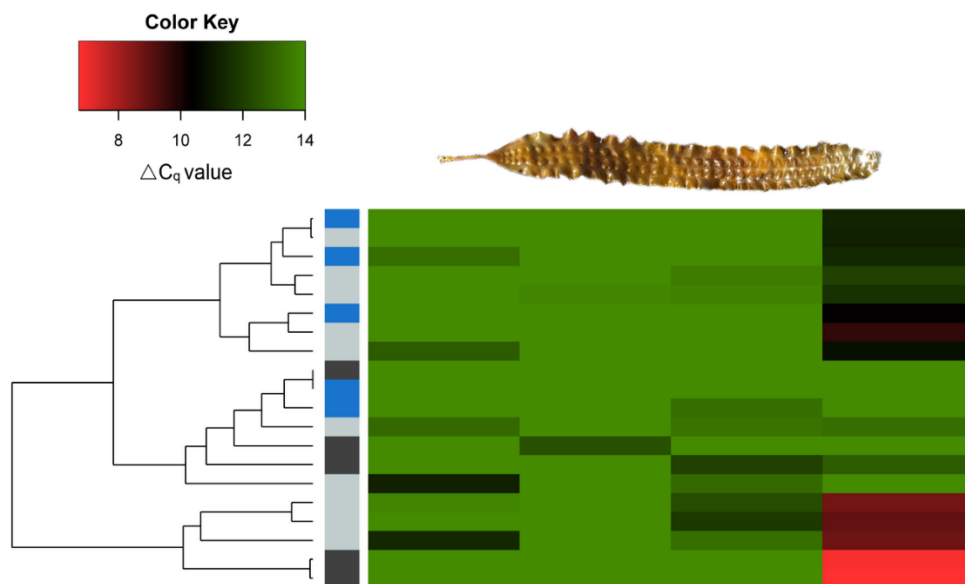

Fig. 1: Distribution of endophyte DNA in field sporophytes of *S. latissima* (> 160 cm length) collected between March and April 2016. The small column on the left indicates the geographic origin of the sporophytes: light grey = Perharidy (Northern Brittany) N = 10, light blue = Locmariaquer (Southern Brittany) N = 5, and dark grey = bridge over the Atlantic (Western Scotland) N = 5. The four columns of the heat map indicate the four positions: (1) 50% of the stipe; (2) 10% of the blade length = youngest part of the blade, near meristem; (3) 50% of the blade length; and (4) 90% of the blade length = oldest part of the blade. The colours of the heat map represent ΔC_q values obtained by qPCR: green represents absence and red strong presence of *L. elsbetiae*.

Endophyte filaments of *L. elsbetiae* were unequally distributed within the host, with significantly more endophyte DNA being present in the blade tip ($\Delta C_q = 10.8 \pm 3.17$) than in the stipe ($\Delta C_q = 13.72 \pm 0.72$), at 10% of the blade length ($\Delta C_q = 13.94 \pm 0.29$) and at 50% of the blade length ($\Delta C_q = 13.62 \pm 0.63$, Fig. 1, Kruskal-Wallis test, $p \leq 0.01$, Table S1 in the supplementary material). The unequal distribution along the thallus was the same in kelps from all three geographic locations. Due to this result, the samples for the following studies were taken in the blade tips of the kelps, where most endophytes were expected to be present.

The presence of filamentous brown algae at the four positions in the same *Saccharina* sporophytes was also examined in microscopic sections (Fig. 2). Eighty percent of the thalli from Northern Brittany and Western Scotland and 60% of the thalli from Southern Brittany contained filamentous algae in the blade tips (Fig. 2b). Seventy percent and 20% of the stipe sections of sporophytes from Northern Brittany and Southern Brittany, respectively, contained endophytic filaments (Fig. 2a) while no filament was detected in the stipe sections of the *S. latissima* sporophytes from Western Scotland. In all examined sections, no endophytic filaments were visible in the intermediate sections (positions 2 and 3 in Fig. 1).

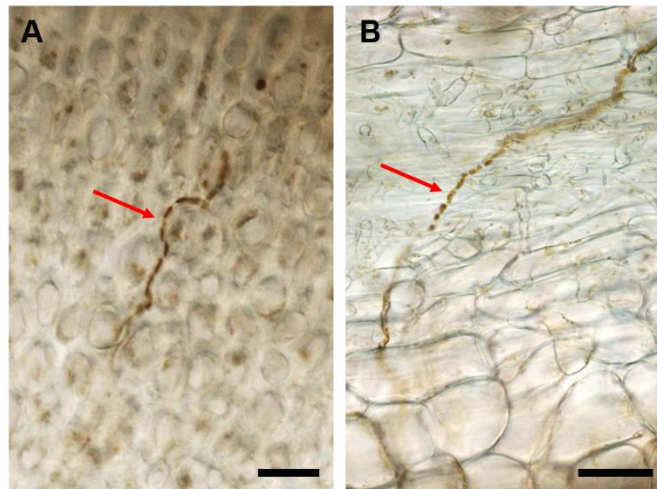

Fig. 2: **A.** microscopic section of the stipe (position 1, 50% of the stipe length) of *S. latissima* from Northern Brittany. **B.** microscopic section of the blade tip (positions 4, 90% of the blade length) of *S. latissima* from Northern Brittany. Red arrows indicate endophytic filaments, and the scale bar presents 25 μm .

3.3 Infection rates in young kelps

The occurrence of the endophyte infection in the field was investigated by determining relative infection rates of young *S. latissima* sporophytes. One hundred percent of the young *S.*

latissima sporophytes collected in Northern Brittany contained DNA of *L. elsbetiae*, compared to 93% of infected thalli in old (> 30 cm) sporophytes collected at the same time (Fig. 3a). When comparing the relative infection rates, no significant difference appeared in the ΔC_q between sporophytes of all lengths ($\Delta C_q = 9.82 \pm 0.6$, Fig. 3b) except for the samples with a thallus length from 6 to 10 cm where infection rates were slightly lower ($\Delta C_q = 11.43 \pm 0.7$, Fig. 3b).

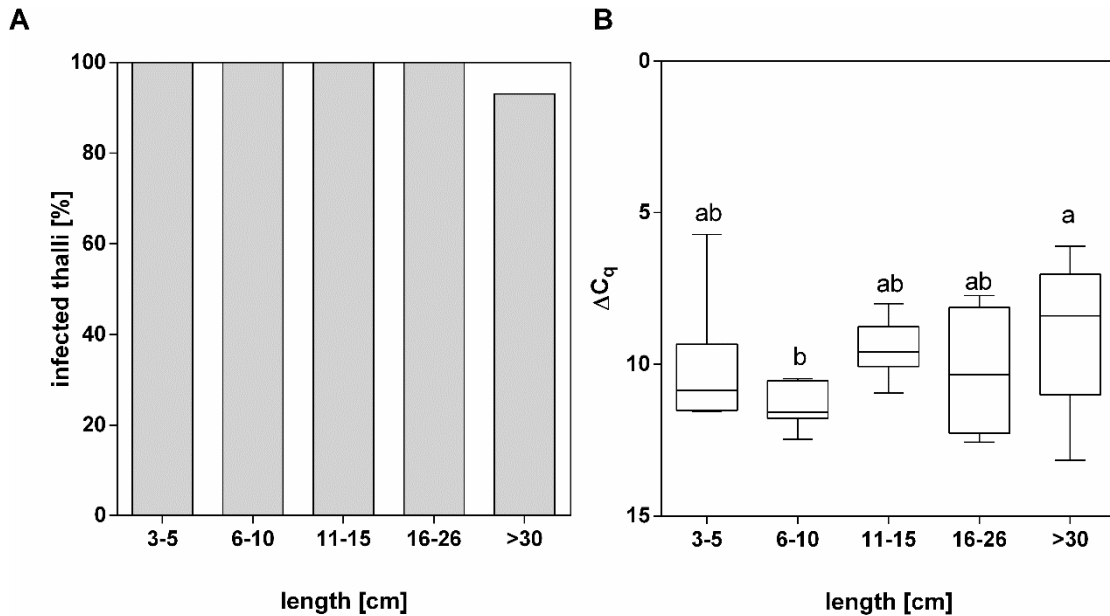

Fig. 3: A. Percentage of *S. latissima* sporophytes with different thallus lengths infected with *L. elsbetiae*. **B.** ΔC_q values obtained by qPCR represent the relative amount of *L. elsbetiae* in *S. latissima* individuals of different thallus lengths obtained from punch-outs of blade tips collected in March 2017 (3–5 cm, N = 6; 6–10 cm, N = 7; 11–15 cm, N = 8; 16–26 cm, N = 4; > 30 cm, N = 30). Whiskers indicate the smallest and largest values, and letters indicate statistically significant differences (one-way ANOVA).

3.4 Natural infection of laboratory-grown samples in a seaweed farm

The course of natural infection of *S. latissima* with *L. elsbetiae* was further explored by an experimental set-up where laboratory-grown samples were transferred to a seaweed farm for 6 months and infection rates were compared to samples from a wild population. The number of thalli infected with *L. elsbetiae* was more than four times higher in wild samples (87% of infected thalli) than in the samples grown in the seaweed farm in close vicinity to the wild population (19%, Fig. 4a). No endophytes were detected in the laboratory controls (Fig. 4a). While the laboratory-grown samples in the seaweed farm were heavily covered with epiphytes (data not shown), the qPCR revealed significantly lower infection rates by the endophyte *L.*

elsbetiae ($\Delta C_q = 11.81 \pm 1.4$) as compared to wild samples ($\Delta C_q = 8.99 \pm 2.5$) (one-way ANOVA, $p \leq 0.01$, Fig. 4b, Table S2 in the supplementary material).

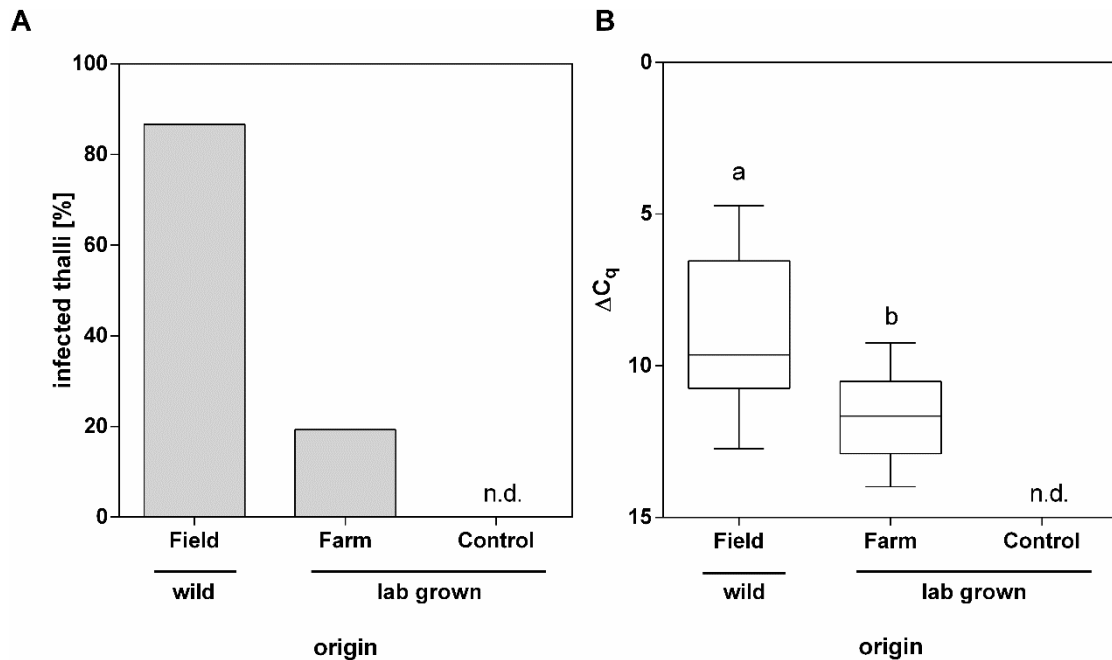

Fig. 4: **A.** Percentage of *S. latissima* sporophytes from different origins infected with *L. elsbetiae*. **B.** ΔC_q values obtained by qPCR represent the relative amount of *L. elsbetiae* in *S. latissima* obtained in October 2016 from a wild population in Northern Brittany (N = 30) and from laboratory-grown samples transferred to a seaweed farm (N = 57) and kept under laboratory conditions (N = 27). Whiskers indicate the smallest and largest values, and letters indicate statistically significant differences (one-way ANOVA), n.d. = no *L. elsbetiae* detected by qPCR.

3.5 Seasonal variation of relative infection rates

To examine the seasonal variation of infection in a natural population, regular samplings took place in Northern Brittany from March 2016 to March 2017. The endophyte prevalence in the *S. latissima* population ranged between 73 and 93% with the lowest number of infected kelps detected in February 2017 (73%) and most kelps infected in July 2016 and March 2017 (93%, Fig. 5a). The relative amount of *L. elsbetiae* filaments in infected thalli also increased during spring and was significantly higher between July and September ($\Delta C_q = 7.38 \pm 1.8$ and 7.06 ± 2.4 , respectively) than during the rest of the year (one-way ANOVA, $p \leq 0.01$, Fig. 5b, Table S2 in the supplementary material). Infection rates decreased in October, reaching the lowest value in February ($\Delta C_q = 10.75 \pm 2.1$) and increasing again in March (Fig. 5b).

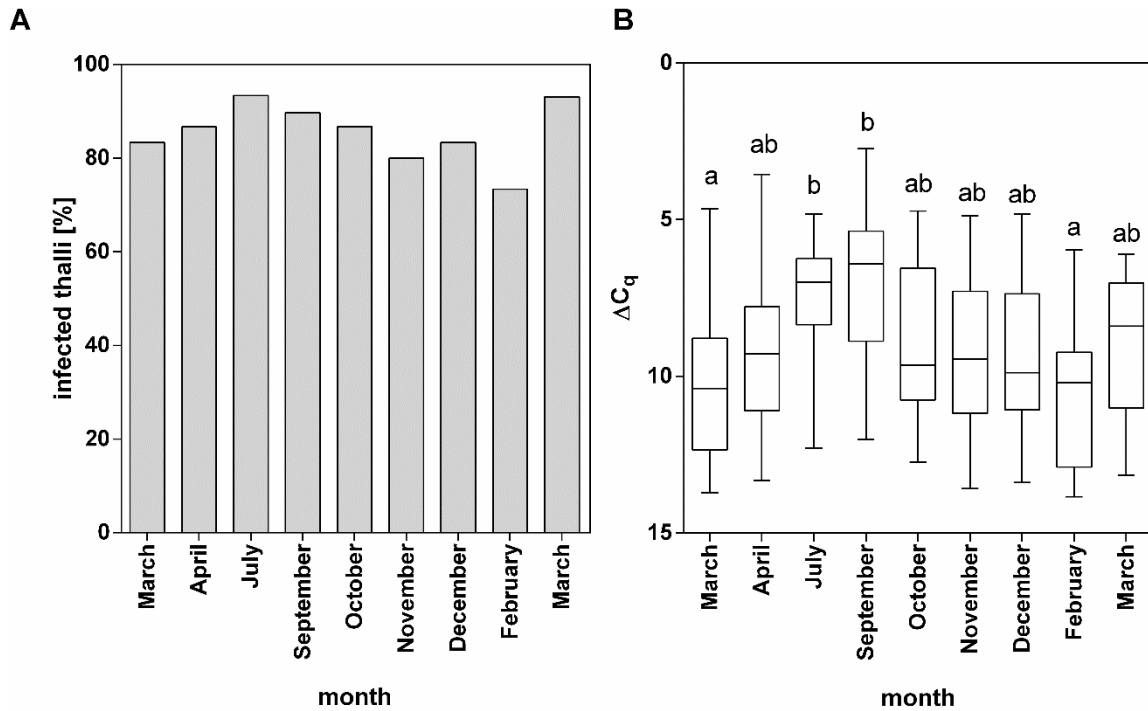

Fig. 5: **A.** Percentage of *S. latissima* sporophytes collected in different months infected with *L. elsbetiae* in a population of *S. latissima* at Perharidy (Northern Brittany). **B.** Seasonal changes in the relative amount of *L. elsbetiae* in a population of *S. latissima* at Perharidy (Northern Brittany) represented by ΔC_q values obtained from punch-outs of blade tips of 30 individuals per sampling. Whiskers indicate the smallest and largest values, and letters indicate statistically significant differences (one-way ANOVA).

3.6 Geographic variation of relative infection rates

Geographic variation of relative infection rates of *L. elsbetiae* in *S. latissima* sporophytes was determined by samplings in three different populations in Southern Brittany, Northern Brittany and Western Scotland during March and April 2016. While 85 and 93% of the sporophytes collected in Northern Brittany and Western Scotland, respectively, were infected with the endophyte, only 33% of sporophytes from Southern Brittany contained detectable amounts of endophytic filaments in their blade tips (Fig. 6a). Moreover, the relative infection rate by *L. elsbetiae* was shown to differ significantly between Western Scotland and Brittany (one-way ANOVA, $p=0.01$, Fig. 6b, Table S2 in the supplementary material). Kelps collected in Southern Brittany (Locmariaquer) contained significantly less *L. elsbetiae* ($\Delta C_q = 11.78 \pm 2.4$) than the ones from Northern Brittany (Perharidy, $\Delta C_q = 9.93 \pm 2.3$). The sporophyte samples collected at the Bridge over the Atlantic (Western Scotland) were most heavily infected ($\Delta C_q = 8.39 \pm 3$, Fig. 6b).

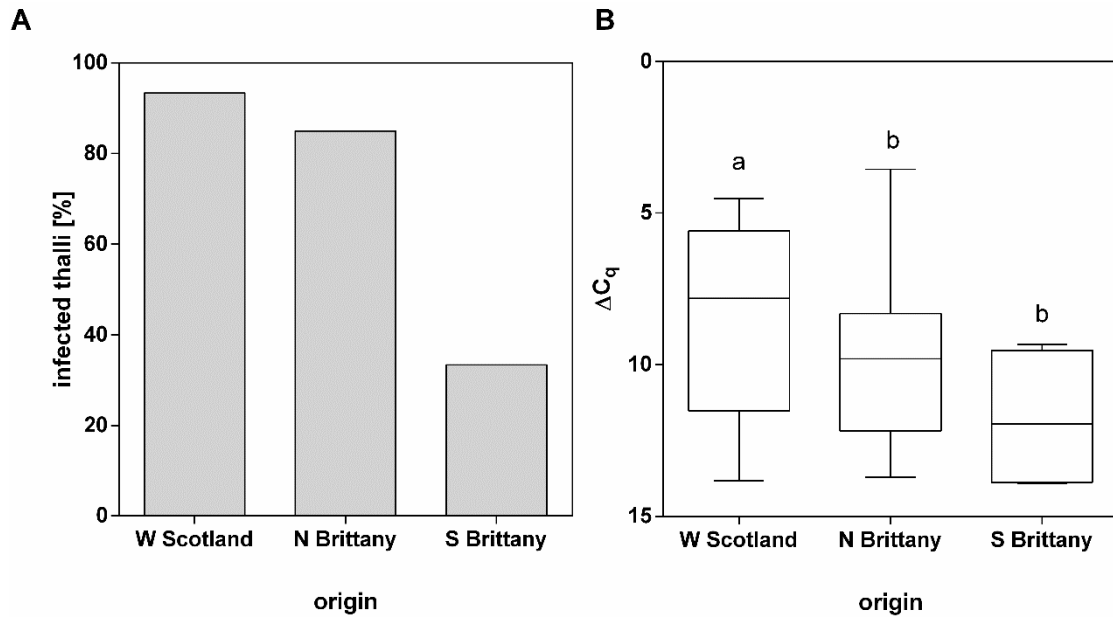

Fig. 6: A. Percentage of *S. latissima* sporophytes from different geographic origins infected with *L. elsbetiae*. **B.** ΔC_q values obtained by qPCR represent the relative amount of *L. elsbetiae* in *S. latissima*, obtained from punch-outs of blade tips of individuals from Western Scotland (N=30), Northern Brittany (N=60) and Southern Brittany (N=12), collected in March and/or April 2016. Whiskers indicate the smallest and largest values, and letters indicate statistically significant differences (one-way ANOVA).

3.7 Host specificity

To explore the host specificity of *L. elsbetiae*, endophyte prevalence and infection rates of *S. latissima* were compared to infection rates of the adjacent kelp species *L. hyperborea*, *L. digitata* and *L. ochroleuca*. While 93% of the *S. latissima* sporophytes were infected with *L. elsbetiae*, endophyte DNA was only detected in 20 and 50% of the *L. digitata* and *L. ochroleuca* individuals, respectively, collected at the same location and the same time (Fig. 7a). *Laminarionema elsbetiae* was not detected in DNA from any sample of *L. hyperborea*. Additionally, infection rates in *S. latissima* sporophytes were significantly higher ($\Delta C_q = 8.97 \pm 2$) than in *L. digitata* and *L. ochroleuca* individuals adjacent to the *Saccharina* population ($\Delta C_q = 11.98 \pm 0.9$ and 12.58 ± 1.3 , respectively, one-way ANOVA, $p \leq 0.01$, Fig. 7b, Table S2 in the supplementary material).

DNA of *L. elsbetiae* was also specifically amplified in the seawater samples collected at three locations in close vicinity to *Saccharina* sporophytes (Fig. S4 in the supplementary material).

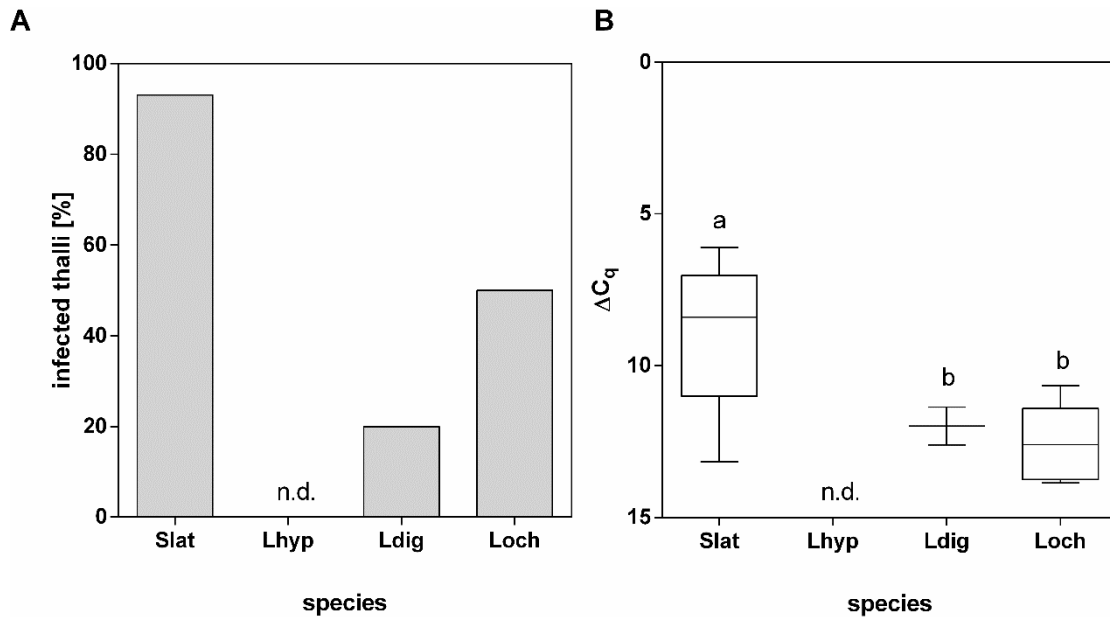

Fig. 7: A. Percentage of sporophytes from different species infected with *L. elsbetiae*. **B.** ΔC_q values obtained by qPCR represent the relative amount of *L. elsbetiae* in *S. latissima* (Slat, N = 30), *L. hyperborea* (Lhyp, N = 10), *L. digitata* (Ldig, N = 10) and *L. ochroleuca* (Loch, N = 10), obtained from punch-outs of blade tips, collected in March 2017. Whiskers indicate the smallest and largest values, and letters indicate statistically significant differences (one-way ANOVA), n.d, no *L. elsbetiae* detected by qPCR.

4. Discussion

4.1 A specific and reliable qPCR approach for epidemiological studies

In our study, we detected a high prevalence of *L. elsbetiae* in *S. latissima* with up to 100% of infected individuals in Northern Brittany. This is in consistence with previous epidemiological studies about filamentous endophytes in brown algae in the Atlantic and Pacific Ocean (Andrews [1977](#); Lein et al. [1991](#); Peters & Schaffelke [1996](#); Ellertsdóttir & Peters [1997](#); Peters [2003](#)). Until now, epidemiological studies were based on different methodological approaches, rendering them difficult to compare. Andrews ([1977](#)) determined an infection rate of 20% by quantifying galls on *S. latissima* presumably caused by a filamentous brown algal endophyte. However, the presence of endophyte filaments is not always directly connected to the occurrence of disease symptoms (Ellertsdóttir & Peters [1997](#); Gauna et al. [2009b](#)) and indeed most of the sporophytes infected with *L. elsbetiae* sampled in our study did not show any disease symptoms. Thus, an epidemiological survey based on the occurrence of symptoms could lead to an underestimation if endophytes do not cause identifiable changes in the host. Other studies were based on counting endophyte filaments in microscopic sections (Lein et al. [1991](#); Gauna et al. [2009a](#)). While this method provides valuable information about the presence

of filamentous endophytes, a precise quantification by visual scoring and the subsequent statistical analysis are difficult. Furthermore, filamentous endophytes are difficult to identify in microscopic sections as species are morphologically little differentiated (Eggert et al. [2010](#)). For a trustworthy identification, the endophyte needs to be isolated and cultivated in a time-consuming process (Ellertsdóttir & Peters [1997](#); Peters [2003](#); Amsler et al. [2009](#)).

The evaluation of our qPCR assay confirmed that this new approach is suitable not only for a relative quantification of the prevalence and the severity of infection but also for a specific, rapid and sensitive identification of *L. elsbetiae*. A possible concern might be that the *L. elsbetiae*-specific primer pair could amplify other so far unknown species. However, up to now, only one species of the genus *Laminarionema* is described and the related genera *Laminariocolax* and *Microspongium* which also contain filamentous endophytes (Peters & Burkhardt [1998](#); Peters [2003](#)) are not targeted by the *L. elsbetiae*-specific primer pair (Fig. S1 in the supplementary material). The results obtained using the qPCR assay correlate with the detection of endophytic filaments by microscopy in highly infected parts. Moreover, low amounts of endophyte DNA could be detected by qPCR in parts of the blade where no filaments were visible in the microscopic sections showing that the qPCR assay is a more sensible tool than microscopy.

4.2 Early occurrence of the infection in nature

Since it has been reported for other host-endophyte pairs that endophytic filaments can be distributed unequally within the host (Amsler et al. [2009](#); Gauna et al. [2009a](#)), we investigated the distribution of endophytes along the host thallus and confirmed that most endophytes were located in the blade tips of *S. latissima*. This stresses the importance of careful planning of samplings for epidemiological studies, as the infection rates may differ significantly depending on where exactly on the thallus samples are taken. The meristematic tissue of kelps lies at the junction between stipe and blade; the blade tip is therefore the oldest part of the sporophyte (Wilkinson [1995](#)). The concentration of endophyte filaments in the blade tip could indicate that hosts are infected very early in their life, and the endophyte subsequently stays in the same tissue while this part grows further away from the meristem. To test this hypothesis, we collected young kelps of different lengths in order to compare the infection rates with the old sporophytes. *Laminarionema elsbetiae* was detected in all of the sampled kelps, even the very young ones (> 5 cm), suggesting an early infection of the kelp. Furthermore, kelps from a seaweed farm, which had been grown in lab conditions for 10 weeks, were significantly less

infected than wild kelps although the farm and population were in vicinity to each other (4 km distance), i.e. exposed to similar environmental conditions. These kelps were kept in the laboratory during their early life, and once they were taken out to the sea, the cell walls might have already changed enough to make it more difficult for the endophyte to enter (Apt [1988a](#)). Similarly, in the case of the closely related pacific kelp species *Saccharina japonica*, only young specimen could be infected by the filamentous brown algal endophyte *Streblonema* sp., while the filaments of the endophyte could not penetrate the tissue of mature kelps, unless it presented a wounding site (Apt [1988a](#)). Previous experimental infection of *S. latissima* with *Laminarionema* used very young host sporophytes (< 10 mm in length), which were readily infected (Heesch & Peters [1999](#)). Overall, our results suggest that *S. latissima* is infected with *L. elsbetiae* while it is still very young and keeping *Saccharina* cultures under controlled conditions for a certain amount of time could reduce infection rates of cultivated *S. latissima* with *L. elsbetiae*.

4.3 Variation of infection rates

The severity of infection differed not only along the thallus but also depended on seasonal and geographic location. Infection rates within the *Saccharina* population in Northern Brittany were significantly higher in summer as compared to the rest of the year. This is in agreement with observations on endophytic infections in *S. latissima* and two other kelp species on Helgoland (Ellertsdóttir & Peters [1997](#)) and in *S. latissima* in the Pacific Northwest (Andrews [1977](#)). However, as seasonal samplings were only conducted in Northern Brittany, additional samplings at other locations are necessary to confirm a general pattern of seasonal variation. Kelps may lose distal parts of their blade in winter, thereby shedding infected tissue (Ellertsdóttir & Peters [1997](#)). Furthermore, it is possible that growth rates of the endophyte benefit from higher summer temperatures. Seasonal variation of infection rates could also be connected to the life cycle of *L. elsbetiae*. The endophyte spreads between hosts via zoospores that penetrate the host tissue (Heesch & Peters [1999](#)) and on Helgoland fertile structures in *L. elsbetiae* were found only during spring (Peters & Ellertsdóttir [1996](#)). As we were able to detect *L. elsbetiae* DNA in seawater samples taken around a *S. latissima* population in spring, it is likely that spores of the endophyte were present in the seawater during this time, spreading to infect new hosts.

Significant differences were found between kelp populations from France and Scotland both, in endophyte prevalence and infection rates, increasing from Southern Brittany to Western

Scotland. Seawater temperature is decreasing along a latitudinal gradient from 14.1°C in Locmariaquer (Southern Brittany) to 12.4°C in Perharidy (Northern Brittany) and 9.5°C of average annual sea surface temperature in Oban (Western Scotland, data provided by the National Oceanic and Atmospheric Administration). However, temperature is not the only factor that discriminates the three populations. The *Saccharina* populations in Western Scotland and Northern Brittany are also denser than the one in Southern Brittany, which lies near the distribution limit of *S. latissima* and host density plays an important role in spreading infective agents like spores (Clay 1990). Furthermore, the different examined populations are exposed to different strengths of currents. Ellertsdóttir and Peters (1997) found that endophyte prevalence was higher at more wave-exposed sites. Water depth is another factor that has a significant impact on endophyte distribution, with stronger disease symptoms in shallow water than in deep water (Schaffelke et al. 1996; Ellertsdóttir & Peters 1997) either by reducing the host fitness under higher UV radiation or by favouring endophyte growth rates due to higher PAR (Schaffelke et al. 1996). Since environmental factors seem to have a significant impact on the host-endophyte relationship, experiments under controlled laboratory conditions are necessary to examine the effect of single environmental factors on the interaction between *S. latissima* and *L. elsbetiae*.

4.4 Host specificity of *L. elsbetiae*

Both—the number of infected thalli and the severity of infection with *L. elsbetiae*—were significantly higher in *S. latissima* than in other kelps collected in the vicinity. Similar to results obtained by microscopic observations and subsequent isolation from kelps on Helgoland (Ellertsdóttir & Peters 1997), we detected *L. elsbetiae* also in 20% of *L. digitata*. Additionally, DNA of *L. elsbetiae* was found in 50% of *L. ochroleuca* sporophytes, but not in *L. hyperborea*, whereas *L. elsbetiae* spores were likely to be present in the surrounding seawater.

Laminarionema elsbetiae was first described based on isolates from *S. japonica* in Japan, where it was not found infecting any other kelp species in close vicinity, pointing out a high specificity of the infection (Kawai & Tokuyama 1995). Electron microscopy of the infection process suggested that *L. elsbetiae* enters the tissue of *S. latissima* by enzymatic dissolution of the cell wall (Heesch & Peters 1999), but so far, it is still unclear what exactly defines the ability of the endophyte to infect certain hosts. Chemical differences in kelp cell wall compositions—for example in the content of celluloses, hemicelluloses and alginates (Siegel & Siegel 1973)—could play an important part in the host specificity of algal endophytes. As the cell wall

composition of brown algae is known to vary based on environmental conditions (Rosell & Srivastava 1984; Adams et al. 2011; Deniaud-Bouët et al. 2014), these differences could also contribute to geographic and seasonal variations in the endophyte prevalence. Furthermore, host specificity might be based on different kelp species having specific defence reactions. The oxidative burst upon elicitation with oligoguluronates, an early defence response, differs amongst several members of the Laminariales (Küpper et al. 2002). Finally, the ability of an endophyte to infect a host is also strongly linked to the life cycles of both, the host and the endophyte. As our results suggest that kelps are infected at a very young age, host specificity might be coupled to the occurrence of young sporophytes of different species in the field and the synchronisation of spore release from *L. elsbetiae*. Fertility periods and subsequently the appearance of young sporophytes are known to be variable within the Laminariales (Bartsch et al. 2008), but further studies on the life cycle of *L. elsbetiae* are necessary to better understand these relationships.

Overall, the consistency in results of our approach with microscopic observation and previous epidemiological studies based on other methods confirm the reliability of our qPCR assay. This efficient tool is well adapted for routine application and processing of large sample numbers for epidemiological studies on infections of *S. latissima* with *L. elsbetiae*. Moreover, the approach could be easily transferred to other host-endophyte pairs by designing specific primers and therefore be applied to extensive studies on kelp-endophyte interactions.

Acknowledgements. We would like to thank Laëtitia Mest for providing us DNA to test primer specificity and Svenja Heesch for assistance with the sampling. We appreciate the help from our colleagues from the Marine Service of Roscoff during the material collection and the implementation of the experiments. We also thank the anonymous reviewer for extensive proofreading of our manuscript.

The presentation of this work at the ISAP2017 was supported by a fellowship provided by the Global Seaweed Network (UK NERC IOF Pump-priming + scheme NE/L013223/1). This project has received funding from the European Union's Horizon 2020 research and innovation programme under the Marie Skłodowska-Curie grant agreement N° 642575 and by the project IDEALG (France: ANR-10-BTBR-04).

5. Supplementary Material

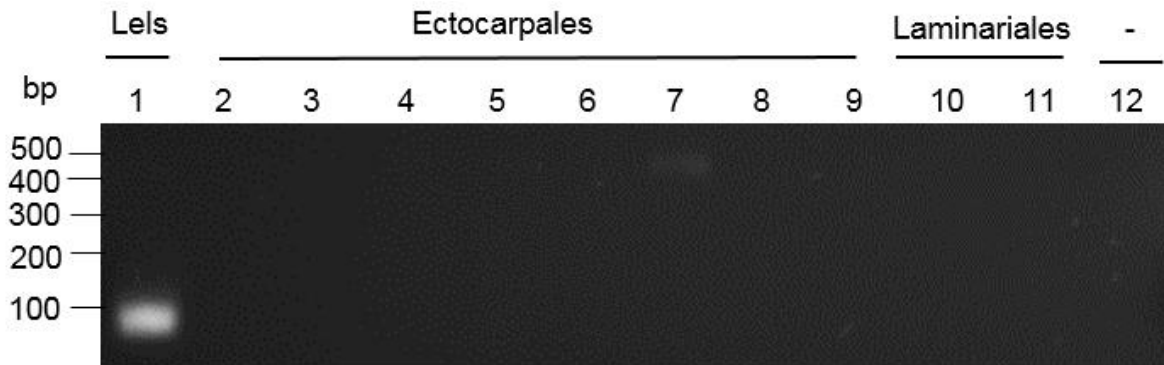

Fig. S1: Agarose gel (2.5%) of qPCR products using the LelsITS1F2 and LelsITS1R2 primer pair. 1 = *Laminarionema elsbetiae*, 2 = *Ectocarpus* strain Ec02 F, 3 = *Ectocarpus fasciculatus*, 4 = *Microspongium tenuissimum*, 5 = *Laminariocolax aecidioides*, 6 = *Laminariocolax tomentosoides*, 7 = *Saccharina latissima*, 8 = *Laminaria digitata*, 9 = *Feldmannia mitchelliae*, 10 = *Hincksia hincksiae*, 11 = *Hecatonema maculans*, 12 = neg. control. (autoclaved milliQ H₂O) Weight marker: SmartLadder SF (Eurogentec, Belgium).

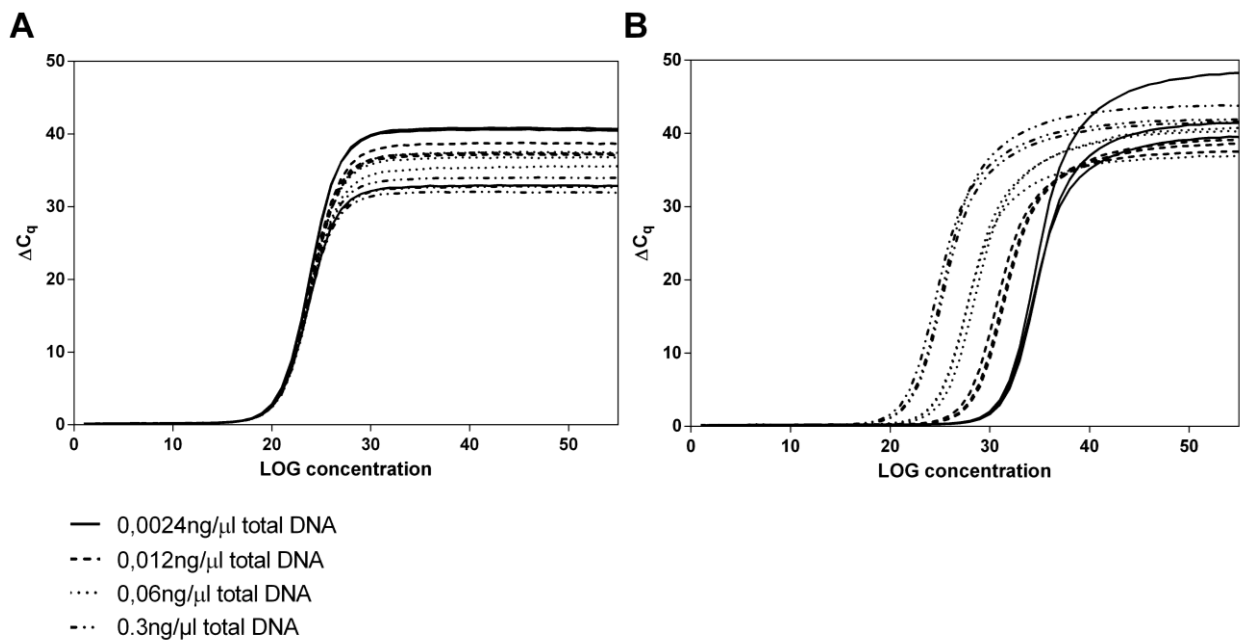

Fig. S2: Artificial mix of 1ng host DNA with different amounts of endophyte DNA run in triplicates: **A.** CG Primer pair. **B.** LelsITS1 primer pair. Patterns of the curve show the different amounts of endophyte DNA in the mix.

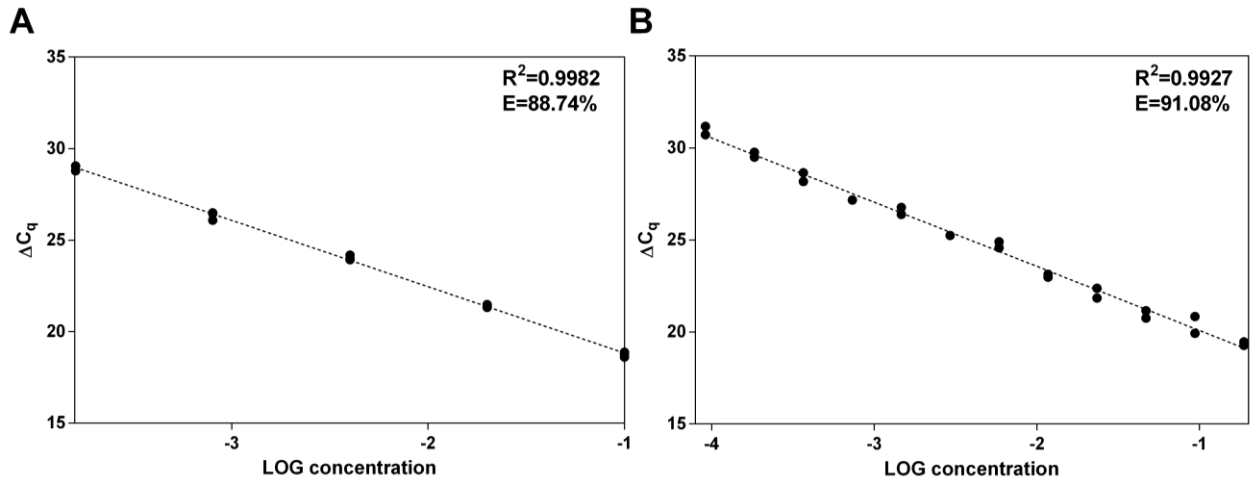

Fig. S3: qPCR standard curves based on serial dilution of DNA from of: **A.** *S. latissima* with the primer pair CG64 and CG65. **B.** *L. elsbetiae* with the primer pair LelsITS1-F2 and LelsITS1-R2.

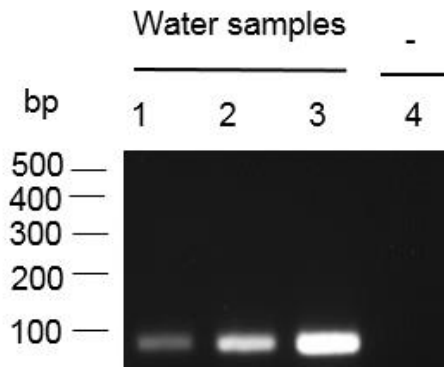

Fig. S4: Agarose gel (2.5%) of qPCR products from 3 sea water samples (1-3) and a negative control (autoclaved milliQ H₂O, 4), amplified with the primer pair LelsITS1F2 and LelsITS1R2. Weight marker: SmartLadder SF (Eurogentec, Belgium).

Table S1: Statistic table: Distribution of endophyte DNA in field sporophytes (Kruskal-Wallis Test).

| Kruskal-Wallis | Chi ² | df | p-value |
|----------------|------------------|----|---------|
| | 36,201 | 3 | 0.001 |

Table S2: Statistic table: Other experiments (One-Way ANOVA).

| One-Way ANOVA | F | df | p-value |
|----------------------|--------|----|---------|
| Young kelps | 2.737 | 4 | 0.04 |
| Natural infection | 12.653 | 1 | 0.001 |
| Seasonal variation | 7.15 | 8 | 0.001 |
| Geographic variation | 4.877 | 2 | 0.01 |
| Host Specificity | 9.126 | 2 | 0.001 |

Chapter III. A highly prevalent filamentous algal endophyte in natural populations of the sugar kelp *Saccharina latissima* is not detected during cultivation in Northern Brittany

Although endophytic infections in natural kelp populations have received a lot of research attention (see chapters I and II), little is known about the impact of endophytes on kelps cultivated in seaweed farms. This chapter presents a study on the prevalence of the endophyte *Laminarionema elsbetiae* in *Saccharina latissima* cultivated in a farm on the North-Western coast of Brittany, based on the qPCR assay that was developed previously (see chapter II).

In European kelp aquaculture, two different methods are used to grow kelps on long-lines in the open sea. The seeding material can either be sown on collectors or on ropes directly. While collectors usually stay protected in a hatchery for up to two months until the young sporophytes reach a size of 1 - 5 cm and are transferred to long lines in the open sea, direct seeded ropes are deployed within days after seeding (Pereira & Yarish [2008](#); Edwards & Watson [2011](#); Rolin et al. [2016](#)). In chapter II, it was shown that *S. latissima* sporophytes in natural population in Northern Brittany get infected by *L. elsbetiae* early in their life. In regard of endophytic infections, seeding the algal material on collectors and keeping them under controlled conditions during the critical time of a possible infection by endophyte spores could therefore be advantageous over direct seeding techniques. In this chapter, the endophytic prevalence is compared in individuals from direct-seeded ropes and collector-seeded lines that were kept in laboratory conditions for different time spans. Additionally, seawater samples were taken to monitor the occurrence of *L. elsbetiae* spores in the seawater surrounding the kelp farm.

Article

**A highly prevalent filamentous algal endophyte in natural populations of the sugar kelp
Saccharina latissima is not detected during cultivation in Northern Brittany**

Authors: Miriam Bernard¹, Nadia Collet¹, Tristan Le Goff², Bertrand Jacquemin², Akira F.
Peters³, Philippe Potin¹, Catherine Leblanc¹

¹ Sorbonne Université, CNRS, UMR 8227, Integrative Biology of Marine Models, Station
Biologique de Roscoff, Roscoff, France

² Centre d'Etude et de Valorisation des Algues, Pleubian, France

³ Bezhin Rosko, 29250 Santec, France

Article in preparation for publication in the Journal of the World Aquaculture Society

Abstract

The sugar kelp *Saccharina latissima* is cultivated in Europe for food, feed or novel cosmetic and pharmaceutical products and ultimately the production of chemical commodities and bioenergy. Being cultivated in the open sea, *S. latissima* is exposed to potentially harmful organisms, such as *Laminarionema elsbetiae*, a filamentous brown algal endophyte with a very high prevalence in wild populations of European *S. latissima*. As it was shown previously that *S. latissima* sporophytes get infected by *L. elsbetiae* very early in their life, seeding the spores on collectors and keeping them under controlled conditions during the critical time of a possible infection with filamentous endophytes could be advantageous over direct seeding techniques, where the ropes are deployed within days after seeding. We used a qPCR-assay to assess the prevalence of the endophyte *L. elsbetiae* in *S. latissima* cultivated during winter in Northern Brittany, comparing individuals from direct-seeded ropes and collector-seeded lines that were kept in laboratory conditions for different time spans. No DNA of the endophyte could be detected in the samples, suggesting that either the kelps were not infected or the amount of endophytic filaments were below the detection rate of the qPCR assay. Furthermore, *L. elsbetiae* could not be detected in the seawater surrounding the kelp farm, indicating that *L. elsbetiae* is not fertile or disperses at a very small scale in Northern Brittany during the deployment time of young kelps. Our results suggest that infections of cultivated *S. latissima* with the endophyte *L. elsbetiae* might be a minor problem in kelp farms in Northern Brittany if the seeding production is kept under controlled conditions without external contamination.

1. Introduction

The sugar kelp *Saccharina latissima* is the closest European relative to the Asian *S. japonica* that contributes to one third of the global production of seaweed (Chung et al. [2017](#)). *S. latissima* has a high carbohydrate content and is one of the fastest-growing European kelp species (Skjermo et al. [2014](#)). While it has traditionally been collected from wild stocks for the use as a source of iodine, fertilizer in agriculture and as animal feed, today this species is cultivated in Europe for food, feed and the production of novel cosmetic and pharmaceutical products and ultimately bioenergy (Adams et al. [2009](#); Mesnildrey et al. [2012](#); Skjermo et al. [2014](#); Chen et al. [2015](#)). Being cultivated in the open sea, *S. latissima* is exposed to potentially harmful organisms, such as viruses, fungi, bacteria or endophytic algae (Andrews [1977](#); Wu et al. [1983](#); Apt [1988b](#); Potin et al. [2002](#)) and also hosts various epibionts (L'Hardy [1962](#); Seed [1976](#)). As these pathogens and pests are a crucial threat to the globally increasing kelp aquaculture, we need a better understanding of their life history, epidemiology and the interaction with their hosts (Gachon et al. [2010](#)).

Endophytic algae invade stipes and fronds of kelps and their presence often coincides with severe disease symptoms, such as galls (Apt [1988b](#); Thomas et al. [2009](#)), dark spots (Ellertsdóttir & Peters [1997](#)) or twisted stipes and blades (Peters & Schaffelke [1996](#)). They have also been reported to lower the commercial value of infected kelps (Yoshida & Akiyama [1979](#)). Amongst them is *Laminarionema elsbetiae*, a filamentous brown algal endophyte that infects up to 100% of individuals in European wild *S. latissima* populations (Peters & Ellertsdóttir [1996](#); Ellertsdóttir & Peters [1997](#); Bernard et al. [2017](#)). Recently, a qPCR-assay was developed to detect and quantify the endophyte *L. elsbetiae* in infected thalli of its host *S. latissima* (Bernard et al. [2017](#)). Using this method, it was shown that *S. latissima* sporophytes get infected by *L. elsbetiae* very early in their life and that environmental factors affect the endophytic prevalence and infection rates in wild *Saccharina* populations significantly (Bernard et al. [2017](#)). However, the impact of endophytic infections on *S. latissima* cultivated in farms is still unclear.

In Europe, *S. latissima* and other kelp species are usually cultivated in the open sea during winter, with deployment of the seaweed lines between October and January, a main growth period during spring and harvesting before summer to avoid biofouling of the crop (Skjermo et al. [2014](#); Lüning & Mortensen [2015](#); Mooney-McAuley et al. [2016](#)). Kelp zoospores are released from sori of wild sporophytes and can either be seeded directly (Kim et al. [2017](#)) or cultivated as gametophyte stock cultures under red light conditions for vegetative growth

(Mooney-McAuley et al. [2016](#)). In the latter case, fertility of the gametophyte culture is induced 2-3 weeks before seeding to obtain young sporophytes by transferring the cultures to blue-light conditions (Mooney-McAuley et al. [2016](#)). Zoospores or young sporophytes can be seeded on collectors or on ropes directly. While collectors usually stay in the hatchery for up to two months until the young sporophytes reach a size of 1 - 5 cm and are transferred to long lines in the open sea, direct seeded ropes can be deployed within days after seeding (Pereira & Yarish [2008](#); Edwards & Watson [2011](#); Rolin et al. [2016](#)).

In regard of endophytic infections, seeding the algal material on collectors and keeping it under controlled conditions during the critical time of a possible infection with filamentous endophytes could be advantageous over direct seeding techniques. In this study we used a qPCR-assay (Bernard et al. [2017](#)) to assess the prevalence of the endophyte *L. elsbetiae* in *S. latissima* cultivated during winter on the North-Western coast of Brittany, comparing individuals from direct-seeded ropes and collector-seeded lines that were kept in laboratory conditions for different time spans.

2. Material and methods

2.1 Algal Material

30 fertile individuals of *S. latissima* (total weight = 1.2kg) were collected from a natural population in Port l'Epine at Treleven (48.82° N, 3.39° W) on 06/11/2017.

2.2 Spore release and seeding procedure

Spores were released by placing the sori in a 15 L tank for 2 hours at 15°C. The resulting spore suspension was transferred to another tank and the release was repeated three times in order to increase the number of spores, resulting in a total amount of 60 L of spore suspension.

Half of the spore suspension was used for direct seeding. A 25 m polyethylene rope was placed in 90 L of filtered seawater (1 µm) and 30 L of spore suspension were added. The spores settled directly on the rope. Additionally, the spore suspension was seeded on two collectors (0.33 m x 0.33 m PVC square frame + 55 m of Kuralon® string). Each collector was placed in 18 L of filtered seawater (1 µm) and 3 L of spore suspension were added.

The rope and the two collectors were kept in the tanks with a photoperiod of 12 h light: 12 h dark cycle. After 6 days, the direct-seeded rope was transferred to the open sea cultivation site

(48.85° N, 3.05° W) in November 2017. Collectors 1 and 2 were kept in the tank for 8 (beginning of January 2018) and 11 weeks (end of January 2018), respectively, before they were transferred to the cultivation site.

2.3 Offshore cultivation

The seeded Kuralon strings on the collectors were rolled on two polyethylene ropes of 12 mm diameter and 25 m long, each. The 50 m ropes were then transferred to the cultivation site (Fig. 1). The ropes were horizontally fixed between moored floats and maintained at a constant depth of 0.5 to 2 meters (distance between the floats varied depending on the tides and currents).



Fig. 1: Cultivation of *S. latissima* on a 50 m rope at the cultivation site.

2.4 Sampling

For each sampling, 30 individuals were collected and pooled in triplets to 10 samples. Samples were taken after 8 (sampling date 1), 11 (sampling date 2) and 14 weeks (sampling date 3). Collector 1 was deployed 8 weeks after seeding. Samples were taken before deployment (sampling date 1) as well as 3 (sampling date 2) and 6 weeks (sampling date 3) after deployment. Collector 2 was deployed 11 weeks after seeding. Samples were taken before deployment (sampling date 2) and 3 weeks (sampling date 3) after deployment. An overview

of the samplings is shown in Fig. 2. The kelps were soaked dry with filter paper, transferred to silica gel and stored in silica gel until DNA extraction.

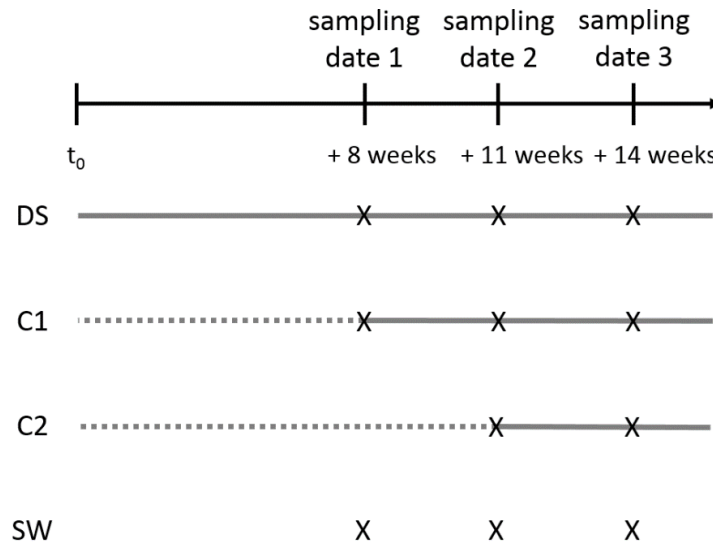

Fig. 2: Overview of the experimental design. Treatments: DS = direct seeded line, C1 = collector 1, C2 = collector 2, SW = seawater. X indicates the samplings, broken grey lines indicate the time of sporophytes grown in laboratory conditions and full grey lines the time of sporophytes grown in the field.

Three replicates of 1L seawater were collected in the surrounding of the cultivation site at each sampling date (Fig. 2). The seawater was filtered through 3 μm polycarbonate filters (Nucleopore Track-Etched Membranes, Whatman, GE Healthcare, USA) using a vacuum pump. Filters were transferred to tubes, frozen and kept in -20°C until DNA extraction.

2.5 DNA extraction

The dried algal material was transferred to a 2 mL Eppendorf tube and ground in a mechanical bead grinder (Tissuelyser II, Qiagen, Germany) three times for 1 min at 30 Hz. DNA was extracted using a CTAB-based chloroform/isoamyl alcohol extraction protocol as described in Bernard et al. (2017). DNA of the water samples was extracted from the frozen polycarbonate filters as described by Bernard et al. (2017).

DNA concentrations were measured with a Qubit Fluorometer (Thermo Fisher, USA) and all samples were diluted to $0.05 \text{ ng}/\mu\text{l}$ with autoclaved milliQ-filtered H_2O .

2.6 qPCR

qPCR of the extracted DNA was performed with two different primer pairs: The first primer pair CG64 and CG65 (Gachon et al. [2009](#)) matched the 18S rDNA of all Ectocarpales and Laminariales and was used to amplify 18S rDNA from both, host and endophyte DNA. The second primer pair LelsITS1-F2 and LelsITS1-R2 (Bernard et al. [2017](#)) specifically matched the partial ITS1 of *L. elsbetiae*. qPCR was performed as described by Bernard et al. ([2017](#)) on a Light Cycler 480 (Roche Life Science, Germany) in white 384 well-plates, sealed with adhesive foil. All samples were run in triplicates. Autoclaved milliQ H₂O was used as negative control. For relative quantification, the differences between the quantification cycles (ΔC_q) obtained by two qPCRs with the different primer pairs run in parallel on the same DNA sample were measured. The resulting ΔC_q values correlate negatively to the relative amount of endophyte DNA in the sample.

3. Results and discussion

For all sampled individuals, C_q values were obtained only with the CG primer pair, but not using the *Laminarionema* specific primer pair (Table 1), indicating that DNA of the kelp could be detected in the extracted samples, but not DNA of the endophyte.

Table 1: Number of qPCR quantification cycles obtained from sample DNA using the general (CG) and endophyte specific (Lels) primer pair (Average \pm standard deviation, N = 30). Treatments: DS = direct seeded line, C1 = collector 1, C2 = collector 2. n.d. = not detected.

| Sampling point | Treatment | CG | Lels |
|----------------|-----------|----------------|------|
| 1 | DS | 21.1 \pm 0.6 | n.d. |
| 1 | C1 | 20.6 \pm 1 | n.d. |
| 2 | DS | 22.5 \pm 3 | n.d. |
| 2 | C1 | 18.9 \pm 0.4 | n.d. |
| 2 | C2 | 19.1 \pm 0.4 | n.d. |
| 3 | DS | 19.8 \pm 1.2 | n.d. |
| 3 | C1 | 19.6 \pm 0.7 | n.d. |
| 3 | C2 | 19.8 \pm 0.7 | n.d. |

These results either suggest that the kelps were not infected or that the amount of endophytic filaments was below the detection rate of the qPCR assay, i.e. below 1.14×10^{-5} ng (Bernard et al. [2017](#)). Similar C_q values were obtained for the three different lines and the result was therefore independent of the seeding technique used and the amount of time spent in the

hatchery before deployment (Table 1). Furthermore, none of the samples showed disease symptoms or morphological changes after up to 14 weeks of growth in the seaweed farm (Fig. 3).

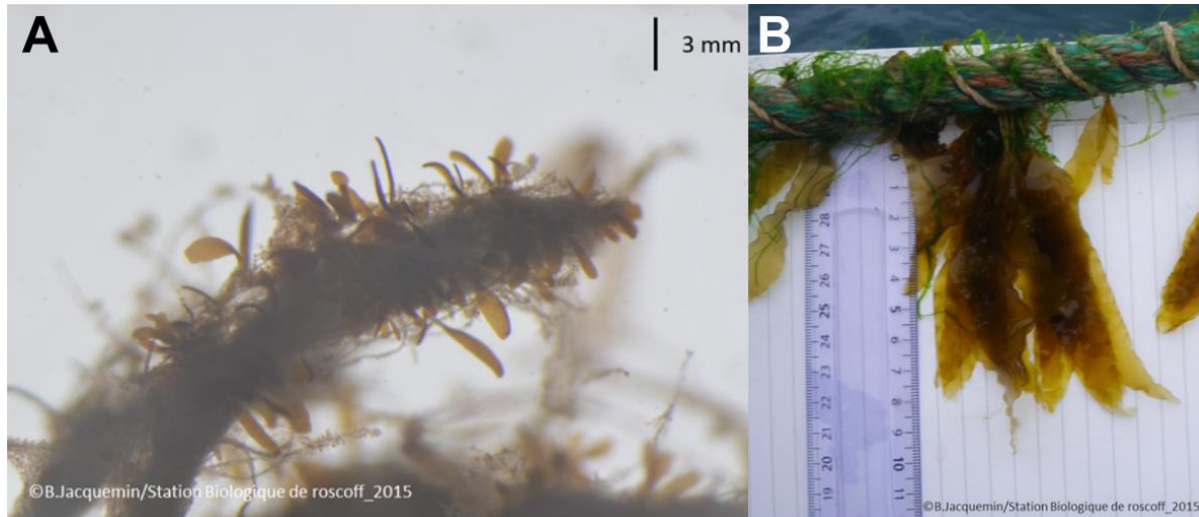

Fig. 3A: 20-day-old *S. latissima* sporophytes on a Kuralon string. **B:** 90-day-old *S. latissima* sporophytes on a long line.

Similar results were obtained for the environmental seawater samples. Whereas the general primer pair showed a positive signal, no C_q values were obtained for the *Laminarionema* specific primer pair during any of the 3 sampling time points (Table 2), indicating that there were no or not enough spores of *L. elsbetiae* present in the sea water to be detectable by qPCR.

Table 2: Quantification cycles obtained by qPCR of the seawater samples (Average \pm standard deviation, $N = 3$). n.d. = not detected. CG = primer pair CG64/65, Lels = *Laminarionema* specific primer pair.

| Sampling point | CG | Lels |
|----------------|----------------|------|
| 1 | 29.1 ± 0.6 | n.d. |
| 2 | 28.4 ± 0.2 | n.d. |
| 3 | 25.2 ± 0.8 | n.d. |

Laminarionema elsbetiae is the most common endophyte in European *S. latissima* populations (Ellertsdóttir & Peters 1997; Bernard et al. 2018). It spreads via zoospores that are released from plurilocular sporangia on infected host plants (Peters & Ellertsdóttir 1996; Heesch & Peters 1999), infecting young kelp tissue which makes the early sporophytes deployed in farms exceptionally threatened (Bernard et al. 2017). In order to infect *S. latissima* sporophytes in

kelp farms, the fertility period of the endophyte needs to be concurrent with the deployment time of young kelps. Although *L. elsbetiae* spores have been observed in Helgoland and Brittany in the end of March (Peters & Ellertsdóttir [1996](#); Bernard et al. [2017](#)), spore release by the endophyte has never been followed over the course of a year and it is unclear when the endophyte releases its spores at other localities. Furthermore, the mechanism of spore release of *Laminarionema* is still unknown. Algal spore release is often controlled by abiotic factors, such as light and temperature conditions (Amsler & Neushul [1989b](#); Ganesan et al. [1999](#)) or desiccation (Suto [1952](#)). It may, however, also involve more complex mechanisms such as cross-talk with hosts or the presence of bacteria (Weinberger et al. [2007b](#)).

The closest natural population of *S. latissima* – i.e. the closest source of *L. elsbetiae* spores in the seawater - was located at 1km distance from the experimental site at the seaweed farm. Since no endophyte spores were detected in the seawater during our experiments, it can be concluded that either no fertile *L. elsbetiae* was present in the natural *Saccharina* population during January and February, or that the 1km distance could not be covered by the endophyte spores. However, since it has been shown that brown algal spores may disperse over distances of several kilometres, depending on abiotic and biotic factors (Gaylord et al. [2002](#); Reed et al. [2004](#); Gaylord et al. [2006](#)), we hypothesize that *L. elsbetiae* was not fertile during the time of the experiment. Further studies on the life cycle and the spore release of *L. elsbetiae* in nature are necessary to confirm these results.

Not only infections with algal endophytes, but also other biotic stresses in kelp aquaculture are avoided by the common cultivation time of *S. latissima* in Europe starting in late autumn or winter. Biofouling and epiphytic animals, like bryozoans, amphipods or gastropods or polychaetes, which are a major constrain to *S. latissima* aquaculture, start to appear in early summer and are highly abundant from June onwards (Forbord et al. [2012](#); Handå et al. [2013](#); Lüning & Mortensen [2015](#)). *S. latissima* is therefore usually harvested in May or June (Peteiro & Freire [2013](#); Stevant et al. [2017](#)). Furthermore, the growth rates and yield of *S. latissima* cultivated over winter from December to April have been shown to be higher than those of individuals grown between February and May (Peteiro & Freire [2009](#)).

Our results suggest that infections of cultivated *S. latissima* with the endophyte *L. elsbetiae* might be a minor problem in kelp farms in Northern Brittany under the premise that seeding production is kept under controlled conditions without external contamination. However, as the life cycle of *L. elsbetiae* in nature is largely unexplored, no generalizations of these results can be made for other localities. Overall, the nature and epidemiology of seaweed pathogens

is still largely understudied (Loureiro et al. [2015](#)) and there is a large number of other potential pathogens that present a potential threat to seaweed aquaculture. We therefore want to stress the importance of the qPCR assay for sample and water monitoring in kelp farms and hatcheries. It is easily adaptable for routine application and processing large sample numbers and can be transferred to other host-pathogen pairs by designing specific primer pairs. Such tools are already used routinely in terrestrial agriculture (Miller et al. [2009](#)) and animal mariculture (Sepulveda et al. [2013](#)) and will facilitate a sustainable development of seaweed cultivation.

Acknowledgements. This project has received funding from the European Union’s Horizon 2020 research and innovation programme under the Marie Skłodowska-Curie grant agreement N° 642575 and was supported by the French National Research Agency via the ‘Investment for the Future’ project IDEALG (no. ANR-10-BTBR-04).

Chapter IV. Physiological and molecular responses of kelps to an infection by *Laminarionema elsbetiae*, a filamentous brown algal endophyte

In chapters I and II, it was shown that the sugar kelp *Saccharina latissima* is the main natural host of the endophyte *Laminarionema elsbetiae*. However, *L. elsbetiae* occasionally infects other kelp species, such as *Laminaria digitata*, in lower numbers and with lower severity. The underlying basic mechanisms of host specificity in endophytic brown algae have never been studied so far and it remains unknown why particular host species are infected preferably by certain endophytes.

The aim of this chapter was to compare the physiological and molecular responses of *S. latissima* and *L. digitata* towards an infection with the endophyte *L. elsbetiae* in order to find out if they are responsible for the different endophytic prevalence in both species that has been observed in nature.

A co-cultivation system was developed, based on laboratory-grown juvenile kelp sporophytes and filaments of the endophyte *L. elsbetiae*. Previously, it has been reported that algal endophytes can reduce the growth of their hosts by up to 70% (Apt [1984](#)). The aim of the co-cultivation system was therefore to monitor the impact of the endophyte on the physiology, and specifically the growth of its main host *S. latissima* and the occasional host *L. digitata*. The qPCR-assay developed previously (chapter II) was used to determine infection rates of the hosts after two weeks of co-cultivation. To study whether the kelps react with an oxidative burst (see general introduction) to the endophyte, H₂O₂ production in co-cultures was measured using a luminol chemiluminescence method. Furthermore, the co-cultivation system was modified during preliminary experiments by including a pre-treatment of the kelp sporophytes with GG and by adding fungal extracts to the interaction. Finally, an RNAseq approach was used to compare changes in the gene regulation of the main host *S. latissima* and the occasional host *L. digitata* during an infection with *L. elsbetiae* after 24 and 48 hours of co-cultivation.

Article in preparation

**Physiological and molecular responses of kelps to an infection by *Laminarionema
elsbetiae*, a filamentous brown algal endophyte**

Authors: Miriam Bernard¹, Qikun Xing¹, Erwan Corre², Akira F. Peters³, Catherine Leblanc¹

¹ Sorbonne Université, CNRS, UMR 8227, Integrative Biology of Marine Models, Station Biologique de Roscoff, Roscoff, France

² Sorbonne Université, CNRS, FR2424, Analysis and Bioinformatics for Marine Science, Station Biologique de Roscoff (SBR), Roscoff, France

³ Bezhin Rosko, 29250 Santec, France

Abstract

The algal endophyte *Laminarionema elsbetiae* is highly prevalent in European populations of the sugar kelp, *Saccharina latissima*, but has also been found occasionally in the finger kelp *Laminaria digitata*. The presence of *L. elsbetiae* coincides with morphological changes in the hosts- such as twisted stipes and deformed blades, however, little is known about the molecular bases of this interaction. Using a co-cultivation experiment, we revealed that the physiological response to the endophyte invasion is different between the main and the occasional host. To get further insight into the molecular mechanism of this interaction, we used a comparative transcriptomic approach to investigate the early transcription regulation of the two kelps during the first contact with the endophyte. After 48h, the analysis revealed 93 differentially expressed genes (DEGs) in the occasional host *L. digitata* and 72 DEGs in the main host *S. latissima*. Among those DEGs, only 8 were common in both species, indicating a crucial difference between the molecular responses of the two hosts. By functional annotation, we identified DEGs related to cell wall modification, host-endophyte recognition and ROS scavenging. The identification of endophyte transcripts further suggested differences in the molecular cross-talk during the interaction with the two kelp species. Our results suggest that differences between the two kelps in the recognition of the endophyte and subsequent defense reactions could explain the variability of natural infection patterns.

1. Introduction

Kelps – brown macroalgae of the order Laminariales – are major elements of rocky intertidal and subtidal habitats (Bold & Wynne [1985](#)). They do not only serve as food source or habitats for animals, but also provide a substratum for smaller organisms growing on (epiphytes) or inside (endophytes) of their thalli, such as fungi, oomycetes or filamentous algae (Dayton [1985](#); reviewed by Bartsch et al. [2008](#) and Gachon et al. [2010](#)). The prevalence of the latter can be very high, reaching up to 100% of infected individuals in natural kelp population (Lein et al. [1991](#); Ellertsdóttir & Peters [1997](#); see chapter II). Furthermore, filamentous algal endophytes often coincide with disease symptoms in their hosts such as twisted stipes, crippled thalli or a reduced growth of the kelps (Apt. [1984](#); Apt [1988a](#); Correa et al. [1988](#); Peters & Ellertsdóttir [1996](#); Gauna et al. [2009b](#); Thomas et al. [2009](#)). As they have also been reported to lower the commercial value of infected kelps (Yoshida & Akiyama [1979](#)), these endophytes represent a potential threat to the globally increasing seaweed aquaculture (Gachon et al. [2010](#)).

Laminarionema elsbetiae is a filamentous brown alga, which is commonly found as an endophyte in the sugar kelp *Saccharina latissima* along European coasts (Ellertsdóttir & Peters [1997](#); see chapters I+II). Occasionally it also infects *Laminaria digitata* (Ellertsdóttir & Peters [1997](#); chapter II), although this kelp is more often associated to another endophyte species, *Laminariocolax tomentosoides* (Russel [1964](#); Kornmann & Sahling [1997](#); Ellertsdóttir & Peters [1997](#); chapter I). In Asia, *L. elsbetiae* has been described infecting the economic important *Saccharina japonica*, but none of the other kelp species in the direct vicinity, such as *Costaria costata* or *Undaria pinnatifida* (Kawai & Tokuyama [1995](#)). Similarly, kelps in Northern Brittany have shown significant variation in the prevalence of *L. elsbetiae* according to different host species (see chapter II). It therefore seems that kelp-endophyte relationships underlie a certain specificity, but the molecular bases of the interaction between kelps and brown algal endophytes remain poorly understood.

In most eukaryotic organisms, the activation of defense responses and innate immunity relies on a successful recognition of the potential attacker. This may either involve the perception of exogenous elicitors, i.e. highly conserved patterns in the cell envelope or cell wall, which are found only on the attacker, but not on the host itself (Küpper et al. [2006](#); Weinberger [2007](#)), or endogenous elicitors, such as oligosaccharides deriving from the host's cell wall which are released following an enzymatic degradation during a biotic attack (Küpper et al. [2001](#), [2002](#)). This *non se* recognition is followed by different inducible defence reactions. A fast and common eukaryotic stress response is the so called oxidative burst, a release of reactive oxygen

species (ROS), such as superoxide ions, hydrogen peroxide or hydroxyl radicals (Bouarab et al. [1999](#); Weinberger and Friedlander [2000](#); Küpper et al. [2001](#)). ROS do not only have direct cytotoxic effects on attackers (Weinberger & Friedlander [2000](#); Küpper et al. [2001](#); Küpper et al. [2002](#)), but are also involved in cell-wall strengthening (Küpper et al. [2002](#)) and signalling processes (Hancock et al. [2001](#); Neill et al. [2002](#)). Other defense pathways in kelps that may be activated during biotic interactions involve the production of fatty acids and oxylipins (Bouarab et al. [2004](#); Küpper et al. [2009](#)) and the emission of volatile halogenated organic compounds (Leblanc et al. [2006](#); La Barre et al. [2010](#)). Furthermore, it was shown that brown algae regulate a part of their gene expression upon oligoalginate elicitation (Cosse et al. [2009](#)) and according to biotic attacks (Flöthe et al. [2014](#); Ritter et al. [2017](#)).

A well-studied alga-endophyte pathosystem is the interaction between the red alga *Chondrus crispus* and the green algal endophyte *Ulvella operculata*. Sporophytes of *C. crispus* are regularly infected by *U. operculata*, but the endophyte cannot penetrate beyond the outer cell layers of the gametophyte of *C. crispus* (Correa & McLachlan [1991](#); Correa & McLachlan [1994](#)). *U. operculata* expresses carrageenolytic activity to degrade and penetrate into the cell wall of *C. crispus* (Bouarab et al. [1999](#)). Similarly, Heesch & Peters ([1999](#)) suggested that the spores of *L. elsbetiae* penetrate the surface of *S. latissima* by locally dissolving the cell wall using alginolytic enzymes. Oligosaccharides which are released during these interaction could act as endogenous elicitors that can be recognized by the kelp and trigger an activation of defense responses. However, further biochemical and molecular studies are necessary to confirm this hypothesis. Previous studies on *C. crispus* also suggest that the oxidative burst and the oxylipin pathway play an important role in the natural resistance of *C. crispus* gametophytes against *U. operculata* (Bouarab et al. [1999](#); Bouarab et al. [2004](#)). This is in concordance with experiments performed by Küpper et al. ([2002](#), [2009](#)) who showed that the resistance of *L. digitata* against the endophyte *L. tomentosoides* was increased after an oxidative burst elicited by endogenous oligoalginate elicitors or a pre-treatment with arachidonic acid, a polyunsaturated fatty acid. Thus, comparable to what has been described for disease signalling in terrestrial plants (Thomma et al. [2001](#)), several different pathways may be involved in the inducible defense of kelps against algal endophytes. As both, the recognition and the defense responses might vary among different kelp species, this could lead to specific infection patterns in natural kelp populations.

In this chapter, we investigated and compared the physiological and molecular responses of the main host *S. latissima* and the occasional host *L. digitata* to an infection with *L. elsbetiae*. We

developed a co-cultivation bioassay to measure the kelps' growth over 14 days in the presence of the endophyte and measured the production of H₂O₂ in kelp-endophyte co-cultures to follow the oxidative response of the kelps in the presence of endophytic algae.

In the natural environment, biotic interactions are not limited to the kelp and the endophyte and several other organisms, especially a large number of microorganisms (Egan et al. [2013](#)), could influence innate immunity of macroalgae and therefore the interactions of kelps with endophytic algae. For instance, it is known from terrestrial plants that endophytic fungi can have an antagonistic effect on the colonisation of pathogens (Brum et al. [2012](#); Kirchmaier et al. [2012](#); Prado et al. [2015](#)). We performed preliminary experiments to explore kelp defence responses and resistance against algal endophytes by testing pre-treatment with oligoalginates according to previous experiments by Küpper et al. ([2002](#)) and the effect of fungal extracts using the co-cultivation bioassay. To further understand the molecular bases of kelp-endophyte interaction and its specificity, a large-scale RNA sequencing analysis was conducted to compare the regulation of the gene expression of both kelp species during the first 2 days of contact with the endophyte *L. elsbetiae* in laboratory conditions.

2. Material & Methods

2.1 Biological material

Spores of fertile individuals of *S. latissima* and *L. digitata*, collected at Perharidy (near Roscoff, 48.73° N, 4.00° W), and of *S. latissima*, collected at the Bridge of the Atlantic in Scotland (56.31° N, 5.58° W), were released onto cover slips using the hanging-drop technique (Wynne [1969](#)). The developing sporophytes were kept in petri dishes with weekly changes of culture medium. For all cultures, natural seawater was filtered, autoclaved and enriched with Provasoli solution (10m Provasoli solution/L seawater, Provasoli [1968](#)). After 4 weeks, the sporophytes were detached from the cover slips and transferred to 10 L bottles connected to an aeration system. Culture medium in the 10 L bottles was changed weekly. The kelp cultures were maintained in 14°C and 20 μmol photons s⁻¹m⁻² with a 12 h light/dark cycle.

Cultures of the filamentous brown algae *L. elsbetiae*, *L. tomentosoides* and *Microspongium tenuissimum* were obtained from the Bezhin Rosko culture collection. They were kept in petri dishes in 14°C and 5 μmol photons s⁻¹m⁻² with monthly changes of culture medium.

The fungal extracts were obtained from fungi isolated from the kelps *S. latissima* and *L. digitata*. They were provided as raw extracts by S. Prado and co-workers (Muséum national

d'histoire naturelle, Paris, France) and were dissolved in Dimethylsulfoxid (DMSO) to obtain a concentration of 5 mg/mL for the use in the co-cultivation bioassay.

2.2 Co-cultivation bioassay

To test whether the endophyte *L. elsbetiae* affects the physiology and growth of its main host *S. latissima* and the occasional host *L. digitata*, both kelp species were co-cultivated with the endophyte for two weeks.

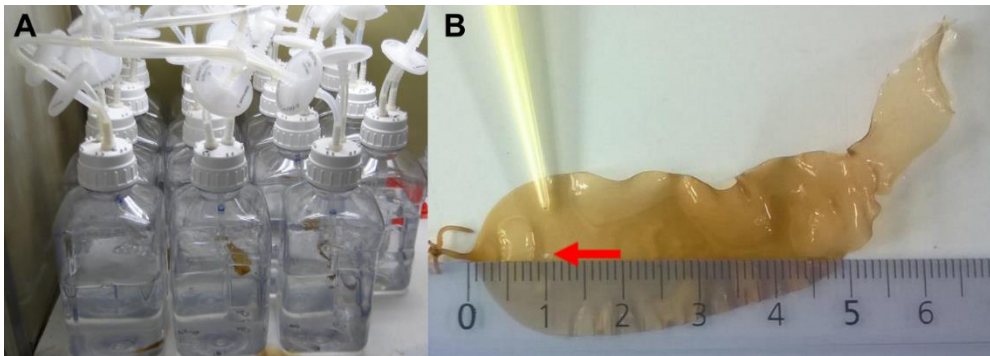

Fig. 1A: Experimental set-up of the co-cultivation bioassay. **B:** Punching hole method. The tip of the red arrow shows the position of the hole punched with a pipet tip in 1cm distance from the basal meristem.

Therefore, fifteen 2 L bottles were filled with 1.5 L sterile Provasoli enriched natural seawater and connected to an aeration system (Fig. 1A). A hole was punched in the kelp sporophytes at 1 cm distance from the basal meristem using a pipet tip (see Fig. 1B). In the following experiment, the longitudinal growth of the kelps blade was measured by monitoring the distance of the hole from the basal meristem with a ruler (Punching hole method, Parke [1948](#)). The first measurement was done after 3-5 days to assure that the growth behaviour of all sporophytes was similar. Subsequently, a filament of *L. elsbetiae* or *M. tenuissimum* of similar size was added to 1 bottles, each containing one kelp sporophyte (N=5). *M. tenuissimum* – a filamentous brown alga which is not endophytic in *S. latissima* and *L. digitata* - was used as a control to test a nutrient competition effect. Nothing was added to the remaining 5 bottles (see Fig. 2 for a schematic overview of the experiment).

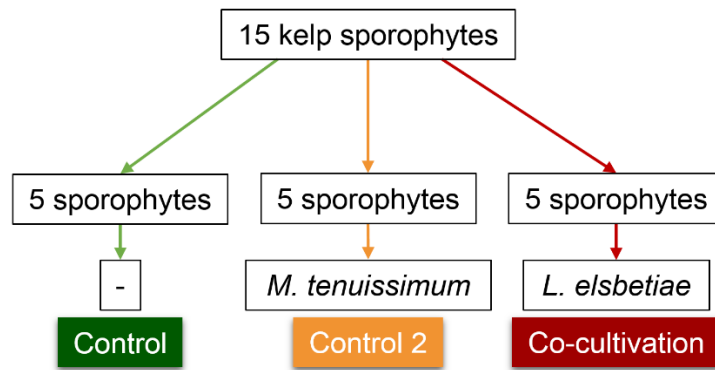

Fig. 2: Schematic overview of the co-cultivation bioassay.

After the addition of the filaments (day 0), growth of *S. latissima* was measured on days 3, 6, 9, 11. Growth of *L. digitata* was measured on days 3, 6, 10 and 14. Additionally, the maximum quantum yield of photosystem II (Fv/Fm) was measured on the same days using a JuniorPAM (Walz, Germany). The sporophytes were dark-adapted for 20 min prior to the measurement. To ensure a sufficient nutrient supply, an amount of 0.5 mL of Provasoli solution per day of experiment was added after each measurement. The experiments with both kelp species were repeated twice for each species with similar results. Furthermore, in case of *S. latissima*, the experiment was performed with kelp sporophytes from France and Scotland with similar results. To avoid redundancy only the results of the first experiments are shown. After the last measurement, the kelp sporophytes were frozen in liquid nitrogen and kept at -80°C for the molecular detection of the endophyte in the kelp tissue.

All co-cultivation experiments were performed in 14°C and $20\mu\text{mol photons s}^{-1}\text{m}^{-2}$ with a 12 h light/dark cycle. The growth curves and Fv/Fm graphs were drawn with GraphPad prism (GraphPad Prism Software, Inc., USA) and SPSS was used for statistical analyses (IBM Corp. Released 2015. IBM SPSS Statistics for Windows, Version 23.0. Armonk, NY: IBM Corp.). Normality of the data and homogeneity of variances were tested with the Shapiro-Wilk test and the Levene test, respectively. Subsequently, data were analysed with one-way ANOVAs. Significant differences were evaluated with the Tukey post hoc test.

DNA extraction and qPCR were performed as described in chapter II. In total, 15 individuals of *S. latissima* and 13 individuals of *L. digitata* from the co-cultivation treatment with *L. elsbetiae* as well as 3 randomly chosen control sporophytes of each species were analysed by qPCR for the quantification of *L. elsbetiae* DNA.

2.3 Extension of the co-cultivation bioassay: preliminary experiments

To assess whether a pre-treatment with GG or an addition of fungal extracts could have an effect on kelp-endophyte interactions, the co-cultivation bioassay was modified for the following preliminary experiments.

2.3.1 GG pre-treatment

Sixteen *L. digitata* sporophytes raised in laboratory culture were transferred to small glass beakers, filled with 50ml autoclaved seawater. 150µg/ml of oligogulonates blocks (GG, prepared from *L. hyperborea* according to Haug et al. 1974) were added to 8 sporophytes (see Fig. 4 for a schematic overview of the experiment).

All beakers were placed on a shaker for 3h (100rpm) and the occurrence of an oxidative burst was measured as described below. After the incubation, the sporophytes were washed by transferring them to new beakers containing 50ml autoclaved seawater and shaking for another 15 minutes. This washing step was repeated twice. A hole was punched in 1 cm distance of the meristem in the kelps and they were transferred to 2 L bottles. The first measurement was done after 3 days to assure that growth behaviour of all sporophytes (control and GG-treated) was similar. Then, filaments of *L. elsbetiae* were added to 4 of the GG pre-treated and to 4 of the untreated *L. digitata* sporophytes (see Fig. 3). Growth was measured as described above on days 3, 7, 10 and 14. Statistical analysis were performed as described above.

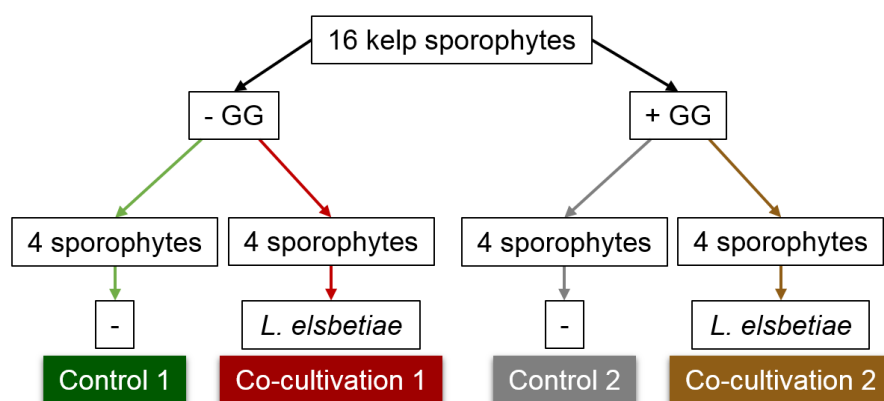

Fig. 3: Schematic overview of the co-cultivation bioassay of *L. digitata* with *L. elsbetiae* including a GG pre-treatment.

2.3.2 Addition of fungal extracts

The co-cultivation bioassay was modified by treating *L. digitata* with fungal extracts or with both, the endophyte *L. elsbetiae* and fungal extracts combined (see Fig. 4 for a schematic overview of the experiment).

The experiment was performed in 500 mL glass bottles that were filled with 100 mL autoclaved seawater and connected to an aeration system. A hole was punched into the kelp sporophytes in 1 cm distance of the meristem and the first measurement was done after 3 days to assure that growth behaviour of all sporophytes was similar, before the co-cultivation treatments were started (day 0). Co-cultivation with *L. elsbetiae* was performed as described above. A final concentration of 50 µg/ml extract of the fungus *Cladosporium cucumerinum* (extract SL469T) was chosen for the first experiment, according to previous experiments performed by S. Prado and her co-workers. To exclude a potential negative effect of the solvent on the growth of *L. digitata*, 3 sporophytes were cultivated in 100 mL of autoclaved seawater containing 50 µg/mL DMSO. Two successive experiments were conducted using 10 µg/mL of *Chaetomium globosum* (extract LD13H) and *Phoma exigua*, (extract SL333T), respectively.

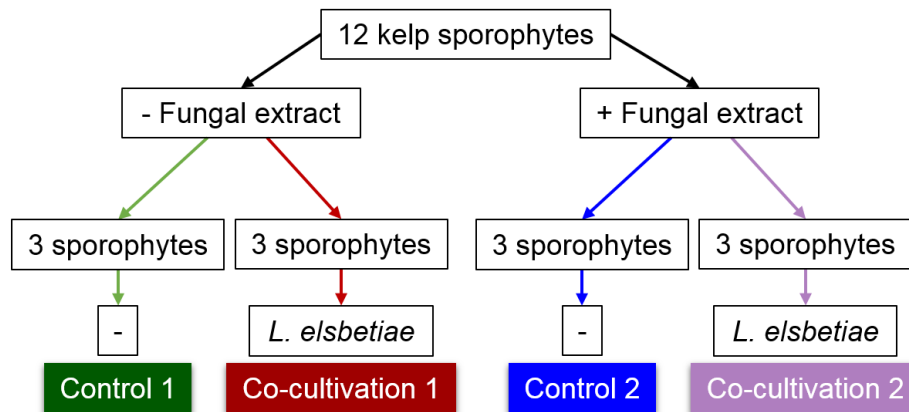

Fig. 4: Schematic overview of the co-cultivation bioassay of *L. digitata* with *L. elsbetiae* including fungal extracts.

Growth of the kelp sporophytes was measured as described above on days 3 and 7 during the experiments with *C. cucumerinum* and *C. globosum* and on days 3, 7, 10 and 12 during the experiment with *P. exigua*. Statistical analysis was performed as described above.

2.4 Oxidative response measurement

The net production of H₂O₂ in seawater surrounding kelp-endophyte co-cultures was determined using a luminol chemiluminescence method (Glazener et al. 1991). After measuring the fresh weight of young sporophytes of *S. latissima* and *L. digitata*, they were transferred to glass beakers containing 50 ml seawater and placed on a shaker (100rpm). The experimental set-up consisted of a control (only *S. latissima*/ *L. digitata*), both kelps co-cultivated with the endophytes *L. elsbetiae* or *L. tomentosoides*, and 50 ml of seawater containing only filaments of *L. elsbetiae* or *L. tomentosoides*. As a positive control, 150 µg/ml of GG (15mg/ml stock solution, prepared from *L. hyperborea* alginates according to Haug et al. 1974) were added to another glass beaker containing 50ml of seawater and a sporophyte of either *L. digitata* or *S. latissima*.

150 µl of seawater were taken as samples for each measurement. Measurements were done before starting the treatment (t=0), and 2, 4, 6, 8, 10, 15, 20, 25 and 30 minutes after the addition of the endophytes/GG. For each measurement, 50 µl of 20 U.ml⁻¹ horseradish peroxidase, dissolved in pH 7.8 phosphate buffer, and 100 µl of 0.3 M luminol (5-amino-2,3-dihydro-1,4-phtalazinedione) were added automatically to the sample by two injectors of the GloMax 20/20 Luminometer (Promega, US). Chemiluminescence was measured without a delay immediately after the injection with a signal time of 1s. A standard calibration curve from 0.1 µM to 20 mM H₂O₂ was drawn to determine the concentration of H₂O₂ in the seawater samples. H₂O₂ production by the kelp per g fresh weight was estimated by integrating the total amount of H₂O₂ monitored over 30 minutes and expressed as log₂-transformed fold changes between control and treatments. The experiment was repeated 3 times and a one-sample-t-test was used for statistical analysis.

2.5 Transcriptomic analysis

2.5.1 Experimental set-up for transcriptomic analysis

16 bottles were filled with 1.5l autoclaved Provasoli enriched natural seawater and adapted to an aeration system. One sporophyte of *S. latissima* (3-5cm) was added to each bottle. After 24 h of adaptation time, filaments of *L. elsbetiae* were added to 12 of the bottles.

Four individuals of the control group and 4 individuals co-cultivated with *L. elsbetiae* were taken after 24h and 48h. The kelp sporophytes were plotted dry with tissue paper, frozen in liquid nitrogen and stored in -80°C until RNA extraction.

The same experimental set-up was used for *L. digitata* sporophytes.

2.5.2 RNA extraction, quality assessment and sequencing

RNA was extracted as described by Heinrich et al. (2012) with a combination of a classical CTAB-based method and the RNeasy Mini kit (QIAGEN, Hilden, Germany) including an on-column DNA digestion. Quantity and purity of the extracted RNA were tested on a NanoDrop™ spectrophotometer (Thermo Fisher Scientific Inc., Waltham, US) and on a 2% agarose gel. Based on the quality and concentration, 3 replicates of each condition were chosen for the transcriptomic analysis. For both kelp species, RNA extraction was followed by commercial library preparation and Illumina sequencing (HiSeq3000) at the Plateforme Génomique du Genopole Toulouse Midi-Pyrénées GeT (France).

2.5.3 De novo assembly and annotation of the transcriptome

The quality of the Illumina reads was checked using FastQC (Andrews 2010). Reads were cleaned by removing adapters, low quality reads (Phred score <33) and short reads (< 50 nucleotides) with Trimmomatic (Bolger et al. 2014) and residual rRNA was removed with SortmeRNA (Kopylova et al. 2012). Another quality check was performed with FastQC (Andrews 2010) on the processed reads to ensure that high quality reads were obtained through the cleaning steps.

A *de novo* transcriptome assembly was created for both kelp species separately based on the pooled processed control reads using Trinity (Haas et al. 2013) with the default options. Transcript abundance was estimated by RPKM implemented in Trinity. The assembly was filtered based on TPM (transcripts per million transcripts, >1) and redundancy further reduced by CD-Hit clustering. The quality of the assembly was assessed by re-mapping the cleaned reads using the bowtie2 aligner (Langmead & Salzberg 2012). Orthofinder (Emms & Kelly 2015) was used for an inference of orthogroups within the two new transcriptomes and the transcriptomes of the brown algae *Ectocarpus siliculosus* and *Saccharina japonica* (based on the published genomes by Cock et al. 2010 and Ye et al. 2015, respectively).

Gene annotation was performed with a Blastx search against the NCBI-nr and the Uniprot database with an E-value cut-off of 10^{-5} . Furthermore, genes were assigned to 2nd level GO

subcategories within the three root categories molecular function, cellular component and biological process using Blast2GO (Conesa et al. [2005](#)).

2.5.4 Identification of differentially expressed (DE) genes

As the PCA results showed a high variability of one of the three biological replicates, only 2 replicates per treatment were included into the analysis of differentially expressed genes (DE genes). Differential gene expression between the control and the co-cultivation treatments was determined separately for the 24h and 48h samples using DESeq2 (Love et al. [2014](#)). Log₂ fold change values ≥ 1 and ≤ -1 with a p-value < 0.01 were considered to be up- and downregulated, respectively. Heat maps were plotted using the R package pheatmap.

The genes that were differentially expressed after 48h in both species were compared with Blastn (E-value cut-off of 10^{-5}) against each other in order to identify common DE genes. Furthermore, they were compared to DE genes identified previously in *L. digitata* during grazing stress (Ritter et al. [2017](#)).

2.5.5 *Laminarionema elsbetiae* read analysis

Reads deriving from the co-cultivation treatments (24 and 48h) with both hosts that could not be aligned to the transcriptome assembly were retrieved and mapped against the unpublished *L. elsbetiae* transcriptome (access provided by ABiMS) using bowtie2 (Langmead & Salzberg [2012](#)). A functional annotation of selected *L. elsbetiae* reads was obtained through a Blastx search against the Uniprot database with an E-value cut-off of 10^{-5} . Genes were assigned to 2nd and 3rd level GO subcategories within the three root categories molecular function, cellular component and biological process using Blast2GO (Conesa et al. [2005](#)).

3. Results

3.1 The effect of co-cultivation with algal endophytes on kelp growth

No significant differences in growth occurred within two weeks of co-cultivation of *S. latissima* with *M. tenuissimum* and *L. elsbetiae* (Fig. 5A, Table 1). At the end of the experiment, DNA of the endophyte was detected in 73.3% of the kelp samples using qPCR specific primers (11 out of 15 samples).

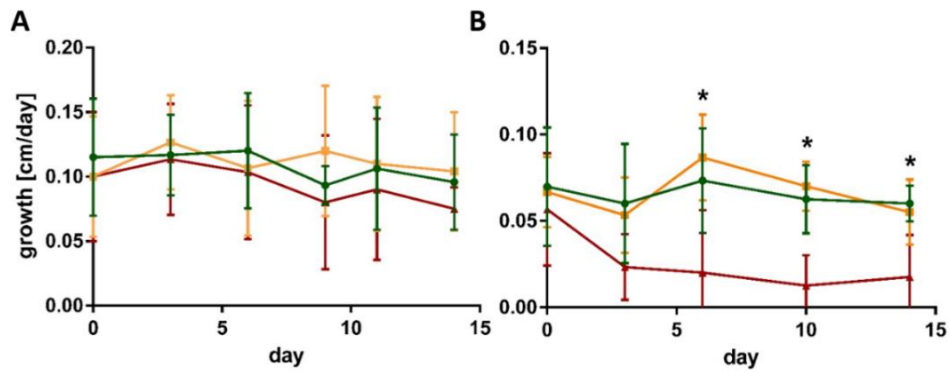

Figure 5: Growth of **A.** *S. latissima* and **B.** *L. digitata* in control conditions (green), in presence of the non-endophytic *M. tenuissimum* (yellow) and the endophyte *L. elsbetiae* (red). The presented values are mean values with standard deviation (N=5). Significant differences are indicated by asterisk (see Table 1).

In case of *L. digitata*, a significant difference between the treatments occurred 6 days after the addition of *M. tenuissimum* and *L. elsbetiae* (Fig. 5B and Table 1).

The growth of *L. digitata* was decreased significantly in the presence of *L. elsbetiae* (Fig. 5B) as compared to the other treatments after 6 days of co-cultivation (Table 1, one-way ANOVA, $p=0.013$) and the difference persisted until the end of the experiment (Table 1). There was no significant effect of co-cultivation with the non-endophytic *M. tenuissimum* on the growth of *L. digitata*. DNA of *L. elsbetiae* was detected in 30.8% of the *Laminaria* sporophytes by qPCR after two weeks of co-cultivation (4 out of 13 samples).

No *L. elsbetiae* DNA was detected in any of the controls.

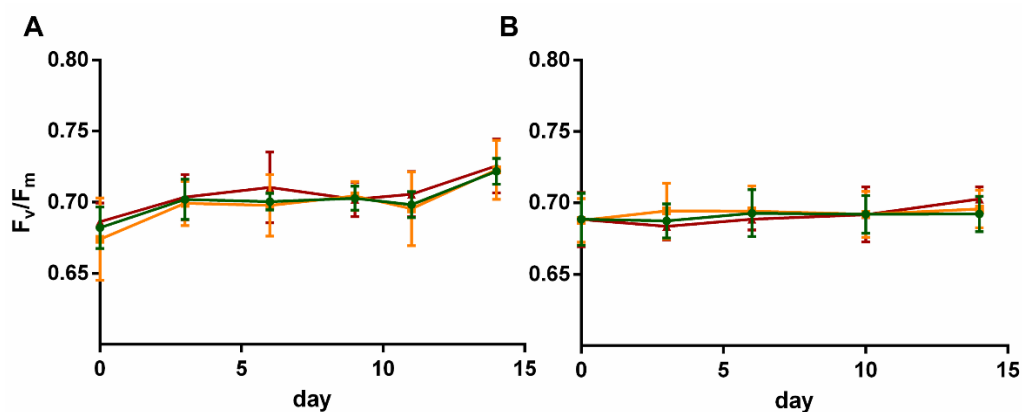

Figure 6: Maximum quantum yield of photosystem II (Fv/Fm) in **A.** *S. latissima* and **B.** *L. digitata* in control conditions (green), in presence of the non-endophytic *M. tenuissimum* (yellow) and the endophyte *L. elsbetiae* (red). The presented values are mean values with standard deviation (N=5).

No significant differences in the maximum quantum yield of photosystem II (Fv/Fm) occurred within two in *S. latissima* (Fig. 6A) or *L. digitata* (Fig. 6B) alone or in co-cultivation with *M. tenuissimum* and *L. elsbetiae* (Table 1).

Table 1: Statistical analysis of the co-cultivation bioassay. Significant p-values are marked by asterisks.

| Experiment | One-Way ANOVA | Growth | | | Fv/Fm | | |
|--|---------------|--------|----|---------|-------|----|---------|
| | | F | Df | p-value | F | df | p-value |
| <i>S. latissima</i> Co-cultivation | Day 0 | 0.17 | 2 | 0.85 | 0.47 | 2 | 0.64 |
| | Day 3 | 0.17 | 2 | 0.84 | 0.11 | 2 | 0.9 |
| | Day 6 | 0.15 | 2 | 0.86 | 0.59 | 2 | 0.57 |
| | Day 9 | 1.14 | 2 | 0.35 | 0.07 | 2 | 0.93 |
| | Day 11 | 0.2 | 2 | 0.82 | 0.39 | 2 | 0.68 |
| | Day 14 | 0.63 | 2 | 0.55 | 0.04 | 2 | 0.96 |
| <i>L. digitata</i> + Co-cultivation | Day 0 | 0.26 | 2 | 0.77 | 0.06 | 2 | 0.94 |
| | Day 3 | 2.82 | 2 | 0.1 | 0.27 | 2 | 0.77 |
| | Day 6 | 6.37 | 2 | 0.01* | 0.02 | 2 | 0.98 |
| | Day 10 | 16.17 | 2 | >0.01* | 0.04 | 2 | 0.96 |
| | Day 14 | 7.58 | 2 | >0.01* | 0.29 | 2 | 0.75 |

3.2 Preliminary experiments to modify kelp responses towards algal endophytes

3.2.1 GG pre-treatment

A significant difference between all treatments occurred from day 3 of the experiment and persisted until day 14 (Table 2).

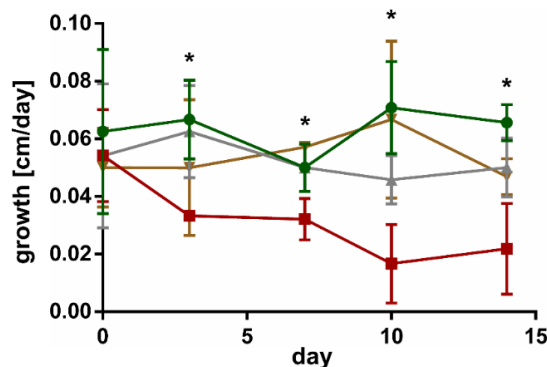

Fig. 7: Growth of *L. digitata* without GG pre-treatment in control conditions (green) and in co-cultivation with *L. elsbetiae* (red) and of *L. digitata* with GG pre-treatment in control conditions (grey) and with *L. elsbetiae* (gold). Significant differences are indicated by asterisks (see table 2). The presented values are mean values with standard deviation (N=4).

Co-cultivation of the untreated *L. digitata* sporophytes with the endophyte *L. elsbetiae* resulted in a significant decrease of growth from day 3 onwards (red line in Fig. 7, Table 2), as already described in the experiments above. However, the addition of *L. elsbetiae* did not have any effect on the growth of *L. digitata* sporophytes that had been pre-treated with GG 3 days before the co-cultivation was started (golden line, Fig. 7). There was no effect of the GG elicitation pre-treatment alone on the growth of *L. digitata* (grey line in Fig. 7).

Table 2: Statistical analysis of the co-cultivation bioassay with GG pre-treatment. Significant p-values are marked by asterisks.

| Experiment | One-Way ANOVA | F | df | p-value |
|---|---------------|-------|----|---------|
| <i>L. digitata</i> + GG pre-treatment | Day 0 | 0.24 | 3 | 0.87 |
| | Day 3 | 3.61 | 3 | 0.04* |
| | Day 7 | 9.73 | 3 | >0.01* |
| | Day 10 | 7.85 | 3 | >0.01* |
| | Day 14 | 12.21 | 3 | >0.01* |

3.2.2 Addition of fungal extracts

The co-cultivation bioassay with fungal extracts was started with a final concentration of 50 $\mu\text{g}/\text{mL}$ of extract from the fungus *Cladosporium cucumerinum*.

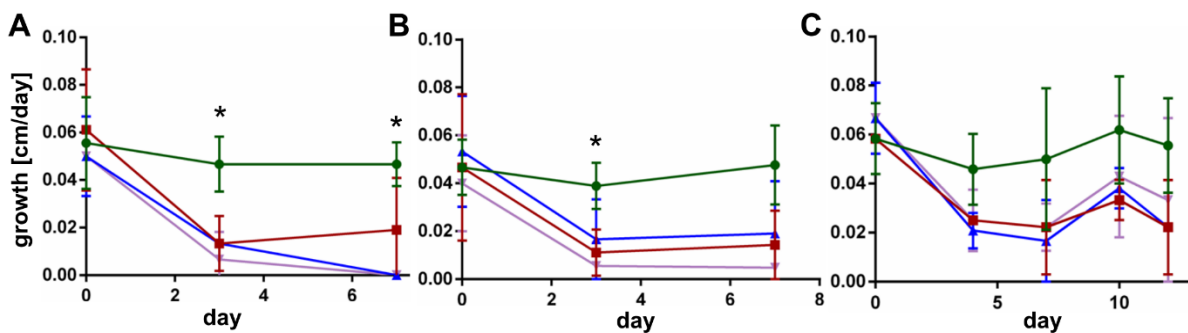

Fig. 8: Growth rates of *L. digitata* in control conditions (green) and in co-cultivation with *L. elsbetiae* (red), fungal extracts (blue) and both (purple). **A:** Extract of *Cladosporium cucumerinum* (50 $\mu\text{g}/\text{mL}$). **B:** Extract of *Chaetomium globosum* (10 $\mu\text{g}/\text{mL}$). **C:** Extract of *Phoma exigua* (10 $\mu\text{g}/\text{mL}$). Significant differences are indicated by asterisks (see Table 3). The presented values are mean values with standard deviation (N=3).

There was a significant difference of growth between the treatments on days 3 and 7 (Table 3). In particular, not only co-cultivation with the endophyte *L. elsbetiae* decreased the growth of *L. digitata* significantly (red line, Fig. 8A) – as observed before - but also the presence of the

fungal extracts and a combination of both (blue and purple lines, respectively, Fig. 8A). However, while the kelps of the control treatment and the co-cultivation with *L. elsbetiae* alone showed a normal coloration after 7 days (Fig. 9A+B), the sporophytes that had been treated with the fungal extracts had lost their coloration after 7 days (Fig. 9C+D).

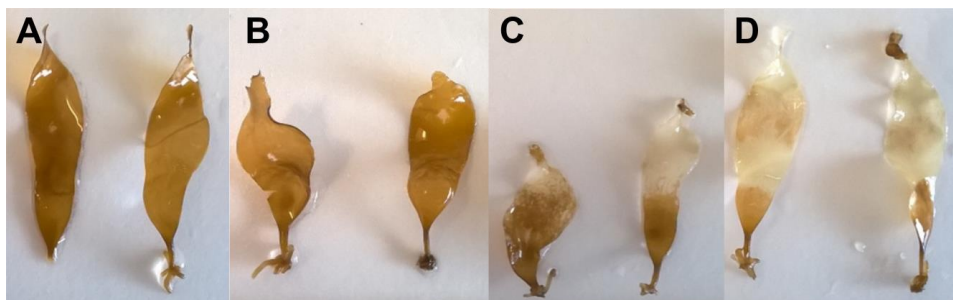

Fig. 9: Sporophytes of *L. digitata* after 7 days of co-cultivation. **A.** *L. digitata* sporophytes from the control treatment. **B.** *L. digitata* sporophytes of the treatment with filaments of the endophyte *L. elsbetiae*. **C.** *L. digitata* sporophytes of the treatment with extracts of the fungus *C. cucumerinum*. **D.** *L. digitata* sporophytes of the treatment with *C. cucumerinum* extracts and *L. elsbetiae* filaments.

Neither a loss of coloration nor a decrease of growth was observed when *L. digitata* was grown in seawater with the same concentration of DMSO only (results not shown).

The concentration of the fungal extract was lowered to 10 µg/mL for the following experiments with the extracts of the fungi *Chaetomium globosum* and *Phoma exigua*. Co-cultivation with the extracts of the fungus *C. globosum* showed a significant difference on day 3 of the experiment (Table 3).

Table 3: Statistical analysis of the co-cultivation bioassay with fungal extracts. Significant p-values are marked by asterisks.

| Experiment | One-Way ANOVA | F | df | p-value |
|--|---------------|-------|----|---------|
| <i>L. digitata</i> + <i>C. cucumerinum</i> extract | Day 0 | 0.22 | 3 | 0.88 |
| | Day 3 | 7.33 | 3 | 0.01* |
| | Day 7 | 11.51 | 3 | >0.01* |
| <i>L. digitata</i> + <i>C. globosum</i> extract | Day 0 | 0.18 | 3 | 0.9 |
| | Day 3 | 4.61 | 3 | 0.04* |
| | Day 7 | 4 | 3 | 0.05 |
| <i>L. digitata</i> + <i>P. exigua</i> extract | Day 0 | 0.33 | 3 | 0.8 |
| | Day 4 | 3.67 | 3 | 0.06 |
| | Day 7 | 1.73 | 3 | 0.24 |
| | Day 10 | 1.54 | 3 | 0.28 |
| | Day 12 | 1.33 | 3 | 0.33 |

Similar to what had been observed for *C. cucumerinum*, the growth of *L. digitata* was significantly reduced when co-cultivated with the endophyte, the fungal extract and a combination of both (red, blue and purple lines, Fig. 8B) and sporophytes treated with the fungal extracts had lost their colouration (not shown). During the experiment with *Phoma exigua*, no significant difference between the treatments (Table 3) and no decolouration occurred. However, growth of *L. digitata* was still higher in the control (green line, Fig. 8C) than in the other treatments.

3.3 Oxidative burst measurement

As already demonstrated by Küpper et al. (2001), oligogulonates (GG) blocks triggered an oxidative burst in both kelp species, which is indicated by a significant fold change of H₂O₂ release as compared to the control (Table 4). *L. tomentosoides* and *L. elsbetiae* without kelp sporophytes did not lead to significant changes in H₂O₂ content in the surrounding seawater (data not shown).

The addition of *L. tomentosoides* to *S. latissima* resulted in a slight increase of H₂O₂ concentration in the seawater (log₂FC = 0.21, one-sample t-test, p=0.09, Table 4). When added to *L. digitata*, on the other hand, *L. tomentosoides* caused a significant decrease of the H₂O₂ concentration in the seawater (log₂FC = -0.42, one-sample t-test, p=0.04, Table 4). No significant changes in the H₂O₂ concentration were observed after the addition of *L. elsbetiae* to both kelp species.

Table 4: Mean values of log₂FC in H₂O₂ content monitored during 30 min in seawater surrounding the treated kelps as compared to the control (N=3) and results of the statistical analysis using a one-sample t-test. Ldig = *L. digitata*, GG = addition of oligogulonates, Lels = *L. elsbetiae*, Ltom = *L. tomentosoides*, Slat = *S. latissima*.

| Treatment | Mean log ₂ FC | Stdev | t | Df | p-value |
|-----------|--------------------------|-------|-------|----|---------|
| Ldig+GG | ↑ 3.49 | 1.31 | 4.60 | 2 | 0.02* |
| Ldig+Lels | ↓ -0.61 | 0.26 | -1.24 | 2 | 0.17 |
| Ldig+Ltom | ↓ -0.42 | 0.07 | -3.10 | 2 | 0.04* |
| Slat+GG | ↑ 3.56 | 1.78 | 3.47 | 2 | 0.04* |
| Slat+Lels | ↓ -0.24 | 0.52 | -0.78 | 2 | 0.26 |
| Slat+Ltom | ↑ 0.21 | 0.40 | 4.54 | 2 | 0.09 |

3.4 Transcriptomics

3.4.1 General overview of the transcriptomes

The cleaned RNA sequencing reads of *S. latissima* were *de novo* assembled by Trinity into 23,049 transcripts with an average contig length of 1,433.51 bp (Table 5). The *de novo* assembly of *L. digitata* consisted of 28,766 transcripts with an average contig length of 1,250.96 bp (Table 5). The average GC content was 55.03% and 54.31% in *S. latissima* and *L. digitata*, respectively.

Table 5: Summary of the Trinity assembly and annotation for *S. latissima* and *L. digitata*.

| | <i>S. latissima</i> | <i>L. digitata</i> |
|--------------------------------------|---------------------|--------------------|
| Total number of reads | 986,800,000 | 1,001,600,000 |
| Number of used reads | 900,200,999 | 910,400,000 |
| Number of Trinity transcripts | 23,049 | 28,766 |
| Total size of the transcriptome (bp) | 33,040,961 | 35,985,095 |
| GC content | 55.03 | 54.31 |
| N50 length (bp) | 1,869 | 1,562 |
| Average contig length (bp) | 1,433.51 | 1,250.96 |
| Average mapping rate | 93.11% | 89.23% |
| Annotation rate (Blastx) | 47.06% | 42.73% |

A comparison of orthogroups, i.e. groups of transcripts showing sequence similarities, within the transcriptomes of *S. latissima* and *L. digitata* with the transcriptomes of two other brown algae, *S. japonica* and *E. siliculosus*, revealed a core of common orthogroups in all four species (42.7%, Fig. 10). Furthermore, the proportion of shared orthogroups between transcriptomes was higher for the two most closely related species *S. latissima* and *S. japonica* (62.1%) than for *S. latissima* and *L. digitata* (56.2%) and for both kelps with *E. siliculosus* (57.7% and 56.5% for *S. latissima* and *L. digitata*, respectively, Fig. 10). The two genome-based transcriptomes of *E. siliculosus* and *S. japonica* shared most orthogroups (78.2%). Very few orthogroups were species-specific, but the highest amount of unique orthogroups was found in *E. siliculosus* (0.2%, Fig. 10).

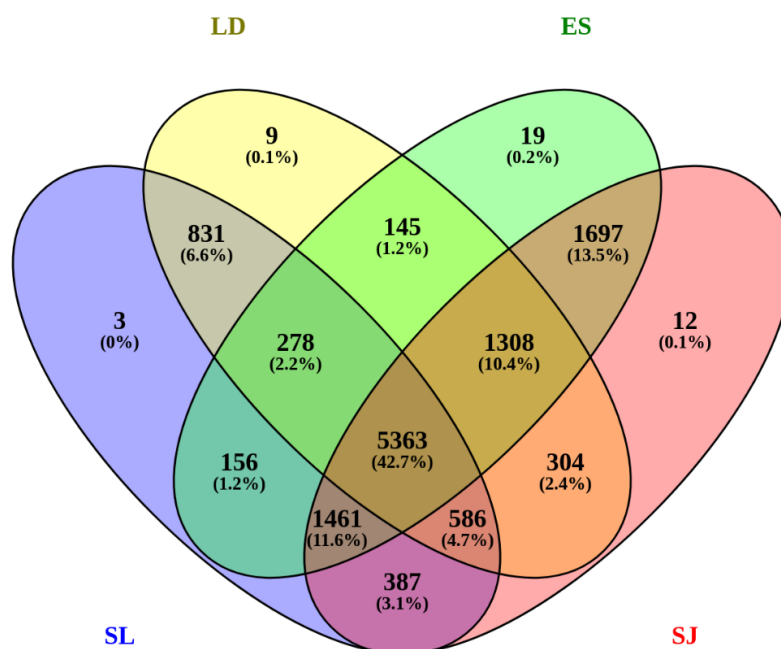

Fig. 10: Orthologous gene families in the transcriptomes of *S. latissima* (SL), *L. digitata* (LD), *E. siliculosus* (ES) and *S. japonica* (SJ).

Overall, the distribution of GO terms for the three root categories “Molecular Function”, “Cellular Component” and “Biological process” were very similar for the assembled transcriptomes of *S. latissima* and *L. digitata* (Fig. 11). Within the molecular function category, most hits were assigned to catalytic activity and binding (Fig. 11). Within the cellular component category, the functions were more equally distributed. However, genes involving functions in supramolecular complexes, membrane-enclosed lumen and extracellular region were less represented than the other functions (Fig. 11). Within the biological process root, most genes belonged to metabolic and cellular processes (Fig. 11).

Overall, 47.06% of the obtained genes of *S. latissima* could be annotated whereas the annotation rate was slightly lower in *L. digitata* (42.73%).

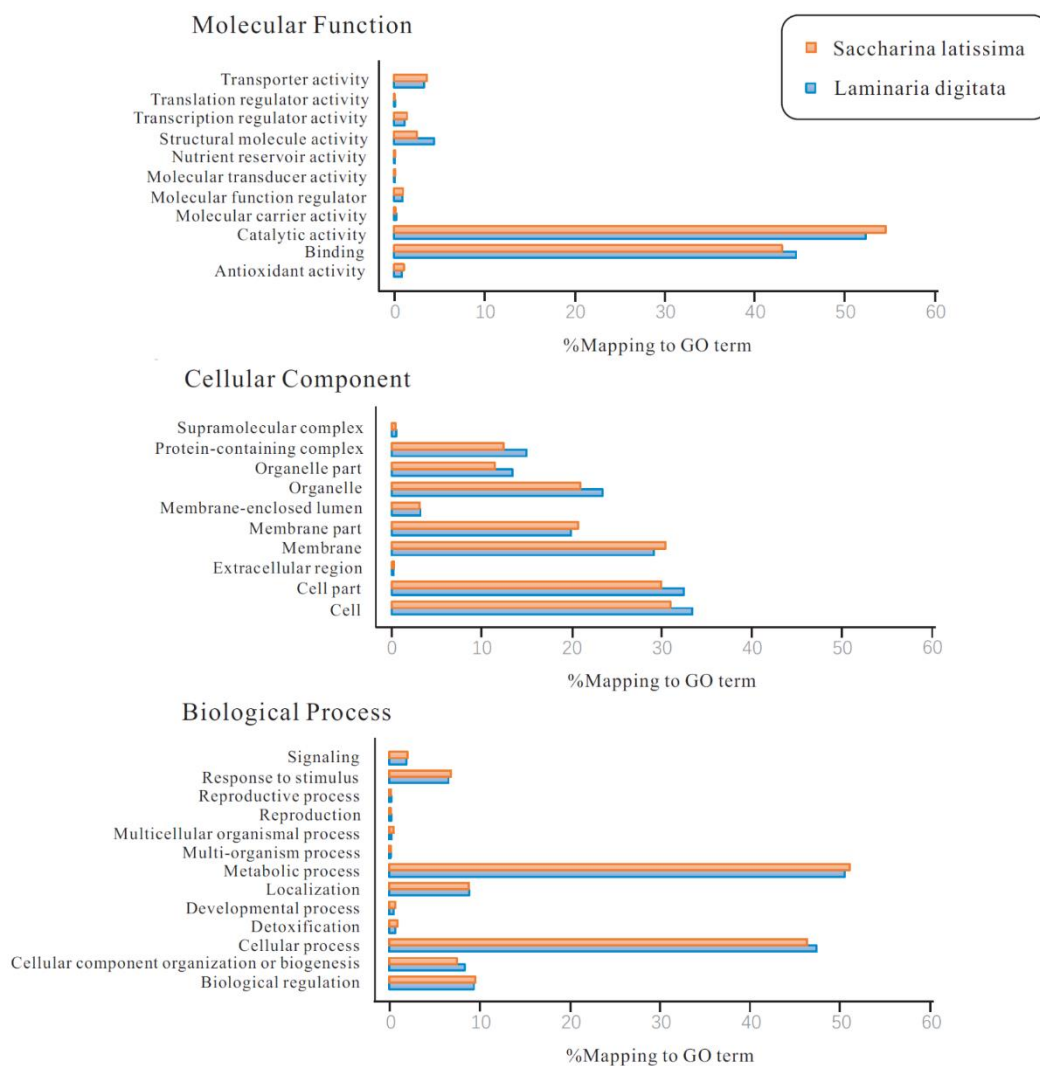

Fig. 11: Distribution of the functional categories derived from Gene Ontology terms obtained by Blast2GO hits of genes from the *S. latissima* and the *L. digitata* transcriptome.

3.4.2 Differentially expressed genes

No difference in gene expression occurred in *S. latissima* when co-cultivated with *L. elsbetiae* after 24 h, whereas five genes were differentially expressed between *Laminaria digitata* under control condition and in co-culture with the endophyte (Table S1).

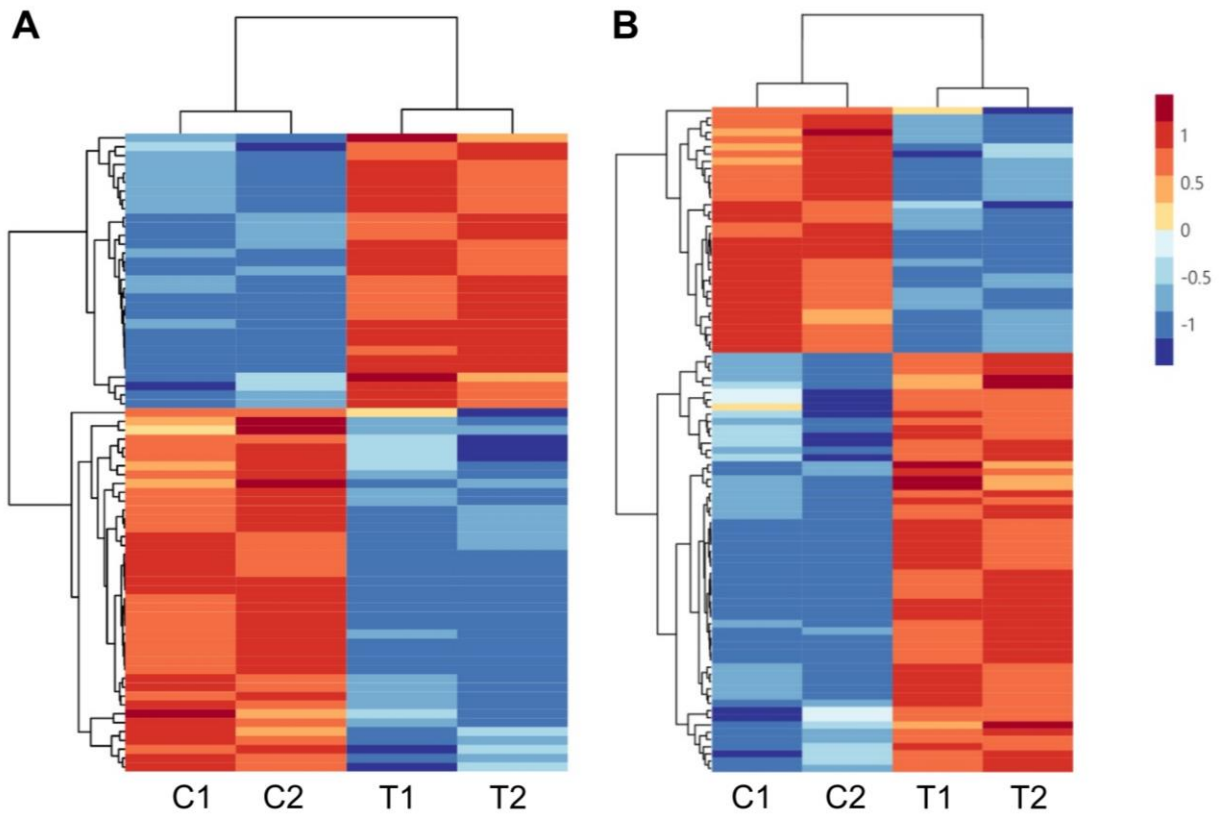

Fig. 11: Differentially expressed genes in **A.** *S. latissima* and **B.** *L. digitata* after 48 h of co-culture.

After 48 h, significant differences in the gene expression occurred in both species. However, only a small fraction of 72 genes (0.34% of the reference transcriptome) showed significant differences ($p < 0.01$) between the control and the endophyte treatment in *S. latissima* (Fig. 11A). 44% of the DE genes were upregulated and 56% downregulated (Fig. 11A). Fold-change values ranged from 7.16 to -5.13 (\log_2 -transformed, Fig. 12A), but the majority of the DE genes showed moderate fold-changes between 3 and -3 (\log_2 -transformed, 69% and 75% in the up- and downregulated genes, respectively, Fig. 12A).

In *L. digitata*, the number of differentially expressed genes was equally low. 93 genes (0.35% of the reference transcriptome) showed significant differences between the control and the endophyte co-culture ($p < 0.01$, Fig. 11B). More genes were upregulated (62%) in the presence of *L. elsbetiae* than downregulated (38%, Fig. 11B). Fold-change values ranged from 6.68 to -6.07 (\log_2 -transformed, Fig. 12B) and were more equally distributed among the upregulated genes in *L. digitata* than in *S. latissima* (Fig. 12B). On the other hand, a majority of the downregulated genes (77%) showed moderate changes between -1 and -3 (\log_2 -transformed Fig. 12B).

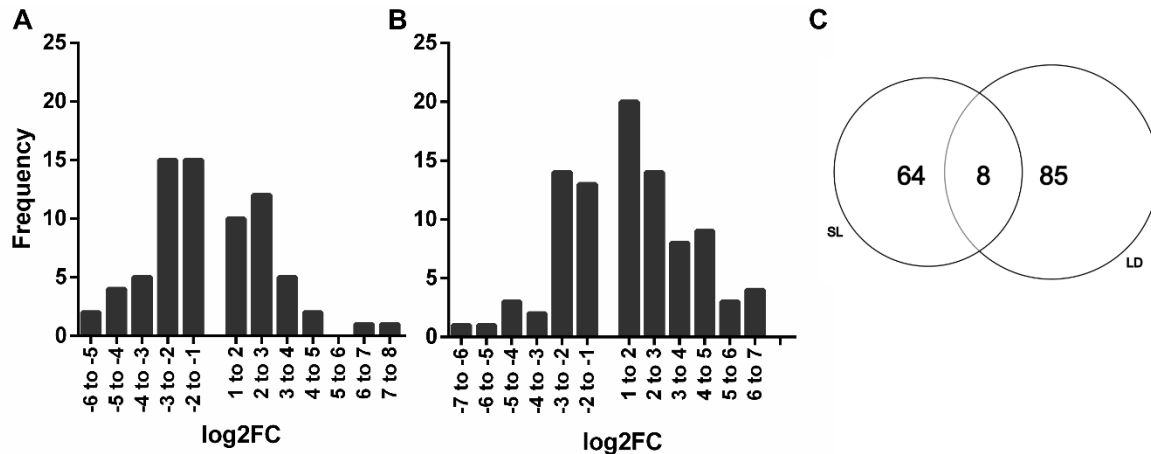

Fig. 12A: Frequency distribution of log₂FC among DE genes in **A.** *S. latissima* and **B.** *L. digitata* after 48 h of co-cultivation. **C:** Venn diagram showing the uniquely differentially expressed genes in *S. latissima* (SL, N=64) and *L. digitata* (LD, N=85) and the common differentially expressed genes after 48 h of co-cultivation (intersection, N=8).

Among those differentially expressed genes during the interaction with the endophyte, only 8 genes were shared by both kelps (Fig. 12C).

3.4.3 Functional annotation of differentially expressed genes

Comparable to the whole transcriptome analysis, an important part of the differential expressed genes did not have a match through Blastx search in the available databases. Therefore no putative functional annotation was associated to 49% and 65% of the DEGs after 48 h in *S. latissima* and *L. digitata*, respectively. These unknown genes also included the 8 DEGs that were shared between the two species.

A functional annotation was obtained for two of the five differentially expressed genes in *L. digitata* after 24 h of co-cultivation (Table S1, supplementary material). One of the upregulated genes was related to cell wall modifications (hydrolysis) whereas a tyrosinase was downregulated in the presence of *L. elsbetiae* (Table S1).

After 48 h of co-cultivation an annotation was obtained for 35% of the genes that were uniquely differentially expressed in *L. digitata*. 15 genes were annotated as conserved unknown or hypothetical *Ectocarpus* proteins whereas a functional annotation was retrieved for 17 genes (see Table S2, supplementary material). Among the upregulated genes were three NB-ARC and TPR repeat-containing protein (log₂FC = 3.81/3.68/3.46), a TPR domain-containing protein (log₂FC = 2.98) and an aryl sulfotransferase (log₂FC = 1.66). Furthermore, a gene with

high similarity to the *Ectocarpus* virus was upregulated in the co-cultivation treatment with *L. elsbetiae* (EsV 1-7, $\log_2\text{FC} = 4.92$, Table S2). Among the downregulated genes were a ferredoxin-dependent glutamate synthase ($\log_2\text{FC} = -2.51$) and a carbonyl reductase ($\log_2\text{FC} = -1.59$). The most strongly upregulated gene was a putative short-chain dehydrogenase ($\log_2\text{FC} = 6.68$), whereas no function was assigned to the most strongly down-regulated gene in the presence of *L. elsbetiae* ($\log_2\text{FC} = 6.07$, Table S2).

In case of *S. latissima*, after 48 h of co-cultivation with the endophyte 22 DE genes corresponded to conserved unknown or hypothetical *Ectocarpus* proteins, and a functional annotation could be retrieved for only 15 genes out of 72 (see Table S3, supplementary material). Among the upregulated genes were a glutathione-S-transferase ($\log_2\text{FC} = 3.47$) and a mannuronan C-5 epimerase ($\log_2\text{FC} = 1.36$, Table S3, supplementary material). Two LRR-GTPases of the ROCO family ($\log_2\text{FC} = -1.68/-1.63$) and a methionine-R-sulfoxide reductase ($\log_2\text{FC} = -4.73$) were downregulated in the presence of *L. elsbetiae* (Table S2, supplementary material). No functions were assigned to the most strongly up- and downregulated genes ($\text{FC} = 7.16$ and -5.13 , respectively, Table S3).

3.4.4 *Laminarionema elsbetiae* reads

The reads mapped to the *L. elsbetiae* transcriptome were analysed on a qualitative level only because the total number of retrieved reads was too low to proceed to a quantitative expression analysis. 36 transcripts of *L. elsbetiae* were found associated to both hosts (Fig. 13A). 67% of them were annotated (Fig. 13B). Among them were several putative housekeeping genes, such as actin and the eukaryotic translation elongation factor 1 alpha (EEF1A2). Furthermore, eight of the expressed genes encoded proteins of the light harvesting complex and one was related to alginate biosynthesis (GDP-mannose-6-dehydrogenase, Table S4, supplementary material).

Fewer transcripts of *L. elsbetiae* were found in RNAseq data associated to the co-culture with *S. latissima* (N=46) than that with *L. digitata* (N=1238, Fig. 13A). 45% of the expressed *L. elsbetiae* genes uniquely associated to *S. latissima* could be annotated (Fig. 13B). Next to some of the functions that were also present among the commonly expressed genes, a LRR-GTPase of the ROCO family was found to be expressed (Table S5, supplementary material). In the case of the *L. elsbetiae* reads associated to *L. digitata*, around 30% of the expressed genes were annotated (Fig. 13B), including several stress-response related genes, such as Glutaredoxin, several heat shock proteins, a vanadium-dependent bromoperoxidase, a glutathione S-

transferase and a TPR repeat-containing protein (Table 6, supplementary material). Furthermore, an exo-1,3-beta-glucanase, family GH5 was found to be expressed in *L. elsbetiae* in the presence of *L. digitata* (Table S6, supplementary material).

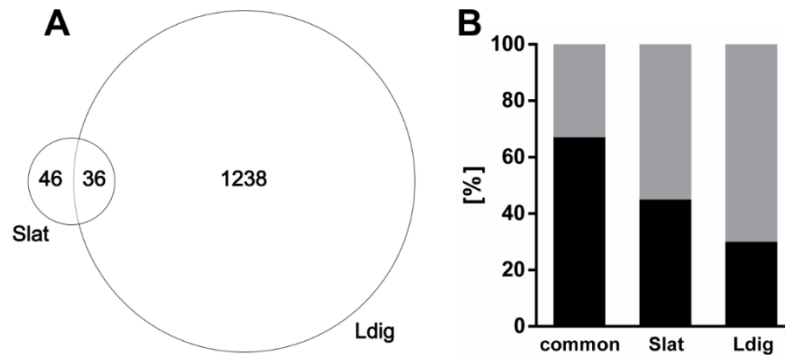

Fig. 13A: Reads belonging to *L. elsbetiae* uniquely associated with *S. latissima* (left, N=46), with *L. digitata* (right, N=1238) and both hosts (intersection, N=36). **11B:** Annotation rates of the *L. elsbetiae* reads. black = functional annotation obtained, grey = no functional annotation obtained.

Overall, the GO terms obtained for the *L. elsbetiae* reads associated to the two kelps showed slight differences. In the root category “Molecular Function” the annotated terms were more diverse for the *L. elsbetiae* reads associated to *L. digitata* than to *S. latissima* (Fig. 14A). Genes involved in molecular carrier activity, molecular function regulation and transcription regulator activity were found to be expressed by *L. elsbetiae* only in the co-culture with *L. digitata* (Fig. 14A). The distribution of expressed genes belonging to the root category “Cellular Component” was more equally and the same functions were represented in the reads associated to both kelp species (Fig. 14B). Similar to what was observed for the category “Molecular Function”, the GO terms in the root category “Biological process” were more diverse for the *L. elsbetiae* reads associated to *L. digitata* than to *S. latissima* (Fig. 14C). For instance, genes involved in detoxification, developmental processes and reproduction were only found to be expressed by *L. elsbetiae* in the co-culture with *L. digitata* (Fig. 14C).

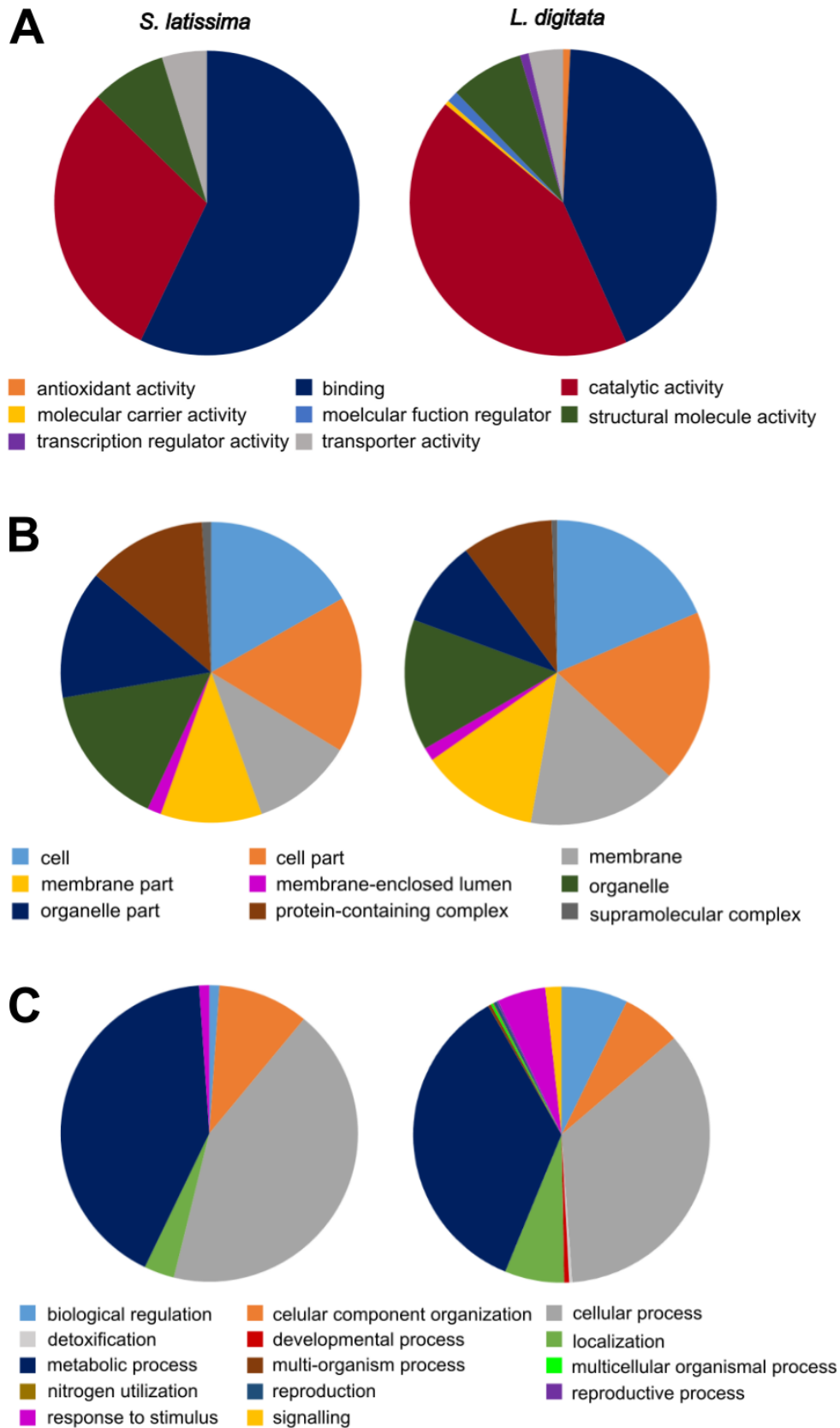

Fig. 14: GO terms of annotated reads belonging to *Laminarionema elsbetiae* retrieved uniquely from *S. latissima* (left, N=46) or *Laminaria digitata* (right, N=1238) RNAseq data. **A.** Root category “Molecular Function”, **B.** Root category “Cellular Component”, **C.** Root category “Biological process”.

4. Discussion

In Brittany, *L. elsbetiae* is mainly found in *S. latissima*, whereas *L. digitata* is not only infected less frequently, but also in lower severity (Bernard et al. [2017](#), [2018](#)). However, until now, these interactions have rarely been studied apart from epidemiological surveys and there is no explanation for these differences in natural infection patterns. This study provides a first insight into the bases of kelp-endophyte interactions on a physiological and a molecular level and highlights the complex cross-talk occurring after the recognition of endophytes by kelps which could explain host specificity.

4.1 The two kelp species show a different physiological response during the co-cultivation with the endophyte

Previously, it was reported that algal endophytes can reduce the growth of their hosts by up to 70%, as it has been shown for the red algal endophyte *Hypneocolax stellaris* in its host, the rhodophyte *Hypnea musciformis* (Apt [1984](#)). Here we show that an effect on growth may be dependent on the host species, as the co-cultivation bioassay developed in this study revealed different physiological responses of the two kelp species *S. latissima* and *L. digitata* towards a co-cultivation with the endophyte *L. elsbetiae*.

The growth of the main host *S. latissima* was not affected by the endophyte during the two weeks of co-cultivation. However, *L. elsbetiae* DNA was detected in most of the sporophytes at the end of the experiment. Although this detection does not indicate that endophytic filaments were already growing inside of the kelp thallus, at least spores of the endophytes were attached to the kelp tissue by the end of the experiment. Thus, a direct contact between the endophyte and the kelp had been established without affecting the growth of *S. latissima*.

Oppositely, the growth of the occasional host *L. digitata* was significantly reduced after a few days of co-cultivation. As the filamentous brown alga *M. tenuissimum* did not have any effect on both kelps, nutrient competition could be excluded as a possible cause of the growth reduction. However, despite the significant effect on growth, *L. elsbetiae* DNA was only detected in a third of the *L. digitata* samples after two weeks of co-cultivation, suggesting a more efficient mechanism against spore settlement compared to *S. latissima*. Since growth was slowed down in all samples, including the uninfected ones, it is unlikely that this effect was caused by a direct contact between the endophyte and the kelp. Instead, it could be possible

that *L. digitata* sporophytes were able to activate energy-costing defense responses and that growth was therefore slowed down as a secondary effect.

Endophytic pathogens may not only affect growth, but can also impair the efficiency of energy transfer from the light harvesting complexes to the reaction centre of PS II, as it has been reported for endophytic fungi and bacteria in plants (Luque et al. [1999](#); Guidi et al. [2007](#)) and for the protist *Labyrinthula zosterae* in the seagrass *Zostera marina* (Ralph & Short [2002](#)). However, PAM measurements did not indicate any impact of the co-cultivation treatment on the performance of photosystem II of the two kelp species.

One of the defence reactions in eukaryotes following the perception of elicitors is the oxidative burst. It is rapid – in *Laminaria digitata* it was measured 2 to 3 minutes after the addition of GG – and transient, lasting no longer than 30 minutes (Küpper et al. [2001](#)). Indeed we observed a significant response of both kelp species to GG elicitation, which is in concordance with previous studies (Küpper et al. [2001](#), [2002](#)) and suggests that kelps are able to recognize breakdown products of their own cell wall (Küpper et al. [2002](#)). Since it was previously hypothesized that *L. elsbetiae* uses alginate lysing enzymes to enter the cell wall of *S. latissima* (Heesch & Peters [1999](#)), GG, which are likely to be released during the enzymatic dissolution of the cell wall, may act as an endogenous elicitor during kelp-endophyte interactions. In our experiments, however, neither of the two different filamentous algal endophytes triggered an oxidative burst in the two kelp species. On the opposite, the amount of H₂O₂ in the seawater decreased after the addition of *L. elsbetiae* filaments to both kelps and the addition of *L. tomentosoides* to *L. digitata*. Similarly, Küpper et al. ([2002](#)) showed that cell-free extracts of *L. tomentosoides* did not elicit a burst in *L. digitata*, but rather had high quenching capability of H₂O₂. The authors concluded that either *L. digitata* would not recognize *L. tomentosoides* as an attacker or that the endophyte could suppress the defense response of the kelp. Our transcriptomic analyses showing defense-related gene induction after 48 hours in both kelp species indicate that both kelps recognized the endophyte as attackers. Rather, an early oxidative responses of the kelps would have been very local and not synchronous for the entire thallus and might therefore not have been detected with the experimental set up. As the beakers were constantly moved on a shaker, a potential local increase in H₂O₂ would have been diluted in the surrounding 50 mL of seawater. The GG treatment that was used as a positive control, on the other hand, affected the whole kelp surface at the same time, thereby leading to bigger overall changes in the H₂O₂ concentration. Secondly, the endophytes might scavenge the H₂O₂ as soon as it is produced, as suggested by the identification of anti-oxidative gene transcripts in *L. elsbetiae*, such as

glutaredoxin or HSP. Therefore, the experimental set-up has to be adapted accordingly for future measurements, for instance by monitoring H₂O₂ responses, using specific probes or confocal microscopy (Küpper et al. [2001](#)).

4.2 Defense elicitation can modify the physiological response of *L. digitata* towards the algal endophyte

Above we hypothesized that the growth of *L. digitata* in the presence of *L. elsbetiae* was slowed down due to an activation of energy-costing defense reactions. Growth behaviour of *L. digitata* in co-cultivation with the endophyte after GG elicitation, however, was similar to the controls. An elicitation with GG has been shown to strongly induce defense-related genes in *L. digitata* (Cosse et al. [2009](#)). The pre-treatment could therefore restore normal growth behaviour of the kelp in co-culture with the endophyte, due to the activation of the kelp defense reactions prior to the co-cultivation. Previously, Küpper et al. ([2002](#)) succeeded to induce resistance of *L. digitata* sporophytes against the filamentous algal endophyte *L. tomentosoides* by a GG pre-treatment. The authors suggested that the oxidative burst caused by the addition of GG activated secondary, long-term defense mechanisms in the kelps that ultimately lead to a strengthening of their cell wall, thereby building up a mechanical barrier against the endophyte. Our experimental set-up, on the other hand, was rather monitoring the initial steps of kelp-endophyte interactions, mainly during the spore settlement and germination. The results suggest rapid and direct defense mechanisms that may have been enhanced through GG-induced priming effect, as already observed in *L. digitata* (Thomas et al. [2011](#)). However, future studies using the qPCR bioassay could test a potential effect on long-term resistance of the kelp against the endophyte. Furthermore, multiple other substances could have an effect on the interactions between kelps and endophytes. For instance, arachidonic acid and methyljasmonate induced a measurable resistance against *L. tomentosoides* similar to the GG pre-treatment (Küpper et al. [2009](#)). It could therefore also be interesting to test the ability of other substances to modify the susceptibility of kelps to algal endophytes.

4.3 Gene regulation during the first contact with the endophytes differs in the two hosts

The transcriptomic assemblies showed high re-mapping rates and similarity to the transcriptomes of other brown algal species. Furthermore, GO terms were distributed equally

within the transcriptomes of both kelp species. We therefore conclude that the quality of our transcriptomes was sufficient for the subsequent analyses.

After 24 hours of co-cultivation with the endophyte, only few genes were differentially regulated in *L. digitata*, whereas *S. latissima* did not show any transcriptomic response. However, after 48 hours, differences in gene expression were found in both kelp species. Our results therefore suggest that there is a temporal delay in the gene-level responses after the start of the co-cultivation with a faster response of *L. digitata* as compared to *S. latissima*. When *L. digitata* was treated with GG, differential responses in the gene expression occurred early with many stress-related genes induced 6 hours after the elicitation (Cosse et al. [2009](#)). GG elicitation is, however, only a simulation of a biotic interaction and can therefore not directly be compared with our experiment. In a laboratory set-up to study biotic interactions of kelps comparable to ours, grazing stress was shown to stimulate gene regulation after 24 hours (Ritter et al. [2017](#)). As we found reads belonging to *L. elsbetiae* in RNA sequencing data of both kelps, we can assume that a direct contact between kelp and endophyte had been established after 24 hours. However, due to the experimental set-up we used, it is unlikely that the endophyte spores attached to the kelp sporophytes at the same time in the replicate treatments, introducing a strong bias in term of time course. This could explain the high variation observed between the three biological replicates.

Until now, the majority of transcriptomic studies on kelps focussed on the effect of abiotic factors (Deng et al. [2012](#); Liu et al. [2014](#); Heinrich et al. [2015](#)). Abiotic stresses usually affect a large part of the transcriptome of kelps. For instance, up to 32% of the genes of *S. latissima* were differentially expressed under temperature, light and UV stress (Heinrich et al. [2012](#); Heinrich et al. [2016](#)). Biotic stresses, on the other hand, seem to generally have smaller impact on the gene regulation as they are often happening on a very local scale, whereas abiotic stresses usually affect the whole sporophyte. 0.8% of the genes of *L. digitata* and *Lessonia spicata* were differentially expressed during interactions with grazers with most significant changes after 24 and 48 hours of grazing pressure (Ritter et al. [2017](#)). Similarly, a transcriptomic analysis of the brown seaweed *Fucus vesiculosus* showed only 61 up- and 124 down-regulated genes when grazed for 3 days (Flöthe et al. [2014](#)). These results are comparable to the amount of differentially expressed genes we detected in our study.

The overall rate of functional annotations was very low, as it is usually the case for non-model organisms (Armengaud et al. [2014](#)). However, some interesting candidates were found related to anti-oxidant and defense responses. A glutathione-S-transferase (GST, Zambounis et al.

[2013](#)) was strongly upregulated in the *S. latissima* samples in the presence of the endophyte. GSTs are involved in scavenging reactive oxygen species (Oztetik [2008](#)) and have been shown to be upregulated in stress-related EST libraries of different brown algae (Roeder et al. [2005](#); de Franco et al. [2008](#)). Furthermore, the response of GSTs to treatments with a fatty acid and methyl jasmonate, made them potential candidate genes to be involved in the oxylipin pathway, a defense pathway that may also be involved in the interactions of kelps with algal endophytes (de Franco et al. [2008](#)). Another gene that was upregulated in *S. latissima* was the mannuronan C-5 epimerase (MC5E). MC5E is catalysing the last step of alginate biosynthesis, i.e. the conversion of nongelling mannuronic acid-rich alginates to GG-rich gelling polysaccharides (Michel et al. [2010b](#)). The fact that this enzyme was upregulated in the presence of the endophyte supports the hypothesis that *S. latissima* strengthens the cell wall as a mechanical protection against biotic attackers (Cosse et al. [2009](#)), a response that has also been observed in terrestrial plants (Bradley et al. [1992](#)). No other known defense related genes were found to be upregulated in *S. latissima*. However, there were also a few downregulated genes of interest: Methionine sulfoxide reductases (MSRs) are involved in the protection of proteins against oxidative stress. Methionine residues in proteins are important ROS scavengers and MSRs subsequently catalyse the reduction of methionine sulfoxides (oxidized methionine) back to methionine, thereby limiting the loss of protein function by oxidative damage (Levine et al. [1996](#)). They may also be involved in signal transduction processes by regulating the function and expression of target proteins (Moskovitz [2005](#); Cabreiro et al. [2006](#)). MSRs are usually upregulated during stress reactions. For instance, in *L. digitata*, MSR was highly upregulated 6 h after GG elicitation (Cosse et al. [2009](#)). However, the regulation decreased quickly back to the normal level 12 and 24 h after the addition of elicitors. MSR was also upregulated in *L. digitata* during copper stress with varying levels 6 to 72 h after the stress induction (Ritter et al. [2008](#)) and in *E. siliculosus* during hyposaline stress (Dittami et al. [2009](#)). Here, on the other hand, we observed a strong downregulation of MSR by *S. latissima* during the interaction with the endophyte. In order to understand the role of this enzyme during the interaction, further experiments, such as a transcript accumulation profile at different time points, are necessary. In addition, two LRR-GTPases of the ROCO family were downregulated in *S. latissima*. In animals and terrestrial plants, Leucin-Rich-Repeats (LRR) receptors are involved in the perception of non-self and modified-self molecules and the mediation of innate immunity responses (Maekawa et al. [2011](#); Boller & Yang [2009](#)). Zambounis et al. ([2012](#)) presented them as potential candidate genes for the recognition of pathogens by the brown algal model *E. siliculosus*. Viruses and bacteria have developed mechanisms to suppress the expression of

genes involved in pathogen recognition in plants before an infection (Stack et al. [2005](#); Akira et al. [2006](#); Boller & Yang [2009](#)) and *L. elsbetiae* might use a similar mechanism. The downregulation of these enzymes in *S. latissima* could result in an incomplete or inaccurate recognition of *L. elsbetiae* as an attacker which could be a possible explanation for the high frequency of *L. elsbetiae* in natural populations of *S. latissima* (Bernard et al. [2017](#), [2018](#)). However, the endophyte recognition does not seem to be suppressed entirely, as certain defense responses, such as an upregulation of the glutathione-s-transferase and the MC5E still occurred. In *L. digitata*, on the opposite, four TPR repeat containing (Tetratricopeptide repeat) proteins were upregulated. Although they are less well-known for their involvement in immune answers, TPR domains have similar functions as LRR-GTPases of the ROCO family and have equally been introduced as potential candidates involved in pathogen recognition in *E. siliculosus* (Zambounis et al. [2012](#)). Their strong upregulation in *L. digitata* suggests that - unlike *S. latissima* - *L. digitata* recognizes the endophyte as a threat. Following the successful recognition, *L. digitata* might activate defense reactions, which could explain the lower infection patterns in natural *L. digitata* populations (Bernard et al. [2017](#), [2018](#)).

The majority of differentially expressed genes were unique in the two kelp species and only eight genes were commonly differentially expressed in both kelps. This confirms that overall the two kelps react differently to the contact with the endophyte. However, due to the low number of functional annotations, it is not possible to fully understand the different responses of the two kelps toward an infection with *L. elsbetiae*. In the future, interesting candidate genes could be further investigated by following their transcript accumulation profile over time. Furthermore, a metabolomics approach could help to reveal which pathways are involved in the defense of kelps against endophytes.

4.4 A complex cross-talk between kelp and endophyte could be involved in host specificity

In the co-cultivation with *S. latissima*, few expressed genes of *L. elsbetiae* were detected. Unsurprisingly, most of them were housekeeping genes, such as actin, ubiquitin-related genes and the eukaryotic translation elongation factor 1 alpha (Dittami et al. [2009](#)).

In co-cultivation with *L. digitata*, on the other hand, several defense-related genes were among the expressed genes. Glutaredoxin, for instance, is involved in the protection against oxidative stress (Meyer et al. 2009; Heinrich et al. [2012](#)). Heat-shock proteins (HSP) are universal stress markers which are important in preventing proteins from denaturation by re-establishing their

original conformation (Wang et al. [2004](#); Richter et al. [2010](#)). While they are commonly upregulated in brown algae during abiotic stresses (Heinrich et al. [2012](#); Ritter et al. 2014; Salavarría et al. [2018](#)), HSPs have also been shown to be involved in biotic stress responses. In *E. siliculosus*, for instance, they were upregulated during an infection with the oomycete *Eurychasma dicksonii* (Strittmatter et al. [2016](#)). Another stress-response related gene expressed by *L. elsbetiae* was a vanadium dependent bromoperoxidase (vBPO). vBPOs are involved in the halide metabolism of brown algae (Colin et al. [2005](#)) and similar to the HSPs, they are upregulated during abiotic and biotic oxidative responses (Cosse et al. [2009](#); Strittmatter et al. [2016](#); Salavarría et al. [2018](#)). Furthermore, Butler et al. ([2001](#)) proposed that vanadium haloperoxidases in endophytic fungi may be involved in the degradation of plant cell walls by the generation of hypochlorous acid. Mannuronan C-5 epimerase and LRR-GTPases of the ROCO family that were already described above, were also found among the expressed *L. elsbetiae* genes. Altogether, the expression of these defense-related genes suggests that *L. digitata* recognizes the attack and activates defense responses against the endophyte which in turn activates defense-response related genes itself. This does not seem to be the case to the same extent in co-culture with *S. latissima*, which further confirms the hypothesis that the recognition of the endophyte by *S. latissima* is impaired.

Since it was hypothesized that *L. elsbetiae* uses alginate lysing enzymes to enter the host cell wall (Heesch & Peters [1999](#)), we also searched for genes that could be involved in the dissolution of the cell wall. The cell wall of brown algae consists of components shared with plants (cellulose) and animals (sulphated fucanes), but it also contains unique polysaccharides (alginates, Michel et al. [2010b](#)). Although we did not find any alginate lyases among the *L. elsbetiae* genes, an exo-1,3-beta-glucanase was expressed in the presence of *L. digitata*. This gene is catalyzing the break-down of cellulose and glucane (Grenville-Briggs et al. [2011](#)) and could therefore be involved in the enzymatic dissolution of these cell-wall compounds. The fact that we did not find more enzymes involved in the cell-wall breakdown does not mean that they are not present in the endophyte. However, our experimental set-up was not well adapted to study the expression of *L. elsbetiae* spores after attachment to the host. Instead, a single cell transcriptomics set-up could present a well-adapted tool to further study the infection process by *L. elsbetiae* in the future.

4.5 Conclusion: first insights into host specificity in kelp-endophyte interactions

The results presented in this study demonstrate that the main host *S. latissima* and the occasional host *L. digitata* both react to the endophyte *L. elsbetiae* on a physiological and a transcriptomic level, but their reactions show crucial differences. This was further emphasised by identified transcripts from the endophyte response that suggested a different response to the two host species. We propose that differences in the early recognition and subsequent defense reactions between the two algal partners could be a possible explanation for the occurrence of different natural infection patterns.

Our work also stresses that any observations made on a single kelp species cannot be generalised (Zambounis et al. [2013](#)). Moreover, variation does not only exist between the two different species, but even between individuals of the same species. There was a high intraspecific variability in the reaction of the kelp individuals towards the endophytes. Indeed, intraspecific differential susceptibility to endophytic infections seems to be common in the algal lineages (Gachon et al. [2009](#); Bernard et al. [2017](#)). An endophyte's fitness is defined by its ability to infect whereas the kelps fitness is defined by its ability to resist the infection. Therefore, both partners are underlying a strong selective pressure which is driving and accelerating co-evolution. A high intraspecific variability in genes involved in immune responses presents an opportunity for kelps to generate new gene copies, new allelic variation and functional specificity during co-evolution with potential pathogens (Rose et al. [2004](#); Holub [2007](#); Gachon et al. [2009](#)).

Another important point to stress is that the artificial system used in our experiments, consisting of only two partners – the kelp and the endophyte – is obviously not representing natural conditions. While laboratory experiments can be very helpful in order to study the basic mechanisms of interactions, in the field, biotic interactions are not limited to the kelp and the endophyte. Instead, several other organisms, especially a large number of microorganisms (Egan et al. [2013](#)), could influence the interactions of kelps with endophytic algae. The addition of a fungal extracts, to the bioassay was based on observations in terrestrial plants that stressed the role of beneficial endophytes as potential biological control against pathogens (Brum et al. [2012](#); Kirchmaier et al. [2012](#); Prado et al. [2015](#)). The preliminary trials to test the effect of fungal endophytes against the growth reduction of *L. digitata* presented in this study did not confirm a potential beneficial effect of the fungal extracts. On the opposite, the fungal extracts had a negative effect on growth and the overall health of the young kelp sporophytes. Furthermore, experiments undertaken by S. Prado showed that the investigated fungal

endophytes were of opportunistic pathogenic nature rather than beneficial (personal communication). Due to these results and temporal restraints, the project could not be followed further. However, studies on multi-species interactions are crucial to obtain a better picture of the functioning of interactions under natural conditions.

Supplementary material

Table S1: Differentially expressed genes in *Laminaria digitata* after 24 h of co-cultivation co-cultivated with *Laminarionema elsbetiae* for 24 h obtained by DESeq2 based on two replicates with Log2 fold change values ≥ 1 and ≤ -1 with a p-value < 0.01 . Putative gene products obtained from a blastx search against the NCBI-nr and the Uniprot database with an E-value cut-off of 10^{-5} .

| ID | Putative gene Product | log2FC | Blast e-value | % identity |
|------------------|---|--------|---------------|------------|
| DN84325_c1_g1_i7 | expressed unknown protein (<i>E. siliculosus</i>) | 1.85 | 2.03E-08 | 50 |
| DN77656_c0_g1_i2 | no annotation | 1.78 | - | - |
| DN85365_c4_g1_i3 | Unsaturated glucuronyl hydrolase | 1.4 | 1.00E-07 | 37.23 |
| DN86302_c3_g1_i4 | Tyrosinase | -3.2 | 2.00E-05 | 69.05 |
| DN76897_c5_g1_i3 | no annotation | -1.53 | - | - |

Table S2: Differentially expressed genes in *L. digitata* after 48 h of co-cultivation co-cultivated with *L. elsbetiae* for 48 h obtained by DESeq2 based on two replicates with Log2 fold change values ≥ 1 and ≤ -1 with a p-value < 0.01 . Putative gene products obtained from a blastx search against the NCBI-nr and the Uniprot database with an E-value cut-off of 10^{-5} .

| <i>L. digitata</i> (48h) | Putative gene Product | log2FC | Blast e-value | % identity |
|--------------------------|---|--------|---------------|------------|
| DN82690_c2_g3_i1 | Short chain dehydrogenase | 6.68 | 4.8E-66 | 44.81 |
| DN79932_c1_g1_i1 | EsV-1-7 | 4.92 | 2.0E-46 | 42.73 |
| DN85164_c0_g1_i5 | Enoyl-CoA hydratase | 4.37 | 6.6E-08 | 60.00 |
| DN83470_c4_g2_i2 | NB-ARC and TPR repeat-containing protein | 3.81 | 2.9E-45 | 44.30 |
| DN83470_c4_g2_i4 | NB-ARC and TPR repeat-containing protein | 3.68 | 1.8E-47 | 37.90 |
| DN83470_c4_g2_i16 | NB-ARC and TPR repeat-containing protein | 3.46 | 6.8E-36 | 36.74 |
| DN75962_c7_g7_i3 | TPR domain-containing protein | 2.98 | 3.4E-16 | 44.12 |
| DN86497_c2_g1_i3 | Ubiquitin carboxyl-terminal hydrolase 20-like | 1.67 | 1.5E-08 | 35.09 |

| | | | | |
|------------------|---|-------|---------|-------|
| DN79319_c5_g2_i4 | Aryl sulfotransferase | 1.66 | 8.6E-13 | 69.00 |
| DN83995_c6_g1_i4 | Malic enzyme | 1.55 | 0.0E+00 | 94.66 |
| DN79316_c7_g1_i5 | UTP-glucose-1-phosphate uridylyltransferase | 1.38 | 5.7E-10 | 94.74 |
| DN78540_c6_g1_i2 | no annotation | -6.07 | - | - |
| DN83624_c5_g1_i3 | Glutamate synthase (ferredoxin-dependent) | -2.51 | 0.0E+00 | 85.26 |
| DN82915_c6_g5_i1 | PR1-like metalloprotease | -2.03 | 4.0E-76 | 45.14 |
| DN7310_c0_g2_i1 | Beta-lactamase hydrolase-family protein | -1.93 | 9.8E-14 | 36.92 |
| DN84366_c3_g1_i3 | Carbonyl reductase | -1.59 | 1.4E-08 | 46.05 |
| DN83893_c3_g1_i3 | Proline iminopeptidase | -1.42 | 0.0E+00 | 86.06 |
| DN82690_c2_g3_i3 | Short chain dehydrogenase | -1.18 | 1.6E-59 | 41.12 |

Table S3: Differentially expressed genes in *Saccharina latissima* after 48 h of co-cultivation co-cultivated with *L. elsbetiae* for 48 h obtained by DESeq2 based on two replicates with Log2 fold change values ≥ 1 and ≤ -1 with a p-value < 0.01 . Putative gene products obtained from a blastx search against the NCBI-nr and the Uniprot database with an E-value cut-off of 10^{-5} .

| ID | Putative gene Product | log2FC | Blast value | e- | % identity |
|-------------------|---|--------|-------------|----|------------|
| DN34961_c2_g6_i2 | expressed unknown protein (<i>E. siliculosus</i>) | 7.16 | 0.0E+00 | | 62.00 |
| DN34516_c0_g5_i1 | Glutathione S-transferase 2 | 3.47 | 2.9E-25 | | 77.14 |
| DN35555_c12_g2_i2 | FAD linked oxidase domain-containing protein | 1.82 | 5.9E-111 | | 56.97 |
| DN30127_c15_g2_i7 | Methionine aminopeptidase | 1.77 | 2.5E-104 | | 50.85 |
| DN34033_c9_g2_i1 | Mitochondrial 2-oxodicarboxylate carrier | 1.51 | 1.3E-23 | | 46.30 |
| DN34957_c2_g2_i2 | Mannuronan C-5 epimerase | 1.36 | 6.9E-87 | | 95.95 |
| DN31451_c7_g3_i2 | Cathepsin H | 1.15 | 1.7E-174 | | 66.51 |
| DN31825_c5_g1_i4 | No annotation | -5.13 | - | | - |
| DN30456_c5_g1_i3 | Methionine-R-sulfoxide reductase | -4.73 | 1.94E-60 | | 64.14 |
| DN28604_c0_g1_i2 | Guanylyl cyclase | -2.30 | 5.7E-102 | | 77.32 |
| DN31582_c8_g1_i7 | Protein required for ubiquinone (coenzyme Q) biosynthesis | -2.23 | 0.0E+00 | | 85.78 |
| DN30929_c4_g3_i4 | Ammonium transporter (ISS) | -1.87 | 1.8E-07 | | 59.65 |

| | | | | |
|-------------------|-------------------------------|-------|----------|-------|
| DN32395_c2_g1_i27 | LRR-GTPase of the ROCO family | -1.68 | 7.1E-43 | 57.58 |
| DN32395_c2_g1_i6 | LRR-GTPase of the ROCO family | -1.63 | 4.9E-40 | 56.73 |
| DN30915_c3_g1_i5 | EF2 | -1.39 | 3.2E-29 | 85.51 |
| DN31121_c7_g3_i2 | Urease accessory protein ureG | -1.03 | 6.5E-135 | 85.06 |
| DN31646_c2_g1_i4 | Lipase precursor | 1.02 | 2.2E-35 | 58.93 |

Table S4: Putative gene products by *L. elsbetiae* in association with both kelp hosts obtained from a blastx search against the the Uniprot database with an E-value cut-off of 10^{-5} .

| ID | Putative gene product |
|-------------------|---|
| BINPACKER.376.2 | chloroplast light harvesting protein lhcf5 |
| BINPACKER.376.5 | Chloroplast light harvesting protein lhcf5 |
| BINPACKER.376.6 | chloroplast light harvesting protein lhcf5 |
| BINPACKER.376.1 | chloroplast light harvesting protein lhcf5 |
| BINPACKER.6482.1 | Light harvesting complex protein |
| BINPACKER.2044.2 | Light harvesting complex protein |
| BINPACKER.376.3 | Light harvesting complex protein |
| BINPACKER.1988.3 | Light harvesting complex protein |
| BINPACKER.39998.1 | Photosystem II cytochrome c550 |
| BINPACKER.43288.1 | apocytochrome B (mitochondrion) |
| BINPACKER.1764.1 | Actin |
| BINPACKER.2697.3 | Ankyrin |
| BINPACKER.50948.2 | Histone H4 |
| BINPACKER.65145.1 | DNA ligase, NAD-dependent |
| BINPACKER.129.2 | similar to ubiquitin |
| BINPACKER.129.7 | similar to ubiquitin |
| BINPACKER.129.8 | similar to ubiquitin |
| BINPACKER.40013.1 | ATP synthase CF1, subunit beta |
| BINPACKER.46602.1 | ATP synthase CF1, subunit alpha |
| BINPACKER.7661.2 | Leucine-zipper-like transcriptional regulator 1 |
| BINPACKER.1506.2 | Transketolase |
| BINPACKER.255.1 | GDP-mannose 6-dehydrogenase |
| BINPACKER.1887.1 | Glyceraldehyde-3-phosphate dehydrogenase |
| BINPACKER.30966.1 | EEF1A2 eukaryotic translation elongation factor 1 alpha |

Table S5: Putative gene products by *L. elsbetiae* in association with *S. latissima* obtained from a blastx search against the the Uniprot database with an E-value cut-off of 10^{-5} .

| ID | Putative gene product |
|--------------------|----------------------------------|
| BINPACKER.105403.1 | Light harvesting complex protein |
| BINPACKER.44782.1 | Light harvesting complex protein |
| BINPACKER.38886.1 | Light harvesting complex protein |
| BINPACKER.747.7 | Light harvesting complex protein |
| BINPACKER.1988.2 | Light harvesting complex protein |
| BINPACKER.37822.1 | Light harvesting complex protein |
| BINPACKER.47685.1 | Light harvesting complex protein |
| BINPACKER.6664.4 | RR-GTPase of the ROCO family |
| BINPACKER.37758.1 | beta tubulin, partial |
| BINPACKER.91195.1 | Beta tubulin |
| BINPACKER.5570.1 | Kinesin light chain-like protein |
| BINPACKER.16804.1 | Serine O-acetyltransferase |
| BINPACKER.10757.2 | Histone H4 |

| | |
|-------------------|--|
| BINPACKER.448.1 | Similar to ribosomal protein S29 |
| BINPACKER.23318.1 | Similar to 20S proteasome alpha5 subunit |
| BINPACKER.50870.1 | Transposase |
| BINPACKER.39303.1 | ATP synthase beta-subunit, partial (chloroplast) |
| BINPACKER.17147.2 | fructose-2,6-bisphosphatase |
| BINPACKER.1887.2 | Glyceraldehyde-3-phosphate dehydrogenase |
| BINPACKER.60385.1 | Putative cell division cycle 20. Subunit |

Table S6: Selection of putative gene products by *L. elsbetiae* in association with *L. digitata* obtained from a blastx search against the the Uniprot database with an E-value cut-off of 10^{-5} .

| ID | Putative gene product |
|-------------------|--------------------------------------|
| BINPACKER.2442.2 | Glutaredoxin |
| BINPACKER.7855.2 | Haloacid dehalogenase-like hydrolase |
| BINPACKER.19276.1 | haloacid dehalogenase-like hydrolase |
| BINPACKER.10836.1 | Heat shock protein 40 |
| BINPACKER.11328.1 | Heat shock protein 40 |
| BINPACKER.7927.2 | Heat shock protein 40 like protein |
| BINPACKER.5245.2 | Heat shock protein 70 |
| BINPACKER.10570.1 | Heat shock protein 70 |
| BINPACKER.10541.1 | heat shock protein 70, partial |
| BINPACKER.6002.1 | Heat shock protein 90 |
| BINPACKER.6716.2 | Heat shock protein 90 |
| BINPACKER.10068.1 | heat shock protein GrpE |
| BINPACKER.2444.2 | Heat Shock transcription factor |
| BINPACKER.954.2 | Heat shock transcription factor |
| BINPACKER.7158.2 | Light harvesting complex protein |
| BINPACKER.3394.1 | Light harvesting complex protein |
| BINPACKER.6025.1 | Light harvesting complex protein |
| BINPACKER.7410.1 | Light harvesting complex protein |
| BINPACKER.7158.1 | Light harvesting complex protein |
| BINPACKER.3053.3 | Light harvesting complex protein |
| BINPACKER.409.1 | Light harvesting complex protein |
| BINPACKER.747.4 | Light harvesting complex protein |
| BINPACKER.5422.1 | Light harvesting complex protein |
| BINPACKER.5812.1 | Light harvesting complex protein |
| BINPACKER.1988.1 | Light harvesting complex protein |
| BINPACKER.747.8 | Light harvesting complex protein |
| BINPACKER.3407.1 | Light harvesting complex protein |
| BINPACKER.6299.1 | Light harvesting complex protein |
| BINPACKER.3553.1 | Light harvesting complex protein |
| BINPACKER.449.4 | Light harvesting complex protein |
| BINPACKER.646.1 | Light harvesting complex protein |
| BINPACKER.6314.1 | Light harvesting complex protein |
| BINPACKER.2363.2 | Light harvesting complex protein |
| BINPACKER.3432.1 | LRR-GTPase of the ROCO family |

| | |
|-------------------|------------------------------------|
| BINPACKER.2063.5 | LRR-GTPase of the ROCO family |
| BINPACKER.3432.2 | LRR-GTPase of the ROCO family |
| BINPACKER.6664.5 | LRR-GTPase of the ROCO family |
| BINPACKER.19282.1 | Mannuronan C-5-epimerase |
| BINPACKER.748.2 | Mannuronan C-5-epimerase |
| BINPACKER.18535.1 | Mannuronan C-5-epimerase |
| BINPACKER.748.4 | Mannuronan C-5-epimerase |
| BINPACKER.4654.1 | Mannuronan C-5-epimerase |
| BINPACKER.6468.2 | TPR repeat-containing protein |
| BINPACKER.16133.1 | UDP-glucuronate 4-epimerase |
| BINPACKER.1009.2 | vanadium-dependent bromoperoxidase |
| BINPACKER.10733.1 | Exo-1,3-beta-glucanase, family GH5 |

Conclusions and perspectives

The results presented in this thesis allow to draw a more precise picture of the molecular bases of kelp-endophyte interactions. The phylogeny of filamentous endophytic brown algae was revised, including the description of a new *Laminariocolax* species which was found as an endophyte in *Saccharina latissima*, *Laminaria digitata* and *Laminaria hyperborea*. A qPCR-based method was applied to study the dynamics of natural kelp-endophyte interactions, focussing on *S. latissima* and *Laminarionema elsbetiae*. Furthermore, I present the first evidence of molecular cross-talk between the two kelp species *Saccharina latissima* and *Laminaria digitata* and the algal endophyte *L. elsbetiae*, which could explain the occurrence of natural infection patterns based on specificity in host-endophyte interactions.

1. Different molecular and chemical responses of kelps to algal endophytes could be the basis of natural infection patterns

The sugar kelp *S. latissima* is the natural main host of *L. elsbetiae*, but the endophyte occasionally also infects other kelp species, such as *Laminaria digitata*, in lower numbers and with lower severity. In laboratory-controlled conditions, the two hosts showed different physiological and molecular responses when co-cultivated with *L. elsbetiae* (Fig. 1).

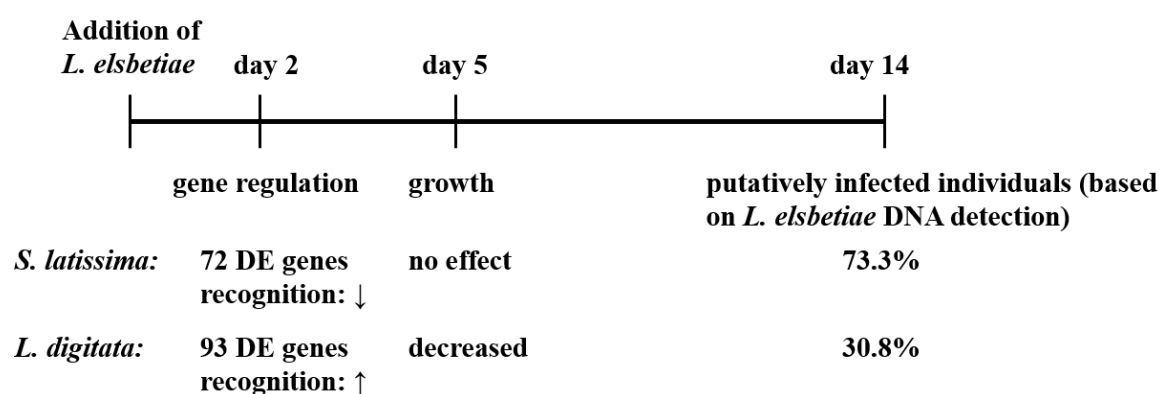

Fig. 1: Overview physiological and molecular responses of the kelps *S. latissima* and *L. digitata* to a co-cultivation with the endophyte *L. elsbetiae*

During the first two days of co-cultivation, the recognition of the endophyte seemed to be impaired in *S. latissima* (Fig. 1) and although certain defense responses were activated after 48 hours (Fig. 2A), a majority of the individuals were infected after 2 weeks of co-cultivation. In

L. digitata, on the other hand, genes potentially involved in the recognition of biotic attacks were significantly upregulated in the presence of the endophyte (Fig. 1 + 2B). Subsequently, *L. digitata* seems to activate more efficient defense responses than *S. latissima*, leading to a lower amount of infected thalli after 2 weeks. The energy-intensive defense responses of *L. digitata* may, however, have caused a temporary deceleration of the kelp growth as a secondary effect (Fig. 1).

Likewise, the endophyte response featured different patterns in the two host species. In *L. digitata*, several identified transcripts were related to defense reactions (Fig. 2B) whereas none were found in co-culture with *S. latissima*. Altogether, these observations are in concordance with the natural infection patterns identified by the barcoding study and the qPCR assay and suggest that specificity in kelp-endophyte interactions may be based on differences in the molecular cross-talk.

A schematic overview of the different induced pathways of *S. latissima* and *L. digitata* during interactions with *L. elsbetiae* is presented in Fig.2. An early transcriptomic regulation was shown to mostly include oxidative responses in both kelp species against *L. elsbetiae*. Contrary to what has been observed for GG elicitation or grazing, an involvement of the oxylipin pathway and the halogen pathway could not be confirmed after 48h of co-cultivation. However, these pathways may be induced at a later stage during kelp-endophyte interactions and a metabolomics approach could be useful to reveal which pathways are involved in the defense of the two kelp species against endophytes at different time points. In the future, interesting candidate genes involved in the defense responses, especially those showing very strong up- and downregulation, could also be further investigated by following their transcript accumulation profile over time in laboratory-grown and field samples.

The high affinity of *L. elsbetiae* to its natural host *S. latissima* differs significantly from the *Laminariocolax* species presented in chapter I that have broader host ranges, including brown algae of other orders and red algae. The molecular bases of the interactions of these endophytes with their hosts are therefore likely to differ from the specific interaction between *L. elsbetiae* and *S. latissima*. Furthermore, the addition of *Laminariocolax tomentosoides* to both kelp cultures showed distinct oxidative responses, suggesting differences in the recognition and later defense responses. Studying the molecular responses of both kelps to *L. tomentosoides*, an epi-endophyte with a broad natural host range which is very common in *L. digitata*, but has only rarely been found in *S. latissima*, could provide additional new insights into the basis of host specificity.

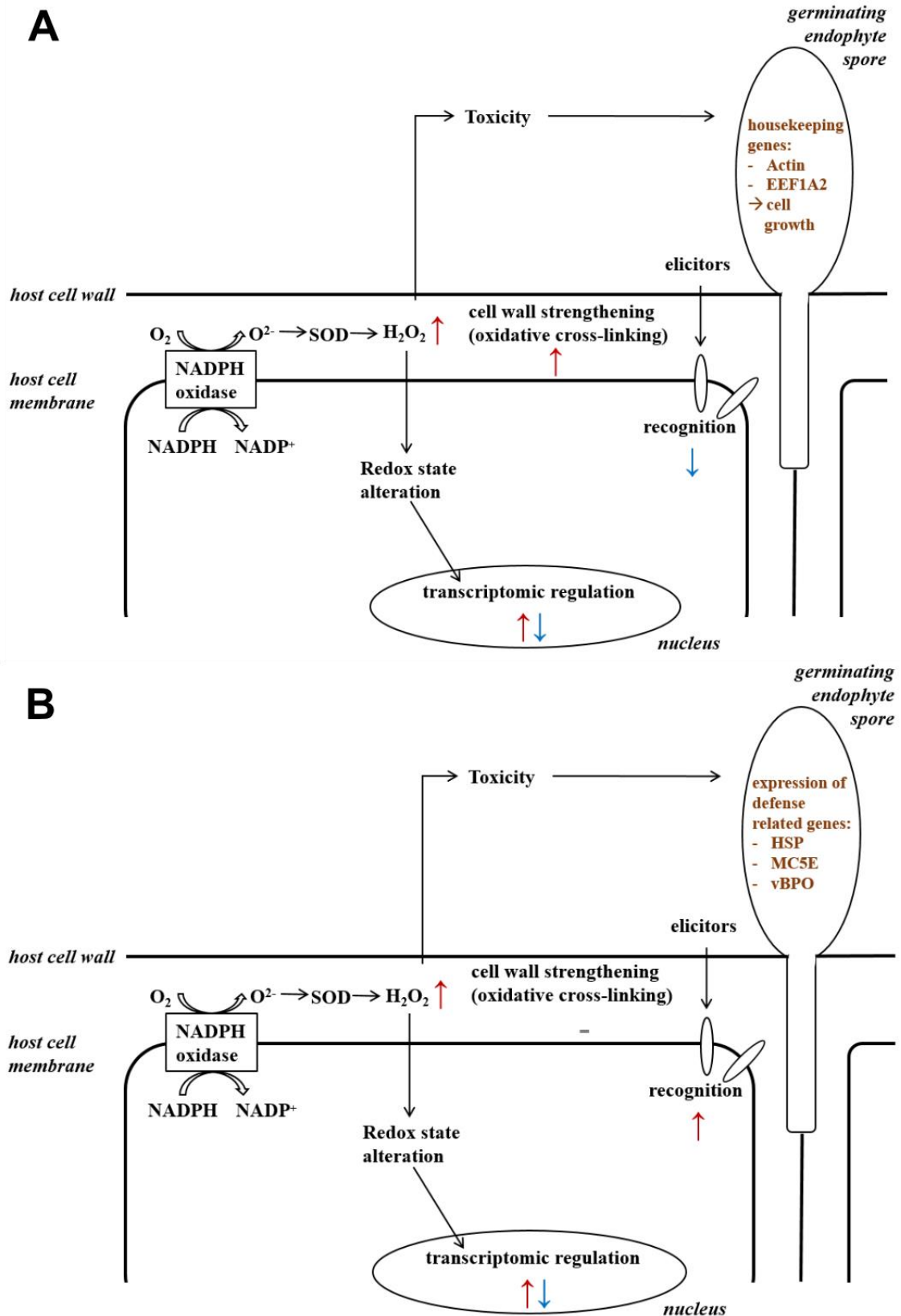

Fig. 2: Scheme of induced pathways putatively involved in the interaction of *L. elsbetiae* with **A.** *S. latissima* and **B.** *L. digitata*. EEf1A2 = eukaryotic translation elongation factor 1 alpha HSP = Heat-shock protein, MC5E = Mannuronan C-5 epimerase, vBPO = vanadium-dependent bromoperoxidase. ↑: upregulated, ↓: downregulated.

2. *Laminarionema elsbetiae* - a kelp pathogen?

The interaction between *L. elsbetiae* and the two kelp hosts is not passive. Both kelp species induce typical defense reactions during the first contact with the endophyte spores. Nonetheless, a classification of the endophyte as a pathogen remains difficult. It is still unclear whether *L. elsbetiae* is causing the disease symptoms that have been reported in hosts infected by the endophyte. However, a local strengthening of the cell wall as a response by *S. latissima* to the infection by the *L. elsbetiae* (Fig. 2A) could be involved in the development of twisted stipes or blades. Another indirect correlation is given by the fact that every thallus with disease symptoms included in the field-surveys contained filamentous endophytes. However, a majority of infected *Saccharina* individuals did not show any disease symptoms. The mere presence of the endophyte seems therefore not to be sufficient to cause the observed disease symptoms. Other factors, such as the endophyte density or distribution in the thallus may be crucial for the development of disease symptoms. Although it is challenging to cultivate adult kelp sporophytes under controlled conditions, kelp-endophyte interactions have to be investigated over larger time spans in order to further assess potential deleterious long-term effects of *L. elsbetiae* on its hosts. Finally, to confirm the pathogenic nature of *L. elsbetiae* through the Koch's postulates, a reinfection of healthy kelp sporophytes under controlled conditions and re-occurrence of the symptoms is required.

3. Variation of kelp-endophyte relationships: a complex interaction depending on different abiotic and biotic factors

Kelp-endophyte interactions under natural conditions are not only underlying the molecular cross-talk between the two partners. Another point that may be crucial for host specificity of *L. elsbetiae* in natural kelp populations is the life cycle of the endophyte. Since it was shown that *S. latissima* gets infected early in its life, the spore release of *L. elsbetiae* may have to be synchronized with the presence of young sporophytes of potential hosts in the field. Although the presence or absence of *L. elsbetiae* spores in the seawater was detected during certain times in Northern Brittany, the life cycle of the endophyte in the field is still poorly understood. Algal spore release is often controlled by abiotic factors, such as light and temperature conditions, but it is unclear which factors trigger the spore release in *L. elsbetiae*. Next to abiotic factors, more complex mechanisms such as chemical signalling and cross-talk with the host could be involved in controlling the spore release by the endophyte. Further studies on the life-cycle of

L. elsbetiae will help to understand how this factor affects the interaction with different kelp hosts.

The molecular data obtained during the barcoding study suggested that host-specificity may also vary dependent on environmental conditions as differences have been observed between kelp populations in Brittany and Scotland. Furthermore, the qPCR assay revealed a high variation of the infection rates within natural *Saccharina* populations and not all *Saccharina* sporophytes responded equally to a co-cultivation with *L. elsbetiae*. The cross-talk of *L. elsbetiae* therefore seems not only to differ with different host species and environmental conditions, but also shows very high intraspecific variability, which has to be considered for future studies. Overall, the presented results stress that any observations made on a single kelp species cannot be generalised and that each kelp-endophyte pair has to be studied individually. Using algal material with different genetic backgrounds and investigating the effects of co-cultivation under varying abiotic conditions could help to further decipher the molecular bases of a specific interaction.

4. Future directions for studying kelp-endophyte interactions

An important question that remains unanswered is how *L. elsbetiae* infects its hosts. Although an enzymatic dissolution of the cell wall has been suggested, similarly to what is known from other algal endophytes, no alginate lyases were found to be expressed by the endophyte in contact with either of the hosts. However, the transcriptomic analysis was not set up to specifically monitor the gene expression of the endophyte and still, a gene catalysing the breakdown of cellulose and glucane was expressed and points towards a possible enzymatic dissolution of these cell-wall compounds. In the future, a single cell transcriptomics approach could present a well-adapted tool to further study the infection process by *L. elsbetiae*.

Another important point that should be further investigated is the effect of other organisms on the interactions between kelps and endophytes. Laboratory experiments on a two partner system are a powerful tool to study the basic mechanisms of interactions, but in the field, biotic interactions are not limited to the kelp and the endophyte. Numerous other organisms, especially a large number of microorganisms, are associated to the kelps and could influence the interactions with endophytic algae. Although the preliminary trials to test the effect of fungal extracts on the interaction between *L. digitata* and *L. elsbetiae* presented in chapter IV

were not successful, further studies on multi-species interactions are crucial to obtain a better understanding of the functioning of interactions under natural condition.

References

- Abrahamsson, K., Choo, K.S., Pedersén, M., Johansson, G. & Snoeijs, P. (2003). Effects of temperature on the production of hydrogen peroxide and volatile halocarbons by brackish-water algae. *Phytochemistry* **64**: 725–734.
- Adams, J.M., Gallagher, J.A. & Donnison, I.S. (2009). Fermentation study on *Saccharina latissima* for bioethanol production considering variable pre-treatments. *Journal of Applied Phycology* **21**: 569–574.
- Adams, J.M.M., Ross, A.B., Anastasakis, K., Hodgson, E.M., Gallagher, J.A., Jones, J.M. & Donnison, L.S. (2011). Seasonal Variation in the chemical composition of the bioenergy feedstock *Laminaria digitata* for thermochemical conversion. *Bioresource Technology* **102**: 226–234.
- Akira, S., Uematsu, S. & Takeuchi, O. (2006). Pathogen Recognition and Innate Immunity. *Cell* **124**: 783–801.
- Altschul, S.F., Gish, W., Miller, W., Myers, E.W. & Lipman, D.J. (1990). Basic local alignment search tool. *Journal of Molecular Biology* **215**: 403–410
- Amsler, C.D. & Neushul, M. (1989a). Chemotactic effects of nutrients on spores of the kelps *Macrocystis pyrifera* and *Pterygophora californica*. *Marine Biology* **102**: 557–564.
- Amsler, C.D. & Neushul, M. (1989b). Diel periodicity of spore release from the kelp *Nereocystis luetkeana* (Mertens) Postels et Ruprecht. *Journal of Experimental Marine Biology and Ecology* **134**: 117–127.
- Amsler, C.D., Amsler, M.O., McClintock, J.B. & Baker, B.J. (2009). Filamentous algal endophytes in macrophytic Antarctic algae: prevalence in hosts and palatability to mesoherbivores. *Phycologia* **48**: 324–334.
- Andrews, J.H. (1977). Observations on the pathology of seaweeds in the Pacific Northwest. *Canadian Journal of Botany* **55**: 1019–1027.
- Andrews, S. (2010). FastQC: A quality control tool for high throughput sequence data. <https://www.bioinformatics.babraham.ac.uk/projects/fastqc/>

- Anis, M., Ahmed, S. & Hasan, M. (2017). Algae as Nutrition, Medicine and Cosmetic: the Forgotten History, Present Status and Future Trends. *World Journal of Pharmacy and Pharmaceutical Sciences* **6**: 1934–1959.
- Apt, K. (1984). Effects of the symbiotic Red Alga *Hypneocolax stellaris* on its host *Hypnea musciformis* (Hypneaceae, Gigartinales). *Journal of Phycology* **20**: 148-150.
- Apt, K.E. (1988a). Etiology and Development of Hyperplasia Induced By *Streblonema* sp. (Phaeophyta) on Members of the Laminariales (Phaeophyta). *Journal of Phycology* **24**: 28–34.
- Apt, K.E. (1988b). Galls and tumor-like growths on marine macroalgae. *Diseases of Aquatic Organisms* **4**: 211–217.
- Apt, K.E., Clendennen, S.K., Powers, D.A. & Grossman, A.R. (1995). The gene family encoding the fucoxanthin chlorophyll proteins from the brown alga *Macrocystis pyrifera*. *Molecular and General Genetics* **246**: 455–464.
- Ar Gall, E., Küpper, F.C. & Kloareg, B. (2004). A survey of iodine content in *Laminaria digitata*. *Botanica Marina* **47**: 30-37.
- Ardre, F. (1970). Contribution à l'étude des algues marines du Portugal. I. La flore. Portugaliae Acta Biologica., Série B. Instituto Botânico de Faculdade de Ciências, Lissabon.
- Armengaud, J., Trapp, J., Pible, O., Geffard, O., Chaumot, A. & Hartmann, E.M. (2014). Non-model organisms, a species endangered by proteogenomics. *Journal of Proteomics* **105**: 5-18.
- Babteste, E. & Philippe, H. (2002). The potential value of indels as phylogenetic markers: position of trichomonads as a case study. *Molecular Biology and Evolution* **19**: 972-977.
- Bainbridge, M.N., Warren, R.L., Hirst, M., Romanuik, T., Zeng, T., Go, A., Delaney, A., Griffith, M., Hickenbotham, M., Magrini, V., Mardis, E.R., Sadar, M.D., Siddiqui, A.S., Marra, M.A. & Jones, S.J.M. (2006). Analysis of the prostate cancer cell line LNCaP transcriptome using a sequencing-by-synthesis approach. *BMC Genomics* **7**: 246.
- Baldauf, S.L. (2003). The deep roots of eukaryotes. *Science* **300**: 1703-1706.

- Baldwin, B.G. (1992). Phylogenetic utility of the internal transcribed spacers of nuclear ribosomal DNA in plants: an example from the Compositae. *Molecular Phylogenetics and Evolution* **1**: 3-16.
- Ball, S.M., Hollingsworth, A.M., Humbles, J., Leblanc, C., Potin, P. & McFiggans, G. (2010). Spectroscopic studies of molecular iodine emitted into the gas phase by seaweed. *Atmospheric Chemistry and Physics* **10**: 6237-6254.
- Bartsch I., Wiencke C., Bischof K., Buchholz C.M., Buck B.H., Eggert A., Feuerpfeil P., Hanelt D., Jacobsen S., Karez R., Karsten U., Molis M., Roleda M.Y., Schubert H., Schumann R., Valentin K., Weinberger F. & Wiese J. (2008). The genus *Laminaria* sensu lato: recent insights and developments. *European Journal of Phycology* **43**: 1–86.
- Begon, M., Townsend, C.R. & Harper, J.L. (2006). *Ecology: From Individuals to Ecosystems*, 4th ed. Blackwell Science, Oxford.
- Bengtsson, B. (2003). Genetic variation in organisms with sexual and asexual reproduction. *Journal of Evolutionary Biology* **16**: 189-199.
- Bernard, M. (2014). Impact of global warming on early developmental stages of Arctic kelps – interspecific competition and multifactorial experiments. Master Thesis, University of Bonn, Germany, 83pp.
- Bernard, M., Rousvoal, S., Jacquemin, B., Ballenghien, M., Peters, A.F. & Leblanc, C. (2017). qPCR-based relative quantification of the brown algal endophyte *Laminarionema elsbetiae* in *Saccharina latissima*: variation and dynamics of host – endophyte interactions. *Journal of Applied Phycology* doi: 10.1007/s10811-017-1367-0
- Bernard, M., Strittmatter, M., Murúa, P. Heesch, S., Cho, G.Y., Leblanc, C. & Peters, A.F. (2018). Diversity, biogeography and host specificity of kelp endophytes with a focus on the genera *Laminarionema* and *Laminariocolax* (Ectocarpales, Phaeophyceae). Accepted for publication in the *European Journal of Phycology*.
- Birkett, D.A., Maggs, C.A., Dring, M.J. & Boaden, P.J.S. (1998). Infralittoral reef biotopes with kelp species, an overview of dynamic and sensitivity characteristics for conservation management of marine SACs. In: Natura 2000 report prepared by Scottish Association of Marine Science SAMS for the UK Marine SACs Project.

- Boehm, T. (2012). Evolution of Vertebrate Immunity. *Current Biology* **22**: 722-732.
- Bold, H.C & Wynne, M.J. (1985). Introduction to the Algae. 2nd ed. Prentice-Hall Inc., Englewood Cliffs, 720 pp.
- Bolger, A.M., Lohse, M. & Usadel, B. (2014). Trimmomatic: A flexible trimmer for Illumina Sequence Data. *Bioinformatics* **30**: 2114-2120.
- Boller, T. & Yang, H.S. (2009). Innate Immunity in Plants: An Arms Race between Pattern Recognition Receptors in Plants and Effectors in Microbial Pathogens. *Science* **324**: 742-743.
- Bolton, J.J., Germann, I. & Lüning, K. (1983). Hybridization between Atlantic and Pacific representatives of the Simplicies section of *Laminaria* (Phaeophyta). *Phycologia* **22**: 133-140.
- Bouarab, K., Potin, P., Correa, J. & Kloareg, B. (1999). Sulfated Oligosaccharides Mediate the Interaction between a Marine Red Alga and Its Green Algal Pathogenic Endophyte. *Plant Cell* **11**: 1635–1650.
- Bouarab, K., Adas, F., Gaquerel, E., Kloareg, B., Salaün, J.P. & Potin, P. (2004). The innate immunity of a marine red alga involves oxylipins from both the eicosanoid and octadecanoid pathways. *Plant Physiology* **135**: 1838–1848.
- Bouckaert, R., Heled, J., Kühnert, D., Vaughan, T., Wu, C.-H., Xie, D., Suchard, M.A., Rambaut, A. & Drummond, A.J. (2014). BEAST 2: A Software Platform for Bayesian Evolutionary Analysis. *PLoS Computational Biology* **10**: e1003537.
- Bradley, D., Kjellbom, P. & Lamb, C. (1992). Elicitor- and wound-induced oxidative cross-linking of a proline-rich plant cell wall protein: a novel, rapid defense response. *Cell* **70**: 21-30.
- Brodie, J., Ball, S.G., Bouget, F.-Y., Chan, C.X., De Clerck, O., Cock, J.M., Gachon, C., Grossman, A.R., Mock, T., Raven, J.A., Saha, M., Smith, A.G., Vardi, A., Yoon, H.S. & Bhattacharya, D. (2017). Biotic interactions as drivers of algal origin and evolution. *New Phytologist* **216**: 670-681.
- Brouwer, M., Lievens, B., Van Hemelrijck, W., Van den Ackerveken, G., Cammue, B.P. & Thomma B.P. (2003). Quantification of disease progression of several microbial pathogens on

- Arabidopsis thaliana* using real-time fluorescence PCR. *FEMS Microbiological Letters* **228**: 241–248.
- Brum, M.C.P., Araújo, W.L., Mai, C.S. & Azevedo, J.L. (2012). Endophytic fungi from *Vitis labrusca* L. ('Niagara Rosada') and its potential for the biological control of *Fusarium oxysporum*. *Genetics and Molecular Research* **11**: 4187-4197.
- Bucklin, A., Hopcroft, R.R., Kosobokova, K.N., Nigro, L.M., Ortman, B.D., Jennings, R.M. & Sweetman, C.J. (2010). DNA barcoding of Arctic Ocean holozooplankton for species identification and recognition. *Deep-Sea Research Part II* **57**: 40–48.
- Burkhardt, E. & Peters, A.F. (1998). Molecular evidence from nrDNA ITS sequences that *Laminariocolax* (Phaeophyceae, Ectocarpales *sensu lato*) is a worldwide clade of closely related kelp endophytes. *Journal of Phycology* **34**: 682–691.
- Buschmann, A.H., Camus, C., Infante, J., Neori, A., Israel, A., Hernández-González, M., Pereda, S.V., Gomez-Pinchetti, J.L., Golberg, A., Tadmor-Shalev, N. & Critchley, A.T. (2017). Seaweed production: overview of the global state of exploitation, farming and emerging research activity. *European Journal of Phycology* **52**: 391-406.
- Bustin, S.A., Benes, V., Garson, J.A., Hellemans, J., Huggett, J., Kubista, M., Mueller, R., Nolan, T., Pfaffl, M.W., Shipley, G.L., Vandesompele, J. & Wittwer, C.T. (2009). The MIQE Guidelines: Minimum Information for Publication of Quantitative Real-Time PCR Experiments. *Clinical Chemistry* **55**: 611–622.
- Butler, A., Carter, J.N. & Simpson, M.T. (2001). In: Bertini, I., Sigel, A. & Sigel, H. (eds). Handbook of Metalloproteins. Marcel Dekker Inc., New York, pp. 153-179.
- Cabioc'h, J., Floc'h, J.-Y. & Le Toquin, A. (2006). Guide des algues des mers d'Europe. Edition Delachaux et Niestlé, 272p.
- Cabreiro, F., Picot, C.R., Friguet, B. & Petropoulos, I. (2006). Methionine Sulfoxide Reductases: Relevance to Aging and Protection against Oxidative Stress. *Annals of the New York Academy of Sciences* **1067**: 37-44.
- Callow, J.A., Callow, M.E. & Evans, L.V. (1979). Nutritional Studies on the parasitic red alga *Choreocolax polysiphoniae*. *New Phytologist* **83**: 451-462.

- Caram, B. & Jónsson, S. (1972). Nouvelle inventaire des algues marines de l'Islande. *Acta Botanica Islandica* **1**: 5-31.
- Chapman, V.J. & Chapman, D.J. (1980). Seaweeds and their uses. Chapman and Hall, London, 3rd edition, 334 pp.
- Chen, J. (2004). Cultured Aquatic Species Information Programme. *Laminaria japonica*. In: FAO Fisheries and Aquaculture Department [online]. Rome. Updated 1 January 2004. [Cited 18 May 2017].
- Chen, H., Zhou, D., Luo, G., Zhang, S. & Chen, J. (2015). Macroalgae for biofuels production: Progress and perspectives. *Renewable and Sustainable Energy Reviews* **47**: 427–437.
- Chung, I.K., Oak, J.H., Lee, J.A., Shin, J.A., Kim, J.G. & Park, K.S. (2013). Installing kelp forests/seaweed beds for mitigation and adaptation against global warming: Korean Project Overview. *ICES Journal of Marine Science* **70**: 1038-1044.
- Chung, I.K., Sondak, C.F.A. & Beardall, J. (2017). The future of seaweed aquaculture in a rapidly changing world. *European Journal of Phycology* **52**: 495–505.
- Cires Rodríguez, E. & Cuesta Moliner, C. (2010). Checklist of benthic algae from the Asturias coast (North of Spain). *Boletín de Ciencias de la Naturaleza, Real Instituto de Estudios Asturianos* **51**: 135-212.
- Clay, K. (1990). The impact of parasitic and mutualistic fungi on competitive interactions among plants. In: Grace, J.B. & Tilman, D. (eds). Perspectives on plant competition. Academic Press, London, UK, pp. 391-412.
- Cock, J.M., Sterck, L., Rouzé, P., Scornet, D., Allen, A.E. et al. (2010). The *Ectocarpus* genome and the independent evolution of multicellularity in brown algae. *Nature* **465**: 617-621.
- Cock, J.M. & Coelho, S.M. (2011). Algal models in plant biology. *Journal of Experimental Botany* **62**: 2425-2430.
- Coelho, S.M., Scornet, D., Rousvoal, S., Peters, N., Dartevelle, L., Peters, A.F. & Cock, J.M. (2012). How to cultivate *Ectocarpus*. *Cold Spring Harbor Protocols* **2012**: 258-261.

- Colin, C., Leblanc, C., Michel, G., Wagner, E., Leize-Wagner, E., van Dorsselaer, A. & Potin, P. (2005). Vanadium-dependent iodoperoxidases in *Laminaria digitata*, a novel biochemical function diverging from brown algal bromo- peroxidases. *Journal of Biological Inorganic Chemistry* **10**: 156–166.
- Collén, J., Guisle-Marsollier, I., Léger, J.J. & Boyen, C. (2007). Response of the transcriptome of the intertidal red seaweed *Chondrus crispus* to controlled and natural stresses. *New Phytologist* **176**: 45-55.
- Conesa, A. Götz, S., García-Gomez, J., Terol, J. & Talon, M. (2005). Blast2GO: a universal tool for annotation, visualization and analysis in functional genomics research. *Bioinformatics* **32**: 3674-3676.
- Correa, J.A., Nielsen, R. & Grund, D.W. (1988). Endophytic algae of *Chondrus crispus* (Rhodophyta). II. *Acrochaete heteroclada* sp. nov., *A. operculata* sp. nov., and *Phaeophila dendrioides* (Chlorophyta). *Journal of Phycology* **24**: 528–539.
- Correa, J.A. & McLachlan, J.L. (1991). Endophytic algae of *Chondrus crispus* (Rhodophyta). III. Host specificity. *Journal of Phycology* **27**: 448–459.
- Correa, J.A. & McLachlan, J.L. (1992). Endophytic algae of *Chondrus crispus* (Rhodophyta). IV. Detrimental effects on the host following infections by *Acrochaete operculata* and *A. heteroclada* (Chlorophyta). *Marine Ecology Progress Series* **81**: 73-87.
- Correa, J.A., Flores, V. & Garrdio, J. (1993). Green patch disease in *Iridea laminarioides* (Rhodophyta) caused by *Endophyton* sp. (Chlorophyta). *Diseases of Aquatic Organisms* **19**: 203-213.
- Correa, J.A. (1994). Infections by pigmented algal endophytes: misuse of concepts and terminology. *Revista Chilena de Historia Natural* **67**: 5–8.
- Correa, J.A. & McLachlan, J.L. (1994). Endophytic algae of *Chondrus crispus* (Rhodophyta). V. Fine structure of the infection by *Acrochaete operculata* (Chlorophyta). *European Journal of Phycology* **29**: 33–47.

- Cosse, A., Leblanc, C. & Potin, P. (2007). Dynamic Defence of Marine Macroalgae Against Pathogens: From Early Activated to Gene-Regulated Responses. *Advances in Botanical Research* **46**: 221–266.
- Cosse, A., Potin, P. & Leblanc, C. (2009). Patterns of gene expression induced by oligoguluronates reveal conserved and environment-specific molecular defence responses in the brown alga *Laminaria digitata*. *New Phytologist* **182**: 239-250.
- Cotton, A.D. (1912). Clare Island Survey. Marine algae. *Proceedings of the Royal Irish Academy 31B* **15**: 1-178.
- Dave, A. & Graham, I.A. (2012). Oxylin signaling: A distinct role for the jasmonic acid precursor cis-(+)-12-oxo-phytodienoic acid (cis-OPDA). *Frontiers in Plant Science* **3**: 1–6.
- Dayton, P.K. (1985). Ecology of Kelp Communities. *Annual Review of Ecology and Systematics* **16**: 215–245.
- De Bary, A. (1879). Die Erscheinung der Symbiose. Verlag von Karl J. Trubner, Strassburg.
- De Franco, P.-O., Rousvoal, S., Tonon, T. & Boyen, C. (2009). Whole genome survey of the glutathione transferase family in the brown algal model *Ectocarpus siliculosus*. *Marine Genomics* **1**: 135-148.
- De Clerck, O., Guiry, M.D., Leliaert, F., Samyn, Y. & Verbruggen, H. (2013). Algal taxonomy: a road to nowhere? *Journal of Phycology* **49**: 215-225.
- De Nadal, E., Ammerer, G. & Posas, F. (2011). Controlling gene expression in response to stress. *Nature Reviews Genetics* **12**: 833-845.
- Dempsey, D.A. & Klessig, D.F. (2012). SOS – too many signals for systemic acquired resistance? *Trends in Plant Science* **17**: 538-545.
- Deng, Y., Yao, J., Wang, X., Guo, H. & Duan, D. (2012). Transcriptome sequencing and comparative analysis of *Saccharina japonica* (Laminariales, phaeophyceae) under blue light induction. *PLoS ONE* **7**: e39704.

- Deniaud-Bouët, E., Kervarec, N., Michel, G., Tonon, T., Kloareg, B. & Hervé, C. (2014). Chemical and enzymatic fractionation of cell walls from Fucales: insights into the structure of the extracellular matrix of brown algae. *Annals of Botany* **114**: 1203-1216.
- Dillehay, T.D., Ramírez, C., Pino, M., Collins, M.B., Rossen, J. & Pino-Navarro, J.D. (2008). Monte Verde: Seaweed, food, medicine, and the peopling of South America. *Science* **320**: 784–786.
- Dittami, S., Scornet, D., Petit, J.-L., Ségurens, B., Da Silva, C., Corre, E., Dondrup, M., Glatting, K.-H., König, R., Sterck, L., Rouzé, P., Van de Peer, Y., Cock, J.M., Boyen, C. & Tonon, T. (2009). Global expression analysis of the brown alga *Ectocarpus siliculosus* (Phaeophyceae) reveals large-scale reprogramming of the transcriptome in response to abiotic stress. *Genome Biology* **10**: R66.
- Dixon, P.S. (1961). List of marine algae collected in the Channel Islands during the joint meeting of the British Phycological Society and the Société Phycologique de France September 1960. *British Phycological Bulletin* **2**: 71-80.
- Edelstein, T., Bird, C. & McLachlan, J. (1973). Investigations of the marine algae of Nova Scotia. XI. Additional species new or rare to Nova Scotia. *Canadian Journal of Botany* **51**: 1741–1746.
- Edgar, R.C. (2004). MUSCLE: a multiple sequence alignment method with reduced time and space complexity. *BMC Bioinformatics* **5**: 113.
- Edwards, M. & Watson, L. (2011). Cultivating *Laminaria digitata*. Aquaculture Explained. Irish Sea Fisheries Board.
- Egan, S., Harder, T., Burke, C., Steinberg, P., Kjelleberg, S. & Thomas, T. (2013). The seaweed holobiont: Understanding seaweed bacteria interactions. *FEMS Microbiology Reviews* **37**: 462-476.
- Eggert, A., Peters, A.F. & Küpper, F.C. (2010). Potential Impact of Climate Change on Endophyte Infections in Kelp Sporophytes. In: Israel, A., Einav, R. & Seckbach, J. (eds). Seaweeds and their Role in Globally Changing Environment. Springer, Netherlands, pp. 139–154.

- Ellertsdóttir, E. & Peters, A.F. (1997). High prevalence of infection by endophytic brown algae in populations of *Laminaria* spp. (Phaeophyceae). *Marine Ecology Progress Series* **146**: 135–143.
- Emms, D. & Kelly, S. (2015). OrthoFinder: solving fundamental bioases in whole genome comparisons dramatically improves orthogroups inference accuracy. *Genome Biology* **16**: 157.
- Evans, L.V., Callow, J.A & Callow, M.E. (1973). Structural and physiological studies on the parasitic red alga *Holmsella*. *New Phytologist* **72**: 393.
- Evans, A. (1976). Causation and Disease: The Henle-Koch Postulates Revisited. *Yale Journal of Biology and Medicine* **49**: 175-195.
- Farlow, W.G. (1889). On Some New or Imperfectly Known Algae of the United States I. *Bulletin of the Torrey Botanical Club* **16**: 1-12.
- Faugeron, S., Martínez, E.A., Sánchez, P.A. & Correa, J.A. (2000). Infectious diseases in *Mazzaella laminarioides* (Rhodophyta): estimating the effect of infections on host reproductive potential. *Diseases of Aquatic Organisms* **42**: 143–148.
- Forbord, S., Skjermo, J., Arff, J., Handa, H., Reitan, K. I. R., Bjerregaard, R & Lüning, K. (2012). Development of *Saccharina latissima* (Phaeophyceae) kelp hatcheries with year-round production of zoospores and juvenile sporophytes on culture ropes for kelp aquaculture. *Journal of Applied Phycology* **24**: 393–399.
- Flöthe, C.R., Molis, M. & John, U. (2014). Induced resistance to periwinkle grazing in the brown seaweed *Fucus vesiculosus* (Phaeophyceae): molecular insights and seaweed-mediated effects on herbivore interactions. *Journal of Phycology* **50**: 564–576.
- Fredriksen, S., Gabrielsen, T.M., Kile, M.R. & Sivertsen, K. (2015). Benthic algal vegetation in Isfjorden, Svalbard. *Polar Research* **34**: 25994.
- Gachon, C., Mingam, A. & Charrier, B. (2004). Real-time PCR: what relevance to plant studies? *Journal of Experimental Botany* **55**: 1445–1454.
- Gachon, C.M.M., Strittmatter, M., Mueller, D.G., Kleinteich, J. & Kuepper, F.C. (2009). Detection of differential host susceptibility to the marine oomycete pathogen *Eurychasma*

dicksonii by real-time PCR: Not all algae are equal. *Applied and Environmental Microbiology* **75(2)**: 322–328.

Gachon, C.M.M., Sime-Ngando, T., Strittmatter, M., Chambouvet, A. & Kim, G.H. (2010). Algal diseases: spotlight on a black box. *Trends in Plant Science* **15**: 633-640.

Ganesan, M., Mairh, O.P., Eswaran, K. & Rao, P.V.S. (1999). Effect of UV radiation and other environmental factors on the liberation of tetraspores from brown alga *Padina boergesenii* (Phaeophyta, Dictyotales). *Indian Journal of Marine Science* **28**: 50–4.

Gauna, M.C. & Parodi, E.R. (2008). Green epi-endophytes in *Hymenena falklandica* (Rhodophyta) from the Patagonian coasts of Argentina: Preliminary observations. *Phycological Research* **56**: 172-182.

Gauna, C., Parodi, E.R. & Cáceres, E. (2009a). The Occurrence of *Laminarionema elsbetiae* (Phaeophyta) on *Rhodymenia pseudopalmata* (Rhodophyta) from the Patagonian coasts Argentina: Characteristics of the relationships in natural and experimental infections and morphology of the epi-endophyte in unialgal free cultures. *Algae* **24**: 249–256.

Gauna, M.C., Parodi, E.R., & Cáceres, E.J. (2009b). Epi-endophytic symbiosis between *Laminariocolax aecidioides* (Ectocarpales, Phaeophyceae) and *Undaria pinnatifida* (Laminariales, Phaeophyceae) growing on Argentinian coasts. *Journal of Applied Phycology* **21**: 11–8.

Gaylord, B., Reed, D.C., Raimondi, P.T., Washburn, L. & McLean, S.R. (2002). A physically based model of macroalgal spore dispersal in the wave and current-dominated nearshore. *Ecology* **83**: 1239-1251.

Gaylord, B., Reed, D.C., Raimondi, P.T. & Washburn, L. (2006). Macroalgal spore dispersal in coastal environments: mechanistic insights revealed by theory and experiment. *Ecological Monographs* **76**: 481-502.

Gerwick, W.H., Roberts, M.A., Vulpanovici, A. & Ballantine, D.L. (1999). Biogenesis and biological function of marine algal oxylipins. In: Nigam, S. & Pace-Ascia, C.R. (eds). Lipoxygenases and their metabolites. Plenum Press, New York, USA, and London, UK, pp: 211–218.

- Glazener, J.A., Orlandi, E.W., Harmon, G.L. & Baker, C.J. (1991). An improved method for monitoring active oxygen I bacteria-treated suspension cells using luminol-dependent chemiluminescence. *Physiological and Molecular Plant Pathology* **39**: 123-133.
- Goff, L.J., Moon, D.A. & Coleman, A.W. (1994). Molecular delineation of species and species relationships in the red algal agarophytes *Gracilariopsis* and *Gracilaria* (Gracilariales). *Journal of Phycology* **30**: 521-537.
- Grenville-Briggs, L., Gachon, C.M.M., Strittmatter, M., Sterck, L., Küpper, F.C. & van West, P. (2011). A molecular insight into algal-oomycete warfare: CDNA analysis of *Ectocarpus siliculosus* infected with the basal oomycete *Eurychasma dicksonii*. *PLoS ONE* **6**: e24500.
- Guidi, L., Mori, S., Innocenti, E.D. & Pecchia, S. (2007). Effects of ozone exposure or fungal pathogen on white lupin leaves as determined by imaging of chlorophyll *a* fluorescence. *Plant Physiology and Biochemistry* **45**: 851-857.
- Guiry, M.D. & Guiry, G.M. 2017. AlgaeBase. World-wide electronic publication, National University of Ireland, Galway. <http://www.algaebase.org>; searched on 07 September 2017.
- Gulliksen, B., Palerud, R., Brattegard, T. & Sneli, J. (editors) 1999. *Distribution of marine benthic macro-organisms at Svalbard (including Bear Island) and Jan Mayen*. Research Report for DN 1999-4. Directorate for Nature Management, Trondheim.
- Haas, B.J., Papanicolaou, A., Yassour, M., Grabherr, M., Blood, P.D., Bowden, J., Couger, M.B., Eccles, D., Li, B., Lieber, M., MacManes, M.D., Ott, M., Orvis, J., Pochet, N., Strozzi, F., Weeks, N., Westerman, R., William, T., Dewey, C.N., Henschel, R., LeDuc, R.D. & Regev, A. (2013). De novo transcript sequence reconstruction from RNA-Seq: reference generation and analysis with Trinity. *Nature Protocols* **8**: 1494-1512.
- Halliwell, B. & Gutteridge, J.M.C. (2007). *Free Radicals in Biology and Medicine*. Oxford University Press Inc., New York, US, 851pp.
- Hancock, J. T., Desikan, R. & Neill, S. J. (2001). Role of reactive oxygen species in cell signalling pathways. *Biochemical Society Transactions* **29**: 345–350.
- Handå, A., Forbord, S., Wang, X., Broch, O.J., Dahle, S.W., Størseth, T.R., Reitan, K.I., Olsen, Y. & Skjermo, J. (2013). Seasonal- and depth-dependent growth of cultivated kelp (*Saccharina*

latissima) in close proximity to salmon (*Salmo salar*) aquaculture in Norway. *Aquaculture* **414–415**: 191–201.

Hanelt, D. (1998). Capability of dynamic photoinhibition in Arctic macroalgae is related to their depth distribution. *Marine Biology* **131**: 361–369.

Hansen, G.I. (1997). A revised checklist and preliminary assessment of the microbenthic marine algae and seagrasses of Oregon. In: Kaye, T.N., Liston, A., Love, R.M., Luoma, D.L., Meinke, R.J. & Wilson, M.V. (eds). Conservation and management of native flora and fungi. Native Plant Society of Oregon, Corvallis, pp. 175–200.

Hardy, G.F. & Guiry, M.D. (2003). A Check-list and Atlas of the Seaweeds of Britain and Ireland. 2nd edn. British Phycological Society, London.

Harper, M.A., Cooper, V.C., Chang, F.H., Nelson, W.A. & Broady, P.A. (2012). Phylum Ochrophyta. Brown and golden-brown algae, diatoms, silicoflagellates, and kin. In: Gordon, D. (ed). New Zealand Inventory of Biodiversity. Canterbury University Press, Christchurch, NZ. 1758pp.

Haug, A., Larsen, B. & Smidsrod, O. (1974). Uronic acid sequence in alginate from different sources. *Carbohydrate Research* **32**: 217–225.

Heesch, S. & Peters, A.F. (1999). Scanning electron microscopy observation of host entry by two brown algae endophytic in *Laminaria saccharina* (Laminariales, Phaeophyceae). *Phycological Research* **47**: 1–5.

Heinrich, S., Valentin, K., Frickenhaus, S., John, U. & Wiencke, C. (2012). Transcriptomic Analysis of Acclimation to Temperature and Light Stress in *Saccharina latissima* (Phaeophyceae). *PLoS ONE* **7**: e44342.

Heinrich, S., Valentin, K., Frickenhaus, S. & Wiencke, C. (2015). Temperature and light interactively modulate gene expression in *Saccharina latissima* (Phaeophyceae). *Journal of Phycology* **51**: 93–108.

Heinrich, S., Valentin, K., Frickenhaus, S. & Wiencke, C. (2016). Origin matters – Comparative transcriptomics in *Saccharina latissima* (Phaeophyceae). *Journal of Experimental Marine Biology and Ecology* **476**: 22–30.

- Herbert, P.D.N., Cywinska, A., Ball, S.L. & Dewaard, J.R. (2003). Biological identification through DNA barcodes. *Proceedings of the royal society of London. Biological sciences* **270**: 313-321.
- Herbert, P.D.N., Penton, E.H., Burns, J.M., Janzen, D.H. & Hallwachs, W. (2004). Ten species in one: DNA barcoding reveals cryptic species in the neotropical skipper butterfly *Astraptes fulgerator*. *Proceedings of the national academy of science* **101**: 14812-14817.
- Holub, E.B. (2007). Natural variation in innate immunity of a pioneer species. *Current Opinion in Plant Biology* **10**: 415-424.
- Jaasund, E. (1962). Beiträge zur Systematik der Norwegischen Braunalgen. *Botanica Marina* **5**: 1-8.
- Jaasund, E. (1965). Aspects of the marine algal vegetation of North Norway. *Botanica Gothoburgensia. Acta Universitatis Gothoburgensis* **4**: 1-174.
- Jackson, G.A. (1983). The physical and chemical environment of a kelp community. In: Bascom, W., Harris, L. & Sibley, G. (eds). *The Effects of Waste Disposal on Kelp Communities*. Scripps Institute of Oceanography, San Diego, US, 328pp.
- Jousson, O., Pawlowski, J., Zaninetti, L., Meinesz, A. & Boudouresque, C.F. (1998). Molecular evidence for the aquarium origin of the green alga *Caulerpa taxifolia* introduced to the Mediterranean Sea. *Marine Ecology Progress Series* **172**: 275-280.
- Kawai, H. & Tokuyama, M. (1995). *Laminarionema elsbetiae* gen. et sp. nov. (Ectocarpales, Phaeophyceae), a new endophyte in *Laminaria* sporophytes. *Phycological Research* **43**: 185-190.
- Keats, D.W., Green, J.M. & Hooper, R.G. (1989). Arctic Algal Communities in the region of the Nuvuk Islands, Northeastern Hudson Bay, Canada. *Annual Review of Ecology, Evolution and Systematics* **116**: 53-59.
- Kim, J.K., Yarish, C., Hwang, E.K., Park, M. & Kim, Y. (2017). Seaweed aquaculture: Cultivation technologies, challenges and its ecosystem services. *Algae* **32**: 1-13.

- Kimura, M. (1980). A simple method for estimating evolutionary rate of base substitutions through comparative studies of nucleotide sequences. *Journal of Molecular Evolution* **16**: 111–20.
- Kirchmair, M., Trenkwalder, S., Huber, L. & Neuhauser, S. (2012). Endophytes of grapevine as potential control agents against fungal vine diseases. *Biological Control of Fungal and Bacterial Plant Pathogens* **78**: 39-43.
- Klochkova, N.G., Korolyova, T.N. & Kusidi, A.E. (2009). Atlas of algae-macrophytes Kamchatka waters. Vol 1. Green algae and brown algae. KamchatNIRO Press, Petropavlovsk-Kamchatsky.
- Koch, R. (1876). Untersuchungen über Bakterien. *Cohns Beiträge zur Biologie der Pflanzen* **2**: 277–310.
- Kogame, K., Rindi, F., Peters, A.F. & Guiry, M.D. (2015). Genetic diversity and mitochondrial introgression in *Scytosiphon lomentaria* (Ectocarpales, Phaeophyceae) in the north-eastern Atlantic Ocean. *Phycologia* **54**: 367-374.
- Kopylova, E., Noé, L. & Touzet, H. (2012). SortMeRNA: Fast and accurate filtering of ribosomal RNAs in metatranscriptomic data. *Bioinformatics* **28**: 3211-3217.
- Kornmann, P. & Sahling, P.H. (1977). Meeresalgen von Helgoland. Benthische Grün-, Braun- und Rotalgen. *Helgoländer Meeresuntersuchungen* **29**: 1-289.
- Kucera, H. & Saunders, G.W. (2008). Assigning morphological variants of *Fucus* (Fucales, Phaeophyceae) in Canadian waters to recognized species using DNA barcoding. *Botany* **86**: 1065–1079.
- Kugrens, P. & West, J.A. (1973). The ultrastructure of the alloparasitic red alga *Choreocolax polysiphonia*. *Phycologia* **12**: 175-186.
- Kumar, S., Stecher, G. & Tamura, K. (2016). MEGA7: Molecular Evolutionary Genetics Analysis Version 7.0 for Bigger Datasets. *Molecular Biology and Evolution* **33**: 1870-1874.
- Küpper, F.C., Kloareg, B., Guern, J. & Potin, P. (2001). Oligoguluronates elicit an oxidative burst in the brown algal kelp *Laminaria digitata*. *Plant Physiology* **125**: 278–291.

- Küpper, F.C., Müller, D.G., Peters, A.F., Kloareg, B. & Potin, P. (2002). Oligoalgininate recognition and oxidative burst play a key role in natural and induced resistance of sporophytes of Laminariales. *Journal of Chemical Ecology* **28**: 2057-208.
- Küpper, F.C., Gaquerel, E., Boneberg, E.M., Morath, S., Salaün, J.P. & Potin, P. (2006). Early events in the perception of lipopolysaccharides in the brown alga *Laminaria digitata* include an oxidative burst and activation of fatty acid oxidation cascades. *Journal of Experimental Botany* **57**: 1991–1999.
- Küpper, F.C., Carpenter, L.J., McFiggans, G.B., Palmer, C.J., Waite, T.J., Boneberg, E.-M., Woitsch, S., Weiller, M., Abela, R., Grolimund, D., Potin, P., Butler, A., Luther, G.W., Kroneck, P.M.H., Meyer-Klaucke, W. & Feiters, M.C. (2008). Iodide accumulation provides kelp with inorganic antioxidant impacting atmospheric chemistry. *Proceedings of the National Academy of Sciences* **105**: 6954-6958.
- Küpper, F.C., Gaquerel, E., Cosse, A., Adas, F., Peters, A.F., Müller, D.G., Kloareg, B., Salaün, J.P. & Potin, P. (2009). Free fatty acids and methyl jasmonate trigger defence reactions in *Laminaria digitata*. *Plant & Cell Physiology* **50**: 789–800.
- Küpper, F.C., Peters, A.F., Shewring, D.M., Sayer, M.D.J., Mystikou, A., Brown, H. & Lane, C. (2016). Arctic marine phytobenthos of northern Baffin Island. *Journal of Phycology* **52**: 532–549.
- L’Hardy, J.P. (1962). Observations sur le peuplement epiphyte des lames de *Laminaria saccharina* (Linné) Lamouroux en Baie de Morlaix (Finistère). *Cahiers de Biologie Marine* **3**: 115-227.
- La Barre, S., Potin, P., Leblanc, C. & Delage, L. (2010). The Halogenated Metabolism of Brown Algae (Phaeophyta), Its Biological Importance and Its Environmental Significance. *Marine Drugs* **8**: 988-1010.
- Langmead, B. & Salzberg, S. (2012). Fast gapped-read alignment with Bowtie 2. *Nature Methods* **9**: 357-359.
- Lane, C.E., Lindstrom, S.C. & Saunders, G.W. (2007). A molecular assessment of northeast Pacific *Alaria* species (Laminariales, Phaeophyceae) with reference to the utility of DNA barcoding. *Molecular Phylogenetics and Evolution* **44**: 634–648.

- Laternus, F., Svensson, T., Wiencke, C. & Öberg, G. (2004). Ultraviolet radiation affects emission of ozone-depleting substances by marine macroalgae: Results from a laboratory incubation study. *Environmental Science & Technology* **38**: 6605–6609.
- Le Gall, L. & Saunders, G.W. (2010). DNA barcoding is a powerful tool to uncover algal diversity: A case study of the Phyllophoraceae (Gigartinales, Rhodophyta) in the Canadian flora. *Journal of Phycology* **46**: 374–389.
- Leblanc, C., Colin, C., Cosse, A., Delage, L., La Barre, S., Morin, P., Fiévet., B., Voiseux, C., Ambroise, Z., Verhaeghe, E., Ammouroux, D., Donard, O., Tessier, E. & Potin, P. (2006). Iodine transfers in the coastal marine environment: the key role of brown algae and of their vanadium-dependent haloperoxidases. *Biochimie* **88**: 1773–1785.
- Leblanc, C. Schaal G., Cosse, A., Destombe, C., Valero, M., Riera, P. & Potin, P. (2011). Trophic and biotic interactions in *Laminaria digitata* beds: which factors could influence the persistence of marine kelp forests in northern Brittany? *Cahiers de Biologie Marine* **52**: 415-427.
- Lee, R.K.S. (1980). A catalogue of the marine algae of the Canadian Arctic. *National Museum of Canada Publications in Botany* **9**: 1-82.
- Lee, W.-K., Namasivayam, P., Abdullah, J.O. & Ho, C.-L. (2017). Transcriptome profiling of sulfate deprivation responses in two agarophytes *Gracilaria changii* and *Gracilaria salicornia* (Rhodophyta). *Scientific reports* **7**: 46563.
- Leigh, R.J., Ball, S.M., Whitehead, J., Leblanc, C., Shillings, A.J.L., Mahajan, A.S., Oetjen, H., Lee, J.D., Jones, C.E., Dorsey, J.R., Gallagher, M., Jones, R.L., Plane, J.M.C., Potin, P. & McFiggans, G.(2010). Measurements and modelling of molecular iodine emissions, transport and photodestruction in the coastal region around Roscoff. *Atmospheric Chemistry and Physics* **10**: 11823-11838.
- Lein, T.E., Sjutun, K. & Wakili, S. (1991). Mass-occurrence of a brown filamentous endophyte in the lamina of the kelp *Laminaria hyperborea* (Gunnerus) Foslie along the southwestern coast of Norway. *Sarsia* **76**: 187–193.

- Levine, R.L., Mosoni, L. Berlett, B.S. & Stadtman, E.R. (1996). Methionine residues as endogenous antioxidants in proteins. *Proceedings of the National Academy of Sciences of the United States of America* **93**: 15036-15040.
- Lindstrom, S.C. (2006). Biogeography of Alaskan seaweeds. *Journal of Applied Phycology* **18**: 637–641.
- Lion, U., Wiesemeier, T., Weinberger, F., Beltrán, J., Flores, V., Faugeron, S., Correa, J. & Pohnert, G. (2006). Phospholipases and galactolipases trigger oxylipin-mediated wound-activated defence in the red alga *Gracilaria chilensis* against epiphytes. *Chembiochem* **7**: 457-462.
- Liu, R. (2008). Checklist of biota of Chinese seas. Academia Sinica, Beijing.
- Liu, F., Wang, W., Sun, X., Liang, Z. & Wang, F. (2014). RNA-Seq revealed complex response to heat stress on transcriptomic level in *Saccharina japonica* (Laminariales, Phaeophyta). *Journal of Applied Phycology* **26**: 1585–1596.
- Lobban, C. & Wynne, M. (1981). (eds). The biology of seaweeds. Blackwell Scientific Publications, Oxford, UK, 786pp.
- Lobban, C.S. & Harrison, P.J. (1994). Seaweed Ecology and Physiology. Cambridge University Press, Cambridge, UK, 366pp.
- Loureiro, R., Gachon, C.M.M. & Rebours, C. (2015). Seaweed cultivation: Potential and challenges of crop domestication at an unprecedented pace. *New Phytologist* **206**: 489–492.
- Love, M.I., Huber, W. & Anders, S. (2014). Moderated estimation of fold change and dispersion for RNA-seq data with DESeq2. *Genome Biology* **15**: 550.
- Lowe, R., Shirley, N., Bleackley, M., Doland, S. & Shafee, T. (2017). Transcriptomics technologies. *PLoS Computational Biology* **13**: e1005457.
- Lüning, K. & Mortensen, L. (2015). European aquaculture of sugar kelp (*Saccharina latissima*) for food industries: Iodine content and epiphytic animals as major problems. *Botanica Marina* **58**: 449–455.

- Luque, J., Cohen, M., Savé, R., Biel, C. & Álvarez, I.F. (1999). Effects of three fungal pathogens on water relations, chlorophyll fluorescence and growth of *Quercus suber* L. *Annals of Forest Science* **56**: 19-26.
- Maekawa, T., Kufer, T.A. & Schulze-Lefert, P. (2011). NLR functions in plant and animal immune systems: so far and yet so close. *Nature Immunology* **12**: 818-826.
- Mann, K.H. (1973). Seaweeds: their productivity and strategy for growth. *Science* **182**: 975–981.
- Mattio, L. & Payri, C. (2010). Assessment of five markers as potential barcodes for identifying *Sargassum* subgenus *Sargassum* species (Phaeophyceae, Fucales). *Cryptogamie Algologie* **31**: 467–485.
- Mazarrasa, I., Olsen, Y.S., Mayol, E., Marbà, N. & Duarte, C.M. (2014). Global unbalance in seaweed production, research effort and biotechnology markets. *Biotechnology Advances* **32**: 1028–1036.
- McDevit, D.C. & Saunders, G.W. (2010). A DNA barcode examination of the Laminariaceae (Phaeophyceae) in Canada reveals novel biogeographical and evolutionary insights. *Phycologia* **49**: 235–248.
- McHugh, D. (2003). A guide to the seaweed industry. FAO Fisheries Technical Paper, No. 441. FAO, Rome, 2003. 105pp.
- Mesnildrey, L., Jacob, C., Frangoules, K., Reunavot, M. & Lesueur, M. (2012). Seaweed industry in France. Report. Interreg program NETALGAE. Les publications du Pôle halieutique AGROCAMPUS OUEST n°9, 34pp.
- Meyer, Y., Buchanan, B.B., Vignols, F., & Reichheld, J.-P. (2009). Thioredoxins and glutaredoxins: unifying elements in redox biology. *Annual Review of Genetics* **43**: 335–367.
- Michel, G., Tonon, T., Scornet, D., Cock, J.M. & Cloareg, B. (2010a). Central and storage carbon metabolism of the brown alga *Ectocarpus siliculosus*: insights into the origin and evolution of storage carbohydrates in Eukaryotes. *New Phytologist* **188**: 67-81.

- Michel, G., Tonon, T., Scornet, D., Cock, J.M. & Cloareg, B. (2010b). The cell wall polysaccharide metabolism of the brown alga *Ectocarpus siliculosus*. Insights into the evolution of extracellular matrix polysaccharides in Eukaryotes. *New Phytologist* **188**: 82-97.
- Mikhaylova, T.A. & Shtrik, V.A. (2007). Macroepiphytes of *Laminaria hyperborea* (Laminariaceae) in the Barents and the White Sea. *Botanicheskiy Zhurnal* **98**: 1818–1828.
- Miller, S.A., Beed, F.D. & Harmon, C.L. (2009). *Annual Review of Phytopathology* **47**: 15-38.
- Miller, K.A. (2012). *Seaweeds of California. Updates of California Seaweed Species List*. University of California Jepson Herbarium, Berkeley.
- Miranda, F. (1931). Sobre las algas y cianofíceas del Cantábrico especialmente de Gijón. *Trabajos Museo Nacional Ciencias Naturales. Serie Botánica* **25**: 1-106.
- Montecinos, A.E., Couceiro, L., Peters, A.F., Desrut, A., Valero, M. & Guillemin, M.-L. (2017). Species delimitation and phylogeographic analyses in the *Ectocarpus* subgroup *siliculosi* (Ectocarpales, Phaeophyceae). *Journal of Phycology* **53**: 17-31.
- Mooney-McAuley, K.M., Edwards, M.D., Champenois J. & Gorman, E. (2016). Best Practice Guidelines for Seaweed Cultivation and Analysis, Public Output report of the EnAlgae project, Swansea, June 2016, 36pp.
- Moskovitz, J. (2005). Methionine sulfoxide reductases: ubiquitous enzymes involved in antioxidant defense, protein regulation, and prevention of aging-associated diseases. *Biochimica et Biophysica Acta* **1703**: 213-219.
- Mtolera, M.S.P., Collén, J., Pedersén, M., Ekdahl, A., Abrahamsson, K. & Semesi, A.K. (1996). Stress-induced production of volatile halogenated organic compounds in *Eucheuma denticulatum* (Rhodophyta) caused by elevated pH and high light intensities. *European Journal of Phycology* **31**: 89–93.
- Neill, S. J., Desikan, R., Clarke, A., Hurst, R. D. & Hancock, J. T. (2002). Hydrogen peroxide and nitric oxide as signalling molecules in plants. *Journal of Experimental Botany* **53**: 1237–1247.

- Nielsen, R. & Gunnarsson, K. (2001). Seaweeds of the Faroe Islands. An annotated checklist. *Fróðskaparrit* **49**: 45-108.
- Nielsen, R. 2005: http://botanik.snm.ku.dk/Samlinger/danish_seaweeds
- Noda, M. (1971). Some new species of marine algae from the northeastern coast of Japan Sea. *Scientific Reports Niigata University, Ser. D. (Biology)* **8**: 53-59.
- Nürnberg, T., Brunner, F., Kemmerling, B. T. & Piater, L. (2004). Innate immunity in plants and animals: Striking similarities and obvious differences. *Immunological Reviews* **198**: 249–266.
- Østgaard, K., Indergaard, M., Markussen, S., Knutsen, S.H. & Jensen, A. (1993). Carbohydrate degradation and methane production during fermentation of *Laminaria saccharina* (Laminariales, Phaeophyceae). *Journal of Applied Phycology* **5**: 333–342.
- Oztek, E. (2008). A tale of plant glutathione-S-transferases: since 1970. *Botanic Review* **74**: 419-437.
- Palmer, C. J., Anders, T. L., Carpenter, L. J., Küpper, F. C. & McFiggans, G. (2005). Iodine and halocarbon response of *Laminaria digitata* to oxidative stress and links to atmospheric new particle production. *Environmental Chemistry* **2**: 282–290.
- Paredes Juárez, G.A., Spasojevic, M., Faas, M.M. & de Vos, P. (2014). Immunological and technical considerations in application of alginate-based microencapsulation systems. *Frontiers in Bioengineering and Biotechnology* **2**: 1-15.
- Parke, M. (1948). Studies on British Laminariaceae. I. Growth in *Laminaria Saccharina* (L.) Lamour. *Journal of the Marine Biological Association of the United Kingdom* **27**: 651-709.
- Pedersen, P.M. (1984). Studies on primitive brown algae (Fucophyceae). *Opera Botanica* **74**: 1-76.
- Perestenko, L.P. (1980). *Vodorosli Zaliva Petra Velikogo* [The seaweeds of Peter the Great Bay]. Leningradskoe Otdelenie., Leningrad.

- Pereira, R. & Yarish, C. (2008). Mass Production of Marine Macroalgae. In: Jørgensen, S.E. & Fath, B.D. (eds). Ecological Engineering. Vol. [3] of Encyclopaedia of Ecology, Elsevier, Oxford, UK, pp 2236-2247.
- Peteiro, C. & Freire, Ó. (2009). Effect of outplanting time on commercial cultivation of kelp *Laminaria saccharina* at the southern limit in the Atlantic coast, N.W. Spain. *Chinese Journal of Oceanology and Limnology* **27**: 54.
- Peteiro, C. & Freire, Ó. (2013). Epiphytism on blades of the edible kelps *Undaria pinnatifida* and *Saccharina latissima* farmed under different abiotic conditions. *Journal of the World Aquaculture Society* **44**: 706-715.
- Peters, A.F. (1991). Field and culture studies of *Streblonema macrocystis* sp. nov. (Ectocarpales, Phaeophyceae) from Chile, a sexual endophyte of giant kelp. *Phycologia* **30**: 365-377.
- Peters, A.F. & Ellertsdóttir, E. (1996). New record of the kelp endophyte *Laminarionema elsbetiae* (Phaeophyceae, Ectocarpales) at Helgoland and its life history in culture. *Nova Hedwigia* **62**: 341–349.
- Peters, A.F. & Schaffelke, B. (1996). *Streblonema* (Ectocarpales, Phaeophyceae) infection in the kelp *Laminaria saccharina* (Laminariales, Phaeophyceae) in the western Baltic. *Hydrobiologia* **326–327**: 111–116.
- Peters, A.F. & Burkhardt, E. (1998). Systematic position of the kelp endophyte *Laminarionema elsbetiae* (Ectocarpales sensu lato, Phaeophyceae) inferred from nuclear ribosomal DNA. *Phycologia* **37**: 114-120.
- Peters, A.F. (2003). Molecular identification, distribution and taxonomy of brown algal endophytes, with emphasis on species from Antarctica. *Proceedings of the 17th International Seaweed Symposium* **302**: 293–302.
- Peters, A.F., Couceiro, L., Tsiamis, K., Küpper, F.C. & Valero, M. (2015). Barcoding of cryptic stages of marine brown algae isolated from incubated substratum reveals high diversity in Acinetosporaceae (Ectocarpales, Phaeophyceae). *Cryptogamie Algologie* **36**: 3–29.

- Pfaffl, M.W. (2004). Relative quantification. In: Tevfik Dorak, M. (ed) Real-Time PCR. Taylor & Francis Group, New York, pp 63–82.
- Potin, P., Bouarab, K., Salain, J.P., Pohnert, G. & Kloareg, B. (2002). Biotic interactions of marine algae. *Current Opinion in Plant Biology* **5**: 308-317.
- Potin, P. (2012). Intimate Associations Between Epiphytes, Endophytes and Parasites of Seaweeds. In Wiencke, C. & Bischof, K (eds). Seaweed Biology. Springer, Berlin, Germany, pp 471-493.
- Prado, S., Nay, B. & Kunz, C. (2015). *Paraconiothyrium variable*, an ascomycete endophyte, suppresses mycotoxin production in the plant pathogen *Fusarium oxysporum*. *Journal de Mycologie Médicale* **25**: 96-97.
- Provasoli, L. (1968). Media and prospects for the cultivation of marine algae. In: Watanabe, A. (ed) Cultures and collections of algae. Japanese Society of Plant Physiologists, Tokyo, pp 63–75.
- Puillandre, N., Lambert, A., Brouillet, S. & Achaz, G. (2012). ABGD, Automatic Barcode Gap Discovery for primary species delimitation. *Molecular Ecology* **21**: 1864-1877.
- R Development Core Team (2013). R: A language and environment for statistical computing. R Foundation for Statistical Computing, Vienna.
- Ralph, P.J. & Short, F.T. (2002). Impact of the wasting disease pathogen, *Labyrinthula zosterae*, on the photobiology of eelgrass *Zostera marina*. *Marine Ecology Progress Series* **226**: 265-271.
- Ramel, C. (1998). Biodiversity and intraspecific genetic variation. *Pure & Applied Chemistry* **70**: 2079-2084.
- Reed, D.C., Schroeter, S.C. & Raimondi, P.T. (2004). Spore supply and habitat availability as sources of recruitment limitation in the giant kelp *Macrocystis pyrifera* (Phaeophyceae). *Journal of Phycology* **40**: 275-284.
- Richter, K., Haslbeck, M. & Buchner, J. (2010). The heat shock response: life on the verge of death. *Molecular Cell* **40**: 253–266.

- Ritter, A., Goulitquer, S., Salaün, J.-P., Tonon, T., Correa, J.A. & Potin, P. (2008). Copper stress induces biosynthesis of octadecanoid and eicosanoid oxygenated derivatives in the brown algal kelp *Laminaria digitata*. *New Phytologist* **180**: 809-821.
- Ritter, A., Dittami, S.M., Goulitquer, S., Correa, J.A., Boyen, C., Potin, P. & Tonon, T. (2014). Transcriptomic and metabolomic analysis of copper stress acclimation in *Ectocarpus siliculosus* highlights signaling and tolerance mechanisms in brown algae. *BMC Plant Biology* **14**: 116.
- Ritter, A., Cabioch, L., Brillet-Guégen, L., Corre, E., Cosse, A., Dartevelle, L., Duruflé, H., Fasshauer, C., Goulitquer, S., Thomas, F., Correa, J.A., Potin, P., Faugeron, S. & Leblanc, C. (2017). Herbivore-induced chemical and molecular responses of the kelps *Laminaria digitata* and *Lessonia spicata*. *PLoS One* **12**: e0173315.
- Roeder, V., Collén, J., Rousvoal, S., Corre, E., Leblanc, C. & Boyen, C. (2005). Identification of stress gene transcripts in *Laminaria digitata* (Phaeophyceae) protoplast cultures by expressed sequence tag analysis. *Journal of Phycology* **41**: 1227-1235.
- Rolin, C., Inkster, R., Laing, J., Hedges, J. & McEvoy, L. (2016). Seaweed cultivation manual: Shetland seaweed growers project 2014-16.
- Rose, L.E., Bittner-Eddy, P.D., Langley, C.H., Holub, E.B., Michelmore, R.W. & Beynon, J.L. (2004). The Maintenance of Extreme Amino Acid Diversity at the Disease Resistance Gene, RPP13, in *Arabidopsis thaliana*. *Genetics* **166**: 1517-1527.
- Rosell, K.G. & Srivastava, L.M. (1984). Seasonal variation in the chemical constituents of the brown algae *Macrocystis integrifolia* and *Nereocystis luetkeana*. *Canadian Journal of Botany* **62**: 2229-2236.
- Rosenvinge, L.K. (1893). Grønlands Havalger. *Meddelelser om Grønland* **3**: 763-981.
- Russel, G. (1964). *Laminariocolax tomentosoides* on the Isle of Man. *Journal of the marine biological association UK* **44**: 601-612.
- Saenko, G. N., Kravtsova, Y. Y., Ivanenko, V. V. & Sheludko, S. I. (1978). Concentration of iodine and bromine by plants in the seas of Japan and Okhotsk. *Marine Biology* **47**: 243–50.

- Salvarría, E., Paul, S., Gil-Kodaka, P. & Villena, G.K. (2018). First global transcriptome analysis of brown algae *Macrocystis integrifolia* (Phaeophyceae) under marine intertidal conditions. *3 Biotech* **8**: 185.
- Saunders, G.W. & Kraft, G.T. (1995). The phylogenetic affinities of *Notheia anomala* (Fucales, Phaeophyceae) as determined from partial small-subunit rRNA gene sequences. *Phycologia* **34**: 383–389.
- Saunders, G.W. (2005). Applying DNA barcoding to red macroalgae: a preliminary appraisal holds promise for future applications. *Philosophical Transactions of the Royal Society of London. Series B, Biological Sciences* **360**: 1879–88.
- Schaffelke, B., Peters, A.F. & Reusch, T. (1996). Factors influencing depth distribution of soft bottom *Laminaria saccharina* (L.) Lamour in Kiel Fjord, Baltic Sea. *Hydrobiologia* **326/327**: 117-123.
- Schaffelke, B., Murphy, N. & Uthicke, S. (2002). Using genetic techniques to investigate the sources of the invasive alga *Caulerpa taxifolia* in the three new locations in Australia. *Marine Pollution Bulletin* **44**: 204-210.
- Schena, M., Shalon, D., Davis, R.W. & Brown, P.O. (1995). Quantitative Monitoring of Gene Expression Patterns with a Complementary DNA Microarray. *Science* **270**: 467-470.
- Schneider, C.W., Suyemoto, M.M. & Yarish, C. (1979). An annotated checklist of Connecticut seaweeds. *Bulletin of the Connecticut State Geological and Natural History Survey* **108**: 1-20.
- Seed, R. (1976). Observations on the ecology of *Membranipora* (Bryozoa) and a major predator *Doridella steinbergae* (Nudibranchiata) along the fronds of *Laminaria saccharina* at Friday Harbor, Washington. *Journal of Experimental Marine Biology and Ecology* **24**: 1–17.
- Selivanova, O.N. & Zhigadlova, G.G. (2013). Marine Benthic Algae of the Commander Islands (Pacific Coast of Russia) with Checklist Revised in 2012. *ISRN Oceanography* **2013**: 1–12.
- Sepúlveda, D., Bohle, H., Labra, Á. Grothusen, H. & Marshall, S.H. (2013). Design and evaluation of a unique RT-qPCR assay for diagnostic quality control assessment that is applicable to pathogen detection in three species of salmonid fish. *BMC Veterinary Research* **9**: 183.

- Setchell, W.A. (1918). Parasitism among the Red Algae. *Proceedings of the American Philosophical Society* **57**: 155-172.
- Setchell, W.A. & Gardner, N.L. (1922). Phycological contributions, V. New species of *Pylaiella* and *Streblonema*. *University of California publications in Botany* **V**: 385-402.
- Shinozaki, K. & Yamaguchi-Shinozaki, K. (2007). Gene networks involved in drought stress response and tolerance. *Journal of Experimental Botany* **58**: 221-227.
- Siegel, B.Z. & Siegel, S.M. (1973). The Chemical Composition of Algal Cell Walls. *Critical Reviews in Microbiology* **3(1)**: 1-26.
- Silberfeld, T., Leigh, J. W., Verbruggen, H., Cruaud, C., de Reviers, B. & Rousseau, F. (2010). A multi-locus time-calibrated phylogeny of the brown algae (Heterokonta, Ochrophyta, Phaeophyceae): investigating the evolutionary nature of the “brown algal crown radiation”. *Molecular Phylogenetics and Evolution* **56**: 659–74.
- Skjermo, J., Aasen, I. M., Arff, J., Broch, O. J., Carvajal, A., Christie, H., Forbord, S., Olsen, Y., Reitan, K. I., Rustad, T., Sandquist, J., Solbakken, R., Steinhovden, K. B., Wittgens, B., Wolff, R. & Handa, A. (2014). A new Norwegian bioeconomy based on cultivation and processing of seaweeds: Opportunities and R&D needs. SINTEF Fisheries and Aquaculture.
- South, G.R. & Cardinal, A. (1970). A check-list of marine algae of eastern Canada-first revision. *Canadian Journal of Botany* **48**: 2077–2095.
- Stack, J., Haga, I.R., Schröder, M., Bartlett, N.W., Maloney, G., Reading, P.C., Fitzgerald, K. A., Smith, G.L. & Bowie, A.G. (2005). Vaccinia virus protein A46R targets multiple Toll-like–interleukin-1 receptor adaptors and contributes to virulence. *The Journal of Experimental Medicine* **201**: 1007-1018.
- Stegenga, H., Mol, I., Prud'homme van Reine, W.F. & Lokhorst, G.M. (1997). Checklist of the marine algae of the Netherlands. *Gorteria Supplement* **4**: 3-57.
- Stévant, P., Rebours, C. & Chapman, A. (2017). Seaweed aquaculture in Norway: recent industrial developments and future perspectives. *Aquaculture International* **25**: 1373–1390.

- Stöver, B.C. & Müller, K.F. (2010). TreeGraph 2: Combining and visualizing evidence from different phylogenetic analyses. *BMC Bioinformatics* **11**: 7.
- Strittmatter, M., Grenville-Briggs, L.J., Breithut, L., van West, P., Gachon, C.M.M. & Küpper, F. (2016). Infection of the brown alga *Ectocarpus siliculosus* by the oomycete *Eurychasma dicksonii* induces oxidative stress and halogen metabolism. *Plant, Cell and Environment* **39**: 259-271.
- Sun, P., Mao, Y., Li, G., Cao, M., Kong, F., Wang, L. & Bi, G. (2015). Comparative transcriptome profiling of *Pyropia yezoensis* (Ueda) M. S. Hwang & H.G. Choi in response to temperature stress. *BMC Genomics* **16**: 463.
- Suto, S. (1952). On shedding of zoospores in some algae of Laminariaceae-II. Bull. *Bulletin of the Japanese Society of Scientific Fisheries* **18**: 1–5.
- Tam, C.E., Cole, K.M. & Garbary, D.J. (1987). In situ and in vitro studies on the endophytic red algae *Audouinella porphyrae* and *A. vaga* (Acrochaetiales). *Canadian Journal of Botany* **65**: 532–538.
- Taylor, W.R. (1957). *Marine algae of the northeastern coast of North America*. The University of Michigan Press, Ann Arbor, US, 427pp.
- Thomas, D., Beltrán, J., Flores, V., Contreras, L., Bollmann, E. & Correa, J.A. (2009). *Laminariocolax* sp. (phaeophyceae) associated with gall developments in *Lessonia nigrescens* (phaeophyceae). *Journal of Phycology* **45**: 1252–1258.
- Thomas, F., Cosse, A., Goullitquer, S., Raimund, S., Morin, P., Valero, M., Leblanc, C. & Potin, P. (2011). Waterborne Signaling Primes the Expression of Elicitor- Induced Genes and Buffers the Oxidative Responses in the Brown Alga *Laminaria digitata*. *PLoS ONE* **6**: e21475.
- Thomas, F., Cosse, A., Le Panse, S., Kloareg, B., Potin, P. & Leblanc, C. (2014). Kelps feature systemic defence responses: insights into the evolution of innate immunity in multicellular eukaryotes. *New Phytologist* **3**: 567-576.
- Thomma, B.P.H.J., Penninckx, I.A., Broekaert, W.F. & Cammue, B.P.A. (2001). The complexity of disease signaling in *Arabidopsis*. *Current Opinion in Immunology* **13**: 63–68.

- Torres, M.A., Jones, J.D.G. & Dangl, J.L. (2006). Reactive oxygen species signaling in response to pathogens. *Plant Physiology* **141**: 373–378.
- Tragin, M., Lopes dos Santos, A., Christen, R. & Vaultot, D. (2016). Diversity and ecology of green microalgae in marine systems: an overview based on 18S rRNA sequences. *Perspectives in Phycology* **3**: 141-154.
- Veiga, A.J., Cremades, J. & Bárbara, I. (1997). *Gononema aecidioides* (Ectocarpaceae) un nuevo feófito para la Península Ibérica. *Anales Jardín Botánico de Madrid* **55**: 155-156.
- Villalard-Bohnsack, M. & Harlin, M.M. (2001). *Grateloupia doryphora* (Halymeniaceae, Rhodophyta) in Rhode Island waters (USA): geographical expansion, morphological variations and associated algae. *Phycologia* **40**: 372–380.
- Wang, W., Vinocur, B., Shoseyov, O. & Altman, A. (2004). Role of plant heat-shock proteins and molecular chaperones in the abiotic stress response. *Trends in Plant Science* **9**: 244–252.
- Weinberger, F. & Friedlander, M. (2000). Response of *Gracilaria conferta* (Rhodophyta) to oligoagars results in defence against agar-degrading epiphytes. *Journal of Phycology* **36**: 1079–1086.
- Weinberger, F. (2007). Pathogen-Induced Defence and Innate in Macroalgae. *The Biological Bulletin* **213**: 290–302.
- Weinberger, F., Coquempot, B., Forner, S., Morin, P., Kloareg, B. & Potin, P. (2007a). Different regulation of haloperoxidation during agar oligosaccharide-activated defence mechanism in two related red algae, *Gracilaria* sp. and *Gracilaria chilensis*. *Journal of Experimental Botany* **58**: 4365-4372.
- Weinberger, F., Beltran, J., Correa, J. A., Lion, U, Pohnert, G., Kumar, N., Steinberg, P., Kloareg, B. & Potin, P. (2007b). Spore release in *Acrochaetium* sp. (Rhodophyta) is bacterially controlled. *Journal of Phycology* **43**: 235-241.
- Westermann, A.J., Gorski, S.A. & Vogel, J. (2012). Dual RNA-seq of pathogen and host. *Nature Reviews Microbiology* **10**: 618–630.

- Womersley, H. B. S. (1987). The Marine Benthic Flora of Southern Australia. Part II. Southern Australian Government Printing Division, Adelaide, 484 pp.
- Wood, R.D. & Villalard-Bohnsack, M. (1974). Marine Algae of Rhode Island. *Rhodora* **76**: 399-421.
- Wu, C., Chen, D. & Li, J. (1983). On the diseases of cultivated *Laminaria japonica*. *Academia Sinica* (763).
- Wynne, M.H. (1969). Life history and systematic studies of some Pacific North American Phaeophyceae (brown algae). *University of California Publications in Botany* **50**: 1-88.
- Yang, E.C, Peters, A.F., Kawai, H., Stern, R., Hanyuda, T., Bárbara, I., Prud'homme van Reine, W.F. & Küpper, F.C. (2014). Ligulate *Desmarestia* (Desmarestiales, Phaeophyceae) revisited: *D. japonica* sp. nov. and *D. dudresnayi* differ from *D. ligulata*. *Journal of Phycology* **166**: 149–166
- Ye, N., Zhang, X., Miao, M., Fan, X., Zheng, Z., Xu, D., Wang, J. Zhou, L., Wang, D., Gao, Z., Wang, Y., Shi, W., Ji, P., Li, D., Guan, Z., Shao, C., Zhuang, Z., Gao, Z., Qi, J. & Zhao, F. (2015). *Saccharina* genomes provide novel insight into kelp biology. *Nature Communications* **6**: 6986.
- Yoshida, T. & Akiyama, K. (1979). *Streblonema* (Phaeophyceae) infection in the frond of cultivated *Undaria* (Phaeophyceae). *Proceedings of the 9th International Seaweed Symposium* 219-223.
- Yoshida, T., Nakajima, Y. & Nakata, Y. (1990). Check-list of marine algae of Japan (revised in 1990). *Japanese Journal of Phycology* **38**: 269-320.
- Wilkinson, M. (1995). Information review on the impact of kelp harvesting. Scottish Natural Heritage Review, UK, No. 34, 58pp.
- Zambounis, S., Elias, M., Sterck, L., Maumus, F. & Gachon, C.M.M. (2012). Highly Dynamic Exon Shuffling in Candidate Pathogen Receptors ... What if Brown Algae Were Capable of Adaptive Immunity? *Molecular Biology and Evolution* **29**: 1263-1276.

Zambounis, A., Strittmatter, M. & Gachon, C. (2013). Chronic stress and disease resistance in the genome model marina seaweed *Ectocarpus siliculosus*. *Aquatic Botany* **104**: 147-152.

List of abbreviations

5'COI: mitochondrial cytochrome oxidase I
ABGD: automatic barcode gap discovery
ALFF: Algal Microbiome: Friends and Foes
ANOVA: analysis of variance
BI: Bayesian analysis
CTAB: cetyltrimethylammonium bromide
DMSO:
DNA: deoxyribonucleic acid
DTT: dithiothreitol
EDTA: ethylenediaminetetraacetic acid
Fv/Fm: maximum quantum yield of photosystem II
GG: homopolymeric guluronate blocks
GST: glutathione-S-transferase
HSP: heat-shock protein
ITS: internal transcribed spacer 1
K2P: Kimura-2-parameter
LRR: leucine-rich-repeats
MAMPs: microbe-associated molecular pattern
MC5E: mannuronan C 5 epimerase
ML: maximum likelihood analysis
MG: alternating mannuronate and guluronate blocks
MM: homopolymeric mannuronate blocks
MSR: Methionine sulfoxide reductase
NADPH: Nicotinamide adenine dinucleotide phosphate
PAMPs: pathogen-associated molecular pattern
PCR: polymerase chain reaction
PhyML: maximum likelihood analysis
qPCR: quantitative polymerase chain reaction
RNA: ribonucleic acid
RNAseq: RNA sequencing
ROS: reactive oxygen species
SOD: superoxide dismutase

VHOCs: volatile halogenated organic compounds

vBPO: vanadium-dependent bromoperoxidase

vHPO: vanadium-dependent haloperoxidase

Appendix I: Oral presentations

- International Conference on Ecological Sciences in Marseille (France) in October 2016:
“Laboratory and field studies on the interaction between kelps and filamentous algal endophytes” (Bernard M., Rousvoal S. Dartevelle L., Peters A.F., Leblanc C.)
- IDEALG annual meeting in Lorient (France) in November 2016:
“Endophytes in the commercially-grown kelp *Saccharina latissima*: interactions between foes and possible friends?” (Bernard M., Rousvoal S. Dartevelle L., Peters A.F., Leblanc C.)
- 6th Congress of the international society for applied phycology (ISAP) in Nantes (France) in July 2017:
“qPCR-based detection of a filamentous brown algal endophyte in *Saccharina latissima* wild populations and kelp farms” (Bernard M., Rousvoal S., Ballenghien M., Jacquemin B., Peters A.F., Leblanc C.)
- 11th International Phycological Congress in Szczecin (Poland) in August 2017:
“qPCR-based detection of a filamentous brown algal endophyte in *Saccharina latissima* wild populations and kelp farms” (Bernard M., Rousvoal S., Ballenghien M., Jacquemin B., Peters A.F., Leblanc C.)
- 58th meeting of the Czech Phycological Society in Ostrava (Czech Republik) in September 2017:
“qPCR-based detection of a filamentous brown algal endophyte in *Saccharina latissima* wild populations and kelp farms” (Bernard M., Rousvoal S., Ballenghien M., Jacquemin B., Peters A.F., Leblanc C.)
- 17th Scientific Conference of the Phycology Section in Berchtesgaden (Germany) in March 2018:
“Deciphering kelp-endophyte interactions” (Bernard, M., Peters, A.F., Rousvoal S., Dartevelle, L., Leblanc C.)
- Young Algaeneers Symposium in Oban (Scotland) in May 2018:
“Deciphering kelp-endophyte interactions” (Bernard, M., Xing, Q., Corre, E., Peters, A.F., Leblanc, C.)

Appendix II: Presented posters

IDEALG annual meeting in Roscoff (France) in November 2015

Defence and resistance against endophytic pathogens in *Saccharina latissima*

Miriam Bernard¹, Catherine Leblanc¹, Akira F. Peters²

1- Sorbonne Université, UPMC Paris 6, CNRS, UMR 8227, Station Biologique de Roscoff, France
2- Bezhin Rosko, Santec, France

Introduction

The sugar kelp *Saccharina latissima* is not only an important primary producer in temperate and cold northern hemisphere shores, but also an economically relevant seaweed with high industrial potential. Recently, disease outbreaks have been observed in seaweed cultivation facilities and in wild populations (symptoms shown below). Putative pathogens are filamentous endophytic brown algae, particularly *Laminarionema elsbetiae*, which is highly prevalent in European wild *S. latissima* populations and has also been found in *Laminaria digitata* (1). It is known to invade the stipe and frond of *S. latissima* and supposed to disturb the morphology of the host, thereby potentially reducing the economical value of the kelp. However, few is known on the molecular mechanism of this infection.

For instance, endophytic marine fungi associated to the kelp might have an antagonistic effect on colonisation of algal endophytes and help to promote kelp growth, as it is known from terrestrial plants (2).

This PhD project is part of the EU Marie Curie Initial Training Network (ITN) "ALFF: The Algal microbiome: Friends and Foes" and aims to investigate the infection processes of endophytic brown algae in kelps.

Hypotheses

Healthy *S. latissima* sporophyte + *L. elsbetiae* → *S. latissima* sporophyte infected with *L. elsbetiae* → disease symptoms

with associated fungal endophytes → Reduced colonisation by algal endophytes → Less strong or no symptoms?

Disease symptoms

Deformed phylloid, *S. latissima*

Twisted cauloid, *S. latissima*

Dark spots on *S. latissima* phylloid, caused by the filamentous brown algal endophyte *Laminarionema elsbetiae* (Photo: Akira F. Peters)

Twisted cauloid, *L. digitata*

Methodology

Establishment of algal cultures

- *S. latissima*

a) + b) → Development of *S. latissima* sporophytes out of crosses of gametophyte cultures (a) and released spores (b)

- *L. elsbetiae*

c) + d) → Development of *L. elsbetiae* algal material from existing cultures maintained at Bezhin Rosko (c) and isolation of new endophytes from infected hosts (d).

→ Infection of lab-reared *S. latissima* / *L. digitata* with *L. elsbetiae* under sterile conditions

- growth measurements
- photosynthesis measurements

→ Quantitative measurements of disease symptoms and endophyte colonisation

- light microscopy
- qPCR

→ Infection/ disease/ resistance processes

- transcriptomics (RNAseq)
- metabolomics (LC-MS)

→ Field surveys

Preliminary results

Growth rate of *L. digitata*

→ Infection of *L. digitata* with *L. elsbetiae* had a significant (Anova: single factor $p < 0.01$) effect on blade growth after 14 days

Efficiency of PSII of *L. digitata*

→ No significant effect of the infection on photosynthetic efficiency of *L. digitata*

Perspectives

The main goal is to develop the infection of *S. latissima* with *L. elsbetiae* into a quantifiable pathosystem according to Koch's postulates (3).

Next steps:

- Repeat infection of *S. latissima* and *L. digitata* with *L. elsbetiae* to confirm results
- Develop qPCR for a quantifiable pathosystem
- Study algal gene and metabolic regulation upon infection
- Start an epidemiological field survey

References

1. Ellefsdottir E., Peters A.F. (1997). High prevalence of infection by endophytic brown algae in populations of *Laminaria* spp. (Phaeophyceae). *Mar. Ecol. Prog. Ser.* 146: 135-143.
2. Pardo S. et al. (2013). *Pirrenomyces striatula*, an acornycyte endophyte, suppresses mycotoxin production in the plant pathogen *Fusarium mycelium*. *J. Mycol. Med.* 25 (2): 96-97
3. Koch, K. (1876). Untersuchungen über Bakterien. *Coblen Beitrage zur Biologie der Pflanzen* 2 (2): 277-310.

Winter meeting of the British Phycological Society in Bangor (Wales) in January 2016

Laboratory and field studies on the interaction between kelps and filamentous algal endophytes

Miriam Bernard¹, Sylvie Rousvoal¹, Laurence Dartevelle¹, Akira F. Peters², Catherine Leblanc¹

1- Sorbonne Université, UPMC Paris 6, CNRS, UMR 8227, Station Biologique de Roscoff, France
2- Bezhin Rosko, Santec, France

Introduction

The kelps *Saccharina latissima* and *Laminaria digitata* are not only important primary producers in temperate and cold northern hemisphere shores, but also economically relevant seaweeds with high industrial potential.

The filamentous endophytic brown alga *Laminariales elsbetiae* is known to invade the stipe and frond of its primary host *S. latissima*, but was also found occasionally in *L. digitata*⁽¹⁾. Few is known on the molecular mechanism and physiology of this interaction, but the presence of algal endophytes has potentially negative effects for the hosts, for instance, it was shown that endophytic red algae can reduce the growth rate of their hosts by up to 70%⁽²⁾. Endophytic infections can also lower the commercial value of seaweeds due to changes in thallus morphology, as in case of *Undaria pinnatifida* when infected with the filamentous brown algal endophyte *Laminariocolax acidoides*⁽³⁾.

To get further insight into this particular host-endophyte relationship and possible defence mechanisms we used the following methods:

- **Co-cultivation bioassay:** to monitor the impact of algal endophytes on growth of laboratory-raised individuals of *S. latissima* and *L. digitata*.
- **q-PCR based approach:** for relative quantification of the endophyte within hosts from laboratory cultures and from the field

Methods & Material

Co-cultivation Bioassay:

Laboratory-reared *S. latissima/L. digitata*

negative control

+ *Microsporangium tenuissimum* (non-infective small brown alga)

+ *L. elsbetiae*

Co-cultivation in aeriated 2l bottles in nutrient enriched natural seawater

Punched-hole method used for growth measurements

Detection of endophytes by qPCR

qPCR of a sample containing host and endophyte DNA using 2 different primer pairs:

| | |
|--|----------------------------------|
| 18S rRNA | ITS 1 |
| CG ₆₄ /CG ₆₅ | LelsITS1F2/R2 |
| Laminariales & Ectocarpales ⁽⁴⁾ | Specific for <i>L. elsbetiae</i> |

ΔC_q value is used for relative quantification

Relative quantification of endophytic filaments within *S. latissima* by qPCR

Sampling positions: 50% of the stipe length, 10/50 and 90% of the blade length

- Sampling at 4 positions along the kelp (see fig., n=120)
- Locations:
 - Perharidy (N. Brittany)
 - Locmariaquer (S. Brittany)
 - Oban (Scotland): wild population and seaweed farm
- Age (according to blade length):
 - old sporophytes
 - young sporophytes

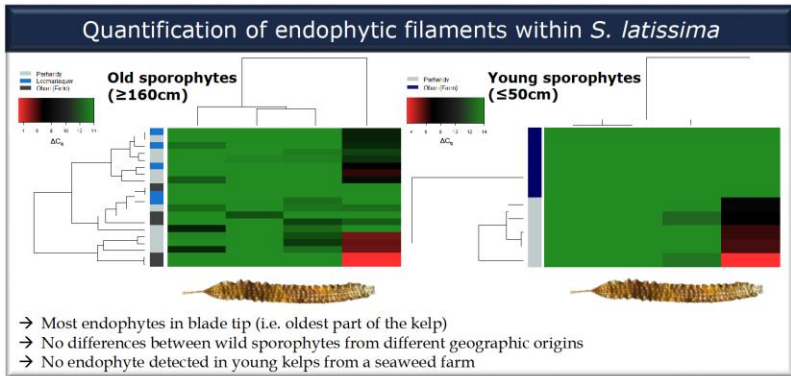
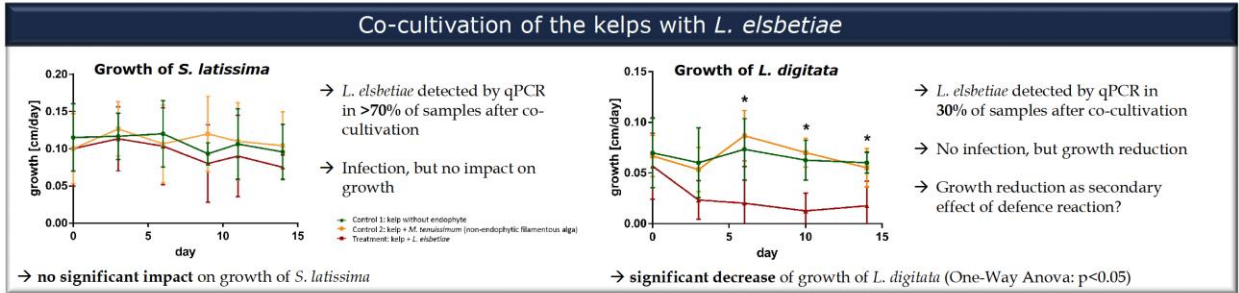

Conclusions

- I. Presence of the endophyte *L. elsbetiae* affects growth of the two hosts differently
- II. The observed growth reduction in *L. digitata* could be an indirect effect of co-cultivation
 - Investigation of metabolic and transcriptomic regulation
- III. Endophytic prevalence in *S. latissima* is highest in the blade tip, i.e. the oldest part of the kelp
- IV. Endophytic abundance is higher in wild young kelps than in young specimen from a seaweed farm
 - Early infection in nature?
 - Further collaboration with seaweed farms

1. Elbertolotti E. & Peters A.F. (1997). High prevalence of infection by endophytic brown algae in populations of *Laminaria* spp. (Phaeophyceae). *Mar. Ecol. Prog. Ser.* 146: 135-143.
 2. Apt K. (1984). Effects of the cyanobacterium *Lyngbya majuscula* on its host *Fucus macleodii* (Phaeophyceae, Gigartinales). *J. Phycol.* 20: 149-150.
 3. Yoshida T. & Akayama K. (1978). *Ströblomyces* (Phaeophyceae) infection in the frond of cultivated *Undaria* (Phaeophyceae). *Proceedings of the International Seaweed Symposium* 9: 219-223.
 4. Gachon C. et al. (2009). Detection of differential host susceptibility to the marine oomycete pathogen *Eurychorda dicksonii* by real-time PCR: Not all algae are equal. *Appl. Environ. Microbiol.* 75(2): 322-328



ALFF mid-term evaluation in Konstanz (Germany) in February 2017

Endophytes in the commercially-grown kelp *Saccharina latissima*: interactions between foes and possible friends?



Miriam Bernard, 27 years, German, SB Roscoff (France), ESR 4



Objectives

Filamentous endophytic brown algae invade stipes and fronds of kelps⁽¹⁾ with potentially negative effects for the hosts⁽²⁾ but few is known on the molecular mechanism and physiology of this interaction. Endophytic marine fungi associated to the kelp might have an antagonistic effect on colonisation of algal endophytes and help to promote kelp growth⁽³⁾. In this context, my objectives were to

- develop a sensitive method for relative quantification of the endophyte *L. elsbetiae*
- decipher the physiological molecular mechanisms of recognition and defence of the kelps against algal endophytes and test the effect of fungal extracts
- investigate diversity and host specificity of algal endophytes by molecular markers

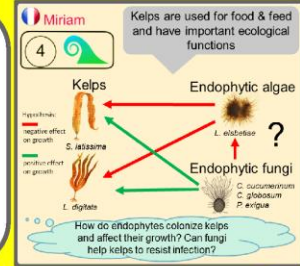

The relative quantification of endophytic infection by qPCR showed significant differences in the distribution of endophytes

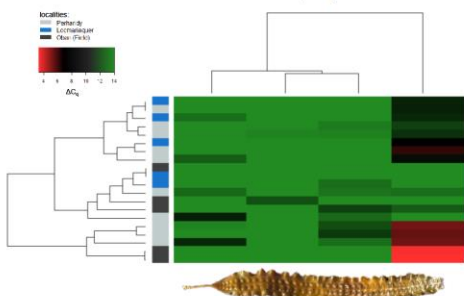

→ Most endophytes in blade tip, i.e. oldest part of the kelp

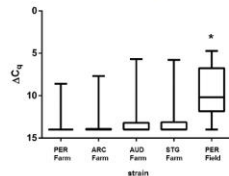

→ significantly fewer endophytes in different strains from a seaweed farm than in wild population

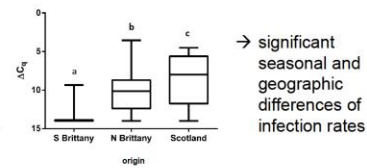
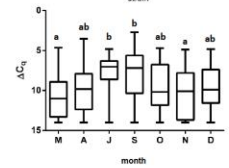

Co-cultivation with endophytes affects hosts differently

• with endophytic alga (*L. elsbetiae*):
S. latissima (main host): infection, but no impact on growth
L. digitata (occasional host): No infection, but growth reduction

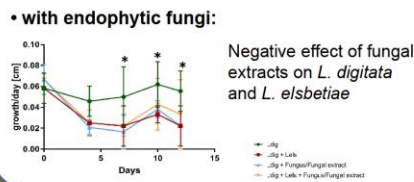

COI barcoding revealed the diversity and host specificity of filamentous endophytic brown algae

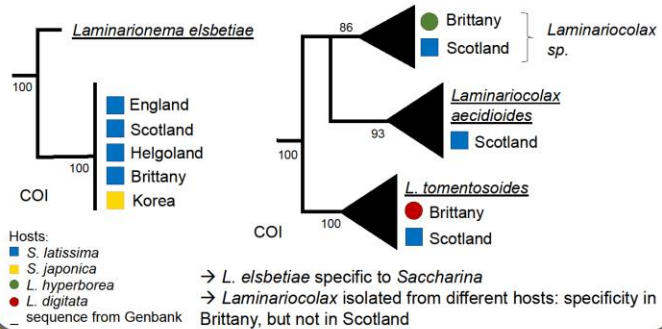

Conclusions

- I. Endophytic filaments: unequal distribution in *S. latissima* sporophytes with seasonal and geographic variation. Infection rates higher in wild kelps than in specimen from a seaweed farm → early infection in the field?
 - II. Fungal endophytes: no positive effect → future work will focus on kelp responses. *L. elsbetiae*: different effect on two hosts → Comparison of metabolic and transcriptomic regulation → balance between growth and defence?
 - III. Diversity and host specificity of kelp endophytes varies across populations
- Future plans:** Finding a postdoctoral position, preferably in the field of macroalgae and their interaction with abiotic/biotic environment

Acknowledgements & references

1. Ellertsdóttir E. & Peters A.F. (1997). High prevalence of infection by endophytic brown algae in populations of *Laminaria* spp. (Phaeophyceae). *Mar. Ecol. Prog. Ser.* 146: 135-143
 2. Apt K. (1984). Effects of the symbiotic Red Alga *Hypneocolax stellaris* on its host *Hypnea musciformis* (Hypneaceae, Gigartinales). *J. Phycol.* 20: 148-150.
 3. Prado S, Nay B, Kunz C (2015). *P. variable*, an ascomycete endophyte, suppresses mycotoxin production in the plant pathogen *Fusarium oxysporum*. *J Med Myc* 25(2): 96-97.
 This project has received funding from the European Union's Horizon 2020 research and innovation programme under the Marie Skłodowska-Curie grant agreement No 642575.
Supervisors: C. Leblanc (UMR8227, SB Roscoff) and A.F. Peters (Bezhin Rosko)
Technical support: S. Rousvoal, L. Darleville (UMR8227, SB Roscoff)
Collaborators: C. Gachon (SAMS, Oban), S. Prado (MNHN Paris), B. Jacquemin (UMI3614, SB Roscoff)

IPC 11 in Szczecin (Poland) in August 2017 and IDEALG annual meeting in Roscoff (France) in November 2017

Diversity and host specificity of kelp endophytes

Bernard Miriam¹, Darteville Laurence¹, Strittmatter Martina², Peters Akira F.³, Leblanc Catherine¹

¹ Sorbonne Universités, UPMC Univ Paris 06, CNRS, UMR 8227, Integrative Biology of Marine Models, Station Biologique de Roscoff, Roscoff, France
² The Scottish Association for Marine Sciences, Oban, UK
³ Bezhin Rosko, Santec, France

Introduction

Kelps are not only important primary producers on temperate to cold shores, but also economically relevant seaweeds with high industrial potential. Filamentous endophytic brown algae are known to invade the stipes and fronds of kelps⁽¹⁾, but few is known on the molecular mechanism and physiology of this interaction. However, the presence of algal endophytes has potentially negative effects for the hosts (see putative disease symptoms shown below). Endophytic infections can also decrease the commercial value of seaweeds due to changes in overall appearance⁽²⁾. The kelp endophytes are principally brown algae belonging to the genera *Laminariocolax* and *Laminarionema*. We have investigated their molecular diversity, host specificity and geographic distribution in wild kelp populations by sequencing the COI-5P and ITS1 regions of more than 50 endophytes isolated from 5 different kelp species. Moreover, to get further insight into the physiology of host-endophyte specific interactions, we set up an experimental design focused on growth measurements of the main host *S. latissima* and the occasional host *Laminaria digitata*⁽¹⁾ in co-cultivation with the endophyte *L. elsbetiae*.

Diversity

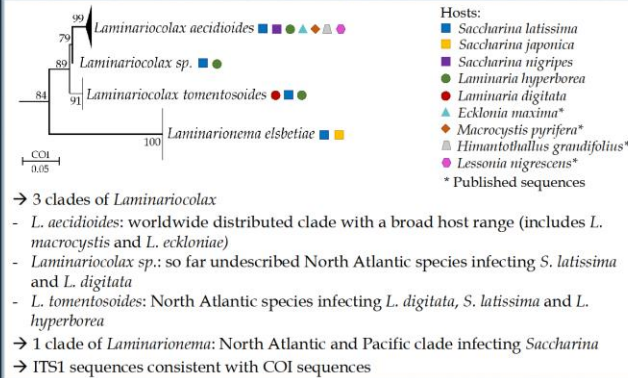

Putative disease symptoms

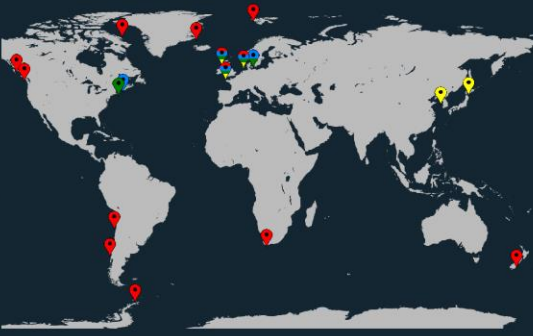

Host Specificity

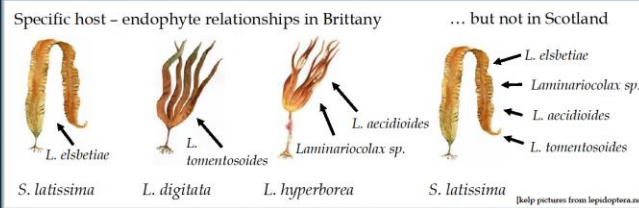

Co-cultivation in laboratory culture

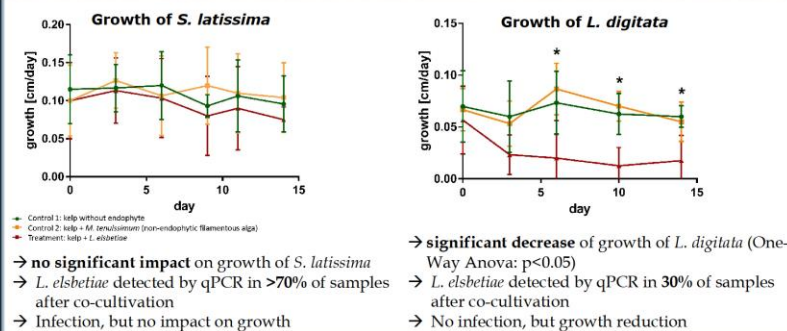

Conclusions

- I. 2 genera of brown algal kelp endophytes: *Laminariocolax*: 3 species with different distribution and host ranges
Laminarionema: 1 species, narrow host range
- II. Host specificity of kelp endophytes variable across populations: specific in Brittany, but not in Scotland
- III. Presence of the endophyte *L. elsbetiae* affects growth of the two hosts differently
- IV. Observed growth reduction in *L. digitata* an indirect effect of co-cultivation? → investigation of metabolomics and transcriptomic regulation

1. Ellertsdóttir E. & Peters A.F. (1997). High prevalence of infection by endophytic brown algae in populations of *Laminaria* spp. (Phaeophyceae). *Mar. Ecol. Prog. Ser.* 146: 135-143.
 2. Yoshida T. & Akizawa K. (1976). *Streptocima* (Phaeophyceae) infections on the frond of cultivated *Lindera* (Phaeophyceae). *Proceedings of the International Seaweed Symposium 9*, 219-223.

Acknowledgements: Dr. Svenja Heesch (SB Roscoff), Dr. Ga Youn Cho (NIBR, Korea), Dr. Inka Bartsch (AWI)



Appendix III: *Microsporgium alariae* in *Alaria esculenta*: a widely-distributed non-parasitic brown algal endophyte that shows cell modifications within its host (Murúa et al. 2018)

[Printed with the permission of WALTER DE GRUYTER GMBH & CO. KG]

DE GRUYTER

Botanica Marina 2018; aop

Pedro Murúa*, Frithjof C. Küpper, Liliana A. Muñoz, Miriam Bernard and Akira F. Peters

***Microsporgium alariae* in *Alaria esculenta*: a widely-distributed non-parasitic brown algal endophyte that shows cell modifications within its host**

<https://doi.org/10.1515/bot-2017-0095>

Received 6 November, 2017; accepted 17 May, 2018

Abstract: *Alaria esculenta* is an important kelp species in northern Europe, Atlantic Canada and USA and the Arctic, with high economic potential. *Microsporgium alariae*, a brown algal endophyte using *A. esculenta* as host, is reported for the first time from Scotland (Great Britain) and Brittany (France), suggesting a wide distribution in NW Europe. The alga was found growing epi-endophytically in *A. esculenta* stipes and was occasionally associated with warts. Isolated *Microsporgium* thalli grew in host-free cultures and formed plurilocular sporangia in a broad range of temperature and irradiance conditions. DNA barcoding using the nuclear ribosomal ITS1, the mitochondrial COI and the plastidial *rbcL* confirmed the identity of the endophyte as *M. alariae*. Electron microscopy was used to compare the alga when endophytic in *Alaria* with a host-free culture. As an endophyte, cell diameter, pyrenoid diameter and cell wall thickness were reduced. In contrast, there were more plasmodesma connections between endophyte cells, possibly to enhance nutrient transport along the endophytic thallus. In the light of this evidence, a parasitic life style is considered

unlikely for the species and the adaptive value of endophytism in *M. alariae* remains to be elucidated.

Keywords: Chordariaceae; COI; ITS1; *rbcL*; ultrastructure.

Introduction

Alaria esculenta (L.) Greville (a.k.a. winged kelp or Atlantic Wakame) is a large brown alga with populations encompassing the lowermost intertidal and the sublittoral in the northern hemisphere, where water temperatures do not exceed 16°C (Munda and Lüning 1977). It is the only species of *Alaria* in the North Atlantic. In Europe, the species is distributed in the British Isles, Faroe Islands, Iceland, Norway and the Swedish West coast, the Netherlands and France (see Guiry and Guiry 2017 and references therein). On the North American Atlantic coast, it occurs north of Cape Cod (Villalard-Bohnsack 1995), and it is a common kelp in the Arctic (Küpper et al. 2016). In addition to the significant importance of kelps to marine ecosystems (Dayton 2006), this species was used as food in the past, but currently it does not have noticeable landings in European fishery statistics (Mouritsen 2013). However, knowledge of mastering its cultivation has been substantially increased due to its use in gourmet cuisine (Chapman et al. 2015) and its potential for biofuel production (López Barreiro et al. 2015).

Like any organism, *Alaria* may be a partner in host-pathogen interactions, with so far only ascomycetes and algal endophytes being reported. Fungal symbionts in *A. esculenta* are limited to *Phycomelaina laminariae* (Rostrup) Kohlm., discovered once (Kohlmeyer 1968, Kohlmeyer and Kohlmeyer 1979). In contrast, there are several records of a brown algal endophyte infecting wild populations of *A. esculenta*. One of them corresponded to *Laminariocolax tomentosoides* (Russell 1964). The most common endophyte though is classified in the genus *Microsporgium* (Peters 2003). As facultative endophytes (concept revisited by Correa 1994) of red or brown algae, *Microsporgium* species may be found either growing as epibionts or sometimes deeply penetrating their hosts, and their presence may be associated with dark spots or areas or with deformations, such as warts, galls or twisted

*Corresponding author: Pedro Murúa, Oceanlab, University of Aberdeen, Main Street, Newburgh AB41 6AA, Scotland, UK; Aberdeen Oomycete Laboratory, International Centre for Aquaculture Research and Development, University of Aberdeen, Foresterhill, Aberdeen AB25 2ZD, UK; and The Scottish Association for Marine Science, Scottish Marine Institute, Culture Collection for Algae and Protozoa, Oban, Argyll PA37 1QA, Scotland, UK, e-mail: pedro.murua@abdn.ac.uk. <http://orcid.org/0000-0002-1598-7261>

Frithjof C. Küpper: Oceanlab, University of Aberdeen, Main Street, Newburgh AB41 6AA, Scotland, UK

Liliana A. Muñoz: Oceanlab, University of Aberdeen, Main Street, Newburgh AB41 6AA, Scotland, UK; and Aberdeen Oomycete Laboratory, International Centre for Aquaculture Research and Development, University of Aberdeen, Foresterhill, Aberdeen AB25 2ZD, UK

Miriam Bernard: CNRS, Sorbonne Université, UPMC University Paris 06, UMR 8227, Integrative Biology of Marine Models, Station Biologique de Roscoff, CS90074, 29688 Roscoff, Brittany, France
Akira F. Peters: Bezhin Rosko, 40 rue des pêcheurs, 29250 Santec, Brittany, France

thalli, the latter possibly due to the infection of the meristematic zone (Pedersen 1981, Peters 2003). *Microspogium alariae* has been found infecting *Alaria esculenta* but also other laminarean and fuclean species (Hardy and Guiry 2003, Peters 2003). *Microspogium alariae* (P.M. Pedersen) A.F. Peters was first described from Greenland by Pedersen (1981) as *Gononema alariae* P.M. Pedersen, after a reclassification from the genus *Entonema* Reinsch initially made by Jaasund (1965). It has also been recorded from Maine (USA), where it infected both *Alaria* and *Saccharina latissima* C.E. Lane, C. Mayes, Druehl and G.W. Saunders, and Tvärminne (Finland, inner Baltic Sea) where it was isolated from *Fucus* Linnaeus (Peters 2003). Using ITS1 and *rbcl* sequences, Peters (2003) classified *G. alariae* in *Microspogium* within Chordariaceae. *Microspogium alariae* has so far only been found as macroalgal endophyte in brown algae, in contrast to the closely related *M. tenuissimum* (Hauck) A.F. Peters, which was isolated from the interior of red algae (Burkhardt and Peters 1998). They have also been isolated from other substrata, viz. hydroids and pebbles and old shells, respectively (Pedersen 1981, Peters et al. 2015).

The effects of *M. alariae* on its host populations are not known. It can infect stipes and sporophylls of *A. esculenta*

(Peters 2003) often causing warts (may not always be present, authors' personal observations), and may represent a potential disturbance in both natural stocks but also in the emergent aquaculture of this kelp. Details of the cell biology and the host-pathogen interface of *M. alariae* have not yet been studied. We have recently isolated *M. alariae* from Scottish and French populations of *Alaria*. After confirmation of the pathogen's identity by DNA barcoding, thalli of this species have been used in the present work to investigate the development and the ultrastructure of the endophyte inside its natural host or as a free-living culture.

Materials and methods

Field sampling

Individuals of *Alaria esculenta* were collected in October 2014 at two localities on the Scottish coast, at (1) Bullers O'Buchan, Aberdeenshire (57° 25' 33" N, 1° 49' 6" W, North Sea), 3 m depth below the low tide, by free diving (four specimens), and (2) Seil Island, Argyll (56° 17' 26" N, 5° 38' 15" W, West coast), beach cast (three specimens) (Figure 1).

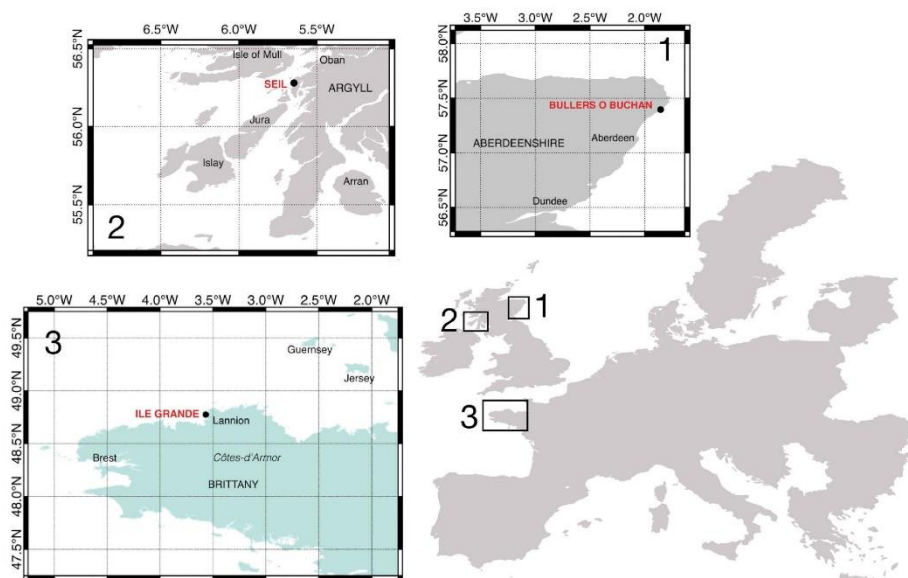

Figure 1: *Alaria esculenta* collection sites in Scotland, United Kingdom (1–2) and Brittany, France (3). Strain localities: (1) Mala CB, (2) Mala OB (CCAP 1317/1) and (3) Endo Aesc BR16-22 (CCAP 1317/2).

Additionally, an *A. esculenta* specimen from (3) the North coast of Brittany (48° 48' 13" N, 3° 35' 15" W, Ile Grande, Côtes-d'Armor) was collected in November 2016 (Figure 1). Samples were characterized by presence of dark surfaces or spots, warts or galls in stipes or fronds.

Culture studies

After confirmation of endophyte presence, raw cultures (12–18 per locality) were initiated from transverse sections of the affected areas. The cortex was removed to avoid contamination from undesirable spores or epiphytes on the host surface. The resulting medullar fragments were cultured in Provasoli-enriched autoclaved seawater (PES, Starr and Zeikus 1993) in dishes containing 8 ml medium in white fluorescent light (General Electric, 35 W) at 40 $\mu\text{mol photons m}^{-2} \text{s}^{-1}$, 12 h day^{-1} photoperiod and 12°C. After 4–6 weeks, filaments emerged from the host tissues; apical fragments of them were cut with sterile surgical blades or Pasteur pipettes with sharp edges and transferred to new dishes with fresh medium to establish clonal isolates; subcultures were grown under the same conditions. The medium in the early raw cultures was supplied with 4–6 mg l^{-1} germanium dioxide during the first month to suppress diatom growth. Following this approach, one isolate from Bullers of Buchan (Mala CB), one from Seil Island (Mala OB) and one from Ile Grande (Endo AescBR16-22) were produced. The Mala CB isolate is no longer available but the other strains were deposited at the Culture Collection of Algae and Protozoa (CCAP, The Scottish Association for Marine Science) under accessions CCAP 1317/1-2.

Subcultures were incubated at four temperatures (5, 10, 12 and 15°C) and two irradiances (60 and 5 $\mu\text{mol photons m}^{-2} \text{s}^{-1}$) measured with an irradiance meter (QSL – 2100, Biospherical Instruments, San Diego, CA, USA), in order to detect developmental or morphological differences under different light and temperature regimes.

Molecular analyses

From the strains Mala CB, Mala OB, Endo AescBR16-22 and *Microspongium radians* (Hauck) A.F. Peters (strain StraLM isolated 1988 from the red alga *Grateloupia* at Valdivia, Chile, see Burkhardt and Peters 1998), DNA was extracted using either the GeneJet™ DNA extraction kit (Thermo-Scientific) or the Nucleospin plant II kit (Macherey-Nagel, Germany), following the manufacturer's instructions, but improved by an initial CTAB buffer treatment according

to Gachon et al. (2009). Polymerase chain reactions (PCR) were performed to amplify fragments of nuclear ribosomal (ITS1, primers ITSP1 and ITSKG4, Tai et al. 2001, Lane et al. 2006), mitochondrial (5'COI, primers GazF2 and GazR2, Lane et al. 2007) and plastidial DNA regions (*rbcL*, primers *rbcL2P* and *rbcS139R*; Peters and Ramirez 2001, Kawai et al. 2007). PCRs were conducted with an initial denaturation at 94°C for 5 min, followed by 35 cycles of amplification consisting of denaturation at 94°C for 30 s, annealing at 45°C for 30 s, and elongation at 72°C for 1 min. The 35 cycles were followed by a final extension at 72°C for 5 min. Amplicons were produced in a total volume of 25 μl , containing 2 mM MgCl_2 , 1.5 μl template DNA, 1 μl of each primer at 10 mM and 21.5 μl Taq ready-mix (VWR® RedTaq, PA, USA). PCR products were commercially sequenced by the Sanger method, chromatograms checked for quality, and sequences aligned and trimmed with Geneious v11.0.03 (Kearse et al. 2012). Consensus sequences were compared to published data by means of NCBI BLAST searches (Altschul et al. 1997) and imported into Geneious, containing several members of *Microspongium* and Chordariaceae and other representative brown algal taxa, with *Ascoseiophila violodora* Peters serving as outgroup for ITS1 analyses and *Fibrocapsa japonica* S. Toriumi and H. Takano for COI and *rbcL*. MAFFT was used as automated alignment method (Kato and Standley 2013). Since ITS1 is challenging to align, in this case we first aligned the sequence manually using the areas in the ITS1 close to the SSU and the 5.8s rDNA regions (which have conservative motifs) and then applied MAFFT (Alignment view in Supplemental Figure S1). The final alignments were manually checked to ensure homology and tested by using the Randomized Accelerated Maximum likelihood method (RaxML; Stamatakis 2014) based on the General Time Reversible Model (1000 rapid bootstraps) and Bayesian inference using MrBayes V3.1.6 (Ronquist et al. 2012) (settings: chain length 2000, subsample frequency 1000, burn in of 10%). Sequences were deposited in GenBank with accession numbers MF040292–MF040299.

Light and electron microscopy

Both *Alaria esculenta* infected tissue (Argyll population) and free-floating endophyte filaments from unialgal cultures (Mala OB) were fixed in 4% paraformaldehyde dissolved in sterile seawater for light microscopy. The samples were dehydrated in an ascending ethanol series (70% and 95% for 2 h and three series of 100%, 3 h each) and defatted/cleared in 1:1 xylene:chloroform solution (three times 1 h). Then, samples were wax-infiltrated

(Cellpath®) by two immersions of 3 h. Final blocks were sectioned at 5 µm on a Leica RM2125RT microtome and stained with 0.05% toluidine blue for 15 s. Bright field and DIC micrographs were obtained from a Zeiss Axio imager D2™ microscope.

For transmission electron microscopy (TEM), similar samples (from diseased and healthy tissues) were immersed for 3 days in fixation buffer (2.5% glutaraldehyde, 0.1 M cacodylate buffer at pH 7.4, 0.5% caffeine, 0.1% CaCl₂ and 3% NaCl in Provasoli-enriched seawater, after Murúa et al. 2017). Fixed material (in EM buffer) was washed three times in 0.1 M cacodylate buffer (pH 7.4) with 0.1% CaCl₂ and 3% NaCl, stained with 1% Osmium tetroxide in distilled water, washed again twice in distilled water and dehydrated in an increasing ethanol series (30%, 50%, 70%, 95%), followed by three washes in 100% acetone. Infiltration with Spurr's resin was performed by ascending Spurr's solutions dissolved in acetone (7:1, 3:1, 1:1, 1:3, 1:6) until 100% Spurr's. Polymerization was carried out at 70°C and resulting blocks were sectioned with an ultramicrotome (Leica UC6). Final sections cut at 90 nm were stained with lead citrate (3%) and uranyl acetate (2%) and imaged with a JEM-1400 Plus (JEOL) TE microscope with an AMT UltraVue™ camera at the University of Aberdeen microscopy facility.

For the examination of living endophytes, small amounts of biomass were harvested from the cultures, incubated for 15 min in a commercial Calcofluor white (CFW, Sigma-Aldrich™, USA, Missouri) solution (0.01 mg ml⁻¹) for β-1-3 and 1-4 glucan detection in the cell wall and mounted on slides in sterile seawater or PES. Imaging was carried out either with a Zeiss Primovert inverted microscope or a Zeiss Axio imager D2™ microscope. For epifluorescence (CFW), live samples were observed with a DAPI filter (excitation: 365 nm, beam splitter: 395 nm, emission: long pass 420 nm). CFW allows the staining of the cell wall, making it easier for measuring cells.

Cell metrics

To evaluate cell ultrastructure modifications, cell morphometric measurements were calculated using FIJI (Schindelin et al. 2012) in TEM and epifluorescence images, measuring in every (up to 50) endophytic and free-living *Microsporgium* cell: cell diameter, nucleus and pyrenoid diameter, chloroplast, cell wall and mitochondrion thicknesses. If more than one organelle was present (e.g. plastids, pyrenoids and mitochondria), only the biggest was measured. In order to compare cell size differences between endophytic and free-living *M. alariae* isolates,

Mann-Whitney tests were performed. Plots were drawn using ggplot2 (Wickham 2009).

Results

Phylogenetic analyses

Our three *M. alariae* isolates had similar sequences and formed a well-supported clade using either nuclear, mitochondrial or plastidal markers, regardless of the phylogenetic method used. With ITS1 sequences all our *M. alariae* strains formed a clade together with previous *M. alariae* isolates from *Saccharina latissima* (AJ439844) and *A. esculenta* from the Northwest Atlantic (AJ439843) and from Baltic *Fucus* (AJ439845) (Figure 2). The ITS of Mala CB (MF040299) and Mala OB (MF040298) was 300–301 bp in length. Sequence identity among the five *M. alariae* sequences ranged from 94.9 to 99.7%; identities with the sequences in the sister clade (*M. tenuissimum*) were between 81.1 and 87.5%. The 5'-partial COI sequences from Mala CB (MF040293), Mala OB (MF040292) and Endo AescBr16 22 (MF040294) spanned 658 nucleotides.

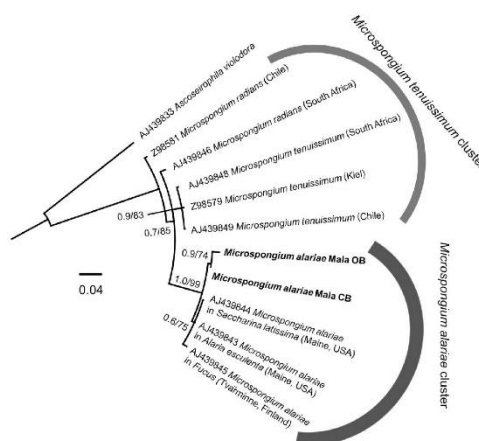

Figure 2: *Microsporgium alariae* molecular phylogeny. MrBayes cladogram of *M. alariae* and representative taxa sequences of the *Microsporgium* genus, based on the ITS1 nrDNA region. This tree contains a total of 11 sequences and 463 positions. Support values correspond to MrBayes posterior probabilities/RAxML bootstrap values. Values lower than 0.5 (or 50%) were displayed as a hyphen. The scale bar indicates the number of substitutions per site. Alignment was deposited at figshare.org (<https://doi.org/10.6084/m9.figshare.5962567.v1>).

In phylogenetic trees inferred from COI our isolates formed a clade with *M. alariae* from the NW Atlantic (LM994993), being consistently separated (genetic distance 3.0–3.4%) from a sister clade comprising *M. radians* and *M. tenuissimum*, (Supplemental Figure S2). In phylogenetic inferences using *rbcl* (Supplemental Figure S3), sequences from our isolates were 1391 bp in length. Mala CB (MF040297) and Mala OB (MF040296) formed a clade together with *Microspongium tenuissimum* and *M. globosum*. As in the COI tree, the *Microspongium* clade was nested in the Chordariaceae.

Microscopy

The surface of *A. esculenta* stipes and blades was smooth in uninfected areas but it had a “velvety” texture in zones with warts and dark spots (Figure 3a and b). Cross sections of such zones demonstrated the presence of heavily infected tissue with a thickening and disorganization of the outer layers (Figure 3d) in comparison to homogeneous healthy tissue (Figure 3c), in which different tissue layers were well-delimited. The irregular arrangement of the diseased host tissues made it difficult to discern the meristoderm-cortex boundary (which was evident in healthy kelps) and the host-pathogen interface. External filaments of *M. alariae* protruding from the host were uniseriate (average length of 45 μm but could reach up to 80 μm) and unbranched (Figure 3e), and consisted of regular, cylindrical cells (10–15 μm length). Some filaments were shorter (about 25 μm), consisted of cells of ca. 5 μm length and represented emerging plurilocular sporangia (Figure 3e).

Internal endophytic filaments were also uniseriate and penetrated deeply into the cortex, often reaching the medullary tissue (Figure 3f). In TEM, endophytic cells were discernible from those of the host by their smaller diameter, position in the interstitium of the host tissue and the organelle composition, in particular well-developed plastids (Figure 3g–j). They were devoid of physodes, in contrast to meristoderm and cortical cells of *A. esculenta* (Figure 3g). Endophytic *M. alariae* cells were 7–12 μm long and 4–7 μm in width, and followed a uniseriate growth from the surface to inner areas of the host tissue (usually perpendicular to the surface). Sometimes, however, this orientation suddenly changed, and the filaments were able to separate adjacent host cells, causing deformations of the latter (Figure 3h). The progress of the filaments was sometimes visualized with a disruption in the intercellular space separated by up to 3 μm from the tip of the endophyte (Figure 3h). Cross and

longitudinal sections of the filaments also showed small pyrenoids (median = 800 nm; Figure 3h, inset), and small nucleus surrounded by parietal plastids (Figure 3i). Cell walls were up to ca. 200 nm in width. Endophytic adjacent cells almost always shared plasmodesma connections (Figure 3g and i). Plasmodesmata were occasionally seen between neighboring host cells as well, but not in host-endophyte interfaces.

The endophyte was able to grow without host in our laboratory conditions; in contrast, the co-inoculated host cells did not develop. Between 1 and 2 months were needed to observe the first filaments overgrowing the host medulla fragment (Figure 4a). After excision, the few-celled endophyte filaments remained uniseriate, branched and formed disorganized thalli of 1–2 mm in diameter (Figure 4b). Ultrastructure of free-floating filaments revealed that the cells were larger than in endophytic filaments (Figure 4c–e). Vegetative filaments usually consisted of squared to rectangular cells of 9 μm \times 5 μm on average (Figure 4f), and were positive for CFW (Figure 4g). Plastids were disk-like, often showing a convex appearance (Figure 4g). We observed nuclei of 2 μm diameter, often with a nucleolus, 1–4 large convex plastids of up to 4 μm in length, several mitochondria (ca. 200–300 nm thick) and pyrenoids (>1 μm in diameter) associated with plastids. Cell walls were 500 nm or thicker, frequently with an additional outer cell wall layer of 0.5–1 μm (Figure 4e). Plasmodesmata were not seen.

Plurilocular sporangia were uniseriate and up to 150 μm long (90 μm on average, Figure 4h). All filaments reached fertility at 5°C and 5 $\mu\text{mol photons m}^{-2} \text{s}^{-1}$, with formation of many plurilocular sporangia in the outer area of the mass of filaments (up to 45 per thallus of 1 mm). The thalli also became reproductive under higher temperatures (12°C and 15°C) and irradiance (60 $\mu\text{mol photons m}^{-2} \text{s}^{-1}$), however the formation of plurilocular sporangia was reduced to a few small sporangia (no more than five per 1 mm filament of 25–40 μm , not shown) per filament. Zoospores were released two weeks after transfer of filaments to new dishes, they were approximately 5 μm in diameter and contained a long anterior and a short posterior flagellum (Figure 4i). Spore release lasted a few minutes and required the compression of the spore to less than 50% of its width in order to pass through the 2 μm sporangium exit orifice (Figure 4i).

Cell metrics in *Microspongium* revealed some quantifiable cellular re-arrangements after endophytic habitus (Figure 5). The cell diameter was significantly reduced, being shrunk by 30% inside *Alaria* tissue. Pyrenoid diameters did not surpass 1.5 μm in endophytic *Microspongium*, which was significantly smaller than

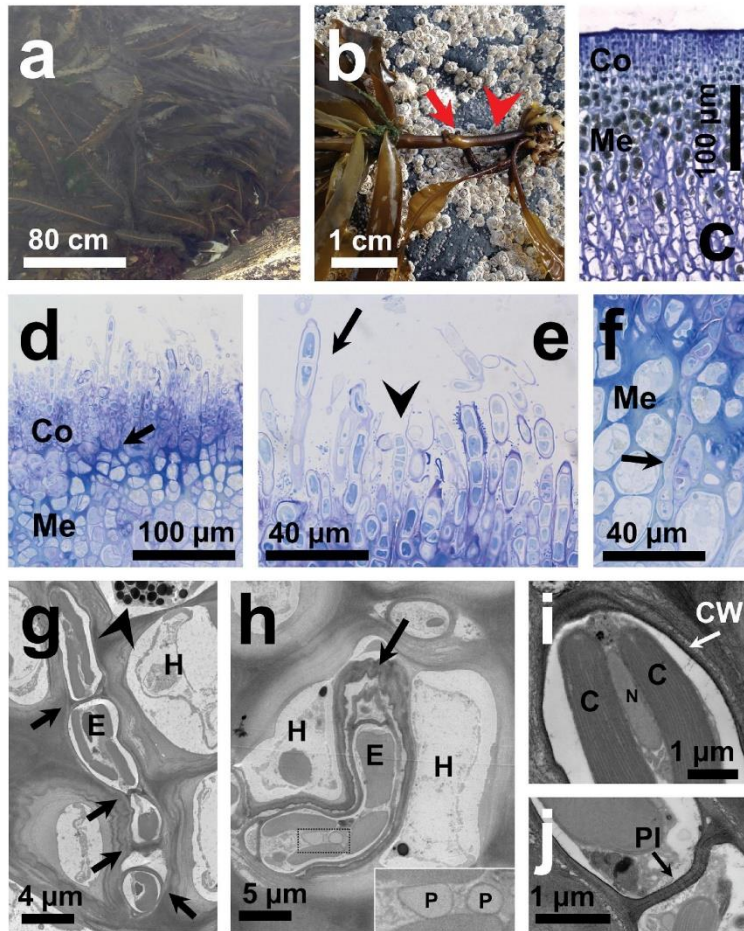

Figure 3: Morphology of the endophytic *Microspongium alariae* (Mala OB) in *Alaria esculenta* from Seil Island, Argyll (Scottish West coast). (a) Population of the host, showing healthy fronds without signs of infection. (b) Host stipe (*A. esculenta*) pointing out warts containing *M. alariae* epi-endobionts (arrow) and a healthy stipe area (arrowhead). (c) Cross section of an uninfected *A. esculenta* stipe. (d) Cross section showing external filaments of *M. alariae* and internal organization of infested *A. esculenta* tissue. Arrow: cortex-medulla transition. (e) *M. alariae* external filaments above the host surface (arrow) and a putative plurilocular sporangium (arrowhead). (f) Endophytic filament of *M. alariae* reaching the medulla (arrow) of *A. esculenta*. (g–j) Transmission electron microscopy of the infected host: (g) Longitudinal section through the host cortex showing a *M. alariae* endophytic filament and a typical host cell (arrows: plasmodesmata, arrowhead: host physodes). (h) *M. alariae* changing orientation, separating two neighbor host cells. Arrow indicates a disruption zone. Inset: pyrenoids of an endophytic *Microspongium* cell. (i) Cross section of an endophytic *M. alariae* cell indicating the cell nucleus, plastids and a thin cell wall (arrow). (j) Magnification of two neighboring endophyte cells showing interconnection by plasmodesmata (arrow). Co, cortex; Me, medulla; E, endophyte (*M. alariae*); H, host (*A. esculenta*); C, endophyte chloroplast; N, endophyte nucleus; CW, endophyte cell wall; P, pyrenoids; Pl, endophyte plasmodesmata.

in free-living cells. Cell wall thickness was probably the most altered cell feature, being reduced to less than 400 nm (median = 275 nm), equivalent to a ca. 4–5-times

shrinkage. Other organelles such as plastids, mitochondria and nuclei did not present significant size modifications.

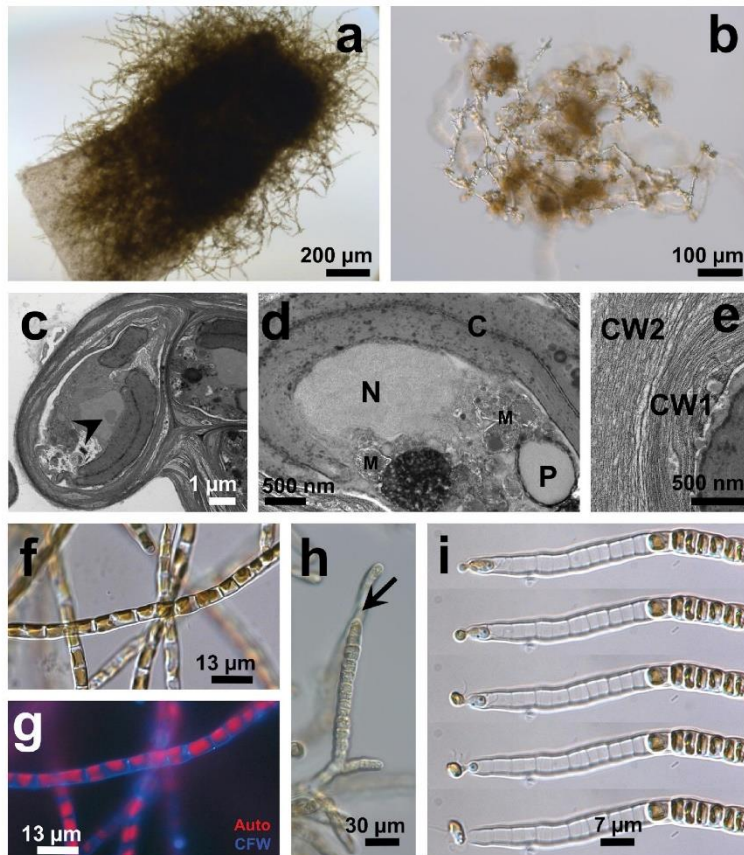

Figure 4: *Microspongium alariae* (Mala OB) in culture.

(a) Outgrowth of *M. alariae* filaments from an *A. esculenta* medullar cross section. (b) Mass of disorganized branched filaments of a *M. alariae* clonal isolate in unialgal culture. (c–e) Ultrastructure of free-floating *M. alariae* filaments: (c) Typical *M. alariae* cell from a free-floating filament (arrowhead: nucleolus). (d) Magnification of a *M. alariae* cell indicating cell nucleus (N), plate-shape chloroplasts (C), mitochondria (M), and one pyrenoid (P). (e) Magnification of the *M. alariae* outer part of the cell indicating the initial cell wall (CW1) and a new polymerized cell wall component (CW2). (f and g) Magnification of a single filament of *M. alariae* under bright field and epifluorescence microscopy. Auto, chlorophyll autofluorescence; CFW, calcofluor white. (h) Uniseriate plurilocular sporangium (arrow). (i) Sequence of the release of a zoospore of *M. alariae* from a plurilocular sporangium.

Discussion

Both morphology and DNA sequences confirmed that *Microspongium alariae* is one of the endobionts associated with warts in the brown alga in *Alaria esculenta*. This species was first described by Pedersen (1981) (as *Gononema alariae*) using unialgal isolates from Greenland (obtained from non-endophytic material). Our endophytes also had uniseriate branched filaments with

diffuse growth, disc-shaped chloroplasts, developed uniseriate plurilocular sporangia at 4–15°C, unipolar germination and lacked unilocular sporangia, as described by Pedersen (1981). Peters (2003) also described phaeophycean hairs, which were not observed in our study. It is unclear whether genetics or different culture media or protocols used in this study were responsible for their lack in our isolates. In phylogenetic analyses based on ITS1, COI and *rbcL*, the new isolates from western Europe clustered

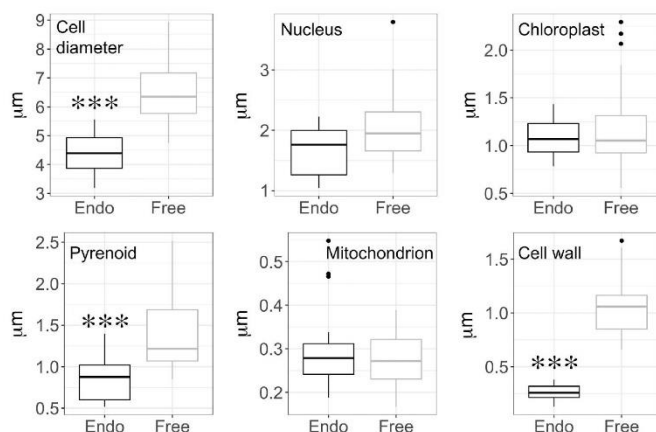

Figure 5: Cellular reductions in endophytic *Microspongiium*.

Endo: endophytic. Free: free-floating *M. alariae*. Arrowheads indicate the organelle/cell structure quantified in every sampling ($n=7-50$). Boxes show median (horizontal line) ± 1.5 times the interquartile range (whiskers). Black dots represent deemed outliers. Asterisks on bars were used to designate statistical differences (Mann-Whitney-Wilcoxon rank-sum test), where ***: $p < 0.001$.

with *M. alariae* from the NW Atlantic and the inner Baltic. The information presented here, therefore, corresponds to the first records of this species from Britain and France.

According to our molecular data, the isolates of *M. tenuissimum* and *M. radians*, which together formed the sister clade of *M. alariae*, are conspecific. Their COI sequences showed 100% identity (BLAST). The species-level cut-off in COI in Ectocarpales lies at approximately 1.8% sequence divergence (Peters et al. 2015). In the more variable ITS1, the two taxa differed only by a 29-bp long indel in the highly variable first part, which in our analyses did not place them in different clades. Both species occur in red algal hosts (Table 1). In conclusion, the two taxa should be merged, with *M. tenuissimum* (Hauck 1884) having priority over *M. radians* (Howe 1914).

Morphological traits do hardly allow to distinguish *M. alariae* and *M. tenuissimum/radians* but they differ in their global distribution and in particular in their hosts (Table 1). Characters typically used to separate species like presence of phaeophycean hairs seem to be plastic in *Microspongiium*, since material barcoded as *M. alariae* in different studies (Peters 2003; this study) may or may not develop hairs. In these species of *Microspongiium* only one generation is known. If they are involved in a more complex life cycle, a possibly existing second generation might reveal differences to separate them morphologically at specific level.

Our results suggest that the endophytic behavior of *M. alariae* is associated with gall development in

A. esculenta, since many galls contained well-developed endophytic filaments that led to *M. alariae* emergence when excised and cultivated. Typically, galls in *A. esculenta* were characterized by hyperplasia and hypertrophy, with a disorganized cortex and medulla development and no clear host/pathogen differentiation in the cortical zone. A complex *M. alariae* endophytic network was also conspicuous in the host medullary tissue. Gall formation has been related to biotic (virus, bacteria, fungal and algal endophytes, animals) or abiotic factors (e.g. carcinogenic compounds) (Apt 1988). In our study, no EM-based evidence of additional gall-triggering factors has been found. However, to confirm the pathogenic nature of *M. alariae* through Koch's postulates (Koch 1882), reinfection of healthy *A. esculenta* in controlled conditions and observation of symptoms would be required.

Cellular modifications appear to represent common adaptations to an endophytic habit within different algal lineages. Several endophytic algal parasites evolved to presumed simpler morphologies, smaller sizes and lower pigmentation levels in comparison to their free-living sister species (Goff 1979, Salomaki and Lane 2014). Algal parasites often also lack plastids and mitochondria or have reduced versions of them. Thus, most of them are biotrophic, i.e. they cannot be propagated without a proper host. In our case, endophytic cells of *M. alariae* were 25–50% smaller than in free-living culture, accompanied by a decrease in the nuclear volume (15–20%) and cell wall thickness (40–60%), as well as reduction

Table 1: Comparison of morphological characters of *Microspongium alariae* with *M. tenuissimum*.

| | <i>Microspongium alariae</i> | <i>Microspongium tenuissimum</i> |
|------------------------------------|--|---|
| Habitus | Epi-endophytic (a) (b)/epilithic (c) | Epi-endophytic (a) (d)/epilithic (e) |
| Macroscopic appearance in the host | Warts, dark spots, felt-like cover, galls or twisted host thallus (b). May be asymptomatic (a) | Dark spots and lesions (d). May be asymptomatic (a) |
| Thallus organization | Microscopic uniseriate branched filaments, diffuse growth (b) (c) | Microscopic uniseriate branched filaments (d) |
| Phaeophyceae hairs | May be present (b) (c) | May be present (d) |
| Plastids | Disc-shaped chloroplasts (c), may be slightly convex (b) | Subcuneate, or somewhat discoid, may be confluent or single (d) |
| Plurilocular sporangia | Uniseriate (b) (c) | Uniseriate (d) |
| Unilocular sporangia | Not reported | Not reported |
| Life history | Direct (only one generation known) (b) (c) | Direct (only one generation known) (d) |
| Geographic distribution | Temperate and polar ecosystems in the northern hemisphere (a) (b) (c) | Cosmopolitan in temperate waters (a) (d) (f) |
| Hosts | <i>Alaria esculenta</i> (a) <i>Saccharina latissima</i> (a) <i>Fucus vesiculosus</i> (a) | <i>Mazzaella laminarioides</i> (Bory de Saint-Vincent) Fredericq (a) <i>Pachymenia (Aeodes) orbitosa</i> (Suhr) L.K. Russell (a) <i>Grateloupia cutleriae</i> Kützing (d) <i>Grateloupia doryphora</i> (Montagne) M. Howe (a) (f) <i>Glaphyrosiphon chilensis</i> M.E. Ramírez, Leister and P.W. Gabrielson (a) <i>Polysiphonia elongata</i> (Hudson) Sprengel (f) |

The latter includes *M. radians* (see Discussion section). (a) Peters (2003), (b) This study, (c) Pedersen (1981), (d) Howe (1914), (e) Peters et al. (2015), (f) Burkhardt and Peters (1998).

of plastids in both number and size. Disappearance of the mucilaginous extracellular matrix was also evident. This size and complexity reduction could enhance the penetration of host tissue or reduce the drag forces (friction), minimizing the damage to/by the host or, alternatively, could be just a consequence of being relieved from external pressures (e.g. desiccation, further biotic interactions). Similar observations were made in the brown alga *Herpodiscus durvilleae* (Lindauer) G.R. South, where internal cells were narrower (sometimes squeezed) than external filament cells and host penetration was likely led by apical cells (Heesch et al. 2008). Once endophytic, plastids of this parasitic species are reduced dramatically, however a functional *rbcL* sequence was detected as well as plastid autofluorescence in the epiphytic and presumably autotrophic gametophyte generation (Heesch 2005).

According to Blouin and Lane (2012), there is no record of algal parasites that do not develop secondary pit connections (or their analogs) with the host for the acquisition of nutrients. This supposition has been confirmed not only for red algal but also for green and brown algal parasites (Heesch 2005). In our case, plasmodesmata were not developed in the *A. esculenta*–*M. alariae* interface, suggesting that the relationship of *M. alariae* with its host

is not parasitic. In addition, endophytic cells of *M. alariae* always contained plastids, ensuring autotrophy. Plasmodesma formation between *M. alariae* endophytic cells may represent a means to improve nutrient translocation along the endophyte filament. Endophytism of *M. alariae* may have evolved as protection against herbivory, competition or detachment, or sudden environmental changes such as desiccation.

A spatial separation of the endophytic filament from the starting point of disruption in the host tissue (Figure 3h) is suggestive of an enzymatic action that allows to penetrate into the intercellular space, possibly through hydrolysis of the polysaccharide matrices of the host. An enzymatic dissolution of host cell wall components by germinating zoospores has been suggested for *Laminariocolax aecidioides* (Rosenvinge) A.F. Peters and *Laminarionema elsbetiae* Kawai et Tokuyama because of the sharp edges around the entrance holes and the absence of inward deformation of the host and for some red algal parasites and epiphytes with some extent of host penetration (Heesch and Peters 1999, Leonardi et al. 2006 and references therein). It would be interesting to investigate the carbohydrate-modifying enzymes of the endophytes, which appear to facilitate a selective degradation of the host cell walls.

World-wide seaweed aquaculture has been increasing at a rate of 8% annually (Loureiro et al. 2015). However, its world-wide, large-scale commercial development has been delayed in many countries by emerging pests and pathogen outbreaks that can affect the desirable yield and quality of the biomass (Araújo et al. 2014) and more indirectly prevent competitive profit by increasing costs and inhibiting investment (Gachon et al. 2010, Westermeier et al. 2011). This situation may be worsened by global warming effects, which could have direct consequences on the prevalence of endophytes and other pathogens, possibly modifying host fitness and endophyte virulence (Eggert et al. 2010). *Alaria esculenta* is currently cultivated in Europe and in North America (Barrington et al. 2009). We found that *M. alariae* is a common endophyte of *A. esculenta*, which was present even in the population in Brittany, near the southern distribution limit of *Alaria*. Additional epidemiological data will be required to estimate whether the infection could represent an important bottleneck for *Alaria* aquaculture.

Acknowledgements: We greatly appreciated field assistance by Martina Strittmatter (SAMS), Françoise Duchemin and Elodie Gahinet (ALEOR) for sampling at Seil Island and Ile Grande, respectively, technical support during laboratory experiments by Dawn Shewring (Oceanlab) and Debbie Wilkinson (Aberdeen Microscopy Facility), and comments from Aldo Asensi regarding TEM. PM was funded by Conicyt (BecasChile no. 41972130422) for PhD studies at the University of Aberdeen, and by the NERC IOF Pump-priming (GlobalSeaweed, scheme NE/L013223/1) for activities at the Scottish Association for Marine Sciences. Endophyte isolation and identification in Brittany was facilitated by the projects IDEALG (France: ANR-10-BTBR-04) and ALFF, respectively. This project has received funding from the European Union's Horizon 2020 research and innovation program under the Marie Skłodowska-Curie grant agreement number 624575. We are also grateful for funding from the MASTS pooling initiative (The Marine Alliance for Science and Technology for Scotland). MASTS is funded by the Scottish Funding Council (grant reference HR09011) and contributing institutions.

References

- Altschul, S.F., T.L. Madden, A.A. Schäffer, J. Zhang, Z. Zhang, W. Miller and D.J. Lipman. 1997. Gapped BLAST and PSI-BLAST: a new generation of protein database search programs. *Nucleic Acids Res.* 25: 3389–3402.
- Apt, K.E. 1988. Galls and tumor-like growths on marine macroalgae. *Dis. Aquat. Organ.* 4: 211–217.
- Araújo, P.G., É.C. Schmidt, M.G. Kreusch, C.H. Kano, S.M.P.B. Guimarães, Z.L. Bouzon, M.T. Fujii and N.S. Yokoya. 2014. Ultrastructural, morphological, and molecular characterization of *Colaconema infestans* (Colaconematales, Rhodophyta) and its host *Kappaphycus alvarezii* (Gigartinales, Rhodophyta) cultivated in the Brazilian tropical region. *J. Appl. Phycol.* 26: 1953–1961.
- Barrington, K., T. Chopin and S. Robinson. 2009. Integrated multi-trophic aquaculture (IMTA) in marine temperate waters. FAO Fisheries and Aquaculture Technical Paper. No. 529. In: (D. Soto, ed) *Integrated mariculture: a global review*. FAO, Rome. pp. 7–46.
- Blouin, N.A. and C.E. Lane. 2012. Red algal parasites: models for a life history evolution that leaves photosynthesis behind again and again. *BioEssays* 34: 226–235.
- Burkhardt, E. and A.F. Peters. 1998. Molecular evidence from nrDNA ITS sequences that *Laminariocolax* (Phaeophyceae, Ectocarpales sensu lato) is a worldwide clade of closely related kelp endophytes. *J. Phycol.* 34: 682–691.
- Chapman, A.S., P. Stévant and W.E. Larssen. 2015. Food or fad? Challenges and opportunities for including seaweeds in a Nordic diet. *Bot. Mar.* 58: 423–433.
- Correa, J.A. 1994. Infections by pigmented algal endophytes: misuse of concepts and terminology. *Rev. Chil. Hist. Nat.* 67: 5–8.
- Dayton, P.K. 2006. Ecology of Kelp Communities. *Annu. Rev. Ecol. Syst.* 16: 1–33.
- Eggert, A., A.F. Peters and F.C. Küpper. 2010. The potential impact of climate change on endophyte infections in kelp sporophytes. In: (A. Israel, R. Einav and J. Seckbach, eds) *Seaweeds and their role in globally changing environments*. Springer Netherlands, Amsterdam. pp. 139–154.
- Gachon, C.M.M., M. Strittmatter, D.G. Müller, J. Kleinteich and F.C. Küpper. 2009. Detection of differential host susceptibility to the marine oomycete pathogen *Eurychasma dicksonii* by real-time PCR: not all algae are equal. *Appl. Environ. Microbiol.* 75: 322–328.
- Gachon, C.M.M., T. Sime-Ngando, M. Strittmatter, A. Chambouvet and G.H. Kim. 2010. Algal diseases: spotlight on a black box. *Trends Plant Sci.* 15: 633–640.
- Goff, L.J. 1979. The Biology of *Harveyella mirabilis* (Cryptonemiales, Rhodophyceae). Vi. Translocation of Photoassimilated ¹⁴C₂. *J. Phycol.* 15: 82–87.
- Guiry, M.D. and G.M. Guiry. 2017. *Alaria esculenta*. AlgaeBase. World-wide Electron. Publ. Natl. Univ. Ireland, Galw. Searched on the 29th September 2017.
- Hardy, G. and M.D. Guiry. 2003. *A check-list and atlas of the seaweeds of Britain and Ireland*. British Phycological Society, London. p. 421.
- Hauck, F. 1884. Die Meeresalgen Deutschlands und Österreichs. In: (L. Rabenhorst, ed) *Kryptogamen-Flora von Deutschland, Österreich und der Schweiz, Zweite Auflage*. Eduard Kummer, Leipzig. pp. 321–512.
- Heesch, S. 2005. Endophytic Phaeophyceae from New Zealand. PhD Thesis, University of Otago, Dunedin. pp. 365.
- Heesch, S. and A.F. Peters. 1999. Scanning electron microscopy observation of host entry by two brown algae endophytic in *Laminaria saccharina* (Laminariales, Phaeophyceae). *Phycol. Res.* 47: 1–5.
- Heesch, S., A.F. Peters, J.E. Broom and C.L. Hurd. 2008. Affiliation of the parasite *Herpodiscus durvillaeae* (Phaeophyceae) with

- the Sphacelariales based on DNA sequence comparisons and morphological observations. *Eur. J. Phycol.* 43: 283–295.
- Howe, M.A. 1914. The marine algae of Peru. *Mem. Torrey Bot. Club* 15: 1–185.
- Jaasund, E. 1965. Aspects of the marine algal vegetation of North Norway. *Bot. Gothobg.* 4: 1–174.
- Katoh, K. and D.M. Standley. 2013. MAFFT multiple sequence alignment software version 7: improvements in performance and usability. *Mol. Biol. Evol.* 30: 772–780.
- Kawai, H., T. Hanyuda, S.G.A. Draisma and D.G. Müller. 2007. Molecular phylogeny of *Discosporangium mesarthrocarpum* (Phaeophyceae) with a reinstatement of the order Discosporangiales. *J. Phycol.* 43: 186–194.
- Kearse, M., R. Moir, A. Wilson, S. Stones-Havas, M. Cheung, S. Sturrock, S. Buxton, A. Cooper, S. Markowitz, C. Duran, T. Thiery, B. Ashton, P. Meintjes and A. Drummond. 2012. Geneious basic: an integrated and extendable desktop software platform for the organization and analysis of sequence data. *Bioinformatics* 28: 1647–1649.
- Koch, R. 1882. Die Aetiologie der Tuberculose (Nach einem in der physiologischen Gesellschaft zu Berlin am 24. März cr. gehaltenen Vortrage). *Berl. Klin. Wochenschr.* 19: 221.
- Kohlmeyer, J. 1968. Revisions and descriptions of algicolous marine fungi. *Phytopathol. Zeitschrift* 63: 341–363.
- Kohlmeyer, J. and E. Kohlmeyer. 1979. *Marine mycology: the higher fungi*. Academic Press, London.
- Küpper, F.C., A.F. Peters, D.M. Shewring, M.D.J. Sayer, A. Mystikou, H. Brown, E. Azzopardi, O. Dargent, M. Strittmatter, D. Brennan, A.O. Asensi, P. van West and R.T. Wilce. 2016. Arctic marine phytobenthos of northern Baffin Island. *J. Phycol.* 52: 532–549.
- Lane, C.E., C. Mayes, L.D. Druehl and G.W. Saunders. 2006. A multi-gene molecular investigation of the kelp (Laminariales, Phaeophyceae) supports substantial taxonomic re-organization. *J. Phycol.* 42: 493–512.
- Lane, C.E., S.C. Lindstrom and G.W. Saunders. 2007. A molecular assessment of northeast Pacific *Alaria* species (Laminariales, Phaeophyceae) with reference to the utility of DNA barcoding. *Mol. Phylogenet. Evol.* 44: 634–648.
- Leonardi, P.L., A.B. Miravalles, S. Faugeron, V. Flores, J. Beltrán and J.A. Correa. 2006. Diversity, phenomenology and epidemiology of epiphytism in farmed *Gracilaria chilensis* (Rhodophyta) in northern Chile. *Eur. J. Phycol.* 41: 247–257.
- López Barreiro, D., M. Beck, U. Hornung, F. Ronsse, A. Kruse and W. Prins. 2015. Suitability of hydrothermal liquefaction as a conversion route to produce biofuels from macroalgae. *Algal Res.* 11: 234–241.
- Loureiro, R., C.M.M. Gachon and C. Rebours. 2015. Seaweed cultivation: potential and challenges of crop domestication at an unprecedented pace. *New Phytol.* 206: 489–492.
- Mouritsen, O.G. 2013. *Seaweeds: edible, available and sustainable*. The University of Chicago Press, Chicago. p. 287.
- Munda, I.M. and K. Lüning. 1977. Growth performance of *Alaria esculenta* off Helgoland. *Helgoländer wiss. Meeresunters* 29: 311–314.
- Murúa, P., F. Goecke, R. Westermeier, P. van West, F.C. Küpper and S. Neuhauser. 2017. *Maullinia braseltonii* sp. nov. (Rhizaria, Phytomyxea, Phagomyxida): a cyst-forming parasite of the bull kelp *Durvillaea* spp. (Stramenopila, Phaeophyceae, Fucales). *Protist* 168: 468–480.
- Pedersen, P.M. 1981. The life histories in culture of the brown algae *Gononema alariae* sp. nov. and *G. acidiodides* comb. nov. from Greenland. *Nord. J. Bot.* 1: 263–270.
- Peters, A.F. 2003. Molecular identification, distribution and taxonomy of brown algal endophytes, with emphasis on species from Antarctica. *Proc. 17th Int. Seaweed Symp.* 302: 293–302.
- Peters, A.F. and M.E. Ramírez. 2001. Molecular phylogeny of small brown algae, with special reference to the systematic position of *Caepidium antarcticum* (Adenocystaceae, Ectocarpales). *Cryptogam. Algol.* 22: 187–200.
- Peters, A.F., L. Couceiro, K. Tsiamis, F.C. Küpper and M. Valero. 2015. Barcoding of cryptic stages of marine brown algae isolated from incubated substratum reveals high diversity in Acinetosporaceae (Ectocarpales, Phaeophyceae). *Cryptogam. Algol.* 36: 3–29.
- Ronquist, F., M. Teslenko, P. Van Der Mark, D.L. Ayres, A. Darling, S. Höhna, B. Larget, L. Liu, M.A. Suchard and J.P. Huelsenbeck. 2012. MrBayes 3.2: efficient bayesian phylogenetic inference and model choice across a large model space. *Syst. Biol.* 61: 539–542.
- Russell, G. 1964. *Laminariocolax tomentosoides* on the Isle of Man. *J. Mar. Biol. Assoc. United Kingdom* 44: 601.
- Salomaki, E.D. and C.E. Lane. 2014. Are all red algal parasites cut from the same cloth? *Acta Soc. Bot. Pol.* 83: 369–375.
- Schindelin, J., I. Arganda-Carreras, E. Frise, V. Kaynig, M. Longair, T. Pietzsch, S. Preibisch, C. Rueden, S. Saalfeld, B. Schmid, J.-Y. Tinevez, D.J. White, V. Hartenstein, K. Eliceiri, P. Tomancak and A. Cardona. 2012. Fiji: an open-source platform for biological-image analysis. *Nat. Methods* 9: 676–682.
- Stamatakis, A. 2014. RAxML version 8: a tool for phylogenetic analysis and post-analysis of large phylogenies. *Bioinformatics* 30: 1312–1313.
- Starr, R.C. and J.A. Zeikus. 1993. UTEX-the culture collection of algae at the University of Texas at Austin 1993. List of cultures. *J. Phycol.* 29: 1–106.
- Tai, V., S.C. Lindstrom and G.W. Saunders. 2001. Phylogeny of the Dumontiaceae (Gigartinales, Rhodophyta) and associated families based on SSU rDNA and internal transcribed spacer sequence data. *J. Phycol.* 37: 184–196.
- Villalard-Bohnsack, M. 1995. *Illustrated key to the seaweeds of New England*. The Rhode Island Natural History Survey, Kingston. p. 144.
- Westermeier, R., D.J. Patiño, P. Murúa and D.G. Müller. 2011. *Macrocystis mariculture in Chile: growth performance of heterosis genotype constructs under field conditions*. *J. Appl. Phycol.* 23: 819–825.
- Wickham, H. 2009. *ggplot2*. Springer-Verlag New York, New York.

Supplemental Material: The online version of this article offers supplementary material (<https://doi.org/10.1515/bot-2017-0095>).

Bionotes



Pedro Murúa
Oceanlab, University of Aberdeen, Main Street, Newburgh AB41 6AA, Scotland, UK; Aberdeen Oomycete Laboratory, International Centre for Aquaculture Research and Development, University of Aberdeen, Foresterhill, Aberdeen AB25 2ZD, UK; and The Scottish Association for Marine Science, Scottish Marine Institute, Culture Collection for Algae and Protozoa, Oban, Argyll PA37 1QA, Scotland, UK, pedro.murua@abdn.ac.uk, <http://orcid.org/0000-0002-1598-7261>

Pedro Murúa is a former research associate at the Instituto de Acuicultura de la Universidad Austral de Chile (UACh), where he worked on various aspects of seaweed biology, particularly kelp ecology and mariculture. Pedro got his PhD at the University of Aberdeen in 2018. During his postgraduate studies, Pedro worked on the characterization of new algal pathosystems from cell and molecular biology perspectives. Currently, Pedro is a postdoctoral research assistant in molecular algal pathology, Scottish Association for Marine Science.



Frithjof C. Küpper
Oceanlab, University of Aberdeen, Main Street, Newburgh AB41 6AA, Scotland, UK

Frithjof C. Küpper has held the Chair in Marine Biodiversity at the University of Aberdeen (Oceanlab) since 2011. Over the past 27 years, he has studied the biodiversity and biochemistry of marine plants/algae – especially abiotic and biotic stress. He conducted graduate studies at Roscoff and Konstanz for a joint French-German PhD. His research resulted in the finding of iodide serving as an inorganic antioxidant in kelp, the first described from a living system, impacting atmospheric and marine chemistry. A certified scientific diver, Frithjof has worked extensively in the Eastern Mediterranean, South Atlantic (Ascension and Falkland Islands), but also in the Antarctic Peninsula and the Canadian Arctic for algal diversity-related projects.



Liliana A. Muñoz
Oceanlab, University of Aberdeen, Main Street, Newburgh AB41 6AA, Scotland, UK; and Aberdeen Oomycete Laboratory, International Centre for Aquaculture Research and Development, University of Aberdeen, Foresterhill, Aberdeen AB25 2ZD, UK

Liliana A. Muñoz is a PhD student at the University of Aberdeen (UoA). She got her BSc in 2009 working with the mariculture of the giant kelp (Universidad Austral de Chile), and her MSc in 2016, studying cryptic algal biodiversity from Easter Island (UoA). Presently, Liliana is working on the molecular characterization of parasitic stramenopiles of marine molluscs.



Miriam Bernard
CNRS, Sorbonne Université, UPMC University Paris 06, UMR 8227, Integrative Biology of Marine Models, Station Biologique de Roscoff, CS90074, 29688 Roscoff, Brittany, France

Miriam Bernard is a PhD candidate at Roscoff Marine Station. She obtained her Master's degree from the University of Bonn and the Alfred Wegener Institute, Bremerhaven working on the impact of global change and interspecific competition on Arctic kelps. Her current research focusses on the interaction of kelps with filamentous algal endophytes.



Akira F. Peters
Bezhin Rosko, 40 rue des pêcheurs, 29250 Santec, Brittany, France

Akira F. Peters is a gentleman scientist in his enterprise Bezhin Rosko at Santec, Brittany, France. He obtained a PhD from Konstanz University in 1986. He likes macroalgae, with a research focus on brown algae, and has worked as post-doc, assistant and associate university professor in Chile, the Netherlands, Germany and France. He is a member of the Marine Biological Association (MBA) and honorary research fellow at the University of Aberdeen.

Graphical abstract

Pedro Murúa, Frithjof C. Küpper, Liliana A. Muñoz, Miriam Bernard and Akira F. Peters
***Microspongium alariae* in *Alaria esculenta*: a widely-distributed non-parasitic brown algal endophyte that shows cell modifications within its host**

<https://doi.org/10.1515/bot-2017-0095>
Botanica Marina 2018; x(x): xxx–xxx

Research article: New records of the phaeophycean endophyte *Microspongium alariae* are described, analyses which also determine that sister *M. tenuissimum* and *M. radians* are conspecific. Evidence from culturing/TEM revealed cell modifications for *M. alariae* endophytic lifestyle, where parasitism hallmarks were not found.

Keywords: Chordariaceae; COI; ITS1; *rbcl*; ultrastructure.

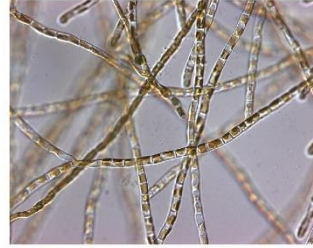

Supplemental material

- Consensus
Identity
1. MalaOb ITS1+2
 2. MalaCB ITS1+2
 3. M.alariae_in_Slat ITS1_AJ439844
 4. M.alariae_in_Aesc ITS1_AJ439843
 5. M.alariae_in_Fucus ITS1_AJ439845
 6. M.tenuissimum_S Afr ITS1_AJ439848
 7. M.tenuissimum_Kiel ITS1_298579
 8. M.tenuissimum_Chile ITS1_AJ439849
 9. M.radians_S Afr ITS1_AJ439846
 10. M.radians_Chile ITS1_298581
 11. Ascoseiophila_violodora_AJ439833

- Consensus
Identity
1. MalaOb ITS1+2
 2. MalaCB ITS1+2
 3. M.alariae_in_Slat ITS1_AJ439844
 4. M.alariae_in_Aesc ITS1_AJ439843
 5. M.alariae_in_Fucus ITS1_AJ439845
 6. M.tenuissimum_S Afr ITS1_AJ439848
 7. M.tenuissimum_Kiel ITS1_298579
 8. M.tenuissimum_Chile ITS1_AJ439849
 9. M.radians_S Afr ITS1_AJ439846
 10. M.radians_Chile ITS1_298581
 11. Ascoseiophila_violodora_AJ439833

- Consensus
Identity
1. MalaOb ITS1+2
 2. MalaCB ITS1+2
 3. M.alariae_in_Slat ITS1_AJ439844
 4. M.alariae_in_Aesc ITS1_AJ439843
 5. M.alariae_in_Fucus ITS1_AJ439845
 6. M.tenuissimum_S Afr ITS1_AJ439848
 7. M.tenuissimum_Kiel ITS1_298579
 8. M.tenuissimum_Chile ITS1_AJ439849
 9. M.radians_S Afr ITS1_AJ439846
 10. M.radians_Chile ITS1_298581
 11. Ascoseiophila_violodora_AJ439833

- Consensus
Identity
1. MalaOb ITS1+2
 2. MalaCB ITS1+2
 3. M.alariae_in_Slat ITS1_AJ439844
 4. M.alariae_in_Aesc ITS1_AJ439843
 5. M.alariae_in_Fucus ITS1_AJ439845
 6. M.tenuissimum_S Afr ITS1_AJ439848
 7. M.tenuissimum_Kiel ITS1_298579
 8. M.tenuissimum_Chile ITS1_AJ439849
 9. M.radians_S Afr ITS1_AJ439846
 10. M.radians_Chile ITS1_298581
 11. Ascoseiophila_violodora_AJ439833

- Consensus
Identity
1. MalaOb ITS1+2
 2. MalaCB ITS1+2
 3. M.alariae_in_Slat ITS1_AJ439844
 4. M.alariae_in_Aesc ITS1_AJ439843
 5. M.alariae_in_Fucus ITS1_AJ439845
 6. M.tenuissimum_S Afr ITS1_AJ439848
 7. M.tenuissimum_Kiel ITS1_298579
 8. M.tenuissimum_Chile ITS1_AJ439849
 9. M.radians_S Afr ITS1_AJ439846
 10. M.radians_Chile ITS1_298581
 11. Ascoseiophila_violodora_AJ439833

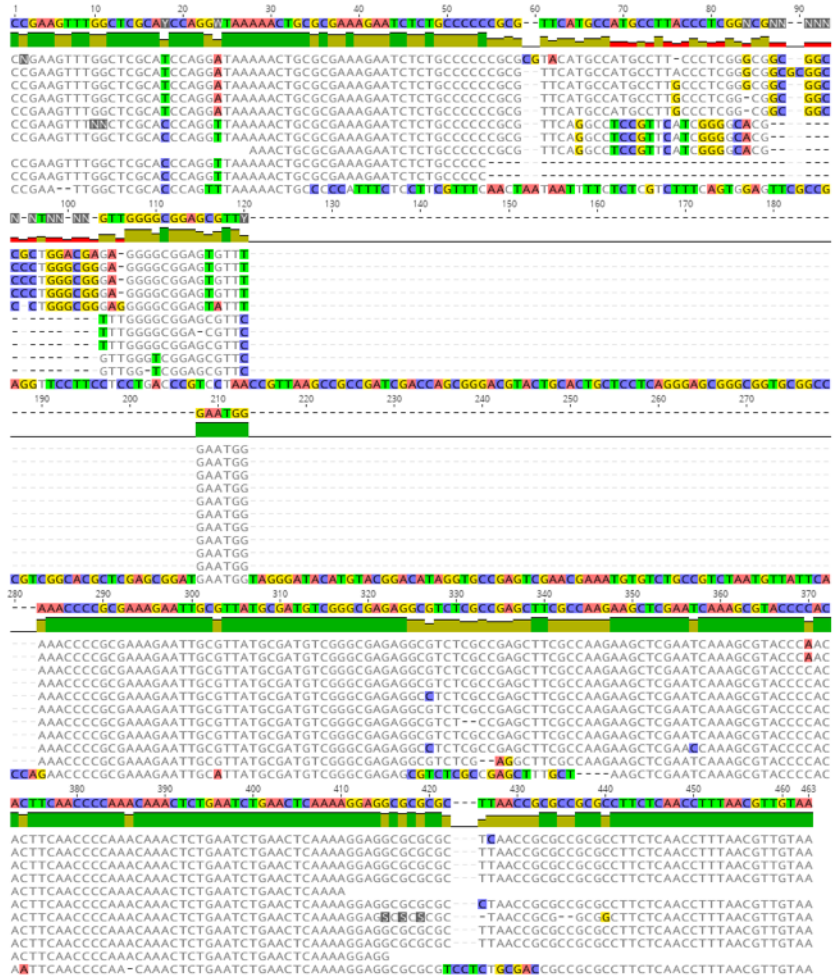

Supplemental Figure S1: Alignment of ITS1 used for *M.alariae* phylogeny reconstruction (Geneious view).

Alignment was deposited at figshare.org (<https://doi.org/10.6084/m9.figshare.5962567.v1>).

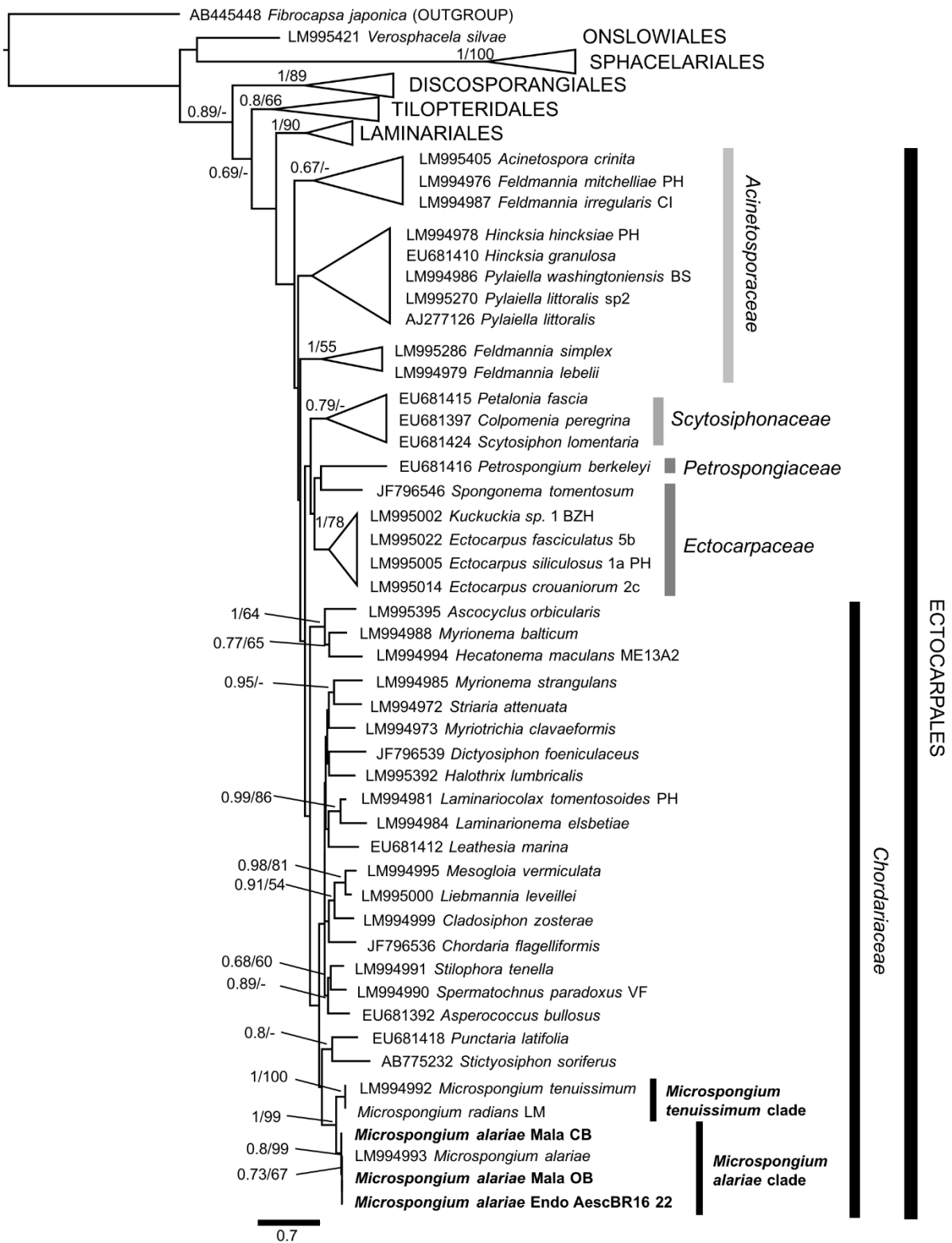

Supplemental Figure S2: MrBayes cladogram of *M. alariae* and representative taxa of Phaeophyceae, based on the 5'-partial COI gene. The alignment contained 58 sequences and 658 positions. Support values correspond to MrBayes posterior probabilities/RAxML bootstrap values. Values lower than 0.5 (or 50%) were displayed as a hyphen. The scale bar indicates the number of substitutions per site. Alignment was deposited at figshare.org (<https://doi.org/10.6084/m9.figshare.5962567.v1>).

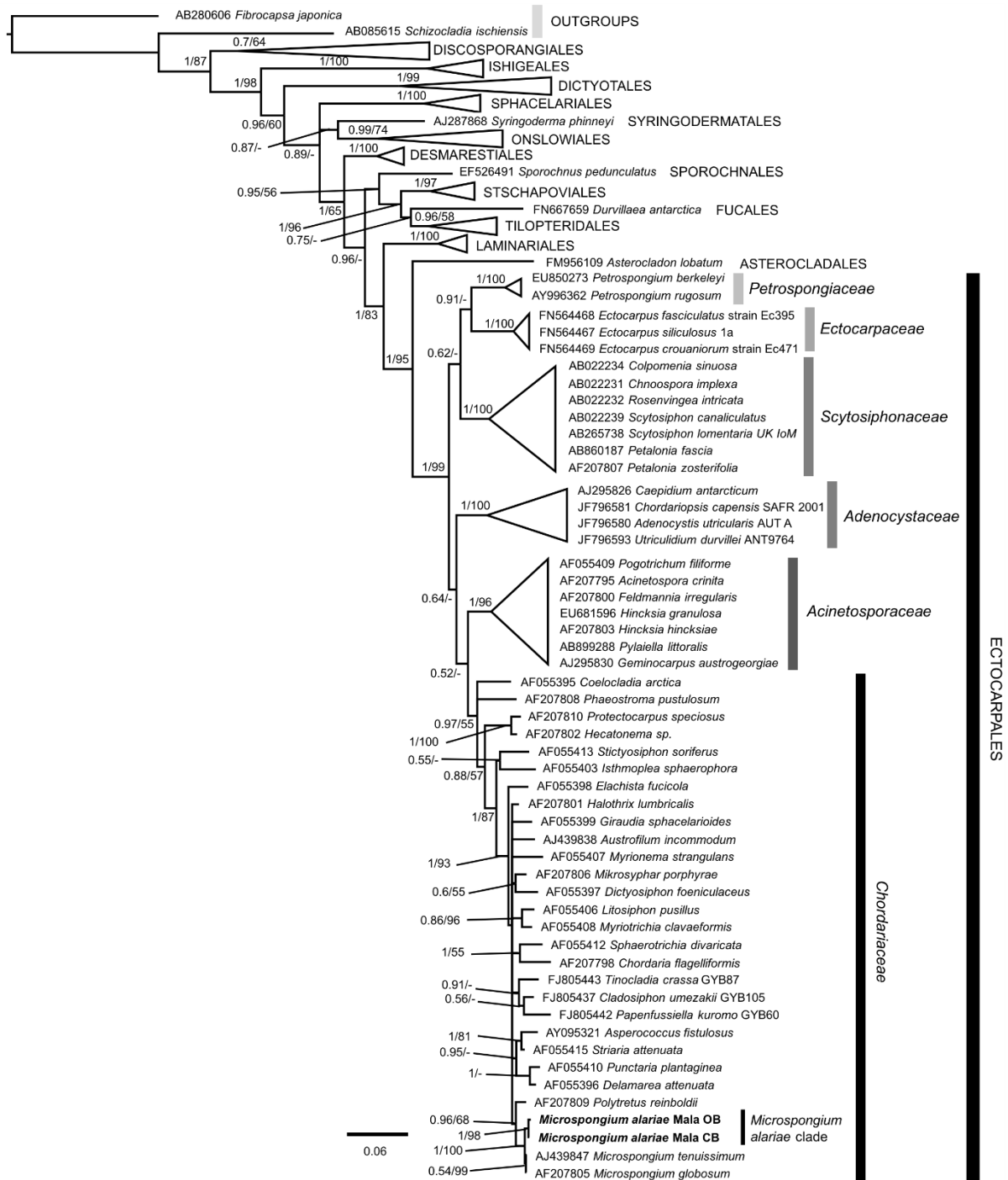

Supplemental Figure S3: MrBayes cladogram of *M. alariae* and representative taxa sequences of Phaeophyceae, based on the *rbcl* gene. This tree contains a total of 80 sequences and 1468 positions. Support values correspond to MrBayes posterior probabilities/RAXML bootstrap values. Values lower than 0.5 (or 50%) were displayed as a hyphen. The scale bar indicates the number of substitutions per site. Alignment was deposited at figshare.org (<https://doi.org/10.6084/m9.figshare.5962567.v1>).

Abstract

Endophytic filamentous brown algae are known to invade stipes and fronds of kelps with potentially negative effects for their hosts. The molecular diversity of endophytes isolated from seven different kelp species was investigated by sequencing two unlinked molecular markers (5'COI and ITS1). A majority of the isolated endophytes belonged to the genera *Laminarionema* and *Laminariocolax* and the results suggest that specific host-endophyte patterns could exist locally, as found in Brittany. The algal endophyte *Laminarionema elsbetiae*, for instance, was shown to be highly prevalent in European populations of *Saccharina latissima*, but also occasionally infects other kelp species, such as *Laminaria digitata* in lower numbers. As a novel approach for epidemiological studies, a qPCR assay for a relative quantification of the endophyte *L. elsbetiae* within its kelp hosts was developed. Using this method, a high endophyte prevalence of up to 100% was detected in natural *S. latissima* populations, especially in young sporophytes. The results also suggested that environmental factors have a significant impact on infection rates, and that the occurrence and severity of an infection by *L. elsbetiae* depend on the host species.

To get further insight into the mechanisms of this interaction and the basis of host specificity, the physiological and molecular responses of the kelps *S. latissima* and *L. digitata* during a co-cultivation with the endophyte *L. elsbetiae* were investigated. Co-cultivation experiments showed different physiological responses of the two hosts during the presence of the endophyte. A transcriptomic approach was used to investigate the gene regulation of the two kelps during the first contact with the endophyte. After 48h, the analysis revealed 72 differentially expressed genes (DEGs) in *S. latissima* and 93 DEGs in *L. digitata*. Among those DEGs, only 8 were common in the two kelp species, indicating a significant difference between the molecular responses. By functional annotation, DEGs were identified related to cell wall modification, host-endophyte recognition and ROS scavenging. The identification of endophyte-related transcripts further suggested differences in the recognition of *L. elsbetiae* by the two kelps and in subsequent mutual defence reactions. Altogether, different molecular cross-talk between the two kelp species and the endophyte could explain the variability of natural infection patterns.

Résumé

Des algues brunes endophytes envahissent les tissus des laminariales, avec des effets potentiellement négatifs sur leur hôte. Des études moléculaires ont permis d'identifier deux genres, *Laminarionema* et *Laminariocolax*, dominant la diversité de ces endophytes. Une étude épidémiologique par qPCR a montré une forte prévalence de l'endophyte *Laminarionema elsbetiae* chez *Saccharina latissima*, avec des variations saisonnières et locales. En laboratoire, la présence de *L. elsbetiae* induit des réponses physiologiques différentes chez *S. latissima*, son hôte principal, et chez *Laminaria digitata*, un hôte occasionnel. Une approche transcriptomique a révélé des réponses moléculaires différentes chez les deux hôtes et l'endophyte, en lien avec les mécanismes de reconnaissance et de défense des deux partenaires. Ces spécificités du dialogue moléculaire lors des premières étapes de l'interaction pourraient expliquer la variabilité des profils d'infection observés dans les populations naturelles.