



**HAL**  
open science

# **Pantoea spp: a new bacterial threat to rice production in sub-Saharan Africa**

Kossi Kini

► **To cite this version:**

Kossi Kini. *Pantoea spp: a new bacterial threat to rice production in sub-Saharan Africa*. Botanics. Université Montpellier; AfricaRice (Abidjan), 2018. English. NNT: 2018MONTG015. tel-02868182v1

**HAL Id: tel-02868182**

**<https://theses.hal.science/tel-02868182v1>**

Submitted on 15 Jun 2020 (v1), last revised 16 Jun 2020 (v2)

**HAL** is a multi-disciplinary open access archive for the deposit and dissemination of scientific research documents, whether they are published or not. The documents may come from teaching and research institutions in France or abroad, or from public or private research centers.

L'archive ouverte pluridisciplinaire **HAL**, est destinée au dépôt et à la diffusion de documents scientifiques de niveau recherche, publiés ou non, émanant des établissements d'enseignement et de recherche français ou étrangers, des laboratoires publics ou privés.

# THÈSE POUR OBTENIR LE GRADE DE DOCTEUR DE L'UNIVERSITÉ DE MONTPELLIER

En ÉVOLUTION DES SYSTÈMES INFECTIEUX

École doctorale GAIA (N°584)

Unité Mixte de recherche IPME Interactions Plantes-Microorganismes-Environnement (IRD, CIRAD, UM)

## *Pantoea* spp: a new bacterial threat for rice production in sub-Saharan Africa.

Présentée par Kossi KINI

Le 22 Mai 2018

Sous la direction de Ralf KOEBNIK  
et Drissa SILUÉ

Devant le jury composé de :

Ralf KOEBNIK, Directeur de Recherche,	IRD	Directeur de thèse
Drissa SILUÉ, Chargé de Recherche,	AfricaRice	Co directeur de thèse
Claude BRAGARD, Professeur des Universités,	UCL	Rapporteur
Marie-Agnès JACQUES, Directrice de Recherche,	INRA	Présidente du jury
Monique ROYER, Cadre Scientifique,	CIRAD	Examinatrice
Alice BOULANGER, Directrice de Recherche,	INRA	Examinatrice



UNIVERSITÉ  
DE MONTPELLIER



## Résumé

Parmi les 24 espèces de *Pantoea* décrites jusqu'à présent, cinq ont été signalées jusqu'à 46 fois dans 21 pays comme phytopathogènes d'au moins 31 cultures. En effet, *P. ananatis* et *P. agglomerans* ont été signalés comme bactéries phytopathogènes pour au moins dix cultures économiquement importantes, y compris le riz. Récemment, le Centre du Riz pour l'Afrique et ses partenaires ont soupçonné la présence d'une bactérie émergente qui cause la bactériose du riz dans plusieurs pays africains. L'agent causal a été confirmé comme appartenant au genre *Pantoea*. Les objectifs de notre projet de thèse étaient (i) d'améliorer la collection d'isolats d'AfricaRice par de nouvelles collections (ii) de développer des outils de diagnostic et de génotypage. Nos résultats ont montré que les bactéries capables de produire des symptômes flétrissement bactérien du riz en Afrique forment un complexe d'espèces composé principalement de *P. ananatis*, *P. stewartii* et *P. agglomerans*. Différents types d'outils de diagnostic et de caractérisations ont ensuite été développés et validés. Les résultats de l'utilisation de ces outils ont permis de mettre en évidence la présence de ce complexe bactérien dans plusieurs pays africains et ont fourni des détails sur sa structuration géographique. En effet, nous avons diagnostiqué un complexe d'espèces bactériennes, phytopathogènes du riz dans 11 pays africains (Bénin, Burkina Faso, Burundi, Ghana, Côte d'Ivoire, Mali, Niger, Nigeria, Sénégal, Tanzanie, Togo). En plus, nous avons analysé trois génomes de *P. ananatis* africains puis développé, évalué et validé des outils d'analyse VNTR à locus multiples. Les résultats ont fourni un aperçu des relations phylogénétiques qui existent entre les souches de *P. ananatis* isolées du riz et les souches provenant d'autres sources (plantes, animaux et environnement). En effet, les résultats préliminaires ont montré que plusieurs souches de *P. ananatis* isolées du riz en Afrique, en Asie et en Europe étaient phylogénétiquement liées et formaient un groupe qui les différenciait de *P. ananatis* d'autres sources. En conclusion, les résultats de ce projet de thèse constituent une base solide pour de futures études de *Pantoea* spp. en Afrique.

### Abstract

Among the 24 species of *Pantoea* described so far, five have been reported up to 46 times in 21 countries as phytopathogens of at least 31 crop plants. Indeed, *P. ananatis* and *P. agglomerans* have been reported as phytopathogenic bacteria for at least ten economically important crops, including rice. Recently, Africa Rice Center and its partners have suspected the presence of an emerging bacterium that causes rice bacterial blight in several African countries. The causal agent has been confirmed as belonging to the genus *Pantoea*. The objectives of our thesis project were (i) to improve the collection of existing AfricaRice isolates through new collections, and (ii) to develop diagnostic and genotyping tools. Our results showed that bacteria capable of producing bacterial blight symptoms of rice in Africa form a species complex composed mainly of *P. ananatis*, *P. stewartii* and *P. agglomerans*. Various types of diagnostic tools were developed and validated. The results obtained using these tools helped to point out the presence of this bacterial complex in several African countries. Moreover, it provided details on its geographical structure. As a result, we diagnosed a bacterial species complex, which is phytopathogenic of rice in 11 African countries (Benin, Burkina Faso, Burundi, Ghana, Ivory Coast, Mali, Niger, Nigeria, Senegal, Tanzania, Togo). In addition, we analyzed three genomes of African *P. ananatis* and developed, evaluated, and validated Multiple Locus VNTR Analysis (MLVA) tools. The data provided insights into the phylogenetic and phylogenomic relationships that exist between *P. ananatis* strains isolated from rice and strains from other sources (plants, animals and environment). Indeed, preliminary results showed that several strains of *P. ananatis* isolated from rice in Africa, Asia and Europe were phylogenetically linked and formed a group that differentiated them from *P. ananatis* from other sources. In conclusion, the results of this thesis project lay a solid foundation for the future studies of *Pantoea* spp. in Africa.

### Acknowledgements

This project was carried out in sandwich program with a collaboration between Africa Rice Cotonou (Benin) and Research Institute for Development (IRD) Montpellier (France). As such, I would like to give thanks to the management of the two institutes and their directors for having offered me good conditions to work.

This project was realized with the financial support of IRD's Research Allocation for Southern Thesis program (ARTS) and International Foundation for Science (IFS) grants. We thank the first officials of ARTS and IFS for their financial support.

I would like to give thanks to the President of the jury and all its members for agreeing to evaluate this thesis.

Special thanks go to:

- ⇒ Dr Valérie VERDIER for allowing me to join her team: Interaction Plantes Microorganismes Environment (IPME).
- ⇒ The management of IPME for all the given services and support.
- ⇒ The Presidency of Montpellier's university and the direction of the Doctoral School GAIA for having allowed me to register at UM as PhD student.

At the end of this project, I was convinced that this thesis was far from being a solitary work. It represents a long-term job, and is, therefore, the thread of a slice of life during its duration. Briefly, I couldn't have done this doctoral work without the support of a broad number of people whose generosity, good humor and interest in our thesis allowed me to progress in this delicate "apprentice researcher phase"

THANKS, to Ralf KOEBNIK and Drissa SILUE, my two thesis co-supervisors who form a complementary duet, which made our thesis a completed work. Without your involvement and dedication in obtaining this scholarship for my thesis, I do not know what my wife will, my children and I would have been right now. As a Christian, I request every time that God provides you an excellent health and long life.

With Drissa, I have understood what the following expressions mean: Producing results by being able to work autonomously under pressure, resistant to stress, be tactful and diplomatic in the exercise of your duties.

With Ralf, I have understood what lies behind the expressions, demonstrating initiative and liking teamwork, having the ability to plan, organize and put in place effective working procedures, work with flexibility, while having the attention to detail and rigor in the accomplishment of his work. For this reason, during this project, I immersed myself in these expressions and made them my work and life mottoes.

I sincerely thank the members of my thesis Committee, who during the three years, were the lighthouse that guided our ship aboard port. Special thanks to Christian Vernière, my Reference for the ED GAIA, for his advice and for sharing his experience with us.

I would like to thank all the members of my two teams (GTIPP of UMR IPME in Montpellier in France and the Phytopathology Lab of Africa Rice Cotonou Benin) who allowed me spend these pleasant years in the laboratory. Thank also to all the staff (researcher, engineers,

technicians, observers, trainees ...) for their help and their kindness. I extend sincere thanks to the other PhD students and MSc students from both teams. I know, I'm not the most available friend and the most smiling because of the experiences during this thesis but you supported my moods, my awkwardness, the problems and incomprehension generated during all these years.

At IRD Montpellier, I address a special thanks to Boris, Emmanuel, Servane, and Charlotte for the discussions and the practical advises. Thanks to Sandrine and Florence for their kindness and availability. To other PhD students and postdocs, past and present, who are: Céline, Mathilde, Tu, Hinda, Alvaro, Jonathan, Taca, Kader, Ganna some thanks for your presence and smiles. I thank all the permanent members of the GTIPP team for their availability. They accepted me and created a framework to achieve our goals.

At Africa Rice Cotonou, I would like to thank Toyin and Ronke for their availability. Thanks to Symphorien, Raoul, Hospice, Bernardin, Rachelle, Jean, Honoré ... for their collaboration and expertise.

A special thanks goes to my model, Dr. Issa WONNI, a big brother with many humility and availability.

Special thanks to Dr. Kossi KPÉMOUA for all the facilities that he provided during the pre-thesis work at ITRA.

Finally, thanks to my family, especially to my mom who spared many efforts for my studies, your baby chick has become a rooster and your dreams, for him, have become a reality. I think about my elder brother who left us in 2015. To you my beloved and my twins DEO & GRATIAS, I say thank you for your patience and your love. I hope finally that with the thesis, we will lead a family life.

This thanks list is not exhaustive. It is, in fact incomplete. However, if I should thank all the people who encouraged me to get here, I should inevitably make a lengthy list than the manuscript itself.

**Index of Tables**

Table 1: Lists of the strains used for the taxonomic description of the genus <i>Pantoea</i> .....	11
Table 2: Epiphytic and parasitic colonisation of plants by strains of <i>Pantoea</i> .....	23



### Index of Figures

Figure 1: Infographic illustrating the versatility and ubiquity of <i>Pantoea</i> spp. ....	6
Figure 2: Phylogenetic neighbor joining tree based on 16S rRNA gene sequences (1319 bp) showing the relationship between type strains of the genera <i>Pantoea</i> , <i>Erwinia</i> and <i>Tatumella</i> .....	19
Figure 3: Phylogenetic neighbor joining tree based on the concatenated partial sequences of <i>atpD</i> , <i>gyrB</i> , <i>infB</i> and <i>rpoB</i> gene sequences (2483 bp), showing the phylogenetic relationships between type strains of the genera <i>Pantoea</i> , <i>Erwinia</i> and <i>Tatumella</i> .....	20
Figure 4: Map of the distribution of plant diseases due to infection by <i>Pantoea ananatis</i> (source: <a href="https://www.cabi.org/isc/datasheet/21909">https://www.cabi.org/isc/datasheet/21909</a> ) .....	23
Figure 5: Map of the distribution of plant diseases due to infection by <i>Pantoea stewartii</i> (source: <a href="https://www.cabi.org/isc/datasheet/2193">https://www.cabi.org/isc/datasheet/2193</a> ) .....	23
Figure 6: Alignments of the loci encoding predicted pathogenicity determinants from representative strains of each clade, pnan1, pnan2 and pnst, as well as representatives of other genera .....	28
Figure 7: Prevalence of the mobilome and pathogenicity factors among the pnan and pnst strains .....	29
Figure 8: Genomic organisation of the type III secretion systems identified in strains of <i>Pantoea</i> .....	30

### Abbreviations and Acronyms

**AFLP:** Amplified Fragment Length Polymorphism  
**AfricaRice:** Africa Rice Center  
**ANI:** Average Nucleotide Identity  
**API:** Analytical Profile Index  
**ARTS:** Allocation de Recherche pour une Thèse au Sud  
**BLAST:** Basic Local Alignment Search Tool  
**BLB:** Bacterial Leaf Blight  
**BLS:** Bacterial leaf Streak  
**DNA:** Acide désoxyribonucléique  
**FAO:** Organisation des Nations Unies pour l'alimentation et l'Agriculture  
**GRiSP:** Global Rice Science Partnership  
**HGDI:** Hunter-Gaston Discriminatory Index  
**ICP:** Integrated Crop Protection  
**ICT:** Information and Communication Technologies  
**IFS:** International Foundation for Science  
**IRD:** Institut de Recherche pour le Développement  
**IRRI:** International Rice Research Institut  
**KIA:** Kligler Iron Agar  
**LAMP:** Loop mediated isothermal amplification  
**MLSA:** Multi Locus Sequence Analysis  
**MLST:** Multilocus Sequence Typing  
**MLVA:** Multiple Loci VNTR Analysis  
**NGS:** Next-Generation Sequencing  
**PCR-RFLP:** Fragment Length Polymorphism of the Gene Fragment PCR product  
**PCR:** Polymerase Chain Reaction  
**PHB:** Plant Health Bulletins  
**RAPD:** Random amplified polymorphic DNA  
**RFLP:** Restriction fragment length polymorphism  
**RYMV:** Rice Yellow Mottle Virus  
**SNP:** Single Neocleotide Polymorphism  
**SSR:** Single Sequence Repeats  
**TM:** Melting temperature  
**UV:** Ultra-Violet  
**VNTR:** Variable Number of Tandem Repeats  
**WGS:** Whole Genome Sequencing

## Content

Résumé .....	ii
Abstract .....	iii
Acknowledgements .....	iv
Index of Tables .....	vi
Index of Figures .....	vii
Abbreviations and Acronyms .....	viii
Content .....	ix
CHAPTER 1. Bibliographic synthesis .....	1
I. Literature review on techniques for plant disease diagnostics.....	2
1. Generalities.....	2
2. Phenotype techniques of plant disease diagnostics .....	2
2.1. Symptom-based techniques.....	2
2.2. Media characteristics-based techniques .....	2
3. Serology-based techniques .....	2
4. Biochemistry-based techniques.....	3
5. DNA-based techniques.....	3
5.1. Polymerase chain reaction (PCR) techniques .....	3
5.2. Amplified fragment length polymorphism (AFLP) .....	3
5.3. Restriction fragment length polymorphism (RFLP) .....	4
5.4. Random amplified polymorphic DNA (RAPD).....	4
5.5. Loop-mediated isothermal amplification (LAMP) .....	4
5.6. 16S ribosomal RNA (16S rRNA).....	4
6. Multilocus analyses .....	4
6.1. Variable number of tandem repeats (VNTR) .....	4
6.2. Multilocus sequence typing (MLST) .....	5
7. Whole genome sequencing (WGS) .....	5
8. Average nucleotide identity (ANI).....	5
9. Plasmid profiles (PP).....	5
II. Literature review of the <i>Pantoea</i> genus.....	5
1. Overview: chronological evolution of the taxonomy of <i>Pantoea</i> .....	5
1.1. Introduction .....	5
1.2. The history of the <i>Pantoea</i> genus: genesis of the taxonomy and evolution.....	7
1.2.1. <i>Pantoea stewartii</i> : from <i>Pseudomonas stewartii</i> in 1894 to <i>Erwinia stewartii</i> in 1963	7

1.2.2. <i>Pantoea agglomerans</i> : From <i>Bacillus agglomerans</i> (1888) to <i>Erwinia herbicola</i> (1974).....	7
1.2.3. <i>Pantoea ananatis</i> : From <i>Bacillus pineapple</i> (1924) to <i>Xanthomonas uredovor</i> (1952).....	8
2. Reclassification of the genus <i>Erwinia</i> by Dye.....	8
3. Proposition of the genus <i>Pantoea</i> by Gavini et al. (1988).....	10
4. Description of new species of the <i>Pantoea</i> genus.....	16
5. <i>Pantoea</i> spp. plurinomial or multi-codification harmonization.....	17
6. Description of the genus <i>Pantoea</i> Gavini et al. (1988) emended. Mergaert et al. (1993) .	21
6.1. The genus <i>Pantoea</i> Gavini et al.(1988) emended. Mergaert et al. (1993).....	21
6.2. Biochemical characterization of the genus <i>Pantoea</i> .....	21
7. Etiology of the <i>Pantoea</i> genus.....	22
7.1. Plant diseases caused by <i>Pantoea</i> genus reported worldwide.....	22
7.2. Insights from genomic analyses of <i>Pantoea</i> spp.: a highly versatile and diverse genus within the family of <i>Erwiniaceae</i> .....	24
7.3. Understanding of <i>Pantoea</i> spp. lifestyle and cross-kingdom colonisation.....	25
8. Understanding of <i>Pantoea</i> spp. phytopathogenicity.....	25
III. Generalities on rice.....	31
1. Rice cultivation.....	31
2. Rice diseases.....	31
2.1. Rice blast.....	31
2.2. Bacterial leaf blight of rice.....	32
2.3. <i>Rice yellow mottle virus (RYMV)</i> .....	33
IV. Background and justification of the thesis project.....	34
Bibliographies cited.....	37
CHAPTER 2. Results.....	51
I. Résumé substantiel des résultats en Français.....	52
1. Introduction.....	52
2. Résultats obtenus.....	52
3. Impacts de l'étude.....	58
4. Les perspectives.....	59
II. News Disease Reports of emerging rice-pathogenic bacteria in sub-Saharan Africa.....	63
1. Context and justification of the project.....	63
2. First Disease Note: First Report of a New Bacterial Leaf Blight of Rice Caused by <i>Pantoea ananatis</i> and <i>Pantoea stewartii</i> in Benin.....	63
3. Second Disease Note: First Report of a New Bacterial Leaf Blight of Rice Caused by <i>Pantoea ananatis</i> and <i>Pantoea stewartii</i> in Togo.....	65

4. Third Disease Note: First report of <i>Sphingomonas</i> sp. causing bacterial leaf blight of rice in Benin, Burkina Faso, The Gambia, Ivory Coast, Mali, Nigeria, Tanzania and Togo .....	66
III. Development of molecular diagnostic tools for detection of <i>Pantoea</i> spp. ....	71
1. Context and justification of the project .....	71
2. First drafted manuscript: A diagnostic multiplex PCR scheme for identification of plant-associated bacteria of the genus <i>Pantoea</i> .....	71
2.1. Abstract .....	71
2.2. Background .....	72
2.3. Materials and Methods .....	73
2.4. Results .....	74
2.5. Discussion .....	76
2.6. Conclusion.....	78
3. Second drafted manuscript: Development of a Loop-Mediated Isothermal Amplification (LAMP) diagnostic tools for fast detection of <i>Pantoea</i> species associated with Rice leaves and seeds .....	95
3.1. Context and justification of the project .....	95
3.2. Abstract .....	96
3.3. Background .....	96
3.4. Material and methods .....	97
3.5. Results .....	100
3.6. Discussion .....	100
3.7. Conclusion.....	101
4. Third drafted manuscript: Development, evaluation and validation of a semi-selective medium for bacteria of the genus <i>Pantoea</i> (PGS medium) .....	113
4.1. Introduction .....	113
4.2. Methodology .....	114
4.3. Results .....	115
4.4. Discussion and conclusion .....	116
IV. Genotyping of <i>Pantoea ananatis</i> by complete WGSs analyses and MLVA schemes... ..	119
1. Fourth drafted manuscript: Draft genome sequences of three strains of <i>Pantoea ananatis</i> , an emerging bacterial phytopathogen threatening rice production in sub-Saharan Africa ....	119
1.1. Context and justification of the project .....	119
1.2. Manuscript.....	120
2. Fifth drafted manuscript: Development and evaluation of two MLVA schemes consisting of micro- and minisatellite loci for global and epidemiological surveillance of <i>Pantoea ananatis</i> .....	139
2.1. Context and justification of the project .....	139
2.2. Abstract .....	140

2.3. Background .....	141
2.4. Materials and Methods .....	142
2.5. Results .....	144
3. Sixth drafted manuscript: Development of a PCR diagnostic tool capable of distinguishing <i>P. ananatis</i> rice strains from <i>P. ananatis</i> of other sources.....	161
3.1. Contexts and justification.....	161
3.2. Introduction .....	161
3.3. Materials and methods .....	162
3.4. Conclusion.....	163
Chapter 3. General discussion and conclusion.....	173
1. The thesis projects.....	174
2. New information and data on rice bacterial diseases in Africa.....	174
3. New tools for the specific, easy, simple, fast and cheaper detection and genotyping of <i>Pantoea</i> genus.....	175
4. Sequencing and analysis (for the first time) of three draft genome <i>Pantoea ananatis</i> phytopathogen rice in sub-Saharan African.....	176
5. Outcomes and impacts of the study.....	176
6. Perspectives.....	177
Attachments.....	I

# **CHAPTER 1. Bibliographic synthesis**

# **I. Literature review on techniques for plant disease diagnostics**

## **1. Generalities**

Several techniques are used for plant disease diagnostics [1–6] and reflect the evolution of scientific techniques. Techniques (developed below in paragraph 2.9) are characterized by different degrees of complexity and various criteria applied for their definition and development. But whatever their degree of complexity, a consensus exists on the following main three criteria for their adoption and use: sensitivity, specificity and reproducibility.

## **2. Phenotype techniques of plant disease diagnostics**

### **2.1. Symptom-based techniques**

Symptoms developed by diseased plants are characterized by structural and physiological changes induced by pathogens on distinct parts of the plant [7,8]. Their localization is therefore used for describing these diseases and local or systemic, primary or secondary, and microscopic or macroscopic are distinguished. Local symptoms are physiological or structural changes in a limited area of host organs. Systemic symptoms such as wilting, yellowing, and dwarfism represent those that involve reactions to more organs of the plant or the whole plant. Primary symptoms are direct results of pathogenic activity on invaded tissues. Secondary symptoms result from the physiological effects of the disease on distant non-invaded tissues or organs. Besides symptoms, the diagnostician recognizes signs characteristic of specific diseases. Signs represent the visible presence of either the pathogen itself or the structures it induces [3].

### **2.2. Media characteristics-based techniques**

The isolation and characteristics of microorganisms on media represent the key steps for disease diagnosis. The isolation consists of obtaining pure isolates of microorganisms from the shreds of the plant organs showing symptoms [3,6]. In practice, after crushing and dilution of the plant tissue, solid culture media are inoculated and incubated. Next, the inoculated plates are usually incubated for 24 to 72 hours. Three types of media are routinely used for isolation of bacteria: Selective, differential and non-selective media.

## **3. Serology-based techniques**

Viral particles, cell walls and cell organelles of microorganisms can act as antigen by inducing in the tissues of warm-blooded animals the formation of specific antibodies [9,10]. The serological antibody binding reaction can be observed in-vitro by bringing together a suspension containing the antigens of these pathogens and the antiserum [11]. The specificity of the antibody-antigen reactions makes it an efficient tool for diseases diagnosis. The use of monoclonal antibodies is widespread in phytopathology because of their specificity with respect to a single epitope, homogeneity, and continuous homogeneous production in unlimited quantities [12].



#### **4. Biochemistry-based techniques**

Biochemical tests are widely used for the identification and characterization of phytopathogenic microorganisms. These tests are numerous and their choice is based on the type of microorganism and the objectives of the test. Biochemical tests are based on the physiological and chemical properties of microorganisms to be tested. In practice, a bacterium can be identified: (i) on its abilities to metabolize a particular substrate by contact with a carbohydrate, peptide, etc., (ii) by inducing some bacterial-specific characteristics like Gram stain or malachite green, (iii) by using miniaturized biochemical tests like the Analytical Profile Index (API).

#### **5. DNA-based techniques**

With the discovery and description of DNA [13,14] followed by the invention of the Polymerase Chain Reaction (PCR) [15], the identification and typing of microorganisms shifted to a modern stage. So, several techniques for the diagnosis and typing of microorganisms based on the properties of DNA and PCR technology have been developed [16]. However, the progress of microbiological diagnostic and typing techniques culminated in 1995 with the whole genome sequencing of *Haemophilus influenzae* by Smith et al. The identification and characterization (diagnosis and typing) of microorganisms, which is one of the basic branches of microbiology, has now taken off in the era of genomics. The availability of these genetic resources has allowed the establishment of globally accessible databases for the characterization of other microorganisms.

##### **5.1. Polymerase chain reaction (PCR) techniques**

PCR has revolutionized diagnosis. The technique consists of amplifying a template DNA (exponential copying) using two primers that bind to the template and an enzyme, the DNA polymerase, that will synthesize new DNA strands. The PCR detection can be made on plant extracts. It is an accurate method to detect and quantify the DNA of a given pathogen. In addition, it is effective for large-scale diagnostics [17] (currently used for detecting Genetically Modified Organisms (GMO) containing products). There are several quantitative PCR detection systems namely Syber green, Taqman and Real-time PCR.

##### **5.2. Amplified fragment length polymorphism (AFLP)**

The AFLP technique is based on the joint demonstration of restriction site polymorphism and hybridization polymorphism of an arbitrary sequence primer. It is used in particular for the selection of lines and for the identification of specific regions in a genome. Without the need for any sequence data, the technique can quickly generate significant numbers of marker fragments for any organism. It is widely used for genetic studies including phytopathogenic bacteria.

### **5.3. Restriction fragment length polymorphism (RFLP)**

The RFLP technique is used for the production of genetic fingerprints and in paternity tests. It can be efficient in distinguishing, comparing, and differentiating DNA molecules from each other. RFLP is used to carry out pathogenic and non-pathogenic race differentiation tests in the same species of bacteria.

### **5.4. Random amplified polymorphic DNA (RAPD)**

RAPD is a DNA analysis technique used in molecular biology. This is a PCR reaction in which the amplified DNA segments are not chosen by the experimenter but amplified "randomly". Electrophoretic analysis of the amplified fragments will give a particular profile that is characteristic of the starting DNA. The RAPD markers are shown to be useful for checking polymorphisms among phytopathogens [18,19].

### **5.5. Loop-mediated isothermal amplification (LAMP)**

LAMP is a single-tube technique for the amplification of DNA. This is used as a low-cost alternative to detect certain diseases. It may be combined with a reverse transcription step to allow the detection of RNA [20–23]. The LAMP technique is an isothermal nucleic acid amplification technique. It has been shown to represent an appropriate approach for amplifying nucleic acid with high specificity, efficiency, and rapidity without the need for a thermal cycler. The LAMP method has been successfully used for detection of many plant-pathogenic bacteria including epiphytic *Erwinia amylovora* in pear and apple [24], *Xanthomonas oryzae* [25], and *Ralstonia solanacearum* [26].

### **5.6. 16S ribosomal RNA (16S rRNA)**

The 16S ribosomal RNA (16S rRNA) is a component of the small subunit of ribosomes of prokaryotes. It is widely used to reconstruct the evolutionary studies and for diagnostic and typing of several phytopathogenic bacteria [27,28].

## **6. Multilocus analyses**

### **6.1. Variable number of tandem repeats (VNTR)**

MLVA (multiple loci VNTR analysis) is used for genetic analysis of particular microorganisms like pathogenic bacteria. It takes advantage of the polymorphism of tandemly repeated DNA sequences. In MLVA the number of repeats in a set of VNTR loci is assessed. For some particular bacteria, VNTR is presented in multiple loci or regions. With the availability of bacterial genomes and the development of algorithms, the prediction of VNTRs has become easily achievable. MLVA has been widely used for epidemiological studies and global surveillance of phytopathogenic microorganism [29–32].

## 6.2. Multilocus sequence typing (MLST)

MLST is a technique in molecular biology for typing multiple loci. It characterizes isolates of microbial species using the DNA sequences of internal fragments of a few housekeeping genes. Approximately 450-500 bp internal fragments of each gene are sequenced on both strands. For each housekeeping gene, the different sequences present within a bacterial species are assigned as distinct alleles. And, for each isolate, the alleles at each of the loci define the allelic profile or sequence type (ST). The first MLST scheme was developed for *Neisseria meningitidis*, the causal agent of meningitis and septicemia [33]. Since its introduction in the history of evolutionary research, MLST has been used for both animal and plant pathogen typing [34].

## 7. Whole genome sequencing (WGS)

WGS analysis involves the sequencing of all the chromosomal DNA of the organism as well as plasmid DNA. Whole genome sequencing has been widely used as a research tool. Several genomes of plant-pathogenic microorganisms have been sequenced and their comparative analysis provided insight that enabled the development of genotyping and diagnosing tools [35].

## 8. Average nucleotide identity (ANI)

ANI represent a means of comparing genetic relatedness between prokaryotic strains [36]. The values around 95% were found to correspond to the 70% DNA-DNA hybridization and this value is widely used to delineate archaeal and bacterial species [37,38]. ANI is one of the available approaches that can be derived from comparative genomic data and used for taxonomic purposes.

## 9. Plasmid profiles (PP)

PP is used when plasmids are considered as markers of various bacterial strains. During an epidemiological situation, a comparative analysis of the plasmid profiles of the epidemiological strains versus non-epidemiological strains is carried out. This analysis makes it possible to compare antibiotic resistance genes and specific virulence factors of each strain type [39]. Typing of plasmid profiles has been used to study outbreaks of many bacterial diseases and to trace the inter- and intra-species spread of antibiotic resistance.

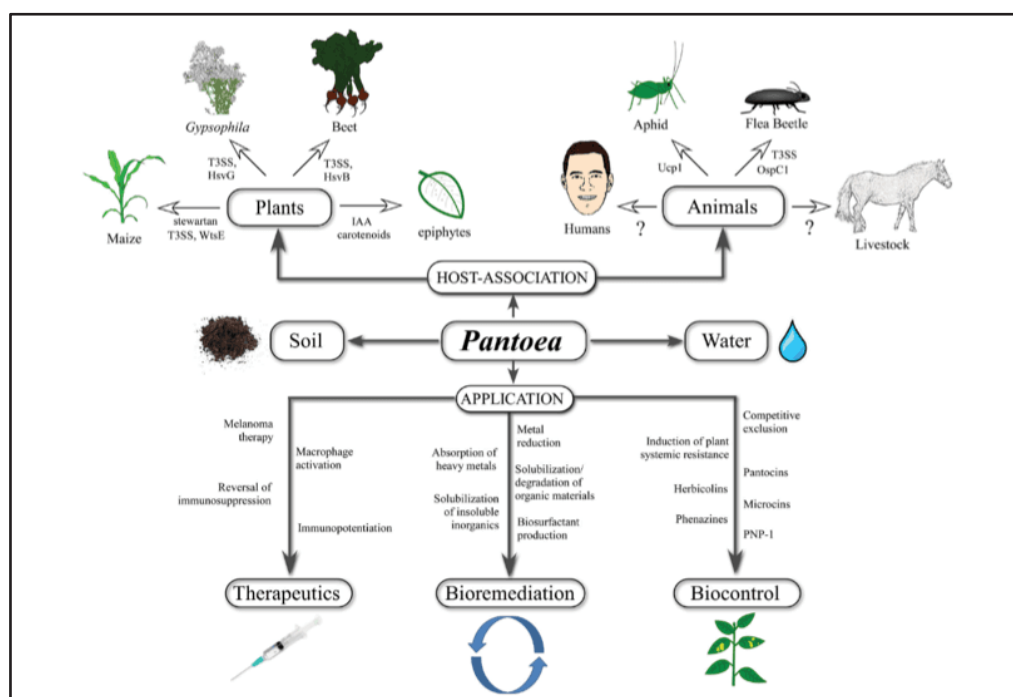
## II. Literature review of the *Pantoea* genus

### 1. Overview: chronological evolution of the taxonomy of *Pantoea*

#### 1.1. Introduction

The word “*Pantoea*” is derived from the Greek word “Pantoios”, which means “of all sorts and sources”. In 1988 Gavini et al. (1989) proposes this word for the genus grouping all [bacteria] from various sources [geographical, ecological]. As the genus name etymologically indicated, the known twenty-two species and two subspecies were isolated from various

geographical origins, environments and several other living organisms (Figure 1). Before the definition of the *Pantoea* genus by Gavini et al. (1989), the taxonomy of the bacteria was complex with a succession of changes. Indeed, at the beginning of taxonomy classifications were based on observations associated with the discovery of the bacteria. However, with the evolution of biology and chemistry, biochemical tests have been set up and widely used. They have been used for the identification and nomenclature according to certain characteristics that brought the bacteria closer to each other and to other reference bacteria. Later, with achievements made in molecular biology especially on DNA, molecular methods were widely used to achieve the same objective. Despite these novel techniques, ancient methods are still being used. Therefore, various polyphasic methods based on the combination of biochemical and molecular tools have been developed and used for the identification and nomenclature of *Pantoea*. The polyphasic methods consist of several steps; initially, the different suspected *Pantoea* strains are diagnosed based on their phenotypic characters like pathogenicity on tobacco, morphology on culture media and microscopy, as well as biochemical analyzes. In addition, the relatedness of bacteria grouped together was confirmed by genotypic methods (e.g. G+C content, DNA-DNA hybridization, MLSA, MLST, WGS). Ultimately, the ordinary phenotypic and biochemical characters of the genotypic groups were verified. In conclusion, the history of *Pantoea* taxonomy was based on series of various biological methods that have evolved over time. These facts and events are detailed chronologically in the following paragraphs.



**Figure 1:** Infographic illustrating the versatility and ubiquity of *Pantoea* spp.

Isolates of *Pantoea* have been isolated from soil and water as well as from different host plants [41,42].

## 1.2. The history of the *Pantoea* genus: genesis of the taxonomy and evolution

Before 1989, most species belonging to the genus *Pantoea* were grouped together based on their phenotypic characteristics. Many nomenclatures related to the different species of different groups are no longer relevant.

### 1.2.1. *Pantoea stewartii*: from *Pseudomonas stewartii* in 1894 to *Erwinia stewartii* in 1963

In 1894, Stewart isolated for the first time in New York the bacterium that was incriminated to cause bacterial wilt of sweet corn [43]. Three years later, Smith named the bacteria *Pseudomonas stewartii* or *Bacterium stewartii* to honor Stewart as per the taxonomical rules [45]. The same year, McCulloch, failing to observe the flagella, renamed the bacterium *Aplanobacter stewartii* (Smith 1898) [45]. But two years later, Holland moved the bacterium to the *Bacillus* genus and named it *Bacillus stewartii* [46]. Then later, Bergey and co-workers named the bacteria *Phytomonas stewartii* (Smith) in the first edition of Bergey's manual [47,48]. However, due to prior use of this name by protozoologists, this nomination was rejected as a genus [48]. Like so, bacteriologists afterwards used *Pseudomonas* or *Bacterium* for these bacteria with polar flagella and *Aplanobacter* or *Bacterium* for non-mobile pathogens. In 1929, Rahn (1929) emphasized the practical impossibility of using pathogenicity to plants as a basis for the taxonomic characteristic of plant-pathogenic bacteria. Burkholder et al (1948) therefore placed the bacteria in the genus of *Bacterium*, which has been accepted by Elliott (1951) but rejected by Dowson (1957) [52,53] who replaced it in the genus *Xanthomonas*. Burkholder included the bacteria in the *Xanthomonas* genus as species *Incertae sedis* [47] (species whose position in the scientific classification of living organisms is not yet fully defined). Consequently, several studies [48,50,52,54,55] have attempted solving this “disorder” in the definition of the taxonomic naming of phytopathogenic bacteria in general and *Xanthomonas stewartii* particularly. Several investigations showed that the arguments put forward by Dowson (1957) to include the bacteria in the *Xanthomonas* genus were unconvincing [52,53]. Indeed, with the yellow pigmentation and despite the lack of mobility, Dowson (1957) has concluded the pathogen was a *Xanthomonas* based only on certain biochemical characteristics. However in 1962, based on physiological characteristic studies [56], Dye showed that *X. stewartii* was not closely related to the genus *Xanthomonas* [57,58]. The bacteria would be more related to the genus *Erwinia* and may represent a “degenerate” member of *Enterobacteriaceae* [59,60]. Therefore, Dye et al in 1963 named the bacteria *Erwinia stewartii*, after half a century of debate about its taxonomic position.

### 1.2.2. *Pantoea agglomerans*: From *Bacillus agglomerans* (1888) to *Erwinia herbicola* (1974)

The name '*Bacillus agglomerans*' has been first published by Beijerinck in 1888 [62]. Then in 1904, Duggeli [63] isolated from a quarantine plant a number of bacteria including a gold-yellow bacterium which he named *Bacterium herbicola aureum*. After this description of Duggeli, many bacteria with similar “Gram-negative, yellow pigmented and stick-like” characteristics were isolated from a broad range of plant varieties. For this reason, Lohnis

1911 [64] and Geilinger [67–69] named the same types of bacteria *B. herbicola* [65–67]. In 1920, the same types of bacteria that caused the gall on *Milletia floribunda* in Japan has been named by Kawakami & Yoshida *Erwinia milletian* [68]. In 1927, de’Rosi renamed them as *Pseudomonas herbicola* [65–67]. In 1934, Brown described the causal organism of the gall on *Gypsophylae paniculata* and named it as *Bacterium gypsophilae* [69]. Tardily, many other names of this organism appeared. In 1943, Starr and Weiss replaced the binomial *Bacterium gypsophilae* by *Agrobacterium gypsophilae* [70]. Indeed, according to him, all bacteria that induced galls must belong to the same genus, i.e. *Agrobacterium* [70]. This proposal tried to eschew the illegitimate use of the genus *Phytomonas*, which included a broad and varied collection of plant-pathogenic bacteria, a fact that Burkholder [71] had already pointed out in 1939. Thus, *A. gypsophilae* has been used for over 30 years for many yellow-pigmented and rod-shaped Gram-negative bacteria that caused galls on plants. In 1960s, Komagata [72], Graham and Hodgkiss [67] and Dye [56] characterised *B. herbicola*, *P. herbicola* and other bacteria by biochemical tests. These works have shown that these bacteria were identical to other yellow-pigmented rod-shaped bacteria isolated from plants and animals. Consequently, Graham and Quinn [73] named some *A. gypsophilae* strains *E. herbicola* (Lohnis).

### **1.2.3. *Pantoea ananatis*: From *Bacillus pineapple* (1924) to *Xanthomonas uredovorus* (1952)**

In 1924, yellow bacteria were isolated from pineapple fruits exhibiting symptoms of brown discoloration, which in advanced cases extended over the fibro-vascular bundles of the nucleus [74]. Based on biochemical results and phenotypic analysis, the bacterium has been named *Erwinia* (or *Bacillus*) *ananus* n.sp [75]. In 1951, Patel and Kulkarni described a yellow bacterium on a medium responsible for bacterial mole rot and named it *Pectobacterium pineapple* (Serrano 1928) [76]. In the summer of 1952, Pon et al. isolated a yellow bacterium from stem rust pustules (*Puccinia graminis*) observed on wheat [77]. Biochemical analyzes later revealed that the bacteria would be previously undescribed. The bacterium has been named *Xanthomonas uredovorus* n.sp and reclassified in the genus *Erwinia* by Dye [58].

## **2. Reclassification of the genus *Erwinia* by Dye**

In 1917, Winslow and collaborators [78] proposed the genus *Erwinia* as the one grouping all phytopathogenic bacteria of the family *Enterobacteriaceae*. They are Gram-negative bacteria associated with plants, not forming spores, fermentative and forming rods. From 1968 to 1969, Dye divided this genus into four groups according to the types of symptoms they caused on plants: Group I was composed of phytopathogenic bacteria which cause dry necrotic diseases [79] and were named “*amylovora*”. Group II contained strains that induce soft rot [80] and were named “*caratovora*”. Group III, called “*herbicola*”, were saprophytes and phytopathogens and contained the “*herbicola*” species (*Bacterium herbicola*, *Pseudomonas herbicola*) and some phytopathogens (*B. gypsophilae*, *A. gypsophilae* and *E. milletiae*). These are *Erwinia* strains that typically produce yellow pigments on nutrient agar media and which can cause opportunistic infections [81]. Finally, group IV included atypical *Erwinia* [81]. Ewing and Fife 1972 studied several clinical isolates of patients in the United States and plant isolates composed of *E. herbicola* and *E. lathyri* (*herbicola-lathyri*

culture) [83]. In addition, he exhumed the previous work of Beijerinck (1888) describing “*Bacillus agglomerans*”. The name “*Enterobacter agglomerans*” (Beijerinck (1888) Ewing et Fife 1972) was proposed for this group “*herbicola-lathyri*” with synonyms *E. herbicola* (Lohnis 1911) Dye 1964 [84] and *E. milletiae* (Kawakami et Yoshida 1920) Magrou 1937 [85]. In 1974, group III (ndlr *Enterobacter agglomerans* (Beijerinck (1888) Ewing et Fife 1972) composed “*herbicola-lathyri*” group) was enlarged with the addition by Lelliot of four species, *E. uredovora* [58], *E. milletiae* [81], *E. stewartii* [58] and *E. herbicola* (*E. herbicola* var. *herbicola* and *E. herbicola* var. *Pineapple*).

Based on two numerical studies, the *E. agglomerans* complex was shown to cover many (20 to 40) phenotypes [86,87]. The first numerical study of Gavini et al (1983) [86], which was based on 169 strains, showed that they belong to the species *E. agglomerans* or *E. herbicola*. Indeed, the taxonomic position of the strains was discussed in relation to the species *Enterobacter sakazakii*, *Rahnella aquatilis* and *Escherichia adecarboxylata*. Consequently, five main groups or phenotypes (A to E) had been defined. Phenon A corresponded to *E. carotovora*. Phenon B, which included strains of the *E. agglomerans* complex was divided into nine smaller phenotypes (B1 to B9). Phenon B4 contained the type strains of *E. herbicola* and *Erwinia milletiae*. Phenon B8 contained the type strain of *Erwinia ananas* and a reference strain of *Erwinia uredovora*. The second “larger numerical study” of Verdonck et al. (1987) was based on 529 enterobacterial strains. These included the “*Erwinia herbicola-E. agglomerans*” complex and other *Erwinia* species, leading to 23 new phenotypic groups [87]. The strains received were under various names, including: *E. agglomerans*, *E. herbicola*, *E. milletiae*, *E. ananas*, *E. uredovora* and *E. stewartii*. *E. agglomerans*, *E. herbicola* and *E. milletiae* strains clustered in phenotypic group 8. At last, *E. coli* strains and *E. uredovora* strains were clustered in group 12 and eight strains of *E. stewartii* in group 29.

In 1984, by DNA-DNA hybridizations, Brenner et al. (1984) demonstrated the extreme genomic diversity of the *E. agglomerans* complex. They studied a total of 124 strains and grouped 90 of them in 13 DNA groups (I to XIII) while 34 were not classified into any group. In addition, four groups (V, XI, XII, and XIII) were found to be heterogeneous with respect to  $\Delta(T_m)$  values. Moreover, aerogenic and anaerogenic strains were not found in the same hybridization group [88]. In 1986, Lind and Ursing compared by DNA-DNA hybridization of 86 strains belonging to *E. agglomerans* (isolated from humans) and strains of *E. herbicola* and *E. milletiae* [89]. The work has allowed them to identify 52 of 86 clinical isolates with *E. agglomerans sensu strictu* by DNA-DNA hybridization. In the same study, they demonstrated the synonymy or specific identity of *E. agglomerans*, *E. herbicola*, and *E. milletiae* [89]. This synonymy was later confirmed by Beji et al. (1988) who, in addition, identified DNA group XIII of Brenner et al. (1984) as *E. agglomerans sensu strictu* [90]. In 1988, Beji et al. studied the DNA “relationship” between the *E. agglomerans* type strain (ATCC 27155) and the *E. herbicola-E. agglomerans* complex of the phenotypic group 7B and 8 of Verdonck et al. (1987). To this group, they added the strains of hybridization groups V and XIII of Brenner et al. (1984) and other reference strains belonging to several species of *Enterobacteriaceae*. Finally, seven distinct protein profiles have been produced by *E. herbicola-E. agglomerans* complex with a 62 to 97% DNA similarity with *E. agglomerans*

strain. That allowed the formation of hybridization group 27155. Beji et al. (1988) concluded that these species names are synonyms [90] because the group was composed of type strains of *E. agglomerans*, *E. herbicola* and *E. milletiae*.

### **3. Proposition of the genus *Pantoea* by Gavini et al. (1988)**

Based on the findings and conclusions of Beji et al. (1988), Gavini et al. (1988) decided to separate the complex *E. agglomerans*/*E. herbicola* from the genera *Enterobacter* and *Erwinia*. Therefore, they proposed a new genus: *Pantoea* (which means bacteria with diverse sorts and sources) with *Pantoea agglomerans* as the type species. The epithet *agglomerans* has been retained because it has been believed to have a priority over that of *herbicola*. The new species grouped together (i) the type strains of *E. agglomerans*, *E. herbicola* and *E. milletiae*, (ii) group I, III and VI of the electrophoretic proteins profile of Beji et al. (1988), and (iii) the DNA hybridization group XIII of Brenner et al. (1984) [88]. At the same time, the strains of the DNA hybridization group III of Brenner et al. (1984) [88] or phenon 8 of the phenotypic profile of Verdonck et al. (1987) [87] were proposed as a new species named *Pantoea dispersa* [40]. In summary (Table 4), the DNA groups that are closest to *P. agglomerans* are groups II, III, IV, V, and VI [89]. Interestingly, Bouvet et al. (1989) have shown that strains of group II to VI and XIII are characterized by the production of 2-ketogluconate from glucose. Ultimately, the proposed new genus *Pantoea* was composed of DNA groups I, II, IV, V, VI, XIII (*P. agglomerans*) and group III (*P. dispersa*) (Table 1).



**Table 1:** Lists of the strains used for the taxonomic description of the genus *Pantoea* [40,90].

Group	Species name as received	Strain <sup>a</sup>	% of relative DNA binding to [ <sup>3</sup> H]DNA from strain ATCC 14589 <sup>Tb</sup>	
Strains assigned by us to <i>Pantoea dispersa</i> (DNA hybridization group 14589)	<i>Erwinia herbicola</i>	ATCC 14589 <sup>Tc</sup>	100	
	<i>Enterobacter agglomerans</i>	Lille 214-6	92	
	<i>Enterobacter agglomerans</i>	Gilardi 961	89	
	<i>Erwinia herbicola</i>	Graham G146	88	
	<i>Enterobacter agglomerans</i>	Gilardi 968	87	
	<i>Erwinia herbicola</i>	NCPPB 2279 (= LMG 2601)	87	
	<i>Enterobacter agglomerans</i>	CDC 1429-71 <sup>c</sup>	85	
	<i>Enterobacter agglomerans</i>	Gouillet 29.2.80	81	
	<i>Erwinia herbicola</i>	NCPPB 2285 (= LMG 2602)	78	
	<i>Erwinia herbicola</i>	IPO 445 (= LMG 2604)	76	
	Strains assigned by us to <i>Pantoea agglomerans</i>	<i>Erwinia herbicola</i>	ICPB 2953	53
		<i>Erwinia herbicola</i>	Graham G150 (= LMG 2581)	52
<i>Enterobacter agglomerans</i>		ATCC 12287 <sup>d</sup>	49	
<i>Erwinia milletiae</i>		NCPPB 2519 <sup>T</sup> (= LMG 2660 <sup>T</sup> )	46	
<i>Enterobacter agglomerans</i>		ATCC 27155 <sup>T</sup> (= NCTC 9381 <sup>T</sup> = LMG 1286 <sup>T</sup> )	44	
<i>Erwinia herbicola</i>		NCPPB 2971 <sup>T</sup> (= LMG 2565 <sup>T</sup> )	41	
<i>Enterobacter agglomerans</i>		Gilardi 1030	44	
Other strains belonging to phenotypic group B5 of Gavini et al. or group 10 of Verdonck et al. <sup>e</sup>	<i>Enterobacter agglomerans</i>	Gilardi 953	41	
	<i>Erwinia herbicola</i>	Angers B.6.2	39	
Other phenotypic groups within the <i>Erwinia herbicola-Enterobacter agglomerans</i> complex according to Gavini et al. <sup>f</sup>				
	B1	<i>Erwinia herbicola</i>	Angers 243-3	32
	B2	<i>Erwinia herbicola</i>	Angers A.17.6	27
	B6	<i>Enterobacter agglomerans</i>	Gilardi 959	30
	B7	<i>Enterobacter agglomerans</i>	Richard 13-78	16
	B9	<i>Erwinia herbicola</i>	Angers 217-8	37
	E1	Atypical coliform	Gavini 98	32
Other DNA hybridization groups within the <i>Erwinia herbicola-Enterobacter agglomerans</i> complex according to Brenner et al. <sup>g</sup>				
	II	<i>Enterobacter agglomerans</i>	CDC 3123-70	43
	IV	<i>Enterobacter agglomerans</i>	CDC 1741-71	45
	V	<i>Enterobacter agglomerans</i>	CDC 3482-71	43
	VI	<i>Enterobacter agglomerans</i>	CDC 6070-69	29
	VII	<i>Enterobacter agglomerans</i>	CDC 6003-71	47
	VIII	<i>Enterobacter agglomerans</i>	CDC 5422-69	43
	IX	<i>Enterobacter agglomerans</i>	CDC 4388-71	21
	X	<i>Enterobacter agglomerans</i>	CDC 1600-71	20
	XII	<i>Enterobacter agglomerans</i>	CDC 219-71	31
	Other <i>Erwinia</i> species	<i>Erwinia stewartii</i>	NCPPB 2295 <sup>T</sup>	51
		<i>Erwinia uredovora</i>	NCPPB 800 <sup>T</sup>	47
<i>Erwinia ananas</i>		NCPPB 1846 <sup>T</sup>	39	
<i>Erwinia carotovora</i>		ATCC 15713 <sup>T</sup>	28	
<i>Erwinia amylovora</i>		ATCC 15580 <sup>T</sup>	28	
<i>Enterobacter dissolvens</i>		NCPPB 1850 <sup>T</sup>	35	
(synonym, <i>Erwinia dissolvens</i> )				
Other <i>Enterobacter</i> species	<i>Enterobacter amnigenus</i>	ATCC 33072 <sup>T</sup>	24	
	<i>Enterobacter sakazakii</i>	ATCC 29544 <sup>T</sup>	23	
	<i>Enterobacter aerogenes</i>	ATCC 13048 <sup>T</sup>	22	
	(synonym, <i>Klebsiella mobilis</i> )			
	<i>Enterobacter asburiae</i>	ATCC 35953 <sup>T</sup>	21	
	<i>Enterobacter cloacae</i>	ATCC 13047 <sup>T</sup>	20	
		CDC 1347-71	18	
	<i>Enterobacter gergoviae</i>	CIP 76.01 <sup>T</sup>	19	
	<i>Enterobacter taylorae</i>	ATCC 35313 <sup>T</sup>	17	
	<i>Enterobacter intermedium</i>	CIP 79.27 <sup>T</sup>	15	

Continued on following page

Strains belong to:	Species name as received	Strain no. <sup>a</sup>	% Relative DNA binding <sup>b</sup> with [ <sup>3</sup> H]DNA of <i>Enterobacter agglomerans</i> ATCC 27155 <sup>T</sup>
Group B4 of Gavini et al. (23) and phenons 7B and 8 of Verdonck et al. (60)			
Protein profile group I <sup>c</sup>	<i>Enterobacter agglomerans</i>	ATCC 27155 <sup>T</sup> (= NCTC 9381 <sup>T</sup> , LMG 1286 <sup>T</sup> )	100
	<i>Erwinia herbicola</i>	Graham G155 (= LMG 2103)	97
	<i>Erwinia herbicola</i>	Angers E.10.6.1	95
	<i>Enterobacter agglomerans</i>	Gilardi 749	95
	<i>Erwinia milletiae</i>	ATCC 23375 (= NCPPB 955, LMG 2659)	94
	<i>Erwinia herbicola</i>	Graham G138 (= LMG 2574)	93
	<i>Erwinia milletiae</i>	NCPPB 2519 <sup>T</sup> (= LMG 2660 <sup>T</sup> )	91
	<i>Enterobacter agglomerans</i>	Richard 14-78	90
	<i>Erwinia herbicola</i>	NCPPB 2971 <sup>T</sup> (= LMG 2565 <sup>T</sup> )	89
	<i>Enterobacter agglomerans</i>	Richard 4-78	82
	<i>Enterobacter agglomerans</i>	Richard 14-77	81
	<i>Enterobacter agglomerans</i>	Gilardi 544, Gilardi 546 (= LMG 2733), Gilardi 556 (= LMG 2734), Gilardi 976, Richard 9-77, Lille(1) 15544, Lille(1) 16229(2), Lille(2) 40V1	ND <sup>d</sup>
	<i>Erwinia herbicola</i>	Angers 179-7, Angers 189-2, Angers 199-2, Angers 217-5, Angers B.903, Angers F.10.2.1, NCPPB 179 (= LMG 2553), NCPPB 601 (= LMG 2554), NCPPB 656 (= LMG 2555), NCPPB 1269 (= LMG 2557), Graham G143 (= LMG 2579), Graham G150 (= LMG 2581), Graham G151 (= LMG 2582), Graham G153 (= LMG 2583), Graham G154 (= LMG 2584), Graham G157 (= LMG 2535), Graham PA (= LMG 2587), IPO 287 (= LMG 2573), NCIB 9680 (= LMG 2572)	ND
	<i>Erwinia milletiae</i>	NCPPB 2600 (= LMG 2661), NCPPB 2601 (= LMG 2662)	ND
Protein profile group II	<i>Enterobacter agglomerans</i>	Goulet DY 27-12	77
	<i>Enterobacter agglomerans</i>	Richard 5-78	75
	<i>Enterobacter agglomerans</i>	Richard biogroup 6	75
	<i>Enterobacter agglomerans</i>	CDC 3482-71	62
Protein profile group III	" <i>Enterobacter pigmenté</i> "	Leclerc a57	94
	" <i>Enterobacter pigmenté</i> "	Leclerc a98	ND
Protein profile group IV	<i>Enterobacter agglomerans</i>	Graham 892	85
Protein profile group V	<i>Erwinia herbicola</i>	ICPB EH101 (= Graham G142, LMG 2578)	96
	<i>Erwinia herbicola</i>	Graham G152 (= LMG 2102)	90
	<i>Erwinia herbicola</i>	Graham G140 (= LMG 2576), Hattinh SUH1 (= LMG 2995), Hattinh SUH2 (= LMG 2996)	ND
Protein profile group VI	<i>Enterobacter agglomerans</i>	Gilardi 722	82
	<i>Erwinia herbicola</i>	ICPB 2953	81
	<i>Erwinia herbicola</i>	CNBP 1189, CNBP 1255	ND
Protein profile group VII	<i>Enterobacter agglomerans</i>	Gilardi 721	73
	<i>Enterobacter agglomerans</i>	Gilardi 698	72
	<i>Erwinia herbicola</i>	NCPPB 1682 (= LMG 2558), NCPPB 1941 (= LMG 2560)	ND
Other phenotypic groups within the " <i>Erwinia herbicola</i> - <i>Enterobacter agglomerans</i> " complex according to Gavini et al. (23)			
B1	<i>Erwinia herbicola</i>	Angers 238-3	34
	<i>Erwinia herbicola</i>	Angers 243-3	28
B2	<i>Erwinia herbicola</i>	Angers A.17.6	27
B3	<i>Enterobacter agglomerans</i>	Gilardi 1030	48
	<i>Enterobacter agglomerans</i>	Gilardi 960	46
B5	<i>Erwinia herbicola</i>	ATCC 14589	53
	<i>Erwinia herbicola</i>	Angers B.6.2	49
	<i>Enterobacter agglomerans</i>	Gilardi 968	46
B6	<i>Enterobacter agglomerans</i>	Gilardi 959	29
B7	<i>Enterobacter agglomerans</i>	Richard 13-78	28
B8	<i>Erwinia herbicola</i>	Graham G144 (= LMG 2101)	41

Strains belong to:	Species name as received	Strain no. <sup>a</sup>	% Relative DNA binding <sup>b</sup> with [ <sup>3</sup> H]DNA of <i>Enterobacter agglomerans</i> ATCC 27155 <sup>T</sup>
B9	<i>Erwinia herbicola</i>	Angers 217-8	40
D1	<i>Enterobacter agglomerans</i>	van Vuuren 84 (= LMG 2104)	19
	<i>Enterobacter agglomerans</i>	van Vuuren 117 (= LMG 2105)	12
D3	<i>Enterobacter agglomerans</i>	Richard 17-78	8
E1	Atypical coliform	Gavini 98	24
	Atypical coliform	Gavini 102	20
	Atypical coliform	Gavini 101	19
E4	<i>Enterobacter agglomerans</i>	Gilardi 552	20
DNA hybridization groups within the " <i>Erwinia herbicola</i> - <i>Enterobacter agglomerans</i> " complex according to Brenner et al. (4)			
II	<i>Enterobacter agglomerans</i>	CDC 3123-70	43
III	<i>Enterobacter agglomerans</i>	CDC 1429-71	39
IV	<i>Enterobacter agglomerans</i>	CDC 1741-71	44
VI	<i>Erwinia uredovora</i>	ICPB XU104	54
VII	<i>Enterobacter agglomerans</i>	CDC 6003-71	15
VIII	<i>Enterobacter agglomerans</i>	CDC 5422-69	44
IX	<i>Enterobacter agglomerans</i>	CDC 4388-71	27
X	<i>Enterobacter agglomerans</i>	CDC 1600-71	15
XI	<i>Enterobacter agglomerans</i>	CDC 5378-71	45
XII	<i>Enterobacter agglomerans</i>	CDC 219-71	45
XIII	<i>Erwinia herbicola</i>	ATCC 12287	95
	<i>Erwinia herbicola</i>	ICPB EH103	94

In 1992, Kageyama et al. (1992) [93] isolated several bacterial strains from fruit and soil samples in Japan. These strains have been classified as three new species in the genus *Pantoea*, namely *P. citrea*, *P. punctata* and *P. terrea* [93]. In 1993, Mergaert et al. (1993) made an electrophoretic comparative analysis prepared from the soluble proteins of 38 strains of the previous work of Brenner (1984) and Verdonck et al. (1987). The results showed that the strains could be grouped into 9 groups according to the electrophoretic profile of their proteins [94]. The representatives of the five protein electrophoretic groups included *E. pineapple* LMG 2665<sup>T</sup> (T = strain type) and *E. uredovora* LMG 2667<sup>T</sup>. These groups had 76-100% DNA homology and constituted the 2665 DNA hybridization group. All *E. stewartii* strains (including LMG 2715<sup>T</sup>) were electrophoretically remarkably similar; the representatives of this species presented 93-99% of DNA identity and constituted the 2715 DNA hybridization subgroup. Strains belonging to the other three electrophoretic groups of proteins were 94-96% DNA identical and constituted the 2632 DNA hybridization subgroup. Two subgroups were 60-83% (average 73%) interconnected and showed 30-39% DNA identity and corresponded to group 2665. Based on these results, Mergaert et al. (1993) proposed:

- *E. pineapple* and *E. uredovora* are considered as the same species, which should be classified in the genus *Pantoea* as *Pantoea ananas* (Serrano 1928) comb. nov.; with type strain as LMG 2665 (= NCPPB 1846). This species includes the DNA VI hybridization group of Brenner (1984). The name was corrected to *P. ananatis* by Trüper and De'Clari (1997);
- The transfer of *E. stewartii* to the genus *Pantoea* and the creation of two distinct subspecies within *Pantoea stewartii* (Smith, 1989) comb. nov. *Pantoea stewartii* subsp. *stewartii* (Smith, 1989) comb. nov. (synonym *Erwinia stewartii*) contains the strains belonging to subgroup 2715, and with as type strain LMG 2715 (= NCPPB 2295); and *Pantoea stewartii* subsp. *indologenes* subsp. nov. contains the strains belonging to subgroup 2632, and with as type strain LMG 2632 (= NCPPB 2280).

In 2005, Bergey's Manual of Systematic Bacteriology [96] recommended additional taxonomic work to justify the classification of *P. citrea*, *P. punctata* and *P. terra* in the genus *Pantoea*. Indeed, the three species, can produce the 2,5-diketo-d-gluconic acid (DKGA) from d-glucose [93], which is not the case for the other *Pantoea* species. However, if they have been included in the genus *Pantoea* based on general phenotypic data and DNA-DNA hybridization values, no phylogenetic studies have been done to confirm this inclusion. According to Grimont (2005), the three "Japanese *Pantoea* species" are more similar to *Tatumella ptyseos* than to *Pantoea* in their nutritional patterns [96]. Indeed, the single species genus *Tatumella* was created for clinical strains isolated in North and South America between 1960 and 1980 [97]. In 2005, Paradis et al. (2005) have carried out a phylogenetic comparative analysis of the partial sequences of two housekeeping genes (elongation factor Tu gene [*tuf*] and F-ATPase  $\beta$ -subunit gene [*atpD*]) for 96 strains [98]. The *Enterobacteriaceae* clinical specimens' strains were composed of 96 strains representing 78 species of 31 *enterobacterial* genera. Analysis of the partial sequences demonstrated the existence of an indel specific to the species of *Pantoea* and *Tatumella*. That proved for the first time a phylogenetic affiliation between these two genera.

Brady et al. (2008) have done more work with MLSA of four housekeeping genes (*gyrB*, *rpoB*, *atpD* and *infB*) on *Pantoea* isolated from plants, humans and the environment [99]. The results gave a more complete idea on the phylogenetic positioning of several species of the genus *Pantoea*. The study included:

- (1) Reference strains from the seven currently recognized species of *Pantoea*;
- (2) Strains belonging to Brenner DNA groups II, IV and V, previously isolated from clinical samples and difficult to identify because of their high phenotypic similarity to *P. agglomerans* or *P. ananatis*;
- (3) Strains isolated from diseased *Eucalyptus*, maize and onion, assigned to the genus based on phenotypic tests;
- (4) Outgroup strains including *E. coli*, *Shigella dysenteriae*, and *Citrobacter rodentium*;
- (5) The phylogenetically most closely related neighbors of *Pantoea* including *Tatumella pyseos* and *Pectobacterium cypripedii*, and several *Erwinia* species.

The MLSA tree revealed that the “Japanese” *Pantoea* species (*P. citrea*, *P. punctata* and *P. terrea*) clustered at a much lower level to the genus and are more closely related to the genus *Tatumella*. Since *T. pyseos* was confirmed as the phylogenetic parent, it was suggested to transfer these three species to the genus *Tatumella*. Interestingly, the MLSA scheme distinguished the seven validly published species of *Pantoea* and revealed ten potential new species and the possible inclusion of *Pectobacterium cypripedii* in the genus *Pantoea*.

Based on the findings from Brady et al. (2008), further studies have been done to confirm the taxonomic positioning of the Japanese *Pantoea* species and to name the new species. In France, Delétoile et al. (2009) [100] carried out a phylogenic study of 36 strains belonging to the genus *Pantoea*. The strains were obtained from various microbiological laboratories of the Emerging Bacterial Diseases Unit (Institut Pasteur, Paris, France). To these strains, they added the reference strains of the genus *Tatumella* and strains of the three Japanese *Pantoea* species. The results of this work suggested the reclassification of the three Japanese *Pantoea* species as *Tatumella* [100]. Additionally to the work of Delétoile et al. (2009) [100], Brady et al. (2010) performed a polyphasic taxonomic analysis where they used 16S rRNA gene sequences, MLSA, DNA–DNA hybridization data, phenotypic characteristics, and DNA G+C content. The results confirmed the phylogenetic distance of *P. citrea*, *P. punctata* and *P. terrea* from the genus *Pantoea* and the affiliation of these species with *Tatumella* [102]. In addition, strains causing pink disease of pineapple, previously identified as *P. citrea* [103,104] was shown to represent a separate species. Therefore, the data from the polyphasic analysis have allowed transferring the “Japanese” species from the genus *Pantoea* to the genus *Tatumella* as follows: *P. citrea*, *P. punctata* and *P. terrea* were transferred to the genus *Tatumella* as *Tatumella citrea* comb. nov., *Tatumella punctata* comb. nov. and *Tatumella terrea* comb. nov., respectively. The authors further proposed the taxon *Tatumella morbirosei* sp. nov. for strains LMG 23359 and LMG 23360<sup>T</sup>, both causing pink disease of pineapple.

#### 4. Description of new species of the *Pantoea* genus

From 2009 to 2010, Brady et al. [101] have described several new *Pantoea* species based on polyphasic taxonomic analyses including phylogenetic studies such as AFLP, 16S rRNA gene sequencing, MLSA of *gyrB*, *rpoB*, *atpD* and *infB* partial sequences, DNA-DNA hybridizations, G+C content and phenotypic tests. The result of these analyses indicated that the strains isolated from eucalyptus and maize as well as those from the protein profiling group IV [90] form distinct genetic groups. These genetic groups were supported by AFLP, nucleotide sequence analysis, DNA-DNA hybridization values and MLSA and form four MLSA groups (A to D). *P. vagans* sp. nov. (MLSA group A) is composed of the strains isolated from eucalyptus and maize. *P. eucalypti* sp. nov. (MLSA group B) is formed by strains isolated from eucalyptus in Uruguay. *P. deleyi* sp. nov. (MLSA group D) is formed by strains isolated from eucalyptus in Uganda. Finally, *P. anthophila* sp. nov. (MLSA group C) is composed of the two strains belonging to Beji protein profiling group VII [99].

To bring order into the taxonomy of the *Pantoea* genus, Brady et al. (2010) re-examined the phylogenetic positions of Brenner's DNA HG II, IV and V and *Pectobacterium cypripedii*. They used 16S rRNA gene sequencing and MLSA based on the *gyrB*, *rpoB*, *atpD* and *infB* genes. This was done because Brenner's DNA HG II, IV and V had been suggested previously to belong to the genus *Pantoea*, but they were never formally described and classified as *P. cypripedii*. The analyses revealed that DNA HG II, IV and V and *P. cypripedii* form five separate branches within the genus *Pantoea* (with strains from HG V split into two subbranches) [101]. These results indicated that *P. cypripedii* should be transferred to the genus *Pantoea* and its description should be emended, as *Pantoea cypripedii* comb. nov. In addition, Brenner's DNA HG II, IV and V represented four novel species named: *Pantoea septica* sp. nov. (for HG II), *P. eucrina* sp. nov. (for HG IV), *P. brenneri* sp. nov. (for most strains of HG V) and *P. conspicua* sp. nov. (for strain LMG 24534<sup>T</sup> from HG V).

Using a polyphasic taxonomic study, Alexandra et al. (2010) considered five bacterial isolates obtained from infant formula and an production environment to represent two novel species. Two names were proposed: *Pantoea gaviniae* sp. nov. and *Pantoea calida* sp. nov. [105].

Brady et al. (2011) [106] isolated eight yellow-pigmented bacterial strains from onion seed in South Africa and onion plants exhibiting center rot symptoms in the USA. Polyphasic analysis and other several phylogenetic studies confirmed the membership of these isolates to the *Pantoea* genus. The results also showed that they represent a novel species, which was named *Pantoea allii* sp. nov.

In 2012, Brady et al. isolated several Gram-negative, facultative anaerobic bacteria from *Eucalyptus* seedlings. These bacteria induced bacterial blight and dieback symptoms in Colombia, Rwanda and South Africa. Polyphasic analyses identified them as three novel species. Therefore, they were classified as *Pantoea rodasii* sp. nov. (isolated in Colombia), *Pantoea rwandensis* sp. nov. (isolated in Rwanda) and *Pantoea wallisii* sp. nov. (isolated in South Africa).

Lui et al. (2008) [109] obtained four Gram-negative, facultatively anaerobic isolates from fruiting bodies of the edible mushroom *Pleurotus eryngii*, which induced soft rot disease in

Beijing, China. These isolates were characterised and confirmed as a novel species and were named *Pantoea beijingensis* sp. nov.

Since 2015, four news species have been proposed. Prakash et al. (2015) performed a polyphasic taxonomic analysis on a novel bacterial strain isolated from a stool sample of a healthy human residing in Pune, Maharashtra, India. The results showed that the strain was closest to *P. gaviniae* DSM 22758<sup>T</sup> and *P. calida* DSM 22759<sup>T</sup>. Both isolats were identified as a novel species and named *Pantoea intestinalis* sp. nov.

Kato Tanaka et al. (2015) declared as a novel species of *Pantoea* a Gram-negative, facultative anaerobic strain isolated from black tea. It was named *Pantoea theicola* sp. nov. [111].

Six isolates recovered from coffee seeds exudating a potato-like flavor have been analyzed by Gueule et al. (2015). The results showed that these isolates also represent a novel species, which was designated *Pantoea coffeiphila* sp. nov. [112].

Chen et al. (2017) described a novel strain, LTZR-11ZT, which exhibited multiple plant growth promoting traits. The strain had been isolated from surface-sterilized leaves of *Alhagi sparsifolia*. It was named *Pantoea alhagi* sp. nov. [113].

In 2016, three strains were obtained from the fruiting bodies of the edible mushroom *Hericium erinaceus* displaying symptoms of soft rot in Beijing, China. Based on the results of polyphasic assays, the strains have been classified as a novel species of *Pantoea* and was named *Pantoea hericii* sp. nov. [114].

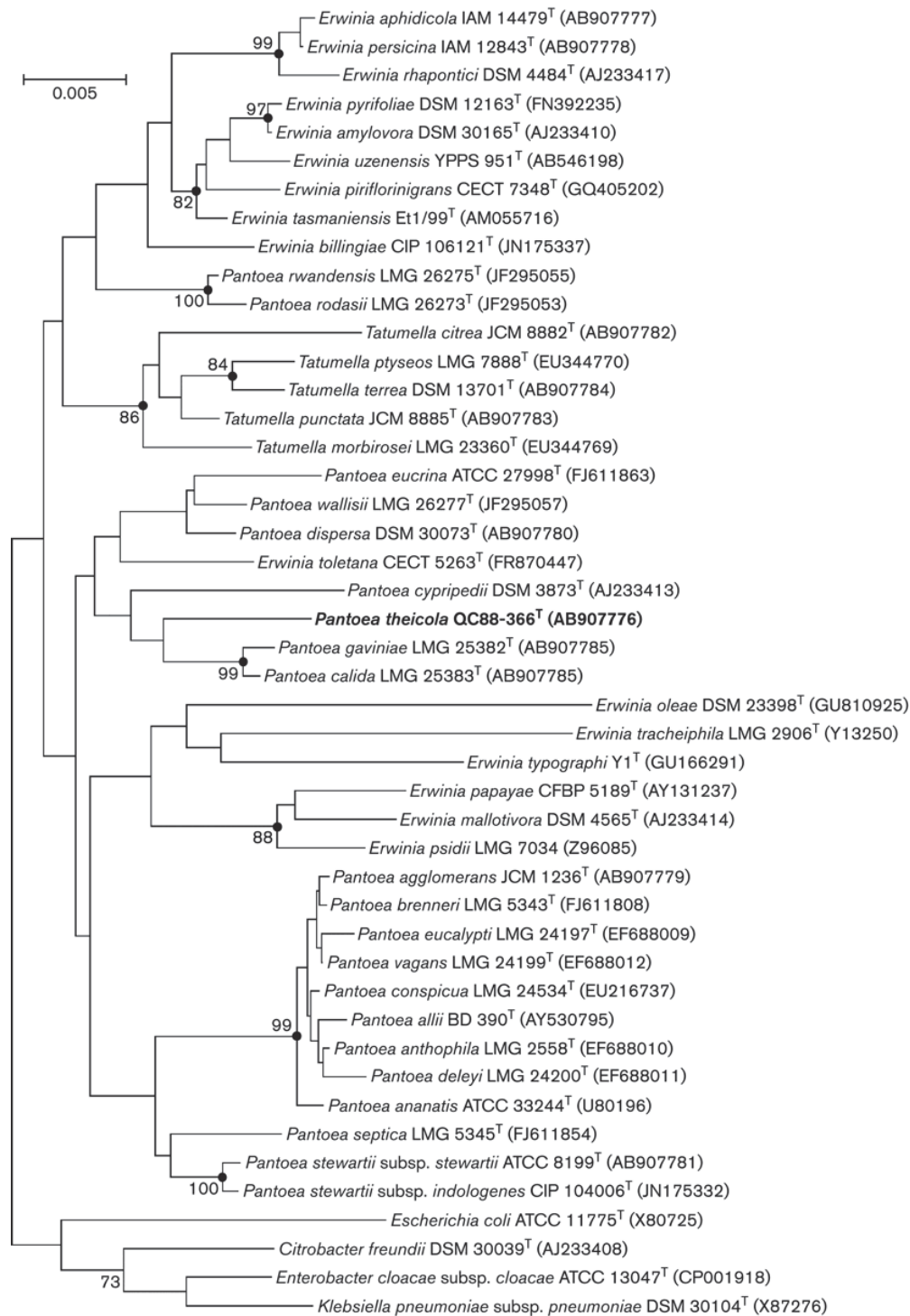
Recently, several phylogenetic and phylogenomic analyses were performed on many genera of *Enterobacteriaceae*. The results suggested to establish a new bacterial family, named *Erwiniaceae*. Importantly, the genus *Pantoea* was shown to belong to this new family [115].

## 5. *Pantoea* spp. plurinominal or multi-codification harmonization

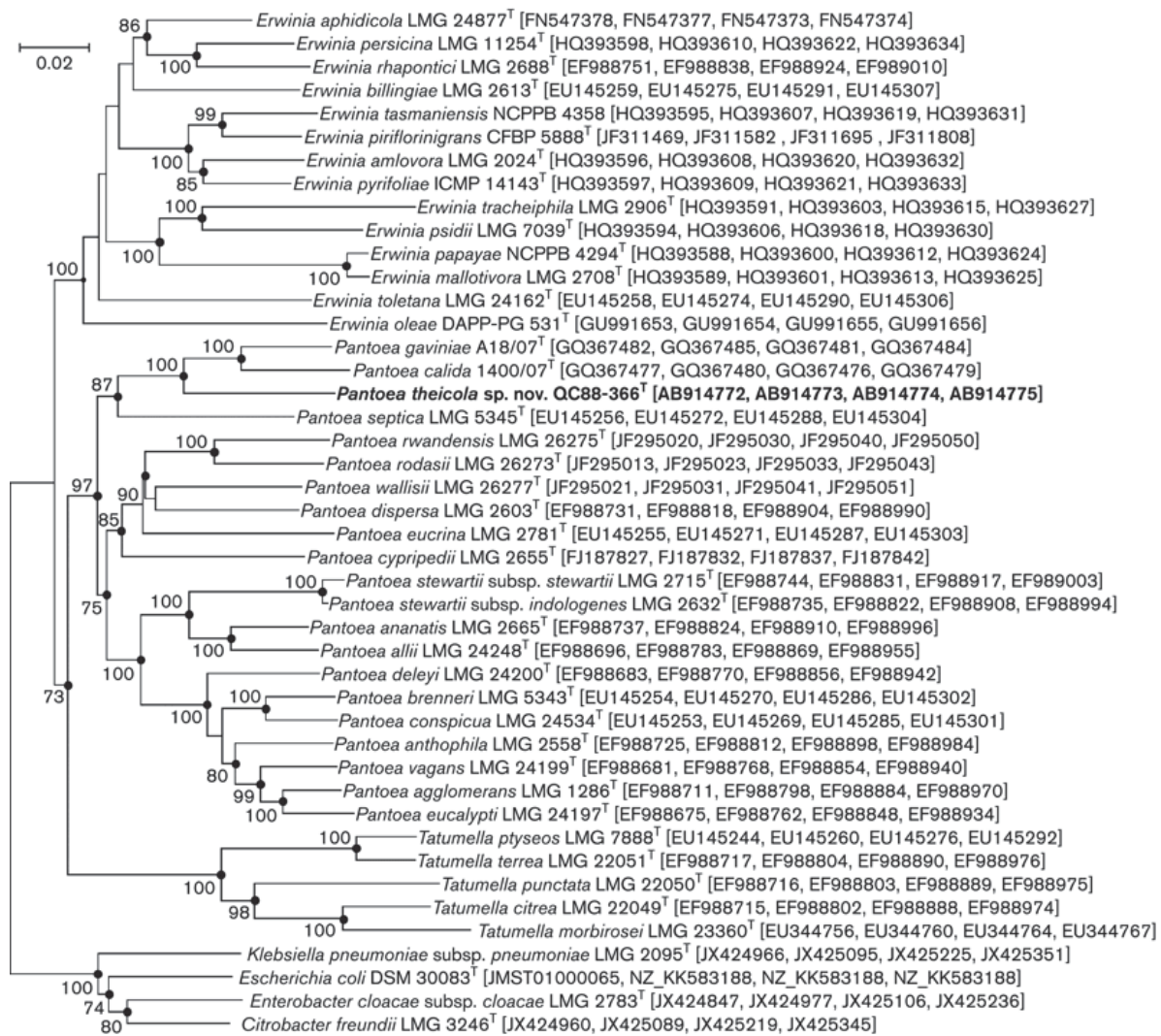
Several collections of microorganism have been established since a long time in several countries. Officially, there are 589 collection centers in 68 countries registered in World Data Center for Microorganisms <http://www.wfcc.info/index.php/collections/display/>. The activities of these collection centers are dedicated to the conservation and distribution of strains of bacterial pathogens isolated from animals, plants and the environment. They aim to acquire, characterize, preserve and distribute microbial strains. In practice, all the strains in their catalogues can be supplied on request for research. The distributions are made after payment of a financial contribution to cover the costs of maintenance, preparation and sending. The number of bacterial strains in the collections gets constantly increased by two main ways: (1) strains deposited by researchers from around the world, allowing a researcher to deposit the same strain in several collections, and (2) acquisition of strains (notably type strains) from other collections. Therefore, these two ways lead to a situation of plurinominal or multi-codification of bacterial strains. Indeed, the same strain can have several names depending on the coding of its collection. This often leads to confusion in comparative studies and writing of manuscripts, which happened to us as well. Indeed, in many publications on the nomenclature and taxonomic studies of *Pantoea* spp, several strains of *Pantoea* spp. have different codification depending on their native collections. For the better understanding of

our manuscript, it is necessary to harmonise them. But in the spirit of respecting the originality of our sources, we tend to withhold the original names according to the publications. However, for ease of reading, we have prepared a table (Attachments, Table 2) summarising the *Pantoea* spp.strains used in our study. In this table, we have listed the BCCM/LMG (Belgian Coordinated Collections of Microorganisms/LMG Bacteria Collection) *Pantoea* spp. strains and we have associated them with the other names they have in other collections.





**Figure 2:** Phylogenetic neighbor joining tree based on 16S rRNA gene sequences (1319 bp) showing the relationship between type strains of the genera *Pantoea*, *Erwinia* and *Tatumella*. Only bootstrap values (expressed as percentages of 1000 replications) >70 % are shown at the nodes. Filled circles indicate that the corresponding nodes have been also recovered in the maximum likelihood tree. The type strains of *Escherichia coli*, *Citrobacter freundii*, *Enterobacter cloacae* subsp. *cloacae* and *Klebsiella pneumoniae* subsp. *pneumoniae* have been used as the outgroup. Bar, 2 % sequence dissimilarity [111].



**Figure 3:** Phylogenetic neighbor joining tree based on the concatenated partial sequences of *atpD*, *gyrB*, *infB* and *rpoB* gene sequences (2483 bp), showing the phylogenetic relationships between type strains of the genera *Pantoea*, *Erwinia* and *Tatumella*.

Only bootstrap values (expressed as percentages of 1000 replications) >70 % are shown at the nodes. Filled circles indicate that the corresponding nodes have been also recovered by the maximum likelihood tree. The type strains of *Escherichia coli*, *Citrobacter freundii*, *Enterobacter cloacae* subsp. *cloacae* and *Klebsiella pneumoniae* subsp. *pneumoniae* have been used as the outgroup. Bar, 2 % sequence dissimilarity [111].

## 6. Description of the genus *Pantoea* Gavini et al. (1988) emended. Mergaert et al. (1993)

The description is based on the data collected by Gavini et al. (1988), Mergaert et al. (1993), Grimont and Grimont (2005) and Brady et al. (2007, 2008, 2009, 2010a, 2010b, 2012).

### 6.1. The genus *Pantoea* Gavini et al.(1988) emended. Mergaert et al. (1993)

*Pantoea* is a genus of Gram-negative bacteria of the family *Erwiniaceae*. Etymologically, *Pantoea* means “Pantoios”, i.e. of all sorts and sources; N.L. fem. n. *Pantoea*, bacteria from diverse geographical and ecological sources (Table 2 and Figures 1, 4 and 5). Many strains of the bacteria have been isolated worldwide from countries such as China, India, Malaysia, South Africa, and the United States of America. Currently, this genus includes 27 species (*P. agglomerans*, *P. alhagi*, *P. allii*, *P. ananatis*, *P. anthophila*, *P. beijingensis*, *P. brenneri*, *P. calida*, *P. coffeiphila*, *P. conspicua*, *P. cyripedii*, *P. deleyi*, *P. dispersa*, *P. eucalypti*, *P. eucrina*, *P. gaviniae*, *P. hericii*, *P. intestinalis*, *P. latae*, *P. rodasii*, *P. rwandensis*, *P. septica*, *P. sesame*, *P. stewartii*, *P. theicola*, *P. vagans*, and *P. wallisii*), including two subspecies (*P. stewartii* subsp *indologenes* and *P. stewartii* subsp *stewartii*).

Microscopically, almost all the strains of the species belonging to *Pantoea* are straight rods, 0.5–1.3 x 1.0–3.0 µm. They are non-encapsulated and do not form spores. Some strains form symplasmata. Most strains are motile by means of peritrichous flagella. Colonies on nutrient agar are smooth, translucent and convex with entire margins or heterogeneous in consistency and adhering to the agar. Colonies are yellow, beige or non-pigmented. The bacteria are facultatively anaerobic. The optimum growth temperature is between 28 and 30 °C. Strains have been isolated from plants, seeds, fruits, soils, water and from humans (urine, blood, wounds, internal organs) and other animals. Strains of several species are phytopathogenic on a wide range of plants. The G+C content of the DNA ranges from 52.7 to 60.6 %. The type species is *P. agglomerans* (Ewing and Fife, 1972; Gavini et al., 1988).

### 6.2. Biochemical characterization of the genus *Pantoea*

Strains of *Pantoea* are oxidase- and urease-negative. They produce active glucose dehydrogenase and gluconate dehydrogenase without an added cofactor. Lysine and ornithine are not decarboxylated. Pectate is not degraded. H<sub>2</sub>S is not produced from thiosulphate. Most strains are Voges–Proskauer-positive and indole-negative. Acid is produced from the fermentation of L-arabinose, D-ribose, D-xylose, D-galactose, D-fructose, L-rhamnose, D-mannitol, *N*-acetylglucosamine, maltose and trehalose. Carbon sources utilized at 28 °C (biotype-100) are *N*-acetyl-D-glucosamine, L-aspartate, D-fructose, D-galactose, D-gluconate, D-glucosamine, D-glucose, L-glutamate, glycerol, D-mannose, D-ribose, and D-trehalose. Carbon sources not utilized at 28 °C (biotype-100) are 5-aminovalerate, benzoate, caprate, caprylate, *m*-coumarate, ethanolamine, gentisate, glutarate, histamine, 3-hydroxybenzoate, 4-hydroxybenzoate, 3-hydroxybutyrate, itaconate, maltitol, D-melezitose, 1-*O*-methyl- $\alpha$ -D-glucoside, palatinose, 3-phenylpropionate, propionate, L-sorbose, tricarballylate, tryptamine, D-turanose, and L-tyrosine. All the species share the characteristics of the genus. They are mainly based on several strains studied by conventional methods by Gavini et al. (Table 8) [40,86].

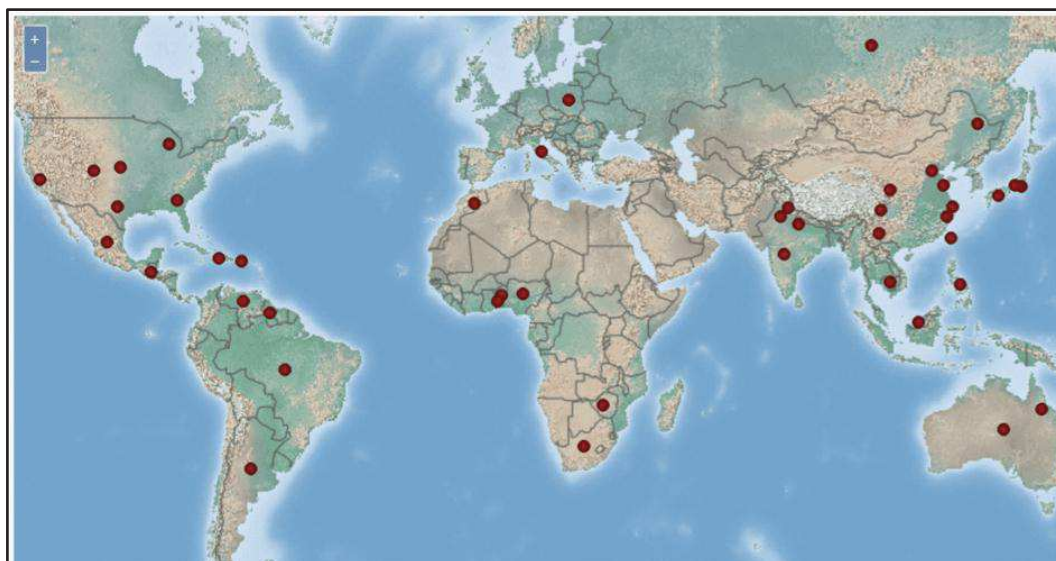
## 7. Etiology of the *Pantoea* genus

### 7.1. Plant diseases caused by *Pantoea* genus reported worldwide

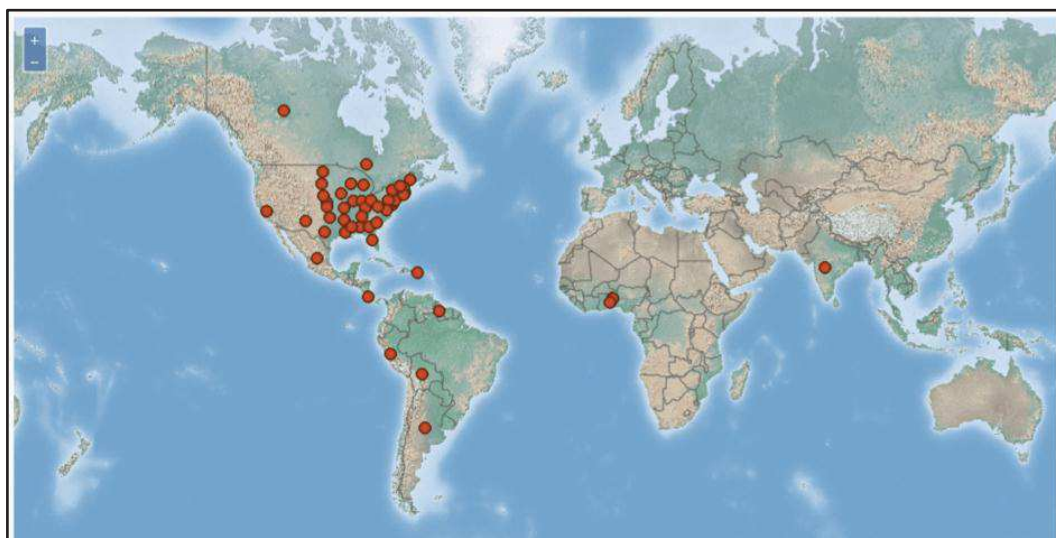
As a plant pathogen, the genus *Pantoea* represents a veritable threat to agricultural production around the world. Indeed, among the 27 species of *Pantoea* described so far, five species have been reported up to 46 times in 21 countries as phytopathogens of at least 31 economically important crops. Although each of the five phytopathogenic species can cause damage to several crops, three of them, *P. ananatis*, *P. agglomerans* and *P. stewartii*, are responsible for more than 80% of the reported cases. Notably, *P. ananatis* and *P. agglomerans* are reported as the causal agents of diseases on at least 10 important crops, namely maize, rice, sorghum, onion, china taro, pineapple, peaches, melon, lemon and *Eucalyptus* [117–127]. For *P. stewartii*, apart from the maize on which the species are widely reported in the USA [129] and Canada [130], they are also reported on water bamboo, jack fruit and sudangrass [130–132] in other countries. In addition to these three major species, two more species, *P. allili*, and *P. dispersa*, have been reported as a pathogen for onion and sugarcane, respectively [106]. For cereals (e.g. maize, rice, sorghum), 15 cases were reported [115,121,125,127,133–143], but also fruits (melon, Jack fruits, citrus, ananas) [118,145] and vegetables (onion, ginger, beans) [105,122,126,145–150] with nine cases each belong to the most attacked plants. Cases on some industrial commodities, like cotton [120,121], wood (*Eucalyptus*) [107,116,152], flowers (garden balsam) [132] and forage plants (sudangrass) [131] were also reported (Table 2 and Figures 1, 4 and 5).

Other disturbing characteristics of these pathogens are the versatility of the various organs attacked and the types of diseases they cause on these organs. On the leaves, the most observed symptoms are leaf blotch, leaf spot and leaf blight. On fruits, cases of internal fruit rot, rot center, soft rot, and bulb decay are observed. On grains and inflorescences, seed stalk rot, palea browning, and grain discoloration were reported [117–127] (Table 2 and Figures 1, 4 and 5).

This overview of the many cases of phytopathogen diseases caused by the different species of *Pantoea* spp. clearly shows that this genus constitutes a significant threat for agricultural production worldwide.



**Figure 4:** Map of the distribution of plant diseases due to infection by *Pantoea ananatis* (source: <https://www.cabi.org/isc/datasheet/21909>).



**Figure 5:** Map of the distribution of plant diseases due to infection by *Pantoea stewartii* (source: <https://www.cabi.org/isc/datasheet/2193>).

**Table 2:** Epiphytic and parasitic colonisation of plants by strains of *Pantoea* [41,42].

Species	Epiphyte	Pathogen	Disease/symptoms
<i>P. agglomerans</i>	Cabbage <sup>1</sup> , leek <sup>1</sup> , spinach <sup>1</sup> , tomato <sup>1</sup> , kiwi <sup>1</sup> , persimmon <sup>1</sup> , wheat <sup>1</sup> , green bean <sup>2</sup> , oat seed <sup>2</sup> , soy bean <sup>2</sup> , onion <sup>2</sup> , baby's breath <sup>2</sup> , raspberry bush <sup>2</sup> , rose bush <sup>2</sup> , Virginia creeper <sup>2</sup> , cherries <sup>2</sup>	Pea <sup>9</sup> , sweet corn <sup>10</sup> , sweet potato <sup>11</sup> , sugarcane <sup>12</sup> , bamboo <sup>13</sup> , wheat <sup>14</sup> .	Various
		Cotton <sup>10</sup>	Seed and ball rot <sup>35</sup>
		Eucalyptus <sup>15</sup>	Bacterial blight and dieback
		<i>Gypsophila paniculata</i> <sup>16</sup>	Gall
		Rice <sup>17</sup>	Red stripe
		Beach pea <sup>18</sup>	Black spot necrosis
		Chinese taro <sup>19</sup>	Bacterial spot
<i>P. allii</i>		Beet <sup>20</sup>	Tumors
		Onion <sup>21</sup>	Centre rot
<i>P. ananatis</i>	Rice <sup>2</sup> , pineapple <sup>3</sup>	Bamboo <sup>13</sup> , switchgrass <sup>22</sup>	Various
		Rice <sup>23</sup>	Stem necrosis
		Netted melon <sup>24</sup>	Fruit rot
		Onion	Centre rot <sup>36</sup> , bulb decay <sup>37</sup>
		Sudangrass <sup>25</sup>	Leaf blotch
		Eucalyptus <sup>26</sup>	Bacterial blight and dieback
		Corn <sup>27</sup>	Leaf spot disease
<i>P. anthophila</i>	Balsam <sup>2,4</sup>	Agave <sup>28</sup>	Red leaf ring
<i>P. beijingsensis</i>	<i>Pleurotus eryngii</i> <sup>5</sup>		
<i>P. cyripedii</i>	Orchid <sup>6</sup>		
<i>P. deleyi</i>	Eucalyptus <sup>4</sup>		
<i>P. dispersa</i>	Sorghum <sup>2</sup>	Grape <sup>29</sup>	
		Sugarcane <sup>12</sup>	
<i>P. eucalyptii</i>	Thistle <sup>2</sup> Eucalyptus <sup>4</sup>		
<i>P. rodasii</i>	Eucalyptus <sup>7</sup>		
<i>P. rwandensis</i>	Eucalyptus <sup>7</sup>		
<i>P. stewartii</i>	Steria italia <sup>3</sup>	Cotton <sup>30</sup>	Seed rot
		Sudangrass <sup>25</sup>	Leaf blotch
		Eucalyptus <sup>26</sup>	Bacterial blight and dieback
		Corn <sup>3,31</sup>	Stewart's wilt
<i>P. vagans</i>	Eucalyptus <sup>4</sup>		
<i>P. wallisii</i>	Eucalyptus <sup>7</sup>		
<i>Pantoea</i> sp.	Plum <sup>8</sup>	Sugarcane <sup>32</sup>	
		Deepwater rice <sup>33,34</sup>	

<sup>1</sup>Oie et al. (2008), <sup>2</sup>Nadarasah and Stavrinides (2014), <sup>3</sup>Mergaert, Verdonck and Kersters (1993), <sup>4</sup>Brady et al. (2009a,b), <sup>5</sup>Liu et al. (2013), <sup>6</sup>Brady et al. (2010a,b), <sup>7</sup>Brady et al. (2012), <sup>8</sup>Janisiewicz et al. (2013), <sup>9</sup>Elvira-Recuenco and van Vuurde (2000), <sup>10</sup>McInroy and Kloepper (1995), <sup>11</sup>Asis and Adachi (2004), <sup>12</sup>Magnani et al. (2013), <sup>13</sup>Nadha et al. (2012), <sup>14</sup>Stets et al. (2013), <sup>15</sup>Brady et al. (2009a,b), <sup>16</sup>Cooksey (1986), <sup>17</sup>Guanlin (2001), <sup>18</sup>Khetmalas et al. (1996), <sup>19</sup>Romeiro et al. (2007), <sup>20</sup>Burr et al. (1991), <sup>21</sup>Brady et al. (2011), <sup>22</sup>Gagne-Bourgue et al. (2013), <sup>23</sup>Cothier et al. (2004), <sup>24</sup>Kido et al. (2008), <sup>25</sup>Azad, Holmes and Cooksey (2000), <sup>26</sup>Coutinho et al. (2002), <sup>27</sup>Pérez-y-Terrón et al. (2009), <sup>28</sup>Fucikovsky and Aranda (2006), <sup>29</sup>Nisiotou et al. (2011), <sup>30</sup>Bell et al. (2004), <sup>31</sup>Roper (2011), <sup>32</sup>Loiret et al. (2004), <sup>33</sup>Verma et al. (2004), <sup>34</sup>Laskar, Nevita and Sharma (2012), <sup>35</sup>Medrano and Bell (2007), <sup>36</sup>Walcott et al. (2002), <sup>37</sup>Gitaitis and Gay (1997).

## 7.2. Insights from genomic analyses of *Pantoea* spp.: a highly versatile and diverse genus within the family of *Erwiniaceae*

Several genomes of *Pantoea* bacteria have been sequenced and analysed. This work helped (i) to identify the genomic variability within the bacterial species up to the strain level; (ii) to make an inventory of the genes, and (iii) to perform sequence comparisons of strains of diverse origins. More than 150 WGSs, including 110 WGSs and 57 plasmids from well-described species and 43 genome assemblies and 6 plasmids from uncharacterized isolates are publicly available in the NCBI genome database. These resources broaden the understanding of cross-kingdom interactions between bacteria and hosts and allow profound studies of the phylogenetic diversity. The technique used is genomic comparative analysis that provides insight into pathogenic and beneficial traits.

### 7.3. Understanding of *Pantoea* spp. lifestyle and cross-kingdom colonisation

The application of powerful bioinformatics tools has made possible to perform several comparative genomics analyses of various isolates [42,152–155]. Sequence analysis of *Pantoea* genomes isolated from plants has allowed genomic understanding of several of the phenotypic mechanisms. These mechanisms constitute the pathogenic, commensal and beneficial growth-promoting effect for several important crops [155–159]. Some analyses have shown that the adaptation of the *Pantoea* genus can be explained at the pan-genomic level. Indeed, its pan-genome encodes several proteins found in the genomes of other bacteria associated with distinct hosts [42,153,156]. Thus, the bacteria carry a few coding DNA sequences (CDSs) with orthologs restricted to bacteria associated with distinct hosts, namely plant-, animal- and insect-associated. Moreover, the phylogenomic analyses revealed that there are two distinct clades within *P. ananatis* while far less phylogenetic diversity was observed in the *P. stewartii* subspecies [42] (Figure 6 and 7). Additionally, the analyses revealed a range of different evolutionary drivers, as well as strain- and species-specific factors which may explain the distinct lifestyles of these two species [42].

### 8. Understanding of *Pantoea* spp. phytopathogenicity

For the pathogenicity of the *Pantoea* genus, most of the strains studied were pathogenic to plants [128,160–163]. Type II, type III and type IV secretion systems are well documented as virulence determinants of several human and plant pathogens [164–169]. Thus, analyses made on the genomes of numerous species associated with different sources showed a heterogeneous distribution of secretion systems. Thus, the type III secretion system (T3SS), one of the key determinants of pathogenicity has been detected in some *Pantoea* species, including *P. agglomerans* and *P. stewartii* subsp. *stewartii* [162,170–172]. According to Correa et al. (2012), *P. stewartii* subsp. *stewartii*, the causal agent of Stewart's bacterial wilt and corn leaf, uses two T3SS systems (PSI-1 and PSI-2), the first one for successful colonization of maize plants and the second one for colonization of the flea beetle vector (*Chaetocnema pulicaria*) (Figure 7 and 8). Later on, a third T3SS system, called PSI-3, was discovered in *P. stewartii* subsp. *stewartii*. It is similar to that found in *Salmonella* [172] (Figure 6-8). Indeed, the type III effector WtsE/AvrE is responsible for water soaking and subsequent cell death in plant hosts [173]. According to Kirzinger et al. (2015), the first two secretion islands are inherited vertically through the evolutionary processes, while PSI-3 was acquired horizontally through genetic exchange with other members of the *Enterobacteriaceae*. These members include genera whose members are known as human pathogens, such as *Salmonella* and *Yersinia* [174] (Figure 8). These results of the comparative analyses of the genomes of these species allowed to identify the mechanisms used by the strains to infect humans and vertebrate animals [41,42]. Further analysis to understand the hypersensitive response induced by some *P. agglomerans* strain have revealed the presence of a complete *hrp/hrc* gene cluster. This gene cluster exhibits remarkable synteny and high sequence similarity with *E. amylovora* and *E. pyrifoliae* homologs.

Other studies on the complete genome sequences demonstrated the presence and conservation of the type VI secretion system [166,175]. It is formed by three loci (T6SS-1, T6SS-2 and

T6SS-3). De Maayer (2011) reported that T6SS-1 is the most important virulence determinant, which plays a role in intra- and interspecies bacterial competition. The type VI secretion system has been identified in the genome sequences of many bacteria (pathogenic, symbiotic and free-living). In order to better understand this secretion system, Shyntum et al. (2014) performed a genomic comparison of strains of *P. ananatis* originating from different hosts and environments. De Maayer et al. (2011) showed that the T6SS-1 locus contains two highly conserved core regions, which alternate with variable regions containing *hcp* and *vgrG* genes encoding secreted effector proteins [166]. The *hcp* and *vgrG* islands contain domains that are conserved across *P. ananatis* strains. These islands play a significant degree of homology with genes with known roles in antibiosis, fungal cell wall degradation and animal and plant pathogenesis [166].

Plasmids determine key functions of bacteria, such as transport and catabolism of various substrates, inorganic ion uptake, antibiotic and heavy metal resistance, colonisation and persistence in the hosts and environments, pathogenesis and antibiosis [161,176,177]. For several species belonging to the genus *Pantoea*, genes coding for pathogenicity-determining proteins and others are often localised on plasmids. For example, *P. stewartii* strain DC283 contains 10 circular plasmids and two type III secretion systems (PSI-1 and PSI-2). They play significant roles in the colonisation of insect and plant hosts [178]. PSI-1 and PSI-2 were found to be located on two separate megaplasmids. Comprehensive genome analysis of some species has identified some plasmids containing a pathogenicity island for plant infection. One example is the 150-kb pPATH plasmid of *P. agglomerans*, which contains a plant pathogenicity island [161]. Another plasmid, LPP-1, is found to be distributed among 20 isolates representing seven different species (*P. agglomerans*, *P. vagans*, *P. eucalyptii*, *P. anthophila*, *P. stewartii*, *P. ananatis* and *P. cyripedii*) [179]. It governs the basic life functions of the bacteria mentioned above. These studies showed that LPP-1 directs the diversification of its functions according to the species and allowed these functions to vary according to distinct ecological niches (pathogenic or beneficial properties). These results may partly explain (i) why strains of the same species can be isolated from diverse sources, (ii) why strains of different species can be isolated from the same sources, (iii) why strains of the same species may have different types of interactions with the same host, and (iv) why strains of different species may have the same interactions with a given host.

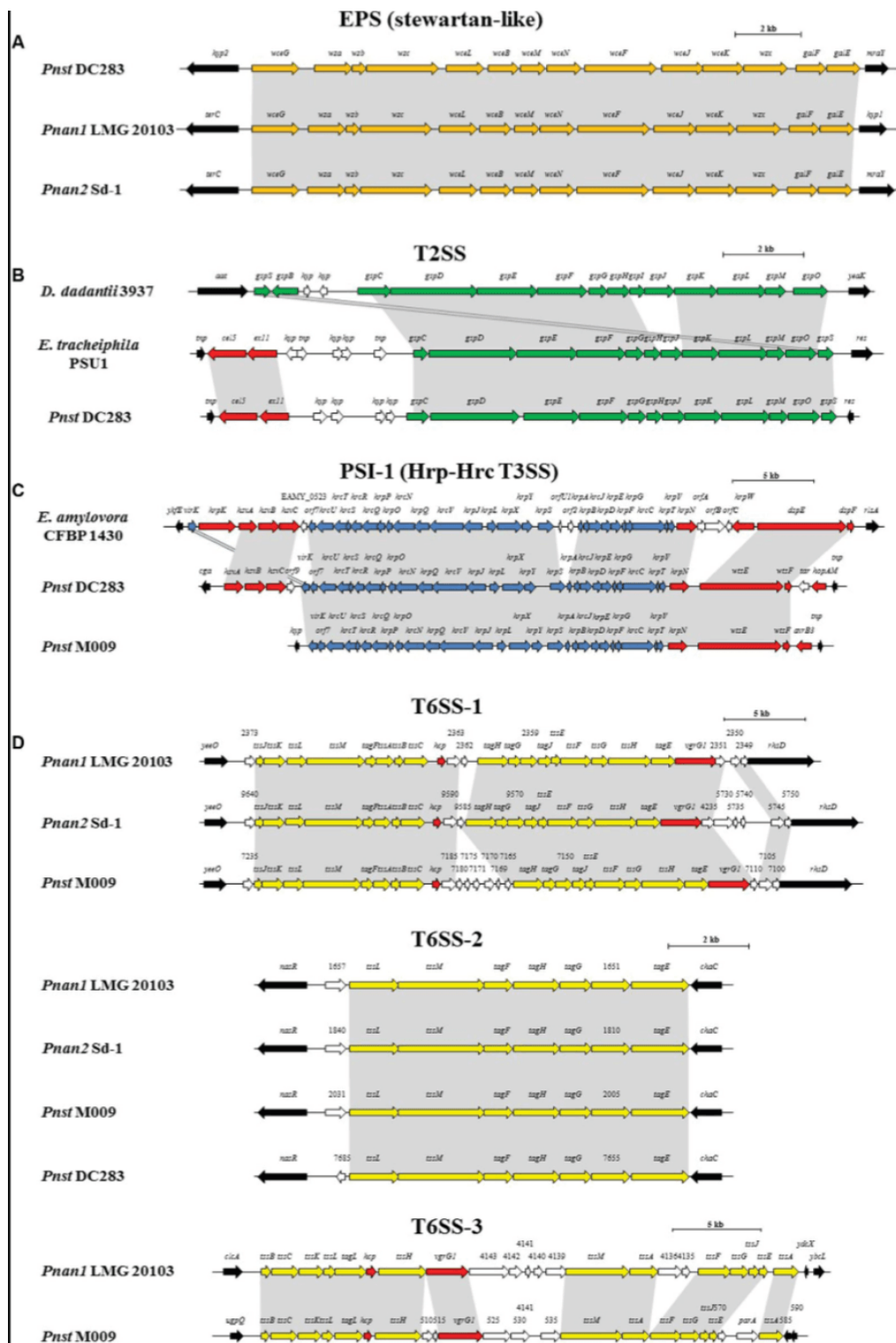
Other studies have shown that apart from secretion systems and plasmids, other genomic elements can explain the pathogenicity of some species. Indeed, studies on the *P. stewartii* subsp. *stewartii* DC283 genome by Duong et al. (2017) showed how xylem-dwelling bacteria establish themselves and induce disease in their hosts [180]. Indeed, one of the most studied processes is quorum sensing for *P. stewartii* subsp. *stewartii*. Quorum sensing has been shown to influence adhesion, motility, dispersion, and exopolysaccharide (EPS) production. It plays an essential role in the development of Stewart's wilt disease of corn [181,182]. The production of EPS by *P. stewartii* during the colonisation of the plant xylem blocks the flow of xylem sap, which causes the wilting of the plant. EPS not only contributes to the onset of Stewart's disease symptoms but also protects the bacteria against plant host defense metabolites [183]. According to Koutsoudis et al. (2006), this production of EPS is regulated by the EsaI/EsaR quorum detection system which governs the carbamoyl-phosphate synthase



(*cps*) gene cluster. This gene cluster is responsible for EPS biosynthesis in a cell density dependent manner. In addition, Ham et al. (2008) showed that the presence of the *cps* gene cluster represents a core genetic component in the pathogenicity of *P. stewartii*.

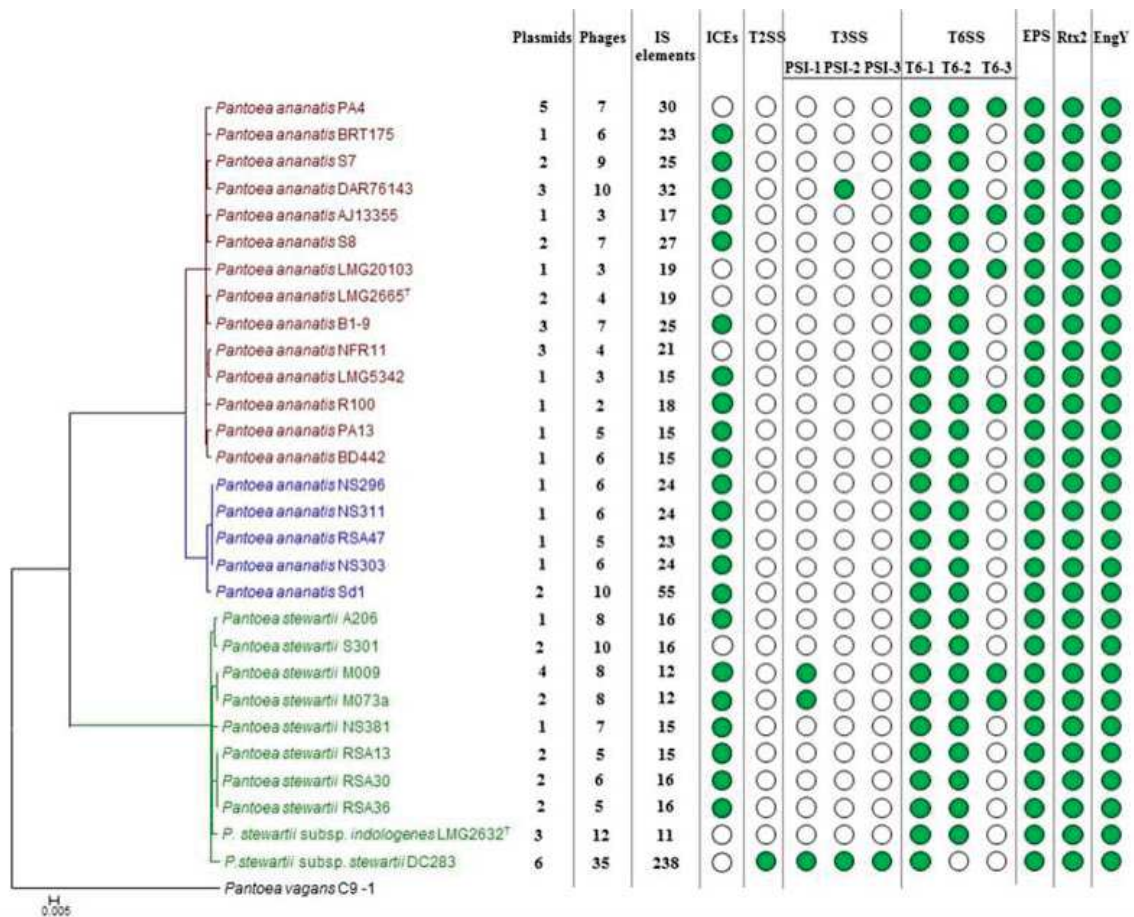
Other studies on strain DC283 revealed the presence of highly conserved flagellar and motility (*fli*, *flg*, *flh*, and *mot*) gene systems in *P. stewartii* [184,185] which are essential for surface motility. This phenomenon is critical for Stewart's wilt disease development on Maize. It is evident that *P. stewartii* requires surface motility to form bacterial aggregates as a key step in bacterial biofilm development. The bacteria colonise the xylem of corn as surface-adherent biofilms. In addition, via RNA-seq analyses of in-planta transcriptome upon infection by the corn pathogen *P. stewartii* subsp. *stewartii*, it was shown by Packard et al. (2017) that bacterial transporters and vital systems for oxidation reduction processes appear to play a critical role when *P. stewartii* colonises and causes wilt disease in maize plants [186].

All the above analyses allowed concluding that the availability of numerous genome sequences contributes to a better understanding of the host colonising and metabolic properties and the underlying genetic and physiologic mechanisms used by strains of *Pantoea*.



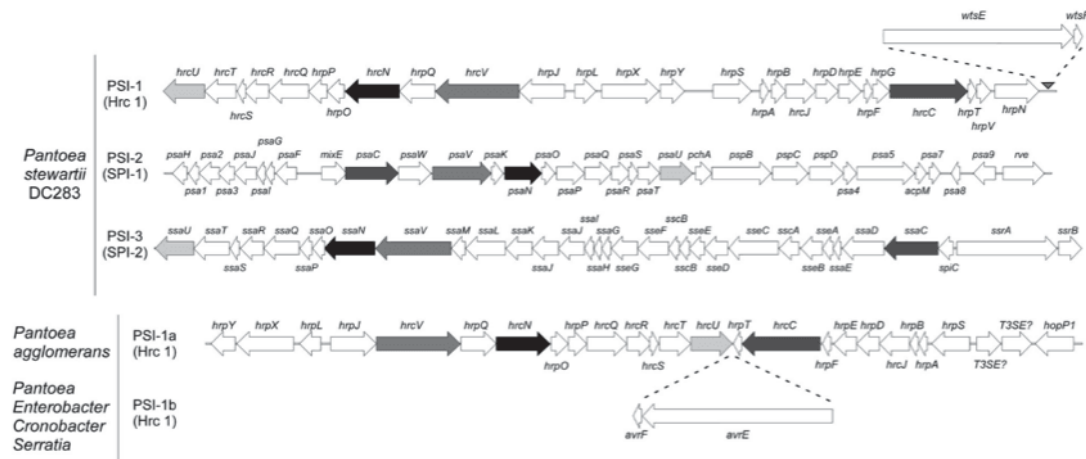
**Figure 6:** Alignments of the loci encoding predicted pathogenicity determinants from representative strains of each clade, Pnan1, Pnan2 and Pnst, as well as representatives of other genera.

(A) EPS (orange), (B) T2SS (green), (C) Hrp-Hrc T3SS (blue) and (D) T6SS-1, T6SS-2 and T6SS-3 loci (yellow). Red arrows indicate genes coding for predicted effectors of the T3SS and T6SS, white arrows indicate genes coding for hypothetical proteins and black arrows denote the flanking genes. Size bars indicate the estimated sizes of the loci [180].



**Figure 7:** Prevalence of the mobilome and pathogenicity factors among the Pnan and Pnst strains.

A core genome phylogeny is shown on the left as constructed on the basis of 2,817 core genes conserved in all compared strains. The number of predicted plasmids, prophages and insertion sequences (IS) present in each genome are indicated. Green dots indicate the presence of integrative and conjugative elements (ICEs) and pathogenicity determinants encoded on the genome [180].



**Figure 8:** Genomic organisation of the type III secretion systems identified in strains of *Pantoea*.

Genome maps of the three systems found in *P. stewartii* subsp. *stewartii* DC283 are shown, including the PSI-1 (Hrc1) and PSI-2 (SPI-1) T3SSs that were previously identified and the new PSI-3 (SPI-2) system described in this study. Two other unique Hrc1-type systems, PSI-1a, and PSI-1b, were also identified in *P. agglomerans* and *P. calida*, which differ in the presence of the *avrE*–*avrF* cassette [174].

### III. Generalities on rice

#### 1. Rice cultivation

Rice is the cereal of the world, it is the staple food of many people, notably for South America, Africa and Asia [187,188]. Rice cultivation has practically begun 10,000 years ago since the Neolithic Revolution [189]. Nowadays, it is practiced everywhere in a wide range of climatic and hydrological conditions: from the seaside in the mangroves up to 3000 m of altitude (in Nepal), and from 40° South in Argentina up to at 53° North in China, passing through all the intertropical zones [188–190]. This multitude of environments is accompanied by a great diversity of practices and germplasm of cultivated rice varieties. In Africa, between 1500 and 800 BC, the African rice “*Oryza glaberrima*” was cultivated. Originating from the Niger Delta, this variety has spread to Senegal [191–193]. However, it has never been developed far from its region of origin and its cultivation has considerably diminished in favor of Asian rice species introduced in East Africa and having spread to the west [192]. According to the Food and Agriculture Organization, 444 million tons of rice was consumed worldwide in 2008 and the demand is expected to raise by 50% until 2050. Being a luxury food in the past in sub-Saharan Africa, rice has become a daily food nowadays. Its total consumption in sub-Saharan Africa is expected to increase from 20 to 48 million tones until 2050 [188]. There are two main rice ecosystems depending on the water regime, the aquatic ecosystem and the non-aquatic ecosystem [195].

#### 2. Rice diseases

Since the 1960s, rice has become increasingly important in sub-Saharan Africa. In West Africa, this demand keeps increasing. Indeed, changes in dietary habits, coupled with population growth, are behind this exceptional expansion of sub-regional demand [188]. Rice is also a strategic crop from an economic point of view as it generates income for the rural population and contributes substantially to fight against poverty. Despite the importance of this cereal for West Africa, this region is currently unable to achieve rice self-sufficiency [196,197]. Thus, most of the sub-region countries have to fill the gaps by massive rice imports each year (up to 40% of the consumption). Several factors or difficulties are at the origin of this situation. Among them, there are socio-political difficulties, land constraints, climatic constraints (drought and flooding) and biological constraints that include pests, weeds and diseases caused by phytopathogenic microorganisms [198]. Viruses, fungi and bacteria are the main pathogenic microorganisms responsible for diseases on rice in West Africa [198–200]. They have a great potential to significantly reduce the yield or value of the rice crop (or seeds). Below, a brief description of the major diseases of rice in West Africa is presented. These descriptions cover a general overview of the pathogen, its incidence and severity, symptoms, damage, yield losses, and methods of control.

##### 2.1. Rice blast

Caused by the ascomycete fungus *Magnaporthe grisea* (Anamorph: *Pyricularia grisea*), this fungal disease affects leaves, stems and panicles [202]. The pathogen in its asexual form

(*Pyricularia grisea* Cavara) has been first described in 1891 [203]. The sexual form, *Magnaporthe grisea* (Hebert) Barr [204], was first obtained in the laboratory by crossing two isolates of *Digitaria sanguinalis*. The disease was already known to occur in China in 1637, but the disease is found in approximately 85 countries throughout the world where it is highly destructive in lowland and upland under temperate and subtropical conditions [200,205]. For example, in Ghana [206] and in Cote d'Ivoire [207], the disease causes up to 20 to 80% yield losses. The disease is present in all types of rice ecology. The use of high nitrogen fertilizer applications represents one of the favourable factors for diseases. [31].

**Pathogen and favourable conditions:** The fungus has stable and environment-resilient mycelia capable of producing conidiospores that carry bouquets of conidia (asexual multiplication organs). Once released, these conidia attach to hydrophobic surfaces using an adhesive glycoprotein mucilage. The spores of *M. grisea* are scattered by wind and rain generally over distances of less than three meters [208]. Under favourable conditions, the foliar infectious cycle of the fungus can be realized in seven days.

**Symptoms:** The disease causes whitish lesions that develop into diamond-shaped necrotic lesions, with a greyish centre and brown margins. Typical susceptibility lesions have brown margins and expand without any limit. In any case, when lesions enlarge and fuse, leaves may die. This is the case when attacks are severe on susceptible plants. The lesions reduce the photosynthetic activity of the leaves, causing a decrease in tillering and global plant development. Nodes, stems, seeds and panicle can also be attacked. This form of the disease is the most damaging to crops. Indeed, it prevents the filling of grains and, like this, directly impacts the yield and the quality of the grains.

**Disease management:** The adoption of appropriate cultural practices can help to control rice blast. For example, it is advisable to use healthy seeds, rotate crops as much as possible and remove contaminated straw. The development and use of blast resistant cultivars is considered the best way of sustainable disease control.

## 2.2. Bacterial leaf blight of rice

Bacterial leaf blight (BLB) of rice caused by *Xanthomonas oryzae* pv. *oryzae* (also referred to as *Xoo*), represents another significant biotic constraint to rice production. In Africa, the disease has been first observed in Mali. BLB is one of the most destructive rice diseases worldwide. It occurs in China, India, Indonesia, Korea, Laos, Myanmar, the Philippines, Sri Lanka, Taiwan, Thailand, Vietnam, Northern Australia and Africa. Incurred yield loss can reach 70% when susceptible varieties are grown and favourable conditions prevail.

**Symptoms:** Symptoms appear on the leaves of young plants as pale-green to grey-green, water-soaked streaks near the leaf tip and margins. These lesions coalesce and become yellowish-white with wavy edges. The whole leaf may eventually be affected and become whitish or greyish and finally dies. Leaf sheaths and culms of more susceptible cultivars may be attacked as well. Systemic infection results in wilting, desiccation of leaves and death, particularly of young transplanted plants [209]. In mature plants, the leaves become yellow and subsequently die.

**Disease management:** Most methods of controlling rice blight are limited and inefficient [209–211]. Chemical control, for example, has been largely ineffective and is causing problems with bacterial antibiotic resistance and negative environmental impacts. Thus, methods based on rice-friendly good practices have been developed. For this purpose, it is recommended that rice producers use healthy, uninfected seeds. They must also remove and burn all the contaminated straw and think about rotating the crops. They are also advised to apply only the optimum level of fertiliser and to absolutely avoid massive doses of nitrogen, which favour the contamination of plants. In addition, good planning of rice planting/sowing is necessary so that weather conditions favourable to the proper development of pathogens do not coincide with the vulnerable stages of plants. Several weeds like *Leersia sayanuka* and *Zizania latifolia* are alternative hosts of the bacteria. It is therefore necessary to manage them before and after rice planting/sowing. Management of BLB is commonly done by planting disease resistant rice varieties [212,213], which is considered the most efficient method to control the disease. Over 30 resistance genes, termed *Xa1* to *Xa33*, have been identified in rice plants, and some of them, like *Xa21*, have been integrated into the genomes of commercial rice varieties [214,215]. These resistant rice varieties have been greatly successful by drastically reducing yield losses in many rice-producing countries.

### 2.3. *Rice yellow mottle virus (RYMV)*

*Rice Yellow Mottle Virus (RYMV)* is endemic and largely restricted to the African continent where it has been found in most rice producing countries [216]. The causal virus agent is a member of the genus *Sobemovirus*. *RYMV* was reported for the first time in 1966 on rice at Otonglo, near the Kisumu region, along the shore of the Gulf of Kavirondo in western Kenya [216]. Bakker coined the phrase “Rice yellow mottle virus” and described the virus in detail. In 1976, Raymundo and Buddenhagen reported a “pale yellow mound disease” in Sierra Leone [199]. It was later discovered that this virus is serologically indistinguishable from the *RYMV* isolate from Kenya [217]. Because of its high genetic variability which contributes to its rapid genetic evolution, *RYMV* has the ability to easily bypass resistance genes [218]. Consequently, this virus represents a significant biotic constraint to rice production mostly in irrigated areas. Yield losses vary widely from 10 to 100% depending on the varieties grown and the period of infection.

**Symptoms:** Symptoms characteristic of the disease include yellow or orange discoloration of leaves, stunting, sterility, and empty spikelets [216]. In high incidence situations, non-synchronous flowering and plant death are observed. The discoloration of the grains is noticed during the late attacks of the rice plants. Plant infection by *RYMV* is systemically [219]. Thus, in cases of infections with high severity, rice plants display leaf yellowing of varying intensity, mottling, necrosis, and stunted growth. Young plants at the 3-4 leaf stage are most susceptible to infection [219,220]. On freshly emerged leaves, the symptoms of the virus consist of a linear chlorotic mottle. Later, they develop into broken pale green or yellowish or continuous stripes up to 10 cm long [219]. They can evolve while spiraling. The expression of symptoms can be strongly influenced by light intensity, day length, humidity, temperature and stage of plant growth among other factors [216].

**Disease management:** The most sustainable way to control *RYMV* represents the use of host resistance [220–222]. Exotic rice varieties have generally been very susceptible to *RYMV* while traditionally grown African upland varieties are moderately resistant or tolerant to the virus [221,222]. Research on disease resistance has identified several accessions of *O. glaberrima* and *O. barthii*, which are native African *Oryza* species, as highly resistant [221,224,225].

Rice genome analyses from rice-*RYMV* interactions revealed that *RYMV* resistance was under monogenic and polygenic determinism and 15 quantitative trait loci (QTL) were detected on seven chromosomal fragments [225–227]. Studies on the identification of sources of resistance have discovered three genes (*RYMV1*, *RYMV2* and *RYMV3*) for *RYMV* resistance in *O. glaberrima* [225,228]. Other sources of resistance genes and the use of gene pyramids are currently being explored as the pathogen can overcome the known resistance genes.

#### IV. Background and justification of the thesis project

In Africa, population growth has a significant impact on food availability [229]. Indeed, according to several UN forecast reports, the average scenario predicts that the world's population will reach nearly ten billion in 2050, among them two billion in sub-Saharan Africa (SSA), which will have a strong impact on the use of natural resources [230]. As follows, this will cause their depletion and therefore create more constraints for food production by 2050 [229]. For policymakers (politicians, NGOs, researchers and scholars), the prospect of a possible doubling of the population by 2050 poses a food challenge. According to forecasts by the African Development Bank (AfDB), food demand will increase by 60% by 2050 in SSA [231].

Faced with this situation, the intensification of agriculture seems to be accepted as the ideal answer. Consequently, several intensification programs for the staples and strategic crops have been set up [232]. Among them, rice cultivation seems to be one of the means that allows SSA to fight against food insecurity and poverty [233]. Many rice intensification programs have been introduced in several countries in SSA [234]. These programs made it possible to increase the cultivable surface and consequently the yield. However, rice cultivation in SSA faces enormous constraints that hinder its sustainability and profitability [235]. In fact, apart from socio-economic and political problems, there are abiotic problems (drought and floods) and biotic problems (diseases, pests and weeds).

Concerning biotic problems, diseases of rice are caused by several microorganisms. They are at the origin of many symptoms on the various organs of the rice plant. These are: (i) wilting, yellowing, and mottling of leaves; (ii) rotting and discoloration of grains, and (iii) formation of scabies and/or galls on stems. Rice diseases are at the origin of the damage that impact the yield. For rice bacterial diseases, yields can drop as high as 60-70% under certain conditions. Indeed, concerning bacterial rice diseases in Africa, *Xanthomonas oryzae* pv. *oryzae* (*Xoo*) is widely reported in several countries. The bacteria are considered as one of the most threatening pathogens for rice growing in this part of the world [236-238]. For this reason, several works like phytosanitary surveys, diversity analysis, and the identification of sources of resistance were made to get an idea of its incidence and severity. From 2009 to 2011 in



Togo, this work allowed isolating pale yellow, orange-yellow, and lemon-yellow bacteria from symptomatic Rice leaves. On the basis of phenotypic tests and pathogenicity, the bacteria were initially identified and conserved as *Xoo* in Togo (ITRA) and in Benin (AfricaRice) [239]. In 2010, when the laboratory of AfricaRice officials wanted to get an idea about these preserved Togolese *Xoo* strains, they performed molecular diagnostics. The results revealed that the bacteria were not *Xoo*. Consequently, to provide a clear picture of this situation, a number of strains have been sequenced in Belgium and France. Results from the sequence analyses confirmed that the bacteria were not *Xoo* but rather *Pantoea ananatis*.

It was not the first situation in which *P. ananatis* was mistaken for *Xoo*. Indeed, Mondal et al. (2011) noted the presence of bacterial leaf blight disease on basmati rice in the northern states of India [139]. Firstly, the disease was thought to be caused by *Xoo*. However, the physiological and molecular analysis of several strains allowed them to find that the causal agent was *P. ananatis*. Other prospectations have allowed to isolate the same bacteria from leaves and seeds of rice-growing areas of other countries, such as Benin, Burkina Faso, Ghana, Mali, Nigeria, and Senegal. Indeed, during our surveys, we noticed that this newly discovered bacterium causes enormous damage (incidence up to 50 to 60%), leading to reduced yield and poor grain quality. Interrogated producers had no idea about this disease and felt helpless in the face of the damage. Quarantine work done in our laboratory on rice seeds have shown that 45% to 50% of seeds from rice seed production sites were contaminated by *Pantoea* spp.

The discovery of the presence of this new bacterium generated many uncomfortable situations for our laboratory. Indeed, during the isolation work of the bacteria, we noticed that colonies of *Pantoea* spp. have almost the same phenological characteristics as those of *Xoo*, namely the same color and viscosity on PSA (peptone sucrose agar) medium. In addition, the primers of Mondal et al. (2011), which we used for PCR, generated several amplicons and were not specific. The only trick that allowed us to differentiate the two bacteria consisted of their incubation duration. Indeed, colonies of *Pantoea* spp. grow at 24 hours while those of *Xoo* grow only at 48 hours after incubation.

The prevalence and genetic diversity of the populations of this phytopathogenic bacterium are not known in SSA because of the small number of strains collected and characterized to date, which does not allow estimating its adaptive potential. This would complicate the implementation of strategies to combat this phytopathogenic agent of major socio-economic importance for the SSA countries. As demonstrated, *P. ananatis* is present in several SSA countries and causes bacterial leaf blight of rice. The bacterium is considered an important threat to rice production in this part of the world. This disturbing situation has generated several research questions:

- What is the current incidence and epidemic risk of *P. ananatis* in Africa?
- Is this bacterium endemic, epidemic, or emerging in Africa?
- What are the epidemiological characteristics?
- What are the routes of dissemination?
- Is the disease transmitted by seeds?
- Are there any (alternative) hosts besides rice?

- Are there other species besides *P. ananatis* infecting rice? If so, what are the genetic relationships between them?
- Are there resistance and sensitive rice varieties?
- How to facilitate diagnosis and avoid confusion with *Xoo*?
- What is the origin and evolutionary history of the bacteria?
- Have there been one or more introductions?
- What represent its genetic diversity and population structure at local, country and continental level?

In this way, to find answers to these multiple questions, a thesis project was set up with the general objective of contributing to a better control of *Pantoea* spp. In practice, it will be specifically to:

- Develop tools for identification, diagnosis and molecular typing: PCR, LAMP, MLVA, etc.
- Increase the strain collection and assess the incidence of the disease.
- Evaluate the genetic diversity of African populations.
- Perform screenings to identify resistant varieties.

For the expected outputs, this thesis project was set up to generate the following results:

- New, more specific primers and rapid methods of diagnosis of *Pantoea* spp. will be developed;
- New epidemiological baseline data of *Pantoea* spp. will be available;
- New improved techniques for producing healthy seeds and data on resistant / tolerant varieties to *Pantoea* spp. will be developed;
- Sources of resistance to *Pantoea* spp. will be identified, which can be used by farmers and breeders.

For the outcomes, it was expected that this thesis project will generate several useful results.

- The proposed study will allow a better taxonomic knowledge of these bacterial infections of rice.
- For smallholder farmers, it will help improve rice yields through the reduction of damage caused by bacteria by the establishment of new control methods. This will increase producers' income and improve the nutritional balance of consuming populations, particularly in rural and urban areas.
- For the scientific community, the results will contribute to a better knowledge of these bacteria.
- The valorisation of the achievements of the project will be a definite support to the improvement of the technical capacity of the agricultural supervisory staff in the management of bacterial diseases of rice in SSA.
- Technically, new tools for rapid diagnosis of the disease will be developed.
- The identification of resistant varieties will be a major asset for producers and researchers in the sustainable management of bacterial rice diseases. These varieties will serve as basic material for varietal breeding against *Pantoea* spp.

## Bibliographies cited

1. Valverde RA, Nameth ST, Jordan RL. Analysis of double-stranded RNA for plant virus diagnosis. *Plant Dis.* 1990;74:255–258.
2. Sasaki Y, Okamoto T, Imou K, Torii T. Automatic diagnosis of plant disease. *J. Jpn. Soc. Agric. Mach.* 1999;61:119–126.
3. Streets RB (ed.). *The Diagnosis of Plant Diseases: A Field and Laboratory Manual Emphasizing the Most Practical Methods for Rapid Identification.* The University of Arizona Press, Tucson, Arizona, USA; 1972.
4. Wallace HR. The diagnosis of plant diseases of complex etiology. *Annu. Rev. Phytopathol.* 1978;16:379–402.
5. Henson JM, French R. The polymerase chain reaction and plant disease diagnosis. *Annu. Rev. Phytopathol.* 1993;31:81–109.
6. Narayanasamy P (ed.). *Plant Pathogen Detection and Disease Diagnosis, Second Edition.* CRC Press; 2001.
7. Madden L, Hughes G, Van Den Bosch F (eds.). *Study of Plant Disease Epidemics.* The American Phytopathological Press, St Paul, Minnesota, USA; 2007.
8. Fry WE (ed.). *Principles of Plant Disease Management.* Academic Press, London, UK; 2012.
9. Ferenčik M (ed.). *Handbook of Immunochemistry.* Springer Science & Business Media, Dordrecht, The Netherlands; 1993.
10. Wakelin D (ed.). *Immunity to Parasites: How Parasitic Infections Are Controlled (2nd edition).* Cambridge University Press, Cambridge, UK; 1996.
11. Lamanna C. Adhesion of foreign particles to particulate antigens in the presence of antibody and complement (serological adhesion). *Bacteriol. Rev.* 1957;21:30.
12. Halk EL, De Boer SH. Monoclonal antibodies in plant-disease research. *Annu. Rev. Phytopathol.* 1985;23:321–350.
13. Watson JD, Crick FH. The structure of DNA. *Cold Spring Harb Symp Quant Biol.* Cold Spring Harbor Laboratory Press; 1953. p. 123–31.
14. Crick F. The double helix: a personal view. *Nature* 1974;248:766–769.
15. Mullis K, Faloona F, Scharf S, Saiki RK, Horn GT, Erlich H. Specific enzymatic amplification of DNA in vitro: the polymerase chain reaction. *Cold Spring Harb Symp Quant Biol.* Cold Spring Harbor Laboratory Press; 1986. p. 263–273.
16. Olive DM, Bean P. Principles and applications of methods for DNA-based typing of microbial organisms. *J. Clin. Microbiol.* 1999;37:1661–1669.
17. Lie YS, Petropoulos CJ. Advances in quantitative PCR technology: 5' nuclease assays. *Curr. Opin. Biotechnol.* 1998;9:43–58.
18. Louws FJ, Fulbright DW, Stephens CT, De Bruijn FJ. Specific genomic fingerprints of phytopathogenic *Xanthomonas* and *Pseudomonas* pathovars and strains generated with repetitive sequences and PCR. *Appl. Environ. Microbiol.* 1994;60:2286–95.
19. Momol MT, Momol EA, Lamboy WF, Norelli JL, Beer SV, Aldwinckle HS. Characterization of *Erwinia amylovora* strains using random amplified polymorphic DNA fragments (RAPDs). *J. Appl. Microbiol.* 1997;82:389–398.
20. Nagamine K, Hase T, Notomi T. Accelerated reaction by loop-mediated isothermal

- amplification using loop primers. *Mol. Cell Probes* 2002;16:223–229.
21. Parida M, Sannarangaiah S, Dash PK, Rao PVL, Morita K. Loop mediated isothermal amplification (LAMP): a new generation of innovative gene amplification technique; perspectives in clinical diagnosis of infectious diseases. *Rev. Med. Virol.* 2008;18:407–421.
  22. Notomi T, Okayama H, Masubuchi H, Yonekawa T, Watanabe K, Amino N, et al. Loop-mediated isothermal amplification of DNA. *Nucleic Acids Res.* 2000;28:e63.
  23. Mori Y, Notomi T. Loop-mediated isothermal amplification (LAMP): a rapid, accurate, and cost-effective diagnostic method for infectious diseases. *J. Infect. Chemother.* 2009;15:62–69.
  24. Temple TN, Johnson KB. Evaluation of loop-mediated isothermal amplification for rapid detection of *Erwinia amylovora* on pear and apple fruit flowers. *Plant Dis.* 2011;95:423–430.
  25. Lang JM, Langlois P, Nguyen MHR, Triplett LR, Purdie L, Holton TA, et al. Sensitive detection of *Xanthomonas oryzae* pathovars *oryzae* and *oryzicola* by loop-mediated isothermal amplification. *Appl. Environ. Microbiol.* 2014;80:4519–4530.
  26. Kubota R, Vine BG, Alvarez AM, Jenkins DM. Detection of *Ralstonia solanacearum* by loop-mediated isothermal amplification. *Phytopathology* 2008;98:1045–1051.
  27. Hauben L, Vauterin L, Swings J, Moore Erb. Comparison of 16S ribosomal DNA sequences of all *Xanthomonas* species. *Int. J. Syst. Evol. Microbiol.* 1997;47:328–335.
  28. Mirza MS, Rademaker JLW, Janse JD, Akkermans ADL. Specific 16S ribosomal RNA targeted oligonucleotide probe against *Clavibacter michiganensis* subsp. *sepedonicus*. *Can. J. Microbiol.* 1993;39:1029–1034.
  29. Pruvost O, Magne M, Boyer K, Leduc A, Tourterel C, Drevet C, et al. A MLVA genotyping scheme for global surveillance of the citrus pathogen *Xanthomonas citri* pv. *citri* suggests a worldwide geographical expansion of a single genetic lineage. *PloS One* 2014;9:e98129.
  30. Guinard J, Latreille A, Guérin F, Poussier S, Wicker E. New multilocus variable-number tandem-repeat analysis (MLVA) scheme for fine-scale monitoring and microevolution-related study of *Ralstonia pseudosolanacearum* phylotype I populations. *Appl. Environ. Microbiol.* 2017;83:e03095-16.
  31. Zaluga J, Stragier P, Van Vaerenbergh J, Maes M, De Vos P. Multilocus Variable-Number-Tandem-Repeats Analysis (MLVA) distinguishes a clonal complex of *Clavibacter michiganensis* subsp. *michiganensis* strains isolated from recent outbreaks of bacterial wilt and canker in Belgium. *BMC Microbiol.* 2013;13:126.
  32. Cesbron S, Pothier J, Gironde S, Jacques M-A, Manceau C. Development of multilocus variable-number tandem repeat analysis (MLVA) for *Xanthomonas arboricola* pathovars. *J. Microbiol. Methods.* 2014;100:84–90.
  33. Birtles A, Hardy K, Gray SJ, Handford S, Kaczmarek EB, Edwards-Jones V, et al. Multilocus sequence typing of *Neisseria meningitidis* directly from clinical samples and application of the method to the investigation of meningococcal disease case Clusters. *J. Clin. Microbiol.* 2005;43:6007–6014.
  34. Urwin R, Maiden MC. Multi-locus sequence typing: a tool for global epidemiology. *Trends Microbiol.* 2003;11:479–487.

35. Adams IP, Glover RH, Monger WA, Mumford R, Jackeviciene E, Navalinskiene M, et al. Next-generation-sequencing and metagenomic analysis: a universal diagnostic tool in plant virology. *Mol. Plant Pathol.* 2009;10:537–545.
36. Lee I, Ouk Kim Y, Park S-C, Chun J. OrthoANI: An improved algorithm and software for calculating average nucleotide identity. *Int. J. Syst. Evol. Microbiol.* 2016;66:1100–1103.
37. Figueras MJ, Beaz-Hidalgo R, Hossain MJ, Liles MR. Taxonomic affiliation of new genomes should be verified using average nucleotide identity and multilocus phylogenetic analysis. *Genome Announc.* 2014;2:e00927–14.
38. Goris J, Konstantinidis KT, Klappenbach JA, Coenye T, Vandamme P, Tiedje JM. DNA-DNA hybridization values and their relationship to whole-genome sequence similarities. *Int. J. Syst. Evol. Microbiol.* 2007;57:81–91.
39. Mayer LW. Use of plasmid profiles in epidemiologic surveillance of disease outbreaks and in tracing the transmission of antibiotic resistance. *Clin. Microbiol. Rev.* 1988;1:228–243.
40. Gavini F, Mergaert J, Beji A, Mielcarek C, Izard D, Kersters K, et al. Transfer of *Enterobacter agglomerans* (Beijerinck 1888) Ewing and Fife 1972 to *Pantoea* gen. nov. as *Pantoea agglomerans* comb. nov. and Description of *Pantoea dispersa* sp. nov. *Int. J. Syst. Evol. Microbiol.* 1989;39:337–345.
41. Walterson AM, Stavrinides J. *Pantoea*: insights into a highly versatile and diverse genus within the Enterobacteriaceae. *FEMS Microbiol. Rev.* 2015;39:968–84.
42. De Maayer P, Aliyu H, Vikram S, Blom J, Duffy B, Cowan DA, et al. Phylogenomic, pan-genomic, pathogenomic and evolutionary genomic insights into the agronomically relevant enterobacteria *Pantoea ananatis* and *Pantoea stewartii*. *Front Microbiol.* 2017;8:1755.
43. Stewart FC. A Bacterial Disease of Sweet Corn. New York Agricultural Experiment Station; Geneva, New York, USA; 1897.
44. Smith EF. Notes on Stewart's seet-corn germ, *Pseudomonas stewarti*, n. sp. *Amer. Assoc. Adv. Sci. Proc.* 1898;47:422–426.
45. McCulloch L. A morphological and cultural note on the organism causing Stewart's disease of sweet corn. *Phytopathology* 1918;8:440–442.
46. Holland DF. The families and genera of the bacteria. V. Generic index of the commoner forms of bacteria. *J. Bacteriol.* 1920;5:191–229.
47. Bergey David H, Breed Robert S. Bergey's manual of determinative bacteriology. Baltimore, Williams & Wilkins Co.; 1957.
48. Elliott C. The genus *Phytomonas*. *Phytopathology* 1937;27:1181–2.
49. Rahn O. Contributions to the classification of bacteria. *Zentralbl. Bakteriol. Parasitenkd. Infekt. II* 1929;79:321–343.
50. Burkholder WH. Bacteria as plant pathogens. *Annu. Rev. Microbiol.* 1948;2:389–412.
51. Elliott C (ed.). *Manual of Bacterial Plant Pathogens*, 2nd edition. Chronica Botanica Co., Waltham, Massachusetts, USA; 1951.
52. Dowson WJ (ed.). *Plant Diseases Due to Bacteria*. University Press, Cambridge, UK; 1957.
53. Dowson DW. On the systematic position and generic names of the Gram negative

- bacterial plant pathogens. Zentralblatt Bakteriologie, Parasitenkunde, Infektions- und Hygiene II 1939;100:177–193.
54. Elliott C. Recent developments in the classification of bacterial plant pathogens. Bot. Rev. 1943;9:655–666.
  55. Weiss F, Wood JI. A list of names and synonyms of phytopathogenic bacteria occurring in the United States embodying recent changes in nomenclature. Plant Dis. Reports 1943;27:42–62.
  56. Dye DW. Comparative study of the biochemical reactions of additional *Xanthomonas* spp. New Zealand J. Sci. 1963;6:483–486.
  57. Dye DW. The inadequacy of the usual determinative tests for the identification of *Xanthomonas* spp. New Zealand J. Sci. 1962;5:393–416.
  58. Dye DW. The taxonomic position of *Xanthomonas uredovorus* Pon et al. 1954. New Zealand J. Sci. 1963;6:146–9.
  59. Waldee EL. Comparative studies of some peritrichous phytopathogenic bacteria. Iowa State Coll. J. Sci. 1945;19:435–484.
  60. Hayward AC, Hodgkiss W. Taxonomic relationships of *Xanthomonas uredovorus*. Microbiology 1961;26:133–140.
  61. Dye DW. A taxonomic study of the genus *Erwinia*. IV. “Atypical” erwinias. New Zealand J. Sci. 1969;12:833–839.
  62. Beijerinck MW. Cultur des *Bacillus radicolica* aus den Knöllchen. Bot. Ztg. 1888;46:740–750.
  63. Duggeli M. Die Bakterienflora gesunder Samen und daraus gezogener Keimpflänzchen. Zentralbl. Bakteriologie II 1904;13:56–63.
  64. Löhnis F. Landwirtschaftlich-bakteriologisches Praktikum. Verlag von Gebrüder Bornträger; Berlin, Germany; 1911.
  65. Bergey DH. Bergey’s Manual of Determinative Bacteriology, 6th edition (Breed RS, Murray EG, Hitchens AP, eds.); Williams & Wilkins, Baltimore, Maryland, USA; 1948.
  66. Buchanan RE, Holt JG, Lessel jr. EF (eds.). Index Bergeyana. Williams & Wilkins, Baltimore, Maryland, USA; 1966.
  67. Graham DC, Hodgkiss W. Identity of gram negative, yellow pigmented, fermentative bacteria isolated from plants and animals. J. Appl. Microbiol. 1967;30:175–189.
  68. Kawakami K, Yoshida S. Bacterial Gall on *Milletia* Plant. (*Bacillus Milletiae* n. sp.). Shokubutsugaku Zasshi. 1920;34:110–115.
  69. Brown NA. A gall similar to crown gall, produced on *Gypsophila* by a new bacterium. J. Agric. Res. 1934;48:1099–1112.
  70. Starr MP, Weiss JE. Growth of phytopathogenic bacteria in a synthetic asparagin medium. Phytopathology 1943;33:314–8.
  71. Burkholder WH. The taxonomy and nomenclature of phytopathogenic bacteria. Phytopathology 1939;29:128–136.
  72. Komagata K, Tamagawa Y, Iizuka H. Characteristics of *Erwinia herbicola*. J. Gen. Appl Microbiol. 1968;14:19–37.
  73. Graham DC, Quinn CE. Identification of *Agrobacterium gypsophilae* strains NCPPB 179 and NCPPB 1948 as *Erwinia herbicola*. Int. J. Syst. Evol. Microbiol. 1974;24:238–41.

74. Serrano FB. Bacterial fruitlet brown-rot of Pineapple in the Philippines. *Philipp. J. Sci.* 1928;36:271–305.
75. Skerman TM. Isolation and identification of *Bacteroides nodosus*. In: Egerton JR, Yong WK, Riffkin GG (eds.) *Footrot and Foot Abscess of Ruminants*, pp. 85–104. CRC Press, Boca Raton, Florida, USA; 1989.
76. Patel MK, Kulkarni YS. A new bacterial leaf spot on *Vitis woodrowii* stapf. *Curr. Sci.* 1951;20:132.
77. Pon DS, Townsend CE, Wessman GE, Schmitt CG, Kingsolver CH. A *Xanthomonas* parasitic on uredia of cereal rusts. *Phytopathology* 1954;44:707–710.
78. Winslow C-E, Broadhurst J, Buchanan RE, Krumwiede Jr C, Rogers LA, Smith GH. The families and genera of the bacteria: preliminary report of the committee of the society of American bacteriologists on characterization and classification of bacterial types. *J. Bacteriol.* 1917;2:505.
79. Dye DW. A taxonomic study of the genus *Erwinia*. I. The “*amylovora*” group. *New Zealand J. Sci.* 1968;11:590–607.
80. Dye DW. A taxonomic study of the genus *Erwinia*. II. The “*carotovora*” group. *New Zealand J. Sci.* 1969;12:81–97.
81. Dye DW. A taxonomic study of the genus *Erwinia*. III. The “*herbicola*” group. *New Zealand J. Sci.* 1969;12:223–236.
82. Ewing WH, Fife MA. Biochemical characterization of *Enterobacter agglomerans*. Center for Disease Control; Atlanta, Georgia, USA; 1972.
83. Ewing WH, Fife MA. *Enterobacter agglomerans* (Beijerinck) comb. nov. (the *Herbicola-Lathyri* Bacteria). *Int. J. Syst. Evol. Microbiol.* 1972;22:4–11.
84. Dye DW. The taxonomic position of *Xanthomonas trifolii* (Huss, 1907) James, 1955. *New Zealand J. Sci.* 1964;7:261–269.
85. Magrou J. *Phytomonas gypsophila*. In: Haudroy P, Ehringer G, Urbain A, Guillot G, Magrou J (eds.) *Dictionnaire des Bactéries Pathogènes pour l'Homme les Animaux et les Plantes*. Masson & Cie, Paris, France; 1937.
86. Gavini F, Lefebvre B, Leclerc H. Etude taxonomique de souches appartenant ou apparentées au genre *Erwinia*, groupe *Herbicola*, et à l'espèce *Enterobacter agglomerans*. *Syst. Appl. Microbiol.* 1983;4:218–235.
87. Verdonck L, Mergaert J, Rijckaert C, Swings J, Kersters K, De Ley J. Genus *Erwinia*: numerical analysis of phenotypic features. *Int. J. Syst. Evol. Microbiol.* 1987;37:4–18.
88. Brenner DJ. Family I. *Enterobacteriaceae*. *Bergey's Man. Syst. Bacteriol.* 1984;1:408–420.
89. Lind E, Ursing J. Clinical strains of *Enterobacter agglomerans* (synonyms: *Erwinia herbicola*, *Erwinia milletiae*) identified by DNA-DNA hybridization. *Acta Pathol. Microbiol. Immunol. Scand. B.* 1986;94:205–213.
90. Beji A, Mergaert J, Gavini F, Izard D, Kersters K, Leclerc H, et al. Subjective synonymy of *Erwinia herbicola*, *Erwinia milletiae*, and *Enterobacter agglomerans* and redefinition of the taxon by genotypic and phenotypic data. *Int. J. Syst. Evol. Microbiol.* 1988;38:77–88.
91. Bouvet Om, Lenormand P, Grimont Pa. Taxonomic diversity of the D-glucose oxidation pathway in the *Enterobacteriaceae*. *Int. J. Syst. Evol. Microbiol.* 1989;39:61–

- 7.
92. Hwangbo H, Park RD, Kim YW, Rim YS, Park KH, Kim TH, ... Kim KY. 2-Ketogluconic acid production and phosphate solubilization by *Enterobacter* intermedium. *Current Microbiology*. 2003;47:0087-0092.
  93. Kageyama B, Nakae M, Yagi S, Sonoyama T. *Pantoea punctata* sp. nov., *Pantoea citrea* sp. nov., and *Pantoea terrea* sp. nov. isolated from fruit and soil samples. *Int. J. Syst. Bacteriol.* 1992;42:203–210.
  94. Mergaert J, Verdonck L, Kersters K. Transfer of *Erwinia ananas* (synonym, *Erwinia uredovora*) and *Erwinia stewartii* to the genus *Pantoea* emend. as *Pantoea ananas* (Serrano 1928) comb. nov. and *Pantoea stewartii* (Smith 1898) comb. nov., respectively, and description of *Pantoea stewartii* subsp. *indologenes* subsp. nov. *Int. J. Syst. Bacteriol.* 1993;43:162–173.
  95. Trüper HG, De'clari L. Taxonomic note: necessary correction of specific epithets formed as substantives (nouns) “in apposition”. *Int. J. Syst. Evol. Microbiol.* 1997;47:908–909.
  96. Grimont PA, Grimont F. *Pantoea*. *Bergey's Manual of Systematic Bacteriology*. 2005.
  97. Hollis DG, Weaver RE. Gram-positive organisms: a guide to identification. Special Bacteriology Section, Centers for Disease Control; 1981.
  98. Paradis S, Boissinot M, Paquette N, Bélanger SD, Martel EA, Boudreau DK, et al. Phylogeny of the *Enterobacteriaceae* based on genes encoding elongation factor Tu and F-ATPase  $\beta$ -subunit. *Int. J. Syst. Evol. Microbiol.* 2005;55:2013–2025.
  99. Brady C, Cleenwerck I, Venter S, Vancanneyt M, Swings J, Coutinho T. Phylogeny and identification of *Pantoea* species associated with plants, humans and the natural environment based on multilocus sequence analysis (MLSA). *Syst. Appl. Microbiol.* 2008;31:447–460.
  100. Delétoile A, Decré D, Courant S, Passet V, Audo J, Grimont P, et al. Phylogeny and identification of *Pantoea* species and typing of *Pantoea agglomerans* strains by multilocus gene sequencing. *J. Clin. Microbiol.* 2009;47:300–310.
  101. Brady CL, Cleenwerck I, Venter SN, Engelbeen K, De Vos P, Coutinho TA. Emended description of the genus *Pantoea*, description of four species from human clinical samples, *Pantoea septica* sp. nov., *Pantoea eucrina* sp. nov., *Pantoea brenneri* sp. nov. and *Pantoea conspicua* sp. nov., and transfer of *Pectobacterium cypripedii* (Hori 1911) Brenner et al. 1973 emend. Hauben et al. 1998 to the genus as *Pantoea cypripedii* comb. nov. *Int. J. Syst. Evol. Microbiol.* 2010;60:2430–2440.
  102. Brady CL, Venter SN, Cleenwerck I, Vandemeulebroecke K, De Vos P, Coutinho TA. Transfer of *Pantoea citrea*, *Pantoea punctata* and *Pantoea terrea* to the genus *Tatumella* emend. as *Tatumella citrea* comb. nov., *Tatumella punctata* comb. nov. and *Tatumella terrea* comb. nov. and description of *Tatumella morbirosei* sp. nov. *Int. J. Syst. Evol. Microbiol.* 2010;60:484–494.
  103. Cha JS, Pujol C, Ducusin AR, Macion EA, Hubbard CH, Kado CI. Studies on *Pantoea citrea*, the Causal Agent of Pink Disease of Pineapple. *J. Phytopathol.* 1997;145:313–9.
  104. Kado CI. Pink Disease of Pineapple. *APSnet Feature*. 2003.
  105. Popp A, Cleenwerck I, Iversen C, De Vos P, Stephan R. *Pantoea gaviniae* sp. nov. and *Pantoea calida* sp. nov., isolated from infant formula and an infant formula production



- environment. *Int. J. Syst. Evol. Microbiol.* 2010;60:2786–92.
106. Brady CL, Goszczynska T, Venter SN, Cleenwerck I, De Vos P, Gitaitis RD, et al. *Pantoea allii* sp. nov., isolated from onion plants and seed. *Int. J. Syst. Evol. Microbiol.* 2011;61:932
  107. Brady CL, Cleenwerck I, van der Westhuizen L, Venter SN, Coutinho TA, De Vos P. *Pantoea rodasii* sp. nov., *Pantoea rwandensis* sp. nov. and *Pantoea wallisii* sp. nov., isolated from *Eucalyptus*. *Int. J. Syst. Evol. Microbiol.* 2012;62:1457–1464.
  108. Liu H, Coulthurst SJ, Pritchard L, Hedley PE, Ravensdale M, Humphris S, et al. Quorum Sensing coordinates brute force and stealth modes of infection in the plant pathogen *Pectobacterium atrosepticum*. *PLoS Pathog.* 2008;4:e1000093.
  109. Liu Y, Wang S, Zhang D, Wei S, Zhao S, Chen S, et al. *Pantoea beijingensis* sp. nov., isolated from the fruiting body of *Pleurotus eryngii*. *Antonie Van Leeuwenhoek* 2013;104:1039–1047.
  110. Prakash O, Nimonkar Y, Vaishampayan A, Mishra M, Kumbhare S, Josef N, et al. *Pantoea intestinalis* sp. nov., isolated from the human gut. *Int. J. Syst. Evol. Microbiol.* 2015;65:3352–3358.
  111. Kato Tanaka Y, Horie N, Mochida K, Yoshida Y, Okugawa E, Nanjo F. *Pantoea theicola* sp. nov., isolated from black tea. *Int. J. Syst. Evol. Microbiol.* 2015;65:3313–9.
  112. Gueule D, Fourny G, Ageron E, Le Flèche-Matéos A, Vandenbergert M, Grimont PAD, et al. *Pantoea coffeiphila* sp. nov., cause of the “potato taste” of *Arabica* coffee from the African Great Lakes region. *Int. J. Syst. Evol. Microbiol.* 2015;65:23–29.
  113. Chen C, Xin K, Liu H, Cheng J, Shen X, Wang Y, et al. *Pantoea alhagi*, a novel endophytic bacterium with ability to improve growth and drought tolerance in wheat. *Sci. Rep.* 2017;7:41564.
  114. Rong C, Ma Y, Wang S, Liu Y, Chen S, Huang B, et al. *Pantoea hericii* sp. nov., isolated from the fruiting bodies of *Hericium erinaceus*. *Curr. Microbiol.* 2016;72:738–743.
  115. Adeolu M, Alnajjar S, Naushad S, Gupta RS. Genome-based phylogeny and taxonomy of the “*Enterobacteriales*”: proposal for *Enterobacterales* ord. nov. divided into the families *Enterobacteriaceae*, *Erwiniaceae* fam. nov., *Pectobacteriaceae* fam. nov., *Yersiniaceae* fam. nov., *Hafniaceae* fam. nov., *Morganellaceae* fam. nov., and *Budviciaceae* fam. nov. *Int. J. Syst. Evol. Microbiol.* 2016;66:5575–5599.
  116. Brady CL, Venter SN, Cleenwerck I, Engelbeen K, Vancanneyt M, Swings J, et al. *Pantoea vagans* sp. nov., *Pantoea eucalypti* sp. nov., *Pantoea deleyi* sp. nov. and *Pantoea anthophila* sp. nov. *Int. J. Syst. Evol. Microbiol.* 2009;59:2339–2345.
  117. Brady CL. Taxonomic of *Pantoea* associated with bacterial blight of *Eucalyptus*. University of Pretoria; 2007.
  118. Sherafati F, Khodaygan P, Azadvar M, Sedaghati E, Saberi-Riseh R, Baghaee-Ravari S. Association of *Pantoea agglomerans* with the citrus bacterial canker disease in Iran. *J. Crop Prot.* 2014;3:345–355.
  119. Romeiro RS, Macagnan D, Mendonça HL, Rodrigues NJ. Bact. spot of Chinese taro (*Alocasia cucullata*) in Brazil induced by *Pantoea agglomerans*. *New Rep.* 2006;14:51.
  120. Ren YZ, Liu YQ, Ding SL, Li GY, Zhang H. First report of boll rot of cotton caused by *Pantoea agglomerans* in China. *Plant Dis.* 2008;92:1364.

121. Baird RE, Gitaitis RD, Herzog GA. First report of cotton lint rot by *Pantoea agglomerans* in Georgia. *Plant Dis.* 1997;81:551.
122. Lee HB, Hong JP, Kim SB. First report of leaf blight caused by *Pantoea agglomerans* on rice in Korea. *Plant Dis.* 2017;101:242.
123. Edens DG, Gitaitis RD, Sanders FH, Nischwitz C. First report of *Pantoea agglomerans* causing a leaf blight and bulb rot of onions in Georgia. *Plant Dis.* 2006;90:1551.
124. Lu BH, Jia MJ, Gao J. First Report of *Pantoea agglomerans* causing bacterial leaf blight on *Vigna angularis* in Jilin province, China. *Plant Dis.* 2015;99:1269.
125. Yang KQ, Qu WW, Liu X, Liu HX, Hou LQ. First report of *Pantoea agglomerans* causing brown apical necrosis of walnut in China. *Curr. Microbiol.* 2016;72:738–743.
126. Morales-Valenzuela G, Silva-Rojas HV, Ochoa-Martínez D, Valadez-Moctezuma E, Alarcon-Zuniga B, Zelaya-Molina LX, et al. First report of *Pantoea agglomerans* causing leaf blight and vascular wilt in maize and Sorghum in Mexico. *Plant Dis.* 2007;91:1365.
127. Tho KE, Wiriyajitsomboon P, Hausbeck MK. First report of *Pantoea agglomerans* causing onion leaf blight and bulb rot in Michigan. *Plant Dis.* 2015;99:1034.
128. González AD, Franco MA, Contreras N, Galindo-Castro I, Jayaro Y, Graterol E. First report of *Pantoea agglomerans* causing rice leaf blight in Venezuela. *Plant Dis.* 2015;99:552.
129. Pataky JK. Stewart's Wilt of Corn. *APSnet Features*. Online. doi: 10.1094/APSnetFeature-2003-0703. 2003.
130. Anderson TR. An outbreak of Stewart's bacterial wilt of corn in Ontario, Canada. *Plant Dis.* 1986;70:603.
131. Azad HR, Holmes GJ, Cooksey DA. A new leaf blotch disease of sudangrass caused by *Pantoea ananas* and *Pantoea stewartii*. *Plant Dis.* 2000;84:973–979.
132. Choi O, Kim J. *Pantoea stewartii* causing Stewart's wilt on *Dracaena sanderiana* in Korea. *J. Phytopathol.* 2013;161:578–581.
133. Gapasin RM, Garcia RP, Advincula CT, Cruz CS, Borines LM. Fruit bronzing, a new disease affecting jackfruit caused by (Smith) Mergaert *Pantoea stewartii* et al. *Ann. Trop. Res.* 2014;36:17–31.
134. Pérez-y-Terrón R, Villegas MC, Cuellar A, Muñoz-Rojas J, Castañeda-Lucio M, Hernández-Lucas I, et al. Detection of *Pantoea ananatis*, causal agent of leaf spot disease of maize, in Mexico. *Australas. Plant Dis. Notes* 2009;4:96–99.
135. Alippi AM, López AC. First report of leaf spot disease of maize caused by *Pantoea ananatis* in Argentina. *Plant Dis.* 2010;94:487.
136. Krawczyk K, Kamasa J, Zwolinska A, Pospieszny H. First report of *Pantoea ananatis* associated with leaf spot disease of maize in Poland. *J. Plant Pathol.* 2010;807–811.
137. Rahma H, Sinaga MS, Memen S, Giyanto G. First report of Stewart's wilt of maize caused by *Pantoea stewartii* subsp. *stewartii* in bogor district, Indonesia. *J. Int. Soc. Southeast Asian Agric. Sci.* 2014;20:131–141.
138. Orio AA, Brücher E, Plazas MC, Sayago P, Guerra F, De Rossi R, et al. First report of Stewart's wilt of maize in Argentina caused by *Pantoea stewartii*. *Plant Dis.* 2012;96:1819.
139. Mondal KK, Mani C, Singh J, Kim JG, Mudgett MB. A new leaf blight of rice caused

- by *Pantoea ananatis* in India. *Plant Dis.* 2011;95:1582.
140. Cother EJ, Reinke R, McKenzie C, Lanoiselet VM, Noble DH. An unusual stem necrosis of rice caused by *Pantoea ananas* and the first record of this pathogen on rice in Australia. *Australas. Plant Pathol.* 2004;33:495–503.
  141. Yan H, Yu SH, Xie GL, Fang W, Su T, Li B. Grain discoloration of rice caused by *Pantoea ananatis* (synonym *Erwinia uredovora*) in China. *Plant Dis.* 2010;94:482.
  142. Cortesi P, Pizzatti C. Palea browning, a new disease of rice in Italy caused by *Pantoea ananatis*. *J. Plant Pathol.* 2007;89:S76.
  143. Egorova M, Mazurin E, Ignatov AN. First report of *Pantoea ananatis* causing grain discolouration and leaf blight of rice in Russia. *New Dis. Rep.* 2015;32:21.
  144. Cota LV, Costa RV, Silva DD, Parreira DF, Lana UGP, Casela CR. First report of pathogenicity of *Pantoea ananatis* in sorghum (*Sorghum bicolor*) in Brazil. *Australas. Plant Dis. Notes* 2010;5:120–122.
  145. Kido K, Adachi R, Hasegawa M, Yano K, Hikichi Y, Takeuchi S, et al. Internal fruit rot of netted melon caused by *Pantoea ananatis* (= *Erwinia ananas*) in Japan. *J. Gen. Plant Pathol.* 2008;74:302–312.
  146. Goszczynska T. Emerging diseases of maize and onion caused by bacteria belonging to the genus *Pantoea* [PhD dissertation]. University of Pretoria, South Africa; 2007.
  147. Achbani EH, Mazouz H, Benbouazza A, Sadik S. First detection of *Pantoea ananatis*, the causal agent of bacterial center rot of onion in Morocco. *J. Crop Prot.* 2015;5:11–7.
  148. Schwartz HF, Otto K. First report of a leaf blight and bulb decay of onion by *Pantoea ananatis* in Colorado. *Plant Dis.* 2000;84:808.
  149. Carr EA, Bonasera JM, Zaid AM, Lorbeer JW, Beer SV. First report of bulb disease of onion caused by *Pantoea ananatis* in New York. *Curr. Microbiol.* 2016;72:738–743.
  150. Gitaitis R, Walcott R, Culpepper S, Sanders H, Zolobowska L, Langston D. Recovery of *Pantoea ananatis*, causal agent of center rot of onion, from weeds and crops in Georgia, USA. *Crop Prot.* 2002;21:983–989.
  151. Dohroo NP, Kansal S, Ahluwalia N, Shanmugam V. First report of *Pantoea ananatis* strain nvgl-01 on ginger. *Plant Dis. Res.* 2013;28:200–202.
  152. Coutinho TA, Preisig O, Mergaert J, Cnockaert MC, Riedel K-H, Swings J, et al. Bacterial blight and dieback of *Eucalyptus* species, hybrids, and clones in South Africa. *Plant Dis.* 2002;86:20–25.
  153. De Maayer P, Chan WY, Rubagotti E, Venter SN, Toth IK, Birch PR, et al. Analysis of the *Pantoea ananatis* pan-genome reveals factors underlying its ability to colonize and interact with plant, insect and vertebrate hosts. *BMC Genomics* 2014;15:404.
  154. Rezzonico F, Smits TH, Montesinos E, Frey JE, Duffy B. Genotypic comparison of *Pantoea agglomerans* plant and clinical strains. *BMC Microbiol.* 2009;9:204.
  155. Sheibani-Tezerji R, Naveed M, Jehl M-A, Sessitsch A, Rattei T, Mitter B. The genomes of closely related *Pantoea ananatis* maize seed endophytes having different effects on the host plant differ in secretion system genes and mobile genetic elements. *Front. Microbiol.* 2015;6:440.
  156. Weller-Stuart T, De Maayer P, Coutinho T. *Pantoea ananatis*: genomic insights into a versatile pathogen. *Mol. Plant Pathol.* 2017;18:1191–1198.
  157. Kim HJ, Lee JH, Kang BR, Rong X, Gardener BB, Ji HJ, et al. Draft genome sequence

- of *Pantoea ananatis* B1-9, a nonpathogenic plant growth-promoting bacterium. J. Bacteriol. 2012;194:729.
158. Castagno LN, Estrella MJ, Sannazzaro AI, Grassano AE, Ruiz OA. Phosphate-solubilization mechanism and in vitro plant growth promotion activity mediated by *Pantoea eucalypti* isolated from *Lotus tenuis* rhizosphere in the Salado River Basin (Argentina). Journal of applied microbiology, 2011;110:1151–1165.
  159. Shyntum DY, Venter SN, Moleleki LN, Toth I, Coutinho TA. Comparative genomics of type VI secretion systems in strains of *Pantoea ananatis* from different environments. BMC Genomics 2014;15:163.
  160. Smith DD, Kirzinger MW, Stavrinos J. Draft genome sequence of the antibiotic-producing epiphytic isolate *Pantoea ananatis* BRT175. Genome Announc. 2013;1:e00902-13.
  161. Weinthal DM, Barash I, Panijel M, Valinsky L, Gaba V, Manulis-Sasson S. Distribution and replication of the pathogenicity plasmid ppath in diverse populations of the gall-forming bacterium *Pantoea agglomerans*. Appl. Environ. Microbiol. 2007;73:7552–7561.
  162. De Maayer P. Genome comparisons to identify selected pathogenicity factors of a plant-associated *Pantoea ananatis* strain [PhD dissertation]. University of Pretoria, South Africa; 2011.
  163. Block CC, Hill JH, McGee DC. Seed transmission of *Pantoea stewartii* in field and sweet corn. Plant Disease, 1998;82:775–780.
  164. Morohoshi T, Nakamura Y, Yamazaki G, Ishida A, Kato N, Ikeda T. The plant pathogen *Pantoea ananatis* produces N-acylhomoserine lactone and causes center rot disease of onion by quorum sensing. J. Bacteriol. 2007;189:8333–8338.
  165. Bleves S, Viarre V, Salacha R, Michel GPF, Filloux A, Voulhoux R. Protein secretion systems in *Pseudomonas aeruginosa*: a wealth of pathogenic weapons. Int. J. Med. Microbiol. 2010;300:534–543.
  166. De Maayer P, Venter SN, Kamber T, Duffy B, Coutinho TA, Smits TH. Comparative genomics of the type VI secretion systems of *Pantoea* and *Erwinia* species reveals the presence of putative effector islands that may be translocated by the VgrG and Hcp proteins. BMC Genomics 2011;12:576.
  167. Gerlach RG, Hensel M. Protein secretion systems and adhesins: the molecular armory of Gram-negative pathogens. Int. J. Med. Microbiol. 2007;297:401–415.
  168. Ho BT, Dong TG, Mekalanos JJ. A view to a kill: the bacterial type VI secretion system. Cell Host Microbe 2014;15:9–21.
  169. Nissan G, Manulis S, Weinthal DM, Sessa G, Barash I. Analysis of promoters recognized by HrpL, an alternative  $\sigma$ -factor protein from *Pantoea agglomerans* pv. *gypsophylae*. Mol. Plant Microbe Interact. 2005;18:634–643.
  170. Nivaskumar M, Francetic O. Type II secretion system: A magic beanstalk or a protein escalator. Biochim. Biophys. Acta BBA – Mol. Cell Res. 2014;1843:1568–1577.
  171. Barash I, Manulis-Sasson S. Virulence mechanisms and host specificity of gall-forming *Pantoea agglomerans*. Trends Microbiol. 2007;15:538–545.
  172. Correa VR, Majerczak DR, Ammar E-D, Merighi M, Pratt RC, Hogenhout SA, et al. The bacterium *Pantoea stewartii* uses two different type III secretion systems to

- colonize its plant host and insect vector. *Appl. Environ. Microbiol.* 2012;78:6327–6336.
173. Ham JH, Majerczak D, Ewert S, Sreerekha M-V, Mackey D, Coplin D. WtsE, an AvrE-family type III effector protein of *Pantoea stewartii* subsp. *stewartii*, causes cell death in non-host plants. *Mol. Plant Pathol.* 2008;9:633–643.
  174. Kirzinger MWB, Butz CJ, Stavrinides J. Inheritance of *Pantoea* type III secretion systems through both vertical and horizontal transfer. *Mol. Genet. Genomics* 2015;290:2075–2088.
  175. Shyntum DY, Theron J, Venter SN, Moleleki LN, Toth IK, Coutinho TA. *Pantoea ananatis* utilizes a type VI secretion system for pathogenesis and bacterial competition. *Mol. Plant Microbe Interact.* 2014;28:420–431.
  176. Helinski DR (ed.). *Plasmids in Bacteria*. Springer Science & Business Media, Dordrecht, The Netherlands; 2012.
  177. Hughes VM, Datta N. Conjugative plasmids in bacteria of the “pre-antibiotic” era. *Nature* 1983;302:725–726.
  178. Duong DA, Stevens AM, Jensen RV. Complete genome assembly of *Pantoea stewartii* subsp. *stewartii* DC283, a corn pathogen. *Genome Announc.* 2017;5:e00435–17.
  179. De Maayer P, Chan WY, Blom J, Venter SN, Duffy B, Smits TH, et al. The large universal *Pantoea* plasmid LPP-1 plays a major role in biological and ecological diversification. *BMC Genomics* 2012;13:625.
  180. Roper MC. *Pantoea stewartii* subsp. *stewartii*: lessons learned from a xylem-dwelling pathogen of sweet corn. *Mol. Plant Pathol.* 2011;12:628–637.
  181. Von Bodman SB, Majerczak DR, Coplin DL. A negative regulator mediates quorum-sensing control of exopolysaccharide production in *Pantoea stewartii* subsp. *stewartii*. *Proc. Natl. Acad. Sci. U.S.A.* 1998;95:7687–7692.
  182. Koutsoudis MD, Tsaltas D, Minogue TD, von Bodman SB. Quorum-sensing regulation governs bacterial adhesion, biofilm development, and host colonization in *Pantoea stewartii* subspecies *stewartii*. *Proc. Natl. Acad. Sci. U.S.A.* 2006;103:5983–5988.
  183. Wehland M, Kiecker C, Coplin DL, Kelm O, Saenger W, Bernhard F. Identification of an RcsA/RcsB recognition motif in the promoters of exopolysaccharide biosynthetic operons from *Erwinia amylovora* and *Pantoea stewartii* subspecies *stewartii*. *J. Biol. Chem.* 1999;274:3300–3307.
  184. Herrera CM, Koutsoudis MD, Wang X, von Bodman SB. *Pantoea stewartii* subsp. *stewartii* exhibits surface motility, which is a critical aspect of Stewart’s wilt disease development on maize. *Mol. Plant Microbe Interact.* 2008;21:1359–1370.
  185. Gutierrez CM. *Pantoea stewartii* subsp. *stewartii* requires motility for plant infection [PhD dissertation]. University of Connecticut, USA; 2008. <https://opencommons.uconn.edu/dissertations/AAI3300636>.
  186. Packard H, Burke AK, Jensen RV, Stevens AM. Analysis of the in planta transcriptome expressed by the corn pathogen *Pantoea stewartii* subsp. *stewartii* via RNA-Seq. *PeerJ* 2017;5:e3237.
  187. Chang T, Bunting AH. The rice cultures. *Philos. Trans. R. Soc. Lond. B Biol. Sci.* 1976;275:143–157.
  188. Seck PA, Diagne A, Mohanty S, Wopereis MC. Crops that feed the world 7: rice. *Food Secur.* 2012;4:7–24.

189. Khush GS. Origin, dispersal, cultivation and variation of rice. *Plant Mol. Biol.* 1997;35:25–34.
190. Bos D, Grigoras I, Ndiaye A (eds.). *Land Cover and Avian Biodiversity in Rice Fields and Mangroves of West Africa*. Wetlands International, Dakar, Senegal; 2006.
191. Leff B, Ramankutty N, Foley JA. Geographic distribution of major crops across the world. *Global Biogeochemical Cycles*, Vol. 18; 2004. doi: 10.1029/2003GB002108.
192. Agnoun Y, Biaou SS, Sié M, Vodouhè RS, Ahanchédé A. The African rice *Oryza glaberrima* Steud: knowledge distribution and prospects. *Int. J. Biol.* 2012;4:158.
193. Sharma SD. Domestication and diaspora of rice. *Rice Orig. Antiq. Hist.* 2010;1–25.
194. Murray SS. Identifying African rice domestication in the middle Niger delta (Mali). In: Cappers RT (ed.) *Fields of Change: Progress in African Archaeobotany*, pp. 53–61. Barkhuis, Groningen, Netherlands; 2007.
195. Trébuil G, Hossain MA (eds.). *Le Riz. Enjeux Écologiques et Économiques*. Belin, Paris, France; 2004.
196. Somado EA, Guei RG, Nguyen N. *Overview: rice in Africa*. Africa Rice Center, Bouaké, Ivory Coast; 2008.
197. Pearson SR, Stryker JD, Humphreys CP (eds.). *Rice in West Africa: Policy and Economics*. Stanford University Press, Stanford, California, USA; 1981.
198. Balasubramanian V, Sie M, Hijmans RJ, Otsuka K. Increasing rice production in sub-Saharan Africa: challenges and opportunities. *Adv. Agron.* 2007;94:55–133.
199. Raymundo SA, Buddenhagen IW. A rice virus disease in West Africa. *Int. Rice Comm. Newsl.* 1976;25.
200. Zeigler RS, Leong SA, Teng PS (eds.). *Rice blast disease*. International Rice Research Institute, Manila, The Philippines; 1994.
201. Iono BP, Niono M. Rice bacterial leaf blight in West Africa: preliminary studies on disease in farmers. *Asian J. Plant Sci.* 2005;4:577–579.
202. Couch BC, Kohn LM. A multilocus gene genealogy concordant with host preference indicates segregation of a new species, *Magnaporthe oryzae*, from *M. grisea*. *Mycologia* 2002;94:683–693.
203. Cavara F. Note sur le parasitisme de quelques champignons. 1891.
204. Barr ME. *Magnaporthe*, *Telimenella*, and *Hyponectria* (*Physosporaceae*). *Mycologia* 1977;952–966.
205. Malicdem AR, Fernandez PL. Rice blast disease forecasting for northern Philippines. *WSEAS Trans. Inf. Sci. Appl.* 2015;12:120–129.
206. Nutsugah SK, Dogbe W, Twumasi JK, Dartey K, Chipili J, Sreenivasaprasad S, et al. Survey of rice blast and varietal screening in Ghana. 2004:47–62.
207. Séré Y, Sy AA, Akator SK, Onasanya A, Zai K, Sreenivasaprasad S, et al. Analysis of *Magnaporthe grisea* population structure in Côte d'Ivoire as a prerequisite for the deployment of varieties with durable blast resistance. 2004:72–102.
208. Koga H, Nakayachi O. Morphological studies on attachment of spores of *Magnaporthe grisea* to the leaf surface of rice. *J. Gen. Plant Pathol.* 2004;70:11–15.
209. Swings J, Van den Mooter M, Vauterin L, Hoste B, Gillis M, Mew TW, et al. Reclassification of the causal agents of bacterial blight (*Xanthomonas campestris* pv. *oryzae*) and bacterial leaf streak (*Xanthomonas campestris* pv. *oryzicola*) of rice as

- pathovars of *Xanthomonas oryzae* (ex Ishiyama 1922) sp. nov., nom. rev. Int. J. Syst. Evol. Microbiol. 1990;40:309–311.
210. Ogawa T. Methods and strategy for monitoring race distribution and identification of resistance genes to bacterial leaf blight (*Xanthomonas campestris* pv. *oryzae*) in rice. JARQ Jpn. 1993.
211. Niño-Liu Do, Ronald PC, Bogdanove AJ. *Xanthomonas oryzae* pathovars: model pathogens of a model crop. Mol. Plant Pathol. 2006;7:303–324.
212. Gnanamanickam SS, Priyadarisini VB, Narayanan NN, Vasudevan P, Kavitha S. An overview of bacterial blight disease of rice and strategies for its management. Current Science, 1999:1435-1444.
213. Virmani SS, Ilyas-Ahmed M. Rice breeding for sustainable production. Breed. Major Food Staples 2007;141–191.
214. Khan MA, Naeem M, Iqbal M. Breeding approaches for bacterial leaf blight resistance in rice (*Oryza sativa* L.), current status and future directions. Eur. J. Plant Pathol. 2014;139:27–37.
215. Fu C, Wu T, Liu W, Wang F, Li J, Zhu X, et al. Genetic improvement of resistance to blast and bacterial blight of the elite maintainer line Rongfeng B in hybrid rice (*Oryza sativa* L.) by using marker-assisted selection. Afr. J. Biotechnol. 2012;11:13104–13124.
216. Bakker W. Characterization and ecological aspects of *Rice Yellow Mottle Virus* in Kenya. Pudoc; 1974.
217. Rossel HW, Thottappilly G. Virus diseases of important food crops in tropical Africa. Virus Dis. Important Food Crops Trop. Afr. 1985.
218. Hébrard E, Pinel-Galzi A, Oludare A, Poulicard N, Aribi J, Fabre S, et al. Identification of a hypervirulent pathotype of *Rice Yellow Mottle Virus*: a threat to genetic resistance deployment in West-Central Africa. Phytopathology 2017;108:299–307.
219. Bakker W. Rice yellow mottle, a mechanically transmissible virus disease of rice in Kenya. Neth. J. Plant Pathol. 1970;76:53–63.
220. Fauquet C, Thouvenel JC. Isolation of the *Rice Yellow Mottle Virus* in Ivory Coast. Plant Dis. Report 1977;61:443–446.
221. Thottappilly G, Rossel HW. Evaluation of resistance to *Rice Yellow Mottle Virus* in *Oryza* species. Indian J. Virol. 1993;9:65–73.
222. Fomba SN. Screening for seedling resistance to *Rice Yellow Mottle Virus* in some rice cultivars in Sierra Leone. Plant Dis. 1988;72:641–642.
223. Oludare A, Tossou HT, Kini K, Silué D. Diversity of *Rice Yellow Mottle Virus* in Benin and Togo and screening for resistant accessions. J. Phytopathol. 2016;164:924–35.
224. Attere AF, Fatokun CA. Reaction of *Oryza glaberrima* accessions to *Rice Yellow Mottle Virus*. Plant Dis. 1983;67:420–421.
225. Pidon H, Ghesquière A, Chéron S, Issaka S, Hébrard E, Sabot F, et al. Fine mapping of *RYMV3*: a new resistance gene to *Rice Yellow Mottle Virus* from *Oryza glaberrima*. Theor. Appl. Genet. 2017;130:807–818.
226. Ahmadi N, Albar L, Pressoir G, Pinel A, Fargette D, Ghesquière A. Genetic basis and mapping of the resistance to *Rice Yellow Mottle Virus*. III. Analysis of QTL efficiency in introgressed progenies confirmed the hypothesis of complementary epistasis between two resistance QTLs. Theor. Appl. Genet. 2001;103:1084–1092.

227. Albar L, Lorieux M, Ahmadi N, Rimbault I, Pinel A, Sy AA, et al. Genetic basis and mapping of the resistance to *Rice Yellow Mottle Virus*. I. QTLs identification and relationship between resistance and plant morphology. *Theor. Appl. Genet.* 1998;97:1145–1154.
228. Ghesquière A, Albar L, Lorieux M, Ahmadi N, Fargette D, Huang N, et al. A major quantitative trait locus for *Rice Yellow Mottle Virus* resistance maps to a cluster of blast resistance genes on chromosome 12. *Phytopathology* 1997;87:1243–1249.
229. Thiémélé D, Boisnard A, Ndjiondjop M-N, Chéron S, Séré Y, Aké S, et al. Identification of a second major resistance gene to *Rice Yellow Mottle Virus*, RYMV2 in the African cultivated rice species, *glaberrima*. *Theor. Appl. Genet.* 2010;121:169–179.
230. Meerman J, Cochrane SH. Population growth and food supply in sub-Saharan Africa. *Finance Dev.* 1982;19:12–7.
231. World population projected to reach 9.7 billion by 2050 | UN DESA | United Nations Department of Economic and Social Affairs [Internet]. [cited 2018 Jun 18]. Available from: 2015-report.html.
232. Jayne TS, Mather D, Mghenyi E. Principal challenges confronting smallholder agriculture in sub-Saharan Africa. *World development*, 2010;38:1384–1398.
233. Van Ittersum MK, van Bussel LGJ, Wolf J, Grassini P, van Wart J, Guilpart N, et al. Can sub-Saharan Africa feed itself? *Proc. Natl. Acad. Sci. U.S.A.* 2016;113:14964–14969.
234. Seck PA, Diagne A, Mohanty S, Wopereis MC. Crops that feed the world 7: Rice. *Food Security* 2012;4:7–24.
235. Balasubramanian V, Sie M, Hijmans RJ, Otsuka K. Increasing rice production in sub-Saharan Africa: challenges and opportunities. *Adv. Agron.* 2007;94:55–133.
236. Zhu D, Cheng S, Zhang Y, Lin X, Chen H. Analysis of status and constraints of rice production in the world. *Scientia Agricultura Sinica* 2010;43:474–479.
237. Verdier V, Vera Cruz C, Leach JE. Controlling rice bacterial blight in Africa: needs and prospects. *J. Biotechnol.* 2012;159:320–328.
238. Hajri A, Brin C, Zhao S, David P, Feng JX, Koebnik R, et al. Multilocus sequence analysis and type III effector repertoire mining provide new insights into the evolutionary history and virulence of *Xanthomonas oryzae*. *Mol. Plant Pathol.* 2012;13:288–302.
239. Gonzalez C, Szurek B, Manceau C, Mathieu T, Séré Y, Verdier V. Molecular and pathotypic characterization of new *Xanthomonas oryzae* strains from West Africa. *Mol. Plant Microbe Interact.* 2007;20:534–546.
240. Dewa KM, Banito A, Onasanya A, Kpemoua KE, Sere Y. Rice bacterial blight in Togo: importance of the disease and virulence of the pathogen. *Curr. Res. Bacteriol.* 2011;4:94–100.



## **CHAPTER 2. Results**

## I. Résumé substantiel des résultats en Français

### 1. Introduction

Les bactéries du genre *Pantoea* ont fait l'objet de plusieurs études dans le monde entier. Parmi les 24 espèces décrites, cinq ont été signalées comme étant pathogènes pour plusieurs cultures d'importances économiques et stratégiques [1–8], y compris le riz [9–13]. Sur cette dernière, deux espèces nommées *P. ananatis* et *P. agglomerans* sont connues comme phytopathogènes et constituent une menace potentielle pour la production de riz dans le monde entier. Ces deux espèces n'avaient pas encore été officiellement signalées en Afrique en tant que pathogènes du riz car aucune étude n'était pas réalisée à cette fin. Au Togo, des études ont été faites sur d'autres maladies bactériennes du riz, mais les bactéries ont été diagnostiquées à tort comme *Xanthomonas oryzae* pv. *oryzae* avec l'utilisation de techniques d'identification bactériennes phénotypiques et biochimiques [14]. Récemment, grâce à des outils de diagnostic moléculaire, certains des isolats conservés dans les congélateurs à Africa Rice Center Cotonou ont été diagnostiqués par l'équipe de phytopathologie comme appartenant au genre *Pantoea*. Les *Pantoea* spp. sont donc présents au Togo et « éventuellement dans d'autres pays africains » et constitueraient une contrainte pour la production rizicole. La prévalence et la diversité génétique des populations de ces bactéries phytopathogènes n'étaient pas connues car seul un nombre limité de souches ont été collectées.

Les objectifs de notre étude étaient (i) d'améliorer la collection de *Pantoea* spp. disponible en effectuant de nouvelles collections dans d'autres pays africains, (ii) de déterminer la diversité des espèces en décrivant les espèces impliquées, une fois les espèces d'écrites, (iii) développer des outils de diagnostics et de typages moléculaires.

Une fois développés, ces outils et méthodes seront des atouts précieux qui faciliteront d'autres études telles que : une analyse fine de la diversité génétique, phénotypique (virulence / agressivité) de la structuration génétique des *Pantoea* spp. africaines, pour mettre sur pieds des méthodes d'épidémiologie-surveillance.

### 2. Résultats obtenus

#### ❖ De nouvelles maladies bactériennes émergentes menaçantes pour la production rizicoles en Afrique subsaharienne

Plusieurs bactéries phytopathogènes dont *Xanthomonas oryzae* pv. *oryzae* (*Xoo*), *X. oryzae* pv. *oryzicola* (*Xoc*), *Pseudomonas fuscovaginae*, *Burkholderia glumae*, *Burkholderia gladioli*, *Acidovorax avenae* subsp. *avenae*, *Pantoea ananatis* et *Pantoea agglomerans* ont été signalées dans le monde entier comme les principaux agents pathogènes du riz [15–21]. En Afrique, à l'exception de *Xoo*, *Xoc* et *Pseudomonas* spp., le genre *Pantoea* et *Sphingomonas* n'ont jamais été signalés comme agents pathogènes du riz. Ainsi, des prospections phytosanitaires menées pour avoir une idée sur la prévalence et l'incidence de *Xoo* et de *Xoc* ont permis la collection de feuilles présentant des symptômes de brûlure bactérienne (BB). Les tests de diagnostic effectués avec les outils de diagnostic multiplexe PCR n'ont pas donné de résultats positifs. Cependant, ces bactéries sont capables de provoquer, après inoculation, des symptômes identiques à ceux observés sur dans les champs. Ainsi, la question est :

« Quelles sont les bactéries de couleurs jaune pâle, jaune orangé et jaune citron ; isolées des feuilles et des semences du riz, qui ne sont pas *Xoo*, ni *Xoc*, mais après leur inoculation sur des feuilles de riz, sont capables de provoquer les mêmes symptômes que ceux observés dans les champs? »

Pour identifier ces bactéries « mystérieuses », des morceaux de feuilles symptomatiques ont été stérilisés en surface puis macérés dans de l'eau distillée stérilisée. La solution issue de cette macération a été étalée sur un milieu PSA (peptone-saccharose-agar). Des colonies de couleur jaune pâle, jaune orangé et jaune citron ont été obtenues après incubation à 28 °C pendant 1 à 2 jours. Les amplicons issus de la PCR avec les amorces rRNA 16S et du gène *gyrB* de ces différentes colonies ont été séquencés. L'analyse des séquences partielles ont permis de trouver que ces bactéries appartiennent au genre *Pantoea* et sont spécifiquement et principalement deux espèces à savoir *P. ananatis* et *P. stewartii*. Des méthodes de PCR simplexes pour un diagnostic spécifique de chaque espèce ont été développées, évaluées et validées avec des souches du Togo, du Bénin et d'autres souches de référence CFBP. À notre connaissance, il s'agit du premier rapport d'une nouvelle maladie bactérienne causée par des espèces de *Pantoea* au Bénin et au Togo. Les symptômes correspondant à la maladie ont été observés dans les 14 localités du Bénin et dans plus de 12 localités au Togo où des prospections sur le terrain ont été effectuées et la prévalence de la maladie variait entre 30 et 100% dans les deux pays.

En dehors des bactéries du genre *Pantoea*, un grand nombre de souches de couleur jaune foncé, et, qui, elles poussent à 48 (contrairement au *Pantoea* qui poussent à 24) n'avaient pas donné des résultats positifs avec des tests d'identification pour les *X. oryzae* ni pour les *Pantoea* spp. A partir de ces échantillons négatifs pour ces différents tests, un amplicon de 279 pb provenant du gène de l'ARNr 16S a été obtenu pour 604 isolats. Ces isolats ont été obtenus à partir d'échantillons prélevés au Bénin, au Burkina Faso, en Gambie, en Côte d'Ivoire, au Mali, au Nigeria, en Tanzanie et au Togo. Huit des isolats ont été sélectionnés au hasard et séquencés pour une étude ultérieure. Les isolats présentaient une identité de séquence de 90,2-100% entre eux, et une analyse par BLASTn indiquait que les huit isolats présentaient une identité de séquence de 95 à 98% avec les séquences du gène d'ARNr 16S de nombreuses souches type de *Sphingomonas*, y compris *S. paucimobilis* (numéro d'accès GenBank KP814059), *S. melonis* (EU429948) et *S. zae* (NR\_136793). L'arbre phylogénétique de rapport de vraisemblance d'approximation standard de l'ARNr 16S créé en utilisant Phylogeny.fr (Dereeper et al., 2008) a montré que ces isolats appartiennent à *Sphingomonas* spp. mais pas à une espèce spécifique. Sept des séquences ont été déposées dans GenBank chez NCBI: KT729520 (isolat ASP3, Bénin), KT729521 (ASP6, Bénin), KY630528 (ASP160, Togo), KY630529 (ASP283, Côte d'Ivoire), KY630530 (ASP360, Mali), KY630531 (ASP361, Mali), KY630532 (ASP447, Gambie). C'est travaux ont permis de rapporter pour la première fois dans sept pays d'Afrique, la maladie de la brûlure des feuilles du riz causée par *Sphingomonas* spp.

Les postulats de Koch ont été utilisés pour confirmer la pathogénicité de toutes ces complexes bactériennes (*Pantoea* spp. et *Sphingomonas* spp.) suites à des inoculations sur les variétés de riz.

❖ **Un outil de diagnostic PCR (Polymérisation de Réaction par Chaîne) multiplexe (mPCR) pour l'identification des bactéries du genre *Pantoea***

Avec les New Disease Report (NDRs) ci-dessus, *Pantoea* spp. est apparu comme une menace pour la production rizicole en Afrique subsaharienne [22,23]. Face à la situation émergente d'un complexe bactérien phytopathogène, des décisions et actions doivent être prises pour trouver une solution durable enfin réduire les impacts négatifs de cette menace sur la production rizicole. Ainsi, l'une des solutions pour le contrôle efficace des maladies phytopathogènes et l'identification facile de l'agents causal. C'est dans la même veine que nous avons trouvé nécessaire de développer un outil de diagnostic pour l'identification facile de ce complexe bactérien. Et, précisément, puisqu'il s'agit d'un complexe bactérien composé d'au moins trois espèces, la solution idéale pour un diagnostic à moindre coût sera un outil de diagnostic PCR multiplexe.

En utilisant 34 séquences de génomes entiers des trois espèces principales de *Pantoea* (*P. ananatis*, *P. stewartii* et *P. agglomerans*) un ensemble d'amorces de PCR qui détectent spécifiquement chacune des trois espèces, *P. agglomerans*, *P. ananatis* et *P. stewartii*, a été conçu. Un protocole de PCR multiplexe permettant de distinguer ces trois espèces et de détecter d'autres espèces de *Pantoea* a été développé. Après validation par des tests sur un ensemble de souches de référence, 609 souches suspectées de *Pantoea* isolées à partir de feuilles et des semences de riz en provenance de 11 pays africains ont été diagnostiquées. Au total, 41 souches de *P. agglomerans* de huit pays, 79 souches de *P. ananatis* de neuf pays, 269 souches de *P. stewartii* de neuf pays et 220 souches de *Pantoea* spp. de dix pays ont été identifiées.

En raison de sa robustesse, de sa spécificité, de sa sensibilité et de son rapport coût-efficacité, il sera très utile pour les services de protection des végétaux et pour la surveillance épidémiologique de ces bactéries d'importance économique qui menacent la production rizicole en Afrique au sud du Sahara.

❖ **Développement d'une technique LAMP (Amplification Isotherme à Médiation en Boucle) pour la détection rapide des espèces de *Pantoea* spp. associées aux feuilles et aux semence de riz**

Les bactéries du genre *Pantoea* ont été décrites comme omniprésentes et polyvalentes parce qu'elles ont été isolées à partir de plusieurs sources (organismes vivants et environnement). Au total, cinq espèces du genre *Pantoea* (*P. ananatis*, *P. agglomerans*, *P. stewartii*, *P. allii* et *P. wallisii*) [1–8] ont été décrites comme des phytopathogènes. Récemment, trois espèces (*P. ananatis*, *P. stewartii* et *P. agglomerans*) [22,23] ont été signalées comme une menace pour la production rizicole dans 11 pays en Afrique subsaharienne. Plusieurs outils de diagnostic PCR (simplexe et multiplexe) ont été développés mais leur utilisation est limitée au laboratoire. Ici, nous avons développé deux nouveaux outils de détection basé sur la technique LAMP (Amplification Isotherme à Médiation en Boucle) ciblant deux gènes de ménages pour soit détecter de manière générique toutes les bactéries (cultivables ou non-cultivables) appartenant au genre *Pantoea*, soit pour détecter spécifiquement *P. ananatis* directement.

Des séquences partielles de deux gènes de ménage, *gyrB* et *atpD*, ont été utilisées pour générer un ensemble d'amorces pour les deux outils de diagnostic LAMP pour le genre *Pantoea* en générale et l'espèce *P. ananatis* spécifiquement. La spécificité, l'universalité et la sensibilité des deux outils ont été évaluées et confirmées *in silico* et *in vivo*. Des variations de température en série (de 58 à 66 °C) ont été testées pour les amplifications avec les tests LAMP en utilisant des souches de référence provenant de la collection de souches CFBP. Des résultats positifs ont été observés à toutes les températures testées et aucune amplification non spécifique n'a été détectée pour les contrôles négatifs après au moins 120 min d'incubation. Pour les colonies bactériennes, la limite de détection des deux tests LAMP était de 10<sup>4</sup> unités formant des colonies / ml. En utilisant l'ADN purifié comme matrice, les limites de détection étaient de 0,5 fg pour le genre *Pantoea* et de 50 fg pour *P. ananatis*. Les deux outils ont pu détecter positivement la présence de *Pantoea* dans tous les échantillons testés (feuilles et graines).

Les tests LAMP développés dans cette étude permettra une détection rapide, et sensible des bactéries appartenant au genre *Pantoea* et / ou à l'espèce *P. ananatis*. Ces outils de diagnostic ne nécessitent qu'un minimum de temps et d'équipement, ils peuvent potentiellement être utilisés par les services phytosanitaires pour des tests de routine sur le terrain (champs et frontières) ou pour contrôler l'état phytosanitaire des semences de riz et autres céréales destinées à des échanges inter-états.

#### ❖ **Séquençage du génome de trois souches de *Pantoea ananatis*, un phytopathogène bactérien émergent menaçant la production de riz en Afrique subsaharienne**

De nombreuses méthodes moléculaires sont utilisées pour la détection et l'identification des pathogènes des plantes [24–27]. L'utilisation de ces différentes méthodes dépend des circonstances et des problèmes. Pour de nombreux phytopathogènes microbiens, le diagnostic pose des problèmes en raison de l'absence d'outils spécifiques, universels et facilement applicables. En cas de doute sur l'identité d'un micro-organisme, le séquençage et l'analyse de la séquence constituent les moyens efficaces d'identification et de caractérisation ; surtout en situation des pathogènes végétaux émergents ou dans les situations épidémiques. Ainsi, après identification par séquençage partiel du gène de l'ARNr 16S et du gène *gyrB*, des génomes d'isolats de *P. ananatis* provenant des prospections phytosanitaires dans trois pays africains (Burkina Faso, Bénin et le Togo) ont été séquencés et analysés.

Les trois génomes de *P. ananatis* décrits dans cette étude représentent les premières ressources génomiques rapportées pour cette bactérie originaire d'Afrique subsaharienne. Les arbres phylogénétiques basés sur les séquences du gène *atpD* et les valeurs ANI (> 96%) ont mis en évidence la position taxonomique des trois souches par rapport aux autres souches de *Pantoea* spp. caractérisées isolées du riz et d'autres sources et provenant d'autres continents. Il est intéressant de noter que les deux tests ci-dessus ont montré que les souches d'Afrique subsahariennes étaient plus proches des souches isolées du riz en Inde et en Chine que des souches isolées d'autres sources, telles que le maïs, l'oignon et l'eucalyptus. En plus, l'analyse des groupes de gènes LPS et T6SS a révélé des différences intra-lignées en ce qui concerne les caractéristiques sérologiques et une certaine variation intra-lignées par rapport à la configuration T6SS. Dans l'ensemble, ces données représentent une base utile pour l'analyse

fonctionnelle de traits génomiques distincts qui pourraient être impliqués dans l'adaptation de *P. ananatis* à la gamme d'hôtes. Les résultats obtenus à partir des analyses nous ont permis de : (i) Confirmer l'efficacité des outils de diagnostic qui ont été développés sur la base du séquençage partiel des gènes ; (ii) Avoir une meilleure idée des relations phylogénétiques entre les isolats africains, asiatiques (Inde et Chine) et européens (Espagne) de *P. ananatis* isolés du riz et d'autres sources ; (iii) Comparer les repartitions des gènes des isolats africains avec ceux d'autres souches de *P. ananatis*.

❖ **Développement et évaluation de deux outils MLVA (Multiple Loci VNTR Analysis): MLVA-6\_*microsat* et de MLVA-6\_*minisat*, constitués respectivement de locus microsatellites et minisatellites pour la surveillance épidémiologique complémentaire de *P. ananatis***

*Pantoea ananatis* est un agent causal de nombreuses maladies sur des cultures d'importances économiques [1–8]. Plusieurs outils de typages épidémiologiques sont disponibles, mais ils sont souvent coûteux ou pas bien standardisés pour les laboratoires. Dans ce travail, (i) nous avons fait l'inventaire des tandems répétés (les locis minisatellite et locis microsatellite) présents dans les génomes de *P. ananatis*, (ii) développés et évalués les caractéristiques (pouvoir discriminant, fréquence allélique, degré de polymorphisme ...) de deux outils MLVA. Plusieurs isolats provenant des prospections dans huit pays africains et d'autres continents ont été utilisés pour son évaluation et sa validation.

Au total, 15 séquences du génome de *P. ananatis* ont été criblées pour la présence des tandem répétés dans les nombres varies d'une souche à une autre (les VNTRs). Au total, cinquante loci VNTR dont 42 microsatellites (5-9 pb) et 8 minisatellites (10-100 pb) ont été identifiés. Les amorces de PCR ont été développées dans les régions flanquantes conservées et évaluées par PCR *In Silico* et par Primer-BLAST. Au total, 35 loci prometteurs, dont 27 microsatellites et 8 minisatellites, ont été sélectionnés. Parmi eux, six loci ont été sélectionnés pour chacun des deux types de répétitions en tandem pour le développement de deux outils MLVA-6. L'application des deux outils pour le criblage des souches de *P. ananatis* de différents hôtes et origines géographiques a permis de déterminer son pouvoir discriminant et de les valider comme outils pour étudier l'épidémiologie et la diversité de *P. ananatis*. Il est intéressant de noter que certains loci ont démontré leur capacité de distinguer « sous-spécifiquement » les *P. ananatis* des deux clades : ceux isolés du riz et ceux provenant d'autres sources.

Notre étude présente deux outils de typage MLVA spécifiques et universels pour *P. ananatis* provenant de diverses sources. A ce stade, les deux schémas MLVA-6 constituent un outil de typage moléculaire puissant et prometteur, avec une résolution suffisante et un faible coût pour la surveillance épidémiologique de *P. ananatis*. Des travaux complémentaires futurs évalueront plus de loci et d'isolats bactériens afin d'obtenir une résolution suffisante pour les analyses dans les situations d'épidémie.

❖ **Développement d'un outil de diagnostic par réaction de polymérisation par chaîne (PCR) capable de diagnostiquer « sous-spécifiquement » *P. ananatis* appartenant à chacun des deux clades**

*P. ananatis* est l'une des bactéries les plus polyvalentes et omniprésentes dans la nature et en association avec les organismes vivants (plantes et animaux) [28–31]. En effet, la bactérie a été isolée à partir de plusieurs sources dont les plantes, les animaux (insectes et humains) et l'environnement. Pour les plantes, *P. ananatis* été signalé à plusieurs reprises comme pathogène pour le riz. Des travaux récents ont montré que l'espèce est composée de deux clades : l'un composé uniquement de souches isolées du riz comme pathogène ou endophyte et l'autre clade est constitué d'isolats provenant d'autres sources y compris quelques isolats de riz. Ces travaux ont été confirmés par d'autres études faites par notre équipe ces deux dernières années. En effet, l'analyse comparative des valeurs d'Average Nucleotide Identity (ANI) du génome de *P. ananatis* disponible dans la base de données NCBI avec trois génomes de *P. ananatis* isolés de riz en Afrique a montré que *P. ananatis* isolé du riz en Afrique et en Asie sont à 99,20% identiques entre eux comparativement à la valeur de 96,30% avec de *P. ananatis* provenant d'autres sources. Fait intéressant, les deux outils MLVA-6 développés par nos équipes pour *P. ananatis*, distinguent les deux clades par l'analyse de l'homoplasie dans les tandems répétitifs de certains loci et par les SNPs (Single Nucleotide polymorphisme) dans les séquences flanquantes de ces loci. Ces observations ont été confirmées par l'arbre MST (Minimum Spanning Tree) et le diagramme matriciel de distance. De plus, des arbres phylogénétiques construits à partir de quatre gènes de ménage (*infB*, *atpD*, *gyrB* et *rpoB*) ont confirmé les résultats de l'analyse précédente avec la formation des deux clades dans les groupes *P. ananatis*. D'autres travaux sur l'analyse comparative du groupe de gènes LPS de souches de *P. ananatis* représentant la diversité mondiale nous a permis de prédire que les deux clades seraient sérologiquement distincts et seraient susceptibles d'être distingués les uns des autres par des moyens immunologiques. Ainsi, des questions sur une possible pathovarisation de cette espèce se posent, et des réponses doivent être trouvées pour comprendre les éléments qui supportent cette interaction *P. ananatis*-riz. Mais en amont de toutes ces investigations pour trouver ces réponses, il est indispensable d'avoir des outils de diagnostics discriminatoires spécifiques. Ainsi, nous avons développé deux outils de diagnostic PCR constitués d'un ensemble d'amorces spécifiques de chaque clade, capable d'amplifier spécifiquement, une souche appartenant à chacun des deux clades.

L'avantage de cet outil est qu'il permettra de facilement distinguer à l'avance les souches de *P. ananatis* des deux clades, avant que les travaux de confirmation avec des analyses complexes et approfondies (WGSs, MLVA, MLST) ne soient effectués. Ainsi, il sera très utile dans les travaux futurs qui se concentreront sur la compréhension des facteurs qui expliquent l'interaction de *P. ananatis*-riz. Il peut être utilisé par les services de protection des plantes pour les tests de routine de *P. ananatis* surtout pour le contrôle de l'état de santé des semences.

### ❖ **Fiche technique et protocolaire : Développement, évaluation et validation d'un milieu de culture semi-sélectif pour le genre *Pantoea* (PGS medium)**

Un milieu de culture idéal pour un micro-organisme (par exemple des bactéries, des levures et des champignons) est celui-là qui contient tous les éléments essentiels, y compris les nutriments, pour une multiplication rapide de cet organisme. Le milieu de culture est qualifié de sélectif lorsque l'on ajoute des éléments qui permettent de favoriser la croissance d'un micro-organisme particulier et inhibent d'autres « non désirés ». Les éléments ajoutés sont sélectionnés en fonction des caractéristiques du micro-organisme désiré. Pour les bactéries, certaines caractéristiques intrinsèques de certains genres ou familles permettent de concevoir des milieux semi-sélectifs.

Bien que signalées plus tôt comme pathogènes du riz dans d'autres continents, trois espèces de *Pantoea* ont été récemment décrites comme telles en Afrique [1,2]. La bactérie a également été isolée à partir de semences de riz et de feuilles de riz dans plusieurs rizières en Afrique. En plus des bactéries du genre *Pantoea*, des bactéries d'autres genres (*Xanthomonas* spp., *Sphingomonas* spp., *Burkholderia* spp. et *Pseudomonas* spp.) ont également été isolées à partir de feuilles de riz et de semences en Afrique et dans le monde [18,32,33]. Sur certains milieux de culture, toutes ces bactéries y compris les *Pantoea* spp. ont presque les mêmes caractéristiques phénotypiques (pigmentation, forme, élévation ... etc.). Cependant, des cas de co-infection de *Pantoea* spp.-*Sphingomonas* spp. [32] et *Pantoea* spp.-*Xanthomonas oryzae* ont même été observés dans les graines et les feuilles de riz (données non publiées). Ceci est souvent la cause des difficultés d'avoir des colonies bactériennes pures pour chacun des genres et engendre des cas de contaminations posant ainsi des difficultés pour un diagnostic fiable. Ainsi, pour faciliter l'isolement des colonies pures de *Pantoea* spp. à partir de semences, feuilles et autres organes, un milieu de culture spécifique et sélectif de *Pantoea* spp. a été développé. Basé sur la propriété hyper-halophile de *Pantoea* spp. (isolé dans les fonds marins) un milieu de culture avec une concentration élevée de NaCl (65%) en combinaison avec d'autres produits chimiques a été développé et est capable d'inhiber la croissance et la multiplication d'autres isolats bactériens de Gram négatif, les levures et les champignons.

PGS medium n'est pas seulement un média de culture, c'est aussi un outil de diagnostic qui s'ajoute aux outils moléculaires. Il peut être utilisé pour la confirmation des tests, pour les travaux de purification en cas de contamination ou pour les diagnostics préliminaires des bactéries du genre *Pantoea*. L'importance de ce milieu est qu'il peut être facilement applicable dans des laboratoires moins équipés et par des agents de quarantaine pour les tests de diagnostic préliminaires en cas de suspicion de contamination des semences par *Pantoea* spp.

### **3. Impacts de l'étude**

Avant cette étude :

- ⇒ Nous avons dans nos congélateurs des isolats qui appartenaient au genre *Pantoea*, mais nous n'avons aucune idée sur leur diversité spécifique;



- ⇒ Nous avons des outils de diagnostic qui ne sont pas spécifiques, qui sont peu fiables et difficiles à utiliser ; et nous n'avons aucun schéma MLVA pour l'étude épidémiologique et la structuration de la diversité génétique de *P. ananatis* ;
- ⇒ Nous n'avons aucune idée de la diversité génétique et des éléments phylogénomiques qui pourraient expliquer la phytopathogenicity de *P. ananatis* du riz en Afrique ;
- ⇒ Nous n'avons aucune idée sur la relation phylogénétique de *P. ananatis* isolée des organes des plants de riz avec ceux d'autres continents ni avec *P. ananatis* provenant du riz et d'autres sources.

Après cette étude:

- ⇒ La présence dans plusieurs pays africains des trois espèces du genre *Pantoea*, à savoir *P. ananatis*, *P. stewartii* et *P. agglomerans* et d'autres probable espèces, « qui n'avaient pas été documentées » en Afrique, ont été rapportée ;
- ⇒ La phytopathogénicité des trois espèces a été démontrée par des tests d'inoculation ;
- ⇒ Des outils diagnostic (simplex et multiplexe PCR, LAMP) et de typage spécifiques (MLVA) faciles à utiliser et reproductibles ont également été développés et validés ;
- ⇒ L'analyse du génome de trois isolats africains « pour la première fois » a donné une idée de la relation phylogénomique entre les souches africaines de *P. ananatis* isolées du riz et *P. ananatis* isolées d'autres sources et d'autres continents.

#### 4. Les perspectives

Les résultats de cette étude ont fournis de bonnes bases pour de futures travaux de recherche sur le genre *Pantoea* en Afrique. Cependant, la prévalence et l'importance économique de ces maladies en Afrique ne sont pas encore bien documentées. Il n'est donc pas encore possible d'estimer le potentiel adaptatif des bactéries dans les pays africains. Des enquêtes supplémentaires seront donc nécessaires pour répondre à cette importante question. Les prochaines études porteront sur l'adaptation de l'outil MLVA de *P. ananatis* pour une étude fine de la diversité phylogénétique de cette bactérie en Afrique et le développement d'autres outils de MLVA pour les deux autres espèces (*P. stewartii* et *P. agglomerans*). Cela permettra (i) d'identifier les souches types et représentatives pour des travaux d'identification des sources de résistance, (ii) d'effectuer une analyse génétique des résistances identifiées et de développement plus rapidement des variétés résistantes et des marqueurs liés aux gènes de résistance. Enfin, des études liées au développement des symptômes et à leur différenciation en fonction des trois espèces bactériennes impliquées peuvent également être initiées.

**Référence bibliographique**

1. Brady CL, Cleenwerck I, van der Westhuizen L, Venter SN, Coutinho TA, De Vos P. *Pantoea rodasii* sp. nov., *Pantoea rwandensis* sp. nov. and *Pantoea wallisii* sp. nov., isolated from Eucalyptus. *Int. J. Syst. Evol. Microbiol.* 2012;62:1457–1464.
2. Orio AA, Brücher E, Plazas MC, Sayago P, Guerra F, De Rossi R, et al. First report of Stewart's wilt of maize in Argentina caused by *Pantoea stewartii*. *Plant Dis.* 2012;96:1819.
3. Rahma H, Sinaga MS, Surahman M, others. First report of Stewart's wilt of maize caused by *Pantoea stewartii* subsp. *stewartii* in Bogor district, Indonesia. *J. Int. Soc. Southeast Asian Agric. Sci.* 2014;20:131–141.
4. Goszczynska T. Emerging diseases of maize and onion caused by bacteria belonging to the genus *Pantoea* [PhD dissertation]. University of Pretoria, South Africa; 2007.
5. Yang KQ, Qu WW, Liu X, Liu HX, Hou LQ. First report of *Pantoea agglomerans* causing brown apical necrosis of walnut in China. *Curr Microbiol.* 2016;72:738–743.
6. Baird RE, Gitaitis RD, Herzog GA. First report of cotton lint rot by *Pantoea agglomerans* in Georgia. *Plant Dis.* 1997;81:551.
7. Kido K, Adachi R, Hasegawa M, Yano K, Hikichi Y, Takeuchi S, et al. Internal fruit rot of netted melon caused by *Pantoea ananatis* (= *Erwinia ananas*) in Japan. *J. Gen. Plant Pathol.* 2008;74:302–312.
8. Cota LV, Costa RV, Silva DD, Parreira DF, Lana UGP, Casela CR. First report of pathogenicity of *Pantoea ananatis* in sorghum (*Sorghum bicolor*) in Brazil. *Australas. Plant Dis. Notes* 2010;5:120–122.
9. González AD, Franco MA, Contreras N, Galindo-Castro I, Jayaro Y, Graterol E. First report of *Pantoea agglomerans* causing rice leaf blight in Venezuela. *Plant Dis.* 2015;99:552.
10. Lee HB, Hong JP, Kim SB. First report of leaf blight caused by *Pantoea agglomerans* on rice in Korea. *Plant Dis.* 2017;101:242.
11. Cortesi P, Pizzatti C. Palea browning, a new disease of rice in Italy caused by *Pantoea ananatis*. *J. Plant Pathol.* 2007;89:S76.
12. Egorova M, Mazurin E, Ignatov AN. First report of *Pantoea ananatis* causing grain discolouration and leaf blight of rice in Russia. *New Dis. Rep.* 2015;32:21.
13. Mondal KK, Mani C, Singh J, Kim JG, Mudgett MB. A new leaf blight of rice caused by *Pantoea ananatis* in India. *Plant Dis.* 2011;95:1582.
14. Dewa KMK, Banito A, Onasanya A, Kpemoua KE, Sere Y. Rice bacterial blight in Togo: importance of the disease and virulence of the pathogen. *Curr. Res. Bacteriol.* 2011;4:94–100.
15. Gonzalez C, Szurek B, Manceau C, Mathieu T, Séré Y, Verdier V. Molecular and pathotypic characterization of new *Xanthomonas oryzae* strains from West Africa. *Mol. Plant Microbe Interact.* 2007;20:534–46.
16. Poulin L, Grygiel P, Magne M, Gagnevin L, Rodriguez-R LM, Serna NF, et al. New multilocus variable-number tandem-repeat analysis tool for surveillance and local epidemiology of bacterial leaf blight and bacterial leaf streak of rice caused by *Xanthomonas oryzae*. *Appl. Environ. Microbiol.* 2015;81:688–698.

17. Verdier V, Vera Cruz C, Leach JE. Controlling rice bacterial blight in Africa: needs and prospects. *J. Biotechnol.* 2012;159:320–328.
18. Zeigler RS, Alvarez E. *Pseudomonas* species causing rice sheath rot (ShR) and grain discoloration (GID). *Internat. Rice Res. Newslett. (Philippines)* 1989;14:26.
19. Cui Z, Ojaghian MR, Tao Z, Kakar KU, Zeng J, Zhao W, et al. Multiplex PCR assay for simultaneous detection of six major bacterial pathogens of rice. *J. Appl. Microbiol.* 2016;120:1357–1367.
20. Duveiller E, Miyajima K, Snacken F, Autrique A, Maraite H. Characterization of *Pseudomonas fuscovaginae* and differentiation from other fluorescent pseudomonads occurring on rice in Burundi. *J. Phytopathol.* 1988;122:97–107.
21. Cother EJ, Noble DH, Van De Ven RJ, Lanoiselet V, Ash G, Vuthy N, et al. Bacterial pathogens of rice in the Kingdom of Cambodia and description of a new pathogen causing a serious sheath rot disease. *Plant Pathol.* 2010;59:944–953.
22. Kini K, Agnimonhan R, Afolabi O, Soglonou B, Silué D, Koebnik R. First report of a new bacterial leaf blight of rice caused by *Pantoea ananatis* and *Pantoea stewartii* in Togo. *Plant Dis.* 2017; 101:241.
23. Kini K, Agnimonhan R, Afolabi O, Milan B, Soglonou B, Gbogbo V, et al. First report of a new bacterial leaf blight of rice caused by *Pantoea ananatis* and *Pantoea stewartii* in Benin. *Plant Dis.* 2017;101:242.
24. Harper SJ, Ward LI, Clover GRG. Development of LAMP and real-time PCR methods for the rapid detection of *Xylella fastidiosa* for quarantine and field applications. *Phytopathology* 2010;100:1282–1288.
25. Brady C, Venter S, Cleenwerck I, Vancanneyt M, Swings J, Coutinho T. A fAFLP system for the improved identification of plant-pathogenic and plant-associated species of the genus *Pantoea*. *Syst. Appl. Microbiol.* 2007;30:413–417.
26. Barghouthi SA. A universal method for the identification of bacteria based on general PCR primers. *Indian J. Microbiol.* 2011;51:430–44.
27. Cui Z, Ojaghian M r., Tao Z, Kakar K u., Zeng J, Zhao W, et al. Multiplex PCR assay for simultaneous detection of six major bacterial pathogens of rice. *J. Appl. Microbiol.* 2016;120:1357–1367.
28. Brady C, Cleenwerck I, Venter S, Vancanneyt M, Swings J, Coutinho T. Phylogeny and identification of *Pantoea* species associated with plants, humans and the natural environment based on multilocus sequence analysis (MLSA). *Syst. Appl. Microbiol.* 2008;31:447–460.
29. Walterson AM, Stavriniades J. *Pantoea*: insights into a highly versatile and diverse genus within the Enterobacteriaceae. *FEMS Microbiol. Rev.* 2015;39:968–984.
30. Arlet G, Audo J, Brisse S, Courant S, Decré D, Grimont P, et al. phylogeny and identification of *Pantoea* Species and typing of *Pantoea agglomerans* strains by multilocus gene sequencing. *J. Clin. Microbiol.* 2009;47:300–310.
31. Völksch B, Thon S, Jacobsen ID, Gube M. Polyphasic study of plant- and clinic-associated *Pantoea agglomerans* strains reveals indistinguishable virulence potential. *Infect. Genet. Evol.* 2009;9:1381–1391.
32. Dossou B, Silue D. Rice pathogens intercepted on seeds originating from 11 African countries and from the USA. *Seed Sci. Technol.* 2018;46:31–40.

33. Kini K, Agnimonhan R, Dossa R, Soglonou B, Gbogbo V, Ouedraogo I, et al. First report of *Sphingomonas* sp. causing bacterial leaf blight of rice in Benin, Burkina Faso, The Gambia, Ivory Coast, Mali, Nigeria, Tanzania and Togo. *New Dis. Rep.* 2017;35:32.

## II. News Disease Reports of emerging rice-pathogenic bacteria in sub-Saharan Africa

### 1. Context and justification of the project

Several phytopathogenic bacteria, including *Xanthomonas oryzae* pv. *oryzae* (*Xoo*), *X. oryzae* pv. *oryzicola* (*Xoc*), *Pseudomonas fuscovaginae*, *Burkholderia glumae*, *Burkholderia gladioli*, *Acidovorax avenae* subsp. *avenae*, *Pantoea ananatis*, and *Pantoea agglomerans*, have been worldwide reported as major bacterial pathogens of rice. In Africa, apart from *Xoo*, *Xoc* and *Pseudomonas* spp., the *Pantoea* and *Sphingomonas* genera have never been reported as rice pathogens. Therefore, phytosanitary surveys carried out to get an idea of the prevalence and incidence of *Xoo* and *Xoc* allowed the collection of leaves presenting symptoms of bacterial leaf blight. Diagnostic tests performed with the Lang et al. mPCR tools failed to confirm the presence of *X. oryzae*. However, after artificial inoculation these bacteria were able to cause symptoms that were identical to those observed in the field. Hence, the question was: “What are the pale yellow and orange-yellow bacteria isolated from Rice leaves and rice seeds that are not *Xoo* but after inoculation of Rice leaves were able to cause the same symptoms as those observed in fields?” The following three new disease reports have answered this question.

### Personal involvement

I fully worked on these articles in cooperation with all co-authors.

### 2. First Disease Note: First Report of a New Bacterial Leaf Blight of Rice Caused by *Pantoea ananatis* and *Pantoea stewartii* in Benin

Published in *Plant Disease*, January 2017, Volume 101, Number 1, Page 242

<https://doi.org/10.1094/PDIS-06-16-0940-PDN>

**K. Kini**, Africa Rice Center, 01 BP 2031, Cotonou, Bénin, and IRD-Cirad-Univ. Montpellier, UMR Interactions Plantes-Microorganismes-Environnement, Montpellier, France; **R. Agnimonhan**, **O. Afolabi**, **B. Milan**, and **B. Soglonou**, Africa Rice Center, 01 BP 2031, Cotonou, Bénin; **V. Gbogbo**, Service Protection des Végétaux et Contrôle Phytosanitaire, Direction de l’Agriculture, 01 BP 58, Oganla, Porto-Novo, Bénin; **R. Koebnik**, IRD-Cirad-Univ. Montpellier, UMR Interactions Plantes-Microorganismes-Environnement, Montpellier, France; and **D. Silué**, Africa Rice Center, 01 BP 2031, Cotonou, Bénin.

From 2011 to 2015, surveys were conducted in rice fields of Benin to assess the importance of bacterial leaf blight (BLB) of rice caused by *Xanthomonas oryzae* pv. *oryzae*. BLB-like diseased leaf samples were collected showing yellowing symptoms or one to two orange to brown stripes on one or both halves of the leaf blade. Older symptoms enlarged to the entire leaf and showed brown stripes below the leaf tip and along the leaf margins. Severely affected leaves became grayish-brown. To diagnose the disease, symptomatic leaf pieces were surface-

sterilized and macerated in sterile water. Upon plating on semiselective peptone-sucrose-agar (PSA) medium (Poulin et al. 2014), straw-colored to yellow colonies were obtained after incubation at 28 °C for 1 to 2 days. In parallel, the leaf sap was subjected to a diagnostic multiplex PCR assay for *X. oryzae* pathovars (Lang et al. 2010). Over 3,000 samples tested were negative. Because leaf blight can also be caused by species of *Pantoea* (Lee et al. 2010; Mondal et al. 2011), the isolates were tested with PCR primers that amplify a *gyrB* fragment from *Pantoea* spp. (Brady et al. 2008), often resulting in PCR amplicons of the expected size. However, since these primers were not specific to the genus *Pantoea* but also amplified loci from other *Enterobacteriaceae*, we used genomic information from 26 *Pantoea* strains to develop species-specific primers targeting the *gyrB* gene of *P. ananatis* (PANAN\_gyrB-F, 5'-TGACGATGCCCGTGAAGG; PANAN\_gyrB-R, 5'-TAATCAACGTGGCRACTTCC) and *P. stewartii* (PANST\_gyrB-F1, 5'-AGGGATACAGCAAGAAGGC; PANST\_gyrB-R1, 5'-TAGCCACTTCTGAGACG). Single colonies were isolated from PCR-positive samples, including strains ARC22 and ARC570. *gyrB* fragments of both isolates were amplified and sequenced using the above primers. The BLASTN searches of a trimmed 426 and 508 bp DNA fragment revealed that the nucleotide sequences were 99% identical to the *gyrB* gene from *P. ananatis* strain 17671 (GenBank accession no. KF554589) and *P. stewartii* strain 626 (KF554590), respectively. The partial sequences of the *gyrB* gene were deposited at GenBank under KT729518 for ARC22 and KT729519 for ARC570. Pathogenicity assays were conducted on 35-day-old rice plants. To this purpose, bacteria were grown overnight on PSA and inoculum adjusted to 10<sup>8</sup> cells/ml. Inoculation was done by either clipping half of the leaves or by infiltrating the leaves at about 5 to 15 cm below the leaf tips. One to two leaves per plant, three plants per accession, and seven cultivars were inoculated. Control plants were inoculated with sterile water. Fifteen to twenty-one days after incubation, inoculated leaves showed typical BLB-like lesions whereas control plants remained symptomless. The reisolated bacteria from diseased leaves yielded colonies identical to those described above and confirmed as *P. ananatis* and *P. stewartii* by PCR and sequence analysis of the *gyrB* gene portion, thus fulfilling Koch's postulates. To our knowledge, this is the first report of a new bacterial disease caused by species of *Pantoea* in Benin. Symptoms corresponding to the disease were found at all 14 localities in Benin where field prospectations were performed and prevalence of the disease varied between 30 and 100%.

### References:

- Brady, C., et al. 2008. Syst. Appl. Microbiol. 31:447. <https://doi.org/10.1016/j.syapm.2008.09.004>
- Lang, J. M., et al. 2010. Plant Dis. 94:311. <https://doi.org/10.1094/PDIS-94-3-0311>
- Lee, H. B., et al. 2010. Plant Dis. 94:1372. <https://doi.org/10.1094/PDIS-05-10-0374>
- Mondal, K. K., et al. 2011. Plant Dis. 95:1582. <https://doi.org/10.1094/PDIS-06-11-0533>
- Poulin, L., et al. 2014. Plant Dis. 98:1423. <https://doi.org/10.1094/PDIS-02-14-0132-PDN>

### 3. Second Disease Note: First Report of a New Bacterial Leaf Blight of Rice Caused by *Pantoea ananatis* and *Pantoea stewartii* in Togo

Published in *Plant Disease*, January 2017, Volume 101, Number 1, Page 241

<http://dx.doi.org/10.1094/PDIS-06-16-0939-PDN>

**K. Kini**, Africa Rice Center, 01 BP 2031, Cotonou, Bénin, and IRD-Cirad-Univ. Montpellier, UMR Interactions Plantes-Microorganismes-Environnement, Montpellier, France; **R. Agnimonhan**, **O. Afolabi**, **B. Soglonou**, and **D. Silué**, Africa Rice Center, 01 BP 2031, Cotonou, Bénin; and **R. Koebnik**, IRD-Cirad-Univ. Montpellier, UMR Interactions Plantes-Microorganismes-Environnement, Montpellier, France.

In 2013 and 2014, surveys were carried out in the main rice-growing regions of Togo (Kovié and Kpalimé) to evaluate the prevalence of plant-pathogenic bacteria, such as *Xanthomonas oryzae*. Symptomatic Rice leaves showing characteristics of bacterial leaf blight, as typically caused by *X. oryzae* pv. *oryzae* (Niño-Liu et al. 2006), were collected, surface-sterilized, and macerated in sterile water. Upon plating on semiselective peptone-sucrose-agar (PSA) medium (Poulin et al. 2014), yellowish colonies of bacteria were isolated. Similar bacterial colonies were isolated from rice grains. Since all isolates were negative in a diagnostic multiplex PCR assay for *X. oryzae* (Lang et al. 2010), a portion of the 16S rDNA was amplified using universal primers, F1 and R13 (Dorsch and Stackebrandt 1992).

DNA sequence analysis indicated that the bacteria belong to the genus *Pantoea*. New *gyrB*-specific PCR primers (PANsp\_gyrB-F, 5'-TTCCAGGARAAYATYACTGCTT; PANsp\_gyrB-R, 5'-CGGTCATGATRATGCTGTG) were developed based on 26 *Pantoea* genome sequences. *gyrB* fragments of four bacterial isolates from regions where the prevalence and severity of the disease was most important were amplified and sequenced for further diagnosis. Sequence comparisons of the obtained 603-bp DNA fragments revealed that the sequences of the leaf isolate ARC60 (GenBank accession no. KX385187) and of the seed isolate ARC651 (KX342014) were 98% identical to the corresponding *gyrB* gene fragment from the *Pantoea ananatis* type strain LMG 2665 (JMJJ01000009). Interestingly, the sequences of the leaf isolate ARC229 (KX342015) and of the seed isolate ARC646 (KX342016) were 99% and 100% identical to the corresponding *gyrB* gene fragment from the *P. stewartii* type strain LMG 2632 (JPKO01000005), respectively. Using species-specific *gyrB* primers for *Pantoea* (Kini et al. 2016), we confirmed 91 isolates from 12 localities as *P. ananatis* or *P. stewartii*. Pathogenicity of the four isolates was tested on rice plants. Four-week-old rice seedlings of the cultivars Azucena and Nipponbare were inoculated by leaf infiltration at the central vein using a needleless syringe. Bacterial suspensions containing 10<sup>8</sup> CFU/ml prepared in sterile water were used and sterile water served as a negative control. Inoculated plants were kept in a greenhouse at 28 °C and 80% relative humidity. After 7 days, the infiltrated leaves showed necrotic lesions at the inoculation site, which later expanded and turned from straw yellow to light brown color and ultimately developed into typical blight symptoms at 15 to 20 days post inoculation. Symptoms of inoculated leaves were similar to those that had been initially observed in fields and water-treated controls remained symptomless. Yellow-pigmented colonies were reisolated from the infected Rice leaves,

which were similar to the original isolates, and the PCR-amplified *gyrB* fragments were 100% identical to the original sequences, thus fulfilling Koch's postulates. Based on our analyses, we conclude that the bacteria that were isolated from Rice leaves and grains in Togo were *P. ananatis* and *P. stewartii*. To our knowledge, this is the first report of leaf blight of rice caused by species of *Pantoea* in Togo.

#### References:

- Dorsch, M., and Stackebrandt, E. 1992. J. Microbiol. Methods 16:271. 10.1016/0167-7012(92)90017-X
- Kini, K., et al. 2016. Plant Dis. 101:242
- Lang, J. M., et al. 2010. Plant Dis. 94:311. 10.1094/PDIS-94-3-0311
- Niño-Liu, D. O., et al. 2006. Mol. Plant Pathol. 7:303. 10.1111/j.1364-3703.2006.00344.x
- Poulin, L., et al. 2014. Plant Dis. 98:1423. 10.1094/PDIS-02-14-0132-PDN

#### 4. Third Disease Note: First report of *Sphingomonas* sp. causing bacterial leaf blight of rice in Benin, Burkina Faso, The Gambia, Ivory Coast, Mali, Nigeria, Tanzania and Togo

K. Kini<sup>1</sup>, R. Agnimonhan<sup>1</sup>, R. Dossa<sup>1</sup>, B. Soglonou<sup>1</sup>, V. Gbogbo<sup>2</sup>, I. Ouedraogo<sup>3</sup>, K. Kpemoua<sup>4</sup>, M. Traoré<sup>5</sup> and D. Silue<sup>1\*</sup>

Published in *New Disease Reports*, 2017, Volume 35, Page 32

<http://dx.doi.org/10.5197/j.2044-0588.2017.035.032>

**Keywords:** *Oryza sativa*, partial 16S rRNA gene sequence

Surveys of rice growing areas were conducted from 2011 to 2015 with the aim of assessing the importance of bacterial diseases in Benin, Burkina Faso, The Gambia, Ghana, Ivory Coast, Mali, Niger, Nigeria, Senegal, Tanzania and Togo. Between 100 to 500 samples showing symptoms consistent with leaf blight were collected from each country. Symptoms included yellow-brown discolourations along one of the two leaf blades, turning brown to dark-brown with age (Fig. 1). Severely affected leaves developed necrotic patches and died.

Diseased leaf sections were surface-sterilised, crushed in sterile water and the resulting sap subjected to a multiplex polymerase chain reaction developed to identify *Xanthomonas oryzae* pathovars (Lang *et al.*, 2010). Of the approximately 4,000-5,000 samples tested, only 100-120 were positive using this assay (from samples collected in Benin, Burkina Faso, Mali and Niger). All sap samples were plated on peptone sucrose agar (PSA; 10 g peptone, 10 g sucrose, 15 g bacto agar, 50 mg actidione, 40 mg cephalixin and 20 mg kasugamycin per litre distilled water) for strain isolation purposes. From the samples negative for the *Xanthomonas oryzae* assay, a 279 bp amplicon from the 16S rRNA gene was obtained for 604 isolates. These isolates were obtained from samples collected in Benin, Burkina Faso, The Gambia, Ivory Coast, Mali, Nigeria, Tanzania and Togo. Eight of the isolates were randomly selected



and sequenced for further study. The isolates had 90.2-100% sequence identity to each other and analysis using BLASTn indicated that the eight isolates had 95 to 98% sequence identity with the 16S rRNA gene from many type strains of *Sphingomonas* species including *S. paucimobilis* (GenBank Accession No. KP814059), *S. melonis* (EU429948) and *S. zae* (NR\_136793). The 16S rRNA standard approximation likelihood ratio tree created using Phylogeny.fr (Dereeper *et al.*, 2008) showed that these isolates belong to *Sphingomonas* sp. but not to a specific species (Fig. 2). Seven of the sequences were deposited in GenBank: KT729520 (isolate ASP3, Benin), KT729521 (ASP6, Benin), KY630528 (ASP160, Togo), KY630529 (ASP283, Cote d'Ivoire), KY630530 (ASP360, Mali), KY630531 (ASP361, Mali), KY630532 (ASP447, The Gambia).

To assess pathogenicity, bacterial suspensions ( $10^8$  CFU/ml) were prepared from pure cultures grown overnight on PSA plates. Inoculation of 35-day-old *Oryza sativa* seedlings was conducted on several rice accessions including C101A51, Azucena and Kitakea. Inoculations were performed by infiltrating leaves with the inoculum using a needleless syringe. The inoculated plants were kept in a greenhouse at  $27 \pm 5^\circ\text{C}$  and 80% relative humidity. Sterile distilled water served as a negative control. Initial disease symptoms appeared five days after inoculation (DAI), the leaf blade turned yellowish above the inoculation point and this progressed towards the leaf tip (Fig. 3). Blighted leaves, brown to dark-brown necrosis on the entire leaves above and sometimes below the inoculation point, were observed 15-21 DAI on susceptible rice accessions (C101A51, Azucena and Kitakea). Water-inoculated control plants remained symptomless. Symptoms on inoculated leaves resembled those found in the field. Analysis of the 16S rRNA gene partial sequences of the re-isolated bacteria showed that they were identical to the inoculated isolates, thereby fulfilling Koch's postulates. Comparison of the sequences obtained from the re-isolated strains with those of the wild isolates showed 99-100% identity.

This is the first report of a leaf blight disease of rice caused by *Sphingomonas* sp. in Africa. *Sphingomonas* species have frequently been isolated from rice seed (Midha *et al.*, 2016) and have been found on leaves of 26 plant species of 11 families but few are recorded as plant pathogens. *Sphingomonas melonis*, is the causal agent of a brown spot disease on fruits of Cucumis melo (Buonaurio *et al.*, 2001) and *Sphingomonas* sp. causes bacterial leaf blight of *Paliuris spina-christi* (Deldavleh *et al.*, 2013), The present report seems to be the third case of a plant disease caused by a member of this genus.

### Acknowledgements

This research was funded by the Global Rice Science Partnership (GRiSP) and the Ministry of Foreign Affairs, Japan. Ms. T. Afolabi collected and maintained some of the isolates.

### References

**Buonaurio R, Stravato VM, Cappelli C, 2001.** Brown spot caused by *Sphingomonas* sp. on yellow Spanish melon fruits in Spain. *Plant Pathology* **50**, 397-401. [<http://dx.doi.org/10.1046/j.1365-3059.2001.00571x>]

**Deldavleh M, Bahmani K, Harighi B, 2013.** Bacterial leaf blight of Christ's thorn in Iran: a new disease caused by *Sphingomonas* sp. *Journal of Plant Pathology* **95**, 75-78.

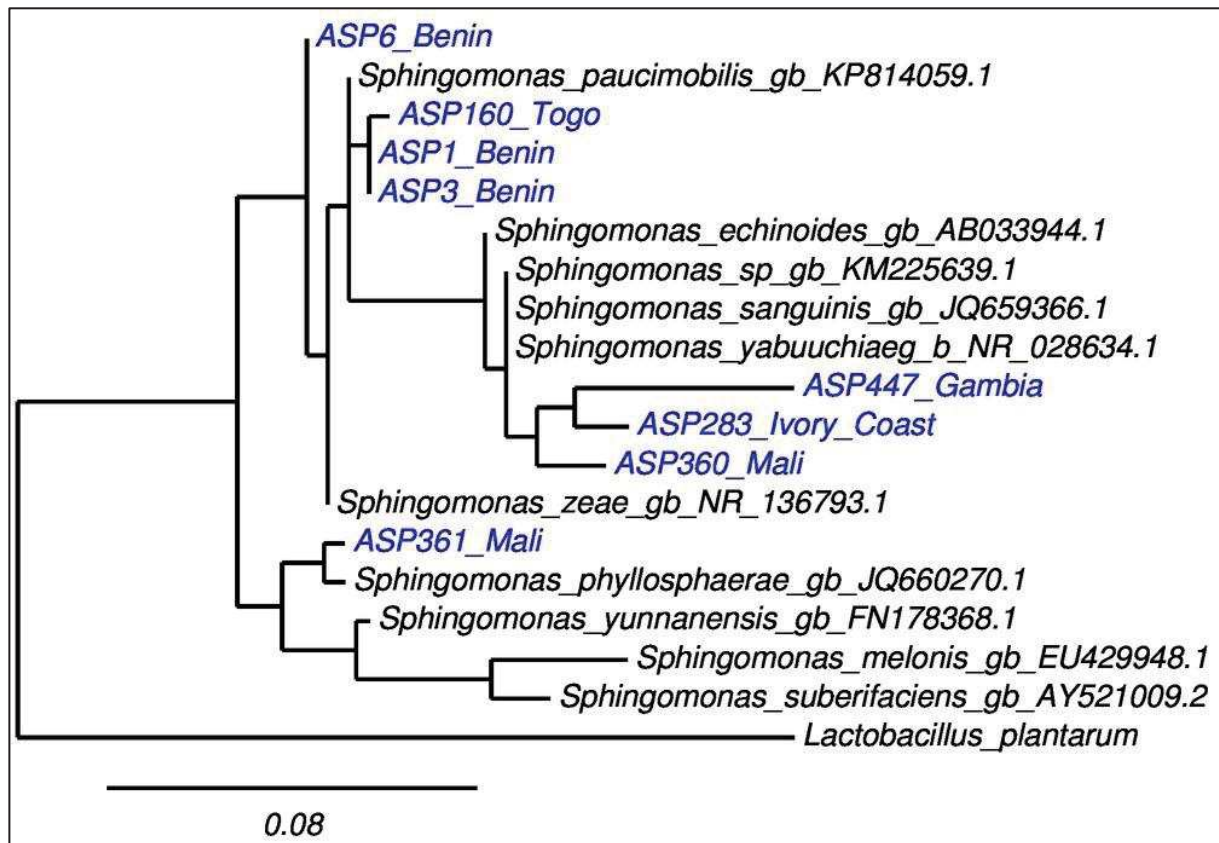
**Dereeper A, Guignon V, Blanc G, Audic S, Buffet S, Chevenet F, Dufayard JF, Guindon S, Lefort V, Lescot M, Claverie JM, Gascuel O, 2008.** Phylogeny.fr: robust phylogenetic analysis for the non-specialist. *Nucleic Acids Research* **36**, W465-W469. [<http://dx.doi.org/10.1093/nar/gkn180>]

**Lang JM, Hamilton JP, Diaz MGQ, Van Sluys MA, Burgos MRG, Vera Cruz CM, Buell CR, Tisserat NA, Leach JE, 2010.** Genomics-based diagnostic marker development for *Xanthomonas oryzae* pv. *oryzae* and *X. oryzae* pv. *oryzicola*. *Plant Disease* **94**, 311-319. [<http://dx.doi.org/10.1094/PDIS-94-3-0311>]

**Midha S, Bansal K, Sharma S, Kumar N, Patil NP, Chaudhry V, Patil PB, 2016.** Genomic resource of rice seed associated bacteria. *Frontiers in Microbiology* **6**, 1551. [<http://dx.doi.org/10.3389/fmicb.2015.01551>]



**Figure 1:** Typical rice leaf blight symptoms in rice fields in Bami, Mali.



**Figure 2:** 16S rRNA standard approximation likelihood ratio tree created using Phylogeny.fr. Note that the eight isolates analysed (ASP 1, ASP 3, ASP 6, ASP 160, ASP 283, ASP 360, ASP 361 and ASP 447) do not belong to a specific species compared with sequences of 12 validated type strains of *Sphingomonas* species.



**Figure 3:** Symptoms on rice (cv. Azucena) leaves inoculated with a bacterial suspension of *Sphingomonas* spp., 14 days after inoculation.

### III. Development of molecular diagnostic tools for detection of *Pantoea* spp.

#### 1. Context and justification of the project

With the above Disease Notes it became evident that *Pantoea* spp. represent a threat to rice production in sub-Saharan Africa. In the face of an emergent situation of a phytopathogen bacterial complex, sustainable solutions must be taken. This solution must provide a durable solution and finally reduce the negative impacts of this threat on rice production. One of the prerequisites for effective control of phytopathogen diseases is the easy identification of causal agents of diseases. Therefore, we have found it necessary to develop a diagnostic tool for the easy identification of this bacterial complex. Precisely, since it is a bacterial complex composed of at least three species, the ideal solution for a low-cost diagnosis will be a multiplex PCR diagnostic tool. Consequently, we have developed this multiplex PCR diagnostic tool, which can simultaneously detect the presence three key species (*P. ananatis*, *P. stewartii* and *P. agglomerans*). The details of the development of this tool are summarized in the draft below.

#### 2. First drafted manuscript: A diagnostic multiplex PCR scheme for identification of plant-associated bacteria of the genus *Pantoea*

Kossi Kini<sup>1,2</sup>, Raoul Agnimonhan<sup>1</sup>, Rachelle Dossa<sup>1</sup>, Drissa Silué<sup>1</sup> and Ralf Koebnik<sup>\*2</sup>

<sup>1</sup> Africa Rice Center (AfricaRice), Cotonou, Benin.

<sup>2</sup> IRD, Cirad, University Montpellier, IPME, Montpellier, France.

\* Correspondence: koebnik@gmx.de

Submitted to *BMC Microbiology*

##### 2.1. Abstract

**Background:** The genus *Pantoea* forms a complex of more than 25 species, among which several cause diseases of several crop plants, including rice. Notably, strains of *Pantoea ananatis* and *Pantoea stewartii* have been found to cause bacterial leaf blight of rice in Togo and Benin, while other authors have observed that *Pantoea agglomerans* can also cause bacterial leaf blight of rice. The contribution of these and perhaps other species of *Pantoea* to plant diseases and yield losses of crop plants is currently not well documented, partly due to the lack of efficient diagnostic tools.

**Result:** Using 34 whole genome sequences of the three-major plant-pathogenic *Pantoea* species, a set of PCR primers that specifically detect each of the three species, *P. agglomerans*, *P. ananatis*, and *P. stewartii*, was designed. A multiplex PCR protocol, which can distinguish these three species and detects members of other *Pantoea* species was further developed. Upon validation on a set of reference strains, 609 suspected *Pantoea* strains that were isolated from Rice leaves or seeds originating from 11 African countries were screened. In total, 41 *P. agglomerans* strains from eight countries, 79 *P. ananatis* strains from nine countries, 269 *P. stewartii* strains from nine countries and 220 unsolved *Pantoea*

strains from ten countries were identified. The PCR protocol allowed detecting *Pantoea* bacteria grown in vitro, in planta and in rice seeds. The detection threshold was estimated at 5 ng/mL of total genomic DNA and  $1 \times 10^5$  CFU/mL of heated cells.

**Conclusion:** This new molecular diagnostic tool will help accurately diagnose major plant-pathogenic species of *Pantoea*. Due to its robustness, specificity, sensitivity, and cost efficiency it will be very useful for plant protection services and for the epidemiological surveillance of these important crop-threatening bacteria.

**Keywords:** Plant pathogen, *Pantoea*, rice, *Oryza sativa*, multiplex PCR, diagnostic tool

## 2.2. Background

The genus *Pantoea* was first described in 1989 and was recently taxonomically classified as a member of the *Erwiniaceae* family [1]. More than 25 species of this genus have been described and reported worldwide [2,3]. Etymologically, the genus name *Pantoea* is derived from the Greek word ‘Pantoiōs’, which means “of all sorts or sources” and reflects the diverse geographical and ecological sources from which the bacteria have been isolated. Several species of the genus are qualified as versatile and ubiquitous bacteria because they have been isolated from many different ecological niches and hosts [2,4]. Remarkably, some species have the ability to colonize and interact with members of both the plant and the animal Kingdom [5]. Among the plant-interacting species, *Pantoea ananatis*, *Pantoea agglomerans* and *Pantoea stewartii* are well known for their phytopathogenic characteristics. They are recognized as the causal agent of several diseases, such as leaf blight, spot disease, dieback, grain discoloration, seed stalk rot, center rot, stem necrosis, palea browning, bulb decay etc. and affect several economically important crops, including cereals, fruits and vegetables [2,6,7].

Bacterial leaf blight caused by *Xanthomonas oryzae* pv. *oryzae* is an important disease of rice and affects rice cultivation in most regions of the world where rice is grown. The bacterium has been associated with this disease since a very long time [8]. Surveys were conducted from 2010 to 2016 to estimate the extent and importance of the disease and the phytosanitary status of rice fields in West Africa. While leaves showing bacterial blight (BB)-like symptoms were frequent, isolation or molecular detection of xanthomonads using the Lang et al. diagnostic tool [9] often failed. Instead, other bacteria forming yellow colonies were observed and turned out to belong to the species *P. ananatis* or *P. stewartii*, as documented for samples from Togo and Benin [10,11]. Additionally, other cases of BB and grain discoloration caused by *Sphingomonas* sp. and other undescribed species have been detected in several sub-Saharan Africa countries [12]. This situation represents an “emerging” bacterial species complex that may constitute a threat to rice production in Africa. Therefore, a robust, specific, sensitive, and cost efficient diagnostic tool is of primary importance for accurate pathogen detection. However, none of the several simplex and multiplex PCR tools [13–18] and other molecular [19–24], physiological, biochemical [24–28] diagnostic tools available for *Pantoea* allows accurate simultaneous detection of the three major plant-pathogenic *Pantoea* species. Some of these methods are poorly reproducible and often limited to a single species while others are

reproducible but again limited to one species or are not suited to doubtlessly detect African strains.

To overcome this unsatisfying situation, a molecular method was set up for detecting in a single reaction the three major plant-pathogenic *Pantoea* species (*P. ananatis*, *P. stewartii* and *P. agglomerans*), as well as other members of the genus. A universal multiplex PCR tool was therefore developed and first tested in silico on available genome sequences and on a set of reference strains from USA, Brazil, Spain and Japan. Afterwards, 609 suspected *Pantoea* strains from eleven African countries were evaluated with the newly described diagnostic tool. *P. agglomerans* was detected in Rice leaves from several African countries for the first time. Finally, the specificity and sensitivity of the multiplex PCR was monitored by analyzing serial dilutions of genomic DNA, serial dilutions of bacterial cell suspensions and solutions of ground leaves and seeds that had been artificially or naturally infected. This new diagnostic tool will prove useful for phytosanitary services in routine diagnostics of *Pantoea* spp. in any type of sample (e.g. leaves, seeds, soil, water).

### 2.3. Materials and Methods

#### Bioinformatics prediction of specific PCR primers

*Pantoea* genome sequences were retrieved from NCBI GenBank (Table 1). Sequences for housekeeping genes were identified by TBLASTN [29]. Sequences were then aligned with MUSCLE [30] at EMBL-EBI [31]. Diagnostic primers that can differentiate the three species, *P. agglomerans*, *P. ananatis* and *P. stewartii*, and one primer pair that would amplify DNA from the whole *Pantoea* genus were designed manually. The  $T_m$  for PCR primers were automatically predicted by  $T_m$  calculator tool at <http://www.thermoscientificbio.com/webtools/multipleprimer/>, which was developed based on the modified nearest-neighbor interaction method [32].

#### Optimization of the multiplex PCR

Different types of samples including total genomic DNA, bacterial cells, symptomatic Rice leaves, as well as discolored and apparently healthy rice seeds were analyzed. Plant material was ground and macerated before use. To develop a multiplex PCR scheme, individual primer pairs were first tested against the different samples mentioned above, using annealing temperatures close to the predicted  $T_m$  ( $T_m \pm 5^\circ\text{C}$ ) and with progressive number of PCR cycles (25 to 35). Primer pairs were then mixed from duplex to quintuplex and PCR conditions were evaluated, testing annealing temperatures close to the optimal  $T_m$  of the individual primer pairs ( $T_m \pm 3^\circ\text{C}$ ) and various numbers of PCR cycles. At the end, three promising combinations of annealing temperatures and numbers of PCR cycles were re-evaluated in simplex PCR with the samples mentioned above. The best combination with high specificity and without background amplification was selected as the new diagnostic tool (Tables 2 to 4).

#### Evaluation of the sensitivity of the multiplex PCR scheme using genomics DNA and heat cells

Simplex and multiplex PCR were then used to evaluate the sensitivity of all the species-specific primer pairs individually or in combination with the genus-specific and the 16 sRNA primer pairs. Serial dilutions of total genomic DNA and heated bacterial cells were used for this evaluation. Three *Pantoea* strains, *P. ananatis* strain ARC60, *P. stewartii* strain ARC222, and *P. agglomerans* strain CFBP3615, were used and distilled sterilized served as a negative control.

To evaluate the PCR scheme on live plant material, leaves and seeds were artificially infected with strains of the three *Pantoea* species. Rice leaves of the cultivar Azucena were inoculated as described previously [10,11]. To produce contaminated seeds, early maturity panicles of the Azucena rice cultivar were spray-inoculated with a 5%-gelatinized bacterial solution ( $10^6$  CFU/mL). Distilled and gelatinized (5%) sterile water served as a negative control. Three weeks post inoculation, approximately 40% of the grains in the panicles exhibited discolorations. Panicles inoculated with sterile distilled water showed no symptoms. A total of five grains whose surface was first treated with a solution of hypochlorite (10%) and ethanol (70%) and then rinsed with sterile distilled water were ground in 100 mL of sterile distilled water. After centrifugation, the supernatant was used for PCR.

#### **Evaluation of the multiplex PCR scheme on a large collection of African *Pantoea* strains**

Bacterial strains used in this study are listed in Additional file 1. In total, 615 *Pantoea* strains from eleven African countries (Benin, Burkina Faso, Burundi, Ghana, Ivory Coast, Mali, Niger, Nigeria, Senegal, Tanzania, Togo) and seven reference strains from USA, Brazil, Spain and Japan were analyzed by the new diagnostic tool. The African strains were isolated from Rice leaves with BB symptoms, and from discolored and apparently healthy rice seeds. The samples had been collected from 2008 to 2016 in the main rice-growing areas of the countries. Other bacteria, including *Xanthomonas* spp, *Sphingomonas* spp, *Escherichia coli*, *Erwinia* spp, *Burkholderia* spp, and *Pseudomonas* spp, were used as controls. The strains were purified as single colonies, individually grown and preserved as pure cultures following routine methods [33]. Bacterial colonies were grown for 24 to 48 h on PSA plates containing 10 g peptone, 10 g sucrose, 16 g agar and 1 g glutamic acid per liter. Total genomic DNA was extracted using the Wizard genomic DNA purification kit (Promega) according to the manufacturer's instructions. DNA quality and quantity were evaluated by agarose gel electrophoresis and spectrophotometry (Nanodrop Technologies, Wilmington, DE).

## **2.4. Results**

### **Development of a diagnostic PCR scheme for plant-associated *Pantoea***

We aimed at designing diagnostic PCR primers that would target conserved housekeeping genes. The rationale behind was that these genes should be present in all strains, including genetic lineages that have not yet been discovered and would not be present in any strain collection. At the same time, we knew from previous work that sequences of housekeeping genes are divergent enough to doubtlessly distinguish and identify *Pantoea* strains at the species level.



A diagnostic *Pantoea* multiplex PCR method was developed in two steps. First, a complete inventory of publicly available *Pantoea* genome sequences was compiled, consisting of nine *P. agglomerans*, 14 *P. ananatis*, and three *P. stewartii* sequences, totaling to 26 whole genome sequences (Table 1). Complete coding sequences of four housekeeping genes that have previously been used for multilocus sequence analyses (MLSA) of *Pantoea* species [2], *atpD*, *gyrB*, *infB*, and *rpoB*, were then extracted and aligned. Sequence regions that were conserved in all strains of one species but were significantly different in the other two species were identified manually and chosen to design PCR primers (Table 2). To allow multiplexing, we made sure that the amplicon sizes would be between 400 and 750 bp and different enough to be easily distinguishable from each other upon gel electrophoresis (Fig. 1). As a positive control for the PCR reaction, one primer pair was included that would amplify DNA from all bacteria belonging to the *Pantoea* genus, resulting in a smaller amplicon of less than 400 bp. Finally, as a second control, a primer pair was included that targets the ribosomal 16S rRNA gene and leads to an amplicon that is larger than the four *Pantoea*-specific amplicons.

In the second step, all primer pairs (Table 2) were evaluated, first by simplex PCR and then by multiplex PCR, with increasing number of primer pairs, as explained in Material and Methods. Three *Pantoea* reference strains were used to develop the PCR scheme using genomic DNA and heat-inactivated bacteria: *P. agglomerans* strain CFBP3615, *P. ananatis* strain ARC60 and *P. stewartii* strain ARC222 (Fig. 1. Lanes 1 to 7). Agarose gel electrophoresis demonstrated that the multiplex PCR was able to detect and distinguish all three *Pantoea* species. Notably, the multiplex PCR scheme was also able to detect two or three *Pantoea* species when the corresponding species were present in the same template DNA, as demonstrated by PCR reactions containing equal amounts of DNA of the different species (Fig. 1. Lanes 8 to 11).

To simplify the analyses and to avoid isolation of bacteria from plant samples, thus reducing the costs per sample, the PCR scheme was also evaluated on infected leaf material and contaminated seeds. As shown in Fig. 3, the multiplex PCR was able to doubtlessly detect all three *Pantoea* species in both types of plant samples, as demonstrated for the strains CFBP3615 (*P. agglomerans*), ARC60 (*P. ananatis*), and ARC222 (*P. stewartii*). At the end, a robust PCR protocol was available that was able to amplify DNA from total genomic DNA, bacterial cells, symptomatic Rice leaves and from infected rice seeds fig 2.

### **Evaluation of the sensitivity of the multiplex PCR scheme using genomic DNA and heated cell suspensions**

The evaluation by simplex and multiplex PCR showed that all the species-specific primers were very sensitive individually or in combination with the genus-specific and the 16 sRNA universal primers (Fig. 3). The most sensitive primer pair in simplex PCR was the one targeting *P. stewartii* with a detection limit of 5 pg under our experimental conditions, followed by the *P. agglomerans*-specific primer pair (detection limit of 50 pg) and the *P. ananatis*-specific primer pair (detection limit of 0.5 ng). A similar trend was observed in the multiplex PCR on genomic DNA, with the same detection limit as in simplex PCR for *P. stewartii* and *P. ananatis* and a tenfold less sensitivity for *P. agglomerans*.

When heated bacterial cell suspensions were used as template, the *P. ananatis*-specific primer pair was the most sensitive allowing detection of  $10^3$  CFU/mL, while the other two primer pairs were able to detect  $10^4$  CFU/mL. However, when all five primers pairs were used in multiplex, the sensitivity was very similar for all three species with a detection limit of approximately  $10^4$  CFU/mL.

### **Evaluation of the multiplex PCR scheme specificity on a large collection of African *Pantoea* strains**

To ensure the specificity of the primers, the PCR scheme had been evaluated using other bacterial strains as controls: *Sphingomonas* spp, *X. oryzae* pv. *oryzae*, *Xanthomonas oryzae* pv. *oryzicola*, *Burkholderia glumae*, *P. syringae* pv. *syringae* and *P. fuscovaginae*. The results showed that *Pantoea*-specific primers were unable to amplify DNA from these bacteria (Fig 4).

Because recent surveys had indicated that *Pantoea* species could be responsible for many unsolved infections of rice fields in sub-Saharan Africa [10,11], we screened a large collection of isolates. We first re-evaluated a few African strains that had been identified as *P. ananatis* (ARC22, ARC60, ARC651) and *P. stewartii* (ARC229, ARC570, ARC646), using species-specific and the genus-specific PCR primers [10,11]. The multiplex PCR scheme confirmed their previous taxonomic classification. Next, we screened a large collection of African bacterial (Fig 4) isolates from rice samples (>1000 strains) (Fig 4) among which 609 strains were found to belong to the genus *Pantoea* (Additional file 1). Specifically, this work diagnosed 41 *P. agglomerans* strains from eight countries (Benin, Ghana, Mali, Niger, Nigeria, Senegal, Tanzania, Togo), 79 *P. ananatis* strains from nine countries (Benin, Burkina Faso, Burundi, Mali, Niger, Nigeria, Senegal, Tanzania, Togo), 269 *P. stewartii* strains from nine countries (Benin, Burkina Faso, Ivory Coast, Mali, Niger, Nigeria, Senegal, Tanzania, Togo) and 220 *Pantoea* sp. strains from ten countries (Benin, Burundi, Ghana, Ivory Coast, Mali, Niger, Nigeria, Senegal, Tanzania, Togo) (Additional file 1, Table 1). This result provided first insights on the presence and prevalence of three important *Pantoea* species in these eleven African countries by the access of geographic distribution of *P. agglomerans*, *P. ananatis*, *P. stewartii* and *Pantoea* spp. in sub-Saharan Africa (Fig 5).

## **2.5. Discussion**

Bacterial infections by *Pantoea* spp. are recognized as being responsible for several diseases of plants, including important crop plants such as rice, maize, sorghum, onion and melon [34–43]. BB of rice caused by species of *Pantoea* were reported in several countries and include Benin, Togo, Korea, India, Australia, China, Italy, Venezuela, and Russia [10,11,40,44–49].

Given the fact that more than 25 species of *Pantoea* are currently known and among them several species can infect plants, efficient diagnostic tools are highly demanded by plant pathologists and extension workers. Some plant diseases were attributed to only three species of *Pantoea*, namely *P. agglomerans*, *P. ananatis* and *P. stewartii*, which can therefore be considered as the major *Pantoea* species infecting plants. For their diagnosis, several PCR

methods are available and have been used but some of them produced amplicons with other species as well [14,50,51], while others are not well reproducible or are inaccessible in typical sub-Saharan laboratory due to specific equipment requirements and/or high costs of some reagents [14,17,18]. Notably, most assays target only one *Pantoea* species or subspecies. For instance, being of major concern, *P. stewartii* subsp. *stewartii* causing Stewart's bacterial wilt can be detected by several methods but none of them can at the same time identify other bacteria of the genus *Pantoea* [14,16,18,52,53]. To the best of our knowledge, no robust diagnostic scheme exists that can specifically detect all three major *Pantoea* species that infect plants.

Based on whole genome sequences, we developed a new multiplex PCR scheme that can specifically detect the three key species of plant-pathogenic *Pantoea*, *P. agglomerans*, *P. ananatis* and *P. stewartii*. Various strategies can be followed when developing such a multiplex scheme using available whole-genome sequences. One possibility is to automatize the procedure by identifying genomic regions that are shared among a set of strains (e.g. the target species) and which are absent in another set of strains (non-target species). For instance, such an approach was used for the development of a *Xanthomonas oryzae*-specific multiplex PCR scheme that can differentiate the two pathovars *oryzae* and *oryzicola* [9]. The problem with this approach is that it might identify non-essential, often hypothetical genes as targets for the primer design. While present in the training set, it is hard to predict if these non-essential genes will be present and conserved in other, hitherto uncharacterized strains, especially when they originate from other geographical zones and/or belong to more distant genetic lineages.

Here, we targeted housekeeping genes, which are conserved throughout the genus, and relied on lineage (species)-specific sequence polymorphisms. This approach is considered as very robust, but it cannot be ruled out that recombination events among strains from other species could undermine the universality of these primer pairs. Yet, we haven't found any evidence for such events in any of the sequenced *Pantoea* strains that were analyzed, including environmental isolates and strains isolated from human and plant samples. Nevertheless, because this study was focused on isolates from African Rice leaves and seeds and only included a few reference strains from other continents (Additional file 1), it might be of interest to evaluate the new multiplex PCR tool on *Pantoea* strains isolated from other organisms (other plants, insects, other animals, humans) and from environmental samples.

To reduce the costs and handling time, we generated a multiplex PCR scheme that can work with both purified genomic DNA or with bacterial lysates. In both cases, sufficient specificity and sensitivity were obtained allowing detection of as low as 0.5 ng of DNA or  $10^4$  CFU/mL for all three *Pantoea* species. Such a simple scheme will be of specific interest to phytopathologists, especially in Africa and other less-developed regions. Indeed, diseases due to infections by *Pantoea* appear to emerge in Africa as recently documented for Benin and Togo [10,11]. In this study, the presence of the three major plant-pathogenic *Pantoea* species has been demonstrated for eleven African countries. The fact that most of the BB-like symptomatic rice samples proved to contain a high number of *Pantoea* bacteria suggests that infection by *Pantoea* is an underestimated source for BB symptoms and might be widespread

in Africa. However, more rigorous sampling schemes are required to determine the incidence and prevalence of *Pantoea* in various rice-growing areas in Africa.

Among the 609 *Pantoea* isolates, we detected 220 strains (36.1%; additional file 1) of *Pantoea* sp. that could not be assigned to any of the three species that are specifically targeted by the multiplex PCR scheme. This is an interesting observation that shows that the genus-specific primer pair does not only serve as an internal positive control of the multiplex scheme but that it has its own diagnostic value. Obviously, other species of *Pantoea* are present in Africa and are likely to cause disease of rice plants as well. Yet, it is still unknown whether or not this group of isolates contains other rice pathogenic species. Pathogenicity assays need to confirm or disprove their status as novel pathogens. Future work will address these isolates, using MLSA and whole genome sequencing.

While screening a large collection of bacterial isolates from rice samples, we also found strains that neither belonged to *Pantoea* nor to *Xanthomonas* (data not shown). Some of them were *Sphingomonas* strains [12], while others may represent new species and genera, which have so far not been connected to rice diseases. These isolates will be further studied by 16S rRNA analysis. From this study, it was concluded that the number of bacterial species that affect rice plants in Africa is certainly larger than previously thought.

## 2.6. Conclusion

A new multiplex PCR scheme was developed to diagnose plant-pathogenic *Pantoea* spp. This tool enabled the efficient confirmation of the presence of *Pantoea* species (*P. ananatis* and *P. stewartii*) in Benin and Togo, as reported previously, and in several other African countries (Burkina Faso, Burundi, Ghana, Ivory Coast, Mali, Niger, Nigeria, Senegal, Tanzania). Moreover, we found evidence for the presence of *P. agglomerans* and other species of *Pantoea* on rice samples from several African countries. This new diagnostic tool will be very useful for crop protection services.

## References

1. Adeolu M, Alnajar S, Naushad S, Gupta RS. Genome-based phylogeny and taxonomy of the “*Enterobacteriales*”: proposal for *Enterobacterales* ord. nov. divided into the families *Enterobacteriaceae*, *Erwiniaceae* fam. nov., *Pectobacteriaceae* fam. nov., *Yersiniaceae* fam. nov., *Hafniaceae* fam. nov., *Morganellaceae* fam. nov., and *Budviciaceae* fam. nov. *Int. J. Syst. Evol. Microbiol.* 2016;66:5575–5599.
2. Brady C, Cleenwerck I, Venter S, Vancanneyt M, Swings J, Coutinho T. Phylogeny and identification of *Pantoea* species associated with plants, humans and the natural environment based on multilocus sequence analysis (MLSA). *Syst. Appl. Microbiol.* 2008;31:447–460.
3. Mergaert J, Verdonck L, Kersters K. Transfer of *Erwinia ananas* (synonym, *Erwinia uredovora*) and *Erwinia stewartii* to the Genus *Pantoea* emend. as *Pantoea ananas* (Serrano 1928) comb. nov. and *Pantoea stewartii* (Smith 1898) comb. nov.,

- Respectively, and Description of *Pantoea stewartii* subsp. *indologenes* subsp. nov. Int. J. Syst. Bacteriol. 1993;43:162–173.
4. Brady CL, Cleenwerck I, Venter SN, Engelbeen K, De Vos P, Coutinho TA. Emended description of the genus *Pantoea*, description of four species from human clinical samples, *Pantoea septica* sp. nov., *Pantoea eucrina* sp. nov., *Pantoea brenneri* sp. nov. and *Pantoea conspicua* sp. nov., and transfer of *Pectobacterium cypripedii* (Hori 1911) Brenner et al. 1973 emend. Hauben et al. 1998 to the genus as *Pantoea cypripedii* comb. nov. Int. J. Syst. Evol. Microbiol. 2010;60:2430–2440.
  5. De Maayer P, Chan WY, Rubagotti E, Venter SN, Toth IK, Birch PR, et al. Analysis of the *Pantoea ananatis* pan-genome reveals factors underlying its ability to colonize and interact with plant, insect and vertebrate hosts. BMC Genomics. 2014;15:404.
  6. Coutinho TA, Venter SN. *Pantoea ananatis*: an unconventional plant pathogen. Mol. Plant Pathol. 2009;10:325–335.
  7. Morin A, Parveen Z. *Pantoea*. Encyclopedias of Food Microbiology. 2014 ;1623–1630.
  8. Triplett L, Koebnik R, Verdier V, Leach JE. The genomics of *Xanthomonas oryzae*. In: Gross DC, Lichens-Park A, Kole C, editors. Genomics of Plant-Associated Bacteria. Heidelberg, New York, Dordrecht, London: Springer; 2014:127–150.
  9. Lang JM, Hamilton JP, Diaz MG, Van Sluys MA, Burgos MR, Vera Cruz CM, et al. Genomics-based diagnostic marker development for *Xanthomonas oryzae* pv. *oryzae* and *X. oryzae* pv. *oryzicola*. Plant Dis. 2010;94:311–319.
  10. Kini K, Agnimonhan R, Afolabi O, Milan B, Soglonou B, Gbogbo V, et al. First report of a new bacterial leaf blight of rice caused by *Pantoea ananatis* and *Pantoea stewartii* in Benin. Plant Dis. 2017;101:242.
  11. Kini K, Agnimonhan R, Afolabi O, Soglonou B, Silué D, Koebnik R. First report of a new bacterial leaf blight of rice caused by *Pantoea ananatis* and *Pantoea stewartii* in Togo. Plant Dis. 2017;101:241.
  12. Kini K, Agnimonhan R, Dossa R, Soglonou B, Gbogbo V, Ouedraogo I, et al. First report of *Sphingomonas* sp. causing bacterial leaf blight of rice in Benin, Burkina Faso, The Gambia, Ivory Coast, Mali, Nigeria, Tanzania and Togo. New Dis. Rep. 2017;35:32.
  13. Asselin JA, Bonasera JM, Beer SV. PCR primers for detection of *Pantoea ananatis*, *Burkholderia* spp., and *Enterobacter* sp. from onion. Plant Dis. 2015;100:836–46.
  14. Coplin DL, Majerczak DR, Zhang Y, Kim WS, Jock S, Geider K. Identification of *Pantoea stewartii* subsp. *stewartii* by PCR and strain differentiation by PFGE. Plant Dis. 2002;86:304–311.
  15. Pérez-y-Terrón R, Villegas MC, Cuellar A, Muñoz-Rojas J, Castañeda-Lucio M, Hernández-Lucas I, et al. Detection of *Pantoea ananatis*, causal agent of leaf spot disease of maize, in Mexico. Australas. Plant Dis. Notes. 2009;4:96–99.

16. Thapa SP, Park DH, Wilson C, Hur JH, Lim CK. Multiplex PCR assay for the detection of *Pantoea stewartii* subsp. *stewartii* using species-specific genetic markers. *Australas. Plant Pathol.* 2012;41:559-564.
17. Uematsu H, Inoue Y, Ohto Y. Detection of *Pantoea stewartii* from sweet corn leaves by loop-mediated isothermal amplification (LAMP). *J. Gen. Plant Pathol.* 2015;81:173-179.
18. Xu R, Chen Q, Robleh Djama Z, Tambong JT. Miniprimer PCR assay targeting multiple genes: a new rapid and reliable tool for genotyping *Pantoea stewartii* subsp. *stewartii*. *Lett. Appl. Microbiol.* 2010;50:216-222.
19. Brady C, Venter S, Cleenwerck I, Vancanneyt M, Swings J, Coutinho T. A FAFLP system for the improved identification of plant-pathogenic and plant-associated species of the genus *Pantoea*. *Syst. Appl. Microbiol.* 2007;30:413-417.
20. Cha JS, Pujol C, Kado CI. Identification and characterization of a *Pantoea citrea* gene encoding glucose dehydrogenase that is essential for causing pink disease of pineapple. *Appl. Environ. Microbiol.* 1997;63:71-76.
21. Carlier A, Burbank L, von Bodman SB. Identification and characterization of three novel EsaI/EsaR quorum-sensing controlled stewartan exopolysaccharide biosynthetic genes in *Pantoea stewartii* ssp. *stewartii*. *Mol. Microbiol.* 2009;74:903-913.
22. Kim SW, Jung WH, Ryu JM, Kim JB, Jang HW, Jo YB, et al. Identification of an alternative translation initiation site for the *Pantoea ananatis* lycopene cyclase (*crtY*) gene in *E. coli* and its evolutionary conservation. *Protein Expr. Purif.* 2008;58:23-31.
23. Wu Q, Jiang Z, Liao J, Chen Z, Li H, Mei M, et al. Identification of genetic markers to distinguish the virulent and avirulent subspecies of *Pantoea stewartii* by comparative proteomics and genetic analysis. *Appl. Microbiol. Biotechnol.* 2007;74:186-193.
24. Andreeva IG, Golubeva LI, Kuvaeva TM, Gak ER, Katashkina JI, Mashko SV. Identification of *Pantoea ananatis* gene encoding membrane pyrroloquinoline quinone (PQQ)-dependent glucose dehydrogenase and *pqqABCDEF* operon essential for PQQ biosynthesis. *FEMS Microbiol. Lett.* 2011;318:55-60.
25. Pataky JK, Block CC, Michener PM, Shepherd LM, McGee DC, White DG. Ability of an ELISA-based seed health test to detect *Erwinia stewartii* in maize seed treated with fungicides and insecticides. *Plant Dis.* 2004;88:633-640.
26. Rezzonico F, Vogel G, Duffy B, Tonolla M. Application of whole-cell matrix-assisted laser desorption ionization-time of flight mass spectrometry for rapid identification and clustering analysis of *Pantoea* species. *Appl. Environ. Microbiol.* 2010;76:4497-509.
27. Feng M, Kong D, Wang W, Liu L, Song S, Xu C. Development of an immunochromatographic strip for rapid detection of *Pantoea stewartii* subsp. *stewartii*. *Sensors* 2015;15:4291-4301.

28. Zhao Y, Liu L, Kong D, Kuang H, Wang L, Xu C. Dual amplified electrochemical immunosensor for highly sensitive detection of *Pantoea stewartii* subsp. *stewartii*. ACS Appl. Mater. Interfaces 2014;6:21178–21183.
29. Gertz EM, Yu Y-K, Agarwala R, Schäffer AA, Altschul SF. Composition-based statistics and translated nucleotide searches: improving the TBLASTN module of BLAST. BMC Biol. 2006;4:41.
30. Edgar RC. MUSCLE: multiple sequence alignment with high accuracy and high throughput. Nucleic Acids Res. 2004;32:1792.
31. McWilliam H, Li W, Uludag M, Squizzato S, Park YM, Buso N, et al. Analysis tool web services from the EMBL-EBI. Nucleic Acids Res. 2013;41:W597–W600.
32. Breslauer KJ, Frank R, Blöcker H, Marky LA. Predicting DNA duplex stability from the base sequence. Proc. Natl. Acad. Sci. U. S. A. 1986;83:3746–3750.
33. Poulin L, Raveloson H, Sester M, Raboin LM, Silué D, Koebnik R, et al. Confirmation of bacterial leaf streak caused by *Xanthomonas oryzae* pv. *oryzicola* on rice in Madagascar. Plant Dis. 2014;98:1423.
34. Azad HR, Holmes GJ, Cooksey DA. A new leaf blotch disease of sudangrass caused by *Pantoea ananas* and *Pantoea stewartii*. Plant Dis. 2000;84:973–979.
35. Goszczynska T. Emerging diseases of maize and onion caused by bacteria belonging to the genus *Pantoea*. <https://repository.up.ac.za/handle/2263/26297> (2007). Accessed 20 Nov 2017.
36. Morales-Valenzuela G, Silva-Rojas HV, Ochoa-Martínez D, Valadez-Moctezuma E, Alarcón-Zúñiga B, Zelaya-Molina LX, et al. First report of *Pantoea agglomerans* causing leaf blight and vascular wilt in maize and sorghum in Mexico. Plant Dis. 2007;91:1365.
37. Romeiro RS, Macagnan D, Mendonça HL, Rodrigues Neto J. Bacterial spot of Chinese taro (*Alocasia cucullata*) in Brazil induced by *Pantoea agglomerans*. Plant Pathol. 2007;56:1038.
38. Kido K, Adachi R, Hasegawa M, Yano K, Hikichi Y, Takeuchi S, et al. Internal fruit rot of netted melon caused by *Pantoea ananatis* (= *Erwinia ananas*) in Japan. J. Gen. Plant Pathol. 2008;74:302–312.
39. Alippi AM, López AC. First report of leaf spot disease of maize caused by *Pantoea ananatis* in Argentina. Plant Dis. 2010;94:487.
40. Lee HB, Hong JP, Kim SB. First report of leaf blight caused by *Pantoea agglomerans* on rice in Korea. Plant Dis. 2010;94:1372.
41. Achbani EH, Mazouz H, Benbouazza A, Sadik S. First detection of *Pantoea ananatis*, the causal agent of bacterial center rot of onion in Morocco. J. Crop Prot. 2015;5:11–17.

42. Carr EA, Bonasera JM, Zaid AM, Lorbeer JW, Beer SV. First report of bulb disease of onion caused by *Pantoea ananatis* in New York. *Curr. Microbiol.* 2016;72:738–743.
43. Cota LV, Costa RV, Silva DD, Parreira DF, Lana UGP, Casela CR. First report of pathogenicity of *Pantoea ananatis* in sorghum (*Sorghum bicolor*) in Brazil. *Australas. Plant Dis. Notes.* 2016;5:120–122.
44. Mondal KK, Mani C, Singh J, Kim JG, Mudgett MB. A new leaf blight of rice caused by *Pantoea ananatis* in India. *Plant Dis.* 2011;95:1582.
45. Cother EJ, Reinke R, McKenzie C, Lanoiselet VM, Noble DH. An unusual stem necrosis of rice caused by *Pantoea ananas* and the first record of this pathogen on rice in Australia. *Australas. Plant Pathol.* 2004;33:495–503.
46. Yan H, Yu SH, Xie GL, Fang W, Su T, Li B. Grain discoloration of rice caused by *Pantoea ananatis* (synonym *Erwinia uredovora*) in China. *Plant Dis.* 2010;94:482.
47. Cortesi P, Pizzatti C. Palea browning, a new disease of rice in Italy caused by *Pantoea ananatis*. *J. Plant Pathol.* 2007;89 Suppl 3:S76.
48. González AD, Franco MA, Contreras N, Galindo-Castro I, Jayaro Y, Graterol E. First report of *Pantoea agglomerans* causing rice leaf blight in Venezuela. *Plant Dis.* 2015;99:552.
49. Egorova M, Mazurin E, Ignatov AN. First report of *Pantoea ananatis* causing grain discoloration and leaf blight of rice in Russia. *New Dis. Rep.* 2015;32:21.
50. Figueiredo JE, Paccola-Meirelles LD. Simple, rapid and accurate PCR-based detection of *Pantoea ananatis* in maize, sorghum and *Digitaria* sp. *J. Plant Pathol.* 2012;94:663–667.
51. Ma Y, Rong C, Wang S, Liu Y, Wang J, Xu F. Development of a species-specific real-time PCR assay for diagnosing *Pantoea beijingensis*. *J. Plant Pathol.* 2016;98:365–8.
52. Gehring I, Wensing A, Gernold M, Wiedemann W, Coplin D I., Geider K. Molecular differentiation of *Pantoea stewartii* subsp. *indologenes* from subspecies *stewartii* and identification of new isolates from maize seeds. *J. Appl. Microbiol.* 2014;116:1553–1562.
53. Tambong JT. Specific identification and detection of *Pantoea stewartii* subsp. *stewartii* using a membrane-based multi-gene oligonucleotide array. *Can. J. Plant Pathol.* 2015;37:414–426.
54. Town J, Dumonceaux TJ, Links M. High-quality draft genome sequences of *Pantoea agglomerans* isolates exhibiting antagonistic interactions with wheat seed-associated fungi. *Genome Announc.* 2016; 4:e00511-16.
55. Lim JA, Lee DH, Kim BY, Heu S. Draft genome sequence of *Pantoea agglomerans* R190, a producer of antibiotics against phytopathogens and foodborne pathogens. *J. Biotechnol.* 2014;188:7–8.



56. Moretti C, Cortese C, Passos da Silva D, Venturi V, Torelli E, Firrao G, et al. Draft genome sequence of a hypersensitive reaction-inducing *Pantoea agglomerans* strain isolated from olive knots caused by *Pseudomonas savastanoi* pv. *savastanoi*. *Genome Announc.* 2014; 2:e00774-14.
57. Wright SA, Zumoff CH, Schneider L, Beer SV. *Pantoea agglomerans* strain EH318 produces two antibiotics that inhibit *Erwinia amylovora* in vitro. *Appl. Environ. Microbiol.* 2001;67:284–292.
58. Matsuzawa T, Mori K, Kadowaki T, Shimada M, Tashiro K, Kuhara S, et al. Genome sequence of *Pantoea agglomerans* strain IG1. *J. Bacteriol.* 2012;194:1258–1259.
59. Corsini G, Valdés N, Pradel P, Tello M, Cottet L, Muiño L, et al. Draft genome sequence of a copper-resistant marine bacterium, *Pantoea agglomerans* strain LMAE-2, a bacterial strain with potential use in bioremediation. *Genome Announc.* 2016;4:e00525-16.
60. Palmer M, de Maayer P, Poulsen M, Steenkamp ET, van Zyl E, Coutinho TA, et al. Draft genome sequences of *Pantoea agglomerans* and *Pantoea vagans* isolates associated with termites. *Stand. Genomic Sci.* 2016;11:23.
61. Gan HY, Gan HM, Savka MA, Triassi AJ, Wheatley MS, Smart LB, et al. Whole-genome sequences of 13 endophytic bacteria Isolated from shrub willow (*Salix*) grown in Geneva, New York. *Genome Announc.* 2014;2:e00288-14.
62. Smith DD, Kirzinger MW, Stavrinides J. Draft genome sequence of the antibiotic-producing cystic fibrosis isolate *Pantoea agglomerans* Tx10. *Genome Announc.* 2013; 1:e00904-13.
63. Hara Y, Kadotani N, Izui H, Katashkina JI, Kuvaeva TM, Andreeva IG, et al. The complete genome sequence of *Pantoea ananatis* AJ13355, an organism with great biotechnological potential. *Appl. Microbiol. Biotechnol.* 2012;93:331–341.
64. Kim HJ, Lee JH, Kang BR, Rong X, McSpadden Gardener BB, Ji HJ, et al. Draft genome sequence of *Pantoea ananatis* B1-9, a nonpathogenic plant growth-promoting bacterium. *J. Bacteriol.* 2012;194:729.
65. Weller-Stuart T, Chan WY, Coutinho TA, Venter SN, Smits TH, Duffy B, et al. Draft genome sequences of the onion center rot pathogen *Pantoea ananatis* PA4 and maize brown stalk rot pathogen *P. ananatis* BD442. *Genome Announc.* 2014;2:e00750-14.
66. Medrano EG, Bell AA. Genome sequence of *Pantoea ananatis* strain CFH 7-1, which is associated with a vector-borne cotton fruit disease. *Genome Announc.* 2015;3:e01029-15.
67. De Maayer P, Chan WY, Venter SN, Toth IK, Birch PR, Joubert F, et al. Genome sequence of *Pantoea ananatis* LMG20103, the causative agent of *Eucalyptus* blight and dieback. *J. Bacteriol.* 2010;192:2936–2937.

68. Adam Z, Tambong JT, Lewis CT, Lévesque CA, Chen W, Bromfield ES, et al. Draft genome sequence of *Pantoea ananatis* strain LMG 2665<sup>T</sup>, a bacterial pathogen of pineapple fruitlets. *Genome Announc.* 2014; 2:e00489-14.
69. De Maayer P, Chan WY, Rezzonico F, Bühlmann A, Venter SN, Blom J, et al. Complete genome sequence of clinical isolate *Pantoea ananatis* LMG 5342. *J. Bacteriol.* 2012;194:1615–1616.
70. Choi O, Lim JY, Seo Y-S, Hwang I, Kim J. Complete genome sequence of the rice pathogen *Pantoea ananatis* strain PA13. *J. Bacteriol.* 2012;194:531.
71. Sheibani-Tezerji R, Naveed M, Jehl MA, Sessitsch A, Rattei T, Mitter B. The genomes of closely related *Pantoea ananatis* maize seed endophytes having different effects on the host plant differ in secretion system genes and mobile genetic elements. *Front. Microbiol.* 2015;6:440.
72. Ma J, Zhang K, Liao H, Hector SB, Shi X, Li J, et al. Genomic and secretomic insight into lignocellulolytic system of an endophytic bacterium *Pantoea ananatis* Sd-1. *Biotechnol. Biofuels.* 2016;9:25.
73. Duong DA, Stevens AM, Jensen RV. Complete genome assembly of *Pantoea stewartii* subsp. *stewartii* DC283, a corn pathogen. *Genome Announc.* 2017;5:e00435-17.
74. Tran PN, Tan NE, Lee YP, Gan HM, Polter SJ, Dailey LK, et al. Whole-genome sequence and classification of 11 endophytic bacteria from poison ivy (*Toxicodendron radicans*). *Genome Announc.* 2015;3:e01319-15.
75. Mohamad NI, Tan WS, Chang CY, Tee KK, Yin WF, Chan KG. Analysis of quorum-sensing *Pantoea stewartii* strain M073a through whole-genome sequencing. *Genome Announc.* 2015;3:e00022-15.

### Acknowledgements

We thank Toyin Afolabi (Africa Rice Center Cotonou, Benin), Sandrine Fabre and Florence Auguy (IRD, Cirad, University Montpellier, IPME, Montpellier, France) for excellent technical support. We are grateful to Charlotte Tollenaere for testing this new diagnostic tool in the international laboratory “LMI Patho-Bios” (IRD-INERA Observatoire des Agents Phytopathogènes en Afrique de l’Ouest) in Burkina Faso and for helpful comments on the manuscript.

### Funding

This study was supported by a PhD scholarship from French National Research Institute for Sustainable Development (IRD) within the programme Allocation de Recherche pour une Thèse au Sud (ARTS). The Africa Rice Center (AfricaRice) received financial support from the Global Rice Science Partnership (GRiSP) and the Ministry of Foreign Affairs, Japan.

**Availability of data and materials**

Not applicable.

**Authors' contributions**

KK and RK conceived and designed the experiments. KK, SD, RA, RD evaluated the primers and multiplex PCR scheme by screening African strains. KK, RK and DS wrote the manuscript. All authors read and approved the final manuscript.

**Ethics approval and consent to participate**

Not applicable.

**Consent for publication**

Not applicable.

**Ethics**

Not applicable.

**Competing interests**

The authors declare that they have no competing interests.

**Authors' details**

Kossi Kini, Institut de Recherche pour le Développement, Montpellier, France; Université de Montpellier, France & Africa Rice Center, Plant Pathology, Cotonou, Benin;

Raoul Agnimonhan, Africa Rice Center, Plant Pathology, Cotonou, Benin;

Rachelle Dossa, Africa Rice Center, Plant Pathology, Cotonou, Benin;

Drissa Silué, Africa Rice Center, Plant Pathology, Cotonou, Benin;

Ralf Koebnik, Institut de Recherche pour le Développement, Montpellier, France.

**Table 1:** List of *Pantoea* genome sequences used for primers design.

Species	Strain	Origin	Country	Year	Accession number	Reference
<i>P. agglomerans</i>	4	Wheat seed	Canada	2012	JPOT01000005	[54]
<i>P. agglomerans</i>	190	Soil	South Korea	2005	JNGC01000002	[55]
<i>P. agglomerans</i>	DAPP-PG734	Olive knot	Italy	2008	JNVA01000008	[56]
<i>P. agglomerans</i>	Eh318	Stem of apple	USA		AXOF01000028	[57]
<i>P. agglomerans</i>	IG1				BAEF01000016	[58]
<i>P. agglomerans</i>	LMAE-2	Sediment	Chile	2010	JWLQ01000032	[59]
<i>P. agglomerans</i>	MP2	Termites	South Africa	2009	JKQ01000009	[60]
<i>P. agglomerans</i>	RIT273	Willow (Salix sp.)	USA	2013	ASJI01000010	[61]
<i>P. agglomerans</i>	Tx10	Sputum of cystic fibrosis	USA	2011	ASJI01000010	[62]
<i>P. ananatis</i>	AJ13355		Japan		AP012032	[63]
<i>P. ananatis</i>	B1-9				CAEJ01000016	[64]
<i>P. ananatis</i>	BD442	Maize stalk rot	South Africa	2004	JM JL01000008	[65]
<i>P. ananatis</i>	BRT175	Strawberry epiphyte			ASJH01000041	[62]
<i>P. ananatis</i>	CFH 7-1	Cotton boll disease	USA	2011	LFLX01000002	[66]
<i>P. ananatis</i>	LMG 20103	Blight and dieback of Eucalyptus	South Africa		CP001875	[67]
<i>P. ananatis</i>	LMG 2665	Pineapple soft rot	Philippines	1928	JMJJ01000009	[68]
<i>P. ananatis</i>	LMG 5342	Human wound	Phillipines	1928	HE617160	[69]
<i>P. ananatis</i>	PA13	Rice grain	Korea		CP003085	[70]
<i>P. ananatis</i>	PA4	Onion seed	South Africa	2004	JMJK01000009	[65]
<i>P. ananatis</i>	S6	Maize seed			CVNF01000001	[71]
<i>P. ananatis</i>	S7	Maize seed			CVNG01000001	[71]
<i>P. ananatis</i>	S8	Maize seed			CVNH01000001	[71]
<i>P. ananatis</i>	Sd-1	Rice seed	China		AZTE01000008	[72]
<i>P. stewartii</i>	DC283	Maize	USA	1967	AHIE01000032	[73]
<i>P. stewartii</i>	M009	Waterfall	Malaysia	2013	JRWI01000004	[74]
<i>P. stewartii</i>	M073a	Waterfall	Malaysia	2013	JSXF01000010	[75]

**Table 2:** List of PCR primers developed for the *Pantoea* mPCR along with the sequences of the GenBank accessions and the corresponding strains.

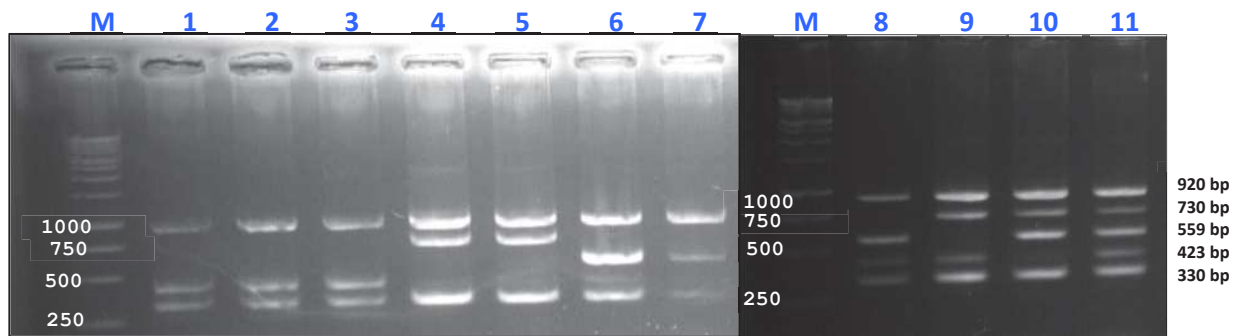
Primer name	Target species	Sequence	Size (bp)	Strain
PANAG_infB_fwd	<i>P. agglomerans</i>	5'-GATGACGARGCCATGCTGC	730	<i>P. agglomerans</i> (CFBP3615)
PANAG_infB_rev		5'-TGTCCGGCGTGCCGGCTG		
PANAN_gyrB_fwd	<i>P. ananatis</i>	5'-GATGACGARGCCATGCTGC	423	<i>P. ananatis</i> (ARC195)
PANAN_gyrB_rev		5'-GATCTTGCGGTATTCGCCAC		
PANST_rpoB_fwd	<i>P. stewartii</i>	5'-CACCGGTGAACTGATTATCG	539	<i>P. stewartii</i> (ARC204)
PANST_rpoB_rev		5'-GTCCTGAGGCATCAATGTGT		
PANsp_atpD_fwd	<i>Pantoea</i> sp.	5'-GAGGGTAACGACTTCTACCAC	330	<i>P. stewartii</i> (ARC222)
PANsp_atpD_rev		5'-CTGTACGGAGGTGATTGAAC		
				<i>P. agglomerans</i> (CFBP3615)
				<i>P. ananatis</i> (ARC235)
16S_27F	<i>Eubacteria</i>	5'-AGAGTTTGATCMTGGCTCAG	920	<i>Eubacteria</i>
16S_907R		5'-CCGTCAATTCMTTTRAGTTT		

**Table 3:** Composition of the multiplex polymerase chain reaction.

PCR component	Volume per reaction ( $\mu\text{L}$ )		Final concentration
	Purified DNA	Bacterial cells	
Type of template:			
Buffer (5x)	5.0	5.0	1x
dNTPs (2.5 mM each)	0.5	0.5	50 $\mu\text{M}$ each
Oligonucleotides (10 $\mu\text{M}$ )	0.4	0.4	0.16 $\mu\text{M}$ each
Takara ExTaq <sup>TM</sup> (5 units/ $\mu\text{L}$ )	0.1	0.1	0.5 U
Template	2.0	5.0	
Sterile nanopure water	13.4	10.4	
Total	25.0	25.0	

**Table 4:** Reaction parameters of the multiplex PCR thermocycler program.

<b>Step</b>	<b>Phase</b>	<b>Time</b>	<b>Temperature (°C)</b>
<b>1</b>	Initial denaturation	3 min	94
<b>2</b>	Denaturation	30 sec	94
<b>3</b>	Annealing	30 sec	58
<b>4</b>	Extension	2 min	72
<b>5</b>	Cycling (steps 2-4)	30 cycles	
<b>6</b>	Final extension	10 min	72
<b>7</b>	Soak/hold	$\infty$	4-10
<b>8</b>	End		



**Figure 1:** The agarose gel pictures showing the evaluation of the mPCR diagnostic tool on the pure DNA from several reference and type strains of *Pantoea* spp. from CFBP.

Lane 1 to 7: Three *P. ananatis* (CFBP446 [1], CFBP3612<sup>T</sup> [2], CFBP3171<sup>T</sup> [3]), two *P. stewartii* (CFPB5846 [4], ARC222 [5]), and two *P. agglomerans* (CFBP3615 [6] and CFBP3845<sup>T</sup> [7]) strains were evaluated.

Lanes 8 to 11: Pools of heated cells of the three *Pantoea* species were evaluated.

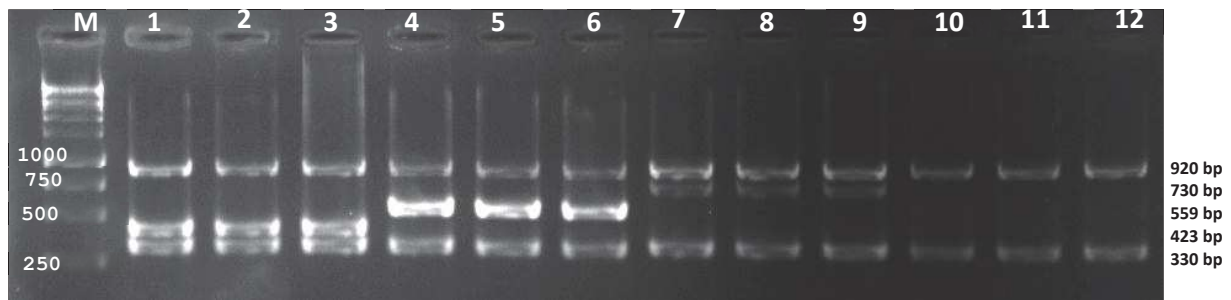
Pool 1 = *P. ananatis* (CFBP446) + *P. stewartii* (CFBP5846) for **lane 8**.

Pool 2 = *P. ananatis* (CFBP446) + *P. agglomerans* (CFBP3845<sup>T</sup>) for **lane 9**.

Pool 3 = *P. stewartii* (CFBP5846) + *P. agglomerans* (CFBP3615) for **lane 10**.

Pool 4 = *P. stewartii* (CFBP5846) + *P. ananatis* (CFBP3171<sup>T</sup>) + *P. agglomerans* (CFBP3615) for **lane 11**.





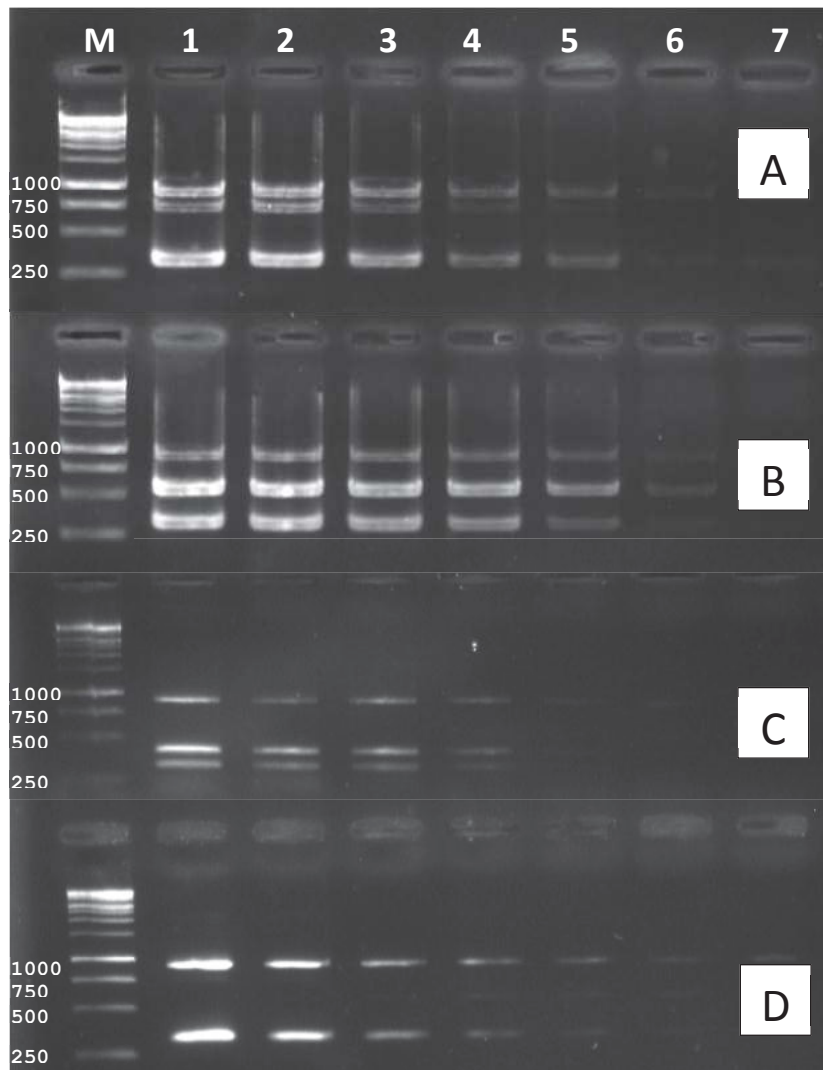
**Figure 2:** Agarose gel pictures showing the detection of three *Pantoea* species in artificially infected Rice leaves and in contaminated seeds. The following *Pantoea* strains were used: *P. ananatis* (strain ARC60), *P. stewartii* (strain ARC222), *P. agglomerans* (strain ARC 530) and *Pantoea* sp. (strain ARC205).

*P. ananatis*: (1 to 3): The pure bacterial inoculum (1), the supernatant of crushed Rice leaves two weeks after inoculation (2), the supernatant crushed rice seed two weeks after spraying the inoculum (3).

*P. stewartii*: (4 to 6): The pure bacterial inoculum (4), the supernatant of crushed Rice leaves two weeks after inoculation (5), the supernatant of crushed rice seed two weeks after spraying the inoculum (6).

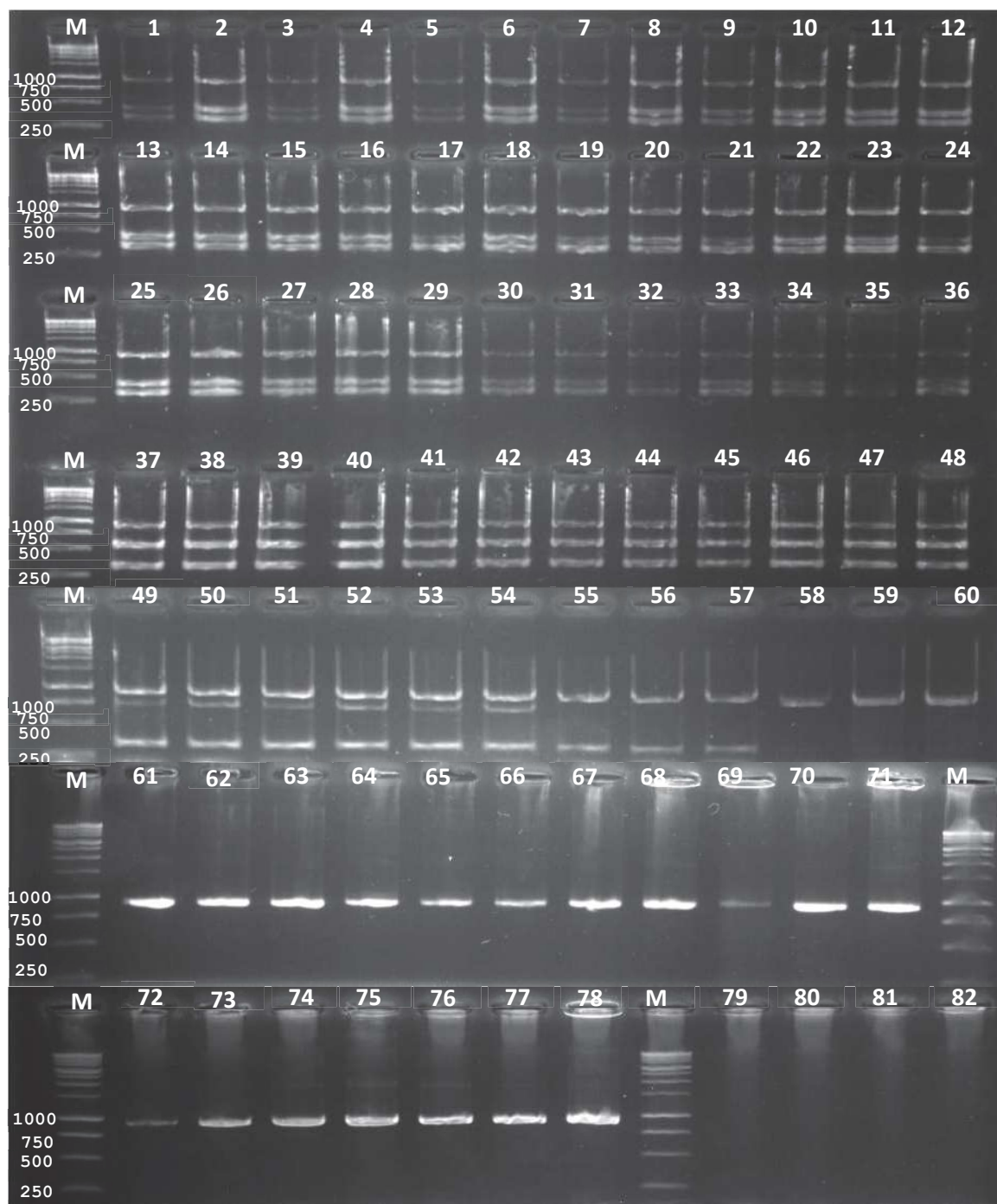
*P. agglomerans*: (7 to 9): The pure bacterial inoculum (7), the supernatant of crushed Rice leaves two weeks after inoculation (8), the supernatant of crushed rice seed two weeks after spraying the inoculum (9).

*Pantoea* sp. (10 to 12): The pure bacterial inoculum (10), the supernatant crushed Rice leaves two weeks after inoculation (11), the supernatant of crushed rice seed two weeks after spraying the inoculum (12).



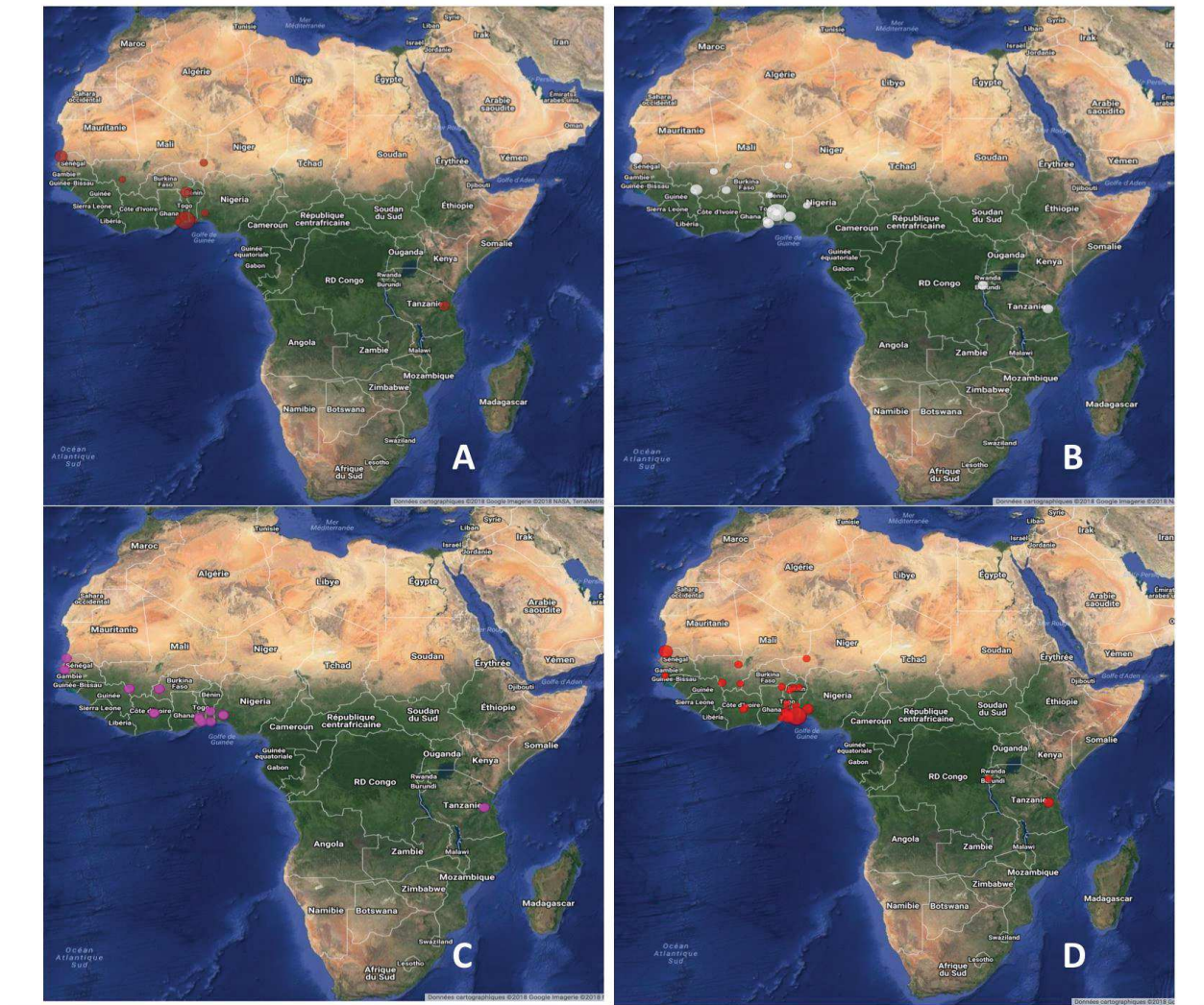
**Figure 3:** Sensitivity of the multiplex PCR scheme.

The PCR included all five primer pairs listed in Table 2. Serial dilutions heated bacterial cells were evaluated. Four *Pantoea* strains were used: *P. agglomerans* strain CFBP3615 (A), *P. stewartii* strain ARC222 (B), *P. ananatis* strain CFBP3I71 (C) and *Pantoea cedenensis* CFPB 6627 (D). The following amounts of bacteria were used as templates for the PCR, corresponding to 10-fold serial dilutions: Lanes 1 to 7:  $10^6$  CFU/mL,  $10^5$  CFU/mL,  $10^4$  CFU/mL,  $10^3$  CFU/mL,  $10^2$  CFU/mL,  $10^1$  CFU/mL, and H<sub>2</sub>O.



**Figure 4:** Evaluation of the multiplex PCR scheme on a large collection of bacteria composed of strains representing the global diversity.

The multiplex PCR was performed on purified DNA and included 57 *Pantoea* spp. (1 to 57): 35 *P. ananatis* (1 to 36); twelve *P. stewartii* (37 a 48), six *P. agglomerans* (49 to 54); *P. cedenensis* (55), *Pantoea / Erwinia oleae* (56) and *Pantoea* spp. (57). Other bacterial strains were used as control included: five *Sphingomonas* spp. (58 to 62); six *X. oryzae* pv. *oryzae* (63 to 68); five *X. oryzae* pv. *oryzicola* (69 to 73); two *B. glumae* (74 to 76); *P. syringae* pv. *syringae* (77) and *P. fuscovaginae* (78). For negative control: Supernatant from apparently healthy surface sterilized crushed rice leaf (79); supernatant from apparently healthy surface sterilized crushed rice seeds/grains (80) and sterile distilled water (81 and 82).



**Figure 5:** Geographic distribution of *P. agglomerans*, *P. ananatis*, *P. stewartii* and *Pantoea* spp. in sub-Saharan Africa.

A = 41 strains of *P. agglomerans* at ten sites in eight countries.

B = 79 strains of *P. ananatis* at 14 sites in nine countries.

C = 269 *P. stewartii* strains at 13 sites in eight countries.

D = 220 strains of *Pantoea* spp. at 21 sites in ten countries.

**Additional file 1 (Attachment, Table 1 and table 3):** List of bacterial strains used to evaluate the multiplex PCR scheme.

### **3. Second drafted manuscript: Development of a Loop-Mediated Isothermal Amplification (LAMP) diagnostic tools for fast detection of *Pantoea* species associated with Rice leaves and seeds**

#### **3.1. Context and justification of the project**

One of the paramount concerns of any plant pathologist is a reliable and fast diagnosis of a disease with an easily applicable diagnostic tool. The identification of the causal agent of a disease can be elaborated in various ways depending on the means and the convenient available diagnostic tools. Indeed, it can be done phenotypically or genotypically. Phenotypic identification can be done by two main means, either with the naked eye of the characteristic symptoms and/or by physiological, biological or biochemical analyses (for example API, ELISA). In both cases, the goal is to establish a causal relationship between the disease and its causative agent. The identification can also be done using molecular diagnostic tools, such as different types of PCR (e.g. simplex, multiplex, nested PCR). However, all these tools are only applicable in laboratories with adequate equipment. But in the field, the ideal would be to have a diagnostic tool capable of performing the diagnosis immediately.

In case of epidemics, these phytodiagnostic tools are major assets to have an idea about the pathogen that causes the infection. Rapid, preliminary results will allow making emergency decisions prior to further laboratory analyses that are crucial for confirmation. One of the most popular field diagnostic tools is loop-mediated isothermal amplification (LAMP). It has been developed and used for the diagnosis of several pathogenic microorganisms of living beings (humans, animals and plants). For plants, several LAMP tools have been developed for diagnostics of pathogenic microorganisms (fungi, viruses and bacteria). For phytopathogenic bacteria, LAMP has been developed for *Xanthomonas oryzae* pv. *oryzae*, *Xanthomonas oryzae* pv. *oryzicola*, *Pseudomonas* spp, and *P. stewartii*.

Recently, *P. ananatis*, *P. stewartii* and *P. agglomerans* have been reported as plant pathogens in several paddy rice fields in sub-Saharan Africa. The same species have also been isolated from rice seeds from the same countries. Therefore, bacteria of the genus *Pantoea* are a threat to rice production in Africa and it is essential to provide ways and means for its control. To provide molecular tools for diagnosis of these *Pantoea* species, PCR schemes (simplex and multiplex) were developed. However, the use of these tools demands much time and is limited to the laboratory. As follows, we wanted to overcome these difficulties and facilitate a quick and cost-effective diagnosis of *Pantoea* directly in rice paddies in sub-Saharan Africa. To perform this, we have developed two LAMP tools: (i) One diagnoses all bacteria belonging to the genus *Pantoea*, and (ii) the other one specifically diagnoses *P. ananatis*.

#### **Personal involvement**

I fully worked on this article in cooperation with all the co-authors and listed collaborators.

### 3.2. Abstract

#### Background

Bacteria of the genus *Pantoea* have been described as ubiquitous and versatile because they can be isolated from several sources (living organisms and environment). In total, five species (*Pantoea ananatis*, *Pantoea agglomerans*, *Pantoea stewartii*, *Pantoea allii*, *Pantoea wallisii*) of the genus *Pantoea* have been described as phytopathogens. Recently, three species (*P. ananatis*, *P. stewartii* and *P. agglomerans*) have been reported as a threat to rice production in 11 countries in sub-Saharan Africa. Several diagnostic PCR tools (simplex and multiplex) have been developed but their use is limited to the laboratory. Here, we developed two novel loop-mediated isothermal amplification (LAMP) schemes targeting two housekeeping genes of *Pantoea*. One of the tools generically detects all bacteria (cultivable or uncultivable) belonging to the genus *Pantoea*, and the other one specifically detects *P. ananatis*.

#### Findings

Partial sequences of two housekeeping genes (*gyrB* and *atpD*) were used to generate a set of primers for two LAMP diagnostic tools, one for the genus *Pantoea* and the other one for the species *P. ananatis*. The specificity, universality and sensitivity of both tools were evaluated and confirmed in silico and in vitro. Serial variations of temperature (from 58 to 66 °C) were tested for the amplifications with the LAMP assays by using reference strains from the CFBP strain collection. Positive results were observed at all temperatures tested and no nonspecific amplification was detected for the negative controls after at least 120 min of incubation. For bacterial colonies, the detection limit of the two LAMP assays was  $10^4$  colony-forming units/mL. Using purified DNA as a template, the detection limits were 0.5 fg for the *Pantoea* genus and 50 fg for *P. ananatis*. The two tools were able to detect *Pantoea* in all tested samples (leaves and seeds).

#### Conclusion

The LAMP assays developed in this study allow rapid and sensitive detection of bacteria belonging to the *Pantoea* genus and/or to the *P. ananatis* species. These diagnostic tools require only a minimum of time and equipment. They can potentially be used by plant protection services for field routine tests (fields and country borders) or to control the phytosanitary status of rice seeds and other cereals.

### 3.3. Background

The *Pantoea* genus is composed of several species characterized by their ubiquity and versatility in their interaction with living organisms and the environment [1–4]. From the 27 species currently described, most are associated with plants, either as epiphytes or as pathogens. For the phytopathogen, several species including *Pantoea ananatis*, *Pantoea agglomerans*, *Pantoea stewartii*, *Pantoea allii* and *Pantoea wallisii* have been widely reported as plant pathogens [5–9]. They cause several symptoms, such as fire blight and

dieback, red streak, black spot, necrosis, bacterial spot, tumors, rot center, stem necrosis, leaf rot, decay seed, and Stewart's wilt.

Phytosanitary surveys conducted in several paddy fields in a dozen sub-Saharan countries showed that a complex of *Pantoea* species is responsible for the bacterial blight of rice. The same species from the *Pantoea* complex were also isolated from rice seeds (symptomatic or not) from several rice fields in the same countries. Bacterial leaf blight caused by *Pantoea* spp. is considered a seed-transmitted disease of rice and a significant threat to rice production in the world. Thus, measures need to be taken to limit its dispersion by interstate and continental seed exchanges.

In order to better diagnose bacterial leaf blight of rice, efficient diagnostic tools for the African *Pantoea* species complex have been developed by our team, consisting of simplex and multiplex PCR schemes that can identify the three major species of *Pantoea* affecting rice plants. However, these tools are only applicable in laboratories and do not allow to directly diagnose *Pantoea* in the field. Therefore, the goal of our work was to develop a very sensitive diagnostic tool that can be used in the field for quick identification, which is inexpensive, highly specific, easily applicable and reproducible.

Isothermal loop-mediated amplification (LAMP) [10,11] is a relatively simple technique that facilitates fast amplification of DNA with a high level of sensitivity and specificity at low cost. The technique uses *Bst* DNA polymerase [12,13] to create reliable and fast polymerization, and operates under isothermal conditions at relatively high temperature. The results of LAMP reactions can be detected without electrophoretic separation by visualization of turbidity, fluorescence or a color change due to a metal ion indicator [10,14]. It has been used for highly specific and sensitive amplification of DNA to detect various pathogens, including viruses, bacteria, protozoa and fungi.

In this study, two diagnostic tools have been developed; one generic for all species of *Pantoea* and another one specific to the globally reported and economically important species *P. ananatis*. The specificity, sensitivity and universality of these tools have been tested by screening a collection of bacterial strains. This collection is composed of the genus *Pantoea* and reference strains belonging to other genera from several geographical origins. These tools will facilitate the first diagnostic tests of *Pantoea* in the field for the verification of the phytosanitary status of rice seeds before exchange of material.

### 3.4. Material and methods

#### Bacterial strains

All bacterial field isolates used in this study have been identified previously by the diagnostic *Pantoea* multiplex PCR tool developed by our teams (listed in Additional File 1). This set of strains consists of African *Pantoea* isolates. In addition, strains from the French collection of phytopathogenic bacteria (<https://www6.inra.fr/cirm/CFBP-Bacteries-associees-aux-Plantes>) have been used (CFBP466, CFBP3612<sup>T</sup>, CFBP3171<sup>T</sup>, CFBP5846, CFBP3615, CFBP3845<sup>T</sup>,

CFBP6632 and CFBP6627<sup>T</sup>), in addition to other reference strains belonging to several genera (*Sphingomonas*, *Xanthomonas*, *Pseudomonas* and *Escherichia*).

### ***Pantoea* genus and species-specific LAMP primers design**

Two sets of LAMP primers, one specific for *P. ananatis* and the other one generic for all *Pantoea* species, were designed on the partial sequences of the housekeeping genes *gyrB* for *P. ananatis*, and *atpD* for *Pantoea* spp. The partial sequences of the housekeeping genes were retrieved from NCBI GenBank (<http://www.ncbi.nlm.nih.gov/genome/?term=Pantoea>) and aligned to identify the conserved and polymorphic regions, using the software CLUSTALW version 1.83 (DNA Data Bank of Japan; <http://clustalw.ddbj.nig.ac.jp/top-e.html>). A potential target region was selected from the aligned sequences, and six pairs of primers listed in Table 1 were automatically generated by Primer Explorer V5 (<http://primerexplorer.jp/lampv5e/index.html>, Eiken Chemical Co., Japan). All six primers per reaction, composed of two external primers F3 and B3, two internal primers FIP and BIP, and two loop primers F-Loop and B-Loop), were synthesized by Kaneka Eurogentec S.A. (Seraing, Belgium).

### **LAMP F3 and B3 primer specificity tested by in silico analyses and conventional PCR assays**

For comparative purposes, each outer LAMP primer pair (F3 and B3; Table 1) of the two sets was initially tested for species and genus specificity by BLAST at the NCBI website <https://www.ncbi.nlm.nih.gov/tools/primer-blast/>. Then conventional PCRs were performed, using *Pantoea* CFPB reference strains (listed in Table 2) and other bacteria belonging to the genera *Sphingomonas*, *Xanthomonas*, *Pseudomonas* and *Escherichia* as control. A ready-to-use 2X Master Mix (Promega) solution was used according to the manufacturer's recommendation (Table 3). The thermal cycling conditions used were: 95 °C for 4 min, 35 cycles consisting of 94 °C for 30 sec, 55 °C for 30 sec, and 72 °C for 30 sec, and a final extension at 72 °C for 10 min. PCR products were electrophoretically separated on a 1.5% (w/v) agarose gel and visualized with ethidium bromide.

### **Loop-mediated isothermal amplification (LAMP) reaction**

For the reaction, two types of mixes were used. In the first mix, the different reagents were individually mixed (Protocol A in Table 3). Secondly, the WarmStart Colorimetric LAMP 2X Master Mix was used according to the recommendations of the manufacturer (Protocol B in Table 2).

#### **Protocol A (Table 3)**

The LAMP reaction was carried out in a 25- $\mu$ l volume containing 0.768  $\mu$ l of each of the outer primers (F3 and B3; 1  $\mu$ M) and inner primers (FIP and BIP; 10  $\mu$ M) 0.384  $\mu$ l of each of the loop primers (F-Loop and B-Loop; 10  $\mu$ M), 3.5  $\mu$ l of dNTPs (10 mM), 1.5  $\mu$ l of MgSO<sub>4</sub> (100 mM), 4  $\mu$ l of betaine (Sigma Aldrich; 5M), 1  $\mu$ l of Bst 2.0 DNA polymerase large fragment (New England Biolabs, Beverly, MA; 8 U/ $\mu$ L), 2.5  $\mu$ l of Isothermal Amplification Buffer 10X (New England Biolabs) and 1  $\mu$ l of target template. Four types of templates were used: (i) genomic DNA (20 ng/ $\mu$ l), (ii) heat-killed bacterial cells, (iii) 24-hours macerated solution from a 10-mm<sup>2</sup> section of a *Pantoea*-symptomatic rice leaf, and (iv) 24-hours



macerated solution from rice seeds. To avoid contaminations, 20  $\mu$ l of mineral oil were used to cover the surface of the LAMP mixture in each reaction tube. The mixture was incubated for the both LAMP reactions at a serial variation of incubation temperatures (from 58 to 66 °C) for 60 min in a thermal cycler or a water bath, followed by heat-inactivation at 80 °C for 3 min. Quant-IT™ Pico Green® Reagent (Invitrogen, Carlsbad, CA, USA) was added to each tube, which were then closed immediately to minimize formation and release of aerosols. Reaction tubes were incubated for 5-20 min at room temperature. Reactions were visually monitored, with positive reactions indicated by a color change from orange to green. Alternatively, tubes were subjected to UV light and changes in fluorescence were observed. As another alternative, the turbidity that was derived from the white precipitate of magnesium pyrophosphate in the mixture was detected by the naked eye. Furthermore, the amplified products were submitted to agarose gel (1.5% [w/v]) electrophoresis and stained with ethidium bromide.

### **Protocol B (Tables 4 and 5)**

To simplify the assays, stocks of a 10X Primer Mix containing all six LAMP primers at appropriate concentration were prepared in nuclease-free water and stored at -20 °C. The final reaction mix was prepared as described below (Table 4) using Colorimetric LAMP Master Mix, pre-mixed LAMP primers and nuclease-free water. Reaction mixes were vortexed and centrifuged. Then, 24  $\mu$ l per reaction were pipetted into reaction vessels and 1  $\mu$ l of template were added. Vessels were sealed, mixed by vortexing and centrifuged. The reaction solutions had a bright pink color, which indicated the initial high pH required for successful LAMP reaction. Reaction vessels were incubated at 65 °C for 30 minutes and examined by eye. Positive reactions had turned into yellow or orange while negative controls remained pink. In case of an orange color, vessels were returned to 65 °C for an additional 10 minutes. In order to intensify the positive-reaction color, reaction vessels were cooled to room temperature. Finally, the vessels were photographed to record the colorimetric results.

### **Specificity, sensitivity and universality of the *Pantoea* species-specific and genus-specific LAMP**

To estimate the specificity and sensitivity of the assays, two protocols were used. Each candidate LAMP assay was initially screened for specificity and universality against a panel of representative genomic DNA and heated bacterial cells. Then, a total of 150 *Pantoea* strains (listed in Additional File 1) previously diagnosed using a *Pantoea*-specific multiplex PCR were tested for confirmation.

The sensitivity assays were performed using protocol B on a serial dilution of genomic DNA from 6 ng to 6 fg and on 10-fold serial dilutions of bacterial cells in distilled water ( $10^8$ -1 cells/mL) of strain CFBP3612T. The bacterial suspensions were incubated at 95 °C for 30 min to lyse the cells and release their DNA

To prevent cross-contamination, different sets of pipettes and different work areas were used for DNA template preparation, PCR mixture preparation and DNA amplification. Gloves have been changed regularly and sterile pipetting techniques were applied during the entire LAMP experiment.

### 3.5. Results

#### **Confirmation of specificity of the LAMP F3 and B3 primers by *in silico* analyses and conventional PCR**

Preliminary analyses, using NCBI Primer-BLAST, verified the specificity of the outer primer pairs (F3 and B3) of the two LAMP schemes. The species-specific primers resulted in amplicons that corresponded to the targeted organism, *P. ananatis*. Indeed, these amplicons were obtained from whole-genome sequences and from partial sequences of species available in the NCBI (<https://www.ncbi.nlm.nih.gov/genome/?term=Pantoea>) and ENA databases (<https://www.ebi.ac.uk/ena/data/search?query=Pantoea>). The genus-specific primers amplified not only all the species officially described as *Pantoea*, including *Pantoea* sequences from uncultured samples in the database, but also some that have not yet assigned a taxonomic status. Conventional PCR using all the CFBP strains listed above confirmed the *in silico* results. Indeed, the outer primers designed for each LAMP assay were species-specific and genus-specific, respectively (data not shown).

#### **Specificity, sensitivity and universality of the *Pantoea* species-specific and genus-specific LAMP assays**

Amplification tests with *Pantoea* strains from the CFBP collection and with other bacterial genera (Additional File) with the two LAMP assays were performed with the two protocols mentioned above. Nonspecific amplification was not detected for any of the tested negative templates (Figure 1). Subsequent LAMP reactions that were conducted with 50 *Pantoea* isolates showed that amplification results with the two tools were in concordance with the results of the *Pantoea*-specific multiplex PCR (Figure 2). Evaluation of the sensitivity of the assays revealed a detection limit of  $10^4$  CFU/mL for both tools. For DNA templates, the detection limit of the genus-specific LAMP assay was 600 fg and 6 pg for the *P. ananatis*-specific assay (Figure 3).

### 3.6. Discussion

Loop-mediated isothermal amplification, originally developed by Notomi et al. [10,11], has been used before for diagnostics of several bacterial plant pathogens, such as *Xanthomonas oryzae* pv. *oryzae*, *X. oryzae* pv. *oryzicola* [15], *Pseudomonas fuscovaginae* [16], *Xylella fastidiosa* [17], *Ralstonia solanacearum* [18], and *Pantoea stewartii* subsp. *stewartii* [19]. Until now, only one LAMP assay has been reported for the genus *Pantoea*. However, the genus *Pantoea* consists of more than 27 species, among them several species that affect important crop plants worldwide [5–8,20]. Recently, three species (*P. ananatis*, *P. stewartii* and *P. agglomerans*) have been reported as threat to rice cultivation in sub-Saharan Africa [21,22]. Considering this situation, several diagnostic tools have been developed. However, these tools are limited to laboratory tests and therefore not applicable for preliminary in-field diagnostics. In order to fill this technological gap, we have developed two new LAMP assays, which can be applied in the field.

The two new LAMP tools for the detection of *Pantoea* spp. and of the *P. ananatis* species are easily applicable and can be performed within two hours. The LAMP tools were developed for *Pantoea* genus by using of *atpD* and *gyrB* housekeeping gene as target. The use of these two genes is based on the fact that they have been historically and continuously used for identification and classification of members of the *Pantoea* genus [6,23–26]. This logic motivated us to use these housekeeping genes to develop another LAMP tool for the detection of *P. ananatis*.

Compared to the simplex PCR [27–31] and multiplex PCR and other molecular biological diagnostics tools [32] developed for *Pantoea* identification, these two LAMP tools are more feasible for in-field diagnosis using hand-held devices. This is the first report of the use of a LAMP approach for the detection of the *Pantoea* species complex and one of its major phytopathogens, *P. ananatis*.

These tools do not substitute other existing diagnostic tools. In case of first positive results in the field, biosecurity measures can be established at the site of discovery within hours. If testes positive, samples can then be submitted to a central laboratory for molecular diagnosis with other diagnostic tools, such as the *Pantoea* multiplex PCR tool, for confirmation. Therefore, LAMP assays are complementary tools for efficient and fast diagnostics. In future work we will explore the potential of these tools under “real-world” settings, i.e. in several regions of sub-Saharan Africa.

### 3.7. Conclusion

We report three major findings. First, we have developed two complementary LAMP tools that either target all the bacteria of the genus *Pantoea* or only bacteria of the species *P. ananatis*. Second, the detection limit of the two LAMP assays is  $10^4$  CFU/mL for bacterial cells and below 50 fg for genomic DNA template. Third, the assay does not show any cross-reactivity with the DNA of other unrelated bacteria. This is the first report on the application of the LAMP assay for early diagnosis of *Pantoea* spp. Because of its simplicity, sensitivity and cost-effectiveness, we suggest this assay to be used as an early diagnostic tool for *Pantoea* in field routine tests.

### References

1. Walterson AM, Stavrinos J. *Pantoea*: insights into a highly versatile and diverse genus within the *Enterobacteriaceae*. FEMS Microbiol. Rev. 2015;39:968–84.
2. Weller-Stuart T, De Maayer P, Coutinho T. *Pantoea ananatis*: genomic insights into a versatile pathogen. Mol. Plant Pathol. 2017;n/a-n/a.
3. Völksch B, Thon S, Jacobsen ID, Gube M. Polyphasic study of plant- and clinic-associated *Pantoea agglomerans* strains reveals indistinguishable virulence potential. Infect. Genet. Evol. 2009;9:1381–91.
4. Dutkiewicz J, Mackiewicz B, Lemieszek M, Golec M, Milanowski J. *Pantoea agglomerans*: a marvelous bacterium of evil and good. Part I. Deleterious effects:

- Dust-borne endotoxins and allergens - focus on cotton dust. *Ann. Agric. Environ. Med. AAEM*. 2015;22:576–588.
5. Brady CL, Goszczynska T, Venter SN, Cleenwerck I, De Vos P, Gitaitis RD, et al. *Pantoea allii* sp. nov., isolated from onion plants and seed. *Int. J. Syst. Evol. Microbiol.* 2011;61:932–937.
  6. Brady CL, Venter SN, Cleenwerck I, Engelbeen K, Vancanneyt M, Swings J, et al. *Pantoea vagans* sp. nov., *Pantoea eucalypti* sp. nov., *Pantoea deleyi* sp. nov. and *Pantoea anthophila* sp. nov. *Int. J. Syst. Evol. Microbiol.* 2009;59:2339–2345.
  7. Cleenwerck I, De Vos P, Coutinho TA, Brady CL, Van der Westhuizen L, Venter SN, Stephanus N. *Pantoea rodasii* sp. nov., *Pantoea rwandensis* sp. nov. and *Pantoea wallisii* sp. nov., isolated from *Eucalyptus*. *Int. J. Syst. Evol. Microbiol.* 2012;62:1457–64.
  8. Coutinho TA, Venter SN. *Pantoea ananatis*: an unconventional plant pathogen. *Mol. Plant Pathol.* 2009;10:325–335.
  9. Delétoile A, Decré D, Courant S, Passet V, Audo J, Grimont P, et al. Phylogeny and identification of *Pantoea* species and typing of *Pantoea agglomerans* strains by multilocus gene sequencing. *J. Clin. Microbiol.* 2009;47:300–310.
  10. Notomi T, Okayama H, Masubuchi H, Yonekawa T, Watanabe K, Amino N, et al. Loop-mediated isothermal amplification of DNA. *Nucleic Acids Res.* 2000;28:E63.
  11. Mori Y, Notomi T. Loop-mediated isothermal amplification (LAMP): a rapid, accurate, and cost-effective diagnostic method for infectious diseases. *J. Infect. Chemother.* 2009;15:62–69.
  12. Mead DA, McClary JA, Luckey JA, Kostichka AJ, Witney FR, Smith LM. Bst DNA polymerase permits rapid sequence analysis from nanogram amounts of template. *BioTechniques.* 1991;11:76–78.
  13. Hafner GJ, Yang IC, Wolter LC, Stafford MR, Giffard PM. Isothermal amplification and multimerization of DNA by Bst DNA polymerase. *Biotechniques.* 2001;30:852–867.
  14. Mori Y, Nagamine K, Tomita N, Notomi T. Detection of loop-mediated isothermal amplification reaction by turbidity derived from magnesium pyrophosphate formation. *Biochem. Biophys. Res. Commun.* 2001;289:150–154.
  15. Lang JM, Langlois P, Nguyen MHR, Triplett LR, Purdie L, Holton TA, et al. Sensitive Detection of *Xanthomonas oryzae* Pathovars *oryzae* and *oryzicola* by Loop-Mediated Isothermal Amplification. *Appl. Environ. Microbiol.* 2014;80:4519–4530.
  16. Ash GJ, Lang JM, Triplett LR, Stodart BJ, Verdier V, Cruz CV, et al. Development of a genomics-based LAMP (Loop-Mediated Isothermal Amplification) assay for detection of *Pseudomonas fuscovaginae* from rice. *Plant Dis.* 2014;98:909–915.
  17. Harper SJ, Ward LI, Clover GRG. Development of LAMP and Real-Time PCR Methods for the rapid detection of *Xylella fastidiosa* for quarantine and field applications. *phytopathology.* 2010;100:1282–1288.
  18. Kubota R, Vine BG, Alvarez AM, Jenkins DM. Detection of *Ralstonia solanacearum* by loop-mediated isothermal amplification. *Phytopathology.* 2008;98:1045–1051.

19. Uematsu H, Inoue Y, Ohto Y. Detection of *Pantoea stewartii* from sweet corn leaves by loop-mediated isothermal amplification (LAMP). *J. Gen. Plant Pathol.* 2015;81:173–179.
20. Cruz AT, Cazacu AC, Allen CH. *Pantoea agglomerans*, a plant pathogen causing human disease. *Journal of Clinical Microbiology.* 2007;45:1989-1992.
21. Kini K, Agnimonhan R, Afolabi O, Milan B, Soglonou B, Gbogbo V, et al. First report of a new bacterial leaf blight of rice caused by *Pantoea ananatis* and *Pantoea stewartii* in Benin. *Plant Dis.* 2017;101:242.
22. Kini K, Agnimonhan R, Afolabi O, Soglonou B, Silué D, Koebnik R. First report of a new bacterial leaf blight of rice caused by *Pantoea ananatis* and *Pantoea stewartii* in Togo. *Plant Dis.* 2017;101:241.
23. Brady C, Cleenwerck I, Venter S, Vancanneyt M, Swings J, Coutinho T. Phylogeny and identification of *Pantoea* species associated with plants, humans and the natural environment based on multilocus sequence analysis (MLSA). *Syst. Appl. Microbiol.* 2008;31:447–460.
24. Brady CL, Cleenwerck I, van der Westhuizen L, Venter SN, Coutinho TA, De Vos P. *Pantoea rodasii* sp. nov., *Pantoea rwandensis* sp. nov. and *Pantoea wallisii* sp. nov., isolated from Eucalyptus. *Int. J. Syst. Evol. Microbiol.* 2012;62:1457–1464.
25. Brady CL, Cleenwerck I, Venter SN, Engelbeen K, De Vos P, Coutinho TA. Emended description of the genus *Pantoea*, description of four species from human clinical samples, *Pantoea septica* sp. nov., *Pantoea eucrina* sp. nov., *Pantoea brenneri* sp. nov. and *Pantoea conspicua* sp. nov., and transfer of *Pectobacterium cypripedii* (Hori 1911) Brenner et al. 1973 emend. Hauben et al. 1998 to the genus as *Pantoea cypripedii* comb. nov. *Int. J. Syst. Evol. Microbiol.* 2010;60:2430–2440.
26. Gavini F, Mergaert J, Beji A, Mielcarek C, Izard D, Kersters K, et al. Transfer of *Enterobacter agglomerans* (Beijerinck 1888) Ewing and Fife 1972 to *Pantoea* gen. nov. as *Pantoea agglomerans* comb. nov. and description of *Pantoea dispersa* sp. nov. *Int. J. Syst. Evol. Microbiol.* 1989;39:337–345.
27. Thapa SP, Hwan D, Park Y-S, Calum, Wilson, Jang, et al. Multiplex PCR assay for the detection of *Pantoea stewartii* subsp. *stewartii* using species-specific genetic markers. *Australas. Plant Pathol.* 2012;41.
28. Tambong JT. Specific identification and detection of *Pantoea stewartii* subsp. *stewartii* using a membrane-based multi-gene oligonucleotide array. *Can. J. Plant Pathol.* 2015;37:414–426.
29. Brady C, Venter S, Cleenwerck I, Vancanneyt M, Swings J, Coutinho T. A fAFLP system for the improved identification of plant-pathogenic and plant-associated species of the genus *Pantoea*. *Syst. Appl. Microbiol.* 2007;30:413–7.
30. Wensing A, Zimmermann S, Geider K. Identification of the corn pathogen *Pantoea stewartii* by mass spectrometry of whole-cell extracts and its detection with novel PCR primers. *Appl. Environ. Microbiol.* 2010;76:6248–6256.
31. Figueiredo JE, Paccola-Meirelles LD. Simple, rapid and accurate PCR-Based detection of *Pantoea ananatis* in maize, sorghum and *Digitaria* sp. *J. Plant Pathol.* 2012;94:663–667.

32. Nunes C, Bajji M, Stepien V, Manso T, Torres R, Usall J, et al. Development and application of a SCAR marker to monitor and quantify populations of the postharvest biocontrol agent *Pantoea agglomerans* CPA-2. *Postharvest Biol. Technol.* 2008;47:422–428.

### **Competing interests**

We declare that we have no competing interests. The funding body had no role in study design, data collection and analysis, preparation of the manuscript or decision to publish.

### **Acknowledgements**

We thank Toyin Afolabi (Africa Rice Center Cotonou, Benin), and Sandrine Fabre and Florence Auguy (IRD, Cirad, University of Montpellier, IPME, Montpellier, France) for excellent technical support.

### **Funding**

This publication has been produced with the financial support of the Allocation de Recherche pour une Thèse au Sud (ARTS) program of the Institut de Recherche pour le Développement (IRD). KK received an individual research grant N° C/5921-1 from the International Foundation for Science (IFS). The Africa Rice Center (AfricaRice) and the IRD received financial support from the Global Rice Science Partnership (GRiSP). In addition, AfricaRice received financial support from the Ministry of Foreign Affairs, Japan.

### **Authors' contributions**

KK, RK, DS and IW participated in the planning of the project, analyzed the results and drafted the manuscript. KK designed the primers and carried out the *in silico* molecular analyses. KK and IW performed experiments in the laboratory. All authors contributed to write and revise the article critically for important intellectual content and have approved the final version of the manuscript to be published.

**Table 1:** Primer sets used for LAMP assays in the present study.

Target gene	Species	Name	Sequence (5' - 3')	Amplicon size with F3+B3 (bp)	Length
<i>atpD</i>	<i>Pantoea</i> sp.	F3	GCAGTAGAGATCGCCTCTA	291	19
		B3	GATAACGTTGGAGTCGGTC		19
		FIP	CCTTGGCGAACGGACACA	37	40
		(F1c+F2)	GTCTAACTCGCAGGAACTG		
		BIP	GTGGTGCGGGTGTAGGTA	40	20
		(B1c+B2)	CGAGTAACCTGAGTGTTTCAG		
		F-Loop	AGGTCGATAACCTTGATGCC	20	
		B-Loop	AACATGATGGA	21	
<i>gyrB</i>	<i>P. ananatis</i>	F3	GAGATACCGATGCAACCG	280	18
		B3	CCAATGCCGTCTTTCTCG		18
		FIP	CAGACGAATCGATACGCCAGA	41	40
		(F1c+F2)	TCGAATACGACATTCTGGC		
		BIP	GCGTGATGCAAGAAACGACC	40	19
		(B1c+B2)	TTCAGGTA		
		F-Loop	TTCAGGAAGGACAGTTCGC	19	
		B-Loop	CACTACGAAGGTGGTATCCG	20	

**Table 2:** PCR components for a 25- $\mu$ l reaction volume for specificity tests of the outer LAMP primers F3 and B3.

<b>Component</b>	<b>Volume</b>	<b>Final concentration</b>
PCR Master Mix, 2X	12.5 $\mu$ l	1X
Upstream primer, 10 $\mu$ M	0.25–2.5 $\mu$ l	0.1–1.0 $\mu$ M
Downstream primer, 10 $\mu$ M	0.25–2.5 $\mu$ l	0.1–1.0 $\mu$ M
Nuclease-free water to	25 $\mu$ l	n.a.
DNA template	1–5 $\mu$ l	

n.a., not applicable



**Table 3:** Protocol A: PCR components for a 25- $\mu$ l reaction volume for the two LAMP assays

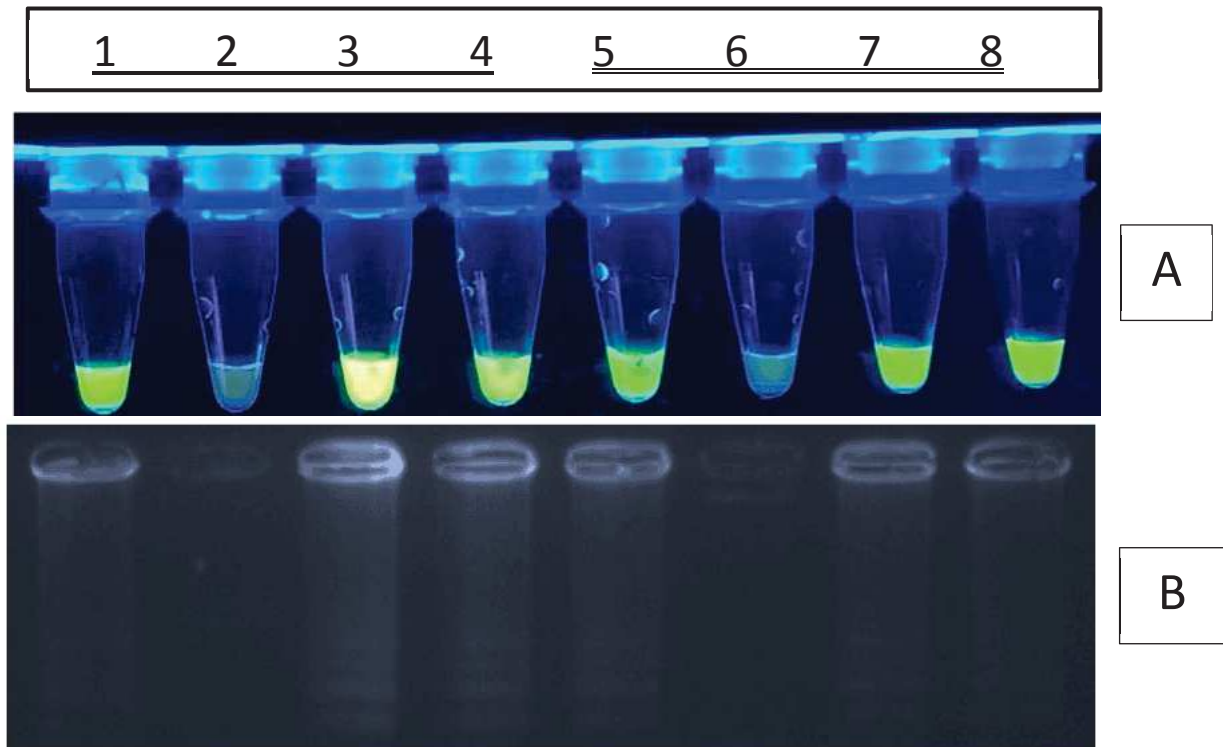
<b>LAMP PCR component</b>	<b>Volume per reaction (<math>\mu</math>L)</b>
<i>Bst</i> 2.0 (New England Biolabs) 8 U/ $\mu$ L	1
Isothermal Amplification Buffer (New England Biolabs) 10X	2.5
Betaine (Sigma Aldrich) 5M	4
dNTPs (10 mM)	3.5
MgSO <sub>4</sub> (100 mM)	1.5
Outer primers (F3 and B3; 1 $\mu$ M)	0.768 (each)
Inner primers (FIP and BIP; 10 $\mu$ M)	0.768 (each)
Loop primers (F-Loop and B-Loop; 10 $\mu$ M)	0.384 (each)
Water	7.66
Template (genomic DNA [20 ng/ $\mu$ l], heat-killed bacterial cells, seed extract or cell suspension from symptomatic plant tissue)	1
<b>Total</b>	<b>25</b>
Mineral oil	20
Quant-IT™ Pico Green® Reagent (Invitrogen, Carlsbad, CA, USA)	0.5

**Table 4:** Preparation of LAMP primers

<b>Primer</b>	<b>10x concentration (stock)</b>	<b>1x concentration (final)</b>
FIP	16 $\mu$ M	1.6 $\mu$ M
BIP	16 $\mu$ M	1.6 $\mu$ M
F3	2 $\mu$ M	0.2 $\mu$ M
B3	2 $\mu$ M	0.2 $\mu$ M
LOOP F	4 $\mu$ M	0.4 $\mu$ M
LOOP B	4 $\mu$ M	0.4 $\mu$ M

**Table 5:** Protocol B. PCR components for a 25- $\mu$ l reaction volume for the two LAMP assays.

	<b>DNA target</b>	<b>No-template control</b>
WarmStart colorimetric LAMP 2x master mix	12.5 $\mu$ l	12.5 $\mu$ l
LAMP primer mix (10x)	2.5 $\mu$ l	2.5 $\mu$ l
Target DNA	1 $\mu$ l	–
dH <sub>2</sub> O	9 $\mu$ l	10 $\mu$ l
Total Volume	25 $\mu$ l	25 $\mu$ l



**Figure 1:** Evaluation of the species-specific and the genus-specific LAMP tools.

A. LAMP reaction tubes under UV light for fluorescence positive reactions for a color change from Light green to dark green.

B. Agarose gel electrophoretogram of *Pantoea* spp. LAMP products.

*P. ananatis*-specific LAMP tool: Lane 1, CFBP466 (*P. ananatis*); lane 2, CFBP6627<sup>T</sup> (*P. cedenensis*); lane 3, CFBP3612<sup>T</sup> (*P. ananatis*); lane 4, CFBP3171 (*P. ananatis*).

*Pantoea* genus LAMP Tool: Lane 5, CFBP3845<sup>T</sup> (*P. agglomerans*); lane 6, BAI3 (*X. oryzae* pv. *oryzae*); lane 7, CFBP466 (*P. ananatis*); lane 8, CFBP6627<sup>T</sup> (*P. cedenensis*).



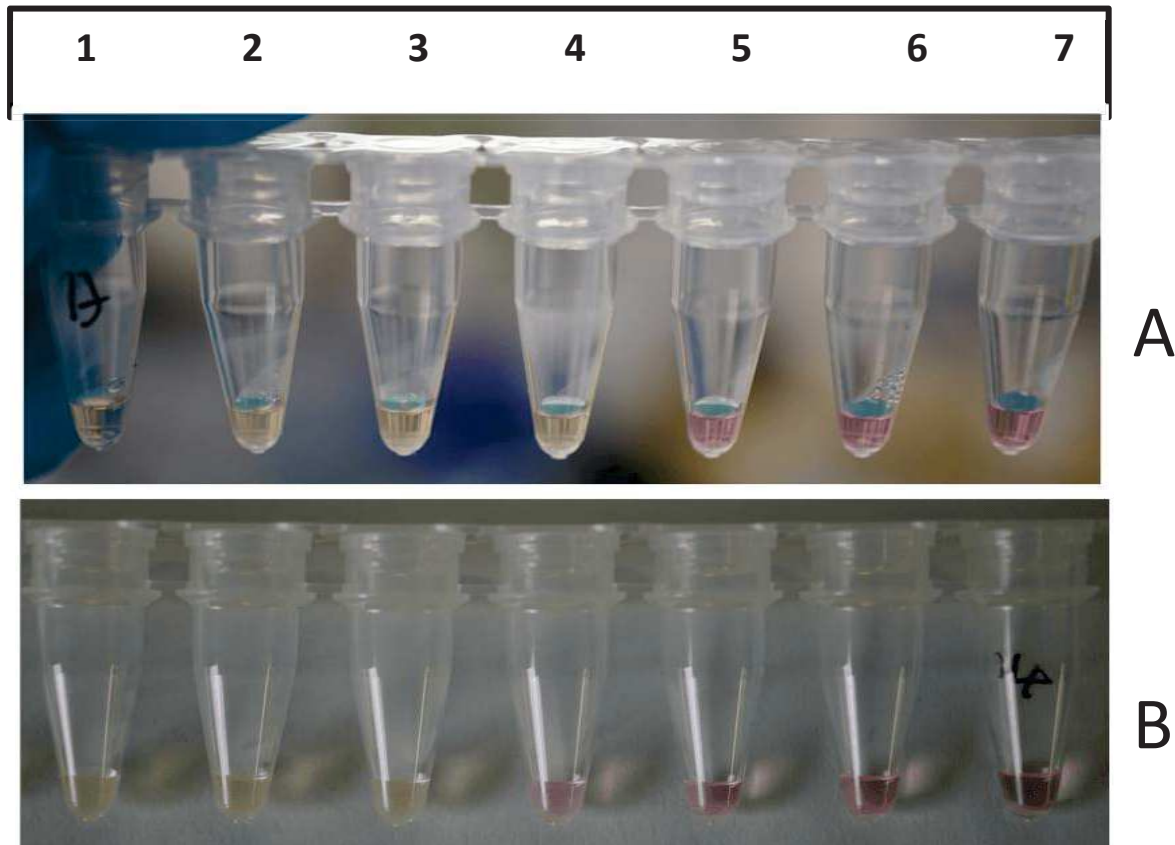
**Figure 2:** Screening of new *Pantoea* isolates using the species-specific and genus-specific LAMP tool.

A. Negative results from the both tests on bacteria belonging to the genus *Sphingomonas* spp., *Xanthomonas* spp., *Pseudomonas* spp. and *Erwinia* spp.

B. Positive results of the genus-specific LAMP tool with some *Pantoea* spp.

C. Positive results of the species-specific LAMP tool with some *P. ananatis* strains.

(listed in Additional File 1, Table 1, 2, 3 & 4)



**Figure 3:** Evaluation of the sensitivity of the species-specific and genus-specific LAMP tools. LAMP assays were carried out using genomic DNA extracted from *P. ananatis* strain CFBP3612T. Lanes 1 to 7 represent 6 ng, 600 pg, 60 pg, 6 pg, 600 fg, 60 fg of DNA and water, respectively. The detection limit of the genus-specific LAMP tool was 600 fg and 6 pg for the species-specific tool.

A. *Pantoea* genus-specific LAMP tool. Reaction sensitivity was assessed with the naked eye.

B. *P. ananatis*-specific LAMP tool. Reaction sensitivity was assessed with the naked eye.

#### **Additional files**

**Attachment, Table 1 and table 3:** List of bacterial strains used to evaluate the LAMP tools.

#### 4. Third drafted manuscript: Development, evaluation and validation of a semi-selective medium for bacteria of the genus *Pantoea* (PGS medium)

Kossi Kini<sup>1,2</sup>, Rachelle Dossa<sup>1</sup>, Mariam Mariko<sup>1</sup>, Ralf Koebnik<sup>2</sup> and Drissa Silué<sup>1</sup>

<sup>1</sup>AfricaRice, Plant Pathology, B.P. 2031, Cotonou, Benin

<sup>2</sup>IRD, Cirad, Université de Montpellier, IPME, Montpellier, France

##### 4.1. Introduction

A culture medium for an organism (e.g. bacteria, yeast and fungi) is the one that enables the in-vitro cultivation. It contains all essential elements including nutrients for a rapid multiplication of these organisms. The medium is qualified as selective when one adds elements that favour the growth of members of a particular and inhibits that of other undesirable microorganisms. The added elements are selected according to the characteristics of the desired microorganism. For bacterial, certain intrinsic characteristics of some genus or family make it possible to design selective media.

Although reported earlier as rice pathogens in other continents, three *Pantoea* species were only recently described as such in Africa [1,2]. The bacterium has also been isolated from rice seeds and leaves of rice plants in several rice fields in Africa [3]. In addition to bacteria of the genus *Pantoea*, other bacteria of other genus (*Xanthomonas* spp., *Sphingomonas* spp. *Burkholderia* spp. and *Pseudomonas* spp.) have also been isolated from Rice leaves and seeds in Africa and worldwide [4–9]. On certain culture media, all these bacteria together with those of *Pantoea* spp. have almost the same phenotypic characteristics (pigmentation, shape, elevation ... etc.). Cases of co-infection of *Pantoea* spp.-*Sphingomonas* spp. and *Pantoea* spp.-*Xanthomonas oryzae* were even observed in seeds [3] and Rice leaves, respectively (unpublished data). This is frequently the cause of the difficulties of providing pure bacterial colonies for each of the genera and results in contaminations, thus posing difficulties for reliable diagnosis.

Hence, a semi-selective culture medium is required, capable of promoting the growth of *Pantoea* spp. and inhibiting the growth of other phytopathogenic or epiphytic bacteria. Goszczynska et al. (2006) had developed a culture medium for *P. ananatis* but not for the other *Pantoea* spp. Moreover, the reagents for its preparation are expensive and difficult to access for laboratories in developing countries.

Here, in order to facilitate the isolation of pure colonies of *Pantoea* spp. from seeds, leaves and other organs, a specific and selective culture medium for *Pantoea* spp. has been developed. Based on the hyper halophilic property of *Pantoea* spp. (isolated in the seabed) a culture medium with a high concentration of NaCl (65%) in combination with other chemicals was developed and was able to inhibit growth and multiplication of other gram-negative isolates of bacteria, yeast and fungi.

## 4.2. Methodology

### Preparation of PGS- Medium (Table 1)

1. The following mixture composition was suspended in 1 liter of sterile distilled water (pH  $7.1 \pm 0.2$ );
2. The medium was heated while stirring to fully dissolve all components;
3. The medium is then autoclaved at 121 degrees Celsius for 15 minutes;
4. The autoclaved PGS medium is left to cool down but not solidify. It is then poured into Petri dishes and left under a sterile surface (laminar flow cabinet) to solidify;
5. The Petri dishes were then put in a plastic bag, sealed and stored either under the laminar flow cabinet or a fridge ( $\pm 5$  degrees Celsius) until their use.

**Table 1: Composition of 1 liter PGS medium**

Sodium chloride	65 g
Cristal violet	0.001 g
Sodium thiosulfate	8.5 g
Agar	13.5 g
Peptone	10 g
Sucrose	10 g

### Evaluation of selectivity and specificity

#### With pure isolats and refence strains

##### Isolates and reference strains used

A total of fifty pure *Pantoea* spp originating from Africa Rice collection were used [1,2]. They were isolated from rice seeds and leaves collected in paddy fields in sub-Saharan Africa (Table 1 Additional file at attachment). Seven reference strains from the French Collection of Phytopatogenic Bacteria (CFBP, Angers, France), nine *Xanthomonas oryzae* pv. *oryzae* strains and five strains of *X. oryzae* pv. *oryzicola*, nine isolates of *Sphingomonas* sp., nine isolates of *Bacillus* sp., three isolates of *Burkholderia* spp., and two strains of *Pseudomonas* sp were used for the media evaluation and validation.

To confirm the selectivity and specificity, comparative tests were made with the above pure isolates and references strains plated on the PGS medium and with two non-selective media including PSA (Peptone sucrose agar) with for 1 L: 10 g peptone, 10 g sucrose, 16 g agar and 1 g glutamic acid, 1 L distilled sterile water with pH adjusted to  $7.1 \pm 0.2$ ) and NA (Nutrient Agar) with for 1 L: 0.5% Peptone, 0.3% beef extract / yeast extract, 1.5% agar, 0.5% sodium chloride, 28 g of nutrient agar powder, 1 L distilled sterile water and pH adjusted to neutral (6.8) at 25 °C).



### - with samples of Rice leaves and seed

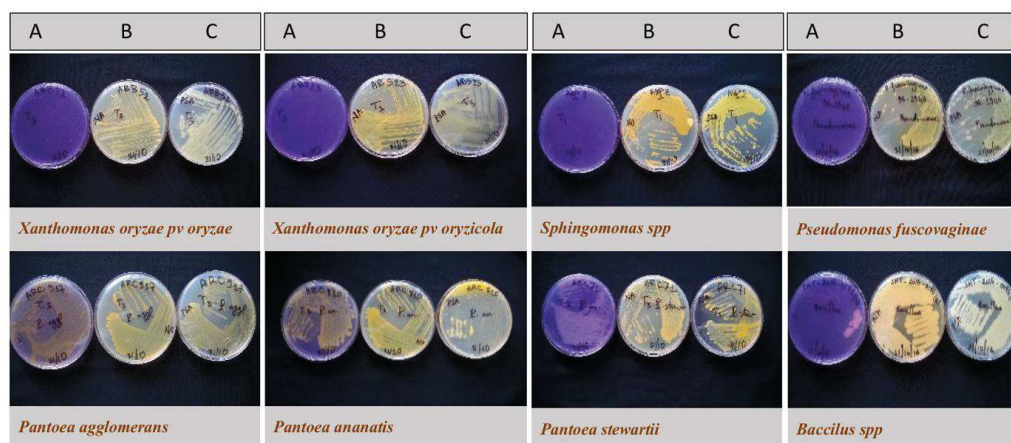
For the rice seeds, each grain had been soaked for 5 min in solution of sodium hypochlorite (1%) followed by ethanol (70%) and then washed 3 times with distilled sterile water for their surface sterilization. The seeds were then plated on 9 cm diameter Petri dishes containing the selective medium. For leaves, diseased rice leaf pieces (1 mm) that were surface-sterilized (as for the seed), were crushed or macerated in distilled sterile water and the resulting sap was plated by striking it on the plates of the selective medium.

The same tests were repeated with two non-selective media including PSA (peptone sucrose agar) with for 1 L: 10 g peptone, 10 g sucrose, 16 g agar and 1 g glutamic acid, 1 L distilled sterile water with pH adjusted to  $7.1 \pm 0.2$ ) and Na (Nutrient Agar) with for 1 L: 0.5% Peptone, 0.3% beef extract / yeast extract, 1.5% agar, 0.5% sodium chloride, 28 g of nutrient agar powder, 1 L distilled sterile water and pH adjusted to neutral (6.8) at 25 °C). PSA and NA were then autoclaved and poured in Petri dishes and stored as described for PGS medium.

### 4.3. Results

The different tests carried out with the three species of *Pantoea* spp. and bacteria of other genera (*Xanthomonas* spp., *Sphingomonas* spp., *Bacillus* spp., *Burkholderia* spp., and *Pseudomonas* spp.) isolated from the rice seeds or leaves have shown that only the bacteria of the genus *Pantoea* grew on the selective medium while that isolates of the other genera were inhibited. Interestingly no fungus grew on the plates with the selective media while PSA ones showed numerous fungi (data not shown)

Concerning the characteristic of the colonies on the media, for PSA and NA, an average of forty beige to yellow, round, convex and smooth with all margins colonies appear after 24 hours. For PGS Media, an average of twenty colonies of the same characteristics with except that they were margins with purple color appears after 48 hours. This color will be due to use crystal violet by colonies. After 72 hrs, for PSA and NA and 96 hrs for PGS, the colonies of *P. ananatis* and *P. agglomerans* coalesce and form a spot that adheres to the culture media. This pale yellow spot, very viscous, was little floury for *P. ananatis* and not floury for *P. agglomerans*. It was unable to mix and flip into the lid when their Petri dishes were shaken or flipped. It was easily scraped and transferable with a handle in cryotubes for preservation. For *P. stewartii*, coalescence of colonies occurred after 48 hrs for PSA and NA and 72 hrs for PGS. The wasn't very viscous but sticky; it was light yellow with water presences which diminishes the color tenner in certain places. Since it is not very adherent to the medium, it easily mixed and spilled in the lid when Petri dish were shaken or flipped. This makes it difficult to scrape and transferable in cryotubes. Note that on the PGS, the purple color of the colonies margins disappears for the three species after their coalescence.



**Figure 1:** Photographs show that the three species *P. ananatis*, *P. stewartii* and *P. agglomerans* grow perfectly on all media including selective medium. However, the bacteria of the other genera (*Xanthomonas*, *Sphingomonas*, *Bacillus* spp. and *Pseudomonas*) are inhibited by the selective medium but grow perfectly on the other media (PSA and NA). A, PGS medium; B, PSA medium; C, NA medium.

#### 4.4. Discussion and conclusion

*Pantoea* has 24 species out of which five cause damage to several crops including [11–14]. However, three of them namely *P. ananatis*, *P. agglomerans* and *P. stewartii*, are responsible for more than 80% of the reported plant disease cases. Colonies of *X. oryzae pv. oryzae*, *Sphingomonas sp.* have phenotypic colonies features that are more or less similar to those of *Pantoea* spp. making thus, their isolation more challenging and requiring other tools (including biochemical and molecular) for differentiating them. In addition, cases of co-infection of *Pantoea spp.* and *Sphingomonas spp* and *Pantoea spp.* and *X. oryzae* were observed in our laboratory on seeds [3] and rice leaves respectively (unpublished data). It is thus important to have tools enabling their diagnosis and pure culture isolation. The aim of the present study was thus to develop a medium that is specific to isolate in this genus as this would help address the difficulties mentioned above. Such a medium would facilitate the isolation of strains of this genus *Pantoea* that are attack the different organs of rice (e.g. leaves, stems and seeds). This medium was developed and contains elements such as high concentration sodium chloride (65%), sodium thiosulfate and crystal violet). This media was shown to inhibit the growth of fungi and other bacteria associated with rice (eg. fungi, bacteria such as *Xanthomonas oryzae* pathovars, *Sphingomonas sp.*, *Bacillus sp.*, *Burkholderia spp.*, and *Pseudomonas spp.*). By contrast, all *Pantoea* spp. isolates tested grew normally like on the non-selective PSA medium. It can thus be stated that this new medium is selective for isolates of the genus *Pantoea*. When saps from diseased rice (seed and vegetative plant organs such as leaves) samples were plated on this medium, only bacteria belonging to the *Pantoea* genus grew. PGS-Media can thus also be used as a diagnostic tool that complements to the molecular diagnosis one [1,2].

Semi-selective media exist for the isolation and culture of *Pantoea* spp isolates [15] but they are not discriminant for the bacterial species mentioned above. Goszczynska et al. (2006) developed a medium that was shown to be specific for *P. ananatis* as only isolates from this species grew on it while other bacterial nor fungal microbe did not. This medium contained

Crystal violet and thallium nitrate for suppressing bacteria and fungi [16,17] but was rich NaCl with 20 g/L (20%). The newly developed media contained Crystal violet but had a much higher sodium content (65%) which probably did not allow the growth other bacteria and fungi that do not have halophilic properties like *Pantoea spp.*

The newly developed medium can also be used for purifying isolates contaminated by other bacteria such as *Sphingomonas* sp. It requires few ingredients, affordable and can be easily prepared and used in less equipped laboratories including Plant Quarantine ones. It is meant for *Pantoea* spp preliminary diagnostic tests when their presence is suspected especially on seeds. However, the use of this medium cannot replace the testing of the individual derived. This media is intended for professional use only. Do not use Petri dishes that show signs of microbial contamination, discoloration, drying, cracking or any other type of deterioration. Please follow the usual procedures on the handling of microbial cultures) and operate under aseptic conditions. Avoid biological hazards and follow strict application of methods for disposal of the products used. After being poured in the Petri dishes, these dishes should be stored at 2-8 ° C in a clean place and can be used for up to one week. Do not freeze or overheat the dishes. The dishes can be plated just after their solidification and incubated for the recommended incubation periods (48 to 72 hours).

#### References cited

1. Kini K, Agnimonhan R, Afolabi O, Milan B, Soglonou B, Gbogbo V, et al. First report of a new bacterial leaf blight of rice caused by *Pantoea ananatis* and *Pantoea stewartii* in Benin. Plant Dis. 2017;101:242.
2. Kini K, Agnimonhan R, Afolabi O, Soglonou B, Silué D, Koebnik R. First report of a new bacterial leaf blight of rice caused by *Pantoea ananatis* and *Pantoea stewartii* in Togo. Plant Dis. 2017;101:241.
3. Dossou B, Silue D. Rice pathogens intercepted on seeds originating from 11 African countries and from the USA. Seed Sci. Technol. 2018;46:31–40.
4. Wonni I, Cottyn B, Detemmerman L, Dao S, Ouedraogo L, Sarra S, et al. Analysis of *oryzae* pv. *oryzicola* population in Mali and Burkina Faso reveals a high level of genetic and pathogenic diversity. Phytopathology 2014;104:520–531.
5. Poulin L, Grygiel P, Magne M, Gagnevin L, Rodriguez-R LM, Serna NF, et al. New Multilocus Variable-Number Tandem-Repeat Analysis tool for surveillance and local epidemiology of bacterial leaf blight and bacterial leaf streak of rice caused by *Xanthomonas oryzae*. Appl. Environ. Microbiol. 2015;81:688–698.
6. Kini K, Agnimonhan R, Dossa R, Soglonou B, Gbogbo V, Ouedraogo I, et al. First report of *Sphingomonas* sp. causing bacterial leaf blight of rice in Benin, Burkina Faso, The Gambia, Ivory Coast, Mali, Nigeria, Tanzania and Togo. New Dis. Rep. 2017;35:32.
7. Duveiller E, Miyajima K, Snacken F, Autrique A, Maraite H. Characterization of *Pseudomonas fuscovaginae* and differentiation from other fluorescent *pseudomonads* occurring on rice in Burundi. J. Phytopathol. 1988;122:97–107.
8. Cui Z, Ojaghian M r., Tao Z, Kakar K u., Zeng J, Zhao W, et al. Multiplex PCR assay for simultaneous detection of six major bacterial pathogens of rice. J. Appl. Microbiol. 2016;120:1357–67.

9. Zhu B, Lou M, Huai Y, Xie G, Luo J, Xu L. Isolation and identification of *Burkholderia glumae* from symptomless rice seeds. *Rice Sci.* 2008;15:145–149.
10. Goszczynska T, Venter SN, Coutinho TA. PA 20, a semi-selective medium for isolation and enumeration of *Pantoea ananatis*. *J. Microbiol. Methods* 2006;64:225–231.
11. Sherafati F, Khodaygan P, Azadvar M, Sedaghati E, Saberi-Riseh R, Baghaee-Ravari S. Association of *Pantoea* agglomerans with the citrus bacterial canker disease in Iran. *J Crop Prot.* 2014;3:345–55.
12. González AD, Franco MA, Contreras N, Galindo-Castro I, Jayaro Y, Graterol E. First report of *Pantoea* agglomerans causing rice leaf blight in Venezuela. *Plant Dis.* 2015;99:552–552
13. De Maayer P. Genome comparisons to identify selected pathogenicity factors of a plant-associated *Pantoea ananatis* strain [PhD dissertation]. University of Pretoria, South Africa; 2011.
14. Block CC, Hill JH, McGee DC. Seed transmission of *Pantoea stewartii* in field and sweet corn. *Plant Disease*, 1998;82:775–780.
15. Mamede MC, Tebaldi ND, Mota LC, Martins OM, Coelho L. Detection of *Pantoea ananatis* in corn seeds on semi-selective medium. *Tropical Plant Pathology*, 2018;43:254-256.
16. Norris P, Man WK, Hughes MN. Toxicity and accumulation of thallium in bacteria and yeast. *Arch. Microbiol.* 1976;110:279–286.
17. Srivastava TN, Bajpai KK, Singh K, Anti-microbial activities of diaryl gallium, indium and thallium compounds. *Indian J. Agric. Sci.* 1973;43:88–93.

#### **IV. Genotyping of *Pantoea ananatis* by complete WGSs analyses and MLVA schemes**

##### **1. Fourth drafted manuscript: Draft genome sequences of three strains of *Pantoea ananatis*, an emerging bacterial phytopathogen threatening rice production in sub-Saharan Africa**

###### **1.1. Context and justification of the project**

Many different molecular methods are used for the detection and identification of plant pathogens. The use of these different methods depends on the circumstances and issues. For many of the microbial phytopathogens, diagnosis poses problems because of the absence of specific tools, which are universally and easily applicable. In situations of doubts about the identity of a microorganism, draft sequencing and analysis of the genome sequence represents an effective means for identification and characterization of emerging plant pathogens in epidemic situations. Therefore, after identification by partial sequencing of the 16S rRNA and *gyrB* housekeeping gene, genomes of *Pantoea* isolates from phytosanitary surveys in three African countries were sequenced and analyzed.

The results obtained from the analyses allowed us to:

- Confirm the efficacy of diagnostic tools that were developed based on partial gene sequencing;
- Have a better idea of the phylogenetic relationships between African, Asian (India and China) and European (Spain) isolates of *P. ananatis* isolated from rice and other sources;
- Compare the gene content of African isolates with those of other strains of *P. ananatis*.

All the details of this first report about the sequencing and analysis of three WGSs of *P. ananatis* are summarized in the following article. The three WGSs and the data from their analyses represent a reference resource for the scientific community. Inventory and understanding of the factors that are involved in the pathogenicity of this pathogen constitute exploitable information for rice breeders.

###### **Personal involvement**

I drafted this manuscript in cooperation with all co-authors.

## 1.2. Manuscript

**Kossi Kini<sup>1,2</sup>, Pierre Leveuvre<sup>3</sup>, Lucie Poulin<sup>2</sup>, Drissa Silué<sup>1</sup>, and Ralf Koebnik<sup>2</sup>**

<sup>1</sup> AfricaRice, Plant Pathology, Africa Rice Centre, B.P. 2031, Cotonou, Benin

<sup>2</sup> IRD, Cirad, Université de Montpellier, IPME, Montpellier, France

<sup>3</sup> Pôle de Protection des Plantes, UMR Peuplements Végétaux et Bioagresseurs en Milieu Tropical, Cirad-Université de la Réunion, Saint-Pierre, Ile de la Réunion, France

Correspondence: koebnik@gmx.de; Institut de Recherche pour le Développement, 911 avenue Agropolis, 34394 Montpellier, France

## 1.3. Abstract

Members of the genus *Pantoea* have been reported as pathogens for many economically important crops, including rice. Little is known about their host-pathogen interactions at the molecular level and the lack of comprehensive genome data impede targeted breeding strategies towards resistant rice cultivars. Here, we describe the structural and functional annotation of the draft genome sequences of three rice-pathogenic *Pantoea ananatis* strains, ARC272, ARC310, and ARC311, which were isolated in Burkina Faso, Togo, and Benin, respectively. The genome sequences of these strains will help in developing molecular diagnostic tools and may provide insight into common traits that enable *P. ananatis* to infect rice.

## Keywords

Extended genome report, *Pantoea ananatis*, *Erwiniaceae*, Rice pathogen, Lipopolysaccharide, Type VI secretion system, West Africa

## Abbreviations

ANI, Average nucleotide identity; CDS, Coding sequence; COG, Cluster of orthologous groups of proteins; CRISPR, Clustered regularly interspaced short palindromic repeat; LPS, Lipopolysaccharide, T6SS, Type VI secretion system

## 1.4. Introduction

The genus *Pantoea* belongs to the *Erwiniaceae* family and is composed of at least 27 species [1–8]. Among them, several are ubiquitous and versatile bacteria, which can interact with animals and plants as a saprophyte, endophyte, epiphyte, or pathogen [1,9,10]. Among the plant-pathogenic *Pantoea*, bacteria of the species *Pantoea ananatis* are implicated in diseases of a wide range of host crops including rice, sudangrass, maize, sorghum, and onion [11–19]. *P. ananatis* was recently reported as responsible for bacterial leaf blight of rice in Togo and Benin [20,21]. Apart from these two countries, many strains of *P. ananatis* were isolated from leaf samples with bacterial leaf blight symptoms and from seeds (discolored or not) of rice

samples originating from other sub-Saharan (SSA) countries. These isolates were shown to cause typical symptoms of bacterial leaf blight after their inoculation to Rice leaves. As in Africa, *Pantoea* species are also a serious threat for crop production in Asia and Latin America [10,22,23].

Genome sequence analysis has revealed insight into candidate pathogenicity determinants of Asian and American strains of *P. ananatis* [23–26]. To complement these data, we report three new genome sequences of *P. ananatis* strains originating from Burkina Faso, Togo, and Benin. These data will help in developing molecular diagnostic tools and may provide insight into the pathogenicity determinants and metabolic features of *P. ananatis* at the molecular level.

## Organism information

### Classification and features

*P. ananatis* is a Gram-negative bacterium that belongs to the family of *Erwiniaceae* [27]. This genus includes at least 27 species [1–8]. Bacteria of the species *P. ananatis* produce yellow pigments, ferment lactose, are motile, and form mucoid colonies. The bacteria show the highest growth rate at 30 °C, pH 7.0, after 50 h cultivation [6]. They consume glucose as a substrate to produce organic acids, which causes the decrease of the culture medium pH [6,28]. Further common characteristics of the species are summarized in Table 1.

Three strains of rice-pathogenic *P. ananatis*, ARC272, ARC310, and ARC311, were isolated in respectively Burkina Faso, Togo, and Benin. ARC310 and ARC311 were isolated from leaves with typical symptoms of bacterial blight and strain ARC272 was isolated from a rice grain. Pure cultures were obtained using the protocol described by Kini and co-workers [20,21].

To get insight into the taxonomic position of the three isolates, we used a well-established multiple locus sequence analysis (MLSA) scheme [1,29]. The corresponding regions of the four housekeeping genes *atpD* (657 bp), *gyrB* (742 bp), *infB* (615 bp), and *rpoB* (637) were extracted from genome sequences (Table 2) and concatenated, resulting in 47 sequences of 2651 bp. Strain MR5 was not included in this analysis because the draft genome sequence does not include the *gyrB* gene. A phylogenetic tree was constructed for all 47 sequences, including the three African strains and the other *Pantoea* strains originating from different sources with different host interactions, using the Phylogeny.fr pipeline at <http://www.phylogeny.fr/phylogeny.cgi> [30]. For better visualization, we used the Interactive Tree Of Life software iTOL v4.2 (<http://itol.embl.de>) [31] (Figure 1).

The phylogenetic tree indicated the presence of two *P. ananatis* clades. One clade contained strains that have been isolated from various animals (e.g. thrips) and plants, such as onion, eucalyptus, and rice while the second clade exclusively contained strains that were isolated from different organs (leaf, grain, and root) of rice. Notably, all three African genomes were found in the rice-specific clade.

Notably, the MLSA revealed cases of apparent taxonomic misidentification. Strain GB1, deposited as *P. ananatis* at GenBank, clustered together with the three *P. agglomerans* strains. Strain MHSD5, likewise deposited as *P. ananatis*, appeared to be distant to all three species of *Pantoea* that were used for the analysis, and might belong to another species of *Pantoea*. Finally, due to the absence of a *gyrB* gene for strain MR5, we performed a MLSA with the remaining three genes which indicated that strain MR5 clusters with the three strains of *P. stewartii* (data not shown).

## Genome sequencing information

### Genome project history

The three African *P. ananatis* strains, ARC272, ARC310, and ARC311, were selected for genome sequencing because no genomic information was available for any *P. ananatis* strain that had been isolated in West Africa. The only available information concerns three strains from South Africa, which were isolated from eucalyptus, maize, and onion. Notably, no African rice-pathogenic *Pantoea* strain has been sequenced before.

The genomes of the three strains were sequenced using the Illumina HiSeq 2500 platform (Fasteris SA, Geneva, Switzerland). Reads from shotgun sequencing were assembled using the Edena algorithm v3.131028 [32]. Annotated high-quality draft genome sequences have been deposited at DDBJ/EMBL/GenBank under the accession numbers PUGD00000000 (ARC272), PUGC00000000 (ARC310) and PUGB00000000 (ARC311) (Tables 3 and 4).

### Growth conditions and genomic DNA preparation

These three strains above used in this study were isolated using routine protocols [20,21] from rice samples (ARC310 and ARC311 from symptomatic blighted Rice leaves and ARC 272 was from rice seeds. Pure cultures these three strains were grown at 28 °C on PSA medium (peptone, 10 g/l<sup>-1</sup>; sucrose, 10 g/l<sup>-1</sup>; agar, 16 g/l<sup>-1</sup>). Genomic DNA was extracted from the cultures using the Wizard<sup>®</sup> genomic DNA purification Kit of Promega (Madison, WI, USA) according to the manufacturer instructions. DNA quality was checked by 0.8% agarose gel electrophoresis and the DNA amount was quantified using a Nanodrop spectrophotometer ND1000 (Nanodrop Technologies, Wilmington, DE, USA) [33].

### Genome sequencing and assembly

The genomes of the three *P. ananatis* strains were sequenced the Illumina HiSeq 2500 platform (Fasteris SA). Libraries with an insert size of 250 bp to 1.5 kb were generated and sequence lengths of 100 nucleotides in both directions were obtained. The shotgun sequencing yielded 1,827,519 100-bp paired-end reads (457 Mb) for strain ARC272, 2,690,980 100-bp paired-end reads (673 Mb) for strain ARC310 and 2,211,169 100-bp paired-end reads (553 Mb) for strain ARC311.



Reads from shotgun sequencing were assembled using the Edena algorithm v3.131028 [32]. For comparison, draft genome sequences were also assembled using the Velvet algorithm v1.1.04 [34]. Both algorithms generated similar numbers of contigs but the Edena algorithm resulted in a better assembly (fewer gaps) of large gene clusters, such as the type VI secretion systems (T6SS) and the lipopolysaccharide biosynthesis gene clusters. Therefore, all further work was done with the Edena-derived assemblies.

### Genome annotation

Edena-derived contigs were annotated with GeneMarkS+ (revision 4.4) [35], as implemented in the NCBI Prokaryotic Genome Annotation Pipeline ([http://www.ncbi.nlm.nih.gov/genome/annotation\\_prok/](http://www.ncbi.nlm.nih.gov/genome/annotation_prok/)).

Functional categorization of predicted CDS included assignment to Clusters of Orthologous Groups (COG) using RPSBLAST and to Protein families (Pfam) using HMMER 3.0, and as implemented at the WebMGA server [36], with an E value of 0.001 as cut-off value (<http://weizhongli-lab.org/metagenomic-analysis/>). Signal peptides were predicted using the SignalP 4.1 server (<http://www.cbs.dtu.dk/services/SignalP/>) [37] and transmembrane alpha-helices were predicted using the TMHMM server v. 2.0 (<http://www.cbs.dtu.dk/services/TMHMM/>) [38] always with default parameters.

The CRISPR Finder web tool at <http://crispr.i2bc.paris-saclay.fr> [39] was used to identify clustered regularly interspaced short palindromic repeats (CRISPRs). The ANI calculator at <http://enve-omics.ce.gatech.edu> [40] was used to calculate genome-wide average nucleotide identities (Table 5) between the three new African *P. ananatis* genome sequences and other publicly available *Pantoea* genome sequences from different sources (Table 2).

### Genome properties

The draft genome sequences of the strains ARC372, ARC311, and ARC310 were 4,615,013 bp, 4,598,241 bp and 4,593,415 bp in size, respectively, and had a G+C content between 53.5 and 53.6%. Between 4420 and 4471 genes were predicted for the three genomes, among which 95% were predicted to encode proteins. The properties and annotation statistics of the genome are presented in Table 4. Functions were predicted for the majority of genes using the GenemarkS+ annotation pipeline and the COG and Pfam databases (Table 6).

## 1.5. Insights from the genome sequences

To assign the taxonomic status and to obtain insight into the phylogenetic relationships among strains of *P. ananatis*, we calculated genome-wide average nucleotide identities among all publicly available *P. ananatis* genome sequences, including our three new African strains. In addition, we included three representative strains of *P. agglomerans* and *P. stewartii* because these species have been reported as rice pathogens as well [20,21,41,42]. This analysis revealed that the hitherto characterized strains of *P. ananatis* form two clades where strains

within each clade are 99% identical to each other while the inter-clade similarity is at only 96% of sequence identity (Table 5). The larger clade contains strains that have been isolated from various plants and animals, such as onion, eucalyptus, rice, and thrips. While the smaller clade exclusively contains strains that have been found to be associated with rice (Table 2). All three African strains described in this study belong the clade of rice-associated *P. ananatis*.

Interestingly, our ANI analyses suggested a taxonomic misidentification of three *P. ananatis* strains for which whole genome sequences were available. Strain GB1 had 98% to 99% sequence identity to the three strains of *P. agglomerans* that were included in our analysis. Similarly, strain MR5 had 99% sequence identity to the three strains of *P. stewartii*. Finally, strain MHSD5 shared less than 91% sequence identity with any of the strains included in our analysis and is thus likely to belong to another *Pantoea* species.

Protein secretion systems are often critical for virulence of plant pathogens. As reported before, all three strains lack type II, type III, and type IV secretion systems, but contain three clusters of type VI secretion systems. However, only strain ARC272 has the full complement of all three T6SSs reported before [25,6] while strains ARC310 and ARC311 share a 2634-bp deletion in T6SS-3 that removes most parts of the genes PANA\_4150-PANA\_4149. Another large deletion of more than 20 kb goes from gene PANA\_4147, removing the last 87 codons, until PANA\_4133, removing the first 37 codons, thus removing/inactivating 15 T6SS-3 genes in strains ARC310 and ARC311. Further work will address the question if the absence of the third T6SS is linked to the occurrence of the strains on Rice leaves, while the strain with an intact T6SS-2 was isolated from a rice grain.

Lipopolysaccharides (LPS) play an important role in the pathogen-plant interaction. Moreover, LPS of another *Pantoea* species, *P. agglomerans* have been reported to exert effects on mammalian cells and have some potential as immunopotentiators and vaccine adjuvant [43,44]; they have also been evaluated in cancer therapy and as a means to maintain bone density in premenopausal women [45,46]. These observations prompted us to compare the LPS gene cluster of strains of *P. ananatis*. All three African strains shared a gene cluster of 18 genes, which are implicated in the synthesis of the O antigen, incl. *rfaC*, *rfaF*, *rfaG*, *rfaL*, *rfaQ*, and *wcaL*. The same genes were found in all the strains that belong to the rice-associated clade of *P. ananatis*. Interestingly, *P. ananatis* strains of the other clade share the seven left (PANA\_3882 to PANA\_3888 in strain LMG 20102) and the six right (PANA\_3894 to PANA\_3899 in strain LMG 20102) genes with the rice-associated strains. However, the five central genes have been replaced by another six genes. Hence, both clades of *P. ananatis* are predicted to be serologically distinct and are likely to be distinguishable from each other by immunological means.

## 1.6. Conclusions

The three *P. ananatis* genomes described in this study represent the first genomic resources reported for this bacterium originating from SSA. Phylogenetic trees based on *atpD* gene sequences and on ANI values (>96%) highlighted the taxonomic position of the three strains relative to other characterized strains isolated from rice and other sources and originating from other continents. Interestingly, the above two tests have shown that the sub-Saharan

African strains were closer to strains isolated from rice in India and China than to strains isolated from other sources, such as maize, onion, and eucalyptus tree. The analysis of LPS and T6SS gene clusters revealed some intra-lineage differences with respect to the serological features and some within-lineage variation with respect to the T6SS configuration. Altogether, these data sets represent a useful basis for the functional analysis of distinct genomic traits that might be involved in host range adaptation of *P. ananatis*.

### **Competing interests**

The authors declare that they have no competing interests.

### **Funding**

This study was supported by a PhD scholarship for Kossi Kini from the French Research Institute for Sustainable Development (IRD) within the programme “Allocation de Recherche pour une Thèse au Sud” (ARTS). The Africa Rice Center (AfricaRice) received financial support from the Global Rice Science Partnership (GRiSP) and the Ministry of Foreign Affairs, Japan that contributed to the project.

### **Authors' contributions**

KK, DS, and RK conceived and designed the experiments. LP managed the genome sequencing and PL performed the genome assemblies. KK and RK analyzed the draft genome sequences. KK, DS, and RK wrote the manuscript. All authors read and approved the final manuscript.

### **Acknowledgements**

We thank Toyin Afolabi (Africa Rice Center Cotonou, Benin), Sandrine Fabre and Florence Auguy (IRD, Cirad, University Montpellier, IPME, Montpellier, France) for respectively isolate collection and excellent technical support.

### **Availability of data and materials**

Draft genome sequences have been deposited at DDBJ/EMBL/GenBank under the accession numbers PUGB00000000 (strain ARC311), PUGC00000000 (strain ARC310), and PUGD00000000 (strain ARC272).

### **Ethics approval and consent to participate**

Not applicable.

### **References**

1. Brady C, Cleenwerck I, Venter S, Vancanneyt M, Swings J, Coutinho T. Phylogeny and identification of *Pantoea* species associated with plants, humans and the natural environment based on multilocus sequence analysis (MLSA). *Syst Appl Microbiol*. 2008;31:447–460.
2. Brady CL, Cleenwerck I, van der Westhuizen L, Venter SN, Coutinho TA, De Vos P. *Pantoea rodasii* sp. nov., *Pantoea rwandensis* sp. nov. and *Pantoea wallisii* sp. nov., isolated from Eucalyptus. *Int J Syst Evol Microbiol*. 2012;62:1457–64.
3. Brady CL, Goszczynska T, Venter SN, Cleenwerck I, De Vos P, Gitaitis RD, et al. *Pantoea allii* sp. nov., isolated from onion plants and seed. *Int J Syst Evol Microbiol*. 2011;61:932–937.
4. Brady CL, Cleenwerck I, Venter SN, Engelbeen K, De Vos P, Coutinho TA. Emended description of the genus *Pantoea*, description of four species from human clinical samples, *Pantoea septica* sp. nov., *Pantoea eucrina* sp. nov., *Pantoea brenneri* sp. nov. and *Pantoea conspicua* sp. nov., and transfer of *Pectobacterium cypripedii* (Hori 1911) Brenner et al. 1973 emend. Hauben et al. 1998 to the genus as *Pantoea cypripedii* comb. nov. *Int J Syst Evol Microbiol*. 2010;60:2430–2440.
5. Brady CL, Venter SN, Cleenwerck I, Engelbeen K, Vancanneyt M, Swings J, et al. *Pantoea vagans* sp. nov., *Pantoea eucalypti* sp. nov., *Pantoea deleyi* sp. nov. and *Pantoea anthophila* sp. nov. *Int J Syst Evol Microbiol*. 2009;59:2339–2345.
6. Gavini F, Mergaert J, Beji A, Mielcarek C, Izard D, Kersters K, et al. Transfer of *Enterobacter agglomerans* (Beijerinck 1888) Ewing and Fife 1972 to *Pantoea* gen. nov. as *Pantoea agglomerans* comb. nov. and description of *Pantoea dispersa* sp. nov. *Int J Syst Bacteriol*. 1989;39:337–345.
7. Kageyama B, Nakae M, Yagi S, Sonoyama T. *Pantoea punctata* sp. nov., *Pantoea citrea* sp. nov., and *Pantoea terrea* sp. nov. isolated from fruit and soil samples. *Int J Syst Bacteriol*. 1992;42:203–210.
8. Mergaert J, Verdonck L, Kersters K. Transfer of *Erwinia ananas* (synonym, *Erwinia uredovora*) and *Erwinia stewartii* to the genus *Pantoea* emend. as *Pantoea ananas* (Serrano 1928) comb. nov. and *Pantoea stewartii* (Smith 1898) comb. nov., respectively, and description of *Pantoea stewartii* subsp. *indologenes* subsp. nov. *Int J Syst Bacteriol*. 1993;43:162–173.
9. Brady, CL: Taxonomy of *Pantoea* associated with bacterial blight of *Eucalyptus* [Dissertation, University of Pretoria, South Africa]. 2007. <https://repository.up.ac.za/handle/2263/27539>. Assessed 31 May 2018.
10. Walterson AM, Stavrinos J. *Pantoea*: insights into a highly versatile and diverse genus within the *Enterobacteriaceae*. *FEMS Microbiol Rev*. 2015;39:968–984.
11. Achbani EH, Mazouz H, Benbouazza A, Sadik S. First detection of *Pantoea ananatis*, the causal agent of bacterial center rot of onion in Morocco. *J Crop Prot*. 2015;5:11–17.
12. Azad HR, Holmes GJ, Cooksey DA. A new leaf blotch disease of sudangrass caused by *Pantoea ananas* and *Pantoea stewartii*. *Plant Dis*. 2000;84:973–979.
13. Cortesi P, Pizzatti C. Palea browning, a new disease of rice in Italy caused by *Pantoea ananatis*. *J Plant Pathol*. 2007;89 Suppl 3:76.
14. Cota LV, Costa RV, Silva DD, Parreira DF, Lana UGP, Casela CR. First report of

- pathogenicity of *Pantoea ananatis* in sorghum (*Sorghum bicolor*) in Brazil. Australas Plant Dis Notes. 2010;5:120–122.
15. Egorova M, Mazurin E, Ignatov AN. First report of *Pantoea ananatis* causing grain discolouration and leaf blight of rice in Russia. New Dis Rep. 2015;32:21.
  16. Gitaitis R, Walcott R, Culpepper S, Sanders H, Zolobowska L, Langston D. Recovery of *Pantoea ananatis*, causal agent of center rot of onion, from weeds and crops in Georgia, USA. Crop Prot. 2002;21:983–989.
  17. Gitaitis RD, Gay JD. First report of a leaf blight, seed stalk rot, and bulb decay of onion by *Pantoea ananas* in Georgia. Plant Dis. 1997;81:1096.
  18. Mondal KK, Mani C, Singh J, Kim JG, Mudgett MB. A new leaf blight of rice caused by *Pantoea ananatis* in India. Plant Dis. 2011;95:1582.
  19. Yan H, Yu SH, Xie GL, Fang W, Su T, Li B. Grain discoloration of rice caused by *Pantoea ananatis* (synonym *Erwinia uredovora*) in China. Plant Dis. 2010;94:482.
  20. Kini K, Agnimonhan R, Afolabi O, Milan B, Soglonou B, Gbogbo V, et al. First report of a new bacterial leaf blight of rice caused by *Pantoea ananatis* and *Pantoea stewartii* in Benin. Plant Dis. 2017;101:242.
  21. Kini K, Agnimonhan R, Afolabi O, Soglonou B, Silué D, Koebnik R. First report of a new bacterial leaf blight of rice caused by *Pantoea ananatis* and *Pantoea stewartii* in Togo. Plant Dis. 2017;101:241.
  22. Dutkiewicz J, Mackiewicz B, Kinga Lemieszek M, Golec M, Milanowski J. *Pantoea agglomerans*: a mysterious bacterium of evil and good. Part III. Deleterious effects: infections of humans, animals and plants. Ann Agric Environ Med. 2016;23:197–205.
  23. Weller-Stuart T, De Maayer P, Coutinho T. *Pantoea ananatis*: genomic insights into a versatile pathogen. Mol Plant Pathol. 2017;18:1191–1198.
  24. Coutinho TA, Venter SN. *Pantoea ananatis*: an unconventional plant pathogen. Mol Plant Pathol. 2009;10:325–335.
  25. De Maayer P, Chan WY, Rubagotti E, Venter SN, Toth IK, Birch PRJ, et al. Analysis of the *Pantoea ananatis* pan-genome reveals factors underlying its ability to colonize and interact with plant, insect and vertebrate hosts. BMC Genomics. 2014;15:404.
  26. De Maayer P, Venter SN, Kamber T, Duffy B, Coutinho TA, Smits TH. Comparative genomics of the type VI secretion systems of *Pantoea* and *Erwinia* species reveals the presence of putative effector islands that may be translocated by the VgrG and Hcp proteins. BMC Genomics. 2011;12:576.
  27. Adeolu M, Alnajar S, Naushad S, Gupta RS. Genome-based phylogeny and taxonomy of the ‘*Enterobacteriales*’: proposal for *Enterobacterales* ord. nov. divided into the families *Enterobacteriaceae*, *Erwiniaceae* fam. nov., *Pectobacteriaceae* fam. nov., *Yersiniaceae* fam. nov., *Hafniaceae* fam. nov., *Morganellaceae* fam. nov., and *Budviciaceae* fam. nov. Int J Syst Evol Microbiol. 2016;66:5575–5599.
  28. Jung I, Park DH, Park K. A study of the growth condition and solubilization of phosphate from hydroxyapatite by *Pantoea agglomerans*. Biotechnol Bioprocess Eng. 2002;7:201–5.
  29. Glaeser SP, Kämpfer P. Multilocus sequence analysis (MLSA) in prokaryotic taxonomy. Syst Appl Microbiol. 2015;38:237–245.
  30. Dereeper A, Guignon V, Blanc G, Audic S, Buffet S, Chevenet F, et al. Phylogeny.fr:

- robust phylogenetic analysis for the non-specialist. *Nucleic Acids Res.* 2008;36:W465- W469.
31. Letunic I, Bork P. Interactive tree of life (iTOL) v3: an online tool for the display and annotation of phylogenetic and other trees. *Nucleic Acids Res.* 2016;44:W242– W245.
  32. Hernandez D, Tewhey R, Veyrieras JB, Farinelli L, Østerås M, François P, et al. De novo finished 2.8 Mbp *Staphylococcus aureus* genome assembly from 100 bp short and long range paired-end reads. *Bioinformatics.* 2013;30:40–49.
  33. Desjardins P, Conklin D. NanoDrop microvolume quantitation of nucleic acids. *J Vis Exp.* 2010. 45:2565.
  34. Zerbino DR, Birney E. Velvet: algorithms for de novo short read assembly using de Bruijn graphs. *Genome Res.* 2008;18:821–829.
  35. Borodovsky M, Lomsadze A. Gene identification in prokaryotic genomes, phages, metagenomes, and EST sequences with GeneMarkS suite. *Curr Protoc Microbiol.* 2014;32:Unit 1E.7.
  36. Wu S, Zhu Z, Fu L, Niu B, Li W. WebMGA: a customizable web server for fast metagenomic sequence analysis. *BMC Genomics.* 2011;12:444.
  37. Nielsen H. Predicting secretory proteins with SignalP. *Protein Funct Predict Methods Protoc.* 2017;59–73.
  38. Krogh A, Larsson B, von Heijne G, Sonnhammer EL. Predicting transmembrane protein topology with a hidden Markov model: application to complete genomes. *J Mol Biol.* 2001;305:567–580.
  39. Grissa I, Vergnaud G, Pourcel C. CRISPRFinder: a web tool to identify clustered regularly interspaced short palindromic repeats. *Nucleic Acids Res.* 2007;35:W52- W57.
  40. Rodriguez-R LM, Konstantinidis KT. The enveomics collection: a toolbox for specialized analyses of microbial genomes and metagenomes. *PeerJ Preprints.* 2016;4:e1900v1.
  41. Lee HB, Hong JP, Kim SB. First report of leaf blight caused by *Pantoea agglomerans* on rice in Korea. *Plant Dis.* 2017;101:242.
  42. González AD, Franco MA, Contreras N, Galindo-Castro I, Jayaro Y, Graterol E. First report of *Pantoea agglomerans* causing rice leaf blight in Venezuela. *Plant Dis.* 2015;99:552.
  43. Dutkiewicz J, Mackiewicz B, Lemieszek MK, Golec M, Milanowski J. *Pantoea agglomerans*: a mysterious bacterium of evil and good. Part IV. Beneficial effects. *Ann Agric Environ Med.* 2016;23:206–222.
  44. Fukasaka M, Asari D, Kiyotoh E, Okazaki A, Gomi Y, Tanimoto T, et al. A lipopolysaccharide from *Pantoea agglomerans* is a promising adjuvant for sublingual vaccines to induce systemic and mucosal immune responses in mice via TLR4 pathway. *PloS One.* 2015;10:e0126849.
  45. Morishima A, Inagawa H. Clinical effects of orally administered lipopolysaccharide derived from *Pantoea agglomerans* on malignant tumors. *Anticancer Res.* 2016;36:3747–3751.
  46. Nakata K, Nakata Y, Inagawa H, Nakamoto T, Yoshimura H, Soma G-I. *Pantoea agglomerans* lipopolysaccharide maintains bone density in premenopausal women: a

- randomized, double-blind, placebo-controlled trial. *Food Sci Nutr*. 2014;2:638–646.
47. Cavalier-Smith T. The neomuran origin of archaeobacteria, the negibacterial root of the universal tree and bacterial mega classification. *Int J Syst Evol Microbiol*. 2002;52:7–76.
  48. Garrity GM, Bell JA, Lilburn T. Phylum XIV. *Proteobacteria* phyl. nov. In: Garrity GM, Brenner DJ, Krieg NR, Staley JT, editors. *Bergey's manual of systematic bacteriology*. Volume 2, Part B. New York: Springer; 2005:1.
  49. Garrity GM, Bell JA, Class III LT. *Gammaproteobacteria* class. nov. In: Garrity GM, Brenner DJ, Krieg NR, Staley JT, editors. *Bergey's manual of systematic bacteriology*. Volume 2, Part B. New York: Springer; 2005:1.
  50. Serrano FB. Bacterial fruitlet brown-rot of pineapple in the Philippines. *Philippine J Sci*. 1928;36:271–305.
  51. Trüper HG, de' Clari L. Taxonomic note: necessary correction of specific epithets formed as substantives (nouns) “in apposition. *Int J Syst Bacteriol*. 1997;47:908–909.
  52. Ashburner M, Ball CA, Blake JA, Botstein D, Butler H, Cherry JM, et al. Gene ontology: tool for the unification of biology. The Gene Ontology Consortium. *Nat Genet*. 2000;25:25–29.
  53. Stice SP, Stumpf SD, Gitaitis RD, Kvitko BH, Dutta B. *Pantoea ananatis* genetic diversity analysis reveals limited genomic diversity as well as accessory genes correlated with onion pathogenicity. *Front Microbiol*. 2018;9:184.
  54. Hara Y, Kadotani N, Izui H, Katashkina JI, Kuvaeva TM, Andreeva IG, et al. The complete genome sequence of *Pantoea ananatis* AJ13355, an organism with great biotechnological potential. *Appl Microbiol Biotechnol*. 2012;93:331–341.
  55. Megías E, Megías M, Ollero FJ, Hungria M. Draft genome sequence of *Pantoea ananatis* strain AMG521, a rice plant growth-promoting bacterial endophyte isolated from the Guadalquivir marshes in southern Spain. *Genome Announc*. 2016;4:e01681-15.
  56. Kim HJ, Lee JH, Kang BR, Rong X, Gardener BB, Ji HJ, et al. Draft genome sequence of *Pantoea ananatis* B1-9, a nonpathogenic plant growth-promoting bacterium. *J Bacteriol*. 2012;194:729.
  57. Weller-Stuart T, Chan WY, Coutinho TA, Venter SN, Smits TH, Duffy B, et al. Draft genome sequences of the onion center rot pathogen *Pantoea ananatis* PA4 and maize brown stalk rot pathogen *P. ananatis* BD442. *Genome Announc*. 2014;2:e00750-14.
  58. Smith DD, Kirzinger MW, Stavrinides J. Draft genome sequence of the antibiotic-producing epiphytic isolate *Pantoea ananatis* BRT175. *Genome Announc*. 2013;1:e00902-13.
  59. Medrano EG, Bell AA. Genome sequence of *Pantoea ananatis* strain CFH 7-1, which is associated with a vector-borne cotton fruit disease. *Genome Announc*. 2015;3:e01029-15.
  60. De Maayer P, Chan WY, Venter SN, Toth IK, Birch PR, Joubert F, et al. Genome sequence of *Pantoea ananatis* LMG20103, the causative agent of Eucalyptus blight and dieback. *J Bacteriol*. 2010;192:2936–2937.
  61. Adam Z, Tambong JT, Lewis CT, Lévesque CA, Chen W, Bromfield ES, et al. Draft genome sequence of *Pantoea ananatis* strain LMG 2665<sup>T</sup>, a bacterial pathogen of

- pineapple fruitlets. *Genome Announc.* 2014;2:e00489-14.
62. Maayer PD, Chan WY, Rezzonico F, Bühlmann A, Venter SN, Blom J, et al. Complete genome sequence of clinical isolate *Pantoea ananatis* LMG 5342. *J Bacteriol.* 2012;194:1615–1616.
  63. Midha S, Bansal K, Sharma S, Kumar N, Patil PP, Chaudhry V, et al. Genomic resource of rice seed associated bacteria. *Front Microbiol.* 2016;6:1551.
  64. Choi O, Lim JY, Seo YS, Hwang I, Kim J. Complete genome sequence of the rice pathogen *Pantoea ananatis* strain PA13. *J Bacteriol.* 2012;194:531.
  65. Sheibani-Tezerji R, Naveed M, Jehl MA, Sessitsch A, Rattei T, Mitter B. The genomes of closely related *Pantoea ananatis* maize seed endophytes having different effects on the host plant differ in secretion system genes and mobile genetic elements. *Front Microbiol.* 2015;6:440.
  66. Ma J, Zhang K, Liao H, Hector SB, Shi X, Li J, et al. Genomic and secretomic insight into lignocellulolytic system of an endophytic bacterium *Pantoea ananatis* Sd-1. *Biotechnol Biofuels.* 2016;9:25.
  67. Town J, Dumonceaux TJ. High-quality draft genome sequences of *Pantoea agglomerans* isolates exhibiting antagonistic interactions with wheat seed-associated fungi. *Genome Announc.* 2016;4:e00511-16.
  68. Moretti C, Cortese C, Passos da Silva D, Venturi V, Torelli E, Firrao G, et al. Draft genome sequence of a hypersensitive reaction-inducing *Pantoea agglomerans* strain isolated from olive knots caused by *Pseudomonas savastanoi* pv. *savastanoi*. *Genome Announc.* 2014;2:e00774-14.
  69. Gan HY, Gan HM, Savka MA, Triassi AJ, Wheatley MS, Smart LB, et al. Whole-genome sequences of 13 endophytic bacteria isolated from shrub willow (*Salix*) grown in Geneva, New York. *Genome Announc.* 2014;2:e00288-14.
  70. Tan WS, Chang CY, Yin WF, Chan KG. Understanding the quorum-sensing bacterium *Pantoea stewartii* strain M009 with whole-genome sequencing analysis. *Genome Announc.* 2015;3:e01509-14.
  71. Duong DA, Stevens AM, Jensen RV. Complete genome assembly of *Pantoea stewartii* subsp. *stewartii* DC283, a corn pathogen. *Genome Announc.* 2017;5:e00435-17.



**Table 1** Classification and general features of *P. ananatis* strains ARC297, ARC310, and ARC311

MIGS ID	Property	Term	Evidence code <sup>a</sup>
	Kingdom	<i>Bacteria</i>	TAS [47]
	Subkingdom	<i>Negibacteria</i>	TAS [47]
	Phylum	<i>Proteobacteria</i>	TAS [48]
	Class	<i>Gammaproteobacteria</i>	TAS [49]
	Order	<i>Enterobacterales</i>	TAS [27]
	Family	<i>Erwiniaceae</i>	TAS [27]
	Genus	<i>Pantoea</i>	TAS [4,6,8]
	Species	<i>Pantoea ananatis</i>	TAS [8,50,51]
	Gram stain	–	TAS [6]
	Cell shape	Rod	TAS [6]
	Pigment	Yellow	TAS [6]
	Growth T °C	4 to 41°C	TAS [6]
	Mobility		TAS [6]
	Indole production	+	TAS [6]
	Acetoin production	+	TAS [6]
	Habitat	Versatile	TAS [23]
MIGS-6.3	Salinity	+ (100 and 300 mM)	TAS [6]
	Carbon sources		
	Sugars (fructose, ribose, dextrin, salicin...)	+	TAS [6]
	Lipids (lecithin, tributyrin, and Tween 80)	+	TAS [6]
	Proteins (gelatin, casein)	+	TAS [6]
	Media	KCN, NB, PSA	TAS [6]
	pH	4 to 8 optimum at 7	TAS [6]
MIGS-14	Pathogenicity	Pathogenic to plants	TAS [24]
MIGS-15	Biotic relationship	Parasitic	TAS [24]
MIGS-22	Oxygen requirement	Not applicable	NAS
MIGS-6	Habitat		
	ARC272	Rice leaf-associated	NAS
	ARC310	Rice leaf-associated	NAS
	ARC311	Rice seed-associated	NAS
MIGS-4	Geographic location		
	ARC272	Burkina Faso	NAS
	ARC310	Togo	NAS
	ARC311	Benin	NAS
MIGS-5	Sample collection		
	ARC272	22/10/2013	NAS
	ARC310	29/06/2010	NAS
	ARC311	2013	NAS
MIGS-4.1	Latitude		
	ARC272	Not reported	
	ARC310	Not reported	
	ARC311	Not reported	
MIGS-4.2	Longitude		
	ARC272	Not reported	
	ARC310	Not reported	
	ARC311	Not reported	

<sup>a</sup> Evidence codes - IDA: Inferred from Direct Assay; TAS: Traceable Author Statement (i.e., a direct report exists in the literature); NAS: Non-traceable Author Statement (i.e., not directly observed for the living, isolated sample, but based on a generally accepted property for the species, or anecdotal evidence). These evidence codes are taken from the Gene Ontology project [52].

**Table 2** List of *Pantoea* genome sequences used for ANI calculations

Species	Strain	Origin	Country	Year	Accession number	Reference
<i>P. ananatis</i>	1.38	<i>Oryza</i> sp.	Spain	2010	NKXT01	
<i>P. ananatis</i>	97-1	<i>Allium cepa</i>	USA	1997	CP020943	[53]
<i>P. ananatis</i>	AJ13355		Japan		AP012032	[54]
<i>P. ananatis</i>	AMG521	Soil rhizosphere	Spain	2005	LMYG01	[55]
<i>P. ananatis</i>	B1-9	Onion rhizosphere	Korea		CAEJ01	[56]
<i>P. ananatis</i>	BD442	Maize	South Africa	2004	JMJL01	[57]
<i>P. ananatis</i>	BRT175	Strawberry			ASJH01	[58]
<i>P. ananatis</i>	CFH 7-1	Cotton	USA	2011	LFLX01	[59]
<i>P. ananatis</i>	DAR 76143	Rice	Australia	2002	BATH01	
<i>P. ananatis</i>	GB1	Poplar	Belgium	2009	JYGW01	
<i>P. ananatis</i>	LMG 20103	Eucalyptus	South Africa		CP001875	[60]
<i>P. ananatis</i>	LMG 2665	Pineapple	Philippines	1965	JMJJ01	[61]
<i>P. ananatis</i>	LMG 5342	Human wound	Philippines		HE617160	[62]
<i>P. ananatis</i>	MHSD5	<i>Pellaea calomelanos</i>	South Africa	2017	PUEK01	
<i>P. ananatis</i>	MR5	Groundnut	India	2013	LBFU01	
<i>P. ananatis</i>	NFIX48				FUXY01	
<i>P. ananatis</i>	NFR11				FPJM01	
<i>P. ananatis</i>	NS296	Rice seed	India	2013	LDQX01	[63]
<i>P. ananatis</i>	NS303	Rice seed	India	2013	LDQY01	[63]
<i>P. ananatis</i>	NS311	Rice seed	India	2013	LDQZ01	[63]
<i>P. ananatis</i>	PA13	Rice grain	Korea		CP003085	[64]
<i>P. ananatis</i>	PA4	Onion seed	South Africa	2004	JMJK01	[57]
<i>P. ananatis</i>	PaMB1	Rice	China	2011	JQZZ01	
<i>P. ananatis</i>	PANS 01-2	<i>Thrips tabaci</i>	USA	2001	NMZU01	[53]
<i>P. ananatis</i>	PANS 04-2	<i>Frankliniella fusca</i>	USA	2004	NMZV01	[53]
<i>P. ananatis</i>	PANS 99-3	<i>Allium cepa</i>	USA	1999	NMZR01	[53]
<i>P. ananatis</i>	PANS 99-23	<i>Cyperus esculentus</i>	USA	1999	NMZS01	[53]
<i>P. ananatis</i>	PANS 99-36	<i>Richardia scabra</i>	USA	1999	NMZT01	[53]
<i>P. ananatis</i>	PNA 06-1	<i>Allium cepa</i>	USA	2006	NMZY01	[53]
<i>P. ananatis</i>	PNA 15-1	<i>Allium cepa</i>	USA	2015	NMZZ01	[53]
<i>P. ananatis</i>	PNA 99-7	<i>Allium cepa</i>	USA	1999	NMZW01	[53]
<i>P. ananatis</i>	PNA 200-3	<i>Allium cepa</i>	USA	2000	NMZX01	[53]
<i>P. ananatis</i>	R100	Rice	China	2013	CP014207	
<i>P. ananatis</i>	RSA47	Rice seed	India	2013	LDRA01	[63]
<i>P. ananatis</i>	S6	Maize			CVNF01	[65]
<i>P. ananatis</i>	S7	Maize			CVNG01	[65]
<i>P. ananatis</i>	S8	Maize			CVNH01	[65]
<i>P. ananatis</i>	Sd-1	Rice seed	China		AZTE01	[66]
<i>P. ananatis</i>	YJ76	Rice	China		CP022427	
<i>P. agglomerans</i>	4	Wheat seed	Canada	2012	JPOT01	[67]
<i>P. agglomerans</i>	DAPP-PG734	Olive knot	Italy	2008	JNVA01	[68]
<i>P. agglomerans</i>	RIT273	Willow	USA	2013	JFOK01	[69]
<i>P. stewartii</i>	LMG 2632	<i>Setaria italica</i>	India	1960	JKO01	
<i>P. stewartii</i>	M009	Waterfall	Malaysia	2013	JRWI01	[70]
<i>P. stewartii</i>	DC283	Maize	USA	1967	AHIE01	[71]

**Table 3** Project information

<b>MIGS ID</b>	<b>Property</b>	<b>ARC272</b>	<b>ARC310</b>	<b>ARC311</b>
MIGS-31	Finishing quality		High-quality draft	
MIGS-28	Libraries used		Paired-end (25 bp to 1.5 kb)	
MIGS-29	Sequencing platforms		Illumina HiSeq 2500	
MIGS-31.2	Fold coverage	62 X	90 X	73 X
MIGS-30	Assemblers		Edena v3.131028	
MIGS-32	Gene calling method		GeneMarkS+ 4.2	
	GenBank ID	PUGD00000000	PUGC00000000	PUGB00000000
	GenBank Date of Release			
	GOLD ID			
	BIOPROJECT	PRJNA399058	PRJNA399062	PRJNA399063
MIGS-13	Source material identifier	SAMN07522540	SAMN07522547	SAMN07522548
	Project relevance	Comparative genomics of rice-associated <i>Pantoea</i> strains		

**Table 4** Nucleotide content and gene count levels of the genomes

Attribute	ARC272		ARC310		ARC311	
	Value	% of total <sup>a</sup>	Value	% of total <sup>a</sup>	Value	% of total <sup>a</sup>
Genome size (bp)	4,615,013	100	4,598,241	100	4,593,415	100
DNA coding (bp)	4,023,130	87.17	4,000,504	87.00	3,995,649	86.99
DNA G + C (bp)	53.50		53.59		53.58	
DNA scaffolds	128		216		166	
Total genes <sup>b</sup>	4471	100	4470	100	4420	100
Protein-coding genes	4258	95.24	4234	94.72	4180	94.57
RNA genes	104	2.33	105	2.35	107	2.42
Pseudo genes	109	2.44	131	2.93	133	3.01
Genes assigned to COGs (with predicted function)	2433	54.42	2468	55.21	2439	55.18
Genes with Pfam domains	2376	53.14	2259	50.54	2331	52.74
Genes with signal peptides	415	9.28	410	9.17	409	9.25
Genes with transmembrane helices	1039	23.24	1048	23.45	1037	23.46
CRISPR repeats	0		0		0	

<sup>a</sup> The percentage of total is based on either the size of the genome in base pairs or the total number of protein coding genes in the annotated genome

<sup>b</sup> Also includes pseudogenes and other genes

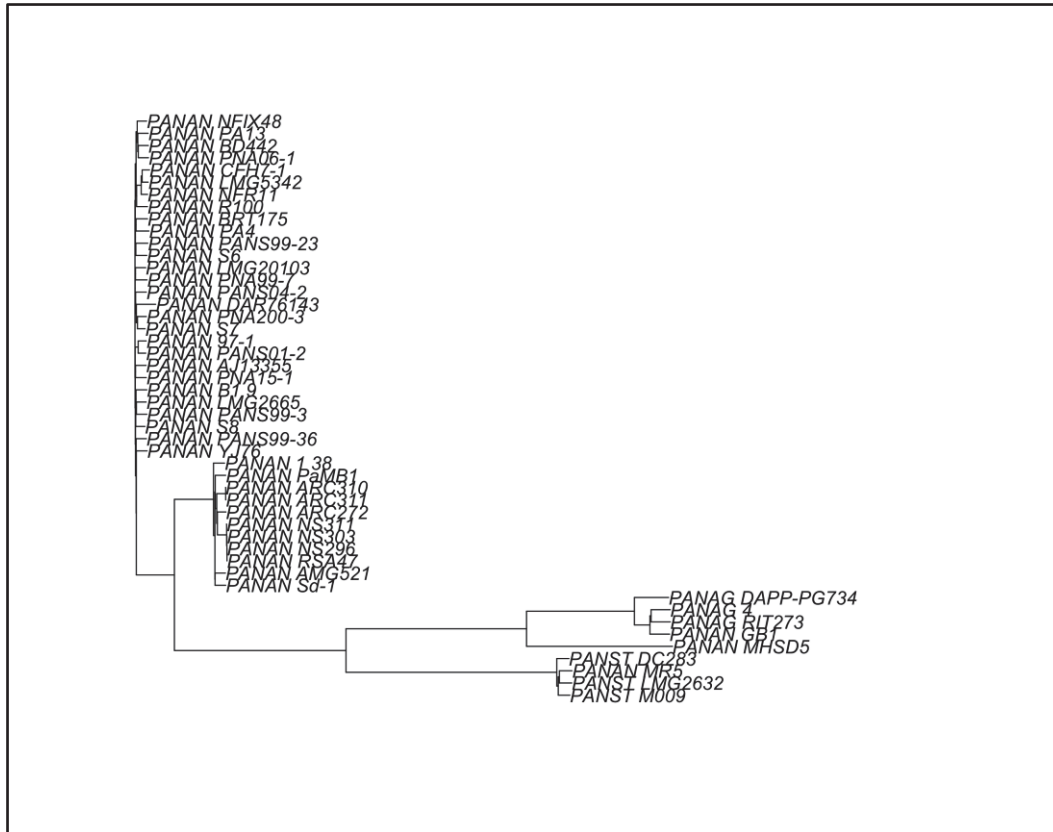
**Table 5** Average nucleotide identities (ANI) for representative strains of the species *P. ananatis*, *P. agglomerans*, and *P. stewartii*

Strain	4	RIT273	DAPP-PG734	ARC310	ARC311	ARC312	RSA47	PaMB1	Sd-1	S6	LMG 20103	LMG 2665	LMG 5632	M009	DC283
4	--	<b>98.7</b>	<b>97.5</b>	78.8	78.8	78.8	80.3	80.4	78.7	80.4	78.8	78.7	78.7	78.6	78.8
RIT273	<b>98.7</b>	---	<b>97.6</b>	78.7	78.7	78.8	80.3	80.3	78.8	80.4	78.7	78.7	78.6	78.6	78.7
DAPP-PG734	<b>97.3</b>	<b>97.4</b>	---	78.7	78.6	78.7	80.4	80.4	78.6	80.4	78.7	78.7	78.6	78.4	78.6
ARC310	78.9	78.9	78.9	---	<b>100</b>	<b>99.3</b>	<b>99.3</b>	<b>99.3</b>	<b>99.2</b>	<b>96.3</b>	<b>96.4</b>	<b>96.5</b>	83.9	84.0	84.2
ARC311	78.8	78.8	78.8	<b>100</b>	---	<b>99.3</b>	<b>99.3</b>	<b>99.3</b>	<b>99.2</b>	<b>96.3</b>	<b>96.5</b>	<b>96.5</b>	83.8	83.9	84.1
ARC272	78.9	78.9	78.9	<b>99.3</b>	<b>99.3</b>	---	<b>99.3</b>	<b>99.2</b>	<b>99.2</b>	<b>96.3</b>	<b>96.4</b>	<b>96.3</b>	83.9	83.9	84.1
RSA47	80.3	80.3	80.4	<b>99.3</b>	<b>99.3</b>	<b>99.3</b>	---	<b>99.1</b>	<b>99.1</b>	<b>96.3</b>	<b>96.2</b>	<b>96.2</b>	84.1	84.1	84.1
PaMB1	80.4	80.4	80.4	<b>99.3</b>	<b>99.3</b>	<b>99.2</b>	<b>99.1</b>	---	<b>99.1</b>	<b>96.3</b>	<b>96.2</b>	<b>96.3</b>	84.0	84.1	84.1
Sd-1	78.7	78.8	78.8	<b>99.1</b>	<b>99.1</b>	<b>99.1</b>	<b>99.1</b>	<b>99.1</b>	---	<b>96.3</b>	<b>96.3</b>	<b>96.3</b>	83.8	83.9	84.1
S6	80.6	80.7	80.5	<b>96.3</b>	<b>96.3</b>	<b>96.3</b>	<b>96.3</b>	<b>96.3</b>	<b>96.2</b>	---	<b>99.2</b>	<b>99.2</b>	84.0	84.0	84.1
LMG 20103	78.8	78.9	78.9	<b>96.5</b>	<b>96.5</b>	<b>96.4</b>	<b>96.2</b>	<b>96.2</b>	<b>96.4</b>	<b>99.1</b>	---	<b>99.2</b>	83.9	83.8	84.0
LMG 2665	78.6	78.8	78.8	<b>96.4</b>	<b>96.4</b>	<b>96.4</b>	<b>96.2</b>	<b>96.3</b>	<b>96.3</b>	<b>99.1</b>	<b>99.2</b>	---	83.6	83.7	83.8
LMG 2632	78.6	78.7	78.6	83.8	83.8	83.8	84.1	84.0	83.8	83.8	83.8	83.6	---	<b>99.1</b>	<b>98.7</b>
M009	78.4	78.6	78.4	83.8	83.8	83.8	84.1	84.1	83.8	83.8	83.7	83.7	<b>99.0</b>	---	<b>98.6</b>
DC283	79.0	79.0	78.5	84.1	84.2	84.1	84.2	84.1	84.3	84.1	84.0	83.9	<b>99.0</b>	<b>98.3</b>	---

Strains 4, RIT273 and DAPP-PG734 belong to the species *P. agglomerans* and strains LMG 2632, M009 and DC283 belong to the species *P. stewartii*. All other strains belong to the species *P. ananatis*. The number of shared genes within and between species ranged from 3,400 to 3,500. Based on the ANI values, the isolates grouped with representatives of the designated species, using species cut-off values of 95% [40]. ANI values above 95% are indicated in bold face.

**Table 6** Number of genes associated with general COG functional categories

Code	ARC272		ARC310		ARC311		Description
	Value	% of total <sup>a</sup>	Value	% of total <sup>a</sup>	Value	% of total <sup>a</sup>	
J	245	5.5	245	5.5	245	5.5	Translation, ribosomal structure and biogenesis
A	25	0.6	25	0.6	25	0.6	RNA processing and modification
K	231	5.2	231	5.2	231	5.2	Transcription
L	238	5.3	238	5.3	238	5.4	Replication, recombination and repair
B	19	0.4	19	0.4	19	0.4	Chromatin structure and dynamics
D	72	1.6	72	1.6	72	1.6	Cell cycle control, cell division, chromosome partitioning
Y	2	0.0	2	0.0	2	0.0	Nuclear structure
V	46	1.0	46	1.0	46	1.0	Defense mechanisms
T	152	3.4	152	3.4	152	3.4	Signal transduction mechanisms
M	188	4.2	188	4.2	188	4.3	Cell wall/membrane/envelope biogenesis
N	96	2.1	96	2.1	96	2.2	Cell motility
Z	12	0.3	12	0.3	12	0.3	Cytoskeleton
W	1	0.0	1	0.0	1	0.0	Extracellular structures
U	158	3.5	158	3.5	158	3.6	Intracellular trafficking, secretion, and vesicular transport
O	203	4.5	203	4.5	203	4.6	Posttranslational modification, protein turnover, chaperones
C	258	5.8	258	5.8	258	5.8	Energy production and conversion
G	230	5.1	230	5.1	230	5.2	Carbohydrate transport and metabolism
E	270	6.0	270	6.0	270	6.1	Amino acid transport and metabolism
F	95	2.1	95	2.1	95	2.1	Nucleotide transport and metabolism
H	179	4.0	179	4.0	179	4.0	Coenzyme transport and metabolism
I	94	2.1	94	2.1	94	2.1	Lipid transport and metabolism
P	212	4.7	212	4.7	212	4.8	Inorganic ion transport and metabolism
Q	88	2.0	88	2.0	88	2.0	Secondary metabolites biosynthesis, transport and catabolism
R	702	15.7	702	15.7	702	15.9	General function prediction only
S	1347	30.1	1347	30.1	1347	30.5	Function unknown



**Figure 1.** Phylogenetic tree based on concatenated partial sequences of the housekeeping genes *atpD*, *gyrB*, *infB*, and *rpoB*. The standard approximation likelihood ratio tree was created using Phylogeny.fr.

**Additional file 1:**

Genome-wide average nucleotide identities (ANI) for all the characterized strains of *P. ananatis*, including our three new African strains, and three representative strains of *P. agglomerans* and *P. stewartii*.

Footnote to Additional file 1: Strains of *P. ananatis* form two clades where strains within each clade are 99% identical to each other while the inter-clade similarity is at only 96% of sequence identity. The larger clade contains strains that have been isolated from various plants and animals, such as onion, eucalyptus, rice, and thrips, while the smaller clade contains strains that have been found to be associated with rice. All three African strains described in this study belong to the clade of rice-associated *P. ananatis*.



## **2. Fifth drafted manuscript: Development and evaluation of two MLVA schemes consisting of micro- and minisatellite loci for global and epidemiological surveillance of *Pantoea ananatis***

### **2.1. Context and justification of the project**

Several bacteria have been reported as a plant pathogen of rice in the world. They are responsible for damage that negatively impacts the production of this importance cereal for sub-Saharan African countries. In Africa, the two pathovars of rice pathogenic *Xanthomonas* bacteria that have been widely reported and studied are *Xanthomonas oryzae* pv. *oryzae* (*Xoo*) and *Xanthomonas oryzae* pv. *oryzicola* (*Xoc*). Recently, bacteria belonging to the genus *Pantoea* have been isolated in several rice fields in Africa and found to cause symptoms and damage similar to those caused by *Xoo*. Molecular studies of identification and diagnosis were carried out and the results suggested that the bacteria responsible of the damage consisted mainly of three *Pantoea* species: *Pantoea ananatis*, *Pantoea stewartii* and *Pantoea agglomerans*. This observation suggests an epidemiological emergence situation of a bacterial complex threatening rice production in sub-Saharan Africa. For an easy, quick and inexpensive identification of the bacterial complex, diagnostic tools such as simplex PCR, multiplex PCR, and LAMP have been developed.

As a next step, it is necessary to evaluate the importance of this epidemiological situation of emergence and to discover the origin of the epidemic. A better understanding of the genetic diversity and population structure of the pathogens is a prerequisite to establish efficient control measures.

Regarding the evolutionary study of infectious bacterial systems belonging to the *Pantoea* genus, several types of molecular diagnostic tools have been developed, including amplified fragment length polymorphism (AFLP), restriction fragment length polymorphism of PCR products (PCR-RFLP), multilocus sequence analysis (MLSA), and whole genome sequencing (WGS). However, all these tools have their specific limitations (ease of use, reproducibility, comparability, costs), which impact their application.

One of the molecular typing tools for bacteria that has been developed is multiple loci variable numbers of tandem repeats (VNTR) analysis (MLVA). This tool has been used for the typing of several phytopathogenic bacteria and provided valuable insight into the evolution of the pathogens. Yet, it has never been developed for bacteria of the genus *Pantoea*. Consequently, we initiated preliminary work for the development of MLVA tools for a molecular epidemiological study of *P. ananatis*. First, we established an inventory of tandem repeats (minisatellite and macrosatellite) present in the WGS of *P. ananatis*. Then, we developed and evaluated the characteristics (e.g. discriminatory power, allelic frequency, degree of polymorphisms) of the two MLVA tools for mini- and microsatellite loci for the study of different types of epidemiological situations.

### **Personal involvement**

I fully worked on this article in cooperation with all co-authors.

**Kossi Kini<sup>1,3</sup>, Wonni Issa<sup>2</sup>, Drissa Silué<sup>1</sup> and Ralf Koebnik<sup>\*3</sup>**

<sup>1</sup> Africa Rice Center (AfricaRice), Cotonou, Bénin

<sup>2</sup> Institut de l'Environnement et de Recherches Agricoles (INERA), 01 BP 910 Bobo Dioulasso, Burkina Faso

<sup>3</sup> IRD, Cirad, University Montpellier, IPME, Montpellier, France

\* Correspondence: koebnik@gmx.de

## 2.2 Abstract

### Background

*P. ananatis* is a worldwide distributed causal agent for many economically important plant diseases. Few epidemiological typing tools are available but they are often expensive or not well standardized in laboratories. In this work, we developed, evaluated and validated the first multiple loci variable number of tandem repeats (VNTR) analysis (MLVA) tool for *P. ananatis*. Several isolates from eight African countries have been used for its evaluation and validation.

### Results

Twenty-one *P. ananatis* whole genome sequences were screened for the presence of variable number of tandem repeats (VNTRs). In total, fifty VNTR loci were identified. PCR primers were designed on the conserved flanking regions and evaluated by *in silico* PCR and by Primer-BLAST. A total of thirty-five promising loci were selected for typing of 16 representative strains of *P. ananatis* with worldwide origin. Based on the Hunter-Gaston discriminatory index (HGDI), twelve loci were selected to set up the MLVA-12 typing scheme. The typing of sixty-five African *P. ananatis* strains isolated from Rice leaves and seeds demonstrated that the MLVA-12 tool represents a new diagnostic tool and allows the easy epidemiological assessment of *P. ananatis*. Interestingly, some loci proved to discriminate *P. ananatis* into two clades: those isolated from rice and those from other sources.

### Conclusion

Our study introduces a specific and universal MLVA typing tool for *P. ananatis* from various sources. At this stage, MLVA-12 is a powerful and promising molecular typing tool with sufficient resolution and low cost for epidemiological surveillance of *P. ananatis*. Future complementary work will assess more loci and bacterial isolates in order to obtain sufficient resolution for outbreak analyses.

### 2.3. Background

The genus *Pantoea* includes a diverse group of yellow-pigmented, rod-shaped Gram-negative bacteria from diverse geographical and ecological sources. A total of 27 species of this genus has been reported worldwide, among which strains for bioremediation, producers of antibiotic, opportunistic human pathogens and many plant-pathogenic bacteria were identified [1]. Through the development and application of various molecular typing tools, such as DNA-DNA hybridization, amplified fragment length polymorphism (AFLP), restriction fragment length polymorphism of the PCR products (PCR-RFLP), multilocus sequence typing/analysis (MLST/MLSA), and whole genome sequencing (WGS) [2–7], the taxonomy, ubiquitousness, versatility and genetic diversity [5,8,9] of the genus have been explained. But there are several limiting factors that compromise the applicability of these methods and thus questioning the usefulness of the generated results [10,11]. For example, AFLP analyses are labour-intensive and the fluorescence detection systems and fluorescent adaptors are expensive. RAPD basically lacks inter-laboratory comparability because this method is extremely sensitive to subtle differences in reagents, protocols, and machines. For epidemiological investigations, MLST/MLSA often lack sufficient discriminatory power between bacterial strains.

Recently, a new technique based on the variable numbers of tandem repeats (VNTR), and the multiple loci VNTR analysis (MLVA), has been introduced for studying population structures of pathogenic bacteria, including those affecting plant [12–14]. Indeed, bacterial genomes contain regions with repetitive sequence motifs (tandem repeats) ranging from a few base pairs to more than 100 in length. Several copies of each of the repeat motifs are clustered together and oriented in the same direction, but their number may vary even among strains of the same species. In VNTR analysis, differences in the number of repeated copies at specific loci are used to distinguish isolates and to gain increased discrimination for studying genetic diversity. MLVA has become a major typing tool in several bacterial pathogens, including human, animal and plant pathogenic bacteria. However, it has not been used yet to better understand the relationship between members of the *Pantoea* genus and their different hosts.

Recently, several species of the genus *Pantoea*, including *P. ananatis*, have been reported as phytopathogens of rice in several African countries [15,16]. This situation makes, it is urgent to find complementary sustainable approaches to fight against these bacteria based on epidemiological data. Therefore, for international surveillance and disease outbreak investigations, we developed for the first time two new robust, multilocus VNTR schemes (MLVA-6\_*Microsat*, and MLVA-6\_*Minisat*). The two tools were set up by a suitable incorporation of six microsatellite and six minisatellite loci for each tool.

The two tools were validated by PCR amplicon sequencing analysis of 70 *P. ananatis* strains of various hosts and geographical origin; In addition to these data, 24 WGSs were added for generating and comparing the genetic diversity, genetic linkage and analyzing of the population structure. Homoplasmy investigation in each loci and single nucleotide polymorphisms (SNPs) of their flanking sequences allowed us find that some loci proved to discriminate *P. ananatis* into two clades: those isolated from rice and those from other sources. Interestingly, this finding was supported by a minimum spanning tree (MST) that

formed two distinct clades. One of the clades consisted of strains isolated only from rice and the other clade harboured strains from other sources.

This paper reports the first *P. ananatis* typing tool based on the PCR sequencing analysis of VNTR loci. The two MLVA-6 schemes represent a very useful tool, not only as a diagnostic tool, but especially for epidemiological studies and analyses of population structures.

## 2.4. Materials and Methods

### Bacterial strains and DNA extraction

Bacterial strains used in this study (Supplemental Table 1) included 67 *P. ananatis* strains from eight African countries (Benin, Burkina Faso, Burundi, Ghana, Mali, Nigeria, Senegal, and Togo). In addition, six reference strains [7] namely CFBP466, CFBP5846, CFBP3612<sup>T</sup>, CFBP3171<sup>T</sup>, CFBP6632 and CFBP6627<sup>T</sup> from the French collection of plant-associated bacteria (CFBP) were included in the study. The African strains had been isolated from Rice leaves with typical bacterial leaf blight symptoms, and from discolored or apparently healthy rice seeds. The samples were collected from 2010 to 2016 in the main rice growing areas of these targeted countries. The strains were purified (single colony), grown and stored using routine methods as described by Poulin et al. (2014) for *Xanthomonas* spp. [17]. Total genomic DNA was extracted from bacterial colonies on peptone sucrose agar (peptone 10 g/l, sucrose 10 g/l, and agar 16 g/l) plates cultured for 24 to 48 h using the Wizard genomic purification kit from Promega according to the manufacturer's instructions. DNA quality and quantity were evaluated by agarose gel electrophoresis and spectrophotometry (Nanodrop Technologies, Wilmington, DE).

### Prediction of VNTR loci and primer design

A total of 15 complete and draft genome sequences of *P. ananatis* listed in Table 1 were analyzed for the presence of candidate VNTR loci using a bioinformatics pipeline (<http://www.biopred.net/VNTR/>), as previously described by Zhao et al (2012) [18]. For VNTR prediction, parameters were set as follows: algorithm, TRF (tandem repeat finder); region length, 30 to 1000 bp; unit length, 5 to 9 bp with at least 6 copies (for microsatellites) or 10 to 100 bp with at least 3 copies (for minisatellites); and at least 80% similarity between adjacent repeats. Predicted VNTR loci were grouped by homology based on conservation of their 500-bp flanking sequences. Loci were named in the order they were found by the prediction pipeline.

For primer design, the flanking regions of the predicted VNTR loci were extracted from all twelve genome sequences and aligned using MUSCLE [19] (<http://www.ebi.ac.uk/Tools/msa/muscle/>). PCR primers were designed on the conserved regions and tested for the optimal annealing temperature and dimer formation [20] (<http://www.thermoscientificbio.com/webtools/multipleprimer/>). Specificity of PCR primers and inter-strain size polymorphisms of PCR amplicons were evaluated by in silico PCR [21] (<http://insilico.ehu.es/PCR/>) and by Primer BLAST [22] ([www.ncbi.nlm.nih.gov/tools/primer-blast](http://www.ncbi.nlm.nih.gov/tools/primer-blast)).

### Identification and selection of polymorphic VNTR loci for MLVA scheme

Based on the specificity of PCR primers, inter-strain size polymorphisms, the widespread presence of the loci in the 15 *P. ananatis* WGSs and Hunter-Gaston discriminatory index (HGDI), promising microsatellite and minisatellite loci were selected for the set-up of two MLVA schemes for each type of loci. Primers targeting the selected loci were used for PCR amplification on a panel of 16 strains representing worldwide diversity with the reference strains [7] of *P. ananatis* (CFBP466, CFBP3612<sup>T</sup> and CFBP3171<sup>T</sup>), *P. stewartii* (ARC229, ARC570, ARC664) [15,16] *P. agglomerans* (CFBP3615, CFBP3845<sup>T</sup>), *P. cedenensis* (CFPB6627) and *Erwinia olea* (CFBP6632) as control. Afterwards, promising primers targeting the selected loci were used for PCR amplification on a larger panel of 70 strains (Table 1) representing worldwide diversity. PCR reactions were carried out in a final volume of 25  $\mu$ l and contained 5  $\mu$ l 5x green GoTaq reaction buffer, 3  $\mu$ l 25 mM MgCl<sub>2</sub>, 1  $\mu$ l with 0.1 mM of each primers, 0.5  $\mu$ l with 0.1 mM of each dNTP, and 0.05  $\mu$ l GoTaq DNA polymerase (Promega Corp., Madison, WI, USA). Amplification reactions started with an initial denaturation step at 95 °C for 3 min, followed by 35 cycles each consisting of 30 s at 95 °C, 20 s at 55-58 °C (depending on the primer pair) and 60 s at 72 °C, and finished by an elongation step of 10 min at 72 °C. PCR-amplified VNTR loci were electrophoretically separated on 1.5% agarose gels. PCR products were sequenced (Beckman Coulter Genomics, UK) using one of the PCR primers, thus assessing the conservation of the loci.

DNA sequences of all selected loci of the panel of 70 strains (Table 1) representing worldwide diversity and those from the 24 WGSs were aligned using MUSCLE and numbers of complete repeats were derived from multiple sequence alignments. The numbers of repeats at each locus for each strain were recorded in a matrix.

The discriminatory power of each locus was evaluated by the Hunter-Gaston discriminatory index (HGDI) [23,24] at [http://insilico.ehu.es/mini\\_tools/discriminatory\\_power/](http://insilico.ehu.es/mini_tools/discriminatory_power/). Based on the HGDI scores, VNTR loci were classified from highly (>0.6), moderately (0.3 to 0.6) to poorly (<0.3) discriminating.

### Description and analysis of VNTR profiles

VNTR loci were analyzed for homoplasmy by comparing their aligned sequences. Similarly, SNPs in the flanking sequences were detected upon sequence alignment. For both tools, the allelic richness, allele frequencies, haploid diversity, allelic patterns, haploid disequilibrium, and frequency distribution analyses [25,26] were calculated using the GenAIEx 6.5 [27] software. The genetic relationships between the 94 *P. ananatis* strains was displayed by a minimum spanning tree using the online software PHYLOViZ 2.0 [28] for the two tools. The haplotypes were connected using the algorithm combining global optimal eBURST (goeBURST) [29] and Euclidian distances [30]. Clonal complexes were identified as groups of single locus variants (SLVs), i.e. haplotypes having 14 identical alleles and differing on a single tandem repeat locus. The model of evolution for each locus was explored by estimating the repeat number profile among the different haplotypes along the evolutionary pathway within clonal complexes.

## 2.5. Results

### Setup of the two MLVA-6 schemes (i.e. MLVA-6\_*Microsat* and MLVA-6\_*Minisat*)

**Prediction of VNTR loci and design of PCR primers.** Using 15 genome sequences listed in Table 1, a total of 50 VNTR loci consisting of 42 microsatellites (6-9 bp) and 8 minisatellites (10-22 bp) were identified and primer pairs for their PCR amplification were designed Table 2. Based on the specificity of PCR primers, inter-strain size polymorphisms, the widespread presence of the loci in the 24 *P. ananatis* WGSs (Table 1) and HGDI, 35 promising loci were selected to develop a MLVA scheme.

On the basis of their universality and specificity: (i) amplification of 95% of 16 strains representing worldwide diversity tested, (ii) absence of multiple amplicons in one strain and (iii) specificity to *P. ananatis*, six loci were selected for each of the two types of tandem repeats for developing the two MLVA-6 schemes (i.e. MLVA-6\_*Microsat* and MLVA-6\_*Minisat*) consisting of six microsatellites (Loc\_1, Loc\_2, Loc\_4, Loc\_23, Loc\_65, Loc\_68) and six minisatellites (Loc\_5, Loc\_16, Loc\_54, Loc\_55, Loc\_66), respectively.

### Evaluation of the two MLVA-6 schemes on a collection of *P. ananatis* strains

A total of 70 strains (Supplementary File: Table 1) representing worldwide diversity were subjected to the MLVA-6\_*Microsat* and MLVA-6\_*Minisat* typing schemes. Discriminatory indices (HGDI) were calculated (Table 2) and the characteristics of the haplotype diversity, based on the analysis of 94 *P. ananatis* strains, were recorded in Table 3. A comparative analysis of the two data sets indicated that four MLVA-6\_*minisat* loci (Loc\_23, Loc\_2, Loc\_1, Loc\_65) are highly discriminatory with HGDI scores between 0.5077 and 0.8395, while the two remaining two loci (Loc\_4 and Loc\_68) are poorly discriminatory with HGDI scores of 0.1112 and 0.1361, respectively. The same repartition of the loci was observed in the MLVA-6\_*microsat* scheme. In fact, four loci (Loc\_56, Loc\_54, Loc\_16, Loc\_5) were highly discriminatory with HGDI scores between 0.6639 and 0.9156 (0.9156, 0.8188, 0.6684, 0.6639) and the two remaining loci (Loc\_66, Loc\_55) were poorly discriminatory with HGDI scores of 0.3119 and 0.1633, respectively.

Thus, even if the two tools have the same loci repartition with regard to their discriminatory power, the HGDI score of MLVA-6\_*microsat* seems to be slightly higher than those of MLVA-6\_*minisat* scheme.

### Insight from DNA sequencing

**Homoplasmy of VNTR loci.** By aligning the sequences of different loci from the African strains and the loci from the WGSs, a high level of homoplasmy was detected. Among the twelve VNTR loci, eleven contained strains with the same number of repeats but with one to three SNPs in some repeats. In general, strains of the rice-specific lineage typically shared the same homoplasmy haplotype. For instance, distinct haplotypes from four loci, two for the MLVA-6\_*minisat* (Loc\_2 and Loc\_65) and two for the MLVA-6\_*microsat* (Loc\_54, and Loc\_56) scheme, were only observed in strains isolated from rice, whether originating from Asia, Africa and Europa, but not in strains from other sources such as cotton, onion, strawberry, pineapple, maize, eucalyptus, soil, etc. (Figs. 1-4).

**DNA sequence polymorphisms in the flanking regions of VNTR loci.** Sequence alignment of the PCR amplified flanking regions revealed several SNPs for eleven of the twelve VNTR loci. Interestingly, the SNPs in the flanking sequences of four VNTR loci, Loc\_2 and Loc\_65 for MLVA-6\_*minisat* scheme and Loc\_54 and Loc\_56 for the MLVA-6\_*microsat* scheme, also correlated with the presence of distinct haplotypes that discriminated the rice strains from the remaining strains isolated from other crops including cotton, onion, strawberry, pineapple, maize, eucalyptus or soil. (Figs. 1-4).

**Diversity analysis.** The analysis of the haplotype diversity using GenAIEx 6.5 was focused on 94 strains (Table 1) representing worldwide diversity (considered as one population in the analysis). This analysis revealed different characteristic values of the two MLVA tools (MLVA-6\_*microsat*, and MLVA-6\_*minisat*); and this separately for the two tools and individually for each locus. Indeed, the analysis revealed that the MLVA-6\_*microsat* tool showed the highest number of alleles 20 in 90.666 strain on average, while it is 15 in 78.167 strain on average in MLVA-6\_*minisat*. In the same proportion, the different parameters of polymorphism are greater for the MLVA-6\_*microsat* than in the MLVA-6\_*minisat*. Indeed, the number of different alleles ( $N_a = 8.333$ ), effective alleles ( $N_e = 4.043$ ), and allelic diversity ( $h = 0.582$ ), as well as the unbiased diversity ( $u_h = 0.589$ ) are more important in MLVA-6\_*Microsat* whereas they are respectively: ( $N_a = 5.333$ ,  $N_e = 2.941$ ,  $h = 0.457$  and  $u_h = 0.465$ ) for the MLVA-6\_*minisat*. The only polymorphism parameter that is slightly high in the MLVA-6\_*minisat* is Shannon's Information Index, which is 1.356, whereas it is 0.931 for the MLVA-6\_*microsat* scheme. The details of the information and values of the different polymorphism and allelic diversity parameters for each locus of the two MLVA schemes are summarized in the Table 3.

Randomization analyses revealed that the greater expected variance ( $V_e = 1.070$ ) and observed variance ( $V_o = 1.875$ ), with  $V_o / V_e = 1.751$ , were observed in the MLVA-6\_*minisat* scheme compared to the MLVA-6\_*microsat* scheme ( $V_e = 1.039$ ,  $V_r = 1.546$  and  $V_o / V_e = 1.489$ ).

Once again, the two minimum spanning trees (Figure 5) also showed the formation of two clades described above namely the one consisting exclusively of *P. ananatis* rice strains from diverse origins around the world and the other one constituted of strains obtained from other sources. These findings had been confirmed and supported by the connection of haplotypes and Euclidean distance (Figure 6). However, apart from this grouping allowing to make a phylogenetic structuring of the 94 *P. ananatis* strains of the world, no clonal complex was observed in either of the two groups.

## 2.6. Discussion

The genus *Pantoea* is one of the most ubiquitous and versatile genera of bacteria. Many *Pantoea* species have been reported as pathogenic to several economically important crops [4,5,8,9]. The species of *P. ananatis* has been reported as pathogenic to more than 20 plant species, with rice as one of the most often reported host [4,31,32] crop. Several diversity studies of the species have been performed using multi locus sequence typing/analysis tools

(MLST and MLSA), which target a few housekeeping genes [7,33]. While these multilocus sequence tools have been used for the taxonomic assignment of *P. ananatis* strains, they have never allowed differentiating *Pantoea* strains according to their sources of isolation.

With the recent availability of several fully sequenced genomes, it has become possible to set-up other tools, such as MLVA, for more robust and accurate typing of *P. ananatis*. MLVA presents several advantages such as high reproducibility, interchangeability of the results and the ability to adapt the targeted loci in a chosen typing scheme. These characteristics of MLVA will facilitate studies of genetic diversity of this economically important bacterium [15,16]. Therefore, in this work, we have developed and evaluated two MLVA typing tools for *P. ananatis*, one targeting microsatellites and the second one targeting minisatellites. The two tools were used to analyze *P. ananatis* strains from various origins and sources. This analysis revealed that the two MLVA-6 tools (MLVA-6\_*minisat* and MLVA-6\_*microsat*) were able to discriminate strains belonging to the clade of rice-associated strains from strains that were isolated from other sources including plants, animals and environment.

The comparative study of the parameters and the polymorphic information of the two tools made it possible to notice that there is no significant difference between the two tools with regard to studies of the diversity and genetic structuring of the *P. ananatis* population, whatever their sources of isolation and their geographical origin. This observation could be explained by the fact that the size of the minisatellite repeat units is not very large (10 to 22 bp). In this study, we had preferred to use tandem repeats that should not be larger than 22 bp because preliminary investigations (data not show) had shown that loci with repeat unit sizes greater than 25 bp were little polymorphic and were not present in most of the African strains. This finding confirms the work of Rubinsztein et al. (1995) who showed that shorter repeats are more likely to be polymorphic [34] compared to longer ones.

The most interesting finding from the evaluation of the two tools is their ability to discriminate *P. ananatis* strains isolated from rice from other strains obtained from other sources. This result showed that the MLVA tool can not only be used as a typing tool but also as a diagnostic tool and can discriminate *P. ananatis* in rice and nonrice clades. The results obtained with the application of the two MLVA tools confirmed those from De Maayer et al. (2017) who found that there are two distinct clades within *P. ananatis* [5]. The two tools distinguished the two clades through the analysis of homoplasmy in the repeat arrays of certain loci and by SNPs in the flanking sequences of these loci. These observations were confirmed by the MST and the distance matrix diagram. These results confirm that these tools may be very useful, not only as diagnostic tools but also for epidemiological studies and analysis of genetic structures of bacterial populations.

Among the limitations that can be highlighted from this work, one can mention that the genetic relationship between the different sources of the strains and their different geographical origins are not disclosed. Indeed, the objective of this study was not to make a phylogenetic study of *Pantoea* or tracking sources of epidemic outbreaks of the bacteria but rather to check the possibility of developing a MLVA tool for *P. ananatis* and its applicability (reproducibility, specificity, and universality). Thus, the strains used came from several surveys whose collection methods were not those intended for a study of phylogenetic



diversity for an understanding of an epidemiological phenomenon [14,35,36]. Also, for budgetary limitation issues, only certain representative isolates were selected based on their geographical origins. In addition, the number (six) of loci per MLVA scheme is relatively small for a phylogenetic study. Thus, with the demonstrated good reproducibility of this tool, future work should consider include more loci in the MLVA. Such a tool useful for phylogenetic studies will not only help understand the genetic relationships among strains but also allow tracking sources of *P. ananatis* epidemic outbreaks.

## 2.7. Conclusion

In this study, we draw three main conclusions: (i) It is possible to develop two specific MLVA tools, which are easily applicable and reproducible to a species of *Pantoea*, despite the plethora of species that the genus contains. (ii) Some loci with homoplasmy in the tandem repeats and with SNPs in their flanking areas distinguish *P. ananatis* isolated from rice from those originating from other sources. (iii) This method provides a starting point for phylogenetic analysis of *P. ananatis* and allows its comparison with other tools and methods.

## References cited

1. Walterson AM, Stavriniades J. *Pantoea*: insights into a highly versatile and diverse genus within the *Enterobacteriaceae*. FEMS Microbiol. Rev. 2015;39:968–984.
2. Brady C, Venter S, Cleenwerck I, Vancanneyt M, Swings J, Coutinho T. A fAFLP system for the improved identification of plant-pathogenic and plant-associated species of the genus *Pantoea*. Syst. Appl. Microbiol. 2007;30:413–417.
3. Brady CL, Cleenwerck I, Venter SN, Engelbeen K, De Vos P, Coutinho TA. Emended description of the genus *Pantoea*, description of four species from human clinical samples, *Pantoea septica* sp. nov., *Pantoea eucrina* sp. nov., *Pantoea brenneri* sp. nov. and *Pantoea conspicua* sp. nov., and transfer of *Pectobacterium cypripedii* (Hori 1911) Brenner et al. 1973 emend. Hauben et al. 1998 to the genus as *Pantoea cypripedii* comb. nov. Int. J. Syst. Evol. Microbiol. 2010;60:2430–2440.
4. De Maayer P, Chan WY, Rubagotti E, Venter SN, Toth IK, Birch PR, et al. Analysis of the *Pantoea ananatis* pan-genome reveals factors underlying its ability to colonize and interact with plant, insect and vertebrate hosts. BMC Genomics 2014;15:404.
5. De Maayer P, Aliyu H, Vikram S, Blom J, Duffy B, Cowan DA, et al. Phylogenomic, pan-genomic, pathogenomic and evolutionary genomic insights into the agronomically relevant *enterobacteria Pantoea ananatis* and *Pantoea stewartii*. Front. Microbiol. 2017;8:1755.
6. Miller AM, Figueiredo JE, Chaves CL, Ruas EA, Balbi-Peña MI, Colauto NB, et al. Genomic variability of *Pantoea ananatis* in maize white spot lesions assessed by AFLP markers. Genet. Mol. Res. 2016;15:4.
7. Delétoile A, Decré D, Courant S, Passet V, Audo J, Grimont P, et al. Phylogeny and identification of *Pantoea* species and typing of *Pantoea agglomerans* strains by multilocus gene sequencing. J. Clin. Microbiol. 2009;47:300–310.

8. Mohamad N, Tan WS, Chang CY, Keng Tee K, Yin WF, Chan KG. Analysis of quorum-sensing *Pantoea stewartii* strain M073a through whole-genome sequencing. *Genome Announc.* 2015;3:e00022-15.
9. Sheibani-Tezerji R, Naveed M, Jehl MA, Sessitsch A, Rattei T, Mitter B. The genomes of closely related *Pantoea ananatis* maize seed endophytes having different effects on the host plant differ in secretion system genes and mobile genetic elements. *Front. Microbiol.* 2015;6:440.
10. Maiden MC. Multilocus sequence typing of bacteria. *Annu. Rev. Microbiol.* 2006;60:561–588.
11. Sabat AJ, Budimir A, Nashev D, Sá-Leão R, Van Dijl JM, Laurent F, et al. Overview of molecular typing methods for outbreak detection and epidemiological surveillance. *Euro Surveill.* 2013;18:20380.
12. Nadon CA, Trees E, Ng LK, Møller Nielsen E, Reimer A, Maxwell N, et al. Development and application of MLVA methods as a tool for inter-laboratory surveillance. *Euro Surveill.* 2013;18:20565.
13. Vergnaud G, Pourcel C. Multiple locus variable number of tandem repeats analysis. *Mol. Epidemiol. Microorg. Humana Press, Totowa, NJ;* 2009:141–58.
14. Van Belkum A. Tracing isolates of bacterial species by multilocus variable number of tandem repeat analysis (MLVA). *FEMS Immunol. Med. Microbiol.* 2007;49:22–27.
15. Kini K, Agnimonhan R, Afolabi O, Milan B, Soglonou B, Gbogbo V, et al. First report of a new bacterial leaf blight of rice caused by *Pantoea ananatis* and *Pantoea stewartii* in Benin. *Plant Dis.* 2017;101:242.
16. Kini K, Agnimonhan R, Afolabi O, Soglonou B, Silué D, Koebnik R. First report of a new bacterial leaf blight of rice caused by *Pantoea ananatis* and *Pantoea stewartii* in Togo. *Plant Dis.* 2017;101:241.
17. Poulin L, Raveloson H, Sester M, Raboin L-M, Silué D, Koebnik R, et al. Confirmation of bacterial leaf streak caused by *Xanthomonas oryzae* pv. *oryzicola* on rice in Madagascar. *Plant Dis.* 2014;98:1423.
18. Zhao S, Poulin L, Rodriguez-R LM, Serna NF, Liu S-Y, Wonni I, et al. Development of a variable number of tandem repeats typing scheme for the bacterial rice pathogen *Xanthomonas oryzae* pv. *oryzicola*. *Phytopathology.* 2012;102:948–956.
19. Edgar RC. MUSCLE: multiple sequence alignment with high accuracy and high throughput. *Nucleic Acids Res.* 2004;32:1792–1797.
20. Breslauer KJ, Frank R, Blocker H, Marky LA. Predicting DNA duplex stability from the base sequence. *Proc. Natl. Acad. Sci. U.S.A.* 1986;83:3746–3750.
21. San Millán RM, Martínez-Ballesteros I, Rementeria A, Garaizar J, Bikandi J. Online exercise for the design and simulation of PCR and PCR-RFLP experiments. *BMC Res. Notes.* 2013;6:513.
22. Ye J, Coulouris G, Zaretskaya I, Cutcutache I, Rozen S, Madden TL. Primer-BLAST: a tool to design target-specific primers for polymerase chain reaction. *BMC Bioinformatics* 2012;13:134.

23. Hunter PR, Gaston MA. Numerical index of the discriminatory ability of typing systems: an application of Simpson's index of diversity. *J Clin Microbiol.* 1988;26:2465–2466.
24. Hunter PR. Reproducibility and indices of discriminatory power of microbial typing methods. *J Clin Microbiol.* 1990;28:1903–1905.
25. Falush D, Stephens M, Pritchard JK. Inference of population structure using multilocus genotype data: dominant markers and null alleles. *Mol Ecol Resour.* 2007;7:574–578.
26. Brown AH, Weir BS. Measuring genetic variability in plant populations. In: Tanksley SD, Orton, TJ (eds.) *Isozymes in Plant Genetics and Breeding.* Elsevier Science Publishers, Amsterdam, The Netherlands; 1983:219–239
27. Peakall R, Smouse PE. GenA1Ex 6.5: genetic analysis in Excel. Population genetic software for teaching and research – an update. *Bioinformatics* 2012;28:2537–2539.
28. Nascimento M, Sousa A, Ramirez M, Francisco AP, Carriço JA, Vaz C. PHYLOViZ 2.0: providing scalable data integration and visualization for multiple phylogenetic inference methods. *Bioinformatics* 2017;33:128–129.
29. Francisco AP, Bugalho M, Ramirez M, Carriço JA. Global optimal eBURST analysis of multilocus typing data using a graphic matroid approach. *BMC Bioinformatics* 2009;10:152.
30. Danielsson PE. Euclidean distance mapping. *Comput. Graph Image Process.* 1980;14:227–248.
31. Kido K, Hasegawa M, Matsumoto H, Kobayashi M, Takikawa Y. *Pantoea ananatis* strains are differentiated into three groups based on reactions of tobacco and welsh onion and on genetic characteristics. *J. Gen. Plant Pathol.* 2010;76:208–218.
32. Weller-Stuart T, De Maayer P, Coutinho T. *Pantoea ananatis*: genomic insights into a versatile pathogen. *Mol. Plant Pathol.* 2017;18:1191–1198.
33. Brady C, Cleenwerck I, Venter S, Vancanneyt M, Swings J, Coutinho T. Phylogeny and identification of *Pantoea* species associated with plants, humans and the natural environment based on multilocus sequence analysis (MLSA). *Syst. Appl. Microbiol.* 2008;31:447–460.
34. Rubinsztein DC, Amos W, Leggo J, Goodburn S, Jain S, Li S-H, et al. Microsatellite evolution – evidence for directionality and variation in rate between species. *Nat. Genet.* 1995;10:337–343.
35. Urwin R, Maiden MCJ. Multi-locus sequence typing: a tool for global epidemiology. *Trends Microbiol.* 2003;11:479–487.
36. Van Belkum A, Tassios PT, Dijkshoorn L, Haeggman S, Cookson B, Fry NK, et al. Guidelines for the validation and application of typing methods for use in bacterial epidemiology. *Clin Microbiol Infect.* 2007;13:1–46.
37. Hara Y, Kadotani N, Izui H, Katashkina JI, Kuvaeva TM, Andreeva IG, et al. The complete genome sequence of *Pantoea ananatis* AJ13355, an organism with great biotechnological potential. *Appl. Microbiol. Biotechnol.* 2012;93:331–341.

38. Megias E, Megias M, Ollero FJ, Hungria M. Draft genome sequence of *Pantoea ananatis* strain AMG521, a rice plant growth-promoting bacterial endophyte isolated from the Guadalquivir marshes in southern Spain. *Genome Announc.* 2016;4: e01681–15.
39. Kim HJ, Lee JH, Kang BR, Rong X, Gardener BBM, Ji HJ, et al. Draft genome sequence of *Pantoea ananatis* B1-9, a nonpathogenic plant growth-promoting bacterium. *J. Bacteriol.* 2012;194:729–729.
40. Weller-Stuart T, Chan WY, Coutinho TA, Venter SN, Smits THM, Duffy B, et al. Draft genome sequences of the onion center rot pathogen *Pantoea ananatis* PA4 and maize brown stalk rot pathogen *P. ananatis* BD442. *Genome Announc.* 2014;2:e00750-14.
41. Smith DDN, Kirzinger MWB, Stavrinides J. Draft genome sequence of the antibiotic-producing epiphytic isolate *Pantoea ananatis* BRT175. *Genome Announc.* 2013;1:e00902-13.
42. Medrano EG, Bell AA. Genome Sequence of *Pantoea ananatis* Strain CFH 7-1, which is associated with a vector-borne cotton fruit disease. *Genome Announc.* 2015;3:e01029-15.
43. De Maayer P, Chan WY, Venter SN, Toth IK, Birch PRJ, Joubert F, et al. Genome sequence of *Pantoea ananatis* LMG20103, the causative agent of Eucalyptus blight and dieback. *J. Bacteriol.* 2010;192:2936–2937.
44. Adam Z, Tambong JT, Lewis CT, Lévesque CA, Chen W, Bromfield ESP, et al. Draft genome sequence of *Pantoea ananatis* strain LMG 2665<sup>T</sup>, a bacterial pathogen of pineapple fruitlets. *Genome Announc.* 2014;2:e00489-14.
45. Maayer PD, Chan WY, Rezzonico F, Bühlmann A, Venter SN, Blom J, et al. Complete genome sequence of clinical isolate *Pantoea ananatis* LMG 5342. *J. Bacteriol.* 2012;194:1615–1616.
46. Midha S, Bansal K, Sharma S, Kumar N, Patil PP, Chaudhry V, et al. Genomic resource of rice seed associated bacteria. *Front. Microbiol.* 2016;6:1551.
47. Choi O, Lim JY, Seo Y-S, Hwang I, Kim J. Complete genome sequence of the rice pathogen *Pantoea ananatis* strain PA13. *J. Bacteriol.* 2012;194:531.
48. Ma J, Zhang K, Liao H, Hector SB, Shi X, Li J, et al. Genomic and secretomic insight into lignocellulolytic system of an endophytic bacterium *Pantoea ananatis* Sd-1. *Biotechnol. Biofuels.* 2016;9:25.

### Competing interests

We declare that we have no competing interests. The funding body had no role in study design, data collection and analysis, preparation of the manuscript or decision to publish.

### Acknowledgements

We thank Toyin Afolabi (Africa Rice Center Cotonou, Benin), and Sandrine Fabre and Florence Auguy (IRD, Cirad, University Montpellier, IPME, Montpellier, France) for excellent technical support.

**Funding**

This publication has been produced with the financial support of the Allocation de Recherche pour une Thèse au Sud (ARTS) program of the Institut de Recherche pour le Développement (IRD). KK received an individual research grant N° C/5921-1 from the International Foundation for Science (IFS). AfricaRice and IRD received financial support from the Global Rice Science Partnership (GRiSP). In addition, AfricaRice received financial support from the Ministry of Foreign Affairs, Japan.

**Authors' contributions**

KK, RK, DS and IW participating in the planning of the project, analyzed the results and drafted the manuscript. KK and RK designed the primers and carried out the in silico molecular analysis. KK performed experiments in the laboratory. All authors critically contributed in the drafting and reviewing the manuscript and checked for important intellectual issues. They all approved the final version of the manuscript to be submitted for publication.

**Ethics approval and consent to participate**

Not applicable.

**Consent for publication**

Not applicable.

**Ethics**

Not applicable.

**Competing interests**

The authors declare that they have no competing interests.

**Authors' details**

Kossi Kini, Institut de Recherche pour le Développement, Montpellier, France; Université de Montpellier, France & Africa Rice Center, Plant Pathology, Cotonou, Benin;

Drissa Silué, Africa Rice Center, Plant Pathology, Cotonou, Benin;

Ralf Koebnik, Institut de Recherche pour le Développement, Montpellier, France

**Table 1:** List of *P. ananatis* genome sequences used for the computational evaluation of the MLVA tools.

Strain	Origin	Country	Year of isolation	Acc number	Ref
AJ13355*	n.a.	Japan	n.a.	AP012032	[37]
AMG521*	Soil rhizosphere	Spain	2005	LMYG01	[38]
B1-9 -37*	Onion	n.a.	n.a.	CAEJ01	[39]
B1-9 -39*	Onion	n.a.	n.a.	CAEJ01	[39]
BD442	Maize stalk rot	South Africa	2004	JM JL01	[40]
BRT175*	Strawberry	n.a.	n.a.	ASJH01	[41]
CFH 7-1	Cotton boll	USA	2011	LFLX01	[42]
NFIX48	n.a	USA	n.a	FUXY01	n.a
NFR11	n.a	USA	n.a	FPJM01	n.a
DAR 76143	Diseased rice plant	Australia	2002	BATH01	n.a
LMG 20103	Eucalyptus	South Africa	n.a.	CP001875	[43]
LMG 2665*	Pineapple	Brazil	1965	JMJJ01	[44]
LMG 5342*	Human wound	Philippines		HE617160	[45]
NS296	Rice seed	India	2013	LDQX01	[46]
NS303	Rice seed	India	2013	LDQY01	[46]
NS311	Rice seed	India	2013	LDQZ01	[46]
RSA47*	Rice seed	India	2013	LDRA01	
PA13*	Rice grain	Korea	n.a.	CP003085	[47]
PA4*	Onion seed	South Africa	2004	JMJK01	[41]
PaMB1*	Rice	China	2011	JQZZ01	
S6*	Maize seed			CVNF01	[9]
S7	Maize seed			CVNG01	[9]
S8	Maize seed			CVNH01	[9]
Sd-1*	Rice seed	China	n.a.	AZTE01	[48]

\* Strains used for computational identification of VNTR loci

**Table 2: Characteristics of VNTR loci for the 94 *P. ananatis* strains tested (details in the Table 1 of Supplementary File).**

Primers	VNTR locus	Repeat size	N° of repeats		N° of samples	N° of types	HGDI*	Class	MLVA-6
			Min.	Max.					
CGGCCTGATTCAGATGCT	Loc_56	8	1	20	88	18	0.9156	Highly	Microsatellite
GGTGGGGGAAACTGAAGG									
GTTGTCGGCGCACAGTTT	Loc_54	8	1	8	91	8	0.8188	Highly	
TTGGCCTGAACGAAGAGC									
GCAGAAAACCAGCGAGGA	Loc_16	9	2	9	91	8	0.6684	Highly	
ATTGTCTTCACGCGGCTC									
GTGAAGCCACACCGGAAG	Loc_5	6	5	7	93	3	0.6639	Highly	
AAGTAAGGCCACCCGGAG									
CCCACATCACGTGGACAA	Loc_66	6	1	6	87	6	0.3119	Poorly	
TATAACGTGCTGACGCCG									
AGCACGCCGAGTAACAGC	Loc_55	6	2	12	94	7	0.1633	Poorly	Minisatellite
TGGGCATAGAGCAGGAGG									
AAAAGGTCAATCACGGCG	Loc_23	12	2	15	48	13	0.8395	Highly	
CGCCGTTCTGGGTACAC									
CCCTGTCTTCCCTCAT	Loc_2	11	3	5	75	3	0.5946	Highly	
ACGATTTGAGGGATGCGA									
AGCGTAAATCCAGTTTATC	Loc_1	22	1	4	91	4	0.5099	Highly	
TGAGGTGAGATTTAACGGC									
CAACATGAGGATGCATTGA	Loc_65	13	1	3	91	3	0.5077	Highly	
CAGAAGAAGTCTGGCTTAC									
CGGGTCTTTTAGCGGGT	Loc_4	12	2	4	87	3	0.1112	Poorly	
CCATGAAGGCAAAAACCG									
CGACAGCGCAGGCAGCTC	Loc_68	10	1	5	85	5	0.1361	Poorly	
CAGCAGCCGAACAAAACG									

The collection consists of African *P. ananatis* strains isolated from Rice leaves and seeds, CFBP reference strains and other strains with complete genome sequences available on NCBI.

\* Hunter-Gaston discriminatory index.

**Table 3:** Haplotype diversity of the 94 *P. ananatis* strains tested.

Locus	N	Na	Ne	I	h	uh	MLVA-6
Loc_16	90	8	2.905	1.484	0.656	0.663	Microsatellite
Loc_56	88	18	10.550	2.560	0.905	0.916	
Loc_54	91	8	5.258	1.852	0.810	0.819	
Loc_66	88	6	1.439	0.717	0.305	0.309	
Loc_55	94	7	1.193	0.439	0.162	0.163	
Loc_5	93	3	2.913	1.083	0.657	0.664	
<b>MLVA-6</b>	90.667	8.333	4.043	1.356	0.582	0.589	
Loc_2	75	3	2.419	0.970	0.587	0.595	Minisatellite
Loc_23	39	14	8.895	2.399	0.888	0.911	
Loc_4	87	3	1.123	0.259	0.110	0.111	
Loc_65	91	3	2.008	0.737	0.502	0.508	
Loc_1	91	4	2.017	0.833	0.504	0.510	
Loc_68	86	5	1.182	0.386	0.154	0.156	
<b>MLVA-6</b>	78.166	5.333	2.94	0.931	0.457	0.465	

Percentage of polymorphic loci=100%;

Na, number of different alleles;

Ne, number of effective alleles =  $1 / (\sum pi^2)$ ;

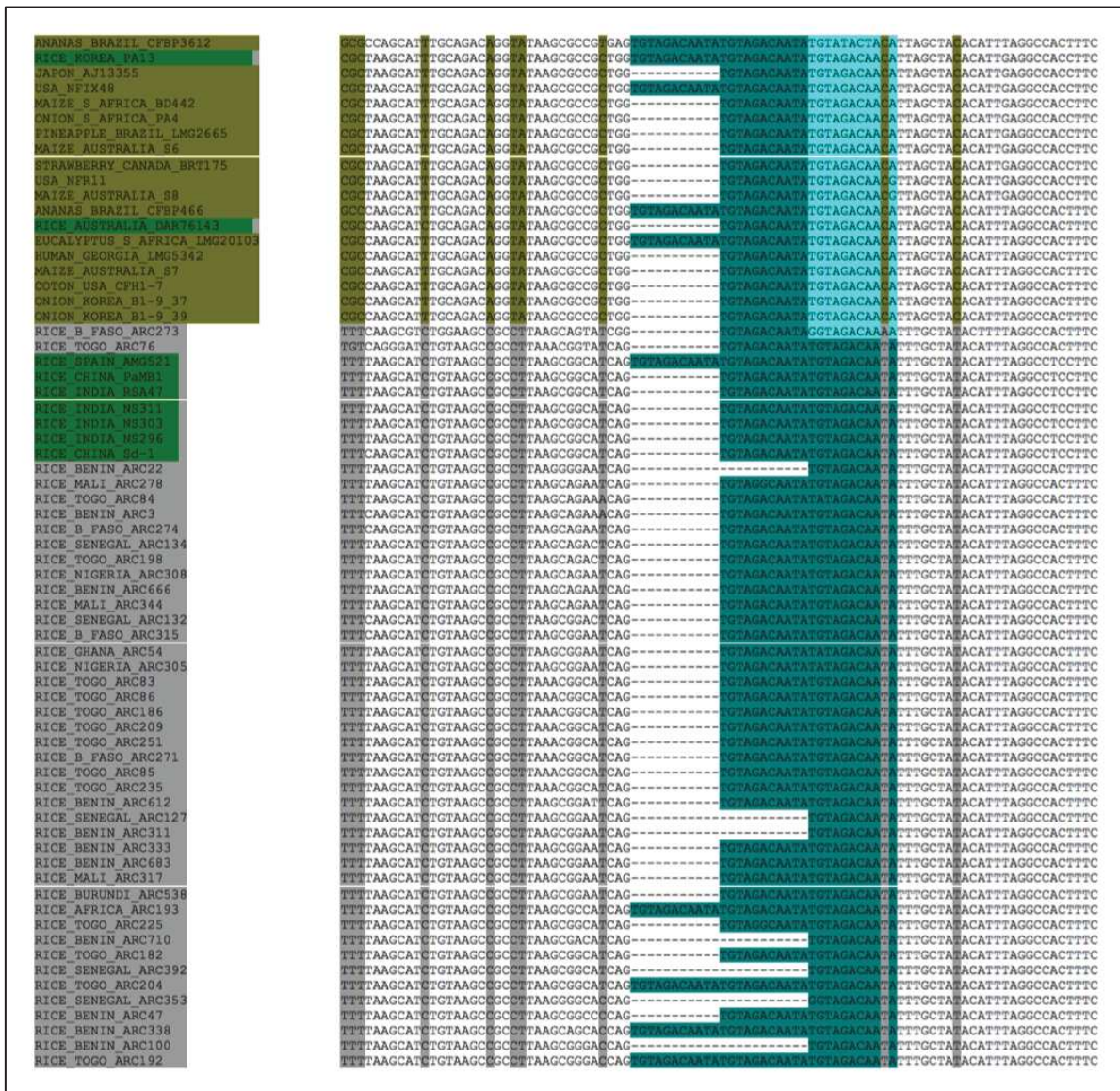
I, Shannon's information index =  $-1 * \sum (pi * \ln [pi])$ ;

h, diversity =  $1 - \sum pi^2$ ;

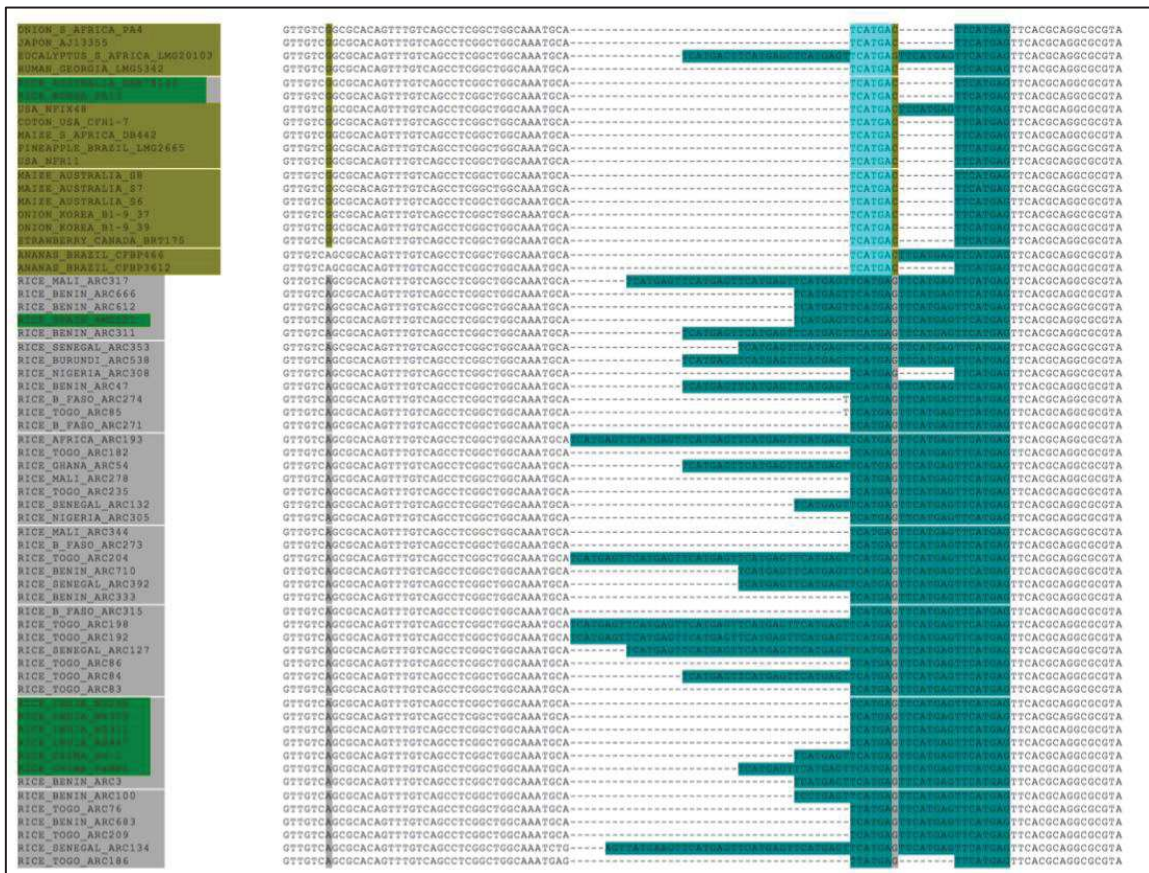
uh, unbiased diversity =  $(N / (N-1)) * h$ ;

pi, frequency of the  $i^{th}$  allele for the population and  $\sum pi^2$  is the sum of the squared population allele frequencies.

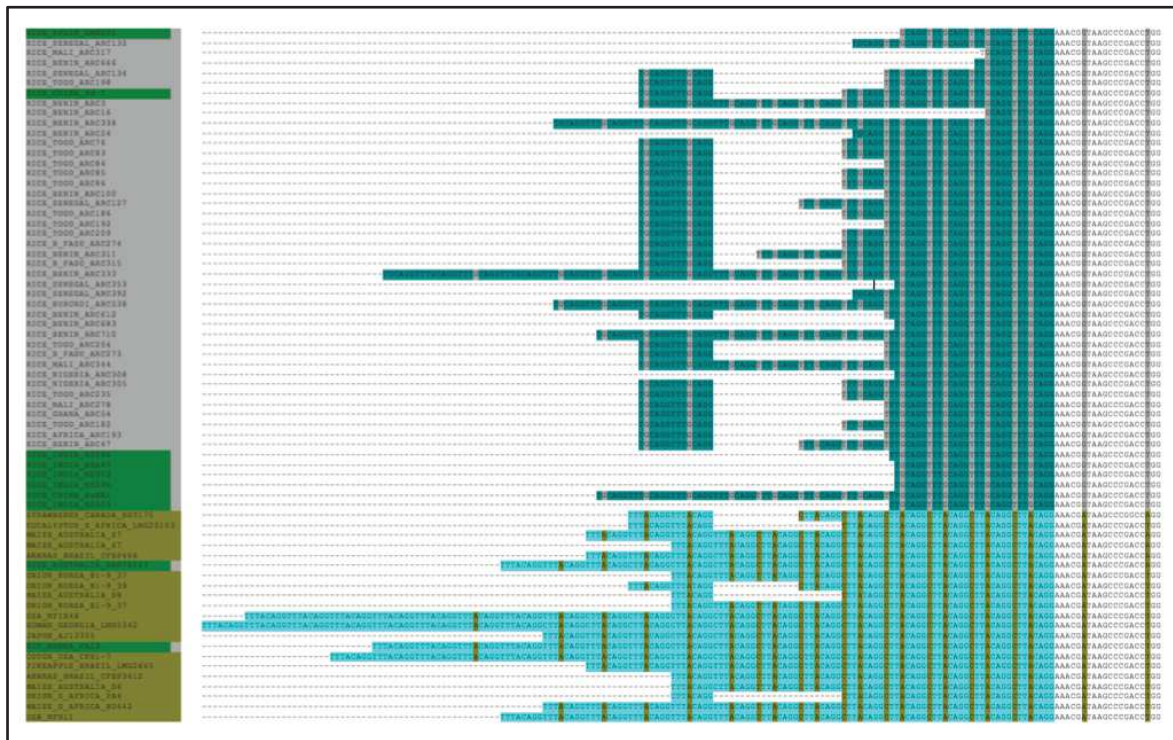




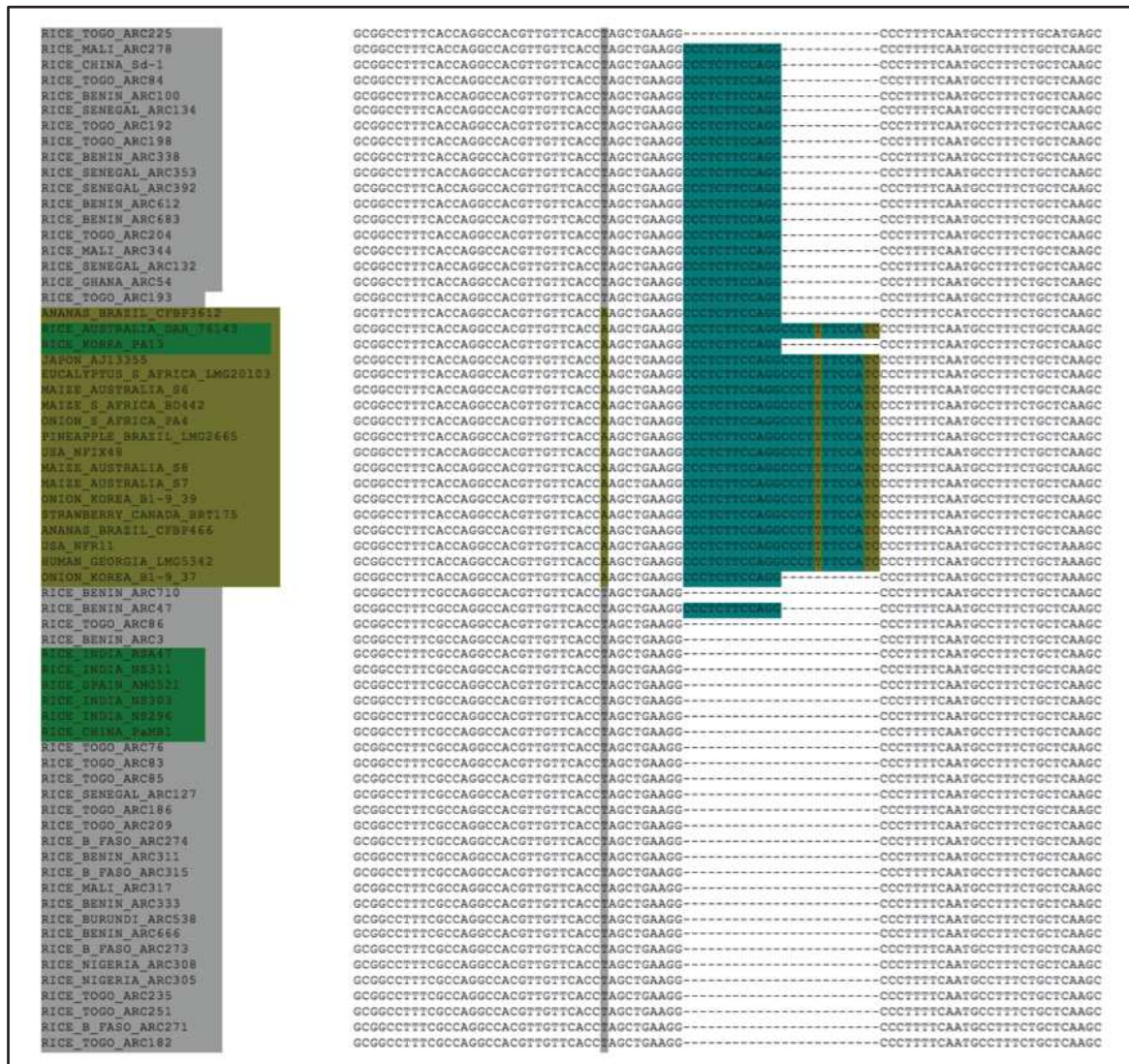
**Figure 1:** Sequence alignment of VNTR locus Loc\_2 and its flanking sequences. The sequences are labeled as follows: Source of isolation\_Country\_Strain. Groups of strains are highlighted in gray for rice isolates from Africa, dark green for rice isolates from other continents and in olive green for isolates from other sources. VNTR repeats loci are highlighted in peacock blue for those isolated from the rice and in turquoise for those specific to isolates from other sources. SNPs specific to rice isolates are highlighted in gray and those specific to isolates from other sources are highlighted in olive green.



**Figure 2:** Sequence alignment of VNTR locus Loc\_54 and its flanking sequences. The sequences are labeled as follows: Source of isolation\_Country\_Strain. Groups of strains are highlighted in gray for rice isolates from Africa, dark green for rice isolates from other continents and in olive green for isolates from other sources. VNTR repeats loci are highlighted in peacock blue for those isolated from the rice and in turquoise for those specific to isolates from other sources. SNPs specific to rice isolates are highlighted in gray and those specific to isolates from other sources are highlighted in olive green.

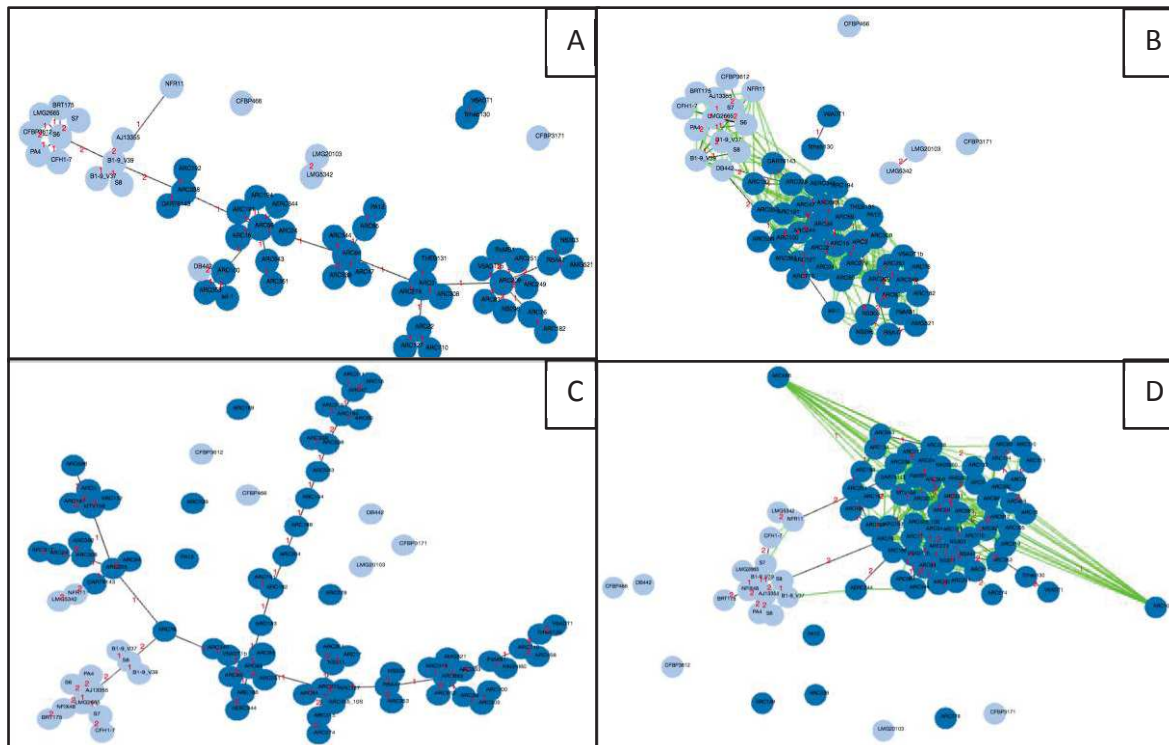


**Figure 3:** Sequence alignment of VNTR locus Loc\_56 and its flanking sequences. The sequences are labeled as follows: Source of isolation\_Country\_Strain. Groups of strains are highlighted in gray for rice isolates from Africa, dark green for rice isolates from other continents and in olive green for isolates from other sources. VNTR repeats loci are highlighted in peacock blue for those isolated from the rice and in turquoise for those specific to isolates from other sources. SNPs specific to rice isolates are highlighted in gray and those specific to isolates from other sources are highlighted in olive green.

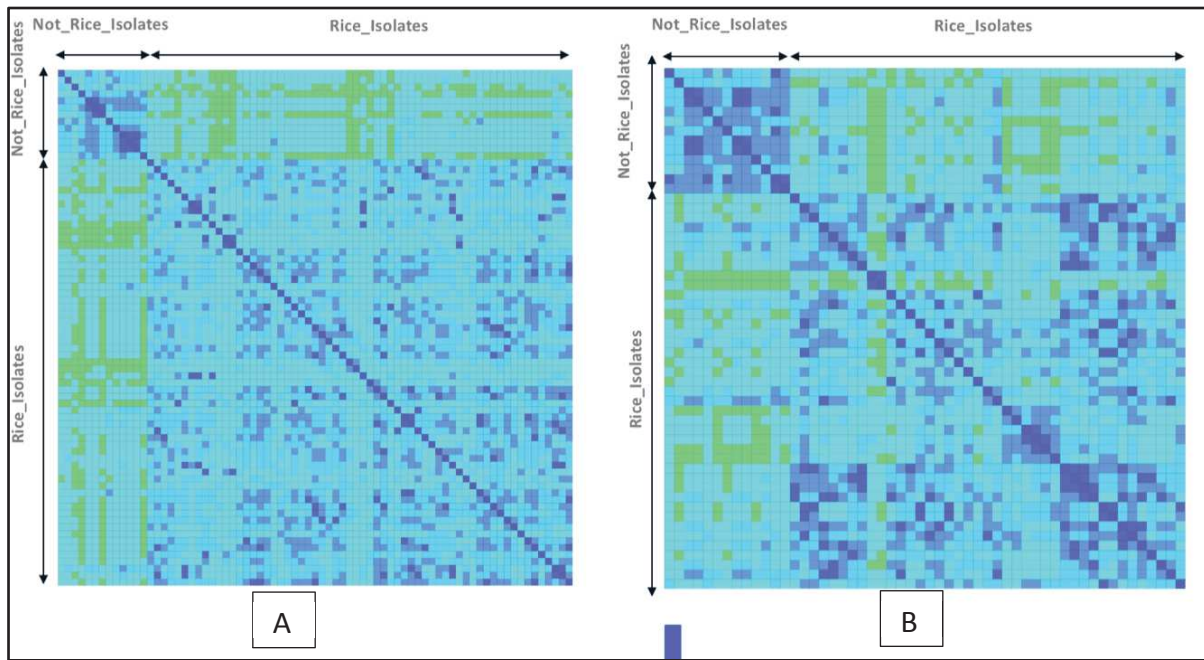


**Figure 4:** Sequence alignment of VNTR locus Loc\_65 and its flanking sequences.

The sequences are labeled as follows: Source of isolation\_Country\_Strain. Groups of strains are highlighted in gray for rice isolates from Africa, dark green for rice isolates from other continents and in olive green for isolates from other sources. VNTR repeats loci are highlighted in peacock blue for those isolated from the rice and in turquoise for those specific to isolates from other sources. SNPs specific to rice isolates are highlighted in gray and those specific to isolates from other sources are highlighted in olive green.



**Figure 5:** Minimum spanning tree (MST) of MLVA-6\_minisat (A) and MLVA-6\_microsat (C) and the connection of haplotypes network of MLVA-6\_minisat (B) and MLVA-6\_microsat (D) showing the formation of two clades, one of which consists exclusively of strains of *P. ananatis* isolated from rice (cerulean blue disc) and the other clade is constituted strains obtained from other sources (sky blue disc). Tree cut-off = 3, NLV graph = 1.



**Figure 6:** Euclidean distance diagram computed with tree cut-off= 3 and NLV graph = 1. The diagram confirmed the formation of two clades, one of which consists exclusively of strains of *P. ananatis* isolated from rice and the other clade is constituted strains obtained from other sources. A= MLVA-6\_minisat and B= MLVA-6\_microsat.

**Supplementary file:**

Attachment, Table 1 (*P. ananatis* strains) and table 3: List of African strains and CFBP reference strains used for the evaluation and validation of the MLVA-6\_minisat and MLVA-6\_microsat tools.

### **3. Sixth drafted manuscript: Development of a PCR diagnostic tool capable of distinguishing *P. ananatis* rice strains from *P. ananatis* of other sources.**

#### **3.1. Contexts and justification**

*Pantoea ananatis* is one of the most versatile and ubiquitous bacteria. Indeed, the bacteria have been isolated from several sources including plants, animals (insects and humans) and environment. For plants, the bacteria have been repeatedly reported as pathogenic for rice. Recent works have shown that the species is composed of two clades: one is composed only of strains isolated from rice as pathogen or endophyte and the other clade consisting of isolates from other sources included some rice isolates.

The ANI of *P. ananatis* genome represented world wide diversity from Africa, Europe and Asia revealed interesting results. Indeed, it shows that they are more than 99.20% identical whereas they are on average 96.30 close to *P. ananatis* from other sources. Interestingly, the two MLVA tools developed by our teams for *P. ananatis*, distinguished the two clades through the homoplasy and SNPs analysis. These observations were confirmed by the MST and the distance matrix diagram. In addition, phylogenetic trees constructed from four housekeeping gene (*infB*, *atpD*, *gyrB* and *rpoB*) confirmed the results of the previous analysis with the formation of the two clades in the *P. ananatis* groups. Further work on the comparative analysis of the LPS gene cluster of strains of represented worldwide diversity allowed us to predict that the both clades would be serologically distinct. It would be likely to be distinguished from each other by immunological means. Thus, questions about a possible pathovarization of this species arise, and answers must be found to understand the element that supports this interaction *P. ananatis*-rice. But upstream of all the investigations to find these answers, it is essential to have specific discriminatory diagnostic tools. Like so, we have developed two PCR diagnostic tools consisting of a set of specific primers of each clade, capable of amplifying specifically, a strain belonging to each of the two clades. The details on the development and validation of this tool are summarized in the draft below.

#### **3.2. Introduction**

*Pantoea ananatis* is a ubiquitous species of the *Enterobacteriaceae* family. Present in a broad variety of environmental contexts (soil, rivers, beef ...), it is however most frequently found in association with plant tissues (roots, leaves, stems, seeds) monocotyledonous and dicotyledonous epiphyte or endophyte [1–3]. Beneficial properties have been found for some strains on various plants including rice, indicating extremely complex modes of interaction with plants. The ability of *P. ananatis* to survive in invertebrate and its identification as responsible for at least two human pathologies shows that its interaction potential exceeds plant kingdom [1,4].

[5], sorghum [6], sugarcane, maize [7], onion [8], and rice [9–11]. At Africa, *P. ananatis* has so far been identified only in South Africa and Morocco, associated with pathologies on Eucalyptus [12], onion [13]. As rice pathogen, the bacterial blight of rice due to *P. ananatis* has been reported at India [9], China [14], Italy [11] and Russia [15]. In these latter cases,

the disease is observed at the leaf level, while it attacks rice kernels (palea) in other published studies.

In 2016 Africa Rice Center identified *P. ananatis* as a rice pathogen [16,17]. The associated symptoms are remarkably similar to those caused by *Xanthomonas oryzae pv oryzae*. Like so, a vast sampling campaign of symptomatic rice organ (leaves and seeds) has allowed detecting the widespread presence of the bacteria in 11 African countries: Senegal, Burkina Faso, Mali, Togo, Gambia, Benin, Nigeria, Niger, Rwanda, Côte d'Ivoire and Ghana (Kini et al in press). Preliminary work has facilitated the diagnostics of *P. ananatis* by the development of several diagnostic tools included LAMP, MLVA, Multiplex PCR. (Kini et al in press.).

Further work on genomic analyses (ANI) and phylogenomic (MLVA-6\_*minisat* and MLVA-6\_*microsat*) shows that *P. ananatis* would form of two clades: one is composed only of strains isolated from rice as Pathogen or endophyte and the other clade consisting of isolates from other sources included some rice isolates. These results confirm the work of De Maayer et al (2017). Several tools of diagnosis and typing (WGSs analyze, MLVA ...) were developed by ours team. These useful tools allow to put in evidence the presence of two clade in species *P. ananatis*. However, they are complex, expensive, laborious and difficult to apply by the majority of the laboratories of Sub-Saharan Africa. As follows, we had filled this gap by developing two simplex PCR diagnostic tools easily accessible with lower costs. The consisted of a set of specific primers of each clade, capable of amplifying specifically, a strain belonging to each of the two clades. Analysis of the partial sequences of housekeeping genes (*infB*, *atpD*, *gyrB* and *rpoB*) of a set of *P. ananatis* isolated from rice and other sources confirm the formation of the two clades. Based on these results two simplexes PCR diagnostic tools were developed. The primers were designed in the SNPs zones of the *infB* gene (which differentiates the two clades). Then, the in vivo evaluation confirmed the results observed during in silico analysis.

### 3.3. Materials and methods

#### Bacterial strain used

All the isolates used in this study come from those used in the development and validation of mPCR, MLVA (Kini et al 2018)

#### Bioinformatics prediction of specific PCR primers

##### Trees constructions

Pantoea genome sequences were retrieved from NCBI GenBank (Table 1). Sequences for housekeeping genes were identified by TBLASTN [19]. Sequences were then aligned with <http://phylogeny.lirmm.fr> [20] and phylogenetic tree were built for the 4 housekeeping

##### Primer designing

Based on SNPs in the alignment of the partial sequencing of *infB* gene that distinguishes the two clades of *P. ananatis*, diagnosis primers that can differentiate *P. ananatis* isolated from rice from *P. ananatis* isolated from other sources were designed (Figure 2 and 3). The Tm for PCR primers was predicted by Tm calculator tool uses a modified nearest-neighbor method based [21,22].



The primers were evaluated *in vivo*, to fix the condition and the PCR reaction, each primer was tested against pure DNA and bacterial lysis of CFPB *Pantoea* sp strains and African strains from rice, using annealing temperatures ( $T_m$ ) close to predicted  $T_m$  ( $T_m \pm 5^\circ \text{C}$ ) and with progressive number of PCR cycles (25 to 35).

### Results and discussions

The phylogenetic tree (Figure 1) of 2706 bp, 2015 bp, 2706 bp and 1420 bp respectively of the, *rpoB* (Fig\_A) and *gyrB* (Fig\_B) *infB* (Fig\_C) and *atpD* (Fig\_D), house-keeping gene, shown the formation of two groups of *Pantoea ananatis* house-keeping gene. First group (in blue) consisting of *P. ananatis* isolated from rice in Africa, Asia and Europe and the second group consisting of *P. ananatis* isolated from other plants and from the environment.

*In vivo* evaluation allowed to fix the PCR conditions (Table 1 and 2) for the two primer pairs. The results from the specificity assessment showed the specificity and universality of the primers (figure 4 and 5) thus confirming the results obtained *in Silico*.

### 3.4. Conclusion

The advantages of this tool are that it will make it easy to distinguish the *P. ananatis* strains from the two clades in advance, before complex and extensive analysis (WGSs, MLVA, MLST) confirmation work is done. In this way, it will be very helpful in future work that will focus on understanding the factors that explain the *P. ananatis*-Rice interaction. It can be used by plant protection services for routine testing of *P. ananatis* on everything for seed control.

### References Cited

1. Brady C, Cleenwerck I, Venter S, Vancanneyt M, Swings J, Coutinho T. Phylogeny and identification of *Pantoea* species associated with plants, humans and the natural environment based on multilocus sequence analysis (MLSA). *Syst. Appl. Microbiol.* 2008;31:447–60.
2. Walterson AM, Stavriniades J. *Pantoea*: insights into a highly versatile and diverse genus within the Enterobacteriaceae. *FEMS Microbiol. Rev.* 2015;39:968–84.
3. Kido K, Hasegawa M, Matsumoto H, Kobayashi M, Takikawa Y. *Pantoea ananatis* strains are differentiated into three groups based on reactions of tobacco and welsh onion and on genetic characteristics. *J. Gen. Plant Pathol.* 2010;76:208–18.
4. Coutinho TA, Venter SN. *Pantoea ananatis*: an unconventional plant pathogen. *Mol. Plant Pathol.* 2009;10:325–35.
5. Kido K, Adachi R, Hasegawa M, Yano K, Hikichi Y, Takeuchi S, et al. Internal fruit rot of netted melon caused by *Pantoea ananatis* (= *Erwinia ananas*) in Japan. *J. Gen. Plant Pathol.* 2008;74:302–312.
6. Cota LV, Costa RV, Silva DD, Parreira DF, Lana UGP, Casela CR. First report of pathogenicity of *Pantoea ananatis* in sorghum (*Sorghum bicolor*) in Brazil. *Australas. Plant Dis. Notes.* 2010;5:120–122.

7. Pérez-y-Terrón R, Villegas MC, Cuellar A, Muñoz-Rojas J, Castañeda-Lucio M, Hernández-Lucas I, et al. Detection of *Pantoea ananatis*, causal agent of leaf spot disease of maize, in Mexico. *Australas. Plant Dis. Notes*. 2009;4:96–99.
8. Schwartz HF, Otto K. First report of a leaf blight and bulb decay of onion by *Pantoea ananatis* in Colorado. *Plant Dis*. 2000;84:808–808.
9. Mondal KK, Mani C, Singh J, Kim J-G, Mudgett MB. A new leaf blight of rice caused by *Pantoea ananatis* in India. *Plant Dis*. 2011;95:1582–1582.
10. Cother EJ, Reinke R, McKenzie C, Lanoiselet VM, Noble DH. An unusual stem necrosis of rice caused by *Pantoea ananas* and the first record of this pathogen on rice in Australia. *Australas. Plant Pathol*. 2004;33:495–503.
11. Cortesi P, Pizzatti C, others. Palea browning, a new disease of rice in Italy caused by *Pantoea ananatis*. *J. Plant Pathol*. 2007; 89.
12. Coutinho TA, Preisig O, Mergaert J, Cnockaert MC, Riedel K-H, Swings J, et al. Bacterial blight and dieback of Eucalyptus species, hybrids, and clones in South Africa. *Plant Dis*. 2002;86:20–25.
13. Achbani EH, Mazouz H, Benbouazza A, Sadik S. First detection of *Pantoea ananatis*, the causal agent of bacterial center rot of onion in Morocco. *J. Crop Prot*. 2015;5:11–17.
14. Yan H, Yu SH, Xie GL, Fang W, Su T, Li B. Grain discoloration of rice caused by *Pantoea ananatis* (synonym *Erwinia uredovora*) in China. *Plant Dis*. 2010;94:482–482.
15. Egorova M, Mazurin E, Ignatov AN, others. First report of *Pantoea ananatis* causing grain discoloration and leaf blight of rice in Russia. *New Dis. Rep*. 2015;32:21.
16. Kini K, Agnimonhan R, Afolabi O, Milan B, Soglonou B, Gbogbo V, et al. First report of a new bacterial leaf blight of rice caused by *Pantoea ananatis* and *Pantoea stewartii* in Benin. *Plant Dis*. 2017 /doi/pdf/10.1094/PDIS-06-16-0940-PDN
17. Kini K, Agnimonhan R, Afolabi O, Soglonou B, Silué D, Koebnik R. first report of a new bacterial leaf blight of rice caused by *Pantoea ananatis* and *Pantoea stewartii* in Togo. *Plant Dis*. /doi/full/10.1094/PDIS-06-16-0939-PDN
18. De Maayer P, Aliyu H, Vikram S, Blom J, Duffy B, Cowan DA, et al. Phylogenomic, pan-genomic, pathogenomic and evolutionary genomic insights into the agronomically relevant enterobacteria *Pantoea ananatis* and *Pantoea stewartii*. *Front. Microbiol*. 2017;8:1755.
19. Gertz EM, Yu Y-K, Agarwala R, Schäffer AA, Altschul SF. Composition-based statistics and translated nucleotide searches: improving the TBLASTN module of BLAST. *BMC Biol*. 2006;4:41.
20. Dereeper A, Guignon V, Blanc G, Audic S, Buffet S, Chevenet F, et al. Phylogeny. fr: robust phylogenetic analysis for the non-specialist. *Nucleic Acids Res*. 2008;36:W465–W469.
21. SantaLucia J. A unified view of polymer, dumbbell, and oligonucleotide DNA nearest-neighbor thermodynamics. *Proc. Natl. Acad. Sci*. 1998;95:1460–5.
22. Breslauer KJ, Frank R, Blöcker H, Marky LA. Predicting DNA duplex stability from the base sequence. *Proc. Natl. Acad. Sci. U. S. A*. 1986;83:3746–50.

**Table 1:** *Pantoea ananatis* Primers sequences

Oligo name	Sequence
KK_PANAN_Others_InfB-f	ACCGTGATGTCATCATTGGC
KK_PANAN_Other_InfB_r	GGATAGCATTTAACAGGTCATCG
KK_PANAN_Rice_infB_f	AACTGATAACGGCATGATCACCT
KK_PANAN_Rice_infB_r	CGGCACGGATAGCCGTCAGTTC

**Table 2:** Composition of the polymerase chain reaction.

<b>PCR component</b>	<b>Volume per reaction (<math>\mu\text{L}</math>)</b>	<b>Final concentration</b>
Buffer (5x)	5.0	1x
dNTPs (2.5 mM each)	0.5	50 $\mu\text{M}$ each
Oligonucleotides (10 $\mu\text{M}$ )	1	4 $\mu\text{M}$ each
Takara ExTaq <sup>TM</sup> (5 units/ $\mu\text{L}$ )	0.1	0.5 U
Template DNA	2.0	
Sterile nanopure water	15.4	
Total	25.0	

**Table 3:** Reaction parameters of the PCR thermocycler program

<b>Step</b>	<b>Phase</b>	<b>Time</b>	<b>Temperature (°C)</b>
1	Initial denaturation	3 min	94
2	Denaturation	30 sec	94
3	Annealing	30 sec	58
4	Extension	2 min	72
5	Cycling (steps 2-4)	30 cycles	
6	Final extension	10 min	72
7	Soak/hold	$\infty$	4-10
8	End		

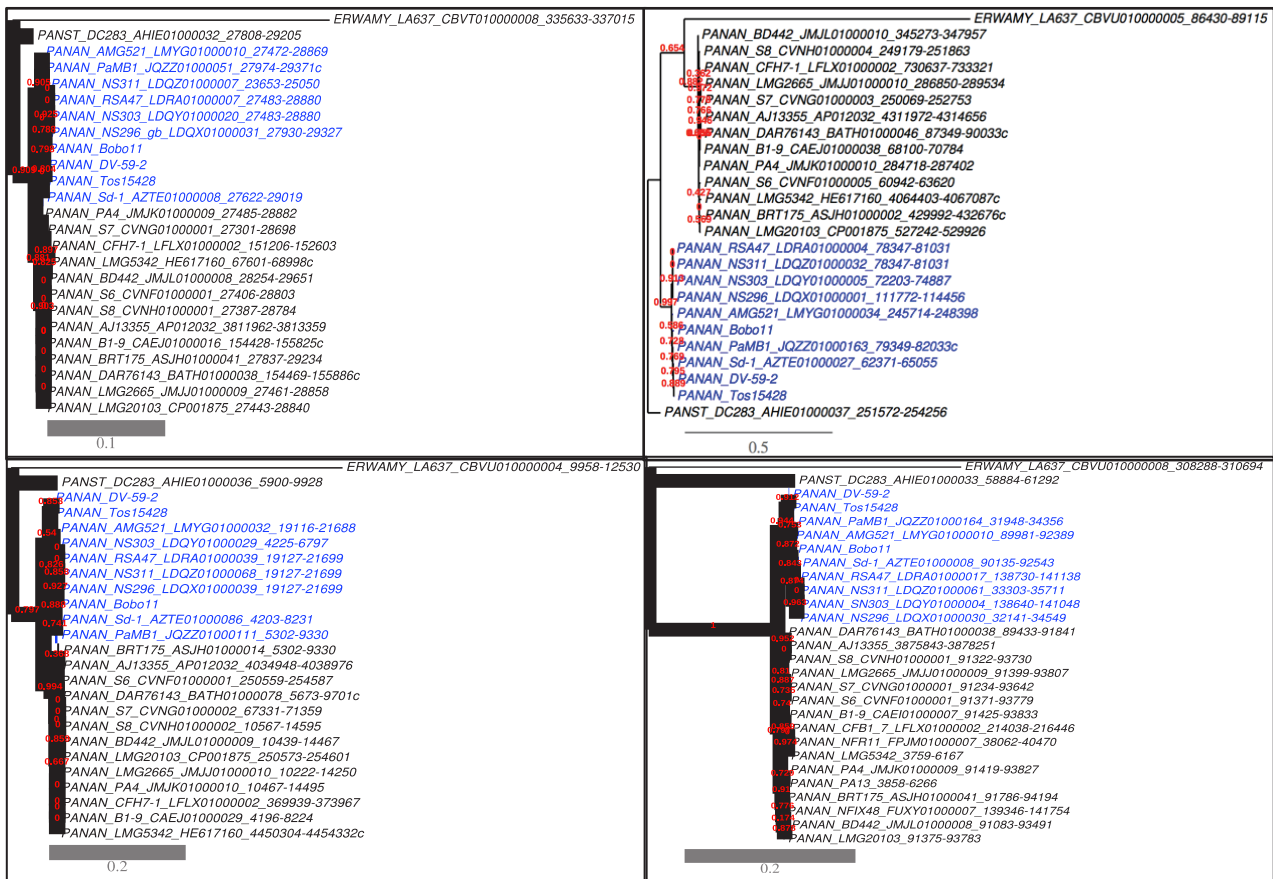
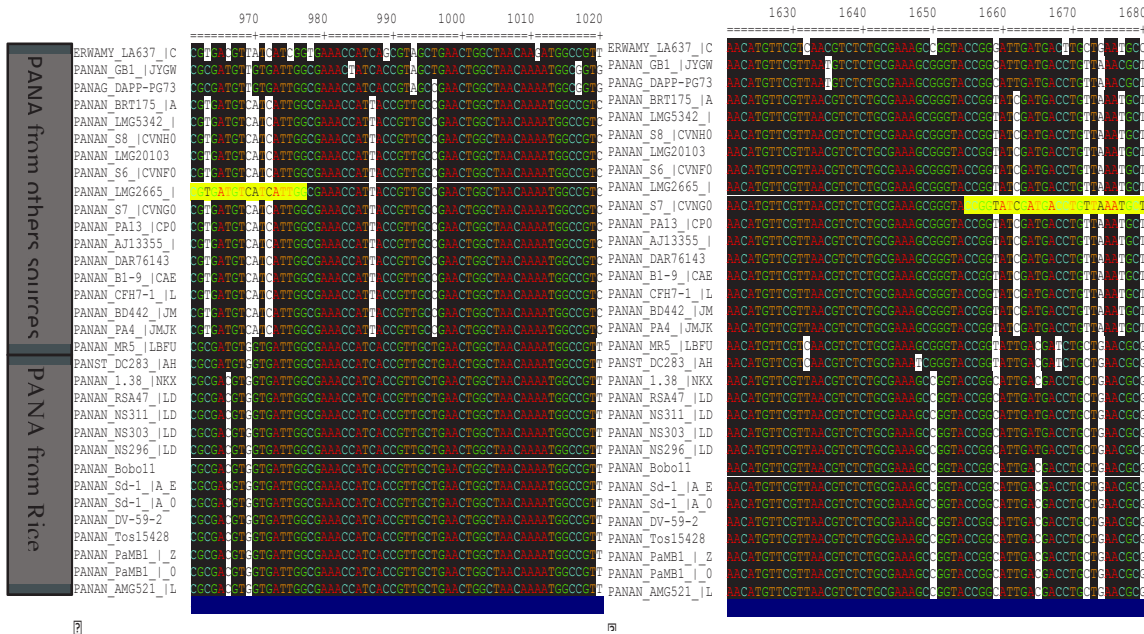
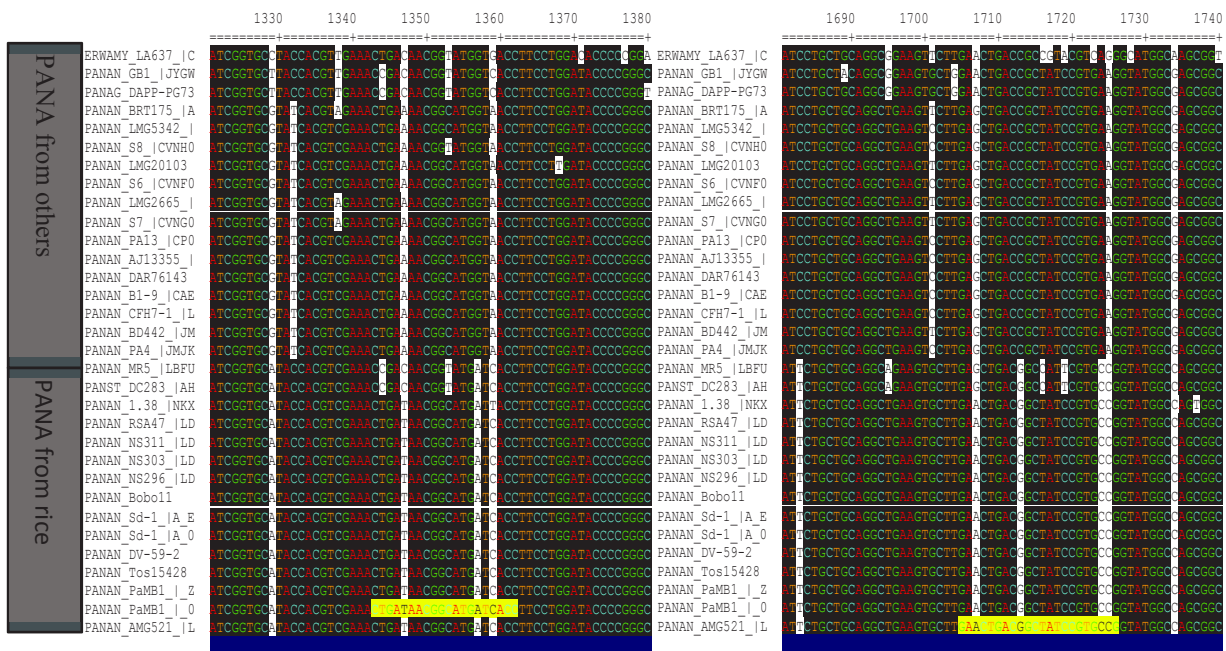


Figure 1: House-keeping gene rpoB (A), gyrB (B) infB (C) and atpD (D), standard approximation likelihood ratio tree created using Phylogeny.fr showed the formation of two groups of *Pantoea ananatis* for each gene. One group (in blue) consisting only of *Pantoea ananatis* isolated from rice in Africa, Asia and Europe and the second group consisting of *Pantoea ananatis* isolated from other plants and from the environment.

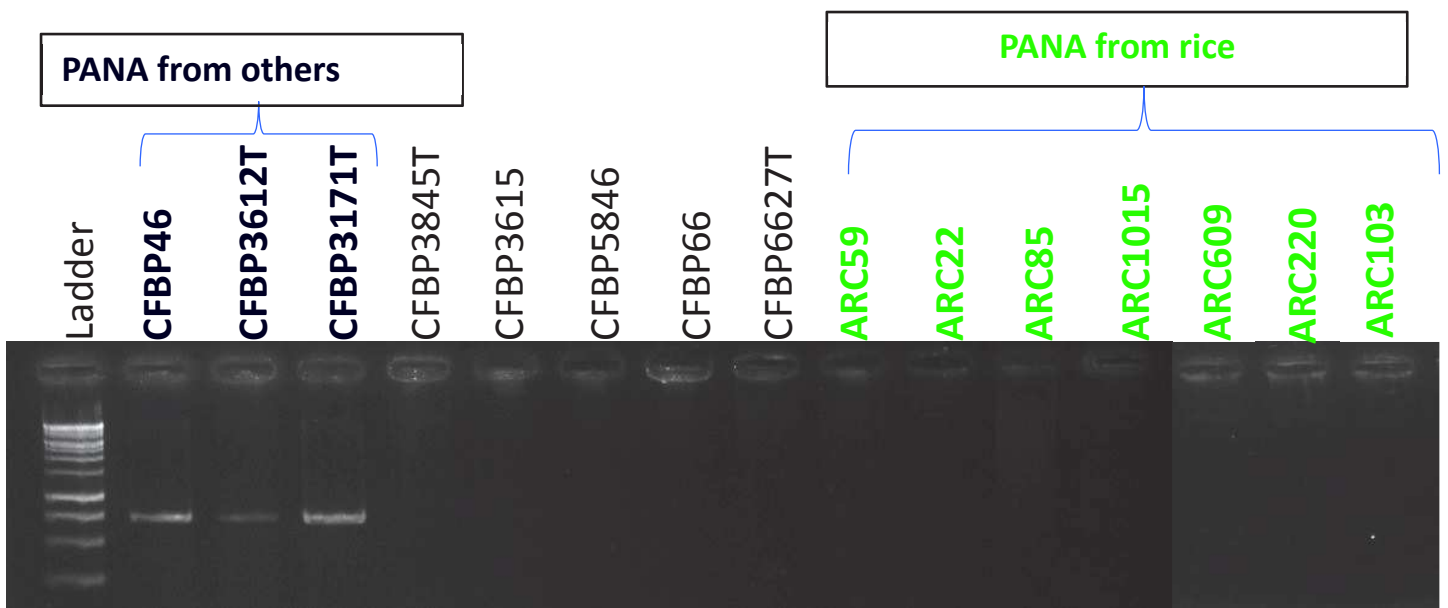


**Figure 3:** *Pantoea ananatis* specific Primers (for identification of *P. ananatis* strains from other sources than rice) designing from infB. In yellow hatching the sequence the primer Forward (A) and reverse (B).



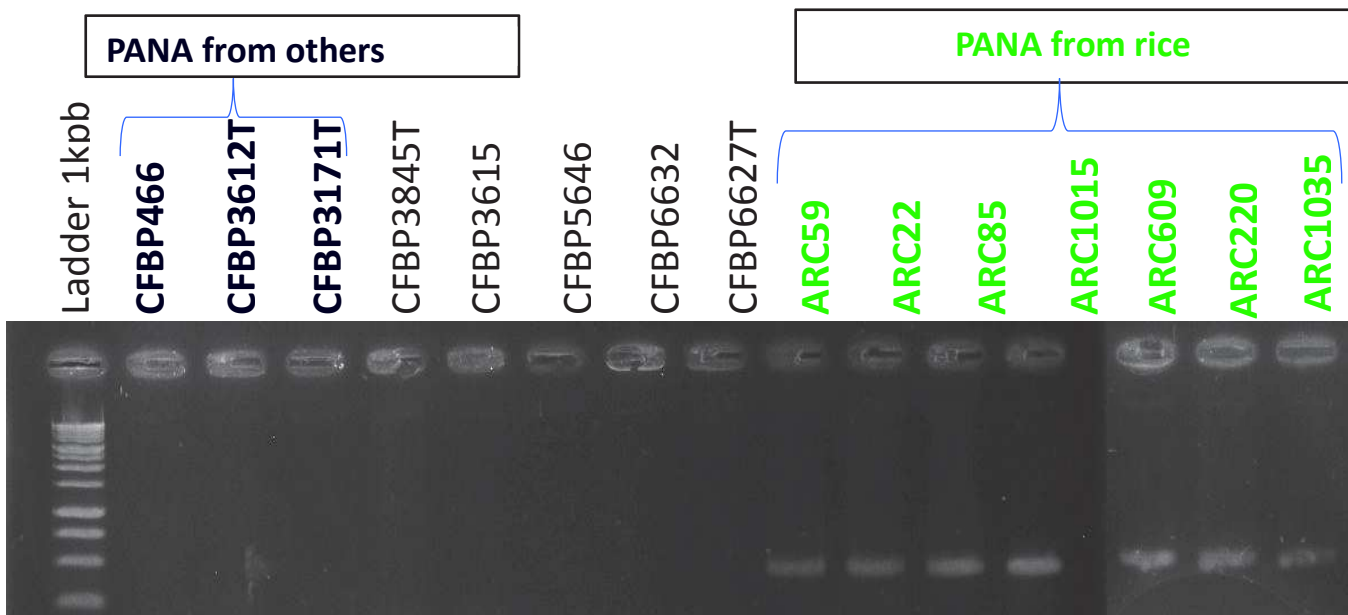
**Figure 2:** *Pantoea ananatis* specific Primers (for identification of *P. ananatis* strains from rice) designing from *infB*. In yellow hatching the sequence the forward primer (A) and reverse (B).





**Figure 4:** *P. ananatis* specific primer amplified *Pantoea ananatis* isolates strains from other sources than rice but do not amplify those isolated from rice and other *Pantoea* genus species.

CFPB 466: *P.ananatis*, CFBP3612T: *P.ananatis* , CFBP3171T : *P.ananatis*,  
 CFBP3845T: *P.agglomerans*, CFBP3615: *P. agglomerans*, CFBP5846:  
*P. stewartii*, CFBP6632: *Erwinia olea*, CFBP6627T : *P.cadenensis*,  
 ARC59 : *P. ananatis*, ARC85 : *P. ananatis*, ARC1015 : *P. ananatis*,  
 ARC609 : *P. ananatis*, ARC220: *P. ananatis*, ARC1035: *P. ananatis*



**Figure 5:** *P. ananatis* specific primer amplified *Pantoea ananatis* isolates strains from rice but do not amplify those isolated from others sources than rice and other *Pantoea* genus species.

CFPB 466: *P.ananatis*, CFBP3612T: *P.ananatis* , CFBP3171T : *P.ananatis*,  
 CFBP3845T: *P.agglomerans*, CFBP3615: *P. agglomerans*, CFBP5846:  
*P. stewartii*, CFBP6632: *Erwinia olea*, CFBP6627T : *P.cadenensis*,  
 ARC59 : *P. ananatis*, ARC85 : *P. ananatis*, ARC1015 : *P. ananatis*,  
 ARC609 : *P. ananatis*, ARC220: *P. ananatis*, ARC1035: *P. ananatis*

# **Chapter 3. General discussion and conclusion**

## 1. The thesis projects

Bacteria of the genus *Pantoea* have been the subject of several studies worldwide. Among the 24 species described, five have been reported as pathogenic to several important economically and strategic crops including rice. On this crop, two species named *P. ananatis* and *P. agglomerans* are known as phytopathogen and as a potential threat to rice production. These two species were not yet officially reported in Africa as rice pathogens as no study to this end was conducted. In Togo, studies are being made on other bacterial diseases of rice, but phyto-bacteria were misdiagnosed as *Xanthomonas oryzae* pv. *oryzae* with the use of phenotypic and biochemical bacterial identification techniques. Recently, some of the isolates kept in fridges at Africa Rice Center Cotonou have been diagnosed by phytopathology team as belonging to the genus *Pantoea* through molecular diagnostic tools. *Pantoea* spp are therefore present in Togo and possibly in other African countries and represented a constraint for rice production. The prevalence and genetic diversity of the populations of these phyto-bacteria are not really known because only a limited number of strains has been collected and characterized to date.

The objectives of our study were (i) to improve the collection of *Pantoea* collection available by implementing new collections in other African countries (ii) to determine species diversity by describing the species involved (iii) to develop the easy-to-use diagnostic and genotyping tools (iv) developed an effective method of disinfection and treatment of rice seeds accessible to rice farmers at lower cost.

Once developed, these tools and methods will be valuable assets that will facilitate other studies such as: a fine analysis of the genetic and phenotypic diversity (virulence/aggressiveness) of African *Pantoea* spp., the genetic structure of these populations to strengthen its control.

## 2. New information and data on rice bacterial diseases in Africa.

This study increased and improved the existing and kept isolates collection of Africa Rice Center at Cotonou by implementing additional surveys across other locations in Togo. Most of these isolates were generically diagnosed as *Pantoea* spp with the primers developed by Mondal et al (2011). In addition, 16 S rRNA analyzed revealed that some strains were suspected to be *P. ananatis*. But Mondal's primers showed some limits (interrogations on their specificity), since it generates multiple amplicons for one and the same isolates. The partial sequences of the *GyrB* gene obtained with PCR conducted on some togolese and Beninese isolates were blasted. The result indicated that the isolate collection had at least three species named *P. ananatis*, *P. stewartii* and *P. agglomerans* and other undescribed species. Specific and generic primers had been designed to set up simplex PCR diagnostic tools. Pathogenicity tests according to the Koch postulate confirmed the pathogenicity of the three species. This was the first report testifying the presence three *Pantoea* species threatening rice producing in Africa. In addition, the published News Disease Report was the first to officially report *P. stewartii* as a rice pathogen in the world.

Several objectives set at the beginning of this thesis were reached with these preliminary results obtained in the first year of the present research. Indeed (i) the bacterial isolate

collection has been increased and improved, isolate specific diversity determined, and molecular diagnostic tools developed for their reliable diagnosis and (ii) Results valorized as scientific publications in [www.apsjournals.apsnet.org](http://www.apsjournals.apsnet.org).

The results of the first year allowed us to highlight the existence of a species complex belonging to the *Pantoea* genus that would represent a potential threat to rice production in several sub-Saharan Africa countries. Front to this situation, we developed a PCR multiplex diagnostic tool that identifies not only the three major *Pantoea* species specifically but also generically. With the development of this tool and the data resulting from its use, several specific objectives of this thesis were achieved. Indeed, the use of the diagnostic tools (PCR, LAMP, MLVA ...) allowed us to have an idea about the distribution of *Pantoea* spp complexes in the rice fields of several African countries.

### **3. New tools for the specific, easy, simple, fast and cheaper detection and genotyping of *Pantoea* genus.**

With the aim of facilitating and improving the diagnosis of bacteria belonging to the *Pantoea* genus, a Loop-mediated Isothermal Amplification (LAMP) diagnostic tool for *Pantoea* spp. associated with rice leaf and seed was developed. The purpose of this tools development was to facilitate a rapid, sensitive, and generic detection of specific those bacteria in all situations especially in the field. Indeed because of its simplicity, ruggedness, and low cost could provide major benefits and benefits. The *Pantoea* spp detection LAMP tools provides the potential to a simple detection in the field or at border, airport, and port for phytosanitary control of plant materials like seeds of rice or other cereals. This tool is ideally recommended for diagnosis during *Pantoea* spp epidemic suspensions, especially in low and middle-income countries Indeed, compared to conventional PCR, LAMP is isothermal and don't need the used of thermocyclers. The tool was able to detect bacteria in exudate or crushed of plant organs like leaves, stems and seeds. This feature of our LAMP tool will be useful in low-resource lab or field settings where a standard DNA or RNA extraction prior to diagnostic testing may be impractical. These tools do not substitute other existing diagnostic tools. It can implement biosecurity measures within an hour if results obtained in the field detect the bacteria. This can be done before all samples are submitted for molecular based diagnosis with *Pantoea* mPCR tools in a central laboratory. Therefore, it is a complementary tool for efficient and fast diagnosis.

Establishing a true foundation for a study of the diversity of the *Pantoea* genus, we developed and validated two MLVA tools for *P. ananatis*. The results from the preliminary evaluation of MLVA-6\_*minisat* and MLVA-6\_*microsat* demonstrated their universality, specificity and ease of application at lower cost. They are flexible tools with the possibility of adapting them according to the objectives of the study. The interesting finding of these two tools was that they could discriminate *P. ananatis* isolated from rice from those of other sources. With the development and validation of these two MLVA tools, analysis of the *P. ananatis* diversity became possible and the objective of the work was achieved.

With the development of the three molecular diagnostic tools and genotyping tools, our objectives were achieved. Indeed, these tools are specific, simple, fast, easily reproducible at lower cost and applicable in any laboratory worldwide (mostly in Africa).

#### **4. Sequencing and analysis (for the first time) of three draft genome *Pantoea ananatis* phytopathogen rice in sub-Saharan African.**

Sequencing of bacterial genomes followed by their analysis is one of the essential methods to confirm the taxonomic and phylogenetic position. For phytopathogen bacteria, this method provides additional information such as (i) the elements that explain its pathogenicity (ii) evolution, adaptation and (iii) the different types of interaction it can have with the hosts. Thus, in the context of our study, we have sequenced and analyzed for the first time in Sub-Saharan Africa, a genome of three strains *P. ananatis* originating from three countries. The data from our analyzes allowed us to (i) confirm the taxonomic position of this bacteria (ii) has ideas on the phylogenetic relationships between African, Asian (India and China) and European (Spain) strains of *P. ananatis* isolated from rice and other sources; (iii) acquire certain understandings that support its phytopathogenicity.

The three WGSs and the data from their analysis constitute a reference resource for the scientific community. In addition, it represents a useful basis data for the functional analysis of distinct genomic traits that might be involved in adaptation of *P. ananatis*.

#### **5. Outcomes and impacts of the study**

Before this study:

- we had in our fridges isolates which were known to belong to the genus *Pantoea*, however, we had no idea about their specific diversity;
- We possess diagnostic tools that are not specific, unreliable and difficult to use and we did not have any MLVA scheme for epidemiology and genetic diversity structuring study of *P. ananatis*.
- We had no idea about the genetic diversity and phylogenomic elements that could explain the phytopathogenicity insights of African *P. ananatis*;
- We had no idea on the phylogenetic relationship of *P. ananatis* isolated from rice plant organs with those from other continents nor on *P. ananatis* from rice and other sources.

After this study:

- The presence in several African countries of three species of the genus *Pantoea* namely *P. ananatis*, *P. stewartii* and *P. agglomerans* and other undescribed species, have now been reported.
- The phytopathogenicity of the three species has been demonstrated through inoculation.
- Simple, specific, universal and easy-to-use and reproducible diversity analysis and diagnostic tools have also been developed and validated.
- The complete genome analysis of three African isolates “for the first time” provided an idea about the phylogenomic relationship between African *Pantoea ananatis* strains isolated from rice and *Pantoea ananatis* isolated from other sources and other continents.

## 6. Perspectives

The results of this study have provided a good foundation for future studies on the *Pantoea* genus in Africa. However, the prevalence and economic importance of these diseases in Africa are not yet thoroughly documented. It is therefore not yet possible to estimate the adaptive potential of bacteria in African. Additional surveys will therefore be needed to respond this burning question. Forthcoming studies will focus on the adaptation of the *P. ananatis* MLVA tool for an accurate study of the phylogenetic diversity of this bacterium in Africa. Other MLVA tools will be developed for *P. stewartii* and *P. agglomerans*. This will help to (i) identify type and representative strains for identification of sources of resistance (ii) perform genetic analysis of identified resistances and develop faster resistant varieties and gene-related markers of resistance. Finally, studies related to the development of symptoms and their differentiation according to the species of the three bacterial species involved can also be initiated.

## Attachments

**Table 1:** List of African strains and CFBP reference stains used for the evaluation and validation of all the tools and protocols set up in the project.

Isolate names	Dates of Sampling	Samples	Localities	Countries	GPS coordinators	references
<i>P. agglomerans</i>						
ARC 150	19/02/2015	Rice seed		Tanzania		This study
ARC 155	19/02/2015	Rice seed		Tanzania		This study
ARC 193	07/10/2014	Rice leaves	Adeta	Togo	N 07° 00.049' E000° 39.196'	This study
ARC 252	27/11/2013	Rice leaves	Tantiégou	Togo	N 07°02'05.8" E 000°42'20"	This study
ARC 298	06/12/2014	Rice leaves		Nigeria	N 7° 30.1041' E 3° 54.7314'	This study
ARC 329	04/10/2015	Rice seed	Ibadan	Nigeria		This study
ARC 351	15/04/2015	Rice seed		Senegal		This study
ARC 369	15/04/2015	Rice seed		Senegal		This study
ARC 385	15/04/2015	Rice seed		Togo		This study
ARC 386	15/04/2015	Rice seed		Senegal		This study
ARC 428	20/05/2015	Rice seed		Tanzania		This study
ARC 454	30/03/2015	Rice seed		Togo		This study
ARC 480	16/04/2015	Rice seed		Burkina Faso		This study
ARC 481	16/04/2015	Rice seed		Niger		This study
ARC 482	16/04/2015	Rice seed		Niger		This study
ARC 484	16/04/2015	Rice seed		Niger		This study
ARC 485	16/04/2015	Rice seed		Niger		This study
ARC 488	16/04/2015	Rice seed		Niger		This study
ARC 489	16/04/2015	Rice seed		Niger		This study
ARC 490	16/04/2015	Rice seed		Niger		This study
<i>P. ananatis</i>						
ARC 3	2013	Rice seed	Cotonou	Benin	N06°25.265 E0002°19.702	This study
ARC 16	2013	Rice seed	Cotonou	Benin		This study
ARC 17	2013	Rice seed	Cotonou	Benin		This study
ARC 21	10/07/2011	Rice leaves	Gogounou	Benin		This study
ARC 22	10/07/2011	Rice leaves	Gogounou	Benin		This study
ARC 24	29/10/2013	Rice leaves	Sikasso	Mali		This study
ARC 36	11/03/2013	Rice leaves	Niono	Mali	N 14°17' 47.2" W 005°56' 59.6"	This study
ARC 46	12/03/2013	Rice leaves	Affagnan	Togo	N 06°31'57.1" E 001°39'17.2"	This study
ARC 54	22/4/2014	Rice leaves		Ghana	N05°47.284' E000°03.528'	This study
ARC 59	20/6/2014	Rice leaves		Togo		This study
ARC 60	20/6/2014	Rice leaves		Togo		This study
ARC 62	20/6/2014	Rice leaves		Togo		This study
ARC 73	17/7/2014	Rice leaves	Bouaké	Ivory Coast	N07°28.384' W005°18.686'	This study
ARC 76	08/10/2014	Rice leaves	Haho	Togo	N 06° 59.049' E001° 08.335'	This study
ARC 77	10/03/2014	Rice leaves	Cotonou	Benin	N06°25.360 E0002°19.630	This study
ARC 79	10/03/2014	Rice leaves	Cotonou	Benin	N06°25.360 E0002°19.630	This study
ARC 83	10/06/2014	Rice leaves	Kpalimé	Togo	N06°25.360 E0002°19.630	This study
ARC 84	10/06/2014	Rice leaves	Kpalimé	Togo	N 07° 05.998' E000° 43.374'	This study
ARC 85	10/06/2014	Rice leaves	Kpalimé	Togo	N 07° 06.010' E000° 43.398'	This study
ARC 86	10/07/2014	Rice leaves	Danyi	Togo	N 07° 15.390' E000° 42.461'	This study
ARC 89	10/07/2014	Rice leaves	Adéta	Togo	N 07° 07.644' E000° 43.678'	This study
ARC 90	10/07/2014	Rice leaves	Kpalimé	Togo	N 06° 59.901' E000° 39.168'	This study
ARC 96	10/09/2014	Rice leaves	Glazoué	Benin	N 07° 58.083' E002° 10.816'	This study
ARC 97	10/09/2014	Rice leaves	Glazoué	Benin	N 07° 58.080' E002° 10.817'	This study
ARC 99	10/09/2014	Rice leaves	Glazoué	Benin	N 07° 58.079' E002° 10.820'	This study
ARC 100	10/09/2014	Rice leaves	Glazoué	Benin	N 07° 58.077' E002° 10.814'	This study
ARC 101	10/09/2014	Rice leaves	Glazoué	Benin	N 07° 58.078' E002° 10.818'	This study



ARC 102	10/09/2014	Rice leaves	Glazoué	Benin	N 07° 58.070' E002° 10.813'	This study
ARC 103	10/09/2014	Rice leaves	Glazoué	Benin	N 07° 58.070' E002° 10.813'	This study
ARC 104	10/09/2014	Rice leaves	Glazoué	Benin	N 07° 58.123' E002° 10.789'	This study
ARC 105	10/10/2014	Rice leaves	Glazoué	Benin	N 07° 58.116' E002° 10.820'	This study
ARC 106	10/10/2014	Rice leaves	Glazoué	Benin	N 07° 58.118' E002° 10.819'	This study
ARC 107	10/10/2014	Rice leaves	Glazoué	Benin	N 07° 58.120' E002° 10.819'	This study
ARC 108	10/10/2014	Rice leaves		Benin	N 07° 58.122' E002° 10.819'	This study
ARC 109	10/10/2014	Rice leaves		Benin	N 07° 58.122' E002° 10.818'	This study
ARC 110	29/10/2014	Rice leaves	Sikasso	Mali	N11°23'00.0 W005°39'37.5"	This study
ARC 112	30/10/2014	Rice leaves	Sikasso	Mali	N14°21'55.5 W005°57'16.3"	This study
ARC 116	23/11/2014	Rice leaves	Bida	Nigeria	N09°04.891' E006°07.231	This study
ARC 124	12/07/2014	Rice leaves	St Louis	Senegal	N16°12'008 W016°15'9.46"	This study
ARC 127	12/07/2014	Rice leaves	St Louis	Senegal	N16°12'002 W016°15'9.54"	This study
ARC 128	12/08/2014	Rice leaves		Senegal	N16°08'42.5 W016°19'8.97"	This study
ARC 132	17/02/2015	Rice seed		Senegal		This study
ARC 134	17/02/2015	Rice seed		Senegal		This study
ARC 154	19/02/2015	Rice seed		Tanzania		This study
ARC 179	20/6/2014	Rice leaves	Amlanme	Togo		This study
ARC 192	10/06/2014	Rice leaves	Adeta	Togo	N 07° 06.002' E000° 43.422'	This study
ARC 194	28/11/2013	Rice leaves	Adeta	Togo	N 07°06'.34.6" E 000°43'37.1"	This study
ARC 195	28/11/2013	Rice leaves	Kpalimé	Togo	N 07°06'.34.6" E 000°43'37.1"	This study
ARC 260	03/11/2013	Rice leaves	Niono	Mali		This study
ARC 262	03/11/2013	Rice leaves	Niono	Mali	N 14°17' 58.2" W 005°56' 30.3"	This study
ARC 267	03/11/2013	Rice leaves	Niono	Mali		This study
ARC 272	22/10/2013	Rice leaves	Bobo	Burkina Faso	N 11°22' 59.1" W 004°23' 03.1"	This study
ARC 276	30/10/2013	Rice leaves	Sikasso	Mali	N 11°38' 47.4" W 008°13' 34.6"	This study
ARC 282	06/10/2014	Rice leaves	Ibadan	Nigeria	N 7° 29.3906' E 3°54.665'	This study
ARC 283	06/10/2014	Rice leaves	Ibadan	Nigeria	N 7° 29.3856' E 3° 54.599'	This study
ARC 284	06/10/2014	Panicle	Ibadan	Nigeria	N 7° 29.3916' E 3° 54.547'	This study
ARC 286	06/10/2014	Rice leaves	Ibadan	Nigeria	N 7° 29.3966' E 3° 54.567'	This study
ARC 287	06/10/2014	Rice leaves	Ibadan	Nigeria	N 7° 29.4006' E 3° 54.523'	This study
ARC 290	06/10/2014	Rice leaves	Ibadan	Nigeria	N 7° 29.3625' E 3° 54.83'	This study
ARC 291	06/10/2014	Rice leaves	Ibadan	Nigeria	N 7° 29.3509' E 3° 53.9932'	This study
ARC 292	06/10/2014	Rice leaves	Ibadan	Nigeria	N 7° 29.3490' E 3° 53.9828'	This study
ARC 293	06/10/2014	Rice leaves	Ibadan	Nigeria	N 7° 29.3497' E 3° 53.9856'	This study
ARC 301	06/12/2014	Rice leaves	Ibadan	Nigeria	N 7° 30.974' E 3° 54.7246'	This study
ARC 302	06/12/2014	Rice leaves	Ibadan	Nigeria	N 7° 29.3414' E 3° 54.7102'	This study
ARC 303	06/12/2014	Rice leaves	Ibadan	Nigeria	N 7° 29.3513' E 3° 54.7284'	This study
ARC 304	06/12/2014	Rice leaves	Ibadan	Nigeria	N 7° 29.3422' E 3° 54.7282'	This study
ARC 308	06/12/2014	Rice leaves	Ibadan	Nigeria	N 7° 29.3592' E 3° 54.120'	This study
ARC 309	06/12/2014	Rice leaves	Ibadan	Nigeria	N 7° 29.3699' E 3° 54.6100'	This study
ARC 315	22/10/2013	Rice leaves		Burkina Faso	N 11°22' 12.0" W 004°24' 58.1"	This study
ARC 318	04/10/2015	Rice seed	Ibadan	Nigeria		This study
ARC 319	04/10/2015	Rice seed	Ibadan	Nigeria		This study
ARC 344	30/10/2013	Rice leaves		Mali		This study
ARC 345	30/10/2013	Rice leaves		Mali		This study
ARC 353	15/04/2015	Rice seed		Senegal		This study
ARC 358	15/04/2015	Rice seed		Senegal		This study
ARC 364	15/04/2015	Rice seed		Senegal		This study
ARC 378	15/04/2015	Rice seed		Senegal		This study
ARC 381	15/04/2015	Rice seed		Senegal		This study
ARC 395	15/04/2015	Rice seed		Togo		This study
ARC 403	15/04/2015	Rice seed		Senegal		This study
ARC 417	20/05/2015	Rice seed		Tanzaniae		This study
ARC 431	20/05/2015	Rice seed		Tanzaniae		This study
ARC 439	20/05/2015	Rice seed		Tanzaniae		This study

ARC 531	04/10/2015	Rice seed		Benin		This study
ARC 533	04/10/2015	Rice seed		Benin		This study
ARC 539	20/05/2015	Rice seed		Burundi		This study
ARC 541	20/05/2015	Rice seed		Burundi		This study
ARC 548	30/10/2013	Rice leaves	Sélingué	Mali		This study
ARC 549	31/10/2013	Rice leaves	Sélingué	Mali		This study
<i>P. stewartii</i>						
ARC 7	2013	Rice seed	Cotonou	Benin	N06°25.265 E0002°19.706	This study
ARC 8	2013	Rice seed	Cotonou	Benin	N06°25.265 E0002°19.707	This study
ARC 10	2013	Rice seed	Cotonou	Benin	N06°25.265 E0002°19.709	This study
ARC 11	2013	Rice seed	Cotonou	Benin	N06°25.265 E0002°19.710	This study
ARC 14	2013			Benin		This study
ARC 15	2013	Rice seed		Benin		This study
ARC 25	30/10/2013	Rice leaves	Sélingué	Mali	N 11°38' 47.5" W 008°13' 34.6"	This study
ARC 27	30/10/2013	Rice leaves	Sélingué	Mali	N 11°38' 47.5" W 008°13' 34.6"	This study
ARC 28	30/10/2013	Rice leaves	Sélingué	Mali	N 11°38' 47.6" W 008°13' 34.4"	This study
ARC 29	30/10/2013	Rice leaves	Sélingué	Mali	N 11°38' 47.6" W 008°13' 34.4"	This study
ARC 31	30/10/2013	Rice leaves	Sélingué	Mali	N 11°38' 47.6" W 008°13' 34.3"	This study
ARC 32	30/10/2013	Rice leaves	Sélingué	Mali	N 11°38' 47.6" W 008°13' 34.5"	This study
ARC 33	30/10/2013	Rice leaves	Sélingué	Mali		This study
ARC 38	26/11/2013	Rice leaves	Zozocodji	Togo	N 06°49'26.2" E 000°50'18.0"	This study
ARC 47	04/08/2014	Rice leaves	Cotonou	Benin	N06°25.265 E0002°19.713	This study
ARC 50	04/08/2014	Rice leaves	Cotonou	Benin	N06°25.265 E0002°19.716	This study
ARC 52	04/08/2014	Rice leaves	Cotonou	Benin	N06°25.265 E0002°19.718	This study
ARC 56	25/4/2014	Rice leaves	Kpong	Ghana	N06°08.043' E000°04.282'	This study
ARC 68	15/7/2014	Rice leaves	Bouaké	Ivory Coast	N07°52.550' W005°06.587'	This study
ARC 69	15/7/2014	Rice leaves	Bouaké	Ivory Coast	N07°52.565' W005°06.579'	This study
ARC 70	15/7/2014	Rice leaves	Bouaké	Ivory Coast	N07°52.565' W005°06.579'	This study
ARC 71	17/7/2014	Rice leaves		Ivory Coast	N07°28.328' W005°18.397'	This study
ARC 72	17/7/2014	Rice leaves		Ivory Coast	N07°28.370' W005°18.684'	This study
ARC 74	18/07/2014	Rice leaves	Bouaké	Ivory Coast	N07°37.007' W005°02.172'	This study
ARC 75	23/7/2014	Rice leaves	Yamoussokro	Ivory Coast	N06°45.319' W005°13.038'	This study
ARC 93	10/09/2014	Rice leaves	Glazoué	Benin	N 07° 58.082' E002° 10.819'	This study
ARC 117	23/11/2014	Rice leaves		Nigeria	N09°04.896' E006°07.232	This study
ARC 129	12/08/2014	Rice leaves		Senegal	N16°08'41.9 W016°19'8.97"	This study
ARC 130	17/02/2015	Rice seed		Senegal		This study
ARC 136	19/02/2015	Rice seed		Tanzania		This study
ARC 139	19/02/2015	Rice seed		Tanzania		This study
ARC 140	19/02/2015	Rice seed		Tanzania		This study
ARC 143	19/02/2015	Rice seed		Tanzania		This study
ARC 144	19/02/2015	Rice seed		Tanzania		This study
ARC 146	19/02/2015	Rice seed		Tanzania		This study
ARC 148	19/02/2015	Rice seed		Tanzania		This study
ARC 149	19/02/2015	Rice seed		Tanzania		This study
ARC 151	19/02/2015	Rice seed		Tanzania		This study
ARC 153	19/02/2015	Rice seed		Tanzania		This study
ARC 157	19/02/2015	Rice seed		Tanzania		This study
ARC 158	03/08/2015	Rice leaves	Calavi	Benin		This study
ARC 159	03/08/2015	Rice leaves	Calavi	Benin		This study
ARC 160	03/08/2015	Rice leaves	Calavi	Benin		This study
ARC 162	03/08/2015	Rice leaves	Calavi	Benin		This study
ARC 163	03/08/2015	Rice leaves	Calavi	Benin		This study
ARC 164	03/08/2015	Rice leaves	Calavi	Benin		This study

ARC 165	03/08/2015	Rice leaves	Calavi	Benin		This study
ARC 166	03/08/2015	Rice leaves	Calavi	Benin		This study
ARC 167	03/08/2015	Rice leaves	Calavi	Benin		This study
ARC 169	03/08/2015	Rice leaves	Calavi	Benin		This study
ARC 171	03/08/2015	Rice leaves	Calavi	Benin		This study
ARC 172	03/08/2015	Rice leaves	Calavi	Benin		This study
ARC 173	03/08/2015	Rice leaves	Calavi	Benin		This study
ARC 181	29/11/2013	Rice leaves	Amlanme	Togo	N 07°22' 42.3" E 000°51'47.9"	This study
ARC 188	11/02/2013	Rice leaves	Kpalime	Togo	N 07°05'58.5" E 001°09'18.8"	This study
ARC 204	01/12/2013	Rice leaves	Blitta	Togo	N 08°18' 07.9" E 000°56'18.9"	This study
ARC 218	07/03/2010	Rice leaves	Mango	Togo		This study
ARC 219	07/03/2010	Rice leaves	Mango	Togo		This study
ARC 220	07/03/2010	Rice leaves	Mango	Togo		This study
ARC 221	07/03/2010	Rice leaves	Mango	Togo		This study
ARC 222	09/03/2010	Rice leaves	Mango	Togo		This study
ARC 232	07/03/2010	Rice leaves	Lome	Togo		This study
ARC 237	28/06/2010	Rice leaves	Lome	Togo		This study
ARC 238	28/06/2010	Rice leaves	Lome	Togo		This study
ARC 258	07/03/2010	Rice leaves		Togo		This study
ARC 261	03/11/2013	Rice leaves	Niono	Mali	N 14°17' 47.2" W 005°56' 59.4"	This study
ARC 266	2013	Rice seed	Cotonou	Benin		This study
ARC 270	22/3/2013	Rice leaves		Tanzania	S 07°45' 941" E 036°58' 567"	This study
ARC 274	22/10/2013	Rice leaves		Burkina Faso	N 11°22' 37.6" W 004°24' 48.3"	This study
ARC 279	31/10/2013	Rice leaves	Sélingué	Mali	N 11°38' 47.6" W 008°13' 34.5"	This study
ARC 285	06/10/2014	Rice leaves	Ibadan	Nigeria	N 7° 29.3924' E 3° 54.585'	This study
ARC 299	06/12/2014	Rice leaves	Ibadan	Nigeria	N 7° 30.1008' E 3° 54.7250'	This study
ARC 306	06/12/2014	Rice leaves	Ibadan	Nigeria	N 7° 29.3439' E 3° 54.7216	This study
ARC 312	2013	Rice seed	Cotonou	Benin		This study
ARC 313	2013	Rice seed	Cotonou	Benin		This study
ARC 320	04/10/2015	Rice seed	Ibadan	Nigeria		This study
ARC 322	04/10/2015	Rice seed	Ibadan	Nigeria		This study
ARC 323	04/10/2015	Rice seed	Ibadan	Nigeria		This study
ARC 325	04/10/2015	Rice seed	Ibadan	Nigeria		This study
ARC 327	04/10/2015	Rice seed	Ibadan	Nigeria		This study
ARC 332	03/08/2015	Rice leaves	Ibadan	Benin		This study
ARC 346	15/04/2015	Rice seed		Senegal		This study
ARC 347	15/04/2015	Rice seed		Senegal		This study
ARC 349	15/04/2015	Rice seed		Senegal		This study
ARC 352	15/04/2015	Rice seed		Senegal		This study
ARC 354	15/04/2015	Rice seed		Senegal		This study
ARC 356	15/04/2015	Rice seed		Senegal		This study
ARC 357	15/04/2015	Rice seed		Senegal		This study
ARC 362	15/04/2015	Rice seed		Senegal		This study
ARC 363	15/04/2015	Rice seed		Senegal		This study
ARC 365	15/04/2015	Rice seed		Senegal		This study
ARC 366	15/04/2015	Rice seed		Senegal		This study
ARC 367	15/04/2015	Rice seed		Senegal		This study
ARC 368	15/04/2015	Rice seed		Senegal		This study
ARC 370	15/04/2015	Rice seed		Senegal		This study
ARC 371	15/04/2015	Rice seed		Senegal		This study
ARC 372	15/04/2015	Rice seed		Senegal		This study
ARC 374	15/04/2015	Rice seed		Senegal		This study
ARC 375	15/04/2015	Rice seed		Senegal		This study
ARC 376	15/04/2015	Rice seed		Senegal		This study
ARC 379	15/04/2015	Rice seed		Senegal		This study
ARC 380	15/04/2015	Rice seed		Senegal		This study
ARC 383	15/04/2015	Rice seed		Senegal		This study

ARC 384	15/04/2015	Rice seed		Senegal		This study
ARC 390	15/04/2015	Rice seed		Senegal		This study
ARC 391	15/04/2015	Rice seed		Togo		This study
ARC 394	15/04/2015	Rice seed		Senegal		This study
ARC 396	15/04/2015	Rice seed		Senegal		This study
ARC 397	15/04/2015	Rice seed		Senegal		This study
ARC 398	15/04/2015	Rice seed		Senegal		This study
ARC 399	15/04/2015	Rice seed		Senegal		This study
ARC 401	15/04/2015	Rice seed		Senegal		This study
ARC 402	15/04/2015	Rice seed		Senegal		This study
ARC 404	15/04/2015	Rice seed		Senegal		This study
ARC 405	15/04/2015	Rice seed		Senegal		This study
ARC 406	15/04/2015	Rice seed		Senegal		This study
ARC 407	20/05/2015	Rice seed		Tanzaniae		This study
ARC 409	20/05/2015	Rice seed		Centrafica		This study
ARC 410	20/05/2015	Rice seed		Tanzaniae		This study
ARC 411	20/05/2015	Rice seed		Tanzaniae		This study
ARC 412	20/05/2015	Rice seed		Tanzaniae		This study
ARC 413	20/05/2015	Rice seed		Tanzaniae		This study
ARC 414	20/05/2015	Rice seed		Tanzaniae		This study
ARC 415	20/05/2015	Rice leaves		Benin		This study
ARC 416	20/05/2015	Rice seed		Tanzaniae		This study
ARC 419	20/05/2015	Rice seed		Tanzaniae		This study
ARC 420	20/05/2015	Rice seed		Tanzaniae		This study
ARC 421	20/05/2015	Rice seed		Tanzaniae		This study
ARC 422	20/05/2015	Rice seed		Tanzaniae		This study
ARC 423	20/05/2015	Rice seed		Tanzaniae		This study
ARC 427	20/05/2015	Rice seed		Tanzaniae		This study
ARC 429	20/05/2015	Rice seed		Tanzaniae		This study
ARC 430	20/05/2015	Rice seed		Tanzaniae		This study
ARC 432	20/05/2015	Rice seed		Tanzaniae		This study
ARC 434	20/05/2015	Rice seed		Tanzaniae		This study
ARC 435	20/05/2015	Rice seed		Tanzaniae		This study
ARC 436	20/05/2015	Rice seed		Tanzaniae		This study
ARC 438	20/05/2015	Rice seed		Tanzaniae		This study
ARC 440	20/05/2015	Rice seed		Tanzaniae		This study
ARC 441	20/05/2015	Rice seed		Tanzaniae		This study
ARC 442	20/05/2015	Rice seed		Tanzaniae		This study
ARC 443	20/05/2015	Rice seed		Tanzaniae		This study
ARC 444	20/05/2015	Rice seed		Tanzaniae		This study
ARC 448	01/11/2013	Rice leaves		Mali		This study
ARC 452	30/03/2015	Rice seed		Togo		This study
ARC 453	30/03/2015	Rice seed		Togo		This study
ARC 456	30/03/2015	Rice seed		Togo		This study
ARC 457	30/03/2015	Rice seed		Togo		This study
ARC 458	30/03/2015	Rice seed		Togo		This study
ARC 459	30/03/2015	Rice seed		Togo		This study
ARC 461	30/03/2015	Rice seed		Togo		This study
ARC 463	30/03/2015	Rice seed		Togo		This study
ARC 464	30/03/2015	Rice seed		Togo		This study
ARC 465	30/03/2015	Rice seed		Togo		This study
ARC 466	30/03/2015	Rice seed		Togo		This study
ARC 467	30/03/2015	Rice seed		Togo		This study
ARC 468	30/03/2015	Rice seed		Togo		This study
ARC 469	30/03/2016	Rice seed		Togo		This study
ARC 470	16/04/2015	Rice seed		Burkina Faso		This study
ARC 472	16/04/2015	Rice seed		Burkina Faso		This study
ARC 478	16/04/2015	Rice seed		Burkina Faso		This study
ARC 479	16/04/2015	Rice seed		Burkina Faso		This study

ARC 483	16/04/2015	Rice seed		Niger		This study
ARC 495	04/10/2015	Rice seed		Benin		This study
ARC 496	04/10/2015	Rice seed		Benin		This study
ARC 497	04/10/2015	Rice seed		Benin		This study
ARC 498	04/10/2015	Rice seed		Benin		This study
ARC 499	04/10/2015	Rice seed		Benin		This study
ARC 500	04/10/2015	Rice seed		Benin		This study
ARC 501	04/10/2015	Rice seed		Benin		This study
ARC 502	04/10/2015	Rice seed		Benin		This study
ARC 503	04/10/2015	Rice seed		Benin		This study
ARC 504	04/10/2015	Rice seed		Benin		This study
ARC 505	04/10/2015	Rice seed		Benin		This study
ARC 506	04/10/2015	Rice seed		Benin		This study
ARC 507	04/10/2015	Rice seed		Benin		This study
ARC 509	04/10/2015	Rice seed		Benin		This study
ARC 513	04/10/2015	Rice seed		Benin		This study
ARC 514	04/10/2015	Rice seed		Benin		This study
ARC 515	04/10/2015	Rice seed		Benin		This study
ARC 516	04/10/2015	Rice seed		Benin		This study
ARC 520	04/10/2015	Rice seed		Benin		This study
ARC 521	04/10/2015	Rice seed		Benin		This study
ARC 522	04/10/2015	Rice seed		Benin		This study
ARC 523	04/10/2015	Rice seed		Benin		This study
ARC 524	04/10/2015	Rice seed		Benin		This study
ARC 525	04/10/2015	Rice seed		Benin		This study
ARC 526	04/10/2015	Rice seed		Benin		This study
ARC 527	04/10/2015	Rice seed		Benin		This study
ARC 528	04/10/2015	Rice seed		Benin		This study
ARC 529	04/10/2015	Rice seed		Benin		This study
ARC 532	04/10/2015	Rice seed		Benin		This study
ARC 534	20/05/2015	Rice seed		Tanzania		This study
ARC 535	20/05/2015	Rice seed		Tanzania		This study
ARC 536	20/05/2015	Rice seed		Tanzania		This study
ARC 537	20/05/2015	Rice seed		Tanzania		This study
ARC 543	18/06/2015	Water		Benin		This study
ARC 552	30/10/2013	Rice leaves		Mali	N 11°38' 47.6" W 008°13' 34.5"	This study
ARC 553	30/03/2015	Rice leaves		Benin		This study
ARC 554	2013	Rice leaves	Assome	Togo		This study
<i>Pantoea sp</i>						
ARC 2	2013	Rice seed	Cotonou	Benin	N06°25.265 E0002°19.701	This study
ARC 4	2013	Rice seed	Cotonou	Benin	N06°25.265 E0002°19.703	This study
ARC 5	2013	Rice seed	Cotonou	Benin	N06°25.265 E0002°19.704	This study
ARC 6	2013	Rice seed	Cotonou	Benin	N06°25.265 E0002°19.705	This study
ARC 12	2013	Rice seed	Cotonou	Benin	N06°25.265 E0002°19.712	This study
ARC 13	2013	Rice seed		Benin		This study
ARC 18	10/02/2011	Rice leaves	Lokossa	Benin		This study
ARC 19	10/02/2011	Rice leaves	Lokossa	Benin		This study
ARC 20	10/07/2011	Rice leaves	Gogounou	Benin		This study
ARC 23	29/10/2013	Rice leaves	Sikasso	Mali	N 11°23' 08.6" W 005°39' 44.6"	This study
ARC 26	30/10/2013	Rice leaves	Sélingué	Mali		This study
ARC 30	30/10/2013	Rice leaves	Sélingué	Mali		This study
ARC 34	31/10/2013	Rice leaves	Sélingué	Mali	N 11°38' 47.1" W 008°13' 40.0"	This study
ARC 35	11/03/2013	Rice leaves	Niono	Mali	N 14°21' 05.3" W 005°57' 18.9"	This study
ARC 37	26/11/2013	Rice leaves	Macoumavo	Togo	N 06°51'20.4" E 000°49'12.4"	This study
ARC 39	26/11/2013	Rice leaves	Zozocodji	Togo	N 06°49'25.8" E 000°50'16.9"	This study
ARC 40	26/11/2013	Rice leaves	Zozocodji	Togo	N 06°49'25.8" E 000°50'16.9"	This study

ARC 41	26/11/2013	Rice leaves	Zozokondji	Togo	N 06°51'00.2" E 000°49'12.4"	This study
ARC 42	26/11/2013	Rice leaves	Zozokondji	Togo	N 06°49'32.5" E 000°49'18.7"	This study
ARC 43	26/11/2013	Rice leaves	Zozokondji	Togo	N 06°49'26.3" E 000°50'18.9"	This study
ARC 44	26/11/2013	Rice leaves	Zozokondji	Togo	N 06°49'32.5" E 000°49'18.7"	This study
ARC 45	29/11/2013	Rice leaves	Amlanme	Togo	N 07°20'29.8" E 000°50'48.4"	This study
ARC 48	04/08/2014	Rice leaves	Cotonou	Benin	N06°25.265 E0002°19.714	This study
ARC 49	04/08/2014	Rice leaves	Cotonou	Benin	N06°25.265 E0002°19.715	This study
ARC 51	04/08/2014	Rice leaves	Cotonou	Benin	N06°25.265 E0002°19.717	This study
ARC 53	04/08/2014	Rice leaves	Cotonou	Benin	N06°25.265 E0002°19.719	This study
ARC 55	22/4/2014	Rice leaves		Ghana	N05°47.297' E000°03.522'	This study
ARC 57	25/4/2014	Rice leaves	Kpong	Ghana	N06°09.035' E000°03.426'	This study
ARC 58	06/06/2014	Rice leaves	Ibadan	Nigeria	N 07° 29.319' E 003° 54.663'	This study
ARC 61	20/6/2014	Rice leaves		Togo		This study
ARC 63	20/6/2014	Rice leaves		Togo		This study
ARC 64	15/7/2014	Rice leaves	Bouaké	Ivory Coast	N07°52.182' W005°06.929'	This study
ARC 65	15/7/2014	Rice leaves	Bouaké	Ivory Coast	N07°52.202' W005°06.950'	This study
ARC 66	15/7/2014	Rice leaves	Bouaké	Ivory Coast	N07°52.207' W005°06.965'	This study
ARC 67	15/7/2014	Rice leaves	Bouaké	Ivory Coast	N07°52.213' W005°06.672'	This study
ARC 78	10/03/2014	Rice leaves	Cotonou	Benin	N06°25.360 E0002°19.630	This study
ARC 80	10/03/2014	Rice leaves	Cotonou	Benin	N06°25.360 E0002°19.630	This study
ARC 81	10/03/2014	Rice leaves	Cotonou	Benin	N06°25.360 E0002°19.630	This study
ARC 82	10/03/2014	Rice leaves	Cotonou	Benin	N06°25.360 E0002°19.630	This study
ARC 87	10/07/2014	Rice leaves	Bémé	Togo	N 07° 04.719' E000° 42.985'	This study
ARC 88	10/07/2014	Rice leaves	Bémé	Togo	N 07° 05.460' E000° 43.331'	This study
ARC 91	10/07/2014	Rice leaves	Kpalimé	Togo	N 07° 00.049' E000° 39.196'	This study
ARC 92	10/07/2014	Rice leaves	Kpalimé	Togo	N 07° 00.049' E000° 39.196'	This study
ARC 94	10/09/2014	Rice leaves	Glazoué	Benin	N 07° 58.081' E002° 10.822'	This study
ARC 95	10/09/2014	Rice leaves	Glazoué	Benin	N 07° 58.081' E002° 10.823'	This study
ARC 98	10/09/2014	Rice leaves	Glazoué	Benin	N 07° 58.080' E002° 10.818'	This study
ARC 111	29/10/2014	Rice leaves	Niono	Mali	N11°23'00.0 W005°39'37.5"	This study
ARC 113	30/10/2014	Rice leaves		Mali	N14°16'55.9 W005°57'16.1"	This study
ARC 114	22/11/2014	Rice leaves	Bida	Nigeria	N09°04.896' E006°07.236	This study
ARC 115	22/11/2014	Rice leaves	Bida	Nigeria	N09°04.891' E006°07.234	This study
ARC 118	24/11/2014	Rice leaves		Nigeria	N08°57.392' E005°53.667	This study
ARC 119	12/04/2014	Rice leaves	St Louis	Senegal	N12°34'26.5 W016°18'54.8"	This study
ARC 120	12/04/2014	Rice leaves	St Louis	Senegal	N12°34'27.0 W016°18'53.5"	This study
ARC 121	12/06/2014	Rice leaves	St Louis	Senegal	N16°12'007 W016°15'9.47"	This study
ARC 122	12/06/2014	Rice leaves	St Louis	Senegal	N16°12'007 W016°15'9.47"	This study
ARC 123	12/06/2014	Rice leaves	St Louis	Senegal	N16°11'9.95 W016°15'9.57"	This study
ARC 125	12/07/2014	Rice leaves	St Louis	Senegal	N16°12'007 W016°15'9.50"	This study
ARC 126	12/07/2014	Rice leaves	St Louis	Senegal	N16°12'006 W016°15'9.61"	This study
ARC 131	17/02/2015	Rice seed		Senegal		This study
ARC 133	17/02/2015	Rice seed		Senegal		This study
ARC 135	24/02/2015	Rice seed		Senegal		This study
ARC 137	19/02/2015	Rice seed		Tanzania		This study
ARC 138	19/02/2015	Rice seed		Tanzania		This study
ARC 141	19/02/2015	Rice seed		Tanzania		This study
ARC 142	19/02/2015	Rice seed		Tanzania		This study
ARC 145	19/02/2015	Rice seed		Tanzania		This study
ARC 147	19/02/2015	Rice seed		Tanzania		This study
ARC 152	19/02/2015	Rice seed		Tanzania		This study
ARC 156	19/02/2015	Rice seed		Tanzania		This study
ARC 161	03/08/2015	Rice leaves	Calavi	Benin		This study
ARC 168	03/08/2015	Rice leaves	Calavi	Benin		This study
ARC 170	03/08/2015	Rice leaves	Calavi	Benin		This study
ARC 174	03/08/2015	Rice leaves	Calavi	Benin		This study
ARC 175	03/08/2015	Rice leaves	Calavi	Benin		This study
ARC 176	03/08/2015	Rice leaves		Benin		This study
ARC 177	03/08/2015	Rice leaves		Benin		This study

ARC 178	24/11/2013	Rice leaves	Adeta	Togo	N 06°48'13.6" E 000°47'17.6"	This study
ARC 180	28/11/2013	Rice leaves	Amlanme	Togo	N 07°06'22.8" E 000°44'3.5"	This study
ARC 182	29/11/2013	Rice leaves	Amlanme	Togo	N 07°20'29.8" E 000°50'48.4"	This study
ARC 183	29/11/2013	Rice leaves	Amlanme	Togo	N 07°20'30.3" E 000°50'48.2"	This study
ARC 184	29/11/2013	Rice leaves	Amlanme	Togo	N 07°20'30.3" E 000°50'48.2"	This study
ARC 185	29/11/2013	Rice leaves	Amlanme	Togo	N 07°20'30.3" E 000°50'48.2"	This study
ARC 186	29/11/2013	Rice leaves	Wahala	Togo	N 07°20'30.3" E 000°50'48.2"	This study
ARC 187	29/11/2013	Rice leaves	Sokodé	Togo	N 07°20'29.8" E 000°50'48.4"	This study
ARC 189	30/11/2013	Rice leaves	Adéta	Togo	N 08°48'22.6" E 000°54'03.9"	This study
ARC 190	27/11/2013	Rice leaves	Kpalimé	Togo	N 07°05'41.5" E 000°44'32.6"	This study
ARC 191	10/07/2014	Rice leaves	Kpalimé	Togo	N 07° 07'644" E 000° 43.678'	This study
ARC 196	28/11/2013	Rice leaves		Togo	N 07°06'34.3" E 000°43'36.8"	This study
ARC 197	10/06/2014	Rice leaves		Togo	N 07° 05'997" E 000° 43.375'	This study
ARC 198	03/12/2014	Rice leaves	Blitta	Togo	N 08°19'08.2" E 000°58'29.3"	This study
ARC 199	03/12/2014	Rice leaves	Blitta	Togo	N 08°19'08.2" E 000°58'29.3"	This study
ARC 200	01/12/2013	Rice leaves	Blitta	Togo	N 08°19'08.9" E 000°58'29.9"	This study
ARC 201	01/12/2013	Rice leaves	Blitta	Togo	N 08°19'9.1" E 000°58'31.2"	This study
ARC 202	01/12/2013	Rice leaves	Blitta	Togo	N 08°18'06.1" E 000°56'18.2"	This study
ARC 203	01/12/2013	Rice leaves	Blitta	Togo	N 08°18'07.9" E 000°56'18.9"	This study
ARC 205	04/12/2014	Rice leaves	Blitta	Togo	N 08°19'28.7" E 000°58'28.6"	This study
ARC 206	03/12/2014	Rice leaves	Blitta	Togo	N 08°19'08.2" E 000°58'29.3"	This study
ARC 207	02/12/2014	Rice leaves	Blitta	Togo	N 08°19'08.2" E 000°58'29.4"	This study
ARC 208	02/12/2014	Rice leaves	Blitta	Togo	N 08°19'08.2" E 000°58'29.4"	This study
ARC 209	01/12/2014	Rice leaves	Blitta	Togo	N 08°18'06.3" E 000°56'47.1"	This study
ARC 210	01/12/2014	Rice leaves		Togo	N 08°18'06.3" E 000°56'47.1"	This study
ARC 211	01/12/2014	Rice leaves		Togo	N 08°19'08.7" E 000°58'29.1"	This study
ARC 212	29/11/2013	Rice leaves		Togo	N 07°30'34.9" E 001°00'23.1"	This study
ARC 213	07/03/2010	Rice leaves	Mango	Togo		This study
ARC 214	07/03/2010	Rice leaves	Mango	Togo		This study
ARC 215	07/03/2010	Rice leaves	Mango	Togo		This study
ARC 216	07/03/2010	Rice leaves	Mango	Togo		This study
ARC 217	07/03/2010	Rice leaves	Mango	Togo		This study
ARC 223	07/03/2010	Rice leaves	Mango	Togo		This study
ARC 224	07/03/2010	Rice leaves	Mango	Togo		This study
ARC 225	07/03/2010	Rice leaves	Mango	Togo		This study
ARC 226	07/03/2010	Rice leaves	Mango	Togo		This study
ARC 227	07/03/2010	Rice leaves	Mango	Togo		This study
ARC 228	07/03/2010	Rice leaves	Mango	Togo		This study
ARC 229	07/03/2010	Rice leaves	Mango	Togo		This study
ARC 230	07/03/2010	Rice leaves	Mango	Togo		This study
ARC 231	07/03/2010	Rice leaves	Lome	Togo		This study
ARC 233	28/06/2010	Rice leaves	Lome	Togo		This study
ARC 234	28/06/2010	Rice leaves	Lome	Togo		This study
ARC 235	28/06/2010	Rice leaves	Lome	Togo		This study
ARC 236	28/06/2010	Rice leaves	Lome	Togo		This study
ARC 239	28/06/2010	Rice leaves	Lome	Togo		This study
ARC 240	28/06/2010	Rice leaves	Lome	Togo		This study
ARC 241	28/06/2010	Rice leaves	Lome	Togo		This study
ARC 242	28/06/2010	Rice leaves	Lome	Togo		This study
ARC 243	28/06/2010	Rice leaves	Kpalime	Togo		This study
ARC 244	28/06/2010	Rice leaves	Kpalime	Togo		This study
ARC 245	27/11/2013	Rice leaves	Blitta	Togo	N 07°02'07.4" E 000°42'22.1"	This study
ARC 246	27/11/2013	Rice leaves	Kpalime	Togo	N 07°04'37.2" E 000°43'80.8"	This study
ARC 247	01/12/2013	Rice leaves	Kpalime	Togo	N 08°18'06.1" E 000°56'18.2"	This study
ARC 248	27/11/2013	Rice leaves	Kpalime	Togo	N 07°04'34.4" E 000°42'59.3"	This study
ARC 249	27/11/2013	Rice leaves	Kpalime	Togo	N 07°02'05.8" E 000°42'20.2"	This study
ARC 250	27/11/2013	Rice leaves	Kpalime	Togo	N 07°02'05.1" E 000°42'20.2"	This study
ARC 251	27/11/2013	Rice leaves	Kpalime	Togo	N 07°02'05.9" E 000°42'20.5"	This study

ARC 253	27/11/2013	Rice leaves	Tantiegou	Togo	N 07°02'07.6" E 000°42'22.3"	This study
ARC 254	07/03/2010	Rice leaves	Blitta	Togo		This study
ARC 255	07/03/2010	Rice leaves	Blitta	Togo		This study
ARC 256	01/12/2014	Rice leaves	Mango	Togo	N 08°18'06.3" E 000°56'47.1"	This study
ARC 257	01/12/2014	Rice leaves	Amlanme	Togo	N 08°18'06.3" E 000°56'47.1"	This study
ARC 259	29/11/2013	Rice leaves		Togo	N 07°20'31.5" E 000°50'49.2"	This study
ARC 263	2013	Rice seed		Benin		This study
ARC 264	03/11/2013	Rice leaves		Mali		This study
ARC 265	03/11/2013	Rice leaves	Niono	Mali	N 14°17' 13.7" W 005°57' 21.6"	This study
ARC 268	03/11/2013	Rice leaves		Mali	N 14°21' 05.3" W 005°57' 18.9"	This study
ARC 269	03/11/2013	Rice leaves		Mali	N 14°17' 47.2" W 005°56' 59.4"	This study
ARC 271	16/11/2013	Rice leaves	Bobo	Burkina Faso	N 11°22' 56.6" W 004°23' 31.1"	This study
ARC 273	22/10/2013	Rice leaves		Burkina Faso	N 11°22' 37.6" W 004°24' 48.3"	This study
ARC 275	30/10/2013	Rice leaves	Sélingué	Mali		This study
ARC 277	30/10/2013	Rice leaves	Sélingué	Mali		This study
ARC 278	29/10/2013	Rice leaves	Niono	Mali	N 11°23' 08.6" W 005°39' 44.6"	This study
ARC 280	11/03/2013	Rice leaves		Mali	N 14°17' 58.2" W 005°56' 30.3"	This study
ARC 281	31/10/2013	Rice leaves		Mali		This study
ARC 288	06/10/2014	Rice leaves	Ibadan	Nigeria	N 7° 29.4006' E 3° 54.523'	This study
ARC 289	06/10/2014	Rice leaves	Ibadan	Nigeria	N 7° 29.3921' E 3° 54.179'	This study
ARC 294	20/6/2014	Rice leaves		Togo		This study
ARC 295	06/12/2014	Rice leaves	Ibadan	Nigeria	N 7° 30.974' E 3° 54.7351'	This study
ARC 296	06/12/2014	Rice leaves	Ibadan	Nigeria	N 7° 30.985' E 3° 54.7238'	This study
ARC 297	06/12/2014	Rice leaves	Ibadan	Nigeria	N 7° 30.985' E 3° 54.7238'	This study
ARC 300	29/10/2014	Rice leaves		Mali	N11°22'59.9 E05°39'39.7"	This study
ARC 305	06/12/2014	Rice leaves	Ibadan	Nigeria	N 7° 29.3439' E 3° 54.7216'	This study
ARC 307	06/12/2014	Rice leaves	Ibadan	Nigeria	N 7° 29.4003' E 3° 54.399'	This study
ARC 310	29/06/2010	Rice leaves		Togo		This study
ARC 311	2013	Rice seed	Cotonou	Benin		This study
ARC 314		Rice seed		Benin		This study
ARC 316	29/10/2013	Rice leaves		Mali	N 11°23' 07.4" W 005°39' 42.3"	This study
ARC 317	11/03/2013	Rice leaves		Mali	N 14°17' 47.2" W 005°56' 59.6"	This study
ARC 321	04/10/2015	Rice seed	Ibadan	Nigeria		This study
ARC 324	04/10/2015	Rice seed	Ibadan	Nigeria		This study
ARC 326	04/10/2015	Rice seed	Ibadan	Nigeria		This study
ARC 328	04/10/2015	Rice seed	Ibadan	Nigeria		This study
ARC 330	04/10/2015	Rice seed		Nigeria		This study
ARC 331	04/10/2015	Rice seed		Nigeria		This study
ARC 333	03/08/2015	Rice leaves	Calavi	Benin		This study
ARC 334	04/10/2015	Rice seed	Ibadan	Nigeria		This study
ARC 335	03/08/2015	Rice leaves		Benin		This study
ARC 336	04/10/2015	Rice seed		Nigeria		This study
ARC 337	04/10/2015	Rice seed		Nigeria		This study
ARC 338	03/08/2015	Rice leaves		Benin		This study
ARC 339	30/10/2013	Rice leaves		Mali		This study
ARC 340	04/10/2015	Rice seed	Ibadan	Nigeria		This study
ARC 341	04/10/2015	Rice seed	Ibadan	Nigeria		This study
ARC 342	04/10/2015	Rice seed		Nigeria		This study
ARC 343	04/10/2015	Rice seed		Nigeria		This study
ARC 348	15/04/2015	Rice seed		Senegal		This study
ARC 350	15/04/2015	Rice seed		Senegal		This study



ARC 355	15/04/2015	Rice seed		Senegal		This study
ARC 359	15/04/2015	Rice seed		Senegal		This study
ARC 360	15/04/2015	Rice seed		Senegal		This study
ARC 361	15/04/2015	Rice seed		Senegal		This study
ARC 373	15/04/2015	Rice seed		Senegal		This study
ARC 377	15/04/2015	Rice seed		Senegal		This study
ARC 382	15/04/2015	Rice seed		Senegal		This study
ARC 387	15/04/2015	Rice seed		Senegal		This study
ARC 388	15/04/2015	Rice seed		Senegal		This study
ARC 389	15/04/2015	Rice seed		Togo		This study
ARC 392	15/04/2015	Rice seed		Senegal		This study
ARC 393	15/04/2015	Rice seed		Senegal		This study
ARC 400	15/04/2015	Rice seed		Senegal		This study
ARC 408	20/05/2015	Rice seed		Tanzaniae		This study
ARC 418	20/05/2015	Rice seed		Tanzaniae		This study
ARC 424	20/05/2015	Rice seed		Tanzaniae		This study
ARC 425	20/05/2015	Rice seed		Tanzaniae		This study
ARC 426	20/05/2015	Rice seed		Tanzaniae		This study
ARC 433	20/05/2015	Rice seed		Tanzaniae		This study
ARC 437	20/05/2015	Rice seed		Tanzaniae		This study
ARC 445	20/05/2015	Rice seed		Tanzaniae		This study
ARC 446	25/04/2014	Rice leaves		Ghana	N06°08.973' E000°03.488'	This study
ARC 447	03/12/2014	Rice leaves	Banjul	Gambia	N13°33'26.5 W014°53'55.1"	This study
ARC 449	22/10/2013	Rice leaves	Bobo	Burkina Faso	N 11°22' 09.6" W 004°24' 59.5"	This study
ARC 450	22/10/2013	Rice leaves		Burkina Faso		This study
ARC 451	22/10/2013	Rice leaves		Burkina Faso	N 11°22' 47.4" W 004°23' 47.3"	This study
ARC 455	30/03/2015	Rice seed		Togo		This study
ARC 460	30/03/2015	Rice seed		Togo		This study
ARC 462	30/03/2015	Rice seed		Togo		This study
ARC 471	16/04/2015	Rice seed		Burkina Faso		This study
ARC 473	16/04/2015	Rice seed		Burkina Faso		This study
ARC 474	16/04/2015	Rice seed		Burkina Faso		This study
ARC 475	16/04/2015	Rice seed		Burkina Faso		This study
ARC 476	16/04/2015	Rice seed		Burkina Faso		This study
ARC 477	16/04/2015	Rice seed		Burkina Faso		This study
ARC 486	16/04/2015	Rice seed		Niger		This study
ARC 487	16/04/2015	Rice seed		Niger		This study
ARC 491	16/04/2015	Rice seed		Niger		This study
ARC 492	04/10/2015	Rice seed		Benin		This study
ARC 493	04/10/2015	Rice seed		Benin		This study
ARC 494	04/10/2015	Rice seed		Benin		This study
ARC 508	04/10/2015	Rice seed		Benin		This study
ARC 510	04/10/2015	Rice seed		Benin		This study
ARC 511	04/10/2015	Rice seed		Benin		This study
ARC 512	04/10/2015	Rice seed		Benin		This study
ARC 517	04/10/2015	Rice seed		Benin		This study
ARC 518	04/10/2015	Rice seed		Benin		This study
ARC 519	04/10/2015	Rice seed		Benin		This study
ARC 530	04/10/2015	Rice seed		Benin		This study
ARC 538	20/05/2015	Rice seed		Burundi		This study
ARC 540	20/05/2015	Rice seed		Burundi		This study
ARC 542	18/06/2015	Water	Calavi	Benin		This study
ARC 544	18/06/2015	Water		Benin		This study
ARC 545	01/11/2013	Rice leaves	Sélingué	Mali	N 12°37' 46.7" W 007°46' 57.3"	This study
ARC 546	30/10/2013	Rice leaves	Sélingué	Mali	N 11°38' 47.5" W 008°13' 35.0"	This study
ARC 547	30/10/2013	Rice leaves	Sélingué	Mali	N 11°38' 47.4" W 008°13'	This study

					35.0"	
ARC 550	30/10/2013	Rice leaves	Sélingué	Mali	N 11°38' 47.7" W 008°13' 34.4"	This study
ARC 551	30/10/2013	Rice leaves		Mali		This study

**Table 2:** Table summarizing information on *Pantoea* spp strains present in the BCCM/LMG collection with their corresponding names in others collections.

Strain N°	Other collections' numbers		Biological origin	Geographic origin
LMG 27579 <sup>T</sup>	KCTC 32406; Xu JZB2120001	<i>P. beijingensis</i>	<i>Pleurotus eryngii</i> , fruiting body	China
LMG 29103 <sup>T</sup>	DSM 29212; NBRC 110557; strain QC88-366	<i>P. theicola</i>	black tea in manufacturing process	Japan
LMG 1286 <sup>T</sup>	ATCC 27155; CCTM 899; CCUG 539; CDC 1461-67; CIP 57.51; DSM 3493; ICPB 3435; JCM 1236; Kosako 83002; NCTC 9381; Pereira strain Graham Price; Sakazaki 236; USCC 1520 ; CFBP2240 ; CFBP3845T.	<i>P. agglomerans</i>	knee laceration	Zimbabwe
LMG 2102	CUETM 79-259; Graham G152; ICPB 2950; Murashi B128		deer	United States
LMG 2103	CUETM 79-249; Graham G155; Murashi M587		human	United States
LMG 2553 <sup>T</sup>	ATCC 13329; Dowson 179; LMG 132; NCPPB 179; Starr TG1; Starr TG101; CFBP998			
LMG 2554	Lelliott RBY1; NCPPB 601		<i>Phaseolus coccineus</i> , Associated with " <i>Pseudomonas phaseolicola</i> " in atypical halo blight lesions (NCPPB)	United Kingdom
LMG 2555	Billing E44; NCPPB 656		<i>Malus sylvestris</i>	United Kingdom
LMG 2557	Baker 119; NCPPB 1269		<i>Pyrus communis</i>	United Kingdom
LMG 2565 <sup>T</sup>	ATCC 33243; CCTM 3231; CCUG 14802; DSM 4609; Dye ZP11; Hagborg 4834; ICMP 272; NCIB 12126; NCPPB 2971; PDDCC 272; Roslycky 19 ; CFBP4740		cereals	Canada
LMG 2567	CUETM 79-206; Leclerc a57		Water	
LMG 2568	CUETM 79-218; Leclerc a98		water	France
LMG 2569	CNBP 1189; CUETM 79-137; Goodman 35A ; CFBP1189		<i>Malus sylvestris</i>	United States
LMG 2570	CNBP 1255; CUETM 79-164; Shaffer 23		<i>Sorbus sp.</i>	United States
LMG 2571	CUETM 79-126; Graham G156; ICPB 2953; Murashi M2722 ; CFBP2237		human	United States
LMG 2572	NCIB 9680; Norman XII.31.46; NRRL B-689		<i>Triticum sp.</i>	Canada
LMG 2573	IPO 287		cactus, tumor	
LMG 2574	CUETM 79-230; Graham G138; Holding Y1; LMG 2938		<i>Avena sativa</i> , seed	United Kingdom
LMG 2576	CUETM 79-254; Graham G140; Holding Y7		<i>Avena sativa</i> , seed	United Kingdom
LMG 2578	CUETM 79-157; CUETM 79-225; CUETM 79- 237; Graham G142; Holding Y13; ICPB EH101		<i>Avena sativa</i> , seed	United Kingdom
LMG 2579	Graham G143; Holding 59		local grass silage	United Kingdom
LMG 2581	Graham G150; ICPB 2948; Murashi B110-5		deer	United States
LMG 2582	Graham G151; ICPB 2949; Murashi B116		deer	United States
LMG 2583	Graham G153; Murashi B351		deer	United States
LMG 2584	Graham G154; Murashi B312		deer	United States
LMG 2585	Graham G157		<i>Vicia faba</i> , seed	
LMG 2587	Dye EA5; ?PDDCC 1414; Graham strain PA		<i>Vicia faba</i> , seed	
LMG 2590	CUETM 79-86; Paulin E.10.6.1		<i>Prunus persica</i> , leaf surface	
LMG 2591	CUETM 79-94; Paulin F.10.2.1		<i>Prunus persica</i> , leaf surface	
LMG 2592	CUETM 79-85; Paulin 179-7		<i>Crataegus sp.</i> , leaf surface	

LMG 2593	CUETM 79-72; Paulin 189-2			
LMG 2594	CUETM 79-84; Paulin 199-2		<i>Prunus persica</i> , leaf surface	
LMG 2595	Hattingh SUH 1; ICMP 7373; PDDCC 7373		<i>Allium cepa</i> cv. <i>Granex</i> , necrotic stalk and leaf	South Africa
LMG 2596	Hattingh SUH 2; ICMP 7374; PDDCC 7374		<i>Allium cepa</i> cv. <i>Granex</i> , necrotic stalk and leaf	South Africa
LMG 2639	CUETM 79-78; Paulin 217-5		<i>Prunus persica</i> , leaf surface	France
LMG 2659	ATCC 23375; DSM 30079; Dye EQ1; ICMP 1574; ICPB EM102; NCPPB 955; PDDCC 1574		<i>Wisteria japonica</i>	Japan
LMG 2660	ATCC 33261; Goto EM01; ICMP 6772; NCPPB 2519; PDDCC 6772 ; CFBP3615		<i>Wisteria floribunda</i> , stem gall	Japan
LMG 2661	Goto EM2; ICMP 6773; NCPPB 2600; PDDCC 6773		<i>Wisteria floribunda</i> , gall	Japan
LMG 2662	Goto EM3; NCPPB 2601		<i>Wisteria floribunda</i>	Japan
LMG 2732	CUETM 79-7; Gilardi 544; LMG 2942 ; CFBP2242		human, peritoneal dialysis fluid	United States
LMG 2733	Gilardi 546		human, ankle wound	United States
LMG 2734	Gilardi 556		human, brain abscess	United States
LMG 2737	CUETM 79-19; Gilardi 976		human, wound	United States
LMG 2740	CUETM 79-229; Richard 4-78		Human clinical material	
LMG 2741	CUETM 79-347; Richard 9-77		Human clinical material	
LMG 2742	CUETM 79-227; Richard 14-77		Human clinical material	
LMG 2743	CUETM 79-245; Richard 14-78		Human clinical material	
LMG 2744	CUETM 79-257; Service Hydrobiologie 15544		Drinking water	
LMG 2745	CUETM 79-285; Service Hydrobiologie 16229(2)		Drinking water	
LMG 2746	CUETM 79-146; Faculté Médecine Lille 40-V1		Human clinical material	
LMG 2764	CUETM 79-18; Gilardi 722		Human, throat	United States
LMG 2936	Graham 892		Human clinical material	
LMG 2941	CUETM 79-82; Paulin B.903		<i>Malus sylvestris</i> , leaf surface	
LMG 2990	CUETM 79-17; Gilardi 749		eye makeup	United States
LMG 20118	Cottyn BPJ 265; Swings R-5698		<i>Oryza sativa</i>	Jalajala Philippines
LMG 20119	Cottyn BPJ 263; Swings R-5717		<i>Oryza sativa</i>	Jalajala Philippines
LMG 24202	Cleenwerck R-27853; PPPPB BD309	<i>P. allii</i>	onion	South Africa
LMG 24203	Cleenwerck R-21588; PPPPB BD377		onion	South Africa
LMG 24248	Cleenwerck R-27856; PPPPB ; BD390 ; CFBP8207		onion	South Africa
LMG 2101	CUETM 79-364; Graham G144	<i>P. ananatis</i>	<i>Oryza sativa</i> , seed	India
LMG 2628	ATCC 23822; ATCC 23988; CCM 2407; HIM 577-8; Sakazaki AJ 2671		<i>Musa</i> sp.	
LMG 2664	Dye EB2; Graham MF27; ICMP 1515; NCPPB 544; PDDCC 1515		<i>Ananas comosus</i>	Hawaii United States
LMG 2665 <sup>1</sup>	ATCC 33244; Dye EB9; ICMP 1850; ICPB EA175; NCPPB 1846; PDDCC 1850; Robbs ENA-318 ; CFBP3612 <sup>T</sup>		<i>Ananas comosus</i>	Brazil

LMG 2666	CNBP 466; CUETM 79-248; Dye EB1; Dye EB3; Graham BG1; ICMP 1415; ICMP 1514; NCPPB 441; PDDCC 1415; PDDCC 1514; Spiegelberg BG1; CFBP466		<i>Ananas comosus</i> , brown and grey rot of fruit	Hawaii United States
LMG 2667	Dye EB4; Graham BG2; ICMP 1416; NCPPB 548; PDDCC 1416; Spiegelberg BG2		<i>Ananas comosus</i> , grey rot of fruit	Hawaii United States
LMG 2668	Dye EB8; Graham MF28; ICMP 1418; PDDCC 1418; Spiegelberg MF28		<i>Ananas comosus</i> , marbled fruit	Hawaii United States
LMG 2669	Dye EB7; Graham Y1; ICMP 1417; PDDCC 1417; Spiegelberg Y1		<i>Ananas comosus</i> , brown rot	Hawaii United States
LMG 2670	Graham YSB; NCPPB 545		<i>Ananas comosus</i>	Hawaii United States
LMG 2672	ATCC 11530; DSM 30070; HIM 597-3; Smith 4294		<i>Ananas comosus</i>	
LMG 2675	ICMP 350; Klement 0.029; NCPPB 391; PDDCC 350 ; CFBP3170		<i>Puccinia graminis</i> f. sp. <i>Tritici</i>	Hungary
LMG 2676 <sup>1</sup>	ATCC 19321; DSM 30080; Dye YJ2; Hayward 81782; ICMP 351; ICPB XU102; LMG 2682; LMG 5255; NCPPB 800; PDDCC 351; Thiry 20D3; CFBP3171T		<i>Puccinia graminis</i> f. sp. <i>tritici</i> , <i>uredia</i>	United States
LMG 2678	Hayward B620; NCPPB 1044; CFBP3158		<i>Puccinia graminis</i> f. sp. <i>Tritici</i>	Zimbabwe
LMG 2679	Dye YJ3; ICMP 352; ICPB XU103; Klement 0.078; NCPPB 1416; PDDCC 352		<i>Puccinia graminis</i> f. sp. <i>Tritici</i>	Hungary
LMG 2680	Klement 0.039; NCPPB 1419; CFBP3159		<i>Puccinia graminis</i> f. sp. <i>Tritici</i>	Hungary
LMG 2681	Klement 0.069; NCPPB 1440 ; CFBP3160		<i>Puccinia graminis</i> f. sp. <i>Tritici</i>	Hungary
LMG 2807	Dye EG46; ICMP 1838; ICPB EC219; NCPPB 1848; PDDCC 1838; Robbs ENA 439		<i>Cattleya</i> sp.	Brazil
LMG 5256	Thiry 20D3BL		White mutant derived from strain 20D3 (LMG 5255)	
LMG 5257	Dye YJ4; Hayward 81784; ICMP 353; ICPB XU104; Klement 0.049; LMG 2677; NCPPB 802; PDDCC 353; Thiry 20D31		<i>Puccinia graminis</i> f. sp. <i>Tritici</i>	Hungary
LMG 5258	Thiry 20D31BL		White mutant derived from strain 20D31 (LMG 5257)	
LMG 5342			human	United States
LMG 20103	Coutinho BBD0001; Mergaert R-13703		<i>Eucalyptus grandis</i> x <i>Eucalyptus nitens</i>	South Africa
LMG 20104	Coutinho BBD0003; Mergaert R-13705		<i>Eucalyptus grandis</i> Clone A	South Africa
LMG 20105	Coutinho BBD0004; Mergaert R-13706		<i>Eucalyptus grandis</i> x <i>Eucalyptus nitens</i>	South Africa
LMG 20106	Coutinho BBD0005; Mergaert R-13708		<i>Eucalyptus grandis</i> Clone B	South Africa
LMG 20121	Cottyn C16; Swings R-3406		<i>Oryza sativa</i>	Jalajala Philippines
LMG 24190	Cleenwerck R-27854; PPPP BD310		onion seed	South Africa
LMG 24191	Cleenwerck R-27858; PPPP BD435		maize	South Africa
LMG 24192	Cleenwerck R-27859; PPPP BD442		maize	South Africa
LMG 24193	Cleenwerck R-27860; PPPP BDPA4		onion seed	South Africa
LMG 2558 <sup>1</sup>	BD 871; NCPPB 1682	<i>P. anthonompha</i>	<i>Impatiens balsamina</i>	India
LMG 2560	ICPB XT113; NCPPB 1941		<i>Tagetes erecta</i>	
LMG 5343 <sup>1</sup>	ATCC 29921; CDC 3482-71	<i>P. breunneri</i>	human, urethra	United States
LMG 24532	CDC 2928-68; Cleenwerck R-35494		human, sputum	United States
LMG 24533	CDC 2525-70; Cleenwerck R-35495			Quebec Canada
LMG 25383 <sup>1</sup>	DSM 22759; Stephan 1400/07	<i>P. calida</i>	powdered infant	Zurich

LMG 25421	Stephan A11/07		formula	Switzerland
LMG 25422	Stephan 484/07		powdered infant formula	Zurich Switzerland
LMG 25423	Stephan 1378/07		powdered infant formula	Zurich Switzerland
LMG 24534 <sup>†</sup>	CDC 3527-71; Cleenwerck R-35496	<i>P. conspicua</i>	human, blood	France
LMG 24200 <sup>†</sup>	BCC 109; BD 767; Cleenwerck R-31523; Coutinho BCC109	<i>P. deleyi</i>	<i>Eucalyptus</i>	Uganda
LMG 2601	Dye WPI; ICMP 1377; NCPPB 2279; PDDCC 1377	<i>P. dispersa</i>	<i>Abelmoschus esculentus</i> , leaf spot	India
LMG 2602	Dye XX1; ICMP 625; NCPPB 2285; PDDCC 625		<i>Sorghum bicolor</i>	India
LMG 2603 <sup>†</sup>	Ajinomoto Co. Inc. 1161; ATCC 14589; CUETM 79-132; DSM 30073		soil	Japan
LMG 2604	IPO 445; NCPPB 2274		Rosa sp.	Netherlands
LMG 2605	Graham G146		<i>Vigna unguiculata</i> , seed	Tanzania
LMG 2748	Gouillet 29.2.80			
LMG 2749	CUETM 79-200; Faculté Médecine Lille 214-6 ; CFBP2254		Human clinical material	
LMG 2769	CUETM 79-12; Gilardi 961		human, blood culture	United States
LMG 2770	CUETM 79-25; Gilardi 968		human, blood culture	United States
LMG 5344	ATCC 29922; CDC 1429-71; Neblett 395		Intravenous fluid cap	
LMG 20116	Cottyn BPJ 158; Swings R-5582		<i>Oryza sativa</i>	Jalajala Philippines
LMG 24197	BCC 076; BD 769; Cleenwerck R-25678	<i>P. eucalypti</i>		Uruguay
LMG 24198	BCC 077; Cleenwerck R-25679		<i>eucalyptus</i>	Uruguay
LMG 2781 <sup>†</sup>	ATCC 27998; CDC 1741-71; HIM 582-7; LMG 5346	<i>P. eucrina</i>	human, trachea	United States
LMG 24529	CDC 3638-70; Cleenwerck R-35491		human, cyst	United States
LMG 24530	CDC 5795-70; Cleenwerck R-35492		human, urine	United States
LMG 24531	CDC 6148-70; Cleenwerck R-35493		human, spinal fluid	United States
LMG 25382 <sup>†</sup>	DSM 22758; Stephan A18/07	<i>P. gaviniae</i>	powdered infant formula	Zurich Switzerland
LMG 26273 <sup>†</sup>	BCC 581; BD 943; Cleenwerck R-43276	<i>P. rodasii</i>	<i>Eucalyptus</i>	Colombia
LMG 26274	BCC 588; Cleenwerck R-43461		<i>Eucalyptus</i>	Colombia
LMG 26275 <sup>†</sup>	BCC 571; BD 944; Cleenwerck R-43274	<i>P. rwandensis</i>	<i>Eucalyptus</i>	Rwanda
LMG 26276	BCC 568; Cleenwerck R-43271		<i>Eucalyptus</i>	Rwanda
LMG 5345 <sup>†</sup>	ATCC 29923; CDC 3123-70; New Jersey State Health Dept. E393	<i>P. septica</i>	human, stool	United States
LMG 24526	CDC 238-70; Cleenwerck R-35488		human, blood	United States
LMG 24527	CDC 1778-70; Cleenwerck R-35489		human, blood	United States
LMG 24528	CDC 217-71; Cleenwerck R-35490		human, blood	United States
LMG 2629	Dye XU1; ICMP 629; LMG 2631; NCPPB 1562; NCPPB 2275; PDDCC 629	<i>P. stewartii</i> subsp. <i>indologenes</i>	<i>Pennisetum americanum</i>	India
LMG 2630	ICPB PC130; NCPPB 1877		<i>Cyamopsis tetragonolobus</i>	
LMG 2631	Dye XU1; ICMP 629; LMG 2629; NCPPB 1562; NCPPB 2275; PDDCC 629; Rangaswami 3		<i>Pennisetum americanum</i>	India
LMG 2632 <sup>†</sup>	Dye XN1; ICMP 77; NCPPB 2280; PDDCC 77; Rangaswami 1; CFBP3614		<i>Setaria italica</i> , leaf spot	India
LMG 2633	Dye XN2; ICMP 81; NCPPB 2281; PDDCC 81; Rangaswami 2		<i>Setaria italica</i> , leaf spot	India
LMG 2634	Dye XT1; ICMP 89; NCPPB 2282; PDDCC 89		<i>Pennisetum</i>	India

			<i>americanum</i> , leaf spot	
LMG 2635	Dye XVI; ICMP 626; NCPPB 2283; PDDCC 626		<i>Zea mays</i>	India
LMG 2671	Dye EB5; ICMP 1516; ICPB EA101; Linford BG3; NCPPB 1845; PDDCC 1516		<i>Ananas comosus</i>	United States
LMG 2673	Dye EB6-1; ICMP 1517; ICPB EA103; PDDCC 1517		<i>Ananas comosus</i>	United States
LMG 2674	Dye EB6-2; ICMP 1518; ICPB EA103; PDDCC 1518		<i>Ananas comosus</i>	United States
LMG 2712	Dye ZO4; ICMP 258; NCPPB 449; PDDCC 258; CFBP3514; CFBP3168	<i>P. stewartii</i> subsp. <i>stewartii</i>	<i>Zea mays</i> var. <i>rugosa</i>	United States
LMG 2713	Hayward B1875; NCPPB 1553; CFBP3515; CFBP3448		<i>Zea mays</i>	United States
LMG 2714	Dye ZO2; ICMP 256; ICPB SS2; NCPPB 2294; PDDCC 256; CFBP3516; CFBP3447		<i>Zea mays</i>	United States
LMG 2715 <sup>T</sup>	ATCC 8199; DSM 30176; Dye ZO3; Dye ZO10; ICMP 257; ICPB SS11; IMET 11187; Lindstrom 3152(A14); NCPPB 2295; PDDCC 257; CFBP3517; CFBP3167		<i>Zea mays</i> var. <i>rugosa</i>	United States
LMG 2716	Dye ZO5; ICMP 270; Natti 3; PDDCC 270; CFBP3393			
LMG 2717	Dye ZO9; ICMP 722; ICPB SS18; PDDCC 722; CFBP3394		Beetle	United States
LMG 2718	ATCC 8200; ATCC 15367; Burkholder SS12; Dye ZO11; ICMP 724; Lindstrom 3153(D51); PDDCC 724; CFBP3395			United States
LMG 2719	ICMP 5929; PDDCC 5929; Turner COL6; CFBP3396		corn flea beetle	United States
LMG 20115	Cottyn BPJ 259; Swings R-5769		<i>Oryza sativa</i>	Jalajala Philippines
LMG 24195	BCC 013; Cleenwerck R-24584		<i>P. vagans</i>	<i>eucalyptus</i>
LMG 24196	BCC 015; Cleenwerck R-25674	<i>eucalyptus</i>		Argentina
LMG 24199 <sup>T</sup>	BCC 005; BD 765; Cleenwerck R-21566	<i>eucalyptus</i>		Uganda
LMG 24201	BD 639; Cleenwerck R-30991	Maize		South Africa
LMG 26277 <sup>T</sup>	BCC 682; BD 946; Cleenwerck R-43473	<i>P. wallisii</i>	<i>Eucalyptus</i>	South Africa
LMG 26278	BCC 692; Cleenwerck R-43474		<i>Eucalyptus</i>	South Africa

**Table 3:** List of CFBP reference strains include some type stains used for the evaluation and validation of all the tools and protocols set up in the project.

CFBP strains	Year of isolation	Other collections' numbers	Biological origin	Geographic origin	References
CFBP 466	<i>P. ananatis</i>	1957	CNBP 466; CUETM 79-248; Dye EB1; Dye EB3; Graham BG1; ICMP 1415; ICMP 1514; NCPPB 441; PDDCC 1415; PDDCC 1514; Spiegelberg BG1; LMG2666.	<i>Ananas comosus</i>	United States (Mergaert et al., 1993)
CFBP3612 <sup>T</sup>	<i>P. ananatis</i>	1965	ATCC 33244 <sup>T</sup> ; Dye EB9 <sup>T</sup> ; ICMP 1850 <sup>T</sup> ; ICPB EA175 <sup>T</sup> ; NCPPB 1846 <sup>T</sup> ; PDDCC 1850 <sup>T</sup> ; Robbs ENA-318 <sup>T</sup> ; LMG2665 <sup>T</sup>	<i>Puccinia graminis</i>	United States (Mergaert et al., 1993)
CFBP3171 <sup>T</sup>	<i>P. ananatis</i>	1954	ATCC 19321T; DSM 30080T; Dye YJ2T; Hayward 81782T; ICMP 351T; ICPB XU102T; LMG 2682T; LMG 5255T; NCPPB 800T; PDDCC 351T; Thiry 20D3T; LMG 2667T	<i>Puccinia graminis</i>	United States (Brady et al., 2008)
CFBP5846	<i>P. stewartii</i>	1991	Strain currently absent from the CFBPdatabase.		Brazilia
CFBP3615	<i>P. agglomerans</i>	1976	ATCC 33261; Goto EM01; ICMP 6772; NCPPB 2519; PDDCC 6772 ; LMG 2660	<i>Wisteria floribunda</i>	Japan (Brady et al., 2008)
CFBP3845T	<i>P. agglomerans</i>	1956	ATCC 27155T; CCTM 899T; CCUG 539T; CDC 1461-67T; CIP 57.51T; DSM 3493T; ICPB 3435T; JCM 1236T; Kosako 83002T; NCTC 9381T; Sakazaki 236T; USCC 1520T; CFBP2240T; LMG 1286T	knee laceration	Zimbabwe (Brady et al., 2008)
CFPB 6627	<i>P. cedenensis</i>	1998	Strain currently absent from the CFBP database		Espagne
CFBP6632	<i>Erwinia olea</i>	1998	Strain currently absent from the CFBP database		Espagne