



**HAL**  
open science

# Fair coexistence between LTE and Wi-Fi in unlicensed spectrum

Amr Abdelfattah

► **To cite this version:**

Amr Abdelfattah. Fair coexistence between LTE and Wi-Fi in unlicensed spectrum. Networking and Internet Architecture [cs.NI]. Sorbonne Université, 2018. English. NNT : 2018SORUS261 . tel-02868480

**HAL Id: tel-02868480**

**<https://theses.hal.science/tel-02868480>**

Submitted on 15 Jun 2020

**HAL** is a multi-disciplinary open access archive for the deposit and dissemination of scientific research documents, whether they are published or not. The documents may come from teaching and research institutions in France or abroad, or from public or private research centers.

L'archive ouverte pluridisciplinaire **HAL**, est destinée au dépôt et à la diffusion de documents scientifiques de niveau recherche, publiés ou non, émanant des établissements d'enseignement et de recherche français ou étrangers, des laboratoires publics ou privés.



UPMC Sorbonne Université  
18 June 2018

# Fair Coexistence between LTE and Wi-Fi in Unlicensed Spectrum

PRESENTED

BY

AMR ABDELFATTAH

FOR OBTAINING

IN PARTIAL FULFILLMENT OF THE REQUIREMENTS FOR THE DEGREE OF  
DOCTOR OF PHILOSOPHY  
IN COMPUTER SCIENCE, TELECOMMUNICATIONS AND ELECTRONICS

COMMITTEE:

MOSTAFA AMMAR	REVIEWER	PROFESSOR, GEORGIA INSTITUTE OF TECHNOLOGY
ANDRÉ-LUC BEYLOT	REVIEWER	PROFESSOR, TOULOUSE UNIVERSITY
VÉRONIQUE VÈQUE	REVIEWER	PROFESSOR, PARIS-SUD UNIVERSITY
SALAH EDDINE ELAYOUBI	EXAMINER	PROFESSOR, CENTRALESUPÉLEC ENGINEERING SCHOOL
MARIA POTOP-BUTUCARU	EXAMINER	PROFESSOR, SORBONNE UNIVERSITY
NACEUR MALOUCH	SUPERVISOR	ASSOCIATE PROFESSOR (HDR), SORBONNE UNIVERSITY

---

TO THE GLORY OF ALLAH, WHO SAYS THAT 'MANKIND HAVE NOT BEEN GIVEN OF KNOWLEDGE EXCEPT A LITTLE'. — THE HOLY QURAN

# Acknowledgments

By the Grace of ALLAH Almighty, prayers and best wishes of my parents, family, and friends. I can honestly say that my thesis was a long journey which would not have been possible without the support of many people.

First of all, I want to thank Naceur, my thesis supervisor and my guru, for his excellent orientation, support and dedication during the whole period of my thesis. It was a great pleasure to do my research under his direction. I am grateful to him for everything, in particular, to give me the freedom to develop my ideas and his way of simplifying things. His suggestions, his recommendations, and his ability to handle a variety of things were very remarkable to me. I take this opportunity to express my greatest gratitude for having such an excellent advisor.

I would like to express my warmest thanks to Professors Mostafa AMMAR, Véronique VÉQUE and André-Luc BEYLOT for their valuable time evaluating and reporting this thesis. I am very aware that the suggestions they have made to me have a great contribution to improve the quality of my work. I would also like to thank Salah Eddine ELAYOUBI and Maria POTOP-BUTUCARU for agreeing to be part of my jury and to evaluate the work I have done over the past four years.

I had a wonderful time at LIP6. I must thank all my colleagues on the NPA team, and in particular : Salah, Narcissus, Mustapha, Quentin, Walid, Wahib, Wafa, Fadwa, Bu, Minh, Mehdi, Clement, Benjamin, Alexander, Giulio, Davide, Antonella, Florian, Filippo, Thiago, Alexandru, Tiph and Matteo.

# Abstract

According to Cisco forecast, by 2019, the monthly global mobile data traffic will exceed 24.3 Exabyte because of the increasing number of mobile broadband data subscribers. The next-generation communication systems such as LTE and LTE-Advanced performance is already close to the well-known Shannon bound in terms of spectrum efficiency! This motivates mobile operators to increase the capacity of their cellular networks by moving towards data traffic offloading from licensed to unlicensed spectrum which stands out as a promising solution. LTE in unlicensed spectrum has been proposed to extend the usual operation of LTE in licensed spectrum to cover also unlicensed spectrum, mainly at the 5GHz band due to its wide spectrum availability. However, this extension poses significant challenges especially regarding the coexistence between LTE and Wi-Fi. The new entrant LTE should fairly coexist with the incumbent Wi-Fi so that LTE can be considered as *Wi-Fi-friendly*.

Knowing that LTE and Wi-Fi were originally designed for different networking purposes, the heterogeneity between their both MAC and PHY layer are quite high, and thus, ensuring the fair coexistence is really a great challenge. Indeed, LTE has to adopt a new Medium Access Control (MAC) layer protocol that allows a fair channel sharing with Wi-Fi Distributed Coordinated Function (DCF) MAC layer protocol. In addition, the new LTE MAC layer protocol has to be suitable for LTE operation so that LTE maintains an acceptable performance in unlicensed spectrum. The key challenge is to *simultaneously* meet the above requirements which makes the design of a new LTE MAC layer protocol quite intricate. Moreover, whatever the MAC layer protocol adopted by LTE to share the channel access with Wi-Fi, the PHY layer heterogeneity between them can also degrade the fair coexistence due to mainly the well-known hidden terminal problem in wireless communications.

In this thesis, we are looking for studying deeply both LTE and Wi-Fi performance in different coexistence scenarios where LTE adopts one of the new four-MAC Layer protocols which were proposed for LTE in unlicensed spectrum by 3GPP. We mainly focused on Time Division

Multiplexing (TDM) based, Frame Based Equipment (FBE) and Category 4 (Cat4) MAC layer protocols for LTE to compete with the Wi-Fi DCF protocol. Our research approach is based on providing several analytical models that describe LTE/Wi-Fi interaction in detail with respect to the channel access. These analytical models rely on Markov chains and random walk theory in order to provide a general framework to study different LTE/Wi-Fi coexistence scenarios. Based on these analytical models we are able to answer the main question: *which technology among LTE and Wi-Fi does not coexist fairly with the other?* Moreover, in case LTE does not coexist fairly with Wi-Fi, we quantify the negative impact of LTE MAC layer protocol on Wi-Fi DCF protocol so that we are able to propose different solutions based on adjusting carefully the configuration parameters of the LTE MAC layer protocol to fairly coexist with the Wi-Fi DCF protocol. In contrast, in case Wi-Fi does not coexist fairly with LTE, we identify the causes that makes LTE struggles to maintain an acceptable performance in coexistence with Wi-Fi. In fact, we will ask LTE to be cautious about the adoption of certain MAC layer protocols to coexist with Wi-Fi since it is still possible that LTE reaches a certain acceptable level of performance only under some conditions on Wi-Fi networks. In addition, we propose some modifications on the new LTE MAC layer protocols and even suggest a new hybrid Mac layer protocol that would ensure LTE/Wi-Fi fair coexistence. To further enhance LTE/Wi-Fi coexistence, LTE has also to tackle the problem that comes from its PHY layer heterogeneity with Wi-Fi PHY layer. In this thesis, we have presented a simple solution to tackle the previous problem based on adaptive adjustment of the energy detection threshold for both LTE and Wi-Fi.

# Contents

<b>1</b>	<b>INTRODUCTION</b>	<b>2</b>
1.1	Context and Motivations . . . . .	2
1.2	LTE in Unlicensed Spectrum . . . . .	3
1.2.1	Network deployment scenarios . . . . .	5
1.3	Research Challenges and Problem Statements . . . . .	6
1.4	Thesis Contributions and Research Approaches . . . . .	9
1.5	Thesis Outline . . . . .	11
<b>2</b>	<b>INTER-RADIO ACCESS TECHNOLOGY COEXISTENCE: STATE OF THE ART</b>	<b>12</b>
2.1	LTE/Wi-Fi Coexistence in Unlicensed Spectrum . . . . .	14
2.1.1	TDM-based MAC layer Protocol . . . . .	17
2.1.2	Frame Based Equipment MAC Layer Protocol . . . . .	21
2.1.3	Load Based Equipment MAC Layer Protocol . . . . .	24
2.1.4	Category 4 MAC Layer Protocol . . . . .	27
2.1.5	Enhancing LTE/Wi-Fi Coexistence . . . . .	29
2.2	WiMAX/Wi-Fi Coexistence . . . . .	33
2.3	Synthesis . . . . .	34
<b>3</b>	<b>TDM-BASED PROTOCOL: STUDYING THE IMPACT OF LTE ON WI-FI DOWNLINK PERFORMANCE</b>	<b>37</b>
3.1	LTE/Wi-Fi Interaction . . . . .	39
3.2	Wi-Fi Analytical Model . . . . .	40
3.2.1	Transition Probabilities and Probability of Collision . . . . .	42
3.2.2	Downlink Wi-Fi Throughput . . . . .	46
3.3	Model Validation and Simulation Results . . . . .	47

3.3.1	Comparison With Simulation Results . . . . .	48
3.3.2	Analyzing LTE Impact on Wi-Fi . . . . .	49
3.4	Summary . . . . .	52
4	<b>TDM-BASED PROTOCOL: MODELING AND PERFORMANCE ANALYSIS OF LTE/WI-FI COEXISTENCE</b>	<b>54</b>
4.1	Revisiting Wi-Fi Analytical Models . . . . .	56
4.2	New Wi-Fi Analytical Models . . . . .	58
4.2.1	Slot-by-Slot Random Walk Model . . . . .	59
4.2.2	Exponential Model for LTE . . . . .	62
4.2.3	Frame-by-Frame Random Walk Model . . . . .	63
4.2.4	Linking the two analytical models . . . . .	65
4.2.5	Wi-Fi Model with Capture Effect . . . . .	66
4.3	LTE Analytical Model . . . . .	67
4.4	Models Validation and Simulation Results . . . . .	68
4.4.1	Validation Through Simulation and Observations . . . . .	69
4.4.2	Wi-Fi/LTE Coexistence Model Analysis and Application . . . . .	72
4.4.3	Comparison Between Different LTE Configurations . . . . .	73
4.4.4	Controlling Wi-Fi/LTE Coexistence Using the Model . . . . .	73
4.4.5	LTE Analytical Model Validation . . . . .	76
4.5	Summary . . . . .	78
5	<b>FBE PROTOCOL: MODELING AND PERFORMANCE ANALYSIS OF LTE/WI-FI COEXISTENCE</b>	<b>80</b>
5.1	LTE/Wi-Fi Interaction . . . . .	82
5.2	LTE/Wi-Fi Analytical Models . . . . .	84
5.2.1	LTE Markov Chain Model . . . . .	84
5.2.2	Transition Probabilities and LTE Throughput . . . . .	86
5.2.3	LTE Renewal Process . . . . .	89
5.2.4	Wi-Fi Throughput . . . . .	90
5.3	Models Validation and Simulation Results . . . . .	91
5.4	Summary . . . . .	97
6	<b>CATEGORY 4 PROTOCOL: ADAPTIVE ENERGY THRESHOLD FOR IMPROVED COEXISTENCE BETWEEN LICENSED ASSISTED ACCESS AND WI-FI</b>	<b>98</b>



6.1	Coexistence Below Energy Detection Threshold . . . . .	99
6.2	Adaptive Energy Detection Threshold Scheme . . . . .	100
6.2.1	Scheme at the Wi-Fi side . . . . .	101
6.2.2	Scheme at the LAA side . . . . .	102
6.3	System Model . . . . .	103
6.4	Performance Comparison . . . . .	104
6.4.1	Single UE per technology located both at the cell-edge . . . . .	104
6.4.2	Single UE per technology located both at the cell-centre . . . . .	105
6.4.3	Multiple UE per technology uniformly distributed . . . . .	107
6.5	Summary . . . . .	109
<b>7</b>	<b>CONCLUSIONS AND FUTURE WORK</b>	<b>111</b>
7.1	TDM-based MAC layer protocol . . . . .	112
7.2	Frame Based Equipment MAC layer protocol . . . . .	113
7.3	Insights towards a New Hybrid MAC layer protocol . . . . .	113
7.4	Enhancing LTE/Wi-Fi Coexistence . . . . .	116
	<b>REFERENCES</b>	<b>17</b>

# List of Figures

1.1	LTE in Unlicensed Spectrum: Deployment Scenario . . . . .	5
2.1	TDM-based MAC layer protocol . . . . .	18
2.2	FBE MAC layer protocol . . . . .	21
2.3	LBE MAC layer protocol . . . . .	24
2.4	Cat4 MAC layer protocol flowchart [7] . . . . .	27
3.1	LTE eNodeB interacting with Wi-Fi Access Point . . . . .	39
3.2	Periodic Discrete Time Markov Chain modeling the three states at the end of an eNodeB-OFF period ( $T_i$ ). Left: The global transition diagram showing the periodicity. Right: Detailed state transitions over time . . . . .	41
3.3	(Left To Right) The probability of collision and throughput versus different packet size for 5x0 ON/OFF pattern . . . . .	49
3.4	(Left To Right):The probability of collision and throughput versus different packet size for 3x2 ON/OFF pattern . . . . .	50
3.5	(Left To Right) The probability of collision and throughput versus different packet size for 4x1 ON/OFF pattern . . . . .	50
3.6	Comparison of the three ON/OFF patterns with different rates . . . . .	51
4.1	Markov chain model for Wi-Fi stations [129]. . . . .	57
4.2	TDM-based protocol (Duty Cycled LTE) . . . . .	58
4.3	Slot-by-Slot random walk model for Wi-Fi. . . . .	60
4.4	Frame-by-Frame random walk model for Wi-Fi . . . . .	63
4.5	Collision probability versus network size: pksize=1500bytes and CBR=6 Mbps. . . . .	69
4.6	Wi-Fi throughput versus network size: pksize=1500 bytes and CBR=6Mbps. . . . .	69

4.7	Frame-by-Frame model. Collision probability versus packet size: $n=10$ , CBR =12Mbps and LTE 5x0 configuration . . . . .	70
4.8	Frame-by-Frame model. Wi-Fi throughput versus packet size: $n=10$ , CBR = 12Mbps and LTE 5x0 configuration . . . . .	70
4.9	Frame-by-Frame model. Collision probability versus network size: pksize= 512bytes, CBR=12Mbps and LTE 5x0 configuration . . . . .	70
4.10	Frame-by-Frame model. Wi-Fi throughput versus network size: pksize=512 bytes, CBR=12Mbps and LTE 5x0 configuration . . . . .	70
4.11	Slot-by-Slot model. Collision probability versus packet size: $n=10$ , CBR= 12 Mbps and LTE 5x0 configuration . . . . .	71
4.12	Slot-by-Slot model. Wi-Fi throughput versus packet size: $n=10$ , CBR=12 Mbps and LTE 5x0 configuration . . . . .	71
4.13	Exponential model. Collision probability versus packet size: $n=10$ , CBR=12 Mbps and $\mathfrak{R} = 400s^{-1}$ . . . . .	71
4.14	Exponential model. Wi-Fi throughput versus packet size: $n=10$ , CBR=12Mbps and $\mathfrak{R} = 400s^{-1}$ . . . . .	71
4.15	LTE arrival possibilities during off-period . . . . .	72
4.16	Comparison of the three LTE configurations. Wi-Fi throughput versus packet size: $n=10$ and CBR=12Mbps. . . . .	73
4.17	LTE duty cycle percentage fairness operation points. Wi-Fi throughput versus LTE duty cycle percentage: $n=10$ , pksize=512bytes, CBR=12Mbps and $K=1$ . . . . .	74
4.18	Wi-Fi throughput versus LTE duty cycle period: $n=10$ , pksize=512bytes, CBR =12Mbps, LTE 5x0 configuration. . . . .	74
4.19	Capture probability versus SIR: $n=10$ , pksize=512bytes, CBR=12Mbps and LTE 5x0 configuration. . . . .	75
4.20	LTE throughput versus Wi-Fi packet size: $n=10$ , CBR=12Mbps and LTE 5x0 configuration. . . . .	76
4.21	LTE throughput versus Wi-Fi packet size: $n=10$ , CBR=12Mbps with $\{3,3,2,2\}$ pattern. . . . .	77
4.22	LTE throughput versus Wi-Fi packet size: $n=10$ , CBR=12Mbps with $\{3,2,2,3\}$ pattern. . . . .	77
4.23	Wi-Fi Residual Life time versus Wi-Fi packet size: $n=10$ , CBR=12Mbps and LTE 5x0 configuration. . . . .	78

4.24	LTE throughput versus Wi-Fi packet size: $n=10$ , $CBR=12Mbps$ and LTE 5x0 configuration. . . . .	78
5.1	LTE interacting with Wi-Fi . . . . .	82
5.2	Discrete Time Markov chain model for LTE using FBE protocol over the time . . . . .	85
5.3	LTE Renewal Process . . . . .	89
5.4	LTE channel access probability versus WiFi packet size: LTE ( $T_{oc} = 1ms$ , $T_{id} = 1ms$ ), WiFi ( $CBR = 6Mbps$ ) . . . . .	91
5.5	LTE throughput versus WiFi packet size: LTE ( $T_{oc} = 1ms$ , $T_{id} = 1ms$ ), WiFi ( $CBR = 6Mbps$ ) . . . . .	91
5.6	Wi-Fi throughput versus WiFi packet size: LTE ( $T_{oc} = 1ms$ , $T_{id} = 1ms$ ), WiFi ( $CBR = 6Mbps$ ) . . . . .	92
5.7	LTE throughput versus WiFi packet size: LTE ( $T_{oc} = 10ms$ , $T_{id} = 1ms$ ), WiFi ( $CBR = 6Mbps$ ) . . . . .	93
5.8	LTE channel access probability versus WiFi packet size: LTE ( $T_{oc} = 10ms$ , $T_{id} = 1ms$ ), WiFi ( $CBR = 6Mbps$ ) . . . . .	93
5.9	LTE channel access probability versus WiFi packet size: LTE ( $T_{oc} = 10ms$ , $T_{id} = 10ms$ ), WiFi ( $CBR = 6Mbps$ ) . . . . .	93
5.10	LTE throughput versus WiFi packet size: LTE ( $T_{oc} = 1ms$ , $T_{id} = 1ms$ ), WiFi ( $CBR = 12Mbps$ ) . . . . .	94
5.11	LTE channel access probability versus WiFi packet size: LTE ( $T_{oc} = 1ms$ , $T_{id} = 1ms$ ), WiFi ( $CBR = 12Mbps$ ) . . . . .	94
5.12	WiFi throughput versus WiFi packet size: LTE ( $T_{oc} = 1ms$ , $T_{id} = 1ms$ ), WiFi ( $CBR = 12Mbps$ ) . . . . .	95
5.13	LTE channel access probability versus WiFi packet size: LTE ( $T_{oc} = 1ms$ , $T_{id} = 1ms$ ), WiFi ( $CBR = 24Mbps$ ) . . . . .	95
5.14	LTE throughput versus $T_{oc}$ period: LTE ( $T_{id} = 1ms$ ), WiFi ( $CBR = 24Mbps$ , packet size = 398 bytes) . . . . .	95
5.15	WiFi throughput versus $T_{oc}$ period: LTE ( $T_{id} = 1ms$ ), WiFi ( $CBR = 24Mbps$ , packet size = 398 bytes) . . . . .	95
5.16	LTE channel access probability versus WiFi packet size: LTE ( $T_{oc} = 1ms$ , $T_{id} = 200\mu s$ ), WiFi ( $CBR = 12Mbps$ ) . . . . .	96
5.17	WiFi throughput versus WiFi packet size: LTE ( $T_{oc} = 1ms$ , $T_{id} = 200\mu s$ ), WiFi ( $CBR = 12Mbps$ ) . . . . .	96

5.18	LTE throughput versus WiFi packet size: LTE ( $T_{oc} = 5\text{ms}$ , $T_{id} = 250\mu\text{s}$ ), WiFi (CBR = 6Mbps) . . . . .	96
5.19	LTE inter-arrival probability distribution function versus time: LTE ( $T_{oc} = 5\text{ms}$ , $T_{id} = 250\mu\text{s}$ ), WiFi (CBR = 6Mbps) . . . . .	96
6.1	Scenario with one UE per technology at the cell-edge. . . . .	104
6.2	CDF of UE file throughput for scenario with one UE per technology located both at the cell-edge. . . . .	104
6.3	Scenario with one UE per technology at the cell-centre. . . . .	106
6.4	CDF of UE file throughput for scenario with one UE per technology located both at the cell-centre. . . . .	106
6.5	CDF of received to created file ratio for scenario with four UE per technology and file size of 2 Mbyte. . . . .	108
6.6	CDF of UE file throughput for scenario with four UE per technology and file size of 2 Mbyte. . . . .	108
6.7	CDF of received to created file ratio for scenario with four UE per technology and file size of 4 Mbyte. . . . .	109
6.8	CDF of UE file throughput for scenario with four UE per technology and file size of 4 Mbyte. . . . .	109
7.1	Hybrid MAC layer protocol for LTE in unlicensed spectrum . . . . .	113

*Si j'avais une heure pour résoudre un problème, je passerais 55 minutes à réfléchir au problème et 5 minutes à penser à des solutions*

Albert Einstein

# 1

## Introduction

### 1.1 CONTEXT AND MOTIVATIONS

No doubt that the first goal of having a mobile phone in our pockets was to make simply a call. With the advent of smart phones that offer a large number of mobile data applications, making a call is not enough any more to meet the needs of people. Having a *broadband* Internet access is becoming more and more necessary. According to Cisco forecast, by 2019, the monthly global mobile data traffic will exceed 24.3 Exabyte [35] because of the increasing number of mobile broadband data subscribers. This motivates mobile operators to increase the capacity of their cellular networks to respond to this revolution in the use of mobile phones. In fact, along several years, mobile operators had evolved their mobile networks from the first generation (1G) to the fourth generation (4G) mobile networks. However, unfortunately, their effort were not in phase with the exponential increase of the number of mobile subscribers and services.

Today, the need of a the fifth generation (5G) mobile network is inevitable to cope with this challenge. According to International Telecommunication Union (ITU), 5G mobile networks should emerge between 2020 and 2030 with a top five fundamental requirements related to five key performance indicators: (i) 1000 times higher mobile data volume per geographical area

and 10 times to 100 times more in typical user data rate (ii) 10 times to 100 times more connected devices (iii) 10 times lower energy consumption (iv) End-to-End latency of less than one millisecond (v) Ubiquitous 5G access including in low density areas. The key challenge of designing 5G networks is to simultaneously meet all of the above performance requirements, which makes the invention of 5G networks a huge challenge.

Even that 5G networks target is to continue improving the mobile network performance just like the past mobile network generations, 5G has a different strategy to achieve this target. The development of 5G networks requires several breakthroughs at each layer of the Open Systems Interconnection (OSI) model of mobile networks [43]. For example, a different physical layer based on a new modulation technique using a filterbank multicarrier (FBMC) promises a more efficient spectrum utilization [96]. Another solution based on using of multiple antennas at both the transmitter and the receiver to achieve the so-called spatial multiplexing or Multi-user MIMO can also improve the network performance [73]. However, most of the proposed solutions based on improving the physical layer are facing the challenge of increasing hardware cost without achieving a significant gain in network performance. In fact, the next-generation communication systems such as LTE and LTE-Advanced performance is already close to the well-known Shannon bound in terms of spectrum efficiency!

In contrast, using network densification [21] with the help of the small cell technology and heterogeneous networks [60] can provide potential increase in cellular network capacity. Today, cellular networks move towards data traffic offloading from licensed to unlicensed spectrum which stands out as a promising solution. One technique to perform offloading is to mix wireless technologies by using Wi-Fi networks as an alternative or as a complementary network for cellular networks. In heterogeneous networks, the user equipment accesses licensed and/or unlicensed spectrum to improve data throughput with the price of adding complexity to the network. Another technique is to extend the operation of LTE to unlicensed spectrum, called LTE in Unlicensed band (LTE-U), so that mobile operators have an easy and transparent usage of unlicensed spectrum in a unified network environment which typically promises higher spectral efficiency than Wi-Fi. In this thesis, LTE in unlicensed spectrum is our main research direction towards 5G mobile networks.

## 1.2 LTE IN UNLICENSED SPECTRUM

Radio spectrum is one of the most fundamental resources for telecommunication systems. The large the spectrum resources, the more telecommunication systems can send and receive data

to improve their system capacity and performance. International and regional telecommunication regulatory agencies managed and carved up the spectrum into chunks called licensed and unlicensed spectrum:

- Unlicensed spectrum: It is also known as licensed-exempt spectrum where any telecommunication systems can be used without license.
- Licensed spectrum: It is part of the spectrum that must be auctioned sometimes by mobile operators to be used exclusively for their communications systems.

Whatever the spectrum is licensed or unlicensed, telecommunication regulatory agencies pose certain regulations on how the communication systems should use the spectrum. However, it is well-known that regulations for unlicensed spectrum are more strict than for licensed spectrum. Indeed, regulatory agencies have to ensure the fair coexistence between all communication systems that use the unlicensed spectrum. To this regard, regulatory agencies define several contention-based Medium Access Control (MAC) layer protocols with the main goal to share fairly the spectrum. Moreover, to mitigate the interference in unlicensed spectrum, the authorized radio transmission power level is relatively low compared to that used in licensed spectrum. This implies that the coverage area of communication systems operating in unlicensed spectrum is relatively smaller than other communication systems operating in a licensed spectrum. Today, we have mainly two unlicensed spectrum chunks: (i) Industrial, Scientific and Medical (ISM) band in 2.4 GHz (ii) Unlicensed National Information Infrastructure (U-NII) band in 5 GHz. Both are currently hosting several communication systems such as IEEE 802.11 (Wi-Fi), IEEE 802.15.1 (Bluetooth), IEEE 802.15.4 (ZigBee) and many others like for instance radar systems.

Licensed spectrum is completely different than unlicensed spectrum in the sense that mobile operators are responsible to manage the spectrum and the interference among their communication systems. Thanks to the exclusivity usage of the licensed spectrum, it offers mobile operators more flexibility to use it in order to maximize spectral efficiency and optimize user experience. Historically, in licensed spectrum, LTE system was originally designed in order to be able to offer LTE users certain services such as high data rates, high reliability, robust mobility which are difficult to obtain over unlicensed spectrum. Today, the idea behind LTE in unlicensed spectrum (LTE-U) is to extend the usual operation of LTE in licensed spectrum to cover also unlicensed spectrum, mainly at 5GHz band due to its wide spectrum availability, with the main goal to boost LTE system capacity for improving both LTE quality of service and



user experience. On the one hand, this extension poses significant challenges especially regarding the coexistence between LTE and legacy systems which use already the unlicensed spectrum. On the other hand, mobile operators do not have to invest their financial resources for the usage of unlicensed spectrum. Besides, today's LTE-Advanced (LTE-A) system has many technical advanced features that can “easily” exploit the unlicensed spectrum thanks to the carrier aggregation (CA) technique and the Supplemental DownLink (SDL) protocol[141]. For these reasons, LTE in unlicensed spectrum is a good economic approach for mobile operators to improve their LTE ecosystem. Thus, it is also considered as an essential stone to build future 5G networks.

### 1.2.1 NETWORK DEPLOYMENT SCENARIOS

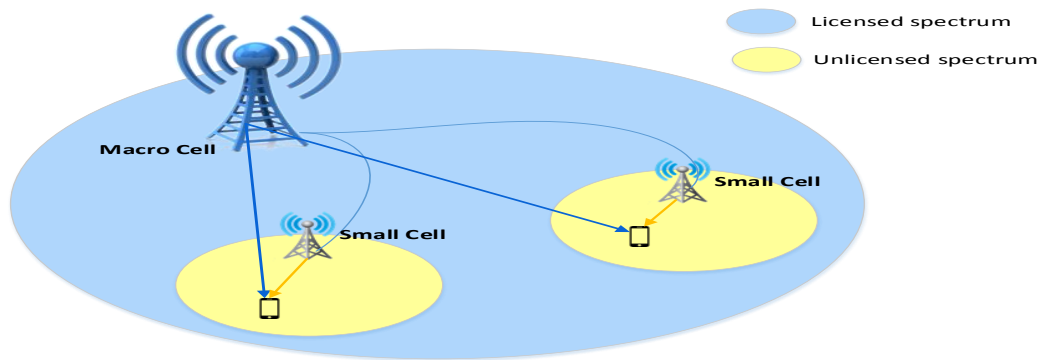


Figure 1.1: LTE in Unlicensed Spectrum: Deployment Scenario

The 3rd Generation Partnership Project (3GPP) has specified how LTE can benefit from the usage of unlicensed spectrum. It was evident for 3GPP that LTE can never guarantee the same performance and quality of service on unlicensed spectrum as on licensed spectrum. The reasons are first, in unlicensed spectrum, LTE has to share the spectrum with other communication systems such as Wi-Fi, as a result, LTE loses the exclusive licensing of spectrum which reduces its performance. Second, LTE has to follow the highly restricted regulations of unlicensed spectrum such as the reduction of its radio transmission power which reduces LTE coverage area. Accordingly, 3GPP insisted on the usage of both its original anchor carrier over licensed spectrum along with another secondary carrier over unlicensed spectrum which is considered as an assistant carrier. 3GPP called the new LTE in unlicensed spectrum in Release 13 by LTE licensed assisted access (LTE-LAA) or simply LAA [70]. Moreover, the usage of secondary carrier over unlicensed spectrum will be restricted in small cell deployment

due to the low transmission power allowed by the regulatory rules. In Figure 1.1, LTE user equipments are connected with LTE base stations over unlicensed spectrum in the small cell and licensed spectrum in the macro cell as usual as before. In such deployment scenario, LTE user equipments continue to enjoy the robust reliability of data exchange, seamless mobility, high quality of service and good coverage over licensed carrier besides enhancing broadband experience with higher data rates over both licensed and unlicensed carriers.

In most cases, LTE user equipments downlink data traffic volume exceeds that of the uplink data traffic. Accordingly, as a first step, 3GPP considered only LTE downlink traffic over unlicensed carrier for LAA. However, in LTE Release 14, enhancement LAA (eLAA) starts to consider both downlink and uplink traffic over unlicensed carrier, but always along with licensed carrier [64]. Today, MuLTEfire alliance [4] is formed by different telecommunication companies where they are looking for a standalone LTE operation in unlicensed spectrum. MuLTEfire system will operate entirely in unlicensed spectrum without the usage of licensed carriers. In such situation, MuLTEfire will be considered as a Wi-Fi-Like in unlicensed spectrum which will soon increase the competition between LTE and Wi-Fi in the telecommunication market. Here, it is the good place to mention that along this thesis, we will deal only with LTE downlink traffic over unlicensed spectrum. However, it is worthy to keep in mind that our work is not really limited to this scenario as it still provides several insights on how LTE can use the unlicensed spectrum for both downlink and uplink data traffic.

### 1.3 RESEARCH CHALLENGES AND PROBLEM STATEMENTS

Extending LTE operation in unlicensed spectrum imposes that LTE have to fulfill telecommunication regulatory agencies requirements to occupy this spectrum. Among different requirements, a key one is that LTE has to fairly coexist with Wi-Fi. Fair coexistence primarily means that the spectrum has to be equally shared between both technologies. More specifically, LTE should not impact Wi-Fi performance and services more than any additional Wi-Fi network that operates over the same spectrum [7] so that LTE can be considered as Wi-Fi-friendly. Therefore, LTE/Wi-Fi fair coexistence is considered as one of the main prerequisite conditions for deploying LTE in unlicensed spectrum. However, LTE was designed to operate in an environment where the spectrum is exclusively reserved for its operation. This is precisely where the challenges come through. Indeed, LTE has to adopt a new MAC protocol that allows a fair channel sharing with Wi-Fi. In addition, the new LTE MAC layer protocol has to be suitable for LTE operation so that it maintains an acceptable performance in unlicensed

spectrum. The key challenge is to *simultaneously* meet the above requirements which makes the design of a new LTE MAC layer protocol quite intricate.

From the other side, Wi-Fi adopts the well-known Distributed Coordinated Function (DCF) MAC layer protocol. The DCF protocol is classified under the so-called Listen Before Talk (LBT) type of protocols. As its name indicates, Wi-Fi has to “Listen” to the channel to perform a Clear Channel Assessment (CCA) “Before” accessing and “Talking” over the channel which means transmitting a frame over the channel. Therefore, LBT protocols are characterized by their politeness with regards to the channel access. Generally speaking, whenever LTE adopts a new MAC layer protocol different from Wi-Fi DCF protocol, the channel access will not be anymore shared equally between LTE and Wi-Fi. This raises several questions: First, does the new LTE MAC layer protocol coexists fairly with Wi-Fi DCF protocol? Second, what is the mutual impact between the new LTE MAC layer protocol and the Wi-Fi DCF protocol? Third, what are LTE and Wi-Fi performances in coexistence scenarios? Fourth, under what coexistence conditions LTE can coexist fairly with Wi-Fi? Fifth, in case the new LTE MAC protocol does not coexist fairly with Wi-Fi, is it still possible to adapt it to achieve the fairness objective? To answer all of the above questions, we have to fully understand how the channel access is shared between the new LTE MAC layer protocol and the Wi-Fi DCF protocol under different coexistence scenarios. Among different MAC layer protocols that could be considered as new candidate for LTE in unlicensed spectrum, 3GPP has classified them into four categories [7]:

- Category 1: Time Division Multiplexing Based (TDM-based) protocol
- Category 2: Frame Based Equipment (FBE) protocol
- Category 3: Load Based Equipment (LBE) protocol
- Category 4: Cat4 protocol

Category 1 protocol is considered as a non-LBT protocol since LTE does not perform CCA before accessing the channel. In contrast, category 2 through 4 protocols, are LBT-like protocols. Accordingly, category 1 is the most dissimilar to DCF protocol and we expect that category 1 protocol will have the highest negative impact on Wi-Fi performance compared to the other LBT protocols. On the other hand, category 1 protocol is the most suitable and easy MAC layer protocol for LTE operation in unlicensed spectrum. Category 1 protocol does not impose any changes on the latest LTE standard and today’s LTE systems can easily adopt it.

This means that a trade-off exists here: On the one hand, category 1 protocol can offer a higher LTE performance compared to LBT protocols, while on the other hand, category 1 protocol can lead to harmful degradation of Wi-Fi performance which leads to losing the fair coexistence. To deal with this trade-off, LTE must measure its negative impact on Wi-Fi performance and must therefore compensate for this negative impact by adequately adjusting its category 1 protocol as we will see in chapters 3 and 4.

In contrast, in case the LTE adopts category 2 protocol, LTE performance will be degraded while Wi-Fi performance will be slightly affected. Therefore, the situation is completely reversed compared to the one with category 1 protocol, this means that Wi-Fi does not coexist fairly with LTE. In fact, DCF protocol dominates the channel access and thus category 2 protocol will have a lower probability to access the channel as we will see in chapter 5. In such a situation, LTE should be cautious about the adoption of category 2 protocol. Indeed, it is still possible that LTE can reach a certain level of acceptable performance in coexisting with Wi-Fi but under some conditions on the coexistence scenarios such as a low Wi-Fi traffic load and a high Wi-Fi data rate.

The fact that LTE adopts an LBT protocols does not necessarily implies that LTE/Wi-Fi fair coexistence is ensured [25]. For example, category 3 protocol is still quite different from DCF protocol, so that LTE continues to be not fairly coexist with Wi-Fi as was the situation with category 1 protocol. However, the negative impact of category 3 protocol on Wi-Fi performance is less than category 1 protocol. On the one hand, LTE can improve the fair coexistence with Wi-Fi by adopting category 3 protocol, while on the other hand, the reduction of the negative impact of LTE on Wi-Fi performance comes with the price of LTE performance degradation because category 3 protocol does not fit well LTE operation as we will see in chapter 2. Finally, category 4 protocol is the most similar to DCF protocol [122]. Thus, we expect that LTE would have slight negative impact on Wi-Fi performance compared to all other protocols. However, again, enhancing LTE coexistence fairness with Wi-Fi comes with the price of LTE performance degradation. Indeed, whenever LTE improves the fair coexistence with Wi-Fi by adopting a MAC layer protocol similar to Wi-Fi DCF protocol, LTE performance will be degraded. **Now, clearly, the ultimate challenge is the design of a new LTE MAC layer protocol that coexists fairly with Wi-Fi and at the same time that maintains a high performance of LTE in the unlicensed spectrum.** To do so, we need to identify the pros and cons of each new LTE MAC layer protocols regarding to LTE performance and the fair coexistence with Wi-Fi.

In general, ensuring fair coexistence between communication systems which have differ-

ent protocol stacks is a huge challenge. As discussed previously, LTE/Wi-Fi fair coexistence faces the main problem which comes from the heterogeneity of their MAC layer protocols. Indeed, the fair coexistence problems are not limited to the heterogeneity of MAC layer since the heterogeneity of Physical (PHY) layer imposes other problems. The new problem due to PHY layer heterogeneity becomes clear whenever we identify the cross-layer relationship between MAC and PHY layers of a communication system. In fact, the CCA mechanism which is needed for the proper operation of any LBT MAC layer protocol is performed by the PHY layer. Accordingly, any poor assessment of the channel state, i.e. busy or idle, by the PHY layer will have an important impact on the MAC layer protocol operation [98]. In LTE/Wi-Fi coexistence scenarios, Wi-Fi faces the problem of poor assessment of LTE transmission activities over the channel and the main reason is that LTE has a different PHY layer than Wi-Fi. In many coexistence scenarios, Wi-Fi considers LTE transmission signal as a background noise and therefore the Wi-Fi DCF protocol will not refrain from the channel access while the channel is occupied by LTE transmissions. As a result, Wi-Fi faces several transmission collisions with LTE which degrades both LTE and Wi-Fi performance. Indeed, LTE is considered as a hidden node for Wi-Fi whenever LTE signal is received by Wi-Fi below its energy detection (ED) threshold, this problem is usually called by LTE/Wi-Fi coexistence below energy detection threshold. Hidden node problem [90] in wireless communications is not a new issue, however, in the context of LTE/Wi-Fi coexistence, it is a more destructive problem which leads to not ensuring fair coexistence. Accordingly, in the extreme case, where LTE adopts exactly the Wi-Fi DCF protocol, fair coexistence is still not ensured. **Therefore, the heterogeneity of both MAC and PHY layer between LTE and Wi-Fi will impact their fair coexistence in unlicensed spectrum.**

#### 1.4 THESIS CONTRIBUTIONS AND RESEARCH APPROACHES

In this thesis, we are looking for studying deeply both LTE and Wi-Fi performance in different coexistence scenarios where LTE adopts one of the new MAC Layer protocols to compete with the Wi-Fi DCF protocol. Among the different goals of this thesis, the main one is to fully understand how the channel access is shared between LTE and Wi-Fi. Therefore, LTE and Wi-Fi interaction regarding the channel access needs to be analyzed so that we will be able to answer clearly this question: Which technology among LTE and Wi-Fi does not coexist fairly with the other? We are also looking for quantifying the mutual impact between LTE and Wi-Fi. In other words, how much LTE does impact negatively Wi-Fi performance and vice versa.

In case LTE does not coexist fairly with Wi-Fi, by quantifying the negative impact of LTE MAC layer protocol on Wi-Fi DCF protocol, we are able to propose different solutions based on adjusting carefully the configuration parameters of the LTE MAC layer protocol to fairly coexist with the DCF protocol. We will see throughout this thesis that each LTE MAC layer protocol has different configuration parameters that define the protocol operation over the channel and provide a degree of freedom to ensure the fair coexistence with Wi-Fi. Therefore, identifying and understanding these configuration parameters will play an important role in the design of LTE/Wi-Fi fair coexistence solutions.

In contrast, in case Wi-Fi does not coexist fairly with LTE, we need to identify the coexistence conditions that make Wi-Fi impacts LTE performance. The coexistence conditions are related to traffic load, the number of nodes, the data rates, etc. Accordingly, LTE can still obtain acceptable performance if the previous conditions are avoided. Since we aim at providing a comparative analysis of new LTE MAC protocols, their configuration parameters and coexistence conditions must be optimized individually in terms of LTE/Wi-Fi performance and fairness.

Our research approach is based on providing several analytical models that describe LTE/Wi-Fi interaction in detail with respect to the channel access. In this thesis, our analytical models rely on Markov chains and random walk theory in order to provide a general framework to study different LTE/Wi-Fi coexistence scenarios. Besides, we pose as few approximations as possible in our models while trying to not affect the LTE/Wi-Fi interaction properties. Finally, we validate our analytical analysis through an extensive simulation study using Network Simulator 3 (NS3). We develop new modules in NS3 to simulate different LTE/Wi-Fi coexistence scenarios.

In this thesis, we mainly focus first on the adoption of category 1 and 2 MAC layer protocols by LTE in unlicensed spectrum. Our choice of these protocols in particular is mainly based on two reasons. The first reason, they are the most favorable new LTE MAC layer protocols that could be easily adopted by today's LTE systems. The second reason, they are the most dissimilar to the Wi-Fi DCF protocol and that is why they impose more challenging problems to ensure fair LTE/Wi-Fi coexistence. Afterwards, we continue to study the adoption of category 4 protocol for LTE where the PHY layer heterogeneity between LTE and Wi-Fi has been taken into consideration. Indeed, with category 4 protocol, the main coexistence problems are resident in the PHY layer more than in the MAC layer as we will see in the next chapter.

## 1.5 THESIS OUTLINE

The remainder of this thesis is organized in four parts. The first part, through chapter 2, we analyze and synthesize the state of the art concerning LTE/Wi-Fi fair coexistence in unlicensed spectrum and we recall the scientific challenges that the research community tried to solve. The second part, through chapters 3 and 4, we consider the adoption of category 1 protocol for LTE to coexist with Wi-Fi. In chapter 3, we present our first analytical model for LTE/Wi-Fi coexistence. There, our main framework is presented which will continue with us in chapter 4 for establishing other analytical models for LTE/Wi-Fi coexistence. The third part is drawn in chapter 5 where we consider the adoption of category 2 protocol for LTE to coexist with Wi-Fi. There, we will also provide another analytical models for LTE/Wi-Fi coexistence. The fourth part is dedicated to solve the problem that comes from PHY layer heterogeneity where LTE adopts category 4 protocol to coexist with Wi-Fi. Finally, we conclude this thesis in chapter 7 and draw our future work directions.

*Étudie le Passé si tu veux connaître l'Avenir.*

Confucius

# 2

## Inter-Radio Access Technology Coexistence: State of the art

Telecommunication agencies are facing the problem of spectrum scarcity with respect to the dramatic increase of demand of new spectrum to support 5G network services such as Ultra-High Definition (UHD) video streaming, Internet of Things (IoT), cloud gaming and remote control of industrial systems. The inefficient usage of the limited spectrum necessitates the coexistence of different radio access technologies in the same spectrum. Fair sharing of the spectrum is a prerequisite for telecommunication agencies before allowing new radio access technology to coexist with incumbent technology already using the spectrum. Primarily, the spectrum has to be equally shared between different radio access technologies where any technology should have the same opportunity to access the channel for achieving roughly the same throughput performance. In addition to the throughput, other factors such as packet delays have also a significant influence on the performance. Accordingly, even if the channel access is same for all radio access technologies, but the new technology has globally a negative impact on the performance of the incumbent technology, we still say that the fair coexistence has not yet been achieved. As a result, fair coexistence may require that the impact of the new technol-



ogy on incumbent technology is less than or equal to the impact of the incumbent technology on itself. Indeed, a fair coexistence may be achieved when the spectrum is equally shared and at the same time the utilization of the spectrum offers the same performance, especially to the incumbent technology.

If we take into consideration the heterogeneity of radio access technologies due to the fact that they were originally designed for different purposes, it becomes clear that ensuring a fair coexistence among them is a huge challenge. When radio access technologies adopt different MAC layer protocols, the channel access will be probably not equally shared. Although, as we will see later, MAC layer protocol heterogeneity is the most challenging obstacle to ensure fair coexistence, Physical (PHY) layer heterogeneity can impose different problems regarding fair coexistence. Indeed, in the extreme case, when the new and incumbent technology adopt the same MAC layer protocol, fair coexistence could be degraded and even may be lost among the two technologies due to PHY layer heterogeneity. Accordingly, we have to deal with both MAC and PHY layer heterogeneity of radio access technology.

In this chapter, we present the state of the art concerning LTE/Wi-Fi coexistence in an unlicensed spectrum where LTE is the new technology that telecommunication agencies have to assess its fair coexistence with the incumbent Wi-Fi. We present the different new MAC layer protocols which have been proposed for LTE to coexist with Wi-Fi. For each LTE MAC layer protocol, we clarify its operation over the channel and its heterogeneity with respect to the Wi-Fi MAC layer protocol and more precisely the Distributed Coordination Function (DCF) protocol. We highlight the main problems that face each LTE MAC layer protocol to coexist fairly with Wi-Fi. Besides, we show what are the proposed modifications and/or solutions for each LTE MAC layer protocol to coexist fairly with Wi-Fi in case it does not do so. We also show under which coexistence scenarios and/or conditions that LTE could coexist fairly or reduce the impact on Wi-Fi performance. Moreover, we will take into consideration the problem of PHY layer heterogeneity between LTE and Wi-Fi. This enable us to present the existing solutions to tackle and overcome this problem in order to enhance LTE/Wi-Fi coexistence. Before concluding the chapter, we present other interesting related work concerning WiMAX/Wi-Fi coexistence. There, we find that the new MAC layer protocols that are proposed for LTE to coexist with Wi-Fi are similar to those proposed earlier for WiMAX to coexist with Wi-Fi. Furthermore, the challenges of WiMAX/Wi-Fi fair coexistence and the related proposed solutions are also close to those of LTE/Wi-Fi coexistence.

## 2.1 LTE/Wi-Fi COEXISTENCE IN UNLICENSED SPECTRUM

As a first step, to discover the challenges facing LTE/Wi-Fi coexistence in an unlicensed spectrum, research communities have gone in the direction of evaluating the performance of LTE and Wi-Fi without any coexistence technique that allows sharing the channel access among both technologies. Without any coexistence technique this means that LTE keeps its usual schedule-based channel access scheme to coexist with Wi-Fi. The performance evaluation of both LTE and Wi-Fi has been presented and shown in [29] for different coexistence scenarios using simulations. The results show that LTE performance is slightly affected whereas Wi-Fi performance is significantly degraded. Indeed, since LTE does not adopt any coexistence technique to share the channel with Wi-Fi, LTE completely dominates the channel access, especially when LTE traffic load is high as shown in [102], and Wi-Fi is blocked the most of time from accessing the channel. The main reason is completely obvious, since LTE adopts a schedule-based channel access scheme that allows access to the channel regardless of the channel state, i.e. it is idle or occupied by Wi-Fi transmission. In contrast, Wi-Fi adopts DCF protocol, i.e. LBT-based protocol, where Wi-Fi is only allowed to access the channel only whenever the channel is idle from LTE transmission. As a result, we can say that the channel access is fully controlled by LTE and Wi-Fi is able to access the channel whenever LTE decides to evacuate the channel, i.e. Wi-Fi is considered as an LTE slave.

The same conclusion has been drawn again using an experimental testbed in [42] where real LTE and Wi-Fi systems have been deployed in a typical indoor office scenario, and using a simulation study in [54] for outdoor scenarios. In addition, in LTE/Wi-Fi sparse deployment scenarios, the results show that Wi-Fi performance has been improved. In fact, increasing the distance between LTE and Wi-Fi systems helps Wi-Fi to find the channel idle from LTE transmission, as a result, Wi-Fi can grab the channel access more times with respect to dense deployment scenarios. However, increasing the channel access probability of Wi-Fi by increasing the distance between LTE and Wi-Fi systems is not necessarily improving Wi-Fi performance as in [56]. Indeed, over a certain range of distance between LTE and Wi-Fi systems, Wi-Fi could find frequently the channel idle from LTE transmission but it does not necessarily guarantee that Wi-Fi transmission will not face a transmission collision with LTE transmission. This problem is known as the LTE/Wi-Fi coexistence below energy detection threshold as we will illustrate in Section 2.1.5. Accordingly, we emphasize that Wi-Fi performance is not directly proportional to the distance between LTE and Wi-Fi systems as shown in both [56] and [72].

The authors in [56] measure the negative impact of LTE on Wi-Fi for different LTE system

configuration parameters such as LTE bandwidth, central frequency and transmission power using an experimental platform. Another testbed in [84] measures also the mutual impact of LTE and Wi-Fi in different coexistence scenarios where LTE coexists with Wi-Fi over its primary and/or secondary channel with fully or partially overlapping. All the results show that the performance of both technologies is completely related to the coexistence conditions and that Wi-Fi is the technology that suffers the most in coexisting with LTE. Another experimental analysis presented in [45], confirms that LTE degrades Wi-Fi performance while the interference of LTE downlink traffic is more harmful than that of LTE uplink traffic on Wi-Fi performance. As a result, for different LTE time division duplex (LTE-TDD) configuration, whenever the number of uplink subframes increases within LTE frame, Wi-Fi performance is improved [102]. To further enhancing Wi-Fi performance, the authors in [32] and [31] propose an interference-aware coexistence scheme based on controlling LTE uplink power transmission. LTE uplink performance has been also examined in [100] for different Wi-Fi traffic loads in different coexistence scenarios. In addition, LTE can leverage its beamforming capability as shown in [78] to avoid causing a noticeable interference to Wi-Fi.

An analytical framework characterizing LTE/Wi-Fi mutual interference has been presented in [106] for dense deployment scenarios where the Wi-Fi throughput performance is degraded by up to 97% due to LTE interference. The authors in [51] developed a new interference analysis technique to quantitatively analyze the mutual interference, where LTE has to increase its cell radius to reduce the interference with Wi-Fi. The authors in [107] propose a statistical model for LTE indoor planning based on an interference model in a way that LTE avoids as much as possible to interfere with Wi-Fi.

The latter research results confirm that **LTE has to adopt a coexistence technique to share the channel access with Wi-Fi otherwise Wi-Fi performance will be severely degraded**. In fact, the above proposed solutions only aim to mitigate the interference between LTE and Wi-Fi without ensuring any fair channel sharing. In other words, these solutions are considered as complementary solutions to enhance LTE/Wi-Fi coexistence. Thus, LTE still needs to adopt a new MAC layer protocol that allows better sharing of the channel access with Wi-Fi. Consequently, a full understanding of each new LTE MAC layer protocols operation is needed. In Table 2.1, we classified the new main MAC layer protocols which were proposed for LTE in unlicensed spectrum by 3GPP. Our classification is mainly based on the answer of several questions related to the MAC layer protocol operation and more precisely the behaviour with regard to the channel access. We list below the most important questions that could help someone to do such classification:

**Table 2.1:** Classification of LTE MAC layer protocols in unlicensed spectrum

Protocol type	Contention type	Configuration parameters
non-LBT (without CCA)	TDM-based	<ul style="list-style-type: none"> <li>• Duty cycle period</li> <li>• ON &amp; OFF periods</li> <li>• Number of ON &amp; OFF periods per duty cycle</li> <li>• The order of ON &amp; OFF periods</li> </ul>
LBT-based (with CCA)	FBE (without Back-off)	<ul style="list-style-type: none"> <li>• ON &amp; OFF periods</li> <li>• Fixed frame period</li> <li>• Sensing period</li> </ul>
	LBE (fixed CW)	<ul style="list-style-type: none"> <li>• COT</li> <li>• CW size</li> <li>• Back-off slot duration</li> </ul>
	Cat4 (Binary exponential CW)	<ul style="list-style-type: none"> <li>• COT</li> <li>• Minimum value of CW size</li> <li>• Maximum value of CW size</li> <li>• Retransmission limit</li> </ul>

- Is the MAC layer protocol a non LBT or LBT-based?
- What is the allowed temporal granularity of the MAC layer protocol to contend the channel access?
- Does the MAC layer protocol apply a back-off period before accessing the channel?
- What are the rules that the MAC layer protocol follows to configure its back-off period?
- What are the constraints imposed on the MAC layer configuration parameters?

LBT-based protocols are a family of protocols such as FBE, LBE and Cat4 protocols. As its name indicates, the communication system has to “Listen” to the channel to perform a clear channel assessment (CCA) “Before” accessing and “Talking” over the channel which means before transmitting a frame over the channel. After performing CCA, if the channel is idle from any transmission, the communication system may transmit its frame, otherwise the channel is busy then it refrains from accessing the channel. In contrast, non LBT-based MAC layer protocols such as TDM-based protocol do not perform any CCA prior to the channel access so that the communication system accesses the channel whether the channel is idle or busy. For this reason, LBT-based protocols are well-known by their “politeness” regards to the channel access with respect to non LBT-based protocols which are considered as “aggressive” protocols.

Indeed, non-LBT or LBT-based MAC layer protocols will mainly determine the behavior of the communication system with other systems and whether it is considered as a polite or aggressive communication systems. Therefore, we can expect that a non-LBT MAC layer protocol will have a negative impact on an LBT-based MAC layer protocol in coexistence scenarios.

Regarding the allowed temporal granularity of the MAC layer protocol to contend and/or access the channel, both TDM-based and FBE protocols are allowed to access and/or contend the channel access periodically after a certain fixed time. In contrast, for other MAC layer protocols such as LBE and Cat4 protocols, are able to contend the channel access at any time instants. Indeed, the temporal granularity of the MAC layer protocol will mainly determine the channel access probability of communication systems and therefore determine its performance. Some LBT-based MAC layer protocols such as LBE and Cat4 protocols adopt a Back-off period prior to the channel access. The main idea behind the back-off period is mitigating the contention on the channel access. In contrast, other LBT-based protocols such as FBE protocol do not adopt a Back-off period. Thus, there is a different impact on the protocol performance in terms of the channel access probability. The Back-off period is randomly selected from a slotted contention window (CW). Therefore, other important information related to the CW size have to be taken into consideration: (1) Is it modifiable to further mitigating the contention on the channel access or not? For example, in the Cat4 protocol, the CW size follows an exponential increase when the contention on the channel access is high causing more collisions. In contrast, in the LBE protocol, the CW size remains fixed. (2) How to select the initial and the maximum value of CW size since they also play an important role?

Up to here, we can identify different configuration parameters for each MAC layer protocol such as the time duration of CCA mechanism, the temporal granularity, initial CW size, etc. Moreover, after the communication system grabs the channel access, it is allowed to occupy the channel only for certain period of time known as Channel Occupancy Time (COT) or Transmission Opportunity (TXOP). All of these configuration parameters define the MAC layer protocol behaviour over the channel and determine the communication system performance.

#### 2.1.1.1 TDM-BASED MAC LAYER PROTOCOL

The TDM-based MAC layer protocol is the first proposal for LTE to coexist with Wi-Fi in unlicensed spectrum [8],[38]. 3GPP also has proposed the same protocol with a different name called Category 1 protocol [7]. Several telecommunication companies formed an industry alliance called LTE-U forum [3],[9] where they show keen interest in considering TDM-based

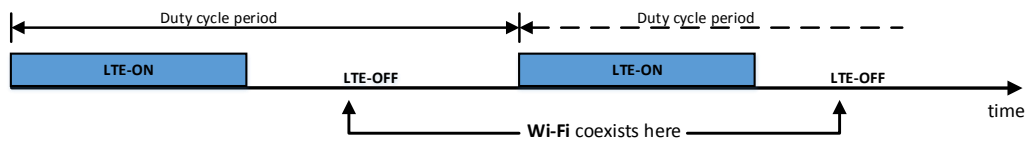


Figure 2.1: TDM-based MAC layer protocol

protocol as a new MAC layer protocol for LTE. The main reason is the simplicity of adopting this protocol by today's LTE systems since the TDM-based protocol exploits one of the key existing LTE features called Small Cell activation/deactivation [108]. Accordingly, LTE in unlicensed spectrum could be deployed fastly based on latest LTE Release 12 [12] without the need of waiting for a new LTE standard, so that mobile operators could enhance their LTE ecosystems quickly. The main idea behind the TDM-based protocol is a sharing between LTE and Wi-Fi in a time division multiplexing fashion where LTE transmission is activated for certain periods called LTE-ON periods, i.e. several LTE frames or subframes, interposed between LTE-OFF periods allocated for Wi-Fi channel access, see Figure 2.1. Accordingly, LTE adopts an ON/OFF pattern to form a duty cycle period that is repeated over the time. That is why this modified LTE is so-called Duty Cycled LTE.

The TDM-based protocol offers a synchronous operation of the channel where LTE frames transmission can only start at subframes boundaries, i.e. at the beginning of subframes. The synchronization of LTE operation is a must to LTE user equipment's to be able to receive and decode LTE signal. In case of LTE adopts a MAC layer protocol such as LBE and Cat4 protocols, LTE will not be able to ensure a synchronization operation of the channel since LTE can grab the channel access at any time. To solve this problem, an LTE reservation signal [20] is used to prevent Wi-Fi from grabbing the channel access until the next LTE subframe boundary where LTE starts its frame transmission. As a result, LTE throughput suffers from reservation signal overhead which is almost equal to one subframe. However, the price of this benefit of the TDM-based protocol is its well known negative impact on Wi-Fi performance in terms of collision as we will see through chapters 3 and 4. With TDM-based protocol, LTE accesses aggressively the channel since LTE does not perform CCA before transmitting LTE frames unlike Wi-Fi. As a result, a collision between LTE and Wi-Fi frames is occurred leading to Wi-Fi performance degradation. For this reason, the TDM-based protocol has been dismissed for being used in different regions such as Europe, Japan and India, where accessing unlicensed spectrum requires that LTE adopts an LBT-based protocol. The usage of TDM-based protocol is

currently limited for regions such as USA and Korea that allow non-LBT protocols. The TDM-based protocol is still a good candidate for other inter-radio access technology coexistence as in [134] and [138].

The authors provide simulation studies in [89] where LTE coexists with Wi-Fi in indoor deployment scenarios. There, both LTE and Wi-Fi use the channel only for downlink data traffic and the main result is that under a relatively low traffic load for both technologies, both are able to sustain an acceptable performance. However, increasing the traffic load degrades severely Wi-Fi performance with respect to LTE performance. In fact, increasing the traffic load means that both LTE and Wi-Fi are in a full competition on the channel access, as a result, several collision will be encountered with respect to low traffic load. Besides, LTE can still recover its frames even in the case of collisions thanks to its robust PHY layer compared to Wi-Fi PHY layer. The authors provide a new technique in [11] where LTE applies a short duty cycle period using its almost blank subframe allocation technique. Almost blank subframes was introduced in LTE Release 10 where LTE mutes certain LTE subframes within an LTE frame to allow Wi-Fi access to the channel during the muted subframes. Although, the previous procedure does not avoid performance degradation of Wi-Fi, the authors propose to improve Wi-Fi performance by increasing the number of muted subframes allocated for Wi-Fi. The results show that the Wi-Fi performance is not only sensitive to the number of muted subframes but also to the way the muted subframes are distributed along the LTE frame.

The same message has been conveyed by the authors in [27] saying that LTE-OFF periods, i.e. muted LTE subframes, duration has to be well configured as it plays an important role on both LTE and Wi-Fi performance. Indeed, Wi-Fi performance is enhanced whenever Wi-Fi transmission fits well LTE-OFF periods so that the collision probability is reduced. In contrast, the authors in [27] proposed that LTE can reduce the negative impact on Wi-Fi performance by adopting an enough long duty cycle as LTE interruptions of Wi-Fi transmission are reduced, i.e. less collision probability. The same observation was made by the authors in [53] where LTE/Wi-Fi coexist in an outdoor deployment. A long continuous LTE-ON periods appears to be better than alternating LTE-ON periods to enhance Wi-Fi throughput. However, this solution comes at the cost of increasing Wi-Fi delay, which makes it inappropriate for real-time services and heavily impact the fair coexistence. As a matter of fact, there is a trade-off between Wi-Fi delay and throughput when LTE adopts a long and short duty cycle period.

An open-source platform has been used in [44] to establish several LTE/Wi-Fi coexistence scenarios. There, it was shown that Wi-Fi performance is inversely proportional to LTE-ON periods within a fixed duty cycle period. In addition, the LTE impact on Wi-Fi has been exam-

ined when LTE uses different transmission power, bandwidth and central frequency. Similarly, an empirical study presented in [28] has examined the impact of LTE on Wi-Fi where Wi-Fi uses different offered loads, transmit power levels, modulation and coding schemes, and packet sizes. We can conclude that LTE and Wi-Fi performance depends heavily on all the various settings.

Qualcomm also has proposed the TDM-based protocol with a different name called Carrier Sensing Adaptive Transmission (CSAT) protocol [5]. The main idea behind CSAT is that LTE controls and adapts its transmission periods, i.e. LTE ON/OFF periods, based on Wi-Fi traffic load. Thus, when Wi-Fi traffic load is high, LTE should increase its OFF periods duration in order to less impact Wi-Fi performance. The simulation results show that LTE is a better neighbor to Wi-Fi than Wi-Fi to itself with the condition that the TDM-based protocol is well configured. An experimental testbed in [104] confirms again that Wi-Fi performance is better by 10-40% in a coexistence with LTE CSAT than in a coexistence with another Wi-Fi. On the same line, the authors proposed Duet as an adaptive algorithm for LTE ON/OFF periods in [57] to improve the overall network throughput, i.e. LTE and Wi-Fi, by up to 74%. There, LTE estimates Wi-Fi traffic load based on measuring Wi-Fi channel utilization time which is reported by LTE user equipments. A Multi-Armed Bandit learning machine has been used in [113] to adjust LTE duty cycle period along with a power control technique to facilitate the coexistence between Wi-Fi and LTE.

To further enhance Wi-Fi performance, the authors proposed to update the Wi-Fi access point software to WiPLUS [93] where Wi-Fi will be able to detect and have a timing information about LTE-ON and OFF periods and to compute LTE duty cycles based on Wi-Fi MAC layer monitoring. As a result, Wi-Fi becomes able to synchronize its operation with LTE to reduce the mutual interference. However, even that previous works confirm that TDM-based protocols can fairly coexist with Wi-Fi if its configuration parameters are well adjusted, they were not able to answer the question: **How exactly LTE can adopt efficiently the TDM-based protocol in order to coexist fairly with Wi-Fi ?** With this regard, an analytical model that links both LTE and Wi-Fi performance based on measuring the mutual negative impact between both technologies is definitely needed. The mutual negative impact is considered as the probability of collision between LTE and Wi-Fi transmission over the channel. Here, it is important to mention that the Wi-Fi DCF protocol behavior that consists of a sensing period followed by a back-off period and a transmission period will not change due to the coexistence with the TDM-based protocol. Nevertheless, the DCF protocol performance will evidently change. As a result, any previous work dealing with the modeling of DCF such as the well-



known Bianchi’s model [23] can be adapted and extended by considering the negative impact of LTE on Wi-Fi.

The authors in [58] follow the strategy of modeling LTE/Wi-Fi coexistence by extending the original DCF model [23] while taking into account the probability of collision between both technologies. However, the analysis does several assumptions to obtain the probability of collision between LTE and Wi-Fi which totally affects their model accuracy. As a result, some important phenomena were not observed such as “throughput fluctuations” observed in our work and in [27]. Moreover, their analytical model is not valid for all coexistence scenarios and the model provides only an upper bound on LTE performance. Another analytical model was presented in [25] where the authors assume that LTE-OFF periods are random and follow an exponential distribution. The reason of adopting such assumption is that the probability of collision between LTE and Wi-Fi becomes easy to compute thanks to the memoryless property, i.e. PASTA property [14]. As a result, in their model, the main advantage of the TDM-based protocol which is the use of *deterministic* LTE-OFF periods is lost and consequently LTE will need to use a reservation signals which degrades LTE performance. In [47], TDM-based protocol has been examined to coexist with Wi-Fi DCF protocol through simulations. The authors claimed that “LTE can be configured to be fair with Wi-Fi” without providing any further information about how to achieve it. Furthermore, they did not consider the possible collisions between the two systems. The probability of channel access for Wi-Fi stations is computed in [13] in presence of Duty Cycled LTE where it is based on the fact that during the LTE transmission period, Wi-Fi stations have to wait before accessing the channel. Neither the collision probability nor the Wi-Fi throughput can be derived using the computations in [13].

### 2.1.2 FRAME BASED EQUIPMENT MAC LAYER PROTOCOL

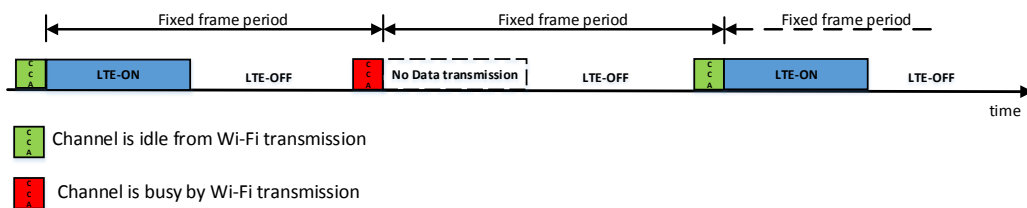


Figure 2.2: FBE MAC layer protocol

In order to fulfill certain telecommunication regulatory agencies in unlicensed spectrum, several LBT-based MAC layer protocols were proposed for LTE. Frame Based Equipment (FBE) protocol is considered as one of LBT-based protocol that is originally standardized by the European Telecommunications Standards Institute (ETSI) in [2] and is considered by 3GPP as Category 2 MAC layer protocol for LTE in [7]. To cope with the main deficiency of TDM-based protocol which is the fact that at the beginning of each LTE-ON period a collision could be occur with Wi-Fi transmissions. FBE protocol was proposed to reduce the collision probability between LTE and Wi-Fi by integrating a CCA at the beginning of each LTE-ON period. When LTE adopts an LBT-based MAC layer protocol such as FBE protocol, LTE is called LTE Licensed Assisted Access (LTE-LAA). Although, the FBE protocol has some constraints imposed by ETSI on its configuration parameters such as LTE-ON period and LTE-OFF period [139], we can consider that the FBE protocol is a TDM-based protocol with the flavor of an LBT-based protocol which is the CCA mechanism. Accordingly, the aforementioned TDM-based protocol benefits apply also to the FBE protocol, but in addition, the FBE protocol should provide a less negative impact on Wi-Fi performance compared to the TDM-based protocol.

At the first glance, the FBE protocol has a major constraint that could impact LTE channel access opportunity. Indeed, LTE is allowed to contend for the channel access only at a specific time instants, see Figure 2.2. In the case when the channel is occupied by Wi-Fi transmissions, LTE will have to wait for the entire fixed frame period which includes LTE-ON and LTE-OFF periods, until it can contend again for the channel access. Moreover, if two different LTE systems belonging to the same or to different operators are synchronized and have the same fixed frame period then both systems can suffer from inevitably collisions [66]. In the case both LTE systems are not synchronized then one of them will completely dominate the channel access [115]. To solve this problem, ETSI is working on a new protocol that allows FBE protocol to change and adapt different fixed frame periods along the time.

In a white paper published by Qualcomm [5], simulations have been conducted to study some outdoor coexistence scenarios. The results show that LTE is a better neighbor to Wi-Fi than Wi-Fi to itself. The previous works [126],[125] have presented an optimal transmission strategy for FBE protocol which is not only based on the channel availability but also on the channel quality to take into account transmission costs. Two optimization problems for both FBE throughput and FBE nominal throughput were formulated, however, without considering the coexistence with Wi-Fi. An analytical model for the FBE protocol based on a Markov chain is presented in [120] without considering again the coexistence with Wi-Fi. Another

theoretical analysis for the FBE protocol was presented in [123] for LTE/Wi-Fi coexistence. The authors tried to determine the channel access probability of FBE protocol under the assumption that the received Wi-Fi signal by LTE follows a Gaussian distribution. Although such analysis does not provide a full answer on how the channel will be shared between LTE and Wi-Fi. The authors propose a method to estimate the channel access probability of the FBE protocol based on measurements of LTE channel activities. It is also worth noting that the author did not follow the ETSI standard related to FBE protocol since they considered that CCA of LTE is not included into LTE-OFF period.

At the time of writing, we did not find in the literature any analytical model for FBE protocol that can describe perfectly how the channel access is shared between LTE and Wi-Fi. In [7], many simulation studies performed by different companies during a 3GPP workshop have evaluated FBE protocol while coexisting with Wi-Fi in different coexistence scenarios. The results confirm that Wi-Fi performance metrics are improved whenever Wi-Fi competes with LTE-FBE rather than another Wi-Fi. One contribution of this thesis, is an analytical model for LTE-FBE protocol coexisting with Wi-Fi DCF protocol. We show how the channel is shared between LTE and Wi-Fi. Moreover, we will answer clearly the question: Does FBE protocol coexist fairly with Wi-Fi?

In [55], LTE adopts a MAC layer protocol that is slightly different from the FBE protocol where LTE-OFF periods are completely deleted. A Matlab-based simulator evaluates the performance of LTE and Wi-Fi, and the results show that the proposed MAC layer protocol can provide a reasonable trade-off between LTE and Wi-Fi performance under certain coexistence conditions. Indeed, LTE-OFF periods are considered as an essential component of the flexibility of FBE protocol to ensure a fair channel access between LTE and Wi-Fi. The authors in [127] propose two variants of FBE protocol called “Enhanced FBE” (E-FBE) and “Back-off and Idle Time Reduction FBE” (BITR-FBE) protocols. For both MAC layer protocols, a backoff procedure has been introduced before any channel access in order to reduce the greediness of FBE channel access. The authors’ claim [127] about greediness of FBE is not really justified. In contrast, we will use both analytical modeling and NS3 simulations in chapter 5 to conclude a different result where the FBE protocol can be considered as a fair MAC layer protocol to coexist with Wi-Fi.

Many other variants of the FBE protocol were proposed with the common feature of using a CCA prior to LTE-ON periods. In TV white space, [17] suggests an LTE MAC layer protocol that is similar to FBE protocol to coexist with Wi-Fi. However, the proposed protocol does not follow the relationship between FBE configuration parameters defined by ETSI, i.e. fixed

frame period is the sum of LTE-ON period and LTE-OFF period. The simulation results still confirm that LTE has a little negative impact on Wi-Fi performance. Almost the same protocol as the previous one was also proposed in [140] for LTE to coexist with Wi-Fi. In addition, an analytic model for both LTE and Wi-Fi performance is developed. It shows that by adjusting the proposed protocol configuration parameters, LTE can ensure certain level of protection for Wi-Fi performance. Indeed, the MAC layer protocols proposed in [17] and [140] could be considered as possible good alternatives to the FBE protocol since LTE will have a major problem to grab the channel access from Wi-Fi in the classic FBE as we will see in Chapter 5. In fact, whenever there is a full competition on the channel access between LTE-FBE and Wi-Fi, LTE-FBE is the technology that will suffer the most while the Wi-Fi will be slightly impacted.

### 2.1.3 LOAD BASED EQUIPMENT MAC LAYER PROTOCOL

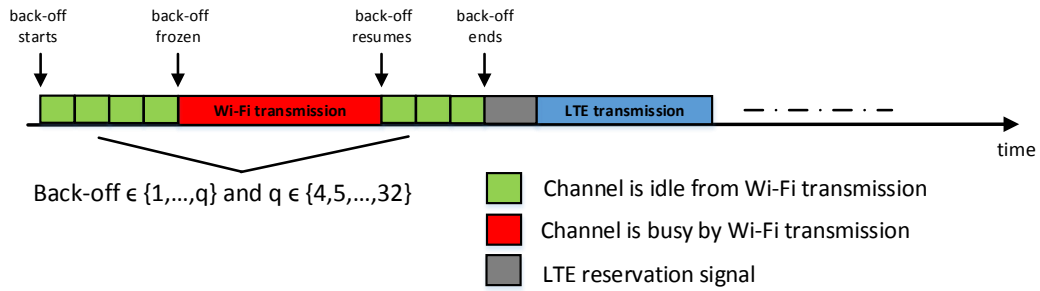


Figure 2.3: LBE MAC layer protocol

Another LBT-based protocol is the Load Based Equipment (LBE) protocol, standardized by ETSI in [2] and considered by 3GPP as Category 3 protocol for LTE in [7]. To cope with the expected LTE performance degradation with FBE protocol, LBE protocol attracted many companies during the same forenamed 3GPP workshop [7]. This is because LTE is allowed to contend for the channel access with Wi-Fi at any time instant. However, to ensure a reasonable fair coexistence with the DCF protocol that adopts a back-off period prior to the channel access, LBE protocol implements also a Back-off period before any frame transmission over the channel. LBE protocol Back-off period is randomly selected from a fixed CW in the range of  $\{1, \dots, q\}$  where the value of  $q$  is selected by the manufacturer in the range  $\{4, \dots, 32\}$ , see Figure 2.3. The main difference between LBE and DCF is that when a collision is occurred over the channel, Wi-Fi CW size follows a binary exponential increase to reduce the contention over

the channel access, whereas LTE CW is kept fixed despite of the number of collisions. For this reason, the standard imposes a limitation on the channel occupancy time by the LBE protocol which must be less than  $\frac{13}{32} \times q$  ms. In such a way, if the manufacturer decides to use a small CW size to increase the channel access probability, the channel occupancy time over the channel is reduced as a compensation to ensure fair coexistence with other communication systems; still, the fixed CW size of LBE protocol poses the problem of heterogeneity with the DCF protocol. In fact, there are two more main differences between LBE and DCF protocols:

- The LBE slot duration that forms LBE Back-off period may be fixed to  $20\mu s$  or even larger, while the DCF slot duration is  $9\mu s$  for most of Wi-Fi (IEEE 802.11) standards. As a result, LTE performance will be degraded as the evolution of its back-off period will be longer than the Wi-Fi back-off period as noticed in [68]. In [83], the author propose a new analytical framework that takes into consideration such heterogeneous sensing and back-off slot duration between both technologies. Based on a novel Markov chain approach, the authors were able to identify and to measure the impact of this heterogeneity. In the context of Wi-Fi/Wi-Fi coexistence, the problem of heterogeneity of back-off slot duration has also been discovered in [22] between different Wi-Fi commercial network cards showing clearly a negative impact on the performance.
- After the channel becomes idle, LBE starts immediately to decrement its frozen back-off counter that forms the back-off period while Wi-Fi waits an additional time before the decrementation known as initial CCA time or simply the DIFS period. As a result, we expect that LTE would have more chance to grab the channel access than Wi-Fi. It is worth to mention here that there are some works such as [37] and [63] do not consider such lack of an equivalent DIFS period for LBE protocol, likely for simplification reasons. Nevertheless, the ETSI standard [2] mentions clearly that LBE Option-B protocol does not include any initial CCA.

To sum up, with LBE protocol, LTE may have a higher probability to grab the channel access than Wi-Fi due to the fixed CW size and the lack of an equivalent additional sensing period DIFS before the back-off period as Wi-Fi. On the contrary, LTE may have a lower probability to grab the channel access than Wi-Fi due to its longer slot duration. Finally, with LBE protocol, LTE will not be able any more to ensure a synchronization operation of the channel as it was the case for both TDM-based and FBE protocols since LTE can grab the channel access at any time instant. In Figure 2.3, an LTE reservation signal is used to prevent Wi-Fi from

grabbing the channel access until the first coming LTE subframe boundary where LTE starts its frame transmission. As a result, LTE throughput suffers from a reservation signal overhead which is almost equal to one subframe. For example, in case of LTE Transmission Opportunity (TXOP) is equal to 3 subframes, LTE can only use for data transmission 2 subframes out of 3 subframes, which will incur almost 33% of reduction of LTE throughput.

In [50], LBE was tested with its maximum CW size, i.e.  $q=32$ , to coexist with Wi-Fi in indoor and outdoor small cell deployments. The simulation results show that Wi-Fi performance is not impacted by LTE whatever the traffic load, low, medium or high. We cannot come to a trustable conclusion through this work because LTE adopts the maximum CW size. A different LBE CW size can lead to another conclusion, specially that DCF protocol minimum contention size for Wi-Fi is equal to 15 which is almost equal to the half of LBE CW size adopted in this work. In fact, the minimum value of the CW size for any LBT-based protocol is considered as one of the most important parameters that determines the protocol performance. In [88], the authors confirm the above remark since Wi-Fi performance degrades when LTE adopts a CW less than 32.

A theoretical analysis for both downlink performance of LTE and Wi-Fi in a coexistence scenario was presented in [41] and [33] based on Markov chains. Even through their analytical models have not been validated by simulations, their numerical results show interestingly that the transmission probability of LTE over the channel is higher than Wi-Fi. As mentioned previously, the main reason is due to the fixed CW size of LBE protocol. As a result, when the traffic load of LTE is very high, LTE performance outperforms Wi-Fi but it comes with the price of degradation of Wi-Fi performance. For this reason, an adaptation of LBE CW size was presented in [116] to enhance Wi-Fi performance by achieving a fair channel access. In this work, LTE adapts LBE CW size based on the collected quality of service metrics from Wi-Fi neighbors. The simulation results confirm the need of an LBE CW size adaptation for enhancing both LTE and Wi-Fi performance in terms of throughput and delay.

Another work in [66] confirms again that LTE coexists better with Wi-Fi when LTE adjusts and resizes its LBE CW size. Moreover, in [66], to cope with the lack of the equivalent DIFS period for LBE protocol, the authors propose a modified version of LBE protocol by integrating an additional sensing period before LBE back-off period to enhance the fairness of channel access. Moreover, during a 3GPP meeting, a similar idea was suggested [97]. On the same line, the authors in [111] adopt an equivalent DIFS period and the same slot duration of Wi-Fi for LBE protocol. In that case, LBE protocol can be considered as DCF protocol adopted by Wi-Fi except for the CW size which remains fixed despite the occurrence of collisions. As a result,

an analytic model for both Wi-Fi and LTE based on Bianchi's model [23] is presented and the numerical results show that the optimal LBE CW size that guarantees a graceful coexistence is 15. The authors conclusion is undeniable intuitive for two reasons: The first is that with an LBE CW size equals to 15 and DCF minimum CW size equal to 16, both LBE and DCF protocols are quite similar. Second, in the paper the authors adopts only 3 back-off stages for Wi-Fi which it is out of the IEEE standard that requires 7 back-off stages for Wi-Fi. Thus, the problem caused by the fixed CW of LBE is relaxed. The same authors in [126],[125] who presented an optimal transmission strategy for FBE protocol extend their work in [124] to consider the optimal transmission strategy for LBE protocol. Their analysis shows that LBE throughput optimal strategy is a pure threshold policy which means that LBE should stop listening and transmit once the channel quality exceeds an optimized threshold.

#### 2.1.1.4 CATEGORY 4 MAC LAYER PROTOCOL

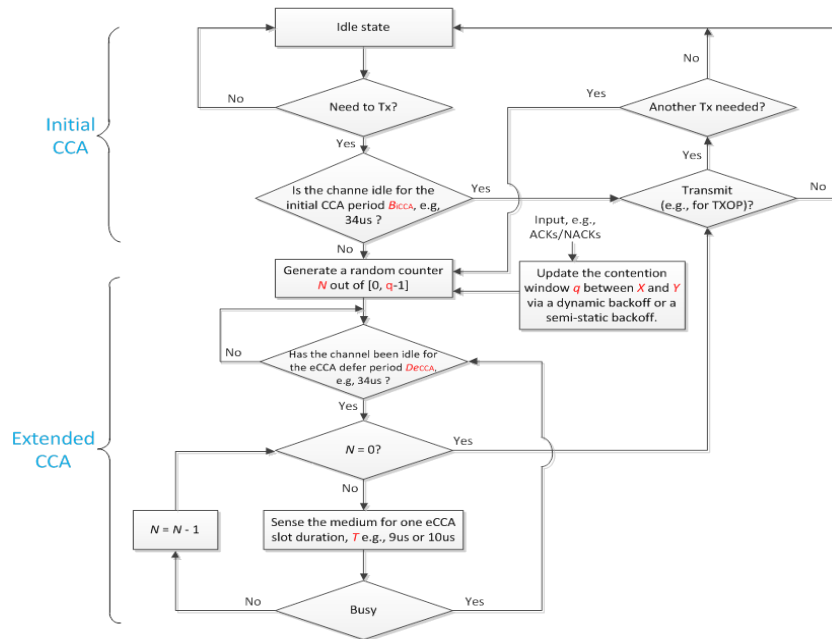


Figure 2.4: Cat4 MAC layer protocol flowchart [7]

To obtain a DCF-like protocol for LTE, 3GPP proposed Category 4 (Cat4) protocol in [7]. Figure 2.4 illustrates the flowchart of Cat4 protocol proposed by 3GPP. Cat4 protocol is similar to DCF protocol in the sense that both have a sensing period prior to each back-off period called

DIFS period for Wi-Fi and Initial CCA period for LTE, see figure 2.4. Moreover, for both Cat4 and DCF protocol, the back-off period is drawn uniformly among a CW size that follows a binary exponential increase when a collision occurs over the channel and the slot duration is also the same and equals to  $9\mu s$ . However, 3GPP has introduced four different traffic priority classes for Cat4 protocol [142] where both the allowed CW size and COT depend on the traffic priority. In contrast, the Wi-Fi DCF protocol has its own traffic priority classes called access categories [112] which are different from the traffic priority classes of Cat4 protocol.

As mentioned in section 2.1, any protocol heterogeneity with respect to configuration parameters will lead to one of the protocol performance being superior than the other. Accordingly, the authors in [137] have discovered that a higher COT for Cat4 protocol compared to DCF protocol will not guarantee a fair airtime between LTE and Wi-Fi. As a result, the authors proposed a COT Adaptation (COTA) algorithm to ensure a fair coexistence. In [70], the authors provide an overview of LTE Release 13 that adopts Cat4 protocol for LTE. There, a simulation result for LTE/Wi-Fi coexistence provided by wide spectrum of companies confirm that LTE is a better neighbor to Wi-Fi than Wi-Fi to itself for any traffic load and traffic type, i.e. real-time and non-real time traffic.

Since the Cat4 protocol is a DCF-like protocol, the authors in [142] adapt the well-know Bianchi's model for modeling Cat4 protocol. The adaptation of Bianchi's model does not consider any changes on the Markov chain model as the Cat4 protocol has the same Markov chain as the DCF protocol. However, the adaptation is mainly about considering Cat4 protocol throughput calculation since the overhead of LTE frame transmission, i.e. reservation signals and Physical Downlink Control Channel, is completely different from Wi-Fi. The coexistence performance analysis for LTE and Wi-Fi indicates that LTE can fairly coexist with Wi-Fi. Another analytical model for Cat4 protocol based again on Bianchi's model could be found in [122]. However, the authors claim that Cat4 protocol has a different Markov chain model than DCF protocol. Indeed, the authors' claim based on whenever the CW size of Wi-Fi reach its maximum value, Wi-Fi CW size remains and do not rest to its initial value until a successful retransmission is occurred which is not the case for LTE. In contrast, as per IEEE 802.11 standard [1] and several previous work such as [129], Wi-Fi will rest its CW size whenever the maximum retransmission reached, Wi-Fi used Retry Limit mechanism for this purpose. Other analytical models for Cat4 protocol based on Markov chains is also presented in [41], [133] and [103] for non-saturated traffic load and in [135], [115] for saturated traffic load.

In fact, 3GPP does not impose only one range of Cat4 CW size, see Figure 2.4 where X and Y are configurable parameters. In [15], the authors propose a dynamic CW size range adjust-



ment algorithm based on observing the traffic load over the channel to enhance the overall channel utilization. Another adaptation algorithm for Cat4 protocol CW size has been proposed in [46] based on the observation of slot utilization over a certain period. On the same line, the authors in [133] propose another mechanism to adjust Cat4 protocol CW size through introducing the so-called Maximum CW Timer Mechanism (DCWTM) that emulates Wi-Fi Retry Limit mechanism. Using machine learning, the authors in [10] proposed a neural network (NN) based scheme that adapts the CW size for Cat4 protocol based on the predicted number of negative acknowledgments of LTE. All the previous works show that Cat4 CW size adaptation outperforms using a fixed CW size for several LTE/Wi-Fi coexistence scenarios. Finally, to completely eliminate any MAC layer protocol heterogeneity between LTE and Wi-Fi, the authors in [136] proposed to employ DCF protocol instead of Cat4 protocol for LTE, in addition to adapting of DCF CW size to improve the fair coexistence with Wi-Fi.

#### 2.1.5 ENHANCING LTE/WI-FI COEXISTENCE

Ensuring fair coexistence between LTE and Wi-Fi is not only a question of both adopting the same MAC layer protocol. Indeed, in the extreme case, when LTE adopts the Cat4 protocol which is similar to the DCF protocol adopted by Wi-Fi, fair coexistence is still not ensured but rather close to be reached. Especially that we know the fact that Wi-Fi is not really coexist fairly with itself even though Wi-Fi networks use the same protocol stack [117], [95], [85]. Regarding to LTE/Wi-Fi coexistence, Wi-Fi will have an important interference from LTE due to the poor Wi-Fi channel assessment of LTE activities over the channel. Indeed, in many coexistence scenarios, Wi-Fi will consider LTE signal as a background noise and will not refrain from the channel access while LTE transmits over the channel. As a result, Wi-Fi transmission have several collisions with LTE transmission which degrades Wi-Fi performance. The origin of this problem is that Wi-Fi has two different CCA mechanisms:

- Carrier Sense CCA (CS-CCA): That defines the ability of Wi-Fi to detect another Wi-Fi frame transmission by decoding its frame preamble. The carrier sense CCA called also the Preamble Detection CCA (PD-CCA).
- Energy Detection CCA (ED-CCA): That defines the ability of Wi-Fi to detect any other communication system transmission such as LTE.

For both CCA mechanisms, Wi-Fi PHY layer measures the total received signal power and compares it with a certain detection threshold. Whenever the signal power is above this de-

tection threshold, Wi-Fi PHY declares that the channel is considered as busy, otherwise it is idle. In fact, Wi-Fi detection thresholds for carrier sense and energy detection mechanisms are different with about 20 dB: The CS threshold is -82 dBm and ED threshold is -62 dBm. The difference comes from the fact that Wi-Fi receiver network card is able to detect easily another Wi-Fi signal thanks to the a priori knowledge of Wi-Fi frame preamble symbols [98]. Accordingly, in Wi-Fi/Wi-Fi coexistence scenarios, Wi-Fi will be able to detect easily the presence of another Wi-Fi and declares the channel as busy and the DCF protocol will refrain from the channel access. In contrast, in LTE/Wi-Fi coexistence scenarios, Wi-Fi can consider LTE signal as a background noise and consider the medium as idle during LTE activity leading to a collisions. Accordingly, below Wi-Fi ED-CCA threshold, LTE is considered as a hidden node for Wi-Fi and the problem is usually called by LTE/Wi-Fi coexistence below energy detection threshold. The hidden node problem [90] in wireless communications is not a new issue, but in the context of LTE/Wi-Fi coexistence, it is more destructive.

Being aware of this problem, 3GPP has decided that LTE must lower its ED threshold down to -72 dBm [7] whereas Wi-Fi ED threshold remains at -62 dBm so that LTE can offer to Wi-Fi some level of protection by decreasing LTE channel access probability in favor of Wi-Fi. In parallel, Wi-Fi alliance had also asked that LTE to lower down more its ED threshold to -82 dBm to further improve Wi-Fi performance. Indeed, lowering LTE ED threshold and keeping Wi-Fi ED threshold will cause another problem called asymmetric hidden nodes problem between LTE and Wi-Fi [74]. Moreover, lowering ED threshold for a communication system is not always an optimal solution for ensuring fair coexistence, especially, if we are also looking for enhancing the spectrum utilization. In fact, lowering the ED threshold will cause sometimes the communication system to suffer from unnecessary backoffs where the communication system is “conservative” with respect to the channel access. This problem is known as the exposed node problem [30]. On the other side, increasing the ED threshold will cause the communication system to access “aggressively” the channel and will possibly lead to several collisions with other communication systems that are considered as hidden nodes [91]. Henceforth, we have to find the balancing point between the hidden and the exposed node problem as in [121] for LTE/Wi-Fi coexistence. At this balancing point, we can ensure a good trade-off between increasing spatial reuse to improve the overall network performance [146]-[145], and maintaining a moderate level of interference between the two systems [66]. Most of research directions seek to reach this balancing point by adaptively adjusting the ED threshold. Other research directions seek to reach this balancing point by adaptively adjusting the transmission power [87] and/or jointly adjusting both ED threshold and transmission power [143]. In real-

ity, reaching this balancing point needs a huge effort since there are many parameters that have to be taken into account such as the geographical distribution of the communication nodes [77] as well as their traffic load (see chapter 6).

Regarding the issue of LTE/Wi-Fi coexistence low energy detection threshold, [59] addressed this problem where LTE adopts a TDM-based protocol to coexist with Wi-Fi. Due to the poor Wi-Fi CCA mechanism, Wi-Fi was not able to identify LTE activities over the channel, i.e. LTE-ON periods. As a result, Wi-Fi was not only attempting to access the channel during LTE-OFF periods allocated by LTE for Wi-Fi channel access, but also it was attempting to access the channel during LTE-ON periods. Thus, Wi-Fi transmissions faced several collisions with LTE during LTE-ON periods, resulting in a poor Wi-Fi performance. Besides, taking into consideration that today's Wi-Fi hardware implementations adopt several data rate adaptation algorithms that mainly depends on the channel quality and the frame retransmission rate, Wi-Fi will tend to lower its data rate during LTE-OFF periods which leads to further degrade its performance since it does not profit maximally from LTE-OFF periods. Actually, the same conclusion regarding the expected degradation of Wi-Fi performance could be drawn regardless of the adopted LTE MAC layer protocol.

In [48], a real-time LTE/Wi-Fi coexistence testbed established by the National Instruments company show that, in case of LTE adopts Cat4 protocol, LTE could enhance the fair coexistence with Wi-Fi by lowering its ED threshold to -72 dBm. However, it should be noted that this conclusion could be radically altered if the conditions of the LTE/Wi-Fi coexistence scenario change. For example, in low-interference LTE/Wi-Fi coexistence scenarios, decreasing the LTE ED threshold will primarily degrades LTE performance due to unnecessary LTE back-offs whereas Wi-Fi performance remains almost the same as shown in [54]. In contrast, in highly interference-limited LTE/Wi-Fi coexistence scenarios, decreasing the LTE ED threshold helps both LTE and Wi-Fi to improve their performance as shown in [80]. To mitigate the problem of LTE performance degradation due to the decrease of its ED threshold, the authors in [66] proposed that LTE ED threshold can keep a lower ED threshold only when LTE coexists with another Wi-Fi. However, LTE can dynamically increase its ED threshold in the case of LTE coexists with another LTE of another operator based on measuring the inter-operator interference. Nevertheless, the proposed CCA threshold algorithm aims to enhance the network performance in case of LTE/LTE coexistence scenarios without providing a practical solution for LTE/Wi-Fi coexistence scenarios. The work is still showing the gain of LTE performance when it adaptively adjusts its ED threshold.

Another proposed solution is the one presented in [76] where LTE could dynamically adjust

its ED threshold based on its traffic load by observing the queue length of the LTE base station. If LTE has a high traffic load then LTE increases its ED threshold to have a more channel access opportunity at the expense of an acceptable sacrifice for Wi-Fi performance. In contrast, if LTE has a low traffic load, LTE decreases its ED threshold. However, this work did not explore ensuring fair coexistence between LTE and Wi-Fi. The authors provide a mathematical framework based on queuing theory to tie up between LTE traffic load and its ED threshold. In [49], the authors realized that lowering LTE ED threshold mitigates without solving totally the problem of the poor Wi-Fi channel assessment which consider the LTE signal as a background noise. The authors proposed that Wi-Fi has to implement an LTE synchronization signal detection module so that Wi-Fi is able to lower its energy detection to -82 dBm and treats LTE as any other Wi-Fi. Simulation results show that both LTE and Wi-Fi performance are improved. However, the proposed solution imposes that Wi-Fi changes its design.

Another distributed algorithm for LTE is proposed in [79] to adjust adaptively LTE ED threshold in order to enhance the fair coexistence with Wi-Fi. The main idea behind the algorithm is that LTE decreases its ED threshold when it encounters frequent collisions with Wi-Fi; otherwise, LTE should maintain a high ED threshold to increase the channel access opportunity. In fact, one of the most deficiencies of the algorithm is that there is still a high possibility that LTE does not discover any collision over the channel while Wi-Fi is suffering from the collision with LTE. For example, in case of LTE user equipments are located in the cell-centre whereas Wi-Fi stations are located in the cell-edge, LTE will not be able to discover a collision over the channel unlike Wi-Fi as we will see in Chapter 6. An analytical model for both LTE and Wi-Fi based on extending Bianchi's model by taking into consideration the impact of changing the ED threshold has been presented in [86]. The extending model is mainly based on modifying the probability of collision between both systems in function of changing ED threshold. Typically, the results show that when one of both technologies decreases its ED threshold while the other technology holds it, the latter will see a higher performance due to the several back-offs of that will be experienced by the one that decreases the ED threshold. Finally, reaching the balancing point between increasing the spatial reuse and maintaining a moderate interference is still needed to improve the fair coexistence. All of the above research works show only the benefits and the gain of the adaptive adjustment of the ED threshold without providing any practical solution to achieve the aforementioned trade-off.

## 2.2 WiMAX/Wi-Fi COEXISTENCE

LTE is not the first radio access technology that aims to improve its capacity through coexisting with Wi-Fi in unlicensed spectrum. Earlier, WiMAX (IEEE 802.16) also has tried to share the spectrum with Wi-Fi [39]. When WiMAX coexists with Wi-Fi without adopting any coexistence technique, we found that Wi-Fi is the technology that suffers most in coexistence scenarios whereas WiMAX performance is slightly affected [118]. Remember that, the same conclusion was drawn for LTE/Wi-Fi coexistence in [29] and [56]. Moreover, the main reason of degrading the Wi-Fi performance when coexisting with WiMAX is still the same as with LTE. It is because Wi-Fi adopts an LBT-based protocol which does not help to grab the channel access from WiMAX or LTE since both adopt a deterministic schedule-based channel access scheme. For these reasons, a coexistence technique is also needed for WiMAX to share the channel access with Wi-Fi.

A new MAC layer protocol has been proposed for WiMAX to coexist with Wi-Fi in [110]. The protocol is called Regular Channel Access (RCA) protocol where WiMAX adopts a Time-Division Multiplexing (TDM) scheme to share the channel access with Wi-Fi. Clearly, RCA protocol is similar to TDM-based protocol proposed by 3GPP for LTE to coexist with Wi-Fi where WiMAX transmission is activated for certain period time, i.e. WiMAX-ON period, followed by a non-activated periods, i.e. WiMAX-OFF period, where Wi-Fi can access the channel. Consequently, RCA protocol, like TDM-based protocol, has its negative impact on Wi-Fi performance since both WiMAX and Wi-Fi may simultaneously attempt to access the channel at the same time causing collisions over the channel. To cope with the mutual interference, the author proposed a method to improve the coordination between WiMAX and Wi-Fi by modifying Wi-Fi to be able to supervise the channel activities of WiMAX so that Wi-Fi will attempt to access the channel only during WiMAX-OFF periods. Remember that similar methods were proposed for LTE/Wi-Fi coexistence in [114] and [93] to reduce such interference. However, during a WiMAX-OFF period, if Wi-Fi transmits a frame longer than the WiMAX-OFF period, a collision is still possible. In [34], the authors proposed an interframe spacing adaptation method that helps Wi-Fi to prioritize the frames which fit well WiMAX-OFF periods to further mitigate the mutual interference and improve the channel utilization of Wi-Fi.

Time Division Operation (TDO) protocol is another name that was given to TDM-based protocol in [65] for WiMAX to coexist with Wi-Fi. However, the authors proposed a different method to confine Wi-Fi transmissions into WiMAX-OFF periods to reduce the interference. The proposed method is based on the Wi-Fi Access Point (AP) that controls transmission of the

other Wi-Fi stations through the usage of vestigial power management (PwrMgt) bit within the Wi-Fi frame structure. Indeed, during WiMAX-ON periods, Wi-Fi AP can tell Wi-Fi stations to move into a power-saving mode by setting up the PwrMgt bit to 1. In power-saving mode the Wi-Fi stations cannot send or receive data frames, so that interference is avoided between WiMAX and Wi-Fi. In contrast, during the WiMAX-OFF period, Wi-Fi AP allows the Wi-Fi stations to send and to receive data frames by setting the PwrMgt bit to 0. It is easy to notice that all the previous methods proposed to mitigate the interference between WiMAX and Wi-Fi could be proposed and/or adapted for LTE/Wi-Fi coexistence.

In WiMAX/Wi-Fi coexistence scenarios, Wi-Fi also can degrade harmfully the WiMAX performance as shown in [18]. Indeed, WiMAX, like LTE, needs uninterrupted channel access for its proper operation. If there is an idle period before a WiMAX frame transmission starts or during the WiMAX frame transmission, Wi-Fi grabs the channel access and degrades the WiMAX performance. To solve this problem, the authors proposed the usage of a reservation signal to prevent Wi-Fi from grabbing the channel access when the channel is idle before or during WiMAX frame transmissions. The same problem was discovered in the case of LTE/Wi-Fi coexistence and the proposed solution is mainly based on the same idea of the reservation signal [26].

Another approach has been proposed in [19] to allow the coexistence between WiMAX and Wi-Fi based on a central coordinator device that coordinates the channel access between the two technologies. The coordinator device adopts Point Coordination Function (PCF) protocol to pool the traffic of both technologies during a contention free period. We should mention here that the concept of allowing inter-working between LTE and Wi-Fi through a third entity that controls the channel access among them has also been investigated in [105], [24] and [131]. However, in this thesis, our research direction focuses on the coexistence between the two technologies without external coordination.

### 2.3 SYNTHESIS

Ensuring fair coexistence between LTE and Wi-Fi in unlicensed spectrum is a huge challenge. The heterogeneity of their MAC and PHY layers is the main source of the problems and the conflicts between them. In this regard, the new entrant LTE has to fairly share the spectrum with the incumbent Wi-Fi by adopting a new MAC layer protocol that could be supported further by some mechanisms at the PHY layer. Indeed, as more as the new LTE MAC layer protocol is similar to that adopted by Wi-Fi, the conflicts are mitigated and fair coexistence is

closely approached. In contrast, as more as the new LTE MAC layer protocol is dissimilar to that adopted by Wi-Fi, we expect that the conflicts are increased and fair coexistence is far to being reached. In this case, it does not mean necessarily that LTE is the one which is not fair to Wi-Fi since Wi-Fi may also be not fair to LTE. It all will depend on which technology has the more powerful MAC layer protocol to grab the channel access more than the other technology. This calls the necessity of understanding how the new LTE MAC layer protocol does operate over the channel.

In the case when the LTE MAC layer protocol is more powerful than Wi-Fi DCF protocol, LTE have to relieve its power for not degrading Wi-Fi performance. Accordingly, LTE needs to make an extra effort to ensure the fair coexistence by adopting some mechanisms that adequately adjust its MAC Layer protocol configuration parameters. However, such mechanisms increase the complexity of LTE MAC layer design and sometimes incur some overheads on LTE performance. It is worthy to note that not all MAC layer protocols do have the same flexibility to ensure the fair coexistence as it depends on their available configuration parameters and how do they operate over the channel. In addition to ensuring fair coexistence, the challenge of designing a new LTE MAC layer protocol will increase if we seek to optimize LTE performance in the unlicensed spectrum. In the case when LTE MAC layer protocol is less powerful than Wi-Fi DCF protocol, LTE has also to modify its MAC layer protocol or adopt another one, otherwise, LTE will suffer from coexisting with Wi-Fi. In all cases, LTE will have to pay the price of its new MAC layer protocol heterogeneity with DCF protocol.

The TDM-based protocol is the most dissimilar and the most powerful to grab the channel access against the DCF protocol, so that LTE is almost completely aggressive and not fair with Wi-Fi. To enhance the coexistence fairness of the TDM-based protocol, LTE has to adjust the protocol configuration parameters to satisfy Wi-Fi needs in terms of channel access. In contrast, the FBE protocol is the most powerless to grab the channel access against the DCF protocol. LTE will suffer the most while Wi-Fi will be slightly impacted. To enhance LTE performance, various MAC layer protocols have been proposed to replace FBE protocol. All these MAC layer protocols have a common feature like the FBE protocol which is the use of a CCA prior to frame transmissions. It is clear that main benefit behind both TDM-based and FBE protocol is the synchronous operation of the channel access which is absolutely needed for LTE user equipment to be able to receive LTE signal. Thus, LTE can avoid transmitting a reservation signal prior to LTE frame transmissions which degrades LTE performance.

Regarding to the LBE protocol, using it allows LTE enhancing its performance compered to FBE protocol. It should normally improve the coexistence fairness with Wi-Fi compared

to TDM-based protocol. However, the LBE protocol benefits come with the price of slowing the LTE performance due to the necessity of using of a reservation signal. Besides, the LBE protocol is only able to guarantee a marginal fair coexistence with Wi-Fi due to its fixed CW size which prioritizes the channel access to LTE over Wi-Fi. To solve this problem, the proposed solutions are mainly based on the adaptation of the LBE CW size to fair coexist with the DCF protocol. Also, different modification has been proposed for LBE protocol such as the adopting of the same back-off slot duration and an equivalent DIFS sensing period as in Wi-Fi. Lastly, to remove any heterogeneity between LTE MAC layer protocol and Wi-Fi DCF protocol, Cat4 protocol has been chosen by 3GPP for LTE in Release 13. Most research efforts about Cat4 protocol aim to improve the spectrum utilization since the fair coexistence is considered to be not an issue any more. To further improve the spectrum utilization and the coexistence fairness, LTE has also to tackle the problem that comes from its PHY layer heterogeneity with Wi-Fi. In this regard, different mechanisms have been proposed based on adaptively adjusting the LTE energy detection threshold. However, a practical solution that solves completely the problem does not exist yet and remains an open future work.



*Soit A un succès dans la vie. Alors  $A = x + y + z$ , où  $x = \text{travailler}$ ,  $y = \text{s'amuser}$ ,  $z = \text{se taire}$ .*

Albert Einstein

# 3

## TDM-based Protocol: Studying the Impact of LTE on Wi-Fi Downlink Performance

An intuitive and simple way to share the spectrum between LTE and Wi-Fi is to prevent them from accessing the channel at the same time using Time-Division Multiplexing (TDM) schemes. In this chapter, we study the case where LTE adopts a TDM-based MAC protocol to share the spectrum with Wi-Fi while the latter keeps its usual MAC protocol. The main concept is indeed simple : LTE transmission is activated for certain periods called LTE-ON periods and it is deactivated during LTE-OFF periods released for Wi-Fi channel access. Using a TDM-based protocol, LTE adopts the so-called ON/OFF pattern which forms a duty cycle period that is repeated over the time. On one hand, TDM-based protocol allows better control on how and when the spectrum is accessed by LTE and thus Wi-Fi, and therefore master better the sharing. On the other hand, the lack of an LTE CCA mechanism leads to several transmission collisions over the channel between LTE and Wi-Fi. Whenever LTE starts a transmission period at the beginning of an LTE-ON period that follows an LTE-OFF periods, the collisions may occur. As a result, we expect that LTE will have a negative impact on Wi-Fi performance.

The TDM-based protocol has different configuration parameters such as the duty cycle pe-

riod and the ON/OFF periods duration. In addition, the number of ON/OFF periods and even the order of ON/OFF periods within a duty cycle lead to different ON/OFF patterns. Indeed, LTE and Wi-Fi performance will entirely depend on the TDM-based protocol configuration parameters, in other words, the ON/OFF pattern adopted by LTE. For example, multiple TDM-based protocol configurations have been examined using a proprietary semi-static system-level simulator in [11] for LTE/Wi-Fi coexistence. Firstly, the results show that the more the number of blank LTE subframes, i.e. LTE-OFF periods, over LTE frame, the higher the offered Wi-Fi throughput. Secondly, for the same number of blank subframes but with different distribution along the LTE frame, Wi-Fi can experience different throughput. These results were partially justified by the system-level simulator since the exact impact of LTE on Wi-Fi performance was not analyzed. Thus, it is hard to compare between the different TDM-based protocol configurations to find the best configuration parameters that maximize both LTE and Wi-Fi throughput and reduce the collision probability. In addition, in [61], the authors found that for a fixed duty cycle percentage, i.e. the fraction of LTE-ON period over duty cycle, the throughput of Wi-Fi can be negatively impacted in the case of the duty cycle period is too short. However, if the duty cycle period is too long, it is more the packet latency that will be degraded.

In this chapter, we provide a formal justification of the possible performance degradation experienced by LTE and Wi-Fi. We show how the Wi-Fi performance is related to the duration of LTE-OFF periods during the duty cycle period and also to their distribution along the duty cycle. We quantify the impact of LTE TDM-based protocol on Wi-Fi downlink performance by computing analytically the probability of collision. We model the interaction between LTE and Wi-Fi using both delayed and ordinary renewal processes associated with a stopping time directly related to LTE-OFF periods. We also use a discrete time Markov chain to model the progress of the interaction over time. Even though, this first model applies for one Wi-Fi access point or one station sending to other stations, it allows us to model Wi-Fi access protocol in detail without much approximations, and hence it is a necessary and useful intermediary step to the model of multiple sending Wi-Fi stations. It can be easily combined with other models to study a network performance that includes Wi-Fi transmissions as we will do in the next chapter. Moreover, in parallel, we implemented the TDM-based protocol in the open-source NS3 (Network Simulator version 3) simulator [92] and we used its complete implementation of Wi-Fi (IEEE 802.11) standard to validate our model and assess its robustness when the model assumptions are not quite valid. This chapter is outlined as follows. In section 3.1, we explore the interaction between LTE and Wi-Fi. In section 3.2, we provide an analytical model for Wi-

Fi coexisting with LTE to quantify the impact of LTE on an infrastructure-based Wi-Fi network in terms of probability of collision and saturation throughput. Section 3.3 validates the accuracy of our model by comparing its results with those obtained by means of NS3 simulations. We investigate the performance of Wi-Fi in various TDM schemes and Wi-Fi configurations. Finally, we summarize the chapter and discuss our next step to consider general network scenarios including possibly Wi-Fi downlink and uplink traffic in section 3.4.

### 3.1 LTE/WI-FI INTERACTION

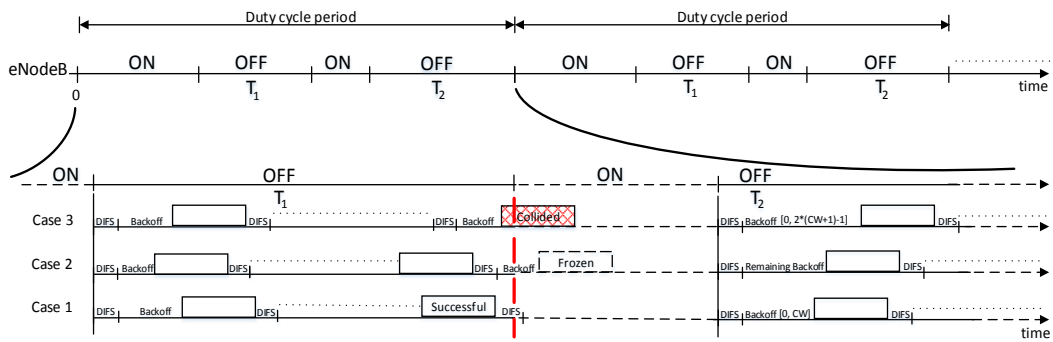


Figure 3.1: LTE eNodeB interacting with Wi-Fi Access Point

In this section, we explore the impact of LTE eNodeB transmissions on Wi-Fi downlink transmissions by an Access Point (AP) in infrastructure mode. The use of different MAC layer protocols by LTE and Wi-Fi creates a major sharing problem. With TDM-based protocol, LTE does not sense the channel before transmitting to know whether it is idle or not unlike Wi-Fi which follows an LBT scheme. As a result, an unexpected interruption of Wi-Fi transmission by LTE can be produced at several times leading to the collision between the two systems.

In Figure 3.1, LTE adopt TDM-based protocol where LTE eNodeB is activated/deactivated during ON/OFF periods. This ON/OFF pattern is controlled by three different parameters. First, the duty cycle period that determines how long it takes to the pattern to be repeated again. Second, the duty cycle percentage which is the portion of time where the eNodeB is activated over the duty cycle period. Third, the transmission periods during the duty cycle period which controls how the eNodeB ON/OFF periods are distributed during the duty cycle. This transmission periods can be continuous or separated by several silence periods.

Now, we turn our attention to the periods where AP can access the channel corresponding to eNodeB-OFF periods. We look first at the end of these periods (See Figure 3.1). In each period, after a successful transmission of some frames, when the next eNodeB-ON period starts, it can start when Wi-Fi is sensing the channel during a DIFS which is the Distributed Inter-Frame Space (Case 1 in Figure 3.1). The eNodeB period can also start during the decrementing of the backoff counter of the AP (Case 2). Effectively, after the DIFS sensing period, the AP transmits its frame after a random number of slots called backoff time. Finally, the eNodeB period can start during the Wi-Fi frame transmission (Case 3).

To get into more details, in the first case, eNodeB interruption comes after the end of a frame transmission that is why the last frame is successfully transmitted. Then, AP defers the next transmission until the eNodeB transmission period is finished. Then, at the next Wi-Fi transmission period (eNodeB-OFF), a new frame will be transmitted after sensing the channel for a time equal to the DIFS and the slotted random backoff time period corresponding to a random backoff counter uniformly chosen in the range of  $[0, CW]$ , where  $CW$  is the initial backoff contention window size. The backoff time is fully determined by this counter since the slot time is fixed. We denote the slot time by  $\delta$ .

In the second case, the eNodeB interruption comes during the slotted random backoff time period while AP is decrementing its backoff counter at the end of each slot time  $\delta$ . When AP senses the channel busy, it freezes the backoff counter and the frame transmission procedure is *frozen* until the next eNodeB-OFF period that is why we call the last frame is a frozen frame. At the next eNodeB-OFF period, the frozen frame is transmitted after sensing the channel again for a time equals to DIFS and after decrementing the rest of the frozen backoff counter from the previous period.

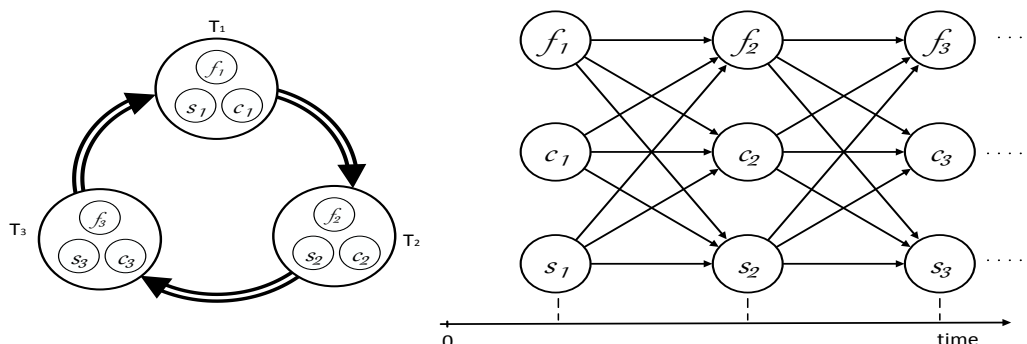
As for the third case, the eNodeB interruption comes during Wi-Fi frame transmission so a collision is occurred and the frame is lost for that reason we call the last frame is a collided frame. At the next eNodeB-OFF period, AP retransmits that collided frame again after a DIFS period and a uniform random backoff time with a doubled backoff contention window size equals to  $2 * (CW + 1) - 1$ . A more complete and detailed review of IEEE 802.11 DCF protocol functionality can be found in [119].

### 3.2 WI-FI ANALYTICAL MODEL

The analysis is divided into two steps. First, we study the behavior over time of the Wi-Fi AP coexisting with LTE eNodeB using a Discrete Time Markov Chain (DTMC). Second, we com-

pute the transition probabilities by considering the Wi-Fi transmissions as a renewal process stopped by LTE arrival. Finally, we obtain the probability of collision under the saturation condition, and we express the Wi-Fi AP downlink throughput.

Over a duty cycle period, AP can access the channel during different eNodeB-OFF time periods. Let us adopt the notation  $T_i$  for such periods where  $i \in (1, \dots, M)$  and  $M$  is the number of disjoint access channel opportunities offered to AP during a duty cycle period (see Figure 3.1 for  $M=2$ ). As mentioned in section 3.1, we enumerated three cases where the AP transmission during any  $T_i$  period terminates with a frozen, collided or success frame, as shown in Figure 3.1. Thus, the end of each  $T_i$  period can be adequately modeled by means of a three-state Markov chain. Let us denote by  $S = \{f_i, c_i, s_i\}$ , the space state for period  $T_i$ , where  $f_i$ ,  $c_i$  and  $s_i$  indicate that the AP transmission has been ended with a frozen, collided and success frame during  $T_i$  period respectively. As a result, any given  $T_i$  period has a set of three states which can be visited again *only* at multiples of  $M$  leading to a periodic DTMC with period  $M$ . This shown in Figure 3.2 for  $M = 3$ , i.e. periods  $T_1, T_2$  and  $T_3$ . We should note also that the Markov chain can lose the periodicity when at least two periods of  $T_i$  periods have the same time values over the duty cycle period.



**Figure 3.2:** Periodic Discrete Time Markov Chain modeling the three states at the end of an eNodeB-OFF period ( $T_i$ ). Left: The global transition diagram showing the periodicity. Right: Detailed state transitions over time

In order to keep the Markov property, we assume that after a collision at the end of a  $T_i$  period, the retransmitted frame at the beginning of the next  $T_i$  period does not face a collision. To relax this assumption, we should add the current number of accumulated successive collisions in the Markov chain states which complexifies too much the model without a significant accuracy gain as we shall see later. Indeed, these  $T_i$  periods are multiples of 1 ms and thus they are relatively large compared to the AP frame transmission time. It is intuitive that this assumption is more valid as long as  $T_i$  period gets larger and AP frame size gets smaller. Besides, the high

rates provided by recent Wi-Fi technologies allows several frame transmissions in 1 ms even for large packet sizes.

### 3.2.1 TRANSITION PROBABILITIES AND PROBABILITY OF COLLISION

In this subsection, we show how we can calculate the transition probabilities between any two states in our Markovian model using renewal processes. Then, we compute the global probability of collision faced by any AP frame transmission.

After the eNodeB transmission is finished, the AP starts immediately to transmit its frames at the beginning of a  $T_i$  period. As described in section 3.1, the amount of time needed for DCF protocol to successfully transmit the first frame depends on how ended the AP transmission during the previous period. The previous period is  $T_{i-1}$  for  $i \in (2, \dots, M)$ , and  $T_M$  for  $i = 1$ . For simplicity of notation and without loss of generality, we denote by  $T_{i-1}$  the previous period for all  $i$ . First, let us consider that  $T_{i-1}$  period state was  $s_{i-1}$  (success). Then, the amount of time needed to successfully transmit the first frame at  $T_i$  period can be represented by the following uniform random variable:

$$X = DIFS + \delta * BFcounter_{unif(0,CW)} + Frametime \quad (3.1)$$

Where  $BFcounter_{unif(0,CW)}$  is the backoff counter which is a uniform random variable with lower and upper limits of 0 and  $CW$  respectively.  $Frametime$  is the frame transmission time which includes the frame airtime over the channel, followed by a period of time equals to Short InterFrame Space (SIFS) and the acknowledgment transmission time (Acktime). That is  $Frametime = \text{frame airtime} + \text{SIFS} + \text{Acktime}$ . We compute frame airtime and Acktime to account for different OFDM physical layer as in [62].

Now, consider that  $T_{i-1}$  period state was  $f_{i-1}$  (frozen), then the first frame at  $T_i$  period will be transmitted after a  $DIFS$  time plus the remaining time of the frozen backoff period. The probability mass function (pmf) of the remaining number of time slots of the frozen backoff counter depends on when the last eNodeB-ON transmission period has been started during the last slotted random backoff at  $T_{i-1}$  period. Whereas the remaining backoff counter random variable has a lower and upper limits of 0 and  $CW$  as the success case, its pmf can be different from the one of a uniform random variable. However, we approximate it as a uniform random variable. As a result, the amount of time needed for DCF protocol to successfully transmit the first frame during  $T_i$  period given a  $s_{i-1}$  or  $f_{i-1}$  state for  $T_{i-1}$  are the same and equal to  $X$ . This approximation would have a light impact on the throughput computation since the sum between the first part of the backoff counter which occurs before the eNodeB-ON period and

the second part of the backoff counter which occurs after the end of the eNodeB-ON period is a normal complete backoff. Indeed, if the eNodeB-ON period starts at the beginning of the backoff period or at the end, the next Wi-Fi frame will be transmitted exactly at the same time. More precisely, the time between the last frame sent before the eNodeB-ON period and the first frame sent after that period is  $DIFS + eNodeB-ON + \delta * BFcounter_{unif(0,CW)} + DIFS$ .

Finally, in the last case when the  $T_{i-1}$  period state is  $c_{i-1}$  (collision), the amount of time needed to successfully transmit the first frame during  $T_i$  can be represented by the following uniform random variable  $Y$ :

$$Y = DIFS + \delta * BFcounter_{unif(0,2*(CW+1)-1)} + Frametime \quad (3.2)$$

As for all the next frames that follow the first one, the amount of time needed to successfully transmit any one of these frames can be easily represented by the same random variable  $X$ . In order to compute the transition probabilities, we need to determine when the last AP transmission is interrupted by the starting of the eNodeB-ON period. To do so, it is necessary to know how much Wi-Fi frames are sent during  $T_i$  period. Let  $N$  be the random variable that counts the number of frames which could be transmitted during any  $T_i$  period. For any given  $N = n$ , the first  $n - 1$  frames will be successfully transmitted and the  $n^{th}$  frame could be a collision, frozen or successful frame as shown in Figure 3.1. According to the above analysis and equations (3.1) and (3.2), the total time needed to transmit successfully  $n$  frames during any  $T_i$  period is the sum of  $n$  uniformly distributed random variables. This sum is equal to  $\sum_{j=1}^n x_j$  if the state of the previous  $T_{i-1}$  period is  $s_{i-1}$  or  $f_{i-1}$ , and it is equal to  $y + \sum_{j=2}^n x_j$  if the state of the previous  $T_{i-1}$  period is  $c_{i-1}$ . The first mentioned sum constitutes an ordinary renewal process ( $n \geq 0$ ), while the second sum is a delayed renewal process because the first random variable in the sum has a different distribution. The pmf of  $N$  depends on the state of  $T_{i-1}$  period. However, in any case, it is clear that  $N$  is a stopping time with respect to the sequence  $\{x_1, x_2, x_3, \dots\}$  or  $\{y, x_2, x_3, \dots\}$ . Consequently, the conditional probability of sending  $n$  frames during any  $T_i$  period given that the state of  $T_{i-1}$  is  $s_{i-1}$  can be written as [101].

$$Pr\{N = n \mid s_{i-1}\} = Pr\left\{\sum_{j=1}^{n-1} x_j + DIFS + \delta < T_i\right\} - Pr\left\{\sum_{j=1}^n x_j + DIFS + \delta < T_i\right\} \quad (3.3)$$

Here, the stopping condition is  $\sum_{j=1}^n x_j > T_i - DIFS - \delta$ .

**Explanation.** This conditional probability corresponds to the number of sent frames regard-

less of what happens to the last sent frame before the end of the  $T_i$  period. As a matter of fact, in equation (3.3), the addition of the  $DIFS + \delta$  period is necessary to cover the three cases, collision, frozen and successful as shown in Figure 3.1. Particularly, if eNodeB-ON starts at the end of the added  $DIFS + \delta$  period, then this case corresponds also to  $n$  sent frames with the last one being successful. Remind that the backoff counter is decremented at the end of the time slot  $\delta$ . Hence, a full  $DIFS + \delta$  period must be added. This probability can be computed exactly by using the pmf of the sum of  $n$  uniform random variables which is the  $n$ -fold convolution of individual pmfs.

Next, we determine the transition probabilities to  $s_i$ ,  $f_i$  and  $c_i$  states with  $n$  transmitted frames during  $T_i$  given  $s_{i-1}$  state in the previous  $T_{i-1}$  as follows

$$Pr\{s_i, n \mid s_{i-1}\} = Pr\left\{\sum_{j=1}^n x_j < T_i \leq \sum_{j=1}^n x_j + DIFS + \delta\right\} \quad (3.4)$$

$$Pr\{f_i, n \mid s_{i-1}\} = Pr\left\{\sum_{j=1}^{n-1} x_j + DIFS + \delta < T_i < \sum_{j=1}^n x_j - Frame_{time}\right\} \quad (3.5)$$

$$Pr\{c_i, n \mid s_{i-1}\} = Pr\left\{\sum_{j=1}^n x_j - Frame_{time} \leq T_i \leq \sum_{j=1}^n x_j\right\} \quad (3.6)$$

For a given  $T_i$  period,  $N$  has an upper bound  $nmax$ , which means that  $Pr\{N > nmax\} = 0$ , where  $nmax = \lceil T_i/xmin \rceil$  with  $xmin = DIFS + Frame_{time}$ . Hence, the transition probability to  $c_i$  state given  $s_{i-1}$  state is expressed as

$$Pr\{c_i \mid s_{i-1}\} = \sum_{n=1}^{nmax} Pr\{c_i, n \mid s_{i-1}\} \quad (3.7)$$

Similarly, we can compute all other transition probabilities. In particular, the conditional probability of sending  $n$  frames and the conditional transition probabilities to  $s_i$ ,  $f_i$  and  $c_i$  states with  $n$  sent frames during  $T_i$  given  $f_{i-1}$  state in the previous  $T_{i-1}$  are the same as equations (3.3), (3.4), (3.5), (3.6) and (3.7). As for the conditional probability of sending  $n$  frames and the conditional transition probabilities to  $s_i$ ,  $f_i$  and  $c_i$  states with  $n$  sent frames during  $T_i$  given  $c_{i-1}$  state in the previous  $T_{i-1}$ , they are obtained similarly except that  $\sum_{j=1}^n x_j$  is replaced by  $y + \sum_{j=2}^n x_j$ . Using the transition probabilities, we can deduce the probability of occurrence of each state at multiples of  $M$ ,  $\forall i \in (1, \dots, M)$ , as follows

$$\pi(s_i) = Pr\{s_i \mid c_{i-1}\} * \pi(c_{i-1}) + Pr\{s_i \mid f_{i-1}\} * \pi(f_{i-1}) + Pr\{s_i \mid s_{i-1}\} * \pi(s_{i-1})$$



$$\pi(c_i) = Pr\{c_i | c_{i-1}\} * \pi(c_{i-1}) + Pr\{c_i | f_{i-1}\} * \pi(f_{i-1}) + Pr\{c_i | s_{i-1}\} * \pi(s_{i-1})$$

$$\pi(f_i) = Pr\{f_i | c_{i-1}\} * \pi(c_{i-1}) + Pr\{f_i | f_{i-1}\} * \pi(f_{i-1}) + Pr\{f_i | s_{i-1}\} * \pi(s_{i-1})$$

$$\pi(s_i) + \pi(c_i) + \pi(f_i) = 1 \quad (3.8)$$

We remind here again that  $i - 1$  refers to  $M$  if  $i = 1$ . Finally, we can compute the probability of collision  $P_C$  seen by any frame during a duty cycle period consisting of  $M$  different  $T_i$  periods

$$\begin{aligned} P_C &= \frac{E[\text{collided frames during duty cycle period}]}{E[\text{sent frames during duty cycle period}]} \\ &= \left( \sum_{i=1}^M E[C \text{ in } T_i] \right) / \left( \sum_{i=1}^M E[N \text{ in } T_i] \right) \end{aligned} \quad (3.9)$$

The numerator of (3.9) is equal to the expected value of collided frames  $C$  in  $T_i$  period. As only the  $n^{th}$  frame during  $T_i$  period would face a collision, we can easily compute it as follows

$$E[C \text{ in } T_i] = \pi(c_i) \quad (3.10)$$

Next, we compute the expected value of  $N$  sent frames in  $T_i$  period

$$E[N \text{ in } T_i] = E[N] - E[F \text{ in } T_i] \quad (3.11)$$

Where  $E[N]$  is the expected values of  $N$  sent frames regardless of what happens to the last sent frame before the end of the  $T_i$  period

$$E[N] = E[N | c_{i-1}] * \pi(c_{i-1}) + E[N | f_{i-1}] * \pi(f_{i-1}) + E[N | s_{i-1}] * \pi(s_{i-1}) \quad (3.12)$$

Hence, the conditional expected values of  $N$  such that  $c_{i-1}$ ,  $f_{i-1}$  or  $s_{i-1}$  are respectively

$$E[N | c_{i-1}] = \sum_{n=1}^{nmax} n * Pr\{N = n | c_{i-1}\} \quad (3.13)$$

$$E[N | f_{i-1}] = \sum_{n=1}^{nmax} n * Pr\{N = n | f_{i-1}\} \quad (3.14)$$

$$E[N | s_{i-1}] = \sum_{n=1}^{nmax} n * Pr\{N = n | s_{i-1}\} \quad (3.15)$$

Finally,  $E[F \text{ in } T_i]$  is the expected value of frozen frames  $F$  in  $T_i$  period which is necessary to not count it in  $E[N \text{ in } T_i]$  (See Figure 3.1 case 2). It is calculated as follows

$$E[F \text{ in } T_i] = \pi(f_i) \quad (3.16)$$

**Discussion.** The probability of collision in (3.9) quantifies the impact of LTE TDM scheme on the Wi-Fi downlink transmissions while assuming one access point AP. The collisions occur exactly at the end of each  $T_i$  period. Let us consider the downlink and uplink Wi-Fi transmission with a finite number of Wi-Fi stations. Bianchi [23] and Altman *et al.* [67] have modeled the exponential behavior of the random backoff time to tie up between the probability of collision and the probability that a station transmits in a randomly chosen time slot. They have shown the intuitive result that when the number of Wi-Fi stations increases, the probability of collision increases as well, which leads to decreasing the probability that a station transmits in a randomly chosen time slot. Consequently, the probability of having the Wi-Fi stations not transmitting at the end of each  $T_i$  period is increased compared to one station. Indeed, these stations would be in a backoff period or colliding. As a result, our probability of collision on Wi-Fi transmission provides an *upper bound* of the impact caused by LTE TDM scheme on a Wi-Fi network with more than one station transmitting over the uplink. Note also that our model is extendible to take into consideration possible capture effects when Wi-Fi is able to receive correctly a frame even in case of collision [75]. It can be done by reducing adequately the transition probabilities from the collision state. Moreover, the model of Bianchi is not valid for a small number of stations and thus it is not applicable to study the performance of Wi-Fi downlink.

### 3.2.2 DOWNLINK WI-FI THROUGHPUT

Let  $\Gamma$  be the downlink saturation throughput defined as the expected value of Wi-Fi successful frames during a duty cycle period. We express  $\Gamma$  as

$$\begin{aligned} \Gamma &= \frac{E[\text{successful frames during duty cycle period}]}{\text{duty cycle period time}} \\ &= \frac{\sum_{i=1}^M E[S \text{ in } T_i]}{\text{duty cycle period time}} \quad \text{frames/second} \end{aligned} \quad (3.17)$$

For the expected value of successful frames  $S$  in any  $T_i$  period, we can use the fact that during the  $T_i$  period, the first  $n-1$  frames are sent successfully. However, the last one is only successful with probability  $\pi(s_i)$ . Hence,

$$E[S \text{ in } T_i] = E[N] - 1 + \pi(s_i) \quad (3.18)$$

Particularly, if the eNodeB-ON periods are equal to eNodeB-OFF periods so that the bandwidth is shared “equally” between LTE and Wi-Fi, the expression of the throughput becomes

$$\Gamma = \frac{\sum_{i=1}^M (E[N] - 1 + \pi(s_i))}{2 \times \sum_{i=1}^M T_i} \text{ frames/second} \quad (3.19)$$

Equation (3.19) provides the maximum throughput that is obtained on the downlink transmissions towards the users of the Wi-Fi access point. This throughput is of course lower than the Wi-Fi bandwidth divided by 2 due to LTE impact as we shall see in the next section.

### 3.3 MODEL VALIDATION AND SIMULATION RESULTS

To validate our analytical model, we have simulated the interaction between LTE and Wi-Fi using NS3 simulator. As this chapter aims to quantify the impact of LTE TDM-based protocol on the Wi-Fi DCF MAC layer protocol and since 802.11a/n/ac have similar definitions of the MAC layer protocol, we choose the implementation of IEEE 802.11a standard in the simulator. We simulate a Wi-Fi access point transmitting continuously to its users. We implement a new model to simulate eNodeB-ON and OFF periods. During eNodeB-ON periods, a signal is generated so that Wi-Fi AP detects a busy channel if it is in sensing periods, otherwise the signal causes interferences with Wi-Fi transmissions leading to collisions and the frame is lost.

Wi-Fi parameters used to obtain the numerical results for both the analytical model and the NS3 simulation are those specified by default in the IEEE 802.11a standard, as reported in Table 3.1. We have used in the simulation runs a Wi-Fi channel with a bit rate equals to 6, 12 or 24Mbps corresponding to different Modulation and Coding Schemes (MCS), i.e. BPSK, QPSK, 16QAM. The packet payload varies from 11 bytes to 1436 bytes. The Wi-Fi probability of collision obtained by simulation is computed by dividing the number of collided frames (i.e. retransmitted frames) over the total number of transmitted frames at the MAC layer. The simulation throughput is obtained by counting the total successfully received frames during the simulation time at the application layer. For a fixed set of parameters, we repeat the simulations

Simulation time	200 s
Payload packet	11 ~ 1436 bytes
ACK packet	14 bytes
UDP header	8 bytes
Network header	20 bytes
MAC header	36 bytes
Channel bit rate	6, 12 and 24 Mbps
Channel bandwidth	20 MHz
Slot time ( $\delta$ )	9 $\mu$ s
SIFS	16 $\mu$ s
DIFS	34 $\mu$ s

**Table 3.1:** Wi-Fi configuration parameters used in the comparison between NS3 simulations and the analytical model

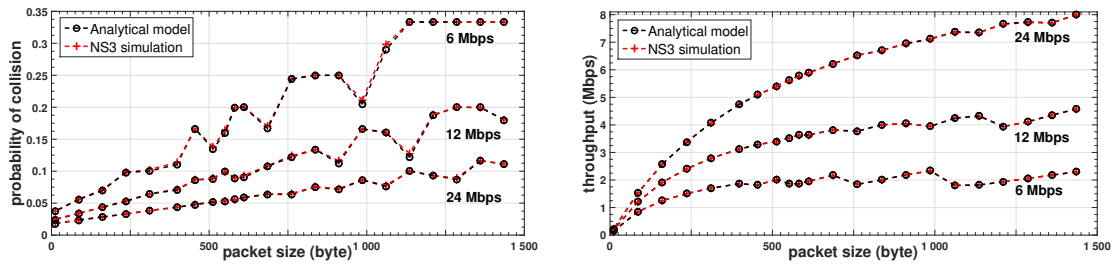
3 times. Confidence intervals are too small to be drawn on the plots. We remark that each simulation run can last for several hours especially for small packet sizes since the number of events in this case is very high.

Without losing the generality of our analysis, the LTE transmission duty cycle period is fixed to 10 ms corresponding to LTE frame duration with duty cycle percentage of 50% so that LTE leaves somewhat an “equal” share to Wi-Fi. We vary the distribution of the ON/OFF transmission periods of LTE inside the duty cycle. First, LTE transmission is activated for 5ms then deactivated for the rest of LTE frame duration. This configuration refers to 5x0 ON/OFF pattern. Second, LTE transmission is activated for 3ms at the beginning of the duty cycle, then deactivated for same amount of time before it is reactivated again for 2ms. Consequently, the Wi-Fi AP gets two disjoint transmission opportunities in the same LTE frame to access the channel. This configuration refers to 3x2 ON/OFF pattern. Third, we consider another LTE transmission pattern similar to the previous one except we replace 3ms by 4ms, and we replace 2ms by 1ms to get a 4x1 ON/OFF pattern.

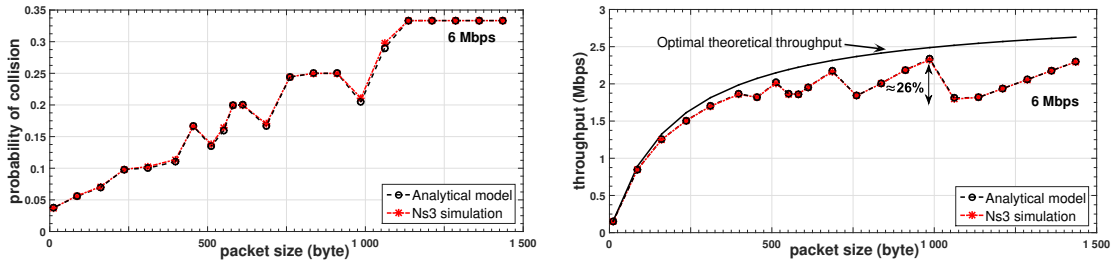
### 3.3.1 COMPARISON WITH SIMULATION RESULTS

Figure 3.3 shows that the analytical results for both the probability of collision and throughput are highly accurate with the simulation results for 6, 12 and 24Mbps when the LTE transmission pattern is 5x0 ON/OFF. Especially, for 6Mbps, the model follows exactly any abrupt fluctuation of the simulation results as shown in Figure 3.3b. As Wi-Fi access the channel for the half of the time with 6Mbps, the optimal theoretical throughput experienced by Wi-Fi in case of full synchronization with LTE (i.e. without collision with LTE) is also shown in Figure 3.3b. Evidently, collisions degrade the throughput by a non-marginal amount.

Figure 3.4 relative to the 3x2 ON/OFF pattern, shows a slight difference between the ana-



(a) Three different rates 6, 12 and 24 Mbps



(b) Zoom in the 6 Mbps case

Figure 3.3: (Left To Right) The probability of collision and throughput versus different packet size for 5x0 ON/OFF pattern

lytical model and the simulation results especially for the rate of 6Mbps. This is explained by the assumption made in the model that after a collision at the end of a  $T_i$  period, the retransmitted frame at the beginning of the next  $T_i$  period does not face a collision. This assumption is rarely violated for some packet sizes during the 2ms period.

Figure 3.5 confirms that our analytical model is still robust even if the previous mentioned assumption is not valid. Actually, the assumption is violated for a larger number of packet sizes in case of 6 and 12Mbps rate and the small period of 1ms. As a result, such scenario can not be modeled by our Markovian chain whereas it still can capture globally the probability of collision and the throughput behavior. In contrast, using a rate of 24Mbps fulfill our assumption and thus the analytical model results coincide again with the simulation results. Note that 6Mbps is the lowest rate defined in the IEEE 802.11 standard.

### 3.3.2 ANALYZING LTE IMPACT ON WI-FI

First of all, the impact of LTE on Wi-Fi performance in terms of probability of collision and downlink throughput can be observed clearly when the total number of Wi-Fi packets that can be sent during a duty cycle period is relatively small. As a matter of fact, equation (3.9)

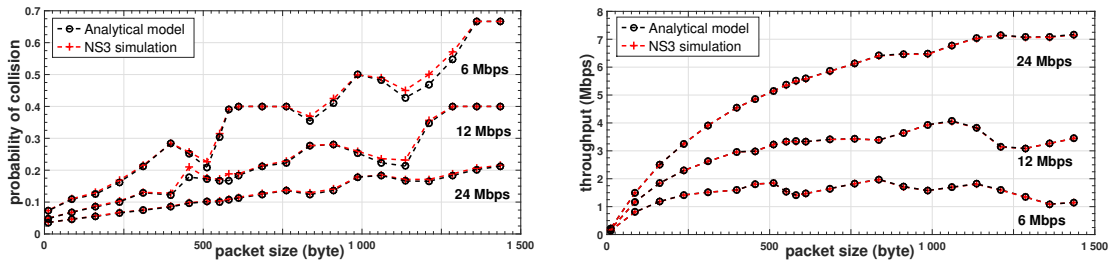


Figure 3.4: (Left To Right):The probability of collision and throughput versus different packet size for 3x2 ON/OFF pattern

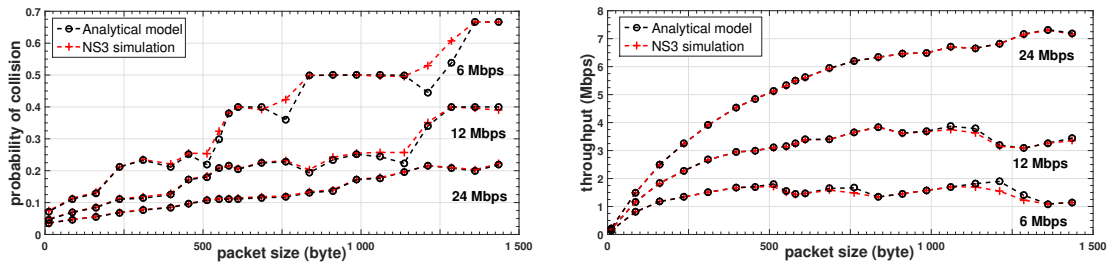


Figure 3.5: (Left To Right) The probability of collision and throughput versus different packet size for 4x1 ON/OFF pattern

shows that for a large number of sent packets by Wi-Fi during a duty cycle, the numerator will be small compared to the denominator, especially that only the last Wi-Fi packet in a  $T_i$  period can be lost. The average number of sent packets depends on the eNodeB-OFF length, the packet size and the Wi-Fi bit rate. For instance, the larger the bit rate, the lower the impact of LTE on Wi-Fi. Also, if the bit rate is small, then the impact is reduced when the packet size is small enough (Figure 3.3b). However, reducing the packet size does not necessarily increase the performance because a small packet size incurs more overhead. The trade-off between a small packet size that reduces the collision probability and a large packet size that reduces the overhead becomes tricky. According to Figure 3.3b, if the rate of Wi-Fi is 6Mbps, then a judicious choice of the packet size must be made to maximize the throughput. This packet size is computed easily through our proposed model.

More precisely, with a small packet size, the probability of collision has a positive linear relationship over the packet size but after a specific packet size, the probability of collision shows some ripples which depends drastically on the value of each packet size. For 24Mbps, we observe the same behavior of the probability of collision except that the ripples appear from larger packet sizes. Accordingly, the throughput curves reflect the same behavior. For 6Mbps,

throughput ripples are so much sharp that may cause losing up to 26% of throughput compared to the maximum. In contrast, for 24Mbps, throughput ripples are negligible. Ripples are explained by the variability of the backoff periods which is not significant if the air frame time is large. In other words, the random part in  $X$  becomes small compared to the constant part (see equation (3.1)). In this case, some periodic behavior appears where the number of Wi-Fi sent frames during the eNodeB-OFF period stays the same while increasing the frame size. As a matter of fact, interrupting the last frame in the eNodeB-OFF period at the beginning of the frame or at its end does not change the number of previous sent frames.

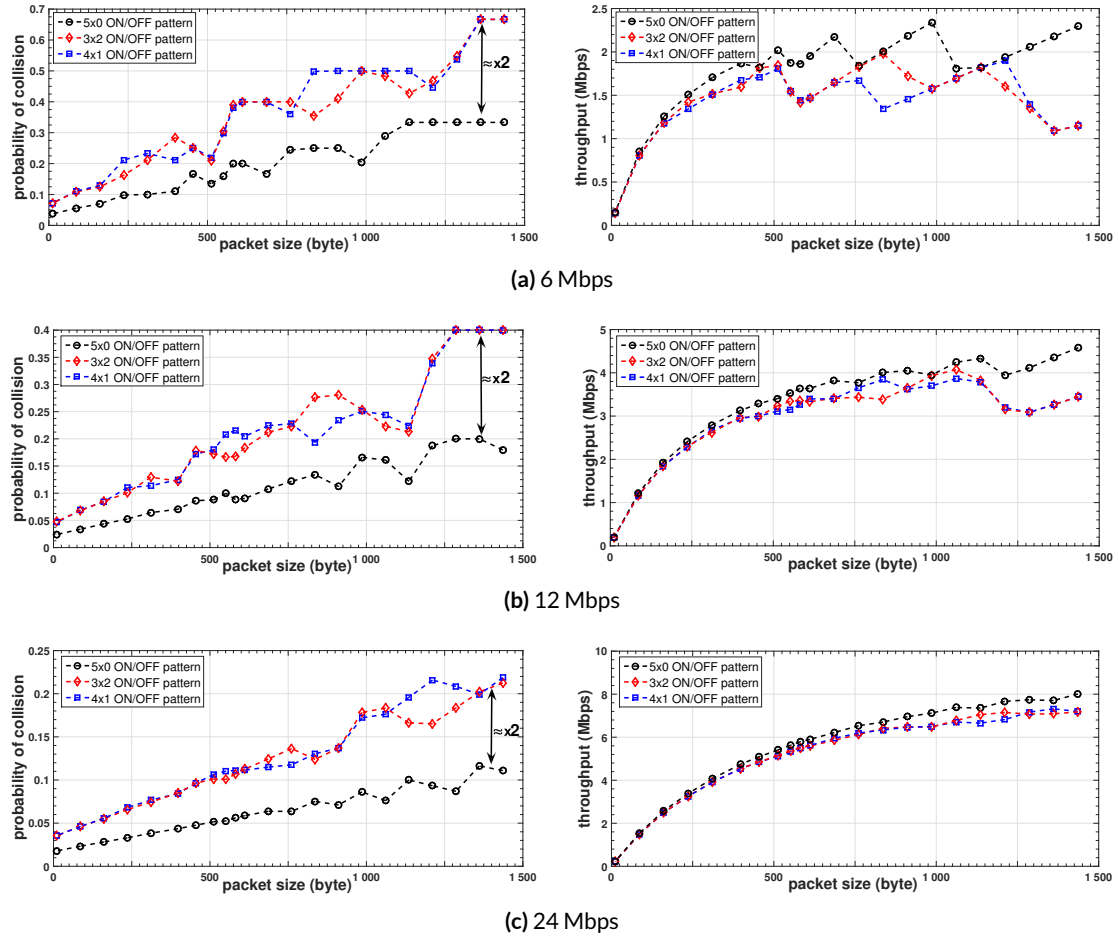


Figure 3.6: Comparison of the three ON/OFF patterns with different rates

Globally, the above observations about the 5x0 ON/OFF pattern apply for 3x2 and 4x1 ON/OFF pattern except that values are different (Figure 3.6). For instance, with 6Mbps the packet sizes that approach the optimal theoretical throughput are different for the 3x2 and 4x1

ON/OFF pattern and throughput ripples causes to losing respectively up to 43% and 40% of throughput compared to the maximum. In contrast, for both 12 and 24Mbps the throughput for both pattern are nearly the same.

Figure 3.6 shows, using our analytical model, that 5x0 ON/OFF pattern has a better performance than 3x2 and 4x1 ON/OFF pattern for both probability of collision and throughput and for all different data rates. That could be explained by the probability of collision of the 3x2 or 4x1 ON/OFF pattern is approximately doubled compared to 5x0 ON/OFF pattern for almost all packet sizes because LTE transmission interrupts Wi-Fi transmission twice over each duty cycle period. Consequently, 5x0 ON/OFF pattern throughput is always better than the 3x2 and 4x1 ON/OFF patterns. Nevertheless, it is intuitive that for 5x0 ON/OFF pattern, the Wi-Fi packets may have higher delays to access the channel in comparison with the 3x2 and 4x1 ON/OFF pattern. This raises the trade-off issue between the delay and the throughput experienced by Wi-Fi.

#### 3.4 SUMMARY

This chapter quantifies the impact of LTE on Wi-Fi downlink performance when a TDM-based protocol is adopted by LTE. Using an efficient analytical model that captures the exact periodic behavior of LTE, the impact has been evaluated in terms of probability of collision between the two systems. This probability of collision represents an upper bound of the negative impact when Wi-Fi downlink and uplink transmissions are activated together. Accordingly, the maximum throughput that can be achieved by Wi-Fi has been evaluated. Comparing our model results to those obtained by NS3 simulations validates both our analytical model and the new implemented model of IEEE 802.11 MAC in NS3 for the research community. Performance analysis show that LTE must share the channel with Wi-Fi intelligently to reduce the negative impact on Wi-Fi due to collisions. In other words, it is not enough to share equally the channel by deploying a 50% ON/OFF duty cycle. How the channel is shared inside the duty cycle is an important factor as well. Different TDM-based protocol configurations adopted by LTE has a different impact on Wi-Fi performance. Relying on our model, we can measure exactly the performance degradation for any TDM-based protocol configurations on Wi-Fi performance. Henceforth, it is possible to find the required compensation that makes the sharing equal, by increasing the access time available to Wi-Fi during each TDM duty cycle. Thus, LTE can recover adequately the disuse of the Wi-Fi CSMA/CA scheme. On the other hand, Wi-Fi can



better protect itself from the negative impact of LTE by frame buffering and aggregation so that a suitable air frame size is used, especially with low data rates.

Through this chapter, we entirely focused on the impact of LTE on Wi-Fi downlink performance. Our first objective was to clarify the interaction between LTE and Wi-Fi in unlicensed spectrum and the impact of different configuration parameters of the both networks on the coexistence performance. Indeed, LTE performance was not clearly shown in this chapter. However, LTE performance could be easily evaluated by means of the probability of collision between the two systems which presents the key information that needed for evaluating both LTE/Wi-Fi performance. Accordingly, we will deal with LTE performance in the next chapter 4 as well as considering both Wi-Fi downlink and uplink performance. In the next chapter, our analysis approach will remain almost the same as presented in this chapter in the sense that we have to recalculate the probability of collision to quantify the impact of TDM-based protocol. To do so, we have to identify the distribution of the inter-arrival time between successive Wi-Fi frames. Besides, the Markov chain presented in this chapter that models the progress of the interaction over time will be replaced by the Bianchi's Markov chain in [23]. The analysis and results that we will show in the next chapter are found thanks to our framework presented in this chapter which draw our strategy.

*Il ne faut pas compter sur ceux qui ont créé les problèmes pour les résoudre*

Albert Einstein

# 4

## TDM-based Protocol: Modeling and Performance Analysis of LTE/Wi-Fi Coexistence

In this chapter, we continue to evaluate LTE/Wi-Fi performance in coexistence scenarios where LTE adopts TDM-based protocol as in chapter 3. However, in this chapter, we will consider Wi-Fi uplink and downlink traffic, in other words, we consider  $n$  Wi-Fi stations coexisting and contending the channel access with LTE. Our research approach remains almost the same as in chapter 3 in the sense that we have to quantify the negative impact of LTE TDM-based protocol on Wi-Fi DCF protocol through the probability of collision, to end by evaluating both LTE and Wi-Fi performance. Moreover, as in chapter 3, we model Wi-Fi transmission activities as a renewal process or more precisely as a random walk during LTE-off periods. In contrast, the Markov chain presented in chapter 3 that models the progress of the LTE/Wi-Fi interaction over time will be replaced by the well-known Bianchi's Markov chain model for Wi-Fi. Based on Bianchi's model, we are able to define a new Wi-Fi random walk. That is completely different than the one adopted in chapter 3. Accordingly, we obtain a first LTE/Wi-Fi analytical model

that we call the slot-by-slot random walk model. In fact, the slot-by-slot random walk model is not enough for evaluating LTE/Wi-Fi performance since it cannot provide all the information that is needed for fully describing LTE/Wi-Fi interaction over the channel. For this reason, we continue to adopt our previous approach presented in previous chapter 3 regarding to modeling Wi-Fi activities as a succession of frame transmissions to end up with a second model that we call the frame-by-frame random walk model. Actually, the two models are complementary and essential for fully understanding LTE/Wi-Fi coexistence.

In this chapter, we investigate deeply this fundamental question: How LTE can adopt efficiently a TDM-based protocol in order to coexist fairly with Wi-Fi? We answer this question through a sophisticated analysis that quantifies the negative impact of adopting TDM-based MAC protocol on Wi-Fi performance. We compute analytically the probability of collision between the two systems and we derive both LTE and Wi-Fi saturation throughput.

In this chapter, our contributions are summarized as follows:

- We combine several analytical models and refinements for a Wi-Fi network that operates alone over the channel based on a state-of-the-art review.
- We build on our refined model for Wi-Fi network to study the coexistence between LTE and Wi-Fi using two complementary analytical model approaches.
- We reintroduce and redescribe the notion of random walk in studying 802.11 Mac performance. We prove that our analytical analysis is general enough to be used in order to analyze other coexistence scenarios.
- We include the capture effect in the model to enable the consideration of classic and recent 802.11 PHY standards which introduce a number of novel features.
- We validate our analytical analysis through an extensive simulation study using NS3.
- We show that LTE negative impact on Wi-Fi performance could be compensated relying on our model. The impact of Wi-Fi packet size and TDM-based LTE parameters are highlighted.

This chapter is outlined as follows. In section 4.1, before of all, we revisit Wi-Fi analytical models without considering the coexistence with LTE. The reason of this revisiting is two folds: (i) Establish a more accurate Wi-Fi model before considering the coexistence with LTE

(ii) Provide a good introduction that is needed for building our LTE/Wi-Fi analytical models. In section 4.2, we provide the two new analytical models for Wi-Fi that coexists with LTE where we quantify the impact of LTE on Wi-Fi performance as well as considering the capture effect. In section 4.3, we provide the LTE analytical model that has been postponed from previous chapter 3. Section 4.4 consolidates the accuracy of our models through NS3 simulations. There, we investigate the performance of Wi-Fi in various LTE TDM schemes and Wi-Fi configurations. Finally, Section 4.5 summarizes this chapter.

#### 4.1 REVISITING WI-FI ANALYTICAL MODELS

Wi-Fi performance was studied through various analytical models that aim to capture the behavior and the procedures of the IEEE 802.11 standard MAC layer protocol and more precisely the DCF protocol. Some of these models have successfully followed the standard in many technical aspects while they have failed to consider few other aspects. In this section, based on a state-of-the-art review, we present the most recent and accurate analytical model that was established for a Wi-Fi network consisting of  $n$  Wi-Fi stations. Indeed, we have harmonized between previous analytical models [129, 23, 119]. Then, we develop our novel analytical models for a Wi-Fi network that coexists with LTE based on two different approaches (subsection 4.2). First, as in [23], we use the same assumptions (i.e. saturation condition and ideal channel condition) to model the behavior of a single Wi-Fi station using a bidirectional discrete time Markov chain. Unfortunately, [23]'s Markov chain model and throughput analysis do not fit perfectly with the IEEE 802.11 MAC protocol. In [129], the authors proposed a first refinement by considering the finite retransmission limit of a Wi-Fi frame, which leads to a different Markov chain as shown in Figure 4.1.  $W_i$  in the figure refers to the contention window (CW) of the  $i^{th}$  backoff stage,  $i \in (0, \dots, m)$  and  $m$  is the maximum backoff stage or the maximum retransmission limit. The contention window CW is doubled whenever unsuccessful transmission occurs:  $W_i = 2^i W_0$ , and  $i \leq m'$ , where  $m' = \log_2 \frac{CW_{max}}{CW_{min}}$  with  $CW_{min} = W_0$ .  $CW_{max}$  denotes the minimum and maximum CW respectively. Whereas, for  $i > m'$ , CW is hold on  $CW_{max}$ .

The key parameter in the Markov chain of Figure 4.1 is  $p$  which is the conditional collision probability, indicating that this is the probability of collision faced by a frame being transmitted on the channel. By considering that the Wi-Fi communication is divided into time slots and by solving the Markov chain for  $m > m'$ , we determine the second key parameter  $\tau$  which is the probability that a station transmits in a randomly chosen time slot. This is done by summing

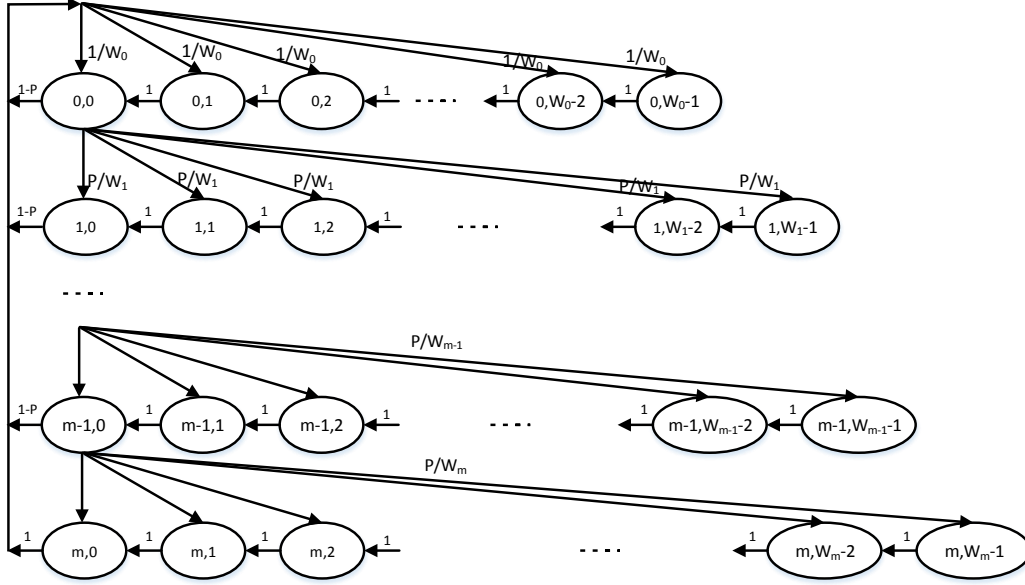


Figure 4.1: Markov chain model for Wi-Fi stations [129].

the probabilities of the states whenever the backoff counter equals zero, i.e. the states of the first column. This yields

$$\tau = \frac{2(1 - p^{m+1})}{W_0(1 - (2p)^{m'+1})\frac{(1-p)}{(1-2p)} + (1 - p^{m'+1}) + W_0 2^{m'} p^{m'+1} (1 - p^{m-m'})} \quad (4.1)$$

Besides,  $p$  can be expressed as

$$p = 1 - (1 - \tau)^{n-1} \quad (4.2)$$

Equations (4.1) and (4.2) establish a fixed point formulation from which  $\tau$  and  $p$  can be determined. These two parameters describe the transmission activity in the Wi-Fi network and are then used to compute the saturation throughput. In a randomly chosen slot, different situations can happen that define the state and the duration of the slot. First, if no station is transmitting during a slot, the state of slot is *idle*. Second, if exactly one station is transmitting, the slot experiences a *successful* transmission. Third, if more than one station transmits, the slot experiences a *collision*. Therefore, the slot is busy whenever at least one station transmits. In other words, a busy slot is a successful slot or a slot with collision. Accordingly, let  $(P_{id}, T_{id})$ ,  $(P_s, T_s)$  and  $(P_c, T_c)$  denote the pair of probability and duration of a slot in the states idle,

successful and collision respectively. As in [119], it easily follows that

$$\begin{aligned}
P_{id} &= (1 - \tau)^n, & T_{id} &= \delta \\
P_s &= n\tau(1 - \tau)^{n-1}, & T_s &= (T_f + DIFS)\left(\frac{W_0}{W_0 - 1}\right) + \delta \\
P_c &= 1 - P_{id} - P_s, & T_c &= T_f + DIFS + \delta
\end{aligned} \tag{4.3}$$

Where  $\delta$  is the empty slot time, DIFS is the Distributed InterFrame Space time and  $T_f = T_{MPDU} + SIFS + T_{ACK}$  is the frame transmission time which includes the time to transmit the MAC Protocol Data Unit MPDU ( $T_{MPDU}$ ) followed by the Short Interframe Space time (SIFS) and the ACK transmission time ( $T_{ACK}$ ). Actually, the reason why  $T_s$  is not equal to  $T_c$  is due to the possibility of transmitting several successful frames by the same station in the same slot without interruption by other stations. Indeed, a station can win the access several times in a row. Such slot is called anomalous slot. This is another refinement of [23]'s model which has been explored in [119]. Now, we can express the normalized throughput  $S$  as [119]

$$\Gamma = \frac{P_s T_{PL}}{E[slot]} = \frac{P_s T_{PL}}{P_{id} T_{id} + P_s T_s + P_c T_c} \tag{4.4}$$

Where  $T_{PL} = \left(\frac{W_0}{W_0 - 1}\right)t_{PL}$  is the correction of  $t_{PL}$ , the packet payload duration, due to the anomalous slot.  $E[slot]$  denotes the mean slot duration.

#### 4.2 NEW WI-FI ANALYTICAL MODELS

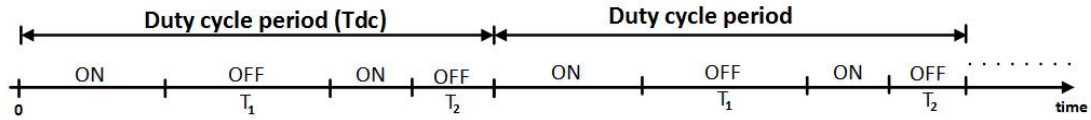


Figure 4.2: TDM-based protocol (Duty Cycled LTE)

Now we consider the coexistence scenario where LTE shares the spectrum with  $n$  Wi-Fi stations using a TDM-based protocol. As shown in Figure 4.2, LTE transmission is activated/deactivated according to an on/off pattern to form the so-called Duty Cycled LTE which is configured by different parameters. The duty cycle period  $T_{dc}$  that determines how long it takes to the pattern to be repeated again. The number of off-periods  $K$  over the duty cycle period which represents the number of disjoint access channel opportunities offered to Wi-Fi during a duty cycle period. Finally, the duty cycle percentage which is the portion of time where the LTE is activated

over the duty cycle period. Practically speaking, Wi-Fi access the channel during different durations of LTE off-periods over each duty cycle. Let us adopt the notation  $T_k$  for such off-periods where  $k \in (1, \dots, K)$ . The tying up between Duty Cycled LTE configuration parameters (i.e.  $K, T_k$  and  $T_{dc}$ ) and Wi-Fi performance is one of the important theoretical contributions of this work. As a result, it becomes malleable to configure LTE parameters so that the spectrum is shared adequately between the two systems.

Evidently, a first LTE negative impact on Wi-Fi performance can be captured by a positive drift in the collision probability  $p$  shown in Figure 4.1 and computed in equation (4.2). It is clear that this drift is considered only when an LTE on-period starts during an ongoing Wi-Fi successful transmission, or by another meaning, an ongoing Wi-Fi transmission without collisions with other Wi-Fi transmissions. As a matter of fact, when LTE on-period starts during a collision among Wi-Fi stations, it does not cause an additional collision. Nevertheless, we will see later that the starting time of the LTE on-period does impact the Wi-Fi performance even during a Wi-Fi collision. We define the LTE probability,  $p_{lte}$ , to be the probability that an on-period starts during an ongoing transmission *whether it is a successful transmission or not*. Thus, the new collision probability of Wi-Fi coexisting with LTE can be rewritten as

$$p = 1 - (1 - \tau)^{n-1} + (1 - \tau)^{n-1}p_{lte} \quad (4.5)$$

Our strategy is best understood by remarking that the “interaction” between the two networks occurs exactly at the end of each  $T_k$  period, possibly in the form of a collision. Therefore, the first step of our strategy is to find an appropriate expression for  $p_{lte}$  to take into account the impact of LTE on Wi-Fi. Accordingly, equations (4.1) and (4.5) formulate our new fixed point system which will enable us to determine Wi-Fi throughput. To do so, we provide two different approaches based on how we model the transmissions in the Wi-Fi network during LTE off-periods. In the second step of our strategy, we provide a new Wi-Fi throughput formulae different than equation (4.4) depending on the adopted modeling approach. We call the two approaches as slot-by-slot random walk and frame-by-frame random walk.

#### 4.2.1 SLOT-BY-SLOT RANDOM WALK MODEL

In this approach, in order to build our new fixed point system and determine  $p_{lte}$ , we model Wi-Fi transmissions during LTE off-periods as a random walk interrupted or stopped by LTE arrival, i.e. starting of LTE on-period (Figure 4.3). The random variable that defines the random walk corresponds to the slot duration. Remember a slot can be empty or busy as mentioned in the previous subsection. The slot-by-slot random walk describes the fact that Wi-Fi



Figure 4.3: Slot-by-Slot random walk model for Wi-Fi.

transmissions are slotted and thus constitutes a succession of slots alternating randomly between idle and busy. Notice that at the beginning of each off-period, Wi-Fi stations have to wait for a period of  $DIFS + \delta$  before starting any transmissions [36]. Thus, the random walk starts at  $DIFS + \delta$  and terminates at  $T_k$ . Let  $Z$  be the random variable representing the slot duration. Its probability density function is the following

$$P(Z = T) = \begin{cases} P_b & \text{for } T = T_b \\ P_{id} & \text{for } T = T_{id} \end{cases} \quad (4.6)$$

Where  $P_b = P_s + P_c$  denotes the probability that the slot is a busy slot and  $T_b = T_f + DIFS + \delta$  is its duration. Only at this stage of our analysis we forsake the second refinement of [23]'s model (i.e.  $T_s \neq T_c$ ) in our random walk since the second refinement provides the *average* of the anomalous slot while here we need *full* slots. Thus, two successive successful transmissions are fully counted in the random walk. Now, let  $N_k$  be the random variable that counts the number of slots which could be occurred during any  $T_k$  period. A slot that has been stopped by an on-period without terminating is considered as it has been occurred (See Figure 4.3). Consequently, the probability that  $n$  slots occur during any  $T_k$  period can be written as [101]

$$Pr\{N_k = n\} = Pr\left\{\sum_{j=1}^{n-1} z_j < T_k - DIFS - \delta\right\} - Pr\left\{\sum_{j=1}^n z_j < T_k - DIFS - \delta\right\} \quad (4.7)$$

For a given  $T_k$  period,  $N_k$  has an upper bound  $nmax$ , which means that  $Pr\{N_k > nmax\} = 0$ , where  $nmax = \lceil T_k / \delta \rceil$ . Hence, we compute the expected number of busy slots that occur in  $T_k$  period,  $E[N_k^b]$ , as follows

$$E[N_k^b] = P_b E[N_k] = P_b \sum_{n=1}^{nmax} n Pr\{N_k = n\} \quad (4.8)$$

According to  $p_{lte}$  definition mentioned above, the collision occurs only if the last slot is a busy slot and the on-period starts exactly during the frame transmission portion of the busy slot



which means  $T_f$  in equation (4.3). Unfortunately, the slot-by-slot model is limited because it does not dissociate between the two portions of time inside a busy slot which are  $T_f$  and  $DIFS + \delta$ . This is due to the slot vision defined in [23] and that we are using in this first approach. It leads to not knowing when exactly the on-period starts during a busy slot. We can still approximate  $p_{lte}$  as follows

$$p_{lte} = \frac{K}{\sum_{k=1}^K E[N_k^b]} \quad (4.9)$$

The numerator of the above formula is an approximation of the average number of busy slots that occur at the end of the off-period (random walk). In other words, it is the average number of off-periods terminating with a busy slot. Typically, this number is lower or equal to  $K$ . The approximation relies on the fact that the total duration of idle slots is very low compared to the duration of frame transmissions, so that the probability of having an on-period starts at an idle slot is low. Now, similarly to equation (4.4), we express the Wi-Fi throughput over a duty cycle period as follows

$$\Gamma_1 = \frac{\left( P_s(1 - p_{lte}) \sum_{k=1}^K E[N_k] \right) * T_{PL}}{T_{dc}} \quad (4.10)$$

Where  $P_s(1 - p_{lte})$  is the probability that a slot is successful and the transmitted frame in that slot does not collide with LTE. We can show that  $N_k$  is a stopping time with respect to  $\{z_j\}$  because  $Pr\{N_k = n\}$  is totally determined through all  $z_j, j \in 1 \dots n$ . Hence, using Wald's equality [101], we have

$$E[N_k]E[Z] = T_k - DIFS - \delta + E[R_k] \quad (4.11)$$

Where  $E[R_k]$  represents the expected residual life time of  $\sum_{j=1}^n z_j, n \geq 1$  with respect to  $T_k - DIFS - \delta$ . Actually,  $E[R_k]$  brings the second and more important information required to adjust the throughput in (4.4) to take into account the coexistence with LTE. This becomes clear by remarking that  $E[Z] = E[slot]$  and by substituting equation (4.11) into equation (4.10). We obtain the modified version of (4.4) which takes into account the coexistence with LTE.

$$\Gamma_1 = \Gamma * (1 - p_{lte}) \frac{\sum_{k=1}^K (T_k - DIFS - \delta + E[R_k])}{T_{dc}} \quad (4.12)$$

To summarize, in order to compute the Wi-Fi throughput coexisting with LTE through equation (4.12), we determine first  $p$  and  $\tau$  using the new fixed point system which involves equation (4.9) as well. Then, we compute  $p_{lte}$  using (4.9) and  $E[R_k]$  using equations (4.7),

(4.8) and (4.11) (Wald's equality). It is worthwhile noticing that the formula of throughput in (4.12) is general enough so that any other method or approximation can be used to compute  $p_{lte}$  and  $E[R_k]$ . Hence, naturally we show in the next paragraph how to compute the coexistence throughput using the classic exponential approximation. Also, other LTE on/off patterns can be studied using the model because they are captured by the two parameters  $p_{lte}$  and  $E[R_k]$ .

#### 4.2.2 EXPONENTIAL MODEL FOR LTE

Here, we assume that the LTE off-period time is drawn from an exponential distribution with a mean equals to the real fixed duration of the off-period. Through the following analysis and numerical results shown later, we will prove that Duty Cycled LTE cannot be well approximated by the "exponential distribution" or even considered as a special case of an exponential LTE as has been remarked in [16]. Accordingly, exponential numerical results display a smooth Wi-Fi throughput while varying the frame size whereas the exact slot-by-slot model and simulations display a more complex behavior with periodicity and fluctuations (See Simulation Section for more details). Finally, we notice that unlike [16], our exponential model covers the case where on-periods are long, again thanks to the expected residual life time term mentioned above. Now, let's first compute  $p_{lte}$  for an exponential off-period with mean  $T_k$ . It is equal to the probability that the frame transmission time  $T_f$  is larger than the remaining time of the off-period, formally written exactly as follows

$$Pr\{\text{off-period} \leq T_f\} = 1 - e^{-T_f/T_k} \quad (4.13)$$

This is because the distribution of the remaining time is also exponentially distributed with the same mean. Equivalently, we can see LTE arrivals as a Poisson process with mean  $\mathfrak{R}_k = \frac{1}{T_k}$ . For  $K$  off-periods, we can write approximately

$$p_{lte} = 1 - e^{-\mathfrak{R}T_f}, \quad \mathfrak{R} = K / \left( \sum_{k=1}^K T_k \right) \quad (4.14)$$

where  $\mathfrak{R}$  is LTE arrival rate during all off-periods. Alternatively, we can compute the probability as a weighted sum by conditioning on the probability that a frame is being transmitted in the  $k^{th}$  off-period:

$$p_{lte} = \sum_{k=1}^K T_k (1 - e^{-\mathfrak{R}_k T_f}) / \sum_{k=1}^K T_k \quad (4.15)$$

Our simulation results show that both approximations are acceptable. Solving (4.14) (or (4.15)), (4.5) and (4.1) yields  $\tau$ . To calculate the throughput in (4.12), we determine  $E[R_k]$  as

$$E[R_k] = P_b(T_b - E[TT_b]) + P_{id}(\delta - E[T\delta]) \quad (4.16)$$

where  $E[TT_b]$  is the expected time before on-period starts during a  $T_b$  period.  $E[T\delta]$  is defined equivalently. These are calculated using standard formulae for truncated exponential distributions:

$$E[TT_b] = \frac{1}{\mathfrak{R}_k} - \frac{T_b e^{-\mathfrak{R}_k T_b}}{1 - e^{-\mathfrak{R}_k T_b}}, \quad E[T\delta] = \frac{1}{\mathfrak{R}_k} - \frac{\delta e^{-\mathfrak{R}_k \delta}}{1 - e^{-\mathfrak{R}_k \delta}} \quad (4.17)$$

#### 4.2.3 FRAME-BY-FRAME RANDOM WALK MODEL

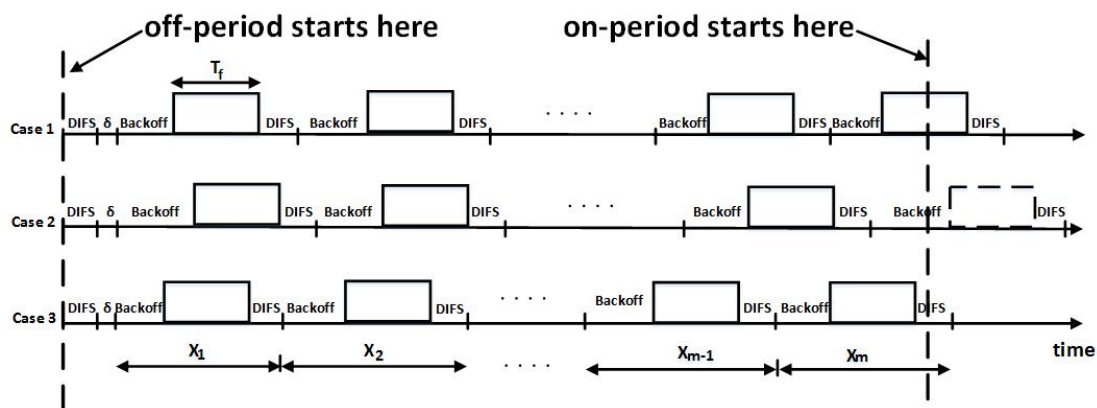


Figure 4.4: Frame-by-Frame random walk model for Wi-Fi

To avoid the approximation made in (4.9), we model the Wi-Fi transmission during off-periods as a succession of transmission rounds stopped by LTE arrivals which is exactly what was shown in the chapter 3. This forms our frame-by-frame random walk because in each round there will be only one  $T_f$  period (Figure 4.4). Remember during a  $T_f$  period, we can have one or several transmitted frames in parallel. A transmission round consists of a random backoff period, followed by the frame transmission(s) period  $T_f$ , terminated by a sensing period  $DIFS$ . Let  $X$  be the random variable denoting the amount of time needed to each transmission round

$$X = \delta * BF + T_f + DIFS \quad (4.18)$$

Where  $BF$  is a random variable that depicts the backoff counter before the frame transmission(s) period. To fully determine  $X$ , we define the probability mass function of  $BF$  as

$$P(BF = j) = \begin{cases} \frac{1}{\eta W_0} & \text{for } j = 0 \\ \frac{1}{\eta} (1 - P_b)^j P_b & \text{for } 1 \leq j \leq W_{m-1} \end{cases} \quad (4.19)$$

Where

$$\eta = (1/W_0) + (1 - P_b)(1 - (1 - P_b)^{W_{m-1}})$$

is a normalization term to ensure that the probability of each backoff counter follows a valid probability distribution. To clarify, the  $BF$ 's distribution cannot follow a geometric distribution because of the existence of the anomalous slots mentioned in [119]. Now, let  $M_k$  be the random variable that counts the number of rounds occurred during any  $T_k$  period. According to (4.18), the total time needed to have  $m$  rounds during any  $T_k$  period is equal to  $\sum_{j=1}^m x_j$ . Hence, the probability of having  $m$  rounds during any  $T_k$  period can be written as

$$Pr\{M_k = m\} = Pr\left\{\sum_{j=1}^{m-1} x_j < T_k - DIFS - \delta\right\} - Pr\left\{\sum_{j=1}^m x_j < T_k - DIFS - \delta\right\} \quad (4.20)$$

We also emphasize that the above probability is the probability that the first  $m - 1$  rounds were fully terminated without interruption by the next on-period whereas the  $m^{th}$  round is interrupted by the starting of the next on-period. This interruption happens according to three possible scenarios. (i) on-period starts during  $T_f$ , (ii) on-period starts during DIFS, and (iii) on-period starts during backoff period. We call the corresponding rounds collided, successful and frozen respectively. We compute the probability of each scenario for a given  $m$  as follows

$$\begin{aligned} Pr\{c_k, m\} &= Pr\left\{\sum_{j=1}^m x_j - T_f \leq T_k \leq \sum_{j=1}^m x_j\right\} \\ Pr\{s_k, m\} &= Pr\left\{\sum_{j=1}^m x_j < T_k \leq \sum_{j=1}^m x_j + DIFS + \delta\right\} \\ Pr\{f_k, m\} &= Pr\left\{\sum_{j=1}^{m-1} x_j + DIFS + \delta < T_k < \sum_{j=1}^m x_j - T_f\right\} \end{aligned} \quad (4.21)$$

For a given  $T_k$  period,  $M_k$  has an upper bound  $mmax$ , where  $mmax = \lceil T_k/xmin \rceil$  with  $xmin = DIFS + T_f$ . Besides, we notice that the event  $\{M_k = m\}$  is included in the event  $\{c_k, m\}$ . Hence, the probability that the last round in an off-period is a collided one is

expressed as

$$Pr\{c_k\} = \sum_{m=1}^{mmax} Pr\{c_k, m\} \quad (4.22)$$

$Pr\{s_k\}$  and  $Pr\{f_k\}$  are similarly written as (4.22) from (4.21). Now,  $p_{lte}$  is calculated over a duty cycle period as

$$p_{lte} = \frac{\sum_{k=1}^K Pr\{c_k\}}{\sum_{k=1}^K (E[M_k] - Pr\{f_k\})} \quad (4.23)$$

Where  $E[M_k] = \sum_{m=1}^{mmax} m Pr\{M_k = m\}$  is the expected number of transmission rounds during a  $T_k$  period regardless of the  $m^{th}$  round was a collision, successful or frozen round. The  $Pr\{f_k\}$  term is necessary to not count the frozen round.

Up to this point of the analysis, equations (4.23), (4.5) and (4.1) represent our new fixed point formulation. Now, we compute differently the throughput based on counting the number of successful Wi-Fi frames during off-periods unlike (4.12). In fact, during  $T_k$  period, the expected number of successful rounds,  $E[S_k]$ , can be calculated by using the fact that the first  $m - 1$  rounds are of type successful, which means no interruption by LTE, whereas the last one is only successful with probability  $Pr\{s_k\}$ . Hence,

$$E[S_k] = E[M_k] - 1 + Pr\{s_k\} \quad (4.24)$$

For the throughput, we consider only the ratio of  $E[S_k]$  where only one Wi-Fi station transmits alone on the channel. Simply, the ratio is the probability that a slot is a successful slot given it is a busy slot denoted by  $P_{s|b} = P_s/P_b$ . Finally, the Wi-Fi throughput is expressed as

$$\Gamma_2 = \frac{P_{s|b} \sum_{k=1}^K E[S_k]}{T_{dc}} \quad frame/sec \quad (4.25)$$

#### 4.2.4 LINKING THE TWO ANALYTICAL MODELS

In fact, the two previous analytical approaches model the same Wi-Fi network behavior during off-periods while providing different informations about the interaction between Wi-Fi and LTE networks. The slot-by-slot random walk approach determines the expected residual life time of Wi-Fi transmission after the arrival of LTE whereas it fails to determine exactly the probability of collision between LTE starting and a single ongoing Wi-Fi frame transmission. In contrast, the frame-by-frame random walk is able to determine exactly the probability of collision with the price of loosing the information on the residual life time of Wi-Fi transmission. Besides, it requires precise computation of the backoff period distribution. The two

approaches are complementary and can be mixed together to determine the Wi-Fi throughput. For example, we can establish our new fixed point system through equations (4.23), (4.5) and (4.1) to yield  $\tau$ , then use equation (4.12) to calculate the throughput. Moreover, by deeply looking into the two models, one realize that it is possible to join between them through the expected number of busy slots, i.e. the number of transmission rounds occurred inside off-periods as follows

$$E[N_k^b] = E[M_k] - Pr\{f_k\} \quad (4.26)$$

#### 4.2.5 WI-FI MODEL WITH CAPTURE EFFECT

So far, the analytical models have focused on capturing the behavior of the Mac layer. It is possible though to consider the capture effect [109] between Wi-Fi and LTE that is a Wi-Fi frame can survive the collision with LTE transmission and be successfully received. It leads also to account for several PHY layer parameters such as transmission powers and antenna gains. The capture probability between LTE and Wi-Fi is equal to  $(1 - BER)^L$  where  $L$  is the number of noisy bits [40]. Equivalently, the capture probability is equal to  $(1 - BER)^{CBR \times r}$  where  $r$  is the overlapping duration between the LTE and Wi-Fi transmission. Thus, the capture probability is computed as

$$p_{cap} = \sum_{k=1}^K \int_0^{T_b} pdf_{R_k}(r) (1 - BER)^{CBR \times r} dr / K \quad (4.27)$$

Where  $pdf_{R_k}()$  is the probability distribution function of the residual life time for the  $k^{th}$  off-period. CBR is the Wi-Fi Channel Bit Rate and BER is the bit error rate probability calculated depending on the signal to noise and interference ratio (SINR) and the modulation and coding scheme. In general, it is not tractable to express the distribution of  $R_k$ . We can use the Jensen's Inequality to approximate  $p_{cap}$  as follows

$$p_{cap} \approx \frac{\sum_{k=1}^K (1 - BER)^{CBR \times E[R_k]}}{K} \quad (4.28)$$

In reality, the above expression is a lower bound on the capture probability because  $(1 - BER)^{CBR \times r}$  is a convex function. Accordingly, (4.5) must be modified to take into consideration the capture effect as

$$p = 1 - (1 - \tau)^{n-1} + (1 - \tau)^{n-1} p_{lte} (1 - p_{cap}) \quad (4.29)$$

Now, (4.29) and (4.1) formulate our new fixed point system that yields  $\tau$ . Next, we similarly revise the throughput formula (4.12) to account for the capture effect as follows

$$\Gamma_3 = \Gamma * \frac{(1 - p_{lte}(1 - p_{cap})) \sum_{k=1}^K (T_k - DIFS + E[R_k])}{T_{dc}} \quad (4.30)$$

#### 4.3 LTE ANALYTICAL MODEL

Now, we turn our attention to evaluate LTE throughput performance. Indeed, evaluating LTE performance is a straightforward analysis since the probability of collision between LTE and Wi-Fi has been calculated. Remember that, at the beginning of LTE on-period, LTE has a probability of a collision with Wi-Fi that is given by Equation (4.22). Here again, we realize the necessity of the frame-by-frame random walk model for LTE throughput evaluation since slot-by-slot random walk model is based on the assumption that LTE always collides with Wi-Fi at the beginning of LTE on-period. Let us adopt the notation  $T_k^{on}$  for LTE on-periods where  $k \in (0, \dots, K - 1)$ . Accordingly, LTE performance could be expressed as follows

$$\Gamma_1^{LTE} = \frac{\sum_{k=0}^{K-1} (1 - Pr\{c_k\}) T_k^{on}}{T_{dc} * T_{LTE}} \quad frame/sec \quad (4.31)$$

Where  $Pr\{c_0\} = Pr\{c_K\}$  since the LTE off-period that comes before the first LTE on-period within a duty cycle is the last LTE off-period within the previous duty cycle. Moreover, we normalized  $\Gamma_1^{LTE}$  with respect to the traditional LTE frame duration  $T_{LTE} = 10ms$ . Interestingly, Equation (4.31) indicates that it is not only the LTE configuration parameters (i.e.  $K$ ,  $T_k$  and  $T_{dc}$ ) mentioned previously that impact LTE performance, but also the order of on/off periods within a duty cycle can change LTE performance. Indeed, the probability of successfully transmitting during an LTE on-period  $T_k^{on}$  depends on  $Pr\{c_k\}$  which determined by the duration of LTE-off period  $T_k$  preceding that  $T_k^{on}$ . In such case, a different LTE-off period  $T_k$  preceding the same  $T_k^{on}$  leads to a different LTE performance. However, we emphasize that the order of on/off periods within a duty cycle does not matter for Wi-Fi performance as it could be seen from Equations (4.12) where the probability of successfully transmitting a Wi-Fi frame is out from the sum of the equation.

Equation (4.31) considers that whenever LTE collides with Wi-Fi, all the entire LTE on-period  $T_k^{on}$  is considered as a lost frame. However, in reality, the collision between LTE and Wi-Fi is accrued only over a portion of time of LTE on-periods  $T_k^{on}$ . As a result, LTE through-

put could be improved by the other portion of time of LTE  $T_k^{on}$  period that does not overlap with the Wi-Fi transmission. Indeed, the portion of time of LTE on-periods  $T_k^{on}$  that overlaps with Wi-Fi frame transmission is well determined through the slot-by-slot random walk model thanks to the expected residual life time of Wi-Fi transmission  $E[R_k]$ . Accordingly, we calculate the expected duration of LTE  $T_k^{on}$  period that does not overlap with Wi-Fi transmission as follows

$$E[T_k^{on}] = Pr\{c_k\}(T_k^{on} + DIFS + \delta - E[R_k]) + (1 - Pr\{c_k\})T_k^{on} \quad (4.32)$$

Remember that, slot-by-slot model assumes that the latest Wi-Fi slot at the end of each LTE-off period is a busy slot with  $T_b = T_f + DIFS + \delta$ . Equation (4.32) follows this approximation so that we have to add  $DIFS + \delta$  to  $E[R_k]$ . Now, we reformulate Equation (4.31) using the expected duration of LTE  $T_k^{on}$  period as follows

$$\Gamma_2^{LTE} \simeq \frac{\sum_{k=0}^{K-1} E[T_k^{on}]}{T_{dc} * T_{LTE}} \quad frame/sec \quad (4.33)$$

Finally, equations (4.33) and (4.32) show clearly how much our two analytical models are complementary and essential to fully understand LTE/Wi-Fi coexistence.

#### 4.4 MODELS VALIDATION AND SIMULATION RESULTS

To validate our analytical model, we simulate different coexistence scenarios between Wi-Fi and LTE using NS3 simulator. We set up a IEEE 802.11 network consisting of  $n$  stations with configuration parameters as reported in Table 4.1. Without losing the generality of our analysis, LTE transmission duty cycle period is fixed to 10ms corresponding to LTE frame duration with duty cycle percentage of 50%. We adopt different configurations of the duty cycle as follows. 5x0 configuration: LTE transmission is activated for 5ms then deactivated for the rest of LTE frame duration. 3x2 configuration: LTE transmission is activated for 3ms then deactivated for same amount of time before it is reactivated again for 2ms. Consequently, the Wi-Fi gets two disjoint transmission opportunities in the same LTE frame to access the channel ( $K = 2$ ). Finally, 4x1 configuration: similar to the previous one except we replace 3ms by 4ms, and we replace 2ms by 1ms.

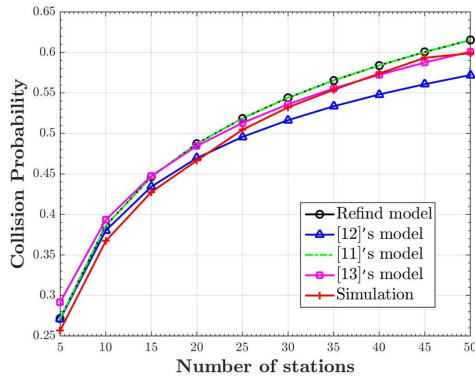


Simulation time	50s	Mac header	36 bytes
Packet size (pksize)	11 ~ 2200 bytes	CBR	6, 12 and 24 Mbps
Channel bandwidth	20 MHz	Slot time ( $\delta$ )	9 $\mu$ s
ACK packet	14 bytes	SIFS	16 $\mu$ s
UDP header	8 bytes	DIFS	34 $\mu$ s
IP header	20 bytes		

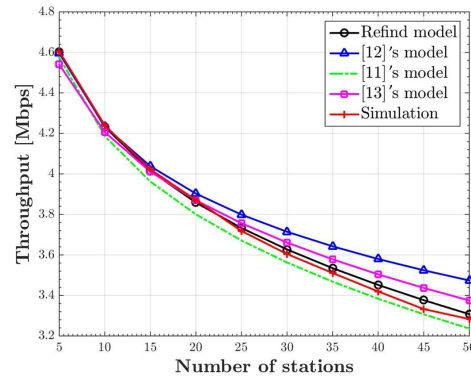
**Table 4.1:** Wi-Fi configuration parameters used in the comparison between NS3 simulations and the analytical model

#### 4.4.1 VALIDATION THROUGH SIMULATION AND OBSERVATIONS

We first verify the accuracy and the utility of our refined model of Wi-Fi when it operates alone on the channel. Figures 4.5 and 4.6 show that our refined model is the closest to simulation results for both collision probability ( $p$ ) and throughput ( $\Gamma$ ) in comparison with the other analytical models, i.e. the models proposed in [23], [128], [119].

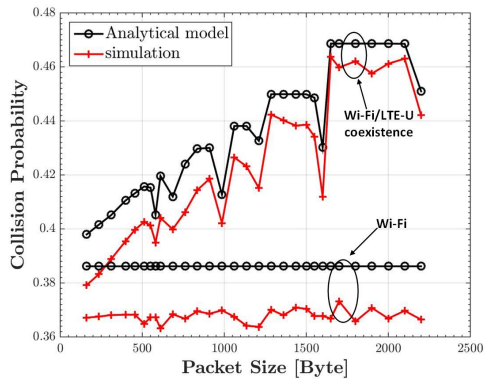


**Figure 4.5:** Collision probability versus network size: pksize=1500bytes and CBR=6 Mbps.

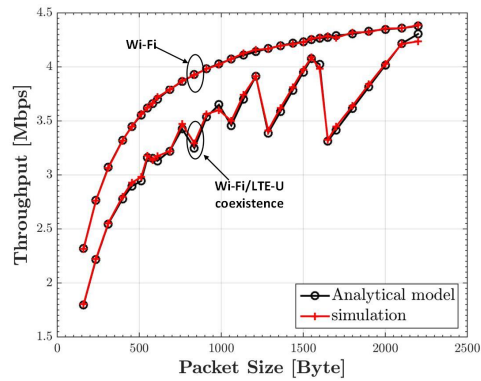


**Figure 4.6:** Wi-Fi throughput versus network size: pksize=1500 bytes and CBR=6Mbps.

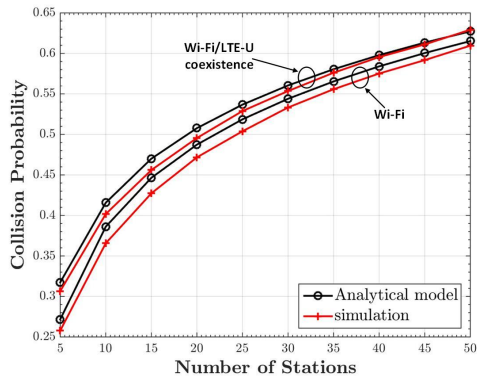
Now, we turn our attention to the coexistence between Wi-Fi and LTE. We start by validating our final frame-by-frame random walk model against NS3 results as shown in Figures 4.7 and 4.8 for a 12Mbps channel. To clarify the impact of LTE on Wi-Fi, we plot also in the same Figures the Wi-Fi collision probability and throughput performance when Wi-Fi operates alone on a 6Mbps channel. This is referred as *Wi-Fi* on the Figures. In coexistence scenario, the model results follow exactly the behavior of simulations for both collision probability and throughput ( $\Gamma_2$ ). The relative error observed from the model of Wi-Fi alone is kept the same for the coexistence meaning that our frame-by-frame random walk model is able to find precisely the additional impact of LTE on Wi-Fi. We will analyze and explain the plots later on.



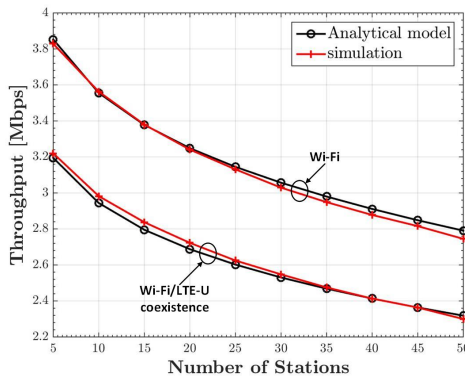
**Figure 4.7:** Frame-by-Frame model. Collision probability versus packet size:  $n=10$ , CBR = 12Mbps and LTE 5x0 configuration



**Figure 4.8:** Frame-by-Frame model. Wi-Fi throughput versus packet size:  $n=10$ , CBR = 12Mbps and LTE 5x0 configuration



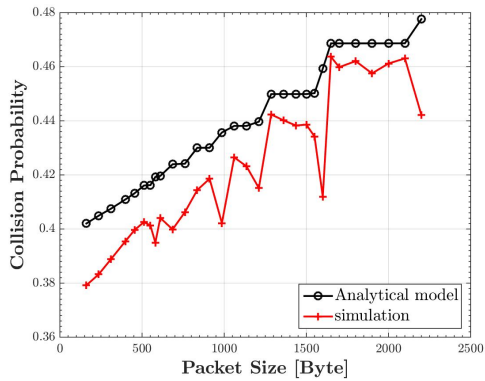
**Figure 4.9:** Frame-by-Frame model. Collision probability versus network size: psize= 512bytes, CBR=12Mbps and LTE 5x0 configuration



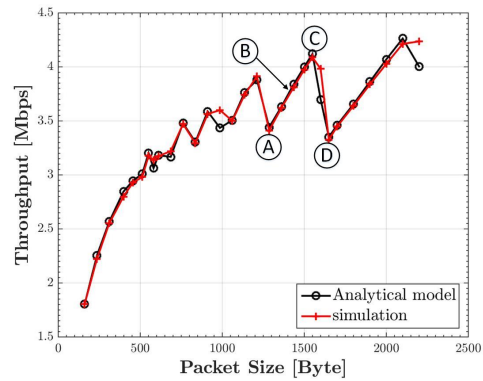
**Figure 4.10:** Frame-by-Frame model. Wi-Fi throughput versus network size: psize=512 bytes, CBR=12Mbps and LTE 5x0 configuration

Moreover, we continue to validate our model for different numbers of Wi-Fi stations as shown in Figures 4.9 and 4.10.

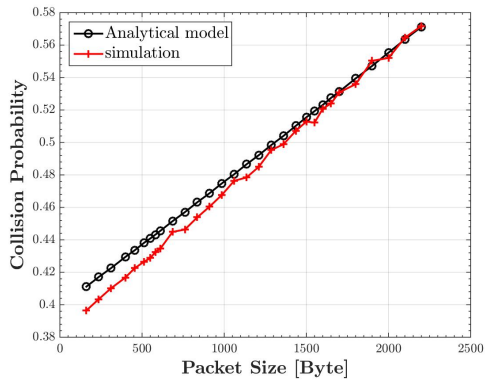
Figures 4.11 and 4.12 present the analytical results obtained by the slot-by-slot random walk model. We observe that globally the model is very accurate except for certain packet sizes, e.g. 986 and 1600 bytes where the model overestimates the collision probability. This is attributed to the approximation made in equation ((4.9)). Actually, the overestimation happens when the probability that the on-period starts during a *DIFS* or backoff period is high. As a matter of fact, for the mentioned packet sizes, the throughput is maximized because collisions with LTE is low. Although the slot-by-slot model is not too accurate to calculate the collision probability for all packet sizes, it is sufficiently accurate to calculate the Wi-Fi throughput with a



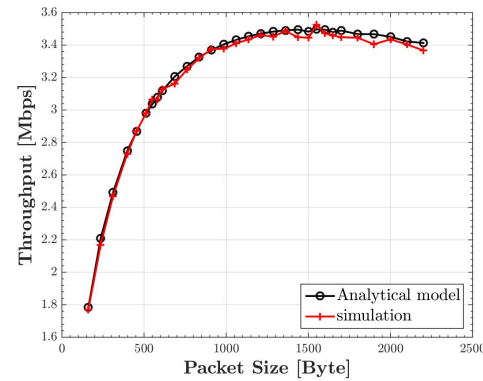
**Figure 4.11:** Slot-by-Slot model. Collision probability versus packet size:  $n=10$ , CBR= 12 Mbps and LTE 5x0 configuration



**Figure 4.12:** Slot-by-Slot model. Wi-Fi throughput versus packet size:  $n=10$ , CBR=12 Mbps and LTE 5x0 configuration



**Figure 4.13:** Exponential model. Collision probability versus packet size:  $n=10$ , CBR=12 Mbps and  $\mathfrak{R} = 400s^{-1}$ .



**Figure 4.14:** Exponential model. Wi-Fi throughput versus packet size:  $n=10$ , CBR=12Mbps and  $\mathfrak{R} = 400s^{-1}$ .

relative error equals to 4% at maximum for all packet sizes. This is because in the throughput expression, the expected residual life time is a weighty factor and compensates well the relatively small error induced by the collision probability.

Since we have shown the utility of the slot-by-slot model to accommodate another LTE traffic model such as exponential LTE off-periods, we plot the corresponding results in Figures 4.13 and 4.14. Again, the collision probability and the throughput versus the packet size show that the analytical results are highly accurate compared with the simulation results. These plots emphasize on the fact that duty cycled LTE are not well approximated by an exponential LTE because it is not able to capture the ripples seen in previous Figures 4.7, 4.8, 4.11 and 4.12.

#### 4.4.2 Wi-Fi/LTE COEXISTENCE MODEL ANALYSIS AND APPLICATION

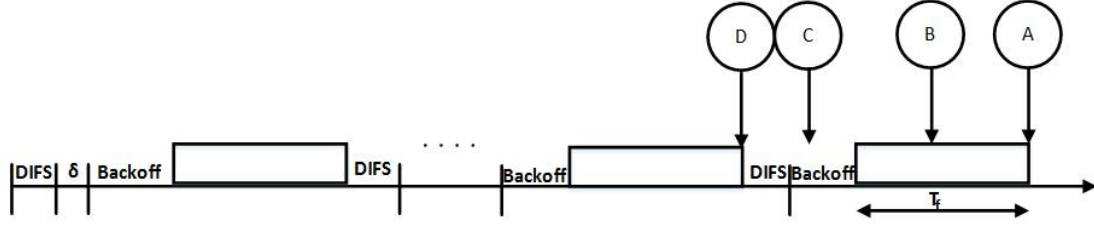


Figure 4.15: LTE arrival possibilities during off-period

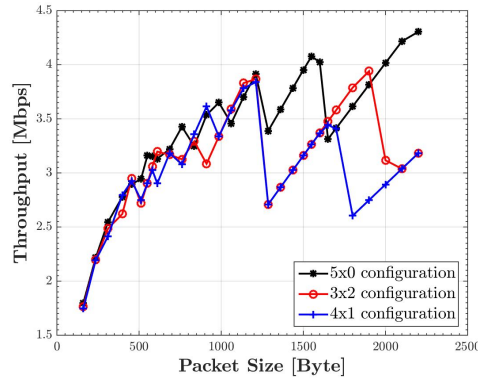
Let us first analyze probably the most eye-catching observation regarding the throughput ripples which becomes even sharper for large packet sizes in Figures 4.8 and 4.12. Particularly, in Figure 4.12, we highlight four points and we analyze them through Figure 4.15. At point A, the LTE transmission starts most often at the tail of Wi-Fi frames which means the end of  $T_f$  period, leading to a maximum damage on Wi-Fi throughput. This is because the whole time spent for Wi-Fi transmission(s) is wasted in extremis. In this case, the expected residual life time  $E[R_k]$  is close to zero and thus the numerator in the throughput equation ((4.12)) is minimized.

From A to B, as the packet size increases the time spent for Wi-Fi transmission(s) before LTE interruption decreases. In this situation, LTE starts during  $T_f$  period, which increases the residual life time of Wi-Fi transmission(s) which in turn increases linearly the throughput. In addition, the throughput increases due to the reduction in the overhead induced by headers. This explains the following result which is at first glance counter-intuitive: The performance when LTE starts at the beginning of the frame transmission(s) is better than the performance when LTE starts at the end.

From B to C, the increase of the packet size switches the LTE arrival over the backoff period or the DIFS period which corresponds evidently to a maximization of the Wi-Fi throughput and a minimization of the collision probability. Finally, from C to D, we move sharply to another minimum point mainly due to the fact that the number of frames that can be sent during the off-period is reduced abruptly by one.

This rippling behavior is reflected on the collision probability as well, Figures 4.7 and 4.11. Indeed, it starts by a positive linear relation over a small range of small packet sizes. Then, it shows some stairs separated by fissures that increase in magnitude as the packet size increases.

#### 4.4.3 COMPARISON BETWEEN DIFFERENT LTE CONFIGURATIONS

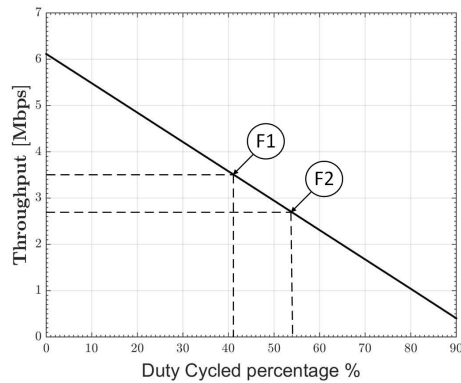


**Figure 4.16:** Comparison of the three LTE configurations. Wi-Fi throughput versus packet size:  $n=10$  and  $CBR=12\text{Mbps}$ .

Using our analytical models, we compare between different duty cycled LTE coexistence configurations with Wi-Fi. Figure 4.16 demonstrates that 5x0 configuration is the best configuration to coexist with Wi-Fi where the throughput is globally the highest for the most of packet sizes. This is justified by the fact that 3x2 and 4x1 configurations approximately double the collision probability between LTE and Wi-Fi relatively to the one obtained with 5x0 configuration. On the other hand, 4x1 configuration shows lower throughput than 3x2 configuration because 1ms is not long enough to allow Wi-Fi transmission without frequent collisions with LTE.

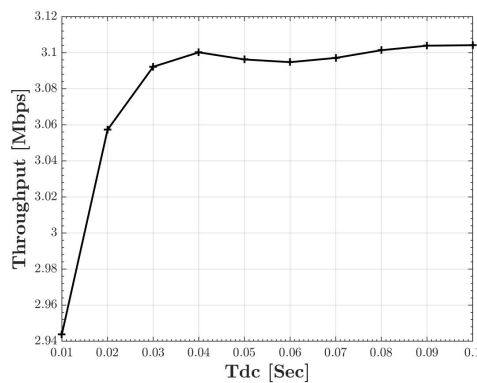
#### 4.4.4 CONTROLLING WI-FI/LTE COEXISTENCE USING THE MODEL

Relying on our analytical model, an effective solution to compensate the negative impact of LTE on Wi-Fi is to modify the duty cycle percentage so that we master better the sharing between the two networks. Figure 4.17 represents a straightforward solution by modifying the duty cycle percentage of LTE. Point F1 in Figure 4.17 corresponds to the LTE duty cycle percentage that should be configured to allow Wi-Fi throughput to achieve the equivalent throughput as if the Wi-Fi network operates alone on the channel with a bit rate equals half the coexistence channel ( $6\text{Mbps} = 12\text{Mbps}/2$ , is used in the Figure). We can consider indeed in this situation as if the channel has been equally shared by Wi-Fi and LTE. To do so, the duty cycle percentage is reduced here from 50% to 41%. The difference of 9% can be considered as a necessary overhead for LTE to use the Wi-Fi channel.



**Figure 4.17:** LTE duty cycle percentage fairness operation points. Wi-Fi throughput versus LTE duty cycle percentage:  $n=10$ ,  $pksize=512$ bytes,  $CBR=12$ Mbps and  $K=1$ .

Another sharing point of view consists for LTE to consume the same bandwidth that would be consumed by another Wi-Fi network having the same properties as the target Wi-Fi network. In other words, if the Wi-Fi network includes 10 stations, then their bandwidth share should be the same to what they would get if the network was 20 stations. So it is like LTE is behaving as 10 Wi-Fi stations (to be Wi-Fi-friendly). This definition of fairness was mentioned by 3GPP in [7]. The point F2 in Figure 4.17 corresponds to the LTE duty cycle percentage to achieve this type of fairness. In this case, the percentage increases from 50% to 55%. It means that it is possible to configure a percentage larger than 50% for LTE and still be fair with Wi-Fi. It means also that a percentage of 50% provides to the Wi-Fi network better performance than another similar Wi-Fi network!



**Figure 4.18:** Wi-Fi throughput versus LTE duty cycle period:  $n=10$ ,  $pksize=512$ bytes,  $CBR=12$ Mbps, LTE 5x0 configuration.

Another way to improve the Wi-Fi throughput is by increasing the duty cycle period  $T_{dc}$  so that the collision probability between the two systems will reduce according to equation ((4.9)). Precisely, the number of busy slots during the LTE off-periods becomes higher while only one collided frame remains possible at the end of such periods. Figure 4.18 confirms what said previously.

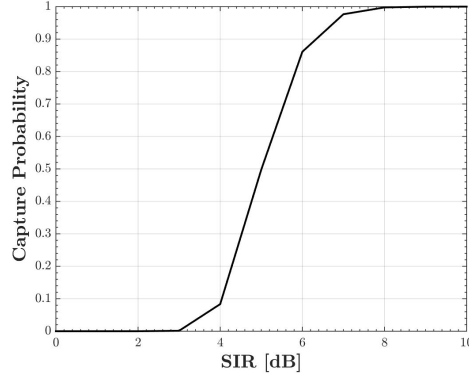


Figure 4.19: Capture probability versus SIR:  $n=10$ ,  $\text{pktsize}=512$ bytes,  $\text{CBR}=12$ Mbps and LTE 5x0 configuration.

Finally, we investigate the capture effect included in our model which is somewhat another solution to reduce the negative impact on Wi-Fi. Our model can determine the relation between the capture capability and the interference caused by LTE as shown in Figure 4.19. The Signal-to-Interference Ratio (SIR) is varied from 0dB to 10dB. The capture probability shown in the Figure is computed through equation ((4.28)), combined with the adequate BER model of OFDM-based WLAN [71]. The plot determines exactly the SIR lower bound before which all collisions will cause a frame loss (no capture effect), and the SIR upper bound beyond which LTE and Wi-Fi can coexist together without any impact (Wi-Fi alone). The Wi-Fi throughput and collision probability are also computed in Tables II and III. Likewise, when  $\text{SIR} \simeq 0$ dB, we re-find the results without capture effect, whereas when  $\text{SIR}=10$ dB, we re-find the results of Wi-Fi alone.

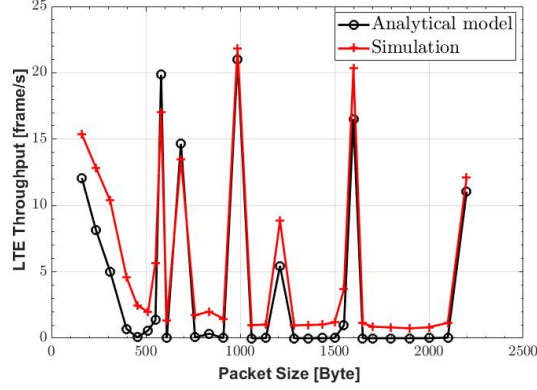
SIR [dB]	0	1	2	3	4	5	6	7	8	9	10
Analytical	3.01	3.01	3.01	3.01	3.03	3.13	3.21	3.24	3.24	3.24	3.24
Simulation	2.98	2.98	2.98	2.98	2.98	2.98	3.1	3.21	3.2	3.2	3.21

Table 4.2: Slot-by-Slot model. Wi-Fi throughput versus SIR:  $n=10$ ,  $\text{pktsize}=512$ bytes,  $\text{CBR}=12$ Mbps and LTE 5x0 configuration.

SIR [dB]	0	1	2	3	4	5	6	7	8	9	10
Analytical	0.415	0.4157	0.415	0.415	0.413	0.4	0.39	0.386	0.386	0.3861	0.386
Simulation	0.401	0.402	0.399	0.398	0.4	0.4	0.383	0.366	0.372	0.37	0.37

**Table 4.3: Slot-by-Slot model.** Collision probability versus SIR:  $n=10$ ,  $\text{pktsize}=512\text{bytes}$ ,  $\text{CBR}=12\text{Mbps}$  and LTE  $5\times 0$  configuration.

#### 4.4.5 LTE ANALYTICAL MODEL VALIDATION



**Figure 4.20:** LTE throughput versus Wi-Fi packet size:  $n=10$ ,  $\text{CBR}=12\text{Mbps}$  and LTE  $5\times 0$  configuration.

Now, we continue to validate LTE analytical model given through Equation (4.31) against NS3 simulation results. Remember that, Equation (4.31) considers that whenever LTE collides with Wi-Fi, all the entire LTE on-periods  $T_k^{on}$  is considered as a lost frame. In Figure 4.20, LTE performance has been evaluated for  $5\times 0$  configuration where LTE throughput is maximum for certain Wi-Fi packet sizes and is almost equal to zero over a range of Wi-Fi packet sizes. Moreover, by carefully comparing Figures 4.20 and 4.8, we can observe that these Wi-Fi packet sizes where LTE and Wi-Fi throughput are maximum are the same. This is well explained by the fact that for these Wi-Fi packet sizes LTE comes during Wi-Fi DIFS or Back-off period (see Figure 4.15 point C). Note that, in case of LTE shares the channel access equally with Wi-Fi, i.e. duty cycle percentage of 50%, and without any collision in between, LTE throughput have to be equal to 50 frame/s. Through Figure 4.20, we find that the maximum LTE throughput reaches almost 20 frame/s in the best case. Accordingly, it indicates that in the best case the probability of collision between the two systems is around 0.6 and in the worst case is equal 1. That explains well why our approximation in slot-by-slot random walk model was acceptable, i.e. the numerator of Equation (4.9) equals to  $K$ . Besides, this probability has to be normalized by the total number of Wi-Fi frames transmitted during LTE-OFF period, i.e. the denominator of Equation (4.9), which is relatively high specially for higher Wi-Fi data rates. As for the slight



difference between the analytical model and the simulation shown in 4.20, it comes from our simulator limitation since not all LTE frames are dropped when there is a collision between LTE and Wi-Fi.

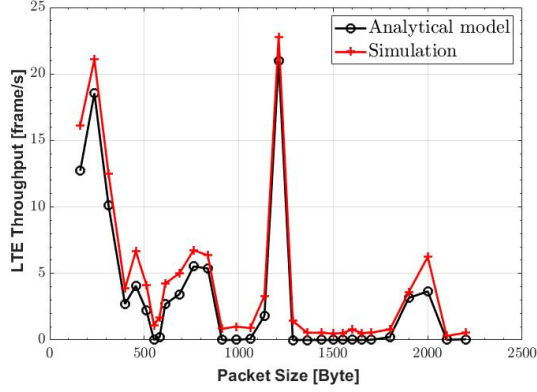


Figure 4.21: LTE throughput versus Wi-Fi packet size:  $n=10$ , CBR=12Mbps with  $\{3,3,2,2\}$  pattern.

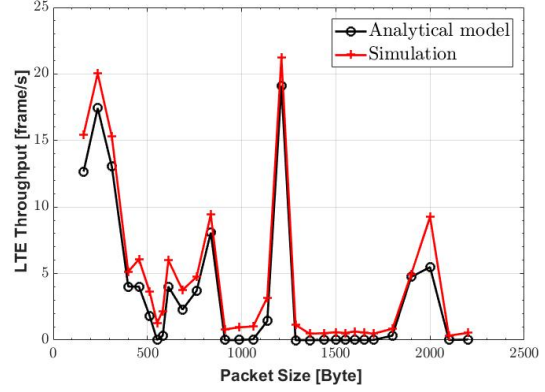
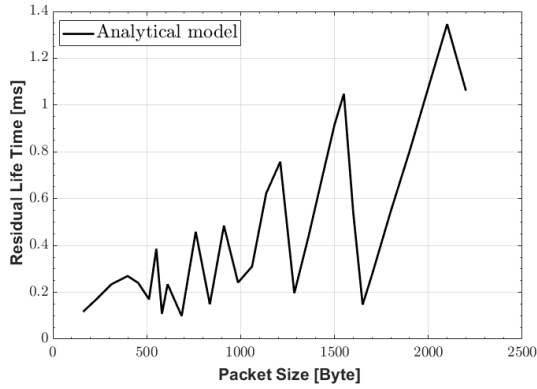


Figure 4.22: LTE throughput versus Wi-Fi packet size:  $n=10$ , CBR=12Mbps with  $\{3,2,2,3\}$  pattern.

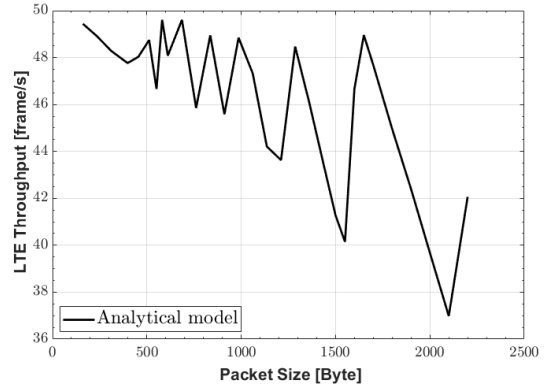
In subsection 4.3, we mentioned that the order of on/off periods within a duty cycle can lead to different LTE performance. In Figure 4.21, LTE adopts  $3 \times 2$  configuration which means LTE transmission is activated for 3ms then deactivated for 3ms before it is reactivated again for 2ms and then re-deactivated for 2ms. Let us note this pattern as  $\{3,3,2,2\}$ . However, in Figures 4.22, LTE adopt a different order of previous on/off periods as follows  $\{3,2,2,3\}$  means that LTE transmission is activated for 3ms then deactivated for 2ms before it is reactivated again for 2ms and re-deactivated for 3ms. Indeed, the difference in between them regarding to LTE performance is not so much since the difference between LTE on-periods  $T_k^{on}$  (1ms) is low. However, globally, we can say that this pattern  $\{3,2,2,3\}$  is slight better than  $\{3,3,2,2\}$ . The reason is that as more as the LTE-off period, i.e.  $T_k$ , is short, Wi-Fi has a higher probability to collide with LTE. Accordingly, for pattern  $\{3,2,2,3\}$ , we find that a longer LTE-off period precedes the longer LTE on-period which maximizes Equation (4.31). Moreover, in case of LTE adopts a different pattern order such as  $\{4,4,1,1\}$  and  $\{4,1,1,4\}$ , we can find more difference in LTE performance since the difference between LTE on-periods  $T_k^{on}$  is high and equals to 3ms. For this reason, we recommend to use  $\{4,1,1,4\}$  rather than  $\{4,4,1,1\}$  pattern since it will help LTE to enhance its throughput without inducing any changes on Wi-Fi throughput performance.

In contrast to equation (4.31), equation (4.33) takes into account the fact that LTE throughput could be improved by the portion of LTE on-periods that does not overlap with Wi-Fi trans-

mission. In Figure 4.23, we show the numerical results of the Wi-Fi residual life time  $E[R_k]$ , that has been used to evaluate Wi-Fi performance in Figure 4.12. Now, the expected duration of LTE  $T_k^{on}$  period that does not overlap with Wi-Fi transmission could be calculated by equation (4.33). Finally, we show LTE throughput that corresponds to equation (4.33) in Figure 4.24 while the simulation results has been omitted due to simulator limitation. Now, the Wi-Fi throughput ripples discovered in Figure 4.12 are well reflected in the LTE throughput in Figure 4.24. Whenever Wi-Fi residual life time is at the maximum which means a maximum overlap duration between LTE and Wi-Fi, then LTE throughput is at the minimum and vice versa. Moreover, whenever Wi-Fi residual life time is close to zero, LTE throughput reaches its maximum throughput that is 50 frame/s since LTE adopts 5x0 configuration.



**Figure 4.23:** Wi-Fi Residual Life time versus Wi-Fi packet size:  $n=10$ , CBR=12Mbps and LTE 5x0 configuration.



**Figure 4.24:** LTE throughput versus Wi-Fi packet size:  $n=10$ , CBR=12Mbps and LTE 5x0 configuration.

#### 4.5 SUMMARY

In this chapter, we have presented two complementary analytical models that provide significant insights on both LTE and Wi-Fi performance in coexistence scenarios. Each model represents a different way of describing the LTE/Wi-Fi interaction and analyzes a particular aspect about it. These models constitute a general framework relying on random walk theory that can be used to study other LTE/Wi-Fi coexistence scenarios. We succeeded to tie up analytically between Duty Cycled LTE configuration parameters and Wi-Fi performance to understand fully how LTE can coexist adequately with Wi-Fi networks.

Accordingly, we present several solutions based on tuning the above mentioned parameters including Physical Layer parameters. We examined our models through extensive simulations

by implementing the Duty Cycles of LTE in the NS3 simulator. We prove several facts such as the inability of approximating Duty Cycled LTE by the exponential distribution and the ability of Duty Cycled LTE to be Wi-Fi-Friendly if well configured.

*Il ne faut pas compter sur ceux qui ont créé les problèmes pour les résoudre*

Albert Einstein

# 5

## FBE Protocol: Modeling and Performance Analysis of LTE/Wi-Fi Coexistence

In this chapter, we study the Frame Based Equipment (FBE) protocol that can be used by LTE to share the channel access with Wi-Fi DCF protocol. We will show how the FBE protocol is different from TDM-based protocol since FBE protocol includes a sensing period called clear channel assessment (CCA) period prior to each LTE frame transmission period. In case of the channel is clear during the CCA period from Wi-Fi transmissions, LTE is allowed to transmit its frame over the channel; otherwise LTE refrains from the channel access. Accordingly, FBE protocol continues to share the same advantage of the TDM-based protocol that is LTE frame transmission starts only at the subframe boundaries which means no need for a reservation signal. However, we expect that FBE protocol has a lower negative impact on Wi-Fi performance in terms of transmission collisions compared to TDM-based protocol thanks to CCA mechanism.

In order to model and analyze the interaction between FBE and Wi-Fi, we should notice that both FBE and TDM-based protocols still share an important feature: The time instants when LTE tries to access or to contend for the channel access with Wi-Fi are deterministic. Besides,

using the FBE protocol, LTE transmission activities follow somewhat the same concept of on and off periods as in TDM-based protocol. However, with FBE protocol, LTE off-periods are not anymore fixed periods but they are variable periods determined by Wi-Fi activities over the channel. Based on these remarks, in this chapter, the LTE/Wi-Fi coexistence analysis will follow a common approach similar to what was presented in chapters 3 and 3 for the TDM-based protocol, in the sense that we will continue to model Wi-Fi activities over the channel as a random walk. In contrast, the Markov chains presented in chapters 3 and 4 that model the progress of LTE/Wi-Fi interaction over the time will be replaced by another Markov chain.

In chapter 4, our analysis has started by evaluating Wi-Fi performance followed by LTE performance. In contrast, in this chapter, it is more suitable to start by evaluating LTE performance followed by Wi-Fi performance as we will see later. In this chapter, we study the performance of the FBE protocol adopted by LTE to coexist with Wi-Fi when both technologies have a saturated downlink traffic. We investigate several fundamental questions such as: Does LTE coexist fairly with Wi-Fi in unlicensed spectrum? and what are LTE and Wi-Fi performance in coexistence scenarios? We answer these questions through a sophisticated analysis that explains how FBE protocol adopted by LTE does share the channel access with the well-know DCF protocol adopted by Wi-Fi. We compute analytically the probability of LTE to grab the channel access from Wi-Fi and we drive both LTE and Wi-Fi saturated throughput.

In this chapter, our contributions are summarized as follows:

- We introduce the notion of regenerative and renewal processes in studying FBE MAC protocol performance. Our analytical analysis is general enough to be used in order to analyze other similar periodic sensing MAC layer protocols [132].
- We study the coexistence between LTE and Wi-Fi using two complementary analytical modeling approaches. Based on our models, both LTE and Wi-Fi throughput performance are evaluated in addition to LTE channel access delay.
- We validate our analytical analysis through an extensive simulation study using NS3. We also develop a new module in NS3 simulator to simulate FBE protocol.
- We show that LTE can coexist fairly with Wi-Fi, and that LTE performance can be different depending on Wi-Fi data rate and packet size.

This chapter is outlined as follows. In section 5.1, we explore the interaction between LTE-FBE and Wi-Fi-DCF over the channel. In section 5.2, we provide two analytical models for

both LTE and Wi-Fi throughput performance, plus LTE channel access delay. Section 5.3 validates the accuracy of our models through NS3 simulations. There, we investigate the performance of both LTE and Wi-Fi in different coexistence scenarios. Finally, section 5.4 summarizes this chapter.

### 5.1 LTE/WI-FI INTERACTION

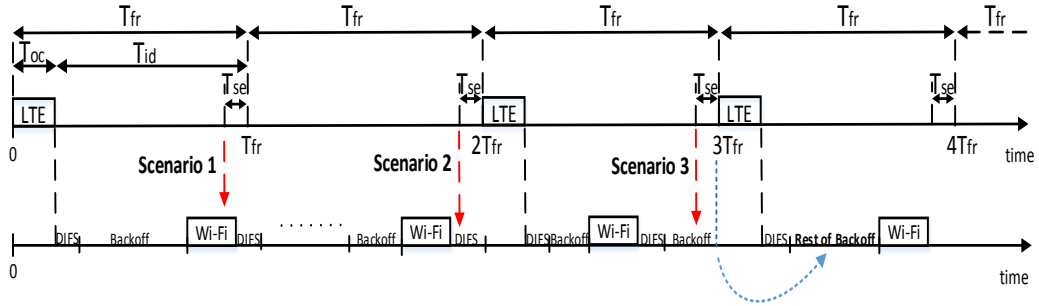


Figure 5.1: LTE interacting with Wi-Fi

In this section, we illustrate the operation of FBE protocol as proposed by European Telecommunications Standards Institute (ETSI) [2] and explore the interaction between LTE-FBE and Wi-Fi over the channel. The FBE protocol indicates that LTE periodically tries to grab the channel access in a frame-based fashion. Indeed, at the beginning of each LTE frames and/or subframes, LTE performs a CCA to determine whether the channel is clear or not from Wi-Fi activities. In case of the channel is clear, LTE is allowed to transmit its frames and/or subframes, otherwise LTE refrains from the channel access.

In Figure 5.1, LTE checks periodically the channel availability at a specific instants. The time between any two instants is fixed and known as the Fixed Frame period ( $T_{fr}$ ). In order to deduce that the channel is clear from Wi-Fi transmissions and decide that the next LTE frame can be transmitted, LTE performs a CCA for a period of time called sensing period ( $T_{se}$ ) where Wi-Fi transmissions have to be absent all the entire  $T_{se}$  period. Otherwise, LTE declares the channel busy and refrains from channel access all the entire next  $T_{fr}$  period (See Figure 5.1 Scenario 1). When LTE starts to transmit its frame, LTE is permitted to occupy the channel only for some portion of the time  $T_{fr}$  called the channel occupancy time  $T_{oc}$ . Accordingly, the remaining time difference between  $T_{fr}$  and  $T_{oc}$  is called the idle period  $T_{id}$  which is necessary

to give Wi-Fi the chance to grab the channel access after each LTE transmission (See Figure 5.1 Scenarios 2 and 3). Now, we can identify four configuration parameters for FBE protocol  $T_{se}$ ,  $T_{oc}$ ,  $T_{id}$  and  $T_{fr}$ . ETSI poses some constraints on each parameter value as follows [139]: (i)  $T_{se} \geq 20\mu s$  (ii)  $1ms \leq T_{oc} \leq 10ms$  (iii)  $T_{id} \geq 5\%T_{oc}$  (iv)  $T_{fr} = T_{oc} + T_{id}$ . Note that in Figure 5.1, the time scale is not respected since normally  $T_{oc}$  should be much greater than  $T_{id}$  but in the figure we show a large  $T_{id}$  for well illustrating the interaction between LTE and Wi-Fi which mainly occurs at the end of each  $T_{id}$ . The  $T_{id}$  period must be multiple of LTE subframe, i.e. multiple of 1 ms, so that LTE can ensure a synchronous operation of the channel access to avoid transmitting reservation signals as it has been mentioned in chapter 2.

Before analyzing the interaction between FBE and DCF protocols, we recall the operation of DCF protocol adopted by Wi-Fi as shown in previous chapters. Indeed, Wi-Fi activities over the channel starts exactly after an LTE frame transmission ends and continues during the  $T_{id}$  period. Wi-Fi performs CCA for a period of time known as Distributed InterFrame Space (DIFS) followed by a random number of idle slots that form a back-off period before any Wi-Fi transmission over the channel. At the beginning of this back-off period, a back-off counter (BF) is internally launched and decremented as long as the channel is idle. when the back-off counter reaches zero, Wi-Fi starts to access the channel and to transmit its frame for a period called frame transmission time  $T_{tr}$  which includes the frame airtime over the channel followed by a Short InterFrame Space (SIFS) and an acknowledgement transmission time  $T_{ack}$ . Accordingly, Wi-Fi activities over the channel consists of three different periods: (i) DIFS period considered as a sensing period; (ii) Back-off period formed by the back-off counter; (iii)  $T_{tr}$  frame transmission time period.

Now, we describe what exactly takes place at the moment when LTE “arrives” and checks the channel availability to try to grab the channel access at multiple of  $T_{fr}$ . In Figure 5.1, we mention three different scenarios that can occur depending on the Wi-Fi activities. For scenario 1, LTE checks the channel while Wi-Fi transmits its frame so that LTE is blocked from the channel access and LTE has to wait another  $T_{fr}$  period before checking again the channel. For both scenario 2 and 3, if the channel is idle for  $T_{se}$  period, LTE will be able to grab the channel access as Wi-Fi was in DIFS or backoff period. But there is still a major difference between scenario 2 and 3. In scenario 2, the last Wi-Fi frame has been transmitted and LTE grabs the channel immediately after it, whereas for scenario 3 the last Wi-Fi frame was frozen since its back-off period has not been yet completed. For scenario 3, the rest of the backoff period of the last Wi-Fi frame will restart when LTE frame transmission ends. This difference is essential for our Wi-Fi throughput analysis as we will see later. To sum up, LTE loses the channel access

in scenario 1 whereas LTE is able to grab the channel in both scenario 2 and 3. In the next section, we have to calculate the probability of occurrence of each scenarios to determine LTE and Wi-Fi throughput performance.

Here, it is important to note that the transmission collision probability between LTE and Wi-Fi is negligible and tends to be zero. Intuitively, the probability that LTE and Wi-Fi frame transmission starts exactly at the same instant is rare due to the following two reasons: (1) The fact that the two technologies adopt too different Mac layer protocols which have different slot time spans, leads to LTE and Wi-Fi not synchronized with each other (2) Moreover, the clear channel assessment embedded into the two Mac layer protocols, i.e DIFS and  $T_{se}$ , have also different times. Unlike the impact of LTE that adopts TDM-based protocol on Wi-Fi performance which is due to collisions induced by LTE, the impact of LTE that adopts FBE protocol on Wi-Fi performance is due to a reduction of available channel airtime.

## 5.2 LTE/WI-FI ANALYTICAL MODELS

In this section, we introduce our analytical model for both LTE and Wi-Fi networks. We consider a saturated downlink traffic for both technologies which means that LTE and Wi-Fi transmission queues always have a frame to transmit over the channel towards their associated stations. In fact, we aim to quantify the ability of FBE protocol to share the channel access with DCF protocol in a full competition scenario regarding to the channel access. Our analysis is divided into several steps. In subsection 5.2.1, we introduce our Markov chain model for LTE where we define different states that describe LTE behavior over the channel. In subsection 5.2.2, we explore more in details the model through calculating the transition probabilities between any two states in our LTE Markov chain. We end by writing out explicitly our formulas for LTE throughput and channel access probability which is more precisely the probability of LTE being able to grab the channel access from Wi-Fi. In subsection 5.2.3, we provide an alternative and complementary model for the previous one where LTE is now modeled as a random walk. In subsection 5.2.4, we provide a new Wi-Fi throughput formula that takes into account the coexistence with LTE as we expect that Wi-Fi throughput will be lower than the case when Wi-Fi operates alone over the channel.

### 5.2.1 LTE MARKOV CHAIN MODEL

From Figure 5.1, when LTE grabs the channel access and transmits the current frame, LTE will try to grab the channel access again to transmit the next frame only at a specific time instants.



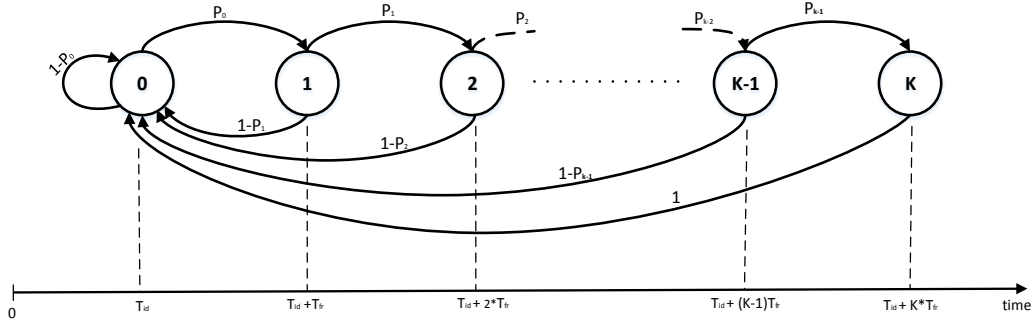


Figure 5.2: Discrete Time Markov chain model for LTE using FBE protocol over the time

From Figure 5.1, these times are clearly  $T_{id}$ ,  $T_{id} + T_{fr}$ ,  $T_{id} + 2 * T_{fr}$  and so on. These time instants are also shown in Figure 5.2. Let us define  $T_k$  for such time instants where

$$T_k = T_{id} + k * T_{fr} \quad \text{where } k = 0, 1, 2, \dots \quad (5.1)$$

For illustration, the first time when LTE tries to grab the channel access for transmitting the next frame is after  $T_{id}$ . In case of LTE succeed to grab the channel access directly after  $T_{id}$  then LTE is not blocked from the channel access. Otherwise, it is blocked from the channel access for a first time at  $T_{id}$ . Then, LTE will continue to try grabbing the channel at the next time instant at  $T_{id} + T_{fr}$  and so on. Accordingly, LTE may be blocked from the channel access zero, one, two or more times before it can grab the channel access to transmit its frames.

In Figure 5.2, we model the interaction between FBE and Wi-Fi by different states representing the number of times LTE has been blocked from accessing the channel before it is able to transmit its frame. LTE has a different state at each  $T_k$  period where the time difference between each state is equal to  $T_{fr}$ . This reflects the fact that LTE tries to grab the channel access after each  $T_{fr}$ . Accordingly, from Figure 5.2, the number of states reflects also the LTE state occurrence time. For example, the state 0 represents the case where LTE is not blocked from the channel access at  $T_k = T_{id}$  and transmits its frame. The state 1 represents the case that LTE is blocked for one time at  $T_k = T_{id}$ . The state 2 represents the case that LTE is blocked for two times successively at  $T_k = T_{id}$  and  $T_k = T_{id} + T_{fr}$ .

From any state, in our Markov chain, there are only two possible transitions. In case of LTE is blocked from the channel access, the LTE state  $k$  changes to the next state  $k+1$  with probability  $P_k$ . Otherwise, if LTE grabs the channel access, LTE transits back to the state 0 that represents the LTE transmission state with probability  $1 - P_k$ . Moreover, the self-loop at state 0 indicates

that LTE can grab the channel access directly after  $T_{id}$ . We note that the subscript  $k$  of the transition probabilities  $P_k$  reflects the time instant at which LTE is blocked as indicated in equation (5.1).

To get into more details, theoretically, LTE has an infinite number of states where  $k$  can tend to infinity. Practically, the probabilities of such high-order states have a negligible weight on the steady state probabilities because LTE will be able to grab the channel access before reaching these far states. Accordingly, we do our first approximation that limits our Markov chain to  $K$  states where the last state  $K$  has only one transition probability to state 0 and equals to 1 (See Figure 5.2). By carefully looking to our Markov chain, LTE could be seen as a regenerative process as in [101]. In the sense that after certain random number of transitions through the states because LTE is blocked from the channel access, LTE will end up by making a transition to state 0 the transmission state. Here, it is our second approximation, whenever LTE returns to state 0 from any higher state, LTE has a probabilistic replica as if it has started from time 0. In the next subsection, we will explain why we do need such assumption which implies that the duration of  $T_{id}$  period must be long enough to allow Wi-Fi sending at least one frame. Our assumption is completely reasonable otherwise the idle period  $T_{id}$  offered by LTE will be useless and Wi-Fi will not be able to profit from it. Moreover, as LTE can start only its frame transmission at subframe boundaries,  $T_{id}$  has to be a multiple of the LTE subframe time duration (1ms) which offers a sufficient time to Wi-Fi.

### 5.2.2 TRANSITION PROBABILITIES AND LTE THROUGHPUT

In this subsection, we would like to answer this main question: Assume that LTE has grabbed the channel access at some time instant, then how long does it take until LTE can grab the channel access again? An equivalent question to the previous one: What is the ratio of the number of LTE frames that succeed to access the channel to the total number of frames? Clearly, the answer of both questions is the LTE channel access probability which is obtained by solving our LTE Markov chain at the steady state. Now, we show how the transition probabilities in our Markov chain can be determined using random walk theory [101].

As described in section 5.1, after the end of LTE frame transmission, Wi-Fi starts immediately to access the channel. The amount of time needed for the DCF protocol to transmit a frame over the channel consists of three periods which can be represented by a random variable called  $X$ :

$$X = DIFS + \delta * BF + T_{tr} \quad (5.2)$$

Where BF is the back-off counter which is a uniform random variable drawn from the interval  $[0, W_0]$ , where  $W_0$  is known as the minimum contention window size of Wi-Fi networks. The Wi-Fi idle slot time is denoted by  $\delta$  and  $T_{tr}$  is the frame transmission time that includes the frame airtime over the channel followed by SIFS and  $T_{ack}$ . Wi-Fi continues to follow the same procedure to send more frames over the channel until LTE grabs the channel access and stops Wi-Fi frame transmission. In other words, Wi-Fi activities could be seen as a succession of transmission rounds possibly stopped by LTE frame transmission in case of LTE grab the channel access. Accordingly, Wi-Fi is nicely modeled as a random walk consisting of a sequence of random variables  $\{x_1, x_2, x_3, \dots\}$ , as we already showed in both chapters 3 and 4.

To consider that  $x_1$  has a uniform probability distribution like all random variables  $x_i$  that follows, LTE must not have any impact on  $x_1$  probability distribution whenever LTE grabs the channel which is not really the case. Particularly, in case of LTE grabs the channel while Wi-Fi is in a back-off period, Wi-Fi will restart its transmission after the end of the LTE frame transmission with  $x_1$  is no longer a uniform distribution as all the following  $x_i$ . Indeed,  $x_1$  will have a truncated uniform distribution that is determined by the exact time instant when LTE accessed the channel. Accordingly, our Markov chain cannot be considered anymore as a regenerative process which complicates too much the model without a significant accuracy gain as we shall see later. In order to keep the regenerative process property,  $T_{id}$  have to be long enough to allow Wi-Fi to be able to send at least one frame before LTE grabs the channel access again. Accordingly, we approximate the probability density function of  $x_1$  as a uniform distribution as all next  $x_i$ . Remember that this approximation has been also adopted in chapter 3 for TDM-based protocol. Moreover, intuitively, this assumption is more valid as long as  $T_{id}$  period gets larger and Wi-Fi frame size gets smaller. Besides, the high rates provided by recent Wi-Fi technologies allows several frame transmissions in  $T_{id}$  even for large packet sizes.

Since LTE can grab the channel access at any time instant  $T_k$ , the number of Wi-Fi frames, i.e. number of  $x_i$ s, that could be transmitted before LTE grabs the channel again depends on the length of the  $T_k$  period. Let's define  $N_k$  as the random variable that represents the number of Wi-Fi frames that could be sent in any  $T_k$  period. Thanks to random walk theory [101], the probability distribution function of  $N_k$  is written as follows:

$$Pr\{N_k = n\} = Pr\left\{\sum_{j=1}^{n-1} x_j + DIFS + \delta < T_k\right\} - Pr\left\{\sum_{j=1}^n x_j + DIFS + \delta < T_k\right\} \quad (5.3)$$

**Explanation.** This probability corresponds to the number of sent frames regardless of what happens to the last sent frame at the end of the  $T_k$  period. Remember from section 5.1, the

last Wi-Fi frame is transmitted over the channel or frozen depending on which scenario 2 or 3 occurred at the end of the  $T_k$  period. Now, we can determine the probability of occurrence of the three scenarios for any given  $n$  and  $T_k$  period. Let's note such probabilities as  $Pr\{b_k, n\}$ ,  $Pr\{d_k, n\}$  and  $Pr\{f_k, n\}$  for scenario 1, 2 and 3 respectively.

$$Pr\{f_k, n\} = Pr\left\{\sum_{j=1}^{n-1} x_j + DIFS + \delta < T_k < \sum_{j=1}^n x_j - T_{tr} + \delta\right\} \quad (5.4)$$

$$Pr\{b_k, n\} = Pr\left\{\sum_{j=1}^n x_j - T_{tr} + \delta \leq T_k \leq \sum_{j=1}^n x_j + T_{se} + \delta\right\} \quad (5.5)$$

$$Pr\{d_k, n\} = Pr\left\{\sum_{j=1}^n x_j + T_{se} + \delta < T_k \leq \sum_{j=1}^n x_j + DIFS + \delta\right\} \quad (5.6)$$

For a given  $T_k$  period,  $N_k$  has an upper bound  $nmax$ , which means that  $Pr\{N_k > nmax\} = 0$ , where  $nmax = \lceil T_k/xmin \rceil$  with  $xmin = DIFS + T_{tr}$ . Hence, the total probability of occurrence of scenario 1 is expressed as

$$Pr\{b_k\} = \sum_{n=1}^{nmax} Pr\{b_k, n\} \quad (5.7)$$

Similarly, we can compute the total probabilities of occurrence of other scenarios. It is clear that the transition probability  $P_k$  is the probability of occurrence of scenario 1 where LTE is blocked from channel access at every  $T_k$ . As a result,  $P_k$  could be written as follows

$$P_k = Pr\{b_k\} = 1 - (Pr\{d_k\} + Pr\{f_k\}) \quad (5.8)$$

Now, we calculate the LTE channel access probability  $P_{ca}$  by determining the steady state probability of state 0 in our Markov chain noted by  $\pi(0)$ , since state 0 is the state when LTE grabs the channel access. Remind that  $P_{ca}$  is also considered as the ratio of LTE frames that are transmitted over the channel among all LTE trials to access the channel. By solving our Markov chain,  $P_{ca}$  is written as follows

$$\begin{aligned} P_{ca} = \pi(0) &= \frac{1}{1 + P_0 + P_0P_1 + P_0P_1P_2 + \dots + P_0P_1\dots P_{K-1}} \\ &= \frac{1}{1 + \sum_{i=1}^K \prod_{j=0}^{i-1} P_j} \end{aligned} \quad (5.9)$$

Finally, LTE throughput  $\Gamma_{LTE}$  is defined as the fraction of time the channel is used for LTE transmissions. Remember that LTE is only allowed to occupy the channel for  $T_{oc}$  during  $T_{fr}$ . Moreover,  $T_{oc}$  has to be a multiple of LTE subframe (1ms), further the traditional LTE frame duration ( $T_{LTE}$ ) is 10 subframes. Accordingly, we normalized  $\Gamma_{LTE}$  with respect to the traditional LTE frame duration. We express  $\Gamma_{LTE}$  as

$$\Gamma_{LTE} = P_{ca} * \frac{T_{oc}}{T_{fr} * T_{LTE}} \quad frame/s \quad (5.10)$$

It is important to note that,  $\Gamma_{LTE}$  is considered as an upper bound for LTE performance when LTE coexists with several Wi-Fi stations. Indeed, in case of several Wi-Fi stations contending for the channel access, the back-off period shrinks and follows a different probability distribution function given in chapter 4. As a result, LTE will have more difficulty to grab the channel access with respect to the case of one Wi-Fi station.

### 5.2.3 LTE RENEWAL PROCESS

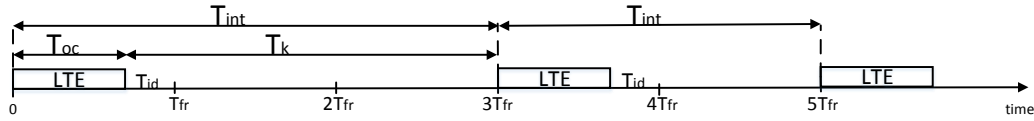


Figure 5.3: LTE Renewal Process

Another essential model of LTE that helps our Wi-Fi throughput analysis in the next subsection, is the one that considers LTE as a random walk. In Figure 5.3, the time between any two instants when LTE grabs the channel access is considered as inter-arrival times of LTE renewals noted by  $T_{int}$ . Clearly, the inter-arrival times are a random variables with a probability distribution function that fully defines LTE renewal process. The inter-arrival time consists of the LTE channel occupancy time  $T_{oc}$  followed by the LTE off-period where LTE is blocked from channel access. Indeed, LTE off-period is a random variable that could be represented by  $T_k$  where  $T_k$  is now considered as a discrete random variable. Let's note

$$T_{int} = T_{oc} + T_k \quad (5.11)$$

Actually, we can use our LTE Markov chain to determine the probability distribution function of  $T_{int}$ , i.e. the probability distribution function of  $T_k$ . The probability distribution of  $T_k$

is the probability that LTE follows certain path on our Markov chain. For example, the probability that  $T_{int} = T_{oc} + T_{id} + 2 * T_{fr}$  ( $k = 2$ ) is the total product of transition probabilities when LTE is starting from state 0, travelling until state 2 and return back again to state 0, that is equivalent to  $P_0 P_1 (1 - P_2)$ . Accordingly, the probability distribution function for  $T_k$  for  $k = 0, 1, 2, \dots, K$  is given by

$$Pr\{T_k = t_k\} = \begin{cases} (1 - P_0) & \text{for } k = 0 \\ (\prod_{i=0}^{k-1} P_i) * (1 - P_k) & \text{for } k \neq 0 \end{cases} \quad (5.12)$$

Accordingly,  $P_{ca}$  could be expressed again using equation (5.12) as follows

$$P_{ca} = \frac{T_{fr}}{E[T_{int}]} = \frac{T_{fr}}{T_{oc} + E[T_k]} \quad (5.13)$$

Where  $E[T_k]$  is the expected value of LTE off-periods. Note also that,  $E[T_k]$  indicates *the expected time of LTE channel access delay* which is another key performance indicator for LTE in addition to the throughput. We can also find after some simplifications that equation (5.13) is the same as Equation (5.9). As a result, we can rewrite Equation (5.10), using equation (5.13) as follows

$$\Gamma_{LTE} = \frac{T_{oc}/T_{LTE}}{T_{oc} + E[T_k]} \quad \text{frame/s} \quad (5.14)$$

#### 5.2.4 WI-FI THROUGHPUT

Wi-Fi throughput  $\Gamma_{Wi-Fi}$  is obtained by determining the expected number of Wi-Fi frames that could be transmitted during LTE off-periods  $T_k$ . Given any  $T_k$  period, the expected number of Wi-Fi frames that could be sent, using equation (5.3), is

$$E[N_k] = \sum_{n=1}^{nmax} n Pr\{N_k = n\} \quad (5.15)$$

Where  $E[N_k]$  is the expected number of Wi-Fi frames during a  $T_k$  period regardless of the  $n^{th}$  frame is a sent or a frozen frame with respect to scenarios 2 and 3 respectively.

$$\Gamma_{Wi-Fi} = \frac{\sum_{i=1}^K [(E[N_k] - 1 + Pr\{d_k\}) * Pr\{T_k\}]}{E[T_{int}]} \quad \text{frame/s} \quad (5.16)$$

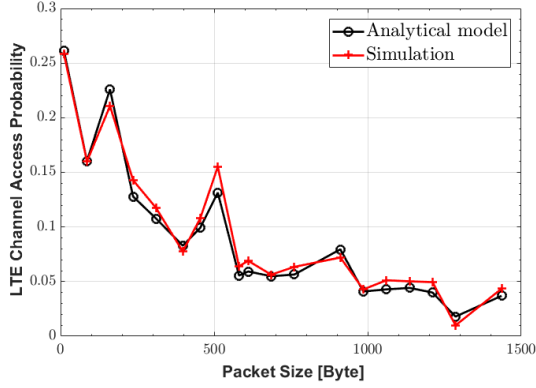
The  $Pr\{d_k\}$  term is necessary to count only the occurrence of scenario 2 where the  $n^{th}$  frame was sent during  $T_k$  and LTE grabs the channel access during DIFS period of Wi-Fi.

### 5.3 MODELS VALIDATION AND SIMULATION RESULTS

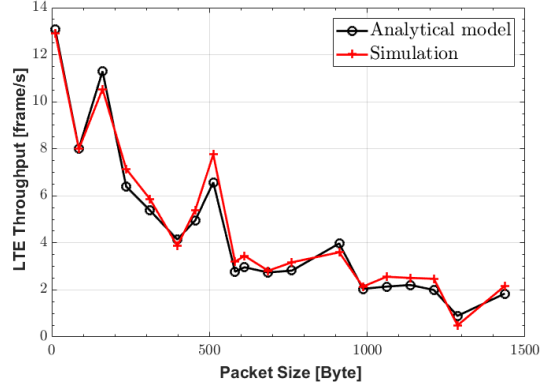
To validate our analytical models, we have simulated the interaction between LTE and Wi-Fi using NS3 simulator. We simulate a Wi-Fi access point transmitting continuously to its users. Wi-Fi parameters used to obtain the numerical results for both the analytical models and the NS3 simulations are those specified by default in the IEEE 802.11 standard, as reported in Table 5.1. We implement also a new model to simulate FBE protocol for LTE in NS3 simulator where we have fixed LTE sensing period  $T_{se}$  to  $25\mu s$ .

Simulation time	200 s
Payload packet	11 ~ 1436 bytes
ACK packet	14 bytes
UDP header	8 bytes
Network header	20 bytes
MAC header	36 bytes
Channel bit rate (CBR)	6, 12 and 24 Mbps
Channel bandwidth	20 MHz
Slot time ( $\delta$ )	9 $\mu s$
SIFS	16 $\mu s$
DIFS	34 $\mu s$

**Table 5.1:** Wi-Fi transmission parameters used in the comparison between NS3 simulations and the analytical model



**Figure 5.4:** LTE channel access probability versus WiFi packet size: LTE ( $T_{oc} = 1ms, T_{id} = 1ms$ ), WiFi (CBR = 6Mbps)



**Figure 5.5:** LTE throughput versus WiFi packet size: LTE ( $T_{oc} = 1ms, T_{id} = 1ms$ ), WiFi (CBR = 6Mbps)

We first verify the accuracy and the utility of our analytical models for both LTE and Wi-Fi in a coexistence scenario. Figure 5.4 shows that LTE channel access probability coincides

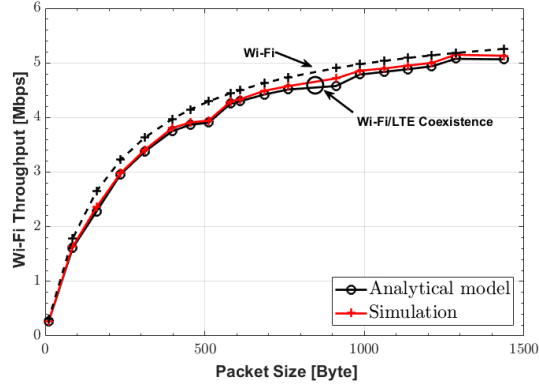


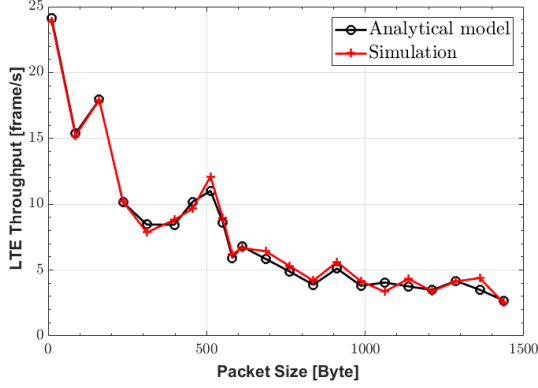
Figure 5.6: Wi-Fi throughput versus WiFi packet size: LTE ( $T_{oc} = 1\text{ms}$ ,  $T_{id} = 1\text{ms}$ ), WiFi (CBR = 6Mbps)

well with simulation results. LTE channel access probability decreases whenever Wi-Fi packet size increases which explained by the fact that increasing the Wi-Fi packet size increases also the time that the channel is busy, as a result, LTE has a lower probability to grab the channel access. Moreover, in figure 5.4, LTE channel probability has ripples with some of them are sharper than the others for certain Wi-Fi packet sizes. That could be explained by equations (5.4), (5.5) and (5.6) where any slight change in  $T_{tr}$  can lead to a big change in the probability. In general, our explanation in previous chapter 4 regarding to the ripples is still valid except that with the FBE protocol, the collision between LTE and Wi-Fi is negligible. Interestingly, if LTE is blocked from the channel access a lot of time due to a given Wi-Fi packet size, it is enough to change slightly this packet size, so that LTE will check the channel more frequently during DIFS and Back-off periods of Wi-Fi leading to a substantial increase in the LTE channel access probability. Indeed, by adopting a *periodic* MAC layer protocol such as FBE and TDM-based protocols, both LTE and Wi-Fi will face such throughput ripples. Figure 5.5 shows that the ripples are well reflected in LTE throughput that coincides again with simulation results. Clearly, LTE is not able to grab the channel access from Wi-Fi enough times since LTE maximum throughput is 14 frame/s. Note that, in case of Wi-Fi shares the channel access equally with LTE, i.e. half of channel airtime for each, LTE throughput has to be equal to 50 frame/s which is corresponding to the half of LTE throughput when it operates alone over the channel, i.e. 100 frame/s.

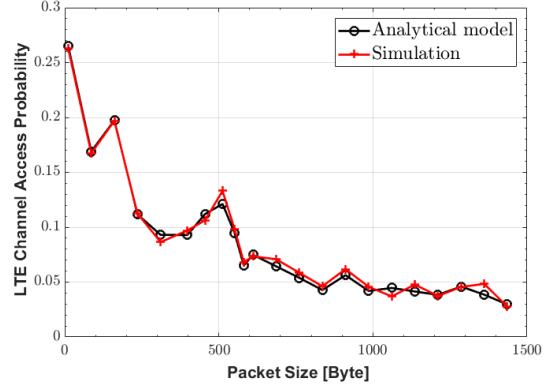
We continue to validate our model for Wi-Fi throughput in Figure 5.6 while coexisting with LTE. To clarify the LTE impact on Wi-Fi performance, in Figure 5.6 we also show theoretical Wi-Fi throughput when Wi-Fi operates alone over the channel. Clearly, LTE has a slight impact on Wi-Fi performance in terms of reduction of channel air time which also confirms that our assumption about LTE collision probability with Wi-Fi is negligible. Finally, LTE throughput



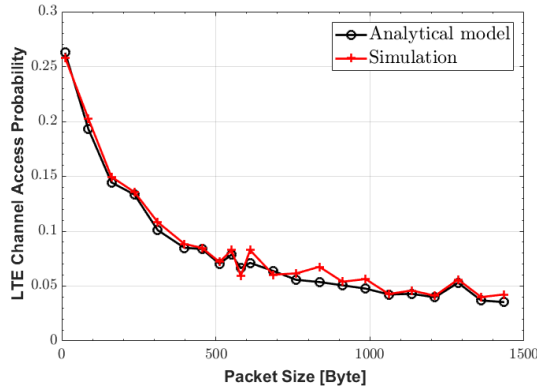
ripples is less reflected and observed in Wi-Fi throughput in Figure 5.6 because LTE throughput is relatively low.



**Figure 5.7:** LTE throughput versus WiFi packet size: LTE ( $T_{oc} = 10\text{ms}$ ,  $T_{id} = 1\text{ms}$ ), WiFi (CBR = 6Mbps)



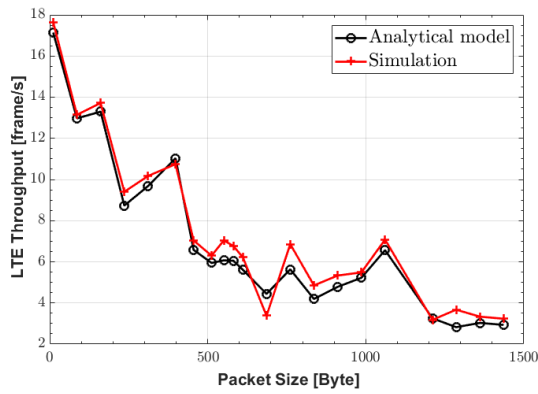
**Figure 5.8:** LTE channel access probability versus WiFi packet size: LTE ( $T_{oc} = 10\text{ms}$ ,  $T_{id} = 1\text{ms}$ ), WiFi (CBR = 6Mbps)



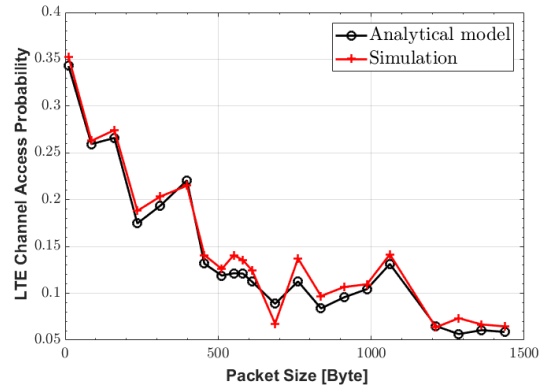
**Figure 5.9:** LTE channel access probability versus WiFi packet size: LTE ( $T_{oc} = 10\text{ms}$ ,  $T_{id} = 10\text{ms}$ ), WiFi (CBR = 6Mbps)

Increasing LTE throughput is still possible by increasing  $T_{oc}$  period front of  $T_{id}$  period, see equation (5.10), to reduce the overhead incurred by LTE for each frame transmission. In Figure 5.7, we keep the same idle period for LTE as in Figure 5.4 whereas  $T_{oc}$  is increased ten times more to improve LTE throughput performance. Actually, increasing  $T_{oc}$  period will cause LTE less frequently contend for the channel access with Wi-Fi as  $T_{fr} = T_{oc} + T_{id}$ . One may think that LTE channel access probability will decrease as a price of increasing  $T_{oc}$ . Counter-intuitively, LTE channel access probability in Figure 5.8 still has almost the same trend as in Figure 5.4. Accordingly, the improvement of LTE throughput comes from the increasing of

$\frac{T_{oc}}{T_{fr}}$  ratio (see equation 5.10) while LTE channel access probability is almost constant. To confirm this result, we show LTE channel access probability in Figure 5.9 where  $T_{fr}$  is further increased to 20 ms. Accordingly, increasing or decreasing LTE contention frequency which means increasing or decreasing  $T_{fr}$  period, it does not change LTE channel access probability. We should mention that this finding is restricted to the full competition scenario between LTE and Wi-Fi when Wi-Fi traffic is saturated and/or Wi-Fi data rate is relatively low. In such scenario, the percentage of channel air time occupied by Wi-Fi is very high (greater than 75% see Figure 5.4) and LTE channel access probability is almost the same for a fixed Wi-Fi packet size and for any LTE contention frequency. However, for other LTE/Wi-Fi coexistence scenarios, the previous conclusion can be different. In fact, in some coexistence scenarios, the LTE channel access probability is fully determined by Wi-Fi configuration parameters such as Wi-Fi data rate and packet size. As a result, Wi-Fi “controls” the LTE channel access and does not fairly coexist with LTE.



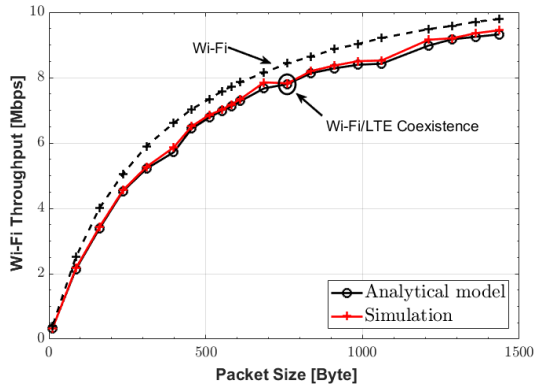
**Figure 5.10:** LTE throughput versus WiFi packet size: LTE ( $T_{oc} = 1\text{ms}$ ,  $T_{id} = 1\text{ms}$ ), WiFi (CBR = 12Mbps)



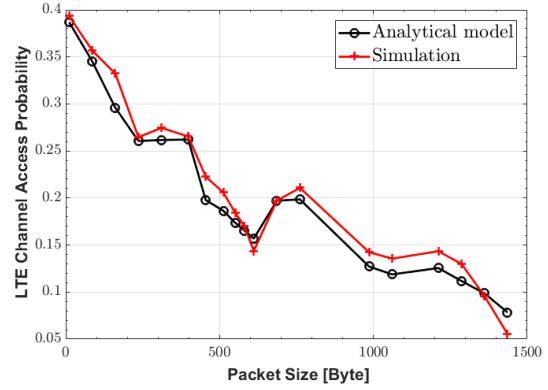
**Figure 5.11:** LTE channel access probability versus WiFi packet size: LTE ( $T_{oc} = 1\text{ms}$ ,  $T_{id} = 1\text{ms}$ ), WiFi (CBR = 12Mbps)

Accordingly, in Figure 5.10, we validate our model for different Wi-Fi data rates where LTE throughput could be improved as Wi-Fi data rate increases. Now, LTE channel access probability can improve thanks to the reduction of channel occupancy by Wi-Fi as in Figure 5.11. As a result, Wi-Fi throughput is reduced and the difference between Wi-Fi throughput when coexisting with LTE and when operating alone over the channel in Figure 5.12 is bigger than the difference shown in Figure 5.6. To further improve LTE channel access probability, we double more Wi-Fi data rate to be 24 Mbps in Figure 5.13. In both Figure 5.14 and 5.15, we fix LTE  $T_{id}$  period at 1 ms and increase  $T_{oc}$  period to improve LTE performance at the price of lowering Wi-Fi performance. Here, we capture one of the “deficiencies” of the FBE protocol: Its perfor-

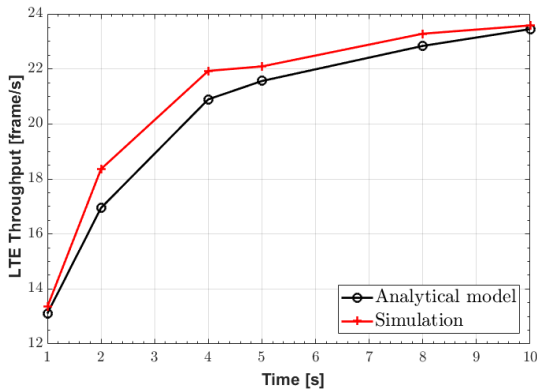
mance is greatly dependent on Wi-Fi data rates. In case Wi-Fi channel conditions are subject to important signal fading and interference, Wi-Fi tends to reduce its data rate, as a result LTE performance will also decrease, we call this phenomenon the *FBE protocol anomaly*.



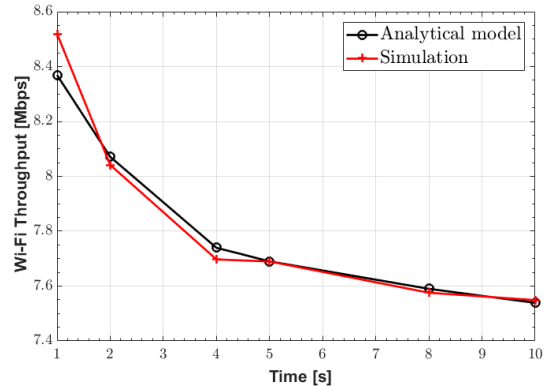
**Figure 5.12:** WiFi throughput versus WiFi packet size: LTE ( $T_{oc} = 1\text{ms}$ ,  $T_{id} = 1\text{ms}$ ), WiFi (CBR = 12Mbps)



**Figure 5.13:** LTE channel access probability versus WiFi packet size: LTE ( $T_{oc} = 1\text{ms}$ ,  $T_{id} = 1\text{ms}$ ), WiFi (CBR = 24Mbps)

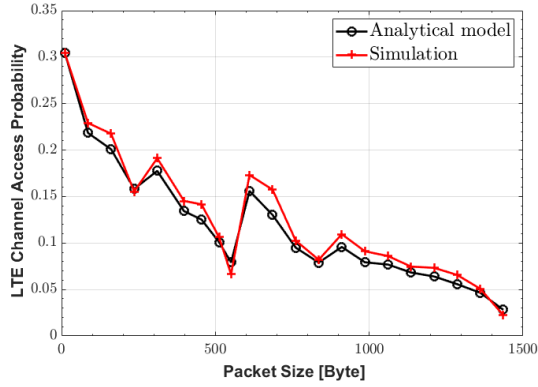


**Figure 5.14:** LTE throughput versus  $T_{oc}$  period: LTE ( $T_{id} = 1\text{ms}$ ), WiFi (CBR = 24Mbps, packet size = 398 bytes)

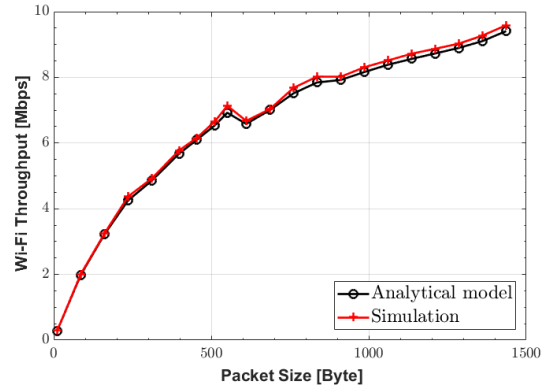


**Figure 5.15:** WiFi throughput versus  $T_{oc}$  period: LTE ( $T_{id} = 1\text{ms}$ ), WiFi (CBR = 24Mbps, packet size = 398 bytes)

The FBE protocol was proposed originally for any communication system operating in unlicensed spectrum. Therefore, it is still important to consider the case where  $T_{id}$  is not a multiple of an LTE subframe of 1 ms. For LTE, this means it will not keep a synchronous operation of the channel since frames can start at any time, so that LTE must use a reservation signal to retard its frame transmission until the first coming subframe. In both Figure 5.16 and 5.17, we validate our model in this case for a  $T_{id}$  that equals 200  $\mu\text{s}$ .

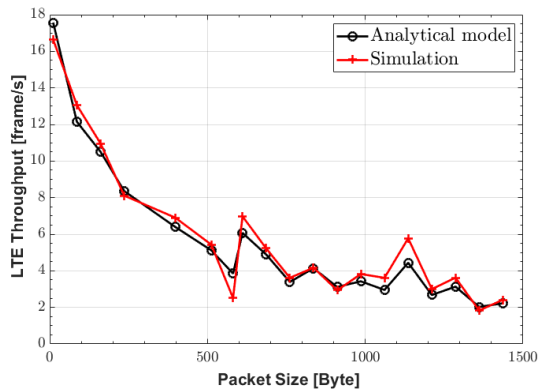


**Figure 5.16:** LTE channel access probability versus WiFi packet size: LTE ( $T_{oc} = 1\text{ms}$ ,  $T_{id} = 200\mu\text{s}$ ), WiFi (CBR = 12Mbps)

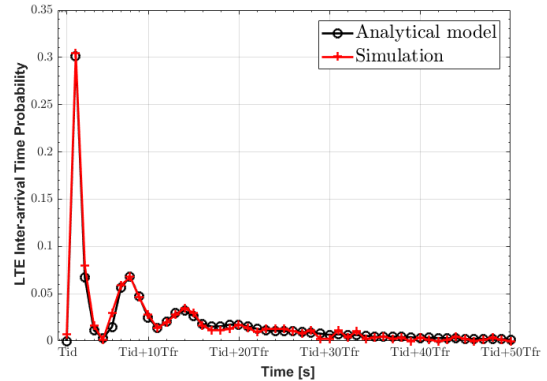


**Figure 5.17:** WiFi throughput versus WiFi packet size: LTE ( $T_{oc} = 1\text{ms}$ ,  $T_{id} = 200\mu\text{s}$ ), WiFi (CBR = 12Mbps)

Another LTE FBE protocol configuration is shown in Figure 5.18. There, LTE uses only 4 subframes for frame transmission out of 5 subframes since 1 subframe is used to send LTE reservation signal. Moreover, we also validate our alternative model for LTE in Figure 5.19 where we show the probability distribution function of the inter-arrival times  $T_{int}$  of LTE frame transmission versus the time.



**Figure 5.18:** LTE throughput versus WiFi packet size: LTE ( $T_{oc} = 5\text{ms}$ ,  $T_{id} = 250\mu\text{s}$ ), WiFi (CBR = 6Mbps)



**Figure 5.19:** LTE inter-arrival probability distribution function versus time: LTE ( $T_{oc} = 5\text{ms}$ ,  $T_{id} = 250\mu\text{s}$ ), WiFi (CBR = 6Mbps)

From Figure 5.19, the probability of the LTE inter-arrival time  $T_{int} = T_{id}$  is almost zero which means that LTE cannot grab the channel access immediately after  $T_{id}$  from its last frame transmission. In contrast, the probability of the inter-arrival time  $T_{int} = T_{id} + T_{fr}$  reaches the maximum which means that with high probability, LTE grabs the channel access after  $T_{id} + T_{fr}$  from its last frame transmission. Consequently, the expected value of LTE inter-arrival times

can be calculated directly from the probability distribution function shown in Figure 5.19 to determine LTE channel access delay. Moreover, we validate our previous approximation that says that the steady state probabilities of higher states in our Markov chain are negligible. In other words,  $T_{int}$  could not very long as shown in Figure 5.19.

#### 5.4 SUMMARY

In this chapter, we have presented two complementary analytical models that provide significant insights on both LTE and Wi-Fi performance in coexistence scenarios while the FBE protocol is employed by LTE. These models constitute a general framework that are based on random walk theory and can be used to study other LTE/Wi-Fi coexistence scenarios. We succeeded to tie up analytically between LTE and Wi-Fi configuration parameters to understand how the channel access is shared in between. We examined our models through extensive simulations by implementing FBE protocol for LTE in the NS3 simulator. We have proved that when LTE adopts FBE protocol, LTE can coexist fairly with Wi-Fi where Wi-Fi throughput performance is slightly affected by LTE. On the other hand, Wi-Fi is completely dominating the channel access, causing LTE to have a lower channel access probability. Moreover, LTE channel access probability was considered as an upper bound when Wi-Fi uplink and downlink traffic are activated together. The main reason that cause LTE throughput performance to be lower than Wi-Fi is that the FBE protocol is allowed only to contend the channel access at certain specific time instants whereas the Wi-Fi DCF protocol is able to contend the channel access at any time. Moreover, an FBE protocol performance anomaly has been highlighted since LTE performance is highly dependent on the Wi-Fi data rate which is in turn dependent on the Wi-Fi wireless environment such as the signal strength.

*Il ne faut pas compter sur ceux qui ont créé les problèmes pour les résoudre*

Albert Einstein

# 6

## Category 4 Protocol: Adaptive Energy Threshold for Improved Coexistence Between Licensed Assisted Access and Wi-Fi

Up to this chapter, we focused on analyzing the coexistence between LTE and Wi-Fi at the MAC layer level while assuming implicitly that the PHY layer heterogeneity between LTE and Wi-Fi does not impact our analysis. It is like we have assumed that Wi-Fi PHY layer is always able to detect LTE signal above its Energy Detection (ED) threshold, so that the proper operation of Wi-Fi DCF protocol is always ensured, precisely the Wi-Fi DCF protocol will refrain from the channel access whenever the channel is occupied by LTE. Likewise, when we studied the LBT-based protocol such as FBE in chapter 5, LTE PHY layer is always able to detect Wi-Fi signal above its ED threshold. Because of the difference values of ED thresholds that are used by Wi-Fi and LTE and the lack of Virtual Carrier Sensing (VCS) at the LTE side, coexistence problems may arise at below such ED thresholds. In order to address this issue, we propose a practical and easy implementable adaptive ED threshold algorithm, which can dynamically tune the ED threshold at the Wi-Fi and LTE nodes.

In this chapter, LTE adopts category 4 (Cat4) MAC protocol which is standardised by 3 GPP in LTE Release 13, the new LTE is called LTE licensed assisted access (LTE-LAA) or simply LAA. Indeed, a good fair coexistence is attained by the LBT framework introduced in the LTE specifications [7], which is largely inspired by the LBT procedure of Wi-Fi. By making both LAA and Wi-Fi Mac layer protocol as similar as possible, coexistence among technologies is facilitated [99] [69]. However, in this chapter, we show that the adoption of similar protocols is not enough to guarantee the fair coexistence, specially if both LTE and Wi-Fi have a different ED threshold due to their PHY layer heterogeneity.

Beside the above, in intra-Wi-Fi coexistence, the fair coexistence is not only governed by the LBT feature but it is further augmented through VCS, whereby Wi-Fi packet headers are received at low power levels, lower than the ED threshold, and used to coordinate the transmissions of neighbouring Wi-Fi nodes. In more detail, the network allocation vector (NAV), i.e., time line at each Wi-Fi node of when the channel is free or occupied, is updated based on the content of such Wi-Fi packet headers, which indicate for how long the sender Wi-Fi node intends to occupy the channel [94]. In certain cases, the lack of VCS at the LAA nodes may degrade the coexistence performance at below ED threshold of LAA nodes with other Wi-Fi nodes when compared to that of Wi-Fi nodes with other Wi-Fi nodes.

In this chapter, we analyze the LAA and Wi-Fi coexistence performance below the ED threshold, and propose a practical and easy implementable adaptive ED threshold algorithm, which can be adopted at the LAA (and the Wi-Fi) nodes to address such concerns. The rest of the chapter is organised as follows: In Section 6.1, the issue of LAA and Wi-Fi coexistence at below ED threshold is introduced. In Section 6.2, an adaptive ED threshold scheme that can be adopted to address below ED coexistence concerns is presented. In Section 6.3, the system model for our performance evaluation is depicted. In Section 6.4, the simulation results are discussed. Finally, in Section 6.5, the summary is drawn.

## 6.1 COEXISTENCE BELOW ENERGY DETECTION THRESHOLD

Wi-Fi uses an ED threshold of -62 dBm, while LAA uses an ED threshold of -72 dBm [7]. Below the ED threshold, Wi-Fi does not back off to other technology transmissions, and only backs off to other Wi-Fi transmission up to -82 dBm through the VCS feature, i.e., doing Wi-Fi preamble decoding. As a result, if Wi-Fi and LAA share an unlicensed channel, Wi-Fi will not back off to LAA below -62 dBm, and LAA will not back off to Wi-Fi below -72 dBm. This mid-range interference zone at below ED threshold, from -72 dBm to -82 dBm, represents a grey area

for coexistence. Indeed, simultaneous multi-radio access technology transmissions at below ED threshold may result in higher interference levels to each co-existing technology sharing an unlicensed channel, leading to reduced spectral efficiency that in turn results in lower overall system throughput.

Moreover, downlink collisions can still occur even when the Wi-Fi access point (AP) and the LAA evolved NodeB (eNB) receive each other's transmissions at levels much higher than their respective ED thresholds. For example, on a downlink transmission of a Wi-Fi AP, let us assume that the LAA eNB easily detects the energy of the Wi-Fi AP, and refrains from transmitting. After the end of the data packet, the energy drops, the channel is clear, and the LAA eNB starts a timer for 1 short interframe space (SIFS) plus 1 slot, according to its LBT procedure. If the Wi-Fi user equipment (UE) acknowledgment (ACK) is detected, i.e., if it is received at greater than -72 dBm, the LAA eNB will refrain from transmitting. If the Wi-Fi UE ACK is received below -72 dB, then the LAA eNB may transmit. It is then clear that collisions are possible whereby a Wi-Fi UE ACK is in the process of being received, while the LAA eNB does not detect it, and goes on to transmit. This ruins the entire Wi-Fi transmission, and the Wi-Fi AP needs to perform retransmissions. The ED threshold of -72 dB, effectively limits the collision-free downlink range of the Wi-Fi AP, i.e., the Wi-Fi UE must be close enough to the Wi-Fi AP and LAA eNB such that the ACK is received at -72 or greater.

## 6.2 ADAPTIVE ENERGY DETECTION THRESHOLD SCHEME

After the channel selection process is completed, we propose that the ED thresholds are adapted at the LAA eNB (and the Wi-Fi AP) to improve efficiency and fairness when both technologies share the same channel, thus addressing the mentioned below ED coexistence problem. Using the proposed adaptive ED threshold mechanism, the incumbent Wi-Fi transmissions will be protected at a much lower level than the fixed -72 dBm. Moreover, by ensuring that Wi-Fi AP also utilise the proposed adaptive ED threshold mechanism in addition to LAA eNB, a more fair coexistence will be achieved, which is otherwise not possible without its participation, e.g., results in [144].

A general study on transmit power and ED threshold adaptation can be found in [130]. However, the authors did not consider the below ED threshold coexistence issue, and they did not provide any algorithm to realise an adaptive ED threshold selection. In the following, our proposed adaptive ED threshold scheme at the Wi-Fi AP and the LAA eNB is described.



### 6.2.1 SCHEME AT THE WI-FI SIDE

On the Wi-Fi side, the AP may or may not have access to LAA network listen module capabilities. The adaptive ED threshold mechanism on the Wi-Fi side will work in a periodical manner as follows:

1. The ED threshold  $\Gamma_w^{\text{WiFi}}$  is initially set to -62 dBm (as per today's operation), where  $w$  denotes the Wi-Fi AP of interest. A minimum ED threshold  $\Gamma_{\min,w}^{\text{WiFi}}$  is also set (e.g., -72 dBm).
2. If an LAA network listen module capability is present at the AP, the Wi-Fi AP  $w$  periodically determines the receive signal strength indicator (RSSI),  $R_{w,i}^{\text{LAA}}$ , of the received master information block (MIB)/system information block (SIB)/cell-specific reference symbol (CRS) from each of the co-existing LAA nodes  $i$ . Then, the Wi-Fi AP  $w$  finds the minimum one, i.e.,  $R_{\min,w}^{\text{LAA}} = \min R_{w,i}^{\text{LAA}} \forall i$ .

**Remark 1:** As proposed in [81], LAA eNB may use friendly co-located Wi-Fi AP to advertise their presence using a Wi-Fi pseudo beacon signal, which can let neighbouring Wi-Fi nodes know in 'Wi-Fi language' about the presence of the LAA eNB<sup>1</sup>. The usage of such Wi-Fi pseudo beacon signal would remove the need for an LAA network listen module capability at the Wi-Fi AP. As a result, this step could be omitted and the algorithm could go to the next one.

**Remark 2:** In case that neither the LAA network listen module or Wi-Fi pseudo beacon signal capabilities are available, the Wi-Fi AP can detect the presence of anonymous other technology nodes, such as LAA, without any preamble transmission by scanning the unlicensed channel and detecting a large increase in receive power followed by a drop some time later. The Wi-Fi AP will periodically perform this other technology detection to adjust the  $R_{\min,w}^{\text{LAA}}$  threshold appropriately.

3. During idle periods, the Wi-Fi AP  $w$  may look for other Wi-Fi transmissions using Wi-Fi beacon signal decoding. If this capability is present, the Wi-Fi AP  $w$  periodically determines the RSSI,  $R_{w,z}^{\text{WiFi}}$ , of the received Wi-Fi beacon signal from each of the co-existing Wi-Fi nodes  $z \forall z \neq w$ . Then, the Wi-Fi AP  $w$  finds the minimum one, i.e.,  $R_{\min,w}^{\text{WiFi}} = \min R_{w,z}^{\text{WiFi}} \forall z \neq w$ .

---

<sup>1</sup>Since the power of the Wi-Fi pseudo beacon signal and the LAA transmission might be different, the Wi-Fi pseudo beacons may need a power factor field, which indicates how much higher or lower the LAA signals are compared to the Wi-Fi pseudo beacon.

4. Thereafter, the Wi-Fi AP  $w$  determines the minimum received RSSI,

$$R_{\min,w} = \min (R_{\min,w}^{\text{laa}}, R_{\min,w}^{\text{WiFi}}).$$

5. Then, the ED threshold is set as follows

$$\Gamma_w^{\text{WiFi}} = \begin{cases} -62\text{dBm} & R_{\min,w} \geq -62\text{dBm} \\ R_{\min,w} & \Gamma_{\min,w}^{\text{WiFi}} < R_{\min,w} < -62\text{dBm} \\ \Gamma_{\min,w}^{\text{WiFi}} & R_{\min,w} \leq \Gamma_{\min,w}^{\text{WiFi}} \end{cases} \quad (6.1)$$

6. If for a period of time  $\Delta T_w$ , the Wi-Fi AP does not detect the presence of any other technology nodes on the unlicensed channel, or their RSSI value is above -62 dBm, it will set the ED threshold back to -62 dBm.

### 6.2.2 SCHEME AT THE LAA SIDE

On the LAA side, the eNB may or may not have access to Wi-Fi network listen module capabilities. The adaptive ED threshold mechanism on the LAA side will work in a periodical manner as follows:

1. The ED threshold  $\Gamma_i^{\text{laa}}$  is initially set to -72 dBm (as per today's operation), where  $i$  denotes the LAA eNB of interest. A minimum ED threshold  $\Gamma_{\min,i}^{\text{laa}}$  is also set (e.g., -82 dBm).
2. If a Wi-Fi network listen module capability is present at the eNB, the LAA eNB  $i$  periodically determines the RSSI,  $R_{i,w}^{\text{WiFi}}$ , of the received beacon signal from each of the co-existing Wi-Fi nodes  $w$ . Then, the LAA eNB  $i$  finds the minimum one, i.e.,  $R_{\min,i}^{\text{WiFi}} = \min R_{i,w}^{\text{WiFi}} \forall w$ .

Remark 2 applies in case a Wi-Fi network listen module capability is not present at the LAA eNB.

3. During idle periods, the LAA eNB  $i$  may look for other LAA nodes using MIB/SIB/CRS decoding. If this capability is present, the LAA eNB  $i$  periodically determines the RSSI,  $R_{i,j}^{\text{laa}}$ , of the received MIB/SIB/CRS from each of the co-existing LAA nodes  $j$ ,  $\forall j \neq i$ . Then, the LAA eNB  $i$  finds the minimum one, i.e.,  $R_{\min,i}^{\text{laa}} = \min R_{i,j}^{\text{laa}} \forall j \neq i$ .
4. Thereafter, the LAA eNB  $i$  determines the minimum received RSSI,  $R_{\min,i} = \min (R_{\min,i}^{\text{WiFi}}, R_{\min,i}^{\text{laa}})$ .

5. Then, the ED threshold is set as follows

$$\Gamma_i^{\text{laa}} = \begin{cases} -72\text{dBm} & R_{\min,i} \geq -72\text{dBm} \\ R_{\min,i} & \Gamma_{\min,i}^{\text{laa}} < R_{\min,i} < -72\text{dBm} \\ \Gamma_{\min,i}^{\text{laa}} & R_{\min,i} \leq \Gamma_{\min,i}^{\text{laa}} \end{cases} \quad (6.2)$$

6. If for a period of time  $\Delta T_i$ , the LAA eNB does not detect the presence of any other technology nodes on the unlicensed channel, or their RSSI value is above -72 dBm, it will set the ED threshold back to -72 dBm.

Note that  $R_{w,i}^{\text{laa}}$ ,  $R_{w,z}^{\text{WiFi}}$ ,  $R_{i,w}^{\text{WiFi}}$  and  $R_{i,j}^{\text{laa}}$  values may be averaged using a filter to mitigate fast-fading effects and smooth measurements.

### 6.3 SYSTEM MODEL

In this section, the system model used to validate the performance of the presented adaptive ED threshold scheme is depicted. The performance evaluation is conducted over an enterprise scenario of  $120\text{ m} \times 50\text{ m}$ , where there is an LAA eNB located at position  $(30,25)\text{ m}$  and a Wi-Fi AP located at position  $(90,25)\text{ m}$ , 60 m apart from each other (see Fig. 6.1). Most simulation assumptions in terms of eNB, AP and UE deployment as well as antenna gain, path loss, shadowing and multi-path fading modelling follow the 3GPP recommendations in [7]. It is important to note that the InH channel model is used in this case [6], but that the link between the LAA eNB and the Wi-Fi AP is always tweaked to be non line of sight (NLOS) and below ED detection threshold. 64 quadrature amplitude modulation (QAM) is the maximum modulation scheme supported. 100 simulation drops are performed, and in each drop 10 seconds are simulated. Please refer to [82] for a more complete description of the simulator.

a) LAA eNB deployment: The eNB, located at position  $(30,25)\text{ m}$ , has a transmit power of 24 dBm and uses a 20 MHz channel in the 5 GHz band. Two omnidirectional antennas with a 5 dBi gain are considered.

b) Wi-Fi AP deployment: The AP, located at position  $(90,25)\text{ m}$ , has a transmit power of 24 dBm and uses the same 20 MHz channel in the 5 GHz band. Two omnidirectional antennas with a 5 dBi gain are considered.

c) UE deployment: A number of stationary UE per technology are uniformly deployed within the enterprise, where the minimum base station-to-UE distance is 3 m. Each UE has a transmit power of 18 dBm, and only associates to the eNB or the AP, if the eNB CRS and the

AP beacon signal are detected at or above  $-100$  dBm or  $-82$  dBm in the 20 MHz channel, respectively. Two omnidirectional antennas with a 0 dBi gain are considered, thus allowing  $2 \times 2$  MIMO transmissions. Fast fading channel gains are assumed with a UE speed of 3 km/h.

d) Services: All UE use a downlink file transfer protocol (FTP) service, following the 3GPP FTP traffic model 3, where the FTP file size is 2 Mbytes (or 4 Mbytes, if specifically stated), and the packet arrival rate is Poisson distributed with an average of 0.625. This leads to an offered traffic of 10 and 20 Mbps per UE. It is important to note that due to the nature of FTP traffic and because it has been shown to improve LAA and Wi-Fi coexistence, request-to-send (RTS)/clear-to-send (CTS) mechanism is present in our simulations [52].

Other relevant WLAN parameters are set as follows: DIFS =  $34 \mu\text{s}$ , SIFS =  $16 \mu\text{s}$ , time slot =  $9 \mu\text{s}$ , transmission opportunity (TXOP) = 3 ms.

#### 6.4 PERFORMANCE COMPARISON

In this section, the system-level simulations results used to assess the performance of the proposed adaptive ED threshold scheme are presented. First of all, we pay attention to two toy examples to shed light on the system mechanics, and then we focus on more general scenarios.

##### 6.4.1 SINGLE UE PER TECHNOLOGY LOCATED BOTH AT THE CELL-EDGE

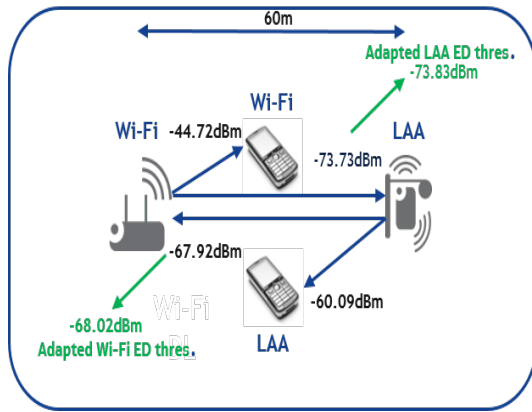


Figure 6.1: Scenario with one UE per technology at the cell-edge.

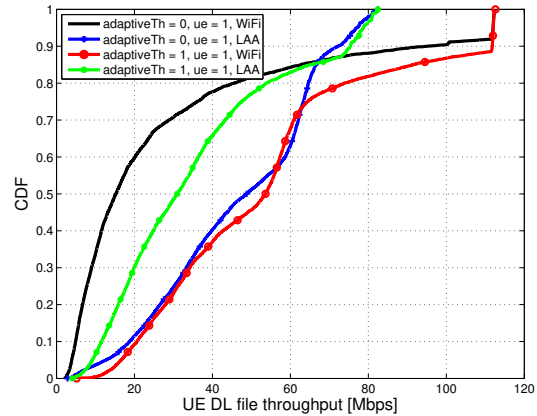


Figure 6.2: CDF of UE file throughput for scenario with one UE per technology located both at the cell-edge.

In this toy example, there is only one UE per technology, and they are forced to be located at the cell-edge between the two base stations, see Fig. 6.1. The LAA UE is at (60, 26) m and the Wi-Fi UE is at (60, 24) m.

*Without the adaptive ED threshold scheme*, the Wi-Fi AP and the LAA eNB do not detect each other (below ED threshold conditions), and thus their downlink transmissions are not coordinated and they attempt to transmit simultaneously. This results in a large number of collisions and re-transmissions, which mostly affect Wi-Fi performance due to its continuous back-off, as explained in the following. The Wi-Fi AP, since it has the RTS/CTS mechanism, is able to quickly detect collisions (missing CTS), and thus backs off to the LAA eNB transmissions. In contrast, the LAA eNB, since it does not have the RTS/CTS mechanism, does not detect collisions, and thus does not back off to the Wi-Fi transmissions. As a result, the LAA eNB pushes the Wi-Fi AP out of the band (LAA drives the channel access). Nonetheless, the Wi-Fi AP is still able to take advantage of the LAA eNB idle times (no file to transmit at the LAA eNB), and transmits its files at a relatively high throughput.

*With the adaptive ED threshold scheme*, the Wi-Fi AP and the LAA eNB detect each other, and thus they are able to coordinate their transmissions. The LAA eNB does not drive the channel access anymore, but instead gives way to the Wi-Fi AP. This results in a fair time sharing, as well as much fewer collisions and retransmissions. Due to this coordination/politeness, the LAA eNB losses air time in favour of the Wi-Fi AP. In other words, such coordination benefits the Wi-Fi AP, which does not back off as much to laa, but impacts the LAA eNB, which decreases its air time to share it with Wi-Fi.

Fig. 6.2 shows the cumulative distribution function (CDF) of the UE file throughput<sup>2</sup>. Driven by the above described behaviour, the adaptive ED threshold scheme provides a substantial gain in Wi-Fi performance at the expense of a reduced LAA performance. In more detail, the median Wi-Fi file throughput increases by 3.5x (from 15.19 Mbps to 53.7 Mbps), while the median LAA file throughput decreases by 36 % (from 48.76 Mbps to 31.03 Mbps).

*Conclusion:* In scenarios where UE are prone to interference, the adaptive ED threshold improves fairness and provides significant gains to Wi-Fi.

#### 6.4.2 SINGLE UE PER TECHNOLOGY LOCATED BOTH AT THE CELL-CENTRE

In this toy example, there is only one UE per technology, and they are forced to be located at their cell-centres, see Fig. 6.3. The LAA UE is at (33, 25) m and the Wi-Fi UE is at (87, 25) m.

*Without the adaptive ED scheme*, the Wi-Fi AP and the LAA eNB do not detect each other (below ED threshold conditions), and thus their downlink transmissions are not coordinated and they attempt to transmit simultaneously. However, this is not really a problem since the

<sup>2</sup>UE file throughput is defined as the file size divided by the time when the last bit of the file is correctly delivered to the receiver minus the time when the file is arrived in the transmit buffer [6].

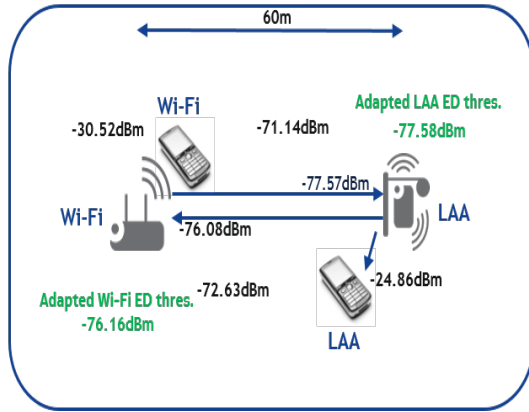


Figure 6.3: Scenario with one UE per technology at the cell-centre.

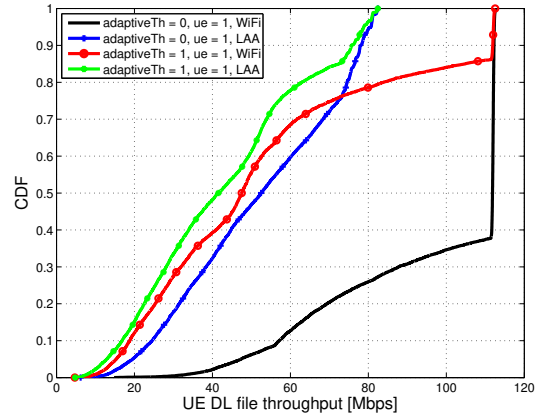


Figure 6.4: CDF of UE file throughput for scenario with one UE per technology located both at the cell-centre.

UEs are very close to their serving nodes and their signal to interference plus noise ratios (SINR) and throughputs are large.

With the adaptive ED scheme, the Wi-Fi AP and the LAA eNB detect each other, and thus they are able to coordinate their transmissions. However, this reduces the performance of both since simultaneous transmissions do not take place, i.e., spatial reuse is prevented.

Fig. 6.4 shows the CDF of the UE file throughput. Driven by the above described behaviour, the adaptive ED threshold scheme results in losses in both Wi-Fi and LAA performance. In more detail, the median Wi-Fi file throughput decreases by 57 % (from 111.7 Mbps to 47.52 Mbps), while the median LAA file throughput decreases by 21 % (from 52.5 Mbps to 41.58 Mbps).

It is important to note that, in Fig. 6.4, without the adaptive ED scheme, the Wi-Fi performance saturates at 111.8 Mbps, which is reasonable for a 20 MHz, 64 QAM 5/6, 2x2 multiple input multiple output (MIMO) transmission with a typical Wi-Fi overhead [94]. In contrast, the LAA transmission is not able to achieve the same peak performance, even though the same configuration is used. The reason why the LAA does not peak at the same throughput is twofold:

- The LAA's reservation signal [27]: Since  $TXOP=3$  ms and because LAA can only start transmissions at a subframe boundary, LAA can only use for data transmission 2 subframes out of the 3 subframes in the TXOP, which reduces the peak throughput by 33% [27].
- The collisions created by the CTS transmissions of the Wi-Fi UE: The interference generated by the CTS of the Wi-Fi UE is strong enough to generate packet losses at the LAA

UE when both UEs are in line of sight (LoS). When the scheme is deactivated, since the link between base stations is always below ED threshold the RTS of the Wi-Fi AP is never detected by the LAA node. As a result, the Wi-Fi and LAA base stations transmit simultaneously, and the CTS of the Wi-Fi UE strongly interferes the LAA one, when both UEs are in LoS. This results in LAA packet retransmissions and throughput loss. With this in mind, note activating the adaptive ED threshold scheme reduces the air-time for LAA transmissions but reduces retransmissions. Due to this trade off, the loss of performance of LAA in Fig. 6.4, 21 %, is lower than that of Wi-Fi, 57 %, which does not benefit from retransmission mitigation, as LAA does not transmit uplink signal in the unlicensed band.

*Conclusion:* In scenarios where interference would have a minimal impact on throughput, coordination via the adaptive ED threshold provides significant losses to Wi-Fi.

As these two toy examples suggest, throughput gain or loss due to coordination is dependent on the UE topology. However, under the assumption of uniform distribution of UE, most of the area is considered the ‘cell-edge’. Section 6.4.3 quantifies the performance of the adaptive ED threshold algorithm for the general scenario. Adaptivity that accounts for topology is the subject of our future research.

#### 6.4.3 MULTIPLE UE PER TECHNOLOGY UNIFORMLY DISTRIBUTED

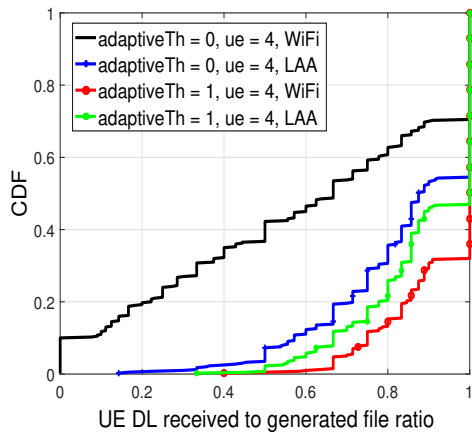
In the following, 4 UE per technology are uniformly deployed within the enterprise, and we analyse two cases. In the first one, the file size is 2 Mbytes, while in the second case, the file size is 4 Mbytes, resulting in an offered load of 40 and 80 Mbps per technology. Files are queued until successfully transmitted.

Fig. 6.5 shows the CDF of the per UE ratio of received to generated files<sup>3</sup>, for the 2 Mbyte file size case, while Fig. 6.6 shows the CDF of the UE file throughput for the same case. It is important to note that files that were not received by a UE and are sitting at the eNB buffer at the end of the simulation are marked with 0 kbps.

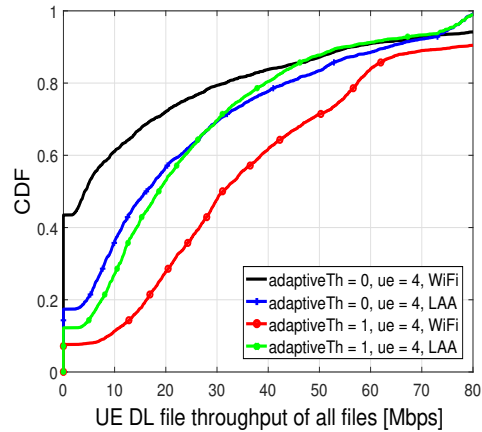
From Fig. 6.5, it can be seen that when the adaptive ED threshold scheme is activated, both LAA and Wi-Fi transmit more files to their connected UE during the simulation time. This

---

<sup>3</sup>Ratio between the number of files successfully received at the UE divided by the number of files generated at the transmitter side. For example, a ratio of 1 means that all generated files at the transmitter for a UE were successfully received by such UE, while a ratio of 0.5 means that only half of the generated files for a UE were successfully received by such UE.



**Figure 6.5:** CDF of received to created file ratio for scenario with four UE per technology and file size of 2 Mbyte.



**Figure 6.6:** CDF of UE file throughput for scenario with four UE per technology and file size of 2 Mbyte.

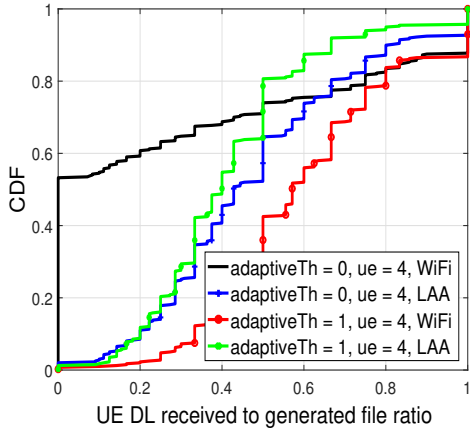
translates into a larger UE file throughput, as can be seen in Fig. 6.6. In more detail, when using the adaptive ED threshold scheme, the average UE throughput of Wi-Fi increases by 2.2x (from 17.4 Mbps to 38.1 Mbps), while the average UE throughput of LAA increases by 2 % (from 23.9 Mbps to 24.3 Mbps).

The coordination introduced by the proposed scheme benefited both technologies. However, Wi-Fi benefits much more than LAA from the proposed scheme, as significant airtime is diverted from LAA to Wi-Fi access, when LAA lowers its ED threshold to become more polite. Moreover, as LAA losses airtime to enhance SINR, it is important note that the LAA median UE throughput gain is small, and that there is a cross over between the CDF of the LAA UE file throughput with and without adaptive ED threshold.

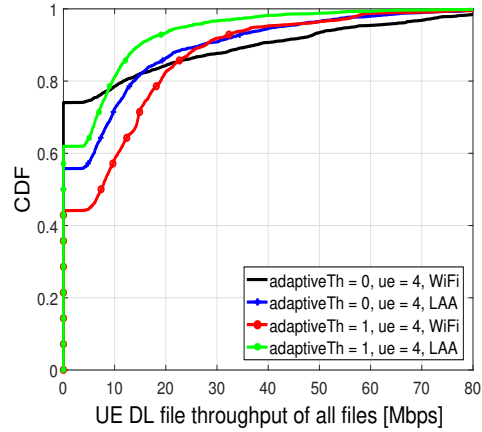
In the same line as previous figures, Fig. 6.5 shows the CDF of the per UE ratio of received to generated files, for the 4 Mbyte file size case, while Fig. 6.6 shows the CDF of the UE file throughput for the same case.

From these figures and following the same reasoning as for the 2 Mbyte file size case, it can be seen how Wi-Fi benefits much more than LAA from the proposed adaptive ED threshold scheme. Indeed, as the load is larger now, LAA suffers more than before from the diversion of airtime from LAA to Wi-Fi access, and as a result, its performance is decreased, transmitting less files and in turn having a lower UE throughput. In more detail, when using the adaptive ED threshold scheme, the average UE throughput of Wi-Fi increases by 23 % (from 8.92 Mbps to 11.0 Mbps), while the average UE throughput of LAA decreases by 38 % (from 8.60 Mbps





**Figure 6.7:** CDF of received to created file ratio for scenario with four UE per technology and file size of 4 Mbyte.



**Figure 6.8:** CDF of UE file throughput for scenario with four UE per technology and file size of 4 Mbyte.

to 5.36 Mbps).

To explain this overall behaviour, it is important to note that LAA UEs cannot connect to the Wi-Fi AP, and that Wi-Fi UEs cannot connect to the LAA eNB, even when the other technologies' signal strength is higher. This is a typical situation in multi-tenant office buildings, having overlapping radio coverage but separate management. This generates closed subscriber group issues, which in turn create large cell-edges and inter-cell interference. This case matches the toy example in which UE were located at the cell-edges, and thus the same conclusion holds: The politeness/interference coordination introduced by the adaptive ED threshold scheme provides fairness i.e., the LAA eNB does not drive the channel access anymore, but instead gives way to the Wi-Fi AP, resulting in a fair time sharing, in which the LAA eNB losses air time in favour of the Wi-Fi AP. As a consequence, such coordination benefits the Wi-Fi AP, which does not back off as much to laa, but impacts the LAA eNB, which decreases its air time to share it with Wi-Fi.

## 6.5 SUMMARY

In this chapter, we have tackled the problem of Wi-Fi and LAA coexistence below the ED threshold. Given the default Wi-Fi and LAA ED thresholds, and the lack of virtual carrier sensing at the LAA side, coexistence problems may arise at below such ED thresholds. In order to address this issue, we propose an adaptive ED threshold scheme that uses broadcast channel transmissions to dynamically tune the ED threshold at the Wi-Fi and LAA nodes. Simulations

results in an enterprise scenario showed that the Wi-Fi performance can be significantly enhanced in scenarios where users are prone to inter-radio access technology interference, up to 2.2 x in average, while moderately impacting LAA performance. Our future research will optimise MAC parameters over node topology and traffic activity.

*Si vous ne pouvez pas l'expliquer simplement, vous ne le comprenez pas assez bien*

Albert Einstein

# 7

## Conclusions and Future work

To address mobile data growth challenges, mobile operators require to access more spectrum resources. LTE over unlicensed spectrum has been proposed to extend the usual operation of LTE over licensed spectrum to cover also unlicensed spectrum, mainly at the 5 GHz band due to its wide spectrum availability. However, this extension poses significant challenges especially regarding the coexistence between LTE and Wi-Fi. The new entrant LTE should fairly coexist with the incumbent Wi-Fi so that LTE can be considered as Wi-Fi-friendly. Knowing that LTE and Wi-Fi were originally designed for different networking purposes, the heterogeneity between them is quite high, and thus, ensuring the fair coexistence is really a great challenge. Indeed, the heterogeneity of the MAC and PHY layer between LTE and Wi-Fi are at the heart of conflicts between them. In order to overcome this problem, LTE has to employ a new MAC protocol that allows a fair channel access with Wi-Fi. Moreover, LTE can further improve the coexistence by adopting additional mechanisms such as the adaptive ED threshold to cope with the PHY layer heterogeneity problem.

## 7.1 TDM-BASED MAC LAYER PROTOCOL

The TDM-based protocol is the most “aggressive” protocol that LTE can adopt to share the channel access with Wi-Fi. The lack of a CCA mechanism may lead to several transmission collisions between LTE and Wi-Fi. On the one hand, the TDM-based protocol can offer high performance results to LTE, while on the other hand, it can lead to harmful degradations of Wi-Fi performance. If LTE has some knowledge about Wi-Fi networks such as the traffic load, the data rate, the packet size and the number of Wi-Fi stations, LTE can tune its TDM configurations parameters based on our analytical models to fairly coexist with Wi-Fi. In such situation, the TDM-based protocol will not only guarantee a fair coexistence with Wi-Fi but also improve the channel utilization since LTE can have maximum profit of the channel access whenever Wi-Fi performance is not really impacted.

In this thesis, we did not show how LTE can gather the related Wi-Fi network information that is needed to tuning the TDM-based protocol. Several previous works have shown that LTE can implement several mechanisms, e.g. based on machine learning, to estimate the Wi-Fi related information. An important future work is to measure the impact of the lack or wrong assessments of this information on the fairness. Besides, we have to analyze the price of obtaining such information. For example, the price related to LTE MAC layer design complexity and the increasing of the LTE base station power consumption since it has to be always on, even during LTE off transmission periods to track Wi-Fi traffic load.

Our LTE/Wi-Fi coexistence analytical models are based on some assumptions on the coexistence conditions. For example, we have assumed that Wi-Fi always refrains from the channel access whenever LTE is transmitting over the channel in other words Wi-Fi receives always the LTE signal above its ED threshold. This is equivalent to assume that LTE and Wi-Fi are nearly located in the same geographical area. We have also assumed that LTE and Wi-Fi traffic are always saturated. Actually, if the coexistence conditions change, we have to revisit our LTE/Wi-Fi coexistence analytical models to find the new TDM configurations that ensures the fair coexistence. However, one of the strengths of our analytical models is their ability to be adapted to take into consideration different coexistence conditions.

Another important aspect that we did not consider is the impact of the TDM-based protocol on Wi-Fi delay performance. Remember that ensuring fair coexistence is not limited to an equal sharing of the channel access. LTE off-periods and collisions may impact negatively delay-sensitive Wi-Fi services such as voice over IP and live video streaming. In this case, the fair coexistence is not that perfect and LTE is not totally Wi-Fi-friendly.

## 7.2 FRAME BASED EQUIPMENT MAC LAYER PROTOCOL

The adoption of FBE protocol can accelerate the deployment of LTE in unlicensed spectrum for regions such as Europe, Japan and India which force the usage of CCA mechanisms. By adopting FBE protocol, we have proved that LTE can coexists fairly with Wi-Fi while Wi-Fi does not. Under certain coexistence conditions such as a saturated Wi-Fi traffic, the adoption of FBE protocol makes LTE struggles to grab the channel access from Wi-Fi which completely dominates the channel access. Moreover, LTE performance heavily depends on Wi-Fi data rate, in case Wi-Fi channel conditions are subject to important signal fading and interference, Wi-Fi tends to reduce its data rate, as a result LTE performance will also decrease. We call this phenomenon the “FBE protocol performance anomaly”.

Indeed, LTE should be cautious about the adoption of the FBE protocol since it is still possible that LTE reaches a certain acceptable level of performance only under some conditions on Wi-Fi networks, i.e. a low Wi-Fi traffic load and a high Wi-Fi data rate. In fact, as a future work, we can explore mechanisms that enables LTE to infer these coexistence conditions dynamically. Thus, LTE can use FBE protocol to coexist with Wi-Fi whenever these conditions are met. Otherwise, LTE can employ the TDM-based protocol. Accordingly, LTE may adopt a hybrid MAC protocol that switch between FBE and TDM-based based on the inferred coexistence conditions. Besides, LTE should identify when and how to toggle from one protocol to another.

## 7.3 INSIGHTS TOWARDS A NEW HYBRID MAC LAYER PROTOCOL

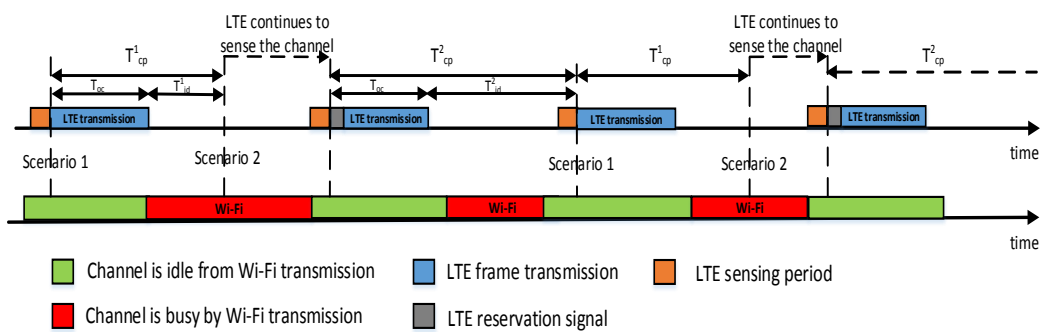


Figure 7.1: Hybrid MAC layer protocol for LTE in unlicensed spectrum

To tackle both problems of the channel access starvation that faces FBE protocol and the transmission collision that faces TDM-based protocol, we can propose a new hybrid MAC protocol for LTE that is shown in Figure 7.1. **The main idea behind the hybrid MAC protocol is that Wi-Fi traffic load will be responsible of defining the way that the hybrid LTE MAC protocol shares the channel with Wi-Fi.** For example, in the case Wi-Fi traffic load is low, LTE can adopt FBE protocol to share the channel access with Wi-Fi since LTE channel access probability is supposed to be high. In contrast, in case the Wi-Fi traffic load is relatively high, LTE should adopt somehow a TDM-based protocol to share the channel access with Wi-Fi but without inducing transmission collisions with Wi-Fi. In fact, the hybrid MAC layer protocol exploits the fact that the sensing period allowed by ETSI can be lower than the sensing period of Wi-Fi (DIFS). With this observation, when LTE tries to access the channel immediately after the end of any Wi-Fi transmission, it is almost sure that LTE will grab the channel access without collisions with Wi-Fi.

The hybrid MAC protocol has two different actions according to two different scenarios defined by the state of the channel. The two scenarios of the hybrid MAC protocol are described as follows:

- Scenario 1: At LTE subframe boundaries, LTE tries to access the channel while the channel is idle from Wi-Fi transmissions. LTE is able to grab the channel access *immediately* and occupy the channel for a period of time called  $T_{oc}$ . Afterwards, LTE will schedule the future time instant to contend for the channel access based on the FBE protocol, i.e. LTE idle period duration  $T_{id}^1$  has to be at least equals to 1ms corresponding to LTE subframe duration to guarantee the synchronous operation of the channel. Accordingly, LTE employs its first contention period with Wi-Fi ( $T_{cp}^1$ ) which includes the transmission period  $T_{oc}$  followed by the idle period  $T_{id}^1$  as shown in Figure 7.1 scenario 1.
- Scenario 2: At LTE subframe boundaries, LTE tries to access the channel while the channel is busy by Wi-Fi transmissions. LTE is blocked from channel access, however, LTE will keep sensing the channel until Wi-Fi transmission is terminated. *Immediately after Wi-Fi transmission is terminated*, LTE grabs the channel access thanks to its smaller sensing period than Wi-Fi. Afterwards, LTE will use its reservation signal to align its LTE frame transmission with the upcoming LTE subframe. The sum of the both durations of reservation signal and the LTE frame has to be equal to  $T_{oc}$  as in scenario 1, in the case LTE has a fixed TXOP. In contrast to scenario 1, LTE will schedule the future time

instant to contend for the channel access based on the TDM-based protocol, i.e. LTE idle period duration  $T_{id}^2$  has to be in the same order of magnitude as the  $T_{oc}$  period. Indeed, we need to increase LTE idle period with respect to scenario 1 for two reasons: (1) Reducing the probability that LTE impacts Wi-Fi performance and becomes selfish with respect to channel access (2) Offering enough time to Wi-Fi for discharging its traffic before LTE contend for the channel access again. Accordingly, LTE employs its second contention period with Wi-Fi ( $T_{cp}^2$ ) which is greater than ( $T_{cp}^1$ ) and includes the transmission period  $T_{oc}$  followed by the idle period  $T_{id}^2$  as shown in Figure 7.1 scenario 2.

We think that the hybrid MAC protocol has several advantages compared to the four MAC layer protocols proposed by 3GPP. We summarize these advantages as follows:

- Orthogonal channel access with Wi-Fi: LTE shares the channel access without inducing a transmission collisions with Wi-Fi whereas it is not the case with TDM-based, LBE and category 4 protocols.
- Minimum transmission overhead: LTE does not need to use a reservation signal every time it accesses the channel whereas it is not the case with both LBE and category 4 protocols.
- Maximum channel utilization: LTE has a better control on the channel access compared to FBE, LBE and category 4 protocols. LTE can maximize its throughput performance if the hybrid MAC protocol idle periods ( $T_{id}^1$  and  $T_{id}^2$ ) are well configured, of course after taking into consideration the fair coexistence with Wi-Fi.
- Cognitive MAC protocol: The time instants that LTE contends for the channel access are randomly spaced in time, see Figure 7.1. Therefore, the hybrid MAC protocol can profit from to measure Wi-Fi channel utilization. Thus, the hybrid MAC protocol can be able to be self-configured whereas it is not the case with TDM-based protocol.
- Non-eccentric: LTE performance is not highly dependent on Wi-Fi performance as for the FBE protocol.

We already started to implement the protocol in NS3 simulator and initial results show that the proposed MAC layer protocol would offer a better fair coexistence between LTE and Wi-Fi as well as a better LTE and Wi-Fi performance with much lower mutual negative impact between both technologies.

#### 7.4 ENHANCING LTE/WI-FI COEXISTENCE

Whatever the MAC layer protocol adopted by LTE to share the channel access with Wi-Fi, the PHY layer heterogeneity between LTE and Wi-Fi can also degrade the fair coexistence due to mainly the well-known hidden terminal problem. It is true that this problem has been studied since a time in wireless communication, a practical solution in our particular case of LTE/Wi-Fi coexistence is still to seek. There is not doubt that finding a solution that works in all coexistence scenarios is a very hard task. However, it might be sufficient to solve the hidden node problem in some coexistence deployments. Such solution must have certain characteristics and must take into account several aspects such as: (i) The geographical distribution of wireless nodes in the network (ii) The traffic load of each node (iii) The ability to ensure a fair coexistence and a moderate level of interference among the nodes.

In the literature, there are several directions of research that may help designing solutions for the hidden node problem. The latest are mainly based on adaptive adjustment of certain parameters of wireless nodes such as the energy detection threshold, the signal transmission power and the usage of control messages such as RTS/CTS messages by Wi-Fi nodes and CTS-to-Self messages by LTE nodes. In this thesis, we have presented a simple solution to tackle the problem based on adaptive adjustment of the energy detection threshold for both LTE and Wi-Fi. Indeed, the first goal of our work is to quantify the gain of using the energy detection threshold to mitigate the problem. In our future work, we aim to improve our proposed solution to not only ensure the fair coexistence but also to provide a higher performance for both LTE and Wi-Fi in unlicensed spectrum.



# List of Publications

## PUBLISHED

- D. Lopez-Pérez, J. Ling, M. R. Khawer and A. Abdelfattah, “Adaptive energy threshold for improved co-existence between licensed assisted access and Wi-Fi”, *IEEE Global Communications Conference (GLOBECOM) workshop*, Singapore, December 2017.
- A. Abdelfattah, N. Malouch, “Modeling and performance analysis of Wi-Fi networks co-existing with LTE-U”, *IEEE International Conference on Computer Communications (INFOCOM)*, Atlanta, USA, May 2017.
- A. Abdelfattah, N. Malouch, “Studying the impact of LTE-U on Wi-Fi downlink performance”, *IEEE International Conference on Wireless and Mobile Computing, Networking and Communications (WiMob)*, New York, USA, October 2016.

# Bibliography

- [1] IEEE Standard for Wireless LAN Medium Access Control (MAC) and Physical Layer (PHY) specifications. *IEEE Std 802.11-1997*, pages 1–445, Nov 1997. doi: 10.1109/IEEESTD.1997.85951.
- [2] Broadband Radio Access Networks (BRAN); 5 GHz high performance RLAN. ETSI EN 301 893 V1.7.1, Harmonized European Standard, Jun. 2012.
- [3] LTE-U Forum, 2014. URL <http://www.lteuforum.org/>.
- [4] MuLTEfire Forum, 2018. URL <https://www.multefire.org/>.
- [5] LTE in unlicensed spectrum: Harmonious coexistence with Wi-Fi, White Paper, Qualcomm, 2014. URL <https://www.qualcomm.com/media/documents/files/lte-unlicensed-coexistence-whitepaper.pdf>.
- [6] 3GPP TR 36.814. Further advancements for E-UTRA physical layer aspects (Release 9). v.12.1.0, Mar. 2010.
- [7] 3GPP TR 36.889. Feasibility Study on Licensed-Assisted Access to Unlicensed Spectrum. v.13.0.0, 2015.
- [8] A. Al-Dulaimi, S. Al-Rubaye, Q. Ni, and E. Sousa. 5G Communications Race: Pursuit of More Capacity Triggers LTE in Unlicensed Band. *IEEE Vehicular Technology Magazine*, 10(1):43–51, March 2015. ISSN 1556-6072. doi: 10.1109/MVT.2014.2380631.
- [9] Alcatel-Lucent, Ericsson, Qualcomm, Samsung, and Verizon. LTE-U CSAT Procedure TS V1.0. Technical report, LTE-U Forum, Oct. 2015.

- [10] Z. Ali, L. Giupponi, J. Mangues-Bafalluy, and B. Bojovic. Machine learning based scheme for contention window size adaptation in LTE-LAA. In *2017 IEEE 28th Annual International Symposium on Personal, Indoor, and Mobile Radio Communications (PIMRC)*, pages 1–7, Oct 2017. doi: 10.1109/PIMRC.2017.8292751.
- [11] Erika Almeida, André M Cavalcante, Rafael CD Paiva, Fabiano de S Chaves, FM Abinader, Robson D Vieira, Sayantan Choudhury, Esa Tuomaala, and Klaus Doppler. Enabling LTE/WiFi coexistence by lte blank subframe allocation. In *Communications (ICC), 2013 IEEE International Conference on*, pages 5083–5088. IEEE, 2013.
- [12] D. Astely, E. Dahlman, G. Fodor, S. Parkvall, and J. Sachs. LTE release 12 and beyond [Accepted From Open Call]. *IEEE Communications Magazine*, 51(7):154–160, July 2013. ISSN 0163-6804. doi: 10.1109/MCOM.2013.6553692.
- [13] A. Babaei, J. Andreoli-Fang, and B. Hamzeh. On the impact of LTE-U on Wi-Fi performance. In *2014 IEEE 25th Annual International Symposium on Personal, Indoor, and Mobile Radio Communication (PIMRC)*, pages 1621–1625, Sept 2014.
- [14] F. Baccelli, S. Machiraju, D. Veitch, and J. Bolot. The Role of PASTA in Network Measurement. *IEEE/ACM Transactions on Networking*, 17(4):1340–1353, Aug 2009. ISSN 1063-6692. doi: 10.1109/TNET.2008.2011129.
- [15] A. M. Baswade and B. R. Tamma. Channel sensing based dynamic adjustment of contention window in LAA-LTE networks. In *2016 8th International Conference on Communication Systems and Networks (COMSNETS)*, pages 1–2, Jan 2016. doi: 10.1109/COMSNETS.2016.7440028.
- [16] Emrah Bayraktaroglu, Christopher King, Xin Liu, Guevara Noubir, Rajmohan Rajaraman, and Bishal Thapa. Performance of IEEE 802.11 under Jamming. *Mobile Networks and Applications*, 18(5):678–696, 2013.
- [17] M. Beluri, E. Bala, Yuying Dai, R. Di Girolamo, M. Freda, J. L. Gauvreau, S. Laughlin, D. Purkayastha, and A. Touag. Mechanisms for LTE coexistence in TV white space. In *2012 IEEE International Symposium on Dynamic Spectrum Access Networks*, pages 317–326, Oct 2012. doi: 10.1109/DYSPAN.2012.6478155.
- [18] L. Berlemann, C. Hoymann, G. Hiertz, and B. Walke. Unlicensed operation of IEEE 802.16: Coexistence with 802.11(A) in shared frequency bands. In *Personal, Indoor*

- and Mobile Radio Communications, 2006 IEEE 17th International Symposium on*, pages 1–5, Sept 2006. doi: 10.1109/PIMRC.2006.254030.
- [19] Lars Berlemann, Christian Hoymann, Guido R Hiertz, and Stefan Mangold. Coexistence and Interworking of IEEE 802.16 and IEEE 802.11 (e). In *Vehicular Technology Conference, 2006. VTC 2006-Spring. IEEE 63rd*, volume 1, pages 27–31. IEEE, 2006.
- [20] A. Bhorkar, C. Ibars, A. Papathanassiou, and P. Zong. Medium access design for LTE in unlicensed band. In *2015 IEEE Wireless Communications and Networking Conference Workshops (WCNCW)*, pages 369–373, March 2015. doi: 10.1109/WCNCW.2015.7122583.
- [21] Naga Bhushan, Junyi Li, Durga Malladi, Rob Gilmore, Dean Brenner, Aleksandar Damnjanovic, Ravi Sukhavasi, Chirag Patel, and Stefan Geirhofer. Network densification: the dominant theme for wireless evolution into 5G. *Communications Magazine, IEEE*, 52(2):82–89, 2014.
- [22] G. Bianchi, A. Di Stefano, C. Giaconia, L. Scalia, G. Terrazzino, and I. Tinnirello. Experimental Assessment of the Backoff Behavior of Commercial IEEE 802.11b Network Cards. In *IEEE INFOCOM 2007 - 26th IEEE International Conference on Computer Communications*, pages 1181–1189, May 2007. doi: 10.1109/INFCOM.2007.141.
- [23] Giuseppe Bianchi. Performance analysis of the IEEE 802.11 distributed coordination function. *Selected Areas in Communications, IEEE Journal on*, 18(3):535–547, 2000.
- [24] F. Cai, Y. Gao, L. Cheng, L. Sang, and D. Yang. Spectrum sharing for lte and wifi coexistence using decision tree and game theory. In *2016 IEEE Wireless Communications and Networking Conference*, pages 1–6, April 2016. doi: 10.1109/WCNC.2016.7565015.
- [25] C. Cano and D. J. Leith. Unlicensed LTE/WiFi coexistence: Is LBT inherently fairer than CSAT? In *2016 IEEE International Conference on Communications (ICC)*, pages 1–6, May 2016. doi: 10.1109/ICC.2016.7510910.
- [26] C. Cano, D. Lopez-Perez, H. Claussen, and D. J. Leith. Using LTE in Unlicensed Bands: Potential Benefits and Coexistence Issues. *IEEE Communications Magazine*, 54(12):116–123, December 2016. ISSN 0163-6804. doi: 10.1109/MCOM.2016.1500413CM.

- [27] Cano and Cristina and Lopez Perez and David and Claussen and Holger and Leith and Douglas J. Using LTE in unlicensed bands: Potential benefits and coexistence issues. *IEEE Communications Magazine*, 54(12):116–123, 2016.
- [28] C. Capretti, F. Gringoli, N. Facchi, and P. Patras. LTE/Wi-Fi Co-existence Under Scrutiny: An Empirical Study. In *Proceedings of the Tenth ACM International Workshop on Wireless Network Testbeds, Experimental Evaluation, and Characterization, WiNTECH '16*, pages 33–40, New York, NY, USA, 2016. ACM. ISBN 978-1-4503-4252-0. doi: 10.1145/2980159.2980164. URL <http://doi.acm.org/10.1145/2980159.2980164>.
- [29] AM Cavalcante, E Almeida, Robson D Vieira, F Chaves, RCD Paiva, F Abinader, S Choudhury, E Tuomaala, and K Doppler. Performance evaluation of LTE and Wi-Fi coexistence in unlicensed bands. In *Vehicular Technology Conference (VTC Spring)*, 2013 *IEEE 77th*, pages 1–6. IEEE, 2013.
- [30] S. Chakraborty, S. Nandi, and S. Chattopadhyay. Alleviating Hidden and Exposed Nodes in High-Throughput Wireless Mesh Networks. *IEEE Transactions on Wireless Communications*, 15(2):928–937, Feb 2016. ISSN 1536-1276. doi: 10.1109/TWC.2015.2480398.
- [31] FS Chaves, AM Cavalcante, EPL Almeida, FM Abinader Jr, RD Vieira, S Choudhury, and K Doppler. LTE/Wi-Fi Coexistence: Challenges and Mechanisms.
- [32] F.S. Chaves, E.P.L. Almeida, R.D. Vieira, AM. Cavalcante, F.M. Abinader, S. Choudhury, and K. Doppler. LTE UL Power Control for the Improvement of LTE/Wi-Fi co-existence. In *IEEE Vehicular Technology Conference (VTC Fall)*, Sep. 2013.
- [33] Cheng Chen, Rapeepat Ratasuk, and Amitava Ghosh. Downlink performance analysis of LTE and Wi-Fi coexistence in unlicensed bands with a simple listen-before-talk scheme. In *Vehicular Technology Conference (VTC Spring)*, 2015 *IEEE 81st*, pages 1–5. IEEE, 2015.
- [34] B. Choi, D. Jung, and H. Lim. Interframe spacing adaptation method for IEEE 802.11 WLANs coexisting with IEEE 802.16 networks. In *2011 IEEE 36th Conference on Local Computer Networks*, pages 299–302, Oct 2011. doi: 10.1109/LCN.2011.6115308.

- [35] Cisco. Cisco visual networking index: Global mobile data traffic forecast update 2014–2019, 2015.
- [36] IEEE Computer Society LAN MAN Standards Committee et al. IEEE Std 802.11. Wireless LAN medium access control (MAC) and physical layer (PHY) specifications, 1997.
- [37] O. El-Samadisy, M. Khedr, and A. El-Helw. Performance Evaluation of MAC for IEEE 802.11 and LAA LTE. In *2016 International Conference on Computational Science and Computational Intelligence (CSCI)*, pages 923–928, Dec 2016. doi: 10.1109/CSCI.2016.0178.
- [38] M. D. Foegelle. Coexistence of LTE-U and LAA in a Wi-Fi world. In *2016 10th European Conference on Antennas and Propagation (EuCAP)*, pages 1–5, April 2016. doi: 10.1109/EuCAP.2016.7481163.
- [39] X. Fu, W. Ma, and Q. Zhang. The IEEE 802.16 and 802.11a Coexistence in the License-Exempt Band. In *2007 IEEE Wireless Communications and Networking Conference*, pages 1942–1947, March 2007. doi: 10.1109/WCNC.2007.364.
- [40] Paul Fuxjaeger and Stefan Ruehrup. Validation of the NS-3 Interference Model for IEEE 802.11 Networks. In *2015 8th IFIP Wireless and Mobile Networking Conference (WMNC)*, pages 216–222. IEEE, 2015.
- [41] Y. Gao, X. Chu, and J. Zhang. Performance Analysis of LAA and WiFi Coexistence in Unlicensed Spectrum Based on Markov Chain. In *2016 IEEE Global Communications Conference (GLOBECOM)*, pages 1–6, Dec 2016. doi: 10.1109/GLOCOM.2016.7842129.
- [42] Y. Gao, Q. Huang, S. Xu, H. Li, Z. Li, and W. Tang. Experimental Performance Evaluation and Analysis of LAA and Wi-Fi Coexistence in the Unlicensed Spectrum. In *2016 IEEE Globecom Workshops (GC Wkshps)*, pages 1–6, Dec 2016. doi: 10.1109/GLOCOMW.2016.7848901.
- [43] Asvin Gohil, Hitesh Modi, and Shital K Patel. 5G technology of mobile communication: A survey. In *Intelligent Systems and Signal Processing (ISSP), 2013 International Conference on*, pages 288–292. IEEE, 2013.

- [44] Ismael Gomez-Miguel, Andres Garcia-Saavedra, Paul D. Sutton, Pablo Serrano, Cristina Cano, and Doug J. Leith. srsLTE: An Open-source Platform for LTE Evolution and Experimentation. In *Proceedings of the Tenth ACM International Workshop on Wireless Network Testbeds, Experimental Evaluation, and Characterization, WiNTECH '16*, pages 25–32, New York, NY, USA, 2016. ACM. ISBN 978-1-4503-4252-0. doi: 10.1145/2980159.2980163. URL <http://doi.acm.org/10.1145/2980159.2980163>.
- [45] Doriana Guiducci, Claudia Carciofi, Claudio Cecchetti, Valeria Petrini, Manuela Vaser, Elisa Ricci, Elio Restuccia, and Gianmarco Fusco. Experimental analysis on possible coexistence issues related to the introduction of LTE in the 2300–2400 MHz band. In *Networks and Communications (EuCNC), 2017 European Conference on*, pages 1–5. IEEE, 2017.
- [46] Fanrong Hao, Chang Yongyu, Hongdou Li, Jian Zhang, and Wei Quan. Contention window size adaptation algorithm for LAA-LTE in unlicensed band. In *2016 International Symposium on Wireless Communication Systems (ISWCS)*, pages 476–480, Sept 2016. doi: 10.1109/ISWCS.2016.7600951.
- [47] William J Hillery, Nitin Mangalvedhe, Roger Bartlett, Zhubo Huang, and Istvan Z Kovacs. A Network Performance Study of LTE in Unlicensed Spectrum. In *2015 IEEE Globecom Workshops (GC Wkshps)*, pages 1–7. IEEE, 2015.
- [48] National Instruments. Real-time lte/wi-fi coexistence testbed, 2016. URL <http://www.ni.com/white-paper/53044/en/>.
- [49] M. Iqbal, C. Rochman, V. Sathya, and M. Ghosh. Impact of changing energy detection thresholds on fair coexistence of Wi-Fi and LTE in the unlicensed spectrum. In *2017 Wireless Telecommunications Symposium (WTS)*, pages 1–9, April 2017. doi: 10.1109/WTS.2017.7943527.
- [50] V. Janardhanan, N. Muhammed, V. Gonuguntla, and N. Akhtar. LTE - Wi-Fi coexistence in 5 GHz band. In *2015 IEEE International Conference on Advanced Networks and Telecommunications Systems (ANTS)*, pages 1–6, Dec 2015. doi: 10.1109/ANTS.2015.7413610.

- [51] J. Jeon, Q. C. Li, H. Niu, A. Papathanassiou, and G. Wu. LTE in the unlicensed spectrum: A novel coexistence analysis with WLAN systems. In *2014 IEEE Global Communications Conference*, pages 3459–3464, Dec 2014. doi: 10.1109/GLOCOM.2014.7037343.
- [52] J. Jeon, H. Niu, Q. Li, A. Papathanassiou, and G. Wu. LTE in the unlicensed spectrum: Evaluating coexistence mechanisms. In *IEEE Global Conference on Communications (GLOBECOM)*, Dec. 2014.
- [53] J. Jeon, H. Niu, Q. C. Li, A. Papathanassiou, and G. Wu. LTE in the unlicensed spectrum: Evaluating coexistence mechanisms. In *2014 IEEE Globecom Workshops (GC Wkshps)*, pages 740–745, Dec 2014. doi: 10.1109/GLOCOMW.2014.7063521.
- [54] J. Jeon, H. Niu, Q. Li, A. Papathanassiou, and G. Wu. LTE with listen-before-talk in unlicensed spectrum. In *2015 IEEE International Conference on Communication Workshop (ICCW)*, pages 2320–2324, June 2015. doi: 10.1109/ICCW.2015.7247527.
- [55] B. Jia and M. Tao. A channel sensing based design for LTE in unlicensed bands. In *2015 IEEE International Conference on Communication Workshop (ICCW)*, pages 2332–2337, June 2015. doi: 10.1109/ICCW.2015.7247529.
- [56] Y. Jian, C. F. Shih, B. Krishnaswamy, and R. Sivakumar. Coexistence of Wi-Fi and LAA-LTE: Experimental evaluation, analysis and insights. In *2015 IEEE International Conference on Communication Workshop (ICCW)*, pages 2325–2331, June 2015. doi: 10.1109/ICCW.2015.7247528.
- [57] Yubing Jian, U. P. Moravapalle, Chao-Fang Shih, and R. Sivakumar. Duet: An adaptive algorithm for the coexistence of LTE-U and WiFi in Unlicensed spectrum. In *2017 International Conference on Computing, Networking and Communications (ICNC)*, pages 19–25, Jan 2017. doi: 10.1109/ICNC.2017.7876095.
- [58] Z. Jiang and S. Mao. Harmonious Coexistence and Efficient Spectrum Sharing for LTE-U and Wi-Fi. In *2017 IEEE 14th International Conference on Mobile Ad Hoc and Sensor Systems (MASS)*, pages 275–283, Oct 2017. doi: 10.1109/MASS.2017.69.
- [59] Nihar Jindal and Donald Breslin. LTE and Wi-Fi in Unlicensed Spectrum: A Coexistence Study, White Paper, Google, 2015. URL <https://drive.google.com/file/d/0B-iq0rxkyMLyVUxkNWtoUzItZDA/view>.



- [60] L Jing, Z Qinghai, and L Jianmin. MSA: A key Technology for the Evolution of Future Wireless Networks. *Huawei COMMUNICATE*, (70):22–24, 2013.
- [61] Lead Architect Joey Padden. Wi-Fi vs. Duty Cycled LTE: A Balancing Act, 2014. URL <http://www.cablelabs.com/wi-fi-vs-duty-cycled-lte/>.
- [62] Jangeun Jun, Pushkin Peddabachagari, and Mihail Sichitiu. Theoretical maximum throughput of IEEE 802.11 and its applications. In *Network Computing and Applications, 2003. NCA 2003. Second IEEE International Symposium on*, pages 249–256. IEEE, 2003.
- [63] Alexander Kanyeshuli. LTE-in unlicensed band: medium access and performance evaluation. Master’s thesis, Universitetet i Agder; University of Agder, 2015.
- [64] R. Karaki, J. F. Cheng, E. Obregon, A. Mukherjee, D. H. Kang, S. Falahati, H. Koorapaty, and O. Drugge. Uplink Performance of Enhanced Licensed Assisted Access (eLAA) in Unlicensed Spectrum. In *2017 IEEE Wireless Communications and Networking Conference (WCNC)*, pages 1–6, March 2017. doi: 10.1109/WCNC.2017.7925553.
- [65] Jongwoo Kim, Dong-Eun Kim, Suwon Park, Seung Hyong Rhee, Kiyoungh Han, and Hyongoo Kang. Use of vestigial power management bit within Wi-Fi frame structure of access point for coexistence of Wi-Fi and WiMAX systems in shared bands. In *Ubiquitous and Future Networks, 2009. ICUFN 2009. First International Conference on*, pages 220–224, June 2009. doi: 10.1109/ICUFN.2009.5174315.
- [66] A. V. Kini, L. Canonne-Velasquez, M. Hosseinian, M. Rudolf, and J. Stern-Berkowitz. Wi-Fi-LAA coexistence: Design and evaluation of Listen Before Talk for LAA. In *2016 Annual Conference on Information Science and Systems (CISS)*, pages 157–162, March 2016. doi: 10.1109/CISS.2016.7460494.
- [67] Anurag Kumar, Eitan Altman, Daniele Miorandi, and Munish Goyal. New insights from a fixed point analysis of single cell IEEE 802.11 WLANs. In *INFOCOM 2005. 24th Annual Joint Conference of the IEEE Computer and Communications Societies. Proceedings IEEE*, volume 3, pages 1550–1561. IEEE, 2005.
- [68] R. Kwan, R. Pazhyannur, J. Seymour, V. Chandrasekhar, S. R. Saunders, D. Bevan, H. Osman, J. Bradford, J. Robson, and K. Konstantinou. Fair co-existence of Licensed

- Assisted Access LTE (LAA-LTE) and Wi-Fi in unlicensed spectrum. In *2015 7th Computer Science and Electronic Engineering Conference (CEEC)*, pages 13–18, Sept 2015. doi: 10.1109/CEEC.2015.7332692.
- [69] R. Kwan, R. Pazhyannur, J. Seymour, V. Chandrasekhar, S.R. Saunders, D. Bevan, H. Osman, J. Bradford, J. Robson, and K. Konstantinou. Fair co-existence of licensed assisted access LTE (LAA-LTE) and Wi-Fi in unlicensed spectrum. In *IEEE Computer Science and Electronic Engineering Conference (CEEC)*, pages 13–18, Sep. 2015.
- [70] H. J. Kwon, J. Jeon, A. Bhorkar, Q. Ye, H. Harada, Y. Jiang, L. Liu, S. Nagata, B. L. Ng, T. Novlan, J. Oh, and W. Yi. Licensed-Assisted Access to Unlicensed Spectrum in LTE Release 13. *IEEE Communications Magazine*, 55(2):201–207, February 2017. ISSN 0163-6804. doi: 10.1109/MCOM.2016.1500698CM.
- [71] Mathieu Lacage and Thomas R Henderson. Yet another network simulator. In *Proceeding from the 2006 workshop on ns-2: the IP network simulator*, page 12. ACM, 2006.
- [72] Y. Lan, L. Wang, H. Jiang, K. Takeda, H. Harada, T. Wenfang, L. Qiang, and S. Nagata. A Field Trial of Unlicensed LTE (U-LTE) in 5.8 GHz Band. In *2015 IEEE 82nd Vehicular Technology Conference (VTC2015-Fall)*, pages 1–5, Sept 2015. doi: 10.1109/VTCFall.2015.7390790.
- [73] Erik Larsson, Ove Edfors, Fredrik Tufvesson, and Thomas Marzetta. Massive MIMO for next generation wireless systems. *Communications Magazine, IEEE*, 52(2):186–195, 2014.
- [74] H. Lee, H. Kim, H. J. Yang, J. T. Kim, and S. Baek. Performance Analysis of License Assisted Access LTE with Asymmetric Hidden Terminals. *IEEE Transactions on Mobile Computing*, PP(99):1–1, 2018. ISSN 1536-1233. doi: 10.1109/TMC.2018.2793230.
- [75] K. Leentvaar and J. Flint. The capture effect in fm receivers. *IEEE Transactions on Communications*, 24(5):531–539, May 1976.
- [76] B. Li, T. Zhang, and Z. Zeng. LBT with adaptive threshold for coexistence of cellular and WLAN in unlicensed spectrum. In *2016 8th International Conference on Wireless Communications Signal Processing (WCSP)*, pages 1–6, Oct 2016. doi: 10.1109/WCSP.2016.7752637.

- [77] J. Li, X. Wang, D. Feng, M. Sheng, and T. Q. S. Quek. Share in the Commons: Coexistence between LTE Unlicensed and Wi-Fi. *IEEE Wireless Communications*, 23(6): 16–23, December 2016. ISSN 1536-1284. doi: 10.1109/MWC.2016.1600057WC.
- [78] L. Li, A. H. Jafari, X. Chu, and J. Zhang. Simultaneous transmission opportunities for LTE-LAA smallcells coexisting with WiFi in unlicensed spectrum. In *2016 IEEE International Conference on Communications (ICC)*, pages 1–7, May 2016. doi: 10.1109/ICC.2016.7511073.
- [79] L. Li, J. P. Seymour, L. J. Cimini, and C. C. Shen. Coexistence of Wi-Fi and LAA Networks With Adaptive Energy Detection. *IEEE Transactions on Vehicular Technology*, 66(11):10384–10393, Nov 2017. ISSN 0018-9545. doi: 10.1109/TVT.2017.2741261.
- [80] Y. Li, J. Zheng, and Q. Li. Enhanced listen-before-talk scheme for frequency reuse of licensed-assisted access using LTE. In *2015 IEEE 26th Annual International Symposium on Personal, Indoor, and Mobile Radio Communications (PIMRC)*, pages 1918–1923, Aug 2015. doi: 10.1109/PIMRC.2015.7343612.
- [81] J. Ling, D. López-Pérez, and Mohammad R. Khawer. Practical LTE and Wi-Fi Coexistence Techniques beyond Listen Before Talk. *arXiv* (<http://arxiv.org/abs/1612.06262>), Dec. 2016.
- [82] D. López-Pérez, J. Ling, B.H. Kim, V. Subramanian, S. Kanugovi, and M. Ding. Boosted WiFi through LTE Small Cells: The Solution for an All-Wireless Enterprise. In *IEEE Personal Indoor and Mobile Radio Conference (PIMRC)*, Valencia, Spain, May 2016.
- [83] Y. Ma, D. G. Kuester, J. Coder, and W. Young. Coexistence analysis of LTE and WLAN systems with heterogenous backoff slot durations. In *2017 IEEE International Conference on Communications (ICC)*, pages 1–7, May 2017. doi: 10.1109/ICC.2017.7997279.
- [84] N. Makris, A. D. Samaras, V. Passas, T. Korakis, and L. Tassiulas. Measuring LTE and WiFi coexistence in Unlicensed spectrum. In *2017 European Conference on Networks and Communications (EuCNC)*, pages 1–6, June 2017. doi: 10.1109/EuCNC.2017.7980769.
- [85] J. Mao, Y. Mao, S. Leng, and X. Bai. An Adaptive MAC Scheme to Achieve Throughput Optimization and Airtime Fairness for IEEE 802.11 Multirate Networks. In *2009 In-*

- ternational Conference on Wireless Networks and Information Systems*, pages 97–101, Dec 2009. doi: 10.1109/WNIS.2009.83.
- [86] Morteza Mehrnoush, Vanlin Sathya, Sumit Roy, and Monisha Ghosh. Analytical Modeling of Wi-Fi and LTE-LAA Coexistence: Throughput and Impact of Energy Detection Threshold. *arXiv preprint arXiv:1803.02444*, 2018.
- [87] V. P. Mhatre, K. Papagiannaki, and F. Baccelli. Interference Mitigation Through Power Control in High Density 802.11 WLANs. In *IEEE INFOCOM 2007 - 26th IEEE International Conference on Computer Communications*, pages 535–543, May 2007. doi: 10.1109/INFCOM.2007.69.
- [88] V. Mushunuri, B. Panigrahi, H. K. Rath, and A. Simha. Fair and Efficient Listen Before Talk (LBT) Technique for LTE Licensed Assisted Access (LAA) Networks. In *2017 IEEE 31st International Conference on Advanced Information Networking and Applications (AINA)*, pages 39–45, March 2017. doi: 10.1109/AINA.2017.135.
- [89] T. Nihtila, Vitaliy Tykhomyrov, Olli Alanen, Mikko A Uusitalo, Antti Sorri, Martti Moisio, Sassan Iraj, Rapeepat Ratasuk, and Nitin Mangalvedhe. System performance of LTE and IEEE 802.11 coexisting on a shared frequency band. In *IEEE Wireless Communications and Networking Conference (WCNC)*, pages 1038–1043, 2013.
- [90] K. Nishide, H. Kubo, R. Shinkuma, and T. Takahashi. Detecting Hidden Terminal Problems in Densely Deployed Wireless Networks. In *2010 IEEE Global Telecommunications Conference GLOBECOM 2010*, pages 1–5, Dec 2010. doi: 10.1109/GLOCOM.2010.5683904.
- [91] K. Nishide, H. Kubo, R. Shinkuma, and T. Takahashi. Detecting Hidden and Exposed Terminal Problems in Densely Deployed Wireless Networks. *IEEE Transactions on Wireless Communications*, 11(11):3841–3849, November 2012. ISSN 1536-1276. doi: 10.1109/TWC.2012.092712.100868.
- [92] NS3. Network Simulator version 3 Official Website, 2018. URL <http://www.nsnam.org>.
- [93] M. Olbrich, A. Zubow, S. Zehl, and A. Wolisz. WiPLUS: Towards LTE-U Interference Detection, Assessment and Mitigation in 802.11 Networks. In *European Wireless 2017; 23th European Wireless Conference*, pages 1–8, May 2017.

- [94] Eldad Perahia and Robert Stacey. *Next Generation Wireless LANs: 802.11n and 802.11ac*. Cambridge University Press, 2 edition, Jun. 2013.
- [95] Eldad Perahia and Robert Stacey. *Next Generation Wireless LANs: 802.11n and 802.11ac*. Cambridge University Press, 2 edition, 2013. doi: 10.1017/CBO9781139061407.
- [96] S Premnath, Daryl Wasden, Sneha Kumar Kasera, Neal Patwari, and Behrouz Farhang-Boroujeny. Beyond OFDM: best-effort dynamic spectrum access using filterbank multicarrier. *Networking, IEEE/ACM Transactions on*, 21(3):869–882, 2013.
- [97] R1-145193. Details of listen-before-talk for laa, November 2014.
- [98] I. Ramachandran and S. Roy. WLC46-2: On the Impact of Clear Channel Assessment on MAC Performance. In *IEEE Globecom 2006*, pages 1–5, Nov 2006. doi: 10.1109/GLOCOM.2006.884.
- [99] R. Ratasuk, N. Mangalvedhe, and A. Ghosh. LTE in Unlicensed Spectrum using Licensed Assisted Access. In *IEEE Global Conference on Communications (GLOBECOM)*, Dec. 2014.
- [100] Rapeepat Ratasuk, Mikko A Uusitalo, Nitin Mangalvedhe, Antti Sorri, Sassan Iraji, Carl Wijting, and Amitava Ghosh. License-exempt LTE deployment in heterogeneous network. In *Wireless Communication Systems (ISWCS), 2012 International Symposium on*, pages 246–250. IEEE, 2012.
- [101] Sheldon M Ross. *Introduction to probability models*. Academic press, 2014.
- [102] N. Rupasinghe and İ. Güvenç. Licensed-assisted access for WiFi-LTE coexistence in the unlicensed spectrum. In *2014 IEEE Globecom Workshops (GC Wkshps)*, pages 894–899, Dec 2014. doi: 10.1109/GLOCOMW.2014.7063546.
- [103] S. Saadat, D. Chen, K. Luo, M. Feng, and T. Jiang. License assisted access-WiFi coexistence with TXOP backoff for LTE in unlicensed band. *China Communications*, 14(3): 1–14, March 2017. ISSN 1673-5447. doi: 10.1109/CC.2017.7897317.
- [104] A. K. Sadek, T. Kadous, K. Tang, H. Lee, and M. Fan. Extending LTE to unlicensed band - Merit and coexistence. In *2015 IEEE International Conference on Communication Workshop (ICCW)*, pages 2344–2349, June 2015. doi: 10.1109/ICCW.2015.7247531.

- [105] S. Sagari, S. Baysting, D. Saha, I. Seskar, W. Trappe, and D. Raychaudhuri. Coordinated dynamic spectrum management of LTE-U and Wi-Fi networks. In *2015 IEEE International Symposium on Dynamic Spectrum Access Networks (DySPAN)*, pages 209–220, Sept 2015. doi: 10.1109/DySPAN.2015.7343904.
- [106] S. Sagari, I. Seskar, and D. Raychaudhuri. Modeling the coexistence of LTE and WiFi heterogeneous networks in dense deployment scenarios. In *2015 IEEE International Conference on Communication Workshop (ICCW)*, pages 2301–2306, June 2015. doi: 10.1109/ICCW.2015.7247524.
- [107] O. Sandoval, G. David González, J. Hämäläinen, and S. Yoo. Indoor planning and optimization of LTE-U radio access over WiFi. In *2016 IEEE 27th Annual International Symposium on Personal, Indoor, and Mobile Radio Communications (PIMRC)*, pages 1–7, Sept 2016. doi: 10.1109/PIMRC.2016.7794858.
- [108] Z. Shen, A. Papasakellariou, J. Montojo, D. Gerstenberger, and F. Xu. Overview of 3GPP LTE-advanced carrier aggregation for 4G wireless communications. *IEEE Communications Magazine*, 50(2):122–130, February 2012. ISSN 0163-6804. doi: 10.1109/MCOM.2012.6146491.
- [109] Jin Sheng and Kenneth S Vastola. Performance Modeling of 802.11 Ad Hoc Networks with Time-Varying Carrier Sense Range and Physical Capture Capability. In *IEEE GLOBECOM*, pages 1–5. IEEE, 2008.
- [110] M. M. Siddique, B. L. Wenning, C. Gorg, and M. Muehleisen. Spectrum sharing between IEEE 802.16 and IEEE 802.11 based wireless networks. In *2010 IEEE International Symposium on "A World of Wireless, Mobile and Multimedia Networks" (WoW-MoM)*, pages 1–6, June 2010. doi: 10.1109/WOWMOM.2010.5534964.
- [111] Y. Song, K. W. Sung, and Y. Han. Coexistence of Wi-Fi and Cellular With Listen-Before-Talk in Unlicensed Spectrum. *IEEE Communications Letters*, 20(1):161–164, Jan 2016. ISSN 1089-7798. doi: 10.1109/LCOMM.2015.2504509.
- [112] P. Sotenga, P. Chuku, and T. Olwal. Analysis of IEEE 802.11n network Access Categories in EDCA non-saturated networks. In *2015 International Conference on Computing, Communication and Security (ICCCS)*, pages 1–6, Dec 2015. doi: 10.1109/ICCCS.2015.7374188.

- [113] M. G. S. Sriyananda, I. Parvez, I. Güvene, M. Bennis, and A. I. Sarwat. Multi-armed bandit for LTE-U and WiFi coexistence in unlicensed bands. In *2016 IEEE Wireless Communications and Networking Conference*, pages 1–6, April 2016. doi: 10.1109/WCNC.2016.7564899.
- [114] Cimini Jr. Chien-Chung Shen Steve Chiou, Leonard J. LTE-U and Wi-Fi Co-Existence, 2014. URL [https://www.eecis.udel.edu/~cimini/memo/2014/20141017\\_Steve\\_report.pdf](https://www.eecis.udel.edu/~cimini/memo/2014/20141017_Steve_report.pdf).
- [115] Z. Tang, X. Zhou, Q. Hu, and G. Yu. Throughput Analysis of LAA and Wi-Fi Coexistence Network with Asynchronous Channel Access. *IEEE Access*, PP(99):1–1, 2018. doi: 10.1109/ACCESS.2018.2803121.
- [116] T. Tao, F. Han, and Y. Liu. Enhanced LBT algorithm for LTE-LAA in unlicensed band. In *2015 IEEE 26th Annual International Symposium on Personal, Indoor, and Mobile Radio Communications (PIMRC)*, pages 1907–1911, Aug 2015. doi: 10.1109/PIMRC.2015.7343610.
- [117] O. Tarasyuk, A. Gorbenko, V. Kharchenko, and T. Hollstein. Contention window adaptation to ensure airtime consumption fairness in multirate Wi-Fi networks. In *The 10th International Conference on Digital Technologies 2014*, pages 344–349, July 2014. doi: 10.1109/DT.2014.6868737.
- [118] N. J. Thomas, M. J. Willis, and K. H. Craig. Analysis of Co-existence between IEEE 802.11 and IEEE 802.16 Systems. In *2006 3rd Annual IEEE Communications Society on Sensor and Ad Hoc Communications and Networks*, volume 2, pages 615–620, Sept 2006. doi: 10.1109/SAHCN.2006.288520.
- [119] Ilenia Tinnirello, Giuseppe Bianchi, and Yang Xiao. Refinements on IEEE 802.11 distributed coordination function modeling approaches. *Vehicular Technology, IEEE Transactions on*, 59(3):1055–1067, 2010.
- [120] J. Um, S. Park, and Y. Km. Analysis of channel access mechanism on 5 GHz unlicensed band. In *2015 International Conference on Information and Communication Technology Convergence (ICTC)*, pages 898–902, Oct 2015. doi: 10.1109/ICTC.2015.7354696.
- [121] P. M. van de Ven, A. J. E. M. Janssen, and J. S. H. van Leeuwen. Balancing Exposed and Hidden Nodes in Linear Wireless Networks. *IEEE/ACM Transactions on*

- Networking*, 22(5):1429–1443, Oct 2014. ISSN 1063-6692. doi: 10.1109/TNET.2013.2277654.
- [122] W. Wang, P. Xu, Y. Zhang, and H. Chu. Performance analysis of LBT Cat4 based downlink LAA-WiFi coexistence in unlicensed spectrum. In *2017 9th International Conference on Wireless Communications and Signal Processing (WCSP)*, pages 1–6, Oct 2017. doi: 10.1109/WCSP.2017.8171009.
- [123] Z. Wang, H. M. Shawkat, S. Zhao, and B. Shen. An LTE-U coexistence scheme based on cognitive channel switching and adaptive muting strategy. In *2017 IEEE 28th Annual International Symposium on Personal, Indoor, and Mobile Radio Communications (PIMRC)*, pages 1–6, Oct 2017. doi: 10.1109/PIMRC.2017.8292568.
- [124] N. Wei, X. Lin, W. Li, Y. Xiong, and Z. Zhang. Throughput optimal listen-before-talk for cellular in unlicensed spectrum. In *2017 IEEE International Conference on Communications (ICC)*, pages 1–6, May 2017. doi: 10.1109/ICC.2017.7996773.
- [125] N. Wei, X. Lin, Y. Xiong, Z. Chen, and Z. Zhang. Joint Listening, Probing and Transmission Strategies for Frame Based Equipment in Unlicensed Spectrum. *IEEE Transactions on Vehicular Technology*, PP(99):1–1, 2017. ISSN 0018-9545. doi: 10.1109/TVT.2017.2761817.
- [126] N. Wei, X. Lin, Y. Xiong, Z. Chen, and Z. Zhang. An Optimal Stopping Approach to Listen-Before-Talk for Frame Based Equipment in Unlicensed Spectrum. In *GLOBECOM 2017 - 2017 IEEE Global Communications Conference*, pages 1–6, Dec 2017. doi: 10.1109/GLOCOM.2017.8254977.
- [127] G. P. Wijesiri and F. Y. Li. Frame Based Equipment Medium Access in LTE-U: Mechanism Enhancements and DTMC Modeling. In *GLOBECOM 2017 - 2017 IEEE Global Communications Conference*, pages 1–6, Dec 2017. doi: 10.1109/GLOCOM.2017.8254612.
- [128] Haitao Wu, Yong Peng, Keping Long, and Shiduan Cheng. A simple model of IEEE 802.11 wireless LAN. In *Info-tech and Info-net, 2001. Proceedings. ICII 2001-Beijing. 2001 International Conferences on*, volume 2, pages 514–519. IEEE, 2001.



- [129] Haitao Wu, Yong Peng, Keping Long, Shiduan Cheng, and Jian Ma. Performance of reliable transport protocol over IEEE 802.11 wireless LAN: analysis and enhancement. In *INFOCOM 2002. Proceedings. IEEE*, volume 2, pages 599–607. IEEE, 2002.
- [130] P. Xia, Z. Teng, and J. Wu. How Loud to Talk and How Hard to Listen-Before-Talk in Unlicensed LTE. In *IEEE Conference on Communications (ICC)*, 2015.
- [131] J. Xiao and J. Zheng. An adaptive channel access mechanism for LTE-U and WiFi co-existence in an unlicensed spectrum. In *2016 IEEE International Conference on Communications (ICC)*, pages 1–6, May 2016. doi: 10.1109/ICC.2016.7511473.
- [132] D. Xue, X. Wang, and E. Hossain. Optimization of Periodic Channel Sensing by Secondary Users in a Cognitive Radio Network. In *2010 IEEE Global Telecommunications Conference GLOBECOM 2010*, pages 1–5, Dec 2010. doi: 10.1109/GLOCOM.2010.5683225.
- [133] X. Yan, H. Tian, and C. Qin. A Markov-Based Modelling with Dynamic Contention Window Adaptation for LAA and WiFi Coexistence. In *2017 IEEE 85th Vehicular Technology Conference (VTC Spring)*, pages 1–6, June 2017. doi: 10.1109/VTCSpring.2017.8108662.
- [134] Z. Yang, J. Zhang, K. Tan, Q. Zhang, and Y. Zhang. Enabling TDMA for today’s wireless LANs. In *2015 IEEE Conference on Computer Communications (INFOCOM)*, pages 1436–1444, April 2015. doi: 10.1109/INFOCOM.2015.7218521.
- [135] J. Yi, W. Sun, S. Park, and S. Choi. Performance Analysis of LTE-LAA Network. *IEEE Communications Letters*, PP(99):1–1, 2017. ISSN 1089-7798. doi: 10.1109/LCOMM.2017.2779752.
- [136] R. Yin, G. Yu, A. Maaref, and G. Y. Li. Adaptive LBT for Licensed Assisted Access LTE Networks. In *2015 IEEE Global Communications Conference (GLOBECOM)*, pages 1–6, Dec 2015. doi: 10.1109/GLOCOM.2015.7417588.
- [137] K. Yoon, T. Park, J. Kim, W. Sun, S. Hwang, I. Kang, and S. Choi. COTA: Channel occupancy time adaptation for LTE in unlicensed spectrum. In *2017 IEEE International Symposium on Dynamic Spectrum Access Networks (DySPAN)*, pages 1–10, March 2017. doi: 10.1109/DySPAN.2017.7920786.

- [138] Sven Zehl, Anatolij Zubow, and Adam Wolisz. hMAC: Enabling Hybrid TDMA/CSMA on IEEE 802.11 Hardware. *CoRR*, abs/1611.05376, 2016. URL <http://arxiv.org/abs/1611.05376>.
- [139] R. Zhang, M. Wang, L. X. Cai, Z. Zheng, X. Shen, and L. L. Xie. LTE-unlicensed: the future of spectrum aggregation for cellular networks. *IEEE Wireless Communications*, 22(3):150–159, June 2015. ISSN 1536-1284. doi: 10.1109/MWC.2015.7143339.
- [140] Ran Zhang, Miao Wang, Lin X Cai, Xuemin Shen, Liang-Liang Xie, and Yu Cheng. Modeling and Analysis of MAC Protocol for LTE-U Co-existing with Wi-Fi. In *2015 IEEE GLOBECOM*, pages 1–6. IEEE, 2015.
- [141] Xiang Zhang, Wenbo Wang, and Y Yang. Carrier aggregation for LTE-advanced mobile communication systems. *IEEE Communications Magazine*, page 89, 2010.
- [142] Y. Zhang, Y. Chang, and T. Zeng. Coexistence performance analysis of LAA based on release 13. In *2017 International Symposium on Wireless Communication Systems (ISWCS)*, pages 90–95, Aug 2017. doi: 10.1109/ISWCS.2017.8108168.
- [143] Zhi Zhou, Yanfeng Zhu, Zhisheng Niu, and Jing Zhu. Joint tuning of physical carrier sensing, power and rate in high-density WLAN. In *2007 Asia-Pacific Conference on Communications*, pages 131–134, Oct 2007. doi: 10.1109/APCC.2007.4433519.
- [144] J. Zhu, B. Metzler, X. Guo, and Y. Liu. Adaptive CSMA for Scalable Network Capacity in High-Density WLAN: A Hardware Prototyping Approach. In *IEEE INFOCOM*, Apr. 2006.
- [145] Jing Zhu, Xingang Guo, L. Lily Yang, W. Steven Conner, Sumit Roy, and Mousumi M. Hazra. Adapting Physical Carrier Sensing to Maximize Spatial Reuse in 802.11 Mesh Networks: Research Articles. *Wirel. Commun. Mob. Comput.*, 4(8):933–946, December 2004. ISSN 1530-8669. doi: 10.1002/wcm.v4:8. URL <https://doi.org/10.1002/wcm.v4:8>.
- [146] Jing Zhu, Xingang Guo, L. L. Yang, and W. S. Conner. Leveraging spatial reuse in 802.11 mesh networks with enhanced physical carrier sensing. In *2004 IEEE International Conference on Communications (IEEE Cat. No.04CH37577)*, volume 7, pages 4004–4011 Vol.7, June 2004. doi: 10.1109/ICC.2004.1313303.