



HAL
open science

Triglyceride-sensing in the mesocorticolimbic system and reward-driven behaviour control

Chloé Berland

► **To cite this version:**

Chloé Berland. Triglyceride-sensing in the mesocorticolimbic system and reward-driven behaviour control. Tissues and Organs [q-bio.TO]. Université Sorbonne Paris Cité, 2018. English. NNT : 2018USPCC297 . tel-02871202

HAL Id: tel-02871202

<https://theses.hal.science/tel-02871202>

Submitted on 17 Jun 2020

HAL is a multi-disciplinary open access archive for the deposit and dissemination of scientific research documents, whether they are published or not. The documents may come from teaching and research institutions in France or abroad, or from public or private research centers.

L'archive ouverte pluridisciplinaire **HAL**, est destinée au dépôt et à la diffusion de documents scientifiques de niveau recherche, publiés ou non, émanant des établissements d'enseignement et de recherche français ou étrangers, des laboratoires publics ou privés.

Thèse de doctorat
de l'Université Sorbonne Paris Cité
Préparée à l'Université Paris Diderot
Ecole doctorale Bio Sorbonne Paris Cité

Laboratoire Unité Biologie Fonctionnelle et Adaptative, UMR CNRS 8251
Equipe Central COntrol oF Feeding behaviour and Energy Expenditure (C₂OFFEE)

Triglyceride-sensing in the mesocorticolimbic system and reward- driven behaviour control

Par Chloé Berland

Thèse de doctorat de Physiologie

Dirigée par le Dr Serge Luquet

Présentée et soutenue publiquement à l'Université Paris Diderot, le 11 Septembre 2018

Président du jury : Pr. Alain Zider, Université Paris Diderot
Rapporteur : Pr. Stephanie Fulton, University of Montreal,
Rapporteur : Dr Vincent Prévot, Université de Lille
Examineur : Dr. Xavier Fioramonti, Université de Bordeaux,
Examineur : Dr. Patricia Parnet, Université de Nantes,
Examineur : Dr. Isabelle Niot, Université de Dijon
Membre invité : Pr. Matthias Tschopp, Technical University of Munich

Contents

Contents	2
Acknowledgments	8
Foreword	10
Introduction	12
Chapter 1: The central control of feeding behaviour integrates multiple peripheral stimuli ..	13
A. Homeostatic regulation of food intake	13
1. Central regions involved in energy sensing.....	13
2. Peripheral molecules signalling energy status.....	15
3. Neurons regulating the energy balance: the melanocortin circuit.....	19
B. Reward-related networks controlling feeding behaviour	23
1. The dopaminergic pathway involved in hedonic aspect of feeding.....	24
2. The lateral hypothalamus, cross-talk between the homeostatic and non-homeostatic regulation of food-intake.....	28
3. Endocannabinoids control of food intake and energy balance.....	29
4. The opioid system encoding the ‘liking’ of food.....	31
C. Dysregulations of feeding behaviour: driven by food reward	32
1. Physiological role of dopamine.....	32
2. Compulsive feeding behaviours: can we talk about food addiction?.....	34
3. Overeating is often associated with dopamine signalling pathologies.....	35
D. Molecular basis underlying dopamine-driven reward	36
1. Dopaminergic firing and dopamine release in the synapse.....	37
2. Two classes of dopamine receptors.....	37
3. G protein induced signalling through PKA pathway.....	38
4. PKC/Calcium signalling pathway of dopamine receptors.....	40
5. Akt/GSK3 dopamine receptor signalling pathway.....	40
Chapter 2: Lipids as signalling molecules for the reward circuit	43
A. Nature and availability of dietary lipids in periphery	43
1. Lipid classification.....	43
2. Lipids availability and transport in periphery.....	45
B. Lipid access to the brain	48
1. Around the brain: the blood-brain-barrier, composed of endothelial cells, astrocytes, pericytes, neurons and microglia.....	48
2. Lipids can cross the blood-brain-barrier.....	49

C. Lipids as signalling molecules within the brain	54
1. Lipids as signalling molecules in charge of glucose homeostasis, food intake and energy expenditure	54
2. Impact of dietary lipids on reward and mood.....	55
3. Cognitive impairments	57
D. The lipoprotein lipase is expressed in the brain and converts TG into FFA	58
1. Lipoprotein lipase expression within the brain.....	58
2. LPL roles	58
3. LPL regulation.....	59
Aim of the thesis	60
Results	61
Chapter 1: Dopamine D2 receptor and dopamine signalling are direct target of nutritional triglycerides in the control of reward driven behaviours	62
A. Article information	62
B. Introduction	64
C. Materials and methods	66
D. Results	70
1. The triglyceride-processing enzyme lipoprotein lipase is expressed in both mouse and human mesocorticolimbic structures.....	70
2. Striatal TG metabolism decreases amphetamine-induced behavioral and molecular adaptations.....	70
3. Triglycerides exert modulatory actions onto dopamine signalling.....	72
4. Central triglyceride delivery alters D2R-mediated functions while sparing D1R.....	72
5. Centrally delivered triglycerides differently recruit post- and pre-synaptic components of the dopaminergic circuit regarding the time of exposure.	73
6. Central triglyceride delivery is reinforcing in lean but not obese animal.....	73
7. Central triglyceride sensing differentially impacts food and non-food reward.....	74
8. Motivational and hedonic aspects of reward are differentially affected by central triglyceride delivery.	75
9. Lipoprotein lipase controls reward seeking behaviour through pre and post synaptic action	76
10. In humans, postprandial triglycerides control brain response to food-cues in dopamine receptor 2-depedent manner.	77
E. Discussion	79
1. Bridging dietary input to reward through triglycerides sensing in the reward system	79
2. Physiological implication of TG-mediated modulation of DRD2 signaling	80
3. Translational aspect of central TG sensing.....	82

F. Acknowledgments	84
G. Figure legends	85
H. Bibliography	89
I. Supplementary experimental procedures	112
Chapter 2: Palatable binge-drinking shapes dopamine signalling in the striatum through gut-striatal mechanisms	122
A. Article Information	122
B. Abstract	123
C. Material and methods	124
D. Introduction	127
E. Results	128
1. Intermittent access to a caloric mixture quickly shifts eating pattern and triggers metabolic signatures.....	128
2. Gut peripheral signals, not circulating insulin and leptin, control bingeing.....	129
3. Intermittent access to a caloric drink triggers protein S6 kinase activation in the striatum and nucleus accumbens	130
4. Increased translational activity in the dorsal striatum and NAc is D1, not D2 dependent	131
5. Bingeing-like behaviour is associated with lipid signalling in reward related structures	132
F. Discussion	133
G. Bibliography	134
H. Figure Legends	146
Discussion	148
A. Results summary	149
B. Comments on NaCl 0.9% as a control for Intralipid in first study	149
C. Comments on D2R indirect pathway inhibition by central TG, and biphasic alteration of reward	151
1. Predilection site for TG sensing?	151
2. Putative mechanism for short-term effect of central TG delivery.....	152
3. Putative mechanism for long-term effect of central TG delivery.....	153
4. Long-term exposure to TG: a mechanism to explain reduced D2R signalling in obese? 154	
D. Comments on different regulation of food reward and drug reward by central TG ..	154
E. TG metabolism and LPL role in lipid sensing	155
1. Putative role for LPL in D2R signalling.....	155
2. Other lipases involved in TG sensing?.....	156
3. LPL as the missing link to understand FFA and TG differences in lipid sensing?	157
F. Potential role of astrocytes in lipid sensing	157

G. Conclusion	158
Index	159
References	162
Annexes	181

Figure 1 Prevalence of overweight (World Health Organisation database).....	10
Figure 2 Central Regions Involved in the Energy Sensing	14
Figure 3 Peripheral signalling of energy status.	16
Figure 4 Some peripheral signals involved in feeding behaviour regulation.	17
Figure 5 Molecular integration of energy signalling: mTOR signalling.	19
Figure 6 The Melanocortin pathway composed of the antagonist NPY/AgRP and POMC neurons	20
Figure 7 Second order Neurons signalling and Food intake regulation	22
Figure 8 Interaction between metabolic signalling and mesocorticolimbic signalling.	23
Figure 9 The Basal Ganglia.....	25
Figure 10 The Mesocorticolimbic Pathway	25
Figure 11 Connectivity of the Nucleus Accumbens.....	26
Figure 12 Synaptic connections involving the Ventral Tegmental Area.....	26
Figure 13 Interactions between the mesocorticolimbic pathways and hunger related regions	27
Figure 14 Lateral hypothalamus interactions with the reward circuit.....	29
Figure 15 Endocannabinoids Synthesis.....	30
Figure 16 Endocannabinoids and the control of energy balance.....	30
Figure 17 Endocannabinoids and the Dopaminergic Synapse	31
Figure 18 The nucleus accumbens μ -opioid hotspot involved in food ‘liking’	31
Figure 19 Dopamine Synthesis and Degradation	32
Figure 20 Dopaminergic Firing in conditioned reward.....	33
Figure 21 Motivational and molecular adaptations in overeating.	35
Figure 22 Brain Dopamine and Obesity.....	36
Figure 23 Tonic and Phasic Firing of Dopaminergic Neurons.....	37
Figure 24 G-Protein coupled Receptors Signalling.....	37
Figure 25 DA Signalling in MSN induced by GPCR.....	39
Figure 26 Dopamine Receptors signalling through G- α -q subunits.....	40
Figure 27 Dopamine D2 Receptor signalling through beta-arrestin/Akt/GSK3 pathway.....	41
Figure 28 Dopamine Receptors Desensitisation and Internalisation through GRK/arrestins	42
Figure 29 Main Fatty Acids in the Brain.....	44
Figure 30 Simplified Classification of lipid species in the brain	45
Figure 31 Triglycerides absorption in the enterocytes	46
Figure 32 Triglycerides transportation in the body	47
Figure 33 The blood brain barrier is formed by several layers protecting and isolating the brain from the periphery.....	48
Figure 34 A neurovascular unit.....	48
Figure 35 Molecular transports across the BBB.....	49
Figure 36 Free Fatty Acids uptake in the Brain	50

Figure 37 Fatty Acid Transporters in the Brain.....	51
Figure 38 Molecules involved in lipoproteins transport and hydrolysis are expressed within the brain.	53
Figure 39 Permeability changes at the blood-brain-barrier in obesity.	53
Figure 40 Central triglycerides sensing inhibits dopaminergic associated behaviours	56
Figure 41 Peripheral Triglycerides increase dopamine release in the NAc.....	57
Figure 42 Lipoprotein lipase roles in the brain	59
Figure 43 Intralipid Composition	150
Figure 44 Mesocorticolimbic structures involved in TG sensing.....	151
Figure 45 Putative effect of short term TG delivery in the MCL.....	152
Figure 46 Putative effect of long term central TG delivery	153
Figure 47 Schematic representation of altered neurotransmission in the dorsal striatum following H- FABP deletion	156
Figure 48 Lipases and lipid metabolism enzymes expression in the central nervous system	157

Acknowledgments

This work would not have been possible without the tremendous amount of people who helped me unconditionally during these four years.

First, I would like to acknowledge the members of my jury for reading this manuscript and attending my PhD defence, I hope you will enjoy the reading as much as I enjoyed the writing.

Ensuite, je voudrais remercier Serge Luquet pour m'avoir recueillie dans son laboratoire plutôt que m'avoir laissée vagabonder en fac de lettres. Je ne te remercierai jamais assez pour avoir toujours été à l'écoute, et pour les innombrables discussions que nous avons eues, je ne me suis jamais sentie seule lors de cette thèse. Merci surtout d'avoir partagé mes éclats de joies pas du tout dissimulés lorsqu'un résultat positif sortait après des semaines de galères, je ne me serais probablement pas investie autant sans cet enthousiasme partagé que nous avons eu pour le projet.

Evidemment, je me dois de remercier ensuite Giuseppe Gangarossa, sans qui cette thèse ne serait que l'ombre d'elle-même. Merci de ta patience devant mes innombrables questions et mon manque d'organisation. Je ne mesure que trop la chance que j'ai eue d'avoir travaillé avec toi, et je voudrais ici souligner combien j'estime tout le temps que tu as passé auprès de moi, depuis ces weekends à pester en EPF, jusqu'à ces heures interminables à relire absolument tous mes écrits, y compris ce pavé interminable. Encore merci.

Je remercie nos collaborateurs au cours de ce projet, ils sont très nombreux. Merci à l'équipe de Martine Cador et Stéphanie Caillé-Garnier pour leur chaleureux accueil à Bordeaux, et leur aide dans l'établissement des protocoles de self-administration. Merci ensuite à l'équipe de Philippe Faure, et notamment Fabio Marti et Stefania Tolu, pour avoir réalisé tous les enregistrements d'électrophysiologie et avoir répondu à mes très nombreuses questions de novice. I would like to thank Tom Hnasko for all the precious advice regarding CPP analysis, reward and dopamine in general, and for the great exchanges we had in San Diego. Ali Shenasa, thank you for sharing so much with me, I'm not talking just about RNAscope data here, but also coffees in San Diego and French literature books, and mostly thank you for understanding the terrific burden that daily carotid infusions can bring in a student's life, and still be happy to go for it. Finally, thank you to Dana Small and her team for sharing the human data with us.

Un immense MERCI à toute l'équipe COFFEE qui m'a épaulée tout au long de cette thèse. D'abord, merci pour leur aide en cette fin de thèse (un peu) chaotique à Julien Castel, Chloé Morel, Anne-Sophie Delbès, Enrica Montalban, Raphaël Denis, Claire Martin, Rim Hassouna, Daniela Herrera, Ewout Foppen, qui ont tous sans exception mis la main à la pâte dans ce travail, et qui en plus l'ont fait avec beaucoup d'humour et de bienveillance. J'apprends constamment auprès de vous, et travailler avec une telle équipe est un réel bonheur. Une petite mention supplémentaire pour mes collègues de bureau, vous qui étiez là depuis le tout début, merci de me faire autant sourire chaque jour, quelles que soient les circonstances !

Notre vie de laboratoire ne serait vraiment pas la même sans l'aide précieuse d'Olja Kacanski, qui arriver presque à nous faire oublier que l'administration universitaire est fort pénible parfois, et à Isabelle Le Parco, Daniel Quintas, Ludovic Maingault, Angélique Dauvin, Florianne Michel. Merci à chacun d'entre vous, pour votre gentillesse et votre aide de chaque jour en animalerie, pour votre bienveillance envers mes innombrables bestioles, et puis envers moi, aussi.

Je voudrais remercier tous ceux qui ont été près de moi ces quatre années, et qui m'ont toujours encouragé, sans toujours comprendre pourquoi je passais autant de temps au labo le weekend, mais qui somme toute, ont compris que cela me tenait à cœur, et même qui sont venus passer du temps à BNF malgré la froideur des rues pour me tenir compagnie pendant deux sessions de conditionnement. Je pense en particulier à un certain anniversaire qu'on a dû passer au Trac juste parce que j'avais manip, encore désolée pour ça les copains. A tous les copains de fac évidemment, les magistériens, les magistériens par procuration, ceux qui ne vivent pas en France aussi. Ça fait 4 ans qu'on est en thèse, 4 ans que je sais toujours pas sur quoi vous travaillez. Merci. Je remercie ici aussi l'équipe de Christophe, pour les midis passés ensemble, sans lesquels nos journées paraîtraient bien plus longues, et le 5^e étage bien plus morose !

Enfin, merci à mes parents, à ma sœur, et à ma petite mamie, pour votre soutien dans ces interminables études. J'en ai fait du chemin, depuis mes balbutiements scientifiques devant la cheminée avec le boulier en bois, jusqu'aujourd'hui ! Merci d'avoir favorisé aux poupées les tours à bois et les cartes électroniques à souder quand on était petites, mine de rien, ça joue dans la décision de faire une thèse tout ça ! Et Thibeault, évidemment. Pour avoir été tellement drôle (Ha !) et parce que on était tellement persuadés qu'à l'issue de nos rédactions de thèses respectives, il y aurait au moins un mort, et que ce ne serait pas Mousse. Juste ça. Merci.

Sur ce je m'en vais profiter, pour m'évader, d'une migration d'oiseaux sauvages.



Foreword

The World Health Organization (WHO) defines overweight and obesity as abnormal or excessive fat accumulation that may impair health. According to the WHO latest report, worldwide obesity (defined as a body mass index (BMI) greater than 30) has nearly tripled since 1975. In 2016, more than 1.9 billion adults (39%), 18 years and older, were overweight (BMI greater than 25). Among these, over 650 million were obese (13%). In France, 59,5% of the population is overweight. Because of the regular worldwide increase of overweight population across the years, obesity is now seen as a ‘major noncommunicable disease’, which kills more people than underweight because of associated diseases such as cardiovascular illnesses (mainly heart disease and stroke), diabetes, musculoskeletal disorders, some cancers (including endometrial, breast, ovarian, prostate, liver, gallbladder, kidney, and colon) (WHO, 2018).

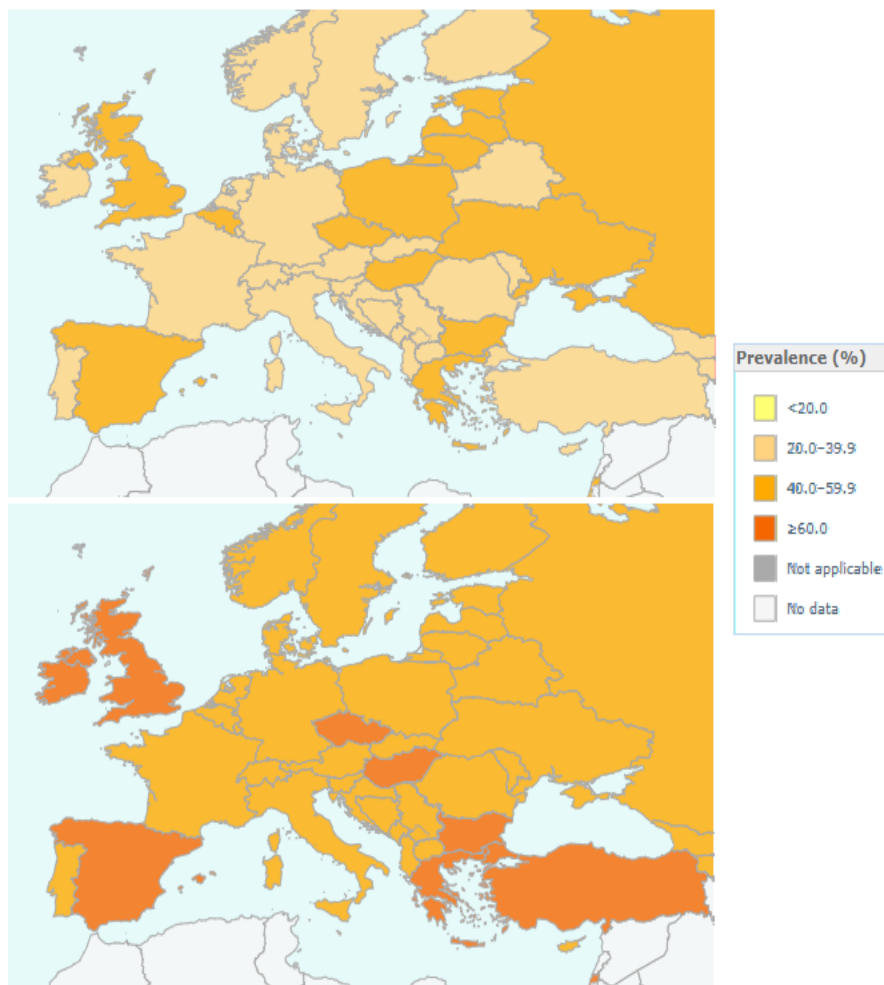

Figure 1 Prevalence of overweight (World Health Organisation database)

The top map shows overweight prevalence among adults in 1975, the bottom one in 2016.

Obesity and overweight are caused by an energy imbalance between calories consumed and calories expended. Physiologically, the brain regulates the body weight to a set point that will remain controlled during the life, by controlling the energy balance, that is to say the levels of input energy (food intake) versus the levels of output energy (metabolism, thermogenesis, activity). Evolutionary speaking, mammals developed a preference for energy-dense foods high in fat and sugar, to sustain an adequate level of energy no matter the circumstances. However, our lifestyles changed towards an increased intake of calorie-rich food, and a decrease in physical activity due to sedentary forms of work, or changing modes of transportation, that leads us to eat more for hedonic reasons than satisfaction of needs. Why are we so prone to eat more than we should? As we will see in the introduction of this thesis, the brain is in charge of energy regulation, thanks to the guidance of many molecular signals from the periphery. Among these signals, dietary lipids were found to signal within the brain, and participate in food intake regulation, and alter food reward and motivation. The aim of this thesis was to understand by which mechanisms the fat contained in a diet can potentially target the mesocorticolimbic system participating in food reward encoding.

Introduction

Chapter 1: The central control of feeding behaviour integrates multiple peripheral stimuli

Living organisms require a fixed energy status with a balance between food intake and energy expenditure consisting in basal metabolism, thermogenesis, and physical activity. This regulation requires a communication between the brain, or central part, and the rest of the body, named periphery. In addition to nutrients requirements to sustain metabolic demands, several emotional factors, such as stress or boredom, can affect food intake and energy expenditure. For that reason, feeding can be qualified as either homeostatic, when it provides the necessary intake of calories to sustain life, or non-homeostatic, when it is driven by other processes, such as pleasure, appeal for food-reward, and often results in a higher intake than required. This chapter reviews the current knowledge regarding the central control of feeding behaviour.

A. Homeostatic regulation of food intake

The first cases of obesity involving central dysfunctions were described after noticing that tumours in the brain region of the hypothalamus were associated to massive gain weight and hyperphagic behaviours in patients (reviewed in Bray and York, 1979). Subsequent research in animals, involving hypothalamic lesions or electrical stimulations, pointed out the ventromedial region of the hypothalamus as inhibiting food intake (Hetherington and Ranson, 1939), and the lateral region of the hypothalamus as increasing food intake (Anand and Brobeck, 1951; Delgado and Anand, 1953). The major role of the hypothalamus in feeding behaviour control was then completed with the study of the two mice strains *ob/ob*, homozygous mutant for the *obese (ob)* gene, and *db/db*, homozygous mutant for the *diabetic gene (db)*, displaying massive overeating and obesity, which showed the existence of a peripheral secreted peptide encoded by the *ob* gene, whereas the *db* gene would encode its corresponding central receptor (Coleman, 1973; Coleman and Hummel, 1969). More recent studies demonstrate that several central regions and not just the hypothalamus are actually involved in food intake regulation, thanks to neuronal communication between these different areas, and the periphery *via* different neurotransmitters and circulating signals.

1. Central regions involved in energy sensing

The brain is surrounded by an impermeable barrier, the **blood-brain-barrier** (BBB), which filters molecules accessing the brain, thus providing an efficient protection for the central nervous system. For

this reason, circulating molecules indicating the energy state from the periphery cannot easily reach the brain, unless some mechanisms allow the BBB crossing (for more details see II.B.1, page 48). Because they are located in brain regions with a thinner BBB, two main areas are able to sense the peripheral energy levels, thanks to a privileged communication with the blood circulation: the **arcuate nucleus** (Arc) of the hypothalamus, and the **nucleus of the tractus solitarius** (NTS) (Morton et al., 2006, 2014; Schwartz et al., 2000) (*Figure 2*).

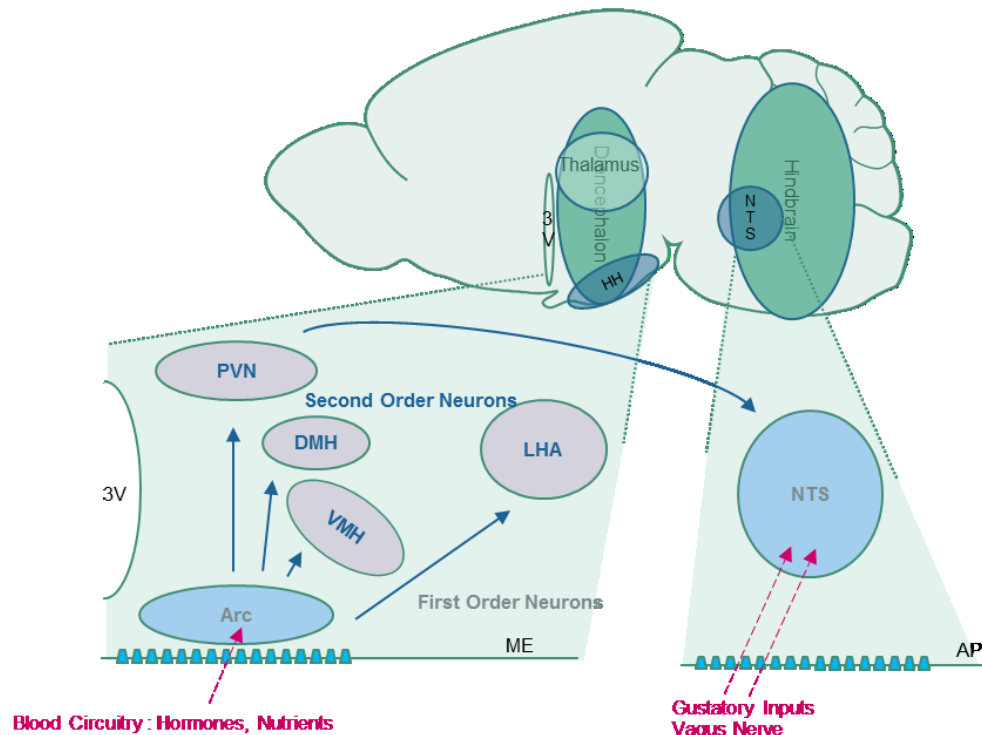

Figure 2 Central Regions Involved in the Energy Sensing

Blue nuclei contain first order neurons, grey nuclei contain second order neurons. Blue arrows represent the neuronal connections between the different areas. Pink arrows represent peripheral outputs signalling the energy state. 3V: third ventricle, HH: hypothalamus, NTS: Nucleus of the Solitary Tract, PVN: paraventricular nucleus, DMH: dorsomedial hypothalamus, VMH: ventromedial hypothalamus, LHA: lateral hypothalamus, Arc: arcuate nucleus, ME: median eminence, AP: area postrema.

i. Anatomy of the mediobasal hypothalamus

The hypothalamus, a brain part of the diencephalon, is located under the thalamus. This area is close to the **median eminence** (ME), a circumventricular organ with many permeable fenestrated capillaries, which facilitate the exchanges with the blood. Consequently, it collects and integrates information from the peripheral organs. The hypothalamus can be divided in different nuclei based on anatomical boundaries (Lechan and Toni, 2000), gene expression and function (Suzuki et al., 2012). Among these nuclei, the Arc is the closest to the ME, and is the first region to perceive peripheral signals. For that reason, the Arc neurons are called **first-order neurons**. These neurons work together with second-order neurons of the hypothalamus, located in several nuclei such as the **paraventricular nucleus** (PVN),

dorsomedial hypothalamus (DMH), ventromedial nucleus of the hypothalamus (VMH), and lateral hypothalamus (LH) (*Figure 2*).

ii. [Anatomy of the Nucleus of the Tractus Solitary](#)

The Nucleus of the Tractus Solitary (NTS) is a sensory nucleus located in the hindbrain. Because of its location near the **area postrema (AP)**, a region composed of fenestrated capillaries, the NTS accesses nutrients circulating after a meal such as glucose (Ritter et al., 2000), or leucine, an essential branched-chain amino-acid (Blouet and Schwartz, 2012). It is also the first region of the central nervous system that receives neural inputs from the **Vagus nerve (X)**, which brings information from the viscera such as the size of the stomach attesting the size of a meal (Phillips and Powley, 1996), and neurotransmitters from the gut. The NTS also receives **gustatory signals** from post-oral sites reflecting chemical, mechanical and nutrient properties of ingested foods (Van Buskirk and Erickson, 1977). Importantly, the NTS **integrates signalling from the PVN** of the hypothalamus (Blevins et al., 2004) (*Figure 2*), and these two structures, in addition to other structures, work together to sense the peripheral energy state (Morton et al., 2014).

2. [Peripheral molecules signalling energy status](#)

After a meal, the energy levels are high, the energy balance favours decreased food intake and increased total energy expenditure. Signals that will lead to this satiety state will be reported as **‘anorexigenic’ signals**. On the other hand, during fasting, the energy levels are low, therefore the brain increases food intake and decrease energy expenditure. Signals that will lead to this hunger state will be reported as **‘orexigenic’ signals**.

i. [Nature of endogenous peripheral signals controlling feeding behaviour](#)

The peripheral energy state signalling to the central nervous system are very diverse: gustatory inputs from the tongue, signals from the stomach and digestive system, post-prandial circulatory signals, energy storage signals (*Figure 3, Figure 4*).

Leptin is an anorexigenic peptidic hormone produced mainly by white adipose cells (Zhang et al., 1994), and its level of production is proportional to the level of adipocytes in periphery (Maffei et al., 1995a, 1995b). It is encoded by the *obese* gene *ob*, and administration of leptin to *ob/ob* mice with no functional *ob* gene results in marked decreases in food intake and body weight (Ahima et al., 1996; Campfield et al., 1995; Halaas et al., 1995; Pelleymounter et al., 1995). Leptin can reach the brain (Banks et al., 1996), where the leptin receptor encoded by the *LepRb* gene is mostly expressed in the Arc and parts of the VMH, DHM (Håkansson et al., 1996; Mercer et al., 1996).

Insulin is a peptidic hormone produced by the pancreatic beta cells depending on blood glucose levels. Insulin can reach the brain proportionally to its plasmatic levels (Baura et al., 1993), where insulin receptors are expressed (Havrankova et al., 1978), most particularly in the Arc, DMH, PVN (Corp et al.,

1986). Intracerebroventricular¹ (ICV) insulin injections decrease food intake and body weight (Ikeda et al., 1986; Woods et al., 1979). Insulin receptor knock-out in the brain and more particularly in the Arc leads to hyperphagia and obesity (Brüning et al., 2000; Obici et al., 2002a).

élément sous droit, diffusion non autorisée

Figure 3 Peripheral signalling of energy status.

In purple: leptin signalling from the adipose tissue. In red: nutrients signalling. FFAs: Free Fatty Acids, aa: amino-acids. In yellow: ghrelin orexigenic signalling from the stomach. In blue: gastro-intestine satiety signals. CCK: cholecystokinin, GLP1: Glucagon-Like Peptide 1, PYY3-36: Peptide YY3-36. The green (+) represent the positive effect of signals on food intake, the red (-) represent the inhibitory effect of signals on food intake. Adapted from (Morton et al. 2014)

Several gastrointestinal peptidic hormones also act as satiety signals. **Cholecystokinin (CCK)** is secreted in the duodenum to release digestive enzymes and acts as an anorexigenic signal on the NTS (Gibbs et al., 1973). Recent studies showed that CCK is also produced in the NTS proportionally to the ingested nutrients (D'Agostino et al., 2016). **Peptide YY₃₋₃₆** (PYY₃₋₃₆) is an enteric hormone released from the gastrointestinal tract proportionally to the calorie-content of a meal (Adrian et al., 1985), that can reduce food intake in rodents and humans by targeting the Arc (Batterham et al., 2002, 2003). **Glucagon-like peptide 1 (GLP-1)** is a post-translational processing of the proglucagon gene, produced by intestinal cells after a meal, and by the NTS (Lockie, 2013) and ICV administration of GLP-1 reduces food intake in fasted rats (Turton et al., 1996).

Molecule	Peripheral Origin	Central Receptors Location	Effect on Food Intake
Leptin	Adipocytes	Hypothalamus, hippocampus, piriform cortex, nucleus of lateral olfactory tract, thalamic nuclei, SNpc, medial habenula nucleus, NTS, VTA (Funahashi et al., 2003)	Anorexigenic signals
Insulin	Pancreatic β -cells	Hypothalamus, choroid plexus, olfactory bulbs, olfactory tubercle, pyriform cortex, ventral striatum, anterior septum, cerebellar cortex (Schulinkamp et al., 2000)	
CCK	Duodenum	Hypothalamus, hippocampus, neurohypophysis, mammillary and supramammillary region, VTA, SNpc, Cpu, NAc, olfactory tubercle, raphe, area postrema, NTS (Ballaz, 2017)	
GLP-1	Intestine	Hypothalamus, circumventricular organs NTS,(Lockie, 2013)	
Peptide YY₃₋₃₆	Intestine	Hypothalamus, amygdala, SNpc, parabrachial area, NTS, brainstem (De Silva and Bloom, 2012)	
Ghrelin	Stomach	Hypothalamus, VTA, NAc, medial prefrontal cortex, hippocampus, amygdala (Howick et al., 2017)	Orexigenic signal

¹ Intracerebroventricular: this injection technique delivers the molecule throughout the brain, with no location specificity, via the brain ventricles.

Introduction

Figure 4 Some peripheral signals involved in feeding behaviour regulation.

CCK: cholecystokinin, GLP-1: glucagon-like peptide 1, SNpc: Substantia Nigra pars compacta, NTS: Nucleus of the Solitary Tract, VTA: Ventral Tegmental Area, Cpu: Caudate putamen, NAc: Nucleus Accumbens

On the contrary, when energy levels are low, **ghrelin** is a well-known orexigenic signal released from the stomach (Kojima et al., 1999). This peptide hormone is also expressed within the central nervous system, in a group of neurons adjacent to the third ventricle, in the mediobasal hypothalamus (Cowley et al., 2003). Circulating ghrelin levels change depending on the energy available, are high during a period of fasting, and decrease after eating (Ariyasu et al., 2001; Cummings et al., 2001). These ghrelin levels are regulated by calorie intake and circulating nutritional signals: the ingestion of food or glucose will induce a decrease of ghrelin, but not the ingestion of water, suggesting that the size of the stomach is not a regulator (Tschöp et al., 2000). Ghrelin has a central action and increases body weight by increasing fat storage, as shown with subcutaneous and ICV administrations in rodents (Tschöp et al., 2000).

Besides these classic signalling molecules (*Figure 4*), current research keeps identifying new molecules potentially involved in feeding behaviour regulation, like **heparin** for example, a mucopolysaccharide produced by basophils and mast cells, that could be a new orexigenic signal. Heparin levels are high during fasting and caloric restriction, and acute intraperitoneal heparin treatment promotes food intake and long term heparin treatment increases body weight (Zhu et al., 2017).

As we see in *Figure 4*, these signals can not only affect the hypothalamus, but also other limbic areas (amygdala, hippocampus, nucleus accumbens) and areas involved in reward and locomotion (ventral tegmental area, substantia nigra). Therefore, it is likely that those signals play several other central roles, yet not fully understood.

ii. Peripheral nutrients signalling for satiety

Carbohydrates, proteins, and lipids are nutrients absorbed in the intestine after a meal, and their metabolism will produce energy that will signal to the brain in order to maintain the energy balance.

Most brain **glucose** is used primarily as a substrate for the energy needs of neurons and the surrounding glial cells. However, glucose was also shown to target neurons in the hypothalamus, and alter their firing rates, more particularly in the VMH and LH (Anand et al., 1964; Oomura et al., 1975). These glucose-sensitive neurons are able to adapt their electrical activity by directly detecting changes in extracellular glucose level (Fioramonti et al., 2004) through an adenosine tri-phosphate (ATP)-sensitive K⁺ channel, and the mere deletion of those K⁺ neurons in the VMH leads to reduced food intake (Miki et al., 2001).

Proteins and amino-acids also contribute to the central homeostatic regulation of food intake and body weight. Moderately low-protein diets are associated with an increase in energy intake, while high-

protein diets reduce energy intake (Krauss and Mayer, 1965; Morrison et al., 2012). Several amino-acid carriers are expressed on the blood-brain-barrier, controlling the levels of each amino-acid reaching the brain (Hawkins et al., 2006). Interestingly, meal supplementation in the amino-acid leucine decreases food intake and growth (Rogers et al., 1967), and central leucine administration in the hypothalamus reduces food intake (Blouet et al., 2009).

Central **lipid** sensing was first evidenced with the work of Oomura, who showed that besides glucose-sensitive neurons, lipid-sensitive neurons could be excited with free-fatty acids (Oomura et al., 1975). In 1989, Golberg et al. noticed that one specific enzyme involved in triglycerides metabolism, the lipoprotein lipase, was present in the brain, and suggested that the presence of this enzyme may not be important to regulate circulating levels of triglycerides, but could be essential for cellular uptake, binding, and transfer of free fatty acids or other lipophilic substances (Goldberg et al., 1989). Later, ICV oleic acid injections blocked food intake and glucose production (Obici et al., 2002b), establishing a convincing signalling function for lipids in feeding regulation, that we will discuss further (see II.C.1, page 54).

iii. [Molecular integration of energy signalling: the mTOR pathway](#)

Within animal cells, energy levels need to be balanced as well. The **Mammalian Target Of Rapamycin** (mTOR) is an evolutionarily conserved serine/threonine kinase that allows energy sensing and integrates many anabolic pathways involved in cell growth, cell cycle (Schmelzle and Hall, 2000). This phosphoinositide 3-kinase (PI3K)-related protein kinase (PIKK) family kinase is found in the cytoplasm as two different protein complexes named mTORC1 and mTORC2 (Giguère, 2018). mTORC1 links nutritional and energy status with the control of cell growth and regulates mRNA translation to allow protein synthesis, a cellular process that requires large amounts of ATP, as well as lipid synthesis (Lee et al., 2017a). This complex is activated by a GTPase enzyme called Ras homolog enriched in brain (Rheb), whose activity is controlled by the tuberous sclerosis complex (TSC) which converts active Rheb-GTP into inactive Rheb-GDP and suppresses mTOR (Lipton and Sahin, 2014). Protein synthesis requires that mTORC1 complex phosphorylates two regulators, the **p70 ribosomal S6 kinase (S6K)** and the inhibitor of translation initiation eukaryotic translation initiation factor 4E (**eIF-4E**) **binding protein** (Burnett et al., 1998) (*Figure 5*).

In neurons, mTOR is important for synaptic plasticity, and it was shown that phosphorylation of S6K in the hypothalamus decreases with starvation, while its overactivation leads to overeating and obesity (Cota et al., 2006; Mori et al., 2009; Yang et al., 2012). **Energy related hormones such as ghrelin, insulin and leptin modulate the mTOR pathway** (Watterson et al., 2013). Central administration of leucine or leptin increases hypothalamic mTOR signalling and decreases food intake and body weight (Cota et al., 2006). Ghrelin activates mTOR in the hypothalamus in order to promote food intake (Martins et al., 2012). A disruption of the mTOR complex in the hypothalamus leads to hyperphagia

and obesity (Mori et al., 2009) and blunts leptin's anorectic effect (Cota et al., 2006). mTOR also senses nutrients like amino-acids within the cell and adapts the activity of S6K and eIF-4E subsequently (Hara et al., 1998), glucose through glycolysis and ATP synthesis (Dennis et al., 2001), and lipids (Foster, 2013; Menon et al., 2017).

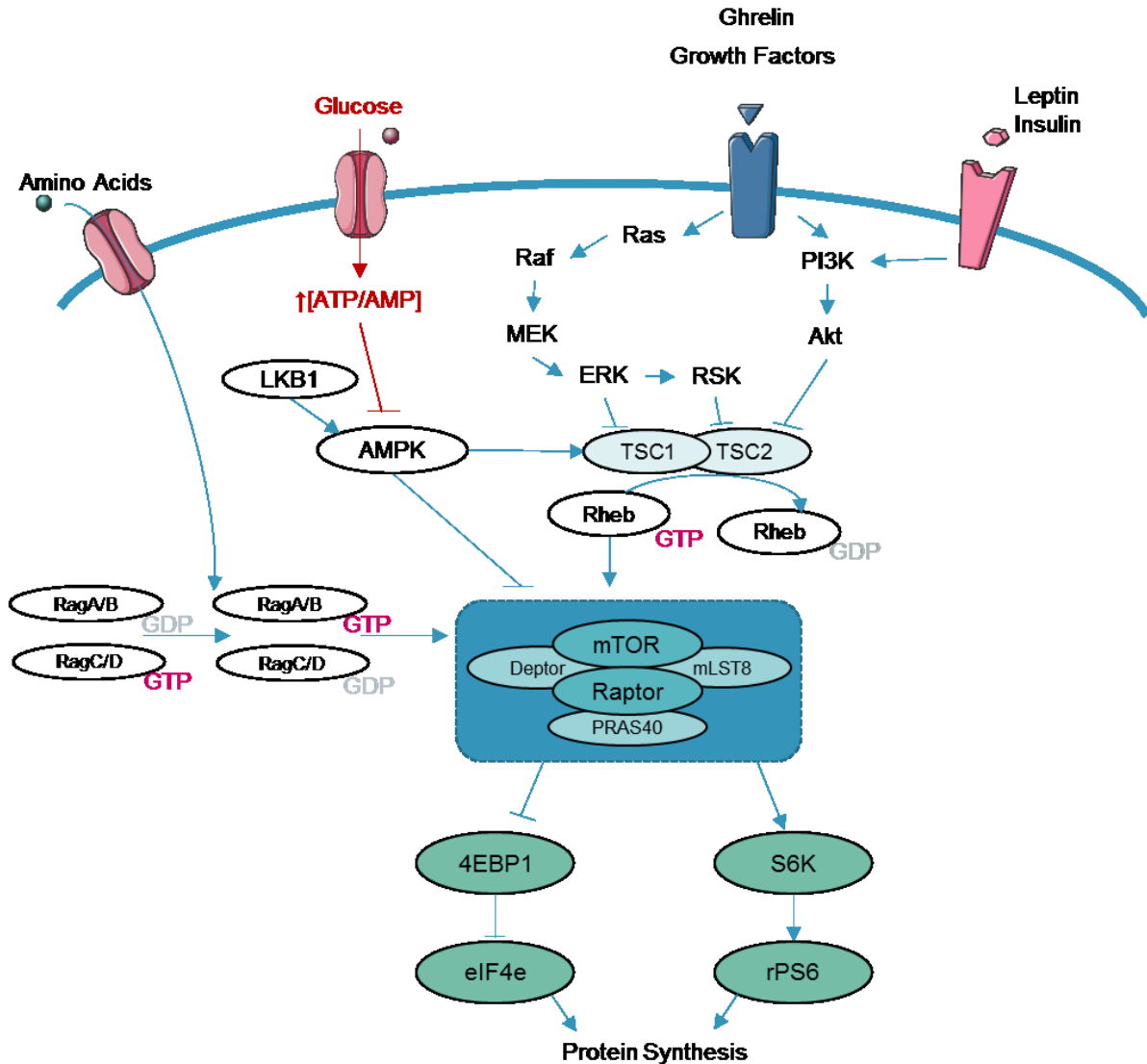

Figure 5 Molecular integration of energy signalling: mTOR signalling.

Once in the cell, glucose is used to produce ATP, changing the [ATP/AMP] ratio. When AMP or ADP bind to AMPK, the kinase is activated and inhibits mTOR. The ERK and the Akt pathway are activated by growth factors, and inhibit the TSC1/TSC2 complex, a GTPase activating protein for Rheb. When the TSC complex is inhibited, Rheb bound to GTP accumulates, promoting mTOR activation. Amino-acids activate the Rag GTPases which bind to Raptor, and recruit the mTOR complex to the lysosomes, where it will meet Rheb-GTP to be active. Adapted from (Kim et al., 2013; Lipton and Sahin, 2014).

3. Neurons regulating the energy balance: the melanocortin circuit

Once the signals regarding the peripheral energy-state reach the brain, their information has to be mediated by specific populations of neurons in order to promote appropriate feeding behaviours. The

melanocortin circuit is one of the most studied pathways involved in feeding behaviour and glucose homeostasis maintenance. These neurones are mostly located in the hypothalamus and the NTS. Depending on the energy state, two mechanisms can be activated: the orexigenic pathway, or the anorexigenic pathway. The orexigenic pathway is stimulated by orexigenic signals when the energy levels are too low, promotes food intake, and decreases energy expenditure. The anorexigenic pathway is activated by anorectic signals when the energy state is too high, and promotes satiety by decreasing food intake and stimulates energy expenditure.

i. The NPY/AgRP and the POMC neurons: two antagonist first-order neuron populations integrating the energy levels information

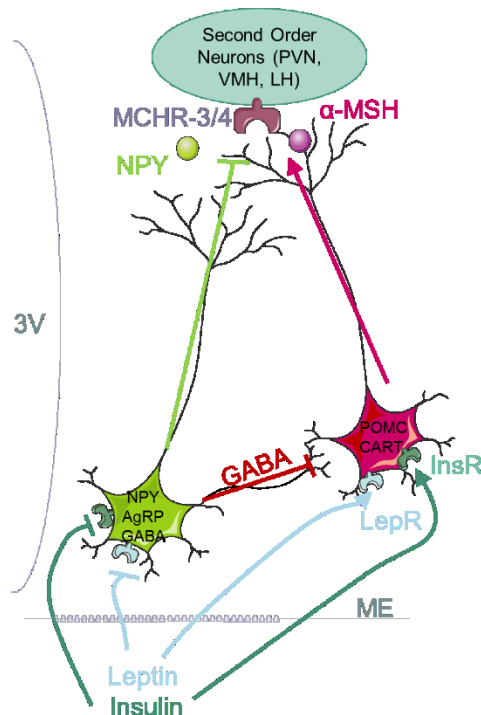

Figure 6 The Melanocortin pathway composed of the antagonist NPY/AgRP and POMC neurons

PVN: paraventricular nucleus, LH: lateral hypothalamus, VMH: ventromedial hypothalamus MCHR-4/3: Melanocortin Hormone Receptor 3 and 4, α-MSH: alpha melanocyte stimulating hormone, NPY: Neuropeptide Y, AgRP: Agouti-Related Protein, GABA: gamma-aminobutyric acid, POMC: pro-opiomelanocortin, CART: Cocaine and Amphetamine Related Transcript, LepR: leptin receptor, InsR: insulin Receptor, ME: median eminence. Adapted from (Cone et al 2006)

Once they cross the BBB, orexigenic and anorexigenic signals reach two distinct neuronal populations, called **first order neurons** because of their closeness to the median eminence: the **Neuropeptide Y (NPY) Agouti-Related Protein (AgRP) neurons**, and the **Proopiomelanocortin (POMC) Cocaine and Amphetamine Related Transcript (CART) neurons** (*Figure 6*). These two neuronal populations express the receptors for peripheral signalling molecules such as leptin, ghrelin or insulin receptor. They are antagonist, and work together to regulate food intake and energy expenditure.

Introduction

The NPY neurons release three neuropeptides: NPY, AgRP, and γ -Aminobutyric acid (GABA), an inhibitory neurotransmitter. NPY has long been considered a major regulator of feeding (Clark et al., 1984), and injection of NPY in the PVN was shown to **increase feeding and decrease energy expenditure** (Billington et al., 1994). Following leptin discovery (Zhang et al., 1994), Stephens et al. (Stephens et al., 1995) showed that leptin inhibits the NPY/AgRP neurons just like insulin (Sipols et al., 1995) or PYY3–36 (Batterham et al., 2002), whereas they are stimulated by peripheral ghrelin (Kamegai et al., 2001), ghrelin released from the Arc (Cowley et al., 2003), and heparin (Zhu et al., 2017). Chemogenetic activation of these neurons by Designer Receptors Exclusively Activated by Designer Drugs (DREADDs)² promotes food intake (Krashes et al., 2011). Because of these discoveries, the NPY/AgRP neurons are therefore identified as orexigenic neurons responsible of food intake.

Adjacent to these cells, the POMC neurons co-express two neurotransmitter, POMC and CART. POMC is the polypeptide precursor of melanocortin, named **α -melanocyte stimulating hormone (α -MSH)**. Once released from axon terminals, α -MSH binds to and activates neuronal **α -melanocortin receptors 3 and 4** (MC3R and MC4R), located on **second order neurons** (Mountjoy et al., 1994; Ramachandrapa et al., 2013; Roselli-Rehfuss et al., 1993). The POMC neurons are activated by leptin, insulin, and inhibited by ghrelin (Pinto et al., 2004; Williams et al., 2010) (*Figure 6*). The POMC/CART are therefore identified as anorexigenic neurons, their activation prevents feeding behaviours.

As mentioned before, the NPY/AgRP and the POMC/CART neurons respond via an antagonist mechanism. There are several molecular reasons for this dichotomy. First of all, **while α -MSH is an agonist of MC3R and MC4R receptors, AgRP is a strong antagonist**. As such, a binding of α -MSH will activate the receptors on the second order neurons, while AgRP will inhibit them (Ollmann et al., 1997). Secondly, the NPY/AgRP also target the POMC/CART neurons, and **release the inhibitory neurotransmitter GABA onto POMC neurons**, which leads to their silencing. Finally, some anorexigenic signals like insulin and leptin bind transcription factors that will allow the transcription of AgRP but inhibit the transcription of POMC. That is for example the case of **Forkhead 1 (FOXO1)** that works oppositely to the transcription factor Signal-activated transcript-3 (STAT3) (Kim et al., 2006). These three mechanisms, antagonist neuropeptides for the MCR, GABA release, and opposite regulation for genes transcription, make these neuronal populations very distinct and allows opposite effects on food intake and energy expenditure.

ii. [The second order neurons release orexigenic and anorexigenic neurotransmitters and target higher regions of the brain](#)

When activated, the NPY/AgRP and the POMC neurons target the **second-order nuclei** of the hypothalamus, the PVN, LH, or VMH, through the MCR3 and MCR4 receptors belonging to the G-

² Designer Receptors Exclusively Activated by Designer Drugs (DREADD) are synthetic G protein-coupled receptors designed to be solely activated by a pharmacologically inert ligand. Their expression can be genetically restrained, allowing a spatial control of the receptor, and a temporal control when the ligand is administered.

coupled protein receptors family. Subsequent activation of the PVN triggers the release of anorexigenic neuropeptides such as **the corticotropin-releasing hormone (CRH)** and **thyrotropin-releasing hormone (TRH)** (Glowa and Gold, 1991; Vijayan and McCann, 1977). LH activation will release **orexins A and B** (Sakurai et al., 1998) and **melanin-concentrating hormone (MCH)** (Qu et al., 1996), which are well-studied orexigenic factors. In addition, the VMH activation releases **brain-derived neurotrophic factor (BDNF)**, a neurotransmitter involved in synaptic plasticity having anorexigenic effects (Kernie, 2000) (*Figure 7*).

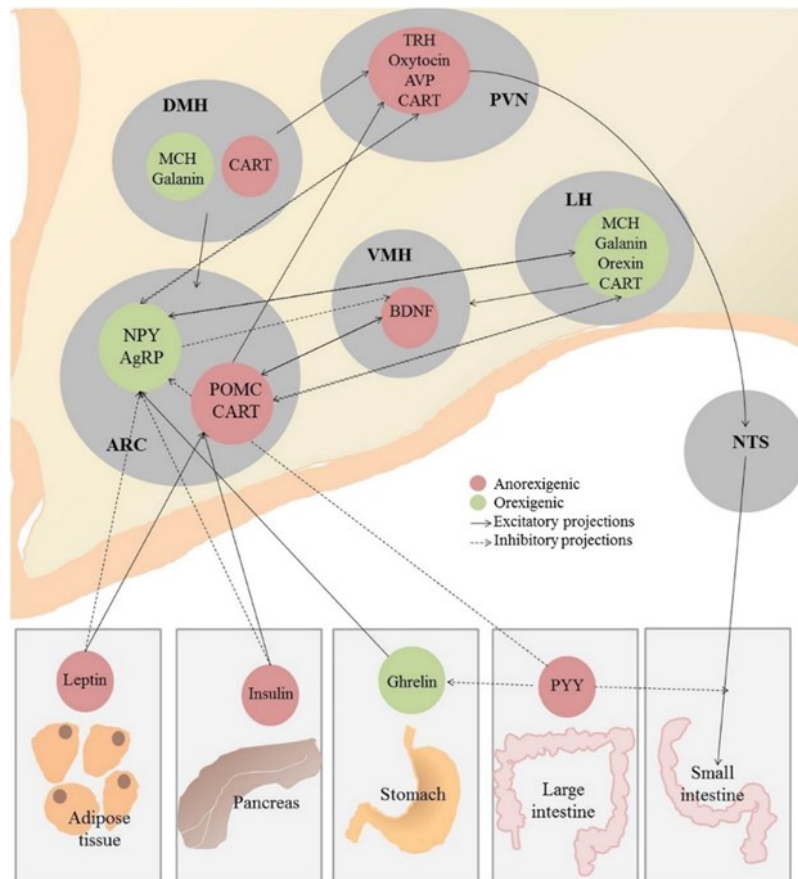

Figure 7 Second order Neurons signalling and Food intake regulation

ARC: Arcuate Nucleus of the hypothalamus, DMH: Dorsomedial Nucleus of the hypothalamus, PVN: paraventricular nucleus of the hypothalamus, LH: Lateral hypothalamus, VMH: Ventromedial hypothalamus, NTS: Nucleus of the solitary tract, MCH: melanin concentrating hormone, CART: cocaine and amphetamine related transcript, TRH: thyrotropin releasing hormone, AVP: brain derived neurotrophic factor, NPY: Neuropeptide Y, POMC: pro-opiomelanocortin, PYY: peptide Y₃₋₃₆.

Finally, these orexigenic and anorexigenic circuits will connect to higher structures in the brain and motor control circuits, and they will regulate food intake. Recent investigation using optogenetics³ highlighted several communication between the hypothalamic melanocortin circuitry and brain regions

³ Optogenetics: this technique allows specific activation or inhibition of a specific subset of neurons genetically expressing ionic channels coupled to light-sensitive opsins and activated by a specific wavelength. These channels will be subsequently targeted by the addition of an optic fibre, bringing light necessary for activation.

involved in reward and motivation (Aponte et al., 2011; Atasoy et al., 2012; Betley et al., 2013). For example, the ventral tegmental area (VTA), which will be described more precisely later (see section I.B.1, page 24), receives inputs from the lateral hypothalamus and the Arc, and contains **ghrelin receptors** (Abizaid et al., 2006; Zigman et al., 2006), and **leptin receptors** (Figlewicz et al., 2003) (*Figure 8*). Although this area was not initially thought to play a role in the regulation of food intake, it was shown that ghrelin injection in the VTA affects dopamine signalling and **promotes food intake** (Abizaid et al., 2006; Cone et al., 2015; Naleid et al., 2005), in addition to being an important factor that **stimulates reward** both in rodents, and in humans (Malik et al., 2008; Perelló and Zigman, 2012). For this reason, the semantic discrimination of homeostatic versus non-homeostatic feeding behaviour that we mentioned earlier seems difficult to untangle from an anatomical and neuronal perspective, and the hypothalamus and its related pathways alone are not sufficient to fully understand the drive associated to food intake mechanisms.

élément sous droit, diffusion non autorisée

Figure 8 Interaction between metabolic signalling and mesocorticolimbic signalling.

The reward circuit shown in light blue integrates peripheral and central mechanisms driven by homeostatic signals and environmental stimuli that result in goal-directed actions. The hypothalamus in light green is central to energy balance, integrates orexigenic and anorexigenic signals from the periphery and the brain and convey them to the reward system. Neurons in the nucleus of the tractus solitarius (NTS; dark blue) integrate peripheral satiety signals and convey the information forward to the locus coeruleus (LC), raphe, and beyond to modulate the sensitivity of upstream networks. Thus, orexigenic and anorexigenic peripheral signals directly influence not only hypothalamic nuclei but also mesocorticolimbic structures. PFC, prefrontal cortex; BLA; basolateral amygdala; Hipp, hippocampus; DS, dorsal striatum; NAc, nucleus accumbens; STN, subthalamic nucleus; VS, ventral striatum; SN, substantia nigra; VTA, ventral tegmental area; ARC, arcuate hypothalamus; LH, lateral hypothalamus; PVT, paraventricular thalamus; DA, dopamine; CCK, cholecystokinin; MCH, melanin-concentrating hormone; GLP1, glucagon-like peptide. From (Volkow et al., 2017)

B. Reward-related networks controlling feeding behaviour

Feeding, among other natural rewards such as breeding or drinking, is a crucial behaviour compulsory for survival, reproduction, and evolution of species. Living organisms evolved with a great preference for foods enriched with fat and sugar, which provide a lot of calories. These nutrients can be considered as **potent rewards which promote eating even in absence of hunger, and trigger learned association between a stimulus and a reward**. Indeed, this trait ensures that food is eaten when available and energy is stored in the body for future needs when resources are limited. The appealing taste of food, or **palatability**, is a crucial determinant of the decision to eat, and highly palatable foods can trigger eating at times when food would not otherwise be consumed. **Brain circuits that process information related to food palatability are influenced by metabolic and hormonal signals that communicate information regarding the status of energy storage to the central nervous system**. Satiety signals reduce perception of food tastiness (Figlewicz and Sipols, 2010; Fulton et al., 2000; Miettlicki-Baase et al., 2014; Nijs et al., 2010). Conversely, weight loss induced by fasting or caloric restriction stimulates hyperphagia partly by increasing the rewarding properties of food through leptin (Farooqi et al., 2007). In this section, we will describe the non-homeostatic, hedonic component of food intake encoded by

dopamine (DA) neurons, a subtype of midbrain cells in charge of encoding reward-related values, thus showing that a strict distinction between homeostatic and non-homeostatic signalling is not that simple or even possible.

1. The dopaminergic pathway involved in hedonic aspect of feeding

Historically, dopaminergic neurons were divided in two different pathways, the nigro-striatal, from the substantia nigra to the dorsal striatum, which help action selection (Gerfen and Surmeier, 2011), and the ventral **mesocorticolimbic system**, from the ventral tegmental area to the ventral striatum or nucleus accumbens, which promotes learning, reward, and motivated behaviours. Recent studies, using optogenetics and retrograde tracing strategies⁴, have shown that these two pathways are more mingled than initially thought, and that some neurons of the substantia nigra project more ventrally, and can also innervate cortical and limbic areas, while some neurons of the ventral tegmental area project more dorsally (Morales and Margolis, 2017). These neurons are still being studied and their purpose is not known yet.

i. The Basal Ganglia in charge of movement

The basal ganglia is a set of highly interconnected nuclei, notably the striatum, the globus pallidus, the subthalamic nucleus, ventral pallidum and the substantia nigra (Ikemoto et al., 2015). DA is secreted from the *substantia nigra pars compacta* (SNpc) to the striatum. This projection of DA neurons is called **nigrostriatal pathway**, and its dysregulations result in motor-related diseases such as the Parkinson's disease. The information then comes back to the *substantia nigra pars reticulata* (SNr), a region containing GABAergic neurons, and projecting to the thalamus. The most widely accepted model of the basal ganglia circuit is based on the segregation of information from the striatum to the SNr into a direct and indirect pathways. The **direct pathway**, or **striatonigral pathway**, contains medium spiny neurons (MSN) in the dorsal part of the striatum (DS) that express dopamine receptor D1 (D1R) and release GABA, and will project directly to the SNr, and to the internal globus pallidus (GPi). The **indirect pathway** contains GABAergic MSN expressing the dopamine receptor D2 (D2R), also called **striatopallidal neurons**, which will project to the external globus pallidus (GPe). The GPe also contains GABAergic neurons that will connect with the subthalamic nucleus. The subthalamic nucleus will finally relay the information to the SNr via glutamatergic inputs, where GABAergic neurons will convey information to the thalamus (*Figure 9*).

⁴ Retrograde markers: this technique allows to visualise neuronal connections from the synapse to the cell body by injecting a retrograde virus expressing a fluorescent gene in the neuronal projection site.

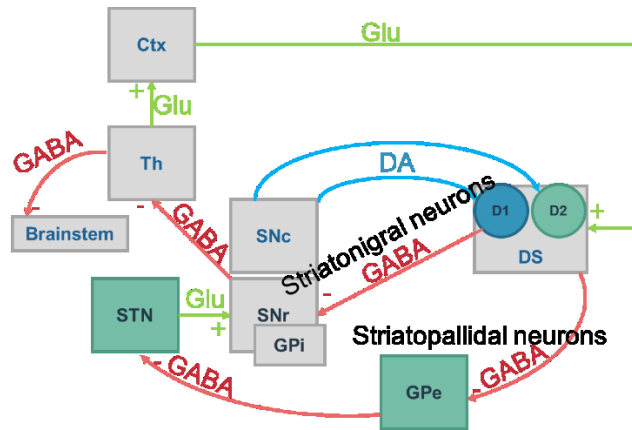

Figure 9 The Basal Ganglia

In blue: neurons releasing dopamine (DA) from the Substantia nigra pars compacta (SNpc) to the Dorsal Striatum (DS). In red: GABAergic neurons of the direct striatonigral pathway from the DS to the Substantia Nigra pars reticulata (SNr), and indirect striatopallidal pathway from the DS to the globus pallidum external (GPe) to the Subthalamic nucleus (STN). In green: glutamatergic neurons conveying information from the thalamus (Th) to the cortex (Ctx).

ii. The mesocorticolimbic pathway

The mesocorticolimbic pathway (MCL) contains DA neurons from the VTA projecting to the ventral part of the striatum, called the Nucleus Accumbens (NAc), but also to the olfactory tubercle, the basolateral amygdala, the hippocampus and the prefrontal cortex (PFC) (*Figure 10*). The MCL is associated with **goal-directed behaviours and motivation**, as well as higher cognitive functions such as learning and memory. Dysfunctions of this circuitry can lead to different forms of maladaptive behaviours, such as addiction, mood disorders, compulsivity. Similarly to the basal ganglia system, the striatal MSN of the NAc also segregate in two pathways to return the information to the VTA. The D1R MSN will target the VTA via the **direct pathway** (Gerfen et al., 1990; Le Moine and Bloch, 1995), while MSN co-expressing the D1R, D2R and Adenosine A2a will target the ventral pallidum (VP) where neurons will relay the information to the VTA via the **indirect pathway** (Lu et al., 1998).

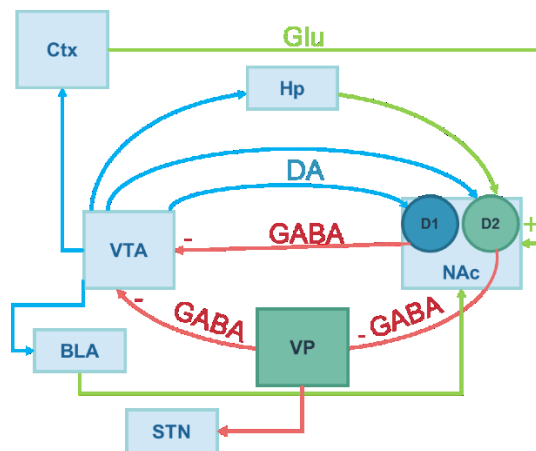

Figure 10 The Mesocorticolimbic Pathway

In blue: neurons releasing dopamine (DA) from the ventral tegmental area (VTA) to the nucleus accumbens (NAc). In red: GABAergic neurons NAc to the VTA, and indirect pathway from the NAc to the ventral pallidum (VP) to the Subthalamic nucleus (STN) and VTA. In green: glutamatergic neurons conveying information from the hippocampus (Hp), cortex (Ctx), basolateral amygdala (BLA).

The NAc is divided in two main regions, the core and the shell. The core is anatomically related to the DS in terms of connections and functions. The shell is highly heterogeneous, with a vast majority of GABAergic D1R MSN, D2R MSN, coexpressing D1R and D2R MSN, cholinergic and GABAergic interneurons (Gangarossa et al., 2013a). Whether D1R and D2R expressing MSNs are randomly distributed or exhibit inhomogeneous distribution patterns in the different subterritories of the NAc shell remains to be established. Due to the diversity of their output targets that include VTA, hypothalamus, VP, and brainstem, a simple division into direct and indirect pathways has been even more difficult to define for the NAc shell MSNs (van Dongen et al., 2008; Sesack and Grace, 2010; Zahm and Brog, 1992). Besides the dopaminergic inputs from the SNpc and the VTA, the NAc mostly receive glutamatergic inputs from the cortex, amygdala and the thalamus (*Figure 11*).

The ventral tegmental area contains the cell bodies of dopaminergic neurons, and sends its axons to the striatum. This area receives many glutamatergic and GABAergic inputs, including from the VP and lateral hypothalamus, and targets the NAc but also the Lateral Habenula, or the PFC (*Figure 12*).

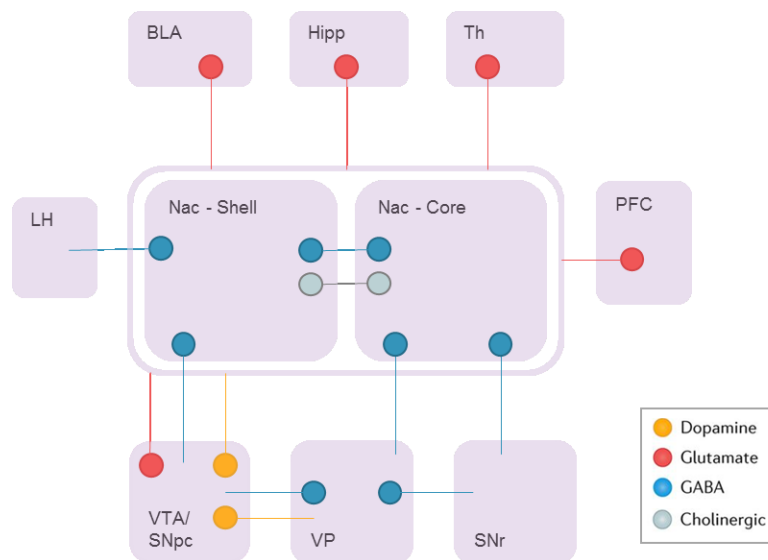

Figure 11 Connectivity of the Nucleus Accumbens

The nucleus accumbens receives major glutamatergic inputs (in red) from the basolateral amygdala (BLA), hippocampus (Hipp), thalamus (Th), prefrontal cortex (PFC), dopamine (in yellow) from the ventral tegmental area (VTA) and substantia nigra pars compacta (SNpc). The main projections are GABAergic MSN reaching the lateral hypothalamus (LH), ventral pallidum (VP) and substantia nigra pars compacta (SNr). In grey : cholinergic interneurons.

élément sous droit, diffusion non autorisée

Figure 12 Synaptic connections involving the Ventral Tegmental Area

Introduction

a. VTA DA neurons receive glutamatergic inputs from the medial prefrontal cortex (mPFC), pedunculopontine tegmentum (PPTg), laterodorsal tegmentum nucleus (LDTg), lateral habenula (LHb), periaqueductal grey (PAG), bed nucleus of the stria terminalis (BNST) and dorsal raphe nucleus (DRN). VTA dopamine neurons receive GABAergic inputs from the rostromedial mesopontine tegmental nucleus (RMTg), PAG, DRN, lateral hypothalamus (LHT) and ventral pallidum (VP). There are also local glutamate and GABA synapses onto VTA dopamine neurons arising from neurons within the VTA. b. VTA GABA neurons receive glutamatergic inputs from the LHb and mPFC and GABAergic inputs from the nucleus accumbens (nAcc) medium spiny neurons (MSNs) expressing the dopamine receptor D1. VTA GABA neurons receive both glutamatergic and GABAergic innervation from the PAG, DRN, LHT and BNST. Most BNST projections establishing synapses in the VTA are from GABA neurons that preferentially synapse on the VTA GABA neurons. c. VTA 'GABA-only' neurons target cholinergic interneurons of the nAcc and glutamatergic neurons of the LHb. d. VTA 'glutamate-only' neurons target glutamate neurons of the LHb and nAcc PV-expressing neurons, whereas VTA combinatorial glutamate–GABA neurons target glutamate neurons of the LHb. e. VTA 'dopamine-only' neurons establish symmetric synapses on MSNs in the nAcc. The combinatorial dopamine–glutamate neurons target nAcc MSNs, nAcc cholinergic interneurons, and mPFC parvalbumin (PV)-expressing GABA-releasing interneurons. The combinatorial dopamine–GABA neurons target nAcc MSN. From (Morales and Margolis, 2017).

iii. The dopaminergic pathway in feeding behaviour

Feeding behaviour depends largely on the perception of food from the taste buds, colour, texture, smell, that will elicit rewarding properties of food thanks to the MCL. The rewarding effect of these cues depends on the satiety state (Morton et al., 2006; Rolls, 2005). As a consequence, the MCL needs to integrate not only cortical inputs related to food-cues, but also the inputs from the homeostatic pathway (*Figure 13*). For example, it was shown in primates that the NTS perceives taste information and connects to the VTA and NAc, that will assign reward to them.

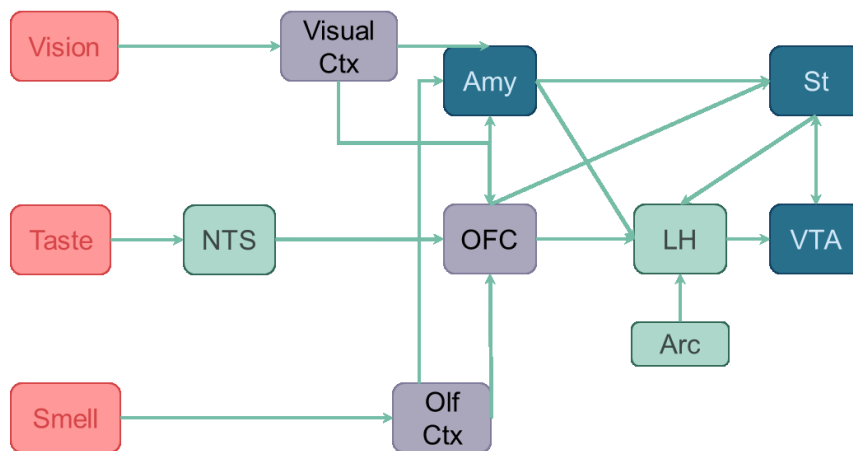

Figure 13 Interactions between the mesocorticolimbic pathways and hunger related regions

The mesocorticolimbic system (MCL) is in blue. The striatum (St) receives inputs from the orbitofrontal cortex (OFC), amygdala (Amy), ventral tegmental area (VTA). In green, structures of the homeostatic system: the lateral hypothalamus (LH) receives input from the arcuate nucleus (Arc), nucleus of the solitary tract (NTS). In purple: visual cortex, olfactory cortex, orbitofrontal cortex. Adapted from (Morton et al., 2006; Rolls, 2005)

The NAc as well as the VTA contain receptors for signalling molecules involved in energy regulation such as leptin, insulin (Figlewicz et al., 2003), ghrelin (Naleid et al., 2005), CCK (Reum et al., 1997), or GLP-1 (Dossat et al., 2011; Miettlicki-Baase et al., 2014). For example, ICV delivery of leptin was shown to **modulate reward** (Fulton et al., 2000), and the absence of its receptor in *ob/ob* mice correlates

with a **reduced DA signalling, demonstrating that leptin is not only a ‘homeostatic’ but also a ‘non-homeostatic’ signal** (Fulton et al., 2006).

2. The lateral hypothalamus, cross-talk between the homeostatic and non-homeostatic regulation of food-intake

The **lateral hypothalamic area (LH)** is a large and heterogeneous area with several distinct nuclei. It contains many populations of neurons, some expressing orexigenic neuropeptides such as orexin/hypocretin, MCH, galanin, others expressing anorexigenic neuropeptides such as neurotensin or CART. Most neurons in the lateral hypothalamic area express more than one peptide, and in addition may express either one of the classical neurotransmitters glutamate or GABA. It is one of the most extensively interconnected areas of the hypothalamus, allowing the reception of a vast range of information and the modulation of feeding functions accordingly. The LH joins rostrally the preoptic area and caudally the VTA, and is close to several hypothalamic nuclei such as the DMH, VMH, and Arc. As described earlier, the Arc sends NPY/AgRP and POMC/CART projections within the LH (for more details see I.A.3, page 19). The LH also receives many inputs from corticolimbic structures such as the PFC, olfactory cortex, hippocampus and amygdala, and from the shell of the NAc, and NTS (Kampe et al., 2009) (*Figure 14*). The LH has efferent projections to the hippocampus, amygdala, basal ganglia and thalamus, midbrain and pons, brainstem and spinal cord, and other nuclei of the hypothalamus (*Figure 14*). Because of this crossroads between the hypothalamus and the regions of the MCL, the **LH was suggested to integrate reward-related input with information related to energy homeostasis** (Mogenson et al., 1980; Stratford and Kelley, 1999), and to influence the MCL in turn (Leininger et al., 2009).

The LH receives peripheral information via the Arc projections, and possesses glucose-sensitive neurons (Burdakov et al., 2005), as well as the ability to sense several signals such as ghrelin, GLP-1, leptin (Berthoud and Münzberg, 2011). Leptin stimulation in the LH inhibits food intake by signalling to the VTA (Leininger et al., 2009) through orexin neurons (Peyron et al., 1998), and promotes locomotor activity (Nakamura et al., 2014). VTA orexin signalling is also involved in cocaine and morphine-induced hyperlocomotion and place preference through the MCL (Borgland et al., 2006; Narita et al., 2006), and orexin-deficient mice are less susceptible to develop drug dependence (Georgescu et al., 2003), while orexin injection into the VTA can reinstate an extinguished preference for drugs of abuse (Harris et al., 2005). **These data support the large involvement of the LH and orexin neurons in reward encoding, and the superposition of pathways involved in reward and food intake.** Using a model of reward-driven food intake in metabolically satiated rats (Zhang et al., 1998), (Kelley et al., 2005; Stratford and Kelley, 1999; Will et al., 2006) showed that **food reward is associated with activation of orexin neurons in the LH**, and that GABA agonist or glutamate

antagonist in the NAc can modulate LH activity to promote feeding. In other words, decreasing the GABAergic input of MSN from the NAc to the LH can promote food intake via orexins.

élément sous droit, diffusion non autorisée

Figure 14 Lateral hypothalamus interactions with the reward circuit

LepRb-expressing GABA neurons within the Lateral hypothalamus (LH) receives inhibitory inputs from D1-expressing medium spiny neurons (MSNs) of the nucleus accumbens (NAc). In turn, LH GABA neurons can inhibit ventral tegmental area (VTA) GABA-ergic neurons that disinhibit VTA DA neurons that may project onto D1-expressing MSNs of the NAc. LH OX neurons receives excitatory inputs from glutamatergic (Glu) innervation under the inhibitory control of presynaptic CB1 receptors, also located on presynaptic GABA-ergic terminals that synapse OX neurons within the LH. OX neurons are thought to form local microcircuits by synapsing VTA DA neurons establishing contacts with D1-expressing MSNs of the NAc, which project back to LepRb-expressing GABA neurons. Glu-ergic innervation from LH to VTA DA neurons is also illustrated as relevant instance of insulin- and leptin-sensitive information processing within the LH-mesolimbic DA circuit. The Glu-ergic pathway, along with presynaptic CB1 receptors on Glu-ergic terminals contacting NAc MSNs illustrate an additional key component of the fine-tuned regulation of VTA DA neurons. Putative Glu-ergic neurons (yellow), GABA-ergic neurons (red), OX neurons (light blue) and DA-ergic neurons (blue). From (Coccorello and Maccarrone, 2018)

3. Endocannabinoids control of food intake and energy balance

Δ^9 -tetrahydrocannabinol (Δ^9 -THC) has long been used as an appetite-inducing drug; its consumption is often associated with increased wanting for food. This molecule targets the **cannabinoid receptors 1 and 2** (CB1 and CB2), CB1 being expressed mostly in the brain while CB2 is mostly in periphery. The CB1 receptors are located in the basal ganglia, hippocampus, cerebellum, PFC (Herkenham et al., 1990) and activated by endogenous molecules named **endocannabinoids**. Cannabinoid receptors are G protein coupled receptors (GPCR) **which modulate neurons activity** via AC, and Ca^{2+} and K^{+} channels regulation (Matsuda et al., 1990). The most studied endocannabinoids are the **N-arachidonoyl ethanolamine** (anandamide, AEA) and the **2-arachidonoyl glycerol** (2-AG), which are metabolised from **arachidonic acid** (Devane et al., 1992) (*Figure 15*). Unlike classical neurotransmitters, these molecules are not stored within vesicles but are **produced on demand** by two enzymes, the **N-acylphosphatidylethanolamine-selective phospholipase D** (NAPE-PLD) and the **diacylglycerol lipase** (DAG-lipase) (Di Marzo et al., 1994) (*Figure 15*). Their lifespan is controlled by a fast degradation by the **fatty acid amide hydrolase** (FAAH) and the **monoacylglycerol lipase** (MAG). Because of their hydrophobic nature, they can diffuse through plasmic membranes, and **act as retrogrades messengers** (Wilson and Nicoll, 2001).

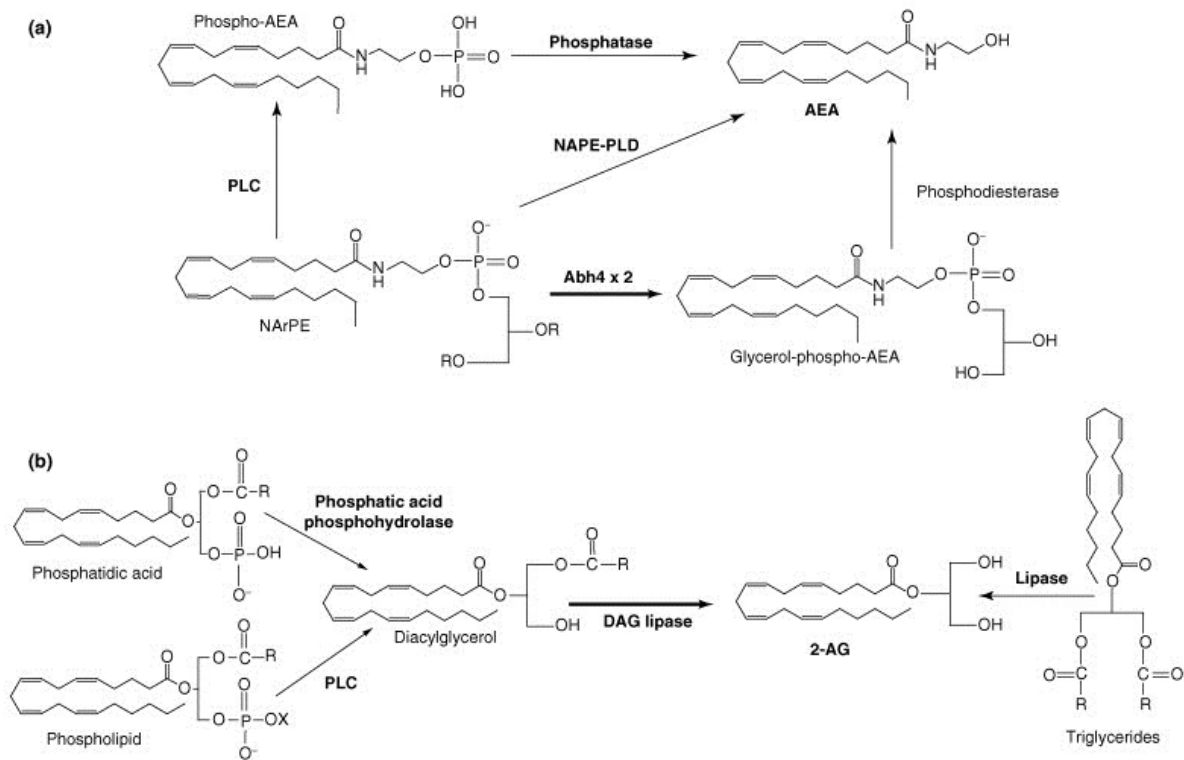

Figure 15 Endocannabinoids Synthesis.

AEA: anandamide; NAPE-PLD: N-acylphosphatidylethanolamine-selective phospholipase D. PLC: phospholipase C; 2-AG: diacylglycerol; DAG: Diacylglycerol lipase. From (Matias and Di Marzo, 2007)

During fasting, endocannabinoids are more expressed in the limbic forebrain and hypothalamus, while **repressed in a fed state** (Kirkham et al., 2002). General activation of the CB1 increases food intake while its inhibition decrease food intake, and modulation of endocannabinoids signalling in the hypothalamus also affects food intake in similar ways (Cota, 2007).

Endocannabinoid modulate the MCL (French et al., 1997; Gessa et al., 1998) although very few CB1 are expressed in the VTA and NAc (Herkenham et al., 1990) (*Figure 16*). This regulation is due to neuronal populations expressing CB1 and projecting to midbrain DA neurons, like the glutamatergic neurons of the PFC and the subthalamic nucleus, or the GABAergic neurons of the striatum and those of the SNr (Marsicano and Lutz, 1999; Matsuda et al., 1993). Thus, CB1 can adjust the release of inhibitory and excitatory neurotransmitters and regulate DA neurons (*Figure 17*).

élément sous droit, diffusion non autorisée

Figure 16 Endocannabinoids and the control of energy balance

(a) In the NAc, endocannabinoids increase following food deprivation and are under the negative control of dopamine released from the ventral tegmental area (VTA). They presumably facilitate the disinhibition of hypothalamic nuclei conveying food intake-stimulatory signals (green dot), such as the MCH expressing neurons of the LHA. In the VTA, CB1 receptors might facilitate the activity of dopaminergic neurons through retrograde inhibition of other inhibitory GABAergic neurons. (b) In the hypothalamus, EC levels are under the positive control of glucocorticoids (Gluc) and, perhaps, NPY and ghrelin, and are under the negative control of leptin. CB1 receptors negatively control the expression of CRH and CART in the PVN and ARC,

Introduction

respectively, as well as MCH release in the LHA and CRH release in the PVN through retrograde signalling. Finally, they both enhance and reduce the activity of POMC-expressing neurons in the ARC through retrograde inhibition of GABA-ergic and glutamatergic inputs, respectively. (c) In the hindbrain nuclei of the brainstem, the nucleus tractus solitarius (NTS) and the vagal terminal of the nodose ganglion, which receive satiety-inducing stimuli from sensory neurons and the vagus, respectively, CB1 receptors act by reducing satiety and, in the latter area, are under the negative control of cholecystokinin (CCK) and the positive control of ghrelin. (d) Peripheral organs with endocrine functions, such as white adipose tissue (WAT), the pancreas, the gastrointestinal (GI) tract, the adrenal gland and the ovaries, secrete the hormones that coordinate EC levels and CB1-mediated actions to secure the appropriate stimulation of food intake after food deprivation and stressful conditions. Arrows denote activation, facilitation or production. Rhomboid arrows denote inhibitory pathways. From (Matias and Di Marzo, 2007)

élément sous droit, diffusion non autorisée

Figure 17 Endocannabinoids and the Dopaminergic Synapse

a. Endocannabinoids (EC) produced by dopaminergic VTA neurons act on CB1Rs on nearby glutamatergic and GABAergic terminals before being degraded by ABHD6 or MAGL. CB1Rs mediate robust inhibition of GABA inputs arising from the pallidus, RMTg nucleus and local interneurons onto VTA DA cells. CB1Rs are also localized on glutamatergic terminals synapsing on VTA DA neurons and suppress glutamate signalling in VTA. Thus, ECs play a prominent role in fine-tuning the activity of the mesolimbic DA projection through modulation of both excitatory and inhibitory signalling in the VTA. b. NAc MSN activity is modulated by glutamatergic inputs from the PFC, BLA and ventral hippocampus that express CB1Rs. Increased EC signalling in the NAc increases approach behaviour while reducing avoidance-related processing thereby enhancing appetitive responding toward a stimulus.

4. The opioid system encoding the ‘liking’ of food

The opioid receptor family contains four members encoding **mu (μ), delta (δ), kappa (κ), and the non-opioid orphaninFQ/nociceptin receptors** (Le Merrer et al., 2009). Opioid receptors are widely expressed in the brain, and also are **GPCR membrane receptors**. When activated, these receptors shut down the synapse by inhibiting the AC pathway, activating the MAP Kinase pathway, closing the Ca^{2+} channels and opening the K^{+} channels. These receptors are endogenously activated by opioids named **endorphin, enkephalin and dynorphin**. GABAergic neurons surrounding the VTA express the μ -opioid receptors, hence an activation of these receptors by opioids will extinct the inhibitory output of these neurons on the VTA. As a consequence, the DAergic neurons will increase their activity (Svingos et al., 2001). Contrary to the opioid effects on the VTA, the NAc opioid system regulates feeding behaviour independently of DA signalling but **involves cholinergic neurons** (Will et al., 2006).

The NAc shell and the VP both express opioid receptors, and it was shown that their activation with an agonist of the μ -receptor **stimulates feeding for palatable food** (Baldo and Kelley, 2007; Kelley et al., 2002; Zhang et al., 1998). The authors of these investigations named the specific area expressing opioid receptors in this region ‘hedonic hotspot’, as their stimulation seems to increase specifically the ‘liking’ associated to palatable food consumption, measured by positive facial reactions⁵ to sucrose in rats, and increased eating behaviour (Peciña and Berridge, 2000) (Figure 18).

élément sous droit, diffusion non autorisée

Figure 18 The nucleus accumbens μ -opioid hotspot involved in food ‘liking’

A, Sagittal summary maps of NAc medial shell for mu, delta, or kappa hedonic enhancements (rostral hotspots) and suppressions (caudal coldspots) of sucrose “liking”. Hotspot outlines are defined anatomically by contiguous groups of

⁵ Facial reactions analysis: in order to better understand animals’ food preference, this protocole uses the application of a small quantity of a test solution in the mouth of videotaped rats. The reactivity of rats faces is then analysed and allows to quantify the liking associated to the substance of interest (Grill and Norgren, 1978).

microinjection sites that caused >250% enhancements of positive orofacial hedonic reactions elicited by sucrose taste, and coldspot boundaries are defined by contiguous sites that caused suppressions to below one-half of control vehicle levels for sucrose “liking” reactions. B, Anatomical circuitry features relevant to the hotspot of rostradorsal medial shell. Hedonic hotspots are shown in yellow, GABAergic projections in red, glutamatergic projections in green, and dopaminergic projections in blue.

C. Dysregulations of feeding behaviour: driven by food reward

As we have discussed above, the MCL controls food reward directly, or by indirect modulation from other systems such as the endocannabinoids or opioids. Additionally, the MCL is incriminated in pathological addictions to many substances of abuse, like nicotine, cocaine, or alcohol. Because of its preponderant role in food intake control and the increasing amount of eating disorders, the question of addiction for food was recently investigated (Volkow and Wise, 2005; Volkow et al., 2011, 2017).

1. Physiological role of dopamine

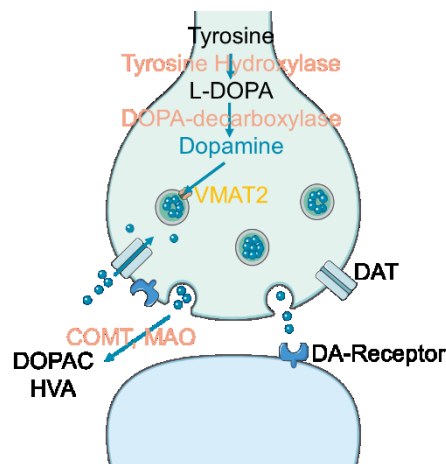

Figure 19 Dopamine Synthesis and Degradation

Dopamine is a neurotransmitter that belongs to the catecholamine family (Carlsson et al., 1958). It is synthesised in the cytosol by the hydroxylation of L-tyrosine by the **Tyrosine Hydroxylase** (TH) into L-3,4-dihydroxyphenylalanine (DOPA) that will be transformed by the aromatic-1-amino-acid decarboxylase (DOPAC) in dopamine (*Figure 19*). DA is then stored in synaptic vesicles through the **vesicular monoamine transporter 2** (VMAT2). When activated, the DA neurons release DA in the synapse, where it will target various DA receptors, and will be recycled through the **Dopamine Transporter** (DAT) (**Erreur ! Source du renvoi introuvable.**).

The role of dopamine was initially suggested as a **mediator** pleasure, or ‘liking’ (Berridge, 2009; Berridge and Robinson, 1998). Indeed, **dopaminergic neurons fire simultaneously when a likeable stimulus is provided** (Schultz, 1986). However, electrophysiological recordings while expected reward

Introduction

are provided show that dopamine firing occurs before the reward is consumed. This observation raised several hypotheses regarding the physiological role of dopamine.

i. Dopamine as a prediction of reward

Reward is defined as ‘an object or an action that generates approach and consummatory behaviour, produces learning of such behaviour, and engages positive emotions and hedonic feelings’ (Schultz, 2010). Foods rich in sugars and fat promote eating even in the absence of energetic requirement, and they can create a **conditioned behaviour** able to trigger associative learning between a stimulus and their consumption (‘Pavlovian conditioning’), hence, they fit the definition of a reward.

Rewards vary in intensity and occur with specific probabilities. When facing a choice leading to a reward, the brain tends to go for the option which will lead to the more likely and strong reward, and needs to predict the probability of a gain. Predictions help to choose more efficiently, and to save energy in order to obtain a reward, therefore, the processes of prediction storage are supposed to be evolutionarily conserved. Brains evolved to store predictions about future events in higher brain centres and compare this information with in lower brain centres (Schultz, 2010). The discrepancy between the actual event and its prediction is called an **event prediction error**, and allows the brain to constantly update a reward’s prediction. This fundamental property of predictions is what we call learning, as defined by changes in behaviour based on updated predictions. The DA response to reward delivery appears to code a prediction error; in this context, a reward that is stronger than predicted elicits an activation (positive prediction error), a fully predicted reward draws no response, and a reward that is worse than predicted induces a depression (negative error) (*Figure 20*). The error response varies quantitatively with the difference between the received reward value and the expected reward value.

In this model, DA neurons respond to reward only when it differs from prediction or when the current reward is better than the previous reward, and the same reward over again will not activate DA neurons. If the activation of DA neurons has a positively reinforcing effect on behaviour, only increasing rewards will provide continuing reinforcement via DAergic mechanisms, ultimately leading to uncontrolled intake of a rewarding stimulus (Schultz, 2010). Importantly, this vision of DA as a corrective molecule for reward prediction has some limits, as some strong stimuli of the MCL, through amphetamine for example, will always lead to a strong DA release.

Coming back to food reward, the presence of palatable food and its related cues activates the mesocorticolimbic system, and releases DA in the NAc and DS (Bassareo and Di Chiara, 1999; Hernandez and Hoebel, 1988; Yoshida et al., 1992), and the palatability depends on the levels of DA

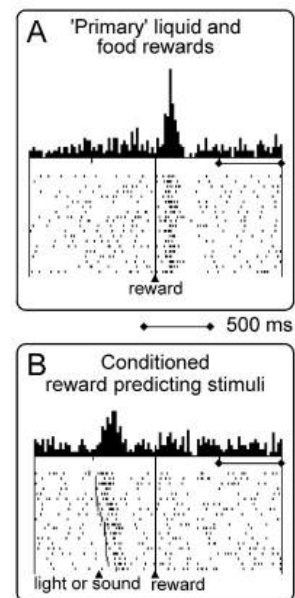

Figure 20 Dopaminergic Firing in conditioned reward

Dopaminergic neurons activity in monkeys facing a palatable food reward for the first time (A) or after a pavlovian conditioning (B). From (Schultz, 2010)

released (Hajnal et al., 2004). Upon first exposure to a food reward, the firing of DA neurons in the VTA increases, increasing DA release in NAc. **Nevertheless, with repeated exposure to the food reward, the DA response habituates and is gradually transferred onto the stimuli associated with the food reward** (for example the smell of food) thanks to synaptic plasticity of glutamatergic NMDA and AMPA receptors located on DA neurons. For this reason, DA could be a predictor of food reward, important to associate food cues to the reward (Volkow et al., 2011).

ii. [Dopamine encodes for motivation and incentive salience](#)

DA is involved in the initiation of **movement** and locomotion, as much as in **goal-directed behaviours**, that is to say behaviours controlled by representation of a goal. This raised the hypothesis that DA encodes for the motivational properties of a reward making it more attractive or wanted, and is commonly named 'incentive salience' (Berridge, 2009). To support this hypothesis, studies showed that DA deletion does not affect the hedonic value of a reward but prevents the behaviour necessary to obtain a reward, like sweet water or palatable food (Berridge and Robinson, 1998) (Kelley and Berridge, 2002). Mice models that can no longer produce DA (tyrosine hydroxylase knocked-out mice) starve to death unless they receive a daily injection of L-DOPA in the Striatum, that will be metabolised in DA and promote feeding (Szczyepka et al., 1999, 2001). This lack of interest for food seems more related to motivation than liking of the food itself, as these mice eat the food that is manually administered to them and like sucrose normally regarding their facial reactions (Cannon and Palmiter, 2003).

2. Compulsive feeding behaviours: can we talk about food addiction?

Obesity comes along with an increase of fat adipose tissue, and often uncontrolled food intake. In general, bland tasting foods are not eaten in excess, whereas palatable foods are often consumed even after energy requirements are set. Simplicity of access to palatable energy-dense food and its overconsumption are a major factor contributing to the recent spread of obesity (Swinburn et al., 2009). In fact, because of the many similarities between overeating in obesity and excessive drug use in addiction, it has been argued that obesity should be considered as a brain disorder and included in the fifth edition of the Diagnostic and Statistical Manual of Mental Disorders (DSM-V) (Volkow and Wise, 2005).

Drug addiction can be defined as a **chronically relapsing disorder**, characterised by compulsion to seek and take a drug, loss of control in limiting intake, and emergence of a negative emotional state (dysphoria, anxiety, irritability) when access to the drug is prevented. Seeking and ingestion habits persist and strengthen despite the threat of negative consequences. Addiction has a three-stage cycle: **binge/intoxication**, **withdrawal/negative affect**, and preoccupation/anticipation named **craving**, that worsens over time and involves neuroplastic changes in the brain reward system (Koob and Volkow, 2016). Drugs of abuse **increase DA levels in the NAc**, called phasic firing (see I.D.2, page 37) (Di Chiara and Imperato, 1988; Koob, 1992). This increase in DA activates specific dopaminergic receptors

Introduction

subtypes named D1R, which are necessary for the rewarding effects of drugs and for conditioned responses (Koob and Volkow, 2016), and enhance the association of reward with environmental cues and initiate goal-directed behaviour (Berridge and Robinson, 1998).

In rodents, addictive-like overeating can be explored with several models, such as extended or restricted access to diets enriched in fat and sugar (Alsiö et al., 2012). When palatable food is removed, behavioural changes appear, that could be compared to withdrawal syndrome seen in drug addiction. **Sugar, fat, also increase DA levels in the MCL** (Hajnal et al., 2004; Liang et al., 2006; Rada et al., 2005; Yoshida et al., 1992), although in smaller quantities than drugs of abuse. The same brain areas (hippocampus, insula, caudate nucleus, and the ventral striatum) respond to food and drug cravings (Wang et al., 2004), suggesting molecular mechanisms promoting reward and overeating or drug taking are related. Furthermore, studies showed that binge-eating or bulimia nervosa are correlated with increased substances consumption (Ross and Ivis, 1999; Wiederman and Pryor, 1996a, 1996b), and signals involved in food intake regulation **also play roles in addiction, like ghrelin increases alcohol consumption** and affects cocaine and amphetamine response for example (Jerlhag et al., 2009, 2010), and **food restriction enhances the central rewarding effect of drugs of abuse** (Cabeza de Vaca and Carr, 1998), whereas injections of **leptin prevents it** (Shalev et al., 2001; Shen et al., 2016).

If it is obvious that drug addiction and palatable food overeating share the same cellular and molecular pathways, whether we can talk about addiction for palatable food is still under discussion. First, food is mandatory for living, and the compulsive behaviours related to cafeteria diets are not as strong as the ones observed in drug addicts. Second, addiction suggests molecular adaptations and brain plasticity that promotes abusive consumption, and a shift from binge to withdrawal, that is still not understood to date.

élément sous droit, diffusion non autorisée

Figure 21 Motivational and molecular adaptations in overeating.

Signalling molecules implicated in food reward, hunger and satiety contribute to the positive feedback loop that drives eating behaviour from a pleasurable experience to craving and compulsivity. AgRP, agouti-related peptide; BDNF, brain-derived neurotrophic factor; CamKIIa, Ca²⁺/calmodulin-dependent protein kinase alpha; CART, cocaine- and amphetamine-regulated transcript; CB1, type 1 cannabinoid receptor; COMT, catechol-O-methyl transferase; CREB, cAMP response element-binding protein; CREBbp, CREB binding protein; CRH, corticotropin-releasing hormone; DAT, dopamine transporter; D1R and D2R, types 1 and 2 dopamine receptor; GluR3, glutamate receptor 3; MOR, mu opioid receptor; mTOR, mammalian target of rapamycin; NR2a, NMDA receptor 2A; NPY, neuropeptide Y; POMC, proopiomelanocortin. Top arrow denotes higher levels or activity. Bottom arrow denotes reduced activity. Two opposite arrows denote that both up-regulated and down-regulated activity have been reported. From (Alsiö et al., 2012)

3. Overeating is often associated with dopamine signalling pathologies

Data in both humans and rodents have shown that obesity is associated with lower activation of central areas involved in reward (Davis et al., 2008; Wang et al., 2001). Based on this observation, overeating could be a compensatory mechanism to adjust for decreased dopamine activity. This process, referred

to as the ‘**reward deficiency syndrome**’, is often used as a model to explain compulsive behaviours. Consistent with this notion, Wang and colleagues (Wang et al., 2002) have proposed the *dopaminergic hypofunction theory* of overeating, where overeating is an adjustment of the obese brain to compensate for low extracellular dopamine levels (Stice et al., 2009, 2015).

élément sous droit, diffusion non autorisée

Figure 22 Brain Dopamine and Obesity

On the left: Group average images of [^{11}C] raclopride, a D2R antagonist positron emission tomography for obese individuals and controls at the level of the basal ganglia. The images are scaled with respect to the maximum value obtained from the controls and presented by means of the rainbow scale. For [^{11}C] raclopride, red represents the highest value (2-0) and dark violet represents the lowest value (0 ml/Gm). On the right: Linear regression between striatal dopamine receptor availability (Binding max B_{max}/K_d) and Body Mass Index BMI in obese individuals. From (Wang et al., 2001)

We have mentioned earlier that drugs of abuse trigger a phasic firing of DA neurons received by the D1R. However, investigations on MCL abnormalities in obese patients point out **decreased levels of another class of DA receptors, the D2R** (Friend et al., 2017; Hamdi et al., 1992; Huang et al., 2006; Johnson and Kenny, 2010). Whether this D2R deficiency in obese people is a consequence of maladaptive feeding behaviour or that individuals with low density of D2 receptors may be more vulnerable to addictive behaviours, including compulsive food intake, is still matter of debate (Wang et al., 2001).

The association between D2R genotype variability and obesity in humans has been investigated, and it has been suggested that allelic variants of the ***Taq1A polymorphism*** in the D2R gene affect D2R expression, and **increase addiction susceptibility** (Fossella et al., 2006; Ritchie and Noble, 2003; Stice et al., 2011). This polymorphism lies 10 kb downstream of the coding region of the D2R gene and is located in the gene encoding for ***ankyrin repeat and kinase domain containing 1*** (ANKK1). The *Taq1A* polymorphism has three allelic variants: A1/A1, A1/A2, and A2/A2. Clinical studies suggest that the **A1 allele is associated with a decreased amount of D2R**. Interestingly, the A1 allele seems to **increase food reinforcement in obese**, and excessive food intake (Epstein et al., 2007). Finally, this allele is correlated with **weaker D2R striatal activation in response to food intake** and more susceptibility to gain weight (Stice et al., 2008, 2010).

D. Molecular basis underlying dopamine-driven reward

To further investigate the potential dysregulations leading to compulsive feeding behaviours, it is necessary to understand the molecular mechanisms underlying dopamine signalling within the MCL. In this section, we will focus on the dopaminergic synapse and dopaminoceptive cells carrying dopamine receptors. DA and its receptors are widely expressed in the brain as well as in periphery.

Introduction

1. Dopaminergic firing and dopamine release in the synapse

In vivo, DA neurons fire in two main different patterns: **regular pacemaker-like activity** (tonic firing) and **burst firing** (phasic firing) (Grace and Bunney, 1983), the latter being associated with transient increases in DA release (Gonon, 1988) (*Figure 23*). Firing rate and pattern of DA neurons depend on the activity of excitatory and inhibitory inputs they receive (Marinelli et al., 2006). These inputs can be **glutamatergic** (DA neurons receive **glutamate**, an excitatory neurotransmitter) (Meltzer et al., 1997) or **GABAergic** (DA neurons receive **GABA**, an inhibitory neurotransmitter). Both neurochemical inputs can activate or inhibit DA neurons' activity, respectively.

élément sous droit, diffusion non autorisée

Figure 23 Tonic and Phasic Firing of Dopaminergic Neurons

Tonic stimulation of dopaminergic neurons (on the left) consists in slow and irregular firing, that is not sufficient to release dopamine (DA) in the synapse. When they get excited by glutamate, DA neurons fire in a more important, phasic firing, that elicits DA release in the synapse. From (Grace, 2016).

2. Two classes of dopamine receptors

Five receptors mediate DA signalling, named D1, D2, D3, D4 and D5 (Kebabian and Greengard, 1971). These receptors are **metabotropic G-protein coupled receptors** (GPCR), the G protein being composed of three subunits α , β , and γ . The α subunit possesses a binding site to guanosine di-phosphate (GDP), and a binding site to the β - γ subunits. When an agonist binds to the receptor, GDP is replaced with guanosine tri-phosphate (GTP), causing the release of the β - γ subunit. The separated α and β - γ subunits will both transduce independent signalling within the cell. Later, the GTP is hydrolysed, the α subunit then reassociates with the β - γ subunit and reintegrates its inactive state (*Figure 24*) (Beaulieu and Gainetdinov, 2011)).

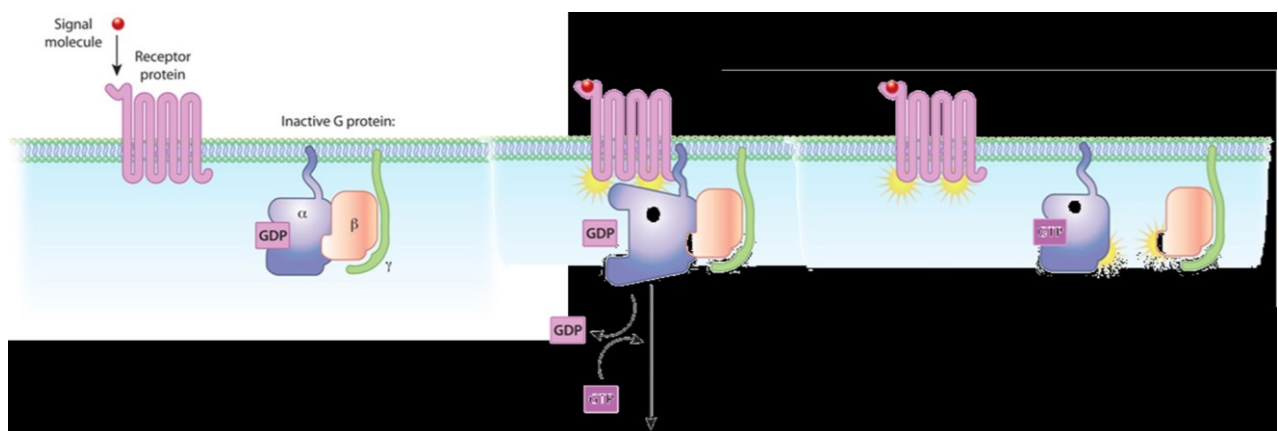

Figure 24 G-Protein coupled Receptors Signalling

In the inactive state, G proteins are composed of 3 subunits and linked to GDP. When the G-protein coupled receptor binds its ligand, the G-protein is activated, GDP is replaced with a GTP. The α and β - γ subunits pull apart to transduce different signalling pathways. Illustration from Nature education (2010)

DA receptors are classified into **D1-family** or **D2-family**, depending on the capacity of their coupled G-proteins to activate or inhibit **adenylate cyclase (AC)** (Kebabian and Calne, 1979; Stoof and Kebabian, 1981), the enzyme which convert ATP into **cyclic Adenylate Monophosphate (cAMP)**.

Receptors of the D1-like family (i.e. D1R and D5R) (D1R) are coupled to $G_{s/olf}$ that will **stimulate cAMP production** by AC activation (*Figure 25*). They are found **exclusively postsynaptically** on dopaminergic cells, such as the GABAergic MSN of the striatum, the olfactory bulbs, amygdala, prefrontal cortex, hippocampus, cerebellum, thalamic areas and hypothalamic areas (Beaulieu and Gainetdinov, 2011). **The D1R are stimulated following phasic firing** of DA neurons rather than a tonic stimulation, that is a rapid set of action potentials.

The D2-family dopamine receptors (i.e. D2, D3, and D4 receptors) are coupled to $G_{i/o}$ which **leads to inhibition of cAMP production**. The D2 receptors (D2R) have high affinity for DA and are **tonically activated** by low basal concentrations of DA in the extracellular space. These receptors are expressed both presynaptically on dopaminergic neurons themselves (in this case, we will talk about DA autoreceptors), and postsynaptically on dopaminergic neurons. They are mostly found in the dorsal and ventral striatum, but also in the substantia nigra, ventral tegmental area, hypothalamus, amygdala, or hippocampus (Beaulieu and Gainetdinov, 2011). Contrary to the genes encoding for D1Rs, those encoding for D2Rs possess introns in their coding sequences. This genetic particularity allows the existence of **receptor splice variants** (Gingrich and Caron, 1993). As such, the D2R has a **short (D2S)** and a **long isoform (D2L)** with 29 additional amino-acids. These variants of the D2R have distinct anatomical, physiological, signalling, and pharmacological properties (Lindgren et al., 2003; Usiello et al., 2000). **The D2S is mostly expressed presynaptically**, on the dopaminergic neurons themselves, and mostly involved in autoreceptor functions, while the **D2L is predominantly postsynaptic**. The D2S autoreceptors provide a negative feedback mechanism to DA neurons that adjusts neuronal firing rate, and DA release. They possess a higher affinity for DA than the D2L, hence are activated first when DA is released.

3. G protein induced signalling through PKA pathway

Stimulatory G proteins activate adenylate cyclase that converts AMP in cAMP. cAMP activates the **Protein Kinase A (PKA)** pathway, which will phosphorylate **ionotropic glutamate receptors** α -amino-3-hydroxy-5-methylisoxazol-4-propionate (AMPA) and N-Methyl-D-aspartic acid (NMDA). The AMPA receptors allow sodium (Na^+) entrance and potassium (K^+) exit, inducing a depolarisation of the membrane and an action potential. The NMDA receptors allow calcium (Ca^{2+}) entrance in the cell, inducing molecular signalling downstream the receptor, involving the transcription factor cAMP

Introduction

Response Element-binding protein (**CREB**) (Greengard 2001), and the **32 kDa dopamine and cAMP regulated phosphoprotein** (DARPP-32) on its threonine (Thr) 34 residue. When phosphorylated, DARPP-32 will inhibit the **Protein Phosphatase 1** (PP1), whose substrates are the same as PKA. The balance between phosphorylation of PKA and phosphatase activity of PP1 under the control of DARPP-32 allows a fine regulation of dopaminergic cells (*Figure 25*).

cAMP in association with a glutamatergic signalling also target the **mitogen-activated protein kinase** (MAPK) pathway, that activate the **Extracellular-signal Regulated Kinases 1 and 2** (ERK1 and ERK2). In absence of DA signalling, and in presence of glutamate excitatory input, ERK is activated by the MAPK, but inhibited by the **Striatal-enriched Tyrosine Phosphatase** (STEP). When the DA pathway is activated however, DARPP-32 inhibits the PP1 in charge of activating STEP. Therefore, the ERK pathway becomes effective (*Figure 25*).

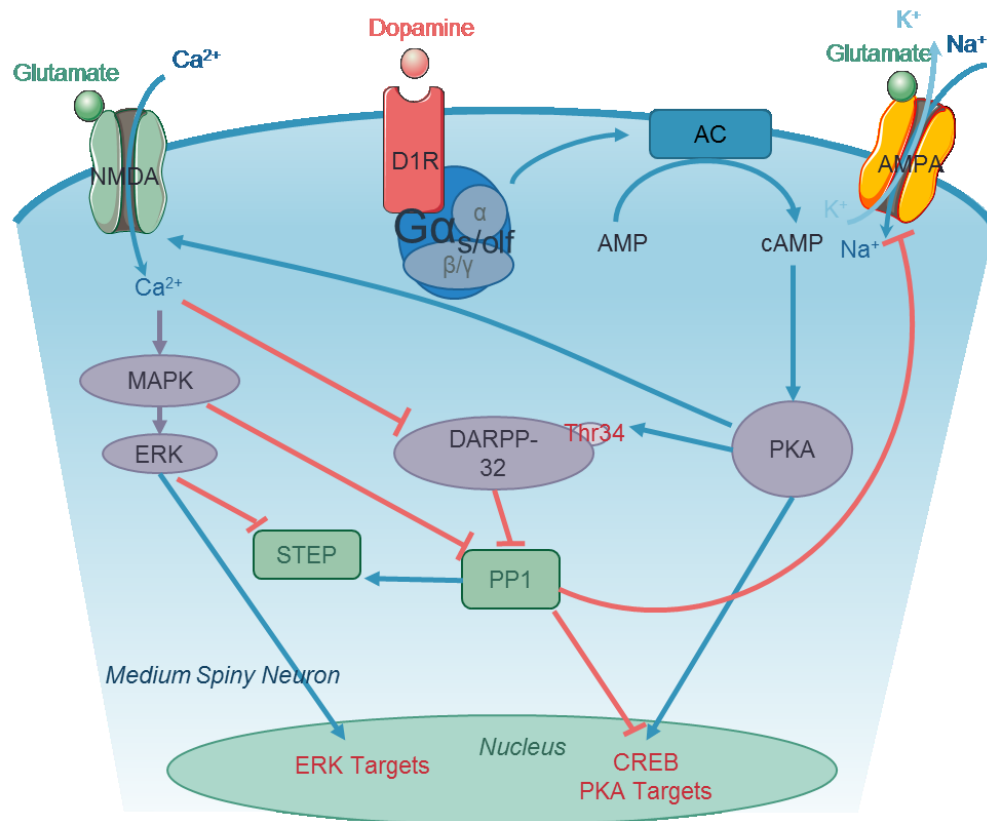

Figure 25 DA Signalling in MSN induced by GPCR

NMDA: N-Methyl-D-aspartic acid Receptor; AMPA: α -amino-3-hydroxy-5-methylisoxazol-4-propionate receptor, D1R, Dopamine receptor; Gs/olf: stimulating G protein; AC: adenylyl cyclase; PKA: protein kinase A; DARPP-32: 32 kDa dopamine and cAMP regulated phosphoprotein; PP1: Protein phosphatase 1; STEP: Striatal-enriched tyrosine phosphatase; MAPK: mitogen-activated protein kinase A; ERK: extracellular signal regulated kinase; CREB: cAMP Response Element-binding protein

4. PKC/Calcium signalling pathway of dopamine receptors

Alternatively, few neurons, carrying both the D1R and the D2R, have DA receptors coupled with a GPCR carrying a $G_{\alpha-q}$ subunit. In these neurons, the **D1R and the D2R can form a heterodimer** as shown with Fluorescence Resonance Energy Transfert (FRET) (Hasbi et al., 2009, 2011). When activated, the $G_{\alpha-q}$ subunit associated with this heterodimer can activate the **phospholipase C (PLC)**, that will produce **inositol triphosphate (IP3)** and **diacylglycerol (DAG)**. Subsequently, IP3 will increase intracellular Ca^{2+} levels, and the DAG will activate the **Protein Kinase C (PKC)** pathway. The Ca^{2+} increase will then activate a kinase named **calcium/calmodulin-dependent protein kinase II (CAMKII)**, and **BDNF** (*Figure 26*).

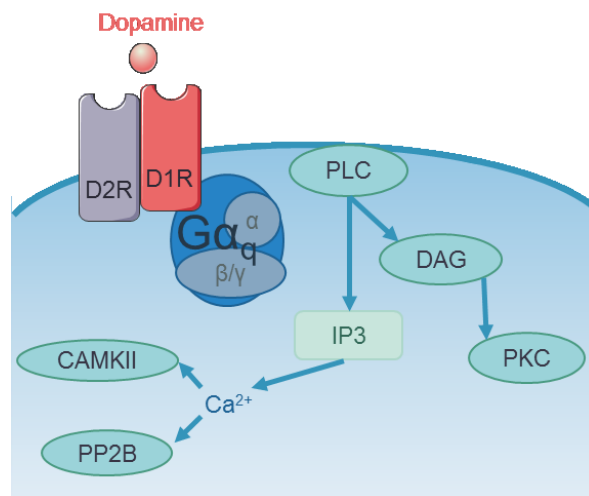

Figure 26 Dopamine Receptors signalling through G- α -q subunits

PLC: phospholipase C; DAG: diacylglycerol; PKC: protein kinase C; IP3: inositol triphosphate; CAMKII: calcium/calmodulin dependent protein kinase II; PP2B: protein phosphatase 2B. From (Beaulieu and Gainetdinov, 2011)

5. Akt/GSK3 dopamine receptor signalling pathway

When the DA receptors are extensively activated, they get **desensitised** through a mechanism involving **G protein-coupled receptor kinases (GRK)** and **arrestins**. The GRK have the ability to phosphorylate an activated DA GPCR. Once phosphorylated, an arrestin is recruited, and the receptor becomes inactive, even though the receptor is constitutively stimulated. Furthermore, the arrestins form a complex with **clathrin**, which leads to **endocytosis and internalisation of the receptors**. These receptors will either be recycled in the lysosomes, either dephosphorylated and inserted into the membrane again. Interestingly, the β -arrestin 2, an arrestin known to promote the D2R internalisation, is also an intermediate molecule for the D2R signalling, that will scaffold the phosphatase **PP2A** and the protein kinase B also named **Akt**. The interaction between Akt and PP2A gathered by the β -arrestin 2 leads to Akt dephosphorylation and inhibition (Beaulieu et al., 2005) (*Figure 27*). In parallel, β -arrestin 2 activates the **glycogen synthase kinase 3 (GSK-3)**. Lithium chloride, for example, is largely prescribed

Introduction

for mood disorders, and as was found to regulate dopamine signalling through the GSK3 pathway (Beaulieu et al., 2004). Provided that Akt is involved in the mTOR pathway and is activated by insulin and BDNF, two orexigenic factors mentioned earlier, and that GSK-3 is involved in glycogen synthesis in response to insulin (Embi et al 1980, Frame et Cohen 2001, Beaulieu et Gaitidinov 2001), this pathway deserves investigation to correlate feeding behaviour involving the dopaminergic neurons, and the standard signalling molecules evoked earlier.

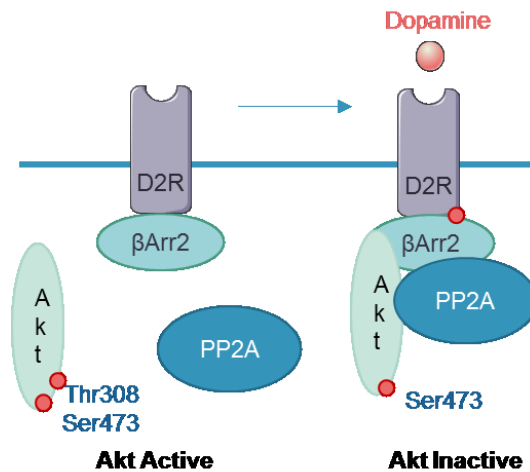

Figure 27 Dopamine D2 Receptor signalling through beta-arrestin/Akt/GSK3 pathway

βArr2: beta-arrestin 2; *PP2A*: protein phosphatase A. In red: phosphorylated sites on Akt, on serine 473 (*Ser473*) and threonine 308 (*Thr308*). From (Beaulieu et al., 2005)

Because β -arrestin 2 and G protein-mediated responses to GPCR stimulation are characterized by different kinetics, some DA receptor signalling are composed of two separate phases. The early response to DA signalling is promoted by cAMP/PKA. The receptor is then desensitised and the late phase is characterised by the β -arrestin 2 signalling (*Figure 28*).

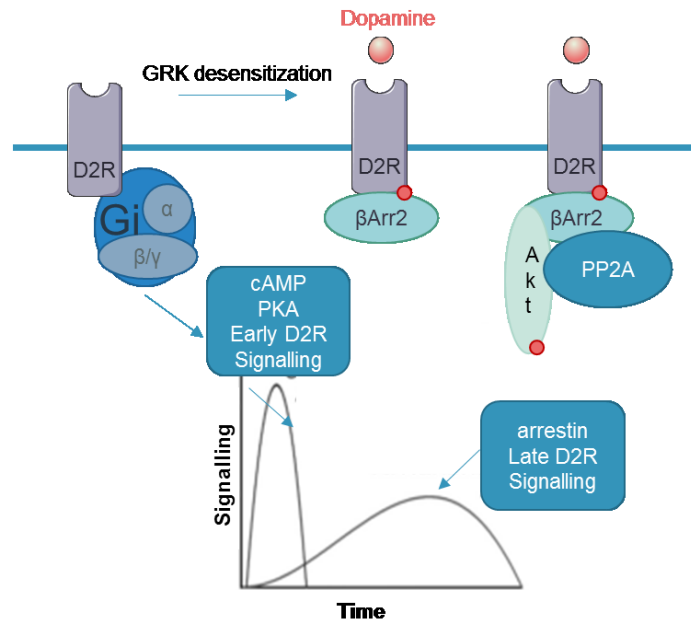

Figure 28 Dopamine Receptors Desensitisation and Internalisation through GRK/arrestins

PKA: protein kinase A; GRK: G-protein coupled receptor kinase; βArr2: beta-arrestin 2; PP2A: protein phosphatase A. Adapted from (Beaulieu and Gainetdinov, 2011)

Chapter 2: Lipids as signalling molecules for the reward circuit

In the first part of this introduction, we briefly mentioned that central administration of oleic acid decreases food intake (Obici et al., 2002b). Lipids bring 9 kcal of energy per gram, when carbohydrates and protein produce only 4 kcal of energy per gram. However, contrary to carbohydrates energy that can be immediately used by the cells, lipids need to be metabolised, which takes a longer time, and are mostly used as reserve substrates. Because of their amphiphilic nature, lipids play physiologically compulsory roles in biological membranes formation or cell signalling. In the central nervous system, the knowledge that lipids can be metabolised and have signalling properties is quite recent. In 1975, Oomura showed that neurons were not only glucose-sensitive, but also lipid-sensitive, as they can be excited by free-fatty acids such as oleic and palmitic acid (Oomura et al., 1975). In 1989, Golberg noticed that a specific enzyme involved in triglycerides metabolism, the lipoprotein lipase, was present in the brain, and suggested that LPL in central areas might not be important in regulating circulating levels of lipoproteins, but be essential for cellular uptake, binding, and transfer of free fatty acids or other lipophilic substances (Goldberg et al., 1989). In this chapter, we will first discuss the nature and absorption of dietary lipids, and their access to the brain. We will present the current knowledge on central lipid-sensing, that is to say their signalling role in the central nervous system. Finally, we will present the important role of the enzyme lipoprotein lipase in the brain, a major protein of interest in this work.

A. Nature and availability of dietary lipids in periphery

1. Lipid classification

Lipids are hydrophobic or amphiphilic molecules with various ways of anabolism, rather complicated to classify due to their important diversity (Fahy et al., 2011). The brain is highly enriched in many different species of lipids, including free fatty acids, glycerolipids, glycerophospholipids, sphingolipids, and cholesterol (*Figure 30*).

The free fatty acids (FFA) are carboxylic acids molecules containing a carbonated aliphatic chain (*Figure 29*). They arise from glycerolipids hydrolysis, or can be synthesized in the cells by associating an acetyl-coenzyme A (Acetyl-CoA) with one or several malonyl-coenzyme A (Malonyl-CoA). Depending on the length of FFA carbonated chain, one can discriminate **short-chain fatty acids** (5 atoms of carbon maximum), **medium-chain fatty acids** (6-12 carbon atoms), and **long-chain fatty**

acids (13 carbon atoms and higher). FFA can be **saturated** when they do not contain any double bond between their carbon atoms, **mono-unsaturated** when two carbons of the FFA aliphatic chain are linked with a double bond, or **poly-unsaturated** (PUFA) if several double bonds are formed. PUFA can be classified into two families depending on the position of the double bond on the methyl terminal end, the ω -3, and the ω -6. Within the brain, palmitic acid and stearic acid are the main saturated FFA and oleic acid is the most common unsaturated FFA, as it is a major component for myelinisation (Bazinet and Layé, 2014). The two predominant PUFAs in the brain are **ω -6 arachidonic acid (ARA)** and **ω -3 docosahexaenoic acid (DHA)** (*Figure 29*). They are involved in **endocannabinoids** synthesis and are precursors for **eicosanoids**, a major family of immunity molecules including prostaglandins, thromboxane or leukotrienes. The PUFA also help in synapse maintenance and integrity, and play an important yet poorly understood role in neurogenesis. The ratio of ω -3 and ω -6 seems to matter for mood regulation, as depressive subjects show lower levels of ω -3, or higher levels of ω -6 (Bazinet and Layé, 2014). FFA can be used to synthesise many other more complex lipids, and bring energy if they are oxidised in the mitochondria. They can also act as signalling molecules, as some transcription factors like the peroxisome-proliferator-activated receptors (PPAR) or GPCR like the GPR-40 are specifically activated by FFA.

Name	Type	Number of carbon atoms	Number of double bonds	Symbol
Palmitic acid	Saturated	16	0	16:0
Stearic acid	Saturated	18	0	18:0
Oleic acid	Monounsaturated	18	1	18:1n-9
α -linolenic acid (ALA)	ω -3 polyunsaturated	18	3	18:3n-3
Eicosapentaenoic acid (EPA)	ω -3 polyunsaturated	20	5	20:5n-3
Docosapentaenoic acid (DPA) n-3	ω -3 polyunsaturated	22	5	22:5n-3
Docosahexaenoic acid (DHA)	ω -3 polyunsaturated	22	6	22:6n-3
Linoleic acid (LNA)	ω -6 polyunsaturated	18	2	18:2n-6
DPA n-6	ω -6 polyunsaturated	22	5	22:5n-6
Arachidonic acid (ARA)	ω -6 polyunsaturated	20	4	20:4n-6

Figure 29 Main Fatty Acids in the Brain.

From (Bazinet and Layé, 2014)

Glycerides, also named glycerolipids or acylglycerols, are formed from a glycerol molecule whose hydroxyl function is esterified by one or several FFA. Depending on the amount of hydroxyl groups esterified, the molecules can be **monoglycerides** (MAG), **diglycerides** (DAG), or **triglycerides** (TG) (*Figure 30*). MAG and DAG are important for cell signalling, while TG are important energy substrates and a way to store FFA in the cytosol, by forming lipid droplets in astrocytes (Lee et al., 2017b).

Phospholipids, also named phosphoglycerides, glycerophospholipids or phosphoacylglycerides, are formed from phosphatidic acid, which is a DAG associated with a phosphate group, and an alcohol such

Introduction

as serine, choline, ethanolamine or inositol (*Figure 30*). As such, **phosphatidylcholine**, **phosphatidylethanolamine** and **phosphatidylserine** are the main component of biological membranes. **Phosphatidylinositol** is a common intracellular messenger involved in many signalling pathways.

Sphingolipids, or **ceramides** or glycosylceramides, are derivatives from the alcohol sphingosine and FFA (*Figure 30*). These lipids are important for membranes composition, but are also signalling molecules (Cruciani-Guglielmacci et al., 2017).

Sterols are hydroxylated steroids, the main one is the cholesterol (*Figure 30*), that has a crucial role in membranes fluidity and is an important precursor for steroid hormones.



Free Fatty Acids (FFA) Also named Non Esterified Fatty Acids (NEFA)		Glycerides Also named glycerolipids, acylglycerols	Phospholipids Also named phosphoglycerides, glycerophospholipids, phosphoacylglycerides	Sphingolipids Also named glycosylceramides
One Aliphatic chain, carboxy group 		Glycerol esterified by FFA 	DAG+ phosphate group+alcohol 	Derivatives of sphingosine 
Saturated: no double bound 	Unsaturated: one double bound 	Monoacylglycerol = monoglyceride (MAG) 	<i>Phosphatidylserine</i> 	Ceramides 
Short Chain n<6	<i>Oleic acid</i>	Diacylglycerol = diglyceride (DAG) 	<i>Phosphatidylcholine</i> 	Sterols Steroids derived from cholestrane with hydroxyl group <i>Cholesterol</i> 
Medium Chain 6≤n≤12	Polyunsaturated: several double bounds (ω) <i>Arachidonic acid</i> 	Triacylglycerol = triglyceride (TG) 	<i>Phosphatidylethanolamine</i> 	
Long Chain n>12			<i>Phosphatidylinositol</i> 	

Figure 30 Simplified Classification of lipid species in the brain

2. Lipids availability and transport in periphery

After lipids are brought by a meal they will be addressed to different organs for storage in the adipose tissue or energy delivery in the muscles. These **dietary lipids** are mostly TG, and contain some phospholipids, sterols, and vitamins (Iqbal and Hussain, 2009).

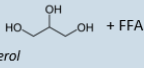
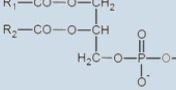
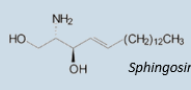
The digestion of dietary lipids begins in the oral cavity through exposure to lingual lipases, then continues in the stomach through the effects of both lingual and gastric enzymes. Emulsification of dietary fat and fat-soluble vitamins occurs in the stomach through peristalsis. These emulsions of lipids enter the duodenum as lipid droplets and then mix with bile and pancreatic fluid in micelles, and the TG

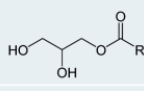
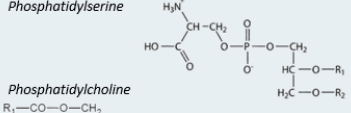
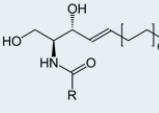
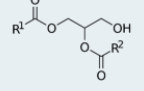
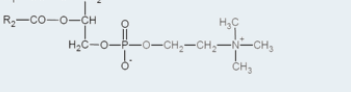
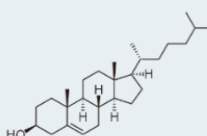
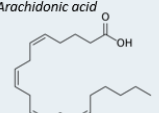
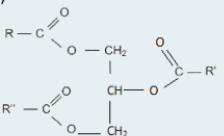
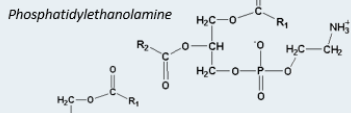
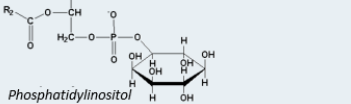
get hydrolysed in preparation for absorption across the intestinal wall by the **enterocytes**, the cells of the intestine. The TG hydrolysis by pancreatic lipases releases MAG and FFA which enter the enterocytes by diffusion or through transporters like **FAT/CD36** or **fatty acids transport proteins (FATP)** (*Figure 31*).

Once the FFA cross the enterocyte membrane, they get carried through the cytoplasm by **fatty acid binding proteins (FABP)** to the endoplasmic reticulum, where they will react with MAG to be transformed in TG. Two main enzymes are supervising this synthesis: the **monoacylglycerol acyltransferase (MGAT)** catalyses the bounding between a MAG and acyl-Coenzyme A (acyl-CoA) into diacylglycerol, the **diacylglycerol acyltransferase (DGAT)** catalyses the transformation of DAG into TG. The newly-synthesised TG bind to a **microsomal triglyceride transport protein (MTP)** and are packed into hydrosoluble particles named **lipoproteins** to be transported within the lymphatic circulation, and finally the blood circulation (*Figure 31*).

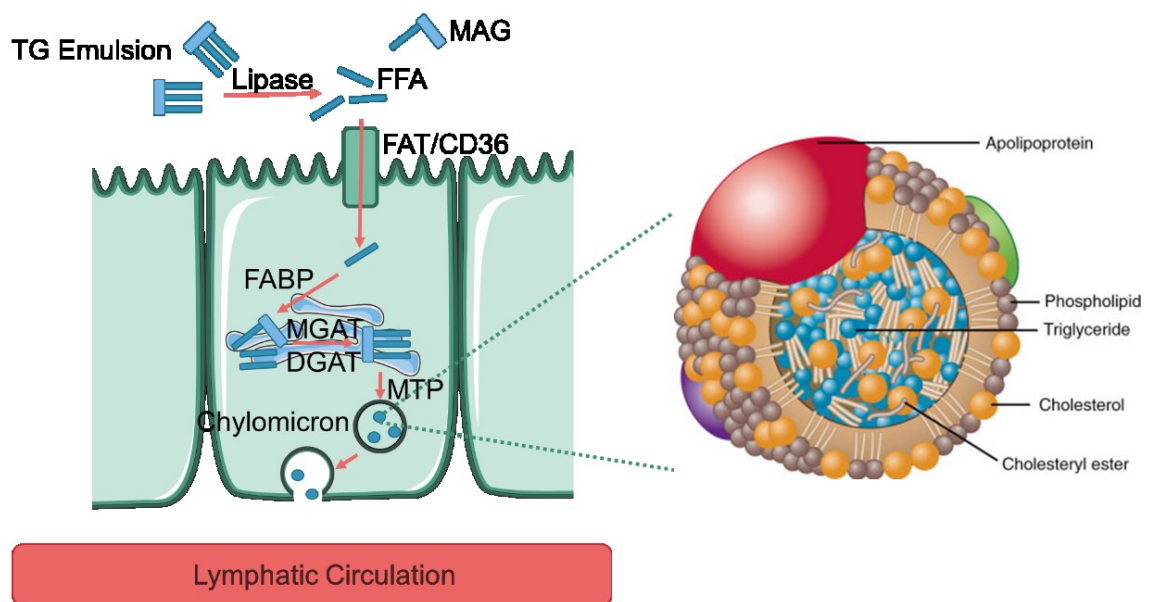

Figure 31 Triglycerides absorption in the enterocytes

The triglycerides absorption is summed up on the left of the figure, while the right part represents a chylomicron, a lipoprotein allowing hydrophobic lipid transport into the lymphatic circulation and blood circuitry. TG, triglycerides; FFA, free fatty acids; MAG, monoacylglycerides, FABP, fatty acids transport protein, MGAT, monoacylglycerol acyltransferase; DGAT, diacylglyceroltransferase; MTP, microsomal triglyceride transport protein

The first lipoproteins formed at the enterocyte level are entitled **chylomicrons** (Iqbal and Hussain, 2009) (*Figure 31*). They are composed of TG, but also phospholipids, cholesterol, vitamins that were also absorbed by the enterocytes, and structural **apolipoproteins** ApoB48, which are soluble proteins allowing lipids transportation in the blood circuit. These apolipoproteins are constitutively produced, independently of TG levels. As a consequence, the more the levels of TG increase after a meal ingestion,

Introduction

the richer the chylomicrons particles, and the bigger they will be (Hodson and Fielding, 2010; Iqbal and Hussain, 2009).

TG will be hydrolysed by the **lipoprotein lipase** (LPL), an enzyme expressed at the surface of endothelial cells, and FFA will be delivered to the different organs requiring energy. Consequently, the circulating chylomicrons will decrease in size as their TG levels will reduce, their density will increase, and they will gradually be transformed in **low-density lipoproteins** (LDL) and **high-density lipoproteins** (HDL). When most of chylomicrons TG content is hydrolysed, the HDL return to the liver, where they will be recycled in **very low density lipoproteins** (vLDL), carrying TG produced in the liver (*Figure 32*). This neosynthesis by the liver provides a second TG delivery after a body. For this reason, the daily plasmatic TG profile in humans slowly increases after a meal, to reach a first peak after 2 hours, and a second one after 5-6 hours (Ahmed et al., 1976).

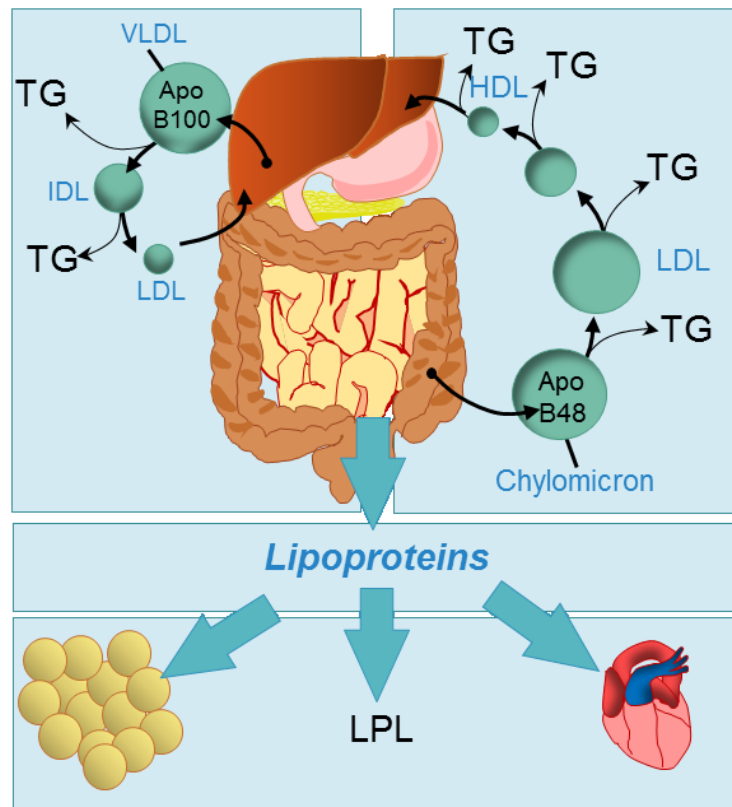

Figure 32 Triglycerides transportation in the body

TG, triglycerides; HDL, high density lipoprotein; LDL, low density protein; vLDL, very low density protein; LPL, lipoprotein lipase

In parallel to lipoproteins transport, FFA coming from the adipose tissue lipolysis by **hormone-sensitive lipase** (HSL), **adipose triglyceride lipase** (AGTL) and **monoacylglycerol lipase** (MGL) are transported within the adipocytes by **FABP**, and released in the bloodstream, where they will be carried by **albumin** (Mitchell and Hatch, 2011).

Because of these two parallel transportation of TG and FFA, triglycerides levels are strong after a meal and decrease in fasting conditions when they are used by peripheral tissues (Banks et al., 2018; Frayn et al., 1994; Ruge et al., 2009). They will increase again if fasting lasts a long time (starving conditions) (Banks et al., 2004; Urayama and Banks, 2008). On the opposite, the concentration of FFA increase in fasting conditions as the adipose tissue is hydrolysed, and decrease after a meal, when the lipases are inhibited by insulin (Duncan et al., 2007). **For this reason, circulating TG can be perceived as a signalling the peripheral energy state in the brain, and might have the ability to regulate feeding behaviour** (Banks et al., 2018; Cansell et al., 2014).

B. Lipid access to the brain

As we mentioned earlier, the brain possesses a characteristic lipid composition, that includes α -linolenic acid and linoleic acid, two essential PUFA that cannot be synthesised *de novo* (DeMar et al., 2006). Furthermore, besides adipocytes and hepatocytes, most cells cannot synthesize or store fatty acids in the amounts required for their oxidative energy needs and are dependent on fatty acid uptake from the blood (Mitchell and Hatch, 2011). As a consequence, TG and FFA mostly come from the periphery, and to access the brain, they need to cross the blood-brain-barrier, a non-permeable structure in charge of filtering molecules.

1. Around the brain: the blood-brain-barrier, composed of endothelial cells, astrocytes, pericytes, neurons and microglia

The brain and the blood circulation are isolated by several layers in charge of filtering and regulating the exchanges with the periphery: the **blood-brain-barrier (BBB)**, the **choroid plexus epithelium**, and the **arachnoid epithelium**. The choroid plexuses are invagination of **ependymal cells** covering the brain ventricles and releasing **cerebrospinal fluid (CSF)** (*Figure 33*).

élément sous droit, diffusion non autorisée

Figure 33 The blood brain barrier is formed by several layers protecting and isolating the brain from the periphery

From (Abbott et al., 2006)

élément sous droit, diffusion non autorisée

Figure 34 A neurovascular unit

The BBB is composed of endothelial cells forming **brain capillaries**, and surrounded by other cell-types such as pericytes, astrocytes, neurons, and microglial cells. The neurons are located close to these capillaries, approximately 10 μm distance (Abbott et al., 2006). This configuration of neurons, astrocytes, and endothelial cells is called a **neurovascular unit**, and allows the delivery of nutrients to

Introduction

the neurons involved (*Figure 34*). The endothelial cells of the BBB lie on a **basal lamina**, containing type IV collagen, heparane sulfate proteoglycans, laminin, fibronectins. They are firmly joined thanks to **tight junctions**, a gathering of claudins, occludins, junctional adhesion molecules accumulated in a belt-like region of adhesion between adjacent cells. Because of these junctions, endothelial cells are polarised, with an apical and a basal region, and molecules from the brain capillaries cannot access the brain tissue (Abbott et al., 2006). **Pericytes** are cells surrounding the endothelium with contractile properties in charge of flow regulation and capillaries maintenance. **Astrocytes** are glial cells shaped like stars, that supply energy to the surrounding neurons thanks to their perivascular end-feet, and insure the BBB maintenance (Abbott et al., 2006).

The smallest molecules, including short-chain fatty acids, lipophilic molecules, or dioxygen, can cross the endothelial cells of the BBB without any transporter. For most of other molecules however, transport proteins are necessary. The endothelial cells of the BBB can perform **pinocytosis**, a mode of endocytosis of extracellular fluid in direction of the lysosomes. **Transcytosis** is another model of BBB crossing with membrane invagination that pairs endocytosis in the apical part of endothelial cells, and exocytosis on the basal part. The apical part of endothelial cells expresses specific **protein transporters** such as glucose carriers (GLUT) or amino acids carriers (LAT1), which allow molecules reuptake from the blood. When the transport of molecules is against the concentration gradient of the molecule, the transport requires energy and is usually performed by **ATP-binding cassette (ABC) transporters**, or coupled with Na^+ gradient (Abbott et al., 2006) (*Figure 35*).

élément sous droit, diffusion non autorisée

Figure 35 Molecular transports across the BBB

From (Abbott et al., 2006)

Some areas of the brain, named **circumventricular organs**, contain permeable capillaries rather than a BBB. They are localised near the ventricles containing CSF, and allow exchanges with the blood flow. In these organs, the tight junctions are missing, and the capillaries are **fenestrated**, allowing some molecules to cross. The **median eminence** and the **area postrema** are two circumventricular organs where energy signals can easily access the brain areas involved in food intake regulation, respectively the Arc of the hypothalamus and the NTS.

2. Lipids can cross the blood-brain-barrier

Lipid are transported through the BBB by several means. Some might simply cross the biological membrane by **passive diffusion**, although this theory probably applies only to short-chain fatty acids. Others involve specialised transporters, that we will describe below.

i. Fatty acids transport

Several experiments show that **FFA can cross the BBB and access the brain from the periphery**. Radiolabelled molecules like palmitic acid and arachidonic acid were shown to enter in rat brain microvessels from the plasma (Williams et al., 1997). Whether FFA cross the BBB by passive diffusion or thanks to the help of protein complexes is not clear. Either way, they need to be seclused from their carriers (albumin, micelles, TG) and delivered to the membrane of endothelial cells before crossing it and being carried away in the cytoplasm (Mitchell and Hatch, 2011). Short-chain fatty acids can diffuse through the plasmic membrane, but long-chain fatty acids generally require the help of proteins in order to cross the BBB. Simple transporters expressed at the membrane could also uptake FFA. Lipoprotein internalisation through lipoprotein receptors (LDLR) and TG hydrolysis could also deliver FFA, as well as lipoprotein hydrolysis by the lipoprotein lipase, and internalisation of its products by FFA transporters (*Figure 36*) (Chen et al., 2008).

élément sous droit, diffusion non autorisée

Figure 36 Free Fatty Acids uptake in the Brain

FATP, fatty acid transport protein; HDL, high density lipoprotein; LPL, lipoprotein lipase; LDL, low density lipoprotein; PUFA, poly-unsaturated fatty acid; vLDL, very low-density lipoprotein; CoA, coenzyme A. From (Chen et al., 2008)

The Fatty acid transport protein FATP encoded by the gene *Slc27A* has several isoforms named from 1 to 6, and are integral membrane proteins with a transmembrane domain (Lewis et al., 2001; Schaffer and Lodish, 1994). These proteins are able to **transport long-chain fatty acids** specifically, regardless of their saturation (Schaffer and Lodish, 1994) and possess an **AcylCoA synthetase activity**, which ligates a Coenzyme A (CoA-SH). Thanks to this addition, the transported long-chain fatty acids become activated and they can be used by the cell for fatty acid synthesis or oxidation (Anderson and Stahl, 2013). In periphery, insulin increases FATP translocation to the membrane, which increases post-prandial FFA uptake in adipocytes (Stahl et al., 2002). Two isoforms are expressed in the brain, the **FATP-1** being located in astrocytes, and **FATP-4** in the neurons and astrocytes (Zhang et al., 2014) (*Figure 37*). Recent studies show that FATP-1 is an important factor to allow DHA access to the brain (Ochiai et al., 2017).

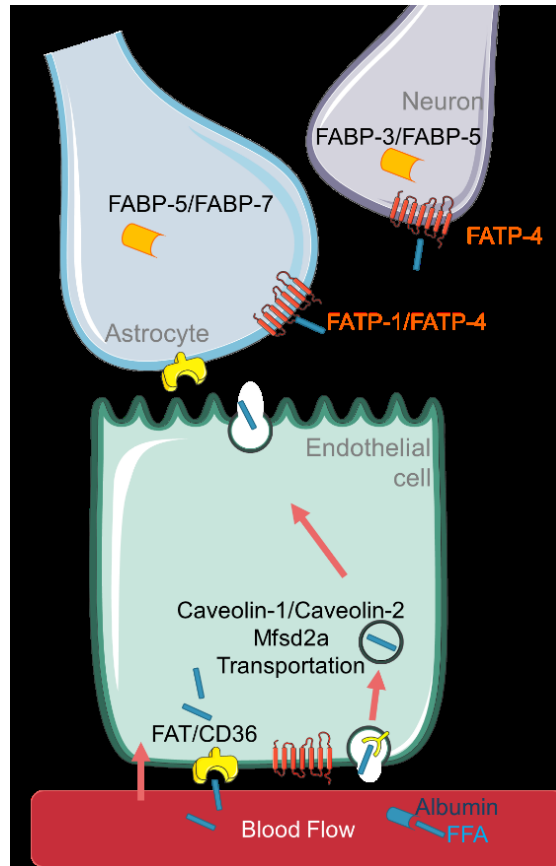

Figure 37 Fatty Acid Transporters in the Brain

Fatty acid translocase/CD36 (FAT/CD36) is an integral membrane protein whose binding site with FFA has not been identified yet. It can bind many lipid ligands, such as cholesterol, DAG, phospholipids, long chain FFA and lipoproteins (Pepino et al., 2014). CD36 is expressed in the brain glia and the endothelial cells of the brain microvasculature, as assessed with immunohistochemistry (Husemann et al., 2002) and RNA sequencing (Zhang et al., 2014) (*Figure 37*). This transporter is involved in many different molecular pathways, such as activation of phospholipases, eicosanoids production, modulation of Ca^{2+} cytosolic levels (Pepino et al., 2014). Interestingly, the **taste buds of the tongue express CD36**, and this receptor is involved in fat taste (Laugerette et al., 2005), and although dietary fat are mostly composed of TG, only the FFA matter for oral perception (Pepino et al., 2014). Neurons expressing CD36 can be found in the olfactory epithelium and are involved in fat olfaction (Xavier et al., 2016).

Fatty acid binding proteins (FABP) are proteins localised both at the plasmic membrane, and in the cytoplasm. They allow FFA uptake and translocation within the cell, modulate intracellular FFA levels, signal transduction and gene transcription. Because they are less soluble, saturated FFA do not bind FABP as well as unsaturated FFA (Mitchell and Hatch, 2011). Isoforms such as **FABP-3**, **FABP-5** and **FABP-7** are expressed in the brain, FABP-3 in neurons, FABP-5 in neurons and astrocytes, FABP-7 in astrocytes (Zhang et al., 2014) (*Figure 37*).

Caveolae are invaginations of the plasmic membrane lipid rafts, regions enriched in sphingolipids and cholesterol. Their formation requires proteins named caveolin-1, caveolin-2 and caveolin-3 that is muscle specific. Caveolae allow cholesterol transport, endocytosis and potocytosis, a phenomenon of endocytosis allowing uptake of small molecules and ions (Anderson, 1993). Some data show that caveolin-1 can bind FFA and internalise them either by controlling CD36 location in the plasmic membrane, either by binding the FFA into the caveolae domains that will invaginate with the FFA on their inside (Mitchell and Hatch, 2011). Major facilitator superfamily domain-containing 2a (**Mfsd2a**) has recently been identified as an endothelial constitutively expressed carrier of DHA in the brain (Nguyen et al., 2014), that suppresses caveolae-mediated transcytosis in endothelial cells of the BBB, therefore maintains its filter role. The hypothesis is that DHA is transported by Mfsd2a through the endothelial membrane, and that the increase of DHA levels displaces caveolin-1, therefore inhibiting caveolae formation (Andreone et al., 2017).

ii. TG and lipoproteins

A recent publication from Banks et al (Banks et al., 2018) injected ^3H -triolein in mice jugular vein and measured radioactivity levels in the brain, and in the plasma taken from the carotid (Banks et al., 2018). Their results suggest that TG can cross rapidly the BBB at a rate of $5 \mu\text{L.g}^{-1}.\text{min}^{-1}$. **To this date, the mechanisms of BBB crossing for TG are unknown.**

Molecular analysis of the CSF composition showed the presence of lipoproteins (Pitas et al., 1987). The brain expresses lipoprotein receptors such as **LDL Receptors** (LDLR) or **vLDL Receptors** (vLDLR), **LDL related receptor protein** (Lrp) and apolipoproteins, such as ApoE and ApoJ, mostly in astrocytes (Zhang et al., 2014) (*Figure 38*). Smaller lipoproteins such as **HDL** can enter the brain (Wang and Eckel, 2014), but experiments tracing lipoproteins composed of ApoE produced in the liver showed that those cannot cross the BBB. Because astrocytes can synthesise ApoE, and because ApoE-enriched lipoproteins are present in the brain, it is possible that the **BBB dismantle the peripheral lipoproteins and reforms them later on** (Liu et al., 2012; Wang and Eckel, 2014).

Central lipoproteins play important roles, as disruption of their docking receptors LDLR, vLDLR, Lrp or removal of apolipoprotein expression lead to neurological damages such as learning and memory impairment (Wang and Eckel, 2014). They allow cholesterol synthesis and distribution, associate to amyloid beta, a peptide whose pathological accumulation is involved in Alzheimer's disease, from which ApoE4 variants were identified as a major risk (Wang and Eckel, 2014).

Introduction

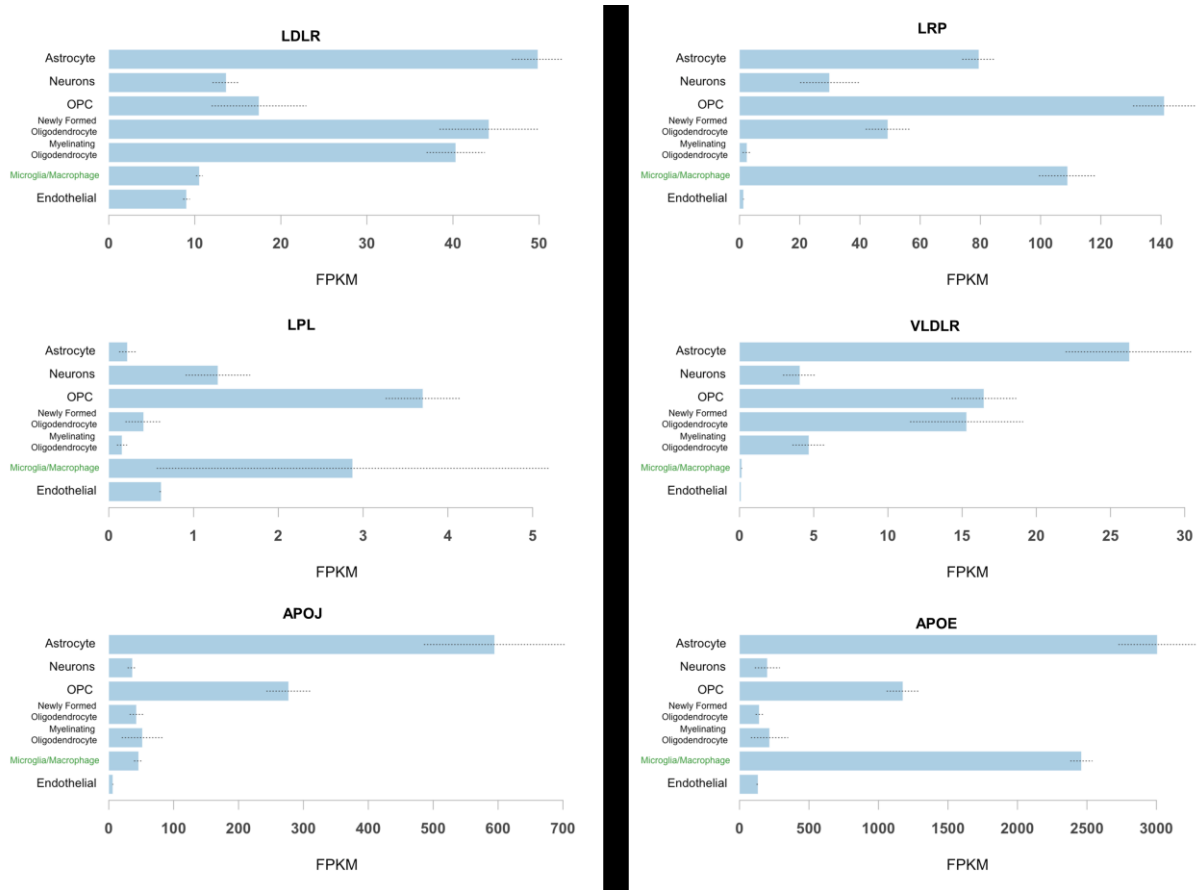

Figure 38 Molecules involved in lipoproteins transport and hydrolysis are expressed within the brain.

(Zhang et al, 2014) generated a transcriptome database by RNAsequencing from purified representative populations of neurons, astrocytes, oligodendrocyte precursor cells (OPC), newly formed oligodendrocytes, myelinating oligodendrocytes, microglia, endothelial cells. FPKM: fragments per kilobase of transcript sequence per million mapped fragments, represents the expression level estimation of each gene. LDLR: LDL receptor, LRP: LDL related protein, LPL: lipoprotein lipase, vLDLR: vLDL receptor, APOJ: apolipoprotein J, APOE: apolipoprotein E. From (Zhang et al, 2014).

iii. BBB disruption in obesity

Diets enriched in fat and sugar disrupt the natural filter of the BBB, leading to abnormal levels of FFA, leptin, insulin or ghrelin, access in the brain (Rhea et al., 2017) (Figure 39).

élément sous droit, diffusion non autorisée

Figure 39 Permeability changes at the blood-brain-barrier in obesity.

In obesity, the BBB is exposed to increased circulating levels of leptin, insulin, free fatty acids, and the cytokines IL-6 and TNF- α , whereas ghrelin and adiponectin levels are decreased (black vertical arrows). The blood-to-brain transport of leptin, insulin, and ghrelin (blue arrows) is decreased and transport of free fatty acids (FFA, purple arrow) is increased in obesity. Triglycerides (TG) can also decrease leptin transport while increasing insulin and ghrelin transport (horizontal arrows).

More and more and more evidence suggest that dietary **TG are responsible for this BBB leaking**. Hypertriglyceridemia in diet-induced obesity mice models shows that TG, not FFA, prevent leptin crossing of the BBB. In starvation conditions (48h without food), TG are also elevated and leptin does not cross the BBB, as proven with leptin measurements. Interestingly, it seems that animal-derived TG, not plant-derived TG such as Intralipid can oppose the leptin BBB crossing. The use of gemfibrozil, a

drug decreasing plasmatic TG levels, restored leptin crossing, showing the rapid effect of TG on leptin transport (Banks et al., 2004). Similarly, triolein was found to increase insulin brain uptake (Urayama and Banks, 2008). A very recent study showed that infusion an emulsion of triolein 0.5-2% in the carotid artery increases brain permeability to anticancer agents in rabbits (Kim et al., 2016), and infusions of TG-rich lipoproteins and LPL, as well as western-diet and genetically induced hyperlipidaemia (LdlR null mice) increase the BBB transfer coefficient in mice (Lee et al., 2017b; Rutkowsky et al., 2018).

C. Lipids as signalling molecules within the brain

Once they have crossed the BBB, FFA are taken up and oxidized mainly by astrocytes (Escartin et al., 2007). We saw that lipoproteins are synthesised by astrocytes (Wang and Eckel, 2014). However, the neurons also express genes involved in lipid transport, metabolism, and synthesis. Because energy from fat oxidation requires a long process, it is unlikely that neurons, which need rapid inputs of energy, use fat as a substrate, and mostly take it from glucose. Consequently, the presence of molecules involved in lipid metabolism in neurons is questionable, and raise a potential signalling role to the central nervous system. Some species of lipids have been known as signalling molecules for some time. For example, the FFA anandamide and the MAG 2-arachidonoylglycerol are two endocannabinoids involved in several signalling pathways regulating feeding behaviour (see I.B.3, p. 29), and eicosanoids are derivatives from arachidonic acid including prostaglandins, leukotrienes, which are important signalling molecules for immune response.

Obesity is often associated with hyperlipidaemia, an abnormal level of lipids circulating in periphery, that can be TG as well as lipoproteins. Many investigations showed that this hyperlipidaemia could be related to several brain disorders, such as cognitive impairments, mood disorders including depression and anxiety, and reward deficiencies, and raise potential signalling functions of TG in the brain. In this section, we will review the potential signalling roles of FFA and TG, as well in physiological as in pathological conditions.

1. Lipids as signalling molecules in charge of glucose homeostasis, food intake and energy expenditure

Neurons firing can be modulated by oleic acid just as well as glucose (Oomura et al., 1975), as confirmed with patch-clamp experiments in the VMH (Le Foll et al., 2009; Wang et al., 2006). Oleic acid directly alters POMC neurons activity as assessed with slice electrophysiology recordings (Jo et al., 2009), decreases food intake and alters glucose metabolism when administered i.c.v. (Obici et al., 2002b).

Carnitine palmitoyltransferase-1 (CPT1) is an enzyme expressed in mitochondria playing an essential step in long-chain fatty acid oxidation. It allows activated FFA binding to CoA (LCFA-CoA) to enter

the mitochondria. Inhibiting this enzyme increases the amount of LCFA-CoA in the cytoplasm, and similarly to i.c.v oleic injections, CPT1 inhibition led to decreased food intake (Obici et al., 2003). Similarly, **Fatty Acid Synthase** (FAS) is expressed both in astrocytes and neurons (Zhang et al., 2014), and allows FFA synthesis from successive Malonyl-CoA on one Acetyl-CoA. ICV inhibition of this enzyme prevents food intake and leads to weight loss (Loftus, 2000). More recent data show that **ghrelin modulates FFA synthesis** via FAS or CTP1 through AMP-activated protein kinase (AMPK) regulation (López et al., 2008).

Similarly, **Uncoupling protein-2** (UCP2) is a mitochondrial protein in charge of FFA oxidation expressed in hypothalamic neurons (Horvath et al., 1999) involved in NPY/AgRP activation by ghrelin (Andrews et al., 2008).

Lipoprotein lipase inhibition specifically in neurons prevents neuronal lipoproteins hydrolysis and leads to obesity and hyperphagia (Wang et al., 2011). More recently, (Gao et al., 2017a) established a mouse model where **LPL is deleted in astrocytes**. As a consequence, astrocytes have a reduced lipid content, and display abnormal body weight phenotypes and obesity.

Altogether, these data suggest that lipids act as molecules regulating feeding behaviour, and that the enzymes involved in their metabolism are key signalling molecules for this regulation.

2. Impact of dietary lipids on reward and mood

Evidence that lipids could act as signalling molecules within the reward system are very new. More and more papers suggest associations between addictive-like behaviours and high-fat diets, and increasing evidence link mood disorders such as depression and schizophrenia with brain lipid composition. Because these disorders are related to DA, investigations tend to find a correlation between lipid signalling and the MCL.

i. High-fat diet exposure is associated with reward deficits and increased anxiety

Chronic exposure to diets enriched in fat or obesity have been correlated with **reward deficiencies**, and abnormal DA signalling. For instance, rats chronically exposed to high-fat diet show reward deficiencies and a 50% **D2R expression reduction in the striatum** (Johnson and Kenny, 2010). The abundance of D2R in the striatum is **inversely correlated to body weight** (Kenny et al., 2013). Independently of body weight gain, chronic high-fat diet exposure also promotes changes in DA turn-over rate, DA transporter (DAT) function, response to amphetamines, and operant responding for food reward (Davis et al., 2008; South and Huang, 2008).

It remains unclear whether altered DA signalling is a cause or a consequence of body weight gain. In humans, striatal D2R availability is significantly lower in obese individuals and negatively correlated with body-mass index (Volkow et al., 2011). Blood-Oxygen Level Dependent (BOLD) signal assessed by brain functional magnetic resonance imaging (fMRI) in striatal structures is decreased in obese versus

lean subjects, suggesting a **defect in striatal neuron activity** (Stice et al., 2008). On the other hand, obesity is associated with a **greater BOLD response to food-related cues** in brain regions associated with reward and motivation (Rothenmund et al., 2007a), suggesting that striatal neurons are underactive at baseline in obese individuals but show sensitized responses to food signals.

Chronic high-fat diet is associated with increased anxiety, increased corticosterone levels, and animals under this diet fail at forced-swim test⁶. For these reasons, elevated fat in the diet could be associated to depressive behaviours (Sharma and Fulton, 2013).

ii. TG specifically as signalling molecules inhibiting reward

In 2014, Cansell et al. evaluated the direct role of TG on motivation and preference for palatable food, showing that central **TG delivery decreased the preference for palatable food** in a food choice paradigm and decreased operant responding performance for sucrose pellets, probably in a LPL dependant mechanism. In addition, direct brain TG delivery decreased amphetamine-induced locomotion, suggesting a modulation of the dopaminergic circuitry (Cansell et al., 2014) (*Figure 40*).

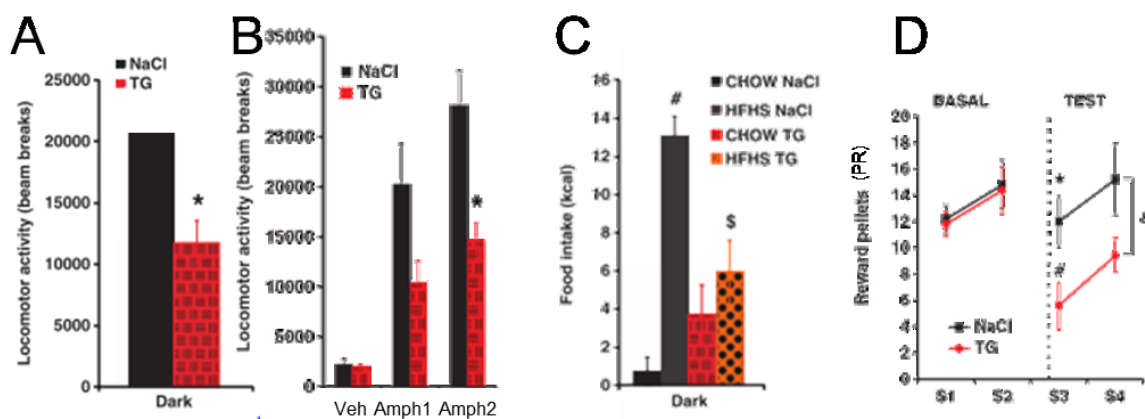

Figure 40 Central triglycerides sensing inhibits dopaminergic associated behaviours

Triglycerides (TG) centrally addressed to the brain in physiological amounts decrease spontaneous locomotor activity (A), amphetamine induced locomotor activity (B), preference for palatable food (C), and motivation to sucrose reward (D). Adapted from (Cansell et al., 2014)

On the other hand, fMRI studies in humans measured brain response to palatable food under fast and fed conditions and found that plasma **TG and ghrelin levels, but not FFA, glucose or insulin, correlate with decreased brain response to food cues** (Sun et al., 2014). Similarly, circulating **TG levels after a high-fat meal was evidenced as a predictor for obesity onset or resistance** in rats

⁶ Forced swim test: this protocol is used to assess the effect of antidepressant drugs. Mice are placed in an inescapable tank filled with water, and the observer measures the escape related mobility.

(Karatayev et al., 2009), and peripheral administration of emulsified triglycerides (Intralipid) increased DA release in the NAc (Rada et al., 2012).

élément sous droit, diffusion non autorisée

Figure 41 Peripheral Triglycerides increase dopamine release in the NAc

i.p. injections of Intralipid increase DA in the NAc with microdialysis more than equicaloric glucose in rats. From (Rada et al., 2012)

iii. FFA as signalling molecules targeting the MCL

FFA also specifically modulate reward, and this effect on DA signalling depends on FFA molecular nature (see II.A.1, p. 43). Indeed, prolonged exposure to diets enriched in **unsaturated FFA but not saturated FFA** blocks amphetamine conditioned place preference, and associated locomotor activity and sensitization, and decreases DAT levels and D1 signalling in the NAc (Hryhorczuk et al., 2015). Recent evidence show that this phenomenon is associated to depressive-like behaviours and is related to **NAc inflammation** and abnormal activation of the tumour necrosis factor (TNF) and interferon-gamma (IFN- γ) pathways (Décarie-Spain et al., 2018). Similarly, specific injections of saturated oleic acid in the VTA stimulate locomotor activity, inhibit food reward and food intake, and inhibit DA neuronal firing (Hryhorczuk et al., 2018).

On possible molecular mechanism of FFA effects on food intake is mediated by a GPCR expressed in the NAc, the **GPR120**. This GPCR is specifically activated by long-chain PUFA. ICV administration of agonist of GPR120 acutely reduced food intake, and motivation to lever press for sucrose pellets (Auguste et al., 2016).

3. Cognitive impairments

Obesity is associated with cognitive impairments in men (Elias et al., 2005; Sellbom and Gunstad, 2012). **These impairments could be related to hyperlipidaemia**. Indeed, obese mice showed impaired acquisition in Morris water maze⁷, and food reward lever press⁸, which was improved by selectively lowering TG with gemfibrozil. Intracerebroventricular injections of triolein, but not of palmitate, impaired acquisition in normal body weight, again showing the TG, not FFA implication in such impairments (Farr et al., 2008). Because FFA come out from TG hydrolysis, the roles of lipases involved in TG hydrolysis has to be further investigated. Indeed, **neuronal LPL disruption leads to abnormal behavioural tests in mice** (Pellinen et al., 2014; Xian et al., 2009; Yu et al., 2015), and disruption of Ldl-receptor is associated with impaired memory (Rutkowsky et al., 2018), enlightening the potential role of lipoproteins and their hydrolysis as signalling molecules for memory.

⁷ Morris water maze: this test is used to investigate spatial memory. Rodents are placed in a large compartment filled with water and need to find a platform allowing them to escape the compartment.

⁸ Food reward lever press: animals are trained to press a lever in order to obtain a food reward. This test allows to quantify motivation for food.

D. The lipoprotein lipase is expressed in the brain and converts TG into FFA

TG must be hydrolysed to release FFA that will be used by the cell. This hydrolysis can be performed in the brain as several lipases are expressed, such as lipoprotein lipase (LPL), adipose triglyceride lipase (AGTL) or patatin-like phospholipase domain containing-protein (Pnpla2). Because LPL seems involved in central energy balance regulation (Wang et al., 2011), a lot of investigations tried to unveil its roles in the central nervous system.

1. Lipoprotein lipase expression within the brain

We know that **LPL is synthesised in the brain** thanks to radiolabelled methionine experiments. It has a tissue-specific activity, and it is **regulated depending on energy levels**, as fasting increases LPL activity in the hippocampus, decreases LPL activity in the hypothalamus (Ben-Zeev et al., 1990; Eckel and Robbins, 1984; Wang and Eckel, 2012). The mRNA is expressed **both in neurons and astrocytes** (Zhang et al., 2014), in many different regions such as hippocampus, NAc, midbrain, hypothalamus, cortex (Lein et al., 2007).

2. LPL roles

LPL is the rate limiting **enzyme for TG hydrolysis contained in lipoproteins**, therefore, one of its main role, at least in periphery, is to uptake TG and deliver them to the cells. In the brain, this function was shown on cultured brain cells (Eckel and Robbins, 1984), and by injecting radiolabelled chylomicrons in periphery of wild-type and LPL-neurons deficient mice, and looking for them in the brain (Wang et al., 2011). Cell-cultured neurons showed that **LPL activity is primordial for cell differentiation and neurite extension, and prevents oxidised lipoproteins neurotoxicity** (Paradis et al., 2004). LPL also binds to ApoE lipoproteins and LDL receptor-related protein (LRP), suggesting that **LPL helps lipoproteins uptake** (Wang and Eckel, 2012). LPL could have a role in Alzheimer's disease as ApoE, LRP, LPL can bind beta-amyloids plaques and have some polymorphisms correlated with higher risks for this disease. **Cognition is altered in LPL-deleted mice** (Pellinen et al., 2014; Xian et al., 2009; Yu et al., 2015).

Interestingly, **neuronal deleted LPL mice are obese animals with increased food intake and decreased locomotor activity** (Wang et al., 2011). This phenotype has been later related to the fact that **LPL can activate AgRP** in immortalised hypothalamic neurons (Libby et al., 2015). More specifically, both hippocampal and hypothalamic LPL knock-down increased body weight (Laperrousaz et al., 2017; Picard et al., 2014) and its chemical inhibition with angiopoietin-like 3 (Angptl3) increases food intake (Kim et al., 2015).

When LPL is deleted in astrocytes, animals maintained on a high fat diet display increased levels of AgRP and ceramides. These animals gain more weight and are glucose intolerant, in agreement with the

observations that AgRP is increased, and that ceramides, lipids involved in lipid toxicity and insulin resistance in periphery, accumulate in the hypothalamus (Gao et al., 2017a). Interestingly, LPL is also expressed in hypothalamic microglia and regulated microglial immune reactivity (Gao et al., 2017b).

Finally, our lab previously suggested that **LPL is a key component of food reward and appetite-driven behaviours** (Cansell et al., 2014).

élément sous droit, diffusion non autorisée

Figure 42 Lipoprotein lipase roles in the brain

Lipoprotein lipase is expressed in brain endothelial cells and neurons. LPL helps for lipoproteins uptake in brain capillaries. LPL deficiencies in neurons ('X-LPL deficiency in neurons') lead to deficiencies in PUFA and could be a mechanism to explain increased food intake, energy expenditure leading to obesity, and cognitive deficiencies. From (Wang and Eckel, 2012). AD: Alzheimer's disease, A-beta: amyloid beta

3. LPL regulation

The active form of LPL is a **non-covalent homodimer**. Once the protein is translated, LPL receives **post-translational glycosylation** in the endoplasmic reticulum and Golgi. The mature enzyme will then be secreted in vesicles to cell surface, where it **binds to heparane sulfate proteoglycans (HSPG)**. In order to hydrolyse TG, LPL interacts with several molecules: HSPG, and coenzymes like inhibitor ApoC3, activator Apoc2. Angiopoietin-like-3 and angiopoietin-like-4 are two cofactors recently evidenced as regulators of LPL and energy balance in the hypothalamus (Kim et al., 2015; Vienberg et al., 2015). **Heparin activates LPL** by hydrolysing HSPG, therefore releasing LPL (Persson, 1988). When too many FFA are present, they compete with the LPL interaction site with HSPG and the LPL unbinds the membrane, therefore is released (Mead et al., 2002).

Many factors regulate LPL including catecholamines, growth hormone, glucocorticoids, oestrogen, prolactin, parathyroid hormone, retinoic acid, thyroxine, vitamin D3, at least in periphery. Specific focus on astrocytic LPL showed that its expression is regulated by nutrients and more specifically **downregulated by TG and FFA** in primary isolated cultured astrocytes (Gao et al., 2017a). LPL transcription is induced by two transcription factors activated by FFA, **PPAR α and γ** . **mRNA levels are not representative of protein levels** since LPL control expression is highly post translational. For example, **insulin increases LPL** activity through mTOR, and rapamycin treatment blocks this effect, however, this increase of LPL does not change the LPL mRNA levels. Interestingly, elevation of cAMP decreases LPL expression in mouse, not in rats and humans (Mead et al., 2002).

Aim of the thesis

Because obesity rates in western countries keep increasing, it is important to understand the environmental and biological effects responsible for such a spread, as addressed here. This bibliographical introduction summarised the importance of central regulation in feeding behaviour, and highlighted the signalling role of lipids in the brain. It is now accepted that lipids, whether they are triglycerides or free fatty acids, alter the energy balance via food reward modulation, and alter cognitive abilities.

The work conducted throughout this thesis had two independent goals, listed as two chapters below.

The laboratory of Dr Serge Luquet previously evidenced that a central administration of dietary triglycerides impairs locomotor activity, motivation, food preference in rodents (Cansell et al., 2014). The aim of the first chapter was to identify the **molecular mechanisms through which dietary triglycerides alter dopaminergic signalling** leading to such phenotypic behaviour.

The second chapter intended to **decipher the dopamine signature associated with feeding behaviours dysregulations** (referred as binge-eating) and opens a **putative correlation between unbalanced food-intake and lipid signalling in the reward system**. To date, experimentation is still ongoing.

Results

Chapter 1: Dopamine D2 receptor and dopamine signalling are direct target of nutritional triglycerides in the control of reward driven behaviours

A. Article information

Chloé Berland^{1,2}, Giuseppe Gangarossa¹, Yuko Nakamura^{3,4}, Mary Burke^{3,4}, Xue Sun^{3,4}, Mohammad Ali Shenasa⁵, Julien Castel¹, Chloé Morel¹, Claire Martin¹, Martine Cador^{6,7}, Stephanie Caille^{6,7}, Stefania Tolu⁸, Fabio Marti⁸, Philippe Faure⁸, Jacob Hecksher-Sørensen^{9,10}, Casper Bo Jensen^{9,10}, Matthias H. Tschöp^{2,11,12}, Thomas S. Hnasko⁵, Dana M Small^{3,4}, and Serge Luquet¹

¹Univ Paris Diderot, Sorbonne Paris Cité, Unité de Biologie Fonctionnelle et Adaptative, CNRS UMR 8251, F-75205 Paris, France.

²Helmholtz Diabetes Center, Helmholtz Zentrum München, German Research Center for Environmental Health, München/Neuherberg, Germany.

³The John B Pierce Laboratory, 290 Congress Ave, New Haven CT, USA

⁴Yale University, 333 Cedar, New Haven CT, USA

⁵Department of Neurosciences, University of California, San Diego, La Jolla CA, USA.

⁶Univ. Bordeaux, Institut de Neurosciences Cognitives et Intégratives d'Aquitaine, UMR5287, 33076 Bordeaux, France

⁷CNRS, Institut de Neurosciences Cognitives et Intégratives d'Aquitaine, UMR5287, 33076 Bordeaux, France

⁸Neuroscience Paris-Seine – IBPS - UPMC UM CR18 – CNRS UMR 8246 – INSERM U1130. Equipe Neurophysiologie et Comportement (NPC), Université P. et M. Curie, Paris, FRANCE

⁸Global Research, Novo Nordisk A/S, Måløv, Denmark;

⁹Image Analysis & Computer Graphics, Department of Applied Mathematics and Computer Science, Technical University of Denmark, Kgs. Lyngby, Denmark;

¹⁰Gubra ApS, Hørsholm Kongevej 11B, 2970 Hørsholm, Denmark

¹¹Division of Metabolic Diseases, TUM, Munich, Germany;

¹²Institute for Advanced Study, TUM, Munich, Germany

CB designed the experiments, performed all the surgeries, behavioural tests, molecular studies, data analyses and wrote the manuscript. GG provided subsequent guidance in experimental design, molecular studies, immunohistochemistry staining, and manuscript writing. YN, MB, XS performed the human studies and data analysis. MAS performed the RNA-scope and lipidomics studies, JC helped with the surgeries, CM helped with western blot analysis, CM performed the VEVO experiment, MC and SC helped with self-administration design and experiments, ST, FM and PF performed the electrophysiology recording, JHS and CBJ performed the DISCO analysis. MHT provided funding, TSH and DS provided scientific guidance and experimental design, GG and SL provided funding, scientific guidance, and wrote the manuscript. The authors declared that no conflict of interest exist.

Keywords

Dopamine – Dopamine receptor D2 – lipoprotein lipase – food-reward – triglycerides

Running title

Circulating Triglyceride controls mesolimbic dopamine neurotransmission

Corresponding author

serge.luquet@univ-paris-diderot.fr

Phone: +33 1 57 27 77 93

Fax: +33 1 57 27 77 96

Abstract

Emerging evidence suggests that energy-dense food deeply alters the dopaminergic (DA) transmission in brain structures composing the mesocorticolimbic (MCL) system by promoting the development of compulsive-like feeding, reward dysfunctions and ultimately weight gain. Postprandial elevation of circulating triglycerides (TG) is a conserved metabolic signature among mammals. Several observations suggest that high plasma TG, independently from body weight fluctuations, are associated with reward deficit, thus suggesting a role for plasma TG in the modulation of DA signalling.

Here, we show that the TG-processing enzyme lipoprotein lipase (LPL) displays overlapping expression patterns in the MCL of both mouse and human brains, and specifically clusters in both VTA DA neurons and striatal medium-sized spiny neurons (MSNs). Using brain-specific TG delivery (BTGD), we show that nutritional TG are metabolized within the MCL system where they modulate DA signalling, through a specific involvement of DA receptor 2 (DRD2)-mediated action. We show that central TG-sensing initiated in striatal structures is reinforcing in lean but not obese mice, while sustained BTGD leads to the recruitment of presynaptic DA-neurons and consequent decrease in motivational drive.

Using functional magnetic resonance (fMRI) we found that in humans, post-prandial TG excursions modulate brain responses to food cues in various MCL-related structures. In the ventromedial prefrontal cortex (vmPFC), fMRI response to food cues was specifically modulated by TG and no other energy-related signals. Finally, we show that the action of TG onto brain responses showed opposite correlation according to the genetic polymorphism TaqAI, a mutation known to affect D2DR signalling and predisposition to addictive disorders.

Collectively, these findings reveal novel mechanisms by which dietary TG alter behavioural and cellular dopamine-dependent functions, and provide a novel hypothesis by which energy-rich diet might lead to dopamine circuitry adaptation and ultimately addictive behaviour.

B. Introduction

Obesity and associated diseases aetiology lies in a mismatch between evolutionary conserved mechanisms insuring appropriate energy intake and recent changes in human food environment (Reaven, 2006). Feeding results in a dynamic integration of signals reflecting metabolic needs but also cognitive, appetitive, and emotional inputs which altogether contribute to adaptive strategies maintaining caloric intake and body weight stability. While the hypothalamus-brainstem axis classically promotes adaptive behaviour and metabolic responses to circulating and nervous inputs reflecting energy status (Blouet and Schwartz, 2010; Thaler et al., 2012), the mesolimbic dopaminergic circuit encodes the reinforcing and motivational properties of foods (Volkow et al., 2011).

Dopamine (DA) neurons in the ventral tegmental area (VTA) and substantia nigra pars compacta (SNc) represent a major source of DA in the dorsal and ventral striatum, where it binds to DA receptors located onto striatal medium-sized spiny neurons (MSNs). The DA receptors are G-coupled receptors, coupled with the $G_{\text{sa/olf}}$ protein for the D1 family (DRD1), or coupled with the G_i protein for the D2 family (DRD2), forming two distinct MSNs populations, notably the DRD1R-MSNs and the DRD2R-MSNs (Baik, 2013; Jackson and Westlinddanielsson, 1994). MSNs integrate inputs from the cerebral cortex such as the prefrontal cortex (PFC) and from limbic structures such as the hippocampus, the thalamus and the amygdala, forming the mesocorticolimbic system (MCL). DA release and signalling within the MCL plays a pivotal role in reward prediction errors (Schultz, 2010), associative learning (Frank and Fossella, 2011), motor-planning, decision-making, and the attribution of incentive salience to reward-related stimuli (i.e. hedonic and motivational drive to collect natural reward such as food, sex, water or non-natural reward such as drugs of abuse) (Berridge, 2009).

Converging lines of evidence have now clearly established that both overconsumption of palatable food and metabolic syndrome (obesity) drive maladaptive modifications of DA signalling. These dysfunctions lead to impulsivity (Adams et al., 2015; Babbs et al., 2013; Guo et al., 2014), altered hedonic and motivational drive, uncontrolled craving and, ultimately, compulsive/addictive-like feeding (Johnson and Kenny, 2010; Michaelides et al., 2012; Vucetic and Reyes, 2010; Wang et al., 2001). The DRD2 DA receptor is more and more incriminated, as genetic silencing of striatal DRD2 precipitates the development of a reward-deficit state and compulsive eating in rats exposed to high-fat food (Johnson and Kenny, 2010), and in humans, body-mass index (BMI) was shown to be associated with reshaping of striatal DRD2 distribution and habitual/opportunistic eating behaviour (Guo et al., 2014). Furthermore, genetic polymorphisms such as the inheritable *TaqIA* A1 allele, correlating in humans with a 30~40% decrease of striatal DRD2 density, create a favourable substrate for uncontrolled feeding and obesity (Ritchie and Noble, 2003; Stice et al., 2008, 2015).

Several observations suggest that a diet enriched in fat might alter DA transmission: high-fat diet was shown to reduce DRD2 expression, DA signalling and turn-over, leading to decreased reward seeking

Results

behaviours (Davis et al., 2008; Hryhorczuk et al., 2015; South and Huang, 2008), cognitive function (Farr et al., 2008) and impulsive control, independently of BMI (Adams et al., 2015). More precisely, triglycerides (TG) represent a major source of available lipid substrates, and transient increase of TG-rich particles after a meal is a naturally-occurring physiological phenomenon, but are chronically high in obese condition (Ruge et al., 2009). Postprandial plasma TG levels predict body weight gain and uncontrolled feeding in rodents (Karatayev et al., 2009) and promote cognitive impairments in obese mice (Farr et al., 2008). In humans, brain-imaging studies have highlighted a correlation between circulating TG and response to food reward (Sun et al., 2014). Collectively, these observations suggest that plasma TG potentially act on DA signalling substrates to modulate reward. Several experiments using radio-labelled FFA (free fatty acids) or TG confirmed that both TG and TG-rich particles cross the blood brain barrier (BBB) and are transported and locally metabolized in the brain (Banks et al., 2018; Cansell et al., 2014). Finally, the rate-limiting enzyme for TG metabolism lipoprotein lipase (LPL) is expressed in rodents' brain (Eckel and Robbins, 1984; Ben-Zeev et al., 1990; Bessesen et al., 1993; Goldberg et al., 1989; Paradis et al., 2004). At the functional level, genetic manipulations of central LPL trigger changes in body weight, metabolic parameters and food intake (Wang et al., 2011). These observations strongly support the concept that post-prandial TG-rich particles hydrolysis by the LPL can directly affect neural networks and functions (Berland et al., 2016).

Here, we emphasize that in both human and mouse brains, *Lpl* mRNA is specifically enriched in MCL structures, with a large expression of LPL specifically on DA-neurons and striatal MSNs. Using a model in which TG are centrally perfused through the physiological route of brain access, we show that nutritional TG reach the striatum and are metabolized in the MSNs, where they promote a decreased cell response to amphetamine and DRD2- but not DRD1-dependent neurotransmission. In addition, we provide molecular, electrophysiological and behavioural evidence revealing that TG-sensing regulates pre- and post-synaptic DA circuit. We find that acute or long-term TG exposure gives differential outputs regarding reinforcement/liking and motivational/wanting aspects of reward, along with a differential response between lean and obese animals' preference for central TG infusion. We used functional magnetic resonance imaging (fMRI) in human to show that TG levels modulate several MCL structures activity including the ventromedial prefrontal cortex (vmPFC), the hippocampus and the globus pallidus. Because we find opposite correlations between TG levels and reward intensity responses in populations bearing the genetic polymorphism TaqAI closely related to DRD2 dysfunctions, we suggest that DRD2 signalling matters for central TG-sensing. Collectively, these findings reveal a previously unappreciated mechanism by which dietary TG can alter MCL circuit functions and reward seeking behaviour.

C. Materials and methods

Supplementary materials and methods are provided in the supplementary data and materials section.

Animals

All animal experiments were performed with approval of the Animal Care Committee of the University Paris Diderot-Paris 7 (CEB-25-2016). Ten week old male mice C57Bl/6J (25-30g, Janvier, Le Genest St Isle, France) were individually housed in stainless steel cages in a room maintained at $22 \pm 3^\circ\text{C}$ with light from 0700 to 1900 hours. Regular chow diet (3 438 kcal/kg, protein 19%, lipid 5%, carbohydrates 55%, reference #U8959 version 63 Safe, Augy, France) and water were provided *ad libitum*, unless stated otherwise. All the behavioural experiments were performed during the light cycle, unless stated otherwise.

Catheter implantation and infusion procedures

Surgery and central infusion were carried out as previously described (Cansell et al., 2014). Briefly, mice were anesthetized with isoflurane and received 10 mg.kg^{-1} intraperitoneal injection (i.p.) of Buprécare® (Buprenorphine 0.3 mg) diluted 1/100 in NaCl 0.9% and 10 mg.kg^{-1} of Ketofen® (Ketoprofen 100 mg) diluted 1/100 in NaCl 0,9%. Home-made catheters were inserted in the left carotid artery towards the brain. Importantly, no heparin was used during the study to prevent LPL activity changes. Catheters clotting was prevented through regular flushing with small volumes of NaCl 0.9%. Infusions started after a recovery period of 7–10 days by connecting catheters to a swivelling infusion device allowing animals to move freely and access to water and food. After 2 days of habituation to the infusion device, mice received NaCl 0,9% (SAL mice) or TG emulsion (TG mice) (Intralipid™ 20%) at a rate of $0.1\text{--}0.3 \mu\text{l min}^{-1}$ for 6 hrs. At the end of a procedure, catheters viability was assessed with Etomidate injections after behavioral studies.

Viral production

The plasmid CBA.nls myc Cre.eGFP expressing the myc-nls-Cre-GFP fusion protein (Wu and Palmiter, 2011) was kindly provided by Richard Palmiter (Univ. of Washington, Seattle, USA). Adeno-associated virus serotype 2/9 (AAV2/9) (6×10^{11} genomes/ml and 1.7×10^8 infectious units/ μl) were produced by the viral production facility of the UMR INSERM 1089 (Nantes, France). The plasmid CAG/CBA-Lpl-P2-AmCherry-WRPE, expressing the Lpl and the control CAG/CBA- mCherry-WRPE mCherry protein (9.08×10^{11} vg/ml for the control and 8×10^{11} vg/ml for the Lpl) were designed and packaged into AAV produced by Virovek (Hayward, CA, USA).

Stereotaxic procedures

Mice were anesthetized with isoflurane and received 10 mg.kg^{-1} intraperitoneal injection (i.p.) of Buprécare® (Buprenorphine 0.3 mg) diluted 1/100 in NaCl 0.9% and 10 mg.kg^{-1} of Ketofen®

Results

(Ketoprofen 100 mg) diluted 1/100 in NaCl 0,9%, and placed on a stereotactic frame (Model 940, David Kopf Instruments, California). 0.5 μ L of viruses were injected bilaterally into the VTA ($x=\pm 0.5$; $y=-3.4$; $z=-4.4$) or the NAc ($x=\pm 1$; $y=\pm 1$; $z=-4.2$) at a rate of 0.1 μ L.min⁻¹. The injection needle was carefully removed after 5 minutes waiting at the injection site and 2 minutes waiting half way to the top.

Measurement of locomotor activity

Locomotor activity was recorded in an automated online measurement system using high sensitivity feeding and drinking sensors and an infrared beam-based activity monitoring system (Phenomaster, TSE Systems GmbH, Bad Homburg, Germany).

Pharmacological manipulations

During two consecutive days before any procedure (habituation phase) mice were injected with NaCl 0,9% (i.p.). All the injections were performed in home-cage. On the test days, animals were perfused for 6 hours with NaCl 0,9% or TG and received injections (i.p) of d-Amphetamine sulfate (3mg/kg, A5880, Sigma-Aldrich, L'Isle d'Abeau, France), or haloperidol hydrochloride (0.5 mg/kg, Tocris Biosciences, Bristol, United Kingdom), or SKF38393 (10 mg/kg, Tocris Biosciences, Bristol, United Kingdom). All drugs were dissolved in NaCl 0,9%.

Catalepsy test

Animals were centrally infused with saline or TG for 6 hours and then injected with haloperidol (0.5 mg/kg) one hour prior to the catalepsy test. At $t=0$, 15, 30, 45, 60, 75, 90 minutes, animals were taken out of their homecages and placed in front of a 4cm elevated steel bar, with the forelegs placed upon the bar while the hind legs remained on the ground surface. The time during which animals remained still was measured. Animals that failed in remaining on the bar for at least 30 seconds during the whole test were excluded. A behavioral threshold of 180 seconds was set so the animals staying more than this amount of time in cataleptic position were put back in their cages until the next time point.

Operant conditioning system

Mice were food-restricted and maintained at 90% of initial body weight to facilitate initial learning and performance during the whole operant conditioning. Computer-controlled operant conditioning was conducted in 12 identical conditioning chambers (Phenomaster, TSE Systems GmbH, Bad Homburg, Germany) during the light phase, at the same hour every single day until the end of the procedure. The mice had access to an operant wall 2 hrs/day, in their home cages. Each operant wall has two levers located 3 cm lateral to a central pellet dispenser, with the left lever arbitrarily designated as the active lever. The reinforcer was a single 20-mg peanut butter flavored sucrose tablet (TestDiet, Richmond, USA). Operant training was carried out with no interruption on consecutive days for 2-hours under a fix-ratio 1 (FR1). When the discrimination score between active and inactive lever press (active lever

presses/inactive lever presses) exceeds 2, mice are shifted for 4 consecutive days to 1,5 hr sessions under a progressive ratio (PR) (3 lever press more for each subsequent reinforcer ($r=3N+3$; N =reinforcer number)).

Self-administration

Nosepokes challenge: Mice were single housed on a 12 h reverse light/dark cycle (lights off 08:00h) with water and food ad libitum. Operant conditioning chambers (Imetronic, Pessac, France) individually housed in sound attenuation boxes, were equipped with two nose-pokes counterbalanced as active or inactive across left and right. Mice were first trained to explore the NP with saccharine pre-training sessions of 30 minutes. Illumination of a dim house-light signalled the start and the end of each session. Active hole visits resulted in 50 μ L saccharine 0,1% delivery. Mice received saccharine training sessions on a Fixed Ratio 1 (FR-1) reinforcement schedule, then increased to FR-2 until mice reached criterion (>10 reinforcements in 30 min and >50% discrimination between NP). After training, mice were challenged with self-administration sessions of 60 minutes, during which active NP visits delivered Intralipid 20% across 60 seconds. Each infusion was accompanied by compound visual stimulus consisting of the illumination of a cue light above the active NP. Mice were randomly assigned to self-administer saline ($n=5$) or IL ($n=13$) under a fixed-ratio 2 (FR-2) schedule of reinforcement. Last part of the experiment consisted in 24h food deprivation before “deprivation” TG self-administration test day.

Lever press challenge: All the self-administration procedures were performed in a different cage for 1.5 hour, during the night phase, without any food restriction. The cages and apparatus were completely cleaned between two sessions. Animals implanted with carotid catheters endure a first step of training with a FR1 program delivering peanut-butter sucrose pellet. They are then shifted to FR2 program delivering one pellet of sucrose for 2 active lever press. Once the learning criteria is reached (50% of active lever presses), the animals are shifted to a second step for 4 days, where 2 active lever presses centrally deliver 3 μ L of Intralipid 20% in 10 seconds. After one injection, the system gets desensitized for 30 seconds. The last night of the procedure, animals get the opportunity to lever press (FR3) to get one Intralipid 20% injection followed by one sucrose pellet delivery.

Conditioned place preference

Before any experimentation, we checked that our apparatus was unbiased, and that the compartment design does not impulse a systematic preference on animals tested. All the compartments were completely cleaned between two sessions of conditioning. The CPP experiments were performed at the onset of the dark period. Locomotor activity was recorded with infrared beam-based activity monitoring system and analysed with the provided software (Phenomaster, TSE Systems GmbH, Bad Homburg, Germany). For all protocols, the least preferred compartment during the exploration phase is associated to the reward (biased protocol). Animals with more than 65% of preference for a compartment on the

Results

pre-test day were removed. On day 1, animals are carefully put in the middle of the cage and explore freely a two compartments apparatus for 15 minutes. The following days are conditioning sessions of 30 minutes, except for BTGD where the sessions last for one hour, during which the animals learn to associate one or another compartment to the reward tested. After 8 days of conditioning (4 sessions in each compartment), animals explore the two compartments freely for 15 minutes. The analysis takes into account the time spent in the rewarded compartment before and after conditioning.

For High-Fat high-sugar (HFHS) conditioning, animals are centrally infused for 6 hours in their homecages prior to conditioning sessions, for 10 consecutive days.

For TG conditioning, animals received TG or saline central infusions for one hour every days of conditioning.

For Amphetamine conditioning, animals were centrally infused for 6 hours in their homecages prior to conditioning sessions, and received the i.p. injection right on the top of the conditioned compartment.

Bingeing experiment

Animals were single-housed one week prior to any experiments. Food intake and body weight were measured daily at 10 AM. Intermittent high fat-high sugar solution (Intralipid 20% enriched with sucrose 10%) access was provided daily at 10:30 AM during 10 consecutive days for one hour.

Statistical analysis (rodent analysis)

Displayed values are means \pm SEM. Unless otherwise stated, comparisons between groups were carried out using analysis of variance (ANOVA corrected with Bonferroni, GraphPad Prism 6®). A p-value of less than 0.05 was considered statistically significant.

D. Results

1. The triglyceride-processing enzyme lipoprotein lipase is expressed in both mouse and human mesocorticolimbic structures.

In rodents, brain expression of *Lpl* mRNA has been demonstrated by several pioneering studies (Ben-Zeev et al., 1990; Bessesen et al., 1993; Goldberg et al., 1989; Paradis et al., 2004). Comparative RNA-sequencing database indicate a relative enrichment of *Lpl* transcript in neurons compared to other cell types (Zhang et al., 2014). We checked *Lpl* RNA central expression in both mouse and human brains using available resources from the Allen Brain Atlas (Lein et al., 2007). In rodents, *Lpl* mRNA expression is unevenly distributed in MCL including the frontal pole layer 2/3, the primary sensory motor area, the prelimbic area, the hippocampus (CA1, CA2, CA3), the amygdala, the caudate putamen, the nucleus accumbens, the VTA, together with the hypothalamus and the pontine structure as previously observed (Paradis et al., 2004; Wang and Eckel, 2012). Importantly, *Lpl* expression is widely distributed in the PFC and the striatum, and in the midbrain DA structures, with a restriction to VTA neurons and not or weakly expression in the substantia nigra (SN), in accordance with the literature (Greene, 2006) (**Supplementary Figure 1 A**). In the human brain, microarray data set from the Allen Human Brain Atlas (Hawrylycz et al., 2012) reveals a similar expression pattern for *Lpl* mRNA with the highest expression in striatal sectors followed by cerebellar cortex, hypothalamus, basal forebrain, hippocampal formation, cerebellar cortex and nuclei (**Supplementary Figure 1 B**). As in rodents, *Lpl* expression is abundant throughout striatal structures including the head and tail of the caudate nucleus, caudate putamen and nucleus accumbens (**Supplementary Figure 1 C**).

We next investigated *Lpl* expression within the MCL and its specificity to dopamine-related neurons pattern (dopaminergic neurons from the VTA and striatal MSNs) using Fluorescent *in-situ* hybridization (FISH). We found that 79% of *TH*-neurons in the VTA also co-express *Lpl* while only ~3% accounted for *TH*-negative/*Lpl*-positive cells, the remaining population being *TH*-neurons devoid of *Lpl* (**Figure 1 A**). In both striatum and NAc, nearly all (>99%) *Lpl*-positive counted neurons appeared to be either D1R- or D2R-MSNs, with ~90% of both DRD1- and DRD2-containing MSNs also expressing *Lpl* mRNA, respectively (**Figure 1 B, C**). DRD1 and DRD2 *in-situ* probes were validated by showing absence of signal in motor cortex and medial septum, two regions with poor dopamine receptors (**Supplementary Figure 2**).

2. Striatal TG metabolism decreases amphetamine-induced behavioral and molecular adaptations

As for any nutrient, plasma TG can access the brain through the blood brain barrier where they will be distributed and processed according to brain microvasculature and local expression for TG-processing enzymes. In addition, the central distribution of *Lpl* (**Figure 1, Supplementary Figure 1**) suggest that

Results

post-prandial TG-rich particles could reach critical regions of the MCL where TG processing would modulate the neural response both pre- and post-synaptically. To investigate the central action of TG we took advantage of the BTGD technique which respects the physiologic route of nutrient access into the brain. Freely-moving mice were perfused with TG-emulsion (Intralipid 20%, 2 kcal/mL,) through an indwelled catheter into the carotid artery in the direction of the brain (Cansell et al., 2014). While we have already established that BTGD does not affect peripheral FFA or TG contents, we investigated whether TG or any derived metabolite could be detected in the striatum. C57Bl6/J mice received a 6-hrs saline or TG perfusion at a rate of $0.1 \mu\text{L}\cdot\text{min}^{-1}$ (36 μL total, 0.072 kcal, **Figure 2 A**) after which they were sacrificed and striata dissected out and subjected to lipidomic analyses. BTGD significantly increased several TG species in the striatum together with their metabolites (unpaired t-test, 54:4 TAG, $p=0.0141$, $t=3.424$, $df=6$; 38:5 diacylglycerol (DAG), $p=0.0332$, $t=2.751$, $df=6$, FFA 18:3 N6 γ -linolenic acid, $p=0.0216$, $t=3.084$, $df=6$) (**Figure 2 B and supplemental Figure 3**). These data confirm that our experimental setting efficiently reproduces blood-to-brain TG entry allowing circulating TG to cross the BBB and reach the striatum, where they are metabolized.

We have previously described that BTGD counteracts amphetamine-induced locomotor responses (Cansell et al., 2014). We next performed a 6-hrs saline or TG central perfusion at a rate of $0.1 \mu\text{L}\cdot\text{min}^{-1}$ and sacrificed animals 60 min after i.p injection of d-amphetamine (3mg/kg) (2-way ANOVA, interaction $F_{(6,48)} = 5.710$, $p=0.0002$; time factor $F_{(6,48)} = 39.75$, $p<0.0001$, treatment factor $F_{(1,8)} = 10.94$, $p=0.0107$, sum locomotor activity, Mann-Whitney test, $p=0.03$) (**Figure 2 C**). The impaired behavioral response was associated to a large reduction in the striatum of c-Fos-positive cells, molecular readouts for neuronal activation (one-way ANOVA, $F_{(2, 11)} = 150.9$; $P < 0,0001$,) and in the NAc (one-way ANOVA, $F_{(2, 11)} = 111.0$, $P<0,0001$) (**Figure 2 D-E**).

In order to capture how BTGD affects whole-brain amphetamine-induced c-Fos, we performed a whole-brain staining (iDISCO) of animals challenged with central infusions of either saline or TG (6 hrs, $0.1 \mu\text{L}/\text{min}$) followed by amphetamine (3 mg/kg) (**Figure 2 F**). Heat maps related to c-Fos labelling revealed differential responses in anatomically distinct structures that are part of the cerebral cortex/isocortex (Frontal pole layer 2/3 FRP2/3, $p=0.026$, prelimbic area PL, $p=0.057$, primary somatosensory area SSp, $p=0.016$ and primary motor area MOP, $p=0.025$), Striatal structure/ striatum-like amygdala area (Bed nucleus of the accessory olfactory tract BA, $p=0.05$), Ventral Pallidum (Magnocellular nucleus MA, $p=0.04$), the hypothalamus (Arcuate hypothalamic nucleus ARH, $p=0.07$), the pontine structures (Supratrigeminal nucleus SUT, $p=0.08$) and Cerebellar cortex structure (Nodulus (X) NOD, $p=0.017$) while the VTA displayed a tendency for decreased signal ($p=0.07$) (**Figure 2 G**). These results indicate that central TG sensing might exert both a positive and negative modulatory action onto brain structures containing *Lpl* and confirm an overall action of TG in MCL structures.

To further extend our molecular analyses, we checked the regulation/activation of the ribosomal protein S6, a marker of translational activity. In agreement with c-Fos activation pattern, we observed a dramatic

decrease of amphetamine-triggered rpS6 phosphorylation (Ser^{235/236}) in the PFC (One-way ANOVA $F_{(2, 11)} = 111,0$; $P < 0,0001$), the striatum (One-way ANOVA $F_{(2, 11)} = 195,3$; $P < 0,0001$) and the NAc ($F_{(2, 11)} = 27,89$, $P < 0,0001$) (**Figure 2 H, I**).

Altogether, these results indicate that BTGD decreases neuronal activation and protein translation (Valjent et al., 2011) (Gangarossa et al., 2013) in MCL-related structures.

3. Triglycerides exert modulatory actions onto dopamine signalling.

The above-mentioned results suggest that TG alter the ability of MSNs to integrate dopamine-dependent signals, thus impacting basal ganglia output functions. We then decided to explore whether central TG-sensing was accompanied by alterations of key molecular pathways known to shape MSNs activity and to be strongly modulated by dopamine (Beaulieu 2001) (**Figure 3 B**). Striatal western blot analysis revealed that central TG delivery decreased p70S6K and rpS6 phosphorylation, at both MAPK-dependent (Ser^{235/236}) and mTOR-dependent (Ser^{240/244}) sites, as well as ERK1/2 phosphorylation (unpaired t-tests: rpS6^{235/236}, $p=0.026$, rpS6^{240/244}, $p=0.0048$, p70S6K^{t389}, $p=0.0456$, p70S6K^{t421}, $p=0.0074$, p-ERK1, $p=0.0003$, p-ERK2, $p=0,0032$). In addition, a reduction of phosphorylated DARPP-32^{Thr34}, a PKA-dependent target, was observed (unpaired t-test, $p=0.001$). Interestingly, in addition to the latter molecular events, we observed reduced levels of tyrosine hydroxylase (TH) phosphorylation (unpaired t-test, p-TH^{Ser40}, $p=0.0034$, p-TH^{S31}, $p=0.05$, total TH, $p=0.88$) indicating a reduction in TH activity (Lew et al., 1999; Salvatore et al., 2016) (**Figure 3 A**). DA signalling in MSN can also trigger the PKB/Akt-GSK3 pathway. We investigated phosphorylation status of Akt, which remained unchanged on Thr³⁰⁸ ($p=0.95$), but was significantly decreased in Ser⁴⁷³ ($p=0.03$), together with reduced phosphorylation/ of GSK3□ on Ser⁹ ($p=0.002$) (**Figure 3 C**), showing that this pathway is activated. These results indicate that striatal TG sensing strongly modulates MSNs signalling by decreasing PKA-, MAPK- and mTOR-dependent signalling and potentiating Akt/GSK-3 signalling.

4. Central triglyceride delivery alters D2R-mediated functions while sparing D1R.

We next decided to explore whether central TG delivery could exert a selective modulation on DRD1- or DRD2-coupled signalling pathways. Behavioral and cellular responses to the selective DRD1 agonist SKF 38393 (10 mg/kg) and the DRD2 antagonist haloperidol (0.5 mg/kg) were evaluated in saline- and BTGD-perfused mice. Remarkably, BTGD did not affect SKF 38393-induced locomotion on either the first or second day of injection (injection 1, 2-Way ANOVA Time factor $F_{(29,290)}=6,004$, $p<0,0001$, Treatment factor $F_{(1,10)}=1,05123$, $p=0,8255$; injection 2, time factor $F_{(35,175)}=7,77$, $p=0,0001$; treatment factor $F_{(1,5)}=0,7370$, $p=0,4299$) (**Figure 3 D**). However, the lack of effect was not the result of altered catheter patency since BTGD was still fully efficient in reducing amphetamine-induced hyperlocomotion when assessed on the same group of animals on day 3 after SKF treatment (2-Way ANOVA Time factor $F_{(35,280)}=16,74$, $p<0,0001$, treatment factor $F_{(1,8)}= 5,116$, $p=0,0536$)(**Figure 3 D**). Consistently, DRD1-dependent increase in striatal c-Fos remained unaffected by central TG delivery

(**Figure 3 E**). In sharp contrast, mice centrally perfused with TG showed a dramatic reduction in haloperidol-induced catalepsy when compared to saline-treated animals (2-way ANOVA time factor $F_{(5,130)}=9,224$, $p<0,0001$, treatment factor $F_{(1,26)}=27,89$, $p<0,0001$; unpaired t-test between areas under the curve, $p=0,0058$, $t=3,005$, $df=26$) (**Figure 3 F**). Consistently with the literature (Bertran-Gonzalez et al., 2008), pharmacological blockade of DRD2 robustly increased the number of c-Fos- and rpS6-Ser^{235/236}-positive neurons (putative D2R-MSNs) in saline-treated animals while this molecular response was fully abolished in BTGD-mice (One-way ANOVA, $F_{(2,11)}=47.84$, $p<0.0001$) (**Figure 3 G**).

5. Centrally delivered triglycerides differently recruit post- and pre-synaptic components of the dopaminergic circuit regarding the time of exposure.

We next investigated the consequences of central TG delivery onto presynaptic DA-neurons. Indeed, local injection of FFA into the VTA has been shown to decrease DA-neurons firing and food-reward seeking (Hryhorczuk et al., 2018). We used extracellular single-unit recording of VTA dopaminergic neurons in anesthetized mice during acute and longer BTGD exposure (**Figure 4 A, B**). While we previously demonstrated that central TG delivery could rapidly (within 10-20min) oppose to spontaneous locomotor activity at the onset of the dark period (Cansell et al., 2014), we found that a 10min acute BTGD did not affect the electrical activity of VTA-DA neurons (Wilcox paired tests, max frequency variation, $p=0.94$, $V=15$; for max burst variation, $p=1$, $V=11$) (**Figure 4 A**). In contrast, prolonged TG perfusion (5-6h) led to a significant decrease in DA-neurons firing rate and reduced firing burst (for Frequency, t-test, $p=0.0007$, $t=3.4512$, $df=123.16$; for spike within burst, Wilcox test, $p=0.046$, $t=W=3362$) (**Figure 4 B**). This decrease in DA-neurons activity is consistent with the decreased phosphorylation of TH (Ser³¹ and Ser⁴⁰) observed in the striata of BTGD-mice (**Figure 3 A**). Altogether, these data suggest that altered DA firing by TG is not immediate, and that once set, TG shut down dopaminergic neurons.

6. Central triglyceride delivery is reinforcing in lean but not obese animal.

Because DA-related signals were importantly impacted, we next explored how short- vs long-term BTGD might participate in uncoupling the hedonic/reinforcing and motivational components of reward. We used the conditioned-place preference test (CPP) to assess whether short-term BTGD could be reinforcing. We used an unbiased apparatus/biased protocol in which animals were first allowed to explore two defined compartments (pre-test) before enduring 8-days of conditioning sessions. The less-preferred compartment (pre-test) was associated with a 1-hr central saline perfusion (SAL) or 1-hr central TG delivery (TG). Following the conditioning, animals were allowed to explore the two compartments for a post-test session (**Figure 5 A**). Importantly, the pre-test and post-test sessions were performed ahead of any central TG administration, so that exploration of the complete apparatus was not affected by the treatment itself, but only by conditioned associative learning. As shown in **Figure 5 B**, animals conditioned with 1-hr BTGD displayed a significant preference for the compartment

associated with TG (paired t-test: for SAL between pre and post-test, $p=0.2791$, $t=1.144$, $df=10$, for TG between pre and post-test, $p=0.0084$, $t=3.105$, $df=13$; unpaired t-test for comparison between post-test SAL and post-test TG, $p=0.0328$, $t=2.272$, $df=23$; unpaired t-test between SAL and TG (post-pre) paired side time, $p=0.0474$, $t=2.062$, $df=32$). This result indicates that central detection of TG may act as a positive reinforcement, thus suggesting that postprandial increase in circulating TG and central TG-sensing might directly participate in the hedonic components of food reward. Because metabolic and behavioral differences between lean and obese mice have been widely observed, we then investigated whether central TG-sensing may exert modulatory actions depending on metabolic states. We are currently replicating the same CPP paradigm in both lean and DIO mice (**Figure 5 C, D**). Preliminary results suggest that while BTGD is once again able to promote positive reinforcement in lean animals, the same stimulus could be inefficient in DIO mice, thus failing to produce any reinforcement (paired t-test: for lean between pre and post-test, $p=0.0513$, $t=2.752$, $df=4$, for obese between pre and post-test, $p=0.7048$, $t=0.4369$, $df=2$; unpaired t-test for comparison between post-test lean and post-test obese, $p=0.6647$, $t=0.4499$, $df=8$) (**Figure 5 D**). To date, experiment is still ongoing to confirm this hypothesis.

7. Central triglyceride sensing differentially impacts food and non-food reward

Uncontrolled food intake or drugs seeking share some common mechanisms since they both lead to (mal) adaptive desensitization of DA transmission. However, while drugs of abuse (cocaine and amphetamine) directly impinge on DA release or signalling properties (DiLeone et al., 2012), feeding drive is under the complex regulatory action of the homeostatic hypothalamic-brainstem circuits (Morton et al., 2006). We therefore explored how BTGD could differentially modulate actions and properties of palatable food (HFHS)- or amphetamine-mediated reinforcements.

Two sets of experiments were performed with a 6-hr central administration of saline or TG before every conditioning session: (i) food-induced and (ii) amphetamine-induced CPP (**Figure 6 A and B**). In the CPP coupled with palatable food, consistently with our previous observations (Cansell et al., 2014), TG-perfused mice decreased their palatable food consumption during conditioning sessions. Surprisingly, despite decreased HFHS consumption, TG-perfused mice displayed a stronger preference for HFHS-associated compartment during post-test session (paired t-test: for SAL between pre and post-test, $p=0.6018$, $t=0.5505$, $df=6$, for TG between pre and post-test, $p=0.0007$, $t=5.385$, $df=8$; for comparison between SAL post and TG post, $p=0.0270$, $t=2.470$, $df=14$, unpaired t-test between SAL and TG (post-pre) paired side time, $p=0.0162$, $t=2.652$, $df=18$), suggesting that BTGD potentiates the reinforcing aspects of palatable food (**Figure 6 A**). Importantly, in this experiment mice were not body-weight restricted in order to maximize reward-driven food preference over metabolic demands. This could explain why we did not observe a positive CPP for the saline treated group.

CPP with either saline or amphetamine ($3\text{mg}\cdot\text{kg}^{-1}$) conditioning after 6-hr of central perfusion showed that no difference between SAL and TG-perfused mice (paired t-test: for SAL between pre and post-

Results

test, $p=0.0176$, $t=3.899$, $df=4$, for TG between pre and post-test, $p=0.0313$, $t=3.833$, $df=3$; unpaired t-test for comparison between post-test SAL and post-test TG, $p=0.9408$, $t=0.07701$, $df=7$; unpaired t-test between SAL and TG (post-pre) paired-side time, non-significant) (**Figure 6 B**). This result suggests that central TG-sensing exerts a differential modulatory action on natural-palatable food and non-natural amphetamine reward.

In order to confirm central TG role in food reward, we next assessed how a single 6-hrs BTGD could alter compulsive food consumption in a model of binge-eating behaviour (Kessler et al., 2016; Valdivia et al., 2015). *Ad libitum* fed mice were exposed to intermittent, restricted access to fat and sugar milkshake (10% Sucrose and 20% lipids from Intralipid™) for 10 days (**Figure 6 C**). Mice showed a rapid escalation in palatable drinking (**Supplemental Figure 5**). On day 10 animals received a 6-hrs central saline or TG perfusion prior to access to HFHS drink. This single TG central perfusion was able to decrease by ~50% binge-directed HFHS consumption compared to saline (**Figure 6 C**), indicating that central TG detection can also partially counteract compulsive eating (2-way ANOVA, interaction $F_{(1,14)} = 7.826$, $p=0.01$, time $F_{(1,14)} = 19.5$, $p= 0.0006$, treatment $F_{(1,14)} = 5.03$, $p=0.04$, day 10 SAL compared to TG, $p=0.01$).

8. Motivational and hedonic aspects of reward are differentially affected by central triglyceride delivery.

Self-administration paradigm has been widely used to demonstrate the reinforcing aspects of a stimulus. We used this paradigm to further understand central actions of TG on both hedonic and motivational components of reward. Because self-administration requires a faster delivery of central TG, we checked that increased rates of BTGD did not perturb general brain hemodynamics with photoacoustic imaging and found no modifications in oxygenated haemoglobin and cerebral blood flow at 1 and 10 $\mu\text{L}\cdot\text{min}^{-1}$ (**Supplemental Figure 4**).

Unlike CPP, self-administration requires both hedonic and motivational drive for lever pressing or nose-poking. We designed a protocol where animals were placed in operant chambers equipped with two nose-pokes (NP), one being coupled with central TG injection or saline for the controls. Animals were first pre-trained to discriminate between inactive and active nose-poke using saccharine delivery as reward. While discriminatory capabilities are intact between saline- and TG-perfused groups, mice receiving TG tended to increase active NP visits in both fed and fasted condition (ANOVA, $p=0.057$, $f=4.19$) (**Figure 7 A**), consistently with the positive place preference observed in Figure 5.

In order to further dissociate the reinforcing and motivational components, we next assessed the reinforcing power of BTGD in a more complex operant task in which acute BTGD was coupled to active lever press+NP, as the effort required to respond on a lever has been shown to be greater to NP which is an extension of natural exploratory behaviour (Clemens et al., 2010). After sucrose training to distinguish active and inactive lever presses, new animals were shifted to 4 daily sessions in which two

active lever presses (Fixed ratio 2:FR2) resulted in centrally delivery of saline or TG (3 μ l, in 10 seconds) (**Figure 7 B**). TG-infused animals progressively reduced their performance in the active lever press (2-Way ANOVA $p=0.0016$, $F_{(3, 40)} = 6.122$ for time effect, $p=0.0028$, $F_{(3, 40)} = 6.122$ for treatment) and infusion (2-Way ANOVA $p=0.0069$, $F_{(3, 40)} = 4,672$ for time factor, $p=0.0093$, $F_{(1, 40)} = 7,476$ for treatment) compared to saline-infused animals (**Figure 7 B**).

Given the modulatory effect of BTGD on food-reward reinforcement (**Figure 6 A**) we explored how acute BTGD would impact the performance to lever press for food reward. In that setting, 2 consecutive lever presses (Fixed ratio 2:FR2) initiated a 3- μ L saline or TG central perfusion followed by one sucrose pellet delivery (**Figure 7 C**). This session was not restricted in time and animals were free to engage at leisure through a ~12-hrs overnight access. While the two groups displayed similar performances during the first 3-4-hrs of the session (**Figure 7 C**), the TG group reached a breaking point at ~50 lever presses after which their performance was significantly decreased compared to the saline group (2-way ANOVA, interaction $F_{(16,160)} = 5.79$, $p<0.0001$; time effect $F_{(16,160)} = 12.42$, $p<0.0001$, treatment effect $F_{(16,160)} = 9.03$, $p=0.01$). Because the rewards are low in calories (0.016 kcal per pellet), and the volume of TG infused is small (max 60 μ L) we exclude that this observation is due to satiety signals, and we conclude that BTGD alters food reward to the long term, not short term. Interestingly, the volume of BTGD required to tip the motivational-drive (~50 μ l) was equivalent to the one received during a 6-hrs BTGD described above (36-45 μ l).

9. Lipoprotein lipase controls reward seeking behaviour through pre and post synaptic action

We used genetics gain and loss of function approaches to apprehend the importance of TG hydrolysis by LPL in reward-seeking changes described above. Using Cre/Lox strategies, we deleted *Lpl* in the NAc and the VTA of *Lpl*^{lox/lox} animals (**Figure 8 A, Supplemental Figure 6**). As previously published, we confirm that knock-down of *Lpl* in the NAc (referred as to *NAc-Lpl*^{lox/lox} and *NAc-Lpl* ^{Δ/Δ}) increases food-reward operant conditioning (2-Way ANOVA, For active lever presses, time treatment $F_{(2,24)}=5,053$, $p=0,0147$, genotype factor $F_{(1,24)}=8,898$, $p=0,0065$) (**Figure 8 B**).

Strikingly, intra-VTA knock-down of *Lpl* (referred as to *VTA-Lpl*^{lox/lox} and *VTA-Lpl* ^{Δ/Δ}) had the opposite consequence (2-Way ANOVA, for active presses: time factor $F_{(3,36)}= 4,505$, $p=0,0088$, treatment factor $F_{(1,36)}=31,13$, $p<0,0001$) (**Figure 8 C**).

In a mirror approach, intra-NAc and intra-VTA stereotactic injection were performed on C57Bl6 mice using AAV9-pCAG/CBA-mCherry-WRPE (control) and AAV9-pCAG/CBA-Lpl-P2-AmCherry-WRPE (LPL overexpression) (**Figure 8 D, Supplemental Figure 6**). Animals injected with cherry or LPL expressing viruses in the NAc, referred as to *NAc*^{LPL} and *NAc*^{CTRL} or in the VTA, referred as to *VTA*^{LPL} and *VTA*^{CTRL} were subjected to the same training as described above. Overexpressing *Lpl* in the NAc did not affect operant behaviour (**Figure 8 C**). However, *Lpl* overexpression in the VTA led to a

Results

significant increase in inactive lever press (2-Way ANOVA: time factor, $F_{(3,36)}=1,065$, $p=0,3762$, genotype factor $F_{(1,36)}=5,742$, $p=0,0219$) and degraded discriminatory ratio (2-Way ANOVA : interaction $F_{(3,36)} = 2.18$, $p=0.1$, time effect $F_{(3,36)} = 6.2$, $p=0.001$, genotype effect $F_{(3,36)} = 29.02$, $p<0.0001$) . Noteworthy, a thorough analysis revealed that when transitioned under escalating effort in PR session, VTA^{LPL} mice significantly visited more the pellet dispenser between cues, although no rewards were provided (2-way ANOVA interaction $F_{(3,36)}=0.28$, $p=0.83$, time factor $F_{(3,36)}=20,08$, $p<0,0001$, genotype effect $F_{(3,36)} = 21.15$, $p<0.0001$), suggesting an impaired association between the operant task and the reward. We measured locomotor activity of these animals in their homecage for 72 hrs, and found no significant changes (data not shown). Altogether these result support LPL-mediated TG sensing in food-reward seeking behaviour, both in the VTA and the NAc. Because the impaired discriminatory ratio and increased visit of the pellet dispenser outside of cues were shown to be a potential sign of compulsive/habitual behaviour (Guegan et al., 2013), altered LPL/TG signalling in VTA might be operant in the transition from goal-directed to compulsive behaviour.

10. In humans, postprandial triglycerides control brain response to food-cues in dopamine receptor 2-dependent manner.

Since post-prandial increase in TG is a common feature to rodents and humans (Liu et al., 2013; Ruge et al., 2009) and *Lpl* mRNA shares overlapping expression territory in the rodent and human brain (**Figure 1**), we hypothesized that post-prandial TG might regulate brain-response to food cues in a DRD2 dependent manner. In human, we used functional magnetic resonance imaging (fMRI) to evaluate whether meal-induced TG changes modulate brain response to food versus non-food cues. Because our rodent data involve the D2R signalling, we performed analyses with two groups of participants, carrying different TaqIA polymorphism, a mutation known to affect D2R signalling and susceptibility to addiction in human (Jonsson et al., 1999) (Stice et al., 2010) (Stice et al., 2015) (Barnard et al., 2009; Ritchie and Noble, 2003) (Stice et al., 2008; Wang et al., 2001).

We recruited 29 participants carrying the A1 allele of the D2 receptor gene region (A1+, n=16) or not (A1-, n=13). The participants were trained to rate food-related or non-food-related odour stimuli after eating a fixed-portion lunch (Fixed condition), an ad libitum lunch (Sated condition), or nothing (Hungry condition) (**Figure 9 A**). Participants went for fMRI scanner and underwent four odour runs. We tested the effect of odorant, condition, genotype, and interaction among odorant and condition and genotype on stimulus ratings. The effect of time, condition, group, and interaction among those factors on the concentration of TG were tested using a mixed-design ANOVA. There were significant effect of condition ($F_{(2,54)} = 8.00$ $p = 0.001$) and interaction between condition and time ($F_{(2,54)} = 10.15$ $p < 0.001$) on TG levels (**Supplementary Figure 7 A**). TG levels in Hungry condition were lower than that in Fixed or Sated condition ($p = 0.040$ and $p = 0.01$ respectively). In both group, TG levels at baseline were greater than that at 60 min after ($p = 0.001$ in A1+ group, $p < 0.001$ in A1- group) in Hungry condition,

and TG levels at 60 min after lunch were greater than that at baseline in Fixed session and Sated session ($p = 0.036$ and $p = 0.027$ respectively) (**Supplementary Figure 7A**). Intake calories from lunch in Sated condition was negatively associated with triglyceride levels at baseline in the A1- group at a trend level ($p = 0.08$, $r = -0.50$), but not in the A1+ group ($p = 0.40$, $r = -0.23$) (**Supplementary Figure 7B**). Data acquired through fMRI demonstrated that between A1 and A2 groups, there was significant difference in association between postprandial serum triglyceride change and difference in brain response to [(food odour vs non-food odour) between conditions (Hungry > Fix)] in the lateral Globus pallidus (**Figure 9 B**) and the ventromedial prefrontal cortex (vmPFC) (**Figure 9 C**). In addition, between A1/A2 groups, there was significant difference in association between postprandial serum triglyceride change and difference in brain response to [(food odour vs non-food odour)] between conditions (Hungry > Sated)] in the hippocampus and para-hippocampus (**Supplementary Figure 8**).

These data demonstrate that-according to the status of DRD2 signalling in human i.e A1 or A2 status, postprandial TG positively (A1) or negatively (A2) correlate with brain response to food cues in the PFC, GP, hippocampus and para-hippocampus (**Figure 9, Supplementary Figure 8**).

Since these structures were shown to express *Lpl* mRNA (**Figure 1**) we were eager to further precise whether TG were solely involved in the modulation of brain response or whether they could be an adjuvant to other circulating peptide, nutrient, or product of TG metabolite. By running systematic correlation, we demonstrated that the correlation between postprandial TG and the response of the vmPFC survived after controlling for potential confounders (FFA, glucose, insulin, (data not shown) fullness, hunger (**Supplementary Figure 7 C**) and liking ($p = 0.047$ false discovery rate (FDR) corrected ($p = 0.055$ FWE corrected)) (**Supplementary Figure 7 D**) indicating that in the vmPFC post-prandial TG might prevail as a unique modulator of vmPFC activity in this experimental setting (**Figure 9 E, F**).

Altogether these data strongly support our hypothesis that in human, circulating TG controls brain-response to food cues in the PFC, Globus Pallidum, and hippocampal structure in DRD2-dependent manner.

E. Discussion

Physiological mechanisms optimizing feeding behaviour have been positively selected during evolution, with a specific appeal for highly energetic lipid and sugar rich-food, representing a promise of survival. Nowadays, the highly conserved and sophisticated systems controlling food intake are challenged by radical modifications in food supplying characterized by the ubiquitous availability of highly palatable diets. Although inheritable genetic traits affect susceptibilities, inappropriate food consumption and dysfunction of energy balance often lead to obesity pandemic.

DA signalling in the mesocorticolimbic system (MCL) is a critical circuit which integrates cognitive, perceptual, appetitive processing directing feeding, and encodes the motivational “wanting” and reinforcing “liking” aspects of food and non-food rewards (Berridge, 2009; Dallman et al., 2005; Di Chiara and Imperato, 1988). In particular, projections from VTA DA neurons to the NAc represent a principal neural substrate upon which drugs of abuse exert their actions; and thus the MCL is often referred to as the brain “reward circuit”. Whereas a debate still exists to selectively restrict DA function to learning, error-predicting signals, incentive salience and cognitive flexibility (Dayan and Berridge, 2014), it has become evident that over solicitation of the DA circuit by repeated exposures to rewarding stimuli alters the basal dynamics by which the DA circuit coordinate goal-directed versus habitual responses (Furlong et al., 2015; Ostlund et al., 2010; Voon et al., 2015). Hence, repeated exposure to drugs of abuse or highly palatable food creates similar, even though not identical, alterations in DA neurotransmission (DiLeone et al., 2012; Volkow et al., 2012). Excessive consumption of energy-dense food increases vulnerability to develop uncontrolled craving, compulsive feeding and ultimately excessive body weight gain (Kenny et al., 2013; Rothmund et al., 2007; Stice et al., 2008; Volkow et al., 2013). However, unlike drugs of abuse that specifically target the DA circuit, feeding triggers a constellation of metabolic signals, including postprandial changes in circulating nutrients like carbohydrates and lipids, and specifically TG. Indeed high plasma TG were shown to correlate with DA signalling, reward and altered cognitive function associated with obesity (Davis et al., 2008; South and Huang, 2008) (Farr et al., 2008; Karatayev et al., 2009; Sun et al., 2014). Importantly, restricted access to high-fat but not high-sugar diet increases impulsivity, decreases attention and reduces DRD2 signalling in the ventral striatum despite similar body weight, suggesting a specific role for dietary fat in modulating the MCL system (Adams et al., 2015).

1. Bridging dietary input to reward through triglycerides sensing in the reward system

Circulating lipids are found in the form of albumin-bound free-fatty acids (FFA) and TG. While FFA are typically released from adipose tissue during nutrient deprivation, (TG)-rich lipoproteins accumulate after a meal from gut-derived TG-rich lipoprotein chylomicron (CM) (Ruge et al., 2009). FFA are not considered as a primary fuel currency for the brain, yet several studies have clearly established that FFA signal to the hypothalamus and DA-neurons to decrease feeding (Benoit et al., 2009; Hryhorczuk et al.,

2018; Lam et al., 2005; Migrenne et al., 2011), food reward and dopamine tone (Hryhorczuk et al., 2018). However, unlike circulating FFA, cellular entry of FFA derived from TG-rich particles relies on local (neuronal) expression of LPL. A physiologically relevant model is warrant to decipher the relative contribution of postprandial TG-rich particles versus fasting-induced FFA in brain functions, considering that these two potential lipids signals stand at the two extreme of nutrients availability.

In the present study we used available mRNA expression databases to assess Lpl expression in mouse and human brains, and highlight that both species display Lpl mRNA enrichment in MCL structures (**Figure 1**). Using in situ hybridization we further demonstrated that Lpl expression is highly distributed onto presynaptic DA neurons and post-synaptic DRD1 & DRD2 medium-sized spiny neurons (MSNs). This suggests that Lpl could be a valid candidate to mediate the previously described TG-sensing in the MCL (Cansell et al., 2014). We provide evidence that Lpl gene expression in both presynaptic VTA neurons and postsynaptic NAc regulate food-reward seeking behaviour (**Figure 8**). To date, we are unable to formally establish whether behavioral changes are the fate of local cellular TG-hydrolysis or the indirect consequences of modified synaptic input.

Consistent with this hypothesis, we confirmed that circulating TG access the MCL areas expressing LPL and affect the amphetamine-induced response in several brain areas, with a specific emphasis on PFC, NAc, and CPU. DA binding at the post-synaptic level involves DRD1 and DRD2 receptors, located on MSNs populations which segregate in two different pathways. At the biochemical level, activation of DRD1 increases cAMP and protein kinase A pathway (Bateup et al., 2010), the extracellular signal-regulated kinase (ERK) cascade and its downstream target the ribosomal protein S6 (rS6) (Gangarossa et al., 2013) (Valjent et al., 2011) together with the mammalian target of rapamycin (mTOR) (Sutton and Caron, 2015), ultimately leading to DRD1 MSNs activation and consequent release of GABA in striatal downstream brain regions (SNr). Conversely, DRD2 activation inhibits PKA pathway and MSNs activity through direct Gi-mediated inhibition of adenylyl cyclase.

We found that a central administration of TG dampened key striatal molecular pathways, notably the MAPK- and mTOR-dependent phosphorylations of p70S6K and rpS6 protein together with decreased phosphorylation of the cAMP responsive target DARPP-32, revealing an impaired DA signalling. Such molecular impairment was highlighted also under amphetamine treatment.

2. Physiological implication of TG-mediated modulation of DRD2 signaling

Noteworthy, activated DRD2 can dimerize with β -arrestin, mediating DRD2 internalization and activation of the protein kinase B/Akt, β -Arrestin 2 and protein phosphatase 2 (PP2A) complex (Beaulieu et al., 2005). This complex has been shown to operate in striatal DRD2-MSN independently of cAMP pathway through the Akt/GSK-3 β (Beaulieu et al., 2005; Beaulieu et al., 2004). Elevated DA levels lead to a reduction p-Akt Ser⁴⁷³/Thr³⁰⁸, and GSK-3 activation through the reduction of its phosphorylation on Ser⁹ (Beaulieu et al., 2005; Beaulieu et al., 2004; Peterson et al., 2015). In our

Results

experiments, while decreasing MAPK, mTOR and cAMP DA-dependent signalling, BTGD rather activated DRD2- β -arrestin signaling pathway as indicated by the phosphorylation status of both pAkt-Thr⁴⁷³ and GSK3b^{Ser9} (**Figure 3**). Studies using DRD2 receptor or ligand that exert biased signal transduction for β -arrestin have clearly shown that DRD2- β -arrestin signalling is mandatory for psychostimulants-induced hyperlocomotion (Allen et al., 2011) (Peterson et al., 2015). In that view, a specific action onto DRD2-mediated β -arrestin signalling would provide a mechanism by which central TG delivery oppose to amphetamine-induced locomotion.

Since the striatum harbours two distinct cell-type specific populations, notably the direct and the indirect pathways, we tried to assess the impact of TG on each MSNs projecting population. Interestingly, we found that behavioural and molecular consequence of DRD2 pharmacological blockade by haloperidol, which in turn activates striatal D2R-MSN, was almost completely blunted by central TG delivery. Surprisingly, SKF38393-induced activation of D1R-MSN and associated behaviour remained unchanged. These results show for the first time that circulating TG directly and specifically alters DRD2 transmission.

This result is specifically enlightening given that defective DRD2 abundance/signaling has been repeatedly associated with condition of hypertriglyceridemia such as high-fat feeding or obesity (Adams et al., 2015; Alsio et al., 2010; Guo et al., 2014; Kenny et al., 2013; Volkow et al., 2008). In addition, a restricted action of TG onto DRD2 allows to make prediction on DA-directed based on DRD2 specificity.

One possible mechanism underlying TG-induced blunted DA signalling could be the recruitment of DRD2 by the β -arrestin 2 protein, leading to its internalisation and the inactivation of the Akt pathway by the phosphatase PP2A (Beaulieu and Gainetdinov, 2011). This hypothesis is in agreement with our data showing a decreased activation of Akt and increased GSK-3 β activity. Whether the DRD2 internalisation is facilitated by MCL TG sensing still needs to be investigated.

Our hypothetical framework suggests a biphasic signalling of central TG administration, with a primary rapid PKA dependent response, and followed by a long-lasting β -arrestin dependent response and potentially and secondary effect in presynaptic VTA neurons.

This response would alter the tonic as well as firing state of dopamine signalling (Marcott et al., 2014), and lead to increase incentive salience/reduced motivation due to post-synaptic imbalance between DRD1 and DRD2 transmission. Indeed, the classical view of a “Go” reinforcement/reward positive and “no-go” negative reinforcement and aversion or negative reinforcement associated to DRD2 activation (Hikida et al., 2010; Kravitz et al., 2012) has been recently revised. Optogenetic activation or inhibition of DRD2-MSN in the NAc were shown to increase and decrease respectively the motivational aspect of food seeking (Soares-Cunha et al., 2016; Soares-Cunha et al., 2018). In this study, primary manipulation of the NAc also impacted onto a ventral pallidum (VP) inhibitory output to the VTA (Soares-Cunha et

al., 2016; Soares-Cunha et al., 2018). Furthermore, rapid chemogenetic-based inhibition of DRD2 in the striatum were shown to increase “Go”-mediated reinforcement (Carvalho Poyraz et al., 2016).

Hence, by exerting an inhibitory action onto DRD2 transmission central TG sensing would favour DRD1-mediated reinforcement/reward while opposing DRD2-dependent increase of motivation. Furthermore, in condition where BTGD is sustained presynaptic DA-neurons would be engaged either by direct FFA delivery or indirect change in VP-inhibitory tone which altogether would decrease motivation. This hypothesis is supported by our observation that only sustained long-term (5-6 hrs), but not short-term (10min), BTGD decreases VTA DA neurons activity (**Figure 4 A, B**), thus suggesting that BTGD can exert reinforcing properties as evidenced in CPP (**Figure 5A**) while reducing motivational drive in operant performance (**Figure 7**).

Post-prandial increase in TG is typically transient (Ruge et al., 2009) but plasma TG are chronically increased in condition of obesity or high-fat feeding. So, similar to drug of abuse, hypertriglyceridemia could promote DRD2 desensitization. Coherent with that view is the loss of BTGD-mediated reinforcement in obese animals (**Figure 5 A-D**).

3. Translational aspect of central TG sensing

During nutrient deprivation the human brain exhibits heightened response to signal predicting food availability (Sun et al., 2015; Sun et al., 2014). After a meal, this response is decreased as a result of satiety signals. However, the precise nature of nutrients or signals which, once in the plasma after a meal, can directly or indirectly affect brain responses is still puzzling. We measured the correlation between meal-induced plasma change and brain responses to food cues in both hungry state and after a meal. Using unbiased whole-brain approach we found correlation between postprandial TG variation and change in fMRI signals in the vmPFC, globus pallidus, hippocampus and para-hippocampus. In the vmPFC, we co-varied out plasma FFA, glucose, insulin together with measured calorie intake and internal state rating for liking, fullness or hunger.

This result indicates that, among the plasmatic parameters measured, postprandial TG were solely responsible for meal-induced change in vmPFC responsiveness to food cues (**Figure 9**). In addition, and very importantly, we found opposite correlations between plasma TG and brain responses to food cues in the genetic background of the TaqIA A1/A2 allele, a polymorphism that has been consistently associated with defective DRD2 signaling and predisposition to compulsive/addictive disorders (Jonsson et al., 1999) (Stice et al., 2010) (Stice et al., 2015) (Barnard et al., 2009; Ritchie and Noble, 2003).

This result demonstrates that postprandial TG controls brain responses to food cues in a DRD2-dependent manner.

Results

Interestingly, the A1 allele results from a single-nucleotide polymorphism (SNP) located at the gene that encodes Ankyrin repeat and kinase domain containing 1 (ANKK1) near the gene encoding DRD2. ANKK1 belongs to the receptor-interacting protein (RIP) kinase which encompasses several structurally related family of factors that integrates various stimuli including inflammation, innate immune response downstream of Tumour-necrosis factor alpha (TNF α R1) receptor and Toll-like receptor (TLR), and converge upon c-jun N-terminal kinase (JNK), MAPK activity or NF- κ B signaling pathways (Meylan and Tschopp, 2005). *In silico* analysis of human protein-protein interaction reveals that among the ~30 predicted partners for human ANKK1 (Kotlyar et al.; Kotlyar et al., 2015b) half are found in the NF- κ B JNK or MAPK pathway (Berland et al., 2016). Given that central TLR, NF- κ B JNK or MAPK pathway were shown to serve as integrative signaling platform in response to high-fat feeding (Milanski et al., 2009; Posey et al., 2009; Shi et al., 2006; Zhang et al., 2008) it is tempting to speculate that the TaqA1-ANKK1 could directly participate in cellular TG sensing (Sun et al., 2017).

In conclusion, this study reveals that dietary TG can directly alter MCL circuit functions and reward seeking behaviour through DRD2-specific mechanism in both human and rodent. To our knowledge, it is the first time that behavioral, cellular and molecular evidence converged to bridging dietary TG inputs and DA-encoded reward. While we believe that this discovery might provide new avenues for therapeutic intervention in addictive/compulsive feeding and behaviour, obesity and obesity-associated pathologies, further studies are warrant to decipher the molecular events by which TG signal in the MCL together with the mechanism by which hypertriglyceridemia produce desensitization in striato-limbic neural circuits.

F. Acknowledgments

This work was supported by the Centre National la Recherche Scientifique (CNRS). C. B received a PhD fellowship from the Bayerische Forschungsstiftung and funding from The Fondation pour la Recherche Médicale (FRM). We acknowledge funding support from the Allen Foundation, The Nutricia research Foundation, The groupe lipides et nutrition (GLN), Modern Diet and Physiology Research Center (MDPRC). T.S.H obtained support from NIH-NIDA R01DA036612. This study was supported by grants from National Research Agency ANR SVSE 1 2011: “lipobrain” and ANR-16-CE14-0026 “Fat4Brain”.

We thank Enrica Montalban, Ewout Foppen, Anne Sophie Delbes, Raphaël GP Denis, Florence Darlot, for valuable technical and conceptual help.

We acknowledge the technical platform Functional and Physiological Exploration platform (FPE) of the Unit ‘Biologie Fonctionnelle et Adaptative’ (University Paris Diderot, Sorbonne Paris Cité, BFA, UMR 8251 CNRS, F-75205 Paris, France) for metabolic and behavioural analysis. We also acknowledge the animal core facility ‘Buffon’ of the University Paris Diderot Paris 7/Institut Jacques Monod, Paris for animal husbandry and breeding. We thank Olja Kacanski for administrative support, Isabelle Le Parco, Ludovic Maingault, Angélique Dauvin, Florianne Michel and Daniel Quintas for animals’ care and Sabria Allithi for genotyping.

G. Figure legends

Figure 1. Distribution of *Lpl* in the MCL

(A). Representative photo micrograph and quantification of RNA-scope *in-situ* hybridization signal for LPL, tyrosine hydroxylase (TH), dopamine receptor 1 and 2 (Drd1, Drd2) in the ventral tegmental area (VTA), nucleus accumbens (NAc) and Caudate putamen (CPu).

Figure 2. Striatal TG metabolism decreases amphetamine-induced behavioral and molecular adaptations

(A). Experimental design for brain TG delivery (BTGD). Animals were perfused for 6 hours prior to amphetamine i.p. injection (3 mg.kg⁻¹) (B). Lipidomic analysis of 54:4 TG, 38:5 DAG, 18:3 N6 FFA content in the NAc of animals centrally perfused with saline (SAL, n=7) or TG (TG, n=7). (C). Amphetamine-induced locomotor activity after a 6-hrs saline (SAL, n=5) or TG (TG, n=5) central perfusion (D,E). Representative photo micrograph and cell number quantification of cells positive for c-Fos ; in the nucleus accumbens (NAc) and dorsal striatum (DS) of animals infused with saline and injected with saline (SAL/SAL, n=3) or amphetamine (SAL/AMPH, n=6) and animals infused with TG and injected with amphetamine (TG/AMPH, n=5). (F,G). Representative pictures showing whole brain c-Fos-based signal and heatmaps quantification of brain structures in which central triglyceride perfusion (TG/AMPH, n=5) affect negatively or positively amphetamine-induced c-Fos response compared to controls (SAL/AMPH, n=5). ARH: Arcuate hypothalamic nucleus, BA: Bed nucleus of the accessory olfactory tract, MA: Magnocellular nucleus, PL: Prelimbic area, VTA: Ventral tegmental area, Mop: Primary motor area, NOD: Nodulus (X), SSP: Primary somatosensory area, SUT: Supratrigeminal nucleus, FRP2/3: Frontal pole, layer 2/3. (H,I) Representative photo micrograph and cell number quantification of cells positive for the phosphorylated Ser^{235/236} of the ribosomal protein S6 (rpS6) in the prefrontal cortex (PFC), striatum (DS), Nucleus accumbens (Nac) of animals infused with saline and injected with saline (SAL/SAL, n=3) or amphetamine (SAL/AMPH, n=6) and animals infused with TG and injected with amphetamine (TG/AMPH, n=5).

Figure 3. Central triglyceride delivery inhibits post-synaptic DRD2 but not DRD1 signaling. (A).

Representative western blot signals and quantification of signaling cascade downstream of dopamine 1 and 2 receptor in the striatum in mice after a 6-hrs central delivery of triglycerides (TG, n=9) or saline (SAL, n=9) p70S6K: p70 ribosomal S6 kinase, rpS6: ribosomal protein S6, t-rpS6: total-ribosomal protein S6, ERK: Extracellular-signal Regulated Kinase, DARPP-32: 32 kDa dopamine and cAMP regulated phosphoprotein, TH: tyrosine hydroxylase, t-TH: total Tyrosine hydroxylase. (B). Post-synaptic molecular signaling induced by DA in MSNs . (C). Representative western blot signals and quantification of signaling of the Akt/GSK3 pathway. GSK-3: glycogen synthase kinase 3 (D). SKF-38393 (10 mg.kg⁻¹) and Amphetamine (3 mg.kg⁻¹) induced-activity on 3 consecutive days after 6 hours of central saline (SAL, n=6) or triglycerides (TG, n=6) delivery. (E). Representative photo micrograph and cell number quantification of cells positive for c-Fos after one hour in animals infused with saline and injected with saline (SAL/SAL, n=3) or SKF-38393 (SAL/AMPH, n=6) and animals infused with TG and injected with SKF-38393 (TG/AMPH, n=5). (F). Catalepsy time induced by haloperidol i.p. injection (0.5 mg.kg⁻¹) after 6 hr central saline (SAL, n=13) or triglyceride (TG, n=15) delivery. (G). Representative photo

micrograph and cell number quantification of cells positive for c-Fos and rpS6 235/236 after one hour in animals infused with saline and injected with saline (SAL/SAL, n=4) or haloperidol (SAL/HALO, n=5) and animals infused with TG and injected with haloperidol (TG/HALO, n=5).

Figure 4. Short- and long-term TG perfusion differentially affect presynaptic component of the dopaminergic circuit.

(A). Data show single-cell extracellular electrophysiological recording of dopaminergic neurons in the VTA on anaesthetized animals receiving SAL or TG injections through the carotid artery, with a follow-up of neuronal frequency and firing for 10 minutes. Histograms display the maximum frequency recorded for each neurons and the maximal spike in burst. (B). Animals were centrally infused for 6 hours with SAL or TG then anaesthetized and dopaminergic neurons of the VTA were recorded. Data show representative traces of dopaminergic neurons records as well as average frequencies and spikes observed during the recording.

Figure 5. Central triglyceride delivery is reinforcing in lean but not obese animal. (A). Experimental design for CPP. On day 1, animals are carefully put in the middle of the cage and explore freely a two compartments apparatus for 15 minutes. The following days are conditioning sessions of one hour, during which the animals learn to associate one or another compartment to saline (SAL) or triglycerides (TG). After 8 days of conditioning (4 sessions in each compartment), animals explore the two compartments freely for 15 minutes. The analysis takes into account the time spent in the rewarded compartment before and after conditioning. (B). Difference of time (in seconds) spent in the compartment rewarded with either saline (n=11) or triglycerides (n=14). (C). Body weight of lean (n=5) and obese (n=3) animals (g) and CPP (D).

Figure 6. Central triglyceride sensing differentially affects food and non-food reward encoding.

(A). Experimental design of CPP. Pre-test and post-test are performed as described in Figure 5. Each conditioning session is preceded with 6 hours central perfusion of saline (SAL, n=8) or triglycerides (TG, n=9). Conditioning consisted in 8 alternated sessions with standard diet (SD) or high-fat-high sucrose (HFHS) diet access for 30 minutes. The histogram shows HFHS consumption during conditioning sessions, in kcal. (B). CPP with amphetamine (3 mg.kg^{-1}) with conditioning preceded with 6 hours of central saline infusion (SAL, n=5) or triglycerides (TG, n=5). (C). Binge eating design: animals had intermittent access to palatable drink enriched in triglycerides and sugar (HFHS drink) for 9 days. On day 10, animals were centrally infused with saline (SAL/binge, n=4) or triglycerides (TG/binge, n=5) 6 hours before intermittent access to HFHS drink. The graph shows HFHS drink consumption on day 9 and 10, after central infusions.

Figure 7. Motivational and hedonic aspects of reward are differentially affected by central triglycerides delivery. (A). Self-administration of saline (SAL, n=5) or triglycerides (TG, n=13) based on nose-pokes. Active nose-pokes and nose-pokes discrimination (=distinction between active and inactive nose-pokes) are shown in non-

Results

deprived ad libitum conditions, and deprived conditions. **(B)**. Self-administration of saline (SAL, n=6) or triglycerides 3 μ L per success (TG, n=6) based on lever press. Active lever press during 4 consecutive sessions are shown, as well as the kinetics of lever presses during the last session. **(C)**. After the 4 sessions of self-administration shown in **(B)**, animals performed one single operant task during which 2 lever presses led to central infusion of SAL or TG followed by one sucrose pellet reward delivery.

Figure 8. Central Lipoprotein lipase act onto food reward pre and post-synaptically

(A). Virus backbone used to decrease Lpl expression in the NAc and VTA. **(B)**. Operant behaviour responses related to NAc LPL knock-down. FR1: fix ratio 1. PR: Progressive ratio 1. Control animals are NAc-Lpl^{lox/lox}, n=6, while deleted animals are NAc-LPL ^{Δ/Δ} , n=4. **(C)**. Operant behaviour responses related to VTA LPL knock-down. Control animals are VTA-Lpl^{lox/lox}, n=6, while deleted animals are VTA-LPL ^{Δ/Δ} , n=5. **(D)**. Virus backbone used to increase Lpl expression in the NAc and VTA. **(E)**. Operant behaviour responses related to NAc LPL knock-in. Control animals are NAc^{Ctrl}, n=6, animals overexpressing LPL are NAc^{LPL}, n=6. **(F)**. Operant behaviour responses to VTA-LPL knock-in. Control animals are VTA^{Ctrl}, n=5, animals overexpressing LPL are VTA^{LPL}, n=6.

Figure 9. Postprandial triglycerides controls brain response to food-cues in dopamine receptor 2-dependent manner.

(A). Experimental protocol for fMRI studies and food stimulation **(B)**. Brain response imaging differential between hungry and fixed condition. Lateral Globus Pallidus **(B)** vmPFC before **(C, left)** and after confounding factors signals were covaried out **(C, right)** **(D, E)**. correlation with plasma TG and A1/A2 dosage in GP **(D)**, and vmPFC before **(E, left)** and after **(E, right)** confounding factors signals were covaried out **(E)**.

Supplementary Figure 1: (A). Lpl expression sites based on *In situ* hybridization data in C57Bl6/J mouse brain (male) from the Allen Institute. FRP: frontal pole layer, NAc: nucleus accumbens, PFC: prefrontal cortex, VTA: ventral tegmental area, SUP: pontine structures. **(B)**. Quantification of Lpl expression in human brain structures **(C)** and substructures based on the Allen Institute database. FL: frontal lobe, Ins: insula, CgG : cingulate gyrus, HiF : hippocampal formation, PHG : parahippocampal gyrus, OL: occipital lobe, PL : parietal lobe, TL: temporal lobe, Amg: amygdala, BF: basal forebrain, GP: globus pallidus, Str: striatum, Cl: claustrum, ET: epithalamus, Hy: hypothalamus, Sbt: subthalamus, DT: dorsal thalamus, VT: ventral thalamus, MES: mesencephalon, CbCx: cerebellar cortex, CbN: cerebellar nuclei, Bpons: basal part of pons, PTg: pontine tegmentum, MY: myelencephalon, WM: white matter. Hippocampal formation expressing Lpl: DG: dentate gyrus, CA2: CA2 field, CA3: CA3 field, CA4: CA4 field. Amygdala formation expressing Lpl: CeA: central nucleus. Basal forebrain formation expressing Lpl: SI: substantia inominata. Striatal structures expressing Lpl: BCd: body of the caudate nucleus, HCd: head of the caudate nucleus, TCd: tail of the caudate nucleus, Acb: nucleus accumbens, Pu: putamen. Hypothalamic structures expressing Lpl: LHM: lateral hypothalamic area, mammillary region, MB: mammillary body, SuM: supramammillary nucleus, TM: tuberomammillary nucleus, LTu: lateral tuberal nucleus, PeF: perifornical nucleus.

Supplementary Figure 2: negative controls of RNAscope specificity. Images show the medial septum, motor cortex, brain regions with very few dopamine receptors expression.

Supplemental Figure 3: significant TAG and DAG changes found in lipidomics in mice perfused with 6 hr TG or saline.

Supplemental Figure 4: Vevo-photoacoustic on different rates of TG perfusion did not alter blood flow in anaesthetized animals. The big picture shows the main brain blood vessels, with the orientation axes on the right. On the bottom, images display representative observations of blood vessels while animals were not perfused, perfused with saline, or with triglycerides at two different rates of 1 $\mu\text{L}/\text{min}$ and 10 $\mu\text{L}/\text{min}$.

Supplemental Figure 5: behavioral optimization of HFHS intermittent access consumption. Animals get one-hour access to a palatable beverage for 10 days. Within a few days, animals quickly learn to eat the available palatable food until reaching a threshold of approximately 1.4 mL per session. The graph shows the daily consumption of palatable drink throughout the experiment.

Supplementary Figure 6: Representative photo micrograph of injection sites for viral modifications of LPL expression.

Supplementary Figure 7 : (A). Triglycerides levels at baseline or 60 minutes after lunch in hungry, fixed, or sated condition, depending on the genotype (A1+ in blue, A1- in red). (B). triglycerides correlations with intake calories in sated participants depending on genotype. (C). Scores of hunger and fullness in participants depending on the genotype. (D). Ratings of liking, intensity, wanting, edibility and familiarity for presented odours depending on condition and genotype.

Supplementary Figure 8: Postprandial triglyceride controls brain response to food-cues in dopamine receptor 2-dependent manner. Hippocampus on the left, para-hippocampus on the right.

H. Bibliography

- Adams, W.K., Sussman, J.L., Kaur, S., D'Souza A, M., Kieffer, T.J., and Winstanley, C.A. (2015). Long-term, calorie-restricted intake of a high-fat diet in rats reduces impulse control and ventral striatal D2 receptor signalling - two markers of addiction vulnerability. *Eur J Neurosci* *42*, 3095-3104.
- Allen, J.A., Yost, J.M., Setola, V., Chen, X., Sassano, M.F., Chen, M., Peterson, S., Yadav, P.N., Huang, X.P., Feng, B., et al. (2011). Discovery of beta-arrestin-biased dopamine D2 ligands for probing signal transduction pathways essential for antipsychotic efficacy. *Proc Natl Acad Sci U S A* *108*, 18488-18493.
- Alsio, J., Olszewski, P.K., Norback, A.H., Gunnarsson, Z.E., Levine, A.S., Pickering, C., and Schioth, H.B. (2010). Dopamine D1 receptor gene expression decreases in the nucleus accumbens upon long-term exposure to palatable food and differs depending on diet-induced obesity phenotype in rats. *Neuroscience* *171*, 779-787.
- Babbs, R.K., Sun, X., Felsted, J., Chouinard-Decorte, F., Veldhuizen, M.G., and Small, D.M. (2013). Decreased caudate response to milkshake is associated with higher body mass index and greater impulsivity. *Physiol Behav* *121*, 103-111.
- Baik, J.H. (2013). Dopamine signaling in reward-related behaviors. *Front Neural Circuits* *7*, 152.
- Banks, W.A., Farr, S.A., Salameh, T.S., Niehoff, M.L., Rhea, E.M., Morley, J.E., Hanson, A.J., Hansen, K.M., and Craft, S. (2018). Triglycerides cross the blood-brain barrier and induce central leptin and insulin receptor resistance. *Int J Obes (Lond)* *42*, 391-397.
- Barnard, N.D., Noble, E.P., Ritchie, T., Cohen, J., Jenkins, D.J., Turner-McGrievy, G., Gloede, L., Green, A.A., and Ferdowsian, H. (2009). D2 dopamine receptor Taq1A polymorphism, body weight, and dietary intake in type 2 diabetes. *Nutrition* *25*, 58-65.
- Bateup, H.S., Santini, E., Shen, W., Birnbaum, S., Valjent, E., Surmeier, D.J., Fisone, G., Nestler, E.J., and Greengard, P. (2010). Distinct subclasses of medium spiny neurons differentially regulate striatal motor behaviors. *Proc Natl Acad Sci U S A* *107*, 14845-14850.
- Beaulieu, J.M., and Gainetdinov, R.R. (2011). The physiology, signaling, and pharmacology of dopamine receptors. *Pharmacological reviews* *63*, 182-217.
- Beaulieu, J.M., Sotnikova, T.D., Marion, S., Lefkowitz, R.J., Gainetdinov, R.R., and Caron, M.G. (2005). An Akt/beta-arrestin 2/PP2A signaling complex mediates dopaminergic neurotransmission and behavior. *Cell* *122*, 261-273.
- Beaulieu, J.M., Sotnikova, T.D., Yao, W.D., Kockeritz, L., Woodgett, J.R., Gainetdinov, R.R., and Caron, M.G. (2004). Lithium antagonizes dopamine-dependent behaviors mediated by an AKT/glycogen synthase kinase 3 signaling cascade. *Proc Natl Acad Sci U S A* *101*, 5099-5104.
- Ben-Zeev, O., Doolittle, M.H., Singh, N., Chang, C.H., and Schotz, M.C. (1990). Synthesis and regulation of lipoprotein lipase in the hippocampus. *J Lipid Res* *31*, 1307-1313.
- Benoit, S.C., Kemp, C.J., Elias, C.F., Abplanalp, W., Herman, J.P., Migrenne, S., Lefevre, A.L., Cruciani-Guglielmacci, C., Magnan, C., Yu, F., et al. (2009). Palmitic acid mediates hypothalamic insulin resistance by altering PKC-theta subcellular localization in rodents. *J Clin Invest* *119*, 2577-2589.
- Berland, C., Cansell, C., Hnasko, T.S., Magnan, C., and Luquet, S. (2016). Dietary triglycerides as signaling molecules that influence reward and motivation. *Current Opinion in Behavioral Sciences* *9*, 126-135.
- Berridge, K.C. (2009). 'Liking' and 'wanting' food rewards: brain substrates and roles in eating disorders. *Physiol Behav* *97*, 537-550.
- Bertran-Gonzalez, J., Bosch, C., Maroteaux, M., Matamalas, M., Herve, D., Valjent, E., and Girault, J.A. (2008). Opposing patterns of signaling activation in dopamine D1 and D2 receptor-expressing striatal neurons in response to cocaine and haloperidol. *J Neurosci* *28*, 5671-5685.
- Bessesen, D.H., Richards, C.L., Etienne, J., Goers, J.W., and Eckel, R.H. (1993). Spinal cord of the rat contains more lipoprotein lipase than other brain regions. *J Lipid Res* *34*, 229-238.
- Blouet, C., and Schwartz, G.J. (2010). Hypothalamic nutrient sensing in the control of energy homeostasis. *Behav Brain Res* *209*, 1-12.
- Cansell, C., Castel, J., Denis, R.G., Rouch, C., Delbes, A.S., Martinez, S., Mestivier, D., Finan, B., Maldonado-Aviles, J.G., Rijnsburger, M., et al. (2014). Dietary triglycerides act on mesolimbic structures to regulate the rewarding and motivational aspects of feeding. *Mol Psychiatry* *19*, 1095-1105.
- Carvalho Poyraz, F., Holzner, E., Bailey, M.R., Meszaros, J., Kenney, L., Kheirbek, M.A., Balsam, P.D., and Kellendonk, C. (2016). Decreasing Striatopallidal Pathway Function Enhances Motivation by Energizing the Initiation of Goal-Directed Action. *J Neurosci* *36*, 5988-6001.
- Clemens, K.J., Caille, S., and Cador, M. (2010). The effects of response operandum and prior food training on intravenous nicotine self-administration in rats. *Psychopharmacology (Berl)* *211*, 43-54.
- Dallman, M.F., Pecoraro, N.C., and la Fleur, S.E. (2005). Chronic stress and comfort foods: self-medication and abdominal obesity. *Brain Behav Immun* *19*, 275-280.

Davis, J.F., Tracy, A.L., Schurdak, J.D., Tschop, M.H., Lipton, J.W., Clegg, D.J., and Benoit, S.C. (2008). Exposure to elevated levels of dietary fat attenuates psychostimulant reward and mesolimbic dopamine turnover in the rat. *Behav Neurosci* *122*, 1257-1263.

Dayan, P., and Berridge, K.C. (2014). Model-based and model-free Pavlovian reward learning: revaluation, revision, and revelation. *Cognitive, affective & behavioral neuroscience* *14*, 473-492.

Di Chiara, G., and Imperato, A. (1988). Drugs abused by humans preferentially increase synaptic dopamine concentrations in the mesolimbic system of freely moving rats. *Proc Natl Acad Sci U S A* *85*, 5274-5278.

DiLeone, R.J., Taylor, J.R., and Picciotto, M.R. (2012). The drive to eat: comparisons and distinctions between mechanisms of food reward and drug addiction. *Nat Neurosci* *15*, 1330-1335.

Eckel, R.H., and Robbins, R.J. (1984). Lipoprotein lipase is produced, regulated, and functional in rat brain. *Proc Natl Acad Sci U S A* *81*, 7604-7607.

Farr, S.A., Yamada, K.A., Butterfield, D.A., Abdul, H.M., Xu, L., Miller, N.E., Banks, W.A., and Morley, J.E. (2008). Obesity and hypertriglyceridemia produce cognitive impairment. *Endocrinology* *149*, 2628-2636.

Figlewicz, D.P., Evans, S.B., Murphy, J., Hoen, M., and Baskin, D.G. (2003). Expression of receptors for insulin and leptin in the ventral tegmental area/substantia nigra (VTA/SN) of the rat. *Brain Res* *964*, 107-115.

Frank, M.J., and Fossella, J.A. (2011). Neurogenetics and pharmacology of learning, motivation, and cognition. *Neuropsychopharmacology* *36*, 133-152.

Fulton, S., Woodside, B., and Shizgal, P. (2000). Modulation of brain reward circuitry by leptin. *Science* *287*, 125-128.

Furlong, T.M., Supit, A.S., Corbit, L.H., Killcross, S., and Balleine, B.W. (2015). Pulling habits out of rats: adenosine 2A receptor antagonism in dorsomedial striatum rescues meth-amphetamine-induced deficits in goal-directed action. *Addict Biol*.

Gangarossa, G., Perroy, J., and Valjent, E. (2013). Combinatorial topography and cell-type specific regulation of the ERK pathway by dopaminergic agonists in the mouse striatum. *Brain structure & function* *218*, 405-419.

Goldberg, I.J., Soprano, D.R., Wyatt, M.L., Vanni, T.M., Kirchgessner, T.G., and Schotz, M.C. (1989). Localization of lipoprotein lipase mRNA in selected rat tissues. *J Lipid Res* *30*, 1569-1577.

Greene, J.G. (2006). Gene expression profiles of brain dopamine neurons and relevance to neuropsychiatric disease. *J Physiol* *575*, 411-416.

Guegan, T., Cutando, L., Ayuso, E., Santini, E., Fisone, G., Bosch, F., Martinez, A., Valjent, E., Maldonado, R., and Martin, M. (2013). Operant behavior to obtain palatable food modifies neuronal plasticity in the brain reward circuit. *Eur Neuropsychopharmacol* *23*, 146-159.

Guo, J., Simmons, W.K., Herscovitch, P., Martin, A., and Hall, K.D. (2014). Striatal dopamine D2-like receptor correlation patterns with human obesity and opportunistic eating behavior. *Mol Psychiatry* *19*, 1078-1084.

Hawrylycz, M.J., Lein, E.S., Guillozet-Bongaarts, A.L., Shen, E.H., Ng, L., Miller, J.A., van de Lagemaat, L.N., Smith, K.A., Ebbert, A., Riley, Z.L., et al. (2012). An anatomically comprehensive atlas of the adult human brain transcriptome. *Nature* *489*, 391-399.

Hikida, T., Kimura, K., Wada, N., Funabiki, K., and Nakanishi, S. (2010). Distinct roles of synaptic transmission in direct and indirect striatal pathways to reward and aversive behavior. *Neuron* *66*, 896-907.

Hryhorczuk, C., Sheng, Z., Decarie-Spain, L., Giguere, N., Ducrot, C., Trudeau, L.E., Routh, V.H., Alquier, T., and Fulton, S. (2018). Oleic Acid in the Ventral Tegmental Area Inhibits Feeding, Food Reward, and Dopamine Tone. *Neuropsychopharmacology* *43*, 607-616.

Jackson, D.M., and Westlinddanielsson, A. (1994). Dopamine-Receptors - Molecular-Biology, Biochemistry and Behavioral-Aspects. *Pharmacol Ther* *64*, 291-370.

Johnson, P.M., and Kenny, P.J. (2010). Dopamine D2 receptors in addiction-like reward dysfunction and compulsive eating in obese rats. *Nat Neurosci* *13*, 635-641.

Jonsson, E.G., Nothen, M.M., Grunhage, F., Farde, L., Nakashima, Y., Propping, P., and Sedvall, G.C. (1999). Polymorphisms in the dopamine D2 receptor gene and their relationships to striatal dopamine receptor density of healthy volunteers. *Mol Psychiatry* *4*, 290-296.

Karatayev, O., Gaysinskaya, V., Chang, G.Q., and Leibowitz, S.F. (2009). Circulating triglycerides after a high-fat meal: predictor of increased caloric intake, orexigenic peptide expression, and dietary obesity. *Brain Res* *1298*, 111-122.

Kenny, P.J., Voren, G., and Johnson, P.M. (2013). Dopamine D2 receptors and striatopallidal transmission in addiction and obesity. *Curr Opin Neurobiol*.

Kessler, R.M., Hutson, P.H., Herman, B.K., and Potenza, M.N. (2016). The neurobiological basis of binge-eating disorder. *Neurosci Biobehav Rev* *63*, 223-238.

Kotlyar, M., Pastrello, C., Pivetta, F., Lo Sardo, A., Cumbaa, C., Li, H., Naranian, T., Ding, Z.Y., Vafaei, F., Broackes-Carter, F., et al. (2015a). In silico prediction of physical protein interactions and characterization of interactome orphans. *Nat Methods* *12*, 79-84.

Results

- Kotlyar, M., Pastrello, C., Pivetta, F., Lo Sardo, A., Cumbaa, C., Li, H., Naranian, T., Niu, Y., Ding, Z., Vafaee, F., et al. (2015b). In silico prediction of physical protein interactions and characterization of interactome orphans. *Nat Methods* *12*, 79-84.
- Kravitz, A.V., Tye, L.D., and Kreitzer, A.C. (2012). Distinct roles for direct and indirect pathway striatal neurons in reinforcement. *Nat Neurosci* *15*, 816-818.
- Lam, T.K., Pocai, A., Gutierrez-Juarez, R., Obici, S., Bryan, J., Aguilar-Bryan, L., Schwartz, G.J., and Rossetti, L. (2005). Hypothalamic sensing of circulating fatty acids is required for glucose homeostasis. *Nat Med* *11*, 320-327.
- Laperrousaz, E., Denis, R.G., Kassis, N., Contreras, C., Lopez, M., Luquet, S., Cruciani-Guglielmacci, C., and Magnan, C. (2018). Lipoprotein Lipase Expression in Hypothalamus Is Involved in the Central Regulation of Thermogenesis and the Response to Cold Exposure. *Front Endocrinol (Lausanne)* *9*, 103.
- Lein, E.S., Hawrylycz, M.J., Ao, N., Ayres, M., Bensinger, A., Bernard, A., Boe, A.F., Boguski, M.S., Brockway, K.S., Byrnes, E.J., et al. (2007). Genome-wide atlas of gene expression in the adult mouse brain. *Nature* *445*, 168-176.
- Lew, J.Y., Garcia-Espana, A., Lee, K.Y., Carr, K.D., Goldstein, M., Haycock, J.W., and Meller, E. (1999). Increased site-specific phosphorylation of tyrosine hydroxylase accompanies stimulation of enzymatic activity induced by cessation of dopamine neuronal activity. *Molecular pharmacology* *55*, 202-209.
- Liu, J., Gorski, J.N., Gold, S.J., Chen, D., Chen, S., Forrest, G., Itoh, Y., Marsh, D.J., McLaren, D.G., Shen, Z., et al. (2013). Pharmacological inhibition of diacylglycerol acyltransferase 1 reduces body weight and modulates gut peptide release--potential insight into mechanism of action. *Obesity (Silver Spring)* *21*, 1406-1415.
- Louveau, A., Smirnov, I., Keyes, T.J., Eccles, J.D., Rouhani, S.J., Peske, J.D., Derecki, N.C., Castle, D., Mandell, J.W., Lee, K.S., et al. (2015). Structural and functional features of central nervous system lymphatic vessels. *Nature* *523*, 337-341.
- Marcott, P.F., Mamaligas, A.A., and Ford, C.P. (2014). Phasic dopamine release drives rapid activation of striatal D2-receptors. *Neuron* *84*, 164-176.
- Meylan, E., and Tschopp, J. (2005). The RIP kinases: crucial integrators of cellular stress. *Trends Biochem Sci* *30*, 151-159.
- Michaelides, M., Thanos, P.K., Volkow, N.D., and Wang, G.J. (2012). Dopamine-related frontostriatal abnormalities in obesity and binge-eating disorder: emerging evidence for developmental psychopathology. *Int Rev Psychiatry* *24*, 211-218.
- Migrenne, S., Le Foll, C., Levin, B.E., and Magnan, C. (2011). Brain lipid sensing and nervous control of energy balance. *Diabetes Metab* *37*, 83-88.
- Milanski, M., Degasperi, G., Coope, A., Morari, J., Denis, R., Cintra, D.E., Tsukumo, D.M., Anhe, G., Amaral, M.E., Takahashi, H.K., et al. (2009). Saturated fatty acids produce an inflammatory response predominantly through the activation of TLR4 signaling in hypothalamus: implications for the pathogenesis of obesity. *J Neurosci* *29*, 359-370.
- Morton, G.J., Cummings, D.E., Baskin, D.G., Barsh, G.S., and Schwartz, M.W. (2006). Central nervous system control of food intake and body weight. *Nature* *443*, 289-295.
- Ostlund, S.B., Maidment, N.T., and Balleine, B.W. (2010). Alcohol-Paired Contextual Cues Produce an Immediate and Selective Loss of Goal-directed Action in Rats. *Frontiers in integrative neuroscience* *4*.
- Paradis, E., Clavel, S., Julien, P., Murthy, M.R., de Bilbao, F., Arsenijevic, D., Giannakopoulos, P., Vallet, P., and Richard, D. (2004). Lipoprotein lipase and endothelial lipase expression in mouse brain: regional distribution and selective induction following kainic acid-induced lesion and focal cerebral ischemia. *Neurobiology of disease* *15*, 312-325.
- Peterson, S.M., Pack, T.F., Wilkins, A.D., Urs, N.M., Urban, D.J., Bass, C.E., Lichtarge, O., and Caron, M.G. (2015). Elucidation of G-protein and beta-arrestin functional selectivity at the dopamine D2 receptor. *Proc Natl Acad Sci U S A* *112*, 7097-7102.
- Picard, A., Rouch, C., Kassis, N., Moullé, V.S., Croizier, S., Denis, R.G., Castel, J., Coant, N., Davis, K., Clegg, D.J., et al. (2013). Hippocampal lipoprotein lipase regulates energy balance in rodents. *Molecular Metabolism*.
- Posey, K.A., Clegg, D.J., Printz, R.L., Byun, J., Morton, G.J., Vivekanandan-Giri, A., Pennathur, S., Baskin, D.G., Heinecke, J.W., Woods, S.C., et al. (2009). Hypothalamic proinflammatory lipid accumulation, inflammation, and insulin resistance in rats fed a high-fat diet. *Am J Physiol Endocrinol Metab* *296*, E1003-1012.
- Reaven, G.M. (2006). The metabolic syndrome: is this diagnosis necessary? *The American journal of clinical nutrition* *83*, 1237-1247.
- Ritchie, T., and Noble, E.P. (2003). Association of seven polymorphisms of the D2 dopamine receptor gene with brain receptor-binding characteristics. *Neurochem Res* *28*, 73-82.
- Rothmund, Y., Preuschhof, C., Bohner, G., Bauknecht, H.C., Klingebiel, R., Flor, H., and Klapp, B.F. (2007). Differential activation of the dorsal striatum by high-calorie visual food stimuli in obese individuals. *Neuroimage* *37*, 410-421.

Ruge, T., Hodson, L., Cheeseman, J., Dennis, A.L., Fielding, B.A., Humphreys, S.M., Frayn, K.N., and Karpe, F. (2009). Fasted to fed trafficking of Fatty acids in human adipose tissue reveals a novel regulatory step for enhanced fat storage. *J Clin Endocrinol Metab* *94*, 1781-1788.

Salamone, J.D. (2007). Functions of mesolimbic dopamine: changing concepts and shifting paradigms. *Psychopharmacology* *191*, 389-389.

Salvatore, M.F., Calipari, E.S., and Jones, S.R. (2016). Regulation of Tyrosine Hydroxylase Expression and Phosphorylation in Dopamine Transporter-Deficient Mice. *ACS Chem Neurosci* *7*, 941-951.

Shi, H., Kokoeva, M.V., Inouye, K., Tzameli, I., Yin, H., and Flier, J.S. (2006). TLR4 links innate immunity and fatty acid-induced insulin resistance. *J Clin Invest* *116*, 3015-3025.

Skibicka, K.P., Hansson, C., Alvarez-Crespo, M., Friberg, P.A., and Dickson, S.L. (2011). Ghrelin directly targets the ventral tegmental area to increase food motivation. *Neuroscience* *180*, 129-137.

Soares-Cunha, C., Coimbra, B., David-Pereira, A., Borges, S., Pinto, L., Costa, P., Sousa, N., and Rodrigues, A.J. (2016). Activation of D2 dopamine receptor-expressing neurons in the nucleus accumbens increases motivation. *Nat Commun* *7*, 11829.

Soares-Cunha, C., Coimbra, B., Domingues, A.V., Vasconcelos, N., Sousa, N., and Rodrigues, A.J. (2018). Nucleus Accumbens Microcircuit Underlying D2-MSN-Driven Increase in Motivation. *eNeuro* *5*.

South, T., and Huang, X.F. (2008). High-fat diet exposure increases dopamine D2 receptor and decreases dopamine transporter receptor binding density in the nucleus accumbens and caudate putamen of mice. *Neurochem Res* *33*, 598-605.

Stice, E., Burger, K.S., and Yokum, S. (2015). Reward Region Responsivity Predicts Future Weight Gain and Moderating Effects of the TaqIA Allele. *The Journal of neuroscience : the official journal of the Society for Neuroscience* *35*, 10316-10324.

Stice, E., Spoor, S., Bohon, C., and Small, D.M. (2008). Relation between obesity and blunted striatal response to food is moderated by TaqIA A1 allele. *Science* *322*, 449-452.

Stice, E., Yokum, S., Bohon, C., Marti, N., and Smolen, A. (2010). Reward circuitry responsivity to food predicts future increases in body mass: moderating effects of DRD2 and DRD4. *Neuroimage* *50*, 1618-1625.

Stouffer, M.A., Woods, C.A., Patel, J.C., Lee, C.R., Witkovsky, P., Bao, L., Machold, R.P., Jones, K.T., de Vaca, S.C., Reith, M.E., et al. (2015). Insulin enhances striatal dopamine release by activating cholinergic interneurons and thereby signals reward. *Nat Commun* *6*, 8543.

Sun, X., Kroemer, N.B., Veldhuizen, M.G., Babbs, A.E., de Araujo, I.E., Gitelman, D.R., Sherwin, R.S., Sinha, R., and Small, D.M. (2015). Basolateral amygdala response to food cues in the absence of hunger is associated with weight gain susceptibility. *J Neurosci* *35*, 7964-7976.

Sun, X., Luquet, S., and Small, D.M. (2017). DRD2: Bridging the Genome and Ingestive Behavior. *Trends Cogn Sci* *21*, 372-384.

Sun, X., Veldhuizen, M.G., Wray, A.E., de Araujo, I.E., Sherwin, R.S., Sinha, R., and Small, D.M. (2014). The neural signature of satiation is associated with ghrelin response and triglyceride metabolism. *Physiol Behav* *136*, 63-73.

Sutton, L.P., and Caron, M.G. (2015). Essential role of D1R in the regulation of mTOR complex1 signaling induced by cocaine. *Neuropharmacology* *99*, 610-619.

Thaler, J.P., Yi, C.X., Schur, E.A., Guyenet, S.J., Hwang, B.H., Dietrich, M.O., Zhao, X., Sarruff, D.A., Izgur, V., Maravilla, K.R., et al. (2012). Obesity is associated with hypothalamic injury in rodents and humans. *J Clin Invest* *122*, 153-162.

Valdivia, S., Cornejo, M.P., Reynaldo, M., De Francesco, P.N., and Perello, M. (2015). Escalation in high fat intake in a binge eating model differentially engages dopamine neurons of the ventral tegmental area and requires ghrelin signaling. *Psychoneuroendocrinology* *60*, 206-216.

Valjent, E., Bertran-Gonzalez, J., Bowling, H., Lopez, S., Santini, E., Matamalas, M., Bonito-Oliva, A., Herve, D., Hoeffler, C., Klann, E., et al. (2011). Haloperidol regulates the state of phosphorylation of ribosomal protein S6 via activation of PKA and phosphorylation of DARPP-32. *Neuropsychopharmacology* *36*, 2561-2570.

Volkow, N.D., Wang, G.J., Fowler, J.S., Tomasi, D., and Baler, R. (2012). Food and drug reward: overlapping circuits in human obesity and addiction. *Curr Top Behav Neurosci* *11*, 1-24.

Volkow, N.D., Wang, G.J., Telang, F., Fowler, J.S., Thanos, P.K., Logan, J., Alexoff, D., Ding, Y.S., Wong, C., Ma, Y., et al. (2008). Low dopamine striatal D2 receptors are associated with prefrontal metabolism in obese subjects: possible contributing factors. *Neuroimage* *42*, 1537-1543.

Volkow, N.D., Wang, G.J., Tomasi, D., and Baler, R.D. (2013). Obesity and addiction: neurobiological overlaps. *Obesity reviews : an official journal of the International Association for the Study of Obesity* *14*, 2-18.

Voon, V., Derbyshire, K., Ruck, C., Irvine, M.A., Worbe, Y., Enander, J., Schreiber, L.R., Gillan, C., Fineberg, N.A., Sahakian, B.J., et al. (2015). Disorders of compulsivity: a common bias towards learning habits. *Mol Psychiatry* *20*, 345-352.

Vucetic, Z., and Reyes, T.M. (2010). Central dopaminergic circuitry controlling food intake and reward: implications for the regulation of obesity. *Wiley Interdiscip Rev Syst Biol Med* *2*, 577-593.

Results

- Wang, G.J., Volkow, N.D., Logan, J., Pappas, N.R., Wong, C.T., Zhu, W., Netusil, N., and Fowler, J.S. (2001). Brain dopamine and obesity. *Lancet* *357*, 354-357.
- Wang, H., Astarita, G., Taussig, M.D., Bharadwaj, K.G., DiPatrizio, N.V., Nave, K.A., Piomelli, D., Goldberg, I.J., and Eckel, R.H. (2011). Deficiency of lipoprotein lipase in neurons modifies the regulation of energy balance and leads to obesity. *Cell Metab* *13*, 105-113.
- Wang, H., and Eckel, R.H. (2012). Lipoprotein lipase in the brain and nervous system. *Annu Rev Nutr* *32*, 147-160.
- Wu, Q., and Palmiter, R.D. (2011). GABAergic signaling by AgRP neurons prevents anorexia via a melanocortin-independent mechanism. *Eur J Pharmacol*.
- Zhang, X., Zhang, G., Zhang, H., Karin, M., Bai, H., and Cai, D. (2008). Hypothalamic IKKbeta/NF-kappaB and ER stress link overnutrition to energy imbalance and obesity. *Cell* *135*, 61-73.
- Zhang, Y., Chen, K., Sloan, S.A., Bennett, M.L., Scholze, A.R., O'Keefe, S., Phatnani, H.P., Guarnieri, P., Caneda, C., Ruderisch, N., et al. (2014). An RNA-sequencing transcriptome and splicing database of glia, neurons, and vascular cells of the cerebral cortex. *J Neurosci* *34*, 11929-11947.

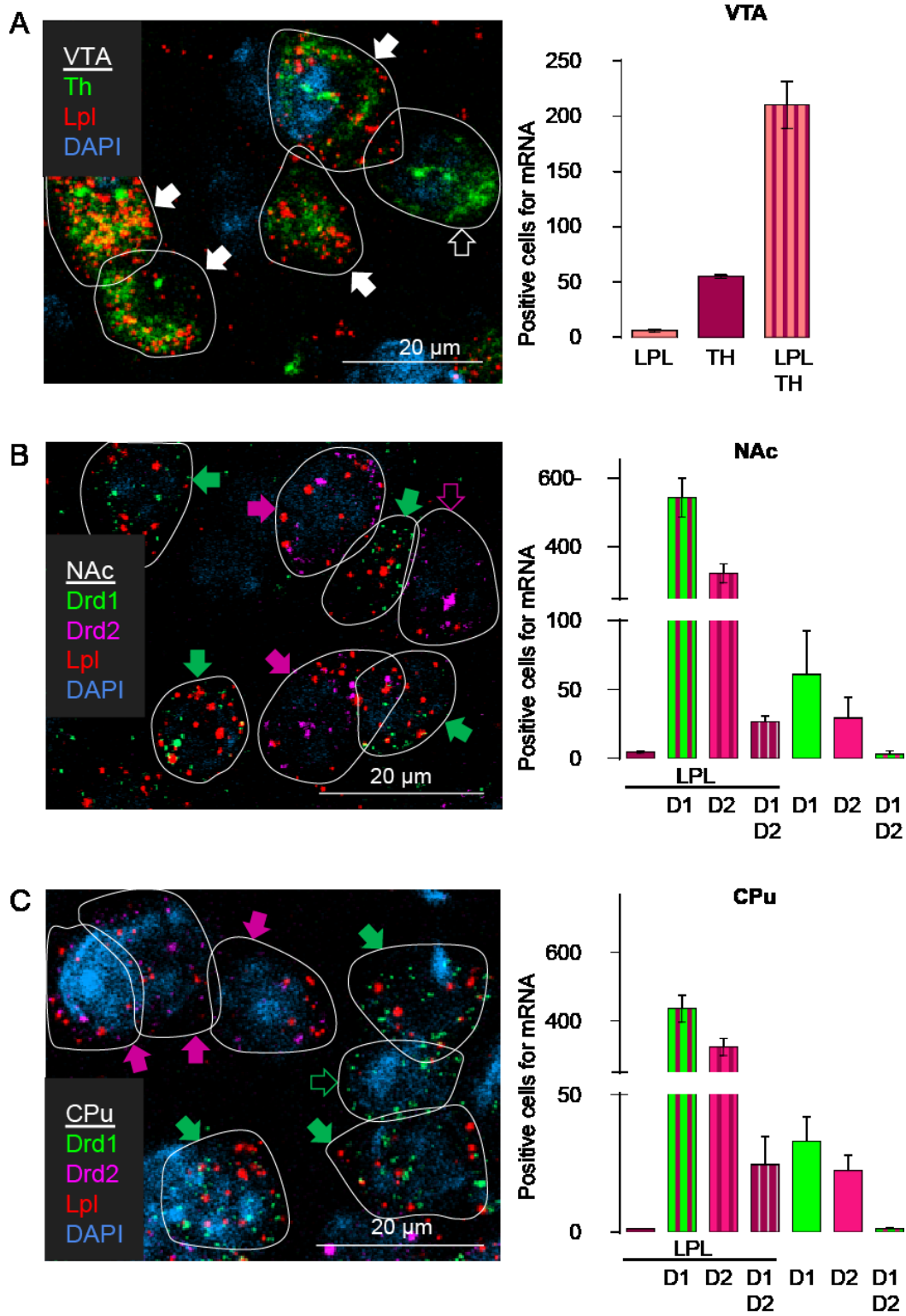
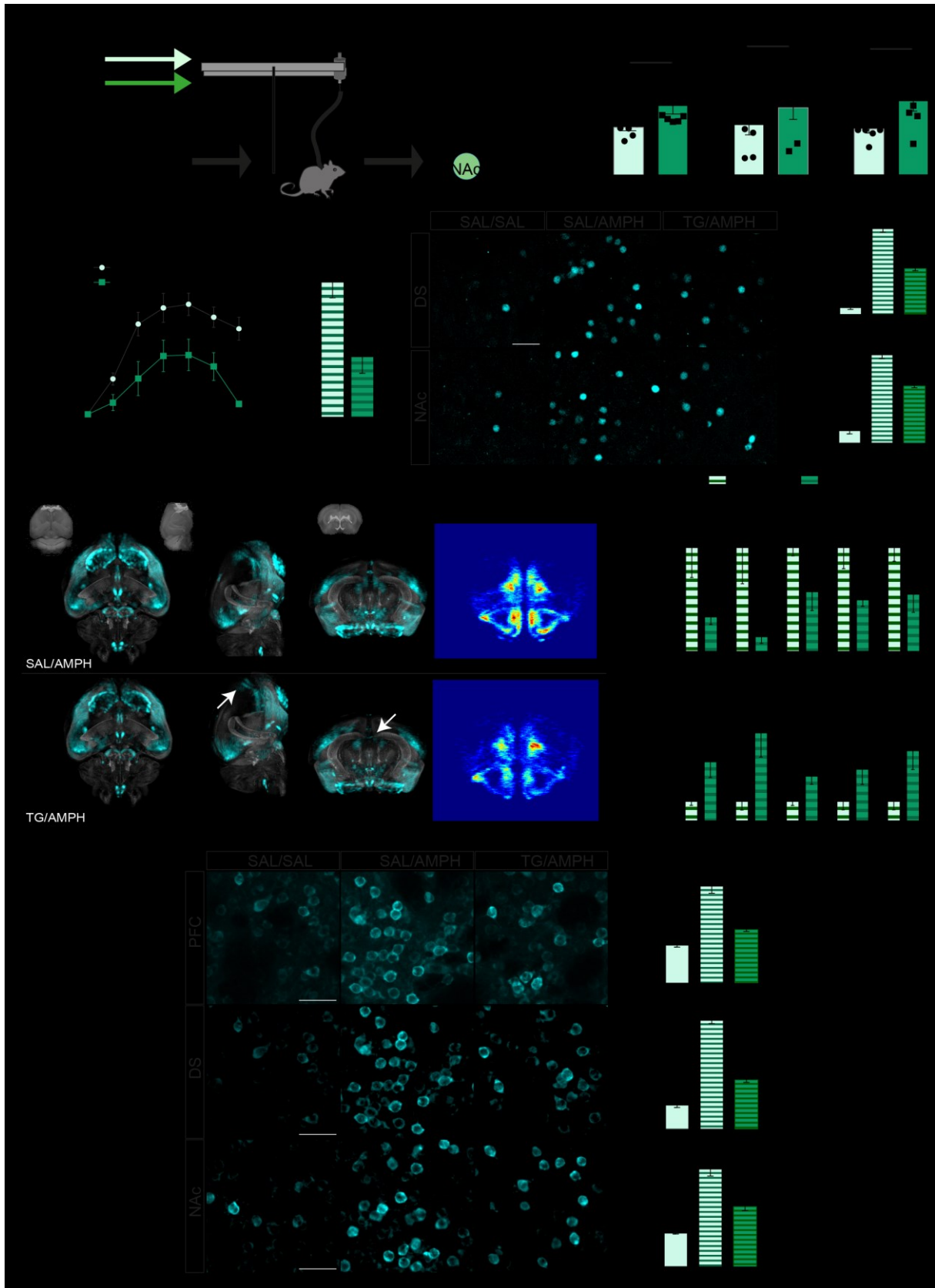
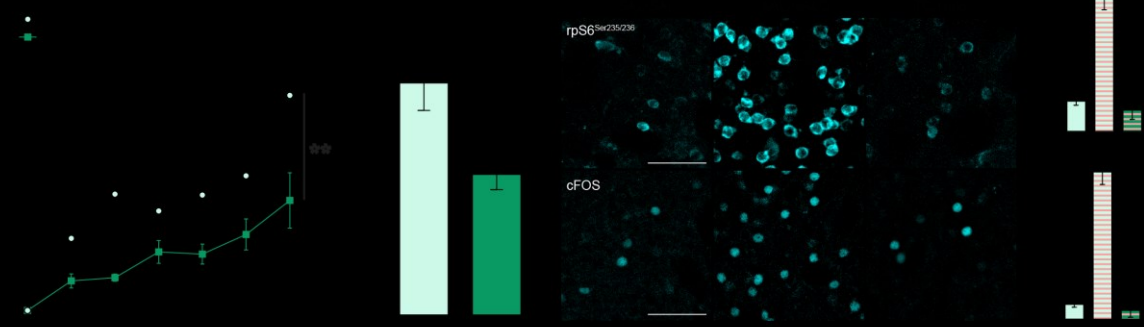
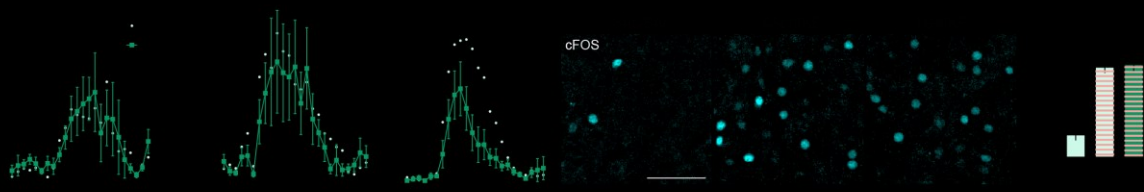
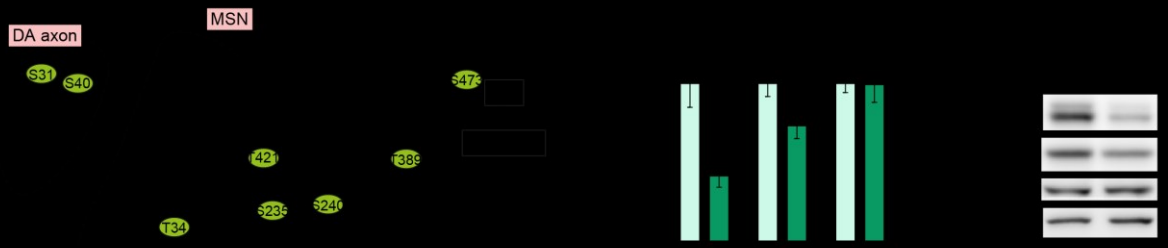
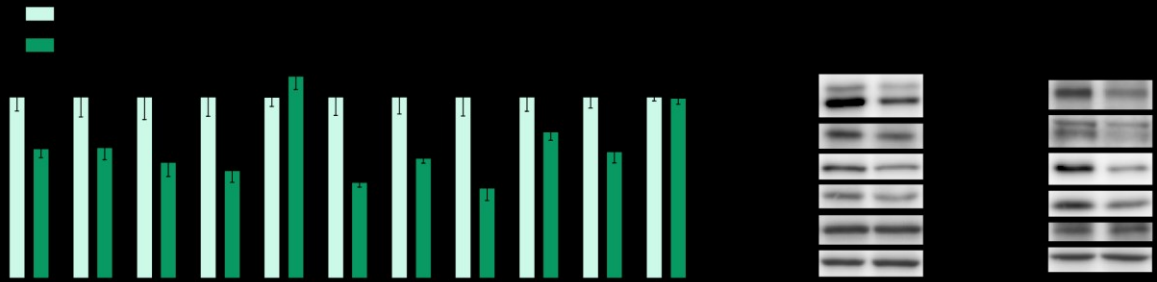

Figure 1

Results





Results

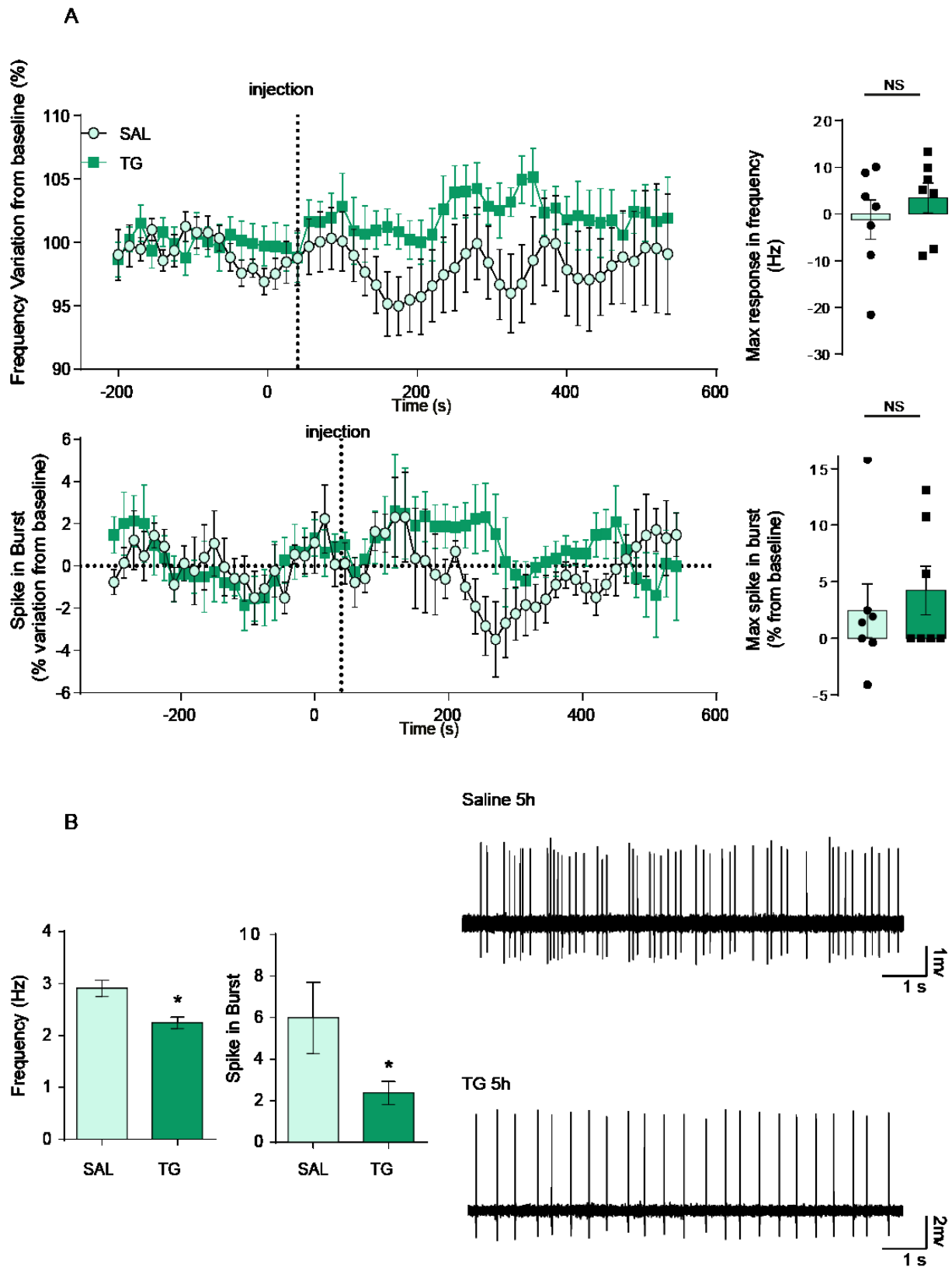

Figure 4

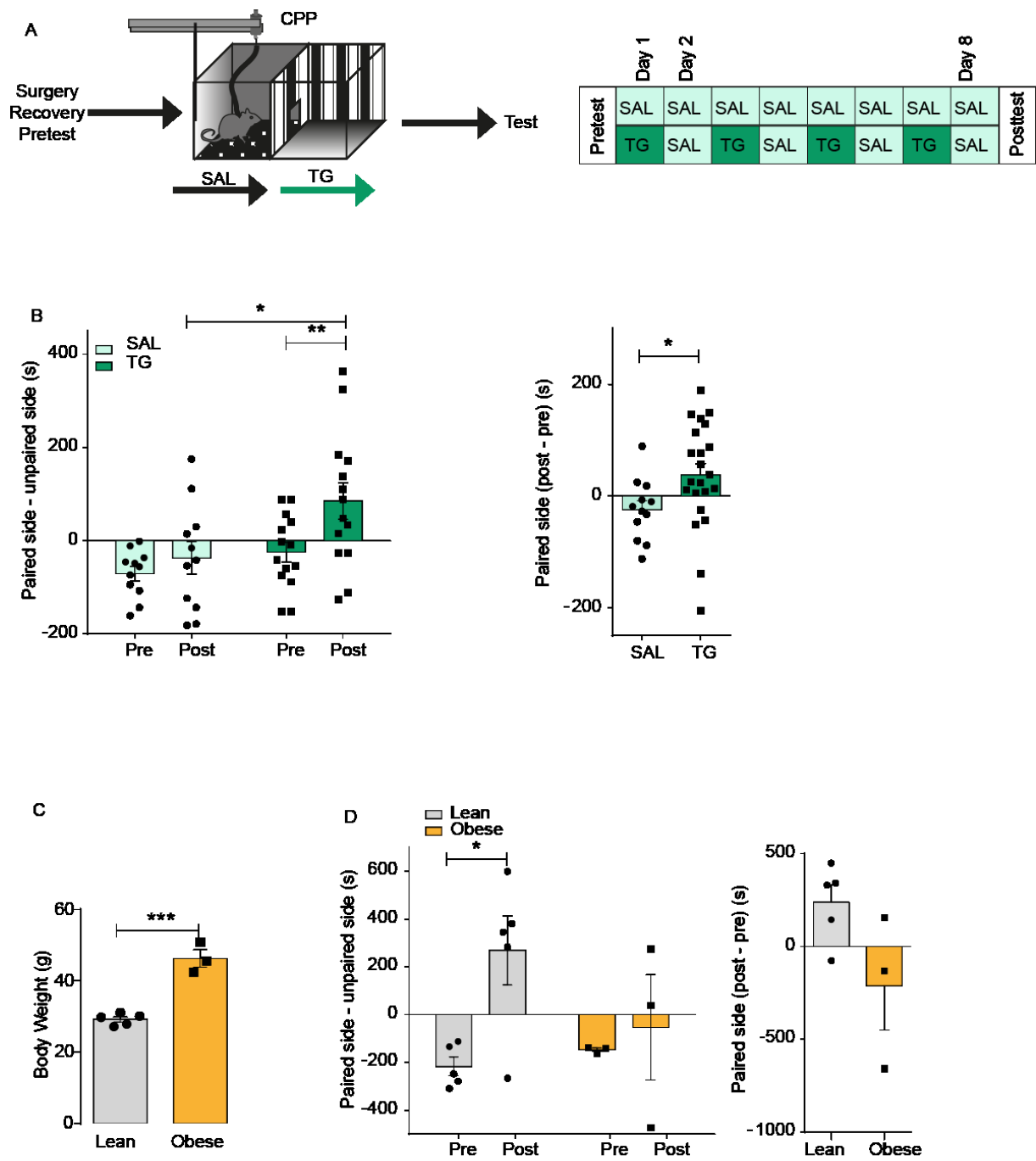

Figure 5

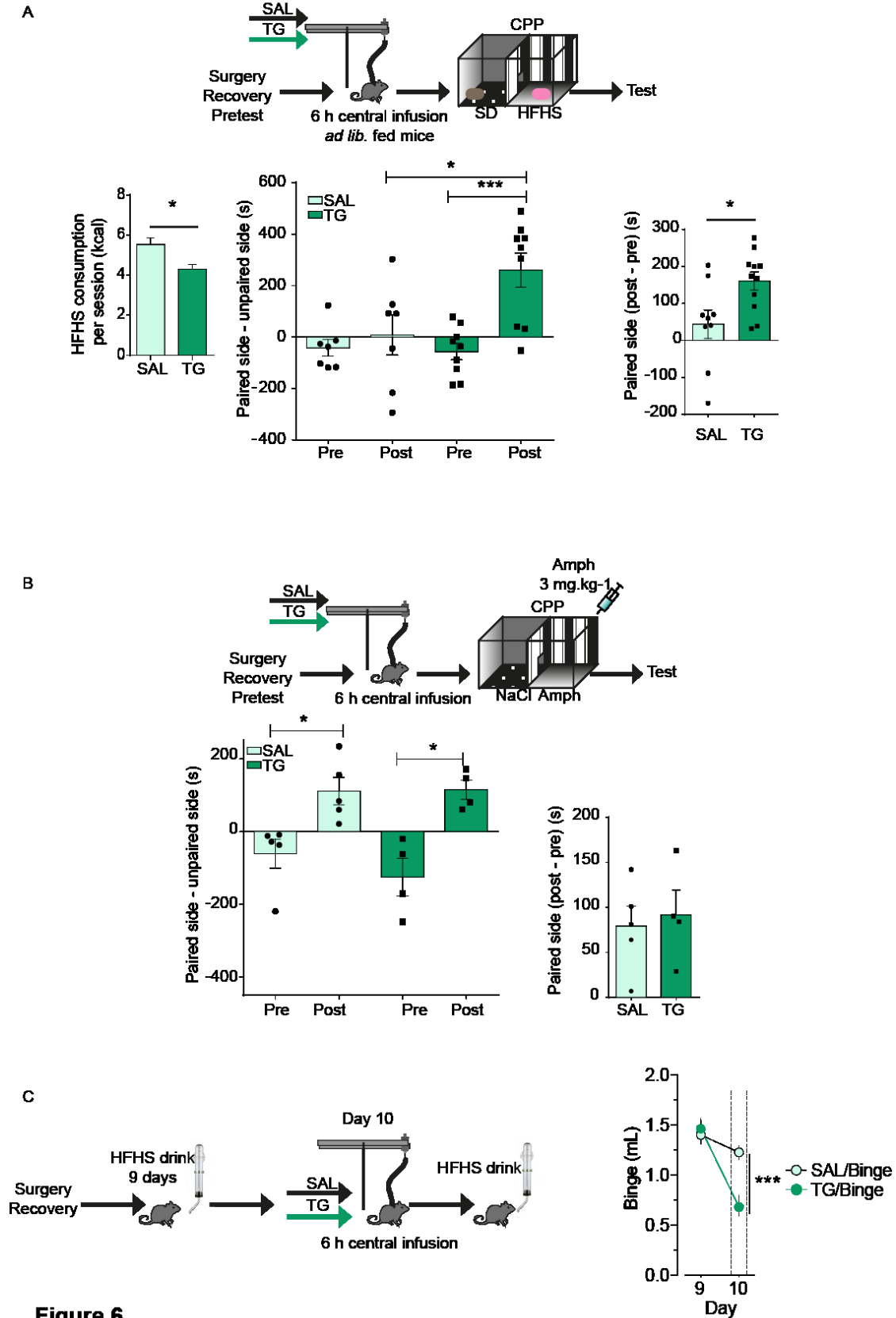

Figure 6

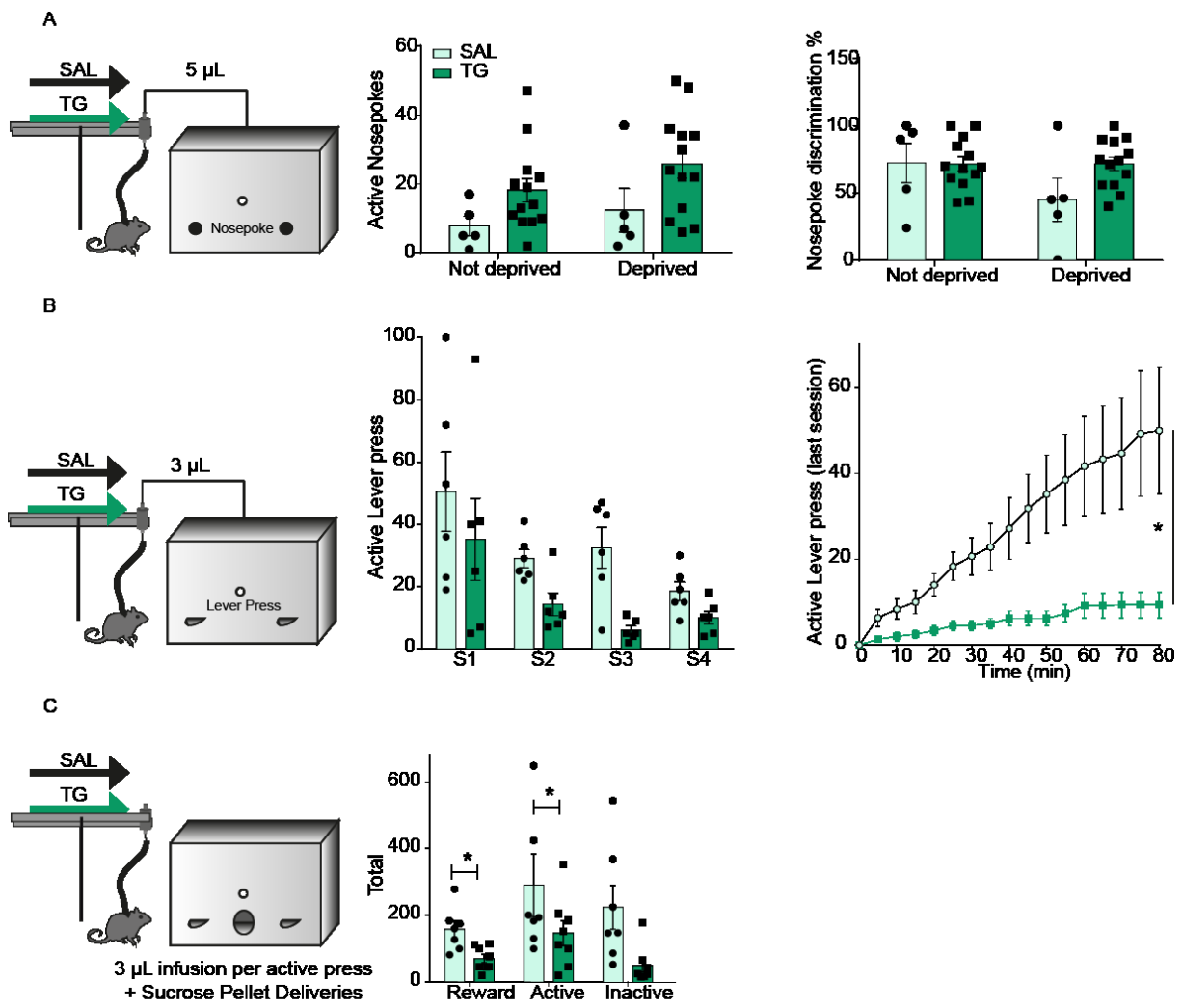
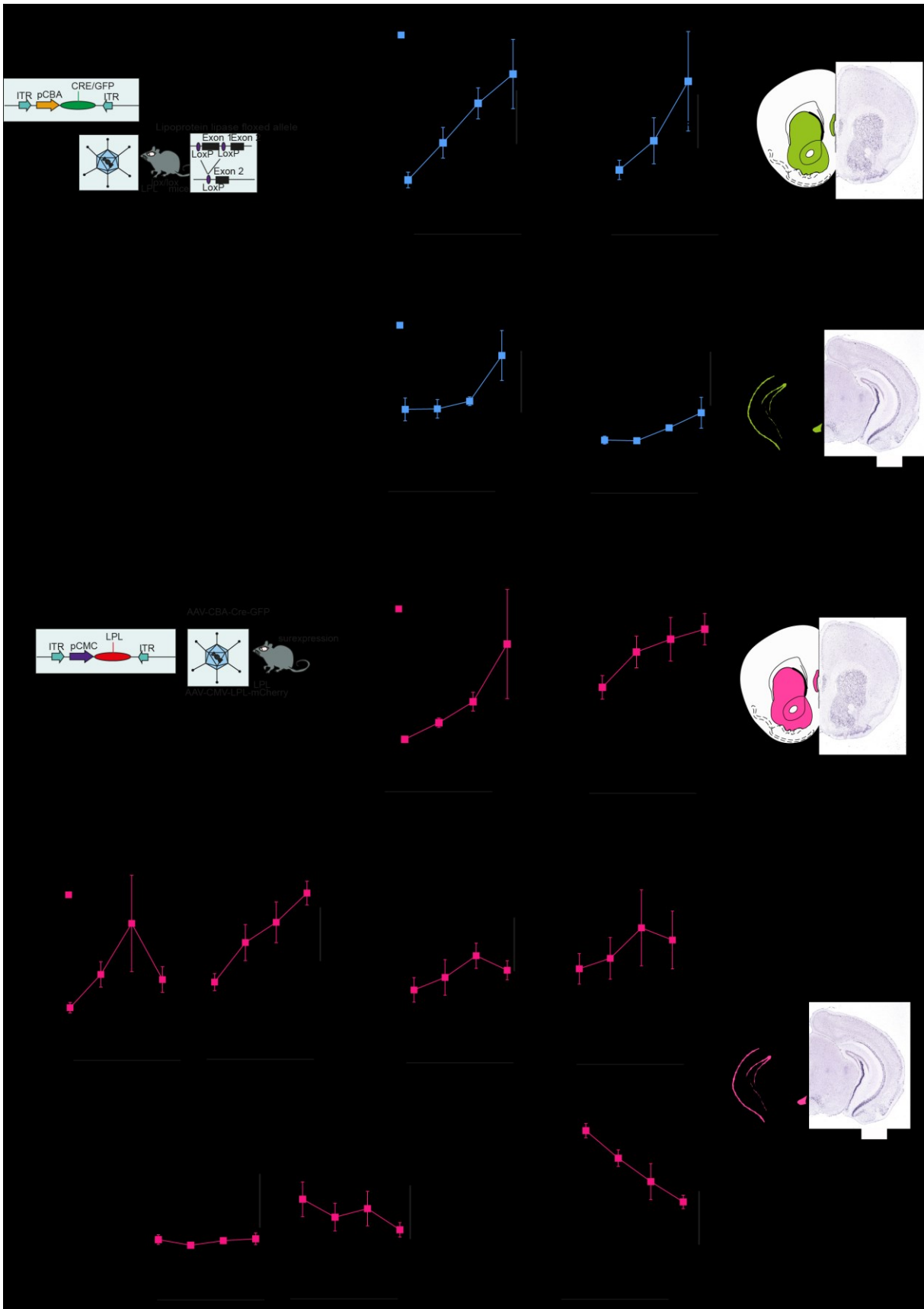

Figure 7

Results





odor/odorless
3 s

9 - 19 s

18x

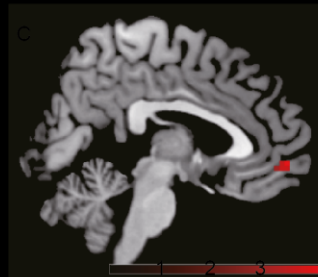
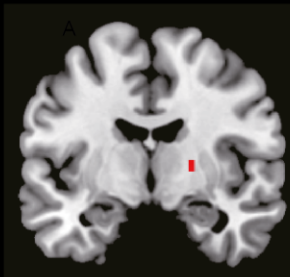

(FFA, glucose, insulin, calorie intake, fullness,
hunger and licking were covaried out)

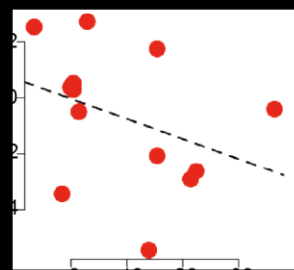
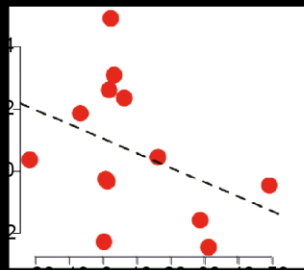
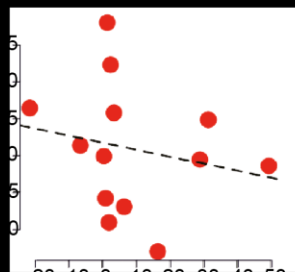
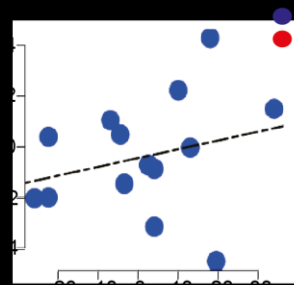
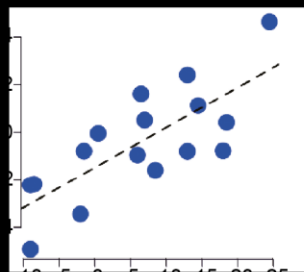
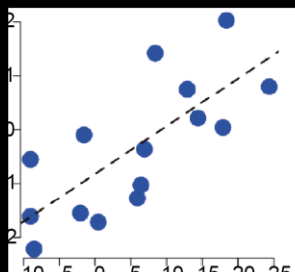

SUPPLEMENTARY RESULTS

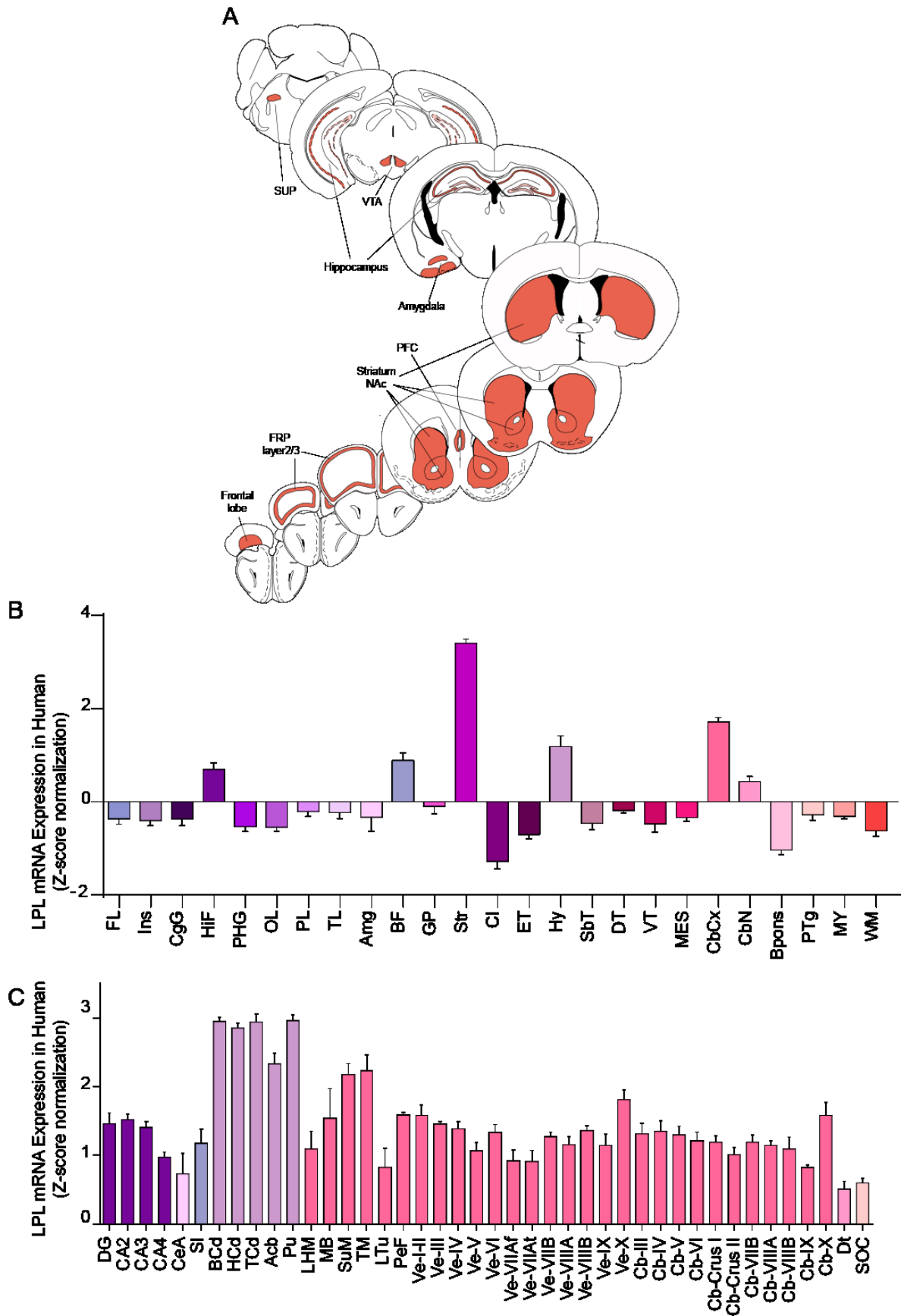

Supp.Figure 1

Results

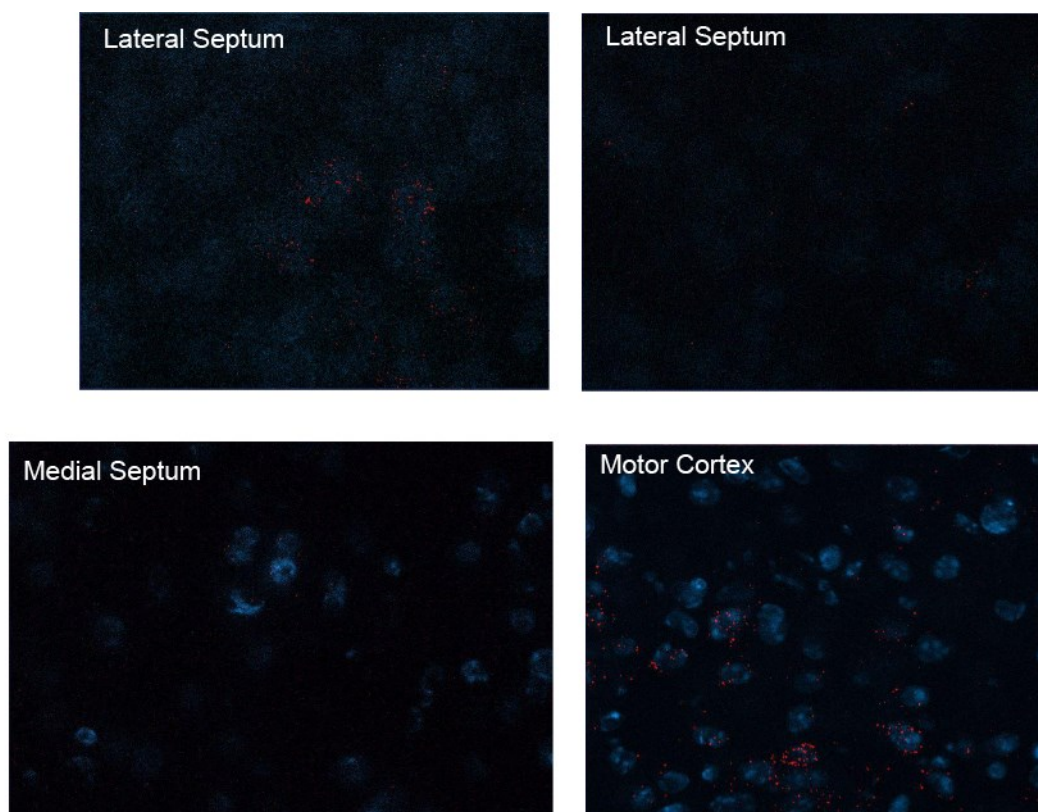

Supp. Figure 2

A. Glycerolipid	Saline (relative intensity/mg)	TG (relative intensity/mg protein)	P value
54:4 TAG	0.06899	0.1007	<u>0.0141</u>
60:9 TAG	0.005516	0.008994	<u>0.0189</u>
52:4 TAG	0.0579	0.08414	<u>0.0202</u>
54:5 TAG	0.05881	0.07751	<u>0.0287</u>
38:5 DAG	0.2182	0.2913	<u>0.0332</u>
50:2 TAG	0.1099	0.1594	<u>0.0332</u>
56:6 TAG	0.162	0.2352	<u>0.0379</u>
50:0 TAG	0.3527	0.4922	<u>0.04</u>
56:4 TAG	0.0229	0.03254	<u>0.0459</u>
52:3 TAG	0.1152	0.1581	<u>0.048</u>
60:12 TAG	0.05009	0.08068	<u>0.0481</u>
50:3 TAG	0.01548	0.01944	<u>0.0494</u>
56:5 TAG	0.05221	0.06834	<u>0.0533</u>
52:2 TAG	0.3677	0.4823	<u>0.0536</u>
Total TAG	3.528	4.655	<u>0.0649</u>
54:1 TAG	0.07028	0.08915	<u>0.068</u>
50:1 TAG	0.4231	0.6237	<u>0.0843</u>
60:11 TAG	0.01862	0.02401	<u>0.092</u>
58:6 TAG	0.01411	0.01989	<u>0.0938</u>
48:1 TAG	0.06114	0.07601	0.0998
B. Free Fatty Acid	(pmol/mg)	TG (pmol/mg protein)	P value
18:3 N6	1.329	2.143	<u>0.0216</u>
20:3 N9	1.071	1.629	<u>0.0554</u>

Supp. Figure 3

Results

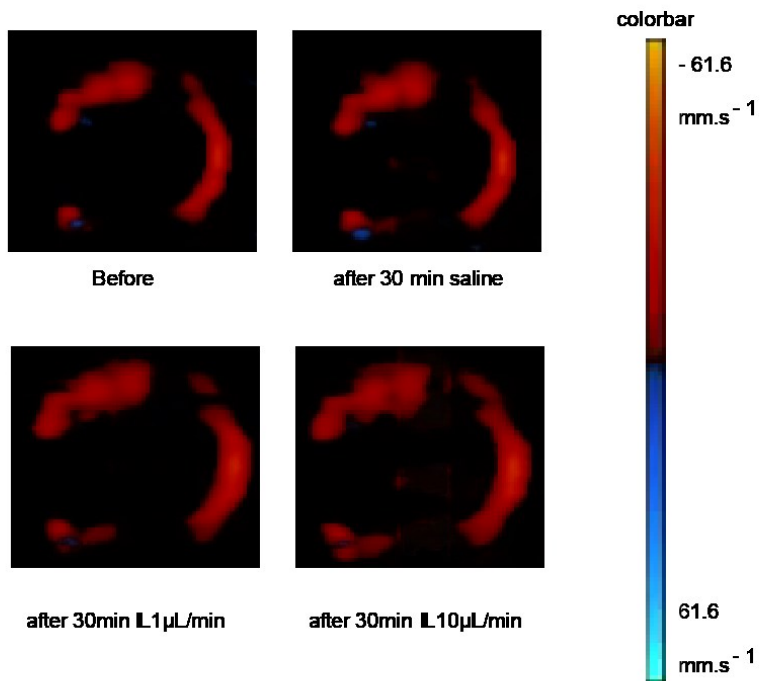
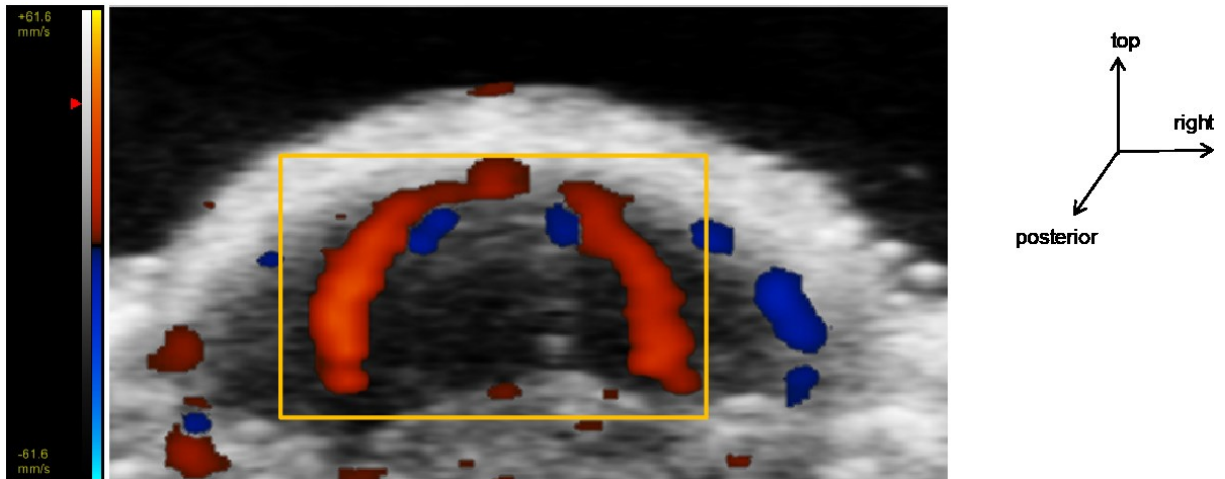

Supp. Figure 4

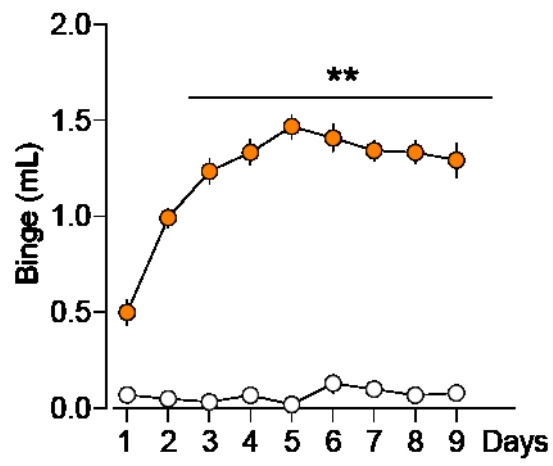

Supp. Figure 5

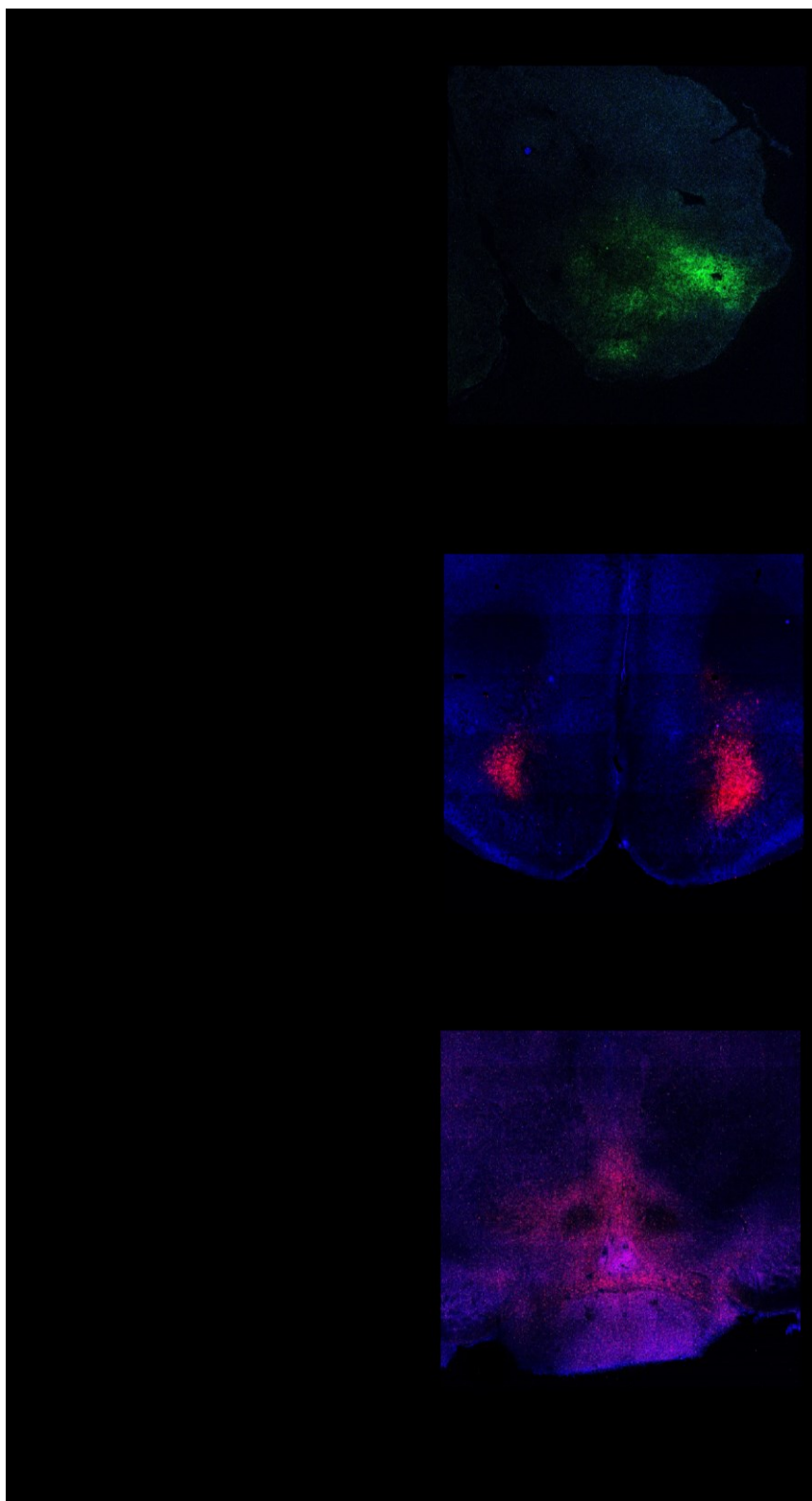

Supp. Figure 6

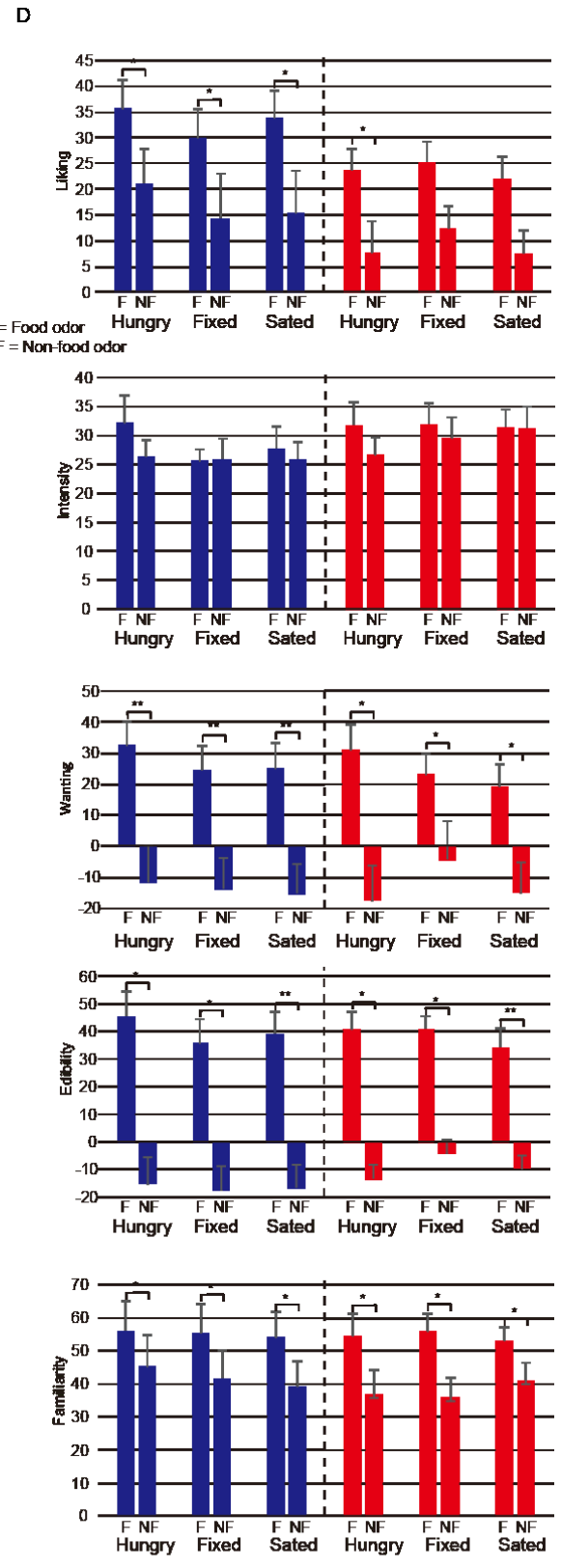
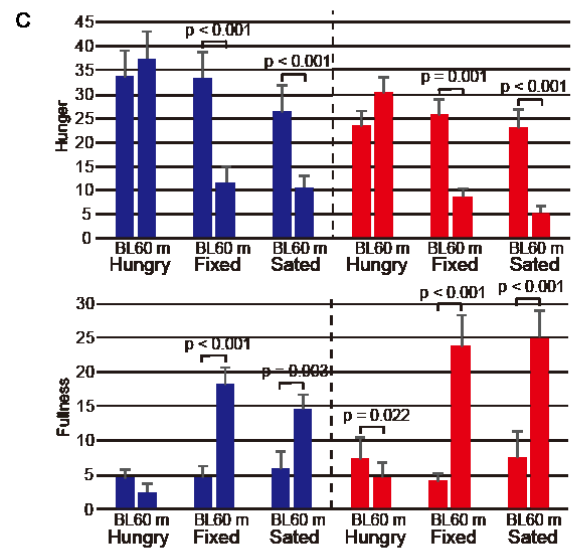
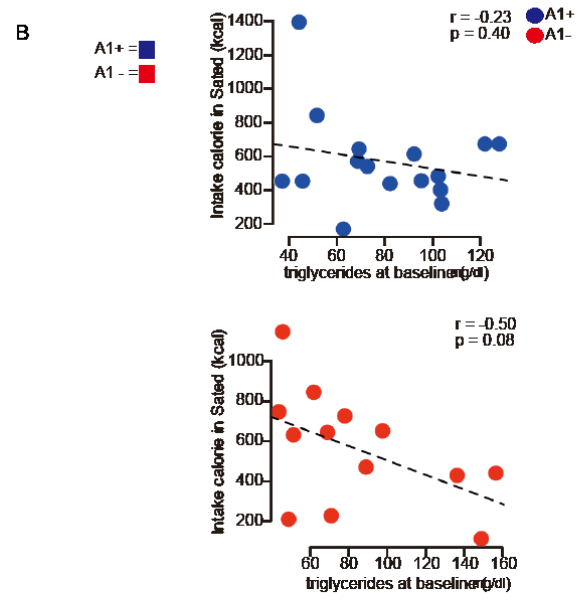
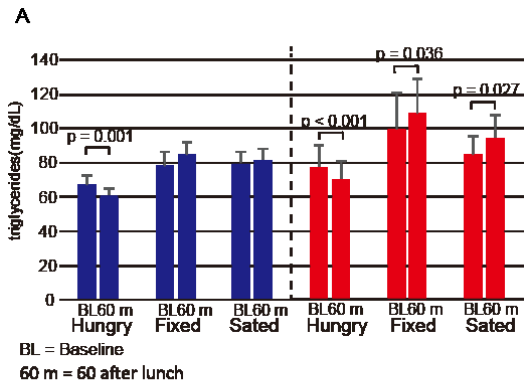

Supp. Figure 7

(Food - Non-food) in Hungry - (Food - Non-food) in Sated

Hippocampus

Para-Hippocampus

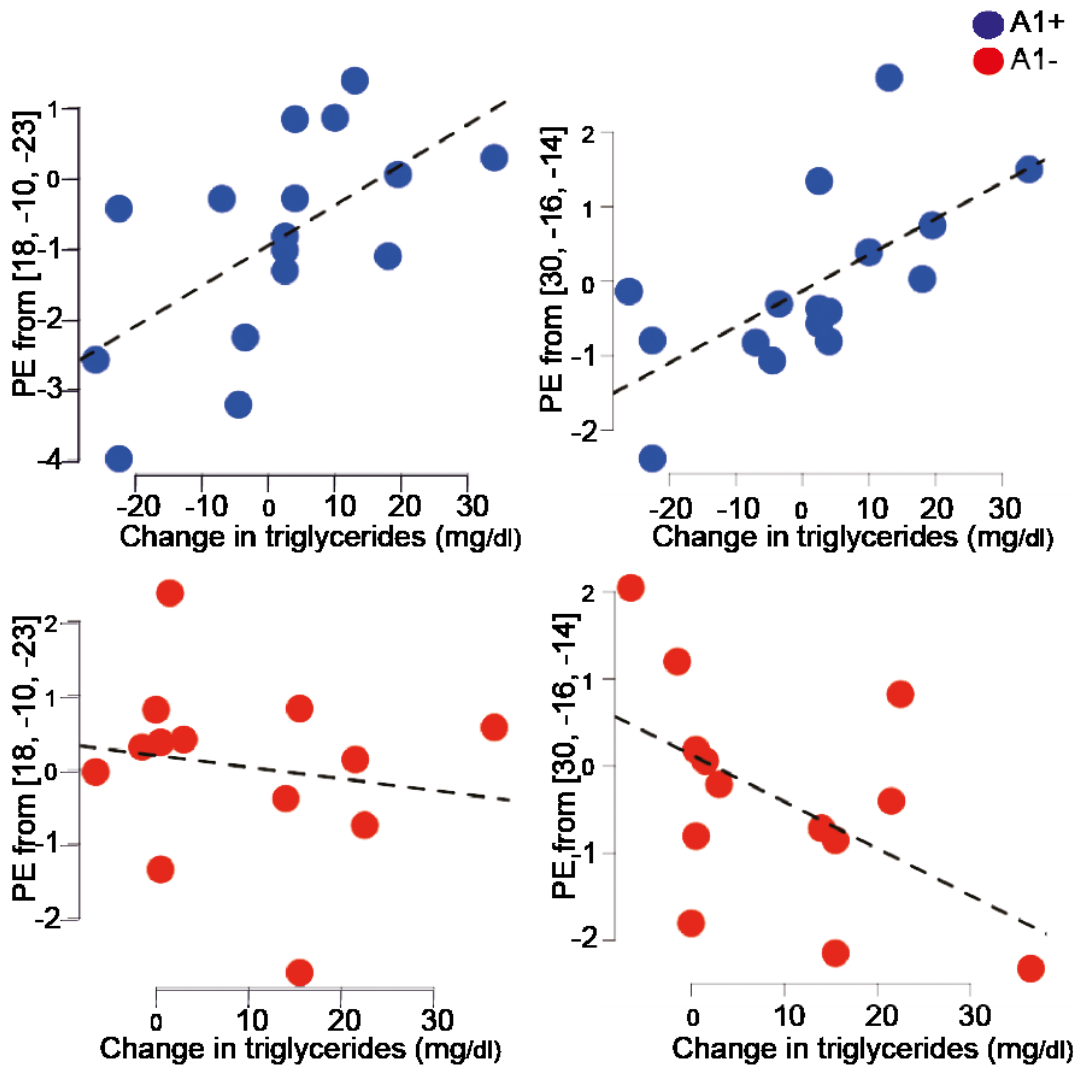
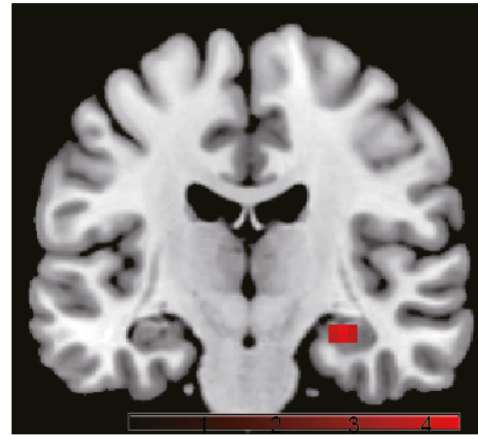
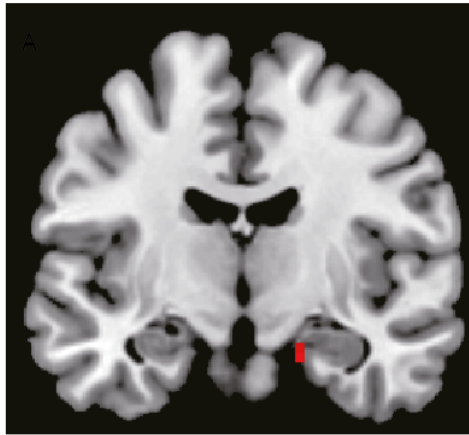

Supp. Figure 8

I. Supplementary experimental procedures

Fluorescent in-situ hybridization

The RNA-scope, a commercial in-situ hybridization assay was used. 3 age and sex matched mice were used. Brains were immediately extracted and frozen in isopentane, then sectioned at 20 μm on a Leica cryostat, and sections were probed for gene expression as per the protocols provided by Advanced Cell Diagnostics. TH and LPL expression were assayed in the VTA; DRD1, DRD2 and LPL expression were assayed in the both the CPu and NAc. Z-stacked images were captured with a Zeiss AxioObserver fluorescent microscope, Zeiss Apotome 2.0, and through a 63x objective lens. Each brain structure had 3 bregma points sampled. VTA sections had 3 images taken from the lateral VTA, and both CPu as well as the NAc sections had 4 images taken each. Counts were added per bregma point, and per structure so as to have a representative sample. Cells that exhibited at least 4 puncta, or RNA molecules in addition to DAPI were counted as expressing the respective gene.

Lipidomics

Seven pairs of mice were infused at 0.2 $\mu\text{l}/\text{min}$ for 4 hours with either saline or triglycerides. Immediately following infusion, mice were euthanized, and had their striatal (CPu and NAc) brain tissues rapidly extracted and frozen on dry ice. Lipid and protein analyses were performed at the UCSD Lipidomics Core. Relative abundances of individual species per sample were normalized to protein concentration per sample.

In vivo electrophysiological recordings

Adult male mice (10 weeks) perfused for 6 hours with TG or saline were anesthetized with chloral hydrate (8%), 400 mg/kg i.p. supplemented as required to maintain optimal anaesthesia throughout the experiment, and positioned in a stereotaxic frame. A hole was drilled in the skull above midbrain DA nuclei (coordinates: 5 ± 1.5 mm posterior to bregma, 1 ± 1 mm [VTA] lateral to the midline, Paxinos and Watson 2007). Recording electrodes were pulled from borosilicate glass capillaries (with outer and inner diameters of 1.50 and 1.17 mm, respectively) with a Narishige electrode puller. The tips were broken under microscope control and filled with 0.5% sodium acetate. Electrodes had tip diameters of 1-2 μm and impedances of 20–50 M Ω . A reference electrode was placed in the subcutaneous tissue. The recording electrodes were lowered vertically through the hole with a micro drive. Electrical signals were amplified by a high-impedance amplifier and monitored with an oscilloscope and an audio monitor. The unit activity was digitized at 25 kHz and stored in Spike2 program. The electrophysiological characteristics of DA neurons were analysed in the active cells encountered when systematically passing the microelectrode in a stereotaxically defined block of brain tissue including the VTA. Its margins ranged from -4.9 to -5.9 mm posterior to bregma (AP), 0.5 to 1 mm mediolateral (ML) and 7 to 8.5 mm ventral (DV). Sampling was initiated on the right side and then on the left side. Extracellular

Results

identification of DA neurons was based on their location as well as on the set of unique electrophysiological properties that distinguish DA from non-DA neurons *in vivo*: (i) a typical triphasic action potential with a marked negative deflection; (ii) a long duration (>2.0 ms); (iii) an action potential width from start to negative trough > 1.1 ms; (iv) a slow firing rate (<10 Hz and >1 Hz). Electrophysiological recordings were analysed using the R software (<https://www.r-project.org>). DA cell firing was analysed with respect to the average firing rate and the percentage of spikes within bursts (%SWB, number of spikes within burst divided by total number of spikes). Bursts were identified as discrete events consisting of a sequence of spikes such that: their onset is defined by two consecutive spikes within an interval <80 ms whenever and they terminate with an inter-spike interval >160 ms. Firing rate and %SWB were measured on successive windows of 60 s, with a 45 s overlapping period on a total period of 300 s. Responses to TG or Saline acute injections are presented as the Mean of percentage of firing frequency variation from the baseline \pm SEM. For statistical analysis, Maximum of firing variation induced by TG occurring 180 secs after the injection are compared to the maximum of firing rate variation induced by saline occurring 180 secs after the injection by non-parametric Mann-Whitney paired test.

Tissue preparation and immunofluorescence

Mice were rapidly anaesthetized with pentobarbital (500 mg/kg, *i.p.*, Sanofi-Aventis, France) and transcardially perfused with 4% (weight/vol.) paraformaldehyde in 0.1 M sodium phosphate buffer (pH 7.5). Brains were post-fixed overnight in the same solution and stored at 4°C. 30 μ m-thick sections were cut with a vibratome (Leica VT1000S, France), stored at -20 °C in a solution containing 30% ethylene glycol, 30% glycerol and 0.1 M sodium phosphate buffer. Sections were processed as follows: Day 1: free-floating sections were rinsed in Tris-buffered saline (TBS; 0.25 M Tris and 0.5 M NaCl, pH 7.5), incubated for 5 min in TBS containing 3% H₂O₂ and 10% methanol, and then rinsed three times for 10 min each in TBS. After 15 min incubation in 0.2% Triton X-100 in TBS, sections were rinsed three times in TBS again. Slices were then incubated overnight or 72 h at 4°C with the following primary antibodies: rabbit anti-phospho-rpS6^{Ser235/236} overnight (1:1,000, Cell Signaling Technology), goat anti-cFos (1:250, Santa Cruz Biotechnology) or rabbit anti-cFos (1:500, Synaptic Systems) for 72 hours. Sections were rinsed three times for 10 min in TBS and incubated for 60 min with secondary antibodies anti-rabbit Cy3 AffiniPure (1:1000, Jackson Immunoresearch) and anti-goat Dylight488 (1:1000, Vector labs). Sections were rinsed twice for 10 min in TBS and once in TB (0.25 M Tris) before mounting.

Acquisitions were performed with a confocal microscope (Zeiss LSM 510) with a colour digital camera and AxioVision 3.0 imaging software. Images used for quantification were all single confocal sections. Photomicrographs were obtained with the following band-pass and long-pass filter settings: A488 (band pass filter: 505–530) and Cy3 (band pass filter: 560–615). The objectives and the pinhole setting (1 airy unit, au) remained unchanged during the acquisition of a series for all images. Quantification of

immunopositive cells was performed using the cell counter plugin of the ImageJ software taking as standard reference a fixed threshold of fluorescence.

Western Blotting

After one hour, mouse head was cut and immediately immersed in liquid nitrogen for 4 seconds. The brain was then removed and dissected on ice-cold surface, sonicated in 200 μ L of 1% SDS supplemented with 0.2% phosphatase inhibitors and 0.1% protease inhibitors, and boiled for 10 minutes. Aliquots (2,5 μ L) of the homogenates were used for protein quantification using a BCA kit (BC Assay Protein Quantitation Kit, Interchim Uptima, Montluçon, France). Equal amounts of proteins (15 μ g) for each sample were loaded onto 10-12% polyacrylamide gels. Proteins were separated by SDS-PAGE and transferred to PVDF membranes (Millipore). The membranes were immunoblotted with the following antibodies: rabbit anti-phospho-rpS6^{Ser235/236} (1:1000, Cell Signaling Technology), rabbit anti-phospho-rpS6^{Ser240/244} (1:1000, Cell Signaling Technology), rabbit anti-phospho-p70S6K^{Thr421/Ser424} (1:1000, Cell Signaling Technology), rabbit anti-phospho-p70S6K^{Thr389} (1:1000, Cell Signaling Technology), mouse β -actin (1:5000, Sigma), rabbit anti-phospho-ERK1/2 (1:2000, Cell Signaling Technology), rabbit anti-phospho-DARPP-32^{Thr34} (1:750, Cell Signaling Technology), rabbit anti-phospho-TH^{Ser31} (1:1000, Cell Signaling Technology), rabbit anti-phospho-TH^{Ser40} (1:1000, Cell Signaling Technology), mouse anti-TH (1:2000, Millipore), rabbit anti-phospho-Akt^{Ser473} (1:1000, Cell Signaling Technology), rabbit anti-phospho-Akt^{Thr308} (1:1000, Cell Signaling Technology), rabbit anti-phospho-GSK3 β ^{S9} (1:1000, Cell Signaling Technology). Detection was based on HRP-coupled secondary antibody binding detected using ECL as detection system. The secondary antibodies were anti-mouse (1:5000, Dako) and anti-rabbit (1:10000, Cell Signaling Technology). Quantification was performed using the ImageJ software.

Doppler Imaging

Color Doppler scans of the brain were performed with a Vevo LAZR system (FujiFilm VisualSonics, Toronto, ON, Canada) using the LZ201 transducer (9–18 MHz bandwidth). Mice equipped with a carotid artery catheter were maintained anesthetized with isoflurane. Hair was removed on the head with depilatory cream and mice were positioned prone for imaging. The transducer was positioned to scan a coronal section of the whole head centred on the posterior cerebral artery. Images were acquired continuously. Catheter was connected to an infusion device that delivered NaCl 0.9% or TG emulsion (Intralipid® 20%) at rates of 0.1 μ L.min⁻¹; 1 μ L.min⁻¹ or 10 μ L.min⁻¹. Images were exported and analysed using ImageJ software.

Whole brain c-Fos staining

C57Bl/6J male mice received a 6-hrs saline or intralipid™ perfusion and were sacrificed 1 hr after amphetamine injection (2mg/kg). Brains were excised and post fixed in 4% paraformaldehyde overnight at room temperature and transferred stepwise to 100% methanol using the following protocol. 20% methanol (in ddH₂O) for 1h, 40% methanol for 1h, 60% methanol for 1h, 80% methanol for 1h, and

Results

100% methanol for 1h twice. iDISCO staining was performed as described in Renier et al (Renier et al., 2014) with one exception. All the washing steps after incubation with primary and secondary antibody were extended from one to three days. Incubation time for primary and secondary antibody was 4 days each. The primary antibody was Rabbit pAb anti c-Fos (Ab-5) (4-17) from Calbiochem (1:10,000 dilution), and the secondary antibody was Cy5-anti rabbit from Jackson ImmunoResearch (1:1000 dilution). Brain samples were scanned using an UltraMicroscope II LSM system (Lavisision Biotec, Bielefeld, Germany) in 4.06 μm for the c-Fos activation study. Whole brain c-Fos staining the auto-fluorescence was recorded at 545 nm, while the c-Fos signal was acquired with a 620 nm emission filter. Images were registered using the Elastix software library¹¹. A source image $I_S(x)$ was registered to a target image $I_T(x)$ by finding a coordinate transformation $T(x)$ that made $I_S(T(x))$ spatially aligned with $I_T(x)$. We used an affine coordinate transformation for initialization followed by non-rigid b-spline coordinate transformation which was iteratively optimized with respect to the mutual information between the source and the target. Registration parameters for mapping of LSM data were similar to those used in Renier et al (Renier et al., 2016). Parameters for registration of histology sections were similar to those used in Abdelmoula et al (Abdelmoula et al., 2014). The estimated auto-fluorescence contribution in the specific channel was calculated and removed based on ratios of voxel intensities between selected voxels in the unspecific recording and the corresponding voxels in the specific recording. A ratio was computed for 40 sets of voxels selected based on the histogram of the unspecific recording. The unmixing algorithm was written in Matlab (Release 2012b, MathWorks, Natick, Massachusetts, United States) and applied as a XT-plugin in Imaris (Release 7.6.5, Bitplane, Zurich, Switzerland). These software programs were also used to generate all figures in the manuscript, except Supplementary Fig. 1e which was generated using SimpleElastix³¹. The atlas templates and associated ImarisXT plugins are freely available and can be requested by emailing the corresponding author. ROI based analysis of the total fluorescence signal for c-Fos heat map intensities were computed using multiple t-tests assuming unequal variance. Statistical significance was determined by correcting for multiple comparisons using a false discovery rate set to 5% for labelled peptides and 20% for c-Fos heat maps. The statistical analysis was performed using GraphPad Prism (Release 6, GraphPad Software, Inc., United States).

Human studies

Participant recruitment

Twenty-nine right-handed participants (age range 18 – 39, M = 26.80, SD = 5.49; BMI range 19.5 – 33.6, M = 23.94, SD = 3.86; male = 16, female = 13) were recruited from the greater New Haven area through the Yale University Interdisciplinary Research Consortium on Stress, Self-Control and Addiction (IRCSSA) P30 Subject's core as well as via flyer advertisement. Participants were screened over the phone to be less than 40 years of age, free of psychiatric disorders, eating disorders, current dieting behaviour, alcoholism, use of tobacco or drugs other than alcohol, history of head injury with

loss of consciousness, use of daily medication other than monophasic birth control, chemosensory impairments, lactose intolerance or food allergies. We did not impose a BMI upper-limit. Individuals were included so long as they felt comfortable while inserted in the scanner bore. Females provided the date of their last period to ensure that they were not scanned during menstruation or ovulation. All participants provided written informed consent at their first lab visit and the study was approved by the Yale Human Investigations Committee.

Genotyping for TaqI A1 polymorphism

Saliva samples were obtained from the participants using Oragene Discover collection kits and DNA extraction was performed as directed by the manufacturer (DNA Genotek). TaqIA A1 allele status was determined by amplifying a 304 bp region with PCR using forward (5`-CCCTTCCTGAGTGTTCATCA-3`) and reverse (5`-CGGCTGGCCAA GTTGTCT-3`) primers as described by Epstein et al. (2007). The products of the amplification were digested overnight with the restriction enzyme TaqIA. The resulting DNA fragments were tagged with ethidium bromide and separated via gel electrophoresis. The appearance of a 304 bp band indicated the presence of the TaqI A1 allele. Sixteen participants were carriers of the A1 allele of the dopamine D2 receptor (DRD2) gene region (A1+; age range 19 – 37, M = 27.38, SD = 5.28; BMI range 19.5 – 33.6, M = 25.04, SD = 4.66; male = 9, female = 7), and 13 were non-carriers (A1-; age range 18 – 39, M = 26.08, SD = 5.87; BMI range 19.9 – 25.68, M = 22.59, SD = 2.00; male = 7, female = 6).

Food and non-food odour Stimuli

Food odours were “chocolate cookie” and “strawberry and cream” odours (6002335, 6106524 from Bell Labs Flavors and Fragrances, Inc.). Non-food odours were “honeysuckle” and “lilac” odours (039831 Chey N-3 from Firmenich, Inc.; 31731066 Lilac 71 from International Flavors and Fragrances, Inc.).

Stimulus delivery

Odours were presented by a custom built, MRI compatible olfactometer programmed in Labview (National Instruments). A detailed description of the olfactory stimulation system can be found in a previous publication (Small et al. 2008). In brief, mass flow controllers (MKS Instruments) adjust the flow of humidified and temperature-controlled air over stainless steel wells containing an odorant, allowing the air to pick up vaporized odour molecules. The independent odour channels converge into a mixing manifold and exit through 1 of 2 Teflon tubes where the first is dedicated to odours and the second is dedicated to clean air. The trunk terminates in a Teflon manifold (Teqcom) resting on the participant’s chest. A vacuum line connected to this manifold creates a closed loop to evacuate odorized as well as odourless (OL) air, preventing head space contamination. The participants receive OL and odour stimuli embedded in a continuous stream of clean, OL air from the manifold through a nasal mask (Philips Respironics). As air exits the mask, it is drawn out through a final Teflon tube by another vacuum line. The mask is also coupled to a pneumotachograph to measure airflow in the nose (Johnson

Results

and Sobel 2007), which is in turn connected to a spirometer (AD Instruments). The signal from the spirometer is fed into an amplifier (AD Instruments, PowerLab 4SP) and digitally recorded at 100 Hz using Chart 5.5.6 (AD Instruments).

Experimental procedures

All participants underwent a training session, and three fMRI scanning sessions (Hungry, Fixed and Sated conditions). All sessions were conducted on separate days and scan order was counterbalanced.

Training session

Participants were instructed to refrain from eating or drinking anything other than water for at least an hour before the session. Anthropometric measurements were taken at the beginning of the session. Body weight and height were measured using a Detecto 439 balance beam scale with stadiometer at The John B. Pierce Laboratory. BMI was calculated as weight (in kilograms) divided by the squared height (in meters) of the participant ($BMI = \text{kg}/\text{m}^2$).

Participants were trained to make computerized ratings of their internal state as well as the perceptual qualities of our stimuli on computerized scales. Participants rated the intensity of their feelings of hunger and fullness using adapted cross modal general Labeled Magnitude Scales (gLMS) consisting of a 100 mm vertical line scale with the labels “no sensation” at the lower anchor point and “strongest imaginable sensation” at the upper anchor point (Bartoshuk et al., 2004; Green et al., 1996, 1993). Stimulus ratings consisted of ratings of each stimulus's intensity, liking, wanting to eat, edibility and familiarity. Intensity was measured by adapted cross modal gLMS. Liking was measured using a labelled hedonic scale (LHS) consisting of a 100 mm vertical line scale with the labels “most disliked sensation imaginable” at the lower anchor point, “most liked sensation imaginable” at the upper anchor point, and “neutral” in the middle (Lim et al., 2009). Wanting to eat, edibility, and familiarity were measured using a 20 mm cross-modal visual analogue scale. Wanting to eat labels were “I would never want to consume this” (-10), “neutral” (0) and “I would want to consume this more than anything” (+10). Edibility labels were “not edible at all” at (-10), neutral at (0) and “very edible” at (+10). Familiarity labels were “not familiar at all” (-10), “neutral” (0) and “very familiar” (+10).

After training to make computerized ratings, participants participated in mock scanner training to become familiarized with the task, and to determine whether it would be uncomfortable to be in the scanner with the nasal mask. During mock scanning, the odour stimuli or odourless were delivered using the olfactometer. First, each odour was delivered one at a time and participants verbally rated the intensity of each presentation by telling the experimenter approximately where on the gLMS the odour's intensity fell in relation to the scale's labels (e.g., “Very Strong,” “A little less than Weak,” “Halfway between Moderate and Strong”). An experimenter then manually adjusted the odorant concentration settings on the olfactometer so that each odour was rated moderate in intensity. This resulted in the creation of a personalized dilution profile for each odour and each participant, allowing us to control for

individual differences in sensory acuity. Next, participants made internal state ratings as well as perceptual ratings of each of the stimuli using a mouse on a computer monitor viewed via back projection on a headcoil-mounted mirror and then underwent a simulated fMRI run. After completing the ratings, participants underwent odour runs in the mock scanner. At the end of this training session, participants were then given commercially available pre-packaged granola bars (190 kcal per package) for breakfast on the day of fMRI scanning session.

fMRI scanning sessions

All participants were instructed to eat the breakfast bars (1 package for women, 1.5 packages for men) in the morning at home, and then refrain from eating or drinking, with the exception of water, until their session. Participants arrived at the scanning centre at 11:45 AM. Starting at 12:15 PM, a Teflon catheter was inserted into an antecubital vein for blood sampling. Baseline blood samples were obtained at 12:30 and 12:45 PM. Five minutes after the baseline blood sampling, participants ate a fixed-portion lunch (1 sandwich and 1 serving of apple slices for women, 1.5 sandwiches and 1 serving of apple slices for men) for the Fixed condition, or an ad libitum lunch (3 sandwiches and 4 servings of apple slices for both women and men and instructed to eat as much as they'd like) for the Sated condition, or nothing for the Hungry condition. For a fixed-portion lunch or an ad libitum lunch, participants received apple slices (approximately 25 kcal of apple per bag) and their choice of sandwich from the options of tuna, ham, turkey, or avocado served on white bread with cheese, tomato, and mayonnaise. Each sandwich was designed to contain approximately 400 kcal and was cut into quarters before serving to discourage participants from interpreting each entire sandwich as one large "portion". The amount and type of foods consumed at ad libitum lunch were recorded without the participants' knowledge.

After eating lunch, participants were escorted to the scanner at approximately 1 PM. The second blood samples were collected at 60 min from time of meal (or no meal) onset. Internal state ratings were obtained concomitant to the baseline and second blood samples were obtained (at 12:45 PM and 1:50 PM). Temporal variability of onset of each blood sampling between each condition was minimized.

Once inside the fMRI scanner, participants underwent four odour runs. Each odour run was 5 min 54 s long. Participants were instructed to breathe in through their nose after receiving the verbal cue "3, 2, 1, sniff" through headphones. Odour or OL delivery always occurred immediately following the auditory cue so that delivery was time-locked to sniff onset. Olfactory stimulation lasted for 3 s followed by a 9–19 s rest period before the next trial. There were 6 repetitions each of food odours, non-food odours, and OL stimuli. Participants were asked to keep their eyes closed during the functional runs, and no behavioral task was required other than to experience the stimuli. Before and after the fMRI scan, participants provided their stimulus ratings in the MRI scanner. At 60 min from meal (or no meal), participants provided their internal state ratings for hunger, fullness. The odour runs were interspersed

Results

with additional anatomical and functional scans using taste stimuli that are reported in a separate manuscript (Sun et al., 2014) (Sun et al. 2014).

fMRI data acquisition

Imaging data were acquired on a Siemens 3.0 Tesla TIM Trio Scanner at the Yale University Magnetic Resonance Research Center. High-resolution T1-weighted structural scans were acquired for each participant with the following parameters: TR = 2230 ms, TE = 1.73 ms, flip angle = 9°, matrix = 256 x 256, 1 mm thick slices, FOV = 250 x 250, 176 slices. For fMRI runs, a susceptibility-weighted single-shot echo-planar sequence was used to image regional distribution of the BOLD signal. At the beginning of each functional run, the MR signal was allowed to equilibrate over 6 scans for a total of 12 s, which were subsequently excluded from the analyses. Acquisition parameters were: TR = 2000 ms, TE = 20 ms, flip angle = 80°, FOV = 220, matrix = 64 x 64, slice thickness = 3 mm. Forty contiguous slices were acquired in an interleaved method to reduce the cross-talk of the slice selection pulse.

Data analysis

Ratings for internal state and stimuli

All statistics were performed in SPSS (SPSS Version 21.0 (SPSS Inc., Chicago, IL, USA)). Internal state ratings for each participant were log transformed. One participant's stimulus ratings from the Hungry, Fixed, and Sated condition and another's from the Sated condition were omitted due to technical malfunction of equipment during collection. One participant's internal state ratings from the Hungry condition and another's from the Sated condition were also omitted due to technical malfunction. Those missing values were completed by inserting mean values. A mixed-design analysis of variance (ANOVA) was performed to assess the effects of condition, the effects of time, the effect of group, and the effect of interaction among condition and time and group on internal state ratings. We also tested the effect of odorant, condition, group, and interaction among odorant and condition and group on stimulus ratings using a mixed-design ANOVA.

Food intake

Unpaired t-test was performed to test whether intake calories from lunch of the Sated condition would differ between groups.

Blood collection and analysis

Samples were centrifuged immediately and kept on ice for the duration of each condition, then frozen at either - 80 °C [free fatty acid (FFA) and insulin] or - 20 °C (glucose, triglycerides). Plasma levels of insulin were measured with radioimmunoassay kits that utilize the double antibody technique with 125I-labeled hormone and hormone antiserum (Cat. # HI-14K, EMD Millipore Corporation, Billerica MA). Glucose, FFA and triglyceride concentrations were measured using enzymatic colorimetric techniques

(FFA: Cat. # 999-34691, 991034891, 993-35191, Wako Pure Chemical Industries, Ltd., Osaka, Japan. Triglycerides: Cat. # SA1023, RX1023; Glucose: Cat. # SA1014, RX1014, Alfa Wassermann Diagnostic Techniques, West Caldwell NJ).

The effect of time, condition, group, and interaction among those factors on the concentration of triglyceride were tested using a mixed-design ANOVA. We then tested association between intake calories and triglyceride concentrations at baseline from Sated session in each group by Pearson's correlation analysis.

Neuroimaging data

Neuroimaging data were analysed using the SPM8 software (Statistical Parametric Mapping, Wellcome Department of Imaging Neuroscience) in MATLAB R2010b 7.11.0 (Mathworks, Inc.). Functional images were time-acquisition corrected to the slice obtained at 50% of the TR and realigned to the mean image. Anatomical and functional images were normalized to the standard MNI template brain implemented in SPM8, resulting in voxel sizes of 3 and 1 mm³, respectively. Functional time-series data were detrended and then smoothed using a 6 mm FWHM isotropic Gaussian kernel. Motion parameters were included as regressors in the design matrix at the single participant level.

A design matrix was created for each participant for odour runs across all scan days that produced 2 events of interest: 1) Odours (food odour and non-food odour) and 2) OL. Event onsets were defined as the beginning of odour onset and event durations were defined as the 3 s of odour delivery. A 270 s high pass filter was applied to the time series data to remove low frequency noise and slow signal drifts. The general linear model was employed to estimate condition-specific effects at each model. A canonical hemodynamic response function was used to model neural response to events of interest.

To investigate the effect of genotype on association between postprandial serum triglyceride change (60 min after lunch - baseline) and difference in brain response to [food odour vs non-food odour] between conditions [(Hungry > Fix) and (Hungry > Sated)], individual [(food odour vs non-food odour) from the Hungry condition - (food odour vs non-food odour) from the Fixed session/Sated condition] contrast maps were entered into regression models with postprandial serum triglyceride changes as a covariate. The T-map threshold was set at p uncorrected < 0.005 and a 5-voxel cluster size. Peak voxels of the unpredicted cluster were considered significant at p < 0.05 family wise error (FWE) corrected across the entire brain for multiple comparisons. Next, region-of-interest (ROI) searches were performed using anatomical ROIs. Peaks within these regions were considered significant at P < 0.05, FWE corrected across the individual ROI. All ROI masks (insula, thalamus, striatum, globus pallidus, amygdala, parahippocampus, hippocampus, ventromedial prefrontal cortex, anterior cingulate cortex, orbitofrontal cortex) were selected from the WFU PickAtlas tool for SPM (Maldjian et al., 2003)(Maldjian et al., 2003) based on previous studies about striatal dopamine signaling pathway, eating

behaviour, and food cues (Eiler et al., 2012; Huerta et al., 2014; Pursey et al., 2014; Veldhuizen and Small, 2011)

SUPPLEMENTARY REFERENCES

- Abdelmoula, W.M., Carreira, R.J., Shyti, R., Balluff, B., van Zeijl, R.J., Tolner, E.A., Lelieveldt, B.F., van den Maagdenberg, A.M., McDonnell, L.A., and Dijkstra, J. (2014). Automatic registration of mass spectrometry imaging data sets to the Allen brain atlas. *Anal Chem* *86*, 3947-3954.
- Eiler, W.J., 2nd, Dziedzic, M., Case, K.R., Considine, R.V., and Kareken, D.A. (2012). Correlation between Ventromedial Prefrontal Cortex Activation to Food Aromas and Cue-driven Eating: An fMRI Study. *Chemosens Percept* *5*, 27-36.
- Huerta, C.I., Sarkar, P.R., Duong, T.Q., Laird, A.R., and Fox, P.T. (2014). Neural bases of food perception: coordinate-based meta-analyses of neuroimaging studies in multiple modalities. *Obesity (Silver Spring)* *22*, 1439-1446.
- Maldjian, J.A., Laurienti, P.J., Kraft, R.A., and Burdette, J.H. (2003). An automated method for neuroanatomic and cytoarchitectonic atlas-based interrogation of fMRI data sets. *Neuroimage* *19*, 1233-1239.
- Pursey, K.M., Stanwell, P., Callister, R.J., Brain, K., Collins, C.E., and Burrows, T.L. (2014). Neural responses to visual food cues according to weight status: a systematic review of functional magnetic resonance imaging studies. *Front Nutr* *1*, 7.
- Renier, N., Adams, E.L., Kirst, C., Wu, Z., Azevedo, R., Kohl, J., Autry, A.E., Kadiri, L., Umadevi Venkataraju, K., Zhou, Y., et al. (2016). Mapping of Brain Activity by Automated Volume Analysis of Immediate Early Genes. *Cell* *165*, 1789-1802.
- Renier, N., Wu, Z., Simon, D.J., Yang, J., Ariel, P., and Tessier-Lavigne, M. (2014). iDISCO: a simple, rapid method to immunolabel large tissue samples for volume imaging. *Cell* *159*, 896-910.
- Sun, X., Veldhuizen, M.G., Wray, A.E., de Araujo, I.E., Sherwin, R.S., Sinha, R., and Small, D.M. (2014). The neural signature of satiation is associated with ghrelin response and triglyceride metabolism. *Physiol Behav* *136*, 63-73.
- Veldhuizen, M.G., and Small, D.M. (2011). Modality-specific neural effects of selective attention to taste and odor. *Chem Senses* *36*, 747-760.

Chapter 2: Palatable binge-drinking shapes dopamine signalling in the striatum through gut-striatal mechanisms

A. Article Information

Chloé Berland¹, Enrica Montalban¹, Rim Hassouna¹, Chloé Morel¹, Anne-Sophie Delbes¹, Raphaël GP Denis¹, Serge Luquet^{1*}, Giuseppe Gangarossa^{1*}

¹Univ Paris Diderot, Sorbonne Paris Cité, Unité de Biologie Fonctionnelle et Adaptative, CNRS UMR 8251, F-75205 Paris, France.

CB and GG designed, performed and analysed all the behaviour experiments, western-blot, immunohistochemistry. EM and CM performed the qPCR, RH and ASD performed the corticosterone, FFA, insulin measurements. RD gave scientific inputs regarding the metabolic analysis. SL and GG gave scientific guidance and provided funding for the study. CB and GG wrote the manuscript.

The authors declared that no conflict of interest exist.

* correspondance to: GG (giuseppe.gangarossa@univ-paris-diderot.fr) and SL (serge.luquet@univ-paris-diderot.fr)

Results

B. Abstract

Understanding the neurobiological and metabolic mechanisms involved in food-driven behaviors is of paramount importance. In fact, intermittent maladaptive responses to palatable food can promote homeostatic modifications, thus leading to eating disorders such as bingeing, a compulsive overconsumption of food. Both sugar and lipids have been identified as common macronutrients consumed during binge-eating episodes and are thus of interest.

Here, we show that intermittent access to a sugar/fat solution induces specific behavioral and metabolic signatures such as altered locomotor responses, impaired respiratory exchange ratio (RER) and increased fatty acid oxidation. Interestingly, this metabolic phenotype did not affect glucose homeostasis, overall caloric intake and body weight, thus suggesting a fine regulation of energy balance despite food-compulsivity. Since binge-eating has been shown to have several similarities to addiction, we also decided to investigate the molecular underpinnings occurring in key regions of the brain reward circuit, notably the dorsal and ventral striatum. Our data reveal that intermittent access to sugar/fat triggered the activation of MAPK/mTOR pathways, a molecular signature known to promote protein translation and local lipid metabolism. Such activation required dopamine release since a differential role of dopamine D1R- and D2R-pathways was observed. Interestingly, peripheral signals and vagal afferents were pointed as critical players for bingeing and its effects on striatal functions.

Altogether our results reveal a novel molecular/systems cascade that triggers specific metabolic and molecular features, thus establishing an unpredicted functional complexity which may lead to a better understanding of the intricate interaction between palatability, homeostatic energy balance and gut-striatum axis.

C. Material and methods

Animal Housing and Diets

8 weeks old male C57bl/6J mice (20-30 grams, Janvier, Le Genest St Isle, France) were single-housed one week prior to any experimentation in stainless steel cages in a room maintained at 22 +/-1 °C, with light period from 7 AM until 7 PM. Regular chow diet (3 438 kcal/kg, protein 19%, lipid 5%, carbohydrates 55%, reference #U8959 version 63 Safe, Augy, France) and water were provided ad libitum. All the experiments were performed with the approval of the animal care committee of the University Paris Diderot – Paris 7.

Bingeing procedure

Animals were single-housed one week prior to any experiments. Food intake and body weight were measured daily at regular time. High fat-high sugar solution (Intralipid 20% enriched with sucrose 10%) intermittent access was provided daily during 10 consecutive days for one hour. For our saccharine experiment, we replaced sucrose 10% by saccharine 0.5%.

Indirect calorimetry and body mass composition analysis

Body mass composition was analyzed before the first bingeing exposure and 10 days after habituation to intermittent binge access using an Echo Medical Systems EchoMRI 100 (EchoMRI, Houston, USA). Body composition was expressed as a percentage of body weight. Mice were analyzed for whole energy expenditure, oxygen consumption and carbon dioxide production, respiratory exchanged rate (RER: $v\text{CO}_2/v\text{O}_2$), food intake and spontaneous locomotor activity using calorimetric cages (Labmaster, TSE Systems GmbH, Bad Homburg, Germany). Activity was recorded using infrared light beam-based locomotion monitoring system (beam breaks per hour). Mice were individually housed and acclimated to the chambers 7 days before experimental measurements. Data analysis was carried out with Excel XP using extracted raw values of the last 3 days of VO_2 consumption, VCO_2 production (in $\text{mL}\cdot\text{h}^{-1}$), and energy expenditure ($\text{kcal}\cdot\text{h}^{-1}$). Subsequently, each value was expressed either per total body weight or whole lean tissue mass extracted from the EchoMRI analysis.

Oral glucose tolerance test

The oral glucose tolerance tests were performed in replacement of high-fat high-sucrose intermittent access. Animals were fasted 6 hours before oral gavage of glucose (2g/kg). Blood glucose was directly measured from the vein blood tail using a glucometer (Menarini, Diagnostics, Rungis, France) at 0, 15, 30, 45, 60, 90, and 120 min. Blood samples were taken at 0, 15 and 30 and 60 min to measure insulin levels. Insulin dosage was performed with ELISA kit (mouse ultrasensitive insulin ELISA (ALPCO, Salem, NH, USA), according to the manufacturer guidelines).

Corticosterone TG and NEFA dosage

Results

Corticosterone was measured with RIA kit (MP Biomedicals, Orangeburg, NY, USA), NEFA levels were measured with NEFA HR-Series (2) in vitro enzymatic colorimetric method assay (Wako Diagnostics, Neuss, Germany), and TG levels were measured with a quantitative enzymatic measurement of glycerol, true glycerides and total triglycerides (Serum Triglyceride Determination Kit, Sigma-Aldrich, Saint-Louis, USA) according to the manufacturer guidelines.

Leptin injections

On test days, animals trained to receive high-fat/high-sugar drink for 11 days were injected with leptin 0.15 mg.kg^{-1} dissolved in saline twice a day (one injection at 10AM, one injection at 6PM), for two consecutive days. The days of the injections, animals had access to the palatable solution at 11AM, one hour after the first leptin injection.

Insulin, SCH23390 hydrochloride and CB1 antagonist injections

On test day, animals trained to receive high-fat/high-sugar drink for 11 days were injected with 0.5 U par kg in saline, 30 min before access to the palatable beverage, or with 3 mg.kg^{-1} of AM251, or AM6545 dissolved in 3% DMSO and 5% Tween-80, or SCH23390 hydrochloride (Tocris) dissolved in saline one hour before access to the palatable beverage. Animals receiving SCH23390 were sacrificed one hour after the beginning of palatable drink consumption.

SKF81297 and haloperidol treatments

On test day, animals trained to receive high-fat/high-sugar drink for 10 days were injected with SKF81297 5 mg.kg^{-1} dissolved in saline (pH=6.8) or haloperidol 0.5 mg.kg^{-1} one hour after intermittent access to the palatable drink. One hour after injection, animals were sacrificed and tissues dissected for western-blot.

Liraglutide injections

Animals were daily treated with $100 \text{ }\mu\text{g.kg}^{-1}$ Liraglutide (NOVONORDISK, Copenhagen, Denmark) for five days at 10AM, then for 10 consecutive days one hour before access to palatable drink.

Western Blotting

After one hour, mouse head was cut and immediately immersed in liquid nitrogen for 3 seconds. The brain was then removed and dissected on ice-cold surface, sonicated in $200 \text{ }\mu\text{L}$ of 1% SDS supplemented with 0.2% phosphatase inhibitors and 0.1% protease inhibitors, and boiled for 10 minutes. Aliquots ($2.5 \text{ }\mu\text{L}$) of the homogenates were used for protein quantification using a BCA kit (BC Assay Protein Quantitation Kit, Interchim Uptima, Montluçon, France). Equal amounts of proteins ($10 \text{ }\mu\text{g}$) supplemented with homemade Laemli buffer were loaded onto 10% polyacrylamide homemade gels.

Proteins were separated by SDS-PAGE and transferred to PVDF membranes (Millipore). The membranes were immunoblotted with the following antibodies: rabbit anti-phospho-Ser235/236-S6 (1:1000, Cell Signaling Technology), rabbit anti-phospho-Ser240/244-S6 (1:1000, Cell Signaling Technology), rabbit anti-p70S6K (1:1000, Cell Signaling Technology), rabbit anti phospho-elf4E (1:500, Cell-Signaling) , beta-actin (1:5000, Sigma), pERK1/2 (1:2000, Cell-Signaling), DARPP-32 Thr34 (1:750, Cell Signaling), anti-rat DAT (1:2000, Millipore), anti-rabbit phospho-Histone H3-Ser10 (1:1000, Cell Signaling)TH Ser 31 (1:1000, Cell Signaling), anti-rabbit phospho-ATC Citrate lyase-Ser455 (1:1000, Cell Signaling), anti-rabbit phospho-acetylCoA carboxylase-Ser79 (1:1000, Cell Signaling), TH total (1:2000, Millipore). Detection was based on HRP-coupled secondary antibody binding detected using ECL as detection system. The secondary antibodies were anti-mouse (1:5000, Dako) and anti-rabbit (1:10000, Cell Signaling). Quantification was performed using the ImageJ software.

Immunohistochemistry

For immunohistochemistry imaging, animals were injected with i.p. pentobarbital 100 μ L. Once anaesthetized, animals were transcardiacally perfused with 4°C PFA 4% for 5 minutes. Brains were collected, put overnight in PFA 4% and then stored in PBS, 4°C. 30 μ m-thick sections were sliced with a vibratome (Leica VT1000S, France), and stored in PBS 4°C. Sections were processed as follows: Day 1: free-floating sections were rinsed in Tris-buffered saline (TBS; 0.25 M Tris and 0.5 M NaCl, pH 7.5), incubated for 5 min in TBS containing 3% H₂O₂ and 10% methanol, and then rinsed three times for 10 min each in TBS. After 15 min incubation in 0.2% Triton X-100 in TBS, sections were rinsed three times in TBS again. Slices were then incubated overnight or 72 h at 4°C with the following primary antibodies: rabbit anti-phospho-Ser235/236-S6 overnight (1:1,000, Cell Signaling Technology), rabbit anti-phospho-Ser240/244-S6 overnight (1:1000, Cell Signaling Technology). Sections were rinsed three times for 10 min in TBS and incubated for 45 min with secondary antibodies Anti-rabbit Cy3 AffiniPure (1:2000, Jackson ImmunoResearch). Sections were rinsed for 10 min twice in TBS and once in TB (0.25 M Tris) before mounting.

Acquisitions were performed with a confocal microscope (Zeiss LSM 510) with a color digital camera and AxioVision 3.0 imaging software. Images used for quantification were all single confocal sections. The objectives and the pinhole setting remained unchanged during the acquisition of a series for all images. Quantification of immunoreactive cells was performed using the cell counter plugin of the ImageJ software taking as standard reference a fixed threshold of fluorescence.

RNA isolation and Real-time quantitative PCR

Mice were sacrificed one hour after HFHS solution exposure by cervical dislocation, and microdisks punched out from the NAc and the DS with a stainless steel cannula and placed on ice. Each tissue sample was homogenized in TRIzol with 3mm tungsten carbide beads (cat no. 69997). Total RNA was

Results

extracted with TRIzol Reagent (Life Technologies) according to manufacturer's instructions. The RNA was quantified by using the Nanodrop 2000 spectrophotometer. Five hundred ng of mRNA from each sample were used for retro-transcription, performed with the M-MLV (Life Technologies) following the manufacturer's instructions. Quantitative real time PCR, was performed using LightCycler SYBR Green one PCR kit in 384-well plates according to the manufacturer's instructions. Results are presented as normalized to the indicated housekeeping genes and the delta-CT method was used to obtain a FC.

Drd1	tctggtttacctgatccctca ; gcctctccctcttcaggt
Drd2	tgaacaggcggagaatgg ; ctggtgcttgacagcatctc
Ankk1	gaccagggttcctttgcttg ; atcagttcccaggcagtc
Lpl	cacagtggccgagagcgagaa ; gctgagtcctttcccttctgcag
Srebp2	acctagacctcgccaaaggt ; gcacggataagcaggtttgt
Fasn	gctgctgttggaagtgcagc ; agtggtcgttctcctggagtg
Pnpla2	tgaccatctgccttcaga ; ttaggtggcgcaagaca
Cpt2	tccaatgccgttct ; cagcacagcatcgta
Cpt1c	ccccataaccctac ; atccccgatacccct
Cnr1	gggcaaatttctttagca ; ggctcaactgactgagaaa
Isr1	ctatgccagcatcagcttcc ; ttgctgaggtcatttaggtcttc
Isr2	gtccaggcactggagcttt ; gcgcttcaactttcacga
Fabp7	aaccagcatagatgacagaaactg ; acttctgcacatgaatgagctt
Dgat2	agtggcaatgctatcatcatcgt ; aaggaataagtgggaaccagatca
Plin2	cctcagctctcctgttaggc ; cactactgctgctgccattt
FgfR	tgtttgaccggatctacacaca ; ctcccacaagagcactccaa
Rpl 19	gggcaggcatatgggcata ; ggcggtcaatcttcttggatt
Hprt	gttgatacaggccagactttgttg ; gattcaactgcgctcatcttagget

D. Introduction

Compulsive eating-behaviours are defined by an uncontrolled intake of food, often leading to energy imbalance. A common way to mimic this uncontrolled behaviour in rodents is to provide intermittent access to palatable food, for which animals will gradually maximise their consumption, to the detriment of less calorie-rich diets. Several studies have shown that bingeing during several weeks is associated with dopamine (DA) release elevation in the nucleus accumbens (NAc) and dysfunctions in DA signaling: decreased dopamine D2 receptor (D2R) and increased dopamine D1 receptor (D1R) expression. However, little is known about the installation of neurological changes associated with

bingeing habits. Here, we exposed C57bl6/j animals for 10-14 days, to a daily one-hour access to a palatable solution composed of 20% emulsified long-chain triglycerides (Intralipid) and 10% of sucrose. After establishing the validity of binge-like installation, we investigated the molecular alterations resulting from this intermittent exposure. The dorsal and ventral striatum, as well as the hippocampus and the frontal cortex, were studied. In addition, we report that peripheral signals shape bingeing behaviour thus suggesting that dopamine endophenotypes require the establishment of complex and dynamic networks.

E. Results

1. Intermittent access to a caloric mixture quickly shifts eating pattern and triggers metabolic signatures

We mimicked binge-eating disorders by exposing one hour a day *ad libitum* fed mice to a caloric and palatable drink composed of 20% emulsified long-chain triglycerides (Intralipid) and 10% sucrose, containing 2.4 kcal.mL^{-1} , or drinking water for the control group (Figure 1A). Mice maximised their food intake within a few days to reach an average consumption of $\sim 1.4 \text{ mL}$ (Figure 1B). Interestingly, intermittent exposure (1h/day) to sucralose (2 mM), or saccharine (0.15%), two non-caloric sweeteners, failed to induce a binge-like behaviour, suggesting that caloric content is necessary for bingeing (Suppl. Figure 1). During this bingeing protocol (10-14 days), we did not observe major changes in body weight, fat mass, lean mass (Figure 1C, D, E).

While standard diet intake is not different between the two groups during the light phase (Figure 1F, G, F), animals with intermittent access to the caloric drink during the day significantly decrease their standard food intake during the dark phase (Figure 1F, G, H). However, no differences were observed in the cumulative caloric intake, thus showing an intact regulation of caloric intake ($\sim 10 \text{ kcal per 24h}$) (Figure 1I), similar to bingeing models published in literature (Corwin and Buda-Levin, 2004).

Animals with intermittent access to palatable drink quickly learnt to anticipate palatable food availability and increased their locomotor activity before access (control vs binge, interaction $F_{(23, 240)} = 1,575$; $P=0,0498$, time $F_{(23, 240)} = 14,14$; $P<0,0001$, binge exposure $F_{(1, 240)} = 21,88$; $P<0,0001$). Such increase in locomotor drive was observed only during the light phase (Figure 2A). In addition, energy expenditure was also significantly increase during light phase (control vs binge, interaction $F_{(23, 240)} = 3,297$; $P<0,0001$, time $F_{(23, 240)} = 15,48$; $P<0,0001$, binge exposure $F_{(1, 240)} = 46,76$; $P<0,0001$), while no differences were detected during the dark phase (Figure 2B). Further metabolic analysis revealed that the respiratory exchange ratio (RER) was significantly decreased during the dark phase in bingeing mice, highlighting a shift of metabolic substrates use from carbohydrates (RER=1) to lipids (RER=0.7) (control vs binge, interaction $F_{(23, 240)} = 17,23$; $P < 0,0001$; time $F_{(23, 240)} = 57,04$; $P < 0,0001$, binge exposure $F_{(1, 240)} = 291,0$; $P < 0,0001$) (Figure 2C). As expected, fatty acid oxidation was increased in

Results

animals with intermittent access to the caloric mixture (control vs binge, interaction $F_{(23, 240)} = 15.08$; $P < 0,0001$; time $F_{(23, 240)} = 49.46$; $P < 0,0001$, binge exposure $F_{(1, 240)} = 537.7$; $P < 0,0001$) (Figure 2D), in agreement with increased energy expenditure. These results indicate that binge-like behaviour triggered a specific pattern of metabolic modifications, even though general parameters such as body weight, fat composition and overall energy intake were stable.

In order to characterize the peripheral metabolic signature of caloric binge-like behaviour, we measured corticosterone, insulin, circulating non-esterified free fatty acids (NEFA), and circulating triglycerides (TG) in control animals, in binge-animals during the anticipatory phase, and in binge-animals one hour after palatable consumption (Figure 3A, D, C, D). Anticipation of binge reward significantly increased corticosterone levels ($F_{(2, 14)} = 10.87$; $P=0.0014$), decreased insulin levels ($F_{(2, 14)} = 5.792$; $P=0.0147$) as well as circulating NEFA ($F_{(2, 14)} = 19.33$; $P < 0,0001$) and TG ($F_{(2, 14)} = 7.56$; $P=0.0059$). Apart from the NEFA levels, these parameters went back to basal levels after bingeing on palatable beverage. Such metabolic signature may indicate a food-anticipatory behaviour, as well as stress-induced changes usually associated with binge.

To further investigate glucose metabolism, we performed an oral glucose tolerance test (OGTT) in 5h fasted mice exposed to bingeing or water the 10 previous days. As shown in Figure 3D, E, glucose and insulin temporal profiling were similar between the two groups of mice, although a significant increase in glycaemia was observed at 30 min post-OGTT (glucose control vs binge: interaction $F_{(6, 154)} = 3,104$, $P=0,0067$, time $F_{(6, 154)} = 74,79$, $P<0,0001$, binge exposure $F_{(1, 154)} = 0,003808$, $P=0,9509$; insulin control vs binge: interaction $F_{(3, 88)} = 0,667$, $P=0,5745$, time $F_{(3, 88)} = 35,19$, $P<0,0001$, binge exposure $F_{(1, 88)} = 4,047$, $P=0,0473$) (Figure 3D, E). No significant changes were observed when we calculated the insulin resistance with homeostasis model assessment of insulin resistance (HOMA IR) (data not shown). These results show that glucose metabolism is mainly unaltered in bingeing mice.

Interestingly, binge-mice showed a pattern of peripheral signals which drive anticipatory food behaviour and associated homeostatic modifications.

2. Gut peripheral signals, not circulating insulin and leptin, control bingeing

We next investigated the contribution of peripheral signals driving binge-like behaviour. After 12 days of intermittent exposure to palatable drink, we investigated the effect of the anorexigenic hormone leptin, an adipose tissue-released mediator, on binge-like behaviour. Animals received two physiological doses of $0,15 \text{ mg.kg}^{-1}$ of leptin for two consecutive days. Standard food intake was significantly reduced following the treatment ($p=0,015$), and a significant reduction in body weight was observed ($p<0,001$). However, the palatable drink intake remained unchanged throughout the leptin treatment ($p=0,72$) (Figure 4A, B, C), suggesting that leptin signalling had no effect on our bingeing model. Similarly, insulin injection (0.5 U/kg , i.p.) did not affect palatable consumption (Figure 4D).

Results

p70S6K phosphorylation was observed in the mouse hippocampus and prefrontal cortex following bingeing, suggesting that the dorsal and ventral striatum undergo specific modifications during bingeing (Suppl. Figure 2). No major alterations of dopamine machinery (TH and DAT) or dopamine receptors (D1R and D2R) were observed (Figure 5E, F, G, H).

Because metabolic readouts revealed changes during food anticipation phase, we investigated whether such striatal molecular modifications were induced by the anticipation of food behaviour or by the consumption of energy-dense food itself. We designed four groups of animals, one exposed to drinking water during the whole protocol (Ctr), one exposed to palatable drink during the whole protocol (binge), one exposed to palatable drink during the whole protocol except for the day of sacrifices (anticipation group), and one chronically exposed to water expect the day of sacrifices, where they received the palatable drink for the first time (acute group) (Figure 6A). As expected, mice from the binge group showed increased phosphorylation of rpS6 (Ser^{235/236} and Ser^{240/244}) in the striatum (rpS6^{Ser235/236} $F_{(3, 18)} = 4.211$; $P=0.02$ and rpS6^{Ser240/244} $F_{(3, 18)} = 8.938$; $P=0.0008$) and the nucleus accumbens (rpS6^{Ser235/236} $F_{(3, 18)} = 5.429$; $P=0.0072$ and rpS6^{Ser240/244} $F_{(3, 18)} = 11.57$; $P=0.0002$) compared to the controls (Figure 6B-F). Interestingly, both anticipation and acute groups failed to trigger rpS6^{Ser240/244} phosphorylation (Figure 6B-F), except for a specific increase of striatal P-rpS6^{Ser235/236} during the anticipatory period ($p<0,05$) (Fig 6E). On the contrary, acute consumption of palatable drink failed in driving rpS6 modifications in both striatum and NAc.

These results indicate that striatal activation requires both reward expectation and reward access.

4. Increased translational activity in the dorsal striatum and NAc is D1, not D2 dependent

The NAc and DS contain GABAergic MSN expressing the D1R and D2R receiving dopaminergic inputs from the substantia nigra pars compacta (SNpc) and the ventral tegmental area (VTA), subdividing DA signalling into direct and indirect pathways. We investigated whether the binge-like behaviour related to intermittent exposure to a caloric mixture was more driven by the direct or indirect pathway. After 10 days of intermittent access to caloric mixture, we pre-treated the animals with the D1R antagonist SCH23390 (0.1 mg/kg) or vehicle (veh) one hour prior to palatable drink access. Animals treated with SCH23390 did not consume any palatable reward the day of the treatment (Interaction $F_{(4, 12)} = 71.98$; $P<0.0001$, Time $F_{(2, 12)} = 103$ $P<0.0001$ and Treatment $F_{(2, 6)} = 271.8$; $P<0.0001$) (Figure 7A). Importantly, locomotor activity of animals treated with SCH23390 was not affected at this dose. Conversely, animals pre-treated with the D2R antagonist haloperidol had no effect on bingeing behaviour ($p>0.05$, both doses) (Figure 7B). Immunohistochemical readout of phospho-rpS6 activation supported our behavioural data, as binge-mice pre-treated with SCH23390 did not show increase in rpS6 phosphorylation in the striatum (rpS6^{Ser235/236} $F_{(2, 6)} = 162.5$; $P<0.0001$ and rpS6^{Ser240/244} $F_{(2, 6)} = 352.4$; $P<0.0001$) and the nucleus accumbens (rpS6^{Ser235/236} $F_{(2, 6)} = 133.3$; $P<0.0001$ and rpS6^{Ser240/244} $F_{(2, 6)} = 196.3$; $P<0.0001$) (Figure 7C).

To further understand the molecular underpinnings involved in bingeing behaviour and the potential involvement of dopamine D1R, we treated bingeing-animals with the D1R agonist SKF81297 (5 mg/kg) or vehicle one hour after access to the caloric mixture, and sacrificed animals 30 minutes later. The positive effect of SKF81297 on rpS6 phosphorylation (Gangarossa et al., 2013b) was observed in controls animals, but not in bingeing animals ($F_{(3, 28)} = 13.05$; $P < 0.0001$) (Figure 7C, D). Conversely, the rpS6 phosphorylation induced by haloperidol remained unchanged ($F_{(3, 28)} = 5.629$; $P = 0.0038$) (Figure 7C, D). Interestingly, D1R-mediated signalling in the hippocampus was not affected as shown for P-p70S6K ($F_{(3, 28)} = 10.54$; $P < 0.0001$) and P-rpS6 ($F_{(3, 28)} = 20.74$; $P < 0.0001$) (Figure 8).

Altogether these results indicate that D1R in the dorsal and ventral striatum is highly involved in the molecular underpinnings of binge-like behaviour.

5. Bingeing-like behaviour is associated with lipid signalling in reward related structures

Dopamine signalling in the nucleus accumbens is increased by peripheral triglycerides more than sucrose (Rada et al., 2012), and triglycerides can signal to the reward circuit and inhibit preference for palatable food (Cansell et al 2014). We investigated the potential central signalling role of triglycerides brought by the palatable beverage. Binge induces a decreased phosphorylation of two enzymes necessary for lipogenesis in the striatum, ATP citrate lyase and Acetyl CoA Carboxylase (ACC) ($p = 0.026$ and $p = 0.0058$, respectively) (Figure 9A, B), and an increase of Fatty acid synthase in the NAc, but not in the dorsal striatum ($p < 0.05$) (Figure 9C, D). Interestingly, a reduction in *lpl* mRNA expression was detected specifically in the NAc of binge-mice ($p < 0.01$) (Figure 9C). This could be related to the shift of metabolic substrates use seen in Figure 2A, although these brain structures are not typically related to energy and metabolic regulations. Importantly, the time point of dissection (protein and mRNA study) was one hour after the beginning of access to the palatable drink. At this time, the palatable solution was not fully digested yet, as attests the stomach content (Figure 1A), suggesting that the enzymatic changes observed are related to local signalling, not energy metabolism.

A central administration of triglycerides was found to decrease palatable food intake and striatal MSN activity (Chloé Berland, unpublished data). We centrally administered a small bolus of emulsified triglycerides prior to bingeing to assess whether or not binge activation is sufficient to restore striatal extinction. In accordance with published results, animals which received central triglycerides decreased their consumption of palatable drink compared to the controls (Figure 9E). Unexpectedly, we found that central triglycerides treatment before intermittent access to a caloric drink drastically increased striatal rpS6 activity (Figure 9F), suggesting that central triglycerides signalling alters binge-like behaviour and associated molecular features.

F. Discussion

In this study, we designed a bingeing model in which animals were exposed for 10-14 days of intermittent access to a caloric drink composed of triglycerides and sucrose. Within this short amount of time, animals compulsively ingest food during their inactive phase, without gaining body weight or developing glucose intolerance, and their overall food intake remains isocaloric, as animals decrease their standard diet consumption to counterbalance the caloric mixture intake. Bingeing on our caloric mixture encodes reward through a D1R-dependent mechanism and is controlled by signals arising from the gastrointestinal tract, not leptin or insulin. Interestingly, we note that sweet-taste solutions devoid of calories are not able to trigger bingeing behaviours. This goes along with the previously published studies showing that the gut possesses some sensing mechanisms able to estimate the caloric values associated to food, and modulate reward accordingly.

The increase of corticosterone and anticipatory increase of locomotor activity assess the compulsive-like behavioural effect of intermittent access to palatable food, and the stress-like behaviours associated to bingeing models. Importantly, the effects observed in this study were driven after only 10-14 days of bingeing, attesting a fast habituation to compulsive eating, concomitant with a fast plasticity of metabolism and a rapid shift to lipid metabolism rather than carbohydrates. The anticipatory changes associated with food reward expectation are not sufficient to mediate striatal activation of MSN, and we showed that both expectation and reward access are necessary to promote reward. Because we know that lipids alter DA signalling, and are present in the rewarding food, they could be a good lead to link gut signalling associated to reward. We note that lipid metabolism is altered by bingeing in the striatum, before the dietary content of the reward is digested, reinforcing the potential role of lipids as signalling molecules affecting food reward. Our increased neuronal activation in the striatum after central triglycerides administration suggests that central lipids could potentiate food reward, in accordance with recent publications (DiFeliceantonio et al., 2018).

It is worth to mention that lipids and glucose can increase striatal dopamine release in the striatum following direct infusion into the gastrointestinal tract (de Araujo et al., 2012; Han et al., 2016; Tellez et al., 2013) and that a gut-striatum D1R-mediated pathway has been recently reported (Hankir et al., 2017)

In ongoing experiments, we are currently trying (*i*) to recapitulate such central and peripheral modifications *via* an intermittent gastric perfusion of TG/sucrose caloric solution, (*ii*) assess the role of peripheral eCBs in binge-like behaviour and associated molecular adaptations and (*iii*) to dissect the contribution of anticipatory stimuli in driving compulsivity.

G. Bibliography

- de Araujo, I.E., Ferreira, J.G., Tellez, L.A., Ren, X., and Yeckel, C.W. (2012). The gut-brain dopamine axis: a regulatory system for caloric intake. *Physiol. Behav.* 106, 394–399.
- Bello, N.T., and Hajnal, A. (2010). Dopamine and binge eating behaviors. *Pharmacol. Biochem. Behav.* 97, 25–33.
- Biever, A., Valjent, E., and Puighermanal, E. (2015). Ribosomal Protein S6 Phosphorylation in the Nervous System: From Regulation to Function. *Front. Mol. Neurosci.* 8, 75.
- Corwin, R.L., and Buda-Levin, A. (2004). Behavioral models of binge-type eating. *Physiol. Behav.* 82, 123–130.
- Cota, D. (2007). CB1 receptors: emerging evidence for central and peripheral mechanisms that regulate energy balance, metabolism, and cardiovascular health. *Diabetes. Metab. Res. Rev.* 23, 507–517.
- DiFeliceantonio, A.G., Coppin, G., Rigoux, L., Edwin Thanarajah, S., Dagher, A., Tittgemeyer, M., and Small, D.M. (2018). Supra-Additive Effects of Combining Fat and Carbohydrate on Food Reward. *Cell Metab.*
- Gangarossa, G., Perroy, J., and Valjent, E. (2013). Combinatorial topography and cell-type specific regulation of the ERK pathway by dopaminergic agonists in the mouse striatum. *Brain Struct. Funct.* 218, 405–419.
- Han, W., Tellez, L.A., Niu, J., Medina, S., Ferreira, T.L., Zhang, X., Su, J., Tong, J., Schwartz, G.J., van den Pol, A., et al. (2016). Striatal Dopamine Links Gastrointestinal Rerouting to Altered Sweet Appetite. *Cell Metab.* 23, 103–112.
- Hankir, M.K., Seyfried, F., Hintschich, C.A., Diep, T.-A., Kleberg, K., Kranz, M., Deuther-Conrad, W., Tellez, L.A., Rullmann, M., Patt, M., et al. (2017). Gastric Bypass Surgery Recruits a Gut PPAR- α -Striatal D1R Pathway to Reduce Fat Appetite in Obese Rats. *Cell Metab.* 25, 335–344.
- Hyde, K.M., Blonde, G.D., le Roux, C.W., and Spector, A.C. (2017). Liraglutide suppression of caloric intake competes with the intake-promoting effects of a palatable cafeteria diet, but does not impact food or macronutrient selection. *Physiol. Behav.* 177, 4–12.
- Matias, I., and Di Marzo, V. (2007). Endocannabinoids and the control of energy balance. *Trends Endocrinol. Metab.* 18, 27–37.
- Morton, G.J., Meek, T.H., and Schwartz, M.W. (2014). Neurobiology of food intake in health and disease. *Nat.Rev. Neurosci.* 15, 367–378.
- Rada, P., Avena, N.M., Barson, J.R., Hoebel, B.G., and Leibowitz, S.F. (2012). A High-Fat Meal, or Intraperitoneal Administration of a Fat Emulsion, Increases Extracellular Dopamine in the Nucleus Accumbens. *Brain Sci.* 2, 242–253.
- Tellez, L.A., Ferreira, J.G., Medina, S., Land, B.B., DiLeone, R.J., and de Araujo, I.E. (2013). Flavor Independent Maintenance, Extinction, and Reinstatement of Fat Self-Administration in Mice. *Biol. Psychiatry* 73, 851–859.

Figure 1

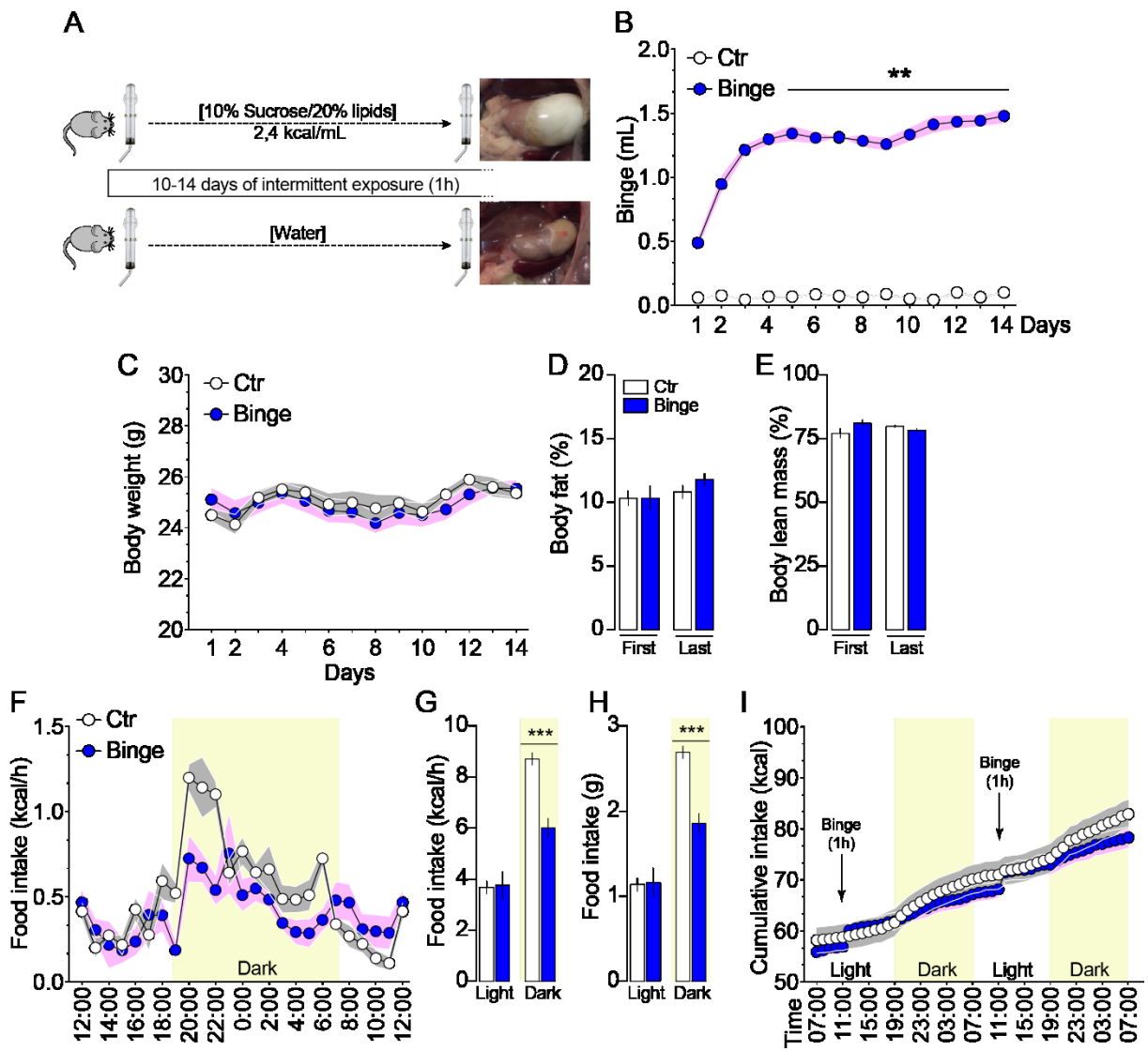
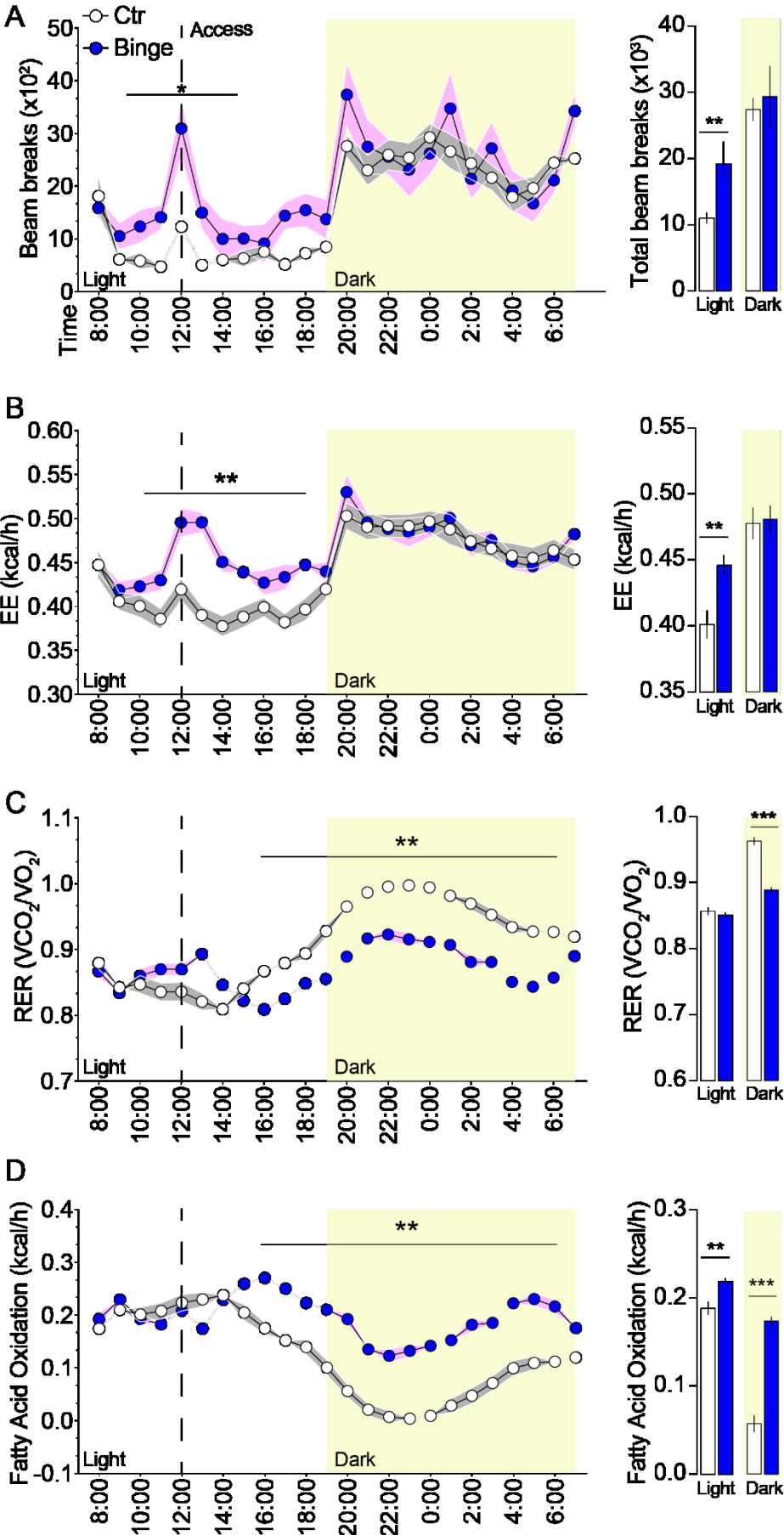

Figure 2



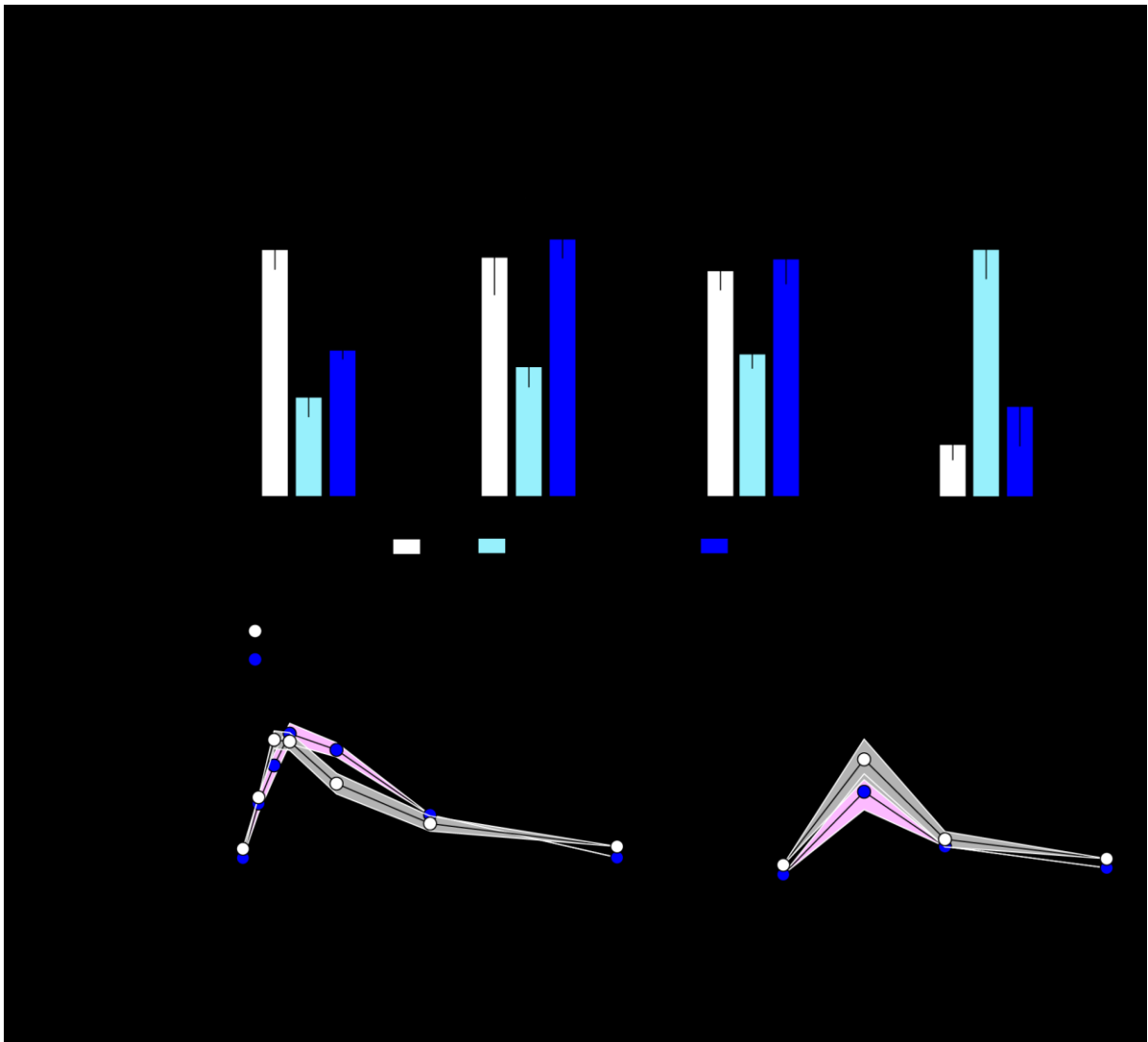

Figure 4

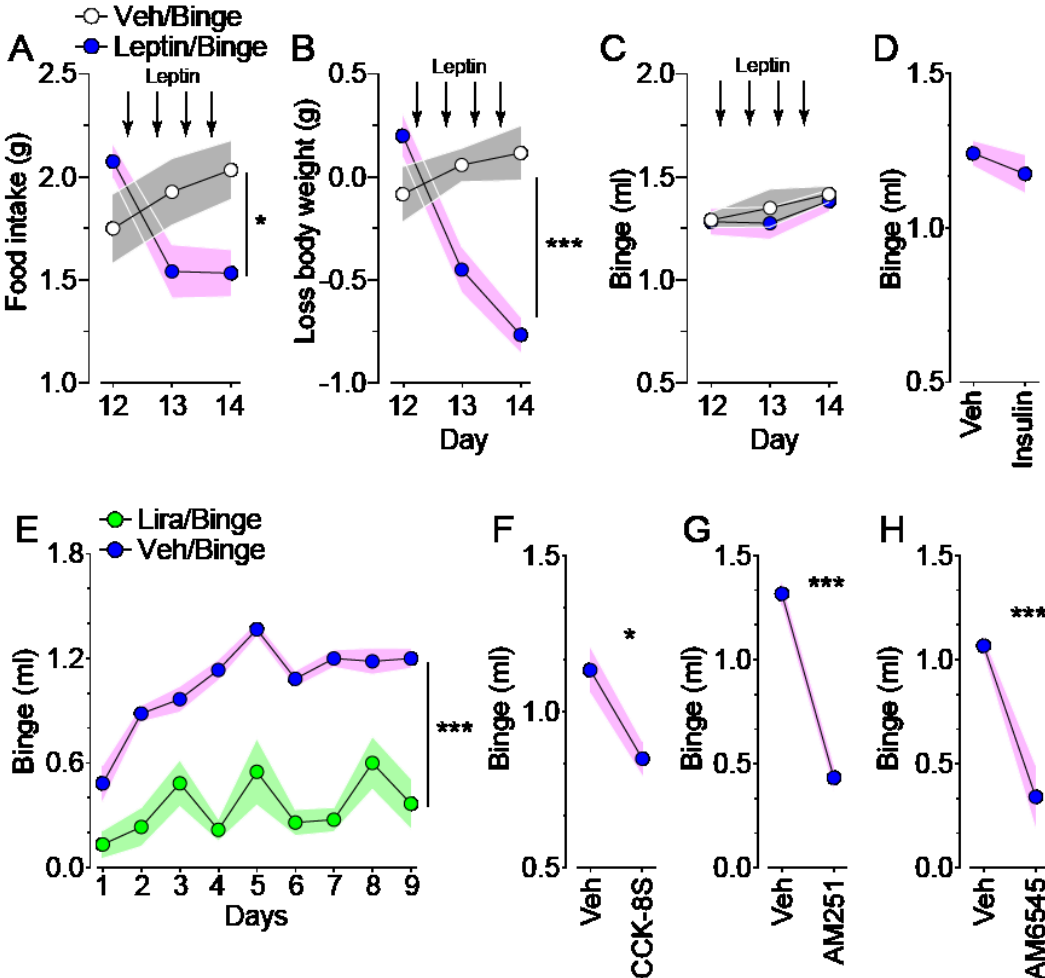
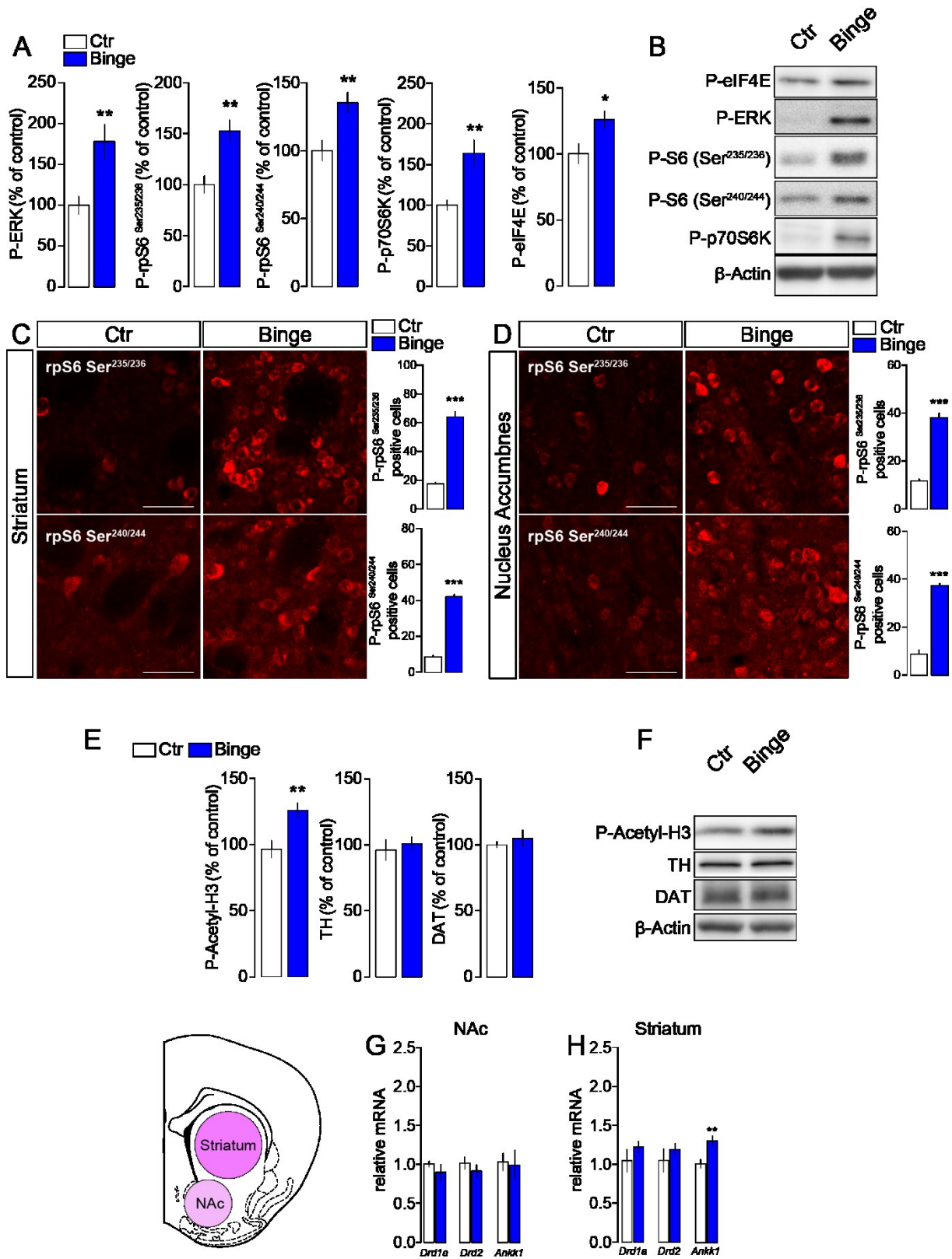
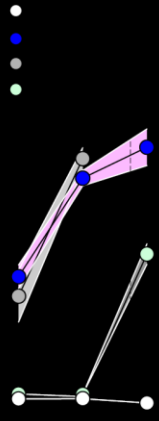

Figure 5





Striatum
C

NAc
D

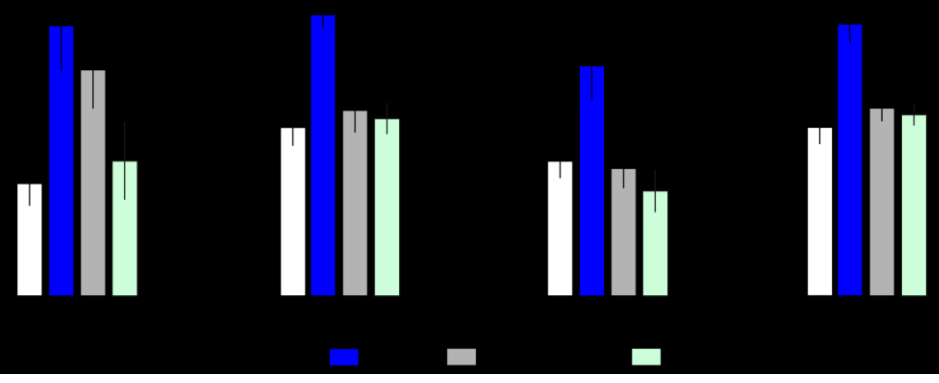
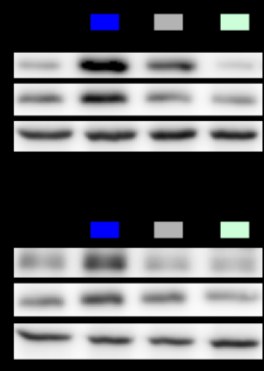

Figure 7

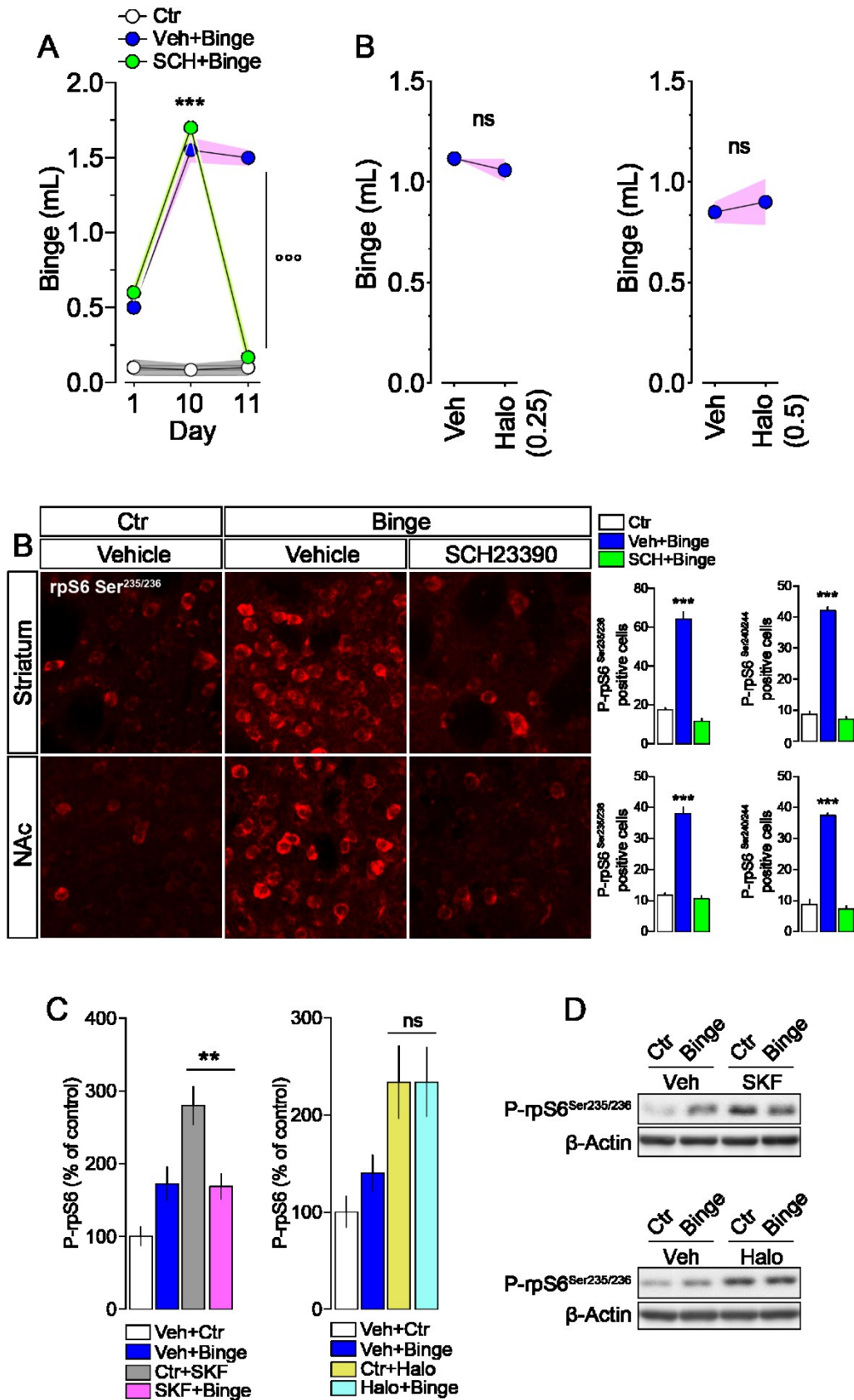

Figure 8

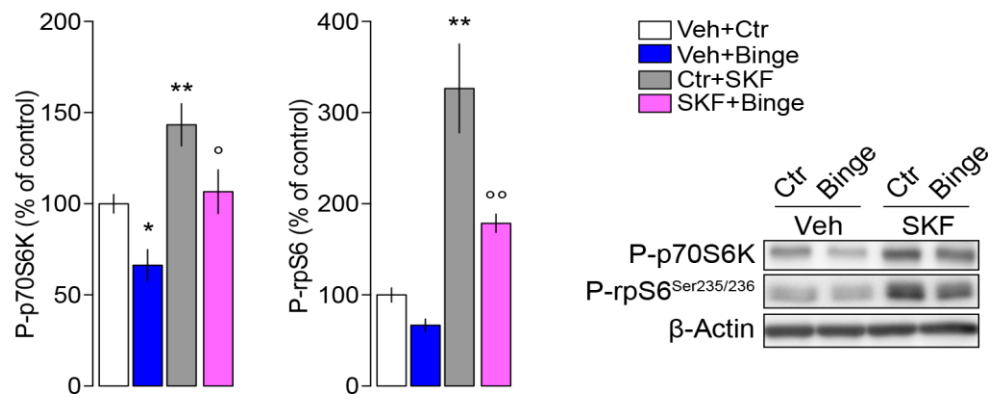
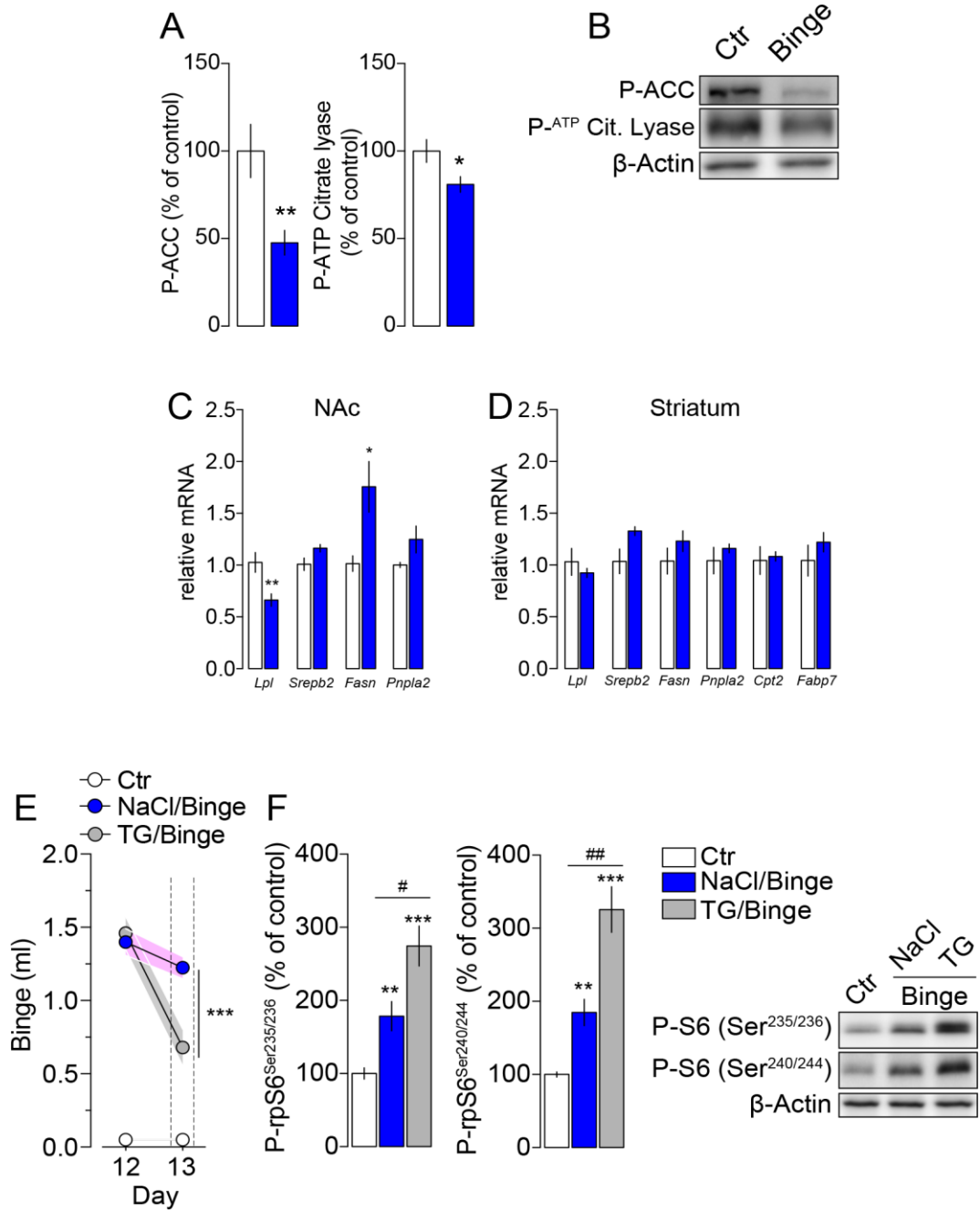
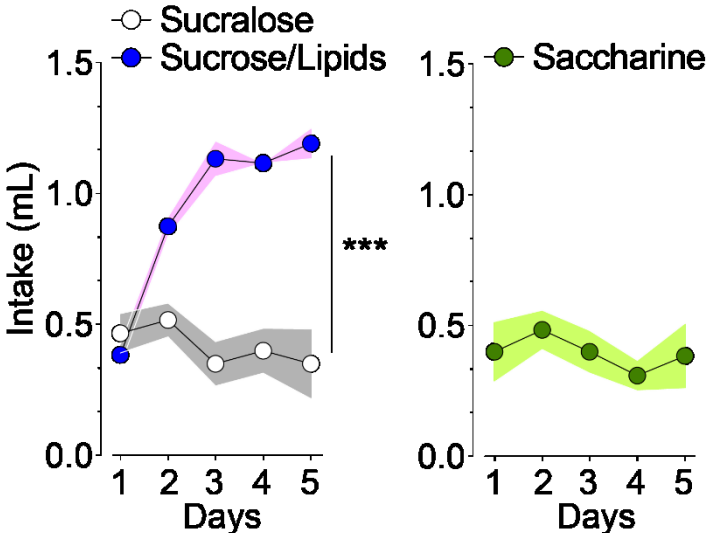

Figure 9



Suppl. Figure 1



Suppl. Figure 2

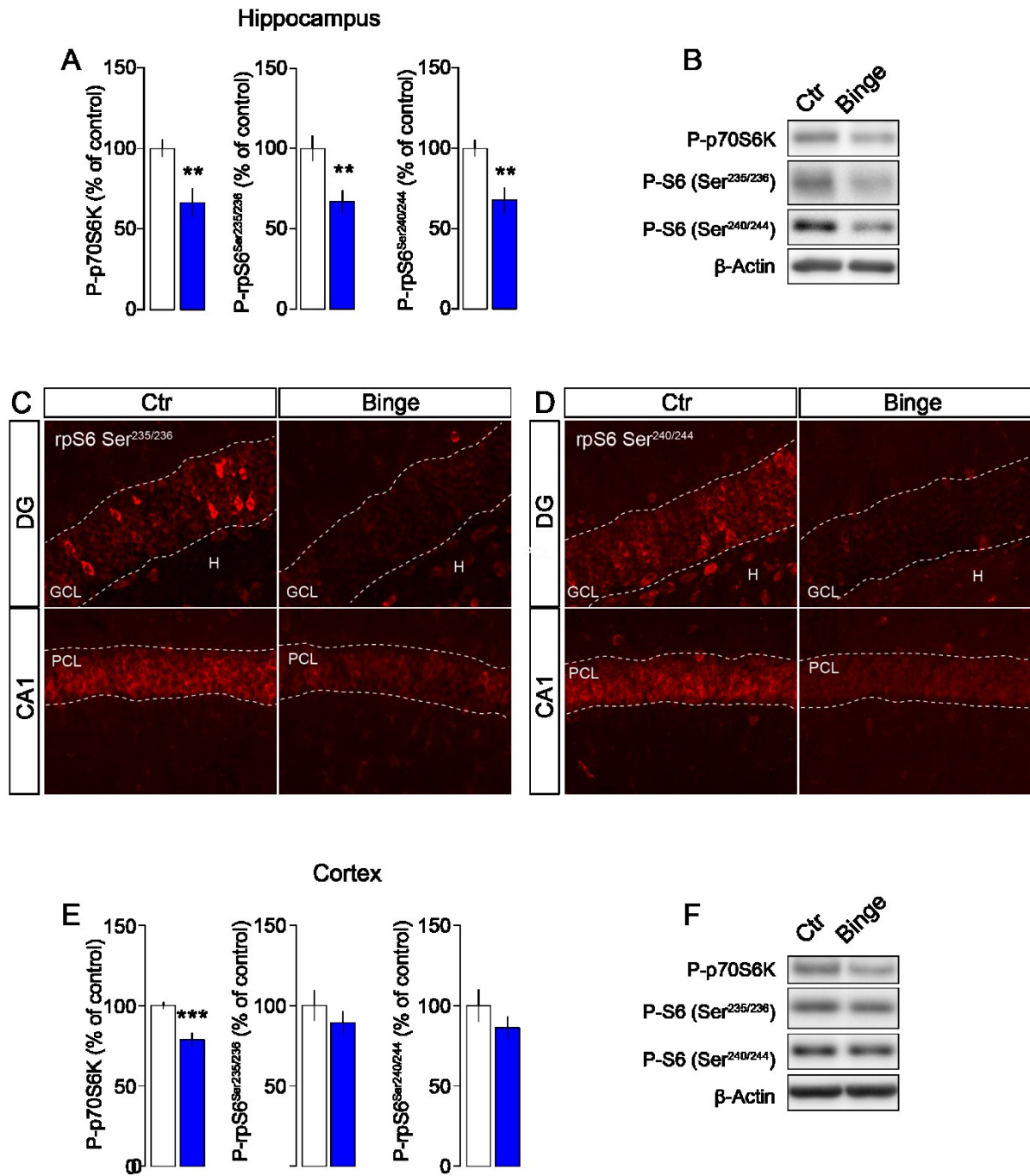

H. Figure Legends

Figure 1: intermittent access to caloric beverage does not affect body weight and caloric balance after 10 days. A: C57bl6 animals have a daily one-hour access to a palatable drink composed of 10% sucrose and 20% lipids (Binge group, n=6) or water (Ctr group, n=6). Animal stomachs after one-hour exposure are shown above. B: Palatable drink intake after one-hour access to water (Ctr) or sugar/lipids drink (binge). Body weight (C), body fat (D), lean body mass (E) are not affected by daily intake of palatable drink. Standard diet intake of animals with access to the palatable drink during the day is reduced compared to controls. F: Standard food intake per hour. G: Average food intake in kcal/h during light and dark phase. H: Standard food intake in grams during light and dark phase. I: total cumulative intake of animals (=standard diet + bingeing intake) on day 6 and 7. The decrease of standard diet intake is counterbalanced by the daily intake of palatable drink, and the amount of calories ingested is the same between the two groups.

Figure 2: intermittent access to caloric mixture leads to anticipatory behaviour and shifts metabolic substrates. A: Access to palatable drink is preceded by anticipative locomotor activity. B. Energy expenditure (EE) is increased in binge animals. C. Respiratory Exchange Ratio (RER) is shifted in binge animals. D. Fatty oxidation in binge animals is increased.

Figure 3: Intermittent access to caloric mixture induces anticipatory metabolic changes but does not alter glucose homeostasis. Plasmatic non-esterified fatty acids (A), triglycerides (B), insulin (C) and corticosterone (D) in controls animals (white), animals acclimated to daily intermittent access expecting the reward (light blue) and animals receiving the reward (navy blue). Glucose levels (E) and insulin levels (F) after oral glucose tolerance tests for control animals (white) and binge animals (blue).

Figure 4: Gastrointestinal signalling affects binge behaviour, not leptin or insulin. A. Standard diet food intake after leptin treatments in physiological doses administered twice daily. B. Body weight subsequently to leptin treatment. C. Caloric mixture consumption after leptin treatment was not affected. D. Insulin injections did not prevent bingeing. E. Daily treatment with liraglutide, a GLP-1 agonist, prevents bingeing establishment. F. Cholecystokinin agonist, as well as CB1 receptor agonists (G, H) prevents bingeing.

Figure 5: Bingeing activates the dorsal and ventral striatum. A, B, E, F show protein quantifications by western blots one hour after the beginning of intermittent access to the caloric mixture. C (dorsal striatum) and D (nucleus accumbens) show rP6 phosphorylation levels one hour after the beginning of intermittent access to the caloric mixture. Ctr animals are in white, binge in blue.

Figure 6: Striatal activation by binge-like behaviour requires both reward expectation and reward access. In white, animals exposed to water daily for 14 days (Ctr). In blue, animals exposed to caloric mixture every day for one hour for 14 days. In grey, animals exposed to caloric mixture for 13 consecutive days and expecting reward on day 14. In light blue: animals exposed to water for 13 consecutive days and receiving access to caloric mixture for the first time on day 14. A. Caloric mixture consumption. B. Brain areas dissected. C, D, E, F: protein quantifications by western blots one hour after the beginning of intermittent access to the caloric mixture.

Figure 7: Increased translational activity in the dorsal striatum and NAc is D1, not D2 dependent. Bingeing consumption of animals treated with D1-antagonist SCH23390 one hour prior to caloric mixture access is decreased (A), but not with D2-antagonist haloperidol (B). C. Bingeing cannot phosphorylate rPS6 on both 235/236 and 240/244 sites when mice are pre-treated with the D1R antagonist SCH23390. D and E: Animals had access for one hour to water or caloric mixture, and were treated with SKF81297, haloperidol, or vehicle. Binge oppose rPS6 phosphorylation induced by the D1R agonist SKF81297, but has not effect on haloperidol phosphorylation induction.

Figure 8: D1R-mediated signaling is intact in the mouse hippocampus.

The molecular activation of p70S6K and rpS6 is intact in binge-mice treated with SKF 81297 (5 mg/kg). ° or °° refers to SKF+Binge vs Ctr+SKF. Western blot quantifications and images are shown for both P-p70S6K and P-rpS6 Ser^{235/236}.

Figure 9: Bingeing is associated with lipid signalling in the striatum. A. bingeing induces decreased fatty acid synthesis in the striatum as assessed with phospho-acetylCoA carboxylase (P-ACC) and phospho-ATP citrate lyase (A, B). mRNA expression in the NAc (C) and Striatum (D) of lipoprotein lipase (Lpl), Srebp2, Fatty acid synthetase (Fasn), Pnpla2, Cpt2 and Fatty acid binding protein 7 (FABP7). E. Binge after central administration of triglycerides through carotid is reduced. F. phosphorylation of rpS6 after binge is increased in animals previously exposed to central triglycerides delivery. Ctr: animals receiving central delivery of NaCl and with intermittent access to water. NaCl/Binge: animals receiving central delivery of NaCl and with intermittent access to caloric mixture. TG/Binge: animals receiving central delivery of triglycerides (TG) and with intermittent access to caloric mixture.

Supp. Figure 1: Sucralose and saccharine are not sufficient to develop bingeing behaviour in mice.

Supp. Figure 2: Binge-like behaviour decreases rpS6 phosphorylation in the hippocampus and frontal cortex.

Discussion

A. Results summary

The aim of this thesis was to investigate the potential interaction between dietary lipids and food reward. In a first study, we focused on triglycerides and their interaction with the MCL. Our results show that:

- Central TG access the brain and the MCL, which is able to hydrolyse them because the dopaminergic and dopaminoceptive cells express LPL.
- Central TG hydrolysis by **LPL in MCL neurons controls motivation and reward**.
- Long term exposure to **central TG disrupts DA signalling** through the indirect, not direct, striatal pathway, leading to decreased locomotor activity and motivation.
- **Reward modulation by central TG is not the same** between food reward and drugs of abuse (amphetamine), attesting the complexity of understanding food-reward.
- **Short-term TG does not impair DA signalling**, and is even rewarding.

In parallel, our second study shows that:

- A calorie-rich reward is enough to impinge compulsivity and binge-eating in mice, contrary to rewards composed of artificial sweeteners devoid of calories, thus suggesting that the **MCL possesses some mechanisms to sense the energy contents of food** and associate a food-reward to the caloric value,
- Intermittent access to palatable foods enriched in sugar in lipids is **sufficient to trigger important molecular changes in DA** and lipid signaling within the MCL system,
- **Bingeing on high-fat/high-sugar alters the striatal direct D1R pathway**, not the indirect D2R pathway,
- The behavioural and molecular changes observed are **controlled by peripheral inputs arising from the gut**.

Altogether, these two studies highlight the important role of nutrients, especially lipids, in central nervous system signaling, and emphasise that the MCL, beyond the hypothalamus, is a crucial circuitry to consider when investigating energy balance and feeding behaviour.

B. Comments on NaCl 0.9% as a control for Intralipid in first study

During the whole central TG effect study presented in the first chapter of our results, we used NaCl 0.9% (SAL) as a control to assess the effects of Intralipid 20% (TG). We are widely aware that this control is far from being optimal: to begin with, Intralipid and saline have different physical properties such as thickness, density, that change the speed of delivery as well as the amount infused in the brain. Next, Intralipid is not a pure solution of TG, and its hydrophilic properties involve several adjuvants, such as glycerine and phospholipids, which are not present in saline (*Figure 43*). To date, we do not have any appropriate vehicle to counterbalance Intralipid.

Previous studies implemented Intralipid 20% with heparin, as this glycosaminoglycan potentiates LPL activity and TG hydrolysis. Because we were prone to investigate physiological role of LPL in the phenotypes we described, no heparin was added in our experimentation. Current studies, still ongoing, will assess whether the reinforcing effect of central Intralipid delivery supplemented with heparin is enough to alter rewarding properties in mice, or not.



Pharmacy Bulk Package
Not For Direct Infusion

DESCRIPTION

Intralipid® 20% (A 20% I.V. Fat Emulsion) Pharmacy Bulk Package is a sterile, non-pyrogenic fat emulsion intended as a source of calories and essential fatty acids for use in a pharmacy admixture program. It is made up of 20% Soybean Oil, 1.2% Egg Yolk Phospholipids, 2.25% Glycerin, and Water for Injection. In addition, sodium hydroxide has been added to adjust the pH so that the final product pH is 8. pH range is 6 to 8.9.

Intralipid® 20% Pharmacy Bulk Package is not intended for direct infusion. It is a sterile dosage form which contains several single doses for use in the preparation of three-in-one or total nutrient admixtures (TNAs) in a pharmacy admixture program.

The soybean oil is a refined natural product consisting of a mixture of neutral triglycerides of predominantly unsaturated fatty acids with the following structure:

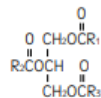

where R₁C-, R₂C- and R₃C- are saturated and unsaturated fatty acid residues.

The major component fatty acids are linoleic acid (44-62%), oleic acid (19-30%), palmitic acid (7-14%), α-linolenic acid (4-11%) and stearic acid (1.4-5.5%).¹ These fatty acids have the following chemical and structural formulas:

Linoleic acid
C₁₈H₃₂O₂

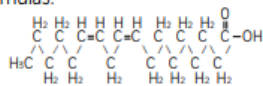

Oleic acid
C₁₈H₃₄O₂

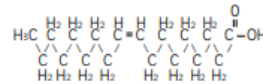

Palmitic acid
C₁₆H₃₂O₂

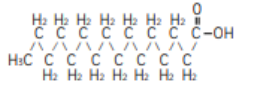

α-Linolenic acid
C₁₈H₃₀O₂

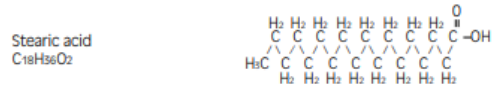
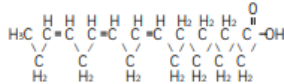

Purified egg phosphatides are a mixture of naturally occurring phospholipids which are isolated from the egg yolk. These phospholipids have the following general structure:

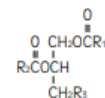

R₁C- and R₂C- contain saturated and unsaturated fatty acids that abound in neutral fats. R₃ is primarily either the choline or the ethanolamine ester of phosphoric acid.



Phosphatidylcholine Phosphatidylethanolamine

Glycerin is chemically designated C₃H₈O₃ and is a clear colorless, hygroscopic syrupy liquid. It has the following structural formula:



Intralipid® 20% (A 20% I.V. Fat Emulsion) has an osmolality of approximately 350 mOsmol/kg water (which represents 260 mOsmol/L of emulsion) and contains emulsified fat particles of approximately 0.5 micron size.

The total caloric value, including fat, phospholipid and glycerin, is 2.0 kcal per mL of Intralipid® 20%. The phospholipids present contribute 47 milligrams or approximately 1.5 mmol of phosphorus per 100 mL of the emulsion.

The primary plastic container (Biofine™), is made from multilayered film specifically designed for parenteral nutrition drug products. The film is polypropylene based comprising three co-extruded layers. It contains no plasticizers and exhibits virtually no leachables. The container does not contain DEHP (di(2-ethylhexyl)phthalate) or PVC. This product is not made with natural rubber latex. The container is nontoxic and biologically inert.

The container-emulsion unit is a closed system and is not dependent upon entry of external air during administration. The container is overwrapped to provide protection from the physical environment and to provide an additional moisture barrier when necessary.

Figure 43 Intralipid Composition

We are currently investigating to find some TG that cells would be unable to metabolise, as these could be an interesting control to validate our data.

C. Comments on D2R indirect pathway inhibition by central TG, and biphasic alteration of reward

1. Predilection site for TG sensing?

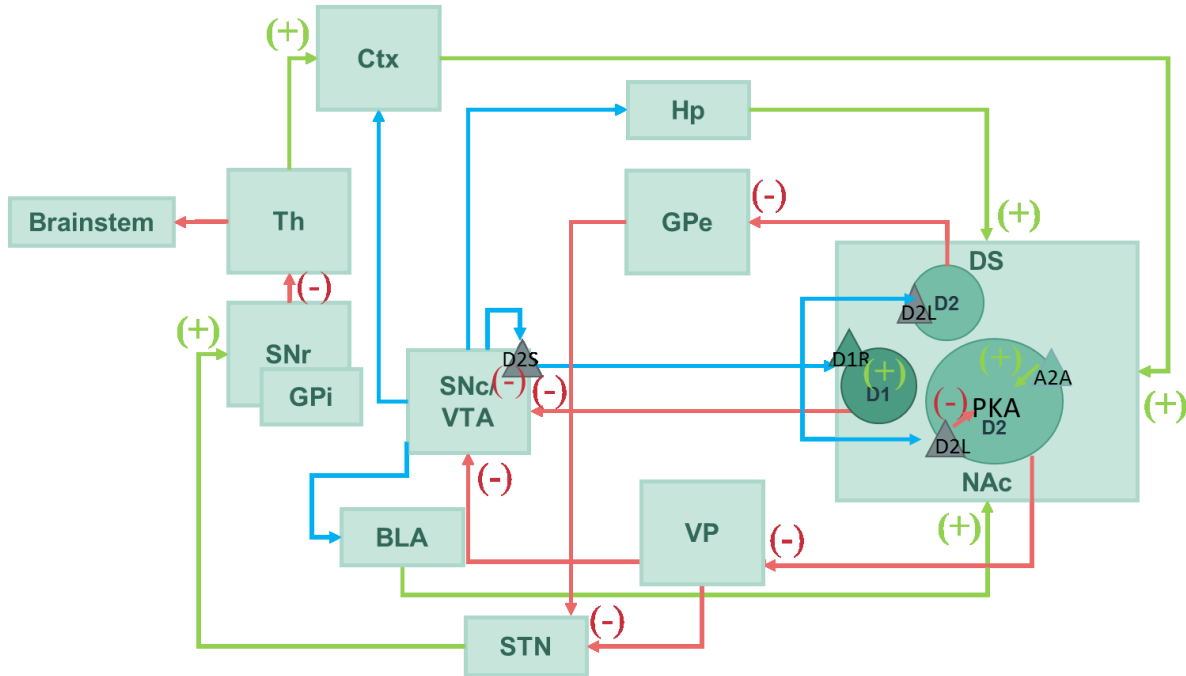

Figure 44 Mesocorticolimbic structures involved in TG sensing.

In red: GABAergic projections. In green: glutamatergic projections. In blue: dopaminergic projections.

Central TG delivery in mice cause important molecular changes in the MCL, whose anatomy is reminded above (*Figure 44*). We found that central TG impairs the **indirect DA pathway, enriched in D2 receptors**. The D2R are expressed both pre-synaptically on dopaminergic neurons themselves and post-synaptically on the striatal dopaminoceptive neurons MSNs (*Figure 44*). If TG target the D2R, it is not surprising to observe molecular effects in both VTA and striatum. Because the indirect pathway feeds back to the VTA, **whether central TG primarily alter the pre-synaptic or the post-synaptic part of dopamine signalling remains unknown**. However, because we see no major electrophysiological signatures in DA neurons of the VTA after acute central TG delivery, **we can conclude that the primary target of central TG occurs post-synaptically, on the D2R-MSN**, and reaches the presynaptic part of DA signaling only after time. This potential mechanism would explain why in our study, central TG act in a biphasic mode, with positive reinforcing effects in short term, and inhibitory effects in long term.

2. Putative mechanism for short-term effect of central TG delivery

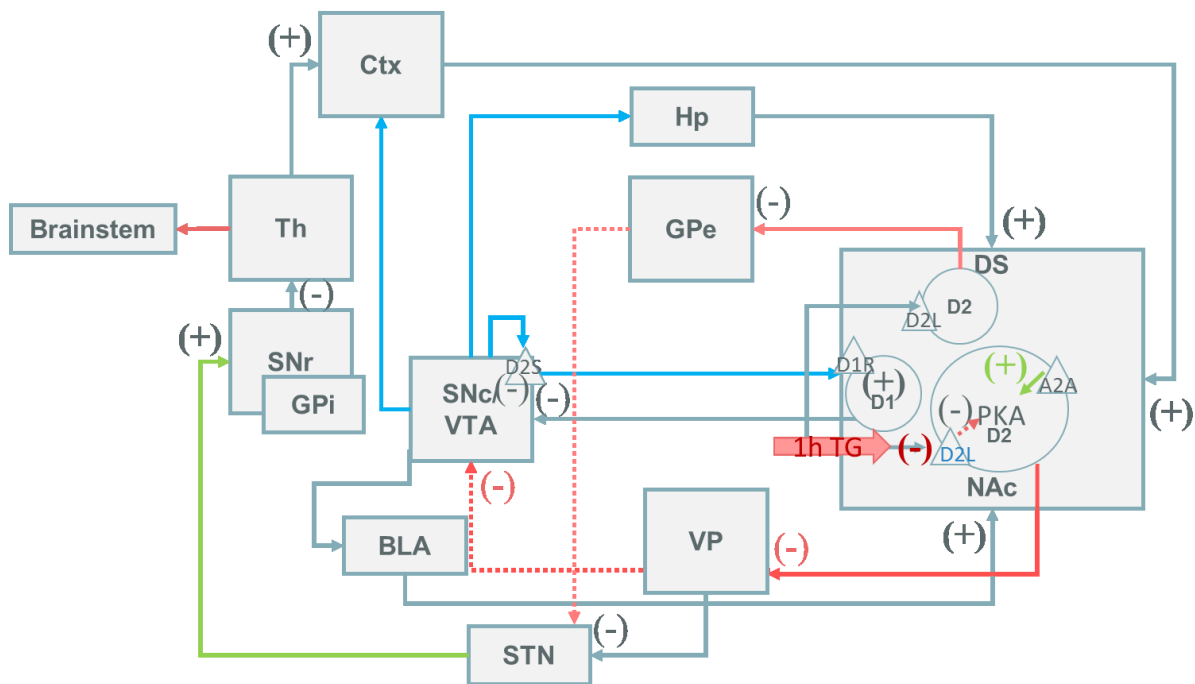

Figure 45 Putative effect of short term TG delivery in the MCL

To date, the positive effect observed in 1-hour CPP and self-administration has not been validated by any substantial data proving an increased DA release in the striatum, a necessary condition to ultimately assess the rewarding effect of central TG.

At the physiological level, since plasma TG increase at the onset of a meal, it would make sense to assume that they could help promoting feeding by increasing the rewarding value of food, or the motivation to eat.

At the cellular scale, one can imagine that the positive behavioural effects associated to central TG delivery may be due to a D2R inhibition in the striatum as follows. The inactivation of the D2R would remove the inhibitory input coupled to the G_i GPCR associated and increase D2R-MSN GABA release. In this model, the D2R-MSN would consequently inhibit the GPe and VP, which would no longer inhibit the SNr/VTA, and release DA sufficiently to promote behavioural effects such as CPP or self-administration. This hypothesis is in agreement with published studies where a short-term inhibition of D2R in the striatum by expressing $G_{\alpha i}$ -coupled designer receptor hM4D leads to increased motivation and activation of the ‘GO’ pathway (Carvalho Poyraz et al., 2016). In return, the DA release associated to increased activity of the VTA would target DA receptors, with a preference for the autoreceptor D2S, whose affinity is the most important (*Figure 45*), followed by the D2L, and the D1R (see introduction I. D.2, p. 37). While the D2R has a high affinity for DA and are tonically activated by low basal concentrations of DA in the extracellular space, the D1R have a lower sensitivity and need a phasic, fast and large DA release to be activated. It is likely that the TG effect on DA release is not sufficient to induce such a firing. For those reasons, one can hypothesize that short-term effects of central TG

delivery may only targets the D2R, in accordance with our behavioural data assessing a mild effect on TG-associated place preference, and puzzling effects on self-administration. Consequently, TG would act as motivational modulators rather than rewarding stimulus itself.

Interestingly, a well-known motivation-modulator is the active component of *Cannabis sativa*, Δ -THC. Many studies tried to evidence the rewarding effects of this drug in rodents, with classical paradigms such as CPP or self-administration, with difficulties and confusing results in a somewhat reminiscent fashion of behavioural TG studies (Panlilio and Justinova, 2018; Valjent and Maldonado, 2000). The mechanisms through which Δ -THC alters the dopaminergic pathway is still unclear, although it is known that long-term exposure to Δ -THC increases D2R and D3R availability in the VTA, not CPu (Panlilio and Justinova, 2018). Ultimately, because Δ -THC targets the same receptors as endocannabinoids (eCBs), molecules derived from lipids, it is appealing to imagine that central TG would alter endocannabinoid signaling, thus leading to part of the observations depicted in our study.

3. Putative mechanism for long-term effect of central TG delivery

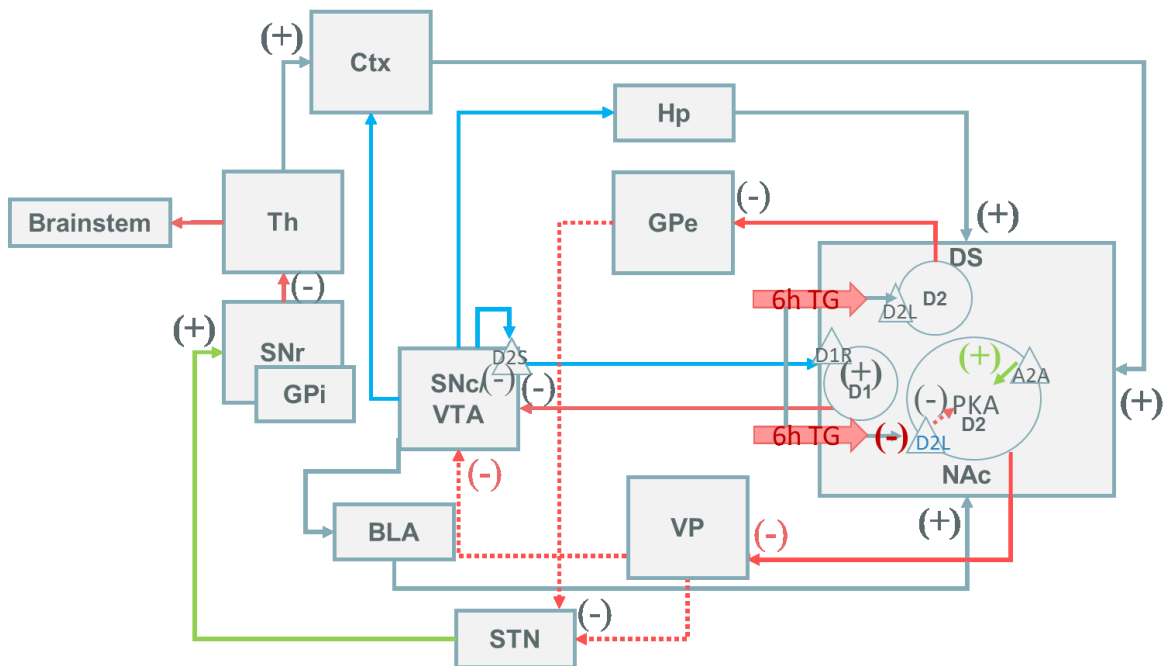

Figure 46 Putative effect of long term central TG delivery

TG exposure after a meal is long-lasting: in humans, pioneering studies have shown that plasmatic TG levels gradually increase after breakfast, and reach a first peak 2 to 3 hours after the first meal, then a second peak 6 to 7 hours later (Ahmed et al., 1976; Olefsky et al., 1976). For that reason, if TG directly trigger the D2R, it is likely that the receptors get desensitised (Beaulieu and Gainetdinov, 2011). **D2R desensitisation is induced by the beta-arrestin 2 protein, and D2R internalisation disrupts the β -arrestin/Akt pathway (Beaulieu, 2011).** Consequently, Akt is less phosphorylated, so is GSK-3. This is in agreement with our data. Interestingly, mice lacking beta-arrestin show impairments regarding

amphetamine-induced locomotor activity (Beaulieu et al., 2005) similarly to mice treated with 6-hours central TG delivery.

In our model, long-term exposure to TG would lead to D2R internalisation driven by β -arrestin, and in parallel, an inhibition of PKA signaling, and an activation of GSK-3 pathway. This would explain the results observed with amphetamine, haloperidol resistance, and the molecular data showing a disruption of PKA, mTOR and ERK pathways in the mouse striatum. Assuming that GSK-3 suppresses GABAergic transmission (Cheng et al., 2017), TG activation of this pathway would consequently increase GABAergic inputs from the VP and GPe on DAergic neurons, and ultimately leading to the inhibition that we detected in DA neurons.

4. Long-term exposure to TG: a mechanism to explain reduced D2R signalling in obese?

Our model allows the specific study of a central hypertriglyceridemia in the MCL. It must be mentioned that **TG-induced behavioural modifications are reversed when the treatment stops**, indicating lack of long-lasting modifications. Indeed, it is likely that fasting, as it occurs during sleeping periods and characterized by rebooted plasmatic TG levels (Ahmed et al., 1976), is sufficient to restart the system paralleling the circadian clock functions. However, the question of a **chronic exposure to high TG levels, as observed in hyperlipidemic patients, is still under investigation**. A previous study in our lab using the same carotidic infusions reported that high-fat diet induced obese animals perfused with central TG display the same locomotion and motivation impairments, however the balance for food preference towards low-energy foods was no longer affected. In this study, Cansell and colleagues (2014) concluded that hypertriglyceridemia could be an important factor promoting obesity, by reducing energy expenditure and increasing palatable food consumption. In our study, obese animals failed to acquire a CPP, suggesting that the acute TG effect is no longer effective, and that only the long term inhibition of the MCL remains.

Interestingly, several studies point to an **important role of the D2R in food intake disorders** (Guo et al., 2014; Johnson and Kenny, 2010), and obesity is correlated with a lower amount of D2R (Hajnal et al., 2007; Volkow et al., 2008; Wang et al., 2001). As such, one can imagine that **a long-term exposure to high plasmatic TG levels could completely dysregulate the D2R present in the MCL**, leading to excessive feeding behaviours and worsening body weight unbalance.

D. Comments on different regulation of food reward and drug reward by central TG

Our behavioural data coupling palatable food and central TG administration show a decreased food consumption when TG signal to the brain. This goes in the direction of previously published data where food preference is shifted to standard diet when TG are centrally administered (Cansell et al., 2014). However, while animals **consumed less palatable food than the controls in CPP conditioning, they**

spent more time in the rewarded compartment, and while they binged less compared to animals receiving central saline, striatum of animals trained in a binge protocol had increased S6 activity compared to animals infused with saline. The decreased palatable food consumption could be due to **impaired motivation** and locomotor activity going along with central TG administration, although animals still display sufficient locomotor activity to eat regular diet normally. Alternatively, our study on bingeing behaviour in rodents suggests that food-reward is associated with calories contained in the meal. Several articles support this view, in rodents, and in humans (DiFeliceantonio et al., 2018; Rothmund et al., 2007b), so it is possible that the decreased food consumption is due to a **faster reaching of hedonic ‘satiety’** when TG are administered.

Contrary to drugs of abuse, the liking of food is not entirely driven by DA, and many other pathways (eCBs, opioids, neuropeptides) still need to be considered in order to understand TG effect on reward. For instance, leptin is a peptidic hormone released by the adipose tissue, which access the VTA, regulates reward, inhibits food intake. **TG were shown to increase brain leptin uptake in the striatum, but impair its signalling** (Banks et al., 2018). The concomitant effect of reduced locomotor activity and leptin resistance effect could explain the reduced motivation, but increased liking, that we observe when administering TG.

While amphetamine *per se* does not display appealing cues for rodents, food is associated with odours, taste... perceived by the brain, and that central TG could modulate such parameters in order to control food reward. Importantly, some neurons, such as the **dopaminergic neurons of the olfactory tubercle, which show anatomical similarities with the D2 MSN from the NAc, also express the LPL, and can possibly sense TG** (Lein et al., 2007). These neurons directly target the VP, and because they interact closely with the olfactory bulbs and olfactory cortex, they receive inputs related to odorant food cues and could modulate reward accordingly.

E. TG metabolism and LPL role in lipid sensing

1. Putative role for LPL in D2R signalling

Recent publications show that **oleic acid injections in the VTA suppress feeding and food reward**, and increase locomotor activity (Hryhorczuk et al., 2018). DAergic neurons express a larger number of FABP3 transporters, and Hryhorczuk et al. showed that **these neurons need the uptake of FFA** in order to affect feeding behaviour and motivation. These observations, in agreement with the work presented here, raise the question of lipids entry to the MCL. We saw that a genetic **disruption of the lipoprotein lipase in the MCL regions affects motivation for food reward**. These data point out the **importance of TG hydrolysis in order to target DAergic neurons**, but is not sufficient to understand the role of LPL in lipid-sensing. Interestingly, a paper published by (Shioda et al., 2010) suggests that in dopaminergic neurons, the D2R and FABP7 co-localise together and modulate D2R signaling, not the D1R. One possible explanation for the central TG effect could be a **first hydrolysis by the LPL**

followed by a transport of resulting FFA, coupled with a dimerization of FABP and D2R, and ultimately a dopamine signalling modulation.

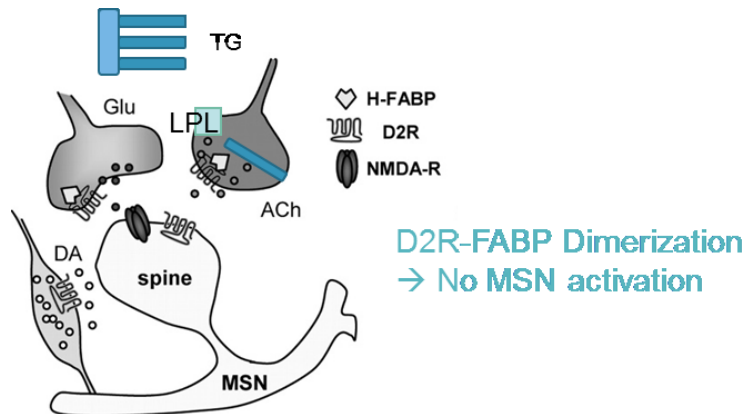

Figure 47 Schematic representation of altered neurotransmission in the dorsal striatum following H-FABP deletion.

The striatal microcircuit is composed of medium spiny neurons (MSNs) that receive input from excitatory corticostriatal glutamatergic projections, dopaminergic nigrostriatal fibers, and cholinergic terminals. D2R is present at the postsynapse (spine) of MSN and in each terminal. However, H-FABP is present only in glutamatergic and cholinergic terminals. H-FABP binds to the third cytoplasmic loop of D2R. D2R coupled to H-FABP inhibit MSN. Adapted from (Shioda et al., 2010).

2. Other lipases involved in TG sensing?

Because **LPL is not the only lipase expressed in the brain**, one cannot exclude the possible role of other lipases in brain lipid sensing. For example, DDHD2 is a major lipase expressed in the brain, and a knock-out of this enzyme leads to severe cognitive and motor impairments and ectopic lipid droplets in neurons (Inloes et al., 2014, 2018). Because this enzyme has just been involved in central TG metabolism, its role regarding lipid sensing and energy regulation has not been investigated yet. Following the idea that LPL is not the only enzyme able to catalyse TG hydrolysis, we measured the mRNA levels of several other brain lipases such as Pnpla2, AGTL, Lipe HSL depending on fasted, fed ad libitum or fasted and refed state in the hypothalamus, hippocampus, cortex and striatum. Our data suggest that **the energy states of animals regulate lipases expression not only in the hypothalamus, but also in other limbic regions**, raising the question of their potential role in energy balance and lipid sensing (Figure 47).

Discussion

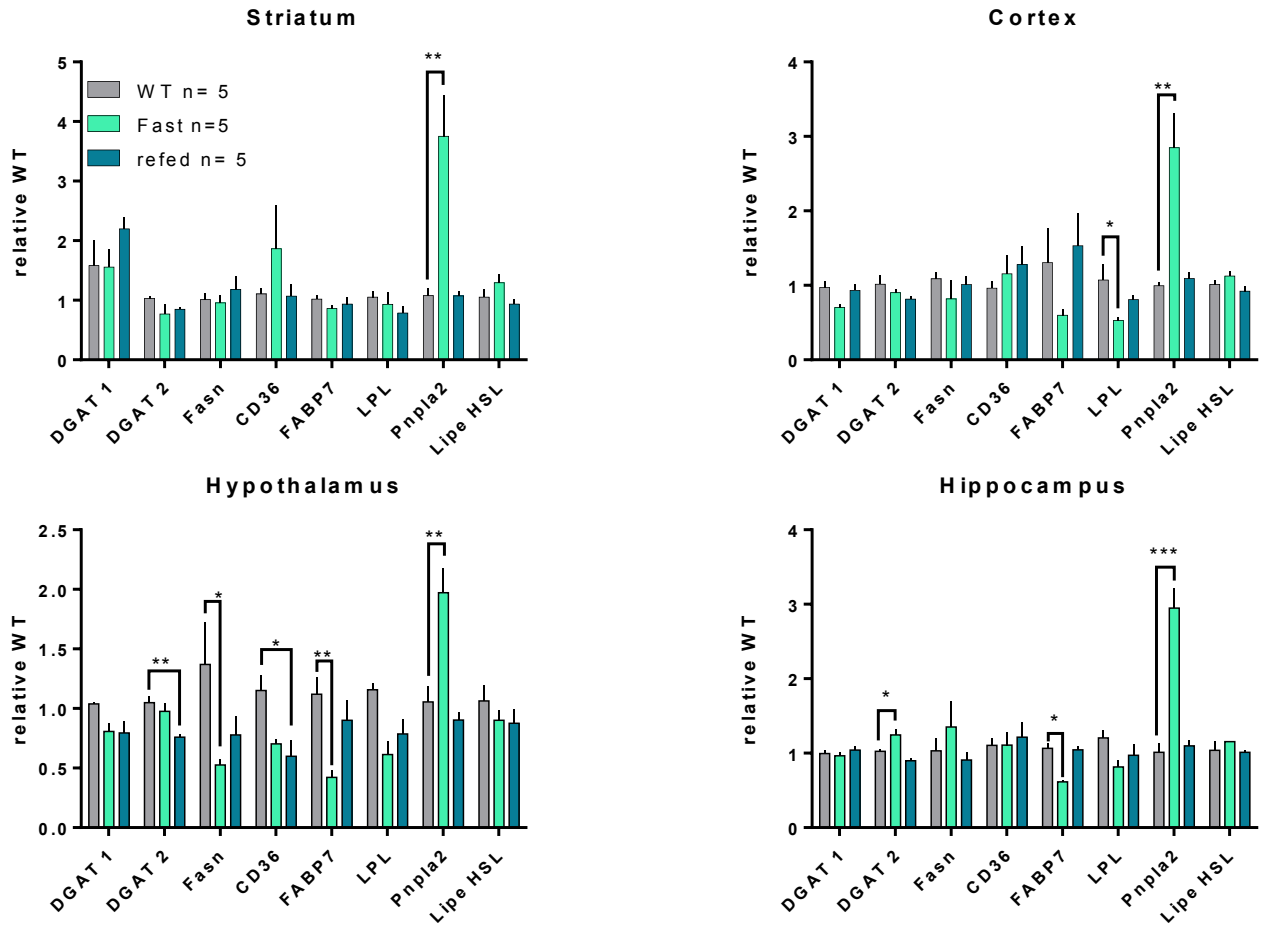

Figure 48 Lipases and lipid metabolism enzymes expression in the central nervous system

mRNA expression of *C57bl6/j* animals fed ad libitum (WT), fasted overnight (Fast) or refed (refed). DGAT: diacylglycerol acetyl transferase, Fasn: fatty acid synthase, FABP7: Fatty acid binding protein, LPL; lipoprotein lipase, Pnpla2: Patatin-like phospholipase 2, Lipe HSL: Hormone-sensitive lipase.

3. LPL as the missing link to understand FFA and TG differences in lipid sensing?

As mentioned in (Hryhorczuk et al., 2018), once FFA cross the membrane and enter the neurons, they need to be esterified in TG again, and stored in lipid droplets. **TG neosynthesis is under the control of diglyceride acyltransferases (DGAT)**, which catalyse the conversion of DAG and Acyl-CoA into TG (Shi and Cheng, 2009). According to (Cases et al., 2001; Zhang et al., 2014), DGAT-2 is the most expressed isoform in the brain. DGAT-2 central expression depends on the energy state of animals (Figure 47). Again, these preliminary data highlight the potential role of central TG neosynthesis as signalling for energy balance, not only in the hypothalamus, but also in other limbic brain areas.

F. Potential role of astrocytes in lipid sensing

As mentioned in (Hryhorczuk et al., 2018), once FFA cross the membrane and enter the neurons, they need to be esterified in TG again, and stored in lipid droplets. **TG neosynthesis is under the control of**

diglyceride acyltransferases (DGAT), which catalyse the conversion of DAG and Acyl-CoA into TG (Shi and Cheng, 2009). According to (Cases et al., 2001; Zhang et al., 2014), DGAT-2 is the most expressed isoform in the brain. DGAT-2 central expression depends on the energy state of animals (*Figure 47*). Again, these preliminary data highlight the potential role of central TG neosynthesis as signalling for energy balance, not only in the hypothalamus, but also in other limbic brain areas.

G. Conclusion

This work highlights the physiological importance of TG sensing in the brain, not only in the hypothalamus, but also in structures related to reward encoding. In our work, we suggest that abnormal TG signalling, or abnormal TG exposure (i.e. hypertriglyceridemia associated to body weight dysregulations) could lead to abnormal dopamine signalling. This thesis shows for the first time that TG themselves interact with a specific neuronal population of the brain carrying the DRD2 receptor, and provide interesting trails regarding previous correlations between the DRD2 receptor dysfunctions and obesity. As such, TG could be important in obesity settling and hyperphagia disorders.

Because the neurons we studied are involved not only in food reward, but also in cognition, mood disorders or addiction, understanding the physiological and pathological mechanisms of central TG is really significant. More and more studies prove that what we eat as well as our feeding behaviours shape the brain; the nature of the ingested fat largely matters in depression disorders, and we cited many studies showing that fat also alters cognition. As a consequence, the fast and uncontrolled evolution of our diet, enriched in fat, urgently needs clarification regarding the associated biological consequences, and understanding the protective or deleterious central effect of lipids matters.

Index

2-AG		Cocaine and Amphetamine Related	
2-arachidonoyl glycerol.....	32	Transcript.....	21
ABC		CB1	
ATP-binding cassette	55	cannabinoid receptor 1.....	31
AC		CCK	
adenylate cyclase.....	43	cholecystokinin.....	17
Acetyl-CoA		CPT1	
acetyl-coenzyme A.....	48	Carnitine palmitoyltransferase-1.....	62
acyl-CoA		CREB	
acyl-Coenzyme A.....	51	cAMP Response Element-binding protein	44
AgRP		CRH	
Agouti-Related Protein.....	21	corticotropin-releasing hormone.....	22
AGTL		CSF	
adipose triglyceride lipase	52, 65	cerebrospinal fluid	53
Akt		D1R	
protein kinase B.....	46	dopamine receptor D1.....	26, 43
AMPA		D2L	
α -amino-3-hydroxy-5-méthylisozazol-4-		D2 long isoform.....	44
propionate.....	44	D2R	
AMPK		dopamine receptor D2.....	26
AMP-activated protein kinase	62	D2S	
anandamide		D2-short isoform.....	44
N-arachidonoyl ethanolamine	32, 61	DA	
Angptl3		dopamine	25
angiopoietin-like 3.....	66	DAG	
ANKK1		diacylglycerol	45
ankyrin repeat and kinase domain containing		diglyceride	49
1.....	41	DAG-lipase	
AP		diacylglycerol lipase	32
area postrema.....	15	DARPP-32	
Apo		32 kDa dopamine and cAMP regulated	
apolipoprotein.....	51	phosphoprotein	44
ARA		DAT	62
arachidonic acid.....	49	dopamine transporter	37
Arc		DGAT	
arcuate nucleus	14	diacylglycerol acyltransferase	51
ATP		DHA	
adenosine tri-phosphate.....	18	docosahexaenoic acid	49
BBB		DMH	
blood-brain-barrier	13, 53	dorsomedial hypothalamus	15
BDNF		DOPA	
brain-derived neurotrophic factor.....	23	L-3,4-dihydroxyphenylalanine	37
BOLD		DOPAC	
Blood-Oxygen Level Dependant.....	63	aromatic-1-amino-acid decarboxylase.....	37
CAMKII		DREADD	
calcium/calmodulin-dependent		Designer Receptors Exclusively Activated by	
kinase II	45	Designer Drugs	22
cAMP		DS	
cyclic Adenylate Monophosphate	43	dorsal striatum	26
CART		DSM-V	

Diagnostic and Statistical Manual of Mental Disorders V.....	39	inositol triphosphate.....	45
eIF-4E		LDL	
eukaryotic translation initiation factor 4E .19		low-density lipoprotein.....	52
ERK		LDLR	
Extracellular-signal Regulated Kinase	44	lipoprotein receptor.....	56, 59
FAAH		LH	
fatty acid amide hydrolase.....	32	lateral hypothalamic area.....	30
FABP		lateral hypothalamus.....	15
fatty acid binding protein	51, 58	LPL	
FAS		lipoprotein lipase	52, 65
Fatty Acid Synthase.....	62	Lrp	
FAT/CD36		LDL related receptor protein	59
Fatty acid translocase/CD36.....	58	LRP	
FATP		LDL receptor-related protein	66
fatty acids transport protein.....	51	MAG	
FFA		monoacylglycerol lipase	32
free fatty acid.....	48	monoglyceride	49
fMRI		Malonyl-CoA	
functional magnetic resonance imaging	63	malonyl-coenzyme A.....	48, 62
FOXO1		MAPK	
Forkhead 1.....	22	mitogen-activated protein kinase	44
FRET		MC3R	
Fluorescence Resonance Energy Transfert	45	α -melanocortin receptors 3	22
GABA		MCH	
γ -Aminobutyric acid.....	21	melanin-concentrating hormone	23
GDP		MCL	
guanosine di-phosphate	43	mesocorticolimbic pathway	26
GLP-1		ME	
glucagon-like peptide 1	17	median eminence	14
GLUT		Mfsd2a	
glucose carrier	55	major facilitator superfamily domain-containing 2a.....	59
GPCR		MGAT	
G-protein coupled receptors	32, 43	monoacylglycerol acyltransferase	51
GPe		MGL	
external globus pallidus.....	26	monoacylglycerol lipase	52
GPI		MSN	
internal globus pallidus	26	medium spiny neurons.....	26, 43
GRK		mTOR	
G protein-coupled receptor kinase.....	46	mammalian target of rapamycin	19
GSK-3		MTP	
glycogen synthase kinase 3	46	microsomal triglyceride transport protein. 51	
GTP		NAc	
guanosine tri-phosphate.....	43	Nucleus Accumbens	26
HDL		NAPE-PLD	
high-density lipoprotein	52	N-acylphosphatidylethanolamine-selective phospholipase D.....	32
HSL		NMDA	
hormone-sensitive lipase	52	N-Methyl-D-aspartic acid.....	44
HSPG		NPY	
heparane sulfate proteoglycan.....	67	neuropeptide Y	21
ICV		NTS	
intracerebroventricular	16	nucleus of the tractus solitarius	14
IFN- γ		PFC	
interferon-gamma	64	prefrontal cortex.....	27
IP3			

Index

PI3K	22
phosphoinositide 3-kinase	19
PIKK	
PI3K-related protein kinase	19
PKA	
Protein Kinase A	44
PKC	
Protein Kinase C	45
PLC	
phospholipase C	45
Pnpla2	
patatin-like phospholipase domain containing-protein	65
POMC.....	61
proopiomelanocortin	21
PP1	
Protein Phosphatase 1	44
PPAR	
peroxisome-proliferator-activated receptors	49
PUFA	
poly-unsaturated free fatty acid	49
PVN	
paraventricular nucleus	15
PYY ₃₋₃₆	
peptide YY3-36	17
Rheb	
Ras homolog enriched in brain.....	19
S6K	
p70 ribosomal S6 kinase.....	19
SNpc	
substantia nigra pars compacta.....	26
SNr	
substantia nigra pars reticulata	26
STAT3	
Signal-activated transcript-3	22
STEP	
Striatal-enriched Tyrosine Phosphatase....	44
TG	
triglyceride.....	49
TH	
tyrosine hydroxylase.....	37
Thr	
Threonine.....	44
TNF	
tumor necrosis factor	64
TRH	
thyrotropin-releasing hormone	23
TSC	
tuberous sclerosis complex.....	19
UCP2	
Uncoupling protein-2	62
vLDL	
very low density lipoprotein	52
vLDLR	
vLDL Receptor	59
VMAT2	
vesicular monoamine transporter 2.....	37
VMH	
ventromedial nucleus of the hypothalamus	15
VP	
ventral pallidum	27
VTA	
ventral tegmental area.....	23
α-MSH	
α-melanocyte stimulating hormone	22
Δ9-THC	
Δ9-tetrahydrocannabinol	31

References

- Abbott, N.J., Rönnbäck, L., and Hansson, E. (2006). Astrocyte–endothelial interactions at the blood–brain barrier. *Nat. Rev. Neurosci.* 7, 41–53.
- Abizaid, A., Liu, Z.-W., Andrews, Z.B., Shanabrough, M., Borok, E., Elsworth, J.D., Roth, R.H., Sleeman, M.W., Picciotto, M.R., Tschöp, M.H., et al. (2006). Ghrelin modulates the activity and synaptic input organization of midbrain dopamine neurons while promoting appetite. *J. Clin. Invest.* 116, 3229–3239.
- Adrian, T.E., Ferri, G.L., Bacarese-Hamilton, A.J., Fuessl, H.S., Polak, J.M., and Bloom, S.R. (1985). Human distribution and release of a putative new gut hormone, peptide YY. *Gastroenterology* 89, 1070–1077.
- Ahima, R.S., Prabakaran, D., Mantzoros, C., Qu, D., Lowell, B., Maratos-Flier, E., and Flier, J.S. (1996). Role of leptin in the neuroendocrine response to fasting. *Nature* 382, 250–252.
- Ahmed, M., Gannon, M.C., and Nuttall, F.Q. (1976). Postprandial Plasma Glucose, Insulin, Glucagon and Triglyceride Responses to a Standard Diet in Normal Subjects. *Diabetologia* 12, 61–67.
- Alsö, J., Olszewski, P.K., Levine, A.S., and Schiöth, H.B. (2012). Feed-forward mechanisms: Addiction-like behavioral and molecular adaptations in overeating. *Front. Neuroendocrinol.* 33, 127–139.
- Anand, B.K., and Brobeck, J.R. (1951). Hypothalamic control of food intake in rats and cats. *Yale J. Biol. Med.* 24, 123–140.
- Anand, B.K., Chhina, G.S., Sharma, K.N., Dua, S., and Singh, B. (1964). Activity of single neurons in the hypothalamic feeding centers: effect of glucose. *Am. J. Physiol. Content* 207, 1146–1154.
- Anderson, R.G.W. (1993). Potocytosis of small molecules and ions by caveolae. *Trends Cell Biol.* 3, 69–72.
- Anderson, C.M., and Stahl, A. (2013). SLC27 fatty acid transport proteins. *Mol. Aspects Med.* 34, 516–528.
- Andreone, B.J., Chow, B.W., Tata, A., Lacoste, B., Ben-Zvi, A., Bullock, K., Deik, A.A., Ginty, D.D., Clish, C.B., and Gu, C. (2017). Blood-Brain Barrier Permeability Is Regulated by Lipid Transport-Dependent Suppression of Caveolae-Mediated Transcytosis. *Neuron* 94, 581–594.e5.
- Andrews, Z.B., Liu, Z.-W., Wallingford, N., Erion, D.M., Borok, E., Friedman, J.M., Tschöp, M.H., Shanabrough, M., Cline, G., Shulman, G.I., et al. (2008). UCP2 mediates ghrelin’s action on NPY/AgRP neurons by lowering free radicals. *Nature* 454, 846–851.
- Aponte, Y., Atasoy, D., and Sternson, S.M. (2011). AGRP neurons are sufficient to orchestrate feeding behavior rapidly and without training. *Nat. Neurosci.* 14, 351–355.
- de Araujo, I.E., Ferreira, J.G., Tellez, L.A., Ren, X., and Yeckel, C.W. (2012). The gut-brain dopamine axis: a regulatory system for caloric intake. *Physiol. Behav.* 106, 394–399.
- Ariyasu, H., Takaya, K., Tagami, T., Ogawa, Y., Hosoda, K., Akamizu, T., Suda, M., Koh, T., Natsui, K., Toyooka, S., et al. (2001). Stomach Is a Major Source of Circulating Ghrelin, and Feeding State Determines Plasma Ghrelin-Like Immunoreactivity Levels in Humans. *J. Clin. Endocrinol. Metab.* 86, 4753–4758.

References

- Atasoy, D., Betley, J.N., Su, H.H., and Sternson, S.M. (2012). Deconstruction of a neural circuit for hunger. *Nature* 488, 172–177.
- Auguste, S., Fiset, A., Fernandes, M.F., Hryhorczuk, C., Poitout, V., Alquier, T., and Fulton, S. (2016). Central Agonism of GPR120 Acutely Inhibits Food Intake and Food Reward and Chronically Suppresses Anxiety-Like Behavior in Mice. *Int. J. Neuropsychopharmacol.* 19, pyw014.
- Baldo, B.A., and Kelley, A.E. (2007). Discrete neurochemical coding of distinguishable motivational processes: insights from nucleus accumbens control of feeding. *Psychopharmacology (Berl.)* 191, 439–459.
- Ballaz, S. (2017). The unappreciated roles of the cholecystokinin receptor CCK(1) in brain functioning. *Rev. Neurosci.* 28, 573–585.
- Banks, W.A., Kastin, A.J., Huang, W., Jaspan, J.B., and Maness, L.M. (1996). Leptin enters the brain by a saturable system independent of insulin. *Peptides* 17, 305–311.
- Banks, W.A., Coon, A.B., Robinson, S.M., Moinuddin, A., Shultz, J.M., Nakaoka, R., and Morley, J.E. (2004). Triglycerides induce leptin resistance at the blood-brain barrier. *Diabetes* 53, 1253–1260.
- Banks, W.A., Farr, S.A., Salameh, T.S., Niehoff, M.L., Rhea, E.M., Morley, J.E., Hanson, A.J., Hansen, K.M., and Craft, S. (2018). Triglycerides cross the blood-brain barrier and induce central leptin and insulin receptor resistance. *Int. J. Obes.* 42, 391–397.
- Bassareo, V., and Di Chiara, G. (1999). Modulation of feeding-induced activation of mesolimbic dopamine transmission by appetitive stimuli and its relation to motivational state. *Eur. J. Neurosci.* 11, 4389–4397.
- Batterham, R.L., Cowley, M.A., Small, C.J., Herzog, H., Cohen, M.A., Dakin, C.L., Wren, A.M., Brynes, A.E., Low, M.J., Ghatei, M.A., et al. (2002). Gut hormone PYY3-36 physiologically inhibits food intake. *Nature* 418, 650–654.
- Batterham, R.L., Cohen, M.A., Ellis, S.M., Le Roux, C.W., Withers, D.J., Frost, G.S., Ghatei, M.A., and Bloom, S.R. (2003). Inhibition of Food Intake in Obese Subjects by Peptide YY 3–36. *N. Engl. J. Med.* 349, 941–948.
- Baura, G.D., Foster, D.M., Porte, D., Kahn, S.E., Bergman, R.N., Cobelli, C., and Schwartz, M.W. (1993). Saturable transport of insulin from plasma into the central nervous system of dogs in vivo. A mechanism for regulated insulin delivery to the brain. *J. Clin. Invest.* 92, 1824–1830.
- Bazin, R.P., and Layé, S. (2014). Polyunsaturated fatty acids and their metabolites in brain function and disease. *Nat. Rev. Neurosci.* 15, 771–785.
- Beaulieu, J.-M. (2011). Beyond cAMP: the regulation of Akt and GSK3 by dopamine receptors. *Front. Mol. Neurosci.* 4, 38.
- Beaulieu, J., and Gainetdinov, R.R. (2011). The physiology, signaling, and pharmacology of dopamine receptors. *Pharmacol. Rev.* 63, 182–217.
- Beaulieu, J.-M., Sotnikova, T.D., Yao, W.-D., Kockeritz, L., Woodgett, J.R., Gainetdinov, R.R., and Caron, M.G. (2004). Lithium antagonizes dopamine-dependent behaviors mediated by an AKT/glycogen synthase kinase 3 signaling cascade. *Proc. Natl. Acad. Sci. U. S. A.* 101, 5099–5104.
- Beaulieu, J.-M., Sotnikova, T.D., Marion, S., Lefkowitz, R.J., Gainetdinov, R.R., and Caron, M.G. (2005). An Akt/ β -Arrestin 2/PP2A Signaling Complex Mediates Dopaminergic Neurotransmission and Behavior. *Cell* 122, 261–273.
- Bello, N.T., and Hajnal, A. (2010). Dopamine and binge eating behaviors. *Pharmacol. Biochem. Behav.* 97, 25–33.
- Ben-Zeev, O., Doolittle, M.H., Singh, N., Chang, C.H., and Scholtz, M.C. (1990). Synthesis and

regulation of lipoprotein lipase in the hippocampus. *J. Lipid Res.* *31*, 1307–1313.

Berridge, K.C. (2009). “Liking” and “wanting” food rewards: Brain substrates and roles in eating disorders. *Physiol. Behav.* *97*, 537–550.

Berridge, K.C., and Robinson, T.E. (1998). What is the role of dopamine in reward: hedonic impact, reward learning, or incentive salience? *Brain Res. Brain Res. Rev.* *28*, 309–369.

Berthoud, H.-R., and Münzberg, H. (2011). The lateral hypothalamus as integrator of metabolic and environmental needs: from electrical self-stimulation to opto-genetics. *Physiol. Behav.* *104*, 29–39.

Betley, J.N., Cao, Z.F.H., Ritola, K.D., and Sternson, S.M. (2013). Parallel, redundant circuit organization for homeostatic control of feeding behavior. *Cell* *155*, 1337–1350.

Biever, A., Valjent, E., and Puighermanal, E. (2015). Ribosomal Protein S6 Phosphorylation in the Nervous System: From Regulation to Function. *Front. Mol. Neurosci.* *8*, 75.

Billington, C.J., Briggs, J.E., Harker, S., Grace, M., and Levine, A.S. (1994). Neuropeptide Y in hypothalamic paraventricular nucleus: a center coordinating energy metabolism. *Am. J. Physiol. Integr. Comp. Physiol.* *266*, R1765–R1770.

Blevins, J.E., Schwartz, M.W., and Baskin, D.G. (2004). Evidence that paraventricular nucleus oxytocin neurons link hypothalamic leptin action to caudal brain stem nuclei controlling meal size. *Am. J. Physiol. Regul. Integr. Comp. Physiol.* *287*, R87–96.

Blouet, C., and Schwartz, G.J. (2012). Brainstem nutrient sensing in the nucleus of the solitary tract inhibits feeding. *Cell Metab.* *16*, 579–587.

Blouet, C., Jo, Y.-H., Li, X., and Schwartz, G.J. (2009). Mediobasal Hypothalamic Leucine Sensing Regulates Food Intake through Activation of a Hypothalamus-Brainstem Circuit. *J. Neurosci.* *29*, 8302–8311.

Borgland, S.L., Taha, S.A., Sarti, F., Fields, H.L., and Bonci, A. (2006). Orexin A in the VTA Is Critical for the Induction of Synaptic Plasticity and Behavioral Sensitization to Cocaine. *Neuron* *49*, 589–601.

Bray, G.A., and York, D.A. (1979). Hypothalamic and genetic obesity in experimental animals: an autonomic and endocrine hypothesis. *Physiol. Rev.* *59*, 719–809.

Brüning, J.C., Gautam, D., Burks, D.J., Gillette, J., Schubert, M., Orban, P.C., Klein, R., Krone, W., Müller-Wieland, D., and Kahn, C.R. (2000). Role of brain insulin receptor in control of body weight and reproduction. *Science* *289*, 2122–2125.

Burdakov, D., Gerasimenko, O., and Verkhatsky, A. (2005). Physiological Changes in Glucose Differentially Modulate the Excitability of Hypothalamic Melanin-Concentrating Hormone and Orexin Neurons In Situ. *J. Neurosci.* *25*, 2429–2433.

Burnett, P.E., Barrow, R.K., Cohen, N.A., Snyder, S.H., and Sabatini, D.M. (1998). RAFT1 phosphorylation of the translational regulators p70 S6 kinase and 4E-BP1. *Proc. Natl. Acad. Sci. U. S. A.* *95*, 1432–1437.

Van Buskirk, R.L., and Erickson, R.P. (1977). Odorant responses in taste neurons of the rat NTS. *Brain Res.* *135*, 287–303.

Cabeza de Vaca, S., and Carr, K.D. (1998). Food restriction enhances the central rewarding effect of abused drugs. *J. Neurosci.* *18*, 7502–7510.

Campfield, L.A., Smith, F.J., Guisez, Y., Devos, R., and Burn, P. (1995). Recombinant mouse OB protein: evidence for a peripheral signal linking adiposity and central neural networks. *Science* *269*, 546–549.

Cannon, C.M., and Palmiter, R.D. (2003). Reward without dopamine. *J. Neurosci.* *23*, 10827–10831.

References

- Cansell, C., Castel, J., Denis, R.G.P., Rouch, C., Delbes, A., Martinez, S., Mestivier, D., Finan, B., Maldonado-Aviles, J.G., Rijnsburger, M., et al. (2014). Dietary triglycerides act on mesolimbic structures to regulate the rewarding and motivational aspects of feeding. *Mol. Psychiatry* 1–11.
- Carlsson, A., Lindqvist, M., Magnusson, T., and Waldeck, B. (1958). On the presence of 3-hydroxytyramine in brain. *Science* 127, 471.
- Carvalho Poyraz, F., Holzner, E., Bailey, M.R., Meszaros, J., Kenney, L., Kheirbek, M.A., Balsam, P.D., and Kellendonk, C. (2016). Decreasing Striatopallidal Pathway Function Enhances Motivation by Energizing the Initiation of Goal-Directed Action. *J. Neurosci.* 36, 5988–6001.
- Cases, S., Stone, S.J., Zhou, P., Yen, E., Tow, B., Lardizabal, K.D., Voelker, T., and Farese, R. V (2001). Cloning of DGAT2, a Second Mammalian Diacylglycerol Acyltransferase, and Related Family Members. *J. Biol. Chem.* 276, 38870–38876.
- Chen, C.T., Green, J.T., Orr, S.K., and Bazinet, R.P. (2008). Regulation of brain polyunsaturated fatty acid uptake and turnover. *Prostaglandins, Leukot. Essent. Fat. Acids* 79, 85–91.
- Cheng, Y., Huang, C.C.Y., Ma, T., Wei, X., Wang, X., Lu, J., and Wang, J. (2017). Distinct Synaptic Strengthening of the Striatal Direct and Indirect Pathways Drives Alcohol Consumption. *Biol. Psychiatry* 81, 918–929.
- Di Chiara, G., and Imperato, A. (1988). Drugs abused by humans preferentially increase synaptic dopamine concentrations in the mesolimbic system of freely moving rats. *Proc. Natl. Acad. Sci. U. S. A.* 85, 5274–5278.
- Clark, J.T., Kalra, P.S., Crowley, W.R., and Kalra, S.P. (1984). Neuropeptide Y and human pancreatic polypeptide stimulate feeding behavior in rats. *Endocrinology* 115, 427–429.
- Coccorello, R., and Maccarrone, M. (2018). Hedonic Eating and the “Delicious Circle”: From Lipid-Derived Mediators to Brain Dopamine and Back. *Front. Neurosci.* 12, 271.
- Coleman, D.L. (1973). Effects of parabiosis of obese with diabetes and normal mice. *Diabetologia* 9, 294–298.
- Coleman, D.L., and Hummel, K.P. (1969). Effects of parabiosis of normal with genetically diabetic mice. *Am. J. Physiol.* 217, 1298–1304.
- Cone, J.J., Roitman, J.D., and Roitman, M.F. (2015). Ghrelin regulates phasic dopamine and nucleus accumbens signaling evoked by food-predictive stimuli. *J. Neurochem.* 133, 844–856.
- Corp, E.S., Woods, S.C., Porte, D., Dorsa, D.M., Figlewicz, D.P., and Baskin, D.G. (1986). Localization of 125I-insulin binding sites in the rat hypothalamus by quantitative autoradiography. *Neurosci. Lett.* 70, 17–22.
- Corwin, R.L., and Buda-Levin, A. (2004). Behavioral models of binge-type eating. *Physiol. Behav.* 82, 123–130.
- Cota, D. (2007). CB1 receptors: emerging evidence for central and peripheral mechanisms that regulate energy balance, metabolism, and cardiovascular health. *Diabetes. Metab. Res. Rev.* 23, 507–517.
- Cota, D., Proulx, K., Blake Smith, K.A., Kozma, S.C., Thomas, G., Woods, S.C., and Seeley, R.J. (2006). Hypothalamic mTOR signaling regulates food intake. *Science* (80-.). 312, 927–930.
- Cowley, M.A., Smith, R.G., Diano, S., Tschöp, M.H., Pronchuk, N., Grove, K.L., Strasburger, C.J., Bidlingmaier, M., Esterman, M., Heiman, M.L., et al. (2003). The distribution and mechanism of action of ghrelin in the CNS demonstrates a novel hypothalamic circuit regulating energy homeostasis. *Neuron* 37, 649–661.
- Cruciani-Guglielmacci, C., López, M., Campana, M., and le Stunff, H. (2017). Brain Ceramide Metabolism in the Control of Energy Balance. *Front. Physiol.* 8, 787.

- Cummings, D.E., Purnell, J.Q., Frayo, R.S., Schmidova, K., Wisse, B.E., and Weigle, D.S. (2001). A preprandial rise in plasma ghrelin levels suggests a role in meal initiation in humans. *Diabetes* 50, 1714–1719.
- D'Agostino, G., Lyons, D.J., Cristiano, C., Burke, L.K., Madara, J.C., Campbell, J.N., Garcia, A.P., Land, B.B., Lowell, B.B., DiLeone, R.J., et al. (2016). Appetite controlled by a cholecystokinin nucleus of the solitary tract to hypothalamus neurocircuit. *Elife* 5.
- Davis, J.F., Tracy, A.L., Schurdak, J.D., Tschöp, M.H., Lipton, J.W., Clegg, D.J., and Benoit, S.C. (2008). Exposure to elevated levels of dietary fat attenuates psychostimulant reward and mesolimbic dopamine turnover in the rat. *Behav. Neurosci.* 122, 1257–1263.
- Décarie-Spain, L., Sharma, S., Hryhorczuk, C., Issa-Garcia, V., Barker, P.A., Arbour, N., Alquier, T., and Fulton, S. (2018). Nucleus accumbens inflammation mediates anxiodepressive behavior and compulsive sucrose seeking elicited by saturated dietary fat. *Mol. Metab.* 10, 1–13.
- Delgado, J.M.R., and Anand, B.K. (1953). Increase of food intake induced by electrical stimulation of the lateral hypothalamus. *Am. J. Physiol.* 172, 162–168.
- DeMar, J.C., Lee, H.-J., Ma, K., Chang, L., Bell, J.M., Rapoport, S.I., and Bazinet, R.P. (2006). Brain elongation of linoleic acid is a negligible source of the arachidonate in brain phospholipids of adult rats. *Biochim. Biophys. Acta - Mol. Cell Biol. Lipids* 1761, 1050–1059.
- Dennis, P.B., Jaeschke, A., Saitoh, M., Fowler, B., Kozma, S.C., and Thomas, G. (2001). Mammalian TOR: A Homeostatic ATP Sensor. *Science* (80-.). 294, 1102–1105.
- Devane, W.A., Hanus, L., Breuer, A., Pertwee, R.G., Stevenson, L.A., Griffin, G., Gibson, D., Mandelbaum, A., Etinger, A., and Mechoulam, R. (1992). Isolation and structure of a brain constituent that binds to the cannabinoid receptor. *Science* 258, 1946–1949.
- DiFelicantonio, A.G., Coppin, G., Rigoux, L., Edwin Thanarajah, S., Dagher, A., Tittgemeyer, M., and Small, D.M. (2018). Supra-Additive Effects of Combining Fat and Carbohydrate on Food Reward. *Cell Metab.*
- van Dongen, Y.C., Mailly, P., Thierry, A.-M., Groenewegen, H.J., and Deniau, J.-M. (2008). Three-dimensional organization of dendrites and local axon collaterals of shell and core medium-sized spiny projection neurons of the rat nucleus accumbens. *Brain Struct. Funct.* 213, 129–147.
- Dossat, A.M., Lilly, N., Kay, K., and Williams, D.L. (2011). Glucagon-Like Peptide 1 Receptors in Nucleus Accumbens Affect Food Intake. *J. Neurosci.* 31, 14453–14457.
- Duncan, R.E., Ahmadian, M., Jaworski, K., Sarkadi-Nagy, E., and Sul, H.S. (2007). Regulation of Lipolysis in Adipocytes. *Annu. Rev. Nutr.* 27, 79–101.
- Eckel, R.H., and Robbins, R.J. (1984). Lipoprotein lipase is produced, regulated, and functional in rat brain. *Proc. Natl. Acad. Sci. U. S. A.* 81, 7604–7607.
- Elias, M.F., Elias, P.K., Sullivan, L.M., Wolf, P.A., and D'Agostino, R.B. (2005). Obesity, diabetes and cognitive deficit: The Framingham Heart Study. *Neurobiol. Aging* 26 Suppl 1, 11–16.
- Epstein, L.H., Temple, J.L., Neaderhiser, B.J., Salis, R.J., Erbe, R.W., and Leddy, J.J. (2007). Food reinforcement, the dopamine D₂ receptor genotype, and energy intake in obese and nonobese humans. *Behav. Neurosci.* 121, 877–886.
- Escartin, C., Pierre, K., Colin, A., Brouillet, E., Delzescaux, T., Guillermier, M., Dhenain, M., Deglon, N., Hantraye, P., Pellerin, L., et al. (2007). Activation of Astrocytes by CNTF Induces Metabolic Plasticity and Increases Resistance to Metabolic Insults. *J. Neurosci.* 27, 7094–7104.
- Fahy, E., Cotter, D., Sud, M., and Subramaniam, S. (2011). Lipid classification, structures and tools. *Biochim. Biophys. Acta* 1811, 637–647.

References

- Farooqi, I.S., Bullmore, E., Keogh, J., Gillard, J., O’Rahilly, S., and Fletcher, P.C. (2007). Leptin Regulates Striatal Regions and Human Eating Behavior. *Science* (80-.). *317*, 1355–1355.
- Farr, S.A., Yamada, K.A., Butterfield, D.A., Abdul, H.M., Xu, L., Miller, N.E., Banks, W.A., and Morley, J.E. (2008). Obesity and hypertriglyceridemia produce cognitive impairment. *Endocrinology* *149*, 2628–2636.
- Figlewicz, D.P., and Sipols, A.J. (2010). Energy regulatory signals and food reward. *Pharmacol. Biochem. Behav.* *97*, 15–24.
- Figlewicz, D.P., Evans, S.B., Murphy, J., Hoen, M., and Baskin, D.G. (2003). Expression of receptors for insulin and leptin in the ventral tegmental area/substantia nigra (VTA/SN) of the rat. *Brain Res.* *964*, 107–115.
- Fioramonti, X., Lorsignol, A., Taupignon, A., and Pénicaud, L. (2004). A new ATP-sensitive K⁺ channel-independent mechanism is involved in glucose-excited neurons of mouse arcuate nucleus. *Diabetes* *53*, 2767–2775.
- Le Foll, C., Irani, B.G., Magnan, C., Dunn-Meynell, A.A., and Levin, B.E. (2009). Characteristics and mechanisms of hypothalamic neuronal fatty acid sensing. *Am. J. Physiol. Integr. Comp. Physiol.* *297*, R655–R664.
- Fossella, J., Green, A.E., and Fan, J. (2006). Evaluation of a structural polymorphism in the ankyrin repeat and kinase domain containing 1 (ANKK1) gene and the activation of executive attention networks. *Cogn. Affect. Behav. Neurosci.* *6*, 71–78.
- Foster, D.A. (2013). Phosphatidic acid and lipid-sensing by mTOR. *Trends Endocrinol. Metab.* *24*, 272–278.
- Frayn, K.N., Shadid, S., Hamlani, R., Humphreys, S.M., Clark, M.L., Fielding, B.A., Boland, O., and Coppack, S.W. (1994). Regulation of fatty acid movement in human adipose tissue in the postabsorptive-to-postprandial transition. *Am. J. Physiol.* *266*, E308-17.
- French, E.D., Dillon, K., and Wu, X. (1997). Cannabinoids excite dopamine neurons in the ventral tegmentum and substantia nigra. *Neuroreport* *8*, 649–652.
- Friend, D.M., Devarakonda, K., O’Neal, T.J., Skirzewski, M., Papazoglou, I., Kaplan, A.R., Liow, J.-S., Guo, J., Rane, S.G., Rubinstein, M., et al. (2017). Basal Ganglia Dysfunction Contributes to Physical Inactivity in Obesity. *Cell Metab.* *25*, 312–321.
- Fulton, S., Woodside, B., and Shizgal, P. (2000). Modulation of brain reward circuitry by leptin. *Science* *287*, 125–128.
- Fulton, S.E., Pissios, P., Manchon, R.P., Stiles, L., Frank, L., Pothos, E.N., Maratos-Flier, E., and Flier, J.S. (2006). Leptin Regulation of the Mesoaccumbens Dopamine Pathway. *Neuron* *51*, 811–822.
- Funahashi, H., Yada, T., Suzuki, R., and Shioda, S. (2003). Distribution, function, and properties of leptin receptors in the brain. *Int. Rev. Cytol.* *224*, 1–27.
- Gangarossa, G., Espallergues, J., de Kerchove d’Exaerde, A., El Mestikawy, S., Gerfen, C.R., Hervé, D., Girault, J.-A., and Valjent, E. (2013a). Distribution and compartmental organization of GABAergic medium-sized spiny neurons in the mouse nucleus accumbens. *Front. Neural Circuits* *7*, 22.
- Gangarossa, G., Perroy, J., and Valjent, E. (2013b). Combinatorial topography and cell-type specific regulation of the ERK pathway by dopaminergic agonists in the mouse striatum. *Brain Struct. Funct.* *218*, 405–419.
- Gao, Y., Layritz, C., Legutko, B., Eichmann, T.O., Laperrousaz, E., Moullé, V.S., Cruciani-Guglielmacci, C., Magnan, C., Luquet, S., Woods, S.C., et al. (2017a). Disruption of Lipid Uptake in Astroglia Exacerbates Diet-Induced Obesity. *Diabetes* *66*, 2555–2563.

- Gao, Y., Vidal-Itriago, A., Kalsbeek, M.J., Layritz, C., García-Cáceres, C., Tom, R.Z., Eichmann, T.O., Vaz, F.M., Houtkooper, R.H., van der Wel, N., et al. (2017b). Lipoprotein Lipase Maintains Microglial Innate Immunity in Obesity. *Cell Rep.* *20*, 3034–3042.
- Georgescu, D., Zachariou, V., Barrot, M., Mieda, M., Willie, J.T., Eisch, A.J., Yanagisawa, M., Nestler, E.J., and DiLeone, R.J. (2003). Involvement of the lateral hypothalamic peptide orexin in morphine dependence and withdrawal. *J. Neurosci.* *23*, 3106–3111.
- Gerfen, C.R., and Surmeier, D.J. (2011). Modulation of striatal projection systems by dopamine. *Annu. Rev. Neurosci.* *34*, 441–466.
- Gerfen, C.R., Engber, T.M., Mahan, L.C., Susel, Z., Chase, T.N., Monsma, F.J., and Sibley, D.R. (1990). D1 and D2 dopamine receptor-regulated gene expression of striatonigral and striatopallidal neurons. *Science* *250*, 1429–1432.
- Gessa, G.L., Melis, M., Muntoni, A.L., and Diana, M. (1998). Cannabinoids activate mesolimbic dopamine neurons by an action on cannabinoid CB1 receptors. *Eur. J. Pharmacol.* *341*, 39–44.
- Gibbs, J., Young, R.C., and Smith, G.P. (1973). Cholecystokinin decreases food intake in rats. *J. Comp. Physiol. Psychol.* *84*, 488–495.
- Giguère, V. (2018). Canonical signaling and nuclear activity of mTOR—a teamwork effort to regulate metabolism and cell growth. *FEBS J.*
- Gingrich, J.A., and Caron, M.G. (1993). Recent Advances in the Molecular Biology of Dopamine Receptors. *Annu. Rev. Neurosci.* *16*, 299–321.
- Glowa, J.R., and Gold, P.W. (1991). Corticotropin releasing hormone produces profound anorexigenic effects in the rhesus monkey. *Neuropeptides* *18*, 55–61.
- Goldberg, I.J., Soprano, D.R., Wyatt, M.L., Vanni, T.M., Kirchgessner, T.G., and Schotz, M.C. (1989). Localization of lipoprotein lipase mRNA in selected rat tissues. *J. Lipid Res.* *30*, 1569–1577.
- Gonon, F.G. (1988). Nonlinear relationship between impulse flow and dopamine released by rat midbrain dopaminergic neurons as studied by in vivo electrochemistry. *Neuroscience* *24*, 19–28.
- Grace, A.A. (2016). Dysregulation of the dopamine system in the pathophysiology of schizophrenia and depression. *Nat. Rev. Neurosci.* *17*, 524–532.
- Grace, A.A., and Bunney, B.S. (1983). Intracellular and extracellular electrophysiology of nigral dopaminergic neurons—1. Identification and characterization. *Neuroscience* *10*, 301–315.
- Grill, H.J., and Norgren, R. (1978). The taste reactivity test. I. Mimetic responses to gustatory stimuli in neurologically normal rats. *Brain Res.* *143*, 263–279.
- Guo, J., Simmons, W.K., Herscovitch, P., Martin, A., and Hall, K.D. (2014). Striatal dopamine D2-like receptor correlation patterns with human obesity and opportunistic eating behavior. *Mol. Psychiatry* *19*, 1078–1084.
- Hajnal, A., Smith, G.P., and Norgren, R. (2004). Oral sucrose stimulation increases accumbens dopamine in the rat. *Am. J. Physiol. Integr. Comp. Physiol.* *286*, R31–R37.
- Hajnal, A., De Jonghe, B.C., and Covasa, M. (2007). Dopamine D2 receptors contribute to increased avidity for sucrose in obese rats lacking CCK-1 receptors. *Neuroscience* *148*, 584–592.
- Håkansson, M.L., Hulting, A.L., and Meister, B. (1996). Expression of leptin receptor mRNA in the hypothalamic arcuate nucleus—relationship with NPY neurones. *Neuroreport* *7*, 3087–3092.
- Halaas, J.L., Gajiwala, K.S., Maffei, M., Cohen, S.L., Chait, B.T., Rabinowitz, D., Lallone, R.L., Burley, S.K., and Friedman, J.M. (1995). Weight-reducing effects of the plasma protein encoded by the obese gene. *Science* *269*, 543–546.

References

- Hamdi, A., Porter, J., and Prasad, C. (1992). Decreased striatal D2 dopamine receptors in obese Zucker rats: changes during aging. *Brain Res.* *589*, 338–340.
- Han, W., Tellez, L.A., Niu, J., Medina, S., Ferreira, T.L., Zhang, X., Su, J., Tong, J., Schwartz, G.J., van den Pol, A., et al. (2016). Striatal Dopamine Links Gastrointestinal Rerouting to Altered Sweet Appetite. *Cell Metab.* *23*, 103–112.
- Hankir, M.K., Seyfried, F., Hintschich, C.A., Diep, T.-A., Kleberg, K., Kranz, M., Deuther-Conrad, W., Tellez, L.A., Rullmann, M., Patt, M., et al. (2017). Gastric Bypass Surgery Recruits a Gut PPAR- α -Striatal D1R Pathway to Reduce Fat Appetite in Obese Rats. *Cell Metab.* *25*, 335–344.
- Hara, K., Yonezawa, K., Weng, Q.P., Kozlowski, M.T., Belham, C., and Avruch, J. (1998). Amino acid sufficiency and mTOR regulate p70 S6 kinase and eIF-4E BP1 through a common effector mechanism. *J. Biol. Chem.* *273*, 14484–14494.
- Harris, G.C., Wimmer, M., and Aston-Jones, G. (2005). A role for lateral hypothalamic orexin neurons in reward seeking. *Nature* *437*, 556–559.
- Hasbi, A., Fan, T., Alijaniam, M., Nguyen, T., Perreault, M.L., O'Dowd, B.F., and George, S.R. (2009). Calcium signaling cascade links dopamine D1-D2 receptor heteromer to striatal BDNF production and neuronal growth. *Proc. Natl. Acad. Sci. U. S. A.* *106*, 21377–21382.
- Hasbi, A., O'Dowd, B.F., and George, S.R. (2011). Dopamine D1-D2 receptor heteromer signaling pathway in the brain: emerging physiological relevance. *Mol. Brain* *4*, 26.
- Havrankova, J., Roth, J., and Brownstein, M.J. (1978). Insulin receptors are widely distributed in the central nervous system of the rat. *Nature* *272*, 827–829.
- Hawkins, R.A., O'Kane, R.L., Simpson, I.A., and Viña, J.R. (2006). Structure of the blood-brain barrier and its role in the transport of amino acids. *J. Nutr.* *136*, 218S–26S.
- Herkenham, M., Lynn, A.B., Little, M.D., Johnson, M.R., Melvin, L.S., de Costa, B.R., and Rice, K.C. (1990). Cannabinoid receptor localization in brain. *Proc. Natl. Acad. Sci. U. S. A.* *87*, 1932–1936.
- Hernandez, L., and Hoebel, B.G. (1988). Food reward and cocaine increase extracellular dopamine in the nucleus accumbens as measured by microdialysis. *Life Sci.* *42*, 1705–1712.
- Hetherington, A.W., and Ranson, S.W. (1939). Experimental Hypothalamico-Hypophyseal Obesity in the Rat. *Exp. Biol. Med.* *41*, 465–466.
- Hodson, L., and Fielding, B.A. (2010). Trafficking and partitioning of fatty acids: the transition from fasted to fed state. *Clin. Lipidol.* *5*, 131–144.
- Horvath, T.L., Warden, C.H., Hajos, M., Lombardi, A., Goglia, F., and Diano, S. (1999). Brain uncoupling protein 2: uncoupled neuronal mitochondria predict thermal synapses in homeostatic centers. *J. Neurosci.* *19*, 10417–10427.
- Howick, K., Griffin, B.T., Cryan, J.F., and Schellekens, H. (2017). From belly to brain: Targeting the ghrelin receptor in appetite and food intake regulation. *Int. J. Mol. Sci.* *18*.
- Hryhorczuk, C., Florea, M., Rodaros, D., Poirier, I., Daneault, C., Des Rosiers, C., Arvanitogiannis, A., Alquier, T., and Fulton, S.E. (2015). Dampened Mesolimbic Dopamine Function and Signaling by Saturated but not Monounsaturated Dietary Lipids. *Neuropsychopharmacology*.
- Hryhorczuk, C., Sheng, Z., Décarie-Spain, L., Giguère, N., Ducrot, C., Trudeau, L.-É., Routh, V.H., Alquier, T., and Fulton, S. (2018). Oleic Acid in the Ventral Tegmental Area Inhibits Feeding, Food Reward, and Dopamine Tone. *Neuropsychopharmacology* *43*, 607–616.
- Huang, X.-F., Zavitsanou, K., Huang, X., Yu, Y., Wang, H., Chen, F., Lawrence, A.J., and Deng, C. (2006). Dopamine transporter and D2 receptor binding densities in mice prone or resistant to chronic high fat diet-induced obesity. *Behav. Brain Res.* *175*, 415–419.

- Husemann, J., Loike, J.D., Anankov, R., Febbraio, M., and Silverstein, S.C. (2002). Scavenger receptors in neurobiology and neuropathology: Their role on microglia and other cells of the nervous system. *Glia* 40, 195–205.
- Hyde, K.M., Blonde, G.D., le Roux, C.W., and Spector, A.C. (2017). Liraglutide suppression of caloric intake competes with the intake-promoting effects of a palatable cafeteria diet, but does not impact food or macronutrient selection. *Physiol. Behav.* 177, 4–12.
- Ikeda, H., West, D.B., Pustek, J.J., Figlewicz, D.P., Greenwood, M.R., Porte, D., and Woods, S.C. (1986). Intraventricular insulin reduces food intake and body weight of lean but not obese Zucker rats. *Appetite* 7, 381–386.
- Ikemoto, S., Yang, C., and Tan, A. (2015). Basal ganglia circuit loops, dopamine and motivation: A review and enquiry. *Behav. Brain Res.* 290, 17–31.
- Inloes, J.M., Hsu, K.-L., Dix, M.M., Viader, A., Masuda, K., Takei, T., Wood, M.R., and Cravatt, B.F. (2014). The hereditary spastic paraplegia-related enzyme DDHD2 is a principal brain triglyceride lipase. *Proc. Natl. Acad. Sci. U. S. A.* 111, 14924–14929.
- Inloes, J.M., Kiosses, W.B., Wang, H., Walther, T.C., Farese, R. V., and Cravatt, B.F. (2018). Functional Contribution of the Spastic Paraplegia-Related Triglyceride Hydrolase DDHD2 to the Formation and Content of Lipid Droplets. *Biochemistry* 57, 827–838.
- Iqbal, J., and Hussain, M.M. (2009). Intestinal lipid absorption. *Am. J. Physiol. Endocrinol. Metab.* 296, E1183-94.
- Jerlhag, E., Egecioglu, E., Landgren, S., Salome, N., Heilig, M., Moechars, D., Datta, R., Perrissoud, D., Dickson, S.L., and Engel, J.A. (2009). Requirement of central ghrelin signaling for alcohol reward. *Proc. Natl. Acad. Sci.* 106, 11318–11323.
- Jerlhag, E., Egecioglu, E., Dickson, S.L., and Engel, J.A. (2010). Ghrelin receptor antagonism attenuates cocaine- and amphetamine-induced locomotor stimulation, accumbal dopamine release, and conditioned place preference. *Psychopharmacology (Berl)*. 211, 415–422.
- Jo, Y.-H., Su, Y., Gutierrez-Juarez, R., and Chua, S. (2009). Oleic Acid Directly Regulates POMC Neuron Excitability in the Hypothalamus. *J. Neurophysiol.* 101, 2305–2316.
- Johnson, P.M., and Kenny, P.J. (2010). Dopamine D2 receptors in addiction-like reward dysfunction and compulsive eating in obese rats. *Nat. Neurosci.* 13, 635–641.
- Kamegai, J., Tamura, H., Shimizu, T., Ishii, S., Sugihara, H., and Wakabayashi, I. (2001). Chronic central infusion of ghrelin increases hypothalamic neuropeptide Y and Agouti-related protein mRNA levels and body weight in rats. *Diabetes* 50, 2438–2443.
- Kampe, J., Tschöp, M.H., Hollis, J.H., and Oldfield, B.J. (2009). An anatomic basis for the communication of hypothalamic, cortical and mesolimbic circuitry in the regulation of energy balance. *Eur. J. Neurosci.* 30, 415–430.
- Karatayev, O., Gaysinskaya, V., Chang, G.-Q., and Leibowitz, S.F. (2009). Circulating triglycerides after a high-fat meal: Predictor of increased caloric intake, orexigenic peptide expression, and dietary obesity. *Brain Res.* 1298, 111–122.
- Kebabian, J.W., and Calne, D.B. (1979). Multiple receptors for dopamine. *Nature* 277, 93–96.
- Kebabian, J.W., and Greengard, P. (1971). Dopamine-sensitive adenyl cyclase: possible role in synaptic transmission. *Science* 174, 1346–1349.
- Kelley, A.E., and Berridge, K.C. (2002). The neuroscience of natural rewards: relevance to addictive drugs. *J. Neurosci.* 22, 3306–3311.
- Kelley, A.E., Bakshi, V.P., Haber, S.N., Steininger, T.L., Will, M.J., and Zhang, M. (2002). Opioid

References

- modulation of taste hedonics within the ventral striatum. *Physiol. Behav.* *76*, 365–377.
- Kelley, A.E., Baldo, B.A., Pratt, W.E., and Will, M.J. (2005). Corticostriatal-hypothalamic circuitry and food motivation: Integration of energy, action and reward. In *Physiology and Behavior*, pp. 773–795.
- Kenny, P.J., Voren, G., and Johnson, P.M. (2013). Dopamine D2 receptors and striatopallidal transmission in addiction and obesity. *Curr. Opin. Neurobiol.* *23*, 535–538.
- Kernie, S.G. (2000). BDNF regulates eating behavior and locomotor activity in mice. *EMBO J.* *19*, 1290–1300.
- Kim, H.-K., Shin, M.-S., Youn, B.-S., Kang, G.M., Gil, S.Y., Lee, C.H., Choi, J.H., Lim, H.S., Yoo, H.J., and Kim, M.-S. (2015). Regulation of energy balance by the hypothalamic lipoprotein lipase regulator Angptl3. *Diabetes* *64*, 1142–1153.
- Kim, H.J., Kim, Y.W., Choi, S.H., Cho, B.M., Bandu, R., Ahn, H.S., and Kim, K.P. (2016). Triolein emulsion infusion into the carotid artery increases brain permeability to anticancer agents. *Neurosurgery* *78*, 726–733.
- Kim, M.-S., Pak, Y.K., Jang, P.-G., Namkoong, C., Choi, Y.-S., Won, J.-C., Kim, K.-S., Kim, S.-W., Kim, H.-S., Park, J.-Y., et al. (2006). Role of hypothalamic Foxo1 in the regulation of food intake and energy homeostasis. *Nat. Neurosci.* *9*, 901–906.
- Kim, S.G., Buel, G.R., and Blenis, J. (2013). Nutrient regulation of the mTOR Complex 1 signaling pathway. *Mol. Cells* *35*, 463–473.
- Kirkham, T.C., Williams, C.M., Fezza, F., and Marzo, V. Di (2002). Endocannabinoid levels in rat limbic forebrain and hypothalamus in relation to fasting, feeding and satiation: stimulation of eating by 2-arachidonoyl glycerol. *Br. J. Pharmacol.* *136*, 550–557.
- Kojima, M., Hosoda, H., Date, Y., Nakazato, M., Matsuo, H., and Kangawa, K. (1999). Ghrelin is a growth-hormone-releasing acylated peptide from stomach. *Nature* *402*, 656–660.
- Koob, G.F. (1992). Drugs of abuse: anatomy, pharmacology and function of reward pathways. *Trends Pharmacol. Sci.* *13*, 177–184.
- Koob, G.F., and Volkow, N.D. (2016). Neurobiology of addiction: a neurocircuitry analysis. *The Lancet. Psychiatry* *3*, 760–773.
- Krashes, M.J., Koda, S., Ye, C., Rogan, S.C., Adams, A.C., Cusher, D.S., Maratos-Flier, E., Roth, B.L., and Lowell, B.B. (2011). Rapid, reversible activation of AgRP neurons drives feeding behavior in mice. *J. Clin. Invest.* *121*, 1424–1428.
- Krauss, R.M., and Mayer, J. (1965). Influence of protein and amino acids on food intake in the rat. *Am. J. Physiol. Content* *209*, 479–483.
- Laperrousaz, E., Moullé, V.S., Denis, R.G., Kassis, N., Berland, C., Colsch, B., Fioramonti, X., Philippe, E., Lacombe, A., Vanacker, C., et al. (2017). Lipoprotein lipase in hypothalamus is a key regulator of body weight gain and glucose homeostasis in mice. *Diabetologia* *60*, 1314–1324.
- Laugerette, F., Passilly-Degrace, P., Patris, B., Niot, I., Febbraio, M., Montmayeur, J.-P., and Besnard, P. (2005). CD36 involvement in orosensory detection of dietary lipids, spontaneous fat preference, and digestive secretions. *J. Clin. Invest.* *115*, 3177–3184.
- Lechan, R.M., and Toni, R. (2000). *Functional Anatomy of the Hypothalamus and Pituitary* (MDText.com, Inc.).
- Lee, G., Zheng, Y., Cho, S., Jang, C., England, C., Dempsey, J.M., Yu, Y., Liu, X., He, L., Cavaliere, P.M., et al. (2017a). Post-transcriptional Regulation of De Novo Lipogenesis by mTORC1-S6K1-SRPK2 Signaling. *Cell* *171*, 1545–1558.e18.

- Lee, L.L., Aung, H.H., Wilson, D.W., Anderson, S.E., Rutledge, J.C., and Rutkowsky, J.M. (2017b). Triglyceride-rich lipoprotein lipolysis products increase blood-brain barrier transfer coefficient and induce astrocyte lipid droplets and cell stress. *Am. J. Physiol. Physiol.* *312*, C500–C516.
- Lein, E.S., Hawrylycz, M.J., Ao, N., Ayres, M., Bensinger, A., Bernard, A., Boe, A.F., Boguski, M.S., Brockway, K.S., Byrnes, E.J., et al. (2007). Genome-wide atlas of gene expression in the adult mouse brain. *Nature* *445*, 168–176.
- Leininger, G.M., Jo, Y.-H., Leshan, R.L., Louis, G.W., Yang, H., Barrera, J.G., Wilson, H., Opland, D.M., Faouzi, M.A., Gong, Y., et al. (2009). Leptin Acts via Leptin Receptor-Expressing Lateral Hypothalamic Neurons to Modulate the Mesolimbic Dopamine System and Suppress Feeding. *Cell Metab.* *10*, 89–98.
- Lewis, S.E., Listenberger, L.L., Ory, D.S., and Schaffer, J.E. (2001). Membrane topology of the murine fatty acid transport protein 1. *J. Biol. Chem.* *276*, 37042–37050.
- Liang, N.-C., Hajnal, A., and Norgren, R. (2006). Sham feeding corn oil increases accumbens dopamine in the rat. *Am. J. Physiol. Integr. Comp. Physiol.* *291*, R1236–R1239.
- Libby, A.E., Wang, H., Mittal, R., Sungelo, M., Potma, E., and Eckel, R.H. (2015). Lipoprotein lipase is an important modulator of lipid uptake and storage in hypothalamic neurons. *Biochem. Biophys. Res. Commun.* *465*, 287–292.
- Lindgren, N., Usiello, A., Goigny, M., Haycock, J., Erbs, E., Greengard, P., Hokfelt, T., Borrelli, E., and Fisone, G. (2003). Distinct roles of dopamine D2L and D2S receptor isoforms in the regulation of protein phosphorylation at presynaptic and postsynaptic sites. *Proc. Natl. Acad. Sci.* *100*, 4305–4309.
- Lipton, J.O., and Sahin, M. (2014). The neurology of mTOR. *Neuron* *84*, 275–291.
- Liu, M., Kuhel, D.G., Shen, L., Hui, D.Y., and Woods, S.C. (2012). Apolipoprotein E does not cross the blood-cerebrospinal fluid barrier, as revealed by an improved technique for sampling CSF from mice. *Am. J. Physiol. Integr. Comp. Physiol.* *303*, R903–R908.
- Lockie, S.H. (2013). Glucagon-Like Peptide-1 Receptor in the Brain: Role in Neuroendocrine Control of Energy Metabolism and Treatment Target for Obesity. *J. Neuroendocrinol.* *25*, 597–604.
- Loftus, T.M. (2000). Reduced Food Intake and Body Weight in Mice Treated with Fatty Acid Synthase Inhibitors. *Science (80-)*. *288*, 2379–2381.
- López, M., Lage, R., Saha, A.K., Pérez-Tilve, D., Vázquez, M.J., Varela, L., Sangiao-Alvarellos, S., Tovar, S., Raghay, K., Rodríguez-Cuenca, S., et al. (2008). Hypothalamic Fatty Acid Metabolism Mediates the Orexigenic Action of Ghrelin. *Cell Metab.* *7*, 389–399.
- Lu, X.Y., Ghasemzadeh, M.B., and Kalivas, P.W. (1998). Expression of D1 receptor, D2 receptor, substance P and enkephalin messenger RNAs in the neurons projecting from the nucleus accumbens. *Neuroscience* *82*, 767–780.
- Maffei, M., Halaas, J.L., Ravussin, E., Pratley, R.E., Lee, G.H., Zhang, Y., Fei, H., Kim, S., Lallone, R.L., and Ranganathan, S. (1995a). Leptin levels in human and rodent: measurement of plasma leptin and ob RNA in obese and weight-reduced subjects. *Nat. Med.* *1*, 1155–1161.
- Maffei, M., Fei, H., Lee, G.H., Dani, C., Leroy, P., Zhang, Y., Proenca, R., Negrel, R., Ailhaud, G., and Friedman, J.M. (1995b). Increased expression in adipocytes of ob RNA in mice with lesions of the hypothalamus and with mutations at the db locus. *Proc. Natl. Acad. Sci. U. S. A.* *92*, 6957–6960.
- Maldjian, J.A., Laurienti, P.J., Kraft, R.A., and Burdette, J.H. (2003). An automated method for neuroanatomic and cytoarchitectonic atlas-based interrogation of fMRI data sets. *Neuroimage* *19*, 1233–1239.
- Malik, S., McGlone, F., Bedrossian, D., and Dagher, A. (2008). Ghrelin Modulates Brain Activity in Areas that Control Appetitive Behavior. *Cell Metab.* *7*, 400–409.

References

- Marinelli, M., Rudick, C.N., Hu, X.-T., and White, F.J. (2006). Excitability of dopamine neurons: modulation and physiological consequences. *CNS Neurol. Disord. Drug Targets* 5, 79–97.
- Marsicano, G., and Lutz, B. (1999). Expression of the cannabinoid receptor CB1 in distinct neuronal subpopulations in the adult mouse forebrain. *Eur. J. Neurosci.* 11, 4213–4225.
- Martins, L., Fernández-Mallo, D., Novelle, M.G., Vázquez, M.J., Tena-Sempere, M., Nogueiras, R., López, M., and Diéguez, C. (2012). Hypothalamic mTOR Signaling Mediates the Orexigenic Action of Ghrelin. *PLoS One* 7, e46923.
- Di Marzo, V., Fontana, A., Cadas, H., Schinelli, S., Cimino, G., Schwartz, J.-C., and Piomelli, D. (1994). Formation and inactivation of endogenous cannabinoid anandamide in central neurons. *Nature* 372, 686–691.
- Matias, I., and Di Marzo, V. (2007). Endocannabinoids and the control of energy balance. *Trends Endocrinol. Metab.* 18, 27–37.
- Matsuda, L.A., Lolait, S.J., Brownstein, M.J., Young, A.C., and Bonner, T.I. (1990). Structure of a cannabinoid receptor and functional expression of the cloned cDNA. *Nature* 346, 561–564.
- Matsuda, L.A., Bonner, T.I., and Lolait, S.J. (1993). Localization of cannabinoid receptor mRNA in rat brain. *J. Comp. Neurol.* 327, 535–550.
- Mead, J., Irvine, S., and Ramji, D. (2002). Lipoprotein lipase: structure, function, regulation, and role in disease. *J. Mol. Med.* 80, 753–769.
- Meltzer, L.T., Christoffersen, C.L., and Serpa, K.A. (1997). Modulation of dopamine neuronal activity by glutamate receptor subtypes. *Neurosci. Biobehav. Rev.* 21, 511–518.
- Menon, D., Salloum, D., Bernfeld, E., Gorodetsky, E., Akselrod, A., Frias, M.A., Sudderth, J., Chen, P.H., DeBerardinis, R., and Foster, D.A. (2017). Lipid sensing by mTOR complexes via de novo synthesis of phosphatidic acid. *J. Biol. Chem.* 292, 6303–6311.
- Mercer, J.G., Hoggard, N., Williams, L.M., Lawrence, C.B., Hannah, L.T., and Trayhurn, P. (1996). Localization of leptin receptor mRNA and the long form splice variant (Ob-Rb) in mouse hypothalamus and adjacent brain regions by in situ hybridization. *FEBS Lett.* 387, 113–116.
- Le Merrer, J., Becker, J.A.J., Befort, K., and Kieffer, B.L. (2009). Reward processing by the opioid system in the brain. *Physiol. Rev.* 89, 1379–1412.
- Mietlicki-Baase, E.G., Ortinski, P.I., Reiner, D.J., Sinon, C.G., McCutcheon, J.E., Pierce, R.C., Roitman, M.F., and Hayes, M.R. (2014). Glucagon-like peptide-1 receptor activation in the nucleus accumbens core suppresses feeding by increasing glutamatergic AMPA/kainate signaling. *J. Neurosci.* 34, 6985–6992.
- Miki, T., Liss, B., Minami, K., Shiuchi, T., Saraya, A., Kashima, Y., Horiuchi, M., Ashcroft, F., Minokoshi, Y., Roeper, J., et al. (2001). ATP-sensitive K⁺ channels in the hypothalamus are essential for the maintenance of glucose homeostasis. *Nat. Neurosci.* 4, 507–512.
- Mitchell, R.W., and Hatch, G.M. (2011). Fatty acid transport into the brain: Of fatty acid fables and lipid tails. *Prostaglandins, Leukot. Essent. Fat. Acids* 85, 293–302.
- Mogenson, G.J., Jones, D.L., and Yim, C.Y. (1980). From motivation to action: functional interface between the limbic system and the motor system. *Prog. Neurobiol.* 14, 69–97.
- Le Moine, C., and Bloch, B. (1995). D1 and D2 dopamine receptor gene expression in the rat striatum: Sensitive cRNA probes demonstrate prominent segregation of D1 and D2 mRNAs in distinct neuronal populations of the dorsal and ventral striatum. *J. Comp. Neurol.* 355, 418–426.
- Morales, M., and Margolis, E.B. (2017). Ventral tegmental area: Cellular heterogeneity, connectivity and behaviour. *Nat. Rev. Neurosci.* 18, 73–85.

- Mori, H., Inoki, K., Münzberg, H., Opland, D.M., Faouzi, M.A., Villanueva, E.C., Ikenoue, T., Kwiatkowski, D., MacDougald, O.A., Myers, M.G., et al. (2009). Critical Role for Hypothalamic mTOR Activity in Energy Balance. *Cell Metab.* *9*, 362–374.
- Morrison, C.D., Reed, S.D., and Henagan, T.M. (2012). Homeostatic regulation of protein intake: in search of a mechanism. *Am. J. Physiol. Regul. Integr. Comp. Physiol.* *302*, R917–28.
- Morton, G.J., Cummings, D.E., Baskin, D.G., Barsh, G.S., and Schwartz, M.W. (2006). Central nervous system control of food intake and body weight. *Nature* *443*, 289–295.
- Morton, G.J., Meek, T.H., and Schwartz, M.W. (2014). Neurobiology of food intake in health and disease. *Nat. Rev. Neurosci.* *15*, 367–378.
- Mountjoy, K.G., Mortrud, M.T., Low, M.J., Simerly, R.B., and Cone, R.D. (1994). Localization of the melanocortin-4 receptor (MC4-R) in neuroendocrine and autonomic control circuits in the brain. *Mol. Endocrinol.* *8*, 1298–1308.
- Nakamura, T., Sato, A., Kitsukawa, T., Momiyama, T., Yamamori, T., and Sasaoka, T. (2014). Distinct motor impairments of dopamine D1 and D2 receptor knockout mice revealed by three types of motor behavior. *Front. Integr. Neurosci.* *8*, 56.
- Naleid, A.M., Grace, M.K., Cummings, D.E., and Levine, A.S. (2005). Ghrelin induces feeding in the mesolimbic reward pathway between the ventral tegmental area and the nucleus accumbens. *Peptides* *26*, 2274–2279.
- Narita, M., Nagumo, Y., Hashimoto, S., Narita, M., Khotib, J., Miyatake, M., Sakurai, T., Yanagisawa, M., Nakamachi, T., Shioda, S., et al. (2006). Direct Involvement of Orexinergic Systems in the Activation of the Mesolimbic Dopamine Pathway and Related Behaviors Induced by Morphine. *J. Neurosci.* *26*, 398–405.
- Nguyen, L.N., Ma, D., Shui, G., Wong, P., Cazenave-Gassiot, A., Zhang, X., Wenk, M.R., Goh, E.L.K., and Silver, D.L. (2014). Mfsd2a is a transporter for the essential omega-3 fatty acid docosahexaenoic acid. *Nature* *509*, 503–506.
- Nijs, I.M.T., Muris, P., Euser, A.S., and Franken, I.H.A. (2010). Differences in attention to food and food intake between overweight/obese and normal-weight females under conditions of hunger and satiety. *Appetite* *54*, 243–254.
- Obici, S., Feng, Z., Karknias, G., Baskin, D.G., and Rossetti, L. (2002a). Decreasing hypothalamic insulin receptors causes hyperphagia and insulin resistance in rats. *Nat. Neurosci.* *5*, 566–572.
- Obici, S., Feng, Z., Morgan, K., Stein, D., Karknias, G., and Rossetti, L. (2002b). Central administration of oleic acid inhibits glucose production and food intake. *Diabetes* *51*, 271–275.
- Obici, S., Feng, Z., Arduini, A., Conti, R., and Rossetti, L. (2003). Inhibition of hypothalamic carnitine palmitoyltransferase-1 decreases food intake and glucose production. *Nat. Med.* *9*, 756–761.
- Ochiai, Y., Uchida, Y., Ohtsuki, S., Tachikawa, M., Aizawa, S., and Terasaki, T. (2017). The blood-brain barrier fatty acid transport protein 1 (FATP1/SLC27A1) supplies docosahexaenoic acid to the brain, and insulin facilitates transport. *J. Neurochem.* *141*, 400–412.
- Olefsky, J.M., Crapo, P., and Reaven, G.M. (1976). Postprandial plasma triglyceride and cholesterol responses to a low-fat meal. *Am. J. Clin. Nutr.* *29*, 535–539.
- Ollmann, M.M., Wilson, B.D., Yang, Y.K., Kerns, J.A., Chen, Y., Gantz, I., and Barsh, G.S. (1997). Antagonism of central melanocortin receptors in vitro and in vivo by agouti-related protein. *Science* *278*, 135–138.
- Oomura, Y., Nakamura, T., Sugimori, M., and Yamada, Y. (1975). Effect of free fatty acid on the rat lateral hypothalamic neurons. *Physiol. Behav.* *14*, 483–486.

References

- Panlilio, L. V., and Justinova, Z. (2018). Preclinical Studies of Cannabinoid Reward, Treatments for Cannabis Use Disorder, and Addiction-Related Effects of Cannabinoid Exposure. *Neuropsychopharmacology* 43, 116–141.
- Paradis, É., Julien, P., and Ven Murthy, M.R. (2004). Requirement for enzymatically active lipoprotein lipase in neuronal differentiation: a site-directed mutagenesis study. *Dev. Brain Res.* 149, 29–37.
- Peciña, S., and Berridge, K.C. (2000). Opioid site in nucleus accumbens shell mediates eating and hedonic “liking” for food: map based on microinjection Fos plumes. *Brain Res.* 863, 71–86.
- Pelleymounter, M.A., Cullen, M.J., Baker, M.B., Hecht, R., Winters, D., Boone, T., and Collins, F.S. (1995). Effects of the obese gene product on body weight regulation in ob/ob mice. *Science* 269, 540–543.
- Pellinen, J., Wang, H., and Eckel, R.H. (2014). Mice with Altered Brain Lipoprotein Metabolism Display Maladaptive Responses to Environmental Challenges That May Predispose to Weight Gain. *Metab. Syndr. Relat. Disord.* X, 1–8.
- Pepino, M.Y., Kuda, O., Samovski, D., and Abumrad, N.A. (2014). Structure-function of CD36 and importance of fatty acid signal transduction in fat metabolism. *Annu. Rev. Nutr.* 34, 281–303.
- Perelló, M., and Zigman, J.M. (2012). The Role of Ghrelin in Reward-Based Eating. *Biol. Psychiatry* 72, 347–353.
- Persson, E. (1988). Lipoprotein lipase, hepatic lipase and plasma lipolytic activity. Effects of heparin and a low molecular weight heparin fragment (Fragmin). *Acta Med. Scand. Suppl.* 724, 1–56.
- Peyron, C., Tighe, D.K., van den Pol, A.N., de Lecea, L., Heller, H.C., Sutcliffe, J.G., and Kilduff, T.S. (1998). Neurons containing hypocretin (orexin) project to multiple neuronal systems. *J. Neurosci.* 18, 9996–10015.
- Phillips, R.J., and Powley, T.L. (1996). Gastric volume rather than nutrient content inhibits food intake. *Am. J. Physiol. Integr. Comp. Physiol.* 271, R766–R769.
- Picard, A., Rouch, C., Kassis, N., Moullé, V.S., Croizier, S., Denis, R.G.P., Castel, J., Coant, N., Davis, K., Clegg, D.J., et al. (2014). Hippocampal lipoprotein lipase regulates energy balance in rodents. *Mol. Metab.* 3, 167–176.
- Pinto, S., Roseberry, A.G., Liu, H., Diano, S., Shanabrough, M., Cai, X., Friedman, J.M., and Horvath, T.L. (2004). Rapid Rewiring of Arcuate Nucleus Feeding Circuits by Leptin. *Science* (80-.). 304, 110–115.
- Pitas, R.E., Boyles, J.K., Lee, S.H., Foss, D., and Mahley, R.W. (1987). Astrocytes synthesize apolipoprotein E and metabolize apolipoprotein E-containing lipoproteins. *Biochim. Biophys. Acta - Lipids Lipid Metab.* 917, 148–161.
- Qu, D., Ludwig, D.S., Gammeltoft, S., Piper, M., Pelleymounter, M.A., Cullen, M.J., Mathes, W.F., Przypek, J., Kanarek, R., and Maratos-Flier, E. (1996). A role for melanin-concentrating hormone in the central regulation of feeding behaviour. *Nature* 380, 243–247.
- Rada, P., Avena, N.M., and Hoebel, B.G. (2005). Daily bingeing on sugar repeatedly releases dopamine in the accumbens shell. *Neuroscience* 134, 737–744.
- Rada, P., Avena, N.M., Barson, J.R., Hoebel, B.G., and Leibowitz, S.F. (2012). A High-Fat Meal, or Intraperitoneal Administration of a Fat Emulsion, Increases Extracellular Dopamine in the Nucleus Accumbens. *Brain Sci.* 2, 242–253.
- Ramachandrapa, S., Gorrigan, R.J., Clark, A.J.L., and Chan, L.F. (2013). The melanocortin receptors and their accessory proteins. *Front. Endocrinol. (Lausanne).* 4, 9.
- Reum, T., Schäfer, U., Marsden, C.A., Fink, H., and Morgenstern, R. (1997). Cholecystokinin increases

extracellular dopamine overflow in the anterior nucleus accumbens via CCK(B) receptors in the VTA assessed by in vivo voltammetry. *Neuropeptides* 31, 82–88.

Rhea, E.M., Salameh, T.S., Logsdon, A.F., Hanson, A.J., Erickson, M.A., and Banks, W.A. (2017). Blood-Brain Barriers in Obesity. *AAPS J.* 19, 921–930.

Ritchie, T., and Noble, E.P. (2003). Association of seven polymorphisms of the D2 dopamine receptor gene with brain receptor-binding characteristics. *Neurochem. Res.* 28, 73–82.

Ritter, S., Dinh, T.T., and Zhang, Y. (2000). Localization of hindbrain glucoreceptive sites controlling food intake and blood glucose. *Brain Res.* 856, 37–47.

Rogers, Q.R., Tannous, R.I., and Harper, A.E. (1967). Effects of Excess Leucine on Growth and Food Selection. *J. Nutr.* 91, 561–572.

Rolls, E.T. (2005). Taste, olfactory, and food texture processing in the brain, and the control of food intake. *Physiol. Behav.* 85, 45–56.

Roselli-Rehffuss, L., Mountjoy, K.G., Robbins, L.S., Mortrud, M.T., Low, M.J., Tatro, J.B., Entwistle, M.L., Simerly, R.B., and Cone, R.D. (1993). Identification of a receptor for gamma melanotropin and other proopiomelanocortin peptides in the hypothalamus and limbic system. *Proc. Natl. Acad. Sci. U. S. A.* 90, 8856–8860.

Ross, H.E., and Ivis, F. (1999). Binge eating and substance use among male and female adolescents. *Int. J. Eat. Disord.* 26, 245–260.

Rothmund, Y., Preuschhof, C., Bohner, G., Bauknecht, H.-C., Klingebiel, R., Flor, H., and Klapp, B.F. (2007a). Differential activation of the dorsal striatum by high-calorie visual food stimuli in obese individuals. *Neuroimage* 37, 410–421.

Rothmund, Y., Preuschhof, C., Bohner, G., Bauknecht, H.-C., Klingebiel, R., Flor, H., and Klapp, B.F. (2007b). Differential activation of the dorsal striatum by high-calorie visual food stimuli in obese individuals. *Neuroimage* 37, 410–421.

Ruge, T., Hodson, L., Cheeseman, J., Dennis, A.L., Fielding, B.A., Humphreys, S.M., Frayn, K.N., and Karpe, F. (2009). Fasted to fed trafficking of Fatty acids in human adipose tissue reveals a novel regulatory step for enhanced fat storage. *J. Clin. Endocrinol. Metab.* 94, 1781–1788.

Rutkowski, J.M., Lee, L.L., Puchowicz, M., Golub, M.S., Befroy, D.E., Wilson, D.W., Anderson, S.E., Cline, G., Bini, J., Borkowski, K., et al. (2018). Reduced cognitive function, increased bloodbrain-barrier transport and inflammatory responses, and altered brain metabolites in LDLr^{-/-}And C57BL/6 mice fed a western diet. *PLoS One* 13, e0191909.

Sakurai, T., Amemiya, A., Ishii, M., Matsuzaki, I., Chemelli, R.M., Tanaka, H., Williams, S.C., Richardson, J.A., Kozlowski, G.P., Wilson, S., et al. (1998). Orexins and orexin receptors: a family of hypothalamic neuropeptides and G protein-coupled receptors that regulate feeding behavior. *Cell* 92, 573–585.

Schaffer, J.E., and Lodish, H.F. (1994). Expression cloning and characterization of a novel adipocyte long chain fatty acid transport protein. *Cell* 79, 427–436.

Schmelzle, T., and Hall, M.N. (2000). TOR, a central controller of cell growth. *Cell* 103, 253–262.

Schulinkamp, R.J., Pagano, T.C., Hung, D., and Raffa, R.B. (2000). Insulin receptors and insulin action in the brain: review and clinical implications. *Neurosci. Biobehav. Rev.* 24, 855–872.

Schultz, W. (1986). Responses of midbrain dopamine neurons to behavioral trigger stimuli in the monkey. *J. Neurophysiol.* 56, 1439–1461.

Schultz, W. (2010). Dopamine signals for reward value and risk: basic and recent data. *Behav. Brain Funct.* 6, 24.

References

- Schwartz, M.W., Woods, S.C., Porte, D., Seeley, R.J., and Baskin, D.G. (2000). Central nervous system control of food intake. *Nature* 404, 661–671.
- Sellbom, K.S., and Gunstad, J. (2012). Cognitive function and decline in obesity. *J. Alzheimers. Dis.* 30 *Suppl 2*, S89-95.
- Sesack, S.R., and Grace, A.A. (2010). Cortico-Basal Ganglia Reward Network: Microcircuitry. *Neuropsychopharmacology* 35, 27–47.
- Shalev, U., Yap, J., and Shaham, Y. (2001). Leptin attenuates acute food deprivation-induced relapse to heroin seeking. *J. Neurosci.* 21, RC129.
- Sharma, S., and Fulton, S. (2013). Diet-induced obesity promotes depressive-like behaviour that is associated with neural adaptations in brain reward circuitry. *Int. J. Obes. (Lond).* 37, 382–389.
- Shen, M., Jiang, C., Liu, P., Wang, F., and Ma, L. (2016). Mesolimbic leptin signaling negatively regulates cocaine-conditioned reward. *Transl. Psychiatry* 6, e972.
- Shi, Y., and Cheng, D. (2009). Beyond triglyceride synthesis: the dynamic functional roles of MGAT and DGAT enzymes in energy metabolism. *Am. J. Physiol. Metab.* 297, E10–E18.
- Shioda, N., Yamamoto, Y., Watanabe, M., Binas, B., Owada, Y., and Fukunaga, K. (2010). Heart-Type Fatty Acid Binding Protein Regulates Dopamine D2 Receptor Function in Mouse Brain. *J. Neurosci.* 30, 3146–3155.
- De Silva, A., and Bloom, S.R. (2012). Gut Hormones and Appetite Control: A Focus on PYY and GLP-1 as Therapeutic Targets in Obesity. *Gut Liver* 6, 10–20.
- Sipols, A.J., Baskin, D.G., and Schwartz, M.W. (1995). Effect of intracerebroventricular insulin infusion on diabetic hyperphagia and hypothalamic neuropeptide gene expression. *Diabetes* 44, 147–151.
- South, T., and Huang, X.-F. (2008). High-Fat Diet Exposure Increases Dopamine D2 Receptor and Decreases Dopamine Transporter Receptor Binding Density in the Nucleus Accumbens and Caudate Putamen of Mice. *Neurochem. Res.* 33, 598–605.
- Stahl, A., Evans, J.G., Pattel, S., Hirsch, D., and Lodish, H.F. (2002). Insulin causes fatty acid transport protein translocation and enhanced fatty acid uptake in adipocytes. *Dev. Cell* 2, 477–488.
- Stephens, T.W., Basinski, M., Bristow, P.K., Bue-Valleskey, J.M., Burgett, S.G., Craft, L., Hale, J., Hoffmann, J., Hsiung, H.M., Kriauciunas, A., et al. (1995). The role of neuropeptide Y in the antiobesity action of the obese gene product. *Nature* 377, 530–532.
- Stice, E., Spoor, S., Bohon, C., and Small, D.M. (2008). Relation between obesity and blunted striatal response to food is moderated by TaqIA A1 allele. *Science* (80-.). 322, 449–452.
- Stice, E., Spoor, S., Ng, J., and Zald, D.H. (2009). Relation of obesity to consummatory and anticipatory food reward. *Physiol. Behav.* 97, 551–560.
- Stice, E., Yokum, S., Zald, D., and Dagher, A. (2010). Dopamine-Based Reward Circuitry Responsivity, Genetics, and Overeating. pp. 81–93.
- Stice, E., Yokum, S., Zald, D., and Dagher, A. (2011). Dopamine-based reward circuitry responsivity, genetics, and overeating. *Curr. Top. Behav. Neurosci.* 6, 81–93.
- Stice, E., Burger, K.S., and Yokum, S. (2015). Reward Region Responsivity Predicts Future Weight Gain and Moderating Effects of the TaqIA Allele. *J. Neurosci.* 35, 10316–10324.
- Stoof, J.C., and Kebabian, J.W. (1981). Opposing roles for D-1 and D-2 dopamine receptors in efflux of cyclic AMP from rat neostriatum. *Nature* 294, 366–368.
- Stratford, T.R., and Kelley, A.E. (1999). Evidence of a functional relationship between the nucleus accumbens shell and lateral hypothalamus subserving the control of feeding behavior. *J. Neurosci.* 19,

11040–11048.

Sun, X., Veldhuizen, M.G., Wray, A.E., de Araujo, I.E., Sherwin, R.S., Sinha, R., and Small, D.M. (2014). The neural signature of satiation is associated with ghrelin response and triglyceride metabolism. *Physiol. Behav.* *136*, 63–73.

Suzuki, K., Jayasena, C.N., and Bloom, S.R. (2012). Obesity and Appetite Control. *Exp. Diabetes Res.* *2012*, 1–19.

Svingos, A.L., Garzón, M., Colago, E.E.O., and Pickel, V.M. (2001). μ -Opioid receptors in the ventral tegmental area are targeted to presynaptically and directly modulate mesocortical projection neurons. *Synapse* *41*, 221–229.

Swinburn, B., Sacks, G., and Ravussin, E. (2009). Increased food energy supply is more than sufficient to explain the US epidemic of obesity. *Am. J. Clin. Nutr.* *90*, 1453–1456.

Szczypka, M.S., Rainey, M.A., Kim, D.S., Alaynick, W.A., Marck, B.T., Matsumoto, A.M., and Palmiter, R.D. (1999). Feeding behavior in dopamine-deficient mice. *Proc. Natl. Acad. Sci. U. S. A.* *96*, 12138–12143.

Szczypka, M.S., Kwok, K., Brot, M.D., Marck, B.T., Matsumoto, A.M., Donahue, B. a, and Palmiter, R.D. (2001). Dopamine production in the caudate putamen restores feeding in dopamine-deficient mice. *Neuron* *30*, 819–828.

Tellez, L.A., Ferreira, J.G., Medina, S., Land, B.B., DiLeone, R.J., and de Araujo, I.E. (2013). Flavor-Independent Maintenance, Extinction, and Reinstatement of Fat Self-Administration in Mice. *Biol. Psychiatry* *73*, 851–859.

Tschöp, M.H., Smiley, D.L., and Heiman, M.L. (2000). Ghrelin induces adiposity in rodents. *Nature* *407*, 908–913.

Turton, M.D., O’Shea, D., Gunn, I., Beak, S.A., Edwards, C.M.B., Meeran, K., Choi, S.J., Taylor, G.M., Heath, M.M., Lambert, P.D., et al. (1996). A role for glucagon-like peptide-1 in the central regulation of feeding. *Nature* *379*, 69–72.

Urayama, A., and Banks, W.A. (2008). Starvation and triglycerides reverse the obesity-induced impairment of insulin transport at the blood-brain barrier. *Endocrinology* *149*, 3592–3597.

Uziel, A., Baik, J.-H., Rougé-Pont, F., Picetti, R., Dierich, A., LeMeur, M., Piazza, P.V., and Borrelli, E. (2000). Distinct functions of the two isoforms of dopamine D2 receptors. *Nature* *408*, 199–203.

Valjent, E., and Maldonado, R. (2000). A behavioural model to reveal place preference to delta 9-tetrahydrocannabinol in mice. *Psychopharmacology (Berl)*. *147*, 436–438.

Vienberg, S.G., Kleinridders, A., Suzuki, R., and Kahn, C.R. (2015). Differential effects of angiopoietin-like 4 in brain and muscle on regulation of lipoprotein lipase activity. *Mol. Metab.* *4*, 144–150.

Vijayan, E., and McCann, S.M. (1977). Suppression of feeding and drinking activity in rats following intracentricular injection of Thyrotropin Releasing Hormone (TRH). *Endocrinology* *100*, 1727–1730.

Volkow, N.D., and Wise, R.A. (2005). How can drug addiction help us understand obesity? *Nat. Neurosci.* *8*, 555–560.

Volkow, N.D., Wang, G.-J., Telang, F., Fowler, J.S., Thanos, P.K., Logan, J., Alexoff, D., Ding, Y.-S., Wong, C., Ma, Y., et al. (2008). Low dopamine striatal D2 receptors are associated with prefrontal metabolism in obese subjects: Possible contributing factors. *Neuroimage* *42*, 1537–1543.

Volkow, N.D., Wang, G.-J., and Baler, R.D. (2011). Reward, dopamine and the control of food intake: implications for obesity. *Trends Cogn. Sci.* *15*, 37–46.

Volkow, N.D., Wise, R.A., and Baler, R. (2017). The dopamine motive system: implications for drug

References

- and food addiction. *Nat. Rev. Neurosci.* *18*, 741–752.
- Wang, H., and Eckel, R.H. (2012). Lipoprotein Lipase in the Brain and Nervous System. *Annu. Rev. Nutr.* *32*, 147–160.
- Wang, H., and Eckel, R.H. (2014). What are lipoproteins doing in the brain? *Trends Endocrinol. Metab.* *25*, 8–14.
- Wang, G.-J., Volkow, N.D., and Fowler, J.S. (2002). The role of dopamine in motivation for food in humans: implications for obesity. *Expert Opin. Ther. Targets* *6*, 601–609.
- Wang, G.-J., Volkow, N.D., Thanos, P.K., and Fowler, J.S. (2004). Similarity Between Obesity and Drug Addiction as Assessed by Neurofunctional Imaging. *J. Addict. Dis.* *23*, 39–53.
- Wang, G.J., Volkow, N.D., Logan, J., Pappas, N.R., Wong, C.T., Zhu, W., Netusil, N., and Fowler, J.S. (2001). Brain dopamine and obesity. *Lancet (London, England)* *357*, 354–357.
- Wang, H., Astarita, G., Taussig, M.D., Bharadwaj, K.G., Dipatrizio, N. V., Nave, K.A., Piomelli, D., Goldberg, I.J., and Eckel, R.H. (2011). Deficiency of lipoprotein lipase in neurons modifies the regulation of energy balance and leads to obesity. *Cell Metab.* *13*, 105–113.
- Wang, R., Cruciani-Guglielmacci, C., Migrenne, S., Magnan, C., Cotero, V.E., and Routh, V.H. (2006). Effects of Oleic Acid on Distinct Populations of Neurons in the Hypothalamic Arcuate Nucleus Are Dependent on Extracellular Glucose Levels. *J. Neurophysiol.* *95*, 1491–1498.
- Watterson, K.R., Bestow, D., Gallagher, J., Lee, D., Fiona, H., Ashford, B., Meakin, P.J., and Ashford, M.L.J. (2013). Anorexigenic and Orexigenic Hormone Modulation of Mammalian Target of Rapamycin Complex 1 Activity and the Regulation of Hypothalamic Agouti-Related Protein mRNA Expression. *Neurosignals* *21*, 28–41.
- WHO (2018). WHO | Obesity and overweight (World Health Organization).
- Wiederman, M.W., and Pryor, T. (1996a). Substance use among women with eating disorders. *Int. J. Eat. Disord.* *20*, 163–168.
- Wiederman, M.W., and Pryor, T. (1996b). Substance use and impulsive behaviors among adolescents with eating disorders. *Addict. Behav.* *21*, 269–272.
- Will, M.J., Pratt, W.E., and Kelley, A.E. (2006). Pharmacological characterization of high-fat feeding induced by opioid stimulation of the ventral striatum. *Physiol. Behav.* *89*, 226–234.
- Williams, K.W., Margatho, L.O., Lee, C.E., Choi, M., Lee, S., Scott, M.M., Elias, C.F., and Elmquist, J.K. (2010). Segregation of Acute Leptin and Insulin Effects in Distinct Populations of Arcuate Proopiomelanocortin Neurons. *J. Neurosci.* *30*, 2472–2479.
- Williams, W.M., Chang, M.C.J., Hayakawa, T., Grange, E., and Rapoport, S.I. (1997). In vivo incorporation from plasma of radiolabeled palmitate and arachidonate into rat brain microvessels. *Microvasc. Res.* *53*, 163–166.
- Wilson, R.I., and Nicoll, R.A. (2001). Endogenous cannabinoids mediate retrograde signalling at hippocampal synapses. *Nature* *410*, 588–592.
- Woods, S.C., Lotter, E.C., McKay, L.D., and Porte, D. (1979). Chronic intracerebroventricular infusion of insulin reduces food intake and body weight of baboons. *Nature* *282*, 503–505.
- Xavier, A.M., Ludwig, R.G., Nagai, M.H., de Almeida, T.J., Watanabe, H.M., Hirata, M.Y., Rosenstock, T.R., Papes, F., Malnic, B., and Glezer, I. (2016). CD36 is expressed in a defined subpopulation of neurons in the olfactory epithelium. *Sci. Rep.* *6*, 25507.
- Xian, X., Liu, T., Yu, J., Wang, Y., Miao, Y., Zhang, J., Yu, Y., Ross, C., Karasinska, J.M., Hayden, M.R., et al. (2009). Presynaptic defects underlying impaired learning and memory function in

lipoprotein lipase-deficient mice. *J. Neurosci.* *29*, 4681–4685.

Yang, S.-B., Tien, A.-C., Boddupalli, G., Xu, A.W., Jan, Y.N., and Jan, L.Y. (2012). Rapamycin Ameliorates Age-Dependent Obesity Associated with Increased mTOR Signaling in Hypothalamic POMC Neurons. *Neuron* *75*, 425–436.

Yoshida, M., Yokoo, H., Mizoguchi, K., Kawahara, H., Tsuda, A., Nishikawa, T., and Tanaka, M. (1992). Eating and drinking cause increased dopamine release in the nucleus accumbens and ventral tegmental area in the rat: measurement by in vivo microdialysis. *Neurosci. Lett.* *139*, 73–76.

Yu, T., Taussig, M.D., Dipatrizio, N. V., Astarita, G., Piomelli, D., Bergman, B.C., Dell’Acqua, M.L., Eckel, R.H., and Wang, H. (2015). Deficiency of Lipoprotein Lipase in Neurons Decreases AMPA Receptor Phosphorylation and Leads to Neurobehavioral Abnormalities in Mice. *PLoS One* *10*, e0135113.

Zahm, D.S., and Brog, J.S. (1992). On the significance of subterritories in the “accumbens” part of the rat ventral striatum. *Neuroscience* *50*, 751–767.

Zhang, M., Gosnell, B.A., and Kelley, A.E. (1998). Intake of high-fat food is selectively enhanced by mu opioid receptor stimulation within the nucleus accumbens. *J. Pharmacol. Exp. Ther.* *285*, 908–914.

Zhang, Y., Proenca, R., Maffei, M., Barone, M., Leopold, L., and Friedman, J.M. (1994). Positional cloning of the mouse obese gene and its human homologue. *Nature* *372*, 425–432.

Zhang, Y., Chen, K., Sloan, S.A., Bennett, M.L., Scholze, A.R., O’Keefe, S., Phatnani, H.P., Guarnieri, P., Caneda, C., Ruderisch, N., et al. (2014). An RNA-Sequencing Transcriptome and Splicing Database of Glia, Neurons, and Vascular Cells of the Cerebral Cortex. *J. Neurosci.* *34*, 11929–11947.

Zhu, C., Xu, P., He, Y., Yuan, Y., Wang, T., Cai, X., Yu, L., Yang, L., Wu, J., Wang, L., et al. (2017). Heparin Increases Food Intake through AgRP Neurons. *Cell Rep.* *20*, 2455–2467.

Zigman, J.M., Jones, J.E., Lee, C.E., Saper, C.B., and Elmquist, J.K. (2006). Expression of ghrelin receptor mRNA in the rat and the mouse brain. *J. Comp. Neurol.* *494*, 528–548.

Annexes

See enclose a resume as well as the collaborations during this thesis which led to publications.

Chloé Berland

berland.ch@gmail.com Born March 8th 1990, Paris France

Research

- 2014** PhD project under the supervision of Dr. Serge Luquet. Univ. Paris 7. Unité Biologie Fonctionnelle et Adaptative. Study of central triglycerides impact on the mesocorticolimbic system and reward-driven behaviour.
- 2013** Master research project, Dr. Denise Belsham. Univ. of Toronto (Canada), Physiology Department. Fat detection in hypothalamic immortalised cell lines and impact on neuronal signalling.
- 2012** Bachelor Internship, Pr. David Summers. Univ. of Cambridge (United Kingdom), Department of Genetics. Impact of indole of E. coli replication.

Technical skills

- Neurosciences** Stereotaxic surgery – cannula implantations – carotid catheterisation – brain immunohistochemistry – brain microdissection
- Metabolism** Indirect calorimetry analysis – feeding behaviour analysis – oral glucose tolerance tests – insulin tolerance tests
- Behaviour** Operant conditioning – conditioned place preference – self-administration – locomotor activity recording and analysis
- Mol. biology** Western-blot analysis, immunohistochemistry, ELISA.

Education

- 2018** PhD in physiology “Brain fat sensing: a new mechanism involved in body weight regulation” under the supervision of Dr Luquet, Biologie Fonctionnelle et Adaptative, Univ. Paris 7, and Pr Dr. Tschöp, Institute for Diabetes and Obesity, Munich. Defence planned on Sept. 11th in front of Pr Stephanie Fulton, University of Montreal, Pr Vincent Prevot, University of Lille, Dr Xavier Fioramonti, University of Bordeaux, Dr Patricia Parnet, University of Nantes, Dr Isabelle Niot, University of Bourgogne, and Pr Alain Zider, University Paris Diderot.
- 2014** Master degree in Genetics - Magistère Européen de Génétique. Université Paris 7 Paris Diderot.
- 2012** Bachelor degree in Genetics - Université Paris Diderot.

Publications

The Nucleus Accumbens Shell regulates Hepatic Glucose Production via a Lateral Hypothalamic Vagal Liver axis, in press.

C. Diepenbroek, M. Rijnsburger, L. Eggels, A. Kisner, C. Berland, S. Dolléman, E. Foppen, U.A. Unmehopa, C. Cruciani-Guglielmacci, E. Fliers, M.T. Ackermans, A. Kalsbeek, S. Luquet, Y. Aponte, M.J. Serlie, S.E. la Fleur

Lipoprotein Lipase in Hypothalamus is a key regulator of body weight gain and glucose homeostasis in mice, Diabetologia, 2017.

E. Laperrousaz, V.S Moullé, R.G Denis, N. Kassis, C. Berland, B. Colsch, X. Fioramonti, E. Philippe, A. Lacombe, C. Vanacker, N. Butin, K.D Bruce, H. Wang, Y. Wang, Y. Gao, C. Garcia-Caceres, V.Prévoit, M. Tschöp, R.H Eckel, H.Le Stunff, S. Luquet, C. Magnan, C. Cruciani-Guglielmacci

Dietary triglycerides as signalling molecules that influence reward and motivation, Current Opinion in Behavioural Sciences, 2016.

C.Berland, C. Cansell, T.S Hnasko, C. Magnan, S. Luquet.

Scholarships and awards

- 2018** Travel grant of Société Française de Neuroendocrinologie (SNE) for the International Congress of Neuroendocrinology (ICN), Toronto, Canada, 650€.
- 2017** Research grant of Fondation Médicale pour la Recherche (FRM), 34 000€
- 2016** Best poster presentation award, FENS Summer school on cellular mechanisms and networks in addiction
- 2015** Travel grant of Société Française de Neuroendocrinologie (SNE) for the British Society for Neuroendocrinology-Société Française de Neuroendocrinologie (BSN-SNE) 2015 Congress, 500€
- 2014** G.L.N. (Groupe Lipides et Nutrition) Award 2014, 10 000€
- 2014** Doctoral funding for 3 years from The Bayerische Forschungsförderung, Germany (Doktorandenprogramm der Bayerische Forschungsförderung), 60 000€

Oral presentations

- 2018** Talk at the International Congress of Neuroendocrinology (ICN) 2018, Toronto, Canada
- 2017** Poster Presentation NeuroFrance 2017, Bordeaux, France
- 2016** Poster Presentation in FENS Summer School, Bertinoro, Italy.
- 2016** Poster Presentation in BSN-SNE congress, Lille, France
- 2015** Oral presentation at the Donders Institute for Brain, Cognition and behaviour, Donders discussions.

Other trainings

- 2016** Federation of European Neuroscience Societies (FENS) summer school on cellular mechanisms and networks in addiction, 1 week, Bertinoro, Italy. Under the supervision of Dr. G. D Stuber and Pr. C. Lüscher
- 2014** European certificate for animal research, University Paris Descartes, Paris, France.
- 2013** Pasteur Institute Course on development and plasticity of the nervous system, 6 weeks, Institut Pasteur, Paris (XV). Under the supervision of Dr P.M. Lledo, Dr A. Trembleau.

Teaching

- 2016-present** First and second year biology teacher at the Lycée Saint Hilaire, Paris 13 (classes préparatoires aux grandes écoles, BCPST, 7 hours a week)

Résumé de la thèse

La progression rapide de l'obésité en Europe est en partie due à un déséquilibre de l'homéostasie énergétique lié à une consommation excessive d'aliments gras et sucrés, et à des modes de vie sédentaires. Cette consommation excessive d'aliments riches en calories, à fort impact hédonique, dépend en partie de la libération de dopamine dans le système mésocorticolimbique, autrement nommé circuit de la récompense. La libération de dopamine dans le système mésocorticolimbique est un facteur nécessaire aux comportements compulsifs liés à la nourriture, et les aliments riches pourraient être responsables d'une alimentation trop excessive, assimilable aux dysfonctionnements du système mésocorticolimbique relatifs aux drogues d'abus. En particulier, la majorité des lipides issus de notre alimentation circulent sous forme de triglycérides devant être hydrolysés en acides gras libres pour pouvoir être oxydés par la cellule, et s'accumulent en condition obèse (hypertriglycéridémie). Les neurones du système mésocorticolimbique expriment certaines enzymes liées au métabolisme de ces triglycérides, notamment la lipoprotéine lipase, ce qui suggère qu'ils peuvent les détecter et moduler en conséquence leur activité, et donc la libération de dopamine. Le but de cette thèse est d'étudier les mécanismes moléculaires et cellulaires qui relient prise alimentaire et signalisation induite par les lipides dans le système nerveux central, et en particulier dans le système dopaminergique.

Obesity spreading is due to an imbalance of energy homeostasis, with excessive consumption of sweet and fat food, and sedentary lifestyles. Food intake partly depends on dopamine release in the mesocorticolimbic system, and calorie-rich hedonic food, among other objects of desire, stimulate this reward circuit. Dopaminergic release in the mesocorticolimbic system is a main factor for compulsive feeding, and calorie-rich food could be responsible for abnormal feeding behaviours, where excessive food intake is assimilated to MCL malfunctions similar to drugs addiction. More particularly, postprandial triglycerides represent a major source of dietary lipids, and obesity is often associated with hypertriglyceridemia, but also with dopaminergic signalling impairments. Mesocorticolimbic system neurons express several enzymes involved in triglycerides hydrolysis, such as the lipoprotein lipase, suggesting an ability to sense triglycerides and modulate their activity accordingly. The aim of this thesis is to identify cellular and molecular mechanisms by which dietary triglycerides act onto dopaminergic structures and control food intake.

Mots-clefs :

triglycérides - dopamine - lipoprotéine lipase - D2 récepteur - récompense - comportement alimentaire
triglycerides - dopamine - lipoprotein lipase - D2 receptor - reward - feeding behaviour