



HAL
open science

The role of integrin α_v expressed by VSMCs in vascular fibrosis

Lei Tian

► **To cite this version:**

Lei Tian. The role of integrin α_v expressed by VSMCs in vascular fibrosis. Cellular Biology. Sorbonne Université, 2018. English. NNT : 2018SORUS103 . tel-02886136

HAL Id: tel-02886136

<https://theses.hal.science/tel-02886136>

Submitted on 1 Jul 2020

HAL is a multi-disciplinary open access archive for the deposit and dissemination of scientific research documents, whether they are published or not. The documents may come from teaching and research institutions in France or abroad, or from public or private research centers.

L'archive ouverte pluridisciplinaire **HAL**, est destinée au dépôt et à la diffusion de documents scientifiques de niveau recherche, publiés ou non, émanant des établissements d'enseignement et de recherche français ou étrangers, des laboratoires publics ou privés.

Acknowledgement

I thank my supervisor Dr. Zhenlin Li. He is a very hard-working scientist, his spirit inspires me to do my best every day. He is an erudite scientist, he always gives me some useful suggestions, He is a responsible scientist, when I meet some difficulties in my PhD project, he always tries to solve my problems. He provides me a platform to do my research and accomplish my PhD career.

I thank Pr. Denise Paulin. She is so important in my PhD career. She helps me to open a window to understand the French society. She is so kind to me. Each time, when I am in difficult conditions, I always want to ask her for help. She is so tolerant, sometimes, even though I make some mistakes, she always forgives me and gives me chances to try again. Her personality is an example for me and gives me forces to go ahead in the future. Her tolerances and patience give me a relatively ideal environment to do my research.

I thank Pr. Bertrand Friguet. As a director of our department, he gives me so many supports. He is always so optimistic. His encouragements give me the courage to overcome difficulties. This time, he also agrees to be the president of my PhD defense, it is a great honor for me.

I thank Dr. Dario Coletti. He gives me so many helps. From the experimental designs to the statistic knowledge, from the experimental reagents to the thesis revision. He always tries his best to help me to solve my problems. I learn a lot from him, not only the knowledge of statistic and electronic microscope, but also his personality.

I thank my PhD school. Dr. Catherine Monnot gives me so many supports, her responsibility and supports inspire me to accomplish my PhD thesis better and better.

I thank Dr. Céline Fassot. As a reviewer of my thesis, she helps me revise my manuscript and gives me many useful suggestions. More importantly, she gives me so many positive evaluations.

I thank Pr. Marina Bouche. As a reviewer of my thesis, she gives me careful revision of my manuscript. Your careful corrections and important suggestions help me to improve the quality of my manuscript.

I thank Dr. Isabelle Brunet. As the tutor in my PhD career. About 2 years ago, I first met her, from then on, she gives me some useful suggestions for my PhD project. She builds a bridge between me and PhD school. This time, it is my

honor to invite her to be examiner of my PhD jury.

I also would like to express my thanks to Dr. Jean-Sébastien Silvestre. He is the famous scientist in my research field. He gives me some suggestions. His kindness gives me a deep impression.

I also thank Dr. Carine le Goff. I was nervous, when I first met her. She gave me so many patience to express myself. I can feel her friendship and sincerity.

I thank Dr. Mathias Mericskay. We have not spent a lot of time together, but he is so kindness to me. Every time I meet him, he always gives me encouragement. In my PhD career, he indeed gives me so many critical suggestions.

I thank Mrs. Jocelyne Blanc. She helps me do the first experiment in this new lab. As a secretary of our lab, she knows all kinds of affaires in our labs. She is so kindness and always gives me some useful information in my experiments.

I thank Dr. Jean-François Decaux, Dr. Zhigang Xue, Mrs Jie Gao and Dr. Ara Pariakian. They help me do some experiences and give me some good suggestions. They teach me how to make some kinds of experimental reagents by ourselves. There are so many useful formulas in our labs. They also help me to improve my French. Through their helps, I can understand the French society better.

I thank Rachel Gergondey, Maria Kisara, Ekaterini Kordeil, Gaelle Revet, Janek Hyzewicz, Fanny Canesi, Elodie Bosc, Marie-Paule Hamon. We are in the same big lab, they give me so many helps. they help me get the softwares, they lend me some chemical reagents, they teach me how to use the machine.....they create a harmony environment for me. Their kindness give me a deep impression and good memory for my PhD career.

I thank Dr. Emmanuelle Lacaze. She teaches me how to use Atomic Force Microscope. With her help, I have a better understanding of this microscope. I have gotten some meaning results by using this microscope.

I thank my parents. They always give me a lot of unconditional supports. Even though they are in China, When I am sad, I always want to talk with them. In the past several years, they have suffered a lot with me. They are my harbor forever.

List of publications

Langlois B, Belozertseva E, Parlakian A, Bourhim M, Gao-Li J, Blanc J, **Tian L**, Coletti D, Labat C, Ramdame-Cherif Z, Challande P, Regnault V, Lacolley P, Zhenlin L. Vimentin knockout results in increased expression of sub-endothelial basement membrane components and carotid stiffness in mice. *Sci Rep*. 2017 Sep 14;7(1):11628.

Tian L, Chen K, Cao J, Han Z, Gao L, Wang Y, Fan Y, Wang C. Galectin-3 induces the phenotype transformation of human vascular smooth muscle cells via the canonical Wnt signaling. *Mol Med Rep*. 2017 Jun;15(6):3840-3846.

Tian L, Chen K, Cao J, Han Z, Gao L, Wang Y, Fan Y *, Wang C* Galectin-3 elicited by oxLDL promotes the phenotype transformation of vascular smooth muscle cells. *Mol Med Rep*. 2015 Oct;12(4):4995-5002.

Cao J*, Han Z*, **Tian L***, Chen K, Fan Y, Ye B, Wang C, Huang Z. Curcumin inhibits EMMPRIN and MMP-9 expression through AMPK-MAPK and PKC signaling in PMA induced macrophages. *J Transl Med*. 2014 Sep 21;12(1):266.

Cao J, Ye B, Lin L, **Tian L**, Yang H, Wang C, Huang W, Huang Z. Curcumin Alleviates oxLDL Induced MMP-9 and EMMPRIN Expression through the Inhibition of NF- κ B and MAPK Pathways in Macrophages. *Front Pharmacol*. 2017 Feb 14;8:62.

Han Z, Cao J, Song D, **Tian L**, Chen K, Wang Y, Gao L, Yin Z, Fan Y, Wang C. Autophagy is involved in the cardioprotection effect of remote limb ischemic postconditioning on myocardial ischemia/reperfusion injury in normal mice, but not diabetic mice. *PLoS One*. 2014 Jan 23;9(1):e86838.

The role of integrin α_v expressed by VSMCs in vascular fibrosis

Content

Abstract	10
Abbreviations	12
Introduction	15
Part I Integrins are related to fibrosis	15
1.1 Integrins and integrin-related proteins.....	15
1.2 The role of integrins in fibrosis.....	16
Part II VSMCs play an important role in vascular fibrosis	18
2.1 Microanatomy of arteries.....	18
2.2 VSMCs is one of the main cell types in the arterial wall.....	19
2.3 Two important phenotypes of SMCs: contractile and synthetic SMCs.....	20
2.4 ECM plays an important role in vascular fibrosis.....	21
Part III Ang II or TGF-β induces vascular fibrosis	22
3.1 Ang II is an important factor in cardiovascular fibrosis.....	22
3.1.1 Ang II induces cardiovascular fibrosis.....	23
3.1.2 Ang II and its receptors in cardiovascular fibrosis.....	23
3.1.3 Downstream of Ang II Receptors: signaling pathways in cardiovascular fibrosis.....	27
3.2 TGF- β 1 is a crucial determinant in cardiovascular fibrosis.....	29
3.2.1 TGF- β 1 interacts with integrins via LAP and induces cardiovascular fibrosis.....	30
3.2.2 TGF- β 1 and its receptors.....	32
3.2.3 TGF- β 1 and its signaling pathways in cardiovascular fibrosis.....	32
Part IV Galectin-3: a novel factor involved in fibrosis and cardiovascular diseases	37
4.1 Structure and expression of galectin-3.....	37
4.2 Galectin-3 is related to fibrosis.....	38
4.3 The role of galectin-3 in a variety of cardiovascular diseases.....	39
4.4 Galectin-3 is related to fibrosis in cardiovascular system.....	42
4.4.1 Galectin-3 mediates the fibrosis in several different cell types in the cardiovascular systems.....	42
4.4.2 Galectin-3 is involvement in mechanisms of cardiovascular fibrosis suggests its potential as a therapeutic target.....	44
4.5 The relationship between galectin-3 and integrins.....	45
Part V Vascular stiffness is a multifactor process	45
5.1 The importance of vascular stiffness in cardiovascular diseases.....	45
5.2 Factors regulating vascular stiffness.....	46
Aim of the thesis	51
Results	52
Part I Ang II or TGF-β1 induces the vascular fibrosis via integrin αv	52
1.1 Knock-out integrin α v in smooth muscle cell reduces Ang II-induced vascular fibrosis.....	52
1.2 Transcriptomic analysis of α vSMKO and WT mice.....	57
1.3 Ang II or TGF- β induces the upregulation of fibrosis-related proteins by integrin	

α v in vitro.....	66
1.4 Ang II or TGF- β induces the activation of ERK and smad-2/3 signaling pathways via integrin α v.....	68
Part II Galectin-3 induces the activation of VSMCs via integrin α/AKT/Wnt/β-catenin signaling pathway	71
2.1 Integrin α v interacts with galectin-3 and mediates galectin3-induced synthesis of fibrosis-related proteins in VSMCs.....	71
2.2 Integrin α v mediates galectin-3-induced activation of AKT and Wnt/ β -catenin signaling pathways.....	74
2.3 Integrin α v mediates the proliferation and migration induced by galectin-3 in VSMCs.....	77
2.4 Integrin α v does not mediate the endocytosis of galectin-3.....	78
2.5 Galectin-3 induces activation of Wnt signaling pathway through AKT signaling pathway.....	79
2.6 Galectin-3 induced the proliferation and migration of VSMCs through AKT signaling pathway.....	80
Part III Knock-down integrin αv increases VSMCs stiffness.....	81
3.1 Knock-down integrin α v affects the stiffness of VSMCs.	81
3.2 Knock-down integrin α v increases the expression of β -tubulin	81
Discussion	84
Perspective	91
Materials and Methods.....	93
References.....	99

List of Figures

Figure 1. Integrins and Integrin-related proteins.	16
Figure 2. Some of the multiple functions of integrins in the cardiac myocyte (CM). .	17
Figure 3. Schematic structure, including main cell types and ECM components in small and large arteries.....	18
Figure 4. VSMCs are one of the most important cell types involved in atherosclerosis.	20
Figure 5. Ultrastructural characteristics of contractile and synthetic SMCs.	21
Figure 6. Pathogenesis and risk factors of vascular fibrosis in atherosclerosis.	22
Figure 7. Role of Ang II role in cardiovascular pathology.....	25
Figure 8. Model of mechanical activation of latent TGF β 1.	31
Figure 9. Functional and structural characteristics of Smad family members.	33
Figure 10. Signaling crosstalk in vascular fibrosis.	34
Figure 11. Vascular signaling mediating ECM remodeling, fibrosis, and arterial stiffening in aging and hypertension.	36
Figure 12. Western blot analysis of different tissues reveals differential expression levels of galectin-3.	38
Figure 13. galectin-3 induces fibrosis through TGF- β dependent and independent mechanisms.	39
Figure 14. Galectin-3 is upregulated in a variety of cardiovascular diseases	42
Figure 15. Galectin-3 affects the functions of several cell types in the cardiovascular systems.	44
Figure 16. Large artery stiffness: cross-talk between local and systemic stiffness in large arteries.	50
Figure 17. Specific knock-out integrin α v gene in smooth muscle cells of mouse. ...	53
Figure 18. Decrease of fibrosis in Ang II-treated α vSMKO mice.	53
Figure 19. Electronic microscopy analysis of mice carotids.	56
Figure 20. Decreased TGF- β 1 and its receptor in Ang II-treated carotids of α vSMKO mice.	57
Figure 21. Western blot analysis of control and integrin α v knock-down (KD) VSMCs at the baseline and under Ang II treatment.	67
Figure 22. Western blot analysis of control and integrin α v knock-down (KD) VSMCs at the baseline and TGF- β 1 treatment.	68
Figure 23. Western blot analysis of phosphorylation of ERK1/2 and smad-2 in control and integrin α v knock-down (KD) VSMCs in response to Ang II treatment.....	69
Figure 24. Western blot analysis of phosphorylation of ERK1/2 and smad-3 in control and integrin α v knock-down (KD) VSMCs in response to TGF- β 1 treatment. ...	70
Figure 25. Galectin-3 interacts with integrin α v.	72
Figure 26. Galectin-3 induces expression of ECM proteins via integrin α v.	73
Figure 27. Time-dependence of galectin-3-mediated activation of ERK, AKT and Wnt/ β -catenin signaling pathways.	75
Figure 28. Integrin α v-mediated galectin-3-induced activation of AKT and Wnt/ β -catenin signaling pathways.	76

Figure 29. Integrin α_v mediates gal3-induced VSMCs activation.	78
Figure 30. Integrin α_v does not mediate endocytosis of galectin-3.	78
Figure 31. Gal3-induced activation of Wnt signaling pathway through AKT signaling pathway.	79
Figure 32. AKT signaling pathway mediates galectin-3 induced proliferation and migration.	80
Figure 33. Knock-down integrin α_v has little effect on the expression of vinculin and α -tubulin.	82
Figure 34. Knock-down of integrin α_v could obviously increase β -tubulin.	83
Figure 35. Proposed model in which integrin α_v mediates galectin-3 induced activation of Wnt/ β -catenin signaling in VSMCs.	87
Figure 36. Hypothetic schema for the influence of integrin α_v on the vascular fibrosis in the Ang II treatment.	90
Figure 37. Flowchart of in vitro experiments.	98

List of Tables

Table 1. Growth factors and cytokines involved in expression of AT1R	24
Table 2. Number of genes that have been differently expressed.....	58
Table 3. The genes whose expression is increased by knock-out of integrin α v.....	58
Table 4. The genes whose expression is decreased by knock-out of integrin α v.....	59
Table 5. The five pathways more implicated in the change of gene expression	60
Table 6. Genes involved in fibrosis pathway	61
Table 7. Genes involved in TGF- β pathway	63
Table 8. The genes involved in the actin cytoskeleton pathway	64
Table 9. Summary of Young's modulus of control and integrin α v knock down cells	81

Abstract

Arterial stiffness is an independent risk factor for cardiovascular morbidity/mortality. It has been demonstrated that arterial stiffness is linked to arterial fibrosis manifested by increased synthesis of collagen and other extracellular matrix components. Integrins, Transmembrane receptors mediating cell-cell and cell-matrix signaling pathways, are involved in tissue fibrosis. Galectin-3, a novel marker for diagnosis and prognosis of heart failure patients, also plays an important role in fibrosis. However, the molecular mechanisms whereby galectin-3 induces vascular fibrosis are still unclear. We studied the role of integrin α v in Ang II-induced VSMCs arterial fibrosis and stiffness via a SMC specific knock-out of integrin α v mouse model (α v SMKO), induced in adult mice by injection of tamoxifen. We could not find any difference in vascular fibrosis in basal conditions between control and mutant mice. However, decreased arterial fibrosis was observed in α v SMKO mutant mice 28-day after Ang II perfusion. Analysis of RNA from aorta of control and mutant mice by Affymetrix microarrays indicated alteration of TGF- β pathway in Ang II-treated mutant mice. In order to examine the mechanism associated to the decreased fibrosis in VSMCs of α vSMKO mice, we used integrin α v-floxed VSMCs in culture and biochemical methods to analyze the phosphorylation of signaling components and fibrosis-related proteins synthesis following integrin α v inactivation and/or treatment of TGF- β 1, Ang-II or galectin-3. Our results indicated that TGF- β 1 or Ang-II increased the expression of collagen and fibronectin at the protein level as well as the phosphorylation of ERK and smad2/3 in the control cells, while inactivation of integrin α v partly inhibited the TGF- β 1- and Ang-II-induced effects above. Integrin α v was required for Ang II-induced expression of galectin-3 in the VSMCs. Duolink method demonstrated that galectin-3 interacted directly with integrin α v. We also showed that galectin-3 activated AKT, ERK, and Wnt/ β -catenin signaling components. The activation of AKT and Wnt/ β -catenin signaling pathways, but not ERK signaling pathway, by galectin-3 was inhibited by the knock-down of integrin α v. At cellular level, galectin-3-induced an increase in cell proliferation, migration and synthesis of several fibrosis-related proteins were also significantly inhibited by knock-down of integrin α v. The specific inhibitor of AKT signaling pathway (LY294002) inhibited the activation of downstream Wnt/ β -catenin signaling pathway and decreased the response of VSMCs to galectin-3 treatment. Our study indicates a role of integrin α v in the Ang II or TGF- β 1 induced arterial fibrogenesis. Galectin-3, interacting with integrin α v, depends on integrin α v/AKT/Wnt/ β -catenin signaling pathway to regulate the proliferation, migration and expression of fibrosis-related proteins in VSMCs.

Keywords: integrin α v, galectin-3, fibrosis

Visual abstract

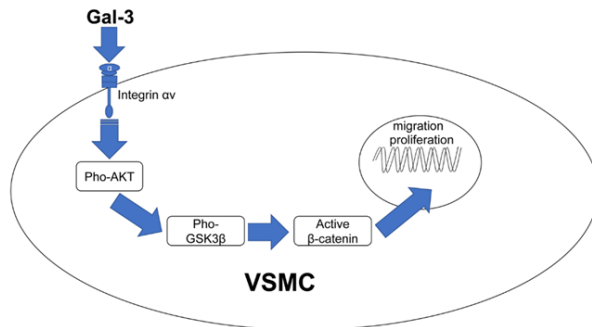

Proposed model in vitro, integrin αv mediates galectin-3 induced activation of Wnt/ β -catenin signaling in VSMCs. integrin αv /AKT/ β -catenin axis mediates galectin-3 induced proliferation and migration in VSMCs. Galectin-3 interacts with integrin αv directly on the cell surface of VSMCs, inducing the phosphorylation of AKT and, consequently, GSK-3 β phosphorylation. Activation of AKT signaling pathway could phosphorylate several targets including GSK-3 β and lead to the degradation of GSK-3 β . In turn, the inactivation of GSK-3 β reduces the β -catenin degradation and increases the expression of active β -catenin. Thus, β -catenin translocate to the nucleus and induces gene expression leading to the proliferation and migration of VSMCs.

A - Control mice

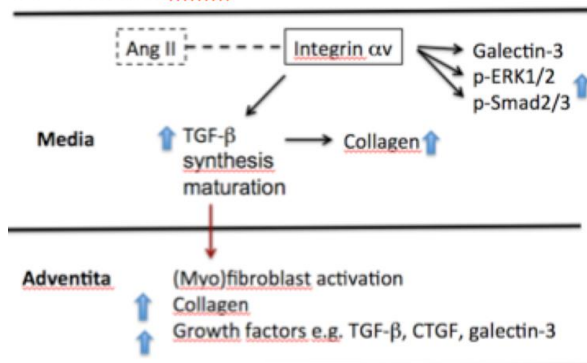

B - αv SMKO mutant mice

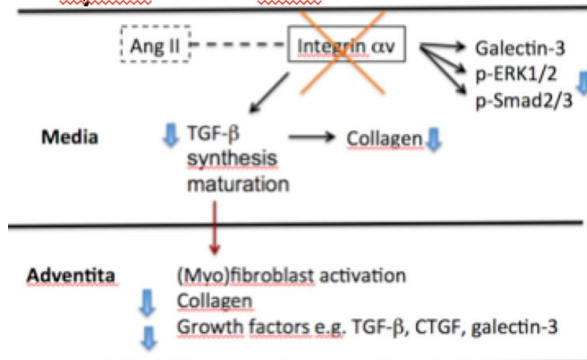

Proposed model in vivo. Hypothetic scheme for the influence of integrin αv on the vascular fibrosis in the Ang II treatment. Red arrows indicate the transport of TGF- β between media and adventitia. Possible further interaction with endothelial and circulating/resident leukocytes are not considered

Abbreviations

AA	arachidonic acid
AFM	atomic force microscope
ALK	activin receptor-like kinase
Aldo	aldosterone
Ang II	angiotensin II
AP	activator protein
AT1R	angiotensin type I receptor
AT2R	angiotensin type II receptor
AF	atrial fibrillation
Bcl-2	B-cell lymphoma-2
bFGF	basic fibroblast growth factor
BM	basement membrane
BMP	bone morphogenetic protein
CADASIL	Cerebral autosomal dominant arteriopathy with subcortical infarcts and leukoencephalopathy
CM	cardiac myocytes
Col	collagen
CRBP	cellular retinol binding protein
CTGF	connective tissue growth factor
DVT	deep venous thrombosis
ECM	extracellular matrix
ECV	extracellular volume fraction
EGFR	epidermal growth factor receptor
ENPP	ectonucleotide pyrophosphate/phosphodiesterase
EMMPRIN	extracellular matrix metalloproteinase inducer
ERK	extracellular signal–regulated kinases
FAK	focal adhesion kinase
FOSL1	fos-like 1
G-CSF	granulocyte colony stimulating factor
cGMP	cyclic guanine 3',5'-monophosphate
GPCR	G-protein coupled receptors
GS	glycine–serine rich
HA	hyaluronic acid
HB-EGF	heparin-binding epidermal growth factor
HCII	heparin cofactor II
HCM	hypertrophic cardiomyopathy
HES	hairy and enhancer of split
HEY	HES-related with YRPW motif
HF	heart failure
HUVEC	Human Umbilical Vein Endothelial Cells
IL	interleukin

ILK integrin linked kinase
JAK Janus kinases
KD Kawasaki disease
LAP latency associated peptide
LDL low density lipoproteins
LLC large latent complex
LVEF left ventricular ejection fraction
MACE major adverse cardiac events
MACO major adverse cardiovascular outcomes
MAPK mitogen-activated protein kinase
MCP modified citrus pectin
MCP-1 monocyte chemoattractant protein
MFG-E8 milk fat globule epidermal growth factor 8
MGP matrix gla-protein
MH1 mad-homology 1
MI myocardial infarction
MMP matrix metalloprotease
MT membrane type
MTT Thiazolyl Blue Tetrazolium Bromide
NADPH nicotinamide adenine dinucleotide phosphate
NO nitric oxide
NECD Notch Extra-Cellular Domain
NICD Notch Intra- Cellular Domain
NT-proBNP N-terminal prohormone of brain natriuretic peptide
PAF pulmonary adventitial fibroblast
PAH pulmonary arterial hypertension
PAI-1 plasminogen Activator Inhibitor-1
PAR-1 protease-activated receptor 1
PASMC pulmonary artery smooth muscle cells
Pax paxillin
PDBu phorbol dibutyrate
PDGFR platelet-derived growth factor receptor
PG proteoglycans
PIIINP propertied of type III collagen type
PKC protein kinase C
PLA2 phospholipase A2
PSC pancreatic stellate cells
PTEN phosphatase and Tenzin Homologue
PWV pulse wave velocity
PY poly-proline-tyrosine
Pyk2 proline-rich tyrosine kinase 2
RAAS renin-angiotensin-aldosterone system
RAS renin-angiotensin system
ROS reactive oxygen species

ROCK rhoassociated coiled-coil forming protein kinase
RWT relative wall thickness
 α -SMA α -smooth muscle actin
SAN sinoatrial node
SHR spontaneously hypertensive rat
SLC short latent complex
SMC smooth muscle cell
Smurf smad ubiquitination-related factor
SM-MHC smooth muscle-myosin heavy chain
SOD superoxide dismutase
STEMI ST-elevation MI
 α v^{SMKO} knock out integrin α v in smooth muscle cells of mouse
TGF transforming growth factor
TIMP-1 tissue inhibitor of metalloproteinase-1
Tln talin
TNF- α tumor necrosis factor alpha
TRPM transient receptor potential melastatin
WKY normotensive Wistar-Kyoto
VANGL2 transmembrane protein Vang-like 2
Vcl vinculin
VEGF vascular endothelial growth factor

Introduction

Part I Integrins are related to fibrosis

1.1 Integrins and integrin-related proteins

Integrins are cell surface receptors which are able to sense mechanical forces such as vascular wall stress, through the binding to ECM components (Chao, et al., 2011). These receptors were named integrin because they had an integral membrane nature and they have a role in maintaining integrity of the cellular ECM–cytoskeletal connection (Tamkun, et al., 1986). In human beings, there are about 18 integrin α subunits and 8 integrin β subunits which combine to make up 24 different integrin combinations. The integrin subunits have a molecular weight of 90–160 kDa and generally consist of a large extracellular domain, a single transmembrane spanning domain, and a short cytoplasmic tail (Nermut, et al., 1988). The cytoplasmic domain of many of the β subunits is highly homologous, while the α subunit sequences vary significantly.

Integrins themselves do not possess enzymatic or actin-binding activity, therefore, various adaptor proteins that bind to the cytoplasmic tails of α and β subunits are required to mediate structural or scaffolding properties, and to produce catalytic activity (i.e. outside-in signalling), or, vice versa, to activate integrins to affect ECM binding (inside-out signalling). Some of these proteins are crucial for integrin function in the fibrotic process, including, ILK, FAK, Pax, Vcl, Tln, Kindlin, PINCH, Parvin, actinin and actin (Figure 1) (Chen, et al., 2016, Israeli-Rosenberg, et al., 2014).

It is through the cytoplasmic tail, mainly made of β subunits, that the integrins bind both cytoskeletal linkers and activate intracellular signalling (Figure 1) (Chen, et al., 2016). The extracellular and cytoplasmic domains of both subunits are required for proper heterodimerization, which, in turn, is needed to form a functional integrin receptor (Campbell, et al., 2011).

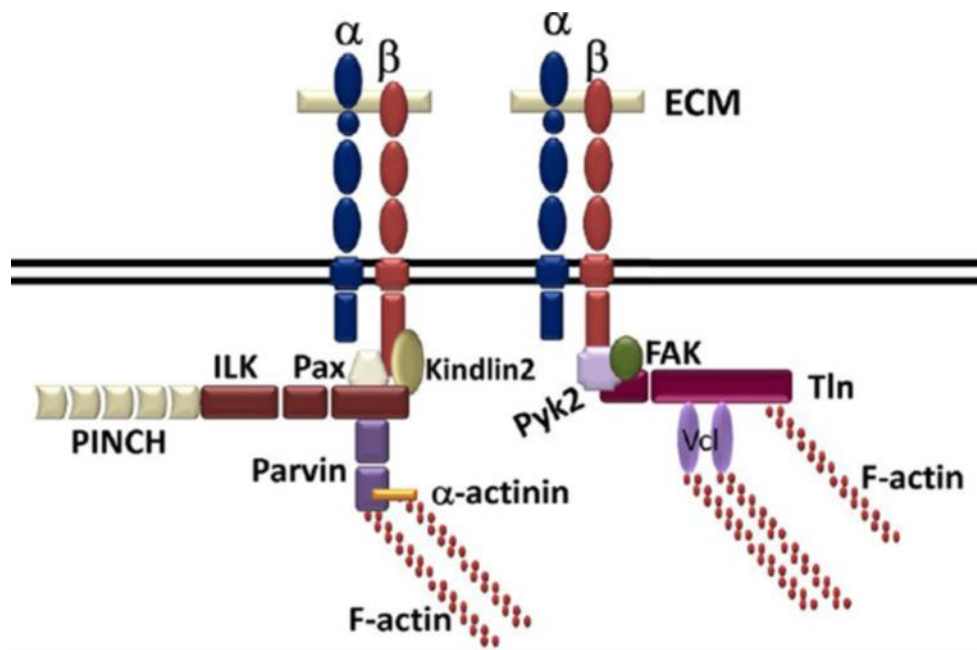

Figure 1. Integrins and Integrin-related proteins. Integrins are surface receptors spanning the cell membrane; they connect and aggregate a range of adapter and signalling proteins such as ILK, FAK, Pax, Vcl, Tln, Kindlin, PINCH, Parvin, actinin and even actin. This allows both bridging of ECM to the intracellular cytoskeleton, and also allows propagation of signals bidirectionally across the cell membrane (Chen, et al., 2016).

1.2 The role of integrins in fibrosis

Integrins have been implicated in the development of fibrosis (Chen, et al., 2016, Shen, et al., 2017). Upregulation of integrins stimulates cellular proliferation and migration and, more importantly, integrins are activated by their binding to ECM proteins (Jessen, et al., 2017, Murray, et al., 2017), however, diffusible factors are also potent integrin activators. Ang II plays a critical role in cardiac and vascular remodelling and it could also accelerate the pathological process of cardiac fibrosis (Ren, et al., 2017). In the process of driving cardiac fibrosis, Ang II increases the expression of TGF- β 1 through the AT1R (Chen, et al., 2016). TGF- β 1 has been regarded as a major factor in the development of fibrosis in several organs (Mackinnon, et al., 2012). Integrin α v has indirect effects on mediating some signalling pathways of TGF- β 1, meanwhile, it has also been shown to play an important role in the activation of TGF- β 1 itself (Campbell, et al., 1997, Chen, et al., 2016).

Integrin signalling, mechanotransduction, and integrin-related proteins in the ECM have been reviewed by Israeli-Rosenberg et.al (Israeli-Rosenberg, et al., 2014). Integrins have a wide variety of functions that are related to cardiac

fibrosis, including non-cardiac-specific ones such as adhesion, formation of ECM–cytoskeletal junctions, signalling or viral uptake (Figure 2) (Israeli-Rosenberg, et al., 2014). There are also integrin functions that are not yet well understood and are important in the CM, such as modification of ion channel function, or stem cell growth and engraftment, hypertrophic growth, mechanotransduction, and ischemic protection. ERKs play a pivotal role in mediating downstream signalling upon integrin activation (Israeli-Rosenberg, et al., 2014).

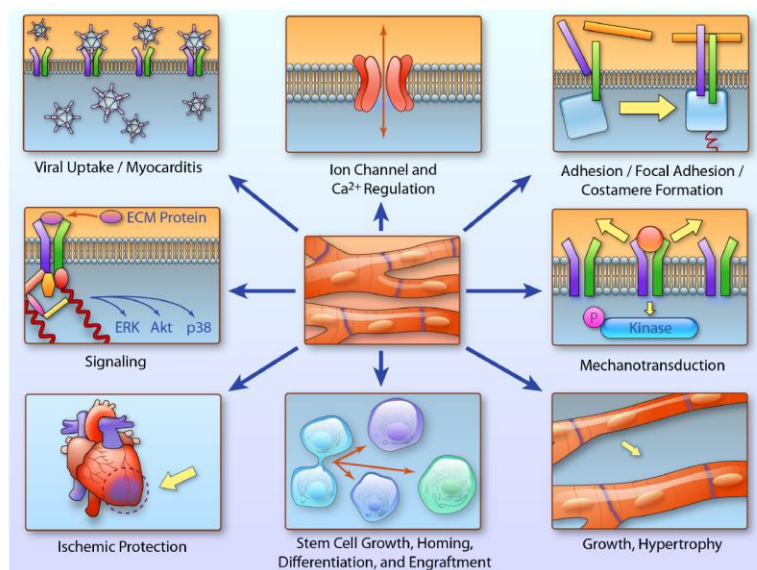

Figure 2. Some of the multiple functions of integrins in the cardiac myocyte (CM). Integrins can have a wide variety of functions including adhesion, formation of extracellular matrix–cytoskeletal junctions, signalling or viral uptake, modification of ion channel function, or stem cell growth and engraftment; hypertrophic growth, mechanotransduction, and ischemic protection (Israeli-Rosenberg, et al., 2014).

Being at the interface between cells and ECM, integrins are also involved in different remodelling processes (Chen, et al., 2016). For example, $\alpha4\beta1$, $\alpha5\beta1$ as well as $\alpha\nu\beta3$ integrins can mediate expression and activity of MMPs and their effectors in different cellular systems. In turn, some ECM components are able to regulate expression and activity of several MMPs, through interaction with integrin receptor and modulation of downstream signalling. For example, fibronectin regulates MMPs expression by bounding to $\alpha4\beta1$ and $\alpha5\beta1$ integrins in rabbit synovial fibroblasts (Huhtala, et al., 1995). The interaction between MMP-2 and integrins also regulate cell migration: for instance, MMP-2 is up-regulated in invasive colorectal tumours; also, shedding of $\beta1$ integrin followed by subsequent integrin degradation, leads to decreased adhesion and enhanced cell motility (Kryczka, et al., 2012).

In particular, integrin $\alpha\nu$ plays an important role in fibrosis. Integrin $\alpha\nu$ mediates Ang II or TGF- β induced cardiac fibrosis. Selective depletion of $\alpha\nu$ integrin on

PDGFR β ⁺ cells are protected from Ang II-induced cardiac fibrosis, while integrin α v blockade also reduces TGF- β activation in cardiac PDGFR β ⁺ cells (Murray, et al., 2017). VANGL2 regulates cell surface integrin α v β 3 expression which influence cell adhesion to fibronectin, laminin, and vitronectin, Tammy et.al also found that integrin α v β 3 was a novel VANGL2 binding partner and was required for increased MMP-2 by VANGL2 (Jessen, et al., 2017). The transcription factor FOSL1-dependent negative regulation of integrin α v β 3 expression in HUVEC is required for angiogenesis, increases cell adhesion, and decreases cell mobility (Evellin, et al., 2013).

Part II VSMCs play an important role in vascular fibrosis

2.1 Microanatomy of arteries

The cells of the three layers of the vascular wall, intima, media and adventitia, lie on or are embedded in their ECM (Figure 3). Endothelial cells are widely spread in the intima. Endothelial cells lie on their basement membrane, including, type IV collagen, laminins, perlecan. There is an internal elastic lamina between the intima and the media in small and large arteries. Between these elastic laminae, VSMC and some ECM components (collagen fibers, structural glycoproteins, PGs) are present. Collagen fibers and fibroblasts are mainly found in the adventitia (Jacob. 2003).

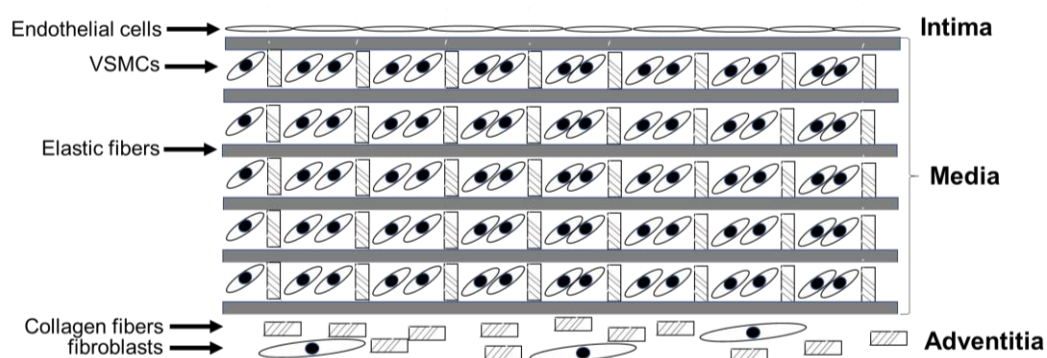

Figure 3. Schematic structure, including main cell types and ECM components in small and large arteries. adapted from (Jacob. 2003).

2.2 VSMCs is one of the main cell types in the arterial wall

The structure of blood vessels based on lamellar units (an elastic lamella and adjacent VSMCs) varies along the arterial tree (Intengan, et al., 2000). The aorta and proximal branches contain the greatest number of medial elastic layers. The contents of VSMCs decrease from the thoracic aorta to distal arteries (Dinardo, et al., 2014, Greenwald. 2007). VSMCs decrease in arterioles, and only ECs and pericytes are found in the capillaries (Lacolley, et al., 2017).

SMCs are one of the most important cell types in the arterial wall, since they are essential for a good performance of the vasculature. By contraction and relaxation, they alter the luminal diameter, which enables blood vessels to maintain an appropriate blood pressure. However, VSMCs also play an important role in vessel remodeling in physiological and pathophysiological conditions such as pregnancy, exercise, and vascular injury. In these cases, VSMCs synthesize large amounts of ECM components and increase their proliferation and migration (Rensen, et al., 2007). Because of these properties, VSMCs are important not only for short-term regulation of the vessel diameter, but also for long-term adaptation, via structural remodeling by changing cell number and connective tissue composition (Lacolley, et al., 2017, Rensen, et al., 2007). Vascular fibrosis is a risk factors for atherosclerosis, and the latter represents an example of VSMCs role in vascular pathology (Figure 4). The transformation of macrophages into foam cells contributing to fatty streaks in atheroma is a key event during plaque formation (Figure 4). Foam cell and its apoptosis release a variety of cytokines and chemoattractant to induce inflammation in the plaque; on the other hand, apoptotic foam cells, the essential hallmark of vulnerable plaques, constitute the physical center of the plaque that critically impacts plaque progression, destabilization, and rupture (Domschke, et al., 2018, Wu, et al., 2018).

In this pathological process VSMCs are, therefore, one of the major sources of foam cells. VSMCs enter the intima of artery and endocytose LDL; to do so, VSMCs have a high ability of proliferation and migration which could deteriorate the stability of atherosclerosis plaque and induce plaque rupture. Inflammatory cytokines play an important role in the transformation of VSMCs, since inflammation factors promote the migration of VSMCs from the media to the intima of artery (Figure 4). All these changes have also an influence on the vascular stiffness and fibrosis (Part III for further details).

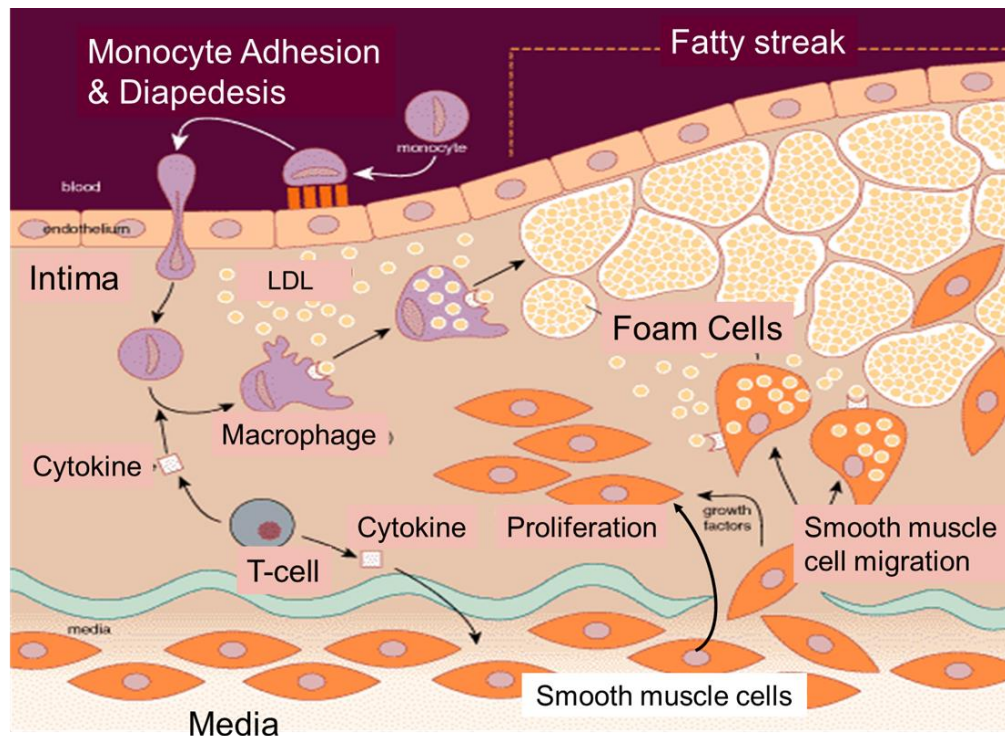

Figure 4. VSMCs are one of the most important cell types involved in atherosclerosis. In the pathological process of atherosclerosis, VSMCs are an important sources of foam cells. VSMCs enter the intima of artery and endocytose the Low-Density Lipoproteins (LDL) which accumulate locally. More importantly, these VSMCs have a high ability of proliferation and migration which could deteriorate the stability of atherosclerosis plaque and induce plaque rupture. Inflammation plays an important role in the transformation of VSMCs in atherosclerosis plaque, since it promotes the migration of VSMCs from the media to the intima of artery. <http://sphweb.bumc.bu.edu>

2.3 Two important phenotypes of SMCs: contractile and synthetic SMCs

Traditionally, there are two populations of SMCs, with a spectrum of intermediate phenotypes: contractile and synthetic SMCs, which are characterized by clearly different morphologies. Contractile SMCs are elongated, spindle-shaped cells (Chamley-Campbell, et al., 1979, Hao, et al., 2003) and have contractile filaments, whereas synthetic SMCs possess a cobblestone morphology and contain a high number of organelles involved in protein synthesis. In addition, synthetic SMCs exhibit higher proliferation and migration activity than contractile SMCs (Hao, et al., 2003). There are a variety of SMC marker proteins which can be used to define SMCs phenotypes (Figure 5): α -SMA, SM-MHC, and smoothening-A/B are usually considered as the contractile SMC phenotype markers. SMemb/non-muscle MHC isoform-B, CRBP-1, h-caldesmon, meta-vinculin can be used to indicate a synthetic

phenotype (Glukhova, et al., 1988, Kuro-o, et al., 1991, Neuville, et al., 1997). In fact, these so-called contractile and synthetic phenotypes are just an oversimplification : it is now being recognized that there is a variety of SMC phenotypes, ranging from contractile to synthetic (Hao, et al., 2003, Matsushita, et al., 2007, Rensen, et al., 2007). Actually, recent studies proved that different synthetic and contractile markers could be upregulated at the same time (Hao, et al., 2003, Nangia-Makker, et al., 2000). In some cases, contractile differentiation can be observed in the ‘synthetic’ phenotype and contractile differentiation markers may be expressed along with with matrix synthesis (Carthy, et al., 2012, Rama, et al., 2006, Tian, et al., 2017).

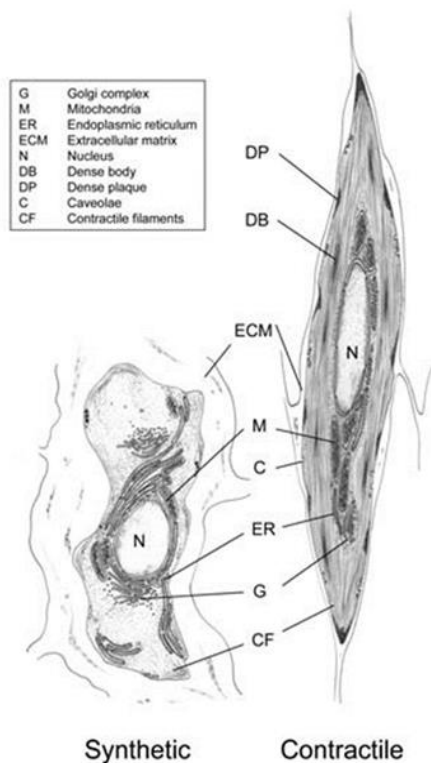

Figure 5. Ultrastructural characteristics of contractile and synthetic SMCs. Contractile SMCs are elongated, spindle shaped cells and have contractile filaments, whereas synthetic SMCs have a cobblestone morphology and contain a high number of organelles involved in protein synthesis (Rensen, et al., 2007).

2.4 ECM plays an important role in vascular fibrosis

ECM plays an important role in vascular fibrosis, since the absolute and relative quantities of collagens and elastin largely affect the biomechanical properties of vessels, particularly of the major arteries and veins (Figure 6) (Arteaga-Solis, et al., 2000, Hartner, et al., 2009, Lan, et al., 2013). Lack of elastin or increased collagen in the vascular wall lead to vascular fibrosis and

increased stiffness (Arribas, et al., 2006). The primary sources of the tensile strength of the vessel wall are collagen fibers around fibroblast of the adventitial layer (Arteaga-Solis, et al., 2000). Among the 26 different collagen types, type I and III collagens are the major fibrillar collagens in vessels, representing 60% and 30% of vascular collagens, respectively (Jacob. 2003). However, only mutations in collagen III have been associated so far with vascular diseases. Type III collagen fibrils are relatively more abundant in tissues subjected to periodic stress, such as the vasculature (Jacob. 2003). Type III molecules participate in the tridimensional organization of type I collagen networks (Arteaga-Solis, et al., 2000). In the arterial wall, the structure and function of the ECM are also affected by several other structural glycoproteins, including fibronectin, vitronectin, laminin, entactin/nidogen, tenascin and thrombospondin these glycoproteins have a multidomain structure, potentially mediating interactions between cells and other ECM components (Chothia, et al., 1997, Labat-Robert. 1998).

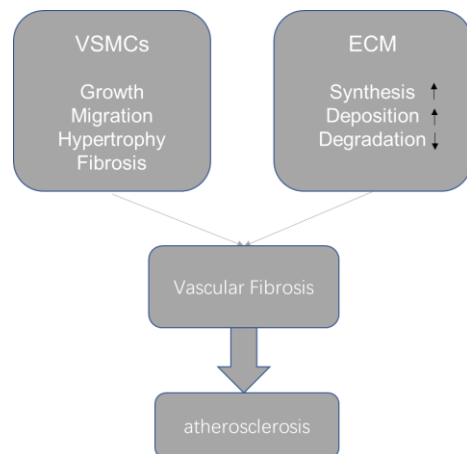

Figure 6. Pathogenesis and risk factors of vascular fibrosis in atherosclerosis. Vascular fibrosis involves proliferation, migration, hypertrophy and fibrotic features of VSMCs, accumulation of ECM and inhibition of matrix degradation adapted from (Lan, et al., 2013).

Part III Ang II or TGF- β induces vascular fibrosis

3.1 Ang II is an important factor in cardiovascular fibrosis

3.1.1 Ang II induces cardiovascular fibrosis

Arterial stiffness and atherosclerosis-related hypercoagulability increase the risk of stroke. As shown above, VSMCs play a pivotal role in the onset of atherothrombotic diseases. The ability of VSMCs to adapt to environmental cues is related to their high plasticity to reprogram their expression pattern in response to acute stimuli, mainly mediated by ligand-receptor interactions. Ang II has emerged as an important hormone that affects cardiovascular physiology, and long-term exposure to Ang II plays a critical role in cardiac hypertrophy and remodeling (Geisterfer, et al., 1988, Mehta, et al., 2007, Xi, et al., 1999). In the pathogenesis of atherosclerosis, alteration in ECM composition is an important component in the regulation of VSMCs activities, including migration and secretion. Ang II could not only increase the production of collagen, but also regulate fibronectin and TGF- β synthesis by EGFR (Moriguchi, et al., 1999). A series of in vitro and in vivo experiments have shown that Ang II is a pivotal growth factor for VSMCs, causing VSMCs cell proliferation, hypertrophy, and migration (Bumpus, et al., 1991, Dzau. 2001). In Ang II-treated VSMCs, CDK2 activity was suppressed (secondary to failure of p27kip1 repression), leading to G1-phase arrest and cell hypertrophy. In a murine model of atrial fibrillation, Kai et.al found Ang II induced atrial fibrosis depends on the integrins (Friedrichs, et al., 2014).

3.1.2 Ang II and its receptors in cardiovascular fibrosis

Ang I, II, III and their receptors (AT1R, AT2R, Mas and MrgD) have been regarded as the principle components in RAS, an important hormonal cascade regulating blood pressure and heart functions. Ang II, the primary effector molecule of this system, regulates the function of several organs, including heart, kidney and the vasculature. Ang II binds to both AT1R and AT2R, which, in turn have opposite effects. Ang II induces cell proliferation, myocyte hypertrophy, myocardial remodeling, fibrosis, and oxidative stress via AT1R (Mehta and Griendling. 2007). In contrast, stimulation of AT2R produces an anti-fibrotic, anti-proliferative and pro-apoptotic effects (Mehta and Griendling. 2007).

Ang II-mediated cardiovascular responses largely depend on the activation of AT1R (Figure 7) (Lan, et al., 2013). AT1R, which belongs to the seven-membrane superfamily of G protein-coupled receptors, is widely spread in all organs, including liver, adrenals, brain, lung, kidney, heart, and

vasculature (Mehta and Griendling. 2007). On the extracellular region of AT1R, the four cysteine residues form disulfide bridges and are essential for Ang II binding (Mehta and Griendling. 2007, Ohyama, et al., 1995). AT1R cytoplasmic tail contains many serine/threonine residues, which are phosphorylated by G protein receptor kinases or GRKs (Mehta and Griendling. 2007). In VSMCs, numerous growth factors and cytokines regulate the expression of AT1R (Table 1).

Table 1. Growth factors and cytokines involved in expression of AT1R

Factors that Upregulate	Factors that downregulate
LDL(Nickenig, et al., 1997)	Angiotensin II (Gunther, et al., 1980)
Insulin (Takayanagi, et al., 1992)	Interferon- γ (Ikeda, et al., 1999)
Progesterone(Nickenig, et al., 2000)	Estrogen (Nickenig, et al., 2000)
Erythropoietin(Barrett, et al., 1998)	Vitamin A (Takeda, et al., 2000)
	HMG CoA reductase inhibitors (Ichiki, et al., 2001)
	Epidermal growth factor (Guo, et al., 1994, Howard, et al., 2000)
	Platelet-derived growth factor (Nickenig, et al., 1996)
	Thyroid hormone (Fukuyama, et al., 2003)
	Nitric oxide(Ichiki, et al., 1998)
	Forskolin (Griendling, et al., 1994)

HMG, 3-hydroxy-3-methyl-glutaryl. (Mehta and Griendling. 2007)

Ang II-mediated AT1R activation is one of the main pathogenesis mechanisms of hypertension (Figure 7). Ang II binds to the AT1R activating a series of signaling cascades, including c-Src family kinases, Ca²⁺-dependent Pyk2, FAK, JAK, PKC, MAPKs and transactivation of EGFR, PDGFR and insulin receptor (Hunyady, et al., 2006, Suzuki, et al., 2005). The activation of AT1R by Ang II induces cell proliferation, myocyte hypertrophy, myocardial remodeling and fibrosis. Importantly, Ang II increases the expression of TGF- β 1 via AT1R, which, in turn, drives fibrosis. Ang II could also induce NADPH oxidase to generate excessive superoxide anion (O₂⁻), which plays an important role in the vascular fibrosis (Sakurada, et al., 2013).

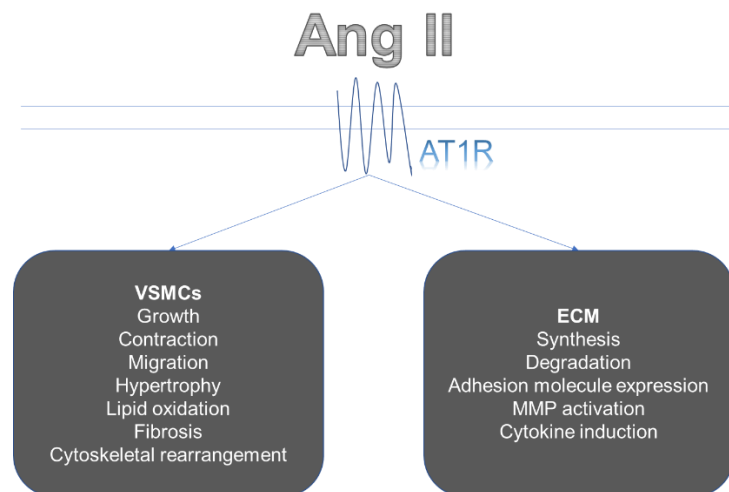

Figure 7. Role of Ang II role in cardiovascular pathology. The octapeptide Ang II exerts its numerous effects in modulating cardiovascular physiology and pathology by inducing signaling pathways in vascular smooth muscle cells, endothelial cells, and cardiac fibroblasts, and by affecting their interaction with the ECM adapted from (Mehta and Griendling. 2007).

In contrast to the effect of AT1R, the majority of experimental data show that AT2R stimulation produces an anti-fibrotic effect. AT2R also belongs to the seven-membrane superfamily of G protein-coupled receptors. AT2R plays a critical role in fetal development, and is highly expressed in fetal tissue, and its expression decreases after birth (Shanmugam, et al., 1996). In adults, the AT2R has been localized to the heart, kidney, adrenal gland, brain, uterus, pancreas, retina, skin, and both endothelial and VSMCs of the vasculature (Roulston, et al., 2003, Wang, et al., 1999, Wheeler-Schilling, et al., 1999). In the central nervous system, AT2R is expressed in neurons (Steckelings, et al., 2017).

Several cardiovascular pathologies can increase AT2R expression (Jones, et al., 2008). In contrast to AT1R, the activation of AT2R receptors induces vasorelaxation by increasing the production of nitric oxide and cGMP (Jones, et al., 2008). The stimulation of AT2R directly counteracts the dysregulation of sympathetic outflow in neurogenic hypertension. Selective activation of brain AT2R causes moderate decreases in blood pressure in vivo (Steckelings, et al., 2017). AT2R activates the NO/cGMP pathway, and has vasodilatory effects in the vasculature (Savoia, et al., 2006). NO/cGMP activates a cGMP dependent protein kinase causing decreased RhoA activity and AT1R-mediated vasoconstriction (Savoia, et al., 2006, Savoia, et al., 2005).

In the sites of MI and MI repair, ACE, AT1R and AT2R are all expressed at high levels (Jones, et al., 2008, Weber, et al., 1997). There is also a link between upregulation of AT2R expression and fibrosis present in hypertrophied and failing hearts, the increased expression of AT2R was specifically localized to cardiac fibroblasts (Jones, et al., 2008). TGF- β 1 and its receptors, and type I

and III collagens, are also expressed in AT2R-rich fibroblasts and myofibroblasts (Jones, et al., 2008, Katwa, et al., 1997, Lijnen, et al., 2003). However, the majority of the studies indicate an inhibitory effect of AT2R on cardiac fibrosis. AT2R has also been found in endothelial cells and in VSMCs of vessel (Nora, et al., 1998). In AT2R deficient mice, the antifibrotic effect of AT1R inhibition was not obvious (Wu, et al., 2002, Xu, et al., 2002). Specific over-expression of AT2R in heart decreased the amount of both perivascular and interstitial fibrosis induced by Ang II infusion (Jones, et al., 2008). Recently, it has been shown that AT2R antagonizes the function of AT1R by directly binding to AT1R, but, agonist-induced activation of AT2R could not inhibit AT1R signaling (AbdAlla, et al., 2001).

While the effect of AT1R on collagen synthesis is well established, AT2R seems to have no effect on collagen secretion. Indeed, AT1R blockade, but not AT2R inhibition, suppressed Ang II stimulation of collagen production in cultured rat and porcine cardiac fibroblasts, as well as rat mesenteric VSMCs (Lijnen, et al., 2000, Touyz, et al., 2001, Warnecke, et al., 2001). In VSMCs, AT2R could produce anti-proliferative and pro-apoptotic effects (Mehta and Griendling. 2007). Resveratrol protection against arterial fibrosis is associated with increased expression of AT2R (Kim, et al., 2018). In cultured cardiac fibroblasts, Ang II stimulation induces the decrease in collagenase activity which could be abolished by AT2R blockade but not influenced by AT1R (Brilla, et al., 1994).

AT2R stimulation may also activate lipid-signaling pathways. Ang II increases PLA2 activity and AA release via AT2R (Lokuta, et al., 1994) in rabbit proximal tubule epithelia (Jacobs, et al., 1996) and cultured neurons (Zhu, et al., 1998). Long-term AT2R stimulation by Ang II could also increase synthesis of ceramides, which may then activate stress kinases and caspases involved in the induction of apoptosis (Gallinat, et al., 1999, Lehtonen, et al., 1999)

Ang II could also affect the fibrosis through the cross-talk with other receptors and pathways. TRPM is a group of receptors that could mediate the influx of Ca^{2+} and Mg^{2+} . Zhong et.al found Ang II could regulate SAN fibrosis through TRPM7 (Zhong, et al., 2018). TRPM7 mediated both calcium and magnesium homeostasis in the CFs, 2-APB (TRPM7 inhibitor) inhibited Ang II-induced CTGF, SMA expression and CFs proliferation which contribute to fibrosis progress (Yu, et al., 2014).

PAR-1 which is primarily known as the receptor of thrombin also mediates the Ang II-induced vascular and cardiac fibrosis. Knock-out of PAR-1 effectively attenuated the increasing medial wall thickening and perivascular fibrosis which were increased by Ang-II (Antoniak, et al., 2017).

TNF has been found to regulate the cardiac structure and function in health and disease (Kleinbongard, et al., 2010, Mann. 2001, Meldrum. 1998). TNF has two distinct TNF receptors, TNFR1 and TNFR2. Duerrschmid et.al found that TNFR1 mediated the Ang-II-induced development of cardiac fibrosis and adverse cardiac remodeling (Duerrschmid, et al., 2013).

C5a, a potent chemotactic and inflammatory mediator, activated monocytes in many remodeling processes. PMX53 is a specific C5aR (receptor of C5a) antagonist that effectively suppressed inflammation and perivascular fibrosis and increased cardiac function in mice treated with Ang II (Zhang, et al., 2014) The transactivation of EGFR, plays a crucial role in the development of atherosclerotic lesion. In VSMCs, Ang II promotes the proliferation and migration of SMCs through the release of HB-EGF and transactivation of EGFR, MMPs also plays an indispensable role in this process (Yang, et al., 2005).

3.1.3 Downstream of Ang II Receptors: signaling pathways in cardiovascular fibrosis

Ang II activates a series of signaling cascades by binding to its different receptors, which in turn regulate the physiological and pathological effects of Ang II in the cardiovascular system (reviewed by Mehta and Griendling. 2007). Here, we just briefly review some signaling pathways related to fibrosis. Ang II mediates cardiovascular fibrosis primarily via TGF- β -dependent smad2/3 signaling pathway (see the dedicated section in the next chapter). However, many other mediators could also play a role in Ang II-induced activation of TGF- β /smad2/3 signaling pathway (Bhattacharjee, et al., 2016, Chung, et al., 2010). Ang II could also activate smad 2/3 signaling pathway through activin A and its specific downstream component ALK4 (Wang, et al., 2017). Ang II increases ECM production by activating smad signals through the AT1R and ERK/p38MAPK-Smad pathway (Figure 7). Similarly, in diabetes AGE could activate smad2/3 via ERK/p38MAPK-dependent mechanism instead of TGF- β 1-pathway (Li, et al., 2004).

MAPKs regulate a plethora of cellular responses, including protein synthesis and metabolism, intracellular transport, cell volume regulation, gene expression, and growth. The signaling cascades including ERK1/2, JNK, and p38MAPK, are implicated in VSMCs differentiation, proliferation, migration, and fibrosis (Srivastava. 2002, Taniyama, et al., 2004). In particular, the MAPK signaling pathway mediates Ang II induced cardiac fibrosis. In atrial fibroblasts,

MAPKs are be activated by Ang II, inducing upregulation of TRAF6 and, ultimately, fibroblast proliferation (Gu, et al., 2012). In skeletal muscle cells, Ang II induces the pro-fibrotic factors (TGF- β 1 and CTGF) through P38 MAPK activity, instead of ERK1/2 signaling pathway (Morales, et al., 2012, Wong, et al., 2018). Ang II activates P38 MAPK and JNK through TNF- α , and these effects are associated with Ang II-induced hypertension and adverse cardiac remodeling (Sriramula, et al., 2015). P38 MAPK is a downstream target of TGF- β in the pathogenesis of renal fibrosis (Stambe, et al., 2004). Ang II increases the expression of MAPKs/TGF β 1/TRAF6 pathway which is an important signaling pathway in Ang II-induced CTGF expression (Gu, et al., 2017). Ang II activates CaSR, and activates MEK/ERK pathways; interesting, pretreating the cells with CaSR inhibitor (Calhex231) or PD98059 (ERK signaling pathways inhibitor) partially decreased AngII-induced cardiac fibrosis, suggesting the relevance these pathways have in fibrosis (Chi, et al., 2018). G-CSF is a key mediator of neutrophil infiltration and induces fibrosis in infarcted heart; interestingly, it has been shown that Ang II activates ERK1/2 signaling pathway in G-CSF in the heart (Jiang, et al., 2013).

The JAK/STAT signaling pathway plays an important role in Ang II induced expression of granulocyte G-CSF and increases cardiac fibrosis via STAT3 signaling pathway (Jiang, et al., 2013). Accordingly, the proteasome inhibitor bortezomib decreased Ang II-induced hypertrophy by inactivation of AT1R-mediated p38MAPK and STAT3 signaling pathways (Li, et al., 2015). STAT3 is also necessary in Ang II-induced cardiac remodeling, since, Ang II could not increase the mass of myofibrils in STAT3 knock-out mice in contrast to WT mice (Zouein, et al., 2013).

The adaptor molecule CIKS (connection to IKK and SAPK/JNK) played an important role in the I κ B kinase/nuclear factor (NF)- κ B and JNK/AP-1 pathways. Knock-down CIKS attenuated Ang-II-induced IKK/p65 and JNK/c-Jun phosphorylation, NF- κ B and AP-1 activation, and MMP-9 expression (Valente, et al., 2012). ILK, a serine/threonine protein kinase, interacts with β 1 and β 3 integrin cytoplasmic domains, Ang II stimulated pro-fibrotic process involving crosstalk between ILK and NF- κ B activation in cardiac fibroblasts (Thakur, et al., 2014).

Notch proteins share a highly conserved domain architecture (Chillakuri, et al., 2012, Ni, et al., 2018). Notch proteins are a family of transmembrane receptors (300–350 kDa), including an extracellular domain (NECD), an intracellular domain (NICD), and a transmembrane domain. Upon activation the NICD is released and will translocate to the nucleus, based on the presence of an NLS. Binding of Notch ligands trigger the γ -secretase complex to release the NICD into the cytoplasm and the nucleus (Couturier, et al., 2014, Guruharsha, et al., 2012, High, et al., 2008, Ozasa, et al., 2013). In the latter, the NICD regulates

transcription of the target genes, HES and HEY (Jarriault, et al., 1995, Maier, et al., 2000, Meester, et al., 2018). Notch signaling pathway play an important role in cell proliferation, differentiation, and apoptosis. Through the AT1R, Ang II increases the expression of NICD, promotes the proliferation and migration of VSMCs, and contributes to the progression of vascular fibrosis (Ozasa, et al., 2013). In mammals, there are four Notch proteins (Notch 1–4). Notch 3 is predominantly expressed in VSMCs of the small arteries (Joutel, et al., 2000, Prakash, et al., 2002), where it plays an important role in their maturation and differentiation (Domenga, et al., 2004, Meester, et al., 2018). Mutations in notch 3 leads to the CADASIL (Joutel, et al., 1996, Meester, et al., 2018). In pathological process of CADASIL, the small cerebral and leptomenigeal arteries show thickening of the arterial wall, which is accompanied by lumen stenosis, destruction of VSMCs, and abundance of ECM proteins (Chabriat, et al., 2009, Meester, et al., 2018, Miao, et al., 2004).

AMPK and some downstream signaling pathways are also related to the Ang II induced fibrosis. Alamandine activates AMPK, induces NO production, and produces the protective effects in cardiomyocytes (Zhang, et al., 2017). Sirtuin 6 increases the expression of pAMPK α -ACE2 signaling and suppress CTGF-FKN pathway, an effect which diminishes Ang II-induced myocardial fibrosis (Jesus, et al., 2018).

NF- κ B is a nuclear transcription factor, NF- κ B is related to the production of some inflammatory cytokines and its role in inflammation is well established (Zhao, et al., 2018). The NF- κ B mediated pathways have been found to be involved in MMPs and EMMPRIN expression in previous study (Cao, et al., 2017, Huang, et al., 2012). Inflammation has also been shown to play a major part in development and progression of atherosclerotic lesion formation (Pant, et al., 2014). In monocytes, macrophages, VSMCs, and endothelial cells, Ang II induces the production of cell adhesion molecules such as VCAM-1, ICAM-1, and E-selectin, and chemokines such as MCP-1, IL-6, IL-8 and IL-18 (Ruiz-Ortega, et al., 2001, Ruiz-Ortega, et al., 2000, Schieffer, et al., 2000) depending on NF- κ B.

3.2 TGF- β 1 is a crucial determinant in cardiovascular fibrosis

3.2.1 TGF- β 1 interacts with integrins via LAP and induces cardiovascular fibrosis

There are three structurally similar isoforms of TGF- β , including TGF- β 1, 2 and 3 in mammals. All three isoforms share the same cell surface receptors and have similar cellular targets. TGF- β 1 is the prevalent isoform and is widely spread in mammalian tissues, whereas the other isoforms are expressed in a more limited spectrum of cells and tissues (Biernacka, et al., 2011). Although all three isoforms are expressed in fibrotic tissues, TGF- β 1 plays the major role in the development of tissue fibrosis (Ask, et al., 2008).

TGF- β 1 associates with LAP, SLC, and LTBP-1, participating in a Large Latent Complex, LLC (Chen, et al., 2016). The covering of TGF- β by LAP prevents it from binding to its receptors and activating related downstream pathway (see below) (Figure 8). Integrin $\alpha\beta$ 3, $\alpha\beta$ 5, $\alpha\beta$ 6 and $\alpha\beta$ 8 bind to the integrin-recognition motif (arginine–glycine–aspartic acid) of LAP and mediate the activation of TGF- β (Pozzi, et al., 2011) (see Figure 8). Latent TGF β 1 is converted into its active form by various mechanisms, including integrins, bone morphogenetic protein 1, several MMPs (MMP-2 and MMP-9), plasmin, elastase, thrombin, and cathepsin. Interaction between LAP and TSP-1 also promote latent TGF β 1 activation (Chen, et al., 2016). Integrin $\alpha\beta$ 6 interacts directly with TGF- β 1-bound LAP of and induces a spatially restricted activation of the TGF- β 1 signaling. Anti- β 6 integrin blocking antibodies completely inhibit the activation of TGF- β (Annes, et al., 2002). Integrin β 6 knock-out mice are protected from bleomycin-induced pulmonary fibrosis (Munger, et al., 1999). TGF- β -dependent and -independent pathways of induction of tubulointerstitial fibrosis were reported in integrin β 6- mice (Ma, et al., 2003). The interaction between integrin $\alpha\beta$ 8 and an RGD of TGF- β 1 results in the MT1-MMP-dependent release of active TGF- β 1 which produces autocrine and paracrine effects on cell growth, matrix production and fibrogenesis in lung cancer tumor xenografts (Mu, et al., 2002).

Two main models have been proposed to explain how integrins contribute to the activation of TGF- β . In the first model, integrins simultaneously bind the latent TGF- β 1 complex and MMPs. This allows the latent TGF- β 1 complex and proteases to come close together and facilitates the enzymatic cleavage and release of active TGF- β 1. The second mechanism requires the interaction between the latent complex and ECM, and is independent from proteolysis. Integrin α v can change the conformation of the latent TGF- β 1 complex by transmitting cell traction forces (Chen, et al., 2016).

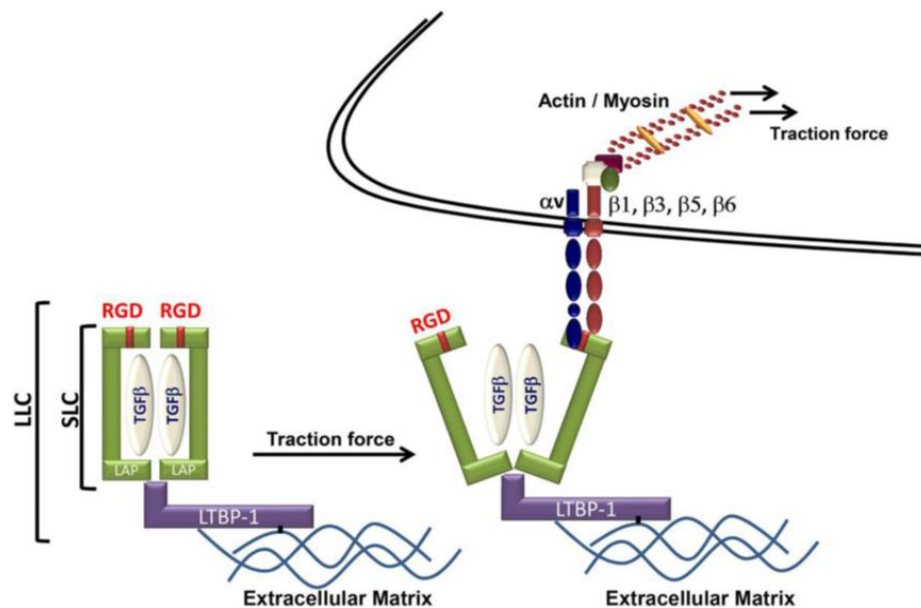

Figure 8. Model of mechanical activation of latent TGF β 1. TGF β 1 participate in LLC that consists of TGF β 1 associated with LAP, SLC, and LTBP-1. LAP contains the amino acid sequence motif RGD (Arg-Gly-Asp) which serves as a recognition site for several integrins. Actin / myosin-mediated cell contraction force can be transmitted to an RGD binding site in LAP through the α v integrins and induces a putative conformational change that liberates TGF β 1, activating it (Chen, et al., 2016).

TGF- β induction and activation are consistently observed in experimental models of tissue fibrosis (Biernacka, et al., 2011, Leask and Abraham. 2004, Pohlers, et al., 2009). There are extensive evidences demonstrating upregulation of TGF- β and its key role in the pathogenesis of renal fibrosis in both animal models and humans with kidney diseases (Chen, et al., 2018, Lan. 2011, Meng, et al., 2016). The activated HSC have significant increase in TGF- β expression that acts as an autocrine positive regulator for ECM production. TGF- β signal is associated with the accelerated ECM accumulation (Kisseleva, et al., 2008), TGF- β 1 mRNA expression is increased predominantly in alveolar macrophages, but also in pulmonary endothelial cells, mesenchymal cells, fibroblasts, and mesothelial cells in bleomycin-induced pulmonary fibrosis in human patients and experimental animals (Chen, et al., 2016). TGF- β also contributes to fibrogenesis through inflammation in chronic liver disease (Dooley, et al., 2012). TGF- β plays a pivotal role in the development of fibrosis in heart and consistently is involved in a variety of cardiac pathologies (Leask, et al., 2004). In a model of myocardial fibrosis, Ang II increases the expression of TGF- β (Wong, et al., 2018). TGF- β inhibition reduced hepatic (Nakamura, et al., 2000), renal (Fukasawa, et al., 2004) and cardiac fibrosis (Teekakirikul, et al., 2010) highlighting the role of TGF- β in a wide range of fibrotic conditions (Biernacka, et al., 2011). Serum TGF- β 1 level is upregulated in AF patients and could be used as an independent predictor of AF recurrence (Zhao, et al., 2014).

3.2.2 TGF- β 1 and its receptors

There are three types of TGF- β -receptors (TGF- β RI, TGF- β RII and TGF- β RIII). TGF- β signals require a heteromeric complex of type I and type II transmembrane serine/threonine kinase receptors (TGF- β RI and TGF- β RII). TGF- β binds to TGF- β RII, thus recruiting TGF- β RI. The formation of this heteromeric complex of type I and two type II receptors seems to be necessary for signaling (Luo, et al., 1996, Weis-Garcia, et al., 1996, Yamashita, et al., 1994). Phosphorylation of serine and threonine residues in glycine-serine rich (GS)-domain of TGF- β RI could be phosphorylated by TGF- β RII which results in a conformational change of TGF- β RI. Subsequently, phosphorylation of smads transfers the signal into the nucleus (Wieser, et al., 1995). There are two distinct isoforms of the TGF- β RI: the endothelium restricted ALK1 and the widely expressed ALK5. The activation of ALK1 induces smad1, smad5, and smad8 phosphorylation, while ALK5 promotes the phosphorylation of smad2 and smad3 (Lebrin, et al., 2005).

In contrast to the type I and II receptors, our knowledge about the role played by TGF- β RIII in TGF- β biology remains poorly understood. The TGF- β RIII, the most abundant and ubiquitously expressed TGF- β superfamily co-receptor, binds each of the three TGF- β isoforms with high affinity. TGF- β RIII is classically thought to function as a co-receptor, adjusting the TGF- β superfamily ligands to their respective signaling receptors (Cheifetz, et al., 1990). TGF- β has low affinity for TGF- β RII in the absence of TGF- β RIII, and overexpression of TGF- β RIII increases the binding of TGF- β to their receptors and in some cases have been shown to augment TGF- β actions, particularly those of TGF- β 2 (Esparza-Lopez, et al., 2001, Lopez-Casillas, et al., 1993, Sankar, et al., 1995).

3.2.3 TGF- β 1 and its signaling pathways in cardiovascular fibrosis

In general, TGF- β 1 is known to signal through smad signaling pathways, which, accordingly, play an important role in fibrosis. The smad family members are well conserved and widely spread in almost all vertebrates (Figure 9). This family has eight members, two TGF- β R-smads (smad2 and 3), three BMP R-smads (smad1, 5 and 8), one Co-smad (smad4) and two I-smads (smad6 and 7). Smad proteins have two globular conserved N-terminal MH1 and C-terminal MH2 domains connected by a linker region. R-smads and Co-smad

share two conserved MH1 and MH2 domains (Heldin, et al., 2012, Massague, et al., 2005, Moustakas, et al., 2001, Ross, et al., 2008), whereas I-smads have only a MH2 domain. Both the MH1 and the MH2 domains can interact with cytoplasmic adaptors, transcription factors, co-activators, co-repressors, and chromatin-remodeling factors (Zhang, et al., 2015).

The linker regions between the MH1 and MH2 domains also play an important function in smad regulation. Since this region contains PY motifs and flexible binding sites for Smurf ubiquitin ligases, sites of phosphorylation targeted by various kinases phosphorylation of protein (Moustakas, et al., 2009, Shi, et al., 2003), the R-Smad linker region is involved in pathways including, MAPKs, CDKs (Figure 9) (Zhang, et al., 2015).

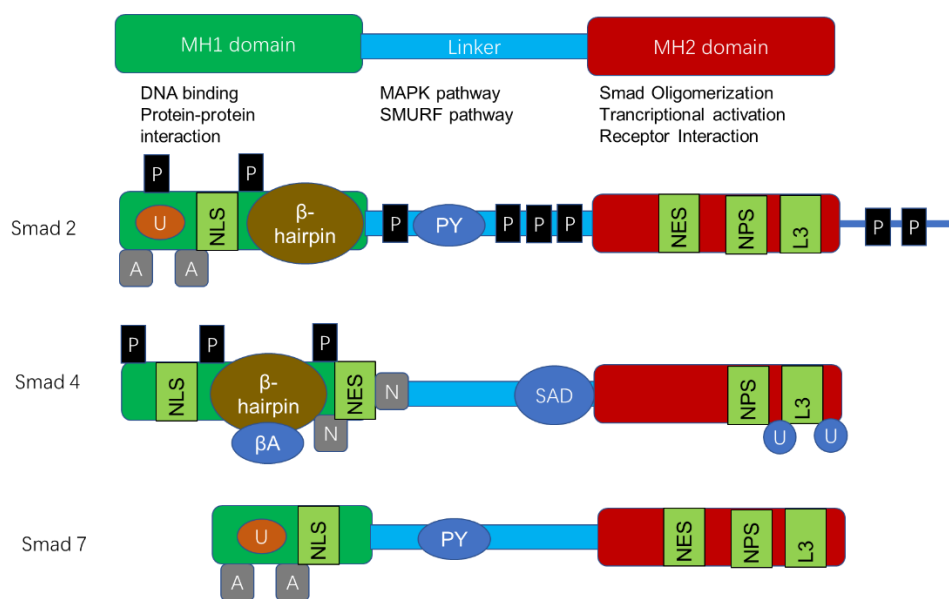

Figure 9. Functional and structural characteristics of Smad family members. Smad proteins consist of two conserved globular domains (MH1 and MH2) and a variable linker region R-Smads and Smad4 have a MH1 domain that contains a β -hairpin structure for DNA binding and protein-protein interactions. The R-Smad linker region is involved in pathways for MAPKs and Smurf pathway. The MH2 domain is responsible for Smad oligomerization, transcriptional activation and receptor interaction. Abbreviations: A: acetylation, NES: nuclear export signal, NLS: nuclear localization signal, NPS: nucleopore signal, P: phosphorylation, pA: poly-ADP-ribosylation, S: sumoylation, SAD: Smad activation domain, U: ubiquitination. Adapted from Zhang, et al., 2015.

TGF- β signaling is initiated with serine/threonine kinase receptor oligomerization and R-smad phosphorylation (Derynck, et al., 1998, Moustakas, et al., 2001, Whitman. 1998). Subsequently, a R-smad/Co-smad complex is generated to translocate to the nucleus and regulates downstream gene transcription. I-smads (smad6 and smad7) could block TGF- β signaling pathway by preventing R-smads from interacting with the TGF- β receptor or competing with Co-smad for the generation of R-smad/Co-smad complexes

(Figure 10) (Zhang, et al., 2015).

Smad 2/3 signaling pathway has been proved to be related to vascular fibrosis. Some fibrogenic genes have been shown to be the downstream targets of TGF- β /smad3 signaling, including, collagen type 1 α 1, collagen type 1 α 2, collagen type 5 α 2, collagen type 6 α 1, collagen type 6 α 3, CTGF, tissue inhibitor of metalloproteinase-1 (Verrecchia, et al., 2001).

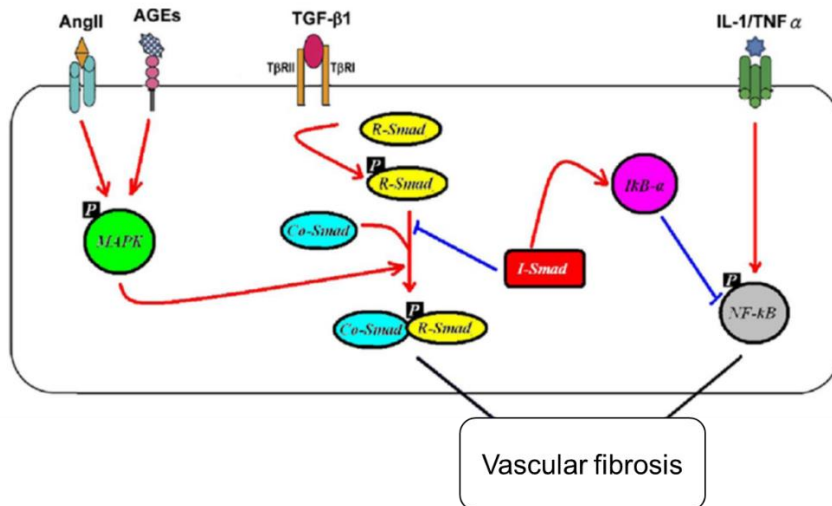

Figure 10. Signaling crosstalk in vascular fibrosis. TGF- β 1/TGF- β 1R activation phosphorylates R-Smads, Smad2 and 3. Activated R-Smads form a complex with Co-Smad4 which then translocate to the nucleus and regulates gene transcription. The ECM deposition is also mediated through AngII/AGEs—mediated ERK/p38 MAP kinase-Smad crosstalk. Adapted from (Zhang, et al., 2015)

The activation of TGF- β /smads signaling plays a pivotal role in the pathogenesis of cardiac fibrosis and hypertrophy (Flevaris, et al., 2017, Gao, et al., 2017, Jeong, et al., 2015, Xiao, et al., 2018). ALK5 inhibitor inhibited fibrogenesis in a rat model of progressive TGF- β 1-induced pulmonary fibrosis (Bonniaud, et al., 2005). Smad3 null mice exhibit attenuated cardiac fibrosis (Bujak, et al., 2007, Dobaczewski, et al., 2010) and are resistant to bleomycin-induced pulmonary fibrosis (Zhao, et al., 2002), dermal fibrosis following irradiation (Flanders, et al., 2002), unilateral ureteral obstruction induced renal interstitial fibrosis (Biernacka, et al., 2011, Sato, et al., 2003). Through binding to the membrane-bound type I and II receptors, TGF- β increases the phosphorylation of smad2 and smad3. Once activated by TGF- β , smad3 and smad4 form a complex, translocate to the nucleus, and recruit some co-activators such as p300 (Xiao, et al., 2018). The smad3/4 complex then binds to the promoter regions of target genes and increases the expression of some fibrosis related protein (Derynck, et al., 2003, Liu, et al., 2017, Wu, et al., 2015). TGF- β 1 is not the sole mediator that could activate the

smad2/3 signaling pathway. We have mentioned alternative triggers in the Ang II part.

Smad 7, a downstream inhibitory smad in TGF- β signaling (Kavsak, et al., 2000, Rodriguez-Vita, et al., 2005, Wang, et al., 2006), acts in a negative feedback loop. Smad 7 competes with R-smads for receptor binding, thus inhibiting their phosphorylation; in addition, it recruits ubiquitin ligases to the receptors thus promoting their ubiquitination and proteasomal degradation; it also recruits phosphatases to the receptors thus promoting their dephosphorylation and deactivation, and interferes with the binding of smad complexes to DNA (Lorenzen, et al., 2015). For these reasons, Smad 7 stops the progression of cardiac injury via blocking TGF- β /smad3-mediated cardiac fibrosis and NF- κ B-driven inflammation (Wei, et al., 2013). Johan M et.al also found that smad 7 is required by Ang II to induce ERK activation as well as AKT signaling pathway and reduced expression of PTEN in the heart (Lorenzen, et al., 2015). In summary, TGF- β signaling activates multiple smad signaling, leading to fibrosis as a main response, in the presence of a finely tuned regulatory feedback.

Recently, there are also some non-smad signaling pathways which are proven to mediate the TGF- β induced vascular fibrosis (Lan, et al., 2013). The JNK/p38, ERK/MAPK, Rho-like GTPase, and PI3/AKT pathways have been found to reinforce, attenuate or modulate downstream cellular responses, accounting for the varying effects of TGF- β (Lan, et al., 2013). ERK, FAK, Src and β -catenin have been proven to be related with integrin signaling (Chen, et al., 2016), further regulating smad-independent TGF- β effects. Worth noting, TGF- β uses non-smad signaling pathways i.e. MAPK pathways, to convey the same fibrogenic signals (Zhang, 2009). MAPK family is a well-known serine/threonine-specific protein kinase which regulate extracellular mitogenic and stress stimuli and regulate cell differentiation, proliferation, survival and apoptosis. TGF- β activates all three known MAPK pathways: ERK, p38 and JNK (Biernacka, et al., 2011). MAPK pathways may further regulate smad proteins or mediate smad-independent TGF- β responses. p38 and JNK usually potentiate TGF- β /smad-induced responses, in contrast, ERK activation either increases or decreases smad signals depending on the cell type (Biernacka, et al., 2011). p38 MAPK mediates TGF- β -induced G0/G1 cell cycle arrest without smad proteins (Seay, et al., 2005). In a mouse model of scleroderma-like fibrosis, activation of a fibrotic gene program was dependent on smad1 and ERK1/2, and not on smad2/3 (Biernacka, et al., 2011, Pannu, et al., 2007). Besides, both in vitro and in vivo findings have suggested that p38 MAPK may play a role in the pathogenesis of renal fibrosis acting downstream of TGF- β (Biernacka, et al., 2011). JNK and ERK could mediate TGF- β 1 induced upregulation of fibronectin and α -SMA in pancreatic stellate cells (Xu, et al., 2018). TGF- β 1 induced the phenotypic changes in fibroblasts to become

myofibroblasts, which have a high ability of production of ECM components and cytokines via AKT/S6K signaling (Narikawa, et al., 2018). Increasing AKT phosphorylation suppress TGF- β 1-induced smad3 phosphorylation by promoting the interaction between AKT and smad3 (Zhang, et al., 2018). TGF- β has been shown to activate AKT, Abelson non-receptor tyrosine kinase (c-Abl), and Rho GTPase pathways and cooperate with Wnt and Notch signaling cascades (Derynck and Zhang. 2003). Activation of c-Abl kinase is involved in TGF- β -mediated renal and pulmonary fibrosis (Biernacka, et al., 2011). For what concerns kinases, one can summarize TGF-induced responses by saying that all three major MAPK pathways are activated by TGF- β , in addition to other kinases, leading to cell cycle entry and fibrosis.

CTGF, a cysteine-rich peptide, has also been regarded as a target gene of TGF- β /smads signaling (Figure 11) (Sun, et al., 2018). TGF- β also increases CTGF production which is involved in other several signal pathways, including Ras/MEK/ERK, Ap-1/JNK, PKC, and Tyr (Leask, et al., 2003). CTGF is coexpressed with TGF- β at sites of tissue fibrosis and stimulates ECM production by fibroblasts (Branton, et al., 1999, Frazier, et al., 1996, Kothapalli, et al., 1997). CTGF also induces the expression of MMP-2 via AP-1 activation in VSMC culture (Fan, et al., 2002). The addition of CTGF promotes fibronectin production, cell migration, and cytoskeletal rearrangement in primary mesangial cells (Crean, et al., 2002).

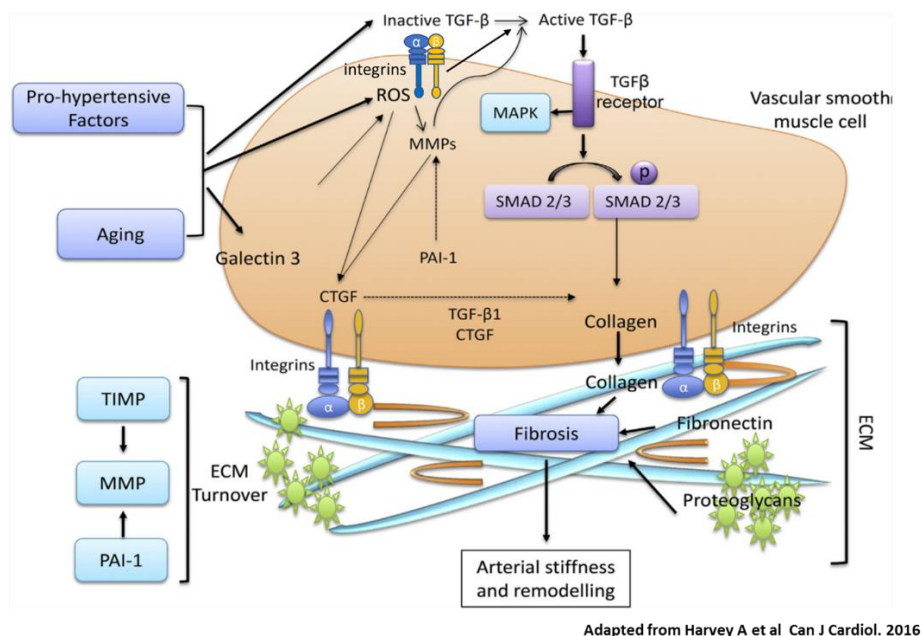

Figure 11. Vascular signaling mediating ECM remodeling, fibrosis, and arterial stiffening in aging and hypertension (Harvey, et al., 2016).

Part IV Galectin-3: a novel factor involved in fibrosis and cardiovascular diseases

4.1 Structure and expression of galectin-3

Galectin-3, a member of the β -galactoside-binding lectin family (Dumic, et al., 2006), displays a similarity in its sequence with Bcl-2. Galectin-3, which is a 29-35 kDa protein, is composed of a C-terminal carbohydrate-recognition domain, a collagen-like internal R-domain, and a N-terminal domain that promotes lectin oligomerization (Dumic, et al., 2006, Markowska, et al., 2010). A 21-kD C-terminal domain of galectin-3 contains the entire CRD and retains its ability to bind to lactosamine-containing glycans, but C-terminal domain is unable to form dimers or higher order oligomers because of lacking the N-domain (Markowska, et al., 2010).

Galectin-3 is widely expressed, with differential expression levels in hematopoietic tissue, brain, circulatory systems, thymus, lymph nodes, skin, the respiratory, digestive tract, reproductive and urinary apparatuses (Figure 12) (Dumic, et al., 2006, Suthahar, et al., 2018). Galectin-3 plays an important role in embryogenesis, growth and development, and also in maintaining tissue homeostasis (Dalton, et al., 2007). The expression of galectin-3 varies depending on tissue-type and is modulated in some pathophysiological process (Suthahar, et al., 2018).

At cellular level, galectin-3 is present in the cytoplasm, nucleus, extracellular space, and also bounds to the cell surface (Dumic, et al., 2006). There are numerous biological ligands of galectin-3 which are structurally and functionally very different, including Bcl-2 (Yang, et al., 1996), Gemin4 (Park, et al., 2001), β -catenin (Shimura, et al., 2004), K-Ras, AKT, Alix/AIP1, Synexin, Nucling (Dumic, et al., 2006). Intracellular galectin-3 interacts directly with the GSK-3 β / β -catenin complex and increases the stability of β -catenin. Axin, a regulator protein of Wnt pathway, forms a complex with β -catenin, enhances its GSK-3 β -dependent phosphorylation, and promotes GSK-3 β -dependent phosphorylation of galectin-3 (Shimura, et al., 2005). All these effects eventually activate the Wnt/ β -catenin signaling pathway (Dumic, et al., 2006). Extracellular galectin-3 also acts as an interpreter of glycocodes by binding to glycan-rich molecules in cell-surface glycoproteins and glycolipids (Suthahar, et al., 2018). Galectin-3 can be secreted into the extracellular matrix and serum, where it binds to the laminin, fibronectin, tenascin and collagen IV

(Suthahar, et al., 2018)



Figure 12. Western blot analysis of different tissues reveals differential expression levels of galectin-3. adapted from (Suthahar, et al., 2018).

4.2 Galectin-3 is related to fibrosis

Galectin-3 is a protein related to fibrosis in many different organs, including heart, vessels, lung, liver and kidney. In pulmonary fibrosis, galectin-3 is a crucial regulator by activating macrophages and fibroblasts (Mackinnon, et al., 2012). In a kidney injury animal model, macrophages secrete galectin-3 which is a main driver of renal fibrosis (Desmedt, et al., 2016). Galectin-3 is sufficient to promote fibrosis independently from TGF- β under certain circumstances (Figure 13) (Henderson, et al., 2008, Martinez-Martinez, et al., 2015). Knock-out of galectin-3 could produce a protective effect against renal interstitial fibrosis, resulting in reduced collagen I and α -SMA expression, further supporting its fundamental role in this process (Dang, et al., 2012).

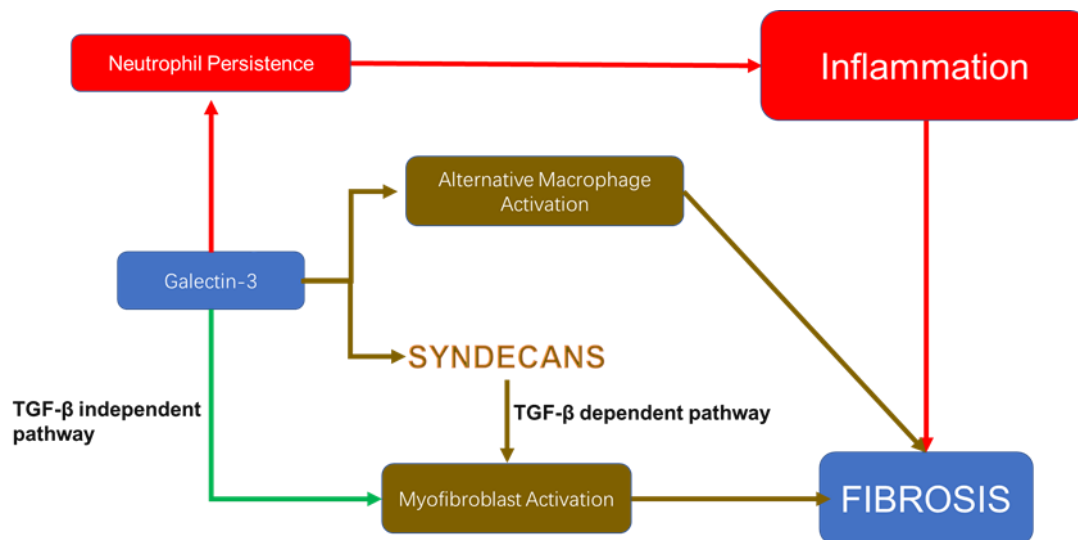

Figure 13. galectin-3 induces fibrosis through TGF- β dependent and independent mechanisms. The role of galectin-3 in fibrosis is well-established, and increased galectin-3 levels contribute to (myo)fibroblast activation through a TGF- β independent pathway and also through a TGF- β dependent pathway adapted from (Suthahar, et al., 2018)

4.3 The role of galectin-3 in a variety of cardiovascular diseases

Several clinical researches have shown that galectin-3 played an important role in cardiovascular diseases (Figure 14). In the general population, elevated plasma galectin-3 can be used to predict all-cause mortality, cardiovascular mortality, and HF (Imran, et al., 2017). Galectin-3 has been found to be upregulated in HF, MI, and AF patients, and the serum level of galectin-3 is predictive of bad prognosis (Chen, et al., 2015, Fashanu, et al., 2017, Sharma, et al., 2017). Recently, some rare cardiovascular diseases have also been associated to an increase in the expression of galectin-3, including, hypertrophic cardiomyopathy, chronic Chagas disease, aortic valve stenosis and Kawasaki disease (Numano, et al., 2015, Souza, et al., 2017, Yakar Tuluca, et al., 2016, Zhou, et al., 2016)

The clinical use of galectin-3 for HF has been widely explored, as a marker for the diagnosis and accurate estimate of prognosis in HF patients (Chen, et al., 2015). Although in some clinical studies, NT-proBNP might be better than galectin-3 to diagnose heart failure, galectin-3 is also widely considered as a novel biomarker to diagnosis heart failure (Chen, et al., 2013, Gullestad, et al., 2012). In addition, serum level of galectin-3 could be used to predict all-cause mortality and cardiovascular mortality in HF patients (Chen, et al., 2015). The combination of galectin-3 with NT-proBNP is the best predictor for all-cause

mortality and cardiovascular mortality in subjects with acute HF (van Kimmenade, et al., 2006). Aldosterone likely mediates myocardial damage via galectin-3 in a murine model of heart failure, and specific inhibition of galectin-3 prevents isoproterenol-induced cardiac fibrosis (Vergaro, et al., 2016).

In addition to HF, galectin-3 has been regarded as an important prognostic biomarker in MI and AF. To some extent, MACE after MI and AF also depend on the level of cardiac fibrosis. Galectin-3 levels are increased in patients with ischemic heart disease, and there is a significant relationship between galectin-3 level, MI size and LV remodeling (Sharma, et al., 2017). In the coronary heart disease patients, AMI increases galectin-3 level which shows a positive correlation with the number of criminal vessels (Martinez-Martinez, et al., 2015) and LVEF (Bivona, et al., 2016), Sharma et.al analysed the serum galectin-3 level in STEMI patients, and found that if galectin-3 is upregulated after acute MI it is positively associated with the development of MACO (Sharma, et al., 2017). Even though there is no statistically significant correlation of galectin-3 and LVEF in the STEMI patients, galectin-3 value is significantly correlated with mid-term infarct size (Mayr, et al., 2013). In AMI patients, Szadkowska et al. found that baseline galectin-3 value is a significant predictor of in hospital new-onset atrial fibrillation (Szadkowska, et al., 2013). The mean serum galectin-3 level is significantly higher in non-valvular atrial fibrillation cases than in controls (Sonmez, et al., 2014). High galectin-3 serum level during acute period of STEMI is an independent predictor of increased myocardial ECV at 6-month follow-up (Perea, et al., 2016). Coronary computed tomography angiography is usually used to detect the coronary plaque burden, serum galectin-3 positively correlates with the total number of coronary plaques (Pusuroglu, et al., 2017). Galectin-3 could be a useful biomarker of the atherosclerotic plaque destabilization (Salvagno and Pavan. 2016).

Galectin-3 also plays an important role in AF. In the Atherosclerosis Risk in Communities (ARIC) study, an increased plasma galectin-3 is associated with an increased risk of AF (Fashanu, et al., 2017). Diana et.al measured galectin-3 in the cardiac surgery patients describing that the galectin-3 serum levels are higher in controls with permanent AF than patients without previous known AF (Hernandez-Romero, et al., 2017). The galectin-3 level in patients with persistent AF is significantly higher than that in patients with paroxysmal AF, galectin-3 is an independent predictor of left atrial volume index (Gurses, et al., 2015). Patients with new onset of AF have elevated galectin-3 levels in contrast to those with preexisting chronic AF (Chen, et al., 2016). In symptomatic atrial fibrillation patients, serum level of galectin-3 is a significant predictor of reduced LVEF; besides, galectin-3 is positively correlated with the CHA2DS2-VaSC score (Clementy, et al., 2016). Galectin-3 serum levels

predict atrial fibrosis of the atrial appendage (Hernandez-Romero, et al., 2017). A significant correlation between serum galectin-3 level and extent of left atrium fibrosis is found in paroxysmal atrial fibrillation patients who undergo delayed-enhancement magnetic resonance imaging prior to cryoballoon-based atrial fibrillation ablation (Yalcin, et al., 2015). In persistent atrial fibrillation patients without structural heart disease, plasma galectin-3 concentrations can be used to predict AF recurrence after ablation (Clementy, et al., 2016, Wu, et al., 2015)

In the Ang II-induced hypertension model, the cardiac inflammation and fibrosis induced by Ang II partly depend on galectin-3 (Gonzalez, et al., 2016). In experimental hyperaldosteronism, galectin-3 is increased in cardiac fibroblasts and mediates aldosterone induced cardiac inflammation and fibrosis (Martinez-Martinez, et al., 2015). In inflammatory cardiomyopathy patients, myocardial galectin-3 expression significantly correlates with inflammatory cell count on endomyocardial biopsy, and there is an inverse association between myocardial galectin-3 expression and cardiac fibrosis (Besler, et al., 2017).

Galectin-3 levels are increased and correlate with the degree of left ventricle hypertrophy in HCM patients, even though the relationship between galectin-3 and myocardial left ventricle diastolic and systolic functions is not significant (Yakar Tuluca, et al., 2016). In chronic chagas disease, T. cruzi infection increases the expression of galectin-3, which plays a role in favoring inflammation and fibrogenesis (Souza, et al., 2017). Galectin-3 positively correlates with fibrosis and RWT, thus, it could be used as a valuable prognostic predictor in patients with aortic valve stenosis (Zhou, et al., 2016). In KD patients with giant aneurysms, increasing of galectin-3 may help to identify a subset of KD patients at highest risk of myocardial and vascular fibrosis (Numano, et al., 2015). Galectin-3 plasma concentration is significantly higher in PAH patients, and galectin-3 increases the proliferation, differentiation and extracellular matrix deposition of PAFs (Luo, et al., 2017). In obese patients, galectin-3 could deteriorate the cardiac damage (Martinez-Martinez, et al., 2015).

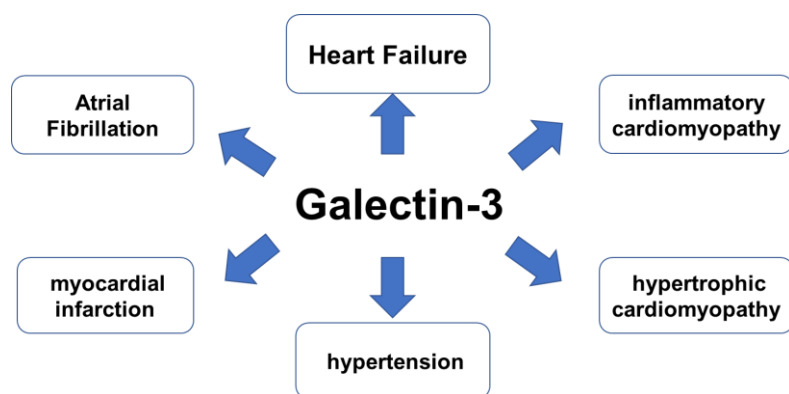

Figure 14. Galectin-3 is upregulated in a variety of cardiovascular diseases

4.4 Galectin-3 is related to fibrosis in cardiovascular system

4.4.1 Galectin-3 mediates the fibrosis in several different cell types in the cardiovascular systems.

Galectin-3 affects the functions of several cell types in the cardiovascular systems (Figure 15). Galectin-3 is expressed in VSMCs and mediates the oxLDL-induced phenotypic transformation of VSMCs. Silencing galectin-3 reduces the oxLDL-induced proliferation and migration of VSMCs (Tian, et al., 2015). Galectin-3 promotes the phenotype transformation of VSMCs by activating Wnt/ β -catenin signaling pathway (Tian, et al., 2017). In a series of cardiovascular diseases, galectin-3 level is upregulated in serum, which in turn contributes to accumulation and activation of inflammatory cells in cardiac tissue, and promotes activation and proliferation of fibroblast and VSMCs, thus leading to cardiac fibrosis and remodeling (Lippi, et al., 2015). Galectin-3 is an important player in Aldo-induced vascular inflammation and mediates Aldo-induced vascular fibrosis, since galectin-3 silencing blocks Aldo-induced collagen type I deposition both in vivo and in vitro (Calvier, et al., 2013). In HUVEC, galectin-3 plays an important role in VEGF-and bFGF-mediated angiogenesis (Markowska, et al., 2010). Recombinant galectin-3 could promote proliferation, differentiation and increased production of collagen in cardiac fibroblasts (He, et al., 2017). oxLDL can promote the expression of galectin-3 in macrophages (Kim, et al., 2003). M2 macrophages have an important role in collagen turnover affecting wound remodeling (Henderson, et al., 2008, MacKinnon, et al., 2008). More importantly, in myocardial biopsies from failure-prone rats, galectin-3 co-localizes with activated macrophages.

These evidences suggest that macrophage-derived galectin-3 could be an important player in cardiac remodeling (Sharma, et al., 2004). Cardiomyocytes could also secrete galectin-3 which may also affect collagen secretion. In a different study investigating effects of PKC in cardiac hypertrophy, exposure of to PDBu, a PKC activator, promotes hypertrophy and increases galectin-3 protein expression as well as collagen production in rat cardiomyocytes; a galectin-3 inhibitor (β -lactose) blocks collagen production in HL-1 cells. (Kim, et al., 2003, Suthahar, et al., 2018)

Galectin-3 could increase the production of ECM in several different cell types in the cardiovascular systems. The activation of PKC- α increases galectin-3 expression which subsequently promotes cardiac fibrosis and HF (Song, et al., 2015). Cardiomyocytes could secrete galectin-3 which has a paracrine effect on cardiac fibroblasts, inducing their activation (Asensio-Lopez, et al., 2018). Hypertensive cardiac remodeling is associated with molecular inflammation and fibrosis, and aldosterone-induced cardiac inflammation and fibrosis also depend on galectin-3 (Martinez-Martinez, et al., 2015). In a HF mice model, galectin-3 triggers cardiac fibroblast proliferation, collagen deposition, thus, eventually causing ventricular dysfunction (Sharma, et al., 2004). Recombinant galectin-3 promotes angiogenesis and migration of HUVEC (Markowska, et al., 2010). Overexpression of galectin-3 in macrophage prompt fibroblasts to synthesize some fibrosis-related factors (Lin, et al., 2014). Galectin-3 is upregulated in AF patients, where it activates the TGF- β 1/ α -SMA/Col I pathway in cardiac fibroblasts, which may enhance atrial fibrosis (Shen, et al., 2018). In the process of pulmonary fibrosis, galectin-3 induces the profibrotic process via smads and AKT signaling pathway (He, et al., 2016). In the heart tissue, galectin-3 could increase macrophage and mast cell infiltration, enhance interstitial and perivascular fibrosis, thus ultimately leading to cardiac hypertrophy (Liu, et al., 2009). Galectin-3 levels positively correlate with the ECM markers TIMP-1 and HA, but not with N-terminal propeptide of PIIINP in pulmonary arterial hypertension patients (Fenster, et al., 2016). The all above clearly point to a role for galectin-3 in cardiovascular diseases.

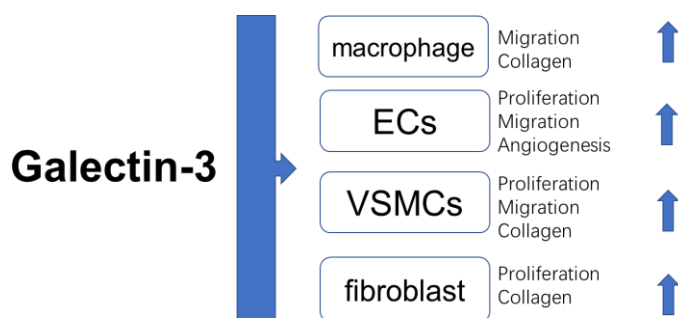

Figure 15. Galectin-3 affects the functions of several cell types in the cardiovascular systems.

4.4.2 Galectin-3 is involvememnt in mechanisms of cardiovascular fibrosis suggests its potential as a therapeutic target

Two RAAS effector hormones (Ang II and Aldo) induce cardiovascular fibrosis via galectin-3. In Ang II-induced cardiac remodeling and hypertension mice model, galectin-3 knockout mice have less LV dysfunction and fibrosis than WT mice (Gonzalez, et al., 2016, Yu, et al., 2013), while Galectin-3 is required for fibrotic responses to Aldo in vascular smooth muscle cells. Hypertensive Aldo-treated rats show vascular hypertrophy, inflammation, fibrosis, and increased aortic galectin-3 expression; on the other hand, galectin-3 inhibition by modified citrus pectin or small interfering RNA suppressed Aldo-induced collagen type I synthesis (Calvier, et al., 2013). Exogenous galectin-3 induces the expression of fibrosis-related proteins, including α -SMA and connective tissue growth factor in corneal fibroblasts, small molecule inhibitor, 33DFTG, reduced galectin-3 induced expression of α -SMA (Chen, et al., 2017).

Several studies showed that inhibition of synthesis or activity of galectin-3 could be regarded as a therapeutic option to decrease fibrosis in cardiovascular systems. The knocking down of galectin-3 effectively reduced the increased synthesis of type I collagen induced by aldosterone in heart (Calvier, et al., 2013), Knockout galectin-3 or galectin-3 inhibitor MCP could prevent aldosterone induced cardiac fibrosis (Calvier, et al., 2015). Galectin-3 may also play a role in maintaining the integrity of cardiac tissue after necrosis and is essential for normal wound healing in the initial phases of cardiac repair. In a MI mouse model, knockout galectin-3 has a high rate of mortality, mainly due to ventricular rupture (Gonzalez, et al., 2014). The excessive proliferation and differentiation of PAFs play a crucial role in the pathogenesis of PAH, TGF- β 1 increases galectin-3 expression in PAFs, whereas N-Acetyl-D-lactosamine (galectin-3 inhibitor) significantly suppresses TGF- β 1-induced proliferation, differentiation, and collagen synthesis of PAFs (Luo, et al., 2017). Inhibition of galectin-3 effectively decreases production, processing, cleavage, cross-linking and deposition of collagen, thus limiting or even reversing the cardiac remodeling (Yu, et al., 2013). Galectin-3 inhibition effectively reduces fibrosis and inflammatory biomarkers in cardiac tissue (Lax, et al., 2015). Galectin-3^{-/-} mice has a dramatically reduced number of infiltrating macrophages, CD4⁺ T lymphocytes, and CD8⁺ T lymphocytes in

heart during Chagas disease, accompanied by a diminished cardiac fibrosis (Pineda, et al., 2015).

4.5 The relationship between galectin-3 and integrins

There are many integrins which have been identified as the major galectin-3-binding proteins, for example, integrin $\alpha v\beta 3$ (Markowska, et al., 2010), integrin $\alpha 3\beta 1$ (Saravanan, et al., 2009), integrin $\beta 1$ (Lakshminarayan, et al., 2014), integrin $\alpha 1\beta 1$ (Ochieng, et al., 1998). This binding triggers a series of intracellular signaling, including FAK signaling and ILK signaling (Wesley, et al., 2013). Galectin-3 plays an important role in the process of cellular uptake of the CLIC cargo CD44 and endocytosis of $\beta 1$ -integrin (Lakshminarayan, et al., 2014). Furthermore, it mediates endocytosis of integrin $\beta 1$ via a caveolae-like pathway (Furtak, et al., 2001) as well as endocytosis of AGE products and acetylated low-density lipoproteins (Wang, et al., 2017). Integrins have been found to mediate the functions of galectin-3 in many different cells. Galectin-3 increases lateral mobility of integrin receptors, cluster size of integrins, and cell migration in HeLa cells (Yang, et al., 2017). Integrin $\beta 1$ also mediated galectin-3 induced production of inflammatory cytokines in PSCs (Zhao, et al., 2018). Galectin-3 activates outside-in integrin signaling promoting cell migration and matrix remodeling in metastatic cancer cells (Boscher, et al., 2013). Integrin $\alpha v\beta 3$ is the major galectin-3-binding protein in endothelial cells, and anti- αv , anti- $\beta 3$ and anti- $\alpha v\beta 3$ integrin antibodies significantly inhibit galectin-3-induced cell migration and capillary tubule formation (Markowska, et al., 2010).

Part V Vascular stiffness is a multifactor process

5.1 The importance of vascular stiffness in cardiovascular diseases

Vascular stiffness plays an important role in aging and in many cardiovascular diseases, including myocardial infarction, heart failure, and atherosclerosis (Safar, et al., 2003). Arterial stiffness is also an independent predictive risk factor for major adverse cardiovascular events. The elasticity, distensibility,

and compliance of the arterial system affects blood pressure which in turn leads to increased cardiac work load, followed by cardiac hypertrophy and adverse cardiovascular events. The principle of PWV, used to assess the arterial stiffness, is measuring the speed of pressure pulse from the heart to the arteries; in the presence of arterial stiffness pressure pulse takes less time to travel the defined distance (Van Bortel, et al., 2012). PWV can be measured by various approaches, including applanation tonometry, oscillometry, doppler echocardiography, and magnetic resonance imaging (Laurent, et al., 2006, Van Bortel, et al., 2012). Carotid-femoral PWV is now considered as the gold standard for evaluation the aortic stiffness in clinical practice (Laurent, et al., 2006, Van Bortel, et al., 2012).

5.2 Factors regulating vascular stiffness

Many mechanisms contribute to the regulation of arterial; their nature may be systemic (blood pressure, hemodynamics), vascular (vascular contraction/dilatation, ECM remodeling), cellular (cytoskeletal organization, inflammatory responses, endothelial dysfunction, phenotype of VSMC), and molecular (oxidative stress, calcification, intracellular signaling, mechanotransduction, “extrinsic factors” such as hormones, salt, and glucose regulation) (Harvey, et al., 2016).

Oxidative stress

Oxidative stress is an important factor which contributes to arterial stiffness. The formation of ROS including free radicals, hydrogen peroxide. The increasing ROS leads to oxidation of proteins and DNA affecting cell signaling and inducing inflammation, vascular fibrosis, and calcification (Harvey, et al., 2015). Importantly, oxidative stress can be altered by the imbalance between antioxidant defenses and ROS that are produced in vessel walls and regulate cell functions and cellular senescence. Decreased NO accentuates vascular injury and/or impairs vascular repair (Steppan, et al., 2014).

Calcification

Calcification of the arterial media is proposed to be involved with stiffening of the aorta. Oxidative stress, apoptosis, mitochondrial dysfunction, mechanical stress and inflammation are the known drivers in arterial medial calcification (Durham, et al., 2018). It is currently believed that VSMCs phenotype switching during calcification varies depending on the location of calcification. Calcification is likely to happen in both medial (arterial medial calcification) and intimal (arterial intimal calcification). There may be pronounced differences for

the mechanisms driving calcification at either site, inflammation is more important in the process of arterial intimal calcification (Durham, et al., 2018). ENPP1 is a gene whose expression is associated with calcification: higher ENPP1 is also related to the increasing brachial-ankle PWV (Pierce. 2017). MGP is a strong inhibitor of soft tissue calcification. The inactive form of MGP and dephospho-uncarboxylated MGP could be used to predict the higher aortic stiffness, however, in some clinical researches, the correlation between aortic stiffness and uncarboxylated MGP without phosphorylation is failed to identify (Pivin, et al., 2015).

ECM

ECM maintains vascular structural stability and is essential for the mechanical and biological properties of vessel walls. Excessive ECM protein deposition leads to vascular fibrosis and increased stiffness. Collagens are especially important in these processes, because collagen types I and III are the predominant isoforms in the vascular ECM. The absolute and relative quantities of collagen and elastin regulate the biomechanical properties of vessels, in which an elastin deficiency/collagen excess leads to vascular fibrosis and increased stiffness (Alpert. 2005, Nicolson. 1976). Upregulation of collagen content and decreased elastin together with a proinflammatory microenvironment contribute to ECM remodeling, increased intima-media thickening and vascular stiffness in human and experimental hypertension (Nicolson. 1976). ECM is degraded with advancing age, which facilitates VSMCs migration.

Endothelial dysfunction

Endothelial integrity is of great importance to a normal vessel. The endothelium is one of the largest endocrine organs in the human body. Vascular ECs secrete a series of biologically vasoactive molecules (through both autocrine and paracrine processes) that play important roles in maintaining vascular structural and functional stability (Kalaria. 2002). Healthy endothelium maintains vascular structure and regulates vascular tone, which has the potential to directly lower vascular resistance. Endothelial dysfunction may also contribute, at least in part, to the development of aortic stiffness through chronic increases in VSMCs tone (Pierce. 2017). By using AFM, DeMarco et al., found that a HFS diet increased the surface stiffness of endothelial cell and VSMCs in aorta (DeMarco, et al., 2015).

Ang II

Many hormones have been proved to modulate vascular stiffness. Ang II could stimulate collagen formation, trigger matrix remodeling and vascular

hypertrophy, depresses nitric oxide-dependent signaling, increases oxidant stress, and reduces elastin synthesis.

Inflammation mediated by Ang II plays an important role in the arterial stiffness. Atherosclerosis has been regarded as an inflammatory reaction. Ang II increases the expression of IL-6 (Kranzhofer, et al., 1999), MCP-1, and TNF- α in monocytes (Hahn, et al., 1994), which deteriorate the progression of atherosclerosis. In vascular inflammation, Ang II provides a positive feedback loop via recruitment of inflammatory cells, which then produce more Ang II, and deteriorate vascular inflammation (Neves, et al., 2018). Pro-inflammatory and pro-fibrotic effects furtherly promote insulin resistance and vascular remodeling in VSMCs, and therefore influence the development of atherosclerosis (Cascella, et al., 2010).

There is also a positive feedback loop between Ang II and ROS generation in the oxidative stress. Ang II stimulates the expression and activation of NADPH in endothelial and vascular smooth muscle cells (Harvey, et al., 2015), Ang II increases ROS formation by activating mitochondrial protein kinase C and ATP-dependent potassium channel opening (Yung, et al., 2015); on the other hand, ROS increases the expression of AT1 receptor (Leong, et al., 2010). Ang II increases the expression of MCP-1 which, in turn, can stimulate VSMCs migration (Chen, et al., 1998, Tsuchiya, et al., 2006). Finally, RAAS activation reduces the production and activity of natural anti-oxidants, such as SOD and glutathione (McNulty, et al., 2005). These mechanisms have been pointed out as the main reasons why RAAS inhibition is a key step in reversing the processes of vascular aging.

Ang II could increase the vascular stiffness which is assumed to be attributable to changes in ECM (Miner, et al., 2006, Nanthakumar, et al., 2015). There are more and more researches showing that the treatment of large artery stiffening in patients involves the utilization of calcium channel blockers and Ang II receptor antagonists which are usually thought to primarily affect the tone of VSMCs but not the ECM (Chen, et al., 2016).

MFG-E8

MFG-E8 increases the proliferation and invasion capacity of VSMCs. Since Ang II enhances the expression of MFG-E8, and through MCP-1 stimulates VSMCs invasion. MFG-E8 is an important relay factor within the Ang II/MCP-1/VSMCs invasion-signaling cascade. In ECs, overexpression of MFG-E8 induces apoptosis through increasing the Bax/Bcl-2 ratio and caspase-9 and caspase-3 activation (Li, et al., 2011).

MMPs

MMPs comprise the M10 family of the zinc-containing MA clan of metallopeptidases. They are ubiquitous enzymes, with an active site where a Zn atom, coordinated by three histidines, can play a catalytic role to degrade the vascular ECM (Sbardella, et al., 2012).

MMPs are involved in ECM and BMs degradation. MMPs play important roles in the physiology of fibrosis, including atherosclerosis, liver cirrhosis, fibrotic lung disease, otosclerosis, and multiple sclerosis. MMPs play a key role in mediating the progression of stable atherosclerotic lesions to an unstable phenotype that is prone to rupture through the destruction of strength-giving ECM proteins (Amalinei, et al., 2010). MMPs involved in vascular ECM remodeling consist of five groups: interstitial collagenases (MMP-1 and MMP-8, expressed by ECs and SMCs) mainly degrade primarily interstitial matrix collagens, particularly collagen I, II, and III; gelatinases (MMP-2, expressed by SMCs and macrophages; MMP-9, expressed in macrophages and vascular cells) degrade collagens IV and V, denatured collagens, and elastin; stromelysin degrade basement membrane proteins such as collagen IV and V, laminin and fibronectin; MT-MMPs degrade collagen I and III, fibronectin, laminin, entactin/nidogen, tenascin and perlecan (Galis, et al., 2002, Jacob. 2003, Xiao, et al., 2014) and elastases (MMP-7, expressed at a low level in the vascular wall, MMP-12, synthesized by macrophages) (Birkedal-Hansen. 1993, Davies, et al., 1992, Norman, et al., 1996). In addition, MMP-1, MMP-2, MMP-3, MMP-8 and MMP-9 can promote the migration and proliferation of VSMCs (Amalinei, et al., 2010, Xiao, et al., 2014).

The expression of most MMPs is mediated by a variety of inflammatory cytokines, hormones, and growth factors, including IL-1, IL-6, TNF- α , EGF, PDGF, bFGF, and CD40 (Moon, et al., 2004, Schonbeck, et al., 1997, Sheu, et al., 2004). MMPs are involved in ECM and BMs degradation. MMP-1, MMP-2, MMP-3 and MMP-9 induce plaque rupture, acute thrombosis, and SMC proliferation and migration via weakening the connective tissue matrix in the intima (Amalinei, et al., 2010). MMP induces EC basement membrane degradation destroying endothelial barrier function with diapedesis of inflammatory cells (Lan, et al., 2013).

VSMCs stiffness

VSMCs stiffness is an important component that contributes to arterial stiffening (Zieman, et al., 2005). There are many factors which could affect the stiffness of VSMCs. Mechanical properties of VSMCs maybe play a more significant role in hypertension than the ECM proteins elastin and collagen. Moreover, VSMCs and ECM seem to contribute synergistically to vascular stiffness (Figure 16).

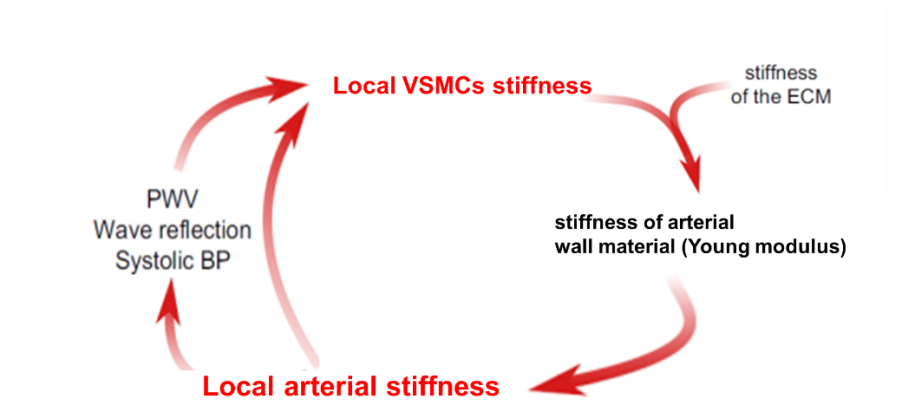

Figure 16. Large artery stiffness: cross-talk between local and systemic stiffness in large arteries. adapted from (Lacolley, et al., 2017)

The stiffness of VSMCs can be a mechanism contributing to the overall increased aortic stiffness. Hypertension could increase the stiffness of individual VSMCs. Increased VSMCs stiffness is an important part of the disease process and plays a critical role in the stiffening of the process taking place in the vascular wall (Sehgel, et al., 2015), on the other hand, arterial stiffness induces remodeling of artery smooth muscle cells (Dieffenbach, et al., 2017). Thus, there is a feedback between vascular stiffness and VSMCs stiffness.

In SHR, aortic and VSMCs stiffness are increased, compared with WKY rats. Also, expression of some cytoskeletal proteins (actin, phosphorylated myosin light chain and myosin light chain kinase) are elevated in SHR, compared with WKY rats, the inhibitors of these cytoskeletal proteins could dramatically reverse the increase in VSMCs stiffness (Sehgel, et al., 2013). Sehgel et.al also found that the VSMCs stiffness in old SHR is higher than that in the young mice (Sehgel, et al., 2015). Even though the aging WKY have no change in blood pressure, they do show an increase in VSMCs stiffness in contrast to the young mice. This demonstrates that intrinsic changes in VSMCs mechanical properties indeed contribute to vascular stiffening (Sehgel, et al., 2015).

Aim of the thesis

The main objective of this thesis is to gain a better understanding of the role of integrin α_v expressed by VSMCs in vascular fibrosis and stiffness. Integrin $\alpha_v\beta_3$ has been implicated in the mechanosensitive proliferative response and in the prevention of mechanical stretch-induced apoptosis of VSMCs (Cheng, et al., 2007., Sedding, et al., 2005, Zhou, et al., 2005), however, the role of integrin α_v expressed by VSMCs in vascular fibrosis is still unclear. A full understanding of the role of VSMCs in arterial fibrosis requires not only the knowledge of individual receptor involved in cell-matrix attachment and the binding of coagulation factors but also the influence of cell differentiation.

For the all above, we wanted to determine the role of integrin α_v on vascular fibrosis and stiffness. Specifically, until now, the role of integrin α_v in vascular fibrosis is still unclear, in particular, we still do not know how galectin-3, a fibrosis-related protein, induces the vascular fibrosis and if its effects are integrin-mediated. Here we show that Galectin-3 binds integrin α_v inducing VSMCs proliferation, migration and ECM deposition, and the underlying signaling pathways are analyzed.

Results

Part I Ang II or TGF- β 1 induces the vascular fibrosis via integrin α v

1.1 Knock-out integrin α v in smooth muscle cell reduces Ang II-induced vascular fibrosis

In collaboration with Drs. Véronique Regnault and Patrick Lacolley (INSERM U1116 Nancy), we obtained the mouse model of conditional inactivation of integrin α v. Two transgenic mice lines were used in this study. One line contains the inducible recombinase cre (Cre-ER^{T2}) in the locus of SM22 gene in C57/B6 mice (Kuhbandner, et al., 2000), the other contains two Cre-recognized LoxP sites that were inserted into intron 3 and intron 4 of integrin α v gene in the C57/B6 mice (Lacy-Hulbert, et al., 2007). These two kinds of mice were bred to get our inducible knockout mice. Tamoxifen was injected into the mice to activate the cre (Figure 17) to inactivate integrin α v gene (abbreviation for mutant mice : α v^{SMKO}). The control and mutant mice were analysed at the baseline and some of them were further treated with the mini-pump that was implanted under the skin of mouse, and diffused Ang II at two kinds of dose (0.3mg/kg/d or 1.5mg/kg/d) for 28 days. The systolic blood pressure of mutant mice is slightly lower than the control mice. Carotids were dissected and stained with Sirius red to characterize fibrosis (Figure 18), no difference of fibrosis in the media region was observed between control and mutant mice at baseline, however, less fibrosis was found in the mutant mice treated by Ang II, compared with control mice treated by Ang II at histological level.

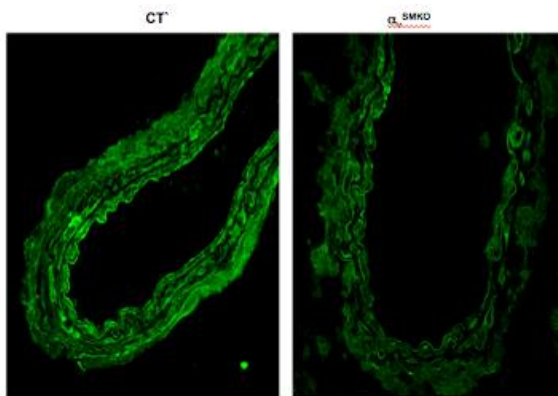
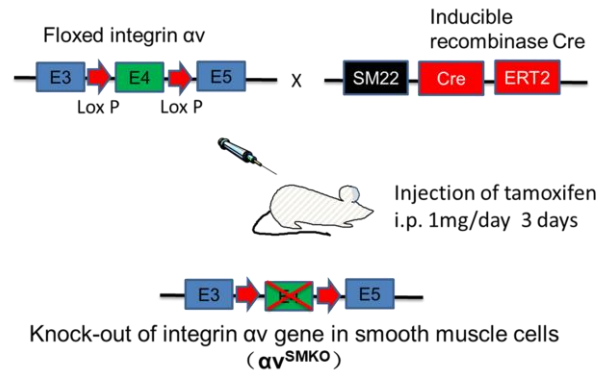

Figure 17. Specific knock-out integrin αv gene in smooth muscle cells of mouse. Schematic presentation of specific knock-out integrin αv gene in smooth muscle cells of mouse (upper part) and immunofluorescence staining of integrin αv (in green) of carotids (down part). The red arrows indicate the LoxP Sites; E3, E4, E5 represent the exon 3, 4 and 5 of integrin αv gene. SM22 indicates the promoter of SM22 gene

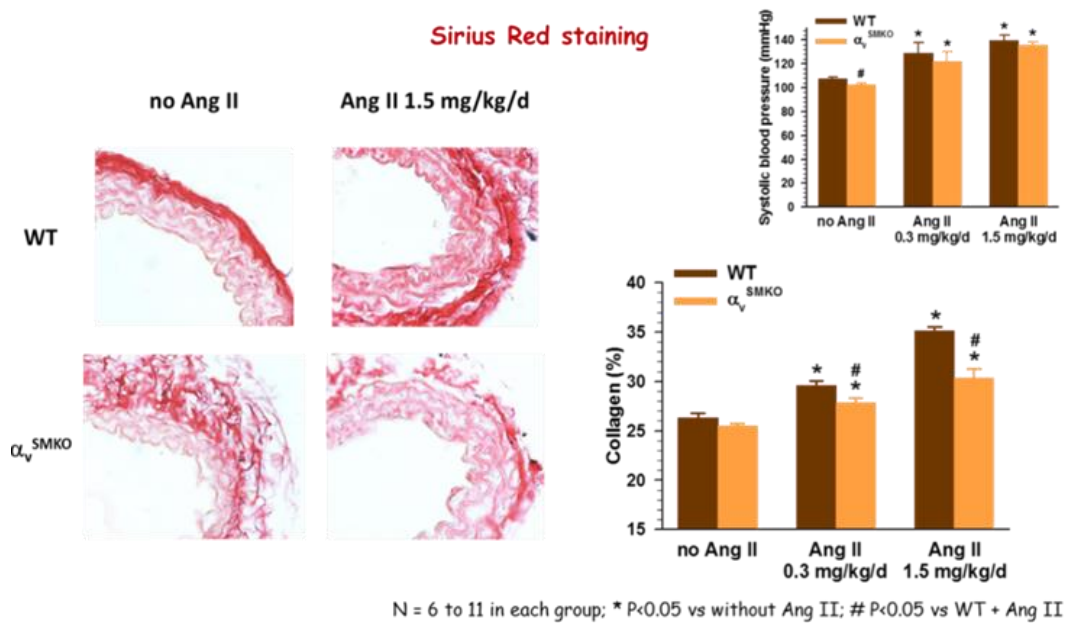
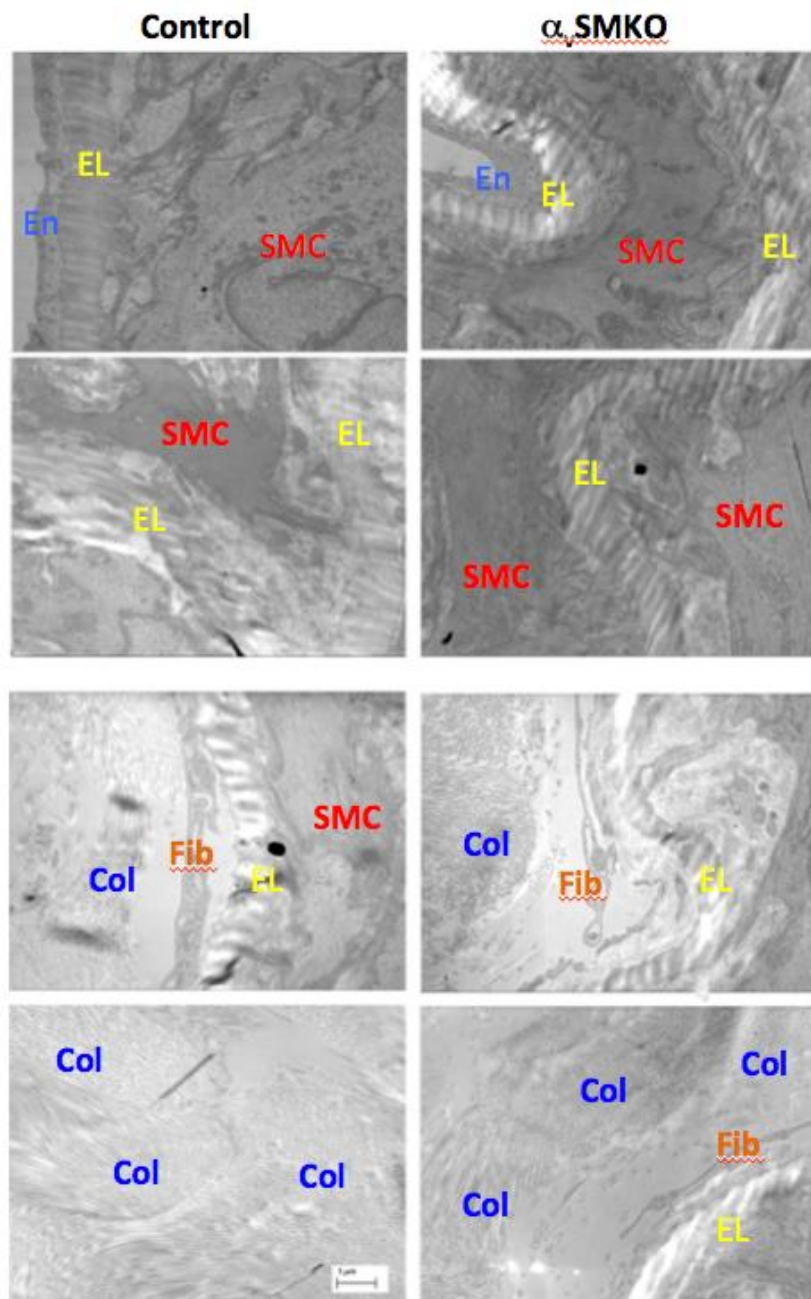

Figure 18. Decrease of fibrosis in Ang II-treated αv^{SMKO} mice. Left: Sirius Red Staining of carotids, Right: systolic blood pressure (upper panel) and relative collagen content in media regions (lower panel). WT: wild-type mice. αv^{SMKO} : knockout mice; in the absence (no Ang II) or presence (Ang II) at the indicated doses.

Electronic microscopy analysis of carotids of control and $\alpha\text{v}^{\text{SMKO}}$ mutant mice confirmed that there was no significant difference between the control and mutant mice at baseline at histological level (Figure 19). However, more collagen fibers (blue arrows, Figure 19) were observed between the elastin layer and smooth muscle cells in the media of Ang II-treated control and $\alpha\text{v}^{\text{SMKO}}$ mutant mice compared to the non-treated mice. In addition, less vesicles containing fiber-like materials (indicated by blue stars, Figure 19) were found in the smooth muscle cells of $\alpha\text{v}^{\text{SMKO}}$ mutant mice compared to the control mice. There is no significant difference in finger-like structures observed between the smooth muscle cells and extracellular matrix. In the adventitia, the content of collagen fibers was decreased in the $\alpha\text{v}^{\text{SMKO}}$ mutant mice when compared to control mice, the collagen fiber beam and fibroblasts are smaller in the $\alpha\text{v}^{\text{SMKO}}$ mutant mice than that in the control mice (Figure 19). This observation of electronic microscopy analysis is correlated with the results of the histological analysis. In addition, immunofluorescence staining experiments indicated that the expression of TGF- β 1 and TGF- β 1 receptor was decreased in the adventitia of Ang II-treated $\alpha\text{v}^{\text{SMKO}}$ mutant mice compared to control mice (Figure 20).

A



B

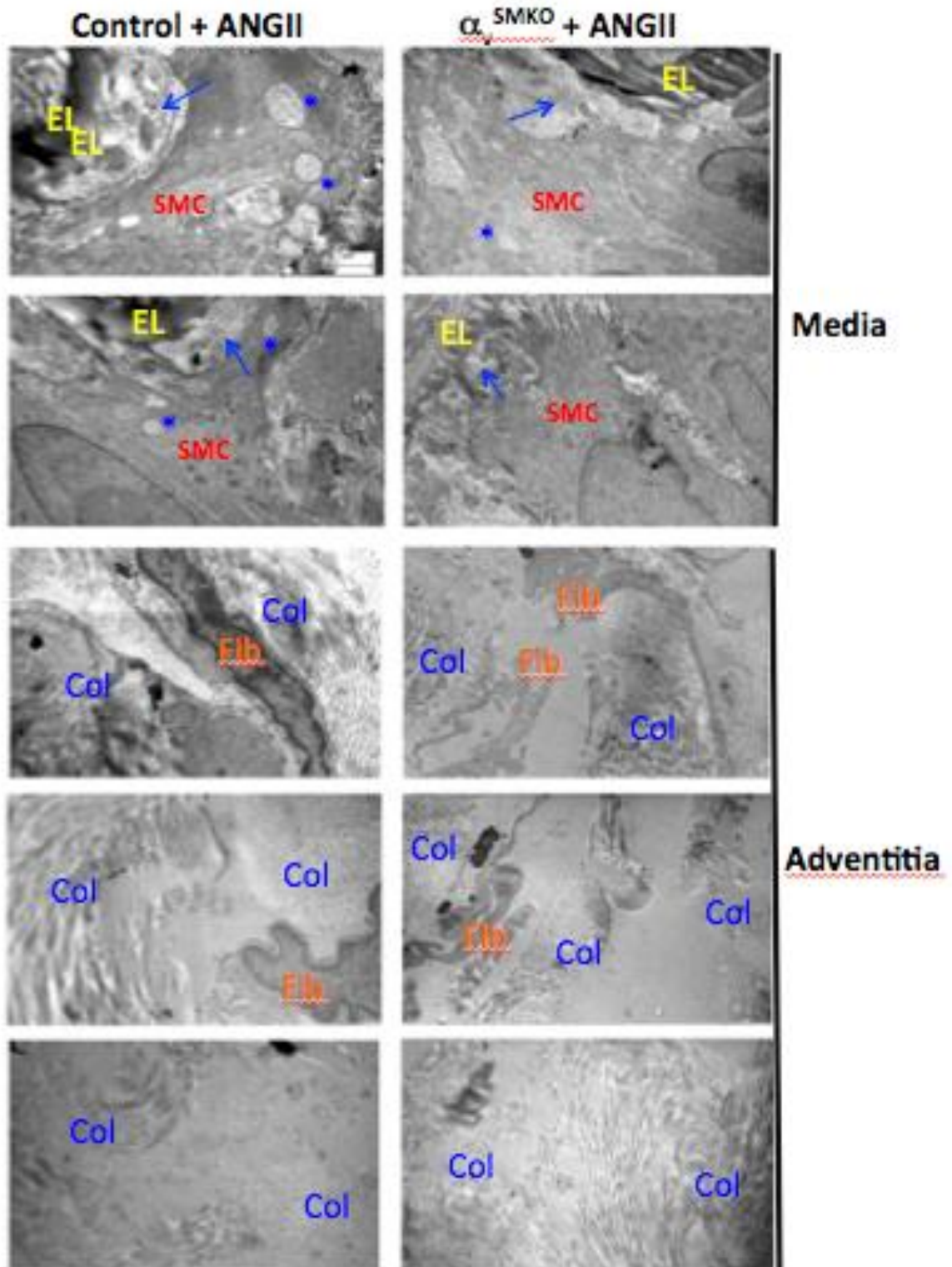

Figure 19. Electronic microscopy analysis of mice carotids. (A) Four representative images from the media region of carotids are presented in the upper panel and four representative images from the adventitia region in the lower panels. (B) Four representative images from the media region of carotids are presented in the upper panel and six representative images from the adventitia region in the lower panels. Blue arrows indicate the collagen fibers in the media, and blue stars the vesicle containing fiber-like materials in the smooth muscle cells. Abbreviations: EL: elastin, En: endothelial cell, Col: Collagen,

SMC: smooth muscle cell, Fib: fibroblast.

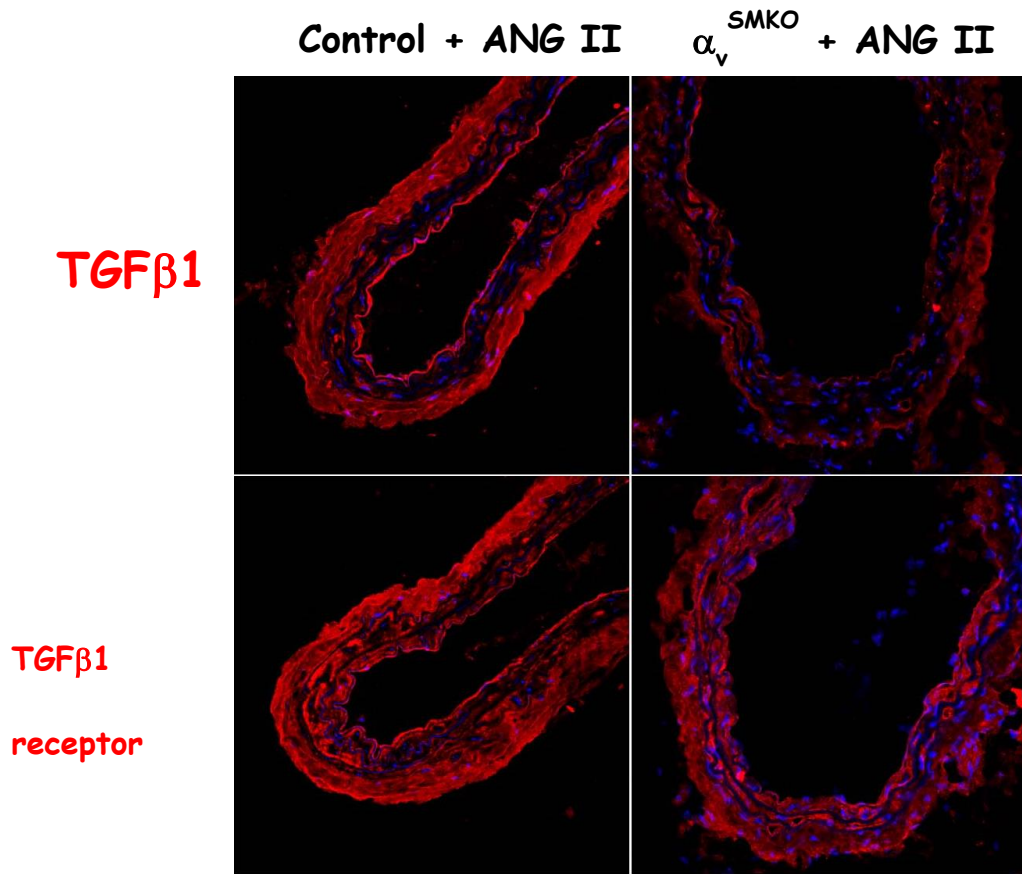

Figure 20. Decreased TGF- β 1 and its receptor in Ang II-treated carotids of α_v SMKO mice. Confocal microscopy analysis of TGF- β 1 and TGF- β 1 receptor of carotids from Ang II-treated control and α_v mutant mice. TGF- β 1 and TGF- β 1 receptor are shown in red and nuclei in blue.

1.2 Transcriptomic analysis of α_v^{SMKO} and WT mice.

With the aim to identify the alteration in gene expression due to lack of integrin α_v , we used the method of microarray to analyse the gene expression of integrin α_v^{SMKO} and WT. Four groups mice were used: 1: WT (wild-type); 2: Integrin α_v^{SMKO} (inactivation of integrin α_v in SMC); 3: WT+Ang II; 4: Integrin α_v^{SMKO} +Ang II. Mice aged 3-4 months were treated with tamoxifen injection each day for three days (1 mg/day/mouse). 15 days after tamoxifen injection, mice included in group 3 and 4 mice were treated with Ang II for 28 days. At the end of treatment, thus 45 days after tamoxifen injection, mice were killed. Thoracic aorta was isolated and RNAs were prepared. RNAs were reverse transcribed into cDNA and hybridized to Affymetrix arrays at genomic platform

of Cochin Institute. Profile of expression change was obtained (FC (fold change) > 1,2 p < 0,05).

Table 2. Number of genes that have been differently expressed

Group	<u>up-regulated genes</u>	<u>down-regulated genes</u>
α_v^{SMKO} vs WT	169	519
α_v^{SMKO} +ANGII vs WT+ANGII	459	91
α_v^{SMKO} +ANGII vs α_v^{SMKO}	674	446
WT+ANGII vs WT	2323	2277

The result of microarray indicated that the number of down-regulated genes was higher than that of upregulated genes in α_v^{SMKO} mice. Moreover, the treatment with Ang II induces more changes in gene expression in WT mice compared to mutant mice (Table 2).

Table 3. The genes whose expression is increased by knock-out of integrin α_v

Gene	α_v^{SMKO} vs WT	α_v^{SMKO} +ANGII vs α_v^{SMKO}	α_v^{SMKO} +ANGII vs WT
	<u>Fold change</u>	<u>Fold change</u>	<u>Fold change</u>
<u>Ttn</u>	6,157	-6,161	-0,004
<u>Ckmt2</u>	3,933	-3,681	0,252
<u>Actn2</u>	3,029	-2,628	0,401
<u>Sln</u>	2,874	-2,81	0,064
<u>Cox6a2</u>	2,737	-2,339	0,398
<u>Nrap</u>	2,394	-1,974	0,42
<u>Txinb</u>	2,109	-2,191	-0,082
<u>Xirp2</u>	2,089	-2,011	0,078
<u>Ppp1r3a</u>	1,998	-2,011	-0,013
<u>Myh7</u>	1,939	-1,698	0,241
<u>Lrrc2</u>	1,852	-1,743	0,109
<u>Trdn</u>	1,848	-1,863	-0,015
<u>Fsd2</u>	1,678	-1,531	0,147
<u>Asb15</u>	1,521	-1,432	0,089
<u>Klhl41</u>	1,425	-1,527	-0,102

We identified a group of 16 genes (Table 3) whose expression was increased in α_v^{SMKO} mice (α_v^{SMKO} vs WT column), indicating that integrin α_v could be involved in the negative control pathway of expression of these genes. This inhibitory effect was abolished by Ang II treatment of mutant mice for the genes such as Ttn, Txinb, Ppp1r3a, Trdn et Klhl41 (α_v^{SMKO} + ANGII vs α_v^{SMKO}

column) so that the difference of expression of these genes between α_v^{SMKO} + ANGII and WT mice is near zero (last column). This inhibitory effect was abolished partially for genes like Ckmt2, Actn2, Sln, Cox6a2, Nrap, Xirp2, Myh7, Lrrc2, Fsd2, et Asb15 (last column).

Table 4. The genes whose expression is decreased by knock-out of integrin α_v

Gene	α_v^{SMKO} vs WT Fold change	WT+ANGII vs WT Fold change	α_v^{SMKO} vs WT+ANGII Fold change
Slc22a3	-2,683	-2,749	0,066
Scn3b	-1,52	-1,51	-0,01
Efemp1	-1,491	-1,904	0,413
Glo1	-1,439	-1,635	0,196
Russfg	-1,428	-1,409	-0,019
Zfg960	-1,374	-1,767	0,393
Ndn	-1,37	-1,644	0,274
C19tnt3	-1,368	-1,428	0,06
Smc4	-1,36	-1,418	0,058
Wbp5	-1,356	-1,445	0,089
Zfg97	-1,341	-1,617	0,276
Rps25	-1,302	-1,489	0,187
Adamts15	-1,293	-1,559	0,266
Rpl36a	-1,245	-1,465	0,22
Rps4x	-1,244	-1,405	0,161
Npm1	-1,241	-1,491	0,25

We also identified a group of 16 genes (Table 4) whose expression was decreased in α_v^{SMKO} mice (α_v^{SMKO} vs WT column), indicating that integrin α_v could be involved in the positive control pathway of expression of these genes. It is interesting to note that the treatment of Ang II in the wild-type mice resulted in similar effect on the expression of these genes (WT + ANGII vs WT column), suggesting that the pathways linked to integrin α_v on the expression of these genes could be inhibited by the treatment of Ang II. Last column compared the value obtained from α_v^{SMKO} and ANG II-treated WT mice, indicating the similar value in the mice of these two groups.

By using software « Ingenuity Pathway Analysis » provided by affyletrix company, we identified five pathways that were more implicated in the change of gene expression in the groups of α_v^{SMKO} vs WT, WT + ANGII vs WT and α_v^{SMKO} + ANGII vs α_v^{SMKO} (Table 5). The pathway “Hepatic Fibrosis/Hepatic Stellate Cell Activation” is the common pathway found in these three groups (yellow in Table 5).

Table 5. The five pathways more implicated in the change of gene expression

α_v^{SMKO} vs WT	WT+ANGII vs WT	α_v^{SMKO} +ANGII Vs α_v^{SMKO}
<u>ILK Signaling</u>	<u>Hepatic Fibrosis / Hepatic Stellate Cell Activation</u>	<u>Cholesterol Biosynthesis</u>
<u>T Cell Receptor Signaling Hematopoiesis from</u>	<u>PAK Signaling</u>	<u>Cholesterol Biosynthesis II (via 24,25-dihydrolanosterol)</u>
<u>Pluripotent Stem Cells Primary</u>	<u>Adipogenesis pathway</u>	<u>Cholesterol Biosynthesis III (via Desmosterol)</u>
<u>Immunodeficiency Signaling</u>	<u>Glioblastoma Multiforme Signaling</u>	<u>Hepatic Fibrosis / Hepatic Stellate Cell Activation</u>
<u>Hepatic Fibrosis / Hepatic Stellate Cell Activation</u>	<u>Neuregulin Signaling</u>	<u>Pathway of Cholesterol Biosynthesis</u>

Note: common pathway is colored in yellow.

We examined the genes involved in fibrosis pathway. 56 of 176 genes in this pathway are changed in the group WT+ANG II vs WT (first column in Table 6); 28 genes in the group α_v^{SMKO} +Ang II vs α_v^{SMKO} (second column in Table 6) and 8 genes in the group α_v^{SMKO} vs WT (third column in Table 6). The 20 of 28 genes indicated by yellow colour in the group α_v^{SMKO} +ANG II vs α_v^{SMKO} (second column) were present in the group WT+Ang II vs WT (first column). The change on the expression of these 20 genes is similar between these two groups, suggesting that the expression of these genes is less dependent on the pathways linked to integrin α_v under the Ang II treatment. On the other hand, the expression of genes that is increased only in the group WT+ANG II vs WT (first column), but not in α_v^{SMKO} +ANG II vs α_v^{SMKO} (second column), such as COL11A2, COL13A1, COL16A1, COL22A1, COL24A1, COL25A1, COL27A1, COL4A1, COL4A3, COL4A4, COL5A3, COL6A6, COL7A1, COL8A2, COL9A2, COL9A3, FGF2, FGFR1, IFNGR2, IL1B, LHX2, MYL6B, PDGFA, TGFB1, TNF, TNFRSF1B and SERPINE1, could be dependent directly or indirectly on the pathways relayed by integrin α_v . Higher fibrosis-related genes activation by Ang II in the WT mice is consisted with the more fibrosis in WT mice compared to α_v^{SMKO} mice.

Table 6. Genes involved in fibrosis pathway

WT+ANGII vs WT		a _v ^{SMKO} +ANGII vs Itgav- SMKO		a _v ^{SMKO} vs WT	
Gene	Fold Change	Gene	Fold Change	Gene	Fold Change
Agtr1b	1.204	BAMBI	-1.339	COL3A1	-1.254
CD40	1.223	BCL2	-1.352	FIGF	-1.255
COL11A2	1.275	COL15A1	1.739	IGF1	-1.385
COL13A1	1.276	COL18A1	1.327	MYH7	1.840
COL15A1	1.934	COL1A1	1.641	MYL3	1.564
COL16A1	1.256	COL1A2	1.300	PGF	1.211
COL18A1	1.749	COL3A1	1.431	SERPINE1	1.926
COL1A1	1.291	COL4A2	1.409	VEGFB	1.215
COL22A1	1.264	COL5A1	1.254		
COL24A1	1.224	COL5A2	1.433		
COL25A1	1.239	COL6A3	1.597		
COL27A1	1.252	COL8A1	1.727		
COL4A1	1.297	CSF1	-1.277		
COL4A2	1.511	EDN1	-1.403		
COL4A3	1.267	FAS	-1.416		
COL4A4	1.207	FN1	1.669		
COL5A1	1.373	IGF1	1.353		
COL5A2	1.336	KDR	1.743		
COL5A3	1.295	LEPR	-1.755		
COL6A3	1.492	MMP2	1.363		
COL6A6	-1.333	MYH7	-1.662		
COL7A1	1.279	MYH10	-1.323		
COL8A1	2.139	MYH11	-1.235		
COL8A2	1.289	PDGFB	1.460		
COL9A2	1.306	PDGFC	1.478		
COL9A3	1.260	PGF	1.260		
CSF1	-1.215	TIMP1	1.363		
EDN1	-1.537	TNFRSF11B	2.010		
EGFR	-1.301				
FAS	-1.435				
FGF2	1.352				
FGFR1	1.202				
FN1	2.059				
IFNGR2	1.219				
IL1B	1.202				
LEPR	-2.280				
LHX2	1.208				
MYH10	-1.292				
MYH11	-1.222				
MYH7B	1.208				
MYL6	-1.248				
MYL6B	1.322				
PDGFA	1.330				
PDGFB	1.688				
PDGFC	1.954				
PDGFD	-1.488				
PDGFRA	-1.530				
PGF	1.572				
SERPINE1	2.481				
SMAD4	-1.279				
TGFB1	1.329				
TIMP1	1.559				
TNF	1.265				
TNFRSF11B	2.452				

Note: Common genes between the groups are colored in yellow, three genes with opposite expression profile between column two and three are colored in green. One gene common to column one and three in red.

The TGF- β pathway is the major pathways for the tissue fibrosis. We compared

the different groups. Among the 23 genes involved in this pathway in the comparison of WT+ANG II vs WT, there are only 4 genes which are changed in the comparison α_v^{SMKO} +ANG II vs α_v^{SMKO} . One gene Serpine1 in the comparison α_v^{SMKO} vs WT. Overall, these results indicate that the activation of TGF- β pathway is less important in the mice lacking integrin α_v in SMCs in response to the Ang II treatment (Table 7).

Table 7. Genes involved in TGF- β pathway

gene	WT+ANGII vs WT Fold Change	α_v^{SMKO} +ANGII vs α_v^{SMKO} Fold Change	α_v^{SMKO} vs WT Fold Change
ACVR2A	-1.327		
AMHR2	1.206		
BMPR1A	-1.621	-1,34	
CREBBP	-1.303	-1,279	
EP300	-1.260		
GSC	1.213		
HOXC9	1.212		
INHBB	1.244		
IRF7	1.209		
MAP2K3	1.316	1,219	
MAPK8	-1.312		
NKX2-5	1.298		
NODAL	1.273		
NRAS	-1.276		
PITX2	1.210		
PMEPA1	1.310		
RAF1	-1.292		
SERPINE1	2.481		1,934
SMAD4	-1.279		
SOS1	-1.219		
SOS2	-1.258		
TGFB1	1.329	1,104	
TLX2	1.405		

Note: Common genes between the column two and three are colored in yellow, One gene common to column two and four in red.

The capacity of contraction/relaxation is a character of smooth muscle cells. Therefore, we also examined the genes involved in the actin cytoskeleton pathway. We found that the expression of 45 genes over 216 of this pathway was altered in the comparison WT+ANG II vs WT, 17 genes in the comparison α_v^{SMKO} +ANG II vs α_v^{SMKO} and 6 genes in the comparison α_v^{SMKO} vs WT (table 8). We observed 9 of 17 genes (in yellow) in the comparison α_v^{SMKO} +ANG II vs α_v^{SMKO} were presented in the group WT+ANG II vs WT. The change trend of these genes is similar between these two groups, indicating that their expression is not dependent on the pathway relayed by integrin α_v in response

to Ang II treatment. On the other hand, the genes whose expression is increased only in the comparison WT+ANG II vs WT, such as APC2, ARHGEF4, BCAR1, FGF2, FGF3, FGF8, FGF16, FGFR1, FGFR4, INS, IQGAP3, ITGA3, ITGA5, LIMK1, MATK, MYH7B, MYL10, MYL6B, MYLK2, PAK3, PAK6, PDGFA et TIAM2, could be directly or indirectly on the integrin α related pathways. The expression of other genes like IRS1, MYL6, MYL12A, NRAS, PAK2, PDGFD, PIK3C3, PIK3R1, PPP1CB, RAF1, RDX, SOS1 and SOS2, is decreased only in the comparison WT+ANG II vs WT, suggesting that their expression could be linked directly or indirectly to the inhibition of the integrin α v related pathway by Ang II treatment. Involvement of these genes in the phenotype of contraction/relaxation in the mice requires to be further studied. Four genes (ACTN2, MYH7, PIK3R3 et TTN in green) have the opposite trends between the comparison of α_v^{SMKO} +ANG II vs α_v^{SMKO} and α_v^{SMKO} vs WT (Table 8).

Table 8. The genes involved in the actin cytoskeleton pathway

WT+ ANGII vs WT		a _v ^{SMKO} +ANGII vs Itgav-SMKO		a _v ^{SMKO} vs WT	
Gene	Fold Change	Gene	Fold Change	Gene	Fold Change
APC2	1.252	ACTG2	-1.353	ACTN2	3.595
ARHGEF4	1.246	ACTN2	-3.066	MYH7	1.840
BCAR1	1.301	CRKL	-1.205	MYL3	1.564
CRKL	-1.229	FN1	1.669	PIK3R3	-1.257
FGF2	1.352	GSN	-1.242	TIAM2	1.211
FGF3	1.243	KNG1	2.753	TTN	6.900
FGF8	1.204	MYH7	-1.662		
FGF16	1.502	MYH10	-1.323		
FGFR1	1.202	MYH11	-1.235		
FGFR4	1.229	PDGFB	1.460		
FN1	2.059	PDGFC	1.478		
GSN	-1.376	PIK3R3	1.331		
INS	1.396	PIP5K1B	-1.511		
IQGAP3	1.257	PPP1R12A	-1.547		
IRS1	-1.324	Ppp1r12b	-1.267		
ITGA3	1.323	ROCK1	-1.802		
ITGA5	1.807	TTN	-6.922		
LIMK1	1.203				
MATK	1.244				
MYH10	-1.292				
MYH11	-1.222				
MYH7B	1.208				
MYL6	-1.248				
MYL10	1.209				
MYL12A	-1.334				
MYL6B	1.322				
MYLK2	1.496				
NRAS	-1.276				
PAK2	-1.203				
PAK3	1.301				
PAK6	1.217				
PDGFA	1.330				
PDGFB	1.688				
PDGFC	1.954				
PDGFD	-1.488				
PIK3C3	-1.203				
PIK3R1	-1.319				
PPP1CB	-1.360				
PPP1R12A	-1.688				
RAF1	-1.292				
RDX	-1.342				
ROCK1	-1.853				
SOS1	-1.219				
SOS2	-1.258				
TIAM2	1.418				

Note: Common genes between the groups are colored in yellow, four genes with opposite expression profile between column two and three are colored in green. One gene common to column one and three in red.

1.3 Ang II or TGF- β induces the upregulation of fibrosis-related proteins by integrin α v in vitro

With the aim to investigate in detail integrin α v role in TGF-mediated fibrosis and the underlying signaling pathway, we exploited an in vitro model consisting of VSMCs. A primary culture of mouse VSMCs was established by enzymatic digestion of aorta of the loxP-flxed integrin α v mice in which exon 4 was flanked by two loxP sequences, and then we transfected the cells with adeno-cre-GFP to knock down integrin α v, or adeno-GFP as control. Adeno-cre reduced the protein expression of integrin α v by 85% (Figure 21). Following 48h of Ang II treatment, we found that Ang II increased the expression of fibrosis-related proteins such as fibronectin, collagen1A1, collagen3A1 and galectin-3. However, when integrin α v was knocked down, Ang II could not increase the expression of these fibrosis-related proteins (Figure 21). These data indicate that integrin α v is involved in the increasing expression of these fibrosis-related proteins induced by Ang II in VSMCs.

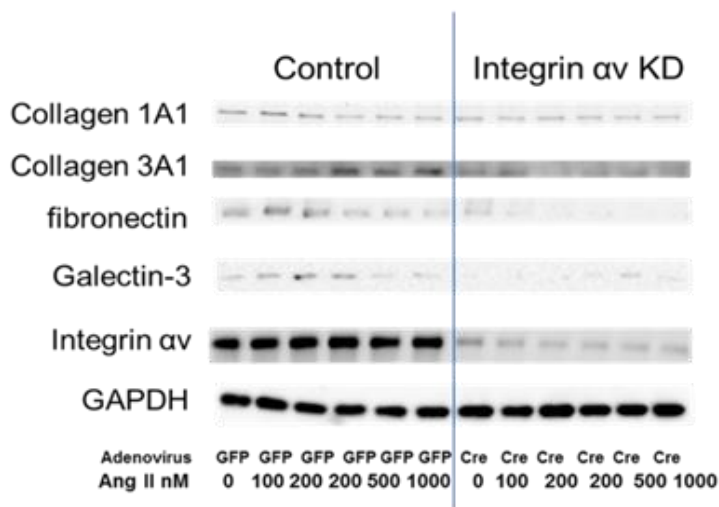

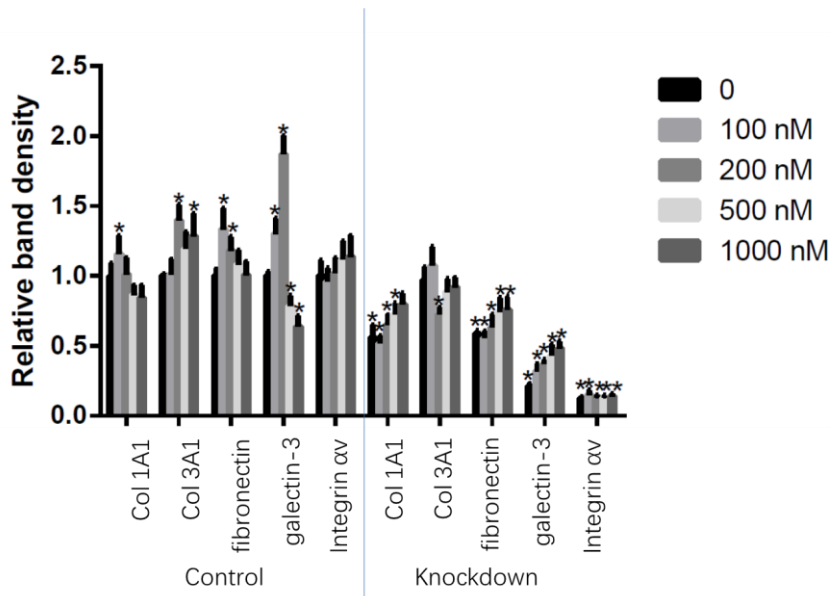
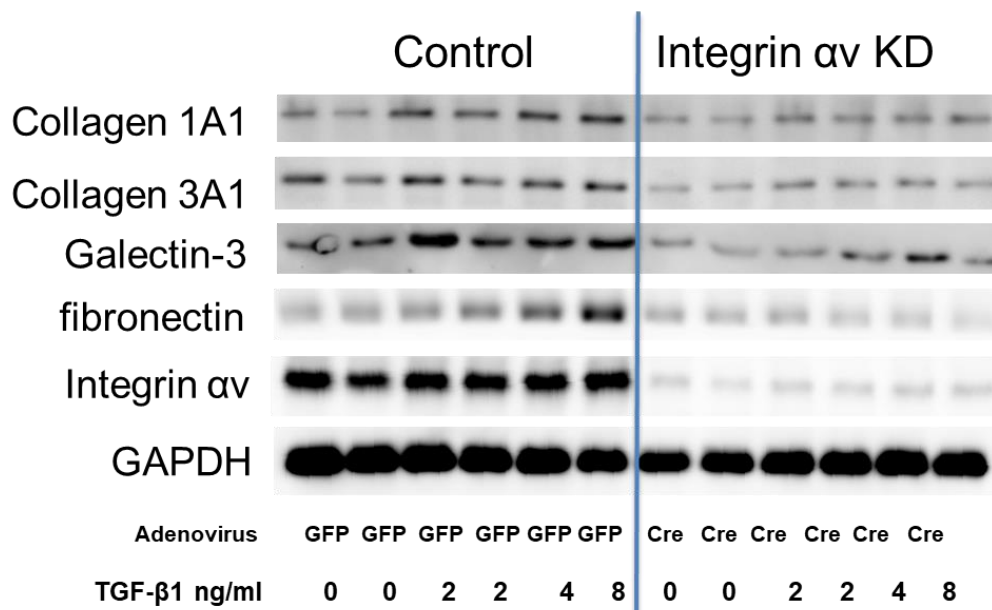

Figure 21. Western blot analysis of control and integrin α knock-down (KD) VSMCs at the baseline and under Ang II treatment. Ang II-induced upregulation of fibrosis-related proteins is decreased by integrin α knock-down. GAPDH is used as the loading control. Densitometric measurements of replicate results are given in the down panel. Band density of VSMCs infected with GFP adenovirus was chosen as reference for relative expression and set to 1. *P<0.05 compared with control.

We also treated VSMCs with TGF- β 1 for 48h, and the expression of fibronectin, collagen1A1, collagen3A1 and galectin-3 was analysed by Western blot. As expected, TGF- β 1 could increase the expression of fibronectin, collagen 1A1 and galectin-3 in control cells, while in integrin α knockdown cells, TGF- β 1 could not upregulate the expression of these fibrosis related proteins (Figure 22).



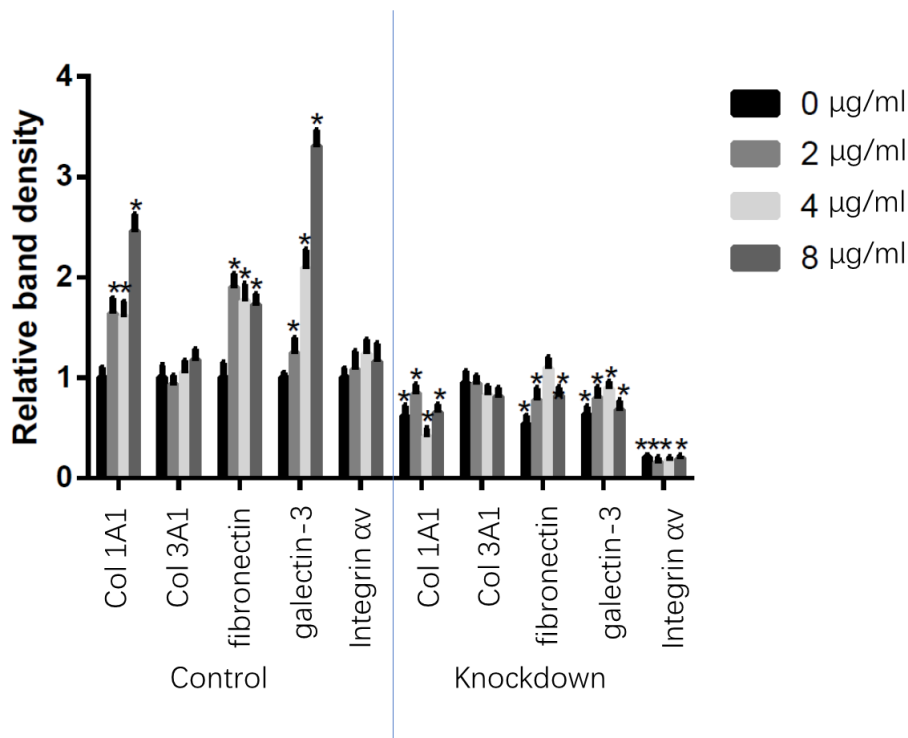

Figure 22. Western blot analysis of control and integrin αv knock-down (KD) VSMCs at the baseline and TGF- $\beta 1$ treatment. TGF- $\beta 1$ induces the upregulation of fibrosis-related proteins is inhibited by integrin αv knock-down. GAPDH is used as the loading control. Densitometric measurements of replicate results are given in the down panel. Band density of VSMCs infected with GFP adenovirus was chosen as reference for relative expression and set to 1. * $P < 0.05$ compared with control.

1.4 Ang II or TGF- β induces the activation of ERK and smad-2/3 signaling pathways via integrin αv .

In order to characterize the signal transduction pathways activated by Ang II in VSMCs, we used the most effective Ang II concentration (200 nM) to deal with VSMCs for a relatively short time (30 min to 8h). The phosphorylation of smad-2 and ERK1/2 was detected by Western blot. As expected, Ang II could obviously activate ERK signaling pathways after 30 min treatment with a maximal effect after 1h. The phosphorylation of smad-2 was observed 1h after the treatment of Ang II and reached to the highest level at 2h, indicating slightly lower kinetics. The knock-down of integrin αv effectively reduced Ang II induced activation of these two signaling pathways (Figure 23).

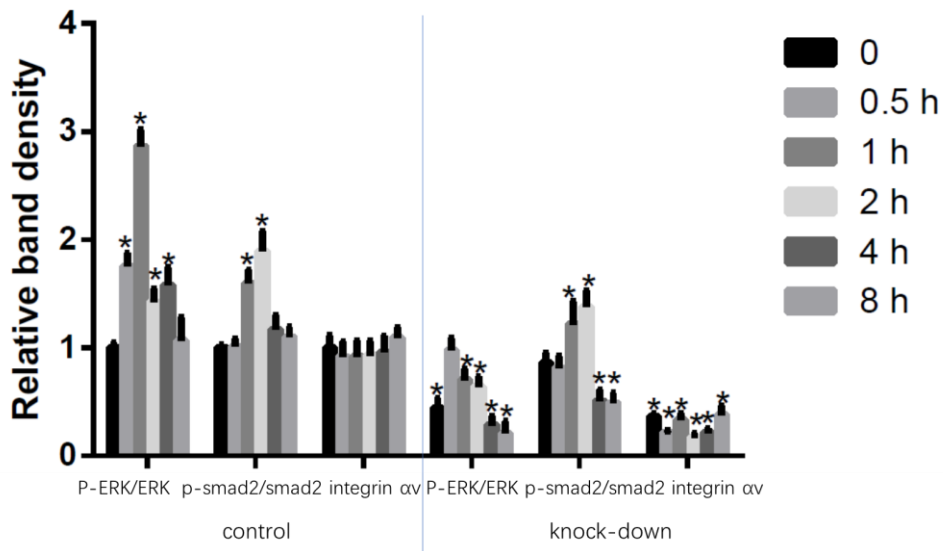
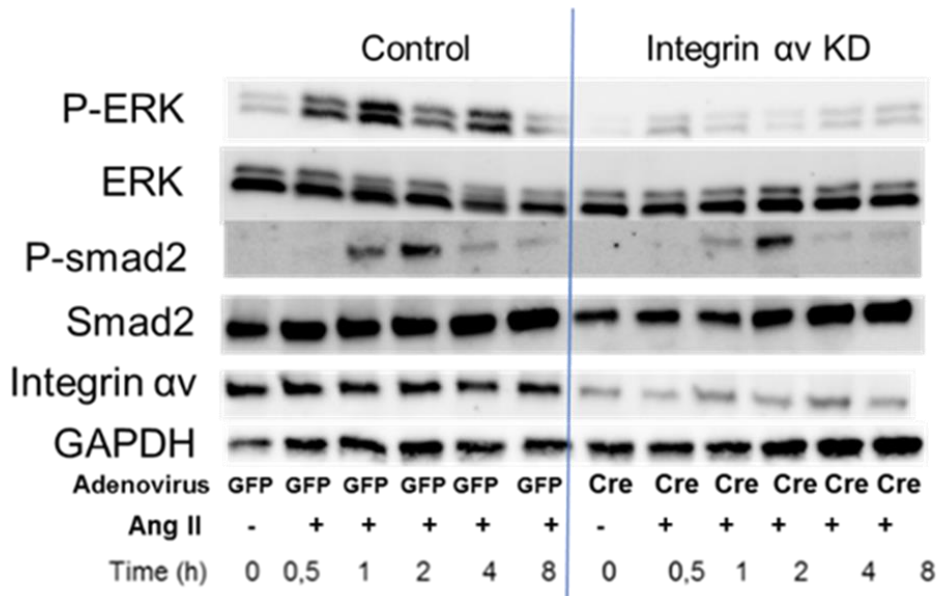

Figure 23. Western blot analysis of phosphorylation of ERK1/2 and smad-2 in control and integrin α v knock-down (KD) VSMCs in response to Ang II treatment. Ang II induces the phosphorylation of ERK1/2 and smad-2 is decreased by integrin α v knock-down. GAPDH is used as the loading control. Ang II concentration used in experiment is 200 nM. Densitometric measurements of replicate results are given in the down panel. Band density of VSMCs infected with GFP adenovirus was chosen as reference for relative expression and set to 1. *P<0.05 compared with control.

TGF- β 1 was also applied to deal with VSMCs, we find that TGF- β 1 significantly increases the phosphorylation of smad-3 and ERK1/2. The phosphorylation of smad-3 and ERK1/2 reaches a peak after the treatment of TGF- β 1 for 2h. In integrin α v knock-down cells, phosphorylation of smad-3 and ERK1/2 induced by TGF- β 1 is decreased (Figure 24).

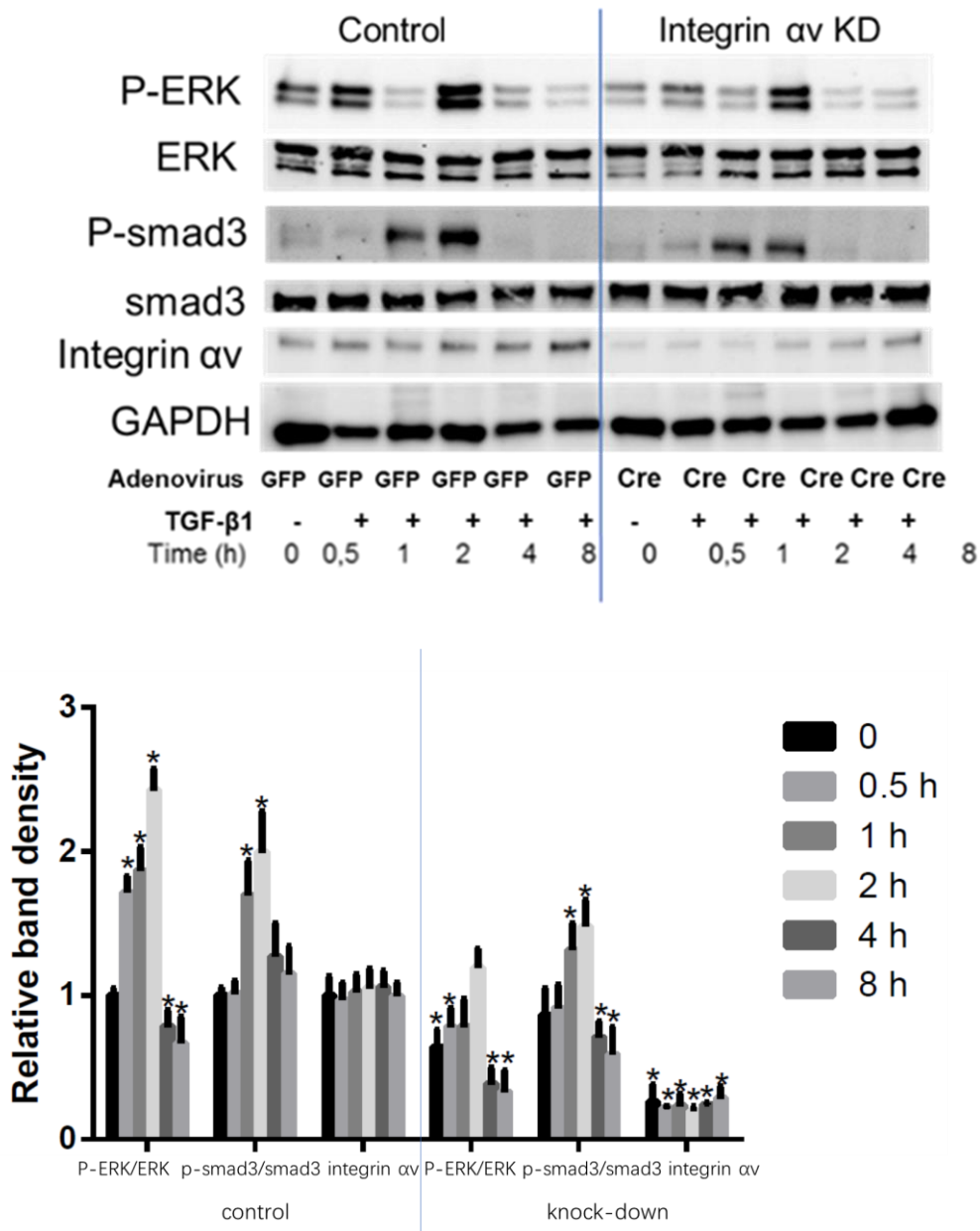

Figure 24. Western blot analysis of phosphorylation of ERK1/2 and smad-3 in control and integrin α knock-down (KD) VSMCs in response to TGF- β 1 treatment. TGF- β 1 induced the phosphorylation of ERK1/2 and smad3. Knock-down integrin α abolishes the early TGF- β 1 induces P-ERK peak and diminishes TGF- β 1 induced smad3 phosphorylation. GAPDH is used as the loading control. The concentration of TGF- β 1 used in the experiments is 2 ng/ml. Densitometric measurements of replicate results are given in the down panel. Band density of VSMCs which is transfected with GFP chosen as a reference for relative expression and set to 1. *P<0.05 compared with control.

Part II Galectin-3 induces the activation of VSMCs via integrin α v/AKT/Wnt/ β -catenin signaling pathway

2.1 Integrin α v interacts with galectin-3 and mediates galectin3-induced synthesis of fibrosis-related proteins in VSMCs

Galectin-3 is a member of the β -galactoside-binding lectin family, integrin α v is a cell surface receptor. It has been reported that galectin-3 and integrin α v play an important role in cardiac fibrosis (Chen, et al., 2016, Dunic, et al., 2006). The observed co-regulation of gal3 and integrin α v prompted us to further explore a possible interaction of these two proteins. By using the Duolink method, we found that integrin α v is a galectin-3 binding protein (Figure 25). By the comparison of the same experiment in the absence or presence of Triton-100, we did not observe any difference in the signal, which suggests that such interaction occurs at the cell surface (Figure 25A and B).

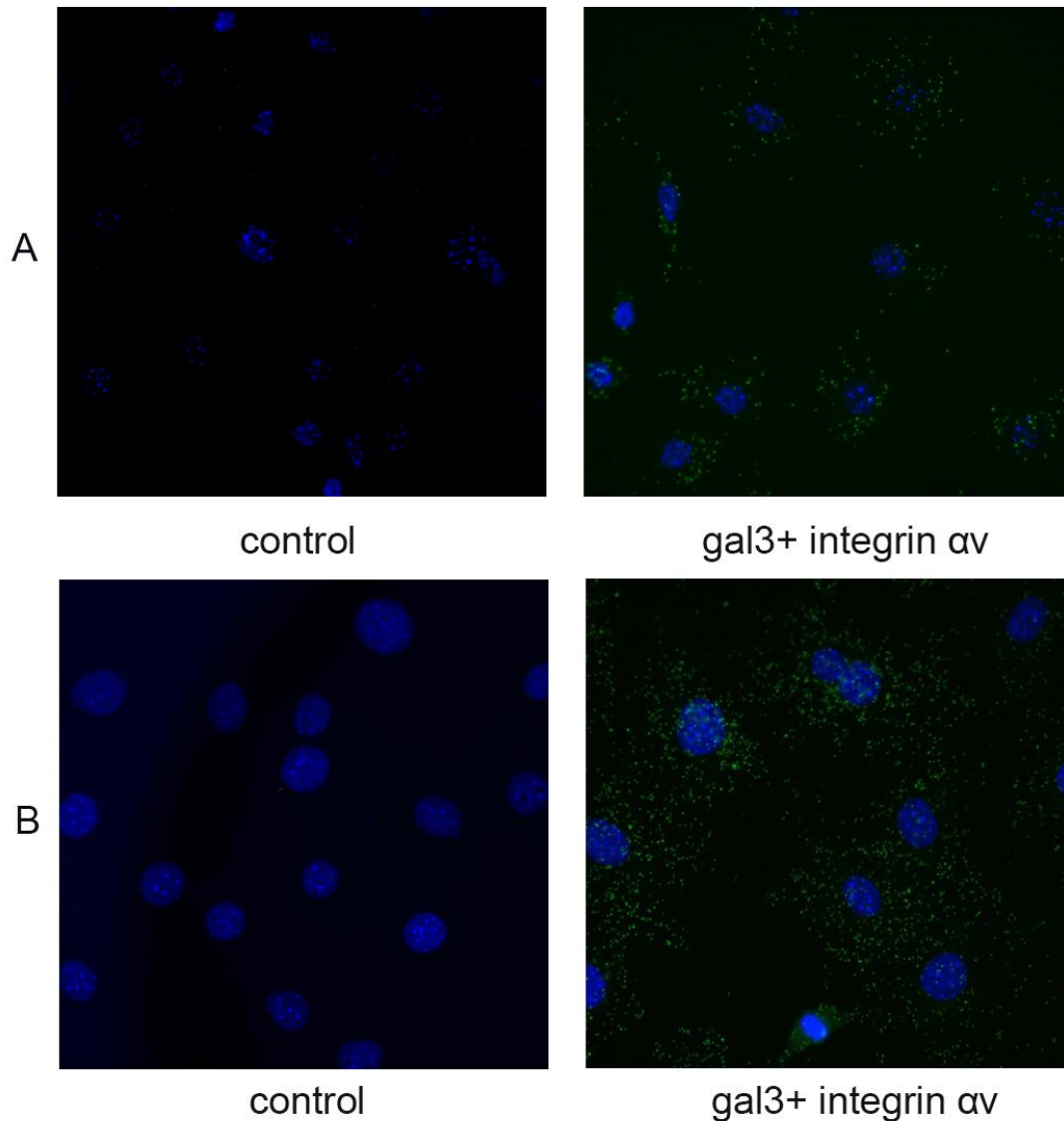

Figure 25. Galectin-3 interacts with integrin αv . The cells were incubated with 10 $\mu\text{g/ml}$ his-tagged galectin-3 for 30min (gal3 + integrin) or not (control). The interaction between his-tagged galectin-3 and integrin αv was detected by Duolink (CD3 and myoD antibody were used as negative control): the green signal represents interaction, while nuclei were counterstained in blue. After fixing, cells were treated by 0.5% Triton X-100 for 20min (A) or not (B) before using blocking buffer. Representative images of the cells are shown.

Some ECM proteins (col1A1, col3A1, fibronectin and laminin) are well known for their role in the process of vascular fibrosis and contribute to arterial stiffness in aging and hypertension (Harvey, et al., 2016), therefore, we explored the effects of galectin-3 on the expression of these proteins. We found that all of these proteins are upregulated by gal-3, in addition, knock-down of integrin αv significantly inhibits the expression of the ECM proteins in the absence or presence of gal-3 (Figure 26)

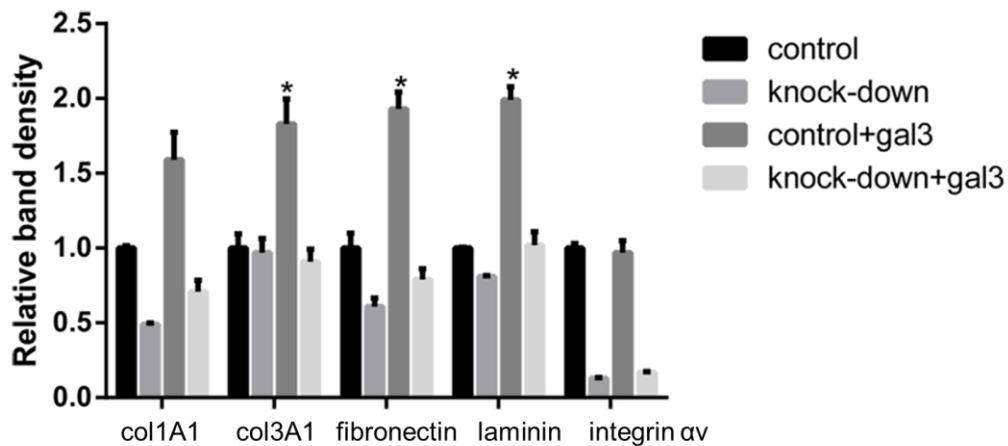
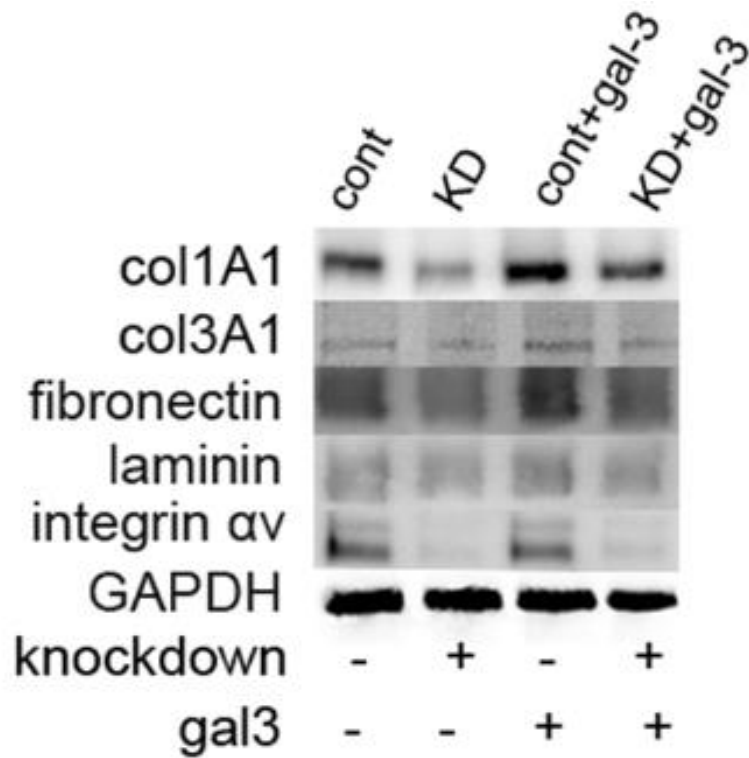
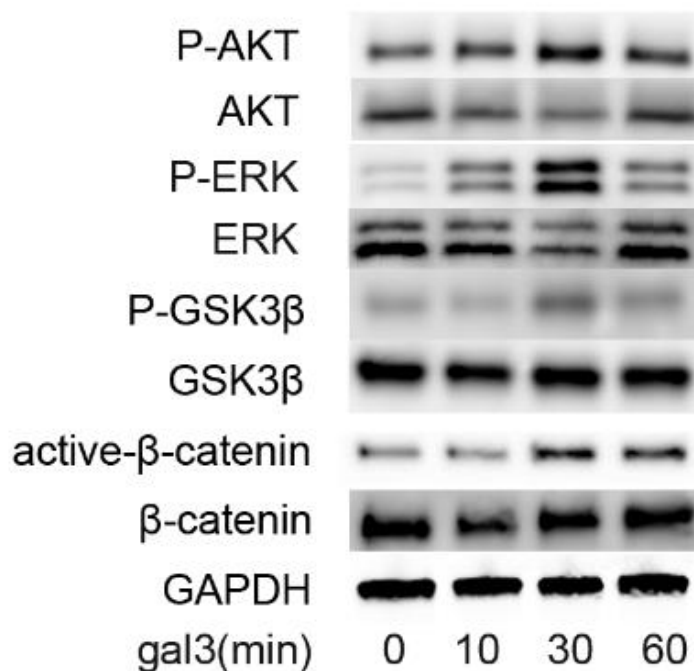

Figure 26. Galectin-3 induces expression of ECM proteins via integrin α . 48 h after infection with either GFP (control) or cre (knock-down) adenovirus, VSMC were incubated for 48 h in the absence or presence of galectin-3 (10 μ g/ml), the expression of col1A1, col3A1, fibronectin and laminin were measured by Western blot (upper panel). The GAPDH expression was used for protein level normalization. Densitometric measurements of replicate results are given in the down panel. Band density of VSMCs infected with GFP adenovirus was chosen as reference for relative expression and set to 1. *: P<0.05 compared with any other treatments. Data (means \pm SEM) were obtained from three independent experiments.

2.2 Integrin α_v mediates galectin-3-induced activation of AKT and Wnt/ β -catenin signaling pathways

While it has been reported that components of the galectin family could affect integrin clustering and function (Lakshminarayan, et al., 2014), the observation of a direct interaction between gal3 and integrin α_v was quite striking, and suggested us to verify whether gal3 could induce the activation of an integrin-dependent signal transduction. Therefore, we analysed the activation of the AKT-, ERK- and β -catenin signaling pathways in VSMCs. As shown by the accumulation of the phosphorylated forms of AKT and ERK by 30 min of galectin-3 treatment in VSMCs, these pathways were transiently activated, since the phosphorylated forms of AKT and ERK reached a peak by 30 min and was back to control (untreated) cells at 60 min (Figure 27). Galectin-3 also activated the Wnt/ β -catenin signaling pathway, as shown by GSK-3 β phosphorylation and by the accumulation of the active (nuclear) form of β -catenin in a more persistent manner, i.e. at 30 and 60 min of treatment (Figure 27).



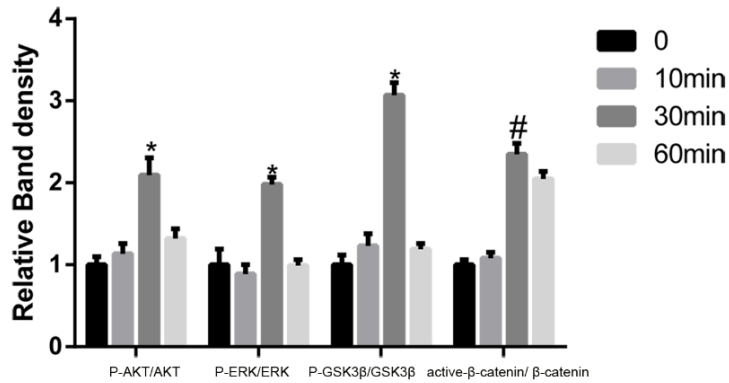

Figure 27. Time-dependence of galectin-3-mediated activation of ERK, AKT and Wnt/ β -catenin signaling pathways. Cells were treated with 10 μ g/ml of galectin-3 over a range of times (0-60min), and the expression of p-AKT, AKT, p-GSK3 β , GSK3 β , p-ERK, ERK, active β -catenin and β -catenin were measured by Western blot (upper panel). GAPDH protein expression was used as a loading control. Densitometric measurements of replicate results are given in the down panel. Band density of native VSMCs was chosen as a reference for relative expression and set to 1, *: $p < 0.01$ compared with any other time-points. #: $p < 0.01$ compared with the native VSMC. Data (means \pm SEM) were obtained from three independent experiments.

In order to demonstrate whether integrin α v is necessary to mediate the activation of the signaling pathways above in the presence of galectin-3, we infected the cells with adeno-GFP or adeno-cre to knock down integrin α v expression in VSMCs before galectin-3 treatment. After this treatment, galectin-3 was used to treat VSMCs for the shortest time (30 min) proven to be effective in the previous experiments. In these conditions, we found that the knock-down of integrin α v effectively reduces the phosphorylation of AKT, but not that of ERK and that galectin-3 increases the phosphorylation of AKT in a integrin α v-dependent fashion (Figure 28). We also analysed major effectors of Wnt signaling pathways, including β -catenin and GSK-3 β . We found that galectin-3 increases the phosphorylation of GSK-3 β , and inhibits the phosphorylation of β -catenin (active β -catenin is present in non-phosphorylated form) in a integrin α v-dependent fashion (Figure 28).

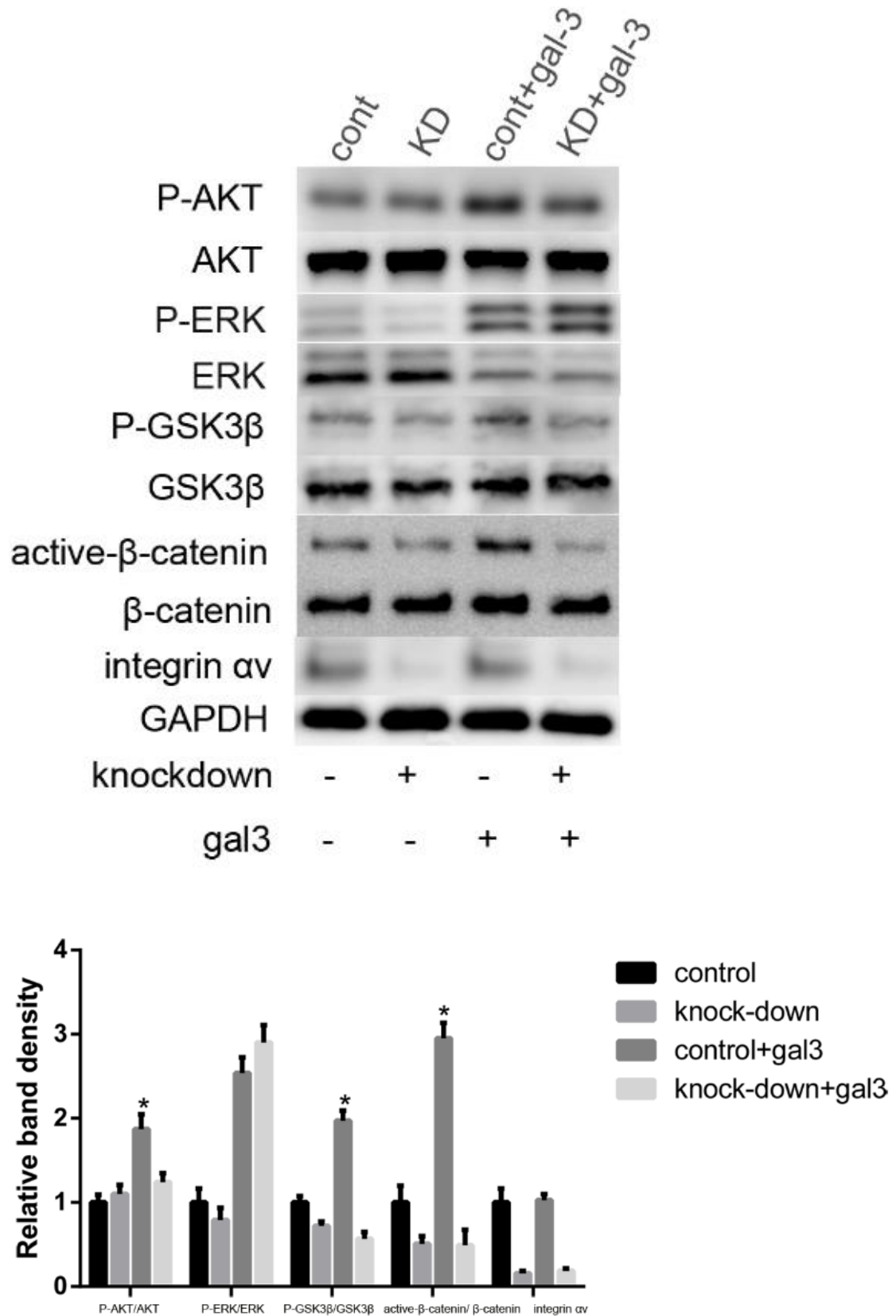

Figure 28. Integrin αv -mediated galectin-3-induced activation of AKT and Wnt/ β -catenin signaling pathways. After infection with either adeno-GFP or -cre for 48h, VSMC were incubated for 30min in the absence or presence of galectin-3(10 μ g/ml), the

expression of p-AKT, AKT, p-GSK3 β , GSK3 β , p-ERK, ERK, active β -catenin and β -catenin were measured by Western blot (upper panel). The GAPDH expression was used for protein level normalization. Densitometric measurements of replicate results are given in the down panel. The cells infected with adeno-GFP was chosen as a reference for relative expression and set to 1. *: P<0.05 compared with any other treatments. Data (means \pm SEM) were obtained from three independent experiments.

2.3 Integrin α v mediates the proliferation and migration induced by galectin-3 in VSMCs

Exogenous galectin-3 is known to promote VSMC proliferation and migration (Tian, et al., 2017), that play an important role in atherosclerosis and vascular remodeling. Wnt/ β -catenin signaling pathway is a well-known regulator of cell migration and proliferation. Proliferation and migration assays were performed to determine the effects of integrin α v silencing on cell motility and proliferation in the presence of galectin-3. Cell migration was increased by galectin-3 treatment and decreased by integrin α v knock-down, both in the absence and presence of galectin-3, indicating that integrin α v expression is dominant over galectin-3 effect (Figure 29A and B). Similarly, we found that silencing of integrin α v decreases VSMCs proliferation in respect to control, untreated cells and totally abolishes galectin-3-induced increase of cell proliferation (Figure 29C).

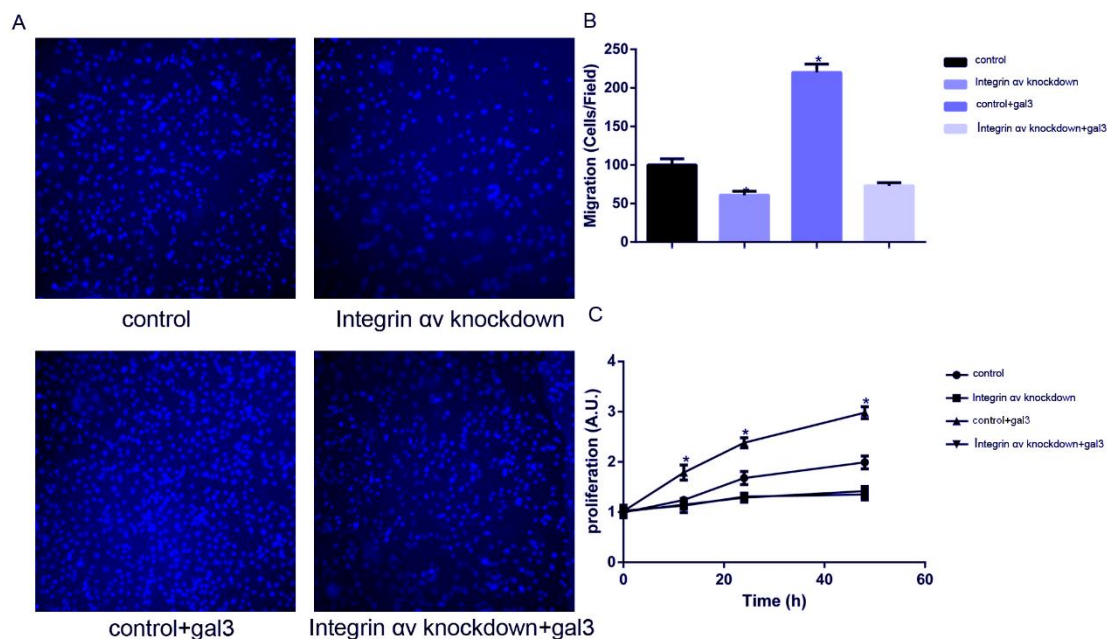

Figure 29. Integrin α_v mediates gal3-induced VSMCs activation. Cell migration was tested by a transwell method: the cells migrated to the lower surface of each chamber in response to the indicated treatment are shown (A); in particular, after infection with either adeno-GFP or -cre for 48h, VSMCs were incubated for 12h in the absence or presence of galectin-3 (10 μ g/ml), migration was tested by a transwell method. Migrated cells from the upper chamber to the lower chamber were counted in five non-overlapping fields under a microscope (100x). Data are represented as the mean \pm SEM in B (n=5). Turkey HSD was used as a post-hoc test, *: P< 0.05 vs any other treatments. Cell proliferation was detected by MTT assay (C). After infection with either adeno-GFP or -cre for 48h, VSMCs were incubated for 12h, 24h or 48h in the absence or presence of galectin-3 (10 μ g/ml) and the cell number assessed. Cells infected with adeno-GFP were defined as control. *: P< 0.05 vs any other treatments.

2.4 Integrin α_v does not mediate the endocytosis of galectin-3

Integrin α_v has been proven to mediate endocytosis (Lakshminarayan, et al., 2014), It will be interesting to observe the effects of integrin α_v in regulating the endocytosis of galectin-3. After knock down of integrin α_v using Adeno-cre, the VSMCs were incubated with his-tagged galectin-3 for 2h, and then analysed by immunofluorescence staining using anti-his antibody, we observed that the endocytosis of his-tagged galectin-3 in VSMCs was not affected by integrin α_v knock down (Figure 30).

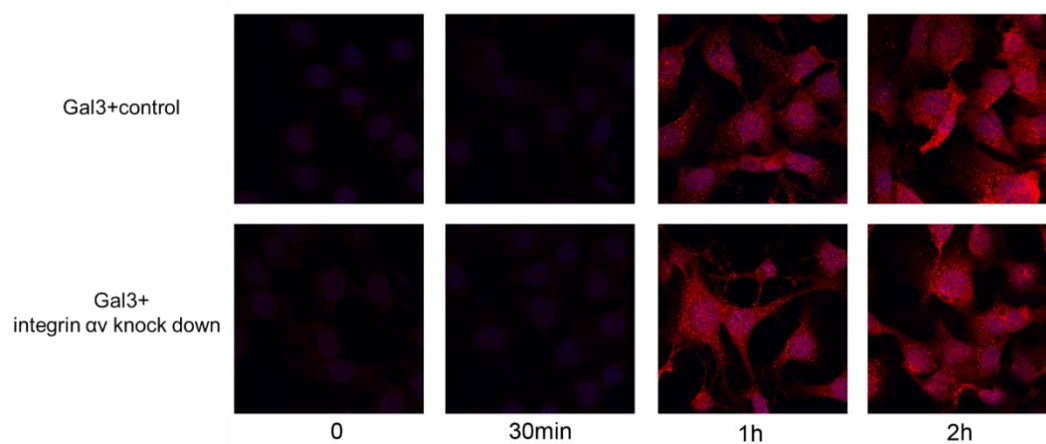

Figure 30. Integrin α_v does not mediate endocytosis of galectin-3. After infection with either adeno-GFP (control) or -cre (knock-down) for 48h, VSMCs were incubated with his-tagged galectin-3 (10 μ g/ml) for up to 2 h, the confocal images of VSMCs used anti his-tag (red) antibodies, followed by DAPI nuclear counter staining (blue) are shown. The merged images are shown.

2.5 Galectin-3 induces activation of Wnt signaling pathway through AKT signaling pathway

AKT signaling pathway has been implicated in the process of β -catenin activation and we observed the co-activation of both pathways in the presence of galectin-3 treatment (Liu, et al., 2018, Majewska, et al., 2017). In order to determine whether phosphorylation of AKT is required for galectin-3-induced activation of Wnt/ β -catenin signaling pathway, VSMCs were incubated with the AKT inhibitor LY294002 before the treatment with galectin-3. As expected LY294002 per se inhibited AKT, but not ERK phosphorylation (Figure 31). Interestingly, LY294002 also inhibits the β -catenin pathway (Figure 31). We found that LY294002 prevented galectin-3-induced activation of AKT, GSK-3 β and β -catenin (Figure 31). However, LY294002 did not interfere with the activation of ERK signaling pathway induced by galectin-3. In conclusion, galectin-3 could activate the Wnt/ β -catenin signaling pathway through AKT signaling pathway but not through ERK signaling pathway.

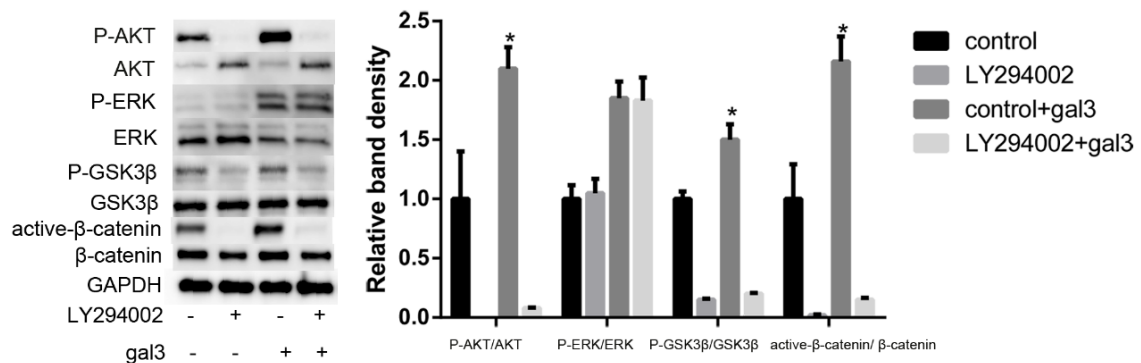

Figure 31. Gal3-induced activation of Wnt signaling pathway through AKT signaling pathway. After the addition of a specific AKT signaling pathway inhibitor (LY294002) for 1h, VSMCs were incubated for 30 min in the absence or presence of galectin-3 (10 μ g/ml), the relative quantity of p-AKT, AKT, p-GSK3 β , GSK3 β , p-ERK, ERK, active β -catenin and β -catenin were measured by Western blot (left panel). The GAPDH expression was used for protein level normalization. Densitometric measurements of replicate results were given in the right panel. Band density of native VSMCs was chosen as a reference for relative expression and set to 1. *: $P < 0.05$ vs any other treatments. Data (means \pm SEM) were obtained from three independent experiments.

2.6 Galectin-3 induced the proliferation and migration of VSMCs through AKT signaling pathway

The role of AKT signaling pathway in vascular cell proliferation is still controversial (Yu, et al., 2015). We wanted to explore the role of AKT signaling pathway in cell proliferation and migration in response to galectin-3. We used increasing concentrations of LY294002 (up to 50 nM) to pre-treat the cells for 1 h, and then galectin-3 was added to the cells for 24 h. We measured cell proliferation by using the MTT assay. We found that the proliferation of VSMCs was significantly inhibited by LY294002 in a concentration-dependent manner (Figure 32A); in addition, we confirmed that galectin-3 induced cell proliferation and LY294002 significantly inhibited galectin-3 effect in a dose-dependent manner, with significant effects at all the concentration tested (Figure 32A)

The transwell migration assay was used to investigate the effect of LY294002 on cell migration at the 50 nM concentration, since this was proven effective in the previous experiment. As shown in Figure 32B and C, LY294002 inhibits and galectin-3 enhanced VSMCs migration.

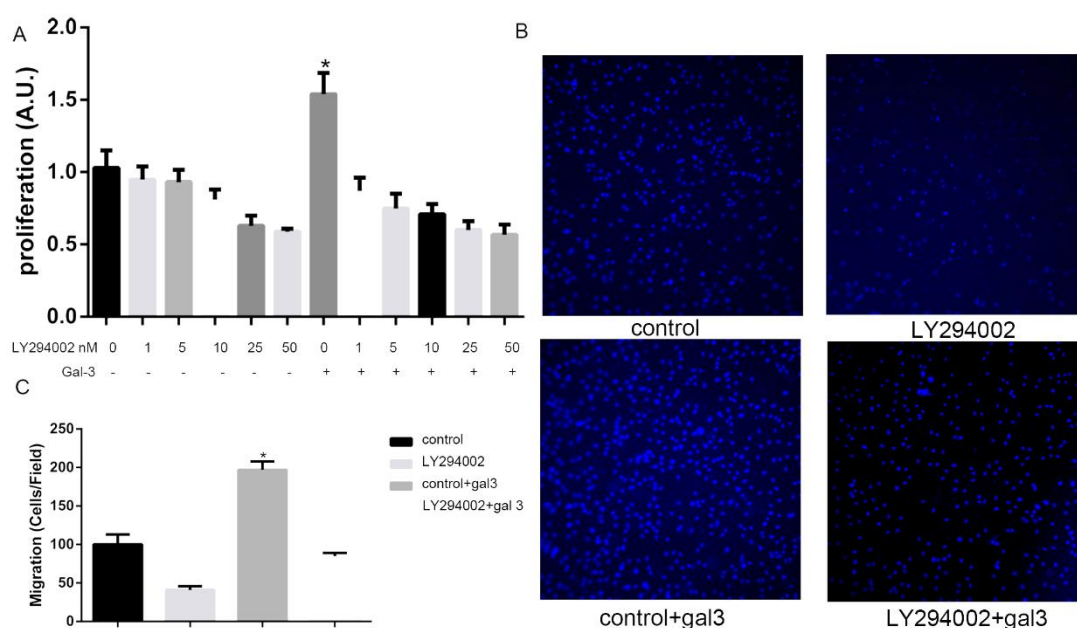

Figure 32. AKT signaling pathway mediates galectin-3 induced proliferation and migration. (A) Proliferation assays. Cells were treated with LY294002 over a range of concentration (1-50 μ M) for 1h, VSMCs were incubated for 24h in the absence or presence of galectin-3 (10 μ g/ml). MTT was used to detect cell proliferation. Bars are represented as the mean \pm SEM. Turkey HSD was used as a post-hoc test, *: $P < 0.05$ vs any other treatments. (B and C) Cell migration was tested by a transwell method: the cells migrated to the lower surface of each chamber in response to the indicated treatments are shown. After

treatment with LY294002 or not, VSMC were incubated for 12h in the absence or presence of galectin-3 (10 μ g/ml), migration was tested by a transwell method. Migrated cells that migrated from the upper chamber to the lower chamber were counted in five non-overlapping fields under a microscope (100x). *: P< 0.05 vs any other treatments.

Part III Knock-down integrin α v increases VSMCs stiffness

3.1 Knock-down integrin α v affects the stiffness of VSMCs.

VSMCs were isolated from the aortas of integrin α v-floxed mice, we used the adeno-cre to specifically knock down integrin α v in VSMCs for 48h, then AFM was used to detect the VSMCs stiffness. In contrast to control cells, integrin α v mutant cells have relatively high Young's modulus, indicating reduced flexibility and increased stiffness compared to control cells.

Table 9. Summary of Young's modulus of control and integrin α v knock down cells

	control	Integrin αv knock down
Young's modulus (Mpa)	0.069\pm0.012	0.314\pm0.113

3.2 Knock-down integrin α v increases the expression of β -tubulin

In our first part, knock-down integrin α v reduced the expression of some fibrosis-related proteins, however, here, we find that integrin α v knock-down cells have increased stiffness. In order to highlight possible intracellular mechanisms explaining this phenomenon, we also analysed the expression of some cytoskeleton proteins, knock-down integrin α v has little effect on the expression of vinculin and α -tubulin (Figure 33), however, knock-down integrin α v increased β -tubulin expression in the immunofluorescence staining experiments (Figure 34). We further explored the expression of β -tubulin isoforms in the integrin α v knock-down VSMCs by qRT-PCR (Figure 34). We found that β -tubulin-3 was upregulated in the integrin α v knock-down VSMCs,

while, other isoforms of β -tubulin (β -tubulin-4A, β -tubulin-4B, and β -tubulin-5) did not significantly changed (Figure 34).

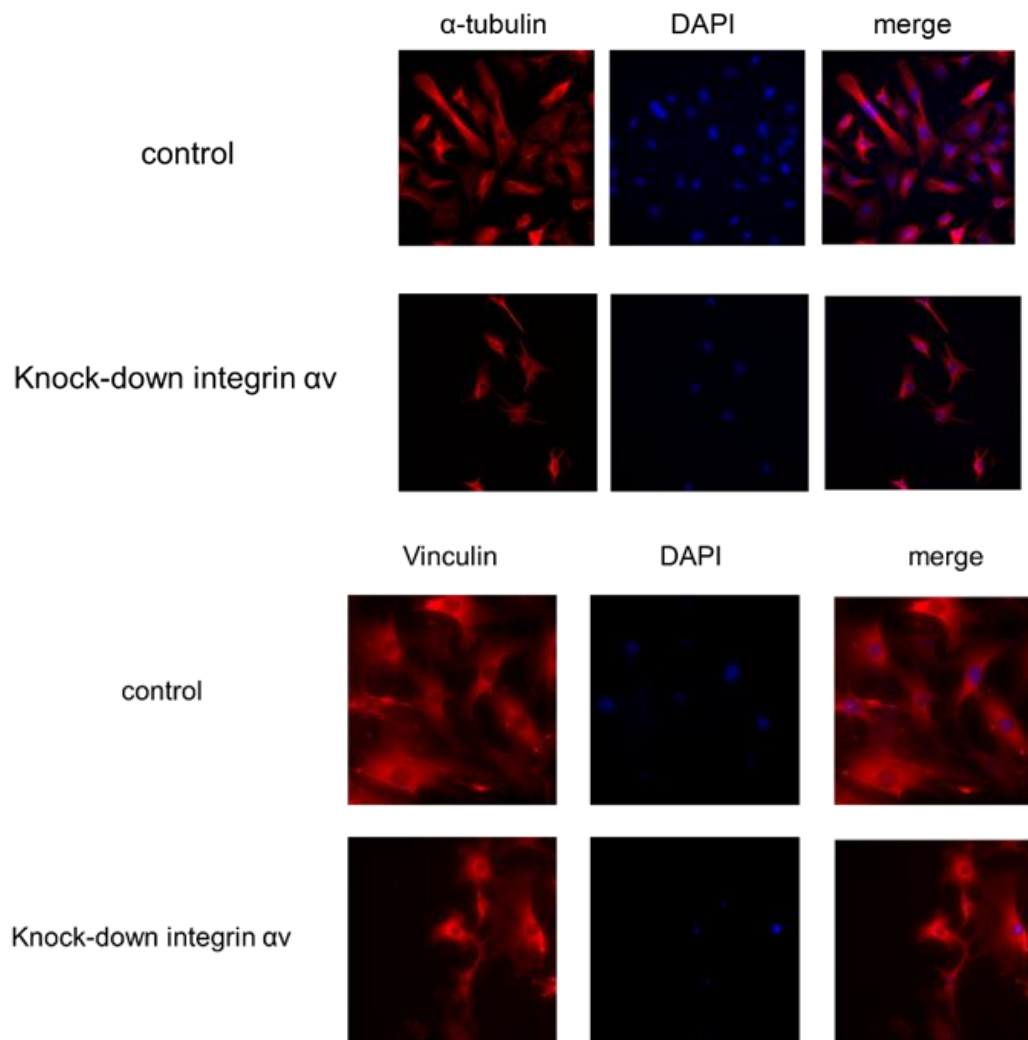

Figure 33. Knock-down integrin αv has little effect on the expression of vinculin and α -tubulin. After transfection with either GFP or cre for 48h, the expression of α -tubulin and vinculin was measured by immunofluorescence. The images of VSMCs used anti α -tubulin or vinculin (red) antibodies, followed by DAPI nuclear counter staining (blue) are shown. The merged images containing all markers are also shown.

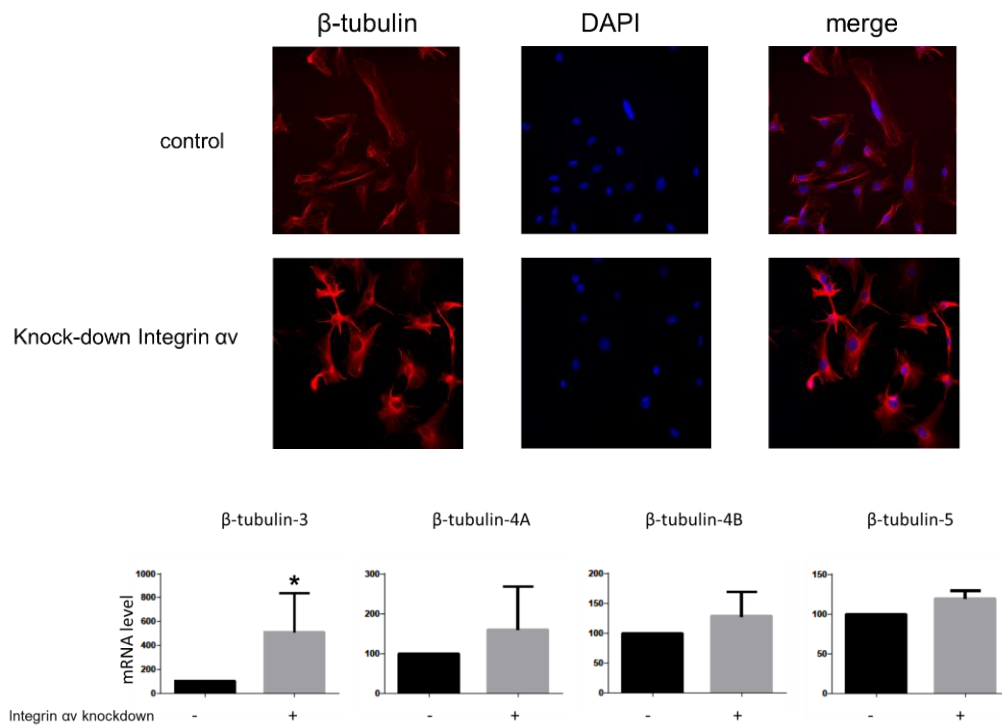

Figure 34. Knock-down of integrin αv could obviously increase β -tubulin. After transfection with either GFP or cre for 48h, the expression of β -tubulin was measured by immunofluorescence. The images of VSMCs used anti β -tubulin (red) antibodies, followed by DAPI nuclear counter staining (blue) are shown. The merged images are also shown. qRT-PCR was used to analyse the expression of β -tubulin isoforms.

Discussion

Organ fibrosis is often the consequence of tissue response to pathological conditions or injuries. In particular, vascular fibrosis is one of the multiple factors affecting arterial stiffness that is an independent cardiovascular risk factor (Lacolley, et al., 2017, Harvey, et al., 2016). The accumulation of ECM components such as collagen, fibronectin, and laminin in the vasculature is associated with vascular fibrosis. My PhD project was undertaken to examine the role of integrin α_v in the occurrence of VSMCs-mediated fibrosis. Ang II and TGF- β 1 have been proven to play an important role in vascular fibrosis. Recently, galectin-3 has been regarded as an important fibrosis marker, but its potential role in this phenomenon is unknown (Kang, et al., 2018). Ang II increases the expression of galectin-3, Both Ang II and galectin-3 are potent humoral mediators of cardiovascular fibrosis (Harvey, et al., 2016). We demonstrated integrin α_v involvement in Ang II- or TGF- β 1-induced activation of fibrosis-related signaling pathways (ERK and smad) and increased synthesis of fibrosis-related proteins (col1A1, col3A1 and fibronectin). We also demonstrated that galectin-3 increased the synthesis of fibrosis-related ECM proteins, as well as the proliferation and migration of VSMCs in an integrin α_v -dependent manner. This action is associated with an integrin α_v /AKT/Wnt/ β -catenin signaling pathway, following the interaction between integrin α_v and galectin-3 and accounting for the phenotype change of VSMCs. By using AFM, we found that integrin α_v knock-down VSMCs have a relatively higher cellular stiffness. In collaboration with the group of Drs Patrcik Lacolley et Véronique Regnault à Nancy, we found that Ang II-induced vascular fibrosis was decreased in the α_v^{SMKO} mutant mice (in which integrin α_v gene is inactivated specifically in SMCs) when compared to the Ang II-treated control mice, although no significant difference in vascular fibrosis was observed at baseline between these two types of mice. Electron microscopy analysis confirmed the observations done at histological and molecular level. The integrin α_v gene is inactivated in the SMCs of the vessel media, but the difference of fibrosis between Ang II-treated control mice and mutant mice is observed in the adventitia of carotids. The result of transcriptomic analysis (Affymetrix array) indicated the fibrosis pathway is affected in α_v^{SMKO} mutant mice.

The RAS plays a vital role in the cardiovascular system. Ang II is not only an endocrine factor, but it also plays local paracrine and autocrine functions in tissues and organs. During process of vascular fibrosis, Ang II activates the TGF- β /smad2/3 signaling pathway, resulting in increased expression of fibrosis-related proteins. ERK has also been implicated in Ang II-induced cellular growth and protein synthesis (Rocic, et al., 2003). In addition, Ang II-mediated ERK1/2 activation could also be involved in VSMC contraction and

hypertension that could result in micro- and macrovascular target-organ damage (Ishida, et al., 1998, Ishida, et al., 1999, Touyz, et al., 1999). (Based on our findings Ang II activates ERK and smad2/3 in VSMCs depending on integrin α . deleted) We demonstrated the expression of several fibrosis-related proteins (col1A1, col3A1, galectin-3 and fibronectin) is upregulated by Ang II in VSMCs. This increased expression is dependent on integrin α , since knock down of integrin α prevents Ang II from inducing upregulation of these fibrosis-related proteins. However, the mechanisms underlying this phenomenon are not clear. One the mechanism could be linked to the fact that integrin α plays an important role in the process of TGF- β 1 activation (Chen, et al., 2016). It is possible that knock down integrin α could reduce the activation of TGF- β 1 and its downstream signaling pathways, hereby reducing the effects of Ang II.

TGF- β is a major factor in VSMCs fibrosis. TGF- β induction and activation are consistently observed in experimental models of tissue fibrosis. TGF- β also induces the synthesis of inhibitors such as PAI-1 and TIMPs to promote ECM accumulation (Biernacka, et al., 2011). TGF- β /smad signaling pathway plays an important role in the development of fibrosis and in a variety of cardiovascular pathologies. Smad3 null mice exhibit attenuated fibrosis and are resistant to bleomycin-induced pulmonary fibrosis (Zhao, et al., 2002). Although the key role of smad3 in TGF- β -induced fibrous tissue deposition is well known, activation of smad-independent pathways may also play an important role in certain fibrotic conditions. Activation of a fibrotic gene program was dependent on ERK instead of smad2/3 in a mouse model of scleroderma-like fibrosis (Pannu, et al., 2007). In our study, we found that TGF- β 1 could not only activate smad2/3, but also increase the phosphorylation of ERK. When we specifically inhibit the expression of integrin α in VSMCs, activation of these signaling pathways by TGF- β 1 is decreased. In normal conditions, the degradation and remodeling of ECM are in balance: excessive ECM protein deposition results in vascular fibrosis and increases vascular stiffness. TGF- β 1 stimulates the expression of matrix components such as fibronectin, collagens, and matrix proteoglycans (Bassols, et al., 1988, Kahari, et al., 1991). Integrins mediate cell-ECM connections and, indirectly, cell-cell interactions. Upon binding with their ligands, integrins sense both the chemical composition and the mechanical status of the ECM outside the cell (Chen, et al., 2016). Our results indicate that the treatment of TGF- β 1 increases the expression of col1A1, col3A1 and fibronectin required the participation of integrin α in VSMC.

Galectin-3 has been reported to affect the functions of almost all the cells in the wall of blood vessel. Galectin-3 was also found to be upregulated in many kinds of cancers. Galectin-3 is a mediator of VEGF- and bFGF-induced angiogenesis (Markowska, et al., 2010). Galectin-3 can also induce migration

of macrophage in mouse (Jia, et al., 2013). Atherosclerosis is characterized by the activation and accumulation of smooth muscle cells in the intimal layer of blood vessels where they internalize lipids (Carthy, et al., 2012). Galectin-3 was also found play an important role in the phenotype transformation of VSMCs (Tian, et al., 2007). In adult vessels, smooth muscle cells are thought of being exist in two different phenotypes: contractile and synthetic phenotype (Matsushita, et al., 2007, Rensen, et al., 2007). VSMCs can be categorized based on two main morphological phenotypes, spindle-shaped (contractile phenotype), and epithelioid (synthetic phenotype) cells, to which can be added the thin elongated and the senescent cells (Rensen, et al., 2007). Phenotypic plasticity of VSMCs is a well-known major contributor to the progression of several vascular diseases. Mature VSMCs usually has a quiescent and contractile phenotype. However, mature VSMCs can be activated and transformed into the synthetic phenotype in some pathological processes, including atherosclerosis and aging-related pathologies. The synthetic VSMCs have a high capacity of proliferation and migration; they could secrete a series of proteins and play a major role in ECM remodeling and vascular fibrosis (Yang, et al., 2018). We think that galectin-3 induces the transformation of VSMCs to be the synthetic phenotype based on the following observation: 1) Galectin-3 increases the expression of some fibrosis-related proteins (col1A1, col3A1, fibronectin and laminin); 2) the treatment of galectin-3 promotes the cell migration and proliferation.

Integrin α_v is one major integrins involved in the development of fibrosis and an increase in its activity is associated with the increased fibrosis in different tissues (Chen et al 2015, Sun, et al., 2016, Henderson, et al., 2013, Murray, et al., 2017). The significance of integrin α_v in mediating the fibro genic actions of galectin-3 remains poorly understood. Galectin-3, as an ECM, interacts with a series of cell surface receptors, and then activate some downstream signaling pathways. We find that galectin-3 can bind to integrin α_v in the cell surface and trigger a series of intracellular signaling. The expression of galectin-3 in VSMCs is increased by Ang II treatment, and this effect of Ang II is decreased by knocking-down integrin α_v , which do not only prevents galectin-3-induced expression of fibrosis-related proteins, but also inhibits the proliferation and migration abilities of VSMCs induced by galectin-3.

The enhanced proliferation and migration of SMC are classical signs of early pathology of atherosclerosis. Galectin-3 could induce proliferation, migration, and phenotype transformation of VSMCs, and this effect depends on Wnt/ β -catenin signaling pathway (Tian, et al., 2017) whose role in regulating proliferation and migration is well established (Liu, et al., 2018, Zeng, et al., 2017). Accordingly, we find that galectin-3 increases the expression of active β -catenin through integrin α_v and the AKT signaling pathway. The role of AKT signaling pathway in cell proliferation is still controversial, AKT has been

reported to play a role in skeletal muscle cells in which proliferation upon activation is particularly important (Moriya, et al., 2018, Yu, et al., 2015) and AKT is frequently observed to be activated during proliferation and invasion in cancer cells; however, AKT1 phosphorylation (Ser473) is decreased in VSMCs in human atherosclerotic plaques and , consistently, upregulation of AKT1 in VSMCs has been reported not to induce VSMC proliferation in normal arteries, after carotid ligation, or in atherosclerosis (Tucka, et al., 2014). Our result indicates that AKT signaling pathway is necessary for in vitro VSMC proliferation as well as migration at the baseline and upon galectin-3 stimulation. Although the ERKs signaling pathway has already been shown to mediate proliferation of SMC (Liu 2017,), our results indicate that phosphorylation of ERK is poorly influenced by the knocking-down of integrin α_v and AKT inhibiting in galectin-3 treated cells, suggesting an ERK-independent, but AKT-dependent activation of the β -catenin pathways in VSMC proliferation. This is a novel, original observation, underlining the importance of AKT as a regulator of these processes.

In summary, here we show that the integrin α_v /AKT/ β -catenin axis mediates galectin-3 induced proliferation and migration in VSMCs. Galectin-3 interacts with integrin α_v directly on the cell surface of VSMCs, inducing the phosphorylation of AKT and, consequently, GSK-3 β phosphorylation. Activation of AKT signaling pathway could phosphorylate several targets including GSK-3 β and lead to the degradation of GSK-3 β . In turn, the inactivation of GSK-3 β reduces the β -catenin degradation and increases the expression of active β -catenin. Thus, β -catenin translocate to the nucleus and induces gene expression leading to the proliferation and migration of VSMCs. Since Galectin-3 expression is induced by Ang II treatment, the latter could activate a positive feedback loop, ultimately resulting in VSMCs activation contributing to ECM remodeling and increased vascular stiffness.

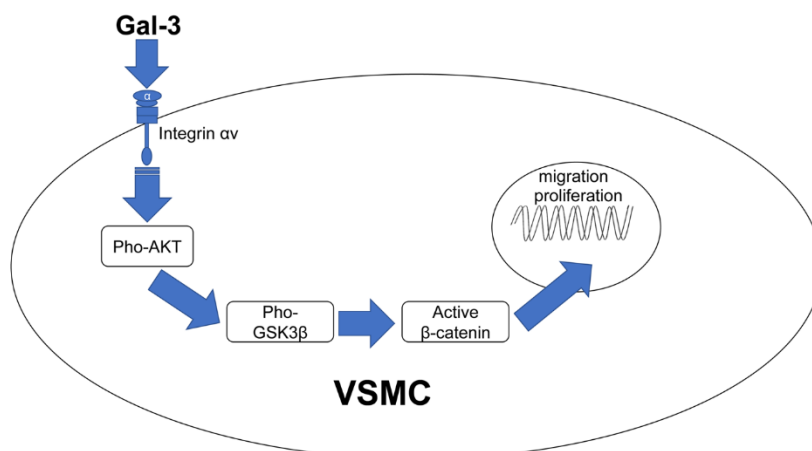

Figure 35. Proposed model in which integrin α_v mediates galectin-3 induced activation of Wnt/ β -catenin signaling in VSMCs.

Given the important role of galectin-3 in the process of vascular osteogenesis in atherosclerosis (Menini, et al., 2013), our research could contribute to clarify the role of galectin-3 in the pathological process of atherosclerosis. Galectin-3, as well as components of the integrin α / AKT/ β -catenin axis may be used as a valuable target for future therapeutic strategies designed to inhibit VSMCs activation.

Multiple interacting factors affect arterial stiffness: blood pressure, oxidative stress, calcification, endothelial dysfunction, VSMCs stiffness and ECM remodeling (Harvey, et al., 2016). The intrinsic mechanical properties of VSMCs play a key role in aortic stiffening in both aging and hypertension (Hays, et al., 2018). VSMCs derived from the aged animals showed a tense internal network of the actin cytoskeleton than those derived from the adult animals (Zhu, et al., 2018). The accumulation of collagen, fibronectin and laminin could increase vascular stiffness. In our research, knock-down of integrin α indeed reduces Ang II, TGF- β 1 or galectin-3-induced upregulation of some fibrosis-related proteins, but increases the VSMCs stiffness in vitro. The classical mechanism is an increase in collagen deposition and a breakdown of elastin, which could contribute to increases in vascular stiffness. However, in some cases, ECM changes alone cannot provide a mechanistic explanation for the acceleration of vascular stiffness in hypertensive aging, e.g. the expression of collagen was downregulated in vascular vessel in the pathological process of hypertension (Cox. 1981, Mizutani, et al., 1999). Sehgel et.al found that aging and hypertension could increase individual VSMCs stiffness, which may play a key role in hypertensive vascular stiffness. However, when these authors analyzed certain ECM proteins and elastin density, they found that the total content and density of collagen or elastin were no different between SHR and WKY rats (Sehgel, et al., 2015). In the SHR, hypertension could induce the hypertrophy of VSMCs and then contribute to increases in VSMCs stiffness (Sehgel, et al., 2015). VSMCs hypertrophy contributes an increased medial thickness (Imanishi, et al., 2014). In some clinical researches, collagen content in the aorta was unchanged with hypertension (Hoshino, et al., 1995, Schlatmann, et al., 1977), some other types of ECM remodeling, such as changes in ECM protein type, cross-linking, glycation, and structural or architectural rearrangement, may contribute to altering the stiffness of the vascular wall (Sehgel, et al., 2015).

Cytoskeletal proteins are more likely to determine VSMCs stiffness. Cytoskeletal network contributes to age-associated changes in the mechanic properties of VSMCs (Zhu, et al., 2018). Expression of actin, phosphorylated myosin light chain, and MLCK was found to be increased in SHRs, compared with WKY rats (Sehgel, et al., 2013). This suggests that cytoskeletal proteins involved in the VSMCs contraction, the cross-bridging components myosin and

actin and/or cytoskeletal remodeling, contribute to the increase in VSMCs stiffness. In our research, we also analyzed some cytoskeletal proteins, including vinculin, vimentin, fibronectin, α -tubulin and β -tubulin. We found that knock-down of integrin α v could increase the expression of β -tubulin. This increase of β -tubulin could be linked to the increased cellular stiffness in VSMCs lacking integrin α v.

The most prominent feature of the phenotype of α v^{SMKO} mutant mice is the decreased vascular fibrosis under the treatment of Ang II. This result agrees with our results obtained in vitro in which knock-down of integrin α v decreases the effect of Ang II, TGF- β 1 or galectin-3 on the synthesis of fibrosis-related proteins. Interestingly, although the integrin α v gene is inactivated in the SMC of vessel media layer, the difference of fibrosis is observed in adventitia between Ang II-treated control and mutant mice. This suggests the possible media-adventitial coupling. Based on the fact that decreased collagen deposition is observed both in the media and in the adventitia in response to Ang II in mutant mice, and an increased TGF- β 1 and its receptor is observed in the adventitia of Ang II treated control mice compared to mutant mice, we hypothesize that in mice lacking integrin α v in VSMCs, the impairment in TGF- β signaling at high blood pressure is due either to a decrease in TGF- β synthesis and/or activation dependent of integrin α v or a reduction in the diffusion of secreted TGF- β from medial cells to adventitia (or both). It has been suggested that transmural flow is affected in large part (in elastic arteries) by the sizes of the pores (fenestrations) in the elastic lamina (Shi, et al., 2011). The pressure gradient driving the transmural flow increases in the case of Ang II treatment. If we suppose that the increase of transmural flow under Ang II is the same in both groups, we could exclude hemodynamic role in TGF- β gradient changes. In the study of smooth muscle specific knock-out of *Tgfb2* gene, it has been suggested that there is a layer-to-layer (media \rightarrow adventitial) coupling (Li, et al., 2014). It is possible that there is cytokine diffusion between the media and adventitia, particularly in the sense of media verse adventitia. In Ang II-treated α vSMKO mutant mice, due to the inactivation of integrin α v inactivation in SMCs, the synthesis and/or maturation of TGF- β is affected in the media. In addition, the expression of other fibrosis-related factors such as galectin-3 or the factors-induced signaling pathways such as ERK and smad could be affected by integrin α v inactivation. All these changes could have an impact on the quantity of mature TGF- β molecules transfer from the media to the adventitia, furthermore influencing the synthesis of collagen in the adventitia (this model is summarized and schematized in the following Figure).

A - Control mice

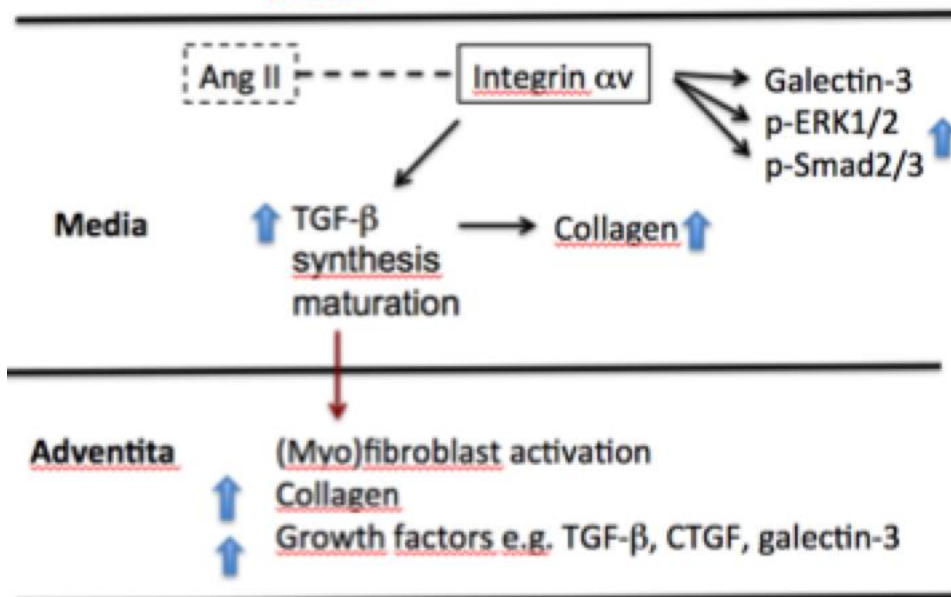

B - α_v SMKO mutant mice

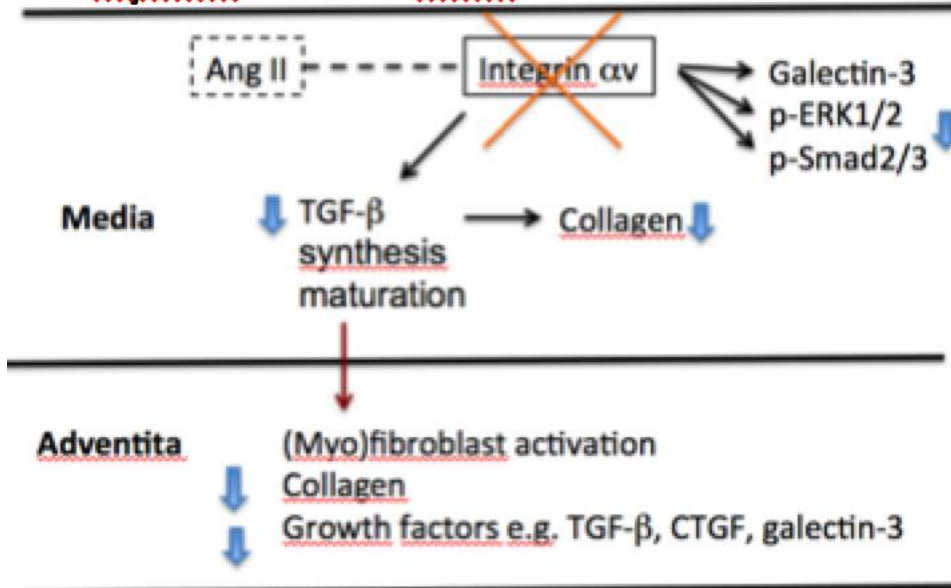

Figure 36. Hypothetic schema for the influence of integrin α_v on the vascular fibrosis in the Ang II treatment. Red arrows indicate the transport of TGF- β between media and adventitia. Possible further interaction with endothelial and circulating/resident leukocytes are not considered.

Perspective

Integrins, as a cell surface receptor, could mediate the process of endocytosis and exocytosis, however, the effects of different subtypes of integrins in affecting endocytosis and exocytosis are variety. Endocytosis of integrin $\beta 1$ depended on galectin-3 which triggered the glycosphingolipid (GSL)-dependent biogenesis of a morphologically distinct class of endocytic structures, termed clathrinid-independent carriers (CLICs) (Lakshminarayan, et al., 2014). In immature rat Sertoli cells, calcium uptake and exocytosis depended the integrin $\alpha\beta 3$ (Zanatta, et al., 2013). Integrin $\alpha\beta 3$ mediated exocytosis of mucin which was induced by the Entamoeba histolytica Cysteine Proteinase 5 in Colonic Goblet Cells (Cornick, et al., 2016). Active Matrix metalloproteinase-2 (MMP-2) induced secretion of VEGF-A via integrin $\alpha\beta 5$ instead of integrin $\beta 1$ in the vascular endothelium (Desch, et al., 2012). Integrin $\alpha\beta 3$ could also mediate internalization of cRGDfK modified gold nanoparticles (cRGDfK-PEG-AuNPs), but it has little effect on the endocytosis of PEG conjugated gold nanoparticles (PEG-AuNPs) (Cui, et al., 2017), however, our knowledge about the endocytosis and exocytosis of galectin-3 in Ang II induced upregulation of galectin-3 was still limited, and the role of integrin α in this process should also be furtherly determined.

MMP-9 is a member of the MMPs, which are enzymes that can degrade ECM, including collagens IV and V, denatured collagens, and elastin. MMP-9 also regulates numerous cell activities, involving in cell-cell contact, tissue remodeling, cell migration and cellular differentiation (Vandooren, et al., 2013). EMMPRIN, also termed CD147 or M6 antigen, is a 58-kDa cell surface glycoprotein described first in tumor cells. It has been found participates in numerous physiological processes, play a central role in tumor metastasis, cell adhesion, angiogenesis, chemo resistance and atherosclerosis (Joghetaei, et al., 2013, Zhu, et al., 2014). EMMPRIN has been reported to stimulates secretion of MMP-9 in monocytes (Kim, et al., 2009), and activates MMP-9 in atherosclerotic plaque (Yoon, et al., 2005). Recent data showed that increased MMP-9 and EMMPRIN expression deteriorates plaque stability (Joghetaei, et al., 2013, Yoon, et al., 2005), and accelerates the transition from a stable plaque to an unstable plaque by affecting coronary smooth muscle cells (Cipollone, et al., 2003).

Integrin receptor and its downstream signaling are able to regulate expression and activity of several MMPs. $\alpha 4\beta 1$, $\alpha 5\beta 1$ and $\alpha\beta 3$ integrins can mediate expression and activity of MMPs and their effector responses, in different cellular systems, fibronectin could regulate MMP expression by binding to $\alpha 4\beta 1$ and $\alpha 5\beta 1$ integrins in rabbit synovial fibroblasts (Chen, et al., 2016, Huhtala, et al., 1995). The interaction between MMP-2 and integrins also

regulate cell migration, for example, MMP-2 is up-regulated in invasive colorectal tumors and mediated shedding of $\beta 1$ integrin followed by subsequent integrin degradation, this led to decreased adhesion and enhanced cell motility (Kryczka, et al., 2012).

Until now, the role of integrin αv in vascular fibrosis is still unclear, in particular, we still do not know how galectin-3, a fibrosis related protein, induces the vascular fibrosis and the role of integrin αv in this process should also be further determined. In addition, the results obtained by Nancy team indicate that the vascular rigidity between control and αv^{SMKO} mutant mice is similar at the baseline and under Ang II treatment. However, in cell culture, knock-out of integrin αv increases the cellular rigidity. As the vascular rigidity is determined by multiple factors, it will be interesting to examine the contribution of different elements such as the fibrosis, cellular rigidity, focal adhesion, contractility to vascular rigidity. In this register, it will be interesting to examine the contribution of titin smooth muscle isoform on vascular rigidity, because its expression is increase 6 times by SMC specific knock-out of the integrin αv and it is an elastic molecular with spring structure. The giant protein titin plays a critical role in regulating the passive elasticity of muscles, mainly through the stochastic unfolding and refolding of its numerous immunoglobulin domains in the I-band of sarcomeres of striated muscles. It's role in SMCs is not known.

Materials and Methods

Reagents.

The Dulbecco's modified eagle's medium (DMEM) was purchased from Lonza, fetal bovine serum (FBS) and penicillin/streptomycin (pen/strep, 10,000 U/ml each) were purchased from Gibco. Recombinant galectin-3 was purchased from ATGen (Los Angeles, CA, USA). The Thiazolyl Blue Tetrazolium Bromide (MTT) was purchased from Sigma. The primary antibody against phospho-AKT (no. CST-4060), AKT (no. CST-9272), phosphoGSK3 β (no. CST-9322), GSK3 β (no. CST-9315), nanophosphor (active) β -catenin (no. CST-8814), β -catenin (no. CST-8480), phosphor ERK (no. CST-4370), ERK (no. CST-9102) and GAPDH (no. CST-2118) were acquired from Cell Signaling Technology, Inc. (Danvers, MA, USA). The primary antibody against laminin (no. L9393) was purchased from sigma. Anti-galectin-3 (no. ab76245), anti-integrin α_v (no. ab179475) and anti-fibronectin (no. ab45688) were obtained from Abcam (Cambridge, UK). The antibody against collagen 1A1 (no. GTX 112731) was obtained from Gene Tex (Irvine, CA, USA). The collagen 3A1 (no. sc-28888) antibody from Santacruz Biotechnology, Inc. (Dallas, TX, USA). His-tagged antibody was purchased from invitrogen. All other chemicals were from commercial sources.

Generation of SMC-specific integrin α_v mutants

Generation of loxP-floxed integrin α_v mice (α_vF/ α_vF) in which exon 4 was flanked by two loxP sequences.) and SM22-CreERT2ki (SmCreki/+) mice have been described previously ([Lacy-Hulbert A et al., 2007; Kuhbandner et al., 2000). To generate smooth muscle specific integrin α_v knockout, 4-month-old α_vF/ α_vF ; SmCreki/+ mice (abbreviated α_v^{SMKO}) were injected i.p. with 1mg of tamoxifen (TAM) (Sigma, Saint Louis, MO) in 100 ml of peanuts oil for 3 days. Similar doses of TAM were also injected to wild type (α_vF/ α_vF) mice as control. Mice were treated with the mini-pomp that was implanted under the skin of mouse, and diffused Ang II at two kinds of dose (0.3mg/kg/d or 1.5mg/kg/d) for 28 days. Male and female mice were sacrificed by a lethal dose of pentobarbital sodium. Following the experiments, the carotid (CA) or aortic artery was used. The animal use confirmed with the principles of the declaration of Helsinki and was authorized by the local ethical committee Prevention and Wellbeing of Animals of Institut National de la Santé et de la Recherche Médicale (INSERM) and the Comité d'Ethique Lorrain en Matière d'Experimentation Animale (CELMEA).

Cell culture

A primary culture of mouse VSMCs was established by enzymatic digestion of aorta of loxP-floxed integrin α v mice. Primary cultures were maintained in DMEM with 1g/L glucose supplemented with 10% FBS and 1% penicillin/streptomycin. Cells between 5th and 10th passages were used in these experiments.

Adeno-Cre interference

Adenovirus containing recombinase Cre and GFP was used to excise the exon 4 of integrin α v. Integrin α v expression was decreased to less 15% compared to the cell infected with adenovirus containing only GFP. Briefly, 5×10^5 VSMCs per well were cultured in 6-well plates to 75% confluence. The cells were then infected with 0.5 μ l/well Adeno-GFP or Adeno-cre-GFP/well. The cells were used for experiments 48h after adenovirus infection.

Cell proliferation assay

The effect of galectin-3 on cell proliferation was measured using the Thiazolyl Blue Tetrazolium Bromide (MTT) assay. In brief, 5,000 cells/well were plated in 96-well plate and allowed to attach for 12h. VSMCs were incubated for 0h, 12h, 24h or 48h in the presence of galectin-3 or in combination with AKT pathway inhibitor LY294002. Subsequently, the plate was incubated with MTT for 4h at 37 °C and the absorbance at 570 nm was taken after dissolving the cells in dimethyl sulfoxide.

Migration assay

The migration of VSMCs was assayed in 24-Well Transwell plates (VWR, Fontenay-sous-Bois, France). Upper surface of the polycarbonate with 8 mm pores coated with 0.2% gelatin). Suspensions of cells (5×10^4 cells / 200 μ l serum-free DMEM medium) were loaded into the upper chambers. The lower chambers were filled with 400 μ l of DMEM in the presence or absence of 10 μ g/ml recombinant galectin-3 or in combination with AKT pathway inhibitor LY294002. The lower side of the filter was washed with PBS 12 h after treatment at 37°C and fixed with 4% paraformaldehyde for 5 minutes. Nuclei were stained with 4',6-Diamidino-2-Phenylindole (DAPI 1:3000 Sigma) for 5 min at room temperature. The cells were counted in five random fields in each well.

Duolink assay

The interaction between recombination galectin-3 and integrin α v were performed with the Duolink assay kit (Sigma-Aldrich). The cells (5×10^4) were seeded onto coverslips and incubated with his-tagged galectin-3 for 30 min.

The cells were washed with PBS, and subsequently fixed with 4% paraformaldehyde for 15 min, permeabilized or not with 0.5% Triton X-100 for 20 min, the samples were then blocked with 5% bovine serum albumin (BSA) for 1 h in a humid chamber. Cells were incubated overnight at 4 °C with rabbit anti-integrin α_v and mouse anti-his-tagged antibodies. Cells were washed 3 times with PBS buffer for 10 min each and then incubated with two PLA probes (anti-mouse and anti-rabbit) for 1 h at 37 °C in a wet chamber. After incubation, cells were washed twice for 5 min each, and ligation solution was added. Subsequently, bound antibody-oligonucleotide conjugates were ligated together for 30 min at 37 °C. Amplification solution was added to the cells after two 5-min washes, and ligated templates were amplified for 100 min at 37 °C. The nuclei were stained with the DAPI. Cells were then washed twice for 10 min each, mounted on slides with mounting medium and observed with Zeiss fluorescence microscopy.

Histomorphometry and immunohistochemical staining.

Histological studies of the arteries were performed on carotids fixed in situ with 10% buffered formalin at a constant pressure of 90 mm Hg for 1 hour to provide conditions of fixation close to the physiological in situ state of the vessel. For morphological analysis, all arterial samples were embedded in paraffin and 5 μ m sections were stained with hematoxylin and eosin for nuclei and Sirius red F3B for collagen. For immunofluorescence, 5 μ m sections were incubated with primary antibody in BSA 2% in PBS overnight at 4°C. After repeated washing in PBS, sections were then incubated with the appropriate secondary antibody in BSA 2% in PBS for 60 minutes at room temperature. Image acquisition was made on a Leica TCS SP5 confocal microscope (Leica, Wetzlar, Germany). Images were captured at the same depth and with identical settings for laser, gain and offset intensity.

Immunofluorescence of cell culture

Immunofluorescence staining and confocal laser microscopy. The cells (5×10^5) were seeded on the flame-sterilized coverslips and placed into 24-well tissue culture plates. The integrin α_v were knocked down by adeno-cre for 48 h. and then the cells were incubated with his-tagged galectin-3 for different times (0, 30min, 1h, 2h). The cells were subsequently fixed with 4% paraformaldehyde for 15 min, permeabilized with 0.1% Triton X-100 for 20 min, blocked with 1% bovine serum albumin for 1 h, and incubated with specific primary antibody overnight at 4°C. The cells were incubated with Alexa Fluor 488-conjugated goat anti-rabbit immunoglobulin G (Invitrogen Life Technologies) for 1 h at room temperature. The nuclei were stained with DAPI (1:1,000) for 5 min at room temperature.

Western blot

Cells were lysed in a lysis buffer containing 50 mM Tris (pH 7.6), 250 mM NaCl, 3 mM EDTA, 3 mM EGTA, 0.5% NP40, 2 mM dithiothreitol, 10 mM sodium orthovanadate, 10 mM NaF, 10 mM glycerophosphate and 2% of protease inhibitor cocktail (Sigma-Aldrich, Saint-Quentin Fallavier, France) for 30 min on ice. Protein concentrations were measured with the Bio-Rad Protein Assay (Bio-Rad). The lysates (20 μ g) were electrophoresed on 4-15% SDS-PAGE (Bio-Rad) and transferred to nitrocellulose membranes (Amersham Hybond-ECL, GE Healthcare, Velizy-Villacoublay, France). The membrane was blocked with 5% nonfat dry milk in TBST buffer (100 mM NaCl, 10 mM Tris-HCl, pH 7.4, and 0.1% Tween-20) for 1 h at room temperature. The blots were then incubated with diluted primary antibodies in TBST at 4°C overnight, and then washed three times 10 min each with TBST buffer at room temperature and incubated for 1 h with the appropriate peroxidase-conjugated secondary antibody (1:3000 dilution). To quantify the protein, band intensity was assessed by Image J software.

Microarray analysis

45 days after the first injection of TAM, total RNA was isolated and purified from the aorta of α_v^{SMKO} and control mice with the RNeasy fibrous tissue kit (Qiagen), according to the manufacturer's instructions. Total RNA quality was assessed on the basis of the A260/A280 ratio from the Agilent 2100 Bioanalyzer (Agilent Technologies, Palo Alto, CA). Microarray analysis for each genotype was performed with four individually derived 3 RNA samples, each being hybridized to one Affymetrix GeneChip MOE 430 2.0 array (Affymetrix, Santa Clara, CA) with a coverage of 45,000 transcripts, corresponding to over 30,000 mouse genes. All technical microarray procedures were carried out by genomic platform of Cochin institute ((Paris, France) under Affymetrix guideline. All gene chips were scanned on an Affymetrix GeneChip 3000 scanner, and data were extracted from scanned images using AFX GCOS 1.4 software. Background intensities were adjusted and normalized using GC-RMA method implemented in R. Two-tailed, unpaired t-tests were performed comparing mutant (n = 3) and wild-type (n = 3) log₂ expression values. The probe sets with a P value of <0.05 were considered differentially expressed. « Ingenuity Pathway Analysis » software is used to analyze the signaling pathway.

Quantitative RT-PCR assay

Total RNA was extracted from each aorta as described above and reverse transcribed with random hexamers (Roche Diagnostics, Mannheim, Germany), according to the manufacturer's instructions. Relative quantification of gene

expression level was performed in duplicates on a Light Cycle 480 Real-Time PCR Detection System (Roche Diagnostics) using SYBR green PCR technology (Roche Diagnostics). Relative quantification was achieved with the following equation: $R = 2^{C_{t(\text{target})} - C_{t(\text{Ref})}}$ (control - sample) - $C_{t(\text{Ref})}$ (control - sample), where C_t is threshold cycle (www.gene-quantification.de) and the housekeeping gene HPRT was used as a reference gene to normalize expression level.

Electron microscopy

The carotid artery was isolated from mice and fixed in a Carson solution of pH 7.2 (3.5% formaldehyde, 110 mM Na₂HPO₄). All samples were transferred to 2% osmium tetroxide in 0.1 mol/L of phosphate buffer pH 7.2. This was followed by rapid dehydration using a series of graded concentrations of alcohol and acetone and embedded in Epon. Semithin sections (1 μ m) stained with toluidine blue were observed under a light microscope to select areas of interest. Ultrathin sections, stained with uranyl acetate and lead citrate, were observed with a Zeiss omega TEM microscope.

AFM analysis

AFM is ideal for measuring alterations in adhesive force (a proxy of aggregation), and rigidity (a proxy of deformability) (Loyola-Leyva, et al., 2018). The Peak Force mode, as a recent development, permits to obtain nanomechanical properties, as Young's modulus and adhesion. The Peak Force mode covers a wide range of Young's modulus values, between 1 MPa and 50 GPa, and adhesion values, between 10 pN and 10 μ N (Torrent-Burgues, et al., 2014). The mechanical properties of VSMCs were investigated by using AFM in Peak force mode. Each cell sample was placed in a sample holder and facing upward. Measurements were performed with the samples immersed in DMEM. The spring constant and detector sensitivity were measured by each tip and sample.

Statistical analysis

All data are expressed as the mean \pm SEM. Statistics were performed using the SPSS 13.0 software. One-way or two-way ANOVA followed by the Turkey-HSD post hoc analyses was used when appropriate. A value of $P < 0.05$ was considered statistically significant. All experiments were performed at least three times in a triplicate assay.

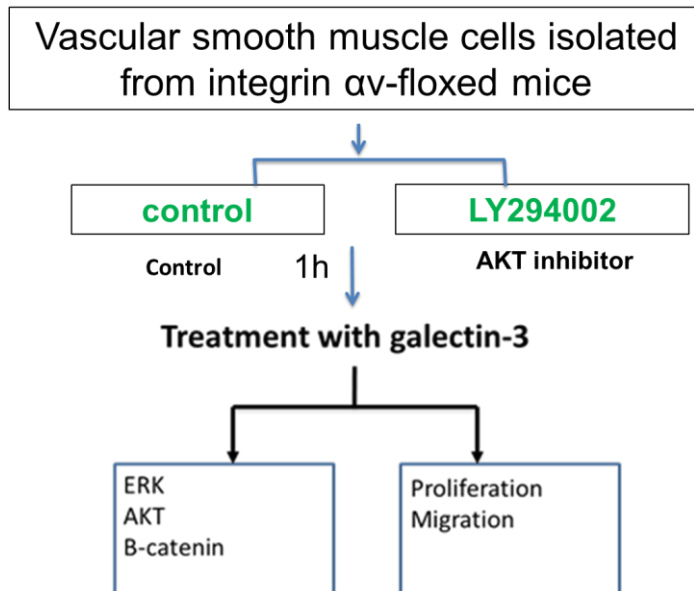
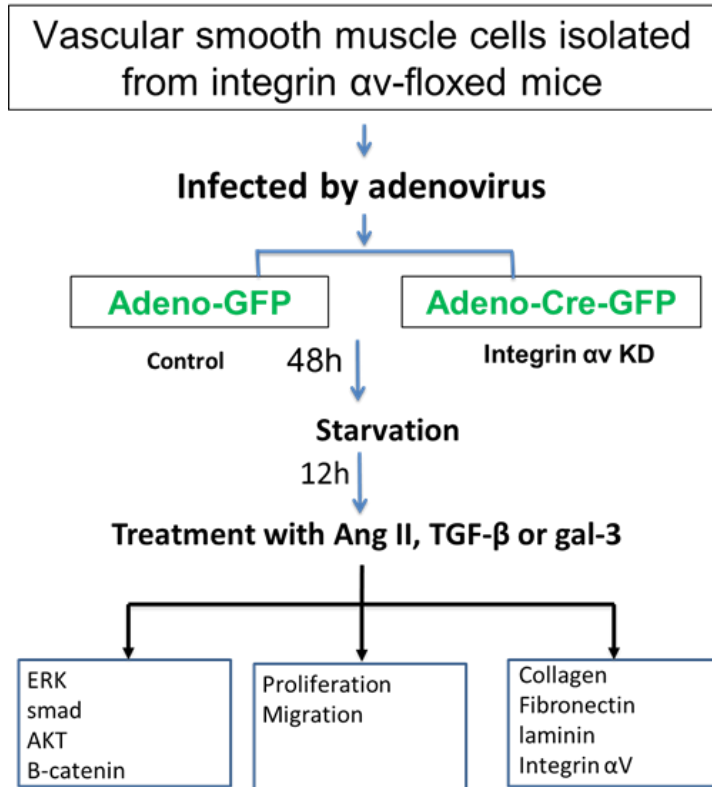

Figure 37. Flowchart of in vitro experiments.

References

- 1 AbdAlla S, Lothar H, Abdel-tawab AM and Quitterer U. The angiotensin II AT2 receptor is an AT1 receptor antagonist. *J Biol Chem* 276: 39721-39726, 2001.
- 2 Alpert P. The limits and frontiers of desiccation-tolerant life. *Integr Comp Biol* 45: 685-695, 2005.
- 3 Amalinei C, Caruntu ID, Giusca SE and Balan RA. Matrix metalloproteinases involvement in pathologic conditions. *Rom J Morphol Embryol* 51: 215-228, 2010.
- 4 Annes JP, Rifkin DB and Munger JS. The integrin alphaVbeta6 binds and activates latent TGFbeta3. *FEBS Lett* 511: 65-68, 2002.
- 5 Antoniak S, Cardenas JC, Buczek LJ, Church FC, Mackman N and Pawlinski R. Protease-Activated Receptor 1 Contributes to Angiotensin II-Induced Cardiovascular Remodeling and Inflammation. *Cardiology* 136: 258-268, 2017.
- 6 Arribas SM, Hinek A and Gonzalez MC. Elastic fibres and vascular structure in hypertension. *Pharmacol Ther* 111: 771-791, 2006.
- 7 Arteaga-Solis E, Gayraud B and Ramirez F. Elastic and collagenous networks in vascular diseases. *Cell Struct Funct* 25: 69-72, 2000.
- 8 Asensio-Lopez MDC, Lax A, Fernandez Del Palacio MJ, Sassi Y, Hajjar RJ and Pascual-Figal DA. Pharmacological inhibition of the mitochondrial NADPH oxidase 4/PKCalpha/Gal-3 pathway reduces left ventricular fibrosis following myocardial infarction. *Transl Res* 2018.
- 9 Ask K, Bonniaud P, Maass K, Eickelberg O, Margetts PJ, Warburton D, Groffen J, Gauldie J and Kolb M. Progressive pulmonary fibrosis is mediated by TGF-beta isoform 1 but not TGF-beta3. *Int J Biochem Cell Biol* 40: 484-495, 2008.
- 10 Barrett JD, Zhang Z, Zhu JH, Lee DB, Ward HJ, Jamgotchian N, Hu MS, Fredal A, Giordani M and Eggena P. Erythropoietin upregulates angiotensin receptors in cultured rat vascular smooth muscle cells. *J Hypertens* 16: 1749-1757, 1998.
- 11 Bassols A and Massague J. Transforming growth factor beta regulates the expression and structure of extracellular matrix chondroitin/dermatan sulfate proteoglycans. *J Biol Chem* 263: 3039-3045, 1988.
- 12 Besler C, Lang D, Urban D, Rommel KP, von Roeder M, Fengler K, Blazek S, Kandolf R, Klingel K, Thiele H, Linke A, Schuler G, Adams V and Lurz P. Plasma and Cardiac Galectin-3 in Patients With Heart Failure Reflects Both Inflammation and Fibrosis: Implications for Its Use as a Biomarker. *Circ Heart Fail* 10: 2017.
- 13 Bhattacharjee N, Barma S, Konwar N, Dewanjee S and Manna P. Mechanistic insight of diabetic nephropathy and its pharmacotherapeutic targets: An update. *Eur J Pharmacol* 791: 8-24, 2016.
- 14 Biernacka A, Dobaczewski M and Frangogiannis NG. TGF-beta signaling in fibrosis. *Growth Factors* 29: 196-202, 2011.
- 15 Birkedal-Hansen H. Role of Matrix Metalloproteinases in Human Periodontal Diseases. *J Periodontol* 64 Suppl 5S: 474-484, 1993.
- 16 Bivona G, Bellia C, Lo Sasso B, Agnello L, Scazzone C, Novo G and Ciaccio M. Short-term Changes in Gal 3 Circulating Levels After Acute Myocardial Infarction.

Arch Med Res 47: 521-525, 2016.

17 Bonniaud P, Margetts PJ, Kolb M, Schroeder JA, Kapoun AM, Damm D, Murphy A, Chakravarty S, Dugar S, Higgins L, Protter AA and Gaudie J. Progressive transforming growth factor beta1-induced lung fibrosis is blocked by an orally active ALK5 kinase inhibitor. *Am J Respir Crit Care Med* 171: 889-898, 2005.

18 Boscher C and Nabi IR. Galectin-3- and phospho-caveolin-1-dependent outside-in integrin signaling mediates the EGF mitogenic response in mammary cancer cells. *Mol Biol Cell* 24: 2134-2145, 2013.

19 Branton MH and Kopp JB. TGF-beta and fibrosis. *Microbes Infect* 1: 1349-1365, 1999.

20 Brilla CG, Zhou G, Matsubara L and Weber KT. Collagen metabolism in cultured adult rat cardiac fibroblasts: response to angiotensin II and aldosterone. *J Mol Cell Cardiol* 26: 809-820, 1994.

21 Bujak M, Ren G, Kweon HJ, Dobaczewski M, Reddy A, Taffet G, Wang XF and Frangogiannis NG. Essential role of Smad3 in infarct healing and in the pathogenesis of cardiac remodeling. *Circulation* 116: 2127-2138, 2007.

22 Bumpus FM, Catt KJ, Chiu AT, DeGasparo M, Goodfriend T, Husain A, Peach MJ, Taylor DG, Jr. and Timmermans PB. Nomenclature for angiotensin receptors. A report of the Nomenclature Committee of the Council for High Blood Pressure Research. *Hypertension* 17: 720-721, 1991.

23 Calvier L, Martinez-Martinez E, Miana M, Cachofeiro V, Rousseau E, Sadaba JR, Zannad F, Rossignol P and Lopez-Andres N. The impact of galectin-3 inhibition on aldosterone-induced cardiac and renal injuries. *JACC Heart Fail* 3: 59-67, 2015.

24 Calvier L, Miana M, Reboul P, Cachofeiro V, Martinez-Martinez E, de Boer RA, Poirier F, Lacolley P, Zannad F, Rossignol P and Lopez-Andres N. Galectin-3 mediates aldosterone-induced vascular fibrosis. *Arterioscler Thromb Vasc Biol* 33: 67-75, 2013.

25 Campbell ID and Humphries MJ. Integrin structure, activation, and interactions. *Cold Spring Harb Perspect Biol* 3: 2011.

26 Cao J, Ye B, Lin L, Tian L, Yang H, Wang C, Huang W and Huang Z. Curcumin Alleviates oxLDL Induced MMP-9 and EMMPRIN Expression through the Inhibition of NF-kappaB and MAPK Pathways in Macrophages. *Front Pharmacol* 8: 62, 2017.

27 Carthy JM, Luo Z and McManus BM. WNT3A induces a contractile and secretory phenotype in cultured vascular smooth muscle cells that is associated with increased gap junction communication. *Lab Invest* 92: 246-255, 2012.

28 Cascella T, Radhakrishnan Y, Maile LA, Busby WH, Jr., Gollahon K, Colao A and Clemmons DR. Aldosterone enhances IGF-I-mediated signaling and biological function in vascular smooth muscle cells. *Endocrinology* 151: 5851-5864, 2010.

29 Chabriat H, Joutel A, Dichgans M, Tournier-Lasserre E and Boussier MG. Cadasil. *Lancet Neurol* 8: 643-653, 2009.

30 Chamley-Campbell J, Campbell GR and Ross R. The smooth muscle cell in culture. *Physiol Rev* 59: 1-61, 1979.

31 Chang JZ, Hsieh YP, Lin WH, Chen HM and Kuo MY. Activation of transforming growth factor-beta1 by thrombin via integrins alphavbeta1, alphavbeta3, and

alphavbeta5 in buccal fibroblasts: Suppression by epigallocatechin-3-gallate. *Head Neck* 39: 1436-1445, 2017.

32 Cheifetz S, Hernandez H, Laiho M, ten Dijke P, Iwata KK and Massague J. Distinct transforming growth factor-beta (TGF-beta) receptor subsets as determinants of cellular responsiveness to three TGF-beta isoforms. *J Biol Chem* 265: 20533-20538, 1990.

33 Chen A, Hou W, Zhang Y, Chen Y and He B. Prognostic value of serum galectin-3 in patients with heart failure: a meta-analysis. *Int J Cardiol* 182: 168-170, 2015.

34 Chen C, Li R, Ross RS and Manso AM. Integrins and integrin-related proteins in cardiac fibrosis. *J Mol Cell Cardiol* 93: 162-174, 2016.

35 Chen D, Procter N, Goh V, Liu S, Chua SJ, Assadi-Khansari B, Stewart S, Horowitz JD, Sverdlov AL and Ngo DT. New onset atrial fibrillation is associated with elevated galectin-3 levels. *Int J Cardiol* 223: 48-49, 2016.

36 Chen K, Jiang RJ, Wang CQ, Yin ZF, Fan YQ, Cao JT, Han ZH, Wang Y and Song DQ. Predictive value of plasma galectin-3 in patients with chronic heart failure. *Eur Rev Med Pharmacol Sci* 17: 1005-1011, 2013.

37 Chen L, Yang T, Lu DW, Zhao H, Feng YL, Chen H, Chen DQ, Vaziri ND and Zhao YY. Central role of dysregulation of TGF-beta/Smad in CKD progression and potential targets of its treatment. *Biomed Pharmacother* 101: 670-681, 2018.

38 Chen WS, Cao Z, Leffler H, Nilsson UJ and Panjwani N. Galectin-3 Inhibition by a Small-Molecule Inhibitor Reduces Both Pathological Corneal Neovascularization and Fibrosis. *Invest Ophthalmol Vis Sci* 58: 9-20, 2017.

39 Chen XL, Tummala PE, Olbrych MT, Alexander RW and Medford RM. Angiotensin II induces monocyte chemoattractant protein-1 gene expression in rat vascular smooth muscle cells. *Circ Res* 83: 952-959, 1998.

40 Cheng J, Zhang J, Merched A, Zhang L, Zhang P, Truong L, Boriek AM and Du J. Mechanical stretch inhibits oxidized low density lipoprotein-induced apoptosis in vascular smooth muscle cells by up-regulating integrin alphavbeta3 and stabilization of PINCH-1. *J Biol Chem* 282: 34268-34275, 2007.

41 Chi J, Wang L, Zhang X, Fu Y, Liu Y, Chen W, Liu W, Shi Z and Yin X. Activation of calcium-sensing receptor-mediated autophagy in angiotensinII-induced cardiac fibrosis in vitro. *Biochem Biophys Res Commun* 497: 571-576, 2018.

42 Chillakuri CR, Sheppard D, Lea SM and Handford PA. Notch receptor-ligand binding and activation: insights from molecular studies. *Semin Cell Dev Biol* 23: 421-428, 2012.

43 Chothia C and Jones EY. The molecular structure of cell adhesion molecules. *Annu Rev Biochem* 66: 823-862, 1997.

44 Chung AC, Zhang H, Kong YZ, Tan JJ, Huang XR, Kopp JB and Lan HY. Advanced glycation end-products induce tubular CTGF via TGF-beta-independent Smad3 signaling. *J Am Soc Nephrol* 21: 249-260, 2010.

45 Cipollone F, Fazio M, Iezzi A, Zucchelli M, Pini B, De Cesare D, Uchino S, Spigonardo F, Bajocchi G, Bei R, Muraro R, Artese L, Piattelli A, Chiarelli F, Cuccurullo F and Mezzetti A. Suppression of the functionally coupled

cyclooxygenase-2/prostaglandin E synthase as a basis of simvastatin-dependent plaque stabilization in humans. *Circulation* 107: 1479-1485, 2003.

46 Clementy N, Benhenda N, Piver E, Pierre B, Bernard A, Fauchier L, Pages JC and Babuty D. Serum Galectin-3 Levels Predict Recurrences after Ablation of Atrial Fibrillation. *Sci Rep* 6: 34357, 2016.

47 Conroy KP, Kitto LJ and Henderson NC. α v integrins: key regulators of tissue fibrosis. *Cell Tissue Res* 365: 511-519, 2016.

48 Cornick S, Moreau F and Chadee K. Entamoeba histolytica Cysteine Proteinase 5 Evokes Mucin Exocytosis from Colonic Goblet Cells via α v β 3 Integrin. *PLoS Pathog* 12: e1005579, 2016.

49 Coughlin SR. Thrombin signalling and protease-activated receptors. *Nature* 407: 258-264, 2000.

50 Couturier L and Schweisguth F. Antibody uptake assay and in vivo imaging to study intracellular trafficking of Notch and Delta in Drosophila. *Methods Mol Biol* 1187: 79-86, 2014.

51 Cox RH. Basis for the altered arterial wall mechanics in the spontaneously hypertensive rat. *Hypertension* 3: 485-495, 1981.

52 Crean JK, Finlay D, Murphy M, Moss C, Godson C, Martin F and Brady HR. The role of p42/44 MAPK and protein kinase B in connective tissue growth factor induced extracellular matrix protein production, cell migration, and actin cytoskeletal rearrangement in human mesangial cells. *J Biol Chem* 277: 44187-44194, 2002.

53 Cui Y, Song X, Li S, He B, Yuan L, Dai W, Zhang H, Wang X, Yang B and Zhang Q. The impact of receptor recycling on the exocytosis of α v β 3 integrin targeted gold nanoparticles. *Oncotarget* 8: 38618-38630, 2017.

54 Dalton P, Christian HC, Redman CW, Sargent IL and Boyd CA. Membrane trafficking of CD98 and its ligand galectin 3 in BeWo cells--implication for placental cell fusion. *FEBS J* 274: 2715-2727, 2007.

55 Dang Z, MacKinnon A, Marson LP and Sethi T. Tubular atrophy and interstitial fibrosis after renal transplantation is dependent on galectin-3. *Transplantation* 93: 477-484, 2012.

56 Daniels CE, Wilkes MC, Edens M, Kottom TJ, Murphy SJ, Limper AH and Leof EB. Imatinib mesylate inhibits the profibrogenic activity of TGF- β and prevents bleomycin-mediated lung fibrosis. *J Clin Invest* 114: 1308-1316, 2004.

57 Davies M, Martin J, Thomas GJ and Lovett DH. Proteinases and glomerular matrix turnover. *Kidney Int* 41: 671-678, 1992.

58 DeMarco VG, Habibi J, Jia G, Aroor AR, Ramirez-Perez FI, Martinez-Lemus LA, Bender SB, Garro M, Hayden MR, Sun Z, Meininger GA, Manrique C, Whaley-Connell A and Sowers JR. Low-Dose Mineralocorticoid Receptor Blockade Prevents Western Diet-Induced Arterial Stiffening in Female Mice. *Hypertension* 66: 99-107, 2015.

59 Derynck R, Zhang Y and Feng XH. Smads: transcriptional activators of TGF- β responses. *Cell* 95: 737-740, 1998.

60 Derynck R and Zhang YE. Smad-dependent and Smad-independent pathways

- in TGF-beta family signalling. *Nature* 425: 577-584, 2003.
- 61 Desch A, Strozyk EA, Bauer AT, Huck V, Niemeyer V, Wieland T and Schneider SW. Highly invasive melanoma cells activate the vascular endothelium via an MMP-2/integrin alphavbeta5-induced secretion of VEGF-A. *Am J Pathol* 181: 693-705, 2012.
- 62 Desmedt V, Desmedt S, Delanghe JR, Speeckaert R and Speeckaert MM. Galectin-3 in Renal Pathology: More Than Just an Innocent Bystander. *Am J Nephrol* 43: 305-317, 2016.
- 63 Dickson MC, Martin JS, Cousins FM, Kulkarni AB, Karlsson S and Akhurst RJ. Defective haematopoiesis and vasculogenesis in transforming growth factor-beta 1 knock out mice. *Development* 121: 1845-1854, 1995.
- 64 Dieffenbach PB, Haeger CM, Coronata AMF, Choi KM, Varelas X, Tschumperlin DJ and Fredenburgh LE. Arterial stiffness induces remodeling phenotypes in pulmonary artery smooth muscle cells via YAP/TAZ-mediated repression of cyclooxygenase-2. *Am J Physiol Lung Cell Mol Physiol* 313: L628-L647, 2017.
- 65 Dinardo CL, Venturini G, Zhou EH, Watanabe IS, Campos LC, Dariolli R, da Motta-Leal-Filho JM, Carvalho VM, Cardozo KH, Krieger JE, Alencar AM and Pereira AC. Variation of mechanical properties and quantitative proteomics of VSMC along the arterial tree. *Am J Physiol Heart Circ Physiol* 306: H505-516, 2014.
- 66 Dobaczewski M, Bujak M, Li N, Gonzalez-Quesada C, Mendoza LH, Wang XF and Frangogiannis NG. Smad3 signaling critically regulates fibroblast phenotype and function in healing myocardial infarction. *Circ Res* 107: 418-428, 2010.
- 67 Domenga V, Fardoux P, Lacombe P, Monet M, Maciazek J, Krebs LT, Klonjkowski B, Berrou E, Mericskay M, Li Z, Tournier-Lasserre E, Gridley T and Joutel A. Notch3 is required for arterial identity and maturation of vascular smooth muscle cells. *Genes Dev* 18: 2730-2735, 2004.
- 68 Domschke G, Linden F, Pawig L, Hafner A, Akhavanpoor M, Reymann J, Doesch AO, Erbel C, Weber C, Katus HA, Noels H, Erfle H, Gleissner CA and Runz H. Systematic RNA-interference in primary human monocyte-derived macrophages: A high-throughput platform to study foam cell formation. *Sci Rep* 8: 10516, 2018.
- 69 Dooley S and ten Dijke P. TGF-beta in progression of liver disease. *Cell Tissue Res* 347: 245-256, 2012.
- 70 Duerrschmid C, Crawford JR, Reineke E, Taffet GE, Trial J, Entman ML and Haudek SB. TNF receptor 1 signaling is critically involved in mediating angiotensin-II-induced cardiac fibrosis. *J Mol Cell Cardiol* 57: 59-67, 2013.
- 71 Dumeric J, Dabelic S and Flogel M. Galectin-3: an open-ended story. *Biochim Biophys Acta* 1760: 616-635, 2006.
- 72 Durham AL, Speer MY, Scatena M, Giachelli CM and Shanahan CM. Role of smooth muscle cells in vascular calcification: implications in atherosclerosis and arterial stiffness. *Cardiovasc Res* 114: 590-600, 2018.
- 73 Dzau VJ. Theodore Cooper Lecture: Tissue angiotensin and pathobiology of vascular disease: a unifying hypothesis. *Hypertension* 37: 1047-1052, 2001.
- 74 Esparza-Lopez J, Montiel JL, Vilchis-Landeros MM, Okadome T, Miyazono K and Lopez-Casillas F. Ligand binding and functional properties of betaglycan, a

co-receptor of the transforming growth factor-beta superfamily. Specialized binding regions for transforming growth factor-beta and inhibin A. *J Biol Chem* 276: 14588-14596, 2001.

75 Evellin S, Galvagni F, Zippo A, Neri F, Orlandini M, Incarnato D, Dettori D, Neubauer S, Kessler H, Wagner EF and Oliviero S. FOSL1 controls the assembly of endothelial cells into capillary tubes by direct repression of alpha_v and beta₃ integrin transcription. *Mol Cell Biol* 33: 1198-1209, 2013.

76 Fan WH and Karnovsky MJ. Increased MMP-2 expression in connective tissue growth factor over-expression vascular smooth muscle cells. *J Biol Chem* 277: 9800-9805, 2002.

77 Fashanu OE, Norby FL, Aguilar D, Ballantyne CM, Hoogeveen RC, Chen LY, Soliman EZ, Alonso A and Folsom AR. Galectin-3 and incidence of atrial fibrillation: The Atherosclerosis Risk in Communities (ARIC) study. *Am Heart J* 192: 19-25, 2017.

78 Fenster BE, Lasalvia L, Schroeder JD, Smyser J, Silveira LJ, Buckner JK and Brown KK. Galectin-3 levels are associated with right ventricular functional and morphologic changes in pulmonary arterial hypertension. *Heart Vessels* 31: 939-946, 2016.

79 Flanders KC, Sullivan CD, Fujii M, Sowers A, Anzano MA, Arabshahi A, Major C, Deng C, Russo A, Mitchell JB and Roberts AB. Mice lacking Smad3 are protected against cutaneous injury induced by ionizing radiation. *Am J Pathol* 160: 1057-1068, 2002.

80 Flevaris P, Khan SS, Eren M, Schuldt AJT, Shah SJ, Lee DC, Gupta S, Shapiro AD, Burrige PW, Ghosh AK and Vaughan DE. Plasminogen Activator Inhibitor Type I Controls Cardiomyocyte Transforming Growth Factor-beta and Cardiac Fibrosis. *Circulation* 136: 664-679, 2017.

81 Frazier K, Williams S, Kothapalli D, Klapper H and Grotendorst GR. Stimulation of fibroblast cell growth, matrix production, and granulation tissue formation by connective tissue growth factor. *J Invest Dermatol* 107: 404-411, 1996.

82 Friedrichs K, Adam M, Remane L, Mollenhauer M, Rudolph V, Rudolph TK, Andrie RP, Stockigt F, Schrickel JW, Ravekes T, Deuschl F, Nickenig G, Willems S, Baldus S and Klinke A. Induction of atrial fibrillation by neutrophils critically depends on CD11b/CD18 integrins. *PLoS One* 9: e89307, 2014.

83 Fukasawa H, Yamamoto T, Suzuki H, Togawa A, Ohashi N, Fujigaki Y, Uchida C, Aoki M, Hosono M, Kitagawa M and Hishida A. Treatment with anti-TGF-beta antibody ameliorates chronic progressive nephritis by inhibiting Smad/TGF-beta signaling. *Kidney Int* 65: 63-74, 2004.

84 Fukuyama K, Ichiki T, Takeda K, Tokunou T, Iino N, Masuda S, Ishibashi M, Egashira K, Shimokawa H, Hirano K, Kanaide H and Takeshita A. Downregulation of vascular angiotensin II type 1 receptor by thyroid hormone. *Hypertension* 41: 598-603, 2003.

85 Furtak V, Hatcher F and Ochieng J. Galectin-3 mediates the endocytosis of beta-1 integrins by breast carcinoma cells. *Biochem Biophys Res Commun* 289: 845-850, 2001.

- 86 Galis ZS and Khatri JJ. Matrix metalloproteinases in vascular remodeling and atherogenesis: the good, the bad, and the ugly. *Circ Res* 90: 251-262, 2002.
- 87 Gallinat S, Busche S, Schutze S, Kronke M and Unger T. AT2 receptor stimulation induces generation of ceramides in PC12W cells. *FEBS Lett* 443: 75-79, 1999.
- 88 Gao Y, Zhang YM, Qian LJ, Chu M, Hong J and Xu D. ANO1 inhibits cardiac fibrosis after myocardial infarction via TGF-beta/smad3 pathway. *Sci Rep* 7: 2355, 2017.
- 89 Geisterfer AA, Peach MJ and Owens GK. Angiotensin II induces hypertrophy, not hyperplasia, of cultured rat aortic smooth muscle cells. *Circ Res* 62: 749-756, 1988.
- 90 Glukhova MA, Kabakov AE, Frid MG, Ornatsky OI, Belkin AM, Mukhin DN, Orekhov AN, Koteliatsky VE and Smirnov VN. Modulation of human aorta smooth muscle cell phenotype: a study of muscle-specific variants of vinculin, caldesmon, and actin expression. *Proc Natl Acad Sci U S A* 85: 9542-9546, 1988.
- 91 Gonzalez GE, Cassaglia P, Noli Truant S, Fernandez MM, Wilensky L, Volberg V, Malchiodi EL, Morales C and Gelpi RJ. Galectin-3 is essential for early wound healing and ventricular remodeling after myocardial infarction in mice. *Int J Cardiol* 176: 1423-1425, 2014.
- 92 Gonzalez GE, Rhaleb NE, D'Ambrosio MA, Nakagawa P, Liao TD, Peterson EL, Leung P, Dai X, Janic B, Liu YH, Yang XP and Carretero OA. Cardiac-deleterious role of galectin-3 in chronic angiotensin II-induced hypertension. *Am J Physiol Heart Circ Physiol* 311: H1287-H1296, 2016.
- 93 Greenwald SE. Ageing of the conduit arteries. *J Pathol* 211: 157-172, 2007.
- 94 Griendling KK, Lassegue B, Murphy TJ and Alexander RW. Angiotensin II receptor pharmacology. *Adv Pharmacol* 28: 269-306, 1994.
- 95 Gu J, Liu X, Wang QX, Tan HW, Guo M, Jiang WF and Zhou L. Angiotensin II increases CTGF expression via MAPKs/TGF-beta1/TRAF6 pathway in atrial fibroblasts. *Exp Cell Res* 318: 2105-2115, 2012.
- 96 Gu X, Xu D, Fu L, Wang Y, Mei C and Gao X. KLF 15 Works as an Early Anti-Fibrotic Transcriptional Regulator in Ang II-Induced Renal Fibrosis via Down-Regulation of CTGF Expression. *Kidney Blood Press Res* 42: 999-1012, 2017.
- 97 Gullestad L, Ueland T, Kjekshus J, Nymo SH, Hulthe J, Muntendam P, McMurray JJ, Wikstrand J and Aukrust P. The predictive value of galectin-3 for mortality and cardiovascular events in the Controlled Rosuvastatin Multinational Trial in Heart Failure (CORONA). *Am Heart J* 164: 878-883, 2012.
- 98 Gunther S, Gimbrone MA, Jr. and Alexander RW. Regulation by angiotensin II of its receptors in resistance blood vessels. *Nature* 287: 230-232, 1980.
- 99 Guo DF and Inagami T. Epidermal growth factor-enhanced human angiotensin II type 1 receptor. *Hypertension* 23: 1032-1035, 1994.
- 100 Gurses KM, Yalcin MU, Kocyigit D, Canpinar H, Evranos B, Yorgun H, Sahiner ML, Kaya EB, Ozer N, Tokgozoglul L, Oto MA, Guc D and Aytemir K. Effects of persistent atrial fibrillation on serum galectin-3 levels. *Am J Cardiol* 115: 647-651, 2015.

- 101 Guruharsha KG, Kankel MW and Artavanis-Tsakonas S. The Notch signalling system: recent insights into the complexity of a conserved pathway. *Nat Rev Genet* 13: 654-666, 2012.
- 102 Hahn AW, Jonas U, Buhler FR and Resink TJ. Activation of human peripheral monocytes by angiotensin II. *FEBS Lett* 347: 178-180, 1994.
- 103 Hao H, Gabbiani G and Bochaton-Piallat ML. Arterial smooth muscle cell heterogeneity: implications for atherosclerosis and restenosis development. *Arterioscler Thromb Vasc Biol* 23: 1510-1520, 2003.
- 104 Hartner A, Cordasic N, Rascher W and Hilgers KF. Deletion of the alpha8 integrin gene does not protect mice from myocardial fibrosis in DOCA hypertension. *Am J Hypertens* 22: 92-99, 2009.
- 105 Harvey A, Montezano AC, Lopes RA, Rios F and Touyz RM. Vascular Fibrosis in Aging and Hypertension: Molecular Mechanisms and Clinical Implications. *Can J Cardiol* 32: 659-668, 2016.
- 106 Harvey A, Montezano AC and Touyz RM. Vascular biology of ageing-Implications in hypertension. *J Mol Cell Cardiol* 83: 112-121, 2015.
- 107 He B, Huang B, Lu Z, He W and Jiang H. Galectin-3: A potential new target for upstream therapy of atrial fibrillation. *Int J Cardiol* 203: 1131-1132, 2016.
- 108 He J, Li X, Luo H, Li T, Zhao L, Qi Q, Liu Y and Yu Z. Galectin-3 mediates the pulmonary arterial hypertension-induced right ventricular remodeling through interacting with NADPH oxidase 4. *J Am Soc Hypertens* 11: 275-289 e272, 2017.
- 109 Heldin CH and Moustakas A. Role of Smads in TGFbeta signaling. *Cell Tissue Res* 347: 21-36, 2012.
- 110 Henderson NC, Arnold TD, Katamura Y, Giacomini MM, Rodriguez JD, McCarty JH, Pellicoro A, Raschperger E, Betsholtz C, Ruminiski PG, Griggs DW, Prinsen MJ, Maher JJ, Iredale JP, Lacy-Hulbert A, Adams RH and Sheppard D. Targeting of alphav integrin identifies a core molecular pathway that regulates fibrosis in several organs. *Nat Med* 19: 1617-1624, 2013.
- 111 Henderson NC, Mackinnon AC, Farnworth SL, Kipari T, Haslett C, Iredale JP, Liu FT, Hughes J and Sethi T. Galectin-3 expression and secretion links macrophages to the promotion of renal fibrosis. *Am J Pathol* 172: 288-298, 2008.
- 112 Hernandez-Romero D, Vilchez JA, Lahoz A, Romero-Aniorte AI, Jover E, Garcia-Alberola A, Jara-Rubio R, Martinez CM, Valdes M and Marin F. Galectin-3 as a marker of interstitial atrial remodelling involved in atrial fibrillation. *Sci Rep* 7: 40378, 2017.
- 113 High FA and Epstein JA. The multifaceted role of Notch in cardiac development and disease. *Nat Rev Genet* 9: 49-61, 2008.
- 114 Hoshino H, Takahashi M, Kushida K, Ohishi T, Kawana K and Inoue T. Quantitation of the crosslinks, pyridinoline, deoxypyridinoline and pentosidine, in human aorta with dystrophic calcification. *Atherosclerosis* 112: 39-46, 1995.
- 115 Howard M, Jiang X, Stolz DB, Hill WG, Johnson JA, Watkins SC, Frizzell RA, Bruton CM, Robbins PD and Weisz OA. Forskolin-induced apical membrane insertion of virally expressed, epitope-tagged CFTR in polarized MDCK cells. *Am J Physiol Cell Physiol* 279: C375-382, 2000.

- 116 Huang Z, Meng S, Wang L, Wang Y, Chen T and Wang C. Suppression of oxLDL-induced MMP-9 and EMMPRIN expression by berberine via inhibition of NF-kappaB activation in human THP-1 macrophages. *Anat Rec (Hoboken)* 295: 78-86, 2012.
- 117 Huhtala P, Humphries MJ, McCarthy JB, Tremble PM, Werb Z and Damsky CH. Cooperative signaling by alpha 5 beta 1 and alpha 4 beta 1 integrins regulates metalloproteinase gene expression in fibroblasts adhering to fibronectin. *J Cell Biol* 129: 867-879, 1995.
- 118 Hunyady L and Catt KJ. Pleiotropic AT1 receptor signaling pathways mediating physiological and pathogenic actions of angiotensin II. *Mol Endocrinol* 20: 953-970, 2006.
- 119 Ichiki T, Takeda K, Tokunou T, Iino N, Egashira K, Shimokawa H, Hirano K, Kanaide H and Takeshita A. Downregulation of angiotensin II type 1 receptor by hydrophobic 3-hydroxy-3-methylglutaryl coenzyme A reductase inhibitors in vascular smooth muscle cells. *Arterioscler Thromb Vasc Biol* 21: 1896-1901, 2001.
- 120 Ichiki T, Usui M, Kato M, Funakoshi Y, Ito K, Egashira K and Takeshita A. Downregulation of angiotensin II type 1 receptor gene transcription by nitric oxide. *Hypertension* 31: 342-348, 1998.
- 121 Ikeda Y, Takeuchi K, Kato T, Taniyama Y, Sato K, Takahashi N, Sugawara A and Ito S. Transcriptional suppression of rat angiotensin AT1a receptor gene expression by interferon-gamma in vascular smooth muscle cells. *Biochem Biophys Res Commun* 262: 494-498, 1999.
- 122 Imanishi M, Tomita S, Ishizawa K, Kihira Y, Ueno M, Izawa-Ishizawa Y, Ikeda Y, Yamano N, Tsuchiya K and Tamaki T. Smooth muscle cell-specific Hif-1alpha deficiency suppresses angiotensin II-induced vascular remodeling in mice. *Cardiovasc Res* 102: 460-468, 2014.
- 123 Imran TF, Shin HJ, Mathenge N, Wang F, Kim B, Joseph J, Gaziano JM and Djousse L. Meta-Analysis of the Usefulness of Plasma Galectin-3 to Predict the Risk of Mortality in Patients With Heart Failure and in the General Population. *Am J Cardiol* 119: 57-64, 2017.
- 124 Intengan HD and Schiffrin EL. Structure and mechanical properties of resistance arteries in hypertension: role of adhesion molecules and extracellular matrix determinants. *Hypertension* 36: 312-318, 2000.
- 125 Ishida M, Ishida T, Thomas SM and Berk BC. Activation of extracellular signal-regulated kinases (ERK1/2) by angiotensin II is dependent on c-Src in vascular smooth muscle cells. *Circ Res* 82: 7-12, 1998.
- 126 Ishida T, Ishida M, Suero J, Takahashi M and Berk BC. Agonist-stimulated cytoskeletal reorganization and signal transduction at focal adhesions in vascular smooth muscle cells require c-Src. *J Clin Invest* 103: 789-797, 1999.
- 127 Israeli-Rosenberg S, Manso AM, Okada H and Ross RS. Integrins and integrin-associated proteins in the cardiac myocyte. *Circ Res* 114: 572-586, 2014.
- 128 Jacob MP. Extracellular matrix remodeling and matrix metalloproteinases in the vascular wall during aging and in pathological conditions. *Biomed Pharmacother* 57: 195-202, 2003.

- 129 Jacobs LS and Douglas JG. Angiotensin II type 2 receptor subtype mediates phospholipase A2-dependent signaling in rabbit proximal tubular epithelial cells. *Hypertension* 28: 663-668, 1996.
- 130 Jarriault S, Brou C, Logeat F, Schroeter EH, Kopan R and Israel A. Signalling downstream of activated mammalian Notch. *Nature* 377: 355-358, 1995.
- 131 Jeong MH, Kim SJ, Kang H, Park KW, Park WJ, Yang SY and Yang DK. Cucurbitacin I Attenuates Cardiomyocyte Hypertrophy via Inhibition of Connective Tissue Growth Factor (CCN2) and TGF- beta/Smads Signalings. *PLoS One* 10: e0136236, 2015.
- 132 Jessen TN and Jessen JR. VANGL2 interacts with integrin alphaV to regulate matrix metalloproteinase activity and cell adhesion to the extracellular matrix. *Exp Cell Res* 361: 265-276, 2017.
- 133 Jesus ICG, Scalzo S, Alves F, Marques K, Rocha-Resende C, Bader M, Santos RAS and Guatimosim S. Alamandine acts via MrgD to induce AMPK/NO activation against ANG II hypertrophy in cardiomyocytes. *Am J Physiol Cell Physiol* 314: C702-C711, 2018.
- 134 Jia W, Kidoya H, Yamakawa D, Naito H and Takakura N. Galectin-3 accelerates M2 macrophage infiltration and angiogenesis in tumors. *Am J Pathol* 182: 1821-1831, 2013.
- 135 Jiang HB, Xu M and Wang XP. Pancreatic stellate cells promote proliferation and invasiveness of human pancreatic cancer cells via galectin-3. *World J Gastroenterol* 14: 2023-2028, 2008.
- 136 Jiang HM, Wang HX, Yang H, Zeng XJ, Tang CS, Du J and Li HH. Role for granulocyte colony stimulating factor in angiotensin II-induced neutrophil recruitment and cardiac fibrosis in mice. *Am J Hypertens* 26: 1224-1233, 2013.
- 137 Jiang JX, Chen X, Hsu DK, Baghy K, Serizawa N, Scott F, Takada Y, Fukada H, Chen J, Devaraj S, Adamson R, Liu FT and Torok NJ. Galectin-3 modulates phagocytosis-induced stellate cell activation and liver fibrosis in vivo. *Am J Physiol Gastrointest Liver Physiol* 302: G439-446, 2012.
- 138 Joghetaei N, Stein A, Byrne RA, Schulz C, King L, May AE and Schmidt R. The Extracellular Matrix Metalloproteinase Inducer (EMMPRN, CD147) - a potential novel target in atherothrombosis prevention? *Thromb Res* 131: 474-480, 2013.
- 139 Jones ES, Vinh A, McCarthy CA, Gaspari TA and Widdop RE. AT2 receptors: functional relevance in cardiovascular disease. *Pharmacol Ther* 120: 292-316, 2008.
- 140 Jones JI, Pevette T, Gockerman A and Clemmons DR. Ligand occupancy of the alpha-V-beta3 integrin is necessary for smooth muscle cells to migrate in response to insulin-like growth factor. *Proc Natl Acad Sci U S A* 93: 2482-2487, 1996.
- 141 Joutel A, Andreux F, Gaulis S, Domenga V, Cecillon M, Battail N, Piga N, Chapon F, Godfrain C and Tournier-Lasserre E. The ectodomain of the Notch3 receptor accumulates within the cerebrovasculature of CADASIL patients. *J Clin Invest* 105: 597-605, 2000.
- 142 Joutel A, Corpechot C, Ducros A, Vahedi K, Chabriat H, Mouton P, Alamowitch S, Domenga V, Cecillon M, Marechal E, Maciazek J, Vayssiere C, Cruaud C, Cabanis EA, Ruchoux MM, Weissenbach J, Bach JF, Bousser MG and Tournier-Lasserre E.

Notch3 mutations in CADASIL, a hereditary adult-onset condition causing stroke and dementia. *Nature* 383: 707-710, 1996.

143 Kahari VM, Larjava H and Uitto J. Differential regulation of extracellular matrix proteoglycan (PG) gene expression. Transforming growth factor-beta 1 up-regulates biglycan (PGI), and versican (large fibroblast PG) but down-regulates decorin (PGII) mRNA levels in human fibroblasts in culture. *J Biol Chem* 266: 10608-10615, 1991.

144 Kalaria RN. Small vessel disease and Alzheimer's dementia: pathological considerations. *Cerebrovasc Dis* 13 Suppl 2: 48-52, 2002.

145 Kang Q, Li X, Yang M, Fernando T and Wan Z. Galectin-3 in patients with coronary heart disease and atrial fibrillation. *Clin Chim Acta* 478: 166-170, 2018.

146 Katwa LC, Campbell SE, Tyagi SC, Lee SJ, Cicila GT and Weber KT. Cultured myofibroblasts generate angiotensin peptides de novo. *J Mol Cell Cardiol* 29: 1375-1386, 1997.

147 Kim EN, Kim MY, Lim JH, Kim Y, Shin SJ, Park CW, Kim YS, Chang YS, Yoon HE and Choi BS. The protective effect of resveratrol on vascular aging by modulation of the renin-angiotensin system. *Atherosclerosis* 270: 123-131, 2018.

148 Kim H, Lee J, Hyun JW, Park JW, Joo HG and Shin T. Expression and immunohistochemical localization of galectin-3 in various mouse tissues. *Cell Biol Int* 31: 655-662, 2007.

149 Kim JY, Kim WJ, Kim H, Suk K and Lee WH. The Stimulation of CD147 Induces MMP-9 Expression through ERK and NF-kappaB in Macrophages: Implication for Atherosclerosis. *Immune Netw* 9: 90-97, 2009.

150 Kim K, Mayer EP and Nachtigal M. Galectin-3 expression in macrophages is signaled by Ras/MAP kinase pathway and up-regulated by modified lipoproteins. *Biochim Biophys Acta* 1641: 13-23, 2003.

151 Kisseleva T and Brenner DA. Mechanisms of fibrogenesis. *Exp Biol Med (Maywood)* 233: 109-122, 2008.

152 Kleinbongard P, Heusch G and Schulz R. TNFalpha in atherosclerosis, myocardial ischemia/reperfusion and heart failure. *Pharmacol Ther* 127: 295-314, 2010.

153 Kothapalli D, Frazier KS, Welply A, Segarini PR and Grotendorst GR. Transforming growth factor beta induces anchorage-independent growth of NRK fibroblasts via a connective tissue growth factor-dependent signaling pathway. *Cell Growth Differ* 8: 61-68, 1997.

154 Kranzhofer R, Schmidt J, Pfeiffer CA, Hagl S, Libby P and Kubler W. Angiotensin induces inflammatory activation of human vascular smooth muscle cells. *Arterioscler Thromb Vasc Biol* 19: 1623-1629, 1999.

155 Kryczka J, Stasiak M, Dziki L, Mik M, Dziki A and Cierniewski C. Matrix metalloproteinase-2 cleavage of the beta1 integrin ectodomain facilitates colon cancer cell motility. *J Biol Chem* 287: 36556-36566, 2012.

156 Kuhbandner S, Brummer S, Metzger D, Chambon P, Hofmann F and Feil R. Temporally controlled somatic mutagenesis in smooth muscle. *Genesis* 28: 15-22, 2000.

- 157 Kuro-o M, Nagai R, Nakahara K, Katoh H, Tsai RC, Tsuchimochi H, Yazaki Y, Ohkubo A and Takaku F. cDNA cloning of a myosin heavy chain isoform in embryonic smooth muscle and its expression during vascular development and in arteriosclerosis. *J Biol Chem* 266: 3768-3773, 1991.
- 158 Labat-Robert J. Cell-matrix interactions, alterations with aging, involvement in angiogenesis. *Pathol Biol (Paris)* 46: 527-533, 1998.
- 159 Lacolley P, Regnault V, Segers P and Laurent S. Vascular Smooth Muscle Cells and Arterial Stiffening: Relevance in Development, Aging, and Disease. *Physiol Rev* 97: 1555-1617, 2017.
- 160 Lacy-Hulbert A, Smith AM, Tissire H, Barry M, Crowley D, Bronson RT, Roes JT, Savill JS and Hynes RO. Ulcerative colitis and autoimmunity induced by loss of myeloid alpha ν integrins. *Proc Natl Acad Sci U S A* 104: 15823-15828, 2007.
- 161 Lacy-Hulbert A, Ueno T, Ito T, Jurewicz M, Izawa A, Smith RN, Chase CM, Tanaka K, Fiorina P, Russell PS, Auchincloss H, Jr., Sayegh MH, Hynes RO and Abdi R. Beta 3 integrins regulate lymphocyte migration and cytokine responses in heart transplant rejection. *Am J Transplant* 7: 1080-1090, 2007.
- 162 Lakshminarayanan R, Wunder C, Becken U, Howes MT, Benzing C, Arumugam S, Sales S, Ariotti N, Chambon V, Lamaze C, Loew D, Shevchenko A, Gaus K, Parton RG and Johannes L. Galectin-3 drives glycosphingolipid-dependent biogenesis of clathrin-independent carriers. *Nat Cell Biol* 16: 595-606, 2014.
- 163 Lan HY. Diverse roles of TGF- β /Smads in renal fibrosis and inflammation. *Int J Biol Sci* 7: 1056-1067, 2011.
- 164 Lan TH, Huang XQ and Tan HM. Vascular fibrosis in atherosclerosis. *Cardiovasc Pathol* 22: 401-407, 2013.
- 165 Laurent S, Cockcroft J, Van Bortel L, Boutouyrie P, Giannattasio C, Hayoz D, Pannier B, Vlachopoulos C, Wilkinson I and Struijker-Boudier H. Expert consensus document on arterial stiffness: methodological issues and clinical applications. *Eur Heart J* 27: 2588-2605, 2006.
- 166 Lax A, Sanchez-Mas J, Asensio-Lopez MC, Fernandez-Del Palacio MJ, Caballero L, Garrido IP, Pastor-Perez FJ, Januzzi JL and Pascual-Figal DA. Mineralocorticoid receptor antagonists modulate galectin-3 and interleukin-33/ST2 signaling in left ventricular systolic dysfunction after acute myocardial infarction. *JACC Heart Fail* 3: 50-58, 2015.
- 167 Leask A and Abraham DJ. TGF- β signaling and the fibrotic response. *FASEB J* 18: 816-827, 2004.
- 168 Leask A, Holmes A, Black CM and Abraham DJ. Connective tissue growth factor gene regulation. Requirements for its induction by transforming growth factor- β 2 in fibroblasts. *J Biol Chem* 278: 13008-13015, 2003.
- 169 Lebrin F, Deckers M, Bertolino P and Ten Dijke P. TGF- β receptor function in the endothelium. *Cardiovasc Res* 65: 599-608, 2005.
- 170 Lehtonen JY, Horiuchi M, Daviet L, Akishita M and Dzau VJ. Activation of the de novo biosynthesis of sphingolipids mediates angiotensin II type 2 receptor-induced apoptosis. *J Biol Chem* 274: 16901-16906, 1999.
- 171 Leong XF, Mustafa MR, Das S and Jaarin K. Association of elevated blood

pressure and impaired vasorelaxation in experimental Sprague-Dawley rats fed with heated vegetable oil. *Lipids Health Dis* 9: 66, 2010.

172 Leonhardt J, Vilella DC, Teichmann A, Munter LM, Mayer MC, Mardahl M, Kirsch S, Namsolleck P, Lucht K, Benz V, Alenina N, Daniell N, Horiuchi M, Iwai M, Multhaup G, Schulein R, Bader M, Santos RA, Unger T and Steckelings UM. Evidence for Heterodimerization and Functional Interaction of the Angiotensin Type 2 Receptor and the Receptor MAS. *Hypertension* 69: 1128-1135, 2017.

173 Li BY, Li XL, Cai Q, Gao HQ, Cheng M, Zhang JH, Wang JF, Yu F and Zhou RH. Induction of lactadherin mediates the apoptosis of endothelial cells in response to advanced glycation end products and protective effects of grape seed procyanidin B2 and resveratrol. *Apoptosis* 16: 732-745, 2011.

174 Li JH, Huang XR, Zhu HJ, Oldfield M, Cooper M, Truong LD, Johnson RJ and Lan HY. Advanced glycation end products activate Smad signaling via TGF-beta-dependent and independent mechanisms: implications for diabetic renal and vascular disease. *FASEB J* 18: 176-178, 2004.

175 Li N, Wang HX, Han QY, Li WJ, Zhang YL, Du J, Xia YL and Li HH. Activation of the cardiac proteasome promotes angiotensin II-induced hypertrophy by down-regulation of ATRAP. *J Mol Cell Cardiol* 79: 303-314, 2015.

176 Li W, Li Q, Jiao Y, Qin L, Ali R, Zhou J, Ferruzzi J, Kim RW, Geirsson A, Dietz HC, Offermanns S, Humphrey JD and Tellides G. Tgfbr2 disruption in postnatal smooth muscle impairs aortic wall homeostasis. *J Clin Invest* 124: 755-767, 2014.

177 Li Y, Xu X, Wang L, Liu G, Wu X, Jing Y, Li H and Wang G. Senescent mesenchymal stem cells promote colorectal cancer cells growth via galectin-3 expression. *Cell Biosci* 5: 21, 2015.

178 Lijnen P, Petrov V, Rumilla K and Fagard R. Transforming growth factor-beta 1 promotes contraction of collagen gel by cardiac fibroblasts through their differentiation into myofibroblasts. *Methods Find Exp Clin Pharmacol* 25: 79-86, 2003.

179 Lijnen PJ, Petrov VV and Fagard RH. Induction of cardiac fibrosis by angiotensin II. *Methods Find Exp Clin Pharmacol* 22: 709-723, 2000.

180 Lin YH, Chou CH, Wu XM, Chang YY, Hung CS, Chen YH, Tzeng YL, Wu VC, Ho YL, Hsieh FJ and Wu KD. Aldosterone induced galectin-3 secretion in vitro and in vivo: from cells to humans. *PLoS One* 9: e95254, 2014.

181 Lippi G, Cervellin G and Sanchis-Gomar F. Galectin-3 in atrial fibrillation: Simple bystander, player or both? *Clin Biochem* 48: 818-822, 2015.

182 Liu G, Ma C, Yang H and Zhang PY. Transforming growth factor beta and its role in heart disease. *Exp Ther Med* 13: 2123-2128, 2017.

183 Liu L, Zhang Y, Wong CC, Zhang J, Dong Y, Li X, Kang W, Chan FKL, Sung JJY and Yu J. RNF6 Promotes Colorectal Cancer by Activating the Wnt/beta-Catenin Pathway via Ubiquitination of TLE3. *Cancer Res* 78: 1958-1971, 2018.

184 Liu YH, D'Ambrosio M, Liao TD, Peng H, Rhaleb NE, Sharma U, Andre S, Gabius HJ and Carretero OA. N-acetyl-seryl-aspartyl-lysyl-proline prevents cardiac remodeling and dysfunction induced by galectin-3, a mammalian adhesion/growth-regulatory lectin. *Am J Physiol Heart Circ Physiol* 296: H404-412,

2009.

185 Lokuta AJ, Cooper C, Gaa ST, Wang HE and Rogers TB. Angiotensin II stimulates the release of phospholipid-derived second messengers through multiple receptor subtypes in heart cells. *J Biol Chem* 269: 4832-4838, 1994.

186 Lopez-Casillas F, Wrana JL and Massague J. Betaglycan presents ligand to the TGF beta signaling receptor. *Cell* 73: 1435-1444, 1993.

187 Loyola-Leyva A, Loyola-Rodriguez JP, Atzori M and Gonzalez FJ. Morphological changes in erythrocytes of people with type 2 diabetes mellitus evaluated with atomic force microscopy: A brief review. *Micron* 105: 11-17, 2018.

188 Luo H, Liu B, Zhao L, He J, Li T, Zha L, Li X, Qi Q, Liu Y and Yu Z. Galectin-3 mediates pulmonary vascular remodeling in hypoxia-induced pulmonary arterial hypertension. *J Am Soc Hypertens* 11: 673-683 e673, 2017.

189 Luo K and Lodish HF. Signaling by chimeric erythropoietin-TGF-beta receptors: homodimerization of the cytoplasmic domain of the type I TGF-beta receptor and heterodimerization with the type II receptor are both required for intracellular signal transduction. *EMBO J* 15: 4485-4496, 1996.

190 Ma LJ, Yang H, Gaspert A, Carlesso G, Barty MM, Davidson JM, Sheppard D and Fogo AB. Transforming growth factor-beta-dependent and -independent pathways of induction of tubulointerstitial fibrosis in beta6(-/-) mice. *Am J Pathol* 163: 1261-1273, 2003.

191 MacKinnon AC, Farnworth SL, Hodgkinson PS, Henderson NC, Atkinson KM, Leffler H, Nilsson UJ, Haslett C, Forbes SJ and Sethi T. Regulation of alternative macrophage activation by galectin-3. *J Immunol* 180: 2650-2658, 2008.

192 Mackinnon AC, Gibbons MA, Farnworth SL, Leffler H, Nilsson UJ, Delaine T, Simpson AJ, Forbes SJ, Hirani N, Gauldie J and Sethi T. Regulation of transforming growth factor-beta1-driven lung fibrosis by galectin-3. *Am J Respir Crit Care Med* 185: 537-546, 2012.

193 Maier MM and Gessler M. Comparative analysis of the human and mouse Hey1 promoter: Hey genes are new Notch target genes. *Biochem Biophys Res Commun* 275: 652-660, 2000.

194 Mann DL. Recent insights into the role of tumor necrosis factor in the failing heart. *Heart Fail Rev* 6: 71-80, 2001.

195 Markowska AI, Liu FT and Panjwani N. Galectin-3 is an important mediator of VEGF- and bFGF-mediated angiogenic response. *J Exp Med* 207: 1981-1993, 2010.

196 Martinez-Martinez E, Calvier L, Fernandez-Celis A, Rousseau E, Jurado-Lopez R, Rossoni LV, Jaisser F, Zannad F, Rossignol P, Cachofeiro V and Lopez-Andres N. Galectin-3 blockade inhibits cardiac inflammation and fibrosis in experimental hyperaldosteronism and hypertension. *Hypertension* 66: 767-775, 2015.

197 Martinez-Martinez E, Ibarrola J, Calvier L, Fernandez-Celis A, Leroy C, Cachofeiro V, Rossignol P and Lopez-Andres N. Galectin-3 Blockade Reduces Renal Fibrosis in Two Normotensive Experimental Models of Renal Damage. *PLoS One* 11: e0166272, 2016.

198 Martinez-Martinez E, Ibarrola J, Fernandez-Celis A, Calvier L, Leroy C, Cachofeiro V, Rossignol P and Lopez-Andres N. Galectin-3 pharmacological

inhibition attenuates early renal damage in spontaneously hypertensive rats. *J Hypertens* 36: 368-376, 2018.

199 Martinez-Martinez E, Lopez-Andres N, Jurado-Lopez R, Rousseau E, Bartolome MV, Fernandez-Celis A, Rossignol P, Islas F, Antequera A, Prieto S, Luaces M and Cachofeiro V. Galectin-3 Participates in Cardiovascular Remodeling Associated With Obesity. *Hypertension* 66: 961-969, 2015.

200 Massague J, Seoane J and Wotton D. Smad transcription factors. *Genes Dev* 19: 2783-2810, 2005.

201 Matsushita T, Rama A, Charolidi N, Dupont E and Severs NJ. Relationship of connexin43 expression to phenotypic modulation in cultured human aortic smooth muscle cells. *Eur J Cell Biol* 86: 617-628, 2007.

202 Mayr A, Klug G, Mair J, Streil K, Harrasser B, Feistritzer HJ, Jaschke W, Schocke M, Pachinger O and Metzler B. Galectin-3: relation to infarct scar and left ventricular function after myocardial infarction. *Int J Cardiol* 163: 335-337, 2013.

203 McNulty M, Spiers P, McGovern E and Feely J. Aging is associated with increased matrix metalloproteinase-2 activity in the human aorta. *Am J Hypertens* 18: 504-509, 2005.

204 Meester JAN, Verstraeten A, Alaerts M, Schepers D, Van Laer L and Loeys BL. Overlapping but distinct roles for NOTCH receptors in human cardiovascular disease. *Clin Genet* 2018.

205 Mehta PK and Griendling KK. Angiotensin II cell signaling: physiological and pathological effects in the cardiovascular system. *Am J Physiol Cell Physiol* 292: C82-97, 2007.

206 Meldrum DR. Tumor necrosis factor in the heart. *Am J Physiol* 274: R577-595, 1998.

207 Meng XM, Nikolic-Paterson DJ and Lan HY. TGF-beta: the master regulator of fibrosis. *Nat Rev Nephrol* 12: 325-338, 2016.

208 Menini S, Iacobini C, Ricci C, Blasetti Fantauzzi C, Salvi L, Pesce CM, Relucenti M, Familiari G, Taurino M and Pugliese G. The galectin-3/RAGE dyad modulates vascular osteogenesis in atherosclerosis. *Cardiovasc Res* 100: 472-480, 2013.

209 Miao Q, Paloneva T, Tuominen S, Poyhonen M, Tuisku S, Viitanen M and Kalimo H. Fibrosis and stenosis of the long penetrating cerebral arteries: the cause of the white matter pathology in cerebral autosomal dominant arteriopathy with subcortical infarcts and leukoencephalopathy. *Brain Pathol* 14: 358-364, 2004.

210 Miner EC and Miller WL. A look between the cardiomyocytes: the extracellular matrix in heart failure. *Mayo Clin Proc* 81: 71-76, 2006.

211 Mizutani K, Ikeda K, Kawai Y and Yamori Y. Biomechanical properties and chemical composition of the aorta in genetic hypertensive rats. *J Hypertens* 17: 481-487, 1999.

212 Monroe DM, Hoffman M and Roberts HR. Platelets and thrombin generation. *Arterioscler Thromb Vasc Biol* 22: 1381-1389, 2002.

213 Moon SK, Cha BY and Kim CH. ERK1/2 mediates TNF-alpha-induced matrix metalloproteinase-9 expression in human vascular smooth muscle cells via the regulation of NF-kappaB and AP-1: Involvement of the ras dependent pathway. *J*

Cell Physiol 198: 417-427, 2004.

214 Morales MG, Vazquez Y, Acuna MJ, Rivera JC, Simon F, Salas JD, Alvarez Ruf J, Brandan E and Cabello-Verrugio C. Angiotensin II-induced pro-fibrotic effects require p38MAPK activity and transforming growth factor beta 1 expression in skeletal muscle cells. Int J Biochem Cell Biol 44: 1993-2002, 2012.

215 Moriguchi Y, Matsubara H, Mori Y, Murasawa S, Masaki H, Maruyama K, Tsutsumi Y, Shibasaki Y, Tanaka Y, Nakajima T, Oda K and Iwasaka T. Angiotensin II-induced transactivation of epidermal growth factor receptor regulates fibronectin and transforming growth factor-beta synthesis via transcriptional and posttranscriptional mechanisms. Circ Res 84: 1073-1084, 1999.

216 Moriya N and Miyazaki M. Akt1 deficiency diminishes skeletal muscle hypertrophy by reducing satellite cell proliferation. Am J Physiol Regul Integr Comp Physiol 314: R741-R751, 2018.

217 Moustakas A and Heldin CH. The regulation of TGFbeta signal transduction. Development 136: 3699-3714, 2009.

218 Moustakas A, Souchelnytskyi S and Heldin CH. Smad regulation in TGF-beta signal transduction. J Cell Sci 114: 4359-4369, 2001.

219 Mu D, Cambier S, Fjellbirkeland L, Baron JL, Munger JS, Kawakatsu H, Sheppard D, Broaddus VC and Nishimura SL. The integrin alpha(v)beta8 mediates epithelial homeostasis through MT1-MMP-dependent activation of TGF-beta1. J Cell Biol 157: 493-507, 2002.

220 Munger JS, Huang X, Kawakatsu H, Griffiths MJ, Dalton SL, Wu J, Pittet JF, Kaminski N, Garat C, Matthay MA, Rifkin DB and Sheppard D. The integrin alpha v beta 6 binds and activates latent TGF beta 1: a mechanism for regulating pulmonary inflammation and fibrosis. Cell 96: 319-328, 1999.

221 Murray IR, Gonzalez ZN, Baily J, Dobie R, Wallace RJ, Mackinnon AC, Smith JR, Greenhalgh SN, Thompson AI, Conroy KP, Griggs DW, Ruminski PG, Gray GA, Singh M, Campbell MA, Kendall TJ, Dai J, Li Y, Iredale JP, Simpson H, Huard J, Peault B and Henderson NC. alphav integrins on mesenchymal cells regulate skeletal and cardiac muscle fibrosis. Nat Commun 8: 1118, 2017.

222 Nakamura T, Sakata R, Ueno T, Sata M and Ueno H. Inhibition of transforming growth factor beta prevents progression of liver fibrosis and enhances hepatocyte regeneration in dimethylnitrosamine-treated rats. Hepatology 32: 247-255, 2000.

223 Nangia-Makker P, Honjo Y, Sarvis R, Akahani S, Hogan V, Pienta KJ and Raz A. Galectin-3 induces endothelial cell morphogenesis and angiogenesis. Am J Pathol 156: 899-909, 2000.

224 Nanthakumar CB, Hatley RJ, Lemma S, Gauldie J, Marshall RP and Macdonald SJ. Dissecting fibrosis: therapeutic insights from the small-molecule toolbox. Nat Rev Drug Discov 14: 693-720, 2015.

225 Narikawa M, Umemura M, Tanaka R, Fujita T, Yokoyama U, Ishigami T, Kimura K, Tamura K and Ishikawa Y. Acute Hyperthermia Inhibits TGF-beta1-induced Cardiac Fibroblast Activation via Suppression of Akt Signaling. Sci Rep 8: 6277, 2018.

226 Nermut MV, Green NM, Eason P, Yamada SS and Yamada KM. Electron microscopy and structural model of human fibronectin receptor. EMBO J 7:

4093-4099, 1988.

227 Neuville P, Geinoz A, Benzonana G, Redard M, Gabbiani F, Ropraz P and Gabbiani G. Cellular retinol-binding protein-1 is expressed by distinct subsets of rat arterial smooth muscle cells in vitro and in vivo. *Am J Pathol* 150: 509-521, 1997.

228 Neves MF, Cunha AR, Cunha MR, Gismondi RA and Oigman W. The Role of Renin-Angiotensin-Aldosterone System and Its New Components in Arterial Stiffness and Vascular Aging. *High Blood Press Cardiovasc Prev* 25: 137-145, 2018.

229 Ni MM, Wang YR, Wu WW, Xia CC, Zhang YH, Xu J, Xu T and Li J. Novel Insights on Notch signaling pathways in liver fibrosis. *Eur J Pharmacol* 826: 66-74, 2018.

230 Nickenig G, Jung O, Strehlow K, Zolk O, Linz W, Scholkens BA and Bohm M. Hypercholesterolemia is associated with enhanced angiotensin AT1-receptor expression. *Am J Physiol* 272: H2701-2707, 1997.

231 Nickenig G, Sachinidis A, Ko Y and Vetter H. Regulation of angiotensin AT1 receptor gene expression during cell growth of vascular smooth muscle cells. *Eur J Pharmacol* 297: 307-312, 1996.

232 Nickenig G, Strehlow K, Wassmann S, Baumer AT, Albory K, Sauer H and Bohm M. Differential effects of estrogen and progesterone on AT(1) receptor gene expression in vascular smooth muscle cells. *Circulation* 102: 1828-1833, 2000.

233 Nicolson GL. Transmembrane control of the receptors on normal and tumor cells. I. Cytoplasmic influence over surface components. *Biochim Biophys Acta* 457: 57-108, 1976.

234 Nora EH, Munzenmaier DH, Hansen-Smith FM, Lombard JH and Greene AS. Localization of the ANG II type 2 receptor in the microcirculation of skeletal muscle. *Am J Physiol* 275: H1395-1403, 1998.

235 Norman JT and Lewis MP. Matrix metalloproteinases (MMPs) in renal fibrosis. *Kidney Int Suppl* 54: S61-63, 1996.

236 Numano F, Shimizu C, Jimenez-Fernandez S, Vejar M, Oharaseki T, Takahashi K, Salgado A, Tremoulet AH, Gordon JB, Burns JC and Daniels LB. Galectin-3 is a marker of myocardial and vascular fibrosis in Kawasaki disease patients with giant aneurysms. *Int J Cardiol* 201: 429-437, 2015.

237 Ochieng J, Leite-Browning ML and Warfield P. Regulation of cellular adhesion to extracellular matrix proteins by galectin-3. *Biochem Biophys Res Commun* 246: 788-791, 1998.

238 Ohyama K, Yamano Y, Sano T, Nakagomi Y, Hamakubo T, Morishima I and Inagami T. Disulfide bridges in extracellular domains of angiotensin II receptor type IA. *Regul Pept* 57: 141-147, 1995.

239 Ozasa Y, Akazawa H, Qin Y, Tateno K, Ito K, Kudo-Sakamoto Y, Yano M, Yabumoto C, Naito AT, Oka T, Lee JK, Minamino T, Nagai T, Kobayashi Y and Komuro I. Notch activation mediates angiotensin II-induced vascular remodeling by promoting the proliferation and migration of vascular smooth muscle cells. *Hypertens Res* 36: 859-865, 2013.

240 Pannu J, Nakerakanti S, Smith E, ten Dijke P and Trojanowska M. Transforming growth factor-beta receptor type I-dependent fibrogenic gene program is mediated via activation of Smad1 and ERK1/2 pathways. *J Biol Chem* 282: 10405-10413, 2007.

- 241 Pant S, Deshmukh A, Gurumurthy GS, Pothineni NV, Watts TE, Romeo F and Mehta JL. Inflammation and atherosclerosis--revisited. *J Cardiovasc Pharmacol Ther* 19: 170-178, 2014.
- 242 Park JW, Voss PG, Grabski S, Wang JL and Patterson RJ. Association of galectin-1 and galectin-3 with Gemin4 in complexes containing the SMN protein. *Nucleic Acids Res* 29: 3595-3602, 2001.
- 243 Perea RJ, Morales-Ruiz M, Ortiz-Perez JT, Bosch X, Andreu D, Borrás R, Acosta J, Penela D, Prat-Gonzalez S, de Caralt TM, Martínez M, Morales-Romero B, Lasalvia L, Donnelly J, Jimenez W, Mira A, Mont L and Berruezo A. Utility of galectin-3 in predicting post-infarct remodeling after acute myocardial infarction based on extracellular volume fraction mapping. *Int J Cardiol* 223: 458-464, 2016.
- 244 Pineda MA, Cuervo H, Fresno M, Soto M and Bonay P. Lack of Galectin-3 Prevents Cardiac Fibrosis and Effective Immune Responses in a Murine Model of *Trypanosoma cruzi* Infection. *J Infect Dis* 212: 1160-1171, 2015.
- 245 Pivin E, Ponte B, Pruijm M, Ackermann D, Guessous I, Ehret G, Liu YP, Drummen NE, Knapen MH, Pechere-Bertschi A, Paccaud F, Mohaupt M, Vermeer C, Staessen JA, Vogt B, Martin PY, Burnier M and Bochud M. Inactive Matrix Gla-Protein Is Associated With Arterial Stiffness in an Adult Population-Based Study. *Hypertension* 66: 85-92, 2015.
- 246 Pohlors D, Brenmoehl J, Löffler I, Müller CK, Leipner C, Schultze-Mosgau S, Stallmach A, Kinne RW and Wolf G. TGF-beta and fibrosis in different organs - molecular pathway imprints. *Biochim Biophys Acta* 1792: 746-756, 2009.
- 247 Pozzi A and Zent R. TGF-beta sequestration by mesangial cell integrin α v β 8: A novel mechanism of glomerular endothelial cell regulation. *Am J Pathol* 178: 485-489, 2011.
- 248 Prakash N, Hansson E, Betsholtz C, Mitsiadis T and Lendahl U. Mouse Notch 3 expression in the pre- and postnatal brain: relationship to the stroke and dementia syndrome CADASIL. *Exp Cell Res* 278: 31-44, 2002.
- 249 Pusuroglu H, Somuncu U, Bolat I, Akgul O, Ornek V, Yildirim HA, Akkaya E, Karakurt H, Yildirim A and Savas AU. Galectin-3 is associated with coronary plaque burden and obstructive sleep apnoea syndrome severity. *Kardiol Pol* 75: 351-359, 2017.
- 250 Rajput VK, MacKinnon A, Mandal S, Collins P, Blanchard H, Leffler H, Sethi T, Schambye H, Mukhopadhyay B and Nilsson UJ. A Selective Galactose-Coumarin-Derived Galectin-3 Inhibitor Demonstrates Involvement of Galectin-3-glycan Interactions in a Pulmonary Fibrosis Model. *J Med Chem* 59: 8141-8147, 2016.
- 251 Rama A, Matsushita T, Charolidi N, Rothery S, Dupont E and Severs NJ. Up-regulation of connexin43 correlates with increased synthetic activity and enhanced contractile differentiation in TGF-beta-treated human aortic smooth muscle cells. *Eur J Cell Biol* 85: 375-386, 2006.
- 252 Rensen SS, Doevendans PA and van Eys GJ. Regulation and characteristics of vascular smooth muscle cell phenotypic diversity. *Neth Heart J* 15: 100-108, 2007.
- 253 Rocic P, Jo H and Lucchesi PA. A role for PYK2 in ANG II-dependent regulation

of the PHAS-1-eIF4E complex by multiple signaling cascades in vascular smooth muscle. *Am J Physiol Cell Physiol* 285: C1437-1444, 2003.

254 Ross S and Hill CS. How the Smads regulate transcription. *Int J Biochem Cell Biol* 40: 383-408, 2008.

255 Roulston CL, Lawrence AJ, Jarrott B and Widdop RE. Localization of AT(2) receptors in the nucleus of the solitary tract of spontaneously hypertensive and Wistar Kyoto rats using [125I] CGP42112: upregulation of a non-angiotensin II binding site following unilateral nodose ganglionectomy. *Brain Res* 968: 139-155, 2003.

256 Ruiz-Ortega M, Lorenzo O, Ruperez M, Esteban V, Suzuki Y, Mezzano S, Plaza JJ and Egido J. Role of the renin-angiotensin system in vascular diseases: expanding the field. *Hypertension* 38: 1382-1387, 2001.

257 Ruiz-Ortega M, Lorenzo O, Ruperez M, Konig S, Wittig B and Egido J. Angiotensin II activates nuclear transcription factor kappaB through AT(1) and AT(2) in vascular smooth muscle cells: molecular mechanisms. *Circ Res* 86: 1266-1272, 2000.

258 Safar ME, Levy BI and Struijker-Boudier H. Current perspectives on arterial stiffness and pulse pressure in hypertension and cardiovascular diseases. *Circulation* 107: 2864-2869, 2003.

259 Sakurada T, Ishizawa K, Imanishi M, Izawa-Ishizawa Y, Fujii S, Tominaga E, Tsuneishi T, Horinouchi Y, Kihira Y, Ikeda Y, Tomita S, Aihara K, Minakuchi K, Tsuchiya K and Tamaki T. Nitrosonifedipine ameliorates angiotensin II-induced vascular remodeling via antioxidative effects. *Naunyn Schmiedebergs Arch Pharmacol* 386: 29-39, 2013.

260 Sankar S, Mahooti-Brooks N, Centrella M, McCarthy TL and Madri JA. Expression of transforming growth factor type III receptor in vascular endothelial cells increases their responsiveness to transforming growth factor beta 2. *J Biol Chem* 270: 13567-13572, 1995.

261 Saravanan C, Liu FT, Gipson IK and Panjwani N. Galectin-3 promotes lamellipodia formation in epithelial cells by interacting with complex N-glycans on alpha3beta1 integrin. *J Cell Sci* 122: 3684-3693, 2009.

262 Sato M, Muragaki Y, Saika S, Roberts AB and Ooshima A. Targeted disruption of TGF-beta1/Smad3 signaling protects against renal tubulointerstitial fibrosis induced by unilateral ureteral obstruction. *J Clin Invest* 112: 1486-1494, 2003.

263 Savoia C, Ebrahimian T, He Y, Gratton JP, Schiffrin EL and Touyz RM. Angiotensin II/AT2 receptor-induced vasodilation in stroke-prone spontaneously hypertensive rats involves nitric oxide and cGMP-dependent protein kinase. *J Hypertens* 24: 2417-2422, 2006.

264 Savoia C, Tabet F, Yao G, Schiffrin EL and Touyz RM. Negative regulation of RhoA/Rho kinase by angiotensin II type 2 receptor in vascular smooth muscle cells: role in angiotensin II-induced vasodilation in stroke-prone spontaneously hypertensive rats. *J Hypertens* 23: 1037-1045, 2005.

265 Sbardella D, Fasciglione GF, Gioia M, Ciaccio C, Tundo GR, Marini S and Coletta M. Human matrix metalloproteinases: an ubiquitous class of enzymes involved in

several pathological processes. *Mol Aspects Med* 33: 119-208, 2012.

266 Schieffer B, Schieffer E, Hilfiker-Kleiner D, Hilfiker A, Kovanen PT, Kaartinen M, Nussberger J, Harringer W and Drexler H. Expression of angiotensin II and interleukin 6 in human coronary atherosclerotic plaques: potential implications for inflammation and plaque instability. *Circulation* 101: 1372-1378, 2000.

267 Schlatmann TJ and Becker AE. Histologic changes in the normal aging aorta: implications for dissecting aortic aneurysm. *Am J Cardiol* 39: 13-20, 1977.

268 Schonbeck U, Mach F, Sukhova GK, Murphy C, Bonnefoy JY, Fabunmi RP and Libby P. Regulation of matrix metalloproteinase expression in human vascular smooth muscle cells by T lymphocytes: a role for CD40 signaling in plaque rupture? *Circ Res* 81: 448-454, 1997.

269 Seay U, Sedding D, Krick S, Hecker M, Seeger W and Eickelberg O. Transforming growth factor-beta-dependent growth inhibition in primary vascular smooth muscle cells is p38-dependent. *J Pharmacol Exp Ther* 315: 1005-1012, 2005.

270 Sedding DG, Hermsen J, Seay U, Eickelberg O, Kummer W, Schwencke C, Strasser RH, Tillmanns H and Braun-Dullaeus RC. Caveolin-1 facilitates mechanosensitive protein kinase B (Akt) signaling in vitro and in vivo. *Circ Res* 96: 635-642, 2005.

271 Sehgel NL, Sun Z, Hong Z, Hunter WC, Hill MA, Vatner DE, Vatner SF and Meininger GA. Augmented vascular smooth muscle cell stiffness and adhesion when hypertension is superimposed on aging. *Hypertension* 65: 370-377, 2015.

272 Sehgel NL, Zhu Y, Sun Z, Trzeciakowski JP, Hong Z, Hunter WC, Vatner DE, Meininger GA and Vatner SF. Increased vascular smooth muscle cell stiffness: a novel mechanism for aortic stiffness in hypertension. *Am J Physiol Heart Circ Physiol* 305: H1281-1287, 2013.

273 Shanmugam S, Corvol P and Gasc JM. Angiotensin II type 2 receptor mRNA expression in the developing cardiopulmonary system of the rat. *Hypertension* 28: 91-97, 1996.

274 Sharma UC, Mosleh W, Chaudhari MR, Katkar R, Weil B, Evelo C, Cimato TR, Pokharel S, Blankesteyn WM and Suzuki G. Myocardial and Serum Galectin-3 Expression Dynamics Marks Post-Myocardial Infarction Cardiac Remodelling. *Heart Lung Circ* 26: 736-745, 2017.

275 Sharma UC, Pokharel S, van Brakel TJ, van Berlo JH, Cleutjens JP, Schroen B, Andre S, Crijns HJ, Gabius HJ, Maessen J and Pinto YM. Galectin-3 marks activated macrophages in failure-prone hypertrophied hearts and contributes to cardiac dysfunction. *Circulation* 110: 3121-3128, 2004.

276 Shen H, Wang J, Min J, Xi W, Gao Y, Yin L, Yu Y, Liu K, Xiao J, Zhang YF and Wang ZN. Activation of TGF-beta1/alpha-SMA/Col I Profibrotic Pathway in Fibroblasts by Galectin-3 Contributes to Atrial Fibrosis in Experimental Models and Patients. *Cell Physiol Biochem* 47: 851-863, 2018.

277 Sheu JR, Fong TH, Liu CM, Shen MY, Chen TL, Chang Y, Lu MS and Hsiao G. Expression of matrix metalloproteinase-9 in human platelets: regulation of platelet activation in in vitro and in vivo studies. *Br J Pharmacol* 143: 193-201, 2004.

278 Shi Y and Massague J. Mechanisms of TGF-beta signaling from cell membrane

to the nucleus. *Cell* 113: 685-700, 2003.

279 Shi ZD and Tarbell JM. Fluid flow mechanotransduction in vascular smooth muscle cells and fibroblasts. *Ann Biomed Eng* 39: 1608-1619, 2011.

280 Shimura T, Takenaka Y, Fukumori T, Tsutsumi S, Okada K, Hogan V, Kikuchi A, Kuwano H and Raz A. Implication of galectin-3 in Wnt signaling. *Cancer Res* 65: 3535-3537, 2005.

281 Shimura T, Takenaka Y, Tsutsumi S, Hogan V, Kikuchi A and Raz A. Galectin-3, a novel binding partner of beta-catenin. *Cancer Res* 64: 6363-6367, 2004.

282 Song X, Qian X, Shen M, Jiang R, Wagner MB, Ding G, Chen G and Shen B. Protein kinase C promotes cardiac fibrosis and heart failure by modulating galectin-3 expression. *Biochim Biophys Acta* 1853: 513-521, 2015.

283 Sonmez O, Ertem FU, Vatankulu MA, Erdogan E, Tasal A, Kucukbuzcu S and Goktekin O. Novel fibro-inflammation markers in assessing left atrial remodeling in non-valvular atrial fibrillation. *Med Sci Monit* 20: 463-470, 2014.

284 Souza BSF, Silva DN, Carvalho RH, Sampaio GLA, Paredes BD, Aragao Franca L, Azevedo CM, Vasconcelos JF, Meira CS, Neto PC, Macambira SG, da Silva KN, Allahdadi KJ, Tavora F, de Souza Neto JD, Dos Santos RR and Soares MBP. Association of Cardiac Galectin-3 Expression, Myocarditis, and Fibrosis in Chronic Chagas Disease Cardiomyopathy. *Am J Pathol* 187: 1134-1146, 2017.

285 Spronk HM, De Jong AM, Verheule S, De Boer HC, Maass AH, Lau DH, Rienstra M, van Hunnik A, Kuiper M, Lumeij S, Zeemering S, Linz D, Kamphuisen PW, Ten Cate H, Crijns HJ, Van Gelder IC, van Zonneveld AJ and Schotten U. Hypercoagulability causes atrial fibrosis and promotes atrial fibrillation. *Eur Heart J* 38: 38-50, 2017.

286 Sriramula S and Francis J. Tumor Necrosis Factor - Alpha Is Essential for Angiotensin II-Induced Ventricular Remodeling: Role for Oxidative Stress. *PLoS One* 10: e0138372, 2015.

287 Srivastava AK. High glucose-induced activation of protein kinase signaling pathways in vascular smooth muscle cells: a potential role in the pathogenesis of vascular dysfunction in diabetes (review). *Int J Mol Med* 9: 85-89, 2002.

288 Stambe C, Atkins RC, Tesch GH, Masaki T, Schreiner GF and Nikolic-Paterson DJ. The role of p38alpha mitogen-activated protein kinase activation in renal fibrosis. *J Am Soc Nephrol* 15: 370-379, 2004.

289 Steckelings UM, Kloet A and Sumners C. Centrally Mediated Cardiovascular Actions of the Angiotensin II Type 2 Receptor. *Trends Endocrinol Metab* 28: 684-693, 2017.

290 Steppan J, Sikka G, Jandu S, Barodka V, Halushka MK, Flavahan NA, Belkin AM, Nyhan D, Butlin M, Avolio A, Berkowitz DE and Santhanam L. Exercise, vascular stiffness, and tissue transglutaminase. *J Am Heart Assoc* 3: e000599, 2014.

291 Sun KH, Chang Y, Reed NI and Sheppard D. alpha-Smooth muscle actin is an inconsistent marker of fibroblasts responsible for force-dependent TGFbeta activation or collagen production across multiple models of organ fibrosis. *Am J Physiol Lung Cell Mol Physiol* 310: L824-836, 2016.

292 Sun YW, Zhang YY, Ke XJ, Wu XJ, Chen ZF and Chi P. Pirfenidone prevents

radiation-induced intestinal fibrosis in rats by inhibiting fibroblast proliferation and differentiation and suppressing the TGF-beta1/Smad/CTGF signaling pathway. *Eur J Pharmacol* 822: 199-206, 2018.

293 Suthahar N, Meijers WC, Sillje HHW, Ho JE, Liu FT and de Boer RA. Galectin-3 Activation and Inhibition in Heart Failure and Cardiovascular Disease: An Update. *Theranostics* 8: 593-609, 2018.

294 Suzuki H, Motley ED, Frank GD, Utsunomiya H and Eguchi S. Recent progress in signal transduction research of the angiotensin II type-1 receptor: protein kinases, vascular dysfunction and structural requirement. *Curr Med Chem Cardiovasc Hematol Agents* 3: 305-322, 2005.

295 Szadkowska I, Wlazel RN, Migala M, Szadkowski K, Zielinska M, Paradowski M and Pawlicki L. The association between galectin-3 and clinical parameters in patients with first acute myocardial infarction treated with primary percutaneous coronary angioplasty. *Cardiol J* 20: 577-582, 2013.

296 Takayanagi R, Ohnaka K, Sakai Y, Nakao R, Yanase T, Haji M, Inagami T, Furuta H, Gou DF, Nakamuta M and et al. Molecular cloning, sequence analysis and expression of a cDNA encoding human type-1 angiotensin II receptor. *Biochem Biophys Res Commun* 183: 910-916, 1992.

297 Takeda K, Ichiki T, Funakoshi Y, Ito K and Takeshita A. Downregulation of angiotensin II type 1 receptor by all-trans retinoic acid in vascular smooth muscle cells. *Hypertension* 35: 297-302, 2000.

298 Tamkun JW, DeSimone DW, Fonda D, Patel RS, Buck C, Horwitz AF and Hynes RO. Structure of integrin, a glycoprotein involved in the transmembrane linkage between fibronectin and actin. *Cell* 46: 271-282, 1986.

299 Taniyama Y, Ushio-Fukai M, Hitomi H, Rocic P, Kingsley MJ, Pfahnl C, Weber DS, Alexander RW and Griendling KK. Role of p38 MAPK and MAPKAPK-2 in angiotensin II-induced Akt activation in vascular smooth muscle cells. *Am J Physiol Cell Physiol* 287: C494-499, 2004.

300 Teekakirikul P, Eminaga S, Toka O, Alcalai R, Wang L, Wakimoto H, Naylor M, Konno T, Gorham JM, Wolf CM, Kim JB, Schmitt JP, Molkentin JD, Norris RA, Tager AM, Hoffman SR, Markwald RR, Seidman CE and Seidman JG. Cardiac fibrosis in mice with hypertrophic cardiomyopathy is mediated by non-myocyte proliferation and requires Tgf-beta. *J Clin Invest* 120: 3520-3529, 2010.

301 Thakur S, Li L and Gupta S. NF-kappaB-mediated integrin-linked kinase regulation in angiotensin II-induced pro-fibrotic process in cardiac fibroblasts. *Life Sci* 107: 68-75, 2014.

302 Tian L, Chen K, Cao J, Han Z, Gao L, Wang Y, Fan Y and Wang C. Galectin-3-induced oxidized low-density lipoprotein promotes the phenotypic transformation of vascular smooth muscle cells. *Mol Med Rep* 12: 4995-5002, 2015.

303 Tian L, Chen K, Cao J, Han Z, Wang Y, Gao L, Fan Y and Wang C. Galectin3 induces the phenotype transformation of human vascular smooth muscle cells via the canonical Wnt signaling. *Mol Med Rep* 15: 3840-3846, 2017.

304 Torrent-Burgues J and Sanz F. AFM in mode Peak Force applied to the study of un-worn contact lenses. *Colloids Surf B Biointerfaces* 121: 388-394, 2014.

- 305 Touyz RM, He G, Deng LY and Schiffrin EL. Role of extracellular signal-regulated kinases in angiotensin II-stimulated contraction of smooth muscle cells from human resistance arteries. *Circulation* 99: 392-399, 1999.
- 306 Touyz RM, He G, El Mabrouk M and Schiffrin EL. p38 Map kinase regulates vascular smooth muscle cell collagen synthesis by angiotensin II in SHR but not in WKY. *Hypertension* 37: 574-580, 2001.
- 307 Tsuchiya K, Yoshimoto T, Hirono Y, Tateno T, Sugiyama T and Hirata Y. Angiotensin II induces monocyte chemoattractant protein-1 expression via a nuclear factor-kappaB-dependent pathway in rat preadipocytes. *Am J Physiol Endocrinol Metab* 291: E771-778, 2006.
- 308 Tucka J, Yu H, Gray K, Figg N, Maguire J, Lam B, Bennett M and Littlewood T. Akt1 regulates vascular smooth muscle cell apoptosis through FoxO3a and Apaf1 and protects against arterial remodeling and atherosclerosis. *Arterioscler Thromb Vasc Biol* 34: 2421-2428, 2014.
- 309 Ulmasov B, Neuschwander-Tetri BA, Lai J, Monastyrskiy V, Bhat T, Yates MP, Oliva J, Prinsen MJ, Ruminski PG and Griggs DW. Inhibitors of Arg-Gly-Asp-Binding Integrins Reduce Development of Pancreatic Fibrosis in Mice. *Cell Mol Gastroenterol Hepatol* 2: 499-518, 2016.
- 310 Valente AJ, Clark RA, Siddesha JM, Siebenlist U and Chandrasekar B. CIKS (Act1 or TRAF3IP2) mediates Angiotensin-II-induced Interleukin-18 expression, and Nox2-dependent cardiomyocyte hypertrophy. *J Mol Cell Cardiol* 53: 113-124, 2012.
- 311 Van Bortel LM, Laurent S, Boutouyrie P, Chowienczyk P, Cruickshank JK, De Backer T, Filipovsky J, Huybrechts S, Mattace-Raso FU, Protogerou AD, Schillaci G, Segers P, Vermeersch S and Weber T. Expert consensus document on the measurement of aortic stiffness in daily practice using carotid-femoral pulse wave velocity. *J Hypertens* 30: 445-448, 2012.
- 312 van Kimmenade RR, Januzzi JL, Jr., Ellinor PT, Sharma UC, Bakker JA, Low AF, Martinez A, Crijns HJ, MacRae CA, Menheere PP and Pinto YM. Utility of amino-terminal pro-brain natriuretic peptide, galectin-3, and apelin for the evaluation of patients with acute heart failure. *J Am Coll Cardiol* 48: 1217-1224, 2006.
- 313 Vandooren J, Van den Steen PE and Opdenakker G. Biochemistry and molecular biology of gelatinase B or matrix metalloproteinase-9 (MMP-9): the next decade. *Crit Rev Biochem Mol Biol* 48: 222-272, 2013.
- 314 Vergaro G, Prud'homme M, Fazal L, Merval R, Passino C, Emdin M, Samuel JL, Cohen Solal A and Delcayre C. Inhibition of Galectin-3 Pathway Prevents Isoproterenol-Induced Left Ventricular Dysfunction and Fibrosis in Mice. *Hypertension* 67: 606-612, 2016.
- 315 Verrecchia F, Chu ML and Mauviel A. Identification of novel TGF-beta /Smad gene targets in dermal fibroblasts using a combined cDNA microarray/promoter transactivation approach. *J Biol Chem* 276: 17058-17062, 2001.
- 316 Wang J, Wang S, Zhang W, Wang X, Liu X, Liu L, Li L, Liang Y, Yu J, Jeong LS, Jia L, Zhao H and Zhang Y. Targeting neddylation pathway with MLN4924 (Pevonedistat) induces NOXA-dependent apoptosis in renal cell carcinoma.

- Biochem Biophys Res Commun 490: 1183-1188, 2017.
- 317 Wang Q, Yu Y, Zhang P, Chen Y, Li C, Chen J, Wang Y and Li Y. The crucial role of activin A/ALK4 pathway in the pathogenesis of Ang-II-induced atrial fibrosis and vulnerability to atrial fibrillation. *Basic Res Cardiol* 112: 47, 2017.
- 318 Wang S, Wilkes MC, Leof EB and Hirschberg R. Imatinib mesylate blocks a non-Smad TGF-beta pathway and reduces renal fibrogenesis in vivo. *FASEB J* 19: 1-11, 2005.
- 319 Wang ZQ, Millatt LJ, Heiderstadt NT, Siragy HM, Johns RA and Carey RM. Differential regulation of renal angiotensin subtype AT1A and AT2 receptor protein in rats with angiotensin-dependent hypertension. *Hypertension* 33: 96-101, 1999.
- 320 Warnecke C, Kaup D, Marienfeld U, Poller W, Yankah C, Grafe M, Fleck E and Regitz-Zagrosek V. Adenovirus-mediated overexpression and stimulation of the human angiotensin II type 2 receptor in porcine cardiac fibroblasts does not modulate proliferation, collagen I mRNA expression and ERK1/ERK2 activity, but inhibits protein tyrosine phosphatases. *J Mol Med (Berl)* 79: 510-521, 2001.
- 321 Weber KT, Sun Y and Katwa LC. Myofibroblasts and local angiotensin II in rat cardiac tissue repair. *Int J Biochem Cell Biol* 29: 31-42, 1997.
- 322 Weis-Garcia F and Massague J. Complementation between kinase-defective and activation-defective TGF-beta receptors reveals a novel form of receptor cooperativity essential for signaling. *EMBO J* 15: 276-289, 1996.
- 323 Wesley UV, Vemuganti R, Ayvaci ER and Dempsey RJ. Galectin-3 enhances angiogenic and migratory potential of microglial cells via modulation of integrin linked kinase signaling. *Brain Res* 1496: 1-9, 2013.
- 324 Wheeler-Schilling TH, Kohler K, Sautter M and Guenther E. Angiotensin II receptor subtype gene expression and cellular localization in the retina and non-neuronal ocular tissues of the rat. *Eur J Neurosci* 11: 3387-3394, 1999.
- 325 Whitman M. Smads and early developmental signaling by the TGFbeta superfamily. *Genes Dev* 12: 2445-2462, 1998.
- 326 Wieser R, Wrana JL and Massague J. GS domain mutations that constitutively activate T beta R-I, the downstream signaling component in the TGF-beta receptor complex. *EMBO J* 14: 2199-2208, 1995.
- 327 Wong CKS, Falkenham A, Myers T and Legare JF. Connective tissue growth factor expression after angiotensin II exposure is dependent on transforming growth factor-beta signaling via the canonical Smad-dependent pathway in hypertensive induced myocardial fibrosis. *J Renin Angiotensin Aldosterone Syst* 19: 1470320318759358, 2018.
- 328 Wu D, Lei H, Wang JY, Zhang CL, Feng H, Fu FY, Li L and Wu LL. CTRP3 attenuates post-infarct cardiac fibrosis by targeting Smad3 activation and inhibiting myofibroblast differentiation. *J Mol Med (Berl)* 93: 1311-1325, 2015.
- 329 Wu H, Chen Z, Chen JZ, Pei LG, Xie J, Wei ZH, Kang LN, Wang L and Xu B. High Mobility Group B-1 (HMGB-1) Promotes Apoptosis of Macrophage-Derived Foam Cells by Inducing Endoplasmic Reticulum Stress. *Cell Physiol Biochem* 48: 1019-1029, 2018.
- 330 Wu L, Iwai M, Nakagami H, Chen R, Suzuki J, Akishita M, de Gasparo M and

Horiuchi M. Effect of angiotensin II type 1 receptor blockade on cardiac remodeling in angiotensin II type 2 receptor null mice. *Arterioscler Thromb Vasc Biol* 22: 49-54, 2002.

331 Wu XY, Li SN, Wen SN, Nie JG, Deng WN, Bai R, Liu N, Tang RB, Zhang T, Du X, Dong JZ and Ma CS. Plasma galectin-3 predicts clinical outcomes after catheter ablation in persistent atrial fibrillation patients without structural heart disease. *Europace* 17: 1541-1547, 2015.

332 Xi XP, Graf K, Goetze S, Fleck E, Hsueh WA and Law RE. Central role of the MAPK pathway in ang II-mediated DNA synthesis and migration in rat vascular smooth muscle cells. *Arterioscler Thromb Vasc Biol* 19: 73-82, 1999.

333 Xiao Q, Zhang F, Grassia G, Hu Y, Zhang Z, Xing Q, Yin X, Maddaluno M, Drung B, Schmidt B, Maffia P, Ialenti A, Mayr M, Xu Q and Ye S. Matrix metalloproteinase-8 promotes vascular smooth muscle cell proliferation and neointima formation. *Arterioscler Thromb Vasc Biol* 34: 90-98, 2014.

334 Xiao Y, Ye J, Zhou Y, Huang J, Liu X, Huang B, Zhu L, Wu B, Zhang G and Cai Y. Baicalin inhibits pressure overload-induced cardiac fibrosis through regulating AMPK/TGF-beta/Smads signaling pathway. *Arch Biochem Biophys* 640: 37-46, 2018.

335 Xu J, Carretero OA, Liu YH, Shesely EG, Yang F, Kapke A and Yang XP. Role of AT2 receptors in the cardioprotective effect of AT1 antagonists in mice. *Hypertension* 40: 244-250, 2002.

336 Xu XF, Liu F, Xin JQ, Fan JW, Wu N, Zhu LJ, Duan LF, Li YY and Zhang H. Respective roles of the mitogen-activated protein kinase (MAPK) family members in pancreatic stellate cell activation induced by transforming growth factor-beta1 (TGF-beta1). *Biochem Biophys Res Commun* 501: 365-373, 2018.

337 Yakar Tuluçe S, Tuluçe K, Cil Z, Emren SV, Akyildiz ZI and Ergene O. Galectin-3 levels in patients with hypertrophic cardiomyopathy and its relationship with left ventricular mass index and function. *Anatol J Cardiol* 16: 344-348, 2016.

338 Yalcin MU, Gurses KM, Kocyigit D, Canpinar H, Canpolat U, Evranos B, Yorgun H, Sahiner ML, Kaya EB, Hazirolan T, Tokgozoglu L, Oto MA, Ozer N, Guc D and Aytemir K. The Association of Serum Galectin-3 Levels with Atrial Electrical and Structural Remodeling. *J Cardiovasc Electrophysiol* 26: 635-640, 2015.

339 Yamashita H, ten Dijke P, Franzen P, Miyazono K and Heldin CH. Formation of hetero-oligomeric complexes of type I and type II receptors for transforming growth factor-beta. *J Biol Chem* 269: 20172-20178, 1994.

340 Yang EH, Rode J, Howlader MA, Eckermann M, Santos JT, Hernandez Armada D, Zheng R, Zou C and Cairo CW. Galectin-3 alters the lateral mobility and clustering of beta1-integrin receptors. *PLoS One* 12: e0184378, 2017.

341 Yang F, Chen Q, He S, Yang M, Maguire EM, An W, Afzal TA, Luong LA, Zhang L and Xiao Q. miR-22 Is a Novel Mediator of Vascular Smooth Muscle Cell Phenotypic Modulation and Neointima Formation. *Circulation* 137: 1824-1841, 2018.

342 Yang RY, Hsu DK and Liu FT. Expression of galectin-3 modulates T-cell growth and apoptosis. *Proc Natl Acad Sci U S A* 93: 6737-6742, 1996.

343 Yang X, Zhu MJ, Sreejayan N, Ren J and Du M. Angiotensin II promotes smooth muscle cell proliferation and migration through release of heparin-binding

epidermal growth factor and activation of EGF-receptor pathway. *Mol Cells* 20: 263-270, 2005.

344 Yoon YW, Kwon HM, Hwang KC, Choi EY, Hong BK, Kim D, Kim HS, Cho SH, Song KS and Sangiorgi G. Upstream regulation of matrix metalloproteinase by EMMPRIN; extracellular matrix metalloproteinase inducer in advanced atherosclerotic plaque. *Atherosclerosis* 180: 37-44, 2005.

345 Yu H, Littlewood T and Bennett M. Akt isoforms in vascular disease. *Vascul Pharmacol* 71: 57-64, 2015.

346 Yu L, Ruifrok WP, Meissner M, Bos EM, van Goor H, Sanjabi B, van der Harst P, Pitt B, Goldstein IJ, Koerts JA, van Veldhuisen DJ, Bank RA, van Gilst WH, Sillje HH and de Boer RA. Genetic and pharmacological inhibition of galectin-3 prevents cardiac remodeling by interfering with myocardial fibrogenesis. *Circ Heart Fail* 6: 107-117, 2013.

347 Yu Y, Chen S, Xiao C, Jia Y, Guo J, Jiang J and Liu P. TRPM7 is involved in angiotensin II induced cardiac fibrosis development by mediating calcium and magnesium influx. *Cell Calcium* 55: 252-260, 2014.

348 Yung LM, Sanchez-Duffhues G, Ten Dijke P and Yu PB. Bone morphogenetic protein 6 and oxidized low-density lipoprotein synergistically recruit osteogenic differentiation in endothelial cells. *Cardiovasc Res* 108: 278-287, 2015.

349 Zanatta AP, Zanatta L, Goncalves R, Zamoner A and Silva FR. Rapid responses to reverse T(3) hormone in immature rat Sertoli cells: calcium uptake and exocytosis mediated by integrin. *PLoS One* 8: e77176, 2013.

350 Zeng S, Seifert AM, Zhang JQ, Kim TS, Bowler TG, Cavnar MJ, Medina BD, Vitiello GA, Rossi F, Loo JK, Param NJ and DeMatteo RP. ETV4 collaborates with Wnt/beta-catenin signaling to alter cell cycle activity and promote tumor aggressiveness in gastrointestinal stromal tumor. *Oncotarget* 8: 114195-114209, 2017.

351 Zhang C, Li Y, Wang C, Wu Y and Du J. Antagonist of C5aR prevents cardiac remodeling in angiotensin II-induced hypertension. *Am J Hypertens* 27: 857-864, 2014.

352 Zhang CL, Zhao Q, Liang H, Qiao X, Wang JY, Wu D, Wu LL and Li L. Cartilage intermediate layer protein-1 alleviates pressure overload-induced cardiac fibrosis via interfering TGF-beta1 signaling. *J Mol Cell Cardiol* 116: 135-144, 2018.

353 Zhang Y, Wang S, Liu S, Li C and Wang J. Role of Smad signaling in kidney disease. *Int Urol Nephrol* 47: 1965-1975, 2015.

354 Zhang YE. Non-Smad pathways in TGF-beta signaling. *Cell Res* 19: 128-139, 2009.

355 Zhang ZZ, Cheng YW, Jin HY, Chang Q, Shang QH, Xu YL, Chen LX, Xu R, Song B and Zhong JC. The sirtuin 6 prevents angiotensin II-mediated myocardial fibrosis and injury by targeting AMPK-ACE2 signaling. *Oncotarget* 8: 72302-72314, 2017.

356 Zhao F, Zhang S, Chen Y, Gu W, Ni B, Shao Y, Wu Y and Qin J. Increased expression of NF-AT3 and NF-AT4 in the atria correlates with procollagen I carboxyl terminal peptide and TGF-beta1 levels in serum of patients with atrial fibrillation. *BMC Cardiovasc Disord* 14: 167, 2014.

- 357 Zhao J, Shi W, Wang YL, Chen H, Bringas P, Jr., Datto MB, Frederick JP, Wang XF and Warburton D. Smad3 deficiency attenuates bleomycin-induced pulmonary fibrosis in mice. *Am J Physiol Lung Cell Mol Physiol* 282: L585-593, 2002.
- 358 Zhao W, Ajani JA, Sushovan G, Ochi N, Hwang R, Hafley M, Johnson RL, Bresalier RS, Logsdon CD, Zhang Z and Song S. Galectin-3 Mediates Tumor Cell-Stroma Interactions by Activating Pancreatic Stellate Cells to Produce Cytokines via Integrin Signaling. *Gastroenterology* 154: 1524-1537 e1526, 2018.
- 359 Zhong H, Wang T, Lian G, Xu C, Wang H and Xie L. TRPM7 regulates angiotensin II-induced sinoatrial node fibrosis in sick sinus syndrome rats by mediating Smad signaling. *Heart Vessels* 2018.
- 360 Zhou D, Herrick DJ, Rosenbloom J and Chaqour B. Cyr61 mediates the expression of VEGF, alphav-integrin, and alpha-actin genes through cytoskeletally based mechanotransduction mechanisms in bladder smooth muscle cells. *J Appl Physiol* (1985) 98: 2344-2354, 2005.
- 361 Zhou K, Zhou Y, Zhao Y, Tan C, Yuan Z, Li J, Liao X, Gu L and Zhou X. The Relationship between Galectin-3 and Different Patterns of Ventricular Geometry Remodelling in Aortic Valve Stenosis. *Heart Lung Circ* 25: 371-377, 2016.
- 362 Zhu M, Gelband CH, Moore JM, Posner P and Sumners C. Angiotensin II type 2 receptor stimulation of neuronal delayed-rectifier potassium current involves phospholipase A2 and arachidonic acid. *J Neurosci* 18: 679-686, 1998.
- 363 Zhu W, Kim BC, Wang M, Huang J, Isak A, Bexiga NM, Monticone R, Ha T, Lakatta EG and An SS. TGFbeta1 reinforces arterial aging in the vascular smooth muscle cell through a long-range regulation of the cytoskeletal stiffness. *Sci Rep* 8: 2668, 2018.
- 364 Zhu X, Song Z, Zhang S, Nanda A and Li G. CD147: a novel modulator of inflammatory and immune disorders. *Curr Med Chem* 21: 2138-2145, 2014.
- 365 Ziemann SJ, Melenovsky V and Kass DA. Mechanisms, pathophysiology, and therapy of arterial stiffness. *Arterioscler Thromb Vasc Biol* 25: 932-943, 2005.
- 366 Zouein FA, Zgheib C, Hamza S, Fuseler JW, Hall JE, Soljancic A, Lopez-Ruiz A, Kurdi M and Booz GW. Role of STAT3 in angiotensin II-induced hypertension and cardiac remodeling revealed by mice lacking STAT3 serine 727 phosphorylation. *Hypertens Res* 36: 496-503, 2013.