



**HAL**  
open science

# Analysis and valorization of co-products from industrial transformation of Mahogany (Gabon): (Khaya ivorensis A. Chev)

Arsène Bikoro Bi Athomo

## ► To cite this version:

Arsène Bikoro Bi Athomo. Analysis and valorization of co-products from industrial transformation of Mahogany (Gabon): (Khaya ivorensis A. Chev). Analytical chemistry. Université de Pau et des Pays de l'Adour, 2020. English. NNT : 2020PAUU3001 . tel-02887477

**HAL Id: tel-02887477**

**<https://theses.hal.science/tel-02887477>**

Submitted on 2 Jul 2020

**HAL** is a multi-disciplinary open access archive for the deposit and dissemination of scientific research documents, whether they are published or not. The documents may come from teaching and research institutions in France or abroad, or from public or private research centers.

L'archive ouverte pluridisciplinaire **HAL**, est destinée au dépôt et à la diffusion de documents scientifiques de niveau recherche, publiés ou non, émanant des établissements d'enseignement et de recherche français ou étrangers, des laboratoires publics ou privés.



# THÈSE

Présentée et soutenue publiquement pour l'obtention du grade de  
**DOCTEUR DE L'UNIVERSITÉ DE PAU ET DES PAYS DE  
L'ADOUR**

**Spécialité** : Chimie Analytique et environnement

Par

**Arsène BIKORO BI ATHOMO**

---

**Analyse et valorisation des coproduits de la transformation  
industrielle de l'Acajou du Gabon (*Khaya ivorensis* A. Chev)**

---

Sous la direction de **Bertrand CHARRIER et Florent EYMA**

À Mont de Marsan, le 20 Février 2020

**Rapporteurs :**

Pr. Philippe GERARDIN

Professeur, Université de Lorraine

Dr. Jalel LABIDI

Professeur, Université du Pays Basque

**Examineurs :**

Pr. Antonio PIZZI

Professeur, Université de Lorraine

Dr. Rodrigue SAFOU TCHIAMA

Maitre assistant, Université des Sciences et  
Techniques de Masuku

Dr. Alain ONDO-AZI

Maitre assistant, Université des Sciences et  
Techniques de Masuku

Pr. Remy MARCHAL

Professeur, Ecole Nationale Supérieure des  
Arts et Métiers

**Directeur de Thèse :**

Pr. Bertrand CHARRIER

Professeur, Université de Pau et des Pays de  
l'Adour

Pr. Florent EYMA

Professeur, Université de Toulouse

Xylomat-IPREM, 403 rue Saint Pierre, 40000, Mont de Marsan (France)



# Résumé

Au Gabon, la forêt recouvre plus de 85% du territoire soit environ 22 millions d'hectares de forêt ce qui représente un potentiel de plus de 400 millions de m<sup>3</sup> de bois exploitables. Pour plus de 400 essences répertoriées exploitables, environ 80 sont exploitées, mais seules 13 font l'objet d'une exploitation à l'échelle industrielle. Le bois massif issu de l'exploitation forestière sous forme de grumes était, jusqu'à 2009, principalement destiné à l'exportation. Cependant depuis cette date, l'Etat Gabonais a décidé de développer son industrie, en imposant aux exploitants forestiers d'effectuer au minimum une première transformation dans le pays.

Cette, réforme a conduit à augmentation de la transformation locale des grumes, et par conséquent à une hausse de la production de co-produits. Ces derniers représentent environ 50% de la masse initiale des grumes en ce qui concerne le sciage et environ 5% pour le déroulage. Les acteurs de la filière doivent actuellement faire face à une nouvelle problématique : un excès de produits connexes générés par la transformation locale du bois.

Cette thèse a ainsi pour objectif général de proposer une démarche permettant de trouver des solutions de valorisation de ces co-produits, dont 85% sont actuellement brûlés à ciel ouvert.

Les co-produits de la transformation industrielle de l'acajou (*Khaya ivorensis* A. Chev) du Gabon ont été ainsi étudiés en trois phases. Un premier travail a été réalisé sur la caractérisation physico-chimique des extraits d'écorce, d'aubier et de bois de cœur d'acajou. Nous avons particulièrement travaillé sur les extraits phénoliques, dont les tanins. Ensuite, une voie de valorisation de ces composés a été étudiée : l'élaboration d'un adhésif à base de tanins d'acajou. Enfin, une autre piste de valorisation a été explorée : la mise au point d'un composite bois/plastique avec les co-produits de bois et les déchets issus de bouteilles plastiques.

Les résultats des différents travaux effectués ont montré que les tanins d'acajou étaient riches en monomères de fisitinidine et de gallocatéchine. L'absence d'acide gallique sous forme libre a aussi été constatée. Par ailleurs, les colles à base de tanins d'acajou ont montré de bonnes caractéristiques thermiques. Enfin, le composite

fabriqué a présenté des propriétés physico-mécaniques intéressantes qui permettent d'envisager une valorisation à plus grande échelle.

Mots clés : Co-produits de bois, *Khaya ivorensis*, tanins, caractérisations physico-chimiques, colle, composite, propriétés physico-mécaniques.

# Abstract

The Gabon forest covers more than 85% of the country, so about 22 million hectares of forest, which represents a potential of more than 400 million m<sup>3</sup> of exploitable wood. For more than 400 species listed as exploitable, about 80 are exploitable, but only 13 are exploited on an industrial scale. Solid wood from logging in the form of logs was, until 2009, mainly intended for export. However, since that date, the Gabonese State has decided to develop its industry by requiring loggers to carry out at least a first transformation in the country.

This reform has led to an increase in local transformation of logs, and therefore increased the production of co-products. The latter represents approximately 50% of initial log mass for sawing and around 5% for peeling. The actors of the sectors thus found themselves with the problem of an excess of products derived from the local processing of wood.

General objective of this thesis is to propose an approach that makes it possible to find recovery solutions for these by-products, 85% of which are burnt in open air.

Co-products of the industrial transformation of mahogany (*Khaya ivorensis* A. Chev) from Gabon were thus studied in three phases. Initial work on the physicochemical characterization of bark, sapwood and heartwood of mahogany extracts has been carried out in general. We have particularly worked on phenolic extracts, including tannins. Then, a way of valuing these compounds was studied: development of a tannin-based adhesive with mahogany tannins. Finally, another recovery avenue was explored: development of wood/ plastic composite with wood by-products and waste from plastic bottles.

Results of various studies have shown that the mahogany tannins are rich in fisitinidin and gallo catechin monomers. The absence of free form of gallic acid was also noted. In addition, tannin-based adhesives of mahogany have shown good thermal characteristics. Furthermore, the composite has interesting physico-mechanical properties that would allow a possible valorization on a large scale.

Keywords: Wood by-products, *Khaya ivorensis*, tannins, physico-chemical characterizations, adhesive, composite, physico-mechanical properties.

# Remerciements

*« Mvèñ é ne mindzuk ayèt »*

*« Le bonheur se trouve au bout de l'effort »*



Je tiens tout d'abord à remercier le Professeur Bertrand **CHARRIER** de l'Université de Pau et des Pays de l'Adour, site Mont de Marsan pour avoir accepté de m'encadrer durant ces trois années de thèse à Xylomat. Je remercie également le Professeur Florent **EYMA** de l'Université de Toulouse et de l'Institut Clément Ader (ICA) de Tarbes ainsi que le Professeur Antonio **PIZZI** de l'Université de Lorraine Henry Poincaré, le Docteur Rodrigue **SAFOU-TCHIAMA** de l'Université des Sciences et Techniques de Masuku qui m'ont aidé à mieux assoir mes connaissances et à développer un esprit critique tout au long de ce projet de thèse.

Ma reconnaissance va aussi à l'endroit de l'équipe **Xylomat-lprem** notamment au Docteur Leo **LEROYER** de l'Université de Pau et des Pays de l'Adour, à madame Fatima Charrier **EL BOUHTOURY** Maître de Conférences de l'Université de Pau et des Pays de l'Adour, au Docteur Manon **FRANCES** de l'Université de Pau et des Pays de l'Adour, au Docteur Thomas **CABARET** de l'Université de Pau et des Pays de l'Adour, messieurs Peguy Sartlin **Engozogho Anris**, Morandise **RUBINI** et Hamed **ISSAOUI**.

Je tiens aussi à exprimer ma gratitude à l'Agence Nationale des Bourses du Gabon (**ANBG**) pour son aide financière, et aux rapporteurs de ce travail : le Professeur Philippe **GERARDIN**, Professeur à l'Université de Lorraine et directeur du LERMAB, le Docteur Jalel **LABIDI**, Professeur de l'Université du Pays Basque et directeur du groupe de recherche BIOREFINERY PROCESSES.

Mes remerciements vont également à l'encontre du personnel du département Sciences et Génie des Matériaux (**SGM**) de l'IUT de Pau et des Pays de l'Adour.

Toutes les personnes qui ont contribué à l'élaboration de ce mémoire méritent une reconnaissance, notamment les stagiaires : Monsieur Mathieu **BOUCARD** et Mademoiselle Elsa **DURET**.

Je ne saurais passer outre l'appui inconditionnel de mes ami(e)s et ma famille, qui n'ont cessé de m'encourager dans l'élaboration de ce travail.

Enfin, je remercie toutes les personnes qui, d'une manière ou d'une autre, m'ont accompagné dans la réalisation de ce travail.

Résumé .....	2
Abstract .....	4
Remerciements.....	5
Liste des Figures.....	16
Liste des Tableaux .....	17
Introduction Générale .....	19
Partie 1 : Contexte et état de l'art.....	22
Contexte économique et technologique : état des lieux .....	23
I. La forêt gabonaise.....	23
II. Enjeux économiques de la transformation du bois au Gabon .....	24
Le matériau bois.....	27
I. Généralité .....	27
II. Structure .....	27
III. Composition chimique des bois.....	29
III.A. Organisation macromoléculaire .....	29
III.B. Les extractibles.....	31
III.B.1. Généralités .....	31
III.B.2. La résine et les dérivés terpéniques .....	32
III.B.3. Les tanins et les dérivés phénoliques .....	33
III.B.3.a. Les tanins condensés .....	34
III.B.3.b. Les tanins hydrolysables .....	35
III.B.3.c. Les tanins complexes.....	36
III.B.3.d. Les phlorotanins .....	36
III.B.3.e. Applications des composés phénoliques.....	37
IV. Le genre Khaya.....	38

IV.A. Généralités.....	38
IV.B. Utilisation du bois de <i>khaya</i> .....	39
IV.B.1. Utilisation en construction .....	40
IV.B.2. Utilisation ancestrale.....	40
IV.B.3. Utilisation pharmacologique des extraits.....	41
IV.B.4. Autres utilisations .....	43
Composites bois-plastique.....	44
I. Généralités.....	44
II. Mise en œuvre .....	44
II.A. Rôle du bois .....	45
II.B. Rôle et choix du plastique .....	45
II.C. Rôle des compatibilisants .....	47
Objectifs de la thèse.....	48
Références bibliographiques.....	50
Partie 2 : Caractérisation physico-chimique d'extraits d'acajou.....	60
I. Introduction .....	61
II. Composition chimique des extraits d'écorce d'Acajou.....	63
II.A. Résumé.....	63
II.B. Abstract.....	64
II.C. Graphical abstract .....	65
II.D. Introduction .....	65
II.E. Materials and Methods.....	67
II.E.1. Materials.....	67
II.E.1.a. Chemicals .....	67
II.E.1.b. Wood sampling.....	67
II.E.2. Methods .....	67
II.E.2.a. Biocidal activity control of <i>K. ivorensis</i> wood powders ...	67

II.E.2.b.	Extraction of polyphenols at room temperature .....	67
II.E.2.c.	Total phenolic content measurement .....	67
II.E.2.d.	Determination of proanthocyanidin content.....	68
II.E.2.d.i.	Anthocyanes measurement by the acid hydrolysis in butanol method	68
II.E.2.d.ii.	Condensed tannins measurement by the acid condensation of vanillin method .....	69
II.E.2.e.	MALDI-TOF analysis.....	69
II.E.2.f.	Fourier Transformed Infrared (FTIR) spectroscopy analysis 69	
II.F.	Results and discussion.....	70
II.F.1.	Polyphenol content.....	70
II.F.2.	Biocide activity control.....	70
II.F.3.	Condensed tannins structures as revealed by MALDI-TOF .	72
II.G.	Conclusion .....	81
II.H.	References.....	82
III.	Analyse chimique et stabilité thermique des tanins condensés d'Acajou	95
III.A.	Résumé.....	95
III.B.	Abstract.....	96
III.C.	Graphical abstract .....	97
III.D.	Introduction .....	97
III.E.	Material and methods.....	99
III.E.1.	Materials.....	99
III.E.1.a.	Chemicals.....	99
III.E.1.b.	Wood sampling.....	99
III.E.2.	Methods .....	99
III.E.2.a.	Extraction of polyphenols at room temperature .....	99

III.E.2.b. Alkaline extraction of tannins for yield measurement, Stiasny number test and TGA and DSC analysis. ....	99
III.E.2.c. Stiasny number determination .....	100
III.E.2.d. Thermogravimetric analysis.....	100
III.E.2.e. Differential scanning calorimetry.....	100
III.E.2.f. MALDI-TOF analysis.....	101
III.E.2.f.i. MALDI-TOF mass spectrometry .....	101
III.E.2.f.ii. MALDI-TOF sample preparation .....	101
III.E.2.g. Fourier Transformed Infrared spectroscopy analysis ...	101
III.E.3. Results and discussion.....	102
III.E.3.a. Tannins extraction.....	102
III.E.3.b. Condensed tannin structures as revealed by MALDI-TOF	102
III.E.3.c. Proanthocyanidin monomers .....	102
III.E.3.d. Proanthocyanidin dimers .....	104
III.E.3.e. Proanthocyanidin oligomers .....	107
III.E.3.f. Proanthocyanidin linked to other functions.....	111
III.E.3.g. Proanthocyanidin oligomers linked to glycosyl units ....	112
III.E.3.h. Condensed tannin structures as revealed by FTIR .....	113
III.E.3.i. Stiasny number determination .....	116
III.E.3.j. Thermogravimetric analysis and differential scanning calorimetry of <i>K. ivorensis</i> tannins extractives .....	117
III.F. Conclusion.....	120
III.G. References.....	120
III.H. Matériel supplémentaire de <<Chemical analysis and thermal stability of African mahogany ( <i>Khaya. ivorensis</i> A. Chev) condensed tannins >>.	

IV. Identification par RP-HPLC/UV/ESI-FTMS des composés phénoliques d'acajou .....	147
IV.A. Résumé .....	147
IV.B. Abstract.....	148
IV.C. Graphical abstract .....	149
IV.D. Introduction .....	149
IV.E. Materials and Methods .....	150
IV.E.1. Materials .....	150
IV.E.1.a. Chemicals .....	150
IV.E.1.b. Wood sampling.....	151
IV.E.2. Methods.....	151
IV.E.2.a. Extraction of polyphenols at room temperature.....	151
IV.E.2.b. High Performance Liquid Chromatography (HPLC) analysis	151
IV.E.2.c. Mass spectrometry (MS) analysis.....	152
IV.F. Results and discussion .....	152
IV.F.1. Chemical variability of <i>K. ivorensis</i> according to method 1	153
IV.F.2. Chemical variability of <i>K. ivorensis</i> according to method 2	156
IV.G. Conclusion.....	163
IV.H. References .....	164
Partie 3 : Valorisation des co-produits générés lors de la transformation du bois d'acajou.....	178
I. Introduction .....	179
II. Caractéristiques physico-chimiques d'adhésifs biosourcés à partir de tanins d'acajou .....	181
II.A. Résumé.....	181
II.B. Abstract.....	182
II.C. Graphical abstract .....	182

II.D.	Introduction .....	182
II.E.	Material and methods .....	183
II.E.1.	Materials.....	183
II.E.1.a.	Chemicals .....	183
II.E.1.b.	Wood sampling.....	184
II.E.2.	Methods .....	184
II.E.2.a.	Alkaline extraction of tannins.....	184
II.E.2.b.	Adhesive formulation .....	184
II.E.2.c.	Thermogravimetric analysis (TGA).....	185
II.E.2.d.	Differential scanning calorimetry (DSC) .....	185
II.E.2.e.	Fourier Transformed Infrared spectroscopy analysis (FTIR) 185	
II.E.2.f.	Thermomechanical analysis (TMA) .....	185
II.E.2.g.	2D HSQC NMR analysis .....	186
II.F.	Results and discussion .....	186
II.F.1.	FTIR-ATR spectroscopy analysis.....	186
II.F.2.	<i>TMA analysis</i> .....	187
II.F.3.	TGA and DSC analysis .....	189
II.F.4.	NMR <sup>13</sup> C and <sup>1</sup> H analysis.....	191
II.G.	Conclusion .....	193
II.H.	References.....	194
III.	Élaboration d'un composite à partir de sciure de bois et de bouteilles plastiques broyées .....	196
III.A.	Résumé.....	196
III.B.	Abstract.....	197
III.C.	Graphical abstract .....	197
III.D.	Introduction .....	198
III.E.	Experimental.....	199

III.E.1. Compositions and materials .....	199
III.E.2. Methods .....	200
III.E.2.a. Wood flour preparation.....	200
III.E.2.b. Plactic powder preparation .....	200
III.E.2.c. Composite preparation .....	200
III.E.2.d. Thermogravimetric analysis (TGA) .....	201
III.E.2.e. Differential scanning calorimetry (DSC) .....	201
III.E.2.f. Principal component analysis (PCA).....	201
III.E.2.g. Shore A hardness .....	202
III.E.2.h. Monnin hardness .....	203
III.E.2.i. Brinell hardness .....	204
III.E.2.j. 3 points bending test .....	204
III.E.2.k. Swelling test .....	206
III.E.2.l. Thermal conductivity .....	206
III.F. Results and discussion.....	207
III.G. Conclusion .....	213
III.H. References.....	214
Partie 4 : Autres exemples de valorisation de bois tropicaux .....	221
I. Introduction .....	222
II. Caractérisation de quelques bois tropicaux du Gabon. ....	223
II.A. Résumé.....	223
III. Caractérisation de la lignine de bois de Coeur de certains bois tropicaux 225	
III.A. Résumé.....	225
IV. Réactivité chimique des celluloses de bois durs .....	227
IV.A. Résumé .....	227
V. Durabilité naturelle de certains bois tropicaux contre le <i>pycnoporus</i> <i>sanguineus</i> et <i>Antrodia sp</i> .....	229



V.A. Résumé .....	229
Conclusion et Perspectives .....	231
I. Caractérisations physico-chimiques des extraits .....	232
II. Valorisation des coproduits .....	234
III. Valorisation d'autres bois tropicaux .....	235
Annexes .....	237
Annexe 1 .....	238
Liste des publications .....	238
Annexe 2 .....	240
Communications internationales .....	240
Annexe 3 .....	243
Participation aux écoles thématiques et prix .....	243
Annexe 4 .....	244
I. Enseignements et encadrements .....	244
II. Vulgarisation Scientifique .....	246
Annexe 5 .....	247
Formations suivies au cours de la thèse .....	247
Annexe 6 .....	248
Matériel supplémentaire sur le composite bois/ plastique .....	248

# Liste des Figures

Figure 1 : Pays exportateurs de sciages (OIBT, 2017). .....	25
Figure 2 : Pays exportateurs de placages (OIBT, 2017) .....	26
Figure 3 : Exemples de co-produits de l'industrie forestière du Gabon (SNBG 2016) .....	26
Figure 4 : Principaux éléments structuraux du bois (Anatomie des bois, 2011, CRPF).....	28
Figure 5 : Structure macroscopique et microscopique du bois (Harrington, 1998). .....	28
Figure 6 : Unité cellobiose.....	29
Figure 12 : Exemples de liaisons des tanins condensés .....	35
Figure 13 : différents types de tanins hydrolysables.....	36
Figure 14 : structure caractéristique des tanins complexes .....	36
Figure 15 : Structure du noyau A des phlorotanins .....	37
Figure 16 : Synthèse de l'aspirine. ....	37
Figure 17 : Dimère de catéchine, utilisé en cosmétique (Tonifiant anti-âge)..	38
Figure 18 : différents organes du Khaya (a=fleurs, b=fruits, c=écorces de tige, d= feuilles). Takin et al., 2013. ....	38
Figure 19 : <i>K. Ivorensis</i> , arbre de 85 ans (a) et 75 ans (b). SNBG 2018. ....	39
Figure 21 : Quelques applications actuelles de l'utilisation du bois d'acajou..	40
Figure 22 : Structures moléculaires des principaux limoïdes responsables de l'activité biocide chez <i>KI</i> et <i>KS</i> . ....	43
Figure 23 : Schéma montrant le rôle de l'agent compatibilisant .....	47

# Liste des Tableaux

Tableau 1 : Résumé global de l'activité forestière en 2017.....	25
Tableau 2 : Composition chimique générale du bois de Khaya ivorensis. ....	41
Tableau 3 : Caractéristiques physiques des principaux polymères thermoplastiques (Sliwa, F. 2011) .....	46

**Analyse et Valorisation des coproduits de la  
transformation industrielle de l'Acajou du Gabon  
(*Khaya ivorensis* A. Chev)**

# Introduction Générale

Le présent projet de thèse a été réalisé au sein du laboratoire Iprem - Xylomat (ANR-10-EQPX-16 Xyloforest) de janvier 2017 à février 2020. Xylomat est l'un des six plateaux de la plateforme Xyloforest orientée dans la recherche, l'innovation et les services pour les systèmes forêts cultivées-produits & matériaux bois. Xylomat est aussi le plateau technique, pour les matériaux à base de bois, de l'Institut des Sciences Analytiques et de Physico-chimie pour les Matériaux et l'environnement (IPREM) de l'Université de Pau et des Pays de l'Adour (UPPA).

Cette thèse résulte de la collaboration entre le Pr Bertrand CHARRIER de l'UPPA, l'Ecole Nationale des Eaux et Forêt (ENEF) du Gabon, et le Dr Rodrigue SAFOU TCHIAMA de l'Université des Sciences et Techniques de Masuku (USTM). Elle a pour objectif la valorisation d'une biomasse forestière du Gabon. La partie française s'est chargée de financer l'expérimentation en laboratoire et la formation doctorale, tandis que le Gabon a mis à disposition les échantillons et la bourse d'étude sur toute la durée de la thèse.

La recherche scientifique en sciences du bois en Afrique Centrale est encore limitée. Pour pallier au problème du faible niveau de connaissance sur le matériau bois, certains pays d'Afrique mettent en œuvre des moyens et des partenariats leur permettant de valoriser la biomasse locale. C'est le cas du Gabon et du Canada qui ont mis en place en 2014 un Master en Sciences du bois entre l'Université Laval, l'Ecole Nationale des Eaux et Forêts du Gabon et le Réseau des Institutions de Formation Forestière et Environnementale d'Afrique Centrale (RIFFEAC). Ce Master permet de former des cadres de la sous-région afin d'améliorer la connaissance du matériau bois local et de mieux le valoriser. C'est dans cette dynamique que s'inscrit ce projet de thèse portant sur l'étude du *Khaya ivorensis* A. Chev (*acajou*) du Gabon.

Le bois est utilisé principalement pour le sciage et le déroulage. Les produits qui en sont issus sont majoritairement destinés à l'exportation. Au regard de l'utilisation en médecine traditionnelle, certaines propriétés de l'écorce, des feuilles, des graines et des racines de quelques arbres ont fait l'objet d'analyses préliminaires en pharmacologie. Les activités anti-inflammatoires, antipaludéennes, antifongiques, cytotoxiques, ainsi que l'usage de différents organes de l'arbre (écorce, fruits et feuilles) pour la production de cosmétiques ont été particulièrement étudiées (Iwu and

Kiayman, 1992 ; Lompo et al., 1998; Adekunle, 2003; Lompo et al., 2007; Atawodi et al., 2009 ; Mane, 2012 ; Wu et al., 2014).

Ce projet de thèse porte principalement sur l'analyse chimique et la valorisation des coproduits de la transformation industrielle du bois d'acajou du Gabon. L'idée consiste à étudier des voies de valorisation des produits de sciages actuellement brûlés à 85% par les scieries locales (Ekomy Ango and Moutou Pitti, 2017). Ainsi, nous avons mis en place un programme de recherche divisé en trois phases :

- Analyse chimique des extraits afin de repérer des molécules à haute valeur ajoutée pour une possible valorisation industrielle,
- Evaluation du potentiel de ces extraits pour l'élaboration d'une colle biosourcée à base de tanins,
- Elaboration d'un composite bois/plastique à partir de bouteilles plastiques recyclées et de coproduits du bois,

Ce travail a été supervisé par le Pr Bertrand Charrier pour les deux premières parties, tandis que la troisième l'a été par le Pr Florent Eyma de l'Institut Clément Ader (ICA) de Tarbes.

Le travail a été réalisé dans le cadre du projet global de développement de l'industrie forestière du Gabon. Il aura permis d'améliorer les connaissances sur la composition chimique des extraits du bois d'acajou, et ainsi d'ouvrir de nouvelles voies de valorisation à long terme. Par ailleurs, il a proposé à court terme une solution pratique de valorisation de co-produits de l'acajou par l'élaboration d'un composite bois-plastique qui permettrait de redonner une nouvelle vie aux co-produits bois et plastiques et ainsi réduire les quantités importantes de déchets de bouteilles plastiques.



# **Partie 1 : Contexte et état de l'art**



# Contexte économique et technologique : état des lieux

## I. La forêt gabonaise

Le Gabon est un pays d'Afrique Centrale doté d'une biodiversité forestière importante (White, 2008). Il est un des six pays du bassin du Congo qui constitue le deuxième "poumon mondial" après l'Amazonie. Cependant, depuis les années 2000, une augmentation de la déforestation est observée dans ces pays (Tchat chou et al., 2015). L'agriculture itinérante sur brûlis pratiquée par les populations en constitue la cause principale. Par ailleurs, elle est liée à plusieurs facteurs : les besoins en bois de feu des populations liées à une démographie croissante et à la pauvreté, le développement des infrastructures, l'expansion agricole, l'exploitation minière et la surexploitation forestière. D'autre part, chaque pays entend stabiliser la production des grumes et même assurer leur transformation sur place, ceci dans le but d'augmenter la valeur ajoutée du secteur, mais aussi d'alimenter le marché intérieur, régional et sous régional (Infogabon, 2014).

Au Gabon, la forêt qui s'y étend regorge de vies animales et végétales, témoins d'une biodiversité abondante. L'homme y a depuis longtemps trouvé son compte, notamment au travers de l'exploitation du bois d'œuvre.

Le domaine forestier national gabonais couvre plus de 80% du territoire. Ce dernier, selon le code forestier, est divisé en deux parties : le domaine forestier permanent de l'Etat (95%) d'une part et le domaine forestier rural (5%) d'autre part (Etat Gabonais, 2001 ; Chevalier et al., 2009 ; Tchatchou et al., 2015). Le premier est constitué des forêts domaniales productives. Pour les exploiter, il est nécessaire d'obtenir un permis forestier industriel. Les concessions forestières doivent bénéficier d'une organisation d'aménagement durable. Les forêts domaniales classées (parcs nationaux, soit 13% du territoire, réserves, forêts classées...) font également partie du domaine national. Le domaine forestier rural quant à lui, est dédié aux populations locales. Il est réservé aux autorisations de sciage de long, ainsi qu'aux autorisations

spéciales de coupe, aux permis de gré à gré et aux futures forêts communautaires (Morin et al., 2014).

## II. Enjeux économiques de la transformation du bois au Gabon

Dans l'optique de développer son économie, le Gabon a décidé de mieux valoriser d'autres secteurs que le secteur pétrolier. En effet, depuis 2009 l'Etat a entrepris de diversifier l'économie du pays en valorisant les secteurs comme l'agriculture, l'élevage, l'apiculture et l'industrie forestière. Ainsi, l'Etat gabonais a, d'une part, interdit l'exportation de grumes des principales essences exploitées, et d'autre part, favorisé une première transformation sur place. L'objectif était d'aboutir à une industrialisation de la filière bois en créant des produits "*made in Gabon*". Cependant, l'accès aux documents officiels concernant l'industrie du bois au Gabon nous a été difficile, en particulier pour l'obtention de données récentes et détaillées sur l'exploitation des différentes essences. Certaines sources ont été obtenues via l'Organisation Internationale des Bois tropicaux (OIBT), le Ministère des Eaux et Forêts du Gabon et quelques articles scientifiques.

D'une manière générale, les exportations des grumes tropicales ont augmenté entre 2010 et 2012. Par contre, avec l'interdiction en 2009 d'exporter du bois sous forme de grume, au-delà d'un certain quota, l'offre gabonaise a drastiquement diminuée. En conséquence, les principaux clients (Chine et France) du pays ne pouvaient plus obtenir leurs stocks de grumes, principalement constitués d'okoumé. En 2013, les exportations ont encore chuté de 18% passant à 661 000 m<sup>3</sup> bien que les demandes chinoises se soient envolées concernant d'autres essences que l'okoumé, telles que des bois rouges comme l'acajou.

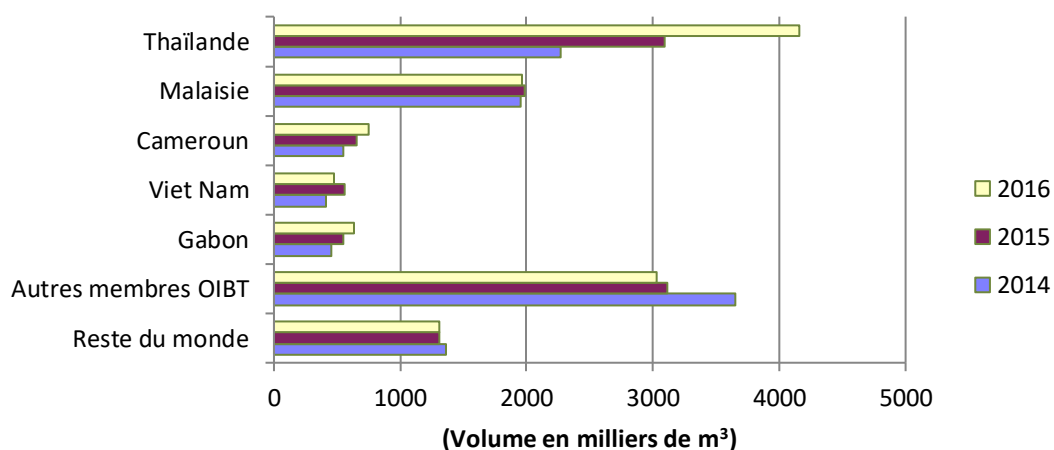
Le tableau de bord de l'économie 2017 (Immongault et al., 2017) confirme une hausse de l'activité de transformation des grumes locales. En effet, la production des grumes a augmenté de 13,5% (soit une hausse de production de 196 481 m<sup>3</sup>) pour atteindre 1 647 531 m<sup>3</sup> en 2017. Ce regain est aussi lié à la mise en exploitation de nouvelles surfaces forestières, à la fermeté de la demande des industries locales et à l'assouplissement de la législation sur les conditions d'exploitation du *Kévazingo* et de l'*Ozigo*. Aussi, les ventes de grumes aux industries ne disposant pas de permis forestiers ou d'essences appropriées sont passées de 444 099 m<sup>3</sup> en 2016 à 497 979 m<sup>3</sup> en 2017, soit une hausse de 12,1%.

**Tableau 1 : Résumé global de l'activité forestière en 2017.**

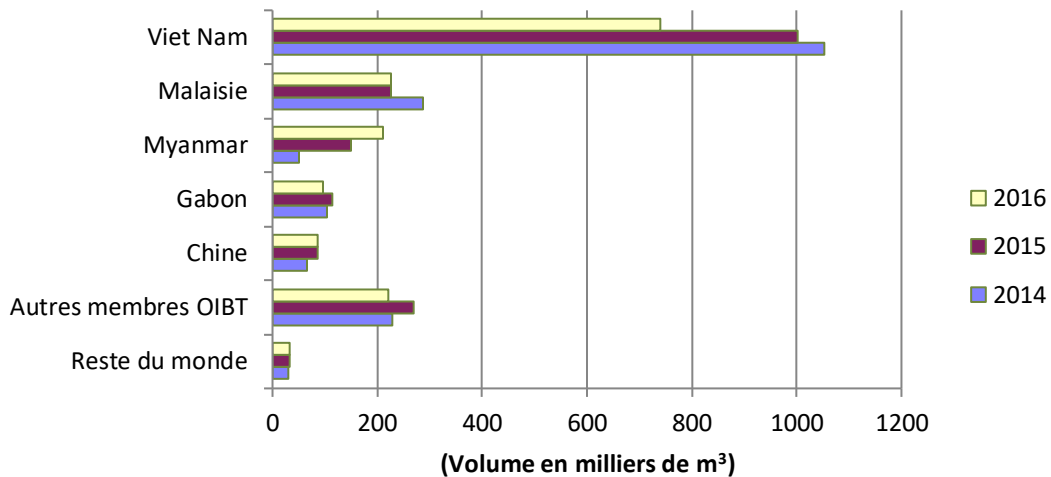
	2015	2016	2017	17/16
Production forestière (m <sup>3</sup> )	1 364 815	1 451 050	1 647 531	13,5%
<i>Okoumé</i>	992 112	1 054 798	1 125 498	6,7%
<i>Bois divers</i>	372 703	396 252	522 033	31,7%
Ventes aux industries locales (m <sup>3</sup> )	387 676	444 099	497 979	12,1%
<i>Okoumé</i>	305 466	349 888	378 553	8,2%
<i>Bois divers</i>	82 210	94 211	119 426	26,8%

Principaux exportateurs de Sciages tropicaux (OIBT, 2017)

Durant les années 2014, 2015 et 2016, on observe une augmentation constante (Figure 1), ce qui place le Gabon à la quatrième place dans l'ordre des premiers pays producteurs de sciages. Il se place ainsi devant le Vietnam, mais derrière le Cameroun, la Malaisie et la Thaïlande avec des productions respectives de 453 000 m<sup>3</sup>, 554 000 m<sup>3</sup> et 635 000 m<sup>3</sup>. Malgré cette augmentation, une légère baisse des exportations de placages est observée durant cette même période, même si depuis 2014, la Chine et la France se sont orientées vers l'importation des placages d'okoumé originaires du Gabon (OIBT, 2016), et non directement de grumes.



**Figure 1 : Pays exportateurs de sciages (OIBT, 2017).**



**Figure 2 : Pays exportateurs de placages (OIBT, 2017)**

Finalement, avec cette augmentation globale de la production de bois transformé, la production de déchets de bois s'est accrue. Ce sont pour une partie des dosses, des plaquettes de sciage, des résidus de production de placages par tranchage ou des cœurs de déroulage. Ainsi, les déchets de sciage représentaient respectivement 557 000 m<sup>3</sup>, 668 000 m<sup>3</sup>, 732 000 m<sup>3</sup> et 707 135 m<sup>3</sup> pour les années 2014, 2015, 2016 et 2017 (Morin et al., 2014 ; OIBT, 2016). Le déchet le plus important reste les sciures de bois provenant des usines de transformation, il représente environ 5 000 000 m<sup>3</sup> (Ekomy Ango and Moutou Pitti, 2017). Ces déchets, représentent environ 50 % de la grume de départ et sont rarement valorisés par les exploitants, ou les industriels de la première transformation. Environ 10% sont quand même exploités par les scieries pour alimenter les chaudières des unités de transformation du bois, et 5% par les populations qui les utilisent pour produire du charbon de bois. Cela implique que les 85% restant sont brûlés à ciel-ouvert (Ekomy Ango and Moutou Pitti, 2017).

L'image ci-dessous illustre l'importance de ces produits connexes et le potentiel que cela représente en terme de biomasse valorisable.



**Figure 3 : Exemples de co-produits de l'industrie forestière du Gabon (SNBG 2016)**

# Le matériau bois

## I. Généralité

Le bois est matériau fibreux à renfort filamentaire au même titre que les fibres de lin, chanvre, bananier, jute, sisal, bambou, canne à sucre, coton, etc. C'est un élément important pour l'économie mondiale. Les demandes mondiales en ce matériau sont en augmentation constante avec une production de plus de 250 millions m<sup>3</sup> en 2016 pour le bois rond industriel (OIBT, 2017), mais l'offre ne suit pas toujours la tendance (Stevanovic, 2019). Cette inadéquation entre l'offre et la demande est liée à des facteurs différents parmi lesquels figure la diversité des types de bois qui ne sont pas forcément adaptés à tous les usages. Cette diversité peut être expliquée en partie par le processus de formation du bois lié aux aspects génétiques de l'espèce mais également à l'influence de l'environnement dans lequel le bois va se former (Guedes et al., 2019). Par ailleurs, en fonction du sens de coupe, le bois va présenter des propriétés différentes. Les différentes propriétés du bois lui confèrent le nom de matériau hétérogène et anisotrope.

## II. Structure

Le bois est un matériau complexe et hétérogène, ses caractéristiques étant pour partie liées à son appartenance à une espèce végétale donnée (feuillus ou résineux). Il possède plusieurs éléments de structures. Les principaux sont ceux visibles à l'œil nu ou à la loupe. Des éléments tels que les cernes de croissance (Figure 4), les différences entre le bois de cœur et l'aubier, les rayons ou la répartition des cellules peuvent être reconnues à ce stade. Les principales parties d'un morceau du tronc d'un arbre sont, depuis l'extérieur jusqu'à l'intérieur, l'écorce, le phloème, le cambium, l'aubier et le bois de cœur. Le cambium est une partie vitale de l'arbre puisqu'il correspond à la zone où a lieu la production des nouvelles cellules (Figure 5). Le cambium synthétise les cellules de bois à la fois dans le sens radial et vertical, en direction du centre du tronc. L'assise subéro phellodermique qui se situe juste sous l'écorce génère des cellules qui vont ensuite se transformer en écorce interne et externe.

L'aubier fait partie des tissus vivants de l'arbre. C'est dans cette zone que circule de manière ascendante la sève brute. L'aubier est situé en périphérie du bois de cœur (ou duramen). En se déplaçant vers le centre de l'arbre, les parois cellulaires de l'aubier se transforment et les tissus meurent. C'est alors la transformation des cellules d'aubier en bois de cœur selon un procédé que l'on appelle la duraminisation.

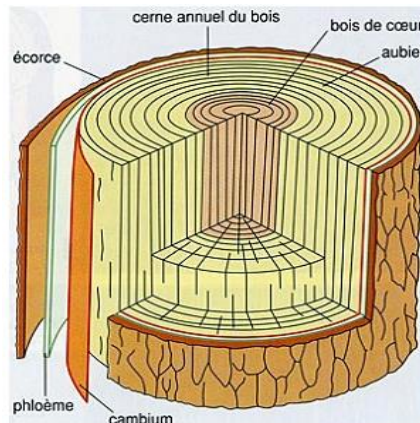


Figure 4 : Principaux éléments structuraux du bois (Anatomie des bois, 2011, CRPF).

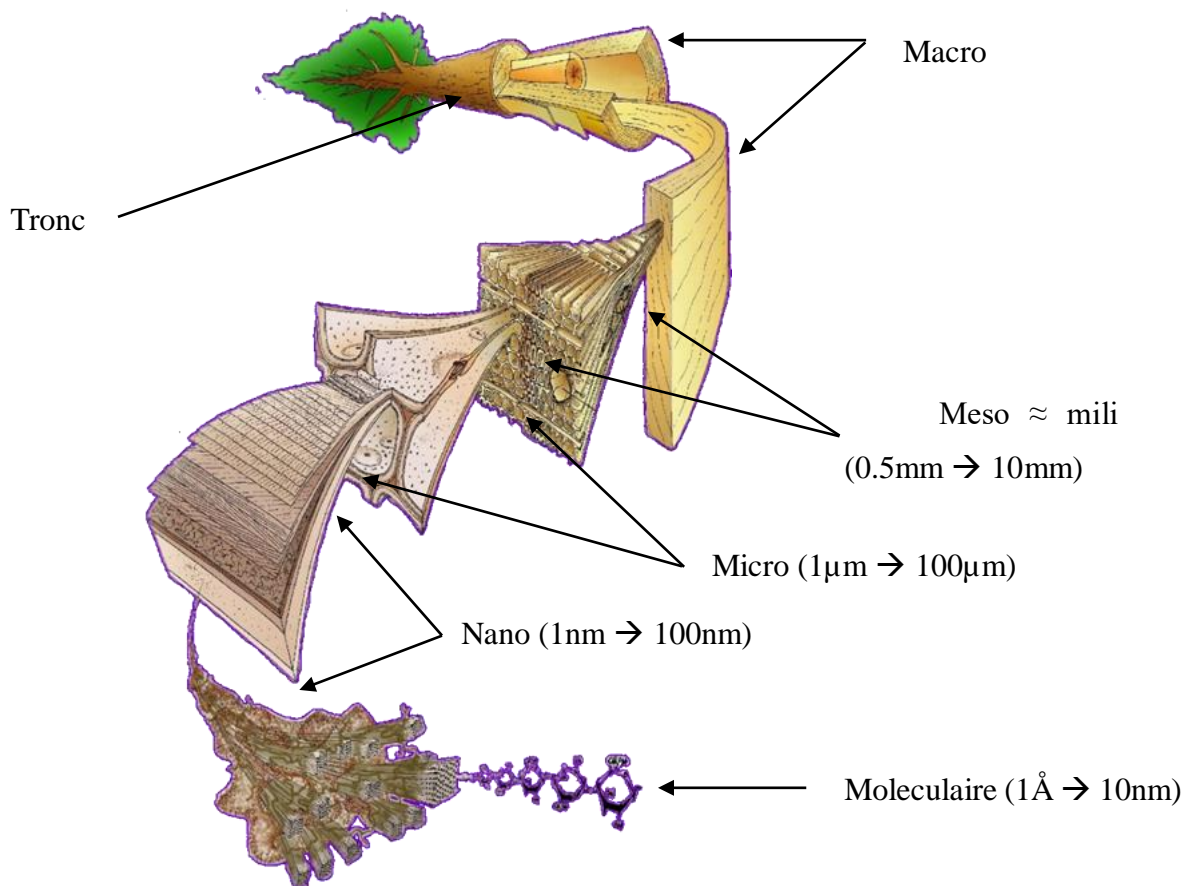
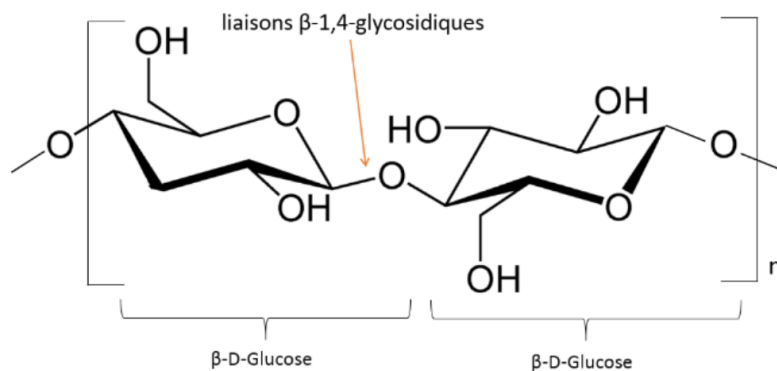


Figure 5 : Structure macroscopique et microscopique du bois (Harrington, 1998).

### III. Composition chimique des bois

#### III.A. Organisation macromoléculaire

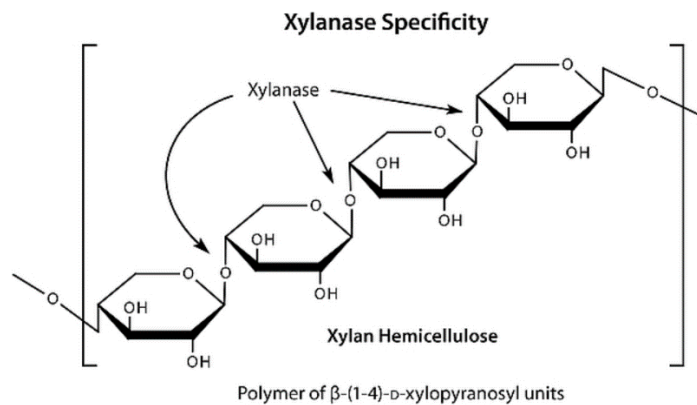
Les constituants principaux du bois sont la cellulose, les hémicelluloses et la lignine. La part de chacun dans la composition chimique du bois varie peu entre les essences. Les différences de structure chimique qui existent entre-eux, sont minimales entre les arbres (Hon et al., 2001). La cellulose (Figure 6) est le principal composant et représente environ 40% de la masse du bois (Montero., 2010). Selon sa disposition dans la paroi cellulaire, elle peut être partiellement cristalline ou organisée en fibrilles. C'est un biopolymère à longues chaînes constitué d'unités répétitives de D-anhydroglucopyranose reliées entre-elles par des liaisons  $\beta$ -O-4 glycosidiques (unité cellobiose) comme présenté à la figure 6 ci-dessous.



**Figure 6 : Unité cellobiose**

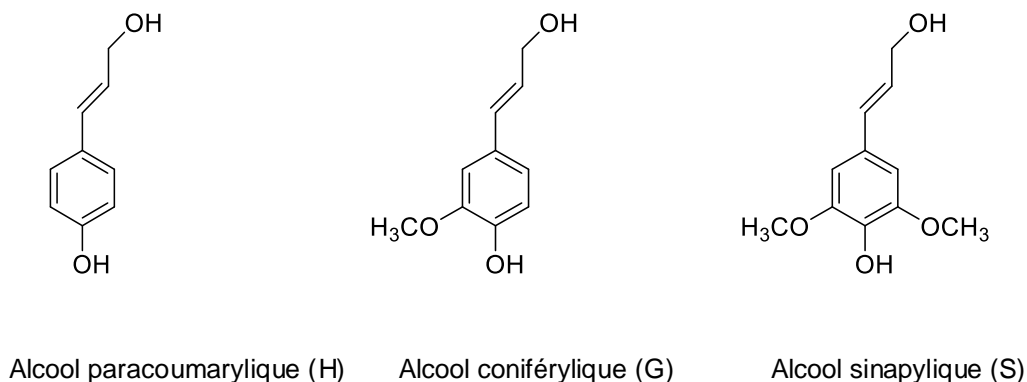
La chaîne de cellulose n'est pas plane et peut être sujette à des liaisons hydrogène intra et inter-chaînes. Ce phénomène est à l'origine des propriétés remarquables de la cellulose et de son caractère cristallin à environ 70%.

Les hémicelluloses (Figure 7) arrivent en seconde position en terme d'abondance (la cellulose et l'hémicellulose (15 à 35%), que l'on appelle aussi l'holocellulose, représentent environ 65-75% en masse du bois). Elles sont ramifiées et constituent un vaste groupe de polyholosides dont l'hydrolyse conduit à des sucres en C5 (xylose ou arabinose) et C6 (mannose, galactose ou rhamnose). Leurs degrés de polymérisation sont dix à cent fois inférieurs à celui de la cellulose.



**Figure 7 : Hémicellulose**

Le troisième constituant du bois est la lignine (Figure 8). Elle apporte la rigidité et la cohésion au bois. Sa teneur varie au sein des deux grandes familles de bois. Chez les conifères, elle représente 24 à 27% du bois sec alors que dans les feuillus, cette proportion est de 18 à 23% du bois sec (Sliwa, 2011). Il existe également des différences structurales entre les lignines des conifères et des feuillus. En effet, la proportion des précurseurs ou des unités permettant la formation des lignines est différente dans les bois durs et les bois tendres. Les différents précurseurs de la lignine sont présentés ci-dessous.



**Figure 8 : Précurseurs de la lignine**

L'organisation moléculaire de la cellulose, de l'hémicellulose et de la lignine permet de considérer que le bois se comporte comme un composite à fibres naturelles. En effet, le terme composite désigne un matériau constitué d'éléments discontinus appelés renforts, noyés dans une phase continue appelée matrice. Il est généralement utilisé pour des matériaux à base de résines plastiques, céramiques, de carbone ou métalliques, renforcés par des fibres. Cependant, cette définition peut s'appliquer à



des "matériaux" élaboré plus anciens comme le torchis ou le béton armé, et même à d'autres matériaux naturels comme le tissu osseux. Dans le cas du bois, ses fibres sont représentées à l'échelle moléculaire par les chaînes de cellulose organisées en microfibrilles et microfibrilles qui, associées aux hémicelluloses, sont liées par un gel de lignine.

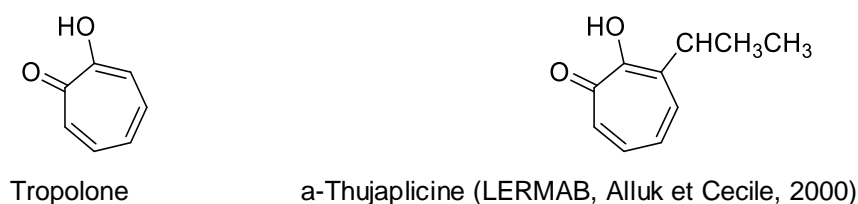
### **III.B. Les extractibles**

#### **III.B.1. Généralités**

Les extractibles sont des composés de faible poids moléculaire solubles dans les solvants organiques ou aqueux. Ils regroupent toute une gamme de molécules dont la plupart sont des métabolites secondaires, c'est-à-dire des composés générés lors de mécanismes biologiques de la plante, et qui ne sont pas indispensables à sa croissance. Leurs compositions varient d'une essence à l'autre. Leur teneur peut varier de 5 à 25%, tandis que la nature des extractibles varie selon l'essence, la localisation géographique, le patrimoine génétique ou la saison.

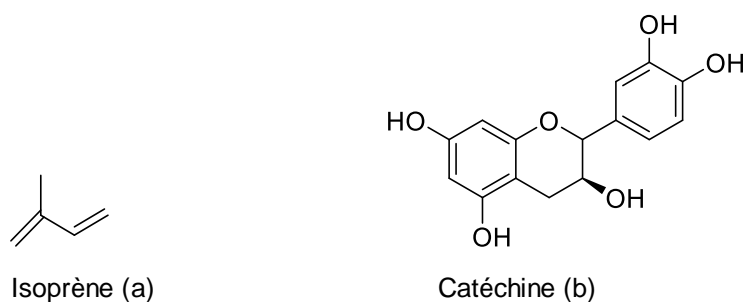
La plupart des extractibles sont localisés dans les lumens des cellules du bois qui sont des espaces vides à l'intérieur des cellules. Chez les résineux, ils peuvent être élaborés et transportés par des cellules spéciales appelées canaux résinifères.

Les extractibles du bois sont responsables de sa couleur (Amusant, 2003), de son odeur, de son hygroscopie (Krutul., 1992) et de sa durabilité naturelle (Aloui et al., 2004). Ils jouent un rôle important dans ses propriétés physiques (propriétés acoustiques) et mécaniques (stabilité dimensionnelle). Les extractibles sont également responsables de la qualité de la pâte et de la capacité d'adhésion de la colle (Nussbaum et al., 2002). De nombreux extractibles présentent des activités biologiques particulières. Certaines de ces molécules sont de véritables marqueurs chimiques dont la présence est caractéristique de la famille, du genre ou de l'espèce. C'est le cas de la famille des Cupressacées qui est la seule source de composés terpéniques de type tropolones (Figure 9), parmi lesquels les thuyaplicines (Figure 8) retrouvées dans le bois du cœur de thuya ou du cèdre au Canada (*Tetraclinis articulata*, UICN, 2011).



**Figure 9 : Structures des principaux composés terpéniques de nature aromatique.**

Les structures de ces molécules permettent de les classer en plusieurs familles (Stevanovic et al, 2019) : les terpénoïdes (Figure 10), les cires et les graisses, les polyphénols, les sels d'acides organiques, les glucides complexes et les composés azotés (protéines, alcaloïdes). Les trois groupes d'extractibles qui ont une valeur très importante dans l'industrie forestière sont les terpènes, les polyphénols (Figure 9) et les alcaloïdes. En effet, ces composés sont non seulement les extractibles les plus abondants dans les essences qui nous intéressent, mais, ils offrent aussi diverses applications pratiques dans les domaines pharmaceutiques, nutraceutiques et cosmétiques en raison de leurs propriétés physico-chimiques et biologiques.



**Figure 10 : Structure de base des terpènes (a) et polyphénols dont un flavonoïdes (b).**

### III.B.2. La résine et les dérivés terpéniques

Les terpènes et terpénoïdes représentent le plus gros groupe de composés organiques d'origine naturelle découvert à ce jour, avec au moins 20 000 molécules distinctes dans des milliers d'espèces de plantes. Ils sont également appelés isoprénoïdes, car leur structure repose sur la répétition d'unités d'isoprène ( $C_5H_8$ ). Formellement, les terpènes sont des hydrocarbures simples, tandis que les terpénoïdes contiennent des groupes fonctionnels supplémentaires. Néanmoins, le terme « terpène » englobe souvent les terpénoïdes dans de nombreux écrits. Ils sont les principaux composants de la résine végétale et des huiles essentielles extraites des plantes et sont à l'origine de différentes saveurs et parfums. Chez les conifères,

la résine est une substance visqueuse et combustible, produite au niveau de l'aubier par les arbres dits résineux comme le sapin, l'épicéa ou le pin.

Nous pouvons citer quelques produits contenant des terpénoïdes (Mariana et al., 2010) :

- Le caoutchouc naturel ;
- La gemme qui est un mélange de terpènes extraits du pin maritime (les adhésifs, les polymères, les émulsifiants, les revêtements et les produits d'apprêt dans la fabrication de papier) ;
- L'ambre ;
- L'encens ;
- Les huiles essentielles (constituées principalement de monoterpènes, de sesquiterpènes et de leurs dérivés).
- Leur présence dans le cannabis est connue depuis des décennies, mais la prise de conscience de leurs propriétés thérapeutiques n'est que récente (Mariana et al, 2010).
- En agro-alimentaire, etc.

### III.B.3. Les tanins et les dérivés phénoliques

Les tanins sont inégalement répartis dans l'écorce, l'aubier et le duramen du bois. Ils jouent un rôle important dans la protection de la matière lignocellulosique de l'arbre contre les agressions extérieures, notamment les pourritures et les insectes. Les tanins sont présents dans les environnements terrestres et aquatiques. On les retrouve principalement dans les zones tropicales arides, semi-arides mais aussi en atlantique ou en méditerranée (Jackson et al., 1996 ; Balogun et al., 1998 ; Barbehenn and Peter Constabel, 2011).

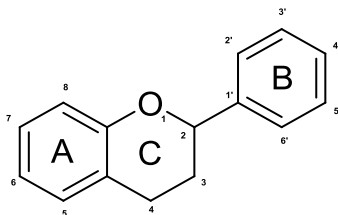
Les tanins ont joué un rôle important dans l'histoire car ils permettaient de réaliser des cuirs de bonne qualité avec des peaux d'animaux traitées avec du tanin. L'une des premières plantes utilisée pour le tannage du cuir fut le chêne (Frutos et al., 2004 ; Arapitsas, 2012).

Les tanins sont catégorisés en fonction de leur structure moléculaire. Initialement, ils ont été distingués en deux classes principales, les tanins hydrolysables

et les tanins condensés, mais deux autres groupes ont ensuite été ajoutés : les tanins complexes et les phlorotanins.

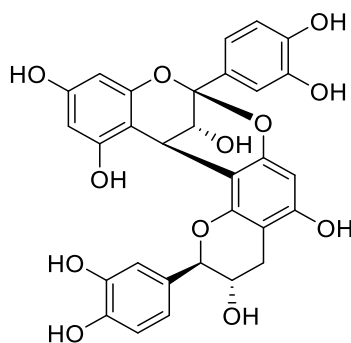
### III.B.3.a. Les tanins condensés

Les tanins condensés peuvent être sous forme de monomère ou d'oligomères (Hagerman, 2002 ; Haslam, 2007). La structure type des flavonoïdes est représentée ci-dessous :

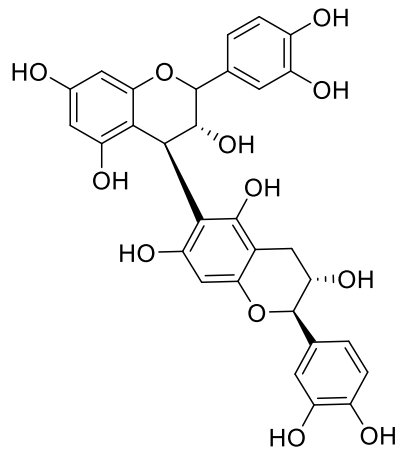


**Figure 11 : Motif de base des tanins condensés.**

En général, les liaisons entre monomères se font entre le cycle C et le cycle A (Figure 12), on parle de proanthocyanidols. On note une douzaine d'unités de monomères flavanols représentant les éléments constructifs des tanins condensés. Dans la nature, ces unités peuvent parfois être remplacées par de l'acide gallique ou des sucres dans les positions 3 ou parfois 5 et 7. En général, le cycle A des proanthocyanidols comporte un ou deux hydroxyles, l'hétérocycle avec des carbones asymétriques 2 et 3 (avec un hydroxyle en position 3). Le cycle B peut comporter jusqu'à 3 hydroxyles. Dans ces composés, les liaisons interflavoniques des unités sont majoritairement de type C<sub>4</sub>-C<sub>8</sub> (*proanthocyanidol de type A*) et représentent les deux groupes les plus abondants (procyanidols et prodelfinidols) des proanthocyanidols dans la nature. Parfois, les liaisons de type C<sub>4</sub>-C<sub>6</sub> sont aussi observées, on parle dans ce cas de *proanthocyanidol de type B*.



Proanthocyanidol de type A avec liaison interflavanique double (C<sub>4</sub>-C<sub>8</sub> et C<sub>2</sub>-C<sub>7</sub>).

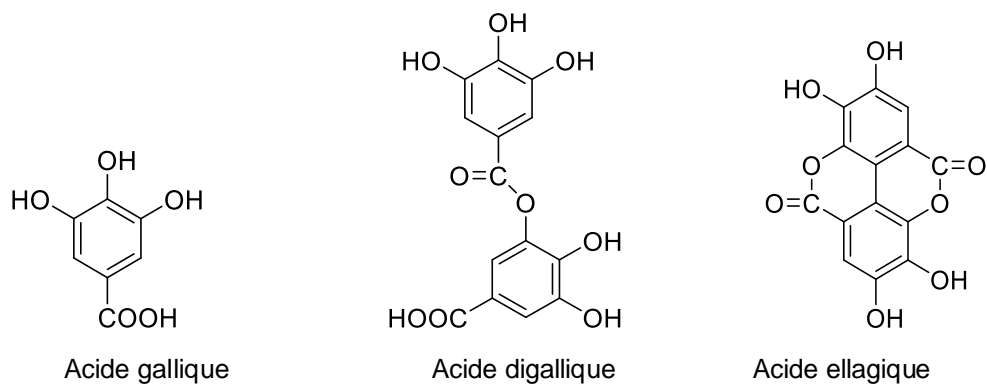


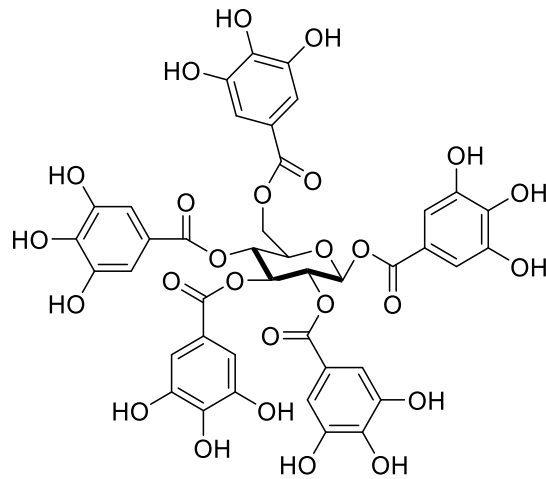
Proanthocyanidinol de type B avec liaison interflavanique simple (C<sub>4</sub>-C<sub>6</sub>).

**Figure 7 : Exemples de liaisons des tanins condensés**

### III.B.3.b. Les tanins hydrolysables

Les tanins hydrolysables (Figure 13) sont constitués de monomères simples tels que le pyrogallol, l'acide gallique, mais aussi d'esters de sucres ou d'acide digallique. Ils présentent des propriétés remarquables et ont souvent été utilisés comme substituts de phénol dans la fabrication de résines phénol-formaldéhyde (Falcão and Araújo, 2013; Spina et al., 2013). Ils ont la capacité de précipiter les protéines, les alcaloïdes et les polysaccharides en solution aqueuse.





Penta-O-galloyl-D-glucose, précurseurs de nombreux tanins hydrolysables.

### Figure 8 : différents types de tanins hydrolysables

#### III.B.3.c. Les tanins complexes

Les tanins complexes représentent un groupe minoritaire au sein de la famille des tanins. Ils sortent un peu de la classification traditionnelle et sont caractérisés par la présence d'unités monomères de tanins hydrolysables et de tanins condensés. Ce sont souvent des gallotanins ou ellagitanins dont la structure est souvent de type flavan-3-ol connecté (Hatano et al., 1991) par une liaison C-C entre eux..

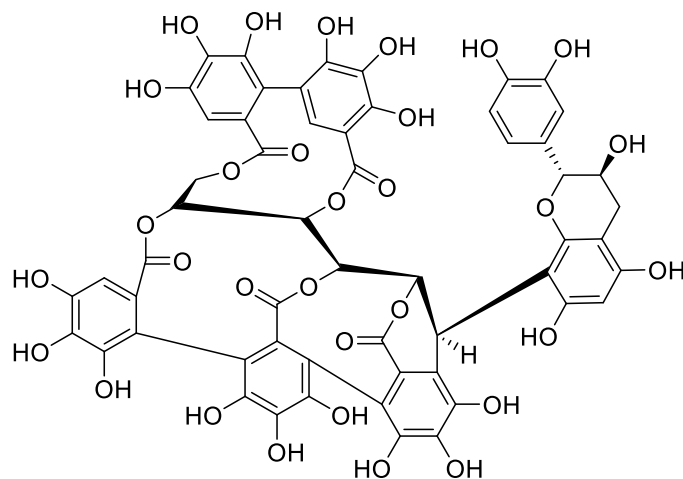
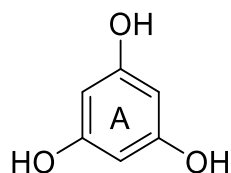


Figure 9 : structure caractéristique des tanins complexes

#### III.B.3.d. Les phlorotanins

Le groupe des phlorotanins est présent dans les algues brunes et est composé principalement d'unités de phloroglucinol (1,3,5-trihydroxybenzène). Ce groupe a récemment été découvert et les études ont conduit à l'élucidation structurale de plus de 150 composés avec une large gamme de masses molaires comprises entre 126 et

625000 g.mol<sup>-1</sup> (Glombitza and Fucols, 2003 ; Lopes et al., 2012 ; Sathya et al., 2017). Les phlorotanins forment des déshydro-oligomères et des polymères de groupements phloroglucinol liés via des liaisons de type aryl-aryle (C-C) et/ou C-O-C.

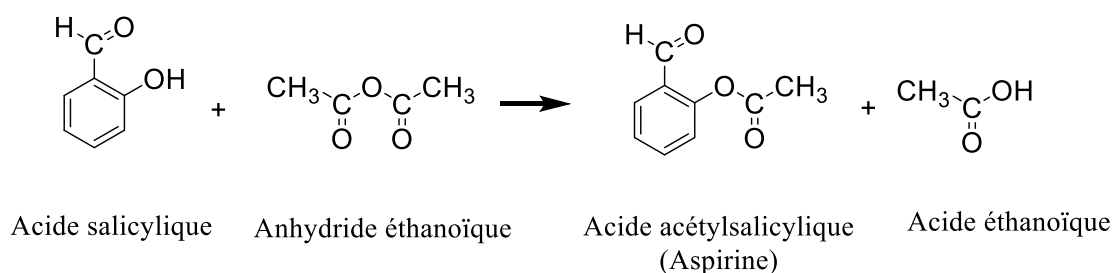


**Figure 10 : Structure du noyau A des phlorotanins**

### III.B.3.e. Applications des composés phénoliques

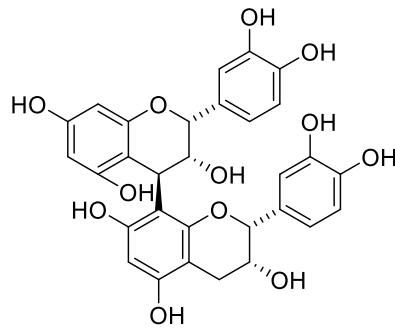
Les tanins sont aujourd'hui la source de biomasse la plus abondante après la cellulose, les hémicellulose et la lignine (Arbenz and Avérous, 2016). Les principaux tanins commercialisés sont ceux de mimosa (120 000 tonnes/an soit : 42 000 tonnes en Afrique du Sud, 8 000 tonnes au Zimbabwe, 70 000 tonnes au Brésil et 6 000 tonnes en Tanzanie) et de quebracho (80-85 000 tonnes/an), mais d'autres essences comme le pin ou le chêne présentent aussi des taux de tanins élevés dans leur écorce. On retrouve cette famille de molécules naturelles dans les produits utilisés quotidiennement, dont quelques applications sont présentées ci-dessous.

- Principes actifs de nombreux médicaments (l'acide acétylsalicylique, la rutine, etc.) ;



**Figure 11 : Synthèse de l'aspirine.**

- En cosmétique (oligomères procyanidoliques, lutte contre le vieillissement) ;



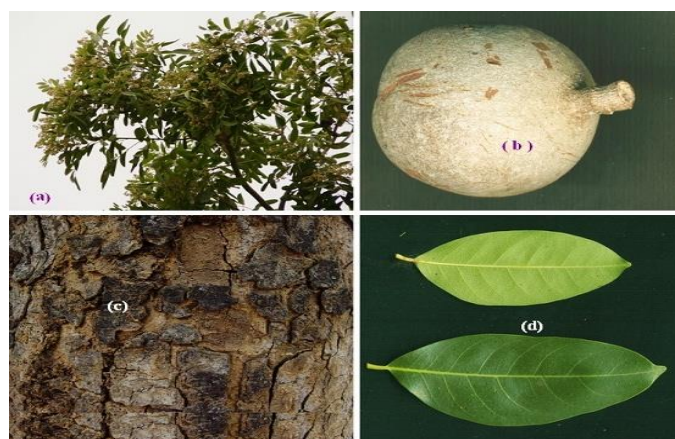
**Figure 12 : Dimère de catéchine, utilisé en cosmétique (Tonifiant anti-âge).**

- En agro-alimentaire (conservateurs, etc.)
- Peintures

#### IV. Le genre Khaya

##### IV.A. Généralités

Le Khaya est une angiosperme de la famille des Méliacées qui comprend 50 genres et 1400 espèces. Parmi les genres les plus importants se trouve Khaya (Mane, 2012). Le genre *Khaya* originaire d'Afrique compte six espèces (Banerji, 1984) qui sont : *Khaya ivorensis*, *Khaya anthoteca*, *Khaya grandifolia*, *Khaya senegalensis*, *Khaya nyasica* et *Khaya madagascarzensis*. *Khaya senegalensis* et *Khaya ivorensis* sont les plus répandus du genre Khaya. Le premier est une essence présente dans plusieurs pays de l'Afrique de l'Ouest tels que le Tchad et le Burkina Faso. Il pousse principalement dans les forêts de feuillus de savane (Zhang et al., 2009).



**Figure 13 : différents organes du Khaya (a=fleurs, b=fruits, c=écorces de tige, d=feuilles). Takin et al., 2013.**

*K. ivorensis* est généralement appelé l'acajou d'Afrique. Il est natif de nombreux pays africains comme le Gabon, le Cameroun, la Cote d'Ivoire et le Ghana. *Khaya*



*ivorensis* est un très grand arbre qui peut atteindre une hauteur de 40 à 50 m. Son écorce est épaisse et grossière, brun rougeâtre avec un goût amer. L'aubier est brun-jaunâtre et le bois de cœur est pâle brun rougeâtre. Les fruits se développent très rapidement et sont remarquables. Le bois est durable et a un grain fin assez régulier; mais est difficile à imprégner. Il a une masse volumique moyenne de 0,53 g/cm<sup>3</sup>.



Figure 14 : *K. Ivorensis*, arbre de 85 ans (a) et 75 ans (b). SNBG 2018.

#### IV.B. Utilisation du bois de *khaya*

*K. ivorensis* et d'autres essences sont exploitées par beaucoup de scieries. L'acajou est l'une des 7 essences les plus exploitées au niveau industriel au Gabon. Cette essence a montré une grande aptitude au reboisement sur les 13 essences les plus utilisées au Gabon (Koumba Zaou et al., 1998). Sa croissance est proche de celle l'Okoumé et pourrait donc le compléter ou le substituer dans le cadre des forêts productives d'un point de vue industriel.

C'est l'une des principales essences exploitées dans l'industrie forestière en raison de la qualité de son bois et de son aspect.



Figure 20 : Aspect du bois d'acajou: aubier (a), duramen (b) et cœur (c).

Au Gabon, plusieurs entreprises comme la SNBG, ROUGIER, ECOWOOD exploitent ce bois et l'exportent principalement sous forme de grumes, avivés, placages et contreplaqués (Koumba Zaou et al., 1998 ; Cirad, 1998 ; Etat Gabonais, 2003; Nze Nguema, 2009 ; Ndiade Bourobou et al., 2010; Cirad, 2011; Infogabon, 2014).

Les grumes d'acajou se conservent bien sauf pendant l'intersaison, c'est-à-dire entre la sécheresse et la période des pluies durant laquelle on peut observer des attaques d'insectes à piqûre noire (platytes et scolytes). On note aussi des attaques

de longicornes mais qui ne présentent qu'une gravité limitée. Concernant l'attaque des champignons, cela se fait juste au niveau de l'aubier qui peut parfois bleuir. L'aubier du Khaya est un bois de classe 3 pour une perte de masse comprise entre 10 et 15% lors de l'attaque des champignons ou insecte. Son duramen est de classe 2 (durable, avec une perte de masse vis-à-vis des champignons lignivores comprise entre 5 et 10%).

#### IV.B.1. Utilisation en construction

En Europe et dans les pays qui maîtrisent la technologie du bois, l'acajou d'Afrique est valorisé dans plusieurs domaines, notamment en construction en ossature bois (Figure 21). En effet, en bois massif, il peut être utilisé en menuiserie intérieure et extérieure dans le bâtiment, mais aussi en ébénisterie, ameublement et décoration, aménagements intérieurs des maisons personnelles ou des hôtels.

Enfin, le bois d'acajou est souvent utilisé en construction navale pour des bateaux de plaisance à l'instar des coques des embarcations légères.



Figure 15 : Quelques applications actuelles de l'utilisation du bois d'acajou.

#### IV.B.2. Utilisation ancestrale

*K. senegalensis* est l'une des plantes médicinales les plus utilisées pour les remèdes traditionnels africains. La décoction ou infusion de son écorce est couramment employée pour soigner la malaria, la fièvre, la diarrhée et les maladies vénériennes ainsi que comme vermifuge et taeniocide (Olayinkaal, 1992; Iwu, 1993). Elle est également utilisée contre les infections bactériennes, le cancer, etc. (Takin et al, 2013).

Comme *K. senegalensis*, *K. ivorensis* est beaucoup utilisé en médecine pour traiter certains cas de maladies. En effet, on l'utilise pour la toux et la coqueluche, la diarrhée, la dysenterie, comme boisson ou bain pour les maux de dos et en lotion pour

les rhumatismes. En Afrique, ses extraits sont très utilisés en médecine traditionnelle comme remède contre de nombreuses maladies telles que le paludisme (Roselyne et al., 2011), le diabète (Mohammed et al., 2014), ou encore pour ses propriétés bactéricides (Ugoh et al., 2014).

Les observations empiriques des paysans du Tchad ont permis de montrer que les extraits aqueux des feuilles et des fruits de *K. senegalensis* ont un effet répulsif contre les insectes et les prédateurs des produits agricoles. Ces observations ont été scientifiquement démontrées par la mise en évidence des effets pesticides en milieu artificiel des extraits eau/acétone des écorces de branches de *K. senegalensis* sur les pucerons *Acyrtosiphon pisum* (Djongaïbe Laïba, 2015).

#### IV.B.3. Utilisation pharmacologique des extraits

La composition chimique des bois africains reste peu ou mal connue malgré les avancées des connaissances en mécanique, en physique, ou en termes de contrôle de la durabilité naturelle des bois tropicaux (Detienne et al., 1960). L'acajou africain (*Khaya spp.*) figure parmi ces essences à fort potentiel de valorisation technologique. Sa diversité géographique interpelle le chercheur sur sa variabilité chimique et les possibles applications associées à sa transformation. Cependant, des études ont montré une faible variabilité entre les différentes espèces d'acajou (Bois et Forêts des Tropiques, 1979 ; Tchoundjeu and Leakey, 2000 ; França et al., 2016).

En général, les méliacées sont riches en composés naturels valorisables. Des études antérieures obtenues par le CIRAD (Catinot, 1979 ; Dupuy, 1993 ; Doat, 1978) ont pu nous renseigner sur la composition chimique du bois de *Khaya* en étudiant quelques échantillons de *K. ivorensis*, *K. anthotheca*, *K. grandifolia* et *K. senegalensis*.

**Tableau 2 : Composition chimique générale du bois de *Khaya ivorensis*.**

Constituants	Nombre d'échantillons	Moyenne (% bois Sec)	$\sigma$ (%)
Extrait alcool-benzène	6	3,25	2,85
Extrait à l'eau	6	4,1	4,2
Silice	7	0,015	0,010
Pentosanes	6	18,1	18,4
Cellulose	6	40,45	39,8
Lignine	6	29,5	29,6
Cendre	6	1,25	1,25

Les données du Tableau 2 montrent qu'il existait peu de variabilité inter-espèce en ce qui concerne la composition chimique. En 1971 (Savard et al., 1971), cette même revue avait déjà donné un aperçu de la composition de *K. ivorensis*. Les proportions étaient les suivantes : Extraits totaux (8,07%), lignine (24,6%) et pentosanes (18.5%). Trente ans plus tard, la présence des grands groupes chimiques, (tels que les acides phénoliques, les flavonoïdes, les saponosides, les triterpènes et stérols, les anthraquinones, les anthocyanes et les caroténoïdes) a été identifiée dans les extraits totaux de *K. ivorensis* (Mane, 2012).

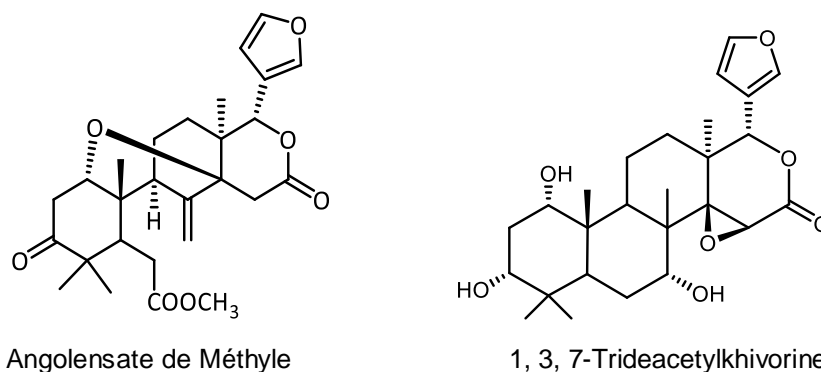
Les études chimiques réalisées sur l'acajou ont concerné principalement les limonoïdes présents dans différentes parties. En effet, ces composés ont montré une activité fongicide sur des pourritures comme *Botryosphaeria rhodona*, *Botrytis cinerea* Pers (El-Aswad et al., 2004; Abdelgaleil et al., 2005b; Takin et al., 2013; Karine et al., 2009). Il en ressort que le limonoïde qui a l'activité la plus élevée est l'angolensate de méthyle qui existe chez *Khaya senegalensis* Desr. A. Juss (*K. senegalensis*) et *Khaya ivorensis* A. Chev. (*K. ivorensis*). L'activité des limonoïdes présents dans les extraits de *Khaya* peut expliquer leur utilisation en médecine traditionnelle (Taylor, 1984, Champagne et al., 1992, Mulholland et al., 2000; Obbo et al., 2013).

Les différentes études réalisées sur cette essence se sont majoritairement concentrées sur les extraits d'écorce du tronc et des branches, des feuilles, des racines et des graines (Iwu and Kiayman, 1992; Nakatani et al., 2000; Ibrahim et al., 2006 ; Zhang et al., 2009).

Le *Khaya* est beaucoup utilisé en Afrique pour ses propriétés pharmacologiques et cosmétiques, notamment pour la fabrication de crèmes et de gels (Lompo, 1999), ses activités anti-inflammatoires et ses propriétés antioxydantes (Mane, 2012) en ce qui concerne les extraits d'écorces de tronc, des feuilles et de fruits. Ces derniers, ont montré leur efficacité pour traiter les maladies comme la malaria, (la fièvre), la diarrhée, la muqueuse et les maladies vénériennes (Olayinkaal., 1992 ; Iwu and Kiayman, 1992).

Certains auteurs ont aussi valorisé les propriétés antimicrobiennes et antifongiques des écorces de *K. ivorensis*. Ainsi, Abdelgaleil (Abdelgaleil et al., 2005a, 2005b), a testé l'efficacité de dix (10) limonoïdes sur le *Botrytis cinerea* pers (pourriture grise attaquant les cultures). Parmi ces dix molécules, l'angolensate de méthyle

(73,3%) et la 1,3,7-tridéacétylkhivorine (68,6%) présentait les meilleurs effets antifongiques.



**Figure 16 : Structures moléculaires des principaux limoïdes responsables de l'activité biocide chez *Khaya ivorensis* et *Khaya senegalensis*.**

#### IV.B.4. Autres utilisations

La capacité de produire de la pâte à papier de bonne qualité avec le bois de *Khaya* a également été démontrée. En effet, en 1979, le centre technique forestier tropical par un procédé kraft (soude-soufre) a effectué un traitement sans parvenir à l'étape de blanchiment. Les résultats obtenus furent satisfaisants car la pâte avait un indice de permanganate favorable pour des quantités de réactifs de l'ordre de 20%. Les papiers écrus préparés avaient montré de très bonnes qualités notamment pour la longueur de rupture et la résistance à l'éclatement mais la résistance à la déchirure fut moyenne.

# Composites bois-plastique

## I. Généralités

La prise en compte de la nécessité de lutter contre la pollution des environnements naturels, des océans, des mers et des rivières contre les plastiques est une problématique majeure du 21<sup>ème</sup> siècle (Petithuguenin, 2014; Monsaingeon, 2016; Bongartz, 2019). Le fait que la grande majorité de ces plastiques ne soient pas biodégradables, oblige à trouver des solutions pour leur valorisation. L'une d'elles est l'élaboration d'un nouveau type de matériau à partir de ces plastiques : les composites bois/plastique ou bois/polymères. Aussi, l'utilisation des matériaux issus des sources renouvelables s'est accrue ces vingt dernières années, et notamment dans la filière des composites (Rabetafika et al., 2006 ; Elbariji et al., 2006; Souhila, 2017)

Les composites bois/polymères ou Wood Plastic Composites (WPC) sont définis comme des matériaux composites à matrice polymère (thermoplastique ou thermodurcissable) contenant des particules de bois de forme variable. Cependant, le terme WPC est principalement utilisé pour dénommer les composites à matrice thermoplastique. Les WPCs offrent de nombreux avantages, tels qu'une faible densité, une amélioration des propriétés acoustiques, de bonnes propriétés mécaniques et de conductivité thermique, ainsi qu'un faible coût. Le marché des composites bois/polymères s'est largement développé depuis ces dernières années. En 2010, la production des WPC (secteur automobile exclu) était de l'ordre de 160000 tonnes/ an avec une croissance de 20% entre 2005 et 2010 (Sliwa, 2011). En 2018, la production représente 359 millions de tonnes. Cette production a augmenté de 3,2% par rapport à 2017 (Ghazali., 2019).

## II. Mise en œuvre

De manière générale, les composites sont mis en œuvre en suivant deux étapes. La matrice thermoplastique et le renfort sont tout d'abord mélangés et transformés en granules (c'est le compoundage), puis ces granules sont utilisés pour fabriquer le composite final mis en forme.

Les propriétés des composites dépendent à la fois des propriétés du renfort, de la matrice et de celles de l'interface/interphase entre la matrice et le renfort. Schématiquement, les renforts assurent une part importante de la tenue mécanique (rigidité et résistance) du matériau composite, tandis que la matrice maintient les renforts en position, transfère les efforts entre eux, et assure toutes les autres fonctions techniques. Il peut par exemple s'agir d'une protection contre diverses agressions (thermique, chimique, choc...), de fonctions esthétiques (couleur, aspect...), de donner sa forme extérieure au produit fini. Les renforts peuvent avoir plusieurs géométries, et les deux constituants peuvent être réalisés dans de nombreux matériaux.

### **II.A. Rôle du bois**

Le bois peut être utilisé pour deux types de fonctions :

- Comme charge afin de réduire le coût et le poids du composite : il joue un rôle analogue à celui des charges telles que le talc et d'autres charges minérales.
- Comme renfort afin d'améliorer les propriétés d'usage de la matrice.

### **II.B. Rôle et choix du plastique**

Pour obtenir un composite présentant de bonnes propriétés, il est essentiel que la matrice ait une bonne affinité avec le renfort. Les matrices utilisées sont classées en deux grandes familles : les polymères thermodurcissables et les polymères thermoplastiques.

Les thermodurcissables sont non fusibles une fois leur polymérisation réalisée. Ils sont obtenus par réticulation d'une résine en présence d'un catalyseur. Ils ont une structure réticulée qui forme un réseau tridimensionnel dense et stable. C'est le cas par exemple des résines époxy, polyester, polyuréthane et phénoliques. Ces polymères sont beaucoup utilisés en tant que colles pour la fabrication des panneaux de bois, dont les panneaux de particules. Dans ce cas, ils jouent le rôle de liant aux fibres de bois et donnent de la rigidité aux panneaux ainsi fabriqués (Michaud, 2003 ; Sliwa, 2011).

Les polymères thermoplastiques sont, quant à eux, élaborés à partir de monomères spécifiques et peuvent présenter une structure ramifiée ou linéaire. Au moment de la polymérisation, il y a formation de chaînes macromoléculaires pour

former un polymère. Aussi, les polymères thermoplastiques sont caractérisés principalement par le fait qu'ils se ramollissent sous l'effet de la chaleur (fusion ou transition vitreuse) et se solidifient par refroidissement. C'est un processus réversible et répétable, contrairement aux polymères thermodurcissables qui sont infusibles après la polymérisation. Ce caractère réversible de leur transition de phase sous l'action de la chaleur fait d'eux, de bons matériaux pour le recyclage, contrairement aux thermodurcissables. Les propriétés physiques de ces polymères vont alors dépendre de la nature du monomère utilisé et du procédé de polymérisation. Le tableau 2 donne les propriétés de quelques thermoplastiques usuels.

**Tableau 3 : Caractéristiques physiques des principaux polymères thermoplastiques (Sliwa., 2011)**

Polymère	T <sub>g</sub> (°C)	T <sub>f</sub> (°C)	Thermoformage (°C)	Densité	σ <sub>t</sub> (MPa)	Module Elastique (GPa)
<b>PP</b>	5	165	150-195	0,92	30	1,2
<b>HDPE</b>	-100	134	130-205	0,95	28	1,1
<b>PVC</b>	75-105	160-220	100-180	1,39	58	2,9
<b>PET</b>	70	255-265	120-170	1,30	47	2,6
<b>ABS</b>	90-120		130-200	1,05	50	2,5
<b>PS</b>	90-100		130-155	1,05	55	3,2
<b>PMMA</b>	100		150-190	1,18	72-80	3,3

PP : polypropylène à l'état sémicristallin, HDPE : polyéthylène à haute densité, PVC : polychlorure de vinyle amorphe, PET : polyéthylène téréphtalique sémi-cristallin, ABS : acrylonitrile butadiene styrène (amorphe), PS : polystyrène (amorphe), PMMA : poly méthacrylate de méthyle (amorphe).

Pour les WPC, les polymères thermoplastiques les plus utilisés sont les polyoléfines (PP, PE ...) et les PVC. Du fait de leur température de fusion qui est inférieure à 200°C, ces polymères peuvent être thermo pressés en évitant la dégradation des fibres de bois (Marcovich et al., 2000; Shebabi et al., 2009). Par contre, leur hydrophobicité peut présenter un inconvénient pour la mise au point des WPCs car les fibres naturelles sont le plus souvent hydrophiles.



## II.C. Rôle des compatibilisants

Pour améliorer l'interface entre les fibres de bois et les polymères, des agents de liaison ou compatibilisants peuvent être utilisés. Le polypropylène greffé à l'anhydride maléique (MAPP) est largement utilisé dans ce cadre. La figure 23 résume le rôle de l'agent de liaison dans la formation du composite.

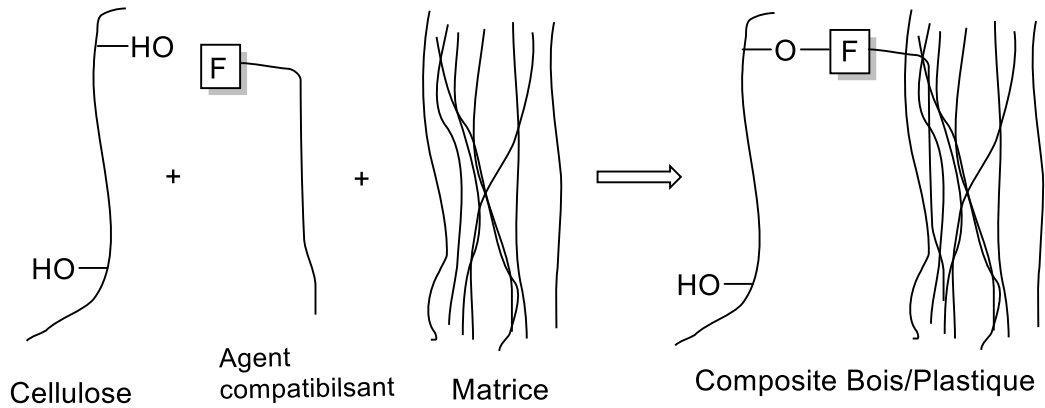


Figure 17 : Schéma montrant le rôle de l'agent compatibilisant

# Objectifs de la thèse

Comme souligné dans l'introduction, le bois, matériau composite naturel et renouvelable, est très abondant dans les forêts du bassin du Congo. Il suscite désormais un intérêt majeur pour le développement de certains pays d'Afrique, en particulier au Gabon. Des thématiques liées à son étude sont de plus en plus développées dans le domaine de la recherche scientifique et technologique. En effet, alors que les propriétés des bois tempérés (structure macroscopique, microscopique et composition chimique) sont déjà bien connues dans les pays d'Europe, d'Asie et d'Amérique, celles des bois tropicaux restent assez peu étudiées. Il est donc important de mieux connaître ces bois afin de mieux les valoriser pour le développement social et économique de l'Afrique en général, et du Gabon en particulier.

Dans notre analyse bibliographique, nous avons montré que l'extraction et l'analyse chimique d'extraits des différentes parties de l'acajou pourraient permettre de produire des molécules d'intérêt à partir des co-produits de la transformation de l'acajou. Leur valorisation nécessite d'optimiser les techniques d'extraction (type de solvant, conditions, etc.) et de compléter les analyses au travers d'une campagne d'études chimiques (chromatographie, spectroscopie, etc.) et physico-chimiques (thermiques, etc.). Enfin, les propriétés collantes de certains extraits (indice de Stiasny) pourraient être évaluées.

Bien que la voie chimique semble présenter un large choix de valorisation de ces déchets, le secteur des composites constitue aussi un atout majeur qui pourrait apporter une solution directe à la problématique de la gestion de deux catégories de déchets au Gabon :

- Les déchets de bois, brûlés quotidiennement, dont la valorisation actuelle a un impact carbone négatif sur le climat
- Les déchets de bouteilles plastique, qui représentent un facteur important de l'insalubrité dans les principales villes du Gabon

Ainsi, il a été imaginé mettre au point un composite bois-plastique adapté aux climats tropicaux chauds et humides. Ce composite aurait un procédé de fabrication simple, et serait utilisable aussi bien en intérieur qu'en extérieur sous différentes

formes et peut remplacer certains matériaux de constructions locaux ou importés, et souvent onéreux. En effet, les principaux matériaux de construction utilisés sont essentiellement liés à la production du ciment et de l'extraction de sable. De plus, la production locale de ciment a baissé de 4,2% à 341 352 tonnes en 2017, et celle de l'extraction de sable de 28% à 550 000 m<sup>3</sup> (França et al., 2016). Ces diminutions sont directement liées à la concurrence exercée par les importations des ciments chinois et la faiblesse des commandes domestiques (BTP et ménages). Ce nouveau matériau pourrait ainsi constituer une alternative abordable.

Cette élaboration d'un composite bois/plastique peut ainsi s'orienter sur l'utilisation de matrices thermoplastiques comme modèle, puis sur du plastique provenant de bouteilles recyclées. L'étude des propriétés en fonction de la granulométrie semble primordiale, ainsi que celle de l'interface fibre/polymère (amélioration via l'utilisation de comptabilisant). Les performances mécaniques (flexion 3 points, dureté, etc.), morphologiques (microscopie, etc.) et thermique (conductivité, résistance au feu, etc.) devront être évaluées.

Nous avons choisi d'orienter les travaux de thèse sur deux axes principaux :

- Axe 1 : Analyse et identification des flavonoïdes de type tanins condensés présents dans les différents extraits d'écorce, d'aubier et du bois de cœur d'acajou.
- Axe 2 : Valorisation par la mise au point de formulations collantes à base de tanins et mise en œuvre d'un composite à partir de bouteilles plastiques et de co-produits de bois.

# Références bibliographiques

Abdelgaleil, S.A., Hashinaga, F., Nakatani, M., 2005a. Antifungal activity of limonoids from *Khaya ivorensis*. *Pest Manag. Sci.* 61, 186–190. <https://doi.org/10.1002/ps.978>

Abdelgaleil, S.A., Hashinaga, F., Nakatani, M., 2005b. Antifungal activity of limonoids from *Khaya ivorensis*. *Pest Manag. Sci.* 61, 186–190.

Abdelgaleil, S.A., Iwagawa, T., Doe, M., Nakatani, M., 2004. Antifungal limonoids from the fruits of *Khaya senegalensis*. *Fitoterapia* 75, 566–572.

Adekunle, 2003. Antifungal activity and phytochemical screening of the crude extracts of *Khaya ivorensis* Juss (Meliaceae) and *Tetracera potatoria* L. (Dilleniaceae). *South Afr. J. Bot.* 4, 568–571.

Arapitsas, P., 2012. Hydrolyzable tannin analysis in food. *Food Chem.* 135, 1708–1717.

Arbenz, A., Avérous, L., 2016. Tannins: A resource to elaborate aromatic and biobased polymers. *Biodegrad. Biobased Polym. Environ. Biomed. Appl.* Scrivener Publ. Salem MA 97–148.

Azwa, Z.N., Yousif, B.F., Manalo, A.C., Karunasena, W., 2013. A review on the degradability of polymeric composites based on natural fibres. *Mater. Des.* 47, 424–442. <https://doi.org/10.1016/j.matdes.2012.11.025>

Baaka, N., Haddar, W., Ben Ticha, M., Amorim, M.T.P., M'Henni, M.F., 2017. Sustainability issues of ultrasonic wool dyeing with grape pomace colourant. *Nat. Prod. Res.* 31, 1655–1662.

Balogun, R.O., Jones, R.J., Holmes, J.G., 1998. Digestibility of some tropical browse species varying in tannin content. *Anim. Feed Sci. Technol.* 76, 77–88.

Barbehenn, R.V., Peter Constabel, C., 2011. Tannins in plant-herbivore interactions. *Phytochemistry* 72, 1551–1565. <https://doi.org/10.1016/j.phytochem.2011.01.040>

Basso, M.C., Pizzi, A., Maris, J.P., Delmotte, L., Colin, B., Rogaume, Y., 2017. MALDI-TOF, <sup>13</sup>C NMR and FTIR analysis of the cross-linking reaction of condensed tannins by triethyl phosphate. *Ind. Crops Prod.* 95, 621–631.

Belewu, M.A., Olatunde, O.A., Giwa, T.A., 2009. Underutilized medicinal plants and spices: Chemical composition and phytochemical properties. *J. Med. Plants Res.* 3, 1099–1103.

Bianchi, S., Krosiakova, I., Janzon, R., Mayer, I., Saake, B., Pichelin, F., 2015. Characterization of condensed tannins and carbohydrates in hot water bark extracts of European softwood species. *Phytochemistry* 120, 53–61.

Boeriu, C.G., Bravo, D., Gosselink, R.J., van Dam, J.E., 2004. Characterisation of structure-dependent functional properties of lignin with infrared spectroscopy. *Ind. Crops Prod.* 20, 205–218.

Broadhurst, R.B., Jones, W.T., 1978. Analysis of condensed tannins using acidified vanillin. *J. Sci. Food Agric.* 29, 788–794.

Broda, M., Popescu, C.-M., 2019. Natural decay of archaeological oak wood versus artificial degradation processes — An FT-IR spectroscopy and X-ray diffraction study. *Spectrochim. Acta. A. Mol. Biomol. Spectrosc.* 209, 280–287. <https://doi.org/10.1016/j.saa.2018.10.057>

Catinot, R., 1979. Comment utiliser les forêts tropicales comme source d'énergie. *Prospectives sur leurs potentialités actuelles et futures. BOIS FORETS Trop.* 184, 3–30.

Charrier, B., Janin, G., Haluk, J.-P., Mosedale, J.R., 1995. Colour and Chemical Characteristics of Moon Rings in Oakwood. *Holzforschung* 49, 287–292.

Chevalier, J.F., Nguema Magnagna, V., Assoumou, S., 2009. *Etat-des-forets\_2008-03.pdf*. WWF 61–73.

Chupin, L., Maunu, S.L., Reynaud, S., Pizzi, A., Charrier, B., Charrier-EL Bouhtoury, F., 2015. Microwave assisted extraction of maritime pine (*Pinus pinaster*) bark: Impact of particle size and characterization. *Ind. Crops Prod.* 65, 142–149.

Chupin, L., Motillon, C., Charrier-El Bouhtoury, F., Pizzi, A., Charrier, B., 2013. Characterisation of maritime pine (*Pinus pinaster*) bark tannins extracted under

different conditions by spectroscopic methods, FTIR and HPLC. *Ind. Crops Prod.* 49, 897–903.

Crocker, D.R., Perry, S.M., 1990. Plant chemistry and bird repellents. *Ibis* 132, 300–308.

Cui, Y.H., Tao, J., Noruziaan, B., Cheung, M., Lee, S., 2010. DSC Analysis and Mechanical Properties of Wood—Plastic Composites. *J. Reinf. Plast. Compos.* 29, 278–289. <https://doi.org/10.1177/0731684408097766>

Dai, D., Fan, M., 2015. Preparation of bio-composite from wood sawdust and gypsum. *Ind. Crops Prod.* 74, 417–424. <https://doi.org/10.1016/j.indcrop.2015.05.036>

Détienne, P, 1979. Contrefil à rythme annuel dans les Faro, *Daniella* sp. pl. *Bois Trop* 67–71.

Doat, J., 1978. Les tanins dans les bois tropicaux. *Bois For. Trop.* 37–54.

Dos Santos Grasel, F., Ferrão, M.F., Wolf, C.R., 2016. Development of methodology for identification the nature of the polyphenolic extracts by FTIR associated with multivariate analysis. *Spectrochim. Acta. A. Mol. Biomol. Spectrosc.* 153, 94–101.

Drovou, S., Pizzi, A., Lacoste, C., Zhang, J., Abdulla, S., El-Marzouki, F.M., 2015. Flavonoid tannins linked to long carbohydrate chains—MALDI-TOF analysis of the tannin extract of the African locust bean shells. *Ind. Crops Prod.* 67, 25–32.

Dupuy, B., 1993. Les plantations d’Acajou d’Afrique. Leur sylviculture en forêt dense humide ivoirienne. *BOIS FORETS Trop.* 236, 25–42.

Ekomy Ango, S., Moutou Pitti, R., 2017. Caractéristiques mécaniques et thermiques d’une brique d’argile à base de sciure de bois du Gabon. *GDR 3544 « Sci. Bois »* 38–39.

Elbariji, S., Elamine, M., Eljazouli, H., Kabli, H., Lacherai, A., Albourine, A., 2006. Traitement et valorisation des sous-produits du bois. Application à l’élimination des colorants industriels. *Comptes Rendus Chim.* 9, 1314–1321. <https://doi.org/10.1016/j.crci.2006.05.006>

Etat Gabonais, 2003. Arrete n°000117 diamètre minimum d'exploitation des bois du Gabon.

Etat Gabonais, 2001. Gabon - Code forestier. Loi n°16-01 du 31 décembre 2001.

Eva Heřmánková-Vavříková, Alena Křenková, Lucie Petrásková, Christopher Chambers, Jakub Zápál, Marek Kuzma, Kateřina Valentová, Vladimír Křen, 2017. Synthesis and Antiradical Activity of Isoquercitrin Esters with Aromatic Acids and Their Homologues. *Int. J. Mol. Sci.* 18, 1074. <https://doi.org/10.3390/ijms18051074>

Falcão, L., Araújo, M.E., 2013. Tannins characterization in historic leathers by complementary analytical techniques ATR-FTIR, UV-Vis and chemical tests. *J. Cult. Herit.* 499–508. <https://doi.org/10.1016/j.culher.2012.11.003>

França, T.S.F.A., França, F.J.N., Arango, R.A., Woodward, B.M., Arantes, M.D.C., 2016. Natural resistance of plantation grown African mahogany (*Khaya ivorensis* and *Khaya senegalensis*) from Brazil to wood-rot fungi and subterranean termites. *Int. Biodeterior. Biodegrad.* 107, 88–91.

Friedrich, D., Luible, A., 2016. Standard-compliant development of a design value for wood–plastic composite cladding: An application-oriented perspective. *Case Stud. Struct. Eng.* 5, 13–17. <https://doi.org/10.1016/j.csse.2016.01.001>

Frutos, P., Hervás, G., Giráldez, F.J., Mantecón, A.R., 2004. Tannins and ruminant nutrition, Review. *Span. J. Agric. Res.* 2, 191–202.

Galichet, A., Sockalingum, G.D., Belarbi, A., Manfait, M., 2001. FTIR spectroscopic analysis of *Saccharomyces cerevisiae* cell walls: study of an anomalous strain exhibiting a pink-colored cell phenotype. *FEMS Microbiol. Lett.* 1, 179–186.

García-Villalba, R., Espín, J.C., Tomás-Barberán, F.A., Rocha-Guzmán, N.E., 2017. Comprehensive characterization by LC-DAD-MS/MS of the phenolic composition of seven *Quercus* leaf teas. *J. Food Compos. Anal.* 63, 38–46. <https://doi.org/10.1016/j.jfca.2017.07.034>

Geethu, M.G., Suchithra, P.S., Kavitha, C.H., Aswathy, J.M., Dinesh, B., Murugan, K., 2014. Fourier-transform infrared spectroscopy analysis of different

solvent extracts of water Hyacinth (*Eichhornia Crassipes* Mart Solms.) an allelopathic approach. *World J. Pharm. Pharm. Sci.* 3, 1256–1266.

Glombitza, K.W., Fucols, P.K., 2003. phlorethols from the brown alga *Scytothamnus australis*. *Hook. et Harv.(Chnoosporaceae) Bot.*

Hagerman, A.E., 2002. *Tannin Chemistry*. Miami University. Oxf. OH 45056, 2–17.

Haluk, J.-P., Roussel, C., 2000. Caractérisation et origine des tropolones responsables de la durabilité naturelle des Cupressacées. Application potentielle en préservation du bois. *Ann. For. Sci.* 57, 819–829.

Haslam, E., 2007. Vegetable tannins—Lessons of a phytochemical lifetime. *Phytochemistry* 68, 2713–2721.

Hatano, T., SHIDA, S., HAN, L., OKUDA, T., 1991. Tannins of theaceous plants. III. Camelliatannins A and B, two new complex tannins from *Camellia japonica* L. *Chem. Pharm. Bull. (Tokyo)* 39, 876–880.

Heryati, Y., Belawan, D., Abdu, A., Mahat, M.N., Abdul Hamid, H., Majid, N., Muhamad, N., Hassan, A., 2011. Growth performance and biomass accumulation of a *Khaya ivorensis* plantation in three soil series of ultisols. *Am. J. Agric. Biol. Sci.* 6, 33–44.

Hung, C.D., Trueman, S.J., 2011. In vitro propagation of the African mahogany *Khaya senegalensis*. *New For.* 42, 117–130.

Ibrahim, J.A., Ayodele, E.A., Jegede, A.I., Kunle, Y.F., 2006. Comparative studies on *Khaya*. A. Juss (*Meliaceae*) in Nigeria. *Afr. J. Biotechnol.* 5, 1154–1160.

Immongault, Mboumba, Ngolo Allini, Kassat, 2017. *Tableau de bord de l'économie*. 137 pages.

Infogabon, 2014. La transformation du bois au Gabon : des chiffres encourageants. *INFOS GABON*. URL <https://fr.infosgabon.com/la-transformation-du-bois-au-gabon-des-chiffres-encourageants/> (accessed 11.28.17).

Iwu, M.M., Kiayman, D.L., 1992. Evaluation of the in vitro antimalarial activity of *Picralima nitida* extracts. *J. Ethnopharmacol.* 36, 133–135.



Jackson, F.S., McNabb, W.C., Barry, T.N., Foo, Y.L., Peters, J.S., 1996. The condensed tannin content of a range of subtropical and temperate forages and the reactivity of condensed tannin with ribulose-1, 5-bis-phosphate carboxylase (Rubisco) protein. *J. Sci. Food Agric.* 72, 483–492.

Jeske, H., Schirp, A., Cornelius, F., 2012. Development of a thermogravimetric analysis (TGA) method for quantitative analysis of wood flour and polypropylene in wood plastic composites (WPC). *Thermochim. Acta* 543, 165–171. <https://doi.org/10.1016/j.tca.2012.05.016>

Kalendi, M.N., Safou-Tchiama, R., Souloungounga, P., Mabicka, I.S.B., Nzue, O.J.L., Tasi, M.J.P., Ndoutoume, C., 2016. Evaluation of anatomical and physical properties of *Khaya nthotheca* (Welw.) C. DC. from forests of different altitudes in the democratic Republic of Congo. *J. Res. For. Wildl. Environ.* 8, 116–125.

Karou, D., Dicko, M.H., Simporé, J., Traore, A.S., 2005. Antioxidant and antibacterial activities of polyphenols from ethnomedicinal plants of Burkina Faso. *Afr. J. Biotechnol.* 4, 823–828.

Kassambara, A., 2015. Factoextra: Extract and visualize the results of multivariate data analyses. R package version 1.0. 3, 2015.

Kim, S., Kim, H.-J., 2003. Curing behavior and viscoelastic properties of pine and wattle tannin-based adhesives studied by dynamic mechanical thermal analysis and FT-IR-ATR spectroscopy. *J. Adhes. Sci. Technol.* 17, 1369–1383.

Koumba Zaou, P, Nze Nguema, S, Mapaga, D, Delporte, P, 1998. Croissance de 13 essences de bois d'oeuvre planté en forêt Gabonaise. *Bois For. Trop.* 2, 21–33.

Lê, S., Josse, J., Husson, F., 2008. FactoMineR: An R Package for Multivariate Analysis. *J. Stat. Softw.* 25, 1–18. <https://doi.org/10.18637/jss.v025.i01>

Lee, J., Kim, J.H., 2016. Kaempferol Inhibits Pancreatic Cancer Cell Growth and Migration through the Blockade of EGFR-Related Pathway In Vitro. *PLOS ONE* 11, e0155264. <https://doi.org/10.1371/journal.pone.0155264>

Li, C., Zhang, J., Yi, Z., Yang, H., Zhao, B., Zhang, W., Li, J., 2016. Preparation and characterization of a novel environmentally friendly phenol–formaldehyde adhesive modified with tannin and urea. *Int. J. Adhes. Adhes.* 66, 26–32.

Lompo, M., Guissou, I.P., Dubois, J., Dehaye, J.P., Ouedraogo, S., Traore, A., Some, N., 2007. Mechanism of the Anti-inflammatory Activity of *Khaya senegalensis* A. Juss. (Meliaceae). *Int. J. Pharmacol.* 3, 137–142.

Lompo, M., Nikiéma, J.B., Guissou, I.P., Moës, A.J., Fontaine, J., 1998. The topical antiinflammatory effect of chloroform extract from *Khaya senegalensis* stem barks. *Phytother. Res.* 12, 448–450.

Lopes, G., Sousa, C., Silva, L.R., Pinto, E., Andrade, P.B., Bernardo, J., Mouga, T., Valentão, P., 2012. Can phlorotannins purified extracts constitute a novel pharmacological alternative for microbial infections with associated inflammatory conditions? *PloS One* 7, e31145.

Marques, A.I. da F., 2014. Isolation of xylans from bleached *Eucalyptus* kraft pulp by precipitation with antisolvents. *Tec. Lisb.* 1–11.

Meyers, V., 1983. Chemicals which cause birth defects — teratogens: A special concern of research chemists. *Sci. Total Environ.* 32, 1–12. [https://doi.org/10.1016/0048-9697\(83\)90128-6](https://doi.org/10.1016/0048-9697(83)90128-6)

Monsaingeon, B., 2016. Plastiques: ce continent qui cache nos déchets. *Mouvements* 48–58.

Montero, C., 2010. Caractérisation du comportement viscoélastique asymptotique du bois. Thèse de Doctorat Université de Montpellier 2. 155 pages.

Morais, S.A.L., Nascimento, E.A., Queiroz, C.R.A.A., Piló-Veloso, D., Drumond, M.G., 1999. Studies on polyphenols and lignin of *Astronium urundeuva* wood. *J. Braz. Chem. Soc.* 10, 447–452. <https://doi.org/10.1590/S0103-50531999000600005>

Morin, A., Meunier, Q., Boldrini, S., Vermeulen, C., 2014. Entre permis forestier et permis minier, la difficile émergence des forêts communautaires au Gabon. *Parcs Réserves* 68, 16–22.

Moubarik, A., Pizzi, A., Allal, A., Charrier, F., Charrier, B., 2009. Cornstarch and tannin in phenol–formaldehyde resins for plywood production. *Ind. Crops Prod.* 30, 188–193. <https://doi.org/10.1016/j.indcrop.2009.03.005>

Navarrete, P., Pizzi, A., Pasch, H., Delmotte, L., 2012. Study on Lignin–Glyoxal Reaction by MALDI-TOF and CP-MAS <sup>13</sup>C-NMR. *J. Adhes. Sci. Technol.* 26, 1069–1082. <https://doi.org/10.1163/016942410X550030>

Ndiade Bourobou, D., DemikoyoKanghou, D., Inguenza, D., 2010. la République Gabonaise: Etat des Ressources Génétiques Forestières dans le Monde. Ministère des Eaux et Forêts (Gabon), FAO.

Nze Nguema, S., 2009. Présentation du secteur Forestier au Gabon. 36 pages

OIBT, 2017. Revue biennale et évaluation de la situation mondiale des bois 2015-2016.

Pasch, H., Pizzi, A., 2002. Considerations on the Macromolecular Structure of Chestnut Ellagitannins by Matrix-Assisted Laser Desorption/ Ionization–Time-of-Flight Mass Spectrometry. *JApplPolymer Sci* 85, 429–437.

Petithuguenin, J.-L., 2014. Le développement du recyclage: potentialités et freins, in: *Annales Des Mines-Responsabilite et Environnement*. ESKA, pp. 55–57.

Pilla, S., Gong, S., O'Neill, E., Yang, L., Rowell, R.M., 2009. Polylactide-recycled wood fiber composites. *J. Appl. Polym. Sci.* 111, 37–47.

Ping, L., Pizzi, A., Guo, Z.D., Brosse, N., 2011. Condensed tannins extraction from grape pomace: characterization and utilization as wood adhesives for wood particleboard. *Ind. Crops Prod.* 34, 907–914.

Pizzi, A., 2003. Tailoring Adhesion of Adhesive Formulations by Molecular Mechanics/Dynamics. *Handb. Adhes. Technol. Revis. Expand.* 159.

Pizzi, A., 2000. Tannery row–The story of some natural and synthetic wood adhesives. *Wood Sci. Technol.* 34, 277–316.

Pizzi, A., Cameron, F.-A., Eaton, N.J., 1985. The tridimensional structure of polyflavonoid tannins by conformational analysis. *J. Macromol. Sci.* 22, 515–540.

Rabetafika, H.N., Paquot, M., Dubois, P., 2006. Les polymères issus du végétal : matériaux à propriétés spécifiques pour des applications ciblées en industrie plastique. *Biotechnol. Agron. Société Environ.* 10, 185–196.

Saad, H., Charrier-El Bouhtoury, F., Pizzi, A., Rode, K., Charrier, B., Ayed, N., 2012. Characterization of pomegranate peels tannin extractives. *Ind. Crops Prod.* 40, 239–246.

Savard, J., Caumartin, L., Ducasse, Y., 1971. Action sur les bois d'une solution de nitrate d'aluminium ou de sulfate de cuivre. *BOIS FORETS Trop.* 135, 39–64.

Scalbert, A., Monties, B., Janin, G., 1989. Tannins in Wood: Comparison of Different Estimation Methods. *J Agric Food Chem* 1324–1329.

Sliwa, F., 2011. Etude de nouveaux composites de source renouvelable à base de copolyamide et de farine de bois. Doctorat de l'Université de Pau et des Pays de l'Adour. 204 pages.

Souhila, O.R.A., 2017. Valorisation de la sciure de bois par modification chimique: Application à l'élimination par adsorption d'un pesticide, le DDT. *Eur. j. water qual.* 40, 75-93. <https://doi.org/10.1051/water/2009006>.

Spina, S., Zhou, X., Segovia, C., Pizzi, A., Romagnoli, M., Giovando, S., Pasch, H., Rode, K., Delmotte, L., 2013. Phenolic resin adhesives based on chestnut ( *Castanea sativa* ) hydrolysable tannins. *J. Adhes. Sci. Technol.* 27, 2103–2111. <https://doi.org/10.1080/01694243.2012.697673>

Stevanovic, T., 2019. Chimie pour la transformation durable de la ressource lignocellulosique. *Esprit des bois*, tome 1. 245 pages.

Taiwo, E.A., Ogunbodede, R.A., 1995. Production of tannin adhesives from bark of Nigerian trees. *Wood Sci. Technol.* 29, 103–108.

Takin, M.C., Attindehoua, S., Sezan, A., Attakpa, S.E., Baba-Moussa, L., 2013. Bioactivity, therapeutic utility and toxicological risks of *Khaya senegalensis*. *Indian J. Pharm. Biol. Res Earch* 1, 22–129.

Taşdemir, M., Biltekin, H., Caneba, G.T., 2009. Preparation and characterization of LDPE and PP-Wood fiber composites. *J. Appl. Polym. Sci.* 112, 3095–3102. <https://doi.org/10.1002/app.29650>

Tchatchou, B., Sonwa, D.J., Ifo, S., Tiani, A.M., 2015. Déforestation et dégradation des forêts dans le Bassin du Congo: état des lieux, causes actuelles et perspectives. *CIFOR*. 60 pages.

Tchoundjeu, Z., Leakey, R.R.B., 2000. Vegetative propagation of *Khaya ivorensis* (African mahogany): effects of stockplant flushing cycle, auxin and leaf area on carbohydrate and nutrient dynamics of cuttings. *J. Trop. For. Sci.* 77–91.

Ucar, M.B., Ucar, G., Pizzi, A., Gonultas, O., 2013. Characterization of *Pinus brutia* bark tannin by MALDI-TOF MS and <sup>13</sup>C NMR. *Ind. Crops Prod.* 49, 697–704.

Valentová, K., Vrba, J., Bancířová, M., Ulrichová, J., Křen, V., 2014. Isoquercitrin: Pharmacology, toxicology, and metabolism. *Food Chem. Toxicol.* 68, 267–282. <https://doi.org/10.1016/j.fct.2014.03.018>

Voulgaridis, E., Grigoriou, A., Passialis, C., 1985. Investigations on bark extractives of *Pinus halepensis* Mill. *Holz Als Roh- Werkst.* 43, 269–272.

Wold, S., Esbensen, K., Geladi, P., 1987. Principal component analysis. *Chemom. Intell. Lab. Syst.* 2, 37–52. [https://doi.org/10.1016/0169-7439\(87\)80084-9](https://doi.org/10.1016/0169-7439(87)80084-9)

Wu, W.-B., Zhang, H., Liu, H.-C., Dong, S.-H., Wu, Y., Ding, J., Yue, J.-M., 2014. Ivorenoids A–F: limonoids from *Khaya ivorensis*. *Tetrahedron* 70, 3570–3575.

Yazaki, Y., Collins, P.J., 1994. Wood adhesives based on tannin extracts from barks of some pine and spruce species. *Holz Als Roh- Werkst.* 52, 307.

Zhao, Y., Wang, J., Balleve, O., Luo, H., Zhang, W., 2012. Antihypertensive effects and mechanisms of chlorogenic acids. *Hypertens. Res.* 35, 370–374. <https://doi.org/10.1038/hr.2011.195>

## **Partie 2 : Caractérisation physico-chimique d'extraits d'acajou**

## I. Introduction

Dans cette partie, le travail présenté concerne essentiellement l'extraction et la caractérisation des polyphénols extraits des différentes parties (écorce, aubier, et duramen) du bois d'acajou (tanins hydrolysables et condensés, et autres composés aromatiques). Il est présenté sous forme de trois articles (deux publiés et un soumis)

Le premier article présente un screening chimique de la présence des tanins condensés dans les trois parties de l'arbre analysées. Mais il traite surtout de l'analyse MALDI-TOF des tanins d'écorce d'acajou et de l'activité biocide des sciures de bois face à la croissance du *Coriolus versicolor*.

Le second article est la continuité du premier. Il concerne cette fois l'analyse MALDI-TOF de l'aubier et du bois de Cœur d'acajou. Mais il présente aussi une analyse globale du comportement thermique des tanins des trois parties de l'arbre analysées. Il nous renseigne sur les transitions de phase de ces tanins et leur température de dégradation maximale. Il complète les informations sur le comportement des tanins d'acajou en général et permet d'avoir une idée sur la voie de valorisation de ces molécules.

Le troisième article complète les deux premiers. En effet, le travail nous a permis de mettre au point une méthode de séparation de certains polyphénols du bois d'acajou. Avec cette méthode, nous avons pu séparer et récupérer quelques fractions et les purifier. La quantité maximale que nous avons obtenue était de 0.5 mg d'extrait.

Ces résultats sont présentés comme suit :

- Analyse de la composition de l'écorce et dosage des tanins

“Chemical composition of African mahogany (*K. ivorensis* A. Chev) extractive and tannin structures of the bark by MALDI-TOF”. 2018, Ind. Crops Prod. 113, 167–178.

- Analyse physico-chimique des tanins d'aubier et du cœur d'acajou

“Chemical analysis and thermal stability of African mahogany (*Khaya. ivorensis* A. Chev) condensed tannins.” 2019, Holzforschung, 1-19.

- Analyse des extraits méthanol/eau en LC/MS

“Identification of phenolic compounds from *K. ivorensis* by RP-HPLC/UV/ESI-FTMS.” En revision au Journal of wood chemistry and Technology. 2019



## II. Composition chimique des extraits d'écorce d'Acajou

<< **Chemical composition of African mahogany (*K. ivorensis* A. Chev) extractive and tannin structures of the bark by MALDI-TOF** >>.

Bikoro Bi Athomo<sup>1, 2\*</sup>, A., EngozoghoAnris<sup>1, 2</sup>, S.P., Safou-Tchiama<sup>2, 3</sup>, R., Santiago-Medina<sup>4</sup>, F.J., Cabaret, T., Pizzi<sup>4</sup>, A., Charrier<sup>1,\*</sup>, B.

<sup>1</sup> CNRS/ Université de Pau des Pays de l'Adour, Institut des sciences analytiques et de physico-chimie pour l'environnement et les matériaux - Xylomat, UMR5254, 40004, Mont de Marsan, France.

<sup>2</sup> Laboratoire de Recherche et de Valorisation du Matériau Bois (LaReVa Bois). Bâtiment du Master Recherche en Sciences du Bois. BP. 3960, Ecole Nationale des Eaux et Forêts (ENEF), Cap-Estérias (Gabon).

<sup>3</sup> Laboratoire de Chimie des Substances Naturelles et de Synthèse Organométalliques (LASNSOM). Unité de Recherche en Chimie. BP 941, Université des Sciences et Techniques de Masuku, Gabon.

<sup>4</sup> LERMAB, University of Lorraine, 27 rue Philippe Séguin, 88000 Epinal, France.

[\\*arsene.bikoro-bi-athomo@univ-pau.fr](mailto:*arsene.bikoro-bi-athomo@univ-pau.fr)

### II.A. Résumé

Ces premiers travaux ont permis de démarrer le travail de valorisation des coproduits de la transformation industrielle du bois d'acajou du Gabon. Ils regroupent différentes techniques de mise en évidence de certains composés phénoliques dans différentes parties de l'arbre (écorce, aubier et duramen), avant de se concentrer sur l'écorce. Ainsi, la teneur totale en phénols d'extraits à l'acétone/eau de l'écorce, de l'aubier et du bois de cœur de *Khaya ivorensis* (*K. ivorensis*) de la forêt naturelle du Gabon a été étudiée par les techniques de Folin-Ciocalteu, dosage à la vanilline et dosage à l'acide dans le butanol. Par la suite, la teneur massique en tanins condensés contenus dans l'écorce a été évaluée. Toutes ces méthodes ont montré que l'écorce, l'aubier et le bois de cœur de *K. ivorensis* ne présentaient pas de différence significative ( $p > 0,05$ ) en ce qui concerne leur teneur en composés phénoliques. Les

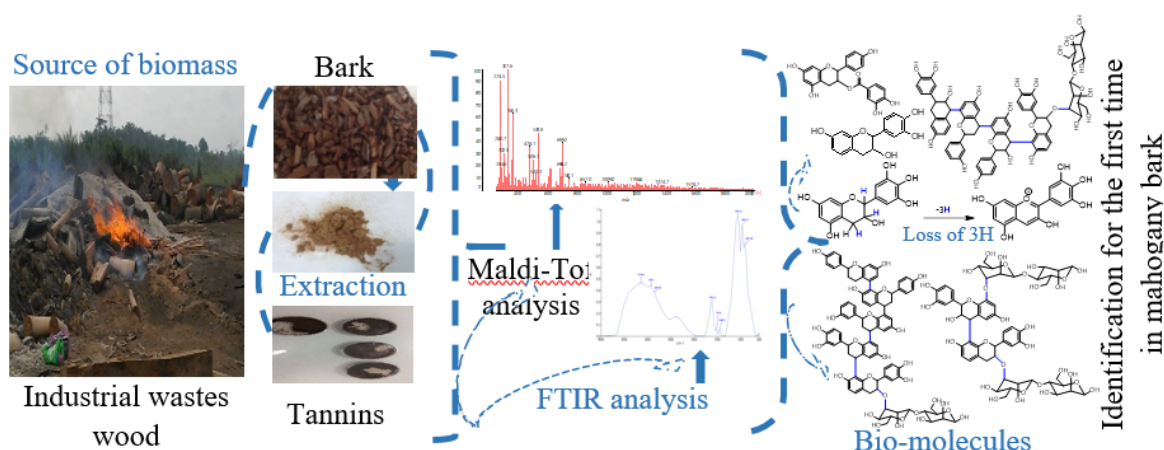
tanins de l'écorce extraits à l'acétone et à l'eau ont été caractérisés par spectrométrie de masse MALDI-TOF et FTIR. La présence de monomères fisitinidine, gallocatéchine et trihydroxyflavane a été observée pour la première fois. Des oligomères de flavonoïdes liés à des sucres ont été trouvés dans les tanins condensés de *K. ivorensis*. Un heptamère formé d'un mélange de fisitinidine, de trihydroxyflavan, de trois dihydroxyflavanes et d'un dimère glucidique comprenant du mannose a également été identifié pour la première fois dans l'écorce de *K. ivorensis*. Cette espèce de feuillus d'acajou ne présentait aucune activité antifongique contre le champignon *Coriolus versicolor*. Cependant, la poudre d'écorce diminuait la croissance radiale de ce champignon.

## **II.B. Abstract**

The total phenolic and the condensed tannins content of the bark, the sapwood and the heartwood of *Khaya ivorensis* (*K. ivorensis*) from the natural forest of Gabon was investigated by Folin-Ciocalteu, vanillic assay and acid/butanol methods. All these methods showed that the bark, the sapwood and the heartwood of *K. ivorensis* did not display a significant difference ( $p > 0.05$ ) regarding their phenolic content and their condensed tannins content as well. The acetone/water extracted tannins from the bark were characterized by Matrix Assisted Laser Desorption /ionization time of flight (MALDI-TOF) mass spectrometry and by Fourier Transform InfraRed spectroscopy (FTIR). The presence of fisetinidin, gallo catechin, and trihydroxyflavan monomers was observed for the first time. Flavonoid oligomers linked to sugars were found within *K. ivorensis* condensed tannins. A heptamer formed by mixed Fisetinidin, trihydroxyflavan, three dihydroxyflavans, and a carbohydrate dimer including mannose was also identified for the first time in the bark of *K. ivorensis*. That mahogany hardwood species did not exhibit any antifungal activity against the white rot fungus *Coriolus versicolor*. However, bark powder decreased the radial fungus growth.

Key words: *Khaya ivorensis*, bark, sapwood, heartwood, tannins, Maldi-Tof.

## II.C. Graphical abstract



## II.D. Introduction

In African traditional medicine, the bark, the leaves, the seeds, and the roots of *K. ivorensis* trees have been extensively used in pharmacology for decades as an anti-inflammatory remedy (Lompo et al., 2007). Such a mahogany wood species was used as an ingredient in cosmetics (Iwu and Kiayman, 1992); (Wu et al., 2014), and displayed antimalarial, antifungal, and cytotoxic activities. Furthermore, limonoids extracted from fruit, flowers, stem bark or leaf of *K. ivorensis* and *Khaya senegalensis* (*K. senegalensis*) displayed antifungal activities against *Botryosphaeria rhodona*, *Botrytis cinerea* Pers (brown rot) rots (Haluk and Roussel, 2000; Abdelgaleil et al., 2004., 2005; Takin et al., 2013). In addition, methyl angolensate located in the wood, bark, and fruits of these mahogany species were assumed to exhibit the highest biocide activity. However, all the studies regarding the chemical composition of mahogany wood species mainly concerned extractives from the stems, barks, branches, leaves, roots, and seeds (Lompo et al., 1998) whereas the chemical composition of mahogany xylem including the sapwood and the heartwood remained to be investigated.

The forest inventory of 2006 showed that the total volume of logs exported from Gabon averaged 1500000 m<sup>3</sup> per year ((Nze Nguema, 2009). Ten wood species, including *K. ivorensis*, represented 70% of that total annual volume of exported sawns and veneers (Bayol et al. 2011; Ndiade Bourobou, D et al., 2010; Koumba Zaou, P et al., 1998). Considering the national and international pressure demand on transformed wood based products, the governments of the Congo basin decided to increase their

local timber transformation. Consequently, Gabon adopted a new forestry code in 2001 (Code forestier, 2001). These new forest policies were reinforced in 2009 by the total ban on exporting logs. This has led to the logs being used for new market sectors based on second and third transformation products instead of the traditional plywood industry of *Aucoumea klaineana* Pierre (*A. klaineana*). This new industrial activity increased the production of a considerable amount of underutilized wood wastes (bark, first and last board of trunks, rotary cutting heartwoods, abandoned blocks from cut down woods, spurs, forks...). With the exception of *Aucoumea* for which its chemical structure and composition as well as its sapwood and heartwood potential for cellulose and ethanol production have been investigated (Safou-Tchiama et al., 2007, 2016, 2017). However the chemical composition of the most of woods from the Congo basin, including *K. ivorensis* remains little known.

A *K. ivorensis* tree can reach 50 m in height and a diameter up to 1.2 m. It has an average density of 0.6, which renders that mahogany buoyant in water. This tropical hardwood displays little interspecies variability ((P D tienne, 1979); (Fran a et al., 2016) as found for another mahogany, *Khaya anthotheca* (Kalendi et al., 2016). However, *K. ivorensis* displays a low natural resistance to fungal decay (Fran a et al., 2016). According to the Gabonese forest policies, the minimum diameter for exploitation of *K. ivorensis* is 80 cm (Etat Gabonais, 2003). In Gabon, this african mahogany is very adapt for afforestation such as *A. klaineana* (Koumba Zaou, P et al., 1998) and as easily everywhere else in the world (Hung and Trueman, 2011) Tchoundjeu and Leakey, 1996). The interest in african mahogany is growing on the world timber market due to its good quality (Heryati et al., 2011). However, wood processing in Central Africa produces a high content of waste as suitable wood waste recovering strategies are lacking, in particular about mahogany wood. This limits a proper enhancement of its potential by products, which could help to develop the timber industry in Central Africa in general and in Gabon in particular.

The aim of the present study was to determine the polyphenols content of the bark, sapwood, and heartwood of *K. ivorensis*. An attempt was made to determine the molecular structure of condensed tannins extracted from the bark by MALDI-TOF and FTIR

## **II.E. Materials and Methods**

### **II.E.1. Materials**

#### **II.E.1.a. Chemicals**

All the chemicals used in this study were purchased from Fisher and Sigma Aldrich.

#### **II.E.1.b. Wood sampling**

The bark, sapwood, and heartwood were collected from a *K. ivorensis* of 80 years hold sampled from a section disk of 10 cm of thickness and 85 cm of diameter. The wood was harvested at Mitzic in the North of Gabon by the SNBG (Société Nationale des Bois du Gabon) in February 2016. The fresh samples were put in sterilized bags, air-dried for one week in the laboratory and oven-dried (105°C) for 48h. The dried samples were grinded to pass through 60 mesh ( $\approx$ 1 mm diameter) with a rotative knife grinder (Retsch SK1).

### **II.E.2. Methods**

#### **II.E.2.a. Biocidal activity control of *K. ivorensis* wood powders**

The biocide activity of the bark, sapwood, and heartwood powders from *K. ivorensis* against the radial growth of the white rot-fungus *Coriolus versicolor* (*C. versicolor*) was controled by adaption of the international standard XP CENT/TS 15083-1. 2006 version.

*Preparation of the culture medium* - The culture medium used contained malt (4g)-agar (2g) in 100 ml of demineralized water. Each culture received different powder concentrations (0% to 6% m/v), and was then placed in a VOTSCH climate control chamber at 70% relative humidity and 25°C. The radial growth was controled every two days for 15 days.

#### **II.E.2.b. Extraction of polyphenols at room temperature**

350 mg of dried wood powder ( $M_{dried}$ ) from each sample was mixed separately at room temperature with 30 ml of acetone/water solution (7:3, v/v). The mixtures were stired for 3 hours. The supernatant was recovered, and then acetone was evaporated. Four repetitions of each extraction were performed.

#### **II.E.2.c. Total phenolic content measurement**

The total phenol content was determined by the Folin-Ciocalteu method (Singleton and Rossi, 1965)) as follows: 1 ml of extracts were diluted with 9 ml of demineralized water. Then 0.5 ml of the diluted extracts was poured into 2 ml of Folin-Ciocalteu reagent (1/10, v/v in demineralized water). Then, 2.5 ml of sodium carbonate solution (0.7 M) was added to the Folin-Ciocalteu reagent containing the extracts. The final solution obtained was placed into test tubes and left for 5 minutes in a water bath maintained at 50°C. The absorbance was registered at 760 nm. The results were expressed as gallic acid equivalent, based on the extracted dry powder amount. The total phenol content was determined according to the following equation below (1):

$$Total\ phenols(\%) = \frac{C \times D \times V}{1000 \times M_{dried}} \times 100 \quad (1)$$

C: total phenol concentration (ppm). D: degree of dilution (10). V: volume of starting solution (30 ml).  $M_{dried}$ : mass of dry powder.

#### II.E.2.d. Determination of proanthocyanidin content

##### *II.E.2.d.i. Anthocyanes measurement by the acid hydrolysis in butanol method*

0.5 ml of dried aqueous extracts were added to 5 ml of ferrous sulfate solution obtained by dissolving 77 mg of  $FeSO_4 \cdot 7H_2O$  previously poured into 500 ml of HCl (37 %) in nBuOH (2/3, v/v). The mixtures obtained were placed for 15 minutes in a water bath maintained at 95°C. After cooling, the absorbances were recorder at 530 nm and the results were expressed as cyanidin equivalent based on the dried wood extracts content. Proanthocyanidins (PA) was determined (Saad et al., 2012) according to the following equation (2):

$$[PA] = \frac{A \times V \times D \times V' \times M}{\epsilon \times v \times m} \quad (2)$$

PA: Proanthocyanidins content (mg cyaniding E/g dry weight expressed as mg cyaE/ g DM); V: volume of reaction (ml). D: dilution factors (10). V ' : volume of the aqueous extract recovered after extraction with diethyl ether (ml). M: cyaniding molar mass (287 g/mol). v: volume of the sample (ml). A: absorbance of the sample. m: mass of dry powder samples (g).  $\epsilon$ : molar extinction coefficient ( $34700\ M^{-1} \cdot cm^{-1}$ ) according to (Scalbert et al., 1989).

#### *II.E.2.d.ii. Condensed tannins measurement by the acid condensation of vanillin method*

Condensed tannins in an acid medium were measured according to the vanillin condensation method described by (Broadhurst and Jones, 1978) as following: 0.5 ml of aqueous extracts contained in a tube were mixed with 3 ml of vanillin reagent dissolved in methanol (4%, w/v). Then, 1.5 ml of concentrated HCl (37%) was added, and the mixture was kept in the dark at 20°C for 15 min. Absorbances were registered at 500 nm. The results obtained were expressed as catechin equivalent based on the amount of dry extracted samples. The calibration was carried out using an aqueous solution of catechin (30 mg/l).

#### II.E.2.e. MALDI-TOF analysis

Tannins extracted from *K. ivorensis* bark were obtained using an acetone/water solvent (7/3, v/v). The samples were oven-dried at 105°C for 24h and dissolved in a solution of water/ acetone (1:1, v/v) up to 7.5 mg/ml. To increase ion formation, NaCl solution (1.5 µl of a 0.1 M) in a methanol/water mixture (1:1) was added and placed on the Maldi target .The solutions of the sample and the matrix were then mixed in equal amounts, and 1.5 µl of the resulting solution was placed on the Maldi target. A matrix of 2,5-dihydroxy benzoic acid was used. Red phosphorous (500-3000 Da) was used as reference for spectrum calibration. Finally, after evaporation of the solvent, the Maldi target was introduced into the spectrometer. The spectra were recorded on a KRATOS AXIMA Performance mass spectrometer from Shimadzu Biotech (Kratos Analytical Shimadzu Europe Ltd., Manchester, UK). The irradiation source was a pulsed nitrogen laser with a wavelength of 337 nm. The length of one laser pulse was 3 ns. Measurements were carried out using the following conditions: polarity-positive, flight path-linear, 20 kV acceleration voltages, 100-150 pulses per spectrum. The delayed extraction technique was used applying delay times of 200-800 ns. The software Maldi-MS was used for the data treatment.

#### II.E.2.f. Fourier Transformed Infrared (FTIR) spectroscopy analysis

Tannins extracted from *K. ivorensis* bark by the acetone/water solvent method (7/3,v/v) were used for FTIR analysis. The samples were oven-dried at 105°C for 24h then, 5 mg of the dried powders were place in the crystal device and the contact was obtained by applying a strength of 150 Newton on the sample. 32 scans were used

with a resolution of 4 cm<sup>-1</sup> in the range 4000 to 600 cm<sup>-1</sup>. All the FTIR were carried out in ATR (attenuated total reflection) mode with a PerkinElmer Frontier spectrophotometer equipped with a diamond/ZnSe crystal for tannins analysis.

## **II.F. Results and discussion**

### **II.F.1. Polyphenol content**

The polyphenols content obtained from by *K. ivorensis* bark, sapwood, and heartwood was listed in Table 1. No matter what the procedure used for extracting the phenolic compounds was, the ANOVA test did not show significant differences ( $p=0.22$ ) between the phenolics content of the bark, sapwood and heartwood of *K. ivorensis* from Gabon. This result was in close agreement with that published by D tienne (1979) who did not find neither inter nor intra-species significant differences regarding the phenol content of *K. anthotheca*, *K. ivorensis*, and *K. senegalensis*. However, the presence of phenols and tannins in the bark of *K. ivorensis* from Gabon confirmed the results obtained by (Ibrahim et al., 2006) who found tannins in the bark of *K. ivorensis* from Ibadan in Oyo State of Nigeria. Phenols were also identified in *K. senegalensis* bark from the same country.

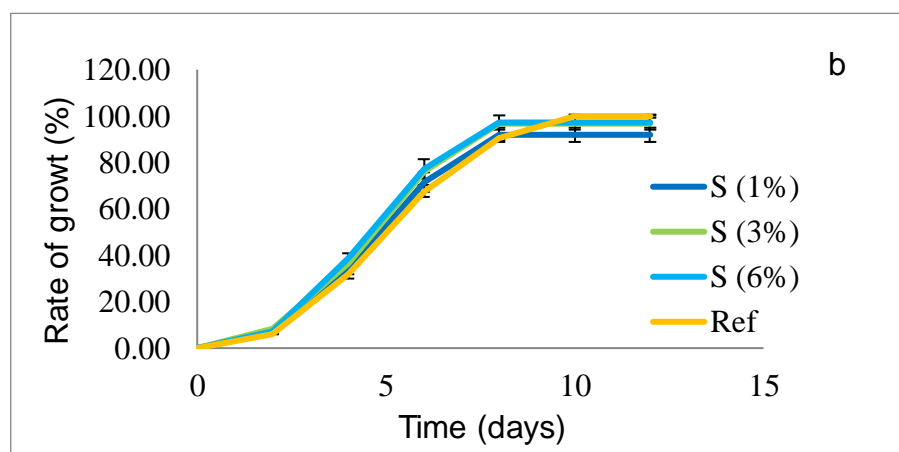
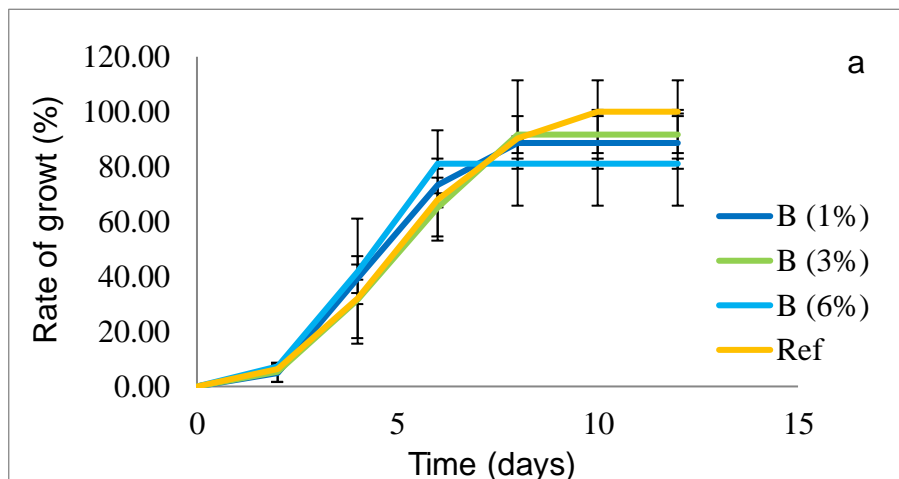
Condensed tannins content measured by the proanthocyanidin or anthocyanidin amount were detected in the bark of *K. ivorensis* confirming the published results by (Adekunle, 2003) who previously identified anthocyanins in the methanol extracts of *K. ivorensis* bark collected in southwestern of Nigeria. Nevertheless, the amount of condensed tannins we found for the bark of *K. ivorensis* (2.8 mgcya E/g DM  $\approx$ 0.28 % of dry mass) was higher than what published by (Chupin et al., 2015) for the same particles size (60 mesh) of *Pinus pinaster* (*P. pinaster*) bark (1.6 mgcyaE/g DM). In addition, the average condensed tannins content displayed by *K. ivorensis* sapwood and heartwood, 3.3 and 2.0 mgcyaE/g DM respectively remained higher than that of *P. pinaster* one. Such a result showed a strong capability of *K. ivorensis* wood wastes to provide usable condensed tannins.

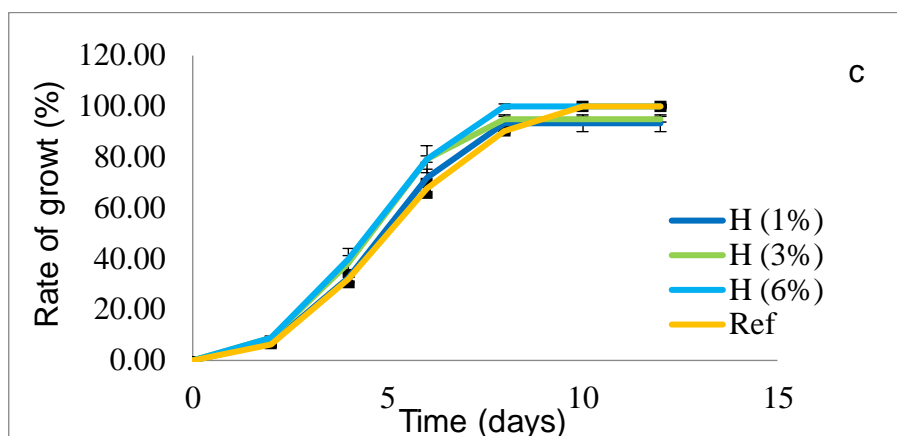
### **II.F.2. Biocide activity control**

In order to understand the compared biocide activity of *K. ivorensis* bark, sapwood, and heartwood against white rot-fungi, their powdered samples were submitted to attack by *C. versicolor* (Fig.1). It was noteworthy that whatever their concentrations, the sapwood and the heartwood powders of *K. ivorensis* did not



decrease the growth rate of *C. versicolor*. Therefore, *K. ivorensis* sapwood and heartwood is not likely to possess molecules with antifungal activity towards *C. versicolor*. This trend agreed with that published by (França et al., 2016) who didn't find any natural resistance for *K. ivorensis* and *K. senegalensis* wood blocks from Brazil when exposed to attack by *T. versicolor*. Among the mahogany powders examined, only *K. ivorensis* bark powder at 6% (w/w) decreased the radial fungus growth of *C. versicolor* by 20 % compared to the control (Fig. 1a). This biocide activity suggests the presence of molecules with antifungal activity against *C. versicolor* although such a result is still worse than that obtained with the bark of *K. senegalensis*. This latter one decreased the radial growth rate of *C. versicolor* by 45% (personal data). Even if the weak durability of *K. ivorensis* sapwood and heartwood as regards white rot-fungi highlighted the poor resistant of its lignin to oxidative degradations, further investigations based on molecules extracted and concentrated tests against wood rot-fungi are necessary to appreciate the potential of *K. ivorensis* bark waste.

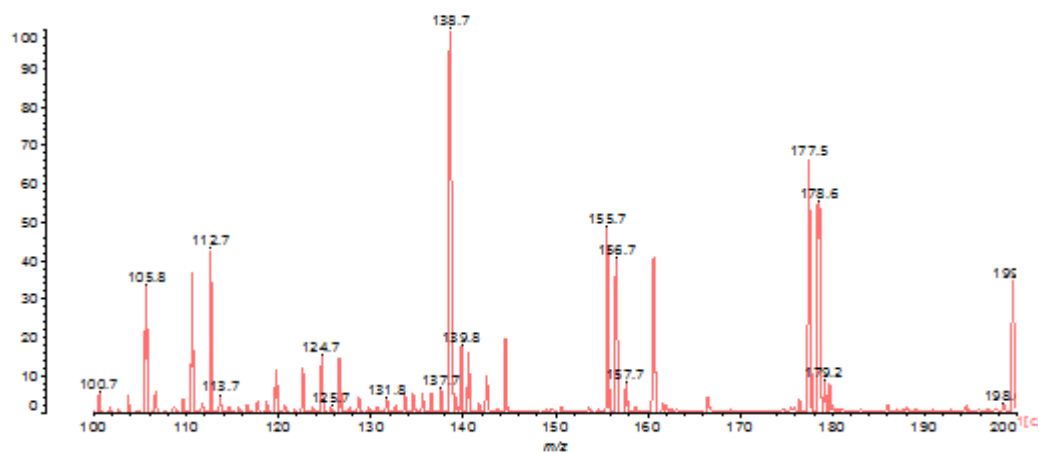




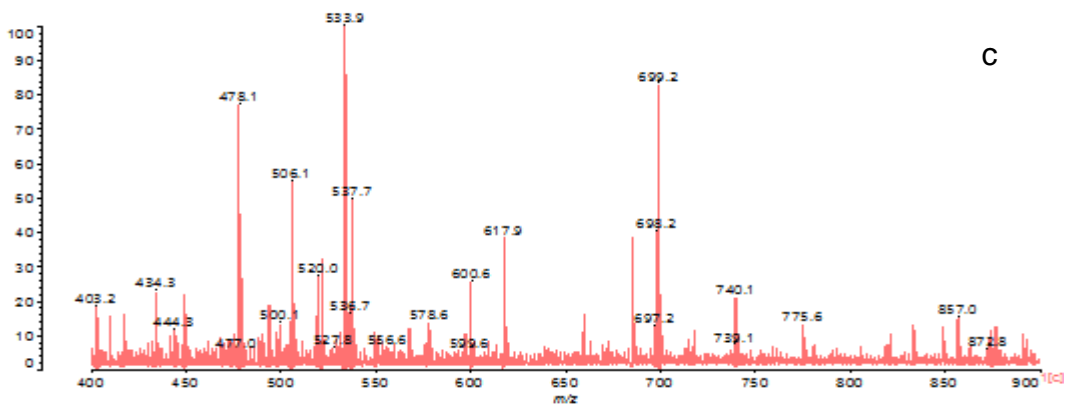
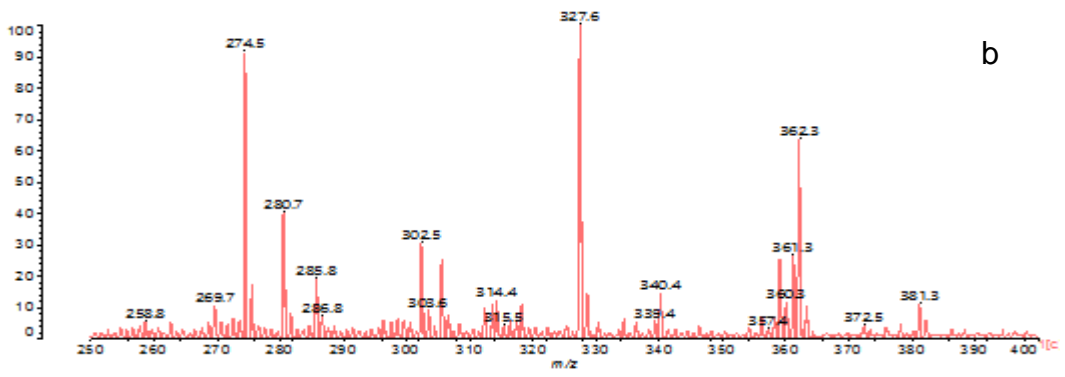
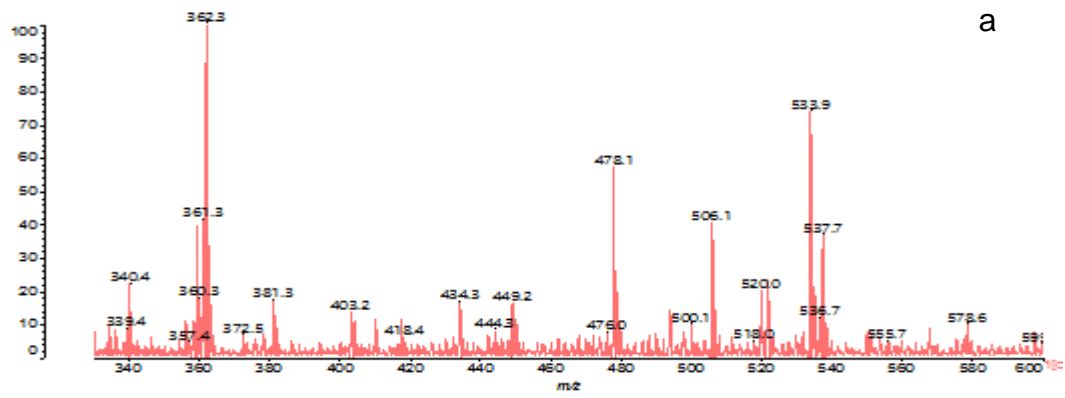
**Fig.1: Biocide activity control of *K. ivorensis* bark (a), sapwood (b) and heartwood (c) powder concentrated at 1%, 3% and 6% against the radial growth of *Coriolus versicolor*.**

### II.F.3. Condensed tannins structures as revealed by MALDI-TOF

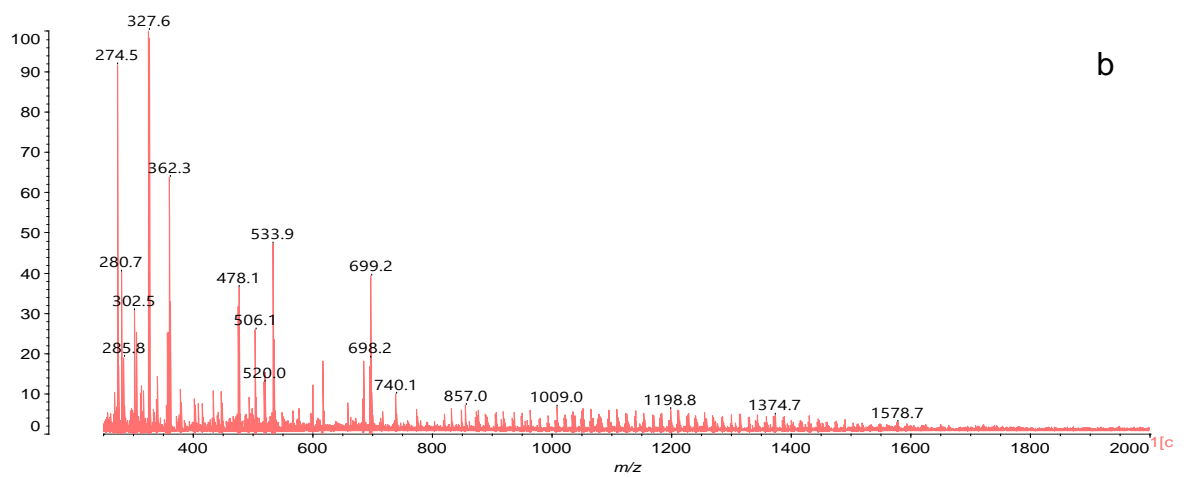
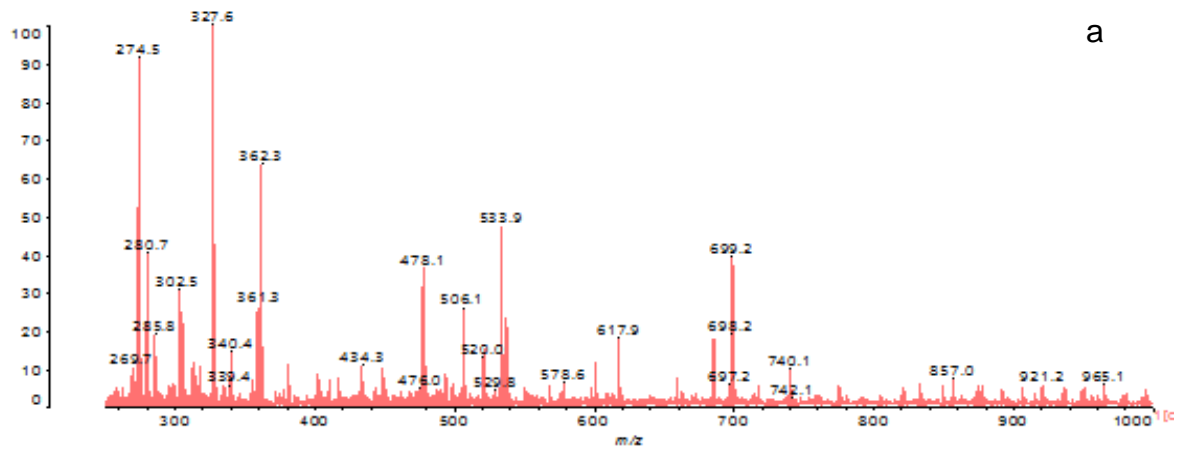
MALDI-TOF mass spectrometry is a useful method to evaluate polyflavonoid tannin which is difficult to determine by other techniques method (Pasch et al., 2001); (Hoong et al., 2010). It is used also to identify sugars, various polyphenols, and oligomer structures (Pizzi et al., 2004 ; Pizzi et al., 2009; Navarrete et al., 2012) . This powerful tool which is now widely used for tannins structure characterization by various authors (Ricci et al., 2016 ; Ricci et al., 2017) ;Sanchez-De Melo et al., 2015; Bianchi et al., 2014; Bianchi et al., 2015) was applied here to determine the molecular structure and oligomers distribution of condensed tannins extracted from *K. ivorensis* bark. Given that monomers and low molecular weight are often identified without Na<sup>+</sup> even if NaCl has been added to the system to enhance the peaks, one can find in the spectra, peaks with Na<sup>+</sup> and peaks without Na<sup>+</sup>. Therefore, experimental and calculated m/z (Da) without Na<sup>+</sup> of major peaks discussed in this study were similar (Fig. 2-4 and Table 2). The spectrum in the range 100-200 Da (Fig. 2) presents a low intensity peak at 131.8 Da. This was assigned to a glucose ring fragment obtained by a cleavage mechanism as stated by (Ricci et al., 2016). Equally, the peak at 155.7 may be assigned to a syringil acid fragment by loss of its –COO function, a similar occurrence having already been described earlier (Ricci et al., 2016). The high intensity of the peak at 178.6 Da indicates the presence of sugar monomers such as glucose, mannose and galactose with 2H lost (180.16 Da-2xH).



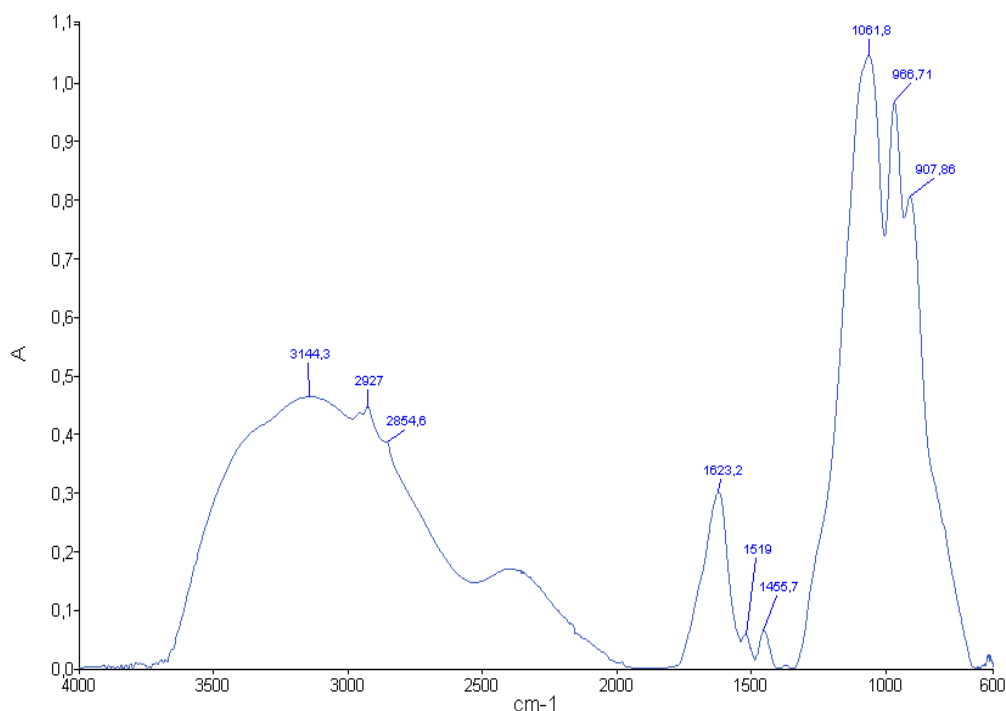
**Fig. 2: MALDI-TOF spectrum of tannin extracts from *K. ivorensis* bark in the range 100-200 Da.**



**Fig. 3: MALDI-TOF spectrum of tannin extracts from *K. ivorensis* bark in the range 250-400 Da (a); 300-600 Da (b) and 400-900 Da (c).**



**Fig. 4: MALDI-TOF spectrum of tannin extracts from *K. ivorensis* bark in the range 250-1000 Da (d) and 250-2000 Da (e).**



**Fig. 5: FTIR analysis spectrum of tannin from bark sawdust of *K. ivorensis***

The FTIR spectrum in Fig. 5 showed a shoulder at 966.7 and a strong band at 907.86  $\text{cm}^{-1}$  assigned to mannans (Kato et al., 1973; Galichet et al., 2001), suggesting that acetone/water extracts of *K. ivorensis* bark contained glucomannans. Given that the band at 1061.8  $\text{cm}^{-1}$  belongs to the C-O stretching of condensed tannins, mannans or xylans (Falcão and Araújo, 2013), one could suppose that xylans are present in the bark tannins extract of *K. ivorensis*. However, the lack of the bands at 893  $\text{cm}^{-1}$  and between 1130 and 1000  $\text{cm}^{-1}$  typical of xylans were not found (Marques, 2014). The bands near 890, 993 and 1028  $\text{cm}^{-1}$  and which are present in almost all different types of  $\beta$ -glucan structures (Galichet et al., 2001) were not found in this spectrum. Further investigation on the neutral carbohydrates present in the acetone/water extracts of condensed tannins from *K. ivorensis* bark would facilitate the assignment of the peaks at 178.6 and 138.4 Da. This notwithstanding, the present results indicating the occurrence of mannose linked to the condensed tannins of *K. ivorensis* bark would indicate that glucose should account for a low proportion of such carbohydrates.

The  $m/z$  displayed in the range 250-2000 Da (Fig. 3a and 4e) revealed typical peaks at 274.5, 305.5, and 258.8 Da assigned respectively to fisetinidin (A), galocatechin (D) and trihydroxyflavan (F) (Table 3, 4). Such monomers were previously found in condensed tannins from other wood species (Navarrete et al., 2010; Ucar et al., 2013; Abdalla et al., 2014a). However, the  $m/z$  of Fig. 2a showed

clearly that condensed tannins from *K. ivorensis* bark did not appear to contain catechin monomers.

The peak at 258.7 Da assigned to a trihydroxyflavan monomer (F) should be derived from as a result of the loss of 17 Da (one OH group) by a fisetinidin (274.3-1xOH) monomer. Since the peaks at 274.5 and 306.3 Da were characteristics of fisetinidin and gallo catechin monomers (Abdalla et al., 2014), the peak at 302.5 Da should be assigned to the compound labeled T (Tables 2, 3) resulting from the loss of 3H from a gallo catechin unit (306.3-3xH). The occurrence of condensed tannin units in *K. ivorensis* extracts was confirmed by FTIR analysis which showed: (i) a typical broad band centered at 3144.3 cm<sup>-1</sup> and assigned to aromatic compounds O-H bond elongation, and (ii) a characteristic bands of C=C-C and C-O bonds of condensed tannins at 1519 and 1061.8 cm<sup>-1</sup> respectively (Falcão and Araújo, 2013).

Moreover, the peak at 340.4 Da indicated the presence of maltose, sucrose, or lactose dimer at 342.2 Da in the *K. ivorensis* bark extracts. Similar carbohydrate type molecules like cellobiose (Glu<sub>2</sub>) which have been previously observed by Sanchez-De Melo et al. (2015) appear to confirm the presence of a glucose degradation product at 131.8 Da (Fig. 2).

The tannin extracts from *K. ivorensis* bark contained dimers, listed in Table 3 the molecular structures of which are shown in Table 4. The high 362.0 Da peak belongs to either a dihydroxyflavan-3-p-hydroxybenzoate (H<sub>1</sub>K<sub>1</sub>) or a trihydroxyflavan-3-benzoate (F<sub>1</sub>L<sub>1</sub>) dimer. Similar compounds were previously identified in *Pinus brutia* by Ucar et al. (2013). In addition, the peak at 360.4 Da should result from N<sub>1</sub>K<sub>1</sub> (363 Da -3xH) or F<sub>1</sub>L<sub>1</sub> (363Da -3xH) dimers (Table 2) formed by the loss of 3H from H<sub>1</sub>K<sub>1</sub> or P<sub>1</sub>L<sub>1</sub> respectively (Table 2). Conversely, the 410.0 Da peak was attributed to a gallo catechin-3-benzoate dimer (D<sub>1</sub>L<sub>1</sub>). This peak could also be assigned to a catechin-3-p-hydroxybenzoate at *m/z* 410.4 Da as found by Sanchez de Melo et al. (2015). The bark of *K. ivorensis* appeared to contain another monogalloyl flavonoid (Pasch and Pizzi, 2002) at 444.3 Da, peak assigned to gallo catechin-3-(3,4-dihydroxy)-benzoate ester labeled D<sub>1</sub>J<sub>1</sub> (Table 2). The occurrence of these compounds shows that the tannin bark extracts of *K. ivorensis* contain dimer esters bearing gallic or galloyl acid moieties. Furthermore, the band at 1632.2 cm<sup>-1</sup> assigned to C=O stretching of tannins (Falcão and Araújo, 2013) confirmed the presence of ester bonds in *K. ivorensis* bark extracts. Nevertheless, the 152 Da and 166 Da peaks from free galloyl and gallic acid

identified as markers in *Quercus robur* hydrolysable tannins (Ricci et al., 2017) were not present in *K. ivorensis* bark. Moreover, the lack of C=O stretching at 1731-1730  $\text{cm}^{-1}$  arising from acid- or ester-like structures showed that neither gallic acid (Falcão and Araújo, 2013) or alkyl esters were present in the tannin extracts from *K. ivorensis* bark. This further confirms that hydrolysable tannins are not mixed to condensed tannins in this bark extract.

A serie of condensed tannins dimers was found in the acetone/water extracts from *K. ivorensis*. Thus, the peak at 500.1 Da (Fig. 3b) labeled  $F_1N_1$  in Table 2 should result from a  $C_4$ - $C_8$  condensation between the trihydroxyflavan at 258.8 Da peak and the dihydroxyflavan of  $m/z$  242.3 Da. Another dimer appearing weakly at 518.5 Da was assigned to the trihydroxyflavan dimer labeled  $F_2$  in Table 2, while the compound at 508.5 Da ( $P_2$ ) should be a dimer resulting from the loss of six hydrogens (518.5 Da-6x1H) by  $F_2$ . The possibility for finding such a type of compounds in tannin extracts was previously reported by (Ucar et al., 2013) who suggested the occurrence of cyanidine glucose like structure in *Pinus brutia* tannin extracts. The peak of high intensity at 478.2 Da should be assigned to a  $C_4$ - $C_8$  condensed dihydroxyflavan dimer ( $H_1N_1$ ). However, it could also derive by the loss of six hydrogens (486.6 Da-6x1H) from the  $C_4$ - $C_8$  condensed dihydroxyflavan dimer labeled  $H_2$  at  $m/z$  486.6 Da. In addition, the peak at 600.6 Da was assigned to the dimer listed  $T_2$  in Table 2. This dimer was thought to result from the dehydrogenation (612.6 Da-6x1H) of the gallo catechin dimer  $D_2$ . Conversely, the small peak at 556.6 suggests the presence of condensed tannin dimers labeled  $Q_1M_1$  or  $Q_1S_1$  resulting from the loss of 6H by a fisetidin/catechin ( $A_1C_1$ ) or a fisetinidin/robinetinidin ( $A_1B_1$ ) condensed moieties. The peak of high intensity at 533.9 Da was attributed to a trihydroxyflavan/fisetinidin ( $F_1A_1$ ), robinetinidol/dihydroxyflavan ( $B_1H_1$ ), catechin/dihydroxyflavan ( $C_1H_1$ ) dimer or a fisetinidin dimer which has lost 6H (Ricci et al., 2017), while the peak of weak intensity at 578.6 Da (Fig. 3c) should be assigned to a fisetinidin/gallo catechin dimer ( $A_1D_1$ ). The peak at 617.9 Da was ascribed to an isoquercetin gallate dimer (Ricci et al., 2017).

The first trimer of condensed tannins free from sugar units is observed at 699.0 Da. It should be assigned to a robinetinidin/tetrahydroxyflavan-3(3,4-dihydroxy) benzoic acid ester (benzoate) labeled  $B_1G_1$  or to a catechin/tetrahydroxyflavan-3(3,4-dihydroxy) benzoic acid ester (benzoate) labeled  $C_1G_1$  in Table 2. This peak could also



be assigned to a protonated catechin/robinetidin dimer ( $C_1G_1-H$ ) with a  $C_3-C_8$  inter unit bond arising at 700.3 Da.

It was noteworthy that several patterns assigned to glycosyl or glycomannosyl-flavonoid oligomers were detected in *K. ivorensis* bark extracts. Thus, the peak at 403.2 Da was assigned to a glycosyl-3-dihydroxyflavan ( $H_1Glu_1$ ) dimer. However, this peak should be attributed to  $F_1Glu_1$  resulting also from the loss of 16 Da (one  $-OH$ ) by a glycosyl-3-trihydroxyflavan ( $420.4-1xOH$ ) (Table 2). Additional peaks forming a series at 403.2 Da, 418.4 Da, 434.3 Da, and 449.2 Da increasing of 16 Da from the glycosyl-3-dihydroxyflavan ( $H_1Glu_1$ ) dimer at 403.2 Da were also observed. The occurrence of these three peaks suggested the presence of glycosyl-3-trihydroxyflavan ( $F_1Glu_1$ :418.4 Da), glycosyl-3-fisetinidin ( $A_1Glu_1$ :434.3 Da) and glycosyl-3-cyanidin ( $M_1Glu_1$ :449.2 Da). The latter was previously observed in condensed tannin extracts of *Pinus brutia* (Balaban et al., 2013). These authors suggested that  $M_1Glu_1$  should be obtained from a dehydrogenation of glycosyl-2-catechin labeled  $C_1Glu_1$  (452.4 Da) in Table 2.

The second trimer found in this study was observed at 740.1 Da and assigned to the glycosyl trimer ( $A_1D_1Glu_1$ ). This compound should consist on a fisetinidin/gallocatechin dimer (578.6 Da) coupled to a carbohydrate type-unit (162 Da). Equally, the peak of weak intensity at 857.0 Da (Fig. 3c) and labeled  $A_1F_1Glu_2$  (Table 2) should correspond to a tetramer of fisetinidin/trihydroxyflavan condensed dimer (532.6 Da) coupled with two carbohydrate units (325.1 Da). Other glycosylated condensed tannin tetramers appeared to occur in *K. ivorensis* bark extracts. For example, the 921.2 Da which peak may correspond to a catechin/robinetidin dimer (594.6 Da) ether linked with a carbohydrate dimer (25.1 Da) by the  $C_3$  oxygen of a flavan unit and was labeled  $D_1C_1Glu_2$  as shown in Table 2. Moreover, other compounds displaying a calculated mass (918.7 Da) near to that found for  $D_1C_1Glu_2$  tetramer could be assigned to the 921.2 Da peak. Among them, catechin ( $C_2Glu_2$ ), robinetidin ( $B_2Glu_2$ ), robinetidin/catechin ( $B_1C_1Glu_2$ ) or the fisetinidin/gallocatechin dimer ( $A_1D_1Glu_2$ ) condensed tannin dimer ether bonded with a carbohydrate dimer by the  $C_3$  oxygen of flavan unit should not be ruled out.

A peak of weak intensity was observed at 965.0 Da. This should result from a flavonoid trimer of condensed gallocatechin, trihydroxyflavan-3-ol, and dihydroxyflavan bearing a carbohydrate unit linked to the  $C_3$  oxygen. Among this

structure possibilities, the one labeled  $D_1F_1H_1Glu_1$  (Table 2) displaying a calculated mass of 965.0 Da was suggested as tetramer model compound (Table 3) arising at 965.0 Da.

The peak of weak intensity at 1009.2 Da derived from the tetramer centered at 857.0 Da ( $A_1F_1Glu_2$ ) by a 152 Da increase, suggesting the occurrence of oligomers with a galloyl unit. Therefore, the peak at 1009.0 Da should be assigned to diglycosyl-3-diflavonoid-3-(3,4,5)-trihydroxybenzoate labeled  $A_1F_1G_1Glu_2$  (Table 2 and 3). Equally, the 1198.8 Da peak derives by an increase of 341.8 Da ( $2 \times Glu$ ) from the peak at 857.0 Da. Thus, the peak at 1198.8 Da should correspond to a flavan dimer ( $A_1F_1Glu_4$ ) involving a fisetinidin, trihydroxyflavan-3-ol and four glucose or related sugar units linked to it. A similar structure of 1200.6 Da in which a polyflavonoid tannin was linked to a carbohydrate dimer at the  $C_3$  position was found by Abdalla et al. (2014). Given that the difference  $1374.7 \text{ Da} - 857.0 \text{ Da} = 517.7 \text{ Da}$  approximately matches a fisetinidin and dihydroxyflavan association (514.6 Da), the 1374.7 Da peak should refer to a hexamer from two fisetinidin, one trihydroxyflavan, one dihydroxyflavan, and two carbohydrate units. The compound obtained was labeled  $A_2F_1H_1Glu_2$  and showed a calculated mass of 1371.6 Da.

The MALDI-TOF spectrum in Fig. 4b shows a peak at 1578.7 Da obtained by an increase of 721.7 Da from the peak at 857.0 Da. The difference observed (721.7 Da) corresponds to 3 dihydroxyflavan condensed units of calculated mass 722.9 Da. Therefore, the 1578.7 Da peak shown as  $A_1F_1H_3Glu_2$  in Tables 2 and 3 should be assigned to a heptamer composed of fisetinidin, trihydroxyflavan, three dihydroxyflavans and two glucose or hexose type mannose units.

Despite their low content, the structure of tannins extracted from the bark of *K. ivorensis* was accordingly condensed up to five flavonoid units. But flavonoids can be linked in 2-10 units (Tondi et al., 2008). In this study, the longest heptamer glycosidic unit contained two glucose or related hexose-like sugars. However, the occurrence of heptamers in condensed tannins was also described by (Pizzi et al., 1985) and MALDI-TOF analysis of tannins extracted from African locust bean tree (*Parkia biglobosa*) have shown short flavonoid oligomers linked to chains presenting up to 22 carbohydrate residues (Drovou et al., 2015). Similar examination performed on Tunisian *Zizyphus jujuba* root bark tannins by MALDI-TOF and  $^{13}C$  NMR showed that flavonoid oligomers up to hexamers were frequently covalently linked to carbohydrate

monomers and dimers in this species (Abdalla et al., 2014b). The results above were in close agreement with that found in this study for which a high content of glycosylated chains linked to condensed tannins by covalent bonds were shown to occur. Nevertheless, these glycosylated units should derive either from the degradation of *K. ivorensis* bark tissues or induced by the rearrangement of glucose or other related hexoses during the acetone/water extraction as already observed for green tea which predominantly present glycosides rather than non-glycosylated forms (Wang and Helliwell, 2001).

## **II.G. Conclusion**

The total phenolic content of the bark, sapwood, and heartwood from the African mahogany *K. ivorensis* from Gabon did not display any significant differences. MALDI-TOF analysis and FTIR analysis showed for the first time the condensed tannins distribution within the acetone/water extracts from *K. ivorensis* bark. The studied bark contained fisetinidin, gallocatechin, and trihydroxyflavan monomers. A variety of oligomers associating flavonoids with carbohydrate units have been identified for the first time; the longest was a flavonoid pentamer linked to two carbohydrates and consisting of a fisetinidin, a trihydroxyflavan, three dihydroxyflavanes units, and one carbohydrate dimer including glucose or mannose units. Given the new policies regarding the timber industry in the Congo river basin, the wood of *K. ivorensis* becomes of increasing interest, as it generates a large amount of underutilized bark, sapwood and heartwood wastes. These lignocellulosic materials offer opportunities for identifying molecules such as condensed tannins or other wood based molecules. However, the results obtained in this study permit to give one good basis to enhance the knowledge of chemical structures of the carbohydrates linked to the condensed tannins, the biological and chemical properties of the glycosylated condensed tannins as well as the potential of condensed tannins from *K. ivorensis* for adhesives in order to increase the added value of African tropical wood wastes.

### **Acknowledgements**

We gratefully acknowledge the financial support of the Agence Nationale des Bourses du Gabon (ANBG). The University de Pau et des Pays de l'Adour are thanked for the material support and facilities offered by the ANR-10-EQPX-16 Xyloforest (Xylomat, Mont de Marsan).

## II.H. References

Abdalla, S., Pizzi, A., Ayed, N., Charrier, F., Bahabri, F., Ganash, A., 2014a. MALDI-TOF and <sup>13</sup>C NMR analysis of Tunisian Zizyphus jujuba root bark tannins. *Ind. Crops Prod.* 59, 277–281. <https://doi.org/10.1016/j.indcrop.2014.05.035>

Abdalla, S., Pizzi, A., Ayed, N., Charrier, F., Bahabri, F., Ganash, A., 2014b. MALDI-TOF and <sup>13</sup>C NMR analysis of Tunisian Zizyphus jujuba root bark tannins. *Ind. Crops Prod.* 59, 277–281.

Abdelgaleil, S.A., Hashinaga, F., Nakatani, M., 2005. Antifungal activity of limonoids from *Khaya ivorensis*. *Pest Manag. Sci.* 61, 186–190. <https://doi.org/10.1002/ps.978>

Abdelgaleil, S.A., Iwagawa, T., Doe, M., Nakatani, M., 2004. Antifungal limonoids from the fruits of *Khaya senegalensis*. *Fitoterapia* 75, 566–572.

Adekunle, 2003. Antifungal activity and phytochemical screening of the crude extracts of *Khaya ivorensis* Juss (Meliaceae) and *Tetracera potatoria* L. (Dilleniaceae). *South Afr. J. Bot.* 4, 568–571.

Bayol, N., Anquetil, F., Bile, C., Bollen, A., Bousquet, M., Castadot, B., Cerutti, P.O., Kongape, J.A., Leblanc, M., Lescuyer, G., others, 2014. Filière bois d'œuvre et gestion des forêts naturelles. Les bois tropicaux et les forêts d'Afrique Centrale face aux évolutions des marchés. *For. Bassin Congo–État For.* 47–66.

Broadhurst, R.B., Jones, W.T., 1978. Analysis of condensed tannins using acidified vanillin. *J. Sci. Food Agric.* 29, 788–794.

Chupin, L., Maunu, S.L., Reynaud, S., Pizzi, A., Charrier, B., Charrier-EL Bouhtoury, F., 2015. Microwave assisted extraction of maritime pine (*Pinus pinaster*) bark: Impact of particle size and characterization. *Ind. Crops Prod.* 65, 142–149.

Détienne, P, 1979. Contrefil à rythme annuel dans les Faro, *Daniella* sp. pl. *Bois Trop* 67–71.

Drovou, S., Pizzi, A., Lacoste, C., Zhang, J., Abdulla, S., El-Marzouki, F.M., 2015. Flavonoid tannins linked to long carbohydrate chains–MALDI-TOF analysis of the tannin extract of the African locust bean shells. *Ind. Crops Prod.* 67, 25–32.

Etat Gabonais, 2003. Arrete n°000117 diamètre minimum d'exploitation des bois du Gabon. 4pp.

Etat Gabonais, 2001. Gabon - Code forestier. Loi n°16-01 du 31 décembre 2001, 36 pp.

Falcão, L., Araújo, M.E., 2013. Tannins characterization in historic leathers by complementary analytical techniques ATR-FTIR, UV-Vis and chemical tests. <https://doi.org/10.1016/j.culher.2012.11.003>

França, T.S.F.A., França, F.J.N., Arango, R.A., Woodward, B.M., Arantes, M.D.C., 2016. Natural resistance of plantation grown African mahogany (*Khaya ivorensis* and *Khaya senegalensis*) from Brazil to wood-rot fungi and subterranean termites. *Int. Biodeterior. Biodegrad.* 107, 88–91.

Galichet, A., Sockalingum, G., Belarbi, A., Manfait, M., 2001. FTIR spectroscopic analysis of *Saccharomyces cerevisiae* cell walls: study of an anomalous strain exhibiting a pink-colored cell phenotype. *FEMS Microbiol. Lett.* 1, 179–186.

Haluk, J.-P., Roussel, C., 2000. Caractérisation et origine des tropolones responsables de la durabilité naturelle des Cupressacées. Application potentielle en préservation du bois. *Ann. For. Sci.* 57, 819–829.

Heryati, Y., Belawan, D., Abdu, A., Mahat, M.N., Abdul Hamid, H., Majid, N., Muhamad, N., Hassan, A., 2011. Growth performance and biomass accumulation of a *Khaya ivorensis* plantation in three soil series of ultisols. *Am. J. Agric. Biol. Sci.* 6, 33–44.

Hoong, Y.B., Pizzi, A., Md. Tahir, P., Pasch, H., 2010. Characterization of *Acacia mangium* polyflavonoid tannins by MALDI-TOF mass spectrometry and CP-MAS <sup>13</sup>C NMR. *Eur. Polym. J.* 46, 1268–1277. <https://doi.org/10.1016/j.eurpolymj.2010.03.002>

Hung, C.D., Trueman, S.J., 2011. In vitro propagation of the African mahogany *Khaya senegalensis*. *New For.* 42, 117–130.

Ibrahim, J.A., Ayodele, E.A., Jegede, A.I., Kunle, Y.F., 2006. Comparative studies on *Khaya*. A. Juss (Meliaceae) in Nigeria. *Afr. J. Biotechnol.* 5, 1154–1160.

Iwu, M.M., Kiayman, D.L., 1992. Evaluation of the in vitro antimalarial activity of *Picralima nitida* extracts. *J. Ethnopharmacol.* 36, 133–135.

Kato, H., Tillotson, J., Nichaman, M., George, R.G., Howard, H.B., 1973. epidemiologic studies of coronary heart disease and stroke in japanese men living in japan, hawaii and california serum lipids and diet. *Am. J. Epidemiol.* 87, 372–385.

Koumba Zaou, P, Nze Nguema, S, Mapaga, D, Delporte, P, 1998. Croissance de 13 essences de bois d'oeuvre planté en forêt Gabonaise. *Bois For. Trop.* 2, 21–33.

Lompo, M., Guissou, I., Dubois, J., Dehaye, J., Ouedraogo, S., Traore, A., Some, N., 2007. Mechanism of the Anti-inflammatory Activity of *Khaya senegalensis* A. Juss. (Meliaceae). *Int. J. Pharmacol.* 3, 137–142.

Lompo, M., Nikiéma, J.B., Guissou, I.P., Moës, A.J., Fontaine, J., 1998. The topical antiinflammatory effect of chloroform extract from *Khaya senegalensis* stem barks. *Phytother. Res.* 12, 448–450.

Marques, A.I. da F., 2014. Isolation of xylans from bleached *Eucalyptus* kraft pulp by precipitation with antisolvents. *Tec. Lisb.* 1–11.

Navarrete, P., Pizzi, A., Pasch, H., Delmotte, L., 2012. Study on Lignin–Glyoxal Reaction by MALDI-TOF and CP-MAS <sup>13</sup>C-NMR. *J. Adhes. Sci. Technol.* 26, 1069–1082. <https://doi.org/10.1163/016942410X550030>

Navarrete, P., Pizzi, A., Pasch, H., Rode, K., Delmotte, L., 2010. MALDI-TOF and <sup>13</sup>C NMR characterisation of maritime pine industrial tannin extract. *IndCrops Prod* 32, 105–110.

Ndiade Bourobou, D., DemikoyoKanghou, D., Inguenza, D., 2010. la République Gabonaise: Etat des Ressources Génétiques Forestières dans le Monde. Ministère des Eaux et Forêts (Gabon), FAO.

Nze Nguema, S., 2009. Présentation du secteur Forestier au Gabon.

Pasch, H., Pizzi, A., 2002. Considerations on the Macromolecular Structure of Chestnut Ellagitannins by Matrix-Assisted Laser Desorption/ Ionization–Time-of-Flight Mass Spectrometry. *JAppIPolymer Sci* 85, 429–437.

Pasch, H., Pizzi, A., Rode, K., 2001. MALDI–TOF mass spectrometry of polyflavonoid tannins. *Polymer* 42, 7531–7539.

Pizzi, A., Cameron, F.-A., Eaton, N.J., 1985. The tridimensional structure of polyflavonoid tannins by conformational analysis. *J. Macromol. Sci.* 22, 515–540.

Pizzi, A., Pasch, H., Rode, K., Giovando, S., 2009. Polymer structure of commercial hydrolysable tannins by MALDI-TOF mass spectrometry. *JApplPolymer Sci* 113, 3847–3859.

Pizzi, A., Pasch, H., Simon, C., Rode, K., 2004. Structure of Resorcinol, Phenol, and Furan Resins by MALDI-TOF Mass Spectrometry and <sup>13</sup>C NMR. *JApplPolymer Sci* 92, 2665 – 2674.

Ricci, A., Lagel, M.-C., Parpinello, G.P., Pizzi, A., Kilmartin, P.A., Versari, A., 2016. Spectroscopy analysis of phenolic and sugar patterns in a food grade chestnut tannin. *Food Chem.* 425–429.

Ricci, A., Parpinello, G.P., Palma, A.S., Teslić, N., Brilli, C., Pizzi, A., Versari, A., 2017. Analytical profiling of food-grade extracts from grape (*Vitis vinifera* sp.) seeds and skins, green tea (*Camellia Sinensis*) leaves and Limousin oak (*Quercus robur*) heartwood using MALDI-TOF-MS, ICP-MS and spectrophotometric methods. *J. Food Compos. Anal.* 1–14.

Saad, H., Charrier-El Bouhtoury, F., Pizzi, A., Rode, K., Charrier, B., Ayed, N., 2012. Characterization of pomegranate peels tannin extractives. *Ind. Crops Prod.* 40, 239–246.

Safou-Tchiama, R., Barhé, T.A., Soulounganga, P., Akagah, A.G., De Jeso, B., 2017. A comparative study of the syringyl, guaiacyl and hydroxyl groups units distribution in some African tropical hardwoods' lignin by Py-GC/MS and spectroscopic techniques. *J. M Aterials Environ. Sci.* 8, 2 530-2 540.

Safou-Tchiama, R., de Jéso, B., Akagah, A.G., Sèbe, G., Pétraud, M., 2007. A preliminary survey of the interfacial bonding of some tropical hardwoods towards succinic anhydride and 2-octen-1-yl succinic anhydride molecules: Impact of lignin and carbohydrate polymers structure on the chemical reactivity. *Ind. Crops Prod.* 26, 173–184.

Safou-Tchiama, R., Obame, S.N., Brosse, N., Soulounganga, P., Barhé, T.A., 2016. Investigating the potential of *Aucoumea klaineana* Pierre sapwood and heartwood wastes to produce cellulosic ethanol. *Afr. J. Biotechnol.* 15, 2587–2595.

Sanchez-De Melo, I., Grassi, P., Ochoa, F., Bolivar, J., García-Cózar, F.J., Durán-Ruiz, M.C., 2015. N-glycosylation profile analysis of Trastuzumab biosimilar candidates by Normal Phase Liquid Chromatography and MALDI-TOF MS approaches. *J. Proteomics* 127, 225–233.

Scalbert, A., Monties, B., Janin, G., 1989. Tannins in Wood: Comparison of Different Estimation Methods. *J Agric Food Chem* 1324–1329.

Singleton, V.L., Rossi, J.A., 1965. Colorimetry of total phenolics with phosphomolybdic-phosphotungstic acid reagents. *Am. J. Enol. Vitic.* 16, 144–158.

Takin, M.C., Attindehoua, S., Sezan, A., Attakpa, S.E., Baba-Moussa, L., 2013. Bioactivity, therapeutic utility and toxicological risks of *Khaya senegalensis*. *Indian J. Pharm. Biol. Res Earch* 1, 22–129.

Tondi, G., Pizzi, A., Pasch, H., Celzard, A., 2008. Structure degradation, conservation and rearrangement in the carbonisation of polyflavonoid tannin/furanic rigid foams – A MALDI-TOF investigation. *Polym. Degrad. Stab.* 93, 968–975. <https://doi.org/10.1016/j.polymdegradstab.2008.01.024>

Ucar, M.B., Ucar, G., Pizzi, A., Gonultas, O., 2013. Characterization of *Pinus brutia* bark tannin by MALDI-TOF MS and <sup>13</sup>C NMR. *Ind. Crops Prod.* 49, 697–704.

Wang, H., Helliwell, K., 2001. Determination of flavonols in green and black tea leaves and green tea infusions by high-performance liquid chromatography. *Food Res. Int.* 34, 223–227.

Wu, W.-B., Zhang, H., Liu, H.-C., Dong, S.-H., Wu, Y., Ding, J., Yue, J.-M., 2014. Ivorenoids A–F: limonoids from *Khaya ivorensis*. *Tetrahedron* 70, 3570–3575.



**Table 1**

Rate of polyphenols in gallic acid equivalent. proantocyanidins in catechin equivalent and antocyanidins in cyanidin equivalent were expressed in % dry matter.

<i>K. ivorensis</i> type sample	Folin-ciocalteu (% of dry wood)	Assay to vanillin (% of dry wood)	Acid in butanol (% of dry wood)
Bark	1.54±0.39*	2.15±0.88*	0.28±0.14*
Sapwood	2.22±0.24*	0.98±0.81*	0.33±0.22*
Heartwood	1.79±0.11*	1.85±0.83*	0.20±0.29*

\*: ± SD, N=4. P>0.05.

**Table 2**

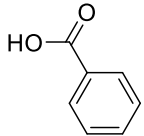
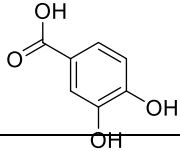
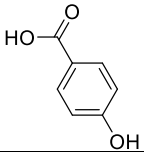
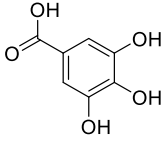
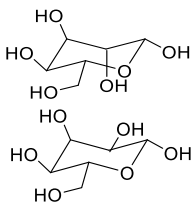
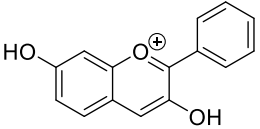
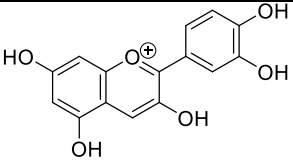
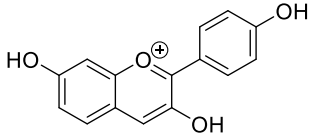
Calculated and experimental MALDI-TOF peaks related to condensed tannins extracted from *K. ivorensis* bark by acetone/water mixture.

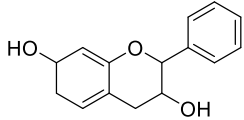
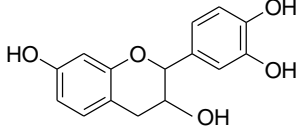
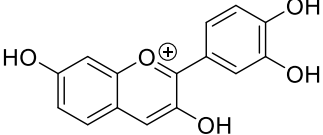
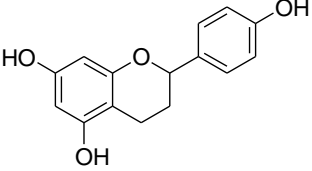
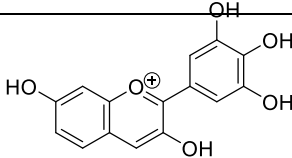
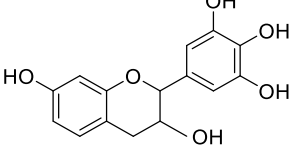
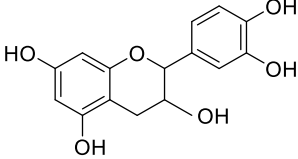
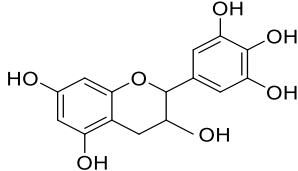
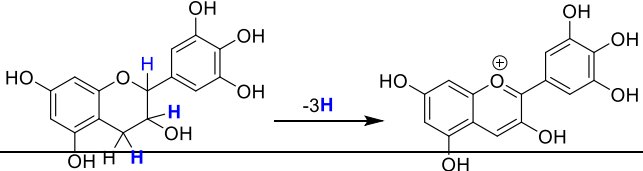
Experimental m/z (Da)	Calculated m/z (Da)	Type of unit	Base monomers
170.1	170.1	E (Gallic acid)	Monomer
241.3	241.3	H (Dihydroxyflavan)	Monomer
258.8	258.3	F (Trihydroxyflavan)	Monomer
274.5	274.3	A (Fisetinidin)	Monomer
290.3	290.3	B (Robinetinidin). C (Catechin)	Monomer
302.5	303.3	T ( Gallocatechin-3xH)	Monomer
305.5	306.3	D (Gallocatechin)	Gallocatechin
340.4	342.2	Glu <sub>2</sub> (Cellobiose)	Carbohydrate dimer
360.3	360.4	N (Dihydroxyflavan-3xH) <sub>1</sub> K (p-Hydroxybenzoic acid) <sub>1</sub> or P (Trihydroxyflavan-3xH) <sub>1</sub> L <sub>1</sub> (benzoic acid)	Monogalloyl flavonoïde dimer

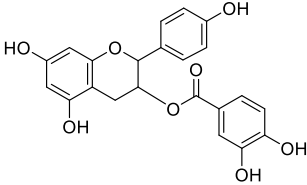
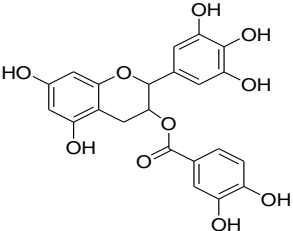
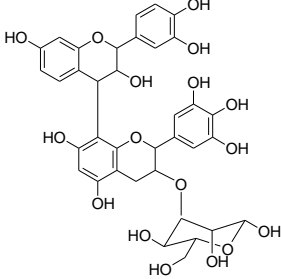
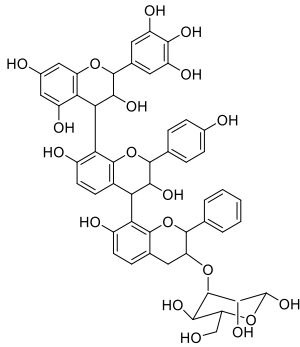
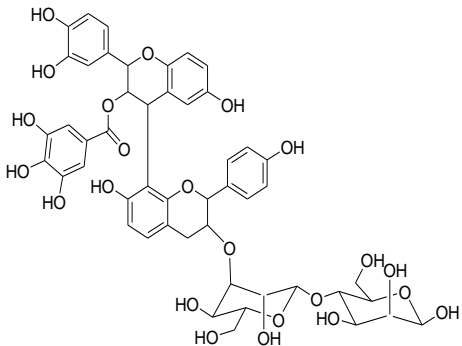
362.3	363.0	$H_1K_1$ or $F_1L_1$	Monogalloyl flavonoïde dimer
403.2	404.4	$H_1Glu(\text{Carbohydrate})$	Monoglycosyl dimer
418.4	420.4	$F_1Glu$	Monoglycosyl dimer
434.3	436.4	$A_1Glu$	Monoglycosyl dimer
444.3	442.4	$D_1J_1$ (-(3.4-dihydroxy)-benzoic acid)	Monogalloyl flavonoïde dimer
449.2	449.4	$M_{(\text{Catechine-3xH})1}Glu_1$	Monoglycosyl dimer
478.1	479.6	$H_1N_1$	Dimer
500.1	498.6	$F_1H_1$	Dimer
506.1	508.6	$P_2$	Dimer
518.0	514.6	$F_2$	Dimer
533.9	532.3	$F_1A_1$ , $B_1H_1$ or $C_1H_1$ .	Dimer
<b>555.7</b>	556.7	$Q_{(\text{Fisitinidin-3xH})1}M_1$ or $Q_1S_{(\text{Robinetinidin-3xH})1}$	Dimer
<b>578.6</b>	578.6	$A_1D_1$	Dimer
<b>600.0</b>	604.6	$T_2$	Dimer
<b>699.0</b>	700.3	$B_1G_{(\text{Tetrahydroxyflavan-3(3.4-dihydroxy)-benzoic acid})1}$ or $C_1G_1$	Trimer
<b>740.1</b>	740.6	$A_1D_1Glu_1$	Monoglycosyl Trimer
<b>857.0</b>	875.6	$A_1F_1Glu_1$	Diglycosyl Tetramer
<b>870. 8</b>	872.8	$B_3$ ou $C_3$	Trimer
<b>921.2</b>	919.4	$D_1C_1Glu_2$	Diglycosyl Tetramer
	918.7	$A_1D_1Glu_2$ , $B_2Glu_2$ or $B_1C_1Glu_2$	Diglycosyl Tetramer
<b>965.1</b>	965.0	$D_1F_1H_1Glu_1$	Monoglycosyl Tetramer
<b>1009.2</b>	1009.7	$A_1F_1G_1Glu_2$	Diglycosyl Pentamer
<b>1198.8</b>	1198.0	$A_1F_1Glu_4$	Tetraglycosyl Hexamer
<b>1374.7</b>	1371.6	$A_2F_2H_1Glu_2$	Diglycosyl Hexamer
<b>1578.7</b>	1578.9	$A_1F_1H_3Glu_2$	Diglycosyl Heptamer

**Table 3**

**Molecular structure of compounds released by the acetone/water extracts from *K. ivorensis* bark as derived by MALDI-TOF characterization.**

Designation	Label	Molecular structure	m/z (Da)
Benzoic acid	L		122
3,4-dihydroxy-benzoic acid	J		153.1
P-hydroxybenzoic acid	K		139
Gallic acid	E		170.1
Glucose	Glu		180
Mannose			
Dihydroxyflavan-3xH	N		238.3
Catechine-3xH	M		287.3
Trihydroxyflavan-3xH	P		255.7

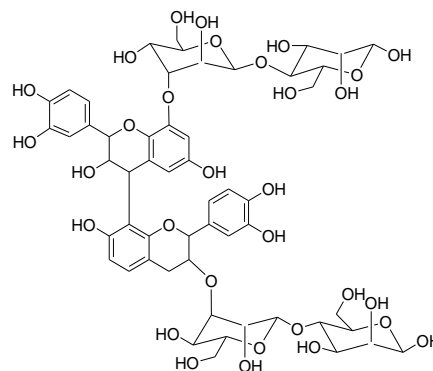
Dihydroxyflavan	H		241.3
Fisetinidin	A		271.5
Fisetinidin-3xH	Q		268.5
Trihydroxyflavan	F		258.7
Robinetinidin-3xH	S		287.3
Robinetinidin	B		290.3
Catechin	C		
Gallocatechin	D		306.3
Gallocatechin unit-3xH	T		302.5

Tetrahydroxyflavan- 3-(3,4-dihydroxy)-benzoate	Z G		427.8
Galocatechin- 3-(3,4-dihydroxy)-benzoate	H <sub>1</sub> K <sub>1</sub>		362.0
Fisetinidin/galocatechin dimer + mannosyl type-unit	A <sub>1</sub> D <sub>1</sub> Glu <sub>1</sub>		740.6
Galocatechin/ trihydroxyflavan / dihydroxyflavan/mannosyl unit	D <sub>1</sub> F <sub>1</sub> H <sub>1</sub> Glu <sub>1</sub>		965.0
Dimannososyl-3-diflavonoid – 3-(3,4,5)-trihydroxybenzoate	A <sub>1</sub> F <sub>1</sub> G <sub>1</sub> Glu <sub>2</sub>		1009.7

---

Fisetinidin. trihydroxyflavan-3-ol  
/4 mannosyl units

A<sub>1</sub>F<sub>1</sub>Glu<sub>4</sub>

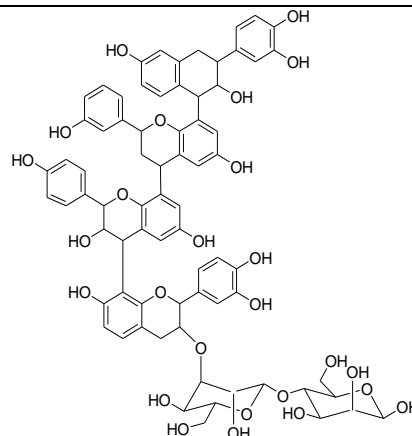


1198.0

---

2 Fisetinidin/ trihydroxyflavan  
/ dihydroxyflavane/  
/2 mannosyl units

A<sub>2</sub>F<sub>1</sub>H<sub>1</sub>Glu<sub>2</sub>

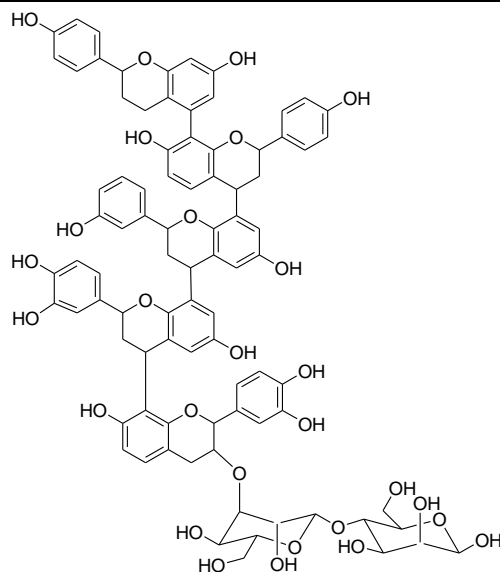


1371.6

---

Fisetinidin/ trihydroxyflavan  
/ 3 dihydroxyflavans  
/2 mannosyl units

A<sub>1</sub>F<sub>1</sub>H<sub>3</sub>Glu<sub>2</sub>

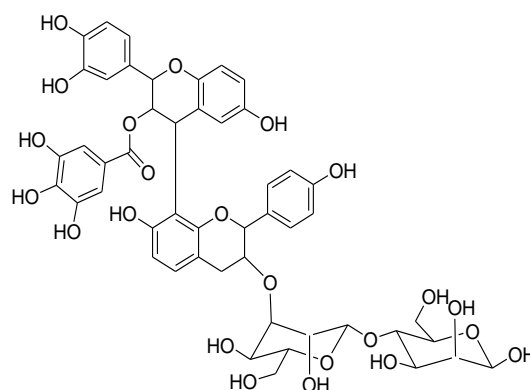


1578.9

---

Dimannosyl-3-diflavonoid –  
3-(3,4,5)-trihydroxybenzoate

A<sub>1</sub>F<sub>1</sub>G<sub>1</sub>Glu<sub>2</sub>

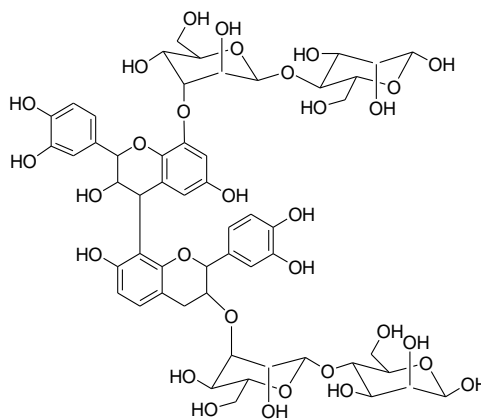


1009.7

---

Fisetinidin. trihydroxyflavan-3-ol  
/4 mannosyl units

A<sub>1</sub>F<sub>1</sub>Glu<sub>4</sub>

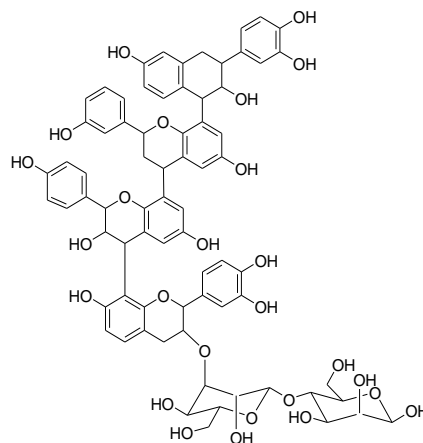


1198.0

---

2 Fisetinidin/ trihydroxyflavan  
/ dihydroxyflavane/  
/2 mannosyl units

A<sub>2</sub>F<sub>1</sub>H<sub>1</sub>Glu<sub>2</sub>

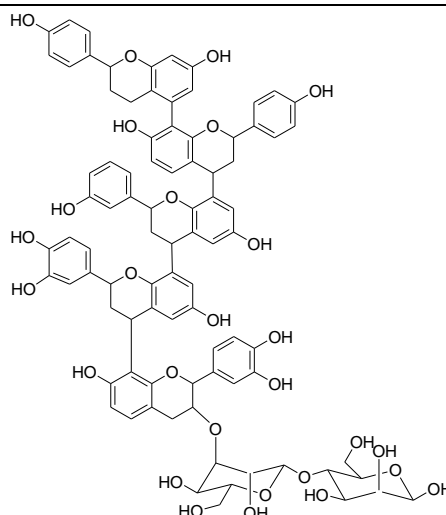


1371.6

---

Fisetinidin/ trihydroxyflavan  
/ 3 dihydroxyflavans  
/2 mannosyl units

$A_1F_1H_3Glu_2$



1578.9

---



### III. Analyse chimique et stabilité thermique des tanins condensés d'Acajou

#### <<Chemical analysis and thermal stability of African mahogany (*Khaya. ivorensis* A. Chev) condensed tannins >>.

Bikoro Bi Athomo<sup>1, 2\*</sup>, A., Engozogho Anris<sup>1,2</sup>, S.P., Safou Tchiama<sup>2,3</sup>, R., Leroyer<sup>1</sup>, L., Pizzi<sup>4</sup>, A., Charrier<sup>1</sup>, B.

<sup>1</sup> CNRS/ Université de Pau et des Pays de l'Adour, Institut des sciences analytiques et de physico-chimie pour l'environnement et les matériaux - Xylomat, UMR 5254, 40004, Mont de Marsan, France.

<sup>2</sup> Laboratoire de Recherche et de Valorisation du Matériau Bois (LaReVa Bois). Ecole Normale Supérieure d'Enseignement Technique (ENSET). BP. 3989 Libreville (Gabon).

<sup>3</sup> Laboratoire des Substances Naturelles et de Synthèses Organométalliques (LASNSOM). Unité de Recherche en Chimie. BP 941, Université des Sciences et Techniques de Masuku, Gabon.

<sup>4</sup> LERMAB, Université de Lorraine, 27 rue Philippe Séguin, 88000 Epinal, France.

[\\*arsene.bikoro-bi-athomo@univ-pau.fr](mailto:arsene.bikoro-bi-athomo@univ-pau.fr)

#### III.A. Résumé

Ce travail est la suite du premier article. Il traite principalement de l'analyse des tanins d'aubier et de duramen. Il a également permis d'évaluer le comportement thermique des tanins provenant d'écorce, d'aubier et de duramen, et de les comparer à ceux des tanins déjà commercialisés afin d'évaluer leur utilisation possible dans l'industrie. Les politiques forestières des pays du bassin du Congo ayant entraîné une augmentation de la production des scieries locales depuis quelques années, une grande quantité de produits connexes, appelés déchets de bois, est générée. Les scieries locales n'ayant pas de moyens techniques, financiers et scientifiques pour

transformer ces produits connexes en produits commercialisables, des projets de recherches sont mis en place pour évaluer le potentiel et proposer des solutions.

Les essences les plus exploitées font l'objet de ces études. C'est le cas ici du bois de *khaya ivorensis* A. Chev (*K. ivorensis*). Par conséquent, une tentative a été faite pour étudier la variabilité chimique et la stabilité thermique des tanins extraits de l'aubier et du bois de cœur par la méthode acétone / eau (7: 3, v: v), tandis que le potentiel de récupération de ces polyphénols pour des applications industrielles était également visé.

L'analyse quantitative a montré que le bois de cœur était le plus abondant en tanins condensés par rapport à l'aubier et à l'écorce, avec une différence significative ( $p < 0,05$ ). Ce résultat indique une variabilité intra-arbre, mais aucune différence significative n'a été constatée pour le contenu en tanin entre les arbres ( $p > 0,05$ ). Ces tanins ont été caractérisés par MALDI-TOF et FTIR. Leurs structures chimiques étaient des unités de type fisitinidine et gallocatéchine. Aucun signe de fragment de cathéchine libre n'a été trouvé dans ces extraits. De plus, des oligomères contenant jusqu'à sept monomères de tanins dépourvus de structures glycosyliques ont été trouvés dans les tannins condensés de *K. ivorensis*. L'ATG et la DSC ont mis en évidence une bonne stabilité thermique du tanin de cette espèce de bois dur. Ces résultats pourraient être utiles pour la valorisation future des déchets de bois d'acajou d'Afrique en tant que source de tanins pour la chimie ou les matériaux composites.

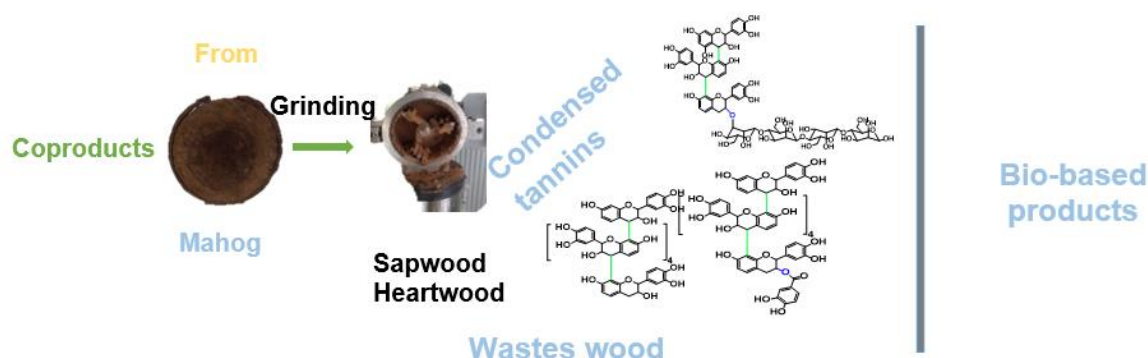
### **III.B. Abstract**

The forest policies of new Congo basin countries increased the wood timber industry output since the years 2000. Thus, a high content of underutilized wood wastes from sawmill, furniture and plywood industry are generated. Among them, the *Khaya ivorensis* A. Chev (*K. ivorensis*) bark, sapwood and heartwood account for the less valorized wood wastes. Therefore, an attempt was made to study the chemical variability and the thermal stability of tannins extracted from the sapwood and heartwood by the acetone/water method (7:3, v:v); the potential recovery of these polyphenols for industrial applications was also aimed. Quantitative analysis pointed out that the heartwood was the most abundant in phenolic units, and a significant difference ( $p < 0.05$ ) regarding the condensed tannins content between the bark, sapwood and heartwood was found. That result indicated an intra-tree variability while

no significant difference was found for the inter-tree tannin contents ( $p > 0.05$ ). These tannins were characterized by Matrix Assisted Laser Desorption Ionization-Time of Flight (MALDI-TOF) mass spectrometry and Fourier Transform InfraRed (FTIR) spectroscopy. Their chemical structures were fisitininidin and gallocatechin type units. No evidence of free catechin moiety was found in these extracts. Moreover, oligomers up to seven tannins monomers free from glycosyl structures were found in the *K. ivorensis* condensed tannins. Moreover, thermogravimetric analysis (TGA) and differential scanning calorimetry (DSC) pointed out good thermal stability of that hardwood species tannin. These findings could be useful for future valorizations of African mahogany wood wastes as source of tannins for chemistry or composite materials.

Keywords: Bark, DSC, FTIR, heartwood, *Khaya ivorensis*, MALDI-TOF, sapwood, Stiasny Number, tannins, TGA.

### III.C. Graphical abstract



### III.D. Introduction

African mahogany (*K ivorensis* A. Chev) is an important tropical hardwood species of a great economic value. It is one of the most exploited logs in the wood industry of Gabon (Koumba Zaou, P et al., 1998). The growth of timber industry in Gabon increased the importance of forest sector, which is the second employer in the country after the oil industry. The first wood transformation like sawmilling and plywood production generates wastes accounting for 50 to 60% of the initial mass of logs. In the past fifteen years, some African countries like Cameroon, Ivory Coast and Gabon changed their legislations to improve the valorization of new wood products with added-value instead of exporting untransformed logs. The industrial units created

since these changes generated a large amount of wood wastes including powders from sawing, slicing and unfurling (Ekomy Ango and Moutou Pitti, 2017). However, it was reported in 2016 that sawdust was the least valorized wood wastes in Gabon, although it represented 4.8 million m<sup>3</sup>. Approximately 85% of these wood powders which could constitute opportunities for fibers, particles or platelets recovery are still burned in open-air.

African mahogany wood was described as low interspecies variability with high planting ability (Heryati et al., 2011)). The lack of variability regarding the physical properties of African mahogany from different growth areas of Democratic Republic of Congo was reported by Kalendi Mathe et al. (Kalendi et al., 2016). Moreover, African mahogany from Gabon showed good properties for plywood manufacture, which highlighted the capability of that hardwood species to replace *Aucoumea klaineana* Pierre (Koumba Nzaou et al. 1998). Furthermore, African mahogany is one of the main species exploited in Gabon (Nze Nguema, 2009) has a high extracts content (Tekpetey et al., 2016), and its leaves, barks, tubers, roots and herbs are used for medicinal treatments since decades (Belewu et al., 2009). Other properties like antifungal and antibacterial activities were related to molecules such as methyl angolensate and 1,3,7-trideacetylkhivorin found in African mahogany by several authors (Karou et al., 2005); Abdelgaleil et al. 2005; (Ugoh et al., 2014). However, other molecules of interest in African mahogany sapwood and heartwood, including condensed tannins, remain unknown. These polyphenols have been extracted from other plant woods, fruits, seeds and tissues (Ricci et al., 2017) for commercial applications. A recent study showed that African mahogany bark contained tannin monomers of commercial interest (Bikoro Bi Athomo et al., 2018). Flavonoids and procyanidin oligomers with a large amount of O-glycosylated flavan-3-ol monomers were found. However, the condensed tannins content as well as their molecular structure and thermal stability of these African mahogany sapwood and heartwood polyphenols have never received attention.

The aim of this work was then to investigate the chemical composition of *K. ivorensis* sapwood and heartwood by Matrix Assisted Laser Desorption Ionisation-Time of Flight (MALDI-TOF) mass spectrometry and Fourier Transform InfraRed (FTIR) spectroscopy. Understanding the thermal stability of these tannins by ThermoGravimetric Analysis (TGA) and Differential Scanning Calorimetry (DSC) was

also aimed. The potential valorization of *K. ivorensis* tannins for adhesives shall be studied by its condensation with formaldehyde.

### **III.E. Material and methods**

#### **III.E.1. Materials**

##### **III.E.1.a. Chemicals**

All the chemicals used in this study were purchased from Fisher Scientific, Acros Organic and Sigma Aldrich. Deionized water, acetone (99.98%, Fisher), phosphoric acid (99%, Fisher), iron sulfate (99%, Acros Organic), sodium carbonate decahydrate (>98%, Fisher), sodium bisulfite for analysis Acros Organic), sodium hydroxide (98.5%, Acros Organic), sodium sulfite (anhydrous, Fisher), formic acid (98.0-100%, Fisher).

##### **III.E.1.b. Wood sampling**

The bark (EA), sapwood (AA) and heartwood (CA) were collected from a *K. ivorensis* sampled from a section disk of 10 cm of thickness and 85 (AMG1) cm, 80 (AMG2) cm and 75 (AMG3) cm of diameter. The wood was harvested at Mitzi in the North of Gabon by the SNBG (Société Nationale des Bois du Gabon) in 2016 and 2017. The fresh samples were put in sterilized bags, air-dried for one week in the laboratory and oven-dried (105°C) for 48h. The dried samples were grinded to pass through 60 mesh ( $\approx 1$  mm diameter) with a rotative knife grinder (Retsch SK1).

#### **III.E.2. Methods**

##### **III.E.2.a. Extraction of polyphenols at room temperature**

350 mg of dried wood powder ( $M_{dried}$ ) from each sample was mixed separately at room temperature with 30 mL of acetone/water solution (7:3, v/v). The mixtures were stirred for 3h. The supernatant was recovered, and then acetone was evaporated. Four repetitions of each extraction were performed.

##### **III.E.2.b. Alkaline extraction of tannins for yield measurement, Stiasny number test and TGA and DSC analysis.**

According to previous optimization of alkaline extractions developed by Chupin (Chupin et al., 2013), African mahogany bark, sapwood and heartwood tannins were extracted by water solution containing 5% of NaOH, 0.25 % of Na<sub>2</sub>SO<sub>3</sub> and 0.25% of NaHSO<sub>3</sub>. The sample/water ratio was 1: 9. NaOH was used in the extraction to ensure high alkaline conditions (pH $\approx$ 9) and to increase the extraction yield. Na<sub>2</sub>SO<sub>3</sub> and

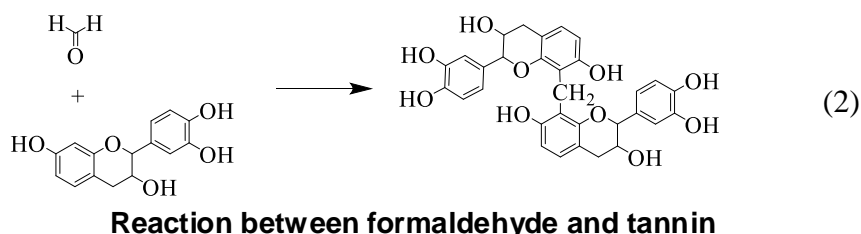
NaHSO<sub>3</sub> were added to lessen the viscosity and to stabilize the extracts. The grounded samples were immersed in water under continuous magnetic stirring for 2h at 80±5°C. The supernatant was filtered through whatman paper n° 3 and the residue was rinsed with water. The filtrates were dried in an oven at 40°C. The yield of extraction was calculated as the percentage of the amount of extract recovered in mass compared with the initial mass of dry material.

### III.E.2.c. Stiasny number determination

The reactivity of extractives with regard to formaldehyde (Eq. (2)) was determined by the Stiasny number measurement as described by (Voulgaridis et al., 1985). A solution of extracts of 4 g.L<sup>-1</sup> was prepared. Then, 25 mL of this solution was put in a round bottom flask and 5 mL of formaldehyde (37%) and 2.5 mL of HCl (10M) were added. The mixture was heated under reflux for 30 min. The residue was filtered through a sintered glass n°4. The precipitate was washed with water and dried a 105°C until constant weight. The reactivity was calculated according to Eq. (1) below:

$$SI = \frac{A}{B} \times 100 \quad (1)$$

Where, **SI**: Stiasny number, **A**: dry weight of the precipitate, **B**: dry weight of extract.



### III.E.2.d. Thermogravimetric analysis

Thermal decomposition was performed using a TA Instrument (TGA Q50 instrument). The temperature program was set from 24 to 600°C at a heating rate of 10°C/min. The measurements were conducted under air (60 mL/min) and nitrogen (40 mL/min).

### III.E.2.e. Differential scanning calorimetry

A TA instrument (DSC Q500) was again used for this test and was run simultaneously with TGA Q50. Mass sample used were between 5 and 22 mg.

Nitrogen gas was set to run at 60ml/min, and two ramps were used at 5°C/ min and 10°C/min until 200°C.

### III.E.2.f. MALDI-TOF analysis

#### *III.E.2.f.i. MALDI-TOF mass spectrometry*

The spectra were recorded on a KRATOS AXIMA Performance mass spectrometer from Shimadzu Biotech (Kratos Analytical Shimadzu Europe Ltd., Manchester, UK). The irradiation source was a pulsed nitrogen laser with a wavelength of 337 nm. The duration of one laser pulse was 3 ns. Measurements were carried out using the following conditions: polarity-positive, flight path-linear, 20 kV acceleration voltages, 100-150 pulses per spectrum. The delayed extraction technique was used applying delay times of 200-800 ns. The software Maldi-MS was used for the data treatment.

#### *III.E.2.f.ii. MALDI-TOF sample preparation*

Tannins for MALDI-TOF analysis were from to acetone/water samples extract, which were oven dried at 105°C during 24 h. The samples were dissolved in a solution of water/acetone (1:1) up to 7.5 mg/mL. For the enhancement of the ion formation NaCl (1.5 µl, 0.1 M) solution was added and placed on the MALDI target. Then, the solutions of the sample and the matrix were mixed in equal amounts and 1.5 µl of the resulting solution were placed on the MALDI target. As the matrix, 2,5-dihydroxy benzoic acid was used. Red phosphorus clusters were used as reference for spectrum calibration. Finally, after evaporation of the solvent, the MALDI target was introduced into the spectrometer. Due to the addition of sodium salt in the positive mode, all mass peaks correspond to  $[M+Na]^+ = 23.0$  (Na) + 2.0 (endgroups, 2 x H) + 272.3A + 288.3B, being A and B the masses of fisitinidin and catechin/robitinidin monomer respectively. In order to obtain some molecular weight of the chemical species of the peak, 23 Da for sodium has been subtracted.

### III.E.2.g. Fourier Transformed Infrared spectroscopy analysis

Tannins extracted from *K. ivorensis* sapwood and heartwood by the acetone/water solvent method (7:3, v/v) were used for FTIR spectroscopy analysis. The samples were oven-dried at 105°C for 24h then, 5 mg of the dried powders were placed on the crystal device and the contact was obtained by applying strength of 150 N on the sample. 32 scans were used with a resolution of 4 cm<sup>-1</sup> in the range 4000 to

600 cm<sup>-1</sup>. All the experiments were carried out in ATR (attenuated total reflection) mode with a PerkinElmer Frontier spectrophotometer equipped with a diamond/ZnSe crystal.

### III.E.3. Results and discussion

#### III.E.3.a. Tannins extraction

High concentrations of NaOH were used to improve the yield of the extraction as previously published (Chupin et al., 2013)(Yazaki and Collins, 1994). The acetone/water extraction yields obtained from *K. ivorensis* are presented in Table 1. The ANOVA test revealed a certain homogeneity regarding the distribution of tannins content in a tree. Therefore, no significant difference was found between the bark, sapwood and heartwood in *AMG2* and *AMG3* tree ( $p>0.05$ ). However, the tannins content was slightly different in *AMG1* tree inside which the bark did not show significant differences ( $p>0.05$ ) with regard to the sapwood and heartwood. The sole intra-tree tannins content difference was displayed between the sapwood and heartwood tree ( $p=0.046$ ) of *AMG1*. Although the limited samples of this study, condensed tannins of trees from the area of sampling did not trend to show significant difference between their bark, sapwood or heartwood. However, a global analysis of the tannins content from that natural forest showed significant differences between the bark ( $37\pm 11\%$ ) and heartwood ( $55.6\pm 19\%$ ) randomly collected in the site ( $p=0.03$ ). This result suggested that the heartwood should be richer in condensed tannins than the bark if they are sampled from different *K. ivorensis* trees. No significant difference should occur ( $p=0.07$ ) between the bark and sapwood ( $46\pm 6.7\%$ ) or the sapwood and heartwood ( $p=0.17$ ) arbitrarily sampled in Mitzic trees. Furthermore, the average condensed tannins yielded by *K. ivorensis* bark were slightly higher than that reported for maritime pine bark by (Chupin et al., 2013).

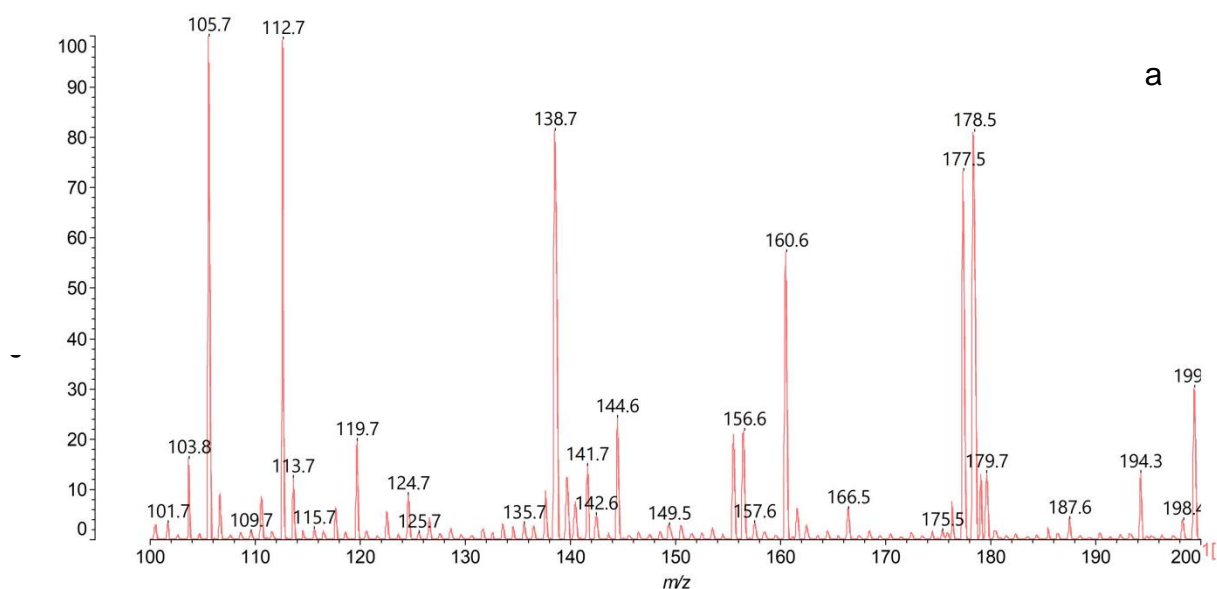
#### III.E.3.b. Condensed tannin structures as revealed by MALDI-TOF

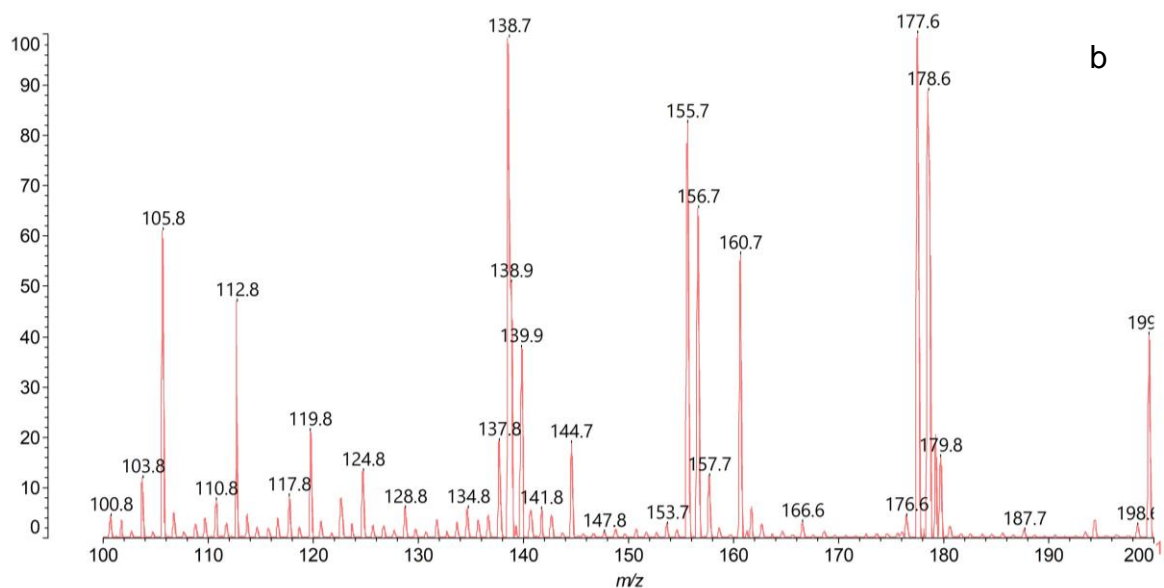
Tannins from *K. ivorensis* sapwood and heartwood were analyzed by MALDI-TOF mass spectrometry. This technique which has been showed to be suitable for condensed tannins evaluation and identification (Pasch et al., 2001); (Pizzi et al., 2004);(Pizzi et al., 2009) was used to elucidate the composition and the molecular structure of *K. ivorensis* tannins. The  $m/z$  of compounds identified in this study was collected in Table 2.

#### III.E.3.c. Proanthocyanidin monomers



The  $m/z$  in the range 250-400 Da (Figure 1) revealed typical peaks at 258.6; 274.5 and 305.5 Da assigned respectively to trihydroxyflavan (F), fisitininidin (A) and galloocatechin (D). These results agreed with those found for *K. ivorensis* bark (Bikoro Bi Athomo et al. 2018) and underlined an homogeneity regarding the tannins composition of *K. ivorensis* wood. Nevertheless, the weak intensity of signal at 258.6 Da suggested low trihydroxyflavan monomers content in these tannins. However, the strong signals of fisitininidin (274.5 Da) and galloocatechin (305.5 Da) observed for the heartwood extracts (Figure 2a) indicated the abundance of these moieties in the inner part of *K. ivorensis* wood wastes. In the light of that result and that reported by Bikoro Bi Athomo et al. (2018) for the bark, one could conclude that fisitininidin and galloocatechin would be in higher extent in *K. ivorensis* bark and heartwood compared to the sapwood.



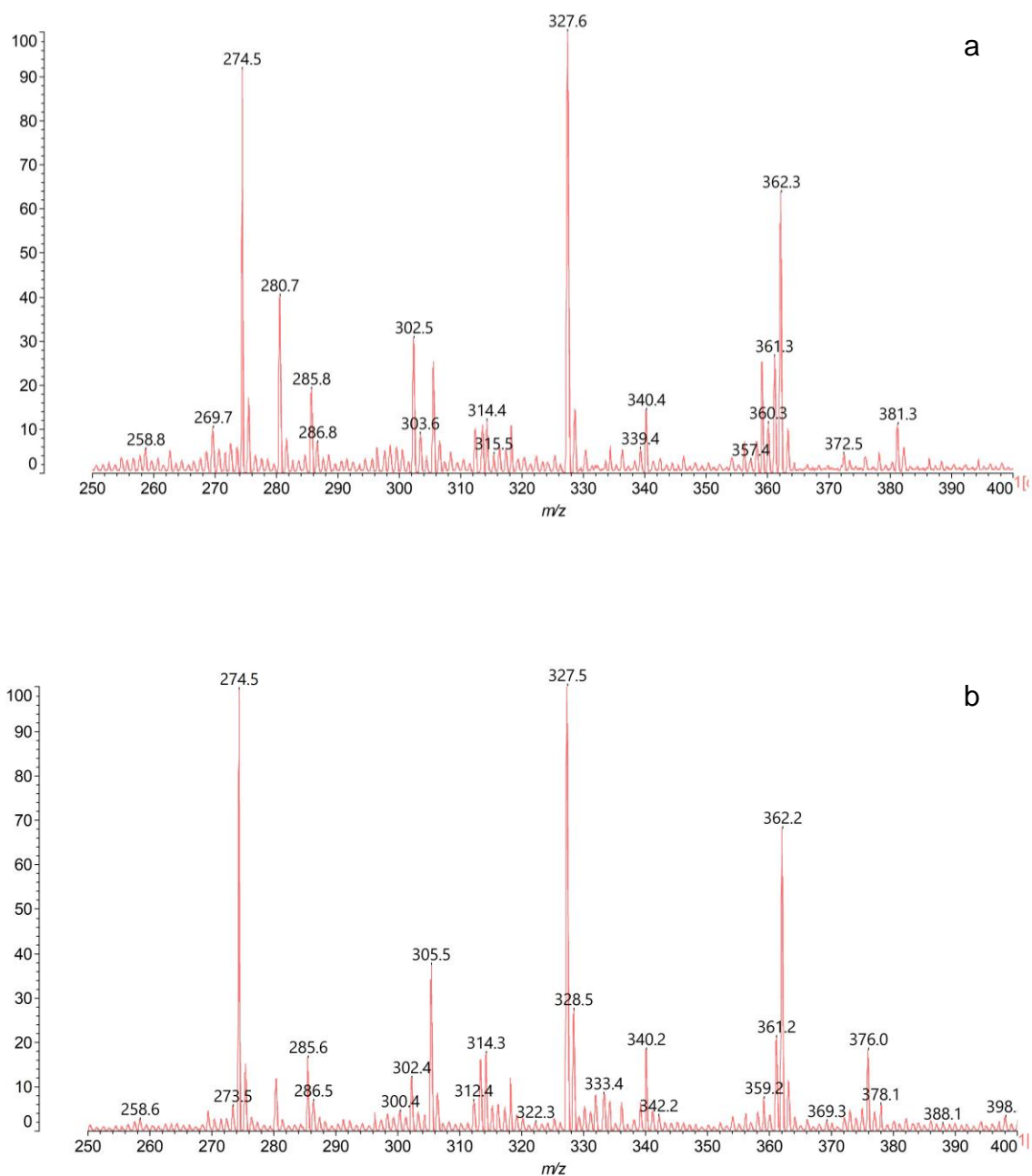


**Figure 1 MALDI-TOF spectrum of tannin extracts from *K. ivorensis* sapwood (a) and heartwood (b) in the range 100-200 Da.**

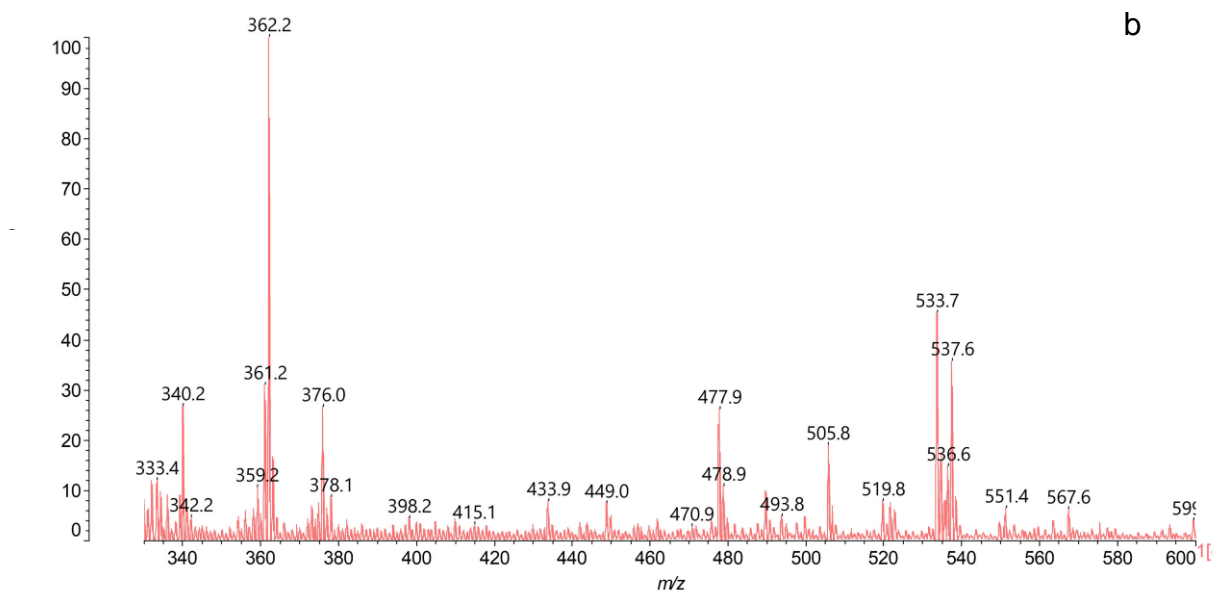
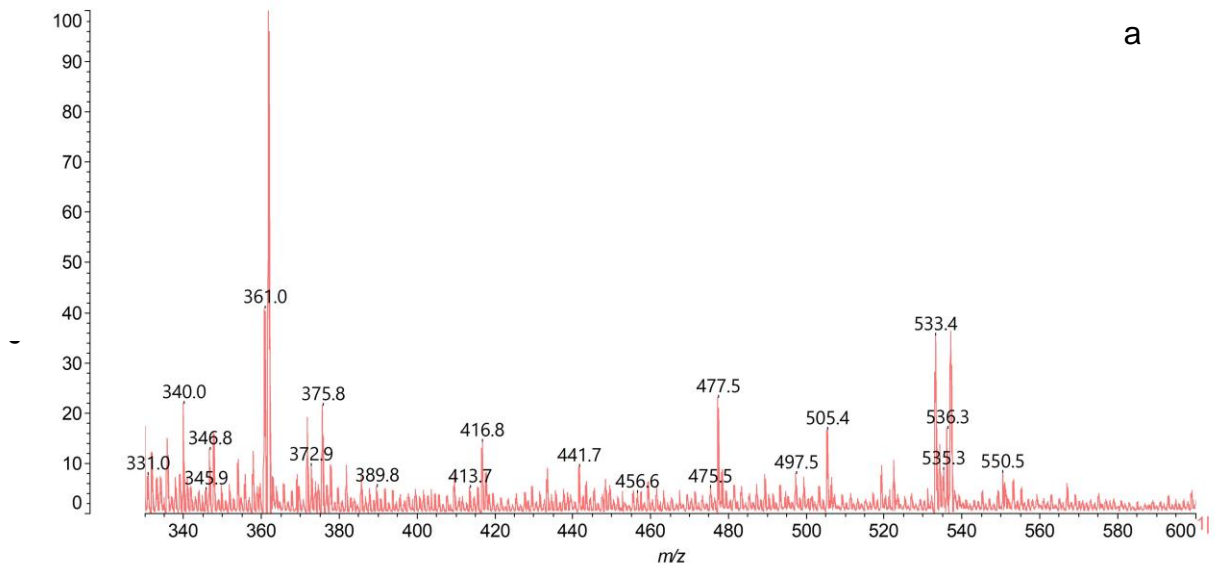
#### III.E.3.d. Proanthocyanidin dimers

Various dimers occurring from condensations between flavonoid units were found in the acetone/water extracts. The first one was observed at 478.9 Da (Figure 3). This should derive from the condensation of a dihydroxyflavan ( $m/z$  242.3 Da) with a dihydroxyflavan which lost  $3xH$  ( $m/z$  242.3- $3xH$ ); thus leading to a dimer of calculated mass 479.3 Da and labelled  $H_1N_1$  in Table 2. A second dimer corresponded to the 500.1 Da peak both in the sapwood and heartwood was assigned to a trihydroxyflavan ( $m/z$  258.6 Da) condensed by a  $C_4-C_8$  bond to a dihydroxyflavan unit, the obtained  $F_1H_1$  dimer of calculated mass 498.6 Da was previously found in *K. ivorensis* bark (Bikoro Bi Athomo et al. 2018). However, the weak intensity of that peak suggested a low content of  $F_1H_1$  dimer in *K. ivorensis* tannins (Figures 2 and 3) 1f). The third condensed tannin dimer appeared at  $m/z$  505-505.8 Da (Figures 2 and 3) and was assigned to a dihydroxyflavan-Na ( $H_2+Na$ ) dimer of calculated mass 505.6 Da. The  $m/z$  519.8 peak belonged to a protonated trihydroxyflavan ( $F_2+4xH$ ) dimer of mass 519.6 (Figures 2 and 3). Nevertheless, the occurrence of  $F_2$  dimer was also noted in the bark of the studied African mahogany. The Medium intensity peak at  $m/z$  551.4-550.5 Da (Figures 2, 3 and 4) was attributed to a protonated fisitinidin ( $546.6+4xH$ ) dimer of mass 550.6 Da, this compound was labelled  $A_2+4xH$  (Table 2) and found both in *K. ivorensis* sapwood and heartwood (Figures 2, 3 and 4). However, no evidence of an  $A_2$  type condensed dimer was found in the bark. Another dimer of weak intensity

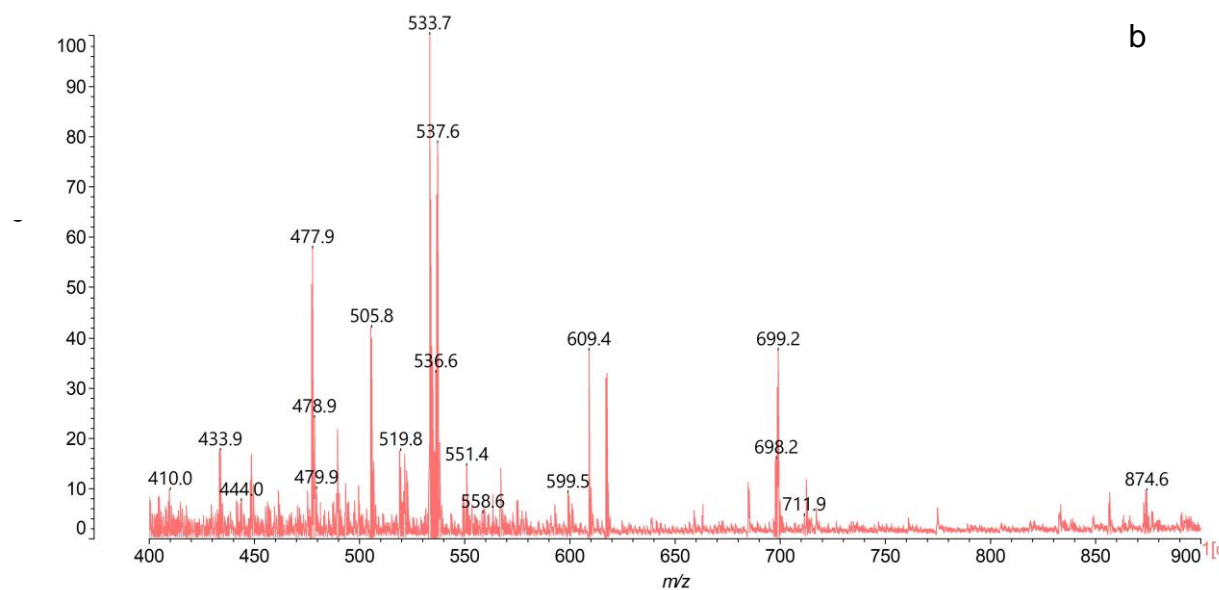
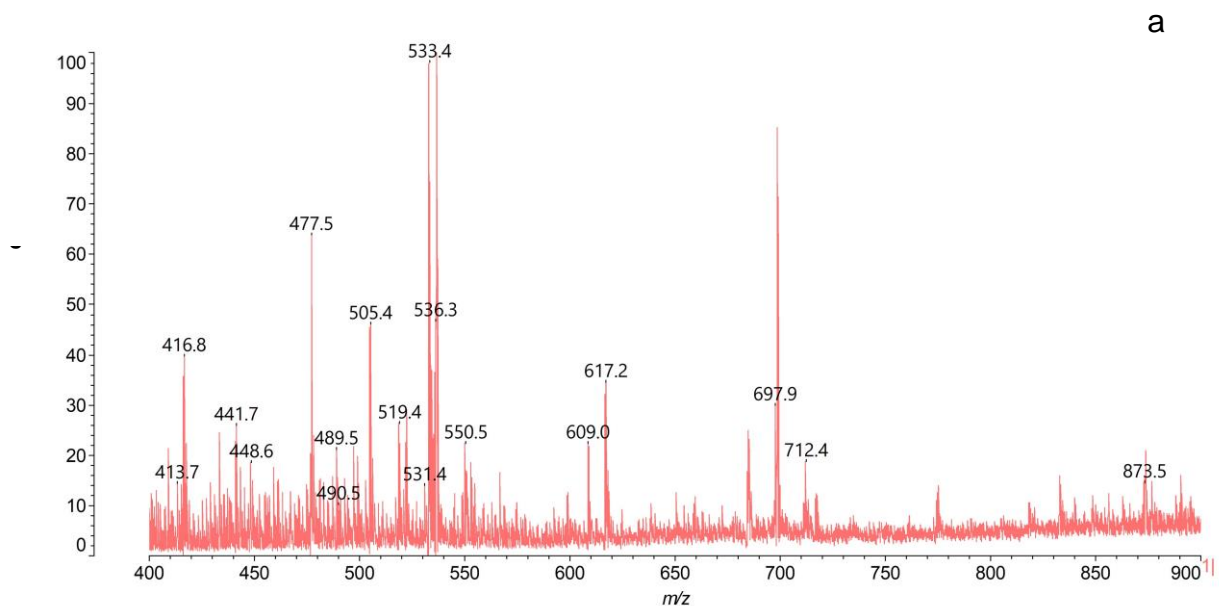
noted T<sub>2</sub> at 599.5 Da and previously described in *K. ivorensis* bark deriving from a gallo catechin dimer which has lost 2x3H (608-6xH) was found both in the sapwood and heartwood (Figure 4). It was noteworthy that a condensed gallo catechin dimer (D<sub>2</sub>) of mass 608.6 Da should appear at *m/z* 609.00-609.4 Da for the two *K. ivorensis* wastes (Figures 4). However, there was no evidence of that gallo catechin dimer in African mahogany's bark studied by Bikoro Bi Athomo et al. (Bikoro Bi Athomo et al., 2018).



**Figure 2 MALDI-TOF spectrum of tannin extracts from *K. ivorensis* sapwood (a) and heartwood (b) in the range 250-400 Da**



**Figure 3 MALDI-TOF spectrum of tannin extracts from *K. ivorensis* sapwood (a) and heartwood (b) in the range 335-600 Da.**

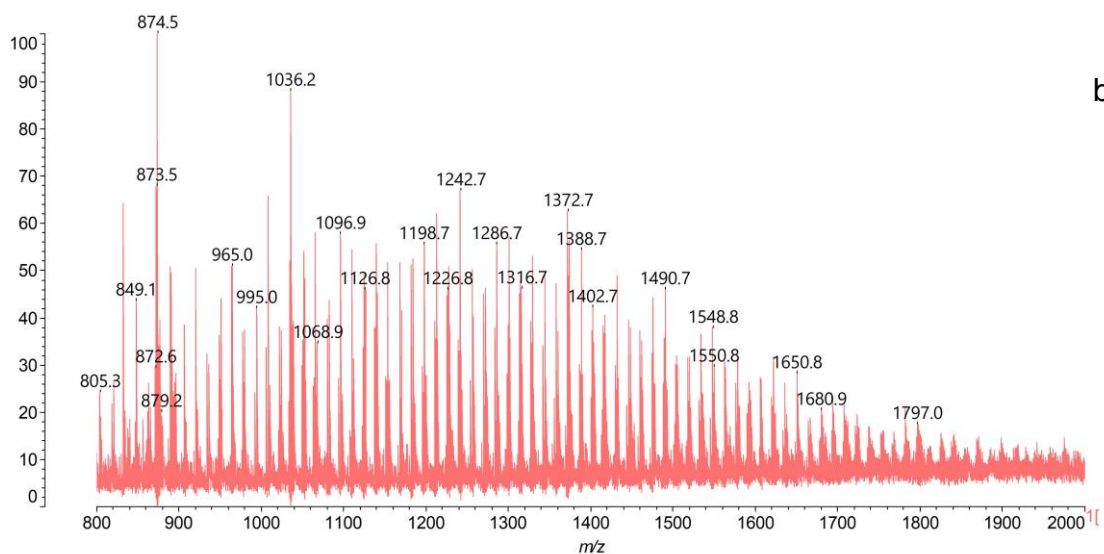
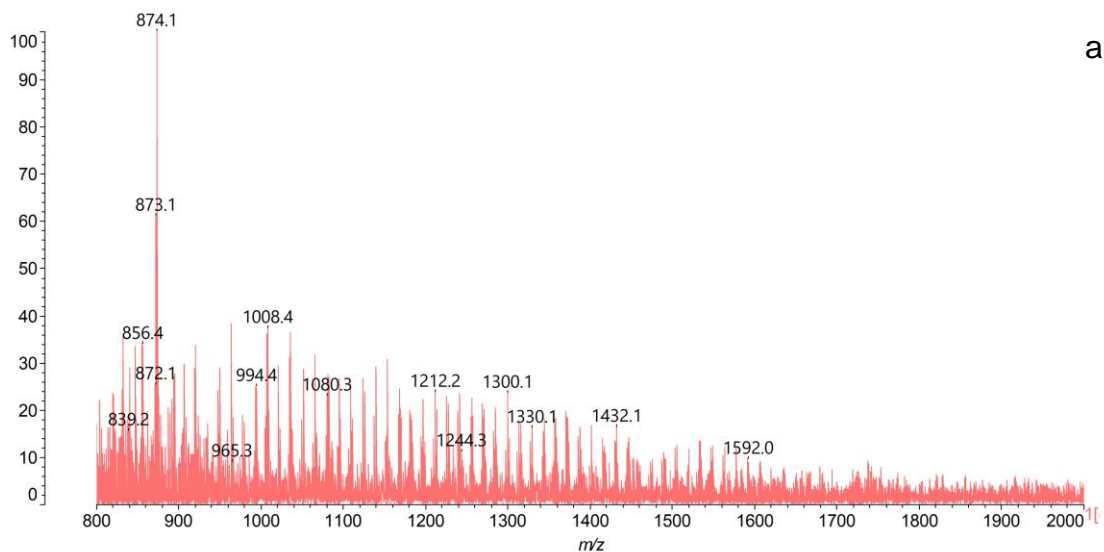


**Figure 4 MALDI-TOF spectrum of tannin extracts from *K. ivorensis* sapwood (a) and heartwood (b) in the range 400-900 Da.**

### III.E.3.e. Proanthocyanidin oligomers

An oligomer series including trimer, tetramer, pentamer and hexamers free from acyl and glycosyl groups were found in *K. ivorensis* condensed tannins. A condensed tannin trimer of two fisitinin units linked to one trihydroxyflavan ( $A_2F_1$ ) of mass 803.4

Da was assigned to the  $m/z$  805.3 Da peak (Figure 5). A fisitinidin exalted sodium trimer ( $A_3Na$ ) of mass 841.9 was assigned to the signal arising at  $m/z$  839.2 Da in the two biomasses spectra (Figure 5). The sapwood and heartwood showed a peak at  $m/z$  849.1 Da ascribed to a condensed tannin trimer from two fisitinidins linked to one trihydroxyflavan unit of mass 850.1 Da (Figure 5). Other condensed tannin oligomers were noted at  $m/z$  874.5-874.1 Da, these signals were assigned to a  $B_2A_1Na$  or  $C_2A_1Na$  trimer (Table 2) deriving from two robitinidins or two catechins condensed with one fisitinidin unit of calculated mass 873.9 Da. The strong signal strength of  $B_2A_1Na$  or  $C_2A_1Na$  trimers suggested a high content of these condensed tannins in the *K. ivorensis* wood (Figure 5).



**Figure 5 MALDI-TOF spectra of tannin extracts from *K. ivorensis* sapwood (a) and heartwood (b) 800-2000 Da.**

Moreover, *K. ivorensis* sapwood and heartwood showed the occurrence of condensed tannin tetramers as listed in Table 2, the corresponding  $m/z$  being in the 1126.8-965.0 Da range (Figure 5). These tetramers had the highest signal strengths for the heartwood and the  $m/z$  965.0 Da peak was assigned to protonated tetrahydroxyflavan tetramer ( $H_4+4xH$ ) of mass 963.2 Da. The peak at  $m/z$  994.4-995.0 Da should be assigned to 1xfisitininidin/3xdihydroxyflavans tetramer ( $A_1H_3$ ) of

mass 949.9 Da. The peak at  $m/z$  1008.4 Da can be ascribed to 1xfisitininidin/1xtrihydroxyflavan/2xdihydroxyflavans condensed tannins tetramer labelled  $A_1F_1H_2$  in Table 2. Furthermore, signal at  $m/z$  1036.2 Da should arise from the loss of 6xH by 2xfisetininidins/1xtrihydroxyflavan/1xdihydroxyflavan ( $A_2F_1H_1$ ) oligomer of mass (1042.2-6xH). In the same manner, the peak at  $m/z$  1068.9 Da was attributed to the loss of 6xH by a tetramer of 3xfisitininidins/1xdihydroxyflavan ( $A_3H_2$ ) of mass (1074.9-6xH). A tetramer of four protonated fisitininidin units ( $A_4$ ) was assigned to  $m/z$  1096.6 Da peak whereas the peak at  $m/z$  1126.8 Da (Figure 5) was depicted to three robitininidins or catechins condensed with one trihydroxyflavan unit ( $B_3H_1$  or  $C_3H_1$ ) of mass 1124.3 Da.

Condensed tannin pentamers were found in *K. ivorensis* sapwood and heartwood as supported by the following signal series: the peak at  $m/z$  1196.7 Da was assigned to dihydroxyflavan pentamer of mass 1198.5 Da while the one at  $m/z$  1212.2 Da was attributed to galocatechin pentamer (Figure 5). Five trihydroxyflavan monomers should rise at  $m/z$  1286.7 Da (Figure 5). A condensation of five fisitininidin monomers leading to  $A_5$  pentamer was ascribed to signal at  $m/z$  1630.0 Da (Figure 5). Moreover, various associations between fisitininidin (A) and trihydroxyflavan (F) monomers should produce  $A_1F_4$ ,  $A_2F_3$ ,  $A_3F_2$  and  $A_4F_1$  pentamers at  $m/z$  1300.1; 1316.7; 1330.5 and 1347.0 Da respectively, as shown in Figure 5 and Tables 2, 5. Nevertheless, pentamers signal strengths remained the strongest for the heartwood tannins as seen in Figure 5.

The presence of condensed tannin hexamers was also observed. Six trihydroxyflavan units ( $F_6$ ) would give the  $m/z$  1539.8 Da peak of calculated mass 1539 Da (Figure 5). The protonated counterpart compound ( $F_6+6xH$ ) at  $m/z$  1548.9 Da confirmed the occurrence of  $F_6$  hexamer in *K. ivorensis* sapwood and heartwood. Additional sapwood and heartwood hexamer was observed at  $m/z$  1680.9 Da, that signal was ascribed to oligomers of 4xfisitininidins/catechin/1xgalocatechin or 4xfisitininidins/1xrobitininidin/1xgalocatechin ( $A_4B_1D_1$  or  $A_4C_1D_1$ ) of mass 1682.2 Da. Nevertheless, signal intensity of these hexamers was approximately twice in the heartwood compared to the sapwood (Figure 5). However, the weakest 1650.8 Da signal strength of  $A_4D_1F_1$  hexamer suggested the almost absence of this compound in the sapwood extracts (Figure 5). These results emphasized the existence of condensed tannin oligomers up to hexamers in *K. ivorensis* sapwood and heartwood,



while the longest bark condensed tannin oligomer was a trimer (Bikoro Bi Athomo et al. 2018) These findings agreed with those reported by (Tondi et al., 2008) who stated that flavonoids can be linked in 2-10 units.

#### III.E.3.f. Proanthocyanidin linked to other functions

As observed in the spectrum discussed above, *K. ivorensis* acetone/water extracts showed similar peak series in the 100-200 Da range (Figure 1). These signals should arise from compounds bearing carbonyl (C=O), acid (COOH) or glycosyl (Gly) groups. The one at  $m/z$  105.7-105.8 was ascribed to benzaldehyde (Kleingeld and Nibbering, 1984). Nevertheless, signal strength at  $m/z$  105.7-105.8 Da suggested that benzaldehyde should be in higher extent in the sapwood than the sapwood. Acid products should also be present in *K. ivorensis* extracts as both the sapwood and heartwood had weak  $m/z$  124.8-124.7 Da peaks of benzoic acid. Signals at  $m/z$  138.7 and 155.7 Da displaying the highest intensity for the heartwood were respectively endorsed to *p*-hydroxybenzoic acid and 3,4-dihydroxybenzoic acid as reported by Ucar et al. (Ucar et al., 2013). The studied acetone/water extracts should contain low gallic acid content for the strength of  $m/z$  166.6-166.5 Da peak was weak, thus supporting what reported for the bark (Bikoro Bi Athomo et al., 2018). In addition, the small  $m/z$  302.2 Da peak intensity assigned to ellagic acid (Ricci et al., 2016) in Figure 2 corroborated the low content of galloyl type compound in *K. ivorensis* sapwood and heartwood.

The occurrence of these galloyl units suggested the presence of hydrolysable tannins in the acetone/water extracts, and the first gallotannin was detected at  $m/z$  413.7 Da (Figure 3). This weak signal was assigned to fisitinidin esterified at the C<sub>3</sub> position of the flavonoid unit by gallic acid (A<sub>1</sub>E<sub>1</sub>). The same trend on low gallotannins content was corroborated by the weak signal strength at  $m/z$  714.7-714.4 Da peak (Figure 4) attributed to 1xfisitinidin/1xgalloocatechin/gallic acid trimer (A<sub>1</sub>D<sub>1</sub>E<sub>1</sub>). Other gallotannins from catechin or robitinidin/gallic acid dimer (C<sub>1</sub>E<sub>1</sub> or B<sub>1</sub>E<sub>1</sub>) should be found at  $m/z$  441.7 Da peak (Figure 4). The signal at  $m/z$  617.2 Da was assigned to isoquercetin-gallate, that compound was previously described in *K. ivorensis* bark (Bikoro Bi Athomo et al. 2018) and found in grape skin condensed tannins (Ricci et al., 2017).

Additional ester like compounds confirmed the presence of hydrolysable tannins in the African mahogany extracts. Hence, dihydroxyflavan or trihydroxyflavan which lost 3xH and subsequently esterified at the C<sub>3</sub> position by *p*-hydroxybenzoic acid respectively labelled N<sub>1</sub>K<sub>1</sub> or P<sub>1</sub>L<sub>1</sub> (Table 2) was assigned to *m/z* 361.2-361.0 Da peak (Figure 3). However, the signal at *m/z* 362.2 Da was assigned to dihydroxyflavan or trihydroxyflavan esterified at the C<sub>3</sub> position by *p*-hydroxybenzoic acid (H<sub>1</sub>L<sub>1</sub> or F<sub>1</sub>L<sub>1</sub>) as claimed for *K. ivorensis* bark. Further monogalloyl flavonoid series of catechin or robitinidin C<sub>4</sub>-C<sub>8</sub> condensed with tetrahydroxyflvan-3-(3,4-dihydroxybenzoic acid) were observed at *m/z* 699.2-699.0 Da (Figure 4). The occurrence of these compounds labelled C<sub>1</sub>G<sub>1</sub> or B<sub>1</sub>G<sub>1</sub> in the sapwood and heartwood (Table 2) corroborated that previously found in *K. ivorensis* bark. Moreover, signal at *m/z* 699.2-699.0 Da should also be assigned to 1xfisetinidin/1xgalocatechin-3-(3,4-dihydroxybenzoic acid) trimer regarded as A<sub>1</sub>D<sub>1</sub>J<sub>1</sub> (Table 2). The strong signal strength of that monogalloyl flavonoid suggested a high content on that compound in the sapwood (Figure 4).

It was outstanding that the strongest signals strength at *m/z* 1140.0; 1226.8; 1242.7 and 1316.7 Da peaks matching respectively for 4xtrihydroxyflavan/1xglutaric acid pentamer (F<sub>4</sub>U<sub>1</sub>), 3xtrihydroxyflavan/1xdihydroxyflavan/2xbenzoic acid hexamer (F<sub>3</sub>H<sub>1</sub>L<sub>2</sub>), 4xtrihydroxyflavan/2xbenzoic acid hexamer (F<sub>4</sub>L<sub>2</sub>) and 5xdihydroxyflavan/1xglutaric acid (H<sub>5</sub>U<sub>1</sub>) hexamer were found in the heartwood (Figure 5). Moreover, signals at *m/z* 1780.0 and *m/z* 1797.0 Da attributed to 4xfisetinidin/1xcatechin/1xgalocatechin/1xlevulenic acid heptamer (A<sub>4</sub>C<sub>1</sub>D<sub>1</sub>V<sub>1</sub>) and 4xfisetinidin/2xgalocatechin/1xlevulenic acid heptamer (A<sub>4</sub>D<sub>2</sub>V<sub>1</sub>) were not identified in the sapwood extracts (Figure 5).

### III.E.3.g. Proanthocyanidin oligomers linked to glycosyl units

An analysis of signals in the range 100-200 Da (Figure 1) showed many degradation products from pentose, hexose or other sugars. Therefore, the signal at *m/z* 137.6-134.8 Da should result from a low fraction of glucose cleavage mechanism of aromatic ring fragment as previously found in Chesnut tannin extracts by Ricci et al. (2016). An arabitol-like sugar should also rose at *m/z* 155.7 Da, that compound of weak intensity was previously described as Chesnut tannins marker (Ricci et al., 2016). The strong peak at *m/z* 178.5 Da and the peak series at 177.5 and 179.7 Da resulted from glucose, mannose (Bikoro Bi Athomo et al. 2018) or other hexoses degradation (Sanchez-De Melo et al. 2015).

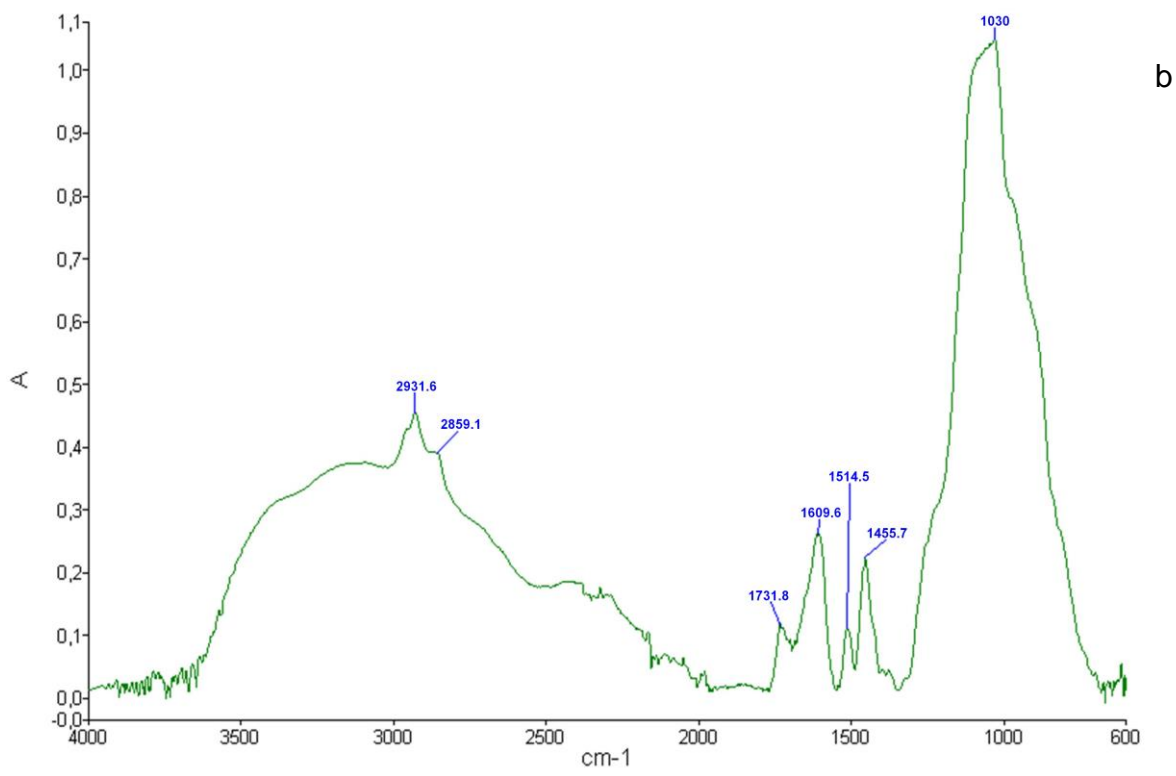
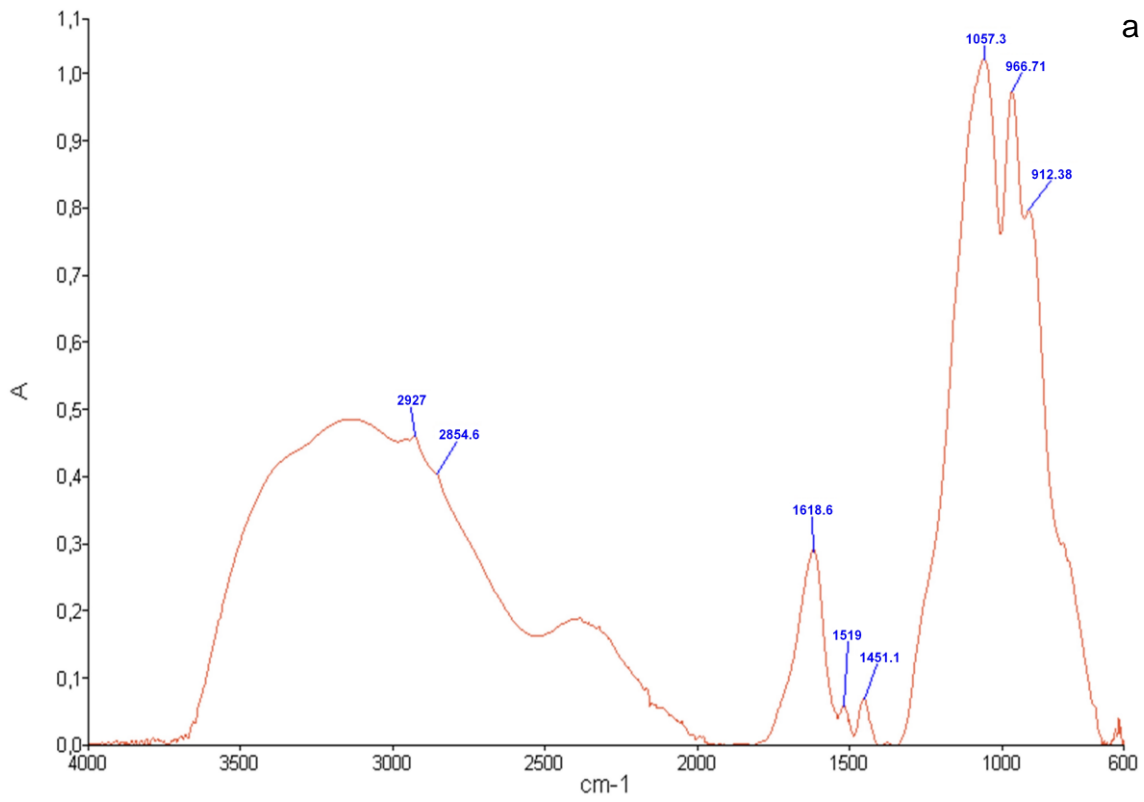
The  $m/z$  177.6; 178.6 and 179.9 Da peak series should be assigned to other sugars like mannitol of  $m/z$  182.2 Da which have lost  $2 \times 1H$  during the MALDI-TOF process (Sanchez-De Melo et al. 2015) as mannitol was found in methanol/water extracts of *K. ivorensis* bark, sapwood and heartwood characterized by LC/MS (personal data). Therefore, the 340.2 Da peak described in *K. ivorensis* bark (Bikoro Bi Athomo et al. 2018) and in other tannins by Sanchez-De-Melo et al. (2015) supported the presence of diglycosyl units of  $m/z$  342.2 Da ( $Gly_2$ ) in *K. ivorensis* sapwood and heartwood acetone/water extracts (Figure 3).

Among the thirty-four types of glycosyl compounds identified in African mahogany acetone/extracts, up to twenty-six appeared as glycosyl linked condensed tannin oligomers (Table 2). One could note that peaks at  $m/z$  416.8 ; 697.9-700 and 856.4 Da were assigned respectively to monoglycosyl-3-fisitinidin ( $F_1Gly_1$ ), protonated monoglycosyl-3-diflavonoid ( $A_1F_1Gly_1$ ) trimer and diglycosyl-3-diflavonoid ( $H_1F_1Gly_2$ ) tetramer; these peaks displayed the sol dominant glycosyl flavonoids signal strength for the sapwood extracts (Figure 3). The major glycosyl flavonoid signals arising from the  $m/z$  965.0 Da peak assigned to monoglycosyl-3-triflavonoid ( $D_1F_1H_1Gly_1$ ) tetramer were the strongest for the heartwood. The increase of glycosyl flavonoids in the 800-2000 Da range corroborated the existence of glycosylated-condensed tannins in *K. ivorensis* wood as previously found in its bark (Bikoro Bi Athomo et al. 2018). Nevertheless, the longest glycosylated flavonoid oligomer found in the sapwood and heartwood contained four glycosyl units, they were tetraglycosyl-3-difisitinidin hexamer ( $A_2Gly_4$ : mass 1198.7 Da) and tetraglycosyl-3-trigallocatechin heptamer ( $D_3Gly_4$ : mass 1560.0 Da), both have lost  $6 \times H$ . Furthermore, the following tetraglycosyl-3-flavonoids heptamer ( $A_2C_1Gly_4$ : mass 1490.7 Da;  $A_1C_2Gly_4$ : mass 1504.5 Da;  $C_3Gly_4$ : mass 1520.0 Da) which exhibited the strongest signal strength for the heartwood tannins should be more abundant in the inner wood of *K. ivorensis*. The occurrence of glycosyl units in tannins was described earlier by (Pizzi et al., 1985), and MALDI-TOF of African locust bean tree revealed the presence of flavonoid oligomers linked to chains having up to 22 carbohydrate residues (Drovou et al., 2015).

#### III.E.3.h. Condensed tannin structures as revealed by FTIR

The occurrence of condensed tannins was confirmed by 1618.6-1609.6  $cm^{-1}$  and 1519-1451.1  $cm^{-1}$  FTIR bands (Figure 6) assigned respectively to their C=C-C and C-O aromatic ring stretching (Falcão and Araújo, 2013). In addition, the 1514.6 and

1455.7  $\text{cm}^{-1}$  bands assigned to C=C aromatic ring stretching vibration which displayed high intensities was closely related to the presence of condensed tannins (Pandey, 1999); (dos Santos Grasel et al., 2016); (Broda and Popescu, 2019). Qualitative analysis of 1514.6 and 1455.7  $\text{cm}^{-1}$  bands suggested a high content of condensed tannins in the heartwood (Figure 6). That result supported the MALDI-TOF signal strength in 2500-2000 Da range which suggested a high content of condensed tannins in the heartwood compared to the sapwood (Figures 2, 3 and 4). On the other hand, the broad between 3500 and 3000  $\text{cm}^{-1}$  attributed to O-H stretching vibration of phenols (Ucar et al., 2013); (dos Santos Grasel et al., 2016); (Ricci et al., 2016) confirmed accordingly the presence of tannins in *K. ivorensis* xylem. Other functional groups such as C=O from ester or acid groups of hydrolysable tannins were found in the *K. ivorensis* wood extracts. The most pronounced peak high of C=O stretching was exhibited by the heartwood at 1731.8  $\text{cm}^{-1}$  (Figure 6) whereas this band lacked in sapwood. That qualitative result suggested a higher content on hydrolysable tannins in the heartwood than the sapwood and was in close agreement with the MALDI-TOF results. Moreover, the high signal strength of condensed tannins linked glutaric acid ( $\text{H}_5\text{U}_1$ ,  $m/z$  1316.7 Da) or levulinic acid ( $\text{A}_4\text{C}_1\text{D}_1\text{V}_1$ ,  $m/z$  1780 Da;  $\text{A}_4\text{D}_2\text{V}_1$ ,  $m/z$  1798 Da) bearing  $-(\text{CH}_2)_3\text{-COOH}$  and  $-(\text{CH}_2)_2\text{-CO-CH}_3$  pending chains should have strengthened the C=O band in the heartwood FTIR spectra in particular.



**Figure 6 FTIR analysis spectra of tannins extracted from *K. ivorensis* sapwood (a) and heartwood (b).**

The presence of free  $\nu(\text{O-H})$  of carboxylic groups in these esterified condensed tannins should explain the broad at  $2800\text{-}2500\text{ cm}^{-1}$  previously reported by various authors (Safou-Tchiama et al., 2007, 2017; Pretsch et al. 2013).

The fingerprint in  $1300\text{-}600\text{ cm}^{-1}$  range usually assigned to sugars or tannin bonds pointed out differences between the sapwood and heartwood (Figure 6). However, the sapwood tannins spectrum was very close to the bark one (Bikoro Bi Athomo et al. 2018). That result suggested a strong similarity between the sugars composition of *K. ivorensis* bark and sapwood. Although the qualitative aspect of FTIR data recorded in this study did not allow an absolute discrimination between mannose, glucose and other sugars in the sapwood and heartwood extracts. An analysis of the  $1300\text{-}600\text{ cm}^{-1}$  range showed that bands at  $1057.3$ ,  $966.71$  and  $912.37\text{ cm}^{-1}$  were more prominent in the sapwood while they appeared as shoulders in the heartwood (Figure 6). These bands assigned to mannose supported at least the occurrence of that hexose among the sugars released by *K. ivorensis* acetone/water extracts. However, the heartwood exhibited a prominent band centered at  $1035\text{ cm}^{-1}$ , such a band should be assigned to antisymmetric aliphatic  $\nu(\text{C-O})$  of ellagic acid (Ricci et al., 2016) (Ricci et al., 2017) glucose primary alcohols (Bodirlau and Teaca, 2009) or glucose pyran ring (Zheng et al., 2016). Although the weak signal strength of ellagic acid at  $m/z\ 302.2\text{ Da}$  (Figure 2) or other galloyl units discussed above which suggested a low content of hydrolysable tannins in the investigated extracts, the  $1514.5\text{ cm}^{-1}$  peak height supported again a high content of condensed tannins in *K. ivorensis* heartwood. On the other hand, the band centered at  $1035\text{ cm}^{-1}$  would indicate the presence of high glucose content in *K. ivorensis* heartwood; the aliphatic ( $-\text{CH}-$ ,  $-\text{CH}_2-$ ) bonds of that hexose would contribute to strengthen signals at  $2931.6\text{-}2927\text{ cm}^{-1}$  and  $2859.1\text{-}2931.6\text{ cm}^{-1}$  usually ascribed to  $\nu(\text{C-H})$  of  $-\text{CH}-$ ,  $-\text{CH}_2-$  and  $-\text{CH}_3-$  in tannins (Boeriu et al., 2004) (Geethu et al., 2014) (dos Santos Grasel et al., 2016). Furthermore, the abundance of heartwood tannins in  $-(\text{CH}_2)_3\text{-COOH}$  and  $-(\text{CH}_2)_2\text{-CO-OCH}_3$  alkyl chains would not be in rest for the strong intensity of its  $2931.6\text{-}2927\text{ cm}^{-1}$  bands (Figure 6).

### III.E.3.i. Stiasny number determination

To avoid any drawback due to the presence of glycosyl units linked to condensed tannins in the reactivity between the flavonoid ring and formaldehyde, the condensation of formaldehyde with the sapwood and heartwood tannins was

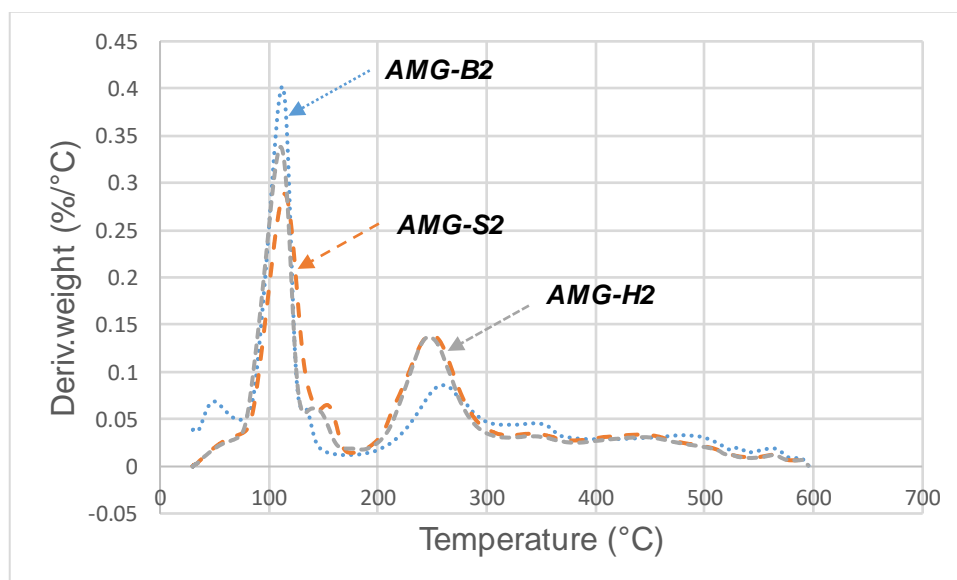
performed on samples extracted by the semi industrial (0.25% of NaOH, 0.25 % of Na<sub>2</sub>SO<sub>3</sub> and 0.25% of NaHSO<sub>3</sub>) based process. The Stiasny numbers (*SI*) shown in Table 3 did not point out inter nor intra-tree significant differences between the bark, sapwood and heartwood tannins ( $p>0.05$ ) whatever the selected tree. However, the global *SI* in the area of sampling revealed the lack of difference between the bark and the heartwood ( $p>0.05$ ). However, significant differences are observed between the bark and the sapwood ( $P<0.02$ ) or the sapwood and the heartwood ( $p=0.046$ ) which underline differences of reactivity with formaldehyde. Furthermore, all the *SI* were above 46% defined as an acceptable limit for the production of good quality adhesives (Ping et al., 2011; Spina et al., 2013). Conversely, all the averaged *SI* of *K. ivorensis* were above 65% determined as a minimum for adhesives of high quality (Yazaki and Collins, 1994). These findings show clearly the strong potential of *K. ivorensis* to be a source of raw materials for adhesives of good to high quality.

The averaged *SI* of *K. ivorensis* were greater than those published by (Navarrete et al., 2012)) for tropical hardwood tannins of commercial interest like quebracho (88.32%) and mimosa (92.2%). The condensation of *K. ivorensis* tannins with formaldehyde gave also interesting results compared to those reported for softwood tannins from temperate zones like *Pinus pinaster* bark (17; 48 and 54%) and brutia pine (88.80%) (Chupin et al. 2013). These results highlighted the strong capability of *K. ivorensis* wood wastes to provide commercial condensed tannins of high quality.

#### III.E.3.j. Thermogravimetric analysis and differential scanning calorimetry of *K. ivorensis* tannins extractives

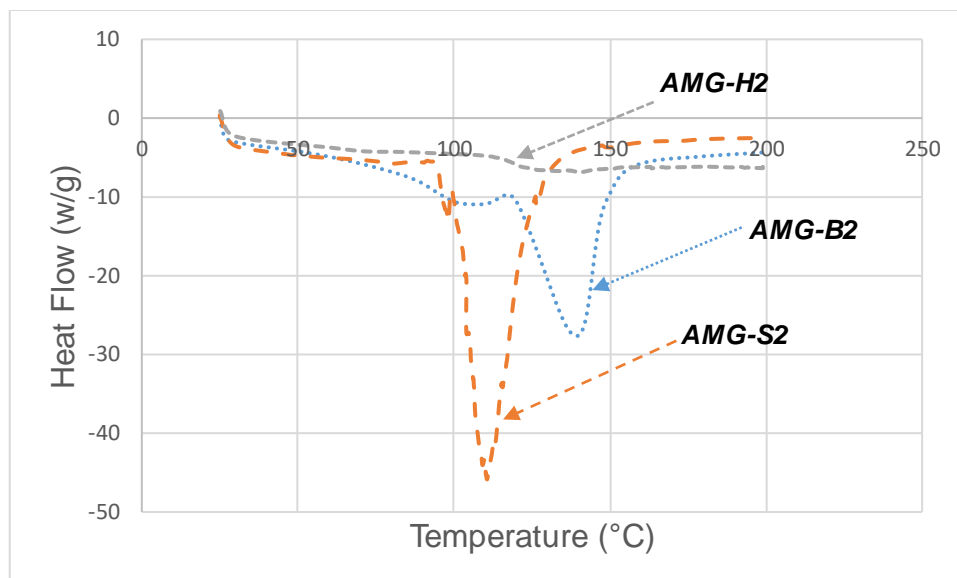
The thermogravimetric analysis curves of *K. ivorensis* were conducted under nitrogen (Figure 7). The data obtained were collected in Tables 4 and Table 6 for TGA and DSC respectively were obtained from averaged values of *K. ivorensis* condensed tannins. TGA and DTG features (Figures 7) showed two typical mass losses of condensed tannins thermal phenomena and intermediary rates which concerned temperatures at 95% of residual mass loss ( $T_{95\%}$ ). The temperatures of degradation indicated a better thermal stability of sapwood tannins which degraded at  $T_{95\%}=104.69^{\circ}\text{C}$  compared to the heartwood ( $98.05^{\circ}\text{C}$ ) and the bark ( $95.59^{\circ}\text{C}$ ). The  $T_{95\%}$  and the onset of first temperature of degradation ( $T_d^1$ ) which didn't vary between the samples (Table 4) emphasized a thermal homogeneity of *K. ivorensis* bark, sapwood and heartwood condensed tannins. The corresponding maximum

temperatures of first degradation ( $T_{max}^1$ ) showed that the sapwood and heartwood had the same thermal behavior ( $p>0.05$ ) while the low  $T_{max}^1$  ( $109.70\pm 1.87^\circ\text{C}$ ) displayed by the bark tannins suggested more susceptibility to thermal degradation than the heartwood (Table 4) in particular.  $T_{max}^1$  which corresponds to absorbed moisture and volatiles compounds, carbohydrate evaporation (Gaugler and Grigsby, 2009; Basso et al., 2017) indicates that easily-thermally degraded simple sugars and organic acids of low molecular weights (Baaka et al., 2017) should be easily eliminated from *K. ivorensis* bark tannins with regard to the heartwood. The onset temperature of second degradation ( $T_d^2$ ) varied in the average 206-207 $^\circ\text{C}$  (Table 4) and culminated at  $T_{max}^2$  as shown in Figure 7 and Table 4. The strong sharp peaks were assigned to thermal decomposition of intermolecular C-O bonds in the flavone C-ring structures or to the breaking of intermolecular C-C bonds between tannin monomers (Saad et al., 2014). The lack of significant difference on  $T_{max}^2$  values (Table 4) should be a consequence of similar molecular structures between the bark, sapwood and heartwood condensed tannins as pointed out by the MALDI-TOF and FTIR results discussed above. This trend was reinforced by their residual masses at the high temperature of 600 $^\circ\text{C}$  ( $W_{600}^R$ ) which did not show significant difference ( $p>0.05$ ) (Figure 7, Table 4).



**Figure 7** DTG spectra of condensed tannins extracted from the bark (AMG-B2) sapwood (AMG-S2) and heartwood (AMG-H2) of *K. ivorensis*. Samples heated at 10 $^\circ\text{C}/\text{min}$  under nitrogen. Tree number 2 (AMG2) was taken for illustration.





**Figure 8** Differential scanning calorimetry spectra of condensed tannins extracted from the bark (AMG-B2) sapwood (AMG-S2) and heartwood (AMG-H2) of *K. ivorensis*. Samples heated at 10°C/min under nitrogen.

Furthermore, differential scanning calorimetry analysis showed two major domains (Figure 8). The first peaks appearing as shoulders centered at 92-96°C for the three condensed tannins were assigned to glass transition. It was worth mentioning that the condensed tannins studied didn't show significant difference between their endothermic peaks of absorbed water elimination (Shnawa et al., 2016), and the lack of statistical difference regarding the softening points of the bark, sapwood and heartwood tannins (Table 6) suggests that similar softening properties would be expected from African mahogany, and the averaged softening point of *K. ivorensis* was  $114.05 \pm 5.02^\circ\text{C}$ . Furthermore, the second and most prominent peaks depicted between 120 and 133°C assigned to endothermic elimination in condensed tannins as previously reported for other wood species (Gaugler and Grigsby, 2009) didn't show significant difference between the three condensed tannins. The average fusion point of *K. ivorensis* tannins was  $124.58 \pm 8.17^\circ\text{C}$ .

Unlike synthetic polymers, *K. ivorensis* tannins did not exhibit the states of crystallization, crosslinking or oxidation. When compared to other tannins data (Gaugler and Grigsby, 2009; Lisperguer et al., 2016), *K. ivorensis* bark, sapwood and heartwood tannins would have a stability similar to quebracho. Nevertheless, *K. ivorensis* tannins displayed better thermal stability than chestnut and mimosa tannins.

These findings highlighted the good thermal stability of *K. ivorensis* condensed tannins in line with that of commercial tannin standards.

### **III.F. Conclusion**

The condensed tannins extracted from the bark, sapwood and heartwood of *K. ivorensis* collected in a natural forest of Gabon were studied. Although the limited samples, the yields obtained in this study did not show significant intra-tree difference between the three parts of the wood. However, an inter-tree variability should be noted in the area of sampling, with the heartwood richer in condensed tannins. No significant intra-tree difference was found regarding the reactivity between *K. ivorensis* condensed tannins and formaldehyde while an inter-tree variability would be expected between the bark and the sapwood as well as the sapwood and the heartwood tannins. The resulting Stiasny numbers would qualify *K. ivorensis* tannins for adhesives of high quality. With the exception of adsorbed water or molecule of low weights released at temperature nearly 100°C, TGA and DSC did not show significant intra or inter-tree thermal variability between the *K. ivorensis* condensed tannins. These African mahogany's polyphenols exhibited temperatures of degradation above those found for commercial condensed tannins, which highlighted their potential utilization for new eco-friendly materials such as green adhesives. Despite these promising results, further investigations including nuclear magnetic resonance (NMR), liquid chromatography coupled to mass spectroscopy (LC/MS) analysis and thermomechanical studies are necessary to discriminate clearly between the adhesive properties of *K. ivorensis* bark, sapwood and heartwood and their real economic value. In addition, the occurrence of high amount of glycosylated phenols in *K. ivorensis* acetone/water extracts should open new opportunities for biological valorization of that African mahogany's wood wastes.

#### **Acknowledgements**

We gratefully acknowledge the financial support of the Agence Nationale des Bourses du Gabon (ANBG). The Université de Pau et des Pays de l'Adour are thanked for the material support and facilities offered by the ANR-10-EQPX-16 Xyloforest (Xylomat, Mont de Marsan).

### **III.G. References**

Abdelgaleil, S.A., Hashinaga, F., Nakatani, M., 2005. Antifungal activity of limonoids from *Khaya ivorensis*. *Pest Manag. Sci.* 61, 186–190.

Baaka, N., Haddar, W., Ben Ticha, M., Amorim, M.T.P., M'Henni, M.F., 2017. Sustainability issues of ultrasonic wool dyeing with grape pomace colourant. *Nat. Prod. Res.* 31, 1655–1662.

Basso, M.C., Pizzi, A., Maris, J.P., Delmotte, L., Colin, B., Rogeau, Y., 2017. MALDI-TOF, <sup>13</sup>C NMR and FTIR analysis of the cross-linking reaction of condensed tannins by triethyl phosphate. *Ind. Crops Prod.* 95, 621–631.

Belewu, M.A., Olatunde, O.A., Giwa, T.A., 2009. Underutilized medicinal plants and spices: Chemical composition and phytochemical properties. *J. Med. Plants Res.* 3, 1099–1103.

Bikoro Bi Athomo, A., Engozogho Anris, S.P., Safou-Tchiama, R., Santiago-Medina, F.J., Cabaret, T., Pizzi, A., Charrier, B., 2018. Chemical composition of African mahogany (*K. ivorensis* A. Chev) extractive and tannin structures of the bark by MALDI-TOF. *Ind. Crops Prod.* 113, 167–178.

Bodirlau, R., Teaca, C.A., 2009. Fourier transform infrared spectroscopy and thermal analysis of lignocellulose fillers treated with organic anhydrides. *Rom J Phys* 54, 93–104.

Boeriu, C.G., Bravo, D., Gosselink, R.J., van Dam, J.E., 2004. Characterisation of structure-dependent functional properties of lignin with infrared spectroscopy. *Ind. Crops Prod.* 20, 205–218.

Broda, M., Popescu, C.-M., 2019. Natural decay of archaeological oak wood versus artificial degradation processes — An FT-IR spectroscopy and X-ray diffraction study. *Spectrochim. Acta. A. Mol. Biomol. Spectrosc.* 209, 280–287. <https://doi.org/10.1016/j.saa.2018.10.057>

Chupin, L., Motillon, C., Charrier-El Bouhtoury, F., Pizzi, A., Charrier, B., 2013. Characterisation of maritime pine (*Pinus pinaster*) bark tannins extracted under different conditions by spectroscopic methods, FTIR and HPLC. *Ind. Crops Prod.* 49, 897–903.

dos Santos Grasel, F., Ferrão, M.F., Wolf, C.R., 2016. Development of methodology for identification the nature of the polyphenolic extracts by FTIR associated with multivariate analysis. *Spectrochim. Acta. A. Mol. Biomol. Spectrosc.* 153, 94–101.

Drovou, S., Pizzi, A., Lacoste, C., Zhang, J., Abdulla, S., El-Marzouki, F.M., 2015. Flavonoid tannins linked to long carbohydrate chains–MALDI-TOF analysis of the tannin extract of the African locust bean shells. *Ind. Crops Prod.* 67, 25–32.

Ekomy Ango, S., Moutou Pitti, R., 2017. caractéristiques mécaniques et thermiques d'une brique d'argile à base de sciure de bois du Gabon. *GDR 3544 « Sci. Bois »* 38–39.

Falcão, L., Araújo, M.E., 2013. Tannins characterization in historic leathers by complementary analytical techniques ATR-FTIR, UV-Vis and chemical tests. *J. Cult. Herit.* 499–508. <https://doi.org/10.1016/j.culher.2012.11.003>

Gaugler, M., Grigsby, W.J., 2009. Thermal Degradation of Condensed Tannins from Radiata Pine Bark. *J. Wood Chem. Technol.* 29, 305–321. <https://doi.org/10.1080/02773810903165671>

Geethu, M.G., Suchithra, P.S., Kavitha, C.H., Aswathy, J.M., Dinesh, B., Murugan, K., 2014. Fourier-transform infrared spectroscopy analysis of different solvent extracts of water Hyacinth (*Eichhornia Crassipes Mart Solms.*) an allelopathic approach. *World J. Pharm. Pharm. Sci.* 3, 1256–1266.

Heryati, Y., Belawan, D., Abdu, A., Mahat, M.N., Abdul Hamid, H., Majid, N., Muhamad, N., Hassan, A., 2011. Growth performance and biomass accumulation of a *Khaya ivorensis* plantation in three soil series of ultisols. *Am. J. Agric. Biol. Sci.* 6, 33–44.

Kalendi, M.N., Safou-Tchiama, R., Souloungounga, P., Mabicka, I.S.B., Nzue, O.J.L., Tasi, M.J.P., Ndoutoume, C., 2016. Evaluation of anatomical and physical properties of *Khaya nthotheca* (Welw.) C. DC. from forests of different altitudes in the democratic Republic of Congo. *J. Res. For. Wildl. Environ.* 8, 116–125.

Karou, D., Dicko, M.H., Simporé, J., Traore, A.S., 2005. Antioxidant and antibacterial activities of polyphenols from ethnomedicinal plants of Burkina Faso. *Afr. J. Biotechnol.* 4, 823–828.

Kleingeld, J.C., Nibbering, N.M.M., 1984. A fourier transform ion cyclotron resonance study of the gas phase negative ion chemistry of benzaldehyde. *Tetrahedron* 40, 2789–2794.

Koumba Zaou, P, Nze Nguema, S, Mapaga, D, Delporte, P, 1998. Croissance de 13 essences de bois d'oeuvre planté en forêt Gabonaise. *Bois For. Trop.* 2, 21–33.

Lisperguer, J., Saravia, Y., Vergara, E., 2016. Structure and thermal behavior of tannins from *Acacia dealbata* bark and their reactivity toward formaldehyde. *J. Chil. Chem. Soc.* 61, 3188–3190. <https://doi.org/10.4067/S0717-97072016000400007>

Navarrete, P., Pizzi, A., Pasch, H., Delmotte, L., 2012. Study on Lignin–Glyoxal Reaction by MALDI-TOF and CP-MAS <sup>13</sup>C-NMR. *J. Adhes. Sci. Technol.* 26, 1069–1082. <https://doi.org/10.1163/016942410X550030>

Nze Nguema, S., 2009. Présentation du secteur Forestier au Gabon.

Pandey, K.K., 1999. A study of chemical structure of soft and hardwood and wood polymers by FTIR spectroscopy. *J. Appl. Polym. Sci.* 71, 1969–1975.

Pasch, H., Pizzi, A., Rode, K., 2001. MALDI–TOF mass spectrometry of polyflavonoid tannins. *Polymer* 42, 7531–7539.

Ping, L., Pizzi, A., Guo, Z.D., Brosse, N., 2011. Condensed tannins extraction from grape pomace: characterization and utilization as wood adhesives for wood particleboard. *Ind. Crops Prod.* 34, 907–914.

Pizzi, A., Cameron, F.-A., Eaton, N.J., 1985. The tridimensional structure of polyflavonoid tannins by conformational analysis. *J. Macromol. Sci.* 22, 515–540.

Pizzi, A., Pasch, H., Rode, K., Giovando, S., 2009. Polymer structure of commercial hydrolysable tannins by MALDI-TOF mass spectrometry. *JApplPolymer Sci* 113, 3847–3859.

Pizzi, A., Pasch, H., Simon, C., Rode, K., 2004. Structure of Resorcinol, Phenol, and Furan Resins by MALDI-TOF Mass Spectrometry and <sup>13</sup>C NMR. *JApplPolymer Sci* 92, 2665 – 2674.

Pretsch, E., Clerc, T., Seibl, J., Simon, W., 2013. *Tables of Spectral Data for Structure Determination of Organic Compounds.* Springer Science & Business Media.

Ricci, A., Lagel, M.-C., Parpinello, G.P., Pizzi, A., Kilmartin, P.A., Versari, A., 2016. Spectroscopy analysis of phenolic and sugar patterns in a food grade chestnut tannin. *Food Chem.* 425–429.

Ricci, A., Parpinello, G.P., Palma, A.S., Teslić, N., Brilli, C., Pizzi, A., Versari, A., 2017. Analytical profiling of food-grade extracts from grape (*Vitis vinifera* sp.) seeds and skins, green tea (*Camellia Sinensis*) leaves and Limousin oak (*Quercus robur*) heartwood using MALDI-TOF-MS, ICP-MS and spectrophotometric methods. *J. Food Compos. Anal.* 1–14.

Saad, H., Khoukh, A., Ayed, N., Charrier, B., Bouhtoury, F.C.-E., 2014. Characterization of Tunisian Aleppo pine tannins for a potential use in wood adhesive formulation. *Ind. Crops Prod.* 61, 517–525. <https://doi.org/10.1016/j.indcrop.2014.07.035>

Safou-Tchiama, R., de Jéso, B., Akagah, A.G., Sèbe, G., Pétraud, M., 2007. A preliminary survey of the interfacial bonding of some tropical hardwoods towards succinic anhydride and 2-octen-1-yl succinic anhydride molecules: Impact of lignin and carbohydrate polymers structure on the chemical reactivity. *Ind. Crops Prod.* 26, 173–184.

Sanchez-De Melo, I., Grassi, P., Ochoa, F., Bolivar, J., García-Cózar, F.J., Durán-Ruiz, M.C., 2015. N-glycosylation profile analysis of Trastuzumab biosimilar candidates by Normal Phase Liquid Chromatography and MALDI-TOF MS approaches. *J. Proteomics* 127, 225–233.

Shnawa, H.A., Jahani, Y., Khalaf, M.N., Taobi, A.H., 2016. The potential of tannins as thermal co-stabilizer additive for polyvinyl chloride. *J. Therm. Anal. Calorim.* 123, 1253–1261. <https://doi.org/10.1007/s10973-015-5082-2>

Spina, S., Zhou, X., Segovia, C., Pizzi, A., Romagnoli, M., Giovando, S., Pasch, H., Rode, K., Delmotte, L., 2013. Phenolic resin adhesives based on chestnut (*Castanea sativa*) hydrolysable tannins. *J. Adhes. Sci. Technol.* 27, 2103–2111. <https://doi.org/10.1080/01694243.2012.697673>

Tekpetey, S.L., Essien, C., Appiah-Kubi, E., Opuni-Frimpong, E., Korang, J., 2016. Evaluation of the chemical composition and natural durability of natural and

plantation grown African Mahogany *Khaya ivorensis* A. Chev. in Ghana. *J. Indian Acad. Wood Sci.* 13, 152–155. <https://doi.org/10.1007/s13196-016-0179-1>

Tondi, G., Pizzi, A., Pasch, H., Celzard, A., 2008. Structure degradation, conservation and rearrangement in the carbonisation of polyflavonoid tannin/furanic rigid foams – A MALDI-TOF investigation. *Polym. Degrad. Stab.* 93, 968–975. <https://doi.org/10.1016/j.polymdegradstab.2008.01.024>

Ucar, M.B., Ucar, G., Pizzi, A., Gonultas, O., 2013. Characterization of *Pinus brutia* bark tannin by MALDI-TOF MS and <sup>13</sup>C NMR. *Ind. Crops Prod.* 49, 697–704.

Ugoh, S.C., Agarry, O.O., Garba, S.A., 2014. Studies on the antibacterial activity of *Khaya senegalensis* [(Desr.) A. Juss)] stem bark extract on *Salmonella enterica* subsp. *enterica* serovar Typhi [(ex Kauffmann and Edwards) Le Minor and Popoff]. *Asian Pac. J. Trop. Biomed.* 4, S279–S283. <https://doi.org/10.12980/APJTB.4.2014C636>

Voulgaridis, E., Grigoriou, A., Passialis, C., 1985. Investigations on bark extractives of *Pinus halepensis* Mill. *Holz Als Roh- Werkst.* 43, 269–272.

Yazaki, Y., Collins, P.J., 1994. Wood adhesives based on tannin extracts from barks of some pine and spruce species. *Holz Als Roh- Werkst.* 52, 307.

Zheng, Y., Zhang, S., Wang, Q., Lu, X., Lin, L., Tian, Y., Xiao, J., Zheng, B., 2016. Characterization and hypoglycemic activity of a  $\beta$ -pyran polysaccharides from bamboo shoot (*Leleba oldhami* Nakal) shells. *Carbohydr. Polym.* 144, 438–446. <https://doi.org/10.1016/j.carbpol.2016.02.073>

**Table 1****Alkaline extraction yields (Mean±SD) of *K. ivorensis* tannins bark, sapwood and heartwood from three trees.**

K. ivorensis type sample condensed tannins	Tree type		
	AMG1 (%)	AMG2 (%)	AMG3 (%)
Bark	36.91±18.68 <sup>a,b</sup>	39.10±6.1 <sup>d</sup>	37.66±8.61 <sup>e</sup>
Sapwood	47.78±3.35 <sup>a</sup>	44.2±9.75 <sup>d</sup>	46±7.89 <sup>e</sup>
Heartwood	55.74±3.48 <sup>c,b</sup>	69±28.40 <sup>d</sup>	41.91±8.17 <sup>e</sup>

Within a column, mean with the same letter was not statistically different at  $\alpha=0.05$  level of significance, N=3.



**Table 2**

**Calculated and experimental MALDI-TOF peaks related to condensed tannins extracted from *K. ivorensis* sapwood and heartwood by acetone/water mixture in the range 100-2000 Da.**

Experimental		Calculated		Unity	
m/z		m/z		type	
(Da)		(Da)			
Sapwood	Heartwood	Sapwood	Heartwood	Sapwood	Heartwood
105.7	105.8	106.1	106.1	Benzaldehyde	Benzaldehyde
117.8	117.8	116.1	116.1	Sodium adduct of phenolic rings	Sodium adduct of phenolic rings
119.7	119.8	120.1	120.1	Erythrulose	Erythrulose
124.7	124.8	122.1	122.1	Benzoic acid	Benzoic acid
135.7	134.8	132.1	132.1	Glucose (cleavage mechanism aromatic ring fragment) Or Resorcinol+Na	Glucose (cleavage mechanism aromatic ring fragment) Or Resorcinol+Na
138.7	138.7	138.1	138.1	p-hydroxybenzoic acid	p-hydroxybenzoic acid

144.6	144.7	143	143	Sodium adduct of mannose fragment	Sodium adduct of mannose fragment
153.7	153.7	150.1	150.1	Ribose	Ribose
155.7	155.7	154.1	154.1	3,4-dihydroxy-benzoic acid Arabitol+3xH	3,4-dihydroxy-benzoic acid Arabitol3+xH
156.6	156.7	155.17	155.17	protonated syringic acid fragment with loss in -COO function	protonated syringic acid fragment with loss in -COO function
157.6	157.7	156.17	156.17	Syringic acid fragment +2xH with loss in -COO function	Syringic acid fragment 2xH with loss in -COO function
160.6	160.7	162.0	162.0	Syringic acid fragment with loss in 2H <sub>2</sub> O	Syringic acid fragment with loss in 2H <sub>2</sub> O
166.5	166.6	170.1	170.1	E (Gallic acid)	E (Gallic acid)

177.5	177.6	177.17	177.17	Syringaldehyde fragment with loss in 5xH	Syringaldehyde fragment with loss in 5xH
178.5	178.6	178.17	178.17	Syringaldehyde fragment with loss in 4xH	Syringaldehyde fragment with loss in 4xH
179.7	179.8	180.1	180.1	Mannose/Glucose	Mannose/Glucose
		182.2	182.2	Mannitol	Mannitol
199.0	199.0	199.0	199.0	Protonated syringic acid fragment	Protonated syringic acid fragment
241.3	241.3	241.3	241.3	H	H
258.2	258.6	258.3	258.3	F	F
274.3	274.5	274.3	274.3	A	A
285.4	285.6	290.3	290.3	C	C
302.2	302.4	302.2	302.2	Ellagic acid	Ellagic acid
	303.2	303.3	303.3	T	T
305.5	305.5	306.3	306.3	D	D
313.3	314.3	313.3	313.3	C <sub>1</sub> Na	C <sub>1</sub> Na
-	333.4	-	334.1	-	E <sub>1</sub> Gly <sub>1</sub>
340.0	340.2	342.2	342.2	Gly <sub>2</sub>	Gly <sub>2</sub>

361.0	361.2	360.4	360.4	$N_1K_1$ or $P_1L_1$	$N_1K_1$ or $P_1L_1$
362.2	362.2	363.3	363.3	$H_1K_1$ or $F_1L_1$	$H_1K_1$ or $F_1L_1$
375.8	376.0	377.3	377.3	$H_1J_1$	$H_1J_1$
403.2	403.2	404.4	404.4	$H_1Gly_1$	$H_1Gly_1$
409.9	409.9	410.3	410.3	$D_1I_1$	$D_1I_1$
413.7	413.7	412.8	412.8	$F_1E_1$	$F_1E_1$
		411.3	411.3	$A_1J_1$	$A_1J_1$
416.8	415.1	419.3	419.3	$P_1Gly_1+3xH$	$P_1Gly_1+3xH$
434.3	433.9	434.3	434.3	$D_1L_1Na$	$D_1L_1Na$
441.7	441.7	441.3	441.3	$C_1E_1$ , $B_1E_1$ or $D_1J_1$	$C_1E_1$ , $B_1E_1$ or $D_1J_1$
444.3	444.3	442.4	442.4	$D_1J_1$	$D_1J_1$
449.2	449.0	451.3	451.3	$M_1Gly_1$	$M_1Gly_1$
477.5	477.9	477.3	477.3	$C_1Gly_1+Na$ or	$C_1Gly_1+Na$ or $B_1Gly_1+Na$
				$B_1Gly_1+Na$	
478.0	478.9	479.6	479.6	$H_1N_1$	$H_1N_1$
500.1	500.1	498.6	498.6	$F_1H_1$	$F_1H_1$
505.4	505.4	505.6	505.6	$H_2+Na$	$H_2+Na$
519.8	519.8	519.6	519.6	$F_2+3xH$	$F_2+3xH$
		533.6	533.6	$F_1A_1+3xH$	$F_1A_1+3xH$
533.4	533.7	534.6	534.6	$F_1P_1 +Na$	$F_1P_1 +Na$
		530.6	530.6	$F_1A_1$	$F_1A_1$

		529.6	529.6	$B_1H_1/C_1H_1/P_2+Na$	$B_1H_1/C_1H_1/P_2+Na$
537.6-536.6	537.6-536.3	536.6	536.6	$A_1H_1 +Na$	$A_1H_1 +Na$
				$B_1F_2+4xH$	$B_1F_2+4xH$
550.5	551.4	550.6	550.6	$C_1F_1+4xH$	$C_1F_1+4xH$
				$A_2+4xH$	$A_2+4xH$
567.6	567.6	564.8	564.8	$A_1C_1$	$A_1C_1$
599.5	599.5	602.6	602.6	$T_2$	$T_2$
609.0	609.0	608.6	608.6	$D_2$	$D_2$
617.2	617.2	620.2	620.2	Isoquercetin gallate	Isoquercetin gallate
698.8-697.9	698.8-697.9	694.6	694.6	$A_1F_1Glu_1+4xH$	$A_1F_1Glu_1+4xH$
				$B_1G_1$ or $C_1G_1$	$B_1G_1$ or $C_1G_1$
699.2	699.2	699.6	699.6	$A_1D_1J_1$	$A_1D_1J_1$
712.4	714.7	714.7	714.7	$A_1D_1E_1$	$A_1D_1E_1$
805.3	805.3	803.4	803.3	$A_2F_1$	$A_2F_1$
839.2	839.2	841.9	841.9	$A_3Na$	$A_3Na$
849.1	849.1	850.1	850.1	$A_2F_1$	$A_2F_1$
856.4	856.4	856.6	856.6	$A_1F_1Gly_2$	$A_1F_1Gly_2$
874.5-873.5	874.1-873.1	873.9	873.9	$B_2A_1Na, C_2A_1Na$	$B_2A_1Na, C_2A_1Na$
921.2	921.2	917.6	917.6	$D_1C_1Gly_2$	$D_1C_1Gly_2$
950.0	950.0	949.9	949.9	$D_1F_2Gly_1$	$D_1F_2Gly_1$

965.0	965.0	963.2	963.2	H <sub>4</sub> +4xH D <sub>1</sub> F <sub>1</sub> H <sub>1</sub> Gly <sub>1</sub>	H <sub>4</sub> +4xH D <sub>1</sub> F <sub>1</sub> H <sub>1</sub> Gly <sub>1</sub>
994.4	995.0	992.2	992.2	A <sub>1</sub> H <sub>3</sub>	A <sub>1</sub> H <sub>3</sub>
1008.4	1008.4	1009.2	1009.2	A <sub>1</sub> F <sub>1</sub> H <sub>2</sub>	A <sub>1</sub> F <sub>1</sub> H <sub>2</sub>
		1009.7	1009.7	A <sub>1</sub> G <sub>1</sub> Gly <sub>2</sub>	A <sub>1</sub> G <sub>1</sub> Gly <sub>2</sub>
1036.2	1036.2	1036.2	1036.2	A <sub>2</sub> F <sub>1</sub> H <sub>1</sub> -6xH	A <sub>2</sub> F <sub>1</sub> H <sub>1</sub> -6xH
1068.9	1068.9	1068.9	1068.9	A <sub>3</sub> F <sub>1</sub> -6xH	A <sub>3</sub> F <sub>1</sub> -6xH
1096.9	1096.9	1091.2	1091.2	A <sub>4</sub>	A <sub>4</sub>
1126.8	1126.8	1124.3	1124.3	C <sub>3</sub> F <sub>1</sub> or B <sub>3</sub> F <sub>1</sub>	C <sub>3</sub> F <sub>1</sub> or B <sub>3</sub> F <sub>1</sub>
1196.7	1196.7	1198.5	1198.6	H <sub>5</sub>	H <sub>5</sub>
				A <sub>1</sub> F <sub>1</sub> Gly <sub>4</sub>	A <sub>1</sub> F <sub>1</sub> Gly <sub>4</sub>
1140	1140.0	1143.3	1143.3	F <sub>4</sub> U <sub>1</sub>	F <sub>4</sub> U <sub>1</sub>
1212.2	1212.2	1215.2	1215.2	D <sub>5</sub>	D <sub>5</sub>
1226.8	1226.8	1222.2	1222.2	F <sub>3</sub> H <sub>1</sub> L <sub>2</sub>	F <sub>3</sub> H <sub>1</sub> L <sub>2</sub>
1242.7	1242.7	1239.2	1239.2	F <sub>4</sub> L <sub>2</sub>	F <sub>4</sub> L <sub>2</sub>
1286.7	1286.7	1283.5	1283.5	F <sub>5</sub>	F <sub>5</sub>
1300.1	1300.1	1299.5	1299.5	A <sub>1</sub> F <sub>4</sub>	A <sub>1</sub> F <sub>4</sub>
		1314.6	1314.6	H <sub>5</sub> U <sub>1</sub>	H <sub>5</sub> U <sub>1</sub>
1316.7	1316.7	1315.5	1315.5	A <sub>2</sub> F <sub>3</sub>	A <sub>2</sub> F <sub>3</sub>
		1330.9	1330.9	A <sub>3</sub> F <sub>2</sub>	A <sub>3</sub> F <sub>2</sub>
1330.5	1330.5	1327.1	1327.1	A <sub>2</sub> C <sub>1</sub> Gly <sub>3</sub>	A <sub>2</sub> C <sub>1</sub> Gly <sub>3</sub>

1347.0	1347.0	1347.5	1347.5	A <sub>4</sub> F <sub>1</sub>	A <sub>4</sub> F <sub>1</sub>
1360.0	1360.0	1363.5	1363.5	A <sub>5</sub>	A <sub>5</sub>
1372.7	1372.7	1370.1	1370.1	A <sub>2</sub> F <sub>1</sub> H <sub>1</sub> Gly <sub>2</sub>	A <sub>2</sub> F <sub>1</sub> H <sub>1</sub> Gly <sub>2</sub>
1388.7	1388.7	1386.2	1386.2	A <sub>3</sub> H <sub>1</sub> Gly <sub>2</sub>	A <sub>3</sub> H <sub>1</sub> Gly <sub>2</sub>
1402.7	1402.7	1403.2	1403.2	A <sub>3</sub> F <sub>1</sub> Gly <sub>2</sub>	A <sub>3</sub> F <sub>1</sub> Gly <sub>2</sub>
1420	1420	1419.2	1419.2	A <sub>4</sub> Gly <sub>2</sub>	A <sub>4</sub> Gly <sub>2</sub>
1432.1	1432.1	1435.2	1435.2	A <sub>3</sub> B <sub>1</sub> Gly <sub>2</sub> A <sub>3</sub> C <sub>1</sub> Gly <sub>2</sub>	A <sub>3</sub> B <sub>1</sub> Gly <sub>2</sub> A <sub>3</sub> C <sub>1</sub> Gly <sub>2</sub>
1450	1450	1451.2	1451.2	A <sub>2</sub> B <sub>2</sub> Gly <sub>2</sub> A <sub>2</sub> C <sub>2</sub> Gly <sub>2</sub>	A <sub>2</sub> B <sub>2</sub> Gly <sub>2</sub> A <sub>2</sub> C <sub>2</sub> Gly <sub>2</sub>
1470	1470	1467.2	1467.2	A <sub>1</sub> B <sub>3</sub> Gly <sub>2</sub> A <sub>1</sub> C <sub>3</sub> Gly <sub>2</sub>	A <sub>1</sub> B <sub>3</sub> Gly <sub>2</sub> A <sub>1</sub> C <sub>3</sub> Gly <sub>2</sub>
1490.7	1490.7	1492.7	1492.5	B <sub>3</sub> D <sub>1</sub> Gly <sub>2</sub> /C <sub>3</sub> D <sub>1</sub> Gly <sub>2</sub>	B <sub>3</sub> D <sub>1</sub> Gly <sub>2</sub> /C <sub>3</sub> D <sub>1</sub> Gly <sub>2</sub>
		1490.9	1490.9	A <sub>2</sub> C <sub>1</sub> Gly <sub>4</sub>	A <sub>2</sub> C <sub>1</sub> Gly <sub>4</sub>
1504.5	1504.5	1504.9	1504.9	A <sub>1</sub> C <sub>2</sub> Gly <sub>4</sub>	A <sub>1</sub> C <sub>2</sub> Gly <sub>4</sub>
1520.0	1520.0	1522.9	1522.9	C <sub>3</sub> Gly <sub>4</sub>	C <sub>3</sub> Gly <sub>4</sub>
1539.0	1539.0	1539.8	1539.8	F <sub>6</sub>	F <sub>6</sub>
1548.8	1548.8	1549.9	1549.9	C <sub>1</sub> D <sub>2</sub> Gly <sub>4</sub> -3xH F <sub>6</sub> +6xH	C <sub>1</sub> D <sub>2</sub> Gly <sub>4</sub> -3xH F <sub>6</sub> +6xH
1560.0	1560.0	1566.9	1561.9	D <sub>3</sub> Gly <sub>4</sub> -6xH	D <sub>3</sub> Gly <sub>4</sub> -6xH
1578.7	1578.7	1576.5	1576.5	A <sub>1</sub> F <sub>1</sub> H <sub>3</sub> Gly <sub>2</sub>	A <sub>1</sub> F <sub>1</sub> H <sub>3</sub> Gly <sub>2</sub>

1592.0	1592.0	1592.8	1592.8	A <sub>2</sub> H <sub>3</sub> Gly <sub>2</sub>	A <sub>2</sub> H <sub>3</sub> Gly <sub>2</sub>
				A <sub>1</sub> F <sub>2</sub> H <sub>2</sub> Gly <sub>2</sub>	A <sub>1</sub> F <sub>2</sub> H <sub>2</sub> Gly <sub>2</sub>
1608	1608	1609.5	1609.5	A <sub>2</sub> F <sub>1</sub> H <sub>2</sub> Gly <sub>2</sub>	A <sub>2</sub> F <sub>1</sub> H <sub>2</sub> Gly <sub>2</sub>
1640	1640	1643.5	1643.5	A <sub>2</sub> F <sub>3</sub> Gly <sub>2</sub>	A <sub>2</sub> F <sub>3</sub> Gly <sub>2</sub>
-	1650.8		1651.5	-	A <sub>4</sub> D <sub>1</sub> F <sub>1</sub>
1680.9	1680.9	1682.2	1682.2	A <sub>4</sub> B <sub>1</sub> D <sub>1</sub>	A <sub>4</sub> B <sub>1</sub> D <sub>1</sub>
				A <sub>4</sub> C <sub>1</sub> D <sub>1</sub>	A <sub>4</sub> C <sub>1</sub> D <sub>1</sub>
-	1780	-	1782.8	-	A <sub>4</sub> C <sub>1</sub> D <sub>1</sub> V <sub>1</sub>
-	1797.0	-	1797.8	-	A <sub>4</sub> D <sub>2</sub> V <sub>1</sub>

---



**Table 3****Stiasny numbers (Mean±SD) of tannins extracted from *K. ivorensis* bark, sapwood and heartwood from 3 trees.**

K. ivorensis type sample condensed tannins	Tree type		
	AMG1 (%)	AMG2 (%)	AMG3 (%)
Bark	73.33±15.30 <sup>a</sup>	91.67±0.00 <sup>b</sup>	73.09±11.06 <sup>c</sup>
Sapwood	90.91±0.58 <sup>a</sup>	93.33±0.00 <sup>b</sup>	91.33±1.53 <sup>c</sup>
Heartwood	90.61±0.00 <sup>a</sup>	80±10.00 <sup>b</sup>	80±17.32 <sup>c</sup>

Within a column, mean with the same letter was not statistically different at  $\alpha=0.05$  level of significance, N=3.

**Table 4**

**Thermal stability estimators for *K. ivorensis* condensed tannins by TGA and DTG (Mean±SD) (nitrogen 60 ml.min<sup>-1</sup>, heating rate 10°C.min<sup>-1</sup>).**

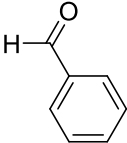
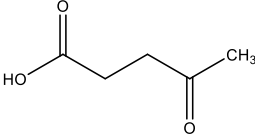
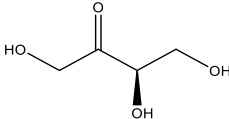
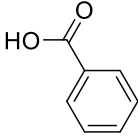
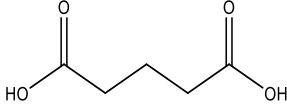
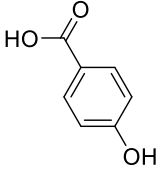
	TGA				DTG		
	Temperature at 95 (T <sub>95%</sub> ) and 75 (T <sub>75%</sub> ) residual weigh		Onset temperature of first degradation (T <sub>d</sub> <sup>1</sup> ), second (T <sub>d</sub> <sup>2</sup> )		Residual weigh at 600°C (W <sub>600</sub> <sup>R</sup> )	Maximum temperatures of degradations (T <sub>max</sub> <sup>i</sup> )	
K. ivorensis type sample condensed tannins	T <sub>95%</sub>	T <sub>75%</sub>	T <sub>d</sub> <sup>1</sup>	T <sub>d</sub> <sup>2</sup>	W <sub>600</sub> <sup>R</sup>	T <sub>max</sub> <sup>1</sup>	T <sub>max</sub> <sup>2</sup>
Bark	87.5.0±8.33 <sup>a</sup>	391.67±22.22 <sup>b</sup>	88.00±0.67 <sup>c</sup>	212.15±2.55 <sup>d</sup>	70.81±1.11 <sup>e</sup>	109.70±1.87 <sup>f</sup>	261.10±7.93 <sup>i</sup>
Sapwood	100.20±5.78 <sup>a</sup>	383.33±94.44 <sup>b</sup>	88.54±4.86 <sup>c</sup>	215.28±6.48 <sup>d</sup>	70.94±2.71 <sup>e</sup>	118.67±4.11 <sup>f,h</sup>	245.81±3.92 <sup>i</sup>
Heartwood	100.33±1.78 <sup>a</sup>	426.04±65.97 <sup>b</sup>	88.53±4.86 <sup>c</sup>	210.42±2.08 <sup>d</sup>	72.50±3.33 <sup>e</sup>	117.97±1.28 <sup>g,h</sup>	259.39±7.64 <sup>i</sup>

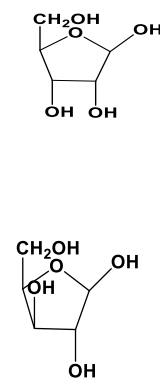
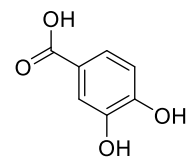
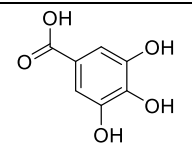
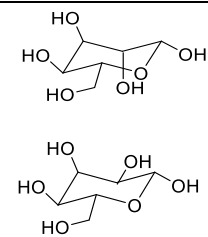
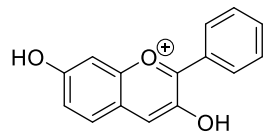
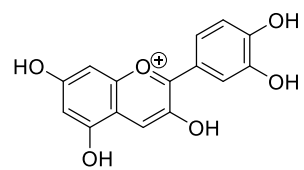
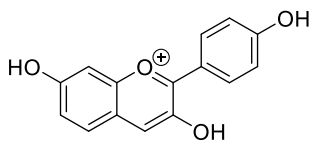
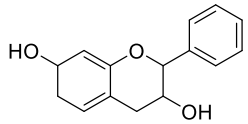
Within a column, mean with

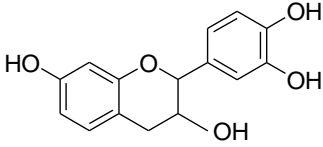
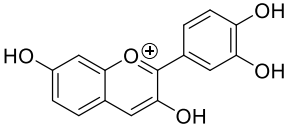
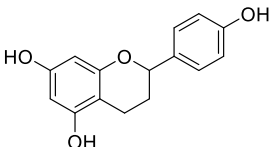
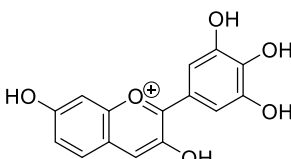
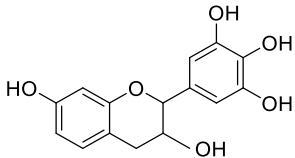
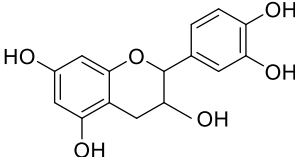
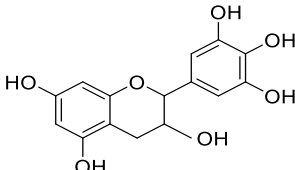
III.H. Matériel supplémentaire de <<Chemical analysis and thermal stability of African mahogany (*Khaya. ivorensis* A. Chev) condensed tannins >>.

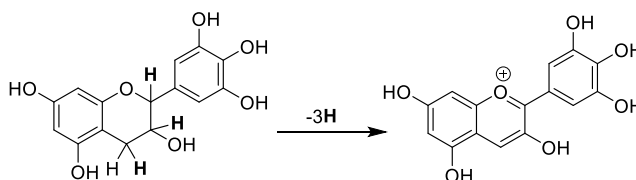
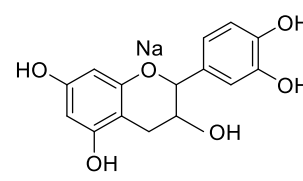
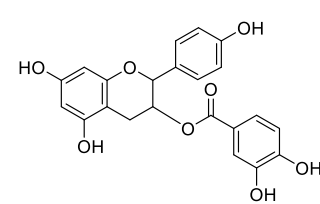
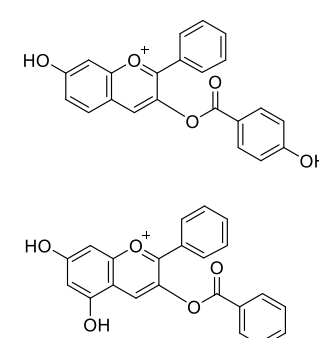
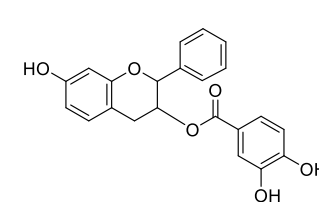
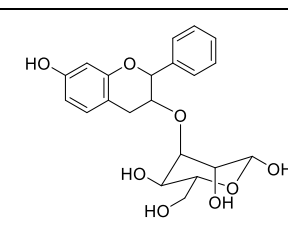
Table 5

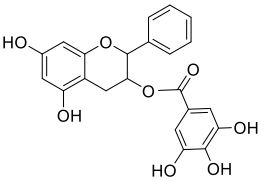
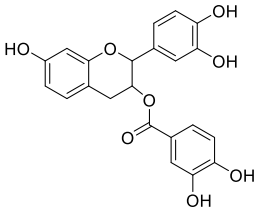
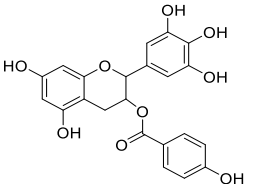
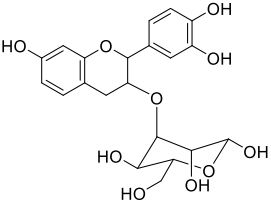
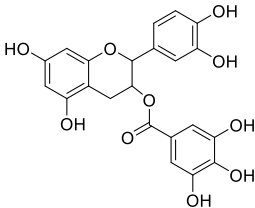
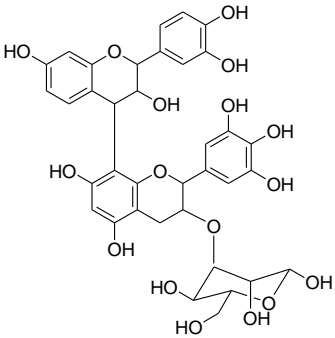
Molecular structure of compounds released by the acetone/water extracts from *K. ivorensis* sapwood and heartwood as derived by MALDI-TOF characterization.

Designation	Label	Molecular structure	m/z (Da)
Benzaldehyde	O		106.1
Levulinic acid	V		116.1
Erythrulose	I		120.1
Benzoic acid	L		122
Glutaric acid	U		132.1
P-hydroxy-benzoic acid	K		138.1

Ribose Xylose	R		150.1
3.4-dihydroxy-benzoic acid	J		153.1
Gallic acid	E		170.1
Glucose Mannose	Gly		180
Dihydroxyflavan-3xH	N		238.3
Catechine-3xH	M		287.3
Trihydroxyflavan-3xH	P		255.7
Dihydroxyflavan	H		241.3

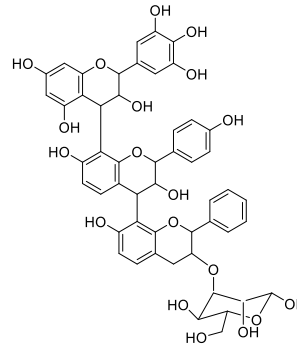
Fisitinidin	A		271.5
Fisitinidin-3xH	Q		268.5
Trihydroxyflavan	F		258.7
Robetinidin-3xH	S		287.3
Robetinidin	B		290.3
Catechin	C		
Gallocatechin	D		306.3

Gallocatechin unit-3xH	T		302.5
Catechin sodium	C <sub>1</sub> Na		314.1
Tetrahydroxyflavan-3-(3,4-dihydroxy)-benzoate	G		427.8
Dihydroxyflavan-3xH-3-p-hydroxybenzoate Or Trihydroxyflavan-3xH-3-benzoate	N <sub>1</sub> K <sub>1</sub> or P <sub>1</sub> L <sub>1</sub>		360.4
Dihydroxyflavan-3-(3,4-dihydroxy)-benzoate	H <sub>1</sub> J <sub>1</sub>		377.3
Dihydroxyflavan-3-mannosyl type unit	H <sub>1</sub> Gly <sub>1</sub>		404.4

Trihydroxyflavan-3-gallate	F <sub>1</sub> E <sub>1</sub>		412.8
Fisitinidin-3-(3,4-dihydroxy)-benzoate	A <sub>1</sub> J <sub>1</sub>		417.8
Galocatechin-3-(p-hydroxy)-benzoate	H <sub>1</sub> K <sub>1</sub>		363.3
Fisitinidin-3-glycosyl type-unit	A <sub>1</sub> Gly <sub>1</sub>		436.4
Catechine-3-gallate	C <sub>1</sub> E <sub>1</sub>		441.3
Fisitinidin/galocatechin dimer + mannosyl type-unit	A <sub>1</sub> D <sub>1</sub> Gly <sub>1</sub>		740.6

Gallocatechin/ trihydroxyflavan  
/ dihydroxyflavan/mannosyl unit

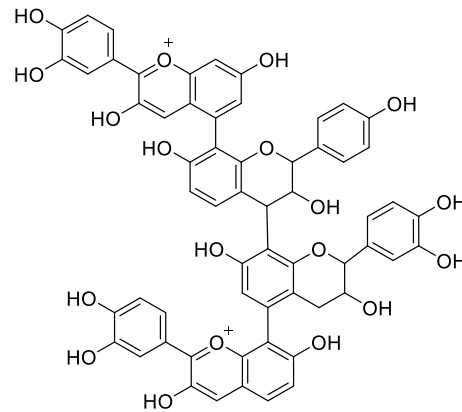
D<sub>1</sub>F<sub>1</sub>H<sub>1</sub>Gly<sub>1</sub>



965.0

Fisitinidin trimer/Dihydroxyflavan

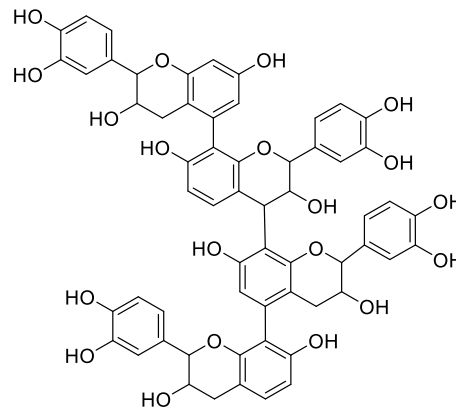
A<sub>3</sub>F<sub>1</sub>-6xH



1068.9

Fisitinidin Tetramer

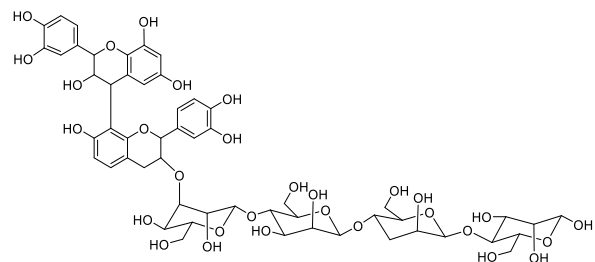
A<sub>4</sub>



1097.2

Fisitinidin. trihydroxyflavan-3-ol  
/4 Glycosyl units

A<sub>1</sub>F<sub>1</sub>Gly<sub>4</sub>



1198.0

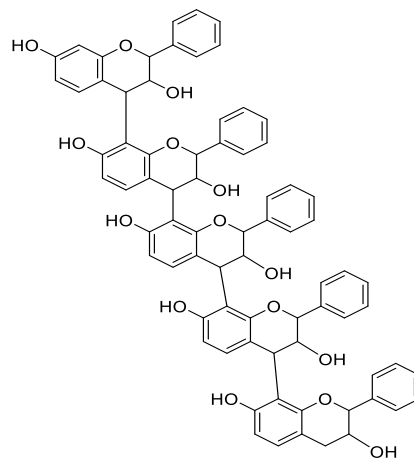


---

---

Dihydroxyflavan pentamer

H<sub>5</sub>

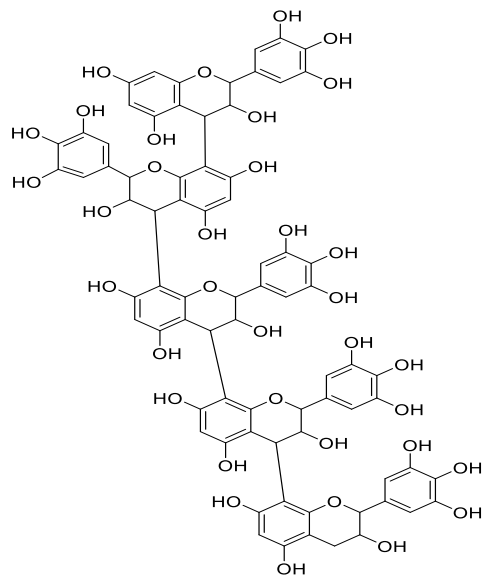


1198.6

---

Gallocatechin pentamer

D<sub>5</sub>

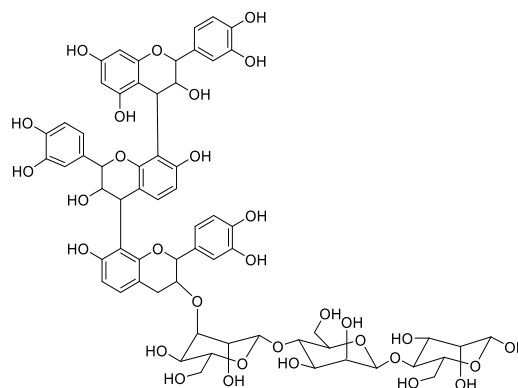


1225.2

---

Fisitinidin dimer/Catechin  
triglycosyl

$A_2C_1Gly_3$



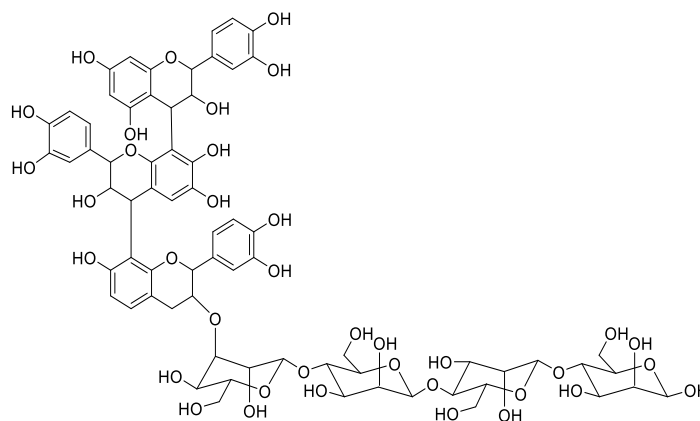
1330.9

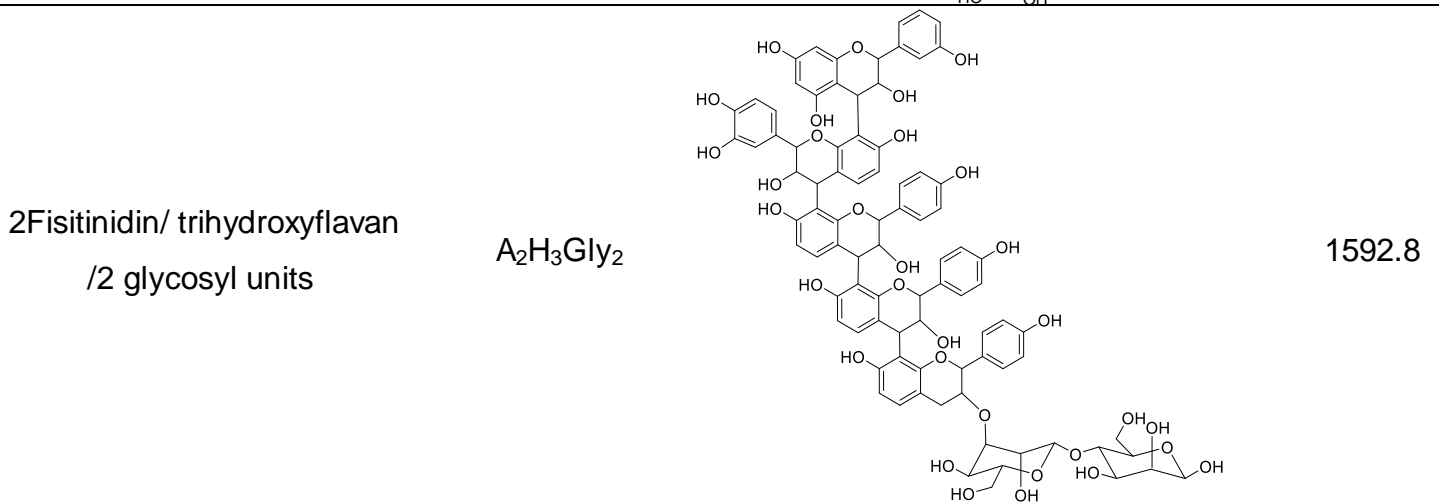
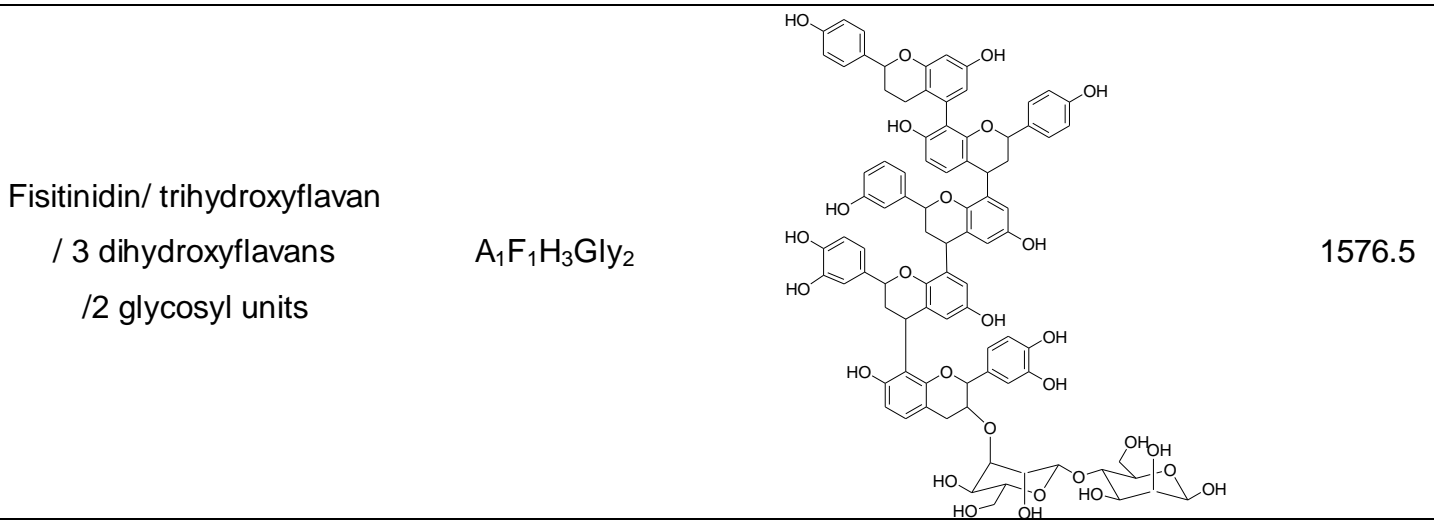
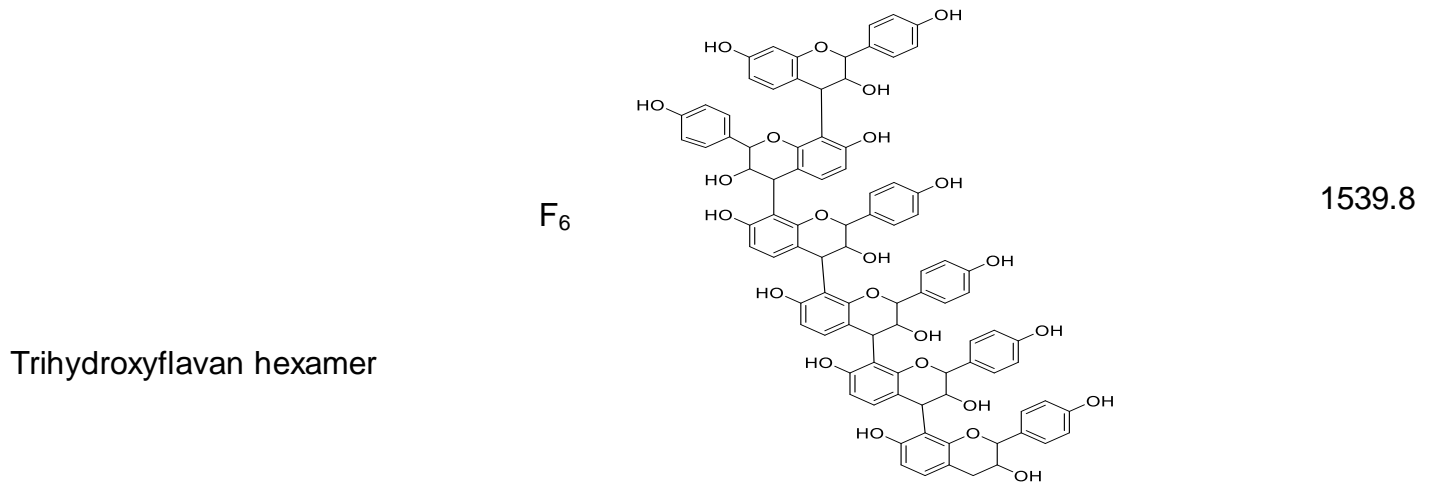
---

1504.9

Fisitinidin/ 2Catechin  
/4 mannosyl units

$A_1C_2Gly_4$





**Table 6****Glass transition and fusion temperature (Mean±SD) of tannins from *K. ivorensis* samples in DSC analysis.**

<i>K. ivorensis</i> type condensed tannins	Softening point (°C)	Endothermic elimination (°C)
Bark	107.67±1.17 <sup>a</sup>	132.10±7.23 <sup>b</sup>
Sapwood	119.28±3.33 <sup>a</sup>	116.45±6.30 <sup>b</sup>
Heartwood	115.23±3.04 <sup>a</sup>	123.33±7.51 <sup>b</sup>

Within a column, mean with the same letter was not statistically different at  $\alpha=0.05$  level of significance, N=3

## IV. Identification par RP-HPLC/UV/ESI-FTMS des composés phénoliques d'acajou

### << Identification of phenolic compounds from *K. ivorensis* by RP-HPLC/UV/ESI-FTMS >>.

Bikoro Bi Athomo<sup>1, 2\*</sup>, A., Engozogho Anris<sup>1,2</sup>, S.P., Safou Tchiama<sup>2,3\*</sup>, R., Eyma<sup>4</sup>, F., Arnaudguilhem<sup>5</sup>, C., Charrier<sup>1</sup>, B.

<sup>1</sup> CNRS/ Université de Pau et es Pays de l'Adour, Institut des sciences analytiques et de physico-chimie pour l'environnement et les matériaux - Xylomat, UMR5254, 40004, Mont de Marsan, France.

<sup>2</sup> Laboratoire de Recherche et de Valorisation du Matériau Bois (LaReVa Bois). Ecole Normale Supérieure d'Enseignement Technique (ENSET). BP. 3989 Libreville (Gabon).

<sup>3</sup> Laboratoire des Substances Naturelles et de Synthèses Organométalliques (LASNSOM). Unité de Recherche en Chimie. BP 941, Université des Sciences et Techniques de Masuku, Franceville (Gabon).

<sup>4</sup> Institut Clément Ader (ICA), Université de Toulouse, CNRSUMR 5312-INSA- ISAE-Mines Albi-UPS, Tarbes, France.

<sup>5</sup> CNRS/ Université de Pau et es Pays de l'Adour, Institut des sciences analytiques et de physico-chimie pour l'environnement et les matériaux - LCABI, UMR5254, 40004, Pau, France.

[\\*arsene.bikoro-bi-athomo@univ-pau.fr](mailto:arsene.bikoro-bi-athomo@univ-pau.fr)

[\\*r\\_safoutchiama@yahoo.fr](mailto:r_safoutchiama@yahoo.fr)

### IV.A. Résumé

Une approche complémentaire par chromatographie en phase liquide couplée à la spectrométrie de masse a été proposée pour caractériser les composés phénoliques extraits (méthanol-eau) de *K. ivorensis* A. Chev. L'idée étant ici de pouvoir optimiser une méthode de séparation et de collection de molécules pures à des quantités suffisantes pour une éventuelle commercialisation. Pour cela, deux

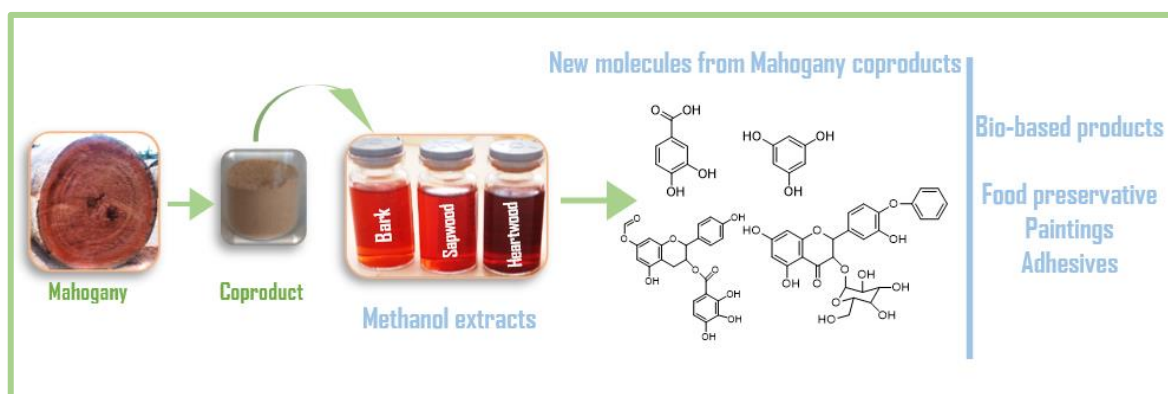
méthodes de chromatographie en phase liquide à haute performance (HPLC) ont été utilisées pour la détermination des composés phénoliques de l'écorce, de l'aubier et du bois de cœur de *K. ivorensis*. Les méthodes utilisées impliquaient une analyse directe après filtration à 0,20 µm, en utilisant une colonne RP C18 et une détection UV-VIS. Les méthodes utilisées étaient différentes par leur gradient d'élution. Dans cette étude, 22 composés phénoliques et dérivés de *K. ivorensis* ont été séparés et déterminés pour la première fois dans un extrait méthanol / eau d'acajou. Parmi les vingt-deux composés identifiés, 8 ont été obtenus avec le premier procédé et 14 avec le second. Les principaux produits étaient l'acide hydroxybenzoïque et ses dérivés, le résorcinol, des composés estérifiés, le mannitol, la quercétine et ses dérivés, le dihydroxyflavane, le trihydroxyflavane.

#### **IV.B. Abstract**

A complementary approach using Liquid Chromatographic-Mass Spectrometric analysis was proposed to characterize phenolic compounds from the methanol-water extracts of *K. ivorensis* A. Chev. Two High Performance Liquid Chromatography (HPLC) methods were used for the determination of phenolic compounds from the bark, sapwood and heartwood of *K. ivorensis*. Methods employed involved direct analysis after filtration at 0.20 µm, using a RP C<sub>18</sub> column and UV-VIS detection. The methods used were different by their elution gradient. In this study, 22 phenolic compounds and derivatives from *K. ivorensis* were separated and determined for the first time in mahogany methanol/water extract. These compound types are present in the plant biomass. Among the twenty-two identified compounds, 8 were obtained with the first method and 14 with the second one. The main products were hydroxybenzoic acid and derivatives, resorcinol, esterified compounds, mannitol, quercetine and derivatives, dihydroxyflavan, trihydroxyflavan.

Keywords: Bark, RP\_HPLC, ESI-FTMS, Sapwood, Heartwood, *K. ivorensis*.

#### IV.C. Graphical abstract



#### IV.D. Introduction

Wood is one of the main sources of biomass in the world. Energy sectors such as carbonization, mechanization, wood pellets and bioenergy have been developed in Europe, America and Asia; giving added value to wood wastes. Wood is also a source of natural molecules that attracts large companies not only for its lignin, cellulose and hemicellulose but also for its extractives compounds, which possess virtues for cosmetic, pharmaceutical or agro-alimentary industries.

In underdeveloped countries of the third world, wood is mostly used as source of energy for cooking. A large amount of wood wastes rising up to 50% of the initial biomass in some industrial transformation of logs in sub-Saharan African countries mainly focused on slicing, rotary cutting for plywood or exporting logs to developed countries, is abandoned in forest or just burned to reduce wastes quantity. New insight for a suitable valorization of wood wastes from African countries as source of raw materials for wood based composites or molecules of interest for cosmetics, green adhesives free from formaldehyde or food industry are extensively investigated since decades. In this order, various tropical wood wastes were used in composites (Safou-Tchiama et al., 2017), their lignin and cellulose extracted and characterized (Safou-Tchiama et al., 2019) and the thermal stability of their tannins were investigated for adhesives (Engozogho Anris et al., 2019) Wood wastes from *K. ivorensis* slicing industry were not in rest. The chemical structure of these African mahogany condensed tannins were identified for the first time by Bikoro Bi Athomo et al. (2018). The hygrothermal stability and the potential of the mahogany wastes for new wood plastic composites were recently reported (Bikoro et al., 2019). Although various phenolic compounds have been found in the bark, sapwood and heartwood of many

tropical woods, comprehensive studies on phenolic compound structures or tannins identification from tropical woods are scarce (Safou-Tchiama et al., 2017; Bikoro Bi Athomo et al., 2018). Major results dealing with phenolic like compounds from woods concerned condensed tannins and related phenols. LC-MS or MALDI-TOF and Fourier Transformed Infrared Spectroscopy (FTIR) generally analyze them. To our knowledge, any African mahogany's species have not been extensively studied for this purpose.

Thus the identification of *K. ivorensis* phenolic compounds profile is still lacking. High-resolution/accurate mass measurement mass spectrometry like Matrix Assisted Laser Desorption/Ionization coupled to Time of Flight (MALDI-TOF) or Electrospray-Fourier Transform Mass Spectrometry (ESI-FTMS) is a good technique for elucidating structure of unknown compounds. Linear ion trap quadrupole-Orbitrap-mass spectrometry (LTQ-Orbitrap-MS) provides single-stage mass analysis that supplies molecular weight information, two-stage mass analysis (MS/MS) and multi-stage mass analysis ( $MS^n$ ) for structural information (Rada et al., 2015). Exact mass measurements and molecular formula assignment are indispensable for the characterization of phenolic compounds. Moreover, accurate mass measurement of the product ions obtained after fragmentation facilitates the elucidation of unknown compounds.

The aim of this study was to analyze the methanol/water extracts from the bark, sapwood and heartwood of African mahogany by developing new methods to separate and isolate phenolic of this tropical wood.

#### **IV.E. Materials and Methods**

##### **IV.E.1. Materials**

###### **IV.E.1.a. Chemicals**

All the chemicals used in this study were purchased from Fisher Scientific, Acros Organic (France) and Sigma Aldrich (France). Acetone (99.98%, Fisher Scientific), phosphoric acid ( $H_3PO_4$ , Fisher Scientific), iron acid sulfate ( $FeSO_4$ , 99%, Acros organic), sodium carbonate decahydrate (>98 %, Fisher Scientific), sodium bisulfite for analysis (Acros organic), sodium hydroxide (98.5 %, Acros organic), sodium sulfite anhydrous (Fisher Scientific), formic acid (98.0-100 %, Fisher



Scientific), methanol-HPLC (99.98%, Fisher Scientific). Ultrapure water (18mΩ cm) was produced using a mQ system (Millipore, France).

#### IV.E.1.b. Wood sampling

The bark, sapwood and heartwood were collected from three *K. ivorensis* or African mahogany (AMG) trees sampled from a disk section of 10 cm of thickness and 85 (AMG1=tree 1) cm, 80 (AMG2=tree 2) cm and 75 (AMG3=tree 3) cm of diameter. Woods were harvested at Mitzic natural forest in the North of Gabon by the SNBG (Société Nationale des Bois du Gabon) in 2016 and 2017. The fresh samples were put in sterilized bags, air-dried for one week in the laboratory and oven-dried (105 °C) for 48 h. The dried samples were grinded to pass through 60 mesh ( $\approx$ 1 mm diameter) with a rotative knife grinder (Retsch SK1).

#### IV.E.2. **Methods**

##### IV.E.2.a. Extraction of polyphenols at room temperature

350 mg of dried wood powder from each sample was mixed separately at room temperature with 30 ml of methanol/water (4:1, v/v). The mixtures were stirred for 3 h. Obtained extracts were then filtrated on Coaster Nylon 0.20 μm before analysis.

##### IV.E.2.b. High Performance Liquid Chromatography (HPLC) analysis

Liquid chromatography analysis was performed using a Dionex Ultimate 3000 (Thermo Scientific, Acclam™ Polar Advantage II) equipped with a quaternary pump, a photodiode array detector (PDA) and a thermostated autosampler. Chromatographic separation was accomplished with Acclam™ C<sub>18</sub> column 150 x 3.0 mm i.d., 3μm. Gradient elution of analysis was carried out with methanol/0.1% formic acid (solvent A) and water/0.1% formic acid/ or orthophosphoric acid (Solvent B) at a constant flow rate 0.5 mL/min and the injection volume was 20 μL. Two multi gradient systems methods were applied and pressure limit was at 500 bar.

Method 1 : 0 min, 0% A; 0-2 min, 0% A; 2-30 min, 10% A; 30-50 min, 100% A; 50-55 min, 100% A; 55-70 min, 0% A; flow rate :0.5 ml/min. At the end, column was equilibrated to 70-73 min at 0% A to return to initial conditions.

Method 2 : 0 min, 5% A; 0-2 min, 5% A; 2-9 min, 25% A; 9-16 m in, 40% A; 16-25 min, 50% A; 25-27 min, 70% A; 27-32 min 70% A; 32-35 min, 90% A; 35-38 min, 92% A; 38-45 min, 100% A; 45-50 min, 100% A; 50-52 min, 15% A; 52-60 min, 5% A;

flow rate: 0.5 ml/min. At the end, column was equilibrated for 2 min at 5% A to return to initial conditions.

#### IV.E.2.c. Mass spectrometry (MS) analysis.

An LTQ Orbitrap Velos mass spectrometer (Thermo-Fisher Scientific, Bremen, Germany) equipped with an HESI source working in positive mode was used for accurate mass measurements. Mass spectra were acquired in profile mode with a setting of 30,000 resolution at  $m/z$  400. Operation parameters were as follows: source voltage, 4 kV; sheath gas, 50; auxiliary gas, 15; sweep gas, 5 (arbitrary units); heat temperature, 250 °C; and capillary temperature, 350 °C. Default values were used for most other acquisition parameters (FT Automatic gain control (AGC) target  $5 \cdot 10^6$  for MS mode and  $5 \cdot 10^5$  for MS<sup>n</sup> mode). Methanol extracts were analyzed in full scan mode ( $m/z$  range 80.000-1500.000) at a resolving power of 30,000 at  $m/z$  400 and data dependent MS/MS events acquired at a resolving power of 15,000. The most intense ions detected during full scan MS triggered data dependent scanning. Data dependent scanning was carried out without the use of a parent ion list. An isolation width of 2 amu was used and precursors were fragmented by collision-induced dissociation (CID) with a normalized collision energy of 35 V and an activation time of 10 ms. The data analysis was achieved using XCalibur software (Thermo Fisher Scientific). An external calibration for mass accuracy was carried out before the analysis to assure a precision < 5ppm.

### IV.F. **Results and discussion**

HPLC-MS analysis performed in this study were adapted from previous published methods (Charrier et al., 1995; Morais et al., 1999). Positive ionization was used for MS assays, and compound absorbances were between 205 nm and 310 nm ( $\lambda_{max}$ ). All samples were analyzed in triplicate. This kind of investigation, which was probed for chemical identification in various natural substances, was performed for the first time on the bark, sapwood and heartwood of *K ivorensis* extracts. The phenolic compounds with accurate retention time were discussed according the mobile phases used.

#### IV.F.1. Chemical variability of *K. ivorensis* according to method 1

All the chromatogram obtained from method 1 are presented in Figure 1 and the corresponding molecular structures were listed in Table 1. All the relative abundances were calculated based on peak area obtained in UV. The method 1 based on mobile phase which leads to molecules of  $m/z < 300$  Da in  $[M+H]^+$  mode eluting with 100% MeOH.

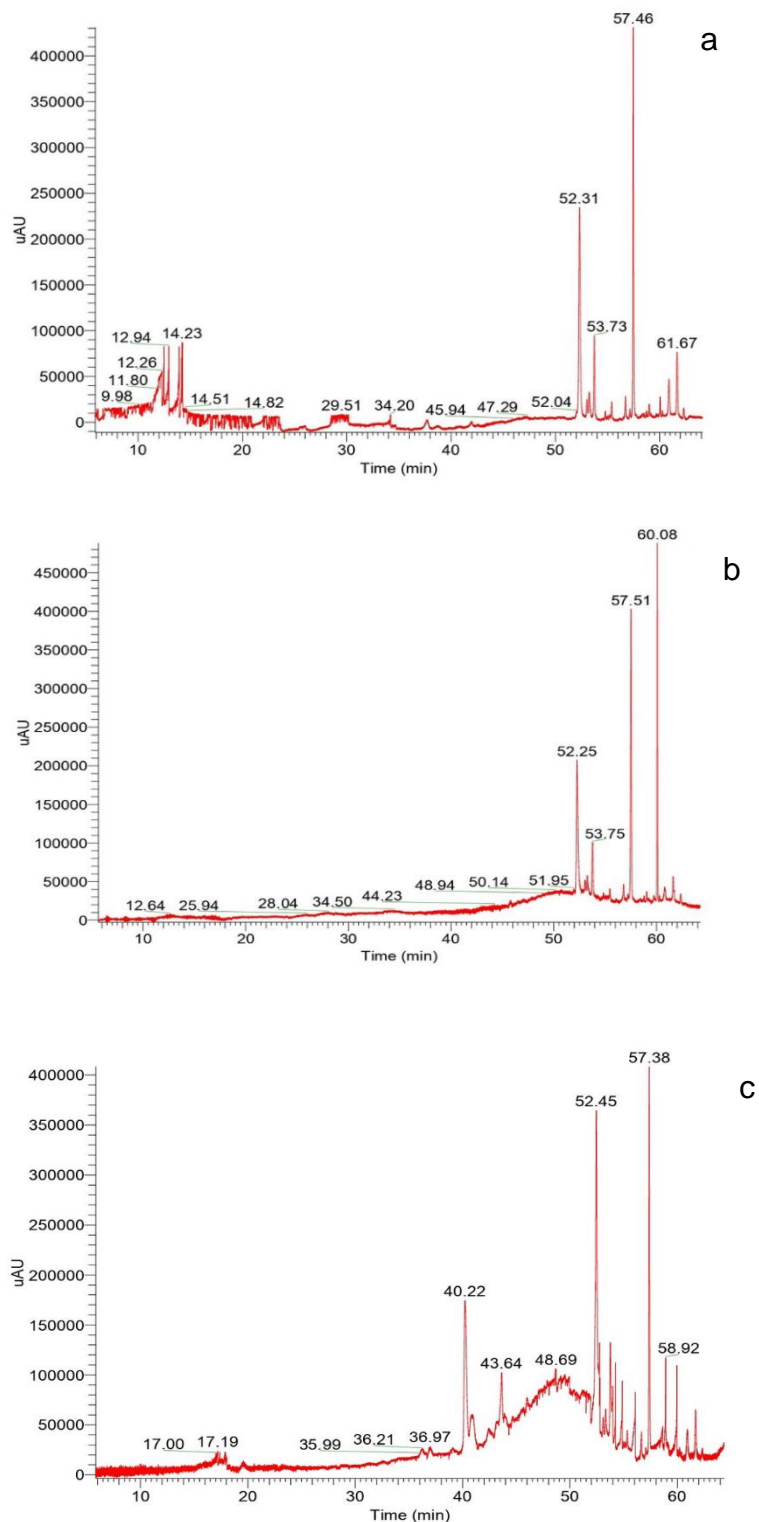
Typical fingerprints of flavanons, flavanols with a strong presence of *p*-hydroxybenzoic acid derivatives were identified in the extracts (Figures 1). Major compounds eluted by method 1 were the same for the three parts of the wood; the cumulated areas of mannitol ( $m/z$  182.0784,  $C_6H_{14}O_6$ ) showed that the heartwood should be more abundant in this sugar of interest (26.41%) for renal blood flow than the bark and sapwood which displayed close mannitol content (Table 1). Evidence of free methyl resorcinol ( $m/z$  123.0440,  $C_7H_8O_2$ ) was identified.

This compound should be found in higher extent in *K. ivorensis*'s bark and sapwood where they showed respective relative abundances of 23.22 and 22.31% compared to the heartwood (Table 1). However, the three wood extracts eluted by method 1 unveiled free resorcinol units ( $m/z$  110.0362 Da,  $C_6H_6O_2$ ) which were slightly higher in the heartwood (6.61%) with regard to the bark and sapwood (Table 1). The presence of free resorcinol and methyl resorcinol moieties in *K. ivorensis* should be supported by their respective signals at  $m/z$  112.7 and 124.7 Da in that African mahogany's bark MALDI-TOF spectra (Bikoro Bi Athomo et al., 2018). These phenolic units of strong reactivity with formaldehyde would explain at least the high Stiasny number (~90%) as observed in *K. ivorensis* condensed tannins (personal data). Similar results previously reported by Pizzi et al. (Pizzi et al., 2004) for phenol-resorcinol-formaldehyde wood resin agreed with the presence of free resorcinol units in wood extracts.

Ester compounds belonging to *p*-hydroxybenzoate-3H-resorcinol and *p*-hydroxybenzoate-4H-resorcinol ( $m/z$  234.0886 and 235.0964,  $C_{13}H_{13}O_4$  and  $C_{13}H_{14}O_4$ ) series were identified in *K. ivorensis*'s bark, sapwood and heartwood.

All the wood extracts pointed out the same *p*-hydroxybenzoate-*x*H-resorcinol content, but *p*-hydroxybenzoate-4H-resorcinol ( $m/z$  235.0964,  $C_{13}H_{15}O_4^+$ ) released at

Rt 52.25; 52.31 and 40.22 with fragmentation patterns 201.1 MS<sup>2</sup>, 158.97 (MS<sup>3</sup> accounted for the most abundant *p*-hydroxybenzoate-resorcinol like compounds (Figure 1 and Table 1). The cumulated integrated areas of these *p*-hydroxybenzoate-resorcinol esters in the bark (28.28%), sapwood (33.32%) and heartwood (16.05%) revealed the predominance of this benzoic-resorcinol type ester in *K. ivorensis*'s methanol/water extracts when the mobile phase including a most speed gradient.



**Figure 1 : LC/MS spectrum of bark (a), sapwood (b) and heartwood (c) extract method 1.**

It was noteworthy that 3-acetate-4-hydroxycyclohexen-1-carboxylate (3) ( $m/z$  202.0835,  $C_9H_{13}O_5^+$ ) was also found in all parts of *K. ivorensis* wood (Table 1). The relative abundances of Table 1 showed that 3-acetate-4-hydroxycyclohex-1-ene-

carboxylate did not have significant different among *K. ivorensis*'s bark (10.63±2.43%), sapwood (19.17%) and heartwood (19.03%). This molecule was listed as teratogen compound causing birth defects (Meyers, 1983). This should explain in some extent the stillbirths usually observed to African women subject to African mahogany's bark traditional treatments (Iwu et al., 1992 ; Meyers et al., 1983 ; Belewu et al., 2009).

LC-MS analysis with method 1 pointed out the occurrence of 4,5-dihydroxycyclohex-1-ene carboxylate ( $m/z$  159.0651,  $C_7H_{11}O_4^+$ ) at Rt 56.80 and 56.73 in the bark, sapwood respectively (Figure 1). This compound which shows structural similarities to chorismic acid was tested as possible inhibitor of chorismate mutase enzymatic activity (GORISCHI and LINGENS, 1973). It has high commercial value, which should open opportunities for African mahogany wood wastes valorization despite the weak yield of 4,5-dihydroxycyclohex-1-ene carboxylate in the bark (3.35%) compared to the sapwood (6.77%) in Table 1.

An extent of flavan-3-ol compounds was found in *K. ivorensis* methanol/water extracts. Trihydroxyflavan ( $m/z$  259.0964,  $C_{15}H_{15}O_4^+$ ) was more abundant in the bark which, displayed stronger peak at Rt 60.08 than the sapwood and heartwood ones indeed (Figure 1 and Table 1). This result emphasized a better extraction of trihydroxyflavan by the methanol/water mixture while the Maldi-ToF spectra of this compound showed a weak 258.8 Da signal strength (Bikoro Bi Athomo et al., 2018) which suggested a low content of free trihydroxyflavan units in *K. ivorensis* acetone/water extracts. The trend of methanol/water solvent system to exact such a compound was reinforced by the presence of high content (12.56%) of dihydroxyflavan+4H ( $m/z$  247.1328,  $C_{15}H_{19}O_3^+$ ) (**7**) released only by the heartwood at Rt 52.45 (Figure 1c).

#### IV.F.2. Chemical variability of *K. ivorensis* according to method 2

The chromatogram obtained with (method 2) used as mobile phase in the LC/MS  $[M+H]^+$  mode have been depicted in Figure 2 and the related compounds were listed in Tables 2. Method 2 eluted molecules of high  $m/z$  which remained inferior to 800 Da in  $[M+H]^+$  mode. Figure 3 show an example of ESI-FTMS full MS chromatogram. 14 phenolic compounds were identified with this method, i.e 4 more than with the previous method. This can be explained by the slower rate of gradient 2

which lead to a better separation and ionization of compounds which were not hampered by other compounds. Method 2 focuses on more polar compounds which reveal themselves, and the heaviest compounds shall be eluted at <100% of methanol. Method 2 shall therefore improve the separation of heavier compounds probably present in method 1 but eluted at the same time, which renders their separation difficult.

With the exception of mannitol (2) and resorcinol (4) which were eluted by both methods (Table 1 and 2), all the compounds released by method 2 were very different with method 1 ones. Mannitol which was appeared in the three wood extracts in method 1 (Table 1) was found only in the heartwood extracts when method 2 was applied. The same trend was observed for resorcinol (4) which was found only in the bark extracts whereas it was exhibited in the three *K. ivorensis* wood extracts for method 1. These results pointed out that the gradient used in mobile phase 2 was more susceptible to the chemical environment of the wood extracts than the gradient used in method 1. This observation highlighted accordingly strong differences on the eluting power of these two methods.

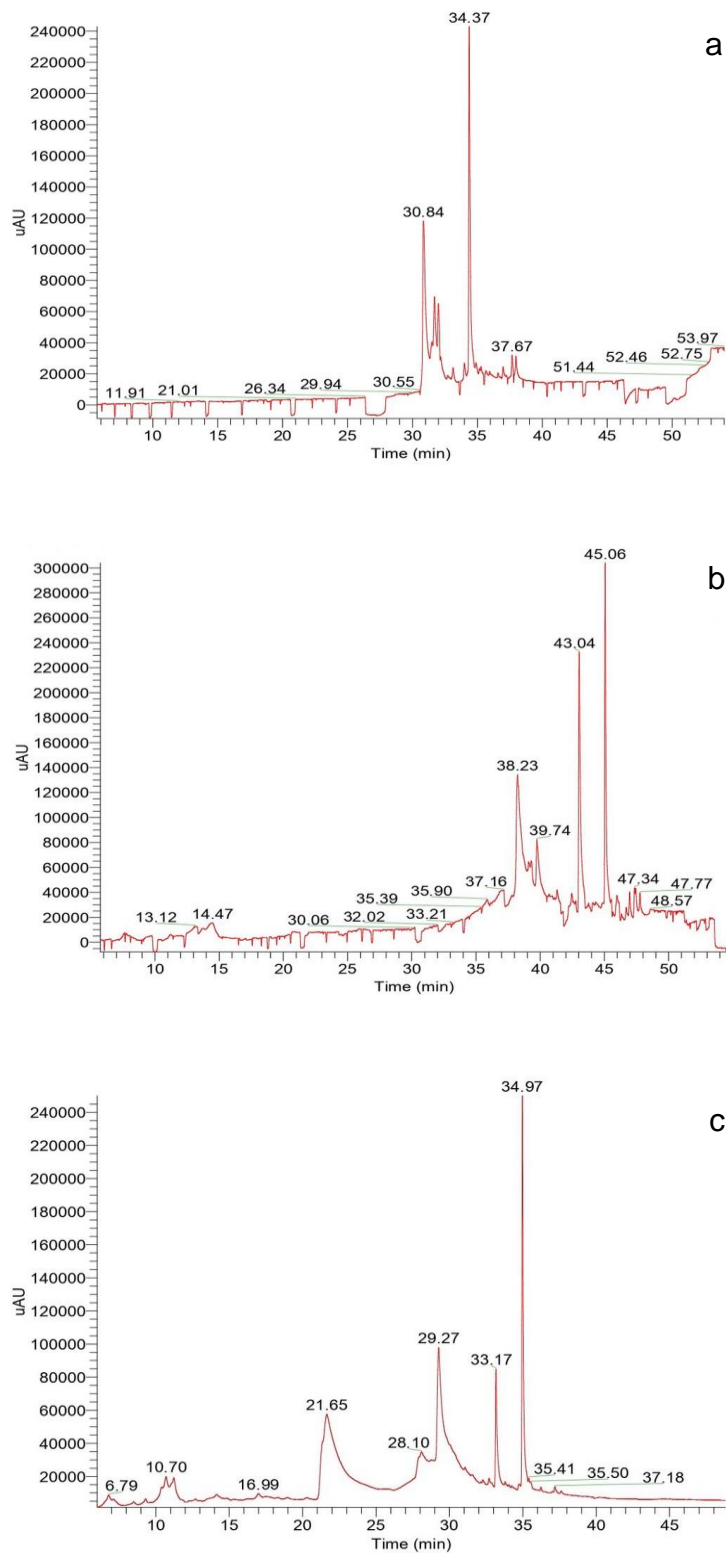
Therefore, contrarily to method 1, a strong chemical variability was found between *K. ivorensis* bark, sapwood and heartwood. Table 2 and Figure 2 have shown that only quercetin-3-O-gallic acid +xH ( $m/z$  455.0578,  $C_{22}H_{15}O_{11}^+$ ;  $m/z$  457.0765,  $C_{22}H_{17}O_{11}^+$ ) was found in the bark, sapwood and heartwood of *K. ivorensis*. The cumulated integrated areas of that quercetin-gallate (Table 2) pointed out its highest content in the bark (37.52%) compared to the sapwood (6.12%) and the heartwood (10.07%). On the other hand, the highest quercetin-3-O-gallic acid isomer was eluted by the bark at  $R_t$  34.37 with  $MS^2=313.16$  and  $MS^3=185.11$  fragments. In addition, 3,4-dihydroxybenzoic acid derivatives ( $m/z$  155.0418, and  $m/z$  154.0260  $C_7H_6O_4^+$ ) (10) was found also in higher content in *K. ivorensis* sapwood (32.97%) than the heartwood (28.01%) while it lacked in the bark extracts (Table 2). However, the absence that free galloyl moiety in the bark agreed with Maldi-ToF analysis where typical signal of gallic acid ( $m/z$  170 Da) were not detected (Bikoro Bi Athomo et al., 2018) as well as in the sapwood and heartwood Maldi-ToF (personal data). Nevertheless, signals at  $m/z$  155.7 Da in the Maldi-ToF spectra of the bark, sapwood and heartwood acetone/water and assigned to free 3,4-benzoic acid (Bikoro Bi Athomo et al., 2018) would support the presence of that galloyl type compound in the present extracts. In addition, the 3,4-

benzoic acid unit should also result from the loss of 1xOH from gallic acid (170-1x16) released by H<sub>2</sub>CO<sub>2</sub> acid hydrolysis of ester like quercetin-3-O-gallic acid structures.

With the exception of quercetin-3-O-gallic acid and 3,4-benzoic acid, all the compounds released by method 2 were completely different between the bark, sapwood and heartwood of the studied African mahogany. That emphasized a strong intra tree chemical variability. It was noted that 3-(2-methoxyphenyl)-2-oxo-2H-chromen-7-yl acetate (*m/z* 311.0913, C<sub>18</sub>H<sub>15</sub>O<sub>5</sub><sup>+</sup>) (**12**) accounted for the second major compound of the bark (34.51%). The occurrence of 3,5-dimethoxycinnamic acid (*m/z* 209.0808, C<sub>11</sub>H<sub>13</sub>O<sub>4</sub><sup>+</sup>) (**13**) like ferulic compound usually linked with arabinose in hemicelluloses side chain units or pectin structures should indicate a difference on hemicelluloses' side chain structures between *K. ivorensis* bark and xylem. This cinnamic acid is a plant second metabolite exclusively released by the bark which displayed repellent properties against deter feeding in herbivores (Crocker and Perry, 1990); hence *K. ivorensis* bark could provide a fruitful source of chemical repellents. The last compound exclusively identified in the bark of *K. ivorensis* extracts eluted in low content by method 2 was isoquercitrin-7-O-*p*-hydroxybenzoic acid or isoquercitrin-3-O-*p*-hydroxybenzoic acid (*m/z* 585.1238, C<sub>28</sub>H<sub>25</sub>O<sub>14</sub><sup>+</sup>) (**16**) (Table 2) linked to glycosyl unit. Similar compound previously reported for antiradical activity of isorquercitrin esters with aromatic acids and their homologues (Eva Heřmánková-Vavříková et al., 2017) put forward the presence of glycosylated flavone or flavonoid like compounds in *K. ivorensis* bark, which supported therefore the presence of glycosylated tannins like isoquercetin-gallate formerly identified in the studied African mahogany acetone/water bark extracts (Bikoro Bi Athomo et al., 2018).

The LC-UV chromatogram of Figure 2 and the compounds listed in Table 2 revealed the presence of molecules only present in the sapwood. Among the major compounds (abundance > 10%), 3-methanoate-5-methyl-*p*-hydroxybenzoic acid (*m/z* 197.0444, C<sub>9</sub>H<sub>9</sub>O<sub>5</sub><sup>+</sup>) (**17**) supported the presence of benzoic acid linked condensed tannins units observed in Maldi-ToF spectra of the *K. ivorensis* sapwood acetone/water extracts. The dominating signal at Rt 43.04 (Figure 2c) assigned to C<sub>4</sub>-C<sub>8</sub> dihydroxyflavan dimer + 4H (*m/z* 487.2114, C<sub>30</sub>H<sub>31</sub>O<sub>6</sub><sup>+</sup>) (**20**) highlighted the existence of such condensed tannins that the integrated area (20.41%) suggested a high content in *K. ivorensis* sapwood (Table 2).



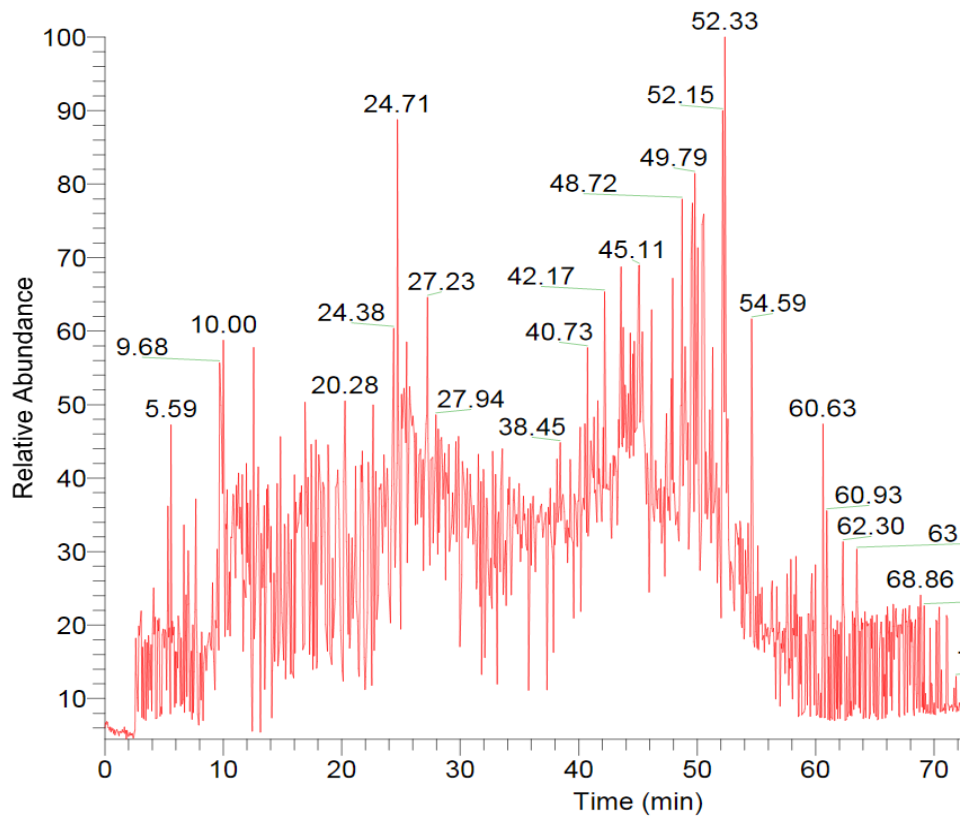


**Figure 2 : LC/MS spectrum of bark (a), sapwood (b) and heartwood (c) extract method 2.**

This compound **20** which lacked in the acetone/water extracts characterized by MALDI-TOF was the most abundant in the methanol/water extracts eluted by method

2. With a relative abundance of 19.43% (Table 2), deoxy-mannitol ( $m/z$  167.0913,  $C_6H_{15}O_5^+$ ) (**21**) which is one of hexitols principally observed in angiosperms and found in high content in *Agave sisalana* (Branco et al., 2010) accounted also among the most abundant compounds in *K. ivorensis* sapwood (Table 2).

Other minor compounds released by the sapwood were listed in Table 2. Traces of kaempferide ( $m/z$  301.0706,  $C_{16}H_{13}O_6^+$ ) (**18**), an 4'-O-methylated flavonol previously reported in wine (García-Villalba et al., 2017) as well as in aromatic ginger *Kaempferia galanga* inhibits pancreatic cancer growth and migration (Lee and Kim, 2016) should be found in *K. ivorensis* sapwood at Rt 41.32 (Figure 2b). However, an analogue of kaempferide methylated at the 3' position known as kaempferol should appear as Kaempferol-8-(3'-methyl) trihydroxyflavan ( $m/z$  557.1417,  $C_{31}H_{25}O_{10}^+$ ) dimer probably condensed in C<sub>4</sub>-C<sub>8</sub> as shown in Table 2. Traces of chlorogenic acid ( $m/z$  355.1023,  $C_{16}H_{19}O_9^+$ ) (**19**) were found in *K. ivorensis* sapwood methanol/water extracts (Table 2). This compound taken as a dietary supplement or in coffee would reduce pressure blood (Zhao et al., 2012; Onakpoya et al., 2015) and displayed anti-inflammatory effects (Tajik et al., 2017). Kaempferol-8-(3'-methyl) trihydroxyflavan (**22**) should be only found in *K. ivorensis* sapwood (Table 2). That compound which has never been reported was found for the first time in *K. ivorensis* showed the following fragmentation patterns: MS<sup>2</sup>=301.18 assigned to 3'-methyl-kaempferol in [M+H]<sup>+</sup> ion and MS<sup>2</sup>=254.08 related to trihydroxyflavan with a loss of 4xH. Therefore, these two fragments should be condensed by a C<sub>4</sub>-C<sub>8</sub> bond as suggested in Table 2.



**Figure 3: ESI-FTMS full MS chromatogram at 80.00-1500.00 of *Khaya ivorensis* heartwood extract (method1)**

Concerning the heartwood, 4-hydroxyresocinol ( $m/z$  126.0362,  $C_6H_6O_3$ ) (**9**) which accounted for low content among the compounds eluted from the heartwood by method 2 (6.5%) (Table 2) did not differ significantly from its counterpart free resocinol (**2**) (8.27%) released by the heartwood extracts eluted with the method 1 (Table 1). On the other hand, 4-benzoate-*p*-hydroxybenzoic acid ( $m/z$  245.0808,  $C_{14}H_{13}O_4^+$ ) (**11**) was found in a higher extent in the heartwood (26.67%). An additional isoquercetin like compound such as isoquercetin-7,4'-*O*-di-*p*-hydroxybenzoic acid+2H ( $m/z$  707.1606,  $C_{35}H_{31}O_{16}^+$ ) bearing a supplementary *p*-hydroxybenzoic acid at the 4' position of flavone unit (**15**) accounted among the major compounds eluted from the heartwood extracts (Table 2). This underlined the potential of *K. ivorensis* heartwood wastes as source of quercetin or isoquercetin derivatives of antiradicalar, antioxidant, antifungal (Valentová et al., 2014).

It was noteworthy that the cumulated areas of benzoic type acid series of Table 2 supported the richest of the heartwood extracts (70.63%) in this galloyl type unit compared to the sapwood (40.68%) and bark (6.62%) ones. Even if benzoic type acid compounds strongly dominated *K. ivorensis* heartwood extracts eluted by method 2, no significant difference was found between benzoate type ester structures entirely released by the bark (37.67%), sapwood (37.81%) and heartwood (36.04%) extracts eluted by method 1 (Table 1). The unique ester obtained by method 2 was 4-benzoate-*p*-hydroxybenzoic acid (**11**) eluted from the heartwood extracts (Table 2). Therefore, LC-MS results from method 2 showed a clear variability regarding *K. ivorensis* acid type units which would be globally dominated by benzoic type acid rather than gallic acid. These acids' distribution varied according to the wood extracts as follows: gallic acid (37.52%) was more abundant than benzoic acid (6.62%) in the bark while the sapwood was more abundant in benzoic acid (46.62%) than gallic acid (6.12%), and the strongest abundance of the heartwood in benzoic acid (70.63%) than gallic acid (10.06%) should be ascertained (Table 2). These results which supported a high content of carbonyl groups (C=O) from the richest heartwood in ester and acid structures compared to the bark and sapwood agreed with the strongest signal of C=O raising at  $1731.8\text{ cm}^{-1}$  in the heartwood tannins FTIR spectra reported in our previous work (Bikoro Bi Athomo et al., 2018).

#### IV.G. Conclusion

The methanol/water extracts from *Khaya ivorensis* bark, sapwood and heartwood eluted with 2 different gradients in liquid chromatography associated with mass spectrometry were studied. The first did not show significant difference regarding the compounds released by *K. ivorensis* bark, sapwood and heartwood. Nevertheless, some compounds eluted by method 1 were specific to certain parts of the wood, hence trihydroxyflavan was only found in the bark, and a protonated dihydroxyflavan type molecule was found in high extent in the heartwood. The second gradient allowed a better separation of the heavier compounds. Although a strong variability was observed among the compounds released by the bark, sapwood and heartwood; both method 1 and 2 showed the occurrence equivalent mannitol content in the three part of *K. ivorensis* wood while free resorcinol unit appeared only in the African mahogany bark and heartwood. This would explain in some extent the better reactivity of their tannins with formaldehyde or hexamine compared to the sapwood ones. Nevertheless, LC/MS analyses of methanol/water extracts eluted by method 2 have shown the richest of *K. ivorensis* heartwood in benzoic acid moiety whereas gallic acid was more abundant in the bark. Hexoside derivatives such as (quercetin-7-O-p-hydroxybenzoic acid)-3-O-hexoside and (quercetin-7, 4'-O-di-p-hydroxybenzoic acid + 2H)-3-O-hexoside released respectively in the bark and the heartwood known for their antiradicalar, antioxidant or antifungal activities without excluding the presence of traces of Kaempferide in the bark of *K. ivorensis*. This compound inhibits pancreatic cancer growth and migration. Despite these promising results, further investigation based on semi-quantitative extraction and biological or microbiological essays of the extracts are necessary to ascertain the potential of *K. ivorensis* industrial wood wastes from Gabon to be source of molecules of interest for medicine, fine chemistry, adhesives or wood protection.

##### Author contribution

Authors' contribution Arsène Bikoro Bi Athomo was the principal investigator of the subject as a PhD student. Carine Arnaudguilhem helped in chemical analysis. Peguy Starlin Engozogho participated as PhD student working in a related field of tropical wood chemistry. Dr. Rodrigue Safou Tchiama contributed actively as wood scientist and PhD committee's member; he criticized and corrected the final manuscript. Pr. Florent Eyma and Pr. Bertrand Charrier acted as scientific directors.

## Funding

This project is not the result of specific funding.

## Acknowledgements

We gratefully acknowledge the financial support of the Agence Nationale des Bourses du Gabon (ANBG). The Université de Pau et des Pays de l'Adour are thanked for the material support and facilities offered by the ANR-10-EQPX-16 Xyloforest (Xylomat, Mont de Marsan).

## Conflicts of interest

The authors declare that they have no competing interests.

## IV.H. References

Belewu, M.A., Olatunde, O.A., Giwa, T.A., 2009. Underutilized medicinal plants and spices: Chemical composition and phytochemical properties. *J. Med. Plants Res.* 3, 1099–1103.

Bikoro Bi Athomo, A., Engozogho Anris, S.P., Safou-Tchiana, R., Santiago-Medina, F.J., Cabaret, T., Pizzi, A., Charrier, B., 2018. Chemical composition of African mahogany ( *K. ivorensis* A. Chev ) extractive and tannin structures of the bark by MALDI-TOF. *Ind. Crops Prod.* 113, 167–178.

Branco, A., Santos, J.D.G., Pimentel, M.M.A.M., Osuna, J.T.A., Lima, L.S., David, J.M., 2010. d-Mannitol from *Agave sisalana* biomass waste. *Ind. Crops Prod.* 32, 507–510. <https://doi.org/10.1016/j.indcrop.2010.06.025>

Charrier, B., Janin, G., Haluk, J.-P., Mosedale, J.R., 1995. Colour and Chemical Characteristics of Moon Rings in Oakwood. *Holzforschung* 49, 287–292.

Crocker, D.R., Perry, S.M., 1990. Plant chemistry and bird repellents. *Ibis* 132, 300–308.

Engozogho Anris, P., Starlin, Arsene, B.B.A., Marcia, V., Louis, D., Rodrigue, S.T., Bertrand, C., 2019. Extraction and Characterization of *Aucoumea klaineana* Pierre (Okoume) Extractives. *JRM* 7.

Eva Heřmánková-Vavříková, Alena Křenková, Lucie Petrásková, Christopher Chambers, Jakub Zápál, Marek Kuzma, Kateřina Valentová, Vladimír Křen, 2017. Synthesis and Antiradical Activity of Isoquercitrin Esters with Aromatic Acids and Their Homologues. *Int. J. Mol. Sci.* 18, 1074. <https://doi.org/10.3390/ijms18051074>

García-Villalba, R., Espín, J.C., Tomás-Barberán, F.A., Rocha-Guzmán, N.E., 2017. Comprehensive characterization by LC-DAD-MS/MS of the phenolic composition of seven *Quercus* leaf teas. *J. Food Compos. Anal.* 63, 38–46. <https://doi.org/10.1016/j.jfca.2017.07.034>

Gorischi, J., Lingens, F., 1973. Chorismate mutase from *Streptomyces aureofaciens*: a heat stable enzyme. *J Bacteriol* 114, 645–651.

Iwu, M.M., Kiayman, D.L., 1992. Evaluation of the in vitro antimalarial activity of *Picralima nitida* extracts. *J. Ethnopharmacol.* 36, 133–135.

Lee, J., Kim, J.H., 2016. Kaempferol Inhibits Pancreatic Cancer Cell Growth and Migration through the Blockade of EGFR-Related Pathway In Vitro. *PLOS ONE* 11, e0155264. <https://doi.org/10.1371/journal.pone.0155264>

Meyers, V., 1983. Chemicals which cause birth defects — teratogens: A special concern of research chemists. *Sci. Total Environ.* 32, 1–12. [https://doi.org/10.1016/0048-9697\(83\)90128-6](https://doi.org/10.1016/0048-9697(83)90128-6)

Morais, S.A.L., Nascimento, E.A., Queiroz, C.R.A.A., Piló-Veloso, D., Drumond, M.G., 1999. Studies on polyphenols and lignin of *Astronium urundeuva* wood. *J. Braz. Chem. Soc.* 10, 447–452. <https://doi.org/10.1590/S0103-50531999000600005>

Onakpoya, I.J., Spencer, E.A., Thompson, M.J., Heneghan, C.J., 2015. The effect of chlorogenic acid on blood pressure: a systematic review and meta-analysis of randomized clinical trials. *J. Hum. Hypertens.* 29, 77.

Pizzi, A., Pasch, H., Simon, C., Rode, K., 2004. Structure of Resorcinol, Phenol, and Furan Resins by MALDI-TOF Mass Spectrometry and <sup>13</sup>C NMR. *JApplPolymer Sci* 92, 2665 – 2674.

Quifer-Rada, P., Vallverdú-Queralt, A., Martínez-Huélamo, M., Chiva-Blanch, G., Jáuregui, O., Estruch, R., Lamuela-Raventós, R., 2015. A comprehensive characterisation of beer polyphenols by high resolution mass spectrometry (LC–ESI-LTQ-Orbitrap-MS). *Food Chem.* 169, 336–343. <https://doi.org/10.1016/j.foodchem.2014.07.154>

Safou-Tchiama, R., Bikoro Bi Athomo, A., Engozogho Anris, S.P., Akagah, A.G., De Jeso, B., 2019. Characterization of some African tropical heartwood lignins by 1D <sup>13</sup>C and <sup>1</sup>H-NMR: molecular structure and hydroxyl groups' distribution. *J. Indian Acad. Wood Sci.*

Safou-Tchiama, R., de Jéso, B., Akagah, A.G., Sèbe, G., Pétraud, M., 2007. A preliminary survey of the interfacial bonding of some tropical hardwoods towards succinic anhydride and 2-octen-1-yl succinic anhydride molecules: Impact of lignin and carbohydrate polymers structure on the chemical reactivity. *Ind. Crops Prod.* 26, 173–184.

Tajik, N., Tajik, M., Mack, I., Enck, P., 2017. The potential effects of chlorogenic acid, the main phenolic components in coffee, on health: a comprehensive review of the literature. *Eur. J. Nutr.* 56, 2215–2244. <https://doi.org/10.1007/s00394-017-1379-1>

Takin, M.C., Attindehoua, S., Sezan, A., Attakpa, S.E., Baba-Moussa, L., 2013. Bioactivity, therapeutic utility and toxicological risks of *Khaya senegalensis*. *Indian J. Pharm. Biol. Res Earch* 1, 22–129.

Valentová, K., Vrba, J., Bancířová, M., Ulrichová, J., Křen, V., 2014. Isoquercitrin: Pharmacology, toxicology, and metabolism. *Food Chem. Toxicol.* 68, 267–282. <https://doi.org/10.1016/j.fct.2014.03.018>

Zhao, Y., Wang, J., Balleve, O., Luo, H., Zhang, W., 2012. Antihypertensive effects and mechanisms of chlorogenic acids. *Hypertens. Res.* 35, 370–374. <https://doi.org/10.1038/hr.2011.195>



**Table 1**

**Relative abundance expressed in percent (%) of phenolic compounds tentatively identified in *K. ivroensis* extracts by method 1.**

Ref	Name	Rt (min)	Experimental m/z	$\sigma$ ppm	Theoretical m/z	Major fragments m/z	Elemental Composition [M+H] <sup>+</sup>	Bark (%)	Sapwood (%)	Heartwood (%)
		40.22	234.0886	-3.584	234.0878	95.05 MS <sup>2</sup> , 201.1	C <sub>13</sub> H <sub>14</sub> O <sub>4</sub> <sup>+</sup>	-	-	16.05
		52.25	235.0964	-0.000	235.0978	(MS <sup>2</sup> ), 158.9 7 (MS <sup>3</sup> ) 201.1	C <sub>13</sub> H <sub>15</sub> O <sub>4</sub> <sup>+</sup>	17.12	-	-
1	p-hydroxybenzoate +xH- resorcinol (x= 3 or 4)	52.31	235.0964	-0.000	235.0978	(MS <sup>2</sup> ), 158.97 (MS <sup>3</sup> ) 123.04		-	16.43	-
		59.00	235.0964	-0.000	235.0978	(MS <sup>2</sup> ), 95.05 (MS <sup>3</sup> )			4.45	
		59.05	235.0964	-0.000	235.0978	123.04 (1 MS <sup>2</sup> ), 95.05 (MS <sup>3</sup> )		3.09	-	-

2	Mannitol	61.61			235.0978	123.04				
			235.0964	-0.000		(MS <sup>2</sup> ),		8.07	-	-
						95.05 (MS <sup>3</sup> )				
		61.67			235.0978	123.04				
			235.0964	-0.000		(MS <sup>2</sup> ),		-	7.75	-
						95.05 (MS <sup>3</sup> )				
					235.0978	201.1				
		62.30	235.0964	-0.000		(MS <sup>2</sup> ),		-	4.69	-
						158.97				
						MS <sup>3</sup> )				
3	Mannitol	53.03	183.0862	-0.000	183.0878	130.03	C <sub>6</sub> H <sub>15</sub> O <sub>6</sub> <sup>+</sup>	6.95	6.66	-
						(MS <sup>2</sup> )				
		53.26	183.0862	-0.000	183.0878	130.03		6.98	8.36	-
						(MS <sup>2</sup> )				
		53.73	202.0835	-2.976	202.0878	158.97	C <sub>9</sub> H <sub>13</sub> O <sub>5</sub> <sup>+</sup>	-	8.44	-
				(MS <sup>2</sup> )						
3	Mannitol	53.75	202.0835	-2.976	202.0878	158.97		7.04	-	-
						(MS <sup>2</sup> )				
		54.23	202.0835	-2.976	202.0878	158.97		-	-	3.89
				(MS <sup>2</sup> )						

	3-acetate-4-hydroxy cyclohexen-1- carboxylate	54.79	202.0835	-2.976	202.0878	158.97 (MS <sup>2</sup> )	-	5.16	-	
		54.83	202.0835	-2.976	202.0878	158.97 MS <sup>2</sup> )	3.59	-	-	
		55.39	202.0835	-2.976	202.0878	158.97 (MS <sup>2</sup> )	-	5.57	-	
		55.46	202.0835	-2.976	202.0878	158.97 (MS <sup>2</sup> )	3.31	-	-	
		56.09	202.0835	-2.976	202.0878	158.97 (MS <sup>2</sup> )	-	-	8.95	
		58.92	202.0835	-2.976	202.0878	158.97 (MS <sup>2</sup> )	-	-	1.41	
		59.96	202.0835	-2.976	202.0878	158.97 (MS <sup>2</sup> )	-	-	4.78	
4	Resorcinol	54.86	111.0440	-4.984	111.0478	111.04 (MS <sup>2</sup> )	C <sub>6</sub> H <sub>7</sub> O <sub>2</sub> <sup>+</sup>	-	-	4.38
		55.98	111.0440	-4.984	111.0478	111.04 (MS <sup>2</sup> )		-	-	2.23
5		56.73	159.0651	-3.851	159.0678	158.97 (MS <sup>2</sup> )	C <sub>7</sub> H <sub>11</sub> O <sub>4</sub> <sup>+</sup>	-	6.77	-

	4,5- dihydroxycyclohexen-1- carboxylate	56.80	159.0651	-3.851	159.0678	158.97 (MS <sup>2</sup> )		3.35	-	-
		43.64	124.0518	-4.457	124.0478	95.05 (MS <sup>2</sup> )		-	-	6.97
		57.38	124.0518	-4.457	124.0478	95.05 (MS <sup>2</sup> )		-	-	1.37
	Methyl-dehydroxy resorcinol	57.46	124.0518	-4.457	124.0478	95.05 (100)		-	10.83	-
6		57.51	124.0518	-4.457	124.0478	95.05 (MS <sup>2</sup> )	C <sub>7</sub> H <sub>8</sub> O <sub>2</sub> <sup>+</sup>	11.30	-	-
		58.62	124.0518	-4.457	124.0478	95.05 (MS <sup>2</sup> )		-	-	4.68
		60.79	124.0518	-4.457	124.0478	95.05 (MS <sup>2</sup> )		11.92		
		60.89	124.0518	-4.457	124.0478	95.05 (MS <sup>2</sup> )		-	11.48	-
		60.94	124.0518	-4.457	124.0478	95.05 (MS <sup>2</sup> )		-	-	6.32
	Dihydroxyflavan+4H	52.45	247.1328	-2.228	247.1378	204.89 (MS <sup>2</sup> ), 204.89 (MS <sup>3</sup> )	C <sub>15</sub> H <sub>19</sub> O <sub>3</sub> <sup>+</sup>	-	-	12.56
7		60.05	259.0964	-2.125	259.0978	123.04 (MS <sup>2</sup> ), 95.05 (MS <sup>3</sup> )		-	3.42	-

8	Trihydroxyflavan	60.08	259.0964	-2.125	259.0978	123.04 (MS <sup>2</sup> ), 95.05 (MS <sup>3</sup> )	C <sub>15</sub> H <sub>15</sub> O <sub>4</sub> <sup>+</sup>	7.88	-	-
---	------------------	-------	----------	--------	----------	---	---	------	---	---

---

**Table 2**

Relative abundance expressed in percent (%) of phenolic compounds tentatively identified in *K. ivroensis* extracts by method 2.

Ref	Name	Rt (min)	Experimental m/z	$\sigma$ ppm	Theoretical m/z	Major fragments m/z	Elemental Composition [M+H] <sup>+</sup>	Bark (%)	Sapwood (%)	Heartwood (%)
2	Mannitol	28.1	183.0862	- 0.000	183.0878	105.03 (MS <sup>2</sup> ), 77.04 (MS <sup>3</sup> )	C <sub>6</sub> H <sub>15</sub> O <sub>6</sub> <sup>+</sup>	-	-	12.8
4	Resorcinol	31.69	111.0440	- 4.984	111.0478	93.03 (MS <sup>2</sup> )	C <sub>6</sub> H <sub>7</sub> O <sub>2</sub> <sup>+</sup>	14.19	-	-
9	4-hydroxyresorcinol	10.7	127.0389	- 4.351	127.0378	109.06 (MS <sup>2</sup> )	C <sub>6</sub> H <sub>7</sub> O <sub>3</sub> <sup>+</sup>	-	-	6.5
10	3,4-dihydroxybenzoic acid	11.23	155.0418	- 4.351	155.0378	125.06 (MS <sup>2</sup> ), 93.03 (MS <sup>3</sup> )	C <sub>7</sub> H <sub>7</sub> O <sub>4</sub> <sup>+</sup>	-	-	1.7
	3,4-dihydroxybenzoic acid-H	21.65	154.0260	- 3.584	154.0278	153.05 (MS <sup>2</sup> )	C <sub>7</sub> H <sub>6</sub> O <sub>4</sub> <sup>+</sup>	-	-	26.31

		38..23	154.0260	-	154.0278	125.06		-	32.97	-
				3.584		(MS <sup>2</sup> ), 109.01 (MS <sup>3</sup> )				
11	4-benzoate- parahydroxybenzoic acid	29.27	245.0808	-	245.0778	199.11	C <sub>14</sub> H <sub>13</sub> O <sub>4</sub> <sup>+</sup>	-	-	26.67
				2.247		(MS <sup>2</sup> ), 153.10 (MS <sup>3</sup> )				
12	3-(2-Methoxyphenyl)- 2-oxo-2H-chromen-7-yl acetate.	30.84	311.0913	-	311.0878	293.17	C <sub>18</sub> H <sub>15</sub> O <sub>5</sub> <sup>+</sup>	34.51	-	-
				1.769		(MS <sup>2</sup> ), 237.11 (MS <sup>3</sup> ), 181.05 (MS <sup>4</sup> )				
13	3,5- Dimethoxycinnamic acid	31.99	209.0808	-	209.2178	193.12	C <sub>11</sub> H <sub>13</sub> O <sub>4</sub> <sup>+</sup>	7.16	-	-
				2.635		(MS <sup>2</sup> ), 151.08 (MS <sup>3</sup> ), 105.07 (MS <sup>4</sup> )				

14	Quercetin-3-O-gallic acid	33.17	455.0608	-	455.0578	458.28	C <sub>22</sub> H <sub>15</sub> O <sub>11</sub> <sup>+</sup>	-	-	10.07
				1.208		(MS <sup>2</sup> ), 314.17 ()				
	Quercetin-3-O-gallic acid+2H					MS <sup>3</sup> , 185.11 MS <sup>4</sup> )	C <sub>22</sub> H <sub>17</sub> O <sub>11</sub> <sup>+</sup>			
		33.99	457.0765	-	457.0678	313.16		6.85	-	-
				1.202		(MS <sup>2</sup> ), 185.11 (MS <sup>3</sup> ), 145.00 (MS <sup>4</sup> )				
		34.37	457.0765	-	457.0678	313.16		23.08	-	-
				1.202		(MS <sup>2</sup> ), 185.11 (MS <sup>3</sup> )				
		37.67	457.0765	-	457.0678	313.16		7.59	-	-
				1.202		(MS <sup>2</sup> ), 185.11 (MS <sup>3</sup> ),				



						148.89				
						(MS <sup>4</sup> )				
		46.96	457.0765	-	457.0678	313.16	-	1.22	-	
				1.202		(MS <sup>2</sup> ),				
						185.11				
						(MS <sup>3</sup> )				
		47.34	457.0765	-	457.0678	458.28	-	4.9	-	
				1.202		(MS <sup>2</sup> ),				
						218.54				
						(MS <sup>3</sup> ),				
						103.32				
						(MS <sup>4</sup> )				
15	(Quercetin-7, 4'-O-di-p-hydroxybenzoic acid + 2H)-3-O-hexoside)	34.97	707.1606	-	707.1578	706.52	C <sub>35</sub> H <sub>31</sub> O <sub>16</sub> <sup>+</sup>	-	-	15.95
				0.777		(MS <sup>2</sup> ),				
						587.41				
						(MS <sup>3</sup> ),				
						543.39				
						(MS <sup>4</sup> )				
16	(Quercetin-7-O-p-hydroxybenzoic acid )-3-O-hexoside)	36.97	585.1238	-	585.0278	541.46	C <sub>28</sub> H <sub>25</sub> O <sub>14</sub> <sup>+</sup>	6.62	-	-
				0.939		(MS <sup>2</sup> ),				
						541.46				

						(MS <sup>3</sup> ), 145.26 (MS <sup>4</sup> )				
17	3-methanoat, 5-methyl-p-hydroxybenzoic acid	39.74	197.0444	- 2.798	197.0678	105.03 (MS <sup>2</sup> ), 77.04 (MS <sup>3</sup> )	C <sub>9</sub> H <sub>9</sub> O <sub>5</sub> <sup>+</sup>	-	13.71	-
18	Kaempferide	41.32	301.0706	- 1.827	301.0678	245.08 (MS <sup>2</sup> ), 171.01 (MS <sup>3</sup> )	C <sub>16</sub> H <sub>13</sub> O <sub>6</sub> <sup>+</sup>	-	1.78	-
19	Chlorogenic acid	42.46	355.1023	- 1.549	355.0978	355.25 (MS <sup>2</sup> )	C <sub>16</sub> H <sub>19</sub> O <sub>9</sub> <sup>+</sup>	-	1.47	-
20	Dihydroxyflavan dimer +4H	43.04	487.2114	- 1.128	487.2078	488.36 (MS <sup>2</sup> ), 488.36 (MS <sup>3</sup> )	C <sub>30</sub> H <sub>31</sub> O <sub>6</sub> <sup>+</sup>	-	20.41	-
21	Deoxy-mannitol	45.06	167.0913	- 3.302	167.0878	149.02 (MS <sup>2</sup> ), 121.03 (MS <sup>3</sup> )	C <sub>6</sub> H <sub>15</sub> O <sub>5</sub> <sup>+</sup>	-	19.43	-

22	Kaempferol-8-(3'-methyl)trihydroxyflavan	47.77	557.1417	-	557.1478	301.18	$C_{31}H_{25}O_{10}^+$	-	4.12	-
				0.986		(MS <sup>2</sup> )				
						254.08				
						(MS <sup>3</sup> )				

---

## **Partie 3 : Valorisation des co-produits générés lors de la transformation du bois d'acajou**

## I. Introduction

La décision prise par le gouvernement de limiter les importations de certains matériaux (comme le ciment) en vue d'accompagner l'industrie locale présente une opportunité pour les matériaux comme le bois. Dans cette partie, nous allons présenter deux possibilités de valorisation de ce dernier, la première consiste à élaborer un adhésif biosourcé et la seconde à fabriquer un composite bois/plastique. Via ces voies de valorisation, nous souhaitons apporter une valeur ajoutée aux différents déchets et participer au développement de l'industrie forestière du Gabon.

Le travail sur l'adhésif a été réalisé avec les tanins extraits d'écorce, d'aubier et de duramen. La formulation collante a été principalement composée de tanins avec de l'hexamine. Dans ce travail il était principalement question de caractérisation thermique et de spectrométrie (IR) des différentes formulations.

Le travail sur le composite a été réalisé à Xylomat (Mont de Marsan) dans sa partie conception, mise en œuvre, optimisation du procédé de thermocompression et caractérisation physico-chimique. Les tests mécaniques ont été réalisés à l'ICA sur le site de l'IUT de Tarbes. L'objectif de ce travail était d'évaluer le potentiel de ce composite en fonction de la taille des particules utilisées (bois et plastique), de proposer un procédé simple de mise en œuvre, et enfin d'évaluer son intérêt pour une application industrielle.

La matière première utilisée pour ces travaux provenait du site de production industriel de l'usine d'Owendo de la Société Nationale des Bois du Gabon (SNBG). Cette matière était constituée de déchets d'écorce, d'aubier et de bois de cœur prélevés sur 5 grumes différentes d'acajou du Gabon. Les grumes ont été tranchées afin de prélever des rondins de 10 cm d'épaisseur et de diamètre compris entre 75 et 125 cm. Les échantillons ont ensuite été filmés et conservés dans une enceinte climatique maintenue à 20°C et 65% d'humidité avant leur arrivée au laboratoire en France. Toutes les grumes provenaient de la même exploitation forestière située au nord dans la province du Woleu-Ntem, Angouma, Mitzic (N° d'indentification : B043/1/UFA2/AAC10, AAC/2016/UFG2). Les bouteilles plastiques ont été collectées à Mont de Marsan et provenaient principalement de structures de restauration rapide (Macdonald), structures sportives (orange bleu, basic-fit) et de ménages.

Ces résultats sont présentés sous forme de deux articles :

- Elaboration d'une formulation collante à base de tanins d'acajou et d'hexamine

“Biobased adhesive from African mahogany tannins: characterization by TGA, DSC, TMA and IR,” Sera soumis à Industrial Crops and Products.

- Mise en oeuvre d'un composite bois-plastique

“Wood polymer composite: Plastic bottles recovery and wood flour”, Sera soumis à European Journal of Wood and Wood Products.

## II. Caractéristiques physico-chimiques d'adhésifs biosourcés à partir de tanins d'acajou

### << **Biobased adhesives from African mahogany tannins: Caracterisation of Physicochemical properties** >>.

Bikoro Bi Athomo<sup>1, 2\*</sup>, A., Engozogho Anris<sup>1,2</sup>, S.P., Safou Tchiama<sup>2,3</sup>, R., Eyma<sup>4</sup>, F., De Hoyos Martines<sup>5</sup>, P. L., Charrier<sup>1</sup>, B.

1 CNRS/ Université de Pau et es Pays de l'Adour, Institut des sciences analytiques et de physico-chimie pour l'environnement et les matériaux - Xylomat, UMR5254, 40004, Mont de Marsan, France.

2 Laboratoire de Recherche et de Valorisation du Matériau Bois (LaReVa Bois). Ecole Normale Supérieure d'Enseignement Technique (ENSET). BP. 3989 Libreville (Gabon).

3 Laboratoire des Substances Naturelles et de Synthèses Organométalliques (LASNSOM). Unité de Recherche en Chimie. BP 941, Université des Sciences et Techniques de Masuku, Franceville (Gabon).

4 Institut Clément Ader (ICA), Université de Toulouse, CNRSUMR 5312-INSA-ISAE-Mines Albi-UPS, Tarbes, France.

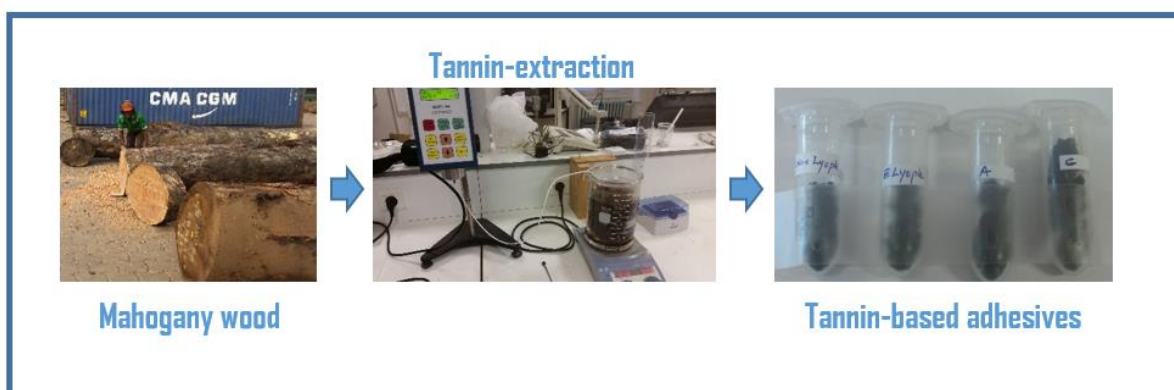
### **II.A. Résumé**

L'élaboration d'un adhésif à base de tanins d'acajou et d'hexamine a été entreprise. Les tanins d'écorce, d'aubier et de bois de cœur ont été extraits par une méthode industrielle, puis utilisés séparément pour formuler des adhésifs (tanins/hexamine/eau). Ils ont ensuite été caractérisés par calorimétrie différentielle à balayage (DSC) afin de déterminer leur changement d'état physique sous l'action de la chaleur. Leur résistance thermique a également été étudiée par analyse thermogravimétrique (ATG). Une analyse thermomécanique (TMA) a été faite pour évaluer leur comportement au moment de la polymérisation sous l'action de la chaleur.

## II.B. Abstract

The study of the development of tannin-based adhesives based on mahogany tannins and hexamine was carried out. Tannins from bark, sapwood and heartwood were extracted by means of the industrial method and they were used to synthesize different formulations of biobased adhesives. These adhesives (tannins / hexamine / water) were characterized by differential scanning analysis (DSC) in order to determine their physical changes under the action of heat. Their heat resistance was also studied by thermogravimetric analysis (TGA). Besides, a thermomechanical analysis (TMA) was carried out to evaluate their behavior at the time of polymerization under the heat action. Finally, 2D HSQC NMR analysis was performed to confirm the presence, the absence and the formation of the different chemical bonds related to the properties of the adhesives.

## II.C. Graphical abstract



## II.D. Introduction

Due to their phenolic nature, tannins are used or have been used for the production of biobased adhesives and leather goods (Pizzi and Stephanou, 1994; Navarrete et al., 2010; Lan, 2011). They are important components of wood just as much as cellulose, hemicellulose and lignin (Pizzi et al., 1986). In this respect, there have been lately a significant interest on the synthesis of tannin-based resins. In fact, tannins are the renewable resource, which is most widely used in the production of adhesives. Tannins used as bio-based adhesive are generally coming from different species such as of mimosa (*Acacia dealbata*), quebracho (*Schinopsis lorentzii*), tsuga (*Tsuga mertensiana*), rhus (*Rhus typhina*), pine (*Pinus radiata* and *Pinus pinaster*) (Kim and Kim, 2003; Li et al., 2016; Ping et al., 2011). Concerning the type, the most



commonly used tannins for adhesives are condensed tannins. They are characterized by a single highly active site (C6), while the other part is engaged in an inter flavonoid bond (C8).

In the formulation of tannins-based adhesives an agent to initiate polymerization is normally added (Moubarik et al., 2009). In this sense formaldehyde (Pizzi, 1980), hexamethylenetetramine (Saayman et al., 1971), furfuralic alcohol, glyoxal, etc are widely used. Hexamine is a compound whose chemistry has been known in the field of resins and adhesives for a long time. It is rather moderately unstable in acid conditions but becomes rather stable in basic conditions ( $\text{pH} \approx 8-10$ ). Thus, in an alkaline medium, only three formaldehyde molecules are released with the corresponding formation of trimethylamine. Accordingly, it has been reported that formulations of adhesives with tannins and hexamine used for particleboards, present very low formaldehyde emission (Pichelin et al., 1999).

The importance of tannins in the industrial environment has already been proven. Particleboard adhesives based on acacia tannins had been used several countries. For instance, in South Africa the totality of the panels used in interior furnishings are made with these adhesives. Their performance is superior to that of synthetic adhesives derived from petroleum derivatives (Pizzi and Scharfetter, 1981). However it should be noted that the quantities of tannins available commercially are less important than those synthetic derived from petroleum. It is therefore important to research other sources of tannins as important as those currently used to extract these compounds. It is within this framework that this study was carried out namely, the elaboration bio-based adhesives with tannins extracted from mahogany wood (Taiwo and Ogunbodede, 1995; Bikoro et al., 2018); Bikoro et al., 2019). Besides that, mahogany wood (*K. ivorensis*), which is one of the most exploited species in Gabon, is mainly sawn and the by-products of its transformation are mainly burnt. It is therefore interesting to evaluate the properties of the tannins extracted from its residues with a view to valorize them into bio-based adhesives.

## **II.E. Material and methods**

### **II.E.1. Materials**

#### **II.E.1.a. Chemicals**

All the chemicals used in this study were purchased from Fisher Scientific, Acros Organic and Sigma Aldrich. Deionized water, acetone (99.98%, Fisher), sodium carbonate decahydrate (>98%, Fisher), sodium bisulfite for analysis Acros Organic), sodium hydroxide (98.5%, Acros Organic), sodium sulfite (anhydrous, Fisher).

#### II.E.1.b. Wood sampling

Bark (TB), sapwood (TS) and heartwood (TH) from a *K. ivorensis* were collected and sampled with a section disk of 10 cm of thickness and 85 cm (AMG1), 80 cm (AMG2) and 75 cm (AMG3) of diameter. The wood was harvested at Mitzic in the North of Gabon by the SNBG (Société Nationale des Bois du Gabon) during the period between 2016 and 2017. The fresh samples were put in sterilized bags, air-dried for one week in the laboratory and oven-dried (105°C) for 48h. The dried samples were grinded to pass through 60 mesh (□1 mm diameter) with a rotative knife grinder (Retsch SK1).

#### II.E.2. **Methods**

##### II.E.2.a. Alkaline extraction of tannins

According to a previous optimization of alkaline extractions developed by Chupin (Chupin et al., 2013), African mahogany bark, sapwood and heartwood tannins were extracted by water solution containing 0.25 % of NaOH, 0.25 % of Na<sub>2</sub>SO<sub>3</sub> and 0.25% of NaHSO<sub>3</sub>. The sample/water ratio was 1: 9. NaOH was used in the extraction to ensure high alkaline conditions (pH≈9) and to increase the extraction yield. Na<sub>2</sub>SO<sub>3</sub> and NaHSO<sub>3</sub> were added to lessen the viscosity and to stabilize the extracts. The grounded samples were immersed in water under continuous magnetic stirring for 2h at 80±5°C. The supernatant was filtered through whatman paper n° 3 and the residue was rinsed with water. The filtrates were dried in an oven at 40°C. Then, the samples were frozen at -20°C and then they were lyophilized by using an Alpha 1-4 LO plus Martin Christ. After 24h the lyophilized samples were crush in a mortar and the powder was recovered.

##### II.E.2.b. Adhesive formulation

Different formulation of the biobased adhesives were synthesise by using different tannins, namely tannins from bark, sapwood and heartwood of mahogany. The composition of the different formulations was as described next: 1.52 g of

mahogany tannins, 2.16 g of water and 0.32 g of hexamine (solution 99%). Three replicates were obtained for each formulation (Saad et al., 2014).

#### II.E.2.c. Thermogravimetric analysis (TGA)

##### Thermogravimetric analysis (TGA)

This analysis was performed in a TA instruments TGA Q5000 IR equipment, under dynamic nitrogen flow with a flow rate of 40 mL/min. Samples of the biobased adhesives of 12 mg were placed in a platinum crucible and heated in a temperature range of 24 to 600 °C; at a constant heating rate of 10 °C/min under air atmosphere. For the quantitative calculations, the response factors between the weight gain (TG) and the mass loss rate (DTG) were determined

#### II.E.2.d. Differential scanning calorimetry (DSC)

A TA instrument (DSC Q500) was used for this test and was run simultaneously with TGA Q50. Mass sample used was between 5 and 22 mg. The analysis was performed under nitrogen atmosphere (60ml/min) from 25°C to 200°C. For the tests two different ramps of temperature were used, one of 5°C/ min and another one of 10°C/min.

#### II.E.2.e. Fourier Transformed Infrared spectroscopy analysis (FTIR)

Tannins extracted from *K. ivorensis* sapwood and heartwood by the acetone/water solvent method (7:3, v/v) were used for FTIR spectroscopy analysis. The samples were oven-dried at 105°C for 24h then, 5 mg of the dried powders were placed on the crystal device and the contact was obtained by applying strength of 150 N on the sample. 32 scans were used with a resolution of 4 cm<sup>-1</sup> in the range 4000 to 600 cm<sup>-1</sup>. All the experiments were carried out in ATR (attenuated total reflection) mode with a PerkinElmer Frontier spectrophotometer equipped with a diamond/ZnSe crystal.

#### II.E.2.f. Thermomechanical analysis (TMA)

TMA sample was composed with two plywood samples (14 mm x 5 mm x 1 mm) and a resin film at 120g/m<sup>2</sup>. Resin composition was like that: 1.52 g of mahogany tannins, 2.16 mL of water and 0.32 g of hexamine. Three replicates was done for all samples.

The temperature program was set from 25°C to 150°C at a heating rate of 10°C/min. Measurements were conducted under applied force at 0.5 N.

#### II.E.2.g. 2D HSQC NMR analysis

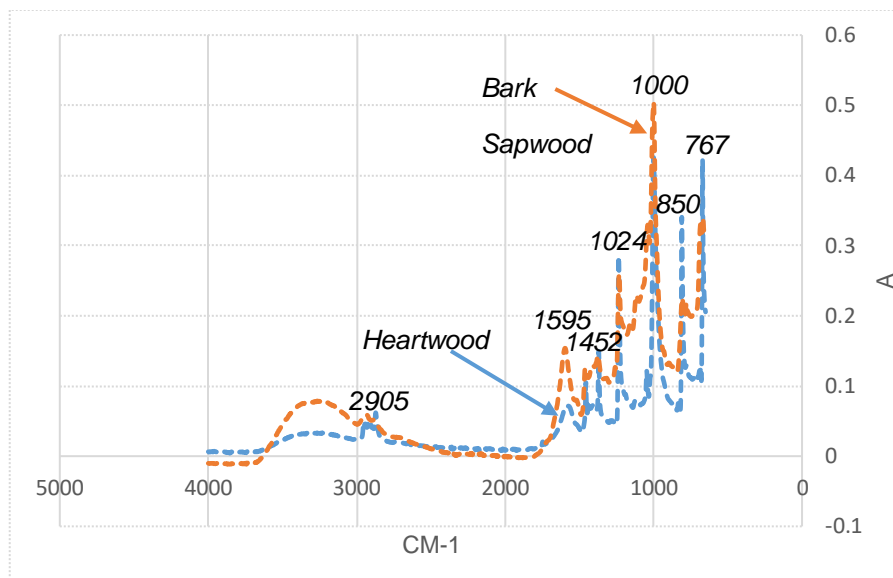
In this analysis, around 50 mg of tannin-based adhesive was dissolved in 0.5 mL of DMSO  $d_6$ . The 2D HSQC NMR spectra were recorded at 25 °C in a Bruker AVANCE 500 MHz equipped with a z-gradient double resonance probe. The spectral widths were 5000 and 12,300 Hz for the  $^1\text{H}$  and  $^{13}\text{C}$  dimensions, respectively. The number of collected complex points was 1024 for the  $^1\text{H}$  dimension with a recycle delay of 1.5 s. The number of transients was 64, and 256 time increments were always recorded in the  $^{13}\text{C}$  dimension. The  $^1J_{\text{CH}}$  used was 145 Hz. Prior to Fourier transformation, the data matrices were zero filled to 2048 points in the  $^{13}\text{C}$  dimension. Data processing was performed using MestReNova software. The central solvent (DMSO) peak was used as an internal chemical shift reference point ( $\delta_{\text{C}}/\delta_{\text{H}}$  39.5/2.49).

### II.F. Results and discussion

#### II.F.1. FTIR-ATR spectroscopy analysis

This analysis was carried out for assessing the structure, main functional groups and the bonds formed during the reaction of polymerization of the adhesives. Thereby, in Figure 1 the spectrum of mahogany adhesive with tannins from bark (TB), sapwood (TS) and heartwood (TH) are shown. The formation of tannin based adhesive is based on the reaction between the tannin and formaldehyde (Kim and Kim, 2003). Previous studies have shown that mahogany tannins are condensed and that the presence of free monomer fragments is rare (Bikoro Bi Athomo et al., 2018). Consequently, it could be assumed that the C8 sites are more involved in the auto condensation reactions. On the other hand, the C6 sites of A ring are the ones remaining more active for the polymerization reaction of tannins with the main product derived from hexamethylenetetramine which is formaldehyde.

In respect to the spectra shown in figure 1, the broad peak in the region 3700-3000  $\text{cm}^{-1}$  was the characteristic of the  $-\text{OH}$  stretching of the benzene nucleus and the methylol group of tannin. Then the low intensity peak at 2905 was assigned to the  $-\text{CH}$  stretching of the benzene nucleus, the methylene ( $-\text{CH}_2-$ ) and dimethylene ether ( $-\text{CH}_2\text{OCH}_2-$ ) bridges present within the structure of the tannin-based adhesives.



**Figure 1 : FTIR spectrums of tannin-based adhesives from *K. ivorensis*.**

The peak at 1595 cm<sup>-1</sup> was assigned to the elongation of the aromatic double bond of benzene ring. The signal in region 1443-1452 cm<sup>-1</sup> were related to the deformation-vibration of the carbon-carbon bonds in the phenolic groups (Nuopponen et al., 2006). However, these groups does not participate in the chemical reaction during the polymerization. The peak at 1238 cm<sup>-1</sup> was assigned to the –CO stretching of the benzene ring and the dimethylene ether bridges formed by reaction with hexamine. Signals between 1024 cm<sup>-1</sup> to 1000 cm<sup>-1</sup> were characteristic of C-O bound in mahogany condensed tannin. The absorption bands between 767 cm<sup>-1</sup> and 850 cm<sup>-1</sup> were assigned to the deformation vibration of C-H in the phenolic rings. This group can be an indicator of the degree of polymerization because it disappeared during the reaction between tannins and hardener.

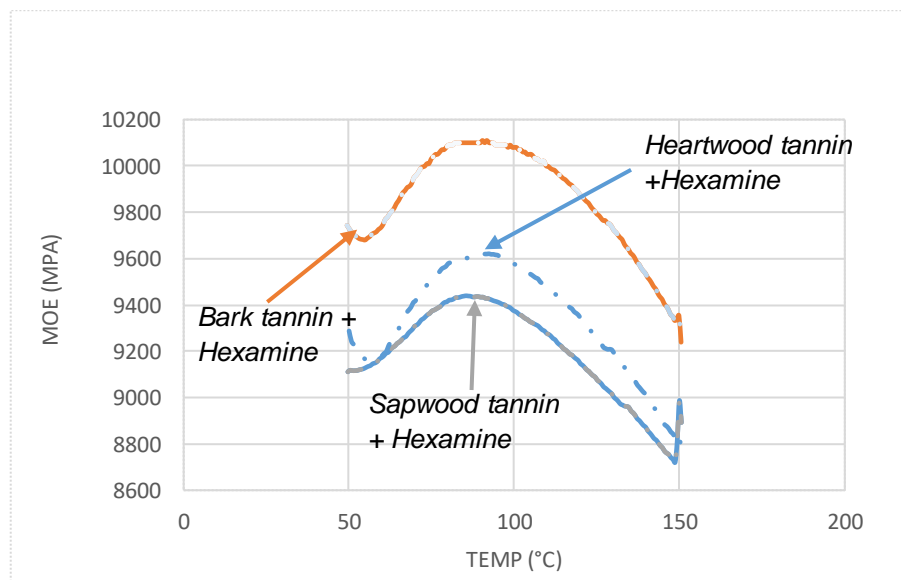
### II.F.2. **TMA analysis**

The results of this analysis corresponding to the different formulations of mahogany tannin-base adhesives are shown in Table 1. The elasticity modulus (MOE) was given as a function of temperature for the formulated resins. MOE was obtained for the same formulation at 150°C for different parts of wood. Thus, it was confirmed that the Mahogany tannin-based adhesives obtained in this work displayed a higher MOE (Table 1) compared the ones from mimosa, Aleppo pine and quebarcho reported in a previous work (Saad et al., 2014). However, in TMA, the MOE depends on the thickness of lamiae used for the sandwich. In this study, we used laminae of 1 mm thickness while the values in literature were using laminae of 0.6 mm. It means that

the sandwich of this study was at minimum 67% thicker (without considering the adhesive that is probably more) than those in literature. We used a force of 0.5 N while in the literature the alternating force used was of 0.6 N, this can too impinges a lot on MOE measure of another 20%.

Regarding the comparison between the different formulations of the mahogany tannin-based adhesives, the MOE values were significantly higher in the tannin-based adhesive from sapwood and heartwood. The other formulation from bark were similar compared that were found by Zanetti and Pizzi (2002).

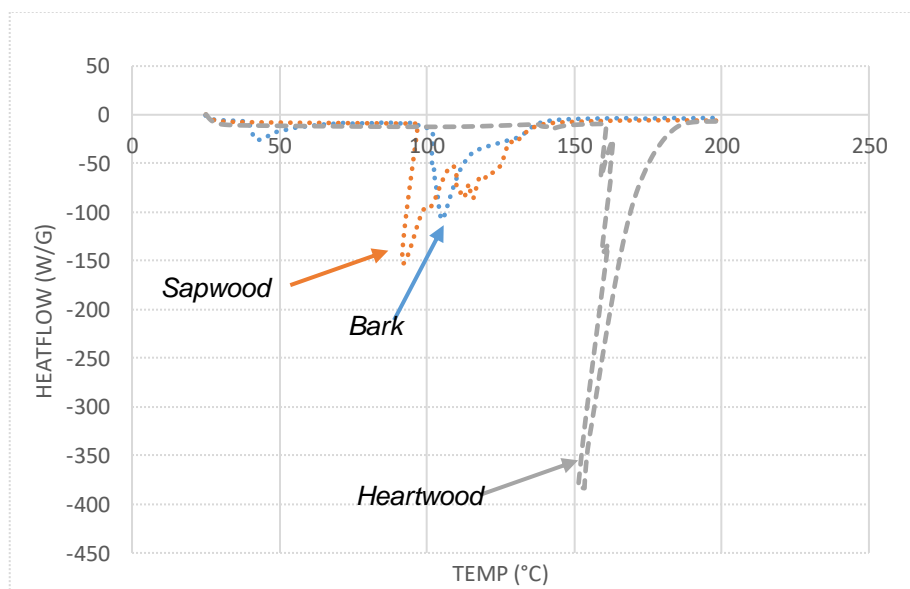
Temperatures corresponding to the maximum values of MOE were lower than 100°C. Either 88°C for the formulations from bark and sapwood, and 92°C for that from heartwood. It was assigned to the temperatures of polymerization reaction. This reaction is significantly dependent from the nature of bridges between the condensed tannins units, from the availability of reactive sites and from nucleus A and B (Yazaki and Collins, 1994; Pizzi, 2000; Pizzi, 2003; Moubarik et al., 2009; Basso et al., 2017). It appears that the MOE of mahogany tannin-based adhesives were stable after 150°C (MOE was around 9000 MPa) and these temperatures values were higher than urea-formaldehyde resin (Moubarik et al., 2013). This temperature was low compared to the conditions for producing particleboards by hot pressure. The mahogany tannin-based adhesives are comparable to those of quebracho tannins but with higher MOE values (for bark and heartwood tannins).



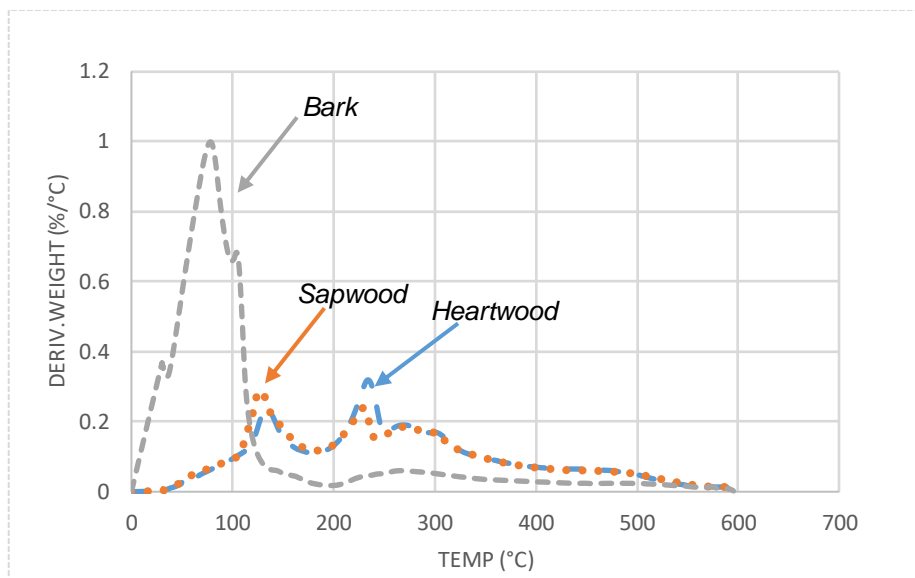
**Figure 2 : Elasticity modulus of tannin-adhesives from *K. ivorensis*. Each curve is one mean of three analysis.**

### II.F.3. TGA and DSC analysis

DSC and TGA analysis are shown in Figure 3 and Figure 4 and show the thermogram (derivative DTG) obtained under nitrogen analysis of the tannin-based adhesives from bark, sapwood and heartwood of mahogany wood. TGA has allowed to check thermal decomposition and thermal stability of formulations (Moubarik et al., 2009). Indeed, we observed two peaks of degradation for each formulation analyzed. Two peaks of degradation thus emerged. The first is between 130 and 140°C for sapwood and heartwood, while that of bark is around 70°C. The second degradation peaks are found between 225°C and 250°C for the different formulations. 228.5°C for the sapwood, 236.9°C for the heartwood and around 250°C for the bark. These results showed that sapwood and heartwood tannin-based adhesives had the same thermal behavior those tannins from the same parts of wood ( $\approx 118^\circ\text{C}$ ).



**Figure 3 : DSC of tannin-based adhesives from *K. ivorensis*. Each curve is a mean of three samples.**



**Figure 4 : TGA of tannin-based adhesives from *K. ivorensis*. Each curve is a mean of three samples.**

This is in agreement with what was previously published by Bikoro Bi Athomo et al (Bikoro Bi Athomo et al., 2018) and (Bikoro et al., 2019). However, the first temperature of degradation from bark ( $\approx 109^{\circ}\text{C}$ ) tannin-based adhesive was low compared to sapwood and heartwood. The first degradation was assigned to the moisture and volatiles evaporation such as carbohydrate,  $\text{H}_2\text{O}$ ,  $\text{H}_2$  (Gaugler and Grigsby, 2009 ; Basso et al., 2017). That suggests the degradation of simple sugars and organic acids. Further, degradation of all tannins-based adhesives were beginning around  $200^{\circ}\text{C}$ . These were assigned to the thermal degradation of intermolecular C-O bond of condensed tannins or intermolecular C-C bond during auto condensation and polymerization reaction. DSC analysis showed one major domain for bark and heartwood. Each curve of the curing process passed one exothermic peak. However, for sapwood, analysis showed two majors domains (Figure 3). The most prominent peaks for the adhesives of each part of wood used depicted between  $105^{\circ}\text{C}$  and  $153^{\circ}\text{C}$ . The values were  $92^{\circ}\text{C}$ ,  $115^{\circ}\text{C}$  and  $153^{\circ}\text{C}$  respectively for sapwood, bark and heartwood. These peaks were assigned to the crosslinking reaction between the extracted tannins and hexamine present in the adhesives (Zhang et al., 2017). The higher peak in the heartwood tannin-based adhesives suggested that heartwood tannins acquired more bonding with hexamine compared to heartwood and sapwood.

Furthermore, a study about production of tannins adhesives with bark of Nigerian trees showed that tannin from *K. ivorensis* could be used and replaced the



best commercially available synthetic adhesives (Taiwo and Ogunbodede, 1995). However, it was with aqueous extracts (yield of 23%) and the hardener used was paraformaldehyde.

#### II.F.4. NMR $^{13}\text{C}$ and $^1\text{H}$ analysis

The 2D HSQC NMR measurements were undertaken to give additional and complementary information on the chemical structure of tannin-based adhesives from *K. ivorensis*. Spectra and peaks intensity of tannin-based adhesive are shown in Figure 5 and Table 1 H/Cn or n' (f1, f2). They have been observed a greater number of points in the sapwood and the heartwood when compared to the bark. Sapwood and heartwood showed identical  $^{13}\text{C}$  and  $^1\text{H}$  NMR spectra. However, bonds with high intensity were observed in tannin-based adhesives from sapwood and heartwood. The reaction has been shown that higher peaks characteristic to C-C bonds were more abundant in the heartwood (Figure 5) tannin-based adhesive of African mahogany compared to bark and sapwood adhesives.

Previous studies investigated by Grabber (Grabber et al., 2013) on acetone extracts, showed  $^1\text{H}$ - $^{13}\text{C}$  HSGC NMR spectrum of condensed tannins in Lotus species. According to these studies, peak assignment for condensed tannins ( $^{13}\text{C}$  and  $^1\text{H}$  chemical shifts in ppm) were: H/C4 (35.7, 4.78), H/C3 (71.1, 3.98), H/C2 (75.0, 5.27), H/C6/8 (95.8, 5.93), H/C2'/6' (prodelphinidin) (105.6, 6.58), H/C2'/5' (procyanidin) (115.0, 6.76) and H/C6' (procyanidin) (117.3, 6.77). Signals at (71.8, 3.47) and (71.9, 3.45) ppm, were mainly present in sapwood and heartwood adhesives respectively. Those peaks were assigned to the H/C3 of condensed tannins of African mahogany. However, signals at (74.3, 4.56), (74.2, 4.56) and (74.2, 4.56) ppm were present in the three parts analyzed and have been assigned to the H/C2 of condensed tannins. It was observed the absence of characteristic peaks for prodelphinidin and procyanidins. Furthermore, this could indicate also that these carbons were involved in bonds other than H/Cn or n', formed during the polymerization process of tannins and hexamine.

Reaction between tannins and hexamine are formed with oligomeric, ionised iminomethylene bases and tannin. The signal at 63.4.6 ppm was assigned to benzylamine bridges.

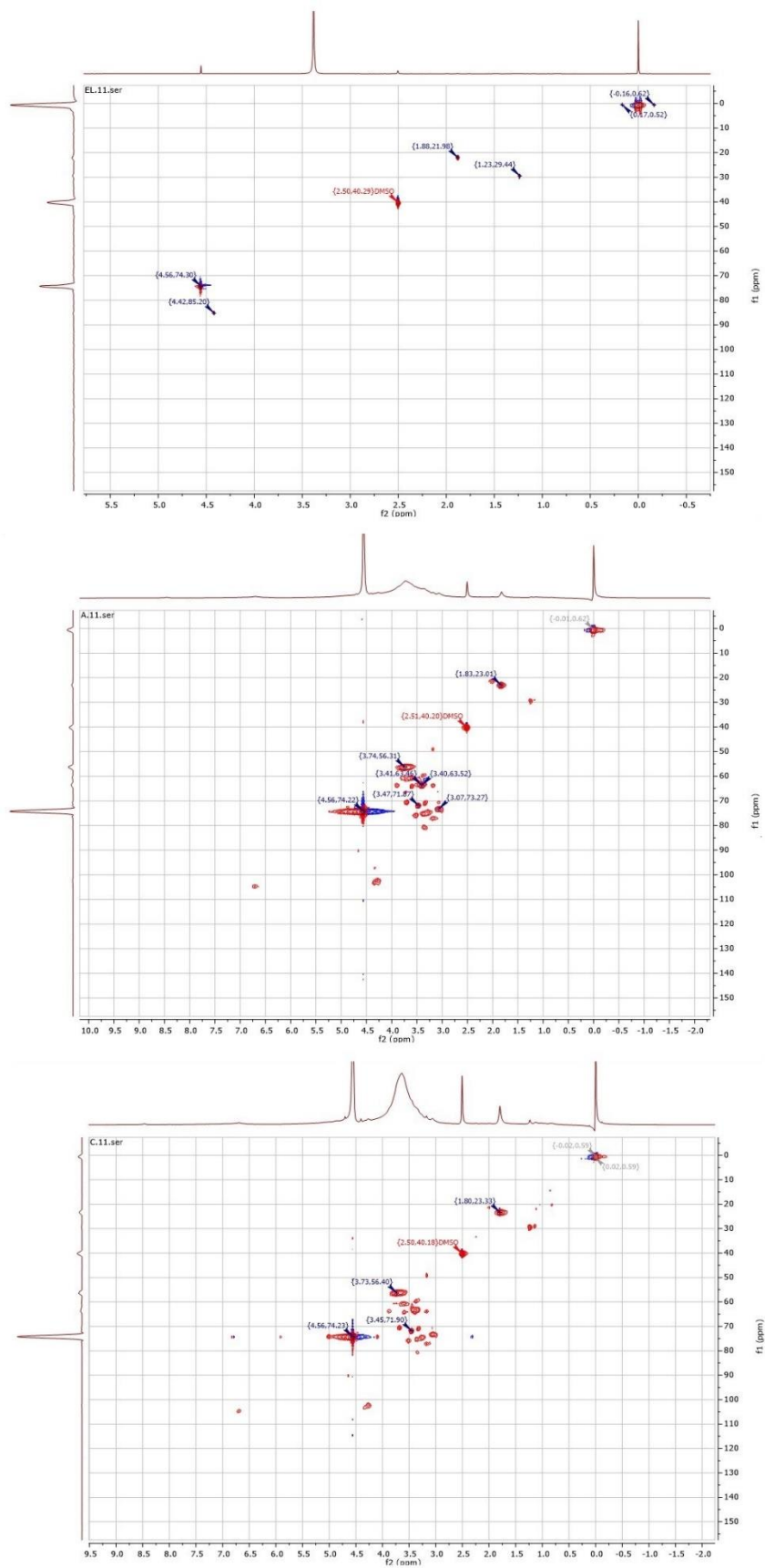


Figure 5: 2D HSQC NMR  $^{13}\text{C}$  (f1) and  $^1\text{H}$  (f2) spectra of mahogany tannin-based adhesive of bark (a), sapwood (b) and heartwood (c).

## **II.G. Conclusion**

This study has concerned the development of a tannin-based adhesive with mahogany tannin extract from bark, sapwood and heartwood. Their thermal characterizations have shown that adhesives assigned heat resistance temperatures up to 250°C. A high degradation step under 100°C was observed for adhesives produced from the bark tannins, attributed to elimination of volatile compounds and moisture. The thermomechanical analysis showed that the adhesives had elasticity modulus comparable to those of adhesives used for production of particleboards. These results are encouraging for a possible industrial production, however it would be necessary to carry out rheology analysis to better characterize the viscosity of this type of formulation. Furthermore, it could be interesting to study NMR analysis on these adhesives in order to observe all chemical modifications, which could explain the behavior of the adhesives.

### Author contribution

Authors' contribution Arsène Bikoro Bi Athomo was the principal investigator of the subject as a PhD student. Morandise Rubini and Peguy Starlin Engozogho participated as PhD student working in a related field of tropical wood chemistry. Dr. Rodrigue Safou Tchiama contributed actively as wood scientist and PhD committee's member; he criticized and corrected the final manuscript. Pr. Florent Eyma and Pr. Bertrand Charrier acted as scientific directors.

### Funding

This project is not the result of specific funding.

### Acknowledgements

We gratefully acknowledge the financial support of the Agence Nationale des Bourses du Gabon (ANBG). The Université de Pau et des Pays de l'Adour are thanked for the material support and facilities offered by the ANR-10-EQPX-16 Xyloforest (Xylomat, Mont de Marsan).

### Conflicts of interest

The authors declare that they have no competing interests.

## II.H. References

Basso, M.C., Pizzi, A., Maris, J.P., Delmotte, L., Colin, B., Rogeau, Y., 2017. MALDI-TOF, <sup>13</sup>C NMR and FTIR analysis of the cross-linking reaction of condensed tannins by triethyl phosphate. *Ind. Crops Prod.* 95, 621–631.

Bikoro, B.A.A., Engozogho, A.S.P., Safou, T.R., Leroyer, L., Pizzi, A., Charrier, B., 2019. Chemical analysis and thermal stability of African mahogany (*Khaya ivorensis* A. Chev) condensed tannins. *Holzforschung* 0. <https://doi.org/10.1515/hf-2019-0113>.

Bikoro Bi Athomo, A., Engozogho Anris, S.P., Safou-Tchiana, R., Santiago-Medina, F.J., Cabaret, T., Pizzi, A., Charrier, B., 2018. Chemical composition of African mahogany (*K. ivorensis* A. Chev) extractive and tannin structures of the bark by MALDI-TOF. *Ind. Crops Prod.* 113, 167–178.

Chupin, L., Motillon, C., Charrier-El Bouhtoury, F., Pizzi, A., Charrier, B., 2013. Characterisation of maritime pine (*Pinus pinaster*) bark tannins extracted under different conditions by spectroscopic methods, FTIR and HPLC. *Ind. Crops Prod.* 49, 897–903.

Gaugler, M., Grigsby, W.J., 2009. Thermal Degradation of Condensed Tannins from Radiata Pine Bark. *J. Wood Chem. Technol.* 29, 305–321. <https://doi.org/10.1080/02773810903165671>.

Kim, S., Kim, H.-J., 2003. Curing behavior and viscoelastic properties of pine and wattle tannin-based adhesives studied by dynamic mechanical thermal analysis and FT-IR-ATR spectroscopy. *J. Adhes. Sci. Technol.* 17, 1369–1383.

Li, C., Zhang, J., Yi, Z., Yang, H., Zhao, B., Zhang, W., Li, J., 2016. Preparation and characterization of a novel environmentally friendly phenol–formaldehyde adhesive modified with tannin and urea. *Int. J. Adhes. Adhes.* 66, 26–32.

Moubarik, A., Mansouri, H.R., Pizzi, A., Allal, A., Charrier, F., Badia, M.A., Charrier, B., 2013. Evaluation of mechanical and physical properties of industrial particleboard bonded with a corn flour–urea formaldehyde adhesive. *Compos. Part B Eng.* 44, 48–51.

Moubarik, A., Pizzi, A., Allal, A., Charrier, F., Charrier, B., 2009. Cornstarch and tannin in phenol–formaldehyde resins for plywood production. *Ind. Crops Prod.* 30, 188–193. <https://doi.org/10.1016/j.indcrop.2009.03.005>.

Ping, L., Pizzi, A., Guo, Z.D., Brosse, N., 2011. Condensed tannins extraction from grape pomace: characterization and utilization as wood adhesives for wood particleboard. *Ind. Crops Prod.* 34, 907–914.

Pizzi, A., 2003. Tailoring Adhesion of Adhesive Formulations by Molecular Mechanics/Dynamics. *Handb. Adhes. Technol. Revis. Expand.* 159.

Pizzi, A., 2000. Tannery row–The story of some natural and synthetic wood adhesives. *Wood Sci. Technol.* 34, 277–316.

Saad, H., Khoukh, A., Ayed, N., Charrier, B., Bouhtoury, F.C.-E., 2014. Characterization of Tunisian Aleppo pine tannins for a potential use in wood adhesive formulation. *Ind. Crops Prod.* 61, 517–525. <https://doi.org/10.1016/j.indcrop.2014.07.035>.

Taiwo, E.A., Ogunbodede, R.A., 1995. Production of tannin adhesives from bark of Nigerian trees. *Wood Sci. Technol.* 29, 103–108.

Yazaki, Y., Collins, P.J., 1994. Wood adhesives based on tannin extracts from barks of some pine and spruce species. *Holz Als Roh- Werkst.* 52, 307.

### III. Élaboration d'un composite à partir de sciure de bois et de bouteilles plastiques broyées

<< **Wood polymer composite: Plastic bottles recovery and mahogany wood flour** >>.

Bikoro Bi Athomo<sup>1, 2\*</sup>, A., Engozogho Anris<sup>1,2</sup>, S., Boucard<sup>4</sup>, M., Eyma<sup>3</sup>, F., Rubini<sup>1</sup>, M., Safou-Tchiama<sup>2</sup>, R., Charrier<sup>1</sup>, B.

<sup>1</sup> CNRS/ Université de Pau et des Pays de l'Adour, Institut des sciences analytiques et de physico-chimie pour l'environnement et les matériaux - Xylomat, UMR5254, 40004, Mont de Marsan, France.

<sup>2</sup> Laboratoire de Recherche et de Valorisation du Matériau Bois (LaReVa Bois). Ecole Normale Supérieure d'Enseignement Technique (ENSET). BP. 3989 Libreville (Gabon).

<sup>3</sup> Institut Clément Ader (ICA), Université de Toulouse, CNRSUMR 5312-INSA-ISAE-Mines Albi-UPS, Tarbes, France.

<sup>4</sup> Faculté sciences & sciences de l'ingénieur, Université Bretagne Sud.

[\\*arsene.bikoro-bi-athomo@univ-pau.fr](mailto:arsene.bikoro-bi-athomo@univ-pau.fr)

#### III.A. Résumé

Les travaux sur l'élaboration d'un composite bois-plastique ont été réalisés avec des produits dérivés du bois (principalement de la sciure) de transformation industrielle de l'acajou du Gabon. L'objectif principal était de faire des mélanges à sec entre les farines de bois et de plastiques recyclés obtenues par des procédés de broyage simples. Les mélanges obtenus étaient utilisés pour élaborer des panneaux de particules en fonction des dimensions des différents moules mis à notre disposition. Les panneaux étaient obtenus par un cycle de presse de moins de 15 minutes à 210°C. Cette méthode a été développée par analogie aux méthodes de fabrication de panneaux de particules à base de bois utilisées par des industriels de la filière bois. Les panneaux fabriqués au cours de ces essais étaient de dimensions carrée de 28 cm sur 28 cm. L'épaisseur variait entre 0.5 cm et 1 cm. Les petites dimensions de

panneaux étaient principalement liées à la faible quantité de matière dont nous disposions.

L'étude préliminaire sur la potentialité de nouveaux matériaux avec les sciures d'acajou et de plastique recyclés a permis de fabriquer près de 15 panneaux composite. Plusieurs tests ont été réalisés sur ces panneaux dont les tests de dureté (monnin, brinell et shore), de conductivité thermique, de résistance à la flexion (3 points), du taux d'humidité et de la mesure de densité.

Les différents tests ont révélé des propriétés intéressantes et comparables aux composites bois-plastiques déjà commercialisés. Ces composites pourraient être utilisés en aménagement intérieur ou extérieur du fait de taux d'humidité moyenne inférieurs à 5 %. Ces nouveaux matériaux pourraient parfaitement s'adapter aux pays tropicaux où le taux d'humidité est assez important toute l'année.

### **III.B. Abstract**

The elaboration of a wood plastic composite was investigated with products derived from wood (mainly sawdust) during the industrial processing of mahogany from Gabon. The main objective was to make dry mixes between wood flours and recycled plastic obtained by simple grinding processes. The resulting mixtures were used to develop particleboards based on the dimensions of the different molds available to us. The panels were obtained by a press cycle of less than 15 min at 210°C. This method was developed by analogy to the methods of manufacturing wood-based particleboards used by wood fillers. The panels manufactured during these tests were in square dimensions (28 cm x 28 cm). The thickness varied between 0.5 and 1 cm.

Study on the potential of making new materials with mahogany sawdust and recycled plastic made it possible to manufacture 15 composite panels. Several tests according to investigation standard were carried out on these panels, including hardness (Monnin, Brinell and shore A), thermal conductivity, bending resistance (3 points bending), humidity and density measurement tests.

### **III.C. Graphical abstract**



### III.D. Introduction

The plastics industry has produced 348 million tons of plastic in 2017 worldwide (Statista. 2018). The most popular plastics are polypropylene (PP), polyethylene (PE) and polyvinyl chloride (PVC) and the main industrial sector is packaging. However, after use, packages are often put directly in the trash. Several recycling channels in France to limit the impact of plastic production. The not recycled French's plastics or the plastic that are not recycled in France (about  $\frac{3}{4}$  of French production) are recovered in underground landfills or incinerated for heat production.

As a result, some materials are developed from its waste. This is the case of wood-polymer composites (WPC). WPC have been developed thanks to the low cost of wood wastes, the abundance of wood in many parts of the world, for its good mechanical properties and as alternative to traditional reinforcements from the petrochemical industry. However, it is important to know the wood / polymer interface, which determines the mechanical properties of the final material. Two types of polymer matrix are generally used in the WPC market: thermoplastic polymers and non-thermoplastic polymers. The most commonly used non-thermoplastic polymers are epoxy resin, polyester, polyurethane or even phenolic resins (Pizzi et al., 2004). They are typically matrices used for WPC when the fiber ratio is much higher than the matrix rate. It is the case for plywood boards (Azwa et al., 2013; Cui et al., 2010). The application of natural fibers as reinforcement in composite materials is constantly in development.

In developed countries, the major development took place in the 19th century during the industrial revolution. In other parts of the world such as Africa, countries are trying to catch up as a quick development, which implies new consumer's society with



a growing demand for plastics. Among them, Libreville, the most populous city in Gabon has to manage 90 000T / year of waste including 50 to 70% plastic bottles waste (Dai and Fan, 2015; Friedrich and Luible, 2016). In this study, we were interested by wood flour valorization. These wastes are the most abundant released by the wood industry in Gabon. Thus, based on WPC made by extrusion (Cui et al., 2010; Friedrich and Luible, 2016. Herrmann, 2011), an attempt was made to valorize the wood and plastics wastes from industrial and household activities. This work presents the different stages to manufacture this WPC, and different tests carried out to obtain a composite adapted in tropical humid African climate (air moisture  $\geq 60\%$  at temperature  $\geq 25^{\circ}\text{C}$ ).

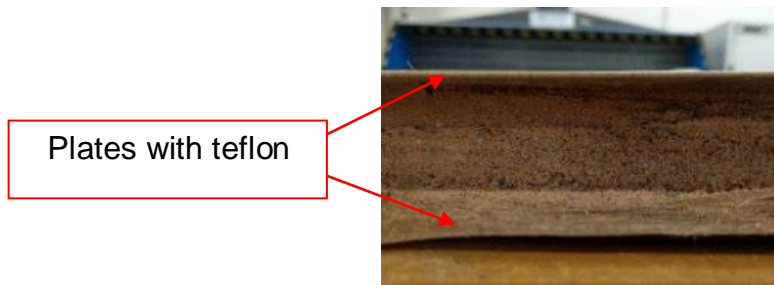
### **III.E. Experimental**

#### **III.E.1. Compositions and materials**

Composition of plastic/wood flour composites choosed is based on results of Dai et al. (2015). In this work, chosen proportions were: 50% wood flour, 47% plastic flour and 3% polypropylene-graft-maleic anhydride (MAPP).

Sigma Aldrich supplied MAPP. Its average properties was  $M_w \approx 9,100$  by GPC, average  $M_n \approx 3,900$  by GPC, maleic anhydride 8-10 wt%. Its appearance was in beads and viscosity around 150-700 cps. The plastics bottles came from recycling of households essentially (waters and soda bottles). All the bottles were recovered whole with the caps. Before composite formulation, each plastic composition was analyzed by thermogravimetric analysis. The average results obtained are 80% of polyethylene terephthalate (PET), 15% of polyethylene (PE) and 5% of polypropylene (PP).

For the manufacture of composites (Fig.1), we had molds consisting of two steel plates (290x290x2 mm<sup>3</sup> each one) and a wedge (280x280x10 mm<sup>3</sup>) in internal dimensions, we have used a Teflon coating, a semi-industrial press with heated plates (3R press, 100KN), an industrial mil (Engin Plast, API'UP), and two laboratory grinders (Retsch ZM 200 and Retsch SK100).



**Figure 1: Mold ready for press and Teflon in direct contact with the mixture**

### III.E.2. **Methods**

#### III.E.2.a. Wood flour preparation

The wood was collected from a *Khaya ivorensis* (*K. ivorensis*) sample from five wood planks with section 1000x300x20 mm<sup>3</sup> section. All sampled from a log of 75 cm of diameter. The wood was harvested at Mitzic in the North of Gabon by the SNBG (Société Nationale des Bois du Gabon) in 2018. The fresh samples were put in sterilized bags, air-dried for one week in the laboratory and oven-dried (105°C) for 48h. The dried samples were grinded to pass through  $\approx 250\mu\text{m}$  and  $500\mu\text{m}$  diameter with a rotative knife grinder (Retsch SK100).

#### III.E.2.b. Plactic powder preparation

The plastic bottles was collected from recycling of households. All samples were cleaned and dried at atmospheric pressure before grinding operations. Then the plastic bottles, including the caps, were crushed in the API'UP association (Capbreton, 40). The particles obtained were mainly 3 mm of diameter, but by sieving amounts were found at 1.5 mm. Particles of different sizes were subsequently prepared with dimensions between  $\square 250\mu\text{m}$  and  $1500\mu\text{m}$ . The goal is to have particles quite close to the wood flour to obtain better composite mixtures. Finally, the 0.8-0.2 mm particles were obtained using another Retsch brand mill and model ZM 200 and the particles at 0.5 mm were recovered.

#### III.E.2.c. Composite preparation

50% of dried wood, plastic (47%) and polypropylene-graft-maleic anhydride (3%) powders were mixed. Each constituent was incorporated into a large beaker in these proportions and a final weight was 0.711 Kg. This mixture is then stirred for 3 to 5 min to obtain good homogenization. The agitator used is a vertical agitator of the Caframo brand. Subsequently, the mixture was placed on a steel plate, covered with

a wedge of dimensions and thickness wanted for the panel is placed. This wedge was U-shaped to allow the excess material to evacuate during the implementation to the press. The mixture undergoes a first compression to maintain a minimum of cohesion of the latter before removing the metal guide and placing a second steel plate covered with Teflon film on top. The assembly was then placed in the press, between two heating plates at 210°C. The compressing cycle (10 min) started by applying the following surface charge: 30Kg/cm<sup>2</sup> (240 s), 25Kg/cm<sup>2</sup> (120s), 25Kg/cm<sup>2</sup> (120 s), 25Kg/cm<sup>2</sup> (120 s). On the 15 panels produced (Table 1), only panels 1 and 2 were tested with industrial plastic powder (PE). In addition, the main difference was on the thicknesses, which had generally an effect on the properties of the materials obtained (Holmberg et al., 2000). Two composites type were produced (Table1): the first one with 0.5 mm particle size (for wood and plastic) and the second one with 1.5 mm of plastic size and 0.5 mm of wood size. There was three panels 10 mm thick with particle size of 0.5 mm (Ref 1, 2 and 3). Ref 1 and 2 were made with industrial plastic (HDPE) and Ref 3 with recycled plastic in order to compare them. All the other panels, which follow, were made with recovery plastic. Then, 5 panels of 5 mm thick whose particles were 0.5 mm (Ref 4, 5, 6, 7 and 8). 6 panels (Ref 9, 10, 11, 13, 14 and 15) of 5 mm thick for a particle size equal to 1.5 mm. Finally a 10 mm thick panel with 1.5 mm particles sizes (Ref 12). Before all the tests, samples were stabilized in climatic chamber at 20°C and 65% humidity during 48h.

#### III.E.2.d. Thermogravimetric analysis (TGA)

Thermal decomposition was performed using a TA Instrument (TGA Q50 instrument). The samples weight were 10-12 mg and temperature program was set from 24 to 600°C at a heating rate of 10°C/min. The measurements were conducted under air (60 mL/min) and nitrogen (40 mL/min).

#### III.E.2.e. Differential scanning calorimetry (DSC)

A TA instrument (DSC Q500) was used for this test and was run simultaneously with TGA Q50. Mass sample used were between 5 and 22 mg. Nitrogen gas was set to run at 60ml/min, and two ramps were used at 5°C/ min and 10°C/min until 200°C.

#### III.E.2.f. Principal component analysis (PCA)

Principal Component Analysis (PCA) (Wold et al., 1987) was used in order to describe variation in our dataset, in terms of uncorrelated variables, each of them is a

linear combination of the original variables. The uncorrelated variables, or Principal Component (PC) are produced by means of decomposition of the data set matrix  $X$  into  $T$  and  $P$  matrixes, respectively, the score matrix and the loadings matrix. The following decomposition is obtained:  $X = TP^T + E$ . Where:  $n$  is the number of rows in the data matrix;  $p$  is the number of column in the data matrix;  $A$  is the number of PCs;  $X(n, p)$  is the data matrix;  $E(n, p)$  is the matrix of residuals.  $X(n, A)$  is the scores matrix, containing the coordinates of the samples in the PCs;  $P^T(A, p)$  is the loadings matrix, containing the contribution of the original variable in the PCs, and furthermore, shows which variables are responsible for the sample dispersions.

The number of PCs is chosen according to the percentage of variance extracts from the dataset.

Scores and loadings are useful for the interpretation of the relations between samples, between variables and both of them together. In practice, two axes (representing two components), are plotted orthogonally. Either, in the case of scores matrix, it is called, *scores plot*, or, in the the case of loadings matrix, it is called, *correlation circle*. A last case, when *scores plot* and *correlation circle* are merged on the same plot, it is called a *Biplot*. Therefore, PCA interpretation is visual. Indeed, thanks to the distance between each other, samples similarities and dissimilarities can be highlighting according to the directions of variables and following a few rules. If two variables form an angle close to  $0^\circ$ , there are positively correlated; If two variables form an angle close to  $90^\circ$ , there are not correlated; If two variables form an angle close to  $180^\circ$ , there are negatively correlated.

All data manipulation and PCA algorithm were performed using R software (*Version 3.6.1, using RStudio Desktop 1.2.1335 interface*) with FactoMineR (Lê et al., 2008) and Factoextra (Kassambara, 2015) packages.

In order to compare easier the variables, the values of each variable are mean-centered, i.e. standardized by centering (mean subtracted to each variable).

### III.E.2.g. Shore A hardness

The Shore hardness was measured according to protocol described by DIN 53505, ASTM D2240 and ISO 868. This type of measurement mainly uses plastics. The measurement was done with a tip by deploying a regular force (1.5 kg) without

seismic movements on the sample 50x50x10mm<sup>3</sup>. This movement was called degree of penetration. Three samples were used for each panels. The Shore A value obtained is noted and compared to the reference values between 0 and 100. The 90 value representing the value of the hard plastic.



**Figure 2: Shore hardness A0**

#### III.E.2.h. Monnin hardness

The hardness measurement brings together the standards NF B 51-125, NF B 51-225 and NF B 51-325. Three replicates were made for each panel. The test pieces are strips 30±0.1 mm wide and 100±0.1 mm long. Sampling and conditioning of the samples were carried out according to standard NF B 51-120. The specimen was placed flat in the center of a steel spherical tray of the test stand. The contact surfaces must be free of foreign objects in order to ensure a uniform bearing of the specimen on its support. Then, the generatrix of the impression cylinder was placed perpendicular to the axis of the specimen. A load was applied at a speed of 10mm / min until a maximum load of 300daN was reached. Finally, the footprint ( $a$ ) obtained was measured using an optic camera (300x, Dino lite) at ±0.05 mm. For the 5 mm thick specimens, we observed a significant bending, which made measuring the fingerprint complicated.

The penetration arrow ( $t$ ) was calculated according to the equation (1) below:

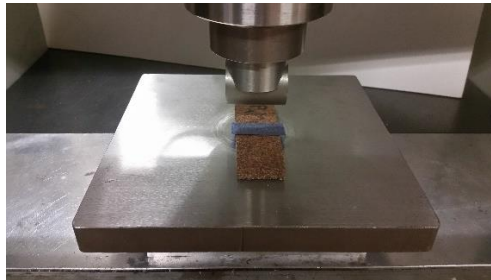
$$t = 15 - \frac{\sqrt{900 - a^2}}{2} \quad (1)$$

Where :

$a$  : width of footprint in mm.

The Monnin hardness number is equal to the inverse of penetration arrow:

$$N = \frac{1}{t} \quad (2)$$



**Figure 3: monnin hardness**

#### III.E.2.i. Brinell hardness

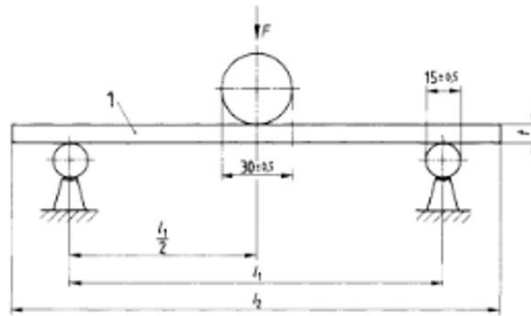
The NF B 51-126 standard makes it possible to describe the Brinell hardness method. Three replicates were made for each panel. It is used to determine the punching resistance of wood-based panels, with organic binders or not, of any thickness. The principle was as follows: a  $10 \pm 0.1$  mm diameter hardened steel ball was used with preload of 1% of the test load was applied to determine the reference position (Figure 4). Then, a force was applied at such a speed that the depth of 2.5 mm was reached in 15 s. The test was carried out with samples 10 mm thick. For samples at 5 mm, two test pieces were superimposed.



**Figure 4: Brinell hardness**

#### III.E.2.j. 3 points bending test

The modulus of elasticity and the flexural strength were determined according to the protocol described in standard NF EN 310 for wood-based panels. Three replicates were made for each panel. The test samples (Figure 4 and 5) used according to the standard were  $150 \pm 0.1$  mm long and  $50 \pm 0.1$  mm wide.



With:

1 test sample

$b$  width of the test sample

$t$  thickness of the test sample

$l_1 = 20 t$  : distance between the two supports

$l_2 = l_1 + 50$  : length of the test sample

$$f_m = \frac{3 F_{max} l_1}{2 b t^2} \quad (3)$$

$f_m$  ( $\sigma_{max}$ ) is the flexural strength

$F_{max}$  is the breaking load

$$MOE = \frac{l_1^3 (F_2 - F_1)}{4 b t^3 (a_2 - a_1)} \quad (4)$$

$$F_1 = 0.1 F_{max}$$

$$F_2 = 0.4 F_{max}$$

$a_2 - a_1$  is the increase in the deflection at mid-length of the test sample corresponding to  $F_2 - F_1$ .

The deflection measurements in the center of specimen were carried out using a displacement sensor (Figure 4) LVDT Salartron AX5S.



**Figure 5 : bending test device in laboratory**

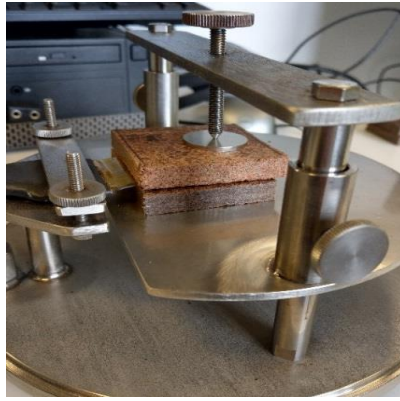
#### III.E.2.k. Swelling test

For the swelling test, the samples were prepared according to the indications of EN 326-1. The samples were in square form with  $50\pm 1$  mm of side. The thicknesses were 5 and  $10\pm 0.1$  mm. The test samples were left for more than 24h in climatic chamber at  $20^{\circ}\text{C}$  and 60% humidity beforehand. Then the sample was taken out of the climatic chamber and thickness was taken. Further, samples were immersed in controlled water bath at  $20\pm 2^{\circ}\text{C}$  during 24h. Once the samples out of bath ( $20\pm 2^{\circ}\text{C}$ ), the new thickness value was taken immediately, then the swelling level has been calculated.

#### III.E.2.l. Thermal conductivity

It is interesting to know the thermal conductivity (Fig.6) of these panels. This could indicate a trend towards possible applications, especially for indoor or outdoor cladding applications. The thermal conductivity was determined on samples of  $50\times 50\times 10\text{mm}^3$  using a "Hot Disk" Model TPS 1500.





**Figure 6: Hot disk measurement**

By panel type, three samples were tested at different locations on the panel. Then, the average thermal conductivities obtained for each panel was calculated (Table 1).

### **III.F. Results and discussion**

The characterization of the composite begins with the physico-chemical characterization of its constituent elements. As a result, differential scanning, thermogravimetric (TGA) and calorimetric (DSC) analyzes were performed on mahogany sawdust, milled plastic and wood plastic composite (Cui et al., 2010). These analyzes showed temperatures at the beginning of wood degradation and WPC around 250°C as indicated in the literature (Fig.7 and 8).

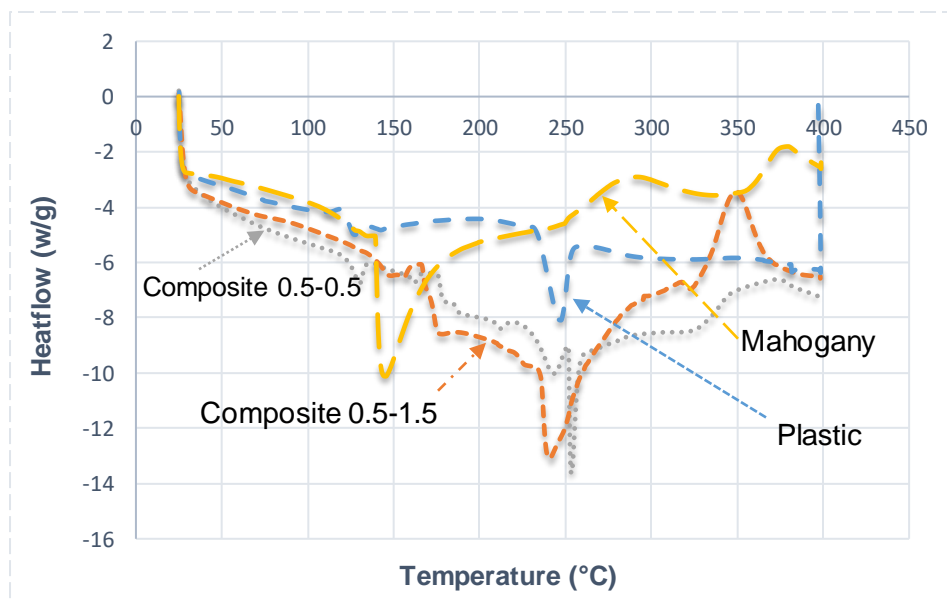


Fig.7: DSC of composite, mahogany wood/plastic, four analysis were made for each sample.

For wood, we observed in DTGA a maximum degradation peak shoulder around 350°C (Jeske et al., 2012). According to Jeske et al (2012), this peak corresponds to the degradation of cellulose and hemicelluloses. The second peak at 453.3°C corresponds to the degradation of lignin. In the literature, lignin degradation can be up to 600°C. In addition, the literature reveals that plastic bottles are mainly made of polyterephthalate (PET) for the body of the bottle and a mixture of polyethylene (PE) and polypropylene (PP) for the caps. The DTGA analyzes of our shreds show a great majority of PET (≈80%, Figure 8).

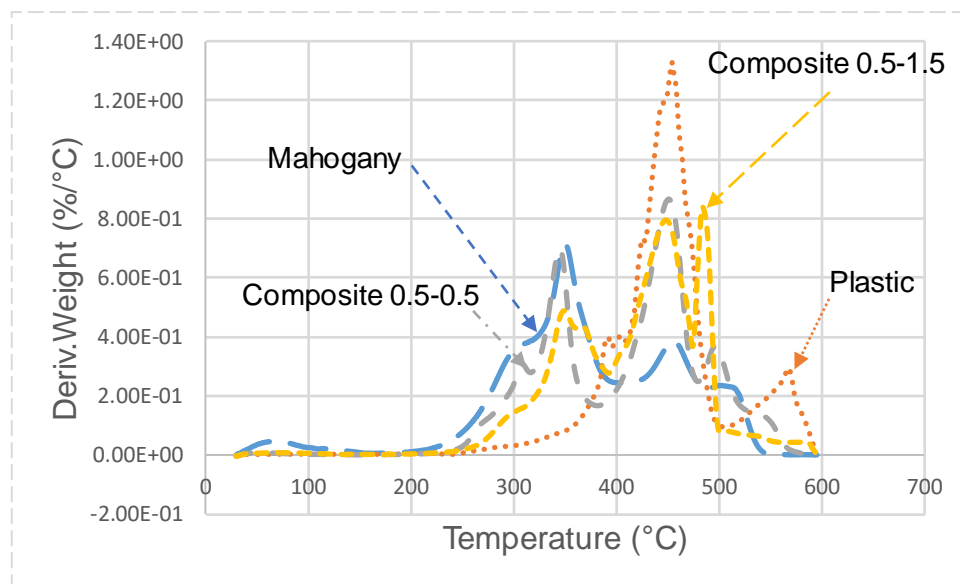


Fig.8: DTGA chromatograms of mahogany composite, four analysis were made for each sample.

We find a small amount of PE and traces of PP. In this study, we observe three peaks degradation of the plastic at 382.2°C, 460°C and 567.7°C (Jeske et al., 2012). However, a slight shoulder appears around 565°C, which could correspond to the degradation of a set of plastic residues. The study by Kiran et al. (Kiran et al., 2000), which deals with the recycling of plastic waste by pyrolysis, showed a peak of maximum degradation of plastic polyesters at 465°C. This result fits well with our study. In addition, the DSC analyzes of the different raw materials confirm the presence of PE and PET, which showed the melting temperature at 130 ° C and 250 °C, respectively (Fig.7). This also confirms the low presence of PP in the composition of the samples analyzed, indeed, we do not observe the melting of the PP at 175°C. For the wood samples, it was observed an exothermic peak at 149°C, which could correspond to the cooking of the wood elements. In the rest of the work, DTGA and

DSC also analyzed the manufactured WPCs. Peaks were observed with a slight shift in the maximum degradation temperatures of each constituent of the composite. This would result in a slight increase in the de-icing temperature of the final material. On the other hand, the degradation start temperature remains around 230 °C for all the materials.

However, for the composite made with 0.5 mm of sawdust and 1.5 mm of plastic particles, we observed a characteristic peak at 494°C. This peak would correspond to a mixture of the second degradation peak of the crushed plastic and the peak of degradation of the lignin (Figure 8). All samples were replicated three time for each tests and a typical behavior of manufactured WPCs was cleared. This behavior breaks down into several phases (Figure 5). In the first place, the melting of the PE at 170°C appears before the glass transition ( $T_g$ ) of the composite. We then found the cooking of wood (cellulose and hemicellulose) between 180°C and 230°C and that of PET thereafter. From these different successive melts, there is a very slight exothermic peak signifying the crosslinking or the firing of the material. Finally, there is a degradation of cellulose and hemicellulose around 350°C.

In addition, thermal conductivity tests were carried out on the two types of composites manufactured. It seems that the composite with particle sizes at 0.5 mm has a mean conductivity (0.104 w/k.m) slightly larger than the composite with t particle sizes at 1.5 mm (0.089 w/k.m). This can be explained by the presence of smaller air gaps in the WPC and act as thermal insulation (Figure 9). The benchmark (Hot Disk) used in this study gives the value of mahogany's thermal conductivity at 0.130 (w/k.m). Another study had shown that the thermal conductivity of WPC based on PP and banana fiber had thermal conductivity values between 0.130 (w/k.m) and 0.150 (w/k.m). The swelling test shows a lower water uptake for the two composites of less than 13% as indicated for panels in the NF EN 312 standard. This type of material could then be well adapted to tropical climates, and therefore that of Gabon.

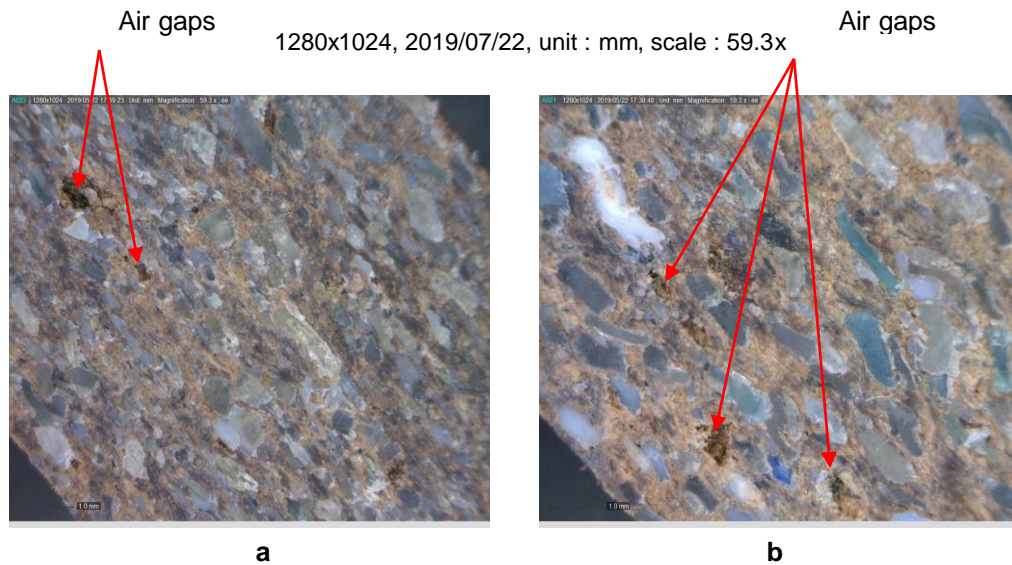


Fig.9: WPC at 0.5-0.5 mm (a) and at 0.5-1.5 mm (b) x59.3.

The principal component analysis (PCA) on the nine parameters measured is presented on Fig.10 and 11: hardness, modulus of elasticity, bending stress, particle size, moisture content and thermal conductivity are indicated in Fig. 9. By correlating the different individual factors, four groups of panels have been distinguished by assuming that the spatially similar samples have the same characteristics. Group 1 consisted of panels 1, 2 and 3; group 2 consisted of panels 4, 5, 6, and 7; group 3 consisted of panels 9, 10, 11 and 12; and the group 4, which was constituted of panels 8, 13, 14 and 15 (Fig.10). The main components in this study accounted for 83.6 % of the behavior of the composites with respect to the each parameters analyzed. The first two PCs were sufficient to explain results. For groups 1 and 2, we found that thermal conductivity and shore hardness were the two main explanatory parameters. Thus, for this group, the smaller the particle size, the greater the values of thermal conductivity and shore hardness. Group 4 was mainly impacted by moisture content. This could be explained by the fact that when working with larger particles, it is easier to have voids or gaps in the panels and therefore a strong water uptake.

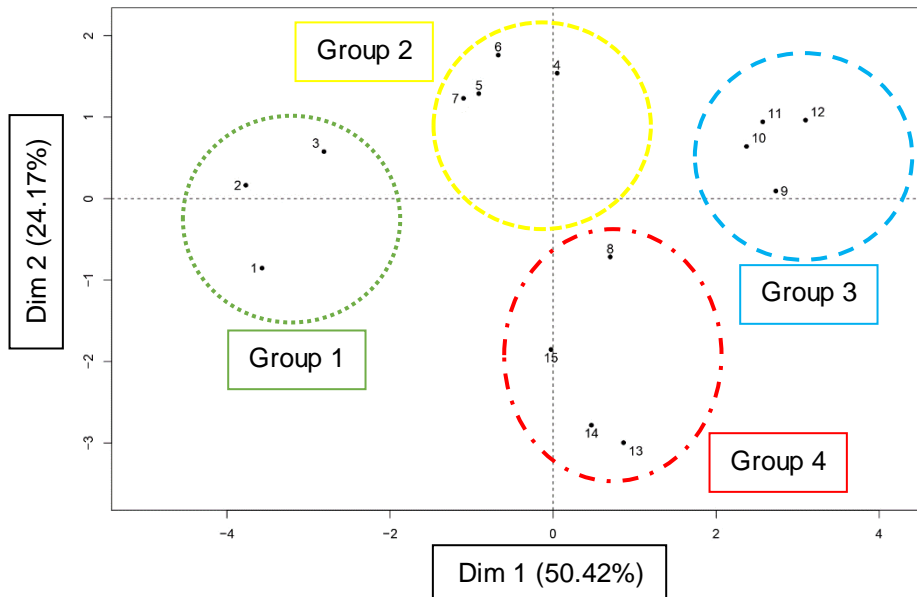


Figure 10: Individuals Factor Map (PCA)

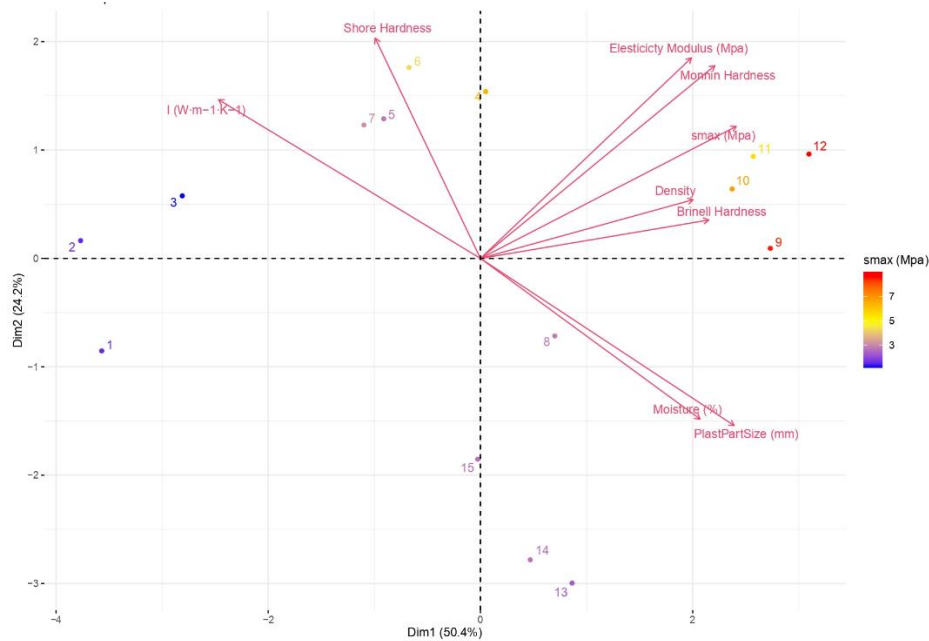


Fig.11: Biplot « projection of variables and samples on to the first two PCs ».

Further, Group 3 was the one that interacted with a maximum of parameters for panels' characterization. Indeed, the density, the Brinell and Monnin hardness, the stress and the elastic modulus in bending, better characterized this group. According to the literature, for panels based on wood particles, Monnin hardness gives a better rendering while Brinell will allow to be able to compare the values to those of the harder materials. According to the NF B 51-126 and EN 326-1, the average Monnin hardness values was  $3.91 \pm 1.97$  and can be compared to the literature (Pilla et al., 2009;

Taşdemir et al., 2009). Again, the density appeared as an important parameter for this group. Nevertheless, it was comparable to the Brinell hardness in terms of their contribution to the explanation of behavior of the materials like describe by several authors (Guitard et al., 1999). The mechanical parameters, in particular the elasticity modulus and the max bending stress explained both the principal component and are also linked to the Monnin hardness and density. Compared to the composite realized with sawdust and gypsum with 20% of sawdust (pretreated) by Dai and Fan (2015) where flexural strength was 4.59 MPa, the composites of this study average was around  $4.88 \pm 3.54$  MPa without treatment of wood sawdust and plastic (Adjovic et al., 2013; Dai and Fan, 2015). Moreover, for some panels as 3, 5, 10, 11 and 13, flexural strength values were higher than 5 MPa, with respectively 14.50 MPa, 6.56 MPa, 8.73 MPa, 7.02 MPa and 8.82 MPa although 50% of sawdust was used. These results give good properties for this type of composite based on recycled waste whose raw material has not been pretreated beforehand. According to the BNBA B2.10- NF B 51-125 the higher Monnin hardness is N=30 for particleboard. For these composites, the average values were  $4.27 \pm 3.1$ , ie were weak, compared to the standard. Yet, panels from 5 to 13 present better hardness values. These properties could allow the use of this type of materials for manufacturing furniture and interior accessories or for cladding inside or outside the house.

It should also be noted a great dispersion (with standard deviation =  $\pm 3.54$  MPa) between samples linked not only to the wood and plastic particles size, but also to the thickness of test pieces. This dispersion could explain a grouping of some parameters or completely distributed in over different areas in PCAs analysis. For these composites, the best parameters, which explain their characteristic, would be the bending test, the density and the Monnin hardness measurement without taking into account the particle size. Nevertheless, these parameters were linked to the thickness and particles size of the panel. Panels 1 and 2 assigned lower values compared to the others for all mechanical parameters. Whereas the panel 3, which has the same particles size that the panels 1 and 2 displays the greatest stress value. Further, this could also be explained by the fact that recycled plastics contains different plastic types, whereas in the case of panels 1 and 2 there is only one plastic type. According to NF EN 310 standard, panel 2 was suitable for use under stress in dry and humid environments; other panels were suitable for interior design, and furniture

manufacturing. Measurements of swelling was important for the manufacturing process and present considerable advantages for these new materials in view of their commercialization.

### **III.G. Conclusion**

This work on valorization of coproducts of mahogany wood of Gabon associated with recycling of plastic bottles demonstrate the opportunity to produce wood-plastic from its two wastes. The mechanical properties are close to those of usual wood product composites. The process used here avoids the mold and then a press pass to obtain composites. The results obtained show that some tests like Shore hardness are not necessary to characterize these materials. Monnin test is more suitable than shore test for hardness measurement of these composites. Furthermore, the latter revealed that the larger the wood particle size, the higher the rate of water uptake. Nevertheless, this work deserves further study in the following, to reduce samples dispersion in the manufacturing process and to improve the properties of the wood-plastic interface and the topography of the materials in order to be able to respond to the different requirements necessary for its use at an industrial level. Economic studies must be enhance to evaluate the production cost of this kind of composite. At this step of our research, we can imagine that production cost will be less expensive than traditional WPC manufacturing.

#### Author contribution

Authors' contribution Arsène Bikoro Bi Athomo was the principal investigator of the subject as a PhD student. Morandise Rubini and Peguy Starlin Engozogho participated as PhD student working in a related field of tropical wood chemistry. Dr. Rodrigue Safou Tchiamia contributed actively as wood scientist and PhD committee's member; he criticized and corrected the final manuscript. Pr. Florent Eyma and Pr. Bertrand Charrier acted as scientific directors.

#### Funding

This project is not the result of specific funding.

#### Acknowledgements

We gratefully acknowledge the financial support of the Agence Nationale des Bourses du Gabon (ANBG). The Université de Pau et des Pays de l'Adour are thanked

for the material support and facilities offered by the ANR-10-EQPX-16 Xyloforest (Xylomat, Mont de Marsan).

Conflicts of interest

The authors declare that they have no competing interests.

### **III.H. References**

Adjovi, E.C., Olodo, E.T., Niang, F., Guitard, D., Foudjet, A., 2013. Wood panels from sawdust and wasted plastic materials: Influence of the composition mixture on density and permeability. *Int. J. Sci. Eng. Res.* 4, 344–347.

ASTM D618-00. Standard practice of conditioning plastics for testing.

ASTM D2240-03. Standard test method for rubber property-Durometer hardness.

Azwa, Z.N., Yousif, B.F., Manalo, A.C., Karunasena, W., 2013. A review on the degradability of polymeric composites based on natural fibres. *Mater. Des.* 47, 424–442. <https://doi.org/10.1016/j.matdes.2012.11.025>

Baaka, N., Haddar, W., Ben Ticha, M., Amorim, M.T.P., M'Henni, M.F., 2017. Sustainability issues of ultrasonic wool dyeing with grape pomace colourant. *Nat. Prod. Res.* 31, 1655–1662.

72, 1551–1565. <https://doi.org/10.1016/j.phytochem.2011.01.040>

Basso, M.C., Pizzi, A., Maris, J.P., Delmotte, L., Colin, B., Rogau, Y., 2017. MALDI-TOF, <sup>13</sup>C NMR and FTIR analysis of the cross-linking reaction of condensed tannins by triethyl phosphate. *Ind. Crops Prod.* 95, 621–631.

Belewu, M.A., Olatunde, O.A., Giwa, T.A., 2009. Underutilized medicinal plants and spices: Chemical composition and phytochemical properties. *J. Med. Plants Res.* 3, 1099–1103.

Bikoro, B.A.A., Engozogho, A.S.P., Safou, T.R., Leroyer, L., Pizzi, A., Charrier, B., 2019. Chemical analysis and thermal stability of African mahogany (*Khaya ivorensis* A. Chev) condensed tannins. *Holzforschung* 0. <https://doi.org/10.1515/hf-2019-0113>



Bikoro Bi Athomo, A., Engozogho Anris, S.P., Safou-Tchiama, R., Santiago-Medina, F.J., Cabaret, T., Pizzi, A., Charrier, B., 2018. Chemical composition of African mahogany ( *K. ivorensis* A. Chev ) extractive and tannin structures of the bark by MALDI-TOF. *Ind. Crops Prod.* 113, 167–178.

Bodirlau, R., Teaca, C.A., 2009. Fourier transform infrared spectroscopy and thermal analysis of lignocellulose fillers treated with organic anhydrides. *Rom J Phys* 54, 93–104.

Bongartz, J., 2019. Mémoire de fin d'études: " Construction durable au 21ème siècle, mythe ou réalité? Approche critique: transition, low tech, résilience."

Branco, A., Santos, J.D.G., Pimentel, M.M.A.M., Osuna, J.T.A., Lima, L.S., David, J.M., 2010. d-Mannitol from Agave sisalana biomass waste. *Ind. Crops Prod.* 32, 507–510. <https://doi.org/10.1016/j.indcrop.2010.06.025>

Catinot, R., 1979. Comment utiliser les forêts tropicales comme source d'énergie. Prospectives sur leurs potentialités actuelles et futures. *BOIS FORETS Trop.* 184, 3–30.

Charrier, B., Janin, G., Haluk, J.-P., Mosedale, J.R., 1995. Colour and Chemical Characteristics of Moon Rings in Oakwood. *Holzforschung* 49, 287–292.

Chevalier, J.F., Nguema Magnagna, V., Assoumou, S., 2009. Etat-des-forets\_2008-03.pdf. WWF 61–73.

Crocker, D.R., Perry, S.M., 1990. Plant chemistry and bird repellents. *Ibis* 132, 300–308.

Cui, Y.H., Tao, J., Noruziaan, B., Cheung, M., Lee, S., 2010. DSC Analysis and Mechanical Properties of Wood—Plastic Composites. *J. Reinf. Plast. Compos.* 29, 278–289. <https://doi.org/10.1177/0731684408097766>.

Dai, D., Fan, M., 2015. Preparation of bio-composite from wood sawdust and gypsum. *Ind. Crops Prod.* 74, 417–424. <https://doi.org/10.1016/j.indcrop.2015.05.036>

Drovou, S., Pizzi, A., Lacoste, C., Zhang, J., Abdulla, S., El-Marzouki, F.M., 2015. Flavonoid tannins linked to long carbohydrate chains—MALDI-TOF analysis of the tannin extract of the African locust bean shells. *Ind. Crops Prod.* 67, 25–32.

Dupuy, B., 1993. Les plantations d'Acajou d'Afrique. Leur sylviculture en forêt dense humide ivoirienne. *BOIS FORETS Trop.* 236, 25–42.

Ekomy Ango, S., Moutou Pitti, R., 2017. Caractéristiques mécaniques et thermiques d'une brique d'argile à base de sciure de bois du Gabon. *GDR 3544 « Sci. Bois »* 38–39.

Elbariji, S., Elamine, M., Eljazouli, H., Kabli, H., Lacherai, A., Albourine, A., 2006. Traitement et valorisation des sous-produits du bois. Application à l'élimination des colorants industriels. *Comptes Rendus Chim.* 9, 1314–1321. <https://doi.org/10.1016/j.crci.2006.05.006>

Etat Gabonais, 2003. Arrête n°000117 diamètre minimum d'exploitation des bois du Gabon.

Etat Gabonais, 2001. Gabon - Code forestier. Loi n°16-01 du 31 décembre 2001.

Friedrich, D., Luible, A., 2016. Standard-compliant development of a design value for wood–plastic composite cladding: An application-oriented perspective. *Case Stud. Struct. Eng.* 5, 13–17. <https://doi.org/10.1016/j.csse.2016.01.001>

Frutos, P., Hervás, G., Giráldez, F.J., Mantecón, A.R., 2004. Tannins and ruminant nutrition, Review. *Span. J. Agric. Res.* 2, 191–202.

García-Villalba, R., Espín, J.C., Tomás-Barberán, F.A., Rocha-Guzmán, N.E., 2017. Comprehensive characterization by LC-DAD-MS/MS of the phenolic composition of seven *Quercus* leaf teas. *J. Food Compos. Anal.* 63, 38–46. <https://doi.org/10.1016/j.jfca.2017.07.034>

Gaugler, M., Grigsby, W.J., 2009. Thermal Degradation of Condensed Tannins from Radiata Pine Bark. *J. Wood Chem. Technol.* 29, 305–321. <https://doi.org/10.1080/02773810903165671>

Geethu, M.G., Suchithra, P.S., Kavitha, C.H., Aswathy, J.M., Dinesh, B., Murugan, K., 2014. Fourier-transform infrared spectroscopy analysis of different solvent extracts of water Hyacinth (*Eichhornia Crassipes* Mart Solms.) an allelopathic approach. *World J. Pharm. Pharm. Sci.* 3, 1256–1266.

Glombitza, K.W., Fucols, P.K., 2003. phlorethols from the brown alga *Scytothamnus australis*. Hook. et Harv.(Chnoosporaceae) Bot.

Guitard, D., Masse, H., Yamamoto, H., Okuyama, T., 1999. Growth stress generation: a new mechanical model of the dimensional change of wood cells during maturation. *J. Wood Sci.* 45, 384–391.

Haluk, J.-P., Roussel, C., 2000. Caractérisation et origine des tropolones responsables de la durabilité naturelle des Cupressacées. Application potentielle en préservation du bois. *Ann. For. Sci.* 57, 819–829.

Herrmann, K., 2011. Hardness testing: principles and applications. ASM International.

Heryati, Y., Belawan, D., Abdu, A., Mahat, M.N., Abdul Hamid, H., Majid, N., Muhamad, N., Hassan, A., 2011. Growth performance and biomass accumulation of a *Khaya ivorensis* plantation in three soil series of ultisols. *Am. J. Agric. Biol. Sci.* 6, 33–44.

Jeske, H., Schirp, A., Cornelius, F., 2012. Development of a thermogravimetric analysis (TGA) method for quantitative analysis of wood flour and polypropylene in wood plastic composites (WPC). *Thermochim. Acta* 543, 165–171. <https://doi.org/10.1016/j.tca.2012.05.016>

Kassambara, A., 2015. Factoextra: Extract and visualize the results of multivariate data analyses. R package version 1.0. 3, 2015.

Kato, H., Tillotson, J., Nichaman, M., George, R.G., Howard, H.B., 1973. epidemiologic studies of coronary heart disease and stroke in japanese men living in japan, hawaii and california serum lipids and diet. *Am. J. Epidemiol.* 87, 372–385.

Kiran, N., Ekinci, E., Snape, C.E., 2000. Recycling of plastic wastes via pyrolysis. *Resour. Conserv. Recycl.* 29, 273–283. [https://doi.org/10.1016/S0921-3449\(00\)00052-5](https://doi.org/10.1016/S0921-3449(00)00052-5).

Koumba Zaou, P, Nze Nguema, S, Mapaga, D, Delporte, P, 1998. Croissance de 13 essences de bois d'oeuvre planté en forêt Gabonaise. *Bois For. Trop.* 2, 21–33.

Morais, S.A.L., Nascimento, E.A., Queiroz, C.R.A.A., Piló-Veloso, D., Drumond, M.G., 1999. Studies on polyphenols and lignin of *Astronium urundeuva* wood. *J. Braz. Chem. Soc.* 10, 447–452. <https://doi.org/10.1590/S0103-50531999000600005>.

Morin, A., Meunier, Q., Boldrini, S., Vermeulen, C., 2014. Entre permis forestier et permis minier, la difficile émergence des forêts communautaires au Gabon. *Parcs Réserves* 68, 16–22.

Ndiade Bourobou, D., DemikoyoKanghou, D., Inguenza, D., 2010. la République Gabonaise: Etat des Ressources Génétiques Forestières dans le Monde. Ministère des Eaux et Forêts (Gabon), FAO.

NF EN 309. Particleboards. 2005. Definition and classification.

NF EN 310. Wood-based panels. 1993. Determination of modulus of elasticity in bending.

NF EN 311. Wood-based panels. 2002. Surface soundness-test method.

NF EN 312. Particleboards. 2010. Specifications.

NF EN 317. Particleboards and fiberboards. 1993. Determination of swelling in thickness after immersion in water.

NF EN 323. Wood-based panels. 1993. Determination of density.

NF EN 325. Wood-based panels. 2012. Determination of dimensions of pieces.

Petithuguenin, J.-L., 2014. Le développement du recyclage: potentialités et freins, in: *Annales Des Mines-Responsabilité et Environnement*. ESKA, pp. 55–57.

Pilla, S., Gong, S., O'Neill, E., Yang, L., Rowell, R.M., 2009. Polylactide-recycled wood fiber composites. *J. Appl. Polym. Sci.* 111, 37–47.

Rabetafika, H.N., Paquot, M., Dubois, P., 2006. Les polymères issus du végétal : matériaux à propriétés spécifiques pour des applications ciblées en industrie plastique. *Biotechnol. Agron. Société Environ.* 10, 185–196.

Souhila, O.R.A., 2017. Valorisation de la sciure de bois par modification chimique: Application à l'élimination par adsorption d'un pesticide, le DDT. *Ecole Natl. Polytech.*

Taiwo, E.A., Ogunbodede, R.A., 1995. Production of tannin adhesives from bark of Nigerian trees. *Wood Sci. Technol.* 29, 103–108.

Tajik, N., Tajik, M., Mack, I., Enck, P., 2017. The potential effects of chlorogenic acid, the main phenolic components in coffee, on health: a comprehensive review of the literature. *Eur. J. Nutr.* 56, 2215–2244. <https://doi.org/10.1007/s00394-017-1379-1>.

Taşdemir, M., Biltekin, H., Caneba, G.T., 2009. Preparation and characterization of LDPE and PP-Wood fiber composites. *J. Appl. Polym. Sci.* 112, 3095–3102. <https://doi.org/10.1002/app.29650>.

**Table 1****Physical and mechanical properties of composite from African mahogany wood and plastic bottles.**

Ref	Flexural strength (Mpa)	Elasticity modulus (Mpa)	Thickness (mm)	Particle size (mm)	Density	(M)	(B)	(S)	Thermal conductivity (W/m.K)	Moisture average (%)
1	1.22±0.69	292.77±0.0	10.00	0.50	0.50±0.01	0.60±0.01	0.70±0.006	92.00±3.5	0.103±0.003	1.49±0.09
2	1.70±0.0	904.79±0.0	10.00	0.50	0.50±0.03	0.60±0.04	0.70±0.008	93.00±3.3	0.112±0.004	1.53±0.21
3	14.50±0.0	4796.39±0.0	10.00	0.50	0.89±0.06	2.50±0.09	7.00±0.01	94.50±1.3	0.101±0.002	2.10±0.04
4	4.59±1.53	961.23±214.95	5.00	0.50	1.08±0.01	1.31±0.20	1.32±0.19	95.00±0.8	0.107±0.0005	2.79±0.84
5	6.24±0.46	1454.53±464.73	5.00	0.50	1.11±0.19	4.90±2.17	4.10±0.9	92.50±1.7	0.106±0.001	3.98±0.80
6	2.08±1.23	835.20±474.28	5.00	0.50	1.37±0.26	5.43±0.75	2.41±0.66	93.40±1.4	0.106±0.0015	3.18±0.67
7	5.14±0.90	1142.94±84.27	5.00	0.50	1.00±0.08	6.70±1.63	5.18±0.15	90.30±1.3	0.106±0.0023	2.05±0.81
8	4.56±1.76	1995.41±858.48	5.00	0.50	0.89±0.15	4.08±0.70	5.24±1.03	93.40±0.8	0.1060.00003	2.73±0.22
9	2.88±0.20	914.11±161.87	5.00	1.50	0.99±0.00	4.71±0.39	4.96±0.02	93.00±1.4	0.091±0.00125	5.44±0.18
10	8.18±0.78	1719.18±632.64	5.00	1.50	1.08±0.03	6.20±0.68	4.83±0.85	90.80±2.1	0.087±0.00131	5.18±0.77
11	6.63±0.56	1379.33±126.45	5.00	1.50	1.25±0.02	8.75±1.34	4.65±1.03	93.30±2.5	0.091±0.00143	6.27±0.62
12	5.15±0.90	837.69±162.20	10.00	1.50	1.17±0.05	10.14±0.56	2.88±0.29	92.30±0.5	0.087±00018	5.39±0.04
13	8.75±0.10	1730.57±401.91	5.00	1.50	1.11±0.14	7.98±1.88	6.80±0.75	92.80±0.6	0.087±0.0044	5.33±0.13
14	2.44±0.04	395.93±43.61	5.00	1.50	1.14±0.11	2.11±0.05	5.04±1.48	88.30±3.3	0.089±0.0051	5.50±0.43
15	2.63±0.33	478.58±113.38	5.00	1.50	1.02±0.09	1.04±0.15	2.30±0.02	91.75±2.0	0.089±0.0001	9.71±0.14

Ref : composite panel reference, n=3 : Three replicates for each Ref, M : Monnin hardness, B : Brinell hardness, S : Shore A hardness.

## **Partie 4 : Autres exemples de valorisation de bois tropicaux**

## I. Introduction

Cette dernière partie présente des résultats de collaborations que j'ai pu développer durant ma thèse. Cette partie concerne la mise en évidence des potentiels chimique, physico-chimique d'autres bois tropicaux du Gabon, tels que *Testulea gabonensis* Pellegr (*T. gabonensis*), *Julbernardia pellegriniana* (*J. pellegriniana*), *A. klaineana* Pierre (*A. klaineana*) et *T. africana* Pierre (*T. africana*). En particulier, la valorisation des extractibles, des éléments de structures tels que la lignine et la cellulose mais également les propriétés de durabilité naturelle de ces essences ont été étudiées. Par soucis de clarté, seuls les résumés de ces travaux publiés (cf articles complets en annexe) sont proposés.

Ainsi, ces résultats sont présentés comme suit :

- Caractérisation de quelques bois du Gabon

*“Extraction and Characterization of Aucoumea klaineana Pierre (Okoume) Extractives”*. Journal of Research Material. JRM. 7, 518-522. Mat. DOI: 10.32604/jrm.2019.0405.

*“Characterization of some African tropical heartwood lignins by 1D 13C and 1H-NMR: molecular structure and hydroxyl groups' distribution”*. J. Indian Acad. Wood Sci. pp.1-14.

- Réactivité chimique de celluloses de bois tropicaux

*“Chemical reactivity and supramolecular susceptibility of hardwood celluloses towards succinic anhydride”*. Int. J. Biol. Chem. Sci. 11, 3110–3131.

- Durabilité naturelle de quelques bois tropicaux

*“Understanding the natural durability of some African tropical heartwoods towards Pycnopus sanguineus and Antrodia sp.: lignin structure and cellulose morphology control.”* J. Indian Acad. Wood Sci. 2, 162–171.



## II. Caractérisation de quelques bois tropicaux du Gabon.

### << **Extraction and Characterization of *Aucoumea klaineana* Pierre (Okoume) Extractives** >>.

Engozogho Anris Starlin Peguy<sup>1,2\*</sup>, Bikoro Bi Athomo Arsene<sup>1,2</sup>, Vidal Marcia<sup>5</sup>, Denaud Louis<sup>4</sup>, Safou Tchiama Rodrigue<sup>2,3</sup> and Charrier Bertrand<sup>1</sup>

<sup>1</sup>CNRS/ Univ Pau & Pays Adour, Institut des Sciences Analytiques et de Physico-Chimie pour l'Environnement et les Matériaux Xylomat, UMR5254, 40004, Mont de Marsan, France.

<sup>2</sup>Laboratoire de Recherche et de Valorisation du Matériau Bois (LaReVa Bois). Ecole Normale Supérieure d'Enseignement Technique (ENSET). BP. 3989, Libreville, Gabon.

<sup>3</sup>Laboratoire des Substances Naturelles et de Synthèses Organométalliques (LASNSOM). Unité de Recherche en Chimie (URChi). BP.941 Université des Sciences et Techniques de Masuku. Franceville, Gabon.

<sup>4</sup>Laboratoire Bourguignon des Matériaux et Procédé, Cluny, France.

<sup>5</sup>Ecole Catholique d'Arts et Métiers (ECAM), 40 Montée Saint Barthélemy, 69321, Lyon cedex 05, France-Lyon.

\*Corresponding Author: Engozogho Anris starlin Peguy. Email: anrispeguy@yahoo.fr.

### **II.A. Résumé**

Toujours dans le cadre de recherche de stratégies pratiques pour l'utilisation des déchets de bois provenant de l'industrie du bois du Gabon, ces travaux concernent *aucoumea klaineana pierre* (okoumé) qui représente le bois le plus exploité. Il est en effet primordial de chercher à valoriser ses déchets qui sont principalement des écorces et des billons de déroulage. Dans ce cadre, diverses analyses chimiques ont été effectuées sur des échantillons d'origines différentes. La teneur totale en extraits de l'écorce, de l'aubier et du bois de cœur de l'okoumé a été évaluée. Des analyses thermogravimétriques ont aussi été effectuées et l'indice de Stiasny a été calculé. Il a

été constaté que l'écorce était plus riche en acides gras de haut poids moléculaire tandis que l'aubier était riche en acides gras de faible poids moléculaire. Par ailleurs, il est apparu que la teneur en tanins condensés varie selon l'origine et la partie de l'arbre. Ces nouvelles informations peuvent constituer une base de travail pour la réalisation d'adhésifs biosourcés à base de tanins d'okoumé.

### III. Caractérisation de la lignine de bois de Coeur de certains bois tropicaux

#### << Characterisation of some African tropical heartwood lignins by 1D <sup>13</sup>C and <sup>1</sup>H-NMR: molecular structure and hydroxyl groups' distribution >>.

Rodrigue Safou Tchiama<sup>1,2\*</sup>, Arsène Bikoro Bi Athomo<sup>1,3</sup>, Péguy Starlin Engozogho Anris<sup>1,3</sup>, Aristide Gervais Akagah<sup>1</sup> and Bernard De Jésus<sup>4</sup>.

<sup>1</sup>Laboratoire de Recherche et de Valorisation du Matériau Bois (LaReVa Bois). Ecole Normale Supérieure d'Enseignement Technique (ENSET). BP 3989, Libreville (Gabon).

<sup>2</sup>Laboratoire des Substances Naturelles et de Synthèse Organométallique (LASNSOM). Unité de Recherche en Chimie. Université des Sciences et Techniques de Masuku. BP. 941, Franceville (Gabon).

<sup>3</sup>Xylomat. 371, rue du Ruisseau, 44000 Mont de Marsan

<sup>4</sup>Laboratoire de Chimie des Polymères Organiques (LCPO). UMR 5629. 16 Avenue Pey Berland 33607 Pessac France.

\*Corresponding author. Email: [r\\_safoutchiama@yahoo.fr](mailto:r_safoutchiama@yahoo.fr); Phone :(+241) 02 45 77 65/(+241) 07 59 60 52.

#### III.A. Résumé

Dans la continuité de notre travail de valorisation de produits connexes encore appelés déchets de l'industrie du bois, des études ont été menées afin de comprendre le potentiel de certains déchets de feuillus tropicaux en tant que sources de lignines utilisables. Les structures chimiques de lignines extraites au dioxane et acétylées de *Testulea gabonensis* Pellegr (*T. gabonensis*), *Julbernardia pellegriniana* (*J. pellegriniana*), *A. klaineana* Pierre (*A. klaineana*) et *T. africana* Pierre (*T. africana*) largement utilisé dans l'industrie des bois tropicaux du bassin du Congo ont été étudiés par RMN 1D <sup>1</sup>H et <sup>13</sup>C. *T. gabonensis* et *J. pellegriniana* étaient les plus riches en unités de guaïacyle (G), tandis que celles d'*A. Klaineana* et *T. africana* présentaient la teneur la plus élevée en syringyle (S). La RMN <sup>1</sup>H présentait un rapport S / G <1 pour *T. gabonensis* et *J. pellegriniana*, tandis que celui des lignines dioxane acides de *A.*

klaineana et *T. africana* était tel que  $S / G > 1$ . Les rapports RMN  $^{13}\text{C}$  des groupes aliphatiques par rapport aux groupes hydroxyle phénoliques étaient de 1,42, 2,10, 2,0 et 1,41 pour *T. gabonensis*, *J. pellegriniana*, *A. klaineana* et *T. africana* respectivement. Les groupes hydroxyle guaiacyl des lignines dioxane acides de *T. gabonensis* et *J. pellegriniana* étaient plus acétylés que ceux de *A. klaineana* et *T. africana*. L'acétylation la plus faible de la lignine dioxane acide de *A. klaineana* a été renforcée par la faible estérification de ses groupes hydroxyle de type guaiacyle en position  $\text{C}_\alpha$  et  $\text{C}_\gamma$ . La même tendance a été observée pour les groupes hydroxyle de type syringyle acétylés en position  $\text{C}_\alpha$  de *A. klaineana*. Néanmoins, *T. gabonensis* était la plus riche en structures condensées de  $\beta\text{-O-4}$  et de  $5\text{-}5'$ . Ces lignines présentaient une faible teneur en liaisons  $\beta\text{-5}$  pour lesquelles le signal le plus faible était celui de *T. africana*, qui présentait toutefois la teneur la plus élevée en structures  $\beta$  des fragments de pinorésinol. L'apparition de formes thréo et érythro de type guaiacyle  $\beta\text{-O-4}$  avec  $\text{C}_\alpha = \text{O}$  ou  $\beta\text{-O-4}$  dans les lignines de bois dur a été étudiées.

## IV. Réactivité chimique des celluloses de bois durs

<< **Chemical reactivity and supramolecular susceptibility of hardwood celluloses towards succinic anhydride** >>.

Rodrigue SAFOU-TCHIAMA<sup>1,2,\*</sup>, Patrice SOULOUNGANGA<sup>3</sup>, Sebastian NGWA OBAME<sup>4</sup>, Arsène BIKORO BI ATHOMO<sup>2,5</sup>, Peguy Starlin ENGOZOGO ANRIS<sup>2,5</sup>, Aristide Gervais AKAGAH<sup>1</sup>, Bernard De JESO<sup>6</sup>

<sup>1</sup>Laboratoire des Substances Naturelles et de Synthèse Organométalliques (LASNSOM). Unité de Recherche en Chimie. Université des Sciences et Techniques de Masuku. BP. 941 Franceville, Gabon. (\*): Author to whom correspondence should be addressed: Email : [r\\_safoutchiama@yahoo.fr](mailto:r_safoutchiama@yahoo.fr). Tel:+241 02 457 765

<sup>2</sup>Laboratoire de Recherche et de Valorisation du Matériau Bois (LaReVa Bois). Bât du Master Recherche en Sciences du Bois. Ecole Nationale des Eaux et Forêts. BP 3960, Libreville, Gabon.

<sup>3</sup>Laboratoire Pluridisciplinaire des Sciences. Ecole Normale Supérieure. BP. 17009, Libreville, Gabon.

<sup>4</sup>Laboratoire d'Etude et de Recherche sur la Matériau Bois. Faculté des Sciences et Techniques, Nancy-Université, Vandoeuvre-lès-Nancy, France

<sup>5</sup>CNRS/ Université de Pau & Pays Adour, Institut des Sciences Analytiques et de Physico-Chimie pour l'Environnement et les Matériaux - Xylomat, UMR5254, 40004, Mont de Marsan, France

<sup>6</sup>Laboratoire de Chimie des Polymères Organiques (LCPO) ; UMR 5629. 16 Avenue Pey Berland, 33607 Pessac France.

### IV.A. Résumé

Dans les études précédentes, nous avons principalement travaillé sur les composés extractibles des essences du Gabon. Cette étude traite la question des fibres de bois et notamment celles de cellulose. La structure morphologique de fibres de cellulose blanchies extraites de *Testulea gabonensis* (*T. gabonensis*), de *Julbernardia pellegriniana* (*J. pellegriniana*), d'*Aucoumea klaineana* (*A. klaineana*) et de *Tieghemella africana* (*T. africana*) a été étudiée avec l'appareil MORFI®. Les fibres étaient les plus longues pour *T. africana* (769 µm), *J. pellegriniana* (717 µm) et *T.*

gabonensis (700  $\mu\text{m}$ ), tandis que celles de *A. klaineana* étaient les plus courtes (624  $\mu\text{m}$ ). Aucune différence n'a été constatée entre les fibres de *T. gabonensis*, *A. klaineana* et *T. africana*, qui variaient de 24,0 à 24,2  $\mu\text{m}$ , tandis que la cellulose de *J. pellegriniana* présentait la plus petite largeur (18,6  $\mu\text{m}$ ). Ces celluloses ont été estérifiées par de l'anhydride succinique chauffé à 120 ° C pendant 4 heures dans un mélange diméthylformamide/pyridine utilisé comme solvant gonflant afin de comprendre leur réactivité avec les agents de couplage portant un groupe succinique. Les fibres de cellulose de *T. gabonensis*, *T. africana* et *J. pellegriniana* présentaient la meilleure réactivité révélée par leurs gains de masse respectifs : 16,57 $\pm$ 1,11%, 14,16 $\pm$ 0,67% et 12,96 $\pm$ 0,77% par rapport à *A. klaineana* (11,85 $\pm$ 0,62%). Ces derniers ont présenté la plus faible diminution de cristallinité parmi ces esters de cellulose. Néanmoins, la RMN  $^{13}\text{C}$  à l'état solide a montré une forte réactivité de la cellulose amorphe et des chaînes exposées sur les surfaces cristallines par rapport aux chaînes cristallites internes. Aucune preuve d'estérification des allomorphes  $\text{I}\alpha$  et  $\text{I}\beta$  n'a été trouvée dans ces fibres de cellulose, à l'exception de *T. africana*, qui présentait une diminution des allomorphes  $\text{I}\alpha$  et  $\text{I}\beta$  sans réactivité préférentielle de la cellulose  $\text{I}\alpha$ .

V. Durabilité naturelle de certains bois tropicaux contre le  
*Pycnoporus sanguineus* et *Antrodia sp*

**<<Understanding the natural durability of some African tropical heartwoods towards *Pycnoporus sanguineus* and *Antrodia sp.*: lignin structure and cellulose morphology control >>.**

Rodrigue Safou Tchiamia<sup>1,2</sup> Patrice Soulounganga<sup>1,3</sup> Péguy Starlin Engoz  
ogho Anris<sup>1,4</sup> Arsène Bikoro Bi Athomo<sup>1,4</sup> Timoléon Andzi Barhé<sup>1,5</sup> Bernard De Jes  
o<sup>6</sup> Bertrand Charrier<sup>4</sup> Aristide Gervais Akagah<sup>2</sup>.

<sup>1</sup>Laboratoire de Recherche et de Valorisation du Matériau Bois (LaReVaBois),  
Ecole Normale Supérieure d'Enseignement Technique, BP 3989, Libreville, Gabon

<sup>2</sup>Laboratoire des Substances Naturelles et de Synthèses  
Organométalliques (LASNSOM), Unité de Recherche en Chimie (URChi), Université  
des Sciences et Techniques de Masuku, BP 941, Franceville, Gabon

<sup>3</sup>Laboratoire Pluridisciplinaire des Sciences, Ecole Normale Supérieure,  
BP 17009, Libreville, Gabon

<sup>4</sup>Xylomat, 371, Rue du Ruisseau, 40000 Mont de Marsan, France

<sup>5</sup>Ecole Normale Supérieure, Laboratoire de Biochimie et de Pharmacologie, de  
la Faculté des Sciences de la Santé. Université Marien Ngouabi, P.O. Box 69,  
Brazzaville, Congo

<sup>6</sup>Laboratoire de Chimie des Polymères Organiques (LCPO),  
UMR 5629, 16 Avenue Pey Berland, 33607 Pessac, France.

Coresponding author: r\_safoutchiamia@yahoo.fr

## V.A. Résumé

Les bois tropicaux peuvent avoir diverses applications dans le domaine de la construction. Il est donc très important de connaître leur comportement face aux agents biologiques qui peuvent les attaquer en extérieur comme en intérieur. C'est

dans ce cadre que la durabilité naturelle des bois de cœur de *Testulea gabonensis* Pellgr. (*T. gabonensis*), *Julbernardia pellegriniana* (*J. pellegriniana*), *Aucoumea klaineana* Pierre (*A. klaineana*) et *Tieghemella africana* Pierre (*T. africana*) largement utilisé pour les fenêtres, les encadrements de portes et les charpentes de maisons, les placards et les contreplaqués au Bassin du Congo ou d'autres pays du monde ont été étudiés. Les échantillons ont été exposés à *Pycnoporus sanguineus* (*P. sanguineus*) et à *Antrodia* sp. Des facteurs tels que la toxicité des extraits, le rapport lignine syringyle / guaiacyle (S / G), la cellulose cristalline et la morphologie des fibres contrôlant la résistance du bois aux champignons blancs et à la pourriture brune ont été étudiés. Les bois non extraits ont montré une forte résistance naturelle à *P. sanguineus* par rapport à *Antrodia* sp., à l'exception de *A. klaineana*, qui n'a pas montré de différence significative en ce qui concerne sa durabilité à l'égard de ces deux champignons. Les bois de cœur non extraits de *T. gabonensis* et *T. africana* étaient très durables contre *P. sanguineus*, alors que ceux d'*A. Klaineana* et de *J. pellegriniana* l'étaient modérément. Pour les bois de cœur extraits, la perte de masse la plus faible contre *P. sanguineus* a été observée pour *T. gabonensis*, dont le bois de coeur était le plus riche en unités de type G. La perte de masse la plus élevée a été obtenue pour les trois autres bois de cœur présentant le contenu le plus élevé en unités S. Les bois de cœur avec un indice de cristallinité élevé et de longues fibres de cellulose étaient plus résistants à *Antrodia* sp. comparé à *A. klaineana*, qui présentait les fibres de cellulose les plus courtes (624 µm) et le plus faible indice de cristallinité (59%).



## **Conclusion et Perspectives**

Cette thèse était principalement orientée sur la valorisation des produits connexes de l'acajou du Gabon. Les travaux ont principalement été basés sur la caractérisation des produits extractibles, tels que les tanins en vue d'une valorisation industrielle possible au niveau du Gabon. Par ailleurs, nous avons élaboré un premier composite bois/plastique recyclé. Enfin, j'ai participé en parallèle de la thèse à des travaux sur la valorisation d'autres bois tropicaux essentiellement sciés ou déroulés au Gabon.

## I. Caractérisations physico-chimiques des extraits

Les travaux d'analyses des composés phénoliques auront montré que la teneur totale en phénols de l'écorce, de l'aubier et du bois de cœur de l'acajou africain *K. ivorensis* du Gabon ne présentait aucune différence significative. Les analyses MALDI-TOF et FTIR ont décrit pour la première fois la distribution des tanins condensés dans les extraits acétone / eau de l'écorce de *K. ivorensis*. L'écorce étudiée contenait des monomères de Fisetinidine, de gallocatéchine et de trihydroxyflavane. Une variété d'oligomères associant des flavonoïdes à des unités glucidiques a été identifiée pour la première fois; la plus longue était un pentamère flavonoïde lié à deux glucides et constitué de fisetinidine, de trihydroxyflavane, de trois unités de dihydroxyflavanes et d'un dimère glucidique comprenant des unités de glucose ou de mannose. Cependant, il semble que le bois de cœur était plus riche en tanins condensés chez certains arbres.

Les nombres de Stiasny qui en résultent nous permettent, pour la première fois, de dire que les tanins de *K. ivorensis* peuvent permettre de fabriquer des adhésifs de bonne performance. Ces polyphénols d'acajou d'Afrique ont présenté des températures de dégradation maximales supérieures à celles trouvées pour les tanins condensés du commerce. Ils peuvent être utilisés dans ce cas pour l'élaboration de nouveaux matériaux ou des produits à base de tanins au même titre que les tanins commercialisés, et apporter une résistance supplémentaire à la décomposition thermique. En outre, les premiers résultats obtenus sur la présence de quantités élevées de phénols glycosylés dans les extraits d'acétone / eau de *K. ivorensis* devraient offrir de nouvelles possibilités de valorisation biologique des déchets de bois de cet acajou africain.

Les extraits méthanol / eau de l'écorce, de l'aubier et du bois de cœur de *Khaya ivorensis* élués avec 2 gradients (méthodes 1 et 2) différents en chromatographie liquide associés à la spectrométrie de masse ont montré que la méthode 1 ou gradient 1 ne présente pas de différences significatives en ce qui concerne les composés élués par l'écorce, l'aubier et le bois de cœur de *K. ivorensis*. Néanmoins, certains composés élués par la méthode 1 étaient spécifiques à certaines parties du bois; par conséquent, le trihydroxyflavane n'a été trouvé que dans l'écorce et une molécule protonée de type dihydroxyflavane a été trouvée dans le bois de cœur. Le second gradient a permis une meilleure séparation des composés plus lourds. Bien que des différences aient été observées entre l'écorce, l'aubier et le bois de cœur pour les composés extraits, les méthodes 1 et 2 ont toutes deux montré une teneur équivalente en mannitol dans les trois parties de bois de *K. ivorensis*. Par contre l'unité de résorcine libre n'apparaissait que dans l'écorce et le bois de cœur, expliquant dans une certaine mesure la meilleure réactivité de leurs tanins avec le formaldéhyde ou l'hexamine par rapport à ceux de l'aubier. Néanmoins, les analyses LC / MS des extraits méthanol / eau élués par la méthode 2 ont montré que le bois de cœur du *K. ivorensis* étudié est plus riche en fragments d'acide benzoïque alors que l'acide gallique est plus abondant dans l'écorce.

Les dérivés d'hexoside tels que l'acide (quercétine-7-O-*p*-hydroxybenzoïque) -3-O-hexoside et le (quercétine-7,4'-O-di-*p*-hydroxybenzoïque + 2H) -3-O-hexoside libérés respectivement dans l'écorce et le bois de cœur sont connus pour leurs activités antiradicalaires, antioxydantes ou antifongiques sans exclure la présence de traces de kaempferide dans l'écorce de *K. ivorensis*. Ce composé inhibe la croissance et la migration du cancer du pancréas (Lee and Kim, 2016)

Compte tenu des nouvelles politiques relatives à l'industrie du bois dans le bassin du Congo, le bois de *K. ivorensis* présente un intérêt croissant, car il génère une grande quantité de co-produits sous-utilisés. Les résultats obtenus durant cette thèse permettent de fournir des informations originales sur la connaissance des structures chimiques des glucides liés aux tanins condensés et des propriétés biologiques et chimiques des tanins condensés glycosylés.

Malgré ces résultats prometteurs, il est nécessaire de poursuivre les recherches dans le but de mieux séparer et collecter les différentes fractions

moléculaires. Nous pourrions ainsi les purifier et évaluer l'activité biologique ou microbiologique pour déterminer le potentiel des déchets de bois industriels de *K. ivorensis* du Gabon en tant que source de molécules d'intérêt pour la médecine, la chimie fine, les adhésifs, ou la protection du bois. Il faudrait également poursuivre les études de caractérisation afin d'élucider les structures stéréochimiques, mais aussi confirmer le type de liaison entre les tanins condensés lors de l'autocondensation. Il faudrait également augmenter l'échantillonnage de façon à mesurer le niveau de variabilité au sein du genre *Khaya*.

## II. Valorisation des coproduits

Concernant le travail de valorisation des déchets plastiques et des coproduits d'acajou pour en faire des composites bois/plastiques, les premiers résultats obtenus sont encourageants, tant par les propriétés obtenues que la simplicité du procédé de fabrication. Les échantillons produits présentent une bonne adhésion entre les particules les plus fines, une bonne dureté, une résistance en flexion comparable aux composites bois/plastique déjà présents sur le marché. La faible reprise d'eau observée est un élément intéressant pour l'utilisation du composite en extérieur ou en zones tropicales. Il est toutefois nécessaire de poursuivre ce travail afin de mieux comprendre et d'améliorer l'interface matrice/ renfort par des techniques d'analyses de morphologie, de caractérisations physique mais aussi par l'optimisation des adjuvants. Ce travail devrait permettre de pouvoir ensuite réaliser de plus grands panneaux en vue d'une possible production industrielle.

Le travail d'élaboration d'une colle biosourcée avec les tanins extraits d'écorce, d'aubier et de bois de cœur par une méthode de laboratoire qui reproduit une technique d'extraction industrielle nous a permis de faire les premières caractérisations physico-chimiques des formulations de colle de tanins d'acajou et d'hexamine. Les formulations réalisées avec les tanins d'écorce et de bois de cœur étaient plus efficaces que celles obtenues à partir des extraits d'aubier. Néanmoins, l'ensemble des colles a montré de bonnes propriétés sous l'effet de la chaleur comparées aux colles de type urée-formol, mélamine-urée-formol, des colles phénoliques ou d'autres colle à base de tanins. Cependant cette étude mérite d'être

complétée afin d'améliorer les formulations, en travaillant notamment avec de plus grandes quantités de tanins.

### III. Valorisation d'autres bois tropicaux

Durant cette thèse, j'ai participé à quelques travaux sur la valorisation d'autres bois tropicaux du Gabon tels que : *T. gabonensis*, *J. pellegriniana*, *A. klaineana* et *T. africana*.

Les premières études étaient orientées sur l'extraction et la caractérisation des lignines de ces bois. Les résultats ont montré une forte variabilité dans la distribution des unités siringyle et guaïacyle dans les lignines extraites. La distribution était inférieure à 1 pour *T. gabonensis* et de *J. pellegriniana* et supérieure à 1 pour *A. klaineana* et de *T. africana*. L'estérification de ces lignines par l'anhydride acétique a montré une meilleure réactivité des groupes hydroxyle guaïacyle des lignines extraites de *T. gabonensis* et *J. pellegriniana* alors que les groupes hydroxyles primaires des chaînes alkyle en C $\gamma$ -OH étaient les plus acétylés pour *T. gabonensis* et *T. africana*. Cependant, le fait que les lignines acides dioxane étudiées présentent un faible signal des chaînes alkyles et une absence de structures typiques de la lignine  $\alpha$ -O-4, fait penser que certaines liaisons chimiques essentielles ont été scindées par l'extraction à l'acide dioxane.

L'examen de la teneur en cellulose de ces quatre bois a ensuite montré que le bois de cœur de *J. pellegriniana*, *A. klaineana* et *T. africana* était plus abondant en cellulose que celui de *T. gabonensis*. La cellulose extraite de *A. klaineana* présentait des fibres courtes et agrégées, tandis que celle de *J. pellegriniana* présentait la plus petite largeur. Leur réactivité chimique au travers de la molécule d'anhydride succinique utilisée comme composé modèle pour les agents de couplage tels que le polypropylène maléate a montré que l'estérification dépendait fortement de l'origine des fibres de cellulose. À l'exception de *T. africana*, aucune diminution significative des allomorphes I $\alpha$  et I $\beta$  n'a été constatée. Cette faible réactivité des chaînes cristallines intérieures permet une stabilité micromécanique des esters de cellulose obtenus. Cependant, des études supplémentaires sont nécessaires pour élucider leur stabilité micromécanique et thermique afin de comprendre les propriétés finales de leurs composites polymères du bois.

Enfin, la durabilité naturelle des bois de cœur non extraits recueillis auprès des quatre bois contre *Antrodia sp.* et *P. sanguineus* a montré que les substances extraites n'avaient pas la même activité antifongique vis-à-vis des champignons sélectionnés. Le bois de cœur de *T. gabonensis* non extrait était plus résistant à l'activité d'*Antrodia*, tandis que *T. gabonensis* et *T. africana* étaient très résistants à *P. sanguineus*. Il est à noter que le bois de cœur d'*A. Klaineana* était le moins résistant aux champignons étudiés. Les résultats préliminaires obtenus dans cette étude ont révélé des informations clés sur la durabilité naturelle des espèces de bois feuillus étudiées.

Ces travaux de valorisation des bois et produits connexes sont des atouts importants pour un développement de l'industrie forestière du Gabon même si des études supplémentaires sont encore nécessaires pour une valorisation efficace.

# **Annexes**

# Annexe 1

## Liste des publications

**Bikoro Bi Athomo, A.**, Engozogho Anris, S.P., Safou-Tchiama, R., Santiago-Medina, F.J., Cabaret, T., Pizzi, A., Charrier, B., 2018. Chemical composition of African mahogany (*K. ivorensis* A. Chev) extractive and tannin structures of the bark by MALDI-TOF. *Ind. Crops Prod.*113, 167–178.

**Bikoro Bi Athomo, A.**, Engozogho Anris, S.P., Safou Tchiama, R., Leroyer, L., Pizzi, A., Charrier, B., 2019. Chemical analysis and thermal stability of African mahogany (*Khaya. ivorensis* A. Chev) condensed tannins: A MALDI-TOF, FTIR, DSC and TGA study. *HOLZ.*2019.0113.

**Bikoro Bi Athomo, A.**, Engozogho Anris, S.P., Safou Tchiama, R., Eyma, F., Arnaudguilhem, C., Charrier, B., 2019. Identification of phenolic compounds from *K. ivorensis* by RP-HPLC/UV/ESI-FTMS. *Talanta*, Soumis.

**Bikoro Bi Athomo, A.**, Engozogho Anris, S.P., Eyma, F., Boucard, M., Safou Tchiama, R., Charrier, B., 2019. Wood-plastic composite as promising waste valorization, *European Journal of Wood and Wood products*.

**Bikoro Bi Athomo, A.**, Engozogho Anris, S.P., Safou Tchiama, R., Eyma, F., Pizzi, A., Charrier, B., 2019. Adhesives analysis from *K. ivorensis* by, TGA, DSC, TMA, FTIR and RMN. En cours de redaction.

Peguy, E.A.S., **Arsene, B.B.A.**, Marcia, V., Louis, D., Rodrigue, S.T., Bertrand, C., 2019. Extraction and Characterization of *Aucoumea klaineana* Pierre (Okoume) Extractives. *JRM.* 7, 518-522. *Mat.* DOI: 10.32604/jrm.2019.04051.

Safou-Tchiama, R., **Bikoro Bi Athomo, A.**, Engozogho Anris, S.P., Akagah, A.G., De Jeso, B., 2019. Characterization of some African tropical heartwood lignins by 1D <sup>13</sup>C and <sup>1</sup>H-NMR: molecular structure and hydroxyl groups' distribution. *J. Indian Acad. Wood Sci.*pp.1-14.



Tchiama, R.S., Soulounganga, P., Anris, P.S.E., **Athomo, A.B.B.**, Barhé, T.A., Jeso, B., Charrier, B., Akagah, A.G., 2018. Understanding the natural durability of some African tropical heartwoods toward *Pycnoporus sanguineus* and *Antrodia* sp.: lignin structure and cellulose morphology control. *J. Indian Acad. Wood Sci.* 2, 162–171.

Safou-Tchiama, R., Barhé, T.A., Soulounganga, P., Obame, S.N., Iwangou, S.-B.M., **Athomo, A.B.B.**, Anris, P.S.E., Jeso, B.D., Akagah, A.G., 2017. Chemical reactivity and supramolecular susceptibility of hardwood celluloses towards succinic anhydride. *Int. J. Biol. Chem. Sci.* 11, 3110–3131.

Engozogho Anris, S.P., **Bikoro Bi Athomo, A.**, Safou-Tchiama, R., Santiago-Medina, F.J., Cabaret, T., Pizzi, A., Charrier, B., 2019. Molecular structure and thermal stability of *Aucoumea klaineana* Pierre (Okoumé) condensed tannins: An attempt to African wood wastes valorization. *Scientific Report*, 10, 1-19.

Engozogho Anris, S.P., **Bikoro Bi Athomo, A.**, Florent. Eyma, Rodrigue. Safou Tchiama., Rubini, M., Boucard, M., Charrier, B., 2019. Utilization of *Aucoumea klaineana* Pierre (Okoumé) wood wastes in plastic panel composites. *JMCWM*. Soumis.

Starlin Peguy Engozogho Anris., **Arsène Bikoro Bi Athomo.**, Rodrigue Safou-Tchiama., Leo Leroyer., Marcia Vidal., Bertrand Charrier., 2019. Development of green adhesives for fiberboard manufacturing, using okoume bark tannins and hexamine: characterization by <sup>1</sup>H NMR, TMA, TGA and DSC analysis. En cours de redaction.

Manon Frances., Yanis Gardere., Morandise Rubini., Elsa Duret., Léo Leroyer., Thomas Cabaret., **Arsène Bikoro Bi Athomo.**, Bertrand Charrier., 2020. Effect of heat treatment on maritime pine rosin: study of physico chemical changes and influence on the quality of rosin linseed oil varnish. *Ind. Crops and Products*. Soumis

# Annexe 2

## Communications internationales

**30<sup>th</sup> September 2019** : 14<sup>ème</sup> édition internationale des Prix « Thèses des Bois », Université Laval, Canada. Etude de la composition chimique de l'acajou et mise en œuvre d'un composite Bois/Plastique.

Bikoro Bi Athomo, A<sup>1,2.</sup>, Safou-Tchiama, R<sup>2.</sup>, Eyma, F., Charrier, B<sup>1.</sup>

<sup>1</sup>CNRS/ Univ Pau & Pays Adour, Institut des Sciences Analytiques et Physico-Chimie pour l'Environnement et les Matériaux- Xylomat, UMR5254, 40004, Mont de Marsan, France.

<sup>2</sup>Ecole Nationale des Eaux et Forêts (ENEF), BP. 3950, Libreville, Gabon.

<sup>3</sup> Institut Clément Ader (ICA), Université de Toulouse, CNRS UMR 5312-INSA- ISAE-Mines Albi-UPS, Tarbes, France

arsene.bikoro-bi-Athomo@univ-pau.fr.

**1<sup>st</sup>-3<sup>rd</sup> July 2019** : Journées Nationales sur les Composites (AMAC) 21 – Bordeaux INP: *Valorization of mahogany wood*.

Bikoro Bi Athomo, A<sup>1,2.</sup>, Safou-Tchiama, R<sup>2.</sup>, Eyma, F., Charrier, B<sup>1.</sup>

<sup>1</sup>CNRS/ Univ Pau & Pays Adour, Institut des Sciences Analytiques et Physico-Chimie pour l'Environnement et les Matériaux- Xylomat, UMR5254, 40004, Mont de Marsan, France.

<sup>2</sup>Ecole Nationale des Eaux et Forêts (ENEF), BP. 3950, Libreville, Gabon.

<sup>3</sup> Institut Clément Ader (ICA), Université de Toulouse, CNRS UMR 5312-INSA- ISAE-Mines Albi-UPS, Tarbes, France

arsene.bikoro-bi-Athomo@univ-pau.fr.

**13<sup>th</sup>-17<sup>th</sup> May : 2019 ISGC** International Symposium on Green Chemistry, 2019 in La Rochelle. Valorization of co-products from the industrial processing of *African Mahogany* (Acajou) and *Aucoumea Klainena* (Okoumé) wood.

Bikoro Bi Athomo, A<sup>1,2</sup>., Engozogho Anris, P<sup>1,2</sup>.

<sup>1</sup>CNRS/ Univ Pau & Pays Adour, Institut des Sciences Analytiques et Physico-Chimie pour l'Environnement et les Matériaux- Xylomat, UMR5254, 40004, Mont de Marsan, France.

<sup>2</sup>Ecole Nationale des Eaux et Forêts (ENEF), BP. 3950, Libreville, Gabon.

arsene.bikoro-bi-Athomo@univ-pau.fr.

**15<sup>th</sup> April 2019** : International contest entitled "ma these en 180 secondes (MT180)". Valorization of mahogany wood industrial by products. Pau, France.

Bikoro Bi Athomo A.

CNRS/ Univ Pau & Pays Adour, Institut des Sciences Analytiques et Physico-Chimie pour l'Environnement et les Matériaux- Xylomat, UMR5254, 40004, Mont de Marsan, France.

**21<sup>th</sup>, 22<sup>nd</sup>, 23<sup>th</sup> November 2018** : Communication entitled " Valorisation de coproduits de la transformation industrielle de l'Acajou (*K. Ivorensis* A. Chev) l' Les 7<sup>ème</sup> journées du GDR 3544 « Sciences du bois » - Cluny, 2018.

Bikoro Bi athomo Arsène<sup>1,2</sup>, Safou-Tchiama Rodrigue<sup>2</sup>, Eyma Florent<sup>3</sup>, Bertrand Charrier<sup>1</sup>

CNRS/ Univ Pau & Pays Adour, Institut des Sciences Analytiques et Physico-Chimie pour l'Environnement et les Matériaux- Xylomat, UMR5254, 40004, Mont de Marsan, France.

<sup>2</sup> Laboratoire de Recherche et de Valorisation du Matériau Bois(LaReVaBois), BP. 3989, LBV, Gabon.

<sup>3</sup> Institut Clément Ader (ICA), Université de Toulouse, CNRS UMR 5312-INSA-ISAE-Mines Albi-UPS, Tarbes, France.

**30<sup>th</sup> April-4<sup>th</sup> May 2018** : Communication entitled " valorization of mahogany wood industrial by products " at the International Conference on Materials and Energy, held in Donastia-san Sebastien-Spain.

Bikoro Bi Athomo.

CNRS/ Univ Pau & Pays Adour, Institut des Sciences Analytiques et Physico-Chimie pour l'Environnement et les Matériaux- Xylomat, UMR5254, 40004, Mont de Marsan, France.

Ecole Nationale des Eaux et Forêts (ENEF), BP. 3950, Libreville, Gabon.

arsene.bikoro-bi-Athomo@univ-pau.fr.

**20<sup>th</sup>, 21<sup>th</sup>, 22<sup>nd</sup> November 2017** : Communication entitled " Valorisation des tanins de produits connexes de l'Acajou (*K. Ivorensis* A. Chev) II" at the 6<sup>ème</sup> journées du GDR 3544 « Sciences du bois » - Nantes, 2017.

Bikoro Bi athomo Arsène<sup>1,2</sup>, Safou-Tchiama Rodrigue<sup>2</sup>, Eyma Florent<sup>3</sup>, Bertrand Charrier<sup>1</sup>

<sup>1</sup> CNRS/ Univ Pau & Pays Adour, Institut des Sciences Analytiques et Physico-Chimie pour l'Environnement et les Matériaux- Xylomat, UMR5254, 40004, Mont de Marsan, France.

<sup>2</sup> Ecole Nationale des Eaux et Forêts (ENEF), BP. 3950, Libreville, Gabon.

<sup>3</sup> Institut Clément Ader (ICA), Université de Toulouse, CNRS UMR 5312-INSA- ISAE-Mines Albi-UPS, Tarbes, France.

# **Annexe 3**

## **Participation aux écoles thématiques et prix**

**18<sup>th</sup> June 2019** : Cosmetic expert forum. Poitier/France.

**3<sup>rd</sup>-7<sup>th</sup> June 2019** : Thematic school Pluribois 2019, Fréjus, France.

**20<sup>th</sup> May 2019** : webinaire L'eau de Graphène : atouts et applications. Aquitaine Chimie Durable, Bordeaux.

**29<sup>th</sup> April 2018** : Thematic school Bioraffinery, San Sebastian, Spain.

**2<sup>nd</sup> May 2018** : Medal of the Best Poster Award at the International Conference on Materials and Energy (ICOME'18), Spain.

**12<sup>nd</sup>-16<sup>th</sup> June 2017** : Member of the organization of the thematic school "Pluribois 2017: *Bioraffinerie* » du GDR bois, 2017 (France). Thematic school PLURIBOIS 2017, Mont de Marsan.

# Annexe 4

## I. Enseignements et encadrements

- Structure de la matière d'octobre à novembre 2017 (SGM1, 24h de TP)
- Chimie des solutions en novembre 2017 (SMG1, 6h de TP)
- Encadrement de projet tuteuré d'octobre à décembre 2017(SGM2)

*Intitulé* : « Moule pour moulage éprouvette en thermoplastique » (2,5 h)

Auteurs : Laussu., Legrand., Peguy Engozogho., Arsène Bikoro., 24 pages.

- Suivis de stagiaires de février à juin 2018 (SGM2, 10h)

Construction d'une mezzamine. Entreprise Bois&Concepts

Auteurs : Axel Croisier., Laurent Neveu., Arsène Bikoro., 23 pages.

- Suivis de stagiaires en licence pro (métiers du bois) LP-Bois, 14h

Sujet 1 : *Intitulé* : « Etude d'un plancher de stockage dans un atelier »

Auteurs : Riverain Samuel., Arsène Bikoro., 38 pages.

Sujet 2 : *Intitulé* : « Analyse et optimisation du tamisage des copeaux de bois »

Entreprise EGGER.

Auteurs : Valery Mbami., Adrien Boumedine., Peguy Engozogho., Arsène Bikoro., 55 pages.

Sujet 3 : *Intitulé* : « Composite bois plastique » Xylomat.

Auteurs : Serges Fota, Peguy Engozogho, Arsène Bikoro., 24 pages.

Sujet 4 : « Actualisation du système de contrôle de production de la charte qualité menuiserie 21 ». Entreprise MR

Auteurs : Serges Fota., Christophe., Arsène Bikoro, 48 pages.

Sujet 5 : intitulé : « Conception d'une gamme d'éléments métalliques destinés aux secteurs de la restauration ». Vezitien, concepteur métallier.

Auteurs : Laurianne Losage., Theil, Arsène Bikoro., 35 pages.

Sujet 6 : Intitulé : « Gestion d'un atelier de menuiserie ». Entreprise La Menuiserie

Auteurs : Côme Stefani., Jules Baty., Arsène Bikoro., 34 pages.

- Encadrement d'étudiants de licence professionnelle « métiers du bois » en alternance d'octobre à juillet 2017-2019 (LP-Bois, 16h)

Sujet 1 : Intitulé : « Exploitation et valorisation d'un massif en montage Ariégeoise ». Alliance Forêt Bois.

Auteurs : Bastien Bouillier., Sylvain Bruyere., Arsène Bikoro., 36 pages.

Sujet 2 : Intitulé : « alternant à l'ONF CASTRES » commercialisation du bois.

Auteurs : Etienne Guiraud, Damien Viguiet, Arsène Bikoro., 45 pages.

Sujet 3 : Intitulé : « Exploitation et commercialisation du bois. Alliance Forêt Bois.

Auteurs : Benjamin Garay., Arsène Bikoro., 58 pages.

Sujet 4 : Intitulé : « Création de références-articles sur nouvel ERP et mise en liaison avec le stockeur vertical ». Theze.

Auteurs : Mathieu Mazier., Arsène Bikoro., 40 pages.

Sujet 5 : Intitulé : « Participation aux activités de l'entreprise : Construction de Tiny house».

Auteurs : Nema, Arsène Bikoro, 38 pages.

Sujet 6 : Intitulé : « Exploitation Forestière et commercialisation des bois ». CFBL.

Auteurs : Josselin Deneux., Arsène Bikoro., 25 pages.

- Cours ISA BTP : 2eme année Génie civil en janvier 2018 (3h)

- Cours Physique des matériaux : Transfert de chaleur et Acoustique (licence Pro, CM : 12h et TD : 3h) et Travaux pratiques sur la réalisation et la caractérisation de panneaux de particules et de cuir (34h en eqTD). Septembre à octobre 2018.
- Participation à la formation des enseignants (du lycée et primaire) sur les matériaux biosourcés (20h). Juin 2018.
- Cours Physique des matériaux : Transfert de chaleur et Acoustique (licence Pro, CM : 14h et TD : 3h). Septembre 2019.
- Participation à la formation des enseignants (du lycée et primaire) sur les matériaux biosourcés (10h). Mai 2019.
- Encadrement de stage Master Polymère (Université de Lorient) et Master Chimie des Matériaux (Université de Pua et des Pays de l'Adour) Février 2019 à fin Mai 2019.  
*Intitulé* : « Elaboration d'un composite Bois/Plastique recyclé » Mathieu Bouchard., Elsa Duret., Peguy Engozogho., Arsène Bikoro., 43 pages.

## II. Vulgarisation Scientifique

- Présentation des travaux aux industriels : Holiste, EGGER
- Participation au village des sciences session octobre 2017 (10h) et octobre 2018 (10h) à Mont de Marsan.
- Présentation des travaux aux primaires : école primaire Dupuy (4h) en 2018 et école primaire Castets (8h) en 2019.
- Présentation des travaux aux lycéens (Despiau, 2h) et école primaire (Dupuy, 2h) en 2018.



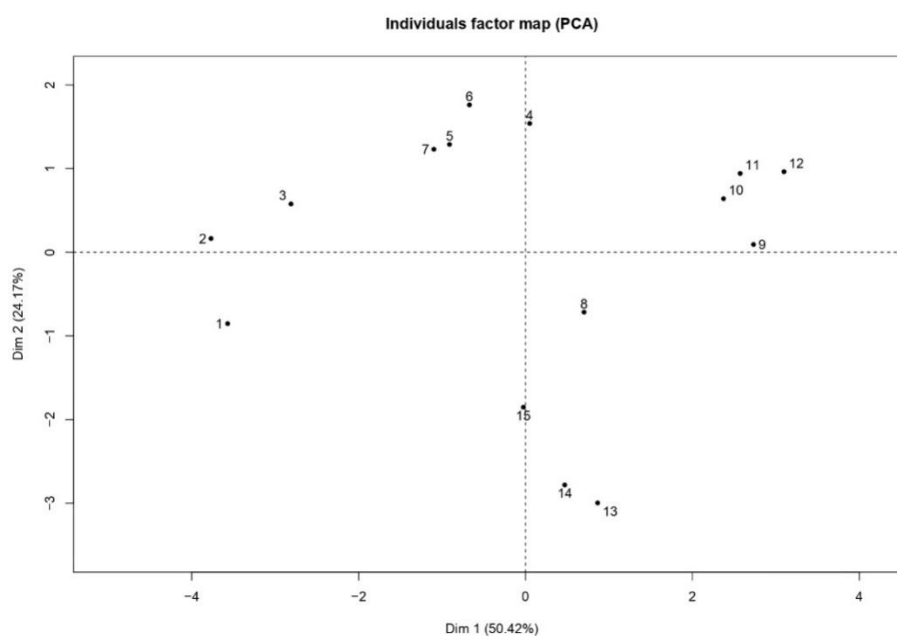
# **Annexe 5**

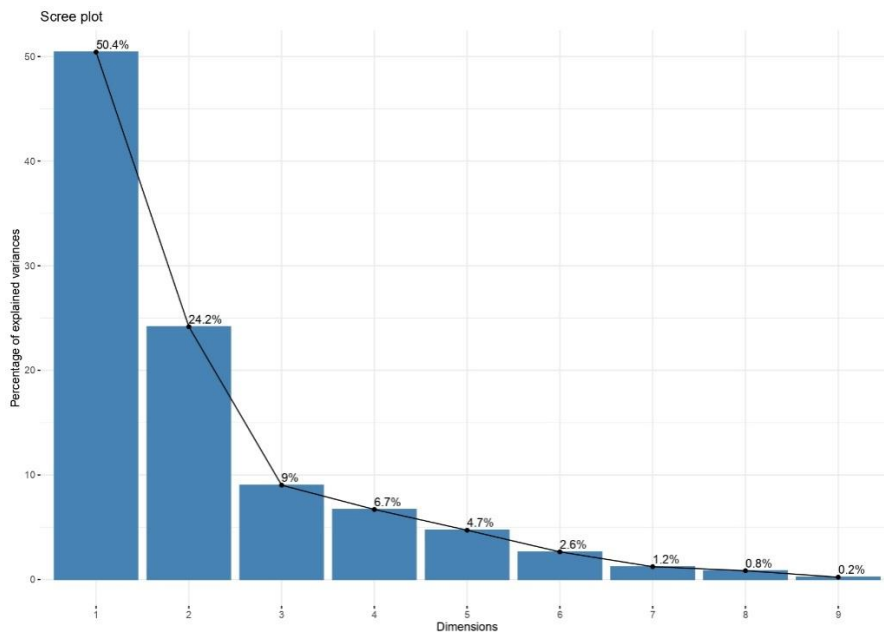
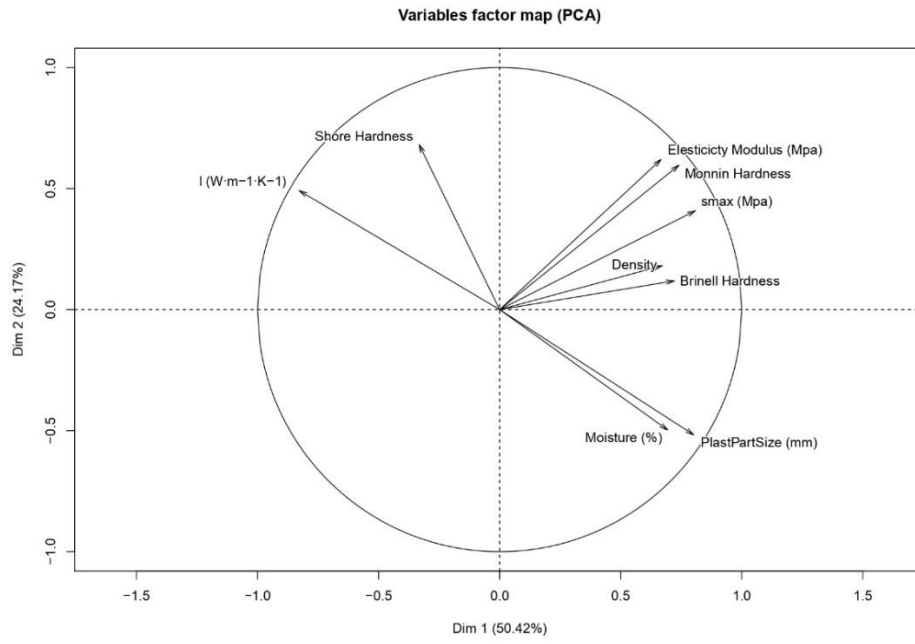
## **Formations suivies au cours de la thèse**

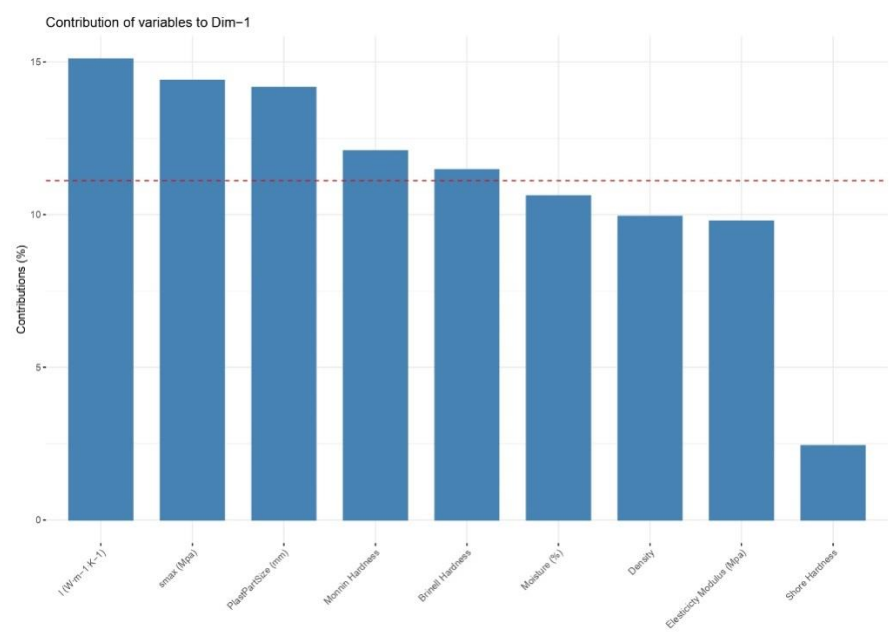
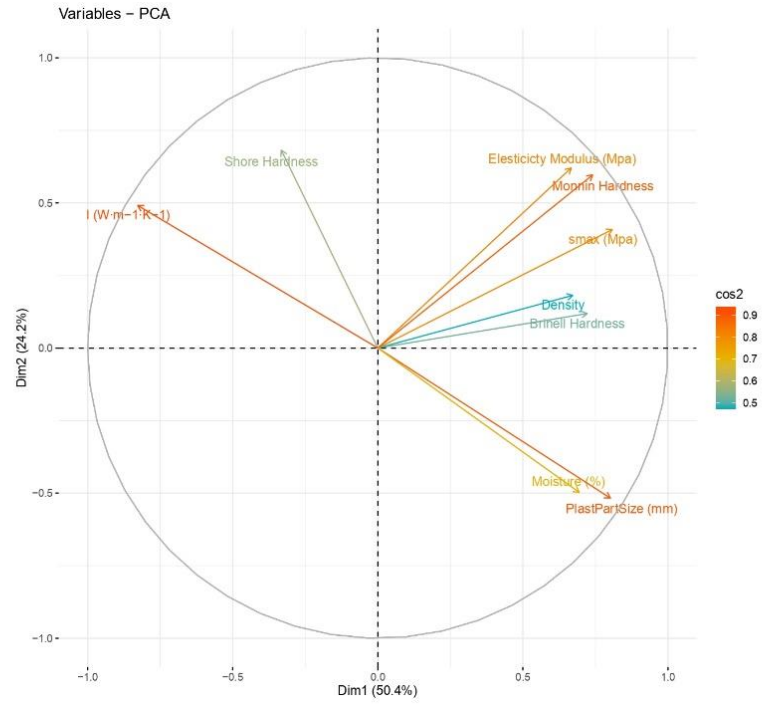
- Formation à l'éthique de la recherche et à l'intégrité scientifique (4h).
- Recherche documentaire (12h).
- Conduire son projet de these (7h).
- Doctoriales (40h).
- Insertion professionnelle Bac + 8 Volet 1 (8h).
- Anglais (si participation > à 75 %) (40h).
- Anglais certification Cambridge (10h).
- Neurosciences et Management (20h).
- Insertion profession. Volet 2: Portefeuille d'expérience et compétences (3h).
- Actions de diffusion de la culture scientifique et technique : Ma thèse en 180 secondes (40h).
- English speaking for scientists (14h).
- Formation scientifique de l'ED, soit (10h).

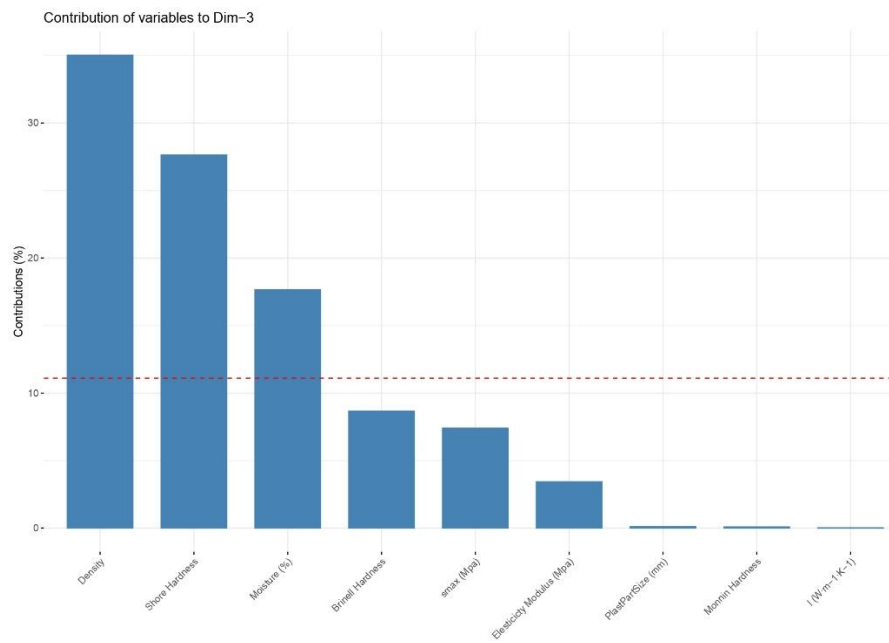
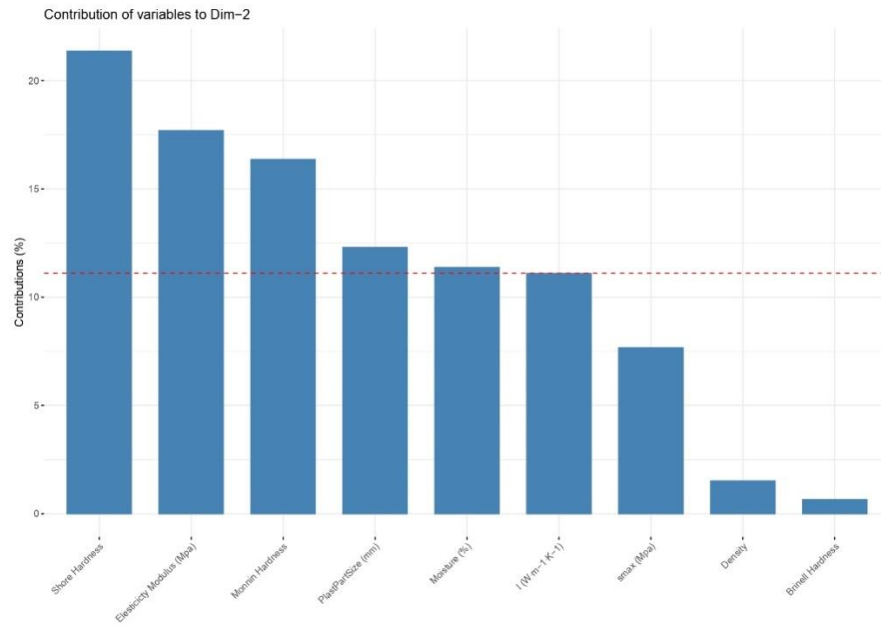
# Annexe 6

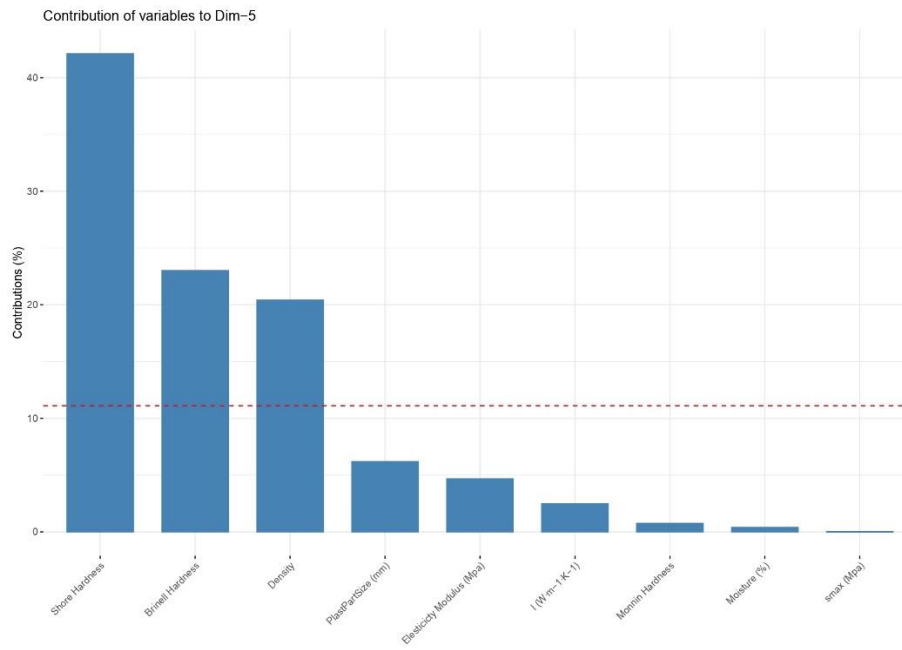
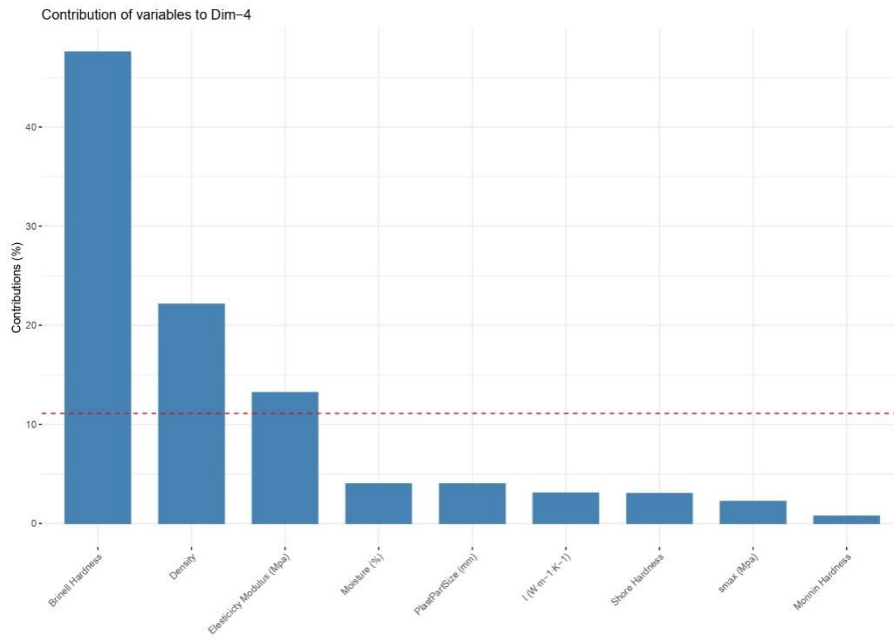
## Matériel supplémentaire sur le composite bois/ plastique

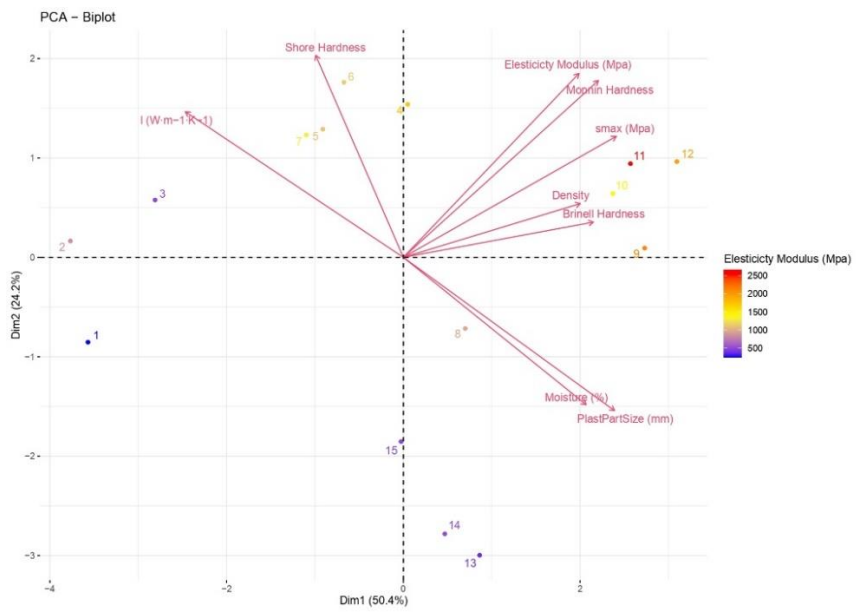
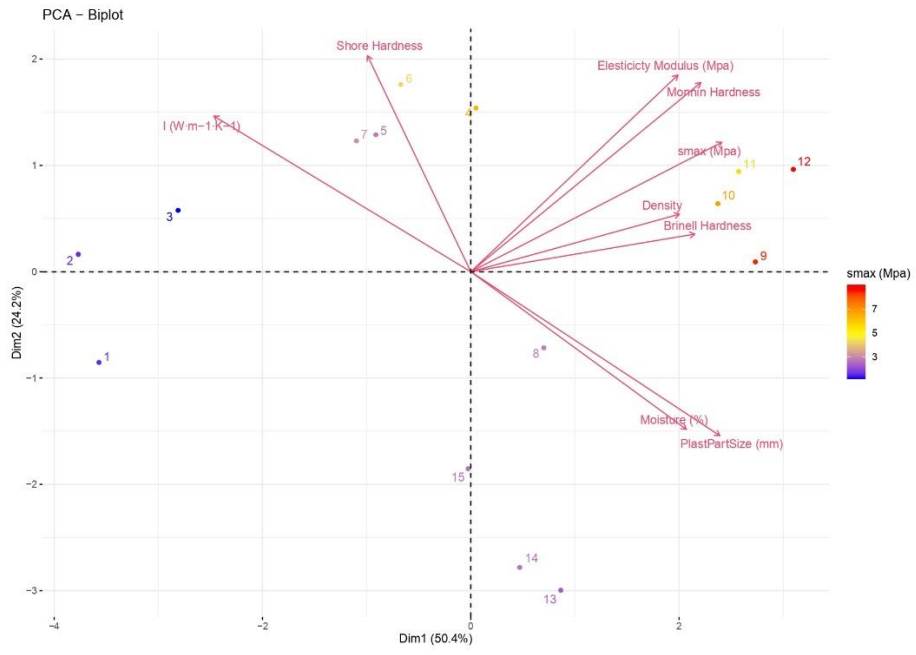


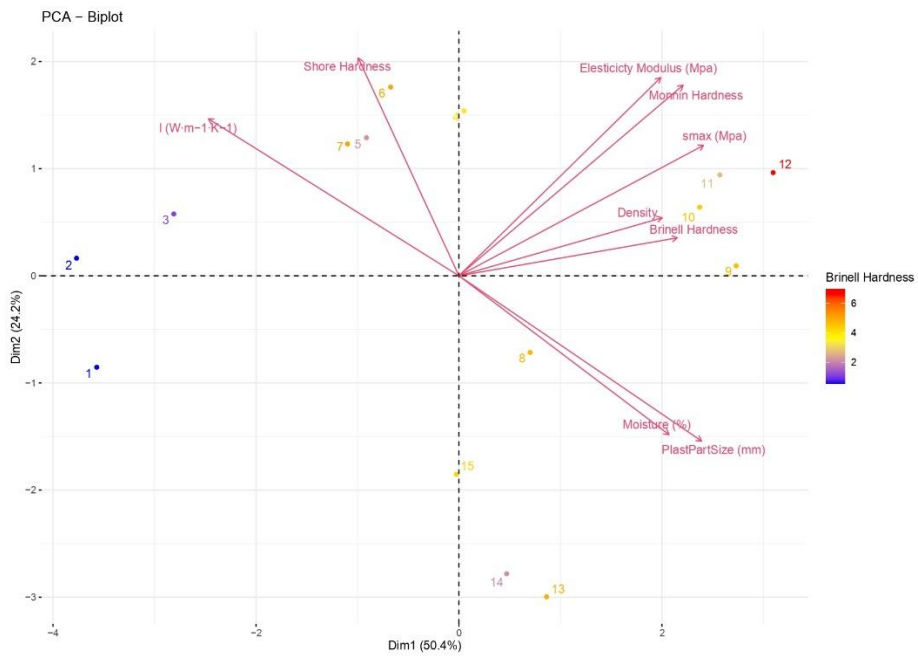
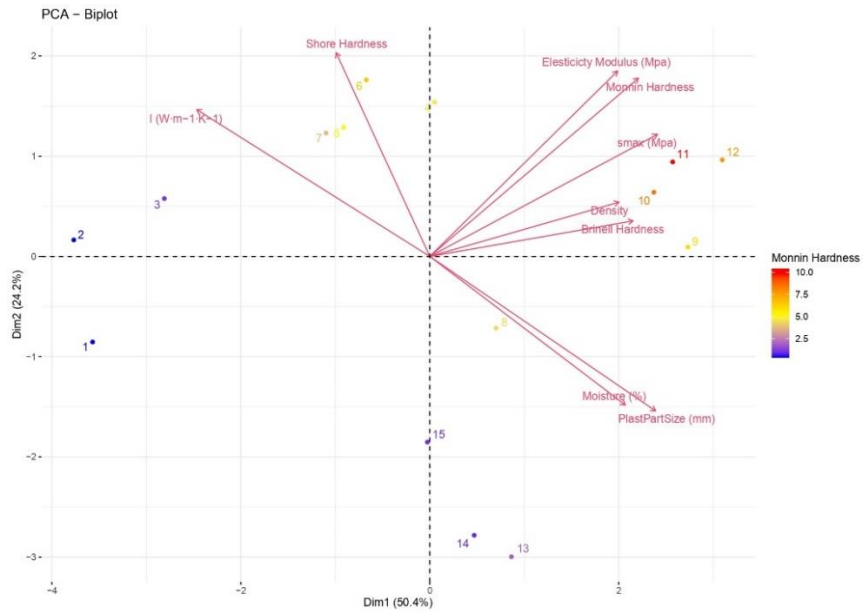




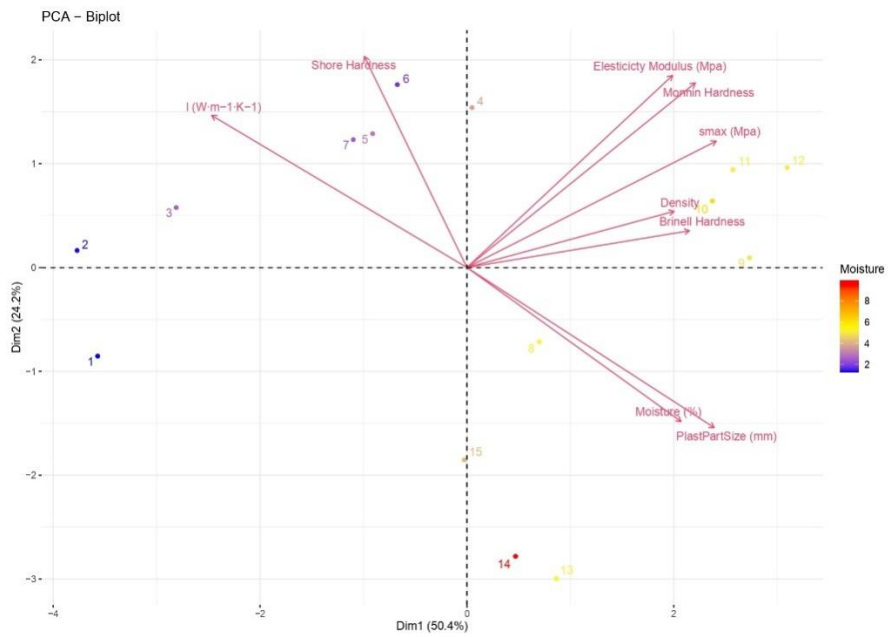
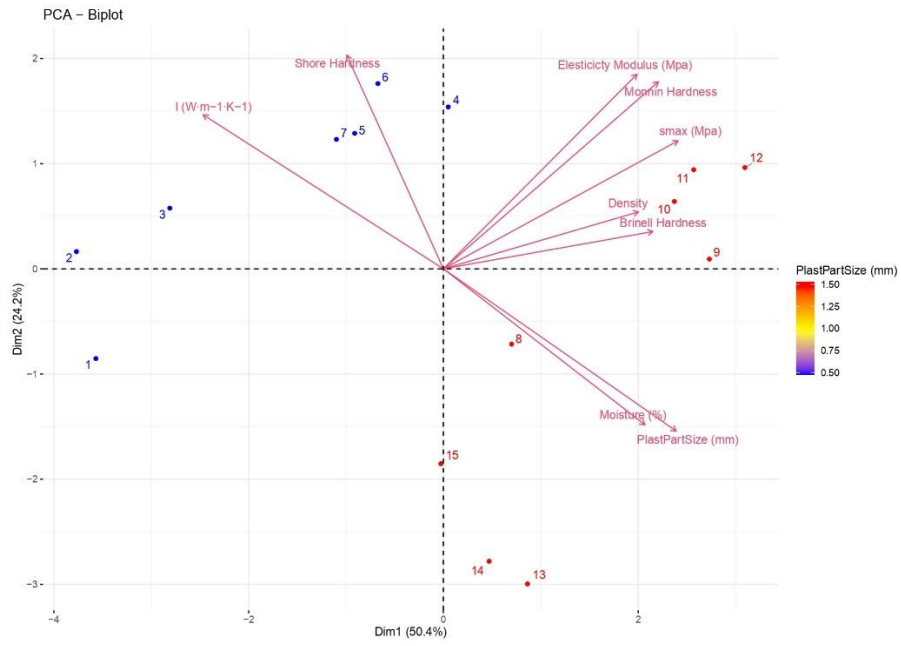


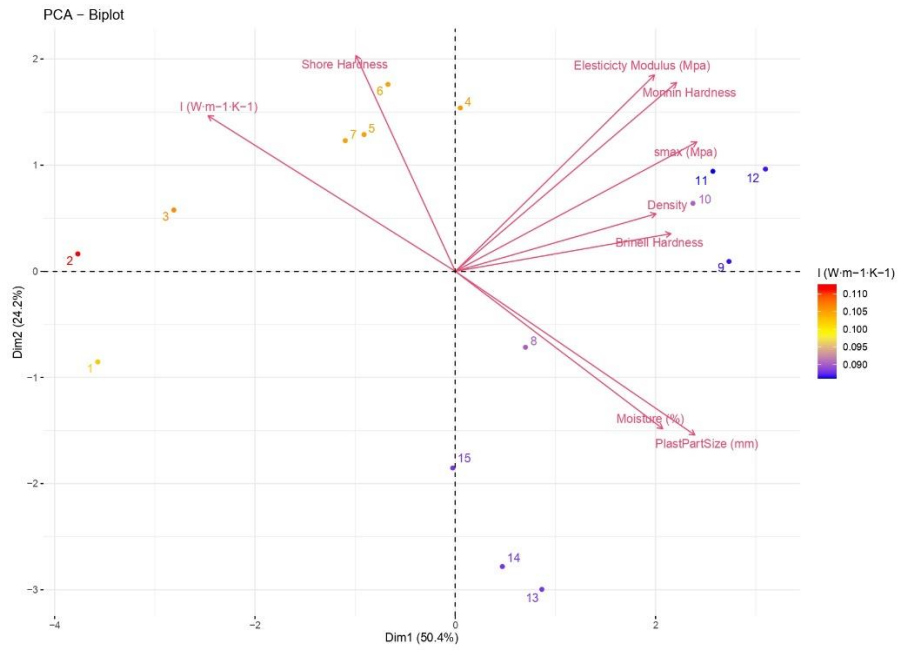












### Analyse ACP des échantillons de composite