



**HAL**  
open science

# Essays in the economics of Spatial Data Infrastructures (SDI) : business model, service valuation and impact assessment

Chadi Jabbour

► **To cite this version:**

Chadi Jabbour. Essays in the economics of Spatial Data Infrastructures (SDI) : business model, service valuation and impact assessment. Economics and Finance. Université Montpellier; Université Libanaise, 2019. English. NNT : 2019MONTD018 . tel-02890518

**HAL Id: tel-02890518**

**<https://theses.hal.science/tel-02890518>**

Submitted on 6 Jul 2020

**HAL** is a multi-disciplinary open access archive for the deposit and dissemination of scientific research documents, whether they are published or not. The documents may come from teaching and research institutions in France or abroad, or from public or private research centers.

L'archive ouverte pluridisciplinaire **HAL**, est destinée au dépôt et à la diffusion de documents scientifiques de niveau recherche, publiés ou non, émanant des établissements d'enseignement et de recherche français ou étrangers, des laboratoires publics ou privés.

**THÈSE PRÉPARÉE EN COTUTELLE POUR OBTENIR  
LE GRADE DE DOCTEUR DE L'UNIVERSITÉ DE MONTPELLIER  
ET DE L'UNIVERSITÉ LIBANAISE**

**Spécialité: Sciences Économiques**

**École Doctorale Économie-Gestion de Montpellier (EDEG)  
Centre d'Économie de l'Environnement – Montpellier (CEE-M)**

**École Doctorale de Droit et des Sciences Politiques, Administratives et Économiques  
(EDDSPAE)  
Université Libanaise, Liban**

**ESSAYS IN THE ECONOMICS OF  
SPATIAL DATA INFRASTRUCTURES (SDI)  
BUSINESS MODEL, SERVICE VALUATION AND IMPACT ASSESSMENT**

**Présentée par Chadi JABBOUR**

**Le 19 Décembre 2019**

**Sous la direction de  
Jean-Michel SALLES  
et  
Latifa GHALAYINI**

Devant le jury composé de

M. Stéphane ROCHE	Professeur	Université de Laval	Rapporteur
M. Hassan OBEID	Professeur	Université Islamique du Liban	Rapporteur
Mme Sophie THOYER	Professeur	Université de Montpellier, SupAgro	Examineur
M. Zaher KHRAIBANI	Professeur (président du jury)	Université Libanaise	Examineur
Mme Latifa GHALAYINI	Professeur	Université Libanaise	Co-directeur de thèse
M. Jean-Michel SALLES	Directeur de recherche	CNRS, CEE-M	Directeur de thèse
Mme Hélène REY-VALETTE	Maître de conférences HDR	Université de Montpellier, CEE-M	Invité
M. Pierre MAUREL	Coordinateur EQUIPEX GEOSUD	IRSTEA, TETIS	Invité



**UNIVERSITÉ  
DE MONTPELLIER**



CENTER FOR ENVIRONMENTAL ECONOMICS,  
MONTPELLIER (CEE-M)  
UNIVERSITY OF MONTPELLIER, FRANCE

DOCTORAL SCHOOL OF LAW, POLITICAL,  
ADMINISTRATIVE AND ECONOMIC SCIENCES  
LEBANESE UNIVERSITY, LEBANON

DOCTORAL THESIS

---

# Essays in the Economics of Spatial Data Infrastructures

---

*Author*

CHADY JABBOUR

*Supervisors*

JEAN-MICHEL SALLES

LATIFA GHALAYINI

*Committee members*

STEPHANE ROCHE

HASSAN OBEID

SOPHIE THOYER

ZAHER KHRAIBANI

HELENE REY-VALETTE

PIERRE MAUREL

*A thesis submitted in fulfillment of the requirements for the degree of  
Doctor of Philosophy*

December 2019



*Heureux celui qui n'a jamais fini de s'émerveiller..*



# Acknowledgments

*" What GEOSUD offers is not only a satellite image ... it is at the same time the image, the technical support, the pooling strategy, the training, the networking, the archiving... it is a whole package "*

Numerous are the seminars in which I've repeated this idea... and now the link appears to be much clearer. Doing a thesis within the GEOSUD SDI seems to conserve those characteristics, but on different scales! What a thesis offers is not just a research career ... it's both new discoveries and life experiences, people for whom I'm grateful for their support during this beautiful journey, and I really want to thank them.

I thank the director of the doctoral school in Montpellier, Mr. Patrick SENTIS and the dean of the Lebanese University, Mr. Tony ATALLAH for having accepted to set up this collaboration procedure between the two research units.

For encouragement and criticism, I am particularly indebted to Mr. Jean-Michel SALLES and Ms. Latifa GHALAYNI, for accepting the scientific direction of my work. While this debt extends well beyond the research area, I am grateful for their kindness and availability every time I asked for advice.

I also wish to express my deeply-felt gratitude to Ms. H el ene REY-VALETTE and Mr. Pierre MAUREL. Without their stimulating guidance, this work would not probably seen the light.

I thank Mr. Zaher KHRAIBANI and Mr. Daniel MELHEM, whose early supports to the success of this project was decisive.

I gratefully acknowledge the members of my Ph.D. committee, more particularly Ms. Sophie THOYER as well as Mr. Hassan OBEID and Mr. Stéphane ROCHE for their time and valuable feedback on a preliminary version of this thesis.

I thank Mr. Anis HOAYEK for his insightful comments and contribution, which enriched largely this work.

Mr. Jean-Marc CALLOIS, Director of the IRSTEA territories department, for the honor he has given me for his participation in my thesis committees and for his suggestions and his judicious remarks.

I thank the OpenIG association, represented by its president Mr. Bertrand MONTHUBERT and its director Ms. Anne FROMAGE-MARIETTE.

Ms. Renée SAKR, Ms. Sabine DE BECHEVEL, Ms. Ahlam DAHER and Ms. Emmanuelle CELIER for their logistical support.

This work could not have been carried out without the help of the different institutions who, through their funding and support, recognized my work: AUF, CNRS-Lebanon, IRSTEA, INRA and the CNES-TOSCA programme. It has been also supported by public funds received in the framework of an "ANR-10-EQPX-20", project of the "Programme d'Investissements d'Avenir" managed by the French National Research Agency.

Audrey NAULLEAU, without her, everything would have been different.

For my family, one heart would not be enough.



# Remerciements

*" Ce qu'apporte GEOSUD ce n'est pas juste une image satellitaire... c'est à la fois l'image, l'accompagnement technique, la mutualisation des traitements, la formation, la mise en réseau, l'archivage... C'est un tout "*

Nombreux sont les séminaires dans lesquels j'ai répété cette phrase... maintenant le lien se présente beaucoup plus clair. Préparer une thèse au sein de GEOSUD tient vraiment à conserver ces caractéristiques, mais à d'autres échelles! Ce qu'apporte une thèse, ce n'est pas juste un travail de recherche... c'est à la fois de nouvelles découvertes, de belles expériences, des personnes à qui je suis reconnaissant pour leur soutien pendant ce parcours, et qui je tiens véritablement à les remercier.

Tout d'abord, je remercie le directeur de l'école doctorale à Montpellier, M. Patrick SENTIS et le doyen de l'école doctorale à l'université Libanaise, M. Tony ATALLAH pour avoir acceptés de mettre en place cette procédure de collaboration entre les deux unités de recherche.

Pour leur encouragement et critiques, je tiens à remercier M. Jean-Michel SALLES et Mme Latifa GHALAYNI, pour la confiance qu'ils m'ont témoigné en acceptant la direction scientifique de mes travaux. J'en suis reconnaissant pour leur gentillesse et disponibilité.

Je souhaite également exprimer ma profonde gratitude à Mme Hélène REY-VALETTE et M. Pierre MAUREL. Sans leurs conseils stimulants, ces travaux n'auraient probablement pas vu le jour.

Ma gratitude va également à M. Zaher KHRAIBANI et M. Daniel MELHEM, pour l'attention initiale portée à l'égard de ce projet.

J'adresse mes remerciements à l'ensemble des membres de mon jury, en particulier Mme Sophie THOYER ainsi qu' à M. Hassan OBEID et M. Stéphane ROCHE, qui ont accepté de rapporter sur ma thèse.

Je remercie M. Anis HOAYEK pour ses commentaires judicieux et sa contribution qui ont largement enrichi ce travail.

M. Jean-Marc CALLOIS, directeur du département des territoires de l'IRSTEA, pour l'honneur qu'il m'a fait, à travers sa participation continue à mes comités de thèse.

Je remercie l'association OpenIG, représentée par son président M. Bertrand MONTHUBERT et sa directrice Mme Anne FROMAGE-MARIETTE.

Mme Renée SAKR, Mme Sabine DE BECHEVEL, Mme Ahlam DAHER et Mme Emmanuelle CELIER pour leur soutien logistique.

Ce travail n'aurait pu être réalisé sans l'aide de différentes institutions qui, par leur financement et soutien, ont permis la réalisation de ce travail: AUF, CNRS-Liban, IRSTEA, INRA et le programme CNES-TOSCA. Il a également été soutenu par une aide de l'État gérée par l'Agence Nationale de la Recherche, dans le cadre du "Programme d'Investissements d'Avenir", portant la référence "ANR-10-EQPX-20".

Audrey NAULLEAU, sans elle, tout aurait été différent.

Pour ma famille, un cœur ne vous suffirait pas.



# Abstract

The development of spatial data infrastructures (SDIs) is hampered by several barriers: from economical, technical to organizational and financial, the hurdles are numerous. This thesis attempts to answer some issues related to the socio-economic aspects of SDIs. It focuses on several topics concerning the SDI economic valuation and impact measurement. The aim has been fivefold: i) to propose a business model for this particular type of infrastructure in order to meet a sustainable financing scheme; ii) to perform an economic valuation of the geospatial information available through the SDI platform, the high resolution (HR) satellite images; iii) to examine the role of a SDI as an information structure; iv) to identify the economic impacts of a SDI; v) to study the stability of the satellite image markets through a SDI.

In this thesis, a challenge consisted of approaching the business models field into the implementation of SDIs. The relevance of a two-sided market approach for analyzing a SDI dynamics was tested through a platform management process, in order for a SDI to transition to a self-sustaining funding mechanism. We explained how a SDI through its platform could ensure continuous interaction between the different components, represented by the developers of spatial data applications and the potential users of such data.

It was important that the economic valuation questions concerning the SDI, need to be refined in parallel with the reflections about the business model of this type of infrastructure. In our context, we examined the economic value of the HR satellite images as perceived by the direct users of a SDI platform. The valuation study came to assess the importance of the satellite imagery as a support for the territorial planning and development economics. In a context of open and distributed innovation within the net-

works, it offered elements allowing to establish pricing scenarios on a next level, in order to sustain the SDI platform business model in the long run.

In addition, we examined the role of a SDI as an information structure. We applied our findings to the clear-cut forest control case in France. Based on heterogeneous information received, we elaborated a decision-making policy in order to help a decision maker better model his decision. An original approach was introduced, articulating between two existing theories: the classic method of Blackwell and the Entropy theory. We advanced a two-level methodological context: The choice of the information structure with the most informative power and the detection of the optimal action.

Similarly, by considering the clear cut example, we analyzed the socio-economic impacts of a SDI based on satellite imagery. A detailed analysis of the geospatial information acquired through the SDI, allowed to characterize the public policies involved in this field, in order to examine the impacts related the SDI ecosystem. In a second step, some of these impacts have been assessed in more details.

Finally, these valuation studies opened a window to examine the market demand stability through the SDI. The spatial data infrastructures, which constitute the direct link between the users and the large Earth Observation (EO) industry, have a leading role in establishing market opportunities. While the users are becoming primary key-drivers for spatial data technology, they contribute through their demand of raw data and services, to its development and growth. We approached the stability of different satellite image markets through two independent French SDIs, by using the Records theory. We implemented an innovative method and provided additional elements for a better comprehension of the EO data management.

# Résumé

Les Infrastructures de Données Géo Spatiales (IDGS) sont définies comme un ensemble de *“technologies appropriées, de politiques et de dispositions institutionnelles, qui facilitent la mise à disposition et l'accès aux données géo-spatiales”*. Elles constituent une réalisation technologique remarquable et restent une source majeure d'innovations. Cependant, l'importance des efforts qu'elles impliquent, tant en termes d'investissement que d'organisation, soulève une multitude de questions. Le développement des IDGS se heurte à plusieurs obstacles: économiques, techniques, organisationnels, financiers, etc.

Cette thèse tente de répondre à plusieurs thématiques liées aux aspects socio-économiques des IDGS. Elle met en particulier l'accent sur plusieurs questions concernant leur évaluation économique et la mesure de leurs impacts. Les objectifs peuvent être résumés autour des cinq points suivants: i) proposer un modèle économique pour ce type d'infrastructure afin d'assurer un financement durable; ii) réaliser une évaluation économique de l'information géo-spatiale issue d'une IDGS et disponible via sa plateforme: les images satellitaires à haute résolution spatiale (HR); iii) examiner le rôle d'une IDGS en tant que structure d'information; iv) identifier les impacts économiques d'une IDGS; v) étudier la stabilité de la demande pour l'imagerie satellitaire à travers les IDGS.

Bien que les aspects économiques des IDGS soulèvent des problèmes divers, une base commune repose clairement sur l'économie de l'information. Depuis plusieurs décennies, l'économie de l'information occupe une place centrale dans le domaine de l'organisation industrielle. Dans une société qui multiplie les informations en augmentant la capacité de stockage, de transformation et de diffusion, valoriser l'information est un processus qui se présente

avec une acuité particulière. L'information peut être diffusée sans être perdue, reçue sans le vouloir, ayant ainsi des caractéristiques de bien public au sens classique de Samuelson.

Les IDGS sont considérées comme sources génératrices d'un type particulier d'information, "*l'information géo-spatiale*". Ces données reflètent des caractéristiques particulières incluant des spécificités relatives à la dimension spatiale du développement économique et des actions de gestion des territoires (planification, gestion des ressources et activités, etc.). En considérant que le premier facteur déterminant l'utilisation des informations géo-spatiales est leur disponibilité, les IDGS se sont orientées vers cette direction, en s'adaptant en continu aux progrès technologiques et organisationnels, en accord avec une volonté "*politique*" de favoriser l'accès à l'information géo-spatiale et à son utilisation. De même, elles ont élargi le périmètre de leurs utilisateurs en passant d'une approche axée sur l'information de base, vers à une approche de plus en plus centrée sur les services et produits à valeurs ajoutées issues de l'information. Ces processus impliquent cependant des investissements massifs, tant financiers qu'humains. Les IDGS font en fait partie d'un ensemble d'investissements productifs qui implique des dépenses considérables (fonctionnement des stations de réception, exploitation des satellites, maintenance, etc.). De même que la valeur d'un investissement consiste dans le flux de valeur qu'il génère, il convient de se demander si cet investissement auprès des IDGS est économiquement justifié du point de vue du choix des financeurs.

- i. Afin de répondre à ces interrogations, un premier défi concernait les modèles économiques (au sens de "*business model*") dans la mise en œuvre des IDGS. Récemment, L'émergence massive des plateformes, a provoqué un changement dans la gouvernance de certaines entreprises, lié au développement de services gratuits et à leur mode de financement . Quelques exemples illustrent cette évolution ; comme la façon dont Google monétise les recherches, Facebook les réseaux sociaux, LinkedIn les réseaux professionnels, etc. Lancer une plateforme, attirer des utilisateurs et capturer la valeur générée par un écosystème dépendent de la numérisation des activités de création de valeur. Tandis que les travaux sur les modèles économiques, l'organisation industrielle et les plateformes ont été développés dans plusieurs secteurs, le phénomène

commun auquel ils se réfèrent est l'innovation en tant que mécanisme de création de valeur et élément essentiel de la compétitivité. Dans un contexte pareil, les IDGS ont besoin de développer des pratiques innovantes afin d'explorer de nouvelles opportunités de marché.

Au fur et à mesure de l'évolution des technologies de l'information, le concept d'IDGS a évolué pour capitaliser sur les nouvelles technologies, afin de répondre aux besoins de sociétés en constante évolution. Dans ce contexte, les IDGS sont devenus des acteurs essentiels dans la détermination de la façon dont les données géo-spatiales sont utilisées. En créant un environnement de coopération entre les parties prenantes et en facilitant l'interaction, les IDGS soutiennent les processus de planification stratégique et décisionnelle à différentes échelles.

En considérant l'IDGS comme un concept de gestion de plateforme, la question repose sur la façon de créer de la valeur. Bien que le concept de plateforme ait prouvé sa pertinence pour réorienter les stratégies des entreprises, il n'avait pas encore été mobilisé suffisamment pour analyser le domaine des IDGS. La compréhension de sa dynamique sous-jacente est encore limitée. Ainsi, afin de répondre à ces défis et à la question de la pérennité des IDGS, il est important de développer l'utilisation de l'information géo-spatiale, c.à.d. de faire travailler ensemble les acteurs scientifiques, publics et privés dans une logique de complémentarité. Il est nécessaire de faciliter l'accès aux données disponibles à travers les IDGS, mais aussi de proposer des services et des outils d'application, permettant ainsi de passer d'une information brute à des services intermédiaires et produits à valeur ajoutée, répondant aux besoins des utilisateurs finaux.

Dans un tel contexte, la pertinence d'une approche des marchés biface a été testée via un processus de gestion de plateforme, pour analyser la dynamique d'une IDGS afin d'assurer une transition de l'IDGS vers un mécanisme de financement durable. Un protocole a été élaboré, décrivant la stratégie à travers laquelle une IDGS via sa plateforme, pourrait interagir en permanence entre les différents composants, représentés par les développeurs d'applications basées sur des données spatiales et les utilisateurs potentiels de ces données. L'IDGS, en tant que plateforme intermédiaire, pourrait s'acquitter de cette tâche et gérer la



dynamique entre les différents utilisateurs de l'information géo-spatiale. Par conséquent, les données et services géo-spatiaux qui pourraient émerger seront le résultat d'une collaboration entre des acteurs hétérogènes et des compétences complémentaires, mobilisés dans le cadre d'un processus d'innovation collectif. De même, ce concept ouvre la voie vers l'analyse de l'élasticité de la demande des utilisateurs potentiels, un élément de base dans les marchés bifaces, permettant d'établir ultérieurement des différents scénarios de tarification.

- ii. Également, il était important d'affiner les questions relatives à l'évaluation des IDGS, en parallèle avec les réflexions sur le modèle économique de ce type d'infrastructure. Dans notre contexte, nous avons examiné la valeur économique des images satellites à haute résolution spatiale (HR) perçue par les utilisateurs directs d'une IDGS. L'étude d'évaluation vient souligner l'importance de l'imagerie satellitaire en tant que support pour l'économie de développement et la planification territoriale.

En s'appuyant sur l'IDGS GEOSUD, basée à Montpellier (France), dont les utilisateurs directs appartiennent principalement à des organismes publics, un protocole basé sur la méthode d'évaluation contingente a été mis en œuvre pour évaluer le consentement à payer de ces utilisateurs pour différents produits et services via l'IDGS. L'approche choisie est basée sur les utilisateurs d'un bien "club", accessible uniquement aux organisations déjà enregistrées sur la plateforme de GEOSUD. Bien que les répondants ne soient pas totalement en mesure de faire des compromis entre les priorités budgétaires des différentes agences, l'enquête réalisée dépasse la simple collecte d'opinions et, en demandant aux sujets enquêtés de penser en termes d'arbitrage, s'efforce de satisfaire aux conditions d'un véritable exercice d'évaluation. Il s'agit de clarifier à partir de l'étude, l'intérêt des utilisateurs pour ce type d'information et, plus généralement, par leur représentativité publique, de contribuer à l'amélioration des systèmes de gouvernance. De plus, la valeur attribuée aux images satellites à haute résolution peut être associée à d'autres raisons de mobilisation des ressources nécessaires pour assumer de nouvelles dépenses éventuelles auprès de ce secteur. Il est important de noter, que GEOSUD a permis de constituer progressivement depuis son lancement en 2007, une base de

données d'images satellitaires réutilisables par les chercheurs et les acteurs publics. D'où, une meilleure compréhension de la valeur attribuée à ces images par les utilisateurs directs, est essentielle pour justifier les investissements réalisés dans ce secteur et pour soutenir les politiques visant à développer ces ressources et à en assurer leur durabilité.

Suite à cet exercice d'évaluation, nous avons pu analyser les différences entre les valeurs collectées en fonction des différents types d'utilisateurs. Une enquête auprès de la totalité des utilisateurs enregistrés sur la plateforme GEOSUD a révélé une valeur moyenne de 1696 euros pour une image à haute résolution de 60 x 60 km<sup>2</sup>. Sur les 7 500 images à haute résolution disponibles sur la plateforme, le surplus net s'élève à environ 12,7 millions d'euros. Imposer ce prix aux utilisateurs directs, conduit à un taux d'acceptation de 43 %, avec 57 % des utilisateurs n'acquérant plus d'images. D'autre part, les résultats de l'enquête ont montré que les prix dont les utilisateurs directs sont prêts à payer pour les images HR sont nettement inférieurs aux tarifs commerciaux. À titre d'exemple, le prix commercial d'une image SPOT 6.7 de 60 x 60 km<sup>2</sup> varie en général entre 13,500 et 16,500 Euros, respectivement pour une image ADS en archive et une image issue d'une demande de programmation (une réduction de 50 % est appliquée si l'utilisation envisagée est à des fins de recherche). Ainsi, tout en considérant le cas de recherche, une simple comparaison entre le prix commercial d'une image satellite résultant d'une demande de programmation (6750 Euros ; 1.875 €/km<sup>2</sup>) et le CAP (consentement à payer) moyen enregistré par les répondants de GEOSUD pour une telle image (1696 Euros ; 0.47 €/km<sup>2</sup>) révèle un ratio de 4. Ce ratio augmente jusqu'à 10 si la comparaison implique la valeur moyenne du CAP et le prix commercial excluant la recherche (13,500 Euros).

De plus, nous avons remarqué des différences significatives entre la valeur des images au sein des divers secteurs. Comme exemple, les "institutions publiques non scientifiques" (telles que l'ONF, le CEREMA, l'IGN, le CNES, les gestionnaires de parcs naturels, les agences de l'eau, l'Office national de la chasse et de la faune, etc.) constituent le secteur étant prêt à payer le plus, avec la moitié de ses utilisateurs prêts à payer 1860 euros par image. En fixant un taux d'acceptation de 60 %, le montant du CAP pour ce secteur est environ cinq fois supérieur

à celui des “autorités locales”, qui présente le CAP le plus faible. La logique derrière un raisonnement basé sur une taille d’image bien précise de 3600 km<sup>2</sup>, était en quelque sorte nécessaire pour disposer d’un cadre de valorisation standard. Cependant, cela présentait certains inconvénients selon les différentes attentes et utilisations des utilisateurs. Ces différences dans certaines situations résultent de l’incohérence entre les besoins des utilisateurs finaux en produits basés sur l’imagerie satellitaire et les solutions disponibles, en raison de la récente adoption des images satellitaires dans certains secteurs.

D’autre part, les résultats montrent que les utilisateurs sont plus prêts à payer pour un montant annuel fixe pour rejoindre un système de mutualisation d’images à haute résolution que d’être facturés au prix par image. Par conséquent, une valeur moyenne de 3022 Euros a été enregistrée avec 12% des utilisateurs acceptant de payer jusqu’à 15,000 Euros comme frais d’adhésion à un tel dispositif.

En estimant la valeur que ces utilisateurs directs perçoivent des images satellites HR, cette étude comble en partie le fossé qui existe entre le besoin en matière de justification et les exigences des investisseurs concernant la disponibilité de l’information géo-spatiale sur le marché. Les résultats obtenus pourraient être utilisés pour éclairer la conception d’une future tarification de l’imagerie satellitaire, visant à pérenniser le financement de ces services. D’autre part, la valeur attribuée aux informations géo-spatiales dans un contexte d’IDGS, reflète la création d’une ressource commune par l’infrastructure, qualifiée de “capital informationnel”. Dans un système de plus en plus axé sur l’économie intangible et comportementale, cet outil informationnel devient de plus en plus important, que ce soit au niveau de la dynamique macroéconomique ou des études de comportement des consommateurs et des agents. Il en quelque sorte, lié à une notion de gestion de l’information au niveau territorial. Les territoires, considérés comme une échelle géographique du système économique, ont des processus de développement économique complexes. Trouver la bonne information, avec une qualité suffisante et à la bonne échelle, met en évidence l’organisation mise en place pour acquérir cette information, la gérer et l’exploiter dans une sphère de décision territoriale.

- iii. Dans un troisième temps, nous avons examiné le rôle d'une IDGS en tant que structure d'information. La méthodologie a été appliquée dans le cas de suivi des coupes rases, liées aux plans de gestion des forêts en France. Sur une base d'informations hétérogènes reçues via une multitude de structures d'information, une méthode de prise de décision a été mise en place, afin de fournir à un décideur un outil pour une meilleure prise de décision. Une approche originale a été introduite, en articulant entre deux théories : la méthode classique de Blackwell et la théorie de l'entropie. Le contexte méthodologique se présente suivant deux niveaux : le choix de la structure d'information ayant le pouvoir le plus informatif et la détection de l'action optimale.

Dans une situation où le décideur est confronté à plusieurs structures d'information, l'application de l'approche de l'entropie permet de mettre en évidence l'infrastructure la plus informative en tenant compte de la différence entre l'entropie a priori et a posteriori. Ainsi, l'information mutuelle, représente le niveau d'incertitude diminué par les signaux reçus. Par conséquent, il devient possible de comparer le pouvoir informatif de plusieurs structures d'information par rapport à la réduction du niveau d'incertitude lié à chacune de ces structures. Ces structures peuvent être ainsi classées selon leur pouvoir informatif. Cependant seules deux structures d'information peuvent être comparées à la fois au sens de Blackwell, afin d'élaborer le pouvoir informatif de chacune d'elles. Ici, nous soulignons le premier avantage de l'approche d'information mutuelle de l'entropie par rapport au théorème de Blackwell. Deuxièmement, afin d'appliquer le théorème de Blackwell, de nombreuses hypothèses doivent être retenues concernant le gain des actions de la première et de la deuxième période, sous différents états de la nature. Des hypothèses supplémentaires concernant les coûts de transition en fonction du changement de périodes pourraient également être présentes et réduire la précision des décisions. Cependant, l'approche de l'information mutuelle est applicable en connaissant seulement les probabilités a priori et a posteriori.

Ainsi, un premier niveau de prise de décision pourrait être utile pour discriminer les structures d'information afin de passer au deuxième niveau concernant l'optimisation des actions. L'importance d'appliquer la méthode de Blackwell juste après la théorie de l'entropie, et non

comme première étape, tient au fait qu'elle évite d'intégrer de nombreux facteurs aux structures d'information initialement disponibles. Calculer le pouvoir informatif de toutes les structures d'information en intégrant les facteurs économiques (tels que le coût, les revenus, etc.) est un exercice quasi impossible. Une fois la première étape dépassée, la méthode de Blackwell est ensuite appliquée aux deux structures, simplifiant ainsi l'affectation des variables et augmentant la précision du processus de prise de décision.

Bien que cette étude propose une articulation entre deux approches théoriques déjà bien connues, elle permet d'obtenir des résultats concrets originaux. Concernant l'IDGS GEOSUD, l'intérêt se présentait suivant une comparaison entre les signaux d'informations non spatiaux d'une part, et d'autre part les informations géo-spatiales. Pour une entité de contrôle responsable de la gestion des coupes rases, il a été démontré que les informations supplémentaires reçues via une IDGS constituent le meilleur scénario (30 % de réduction d'incertitude), comparé aux possibles alternatifs. Ainsi, en fournissant des éléments concrets sur la manière dont les entités de contrôle des forêts pourraient modéliser leurs actions à la lumière d'une information reçue, cette étude présente un outil de décision à travers lequel plusieurs concepts sont associés. La description détaillée de l'étude de cas et du processus aident à mieux comprendre les choix auxquels les entités de contrôle sont confrontées en ce qui concerne leurs actions dans le cadre d'une politique de régulation. De même, les décisions à prendre dans un environnement incertain viennent concrétiser les approches théoriques. Ainsi, la recherche empirique présentée permet de mieux comprendre, la manière dont l'information est utilisée pour soutenir les activités de gestion forestière. Réduire l'incertitude dans un contexte décisionnel lié à la gestion forestière, pourrait offrir de meilleures opportunités pour prendre de meilleures décisions, améliorer la productivité et économiser du temps et de l'argent.

- iv. De même, pour aller plus en détail dans l'identification et l'analyse des impacts socio-économiques d'une IDGS basée sur l'imagerie satellitaire, nous avons considéré l'exemple des coupes rases. Après une analyse des acquisitions d'images satellites pour qualifier le champ des politiques publiques concernées, nous avons étudié la structure des impacts liés

à une IDGS. Dans un deuxième temps nous avons évalué quelques-uns de ces impacts d'une manière plus détaillée. L'évaluation est réalisée à partir d'une enquête en ligne auprès des services de l'État chargés du contrôle des coupes rases. Les effets portent sur des économies de coûts et de productivité, de la valeur ajoutée créée à l'échelle de la chaîne de valeur liée à ces cartes et sur des processus d'innovation au sein des adhérents de GEOSUD. D'autres effets qualitatifs sur les propriétés des politiques forestières et plus généralement sur les dynamiques de développement territorial sont aussi appréhendés. Au total, il apparaît que pour un euro dépensé pour le fonctionnement de l'IDGS (hors investissement initial), la valeur ajoutée créée directement et indirectement s'élève au maximum à 63 € et les coûts de transactions évités à 24 €. Les effets évoqués par les enquêtés témoignent de synergies entre services, avec d'autres organisations partenaires de GEOSUD ainsi qu'avec les sociétés forestières. Ces effets de synergie peuvent favoriser des processus d'innovation ouverte et contribuer à améliorer ou diversifier les produits et les processus qui sont mobilisés dans les pratiques. L'innovation ouverte est efficace, mais elle doit être organisée ; ce qui justifie l'importance du rôle d'intermédiaire joué par une IDGS qui devient alors conjointement une structure d'intermédiation dont les fonctions dépassent la réduction des coûts de transaction. Ce type d'externalité de réseau tend à s'auto renforcer dans le temps au sens où il est d'autant plus efficace que le nombre de participants s'accroît. L'infrastructure de données dans sa fonction d'intermédiation devient alors "un créateur d'écosystèmes" ou encore "un architecte de l'exploration collective" qui facilite le processus d'innovation ouverte entre des communautés de développeurs et d'utilisateurs.

- v. Enfin, ces études d'évaluation nous ont mené à examiner la stabilité de la demande d'images via une IDGS. Les IDGS constituent un lien direct entre les utilisateurs de premier rang et la grande industrie spatiale. Elles jouent également un rôle important dans la création d'opportunités de marché. Bien que les utilisateurs soient considérés comme les principaux moteurs de la technologie des données spatiales, ils contribuent à travers leur demande de données et de services au développement et à la croissance de ce domaine. Nous avons abordé la stabilité de différentes demandes d'images satellitaires, et avons fourni des éléments supplémentaires pour une meilleure compréhension de

la gestion de ces données, en se basant sur la théorie mathématique des Records. En s'appuyant sur deux IDGS, GEOSUD et PEPS, nous avons examiné les fluctuations intervenantes sur différents types d'imagerie satellitaire : les images à haute résolution (HR) via GEOSUD/les images Landsat (États-Unis), Sentinel (Europe) et SPOT (France) via PEPS. Nous avons ensuite évalué la probabilité d'atteindre un *max/min* à court terme sur ces différents marchés.

Cette étude constitue la première application des avancées récentes de la théorie des Records aux données géo-spatiales et, plus particulièrement, aux images satellitaires via une IDGS. Elle s'inscrit dans la continuité des réflexions déployées, afin de mieux comprendre la dynamique liée à la demande d'informations par les utilisateurs. Ainsi, elle permet une meilleure compréhension de la gestion de ces données et des fluctuations qu'une IDGS pourrait faire face sur sa plateforme. Les résultats montrent que la demande d'images à haute résolution via l'IDGS GEOSUD, à laquelle le modèle classique *i.i.d* correspond le mieux, est en quelque sorte stable. De plus, le modèle de Yang-Nevzorov correspond aux données Landsat, en raison du nombre accru de records concentrés au-delà des premières observations. La demande de Landsat est la moins stable parmi les trois autres programmes d'images satellitaires, et la probabilité d'atteindre un record dans les années à venir est la plus élevée. En outre, bien que la demande de Sentinel semble être plus stable à court et à long terme, aucun record n'a été détecté pour les images SPOT, pour lesquelles la demande via PEPS est principalement basée sur des images d'archives non actives. Il convient de noter que le choix de l'imagerie satellitaire via l'IDGS PEPS, pour laquelle nous avons eu un accès privilégié, occupe une place unique dans le panthéon des données de l'observation de la terre. Landsat est le programme d'observation de la Terre le plus ancien et ininterrompu pour l'acquisition d'images satellitaires de la Terre. Il est reconnu comme l'un des programmes les plus importants aux États-Unis, avec une valeur économique annuelle estimée à plus de 1,8 milliard de dollars. En ce qui concerne la constellation des satellites Sentinel, elle est considérée comme le programme d'observation de la terre le plus important développé par l'Agence spatiale européenne (ESA) pour répondre aux différents besoins opérationnels et politiques en Europe. Avec sa continuité programmée sur plus de vingt ans, sa couverture

globale fréquente et sa grande variété de méthodes de détection, il est conçu pour fournir des données pour les services Copernicus. Enfin, les satellites à haute résolution commerciaux SPOT, gérés par le CNES en France, ont déjà capté plus de 10 millions d'images de haute résolution depuis leurs lancements en 1986. Ils sont conçus pour améliorer la connaissance et la gestion de la Terre en explorant ses ressources et surveillances des activités humaines et des phénomènes naturels.

Bien que la stabilité d'un marché dépende de plusieurs facteurs (mécanismes de prix, qualité du service, masse critique des utilisateurs, etc.), l'application de la théorie de Record pourrait clarifier les mouvements se produisant sur un marché de manière continue. Les défis sur les marchés de l'imagerie satellitaire reposent sur l'évolution rapide de la technologie ainsi que sur les cadres politiques de diffusion des données. Autant que la théorie de Record évite plusieurs contraintes, elle démontre sa capacité à offrir un outil simple pour décrire la stabilité d'un marché et par conséquent, ajouter un niveau de précision dans des analyses qui pourraient être plus complexes. Sachant que la demande des utilisateurs des données géo-spatiales révèle une partie du risque du marché, l'étude réalisée propose une nouvelle approche en examinant la stabilité de demande des images satellitaires tout en modélisant ses fluctuations à travers la théorie de Record. La nouveauté réside également dans le fait de permettre à la communauté scientifique de maintenir de nouveaux outils et éléments de traitement, afin d'assurer une meilleure gestion de l'information géo-spatiale via les IDGS.

La dynamique de marché des données d'observation de la terre est interdépendante avec plusieurs faits technologiques et économiques. À travers le cadre présenté, la théorie des Recors utilisée aide à surmonter la complexité de plusieurs modèles et atténue l'utilisation de multiples tests statistiques rendant quasi impossible la vérification complète des approches économétriques classiques. La méthodologie utilisée dans cette étude pourrait être reproduite à plus grandes échelles, tels que les grands programmes d'observation de la terre et d'autres types de données géo spatiales, où les conditions d'accès et de demande diffèrent et la quantité de données est largement supérieure, ayant un impact par conséquent, plus important.



Par leur action de mutualisation, d'accompagnement, de mise en réseau, de prétraitements et d'appui à l'apprentissage, les IDGS ont permis un développement significatif de l'information géo-spatiale et la multiplication dans des domaines très divers de produits et de services mobilisant ces informations. En revanche, l'absence de ressources financières remet en cause la pérennité de ces IDGS, qui dépendent principalement de subventions. Le support des investisseurs pour ce type de projets est souvent limité vu les manques de capacités locales, les finalités attendues par chaque financeurs et la concurrence sur le marché.

Dans la mesure où l'avenir consiste à intégrer des données issues de secteurs divers (public, privé) avec des "*informations citoyennes*", il est devenu indispensable de maintenir des éléments proches des pratiques des utilisateurs, afin de construire des modèles économiques plus appropriés au fonctionnement des IDGS. La capacité d'une IDGS à promouvoir et à présenter ses avantages aux investisseurs est un concept clé qui doit ressortir des exercices d'évaluation. Des cadres évaluatifs plus adaptés, ainsi qu'une hiérarchisation des impacts se révèlent indispensables, vu la complexité des activités et la diversité des effets générés. Fournir à la fois des incitations et des subventions ou envisager des mécanismes de tarification qui attirent les utilisateurs, est un exercice fondamental pour les IDGS, afin de concevoir des bonnes stratégies assurant leur développement.

# Contents

<b>Acknowledgments</b>	<b>3</b>
<b>Remerciements</b>	<b>5</b>
<b>Abstract</b>	<b>8</b>
<b>Résumé</b>	<b>10</b>
<b>1 Introduction</b>	<b>32</b>
1.1 Background . . . . .	33
1.2 Problem Statement . . . . .	34
1.3 Thesis Objectives . . . . .	36
1.4 The GEOSUD SDI . . . . .	36
1.5 Thesis Structure . . . . .	39
<b>2 SDI &amp; Information</b>	<b>42</b>
2.1 The Concept of Information / Communication . . . . .	43
2.2 The Information Theory . . . . .	44
2.3 The Economics of Information . . . . .	45
2.4 The Geospatial Information (GI) . . . . .	54
2.5 The Spatial Data Infrastructures (SDIs) . . . . .	55
2.5.1 The Concept of SDIs . . . . .	55
2.5.2 The Economic Challenges of SDIs . . . . .	56
2.5.3 The SDI Management . . . . .	58
2.5.4 The Economic Valuation of Geospatial Information via a SDI . . . . .	62
2.5.5 The valuation of SDIs . . . . .	66
2.5.6 The SDI Market Stability . . . . .	71

<i>CONTENTS</i>	23
2.6 References . . . . .	73
<b>3 Summary of Papers</b>	<b>92</b>
3.1 Paper I - Spatial Data Infrastructure Management: A two-sided market approach for strategic reflections . . . . .	92
3.2 Paper II - How much would you pay for a satellite image? Lessons learned from a French Spatial Data Infrastructure . . . . .	94
3.3 Paper III - Making the most of “heterogeneous” information by using Blackwell and Entropy theories: A decision support policy applied to forests’ clear-cut control . . . . .	96
3.4 Paper IV - Identifying the economic impacts of a Spatial Data Infrastructure . . . . .	98
3.5 Paper V - Examining market stability using the Records theory: Evidence form French Spatial Data Infrastructures . . . . .	100
<b>4 SDI Management</b>	<b>104</b>
4.1 Introduction . . . . .	105
4.2 Background literature . . . . .	108
4.3 Spatial Data Infrastructures as two-sided market . . . . .	110
4.3.1 The satellite imagery market . . . . .	111
4.3.2 The image-based applications market . . . . .	111
4.3.3 Network externalities & Non-neutrality of prices . . . . .	111
4.4 Case study: the GEOSUD SDI . . . . .	115
4.4.1 Data collection & analysis . . . . .	116
4.4.2 Case description . . . . .	117
4.5 Results: challenges and dynamics of the GEOSUD SDI according to a two-sided market approach . . . . .	120
4.6 Discussion: what are the lessons to be learned? . . . . .	128
4.7 Conclusion . . . . .	134
4.8 References . . . . .	137
<b>5 SDI Economic Valuation</b>	<b>154</b>
5.1 Introduction . . . . .	156
5.2 Methodology . . . . .	158
5.2.1 Description of the case study: The GEOSUD SDI users and data characteristics . . . . .	158
5.2.2 Survey design and data collection . . . . .	160
5.2.3 Model estimation . . . . .	163

5.2.4	Application to the GEOSUD SDI . . . . .	164
5.3	Results . . . . .	166
5.3.1	Descriptive results . . . . .	166
5.3.2	Statistical Results . . . . .	168
5.3.2.1	Sector-by-sector analysis . . . . .	170
5.3.2.2	Membership analysis . . . . .	171
5.3.2.3	Volume Analysis . . . . .	172
5.4	Discussion . . . . .	175
5.4.1	The satellite imagery WTP . . . . .	175
5.4.2	The satellite imagery WTP among sectors . . . . .	177
5.4.3	The membership fees WTP . . . . .	178
5.4.4	The HR satellite images: a place between the free MR and the VHR commercial images . . . . .	179
5.4.5	The SDI pooling mechanisms supporting the use and access to satellite imagery . . . . .	180
5.4.6	The satellite images meet the organizational routine concept . . . . .	182
5.4.7	The satellite imagery as an ‘informational asset’ . . . . .	184
5.4.8	From an image-based towards a data streaming model . . . . .	184
5.5	Conclusion . . . . .	185
5.6	References . . . . .	187
<b>6</b>	<b>SDI Information Structure</b>	<b>196</b>
6.1	Introduction . . . . .	197
6.2	Review of classical results . . . . .	200
6.3	General context and notations . . . . .	202
6.3.1	Blackwell’s approach . . . . .	203
6.3.2	Entropy approach . . . . .	205
6.4	Case study . . . . .	207
6.4.1	Data collection and analysis . . . . .	208
6.4.2	Case description . . . . .	209
6.5	Results . . . . .	213
6.5.1	Entropy Results . . . . .	213
6.5.2	Blackwell results . . . . .	214
6.6	Discussion . . . . .	216
6.7	Conclusion . . . . .	219
6.8	References . . . . .	222

<b>7</b>	<b>SDI Economic Impacts</b>	<b>232</b>
7.1	Introduction . . . . .	233
7.2	L'information satellitaire et l'IDGS GEOSUD comme source de productivité et d'innovation . . . . .	235
7.3	Méthodologie de l'évaluation pour la gestion des coupes rases .	237
7.3.1	Élaboration du questionnaire et réalisation de l'enquête	238
7.3.2	Présentation de l'échantillon enquêté . . . . .	238
7.4	Détails de l'évaluation et des résultats par type d'impact . . .	239
7.4.1	Impacts de la production et de la fourniture des images	240
7.4.1.1	La valeur ajoutée générée par ADS . . . . .	240
7.4.1.2	Les économies de mutualisation générées par GEOSUD . . . . .	241
7.4.2	Impacts de l'usage des images satellitaires de GEOSUD au sein des DRAAF et DDT(M) . . . . .	242
7.4.2.1	Économies de coûts de fonctionnement . . . . .	242
7.4.2.2	Économies de temps de travail pour le suivi des coupes rases . . . . .	243
7.4.2.3	Impacts sur les recettes publiques . . . . .	244
7.4.2.4	Impacts sur le réseau et la gouvernance . . . . .	244
7.4.2.5	Impacts sur les compétences . . . . .	245
7.4.3	Impacts sur les acteurs de la filière-bois . . . . .	245
7.5	Synthèse des résultats et discussion . . . . .	246
7.5.1	Des gains de coût de transaction et des effets de création de valeur ajoutée significatifs . . . . .	246
7.5.2	Un appui à moyen terme en faveur de processus d'innovation ouverte . . . . .	249
7.6	Conclusion . . . . .	251
7.7	Références . . . . .	253
<b>8</b>	<b>SDI Market Stability</b>	<b>258</b>
8.1	Introduction . . . . .	259
8.2	Methodology . . . . .	263
8.2.1	SDI characteristics'—GEOSUD / PEPS . . . . .	263
8.2.2	Satellite-images schemes . . . . .	264
8.2.2.1	GEOSUD high resolution satellite imagery . .	264
8.2.2.2	PEPS satellite imagery: Landsat, Sentinel and SPOT . . . . .	264
8.2.3	Data collection . . . . .	265

<i>CONTENTS</i>	26
8.2.4 Records theory model — general context . . . . .	266
8.2.4.1 Classical model . . . . .	267
8.2.4.2 Beyond iid —Yang-Nevezorov . . . . .	268
8.2.4.3 Distribution free estimation of $\gamma$ . . . . .	270
8.2.4.4 Goodness of fit test . . . . .	271
8.3 Results and discussion . . . . .	273
8.4 Conclusion . . . . .	278
8.5 References . . . . .	280
<b>9 Conclusions and Future Works</b>	<b>290</b>
9.1 Conclusions . . . . .	290
9.2 Future works . . . . .	294
<b>List of Publications</b>	<b>300</b>

# List of Figures

1.1	The development path of the GEOSUD SDI . . . . .	37
2.1	Information economics over time ( <i>source: Michel et al. 2011</i> ). . . . .	46
2.2	A conceptual view of a National SDI development ( <i>source: Kok &amp; Leven, 2005</i> ) . . . . .	59
2.3	The SDI connecting people to data ( <i>source: Rajabifard et al., 2006b</i> ). . . . .	59
2.4	A conceptual diagram of the federated network model of SDI data sharing ( <i>source: Tulloch &amp; Harvey, 2007</i> ) . . . . .	60
2.5	The two-sided market approach for SDIs ( <i>source: Jabbour et al., 2019</i> ) . . . . .	62
2.6	The GI value chain through a SDI ( <i>source: Rey-Valette et al., 2017</i> ) . . . . .	65
2.7	The economic valuation of satellite images . . . . .	65
2.8	The SDI signal within an information structure . . . . .	70
2.9	Informational flows and SDI impact assessment ( <i>source: Jabbour et al., 2019</i> ) . . . . .	71
2.10	SDI satellite images market demand stability . . . . .	72
4.1	The two-sided market for spatial data infrastructure . . . . .	114
4.2	Time line of interconnected events and platform management of GEOSUD/Theia SDI . . . . .	120
5.1	Access to MR and HR satellite images from the GEOSUD archives . . . . .	160
5.2	Demand Curve — ROC curve model performance . . . . .	169
5.3	Zoomed global demand function . . . . .	169
5.4	Demand curve of the significant sectors . . . . .	171

7.1	Structure des flux d'information et des types d'effets générés par GEOSUD . . . . .	236
8.1	Monthly demand of the three PEPS satellite imagery schemes.	265
8.2	Monthly demand of the GEOSUD HR satellite imagery schemes.	266



# List of Tables

2.1	An option value example . . . . .	51
4.1	A two-sided market approach for Spatial Data Infrastructures (SDIs) . . . . .	114
4.2	Case study protocol . . . . .	117
4.3	Management of the GEOSUD/Theia platform towards a two-sided market . . . . .	119
4.4	The evolution of GEOSUD/Theia members 2010-2017 . . . . .	122
4.5	Main characteristics of GEOSUD annual national coverage maps. . . . .	123
4.6	Tools and functionalities proposed through the GEOSUD SDI V2. . . . .	126
4.7	Network externalities & Non-neutrality of prices: Membership fees for users and developers . . . . .	130
5.1	Descriptive results . . . . .	167
5.2	The estimators' analysis . . . . .	168
5.3	Means and medians in Euros of the different significant sectors of users . . . . .	171
5.4	Membership WTP estimators' analysis . . . . .	172
5.5	Threshold volume estimators' analysis . . . . .	173
5.6	Percentage of users accepting to pay above free images acquired. . . . .	174
6.1	Data collection . . . . .	208
6.2	Unit amounts of different factors of the payoffs . . . . .	214
6.3	Elements constituting the payoffs of each action . . . . .	214
6.4	Payoffs of the first period actions ( $R(a_i; s_l)$ ) . . . . .	215
6.5	Payoffs of the second period actions ( $U(b_j; s_l)$ ) . . . . .	215

7.1	Détail des structures enquêtées en fonction des surfaces contrôlées (ha x 1000) . . . . .	239
7.2	Économies de mutualisation liées à l'usage de l'application coupes rases de GEOSUD. . . . .	242
7.3	Valeur monétaire du temps de travail économisé pour le suivi des coupes rases. . . . .	243
7.4	Importance des impacts de GEOSUD sur le réseau et la gouvernance ( <i>Source</i> : enquête GEOSUD, 2016) . . . . .	244
7.5	Estimation des coûts de transactions évités . . . . .	247
7.6	Ratio des effets générés en fonction du budget de fonctionnement de l'infrastructure . . . . .	248
8.1	GEOSUD and PEPS data sets . . . . .	265
8.2	Record results ( $R_n$ , $L_n$ and $N_T$ ) . . . . .	273
8.3	Goodness of fit test for the <i>iid</i> classical model with an asymptotic confidence level of 5% . . . . .	273
8.4	Goodness of fit test for the Yang model based on Chi-squared test with an asymptotic confidence level of 5%. . . . .	274
8.5	Probability of records for each considered series . . . . .	275
8.6	Theoretical vs. empirical number of records . . . . .	277



# Chapter 1

## Spatial Data Infrastructures (SDIs) Economics: An Introduction

The digital trend of everything happening somewhere both in time and space, led to the emergence of spatial data infrastructures (SDIs). SDIs are a result of the technological progress including organization, data and policies. They are scaling up geography and information, involving content ranging from cloud source information and artificial intelligence to synoptic imagery, real time analytics, integrated remote sensing information down to *in situ* data and simple basic tools.

This chapter offers a general overview about the SDIs. We introduce the problem statement and the objectives of the thesis. A brief description of the GEOSUD SDI, for which we had a privilege access during the whole period of this thesis, will be given.

## 1.1 Background

The demand for geospatial data across different fields and organizations, has led since the 1990s, to the growing development of the SDIs. Since then, their expansion is affecting almost all domains at all levels. The SDIs bring together the data, the computer networks, the standardized norms, the organizational agreements and the human resources needed to coordinate the sharing and management of geospatial data. As a consequence, the large diffusion of geospatial information has been accompanied by an expansion of the computing and Geographic information systems (GIS) services. This architecture of distributive and integrated information led to the emergence of a huge mass of informational contents, shared and available, as well as open platforms enabling easy integration and open standards. Today, SDIs are designed to respond to this mass of information, by reorganizing its flows, structuring its networking, and building socio-technical common devices at the local, regional, national and international levels. This process involves the participation of a wide variety of actors whose organization and networking is as important as the technical characteristics.

By allowing a better access to data and greater means of processing, the SDIs are renewing the methods of information transfer. Organizations are no longer firms that accumulate public data rather than nodes of database networks. In such context, where the SDIs are seen as a major support for technical and organizational innovations, the consequences of these technical and societal innovations on the uses of geospatial information in terms of economic and management practices are still largely unknown today. Therefore, in order for SDIs to become more “*User & Societal Friendly*” and to accompany these societal development, some economic key challenges exist. While a remarkable effort has been achieved to better understand the development of SDIs, there are still many issues that need to be studied. Thus, in order to progress on these challenges, this thesis is an attempt to address several aspects regarding the SDIs economics.

## 1.2 Problem Statement

The reality of setting up SDIs with the aim of getting data and information involves a lot of economic concerns. With the fact that, basically, these SDIs relied on public funds, their financing poses a series of economic questioning. The economic problems linked to their emergence and to other considerations such as the competitions between platforms and nations are also present.

Although SDIs are about facilitation and exchange of spatial data, the lack of financial resources challenges their sustainability, which depends mainly on subsidies (Scott & Rajabifard, 2017). Investors' support for this type of project is often limited in time, and complicated in terms of coordination, given the lack of local capacity, the various goals expected and the competition on the market (Steiniger & Hunter, 2012). The major economic problems linked to high external and internal debts, the inflation and high interest rates and the political uncertainty affect the ability to generate investments for the development of SDIs (Masser & Cromptvoets, 2017). The tendency remains in engaging more resources in traditional infrastructures generating more tangible returns, such as roads, utilities, telecommunication, etc.

Today, little researches are handling the economic business models of SDIs. Studies in this field include often technical analyzes about data standardization (Ibannain, 2009), replicability of governance systems across countries (Georgiadou et al., 2006), SDI readiness index (Fernandez et al., 2009), etc. Although research about organizational issues and interoperability of systems are emerging (Mohammadi et al., 2008; van Loenen & Rij, 2008; Georis-Creuseveau, 2013), there exists a need to address the SDI concept from an economic angle (Noucher & Archias, 2007; Genovese et al., 2010). Up to now, there exist no clear framework defining how a SDI could reach a sustainable financing scheme (Hjelmager et al., 2008; Cooper et al., 2013; Georis-Creuseveau et al., 2017). The current SDI business models lie basically on subsidies and government funding. As public funding are becoming scarce, and policy makers funding the launch, but not necessarily the operational functioning of these infrastructures, developing new policies and strategies for an efficient SDI management has become essential. In addition, the inflow of technology, and more specifically the internet, allowed low-cost access and information in many fields, including the spatial industry. We list

the large public observation systems (e.g. the American Landsat and European Copernicus programs) the creation of virtual globes by commercial companies (e.g. Google Earth, Planet), the upstream sharing of commercial images with very high spatial resolution (e.g. GEOSUD project in France), etc. Hence, this growing trend towards free access to data, raises the question of the economic valuation of the SDI services and impacts with a particular acuity. The sustainability of the SDI economic model, leads to use the word “free” with a lot of precautions. It is rather an open access downstream, with the cost covered on the upstream side of the SDIs. Therefore, with the scarcity of the public budgets, financing the SDIs is becoming a complex exercise (Kruse et al.; 2017). In addition to the few jurisdictions frameworks addressing operational and legal SDIs issues (Masser et al., 2007), other economic challenges are also present. The economic literature provides a list that helps introducing these main issues:

1. The need for more inclusive governance models: a combination between government, private and academia sectors (Ranga et al. 2013);
2. The necessity for establishing new market structures providing both spatial data and related services to end users (Gawer et al., 2009; Kruse et al., 2017);
3. The promotion of new forms of data organization and sharing between the various types of users (Parker et al., 2016; Barik, 2018);
4. The accompaniment of the continuous spatial information users’ needs (Pwc, 2016);
5. The need for justification materials on the economic role and impact of SDIs on various societal and organizational scales (De Montalvo, 2017; Alvarez, 2018).

Overcoming these economic concerns may lead to more effective and transparent coordination of the spatial information. By developing appropriate mechanisms that facilitate the delivery of data and services, the economic impacts could emerge on diverse levels: the creation of economic wealth based on spatial information, the conception of relevant choices handled at the decision makers’ levels, the development of strategies for an effective management of the societal and administrative problems, etc.

### 1.3 Thesis Objectives

The general aim of this thesis is to explore the SDI economics and better understand the dynamics behind. There are five specific objectives:

1. Propose a business model for a SDI in order to meet sustainable financing;
2. Perform an economic valuation of the geospatial information available through a SDI platform, the high resolution (HR) satellite images;
3. Examine the role of a SDI as an information structure;
4. Identify the economic impacts of a SDI;
5. Study the stability of the satellite image markets through the SDI.

Besides the grounded theoretical methods used to perform these studies, and in order to provide concrete applied elements, we were based on the GEOSUD SDI located in France. A brief description of the infrastructure is given in the next section.

### 1.4 The GEOSUD SDI

The GEOSUD project (GEO information for Sustainable Development) was born in the mid-2000s from the initiative of the partners of the Remote Sensing Centre in Montpellier (France). The overall objective of the GEOSUD project is to boost the use of geospatial information and more particularly the satellite imagery for researchers and public policy actors in the fields of environment, agriculture and land development. It obtained in 2007 a first regional funding from Europe and the “Languedoc-Roussillon” regional council and a second one, at the national scale in 2011, due to a successful response to the Equipex (Equipment of Excellence) call for proposals in the framework of the French “Investments for the Future” Program. The governance of GEOSUD project is composed of several bodies: a coordination team, a steering committee, an executive board and an international multi-disciplinary scientific committee.

Since 2012, GEOSUD has contributed in bringing out the Theia National Land Data Centre and setting up a joint digital platform to pool, access



and process satellite images in order to develop added-value products and services. The Theia cluster is based on the collaboration between various research teams (CES for *Centre d'Expertise Scientifique*) working on the same topics in order to develop algorithms, qualified products and services as well as networking supports between scientific communities, public actors and private structures (ART for *Animation Régionale Theia*). Methodological and thematic researches have been carried out within the GEOSUD project to assist in the development of its technological platform for the acquisition, management and dissemination of satellite images and derived products and services. Training materials and courses for imagery management and thematic applications, including for distance learning, have been developed. The Equipex funding obtained in 2011 made it possible to scale up and extend the ambition of the project by enlarging the partnership and getting additional resources to accompany the evolution of the technological and institutional contexts (fig.1.1).

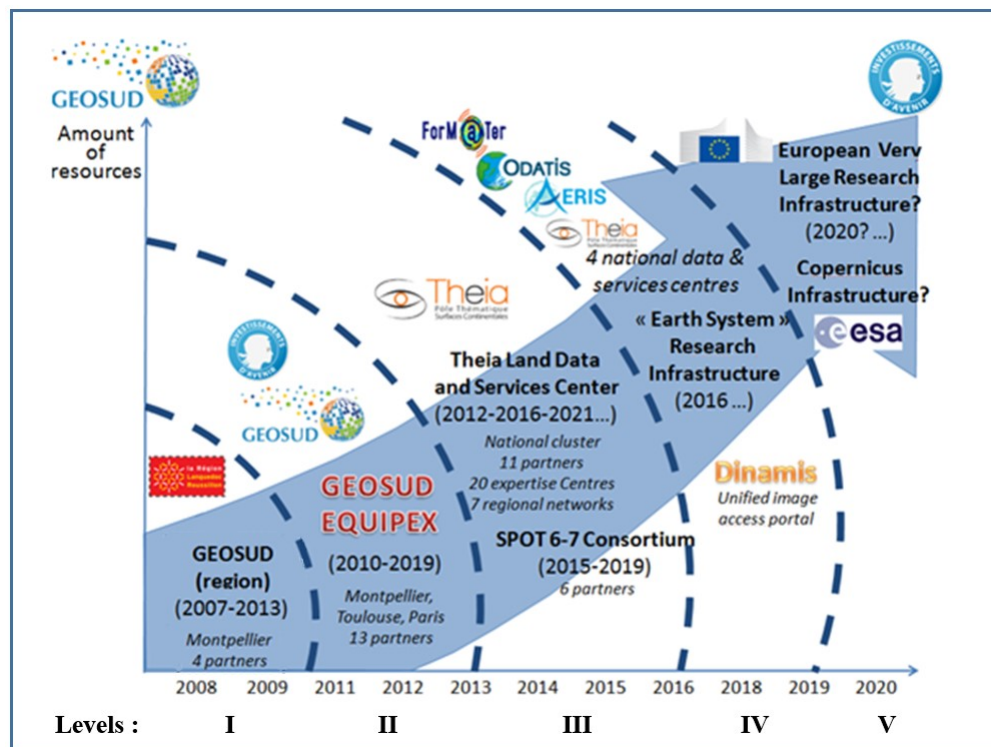

Figure 1.1: The development path of the GEOSUD SDI

- Level.1** A regional funding (CEPR—FEDER) carried by the Remote Sensing Center in Montpellier.
- Level.2** An Equipex program aiming at enlarging the partners, the financial resources and the project duration.
- Level.3** The creation of the Theia National Pole, allowing GEOSUD to fit into a larger context and sharing more resources/The Spot 6\_7 station installation in 2015 for pooling the telemetry purchases.
- Level.4** The deployment of the Earth System Research Infrastructure, uniting Theia with three other poles: AERIS (atmosphere), ODATIS (ocean) and FORMATER (solid earth and geology)/The creation of a transversal device for satellite imagery, DINAMIS, a federated national web portal, for sharing the access to satellite imagery. The GEOSUD SDI will be part of this polling device, with all the acquisition of images and archives accumulated since the beginning of the project.
- Level.5** The continuous development of the Copernicus system at the European level, with other efforts aiming at structuring the international community/Setting up a DIAS market place, for uniting the European partners throughout this platform.

Since the beginning of the project, GEOSUD financed the temporary employment of 58 people for a total of 632 man-months, multiplying the ambition of the first project set in 2007 and contributing to pool the resources and further structure the communities in order to extend the use of satellite images and services. By end-2019, GEOSUD comprised over 540 organizations (research and teaching departments, state departments, local authorities, non-research public institutions, NGOs and various organizations) with more than 1000 direct users registered on the SDI platform.

## 1.5 Thesis Structure

The thesis comprises 9 chapters, and is organized as follows:

Chapter I, this introduction, situates the thesis and summarizes its objectives and content.

Chapter II provides a general overview about the economics of information, the geospatial information (GI) and the spatial data infrastructures (SDIs) concepts. We introduced a briefing about the papers and the way they are embedded and ordered through this thesis.

Chapter III offers a summary of the five papers. While the case studies and subjects present in the papers may be indirectly connected one with another, the common link remains the SDIs themselves and the ecosystem generated around them. We try through these papers, to contribute to the economic studies in the SDIs field, by placing the SDI economic concerns at the heart of our articles.

Chapter IV to VIII represent the papers, sorted as follows:

- i. Chapter IV - Paper I - Jabbour, C., Rey-Valette, H., Maurel, P., & Salles, J.-M. (2019). Spatial data infrastructure management: A two-sided market approach for strategic reflections. *International Journal of Information Management*, 45 (Published).
- ii. Chapter V - Paper II - Jabbour, C., Hoayek, A., Maurel, P., Rey-Valette, H., Salles, J.-M. (2019). How much would you pay for a satellite image? Lessons learned from a French spatial data infrastructure. *IEEE Geoscience and Remote Sensing Magazine* (Accepted - In Editing).
- iii. Chapter VI - Paper III - Jabbour, C., Maurel, P., Rey-Valette, H., & Salles, J.-M., & Ghalayini, L. (2019). Making the most of “heterogeneous” information by using Blackwell and entropy theories: A decision support policy applied to forests’ clear-cut control (Submitted).
- iv. Chapter VII - Paper IV - Niang, A., Rey-Valette, H., Maurel, P., Ose K., Jabbour, C., Salles, J.-M., & (2019). Identifying the economic

impacts of a spatial data infrastructure. *Journal of Regional and Urban Economics (Revue d'Economie Régionale et Urbaine)* (Accepted - In Editing).

- v. Chapter VIII - Paper V - Jabbour, C., Hoayek, A., Maurel, P., Khraibani, Z., & Ghalayini, L. (2019). Examining market stability using the Records theory: Evidence form French Spatial Data Infrastructures (Submitted).

Finally, chapter IX concludes the thesis. We outline the key results and suggest new research prospects about the covered topics.



## Chapter 2

# Spatial Data Infrastructures & Information: An Economic Challenge

While the economics of spatial data infrastructures (SDIs) raise quite different issues, a common basis is “strongly” present through the economics of information. For several decades, the economics of information has been a central element in the field of industrial organization. However, the economic thinking on information issues has older roots, relating to the simple but fundamental idea that better information leads to more effective choices and thus to a gain of well-being for the population concerned. Since this question was addressed explicitly by Stigler (1961), the value of the information was expressed later, in very general contexts of incomplete and improving information structure, and in differentiation of the irreversibility of choice options, through the notion of option value. Economists have developed different conceptual frameworks in order to deal with these issues rigorously.

This chapter aims to shed light on the relationships between these aspects and the way they are embedded, in order to better understand the SDIs economics where the information plays a strategic role in our framework of analysis and reflection. We present on a second step, the papers and the way they are ordered and connected, in order to guide the readers throughout the manuscript.

## 2.1 The Concept of Information / Communication

The concept of information is present at the heart of several debates, which go far beyond the circle of economists. Various theoretical approaches were mobilized in order to better understand the way economic agents search for, process and disseminate the information. The idea that information is worth something, opens the way to a broader set of definitions. It is a difference, a variation, something that could be perceived or estimated. As defined by G. Bateson:

*“Information is a difference that makes a difference” (Bateson, 1972).*

Another well-known citation comes as follows:

*“Information is data processed for a purpose” (Curtis, 1989).*

Initially, the concept of information was linked to the transmission or communication processes; more specifically, a transformation process for those who produce the information, and an acquisition one for those who receive it (Porat, 1977). With the multiplication of sources and the sophistication of transformation mechanisms, the use of information is increasingly framing the decision-making practices of the economic agents (Hurwicz, 1994, Bernardo & Smith, 2009, Kochenderfer, 2015). In a technological context extremely accelerating, highlighting the efficiency of these processes influenced by any activities related to the collection and producing the information is necessary (Gallouj, 1994; Coiera, 2000; Niyato et al., 2016). Due to the development of the internet, the telecommunication systems and the technology, the information induces organizational effects with a very broad scale (Foray & Lundvall, 1996; Castells, 2010). In addition to structural changes and transformation in the nature of activities, we emphasize the market expansion and the emergence of innovation processes, aiming almost every domain in the recent economy (Freeman, 1995, Langlois & Garrouste, 1997, Gawer et al., 2009).

## 2.2 The Information Theory

The information theory initiated with the works of (Shannon, 1948) and (Shannon & Weaver, 1949). The two authors underlined the link and the non-separability of the information and communication concepts. The basic idea of information theory is to measure the rate of information flow as the rate of uncertainty reduction. It therefore starts with a measure of uncertainty, called entropy. Then information is thought of as moving through a “channel,” in which one enters input data, and output data emerges, possibly error carried. The Shannon’s formula below, describes the informative content of a random source:

$$H(X) = \sum_{i=1}^n p_i \log p_i$$

With  $H(X)$  representing the amount of information contained or delivered by an information source (signal);  $X$  discrete random variable having  $n$  symbols, with each symbol  $x_i$  having a probability  $p_i$  to appear. While considering a set of signals, the average amount of information included within the signals could be computed. The emission of these signals constitutes a stochastic process, invariable over time. In other words, the signals are transmitted to an agent via possible events and states in which the system may exist. Thus, the distribution of probabilities concerns a given set of events, and the quantity of information is therefore maximized once the events are with equal probability.

However, there were several objections to the philosophical generalization of this theory. (Savage, 1954) saw in Shannon’s formula no interest in the theory itself, except through the developments it allows. On the other hand, (Boulding, 1955) estimated that this theory identifies the signals and the time needed to acquire the information, while neglecting its proper value. This could also be found years later in (Arrow, 1984), commenting Shannon’s work for what it represents as a useful notion of the cost of acquisition of information, and not of the weight of the value of information. The several limitations of the Shannon’s results concerned primarily the economists, starting with the fact that it is not a theory of information, but a mathematical theory of communication and signal processing. Despite these facts, the economists were not restrained from applying these concepts in studying the



economic forecasting and integrating the basic informational statistical works into econometrics. As an example, (Onicescu & Botez, 1978) were among the first researchers who introduced the statistical theories of information in econometrics.

On the other hand, further works avoided a direct application of the information theory, to move towards a development of the “economics of information”, based on the analysis of the supply and demand for the information itself.

## 2.3 The Economics of Information

By seeking to identify an economic concept of information, it is understood that in its complexity, this concept is irreducible to a finite model. In order to formulate an economy of information, we are taken to consider a diversity of the paradigmatic field in which this perception fits.

The literature trying to introduce a significance to the information, do not leave the economists indifferent. Dealing with the economics of information leads to several possible definitions, either in the market organization or in the establishment of productive structures. Figure 2.1 describes the incidence of the term “information economics” and “economics of information” normalized by the use of the word “economics” in books published from 1900 to 2008<sup>1</sup>.

---

<sup>1</sup>The y-axis depicts the share of “information economics” among all 2-grams plus the share of “economics of information” among all 3-grams divided by the share of “economics” among all 1-grams (all phrases case insensitive) in books published that year. The dots indicate raw data by year while the solid line depicts a 5-year moving average.



Figure 2.1: Information economics over time (*source: Michel et al. 2011*).

The economics of information is often linked to the concept of information technology or telecommunications. A major trend present in most developed economies, where the diversity of uses and their impacts result from the use of the information in all its forms (Repo, 1989). Another approach to this economy comes through an analysis of growth patterns that correspond to it. A broad set of schemes at various levels, depending on whether the analysis focuses on a production activity or on an organizational aspect of structures and markets (Porter, 1981). Other perspectives focus on the economy of the entire system that produces, processes and disseminates the information. (Hayek, 1967) highlighted that the diffusion of the information is a phenomenon for which the economic agents do not react in the same way. In such a context, the information is considered as a resource whose diffusion and production conditions could be followed (Wade & Hulland, 2004).

In fact, (Stiglitz, 1985) by considering the information as a main element to carry out an economic analysis, stated the following:

*“The informational considerations were in the core of the analysis of a wide variety of phenomena, constituting a central part of the foundations of economic analysis...”*

The possibility of generalizing the analysis of the signal transmission, already mentioned in the previous section, to that of getting a closer vision of the reality is essential, insofar as it makes possible to apply the results of this theory to the economic analysis and reasoning. Theories presenting the information as a form of organization that shapes the information itself,

brought an innovative aspect to the economics of information's literature. The works of (Quastler, 1956) and (Forester, 1959) were among the founding texts of these reflections. Other semantic definitions, reducing the information to the organizational transaction, as the example of the theory of the firm (Cremer, 1993; 1998), describe the post-industrial societies as primary users of the information. Societies in which the firms are to consider the information as a resource, such as labor and capital, thus constituting another important factor of competitiveness (Stiglitz, 2000).

Despite the organizational aspect, it is essential to note that a significant part of the resources in the economy, is endowed to the acquisition and dissemination of the information. According to standard microeconomic theory (Arrow & Debreu, 1954), prices play a key role and coordinate the activities of the economic agents. The two authors provided a key benchmark model describing the behavior of a competitive economy with perfect information, through a model of competitive general equilibrium in which all firms were price takers. In the early sixties, the Search theory introduced by (Stigler, 1961, 1962) came to add a dimension to the works already existing, in a context where the agents decide *ex ante* on the number of alternatives to sample. His theory presents the trade-off between the expected benefits of a choice, highlighting the expectation of utility and the cost of getting better informed in order to make a better choice. By considering that the market could reveal differences in the prices availability, Stigler stated that the one-price market could occur only when the cost of information about the prices offered by the buyers and sellers is zero. From his point of view, he considers that the information is rare, costly to obtain and could be seen as an economic good. (Mc Call, 1970) a few years later, proposed a dynamic model based on sequential search formulation, including the individual motives for acquiring additional information given the distribution of options. Although Mc Call's model was not well suited to explain how the option distributions arise (Diamond, 1971), it complemented Stigler's earlier works, and constituted a basis for further research widely used in macroeconomics, but with no direct link with the economics of information (Mortensen, 1986, Stokey, 1989, Adda & Coope, 2002).

Given the fact that the information could be distributed or held in an asymmetrical way, gave place to other research developments. Several papers addressed this matter through everyday life examples. (Akerlof, 1970) in

his famous paper “Market for lemons”, described how car sellers maintain different information than buyers, giving them an incentive to sell goods of less than average market quality. He argued that a knowledge of the prices generates a classic equilibrium role of a market via the management of scarcity, as well as an informational role; the fact that the quality of an information is uncertain, the demand may depend on both price and quality. Agents who do not have an exact knowledge of the situation could use the price as an indicator. (Spence, 1973) in a paper entitled “Job Market Signaling”, added a dimension to Akerlof findings’, by identifying the information asymmetries existing between employers and employees. He considered that low-paying jobs could create a persistent equilibrium trap that discourages the bidding up of wages in certain markets. Later on, (Stiglitz, 1975) through a theory of market screening, introduced the information asymmetry concept in insurance markets, describing the negative externalities within general equilibrium models. He highlighted the premiums rise linked to the uncertain health insurance premium needed for high-risk individuals, causing low-risk individuals to deviate from their preferred insurance policies (Rothschild & Stiglitz, 1976; Stiglitz & Weiss, 1981; Stiglitz, 1987).

On the other hand, (Theil, 1967) addressed the concept of uncertainty related to information, and suggested that the amount of information contained in a message is useful for measuring the uncertainty associated with achieving a set of events. Therefore, the information gain is represented by the difference between the information quantities of two messages. Considering Theil as a major contributor to the economic development of information, (Lancry, 1982) estimated that this definition, even if it is related somehow to the concept of Shannon, does not find the same fields of development. Subsequently, (Hirshleifer, 1973) after defining the uncertainty as a measure of the dispersion of individuals’ subjective probabilities, as to the possible states of the world, defined the information as a set of events likely to modify these probability distributions. In his works, the Shannon’s theory is seen as a negative measure of uncertainty. As an example, if the occurrence of an event is very likely, which supposes other events are unlikely to occur, the amount of information contained in this event is small. On the other hand, if all the events have an equal probability, the amount of information is maximum, and therefore the uncertainty is maximum. However, as for Shannon’s theory, a small amount of uncertainty implies a small amount of information and vice versa.

From the economics of information's perspective, the information serves primarily to reduce the uncertainty. The difference between these two concepts relies in the fact that, with respect to Shannon, the information exists only through the quantity that measures it. While from an economic point of view, the information is not measurable as it is, rather being a qualitative variable through the effect that it could have on the agents' behavior, whose related impacts are measurable. The information therefore has sense, depending on the context in which it arises and the circumstances of the agents who are using it.

In general, the information approaches in the economic theories distinguish an information useful for the present from another which implies, that various options should be preserved in order to benefit from improved information in the future. This reinforces the idea that the information can improve or disrupt an agent's acquisition capability, while taking into account the limited rationality and the imperfect nature of the information made available. Thus, the uncertainties related to the future decisions of each agent, will help to define and characterize the value that an information will have. In other words, the extent to which an information processing and its effect of usage will constitute a development factor or a source of uncertainty. In the economics of information, the uncertainty factor is related to the basic idea that a decision maker is outlined by the information signals he can receive before making his decision. The signals refer to the states of the world set, the possible actions and the utility functions. In such context, the aim remains in identifying the optimal information structure and maximizing the expected profitability of an action. Based on this, the economics of information differs primarily from that of Shannon's theory in the sense that it adds a utility function to the probability function.

Marschak (1971, 1972) discussed and interpreted the differences between an economy of information following statistic economics models and another one following the mathematical theory of communication. The author highlighted the difficulty of using these models to develop a value for the information. (Arrow & Fisher, 1974) proposed another definition of the information, as any signal likely to alter the distribution of probabilities. In other words, the acquisition of information refers to the difference between the distribution of probabilities a posteriori and a priori. A difference resulting from receiv-

ing a signal, message or information. A quantitative dimension similar to that of (Marshall, 1972), integrating information bits equal from the point of view of information theory, but opening towards a very different costs and benefits. The same value of information could result from different resources, mobilized in non-similar contexts. In addition, Arrow & Fisher showed that the cost of searching the information could be introduced, and that there is an equivalence between the independence of the value of information in relation to the income and the utility functions. Recall that the fundamental axiom of this theory is the absence of unforeseen contingencies: the list of states of nature must be fixed and determined. This explains the paradoxes of the extension of the theory to the inter-temporal choices, when certain consequences of choices are irreversible.

This reasoning was developed in parallel by (Henry, 1974) through his works on the option values and the “irreversibility effect”, as the most successful clarification of the work initiated by (Weisbrod, 1964). According to (Friedman, 1962), the fact that a large number of national parks in the United States had financial revenues that were not up to the costs’ level, posed a concern. (Weisbrod, 1964) through the option value, proposed a solution to this problem. He invited people who have not visited a national park, to consider a fraction of their taxes as a possible solution to finance the maintenance of the parks, until their possible expected visit. Preserving this option of maintaining the park open and not destroying the natural assets resulted in the name of “option value”. So, in order to differentiate between these two concepts, several definitions have been developed: the option price, the option value or the static option value referring to (Weisbrod, 1964), versus the option value, the quasi-option value or the dynamic option value as for (Henry, 1974) and (Arrow & Fisher, 1974).

Hence, in this case, the value of the information is in fact the option value. In other words, it is the benefits value of a well-being enabled by the improvement of the information. In order to formalize this gain and to develop the value of the information, it is necessary to construct a risky choice model and to establish the situations before and after the acquisition of the information. A choice situation, in which various options are defined in the form of probabilistic distributions and in an uncertain manner. In order to illustrate this point mathematically, the example below (table. 2.1) consists of two possible actions  $a_1$  and  $a_2$  over a time period  $i$ , under two states of

natures  $s_1$  and  $s_2$  with probabilities  $p_1$  and  $p_2$  respectively;  $p_1 + p_2 = 1$ . The profits generated by the action  $a_l$ ;  $l \in 1, 2$  under state  $s_k$ ;  $k \in 1, 2$  denoted by  $b_{lk}$  are represented in the following table:

	$s_1$	$s_2$
$a_1$	$b_{11}$	$b_{12}$
$a_2$	$b_{21}$	$b_{22}$

Table 2.1: An option value example

Therefore, the value of information (the option value) within the period  $i$  is given by:

$$V_i = \mathbb{E} [\text{Maximum payoffs}] - \text{Max} [\text{Initial expectations}]$$

$$= (p_1 \text{Max}[b_{11}; b_{21}] + p_2 \text{Max}[b_{12}; b_{22}]) - (\text{Max}[p_1 b_{11} + p_2 b_{12} + p_1 b_{21} + p_2 b_{22}])$$

Thus, the process is presented by opposing a risky situation where the future is known but in a probabilistic way (situation without information) v/s a certain choice with a complete information, in order to be capable to compare the two scenarios. However, given the complex assumptions, the theory about option value had received some critics for its weak power of conviction, due the necessity of establishing all the possible scenarios in the future and assigning the corresponding probabilities to each situation.

Thus, between an information theory that evaluates the distribution of information and a more sophisticated one aiming at a more general economic context, the framework of analysis revealed is considerably broad. It opens the way towards a development of more tangible elements in terms of profitability and costs, while keeping the theoretical aspect present. (Landvall, 1996, 2002), tried to introduce another aspect to the economics of information, proposing to decompose this information into three categories, stemming from the use declared by the economic agents (the know-what, the know-why, the know-who). An economic agent does not seek information, rather he wonders how to look for it.

Recently, the most active research area in information economics is probably the “information design”. The “information design” is an exercise about

belief manipulation. This perspective seeks to identify the optimal informational environment, given the preferences of the players and the objective function of the players' actions. (Kamenica & Gentzkow, 2011) studied the general problem of persuading a rational agent by controlling his informational environment. The authors introduced the persuasion factor, in a framework where both the information sender and receiver are rational Bayesians. (Bergemann & Morris; 2016) analyzed a group of interacting agents whose behavior depends, in part, on their beliefs about the uncertain states of the world. In cases where incomplete information environments apply, the information designer may commit to disclosing information for what the strategic transmission of information consist as a tool to affect the agents' behavior by manipulating their beliefs. In the same context, (Taneva, 2015) stated the following:

*“An agent’s beliefs about the other agents’ beliefs about the state, affect his decision as do his beliefs about their beliefs about his beliefs about the state, and so on . . .”*

These higher-order beliefs are absent from the single-agent environment, but they are an important part of the information design problem with multiple interacting agents. Other facts dealing with the behavioral notion about the “information design”, which are far from the intended work in this thesis, could be found in the works of (Kremer et al., 2014) and (Ely et al., 2015).

Another important point to consider, is the amount of information available and the time during which the information is transmitted. Following the technology and the globalization of the markets, the information is in its apogee at the moment. While the price systems may have an impact on the information value, lowering the cost of information can lead to a competition in the market and at the economic agents' level. This does not necessarily imply a reduction in the decision costs. If the interpretation of price makes it possible to reveal the information held, the information can also appear in the form of market efficiencies, due to cases where the informational performance is taken into account; if the market fully transmitted information, no one would devote any resources to its collection (Grossman & Stiglitz, 1976, Stiglitz, 1976). These authors criticized the liberal approach who systematically considers that the market is the best regulator of information; this was the central idea of (Hayek, 1945), who considered that the strength of



market is by allowing to synthesize the information held by agents who do not need to communicate with each other via alternative means. Given the diversity of markets, and the particularities of the economic cases studies, the technology is unable alone to solve this problem, hence a regularization between markets and international standards also appears to be essential. (Grossman & Stiglitz, 1980) demonstrated that in certain markets, the value of acquiring information is lower when a higher fraction of other agents are informed; hence the full-information equilibrium outcomes are not possible.

From a more practical point of view, the economics of information analysis reveals sometimes disadvantages in the proper use of the information. Between individual capacity and organizational skills, we find several debates about the role of information in altering the performances, as well as the role of technology in providing this information. With all what the information may entail in terms of innovation processes and cost reduction, it could have in parallel other impacts on employment reduction, engaging the economy in a spiral of recession (Stiglitz, 2002). As a result of process automation and changes in production methods, an economy centered on the use of information could destabilize a system, offering as many disadvantages as benefits. The concept of the economics of information, often linked to empirical observations about the growing place of the information in our economies, could lead to negative spillovers, once being part and integrated into an ecosystem (Benkler, 2002). In a society which multiplies the information by increasing the capacity of storage, transformation and dissemination, valuing the information is no more to be neglected, especially when strategic issues could also be present. The same is applied concerning its nature. The information could be given without being lost, received without wanting it, thus having a character of a pure public good in the classical sense of Samuelson.

Therefore, knowing the specificities of an informational good, its status in the different activities, its determinants of value and its production methods are essential for a better understanding of its role and its impact.

In the next section, we examine a particular type of information: the geospatial information.

## 2.4 The Geospatial Information (GI)

The geospatial information (GI), is an information describing the location of things and the way they relate to one another on the earth's surface (Devillers et al., 2005). This information includes statistical data, remote sensing, surveying technologies and mapping, charting and related products. We find the terms "geospatial information", "spatial information" and "location information", often used for the same purpose.

Among the first applications beginnings of the 20th century, the US farmers in the 1930s, used several basic techniques based on spatial information (aerial photo, sky shot, etc.) to perform land analysis coupled with an economic reasoning (Donaldson & Storeygard, 2016). Since then, an impressive change occurred in the way the Earth is being watched from above. With the emergence of the new technology, the computer sciences and the internet, the GI is increasingly present in a numerous fields (Tonneau et al., 2017).

Recently, GI is taking a fundamental role in the economics of our emerging information society. It is contributing in monitoring several of the world's greatest issues and considered one of the most essential elements underpinning the decision-making with applications targeting multiple domains: the environment, the land and resource management, the climate change, the health risks, the ecosystem services monitoring, the demographic statistics, the smart cities, etc. (Borzacchiello & Craglia, 2012; Vernier et al., 2017; Roche, 2016, 2017).

In our context, we were interested in a particular type of GI, that resulting from satellite observation. Therefore, one of the economic constraints linked to that kind of information, lies in the capacity of acquisition of the satellites, the initial data providers. It is in direct link with the ecosystem of the GI and it is important to think about it from an economic point of view. The satellites, once put in orbit, the costs of GI production are negligible. The remote sensing technologies can collect panel data at low marginal cost, repeatedly, and at large scale on proxies for a wide range of characteristics. By the time the satellites are in orbits, the production costs of GI data may be ignored (they are powered by solar energy, run on software already programed in advance, with technicians managing on land the operations, etc.) compared to the initial investment phase. This issue reminds us about

the old paradox of the “Voyageur de Calais” related to the railway infrastructures. The paradox illustrates on one hand, the discontinuous nature of marginal costs when fixed costs play a predominant role in relation to the variable costs, and on the other hand, the difficulty of integrating long-term investments (Allais, 1989).

While the GI illustrates particular characteristics of the information concept, it includes specificities relating to the spatial dimension of the economic activities and the management of territories (planning, management of resources and activities, etc.) Hence, an awareness that GI information is changing the way agents act and make decisions, pushes us towards closer examination of the infrastructures responsible for producing and managing the information, the way it is handled and the assessment of its impact once released.

## 2.5 The Spatial Data Infrastructures (SDIs)

The infrastructures underlying the emergence of information societies could be attributed to the “information infrastructures”. By considering the geospatial information at the core of these infrastructures, the “spatial data infrastructures (SDIs)” have seen the light. The SDIs have been a remarkable technological achievement and remains a key source of information and innovation. The importance of the efforts they involve, in terms of both investment and organization, raises a multiplicity of questions for economists.

### 2.5.1 The Concept of SDIs

The term Spatial Data Infrastructure (SDI) emerged in the early 1990s, describing a phenomenon of “coordinating aspects” of the geospatial information (Masser, 2005). Since then, many definitions have been proposed, for which the two following examples seem to offer a relevant synthesis:

*A SDI is “a framework of technologies, policies, and institutional arrangements that together facilitate the creation, exchange, and use of geospatial data and related information resources across an information-sharing community”.*

(U.S. National Research Council, 1993)

SDIs “subsume technology, systems, standards, networks, people, policies, organizational aspects, geo-referenced data, and delivery mechanisms to end users”.

(Crompvoets et al., 2004).

With the concept of SDIs, all the technological progress of the digital information is being used. From analytics, modeling, engineering and design works, the GI is gathered through all these elements in order to make a difference and help in a more efficient way the policy-makers and the decision-making processes. While the SDIs connect various profiles of users and group several components, they come to respond to many economic challenges.

### 2.5.2 The Economic Challenges of SDIs

The economic development of the SDIs, has been one of the most challenging initiatives in the spatial information industry (Bernard et al., 2005). Researchers have suggested different models and methods for approaching SDIs, expressing the need for a better understanding of their objectives, complexity and multifaceted uses (Harvey & Tulloch, 2006; Crompvoets et al., 2008).

The SDIs offer a gateway to geospatial data, often scattered due to the presence of different information providers. The first key driver in the use of geospatial information is their availability (Anselin et al., 2006). The SDIs as a consequence, have pushed toward this direction. While originally, the focus of SDIs was on the type, the development and access to the various spatial datasets, their concept has evolved to be more adapted to the continuous technological and organizational progress (Grus et al., 2007). Therefore, SDIs have expanded to include a focus on users in relation to the data, as well as adopting a shift in emphasis from a “product-based” approach to a “process-based” approach in their development (Rajabifard et al., 2002). By pooling the data, the SDIs through their networking and distributed organizational tasks, promoted the access and use of the information, where their treatment is no longer considered in relationship with a single individual (Noucher, 2009). In addition, the recent success of SDIs depends increasingly on the demand for GI added-value-products and applications. Consequently, the SDI ecosystem seen as an interdisciplinary collaboration, needs to shift from a provider-oriented policy to more consumer-driven initiatives (Macauley et al., 2006). An understanding of this issue is important

to gain support from a wider community of spatial data partnerships and to be aligned with the spatial industry objectives.

In line with these objectives, the SDIs promote the access to geographic data according to the prescriptions and recommendations of National and International directives including the global standards of the Internet and geographic information (e.g. the INSPIRE directive in Europe; the NOTRE law in France) (Bartha & Kocsis, 2011). As for example, the INSPIRE directive at European level, aims to ensure coordination between users and information providers so that information from different sectors can be combined and disseminated. It groups the international standardization bodies in order to organize the geographic information flows in Europe by defining functional specifications for a better interoperability. The purpose of INSPIRE is to overcome the inconsistencies in spatial data collection, the lack or incomplete documentation of available spatial data, the incompatible SDI initiatives in a member state that often function only in isolation and the absence of unified policy agreements on sharing and access, including licensing and charging. The covered topics within the SDIs under the INSPIRE directive, include observation of air quality, water, soil, biodiversity, land use, transport networks, hydrography, altitude, geology, distribution of population or species, habitats, industrial sites or areas at risk, administrative boundaries, etc.

Moreover, the SDIs contribute in sharing the access costs, pooling the skills and creating user communities' networks, for whom open innovation processes could emerge (Johnson et al., 2017). Hence, the combination of heterogeneous data (satellite and aerial imagery, cartographic and statistical data, terrain data, social networks, etc.), accompanied with the recent technological advances, pushed towards the establishment of SDIs equipped with image access services as well as derivative products and applications (Google Earth, Amazon, Copernicus platform, SparkIn Data, Theia National pole, etc.) (Crompvoets et al., 2018). Through the implementation of standardized services and systems interoperability, the SDIs took part of the strategies aiming at the fall of the geospatial information costs and allowed the development of new technological and processing tools aiming at facilitating the collective treatment of information. Moreover, vertical integration strategies have been deployed in order to be more adapted to specific users' needs, going from the upstream processing of geospatial information up to the down-

stream development of products and added-value services (Pepe et al., 2018).

As a consequence, the race toward establishing and developing SDIs all over the world is increasing, as a way to better manage the spatial data assets (Masser, 2014). We see SDIs flourishing at the local, national and international levels, with massive investments behind (Delgado-Fernandez & Crompvoets, 2007; De Man, 2007; Coetzee et al., 2013, 2015). In general, the value of an investment consists of the value flow that it generates. More particularly, the SDIs are part of a productive investment set, which includes huge expenses (ground stations functioning, satellites operation, maintenance, etc.). Therefore, from an investment choice perspective, one should ask whether this investment is economically justified. In addition, the indirect and long-term economic benefits that the SDIs could generate, coupled with the uncertainty factor (not having a clear view of the future added-values), explain the intervention of public funds in financing these infrastructures. Thus, as a first intuition, these facts opened the way on the SDIs management questioning and the economic considerations towards a sustainable ecosystem. The long-term business strategies and new forms of business governance are at the heart of this reasoning.

### 2.5.3 The SDI Management

With the Big Data era and the powerful computing technologies, the concept of SDIs is being driven towards more reaches and targets. The open standards interoperable between the different components of SDIs are engaging everyone and bringing them together in a dynamic aspect. It allows, on the one hand, the SDIs development and, on the other, it increases the competition, hence the risks for investors in SDIs. Among the first attempts trying to respond to this point, (Kok & Leven, 2005) offered a four-stage development method of a National spatial data infrastructure (NSDI) (fig. 2.2). Their approach provided a first vision, on how a SDI could transition from a focus on its individual organization (*stand-alone phase*) towards an interactive between its stakeholders and other shared resources (*network phase*).

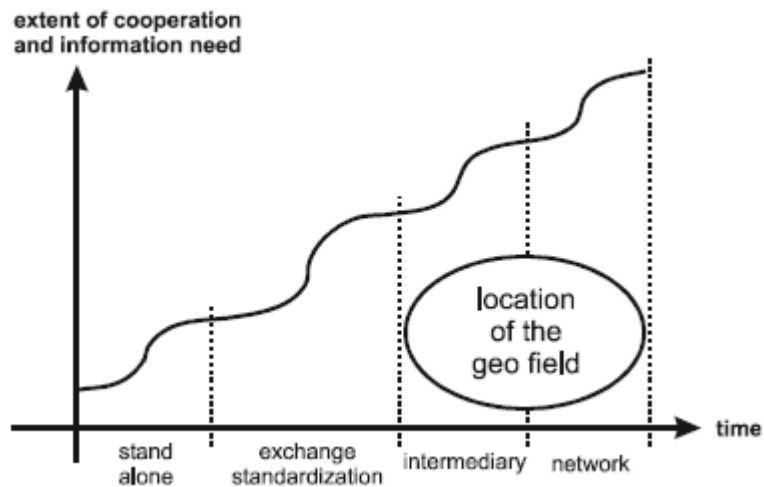

Figure 2.2: A conceptual view of a National SDI development (*source: Kok & Leven, 2005*)

Another approach proposed by (Rajabifard et al., 2006b), consisted of an enabling platform that link data producers, providers and value adders to data users (fig. 2.3):

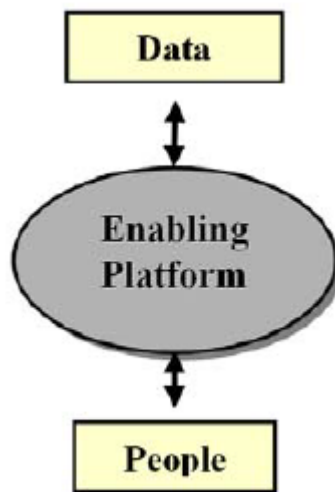

Figure 2.3: The SDI connecting people to data (*source: Rajabifard et al., 2006b*).

Moreover, the SDI as described by (Tulloch & Harvey, 2007), could be perceived as a federated network of data, through which the interaction between different the users highlight the long-term opportunities as well as the problems within a data-sharing communities (fig. 2.4). The authors insisted on the crucial need for continuous and coordinated efforts for advancing better governance schemes for SDIs.

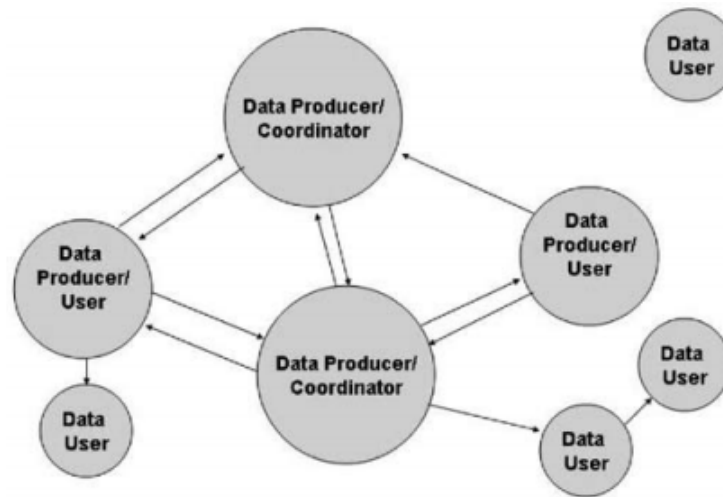

Figure 2.4: A conceptual diagram of the federated network model of SDI data sharing (*source: Tulloch & Harvey, 2007*)

Meanwhile, with the massive emergence of internet and numerical platforms, a shift in the governance of firms started to take place (Gawer et al., 2009). While most of the existing business models initially focused on supply-driven approaches, the consequences were barely oriented to respond to the end-user direct needs. Hence, in such context, the economics of platforms started to take a central role in the firm business models (Hagiui, 2009). The way to build platforms, attract users, and capture the value generated from the emerging ecosystem emerged massively. The recent examples describe clearly how Google is monetizing the searches, Facebook monetizing the social networks, LinkedIn monetizing the professional networks, etc. They all depend on the digitization of value-creation activities.

These examples raise questions about ways to invest in SDIs. The geospatial information produced is on the one hand commodified, with a market



structure (monopoly or various competitors) that determines the various pricing possibilities. Issues of externalities, public good aspects and platforms management are revealed. In such context, the theoretical advances in the field of strategic management are increasingly involving the identification of bridges and linkages between the different existing concepts and theories (Chesbrough, 2010). A novel approach that was able to make a significant change was the introduction of the Brokering Framework (Nativi & Bigagli, 2009; Nativi et al., 2012, 2013). This framework builds the necessary bridges between various disciplinary infrastructures without making any changes to their normal way of operating. Therefore, an SDI could realize the necessary adaptation and distribution of data by interconnecting multidisciplinary infrastructures. While the works on business models, industrial organization and platforms have been developed independently of each other, the common thing for which they all refer, is the phenomenon of “innovation” as a mechanism for creating value and an essential element for competitiveness (Chuang & Lin, 2015). In such context, the SDIs need to develop new practices in order to improve the efficiency of their innovation processes and explore new market opportunities (Pearlman et al., 2016). The SDI, as an intermediate firm, could handle this task and manage the dynamics occurring between the different geo-spatial information markets’ players. As a consequence, the geo-spatial data and services that may emerge, will be the result of a collaboration between heterogeneous actors and complementary skills, mobilized as part of a collective innovation process (Janowski et al., 2018).

As fast as information technology is changing, the SDI concept evolved to capitalize on the new technologies in order to meet the continuous changing needs of society. In such context, the SDIs have become main players in determining the way spatial data is being used. They are allowing spatial information to be integrated and accessible within a networked digitalized environment (Giuliani et al., 2017). By creating a cooperation environment between stakeholders and facilitating the interaction with the information technology systems, SDIs are supporting the strategic planning concerns and decision-making processes at different scales (Demetriou et al., 2017; Dutta & Pande, 2018). Although the platform concept has proved its relevance in reorienting the firms’ strategies, little has been performed in the field of SDIs. The understanding of the dynamics behind is still limited (Caillaud & Jullien, 2003; Tirole, 2003; Roson, 2005). Thus, in order to answer these challenges and respond to the SDI sustainability question, it is important

to develop the use of geospatial data, i.e. to make the scientific actors, the public actors and the private actors work together in a logic of complementarity. It is necessary to facilitate the access to the data available on the SDI platforms, but also, to offer services and application tools. Thus, making it possible to pass from raw and basic GI into intermediate and added-value products or services responding to the needs of end-users (Vancauwenberghe et al., 2018). While the main features of platform economics (two-sided markets, multi-sided markets, etc.) have been analyzed in some domains, this concept remained unused in the field of SDIs.

A detailed study of a two-sided market approach (fig. 2.5) applied to the case of SDIs will be presented in our *first paper* (Chapter IV).

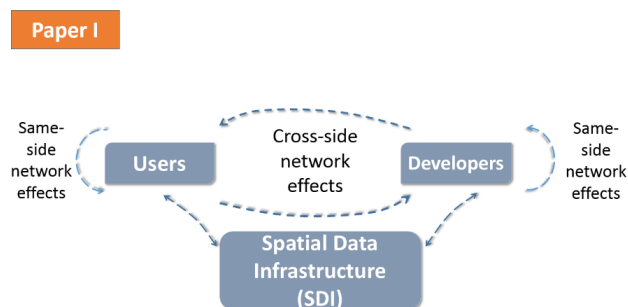

Figure 2.5: The two-sided market approach for SDIs (*source: Jabbour et al., 2019*)

In addition to the SDIs two-sided market reflections, a series of economic concerns were carried in parallel. The next section will provide more detail about this point.

#### 2.5.4 The Economic Valuation of Geospatial Information via a SDI

In general, the valuation of GI is considered as a major challenge in the recent literature (Bernknopf & Shapiro, 2015). Despite the significant progress made, there still exist several difficulties in the understanding of the GI value and its potential benefits (Vandenbroucke et al., 2013; Kruse et al., 2017). Is the GI value just related to cost savings? Is a return on investment view,

sufficient to clarify the GI value? Does the way people are changing their behavior, and adapting to sophisticated GI tools more complicated to master compared to basic information, brings more value?

As stated by (Longley et al., 2001):

*“The value of a GI relies upon its coverage and on its strengths of representation of diversity, on its truth with a constraint definition of that word, and on its availability”.*

The growing use of GI raises several reflections about its value. At various stages of its development, characterizing the way in which the GI intervenes in the decision-making process and the consequences related, consist a major part in the valuation process (Meeks & Dasgupta, 2005; Richter et al., 2010; Dessers et al., 2012; Fardusi et al., 2017). Through the use of information, the welfare of people is increasing, with proportions that could not be recovered either by a system of taxation, nor by payment contributions or other financial schemes (Shaw & Graham, 2017). Therefore, the economic value created may take several forms: number of lives saved, improvements in environmental quality, enhanced regulatory efficiency, etc. (Bernknopf & Shapiro, 2015; Corbane et al., 2015). Similarly, other important societal effects could emerge regarding the fairness and legitimacy of public policies, the democratic value of transparency, etc. Moreover, monitoring the life cycle of GI is an extremely complex exercise. From the moment the data are released, they are hybridized with other contents, which complicates the analysis of the value and the life cycle of the information. The linkage between production and usage of GI is not clear enough. Thereby, their economic assessment presents several barriers and the conceptualization of their value is still to be discussed, due to their complex, dynamic, multi-faceted and constantly evolving nature (Krek, 2002; Craglia & Nowak, 2006). In addition, the pooling and interoperability of the GI data is confronted with the fact that some of the added-values are indirectly recognized among users (Rey-Valette et al., 2017). Impacts such as the improved management of territories and the enhanced institutional coordination at the level of the regulatory systems, do not always give rise to clear monetary exchanges (Craglia & Shanley, 2015).

The assumption that the access to GI is free and generates significant gains in terms of productivity, need to be justified. The fact that GI infor-

mation is not destroyed when it is consumed and is being multiplied when shared through the SDIs, leads to reconsider the basic reflections in which this information is presented. In a digitized world, an information-based economy transforms a tangible production organization into a system of intangible development of organizational behavior. This phenomenon affects the organization of information dissemination methods, with all the impacts linked to it in terms of costs and benefits. Usually, the users' needs are not translated directly into basic or raw spatial information, rather than available solutions through added-value services. Moreover, there are several access points to GI and the informational gain behind is not equal. Finding the right access portals with the relevant and reasonable costs, remains complicated with all the different players present in the Geo spatial information industry (Ivory et al., 2018).

Hence, highlighting the dynamic context of GI remains an essential point, in which multiple discourses and objectives are displayed, but are not always in adequacy one with another or even with the observed uses (Georis-Creuseveau et al., 2018). This disconnection is the result of a fragile and competitive situation, linked to changes in the SDIs legal frameworks and economic constraints. Thus, analyzing the value of GI, need to overpass these discourses in order to understand concretely, the multiple uses and the practices in relation to the needs that are actually emerging. The SDI, considered as an intermediate platform handling two interdependent markets (the satellite imagery & the image-based applications), involves a complex digital environment including a wide range of spatial data technologies and standards. As part of the economic valuation, we examined in our context, the economic value of the high resolution (HR) satellite images as perceived by the direct users of a SDI platform. The direct users constitute a first link between the SDI and the wider community of beneficiaries of image-based products and services (fig. 2.6):

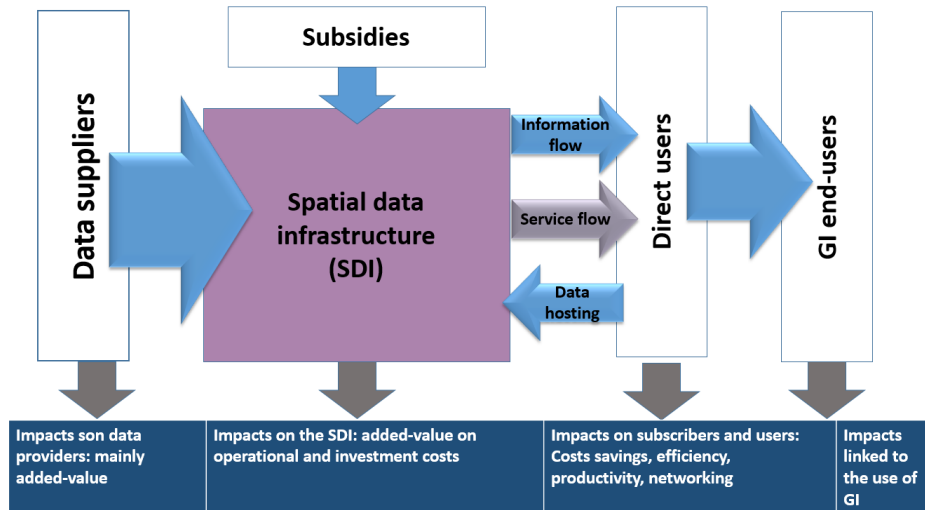

Figure 2.6: The GI value chain through a SDI (source: Rey-Valette et al., 2017)

By estimating the value that these users draw directly from the HR satellite images, the study tries to fill a part of the gap between the users' needs for justification materials and the investors' exigencies on the availability of this technology on the market. The detailed study will form our *second paper* (Chapter V) (fig. 2.7):

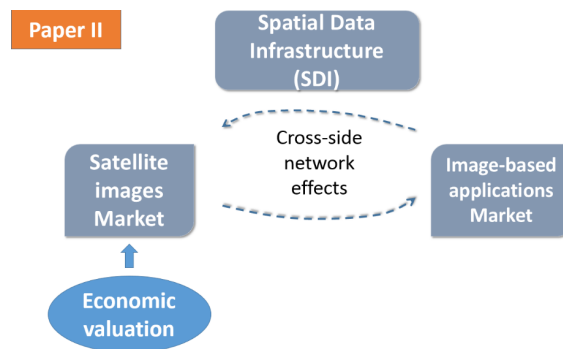

Figure 2.7: The economic valuation of satellite images

As a recent case study, the SIG-LR (a regional SDI platform in the Languedoc-Roussillon, South France) had a relatively very low GI pricing

policy for its users: whether it was a large or a small user (in terms of GI consumption) subscribed on its platform, the payment terms were the same. However, years later, it seems that this process was not viable neither logical, and the SDI was forced to review and consider the pricing model, depending on the volume of GI data consumed.

Hence, providing this example shows that simulating different forms of pricing may further clarify some economic aspects for better improving the functioning of SDIs. The results obtained could be used to enlighten the design of a future pricing of satellite imagery, aiming at sustaining the financing of these services.

### 2.5.5 The valuation of SDIs

Concerning the SDIs valuation, we noticed a diversity of methodologies and approaches. Works attempting to construct theoretical frameworks for valuing the SDIs are still emerging from various scientific disciplines (Hendriks et al., 2012; Coetzee et al., 2015). Among the existing literature review, several aspects regarding the SDIs have been addressed.

(Rodriguez-Pabon, 2005) conducted a qualitative research in order to develop a theoretical framework for the evaluation of SDIs. The author identified firstly, a list of common success criteria across different contextual backgrounds. He then considered two major dimensions including those criteria, on which a SDI evaluation should be based: the quality and the virtue. The process should involve everyone in the social construction of these infrastructures.

The maturity of the SDI was evaluated by (Loenen, 2006), according to various technical and nontechnical measures. The author highlighted the role of the organizational aspects within a SDI as well as the impacts of distinct data policy once adopted (free data policy, cost recovery policy, etc.). He argued that open access policies do not always promote the development of SDIs, for what this issue may represent a counterproductive fact. His findings explain why some nations still adopt a cost recovery policy instead of following open access strategies.

Among other empirical works, a study by Lance et al. (2006) reviewed

the evaluation activities involved in SDI developments. The method presented was quantitative in nature, and was primarily focused on examining the efficiency and rationality of investment decisions. (Loenen & van Rij, 2008) through an organizational perspective, classified the development of a SDI in stages ranging from the initiation phase, standardization, intermediary till a maturity phase. While the author developed the way each stage of development requires a specific organizational setting, his analysis however ignored several other issues such as the technological, social and economic aspects.

Other indicators measuring the strength and weakness of a SDI were introduced by (Giff et al., 2008). The latter defined a performance based management, in order to follow the performance of a SDI within its different stages while reaching its stated objectives; through his work, the author introduced a structured framework in order to guide the SDI managers in designing their coordinating strategies and initiatives. (Grus et al., 2007) and (Crompvets et al., 2008) detailed several approaches for valuing the SDIs, focusing on the different dimensions a SDI could have. They highlighted the importance of the readiness index linking the human factor with the informational and organizational roles in the conception of the SDIs. (Fernández et al. 2010) considered the readiness index as the combination of organizational, informational, financial and human factors for valuing a SDI. He recognized though his study, the effect of putting in place new systems and processes to strengthen the SDI capacities and provide better service delivery through enhanced initiatives. In his suggestions, continuing to monitor the readiness index, may help supporting the managers in implementing and developing successful strategies related to the SDIs. Another indicator, the European INSPIRE directive, was strongly present in (Crompvets et al., 2008), addressing the way a coordination of the information flow within the SDI could help in engaging the SDI towards more connections and development schemes. Similarly, Vandenbroucke et al. (2008) offered a detailed analysis concerning the INSPIRE directive, emphasizing the organizational and legal frameworks affecting the SDIs. He introduced other elements such as the funding mechanisms, the spatial data access, the metadata services and standards in his characterization of a SDI regulative framework.

Georgiadou et al. (2006b) suggested a variety of methodologically evaluation approaches addressing a focus on the data, services and E-governance.

These aspects were associated with a set of policy questions, including community involvement in decision-making and impact assessment. (Janssen, 2008) focused on the legislation facets via the law and jurisprudence elements of a SDI. He distinguished throughout his approach, three levels of legal assessment: the compliance, coherence and quality levels. He insisted on the idea that a good political, social and cultural conditions are vital for the development of a SDI. He concluded that a contribution of a legal framework in formalizing these issues, provides a minimum set of rights and obligations between the different stakeholders and parties concerned within a SDI. In this context, (Onsrud et al. 2010) highlighted a similar aspect about the need for the SDI and the legal communities to work closely, in order to develop legal approaches in this filed. The author presented this fact as a successful strategy in facilitating the legal sharing of resources, and more particularly the spatial data.

(Nedović-Budić et al., 2008) addressed the SDI effectiveness from a user perspective, by defining the impact of potential users of a SDI and highlighting through an empirical assessment, the benefits derived from inter organizational sharing of geographic information. The author concluded with associating the effectiveness factor to four basic elements: the persistence, the extensive communications, the investment of time toward shared objectives and the well-defined roles and responsibilities. His findings suggested that the SDI is useful, as good as it serves the broad set of users in supplying data and services for their particular needs. Another study by (Craglia et al., 2008), identified the efficiency benefits linked to the SDI at the level of local public administration. The findings revealed that smaller local authorities are the key beneficiaries of the web-based spatial services provided by SDIs and they are narrowing their gap with larger ones. While a large number of indicators was proposed, the study remains framed within the local SDI case study context.

(Stuedler et al., 2009) considered various assessment areas with indicators defining the level at which an SDI should be valuated, such as the management, the operational and the policy levels. The study focused on the role and value of performance indicators for assessing and comparing SDIs, based on land administration systems experiences. He considered that a better understanding of the various facets of a SDI leads to an improvement in its entire functioning system.



A Balanced Scorecard method (BSC) was used by (Toomanian et al., 2011), describing the progress factors and driving forces in establishing a SDI. This method introduced the overall management strategy of a SDI, with a summary of business operations measures. The author explained how SDI managers, could value the degree of success of a SDI from both a producers and users' perspective, by assessing the organization involved and the willingness to use spatial products. (Borzacchiello & Craglia, 2013) focused on the benefits of a SDI in terms of time and cost saved, through a methodology comparing the use of an E-cadaster to other traditional services. Their findings comes as an additional justification material to the SDI required investments. (Vandenbroucke et al., 2013) focused on the work processes that take place within a SDI networks and the degree to which the SDI components are being integrated in these work processes. The authors introduced several indicators, to measure on the one hand the performance related to the access, use and sharing of spatial data, and on the other hand, to value the contribution of the SDIs in improving these work processes. This methodology helped in understanding the differences in SDI performance within different scenarios considered.

More recently, (Zwirowicz-Rutkowska, 2017) presented a concept of a multi-criteria method for valuing the SDI effectiveness from a user perspective. The focus was mainly on the following dimensions: the information and support provided, the use process, the user organizational performance, the strategic alignment and the business impact on user enterprise. The author analyzed the impacts and business value of a SDI by integrating these quantitative non-financial aspects and combining them with previous qualitative contributions found in the European Parliament and the Council, 2007, Grus et al., 2008 and the Commission of the European Communities, 2009. Although other approaches such as the multi-view, multi-scale or multi-sectorial methods cover different aspects of a SDI (Cromptvoets et al., 2008), there is still a lack of integrated methods measuring the impacts within the SDI ecosystem (Nushi et al., 2015; Rey-Valette et al., 2017). As we take account of the situation today, we feel more convinced for the need of an evaluation framework with a clear social resultant activities and purposes. A revelation of impacts may give rise to practical, social and public issues in order to ensure a continuous development and secure an economic growth for SDIs based on sustained policies (Noucher & Archias, 2007; Grus et al.,

2010; Conti et al., 2018). The literature exploring the economic impacts of SDIs, reflects a perception focused on tackling the scarcity of things rather than the impact of the SDI information itself and the risk-related (Macauley, 2006). In general, the impact of an information depends on its ability to limit the complexity of choices, increase the future expected value and reduce the risk in favor of the decisions to be taken (Garcia et al., 2018). This phenomenon deals with the relationship between the information availability and the different states of nature of the happening events. Moreover, in a context where the role of information rely upon both the right opportunity on the right time, discriminating the relevant information appears to be crucial (Goodchild et al., 2007; Roche et al., 2012).

In our context, the economics of information consisted in eliminating, prioritizing, classifying the accessible data, in order to reducing the uncertainty of the decision to be taken and optimize the action that could take place. In order to cover these aspects, and provide insights on the impact of a SDI information, we tried to examine in our *third paper* (Chapter VI) the role of the SDI as an information structure. We approached this issue through a decision-making process. We assessed the economic impact of the information provided by a SDI, as part of a wider information framework/structure (fig. 2.8):

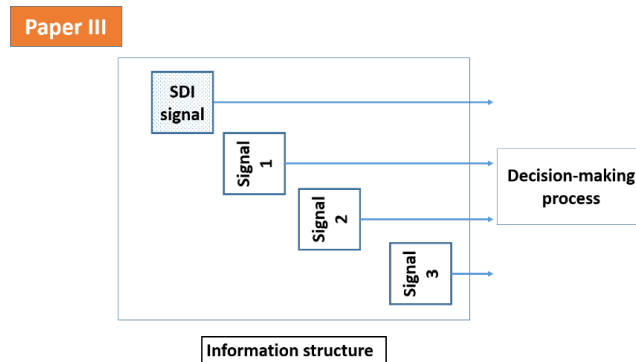

Figure 2.8: The SDI signal within an information structure

On the other hand, assessing the socio-economic impacts of SDIs implies a thorough understanding of their typology, through each step within the value chain. In parallel with the conditions allowing their creation and diffusion,

identifying and measuring the impacts is a critical exercise. We tried to explore these impacts in our *fourth paper* (*Chapter VII*), in terms of added-values, cost savings, time saving, etc. We examined the way a SDI, through the diffusion of its satellite imagery information, could influence the decision-makers' expectations whenever the expected payoffs are improved or the actions taken are becoming much easier with the support of the geospatial information. With all the complex facets of the information that may be present along the SDI value chain, we identified the impacts that could be generated through the SDI ecosystem. Our idea was to look at the value chain starting from the initial data providers, the SDI and towards the direct users (fig. 2.9):

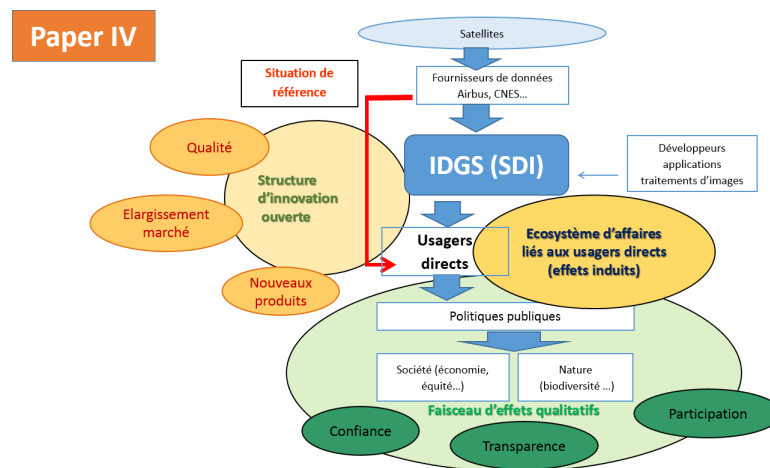

Figure 2.9: Informational flows and SDI impact assessment (*source: Jabbour et al., 2019*)

All this process will feed the public policies, with a qualitative bundle of effects that have global impacts on society. Identifying specific flows at various levels of the value chain clarify how these flow, through the SDI, are able to influence the processes at each level.

### 2.5.6 The SDI Market Stability

The fact that GI is considered a valuable information tool raises the question of access to this data (O'Sullivan et al., 2018). In order to better understand the dynamics of the economic model in relation to the access of the satellite

images already evaluated, we decided to analyze the stability of the satellite images market through the SDI, in terms of demand. While several studies have examined technical issues related to the expansion of the GI markets, little attention has been put to address the users' demand occurring via the web portals or SDI platforms (Beaumont et al., 2005; Coleman et al., 2016). Despite the fact that the stability issue of a market is driven by several factors (price mechanisms, service quality, users' critical mass, etc.), this study addressed the shifts occurring on a market within a time-period continuity. It comes in a sort of continuity of the reflections deployed within the GIS community, to offer an understanding of the dynamics that could occur through the users' Geospatial demand, leading to a better comprehension of the market stability and the fluctuations the SDI could face on its platform. This study will form our *fifth paper* (*Chapter VIII*) (fig. 2.10):

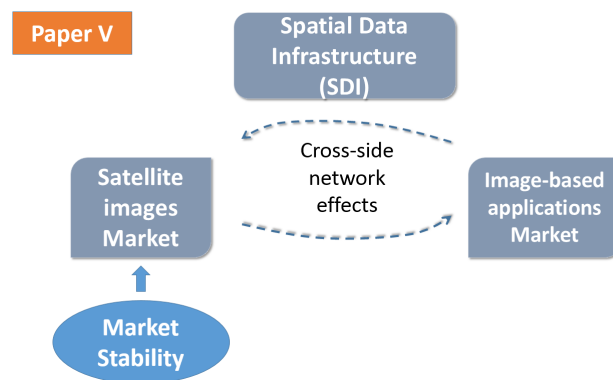

Figure 2.10: SDI satellite images market demand stability

The cases of the GEOSUD and PEPS SDIs, for which the analysis was performed, are in a *fully operational* situation in terms of image access and *intermediary* in terms of processing tools, added-value services and products. That's why the choice was based on the satellite image side, due to the operational concerns regarding the SDI functioning. Through the pooling and networking strategies, pre-processing tools and functionalities, the GEOSUD SDI has enabled a significant development of its geo-spatial information and the multiplication of uses in very diverse fields. In particular, a very significant growth in the use and access to this data was recorded from the launch date of the project 2006 till 2019.

## 2.6 References

Adda, J., & Cooper, R. (2002). *Dynamic economics: quantitative methods and applications*. The MIT Press.

Akerlof, G. A. (1978). The market for “lemons”: Quality uncertainty and the market mechanism. In *Uncertainty in economics* (pp. 235–251). Elsevier.

Allais, M. (1989). L'économie des infrastructures de transport et les fondements du calcul économique. *Revue d'économie Politique*, 159–197.

Almirall, P. G., Ros, P. Q., Craglia, M., & Moix, M. (2008). *The Socio-economic Impact of Spatial Data Infrastructure of Catalonia*. Office for Official Publications of the European Communities.

Alvarez León, L. F. (2018). The political economy of spatial data infrastructures. *International Journal of Cartography*, 4(2), 151–169.

Anselin, L., Syabri, I., & Kho, Y. (2006). GeoDa: an introduction to spatial data analysis. *Geographical Analysis*, 38(1), 5–22.

Arrow, K. J. (1973). Information and economic behavior. Arrow, K. J., & Debreu, G. (1954). Existence of an equilibrium for a competitive economy. *Econometrica: Journal of the Econometric Society*, 265–290.

Arrow, K. J., & Fisher, A. C. (1974). Environmental preservation, uncertainty, and irreversibility. In *Classic papers in natural resource economics* (pp. 76–84). Springer.

Arrow, K. J. (1984). *The economics of information* (Vol. 4). Harvard University Press.

Barik, R. K. (2019). Development and implementation of interoperable secure SDI model using open source GIS. In *Geospatial Intelligence: Concepts, Methodologies, Tools, and Applications* (pp. 582–616). IGI Global.

Bartha, G., & Kocsis, S. (2011). Standardization of geographic data: The european inspire directive. *European Journal of Geography*, 2(2), 79–89.

Bateson, G. (1972). *Steps to an ecology of mind: Collected essays in anthropology, psychiatry, evolution, and epistemology*. University of Chicago Press.

Beaumont, P., Longley, P. A., & Maguire, D. J. (2005). Geographic information portals---a UK perspective. *Computers, Environment and Urban Systems*, 29(1), 49–69.

Benkler, Y. (2002). Freedom in the commons: Towards a political economy of information. *Duke LJ*, 52, 1245.

Bergemann, D., & Morris, S. (2016). Information design, Bayesian persuasion, and Bayes correlated equilibrium. *American Economic Review*, 106(5), 586–591.

Bergemann, D., & Morris, S. (2013). Robust predictions in games with incomplete information. *Econometrica*, 81(4), 1251–1308.

Bernard, L., & Craglia, M. (2005). SDI-from spatial data infrastructure to service driven infrastructure. In *Research Workshop on Cross-Learning Between Spatial Data Infrastructures and Information Infrastructures*, Enschede, The Netherlands.

Bernard, L., & Craglia, M. (2005). *SDI - From Spatial Data Infrastructure to Service Driven Infrastructure*.

Bernardo, J. M., & Smith, A. F. M. (2009). *Bayesian theory* (Vol. 405). John Wiley & Sons.

Bernknopf, R., & Shapiro, C. (2015). Economic assessment of the use value of geospatial information. *ISPRS International Journal of Geo-Information*, 4(3), 1142–1165.

Borzacchiello, M. T., & Craglia, M. (2013). Estimating benefits of Spatial Data Infrastructures: A case study on e-Cadastres. *Computers, Environment and Urban Systems*, 41, 276–288.

Borzacchiello, M. T., & Craglia, M. (2012). The impact on innovation of open access to spatial environmental information: a research strategy. *International Journal of Technology Management*, 60(1–2), 114–129.

Boulding, K. E. (1955). Notes on the information concept. In *Exploration* (Vol. 6, pp. 103–112).

Brillouin, L. (1962). *Science and information theory*. Courier Corporation.

Castells, M. (2010). The information age. *Media Studies: A Reader*, 2(7), 152.

Castells, M. (2010). The information age. *Media Studies: A Reader*, 2(7), 152.

Castells, M. (2010). The information age. *Media Studies: A Reader*, 2(7), 152.

Castells, M. (2010). The information age. *Media Studies: A Reader*, 2(7), 152.

Chesbrough, H. (2010). Business Model Innovation: Opportunities and Barriers. *Long Range Planning*, 43(2–3), 354–363. <https://doi.org/10.1016/j.lrp.2009.07.010>

Chuang, S.-H., & Lin, H.-N. (2015). Co-creating e-service innovations: Theory, practice, and impact on firm performance. *International Journal of Information Management*, 35, 277–291.

Coetzee, S., Harvey, F., Iwaniak, A., & Cooper, A. K. (2013). Sharing and coordinating SDIs in the age of crowdsourcing and mobile technologies.

Coetzee, S., & Wolff-Piggott, B. (2015). A review of sdi literature: Searching for signs of inverse infrastructures. In *Cartography-Maps Connecting the World* (pp. 113–127). Springer.

Coiera, E. (2000). Information economics and the Internet. *Journal of*

the American Medical Informatics Association, 7(3), 215–221.

Coleman, D. J., Rajabifard, A., & Kolodziej, K. W. (2016). Expanding the SDI environment: comparing current spatial data infrastructure with emerging indoor location-based services. *International Journal of Digital Earth*, 9(6), 629–647.

Conti, L. A., Fonseca Filho, H., Turra, A., & Amaral, A. C. Z. (2018). Building a local spatial data infrastructure (SDI) to collect, manage and deliver coastal information. *Ocean & Coastal Management*, 164, 136–146.

Cooper, A. K., Moellering, H., Hjelmager, J., Rapant, P., Delgado, T., Laurent, D., . . . others. (2013). A spatial data infrastructure model from the computational viewpoint. *International Journal of Geographical Information Science*, 27(6), 1133–1151.

Craglia, M., & Nowak, J. (2006). Report of International Workshop on Spatial Data Infrastructures: Cost-Benefit / Return on Investment: Assessing the Impacts of Spatial Data Infrastructures. European Commission, Directorate General Joint Research Centre, Technical report, Institute for Environment and Sustainability, Ispra, Italy.

Craglia, M., de Bie, K., Jackson, D., Pesaresi, M., Remetey-Fülöpp, G., Wang, C., . . . others. (2012). Digital Earth 2020: towards the vision for the next decade. *International Journal of Digital Earth*, 5(1), 4–21.

Craglia, M., & Shanley, L. (2015). Data democracy--increased supply of geospatial information and expanded participatory processes in the production of data. *International Journal of Digital Earth*, 8(9), 679–693.

Cremer, H., & Crémer, J. (1993). L'apport des théories économiques récentes à la planification indicative. *Revue Économique*, 57–73.

Crémer, J. (1998). Information dans la théorie des organisations. Institut d'économie industrielle, Université des Sciences sociales de Toulouse.

Crompvoets, J., Rajabifard, A., van Loenen, B., & Fernández, T. D. (2008). A multi-view framework to assess SDIs. *Space for Geo-Information*



(RGI), Wageningen University and Centre for SDIs and Land Administration, Department of Geomatics, The University of Melbourne.

Crompvoets, J., Vancauwenberghe, G., Ho, S., Masser, I., & de Vries, W. T. (2018). Governance of national spatial data infrastructures in Europe. *International Journal of Spatial Data Infrastructures Research*, 13, 253–285.

Curtis, G., & Cobham, D. (2008). *Business information systems: Analysis, design and practice*. Pearson Education.

da Silva, E. S., & Camboim, S. P. (2018). Eliciting academic SDI requirements through a survey of user practices. *Open Geospatial Data, Software and Standards*, 3(1), 11.

De Man, W. H. E. (2007). Beyond Spatial Data Infrastructures there are no SDIs-so what. *IJSDIR*, 2, 1–23. de Montalvo, U. W. (2017). Mapping the determinants of spatial data sharing. Routledge.

Delgado Fernandez, T., & Crompvoets, J. (2007). Infraestructuras de datos espaciales en Iberoamérica y el Caribe.

Demetriou, D., Campagna, M., Racetin, I., & Konecny, M. (2017). Integrating Spatial Data Infrastructures (SDIs) with Volunteered Geographic Information (VGI) for creating a Global GIS platform. *Mapping and the Citizen Sensor*, 273–297.

Dessers, E., Crompvoets, J., Janssen, K., Vancauwenberghe, G., Vandembroucke, D., Vanhaverbeke, L., & Van Hootegem, G. (2012). A multidisciplinary research framework for analysing the spatial enablement of public sector processes. *IJSDIR*, 7, 125–150.

Devillers, R., Bédard, Y., & Jeansoulin, R. (2005). Multidimensional management of geospatial data quality information for its dynamic use within GIS. *Photogrammetric Engineering & Remote Sensing*, 71(2), 205–215.

Diamond, P. A. (1971). A model of price adjustment. *Journal of Economic Theory*, 3(2), 156–168.

Dutta, D., & Pandey, S. (2018). Development of State Spatial Data Infrastructure (SSDI): Indian Experience. In *Geospatial Infrastructure, Applications and Technologies: India Case Studies* (pp. 31–44). Springer.

Ely, J., Frankel, A., & Kamenica, E. (2015). Suspense and surprise. *Journal of Political Economy*, 123(1), 215–260.

Eyster, E., & Rabin, M. (2014). Extensive imitation is irrational and harmful. *The Quarterly Journal of Economics*, 129(4), 1861–1898.

Fardusi, M. J., Chianucci, F., & Barbati, A. (2017). Concept to practice of geospatial-information tools to assist forest management and planning under precision forestry framework: a review. *Annals of Silvicultural Research*, 41(1), 3–14.

Fernández, T. D., Fernández, M. D., & Andrade, R. E. (2008). The Spatial Data Infrastructure Readiness model and its worldwide application. A Multi-View Framework to Assess SDIs, 117.

Foray, D., & Lundvall, B.-A. (1996). *Employment and Growth in the Knowledge-based Economy*.

Freeman, C. (1995). Le nouveau contexte de l'innovation. *STI Revue*, (15), 2464–2465.

Gallouj, F., & others. (1994). *Economie de l'innovation dans les services*.

Garcia, J. A., Istomin, E. P., Slesareva, L. S., & Pena, J. A. (2018). Spatial data infrastructure for the management and risk assessment of natural disasters. In *Sixth International Conference on Remote Sensing and Geoinformation of the Environment (RSCy2018)* (Vol. 10773, p. 1077310).

Gawer, A. (2009). *Platforms, Markets and Innovation*. Cheltenham, UK: Edward Elgar.

Georgiadou, Y., Rodriguez-Pabón, O., & Lance, K. T. (2006). Spatial data infrastructure (SDI) and e-governance: A quest for appropriate evaluation approaches. *URISA-WASHINGTON DC-*, 18(2), 43.

Georis-Creuseveau, J., Claramunt, C., & Gourmelon, F. (2017). A modelling framework for the study of Spatial Data Infrastructures applied to coastal management and planning. *International Journal of Geographical Information Science*, 31(1), 122–138.

Georis-Creuseveau, J., Claramunt, C., Gourmelon, F., Pinaud, B., & David, L. (2018). A Diachronic Perspective on the Use of French Spatial Data Infrastructures. *Journal of Geographic Information System*, 10(04), 344.

Giuliani, G., Lacroix, P., Guigoz, Y., Roncella, R., Bigagli, L., Santoro, M., . . . Lehmann, A. (2017). Bringing GEOSS services into practice: a capacity building resource on spatial data infrastructures (SDI). *Transactions in GIS*, 21(4), 811–824.

Goodchild, M. F., Fu, P., & Rich, P. (2007). Sharing geographic information: an assessment of the Geospatial One-Stop. *Annals of the Association of American Geographers*, 97(2), 250–266.

Grossman, S. J., & Stiglitz, J. E. (1980). On the impossibility of informationally efficient markets. *The American Economic Review*, 70(3), 393–408.

Grossman, S. J., & Stiglitz, J. E. (1976). Information and competitive price systems. *The American Economic Review*, 66(2), 246–253.

Grus, L., Cromptvoets, J., & Bregt, A. (2007). Multi-view SDI assessment framework. *International Journal of Spatial Data Infrastructures Research*, 2, 33–53.

Hagiu, A. (2009). Two-Sided Platforms: Product Variety and Pricing Structures. *Journal of Economics & Management Strategy*, 18(4), 1011–1043.

Hayek, F. A. (1967). The results of human action but not of human design. *Studies in Philosophy, Politics and Economics*, 96.

Hayek, F. A. (1945). The use of knowledge in society. *The American Economic Review*, 35(4), 519–530.

Hendriks, P. H. J., Dessers, E., & Van Hootegem, G. (2012). Reconsidering the definition of a spatial data infrastructure. *International Journal of Geographical Information Science*, 26(8), 1479–1494.

Henry, C. (1974). Option values in the economics of irreplaceable assets. *The Review of Economic Studies*, 41, 89–104.

Hirshleifer, J. (1973). Where are we in the theory of information? *The American Economic Review*, 63(2), 31–39.

Hjelmager, J., Moellering, H., Cooper, A., Delgado, T., Rajabifard, A., Rapant, P., ... others. (2008). An initial formal model for spatial data infrastructures. *International Journal of Geographical Information Science*, 22(11–12), 1295–1309.

Hurwicz, L. (1994). Economic design, adjustment processes, mechanisms, and institutions. *Review of Economic Design*, 1(1), 1–14.

INSPIRE, E. U. (2007). Directive: Directive 2007/2/EC of the European Parliament and of the Council of 14 March 2007 establishing an Infrastructure for Spatial Information in the European Community (INSPIRE). *Official Journal of the European Union*, L, 108(1), 50.

Ivory, V. C., O'Donnell, K., & Schindler, M. (2018). Potentials, problems and possibilities for developing New Zealand's built environment through high-value geospatial information. *Kōwhiri: New Zealand Journal of Social Sciences Online*, 1–17.

Jabbour, C., Rey-Valette, H., Maurel, P., & Salles, J.-M. (2019). Spatial data infrastructure management: A two-sided market approach for strategic reflections. *International Journal of Information Management*, 45. <https://doi.org/10.1016/j.ijinfomgt.2018.10.022>

Janowski, T., Estevez, E., & Baguma, R. (2018). Platform governance for sustainable development: Reshaping citizen-administration relationships in the digital age. *Government Information Quarterly*.

Janssen, K. (2008). A legal approach to assessing Spatial Data Infrastructures. *A Multi-View Framework to Assess SDIs*, 255.

Johnson, P. A., Sieber, R., Scassa, T., Stephens, M., & Robinson, P. (2017). The cost (s) of geospatial open data. *Transactions in GIS*, 21(3), 434–445.

Kamenica, E., & Gentzkow, M. (2011). Bayesian persuasion. *American Economic Review*, 101(6), 2590–2615.

Kochenderfer, M. J. (2015). *Decision making under uncertainty: theory and application*. MIT press.

Kok, B., & Van Loenen, B. (2005). How to assess the success of National Spatial Data Infrastructures. *Computers, Environment and Urban Systems*, 29, 699–717.

Krek, A. (2002). An agent-based model for quantifying the economic value of geographic information. Institute for Geoinformation, Vienna University of Technology.

Kremer, I., Mansour, Y., & Perry, M. (2014). Implementing the “wisdom of the crowd.” *Journal of Political Economy*, 122(5), 988–1012.

Kruse, J. B., Cromptvoets, J., & Pearlman, F. (2017). *GEOValue: The Socioeconomic Value of Geospatial Information*. CRC Press. Retrieved from <https://books.google.fr/books?id=p7A-DwAAQBAJ>

Lance, K., Georgiadou, Y., & Bregt, A. K. (2006). Understanding how and why practitioners evaluate SDI performance. *International Journal of Spatial Data Infrastructures Research*, 1, 65–104.

Lancry, P.-J. (1982). *Théorie de l’information et économie*. Economica.

Langlois, R., & Garrouste, P. (1997). Cognition, redundancy, and learning in organizations. *Economics of Innovation and New Technology*, 4(4), 287–300.

Loenen, B. (2006). *Developing geographic information infrastructures: The role of information policies*. IOS Press.

Loomis, J., Koontz, S., Miller, H., & Richardson, L. (2015). Valuing geospatial information: Using the contingent valuation method to estimate the economic benefits of Landsat satellite imagery. *Photogrammetric Engineering & Remote Sensing*, 81(8), 647–656.

Lundvall, B.-A. (1996). The social dimension of the learning economy.

Lundvall, B.-Å. (2002). The learning economy: challenges to economic theory and policy. *A Modern Reader in Institutional and Evolutionary Economics: Key Concepts*. Cheltenham: Edward Elgar, 26–47.

Macauley, M. K. (2006). The value of information: Measuring the contribution of space-derived earth science data to resource management. *Space Policy*, 22(4), 274–282.

Mansourian, A., Rajabifard, A., Zoj, M. J. V., & Williamson, I. (2006). Using SDI and web-based system to facilitate disaster management, 32, 303–315. <https://doi.org/10.1016/j.cageo.2005.06.017>

Mansourian, A., & Abdolmajidi, E. (2011). Investigating the system dynamics technique for the modeling and simulation of the development of spatial data infrastructures. *International Journal of Geographical Information Science*, 25(12), 2001–2023.

Mansourian, A., Rajabifard, A., Zoj, M. J. V., & Williamson, I. (2006). Using SDI and web-based system to facilitate disaster management. *Computers & Geosciences*, 32(3), 303–315.

Marschak, J. (1971). Economics of information systems. *Journal of the American Statistical Association*, 66(333), 192–219.

Marschak, J. (1972). Optimal systems for information and decision.

Masser, I. (2014). *Governments and geographic information*. CRC Press.

Masser, I., & Cromptoets, J. (2007). Building European spatial data infrastructures (Vol. 380). Esri Press Redlands, CA.

McCall, J. J. (1970). Economics of information and job search. *The Quarterly Journal of Economics*, 113–126.

McCall, J. J. (1970). Economics of information and job search. *The Quarterly Journal of Economics*, 113–126.

Meeks, W. L., & Dasgupta, S. (2005). The value of using GIS and geospatial data to support organizational decision making. In *Geographic Information Systems in Business* (pp. 175–197). Igi Global.

Michel, J.-B., Shen, Y. K., Aiden, A. P., Veres, A., Gray, M. K., Pickett, J. P., . . . others. (2011). Quantitative analysis of culture using millions of digitized books. *Science*, 331(6014), 176–182.

Milton, F. (1962). *Capitalism and freedom*. University of Chicago.

Mortensen, D. T. (1986). Job search and labor market analysis. *Handbook of Labor Economics*, 2, 849–919.

Nativi, S., Craglia, M., & Pearlman, J. (2013). Earth science infrastructures interoperability: the brokering approach. *IEEE Journal of Selected Topics in Applied Earth Observations and Remote Sensing*, 6(3), 1118–1129.

Nativi, S., Craglia, M., & Pearlman, J. (2012). The brokering approach for multidisciplinary interoperability: A position paper. *IJSDIR*, 7, 1–15.

Nativi, S., & Bigagli, L. (2009). Discovery, mediation, and access services for earth observation data. *IEEE Journal of Selected Topics in Applied Earth Observations and Remote Sensing*, 2(4), 233–240.

Nedović-Budić, Z., Pinto, J. K., & Budhathoki, N. R. (2008). SDI effectiveness from the user perspective. *A Multi-View Framework to Assess SDIs*, 273.

Niyato, D., Lu, X., Wang, P., Kim, D. I., & Han, Z. (2016). Economics of

Internet of Things: An information market approach. *IEEE Wireless Communications*, 23(4), 136–145.

Noucher, M., & Archias, C. (2007). L'évaluation des Infrastructures de Données Spatiales - Application de divers cadres d'évaluation au CRIGE PACA. In *Conference Geo-Evènement 2007*.

Nushi, B., Van Loenen, B., & Cromptvoets, J. (2015). The STIG: A new SDI assessment method. *International Journal of Spatial Data Infrastructures Research* 10, 2015.

O'Sullivan, C., Wise, N., & Mathieu, P.-P. (2018). The Changing Landscape of Geospatial Information Markets. In *Earth Observation Open Science and Innovation* (pp. 3–23). Springer, Cham.

Onicescu, O., & Botez, M. C. (1978). A Stochastic-Informational Approach to Input-Output Analysis. *Economic Computation and Economic Cybernetics Studies and Research*, 12, 19.

Onsrud, H. J., Campbell, J., & van Loenen, B. (2010). Towards Voluntary Interoperable Open Access Licenses for the Global Earth Observation System of Systems (GEOSS). *IJSDIR*, 5, 194–215.

Parker, G., & Van Alstyne, M. (2017). Innovation, openness, and platform control. *Management Science*.

Pearlman, F., Pearlman, J., Bernknopf, R., Coote, A., Craglia, M., Friedl, L., ... others. (2016). Assessing the socioeconomic impact and value of open geospatial information.

Pepe, M., Candiani, G., Pavesi, F., Lanucara, S., Guarneri, T., & Caceffo, D. (2018). SDI and Smart Technologies for the Dissemination of EO-Derived Information on a Rural District. In *International Symposium on New Metropolitan Perspectives* (pp. 44–50).

Porat, M. U. (1977). The information economy: definition and measurement.



Porter, M. E. (1981). The contributions of industrial organization to strategic management. *Academy of Management Review*, 6(4), 609–620.

Pwc. (2016). Study to examine the socio- economic impact of Copernicus in the EU. Retrieved from [http://www.copernicus.eu/sites/default/files/library/Copernicus\\_SocioEconomic\\_Impact\\_October\\_2016.pdf](http://www.copernicus.eu/sites/default/files/library/Copernicus_SocioEconomic_Impact_October_2016.pdf)

Quastler, H. (1956). Studies of human channel capacity. *Information Theory*, 366.

Rajabifard, A., Feeney, M. F., & Williamson, I. P. (2002). Future directions for SDI development. *International Journal of Applied Earth Observation*, 4, 11–22.

Ranga, M., & Etzkowitz, H. (2013). Triple Helix Systems: An Analytical Framework for Innovation Policy and Practice in the Knowledge Society. *Industry and Higher Education*, 27(3), 237–262.

Repo, A. J. (1989). The value of information: Approaches in economics, accounting, and management science. *Journal of the American Society for Information Science*, 40(2), 68–85.

Rey-Valette, H., Maurel, P., Miellet, P., Sy, M., & Pigache, L. (2017). Mesure les impacts des infrastructures de données géographiques (IDG) et des observatoires. Application à l’IDG SIG-LR. *Revue Internationale de Géomatique*, 3, 375–397.

Richter, C., Miscione, G., & Georgiadou, Y. (2010). Conceptualizing people in SDI literature: Implications for SDI research and development. *IJSDIR*, 5, 286–325.

Roche, S. (2016). Geographic information science II: Less space, more places in smart cities. *Progress in Human Geography*, 40(4), 565–573.

Roche, S. (2017). Geographic information science III: Spatial thinking, interfaces and algorithmic urban places--Toward smart cities. *Progress in Human Geography*, 41(5), 657–666.

Roche, S., Nabian, N., Kloeckl, K., & Ratti, C. (2012). Are ‘smart cities’

smart enough. In *Global geospatial conference* (pp. 215–235).

Rochet, J.-C., & Tirole, J. (2003). Platform competition in two-sided markets. *Journal of the European Economic Association*, 1(4), 990–1029.

Rodriguez Pabon, O. (2005). *Cadre théorique pour l'évaluation des infrastructures d'information géospatiale*. Ph.D. Thesis, Département des Sciences Géomatiques, Faculté de Foresterie et de Géomatique, Laval University, Québec.

Rothschild, M., & Stiglitz, J. (1976). J.(1976), Equilibrium in competitive insurance markets: an essay on the economics of imperfect information. *The Quarterly Journal of Economics*, 90.

Savage, L. J. (1954). *The foundations of statistics*. Dover Press, New York.

Scott, G., & Rajabifard, A. (2017). Sustainable development and geospatial information: a strategic framework for integrating a global policy agenda into national geospatial capabilities. *Geo-Spatial Information Science*, 20(2), 59–76.

Senn, J. A. (1990). *Information systems in management*. Wadsworth Publ. Co.

Shannon, C. E., & Weaver, W. (1949). *The mathematical theory of communication* (Urbana, IL. University of Illinois Press IL.

Shannon, C. E. (1948). A mathematical theory of communication. *Bell System Technical Journal*, 27(3), 379–423.

Shaw, J., & Graham, M. (2017). An informational right to the city? Code, content, control, and the urbanization of information. *Antipode*, 49(4), 907–927.

Sims, C. A. (2003). Implications of rational inattention. *Journal of Monetary Economics*, 50(3), 665–690.

Spence, M. (1973). Job market signaling: *Journal of Economics*. August.

Steiniger, S., & Hunter, A. J. S. (2012). Free and open source GIS software for building a spatial data infrastructure. In *Geospatial free and open source software in the 21st century* (pp. 247–261). Springer.

Stedler, D., Rajabifard, A., Williamson, I., & others. (2008). Evaluation and performance indicators to assess spatial data infrastructure initiatives. *A Multi-View Framework to Assess SDIs*, 193.

Stigler, G. J. (1961). The economics of information. *Journal of Political Economy*, 69(3), 213–225.

Stigler, G. J. (1962). Information in the labor market. *Journal of Political Economy*, 70(5, Part 2), 94–105.

Stiglitz, J. E. (1985). Information and economic analysis: a perspective. *The Economic Journal*, 95(Supplement), 21–41.

Stiglitz, J. E. (2002). Information and the Change in the Paradigm in Economics. *American Economic Review*, 92(3), 460–501.

Stiglitz, J. E. (1975). The theory of "screening," education, and the distribution of income. *The American Economic Review*, 65(3), 283–300.

Stiglitz, J. E. (1987). The causes and consequences of the dependence of quality on price.

Stiglitz, J. E. (2000). The contributions of the economics of information to twentieth century economics. *The Quarterly Journal of Economics*, 115(4), 1441–1478.

Stiglitz, J. E., & Weiss, A. (1981). Credit rationing in markets with imperfect information. *The American Economic Review*, 71(3), 393–410.

Stokey, N. L. (1989). *Recursive methods in economic dynamics*. Harvard University Press.

Taneva, I. A. (2016). Information design. Working paper.

Theil, H. (1967). Economics and information theory.

Tonneau, J. ., Lemoisson, P., Coudel, É., & Maurel, P. (2017). Les observatoires territoriaux: Des outils de la société de la connaissance? *Revue Internationale de Géomatique*, 27(3), 335–354.

Toomanian, A., Mansourian, A., Harrie, L., & Rydén, A. (2011). Using balanced scorecard for evaluation of spatial data infrastructures: a Swedish case study in accordance with INSPIRE. *International Journal of Spatial Data Infrastructures Research*, 6, 311–343.

Tulloch, D., & Harvey, F. (2007). When Data Sharing Becomes Institutionalized: Best Practices in Local Government Geographic Information Relationships. *Journal of the Urban and Regional Information Systems Association*, 19(2), 51–59.

Van Loenen, B., & van Rij, E. (2008). Assessment of Spatial Data Infrastructures from an organisational perspective. A Multi-View Framework to Assess Spatial Data Infrastructures. Melbourne: University of Melbourne, 173–192.

Vancauwenberghe, G., Valeckaite, K., Van Loenen, B., & Donker, F. W. (2018). Assessing the Openness of Spatial Data Infrastructures (SDI): Towards a Map of Open SDI. *IJSDIR*, 13, 88–100.

Vandenbroucke, D., Dessers, E., Cromptvoets, J., Bregt, A. K., & Van Orshoven, J. (2013). A methodology to assess the performance of spatial data infrastructures in the context of work processes. *Computers, Environment and Urban Systems*, 38, 58–66.

Vandenbroucke, D., Janssen, K., & Van Orshoven, J. (2008). INSPIRE State of Play: Generic approach to assess the status of NSDIs. A Multi-View Framework to Assess SDIs, 145.

Vernier, F., Miralles, A., & Tonneau, J. . (2017). Vers un observatoire agro-environnemental des territoires: Un système décisionnel multi-échelle

pour le bassin de la Charente. *Revue Internationale de Géomatique*, 27(3), 399–422.

Wade, M., & Hulland, J. (2004). The resource-based view and information systems research: Review, extension, and suggestions for future research. *MIS Quarterly*, 28(1), 107–142.

Weisbrod, B. A. (1964). Collective-consumption services of individual-consumption goods. *The Quarterly Journal of Economics*, 78(3), 471–477.

Wilson, R., & others. (1978). Information, efficiency, and the core of an economy. *Econometrica*, 46(4), 807–816.

Zwirowicz-Rutkowska, A. (2017). A multi-criteria method for assessment of spatial data infrastructure effectiveness. *Earth Science Informatics*, 10(3), 369–382.





# Chapter 3

## Summary of Papers

### **3.1 Paper I - Spatial Data Infrastructure Management: A two-sided market approach for strategic reflections**

The recognition of a spatial data infrastructure (SDI), as a two-sided market, leads the way to an innovative approach for analyzing the strategies used to bring two groups of users into interdependent markets. The literature derived from the recent industrial organization is rich in theoretical models, aiming at the study of price structure and product design, which maximize the participation of the groups, the profits of the firms, and the value created for the entire ecosystem.

The current paper interprets and adopts the theoretical model of the two-sided market in order to fit the case of a SDI. The purpose is to highlight the relevance of a two-sided approach for analyzing a SDI dynamics. The focal research question is how spatial data infrastructure, through a platform management process, can transition from a government-funded entity to a self-sustaining operation. The analysis relies on the specific case of the GEOSUD platform, focusing on strategies ensuring the interest of image-based application developers and satellite image users. The results show that the theory of two-sided markets brings complementary elements for SDI development strategies, by proposing a framework of reasoning, which not only allows for a better understanding of the outflows already established,



but also provides tools to accompany the strategic reflection of public institutions and entrepreneurs, who tend to support the uses of data and services derived from remote sensing.

### **Paper I Contribution**

The main contribution of the paper is in presenting an innovative approach on how spatial data infrastructure, through a platform management process, can transition from a government-funded entity to a self-sustaining mechanism. The usual problem faced by firms is how to get customers to buy its products or services. By considering the SDI as a platform management concept, the question remain how to deliver value to one side while taking into consideration the participants on the other side of the platform. With the massive emergence of platforms, several SDIs companies are competing to establish their appropriate business model. This paper offers a framework though which, a SDI can figure out how to get both sides on board of its platform. In addition, the contribution for the practice is in explaining the ability of a SDI, while providing image-based applications on their own or through a network of developers, to serve multiple actors and fill many functions.

## **3.2 Paper II - How much would you pay for a satellite image? Lessons learned from a French Spatial Data Infrastructure**

Satellite imagery is increasingly used as a main tool for land use analysis and planning. A clear understanding of the value of these images is critical for justifying the large investments made in this sector and supporting policies aiming for the development of these resources and their sustainability in the long run.

In this article, we examine the economic value of high-resolution satellite images as perceived by the direct users. Drawing on a French spatial data infrastructure, whose direct users are mostly from public bodies, a contingent valuation method was used to evaluate their willingness to pay for the satellite imagery. A clear understanding of the value of these images is critical for justifying the large investments made in this sector and supporting policies aiming for the development of these resources and their sustainability. We analyzed the differences in the stated values according to the various types of users. A survey among the totality of the registered users on the GEOSUD platform found a mean value of 1696 Euros for a 60x60 sq.km high-resolution image. Charging this amount, leads to an acceptance rate of 43%, with 57% of users no longer acquiring imagery. Furthermore, we noticed significant differences among the value for images within the sectors. In addition, the results show that users are more willing to pay for a fixed yearly amount in order to join a high-resolution pooling system, than to be priced per image. Hence, we recorded a mean membership value of 3022 Euros, with 12% of users accepting to pay up to 15,000 Euros as a membership fee for joining such a device. For the 7500 HR images available on the platform, the total user benefits amount to some 12.7 Million Euros.

### **Paper II Contribution**

The novelty results from applying the widely used contingent valuation method within the framework of a spatial data infrastructure (SDI) in order to value specific spatial data and their benefits. The direct users constitute a first link between the SDI and the wider community of beneficiaries of image-based products and services. Hence, by estimating the value that these users draw

directly from the HR satellite images, this research fills part of the gap that exists between the users' needs for justification materials and the investors' exigencies on the availability of this technology on the market. The results obtained could be used to enlighten the design of a future pricing of satellite imagery, aiming at sustaining the financing of these services. Additionally, it may stimulate the public awareness about future decision-making related to the Earth observation field and more particularly the satellite images. On the other hand, the main contribution of the paper for the practice comes through different levels. In fact, the value attributed to satellite information in a context of SDIs, reflects the creation of a common resource by the infrastructure, characterized as an "informational asset". In an economy increasingly focused on intangible and behavioral economics, this informational asset is becoming increasingly important, whether at a macroeconomic dynamic level or on behavior studies of consumers and agents. It is somehow linked to a notion of information management at a territorial level. The territories, seen as a geographical scale of the economic system, have complex economic development processes. Finding the right information, with a sufficient quality and at the right scale, highlights the organization set up to acquire this information, manage it and exploit it within a sphere of the territorial decision.

### **3.3 Paper III - Making the most of “heterogeneous” information by using Blackwell and Entropy theories: A decision support policy applied to forests’ clear-cut control**

In this paper, we elaborate a decision-making policy in order to help decision-makers model their decision in light of an additional information received. We provide insights of the theoretical value of information through an original approach that articulates between two existing theories: the classic method of Blackwell and the Entropy theory.

Drawing on the satellite imagery as an additional source of information provided by a French spatial data infrastructure (SDI), a clear-cutting control case study is presented. The control of clear-cutting occupies a center place in forest management activities. In order to perform an efficient control operation, the uncertainty regarding the decisions to be taken need to be minimized. The results show that the information structure through the SDI signals has the most significant information power. In addition, a maximum of two information structures can be compared when applying the Blackwell Theorem. However, while using the Entropy approach, a comparison of several information structures can be performed. The Entropy assumptions are easier to apply by knowing solely the prior and posterior probabilities. These drops several mathematical constraints about the actions’ payoffs under the different states of nature that makes the Blackwell approach more complicated. Reducing the uncertainty in a decision-making context related to forest management, provides greater opportunities for improving productivity and saving time and money.

#### **Paper III Contribution**

The main contribution of this paper is in presenting an original approach that articulates between two existing theories, in order to help and lead a decision-maker to model his decision in light of a received information. While decomposing the decision-making process into many steps, more consistent with one another, this research provides a framework to bring multiple decision elements together and expand their implications in a unified

context. Applying the Blackwell and Entropy theories to analyze a two period's decision-making problem may contribute to understand the flexibility of the available choices and the optimal actions to be taken. It is important to note that these concepts are applied for the first time, with a particular focus on the satellite imagery as an additional source of information. It offers a tool to overcoming the complexity problems, usually present in the decision-making cases. Based on the empirical facts and on the existing theory, the paper seeks to fill a gap between the previous researches in the field of value of information and the decision-making problems under several periods. It provides an additional common basis, to better understand the complex choices the decision-makers face, illustrating how the information might be used to respond to a variety of needs. The environmental consequences related might be of high importance, reflecting the integration of a relevant decisional information into a socioeconomic framework.

### 3.4 Paper IV - Identifying the economic impacts of a Spatial Data Infrastructure

The purpose of this paper is to assess the socio-economic impacts of satellite-based Spatial Data Infrastructures (SDIs) on public environmental and territorial policies. We rely on the GEOSUD SDI located in Montpellier. A detailed analysis of the geospatial information acquired from the GEOSUD SDI allowed examining the impacts related to the SDI ecosystem.

In a second step, some of these impacts are assessed in the case of monitoring the clear-cut forest management plans in France. The use of geospatial information provided via a SDI, generates significant efficiency gains for the public services in terms of productivity and time savings. The results shows that, for each Euro invested in the GEOSUD SDI, the added-value created by the initial data suppliers and the GEOSUD SDI, amounts to 0.93 Euros, while the productivity gains for the French administrative entities responsible of the clear-cutting operations in in metropolitan France “DDT” & “DRAAF” (*direction départementale des Territoires & direction régionale de l'alimentation, de l'agriculture et de la forêt*) are up to 24 Euros. Although this type of approach presented difficulties in measuring both complex and dynamic changing facts, it could be reproduced within other SDIs ecosystem in order to elaborate basic impacts. The proposed methodology is intended to be exploratory and must be replicated and progressively standardized so as to accompany the development of the SDIs. A change, describing the dynamic evolution in the economic models of these infrastructures, the scarcity of public subsidies and the increasing competition between the various information sharing platforms according to the variety of domains and scales.

#### Paper IV Contribution

The main contribution of this paper relies in crossing two complementary approaches within a single framework. The study has been conducted with both an economic and management reasoning in terms of analyzing the value chain of the satellite information, and addressing its collective architecture at the scale of a community of practices. While the methodology used allowed to estimate certain impacts related of the production and the use of the geospatial information, it highlighted the role of a management ecosystem

converting a tacit knowledge into a more explicit context. The application chosen comes to describe the innovation processes generated by GEOSUD spatial data infrastructure. The pooling and coordination benefits resulting, allow to co-build knowledge, leading to new products and processes, or even new standards. The GEOSUD SDI case study, opened up new fields of research in a context where the development of public and private partnerships along with the digital economy tends to reduce the borders within these sectors.

### **3.5 Paper V - Examining market stability using the Records theory: Evidence from French Spatial Data Infrastructures**

In this paper, we study the effect of extreme demands for a particular type of geographical information, the satellite images. Drawing on two French spatial data infrastructures (SDIs) GEOSUD and PEPS, we examine the shifts occurring on different satellite imagery schemes: the very high resolution (HR) images through GEOSUD/the Landsat (U.S.), Sentinel (Europe) and SPOT (France) images through PEPS.

We analyze the market stability through these SDIs, and evaluate the probability of future records, by using the Records theory. The results show that the HR images demand through the GEOSUD platform, for which the classical i.i.d model fits the most, is somehow stable. Moreover, the Yang-Nezvorov model fits to the Landsat data, due to more records concentrated beyond the first observations. The Landsat demand is the less stable out of the other three satellite images programs, and the probability of having a record in the coming years is the highest. In addition, while the sentinel demand seems to be more stable in both the short and long run, no record has been detected for the SPOT images, for which the demand through PEPS is mainly based on non-active archive images.

#### **Paper V Contribution**

The contribution of this paper relies in applying the recent advances of the well-known Records theory to the Geospatial science field. The paper offers a new approach for advancing the Geospatial science, through examining the satellite images market stability and model its fluctuations through this theory. The related literature has not clearly addressed how the EO users' demand can reveal part of the market risk. The time series of the satellite images demand are usually non-i.i.d, and the assumption of the type of distribution is complex. The novelty also relies in allowing the Geospatial community to maintain additional processing elements, in order to enrich their market policy development, by bringing an innovative perspective to other possible risks and facts that could be present while considering the Geospatial markets. The cases of the GEOSUD and PEPS SDIs, for which



the analysis was performed, serve as relevant illustration for the proposed approach. Through the framework presented, the common interest between a grounded mathematical modeling tool and the usage of geographical information emerges, with a focus on the market forecasting analysis techniques. The record theory used, helps overcoming the complexity of others common classical models and alleviates the use of multiple statistical tests that make the classical econometric approaches quasi-impossible to be entirely verified. The methodology used in this study could be reproduced on larger scales such as the large EO observation programs and other types of Geospatial data, where the access and demand conditions differ and the amount of data is largely greater with an impact consequently bigger.





## Chapter 4

# Spatial Data Infrastructure Management: A Two-sided Market Approach for Strategic Reflections

**Article:** Jabbour, C., Rey-Valette, H., Maurel, P., & Salles, J.-M. (2019). Spatial data infrastructure management: A two-sided market approach for strategic reflections. *International Journal of Information Management*, 45 (JIF = 5.06) (Published).

## 4.1 Introduction

In the past forty years, spatial data infrastructures (SDIs) have been developed all over the world, with the aim of improving the access to using and sharing geographic data, in both public and private sectors (ANZLIC, 1996; 2000; FGDC, 1996, 2002; European Commission, 2007; Geoconnections, 2012). In 1993, the U.S. National Research Council defined an SDI as “*a framework of technologies, policies, and institutional arrangements that together facilitate the creation, exchange, and use of geospatial data and related information resources across an information-sharing community*”. The major objectives of the SDI initiatives were to promote economic development, to stimulate better governance and to foster environmental sustainability (Masser, 1998). SDIs facilitate and coordinate the exchange and sharing of spatial data. They subsume technology, systems, standards, networks, people, policies, organisational aspects, geo-referenced data, and delivery mechanisms to end users (Cromptoets et al., 2004; Li et al., 2015). In fact, the lack of financial resources addresses the sustainability of these infrastructures, as they depend mainly on subsidies (Giff & Coleman, 2002). Investors’ support for SDIs is often limited given the lack of local capacities, the end goals of funders and the competition in the market. The financiers are demanding methodologies to be put in place, to justify the implementation of SDIs before additional funds can be accessed (Stewart, 2006; Giff & Cromptoets, 2008). Thus, it is necessary for a SDI, in order to meet the long-term viability, to adopt and design the appropriate business model that suits its needs (Akbar & Bell, 2005; Rodriguez, 2005).

The purpose of this paper is to highlight the relevance of a two-sided market approach for analysing a SDI dynamics. The focal research question is how spatial data infrastructure, through a platform management process, can transition to a self-sustaining funding mechanism. Recently, the concept of ‘platform’ has been developed by several management scholars (Kogut and Kulatilaka, 1994; Sawhney, 1998; Parker & Van Alstyne, 2005; Eisenmann, 2008; Hagi, 2009) and has been often associated with new forms of industry collaboration and innovation, as well as new forms of competitive dynamics (Gawer, 2009). Although the management of digital information platforms has received lately an increasing attention (Tiwana et al., 2010; Eaton et al., 2015; Anderson et al., 2013; Ceccagnoli et al., 2012; de Reuver et al., 2017; Rolland et al., 2018; Song et al., 2018), researches on spatial data infrastruc-

ture management are still limited (Grus et al., 2011; Macharis & Cromptvoets, 2014). The interest of this research is in understanding how a SDI through its platform, can ensure continuous interaction between the different components, represented by the developers of spatial data-based applications and the potential users of such applications and data. These insights allow us to go far beyond the standard strategies that rely solely on the product design or technology, by establishing a management of interactions that occur across common boundaries (Boudreau & Hagi, 2008; Boudreau, 2010; Thomas et al., 2014). As a process theory contribution (Van de Ven, 2007), a two-sided market conceptual framework applied to the spatial data infrastructure field will be investigated. To the authors' knowledge, this work is the first application of the concept of two-sidedness in SDIs. While the objective of a SDI is to attain a self-sustaining mechanism in order to meet the long-term viability, analysing this particular infrastructure as a two-sided market through a platform ecosystem approach, leads to think of this transition toward a self-sustaining operation in an original way. Three elements fundamentally characterise this type of market. First, the necessary simultaneous presence of two distinct groups of users who need each other in some way and who rely on the platform to intermediate transactions between them. Second, the existence of indirect externalities across the groups of users (Parker et al, 2016). Third, the non-neutrality of the price structure, as highlighted by Rochet and Tirole (2003). Credit and debit cards, newspapers, magazines and video game consoles are products sold on two-sided markets (Evans & Schmalensee, 2005; Rysman, 2009). In addition, job seekers and employers through online recruitment, players and developers through networked video games, home buyers and home sellers through real estate association's platforms are examples of how two separately delivered values can create markets that cannot exist without the participation and combination of both sides (Zingal & Becker, 2013).

In order to give a more explicit view and develop concrete arguments, the analysis is based on a specific case study: the GEOSUD SDI in France, specialized in satellite imagery for Earth observation, over a period of nearly 11 years (2007-2018). The assessment of SDIs is complicated due to their dynamic, multi-faceted, and constantly evolving nature (Cromptvoets et al., 2008; De Man, 2006; Georgiadou et al., 2006, Cromptvoets et al., 2010). The theoretical contribution comes to meet the dynamic capabilities concept (Maritan, 2001; Rindova & Kotha, 2001; Sharma, & Vredenburg, 1998;

Snow, 2004), and the development of new propositions in constructing better sets of relationships continually adapting over time (Pablo et al., 2007; Tripas & Gavetti, 2000). The innovative approaches for the creation of services are translating the technological advances into a more productive economic activity (Chuang & Lin, 2015; Mamonov & Triantoro, 2018). However, the lack of well-determined boundaries between producers and users of information enlarge the problem of value capture and pricing of the SDI data (Cromptvoets et al., 2004; Grus et al., 2007; Genovese et al., 2009; Longhorn & Blakemore, 2008). In such situations, where linkages are poorly defined, case studies can help to develop the scientific field further (Barr, 2004), by presenting description of the basic elements of a theory (Eisenhardt, 1989a). It can develop a ground understanding of new relationships, give clear descriptions of complex phenomena (Eisenhardt & Graebner, 2007), and allow to get closer to theoretical constructs by illustrating the underlying mechanisms (Sigglekow, 2007). SDIs based on satellite imagery are set to become essential players in the information society (Smith, 2011). As described in the report on the Copernicus Downstream Sector and User Benefit (PWC, 2016), “*the Earth observation market is more and more dependent on the Geographic Information System market*”. Concretely, neither a user of images or derived products, nor a developer of software or applications is interested in the satellite imagery, if the other one is not. It is necessary to interpret it from a dynamic perspective, initiated by the installation of the platform, with the images as basic fuel, then go to the treatment services and applications, which will enrich themselves further with the emergence of new needs. Satellite operators and SDI platforms are examining new revenue-producing models for developing space-related products and services (Denis, 2015; Onoda & Young, 2017).

GEOSUD has some specificities that make it unique compared to other SDIs. While it pursues initially pooling the access to satellite imagery, especially that with very high spatial resolution, GEOSUD is adopting a product strategy that supports its platform development. It aims to serve both the scientific community and the public actors (State, local authorities), and their private providers as well as the research and development companies outside commercial activities. Initiated and funded primarily by the academic world and placed under public governance, this SDI also aims to develop added value products and services based on the “triple helix” concept of open innovation between academic, public, and private sectors (Ranga & Etzkowitz,

2013).

The current research presents a detailed account of five important events, in which GEOSUD proceeded with the management of its platform towards a two-sided market, focusing on the continuous coordination between the users and the developers. Based on these empirical facts, on the existing theory and on the emerging context of spatial data infrastructure sustainability (Macharis & Crompvets; 2014; Pwc, 2016), we elaborated propositions to better understand the complex choices SDIs face when managing remote sensing platforms and to accompany scholars' existent views and reflections on SDI management practices in order to meet long-term viability. The remainder of the paper is organised as follows: Section 2 presents a set of literature on SDI business models and a review on success factors in multi-sided platforms. Section 3 integrates the concept of a two-sided market applied to a SDI platform, for understanding how a SDI is connected to the satellite images and the image-base application markets. Section 4 presents the case study of GEOSUD's management of their platform with the introduction of the empirical context. The events of the empirical analyses are detailed in Section 5. Section 6 suggests propositions based on the empirical analysis coupled with the existent literature on two-sided markets. Finally, Section 7 offers concluding remarks to the paper.

## 4.2 Background literature

The emergence of platforms is affecting most industries today, from products to services (Gawer, 2009). The relevant academic literature is very rich with studies, extensively exploring the success factors of two-sided or multi-sided markets through reducing transaction costs (Evans and Schmalensee, 2007), promoting better learning (Caffrey et al., 2002), lowering production costs (Bremmer, 1999; 2000), facilitating exchange of value (Zirpoli & Becker, 2008), gaining flexibility in product design (Brusoni & Prencipe, 2006), increasing quality of products (Ghosh & Morita, 2008), and providing incentives for users (Farrell & Katz, 2000), etc. However, these factors depend on several criteria that a platform must take into consideration when designing its own architecture, in order to stimulate and capture value from external and complementary innovation (Eisenmann & Carpenter, 2004; Gawer & Henderson, 2007). Many studies focus on strategies adopted by platforms



that already exist, such as the need to adapt to changing tastes and technologies (Davis & Murphy, 2002; Clements & Ohashi, 2005), to maintain a coherent government approach (Gawer & Cusumano, 2002), and to achieve optimal pricing (Rochet & Tirole, 2006), etc. Parker et al. (2016) identifies eight distinct strategies within the literature of successful implementations of platforms and each provides a different view on how to launch a platform and attract different kinds of users. These points are revealed through several studies: the role of the users critical mass (Fath & Sarvaryi, 2003; Caillaud & Jullien, 2003; Hagiu, 2006; Gawer & Cusumano, 2008), the completion between multiple sides (Lee & Mendelson, 2008; Parker & Van Alstyne, 2008), the level of openness of a platform (West, 2003; Gawer & Henderson, 2007; Boudreau, 2008; Eisenmann, 2008; Parker & Van Alstyne, 2008), and the decisions on design and intellectual property (Iansiti & Levien, 2004). In comparison with traditional business models, the network effects that arise through the platform represent an emergent economic phenomenon based on technological innovation and supply of economies of scale, overpassing the initial boundaries of a firm (Hung et al. 2011; Esterhuizen et al., 2012). This can lead to better production conditions, by aggregating unorganized markets and dispersed individuals and organisations (Parker et al., 2016). Thus, when such effects are present, the platform is driven towards competitive success (Shapiro and Varian, 1999). Hence, the tendency of a service or idea to rapidly circulate attracting users to a wider network increases the chances of a matching (Chesbrough, 2003) by unlocking new sources of value creation and giving greater level of freedom between various members (Parker et al., 2016).

Several studies focused on the analysis of SDI business processes, giving a deeper insight on how SDI components are integrated, and the way they contribute to these processes. De Montalvo (2003) analysed the behavioural approach to spatial data sharing. Tulloch and Harvey (2007) analysed the SDI at the local level within the context of a network of producers and users sharing data. Vandenbroucke et al. (2009) adopted a Social Network Analysis (SNA) focusing on the characterisation of SDI network, the flow between the stakeholders, and the behaviour of individual organisations of the network. In order to plan and finance any type of organisation, the choice of funding models depends on a number of factors, which decision-makers must consider in terms of the nature of the product generated, scale of production and organisational structure (Teece, 2010). The study: *Financing the NSDI:*

*The National Spatial Data Infrastructure* (Urban Logic, Inc., 2000) detailed possibilities on how to harmonise resources for geospatial data infrastructure. In addition, the studies developed by Giff & Coleman in 2002 and 2005 provide a comparative analysis of multi-source financing models between SDI's in developed countries and in emerging and transition economies. Lessons learned from long-term funding strategies, emphasising the importance of collaboration are explained in detail in the “*Report of the Permanent Committee for Geospatial Data Infrastructure of the Americas*” (2013).

The logic is to rely on traditional methods and then move on to a dynamic platform structure that can ensure long-term sustainability. Without detailed and substantial studies on how remote-sensing SDIs shape the interaction between the users of satellite information and application developers, it is difficult to understand how platforms managers design their platform, position it in a strategic context for a value creation and target the interests of each of the types of users.

### 4.3 Spatial Data Infrastructures as two-sided market

Platforms providing easy access to satellite imagery as well as to multiple tools for basic image processing are expected to play a major role in the coming decade in the market of Earth observation data and products (Pwc, 2016). Developing the use of satellite imagery brings together scientific, public and private actors in a logic of complementarity (Ranga et al., 2013) or even crowdsourcing (Sun et al., 2015). Pooling the databases and the tools can irrigate an entire ecosystem downstream and makes it possible to pass from images to intermediate products, applications or even products that meet the needs of application developers. As table. 4.1 summarises, we next elaborate the elements of the two-sided markets: an intermediary platform grouping satellite imagery and the image-based applications' markets, in addition to the concepts of the network externalities and the non-neutrality of prices.

### 4.3.1 The satellite imagery market

Belward and Skolen (2015) analyse the development of remote sensing and its applications in various fields, which is expected to continue further due to the increased availability of satellites as primary sources and the emergence of drones. However in the absence of public subsidies or investment justifications, even as the use of satellite imagery is increasing all areas, its large-scale adoption remains hampered by several barriers (Craglia et al., 2003, Vandenbroucke & Janssen, 2008). Satellite images, in addition to economic and organisational difficulties, hide non-technological barriers that are even more challenging than the technological ones: the complex organisational procedures, the huge data volume, the high cost for this data, the copyright privacy and other limitations for use and reuse (Bernard et al., 2005; Denis et al., 2017; Harris & Baumann, 2015; Kok & Van Loenen, 2005).

### 4.3.2 The image-based applications market

Image-based applications vary depending on the type of data and offer a large variety of use on a regional and national scale (Tralli et al., 2005). By moving from the first to the second generation of SDIs, data evolved from its role as a key driver for development to target the needs of the users through its direct use or through data applications (Rajabifard et al., 2002). Satellite-based observations are in fact at the heart of geo-spatial market (Pwc, 2016). Developing image-processing methods that could be placed in the hand of developers in order to produce thematic products and software applications, combining satellite imagery with other types of data, is one of the main objectives of SDIs in order to create useful information for the end users.

### 4.3.3 Network externalities & Non-neutrality of prices

The concept of network externalities (Katz & Shapiro, 1985) is at the heart of the two-sided market concept (Rochet & Tirole, 2006). If these externalities are positive, the value of a participant in a group entering the market increases with the number of participants in the other group. The SDI platform must interest both users and developers. For a user of satellite images, it is interesting to register on a platform that offers a set of tools, features and variety of applications. The same applies to developers. The optimal

price structure depends on the strength of the indirect network externalities between the participants on both sides (Armstrong, 2006). If we consider a platform that sells two complementary products, when the price of the first one decreases, demand for the other increases. However, by decreasing the price of the first, the firm takes a lower margin of profit on this product, but increases its sales of both products because of their complementarity. Given this point, an appropriate pricing in the case of an imagery-based SDI, consists of proposing the satellites images at a low price, while asking for royalties on added value products developed through the platform. Platforms managers must be attentive to the cross-side network effects linking the two markets to each other, and the same side effects between the users or the developers themselves on a same market side, in order to make appropriate pricing. Because of network effects, successful platforms obtain increasing returns to scale, and the value grows as the platform matches demand from both sides, affecting the other side's growth and willingness to pay. The tariff strategies used by the intermediary to maximise market participation and hence its profits are important points (Caillaud & Julien, 2003; Kaiser & Wright, 2006). The prices charged may be lower than the marginal cost on one side of the market and above the marginal cost of the other. This characteristic is reflected in the non-neutrality of the price structure, or asymmetric price structures: one side benefits from low prices, called subsidy-side, and the other faces high prices, money-side. Firms in two-sided markets can choose the prices they charge and thus influence the volume of transactions. The search for the optimal price structure for maximising profits is both a theoretical issue and an informational challenge (Hagiu, 2009; Weisman, 2010).

A key distinction of SDIs from other two-sided markets is the fact that they facilitate innovation in the creation and design of new products and services. This innovation creates a variety of end-uses which may not be known in advance in other two-sided markets. In addition, the conditions and business choices that favor a SDI platform, may differ from those that favor other markets. Due to the platform dynamics that emerge, with the transformation in the nature of services and end-products, a SDI can benefit from the innovation on complements as well as from the competition at the overall technological and ecosystem level. Maintaining strong interdependence, while providing business incentives through a wide array of innovative key factors, can contribute upon the SDI the platform in determining solu-

tion opportunities that may be absent in other markets. In fact, increasing the level of services within an innovation processes exposes the SDI platform to a different set of users within a wider level of needs. Therefore, the SDIs platform offer the possibility of its services, the image-based applications, to evolve simultaneously with the platform. Thus, when looking for a business model regarding SDI, it is interesting to go beyond traditional funding schemes by emphasising on how SDIs evolve through a dynamic context and provide insights allowing users to exchange between them. It is important to look at how a SDI may “*pull, facilitate and match*” (Parker et al., 2016). The platform pulls the satellite image users, facilitates their tasks by providing them with tools and APIs (Applications Programming Interface) and matches users and developers by using their information to connect them in ways they will find mutually rewarding. Although satellite images cannot be dissociated from related applications (Pwc, 2016), the literature on SDI platforms has not addressed clearly how these two main components can be linked through a well-defined business model (Crompvoets et al., 2004, De man, 2008; Crompvoets & Georgiadou, 2011). While several studies have examined SDI business processes, they paid less attention to the dynamic changes occurring through a remote sensing platform (Kruse et al, 2018). Hence, focusing on the SDI as a two-sided market (fig. 4.1) may contribute to new strategic reflections when we take into consideration the users of satellite images and the image-based application developers as creators of value. This will help us better to understand how a remote sensing platform can structure and coordinate the interactions between these two sides and how they establish mechanisms towards a sustainable business model.

Concept	Definition	Processes
Satellite imagery Image-based applications	Images taken from satellites Image processing tools, thematic products and services based on satellites' images	Identify the markets: examine availability and check access conditions
Network externalities	The effects that one user of a good or service has on the value of that product to other people (Katz & Shapiro, 1985; Rochet & Tirole, 2003)	Detect existence through subscriptions and interactions between the users and the developers
Non-neutrality of prices	Asymmetric pricing on different sides of a market (Caillaud & Julien, 2003; Rochet & Tirole, 2006; Hagiu, 2009)	Examine tariffs imposed through the platform: usage and membership fees
Platform management	The complementarity and interaction between satellite imagery end users and image-based application developers	<i>Pull:</i> A SDI may create a base of image users to establish a developer community <i>Facilitate:</i> A SDI may offer facilities to image users to attract more developers <i>Match:</i> A SDI may leverage from its image-based application services to enlarge its image users' base

Table 4.1: A two-sided market approach for Spatial Data Infrastructures (SDIs)

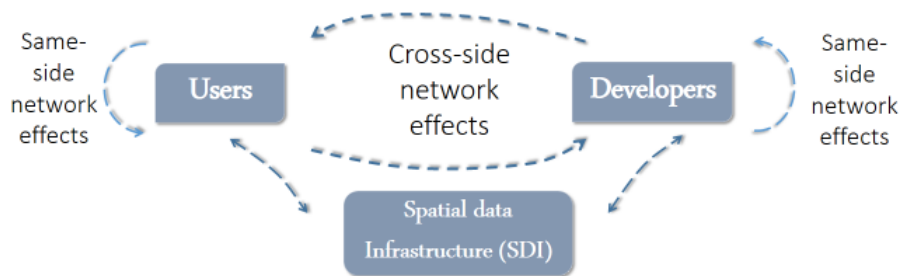

Figure 4.1: The two-sided market for spatial data infrastructure

## 4.4 Case study: the GEOSUD SDI

In order to give a more explicit view and develop concrete arguments, the analysis will be based on a specific case study: the GEOSUD<sup>1</sup> SDI in France and its integration in a wider national network, the Theia Land data centre<sup>2</sup>; GEOSUD and Theia form a unique SDI aiming to progressively build-up an ecosystem of innovation in the field of satellite imagery for Earth observation. Following the increasing number in case study researches (Barr, 2004; Gephart, 2004; Bartunek, Rynes, & Ireland, 2006), many authors approached its potential in making a theoretical contribution (Ridder et al., 2009; Whetten, 1989) through refining and reorienting existing theories (Shah, S. K & Corley, K. G, 2006). Our analysis comes more in adequacy with the interpretive paradigm (Burrell & Morgan, 1979) providing a deeper understanding of how the concept of the two-sided market is possible through a longitudinal SDI management. It is important to note the distinctive characteristics of our approach: GEOSUD/Theia SDI covers an 11-year period (2007-2018); it includes analysis of past and happening events at the same time the study was performed; it groups multidisciplinary participants across different sites (Merriam, 2016; Yin, 2017). GEOSUD has already had a significant positive effect on the availability of geospatial data in France, especially with its aim to pool the access to very high spatial resolution satellite imagery and develop its use. In addition to the recent literature, seminars and international conferences<sup>34</sup> have recently been held to discuss solutions and propositions for sustainable schemes for SDIs. Therefore this case study comes at the right time, as a representative case for similar remote sensing platforms, to enrich the reflections on long-term viability strategies. Furthermore, the availability of platform managers and the possibility of access to many technical documents have strengthened our study on many important aspects. As such, the characteristics of the GEOSUD case study at this particular period, represents a typical research for theory development (Merriam; 2016).

---

<sup>1</sup>GEOSUD web site: <http://equipex-geosud.fr/>

<sup>2</sup>Theia web site: <http://www.theia-land.fr/en>

<sup>3</sup>GIS and Remote Sensing conference - 2017

<sup>4</sup>Geospatial World Forum - 2018

### 4.4.1 Data collection & analysis

Data on GEOSUD were collected during several periods going from September 2016 till February 2018 (table. 4.2). We met with the executive board, had several meetings with the GEOSUD coordinator and interviewed a total of 16 people (managers, satellite receiving station operators, remote sensing experts, project participants, etc.) located on the 3 main sites (Montpellier, Paris, Toulouse). As our interviews progressed, we tried to collect information from different sources. We referred to technical documents including tender proposals, platform strategies and project reports in order to enrich our observations. We attended the regular meeting held annually, aiming to discuss the future strategies to be taken and had the chance to have discuss with several experts. We were invited as well to participate in several workshops and seminars that were held during the research, which gave us a global overview of the events happening at the same time and let us reorient some initial directions we had at the data collection's starting phase. The analysis of the data was carried out according to several periods, progressively enriching our knowledge on the important aspects concerning the platform. Presenting in a detailed way the events concerning the establishment and development of the SDI reveals a chronology of these important aspects and makes it possible to establish a comprehensive and coherent plan of the different observations.



<b>Activity</b>	<b>Time period</b>
Analysed various documents in relation with the implementation of the GEOSUD SDI	September 2016
Attended the GEOSUD annual seminar and held several meetings with the SDI managers	October – December 2016
Conducted interviews with the executive and steering committee of GEOSUD	January 2017
Attended seminars and workshops	May – June 2016; February – April 2017
Conducted interviews with the scientific expertise centres (CES) and regional coordination network (ART) of the Theia Land data Centre	September – November 2017
Held meetings to present observations	December 2017
Analysed the observed findings	January – February 2018

Table 4.2: Case study protocol

#### 4.4.2 Case description

The GEOSUD project (GEO information for Sustainable Development) was born in the mid-2000s from the initiative of the partners of the Remote Sensing Centre in Montpellier (France). The overall objective of the GEOSUD project is to boost the use of satellite imagery by researchers and public policy actors in the fields of environment, agriculture and land development by removing technical, legal, organizational and financial barriers. It obtained in 2007 a first regional funding from Europe and the “Languedoc-Roussillon” regional council and a second one in 2011, at the national scale, thanks to a successful response to the Equipex (Equipment of Excellence) call for proposals in the framework of the French “Investments for the Future” Program. The governance of GEOSUD project is composed of several bodies: a coordination team, a steering committee, an executive board and an international multidisciplinary scientific committee. Since 2012, GEOSUD has contributed in bringing out the Theia national Land Data Centre and setting up a joint digital platform to pool, access and process satellite images in order to develop added-value products and services. The Theia cluster is based on the collaboration between various research teams (CES for *Centre d’Expertise Scientifique in French*) working on the same topics in

order to develop algorithms, qualified products and services as well as networking supports between scientific communities, public actors and private structures (ART for *Animation Régionale Theia in French*). Methodological and thematic researches have been carried out within the GEOSUD project to assist in the development of its technological platform for the acquisition, management and dissemination of satellite images and derived products and services. Training materials and courses for imagery management and thematic applications, including for distance learning, have been developed. The Equipex funding obtained in 2011 made it possible to scale up and extend the ambition of the project by enlarging the partnership and getting additional resources to accompany the evolution of the technological and institutional contexts. Since the beginning of the project, GEOSUD financed the temporary employment of 58 people for a total of 632 man-months, multiplying the ambition of the first project set in 2007 and contributing to pool the resources and further structure the communities in order to extend the use of satellite images and services. By end-2017, GEOSUD comprised 491 members (research and teaching departments, state departments, local authorities, non-research public institutions, NGOs and various organisations) and 700 people with opened user accounts.

Adopting the theoretical framework described in table. 4.1 to examine the SDI management in GEOSUD/Theia from 2007 to 2018, we recognised five events (table. 4.3) in which crucial facts confronted the interaction and organisational structure of the platform (fig. 4.2), towards a two-sided market approach.

Management of the GEOSUD/Theia platform towards a two-sided market.					
Events	Constraints	Satellite images	Image-base applications	Network externalities	Non-neutrality of prices
1. Launching the GEOSUD SDI	Image cost Lack of knowledge of access portals Lack of high-level competences Complexity of processing Lack of structured professional communities. Images technical management Images service access unavailability	Basic image service Single or limited multi-user commercial licenses	Not available	Same side effects	Lowering fees for images Free membership for users
2. Experimenting open access to high-resolution satellite imagery	Images technical management Images service access unavailability	All public actors license Annual national coverage Image acquisition through GFOSUD receiving station Other images acquired through public contracts Process of continuous acquisition of images	Slow growth	Cross side effects	Free access: membership and usage
3. Developing the platform for image access and processing	Lack of computational methods Absence of high-performance computing cluster Lack of networking actions Lack of coordination and flexibility	Process of continuous acquisition of images	Images visualisation and online download Integrating and pre-processing of received images Storage and standardised cataloguing of raw and pre-processed images Cartographic catalogue consultation	Low effects: same side and cross side effects	Free access: membership and usage
4. Developing image processing methods and thematic products	Lack of products' adaptation with operational needs Lack of users' feedback / needs Difficulty in the registration processes and the choice of images according to the users' needs	Process of continuous acquisition of images	Online access to ready-to-use qualified thematic products Geometric correction of images Mosaicking algorithm for large image coverage Collaborative online application for land use change detection Online toolbox of image processing functions Online modellers for developing image processing workflow	Medium effects: same side and cross side effects	Free access: membership and usage
5. Designing of a general pedagogical curriculum	Continuous improvement of products and services	Organising trainings and regular seminars Organising advance learning courses in remote sensing based on the use of the OrfeoToolBox (OTB) Organising hybrid courses in geomatics Educational resources publicly available Online courses publicly available	Thematic modules: -Detection of forest clear cuts -Detection of intermediate nitrate-trap crops Distance learning: QGIS software Educational resources publicly available Online courses publicly available	Strong effects: same side and cross side effects	Possible scenarios of membership fees Possible scenarios of usage fees: beyond a volume of requested images

Table 4.3: Management of the GEOSUD/Theia platform towards a two-sided

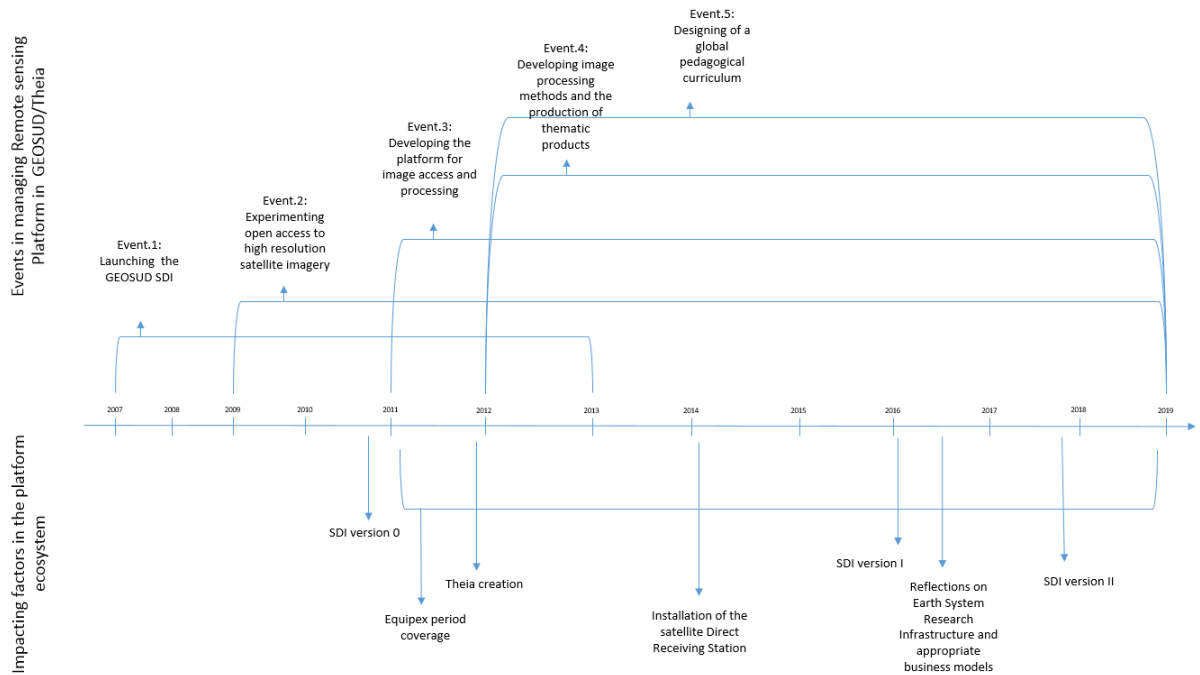

Figure 4.2: Time line of interconnected events and platform management of GEOSUD/Theia SDI

## 4.5 Results: challenges and dynamics of the GEOSUD SDI according to a two-sided market approach

Examining the interconnected events in table. 4.3 as a consistent management work, contributes in highlighting the relevance of a two-sided market approach for analysing a SDI dynamics.

**Event.1 Launching the GEOSUD SDI.** In 2007, a first regional and European funding program made it possible to initiate the GEOSUD project, by financing a future extension of the Remote Sensing Centre facilities in Montpellier. The main objective was to lower several barriers which hampered the use of satellite images in a fully operational

way, such as high costs perceived in selective markets, lack of knowledge of access portals, licence limited to single or small groups of users, and lack of structured professional communities, etc. The idea of the GEOSUD project leaders was to create a base of satellite images users, which would be popular among the public and help attract other satellite image users, consequently enlarging the main base and the circle of adoption of the satellite information.

**Event.2 Experimenting open access to high-resolution satellite imagery.** Previously, the licence offered by providers of high-resolution satellite images (e.g. GEOSYS, Airbus Defence and Space - ADS) depended on the categories of users (teaching / research, public bodies, private actors) with increasing tariffs depending on the number of users. GEOSUD sought to set up a pooling scheme by financing upstream the purchase of images for a free downstream access to authorised users. Besides, no homogeneous coverage of the French national territory with high spatial resolution images had been produced despite the interest, particularly to supplement the aerial coverage carried out every 4 to 5 years by IGN. The logic of pooling and the financial resources brought by GEOSUD, as well as the participation of IGN within the consortium, made it possible to successfully test, as early as 2010, the technical and legal feasibility of a high-resolution coverage of the entire national territory through satellite images, and having it be available to any public sector. Note that, from 2011 to 2015, the end users registered on the GEOSUD platform increased from 77 to 378 members, a 5-fold increase in less than 5 years. From the observations of the evolution of GEOSUD/Theia members (table. 4.4), we observe a linear growth in the number of yearly subscription of members. This character indicates that there is no saturation in the market.

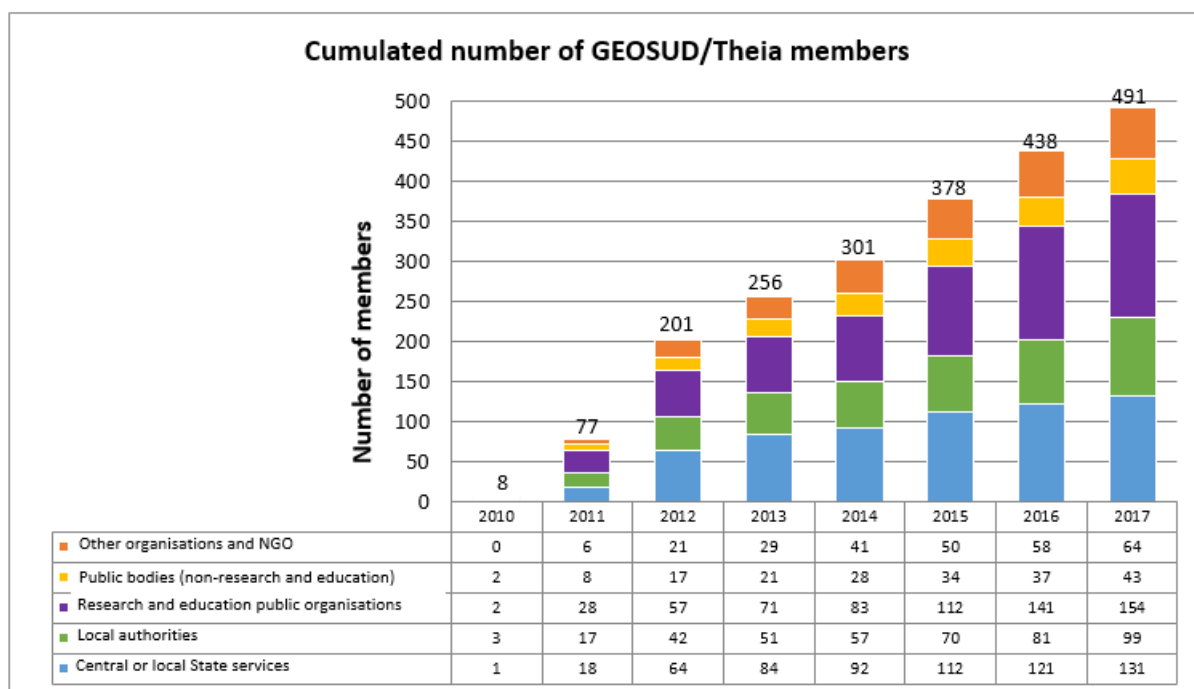

Table 4.4: The evolution of GEOSUD/Theia members 2010-2017

In 2014, in order to further extend the acquisition capacities and enlarge the satellite images' range for users, GEOSUD installed a Direct Receiving Station (DRS) consisting of an antenna and a first terminal to receive very high spatial resolution images from SPOT 6 and 7 satellites. This equipment allows to acquire each year new images through the direct programming of satellites, including the production of annual national coverage maps (table. 4.5).

Year	2003-2006	2010	2011	2012	2013	2014	2015	2016
<b>Satellite (spatial resolution)</b>	SPOT 5 (2,5m, 5m; 10m)	RapidEye (5m)	RapidEye (5m)	SPOT 5 (5m; 10m)	SPOT 5 (5m; 10m)	SPOT 6-7 (1,5m; 6m)	SPOT 6-7 (1,5m; 6m)	SPOT 6-7 (1,5m; 6m)
<b>Provider</b>	ADS	GEOSYS	GEOSYS	ADS	ADS	ADS	<b>ADS &amp; GEOSUD receiving station</b>	

Table 4.5: Main characteristics of GEOSUD annual national coverage maps.

Thus, the former annual procurement contract with image suppliers was replaced by a multi-year contract, which was funded by a consortium of six partners to purchase a base volume of SPOT 6\_7 telemetry.<sup>5</sup> Additional volumes of telemetry were financed by GEOSUD and by other contributors (e.g. IGN, CNES) for specific needs. The receiving station, thus, made it possible for the GEOSUD/Theia community to go up one notch in the technical workflow of image acquisition, by producing itself the images from the telemetry measured by the satellites, rather than buying the images from the suppliers. This helped lower the unit production costs of the images, and GEOSUD was now capable to respond more accurately to its users' needs. Since 2015, the station has been able not only to keep producing the annual national coverage but also to respond to requests for *ad hoc* images anywhere in the world from the national scientific community. Besides, other very high spatial resolution satellite images (Pleiades - 0,5m and 2m) were acquired in relation to user needs (urban areas, coastal areas subject to marine erosion hazard, major infrastructure projects). Also, three very high spatial resolution radar imagery public contracts (TerraSarX, CosmoSkyMed) have been awarded, in order to meet specific needs of the scientific community (Earth science, agriculture, forestry). All the images already acquired by GEOSUD are accessible by the authorised members, via the project portal with functionalities that have evolved from the beginning. Based on the setting up of the GEOSUD receiving station and the SPOT 6\_7 telemetry contract, subscribers can also request via an online form the acquisition of new images from around

<sup>5</sup>The telemetry corresponds to the raw signal measured by the satellites and transmitted to the antenna of a Direct Receiving Station

the world, either by satellites' programming or from the ADS archive. These events come in parallel with the GEOSUD strategy, to benefit from the existing user base to attract image-based application developers. In fact, developers aiming to develop thematic products through the combination of basic processing services and satellite images need to associate with a publicly recognized remote sensing platform, to be able to ensure a maximum number of end users of their image-based applications.

**Event.3 Developing the platform for image access and processing.**

Starting in 2011, GEOSUD initiated the development of its platform in order to respond to the technical complexity of the satellite images. Developments were gradually made with internal resources from GEOSUD partners and a prototype version (V0) of the portal was delivered by the end of 2010. A new and complete version of the SDI (V1) was achieved early in 2016 based on the interoperability standards for data exchange. It included a set of functionalities such as a unique user authentication mechanism, integrating and pre-processing of the received images, storage and standardised cataloguing of raw and pre-processed images, multi-criteria and cartographic catalogue consultation, and full-resolution images visualisation and online download. The delivery of this new version offered the possibility to start in 2016 the gradual integration of all GEOSUD archives. Simultaneously, a first version of the infrastructure for accessing the Pleiades images and the mosaics of the national coverage was set up and progressively enriched (visualisation, access by stream, download reserved for professionals). During this phase, several tests have been carried out to explore computational methods and procedures, in order to prepare the development of GEOSUD SDI V2 version for online image processing services. All these basic processing tools were proposed for free to end users.

**Event.4 Developing image processing methods and thematic products.**

As mentioned in event 2, benefiting from the increase in the satellite user community around GEOSUD (see details in part 6 Discussion) and due to the lack of computational methods, GEOSUD proceeded to develop basic processing tools that could be available for developers in order to create thematic products in line with users' requests. Beginning 2012, developments were initiated and resulted in different



products such as methodological guides, plugins, processing chains, and prototypes. More work has been devoted to developing innovative tools and methods in image processing. In order to broaden its activity of developing added value products and innovative methods meeting the increasing needs of users, GEOSUD has invested in further structuring the Theia national community, based on a network of scientific expertise centres (in French, *Centre d'Expertise Scientifique* – CES) and a regional coordination network (in French, *Animation Régionale Theia* - ART). About 25 CES have been set up for developing and proposing the most advanced operational products and services (land cover, snow cover, soil moisture, clear-cuts forest, etc.). Moreover, the ARTs will serve to facilitate within the regions the exchanges between the scientific community and the public policy players, to identify the operational needs for the CES, in order to develop adapted products and services.

These works came to reinforce all the past events, opening up new possibilities for interaction and complementarity with users, which are reflected in the growing number of subscriptions, with 207 registered members in 2012, up to almost 500 members in 2018. This helped prepare the functional specifications for the online processing services of the new GEOSUD SDI V2 version, which was delivered by the end of 2017 and generated multiple generic tools and methods useful at different stages of the process of image analysis and exploitation of results: acquisition and structuring of images, extraction of information, calculation of uncertainties and insertion of results in models. Table 4.6 summarises all the existing or forthcoming processing services offered by GEOSUD/Theia. GEOSUD can leverage from offering facilities to developers, in order to enlarge again its satellite image user base, by presenting a well-equipped platform that can attract more users, and repeat the steps as in events 1, 2 and 3, iteratively.

**Event.5 Designing of a general pedagogical curriculum.** After widening the range of satellite images, and having launched the development of applications, GEOSUD realized that users were having difficulties choosing products and services that match their interests and some also noticed a lack of adaptability with their specific needs. Therefore, in 2012, it began to design a general pedagogical curriculum called

“*Getting familiar with GEOSUD imagery*”, a learning module in remote sensing, as well as specific modules for the thematic products developed by the GEOSUD/Theia centres of expertise (see above). So far, two thematic modules have been developed, the detection of forest clear-cuts and the detection of intermediate nitrate-trap crops. In addition, training courses were put in place and enriched since 2014, to let users adapt to distance learning. They consisted of course sequences, illustrations and practical exercises offering more and better adaptation. A hybrid training course was organised for the first time in 2015, with a remote part and a face to face part, followed by a thematic training session. GEOSUD’s educational resources published under open licence have been made available at the end of 2017, taking into account users’ needs or feedback from GEOSUD members or similar infrastructures. In addition, since the beginning of the project, the GEOSUD team has provided support for the users to facilitate the registration process and assist them in the choice of images according to their needs. Another networking action is the annual user seminar of the Theia community. This event is prepared with a logic of iterative and incremental co-design of the SDI between developers and users, who express their needs and provide feedback. The first two annual seminars (2013 - 2014) were organised on a strict GEOSUD scale. The three following seminars (2015 - 2016 - 2018) were held within the broader framework of the Theia network.

Storage and standardised cataloguing of raw and pre-processed images
Images visualisation and online download
Geometric correction of images
Mosaicking algorithm for large image coverage
Collaborative online application for land use change detection
Online toolbox of image processing functions
Online processing workflows for thematic products (i.e. forest clear cut mapping)
Online access to ready-to-use qualified thematic products

Table 4.6: Tools and functionalities proposed through the GEOSUD SDI V2.

Identifying the elements of the current management of the GEOSUD SDI, clearly highlights its two-sidedness character. Despite the fact that GEOSUD has a key role in promoting the innovation process, it is lessening the difficulty of transitioning to a platform concept, offering to its users a better understanding of the products and the technology available on its platform. This fact is due to the adoption of an easy access to technical support, specific training and implementation services. In general, organizing one side of a platform could secure the participation of the other side by offering enough incentive to join. These steps are somehow new and recent within the spatial data industry and makes GEOSUD different and a leader within other players in the industry. While articulating its business models toward an alternative ecosystem, it is helping its users to better understand the differences between competing platforms so they can assess the potential impact of choosing a specific platform that offers more appropriate solutions. This is what the Linux community as well as Google with search technology, have done to differ among their industry. With an economic logic based on added-value products, GEOSUD may run differently compared to other SDI business models in order to grow and develop its ecosystem. Attempting a wider circle of satellite image users is a challenge, hampered by the continuous improvement and creation of new systems and technology. GEOSUD has already taken the step, with a transition and openness towards larger markets. At this stage, the issue of the sustainability of GEOSUD after 2019 has been debated on several occasions: the meetings of GEOSUD and the Theia cluster steering committees; the meetings between the four national data centres (Theia, Ocean, Atmosphere, Solid Earth); the working group for setting up a national mechanism for a unified access portal to imagery called DINAMIS; and the meetings concerning the new “Earth System” Research Infrastructure that will gather the four national data centres. The choice was ultimately made to dissociate the upstream image access services from the downstream services of development of added value products and services. Thus, GEOSUD will be divided into a national image access system called DINAMIS and a Theia platform, in order to produce and distribute derived products and services. To cover all the operating costs of GEOSUD, several economic models have been studied and discussed, taking into account the current and future context, as well as feedback on access to satellite images. A major trend is that data users are less inclined to pay for raw or pre-processed data, even at preferential rates, because the upstream pooling mechanisms (e.g. the Copernicus European program, French regional aerial

coverages), the Open Data and data-papers movements have been developed strongly in recent years. Another explanatory factor is the scarcity of public budgets in ministries, local authorities, and research laboratories. Last year, this observation was confirmed with the access to the Pleiades imagery by French public actors. Despite the technical performances of these satellites, the quality of the images and the potential applications demonstrated by the scientific community, few Pleiades images have been used in France since 2012, mainly for lack of support but also due to the access fees applied to the first user of a given image. This led the CNES<sup>6</sup>, owner of the Pleiades satellites, to consider, as it was done for SPOT 6\_7, a full upstream funding for the acquisition of Pleiades images in order to ensure a “free” downstream access to authorised users. This new approach boosted the demands for Pleiades imagery. Financing the costs of access to images, by recovering part of the added value generated by the development of downstream services, seems to be a complex task, due to the lack of effective and equitable mechanisms for identifying value chains, in order to establish tax rules and make them applicable. Recently, mechanisms of user funding, with respect to their use of satellite images and services, are taking place as part of the reflections on complementary sources of funding, in addition to an upstream public funding, in order to cover the full operating costs.

## 4.6 Discussion: what are the lessons to be learned?

In a two-sided market, the intermediary creates a benefit for the participants throughout the platform. This benefit can be translated into larger access to potential transactions, greater facility of services exchange, higher quality of product innovation, etc. How users are linked, what are the needs of every member, and what position to take are questions to be managed dynamically.

The aim was to identify the elements of the current functioning of this infrastructure, which clearly highlight its character of two-sidedness, in order to specify at which levels, these elements can be put in place. The GEO-SUD SDI, to which the authors had a privileged access, has been taken as

---

<sup>6</sup>The Centre national d’études spatiales (CNES) (National Centre for Space Studies) is the French government space agency.

a relevant example to describe the choice that SDI's may face, while taking the transition toward a business model governed by the economy of platforms. It is necessary that once satellite images are available, scientific and intermediate actors of added value have access to this platform to develop new products and services, which will further enrich the platform. We focused on the role of the positive network effect created between the two sides attracting the users interested in engaging in interactions. We presented a theoretical framework of how the two-sided model can fit a spatial data infrastructure through the management of the platform. The framework focuses on how a SDI can manage the interaction between satellite image users and the network of developers around the platform toward a two-sided market approach. As such, through this framework, a SDI should not be looked at as a single entity, but as a hierarchy of modules linked by business processes (Rajabifard, 1999). The management of the SDIs should not be presented as a simple remote sensing process, nor a simple mapping production, but as compatibility between the actors. This coordination seems to be a complex and continuous process a SDI should adopt in order to grow.

The example of GEOSUD and Theia comes to support further theorising on the concept of two-sidedness in remote sensing platforms. The case study of GEOSUD, covering an 11-year period, explained the development of the platform toward targeting a wider ecosystem for technical and non-technical actors. Similarly to the European Copernicus programme that represents in fact a larger view to the digital economy, SDIs must implicitly connect the traditional Earth observation downstream market with the wider geoinformation ecosystem (Pwc, 2016). The GEOSUD/Theia initiatives have profoundly changed the landscape in France for the supply and access of high-resolution satellite (HR) commercial imagery by bringing major innovations: the logic of sharing and pooling through an "all public actor" licensing strategy, the "national coverage" product based on very high-resolution satellite images, the archive of images, the web portal project and the installation of a satellite direct receiving station, and more recently and still under development, online image processing services for derived products and open innovation. Initially focusing on pooling image access as a first step, GEOSUD/Theia is now evolving towards an open and collaborative development platform that will allow in the future to better sharing the benefits of the open innovation processes (Lerner & Tirole, 2002; Henkel, 2008; Lee, 2017).

Taking the USGS<sup>7</sup> portal as an example, all the algorithms of the products available that are coded in open-source software are publicly available on GitHub. Similarly, for Landsat data, an online collaborative platform promoting the use and aggregating the value of this data has been created (Landsat advisory group, 2014). Similar developments are currently carried out within the European Copernicus program.

In SDI platform management, it is necessary to choose strategically and in a coordinated way the prices between the users and the developers. Thus, a remote sensing platform has an interest in practising the lowest prices on the side of the market, which exerts the strongest indirect network externalities. We refer in our case by price, the membership fees applied to both sides of the SDI platform. In addition, price effects have their place in a SDI growth strategy when combined with the network effects that create virtuous cycles leading to a wider network of interconnected users over time. By considering different levels of strength of the network effects, we can generate an analysis for each case, however, herein, without loss of generality, we will focus on the case where the SDI is in the phase of strong network effects that fits our reflections on its viability on the long run. In the following, we draw on the empirical insights, coupled with the existent literature on two-sided markets, to suggest specific recommendations to SDIs (table. 4.7):

Scenario	Number of users	Number of developers	Membership fees	
			Price (users)	Price (developers)
<b>1</b>	Increase	Constant	Constant	Increase
<b>2</b>	Increase	Decrease	Constant	Decrease
<b>3</b>	Decrease	Constant	Decrease	Constant
<b>4</b>	Decrease	Decrease	Decrease	Decrease
<b>5</b>	Increase	Increase	Increase	Increase

Table 4.7: Network externalities & Non-neutrality of prices: Membership fees for users and developers

<sup>7</sup>United States Geological Survey

As the table shows, we propose five scenarios in which we assume that the number of users and developers will vary, in order to establish a policy related to each side. For example, in scenario 1: if the number of satellite image users registered on the remote sensing platform increases, while the number of developers remaining constant, the platform may keep a relatively constant membership fee for the users to boost their enrolment, while increasing the price for the developers, who want to reach a wider community of users and are ready to accept that increase in price. In a two-sided market, a firm's marginal revenue usually has direct and indirect components. A participant on the first side who joins a market generates direct income for the intermediary when the latter requires the payment of a tariff. These direct revenues are present in both traditional and two-sided markets. However, in the latter, participants on the first side also make the market more attractive for individuals on the second side, given the positive indirect network externalities. This increased interest arises from a greater possibility of successful transactions and results in a lower sensitivity to price on individuals in side two. The company can then charge higher prices to side two. Additional marginal income is thus indirectly obtained in side two due to the participants of side one. The results of our analysis and observation can be summarised in a general way by the following:

**Proposition.1** A spatial data infrastructure will more likely benefit and meet the long-term viability of its platform by continually expanding its image user's side in order to attract more users to the same side of the platform as an essential side of its organisational and structural context.

**Proposition.2** A spatial data infrastructure will more likely benefit and meet the long-term viability by diversifying the network of its developers in order to cover a wider range of services and topics.

**Proposition.3** While a spatial data infrastructure may enlarge its user side to establish the developer side, offering facilities to the user side may attract more developers.

**Proposition.4** While a spatial data infrastructure may enlarge its developer side, offering facilities to developers may lead to offering more services to users, and enlarging in an iterative way the user side.

While the services have become important sources of revenues and profits in many two-sided high-tech markets, the set of activities or strategies in the case of SDIs are much of importance in shaping the market dynamics. The one and unique best strategy for a platform to success, do not exist in reality (Evans& Schmalensee, 2005; Gawer & Henderson, 2007; Parker et al., 2016). Choosing the best strategy is intimately related to the choices each SDI faces, about structuring the business relationships among its ecosystem. The strategy will be a set of activities within the platform, in order to develop unique features that are hard to imitate (Pwc, 2016). Providing both incentives and subsidies or considering pricing mechanisms that attract users to the platform is fundamental in designing the best strategy. Overall, the potential role of image-based applications through a SDI two-sided market will be an essential part of its competitive strategy, with the ability to make a huge difference among other platforms and orient the market toward a particular direction. These reflections are useful to all SDIs which may take the transition toward a business model governed by the economy of platforms. Each SDI, within its proper context, come to add elements to the questioning of its equilibrium within the framework of a two-sided market in order to better integrate the constraints linked to the competitive environment it faces. In that way, the SDI can acquire a global vision that takes into consideration the competition between the platforms; a competition that goes beyond the borders of the market, since being able to subvert and reverse the technical systems of other industrial players, remains one of the major challenges facing technological change (Cabanés et al., 2015).

Although our article is based on a specific case study through the GEO-SUD platform, its 11 years of experience allows us to advance general observations on how to shape the interaction between the users of satellite information and application developers. In fact, the particular purpose of a SDI, before targeting profit maximisation, comes at first through optimising its service performance while balancing its budget. In the case of GEO-SUD/Theia, these services primarily focus on the effectiveness of the public action. In the current context, the majority of models based on two-sided markets follow this logic and as GEOSUD largely targets public institutions, which are subject to increasing budget pressure and whose evolution in these sectors is done gradually, it validates the idea that their price elasticity of demand is higher and that they should not be discouraged; which would plague the market. Secondly, because of this budget deficit, price elasticities will be



low enough to impose to the users to pay for images even at marginal cost. This incites GEOSUD to open more and more toward the private sectors in order to develop economic activity and to change its perimeter of actors.

For this, a first element is to draw on the lessons of the two-sided market economy, which shows how the pricing of services must take into account the demand elasticity of potential users. This could be a starting point to test and extend this concept. Several examples fit the notion of starting with a qualitative method in order to build a theoretical framework and then use quantitative methods to test that theory (Van Maanen, 1979; Gioia & Thomae, 1996; Ziedonis, 2004). In fact, real-world experiences show that it can be difficult to predict which side of a platform market is likely to be more price-sensitive (Parker et al., 2016). Between a situation of a multi-product monopoly and another of oligopolistic competition, pricing according to the elasticity of demand must go back at least to Boiteux (1956), on his work on the management of public monopolies constrained to balance their budget. A solution to the complexity of pricing (Evans, 2003) was tested successfully through several platform examples. It consisted of starting with a small platform, the latter being scalable as for Diners Club in cards, Apple in personal computers and Palm OS in developing software applications. Chakravorti (2005), studying the competitiveness of payment systems platforms, notes that the majority of theoretical models rely on a single platform with varying levels of competition among the various players in the network. Regarding monopoly platforms, Hagiu in 2009 also mentioned that the more consumers are interested in the variety of the products, the more profits are made on the producers' side. Thus, empirical research on competition and platform operations is closely linked to the specific institutions and technologies of an industry. We must be cautious in generalising, but these eventualities are often used to clarify or even reveal the differences between the price structures such as practically in the software platforms, the video game consoles and possibly the SDIs. GEOSUD is allowing many users who would never have bought this service to be present in the field of use. That's what Amazon, Google and the European Space Agency (ESA), with their new strategies for providing satellite images Landsat and Sentinel on their platforms, are also performing to enlarge the use and access to such data.

Indeed, this evolution will be part of the reality behind the nesting of structures and SDIs. In France, GEOSUD with Theia are evolving towards

an Earth System Research Infrastructure (IRST). Internationally, the Copernicus program <sup>8</sup> in Europe towards its future DIAS infrastructure (Data Information and Access Service). Multinationally Amazon<sup>9</sup> with its platform AWS, Google with Google Earth and its platform Google Earth Engine, etc. It will therefore be necessary in the long run to wonder about the subsidiarity between platforms and the maximum efficiency to be sought to articulate these different platforms and develop the use of satellite images. Various questions arise about the effects of economies of scale, economies of scope, the expansion of these markets with the balancing choices between variety and quality, the investment's horizons by the platforms and the capabilities of these platforms to create and animate at various scale user communities over time. The most effective organisation is not yet clear, given the ongoing development of these processes.

## 4.7 Conclusion

Our research shows that analysing a spatial data infrastructure (SDI) as a two-sided market is useful for defining both an industrial and pricing strategy for a SDI platform. The main contribution of the paper is in presenting an innovative approach on how spatial data infrastructure, through a platform management process, can transition from a government-funded entity to a self-sustaining mechanism. The usual problem faced by firms is how to get customers to buy its products or services. By considering the SDI as a platform management concept, the question remain how to deliver value to one side while taking into consideration the participants on the other side of the platform. With the massive emergence of platforms, several SDIs companies are competing to establish their appropriate business model. This paper offers a framework through which, a SDI can figure out how to get both sides on board of its platform. In addition, the contribution for the practice is in

---

<sup>8</sup>Copernicus is the world's largest single Earth Observation programme and is managed by the European Commission in partnership with the European Space Agency (ESA). It aims at achieving a global, continuous, autonomous, high quality, wide range Earth observation capacity. The Copernicus programme is based primarily on Sentinel satellites, a constellation of six types of Earth observation satellites providing images available through a free, full and open data policy. Sentinel 1 and 2 satellites provide 10m weekly images, which are complementary to very high-resolution images provided by GEOSUD.

<sup>9</sup>Amazon Web Services is offering its customers free use of over 85,000 satellite images, setting the stage for new types of geographically-oriented cloud applications.

explaining the ability of a SDI, while providing image-based applications on their own or through a network of developers, to serve multiple actors and fill many functions. The availability of a wide range of operational tools and functionalities related to the satellite imagery provides feedback for further innovation and enhances the value of the platform through the integration with a complementary set of actors. On the other hand, the contribution on the theoretical aspect is in the way a SDI platform can influence the market dynamics. In other terms, subsidizing one side of the platform or increasing the network effects between the platform and its complements can provide an important source of revenues in markets that are particularly vulnerable to innovation and price competition. Although the fact that not all satellite image users are similar nor the image-based application developers, the paper offers a useful description to put these concepts together and summarize their implications in a SDI framework. While the existing literature on platform pricing has focused on subsidizing the main product, then expect making profits from the royalties on complementary elements (Cusumano, 2004, 2008; Eisenman & Alstyne, 2006; Hagiu 2009; Boudreau, 2010), similar effects can be observed on the image-based applications', even that some are more valued than others by users. Furthermore, the paper offer a description of the proper context of SDI platform as a contribution to understand the complex choices spatial data infrastructures face regarding the subsidy strategies, as part of a platform pricing policies. By identifying a conceptual framework for the SDI, we examined the events in which crucial facts confronted the interaction and organisational structure of the platform toward a two-sided market approach. The strategies that a SDI adopts to establish, attract and match between the multitudes of actors involve significant efforts and a deep knowledge of the ecosystem around the SDI, for which managers may pay attention to the increasing needs of the users (Barão et al., 2017). Hence by presenting the evolution of the remote sensing platform through interconnected events, we add insights by empirically illustrating how platform managers design their remote sensing platform, position it this into a strategic context for a value creation and target the interests of each of the users on board toward more dynamic interactions (López-Nicolás & Meroño-Cerdán, 2011; Tan et al., 2014; Luo et al., 2016; Venkitachalam & Willmott 2017).

Considering that the geo-information market has already made the switch, with a large number of actors on the satellite imagery market already devel-

oping their own digital SDIs, it also suggests that the two-sided market theory could incorporate a larger value perspective, by creating dynamic links between imagery and very specific information to respond to end-user requirement and create high added value (Choo, 2013; Pwc, 2016), such as the social value for a whole community through the transfer of innovation and efficiency in the implementation of public policies (Citroen, 2011). Similarly, other important societal effects could also be taken into account with regard to enhancing the efficiency and even fairness and legitimacy of public policies through the use of satellite information. Finally, this facilitated access makes it possible to have systematic information (fairness of control for example) and adapted quality (comparison over time due to archiving, regularity of monitoring, and levels of accuracy, etc.). Several other qualitative effects can be observed both in the improvement of the diagnosis and the design of the measures as well as a greater transparency in the implementation of the information, the effects on the images, the collaboration between the services and institutions, the reinforcement of citizens and users' confidence in the policies pursued, as well as the support for consultation and the participation of stakeholders and citizens (Rey-Valette et al., 2017).

## 4.8 References

Akbar, Z., & Bell, G. G. (2005). Benefiting from network position: firm capabilities, structural holes, and performance. *Strategic Management Journal*, 26(9), 809–825.

Anderson Jr, E. G., Parker, G. G., & Tan, B. (2013). Platform performance investment in the presence of network externalities. *Information Systems Research*, 25(1), 152–172.

ANZLIC. (1996). *Spatial Data Infrastructure for Australia and New Zealand*. Canberra, ACT, Australia and New Zealand Land Information Council.

ANZLIC. (2000). *Strategic Plan for 2000–2005*. Canberra, ACT, Australia and New Zealand Land Information Council. Armstrong, M. (2006). Competition in two-sided markets. *RAND Journal of Economics*, 37(3), 668–691.

Barão, A., de Vasconcelos, J. B., Rocha, Á. & Pereira, R. (2017). A knowledge management approach to capture organizational learning networks. *International Journal of Information Management*, 37(6), 735–740.

Barr, P. S. (2004). Current and potential importance of qualitative methods in strategy research. In *Research methodology in strategy and management* (pp. 165–188). Emerald Group Publishing Limited.

Bartunek, J. M., Rynes, S. L., & Ireland, R. D. (2006). What makes management research interesting, and why does it matter? *Academy of Management Journal*, 49(1), 9–15.

Belward, A. S., & Skøien, J. O. (2015). Who launched what, when and why; trends in global land-cover observation capacity from civilian earth observation satellites. *ISPRS Journal of Photogrammetry and Remote Sensing*, 103, 115–128.

Bernard, L., Kanellopoulos, I., Annoni, A., & Smits, P. (2005). The European geoportal –one step towards the establishment of a European Spatial

Data Infrastructure. *Computers, Environment and Urban Systems*, 29, 15–31.

Boiteux, M. (1956). Sur la gestion des monopoles publics astreints à l'équilibre budgétaire. *Econometrica, Journal of the Econometric Society*, 22–40.

Boudreau, K. (2010). Open platform strategies and innovation: Granting access vs. devolving control. *Management Science*, 56(10), 1849–1872.

Boudreau, K., & Hagiu, A. (2008). Platform Rules: Multi-Sided Platforms as Regulators. <https://doi.org/http://dx.doi.org/10.2139/ssrn.1269966>

Bremmer, R. (2000). Big, bigger, biggest. *Automotive World*, 6.

Bremmer, R. (1999). Cutting-edge platforms. *Financial Times Automotive World*, 9, 30–38.

Burrell, G., & Morgan, G. (1979). Assumptions about the nature of science. *Sociological Paradigms and Organizational Analysis*, 1–35.

Cabanes, B., Le Masson, P., Weil, B., Kokshagina, O., & Cogez, P. (2015). Innovation et compétition entre plateformes technologiques : vers une stratégie basée sur la pervasivité des technologies. In *XXIVe Conférence Internationale de Management Stratégique*, Paris, France.

Caffrey, R., Simpson, T., Henderson, R., & Crawley, E. (2002). The economic issues with implementing open avionics platforms for spacecraft. In *20th AIAA International Communication Satellite Systems Conference and Exhibit* (p. 1870).

Caillaud, B., & Jullien, B. (2003). Chicken and Egg: Competition Among Intermediation Service Providers. *RAND Journal of Economics*, 34, 309–328.

Casadesus-masanell, R., & Ricart, J. E. (2010). From Strategy to Business Models and onto Tactics. *Long Range Planning*, 43(2–3), 195–215. <https://doi.org/10.1016/j.lrp.2010.01.004>

Ceccagnoli, M., Forman, C., Huang, P., & Wu, D. J. (2012). Cocreation of Value in a Platform Ecosystem! The Case of Enterprise Software. *MIS Quarterly*, 263–290.

Chakravorti, S. (2005). Platform Competition in Two-Sided Markets: The Case of Payment Networks. *Review of Network Economics*, 5(1).

Chesbrough, H. (2010). Business Model Innovation: Opportunities and Barriers. *Long Range Planning*, 43(2–3), 354–363. <https://doi.org/10.1016/j.lrp.2009.07.010>

Choo, C. W. (2013). Information culture and organizational effectiveness. *International Journal of Information Management*, 33(5), 775–779.

Chuang, S.-H., & Lin, H.-N. (2015). Co-creating e-service innovations: Theory, practice, and impact on firm performance. *International Journal of Information Management*, 35, 277–291.

Citroen, C. L. (2011). The role of information in strategic decision-making. *International Journal of Information Management*, 31(6), 493–501.

Clements, M. T., & Ohashi, H. (2005). Indirect network effects and the product cycle: video games in the US, 1994–2002. *The Journal of Industrial Economics*, 53(4), 515–542.

Craglia, M., Annoni, A., Klopfer, M., Corbin, C., Hecht, L., Pichler, G., & Smits, P. (2003). Geographic Information in the Wider Europe. GINIE Report 6.5.1. European Commission, Joint Research Centre, Ispra.

Crompvoets, J., Bregt, A., Rajabifard, A., & Williamson, I. (2004). Assessing the worldwide developments of national spatial data clearinghouses. *International Journal of Geographical Information Science*, 18(7), 665–689.

Crompvoets, J., De Man, E., & Geudens, T. (2010). Value of spatial data: networked performance beyond economic rhetoric. *IJSDIR*, 5, 96–119.

Crompvoets, J., Rajabifard, A., van Loenen, B., & Fernández, T. D. (2008). A multi-view framework to assess SDIs. *Space for Geo-Information*

(RGI), Wageningen University and Centre for SDIs and Land Administration, Department of Geomatics, The University of Melbourne.

Davis, S. J., MacCrisken, J., & Murphy, K. M. (2002). Economic perspectives on software design: PC operating systems and platforms. In *Microsoft, Antitrust and the New Economy: Selected Essays* (pp. 361–419). Springer.

de Man, W. H. (2006). Understanding SDI; complexity and institutionalization. *International Journal of Geographical Information Science*, 20(3), 329–343.

de Man, W. H. E. (2008). The multi-faceted nature of SDIs and their assessment-dealing with dilemmas. *A Multi-View Framework to Assess SDIs*, 23.

De Montalvo, U. W. (2003). In Search of Rigorous Models for Policy-oriented Research: A Behavioral Approach to Spatial Data Sharing. *URISA Journal*, 15(2003), 19–28.

de Reuver, M., Sørensen, C., & Basole, R. C. (2018). The digital platform: a research agenda. *Journal of Information Technology*, 33(2), 124–135.

de Ven, A. H. (2007). *Engaged scholarship: A guide for organizational and social research*. Oxford University Press on Demand.

Denis, G., Claverie, A., Pasco, X., Darnis, J.-P., de Maupeou, B., Lafaye, M., & Morel, E. (2017). Towards disruptions in Earth observation? New Earth Observation systems and markets evolution: possible scenarios and impacts. *Acta Astronautica*, 137, 415–433.

Eaton, B., Elaluf-Calderwood, S., Sorensen, C., & Yoo, Y. (2015). Distributed tuning of boundary resources: the case of Apple’s iOS service system. *MIS Quarterly: Management Information Systems*, 39(1), 217–243.

Eisenhardt, K. M. (1989). Building theories from case study research. *Academy of Management Review*, 14(4), 532–550.

Eisenhardt, K. M., & Graebner, M. E. (2007). Theory building from



cases: Opportunities and challenges. *Academy of Management Journal*, 50(1), 25–32.

Eisenmann, T. R. (2008). Managing proprietary and shared platforms. *California Management Review*, 50(4), 31–53.

Eisenmann, T. R., & Carpenter, S. (2004). *RealNetworks Rhapsody*.

Eisenmann, T., Parker, G., & Alstyne, M. W. Van. (2006). Strategies for Two- Sided Markets. *Harvard Business Review*.

Esterhuizen, D., Schutte, C. S. L., & Du Toit, A. S. A. (2012). Knowledge creation processes as critical enablers for innovation. *International Journal of Information Management*, 32(4), 354–364.

European Commission 2007 Directive 2007/2/EC of the European Parliament and of the Council of the 14. (2007). Establishing an Infrastructure for Spatial Information in the European Community (INSPIRE). Retrieved from <http://eur-lex.europa.eu/legal-content/EN/TXT/PDF/?uri=CELEX:32007L0002&from=EN>

Evans, D., & Schmalensee, R. (2005). *Paying with Plastic: The Digital Revolution in Buying and Borrowing* (2nd ed.). MIT Press, Cambridge.

Evans, D. S. (2003). Some Empirical Aspects of Multi-sided Platform Industries. *Review of Network Economics*, 2(3).

Evans, D. S., & Schmalensee, R. (2005). The industrial organization of markets with two-sided platforms.

Evans, D. S., & Schmalensee, R. (2007). *Catalyst code: the strategies behind the world's most dynamic companies*. Harvard Business School Press.

Farrell, J., & Katz, M. L. (2000). Innovation, rent extraction, and integration in systems markets. *The Journal of Industrial Economics*, 48(4), 413–432.

Fath, G., & Sarvary, M. (2003). Adoption dynamics in buyer-side ex-

changes. *Quantitative Marketing and Economics*, 1(3), 305–335.

FGDC. (1996). A Strategy for the National Spatial Data Infrastructure. Retrieved from [https://www.fgdc.gov/policyandplanning/A Strategy for the NSDI 1997.pdf](https://www.fgdc.gov/policyandplanning/A%20Strategy%20for%20the%20NSDI%201997.pdf)

FGDC. (2004). NSDI Future Directions Initiative. Towards a National Geospatial Strategy and Implementation Plan. Retrieved from [https://www.fgdc.gov/policyandplanning/future-directions/reports/FD\\_Final\\_Report.pdf](https://www.fgdc.gov/policyandplanning/future-directions/reports/FD_Final_Report.pdf)

Gawer, A. (2009). *Platforms, Markets and Innovation*. Cheltenham, UK: Edward Elgar.

Gawer, A. (2014). Bridging differing perspectives on technological platforms: Toward an integrative framework. *Research Policy*, 43(7), 1239–1249.

Gawer, A., & Cusumano, M. A. (2008). How companies become platform leaders. *MIT Sloan Management Review*, 49(2), 28.

Gawer, A., & Cusumano, M. A. (2002). Platform leadership: How Intel, Microsoft, and Cisco drive industry innovation (Vol. 5). Harvard Business School Press Boston, MA.

Gawer, A., & Henderson, R. (2007). Platform owner entry and innovation in complementary markets: Evidence from Intel. *Journal of Economics & Management Strategy*, 16(1), 1–34.

Gawer, A., & Henderson, R. (2007). Platform owner entry and innovation in complementary markets: Evidence from Intel. *Journal of Economics & Management Strategy*, 16(1), 1–34.

Genovese, E., Cotteret, G., Roche, S., & Caron, C. (2009). Evaluating the socio-economic impact of Geographic Information: A classification of the literature. *International Journal of Spatial Data Infrastructures Research*, 4, 218–238.

Geoconnections. (2012). *Canadian Geospatial Data Infrastructure. Vision, Mission and Roadmap - The Way Forward*. Retrieved from <http://publi>

cations.gc.ca/collections/collection\_2016/rncan-nrcan/M104-8-2012-eng.pdf

Georgiadou, Y., Rodriguez-Pabón, O., & Lance, K. T. (2006). Spatial data infrastructure (SDI) and e-governance: A quest for appropriate evaluation approaches. *URISA-WASHINGTON DC-*, 18(2), 43.

Ghosh, A., & Morita, H. (2008). An economic analysis of platform sharing. *Journal of the Japanese and International Economies*, 22(2), 164–186.

Giff, G., & Coleman, D. (2005). Using simulation to evaluate funding models for SDI implementation. In *Proceedings of FIG working week 2005 and GSDI-8 conference*, April 2005, Cairo, Egypt.

Giff, G. A., & Cromptvoets, J. (2008). Computers, Environment and Urban Systems Performance Indicators a tool to Support Spatial Data Infrastructure assessment. *Computers, Environment and Urban Systems*, 32(5), 365–376.

Giff, G., & Coleman, D. (2002). Spatial data infrastructure funding models: A necessity for the success of sdis in emerging countries. In *FIG XXII International Congress*, Washington DC, USA (pp. 1–16).

Gioia, D. A., & Thomas, J. B. (1996). Identity, image, and issue interpretation: Sensemaking during strategic change in academia. *Administrative Science Quarterly*, 370–403.

Grus, L., Cromptvoets, J., & Bregt, A. (2007). Multi-view SDI assessment framework. *International Journal of Spatial Data Infrastructures Research*, 2, 33–53.

Grus, L., Castelein, W., Cromptvoets, J., Overduin, T., & Loenen, B. Van. (2011). An assessment view to evaluate whether Spatial Data Infrastructures meet their goals. *Computers, Environment and Urban Systems*, 35, 217–229.

Hagiu, A. (2009). Two-Sided Platforms: Product Variety and Pricing Structures. *Journal of Economics & Management Strategy*, 18(4), 1011–1043.

Harris, R., & Baumann, I. (2015). Open data policies and satellite Earth

Observations. *Space Policy*, 32, 44–53.

Hart, S. (1995). A natural-resource-based view of the firm. *Academy of Management Review*, 20(4), 986–1014.

Hart, S., & Sharma, S. (2004). Engaging fringe stakeholders for competitive imagination. *Academy of Management Executive*, 18(1), 7–18.

Henkel, J. (2008). Champions of revealing-the role of open source developers in commercial firms. *Industrial and Corporate Change*, 18(3), 435–471.

Hung, C.-L., Chou, J. C.-L., & Dong, T.-P. (2011). Innovations and communication through innovative users: An exploratory mechanism of social networking website. *International Journal of Information Management*, 31(4), 317–326.

Iansiti, M., & Levien, R. (2004). *The keystone advantage: what the new dynamics of business ecosystems mean for strategy, innovation, and sustainability*. Harvard Business Press.

Kaiser, U., & Wright, J. (2006). Price Structure in Two-Sided Markets: Evidence from the Magazine Industry. *International Journal of Industrial Organization*, 24, 1–28.

Katz, M. L., & Shapiro, C. (1985). Network Externalities, Competition, and Compatibility. *The American Economic Review*, 75(3), 424–440.

Kogut, B., & Kulatilaka, N. (1994). Options thinking and platform investments: Investing in opportunity. *California Management Review*, 36(2), 52–71.

Kok, B., & Van Loenen, B. (2005). How to assess the success of National Spatial Data Infrastructures. *Computers, Environment and Urban Systems*, 29, 699–717.

Landsat advisory group - National geospatial advisory committee. (2014). *The Value Proposition for Landsat Applications*. Retrieved from <https://www.fgdc.gov/ngac/meetings/december-2014/ngac-landsat-economic-value-paper->

2014-update.pdf

Lee, D., & Mendelson, H. (2008). Divide and conquer: Competing with free technology under network effects. *Production and Operations Management*, 17(1), 12–28.

Lee, S., Baek, H., & Jahng, J. (2017). Governance strategies for open collaboration: Focusing on resource allocation in open source software development organizations. *International Journal of Information Management*, 37(5), 431–437.

Lerner, J., & Tirole, J. (2002). Some simple economics of open source. *The Journal of Industrial Economics*, 50(2), 197–234.

Li, S., Dragicevic, S., Castro, F. A., Sester, M., Winter, S., & Coltekin, A. (2016). Geospatial big data handling theory and methods: A review and research challenges. *ISPRS Journal of Photogrammetry and Remote Sensing*, 115, 119–133.

Logic, U. (2000). Financing the NSDI: National Spatial Data infrastructure. URL: <http://www.fgdc.gov/whatsnew/whatsnew.html#financing> (Accessed 30 September 2013).

Longhorn, R., & Blakemore, M. (2008). *Geographic information: Value, pricing, production and consumption*. Boca Raton, FL, CRC Press.

López-Nicolás, C., & Meroño-Cerdán, Á. L. (2011). Strategic knowledge management, innovation and performance. *International Journal of Information Management*, 31(6), 502–509.

Luo, N., Zhang, M., Hu, M., & Wang, Y. (2016). How community interactions contribute to harmonious community relationships and customers' identification in online brand community. *International Journal of Information Management*, 36(5), 673–685.

MAAF. (2016). Programme National de la Forêt et du Bois (PNFB) 2016-2026. Ministère de l'Agriculture, de l'Alimentation et de la Forêt, Paris,

France. Retrieved from <http://www.actu-environnement.com/media/pdf/news-26367-projet-plan-national-foret-bois.pdf>

Macharis, C., & Cromptvoets, J. (2014). A stakeholder-based assessment framework applied to evaluate development scenarios for the spatial data infrastructure for Flanders. *Computers, Environment and Urban Systems*, 46, 45–56.

Mamonova, S., & Triantoro, T. M. (2018). The strategic value of data resources in emergent industries. *International Journal of Information Management*, 38, 146–155.

Maritan, C. A. (2001). Capital investment as investing in organizational capabilities: An empirically grounded process model. *Academy of Management Journal*, 44(3), 513–531.

Masser, I. (1998). *Governments and Geographic Information*. Taylor & Francis, London.

McLeod, P., Martin, A., & Cromptvoets, J. (2013). *Spatial Data Infrastructure (SDI) Manual for the Americas*.

Merriam, S. B. (2016). Qualitative Research: Designing, Implementing, and Publishing a Study. In *Handbook of Research on Scholarly Publishing and Research Methods* (pp. 125–140). IGI Global.

Nedovic-Budic, Z., Cromptvoets, J., & Georgiadou, Y. (2011). *Spatial data infrastructures in context: North and South*. CRC Press.

OECD Competition Committee. (2009). *Two-Sided Markets*. Retrieved from <https://www.oecd.org/daf/competition/44445730.pdf>

Onoda, M., & Young, O. R. (2017). *Satellite Earth Observations and Their Impact on Society and Policy*. Springer.

Ose, K., & Deshayes, M. (2015). *Détection et cartographie des coupes rases par télédétection satellitaire*. Guide Méthodologique. UMR TETIS-Irtea, Montpellier, France.

Pablo, A. L., Reay, T., Dewald, J. R., & Casebeer, A. L. (2007). Identifying, enabling and managing dynamic capabilities in the public sector. *Journal of Management Studies*, 44(5), 687–708.

Parker, G. G., Van Alstyne, M. W., & Choudary, S. P. (2016). *Platform Revolution: How Networked Markets Are Transforming the Economy and How to Make Them Work for You*. WW Norton & Company.

Parker, G., & Van Alstyne, M. (2017). Innovation, openness, and platform control. *Management Science*.

Prencipe, A., Brusoni, S., & others. (2005). Making Design Rules: A Multi-Domain Perspective.

Pwc. (2016). Study to examine the socio-economic impact of Copernicus in the EU. Retrieved from [http://www.copernicus.eu/sites/default/files/library/Copernicus\\_SocioEconomic\\_Impact\\_October\\_2016.pdf](http://www.copernicus.eu/sites/default/files/library/Copernicus_SocioEconomic_Impact_October_2016.pdf)

Rajabifard, A., Chan, T. O., & Williamson, I. P. (1999). The Nature of Regional Spatial Data Infrastructures. In *Proceedings, of the 27th Annual Conference of AURISA, 22-26 November 1999*.

Rajabifard, A., Feeney, M. F., & Williamson, I. P. (2002). Future directions for SDI development. *International Journal of Applied Earth Observation*, 4, 11–22.

Ranga, M., & Etzkowitz, H. (2013). Triple Helix Systems: An Analytical Framework for Innovation Policy and Practice in the Knowledge Society. *Industry and Higher Education*, 27(3), 237–262.

Rey-Valette, H., Maurel, P., Mielle, P., Sy, M., & Pigache, L. (2017). Mesure les impacts des infrastructures de données géographiques (IDG) et des observatoires. Application à l’IDG SIG-LR. *Revue Internationale de Géomatique*, 3, 375–397.

Ridder, H.-G., Hoon, C., & McCandless, A. (2009). The theoretical contribution of case study research to the field of strategy and management. In

Research methodology in strategy and management (pp. 137–175).

Emerald Group Publishing Limited. Rindova, V. P., & Kotha, S. (2001). Continuous “morphing”: Competing through dynamic capabilities, form, and function. *Academy of Management Journal*, 44(6), 1263–1280.

Rochet, J.-C., & Tirole, J. (2003). Platform competition in two-sided markets. *Journal of the European Economic Association*, 1(4), 990–1029.

Rochet, J., & Tirole, J. (2006). Two-sided markets: a progress report. *RAND Journal of Economics*, 37(3), 645–667.

Rodriguez Pabon, O. (2005). Cadre théorique pour l'évaluation des infrastructures d'information géospatiale. Ph.D. Thesis, Département des Sciences Géomatiques, Faculté de Foresterie et de Géomatique, Laval University, Québec.

Rolland, K. H., Mathiassen, L., & Rai, A. (2018). Managing digital platforms in user organizations: The interactions between digital options and digital debt. *Information Systems Research*.

Rynes, S., & Gephart Jr, R. P. (2004). From the Editors: Qualitative Research and the "Academy of Management Journal". *The Academy of Management Journal*, 454–462.

Rysman, M. (2009). The Economics of Two-Sided Markets. *Journal of Economic Perspectives*, 23(3), 125–143.

Sawhney, M. S. (1998). Leveraged high-variety strategies: from portfolio thinking to platform thinking. *Journal of the Academy of Marketing Science*, 26(1), 54–61.

Shah, S. K., & Corley, K. G. (2006). Building better theory by bridging the quantitative--qualitative divide. *Journal of Management Studies*, 43(8), 1821–1835.

Shapiro, C., & Varian, H. R. (1999). *Information rules: A strategic guide to the network economy*. Harvard Business School Press.



Sharma, S., & Vredenburg, H. (1998). A dynamic theory of corporate reputation formation and stability. *Strategic Management Journal*, 19(8), 729–753.

Siggelkow, N. (2007). Persuasion with case studies. *The Academy of Management Journal*, 50(1), 20–24.

Smith, L. J. (2011). Business innovation symposium ‘At what price? IP-related thoughts on new business models for space information.’ *Acta Astronautica*, 69(7–8), 714–721.

Snow, D. A. (2004). Thoughts on alternative pathways to theoretical development: Theory generation, extension, and refinement. In *Workshop on scientific foundations of qualitative research* (pp. 133–136).

Song, P., Xue, L., Rai, A., & Zhang, C. (2018). The ecosystem of software platform: A study of asymmetric cross-side network effects and platform governance. *MIS Quarterly*, 42(1), 121–142.

Stewart, C. (2006). Results-based management accountability framework. In *GEOIDE/ GeoConnections workshop on value/evaluating spatial data infrastructures*, Ottawa, Ontario, Canada.

Sun, Y., Wang, N., Yin, C., & Zhang, J. X. (2015). Understanding the relationships between motivators and effort in crowdsourcing marketplaces: A nonlinear analysis. *International Journal of Information Management*, 35(3), 267–276.

Tan, F. T. C., Pan, S. L., & Zuo, M. (2014). The role of organisational interdependencies and asset orchestration in business integration: A case study of M. com. *International Journal of Information Management*, 34(6), 780–784.

Teece, D. J. (2010). Business Models, Business Strategy and Innovation. *Long Range Planning*, 43(2–3), 172–194. <https://doi.org/10.1016/j.lrp.2009.07.003>

Thomas, L. D. W., Autio, E., & Gann, D. M. (2014). Architectural leverage: putting platforms in context. *The Academy of Management Perspectives*, 28(2), 198–219.

Tiwana, A., Konsynski, B., & Bush, A. A. (2010). Research commentary—Platform evolution: Coevolution of platform architecture, governance, and environmental dynamics. *Information Systems Research*, 21(4), 675–687.

Tralli, D. M., Blom, R. G., Zlotnicki, V., Donnellan, A., & Evans, D. L. (2005). Satellite remote sensing of earthquake, volcano, flood, landslide and coastal inundation hazards. *ISPRS Journal of Photogrammetry & Remote Sensing*, 59, 185–198.

Tripsas, M., & Gavetti, G. (2000). Capabilities, cognition, and inertia: Evidence from digital imaging. *Strategic Management Journal*, 1147–1161.

Tulloch, D., & Harvey, F. (2007). When Data Sharing Becomes Institutionalized: Best Practices in Local Government Geographic Information Relationships. *Journal of the Urban and Regional Information Systems Association*, 19(2), 51–59.

Van Maanen, J. (1979). Reclaiming qualitative methods for organizational research: A preface. *Administrative Science Quarterly*, 24(4), 520–526.

Vandenbroucke, D., & Janssen, K. (2008). Spatial Data Infrastructures in Belgium: State of Play 2007. The Spatial Applications Division, K.U.Leuven R&D.

Vandenbroucke, D., Vancauwenberghe, G., & Dessers, E. (2009). A Network Perspective on Spatial Data Infrastructures: Application to the Sub-national SDI of Flanders (Belgium). *Transactions in GIS*, 13(1), 105–122.

Venkitachalam, K., & Willmott, H. (2017). Strategic knowledge management—Insights and pitfalls. *International Journal of Information Management*, 37(4), 313–316.

Weisman, D. L. (2010). Optimal Price Allocations in Two-Sided Markets.

Review of Network Economics, 9(3).

West, J. (2003). How open is open enough? Melding proprietary and open source platform strategies. *Research Policy*, 32, 1259–1285.

Whetten, D. A. (1989). What constitutes a theoretical contribution? *Academy of Management Review*, 14(4), 490–495.

Yin, R. K. (2017). *Case study research and applications: Design and methods*. Sage publications.

Ziedonis, R. H. (2004). Don't fence me in: Fragmented markets for technology and the patent acquisition strategies of firms. *Management Science*, 50(6), 804–820.

Zingal, F., & Becker, F. (2013). Drivers of optimal prices in two-sided markets: the state of the art. *J Betriebswirtsch*, 63(2), 87–116. <https://doi.org/10.1007/s11301-012-0091-8>

Zirpoli, F., & Becker, M. C. (2011). The limits of design and engineering outsourcing: performance integration and the unfulfilled promises of modularity. *R&d Management*, 41(1), 21–43.

Zott, C., & Amit, R. (2007). The fit between product market strategy and business model: implications for firm performance. *Strategic Management Journal*, 29, 1–26.





## Chapter 5

# How Much Would you Pay for a Satellite Image? Lessons Learned from a French Spatial Data Infrastructure

**Article:** Jabbour, C., Hoayek, A., Maurel, P., Rey-Valette, H., Salles, J.-M. (2019). How much would you pay for a satellite image? Lessons learned from a French spatial data infrastructure. *IEEE Geoscience and Remote Sensing Magazine* (*JIF = 9.65*) (Accepted - In Editing).

**Nomenclature:**

ADS: Airbus Defence and Space

AI: Artificial Intelligence

CDF: Cumulative Distribution Function

CEREMA: Centre d'études et d'expertise sur les risques, l'environnement, la mobilité et l'aménagement (French Centre for Expertise and Engineering on Risks, Environment and Urban Planning)

CNES: Centre National d'Etudes Spatiales (French National Space Agency)

DIAS: Data Information and Access Service

EO: Earth Observation

ESA: European Space Agency

GEOSUD: Geo Information for Sustainable Development

GIS: Geographic Information System

GSD: Ground Spatial Distance

HAPS: High Altitude Pseudo Satellites

HR: High Resolution

IGN: Institut National de l'Information Géographique et Forestière (French National Geographic Institute)

IoT: Internet of Things

ISIS : Incitation à l'utilisation Scientifique des images Spot (Incentive to Scientific use of Spot images)

MR: Medium Resolution

NOAA: National Oceanic and Atmospheric Administration

ONF: Office national des forêts (French National Forest Office)

ROC: Receiver Operating Characteristic

SDI: Spatial Data Infrastructure

UAV: Unmanned Aerial Vehicle

VHR: Very High Resolution

WTP: Willingness To Pay

## 5.1 Introduction

Earth Observation (EO) is contributing to the monitoring of the world's greatest issues: resource and land management, disasters, health risks, biodiversity and ecosystem services monitoring, air quality, etc. (Herold et al., 2002; Wilhelmi et al., 2004; Patino & Duque, 2013; Choy et al., 2016 ; Jordan et al., 2017). The increasing number of satellites launched since the 1970s, with a significant supply of satellite imagery (Belward & Skolen, 2015), brought countless major benefits to societies and humankind: countless of lives saved, improvements in environmental quality, enhanced regulatory efficiency, etc. (Bernknopf & Shapiro, 2015; Corbane et al., 2015). In fact, the growing trend towards free access to satellite images raises the question of valuation with a particular acuity (Pearlman et al. 2016). The valuation of EO is still in its infancy due to the difficulties it presents (Kruse et al. 2017). Valuing the satellite images is not a simple process. Asking "*how valuable is a satellite image*" should be followed by the question, "*how valuable to whom*".

In recent literature, the social value of satellite images is assessed either qualitatively, as for the Landsat and Sentinel images cases (Macauley, 2006; NASA, 2013) or quantitatively: some econometric modeling and estimation examples for the value of satellite information include analyses on agricultural productivity and vegetation dynamics (Weeks et al., 2000; Coltri et al., 2013), land use and management (Yang & Lo, 2002; Yang & Liu, 2005) air and water quality (Reginster & Goffette-Nagot, 2005; Bouma et al., 2009; Frei, 2009), etc. While most of the approaches are based on cost-benefit studies (Hamilton, 2012), other evaluations consist of statistical analysis (Loomis et al., 2015). In fact, a distinction must be made between the impacts of using the satellite images, which can be revealed through the number of lives saved, time saved, reduction of uncertainty, etc. and measuring quantitatively the value of the images, which is about estimating the value that direct users draw directly from the data (Liew, 2007). Recently, Laxminaryan & Macauley (2012) states that the contingent valuation method, which refers to the consumers' willingness to pay (WTP), can be the most important method for the assessment of the benefits derived from Earth observation data. Thus, it could be considered as a very useful tool for assessing the value of satellite images. While this method has been used in over 2000 references of diverse subjects (Mitchell & Carson, 2013), it was applied for the first time in 2015 to evaluate the Landsat satellite images (Loomis et al.,



2015). To the authors' knowledge, this study is the first application of this method to high resolution (HR) satellite images.

This paper explores the economic valuation of geospatial information as perceived by the direct users of a spatial data infrastructure (SDI). The study is based on HR satellite images provided by the GEOSUD/Theia SDI, based in France. In general, the satellite images can be distinguished on the basis of their spatial resolution or Ground Spatial Distance (GSD). In the absence of a real standard, we will use the following categories: the medium resolution (MR) referring to  $> 5\text{m}$  GSD (e.g. Landsat, Sentinel, SPOT 1–5, RapidEye), the high resolution (HR) from  $1\text{m}$  to  $5\text{m}$  GSD (e.g. SPOT 6–7) and the very high resolution (VHR)  $< 1\text{m}$  GSD (e.g. Pleiades, WorldView). Since 2011, the GEOSUD SDI made it possible to acquire each year, a homogeneous national coverage of the French national territory. From 2011 to 2013, this acquisition was based on the MR images (RapidEye and SPOT 5). Later from 2014 to 2019, the HR SPOT 6–7 images were used to produce the national map; the installation in 2014 of a Direct Receiving Station (DRS) with a SPOT 6–7 telemetry contract for the period 2015–2019 made it possible to continue acquiring annual HR national coverage maps and to meet specific HR image requests worldwide from the GEOSUD SDI platform subscribed users. From the very beginning of the project, all the images were acquired with a single multi-user license for public and research purposes only. These images (raw and rectified images, annual national coverage, etc.) differ in terms of fitness for use and price from those acquired directly from the basic image providers (ADS). For instance, at the end of 2018, if these images were not available through the pooling system developed by GEOSUD (an investment of €11 Million), it would have cost €110 Million to all the SDI users to acquire them separately from the image providers at their preferential rates. Many users would have given up due to budget constraints. The valuation comes to assess the importance of satellite imagery in supporting the territorial planning and development economics, in a context of open and distributed innovation within the networks, where the information is considered as a specific asset (Williamson, 1988; Howells & Bessant, 2012). In addition, it provides elements allowing to establish pricing scenarios in order to sustain the GEOSUD business model in the long run. Mid 2018 the launch date of the study, several debates on the question of the sustainability of GEOSUD beyond 2019 are taking place towards an establishment of a national access mechanism for satellite imagery. In fact, the access that GEOSUD has been

providing since 2011 for a wide range of images, covering different themes, is the result of great efforts of an increasingly costly structure towards continuous development of new systems and maintenance of the existing ones. At the current stage of development of GEOSUD, the first socioeconomic impacts are the avoided costs in the purchase of images by public actors and the scientific community due to a pooling, and the beneficial effects linked to the user networking and training. A first study was conducted concerning the direct impacts of the use of GEOSUD satellite imagery in the control of the forest clear-cuts in France; an average ratio of €24 of productivity gains has been obtained for every Euro invested in GEOSUD (Jabbour et al., 2018; Niang et al., 2019). An economic value assessment may address important policy questions and the way HR satellite images are contributing to the economic activity. The specificity of our study is in the fact that it targets a multitude of users mostly from public bodies, to whom the current access to the images through the SDI is free. In addition, it will serve to clarify the sustainability issue of the HR device implemented since 2014 with the receiving station and the SPOT 6.7 terminal. Hence, by presenting elements to establish possible funding scenarios for the future, this study helps justifying past and future investments, in order to ensure the sustainability of this type of data.

The article is organized as follows. We first outline the methodological protocol (characteristics of the data studied through the GEOSUD SDI, survey design and data collection, model estimation of the WTP answers). We then present the main results, followed by a statistical analysis. Next, the discussion brings those elements together with the existing literature, and explains the broader implications for the economic development policy. Finally, we conclude the article by considering future prospects in this field.

## 5.2 Methodology

### 5.2.1 Description of the case study: The GEOSUD SDI users and data characteristics

In 2007, a first regional and European funding program made it possible to initiate the GEOSUD project, by financing a future extension of the Remote Sensing Centre facilities in Montpellier. A spatial data infrastructure (SDI)

consisting of a satellite reception station, a SPOT 6\_7 satellite reception terminal and a web portal for accessing the images and associated services. The GEOSUD SDI is part of a broader framework of the National pole Theia, aiming to progressively build-up an ecosystem of innovation in the field of satellite imagery for Earth observation. In fact, the number of satellite images direct users who have opened accounts through this SDI platform has reached around 1000 members, with 517 structures having free access to satellite images: i) 162 research and education public organizations, composed mainly of experts in remote sensing and other research fields (e.g. archaeologists, economists, geographers); ii) 139 State services at the regional and departmental level, mostly from the ministries of agriculture and environment, with staff trained in geographic information systems (GIS); iii) 105 local authorities, at the regional, departmental and local level, mainly concerned by land planning and sustainable development projects, with staff having the same skill profiles as in the ministries; iv) 44 non-research public institutions, such as the State agencies in charge of natural resources management (e.g. water, biodiversity), national or regional natural parks, etc. v) 67 NGOs and associations.

From the beginning of the GEOSUD project until the end of 2018, GEOSUD members have downloaded more than 15,000 images covering 55 Million sq.km, half of which is represented by the HR images (fig. 5.1). A brief analysis of the acquired data shows that old MR images continue to be downloaded (e.g. 1.4 Million sq.km of RapidEye 2011 images has still been downloaded in 2017). However, it is the recent HR images that are most downloaded as shown by the following figures of SPOT 6\_7 images in 2017: 0.6 Million sq.km of images from 2014, 1.2 Million sq.km of images from 2015, 3.1 Million sq.km of images from 2016 and 2.6 Million sq.km of images from 2017). In addition to the annual national coverage (550,000 sq.km), the GEOSUD SDI responded since 2015 to more than 150 requests for the SPOT 6\_7 images worldwide (single or multi-site, single or multi-date, single, bi or tri stereo) covering an average of 1 Million sq.km/year.

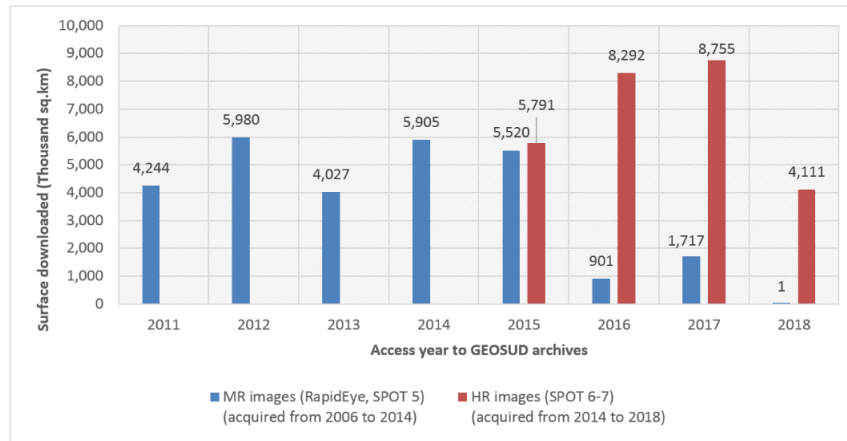

Figure 5.1: Access to MR and HR satellite images from the GEOSUD archives

### 5.2.2 Survey design and data collection

The survey was performed online early June 2018, targeting the totality of the HR satellite images users, identified from the GEOSUD/Theia platform. To be able to download the images, it is necessary for the users to be registered on the Theia's web portal; this feature allowed us to access all the 979 direct users of these images. Data were collected through a questionnaire survey, consisting of five sections:

- I. The type of users' sector/the usage category of the HR satellite images;
- II. The willingness to pay (WTP) for the HR satellite images;
- III. The WTP for a membership to a HR pooling mechanism system/The volume of images above which users are willing to pay for each additional image;
- IV. The preferences on the payment terms;
- V. The impact of the requested volume of images in case of a price imposition.

The respondents had several options for answering the questions in section I, IV and V. With respect to the 'usage category' in section I, the choice

of every respondent was not limited to one usage. An additional choice as ‘Other’ was also included to be filled freely. However, in sections II and III, with the assumption that ‘users are limited to their current budget (budget of the project or that of their organization)’, they were asked to state their WTP for the satellite images and the membership fee. Since the GEOSUD data sampling forms an entire pantheon of satellite image users (research and education public organizations, State services, local authorities, non-research public institutions, NGOs, etc.) integrating this assumption in the questionnaire, emphasized the fact that the money to pay differ from a usual household budget constraint. The questions in these two sections (II and II) were respectively as follows:

**Question(a):** *WTP for a High Resolution satellite image: “Would you be willing to pay an amount of X Euros for a HR satellite image (60x60 sq.km)? Which equal to (X/3600) €/sq.km? “*

**Question(b):** *WTP for a membership fee: “Would you be willing to pay an amount of Y Euros to adhere to a HR pooling mechanism system? “*

**Question(c):** *Volume of images: “After free acquisition of Z images (60x60 sq.km) of high resolution, are you ready to pay for each additional image? (The price per each additional image is fixed at €750, i.e. €0.20/sq.km?) “*

The HR satellite images available through GEOSUD, under the period going from 2014 till 2019, corresponds to the SPOT 6.7 images. In the survey, a standard size of 60x60 sq.km has been fixed for a requested image, for which the WTP of the users has been collected. To simplify the process, the price for each sq.km has been integrated in the question.

In the economic valuation, according the NOAA panel’s recommendations (Hanemann, 1984; Arrow et al., 1993), a double bounded dichotomous choice was adopted. Note that, the dichotomous choice format adopted in the GEOSUD data survey, stimulates a market where the respondent is confronted with a price and asked about his willingness to pay for that price. Additionally this question format, provides less opportunity for strategic behavior as discussed by (Carson & grooves, 2007), thus giving an appropriate

incentive questionnaire structure. The guiding principle behind the NOAA recommendations helps in designing surveys carefully, in order to get accurate economic values and meaningful results out of it. Having a large enough sample as for the GEOSUD database, in order to vary the images bid amount proposed to the respondents and get different valuation answers, also comes in consistency with the NOAA recommendations.

The variables X, Y and Z in the questions (a) (b) and (c) were fixed respectively between 300 and 25,000 Euros, 500 and 15,000 Euros and 2 and 8 images as a result of several meetings between remote sensing experts and the steering committee of GEOSUD. For each question, a value generated randomly between the lower and higher bounds was proposed to each survey subject. Concerning the WTP questions (a) and (b), due to the large range within the fixed lower and higher bounds, each question comes in three levels in order to gain better in precision. On the first level, if an initial response was ‘Yes’, a follow-up question with a higher amount was asked, while a ‘No’ response led to a lower amount. The same applies for the second level. However, question (c) comes in two steps due to the small range of proposed images. A ‘Yes’ response is followed-up by a lower volume of images.

The questionnaire was tested before the main survey. The focus was particularly on the WTP questions to check if they were properly understood. Some 75 respondents among all the databases of users were involved in the test. Two reminders were sent until mid-July 2018, the closing date of the survey. Among the 979 users, to whom the questionnaire was sent, 457 answers were received of which 351 were complete, thus obtaining a response rate of 36%. In addition, 106 partial responses were recorded. The respondents were assured of the anonymity of their answers and the confidentiality in the processing of the data and results. The statistical analyses were made using SPSS® and R®. The representativeness of the data was found to be statistically relevant of the whole population.

In addition, the collected data throughout the survey’s questions have been coupled with the basic respondents’ information registered via the GEOSUD SDI. These different aspects have enriched our observations in order to push our analysis one step further and establish a comparative study while taking into consideration various parameters (bid amount, sector typology, volume of images requested, etc.).

### 5.2.3 Model estimation

Based on the responses of the WTP questions, the probabilistic distribution of the WTP amounts was evaluated through a generalized multilinear model with binary dependent variable, defined by:

$$Y_i = F(\beta' X_i) + \varepsilon_i; i \in \{1, 2, \dots, N\}.$$

Where  $N$  is the number of observations,  $F(\cdot)$  the cumulative distribution function (*CDF*),  $\varepsilon_i$  the residual term with  $\mathbb{E}[\varepsilon_i] = 0$  and  $Y_i$  follows a Bernoulli distribution of parameters

$$\pi_i = \mathbb{E}[Y_i] = \mathbb{P}[Y_i = 1 | X_i] = F(\beta' X_i).$$

Then,

$$Y_i = \begin{cases} 1 & \text{When individual } i \text{ is willing to pay a particular bid} \\ 0 & \text{Otherwise} \end{cases}$$

The vector  $X_i = (X_{1i}, X_{2i}, \dots, X_{ni})$  represents the  $p$  independent variables for the  $i^{\text{th}}$  individual. Finally,  $\beta = (\beta_1, \beta_2, \dots, \beta_p)$  is the vector of coefficients to be estimated. Therefore, the problem consists of estimating  $\pi_i$  based on the  $X_i$  observations.

In the context of this study (a qualitative dependent variable with binary outcomes), the most commonly used *CDF* is that of the logistic distribution (Hosmer & Lemeshow, 2000), defined as:

$$F(u) = \frac{e^u}{1 + e^u}.$$

Thus in this particular situation, the regression will be mentioned as “Binary Logistic Model” (Cox, 1958), where the probability for individual  $i$  of the willingness to pay for a bid, will be estimated by:

$$\pi_i = \frac{e^{\beta' X_i}}{1 + e^{\beta' X_i}}. \quad (1)$$

However, equation (1) is not usable unless the  $\beta$  parameters are estimated. In order to perform this, we referred to the classical principle of maximum likelihood. In our case, the likelihood function is given by:

$$L(y_1, \dots, y_N) = \prod_{i=1}^N \pi_i^{y_i} (1 - \pi_i)^{1-y_i}. \quad (2)$$

Where,  $y_i$  and  $x_i$  are the observed values of  $Y_i$  and  $X_i$  variables.

By applying the logarithmic function, we obtained the log-likelihood function:

$$l(y_1, \dots, y_N) = \sum_{i=1}^N [y_i \ln \pi_i + (1 - y_i) \ln (1 - \pi_i)].$$

Thus, the estimation of  $\beta$  was performed by maximizing the log-likelihood through solving the system of partial derivatives:

$$\frac{\partial l}{\partial \beta_j} = 0; j \in \{1, 2, \dots, p\} \quad (3)$$

The solution of system (3) is obtained by the iterative method of Newton-Raphson (Kendall, 1989). The estimated parameters will be denoted by  $\hat{\beta} = (\hat{\beta}_1, \hat{\beta}_2, \dots, \hat{\beta}_p)$ .

#### 5.2.4 Application to the GEOSUD SDI

In order to apply this approach to the survey's observations, we created four dummy variables for the five different activity sectors of users:  $D_1$  = "NGOs and various organizations",  $D_2$  = "Local authorities",  $D_3$  = "State services" and  $D_4$  = "Non-scientific public institutions". Furthermore, we considered the "Research and education organizations" as a reference level. Note that the choice of the reference level has no impact on the quality of the model and the effect of this sector is implicit within the intercept coefficient. In addition, we considered the variables  $B$  = "the proposed bid amount",  $V$  = "the annual average volume of requested images" and the "four created dummy variables" as independent variables. On the other hand, the response to the WTP question was considered as dependent variable. Note that the annual average



volume of requested images represents the additional variable resulting from the information registered for every respondent via the GEOSUD SDI. It is the global volume of images requested for each structure divided by the overall period in which the structure is already a member to GEOSUD. This variable was chosen to be added instead of the global volume of images requested because of its representativeness of the satellite images demand's reality. We noticed several gaps in the demand of some adherent structures, which may request a huge number of images in one year followed by a zero demand in several next years. Hence, the choice of the average volume which gives a better representation of the images requested since the registration date till now. Therefore, an explicit expression of the logistic model is:

$$Y_i = F(\beta_0 + \beta_1 B_i + \beta_2 V_i + \beta_3 D_{1i} + \beta_4 D_{2i} + \beta_5 D_{3i} + \beta_6 D_{4i}) + \varepsilon_i; i \in \{1, \dots, N\}.$$

Where  $\beta_0$  represents the intercept coefficient.

After estimating all the coefficients of the model and considering the statistically significant ones, we could compute the probability that a particular user agrees to pay a proposed bid amount. In addition, by varying the bid amounts and by applying equation (1), we could also generate for every sector, a probabilistic demand function for the imagery and therefore a global demand function that respects the weights of each sector. Furthermore, in order to generate the demand function for each sector, the variable  $V$  has been fixed and represented by the mean of all the  $V_i$  of the users within the considered sector.

Using these demand functions, it was straightforward to precise the bid amount for which a pre-defined percentage “ $p$ ” of users are ready to pay for an image.

Analytically, the amount that corresponds to a probability of acceptance  $p$  is given by:

$$p = \frac{e^{\beta_0 + \beta_1 B_i + \beta_2 V_i + \sum_{k=1}^4 \beta_{k+2} D_{ki}}}{1 + e^{\beta_0 + \beta_1 B_i + \beta_2 V_i + \sum_{k=1}^4 \beta_{k+2} D_{ki}}},$$

then,

$$p - \text{level } WTP = \frac{1}{\beta_1} \left[ \ln \left( \frac{p}{1-p} \right) - \left( \beta_0 + \beta_2 V_i + \sum_{k=1}^4 \beta_{k+2} D_{ki} \right) \right]. \quad (4)$$

Therefore, the  $p$ -level WTP when charged,  $p\%$  of the users are expected to accept paying and  $(1-p)\%$  will turn down the proposed amount. Based

on the WTP probabilistic distribution, the expected WTP value was simply computed by applying a classical result for continuous random variables:

$$\mathbb{E}[WTP] = \int_0^{\infty} [1 - F(WTP < x)] dx. \quad (5)$$

With  $F(\cdot)$  the *CDF* of the WTP distribution.

Finally, in order to solve the integral in (5), we applied the numerical integration methods (Hanemann, 1984) where we considered the lowest and the highest proposed bids as respectively the lower and the upper boundaries of the integral.

## 5.3 Results

### 5.3.1 Descriptive results

The majority of respondents were from the research and education organizations' sector with 179 responses (51% from 351 fully recorded answers), followed by the local authorities' sector with 60 responses (17.1%). With respect to the 'usage category' of the HR satellite images, we accounted for five main different uses. Two additional uses were recorded for the 'Other' option. We can see that the observation activity occupies the highest percentage of use and almost half of the users consider the images for their research activity (table 5.1). The choice of the segmentation between operational use (e.g. monitoring) and non-operational (e.g. R&D) was guided by the fact that scientists and operational public users do not have the same needs and do not evaluate the satellite imagery on the same criteria due of their job nature. The researchers, direct users of GEOSUD whose majority are remote sensing experts, will rely on the usefulness of images to generate new knowledge and develop transferable methods. They are also used to benefit from support programs for partial or total free access to images (e.g. French CNES ISIS program, ESA, etc.). On the other hand, the operational users, most of the time non-specialists in the remote sensing domain, will react differently to the satellite images or image-based products (manufactured by themselves or by expert providers) in their professional fields of applications.

Section I	Type of sector of satellite image users	Percentage	HR satellite imagery usage	Percentage
	Research and education organizations	50.99	Observation and monitoring (of territory, specific areas, coastlines, forests, etc.)	69.36
	Local authorities	17.09	R & D (research and development)	44.57
	State services	13.67	Monitoring for control	17.94
	Non-scientific public institutions	13.10	Management and planning	17.50
	NGOs	5	Other: Personal interest No use	1.8 1.4
Section IV		Section V		
	The preferences on the payment terms	Percentage	The impact of the requested volume of images in case of a price imposition	Percentage
	By paying a membership to the pooling device	38.46	0% (The requested image's volume will not change)	9.68
	By paying over a certain volume of free images	35.04	25%	6.55
	By combining the two: membership to the pooling device and payment of the images	14.51	50%	18.23
	Other	10.25	75%	24.21
	By paying from the first image	1.42	100% (The structure will not require more images)	41.31

Table 5.1: Descriptive results

The answers to sections IV & V were limited to a single choice by respondent. We noticed in terms of payment, a relatively high percentage of users who preferred to pay a membership fee, in order to access to a pooling device allowing them a free access to HR satellite images. The acquisition of a number of images for free that preconditions the imposition of price comes second, with a percentage of 35% of users choosing this option (The answers to section III question, will provide more details and elements of analysis of this option). In section V, while the majority of the responses (41% of the users) considered that their organization will not require more images in case of a price imposition, 9.7% responded that the requested volume of images will not be affected.

In addition, a list of recorded answers within the ‘Other’ category is presented below:

- i. *No payment seems to be justified for a scientific use;*
- ii. *The structure will acquire a drone instead of paying for satellite images;*
- iii. *Researchers must have access to public data without any specific conditions of payment;*
- iv. *Payment should be for added-value products, not for the satellite images;*
- v. *Communities have declining budgets and the priority is not for image acquisition;*
- vi. *Funding must be done through ministries.*

### 5.3.2 Statistical Results

The respondent’s answers revealed rich information, for which a statistical analysis is needed in order to extract relevant information. To do so, we started by applying the maximum likelihood principle in order to compute the estimators for the different parameters (table 5.2). Note that . , \* , \*\* and \*\*\* indicate statistically significant at 10%, 5%, 1%, and 0.1% asymptotic level respectively. In addition, all the sectors coefficients are measured relatively to the reference level.

The demand curve (figure 5.2) indicates the global probability of acceptance for different proposed bid amounts. In order to represent the global demand probabilities, we considered  $V$  as fixed and represented by the mean of all the  $V_i$  of the significant sectors’ users.

<b>Coefficients</b>	<b>Estimate</b>	<b>Std. Error</b>	<b>z value</b>	<b>Pr (&gt; z )</b>
<b><math>B = \text{Bids } (\beta_1)</math></b>	-5.843e-04	4.717e-05	-12.386	<2e-16 ***
<b><math>V = \text{Volume}(\beta_2)</math></b>	1.785e-02	8.062e-03	2.214	0.0268 *
<b><math>D_2 (\beta_4)</math></b>	5.236e-01	3.086e-01	1.697	0.0898 .
<b><math>D_3 (\beta_5)</math></b>	6.193e-01	2.656e-01	2.332	0.0197 *
<b><math>D_4 (\beta_6)</math></b>	9.642e-01	4.642e-01	2.077	0.0378 *

Table 5.2: The estimators’ analysis

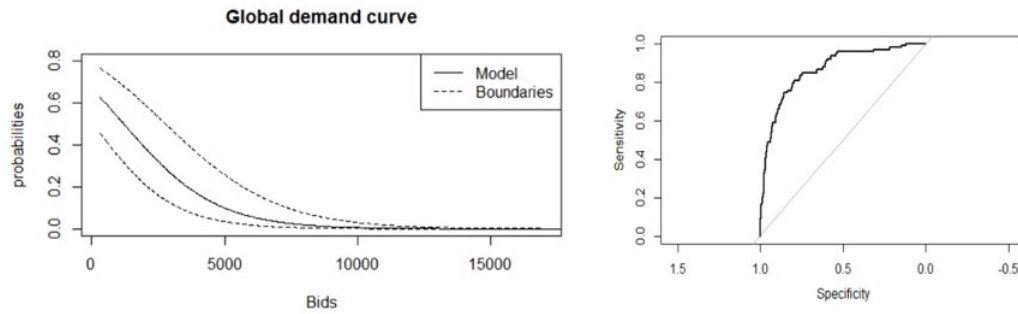

Figure 5.2: Demand Curve — ROC curve model performance

In order to evaluate the global performance of a logistic regression, we used the Receiver Operating Characteristic (ROC) curve (Pontius et al., 2014). The area under the curve is  $\approx 86.8\%$ , indicating a good model performance with a high global prediction accuracy. To be able to perform a graphical WTP analysis, we considered a zoomed version of the global model to clearly visualize the demand curve (figure. 5.3):

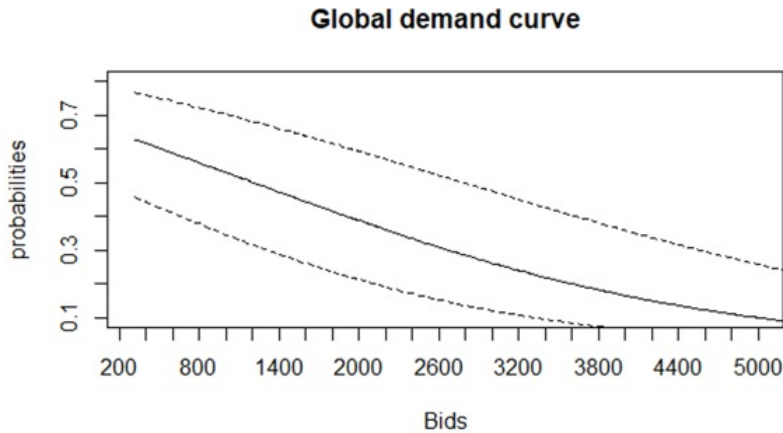

Figure 5.3: Zoomed global demand function

Based on figure 5.3 and by applying equations (4) and (5), several interesting results can be derived. As expected, the percentage of individuals who are ready to accept a proposed bid decreases with the increase in the bid's values. On the other hand, the global median amount (corresponding to a

50%-level WTP) is about 1209 Euros, which means that 50% of individuals are expected to agree paying more than this sum and 50% to refuse. By charging an amount of 1209 Euros per image, GEOSUD could probably lose half of its subscribers. Note that by applying equation (4), one can specify a p-level WTP for any value of p. E.g. about 63% of the users are not willing to pay more than 300 Euros per image. However, about 10% of the users are willing to pay 4969 Euros and more for a HR satellite image. Another important statistical result obtained by a numerical integration of equation (5) is the mean value per image, which is globally about 1696 Euros per image. Charging this amount to GEOSUD users should lead to an acceptance rate of 43%, with 57% of users no longer acquiring imagery.

### 5.3.2.1 Sector-by-sector analysis

Based on the results of table 5.2., sectors  $D_2$ = “Local authorities”,  $D_3$ = “State services” and  $D_4$ = “Non-scientific public institutions” are statistically significant with positive estimated coefficients. An individual belonging to one of these sectors, has a greater probability of accepting a certain bid amount compared to an individual in the reference sector (i.e. Research and education organizations). By considering an individual within a significant class, by fixing  $V$  which represents the mean of all the  $V_i$  of the users within this class and by varying the bids amounts, one can generate a sector-by-sector probabilistic demand function. Figure. 5.4 illustrates the demand functions of  $D_2$ ,  $D_3$  and  $D_4$  sectors. Using these demand functions, it is easy to identify a sector-by-sector p-level WTP for which p% of the users of the corresponding sector are ready to pay. Finally, recall that the global demand curve is based on the sector by sector probabilities and respecting the weight of each significant sector. The results concerning global and sector-by-sector means and medians (in Euros) are presented in table 5.3.

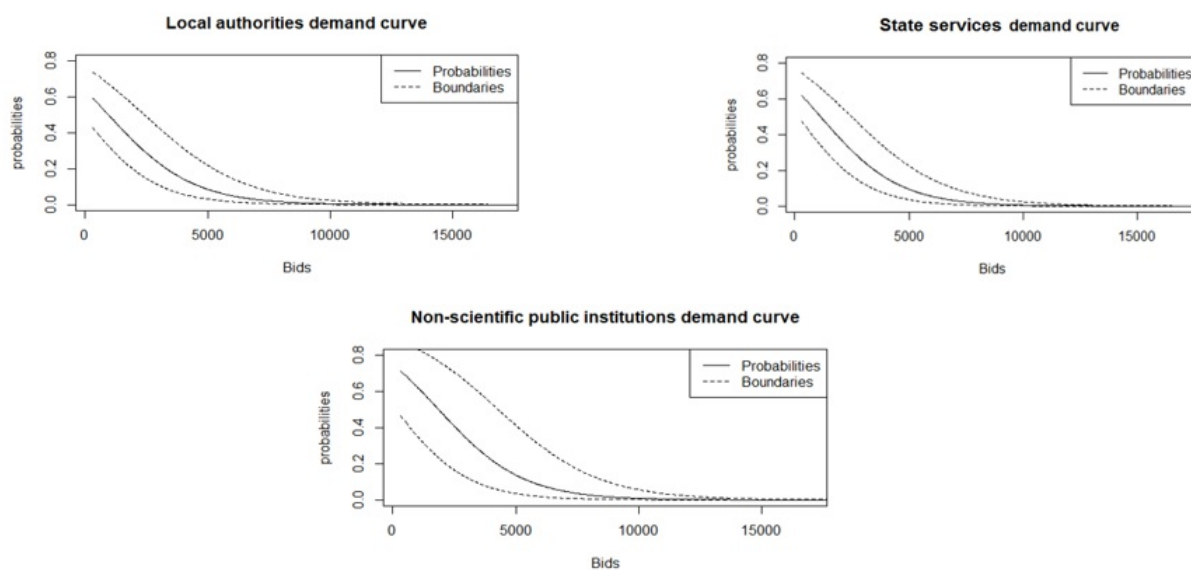

Figure 5.4: Demand curve of the significant sectors

Significant sectors	Mean (€)	Median (€)
$D_2$ = “Local authorities”	1531	950
$D_3$ = “State services”	1645	1139
$D_4$ = “Non-scientific public institutions”	2126	1860
Global	1696	1209

Table 5.3: Means and medians in Euros of the different significant sectors of users

The highest WTP value recorded among the three significant sectors, belongs to the “Non-scientific public institutions” sector, with a mean value of 2126 Euros.

### 5.3.2.2 Membership analysis

In order to consider the membership value analysis, the independent variables introduced come as follows:  $M$  = “the membership proposed bid amount”,  $V$  = “the annual average volume of requested images” and ‘the four dummy

variables' representing the different sectors  $D_1, D_2, D_3$  and  $D_4$  with the "Research and education organizations" sector as a reference level. Using information from the survey on the membership amount that each user is willing to pay, and following closely the same steps previously, the estimators' analysis is presented below (table 5.4):

<b>Coefficients</b>	<b>Estimate</b>	<b>Std. Error</b>	<b>z value</b>	<b>Pr (&gt; z )</b>
$\beta_0$ = Intercept	-7.987e-01	1.410e-01	-5.665	1.47e-08 ***
$M$ = Membership Bids ( $\beta_1$ )	-8.752e-05	2.106e-05	-4.156	3.24e-05 ***
$D_3$ ( $\beta_5$ )	2.713e-01	1.643e-01	1.652	0.0986

Table 5.4: Membership WTP estimators' analysis

As the intercept coefficient is significant, then in the context of membership WTP, the impact of the reference sector "Research and education organizations" on the probabilities of acceptance should be taken into consideration. In addition, sector  $D_3$  = "State services" and obviously the 'membership proposed bid amounts' are also significant. However, the variable  $V$  that represents 'the annual average volume of requested images' is not significant here. By applying equation (5), the means of each significant sector are respectively 2782 Euros ("Research and education organizations"), 3428 Euros ("State services") and 3022 Euros ("Global sector"). Note that in this case, the median cannot be defined because, the decreasing probabilities curve, starts with a probability of 0.32 (<0.5) corresponding to the least proposed membership bid amount 500 Euros. We can notice that the global membership WTP mean (3022 Euros) is clearly higher than that of the global WTP per scene (1696 Euros). This means that, in general, users tend to be willing to pay more for a fixed yearly amount than to be priced per image. The "State services" represents the sector which is willing to pay the most for a membership fee with a mean of 3428 Euros. In fact, almost 12% of users accept to pay a 15,000 Euros membership fee. This percentage of users increase up to 20% for 8000 Euros as a fee.

### 5.3.2.3 Volume Analysis

By proceeding in the same way, the binary logistic model is applied to fit the answers on the two proposed threshold volumes. The responses to the



threshold volumes questions are considered as binary dependent variable. On the other hand, the independent variables are:  $V_{proposed}$  = “the proposed threshold volume”,  $V$  = “the annual average volume of requested mages” and ‘the four dummy variables’ representing the different sectors:  $D_1, D_2, D_3$  and  $D_4$  with the “Research and education organizations” as a reference level. The estimator’s characteristics are as follows (table 5.5):

<b>Coefficients</b>	<b>Estimate</b>	<b>Std. Error</b>	<b>z value</b>	<b>Pr (&gt; z )</b>
$\beta_0$ = Intercept	0.31157	0.14780	2.108	0.03502 *
$V_{proposed}$ ( $\beta_1$ )	0.05716	0.02687	2.128	0.03338 *
$D_2$ ( $\beta_4$ )	0.69706	0.23847	2.923	0.00347 **

Table 5.5: Threshold volume estimators’ analysis

As in the membership WTP model, the intercept coefficient is significant. Then the reference sector “Research and education organizations” should be taken into consideration. In addition, sector  $D_2$  = “Local authorities” and ‘the proposed threshold volume’ are also significant. We found an average volume threshold of 8 images, above which subscribers are ready to pay 750 Euros per additional image (table 5.6).

Number of free images	Percentage of users accepting to pay €750 above a number of free images		
	Research and education organizations	Local authorities	Global
<b>1</b>	59	74	63
<b>2</b>	60	75	64
<b>3</b>	62	76	66
<b>4</b>	63	78	67
<b>5</b>	65	78	68
<b>6</b>	66	79	69
<b>7</b>	67	80	70
<b>8</b>	68	81	72
<b>10</b>	71	83	74
<b>12</b>	73	84	76
<b>14</b>	75	86	78
<b>16</b>	77	87	80

Table 5.6: Percentage of users accepting to pay above free images acquired.

In fact, a simple cross comparison between the descriptive results of section IV and V and the results obtained within the three main questions of sections II and III shows the following: While 9.7% of the users responded that the requested volume of images will not be affected in case of a price imposition, 10% is ready to pay 5000 Euros for an image and 11.8% accept to pay 15,000 Euros as a membership fee to a HR pooling mechanism system. However, with 41% of the users considering that their organization will not require any more images in case of a price imposition, 38% of the users are not even willing to pay 300 Euros per image, with 67% refusing to pay more than 500 Euros as a membership fee. In order to have a global view, we combined the survey's results with the GEOSUD database. A direct way to compute the total economic benefits of the HR satellite images is by multiplying the total number of HR satellite images available on the platform by the global mean value per image. This may result in a total economic benefit of 12.7 Million Euros perceived only for the direct users. Since the global demand WTP curve represents the relationship between the price of the image and the quantity demanded, the area below this curve can be presented as the net consumer surplus, the benefits that users obtain for their use of HR satellite

images. These 12.7 Million Euros represent the economic gain of consumers at a zero price per image. So far, the operating costs of GEOSUD amount to 11 Million Euros. Secondly, while generalizing the results based on the mean membership WTP (3022 Euros), GEOSUD through the 500 structures registered on the platform, could account some 1.5 Million Euros in case of a membership fee imposition.

## 5.4 Discussion

The approach chosen is based on the current users of a club good (Samelson, 1954) that can only be accessed by organizations, majorly from public structures, already registered on the GEOSUD platform. The GEOSUD SDI, to which the authors had a privileged access, has been taken as an example to illustrate the potential of these images in a wide and growing range of uses. Although the respondents were not totally in a position to make trade-offs between different agency budgets priorities, the survey endeavored to frame their answers so as if they could make it by themselves. Hence, the study exceeds a simple opinion gathering vehicle to be more substantively a valuation exercise. It aims at clarifying the users' interest in this type of information, and more generally through their public representativeness, to contributing to the improvement of the governance systems. While the users' WTP depends mainly on their interest for the HR satellite images, their assigned value may be coupled with other reasons for mobilizing necessary resources in order to assume these possible new expenses which are constrained by mandatory public call for tender.

### 5.4.1 The satellite imagery WTP

Since 2014, the images downloaded by the survey respondents from the GEOSUD archives, consist mainly of HR SPOT 6\_7. Likewise, a first study conducted by Loomis et al. (2015) presented a detailed valuation for geospatial information concerning the MR Landsat satellite imagery. The national aspect of Loomis's study, paved the way to consider several types of users for whom, a mean value of 912 USD is recorded for a Landsat image (scene). For an overall of 2.38 Million scene downloaded, a total user benefit of 1.8 billion USD has resulted. Note that, the HR imagery is a highly sensitive information and its characteristics differ greatly from that of the Landsat im-

ages in terms of precision, volume of acquired surface, resolution, available bands, latency, automatic processing, application scenarios, etc. (Denis et al., 2017). This may explain the higher valuation in our study for a HR satellite image (1696 Euros). In addition, the ‘annual average volume requested’ being significant, fits with logically expected results that the probability of a user accepting a proposed bid, increases with the requested volume of images. This may result from the nature of the respondents, who are mainly informed and concerned about the nature of the good they are evaluating. The efforts GEOSUD is making, towards lowering the barriers which hampers the use of satellite images, reinforce the valuation in that direction. In addition to the images, the added-value products and services available through the GEOSUD SDI contribute to the value that users draw. On the other hand, the results of the survey showed that the prices users are willing to pay for the SPOT 6.7 images were significantly below the current Airbus commercial rates. The commercial price of a 60x60 sq.km SPOT 6.7 image varies in general between 13,500 Euros and 16,500 Euros, respectively for an archive ADS image and a programming request demand (a 50% discount is applied within the GEOSUD SDI, if the intended use is for research purposes). Thus, while considering the research case as an example, a simple comparison between the commercial price of a satellite image resulting from a programming request demand (6750 Euros; €1.875/sq.km) and the mean WTP recorded by the GEOSUD SDI respondents for such an image (1696 Euros; €0.47/sq.km), reveals a ratio of 4. This ratio rises up to 10, if the comparison involves the mean WTP value and the commercial price excluding research (13,500 Euros).

Compared to a purely commercial model, the GEOSUD SDI made it possible to progressively build a database of reusable satellite images by researchers and public actors. In a more concrete way, the annual national coverage produced by GEOSUD, comes to complete the IGN’s aerial coverage, renewable once every three years. The national coverage product illustrates a patrimonial logic in accordance with the French public policies, with the need of maintaining a map coverage of an entire territory for the multiple uses that could emerge. Consequently, the GEOSUD pooling system is bringing together, in addition to the HR imagery, an entire ecosystem of innovation including researchers, public actors and private service providers. Thus, by promoting the innovation in various sectors, it is allowing the community of users to become much broader and more diverse than it would have been, if

affected only by a purely commercial model.

### 5.4.2 The satellite imagery WTP among sectors

By examining the WTP for the satellite images, we noticed significant differences among the various sectors. As an example, the “Non-scientific public institutions” (such as the ONF, CEREMA, IGN, CNES, natural park managers, water agencies, the National Office for Hunting and Wild Fauna, etc.) is the sector with the highest WTP with half of its users are ready to pay 1860 Euros per image. By fixing an acceptance rate of 60%, the WTP amount for this sector is about five times the “Local authorities’ ” one, having the lowest WTP. It might be explained by their need for images at a local territory scale, and therefore of smaller size. The logic behind a reasoning based on a number of images by fixing a 3600 sq.km as an image size was somehow necessary to have a standard valuation framework. However, it presented some inconvenient according to the users different expectations and uses. These differences in some situations, result from the inconsistency between the end users’ needs for products based on satellite imagery and the solutions available, due to the recent adoption of the satellite images in certain sectors (Pwc, 2016; Krsue et al., 2017). In fact, the increasing availability of data and rapidly evolving analysis techniques in some particular domains, enhance the value that this data could have on the direct users. As a consequence, some categories of users translate their uses of HR satellite images into greater benefits. As an example, the non-scientific public institutions are considered as macrostructures management covering a wide perimeter, and having strict efficiency requirements with dedicated public funds. Being more effective through their missions, while responding to the needs and ambitions of the various components of the society, can be rewarded back by the society itself. Thus, this process can be translated into a budget increase within these structures; a greater value granted for the improved control and organization (Pee & Kankanhalli, 2016). Hence, given the contribution and the benefits in terms of efficiency that these HR images can provide, these structures are ready to pay large amount in order to acquire them. In addition, as part of the recent reform of the Administration in France, these structures aim to reduce their staff while admitting a higher reliance on automated processes.

Worthy to mention that the 60% threshold, taken above as an example,

refers to the acceptance rate of users' ( $U$ ) related to a certain payment generated ( $P$ ):  $U$  of users will accept to pay  $P$  Euros. The payment could be either for the satellite images, or for the membership fees to join the SDI platform. It could also be a policy combining the two options, which until now, was not established at the level of the GEOSUD SDI platform. It is for the GEOSUD management and steering committee, to choose whether to keep this threshold (which could vary depending on its policy), for which various payment values could be revealed among each separate sector. The same analysis and comparisons between sectors can be performed by fixing the WTP amounts and analyzing the acceptance rates. The SDI, knowing the budget necessary for the ongoing supply of its imagery service, should make a compromise between the service cost and the sufficient number of members accepting to pay this cost, in a way it fulfills its goals. The policy of setting the WTP amounts and the acceptance rate of users, represents a compromise for the SDI regarding several criteria (economic, strategic, managerial, etc.) that must be taken into consideration. As an example, through imposing a high tariff, the SDI could cover its costs, by collecting the necessary amounts from a small proportion of users that are willing to pay these large amounts. However, from a strategic point of view, the SDI will restraint to a small satellite image users' community, for which the networking will be of a less importance, if viewed from a platform exchange service.

### 5.4.3 The membership fees WTP

On the other hand, the GEOSUD SDI users prefer to pay a membership fee for accessing a pooling device than paying per image. The global membership WTP mean (3022 Euros) which is substantially higher than that of the global WTP per image (1696 Euros) illustrates clearly this argument. Despite some light differences between these membership values among the sectors, the logic behind remains the same and can be explained by several issues. First, public bodies by joining a pooling structure, avoid going through tenders to buy the images. Their need in images to support the projects and the wide diagnostic processes cannot be known in advance. Paying for a membership fee, allows for a large access to images that fits better their users' needs. Unlike some traditional management processes, where the basic technological support tool evolve slowly over time, some specific high-tech contexts depend on a large number of images due the nature of the research and mainly the time factor, i.e. once the project is over, this demand may

slow down. For this, several structures despite their low demand for satellite images, are willing to pay large amount for what the pooling device may offer them in terms of the number of images and added value services. This also explains the non-significance of the “annual average volume requested” variable in a context of membership analysis. The HR satellite users, while estimating their WTP to join a HR pooling mechanism system, dissociate their past consumption in images.

Hence, the fact of preferring a membership payment refers to the idea of the uncertainty factor that is more present related of the number of images that will be requested by these structures. Thus, this opportunity represents a security compared to paying for each image requested.

#### **5.4.4 The HR satellite images: a place between the free MR and the VHR commercial images**

By looking to the large satellite images pooling mechanisms, we notice an enormous expected global growth, covering a wide diversity of image resolution (MR, HR, VHR, etc.). Internationally, we see the Copernicus<sup>8</sup> program in Europe heading towards its future DIAS infrastructure (Data Information and Access Service). Multinationally Google with Google Earth and its platform Google Earth Engine, Amazon with its platform AWS<sup>9</sup>, etc. In such context, the introduction of these devices at larger scales, raises the question of the specific value of the HR SPOT 6.7 imagery compared to the commercial VHR images (e.g. Pleiades, WorldView) and the free MR images (e.g. Sentinel-2, Landsat). In fact, there exists an interest of the HR images in terms of technical complementarity. Despite the lower technical properties and characteristics compared to the Pleiades images, the HR images are considered as additional sources to the Sentinel program, with the possibility of covering complete territories with finely exploitable elements. This point was taken into account by the GEOSUD SDI, while selecting the SPOT 6.7 satellite acquisition in 2014. The choice of the SPOT 6.7 images was adopted because of the several technical characteristics (spatial resolution, coverage capabilities, programming agility) which appeared to be very complementary to Pleiades (inframetric resolution but insufficient satellite resources to cover large territories) and Sentinel (free and very high repeatability but with low spatial resolution limited to 10m). Note that, the Pleiades and

Sentinel programs represent a constellation of satellites, entirely financed by public funds with an entrusted exploitation by the space industrial actors. This phenomenon illustrates somehow various mechanisms: The DIAS for pooling the Sentinel images and the DSP for a public use delegation of the Pleiades ones. Through the DIAS pooling mechanism for the Sentinel images, three usage levels are present. First, an open access to the satellite images is provided via the DIAS platform. Secondly, processing tools can be found in order to extract added-value and allow product and service development. Finally, a third-level groups these elements following a “Market Place” logic. The DIAS infrastructure, as a resultant of an industrial consortium with European grants, raises several questions about its sustainability and its long-term economic model. On the other hand, the access to Pleiades images for public use is conditioned by the establishment of a DSP agreement between the CNES and Airbus Defence and Space. Hence, it seems necessary to think about the place occupied by the HR satellite images, between the free MR Sentinel and the VHR Pleiades images.

Furthermore, recent researches confirm the benefits of having a shared access to a multi-sensor and multi resolution image bundle, in order to cover a variety of application domains. As an example, advances in AI and machine learning illustrate the use of VHR and HR imaging as a massive learning base for processing MR Sentinel-2 images (Benedetti et al., 2018; Benecki et al., 2018). In fact, the results of our study serve to highlight this issue, through examining the usefulness of this type of data, whose complementarity to the MR and VHR images needs to be justified.

#### **5.4.5 The SDI pooling mechanisms supporting the use and access to satellite imagery**

In general, the differences in the satellite imagery resolutions are not trivial and can manifest into stark shifts, such as in land cover classifications, image sharpness, patch-level metrics, pattern analyses, etc. The data continuity, the increased affordability and the improved access conditions are essential elements in the supply of high-resolution satellite images, whose benefits are numerous and could be found in several forms and applications (e.g. see Nagendra & Rocchini, 2008 for tropical biodiversity studies; Boyle et al., 2014 for biodiversity conservation; Ma et al., 2017 for land use classification; Wu et



al., 2018 for geology; Sozzi et al., 2018 for precision farming). Furthermore, the cost of satellite imagery has a large impact on its use and the resulting societal benefits (Loomis et al., 2015); if too expensive, it will not be used extensively as originally intended.

In fact, the efficient satellite image pooling mechanisms, such as the GEOSUD SDI, come to reinforce these facts. The large access and use of high-resolution satellite imagery play a role in supporting the institutional services in the implementation of their territorial planning missions, through the assistance and integration of the image-based space technologies into the public policy systems (Drusch et al., 2012; Tonneau & Maurel, 2016). Furthermore, while the satellite images users are increasingly being in proximity to their local and territorial issues, the availability of free high-resolution satellite database allows managing their day-today tasks, in a more precise way. In complementarity with the MR and VHR images, the HR images offer a good compromise between spatial resolution and high coverage capabilities. Thus, the GEOSUD SDI is allowing many users who couldn't afford the images price, to be present in the sphere of the satellite imagery field. By adopting an upstream financing strategy by the public authorities with an open access downstream is conserving a large base of its subscribed users, despite their refusal to pay for the images and services provided. Similarly, Amazon, Google and the European Space Agency (ESA), with their new strategies for providing Landsat and Sentinel satellite images on their platforms, are also heading towards enlarging the use and access to such data. While pooling the access to the satellite imagery, they are creating a networked community whose coordination and collaboration drives towards more innovation processes and development of added-value services and products.

Although the free access and use provide great opportunities for the satellite imagery users' community, the lack of financial resources addresses the sustainability of the SDIs, offering this service for free. Hence, the outcomes of this study could be used in a first level, to secure the public funds for SDIs by providing the public bodies all the impacts and the justification materials related to SDI pooling mechanism strategies. It could also serve to develop appropriate business models, in order to respond to the free supply of high-resolution satellite data. The WTP results make it possible to build economic models, according to economic facts close to the practices of the SDI's direct users. Moreover, it allows to refine the existent economic scenar-

ios, with a least negative impact on the direct users of the satellite imagery. While the GEOSUD SDI is evolving towards the Data Terra National Research Infrastructure which will include the DINAMIS pooling mechanism, it will maintain elements allowing to guide and situate the discussions with its partners on the current funding opportunities (annual membership, price per image, premium beyond a certain volume of free image provided, etc.). Thus, making better future strategic choices based on factual basis. To cover the full costs of DINAMIS estimated at 3.5 M €/year (including the access to HR SPOT 6.7 and VHR Pleiades imagery for non-commercial use), the targeted economic model is based on a first upstream financing provided by a consortium of six public bodies carrying the DINAMIS device. It will be complemented by a financial contribution from the direct users of the device with a differentiated pricing policy. The financial commitments made at the beginning of 2019 by the DINAMIS holders and the simulations of contributions from the direct users come to shape the business model that will be implemented starting 2020.

#### **5.4.6 The satellite images meet the organizational routine concept**

Recently, the GEOSUD/Theia initiatives have profoundly changed the landscape in France for the supply and access of High-resolution satellite commercial imagery to public and academic institutions, by bringing major innovations: the logic of sharing and pooling through an “all public actor”, the licensing strategy and the archive of images. These images and more generally the remote sensing technology produce savings beyond their direct use (Rey-Valette et al., 2017). Integrating them into processes that irrigate other added-value products and capable of generating resources (Pwc, 2016), explains despite the lack of budget, the users’ willingness to pay. This issue comes to meet the organizational routine concept (Becker et al., 2005; Pentland, 2012) stating that a service only becomes fully valuable once its use is completely integrated into the regular operating process and consequently the resources will be mobilized in the same direction. In addition, the images carry a kind of proof due of the visual nature of the data itself, meeting the evidence base planning approach (Davoudi, 2006). Their value to their organizations rely on the fact that they sustain and secure their existence. In such situations, where there is no direct financial gain related,

providing symbolic gains of a notoriety and social legitimacy offers a higher level of influence to the territories, paving the way to think for instance of the urbanization phenomenon and the synergies that may arise between the different types of urban, peri-urban and rural areas (Henderson et al., 2001). In fact, their existence and availability involve responding to new obligations in terms of monitoring, and evaluating emerging activities, as soon as the technology is becoming available. As a particular example, a satellite implementation plan was effectively put in place within the State services of the French Ministry of Ecology. Additionally, in order to face the operational difficulties related to forest controls, the systematic mapping of the clear-cuts, based on HR satellite imagery and developed by GEOSUD, is being used in an operational way since 2013 by the regional and local services of the French Ministry of agriculture; the labeling of the mapping method and the training sessions as well as the accompaniment tools (user manual, on line technical assistance) have been set as a support for the appropriation of these images. However, for the local authorities, the geomatics skills could be found mainly in the large structures due to a culture based on the cadastral plots and aerial images which are always present.

Thus, the satellite remote sensing technology should demonstrate its complementarity, and even its substitution to the aerial images with the arrival of new VHR and large coverage constellations such as Pleiades NEO. A progression that takes into account the know-how of both technicians in charge of using these tools and the elected officials and policy makers. The decision to invest in this technology within the different public administrations is not just necessarily political. There are institutional ministerial decisions in relation to public policies. Unlike the ministries, where an advantage arises by the role of a central administration, which puts in place a strategy and diffuse it within all the decentralized services, the political power of the local authority makes the labeling and recommendation mechanism more difficult, given the need to reproduce these tasks in each of the communities. Hence, the weight of politics is much stronger at a community scale. Technicians must convince the political power such as the intercommunity and municipal councils to invest in this technology. Thus, it will be important to understand with respect to each specific context, to what extent the images have made it possible to change the practices and identify the gain opportunities of their use in the structure's organization.

### 5.4.7 The satellite imagery as an ‘informational asset’

In a context of SDIs, the value attributed to satellite information reflects the creation of a common resource by the infrastructure, characterized as an ‘informational asset’. With an economy increasingly focused on intangible resources (Lam, 2000; Stiglitz & Greenwald, 2014), behavioral economics (Chetty, 2015) and platforms paradigms (Parker et al., 2017), the informational asset is becoming an essential factor, whether at a macroeconomic dynamic level or on behavior studies of consumers and agents. It is somehow linked to a notion of information management at a territorial level (Bathelt & Cohendet, 2014). The territories, seen as a geographical scale of the economic system, have complex economic development processes (Storper, 2011). Finding the right information, with a sufficient quality, at the right scale, highlights the organization set up to acquire this information, manage it and exploit it within a sphere of the territorial decision; thus making part of modernizing the territorial economy and the implementation effectiveness (Boschma & Martin, 2007; Pritchard, 2016). The smart cities are one the most recent example, of how this technology can support the emergence of the innovation within the management of smart territories (Vitanen & Kingston, 2014). In this context, the informational asset according to the geographical scale, contributes in the economic development of the territories (Robinson, 2006) and in reducing the cleavages between the rural and urban ones (Rodriguez-Pose & Storper, 2005). At the economic level, these institutional changes may generate employment within the governance systems and the digital companies in terms of developers of new information products according to the logic of a two-sided market (Jabbour et al., 2019).

### 5.4.8 From an image-based towards a data streaming model

Finally, it remains important to highlight the general evolution from traditional satellite image-based market strategy (the 60x60 sq.km acquisition attempts) to new data-stream models (what you pay is what you use). While in the basic model, the surface covered may be larger but with a lower price, the users’ payment within a data-stream model relies on the “useful sq.km” acquired, depending on the area defined as useful for the user. However, the price in the second case is higher and the covered surface is limited to a defined area. Despite this evolution, the pooling mechanisms could be

still applicable. All the pixels bought through a logic of data stream flow could also be integrated within a pooling mechanism, allowing a collective use of the data stream already bought from the initial suppliers. Similarly, commercial prices for collective data flow may be applied, as in the case of individual data-stream pooling logic. These new models have yet to prove their usefulness from an economic point of view, and their ability to meet the needs of users. In any case, it is likely that these new models will be more effective within the public action, if they succeed in shaping a structured community in the form of an ecosystem of innovation which pool their budgetary resources and its competences, rather than a set of isolated users to be accompanied individually (Ranga & Etzkowitz, 2013). Hence, new models of public-private cooperation are also likely to emerge, as the value chains are being increasingly reorganized into added-value products and services. Such models developed at the European and international levels, will constitute a new opportunity in the satellite imagery field.

## 5.5 Conclusion

The direct users constitute a first link between the SDI and the wider community of beneficiaries of satellite image-based products and services. Hence, by estimating the value that these users draw directly from the satellite images, this research fills part of the gap that exists between the users' needs for justification materials and the investors' exigencies on the availability of this technology on the market. The novelty results from applying the widely used contingent valuation method within the framework of a spatial data infrastructure in order to value specific geospatial data and their benefits. The results obtained could be used to enlighten the design of a future pricing of satellite imagery, aiming at sustaining the financing of these services. In addition, it may also stimulate the public awareness about future decision-making related to the Earth observation field and more particularly the satellite images.

While the development of the HR and VHR satellite markets initiated with various satellites including the French SPOT 6\_7 and Pleiades, a competition with other spatial and aerial data sources (HAPS, UAV) or in situ data (network of terrestrial sensors, IoT, crowdsourcing) could also be present. With some restrictions still existing in the commercial use of the HR and

VHR satellite images, the access conditions already mentioned affect the global satellite imagery prices, through the redistribution of the values across the value chain. The new space actors of ‘small and low-cost’ satellites, coming from IT sectors or new active nations such as China or South Korea, will be largely present with their new commercial offers (Denis et al., 2017); the future seems promising with all the recent satellite launches made. In addition, the satellite constellations such as Planet, Terra Bella, etc. propose several interesting features. With higher revisit rates, lower-cost services and an ability to take better timely decisions, the new space actors are promoting information freshness, applications and data analytics tools through their new platforms development. These constellations through their new forms of business models, will irrigate a wide diversity of fields with appropriated data analytics, establishing thus a more efficient connection nodes and networking systems all around the globe (Peter, 2006; Paikowsky, 2017; Olbrich, 2018). While having the opportunity to book a place among the competing space actor players already present in the market, the new space actors are opening the way to revisit the traditional business models of SDIs. Their influence within the satellite imagery market landscape, questions all the financial capabilities deployed and reoriented towards new solutions and ways in financing the space technology and more particularly, the satellite imagery domain. For this, the valuation approaches should evolve to be more extensive, comprehensive, user-oriented, and more closely tied to explicit targets. Hence, with the absence of standardized practices for measuring the contribution to society of geo-spatial information (Kruse et al., 2017), this study comes to set a cornerstone for future valuation works.

## 5.6 References

Arrow, K., Solow, R., Portney, P. R., Leamer, E. E., Radner, R., Schuman, H., & others. (1993). Report of the NOAA panel on contingent valuation. *Federal Register*, 58(10), 4601–4614.

Bathelt, H., & Cohendet, P. (2014). The creation of knowledge: local building, global accessing and economic development—toward an agenda. *Journal of Economic Geography*, 14(5), 869–882.

Becker, M. C., Lazaric, N., Nelson, R. R., & Winter, S. G. (2005). Applying organizational routines in understanding organizational change. *Industrial and Corporate Change*, 14(5), 775–791.

Belward, A. S., & Skøien, J. O. (2015). Who launched what, when and why; trends in global land-cover observation capacity from civilian earth observation satellites. *ISPRS Journal of Photogrammetry and Remote Sensing*, 103, 115–128. <https://doi.org/10.1016/j.isprsjprs.2014.03.009>

Benecki, P., Kawulok, M., Kostrzewa, D., & Skonieczny, L. (2018). Evaluating super-resolution reconstruction of satellite images. *Acta Astronautica*, 153, 15–25.

Benedetti, P., Ienco, D., Gaetano, R., Ose, K., Pensa, R., & Dupuy, S. (2018). M3fusion: A deep learning architecture for multi- $\{\$Scale/Modal/Temporal\}$  satellite data fusion. *ArXiv Preprint ArXiv:1803.01945*.

Bernknopf, R., & Shapiro, C. (2015). Economic assessment of the use value of geospatial information. *ISPRS International Journal of Geo-Information*, 4(3), 1142–1165.

Boschma, R., & Martin, R. (2007). *Constructing an evolutionary economic geography*. Oxford University Press.

Bouma, J. A., der Woerd, H. J., & Kuik, O. J. (2009). Assessing the value of information for water quality management in the North Sea. *Journal of Environmental Management*, 90(2), 1280–1288.

Boyle, S. A., Kennedy, C. M., Torres, J., Colman, K., Pérez-Estigarribia, P. E., & Noé, U. (2014). High-resolution satellite imagery is an important yet underutilized resource in conservation biology. *PLoS One*, 9(1), e86908.

Carson, R. T., & Groves, T. (2007). Incentive and informational properties of preference questions. *Environmental and Resource Economics*, 37(1), 181–210.

Chetty, R. (2015). Behavioral economics and public policy: A pragmatic perspective. *American Economic Review*, 105(5), 1–33.

Choy, S., Handmer, J., Whittaker, J., Shinohara, Y., Hatori, T., & Kohatake, N. (2016). Application of satellite navigation system for emergency warning and alerting. *Computers, Environment and Urban Systems*, 58, 12–18.

Coltri, P. P., Zullo, J., do Valle Goncalves, R. R., Romani, L. A. S., & Pinto, H. S. (2013). Coffee Crop's Biomass and Carbon Stock Estimation with Usage of High Resolution Satellites Images. *IEEE Journal of Selected Topics in Applied Earth Observations and Remote Sensing*, 6(3), 1786–1795.

Corbane, C., Lang, S., Pipkins, K., Alleaume, S., Deshayes, M., Millán, V. E. G., ... Michael, F. (2015). Remote sensing for mapping natural habitats and their conservation status—New opportunities and challenges. *International Journal of Applied Earth Observation and Geoinformation*, 37, 7–16.

Cox, D. R. (1958). Two further applications of a model for binary regression. *Biometrika*, 45(3/4), 562–565.

Davoudi, S. (2006). Evidence-based planning: rhetoric and reality. *DisP-The Planning Review*, 42(165), 14–24.

Denis, G., Claverie, A., Pasco, X., Darnis, J.-P., de Maupeou, B., Lafaye, M., & Morel, E. (2017). Towards disruptions in Earth observation? New Earth Observation systems and markets evolution: possible scenarios and impacts. *Acta Astronautica*, 137, 415–433.



Drusch, M., Del Bello, U., Carlier, S., Colin, O., Fernandez, V., Gascon, F., ... others. (2012). Sentinel-2: ESA's optical high-resolution mission for GMES operational services. *Remote Sensing of Environment*, 120, 25–36.

Frei, T. (2010). Economic and social benefits of meteorology and climatology in Switzerland. *Meteorological Applications*, 17(1), 39–44.

Hamilton, B. A. (2012). USGS land satellites data system (LSDS) cost benefit analysis. US Geological Survey, Reston Google Scholar.

Hanemann, W. M. (1984). Discrete/continuous models of consumer demand. *Econometrica: Journal of the Econometric Society*, 541–561.

Henderson, J. V., Shalizi, Z., & Venables, A. J. (2001). Geography and development. *Journal of Economic Geography*, 1(1), 81–105.

Herold, M., Scepan, J., & Clarke, K. C. (2002). The Use of Remote Sensing and Landscape Metrics to Describe Structures and Changes in Urban Land Uses. *Environment and Planning A: Economy and Space*, 34(8), 1443–1458.

Howells, J., & Bessant, J. (2012). Introduction: Innovation and economic geography: a review and analysis. *Journal of Economic Geography*, 12(5), 929–942.

Jabbour, C., Rey-Valette, H., Maurel, P., & Salles, J.-M. (2019). Spatial data infrastructure management: A two-sided market approach for strategic reflections. *International Journal of Information Management*, 45.

Jabbour, C., Maurel, P., Rey-Valette, H., Salles, J.-M., & Niang, A. (2018). Identification des impacts économiques d'une Infrastructure de Données Spatiales (IDGS). *Numérique et Organisations - MTO*.

Jordan, H., Cigna, F., & Bateson, L. (2017). Identifying natural and anthropogenically-induced geohazards from satellite ground motion and geospatial data: Stoke-on-Trent, UK. *International Journal of Applied Earth Observation and Geoinformation*, 63, 90–103.

Kendall, E. A. (1989). *An introduction to numerical analysis*. John Wiley and Sons Inc., New York, USA, 37–45.

Kruse, J. B., Cromptvoets, J., & Pearlman, F. (2017). *GEOValue: The Socioeconomic Value of Geospatial Information*. CRC Press. Retrieved from <https://books.google.fr/books?id=p7A-DwAAQBAJ>

Lam, A. (2000). Tacit knowledge, organizational learning and societal institutions: An integrated framework. *Organization Studies*, 21(3), 487–513.

Laxminarayan, R., & Macauley, M. K. (2012). *The value of information: methodological frontiers and new applications in environment and health*. Springer Science & Business Media.

Liew, A. (2007). Understanding data, information, knowledge and their inter-relationships. *Journal of Knowledge Management Practice*, 8(2), 1–16.

Loomis, J., Koontz, S., Miller, H., & Richardson, L. (2015). Valuing geospatial information: Using the contingent valuation method to estimate the economic benefits of Landsat satellite imagery. *Photogrammetric Engineering & Remote Sensing*, 81(8), 647–656.

Ma, L., Li, M., Ma, X., Cheng, L., Du, P., & Liu, Y. (2017). A review of supervised object-based land-cover image classification. *ISPRS Journal of Photogrammetry and Remote Sensing*, 130, 277–293.

Macauley, M. K. (2006). The value of information: Measuring the contribution of space-derived earth science data to resource management. *Space Policy*, 22(4), 274–282.

Mitchell, R. C., & Carson, R. T. (2013). *Using surveys to value public goods: the contingent valuation method*. Rff Press.

Nagendra, H., & Rocchini, D. (2008). High-resolution satellite imagery for tropical biodiversity studies: the devil is in the detail. *Biodiversity and Conservation*, 17(14), 3431.

NASA. (2013). *Measuring the Socioeconomic Impacts of Earth Observa-*

tion. Retrieved from <https://appliedsciences.nasa.gov/system/files/docs/SocioeconomicImpacts.pdf>

Niang, A., Rey-Valette, H., Maurel, P., Osé, K., Jabbour, C., Salle, JM. (2019). Évaluation des impacts d'une infrastructure de données satellitaires : application à la gestion des coupes rases en France. *Economie Rurale*, in press.

Olbrich, P. (2018). *Open space: The global effort for open access to environmental satellite data*. Taylor & Francis.

Paikowsky, D. (2017). What is new space? The changing ecosystem of global space activity. *New Space*, 5(2), 84–88.

Parker, G., & Van Alstyne, M. (2017). Innovation, openness, and platform control. *Management Science*.

Patino, J. E., & Duque, J. C. (2013). A review of regional science applications of satellite remote sensing in urban settings. *Computers, Environment and Urban Systems*, 37, 1–17.

Pearlman, F., Pearlman, J., Bernknopf, R., Coote, A., Craglia, M., Friedl, L., ... others. (2016). Assessing the socioeconomic impact and value of open geospatial information.

Pee, L. G., & Kankanhalli, A. (2016). Interactions among factors influencing knowledge management in public-sector organizations: A resource-based view. *Government Information Quarterly*, 33(1), 188–199.

Pentland, B. T., Feldman, M. S., Becker, M. C., & Liu, P. (2012). Dynamics of organizational routines: A generative model. *Journal of Management Studies*, 49(8), 1484–1508.

Peter, N. (2006). The changing geopolitics of space activities. *Space Policy*, 22(2), 100–109.

Pontius, R. G., & Parmentier, B. (2014). Recommendations for using the relative operating characteristic (ROC). *Landscape Ecology*, 29(3), 367–382.

Pritchard, S. B., Wolf, S. A., & Wolford, W. (2016). Knowledge and the politics of land. *Environment and Planning A: Economy and Space*, 48(4), 616–625. <https://doi.org/10.1177/0308518X15604171>

Pwc. (2016). Study to examine the socio- economic impact of Copernicus in the EU. Retrieved from [http://www.copernicus.eu/sites/default/files/library/Copernicus\\_SocioEconomic\\_Impact\\_October\\_2016.pdf](http://www.copernicus.eu/sites/default/files/library/Copernicus_SocioEconomic_Impact_October_2016.pdf)

Ranga, M., & Etzkowitz, H. (2013). Triple Helix Systems: An Analytical Framework for Innovation Policy and Practice in the Knowledge Society. *Industry and Higher Education*, 27(3), 237–262.

Reginster, I., & Goffette-Nagot, F. (2005). Urban Environmental Quality in Two Belgian Cities, Evaluated on the Basis of Residential Choices and GIS Data. *Environment and Planning A: Economy and Space*, 37(6), 1067–1090. <https://doi.org/10.1068/a3735a>

Rey-Valette, H., Maurel, P., Miellel, P., Sy, M., & Pigache, L. (2017). Mesurer les impacts des infrastructures de données géographiques (IDG) et des observatoires-Application à l’IDG SIG-LR. *Revue Internationale de Géomatique*, 27(3), 375–397.

Robinson, J. A. (2006). Economic development and democracy. *Annu. Rev. Polit. Sci.*, 9, 503–527.

Rodriguez-Pose, A., & Storper, M. (2006). Better rules or stronger communities? On the social foundations of institutional change and its economic effects. *Economic Geography*, 82(1), 1–25.

Samuelson, P. A. (1954). The pure theory of public expenditure. *The Review of Economics and Statistics*, 387–389.

Sozzi, M., Marinello, F., Pezzuolo, A., & Sartori, L. (2018). Benchmark of Satellites Image Services for Precision Agricultural use. In *Proceedings of the AgEng Conference, Wageningen, The Netherlands* (pp. 8–11).

Stiglitz, J. E., & Greenwald, B. C. (2014). *Creating a learning society: A*

new approach to growth, development, and social progress. Columbia University Press.

Storper, M. (2011). Why do regions develop and change? The challenge for geography and economics. *Journal of Economic Geography*, 333–346.

Tonneau, J. P., & Maurel, P. (2016). Satellite imagery: a tool for territorial development. In *Land Surface Remote Sensing in Urban and Coastal Areas* (pp. 101–139). Elsevier.

Viitanen, J., & Kingston, R. (2014). Smart Cities and Green Growth: Outsourcing Democratic and Environmental Resilience to the Global Technology Sector. *Environment and Planning A: Economy and Space*, 46(4), 803–819. <https://doi.org/10.1068/a46242>

Weeks, J. R., Gadalla, M. S., Rashed, T., Stanforth, J., & Hill, A. G. (2000). Spatial Variability in Fertility in Menoufia, Egypt, Assessed through the Application of Remote-Sensing and GIS Technologies. *Environment and Planning A: Economy and Space*, 32(4), 695–714. <https://doi.org/10.1068/a3286>

Wilhelmi, O. V, Purvis, K. L., & Harriss, R. C. (2004). Designing a geospatial information infrastructure for mitigation of heat wave hazards in urban areas. *Natural Hazards Review*, 5(3), 147–158.

Williamson, O. E. (1988). The logic of economic organization. *JL Econ. & Org.*, 4, 65.

Wu, C., Li, X., Chen, W., & Li, X. (2018). A Review of Geological Applications of High-Spatial-Resolution Remote Sensing Data.

Yang, X., & Liu, Z. (2005). Use of satellite-derived landscape imperviousness index to characterize urban spatial growth. *Computers, Environment and Urban Systems*, 29(5), 524–540.

Yang, X., & Lo, C. P. (2002). Using a time series of satellite imagery to detect land use and land cover changes in the Atlanta, Georgia metropolitan area. *International Journal of Remote Sensing*, 23(9), 1775–1798.





## Chapter 6

# Making the Most of “Heterogeneous” Information by Using Blackwell and Entropy Theories: A Decision Support Policy Applied to Forests’ Clear-cut Control

**Article:** Jabbour, C., Maurel, P., Rey-Valette, H., & Salles, J.-M., & Ghaylani, L. (2019). Making the most of “heterogeneous” information by using Blackwell and entropy theories: A decision support policy applied to forests’ clear-cut control (*Submitted*).



## 6.1 Introduction

There exists an obvious intersection between the role of information and the decision-making processes (Menges & Huschen, 1984; Bernardo & Smith, 2009; Guillemette et al., 2014). Researches about these two concepts include various academic disciplines. In fact, the economic value of information (VoI) is considered as an outcome of choice in uncertain situations (Varian et al., 2004). It is the difference between the expected utilities of two uncertain prospects (Kochenderfer, 2015).

In this paper, we explore a decision-making process presented into two levels: the informative power of a structure and the optimization of the actions to be taken. We offer an articulation between two existing theories, the Blackwell theorem and the Entropy approach. Facing an uncertain future, a decision-making process can be improved by forecasting the returns of different actions involved (Epstein, 1980; Cover & Thomas, 2006). These latter are characterized by subjective probabilistic distributions, founded by the economic agents and the decision makers (Brynjolfsson, 1994). The subjective probabilistic distributions affect the degree of uncertainty that may vary from one individual to another, over several periods of time (Howard, 1988). This variation is based on the information that could be gained, when moving from one period to another. Two approaches can be distinguished here. The first one is the probabilistic distribution that generates more information over time, called the “information structure”. In other words, the most informative structure is the one having the least degree of uncertainty (Marschak & Miyasawa, 1968; Sandmo, 1970; Golan, 2002; Haven, 2008). The second approach is based on the degree of irreversibility of the possible actions. An option is said to be more flexible, i.e. less irreversible, as much as it leaves other choices for future periods (Henry, 1974; Conrad, 1980). In this context, an entire economic movement interested in the expected gains of the different feasible options emerged (Jones & Ostroy, 1984; Amigues, 1987; Leroux et al., 2009; Boncompte, 2018). As an example, delaying some decisions in the hope of receiving more precise information on actual returns in the near future, can be considered a way to reducing uncertainty (Arrow & Fisher, 1974). While the application of the mathematical Entropy based on Shannon’s principle evaluates the rate of decrease of uncertainty following a reception of an additional information, the Blackwell approach could help in determining the optimal action to be taken in a decision-making context.

In order to give a more explicit view and develop concrete arguments, the analysis will be applied to a specific case study: the clear-cutting in France, where the forests occupy 30% of the territory i.e. 16.5 million hectares (IGN, 2017). The control of clear-cutting occupies a central place, due to the large economic and environmental consequences it may have (Constantino & Martin, 2018). The clear-cutting is a forestry management practice, in which most or all trees in a certain area are cut down (Pawson et al., 2013). It is used by foresters to create certain types of forest ecosystems and to promote selected species (Carey & Harrington, 2001; Hebblewhite et al., 2009). It responds to the environmental regulations initiatives elaborated by the FAO in 2016, on promoting sustainable practices in the exploitation and preservation of the forests. Designing sustainable management plans in forest activity needs to be coupled with precise inspections control, to be sure that the clear-cuts meet the standards (Hardy, 2010). There exist several approaches addressing the uncertainty in the field of forest management. From the initial models developed (Weintraub & Cholak, 1991) to more recent techniques, the studies in this area are numerous (Diaz-Balteiro & Romero, 2008; Bina et al., 2013; Bouchard et al., 2017). Although most of the studies are based on Goal Programming (Eyvindson & Kangas, 2014) and multi-criteria decision-making methods (Alvarez-Miranda et al., 2018), a common finding is that no unique decision-making method could solve all forest management problems (Kazana, 2003). In general, the decision makers facing uncertainty are positioned in a situation without any initial information available, except prior probabilities of states of nature (Arrow & Fisher, 1974; Leroux et al., 2009). Regarding the clear-cutting control, the entities in charge have to detect cheat cases, using the information provided by different sources. Typically, the control entities responsible for the control operations, decide whether the control units should perform parcel inspections or not, based on received information. Such decisions are made, while taking into account various “information signals” received. Therefore, based on an entire “information structure”, an action has to be taken with regard to the situation of clear-cut that emerges. Hence, in order to perform an efficient control operation, the uncertainty regarding the decisions to be taken needs to be minimized (Spilsbury, 2005; von Detten & Faber, 2013). As a consequence, the problem to be solved can be summarized as follows: (i) find the most powerful information structures; (ii) determine the optimal action in terms of payoffs.

In our study, a collaborative framing of stakeholders were involved in the interviews including the regional and local technical authorities of the French Ministry of agriculture, as well as a group of remote-sensing experts. The high resolution (HR) satellite images, provided by the spatial data infrastructure (SDI) GEOSUD based in France, come as an additional information tool for the control entities. Note that the “clear-cut mapping” application, considered as a pilot case for the development of GEOSUD, is being used in an operational way since 2013 by the regional and local services of the Ministry of agriculture, in order to operate field controls in the French forests. In fact, the use of satellite imagery in forest management, allows a better detection and mapping of changes in the forest ecosystems (Guyon et al., 2015). From a practical point of view, it provides equitable regulation, since the control nowadays could cover entire zones or territories (Baghdadi & Zribi, 2018). Before using the remote sensing technology, performing land control was done upon reception of information, either vis-à-vis some neighbors’ denunciation or by individuals close to the susceptible parcels. On the other hand, it simplifies the process of establishing penalties. The fact that forest control is being performed through technology and not as a result of a neighbor denunciation, avoids local conflicts that could exist. The consideration of being treated equally with respect to the law is strongly present.

While decomposing the decision-making process into many steps, more consistent with one another, this research provides a framework to bring multiple decision elements together and expand their implications in a unified context. Applying the Blackwell and Entropy theories to a two period’s decision-making problem, may contribute to understand the flexibility of the available choices and the optimal actions to be taken. It is important to note that these concepts are applied for the first time, with a particular focus on the satellite imagery as an additional source of information. In this context, the contribution of this paper comes in presenting an original approach that articulates between two existing theories, in order to help and lead a decision-maker to model his decision in light of a received information. It offers a tool to overcoming the complexity problems, usually present in the decision-making cases (Lin et al., 2018). Based on the empirical facts and on the existing theory, the paper seeks to fill a gap between the previous researches in the field of value of information and the decision-making problems under several periods. It provides an additional common basis, to

better understand the complex choices the decision-makers face, illustrating how the information might be used to respond to a variety of needs. The environmental consequences related might be of high importance, reflecting the integration of a relevant decisional information into a socioeconomic framework.

The remainder of the paper is organized as follows: Section 2 integrates some classical results on the value of information. Section 3 presents the general context and notations, followed by a comparison of the informative power of the information structures using the Blackwell and Entropy's approaches. Section 4 presents the case study of GEOSUD with the introduction of the empirical context of a forest's clear-cutting decision-making problem. Section 5 lays out the findings from each of the two approaches. Section 6 offers a discussion based on the empirical analysis coupled with the existent literature. Finally, Section 7 closes the paper.

## 6.2 Review of classical results

The academic literature extensively explores the links between the decision analysis and the value of information (VoI) theories. In this section, we will present a classical results review on the works of Arrow & Fisher (1974) and Henry (1974), with the focus on a practical two periods' model example. In order to find the optimal profit over two periods, Arrow & Fisher (1974) and Henry (1974) used a stochastic dynamic programming approach, which takes into consideration the inter-period information gain. The aim was to characterize the effect of irreversibility, where the information will be acquired at the end of period one. On the other hand, the optimal expected profit was computed by supposing that the possibility of using the information available at the end of the first period is not taken into consideration by the decision maker. The expected benefits are to be maximized at the beginning of the first period. Note that, in the considered case, the available actions differ only in their expected benefits and their degrees of flexibility. By considering the difference between the former and the latter optimal solutions, the result fits the classical definition of the value of information (VoI) which comes as follows:

$$\begin{aligned}
VoI &= \mathbb{E}[\text{Maximum payoffs}] - \text{Max}[\text{Initial expectations}], \\
&= \text{Optimal expected profit under additional information} - \\
&\quad \text{Optimal initial expected profit.} \quad (1)
\end{aligned}$$

In addition, it was shown there may exist a positive VoI associated with the adoption of the most flexible action in the first period. In the same year, Henry (1974) generalized the results of Arrow (1974). He defined the VoI (Which he calls option value) as the willingness to pay for maintaining the possibility of using a certain option in the future. Usually, the willingness to pay for information depends on the level of uncertainty of the individuals about future events. Paying for additional or improved information may arise as long as the expected gain exceeds the cost of the information. In addition, Henry (1974) demonstrated that several conditions must be satisfied for option values to emerge in a decision-making problem:

1. An uncertain future context with heterogeneity space of actions in terms of flexibility;
2. A sequential decision-making process, in which the acquired information during time will be used in an optimal way.

Based on these two assumptions, Henry (1974) showed that for any number of periods, available actions and states of nature, there is always a positive value for the least irreversible option when the possibility of additional information is combined with heterogeneous actions. The phenomenon was defined as the “irreversibility effect”. Readers interested in more details about these classical results can refer to (Arrow & Fisher, 1974; Henry, 1974; Amigues, 1987).

The limits of these classical results are related to the identification of the alternative scenarios that are the basis in valuing the expected information and the optimal actions to be taken, based solely on prior probabilities. However in many situations, additional information is continuously available over time, and may influence the prior probabilities in a Bayesian way. These changes in the information structures could not be captured by classical methods, hence the importance of going beyond the bounds of perfect information contexts.

### 6.3 General context and notations

A definition of the mathematical context and spaces that will be used throughout the paper is necessary. Without loss of generality and for the purpose of reducing the level of complexity, the assumption made consists of a two period's decision-making problem. Let  $\mathcal{A} = \{a_1, a_2, \dots, a_n\}$  the set of available initial actions (at the beginning of the first period) and  $\mathcal{B} = \{b_1, b_2, \dots, b_m\}$  the set of available actions (at the beginning of the second period) after receiving the additional information.  $\mathcal{S} = \{s_1, s_2, \dots, s_L\}$  the set of possible states of nature and  $\mathcal{Y} = \{y_1, y_2, \dots, y_K\}$  the set of messages/signals (additional information) received at the end of period one.  $L$  and  $K$  denote respectively the number of possible states of nature and the number of available signals. The vectors  $\pi = (\pi_1, \pi_2, \dots, \pi_L)$  and  $q = (q_1, q_2, \dots, q_K)$  are defined as the prior probability distributions associated respectively to  $\mathcal{S}$  and  $\mathcal{Y}$  (i.e.  $\pi_i = \mathbb{P}[\mathcal{S} = s_i]$ ;  $1 \leq i \leq L$  and  $q_j = \mathbb{P}[\mathcal{Y} = y_j]$ ;  $1 \leq j \leq K$ ) with  $\sum_{i=1}^L \pi_i = \sum_{j=1}^K q_j = 1$ .

The matrix  $\mathcal{P} = (p_{ij})_{\substack{1 \leq i \leq L \\ 1 \leq j \leq K}}$  represents the set of conditional probabilities of  $s_i$  given  $y_j$  ( $p_{ij} = \mathbb{P}[\mathcal{S} = s_i | \mathcal{Y} = y_j]$ ). Each column of the matrix  $\mathcal{P}$ , represents the posterior probability distribution of  $\mathcal{S}$  for a given received signal from the set  $\mathcal{Y}$ . E.g. the  $j^{\text{th}}$  column of  $\mathcal{P}$  will be denoted by  $\pi(y_j) = (p_{1j}, p_{2j}, \dots, p_{Lj})$ . In the sequel, the couple  $(\mathcal{P}, q)$  will be denoted by “*information structure* “. In addition,  $(\mathcal{P}, q)$  will be used later to rank the information structures according to their informative power.

In order to rank the initial actions, the payoff and cost functions for switching from one action in the first period to another one in the second period, should be well defined.

Let,

$$F(a_i, b_j; s_l) = R(a_i; s_l) + U(b_j; s_l) - C(a_i, b_j; s_l), \quad (2)$$

represents the total payoff produced by switching from  $a_i$  to  $b_j$  under state  $s_l$ .  $R(a_i; s_l)$  and  $U(b_j; s_l)$  stand for the returns generated during the first and second period actions respectively under the state  $s_l$ . While  $C(a_i, b_j; s_l)$  denotes the switching cost from  $a_i$  to  $b_j$  under the state  $s_l$ .

In our context consisting of a decision-making problem, we will try to

compare on one hand, the informative power of two or more information structures, i.e. the amount to be learned from future information. On the other hand, we will seek to find the optimal actions to undertake. In order to perform this, two approaches will be used: the Blackwell theorem and the probabilistic Entropy principle.

### 6.3.1 Blackwell's approach

Considering an information structure  $(\mathcal{P}, q)$ , let  $\Delta = (\delta_{ij})_{\substack{1 \leq i \leq L \\ 1 \leq j \leq K}}$  a Markov matrix of conditional probabilities, such that  $\delta_{ij} = \mathbb{P}[\mathcal{Y} = y_j \mid \mathcal{S} = s_i]$ .  $(\mathcal{P}', q')$  represents another information structure, built on the same sets  $\mathcal{Y}$  and  $\mathcal{S}$  with  $\Delta' = (\delta'_{ij})_{\substack{1 \leq i \leq L \\ 1 \leq j \leq K}}$  the corresponding Markov matrix. Using the Blackwell's terminology (Crémer, 1982), the structure  $(\mathcal{P}, q)$  is said to be more informative than  $(\mathcal{P}', q')$  and we denote  $(\mathcal{P}, q) \succeq (\mathcal{P}', q')$ , in the sense that it offers a greater amount of information at the end of the first period, allowing to take an optimal choice of actions at the beginning of period two. It is applicable if and only if, there exists a Markov matrix  $\mathcal{M}$  with appropriate dimensions such that  $\Delta\mathcal{M} = \Delta'$ . This result is known in the literature as "the Blackwell's Theorem".

In order to avoid a high level of complexity resulting from the direct application of Blackwell's Theorem, equivalent results obtained in Bohnenblust (1949) (which simplify the procedure of ordering the information structures), will be introduced. But first, some mathematical objects need to be defined.

Recall that, for a given information structure  $(\mathcal{P}, q)$  defined on the sets  $\mathcal{A}$ ,  $\mathcal{B}$ ,  $\mathcal{Y}$  and  $\mathcal{S}$ , an optimal decision consists of precisising a first period action  $a_i$  then a second period's one  $b_j$  depending on the observed message/signal  $y_k$  at the end of the first period, in order to maximize the total expected payoff. This maximization procedure can be represented by the following mathematical expression:

$$\Phi(\mathcal{P}, q) = \max_{a_i \in \mathcal{A}} \sum_{y_k \in \mathcal{Y}} q_k \max_{b_j \in \mathcal{B}} \sum_{s_l \in \mathcal{S}} p_{lk} F(a_i, b_j, s_l). \quad (3)$$

Additionally, the prior probability distribution of the states of nature (i.e. probabilities before observing any message/signal) defined previously by the

vector  $\pi$ , will be fixed in a way to verify

$$\pi_i = \sum_{j=1}^K q_j p_{ij} \text{ with } 1 \leq i \leq L, \quad (4)$$

and will be noted as the mean of  $(\mathcal{P}, q)$ . Thus, the main results of Bohnenblust (1949) are represented as follows:

**Theorem 6.1.** *Let  $(\mathcal{P}, q)$  and  $(\mathcal{P}', q')$  two information structures defined on the same sets  $\mathcal{A}, \mathcal{B}, \mathcal{Y}$  and  $\mathcal{S}$ . Then,  $(\mathcal{P}, q) \succeq (\mathcal{P}', q')$  if and only if for all convex function  $\psi : [0, 1]^L \rightarrow \mathbb{R}$ ,*

$$\sum_{j=1}^K q_j \psi(\pi(y_j)) \geq \sum_{j=1}^K q'_j \psi(\pi'(y_j)).$$

*Remark 6.2.* In order to compare two information structures  $(\mathcal{P}, q)$  and  $(\mathcal{P}', q')$  in the sense of Blackwell, they must have the same prior probability distribution related to the states of nature, i.e

$$\sum_{j=1}^K q_j p_{ij} = \sum_{j=1}^K q'_j p'_{ij} \forall i,$$

Remind that, what's interesting to look at, is the effect of the additional information on the posterior probabilities, i.e. the states of nature's probabilities at the beginning of the period two.

The complexity of Theorem 1, relies on the universal quantifier that manages the choice of the convex function. A more practical and simpler method to be used in comparing information structures was introduced by Jones & Ostroy (1984).

Let  $\mathcal{B}$  a finite set of second period actions and  $U(\cdot; \cdot)$  the second period payoffs function defined on  $\mathcal{B} \times \mathcal{S}$ . Jones & Ostroy (1984) have shown that if  $(\mathcal{P}, q)$  and  $(\mathcal{P}', q')$  are two information structures defined on the same sets  $\mathcal{A}, \mathcal{B}, \mathcal{Y}$  and  $\mathcal{S}$ , then  $(\mathcal{P}, q) \succeq (\mathcal{P}', q')$  if and only if

$$\sum_{y_k \in \mathcal{Y}} q_k \max_{b_j \in \mathcal{B}} \sum_{s_l \in \mathcal{S}} p_{lk} U(b_j, s_l) \geq \sum_{y_k \in \mathcal{Y}} q'_k \max_{b_j \in \mathcal{B}} \sum_{s_l \in \mathcal{S}} p'_{lk} U(b_j, s_l). \quad (5)$$



Hence, by applying Equation (5) under the constraint of Remark 1, it is possible to detect which information structure is more informative about the states of nature's posterior distribution.

### 6.3.2 Entropy approach

The Shannon's probabilistic Entropy is used in the field of information theory, to measure the reduction of the uncertainty in a decision-making context caused by an additional amount of information. This approach is defined as follows:

**Definition 6.3.** The Shannon entropy, denoted by  $\mathcal{H}$ , of a probability distribution  $\mathbb{P} = (\mathbb{P}[X = x_1], \dots, \mathbb{P}[X = x_n])$  on a finite random variable  $X = \{x_1, \dots, x_n\}$ , is defined as a degree of uncertainty of a system composed of  $n$  outcomes. The mathematical expression of an entropy is:

$$\mathcal{H}(X) = - \sum_{i=1}^n \mathbb{P}[X = x_i] \log \mathbb{P}[X = x_i],$$

where,  $\log$  represents the binary logarithm function and the Entropy expressed in bits (Yang, 2018). By convention we consider  $0 \log 0 = 0$ . Note that when  $\mathcal{H}(X)$  is close to zero, the random variable  $X$  presents a very slight uncertainty. Consequently, the level of uncertainty increases with the increase of the value of the Entropy to reach a maximum of  $\log n$  in the case of a uniform discrete probability distribution (i.e.  $\mathbb{P}[X = x_i] = \frac{1}{n} \forall i$ ).

In general, the Entropy is useful to compute the level of uncertainty before (based on the prior probabilities) and after (based on the posterior probabilities) receiving additional information about the states of nature. Therefore, by using these measures in our context, it becomes feasible to evaluate the quality of an information structure at the level of the power of information received and compare it to other information structures.

We will start by computing the prior entropy:

$$\mathcal{H}(\mathcal{S}) = - \sum_{i=1}^L \pi_i \log \pi_i, \quad (6)$$

where  $\pi_i$ ,  $1 \leq i \leq L$  denotes the prior probabilities of the states of nature and  $L$  the number of these states. Using Equation (6) we can measure the

uncertainty at the beginning of period one.

By supposing that at the end of period one, additional information is being received in the form of signal/message  $y_k$  about the states of nature, we will compute the posterior entropy:

$$\mathcal{H}(\mathcal{S} | y_k) = - \sum_{i=1}^L p_{ik} \log p_{ik}, \quad (7)$$

where  $p_{ik} = \mathbb{P}[\mathcal{S} = s_i | \mathcal{Y} = y_k]$ . Using Equation (7), defined as the conditional Entropy, the effect of the signal  $y_k$  on reducing the initial uncertainty, can be measured. By considering all the possible signals with their probability distribution, the expected posterior entropy given below will be evaluated:

$$\mathcal{H}(\mathcal{S} | \mathcal{Y}) = \sum_{k=1}^K q_k \mathcal{H}(\mathcal{S} | y_k), \quad (8) \quad (6.3.1)$$

where  $q_k$ ,  $1 \leq k \leq K$  denotes the probability distribution of the received signals and  $K$  the number of available signals. Based on (8), the global expected effect of an additional information on reducing uncertainty can be computed.

In order to combine and compare the prior situation (Equation 6) and the posterior ones (Equations 7 and 8), the mutual information is defined as follows:

**Definition 6.4.** The mutual information of two random variables  $X$  and  $Y$ , denoted  $\mathcal{I}(X, Y)$  is defined as the change in information after observing  $Y$ , given the prior information on  $X$ . It is given by the following expression:

$$\mathcal{I}(X, Y) = \mathcal{H}(X) - \mathcal{H}(X | Y).$$

$\mathcal{I}(X, Y)$  represents the difference between the prior and posterior entropies. Note that  $\mathcal{I}(X, Y) \geq 0$ , because an additional information can never increase the level of uncertainty of a random variable (i.e.  $\mathcal{H}(X) \geq \mathcal{H}(X | Y)$ ). In worst case, when  $Y$  is with no added information value, the level of uncertainty remains unchangeable. Accordingly, a high  $\mathcal{I}(X, Y)$  implies that the amount of information about the variable  $X$  obtained from the variable  $Y$  is significant. Otherwise,  $Y$  is not helpful to obtain information about  $X$ . If  $\mathcal{I}(X, Y) = 0$ , then  $X$  and  $Y$  are independent.

In the context of a decision-making problem, the mutual information of the states of nature and the received signals is defined as follows:

$$\begin{aligned} \mathcal{I}(\mathcal{S}, \mathcal{Y}) &= \mathcal{H}(\mathcal{S}) - \mathcal{H}(\mathcal{S} | \mathcal{Y}), \\ &= - \sum_{i=1}^L \pi_i \log \pi_i + \sum_{k=1}^K q_k \sum_{i=1}^L p_{ik} \log p_{ik}. \end{aligned} \quad (9)$$

Based on Equation (9), the utility of a set of signals on the reduction of the level of posterior uncertainty can be evaluated. In other words, the mutual information can be used to classify different information structures in terms of their informative power.

## 6.4 Case study

In order to give a more explicit view and develop concrete arguments, the analysis will be applied to a specific case study: the control of forest clear-cuts in France. This control is carried out by the regional and local technical authorities of the French ministry of agriculture. By performing land visits, the authorities are not able to carry out an exhaustive control. Additional information should be required. To achieve this process, the satellite images with their related applications, are considered a very useful tool for the mapping and the detection of the changes in the forests. The GEOSUD spatial data infrastructure (SDI) was selected to undergo the study, because of its significant positive effect on the availability of the geospatial data in France; more particularly, with its developed method for systematic mapping of the clear-cuts through high resolution (HR) satellite imagery. In fact, the operational applications of remote sensing in the field of forest management have remained limited for a long time period. Several reasons are of influence: the high cost of available data, the insufficient image resolution and the difficult access to geo-spatial information (Jabbour et al., 2019). Recently, several methods for the detection and mapping of the clear-cuts have emerged (White et al., 2016). Upon the request of the French ministry of agriculture and in order to face the operational difficulties, GEOSUD has developed an algorithm for the systematic mapping of the clear-cuts, based on HR satellite imagery. The satellite images are available free of charge, for the State services already registered on the GEOSUD SDI platform. In addition to the methodological guide and the operational tools available on the

platform, GEOSUD has developed the processing algorithm of the clear-cuts application in the form of a plugin. An extension that could be installed on a QGIS software, a Geographic Information System (GIS) equipped by the State services. Starting in 2019, GEOSUD is offering an online version of this image processing tool. As a result, the involved authorities can benefit from this service to self-compute the clear-cuts mapping by coupling the algorithm with the HR satellite images available on the platform.

### 6.4.1 Data collection and analysis

Data was collected during a seven-month period, going from May until November 2018. We conducted interviews with 116 respondents, representing a total of 23 control entities (table 6.1). The representativeness of the control entities was found to be relevant of the whole French territory.

<b>Date (2018)</b>	<b>Region (France)</b>	<b>Number of people interviewed</b>
May	Occitanie / Nouvelle Aquitaine	26
June	Île-de-France / Centre-Val de Loire	17
July	Pays de la Loire / Bretagne-Normandie	25
September	Hauts-de-France / Grand Est	22
October	Bourgogne-Franche-Comté	12
November	Auvergne-Rhône-Alpes / Provence-Alpes côte d'azur	14

Table 6.1: Data collection

In addition, we referred to technical documents and on-site mission reports, in order to enrich our observations. As our interviews progressed, we tried to collect information from different sources, which we fully integrated in our methodological application (see section 6.4.2). In addition to regular meetings with the GEOSUD executive board, we had different interviews with forest experts and remote sensing operators. We attended the regular meetings held, aiming to discuss the improvement strategies to be taken within the forest control strategies and had the chance to make in-depth discussions with several experts. We were invited as well to participate in several workshops and seminars that were held during our research. This gave us a global overview of the events happening at the same time, and let

us reorient some initial directions we had at the data collection's starting phase.

### 6.4.2 Case description

In order to apply the Blackwell's Theorem and the Entropy principle in a practical way, we considered the French administrative entities "DDT" & "DRAAF" (direction départementale des Territoires & direction régionale de l'alimentation, de l'agriculture et de la forêt) responsible of the clear-cutting operations in France. The aim of these entities is to detect cheat cases, using the information provided by different sources. Based on an entire "information structure", a control entity has to take action with regard to the situation of clear-cut that emerges. The representation of our case, as a two period's decision-making problem, is as follows:

Suppose that, without any information at beginning of period one, the entity must choose between two actions:

Actions in period one
$a_1 = \text{Control}$
$a_2 = \text{No control}$

$$\mathcal{A} = \{a_1, a_2\}.$$

At the end of period one, further information would have been received. Based on these signals, another action should be taken at the beginning of period two. We considered four possible states of nature:

States of nature
$s_1 = \text{Absence of cheating}$
$s_2 = \text{Partially cheating inside management plan}$
$s_3 = \text{Partially cheating outside management plan}$
$s_4 = \text{Strong cheating (clearing)}$

$$\mathcal{S} = \{s_1, s_2, s_3, s_4\} \text{ with } L = 4.$$

In the first place, the state of nature denoted by  $s_1$ . represents an absence of cheating in the land plots'. This is the case where the clear-cuts meet the

standards. Secondly, within the management plans “plans simples de gestion (PSG)”, there exist forest areas in which a number of forest practices are achieved. Cheating in such a context, may take place in the sense of non-compliance with the intended area to be cut. This situation represents the second state of nature  $s_2$ . On the other hand, there are areas that are not subject to management plans, essentially unexploited forests where the cuts are still applied. Despite the fact that these areas regenerate into forests, it is considered as a superior level of cheating with respect to the preceding case, and presents the third state of nature denoted by  $s_3$ . Finally, the highest cheating level which totally changes the plot assignment, will be denoted by  $s_4$ . Due to this situation, the forests are permanently removed. Unlike clearing, which has an effect of destroying the wooded state and leading to a change in the use of the soil, the clear-cuts are accompanied by an obligation for a natural reconstitution or replanting of the cutted surfaces (Barthod et al. 1999). It is the responsibility of the owner or the operator to ensure the renewal of the stands within a period of time after cutting, either through natural regeneration or replanting. Infringements of these obligations are sanctioned with fines, either for non-reconstitution of cuts or for unauthorized cuts considered as illegal and abusive.

On the other hand, the information signals that can be received by the control entity are as follows:

<b>Signals</b>
$y_1 =$ Individual denunciation
$y_2 =$ report from the “Centre national de la propriété forestière” (CRPF)
$y_3 =$ “DDT” & “DRAAF” report
$y_4 =$ GEOSUD image demonstrating a cheat
$y_5 =$ GEOSUD image demonstrating a conformity with the law

$$\mathcal{Y} = \{y_1, y_2, y_3, y_4, y_5\} \text{ with } K = 5.$$

Concerning the information signals that a control entity could receive, the first signal comes out in the form of an individual denunciation and will be denoted by  $y_1$ . The second case,  $y_2$ , is a report from the forest professionals, people who are used to the forest management activities and are legitimate to send information reports to the control entities. The third case,  $y_3$ , is represented by the State services who, through their various missions on the

ground, discover illegal cuts; this will enable a control procedure to be initiated later. Finally, the signals  $y_4$  and  $y_5$  represent the HR satellite images coming from the GEOSUD SDI. These images are additional elements for respectively demonstrating a cheat or a compliance with the law. Previously, the denouncement was considered a primary factor for executing a control operation. Actually, before starting a regularization phase and even after receiving a control signal, the authorities check out this information through the GEOSUD satellite imagery support.

We assume that the available actions at the beginning of period two, after receiving the information signals, are the same as those actions initially available, i.e.  $b_1 = a_1$  and  $b_2 = a_2$  with  $\mathcal{B} = \{b_1, b_2\}$ . Note that the initial action  $a_1$  is considered irreversible. Once  $a_1$  is applied, no other actions can be taken in the second period.

Let the information structure  $(\mathcal{P}, q)$  be described by the following:

$$\mathcal{P} = (p_{ij})_{\substack{1 \leq i \leq 4 \\ 1 \leq j \leq 5}} = \begin{pmatrix} 0.05 & 0 & 0 & 0.20 & 0.80 \\ 0.05 & 0.20 & 0.20 & 0.05 & 0.10 \\ 0.70 & 0.70 & 0.70 & 0.75 & 0.05 \\ 0.20 & 0.10 & 0.10 & 0 & 0.05 \end{pmatrix},$$

and

$$q = (0.066, 0.066, 0.066, 0.04, 0.76).$$

The Matrix  $\mathcal{P}$ , results from the interviews and discussions with the experts, already mentioned above. Using this information structure, we can then compute the prior distribution of the states of nature by applying Equation (4):

$$\pi = (0.619, 0.108, 0.208, 0.065).$$

As the matrix  $\mathcal{P}$  shows, we define respectively four states of nature in rows and five signals in columns. We assume that the probability of a state of nature conditioned by receiving a signal will vary in each scenario in order to establish an information structure called  $\mathcal{P}$ . A more explicit presentation of the matrix can clarify the logic behind some probabilities. As an example, announcing an individual denunciation, while having a state of nature indicating an absence of cheating is affected by a probability of 5% (row 1, column 1). In fact, the control entities reveal that similar cases exist with a

low frequency. This is mainly due to the fact that, some people prefer denouncing clear-cuts activities, even without being well-informed of the whole situation. These denunciations are often related to environmental concerns that people have, and their preference of being assured that the control services are aware of similar situations. Moreover, the zeros probabilities (row 1, column 2 & 3), represent a report case from the forest professionals or the state services announcing a cheating, without this being true in reality. An almost impossible situation. Apparently, what was interesting to look at and unexpected before doing our interviews, is that even though satellite imagery is supposed to give a high level of confidence about the state of the forests, some factors can lead to a misinterpretation of the images. In fact, various entities noted that during particular seasons, by analyzing the satellite images from GEOSUD, some images provided facts that can be interpreted as cases of cheating; by performing field checks, these results appear to be wrong. This is due to factors such as drought, season's change, etc. After discussing with the professionals, a probability of 20% has been assigned for such situations (row 1, column 4). It is noted that in 80% of the cases, a satellite image showing compliance with the law, sticks with the case of absence of cheating (row 1, column 5). Usually, the control entities hold the forest management plans in each department. In parallel, GEOSUD carries out detection work of the land plots, via the satellite images coupled with the necessary applications. In general, if these plots are located within the PSGs, they will not be inspected by the control entities, because this was planned for in the PSGs. Thus, the attention will be mainly turned towards the lands located outside the PSGs. A report provided by the CRPF indicating a partial cheating outside PSG is represented in our matrix by a probability of 70% (column 2, row 3), compared to 20% when cheating is located inside the PSGs (column 2, row 2). Likewise, announcing an individual cheat denunciation in a management plan with the fact to be true remains a rare case, given the lack of ability in measuring the precise changes. So a probability of 5% was affected (row 2, column 1). On the other hand, making an individual denunciation with the fact being a cheat out of the management plans, represents a probability much higher than that of a clearing. It is due to the absence of very frequent cases of clearing, and what it represents as illegal situations with very serious consequences. As a result, a probability of 70% (row 3, column 1) has been assigned, compared to 20% for the state of nature  $s_4$  (row 4, column 1).



## 6.5 Results

### 6.5.1 Entropy Results

Based solely on the probability distributions, we can apply the Entropy approach to assess the effectiveness of the information structure in terms of reducing uncertainty. Starting by the prior entropy we get:

$$\mathcal{H}(\mathcal{S}) = 1.5 \text{ bits.}$$

After receiving the additional information, we can compute the posterior entropy:

$$\mathcal{H}(\mathcal{S} | \mathcal{Y}) = 1.054 \text{ bits.}$$

Hence, the mutual information generated by the structure  $(\mathcal{P}, q)$  is:

$$\begin{aligned} \mathcal{I}(\mathcal{S}, Y) &= \mathcal{H}(\mathcal{S}) - \mathcal{H}(\mathcal{S} | \mathcal{Y}), \\ &= 0.446 \text{ bits.} \end{aligned}$$

Thus, the information structure has an information power of 0.446 bits. Therefore, without any assumptions about the payoffs of the first and second period actions, the reduction of uncertainty can be measured. Due to the additional signals received at the end of the first period, this reduction is equal to:  $\frac{1.5-1.054}{1.5} \times 100 = 29.73\%$ .

On the other hand, in order to compute the reduction of uncertainty made possible just through the additional information due to the GEOSUD HR satellite images (i.e. signals 4 and 5), it is necessary to compute the posterior Entropy which is given by:

$$\mathcal{H}(\mathcal{S} | \mathcal{Y}_{\{4,5\}}) = 1.020 \text{ bits.}$$

with a reduction of uncertainty equal to:  $\frac{1.5-1.020}{1.5} \times 100 = 32\%$ .

In addition, after receiving the additional information provided by signals 1, 2 and 3, the posterior Entropy is as follows:

$$\mathcal{H}(\mathcal{S} | \mathcal{Y}_{\{1,2,3\}}) = 1.190 \text{ bits.}$$

with a reduction of uncertainty equal to:  $\frac{1.5-1.19}{1.5} \times 100 = 20,67\%$ .

According to our data, the additional information received through GEOSUD signals appear more valuable in terms of reduction of uncertainty than the signals 1, 2 and 3, because  $\mathcal{H}(\mathcal{S} | \mathcal{Y}_{\{4,5\}}) < \mathcal{H}(\mathcal{S} | \mathcal{Y}_{\{1,2,3\}})$ . Thus, the GEOSUD information structure has a more significant information power.

### 6.5.2 Blackwell results

Now, in order to apply the Blackwell's Theorem, the payoffs of different actions under different states of nature should be defined. The factors used to compute these payoffs are summarized in tables 6.2 & 6.3.

<b>Factors</b>	<b>Amount per unit</b>
Fuel	0.17 Euros/km
Technician salary	2700 Euros/month - 150 Euros/day
Engineer salary	4750 Euros/month - 250 Euros/day
Average number of working days	19 days/month
Fine due to $s_3$	4000 Euros
Fine due to $s_4$	160,000 Euros

Table 6.2: Unit amounts of different factors of the payoffs

	<b>Number of days / engineer</b>	<b>Number of days / technician</b>	<b>Distance (km)</b>	<b>Fine (€)</b>
$(a_1, s_1)$	1/2	0	150	0
$(a_1, s_2)$	1	0	150	0
$(a_1, s_3)$	15	15	300	4000
$(a_1, s_4)$	15	15	300	160,000

Table 6.3: Elements constituting the payoffs of each action

As table 6.3 shows, we present the elements that constitute the returns of the first action ( $a_1$ ) with respect to the four states of nature. For example, when a control operation is performed and an absence of cheating is recorded, as the case of  $(a_1, s_1)$ , the return (loss or gain) of such scenario for the control entity who is performing the task is the time spent ( $1/2$  represents a half day work for an engineer) and the fuel needed to go on the site ( $150 =$  an average distance of 150 km). In such case, there is no fine applied and the

entity records a loss  $[(0.5 \times 250) + (150 \times 0.17) = -150.5]$  (see table 6.3). To be noted that the depreciation of the vehicles is not taken into account in order to facilitate the calculations. For  $(a_1, s_2)$ , when a control operation is coupled with a partially cheating situation inside management plans, no fine is applied as well, but more time is spent to perform the measurement work, and set a warning. This situation results in a higher cost due to a full day engineer work, with the same average distance of 150 km. In the third scenario  $(a_1, s_3)$ , controlling a case of partial cheating outside management plans require much more time and work. We count for 15 days for an engineer as well as for a technician. In order to meet the prosecutors, establish the report and make a fine (4000 Euros in this case), an average distance of 300 km is recorded. For the scenario  $(a_1, s_4)$ , the same costs apply, but the fine is much higher and accounts for 160,000 Euros. The returns in Euros generated during the first and second period actions, under different states of nature, are respectively summarized in Table 6.4 & 6.5. Note that under states  $s_3$  and  $s_4$  the return generated by action  $a_2$  (during the first period) is 0 due to the assumption that the “DDT” & “DRAAF” entities, still have the ability to collect the fine during the second period.

	$s_1$	$s_2$	$s_3$	$s_4$
$a_1$	-150.5	-275.5	2051	153,949
$a_2$	0	0	0	0

Table 6.4: Payoffs of the first period actions ( $R(a_i; s_l)$ )

	$s_1$	$s_2$	$s_3$	$s_4$
$b_1 = a_1$	-150.5	-275.5	2051	153,949
$b_2 = a_2$	0	0	-4000	-160,000

Table 6.5: Payoffs of the second period actions ( $U(b_j; s_l)$ )

In addition, the cost in Euros of switching from an action to another under different states of nature is considered to be zero because all these costs are financed by state services other than the “DDT” & “DRAAF”. Recall that switching from  $a_1$  to any other action in the second period is impossible.

To assess the informative power of the considered information structure in the sense of Blackwell, we apply Equation (5):

$$\sum_{y_k \in \mathcal{Y}} q_k \max_{b_j \in \mathcal{B}} \sum_{s_l \in \mathcal{S}} p_{lk} U(b_j, s_l) = 7669.62.$$

The optimal action to be taken at the beginning of period one, can be specified by maximizing the expected payoff (Equation 3).

Based on all the previous cost and information assumptions, the best action to be initially taken is  $a_2$  because it generates a maximum expected payoff of 24,125.48 Euros, higher than the  $a_1$  expected payoff equal to -314.72 Euros.

Remark 2. In this application, the comparative aspect of the two approaches (Blackwell and Entropy) was not applied due to a unique information structure represented by  $(\mathcal{P}, q)$ . The availability of another source of information, allows to build another information structure in order to perform a comparison between the two.

## 6.6 Discussion

The aim of this paper is to present an original approach that articulates between two existing theories, in order to help the forest control entities to model their decision in light of a received information. We present a decision-making policy by combining the Entropy and Blackwell methods. This technique decomposes the problem of decision into many steps that are much easier to make, and more consistent with one another. The context comes into two levels: The choice of the information structure with the most informative power and the detection of the optimal action.

On a first level, in a situation where the decision-maker is faced with several information structures, the application of the Entropy approach highlights the structure with the most informative power by taking the difference between the prior and the posterior Entropy. Applying the Entropy approach into a two-period decision context is innovative in this paper. The mutual information represents the level of uncertainty diminished by the received signals. Hence, it becomes possible to compare the informative power of several information structures with respect to their prior probability distribution,

and compute the reduction in the uncertainty level through each of these structures. Thus, without any additional information, these structures can be classified according to their informative input. However, only two information structures can be compared at once in order to elaborate the informative power of each, through the Blackwell Theorem. Herein, we can highlight the first advantage of the Entropy mutual information approach compared to the principle of Blackwell. Secondly, in order to apply the Blackwell comparison theorem, many assumptions should be taken about the payoff of the first and second period actions, under different states of nature. Additional considerations regarding the transition costs in response to a period change could also be present, and may lower the accuracy of the decisions. However, the mutual information approach is applicable by knowing solely the prior and posterior probabilities. To be noted that the time periods should be carefully assigned, due to the consequences it may have when coupled with a multitude of decisions. This conjunction between the probability concepts and the Entropy theory, has been applied in various fields, such as financial modelling (Muzzioli & Reynaerts, 2007), information systems (Intan & Mukaidono, 2004) and water resource management (Singh, 1997). It makes possible to approach complex sets of decisions, along with simple likelihood considerations (Dubois & Prade, 2000). In addition, the Entropy approach helps overcoming several complexities, especially at the level of the definition of the states' space. In some contexts, the sources of fuzziness represent a major cause of imprecision in the decision processes of fuzzy sets (Herrera & Herrera-Viedma, 2000; Olcer et al., 2005). Hence, using the Entropy theory may simplify the decision-makers in their selection process.

Thus, level one could be helpful in discriminating the information structures in order to pass to the second level concerning the actions' optimization. Herein, several steps should be applied. We enumerate these steps as follows, presenting a decision-policy form:

**Step.1** The choice of the two most powerful information structures, based on level one results. Once the information structure are being ranked according to their informative input, the decision-maker may eliminate the other possible alternatives. Hence, making the decision process easier.

**Step.2** The assessment of the information power; the two structures should be assigned with their informative power in the sense of Blackwell.

**Step.3** The computation of the optimal action; the action with the maximum expected payoff.

The importance of applying the Blackwell method right after the entropy theory and not as a first step, relies on the fact that it avoids integrating lots of factors to all the initial information structures available. Computing the information power of all the information structures while integrating the economic factors (such as the cost, the revenues, etc.) is a quasi-impossible exercise. Once step 1 is done, the Blackwell method applied to two structures simplify the variables assignment and increases the precision and accuracy of the decision making process. In our case study, step 1 and 2 representing a comparative aspect for the information power are useless, due to the absence of other information structures. Hence, we were limited to determine the optimal action ( $a_2 = \text{No control}$ ) by applying step 3. To not control in period one, leaves the choice to perform a control under period two. Hence, the optimal action  $a_2$  is the more flexible compared to  $a_1$ . The latter result is not necessarily always true. Several conditions and hypothesis should be verified, especially that Arrow & Fisher (1974) consider that at the end of the first period a perfect information will be available in order to choose the optimal action. However, in our case, the information at the end of the first period is according to a probabilistic distribution, hence a partial information.

While this study offers an articulation between two widely known theoretical approaches, it does also reveal concrete results. Concerning the GEO-SUD SDI, the interesting point was to establish a comparison between the signals  $y_1, y_2, y_3$  on the one hand, and the spatial information denoted by the signals  $y_4, y_5$  on the other hand. For a control entity, it was shown that the additional information received through a SDI is set to be the best scenario in reducing the uncertainty. Although this approach relies on the choice of probabilities in a subjective way, this procedure has been widely used in decision-making because it requires no historical data (De Kluyver & Moskowitz, 1984; Merigo et al., 2016). Other studies such as binomial probabilities are commonly used as well in strategic decision fields, making the problem simpler by analyzing the possible outcomes as either occurring or not occurring (Liao & Ho, 2010). Among the several approaches in decision-making, such as the scenario construction or the cross-impact analysis, the

decision-makers can be asked directly for the required probability if they show familiarity signs with the probability contexts (Schoemaker, 1993; Johnson & Busemeyer, 2001). This method was applied in our case study, where the control entities are aware of the probabilities of the signals received in their work's context. The information is usually highly location and context dependent. Thus, a particular attention is devoted to the construction of the matrix probability and the relationship between the states of nature and the signals of information. In fact, the decision maker must process this information into a decision that reflects the assessment of the probabilities into actions. Therefore, this process implies a deep knowledge and understanding of the appropriate context of each decision-making problem.

Although the case study in our article is based on a specific forest clear-cut example, it allows to advance general observations on how to shape the decisions and actions between different parties concerned. It reveals how the decision-making process can be a complex arrangement of diverse elements from different ecosystems. As a result, an understanding of the value of information may rely in some cases on the decision makers themselves, whose actions tend to be too revealing of the value. In this vein, this study has provided a valuable tool in analyzing how the decision process can accompany the policy-maker reflections. Specifically, it offers a conceptual policy, showing how the decisions are unfolding through various interactions among each constituting elements of an ecosystem.

## 6.7 Conclusion

To date, great efforts have been devoted to study the decision-making processes with the aim of helping people improve their decision quality and better fulfil their goals. These studies suggested several techniques and methods: the utility preferences, the means of values, the use of non-homogeneous information, etc. (Hoseinzadeh et al., 2012; Hwang & Masud, 2012).

Our research shows that combining the Entropy and Blackwell methods is useful for defining a decision-making strategy. The main contribution of the paper is in presenting an innovative approach on how this articulation can influence the decision-maker strategy. The usual problem relies in the set of decisions to take which logically determine the future outcomes. By provid-

ing concrete elements on how forest control entities can model their actions in light of a received information, this paper offers a framework, through which these concepts are associated. A detailed description of the forest clear-cutting case study can contribute to understand the choices the control entities face regarding their actions, as part of a global regulating policy. Furthermore, the decisions to be taken in an uncertain environment, comes to concretize the theoretical approaches. The empirical research presented helps to better understand how the information is being used to support forest management activities. Reducing the uncertainty in a decision-making context related to forest management can provide greater opportunities for making better decision, improving productivity and saving time and money (Rey-Valette et al., 2017).

While the control authorities may be concerned about the precision of their control activities, spatial information can help determine in a more ancient way the land plots that should be targeted for control operations. Although not all control activities are similar nor the actions involved, the paper offers a useful description to put these concepts together and summarize their implications in a decision-making process. It offers a support tool where some analytical models do not capture the decision-makers' intuitive preferences (Miao & Zhon, 2015; Abel et al., 2018). Moreover, it helps overcoming the complexity of group decision-making models (Campanella & Ribeiro, 2011; Lin et al., 2018), the unavailability of sufficient data or time constraints (Ren & Lützen, 2017) and the aggregation of subjective and objective judgements in the evaluation processes (Hoefler & Green Jr, 2016). The results presented in this paper comes in a continuity framework of the existing conceptual decision-making theories. They can be easily adapted to several contexts. As in the multi-criteria approaches, where the decision-makers' preferences are integrated into multiple analytical frameworks (Huang et al., 2015), this methodology could be very useful, especially as it provides a simple tool for analyzing complex managerial and marketing decision processes (Hardy & Comfort, 2015). Additionally, as the public concern for environmental issues is increasing, due to the lack of public participation in decision-making, the results can be used in more formalized manner, pushing the decision processes in the same direction (Therivel, 2013). The environmental assessment, the biodiversity issues, and the climate change, are examples where the decision-makers are faced with long iterative decisions (Noble et al., 2017). Thus, incorporating environmental and sustainability considerations into strate-



gic decision-making processes, could optimize the decision tasks related to project evaluation (Marmier, 2013). Finally, the flexibility of actions was not tested in this analysis. Pursuing further research is needed as a next step in the future, through case studies presenting several information structures. Applying this methodology in a more complicated context with a multi-period decision-making problem can potentially enrich the analysis and results of future works and case studies.

## 6.8 References

Abel, E., Mikhailov, L., & Keane, J. (2018). Inconsistency reduction in decision making via multi-objective optimisation. *European Journal of Operational Research*, 267(1), 212–226.

Álvarez-Miranda, E., Garcia-Gonzalo, J., Pais, C., & Weintraub, A. (2018). A multicriteria stochastic optimization framework for sustainable forest decision making under uncertainty. *Forest Policy and Economics*.

Amigues, J.-P. (1987). L'effet d'irréversibilité en économie de l'environnement. *Cahiers d'économie et Sociologie Rurales*, (4), 98–104.

Arrow, K. J., & Fisher, A. C. (1974). Environmental preservation, uncertainty, and irreversibility. In *Classic papers in natural resource economics* (pp. 76–84). Springer.

Baghdadi, N., Mallet, C., & Zribi, M. (2018). *QGIS and Applications in Agriculture and Forest*. John Wiley & Sons.

Barthod, C., Pignard, G., Guérin, F., & Bouillon-Penrois, E. (1999). Coupes fortes et coupes rases dans les forêts françaises. *Revue Forestière Française*, 51(4), 469–486.

Bernardo, J. M., & Smith, A. F. M. (2009). *Bayesian theory* (Vol. 405). John Wiley & Sons.

Bina, B., Schulte, O., Crawford, B., Qian, Z., & Xiong, Y. (2013). Simple decision forests for multi-relational classification. *Decision Support Systems*, 54(3), 1269–1279.

Bohnenblust, H. F., Shapley, L. S., & Sherman, S. (1949). Reconnaissance in game theory.

Boncompte, M. (2018). The expected value of perfect information in unrepeatable decision-making. *Decision Support Systems*, 110, 11–19.

Bouchard, M., D'Amours, S., Rönnqvist, M., Azouzi, R., & Gunn, E.

(2017). Integrated optimization of strategic and tactical planning decisions in forestry. *European Journal of Operational Research*, 259(3), 1132–1143.

Brynjolfsson, E. (1994). Information assets, technology and organization. *Management Science*, 40(12), 1645–1662.

Campanella, G., & Ribeiro, R. A. (2011). A framework for dynamic multiple-criteria decision making. *Decision Support Systems*, 52(1), 52–60.

Carey, A. B., & Harrington, C. A. (2001). Small mammals in young forests: implications for management for sustainability. *Forest Ecology and Management*, 154(1–2), 289–309.

Conrad, J. M. (1980). Quasi-option value and the expected value of information. *The Quarterly Journal of Economics*, 94(4), 813–820.

Constantino, M., & Martins, I. (2018). Branch-and-cut for the forest harvest scheduling subject to clearcut and core area constraints. *European Journal of Operational Research*, 265(2), 723–734.

Cover, T. M., & Thomas, J. A. (2006). *Elements of information theory* 2nd edition. Wiley-Interscience: NJ.

Crabbé, P. J. (1985). Valeurs d’option et de quasi-option des ressources naturelles. Québec, Canada: Groupe de recherche en économie de l’énergie et des ressources naturelles, Département d’économique, Faculté des sciences sociales, Université Laval.

Crémer, J. (1982). A simple proof of Blackwell’s “comparison of experiments” theorem. *Journal of Economic Theory*, 27(2), 439–443.

De Kluyver, C. A., & Moskowitz, H. (1984). Assessing scenario probabilities via interactive goal programming. *Management Science*, 30(3), 273–278.

Diaz-Balteiro, L., & Romero, C. (2008). Making forestry decisions with multiple criteria: a review and an assessment. *Forest Ecology and Management*, 255(8–9), 3222–3241.

Dubois, D., & Prade, H. (2000). *Fundamentals of Fuzzy Sets*--Kluwer Academic Publishers. Boston, London, Dordrecht.

Epstein, L. G. (1980). Decision making and the temporal resolution of uncertainty. *International Economic Review*, 269–283.

Eyvindson, K., & Kangas, A. (2014). Stochastic goal programming in forest planning. *Canadian Journal of Forest Research*, 44(10), 1274–1280.

FAO. (2016). Sustainable Forest Management Initiative. Retrieved from <http://www.fao.org/forestry/sfm/en/> (Accessed in December 2018).

Ficko, A., & Boncina, A. (2013). Probabilistic typology of management decision making in private forest properties. *Forest Policy and Economics*, 27, 34–43.

Fliedner, T., & Liesjö, J. (2016). Adjustable robustness for multi-attribute project portfolio selection. *European Journal of Operational Research*, 252(3), 931–946.

Golan, A. (2002). Information and entropy econometrics—editor’s view. *Journal of Econometrics*, 107(1–2), 1–15.

Guillemette, M. G., Laroche, M., & Cadieux, J. (2014). Defining decision making process performance: Conceptualization and validation of an index. *Information & Management*, 51(6), 618–626.

Guyon, D., Laventure, S., Belouard, T., Samalens, J.-C., & Wigneron, J.-P. (2015). Retrieving the stand age from a retrospective detection of multinannual forest changes using Landsat data. Application on the heavily managed maritime pine forest in Southwestern France from a 30-year Landsat time-series (1984--2014). In *Geoscience and Remote Sensing Symposium (IGARSS), 2015 IEEE International* (pp. 1968–1971).

Hardy, J. T. (2003). *Climate change: causes, effects, and solutions*. John Wiley & Sons.

Hardy, K., & Comfort, L. K. (2015). *Dynamic decision processes in com-*

plex, high-risk operations: The Yarnell Hill Fire, June 30, 2013. *Safety Science*, 71, 39–47.

Haven, E. (2008). Private information and the ‘information function’: a survey of possible uses. *Theory and Decision*, 64(2–3), 193–228.

Hebblewhite, M., Munro, R. H., & Merrill, E. H. (2009). Trophic consequences of postfire logging in a wolf–ungulate system. *Forest Ecology and Management*, 257(3), 1053–1062.

Henry, C. (1974). Option values in the economics of irreplaceable assets. *The Review of Economic Studies*, 41, 89–104.

Henry, C. (1974). Investment decisions under uncertainty: the "irreversibility effect". *The American Economic Review*, 64(6), 1006–1012.

Herrera, F., & Herrera-Viedma, E. (2000). Linguistic decision analysis: steps for solving decision problems under linguistic information. *Fuzzy Sets and Systems*, 115(1), 67–82.

Hoefler, R. L., & Green Jr, S. E. (2016). A rhetorical model of institutional decision making: The role of rhetoric in the formation and change of legitimacy judgments. *Academy of Management Review*, 41(1), 130–150.

Hoseinzadeh, A. R., Borzadaran, G. R. M., & Yari, G. H. (2012). Aspects concerning entropy and utility. *Theory and Decision*, 72(2), 273–285.

Howard, R. A. (1988). Uncertainty about probability: A decision analysis perspective. *Risk Analysis*, 8(1), 91–98.

Huang, T. C.-K., Chen, Y.-L., & Chang, T.-H. (2015). A novel summarization technique for the support of resolving multi-criteria decision making problems. *Decision Support Systems*, 79, 109–124.

Hwang, C.-L., & Masud, A. S. M. (2012). *Multiple objective decision making—methods and applications: a state-of-the-art survey* (Vol. 164). Springer Science & Business Media.

IGN. (2017). Le memento ; Inventaire forestier. Intan, R., & Mukaidono, M. (2004). Fuzzy conditional probability relations and their applications in fuzzy information systems. *Knowledge and Information Systems*, 6(3), 345–365.

Jabbour, C., Rey-Valette, H., Maurel, P., & Salles, J.-M. (2019). Spatial data infrastructure management: A two-sided market approach for strategic reflections. *International Journal of Information Management*, 45. <https://doi.org/10.1016/j.ijinfomgt.2018.10.022>

Johnson, J. G., & Busemeyer, J. R. (2001). Multiple-stage decision-making: The effect of planning horizon length on dynamic consistency. *Theory and Decision*, 51(2–4), 217–246.

Jones, R. A., & Ostroy, J. M. (1984). Flexibility and uncertainty. *The Review of Economic Studies*, 51(1), 13–32.

Kazana, V., Fawcett, R. H., & Mutch, W. E. S. (2003). A decision support modelling framework for multiple use forest management: The Queen Elizabeth Forest case study in Scotland. *European Journal of Operational Research*, 148(1), 102–115.

Kochenderfer, M. J. (2015). *Decision making under uncertainty: theory and application*. MIT press.

Leroux, A. D., Martin, V. L., & Goeschl, T. (2009). Optimal conservation, extinction debt, and the augmented quasi-option value. *Journal of Environmental Economics and Management*, 58(1), 43–57.

Liao, S.-H., & Ho, S.-H. (2010). Investment project valuation based on a fuzzy binomial approach. *Information Sciences*, 180(11), 2124–2133.

Lin, M., Xu, Z., Zhai, Y., & Yao, Z. (2018). Multi-attribute group decision-making under probabilistic uncertain linguistic environment. *Journal of the Operational Research Society*, 69(2), 157–170.

Marmier, F., Gourc, D., & Laarz, F. (2013). A risk oriented model to assess strategic decisions in new product development projects. *Decision*

Support Systems, 56, 74–82.

Marschak, J., & Miyasawa, K. (1968). Economic comparability of information systems. *International Economic Review*, 9(2), 137–174.

McMahon, S. M., Harrison, S. P., Armbruster, W. S., Bartlein, P. J., Beale, C. M., Edwards, M. E., . . . Prentice, I. C. (2011). Improving assessment and modelling of climate change impacts on global terrestrial biodiversity. *Trends in Ecology & Evolution*, 26(5), 249–259.

Menges, G., & Huschens, S. (1984). The information problem in decision making. *Theory and Decision*, 16(1), 45–58.

Merigo, J. M., Palacios-Marques, D., & Zeng, S. (2016). Subjective and objective information in linguistic multi-criteria group decision making. *European Journal of Operational Research*, 248(2), 522–531.

Miao, B., & Zhong, S. (2015). Risk preferences are not time preferences: separating risk and time preference: comment. *American Economic Review*, 105(7), 2272–2286.

Muzzioli, S., & Reynaerts, H. (2007). The solution of fuzzy linear systems by non-linear programming: a financial application. *European Journal of Operational Research*, 177(2), 1218–1231.

Noble, B., & Nwanekezie, K. (2017). Conceptualizing strategic environmental assessment: Principles, approaches and research directions. *Environmental Impact Assessment Review*, 62, 165–173.

Ölçer, A. I., & Odabaş, A. Y. (2005). A new fuzzy multiple attributive group decision making methodology and its application to propulsion/manoeuvring system selection problem. *European Journal of Operational Research*, 166(1), 93–114.

Partidário, M. R. (1999). Strategic environmental assessment—principles and potential. *Handbook of Environmental Impact Assessment*, 1, 60–73.

Pawson, S. M., Brin, A., Brockerhoff, E. G., Lamb, D., Payn, T. W.,

Paquette, A., & Parrotta, J. A. (2013). Plantation forests, climate change and biodiversity. *Biodiversity and Conservation*, 22(5), 1203–1227.

Ren, J., & Lützen, M. (2017). Selection of sustainable alternative energy source for shipping: Multi-criteria decision making under incomplete information. *Renewable and Sustainable Energy Reviews*, 74, 1003–1019.

Rey-Valette, H., Maurel, P., Miellet, P., Sy, M., & Pigache, L. (2017). Mesure les impacts des infrastructures de données géographiques (IDG) et des observatoires. Application à l’IDG SIG-LR. *Revue Internationale de Géomatique*, 3, 375–397.

Sandmo, A. (1970). The effect of uncertainty on saving decisions. *The Review of Economic Studies*, 37(3), 353–360.

Schoemaker, P. J. H. (1993). Multiple scenario development: Its conceptual and behavioral foundation. *Strategic Management Journal*, 14(3), 193–213.

Singh, V. P. (1997). The use of entropy in hydrology and water resources. *Hydrological Processes*, 11(6), 587–626.

Spilsbury, M. J. (2005). The sustainability of forest management: Assessing the impact of CIFOR’s criteria and indicators research (Vol. 4). CIFOR.

Therivel, R. (2013). Strategic Environmental Assessment: An Overview. In *Strategic Environmental Assessment in Action* (pp. 19–31).

Routledge. Thompson, I., Mackey, B., McNulty, S., & Mosseler, A. (2009). Forest resilience, biodiversity, and climate change. In Secretariat of the Convention on Biological Diversity, Montreal. Technical Series no. 43. 1-67. (Vol. 43, pp. 1–67).

von Detten, R., & Faber, F. (2013). Organizational decision-making by German state-owned forest companies concerning climate change adaptation measures. *Forest Policy and Economics*, 35, 57–65.

Weintraub, A., & Cholaky, A. (1991). A hierarchical approach to forest



planning. *Forest Science*, 37(2), 439–460.

White, J. C., Coops, N. C., Wulder, M. A., Vastaranta, M., Hilker, T., & Tompalski, P. (2016). Remote sensing technologies for enhancing forest inventories: A review. *Canadian Journal of Remote Sensing*, 42(5), 619–641.

Wibowo, S., & Deng, H. (2015). Multi-criteria group decision making for evaluating the performance of e-waste recycling programs under uncertainty. *Waste Management*, 40, 127–135.

Yang, J. (2018). Information theoretic approaches in economics. *Journal of Economic Surveys*, 32(3), 940–960.

Zhang, M.-J., Wang, Y.-M., Li, L.-H., & Chen, S.-Q. (2017). A general evidential reasoning algorithm for multi-attribute decision analysis under interval uncertainty. *European Journal of Operational Research*, 257(3), 1005–1015.

Zheng, C., Chang, C.-T., & Chen, Y.-T. (2017). Combining 3-Level Multichoice Goal Programming with Multicoefficient Goal Programming to Evaluate Forest Ecosystem Service Potential Improved by Thinning. *Forest Science*, 63(3), 310–318.





## Chapter 7

# Identifying the Economic Impacts of a Spatial Data Infrastructure

**Article:** Niang, A., Rey-Valette, H., Maurel, P., Ose K., Jabbour, C., Salles, J.-M., & (2019). Identifying the economic impacts of a spatial data infrastructure. *Journal of Regional and Urban Economics*. (Identification des impacts économiques d'une Infrastructure de Données Spatiales. *Revue d'Economie Régionale et Urbaine*<sup>1</sup>) (*Accepted - In Editing*).

---

<sup>1</sup>Article publié en français

# Identification des impacts économiques d'une Infrastructure de Données Spatiales

## 7.1 Introduction

Longtemps limitées à un usage scientifique, les images issues des satellites sont de plus en plus utilisées par les instances chargées de la gouvernance territoriale et de la mise en œuvre des politiques publiques (Crompvoets et al., 2004 ; CNIG, 2005). Cette amélioration significative de la connaissance et du suivi permet d'améliorer les politiques publiques, notamment en matière d'aménagement du territoire et d'urbanisme, de gestion publique de la forêt et de l'agriculture, de prévention et de suivi des risques ainsi que de protection de la biodiversité (Kazmierski et al., 2014 ; Maurel et al., 2015 ; Tonneau et Maurel, 2016). L'infrastructure de données spatiale GEOSUD dotée d'un terminal de réception des satellites SPOT 6-7 avec un portail Web d'accès aux images et à des services associés (Maurel et al., 2015) répond à ces attentes. Elle contribue à l'animation du pôle THEIA qui fédère la communauté nationale des experts et usagers publics de la télédétection appliquée à l'observation des surfaces continentales (Baghdadi et al., 2015). Au total fin novembre 2018, 517 organismes publics étaient adhérents à GEOSUD (162 structures de recherche et d'enseignement, 139 structures territorialisés de l'État, 105 collectivités territoriales, 44 autres établissements publics, 67 organismes divers et associatifs).

Peu d'études analysent l'impact économique des IDGS, en termes de gain

de productivité ou d'innovations (Rey-Valette et al., 2017). Cet article vise à analyser les effets de GEOSUD en tant que plateforme de mutualisation et d'innovation pour les politiques publiques à partir de l'exemple de la fourniture des cartes de coupes rases<sup>2</sup> pour le contrôle de la réglementation liée à la gestion des forêts. La forêt française métropolitaine occupe 30 % du territoire soit 16,5 millions d'hectares dont 11,7 millions de propriétés privées (IGN, 2014) et génère environ 440 000 emplois directs et indirects pour un chiffre d'affaires de la filière bois de près de 60 milliards d'euros (MAAF, 2016). On note que la forêt métropolitaine est sous-exploitée du fait d'une politique forestière orientée historiquement sur la conservation et la préservation d'un patrimoine (Attali et al., 2013) avec un renouvellement insuffisant pour son aptitude à fixer le carbone. De façon à favoriser une gestion durable, le code forestier et la Loi d'Orientation Forestière de 2001 (LOF) encadrent l'exploitation en réglementant les autorisations de coupes qui sont accompagnées d'une obligation de reconstitution naturelle ou de replantation dans un délai de cinq ans (Barthod et al., 1999). Les infractions sont sanctionnées d'une amende de 1200 € par hectare pour la non-reconstitution des coupes rases et entre 20 000 et 60 000 €/ha pour les coupes illicites et abusives. La gestion durable des forêts privées impose des Plans Simples de Gestion (PSG) au-delà de 25 hectares et un Code de Bonnes Pratiques Sylvicoles pour les forêts de petite taille. Le contrôle de ces dispositions est effectué par les services territorialisés de l'État (DRAAF)<sup>3</sup> et DDT(M)<sup>4</sup>, lors de visites de terrains qui ne permettent pas un contrôle exhaustif. Il s'agit d'étudier dans quelles mesures l'usage de « l'application coupes rases » de GEOSUD (Osé et Deshayes, 2015) génère des gains de productivité et de compétences pour les structures utilisatrices mais aussi comment ces effets impactent l'économie de la filière bois et améliorent certains services éco systémiques rendus par les forêts (Berger et Peyron, 2005).

Dans une première partie, nous présenterons notre cadre d'analyse des effets et la logique de l'application pour le suivi des coupes rases avant de détailler dans une seconde partie notre méthodologie d'enquête. La présentation des résultats s'effectue ensuite par type d'impacts en précisant les hypothèses d'évaluation retenues avant d'en proposer une synthèse dans la dernière partie de discussion.

---

<sup>2</sup>Les coupes rases constituent un mode d'aménagement sylvicole passant par l'abattage de la totalité des arbres d'une parcelle d'une exploitation forestière.

<sup>3</sup>DRAAF : Direction Régionale de l'Agriculture et de la Forêt

<sup>4</sup>DDT(M) : Direction Départementale des Territoires (et de la Mer)

## 7.2 L'information satellitaire et l'IDGS GEOSUD comme source de productivité et d'innovation

En France le numérique est l'un des outils stratégiques du projet de modernisation de l'action publique visant à améliorer l'efficacité des politiques et des services publics, à maîtriser les dépenses publiques ainsi qu'à renforcer la gouvernance des territoires et la gestion durable de l'environnement (Masser et Cromptvoets, 2010 ; AFIGEO, 2013). Il répond aussi à la directive 2007/2/CE INSPIRE qui promeut la fourniture gratuite de données géo-spatiales. Il existe en France de multiples Infrastructures de Données GéoSpatiales nationales ou régionales par rapport auxquelles Hennig et al. (2013) ou Noucher (2013) estiment qu'il est difficile d'identifier les usages et les besoins. Concernant les forêts, la télédétection est utilisée principalement pour le suivi annuel des coupes rases et des défrichements (Maurel et al., 2015 ; Jolly et al., 2014). Elle peut permettre aussi l'évaluation des dégâts causés par les tempêtes, le suivi des risques et l'évaluation des dégâts d'incendies, le suivi de l'état de santé des forêts et l'inventaire des ressources forestières (Jolly et al, 2014 ; Beguet, 2014).

À la demande du Ministère de l'Agriculture et de l'Alimentation (MAA), l'IRSTEA a mis au point un algorithme simple pour la cartographie systématique des coupes rases à partir des couvertures nationales annuelles à haute résolution (de 1.5 à 6 m) réalisées par GEOSUD (Osé et Deshayes, 2015 ; Ferrer, 2015). Ces cartes sont mises gratuitement à disposition des services de l'État adhérents, ainsi qu'un guide méthodologique, des formations et l'animation d'un réseau d'utilisateurs. Plusieurs types d'impacts peuvent être attendus en fonction des acteurs de la chaîne de valeur liée à l'information géographique. On peut distinguer notamment (i) la valeur ajoutée créée pour les fournisseurs de données, c'est-à-dire Airbus Defence & Space (ADS) en amont et GEOSUD, (ii) des gains de productivité (temps de travail, coûts évités) et des recettes supplémentaires (amendes) pour les structures adhérentes chargées du contrôle des coupes rases et (iii) la valeur ajoutée créée en aval dans la filière bois en lien avec l'accroissement des volumes produits. Enfin à l'échelle de la société, il existe des gains de valeur environnementale au niveau de la conservation ou de l'accroissement de certains services écosystémiques ainsi qu'une amélioration de la gouvernance des politiques publiques du fait d'effets

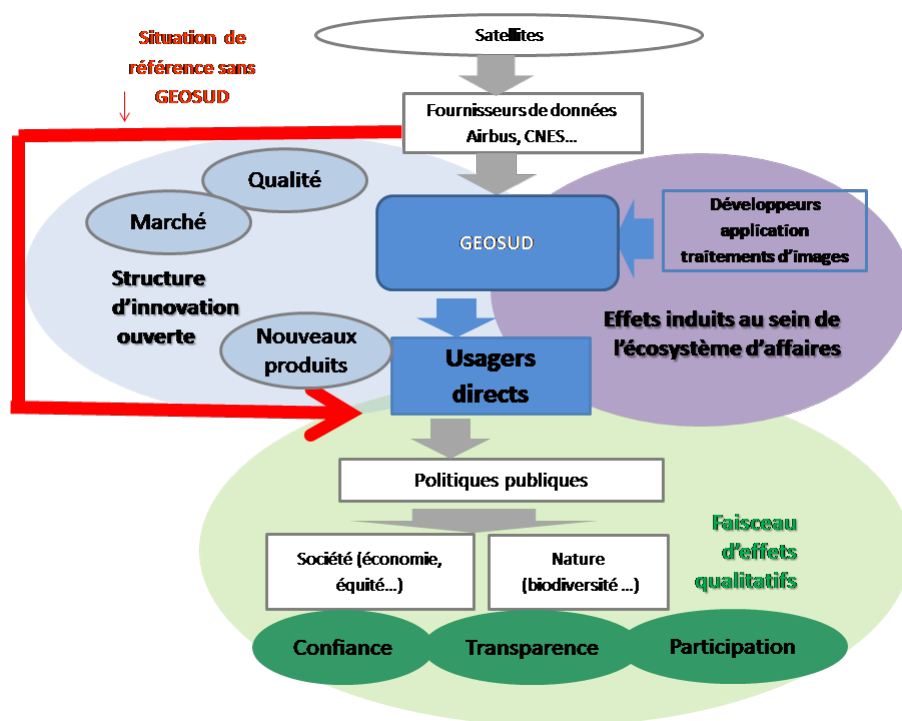

Figure 7.1: Structure des flux d'information et des types d'effets générés par GEOSUD

positifs de la télédétection sur le diagnostic, la prise de décision, la légitimité ainsi que l'acceptation de ces décisions (Tonneau et Maurel, 2016).

La figure 7.1 présente la structure des flux d'information et des types d'effets avec l'IDS GEOSUD et sans cette IDS (situation dite de référence) :

Plus généralement, les analyses relatives aux structures de mutualisation ou plateformes intermédiaires dans le domaine de la connaissance et de l'innovation distinguent deux types de fonctions ou d'effets selon que ceux-ci concernent la gestion de l'information ou la gestion des connaissances. Ainsi Barlantier et al. (2016) caractérisent d'une part les plateformes dites *Technological Transfers Offices (TTO)* et les *Research Technological Organisation (RTO)*. Les plateformes TTO ont des effets de nature organisationnelle en termes d'économie de coût de transaction à travers des gains de productivité ou des économies résultant de la mutualisation et du partage de l'information. En revanche, les structures de types RTO interviennent plutôt



au niveau du partage des connaissances et de la diffusion des savoirs faire, en facilitant les innovations, notamment les processus d'innovation ouverte, impliquant des processus et apprentissages partagés au sein de plateformes associées à des réseaux (Isckia, 2011) qui permettent d'organiser et de stimuler les échanges de connaissances. L'association d'acteurs relevant de statut multiples, bureaux d'études, services de l'État, laboratoires de recherche, collectivité territoriales permet de renforcer les processus d'hybridation des connaissances et d'offrir des conditions favorables à des processus d'innovation ouverte (Teece, 2010). La transposition de ces approches à la plateforme GEOSUD conduit à évaluer d'une part ses effets positifs sur les coûts de transactions autour de l'usage de l'imagerie satellitaire mais aussi à identifier les effets d'innovation plus diffus pour les adhérents résultant des activités d'animation et d'appui à la montée en compétences en accompagnement de la fourniture des images. Ainsi GEOSUD et les infrastructures de données spatiales et géographiques associent à des horizons différents les deux facettes des plateformes d'information distinguées par Barlantier et al. (2016).

### 7.3 Méthodologie de l'évaluation pour la gestion des coupes rases

Notre évaluation des impacts de l'usage des cartes satellites de GEOSUD pour la gestion des coupes rases relève d'une analyse de la chaîne de valeur appliquée à l'information géo spatiale. Ce type d'approche permet d'identifier et de quantifier les effets à l'échelle de l'ensemble des acteurs impliqués directement et indirectement le long de la chaîne des activités. L'estimation des impacts au sein des structures utilisatrices de ces cartes satellites a nécessité d'effectuer une enquête en ligne auprès des 62 DRAAF et DDT(M) adhérentes à GEOSUD. Les effets à l'échelle de la filière ont été évalués en mobilisant des données de référence pour la filière bois. Enfin, l'estimation des impacts économiques de la "méthode coupes rases" sur les structures productrices et fournisseuses de données, c'est-à-dire ADS et l'IDGS GEOSUD, a été réalisée en croisant les informations relatives à la demande des images coupes rases et les données comptables de fonctionnement de GEOSUD.

### 7.3.1 Élaboration du questionnaire et réalisation de l'enquête

Le questionnaire élaboré à l'issue d'entretiens individuels avec diverses personnes ressources, comportait 44 questions réparties entre 6 rubriques :

- i. Présentation de la structure ;
- ii. Moyens internes liés aux activités de suivi des coupes rases sans usage d'images satellitaires ;
- iii. Impacts économiques de GEOSUD sur les activités liées aux coupes rases ;
- iv. Impacts de GEOSUD sur les compétences, le réseau et la gouvernance ;
- v. Impacts du suivi des coupes rases par imagerie satellitaire sur la filière forêt-bois et sur l'environnement ;
- vi. Perspectives d'usage des images satellitaires pour la gestion durable des forêts.

Les enquêtés devaient comparer les pratiques (temps de travail) et les coûts de contrôle des coupes sans recours et avec recours aux images et services "coupes rases" de GEOSUD. Pour ce faire ils devaient évaluer les différentiels de coûts et de temps en pourcentage par rapport à la situation de référence sans recours à GEOSUD. En outre, ils devaient se prononcer en évaluant l'importance de certains impacts selon trois classes (marginal, important, très important). Les questionnaires ont été envoyés par courriels aux 62 correspondants GEOSUD des DRAAF et DDT(M). De nombreuses relances ont été effectuées et certaines questions ont dû être complétées par entretien téléphonique.

### 7.3.2 Présentation de l'échantillon enquêté

Au total, 23 DRAAF et DDT(M) ont répondu à l'enquête, dont 11 utilisatrices des images "coupes rases" de GEOSUD (Tableau 7.1).

<b>Utilisatrices des images coupes rases de GEOSUD</b>	DRAAF : Rhône Alpes (1 762), Centre-Val de Loire (967), Bourgogne (1 018), Limousin (575), Lorraine (882)
	DDT(M) : Alpes de haute Provence (407), Saône-et-Loire (213), Nièvre (235), Aveyron (278), Rhône (75), Savoie(203)
<b>Utilisatrices d'images autres que celles fournies par GEOSUD</b>	DRAAF Poitou-Charentes (429)
	DDT(M) : Landes (565), Vosges (298), Charente (131), Vendée (44), Deux-Sèvres (55), Tarn-et-Garonne (64), Seine-Maritime (113)
<b>Ayant suivi uniquement la formation coupes rases GEOSUD</b>	DDT(M) : Yonne (230), Jura (247), Doubs (228), Haute-Saône (235)

Table 7.1: Détail des structures enquêtées en fonction des surfaces contrôlées (ha x 1000)

Par ailleurs, nous avons identifié l'existence de pratiques d'échange (plus ou moins formels) des cartes satellitaires entre services ou structures qui augmentent les bénéficiaires des effets liés à l'information satellitaire. Ces pratiques existent surtout en interne, entre services d'une même structure ou entre DRAAF et DDT(M). Concernant les traitements des images fournies par GEOSUD, 65 % des structures affirment avoir plutôt recours à des compétences internes tandis que 13 % font intervenir des services d'opérateurs publics (principalement les DDT(M) qui s'appuient sur les services géomatiques des DRAAF ou des bureaux d'études. Notons en termes de renforcement des compétences que plus de 60 % des 23 DRAAF et DDT(M) de l'échantillon ont bénéficié des deux formations spécialisées proposées par GEOSUD.

## 7.4 Détails de l'évaluation et des résultats par type d'impact

Différentes méthodes d'évaluation ont été mobilisées, selon la nature des impacts identifiés. Des méthodes de valorisation d'actifs marchands et non marchands, ainsi que des méthodes spécifiques d'estimation monétaire d'impacts de projets ou de politiques ont été utilisées. Les impacts qualitatifs plus difficilement quantifiables ont été hiérarchisés selon une échelle d'importance croissante de 0 à 10.

### 7.4.1 Impacts de la production et de la fourniture des images

Le croisement des informations relatives à la demande des images coupes rases et des données comptables de fonctionnement de GEOSUD a permis d'évaluer les impacts économiques pour les structures productrices et fournisseuses de données, c'est-à-dire respectivement ADS et GEOSUD.

#### 7.4.1.1 La valeur ajoutée générée par ADS

Dans le cadre d'un consortium et d'un marché pluriannuel, GEOSUD acquiert la télémessure des satellites SPOT 6\_7 nécessaire à la production d'une cartographie satellitaire annuelle du territoire national métropolitain à un prix de 420 000 €/an en faveur d'ADS, pour qui ce montant constitue une recette. Les acquisitions des images de cette couverture nationale démarrent chaque année au mois avril et s'achèvent la plupart du temps courant octobre. Seules les images acquises entre les mois de mai et de septembre sont utilisées pour la détection des coupes rases afin de limiter les fausses détections dans les massifs de feuillus. Ces images estivales de la couverture nationale annuelle ne permettant d'observer en moyenne qu'un tiers du territoire métropolitain, nous avons fait l'hypothèse qu'elles ne permettaient d'observer aussi qu'un tiers de la surface totale des forêts métropolitaines (16,5 millions d'hectares) soit 5,5 millions d'hectares. Le coût de télémessure correspondant aux coupes rases représente donc  $1/42^5$  ( $1/3 \times 1/14$ ) du coût total de la télémessure de la couverture nationale, soit 10 K€/an de chiffre d'affaire pour ADS, correspondant à une valeur ajoutée de 4, 6 K€/an (taux de valeur ajoutée des activités spécialisées scientifiques et techniques – données INSEE 2013). Néanmoins, il convient de souligner que sans l'infrastructure GEOSUD, toutes les DRAAF et DDT(M) n'auraient pas utilisé directement ces données.

---

<sup>5</sup>Le quotient de 42 correspond à  $14 * 3$  (pour tenir compte que les images ont été téléchargées en moyenne 14 fois) et puisque un tiers seulement de la totalité de la couverture nationale est acquise à des dates exploitables pour la détection des coupes rases. Il s'agit d'une hypothèse simplificatrice qui suppose qu'au moins un des téléchargements est lié aux coupes rases et que les coûts soient linéaires.

### 7.4.1.2 Les économies de mutualisation générées par GEOSUD

Les coûts de GEOSUD s'élèvent à 320 K€ (dont 294 K € de valeur ajoutée) pour le fonctionnement (hors amortissement des équipements et logiciels pour lesquels il est difficile d'avoir une comptabilité analytique) et à 4 K€ pour les formations. Nous avons construit trois scénarios possibles avec et sans intervention de GEOSUD de façon à évaluer les gains liés à la mutualisation des achats.

**Scénario “mutualisation”** Les opérations mutualisées concernent les coûts d'acquisition de la télémessure, le fonctionnement de la station GEOSUD, le stockage des images et la formation des agents des DRAAF et DDT(M). Sachant que la couverture nationale représente la moitié du volume de télémessure annuelle acquise et traitée par GEOSUD (l'autre moitié servant à des acquisitions ad-hoc en France et à l'étranger) et que 1/3 de cette couverture nationale est exploitable pour les coupes rases (cf. 7.4.1.1), alors 1/6 ( $1/2 \times 1/3$ ) des charges de fonctionnement de la station GEOSUD (320 K€/an) est liée à la réception et au stockage des images pour les coupes rases, soit 53 K€/an. La formation est évaluée sur la base du montant forfaitaire payé annuellement par le MAA<sup>6</sup>, soit 4 K€. Au total, le coût de fonctionnement de GEOSUD lié aux coupes rases est de 67 K€/an (acquisition des images (10 K€) + réception et stockage (53 K€) + formations (4 K€)).

**Scénario “contrefactuel” Achat en direct** Dans ce scénario, nous supposons que les 26 DRAAF et DDT(M) actuellement concernées par les images “coupes rases” prennent en charge les coûts d'acquisition des images directement auprès d'ADS. Ce coût est évalué au prix marchand d'ADS (4,6€/km<sup>2</sup>) pour les 55,000 km<sup>2</sup>, soit 253 K€ auxquels il faut ajouter des disques durs pour le stockage (26 x 200€) soit 5200€. Nous avons évalué le coût des formations au tarif du catalogue d'AgroParisTech, à savoir 1,430€ pour chacune des 26 DDT(M), soit 37 K€. Au total le coût de ce scénario est de 295 K€.

**Scénario “contrefactuel” Accès gratuit** Dans ce scénario, les DRAAF et DDT(M) utilisent des images de satellites de type Sentinel (Europe) ou

---

<sup>6</sup>Les frais de missions durant la formation, à la charge des DRAAF et DDT(M), n'ont pas été intégrés car ils auraient aussi été payés dans le cadre d'une formation non mutualisée

Landsat 8 (USA) accessibles gratuitement. Dans ce cas, nous déduisons du coût total des opérations du scénario “Achat en direct” le coût d’acquisition des images; ce qui conduit à un coût de 42,4 K€/an. In fine le Tableau 7.2 synthétise les économies de mutualisation en fonction des scénarios. L’économie observée du fait de la mutualisation (228 K€/an) est cependant surestimée car elle est évaluée en phase de démarrage alors qu’en routine ces économies devraient être moindres (équipements disponibles, personnel déjà formé). Par ailleurs en l’absence de GEOSUD, les DRAAF et DDT(M) n’auraient pas forcément les budgets pour acheter les images directement, ou pourraient se regrouper pour négocier un prix.

	<b>Scénarios avec GEOSUD</b>	<b>Scénario achat direct</b>	<b>Scénario accès gratuit</b>
<b>Coût des opérations</b>	67 K € (a)	295 K€ (b)	42 K€ (c)
<b>Économies générées par la mutualisation</b>		228 K€ (b-a)	Pas d’économie (c-a)

Table 7.2: Économies de mutualisation liées à l’usage de l’application coupes rases de GEOSUD.

## 7.4.2 Impacts de l’usage des images satellitaires de GEOSUD au sein des DRAAF et DDT(M)

À partir des données issues de l’enquête réalisée auprès des DDT(M) et DRAAF, nous avons évalué les impacts sur la productivité au sein de ces organismes qui ont en charge le suivi des coupes rases, ainsi que les impacts sur les réseaux et la gouvernance dans la mise en œuvre de la politique publique de contrôle des coupes rases.

### 7.4.2.1 Économies de coûts de fonctionnement

Il s’agit de comparer au sein des DRAAF et DDT(M) les coûts de fonctionnement liés au contrôle des coupes rases avec usage<sup>7</sup> et sans usage<sup>8</sup> des images satellitaires, à savoir en moyenne une économie de 1 447€/an pour

<sup>7</sup>1553 € en moyenne par structure (1086 € de carburant, 100 € d’impression, 100 € d’achat de disque dur et 267 € d’annuités d’achat d’ordinateur)

<sup>8</sup>3000 € de frais de carburant

231 250 hectares de forêt (surface moyenne contrôlée par les structures ayant répondu), soit un coût évité de 0,00625 €/ha.

#### 7.4.2.2 Économies de temps de travail pour le suivi des coupes rases

Les enquêtés étaient invités à évaluer directement les économies de temps de travail avec en moyenne une économie de 48 % pour les emplois en charge du suivi et du contrôle. Il s'agit essentiellement de tâches préalables au contrôle (élaboration des plans de contrôle des coupes rases (80 %), collecte de données (55 %), contrôle des instructions de coupe (35 %), constat d'une infraction aux instructions de coupe (20 %)). S'agissant de structures publiques ces gains de temps seront réaffectés à d'autres tâches sans perte d'emploi. Cependant, on note par ailleurs une augmentation moyenne de 10 % du temps de travail des services géomatiques ; ce qui conduit in fine à un gain moyen de 38 %. En moyenne les activités consacrées au suivi des coupes rases sans usage des images satellitaires représentant 0,92 ETP/an/structure, il est possible d'estimer la valeur monétaire des gains de productivité (tableau 7.3).

Temps de travail à temps plein légal (h/an)	1 607	a
Nombre moyen de personne travaillant au suivi des coupes rases/structure (ETP/an)	0,92	b
Temps effectivement consacré au suivi des coupes rases sans images satellitaires (h/an)	1 478	c=a*b
% d'économie de temps due à l'usage des images coupes rases	38 %	d
Temps de travail économisé avec l'usage des images satellitaires (h/an)	560	e=c*d
Salaire horaire brut moyen déclaré : 2 400 euros, soit 15,82 € de l'heure auquel il convient d'ajouter le taux de charges pour la fonction publique (73 %) et les congés payés	31	f
Équivalence monétaire du temps de travail économisé (€)	17 360	g=e*f

Table 7.3: Valeur monétaire du temps de travail économisé pour le suivi des coupes rases.

### 7.4.2.3 Impacts sur les recettes publiques

Il s'agit ici des amendes supplémentaires résultant de la détection exhaustive des coupes rases. L'évaluation est effectuée pour 3 structures contrôlant 18 480 ha. Notons que la majorité des structures n'appliquent pas les amendes prévues par la réglementation et privilégient la régularisation des infractions en incitant à replanter. Durant les premières années d'un contrôle systématique, il est probable que des amendes seront recouvrées. La comparaison des surfaces de "coupes abusives" constatées sans l'usage des images (10 hectares) et depuis leur usage (68 ha) permet d'estimer le volume des amendes potentiellement recouvrable, soit une recette de 1,16 M€ (20 000 €/ha\*58 ha<sup>9</sup>).

### 7.4.2.4 Impacts sur le réseau et la gouvernance

Des effets sur la gouvernance et les réseaux d'utilisateurs ont été observés pour 62% des structures et évalués selon trois classes (marginal, important, très important) en ne retenant que les contributions importantes et très importantes (Tableau 7.4).

Renforcer la collaboration entre les services au sein des structures	26 %
S'insérer dans un réseau d'utilisateurs de données satellitaires	23 %
Renforcer l'image des structures auprès des exploitations forestières	19 %
Mutualiser les acquisitions de données	19 %
Renforcer la transparence et la collaboration avec les exploitations forestières	13 %

Table 7.4: Importance des impacts de GEOSUD sur le réseau et la gouvernance

(Source: enquête GEOSUD, 2016)

<sup>9</sup>Cette recette n'intègre pas la sanction de 60 000 € pour chaque hectare de forêt supplémentaire coupé à partir du troisième hectare.



#### 7.4.2.5 Impacts sur les compétences

L'impact des formations et de l'accompagnement proposés par GEOSUD ont été jugés importants par 41 % des structures et très importants par 39 %. Ils se répartissent de façon équilibrée entre la formation et l'accompagnement des utilisateurs (36 %), la mise à disposition du guide méthodologique (33 %) et l'accès facilité à une expertise (31 %).

#### 7.4.3 Impacts sur les acteurs de la filière-bois

L'amélioration de la mobilisation du bois est l'un des axes prioritaires de la politique forestière (MAAF, 2016 ; MAAF et IGN, 2016). Dans le cadre de son contrat d'objectifs et de performance 2012-2016, le Centre National de la Propriété Forestière prône une progression de 16 % du taux de prélèvement en forêt privée (CNPFF, 2011). La cartographie des coupes rases permet d'autoriser plus de coupes de bois, de mieux suivre la mise en œuvre des Documents de Gestion Durable (DGD), d'inciter les propriétaires à réaliser les coupes programmées et d'accroître les forêts privées gérées sous DGD. On peut donc estimer que l'usage des images satellitaires facilite l'accroissement de la surface forestière privée gérée sous DGD. Entre 2014 et 2015, cette surface forestière privée dotée de DGD est passée de 3,25 à 3,28 millions d'ha, soit une augmentation de 30 000 ha. En faisant l'hypothèse que cet accroissement est rendu possible par l'efficacité du contrôle permis par le suivi des coupes rases, on peut estimer le volume de bois supplémentaire à 147 840 m<sup>3</sup>, compte tenu de la production biologique nette de bois en forêt privée 154 m<sup>3</sup>/ha (MAAF et IGN, 2016).

L'estimation du chiffre d'affaires généré par cette récolte supplémentaire est effectuée en faisant l'hypothèse de l'absence d'exportation. Pour un prix de vente de 49 €/m<sup>3</sup> (donnée HT 2014) (MAAF et IGN, 2016), on obtient alors un chiffre d'affaires supplémentaire de 7,24 M€, soit une valeur ajoutée de 1,04 M€ (taux de 14,4 %). Cette production de bois génère ensuite 8,8 M€ de chiffre d'affaires lié à la vente de bois à palettes (73 920 m<sup>3</sup><sup>10</sup> à

---

<sup>10</sup>2 m<sup>3</sup> de bois d'œuvre produit 1 m<sup>3</sup> de sciage et 1 m<sup>3</sup> de coproduits (Le Turdu et Astrié, 2014 ; données 2012). L'estimation des recettes, est effectuée avec l'hypothèse d'une production de bois à palettes (sciage toute essence confondue) et de produits dérivés (sciures et chutes de scieries).

119,7 €/m<sup>3</sup><sup>11</sup> ) et 2,8 M€ de chiffre d'affaires lié à la vente de coproduits (sciures et chutes de scieries) soit un chiffre d'affaires supplémentaire pour ces deux activités de 11,6 M€ et un surplus de valeur ajoutée de 3,1 M€ (taux 26,9 %). Au total la valeur ajoutée supplémentaire pour la filière bois s'élève donc à 4,2 M€ maximum voire à 2,08 M€ si on fait l'hypothèse que les cartes de coupes rases n'expliquent que la moitié de l'accroissement des coupes règlementées.

## 7.5 Synthèse des résultats et discussion

Les estimations des valeurs des impacts observées à l'échelle de notre échantillon ont été extrapolées à l'échelle de la France métropolitaine. Selon les impacts, cette extrapolation a été réalisée en fonction de l'effectif des DDT(M) (97) ou des surfaces forestières privées de production, soit 11 761 000 ha pour la France métropolitaine.

### 7.5.1 Des gains de coût de transaction et des effets de création de valeur ajoutée significatifs

Concernant les gains de coûts de transaction qui relèvent de la fonction d'intermédiaire et de mutualisation de l'IDGS, il convient d'extrapoler les résultats observés à l'échelle de l'échantillon enquêté pour l'ensemble des forêts privées de France métropolitaine selon le nombre de structures ou le total des surfaces forestières privées (Tableau 7.5).

---

<sup>11</sup>Prix de vente moyens HT 2014 du m<sup>3</sup> des produits de sciages et dérivés considérés (CEEB, 2016).

	Données observées (enquête)				Données extrapolées	
	Montants observés (K€)	Surface forestière (ha)	Nombre de structures	Coût unitaire (€)	Effectif Échelle nationale	Total (K€)
<b>Mutualisation</b>	228		26	8771/structure	97 structures	851
<b>Coûts de fonctionnement évités</b>	1,4	231 250		0,00625/ha	11,761 millions d'hectares	74
<b>Gain de temps</b>	17	275 000		0,063/ha		742
<b>Total</b>						<b>1 667</b>

Table 7.5: Estimation des coûts de transactions évités

La valeur ajoutée créée regroupe celle directement liée aux activités de production et de traitement des images soit 58 K€ (53 K€ pour GEOSUD et 4,6 K€ pour ADS) et celle indirecte résultant de l'accroissement du bois produit pour la filière (de 4,2 M€ à 2,08 M€ selon les hypothèses). Soulignons que la mise en place d'un contrôle systématique devant conduire à un meilleur respect de la réglementation, nous n'avons pas tenu compte ici de l'augmentation des amendes qui devrait être ponctuelle, uniquement les premières années. Il est possible de comparer les flux générés au budget de fonctionnement de GEOSUD pour la fourniture des cartes de coupes, soit 67 K€ (hors investissement) (tableau 7.6). Ce budget de fonctionnement étant financé par des subventions publiques, il permet d'évaluer un ratio évaluant les effets générés pour 1€ de fonds publics investi dans le budget de l'infrastructure.

<b>Valeur ajoutée directe /budget de fonctionnement</b>	<b>Valeur ajoutée directe et indirecte (filière bois) / budget de fonctionnement</b>	<b>Gains de coût de transaction/budget de fonctionnement</b>
(4,6 K€ +58 K€) /67k€	(4,6 K€ +58 K€ + 4 171 K€) / 67k€ (4,6 K€ +58 K€ + 2 147 K€) / 67k€	1 583 k€/ 67k€
0,93 € par euros investi dans le fonctionnement	De 63 € à 32€ par euros investi dans le fonctionnement	24€ par euros investi dans le fonctionnement

Table 7.6: Ratio des effets générés en fonction du budget de fonctionnement de l'infrastructure

Ces résultats sont comparables à ceux observés par Sawyer et al. (2016) concernant les impacts socioéconomiques des images satellitaires du programme Copernicus pour le suivi des coupes rases en Suède. Ces auteurs obtiennent en effet uniquement pour les effets directs et les gains de coût de transaction un ratio de 32 € par euro investi dans la gestion satellitaire des coupes rases.

Soulignons cependant que notre évaluation économique des impacts de GEOSUD représente seulement un ordre de grandeur. En effet outre la faiblesse de l'échantillon, certaines structures avaient peu de recul pour évaluer les changements parce que leur usage des images satellitaires était récent. Par ailleurs, les gains de productivité et les coûts de fonctionnement évités ont été évalués sur la base de coûts moyens qui seront dans les faits fonction du rythme et des modalités d'usage des cartes GEOSUD. Il est donc difficile de proposer un montant annuel de référence. Comme pour les amendes et plus généralement pour l'ensemble de l'économie numérique, certains des impacts pourront être limités dans le temps et il est difficile de normaliser des ratios annuels dans un contexte de transformations rapides des pratiques (et des coûts). En effet, comme nous l'évoquerons ensuite, ces effets sont inscrits dans un processus d'innovation élargi qui conduit à des changements réguliers limitant toute standardisation. Par ailleurs les impacts indirects sur la filière bois peuvent être surévalués, car le caractère incitatif de l'information satellitaire sur l'accroissement de l'approvisionnement de la filière peut être par-

tiel même si le développement récent d'acteurs privés utilisant ces images pour rationaliser l'identification des zones à exploiter renforce le rôle de la télédétection. Enfin, il faut souligner que les ratios calculés ne tiennent pas compte des coûts d'investissement et ne peuvent prendre en compte certains coûts organisationnels qui devraient cependant disparaître progressivement si les nouvelles pratiques sont routinisées.

### **7.5.2 Un appui à moyen terme en faveur de processus d'innovation ouverte**

Près des deux tiers des structures ont observé des effets qualitatifs en termes de mise en réseaux et un renforcement des compétences du fait des formations et des services d'accompagnement offerts par la plateforme GEOSUD (guide méthodologique et accès facilité à l'expertise). L'importance de ces effets n'est pas seulement montrée par les résultats de l'enquête mais elle ressort aussi de l'analyse de l'activité de l'IDGS GEOSUD et des dynamiques observées lors des actions d'animation. Ainsi, le nombre d'adhérents qui s'établit fin 2018 à 517 a progressé rapidement avec une multiplication par 5 des adhérents sur 7 ans et une diversification croissante des thématiques et des types de structures concernées. Enfin on note une mobilisation importante des adhérents lors des opérations d'animation. Plus précisément, s'agissant de réseau et de gouvernance des politiques publiques, les effets évoqués par les enquêtés témoignent de synergies entre services, avec d'autres organisations partenaires de GEOSUD ainsi qu'avec les sociétés forestières. Ces effets de synergie peuvent favoriser des processus d'innovation ouverte et contribuer à améliorer ou diversifier les produits et les processus qui sont mobilisés dans les pratiques. En effet l'information est intégrée dans des activités matérielles diverses qui caractérisent des chaînes d'actions organisées configurant des référentiels de métiers. Les travaux sur l'innovation ouverte témoignent de l'intérêt des collaborations entre acteurs multiples, c'est-à-dire entre organisations diversifiées et avec les usagers, en termes de créativité et de production d'idées. Selon Boldrini et Schieb-Bienfait (2016) la créativité et l'émergence d'idées sont "particulièrement fécondes dans des environnements collaboratifs complexes, multidisciplinaires et multi sectoriels". Les besoins de coordination sont alors croissants en fonction du degré d'hétérogénéité de ces acteurs et des outils de management et d'échange de connaissances pour faciliter les innovations (Barbaroux et Attour, 2016). Il s'agit en ef-

fet de processus ou dispositifs de partenariat d'exploration collective (Auray, 2007 ; Segrestin 2006 ; Boldrini et Schieb-Bienfait, 2016) qui tendent de plus en plus à s'effectuer en amont des produits technologiques plutôt sur la phase de conception et de création d'usage nouveaux de l'information. L'innovation ouverte est efficace mais elle doit être organisée, ce qui justifie le rôle d'assembleur et d'animateur joué par l'infrastructure de donnée qui devient alors conjointement une structure d'intermédiation (RTO) dont les fonctions dépassent la réduction des coûts de transaction (Barlatier et al., 2016). Ce type d'externalité de réseau (Isckia, 2011) tend à s'auto renforcer dans le temps au sens où il est d'autant plus efficace que le nombre de participants s'accroît ce qui par la suite génère des incitations à adhérer au dit réseau. L'infrastructure de données dans sa fonction d'intermédiation devient alors "un créateur d'écosystèmes" ou encore "un architecte de l'exploration collective" (Barlatier et al., 2016) qui facilite le processus d'innovation ouverte entre des communautés de développeurs et d'utilisateurs. D'un point de vue économique, l'IDGS peut alors être appréhendée sous l'angle d'un marché biface (Jabbour et al., 2019). Si notre évaluation porte seulement sur le suivi des coupes rases, un des effets des échanges autour des apports de l'information satellitaire tient justement à l'identification des autres usages possibles et des perspectives qui en résultent au niveau de la production de nouveaux types de cartes forestières aussi bien pour les services de l'État ou les gestionnaires divers, que pour les exploitants forestiers. Dans le cas de GEOSUD, les processus d'innovation qui sont recherchés concernent à la fois des innovations de procédés pour les organismes de recherche voire les bureaux d'études mais aussi des innovations liées aux usages dans les services publics ou associatifs qui bénéficient des produits issus de l'information satellitaire. Il s'agit alors d'innovations en appui au développement territorial et à la gouvernance qui peuvent être très diversifiées. Elles peuvent être relatives à des gains de capacité d'analyse et d'opérationnalité se traduisant par une amélioration de l'efficacité des mesures mais aussi à des gains de créativité, de participation, de sociabilité permettant de renforcer la légitimité et la transparence de ces mesures (Tonneau et Maurel, 2016). Dans le cas de la gestion forestière, les services de l'État interrogés évoquent aussi un renforcement des relations avec les exploitants forestiers, ce qui permet de passer d'un processus de triple hélice réunissant des gestionnaires, des organismes de recherche et des services R&D à un processus de quadruple hélice associant en plus des acteurs privés, voire des citoyens (Carayannis et Campbell, 2017). Selon Barlatier et al., (2016), cette fonction RTO des infrastructures

“créée de la valeur dans la chaîne d’innovation en se positionnant comme un partenaire privilégié capable d’interagir avec différents acteurs”. Signalons aussi des effets d’image auprès des exploitants forestiers, qui permettent de renforcer les conditions de transparence de l’action publique et par-là qui œuvrent en faveur d’une meilleure acceptabilité du contrôle et plus généralement d’une meilleure qualité des politiques publiques de gestion forestière et de développement territorial. En effet par rapport aux limites de l’évaluation des politiques publiques identifiées par Bourdin et Ragazzi (2018), le recours à l’information satellitaire peut faciliter l’observation plus précise et le contrôle de certaines variables, la spatialisation des facteurs déterminants, l’identification des connectivités et des disparités territoriales pour rendre compte des spécificités des territoires et des effets de localisation et de distance, voire pour définir de nouvelles échelles pertinentes et renforcer les possibilités d’évaluation et de suivi décentralisé.

## 7.6 Conclusion

Dans le contexte actuel d’application des principes et des outils de management public, l’analyse des gains de productivité et des appuis à l’innovation générés par les infrastructures de données et les systèmes d’information du type de GEOSUD ouvre de nouveaux champs de recherche dans un contexte de développement des partenariats publics et privés et de l’économie numérique (Algan et al., 2016). Ce type d’approche encore peu développée se heurte cependant aux difficultés de mesure de processus de changement à la fois complexes et dynamiques au sein desquels les différentiels avec et sans information sont difficiles à objectiver et plus encore à mesurer. Notre approche croise deux points de vue complémentaires. Elle a été menée d’une part dans une logique économique pour estimer certains effets à l’échelle de la chaîne de valeur concernée par la fabrique et l’usage de l’information satellitaire. Elle s’inscrit cependant aussi dans une logique gestionnaire pour appréhender les effets des IDGS liés à leur rôle de gestionnaire et d’architecte de l’exploration collective (Barlatier et al., 2016) à l’échelle d’une communauté de pratique qui permet des gains de coordination et de mutualisation pour co-construire des connaissances conduisant à de nouveaux produits et/ou procédés voire de nouveaux processus et mesures de développement territorial. La méthodologie proposée se veut exploratoire. Elle doit être répliquée et progressivement standardisée de façon à faire évoluer les logiques

et les périmètres de recherche sur les types de modèles économiques pour ces infrastructures dans un contexte d'évolution des pratiques d'ingénierie (Vinck, 2014), de raréfaction des subventions publiques et de concurrence croissante entre les diverses plateformes de mutualisation de l'information selon les domaines et les échelles.



## 7.7 Références

AFIGEO (2013) Catalogue des IDG 2013. Association Française pour l'Information géographique.

Algan Y, Bacache M, Perrot A (2016) Administration numérique. Les notes du conseil d'analyse économique n° 34, septembre 2016. Conseil d'analyse économique, Paris.

Attali C, Fradin G, Dereix C, De Menthière C, Lavarde P (2013) Vers une filière intégrée de la forêt et du bois. Ministère de l'agriculture, de l'alimentation et de la forêt, Paris.

Auray N (2007) Une autre façon de penser le lien entre technique et politique : les technologies de l'Internet et le réagencement de l'activité autour de l'exploration. In : Thévenot L (dir) les Politiques du proche. La Découverte, Paris.

Baghdadi N, Leroy M, Maurel P, Cherchali S, Stoll M, Faure J-F, Desconnets J-C, Hagolle O Gasperi J, Pacholczyk P (2015) The Theia Land Data Centre. Maison de la télédétection, Montpellier : 4.

Barbaroux P, Attour A (2016) Approches interactives de l'innovation et gestion des connaissances, Innovations 1 (49) : 5-14.

Barlatier P-J, Giannopoulou E, Pénin J (2016) Les intermédiaires de l'innovation ouverte entre gestion de l'information et gestion des connaissances : le cas de la valorisation de la recherche publique. Innovation 1 (49) : 55-77.

Barthod C, Pignard G, Guérin F, Bouillon-Penrois E (1999) Coupes fortes et coupes rases dans les forêts françaises. Revue forestière française LI - 4-1999.

Beguet B (2014). Caractérisation et cartographie de la structure forestière à partir d'images satellitaires à très haute résolution spatiale. Thèse des sciences de la Terre. Université Michel de Montaigne Bordeaux III.

Berger A, Peyron J-L (2005) Les multiples valeurs de la forêt française. Les données de l'environnement économie n°105. Institut français de l'environnement.

Boldrini J-P, Schieb-Bienfait N, (2016) Comment initier une exploration collective ? Proposition d'un dispositif organisationnel, prélude aux partenariats d'exploration. Innovations 1 (49) : 15-38.

Bourdin S, Ragazzi E (2018) La science régionale et la performance des politiques publiques : retour sur les méthodes d'évaluation. Revue d'Économie Régionale et Urbaine 2 : 225-242.

Carayannis E G, Campbell D F J, (2017) Les systèmes d'innovation de la quadruple et de la quintuple Hélice. Innovation 3 (54) : 173-195.

CEEB (2016) Prix et indices nationaux. Sciages et bois énergies. 4ème trimestre 2015. Rapport du Centre d'Études de l'Économie du bois.

CNIG (2005) référentiels géographiques et données de référence : définitions. Fiche n°82.

CNPF (2011) Contrat d'objectifs et de performance 2012 – 2016, Etat – CNPF. Développer la gestion durable en forêt privée, en assurant son renouvellement, et une mobilisation accrue des produits forestiers, Paris.

Crompvoets J, Bregt A, Rajabifard A, Williamson I, (2004) Assessing the worldwide developments of national spatial data clearinghouses. International journal of geographical information science 18(7) : 665-689.

Ferrer F. (2015) Télédétection et cartographie des coupes rases en Rhône Alpes. AgroParisTech de Nancy.

Hennig S, Gryl I, Vogler R (2013) Spatial data infrastructures, spatially enabled society and the need for society's education to leverage spatial data. International journal of spatial data Infrastructures research 8 : 98-127.

Isckia T (2011) Écosystèmes d'affaires, stratégies de plateforme et innovation ouverte : vers une approche intégrée de la dynamique d'innovation.

Management & Avenir, 46 : 157-176. IGN (2014) Inventaire Forestier. La forêt en chiffres et en cartes. Le memento, Edition 2014.

Jabbour C, Rey-Valette H, Maurel P, Salles J-M (2019) Spatial Data Infrastructure Management: A two-sided market approach for strategic reflections. International journal of information management, 45 : 69-82.

Jolly A, Durrieu S, bock J, Lucie X, Munoz A, Piboule A (2014) Télé-détection et forêt : comment ça marche ? Foresee : Colloque de restitution 14 novembre 2014 – FCBA, Paris.

Kazmierski M, Desconnet J-C, Guerrero B, Briand D (2014) Geosud Sdi : accessing earth observation data collections with semantic-based services.

Huerta, Schade, Granell (Eds) : Connecting a Digital Europe through Location and Place. Proceedings of the AGILE'2014 International Conference on Geographic Information Science, Castellón, June 3-6 2014.

Le Turdu M, Astrié G (2014) Récolte de bois et production de sciages en 2012. Un faible niveau de récolte. Agreste Primeur, 310.

MAAF (2016) Programme National de la Forêt et du Bois (Pnfb) 2016-2026. Projet présenté au Conseil supérieur de la forêt et du bois le 8 mars 2016. Ministère de l'Agriculture, de l'Alimentation et de la Forêt, Paris. 60 p.

Masser I, Cromptvoets J (2010). Building European spatial data infrastructures, Redlands, ESRI Press.

Maurel P, Faure J-F, Cantou J P, Desconnets J C, Teisseire M, Mougenot I, Martignac C, Bappel E (2015) The GEOSUD remote sensing data infrastructure. RSDI seminar, Geospatial Week, 28 septembre – 2 octobre 2015, La Grande Motte.

Noucher M (2013) Infrastructures de données géographiques et flux d'information environnementale : de l'outil à l'objet de recherche. Networks and communication studies. 27 (1-2) : 120-147.

Ose K, Deshayes M (2015) Détection et cartographie des coupes rases par

téledétection satellitaire. Guide Méthodologique. UMR TETIS-IRSTEA, Montpellier.

Rey-Valette H, Maurel P, Miellet P, Sy M, Pigache L (2017) Mesurer les impacts des infrastructures de données géographiques et des observatoires pour assurer leur pérennité. Application à l'IDG SIG-LR. *Revue Internationale de Géomatique*, 3 : 375-397.

Sawyer G, Dubost A, De Vries M (2016) Copernicus Sentinels' Products Economic Value: A case Study of Forest Management in Sweden. The European Association of Remote Sensing Companies (EARSC).

Segrestin B (2006) 'Towards new governance structure for merging organizations? Lessons derived from the Renault-Nissan Alliance', *International Journal of Automotive Technology and Management*, 6(2): 199-213.

Teece D J (2010) Business Models, Business Strategy, and Innovation. *Long Range Planning*, 43: 172-194.

Tonneau J P, Maurel P, (2016) L'imagerie satellitaire : un outil pour les territoires. In : Baghdadi N, Zribi M (dir) *Observation des surfaces continentales par télédétection. Urbain et zones côtières* ISTE Londres, Ed 5 : 108-144.

Vinck D, (2014) Pratiques d'ingénierie, les savoirs de l'action? *Revue d'archéologie des connaissances*, 8 (2) : 225-243.



## Chapter 8

# Examining market stability using the Records theory: Evidence form French Spatial Data Infrastructures

**Article:** Jabbour, C., Hoayek, A., Maurel, P., Khraibani, Z., & Ghalayini, L. (2019). Examining market stability using the Records theory: Evidence form French Spatial Data Infrastructures (*Submitted*).

## 8.1 Introduction

The Earth observation (EO) market is comprised of several multi-scale markets (local, national, international, etc.) largely developed over the last four decades (Belward & Skøien, 2015). Since the launch of Landsat in 1970s, various types of EO have seen the light. The “new-space” concept of start-ups and big web actors (Silicon Valley, Terra Bella, Planet, etc.), the development of hybrid procurement schemes and the increasing emergence of low-cost satellites are examples of this shift towards the next space generation (Woodcock et al., 2008). Recently, the EO imagery landscape is being shared by two main providers: the Digital Globe (U.S.), considered today as the worldwide leader in EO data and services and Airbus Defence and Space (Europe) (Pwc, 2016). Despite the particularity of each provider’s profile, several common tasks are shared, consisting mainly of delivering satellite imagery and operating direct receiving stations (Denis et al., 2017). The majority of their revenues results from image sales and service delivery. Hence, combining satellite imagery with other types of data, is one of the main objectives in order to create useful information for end-users (Kruse et al., 2017).

In such context, the users are becoming primary key-drivers for this technology (Budhathoki et al., 2008). They contribute, through their demand of raw data and services, to its development and growth (Pearlman et al., 2016). The spatial data infrastructures, which constitute the direct link between the users and the large EO industry, have a leading role in establishing market opportunities (De Montalvo, 2017). In fact, the demand via these SDIs, depends on several factors: the role of the users’ critical mass (Gawer & Cusumano, 2008), the services available to accompany the raw data (Parker & Van Alstyne, 2017), the level of openness of the SDI platforms, etc. (Boudreau & Hagi, 2008). Hence, in general, it is challenging to get an assessment of the global EO market demand, and more particularly the satellite image market. In fact, several factors may be of influence. First, the increasing number of data providers/suppliers make it more complicated to have a precise view over the global market-chain (Pelton et al., 2017). There exist over seventy satellite-based observing programs operated by more than thirty different countries (Belward & Skøien, 2015). Furthermore, the markets are being structured through complex interoperability between the upstream and downstream layers, going from the satellite manufacturing to the delivery of image-based applications and added-value products to end-users

(Shelestov, 2017). Secondly, the redistribution of value between the raw data and the services. A major trend is that data users are less inclined to pay for raw or pre-processed data, even at preferential rates, due to the upstream pooling mechanisms put in place (e.g. the Copernicus European program) and the scarcity of public budgets (Chapman, 2015; Balint & Stevens, 2016). This phenomenon affects the value chain and consequently, the demand side. In addition, the increasing availability of free images may also have a direct effect on the prices of other images present in the market. The Landsat case is an example, where the images are publicly available for free (Woodcock et al., 2008; Wulder et al., 2012). And finally, the images' quality. Up to now, the satellite images prices are mainly driven by their quality (Hansen & Loveland, 2012).

All these elements raise the competition levels between the satellite image markets and highlight the questioning about their future. The satellite images, which are traded either via commercial operators or through other forms of platforms (two-sided market platforms, public-private partnerships, etc.), exhibit large increases in demand volatility (Jabbour et al., 2019). The satellite imagery demand is unpredictable and the market is vulnerable to high evolution shifts. While globally the EO market was worth \$50 Billion in 2017, it is expected to reach \$75.9 Billion by 2020. Additionally, the added-value services are expected to grow from U.S. \$28.3 Billion in 2017 to some U.S.\$ 42.3 Billion estimated by 2020 (GeoBuiz, 2018). In such circumstances, and face to these facts, studying the satellite image market could take several forms.

The objective of this paper is to study the stability of different satellite image markets through two independent French SDIs, by using the Records theory. In fact, the Records theory has been applied in several fields. From climate change, natural gas markets to finance and sports, this method has proved its relevance in capturing the dynamics occurring in certain market or through a set of data through time (Wergen & Krug, 2010; Wergen, 2014; Hoayek et al. 2017; Hamie et al. 2018). In our case, the study will be based first on the HR satellite images demand, through the GEOSUD /Theia SDI, in France. Since 2010, the GEOSUD and Theia Land data center form a unique SDI, aiming to progressively build-up an ecosystem of innovation in the field of satellite imagery for Earth observation. On the other hand, and



more generally, three satellite image markets, through the PEPS<sup>1</sup> SDI platform, will also be explored [Landsat (U.S.), Sentinel (Europe) and SPOT (France)]. Designed since 2015, the PEPS exploitation platform is managed by the French National Space Agency (CNES). It constitutes the direct link between the European Copernicus programme and the French user needs at all levels, from local to national.

We will assess the probability of witnessing a spike/drop in the short term in these different markets. To the authors' knowledge, this work is the first application of the recent advances of the Records theory to the Geospatial science field, and more particularly, the SDI satellite images. It comes in a sort of continuity of the reflections deployed within the GIS community, to offer an understanding of the dynamics that could occur through the users' Geospatial demand, leading to a better comprehension of the management of this data, the fluctuations that the SDI could face on its platform, and thus its market stability. Worthy to note that the choice of the three satellite image markets for which we had a privilege access through the PEPS platform statistical data, occupies a unique place in the EO pantheon. The Landsat is the longest running uninterrupted Earth observation program for acquisition of satellite imagery of Earth's land areas (Loveland & Dwyer, 2012). It is recognized as one of the largest U.S. Earth observation programs, with an estimated annual benefit value of nearly \$1.8 billion (Miller et al., 2013). Concerning the Sentinel satellite constellation, it is considered as the most important EO program developed the European Space Agency (ESA) to support the European operational and policy needs of the GMES<sup>2</sup> (Aschbacher et al., 2012; Donlon et al., 2012; Drusch et al., 2012; Torres et al., 2012). With its long-term continuity of measurements for more than twenty-years' time, its global frequent coverage and its broad variety of sensing methods (Berger et al., 2012), it is designed to provide routine observations for operational Copernicus services. Finally, the SPOT commercial high-resolution EO satellites managed by the CNES in France, has already taken more than 10 million high-quality images since its beginnings in 1986. It was designed to improve the knowledge and management of the Earth by exploring the Earth's resources and monitoring human activities and natural phenomena.

---

<sup>1</sup><http://peps.cnes.fr>

<sup>2</sup>Global Monitoring for Environmental Security

Although the stability of the satellite images markets cannot be dissociated from previously mentioned factors, the literature examining the technical issues related to the expansion of the EO markets (Pwc, 2016; Anderson et al., 2017), has not addressed clearly how the EO users' demand can reveal part of the market risk (Foresman, 2008; Denis et al., 2016). Studying the users' demand occurring via the SDI platforms still present many complications (Yang et al., 2006; McDougall et al., 2009; Rajabifard et al., 2010; Willmes et al., 2017). Usually, the time series of the satellite images demand are non-iid, and the assumption of the type of distribution is complex. Among the various extreme value theory researches, analyzing the high-frequency time series data or the evidence of causality between the supply and demand variables relies basically on stochastic econometric schemes (Lee & Lee; 2015). These models contain a large number of parameters, a fact that poses estimation challenges, and over-parameterization concerns (Claeskens & Hjort, 2008; Harrell, 2014). Such difficulties do not concern the records theory, which drops several mathematical constraints about the choice of the underlying distribution and the quality of the residuals (Hoayek et al., 2017). Additionally, it could be used, in cases where the number of available observations is somehow small (Arnold et al., 2011). Usually, the study of time in record models is accounted through particular random variables called 'Record Indicators' (Ballerini & Resnick, 1987). Moreover, this theory offers an alternative solution to the non-applicability of the machine learning techniques and long-term memory models, where a considerable amount of data is needed for a good performance (Witten et al., 2016; Mullainathan & Spies, 2017). The contribution of this paper, is in presenting a new approach for advancing the Geospatial science. The novelty relies, in offering additional processing elements, in order to enrich the GIS market policy development, by bringing a new perspective on possible risks and facts that could be present while considering the Geospatial markets dynamics. The cases of the GEOSUD and PEPS SDIs, for which the analysis was performed, serve as relevant illustration for the proposed approach. Through the framework presented, the common interest between a grounded mathematical modeling tool and the usage of geographical information emerges, with a focus on the market forecasting analysis techniques.

The remainder of the paper is organized as follows. We first outline the methodological protocol (description of the data, operators' characteristics), then present the main record's models' estimation and result analysis. Next,

the discussion brings those elements together. We explain the significance of the results and highlight their impacts. Finally, these models will be tested to check the reliability of the results. We conclude the article by considering future prospects in this field.

## 8.2 Methodology

### 8.2.1 SDI characteristics'—GEOSUD / PEPS

GEOSUD aimed since its launch, at the development of the Geospatial technology and data with a particular focus on the high resolution satellite images, contributing to its availability and easy access for its direct users. While facilitating the creation of integrated EO environment and supporting the Geospatial communities in developing their ecosystem, it is continuously exploiting new opportunities through the steady development of its platform. It aims at targeting both the scientific community and the public actors based on a concept of open innovation. Through developing a set of functionalities for the accompaniment of its users, GEOSUD is lowering the barriers and reconsidering the value chain of the GI spatial data with all the economic and societal benefits that may emerge behind.

On the other hand, the PEPS platform constitutes the missing link between the European infrastructure and the French institutional users, scientists and industries. Managed by the CNES, it is conceived to offer innovative services and open access, mainly to the Sentinel satellite images and products. By redistributing this data and enabling users to process them on servers close to the source, it is helping in achieving Copernicus goals in implementing and monitoring environmental and security policies. Recently, the Theia scientific community is using PEPS via the CNES' system, to directly access to the whole Sentinel archive and more particularly Sentinel-2 data, in order to make atmospheric corrections (level 2A) and monthly syntheses (level 3A).

## 8.2.2 Satellite-images schemes

### 8.2.2.1 GEOSUD high resolution satellite imagery

In November 2018, more than 15,000 images, covering 55 million sq.km, have been downloaded by GEOSUD direct users since the beginning of the project. Initially, the images provided through the SDI web portal, consisted mainly between Rapid Eye and SPOT 1-5. Lately, GEOSUD extended its image acquisition capacity by settling a new Antenna in Montpellier (south France), with the aim of accomplishing by itself the SPOT 6-7 image production process and responding to the needs of the scientific community. For instance, if the totality of the images acquired since present were not available through the pooling system developed by GEOSUD, (an investment of €11 million), it would have cost €110 million to all the SDI users to acquire them separately from the image providers at their preferential rates.

### 8.2.2.2 PEPS satellite imagery: Landsat, Sentinel and SPOT

While the PEPS has been designed initially to offer an access to Sentinel satellites images, other satellite images are also present on the platform. First, the Landsat EO data. Landsat was the first EO system to employ a global image acquisition strategy, offering satellite imagery in a free and open manner (Woodcock et al., 2008). The USGS Landsat data archive currently contains almost 6 million images (Wulder et al., 2016), with an actual acquisition capacity with the Landsat 7 and 8, of approximately 1200 scenes per day.

Secondly, although the Sentinel images cannot be considered a replacement or alternative for Landsat, it does offer a promising augmentation to the Landsat program (Claverie et al., 2018). From global warming to land use change and the atmosphere, the Sentinel family of satellite offers free of charge data to encourage maximum use. It aims at achieving a global, continuous and wide range of Earth observation capacity.

Similar to the U.S. government's experience, with its decision to no longer charge for access to the Landsat satellite imagery, the CNES opened its SPOT Earth observation data archive. The SPOT system consisting of five satellites launched since 1986, has produced more than 30 million images that now can be used to study environmental change over more than a quarter-century (Nosavan et al., 2018).

### 8.2.3 Data collection

The PEPS data sets, used in this study, consist of monthly demand values for the Landsat, Sentinel and SPOT images, recorded between February 2015 (the launching date of the platform) and May 2018. Figure 8.1 shows the time series of the satellite image demand of the three different markets via the PEPS SDI platform.

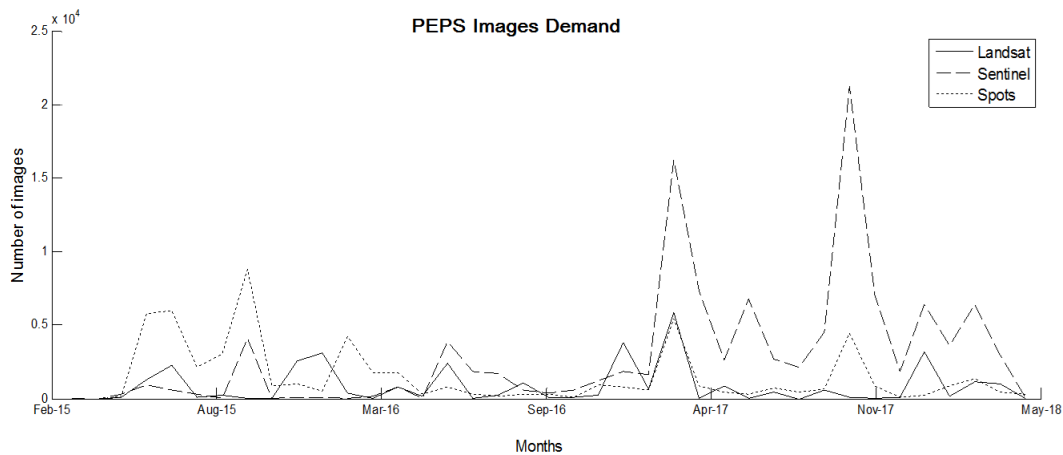

Figure 8.1: Monthly demand of the three PEPS satellite imagery schemes.

Concerning the GEOSUD HR images, the data was recorded for a longer timeframe, going from February 2011 till May 2018, because of its availability since the beginning of the GEOSUD project. Table 8.1 summarizes the data sets used in this study. The monthly demand of the GEOSUD HR satellite images are illustrated in fig. 8.2.

Satellite images program	Frequency	Number of observations	Web portal
Landsat	Monthly	39	PEPS
Sentinel	Monthly	39	PEPS
SPOT	Monthly	39	PEPS
GEOSUD HR images	Monthly	87	GEOSUD/Theia

Table 8.1: GEOSUD and PEPS data sets

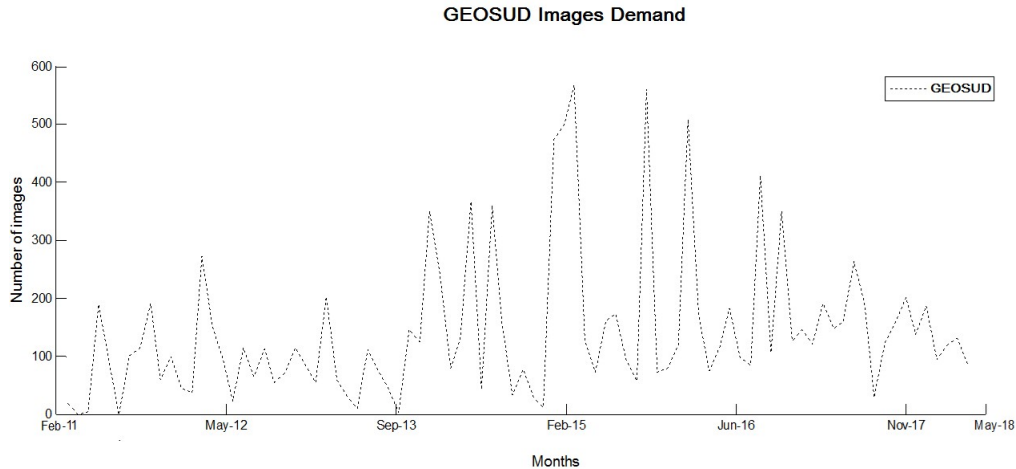

Figure 8.2: Monthly demand of the GEOSUD HR satellite imagery schemes.

We will interpret these graphs statistically and economically by using the Records theory in the next section.

### 8.2.4 Records theory model — general context

The study of records initiated with Chandler (1952). The first results obtained, defined as “classical records model”, presented the case where the underlying random variables (rv) are independent, identically distributed (iid). Nevzorov (1990) and Arnold (1999), through their collaboration, brought significant development to the initial record literature. Later on, recognizing the unavailability of these results to fit several sets of data, an effort was made in order to go beyond the context of classical records, where the observations are independent but not identically distributed. Interested readers can consult the works of Nevzorov (2001) for further details.

We begin by introducing the general context, and then present some useful results in the classical and non-iid cases:

Let  $\{X_t, t \geq 1\}$  be a sequence of *iid* random variables defined on a probability space  $(\Omega, \mathcal{F}, \mathbb{P})$ .  $F(\cdot)$  and  $f(\cdot)$  are respectively the corresponding cumulative distribution and density functions. In a chronological series, an

observation  $X_j$  is said to be an upper record if it is higher than all the previous observations, i.e.  $X_j > \max\{X_1, \dots, X_{j-1}\}$ . In this paper, without loss of generality, we will consider only the upper records, knowing that the lower records can be defined in a similar way (e.g. by multiplying the chronological series by “-1”). Following the increase of  $t$ , the value and the occurrence index of the  $n^{\text{th}}$  record are respectively given by the following sequences  $\{R_n, n \geq 1\}$  and  $\{L_n, n \geq 1\}$ , i.e.  $R_n = X_{L_n}$ . In such context, the available data is a sequence of the couples  $\{(R_n, L_n), 1 \leq n \leq N_T\}$ , where  $T$  is the present time and  $N_T$  is the number of records in the sequence  $\{X_t, 1 \leq t \leq T\}$ .

In fact, there exist a similarity between “records” and “processing of censored data” (Hoayek et al. 2017). To highlight this similarity, we consider the sequence of record indicators  $\{\delta_t, 1 \leq t \leq T\}$  defined by:

$$\delta_t = \begin{cases} 1 & \text{if } X_t \text{ is a record} \\ 0 & \text{otherwise} \end{cases}.$$

Therefore, based on the record indicators, a mathematical expression of the number of records is given by:

$$N_T = \sum_{t=1}^T \delta_t. \quad (1)$$

#### 8.2.4.1 Classical model

Several stochastic properties of the record series in the *iid* case are distribution-free, i.e. they fit to any underlying distribution of  $X_t$ . We present in this section, the most popular results in the *iid* context that will be used later in our work.

Nevzorov (2001) showed that  $\forall T \geq 1$ , the record indicators  $\delta_1, \dots, \delta_T$  are independent and each  $\delta_t$  is distributed according to a Bernoulli distribution of parameter  $\frac{1}{t}$ . i.e.

$$P_t \equiv \mathbb{P}[\delta_t = 1] = \frac{1}{t}. \quad (2)$$

Where,  $P_t$  is the probability that  $X_t$  is a record, defined as “record rate” at time  $t$ . Based on Equation (1) and on the previous result of Nevzorov (2001),

the expected value and the variance of the number of records are expressed by:

$$\mathbb{E}[N_T] = \sum_{t=1}^T \mathbb{E}[\delta_t] = \sum_{t=1}^T P_t = \sum_{t=1}^T \frac{1}{t}. \quad (3)$$

and

$$\mathbb{V}[N_T] = \sum_{t=1}^T \mathbb{V}[\delta_t] = \sum_{t=1}^T P_t(1 - P_t) = \sum_{t=1}^T \frac{1}{t} - \sum_{t=1}^T \frac{1}{t^2}. \quad (4)$$

Based on Equation (2), the record rate converges asymptotically to zero. Hence, in the *iid* case, when  $t$  increases, the records tend to become more distant in time. This means that, in general, records are concentrated among the first observations. However, in several real data sets, this phenomenon is not always true for many reasons. For example, the technological progress can make the occurrence of records more frequent than expected by the *iid* model. This has led to the development of more comprehensive models that can provide better prediction. That's why, in the next section, we go beyond the *iid* case by considering the Yang-Nevezorov (1975; 1990), the most popular model in this context.

#### 8.2.4.2 Beyond iid — Yang-Nevezorov

The Yang-Nevezorov model is considered the most popular in the non-*iid* context due to several reasons:

1. For having the structure of a proportional risk model in survival analysis, which has shown its usefulness in modeling many datasets (Hoayek et al., 2017);
2. For generalizing the results of the Linear Drift Model (LDM) introduced by Ballerini and Resnick (1985) which also represents a case beyond the *iid*.

In this model, the observations are assumed to be independent but not identically distributed. In order to adjust a Yang-Nevezorov or LDM model to a set of data, an additional step is needed. One approach consists of testing the null hypothesis:

$H_0$ : the data derive from a series of iid rv.



Such an adequation test could be based on the sequence of the record indicators  $\delta_1, \dots, \delta_T$  by using the theorem of (Arnold et al., 1999). The theorem states that under the null hypothesis,  $\mathcal{N}_T$ , representing a standardized version of the number of records, converges to the standard normal distribution  $N(0, 1)$ .  $\mathcal{N}_T$  is given as follows :

$$\mathcal{N}_T = \frac{N_T - \log T}{\sqrt{\log T}}, \quad (5)$$

As the Yang-Nevezorov model implies an increase in the number of records,  $H_0$  is rejected if

$$\mathcal{N}_T > z_{1-\alpha},$$

where  $z_{1-\alpha}$  is the  $(1 - \alpha)^{th}$  quantile of  $N(0, 1)$  ( $\alpha$  is the type one error usually set at 5%).

In the Yang-Nevezorov model introduced by Yang (1975), a fixed integer  $\rho_t$  of *iid rv*  $Y$  of cumulative distribution function (CDF)  $F(\cdot)$  is generated simultaneously at time  $t$ , from which  $X_t = \max(y_1, y_2, \dots, y_{\rho_t})$  is extracted. Thus, the sequence  $\{X_t, t \geq 1\}$  of independent but not identically distributed random variables is considered, with the following CDF:

$$F_{X_t}(x) = F(x)^{\rho_t}, \rho_t > 0.$$

Concerning the parameter  $\rho_t$ , we will adapt the parametric form introduced originally by Yang (1975) and developed later by Nevezorov (2001). Let  $\rho_t$  take real values,

$$\rho_t = \gamma^t, \text{ with } \gamma > 1. \quad (6)$$

In this case  $\rho_t$  represents an exponential growth in the number of available *rv*. This parametric form has shown a great utility in various fields of application, especially in survival analysis models and in the detection of records in a context where the Yang-Nevezorov has been also used (Khraibani et al., 2015). Hence, based on the iid property of the generated *rv*, and using the parameterization (6), the rate of record related to the sequence  $X_t$ , at

time  $t$ , is:

$$\begin{aligned} P_t &= \mathbb{P}[\delta_t = 1], \\ &= \frac{\rho_t}{\sum_{k=1}^t \rho_k}, \quad t \geq 1, \\ &= \frac{\gamma^t (\gamma - 1)}{\gamma (\gamma^t - 1)}. \quad (7) \end{aligned}$$

Therefore, in a Yang-Nevezorov model, we can define an asymptotic rate of record by letting  $t$  goes to infinity:

$$\lim_{t \rightarrow \infty} P_t \equiv P(\gamma) = \frac{\gamma - 1}{\gamma}. \quad (8)$$

Note that the existence of an asymptotic rate of record is interpreted in the sense that the occurrence of a record is always possible even in the long run forecast. This case is generally related to context where the studied  $rv$  represents high instability. In other words, a random variable showing high volatility levels. In addition, as in the *iid* classical case, Nevezorov (1990) showed that the indicators are independent and follow a Bernoulli distribution of parameter  $P_t$ . This property is true under any underlying distribution (i.e. the distribution of  $Y$ ). Then, this type of property is called distribution free. Hence, based on Equation (1) and on the previous distribution free property of Nevezorov (1990), the expected value and the variance of the number of records, in the Yang-Nevezorov context, are expressed by:

$$\mathbb{E}[N_T] = \sum_{t=1}^T P_t \text{ and } \mathbb{V}[N_T] = \mathbb{E}[N_T] - \sum_{t=1}^T P_t^2. \quad (9)$$

### 8.2.4.3 Distribution free estimation of $\gamma$

As long as the Yang model parameter  $\gamma$  is unknown, the model cannot be used in practice. The purpose of this section is to perform an estimation of  $\gamma$ . Hoayek et al. (2017) showed that the best estimator, in terms of bias and standard deviation, is obtained by applying the maximum likelihood principle. Using the independence property of the record indicators, the log likelihood function to be maximized is given as follows:

$$\ln L(\gamma) = N_T \ln \left( 1 - \frac{1}{\gamma} \right) + (T - N_T) \ln \frac{1}{\gamma} - \ln \left( 1 - \frac{1}{\gamma^T} \right) - \sum_{t=2}^T \delta_t \ln \left( 1 - \frac{1}{\gamma^{t-1}} \right). \quad (10)$$

By maximizing Equation (10) with respect to  $\gamma$ , we obtain the distribution free maximum likelihood estimator denoted by  $\hat{\gamma}$ . Moreover, Hoayek et al. (2017) studied the asymptotic behavior of the estimator, which is necessary for constructing the estimator's asymptotic confidence intervals:

$$\frac{(\hat{\gamma} - \gamma)}{\sqrt{I_T^{-1}(\gamma)}} \longrightarrow N(0, 1), \quad (11)$$

Where  $I_T(\gamma)$  represents the Fisher information.

#### 8.2.4.4 Goodness of fit test

Once the *iid* classical model is rejected, the goodness of fit of the underlying data to the Yang model, needs to be examined. Hoayek et al. (2017) have shown that such a goodness of fit test can be performed through examining the stochastic behavior of the inter-record time of a Yang-Nevezorov model, i.e. the time between the  $n^{\text{th}}$  and the  $(n + 1)^{\text{th}}$  record defined by:

$$\Delta_{L_n} = L_{n+1} - L_n, n \geq 1.$$

Note that  $L_1 = 1$ , because the first observation is always considered as a record, called "trivial record". Yang (1975) showed that  $\Delta_{L_n}$  follows asymptotically a geometric distribution with a probability density function (which is also a distribution free property):

$$\lim_{n \rightarrow \infty} \mathbb{P}[\Delta_{L_n} = j] \equiv p_j(\gamma) = \left(1 - \frac{1}{\gamma}\right) \left(\frac{1}{\gamma}\right)^{j-1}, j \geq 1.$$

By verifying the previous distribution free property (the null hypothesis  $H_0$ ), we will be able to study the goodness-of-fit of a set of data for a Yang model. Note that, since the previous property is asymptotic, the first observed records should be removed before the application of any goodness of fit test. Thus, in the rest of this section,  $N_T$  will represent the number of records after the elimination of the first observations. The present time will be denoted by  $T$ .

The considered approach consist of performing a goodness of fit test based on the well-known Chi-squared test (also written as  $\chi^2$  test) introduced by Pearson (Plackett, 1983). By conditioning on the event  $N_T = m$  and setting

$K$  an integer  $>1$ , we consider a partition  $\Pi_1, \dots, \Pi_K$ , of disjoint subsets, of  $1, 2, \dots, \infty$  with  $n_k, 1 \leq k \leq K$ , the number of  $\Delta_{L_n}$  which fall within  $\Pi_k$ . Note that  $\sum_{k=1}^K n_k = m - 1$ , which is the number of inter record in a sample of  $m$  records.

By letting  $\pi_k(\gamma) = \sum_{j \in \Pi_k} p_j(\gamma)$ ,  $1 \leq k \leq K$ , the  $\chi^2$  test statistic is defined by:

$$\chi(\gamma) = \sum_{k=1}^K \frac{(n_k - (m-1)\pi_k(\gamma))^2}{((m-1)\pi_k(\gamma))}. \quad (12)$$

If  $\chi(\gamma) > x_{K-1, 1-\alpha}^2$  ( $x_{K-1, 1-\alpha}^2$  is the quantile of order  $(1-\alpha)$  of the chi-square distribution with  $K-1$  degrees of freedom)  $H_0$  is rejected with an asymptotic risk level  $\alpha$ . Then,  $\Delta_{L_n}$  does not follow a geometric distribution and Yang-Nevezorov model is to be rejected.

**Remark.1** While the parameter  $g$  is unknown, the statistic  $\chi(\gamma)$ , as defined in (12), is useless. Therefore,  $\gamma$  should be estimated. Based on the work of (Bishop et al., 2007) an estimator  $\tilde{\gamma}$  of  $\gamma$  is obtained by minimizing  $\chi(\gamma)$  with respect to  $\gamma$ . Hence, a practically usable version of the previous statistic is:

$$\chi(\tilde{\gamma}) = \underset{\gamma}{\operatorname{argmin}} \chi(\gamma). \quad (13)$$

According to Bishop et al. (2007), if  $\chi(\tilde{\gamma}) > x_{K-2, 1-\alpha}^2$  ( $x_{K-2, 1-\alpha}^2$  is the quantile of order  $(1-\alpha)$  of the chi-square distribution with  $K-2$  degrees of freedom) ,  $H_0$  is rejected. This puts the Yang-Nevezorov model in doubt.

**Remark.2** Concerning the choice of  $K$ , this problem has been mentioned in several works (Mann & Wald, 1942; Quesenberry & Miller, 1977; Kallenberg et al., 1985; Inglots & Ledwina, 1996). However, none of these papers has come up with a universal solution of the problem. This has led (Rayner & Rayner, 2001) to state that  $K$  should be fixed by considering the general context of each application.

### 8.3 Results and discussion

As a starting point, we computed the record values ( $R_n$ ), the record indices ( $L_n$ ) and the number of records ( $N_T$ ) of the time series. Results are summarized in table 8.2. Based on the test described in Equation (5), we checked if each of the considered time series follows a classical *iid* model. The results show that both the GEOSUD and SPOT demands, fit an *iid* classical model while Landsat and Sentinel have a non-classical pattern of records (table 8.3). Moreover, these results are confirmed by the goodness of fit test, where GEOSUD and SPOT represent the series having the lowest number of records, knowing that these records are concentrated among the first observations. On the other hand, Landsat and Sentinel represent the highest number of records, with an increasing rate greater than in the *iid* case.

Demand schemes							
Landsat $N_T = 9$		Sentinel $N_T = 7$		SPOT $N_T = 5$		GEOSUD $N_T = 5$	
Record dates	$L_n$	Record dates	$L_n$	Record dates	$L_n$	Record dates	$L_n$
Apr-15	1	Apr-15	1	Apr-15	1	Mar-11	1
May-15	2	May-15	2	May-15	2	May-11	3
Jun-15	3	Jun-15	3	Jun-15	3	Mar-12	13
Aug-15	5	Oct-15	7	Oct-15	7	Jun-14	40
Dec-15	9	Nov-15	8	Nov-15	8	Jan-15	47
Feb-16	11	Mar-17	24			Oct-15	56
Jan-17	22	Oct-17	31				
Mar-17	24						
Apr-17	25						

Table 8.2: Record results ( $R_n$ ,  $L_n$  and  $N_T$ )

Series	Landsat	Sentinel	SPOT	GEOSUD
p-value	0.25%	3.9%	23.75%	23.39%
Decision	Reject <i>iid</i>	Reject <i>iid</i>	Accept <i>iid</i>	Accept <i>iid</i>

Table 8.3: Goodness of fit test for the *iid* classical model with an asymptotic confidence level of 5%

On a second step, we proceeded by checking the Yang's model hypothesis for Landsat and Sentinel. We tested the fitting of the inter-record time  $\Delta_{L_n}$  into a geometric distribution, by using a Pearson's Chi-squared test. Table 8.4 shows the p-value of the  $\chi(\tilde{\gamma})$  statistics, obtained at an asymptotic confidence level  $\alpha$  fixed at 5%. Recall that a p-value significantly greater than 5% indicates a good consistency of the Yang model assumptions. Otherwise, the Yang model should be rejected in order to move to a more general case, where the observations are dependent and not identically distributed. As a consequence, both time series Landsat and Sentinel have an inter-record sequence following a geometric distribution (hypothesis  $H_0$  accepted), for which it is reasonable to adopt the Yang model.

<b>Series</b>	<b>Landsat</b>	<b>Sentinel</b>
<b>p-value</b>	0.1472	0.6868
<b>Result</b>	Accept $H_0$	Accept $H_0$

Table 8.4: Goodness of fit test for the Yang model based on Chi-squared test with an asymptotic confidence level of 5%.

In addition to the previous theoretical findings, the Landsat and Sentinel demand behavior could be reinforced through an economic reasoning:

- i. First, Landsat is heading towards a greater supply of images in the coming years: Landsat 8 is adding data to its global archive at an unprecedented rate (above 700 images per day) (Roy et al., 2014; Loveland & Irons, 2016). Therefore, this could bring more volatility to the market;
- ii. Second, future Landsat missions are designed to ensure a continuity of the oldest archive images. This feature will likely boost the usage of combined images, as Landsat is transitioning to an operational monitoring system, with more explicit characterization (Schroeder et al., 2017; Kardan et al., 2018);
- iii. The huge archive cumulated of the Landsat program, may probably have a strong effect on the global demand volatility, due to the increasing strategic offering of imagery (Goward et al., 2006; Guo et al., 2017);

- iv. While our findings suggest that the Sentinel market presents more stability signs, a lack still remains in the interoperability and integration of this data into other information chains (Helder et al., 2018). The computing technology and the storage power capacity are not sufficiently delivered from neither public nor private institutions in order to better cope with the new data flows (Wicks et al., 2018);
- v. Additionally, the new generation of EO satellites from the Sentinel missions developed, is generating large amounts of data that are not easily integrated into processing chains outside the Copernicus program (Regan et al., 2016);
- vi. Finally, the policy of open and free access to data, which is increasingly adopted instead of the EO paying systems, could be of more influence at periods when the constraints of lack of budgets and financial models of other Earth-observation programs are questioned (Bates, 2014; Zhu et al., 2015).

Moreover, as table 5 shows, the probability of having a record could be computed for each market and for any time in the near future:

<b>Series</b>	<b>Probability of having a record on June 2018</b>
Landsat	$\mathbb{P}[\delta_t = 1] = 14.65\%$
Sentinel	$\mathbb{P}[\delta_t = 1] = 8.60\%$
SPOT	$\mathbb{P}[\delta_t = 1] = 2.56\%$
GEOSUD	$\mathbb{P}[\delta_t = 1] = 1.14\%$

Table 8.5: Probability of records for each considered series

We noted that the probability of a new record on June 2018 is higher in a non-*iid* case than in the *iid* one, which fits well with our previous theoretical findings. Based on these results, one could state the following facts:

- a. The Landsat and Sentinel demands follow a Yang model, with parameters  $\hat{\gamma} = 1.1713$  and  $1.0907$  respectively, which is evident through the

relatively high probability of records. This may be seen as an indicator for an unstable demand in the future for these two schemes with a considerably high probability for future records in Landsat series;

- b. The SPOT series are obedient to an iid model, with a low probability of record due to the fact that the SPOT archive images, accessed through the PEPS operator, are no more active (the demand is based on the SPOT Word Heritage collection of images);
- c. The probability of a record in the GEOSUD data is close to zero. This is in line with the *iid* case and indicates that GEOSUD is stable in terms of demand. The probability of large shifts, representing a high volatility in the future, is low.

As mentioned before, the trend to full free and open data access is on the rise, even for high-resolution data. Although these data are usually distributed on a commercial basis, some are available for free, via web services such as Google Earth and Bing (Keysers, 2015; Swain et al., 2015). The HR satellite imagery through the GEOSUD SDI comes as concrete example. Since its launch, GEOSUD through developing its pooling device, is facilitating the access to a wide variety of Geospatial products and services to its sphere of users (Jabbour et al., 2019). This shift is a major result from the United States policy adopted in 2008, about the open and free data. Other well-known systems, such as CBERS<sup>3</sup>, have followed (Neves Epiphonio, 2011). At the end of 2013 the European Union also adopted for its Sentinel Earth-observing missions (Michael & Coops, 2014). Recently, even new space actors such as Planet Labs and SkyBox are making their data available for free to the academic sector and non-public organizations (Harris & Bauman, 2015). The market stability, in all the various aspects that could take, is a direct consequence of these facts.

Finally, an additional test was performed to check the level of accuracy of the selected theoretical models with respect to the corresponding empirical set of observations. This step was done, by comparing the expected number

---

<sup>3</sup>China–Brazil Earth Resources Satellite program: a cooperation program between Brazil and China aiming at the development and operation of Earth observation satellites.



of records obtained theoretically by  $\mathbb{E}[N_T] = \sum_{t=1}^T P_t$  to the real values computed directly from the set of observations of each series. Results are detailed below (table 8.6).

<b>Series</b>	<b>Landsat</b>	<b>Sentinel</b>	<b>SPOT</b>	<b>GEOSUD</b>
<b>Real number of records</b>	9	7	5	5
<b>Expected Number of records</b>	7.8314	6.0390	4.2279	5.0489
<b>Exact relative error (%)</b>	12.984	13.729	15.442	0.978

Table 8.6: Theoretical vs. empirical number of records

The real number of records is close to the expected ones, which indicates that the considered record models were well-assigned to the series of observations. In addition, the minimal error is recorded for the GEOSUD demand series, indicating a good fitting of the classical *iid* model with the GEOSUD's records behavior. Thus, an interpretation of this result relies in a stable demand expected through the GEOSUD SDI on the long term. This fact is due to the adoption of an easy access to technical support, specific training and implementation services. Note that, GEOSUD, recorded a 7-fold increase in less than 10 years in terms of registered organizations on its platform, with more than 1000 active users.

In general, the demand shifts occurring via a SDI platform can reveal and relatively clarify the future directions to take, or the measure to deviate from, in order to be well-aligned with the user's choices and orientations (Borradaile, 2013; Parker et al., 2016). While the platforms have become important sources of establishing EO market opportunities, the set of activities or strategies in the case of SDI are much of importance in shaping the market dynamics (Jabbour et al., 2019). In the following, we draw on our results to suggest specific recommendations to SDIs concerning a general market policy development:

**Proposition.1** Diversify the SDI web portal with multi-service EO data.

Given that the supply of some EO market is largely superior to other, the attractiveness of one market could be a factor to end-users to show interest in other schemes available on the SDI platform.

**Proposition.2** Promote adequate and accessible SDI developments, both on upstream and downstream levels, through investment in storage capacities in order to increase the satellite image flexibility.

**Proposition.3** Provide incentives and subsidies concerning pricing mechanisms in order to attract more users to the platform. The critical mass of users may increase the stability through a SDI platform.

Equipping the SDI operators with processing capability management (sharing of resources, cloud services, image-based applications, etc.) is necessary in enhancing the dynamic interactions occurring within the platform ecosystem. The sustainability of the future spatial data operators will rely upon the access conditions and availability of the EO resources (Burrough et al., 2015; Nativi et al., 2015). Thus, the stability of the SDI markets, which is in close relation with the development of common value-creation techniques, depends on the implementation of open environment principles and interdependent markets and subsystems (e.g. federated user interfaces, interlinked EO data catalogues, standardized interfaces and data norms, etc.).

## 8.4 Conclusion

In general, the SDIs constitute a direct link between the large EO user community and the EO providers. This study is based on two different record models to explain the demand occurring via an SDI. The novelty results from applying the original Records theory into the Geospatial science field, in order to highlight the shifts happening on various satellite image markets, each having its own characteristics. By studying the market stability of the satellite images, through an SDI platform, this paper offers an innovative and simple tool to exploit the dynamics occurring at the demand level. It provides an additional element in understanding the demand shifts the SDI could face. Despite the fact that the stability issue of a market is driven by several factors (price mechanisms, service quality, users' critical mass, etc.), applying the Record theory could clarify the movements occurring on a market within a time-period continuity. The challenges in the satellite imagery markets, relies in the rapid evolution of technology as well as the policy frameworks of data dissemination (Warekuromor et al., 2017). The market stability through the SDIs depends on factors showing blurring indicators

sometimes, making from the market analysis a complex exercise (Macharis & Crompvoets, 2014). While the Record theory drops several constraints, it showed its capacity in offering an additional tool to describe the market stability, and therefore, adding a precision level into the vague assumption that could be present in a certain market. In addition, the EO market dynamics are interdependent with several technological and economic facts, that even a simple market analysis could be quasi-impossible (Denis et al., 2016). Hence, with the unavailability of sufficient data or the complexity of a global market analysis, the record theory provided a simple tool allowing to group heterogeneous contexts and implicate them together for performing a richer market analysis.

As a first SDI market study using the Records theory, several ways have been revealed for improvement and extension. The main challenge relies on the further development of this research in order to assess the record values in the future. For this to be done, a more detailed and refined technique should be introduced. Moreover, the methodology used in this study could be reproduced on larger scales such as the large EO observation programs and other types of Geospatial data, where the access and demand conditions differ and the amount of data is largely greater with an impact consequently bigger. Other record models may also be added to the assessment, leading to a better examination of the demand occurring via the SDI ecosystems.

## 8.5 References

Anderson, K., Ryan, B., Sonntag, W., Kavvada, A., & Friedl, L. (2017). Earth observation in service of the 2030 Agenda for Sustainable Development. *Geo-Spatial Information Science*, 20(2), 77–96.

Arnold, B. C., Balakrishnan, N., & Nagaraja, H. N. (2011). *Records* (Vol. 768). John Wiley & Sons. Arnold, B. C., & others. (1999). The asymptotic distributions of sums of records. *Extremes*, 1(3), 351–363.

Aschbacher, J., & Milagro-Pérez, M. P. (2012). The European Earth monitoring (GMES) programme: Status and perspectives. *Remote Sensing of Environment*, 120, 3–8.

Balint, T. S., & Stevens, J. (2016). Wicked problems in space technology development at NASA. *Acta Astronautica*, 118, 96–108.

Ballerini, R., & Resnick, S. (1985). Records from improving populations. *Journal of Applied Probability*, 487–502.

Ballerini, R., & Resnick, S. I. (1987). Embedding sequences of successive maxima in extremal processes, with applications. *Journal of Applied Probability*, 827–837.

Bates, J. (2014). The strategic importance of information policy for the contemporary neoliberal state: The case of Open Government Data in the United Kingdom. *Government Information Quarterly*, 31(3), 388–395.

Belward, A. S., & Skøien, J. O. (2015). Who launched what, when and why; trends in global land-cover observation capacity from civilian earth observation satellites. *ISPRS Journal of Photogrammetry and Remote Sensing*, 103, 115–128.

Berger, M., Moreno, J., Johannessen, J. A., Levelt, P. F., & Hanssen, R. F. (2012). ESA’s sentinel missions in support of Earth system science. *Remote Sensing of Environment*, 120, 84–90.

Bishop, Y. M., Fienberg, S. E., & Holland, P. W. (2007). \textit{Discrete

multivariate analysis: theory and practice}. Springer Science & Business Media, New York.

Borradaile, G. J. (2013). *Statistics of earth science data: their distribution in time, space and orientation*. Springer Science & Business Media.

Boudreau, K., & Hagi, A. (2008). *Platform Rules: Multi-Sided Platforms as Regulators*. <https://doi.org/http://dx.doi.org/10.2139/ssrn.1269966>

Budhathoki, N. R., Nedovic-Budic, Z., & others. (2008). Reconceptualizing the role of the user of spatial data infrastructure. *GeoJournal*, 72(3–4), 149–160.

Burrough, P. A., McDonnell, R., McDonnell, R. A., & Lloyd, C. D. (2015). *Principles of geographical information systems*. Oxford university press.

Chandler, K. N. (1952). The distribution and frequency of record values. *Journal of the Royal Statistical Society. Series B*}, 220–228.

Chapman, B. (2015). Waste and duplication in NASA programs: The need to enhance US space program efficiency. *Space Policy*, 31, 13–20.

Claeskens, G., Hjort, N. L., & others. (2008). *Model selection and model averaging*. Cambridge Books.

Claverie, M., Ju, J., Masek, J. G., Dungan, J. L., Vermote, E. F., Roger, J.-C., ... Justice, C. (2018). The Harmonized Landsat and Sentinel-2 surface reflectance data set. *Remote Sensing of Environment*, 219, 145–161.

de Montalvo, U. W. (2017). *Mapping the determinants of spatial data sharing*. Routledge.

Denis, G., Claverie, A., Pasco, X., Darnis, J.-P., de Maupeou, B., Lafaye, M., & Morel, E. (2017). Towards disruptions in Earth observation? New Earth Observation systems and markets evolution: possible scenarios and impacts. *Acta Astronautica*, 137, 415–433.

Denis, G., de Boissezon, H., Hosford, S., Pasco, X., Montfort, B., & Ran-

era, F. (2016). The evolution of Earth Observation satellites in Europe and its impact on the performance of emergency response services. *Acta Astronautica*, 127, 619–633.

Donlon, C., Berruti, B., Buongiorno, A., Ferreira, M.-H., Féménias, P., Frerick, J., others. (2012). The global monitoring for environment and security (GMES) sentinel-3 mission. *Remote Sensing of Environment*, 120, 37–57.

Drusch, M., Del Bello, U., Carlier, S., Colin, O., Fernandez, V., Gascon, F., . . . others. (2012). Sentinel-2: ESA’s optical high-resolution mission for GMES operational services. *Remote Sensing of Environment*, 120, 25–36.

Epiphanio, J. C. N. (2011). CBERS-3/4: características e potencialidades. In *Proceedings of the Brazilian Remote Sensing Symposium*, Curitiba, Brazil (Vol. 30, p. 90099016).

Foresman, T. W. (2008). Evolution and implementation of the Digital Earth vision, technology and society. *International Journal of Digital Earth*, 1(1), 4–16.

Gawer, A., & Cusumano, M. A. (2008). How companies become platform leaders. *MIT Sloan Management Review*, 49(2), 28. Geospatial Industry Outlook and Readiness Index, G. (2018).

Geobuiz. Retrieved from <https://geobuiz.com/geobuiz-2018-report.html>

Gorelick, N., Hancher, M., Dixon, M., Ilyushchenko, S., Thau, D., & Moore, R. (2017). Google Earth Engine: Planetary-scale geospatial analysis for everyone. *Remote Sensing of Environment*, 202, 18–27.

Goward, S., Arvidson, T., Williams, D., Faundeen, J., Irons, J., & Franks, S. (2006). Historical record of Landsat global coverage. *Photogrammetric Engineering & Remote Sensing*, 72(10), 1155–1169.

Guo, H., Liu, Z., Jiang, H., Wang, C., Liu, J., & Liang, D. (2017). Big Earth Data: A new challenge and opportunity for Digital Earth’s development. *International Journal of Digital Earth*, 10(1), 1–12.

Hansen, M. C., & Loveland, T. R. (2012). A review of large area monitoring of land cover change using Landsat data. *Remote Sensing of Environment*, 122, 66–74.

Harrell, F. E. (2014). Regression modeling strategies. As Implemented in R Package ‘Rms’ Version, 3(3).

Harris, R., & Baumann, I. (2015). Open data policies and satellite Earth observation. *Space Policy*, 32, 44–53.

Helder, D., Markham, B., Morfitt, R., Storey, J., Barsi, J., Gascon, F., ... others. (2018). Observations and Recommendations for the Calibration of Landsat 8 OLI and Sentinel 2 MSI for improved data interoperability. *Remote Sensing*, 10(9), 1340.

Hoayek, A. S., Ducharme, G. R., & Khraibani, Z. (2017). Distribution-free inference in record series. *Extremes*, doi:10.100.

Inglot, T., Ledwina, T., & others. (1996). Asymptotic optimality of data-driven Neyman’s tests for uniformity. *The Annals of Statistics*, 24(5), 1982–2019.

Jabbour, C., Rey-Valette, H., Maurel, P., & Salles, J.-M. (2019). Spatial data infrastructure management: A two-sided market approach for strategic reflections. *International Journal of Information Management*, 45. <https://doi.org/10.1016/j.ijinfomgt.2018.10.022>

Kallenberg, W. C. M., & others. (1985). On moderate and large deviations in multinomial distributions. *The Annals of Statistics*, 13(4), 1554–1580.

Kardan, N., Dabney, P., & Babu, S. (2018). Landsat Missions to Sustainable Land Imaging Technology Program. In *IGARSS 2018-2018 IEEE International Geoscience and Remote Sensing Symposium* (pp. 6336–6337).

Keysers, J. (2015). Review of digital globes 2015. Australia and New Zealand Cooperative Research Centre for Spatial Information.

Khraibani, Z., Jacob, C., Ducrot, C., Charras-Garrido, M., & Sala, C. (2015). A Non Parametric Exact Test Based on the Number of Records for an Early Detection of Emerging Events: Illustration in Epidemiology. *Communications in Statistics-Theory and Methods*, 44, 726–749.

Kruse, J. B., Cromptoets, J., & Pearlman, F. (2017). *GEOValue: The Socioeconomic Value of Geospatial Information*. CRC Press. Retrieved from <https://books.google.fr/books?id=p7A-DwAAQBAJ>

Lee, C.-F., & Lee, J. C. (2015). *Handbook of financial econometrics and statistics*. Springer.

Loveland, T. R., & Dwyer, J. L. (2012). Landsat: Building a strong future. *Remote Sensing of Environment*, 122, 22–29.

Loveland, T. R., & Irons, J. R. (2016). Landsat 8: The plans, the reality, and the legacy. *Remote Sensing of Environment*, 185, 1–6.

Macharis, C., & Cromptoets, J. (2014). A stakeholder-based assessment framework applied to evaluate development scenarios for the spatial data infrastructure for Flanders. *Computers, Environment and Urban Systems*, 46, 45–56.

Mann, H. B., & Wald, A. (1942). On the choice of the number of class intervals in the application of the chi square test. *The Annals of Mathematical Statistics*, 13(3), 306–317.

McDougall, K. (2009). The potential of citizen volunteered spatial information for building SDI.

Miller, H. M., Richardson, L., Koontz, S. R., Loomis, J., & Koontz, L. (2013). Users, uses, and value of Landsat satellite imagery—Results from the 2012 survey of users. *US Geological Survey Open-File Report*, 1269(2013), 51.

Mullainathan, S., & Spiess, J. (2017). Machine learning: an applied econometric approach. *Journal of Economic Perspectives*, 31(2), 87–106.



Nativi, S., Mazzetti, P., Santoro, M., Papeschi, F., Craglia, M., & Ochiai, O. (2015). Big data challenges in building the global earth observation system of systems. *Environmental Modelling & Software*, 68, 1–26.

Nevzorov, V. B. (1990). Records for nonidentically distributed random variables. *Proceedings of the Fifth Vilnius Conference*, 2, 227–233.

Nevzorov, V. B. (2001). *Records: mathematical theory*. American Mathematical Society, Rhode Island.

Nosavan, J., Moreau, A., & Henry, P. (2018). Spot world heritage: exploring the past. In *Sensors, Systems, and Next-Generation Satellites XXII* (Vol. 10785, p. 107850T).

Parker, G. G., Van Alstyne, M., Choudary, S. P., & Foster, J. (2016). *Platform revolution: How networked markets are transforming the economy and how to make them work for you*. WW Norton New York.

Parker, G., & Van Alstyne, M. (2017). Innovation, openness, and platform control. *Management Science*.

Pearlman, F., Pearlman, J., Bernknopf, R., Coote, A., Craglia, M., Friedl, L., . . . others. (2016). Assessing the socioeconomic impact and value of open geospatial information.

Pelton, J. N., Madry, S., & Camacho-Lara, S. (2017). *Handbook of satellite applications*. Springer Publishing Company, Incorporated.

Plackett, R. L. (1983). Karl Pearson and the chi-squared test. *International Statistical Review/Revue Internationale de Statistique*, 59–72.

Pwc. (2016). Study to examine the socio-economic impact of Copernicus in the EU. Retrieved from [http://www.copernicus.eu/sites/default/files/library/Copernicus.SocioEconomic\\_Impact\\_October\\_2016.pdf](http://www.copernicus.eu/sites/default/files/library/Copernicus.SocioEconomic_Impact_October_2016.pdf)

Quesenberry, C. P., & Miller Jr, F. L. (1977). Power studies of some tests for uniformity. *Journal of Statistical Computation and Simulation*, 5(3), 169–191.

Rajabifard, A., & others. (2010). Data integration and interoperability of systems and data. In 2nd Preparatory Meeting of the Proposed UN Committee on Global Geographic Information Management.

Ranga, M., & Etzkowitz, H. (2013). Triple Helix Systems: An Analytical Framework for Innovation Policy and Practice in the Knowledge Society. *Industry and Higher Education*, 27(3), 237–262.

Rayner, G. D., & Rayner, J. C. W. (2001). Power of the Neyman smooth tests for the uniform distribution. *Advances in Decision Sciences*, 5(3), 181–191.

Regan, A., Silvestrin, P., & Fernandez, D. (2016). Sentinel Convoy: Synergetic Earth Observation with Satellites Flying in Formation with European Operational Missions. In *Living Planet Symposium* (Vol. 740, p. 379).

Roy, D. P., Wulder, M. A., Loveland, T. R., Woodcock, C. E., Allen, R. G., Anderson, M. C., ... others. (2014).

Landsat-8: Science and product vision for terrestrial global change research. *Remote Sensing of Environment*, 145, 154–172.

Schroeder, T. A., Loveland, T., Wulder, M. A., & Irons, J. R. (2017). Landsat Science Team: 2017 Winter Meeting Summary. *The Earth Observer*, 28(6), 45–50.

Shelestov, A., Lavreniuk, M., Kussul, N., Novikov, A., & Skakun, S. (2017). Exploring Google earth engine platform for Big Data Processing: Classification of multi-temporal satellite imagery for crop mapping. *Frontiers in Earth Science*, 5, 17.

Swain, N. R., Latu, K., Christensen, S. D., Jones, N. L., Nelson, E. J., Ames, D. P., & Williams, G. P. (2015). A review of open source software solutions for developing water resources web applications. *Environmental Modelling & Software*, 67, 108–117.

Torres, R., Snoeij, P., Geudtner, D., Bibby, D., Davidson, M., Attema,

E., ... others. (2012). GMES Sentinel-1 mission. *Remote Sensing of Environment*, 120, 9–24.

Warekuromor, T., James, A., Anifowose, B., & Trodd, N. (2017). A distributed, scalable and provenance-enabled data access protocol for spatial data infrastructure. In *2017 IEEE 21st International Conference on Computer Supported Cooperative Work in Design (CSCWD)* (pp. 180–185).

Wicks, D., Jones, T., & Rossi, C. (2018). Testing the Interoperability of Sentinel 1 Analysis Ready Data Over the United Kingdom. In *IGARSS 2018-2018 IEEE International Geoscience and Remote Sensing Symposium* (pp. 8655–8658).

Willmes<sup>1</sup>, C., Becker<sup>1</sup>, D., Verheul<sup>1</sup>, J., Yener<sup>1</sup>, Y., Zickel<sup>1</sup>, M., Bolten<sup>1</sup>, A., ... Bareth<sup>1</sup>, G. (2017). PaleoMaps: SDI for open paleoenvironmental GIS data. *International Journal*, 12, 39–61.

Witten, I. H., Frank, E., Hall, M. A., & Pal, C. J. (2016). *Data Mining: Practical machine learning tools and techniques*. Morgan Kaufmann.

Woodcock, C. E., Allen, R., Anderson, M., Belward, A., Bindschadler, R., Cohen, W., ... others. (2008). Free access to Landsat imagery. *Science*, 320(5879), 1011.

Wulder, M. A., & Coops, N. C. (2014). Satellites: Make Earth observations open access. *Nature News*, 513(7516), 30.

Wulder, M. A., Masek, J. G., Cohen, W. B., Loveland, T. R., & Woodcock, C. E. (2012). Opening the archive: How free data has enabled the science and monitoring promise of Landsat. *Remote Sensing of Environment*, 122, 2–10.

Wulder, M. A., White, J. C., Loveland, T. R., Woodcock, C. E., Belward, A. S., Cohen, W. B., ... Roy, D. P. (2016). The global Landsat archive: Status, consolidation, and direction. *Remote Sensing of Environment*, 185, 271–283.

Yang, C. P., Cao, Y., Evans, J., Kafatos, M., & Bambacus, M. (2006).

Spatial Web portal for building spatial data infrastructure. *Geographic Information Sciences*, 12(1), 38–43.

Yang, M. C. K. (1975). On the distribution of the inter-record times in an increasing population. *Journal of Applied Probability*, 148–154.

Zhu, Z., Woodcock, C. E., & Olofsson, P. (2012). Continuous monitoring of forest disturbance using all available Landsat imagery. *Remote Sensing of Environment*, 122, 75–91.



# Chapter 9

## Conclusions and Future Works

Spatial Data Infrastructures (SDIs) are making significant contributions to decision-making policies and society. Their growing development has led to an increased call by policy-makers, to justify the benefits resulting from the huge investments deployed. While the lack of financial resources, the dependency on subsidies and the need for justification materials address the existence and sustainability of SDIs, the purpose of our research was to bridge a part of the gap in this domain. We tried through an economic perspective, to advance the understanding of SDIs, with the aim of incorporating better elements into the analysis of economic policies and business management decisions.

### 9.1 Conclusions

To summarize, we have selected the two-sided market approach to analyze the development of a SDI, as a relevant framework to explore its capability in capturing the dynamics occurring within its platform. Although the management of digital information platforms has received lately an increasing attention, no fundamental work related to the SDI development has been investigated through this approach. While the integration of SDIs was traditionally based on authoritative information from public administrations, participatory approaches involving data flows between geospatial information users and multi-connected networks announces a real change.

From static to dynamic information, the vision of platforms is increasingly taking place in most of the domains. Unlocking new sources of value creation, emerges from the simultaneous presence of distinct groups of users who need each other in some way, and rely on the platform to intermediate transactions between them. Hence, the SDI seen through as a two-sided angle, could be characterized by three main elements:

1. The first one is the SDI platform management, providing a complementarity and interaction between two interdependent markets, the satellite imagery end users and the image-based application developers;
2. The second component is the non-neutrality of prices, i.e. the asymmetric pricing on the different sides of a market;
3. The third element is the network externalities; in other words, the effects that one user of a good or service has on the value of that good to other people.

Within the context of our first study, some global and salient conclusions could be drawn:

4. Providing both incentives and subsidies or considering pricing mechanisms that attract users to the platform is fundamental for a SDI in designing the best strategy;
5. Elucidating the best strategy is intimately related to the choices each SDI faces, about structuring the business relationships among its ecosystem;
6. The SDI strategy will be a set of activities within the platform, in order to develop unique features that are hard to imitate by other players in the market.

On the other hand, concerning the economic valuation of the HR satellite images, the main conclusions came as follows:

7. The results obtained could be used first to enlighten the design of a future pricing of the satellite imagery, aiming at sustaining the supply of these services. The WTP results make it possible to build economic models, according to economic facts close to the practices of the SDI's direct users. Moreover, it allows to refine the existent economic scenarios, with a least negative impact on the direct users of the satellite imagery. While the GEOSUD SDI is evolving towards the Data Terra National Research Infrastructure which will include the DINAMIS pooling mechanism, it will maintain additional elements throughout the results obtained, allowing to guide and situate the discussions with its partners on the current funding opportunities (annual membership, price per image, premium beyond a certain volume of free image provided, etc.). Thus, making better future strategic choices based on factual basis;
8. Our findings may also serve to stimulate the public awareness about future decision-making policies related to the Earth observation field, and more particularly the satellite images. This issue comes to meet the organizational routine concept, stating that a service only becomes fully valuable once its use is completely integrated into the regular operating process. Thus consequently, the resources will be mobilized in the same direction.

Subsequently, we presented in our third study an original approach that articulates between two existing theories, the Blackwell and Entropy theories, in order to help the forest control authorities model their decision in light of heterogeneous information received. A decision-policy form was established, consisting of several steps in order to in discriminating the information structures and choosing the optimal action:

9. Our results offer, through the methodological approach chosen, a tool to overcoming several complexity problems, usually present in the decision-making cases;
10. Applying these concepts in a two-period decision-making context, with a particular focus on the satellite imagery as an additional source of information, was innovative in our field of study;



11. The uncertainty regarding the decisions to be taken in order to perform efficient controls operation was shown to be at its minimum, as a result of the SDI information signals.

Moreover, the impact assessment of a SDI through our forth study, revealed different types of impacts involved along the value chain:

12. The first investigation area related to the SDI platform, revealed an ecosystem that generates induced impacts around the use of geospatial information. We have exploited the SDI value chain, in order to capture new activities that could emerge, or on the contrary disappear;
13. Secondly, we approached the link between the SDI platform and the direct satellite images users, as a community of practices with an open innovation phenomenon; our idea was to compare this situation with another reference one, where the direct users have a direct access to their EO suppliers;
14. Concerning the EO providers, we measured the added-value created by the clear-cut activities. However, within the DDTM and DRAAF organizations, the main impacts assessed were the avoided costs, the productivity savings and the time savings;
15. Other qualitative impacts about the forest policies' properties and more generally the territorial development dynamics were considered.

Finally, the last study offered an understanding of the dynamics that could occur through the users' geospatial demand via a SDI:

16. Despite the fact that the stability issue of a market is driven by several factors (price mechanisms, service quality, users' critical mass, etc.), applying the Record theory helped in clarifying the movements occurring via the SDI users demands, within a time-period continuity;
17. We assessed the probability of witnessing a spike/drop in the short term in the different satellite imagery schemes (Landsat, Sentinel, SPOT, GEOSUD imagery) via two independent SDIs: GEOSUD and PEPS;

18. Our results led to a better comprehension of the market stability and the fluctuations the SDI could face on its platform.

Altogether, the results of this thesis provide a step ahead of the existing works related to the development and the economic valuation of the SDIs.

## 9.2 Future works

An extension of this work, towards closer examination of SDIs would take several forms. The results in our first paper could be extended as follows:

1. The first straightforward recommendation, relies in extending the two-sided concept in order to examine the demand elasticity of potential users. Since a first element to draw on about the two-sided market economy, reveals how the pricing of services must take into account the demand elasticity of the different players in the market, this could be a starting point;
2. The two-sided approach could also be tested on other SDI platforms, grouping richer elements about both end-users and developers of geospatial information. The lack of materials concerning the image-based applications side within the GEOSUD SDI, prevented us to push the study one notch up, in order to have a larger analysis;
3. Since the future is about integrating authoritative public sector data with information coming from citizens, a further development could also include the nesting and subsidiarity of SDIs and platforms. Various types of industrial economic models could be tested for a better comprehension of the SDI market extension. The way forward for SDIs to articulate and demonstrate better their value proposition, opens up new challenges, through the integration of data into more participatory approaches.

As a first study in valuing the total economic benefits for direct users of HR satellite images, several ways are revealed for improvement and extension:

4. The main challenge relies on the further development of this research in order to target wider social benefits. For this to be done, a more detailed and refined survey should be introduced;

5. Moreover, the value chain of the HR satellite images should be further explored, as it is shifting more and more from raw data to services and applications. The valuation of added-value products may be added to the assessment. Although putting a value on end-user benefits is more complicated exercise due the multitude of users' profiles emerging in the value chains (start-ups, SMEs, large companies, public entities, scientific players, etc.), the end-users' benefits are expected to be much higher given the larger markets involved;
6. The loss occurring in the case of a price imposition to the HR images could also be a possible extension for analysis. Even though the GEO-SUD images are currently at no cost, the impacts for charging a price in case of a policy change in the future, could be evaluated. Thereby, all the necessary elements are present to initiate a further development of this study in this direction, and elaborate scenarios in which the impacts of a pricing policy can also be seen from the point of view of society.

Regarding the third paper, the extensions could be viewed as follows:

7. The flexibility of the actions under the Blackwell theory was not tested in this analysis. Pursuing further research is needed as a next step in the future, through case studies presenting several information structures;
8. Another possible extension concerns the application of the decision-policy form established into environmental assessment cases, where the decision-makers are faced with long iterative decisions. This could help in optimizing the decision tasks related to long term decisions strategies.

In our fourth paper, we recommend the following extensions:

9. Since our approach crosses two complementary disciplines (an economic logic to estimate the SDI impacts at a value chain scale and another management logic to understand these impacts within an architecture of collective practices), the proposed methodology could be replicated and progressively standardized in order to meet the ongoing changing contexts of SDIs;

10. Similarly, other important societal impacts via the SDIs could be studied in depth, with regard to enhancing the efficiency, fairness and legitimacy of public policies through the use of geospatial information.

Finally, the listed points below could be extended from our last paper:

11. A first development pertains to computing the Record values, which were not performed in our framework of analysis. Future works could include this point;
12. The methodology used through Record theory could be reproduced on larger scales such as the large EO observation programs and other types of Geospatial data, where the access and demand conditions differ and the amount of data is largely greater with impacts consequently bigger. As a more concrete example, analyzing the archive history data of *Copernicus or Airbus Defence and Space*, could highlight possible risks and facts that could be present within the trend of the geospatial market data supply and demand.

Although SDIs have been funded majorly by public authorities, they are addressing the whole society, and allowing the distribution of values and linkages around the use and sharing of the geospatial information.

As part of this evolution, the conditions linked to the role of public sector in providing such type of information are also changing. Public authorities are no longer having sufficient means to interfere in the exploitation of this data. The budgetary constraints and the search for economic opportunities have led some States and governments to involve the private sector in the financing of the space missions. The lack of funding, results as well from a lack of information about the possible “customers” of these new technological capacities, and the possible usages related to it. Thus, moving towards a model based on an interaction between the public sector and the civil society has become a necessity.

Along with these processes, the opening of space to the new actors, with the extension of the space technological goals, are increasingly affecting the traditional economic and organizational concepts already deployed in this field. Made possible by a series of regulatory, geopolitical and technological factors, the open access to space has resulted in reducing the costs and increasing the capacity of the different space actors involved. Start-ups are changing the rules, by introducing new economic logic based on private financing, mass production, cost reduction, etc. This logic contrasts with the one which prevailed half a century ago: public financing, slowness of the decision-making process, high production costs.

As a result, the number of companies involved in marketing the space activities has largely expanded. The new entrants therefore are investing all along the space industry value chain, from the launching processes to the research and scientific development activities. Space is no more restricted to professionals, and seen more as a value proposition tool, oriented towards a large range of end-users.

While this multitude of actors within the space pantheon represents in itself a revolution for a sector accustomed to a small number of protagonists, it is leading somehow to a “cultural paradigm” change. A change, not just from the access democratization perspective of space, but also aiming the main scopes of the spatial missions. A phenomenon, if seen from a more economic angle, reflects the basic idea: *“citizens who have economically contributed in producing the information, give themselves the empowerment to benefiting from it”*.

Thus, with the awareness that SDIs are contributing at various economic, institutional and organizational levels, it would be always interesting to look closely at the repositioning of the different categories of actors, in a system tackled by a continuous and challenging development.



# List of Publications

- i. Jabbour, C., Rey-Valette, H., Maurel, P., & Salles, J.-M. (2019). Spatial data infrastructure management: A two-sided market approach for strategic reflections. *International Journal of Information Management*, 45 (Published).
- ii. Jabbour, C., Hoayek, A., Maurel, P., Rey-Valette, H., Salles, J.-M. (2019). How much would you pay for a satellite image? Lessons learned from a French spatial data infrastructure. *IEEE Geoscience and Remote Sensing Magazine* (Accepted - In Editing).
- iii. Jabbour, C., Maurel, P., Rey-Valette, H., Salles, J.-M., & Niang, A. (2018). Identification des impacts économiques d'une Infrastructure de Données Spatiales (IDGS). *Numérique et Organisations - MTO* (Accepted - In Editing).
- iv. Niang, A., Rey-Valette, H., Maurel, P., Ose K., Jabbour, C., Salles, J.-M., & (2019). Identifying the economic impacts of a spatial data infrastructure. *Journal of Regional and Urban Economics (Revue d'Economie Régionale et Urbaine)* (Accepted - In Editing).
- v. Jabbour, C., Maurel, P., Rey-Valette, H., & Salles, J.-M., & Ghalayini, L. (2019). Making the most of "heterogeneous" information by using Blackwell and entropy theories: A decision support policy applied to forests' clear-cut control (Submitted).
- vi. Jabbour, C., Hoayek, A., Maurel, P., Khraibani, Z., & Ghalayini, L. (2019). Examining market stability using the Records theory: Evidence form French Spatial Data Infrastructures (Submitted).



