



HAL
open science

Polluants organiques : analyse, application au “ biomonitoring ” environnemental et introduction des biopesticides (algues marines) comme alternative

Joséphine Al-Alam

► To cite this version:

Joséphine Al-Alam. Polluants organiques : analyse, application au “ biomonitoring ” environnemental et introduction des biopesticides (algues marines) comme alternative. Chimie analytique. Université de Strasbourg; Université Libanaise, 2017. Français. NNT : 2017STRAF019 . tel-02917953

HAL Id: tel-02917953

<https://theses.hal.science/tel-02917953>

Submitted on 20 Aug 2020

HAL is a multi-disciplinary open access archive for the deposit and dissemination of scientific research documents, whether they are published or not. The documents may come from teaching and research institutions in France or abroad, or from public or private research centers.

L'archive ouverte pluridisciplinaire **HAL**, est destinée au dépôt et à la diffusion de documents scientifiques de niveau recherche, publiés ou non, émanant des établissements d'enseignement et de recherche français ou étrangers, des laboratoires publics ou privés.

ÉCOLE DOCTORALE ED222

ICPEES-UMR 7515

THÈSE présentée par :

Joséphine AL ALAM

Soutenue le : **05 Juillet 2017**

Pour obtenir le grade de : **Docteur de l'université de Strasbourg**

Discipline/ Spécialité : Chimie analytique

TITRE de la thèse

**Polluants organiques : analyse, application au
« biomonitoring » environnemental et
introduction des biopesticides (algues marines)
comme alternative**

THÈSE dirigée par :

[Mr. MILLET Maurice]
[Mr. FAJLOUN Ziad]

Pr, université de Strasbourg
Pr, université Libanaise

RAPPORTEURS :

[Mme. VULLIET Emmanuelle]
[Mr. SAAB Joseph]

Dr-HDR., CR-CNRS, TRACES, ISA- Lyon
Pr., université Saint Esprit de Kaslik-Liban

AUTRES MEMBRES DU JURY :

[Mme CHBANI Asma]
[Mr. ABOUD Maher]
[Mr. DELHOMME Olivier]

Dr-HDR., université Libanaise
Pr., université Saint Joseph -Liban
Dr-MCF., LCP, Metz

Remerciements

Nous y sommes, on est arrivé... Me voilà au bout de cette thèse qui a marqué ma vie avec ses hauts et ses bas, ses rires et ses larmes, ses bonheurs et ses stress, ses rencontres et ses départs. L'ensemble a constitué la meilleure expérience enrichissante et formidable de ma vie dans laquelle j'ai tellement appris et découvert. Ceci n'aurait pas été possible sans toutes les personnes qui ont contribué, de près ou de loin à ce travail de thèse, c'est avec ces quelques lignes que je vous exprime ma reconnaissance.

*Je tiens avant tout à exprimer mon immense gratitude envers mes directeurs de thèse Messieurs **Ziad FAJLOUN** et **Maurice MILLET**. J'ai beaucoup appris à vos côtés et les mots me manquent pour vous exprimer ma gratitude.*

***Mr. FAJLOUN**, vous avez été particulièrement disponible et consciencieux durant tout mon travail de thèse. Depuis mon master, vous m'avez donné le goût de la recherche et m'avez incité à poursuivre dans cette voie. Merci pour tout le temps que vous m'avez accordé, pour votre soutien et votre encouragement, pour votre patience et vos conseils menant toujours aux meilleures solutions, sans oublier votre bonne humeur permettant le déroulement du travail dans une atmosphère amicale et formidable. Je vous remercie d'avoir toujours cru en mes capacités.*

***Mr. MILLET**, vous avez été toujours accessible et prêt à répondre à toutes mes QUESTIONS tout au long de ces trois années. Depuis mon arrivée à Strasbourg, vous m'avez attribué une confiance immense et vous m'avez bien guidé pour mener à terme mes travaux de recherche. Merci pour votre accueil chaleureux au LPCA et à Strasbourg, pour votre persévérance et votre franchise, votre écoute et vos conseils avisés spécialement lors de toutes les discussions agréables et enrichissantes autour de la réparation des machines. Je vous remercie du bon cœur pour toutes vos qualités humaines, votre bonne humeur ainsi que l'environnement familial que vous m'avez assuré.*

*Ma profonde gratitude aussi à Mme. **Asma CHBANI** pour avoir encadré mes travaux ces trois années. Je vous remercie pour la confiance que vous m'avez attribuée et les nombreuses discussions que vous m'avez accordées tout au long de mon parcours. Je vous remercie également pour votre disponibilité, votre rigueur scientifique et je n'oublierai jamais votre gentillesse, votre bon cœur et votre patience. Je vous remercie pour m'avoir fourni toutes les qualités d'encadrement et les conseils éclairés pour la réalisation et le développement de mes travaux.*

*J'exprime tous mes remerciements à l'ensemble des membres de mon jury qui m'ont fait l'honneur d'accepter d'examiner et de juger ce travail: Madame **Emmanuelle VULLIET** et Messieurs **Joseph SAAB**, **Maher ABBOUD** et **Olivier DELHOMME**, merci pour l'attention que vous portez pour mon sujet.*

*J'adresse également mes remerciements à Monsieur **Mohamad KHALIL**, Directeur Du Centre Azm Pour La Recherche En Biotechnologie Et Ses Applications. Merci pour votre accueil, votre appui et votre contribution à l'avancement de mon travail.*

*Je remercie de même, Monsieur **Cuong PHAM-HUU**, directeur de l'Institut de Chimie et Procédés pour l'Energie, l'Environnement et la Santé (ICPEES, UMR 7515 CNRS-UNISTRA), pour son accueil au sein de son laboratoire.*

*J'adresse surtout mes remerciements à l'association **AZM et SAADE** pour le financement de mes travaux de thèse, et à l'**UNISTRA** pour l'aide à mobilité internationale qu'elle m'a accordée.*

*Je voudrais aussi remercier l'ensemble des membres du Centre Azm pour la Recherche en **Biotechnologie et ses Applications** et en particulier à l'équipe du laboratoire de biotechnologie pour leur aide et soutien tout au long de ce travail de thèse.*

*Grand merci aussi à tous les membres de l'équipe « **LPCA** » et particulièrement à **Marine LÉVY** et **Alexandre SONNETTE**, merci pour votre accueil, votre bonne humeur, votre aide et spécialement pour vos réponses aux **QUESTIONS !!!***

*Je remercie infiniment mes amis à qui je n'ai pu jamais exprimer toute l'affection que je leur porte et qui furent présent à mes côtés lorsque j'en avais besoin. Merci à **Josiane** et **Katia**, les amies de galère avec qui j'ai partagé les bons et les mauvais moments ; merci à **Lena** et **Rouba** pour les longues journées de shopping et les nuits éveillées passées à Strasbourg ; merci pour mes amis de bureau avec lesquels j'ai partagé tous les moments de doute et de plaisir : **Joya**, **Joseph**, **Joumana**, **Juliano**, **Mira**, **Mohamad**, **Sandy** ...*

*Merci à ma grande famille, mes oncles, ma tante, ma grand-mère, mes cousins et mes cousines, merci pour vos affections, votre amour et votre support. Enfin, les mots les plus simples étant les plus forts, j'adresse toute mon affection à ma petite famille, un énorme merci à vous. A mes frères, **Antonio** et **Mario**, merci pour vos conseils et pour m'avoir soutenue et encouragée au cours de la réalisation de ce mémoire, merci d'être fier de votre petite sœur. A maman, **Foutine**, je ne pourrai jamais assez te remercier de tous les sacrifices de tous les jours que tu as fait pour nous, tu m'as fait comprendre que la vie n'est pas faite de problèmes qu'on pourrait résoudre grâce à des réactions chimiques. Malgré que tu ne savais pas ce que je faisais ! ta confiance, ta tendresse, ton amour et tes prières me portent et me guident tous les jours. Merci d'avoir fait de moi ce que je suis aujourd'hui. Je suis redevable d'une éducation dont je suis fière !!!*

*Une pensée pour terminer ces remerciements à mon père, **Youssef**, je sais que tu aurais été très fier de ta fille !!!*

J'en oublie certainement encore et je m'en excuse.

Encore un grand merci à tous pour m'avoir conduit à ce jour mémorable.

Joséphine

Polluants organiques : analyse, application au « biomonitoring » environnemental et introduction des biopesticides (algues marines) comme alternative

Résumé

Dans un contexte où les inquiétudes environnementales dues à la pollution sont grandissantes à l'échelle globale, la surveillance de la pollution environnementale constitue un enjeu majeur de recherche afin de préserver au mieux un environnement sain et durable. En effet, la surveillance responsable et continue de l'environnement accompagnée par le développement d'alternatives de lutte « verte » contre les nuisibles, pourrait certainement ralentir voir inhiber la propagation de polluants néfastes pour l'ensemble de la biosphère. Dans ce contexte, les objectifs principaux de cette thèse visent d'une part à caractériser la qualité de l'air par une approche basée sur le biomonitoring, et d'autre part à développer un biopesticide d'origine algale permettant la protection des agrumes en post-récolte comme un exemple d'alternative à l'usage des traitements chimiques classiques. Pour répondre au premier objectif, des méthodes d'extraction multi résidus ont dû être développées. Ces méthodes ont été soit spécifiques d'une famille de pesticides tel que les dithiocarbamates, soit plus large et plus générale en considérant de nombreux polluants comme des pesticides, des HAPs et des PCBs. Ces dernières ont été basées soit sur l'ASE-SPE-SPME, soit sur le QuEChERS-SPME, et ont formé le socle des études de biosurveillance environnementale entreprises. Ces études de surveillance ont permis l'évaluation des modifications spatio-temporelles de la qualité de l'air grâce à des espèces naturelles ayant un rôle de capteurs biologique de la pollution environnementale et permettant par la suite l'estimation de la pollution dans des zones bien définies. Pour répondre au second objectif, des extraits aqueux d'algues vertes, *Ulva linza* et *Ulva lactuca*, ont été préparés et testés comme antifongiques *in vivo* et *in vitro* afin d'étudier leur aptitude à inhiber le développement de *Penicillium digitatum* sur des agrumes en post récolte. Un potentiel de protection des agrumes en poste-récolte contre ce champignon a été mis en évidence, donnant effectivement l'espoir à la fiabilité de cette approche comme alternative biologique pour le remplacement des pesticides chimiques potentiellement toxiques.

Mots clés : biomonitoring, pollution environnementale, pesticides, HAPs, PCBs, dithiocarbamates, multi résidus, ASE, SPE, SPME, QuEChERS, biopesticides, *Ulva linza*, *Ulva lactuca*, *P. digitatum*.

Résumé en anglais

In a context where environmental concerns due to pollution are growing on a global scale, monitoring of environmental pollution is a major research challenge in order to preserve as much as possible a healthy and sustainable environment. Indeed, the responsible and continuous monitoring of the environment escorted by the development of "green" pest control alternatives could certainly decelerate or even inhibit the spread of harmful pollutants into the entire biosphere. In this context, the main objectives of this thesis are intended firstly to characterize air quality by a biomonitoring-based approach and, secondly, to develop a biopesticide of algal origin, that allows the protection of

post-harvested citrus fruit, as an alternative to the use of conventional chemical treatments. In order to answer the first objective, multi-residues extraction methods were developed. These methods were either specific to a family of pesticides such as dithiocarbamates or wider and more general regarding numerous pollutants such as pesticides, PAHs and PCBs. The latter were based either on the ASE-SPE-SPME, or on the QuEChERS-SPME, and formed the base of environmental biomonitoring studies undertaken. These monitoring studies allowed the assessment of spatial and temporal changes in air quality through natural species acting as biological sensors of environmental pollution and subsequently allowing the estimation of pollution in well-defined areas. To answer the second objective aqueous extracts of green algae, *Ulva linza* and *Ulva lactuca*, were prepared and tested as in vivo and in vitro antifungal agents, in order to study their ability to inhibit the development of *Penicillium digitatum* on post-harvested citrus fruits. A potential of post-harvested citrus fruits' protection against this fungus was proved, giving hope to the reliability of this approach as a biological alternative for the replacement of potentially toxic chemical pesticides.

Keywords: biomonitoring, environmental pollution, pesticides, PAHs, PCBs, dithiocarbamates, multiple residues, ASE, SPE, SPME, QuEChERS, biopesticides, *Ulva linza*, *Ulva lactuca*, *P. digitatum*.

Liste des figures

Chapitre 1

Figure 1:	Mécanismes de la pollution atmosphérique	7
Figure 2:	Sources d'émission des polluants dans l'environnement	10
Figure 3:	Structure chimique des principaux groupes de pesticides	12
Figure 4:	Mécanismes de transfert de la pulvérisation de pesticides vers l'air, le sol et l'eau	13
Figure 5:	Sources et voies d'exposition humaine aux pesticides	15
Figure 6:	Liste des HAP classés comme polluants prioritaires par l'USEPA	17
Figure 7:	Sources naturelles et anthropiques de formation des hydrocarbures aromatiques polycycliques (HAPs)	18
Figure 8:	Déposition sèches et humides des HAPs dans l'atmosphère	20
Figure 9:	Diagramme montrant les effets à court et à long terme de l'exposition aux HAPs sur la santé	22
Figure 10:	Structure chimique générale des polychlorobiphényles	23
Figure 11:	Réaction de synthèse des PCBs	24
Figure 12:	Accumulation des PCBs dans les sols et les sédiments	26
Figure 13:	Schéma de l'échantillonneur actif d'air à faible volume conçu pour l'échantillonnage intérieur	30
Figure 14:	Schéma d'un échantillonneur actif d'air à volume élevé conçu pour l'échantillonnage extérieur	30
Figure 15:	Schéma et photo d'un capteur passif de type PUF (« flying saucer design »)	31
Figure 16:	Exposition des escargots aux polluants dans l'écosystème terrestre	38
Figure 17:	Schéma d'un soxhlet	40
Figure 18:	Représentation schématique d'une extraction ASE	41
Figure 19:	Processus d'extraction en phase solide	43
Figure 20:	Procédés d'extraction par espace de tête et d'immersion par fibre SPME, et systèmes de désorption pour les analyses par GC et LC	45
Figure 21:	Principales étapes de l'extraction QuEChERS originale	47
Figure 22:	Composants généraux d'un spectromètre de masse	51
Figure 23:	Processus d'ionisation ESI	53
Figure 24:	Représentation schématique d'une source d'ionisation par impact électronique	54
Figure 25:	Schéma d'un analyseur quadripolaire	55
Figure 26:	Schéma d'un spectromètre de masse quadripolaire triple (TQMS)	55
Figure 27:	Représentation schématique d'une trappe ionique	56
Figure 28:	Trajectoire en 8 tridimensionnel des ions dans une trappe	57

Revue de littérature

Figure 1:	Exposure of snails to soil contaminants	88
Figure 2:	The main steps of the original QuEChERS extraction procedure	92

Chapitre 2: Résultat-I

Figure 1:	Hemolyzed RBCs in suspension with different pesticides [1-Micronized Sulfur (orange), 2-Micronized Sulfur (tomato), 3- Metalaxyl Pop 25, 4-Copper, 5-Metalaxyl Oxylo, 6-Trifluralin, 7-Malathion]	112
Figure 2:	Hemolytic test on blood agar	113
Figure 3:	Mass spectra for the positive peak of tomato eluted with 75/25 of PB/ACN.	114
Figure 4:	Mass spectra for the positive peak of orange eluted with 60/40 of methanol/water.	115

Figure 5:	Mass spectra for the positive peak of orange eluted with 80/20 of methanol/water.	115
Figure 6:	Mass spectra for the positive peak of lemon eluted with 60/40 of methanol/water.	115
Figure 7:	Mass spectra for the positive peak of peach.	115
Figure 8:	Mass spectra for the positive peak of strawberries.	116
Figure 9:	Hemolytic result for strawberries extract containing Trifluralin (E = extract, positive control= triton X-100, negative control =PBS).	117
Figure A1:	Mass spectra of Metalaxyl	118
Figure A2:	Mass spectra of Trifluralin	118
Figure A3:	mass spectra of Micronized Sulfur	118

Chapitre 2: Résultat-II

Figure 1:	Chromatogram of DTCs mixture (1-Dazomet (T.R:6.26), 2-Metam-Na (T.R:7.77), 3-DMDTCs (T.R:15.11), 4-EBDTCs (T.R:22.19), 5-Propineb (T.R:26.35)).	126
Figure 2:	UV-visible spectrum for Zineb, Maneb and Mancozeb.	127
Figure 3:	Complexation reaction of DTCs.	127
Figure 1s:	Different DTCs structures	130
Figure 2s:	Chromatogram of not spiked leeks	131
Figure 3s:	Chromatogram of spiked leeks	131
Figure 4s:	Chromatogram of not spiked apples	132
Figure 5s:	Chromatogram of spiked apples	132

Chapitre 2: Résultat-III

Figure 1:	Sampling site locations: botanical garden for pine needles and the faculty of chemistry area in the university campus for cedar needles.	139
Figure 2:	Variation in total pesticide concentration for <i>P. nigra</i> and <i>C. atlantica</i> per week.	147
Figure 3:	Variation in total OCP concentration for <i>P. nigra</i> and <i>C. atlantica</i> per week.	147
Figure 4:	Variation in total PCB concentration for <i>P. nigra</i> and <i>C. atlantica</i> per week.	147
Figure 5:	Variation in total PAH concentration for <i>P. nigra</i> and <i>C. atlantica</i> per week.	147
Figure 6:	Variation in total pollutant concentration (ng g^{-1}) per week.	147
Figure 7:	Total pollutant concentration (ng g^{-1}) in the second week.	147
Figure 8:	Meteorological variations during the sampling period.	149

Chapitre 2: Résultat-V

Figure 1:	Honey sampling sites	180
Figure 2:	LC-MS/MS chromatogram of a sampling site in Akkar region	183

Chapitre 2: Résultat-VI

Figure 1:	Sampling sites	192
Figure 2:	Distribution of PAHs in the different studied regions	196

Chapitre 2: Résultat-VII

Figure 1:	Average recovery rate for each type of considered pollutants	219
Figure 2:	Mean RSD % of each pollutant type obtained with the two extraction methods	220
Figure 3:	Mean recovery rate of analyzed pollutants obtained with acetonitrile and ethyl acetate used as QuEChERS extraction solvent	222
Figure 1s:	Calibration curves of some analyzed compounds	233

Chapitre 2: Résultat-VIII

Figure 1:	Effect of the crude extract of <i>Ulva lactuca</i> dry at different concentrations on in vivo growth of <i>Penicillium digitatum</i> at 25 °C for 8 weeks	242
Figure 2:	Effect of the crude extract of <i>Ulva linza</i> dry at different concentrations on in vivo growth of <i>Penicillium digitatum</i> at 25 °C for 8 weeks	243
Figure 3:	Inhibition of <i>P. digitatum</i> by crude extracts of <i>Ulva linza</i> and <i>Ulva lactuca</i> (50 g L ⁻¹)	244
Figure 4:	Inhibition of <i>P. digitatum</i> by crude extracts of <i>Ulva linza</i> fresh and <i>Ulva linza</i> dry (50 g L ⁻¹)	245
Figure 5:	Inhibition of <i>P. digitatum</i> by crude extracts of dry <i>Ulva lactuca</i> dry (50 g L ⁻¹) at 4 °C and 25 °C	246
Figure 6:	Inhibition of <i>P. digitatum</i> by crude extracts of dry <i>Ulva linza</i> (50 g L ⁻¹) at 4 °C and 25 °C	246
Figure 7:	(a) Oranges treated by <i>Ulva lactuca</i> (50 g L ⁻¹) and conserved at 4 °C, (b) Oranges treated by <i>Ulva lactuca</i> (50 g L ⁻¹) and conserved at 25 °C	247
Figure 8:	Inhibition of <i>P. digitatum</i> by crude extracts of dry <i>Ulva linza</i> and <i>Ulva lactuca</i> (50 g L ⁻¹) at 4 °C	248
Figure 9:	Orange treated with the crude extract of <i>Ulva lactuca</i> and stored at 4 °C	249

Chapitre 2: Résultat-IX

Figure 1:	Inhibition percentage of the germination of <i>P. digitatum</i> incubated for 20 h at 22 °C in PDB containing <i>Ulva linza</i> extracts at different concentrations, water as negative control and Nystatine as positive control.	259
Figure 2:	Germination of <i>P. digitatum</i> incubated for 20 h at 22 °C in PDB containing <i>Ulva linza</i> extracts at different concentrations (B=25 g L ⁻¹ , C= 50 g L ⁻¹ , D= 100 g L ⁻¹ , E= 200 g L ⁻¹), and water as negative control (A)	259
Figure 3:	Inhibition percentage of the germination of <i>P. digitatum</i> incubated for 20 h at 22 °C in PDB containing <i>Ulva lactuca</i> extracts at different concentrations, water as negative control and Nystatine as positive control	260
Figure 4:	Germination of <i>P. digitatum</i> incubated for 20 h at 22 °C in PDB containing <i>Ulva lactuca</i> extracts at different concentrations (B=25 g L ⁻¹ , C= 50 g L ⁻¹ , D= 100 g L ⁻¹ , E= 200 g L ⁻¹), and water as negative control (A)	260
Figure 5:	<i>P. digitatum</i> development on MEA dishes after 4 days of incubation (A= water, B= <i>U. linza</i> at 50 g L ⁻¹ and C= <i>U. linza</i> at 25 g L ⁻¹)	261
Figure 6:	<i>P. digitatum</i> development on MEA dishes after 4 days of incubation (A= water, B= <i>U. lactuca</i> at 100 g L ⁻¹ and C= <i>U. lactuca</i> at 25 g L ⁻¹)	261

Liste des Tableaux

Chapitre 1

Tableau 1:	Marché mondial des biopesticides par formulation (En millions de dollars américains)	58
Tableau 2:	Exemple de microorganismes utilisés pour la protection des cultures	60

Revue de littérature

Table 1:	Summary of the use of conifer needles as biomonitors	78
Table 2:	Summary of the use of lichens and mosses as biomonitors	81
Table 3:	Summary of the use of bees and their products as biomonitors	84

Chapitre 2 : Résultat-I

Table 1:	Hemolytic percentage of pesticides	114
Table 2:	Pesticides concentrations in plates	114

Chapitre 2: Résultat-II

Table 1:	Retention Time (Rt), Equation, Coefficient of Regression (R ²), DL and QL for Each Subgroup of DTCs	126
Table 2:	Recovery of DTCs from Apples and Leeks	127
Table 3:	Recovery of Zineb and Maneb from Spiked Tomatoes	127
Table Is:	DTCs triplicate analyze results	132
Table IIs:	Mixture triplicate analyze results	132

Chapitre 2: Résultat-III

Table 1:	Properties of volatile pesticides	141
Table 2:	Properties of non-volatile pesticides	142
Table 3:	Properties of PAHs	144
Table 4:	Properties of PCBs	145
Table 5:	Properties of OCPs	146
Table 1S:	Total, range, and mean concentration (ng g ⁻¹) of non-volatile pesticides for 5 weeks	152
Table 2S:	Total, range, and mean concentration (ng g ⁻¹) of OCPs for 5 weeks	152
Table 3S:	Total, range, and mean concentration (ng g ⁻¹) of PCBs for 5 weeks	153
Table 4S:	Total, range, and mean concentration (ng g ⁻¹) of PAHs for 5 weeks	153

Chapitre 2: Résultat-IV

Table 1:	Liquid chromatography (LC)–tandem mass spectrometry (MS/MS) method parameters	162
Table 2:	Gas chromatography (GC)–MS/MS method parameters for organochlorine pesticides (OCPs), polycyclic aromatic hydrocarbons (PAHs), and polychlorinated biphenyls (PCBs)	163
Table 3:	GC–MS/MS method parameters for remaining semivolatile pesticides	165
Table 4:	LC-MS/MS method performance and validation for pesticides analysis	166
Table 5:	GC-MS/MS method performance and validation for OCPs, PAHs and PCBs analysis	167
Table 6:	GC-MS/MS method performance and validation for pesticides analysis	169
Table 7:	Compounds detected in real samples: percentage of samples contaminated and the average quantified concentration	171

Chapitre 2: Résultat-V

Table 1:	Levels of the 10 most found pesticides in collected honey samples	182
----------	---	-----

Chapitre 2: Résultat-VI

Table 1:	Sum of PAHs concentrations in honey samples from all analyzed regions	195
Table 2:	Diagnostic ratios used with their typically reported values as given by Tobiszewski and Namieśnik, 2012	197
Table 3:	Calculated PAHs ratios for the selected areas	197

Chapitre 2: Résultat-VII

Table 1:	LC-MS/MS method parameters	211
Table 2:	GC-MS/MS method parameters for OCPs-PAHs and PCBs	213
Table 3:	GC-MS/MS method parameters for remained volatile pesticides	215
Table 4:	LC-MS/MS method performance and validation for pesticides analysis	223
Table 5:	GC-MS/MS method performance and validation for OCPs, PAHs and PCBs analysis	224
Table 6:	GC-MS/MS method performance and validation for pesticides analysis	226

Liste des abréviations

A:	Absorbance
AAS:	Active air sampling
ACN:	Acetonitrile
AES:	Atomic emission spectrometry
AhR:	Aryl hydrocarbon receptor
Al:	Aluminium
ANSES:	Agence nationale de sécurité sanitaire de l'alimentation, de l'environnement et du travail
ANT:	Anthracene
AOAC:	Association of analytical communities
APPI:	Atmospheric-Pressure PhotoIonisation/ photoionisation à pression atmosphérique
Ar:	Argon
As:	Arsenic
ASE:	Accelerated solvent extraction/ extraction par solvant accéléré
BaA:	Benzo(a)anthracene
BaP:	Benzo(a)pyrene
BeP:	Benzo(e)pyrene
Bt:	<i>Bacillus thuringiensis</i>
Ca :	Calcium
Cd :	Cadmium
CE :	Commission européenne
CHR :	Chrysene
CI:	Chemical Ionization/ ionisation chimique
Co:	Cobalt
CO:	Monoxyde de carbone
CO ₂ :	Dioxyde de carbone
COSV:	Composé organiques semi volatiles
COVs:	Composé organiques volatiles
CPG:	Chromatographie phase gazeuse
CPL:	Chromatographie phase liquide
Cr:	Chrome
CS ₂ :	Disulfure de carbone
Cu:	Cuivre
CUP:	Current-use pesticides
Da:	Dalton
DAD:	Diode array detector
DDD:	Dichlorodiphényldichloroéthane
DDE:	Dichlorodiphényldichloroéthylène
DDT:	Dichlorodiphényltrichloroéthane
DL:	Detection limit
DMDTCs:	Diméthylthiocarbamates
d-SPE:	Dispersive- solid phase extraction
DTCs:	Dithiocarbamates
EA:	Ethyl acetate
EBDTCs:	Ethylenbisdithiocarbamates
ECD:	Electron capture detector/ détecteur à capture d'électron
EDTA:	Ethylenediaminetetraacetic acid
EEC:	European Economic Community

EI :	Electron impact
EN :	European Union
EPA :	Environmental protection agency
ESI :	ElectroSpray Ionisation
Ev :	Electron volt
FAAS :	Flame atomic absorption spectrophotometry
Fe:	Fer
FID:	Flame ionization detector/ détecteur à ionisation de flamme
FL:	Fluorene
FLA:	Fluoranthrene
FLD:	Fluorescence detection
FLU:	Fluoranthrene
GC:	Gaz chromatography
GCB:	Graphitized carbon black
HRMS:	High resolution mass spectrometer
GF:	Graphite furnace
GV:	Granulovirus
H:	Constante de henry
H ₂ S:	Sulfure d'hydrogène
HAPs:	Hydrocarbure aromatiques polycyclique
HBCD:	Hexa-bromo-cyclo-dodecane
HCH:	Hexachlorocyclohexane
HCl:	Chlorure d'hydrogène
Hg:	Mercurie
HMW:	High molecular weight
HNO ₃ :	Acide nitrique
HPHTSE:	High-pressure, high temperature solvent extraction
HPLC:	High Pressure Liquid Chromatography
HPSE:	High-pressure solvent extraction
HRGC:	High resolution gas chromatography
HRMS:	High resolution mass spectrometer
IARC:	International Agency for Research on Cancer
ICP:	Inductively coupled plasma
IMZ:	Imazalil
K:	Potassium
Kow:	Coefficient de partage octanol/eau
LAURE:	Loi sur l'Air et l'Utilisation Rationnelle de l'Energie
LC:	Liquid chromatography
LLE:	Liquid-liquid extraction
LOD:	Limit of detection
LOQ:	Limit of quantification
LRAT:	Long-range atmospheric transport
m/z :	Masse sur nombre de charges
MALDI:	Matrix-Assisted Laser Desorption Ionisation/ ionisation par laser assistées par matrice
MEA:	Malt extract agar
MeOH:	Méthanol
Mg:	Magnesium
MgSO ₄ :	Sulfate de magnesium
Mn:	Manganese

Mo:	Molybdène
MRL:	Maximum Residue Limit
MRM:	Multiple Reaction Monitoring
MS:	Mass spectrometry
MSPD:	Matrix solid phase dispersion
MSW:	Municipal solid waste/ déchets solides municipaux
Na:	Sodium
NaCl:	Chlorure de sodium
NaOH:	Hydroxyde de sodium
NCI:	Negative chemical ionization
NH ₄ NO ₃ :	Nitrate d'ammonium
Ni:	Nickel
NO ₃ :	Nitrate
NO _x :	Oxyde d'azote
NPV:	Nucléopolyhedrovirus
O ₃ :	Ozone
OCPs:	Organochlorine pesticides
OES:	Optical emission spectrometry
P:	Phosphore
PA:	Poly acrylate
PAHs	Polycyclic aromatic hydrocarbons
PAS:	Passive air sampling
Pb:	Plomb
PB:	Phosphate buffer/ tampon phosphate
PBDEs:	Polybrominated diphenyl ethers
PBDTCs:	Propylenebisdithiocarbamates
PBS:	Phosphate buffered saline
PCBFs:	Polychlorinated dibenzofurans
PCBs:	Polychlorinated biphenyls
PCDD/ Fs:	Polychlorinated dibenzo-p-dioxins and -furans
PCN:	Polychlorinated naphthalenes
PDB:	Potato dextrose broth
PDMS:	Polydimethylsiloxane
PE:	Polyethylene
PFE:	Pressurized fluid extraction
PHE:	Phenanthrene
PHSE:	Pressurized hot solvent extraction
PHWE:	Pressurized hot water extraction
PIPs:	Plant Incorporated-Protectants
PLE:	Pressurized liquid extraction
PM:	Poids moléculaire
POM:	Polyoxymethylene
POPs:	Persistent organic pollutants
PSA:	Primary Secondary Amine
PSE:	Pressurized solvent extraction
PTV:	Programmed temperature vaporization
PUF:	Polyurethane foam
PYR:	Pyrene
QL:	Quantification limite
Quad:	Quadrupole

QuEChERS:	Quick, Easy, CHep, Effective, Rugged, and Safe
R ² :	Coefficient de corrélation
RBCs:	Red blood cells
RF:	Radiofréquence
RPM:	Rounds per minute
RSD:	Relative standard deviation
S/N:	Signal over noise
SAA:	Spectrométrie d'absorption atomique
SALLE:	Salting assisted liquid-liquid extraction
SFE:	Supercritical fluid extraction
SLE:	Seaweed liquid extract
SM:	Spectrométrie de masse
Sn:	Etain
SO ₂ :	Dioxyde de soufre
SO ₄ ²⁻ :	Sulfate
SOPP:	Sodium ortho-phenyl phenate
SPE:	Solid phase extraction
SPMD:	Semi permeable membrane device
SPME:	Solid phase microextraction
SSE:	Subcritical solvent extraction
TBZ:	Thiabendazole
Ti:	Titanium
TID:	Thermionic Ionization Detector / détecteur thermoïnique
TOL:	Toluène
Tr:	Temps de rétention
UV:	Ultraviolet
V:	Vanadium
VOC:	Volatile organic compound
WHO:	World Health Organization
Zn:	Zinc

Table des Matières :

Avant-Propos	4
Chapitre 1 : Etat de l'art	6
I. Partie-1: Pollution de l'air.....	7
1. Généralités	7
2. Sources d'émission des polluants dans l'environnement.....	8
2.1. Les sources naturelles	9
2.2. Les sources anthropiques	9
3. Polluants de l'air	10
3.1. Pollution par les pesticides.....	10
3.1.1. Généralités	10
3.1.2. Classification des pesticides	11
3.1.2.a. Premier système de classification	11
3.1.2.b. Deuxième système de classification	12
3.1.3. Devenir des pesticides dans l'atmosphère	13
3.1.4. Expositions humaines aux pesticides.....	14
3.2. Pollution par les polluants organiques persistants (POPs).....	16
3.2.1. Généralités	16
3.3. Les Hydrocarbures aromatiques polycycliques (HAPs).....	17
3.3.1. Généralités	17
3.3.2. Origine et formation des HAPs.....	18
3.3.3. Devenir des HAPs dans l'atmosphère.....	19
3.3.4. Expositions humaines aux HAPs	20
3.4. Les composés chlorés	22
3.4.1. Les polychlorobiphényles (PCBs)	23
3.4.1.a. Généralités.....	23
3.4.1.b. Origine et utilisation des PCBs	24
3.4.1.c. Devenir des PCBs dans l'atmosphère	25
3.4.1.d. Expositions humaines aux PCBs	26
3.4.2. Les pesticides organochlorés (OCPs)	27
3.4.2.a. Généralités.....	27

3.4.2.b. Devenir des OCPs dans l'atmosphère.....	27
3.4.2.c. Expositions humaines aux OCPs	28
4. Echantillonnage et Détection	29
4.1. Techniques d'Echantillonnage.....	29
4.1.1. Echantillonnage actif	29
4.1.2. Echantillonnage passif	31
4.1.3. Biomonitoring ou biosurveillance environnementale.....	32
5. Biomoniteurs :.....	33
5.1. Les végétaux	33
5.1.1. Les végétaux supérieurs: les conifères.....	34
5.1.2. Les végétaux cryptogamiques: les lichens et les mousses	35
5.2. Les abeilles et leurs produits.....	36
5.3. Les mollusques : les escargots	37
6. Analyse des polluants organiques à partir des matrices naturelles	39
6.1. Méthodes d'extraction des polluants des matrices solides	39
6.1.1. Extraction « Soxhlet ».....	39
6.1.2. Extraction accélérée par solvant (Accelerated Solvent Extraction, ASE)	41
6.1.3. Extraction en phase solide (Solid Phase Extraction, SPE)	42
6.1.4. La microextraction en phase solide (Solid Phase Micro Extraction SPME)	44
6.1.5. L'extraction QuEChERS	46
6.2. Méthodes de séparations des polluants.....	48
6.2.1. Chromatographie en Phase Gazeuse (CPG)	48
6.2.2. Chromatographie en Phase Liquide (CPL).....	50
6.3. Méthode de détection des polluants : La spectrométrie de masse	51
II. Partie-2 : Utilisation des biopesticides	58
1. Introduction et généralités.....	58
2. Classification des biopesticides	59
2.1. Les biopesticides microbiens	59
2.1.1. Les bactéries.....	60
2.1.2. Les champignons	61
2.1.3. Les virus.....	62
2.2. Les biopesticides d'origine végétale / biochimiques	63

2.3. Les biopesticides d'origine animale / semio-chimiques	64
3. Utilisation des algues marines comme biopesticides.....	65
4. Avantages et inconvénients des biopesticides	66
III. Partie-3 : Surveillance environnementale de la pollution atmosphérique – Revue sur les biomoniteurs communément utilisés et des polluants couramment étudiés.....	67
Chapitre 2 : Résultats	106
I. Contribution à l'analyse des produits alimentaires: recherche et évaluation de l'effet hémolytique de certains pesticides utilisés au Liban.....	107
II. Analyse des dithiocarbamates dans les matrices végétales par l'HPLC-UV suivie d'une spectrométrie d'absorption atomique.....	119
III. Utilisation d'aiguilles de conifères comme biomoniteurs de la variation temporelle de la pollution atmosphérique à Strasbourg.....	133
IV. Développement d'une méthode d'extraction multi-résidus basée sur QuEChERS-SPME pour l'analyse simultanée de 90 pesticides, 16 HAPs et 22 PCBs dans du miel.	155
V. Utilisation du miel comme biomoniteur de la contamination environnemental en pesticides au Liban Nord.....	174
VI. Détermination de 16 HAPs et 22 PCBs dans des échantillons de miel utilisés comme biomoniteurs de la qualité environnementale dans différentes régions du Liban.	186
VII. Utilisation des escargots comme biomoniteurs environnementaux ; développement d'une méthode d'extraction multi-résidus pour la détermination simultanée de 120 pesticides, 16 HAPs et 22 PCBs par LC-MS / MS et GC-MS / MS à partir des escargots.	202
VIII. Effet des extraits aqueux des algues vertes " <i>Ulva lactuca</i> " et " <i>Ulva linza</i> " sur le bio contrôle de la moisissure verte " <i>Penicillium digitatum</i> " des agrumes en post – récolte.....	235
IX. Inhibition de la germination des conidies de <i>Penicillium digitatum</i> par des extraits d'algues utilisées comme agents de lutte biologique pour la protection des agrumes en post-récolte..	252
Chapitre 3 : Discussion générale	265
Conclusion et perspectives	272
Référence.....	275

Avant-Propos

Pour assurer sa survie et sa protection au fil du temps, l'homme a tenté d'exploiter la nature et de la convertir pour ses biens et ses services. L'exploration et l'usage du pétrole en est l'exemple le plus marquant. Il a dominé et pollué la planète depuis la nuit des temps. En effet, malgré l'idée fortement répandue actuellement qu'«avant la révolution industrielle, l'atmosphère de notre planète était encore non contaminée par des polluants anthropiques », la pollution de la nature remonte réellement aux époques protohistoriques et ne constituent en aucun cas un problème récent ou un phénomène épisodique. Ainsi, la pollution de l'environnement est survenue au moment où les premières citées furent contaminées par les eaux usées domestiques et les ordures ménagères. Depuis lors, la pollution environnementale s'est développée de manière chronique. Au cours du XIXe siècle, la révolution industrielle a redoublé les besoins énergétiques pour l'homme, aboutissant donc à un usage accru du charbon et du pétrole ce qui a conduit à l'augmentation de la pollution environnementale générée par ces combustibles. Cette révolution a bouleversé le mode de vie des sociétés humaines par l'introduction de nouveaux modes de transport et le développement de nombreuses industries.

Depuis le dernier siècle et jusqu'à présent, l'évolution en synergie de secteurs de transport et de l'industrie avec l'urbanisation et l'agriculture intenses ont été à l'origine de l'émission de multiples polluants dans l'environnement qui peuvent, à tout moment, se répartir entre l'eau, l'air et le sol. L'introduction de ces substances engendre des effets néfastes non seulement pour l'environnement mais aussi pour la santé humaine. Toutefois, la survie dans un environnement sain demeure essentielle pour la prospérité et l'amélioration de la qualité de vie désirée pour nous-mêmes et pour les générations futures. De ce fait, la prise de conscience de la présence de ces polluants ainsi que de leurs effets n'a cessé de croître afin de trouver des solutions à leur émergence. L'identification et l'évaluation des sources d'émission des différents polluants deviennent donc une nécessité pour permettre ensuite de prendre certaines mesures de réduction de leur émission dans l'environnement.

L'évaluation de la contamination environnementale par les pesticides et les composés organiques semi-volatils (COSV) tels que les hydrocarbures aromatiques polycycliques (HAPs), les polychlorobiphényles (PCBs) et les pesticides organochlorés OCPs ainsi que la caractérisation de la qualité de l'air sont indispensables pour définir l'état de notre environnement amenant par la suite à les contrôler et les réduire par le développement de différentes techniques de lutte. Le caractère persistant et bio-accumulable des polluants précités peut être utilisé afin de suivre leurs proportions dans l'environnement, ceci grâce à des organismes vivants appelés biomoniteurs. L'évaluation de l'intensité de la pollution via l'accumulation des polluants de l'atmosphère par ces organismes vivants, connue sous le nom de « biomonitoring » ou biosurveillance, constitue une technique d'analyse de la pollution environnementale très efficace et utilisée depuis plusieurs décennies. Cette technique permet l'échantillonnage des polluants à haute densité, à faible coût et à n'importe quelle échelle spatiale et/ou temporelle souhaitée à faible coût. Elle est

par conséquent considérée comme une alternative puissante et intéressante à l'usage des échantillonneurs actifs pour la collecte des polluants.

C'est dans ce contexte que s'inscrivent les objectifs principaux de ces travaux de recherche s'articulant en deux grandes parties. La première correspond aux développements des méthodologies analytiques dans le but d'étudier la qualité de l'air. Cette partie, élément majeur de ce travail de thèse, vise en particulier à évaluer les modifications spatio-temporelles de la qualité de l'air dans une zone urbaine à Strasbourg et dans des zones rurales au Liban nord. La seconde, menée en parallèle avec le volet analytique, vise au développement d'un biopesticide à base d'algues vertes afin de fournir une alternative à l'usage des fongicides chimiques dans le processus de la protection des agrumes en post- récolte.

Le travail mené au cours de ces trois dernières années a été articulé autour de ces deux parties. Toutefois, une étude préliminaire, menée au cours de la deuxième année de master, portant sur l'analyse des pesticides vendues sur le marché Libanais et de leur persistance dans les produits agricoles consommés, ainsi que de leur effet hémolytique sur le sang humain, a formé le point de départ de ces recherches. Pour bien présenter et développer ce travail, le manuscrit de cette thèse est donc divisé en trois chapitres :

Le *premier chapitre*, consacré à une étude bibliographique, dresse un état de connaissance des deux grandes parties de la thèse ; la qualité de l'air et l'utilisation des biopesticides. Dans ce chapitre, les principales caractéristiques de chacune de ces deux parties ont été reportées. De même, une revue scientifique relative à l'étude de la qualité de l'air, rédigée et soumise dans *Environmental pollution*, est présentée à la fin de ce chapitre. Cette revue récapitule et actualise toutes les données bibliographiques concernant la biosurveillance environnementale des polluants organiques semi-volatils, les méthodes d'extraction et d'analyse ainsi que les différents biomoniteurs qui y sont associés.

“Environmental monitoring of atmospheric pollution– A review of biomonitors used and pollutants studied” Al-Alam Josephine, Asma Chbani, Ziad Fajloun, and Maurice Millet; Submitted in Environmental Pollution.

Le *deuxième chapitre* regroupe les résultats obtenus à partir des différentes méthodes développées et utilisées au cours de ces travaux de recherche et qui répondent aux principaux objectifs de cette thèse. Les résultats dans ce chapitre sont présentés sous format de quatre articles publiés, un article accepté, un soumis et quatre en cours de préparations.

Le *troisième chapitre*, consacré à la discussion générale, consiste à une interprétation et une analyse des résultats obtenus au cours des travaux de façon à présenter l'apport de chacune des parties étudiées.

A la fin du manuscrit, une conclusion générale amenant à quelques perspectives est présentée.

Chapitre 1 : Etat de l'art

I. Partie-1: Pollution de l'air

1. Généralités

La Loi sur l'Air et l'Utilisation Rationnelle de l'Energie (LAURE) du 30 décembre 1996 définit la pollution de l'air comme : « l'introduction par l'homme, directement ou indirectement dans l'atmosphère et les espaces clos, de substances ayant des conséquences préjudiciables de nature à mettre en danger la santé humaine, à nuire aux ressources biologiques et aux écosystèmes, à influencer sur les changements climatiques, à détériorer les biens matériels, et à provoquer des nuisances olfactives excessives ». Cette notion intègre toute sorte d'altérations environnementales causées par la pollution atmosphérique. La pollution de l'air est engendrée par l'émission dans l'atmosphère, de façon naturelle ou anthropique, de composés organiques ou inorganiques qui peuvent être par la suite transportés sur de longues distances. Les processus qui régissent la pollution dans l'atmosphère s'échelonnent en 3 étapes principales, lesquelles sont illustrées dans la figure 1: émissions, transports et réactions chimiques, et dépôts.

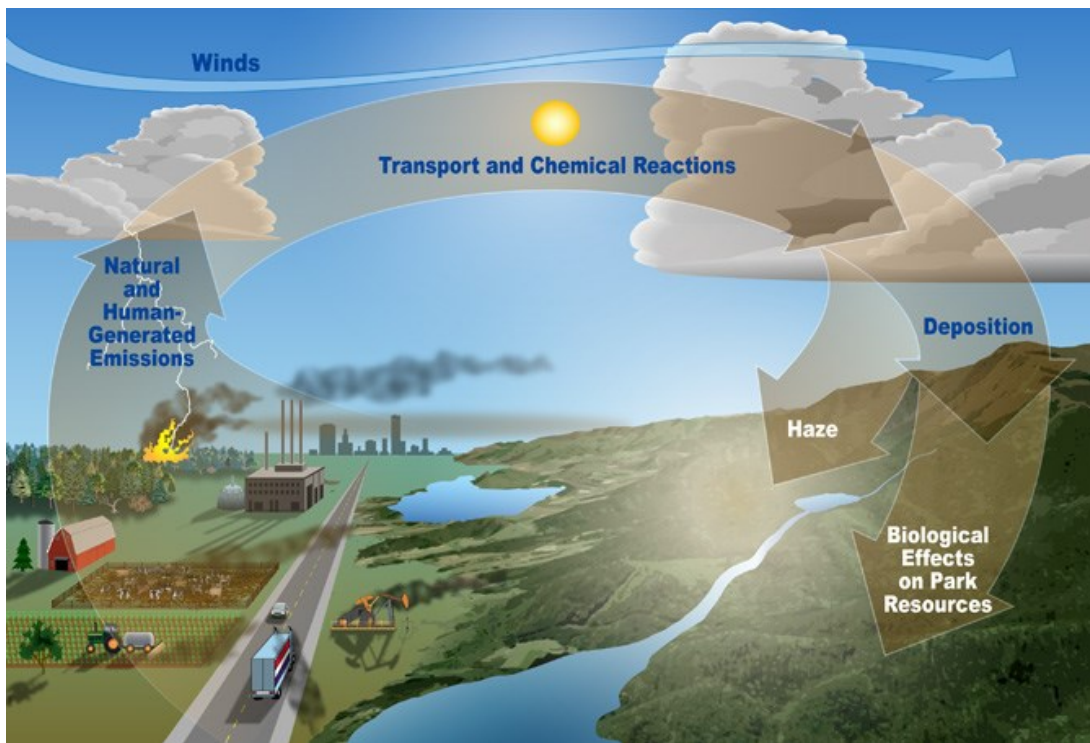


Figure 1. Mécanismes de pollution atmosphériques (d'après N.P.S, 2017)

Les émissions constituent le processus de rejet de polluants dans l'atmosphère. Ces émissions sont nombreuses et variées et peuvent être naturelles ou anthropiques. Les polluants qui y sont émis sont de type primaire et renferment des oxydes, des composés organiques tels que les HAPs et les pesticides, des polluants organiques persistants tels que les dioxines et les furanes, des particules en suspension ainsi que des métaux. Ces polluants sont émis depuis plusieurs sources

telles que les procédés thermiques, les productions d'énergies, les incinérations, les industries chimiques et métallurgiques, les formulations chimiques agricoles, les exploitations agricoles et mobiles (Vallero, 2014).

Une fois émis dans l'atmosphère, les différents polluants peuvent être transportés, spécialement par le vent, parfois loin de leurs zones d'émission. Durant le processus de **transport** et sous l'influence de la dynamique atmosphérique et du rayonnement solaire, les polluants primaires proprement dits peuvent être transformés en polluants secondaires suite à diverses réactions chimiques (réactions photochimiques, réactions acido-basiques, réactions d'oxydo-réductions) et physiques (nucléation, condensation, coagulation). Ainsi, des nouvelles particules sont formées lors de ce processus tels que NH_4NO_3 par exemple. Ces polluants présentent une période de demi-vie plus longue et peuvent être plus dangereux et plus toxiques que les polluants primaires (Ji et al., 2016; Juodis et al., 2016).

Le transport des polluants dans l'atmosphère, dépend de la taille de ces derniers ainsi que des conditions météorologiques, et s'étend à trois niveaux: local dans lequel les polluants restent accumulés autour de leurs zones d'émissions, régional dans lequel la pollution est constatée jusqu'à plus de mille kilomètres loin de la source, et global dont les effets s'étendent à l'échelle de la planète entière.

Finalement, le dernier processus induit par la pollution de l'atmosphère est le **dépôt**. Les dépôts de polluants atmosphériques sont connus comme étant la voie de contamination la plus importante par les POPs provenant de sources ponctuelles. Deux types de dépositions peuvent avoir lieu. Ces deux types sont : la déposition humide (« wet deposition ») associée aux précipitations, et la déposition sèche (« dry ») due à l'effet de la gravité terrestre. Ils permettent en réalité à plusieurs espèces chimiques gazeuses et à la matière en suspension dans l'atmosphère de former des dépôts superficiels dans l'environnement (Arinaitwe et al., 2016).

2. Sources d'émission des polluants dans l'environnement

Les sources à l'origine de la pollution atmosphérique sont de différents types. Il existe les sources naturelles, les sources anthropiques, les sources de combustion, les sources fixes et les sources mobiles. Toutefois, étant donné que les sources de combustion, les sources fixes et les sources mobiles sont considérées comme des sources anthropiques, seules les sources générales réparties en sources naturelles et anthropiques seront reportées.

Les sources générales de la pollution atmosphérique sont divisées entre les sources naturelles présentes évidemment dans l'atmosphère et les sources anthropiques liées aux activités humaines (Boubel, 1994; Vincent, 2002).

2.1. Les sources naturelles

Différents processus naturels sont à l'origine d'une émission des milliers de tonnes de polluants dans l'atmosphère. Parmi ces polluants figure le volcanisme qui est responsable du rejet dans l'atmosphère de quantités importantes de cendres, d'oxydes de carbone (CO, CO₂) ou de soufre (H₂S, SO₂). En plus, le volcanisme forme avec les tempêtes de poussières une source importante d'émission de particules fines dans l'environnement. En outre, la foudre, également considérée une source naturelle de pollution, forme la principale source d'émission d'oxydes d'azotes (NO_x) et spécialement de l'acide nitrique (HNO₃) dans la partie supérieure de la troposphère. D'autres procédés naturels peuvent contribuer aussi à l'accroissement de cette pollution dite naturelle ; dans ce contexte on peut citer les incendies naturels, la décomposition bactérienne de la matière organique ainsi que les divers processus d'érosion.

2.2. Les sources anthropiques

Les sources anthropiques, liées à l'activité humaine ont induit, depuis le début de l'ère industrielle, une modification de la planète et une dégradation de l'environnement suite à l'émission de toutes sorte de polluants. Diverses sources sont qualifiées d'anthropiques parmi lesquelles on trouve les sources industrielles, les sources d'origines domestiques et les émissions d'échappements moteurs (voitures). En effet, les sources industrielles sont stationnaires, et chacune émet différents types et quantités des polluants dans l'atmosphère. Les sources d'origines domestiques regroupent plusieurs sources comme les automobiles, les chaudières et les cheminées de maison, la cuisine, ainsi que le brûlage à ciel ouvert de déchets. Le développement des moyens de transport, a également contribué à l'augmentation importante de la pollution en émettant des milliers de tonnes de NO_x, de COVs, de HAPs et de CO. En outre, la combustion qu'elle soit dans une chaudière domestique ou dans un moteur d'automobile conduit à la formation de polluants primaires. Ces polluants sont le monoxyde de carbone, le dioxyde de carbone, les oxydes de soufre et d'azote, les fumées, les cendres, les métaux, les aldéhydes, les acides, les hydrocarbures non brûlés, les HAPs ainsi que beaucoup d'autres substances. En effet la combustion de combustibles fossiles (combustion du charbon, du gaz et de l'essence dans les voitures, les maisons et les centrales) constitue la principale source à la fois à l'origine de la pollution atmosphérique et de la hausse des niveaux de gaz à effet de serre contribuant aux changements climatiques. A ces sources s'ajoutent les sources agricoles qui sont à l'origine de l'émission de multiples polluants dans l'atmosphère et qui sont principalement dus à l'utilisation des pesticides. Par ailleurs, ces sources peuvent être soit fixes soit mobiles. Les sources fixes, correspondants à diverses installations industrielles sont à l'origine de divers polluants résultant de l'oxydation du carbone organique présent dans les combustibles, d'impuretés (soufre) et de l'azote de l'air, tels que les HAPs, les PCBs et les NO_x. Quant aux polluants provenant de sources mobiles, ils proviennent surtout des effluents d'échappement des moteurs, mais aussi de l'évaporation des essences, ainsi qu'aux épandeurs de pesticides (Gérin et al., 2003).

La figure 2 montre un récapitulatif des sources d'émissions de pollutions ainsi que des différents types de polluants émis dans l'atmosphère.

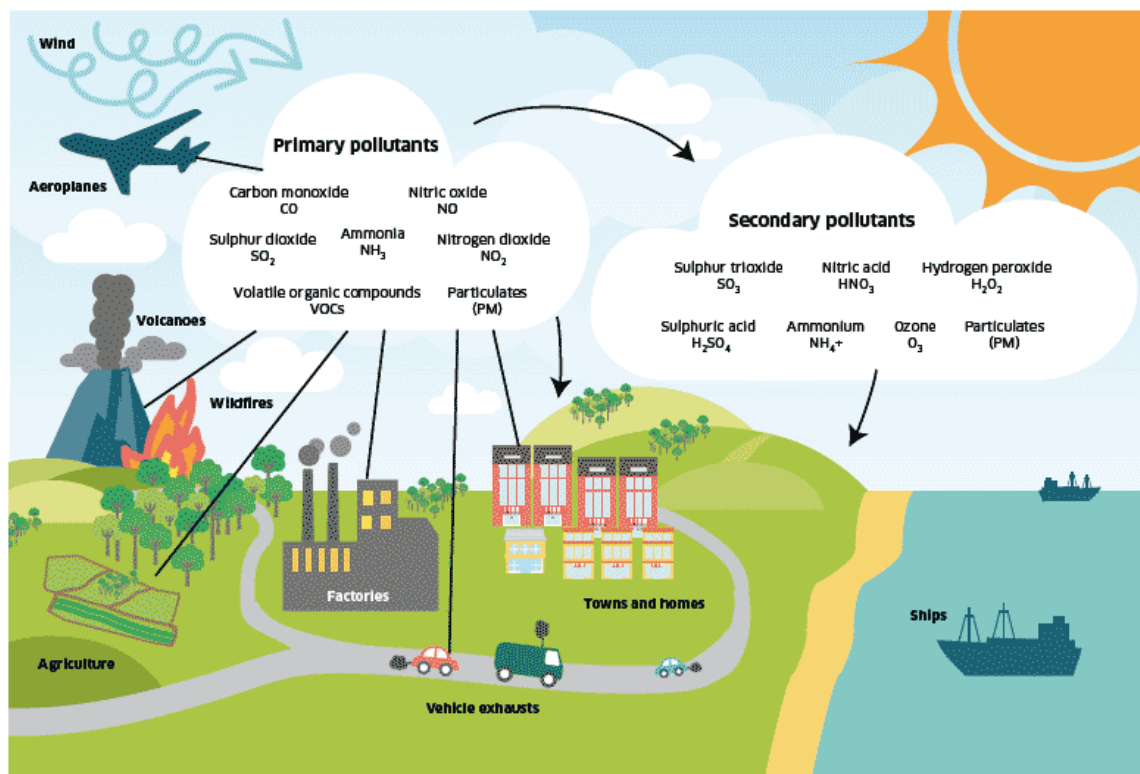


Figure 2. Sources d'émission des polluants dans l'environnement (d'après N.P.S, 2015)

3. Polluants de l'air

Les polluants émis par ces différentes sources sont très nombreux, imparfaitement connus et impossibles à analyser dans leur ensemble. Dans ce travail, nous nous sommes intéressés aux pesticides, HAPs et PCBs. Ces polluants seront donc les seuls à être développés dans cette partie.

3.1. Pollution par les pesticides

3.1.1. Généralités

Les pesticides, encore appelés produits phytosanitaires, sont des substances chimiques utilisées pour la croissance, la protection et la conservation des végétaux. L'agence de protection environnementale américaine (EPA), définit les pesticides comme une substance ou un mélange de substances visant à éviter, réprimer ou éliminer tout organisme nuisible qu'il soit un insecte, un champignon ou une mauvaise herbe (EPA, 2010).

Ce sont des substances actives contenant un ou plusieurs composés chimiques minéraux ou organiques, naturels ou synthétiques qui confèrent au produit l'effet désiré en y exerçant des effets spécifiques.

Ils sont destinés à assurer:

- la protection des végétaux contre les organismes nocifs ;
- les processus vitaux des végétaux ;
- la préservation des produits végétaux ;
- la destruction des végétaux indésirables ;
- la prévention de l'accroissement indésirable des végétaux.

3.1.2. Classification des pesticides

Les pesticides présents actuellement sur le marché dévoilent une grande diversité de groupes fonctionnels, de structures chimiques et de mode d'action ce qui rend leur classification relativement difficile. Cependant, il existe deux systèmes de classifications universels de ces produits: le premier repose sur la nature de l'espèce à défendre alors que le second repose sur la nature chimique de la substance active qui les constitue (Calvet, 2005; Kim et al., 2017).

3.1.2.a. Premier système de classification

Le premier système de classification se base sur le type de parasites à contrôler. Généralement ce système renferme trois grandes familles qui sont : les herbicides, les fongicides et les insecticides.

Les **herbicides** forment la famille de pesticides la plus utilisée mondialement. Ils ont pour rôle d'éliminer les végétaux parasites en inhibant leur croissance. En effet, les herbicides agissent selon différents modes d'action sur les plantes ; ils peuvent agir soit sur la régulation de l'auxine (la principale hormone de croissance des plantes), soit sur la synthèse de la matière organique (photosynthèse), ou même sur la croissance des plantes en inhibant la division cellulaire ainsi que la synthèse des lipides et des acides aminés qui leur sont nécessaires.

Les **fongicides** ont pour rôle de lutter contre la propagation de maladies des plantes provoquées par des champignons ou des bactéries. Ces produits agissent sur leurs cibles soit par l'inhibition de leurs systèmes respiratoires ou de leur division cellulaire, soit par la perturbation de leur métabolisme de glucides ou de leur biosynthèse de stérols, d'acides aminés et de protéines.

Les **insecticides** ont pour rôle de protéger les plantes contre les insectes nuisibles. Ils agissent en éliminant ou en empêchant la reproduction de ces derniers (Calvet, 2005).

En plus de ces grandes familles, d'autres familles, d'usage moins courant, existent comme par exemple : les acaricides, les némantocides, les rodenticides, les taupicides, les molluscicides ainsi que les corvicides et les corvifuges. En effet, ces familles de composés chimiques agissent d'une manière très sélective selon la nature de l'agent nuisible néfaste.

3.1.2.b. Deuxième système de classification

Le deuxième système de classification se base sur la nature chimique de la substance active qui compose les pesticides. Les principaux groupes chimiques sont les **organophosphorés** qui sont des esters obtenus par réaction de divers alcools avec l'acide orthophosphorique ou l'acide thiophosphorique ; les **organochlorés** qui sont obtenus par chloration d'hydrocarbures aromatiques; les **carbamates** qui sont une famille de composés organiques porteur d'une fonction $R-NH-C(=O)-O-R'$, il s'agit d'esters substitués de l'acide carbamique ou d'un amide substitué ; les **pyréthrinoïdes de synthèse** qui sont dérivés de la molécule pyrèthrine présente dans la fleur de pyrèthre ; les **dérivés de l'urée** ayant la formule $(NR_2-CO-NR_2)$ et qui sont exclusivement des herbicides ; les **triazines** caractérisées par un noyau hexagonal insaturé formé par trois atomes de carbone et trois atomes d'azote ; les **diazines** définies par un noyau cyclique hexagonal insaturé renfermant quatre atomes de carbone et deux d'azotes; les **benzimidazoles** résultant de la fusion d'un cycle de benzène et d'un cycle imidazole et les **acétamides** produits par la déshydratation de l'acétate d'ammonium. Néanmoins, ce deuxième système ne permet pas la classification systématique des pesticides vu leur grande variété disponible engendrant un nombre très élevé de familles chimiques. En plus, les pesticides commercialisés peuvent contenir une ou plusieurs substances actives en mélange ce qui rend parfois cette classification difficilement utilisable (Errami, 2012). Les structures chimiques de ces différents groupes fonctionnels cités sont représentées dans la figure 3.

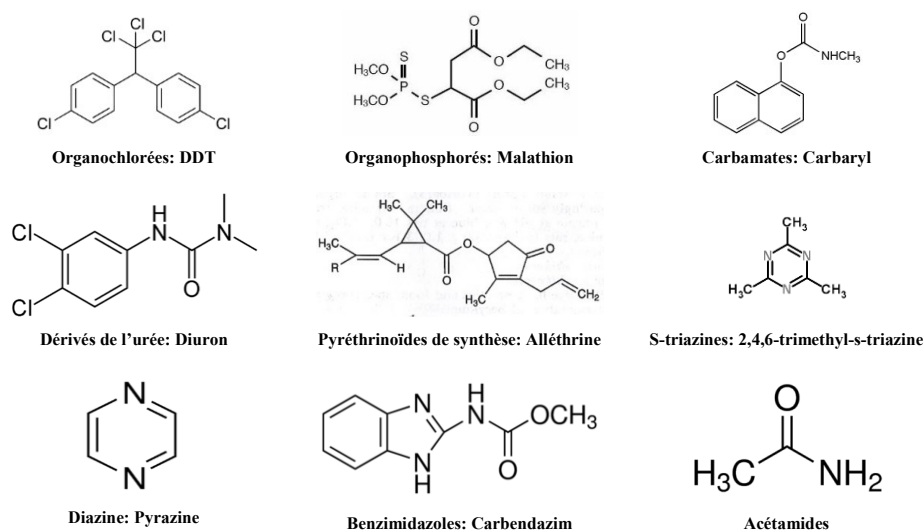


Figure 3. Structure chimique des principaux groupes de pesticides

3.1.3. Devenir des pesticides dans l'atmosphère

Lorsqu'un pesticide est émis dans l'environnement au cours de son application, le produit n'atteint pas en totalité sa cible. En effet, différentes fractions du produit pulvérisé sont directement émises dans l'air, dans le sol et dans l'eau où les organismes non cibles peuvent être affectés. La quantité de pollution dépend de la substance appliquée et de la technique d'application des pesticides.

Le devenir du pesticide dans l'atmosphère, une fois pulvérisé, dépend de son affinité pour le milieu régit par ses différentes propriétés physico-chimiques telles que sa solubilité dans l'eau permettant son transport sous forme dissoute, son coefficient de partage eau/sol indiquant sa capacité à être adsorbé et/ou désorbé par ce dernier, son coefficient de partage octanol/eau permettant son accumulation dans les organismes vivants, sa mobilité associée aux caractéristiques du sol ainsi que de sa constante de Henry (H) rendant compte de son aptitude à se volatiliser (Lacoste et al., 2004; Calvet, 2005).

Le transfert des pesticides pulvérisés dans les différents compartiments environnementaux est régi par divers processus comprenant la volatilisation, le déplacement, la rétention sur le sol, le lessivage et le ruissellement. En outre, les processus de dégradation jouent un rôle dans la contamination environnementale. La figure 4 montre les processus et les mécanismes de transferts des pesticides dans l'environnement.

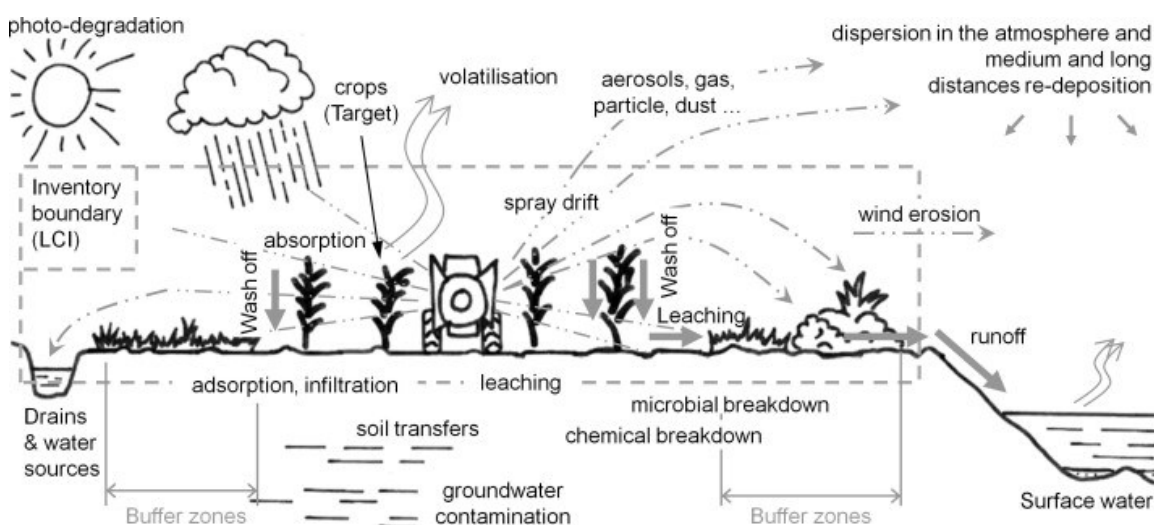


Figure 4. Mécanismes de transfert de la pulvérisation des pesticides vers l'air, le sol et l'eau (d'après van Zelm et al., 2014)

La persistance des résidus de pesticides est régie par de nombreux facteurs tels que la nature et la concentration lors de l'application, la dégradation avec le temps, le métabolisme et la transformation en divers produits ainsi que le déplacement d'une zone à une autre au cours du cycle dans l'environnement. Ce dernier commence dès le stade de l'application des pesticides à

des fins de lutte contre les ravageurs, tant à l'intérieur qu'à l'extérieur (Kailasa et al., 2013). En effet, comme le montre la figure 4, l'évaporation, la volatilisation, la dérive de pulvérisation (dépendant également du type d'appareil de pulvérisation) lors de l'application, le ruissellement, le lessivage, l'absorption, l'adsorption et le lessivage, entraînent les pesticides dans des compartiments environnementaux autres que ceux initiaux à partir desquels ils ont été initialement appliqués (van Zelm et al., 2014).

En outre, les quantités de pesticides intégrées dans le temps et qui restent dans chaque compartiment dépendent de la dégradation et de la transformation, de l'immobilisation et du transport. Certains phénomènes tels que la dispersion dans l'atmosphère ou le lessivage peuvent se produire quelques minutes après l'application des pesticides, tandis que les transferts au sol et la dégradation microbienne et chimique associée peuvent entraîner des transferts de pollution dans les masses d'eau après plusieurs semaines ou mois (van Zelm et al., 2014). Effectivement, la partie non volatilisée entre en contact avec les constituants du sol et une autre partie reste dans la solution du sol. En fonction de la répartition du pesticide, diverses réactions chimiques et/ou biochimiques peuvent conduire à sa dégradation suite à l'activité microbologique des microorganismes vivant dans le sol, des réactions chimiques, ou photochimiques conduisant à une transformation du produit.

3.1.4. Expositions humaines aux pesticides

La présence des pesticides dans l'environnement conduit à une contamination énorme de tous les compartiments qui pourra certainement se transmettre à l'homme. Outre la contamination directe par usage et pulvérisation de pesticides, l'homme est exposé continuellement aux différents types de pesticides *via* sa nourriture. En fait, les pesticides sont transmis aux aliments soit directement lors de la pulvérisation tels que les céréales, les fruits et les légumes, soit indirectement par contamination de certains animaux *via* des productions alimentaires telles que le lait et la viande (Kailasa et al., 2013).

En effet, l'exposition globale aux pesticides dépend du degré de contact avec chaque voie d'exposition qui, à son tour, est affectée par le mode de vie de la personne, comme son lieu de résidence et son statut socioprofessionnel.

La figure 5 montre un diagramme schématique détaillant les sources et les voies d'exposition de l'homme aux pesticides.

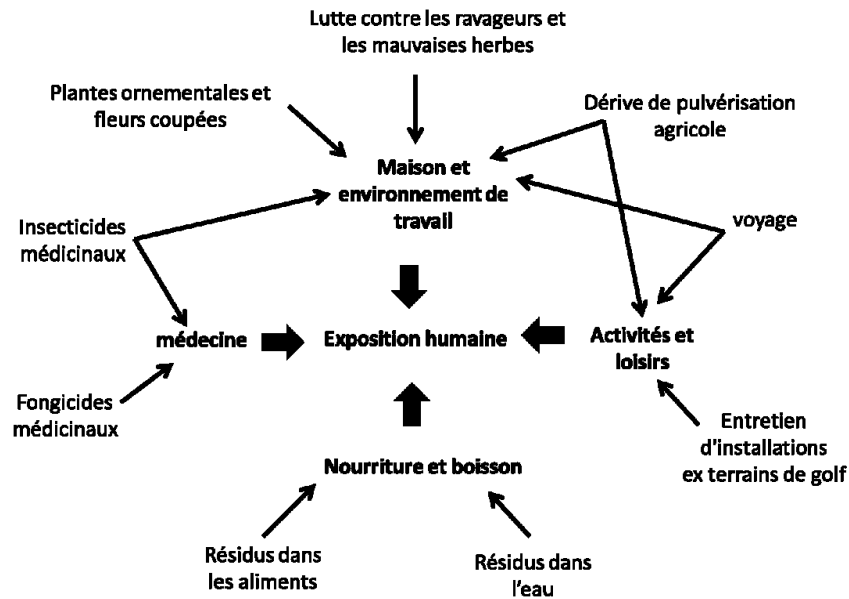


Figure 5. Sources et voies d'exposition humaine aux pesticides (modifiée de (McKinlay et al., 2008)).

La figure 5 résume les différentes sources d'exposition humaine aux pesticides. En effet, le travail dans des secteurs qui utilisent régulièrement des pesticides, comme l'agriculture ou la lutte antiparasitaire, ainsi que la vie ou le travail à proximité de zones traitées avec des pesticides, augmente l'exposition globale d'une personne aux pesticides (Bouvier et al., 2006; Valcke et al., 2006). De même, l'utilisation de pesticides dans l'environnement familial traité spécialement par les insecticides, forme une autre voie importante d'exposition des personnes aux différents types des pesticides (Menegaux et al., 2006). De plus, certaines personnes peuvent être exposées aux pesticides suites aux activités de récréation, de jardinage et d'entretien des installations tel que les terrains de golf (Knopper and Lean, 2004), ainsi que par la consommation d'aliments contaminés par des résidus de pesticides agricoles. Cette dernière source est une voie évidente d'exposition humaine et est fortement influencée par l'âge et les préférences alimentaires. En fait, les personnes ayant un régime basé sur l'alimentation biologique sont moins exposées à cette contamination que les autres personnes (Lu et al., 2006). Finalement, il faut noter que certaines pratiques médicales sont à l'origine des expositions humaines aux pesticides telles que les composés utilisés pour lutter contre les ectoparasites tels que les poux de tête ou pour traiter les infections fongiques (Grey et al., 2006).

Désormais, l'homme est exposé continuellement aux pesticides présentant des effets néfastes pour la santé en provoquant des toxicités aiguës et chroniques. En fait, les pesticides sont considérés comme étant cytotoxiques, neurotoxiques, embryotoxiques, mutagènes, tératogènes ou carcinogènes. Ainsi, des intoxications aiguës et chroniques peuvent avoir lieu amenant à l'apparition des irritations cutanées, des maux de tête, des nausées, des troubles visuels ainsi que des cancers (thyroïde, cerveau, leucémie, pancréas), des maladies respiratoires (asthme), des

troubles cardiaques, des troubles neurologiques (maladie de Parkinson), etc. (Koutros et al., 2015; Sarwar, 2015; Kim et al., 2017).

3.2. Pollution par les polluants organiques persistants (POPs)

3.2.1. Généralités

Les polluants organiques persistants (POPs) sont des composés organiques qui résistent, à des degrés variés, à la dégradation qu'elle soit photolytique, biologique ou chimique. Les POPs sont généralement halogénés et caractérisés par une solubilité faible dans l'eau et élevée dans les lipides, entraînant leur bio accumulation dans les tissus adipeux. En plus, ces produits sont semi-volatils, ce qui permet leur déplacement dans l'atmosphère sur de longues distances avant de se déposer. En effet, la persistance et la semi-volatilité inhabituelle des POPs conduisent à leur présence universelle ; ils sont de ce fait présents dans tous les continents même dans des régions où ils n'ont jamais été utilisés et aussi dispersés dans tous les compartiments de l'environnement, ce qui les rend omniprésents. Vu l'abondance de ces produits, les hommes peuvent y être exposés continuellement par leur alimentation ainsi que par des accidents d'origine professionnelle et / ou environnementale. L'exposition (aiguë ou chronique) aux POPs, peut être associée à de nombreux effets néfastes, ainsi qu'à divers maladies et même à la mort (Ritter et al., 1996).

Les POPs forment ainsi une famille de polluants regroupés par le fait qu'ils répondent à quatre grandes propriétés qui sont: la **toxicité** étant donné les effets néfastes qu'ils présentent pour l'environnement et pour l'homme (Flores-Ramírez et al., 2017) ; la **persistance** vu le temps de demi vie élevé que présente ces produits ainsi que leurs résistance aux divers processus de dégradation (Ritter et al., 1995) ; le **transport à longue distance** vu leur volatilité élevée qui leur permet de se déplacer sur de très longues distances et de se déposer loin de leurs zones d'émissions (Meire et al., 2012); et la **bioaccumulation** due à leur caractéristique lipophile leur permettant de se fixer sur les tissus adipeux et de s'accumuler dans les organismes vivants (Durante et al., 2016). En raison de la persistance et du transport à longue-distance de ces composés, les risques qui leurs sont liés doivent être suivis et gérés au niveau international. De ce fait, la plupart de ces molécules sont inscrites sur la liste de la « Convention de Stockholm », visant à bannir leur utilisation et elle est constamment révisée. Ainsi, l'endosulfane, un pesticide organochloré, a été ajouté en mai 2011 à la liste, après l'ajout de neuf autres composés en 2009 (Ambolet-Camoit et al., 2012).

Les POPs sont répartis en trois grandes catégories : les pesticides (pesticides organochlorés), les produits chimiques industriels tels que les polychlorobiphényles (PCBs) et les polybromodiphényl-éther (PBDEs), et les co-produits tels que les hydrocarbures aromatiques polycycliques (HAPs).

Vu le grand nombre de ces polluants, seuls les HAPs, les PCBs et les OCPs, seront développés par la suite.

3.3. Les Hydrocarbures aromatiques polycycliques (HAPs)

3.3.1. Généralités

Les HAPs constituent une classe étendue des POPs caractérisée par une structure de deux ou plusieurs cycles aromatiques condensés, produits en tant que sous-produits d'une combustion incomplète, d'une éruption volcanique, d'incendies de forêts et d'émissions de véhicules (Abdel-Shafy and Mansour, 2016). Les HAPs sont formés de cycles aromatiques juxtaposés en nombre croissant allant de deux cycles (naphtalène) jusqu'à six (benzo(ghi)pérylène). Le dressage de ces cycles peut être linéaire (anthracène), angulaire (fluoranthène) ou groupé (pyrène). Vu la stabilité de ces produits, 16 d'entre eux ont été déclarés comme polluants prioritaires pour l'agence de protection de l'environnement des Etats Unis (US EPA). Les structures de ces 16 HAPs sont présentées sur la figure 6.

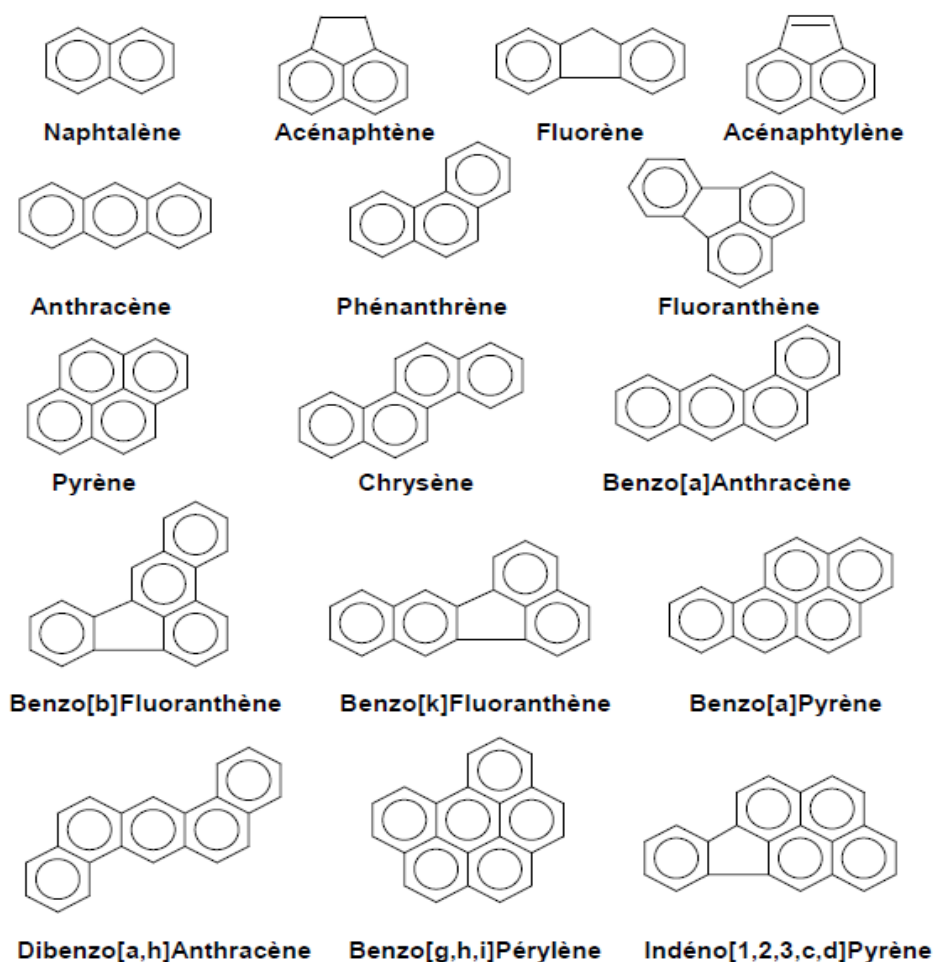


Figure 6. Liste des HAPs classés comme polluants prioritaires par l'USEPA

Suivant leur nombre de cycles benzéniques, ces composés sont classés en HAP "légers" ayant un nombre de cycles \leq à 3 et en HAP "lourds" ayant un nombre de cycles \geq à 4. Les propriétés physico-chimiques des HAPs dépendent principalement de leurs structures et leurs masses moléculaires. En général les HAPs, à l'exception du naphthalène, sont peu volatils. Les caractéristiques communes de ces composés sont : des points de fusion et d'ébullition élevés ainsi qu'une solubilité faible dans l'eau qui diminue avec l'augmentation de la masse moléculaire. En plus, les HAPs sont caractérisés par des coefficients de partage octanol/eau très élevés les rendant lipophiles et ayant une solubilité élevée dans les solvants organiques. Cette propriété rend les HAPs potentiellement concentrés et bio-accumulés dans les sédiments et les sols. La persistance des HAPs et leur temps de demi-vie augmentent avec l'augmentation du nombre de cycles de la molécule (Kanaly and Harayama, 2000; Wang et al., 2017).

3.3.2. Origine et formation des HAPs

La formation des HAPs peut provenir de processus naturels, cependant la source majeure d'introduction de ces composés dans l'environnement reste l'activité anthropique. La figure 7 montre une représentation schématique des sources potentielles d'HAPs dans l'environnement.

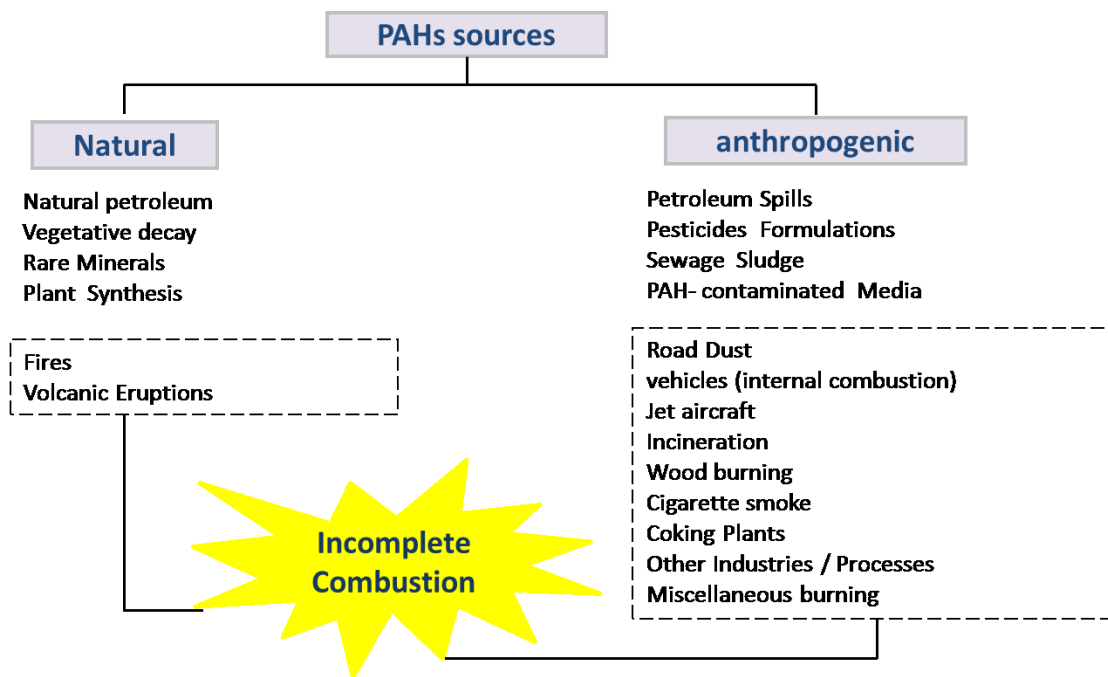


Figure 7. Sources naturelles et anthropiques de formation des HAPs (d'après Abdel-Shafy and Mansour, 2016)

Comme le montre la figure 7, les origines naturelles de ces composés regroupent les feux de forêts, les éruptions volcaniques, le pétrole naturel ainsi que divers processus géochimiques. Cependant, les principales sources de pollution par les HAPs sont d'origine anthropiques et

proviennent de la combustion des matières fossiles (charbon, fuel, pétrole), du transport routier et fluvial, de certaines activités industrielles, de fuites de produits pétroliers, de la fumée de cigarette, des produits alimentaires fumés (poissons, viandes) ainsi que de certaines formulations de pesticides (Ravindra et al., 2008; Abdel-Shafy and Mansour, 2016; Duodu et al., 2017).

La multitude des sources d'HAPs permet d'expliquer leur ubiquité dans l'environnement et leur présence dans les poussières atmosphériques (gaz d'échappement et rejets industriels), dans les sols (retombées atmosphériques) et les sédiments, les eaux de ruissellement (lessivage de l'asphalte par les pluies) ainsi que dans divers compartiments environnementaux (Menzie et al., 1992; Baklanov et al., 2007; Ravindra et al., 2008).

Qu'ils soient naturels ou anthropiques, les HAPs sont classés selon trois catégories d'origines : pyrolytiques, pétrogénique, et diagénétique (Le Bihanic, 2013).

Pyrolytique

Les HAPs d'origines pyrolytiques, proviennent de la combustion incomplète de la matière organique à très haute température (1500-2000°C) comme le pétrole et la biomasse fossile. Les HAPs pyrogènes sont formés chaque fois que des substances organiques sont exposées à des températures élevées dans des conditions d'oxygène faible ou sans oxygène. Ces mélanges de HAPs présentent une majorité de molécules de hauts poids moléculaires. Les HAPs substitués sont généralement retrouvés en faibles quantités dans les mélanges d'origine pyrolytique.

Pétrogénique

Le processus de diagénèse qui peut donner naissance à des pétroles et autres combustibles fossiles contient des HAPs dits pétrogéniques. Ces HAPs sont formés à température moins élevée (150°C), sur des longues périodes de temps. Ils résultent d'une exposition de la matière organique à des conditions adéquates de température et de pression. D'une manière générale les mélanges de HAPs pétrogéniques sont marqués par une prédominance en HAPs de faible poids moléculaire, 3 cycles et moins, et en HAPs substitués.

Diagénétique

Cette source de HAPs est minoritaire dans l'environnement et les HAPs qu'elle regroupe sont d'origines naturelles. Elle correspond plutôt à la diagenèse précoce ainsi qu'à certaine excrétion des plantes comme par exemple le rétène excrété par certaines plantes ainsi qu'à d'autres dérivés du phénanthrène et du chrysène.

3.3.3. Devenir des HAPs dans l'atmosphère

Dès leur émission dans l'atmosphère, les HAPs se partagent entre les phases gazeuse et particulaire. Ils sont soumis à divers processus de transformation tels que des réactions

d'oxydation ou de photolyse et de transfert ou d'élimination par l'intermédiaire des dépôts secs et humides. Une fois déposés, ils peuvent être réactivés et transportés par les masses d'air sur de longues distances et se retrouver dans des sites éloignés de leurs zones d'émission.

En effet, l'atmosphère forme le moyen le plus important de la dispersion des HAPs dans l'environnement. Une fois libérés dans l'atmosphère, les HAPs se retrouvent en deux phases distinctes, une phase vapeur (pour les HAPs ayant un PM faible) et une phase solide dans laquelle les HAPs sont adsorbés sur des particules (pour les HAPs ayant un PM élevé) (Wang et al., 2013b). Suite à leur dépôt sur le sol, les HAPs parviennent au milieu marin par le lessivage des sols ainsi que par les transferts fluviaux. Ensuite, ils seront adsorbés sur les particules afin d'être transmis aux sédiments. Le caractère lipophile de ces composés permet leur absorption et leur accumulation ou transformation par les êtres vivants et ainsi leur transfert dans les différents niveaux des chaînes trophiques jusqu'à l'homme (Le Corfec, 2011).

Contrairement à d'autres polluants organiques persistants, on ne détecte pas de bioamplification dans le cas des HAPs. En fait, les HAPs sont photosensibles et se dégradent sous l'action de la lumière solaire. Les réactions de photo-oxydation conduisent à la formation d'acides, alcools, cétones ainsi que d'autres composés plus solubles dans l'eau et plus biodégradables. En outre, les HAPs peuvent être sujets à des dégradations microbiologiques par certains microorganismes (Lee, 2003). La figure 8 montre les processus de dépôt atmosphérique des HAPs.

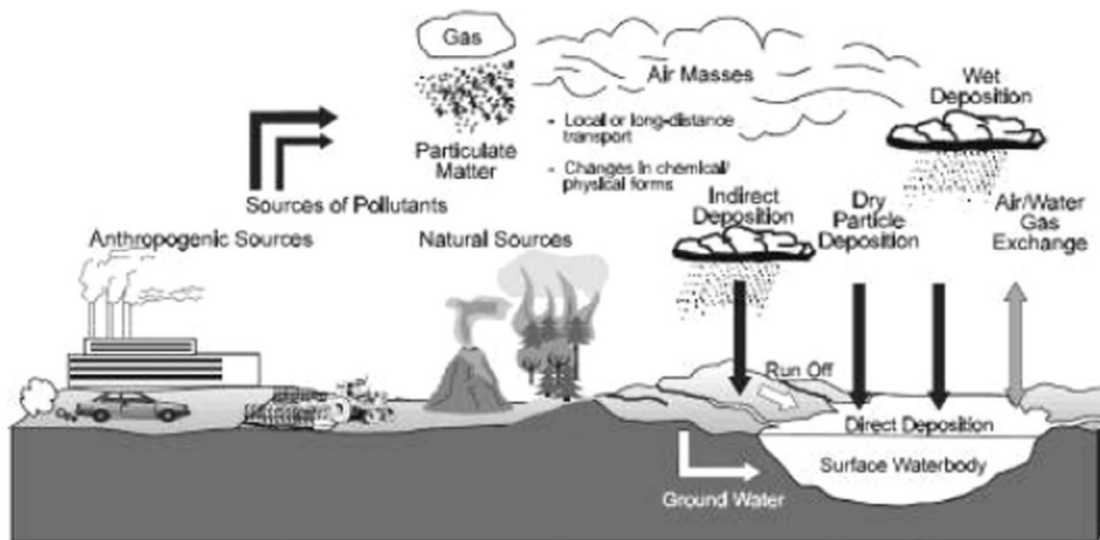


Figure 8. Dépôt sèches et humides des HAPs dans l'atmosphère (d'après Abdel-Shafy and Mansour, 2016).

3.3.4. Expositions humaines aux HAPs

Vu le caractère d'ubiquité des HAPs, l'homme y est exposé d'une façon continue. L'exposition se fait principalement par respiration de l'air ambiant et de l'air intérieur très riches

en HAPs. En plus, consommer de la nourriture contenant des HAPs, fumer des cigarettes ou respirer la fumée de foyers ouverts augmentent l'exposition humaine aux HAPs. En effet, la fumée de tabac contient une variété de HAPs, comme le benzo(a)pyrène, et plus de 40 carcinogènes humains connus ou soupçonnés.

En outre, certaines cultures, comme le blé, le seigle et les lentilles, peuvent synthétiser des HAPs ou les absorber par l'eau, l'air ou le sol et les transférer à l'homme. Par ailleurs, l'eau peut également contenir des quantités d'HAPs susceptible de contaminer la population humaine, puisque ces produits chimiques peuvent se déverser du sol dans l'eau ou ils peuvent pénétrer dans l'eau à partir des effluents industriels.

Par conséquent, l'exposition aux HAPs se produit de façon régulière pour la plupart des gens. Les voies d'exposition incluent l'ingestion, l'inhalation et le contact cutané dans les milieux professionnels et non professionnels. L'exposition professionnelle peut également se produire chez les travailleurs qui respirent des fumées d'échappement, comme les mécaniciens, les vendeurs ambulants, les conducteurs de véhicules automobiles, y compris les travailleurs des mines, des métaux ou du raffinage du pétrole. Certaines expositions peuvent impliquer plus d'une voie simultanément, ce qui affecte la dose totale absorbée (comme les expositions cutanées et par inhalation de l'air contaminé). Les personnes peuvent être exposées aux HAPs dans l'air et le sol de surface par inhalation directe, ingestion ou contact cutané (Wang et al., 2012; Kim et al., 2013; Abdel-Shafy and Mansour, 2016).

L'exposition humaine aux HAPs est plutôt qualifiée d'exposition chronique vu qu'il est en contact continu avec ces polluants.

Le principal risque que présentent ces composés sur la santé, est leur capacité à induire le développement de cancer. En plus, ils sont responsables de graves problèmes de santé respiratoire et cardiovasculaire tels que : une réduction de la fonction pulmonaire, un infarctus du myocarde, de l'asthme, des mutations ainsi qu'un échec du système immunitaire (Ma and Harrad, 2015; Maragkidou et al., 2017).

Divers études ont montré les effets cancérigènes et mutagènes élevés de ces produits dus à leur persistance atmosphérique (Al-Rashdan et al., 2010; de Lima et al., 2017). Il est à noter que, les HAPs les plus toxiques sont ceux qui contiennent cinq cycles benzéniques ou plus, appelés HAPs de haut poids moléculaire, ces derniers sont considérés comme les HAPs les plus toxiques, mutagènes et cancérigènes (Alagić et al., 2016; Elorduy et al., 2016).

La figure 9 représente un organigramme reliant les effets de l'exposition aux HAPs à court et à long terme sur la santé humaine.

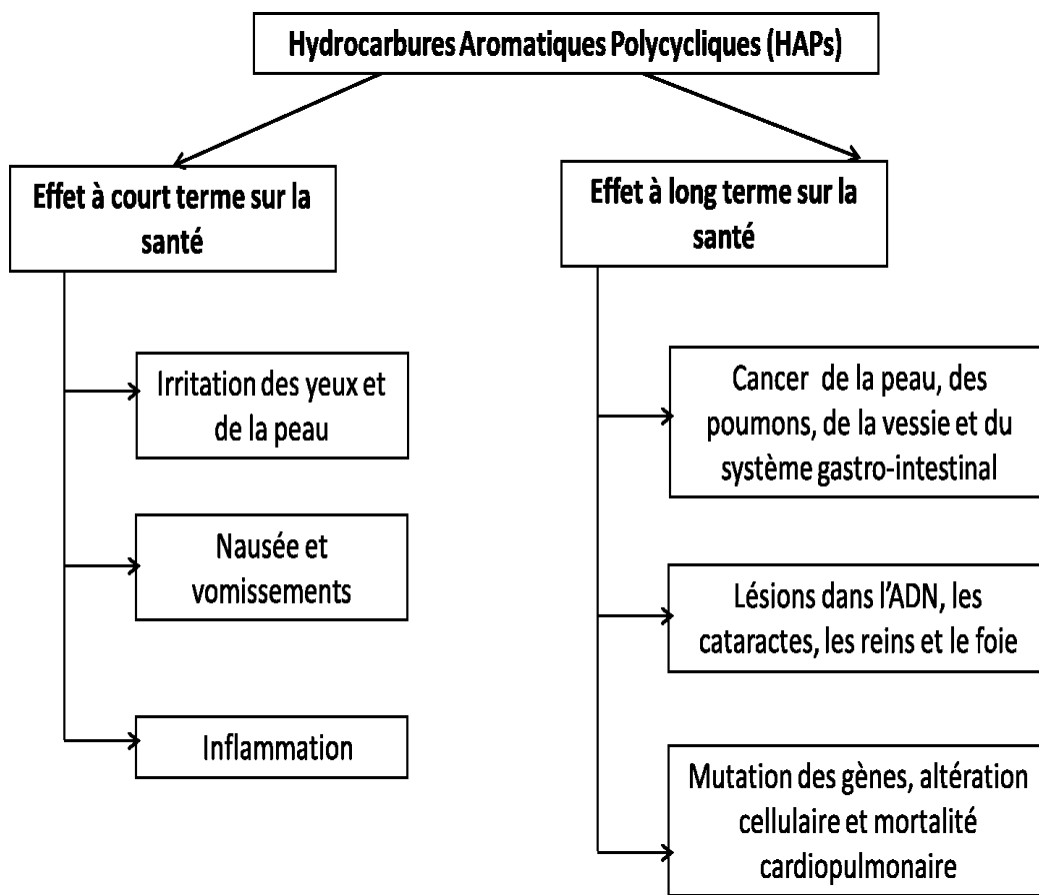


Figure 9. Diagramme montrant les effets à court et à long terme de l'exposition aux HAPs sur la santé (d'après Kim et al., 2013)

3.4. Les composés chlorés

Les composés organochlorés considérés comme des polluants organiques persistants (POPs), sont de plus en plus préoccupants à l'échelle mondiale en raison de leur persistance, toxicité et bioaccumulation. Ces polluants sont très répandus dans l'environnement et peuvent également pénétrer dans la chaîne alimentaire principalement à travers l'apport de graisses animales (viande, poisson et lait) (Contreras López, 2003). Actuellement, l'exposition à de tels polluants pose de véritables soucis pour la santé en raison des effets toxiques et nocifs qui y sont engendrés, y compris la carcinogenèse, les troubles immunologiques et reproductifs chez l'homme (Yu et al., 2014).

Parmi ces composés, nous nous sommes particulièrement intéressés aux polychlorobiphényles (PCBs) et aux pesticides organochlorés (OCPs).

3.4.1. Les polychlorobiphényles (PCBs)

3.4.1.a. Généralités

Les polychlorobiphényles (PCB) sont des composés aromatiques organochlorés synthétisés industriellement. Ces composés sont constitués d'un noyau biphényle comportant jusqu'à cinq atomes de chlore par cycle phényle appelé congénère. Cette famille se compose de 209 congénères qui ont été utilisés commercialement dès 1929.

La structure générale d'un PCB est représentée par la figure 10.

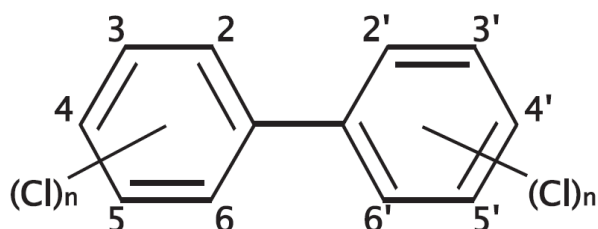


Figure 10. Structure chimique générale des polychlorobiphényles

Une combinaison unique de propriétés, incluant une faible conductance électrique, une stabilité thermique et une faible réactivité, a favorisé l'utilisation généralisée des PCBs dans les produits industriels et commerciaux tels que les lubrifiants, les produits d'étanchéité liquides, les ignifuges et les isolateurs électriques (Manzetti et al., 2014). En effet, ces produits ont été largement produits et utilisés jusqu'à leur interdiction par le congrès des États-Unis en 1979 et par la Convention de Stockholm sur les polluants organiques persistants en 2001 vu leur persistance énorme et leurs effets toxiques avérés (Porta and Zumeta, 2002).

Les PCBs se présentent généralement sous forme d'un liquide huileux dont leur viscosité et leur teinte s'intensifient avec leur degré de chloration. Leur hydrophobicité et leur lipophilie les rendent mal absorbés par les plantes, mais susceptibles d'être bio-accumulés chez les animaux, principalement dans le tissu adipeux et le lait maternel. En fonction du nombre de chlore et de sa position, les congénères des PCBs diffèrent par leurs propriétés chimiques, physiques et toxicologiques. En effet, la substitution du chlore stabilise davantage la structure aromatique par déplacement d'électrons et une augmentation de l'état d'oxydation. En règle générale, plus la molécule est chlorée, moins soluble dans l'eau et plus volatile elle est, ce qui contribue à l'augmentation de sa stabilité. En outre, le coefficient de partage octanol-eau ($\log K_{ow}$) permet de prédire la mobilité des PCBs dans l'environnement, c'est-à-dire que les PCBs à haute teneur en chlore ($\log K_{ow} > 6$) sont associés à des particules dans l'atmosphère, ces PCBs sont caractérisés par une solubilité croissante dans les lipides et les solvants organiques qui contribue à un haut potentiel de bioaccumulation dans la chaîne alimentaire. En conséquence, les sols

contiennent généralement une proportion plus élevée de congénères à nombre de chlore élevés, tandis que l'air est dominé par des PCBs ayant des fractions faiblement chlorées (Passatore et al., 2014). De même, les propriétés chimiques de ces composés varient en fonction de leur degré de chloration : les mélanges à faible chloration sont fluides et incolores, alors que ceux à forte chloration sont plus visqueux (Péan, 2012).

3.4.1.b. Origine et utilisation des PCBs

Les PCBs sont des molécules d'origine exclusivement anthropique. Ces molécules ont été synthétisées pour la première fois en 1881, et produites industriellement à partir de 1929 par la société MONSANTO. La synthèse commerciale des PCBs a été principalement obtenue en faisant réagir du biphenyle avec du chlore anhydre catalysé par des limes de fer ou de l'hydroxyde ferrique. Cette synthèse aboutit à la formation de mélanges techniques de PCB dont le degré moyen de chloration dépend de la durée de la réaction (Chatel et al., 2017). La réaction de synthèse est illustrée par la figure 11.

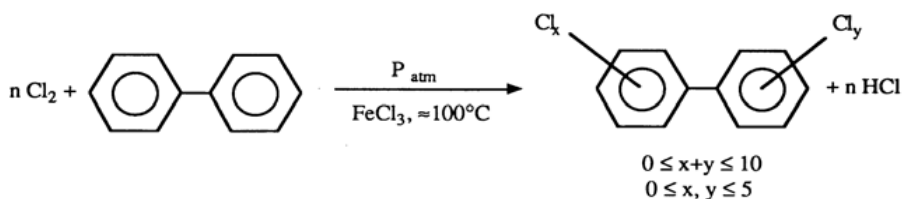


Figure 11. Réaction de synthèse des PCBs

Les PCBs ont été synthétisés pour leur application industrielle et trois types principaux d'utilisation de ces composés existent selon leur impact sur l'environnement. On distingue alors les usages dans des milieux ouverts dits « dispersifs », dans des milieux semi-ouverts et finalement dans des milieux clos (Cornu, 2012).

Utilisation en systèmes ouverts non contrôlables (dispersifs) :

Les PCBs sont en contact direct avec l'environnement, leurs principales utilisations sont en tant que fluides industriels hydrauliques et lubrifiants, additifs dans les formulations d'insecticides et de bactéricides, ainsi que comme des additifs stabilisants ou ignifugeants dans les peintures, les encres et les plastiques.

Utilisation en systèmes clos non contrôlables (semi-ouvert) :

Les PCBs sont dans un système clos, mais il existe un risque d'écoulement dans l'environnement, et ils sont difficilement récupérables pour un retraitement et se trouvent alors dispersés. Leurs principales utilisations sont comme des fluides diélectriques dans les transformateurs et condensateurs de petite taille ainsi que des fluides caloporteurs dans certaines installations thermiques.

Utilisation en systèmes clos contrôlables :

Les PCBs sont en systèmes clos, ils ne risquent pas de s'écouler dans l'environnement et sont récupérables pour un retraitement après utilisation. Leur principal usage étant dans ce cas comme fluides diélectriques dans les transformateurs et condensateurs de grande taille.

3.4.1.c. Devenir des PCBs dans l'atmosphère

Les PCBs sont très répandus dans la nature. Ainsi, ils se trouvent dans l'air, l'eau, le sol et les sédiments. Leur persistance dans l'environnement due à leur temps de demie vie élevée associé à leur caractère lipophile et leur volatilité élevée, permet leur transport sur de longues distances. De ce fait, ces produits peuvent être détectés à des centaines de kilomètres loin de leurs compartiments d'utilisation ou de production. Les PCBs sont donc présents dans tous les compartiments de la biosphère, et une grande partie des êtres vivants y sont exposés. En effet, les PCBs les moins chlorés se retrouvent dans l'air par volatilisation alors que les PCBs à un taux élevé de chlore se trouvent en phase particulaire en se liant à des particules en suspension. Les émissions des PCBs dans l'air peuvent être d'origine primaire ou d'origine secondaire. L'origine primaire est le rejet atmosphérique de l'industrie, les incinérations des déchets industriels et les déchets d'ordures ménagères. L'origine secondaire des PCBs dans l'atmosphère provient de leur évaporation des sols contaminés. La majeure quantité des PCBs se trouve dans les sols et les sédiments, du fait de leur capacité à s'adsorber sur la matrice solide des sols, des sédiments et des matières en suspension dans l'eau (Chahal, 2013). En fait, la contamination des sols et des sédiments par ce type de polluants provient principalement de l'eau qui en est contaminée suite au rejet des transformateurs et des stations d'épuration dans les cours d'eau. Vu l'hydrophobicité des PCBs, ils ont tendance à s'adsorber sur les particules solides et sédimenter (Chahal, 2013; Martinez et al., 2015; Lu et al., 2016). L'accumulation et la présence des PCBs dans les sédiments et le sol sont représentées dans la figure 12.

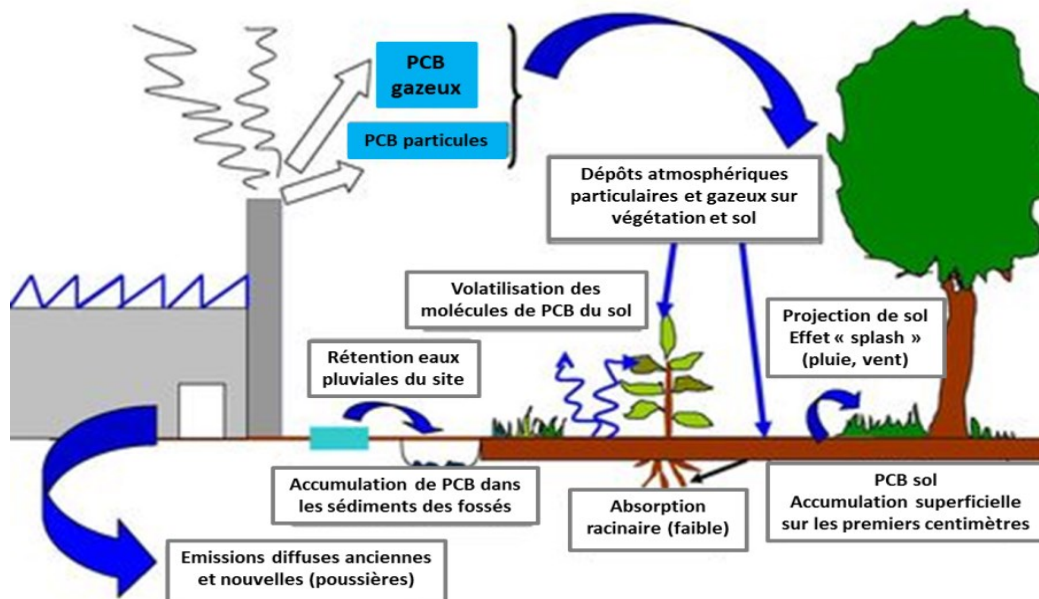


Figure 12. Accumulation des PCBs dans les sols et les sédiments (d'après T.E.V. d'Anjou, 2012)

Au cours de leurs transferts dans l'environnement, les PCBs sont sujets à des processus de dégradation tels que la photolyse et la biodégradation. En effet, la photolyse s'effectuant dans l'eau et l'air provoque une déchloration des atomes en position ortho qui entraîne une concentration des congénères non-ortho-substitués. Alors que, la biodégradation s'effectuant dans le sol et les sédiments est principalement effectuée par les microorganismes (Sinkkonen and Paasivirta, 2000).

3.4.1.d. Expositions humaines aux PCBs

L'exposition humaine aux PCBs peut être professionnelle, accidentelle ou quotidienne. En effet, l'exposition professionnelle ne touche qu'une tranche restreinte de la population, et l'exposition accidentelle se produit rarement. Cependant, l'exposition humaine quotidienne est, dans 90% des cas, due à des aliments contaminés d'origine animale, en particulier le poisson et les produits laitiers conduisant à une estimation de l'exposition humaine aux PCBs chez l'adulte est de 2 à 6 $\text{ng kg}^{-1} \cdot \text{jour}^{-1}$ par voie alimentaire (Abella et al., 2016). En effet, l'homme est le maillon final de la chaîne trophique et donc il est quotidiennement et particulièrement exposé aux produits contaminés qu'il consomme.

En outre, les congénères de PCBs les plus légers peuvent être volatils et inhalés. L'efficacité inadéquate pour l'incinération de déchets solides municipaux (MSW), comme la combustion incomplète des déchets, constitue également une source bien connue de PCBs pouvant être inhalé par l'homme (Pirard et al., 2005).

Bien que la plupart des PCBs ne présentent pas de toxicité aiguë, leur inertie chimique, leur remarquable stabilité et leur caractère lipophile, qui déterminent leur tendance à se bio-accumuler dans les tissus riches en lipides, les rendent principalement responsables des effets toxiques chroniques. Les PCBs sont associés à un certain nombre d'effets indésirables, tels que les effets sur le foie, la thyroïde, la fonction immunitaire et le comportement, ainsi que sur la fonction de reproduction. L'agence internationale de recherche sur le cancer (IRAC) a classé les PCBs comme cancérigènes pour l'homme (Mihats et al., 2015).

3.4.2. Les pesticides organochlorés (OCPs)

3.4.2.a. Généralités

Les pesticides organochlorés sont des composés organiques, obtenus par la chloration de différents hydrocarbures insaturés. Les OCPs ont été principalement utilisés entre les années 1940 et 1980 dans l'agriculture et dans la lutte contre les insectes envahissants et vecteurs de maladies (moustiques) (Rani et al., 2017).

Les propriétés physico-chimiques des OCPs vérifient leur classification parmi les POPs. En effet, les OCPs se présentent généralement sous forme de poudres ou cristaux blancs, jaunâtres ou incolores. Ils sont généralement très odorants avec une odeur aromatique. Ce sont des produits apolaires donc très solubles dans les solvants organiques et les lipides et très peu solubles dans l'eau. Ainsi, ces produits présentent une habilité à une bio-accumulation élevée dans les organismes vivants et au transfert dans les chaînes trophiques par voie alimentaire.

En outre, ces composés sont relativement stables à la lumière, à l'air et aux acides. En milieu alcalin, ils subissent une déchloration; ils sont très stables dans l'eau, les sols et les aliments. Cette stabilité aboutit à une persistance énorme de ces produits dans les milieux naturels où ils sont omniprésents comme ils sont dispersés par l'air, l'eau et les animaux migrateurs. En plus, la semi-volatilité des pesticides organochlorés leur confère un potentiel de mobilité qui leur permet d'atteindre de grandes concentrations dans l'atmosphère et d'être transportés sur de longues distances, avant de se condenser et se déposer dans d'autres régions (Ali et al., 2014).

Les OCPs peuvent agir selon plusieurs modes d'action ainsi on distingue : les produits actifs sur le système nerveux en perturbant la transmission du message nerveux, les produits actifs sur la synthèse de la chitine, les produits actifs aux niveaux des chaînes de transport d'électrons ou au niveau de la glycolyse et les stérilisants.

3.4.2.b. Devenir des OCPs dans l'atmosphère

Comme tous les autres polluants organiques et surtout les pesticides, les OCPs peuvent se propager dans l'environnement et contaminer différentes matrices. Des échanges sol-air, air-eau régissent cette distribution des OCPs dans tous les compartiments environnementaux (Jantunen

et al., 2008; Bidleman et al., 2012). En effet, la présence des OCPs dans l'air est due aux émissions des pesticides suite au traitement des cultures et des insectes nuisibles. Les résidus d'OCPs dans le sol, provenant du traitement des cultures avec des solutions, des poudres ou des suspensions, de l'introduction dans le sol avec les semences traitées ou bien de l'incorporation directe dans le sol, peuvent se redistribuer par évaporation des zones agricoles et urbaines contaminant alors l'atmosphère. Les OCPs peuvent alors se redistribuer par évaporation. Celle-ci dépend de plusieurs facteurs tels que, la modification de la température atmosphérique, la fréquence de labour des champs et le vent. Une fois dans l'air, les OCPs peuvent être dégradés, redistribués, transportés et retournés sous forme de précipités sur le sol ou dans les eaux de surface.

En outre, Les OCPs peuvent pénétrer dans le milieu aquatique à travers différentes voies, telles que les rejets industriels, le ruissellement des terres agricoles et les dépôts (secs ou humides). Compte tenu de leur caractère lipophile relativement élevé et leur faible solubilité dans l'eau ($\log K_{o/w}$ élevé), ces composés peuvent être facilement adsorbés sur les particules en suspension ou de sédiments. Dans des conditions favorables telles que les turbulences dues au mouvement de navires ou par inondation, les sédiments peuvent être remis en suspension, remettre les OCPs adsorbés précédemment dans la phase aqueuse et réinitialiser un autre cycle de contamination environnementale (Zhou et al., 2014). Autrement, lorsque les OCPs pénètrent dans l'eau, ils peuvent être transférés dans la chaîne alimentaire en s'accumulant dans les organismes aquatiques et par suite atteindre l'homme par consommation des aliments et de l'eau contaminés (Zhou et al., 2008).

Malgré leur persistance élevée, les OCPs sont soumis aux décompositions biologiques par différents biotes comme les bactéries, les champignons, les actinomycètes, les algues, les protozoaires et les acariens, ainsi qu'aux décompositions chimiques assurées par de nombreux facteurs tels que la température, l'humidité, l'acidité et le pH.

3.4.2.c. Expositions humaines aux OCPs

Comme pour les autres polluants, l'exposition humaine aux OCPs est essentiellement due à l'alimentation. Cependant, le caractère lipophile de ces pesticides ainsi que leur persistance dans les organismes aquatiques rendent ces derniers comme source majeure de la contamination humaine en OCPs. En général, l'apport quotidien représente la plus grande source d'exposition. Il a été estimé que plus de 90% de la charge corporelle en DDT dans la population générale provient des aliments, en particulier des aliments gras d'origine animale tels que la viande, les poissons et les produits laitiers (Wang et al., 2013a; Pan et al., 2016). D'autres voies d'exposition peuvent avoir lieu en particulier chez les fermiers ou des intoxications par contact ou par inhalation peuvent également avoir lieu.

L'exposition humaine aux OCPs montre de nombreux effets néfastes à sa santé. Il est bien établi que les OCPs peuvent s'accumuler dans le tissu adipeux humain et causer une toxicité chronique après une exposition prolongée, même si l'exposition est à une dose relativement faible. Les

OCPs sont largement connus pour être des perturbateurs endocriniens (Fernández et al., 2004). Ils peuvent, par ailleurs, évoquer des réponses œstrogéniques interférant avec les voies contrôlées par les œstrogènes et également modifier le développement des systèmes endocriniens (Qu et al., 2010). En outre, ces pesticides peuvent être responsables de nombreux troubles neurologiques tels que les maladies neurodégénératives ainsi que le dysfonctionnement neurocomportemental. De plus, l'exposition chronique à ces produits peut induire l'apparition des cancers, des troubles de la reproduction, des problèmes respiratoires, ainsi que diverses affections humaines graves comme l'hypertension et des maladies du foie (Qu et al., 2010; Mumtaz et al., 2015).

4. Echantillonnage et Détection

4.1. Techniques d'Echantillonnage

Les polluants atmosphériques doivent être surveillés afin d'évaluer leur impact potentiel sur l'environnement et sur l'Homme. Deux techniques principales d'échantillonnage ont été couramment utilisées permettant une évaluation qualitative et quantitative précise de la pollution de l'environnement. Les échantillonneurs ont été développés principalement à partir des techniques d'échantillonnage d'air actif (AAS) ou d'échantillonnage d'air passif (PAS) (Wang et al., 2016a).

4.1.1. Echantillonnage actif

L'échantillonnage actif est la méthode de référence depuis de nombreuses années. Ce procédé utilise une pompe fonctionnant à un débit bien défini pour aspirer les polluants de l'air à travers un filtre (pour piéger les composés liés à des particules) et / ou un lit adsorbant (pour piéger les composés en phase gazeuse) (Tuduri et al., 2012). Ces capteurs sont utilisés aussi bien pour les mesures de gaz que pour les particules, ils permettent un échantillonnage à grand volume sur un court laps de temps (Wang et al., 2016a). Suivant le débit du volume à aspirer, les échantillonneurs actifs sont classés en échantillonneurs à volume élevé, conçu pour un échantillonnage extérieur, et en échantillonneurs à volume moyen et faible qui sont plus adaptés à l'air intérieur (Batterman et al., 2009; Lazarov et al., 2015). Les figures 13 et 14 montrent respectivement les schémas d'un échantillonneur actif d'air à faible volume et celui d'un échantillonneur actif d'air à volume élevé.

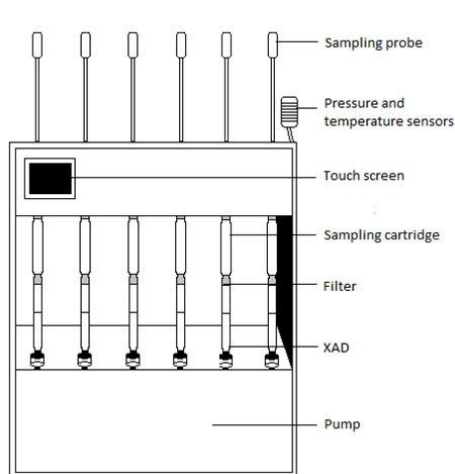


Figure 13. Schéma d'un échantillonneur actif d'air à faible volume conçu pour l'échantillonnage intérieur (d'après MonAirNet, 2007)

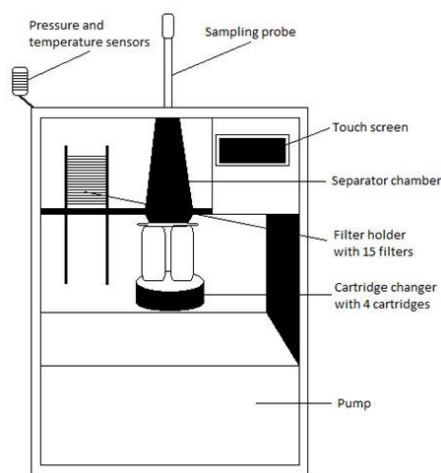


Figure 14. Schéma d'un échantillonneur actif d'air à volume élevé conçu pour l'échantillonnage extérieur (d'après MonAirNet, 2007)

Ce système de prélèvement a été utilisé avec succès pour l'analyse de différents type de polluants organiques comme des pesticides (Sanusi et al., 2000; Schummer et al., 2010), des HAPs (Morville et al., 2004; Melymuk et al., 2015), et des PCBs (Yeo et al., 2003; Milun et al., 2016). En plus, l'échantillonnage actif à l'aide de pompes s'est révélé très utile pour l'étude de l'évolution des polluants dans l'atmosphère (Foreman and Bidleman, 1987). En effet, ce type de méthode d'échantillonnage actif fournit des données fiables en termes de précision et permet d'une part de traiter les données avec un pas horaire ou journalier et d'autre part d'établir d'une manière quasi instantanée le degré de pollution, ce qui les rend utiles notamment dans les grandes agglomérations où les capteurs actifs sont largement utilisés. Néanmoins, ces systèmes souffrent de nombreux inconvénients : ils sont volumineux, lourds, longs et coûteux et nécessitent une alimentation électrique. Par conséquent, le site d'échantillonnage devrait être choisi en fonction de la disponibilité de l'énergie électrique et de l'applicabilité d'un dispositif volumineux plutôt que de la définition du lieu d'échantillonnage (Kot et al., 2000; Wang et al., 2009).

Par ailleurs, les pompes d'échantillonnage d'air coûteuses, les programmes d'étalonnages fréquents ainsi que les matériaux potentiellement toxiques requis par l'adsorption chimique ont été suffisants pour stimuler le développement de nouveaux systèmes d'échantillonnages moins coûteux ce qui conduit au développement des techniques d'échantillonnages passifs (Harner et al., 2006a). En outre, depuis l'entrée en force de la convention de Stockholm le 17 mai 2004, toutes les parties ont présenté des plans nationaux en décrivant les mesures prévues ou prises pour mettre en œuvre les dispositions de la Convention de Stockholm et leur efficacité (POPRC.12, 2016; Wöhrnschimmel et al., 2016). Cela a impliqué alors la nécessité de nombreux échantillonnages dans de nombreux sites, ce qui n'était pas approprié par «échantillonnage actif», d'où le développement de «l'échantillonnage passif».

4.1.2. Echantillonnage passif

Depuis son invention, il y a plus de trois décennies, la technologie de l'échantillonnage passif a été largement utilisée pour la surveillance de l'environnement dans le monde entier. Les échantillonneurs d'air passifs fonctionnent sans l'aide d'une pompe et sont constitués d'un adsorbant avec une capacité de rétention élevée pour les composés cibles (Hazrati and Harrad, 2007).

L'échantillonnage passif a été défini par Górecki et Namieśnik en 2002 comme une technique d'échantillonnage basée sur la libre circulation des molécules d'analyte du milieu échantillonné à un milieu de collecte à la suite d'une différence de potentiels chimiques. Une fois les échantillonneurs exposés au milieu considéré, ils collectent des molécules d'analyte arrivant au milieu collecteur par diffusion à travers une couche statique du milieu examiné contenu dans une ou des ouvertures bien définies de l'échantillonneur, ou par infiltration à travers une membrane non poreuse (Górecki and Namieśnik, 2002). Les échantillonneurs passifs ont été utilisés pour la première fois en 1927 (Gordon and Lowe, 1927) pour l'analyse semi quantitative du monoxyde de carbone et subissent dès lors un développement continu permettant l'analyse d'un grand nombre de molécules. Plusieurs dispositifs d'échantillonneurs passifs ont été alors développés. Les plus connus sont : le dispositif à membrane semi-perméable (SPMD), la fibre de microextraction en phase solide (SPME), le disque de mousse de polyuréthane (PUF) utilisé dans la sorption de matières organiques en phase gazeuse dans des échantillonneurs d'air à volume élevé, la résine XAD-2[®] ainsi que le polyéthylène (PE). Ces échantillonneurs consistent en une phase de sorption (adsorbant) avec un abri de protection utilisé pour minimiser les interférences physiques et microbiennes et / ou faciliter l'analyse instrumentale subséquente (Bao and Zeng, 2014).

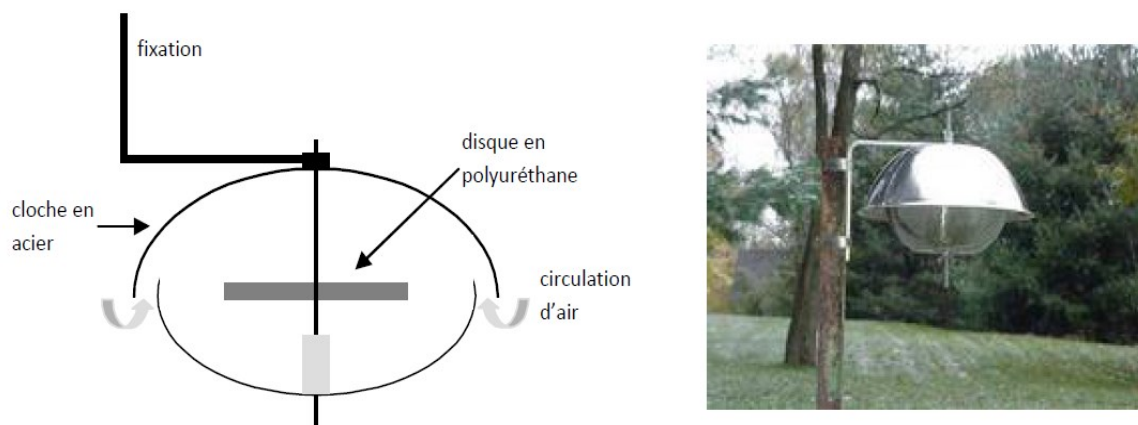


Figure 15. Schéma et photo d'un capteur passif de type PUF (« flying saucer design ») (d'après Harner et al., 2006b)

Ces différents types de capteurs passifs sont légers et peu encombrants. En effet, la technique d'échantillonnage passif est plus avantageuse que la méthode d'échantillonnage active en raison

de son faible coût, de ses faibles besoins d'entretien, de son fonctionnement sans surveillance et de son indépendance vis-à-vis des sources d'énergie. En outre, les échantillonneurs passifs permettent la surveillance de l'environnement sans pompage et donc sans bruits. En outre, ces techniques sont légères, compactes et faciles à manipuler, fournissant des données fiables générant ainsi de nouvelles opportunités de surveillance environnementale (Wania et al., 2003; Bao and Zeng, 2014; Maré et al., 2015).

Cependant, cette technique d'échantillonnage présente certains inconvénients comme l'incompatibilité pour la détermination des variations de polluants à court terme, la difficulté avec l'automatisation et la sensibilité aux conditions environnementales telles que les fluctuations de température, d'humidité et de vitesse de l'air (Maré et al., 2015). L'étalonnage de tels capteurs est également un défi puisque la détermination des taux d'échantillonnage des composés chimiques dans les milieux est difficile à évaluer avec précision. En effet, malgré les essais d'estimation des flux les traversant (Wania et al., 2003), il n'est toutefois pas encore possible d'estimer avec précision le volume d'air analysé. Les résultats fournis donc par ces capteurs doivent être considérés comme semi-quantitative et ces capteurs sont alors préférables dans le but d'avoir des renseignements sur la qualité de l'air au niveau de tous les sites et sur plusieurs endroits en parallèle.

Malgré les inconvénients de cette technique, l'utilisation des capteurs passifs pour qualifier les niveaux de pollution dans différents types de milieux (industriel, urbain et rural) est adaptée pour une étude sur de longues périodes d'échantillonnages.

Parmi les échantillonneurs passifs les plus disponibles et les plus utilisés, figure l'usage de certaines substances naturelles comme capteurs fiables de polluants émis dans l'atmosphère. Il s'agit effectivement de la technique dite de « biomonitoring » ou de « biosurveillance » environnementale.

4.1.3. Biomonitoring ou biosurveillance environnementale

Le biomonitoring environnemental ou la surveillance environnementale biologique, est généralement définie comme « l'utilisation systématique des organismes vivants ou de leurs réponses pour déterminer l'état et/ou les changements de l'environnement » (Yang et al., 2010). Le biomonitoring permet alors de concevoir l'état de l'environnement à l'aide des substances naturelles qualifiées de biomoniteurs ou biocapteurs. En effet, cette technique permet d'utiliser un échantillonnage à haute densité et à toutes les échelles spatiales et temporelles souhaitées à faible coût et permet en conséquence la mesure d'un large éventail de polluants. Ainsi, elle est devenue une technique compétitive, même remplaçante de certaines autres techniques d'échantillonnage.

Le biomonitoring consiste en l'utilisation d'organismes naturels comme échantillonneurs passifs en fournissant des informations sur la qualité de l'environnement. Les biomoniteurs qui sont des organismes vivants peuvent accumuler un ou plusieurs polluants dans leurs tissus. Ils agissent

comme un concentrateur d'analyte ou un échantillonneur qui, après la collecte, peut être analysé afin d'évaluer les concentrations de polluants qui y sont accumulés (Marc et al., 2015).

Le biomonitoring ou la biosurveillance environnementale peut être du type actif ou passif. Le type actif a recours à des espèces élevées dans des modalités normalisées puis qui sont importées sur le site d'étude pour une période limitée (plusieurs semaines), alors que le type passif quant à lui se sert des espèces qui sont présentes sur le site d'étude et permet alors l'étude des zones étendues et sur de longues durées.

5. Biomoniteurs :

Un biomoniteur ou un bio-indicateur de la pollution environnementale est une espèce animale ou végétale, qui du fait de sa particularité réagit à un polluant par une modification nette et spécifique de sa fonction vitale et forme donc l'indice précoce de modification dans la qualité de l'environnement. Les biomoniteurs peuvent donc donner des renseignements sur la qualité du milieu où ils se trouvent et peuvent donc être utilisés pour obtenir des informations sur les variations spatio-temporelles des concentrations des polluants bio-disponibles (Tlili, 2012).

En effet, un biomoniteur environnemental doit répondre à un certain nombre de critères (Wolterbeek, 2002; Wolterbeek and Bode, 1995; Berthet, 2008):

- avoir un pouvoir cumulatif,
- avoir une large distribution spatio-temporelle,
- avoir une sensibilité élevée aux différents types de contaminants,
- être sessile ou sédentaire,
- être émergent,
- ne doit pas figurer parmi les organismes en voie de disparition.

Les critères d'un biomoniteur « idéal » ont été reportés par Li et al en 2010. En effet, il doit être facilement reconnu, même par des non spécialistes, être largement répandu ou ayant une distribution cosmopolite, bien connu, abondant, adapté aux expériences de laboratoire, très sensible aux facteurs de stress environnementaux et possédant une grande capacité de quantification et de standardisation.

Selon la nature et l'état du milieu à étudier ainsi que selon leur disponibilité, différents types de biomoniteurs existent. Ses biomoniteurs sont capables d'évaluer qualitativement et quantitativement la présence de substances néfastes dans l'environnement.

5.1. Les végétaux

L'utilisation de la végétation pour la biosurveillance de la pollution environnementale est connue comme une matrice avantageuse pour l'estimation des polluants atmosphériques. En fait, la

végétation demeure la matrice la moins chère, la plus disponible et la plus simple permettant une surveillance atmosphérique fiable à long terme. Plusieurs études ont montré l'efficacité de cette matrice dans l'identification et la quantification des polluants chimiques dans l'atmosphère (Klánová et al., 2009; St-Amand et al., 2009 ; Ratola et al., 2010; Ratola et al., 2014). En effet, les végétaux permettent l'échantillonnage à la fois des polluants organiques atmosphériques en phase vapeur et en phase particulaire. Les molécules en phase vapeur étant généralement incorporées *via* les stomates tandis que les molécules en phase particulaire s'accumulent à la surface des aiguilles ou des feuilles (De Nicola et al., 2011). En plus, une relation entre les niveaux atmosphériques en polluants et ceux accumulés dans les plantes a pu être observée, permettant alors de démontrer que les polluants accumulés dans les feuilles sont représentatifs de la contamination atmosphérique (Zhu et al., 2008). Néanmoins, le passage d'une quantité de polluants dans le végétal (ng g^{-1}) et une concentration dans l'air reste difficile à établir (ng m^{-3}).

5.1.1. Les végétaux supérieurs: les conifères

Parmi les différentes espèces de végétation, les aiguilles de conifères jouent un rôle important en tant qu'échantillonneurs passifs. Les conifères sont classés parmi les espèces d'arbres à feuilles persistantes car les aiguilles sont habituellement conservées pendant au moins cinq ans, ce qui leur permet de fournir des informations sur les émissions de polluants sur de plus longues périodes (Eriksson et al., 1989; Dreyer et al., 2010). En plus, les conifères ont une répartition géographique étendue et peuvent donc être présents dans les zones rurales peu ou pas accessibles spécialement du point de vue énergétique et électrique limitant l'échantillonnage actif dans ces zones (Romanič and Krauthacker, 2007). En outre, les aiguilles de conifères en raison de leur teneur élevée en lipides, de leur couche cireuse spécifique leur permettant d'accumuler des polluants pendant plusieurs années, ainsi que de leur caractère permanent, forment des excellents biomoniteurs de la qualité de l'air (Ratola et al., 2014; Xu et al., 2004).

L'utilisation des aiguilles de conifères comme biomoniteurs passifs de la contamination environnementale s'est avérée efficace pour l'analyse d'un large éventail de polluants organiques tels que les pesticides (Ratola et al., 2014), les HAPs (De Nicola et al., 2016), les PCBs (Chropeňová et al., 2016), les PBDEs (Ratola et al., 2011), les produits perfluorés (Chropeňová et al., 2016), les métaux lourds (Pietrzykowski et al., 2014), ainsi que les dioxines et les furanes (Holt et al., 2016). En outre, plusieurs études ont montré qu'une seule aiguille de conifères peut accumuler une large gamme de polluants permettant une surveillance environnementale globale (Al Dine et al., 2015; Odabasi et al., 2016; Al-Alam et al., 2017). Ainsi, les aiguilles de pins ont prouvé leur efficacité en fournissant un échantillonneur passif à faible coût, efficace et utile pour le contrôle de polluants chimiques dans l'atmosphère.

5.1.2. Les végétaux cryptogamiques: les lichens et les mousses

En plus des conifères, les lichens et les mousses forment un autre groupe de végétaux largement utilisé dans les études de biomonitoring de la pollution environnementale. En effet, les bryophytes (les mousses) et les lichens sont des bio-organismes sensibles à la pollution de l'air et surtout aux métaux lourds et aux polluants organiques persistants. Plusieurs études ont montré l'efficacité de ces matrices dans la surveillance de la contamination environnementale en polluants organiques (Fernández et al., 2009; Giordano et al., 2010; Harmens et al., 2013). En fait, même si les lichens et les mousses sont des groupes absolument non apparentés d'organismes cryptogamiques, ils ont beaucoup de caractéristiques communes et les deux espèces, selon leur disponibilité, peuvent être utilisées pour un contrôle environnemental efficace.

Les lichens, symbioses de champignons et d'algues, sont des organismes ayant une vie longue et une croissance lente, très efficaces pour intercepter les polluants de l'atmosphère (Augusto et al., 2013). Ces organismes sont persistants, robustes et capables de vivre pendant de nombreuses années dans des conditions extrêmes allant de l'Himalaya glacé aux déserts, ce qui les rend aptes à la biosurveillance environnementale (Bergamaschi et al., 2004; Maphangwa et al., 2012). En plus, les lichens n'ont pas de racines et de cuticules, de sorte qu'ils ne sont exposés aux polluants que par dépôt atmosphérique. Leur diversité reflète la qualité de l'air : un air pur se traduit par une plus grande variété de lichens, faisant ainsi de cette matrice un bon indicateur de la qualité de l'air. En outre, les lichens sont caractérisés par une morphologie constante qui permet de les recueillir à n'importe quelle saison et ils peuvent être trouvés abondamment (Garty, 2001; Bargagli, 2016).

Les mousses ont été utilisées depuis les années 70 dans la biosurveillance environnementale des POPs, de traces de métaux et des excès d'azote (Ruhling and Tyler, 1968; Rühling and Tyler, 1970). Ces organismes sont considérés comme biomoniteurs potentiels pour les dépôts environnementaux, étant donné qu'ils tirent leurs nutriments de l'eau provenant principalement des précipitations (Lequy et al., 2016). Néanmoins, les mousses sont des organismes omniprésents et possèdent une structure leur permettant d'accumuler des polluants à grande concentration, ce qui les rend avantageux pour une surveillance à grande échelle temporelle et / ou spatiale (Harmens et al., 2012; González and Pokrovsky, 2014; Lazić et al., 2016). De plus, les mousses peuvent être simplement transplantées de sites non contaminés vers des sites pollués, dans de tels cas, ils sont maintenus dans des sacs et exposés au contaminant, ce qui permet la surveillance de ces zones (Wu et al., 2014; Marc et al., 2015).

Plusieurs études récentes ont montré que les lichens et les mousses sont principalement utilisés pour le biomonitoring de la pollution atmosphérique causée par les HAPs et les métaux lourds (Agnan et al., 2017; Francová et al., 2017; Shahid et al., 2017; Spagnuolo et al., 2017), alors que leur utilisation pour l'analyse des pesticides est presque limitée à l'étude des OCPs (Zhu et al., 2015).

5.2. Les abeilles et leurs produits

Les abeilles et les produits apicoles ont été largement utilisés en tant qu'indicateurs de la qualité de l'environnement. En effet, en transportant le pollen de fleurs en fleurs et de plantes en plantes, les abeilles jouent un rôle essentiel dans la biosurveillance environnementale (Paradis et al., 2014).

Les abeilles sont considérées comme d'efficaces sentinelles pour la biosurveillance environnementale. En fait, « *une espèce sentinelle est une espèce qui par sa présence ou son absence est capable de donner des informations sur toute sorte de dérèglement du milieu dans lequel elle se trouve* » (Lower and Kendall, 1990). Ces organismes sont caractérisés par un taux de reproduction élevé les rendant faciles à multiplier ainsi que par une régénération continue de la colonie due à leur durée de vie relativement courte. En outre, les abeilles ont une mobilité élevée couvrant une large surface de vol, ce qui les rend aptes à une vaste zone de surveillance. En effet, les abeilles volent jusqu'à 4 km dans toutes les directions depuis leur rucher et ont ainsi accès à une zone d'environ 50 km² leur permettant de détecter différents types de polluants dans leur environnement ambiant. De plus, ces petits organismes, ayant un corps poilu susceptible d'accumuler toute sorte de polluants et de les ramener à la ruche, sont très sensibles à la majorité des pesticides et des polluants chimiques avec lesquels ils entrent en contact durant leur recherche de nourriture (Kujawski and Namieśnik, 2011; Wiest et al., 2011; Badiou-Bénéteau et al., 2013; Malhat et al., 2015).

La contamination des abeilles et de leurs produits par les polluants environnementaux spécialement les pesticides peut se produire soit directement suite aux différentes pratiques apicoles et agricoles soit indirectement à partir de plusieurs sources environnementales. En fait, les abeilles domestiques recherchent des aliments sur une large surface leur permettant d'être en contact avec plusieurs sites contaminés tels que le pollen, le nectar, les plantes et l'eau (Raeymaekers, 2006; Kujawski et al., 2014).

Comme cité, les produits apicoles se sont avérés très efficaces pour la biosurveillance. Tout d'abord, le pollen est facile à recueillir et fréquemment contaminé spécialement avec des pesticides, ce qui le rend parfait pour évaluer la présence de contaminants environnementaux (Chauzat et al., 2011). Une étude récente menée par De Olivera et al., en 2016 a montré que le pollen des abeilles peut fournir une indication utile des pesticides utilisés dans l'environnement (de Oliveira et al., 2016).

Deuxièmement, l'étude de la contamination organique du miel semble être très importante pour l'établissement à la fois d'une surveillance environnementale et alimentaire. En effet, en tant que premier produit majeur des abeilles, le miel est largement surveillé dans le monde entier pour sa contamination (Chiesa et al., 2016; Tette et al., 2016). En plus, ce produit est bien connu dans la médecine traditionnelle pour ses propriétés curatives, ses actions antimicrobiennes, antioxydantes et anti-inflammatoires, antidiabétiques et anticancéreuses (Can et al., 2015; Rao et al., 2016). Par conséquent, l'analyse du miel, connu pour toutes ces propriétés, sa grande

consommation et ses propriétés de biosurveillance environnementale, semble être un élément clé pour une surveillance environnementale et nutraceutique.

L'utilisation des abeilles et des produits apicoles (pollen et miel) comme bio-indicateurs de la contamination de l'environnement a donc été très importante ces dernières années et plusieurs études ont montré l'efficacité de ces trois matrices dans la biosurveillance environnementale (Chiesa et al., 2016; Codling et al., 2016; de Oliveira et al., 2016; Herrera López et al., 2016; Matin et al., 2016). En fait, l'analyse des abeilles et de leurs produits semble être urgente pour les apiculteurs afin de choisir une zone pour la production spécifique de miel biologique, étant donné que cette dernière pourrait être affectée par différents types de contamination et particulièrement ceux qui sont persistants (POPs) (Chiesa et al., 2016). De plus, la plupart des études dans ce domaine se base sur l'analyse multi-résidus de polluants validant le fait que les abeilles, au cours de leurs activités de butinage, sont soumises à un large éventail de contaminants et servent alors comme excellents agents de biomonitoring (Malhat et al., 2015; Chiesa et al., 2016; Kiljanek et al., 2016; Shendy et al., 2016; Tette et al., 2016). Par ailleurs, comme le montre García-Valcárcel et al., en 2016, l'utilisation des abeilles et de leurs produits comme des sentinelles de la pollution environnementale est spécialement dédiée à l'analyse de résidus de pesticides (García-Valcárcel et al., 2016).

5.3. Les mollusques : les escargots

Les organismes de filtrage, tels que les mollusques, sont utilisés dans les programmes de surveillance comme indicateurs biologiques de la pollution en raison de leur capacité à accumuler des concentrations élevées de contaminants organiques. En fait, l'utilisation des escargots comme sentinelles de la contamination environnementale est efficace en raison de leur large distribution, de leur facilité d'échantillonnage et de leur capacité à accumuler divers polluants (Laskowski and Hopkin, 1996; Beeby and Richmond, 2002; Berlioz-Barbier et al., 2014). En effet, les mollusques sont caractérisés par leur capacité à accumuler et à amplifier divers composés chimiques dans leurs tissus mous et à les incorporer dans leurs coquilles. Ces organismes sont très sensibles aux changements même minimes dans leur alimentation (sol-air-eau) du fait de leur métabolisme rapide (Kowalczyk-Pecka et al., 2017a).

En outre, les escargots vivent à l'interface sol-plante-air, puis intègrent différentes sources et voies de contamination (De Vaufleury et al., 2006; Pauget et al., 2013). L'exposition des escargots aux contaminants du sol, comme illustré par De Vaufleury et al., 2012 est représentée dans la figure 16.

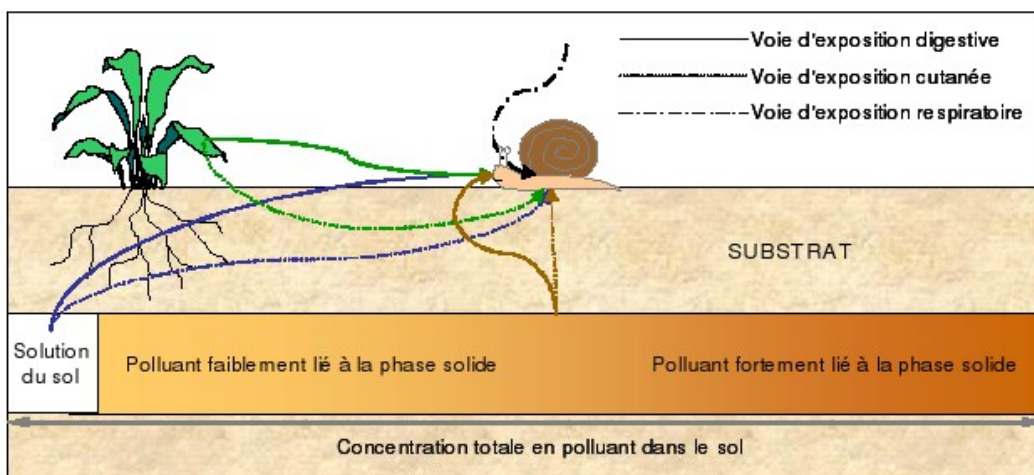


Figure 16. Exposition des escargots aux polluants dans l'écosystème terrestre (d'après De Vaufleury et al., 2012)

Les processus de bioaccumulation et de détoxification, qui progressent dans un temps relativement court chez les mollusques, induisent des changements dans les fonctions physiologiques de leurs organes et tissus (Kowalczyk-Pecka et al., 2017b). Comme le montre la figure 16, les escargots absorbent très facilement les substances chimiques présentes dans l'environnement et en quelques minutes, les composants actifs des substances prises avec de la nourriture et/ou à travers la peau, atteignent l'hémolymphe et sont distribués dans tous les tissus de l'animal, le rendant ainsi comme une excellente sentinelle de biomonitoring de la pollution environnementale.

Bien que certaines études ont montré la capacité de ces organismes à accumuler différentes sources de polluants comme les pesticides (Zawisza-Raszka et al., 2010), les HAPs (Janistcki et al., 2009), les PCBs et les PBDEs (Fu et al., 2011), l'extraction et l'analyse de tels polluants de ces matrices est encore limitée et la plupart des travaux se focalisent sur l'analyse des métaux. La biosurveillance des métaux à l'aide de différentes espèces d'escargots est bien connue dans la littérature (Emilia et al., 2016; Mleiki et al., 2016; Proum et al., 2016).

Ces espèces de gastéropodes pulmonaires vivent en contact et se déplacent sur le sol, mangent des plantes et des déchets et utilisent le sol pour la ponte, le développement embryonnaire, l'abri et l'hibernation et en conséquence leur contamination chimique reflète principalement la biodisponibilité des polluants spécialement des métaux dans le sol et les plantes, et indirectement la charge de ces polluants dans les dépôts atmosphériques. Ainsi, pour surveiller les dépôts de métaux en milieu urbain, il serait préférable d'exposer les escargots terrestres dans des cages en plastique, sorte de « microcosmes » sans contact avec le sol, ce qui permet une étude plus précise de la qualité de l'air dans les zones étudiées (Regoli et al., 2006; Boshoff et al., 2015; Emilia et al., 2016).

6. Analyse des polluants organiques à partir des matrices naturelles

L'analyse des polluants requiert leur extraction à partir des matrices dans lesquelles ils ont été piégés, suivie de leur séparation chromatographique en fonction de leurs propriétés et finalement de leur détection par des outils spectrométriques.

6.1. Méthodes d'extraction des polluants des matrices solides

L'émergence des polluants organiques dans l'environnement ainsi que les effets néfastes qu'ils engendrent, rendent leur recherche inévitable. Pour cela, des techniques d'extraction efficaces, sélectives et sensibles doivent être utilisées préalablement à l'analyse chromatographique. En fait, les extractions des composés organiques à partir des matrices solides sont basées sur la répartition de ces composés entre la phase liquide et la matrice solide qui se produit lorsque les analytes passent de la matrice de l'échantillon vers le solvant sélectionné.

6.1.1. Extraction « Soxhlet »

Le soxhlet est un dispositif qui permet l'extraction des substances chimiques à partir d'une matrice solide. L'extraction par soxhlet a été développée en 1879 par von Soxhlet et a été, pendant longtemps, la technique de lixiviation la plus largement utilisée. Elle constitue l'une des techniques les plus anciennes pour l'extraction à partir des matrices solides (Soxhlet, 1879). Cette méthode permet le traitement des matrices solides avec des solvants liquides. En effet, la matrice est introduite dans une cartouche de cellulose fixée sur un réservoir de solvant surmonté d'un réfrigérant. Le principe de ce type d'extraction repose sur le chauffage d'une quantité de solvant dans un ballon installé sous l'instrument qui va se vaporiser sous l'effet de la température. La vapeur obtenue va monter jusqu'au système de refroidissement, où elle se condense et retombe dans la partie qui renferme la résine. Le solvant va régulièrement s'accumuler dans cette partie, puis par un système de siphon, va retourner dans le ballon amenant avec lui les substances extraites. La figure 17 montre un extracteur du type soxhlet.

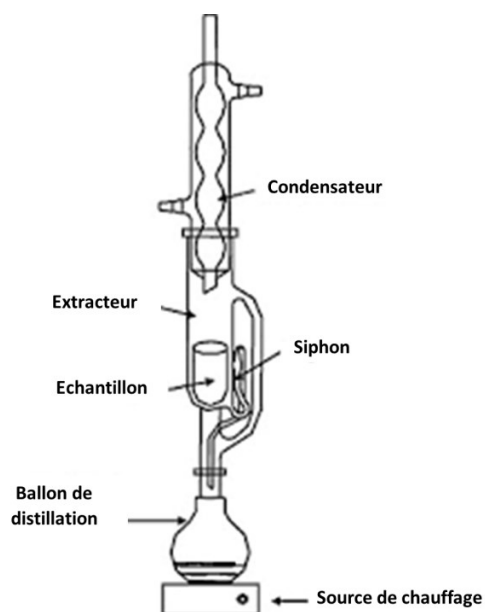


Figure 17. Schéma d'un soxhlet (d'après Luque de Castro and Priego-Capote, 2010)

L'extraction par soxhlet présente de nombreux avantages comme le déplacement de l'équilibre de transfert dû au contact répété entre l'échantillon et les portions fraîches de solvant. Cette méthode indépendante de la matrice et des étapes de filtrations n'est nécessaire après l'étape de lixiviation. En outre, le débit d'échantillon peut être augmenté par extraction simultanée en parallèle, puisque l'équipement de base est peu coûteux. De plus, c'est une méthode très simple qui nécessite peu de formation spécialisée et qui permet l'extraction de grandes masses d'échantillon (Luque de Castro and García-Ayuso, 1998; Luque de Castro and Priego-Capote, 2010; Chen and Urban, 2015). Cependant, ces avantages sont confrontés à de nombreux inconvénients particulièrement la longue durée de manipulation, la quantité énorme de solvants requis, ainsi que la grande quantité des déchets élaborés qui sont non seulement coûteux à éliminer, mais peuvent conduire à plusieurs problèmes environnementaux. En plus, les échantillons sont habituellement extraits au point d'ébullition du solvant (T° élevée) pendant de longues périodes, ce qui peut conduire à la décomposition thermique d'espèces chimiques thermolabiles (Pedersen and Olsson, 2003). Vu les inconvénients de cette méthode, d'autres plus récentes et avantageuses ont été développées et ont tendance à une réduction du volume du solvant utilisé, à une simplification du temps de préparation et d'extraction des échantillons, à une automatisation possible avec une facilité à l'application à de nombreuses matrices, tout en étant robuste, fiable, sélective et ayant un rendement élevé et à faible coût (Frenich et al., 2005). Parmi ces méthodes, figure l'extraction accélérée par solvant (ASE), l'extraction en phase solide (SPE), la microextraction sur phase solide (SPME) et la méthode QuEChERS.

6.1.2. Extraction accélérée par solvant (*Accelerated Solvent Extraction, ASE*)

L'extraction accélérée par solvant (ASE) est une technique qui permet les extractions des composés organiques à l'aide de solvants à des températures et pressions élevées. Différents noms ont été attribués à cette technique, comme l'extraction par fluides sous pression (PFE), l'extraction par liquides sous pression (PLE), l'extraction par solvants sous pression (PSE), l'extraction par solvants sous haute pression (HPSE), l'extraction par solvants à chaud sous pression (PHSE), l'extraction par solvants à haute pression à haute température (HPHTSE), l'extraction par eau chaude sous pression (PHWE) et l'extraction par solvants supercritiques sous-critiques (SSE) (Sun et al., 2012; Zuloaga et al., 2012).

Cette technique permet l'extraction des contaminants à partir d'une matrice solide par un solvant qui est porté à haute température sous pression de façon à rester liquide. En effet, l'utilisation des températures élevées diminue la tension superficielle des solvants ainsi que leur viscosité, ce qui aide à atteindre facilement les surfaces des matrices, tandis que la haute pression accroît le maintien des solvants à l'état liquide même à des températures plus élevées. Dans ce processus, les analytes seront solubilisés et désorbés d'une façon plus facile, plus rapide, avec une moindre quantité de solvants et en obtenant un extrait plus concentré en comparaison avec l'extraction au Soxhlet (Subedi, 2012). Le temps d'extraction est indépendant de la matrice et l'efficacité de l'extraction dépend plutôt de la température et de la nature du solvant utilisé. La figure 18 schématise ce type d'extraction.

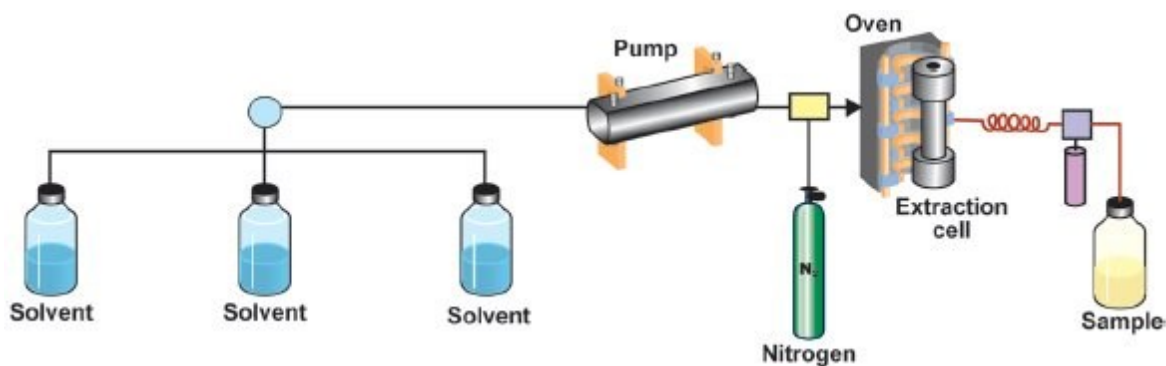


Figure 18. Représentation schématique d'une extraction ASE (d'après Dorich et al., 2008)

L'extraction accélérée par solvant se fait généralement par une alternance de 2 modes statique et dynamique selon les étapes suivantes (Björklund et al., 2000):

- 1- chargement de l'échantillon dans la cellule d'extraction,
- 2- remplissage de la cellule avec le ou les solvant (s) d'extraction,
- 3- chauffage et pressurisation de la cellule,
- 4- extraction statique de l'échantillon,

5- transfert du solvant vers le flacon de récupération et renouvellement du solvant au contact de l'échantillon,

6- purge des résidus de solvants dans l'échantillon vers le flacon de récupération par un gaz adéquat tel que l'azote.

Cette méthode présente de nombreux avantages comme la bonne récupération, la rapidité, la précision ainsi que la diminution de l'utilisation de solvants en comparaison avec l'extraction par soxhlet. En outre, l'ASE est une technique entièrement automatisée, ce qui la rend parfaitement utile pour l'analyse de routine des polluants environnementaux. Néanmoins, ce procédé présente également certains inconvénients, tels que le coût élevé de l'équipement, le volume du solvant utilisé pour le rinçage et la préparation des cellules avant l'extraction ainsi que les étapes supplémentaires de nettoyage et de concentration des analytes extraits avant leurs analyses en raison de la faible sélectivité de cette méthode. De plus, la température élevée utilisée peut conduire à la décomposition d'autres analytes d'intérêts mais thermiquement instables (Carabias-Martínez et al., 2005; Haglund and Spinnel, 2010; Sun et al., 2012). Cette méthode, malgré sa simplicité, nécessite certaines précautions d'emploi, tel que le remplissage du volume mort des cellules, par une matrice inerte par rapport aux composés ciblés comme les billes de verres et le sable de Fontainebleu. Ce volume mort est en effet obtenu suite au remplissage des cellules par l'échantillon à analyser.

Plusieurs études ont montré l'efficacité et l'applicabilité de l'extraction ASE pour la détermination de polluants environnementaux tels que les pesticides, les HAPs, les PCBs, les OCPs et les métaux de plusieurs matrices comme les aliments, les légumes, le sol, les boues et l'eau (Wennrich et al., 2001; Herrera et al., 2002; Morales-Munoz et al., 2002; Alonso-Rodríguez et al., 2006). En plus, cette méthode a été utilisée avec succès pour l'extraction multi résidus des polluants organiques à partir des matrices naturelles dans des études de biomonitoring (Lavin and Hageman, 2012; Al Dine et al., 2015; Zhu et al., 2015; Chiesa et al., 2016; Al-Alam et al., 2017).

Les extraits obtenus par l'ASE nécessitent normalement des étapes supplémentaires de concentration et de purification permettant d'augmenter la sélectivité du procédé. Diverses méthodes de purification existent, néanmoins l'extraction en phase solide (SPE) est la méthode la plus communément utilisée.

6.1.3. Extraction en phase solide (Solid Phase Extraction, SPE)

L'extraction en phase solide (SPE) a été développée en 1980 et depuis, elle a été reconnue comme l'outil le plus puissant pour l'isolement et la purification des analytes ciblés (Varga et al., 2010). En effet, la SPE est la méthode la plus utilisée pour l'extraction des échantillons, les changements de solvants, le nettoyage, la concentration et le fractionnement de composés

organiques provenant de plusieurs échantillons (Andrade-Eiroa et al., 2016a, b; Dimpe and Nomngongo, 2016).

Dans cette technique, l'échantillon aqueux passe à travers des cartouches (contenant par exemple de la résine échangeuse d'ions) qui vont retenir les molécules à analyser. L'échantillon de départ est concentré par une élution à faible volume de solvant. Dans cette méthode, une distribution des composés entre la phase liquide de l'échantillon et la phase solide de la cartouche aura lieu. L'extraction ressemble à un processus chromatographique dans lequel l'échantillon constitue la phase mobile et l'adsorbant la phase stationnaire. La figure 19 représente le processus global d'une extraction SPE.

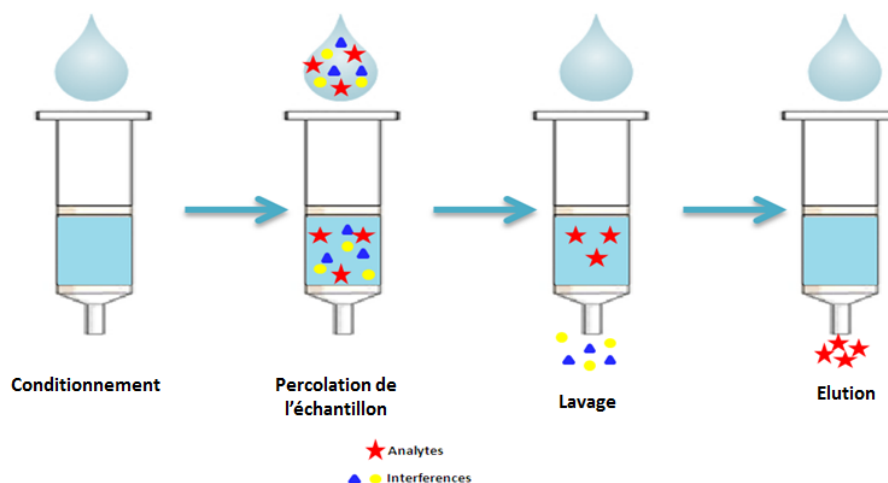


Figure 19. Processus d'extraction en phase solide

Comme le montre la figure 19, la SPE se fait généralement en 4 étapes successives (Humbert, 2010; Varga et al., 2010; Andrade-Eiroa et al., 2016b):

1- Conditionnement de la phase stationnaire (activer les sites de rétention, siège des interactions moléculaires): cette étape a pour objectif de mouiller et d'activer les groupements fonctionnels qui sont présents à la surface de l'adsorbant afin de préparer le support au passage de l'échantillon. La polarité du solvant utilisé est alors proche de celle de l'échantillon.

2- Percolation de l'échantillon (rétention quantitative des analytes d'intérêts sur la phase stationnaire) : dans cette étape, si l'adsorbant greffé est bien choisi, les molécules cibles ayant une affinité élevée pour le support y seront fixées, alors que les interférents n'ayant aucune affinité pour cette phase solide franchiront la colonne avec l'éluant et ne sont pas alors retenus.

3- Lavage et séchage (éliminer l'interférence faiblement retenue et l'évaporation du solvant pour améliorer le rendement d'extraction): le solvant choisi dans cette étape doit être d'une faible force d'élution permettant alors l'élimination des interférents faiblement retenus par le support tout en maintenant les composés d'intérêts bien fixés sur ce dernier.

4- Elution de l'échantillon: un solvant est spécifiquement utilisé pour rompre les interactions entre les molécules d'intérêts et le support. Ce solvant ne doit pas permettre l'éluion des interférents fortement liés au support.

Cette méthode présente de nombreux avantages comme sa simplicité, sa flexibilité, l'automatisation, sa rapidité, les facteurs d'enrichissement, sa capacité d'extraire simultanément des analytes de large plage de polarité, l'absence d'émulsion et l'utilisation de différents adsorbants. En outre, la SPE permet l'extraction d'une large gamme d'analytes organiques provenant d'une grande variété d'échantillon avec une consommation moindre de solvants et une facilité d'utilisation. En plus le développement de la SPE automatique a facilité et simplifié d'avantage cette méthode (Dimpe and Nomngongo, 2016). Cependant, cette méthode souffre de certains inconvénients ; il s'agit d'une technique volumineuse, nécessitant beaucoup de temps et plusieurs étapes pour obtenir un extrait suffisamment concentré pour l'analyse instrumentale. De plus, même si la quantité de solvant utilisée est inférieure à celle de Soxhlet, cette quantité reste une quantité assez importante de solvant organique qui est finalement néfaste pour la santé et l'environnement (Zhao et al., 2008; Andrade-Eiroa et al., 2016b).

La SPE a été largement utilisée dans des études environnementales, telles que l'extraction et l'analyse des médicaments dans les eaux usées (Heuett et al., 2015), des pesticides dans les matrices de miel (Oellig, 2016), des éléments rares (Pyrzynska et al., 2016), des HAPs dans les particules en suspension dans l'air (Li et al., 2007) et les PCBs dans les échantillons d'eau (Wang et al., 2016b). De même, la SPE a été utilisée comme méthode de concentration et de nettoyage dans plusieurs études de biosurveillance utilisant des aiguilles de pin (Al Dine et al., 2015; De Nicola et al., 2016; Al-Alam et al., 2017), les lichens et les mousses (Foan et al., 2015), les abeilles et leurs produits (Shamsipur et al., 2016).

Il est à noter que les analytes extraits par SPE sont généralement concentrés soit par réduction ou par évaporation à sec du solvant de la phase d'éluion avant l'analyse.

6.1.4. La microextraction en phase solide (Solid Phase Micro Extraction SPME)

La microextraction en phase solide (SPME) est une technique d'extraction et de pré concentration développée par Pawliszyn en 1989 afin de surmonter les limites des méthodes précédemment citées, en particulier l'utilisation importante de solvants organiques (Arthur and Pawliszyn, 1990). La SPME consiste à plonger une fibre en silice fondue recouverte à son extrémité d'un polymère approprié et placée à l'intérieur d'une aiguille dans un échantillon donné. La fibre glisse dans l'aiguille par action d'un piston en acier inoxydable. L'extraction est basée sur le partage des analytes d'intérêts entre la phase stationnaire de la fibre et le milieu dans lequel elle est plongée. La procédure d'extraction consiste à positionner la phase d'extraction (fibre) sur un support solide où elle sera en contact avec l'échantillon à extraire, suivie d'un couplage à la chromatographie gazeuse, la chromatographie liquide, ou directement à un

spectromètre de masse permettant la désorption et l'analyse des composés (Bojko and Pawliszyn, 2014; Li et al., 2015; Souza-Silva et al., 2015; Zhao et al., 2015).

La microextraction en phase solide se fait généralement suivant deux modes : extraction par immersion et extraction de l'espace de tête « Headspace » (Harris et al., 1999; Rianawati and Balasubramanian, 2009).

L'extraction par immersion ou extraction directe est un mode d'extraction dans lequel la fibre est plongée directement dans l'échantillon liquide et les analytes se partagent entre la fibre et l'échantillon liquide.

L'extraction de l'espace de tête ("headspace") est un mode d'extraction dans lequel la fibre est exposée dans l'espace de tête au-dessus de l'échantillon. Dans ce mode d'extraction deux équilibres auront lieu: l'équilibre échantillon-phase gazeuse et l'équilibre phase gazeuse-fibre.

En fait, le premier mode d'extraction convient pour l'extraction des COSV, les composés non volatils ainsi que les composés polaires, alors que le second est plutôt utilisé pour extraire des composés apolaires et volatils. Après un temps d'extraction approprié, la fibre est rétractée dans l'aiguille, cette dernière est ensuite insérée directement dans l'orifice d'injection du CG ou dans la chambre de désorption du SPME-HPLC. La figure 20 montre d'après Kataoka et al., 2000 le processus d'extraction SPME par l'espace de tête et la fibre d'immersion ainsi que les systèmes de désorption pour les analyses GC et HPLC.

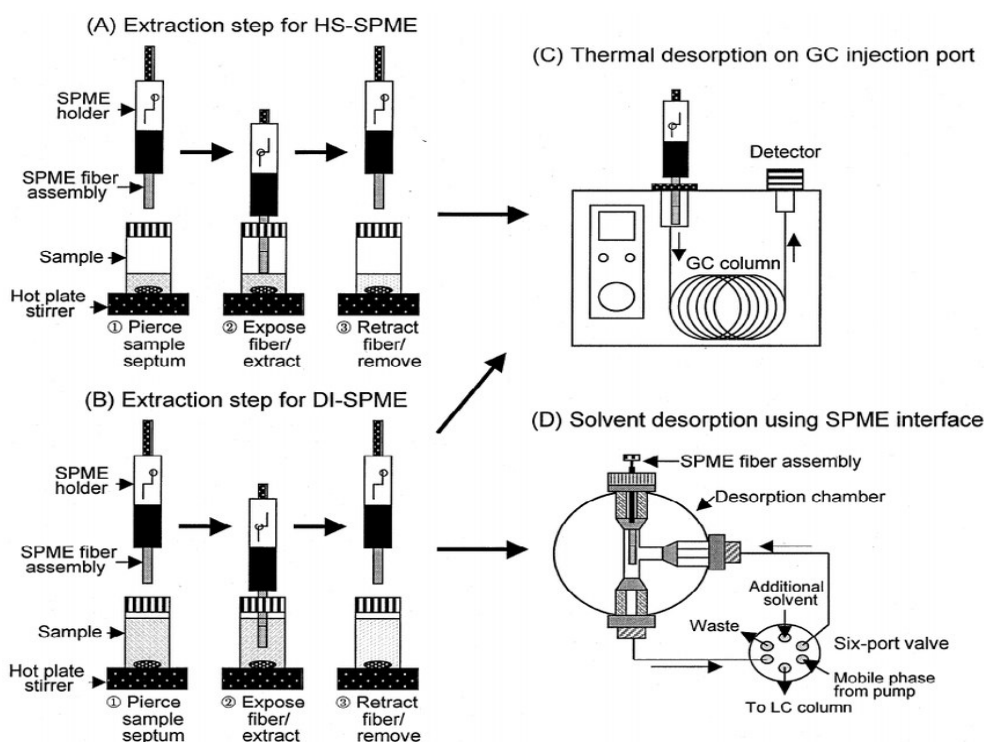


Figure 20. Procédés d'extraction par espace de tête et d'immersion par fibre SPME, et systèmes de désorption pour les analyses par GC et LC (d'après Kataoka et al., 2000)

Cette méthode d'extraction présente de nombreux avantages; d'abord et principalement, c'est une méthode d'extraction sans solvants la rendant ainsi une méthode respectueuse de l'environnement. En outre, la SPME est une méthode simple, nécessitant une petite quantité d'échantillon (de l'ordre du mL), sensible, rentable, fiable, facile à automatiser et portable. En plus, cette méthode permet d'intégrer l'échantillonnage, l'extraction, la concentration et l'introduction d'échantillon en une seule étape permettant alors d'économiser le temps et minimisant les pertes et les erreurs de manipulation. Cependant, comme toute autre méthode d'extraction, le SPME présente certains inconvénients tels que la sélectivité et la faible résistance mécanique de la fibre (Dimpe and Nomngongo, 2016; Zhang et al., 2016).

Cette méthode a été utilisée dans de nombreuses études environnementales, en particulier pour l'analyse et l'identification des COVs (Xie et al., 2015), des pesticides (Mmualefe et al., 2009), des HAPs (Lei et al., 2011) et des métaux (Malik et al., 2006). Cette méthode a également été utilisée comme étape de concentration-purification-injection dans l'extraction des polluants environnementaux de plusieurs aiguilles de conifères dans le processus de biosurveillance environnementale (Al Dine et al., 2015; Al-Alam et al., 2017).

6.1.5. L'extraction QuEChERS

QuEChERS est un acronyme de Quick, Easy, Cheap, Effective, Rugged, and Safe. Il s'agit donc d'une méthode d'extraction qualifiée d'être rapide, facile, bon marché, robuste et fiable. Cette méthode a été développée par Anastassiades et al., en 2003 pour l'analyse de résidus de pesticides dans les fruits et légumes en éliminant les limitations pratiques des méthodes précédentes (Anastassiades et al., 2003). Le principe de la méthode repose sur le fait d'addition des sels dit QuEChERS à la matrice mélangé préalablement dans un solvant.

Le protocole originel est divisé en deux étapes, la première étant considérée comme une méthode d'extraction souple utilisant de l'acétonitrile (ACN) comme agent d'extraction tandis que la seconde est considérée comme une étape de nettoyage facultative par extraction en phase solide dispersive (d-SPE) (Anastassiades et al., 2003). La première étape consiste donc en l'addition du solvant à la matrice à extraire suivie de l'addition d'un mélange de sel de sulfate de magnésium ($MgSO_4$) et de chlorure de sodium (NaCl). En effet, le $MgSO_4$ permet la séparation de l'eau du solvant organique et le NaCl permet de contrôler la polarité. L'agitation et la centrifugation réalisée suite à ces ajouts permettent la séparation de l'échantillon en deux phases, la phase organique contenant les analytes d'intérêts et la phase aqueuse séchée par les sels. La deuxième étape (d-SPE) forme une étape de lavage « clean-up » qui consiste à éliminer les impuretés présentes dans la phase organique à l'aide d'adsorbants tels que le « Primary Secondary Amine (PSA) », le carbone graphite noir (GCB) ou les particules C_{18} , en présence de sels ($MgSO_4$). En fait, le PSA permet de supprimer de nombreux acides organiques polaires de l'extrait, ainsi que des pigments polaires, des sucres et des acides gras, le GCB permet essentiellement de supprimer les stérols et les pigments tels que la chlorophylle, alors que le C_{18} permet d'éliminer des substances interférentes apolaires comme les lipides. La centrifugation suite à l'addition de ces adsorbants conduit de nouveau à deux phases dont la phase organique est récupérée. L'ensemble

de ces opérations nécessite quelques minutes (5 à 10 minutes) ainsi que 5 à 10 mL d'agent d'extraction (Wilkowska and Biziuk, 2011; Albinet et al., 2013).

Bien que cette méthode originale ait montré une grande efficacité pour des centaines d'analytes dans une large gamme de produits, en particulier pour les pesticides dans les matrices alimentaires, plusieurs ajustements ont été effectués afin d'améliorer sa performance et de la rendre encore plus robuste et efficace pour d'autres analytes difficiles (Costa et al., 2014). Ces modifications sont basées sur les deux étapes fondamentales de la méthode avec une modification dans les sels et les sorbants de l'étape de purification (étape d-SPE) (González and Pokrovsky, 2014). Ainsi, cette méthode comporte trois grandes variantes en fonction des sels utilisés: la méthode originale, la méthode standard CEN EN 15662 et la méthode officielle AOAC 2007.01.

- la méthode d'origine (décrite ci-dessus) : 4 g $MgSO_4$ + 1 g NaCl ;
- la méthode « EN 15662 » : 1g citrate trisodique dihydraté + 0.5 g hydrogénocitrate disodique sesquihydraté + 1 g NaCl + 4 g $MgSO_4$;
- la méthode « AOAC 2007.01 » : 6 g $MgSO_4$ + 1.5 g acétate de sodium.

Les principales étapes de l'extraction QuEChERS sont représentées dans la figure 21:

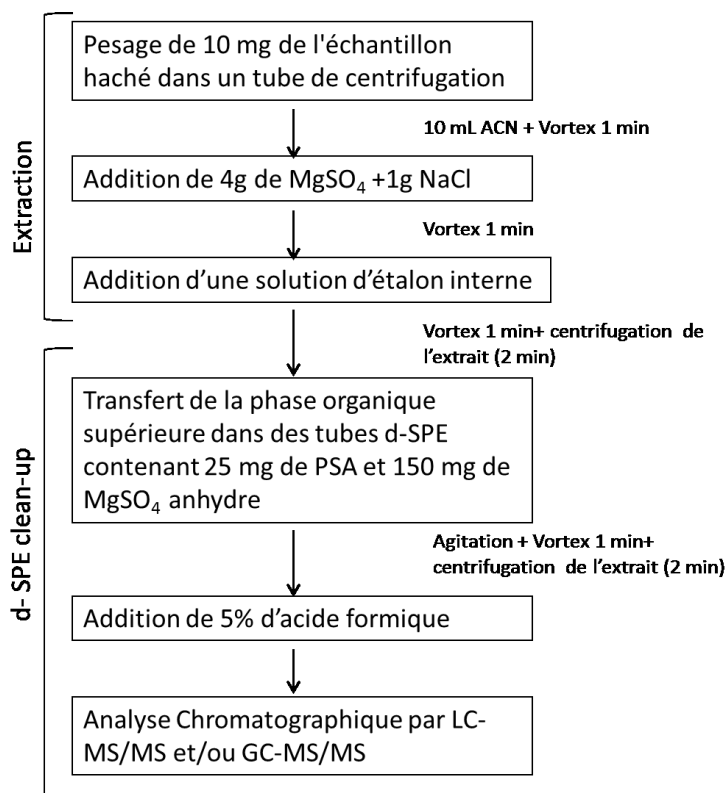


Figure 21. Principales étapes de l'extraction QuEChERS originale

Cette méthode présente de nombreux avantages, tels que des taux de recouvrements élevés (> 85%), un gain de temps (processus pouvant se réaliser en quelques minutes), une faible quantité de solvant utilisé, une robustesse (due au nettoyage de l'extrait obtenu), une simplicité et un faible coût. En plus, cette méthode ne nécessite pas beaucoup de compétences techniques, ni de verrerie et ne requiert aucun appareil spécifique (une simple centrifugeuse suffit) (Lehotay, 2006).

La méthode QuEChERS a d'abord été appliquée pour l'étude des pesticides dans les matrices alimentaires, ensuite elle a prouvé son efficacité pour l'analyse de différents types de polluants dans des échantillons environnementaux comme les analyses multi résidus de pesticides dans le sol (Fernandes et al., 2013), les HAPs dans les matrices alimentaires (Kao et al., 2012), les PCBs (Han et al., 2014), les phtalates (Ma et al., 2010) ainsi que divers composés (Sapozhnikova and Lehotay, 2013). En outre, elle a prouvé son efficacité dans les études de biosurveillance et a été particulièrement utilisée dans les matrices d'abeilles et cela peut être dû au fait que ces matrices sont exposées à des résidus de différents types de polluants au cours de leurs activités de forages alimentaires (Codling et al., 2016; Kiljanek et al., 2016; Tette et al., 2016).

Suite à ces différentes extractions, des étapes supplémentaires devront avoir lieu dans le but de séparer et de quantifier les différents types de polluants présents dans les échantillons testés. En effet, la séparation et la quantification sont cruciales pour l'étude de la pollution de l'environnement et principalement réalisées par la chromatographie liquide couplée en tandem à la spectrométrie de masse (LC-MS/MS) et/ou la chromatographie en phase gazeuse couplée en tandem à la spectrométrie de masse en (GC-MS/MS) (Megson et al., 2016).

6.2. Méthodes de séparations des polluants

Le choix de la technique d'analyse chromatographique nécessaire à la séparation des composés dépend principalement des caractéristiques des polluants d'intérêts. Les composés volatils, semi-volatils et thermiquement stables peuvent être déterminés par GC, tandis que les composés non volatils et thermiquement instables doivent être déterminés par LC (Souza Tette et al., 2016).

Quant à la détection, la spectrométrie de masse a prouvé son efficacité dans ce domaine. En effet, des spectromètres de masse en mode tandem (MS/MS) et des instruments MS à haute résolution sont utilisés afin de fournir une sensibilité maximale permettant d'augmenter significativement l'efficacité de l'analyse (Reiner et al., 2013).

6.2.1. Chromatographie en Phase Gazeuse (CPG)

La chromatographie en phase gazeuse (CPG) est une technique de séparation des composés volatils pouvant être vaporisés par chauffage sans dégradation. Cette méthode a été introduite dans les années 1960, et depuis lors, elle s'est avérée importante pour l'analyse multi résidue des polluants organiques et de leurs métabolites disponibles en raison de sa grande sélectivité et

sensibilité (Santos and Galceran, 2002). Lors d'une analyse par CPG, le mélange à analyser est vaporisé lors de son entrée dans une colonne qui renferme une substance active dite phase stationnaire. Ensuite, il est transporté à travers la colonne par un gaz vecteur. Les différentes molécules du mélange vont être séparées et sorties de la colonne en fonction de leur affinité avec la phase stationnaire pour atteindre finalement un détecteur permettant leur quantification.

L'appareil est couplé à de nombreux détecteurs comme le détecteur à ionisation de flamme (FID), le détecteur thermoïonique (TID) et le détecteur à capture d'électron (ECD). En fait, parmi ces trois types de détecteurs, le détecteur ECD semble être le plus efficace et le plus utilisé pour l'analyse des COSVs présents dans l'environnement (Liška and Slobodnik, 1996; Santos and Galceran, 2002).

En outre, la chromatographie en phase gazeuse pourra être également couplée à la spectrométrie de masse (MS) fournissant une sensibilité et une spécificité de détection très élevée. Ce couplage est qualifié d'être facile du fait que les ions sortant de la colonne sont élués sous forme de vapeur, ce qui permettra ensuite leur introduction dans le vide du spectromètre de masse. Ce couplage est donc très facile et permet de multiples opportunités analytiques en combinant les avantages des deux techniques: le pouvoir séparatif de la chromatographie gazeuse et le pouvoir d'identification de la spectrométrie de masse (Fernandez et al., 2001). L'efficacité de la GC-MS peut être optimisée par un couplage avec la spectrométrie de masse en tandem (MS/MS) fournissant une sensibilité et une spécificité très élevée (Camino-Sánchez et al., 2011; David et al., 2017).

Plusieurs études ont montré l'efficacité de l'analyse des polluants organiques par la GC couplée à la spectrométrie de masse (MS) ou par la GC-MS/MS dans des études de surveillance environnementale. En effet, ces méthodes ont été utilisées avec succès pour l'analyse des HAPs, des pesticides, des PCBs ainsi que des mélanges de polluants organiques persistants dans différents types de biocapteurs (Zhu et al., 2015; Chiesa et al., 2016; Odabasi et al., 2016; Al-Alam et al., 2017).

Malgré l'efficacité de la chromatographie gazeuse dans la détection des polluants organiques environnementaux, cette technique semble être, à elle seule, insuffisante pour couvrir la totalité de ces polluants. En effet, la plupart des polluants et en particulier des pesticides sont polaires, peu volatils et/ou thermolabiles et ne sont donc pas adaptés à une analyse directe par chromatographie en phase gazeuse et nécessite le recours à une étape supplémentaire de dérivation, ce qui rend nécessaire l'usage d'une autre technique analytique permettant l'analyse de différents types de polluants (Fernandez et al., 2001; Wang et al., 2005). Cette tendance conduit au développement et à la forte implantation de la chromatographie liquide dans le domaine de l'analyse des polluants organiques dans des programmes de surveillance environnementale.

6.2.2. Chromatographie en Phase Liquide (CPL)

La chromatographie en phase liquide (CPL) est une technique de séparation des constituants d'un mélange en solution qui se base sur les différences d'affinités et d'interactions des composés pour deux phases. Une phase mobile dans laquelle, les composés d'intérêts sont solubles, et une phase stationnaire, exerçant sur ces composés un effet ralentisseur (Kovalczuk et al., 2006). Il existe deux types de chromatographie en phase liquide:

la chromatographie en phase normale caractérisée par une phase stationnaire polaire et une phase mobile apolaire;

la chromatographie en phase inverse caractérisée par phase stationnaire apolaire et phase mobile polaire.

La chromatographie liquide en phase inverse est la plus utilisée pour l'analyse des polluants environnementaux en raison de leur caractère apolaire ayant donc une plus grande affinité pour la phase stationnaire que des composés polaires.

Cette technique permet l'analyse des pesticides en les séparant suivant leur différence d'hydrophobie par répartition entre les deux phases stationnaire et mobile. Cette dernière est généralement composée d'une phase aqueuse et d'une phase organique composée du méthanol et/ou d'acétonitrile. En fait, le mélange de plusieurs solvants permet d'ajuster le pouvoir d'élution de la phase mobile, et donc de bien adapter la rétention et la séparation d'un mélange complexe. C'est pourquoi, l'utilisation d'un gradient d'élution est majoritaire dans la plupart des études (Benijts et al., 2004; Kovalczuk et al., 2006; Montenarh et al., 2014).

Le principe de la chromatographie liquide en phase inverse est le suivant : la phase mobile contenant l'échantillon est injectée à travers la phase stationnaire, généralement à base de silice chimiquement modifiée par le greffage d'une chaîne en C₈ ou en C₁₈, qui est contenue dans une colonne. Selon leurs propriétés, les molécules sont plus ou moins retenues. Chaque molécule traverse la colonne avec un temps qui lui est propre, appelé temps de rétention (Tr). Ce temps permet l'identification de la molécule.

L'appareil chromatographique nécessite d'être couplé à un détecteur permettant la détection des polluants. Généralement, la chromatographie liquide est couplée à une détection ultra-violet (UV) pour l'analyse des pesticides, mais ce type de détection posent de nombreux problèmes tels que le manque de spécificité et de sélectivité à cause de la ressemblance entre les spectres de différents pesticides appartenant à la même famille ainsi que le manque de sensibilité dans l'analyse de traces dans des matrices complexes. Ce problème a été ultérieurement résolu avec le couplage à la détection par SM qui combine le pouvoir séparatif de la CLHP au pouvoir identificateur de la SM. En plus ce couplage permet une détection des composés très polaires et leurs produits de dégradation sans étape préalable de dérivation (Hajšlová and Zrostlíková, 2003; Freitas et al., 2004; Frenich et al., 2005).

Le couplage de la chromatographie liquide à la spectrométrie de masse s'est révélé donc très efficace pour l'analyse multi résidue de pesticides dans les matrices naturelles permettant la détection des polluants ayant des propriétés physico-chimiques très différentes (Codling et al., 2016; García-Valcárcel et al., 2016; Herrera López et al., 2016; Juan-Borrás et al., 2016).

Ainsi, étant couplée à une détection par spectrométrie de masse (simple ou en tandem), la chromatographie liquide forme avec la chromatographie gazeuse deux techniques complémentaires nécessaires à l'analyse multi résidus des polluants organiques largement répandus dans l'environnement (Vázquez et al., 2015; Kiljanek et al., 2016; Al-Alam et al., 2017).

6.3. Méthode de détection des polluants : La spectrométrie de masse

Différents détecteurs peuvent être couplés à la CPG et à la CPL, cependant la spectrométrie de masse reste la technique de choix, vu sa sélectivité et sa sensibilité très élevée. Cette technique, d'usage universel, permet la détection et l'identification de molécules chargées par mesure de leur rapport masse sur nombre de charge (m/z). Le spectromètre de masse fournit des informations qualitatives et quantitatives précises sur les composés analysés (De Hoffmann and Stroobant, 2005).

La spectrométrie de masse repose sur la transformation des molécules de leur état naturel, en ions sous forme d'état gazeux. Pour mesurer la masse de molécules isolées, le spectromètre de masse doit assurer les opérations primordiales suivantes ; Ionisation, Analyse, Détection. Pour assurer ses opérations, cet appareil est classiquement formé de 3 éléments essentiels : La source, l'analyseur et le détecteur.

La figure 22 montre les composants généraux d'un spectromètre de masse.

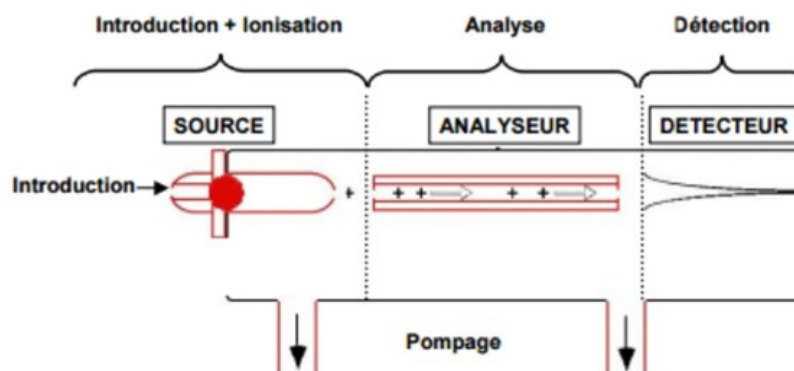


Figure 22. Composants généraux d'un spectromètre de masse (d'après Czeszak, 2003)

La **source** permet l'ionisation de l'échantillon à analyser et le transfert des ions vers l'analyseur de l'appareil. En effet, les molécules à étudier, étant neutres en solution, nécessitent de passer en phase gazeuse puis d'être ionisées dans une source d'ionisation. Cette étape permet donc l'ionisation des molécules d'intérêts ainsi que l'évaporation du solvant.

L'**analyseur** permet la séparation des espèces ionisées transmise de la source suivant leur rapport m/z . Les différentes espèces vont alors être séparées suivant les propriétés des espèces chargées dans les champs magnétiques et/ou électriques.

Le **détecteur** permet finalement de collecter les ions sortant de l'analyseur. Le signal ionique obtenu y est alors transformé en signal électrique. Le détecteur est couplé à un système informatique, qui assure le traitement des données et l'élaboration des spectres de masses relatifs à chaque ion.

Différentes sources d'ionisation existent au niveau de cette technique de détection: électronébulisation (ESI, ElectroSpray Ionisation), ionisation par impact électronique (EI, Electron Ionization), photoionisation à pression atmosphérique (APPI, Atmospheric-Pressure PhotoIonisation), ionisation chimique (CI, Chemical Ionization), et désorption et ionisation par laser assistées par matrice (MALDI, Matrix-Assisted Laser Desorption Ionisation). Cependant, seules les sources d'ionisation ESI et EI seront développées dans cette thèse, du fait qu'elles étaient utilisées respectivement pour les analyses LC-MS/MS et GC-MS/MS au cours de ces travaux de recherches.

Source d'ionisation ESI

Cette technique d'ionisation, appelée aussi électronébulisation, est dédiée à l'analyse de molécules polaires et peut être facilement couplée à la chromatographie en phase liquide, la chromatographie en phase supercritique ou encore l'électrophorèse capillaire. C'est une source d'ionisation dont les mécanismes de désolvatation/ionisation sont peu énergétiques, qui n'induisent pas ou peu de fragmentations.

L'ESI est une source d'ionisation à pression atmosphérique. La phase mobile contenant les molécules d'intérêts est introduite dans un capillaire métallique sur lequel est appliqué un champ électrique résultant d'une différence de potentiel de 1 à 5 kV entre le capillaire et une contre-électrode. Les débits à l'intérieur de ce capillaire sont classiquement compris entre 1 à 1000 $\mu\text{L}/\text{min}$. La différence de potentiel va induire la création et l'accumulation de charges dans la solution via des réactions d'oxydo-réduction, en particulier de l'eau. Sous l'effet du champ entre le capillaire et la contre-électrode, un cône, appelé « cône de Taylor », se forme. D'où se détachent de fines gouttelettes chargées constituées de solvant et d'analytes.

L'évaporation du solvant induite par un flux à contre-courant d'azote chaud au sein de la source provoque alors la diminution du diamètre des gouttelettes et augmente la densité de charges au sein de celles-ci. La gouttelette explose ensuite en gouttelettes de plus faibles diamètres lorsque

le phénomène de répulsion coulombienne devient supérieur à la tension de surface. La figure 23 représente le processus d'ionisation ESI.

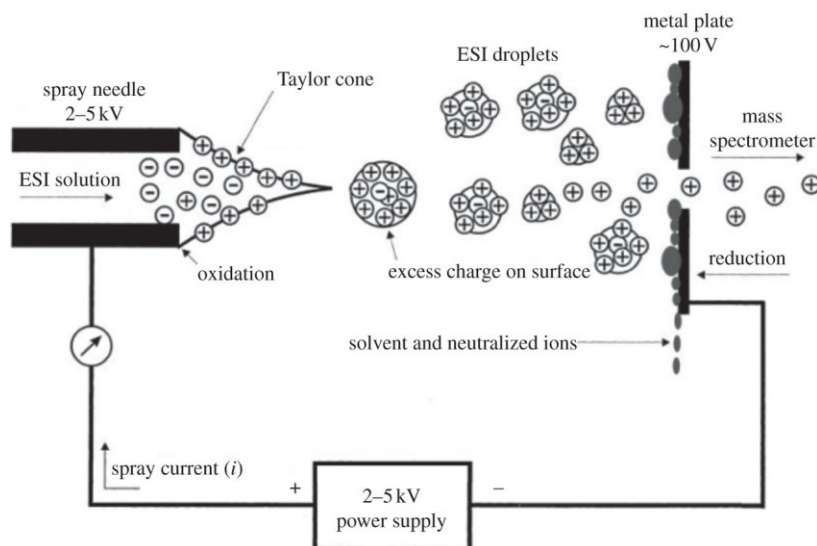


Figure 23. Processus d'ionisation ESI (d'après Staniforth and Stavros, 2013)

L'émission des ions en phase gazeuse s'effectue selon 2 modèles (El-Aneed et al., 2009):

- 1- le modèle d'évaporation ionique dans lequel une série d'explosions coulombiennes provoque une diminution de la taille des gouttelettes jusqu'à atteindre un diamètre de l'ordre de 10 nm environ, et augmente la densité de charge conduisant à une désorption des ions directement en phase gazeuse ;
- 2- le modèle de la charge résiduelle dans lequel une série d'explosions coulombiennes a lieu jusqu'à élimination totale du solvant. Les ions passent alors en phase gazeuse car ils se retrouvent totalement désolvatés.

Source d'ionisation par IE

L'impact électronique (IE) est la source d'ions la plus ancienne. Cette source est largement utilisée par couplage avec la CPG. Elle permet l'ionisation des composés volatils et, des molécules directement dans leurs états gazeux. En revanche, cette source ne permet pas l'ionisation des composés en phase liquide. En outre, les composés doivent être thermiquement stables puisque cette source fonctionne à haute température. De ce fait, les ions engendrés sont très énergétiques et présentent généralement des fragmentations permettant le sondage de la structure des molécules. Cependant, les ions moléculaires ne sont pas préservés du fait de l'énergie interne transmise par l'énergie cinétique des électrons. En effet, l'échantillon est exposé

à un filament de tungstène porté à incandescence conduisant à son ionisation suite à son évaporation et son bombardement par les électrons issus du filament (Almeida, 1999).

La figure 24 schématise la source d'ionisation par impact électronique.

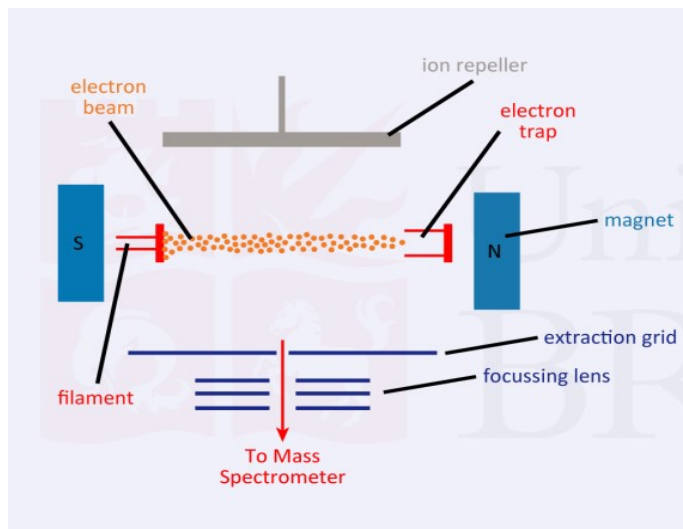


Figure 24. Représentation schématique d'une source d'ionisation par impact électronique (d'après University of Bristol, 2014)

Similairement aux sources d'ionisation, plusieurs types d'analyseurs peuvent être utilisés afin de mesurer le rapport masse/charge (m/z). Les analyseurs quadripolaires, les analyseurs à temps de vol, les analyseurs de type trappe à ions, ainsi que les analyseurs à secteur magnétique sont les plus répandus. Cependant, seuls les analyseurs utilisés dans nos expériences seront développés. Il s'agit des analyseurs du type quadripôle utilisés pour les analyses en LC et ceux de type trappe à ions utilisés pour les analyses en GC.

Analyseurs type quadripôle

L'analyseur quadripolaire est l'analyseur le plus couramment utilisé pour une source d'ionisation ESI. Cet analyseur a recours à la stabilité de la trajectoire des ions dans un champ électrique oscillant permettant leur séparation en fonction de leurs masses. Les analyseurs quadripolaires sont formés de 4 barres parallèles portées à un potentiel opposé, de sorte que deux barres adjacentes soient de potentiels opposés comme le montre la figure 25.

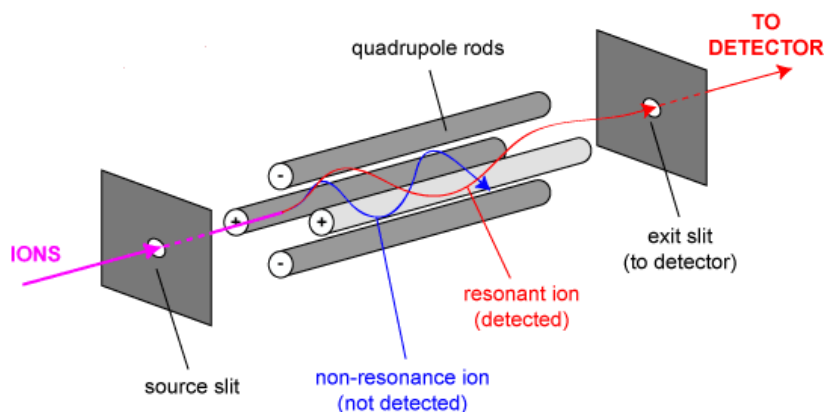


Figure 25. Schéma d'un analyseur quadripolaire (d'après Yinon, 2007)

L'application concomitante d'une tension continue et d'une tension radiofréquence (RF) impose aux ions qui circulent entre les barres une trajectoire oscillante. Mais, seuls les ions dont la trajectoire est mise en résonance traversent l'analyseur et sont détectés par un multiplicateur d'électrons qui transforme le signal chimique en signal électrique. Les analyseurs quadripôles permettent donc de « filtrer » les différents ions.

L'intérêt majeur de l'analyseur quadripôle réside dans la possibilité d'associer plusieurs analyseurs en série. L'analyseur utilisé dans nos travaux pour l'analyse des molécules en chromatographie liquide était du type triple quadripôles (« triple-Quad »). Cet analyseur résulte de l'association de trois quadripôles en série et permet alors d'appréhender des analyses de spectrométrie de masse en tandem (MS-MS). Cet analyseur est schématisé dans la figure 26.

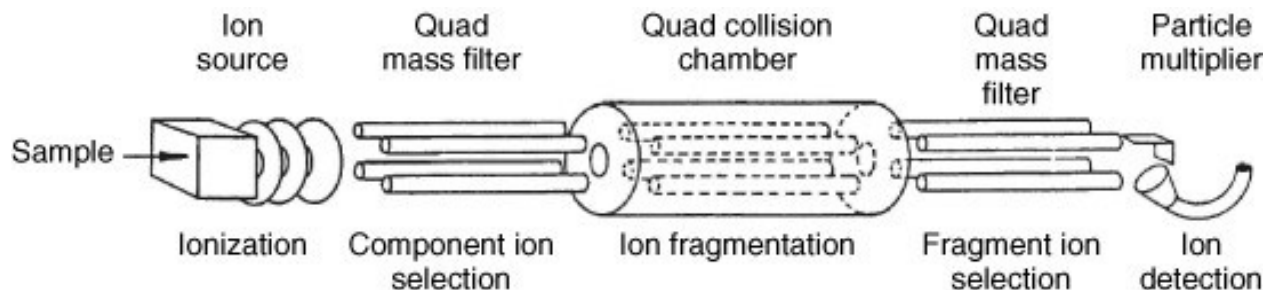


Figure 26. Schéma d'un spectromètre de masse quadripolaire triple (TQMS) (d'après Kero et al., 2005)

Le premier quadripôle agit comme un filtre de masse pour sélectionner uniquement des ions d'un rapport masse / charge spécifique, typiquement des ions $[MH]^+$ ou $[M-H]^-$ de l'analyte, pour entrer dans le second quadripôle. Le deuxième quadripôle est la cellule de collision, où la collision avec un gaz (Ar) provoque la fragmentation des ions par un processus connu sous le nom de dissociation activée par collision. Les ions fragments résultants sont transmis au troisième quadripôle, où seuls les ions fragments du rapport masse / charge souhaitée sont

autorisés à passer et à heurter le détecteur (multiplicateur d'électrons). Les deux niveaux de sélectivité dans l'expérience de surveillance de réactions multiples, combinés à la séparation chromatographique, ont procuré un niveau de sélectivité très élevé et sont essentiels pour obtenir une sensibilité élevée (Ni and Rowe, 2012). En effet, cet analyseur est utilisé en exploitant ses fonctions de suivis de réactions multiples (MRM). Il permet, avec le développement de l'électronique, de suivre un grand nombre de transitions simultanément, ce qui le rend comme analyseur de choix pour les méthodes d'analyse multi-résidus.

Analyseur type trappe à ions

La trappe ionique à l'inverse des analyseurs de type quadripôle qui permettent uniquement le passage des ions ayant un rapport m/z donné, fonctionne comme un piège à ions qui accumule tous les ions triés à l'intérieur de sa zone de champ. La capacité de confinement des ions est reliée à la formation d'un pseudo puits de potentiel. Ensuite, les ions piégés sont libérés, suite à leur déstabilisation, les uns après les autres en fonction de leur rapport m/z . Ce type d'analyseur est formé de deux électrodes chapeaux de forme hyperboliques et d'une électrode annulaire comme le montre la figure 27.

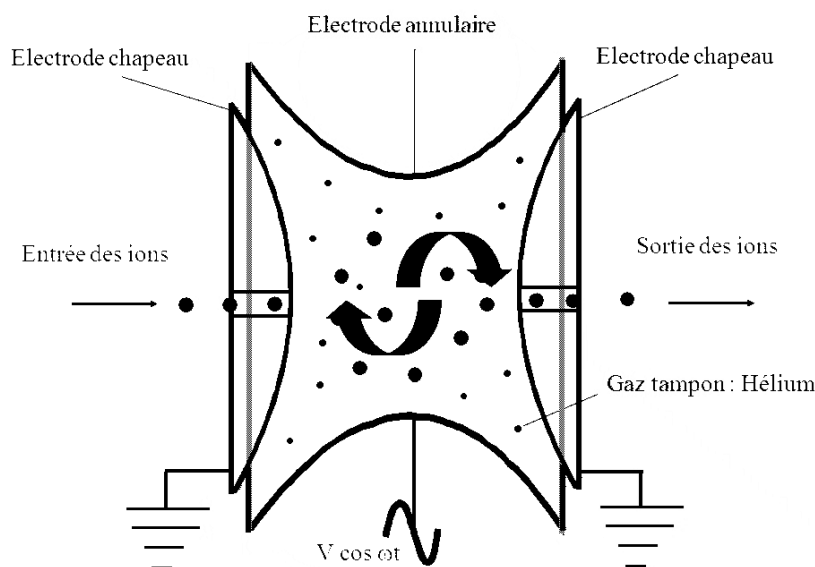


Figure 27. Représentation schématique d'une trappe ionique (modifiée de Droit, 2007)

En mode MS, le fonctionnement de la trappe à ions consiste à piéger les ions puis à les émettre vers le détecteur. Alors qu'en mode MS/MS, les ions parents seront isolés suite au piégeage des ions et ensuite excités, fragmentés et finalement éjectés.

En effet, lors de l'arrivée des ions à l'analyseur, une tension résultante de la superposition de deux tensions, continue et alternative, est appliquée sur l'électrode circulaire. Ainsi, un champ électrique à trois dimensions est formé. Ce dernier, permet le piégeage des ions sur une

trajectoire formant une sorte de huit tridimensionnel, appelé courbe de Lissajous comme le montre la figure 28.

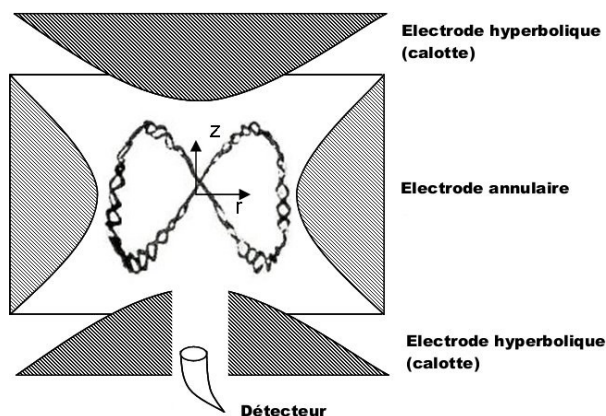


Figure 28. Trajectoire en 8 tridimensionnel des ions dans une trappe (d'après L.S.A., 2008)

Les ions sont piégés, si leur trajectoire dans les deux plans, axial (suivant z) et radial (suivant r), est conjointement stable. L'éjection des ions se fait suivant leur rapport m/z croissant par l'application soit d'une radiofréquence croissante sur l'électrode circulaire, soit d'une tension alternative croissante sur les électrodes chapeau conduisant à une déstabilisation des ions et par la suite à leur émission. Dans une MS/MS, la maîtrise de la trajectoire des ions dans une trappe permet d'isoler spécifiquement des ions de m/z définis correspondant à l'ion que l'on désire fragmenter. Les ions parents seront ensuite déstabilisés par l'application d'une tension sur les électrodes chapeaux dont l'amplitude correspondra à la fréquence de résonance de ces ions. Ces derniers vont alors quitter leur trajectoire de stabilité, entrer en collision avec les molécules de gaz et alors se fragmenter. Les ions fils obtenus seront alors émis en fonction de leur rapport m/z (Van Dorselaer, 2006; Canon, 2010).

II. Partie-2 : Utilisation des biopesticides

1. Introduction et généralités

Le développement de l'agriculture a dû faire face aux activités néfastes de nombreux ravageurs comme les champignons, les mauvaises herbes et les insectes, entraînant une diminution principale des rendements. Suite à l'usage des pesticides chimiques, cette crise a été résolue dans une grande mesure, cependant comme le montre la première partie de ce manuscrit, l'usage énorme de ces produits pourra être la cause majeure de problèmes environnementaux et de santé publique, d'autant plus que les risques immanents à certains d'entre eux reste mal évalués. Par conséquent, l'usage d'une alternative est nécessaire pour générer une meilleure qualité et une plus grande quantité de produits agricoles. D'où le développement des biopesticides pour lutter efficacement contre les ravageurs agricoles sans causer de préjudice grave à la chaîne écologique ni aggraver la pollution de l'environnement (Mnif and Ghribi, 2015).

Les biopesticides sont des substances dérivées naturelles ou des microbes utilisés pour lutter contre les ravageurs, y compris les insectes, les mauvaises herbes et les maladies. Ces protecteurs végétaux sont considérés comme plus respectueux de l'environnement que leurs équivalents chimiques produits par synthèse, car ils ne persistent pas souvent dans l'environnement, ne touchent pas les vertébrés et ont habituellement une sélectivité élevée chez l'hôte (Gupta and Dikshit, 2010).

Les biopesticides sont généralement appliqués sous forme de formulations de base liquide, de granulés dans l'eau, de poudres mouillables ou de pastilles. Les formulations sont basées sur la facilité d'application, les préférences de l'utilisateur final et le type d'équipement de distribution disponible. Souvent, le même produit peut être fabriqué dans les quatre formulations; les exigences du terrain dicteront le choix particulier. Le tableau 1 résume le marché mondial des biopesticides par formulation. Les formulations à base liquide occupent la majeure partie du marché (~ 60%), suivies par les granulés, puis la poudre (Thakore, 2006).

Tableau 1. Marché mondial des biopesticides par formulation (En millions de dollars américains)

FORMULATION DE BIOPESTICIDES	2003	2004	2005
Formulation à base de liquide	280,8	337,2	403,2
Granules dispersées dans l'eau	70,2	84,3	100,8
Poudres mouillables	70,2	84,3	100,8
Pastille	46,8	56,2	67,2
Totale	467,0	562,0	672,0

Les biopesticides sont utilisés à des échelles croissantes et la production de biopesticides augmente actuellement de 16% par an, soit près de trois fois celle des produits agrochimiques classiques, qui croît à un taux de 5,5% par an. Ainsi de nouvelles substances actives ont été introduites avec succès dans le processus de protection de type biopesticides. Ces composants actifs comprennent les protéines, les polysaccharides et les petites molécules (alcaloïdes, flavonoïdes, phénols, huiles essentielles) provenant de plantes, de protéines et de polysaccharides de microorganismes, de polysaccharides d'algues et d'oligochitosane d'animaux. Ces composés sont très actifs, hautement spécifiques, avec moins de pollution environnementale et moins résiduelle (Zhao et al., 2017).

2. Classification des biopesticides

L'usage des biopesticides n'est pas récent ; en effet, dès le VII^e siècle av. J.-C., les agriculteurs chinois ont utilisé des plantes telles que *Illicium lasnceolatum* pour prévenir les ravageurs et la Chine a été l'un des premiers pays ayant utilisé des biopesticides (Leng et al., 2011). Depuis, divers types de biopesticides ont été développés afin d'assurer la protection des plantes à moindre dégâts.

Les biopesticides se divisent en trois types selon la substance active: (i) les biopesticides microbiens; (ii) les biopesticides biochimiques produits généralement par les plantes; et (iii) les biopesticides semio-chimiques ayant les animaux comme origine dans la majorité des cas (Chandler et al., 2011; Leng et al., 2011).

2.1. Les biopesticides microbiens

Les biopesticides microbiens sont constitués par un micro-organisme comme ingrédient actif. Ils peuvent contrôler de nombreux types de parasites, bien que chaque ingrédient actif distinct soit relativement spécifique de son ravageur cible.

Les biopesticides microbiens sont formés par des bactéries, des champignons, des oomycètes, des virus et des protozoaires. De nombreuses substances actives sont dérivées de ces différents microorganismes, ce sont principalement ces substances qui procèdent contre le bio agresseur plutôt que le microorganisme lui-même (Deravel et al., 2014). Ces biopesticides ont habituellement des effets létaux ou inhibiteurs résultant d'une interruption physique ou biochimique de la croissance et du développement de l'organisme nuisible (parasitisme, antagonisme ou allélopathie) (Bailey et al., 2010). En fait, pour tous les types de cultures, les biopesticides bactériens représentent environ 74% du marché; les biopesticides fongiques, environ 10%; les biopesticides viraux, 5%; les biopesticides prédateurs, 8% et les "autres" biopesticides en représentent 3% (Thakore, 2006). Ces micro-organismes sont très répandus dans la nature et contribuent à la régulation naturelle de leurs hôtes. En plus, les micro-organismes sélectionnés pour être utilisés comme agent de contrôle microbien, n'infectent pas naturellement les vertébrés et sont donc considérés comme sûrs pour l'homme, le bétail et la faune des

vertébrés. Ils produisent peu ou pas de résidus toxiques et les coûts de développement et d'enregistrement sont nettement inférieurs à ceux des pesticides chimiques de synthèse (Hajek, 2004). Ils peuvent être appliqués aux cultures en utilisant le même équipement utilisé pour appliquer des pesticides chimiques, et formulés de manière similaire aux pesticides pour améliorer leur efficacité. Cependant, c'est leur potentiel de contrôle auto-perpétuel qui les distingue des pesticides chimiques. De nombreux agents microbiens ont des niveaux élevés de spécificité, rendant leur utilisation compatible avec la croissance d'autres ennemis naturels (Hajek, 2004; Chandler et al., 2008). Le tableau 2 montre des exemples de micro-organismes enregistrés comme agents de contrôle des organismes nuisibles agricoles.

Tableau 2. Exemple de microorganismes utilisés pour la protection des cultures (d'après Chandler et al., 2011)

Organismes	Usage	Parasites	Cultures cibles
Bactéries			
Agrobacterium radiobacter	Agent antibactérien	Agrobacterium tumefaciens	Fruits mous, noisette, vignes
Xanthomas campestris pv. Poannua	Herbicide	Herbe bleue annuelle	Gazon
Bacillus subtilis	Fongicide	Fusarium, Pythium, Rhizoctonia spp.	Légumes, céréales, coton
Bacillus thuringiensis	Insecticide	Divers lépidoptères, diptères, coléoptères	végétaux, fruit, coton, riz, foresterie
Champignon			
Lecanicillium longisporum	Insecticide	Pucerons	Culture sous serre, comestibles et ornementales
Phytophthora palmivora	Herbicide	Vigne étranglée	Agrumes
Trichoderma harzianum	Fongicide	Pythium, Phytophthora, Rhizoctonia	vergers, plante ornementales, végétaux, culture en serre
Protozoaire			
Nosema locustae	Insecticide	Sauterelles, crickets	Pasture
Virus			
Cydia pomonella granulosis virus	Insecticide	Carpocapse	Pomme, poire

2.1.1. Les bactéries

Les espèces appartenant au genre *Bacillus* sont les pesticides les plus largement utilisés dans ce domaine, en particulier *Bacillus thuringiensis* largement utilisé comme biopesticide microbien (Mnif and Ghribi, 2015). Cette bactérie ne nuit pas aux vertébrés et est sans danger pour l'homme et son environnement. Les pulvérisations de *B. thuringiensis* sont efficaces pour la lutte

contre les ravageurs des cultures de fruits et légumes, où leur sélectivité et leur sécurité sont considérées comme souhaitables et où la résistance aux insecticides chimiques synthétiques pose des problèmes (Van Driesche and Hoddle, 2009).

Bacillus thuringiensis est une bactérie gram-positive, qui produit des protéines cristallines appelées δ -endotoxines ou pro-toxines Cry libérées dans l'environnement après lyse de la paroi cellulaire à la fin de la sporulation et qui sont spécifiques de l'hôte et peut causer la mort dans les 48 heures (Jisha et al., 2013). Le mode d'action des protéines de *B. thuringiensis* implique de nombreux événements qui seraient réalisés plusieurs heures après l'ingestion conduisant à la mort des insectes. Après ingestion, les cristaux sont solubilisés par les conditions alcalines dans l'intestin moyen de l'insecte et sont ensuite transformés de manière protéolytique en un fragment de noyau toxique. Pendant l'activation protéolytique, les peptides de l'extrémité N-terminale et de l'extrémité C-terminale sont clivés de la protéine complète. La toxine activée se lie aux récepteurs situés sur les membranes microvillositaires apicales des cellules épithéliales de l'intestin moyen. Après la liaison, la toxine change de conformation, permettant son insertion dans la membrane cellulaire. Par la suite, l'oligomérisation se produit, et cet oligomère forme un canal poreux ou ionique à l'intérieur des récepteurs fonctionnels contenus sur les membranes des bordures en brosse, provoquant une perturbation du transport de la membrane et une lyse cellulaire et conduisant à la mort des insectes (Mnif and Ghribi, 2015; Schünemann et al., 2014).

De plus, les lipopeptides dérivés de *B. thuringiensis* sont reconnus par leurs activités antifongiques et sont impliqués dans le contrôle biologique de champignons phytopathogènes végétaux. En effet, le lipopeptide rétrécirait la surface cellulaire des champignons traités en suggérant son effet létal en agissant sur la surface cellulaire par l'activité perméabilisante puissante (Kim et al., 2004).

En outre, d'autres espèces de *Bacillus* peuvent assurer une protection biologiques des plantes tels que *Bacillus amylolique* faciens et *B. subtilis* qui peuvent coloniser les racines des plantes et produire de ce fait des molécules de nature lipo-peptidique qui peuvent soit activer les protections des plantes, soit exercer directement un effet antifongique ou antibactérien (Pérez-García et al., 2011). Des bactéries autres que le genre *Bacillus* ont été aussi utilisées comme biopesticides. Parmi ces derniers figure la souche *Pseudomonas chlororaphis* qui est utilisée dans la prophylaxie et le traitement de certains champignons. Cette bactérie est capable d'agir contre les phytopathogènes par antibiose directe, par compétition spatiale et nutritive ou par activation des défenses des plantes (Deravel et al., 2014).

2.1.2. Les champignons

Un grand nombre de champignons pourra être associé à une variété d'insectes et d'autres arthropodes, établissant des interactions diverses, y compris la pathogénicité. Environ 750 espèces, appartenant à 100 genres, de champignons entomopathogènes ont été signalés, mais

seulement une dizaine d'entre elles ont été ou sont actuellement développées pour la lutte contre les insectes (Hajek and St. Leger, 1994).

En effet, les champignons entomopathogènes peuvent être classés en deux groupes principaux: les champignons biotrophes et les champignons nécrotrophes. Le premier groupe renferme des champignons nécessitant des cellules vivantes de leurs hôtes, certains d'entre eux sont commensaux qui obtiennent des nutriments de l'appareil digestif de l'insecte. Cette catégorie de champignons est très répandue dans de nombreuses régions, mais ils ne sont pas largement utilisés pour lutter contre les parasites, car ils sont soit asymptomatiques chez les insectes, soit les changements causés par les pathogènes sont difficiles à observer. Cependant, les champignons appartenant au deuxième groupe vivent au détriment des cellules mortes; ils doivent tuer leurs hôtes avant de le consommer. Les champignons appartenant à ce groupe sont très efficaces dans leur attaque, pour cette raison beaucoup d'entre eux sont des agents potentiels de contrôle biologique des insectes. En fait, certaines espèces de champignons entomopathogènes possèdent une spécificité vis-à-vis de leurs hôtes, mais ont généralement un large spectre d'action. Le choix de l'hôte est basé sur l'affinité biochimique au substrat et non sur ses caractères morphologiques. Cette situation a été observée chez *Beauveria bassiana*, *Nomuraea rileyi* et *Metarhizium anisopliae* qui peuvent infecter environ 100 espèces d'insectes d'une grande variété. De même, les champignons appartenant aux genres *Beauveria* et *Metarhizium* se sont avérés efficaces contre de nombreux insectes nuisibles, y compris les acridiens. Ces champignons sont formulés comme des produits commerciaux et sont de bonnes alternatives aux pesticides organophosphorés et organochlorés ayant des actions persistantes et nocives (Fang et al., 2005; Szewczyk et al., 2006). En outre, les techniques moléculaires modernes ont permis l'élucidation des mécanismes impliqués dans la reconnaissance et la pénétration de l'hôte, la production de toxines et la stimulation et l'évasion immunitaire de ces espèces fongiques (Bell et al., 2009). Le mécanisme d'action de *Metarhizium anisopliae* exige l'activation de deux stratégies de virulences lors de l'envahissement de l'insecte par le champignon ; une stratégie de la toxine et une stratégie de croissance. Avec la stratégie de la toxine, les insectes sont tués par des toxines telles que les destruxines produits par certains isolats de *M. anisopliae*; La mort est suivie par la croissance des hyphes dans la cavité du corps de l'insecte. Avec la stratégie de croissance, les insectes sont tués lorsque les hyphes fongiques prolifèrent à travers l'haemocoel en utilisant des nutriments (Kershaw et al., 1999; Leemon and Jonsson, 2012).

2.1.3. Les virus

Parmi les différentes familles de virus infectant les insectes, seuls ceux appartenant à la famille hautement spécialisée Baculoviridae ont été considérés comme des pesticides potentiels. Ils sont très sécuritaires pour les êtres humains et pour la faune. Leur spécificité est très étroite, souvent limitée à une seule espèce. L'usage de ces composés comme biopesticides a été limitée du fait de leur lente action de destruction et ils ont été considérés comme inefficaces. Cependant, cette

attitude change avec le temps et la protection contre les baculovirus devient une méthode de choix pour une protection à long terme des cultures (Szewczyk et al., 2006).

Les baculovirus sont des virus pathogènes des arthropodes avec des génomes d'ADN circulaires à double brin, ayant un génome compris entre 0.1 et 0.18 Mb, protégés par une paroi protéique et des virions enveloppés en forme de tige. La famille Baculoviridae est composée de deux genres: nucléopolyhedrovirus (NPV) et granulovirus (GV) (Bonning, 2005).

Le cycle de vie du baculovirus est bi-phasique. Au cours d'un stade précoce de l'infection, les nucléocapsides de la descendance bourgeonnent à travers la membrane plasmique de la cellule hôte pour former le virus bourgeonné. Plus tard dans le cycle d'infection, les nucléocapsides de progéniture sont occluses dans des matrices protéiniques appelées polyèdres dans le cas des NPV et des granules dans le cas des GV. Les virus dérivés de l'occlusion déclenchent une infection dans l'intestin des insectes alors que les virus bourgeonnés sont impliqués dans la propagation systémique du virus à l'intérieur de l'insecte (Kang et al., 2011).

2.2. Les biopesticides d'origine végétale / biochimiques

Les plantes, source importante de biopesticides, produisent une grande variété de métabolites secondaires qui manquent de fonction apparente dans les processus physiologiques ou biochimiques. Ces composés jouent un rôle important dans la médiation des interactions entre les plantes et leur environnement biotique. Ces substances ont des caractéristiques aseptiques, insecticides, et même régulatrices de la croissance des plantes et des insectes qui défendent les plantes des herbivores (Kessler and Baldwin, 2002 ; Chandler et al., 2011). Certains peuvent être utilisés comme molécules d'aplomb pour le développement d'agents protecteurs contre les insectes et les champignons ainsi que pour le développement des inhibiteurs enzymatiques (Céspedes et al., 2001). Il en résulte un intérêt accru pour l'application de métabolites secondaires dans la lutte antiparasitaire.

Parmi les biopesticides phyto-chimiques, les terpènes et les huiles essentielles riches en terpène sont largement utilisés. Ces composés font partie des mécanismes de défense naturels de nombreuses espèces végétales, montrant généralement une sélectivité élevée vis-à-vis des organismes nuisibles cibles avec une faible toxicité pour les mammifères, les oiseaux et les poissons, en plus d'être biodégradables. En raison de ces propriétés, ils sont généralement considérés comme des produits «à faible risque» (Goñi et al., 2017).

En effet, l'huile de neem est le biopesticide d'origine végétale le plus utilisé. C'est un insecticide extrait des graines d'*Azadirachta indica*. Un certain nombre de composants chimiques ont été isolés dont les composés biologiquement actifs sont l'azadirachtine, le solannine, le deacétylazadirachtinol, la nimbine, la nimbidinine et le méliantriol. En fait, l'azadirachtine, un mélange de sept isomères structurellement liés du tétranortritarpinoïde, est un ingrédient actif majeur isolé de graine de neem qui est connu pour perturber la métamorphose des insectes en

agissant sur leur morphogénèse et leur développement embryonnaire (Srivastava and Raizada, 2007).

En outre, d'autres espèces de plantes peuvent être utilisées à visé bio-insecticides comme par exemples *Tanacetum abrotanifolium* Druce. En effet, cette plante produit dans ces fleurs des pyréthrine. Ces pyréthrine sont des pesticides biologiques qui sont largement utilisés contre un large éventail d'insectes nuisibles dans l'agriculture biologique et dans les ménages pour lutter contre les moustiques du fait de leur activité neurotoxique (Mao et al., 2013; Polatoğlu et al., 2015). De même, des plantes du genre *Calceolaria integrifolia* produisent des terpènes, des composés phénoliques et d'autres composés qui sont accumulés dans les parties aériennes, principalement dans les feuilles et les trichomes de ces plantes, et fournissant des mécanismes de défense contre leur attaque par les prédateurs bactériens, fongiques et herbivores (Céspedes et al., 2014).

Outre les plantes naturellement connues pour leur activité biopesticide, les plantes à pesticides intégrés (*Plant Incorporated-Protectants*, PIPs) peuvent être également considérées comme des biopesticides. Les PIPs sont des organismes modifiés par génie génétique, qui sont capables de produire et d'utiliser des substances qualifiées de pesticides pour se défendre contre les insectes, les virus ou les champignons.

Toutefois, des plantes de pommes de terre, de maïs et du coton qui présentent la particularité de produire la protéine Cry de *B. thuringiensis* sont les plus connus des PIPs. En effet, le besoin économique d'un insecticide efficace, la disponibilité de gènes *Bt* codant pour l'activité insecticide pertinente et la sécurité éprouvée des pulvérisations de Bt ont tous fait des plantes transgéniques *Bt* des candidats évidents pour une exploitation commerciale précoce de la biotechnologie végétale (de Maagd et al., 1999).

2.3. Les biopesticides d'origine animale / semio-chimiques

Les produits semio-chimiques sont des molécules impliquées dans la communication chimique à l'intérieur et entre les espèces. Ce sont des signaux chimiques produits par un organisme qui cause un changement de comportement chez un individu de la même ou d'une espèce différente. Bien que les produits semio-chimiques ne soient pas des biocides par eux-mêmes, les applications pour attirer ou repousser les insectes dans des zones spécifiques ou pour perturber leur accouplement ont rapidement augmenté en tant que stratégie de lutte antiparasitaire (Suckling, 2000). En outre, ces produits permettent de capturer les insectes qui propagent les maladies, de déterminer le moment et la nécessité des applications d'insecticides, de suivre la population et la dispersion des ravageurs, de détecter ainsi que de surveiller les ravageurs (attractifs ou synergiques). Par exemple, les attractifs chimiques d'insectes sont régulièrement utilisés pour surveiller l'activité de vol et la dispersion pour un calendrier efficace des applications d'insecticides, la détection d'espèces non indigènes, la perturbation des capacités de

recherche de partenaires et l'attraction d'insectes bénéfiques pour le contrôle biologique des insectes pestiférés (Heuskin et al., 2011).

La grande majorité des produits sémio-chimiques pour les insectes qui ont été adoptés commercialement et qui sont inclus dans les programmes de lutte intégrée sont des phéromones sexuelles utilisées à des fins différentes, en particulier pour la surveillance et la perturbation de l'accouplement. La perturbation de l'accouplement avec les distributeurs de réservoirs polyvalents appliqués à la main est en effet la technique de contrôle la plus efficace et la plus répandue appliquée à la phéromone utilisée contre les papillons de la vigne dans le monde entier. Cette stratégie repose essentiellement sur le traitement de la culture avec des quantités relativement faibles de phéromones sexuelles synthétiques qui perturbent la communication intra spécifique des espèces cibles et empêchent ainsi l'accouplement (Pertot et al., 2016).

3. Utilisation des algues marines comme biopesticides

Vu la richesse des côtes libanaises en algues, l'exploitation de ces dernières sous forme de biopesticides pourra subvenir aux besoins environnementaux, sanitaires et économiques. Dans notre travail, des extraits algaux ont été utilisés pour induire une protection en post-récolte des agrumes en alternative aux fongicides chimiques.

Les algues sont un groupe diversifié d'organismes photosynthétiques allant des unicellulaires (microalgues ou phytoplancton) à multicellulaires (macroalgues ou filamenteuses) vivant dans des environnements marins et d'eau douce. Ces organismes simples contenant de la chlorophylle sont capables de convertir photosynthétiquement la lumière solaire, l'eau et le CO₂ dans une large gamme de métabolites et de produits chimiques dans la biomasse algale. Ces organismes sont principalement classés en plusieurs groupes basés sur leurs variations de pigmentation photosynthétique ; on trouve alors, les algues vertes, bleu-vert, rouges, brunes et dorées (Vassilev and Vassileva, 2016).

En effet, les algues forment une source riche et variée de produits naturels bioactifs et ont été étudiées en tant qu'agents biocides et pharmaceutiques potentiels. De nombreuses substances ont été identifiées comme agents antimicrobiens à base d'algues marines telles que des dérivés de Chlorelline, l'acide acrylique, des composés aliphatiques, des terpènes, des composés halogénés hétérocycliques contenant du soufre et des inhibiteurs phénoliques (Lavanya and Veerappan, 2011). En outre, en raison de leur teneur élevée en polysaccharides, les algues jouent le rôle d'inducteurs de réponses de défense des plantes conduisant à une résistance contre les pathogènes microbiens. Ils sont également impliqués dans des processus de signalisation précoces comme l'activation de voies métaboliques secondaires et la mobilisation de molécules signal. Par exemple, les carraghénanes, qui forment une famille de galactanes linéaires sulfatés présents dans les parois cellulaires de nombreuses algues, sont de puissants catalyseurs de défense dans les plantes de tabac (Abouraïcha et al., 2015). De même, les oligosaccharides de l'algue verte, *Ulva lactuca*, en particulier l'ulvan et les oligoulvans, ont induit dans les plants de tomates les

défenses systémiques naturelles et une résistance systémique acquise dépendante de l'acide salicylique par une réduction du développement du flétrissement par *F. oxysporum* réduisant la mortalité des plants de tomate traitées (El Modafar et al., 2012).

Outre ces caractéristiques, certaines recherches menées sur les algues marines ont permis d'élucider leurs effets biologiques, en particulier leurs activités fongicides. En effet, diverses molécules antifongiques ont été isolées à partir de l'algue verte *Caulerpa racemosa*, de l'algue verte *Penicillus capitatus* ainsi que de l'algue brune *Lobophora variegata* (El-Hossary et al., 2017).

4. Avantages et inconvénients des biopesticides

L'utilisation de biopesticides en agriculture comporte des avantages et des inconvénients (Brodeur and Caron, 2006; Deravel et al., 2014).

- Avantages
 - Restreindre ou éliminer l'usage des pesticides chimiques nocifs ;
 - Diminuer les risques du développement de la résistance ;
 - Augmenter la spécificité d'action ;
 - Améliorer la qualité de vie des agriculteurs ;
 - Ne prévoir aucun délai avant la récolte ;
 - Offrir aux consommateurs des produits sains ;
 - Diminuer les risques de pollution par dégradation rapide ;
 - Favoriser la croissance des plantes par certains biopesticides microbiens ;
 - Maintenir la biodiversité des environnements.

- Inconvénients
 - Activité plutôt préventive que curative
 - Seuil de tolérance très bas pour les ravageurs
 - Efficacité qui n'est pas toujours constante d'une production à l'autre
 - Activité restreinte lors d'une grande pression du ravageur

En fait, la faible persistance ainsi que l'activité contre un faible spectre de nuisibles que présentent les biopesticides peuvent être considérés à la fois comme avantages et inconvénients. En effet, ces deux avantages associés à leur activité qui dépend souvent des conditions climatiques et environnementales, rendent l'activité des biopesticides moindre que leurs homologues chimiques (Deravel et al., 2014).

III. Partie-3 : Surveillance environnementale de la pollution atmosphérique – Revue sur les biomoniteurs communément utilisés et des polluants couramment étudiés

Cette revue de littérature soumise dans « *Environmental Pollution* » présente un apport bibliographique présentant les matrices utilisées en biomonitoring environnementale, les polluants couramment détectés dans ces matrices ainsi que les méthodes analytiques permettant l'extraction et l'analyse de ces polluants.

La décharge continue de divers produits chimiques dans l'environnement est aujourd'hui une grande préoccupation pour le monde entier, car certains d'entre eux sont considérés en tant que polluants. En effet, bien que plusieurs techniques d'échantillonnage aient été utilisées pour caractériser cette pollution chimique, la biosurveillance à l'aide d'échantillonneurs naturels est récemment devenue la technique de choix dans ce domaine en raison de son efficacité, de sa spécificité et de son faible coût.

Dans cette revue, une description de la surveillance environnementale est présentée. Les deux principales techniques d'échantillonnage sont d'abord signalées, ensuite les polluants environnementaux préoccupants, notamment les pesticides, les composés organochlorés (OCPs, PCBs, PCDD/ Fs), les diphényléthers polybromés (PBDEs), les hydrocarbures aromatiques polycycliques (HAPs) et les métaux lourds, sont considérés. Ultérieurement, un aperçu des matrices naturelles utilisées pour la biosurveillance environnementale a été effectué. Ces matrices comprennent des aiguilles de conifères, des lichens et des mousses, des abeilles et des produits d'abeilles et des escargots. Enfin, les différentes procédures d'extraction utilisées dans ce domaine ont été examinées, suivies d'une aperçue sur les instruments chromatographiques utilisés pour l'analyse et la quantification des principaux polluants à partir des biomoniteurs étudiés.

Environmental monitoring of atmospheric pollution– A review of biomonitors used and pollutants studied.

Josephine AL-ALAM^{1,2}, Asma CHBANI^{1,3}, Ziad FAJLOUN^{1,4}, Maurice MILLET^{2*}

¹Azm Center for Research in Biotechnology and its Applications, Doctoral School of Science and Technology, Lebanese University, El Mittein Street, Tripoli, Lebanon

²Institute of Chemistry and Processes for Energy, Environment and Health ICPEES UMR 7515 Group of Physical Chemistry of the Atmosphere, University of Strasbourg, Strasbourg, France

³Faculty of Public Health III, Lebanese University, Tripoli, Lebanon

⁴Faculty of Sciences III, department of biology, Lebanese University, Tripoli, Lebanon

*Address correspondence to Maurice Millet, Institute of Chemistry and Processes for Energy, Environment and Health (ICPEES UMR 7515 CNRS) Group of Physical Chemistry of the Atmosphere, University of Strasbourg, Strasbourg, France Tel.: + 33 (0)3 68 85 04 22, Fax: + 33 (0)3 68 85 04 02, E-mail: mmillet@unistra.fr

Abstract

The continuous discharge of diverse chemical products in the environment is nowadays a great concern to the whole world as some of them became pollutants. Several sampling techniques have been used for the characterization of this chemical pollution, although biomonitoring using natural samplers has recently become the technique of choice in this field due to its efficiency, specificity and low cost. Here, a review on environmental monitoring is presented. First, both main sampling techniques were reported, then, mainly environmental pollutants of concern including pesticides, organochlorine compounds (OCPs, PCBs, PCDD/Fs), polybrominated diphenylethers (PBDEs), polycyclic aromatic hydrocarbons (PAHs), perfluorinated compounds and heavy metals, were assessed. Then, an overview on the natural matrixes used for the environmental biomonitoring was done. These matrixes include conifer needles, lichen and mosses, bees and bees' products, and snails. Finally, the different extraction procedures used in this field were examined, followed by a view on the chromatographic instruments used for the analysis and the quantification of the major pollutants for each matrix.

Key words: Biomonitoring, pesticides, POPs, extraction, biomonitors.

1. Introduction

The French act on air and the rational use of energy of 30 December 1996 defines air pollution as the introduction by man, directly or indirectly into the atmosphere and enclosed spaces, of hazardous substances presenting risks to health, ecosystems, influencing climate, damaging materials and causing odors (Elichegaray et al., 2010).

Various natural and anthropogenic sources of chemical products could be the cause of different environmental pollution especially of air pollution. These sources include electrical industries, wood combustion, vehicles pollution, buildings and dust, as well as vegetation with the use of pesticides as protective agents (Hu et al., 2014; Masri et al., 2015; McDonald, 2012; Moreira et al., 2016). In fact, air pollution, as shown by numerous studies, contributes to serious diseases of respiratory, cardiovascular and reproductive systems (Deng et al., 2016; Jevtić et al., 2014; Yang et al., 2014). The global organization of protecting human health and environment against pollution was reported and insured by Stockholm Convention requiring regular survey of the atmospheric contamination (POPRC.12, 2016).

The direct measurement of environmental contaminants needs a specific sampling method as well as a precise analytical procedure in order to collect and detect the total amount of emitted pollutants. In fact, even if the use of active sampling for environmental monitoring was the method of choice for long years ago due to its accuracy and efficiency, these methods suffers from many drawbacks leading to the development and use of passive samplers (Tuduri et al., 2012). Among all passive samplers, the use of natural substances remains the most efficient due to its availability, efficiency and sensitivity to accumulate pollutants (Wolterbeek, 2002; Wolterbeek and Bode, 1995).

In this paper, the three sampling techniques are reported followed by a review on the main pollutants and compounds present in the atmosphere. As biomonitoring remains the technique of choice to estimate environmental pollution, this review also describes the frequent matrixes used as biomonitors candidates as well as the different extraction and analytical procedures recently used in the literature. Note that, to our knowledge, a global environmental review describing all these parameters has never been reported.

2. Sampling techniques

Atmospheric pollutants need to be monitored in order to evaluate their potential impact to the environment. Two main sampling techniques were commonly used allowing an accurate qualitative and quantitative assessment of environmental pollution.

2.1 Active sampling

Active sampling is the method of reference for many years. This method uses a pump running at a defined flow rate in order to accumulate air pollutants through a filter (to trap the particle-bound compounds) and/or an adsorbent bed (to trap the gaseous-phase compounds) (Tuduri et al., 2012). In fact, large volume sampling system provides repeatable quantitative results and is well suited for the sampling of trace molecules in the air. Different studies have shown the effectiveness of these pumps for the analysis of organic pollutants such as pesticides (Sanusi et

al., 1999, 2000; Schummer et al., 2010), polycyclic aromatic hydrocarbons (PAHs) (Melymuk et al., 2016; Morville et al., 2004) or polychlorinated biphenyls (PCBs) (Milun et al., 2016; Yeo et al., 2003). Even that these methods are well known for their reliable data, they also suffer from numerous drawbacks. Indeed, these systems are bulky, heavy, time consuming and expensive and require a power supply. Therefore, the sampling site should be selected based on the availability of electrical power and the applicability of a bulky device rather than on the definition of the place of sampling (Kot et al., 2000; Wang et al., 2009). Furthermore, costly air-sampling pumps, frequent calibration routines, as well as, potentially toxic solvents required by chemical adsorption were enough to provide the incentive to develop new and cheaper systems which led to the development of passive samplers (Harner et al., 2006). Moreover, since the Stockholm convention entered into force on 17 May 2004, all the parties have submitted national implementation plans describing the measures planned or taken to implement the provisions of the Stockholm Convention and their effectiveness (POPRC.12, 2016; Wöhrnschimmel et al., 2016). This later implied the need of numerous sampling in many sites, which was not appropriate by "active sampling", hence the development of the "passive sampling".

2.2 Passive sampling

Passive sampling technology has been emerging very fast since it was first published by Palmes and Gunnison in 1973 (Palmes and GUNNISON, 1973). It offers substantial advantages as a low-tech and cost-effective monitoring tool, omitting almost every drawback of active sampling and sample preparation techniques keeping at the same time the ability to produce accurate results (Marć et al., 2015). Passive sampling was defined by Górecki and Namieśnik (Górecki and Namieśnik, 2002) as a sampling technique based on free flow of analyte molecules from the sampled medium to a collecting medium as a result of a difference in chemical potentials; once the samplers exposed to the examined medium, they collect analyte molecules reaching the collecting medium by diffusion through a static layer of the examined medium contained in well-defined opening(s) in the sampler, or by permeation through a nonporous membrane (Górecki and Namieśnik, 2002).

Generally, passive samplers, such as semi permeable membrane device (SPMD), solid phase microextraction (SPME) fiber, polyurethane foam (PUF) disk, XAD-2® resin, polyethylene (PE) device and polyoxymethylene film (POM), consist of a sorption phase (sorbent) together with a protection/support shelter used to minimize physical/microbial damage and/or facilitate subsequent instrumental analysis (Bao and Zeng, 2014). Passive sampling technique is more advantageous than active sampling method due to its low cost, low maintenance requirements, unattended operation and independence from power sources. In addition, passive samplers permit environment monitoring without pumping and therefore without harmful sounds and energy requirement. Furthermore, these techniques are lightweight, compact and easy to manipulate, providing reliable data and creating then new opportunities for environmental monitoring (Bao and Zeng, 2014; Marć et al., 2015; Seethapathy et al., 2008; Wania et al., 2003). However, this sampling technique presents some disadvantages as incompatibility for the determination of short-term pollutants variations, difficulty with automation and sensitivity to environmental situations, such as temperature fluctuations, humidity and air velocity (Marć et al., 2015; Seethapathy et al., 2008; Tuduri et al., 2006). Their calibration is also a challenge since the determination of sampling rates of chemical compounds to the media is difficult to assess with accuracy. Among the most physic passive samplers available, some natural substances can be

used as reliable sensors of pollutants emitted into the atmosphere. This latter constitutes the “biomonitoring”.

2.2.1 Biomonitoring

Biomonitoring, or biological monitoring, is generally defined as “the systematic use of living organisms or their responses to determine the condition or changes of the environment” (Yang et al., 2010). In fact, biomonitoring can execute the high-density sampling at any desired spatial and temporal scales at low cost and permit the measurement of a wide range of pollutants which makes it competitive even replacing others sampling techniques. Furthermore, biomonitors can be assimilate as passive samplers, and their application overcomes all active and passive samplers’ problems as no extra devices is required during the sampling permitting a highly representative sample collection (Ares et al., 2011; De Nicola et al., 2013; Wu et al., 2014).

Biomonitoring consists of the use of natural organisms as passive sampler providing information on the quality of the environment. Biomonitors are living organism naturally present in the environment which can accumulate one or several pollutants in their tissues. Then, they act as an analyte concentrator or sampler, and after collection, they can be analyzed to determine pollutants concentrations (Maré et al., 2015). Environmental biomonitor species should be accumulative and characterized by a time- integrative behavior. Different criteria such as specificity, accumulation ratio, occurrence, biodiversity and species richness are involved in the selection of biomonitoring species. (Wolterbeek, 2002; Wolterbeek and Bode, 1995).

As reported by Li et al., in 2010 (Li et al., 2010), an “ideal” bioindicator should be easy to be recognized even by non-specialist, wide or having cosmopolitan distribution, well-known, abundant, suitable for laboratory experiments, highly sensitive to environmental stressor (s) as well as having a high ability for quantification and standardization (Füreder and Reynolds, 2003; Markert et al., 1999). Likewise, Alan Beeby in 2001 (Beeby, 2001) showed that different types of biomonitors exist and each sentinel has its own purpose. For this, the use of biomonitors has three main goals; the first is the accumulation potential in order to increase analytical sensitivity for a contaminant; to compare the level of variability between sites and to summarize a complex pollution signal. The second is the property of integration to provide a running mean over time or space and the third is a measure of the exposure: to quantify bioavailability of a pollutant from a particular source (Beeby, 2001).

3. Environmental pollutants and compounds

Diverse environmental pollutants are widespread in the environment and many of them are stored and bioaccumulated in the environment. In fact, monitoring the presence and the amount of these pollutants in the environment seems to be crucial and challenging as different types of pollutants might be present as complex mixtures or alone in varied matrices and quantities (Seethapathy et al., 2008). This paragraph briefly presents the pollutants commonly monitored in the atmosphere.

3.1 Pesticides

The United States Environmental Protection Agency (EPA) defines pesticides as a substances or combination of substances aiming to avoid, moderate or eliminate any pest whether it is an insect, a fungi, a weed, or different animals and prions (epa, 2010).

Although pesticides are important in agricultural practices, the control of pesticides residues in all environmental sections is a real concern regarding the potential risks they induce. The general population is exposed to pesticides mostly through their daily intake or the domestic use of pesticides, while environmental exposure from polluted air can occur in agricultural areas (Authority, 2014). Several studies have shown consistent links between exposure to pesticides and serious illnesses such as neurological disorders, cancers, reproductive complications, birth defects, intrauterine growth retardation, and fetal death (Barker et al., 1989; Rogan et al., 1987; Saeedi Saravi and Dehpour, 2016). Moreover, pesticides practically always occur in mixtures, whose toxicological combined effects on human health are mostly unknown and severe (Hernández et al., 2013; Rousis et al., 2016).

3.2 Organochlorine compounds

Organochlorine compounds are considered as persistent organic pollutants (POPs). These pollutants are widespread in the environment and can also enter the food chain mainly through the intake of animal fats (meat, fish and milk) (Contreras López, 2003). Currently, exposure to such pollutant are one of the important environmental issues due to its variety of toxic and adverse health effects, including carcinogenesis, immunological and reproductive disorders for human (Ali et al., 2014).

3.2.1 Organochlorine pesticides (OCPs)

Organochlorine pesticides (OCPs) are synthetic chemicals well effective against insects but highly persistent in the environment (Saoudi et al., 2014). The high persistence of these pesticides in the environment is associated with their high lipophilicity, high stability, long half – life and slow rate of excretion from the body (Bapayeva et al., 2016; Liu et al., 2016; Luo et al., 2016; Saeedi Saravi and Dehpour, 2016). In fact, many studies show that OCPs are accumulated in human tissues by the consumption of contaminated food especially marine food and water (Musgrave et al., 1998; Ouyang et al., 2005; Ren et al., 2011; Saeedi Saravi and Otadi, 2012). OCPs can be accumulated in the environment through many processes especially due to their low water solubility, high n-octanol/water partition coefficients permitting their persistence in sediments (Shen and Wania, 2005). Air pollution caused by organochlorine pesticides raise concern because of the transfer of these pollutants from all environment compartments to air increasing its pollution. In fact, organochlorine pesticides while present in soil and water are directly released in the atmosphere and distributed in the air. Bidleman et al showed that secondary emission of POPs especially OCPs are due to soil-air and water-air exchange (Bidleman et al., 2012). Moreover, Jantunen et al., in 2008 found a correlation between OCPs concentration found in air and found in the lakes providing evidence of water-air exchange (Jantunen et al., 2008). In fact, under favorable conditions sediments can release previously adsorbed OCPs back into the water, and reinitiate another cycle of environmental contamination (Feng et al., 2011). Then, when OCPs enter water, they can transfer into food chain by

accumulating in aquatic organisms (Liu et al., 2016; Zhou et al., 2014). Despite their banned in many countries due to their high persistence associated with adverse health effects, these pesticides are still in use especially in developing countries, mainly to control vector-borne diseases (Bergman et al., 2012; Bergonzi et al., 2009; Namulanda et al., 2016; Ribas-Fitó et al., 2007). OCPs exerts many several disorders on human health leading to nervous alterations, cancer development and endocrine dysfunction (Karami-Mohajeri and Abdollahi, 2010; Siddiqui et al., 2003).

3.2.2 Polychlorinated biphenyls (PCBs)

PCBs are artificial organic chlorinated compounds widely used for their dielectric properties especially as fluids in transformers and capacitors. These products are widely produced and used until they were banned by the United States Congress in 1979, by the French government in 1987 and by the Stockholm Convention on Persistent Organic Pollutants in 2001 (Porta and Zumeta, 2002). PCBs are characterized by a high lipophilic nature which contributes to their high potential bioaccumulation in food chain (Chamkasem et al., 2016). In fact, Biterna and Voutsas in 2005 showed that these pollutants are persistent in the environment, and could be transported to large distances (Biterna and Voutsas, 2005). It was reported that PCBs were extensively used in various industrial applications are widely emitted into the environment from PCB containing wastes, open burning, waste incineration, evaporation from PCB containing products and contaminated surfaces, and accidental spills to soil (Breivik et al., 2002; Dumanoglu et al., 2016). PCBs can be transferred to air through soil-air exchange as well as from urbanization; the volatilization of PCBs in soil was thought to be the primary source of PCBs in the atmosphere, but recent research suggests ventilation of PCB-contaminated indoor air from buildings is the primary source of PCB contamination in the atmosphere (Van den Berg et al., 1998).

PCBs are considered as endocrine disruptors linked to adverse health effects on male reproductive function in humans and animals (Fiandanese et al., 2016; Hauser et al., 2005). Moreover, PCBs have been classified by the International Agency for Research on Cancer (IARC) as carcinogenic to humans and included in Group 1 (IARC, 2015), with evidence of an aryl hydrocarbon receptor (AhR) mediated mechanism of carcinogenicity in humans and experimental animals for the higher chlorinated PCB congeners (Magoni et al., 2016).

3.2.3 Polychlorinated dibenzo-p-dioxins and -furans (PCDD/Fs)

As one group of POPs, polychlorinated dibenzo-p-dioxins and polychlorinated dibenzofurans (PCDD/Fs) are widespread in environment (Squadrone et al., 2016). These pollutants are emitted during different industrial practices such as waste incineration, metal processing, production of chlorinated compounds or combustion processes where chlorinated substances are present (Martínez-Guijarro et al., 2017; McKay, 2002). PCDDs and PCBFs are as PCBs characterized by a high chemical stability, due to the strength of the carbon-chlorine bond, allowing them to resist on microbial, photochemical, chemical or thermal degradation (Ghimpețeanu et al., 2014). The high persistence of these pollutants leads to their accumulation in all environmental compartments. In fact, the hydrophobic nature of these compounds allows their ubiquitous presence in soils, sediments, landfill sites, vegetation and organic matter (Kulkarni et al., 2008).

Dioxins and furans simply known as dioxins are then able to move for long distance before their deposition and needles thus to be monitored. Several biomonitoring studies have shown the ability of environmental matrixes to capture these persistent pollutants, for example, Holt et al., in 2016 have shown the effectiveness of the use of *Pinus sylvestris* as biomonitor candidate for the analysis of PCDD/Fs in Europe (Holt et al., 2016). In fact, the uptake of these pollutants by the conifer species usually occurs through atmospheric gas-phase or particle-phase deposition on the foliage cuticle and through leaf stomata followed by phloem translocation (Simonich and Hites, 1995). Moreover, Zhu et al. in 2007 showed a good correlation between the accumulations of PCDD/Fs by spruce needles and passive samplers' devices (Zhu et al., 2007). Furthermore, lichens have proven their efficiency in this domain allowing the comparison of the accumulation of PCDD/Fs in two lichen species (Augusto et al., 2015a).

3.3 Polybrominated diphenyl ethers (PBDEs)

Polybrominated diphenyl ethers (PBDEs) are synthetic chemicals that were widely used, since the 1970s, as flame retardants in a diversity of consumer products such as in vehicles, electronic devices, equipment, building materials and electrical apparatus (De Wit, 2002; Rahman et al., 2001). These anthropogenic compounds are characterized by structures similar to PCBs with an atom of oxygen between the atomic rings (Polo et al., 2004). PBDEs are highly persistent in the environment, lipophilic and have a widespread usage which contributes to their addition in 2009 to the list of persistent organic pollutants (POPs) under the Stockholm convention (Besis and Samara, 2012; Mariottini et al., 2008). PBDEs are sufficiently stable which allow their environmental long distance transport, deposition and re-volatilization (Besis and Samara, 2012; Wang et al., 2007). These pollutants can be accumulated in many environmental matrixes such as soil and sediments (McGrath et al., 2016; Tombesi et al., 2017), water (Wang et al., 2016b) and dusts (Król et al., 2012). It is also noted that PBDEs can be accumulated by different biomonitor candidates for monitoring their environmental persistence such as conifer needles through absorbance upon their waxy lipid layer (Chropeňová et al., 2016; Ratola et al., 2011a; St-Amand et al., 2008), lichen and moss (Zhu et al., 2015), as well as apple snail (Fu et al., 2011).

3.4 Polycyclic aromatic hydrocarbons (PAHs)

PAHs are a wide class of organic compounds, characterized by a structure of two or more condensed aromatic rings, produced as byproducts of an incomplete combustion, volcanic eruption, forest fires, and vehicle emissions (Abdel-Shafy and Mansour, 2016; Elorduy et al., 2016; Pongpiachan et al., 2013). They can have high carcinogenic and mutagenic effects (Al-Rashdan et al., 2010; de Lima et al., 2017). They are, in fact, due to their atmospheric persistence, of great concern as they are known for their carcinogenic and mutagenic properties (Delistraty, 1997; Kamal et al., 2014). In addition, the most toxic PAHs are those with five or more benzene rings, known as high-molecular weight PAHs (HMW PAHs). They are considered as most toxic, mutagenic and carcinogenic. Especially in urban areas, they are responsible of several respiratory problems, human cancer of skin, lungs and bladder (Alagić et al., 2016; Elorduy et al., 2016; Li et al., 2016b).

3.5 Heavy metals

Pollution caused by heavy metals has become a serious environmental problem due to their high stability, high persistence and non-biodegradability (Saha and Zaman, 2013). Even if some heavy metals are important for human health, an excess amount of these metals can have harmful effects (USEPA, 2015). Heavy metals are released into the environment over natural process and/or anthropogenic activities such as industrialization and urbanization, massive land use changes, traffic pollution, agricultural activities, electroplating, metal manufacturing and chemical industries (Chowdhury et al., 2016; He et al., 2008; Rahman et al., 2012; Saha et al., 2016; Wang et al., 2015). Heavy metals can be accumulated in sediments, water and aquatic organisms. They can be transferred to the environment through natural and anthropogenic practices; natural sources include volcanic eruptions, oceanic manners and atmospheric deposition, while anthropogenic processes as fossil fuel burning, coal combustions, agricultural activities, industrial practices as well as vehicular emissions leading to the metal transfer into dusts and air (Chen et al., 2010; Jandacka et al., 2017; Li et al., 2016a; Tang et al., 2017). Consequently, these contaminants are transferred to human body through diet. Furthermore, the increase in soil acidification leads to the evolution in the mobility of heavy metals which may menace plants and groundwater, and then leads to the incorporation of these elements into the food chain (Chowdhury et al., 2016; Drozd-Hara, 1978; Saha et al., 2016; Wilhelm Scherer, 2009). Heavy metals persistence can exert various adverse health effects on human as impaired kidney function, poor reproductive capacity, liver damage, skin and bladder cancer, cardiovascular disease and even death (Niu et al., 2013; Wei et al., 2014).

4. Matrixes used for biomonitoring

Biomonitoring permit the evaluation of environmental pollution qualitatively and quantitatively. In this study, the common living organisms used as biomonitors are presented and discussed.

4.1 Conifers needles

The use of vegetation for environmental biomonitoring is well known as an advantageous matrix for the assessment of airborne pollutants. In fact, vegetation remains the cheapest, the most available and the simplest matrix to atmospheric monitoring. Several studies have shown the effectiveness of this matrix in the identification and quantification of chemical pollutants in the atmosphere (Gerdol et al., 2002; Klánová et al., 2009; Ratola et al., 2010; Ratola et al., 2014; Schulz et al., 1999; St-Amand et al., 2009).

Among different vegetation species, conifer needles play an important role as passive samplers. Conifers are classified among the evergreen tree species as the needles are usually preserved for at least five years, which allow them to provide information about pollutants emissions over longer periods (Dreyer et al., 2010; Eriksson et al., 1989). Moreover, conifer trees are widespread and can be found over large and poorly accessible areas (Romanič and Krauthacker, 2007). Furthermore, conifers needles are characterized by a high affinity towards low or medium polar compounds due to their high wax leaf content, which allow them to fix pollutants over the years (Xu et al., 2004). The use of conifers as environmental monitors for pesticides, PAHs, PCBs, PBDEs, OCPs and heavy metals is widely reported in the literature. Table 1 summarizes the use of conifer needles as biomonitors during the last six years (2010-2016).

Table 1: Summary of the use of conifer needles as biomonitors

Conifer species	Aim of the study	Analytes	Extraction and clean-up	Analytical method	Ref.
<i>P. halepensis</i> Mill., <i>P. nigra</i> Arn and <i>P. pinea</i> L.	Determination of PBDEs in pine needles of three species distributed in NE Spain	8 PBDEs	Sonication followed by two purification steps using respectively alumina and florisil SPE cartridges	GC-negative chemical ionization (NCI)-MS	(Ratola et al., 2011a)
<i>Pinus radiata</i>	analyzing the relationship between the accumulation of PAHs and heavy metals in tree foliage <i>Pinus radiata</i>	12 PAHs, 6 heavy metals (Cd, Cu, Fe, Mn and Zn)	Miniaturized method for PAHs, Digestion with HNO ₃ + centrifugation for heavy metals	High Performance Liquid Chromatography coupled to ultra violet detection (HPLC-UV) detection for PAHs, Atomic absorption spectroscopy (AAS) for heavy metals	(Rodriguez et al., 2012)
<i>Pinus nigra</i> Arn	Assessing the suitability of bioindicators on urban air pollution	Heavy metals	Digestion with concentrated HNO ₃	AAS	(Sawidis et al., 2011)
<i>P. pinaster</i> Ait and <i>P. pinea</i> L.	Comparison between species	16 PAHs	sonication followed by purification with alumina SPE cartridges	GC-EI-MS	(Ratola et al., 2011b)
<i>P. jeffreyi</i>	Characterization of spatial distribution phenanthrene, in Fresno	Phenanthrene	ASE	GC-MS	(Noth et al., 2013)
<i>P. sylvestris</i> L.	Assessing the effect of Scots pine as a bioindicator species	Zn, Cu, Cd, and Pb	digestion in a mixture of HNO ₃ (d = 1.40) and 60% HClO ₄ acid in a 4:1 ratio	AAS	(Pietrzykowski et al., 2014)
<i>Pinus pinaster</i> and <i>Pinus pinea</i>	Examining the use of using pine needles as biomonitors of PAH levels, relating them with several socio-geographic parameters.	PAHs	Sonication followed by purified clean-up with polypropylene SPE alumina cartridges	GC-MS	(Fernández-Varela et al., 2015)
<i>Pinus mugo</i> Turra	Long range transport + Determination of the accumulation of POPs and lead in the collected samples	POP compounds (PCBs, OCPs, PBDEs), PAHs and lead	Extraction with an automatic extractor with dichloromethane and methanol. Clean-up with activated silica gel for PAHs followed by a treatment using gel permeation chromatography, activated silica gel modified with sulphuric acid for PCBs + OCPs + PBDEs.	GC-MS/MS for PAHs, High resolution gas chromatography coupled to high resolution mass spectrometer (HRGC/HRMS) for PDBEs, GC-MS/MS for PCBs and OCPs, For lead: X-ray fluorescence spectrometry	(Chropeňová et al., 2016)
<i>Pinus pinea</i>	Determining the levels of 18 pesticides in collected samples and correlating them to several characteristics as population and meteorology	18 pesticides	Sonication followed by a clean-up procedure using 500 mg of ENVI C ₁₈ cartridges	GC-MS	(Ratola et al., 2014)
<i>Pinus pinaster</i> Arton	optimization of analytical procedures for the extraction of 19 PAHs in <i>Quercus robur</i> L. leaves and <i>Pinus pinaster</i>	19 PAHs	Matrix solid phase dispersion extraction followed by a clean-up using Florisil SPE tube added with 0.5 g of partially deactivated (10%) silica	GC-MS/MS	(De Nicola et al., 2016)

Pine needles	Establishing a method for multi-residuals analysis of pine needles used as biomonitors	PCBs, HCB, and PAHs	ultrasonic solvents extraction (USE), clean-up using SPE with alumina followed by GPC	GC-MS	(Silva et al., 2015)
<i>Pinus sylvestris</i>	Identifying the potential sources of atmospheric PCDD/Fs, using pine needles from Scots pine	Polychlorinated dibenzop-dioxins/furans	Soxhlet extraction, clean-up using column elution	GC-HRMS	(Holt et al., 2016)
<i>Pinus radiata</i>	optimizing an S-PLE method for simultaneously extracting halogenated current- and historic-use pesticides and polychlorinated biphenyls (PCBs) from pine needles	Pesticides and PCBs	ASE/S-PLE, Clean-up using silica SPE and GPC	GC-MS	(Lavin and Hageman, 2012)
Pine needles	Evaluation of the use of tree components, litter, and soil as passive samplers by investigating their relationships with atmospheric POPs concentrations	16 PAHs, 41 PCBs, 32 Polychlorinated naphthalenes (PCNs) and 7 PBDEs	Ultrasonic extraction, Clean-up using GPC	GC-MS	(Odabasi et al., 2016)
Pine needles	demonstrating the possibility of spatial and temporal distribution of pesticides and POPs using pine needles collected from three sites representative of urban, suburban, and rural areas in and around Strasbourg	PCBs, OCPs PAHs	ASE-SPE-SPME	GC-ECD for PCBs and OCPs, HPLC-FLD for PAHs	(Al Dine et al., 2015)
<i>Pinus halepensis</i>	observing spatial and temporal trends of PAH levels in airborne using pine needles and to evaluate the source of PAHs	PAHs	ultrasonic extraction and alumina cartridge clean-up	GC-MS	(van Drooge et al., 2014)
<i>Pinus nigra</i> <i>Cedrus atlantica</i>	study of temporal air pollution variation in Strasbourg-France using two species of conifer needles	Pesticides, PAHs, PCBs	ASE-SPE-SPME	GC-MS/MS LC-MS/MS	(Al-Alam et al., 2017)

As seen from table 1 as well as from older studies, research on conifer needles had different goals from assessing sources of pollutants (Odabasi et al., 2016; Pietrzykowski et al., 2014; Sinkkonen et al., 1996), identifying long-range transport (Chropeňová et al., 2016; Grimalt and Van Drooge, 2006), quantifying levels of contamination (Klánová et al., 2009; Ratola et al., 2014), comparing methodologies (Lavin and Hageman, 2012; Ratola et al., 2006), to the investigation of the effect of needle age on final results (Romanić and Krauthacker, 2006).

In fact, different conifer species were used in order to assess environmental pollution. Between all studied species, *Pinus Pinea* and *Pinus nigra* were the most studied species and this may be due to their enormous geographical distribution. Moreover, it can be noted that, even if all conifer species can be used for environmental monitoring, most of the studies focused on pine needles in comparison to other species. For instance, Ratola et al., in 2011 used three pine needles species to study 8 PBDEs in Spain (Ratola et al., 2011a), while Al-Alam et al., in 2017, used pine and cedars needles (two conifer species) in order to compare the accumulation of

pollutants in both species in Strasbourg (Al-Alam et al., 2017). The main explanation of the use of one conifer species may be due to the fact that different characteristics of conifers species such as lipid content, waxy layer, and available surface area could lead to the accumulation of different pollutants what makes their use in one study mainly comparative and not quantitative.

Furthermore, it can be also noted that one single needle can accumulate a wide range of pollutants allowing a global environmental monitoring (Al Dine et al., 2015). Thus, pine needles have well proven their effectiveness providing a cheap, effective and useful passive sampler for monitoring the occurrence of chemical pollutants in the atmosphere.

4.2 Lichens and mosses

Bryophytes and lichens are bio-organisms that are sensitive to air pollution and especially to heavy metals and POPs. Several studies have shown the efficiency of mosses and lichens in monitoring the presence of persistent organic pollutants in the environment (Fernández et al., 2009; Giordano et al., 2005; Giordano et al., 2010). Lichens, symbioses of fungi and algae, are long-lived, slow growing organisms, which are very efficient in intercepting pollutants from atmosphere (Augusto et al., 2013; Nimis et al., 2002). These organisms are persistent, robust and are able to live for many years in extreme conditions – being found in locations from the icy Himalayas to deserts which makes them suitable for environmental biomonitoring (Bergamaschi et al., 2004; Maphangwa et al., 2012). Bryophytes such as mosses have been used by Ruhling and Taylor since the 1970s for the environmental biomonitoring of POPs, trace metals, and excess of nitrogen (Ruhling and Tyler, 1968; Rühling and Tyler, 1970).

Many recent reviews on environmental biomonitoring focused on the use of lichens and mosses for monitoring several pollutants (Bargagli, 2016; Harmens et al., 2013; Van der Wat and Forbes, 2015). Lichens do not have roots and cuticle, so they are exposed to pollutants only through atmospheric deposition. Furthermore, lichens are characterized by a constant morphology which allows collecting them at any season and they can be found extensively (Bargagli, 2016; Garty, 2001). Likewise, mosses are considered as useful tool for biomonitoring. They take their nutrients from water which is originated mostly from rainfall, leading mosses as potential biomonitors for environmental deposition (Lequy et al., 2016). Moreover, mosses are ubiquitous and they have a structure allowing them to accumulate pollutants at large concentration making them advantageous for monitoring at large temporal and/or spatial scale (González and Pokrovsky, 2014; Harmens et al., 2013; Harmens et al., 2012; Lazić et al., 2016). Moreover, mosses can be simply transplanted from uncontaminated sites to polluted ones. In such cases, they are held in bags and exposed to the contaminant allowing monitoring in these zones (Goodman and Roberts, 1971; Maré et al., 2015; Salo et al., 2012; Wu et al., 2014). Even if lichens and mosses are absolutely unrelated groups of cryptogrammic organisms, they have a lot of features in common and both species, depending on their availability, can be used for an effective environmental biomonitoring.

Since lichens and mosses are abundant and have a wide distribution as well as a special morphology structure and physiological features, they have been increasingly used to the biomonitoring of POPs and heavy metals in the atmosphere. Table 2 summarizes the use of lichen and mosses recently reported in the literature (since 2015).

Table 2: Summary of the use of lichens and mosses as biomonitors

Species	Aim of the study	Analytes	Extraction and clean-up	Analytical method	Ref.
Lichen: <i>Xanthoria parietina</i>	Monitoring how pollutant concentrations vary in space and over time nearby an incinerator in industrial area in Central Italy, + comparison between lichens and trees in pollutants accumulation	trace elements: Al, As, Cd, Co, Cr, Cu, Fe, Hg, Mn, Ni, P, Pb, Sn and Zn.	Extraction with HNO ₃ , for 8 h at 120°C in a pressurized digestion system	inductively coupled plasma atomic emission spectrometry (ICP-AES) for Al, Mg and Mo, and P electrothermal atomic absorption spectrometry for Cd, Co, Cr, Cu, Fe, Mn, Ni, Pb, Sn and Zn AAS for As and Hg	(Cocozza et al., 2016)
<i>Lichen: Xanthoria parietina</i>	Analysis of trace elements to assess environmental inequalities	18 trace elements	-	ICP-AES for: Mn, Ti, Zn. ICP-MS for : Al, Sb, As, Be, Cd, Co, Cr, Cu, Hg, N, Pb, Pd, Pt, Rh, V	(Occelli et al., 2016)
<i>Lichen : Peltigera aphthosa, Peltigera neopolydactyla, Peltigera scabrosa, Nephroma arcticum</i>	Establishing background levels for metals in boreal muscicolous/terricolous macrolichens over non-urbanized areas of northeastern Canada	18 elements: Na, Mg, Al, P, K, Ca, Ti, V, Cr, Mn, Fe, Co, Ni, Cu, Zn, Mo, Cd, and Pb	Concentration with HNO ₃ followed by a microwave assisted digestion	Inductively-Coupled Plasma Mass Spectrometer (ICP-MS)	(Darnajoux et al., 2015)
<i>Moss: Hylocomium splendens</i>	Studying atmospheric deposition in Northern Spain, assessing monthly and annual PAH atmospheric deposition fluxes, comparing biomonitoring with measurements of contaminants in total deposition and, identifying the emission sources.	13 PAHs	PLE using n-hexane, followed by SPE clean-up and a solvent exchange filtration	HPLC-FLD	(Foan et al., 2015)
fruticose lichen <i>Ramalina canariensis</i> and foliose lichen <i>Xanthoria parietina</i>	Comparing the concentrations of PCDD/Fs in two lichen species collected in four sampling periods	Dioxin and Furan: PCDD/F	Soxhlet, followed by a clean-up using column chromatography	Gas chromatography-high resolution mass spectrometry	(Augusto et al., 2015a)
lichen <i>Xanthoria parietina</i>	Studying the uptake and the accumulation of gas phase PAHs (namely FLU and BaP) in the foliose lichen <i>X. parietina</i>	fluoranthene (FLU) and benzo[a]pyrene (BaP)	-	Fluorescence microscope	(Augusto et al., 2015b)
<i>Mosses:</i>	Studying if the active	Heavy	For heavy metals: microwave	For heavy metals:	(Vuković et

<i>Sphagnum girgensohnii</i> and <i>Hypnum cupressiforme</i>	moss biomonitoring data could be used to produce a credible city zonation of air pollution.	metals: Al, Ba, Cd, Co, Cr, Cu, Fe, Ni, Pb, Sr, V and Zn and 16 PAHs	digestion For PAHs: ultrasonication	inductively coupled plasma optical emission spectrometry(ICP-OES), For PAHs: GC-MSD	al., 2015)
<i>Moss: Barbula lambaranensis</i>	The use of surrogate heavy metals to determine other heavy metals	Heavy metals: Zn, Cd, Cr, Pb, Cu and Ni	Digestion for 30min on hot plate with conc. HNO ₃	Flame Atomic Absorption Spectrophotometer	(Ogunkunle et al., 2016)
<i>Moss: Sphagnum palustre</i>	Development of a MSPD procedure in order to analyze 19 PAHs in mosses	19 PAHs	MSPD followed by a clean-up using florisil SPE tube	GC-MS/MS	(Concha-Graña et al., 2015a)
<i>Moss: Sphagnum capillifolium</i>	Characterizing the deposition of trace elements in northeastern France by determining the concentrations of trace elements in <i>S. capillifolium</i> +describing the distribution of trace elements among the <i>Sphagnum</i>	Heavy metals	Dissolution of the powdered moss in a solution of concentrated suprapure HNO ₃ , HF, and HCl	ICP-OES for : Al, Cd, Cr, Fe, Ti, V, and Zn ICP-MS for Pb and Cu	(Meyer et al., 2015)
<i>Lichen: Usnea longissima,</i> <i>mosses: Hypnaceae and Pottiaceae</i>	Investigating the spatial distributions, contamination level, source and cold trapping effect of SVOCs on the southeastern Tibetan Plateau, using lichens and mosses as passive samplers.	28 OCPs, 18 PCBs, 13 PBDEs, 3 Hexa-bromo-cyclo-dodecane (HBCDs)	For OCPs: ASE with n-hexane:acetone (75:25) followed by a column purification and a SPE clean-up, For PCBs, PBDEs and HBCDs: ASE with dichloromethane: hexane (1:1) followed by a column purification	GC-MS: pesticides, HRGC-HRMS: PBDES and PCBs, HBCDs: HPLC-MS/MS	(Zhu et al., 2015)
<i>Transplanted lichen Pseudevernia furfuracea</i>	Verifying the seasonal differences of the PAHs content in lichen transplants in a mixed land use area of NE Italy	10 PAHs	ASE using dichloromethane: acetone (1:1) followed by a purification using column chromatography	GC-MS	(Kodnik et al., 2015)
<i>Lichen: Evernia prunastri</i>	Comparing the accumulation and profile of PAHs in transplanted lichens with those in co-located passive gas-phase samplers	16 PAHs	Soxhlet using n-hexane followed by a purification using silica column	GGC-MS	(Loppi et al., 2015)
<i>Mosses: Fissidens crassipes, Plagiomnium undulatum, and Leucodon sciuroides</i>	Application of Alkyl carboxylic acid-based nanostructured solvents in the extraction of 14 PAHs from mosses prior to their separation by liquid chromatography and	14 PAHs	SUPRAS-based microextraction using alkanol-based supramolecular solvents formed with Decanoic acid dissolved in THF followed by addition of aqueous hydrochloric acid	LC-FLD	(Caballero-Casero et al., 2015)

	fluorescence detection (LC-FLD)				
<i>Mosse: Pseudo-scleropodium purum</i>	Application of MAE for the extraction of PAHs from mosses	19 PAHs	microwave assisted extraction using a mixture of hexane: acetone (90:10) followed by a clean-up using florisil SPE tube	programmed temperature vaporization-gas chromatography-tandem mass spectrometry (PTV-GC-MS/MS)	(Concha-Graña et al., 2015b)

Table 2 shows that lichens and mosses are mostly used to biomonitor atmospheric pollution caused by PAHs and heavy metals while their use for pesticides analysis is mainly based on OCPs accumulation (Zhu et al., 2015). Recent publications focused on the role of these two species in the biomonitoring of these pollutants which may be due to the physical properties of lichens and mosses allowing them to accumulate pollutants through atmospheric deposition.

For lichens analysis, it can be mentioned that the foliose lichen *Xanthoria parietina* was abundantly used for environmental biomonitoring (Augusto et al., 2015a; Augusto et al., 2015b; Coccozza et al., 2016; Occelli et al., 2016). The two lichen classes fruticose (fully exposed to ambient air) and foliose (exposed by upper surface to ambient air) were the mostly used in biomonitoring (Augusto et al., 2015a; Darnajoux et al., 2015; Foan et al., 2015; Kodnik et al., 2015; Zhu et al., 2015). In fact, lichens are classified in three groups according to their form and their contact with ambient air. The use of these two lichen classes may be due to their high capacity in accumulating pollutants because of their large surface in contact with air and pollutants while, the third class, crustose lichen are extremely attached to their substrate, which make their ability of accumulating pollutants and therefore their use limited (Blasco et al., 2011). The lichen *Evernia prunastri*, studied by Loppi et al., in 2015 plays a major role in this distribution due to its classification as foliose lichen while appearing as a fruticose lichen (Loppi et al., 2015).

For mosses analysis, it can be mentioned that these candidates have an important role in metals accumulation (Concha-Graña et al., 2015a; Meyer et al., 2015; Ogunkunle et al., 2016; Vuković et al., 2015). In fact, this latter observation was reported by González and Pokrovsky in 2014 clarifying that mosses are well known for metal monitoring due to the absence of waxy cuticles which increases the ratio surface/volume and then accelerates their uptake of metals (González and Pokrovsky, 2014). Finally, one can note that even if these matrixes are known for metals accumulation, they are also able for all other pollutants accumulation. In their work Harmens et al., in 2013 (Harmens et al., 2013) reviewed the application of mosses in biomonitoring POPs focusing on PAHs, on Organochlorine, on dioxins and furans as well as PBDEs.

4.3 Bees and bees products

By transporting pollen from flower to flower and from plant to plant, bees play an essential role in environmental biomonitoring (Paradis et al., 2014). The contamination of honeybees and their products by pesticides as well as other environmental pollutants may occur through direct infection from beekeeping practices as well as indirect contamination from several environmental sources (Kujawski et al., 2012). Honeybees search for food in a wide range, which allows them to be in contact with several contaminated sites such as pollen, nectar, plants and water (Raeymaekers, 2006). In fact, bees are exposed to pollutants through collected pollen and nectar, through air contamination and raindrops, through dusts and derived soil pollutants as

well as extra floral secretions that are produced from some plants. The exposure procedure figured above was reported by many authors (Chauzat and Faucon, 2007; Girolami et al., 2009; Greatti et al., 2003; Kasiotis et al., 2014). Bees collect pollen and nectar and stored them in the hive which leads to infection of the brood.

Bees are considered as an efficient sentinel for environmental biomonitoring due to several characteristics as bees are ubiquitous and consequently they can be found in every continent in most countries; they are characterized by a high reproduction rate which makes them easy to multiply; bees have a relatively short lifetime which leads to a continual regeneration of the colony. Furthermore, bees have a high mobility and a wide flight area which makes them suitable for a wide monitoring area; in fact, honey bees fly up to 4 km in all directions from their apiary and thus have access to an area of about 50 km² allowing them to monitor a large area and to detect different type of pollutants in their ambient environment (Malhat et al., 2015). Moreover, these small organisms are very sensitive to the majority of pesticides and chemical products and pollutants due to their specific body covered with fur, which makes them particularly suitable to keep the substances with which they come into contact (Badiou-Bénéteau et al., 2013; Kujawski and Namieśnik, 2011; Wiest et al., 2011). For all these reasons, the use of honeybees and bee products (pollen and honey) as bioindicators of environmental contamination has been of great concern in recent years. Several studies have shown the effectiveness of these three matrixes in environmental biomonitoring (Chiesa et al., 2016; de Oliveira et al., 2016; Lambert et al., 2012a; Lambert et al., 2012b; Matin et al., 2016).

As cited, bee products are effective for biomonitoring. Firstly, pollen is easy to collect and frequently contaminated specially with pesticides which makes it perfect for assessing the presence of environmental contaminants (Chauzat et al., 2011). A recent study conducted by De Olivera et al., in 2016 (de Oliveira et al., 2016) showed that bee pollen could provide a useful indication of pesticides used in the environment which indicates the effectiveness of this matrix as biomonitors. Secondly, honey is one of the most traditional and popular nutrients used throughout the world with massive quantities. Being the first and major product of bees, honey is widely monitored worldwide for its contamination (González Paramás et al., 2000; Malhat et al., 2015; Moniruzzaman et al., 2014; Panseri et al., 2014; Zhelyazkova, 2012).

Honeybees and bee products are then widely used in order to monitor environmental pollution caused by pesticides, and other environmental pollutants. Publications in this field are numerous, and table 3 summarizes some of the works reporting the use of these matrixes as biomonitors for environmental pollutants.

Table 3: Summary of the use of bees and their products as biomonitors

Matrix	Aim of the study	Analytes	Extraction and clean-up	Analytical method	Ref.
Organic honey	investigating the presence of POPs in organic honeys arising from different Italian regions	OCPs, organophosphates (OPs), PCBs, PBDEs	ASE using hexane/ethyl acetate (4:1, v/v)	GC-MS/MS	(Chiesa et al., 2016)
Honey	Monitoring residues of OCPs and synthetic pyrethroid pesticides in honey	organochlorine and synthetic pyrethroid pesticides	QuEChERS	GC- μ ECD	(Malhat et al., 2015)

	samples collected from Egypt in order to assess the risks related to the consumption of this honey				
Honey	Developing a selective and rapid method for the determination and quantification of 116 pesticides from different class. This method was used for the assessment of the quality of the Brazilian honey	116 pesticides	QuEChERS	UHPLC-MS/MS	(Tette et al., 2016)
Polyfloral honey	Quantifying pesticides residues in retail brands of polyfloral honey in order to assess the risk for consumers	11 pesticides	QuEChERS	LC-MS/MS	(Juan-Borrás et al., 2016)
Honeybees	Development of an analytical method for the determination of pesticides currently approved to use within European Union and their metabolites in honeybee	200 pesticides and metabolites	QuEChERS	LC-MS/MS and GC-MS/MS	(Kiljanek et al., 2016)
Honey	Application of SPE-DLLE to the extraction of pesticides residues in water, milk, honey and fruit juice	19 Pesticides	SPE followed by DLLE	GC-MS	(Shamsipur et al., 2016)
Bee pollen	Evaluation of the potential of bee pollen as a bioindicator of environmental contamination by pesticides	26 pesticides	QuEChERS	GC-MS/MS	(de Oliveira et al., 2016)
honey bee wax comb	Development, validation, and application of an analytical multiresidue method for 120 pesticides in bee wax comb, based on QuEChERS extraction followed by detection with a microflow-LC-ESI-QqQ-MS.	120 pesticides	QuEChERS	LC-ESI-MS/MS	(Herrera López et al., 2016)

Honey	Developing a method based on modified QuEChERS for the analysis of 200 pesticides residues in honey in order to apply it on a monitoring program	200 pesticides	QuEChERS	GC-MS/MS	(Shendy et al., 2016)
Honeybees	Optimization of a rapid and robust method for the simultaneous extraction of OPs and azole compounds from honeybees	Organo-phosphorus esters, Azoles	MSPD	LC-MS/MS	(García-Valcárcel et al., 2016)
honey, pollen and honey bees, (<i>Apis mellifera</i>)	Detection of Neonicotinoid insecticides (NIs) and their transformation products in honey, pollen and honeybees from hives located within 30 km of the City of Saskatoon, Saskatchewan, Canada	neonicotinoid insecticides	QuEChERS	LC-MS/MS	(Codling et al., 2016)
Honey	developing and validating a simple analytical tool for the determination of twelve PAHs in honey using the SALLE approach	12 PAHs	Salting assisted liquid-liquid extraction (SALLE) using CAN	UHPLC with fluorescence detection	(Koltsakidou et al., 2015)
Honeybees	Analysis of cadmium, lead, arsenic and mercury in industrial districts of Izmir, Turkey using honey bees, propolis and pine tree leaves	Cd, Pb, As and Hg	Wet digestion using concentrated nitric acid and hydrogen peroxide Pre-concentration using LLE is required only for Lead analysis	for AS and Hg: electrothermal atomic absorption spectrophotometry for Pb and Cd: flame atomic absorption spectrophotometer	(Matin et al., 2016)
Honey	Determination of the concentrations of some heavy metals in honey collected in China, and examining the potential human health risks to honey consumers in Zhejiang Province, China.	copper (Cu), zinc (Zn), cadmium (Cd), lead (Pb), arsenic (As), and mercury (Hg)	Digestion using a Multiwave 3000 microwave closed system	Cu and Zn: flame atomic absorption spectrophotometry (FAAS) system Cd and Pb: graphite furnace atomic absorption spectrometry (GF-AAS) system As and Hg: AFS-970 dual-channel atomic fluorescence spectrometer	(Ru et al., 2013)
Honey	Reporting and comparing the residues of BFRs	17 brominated flame retardants (BFRs)	LLE followed by a clean-up using a multilayer column using n-hexane as	GC-QqQ-MS/MS	(Mohr et al., 2014)

	found in honey collected from Brazil, Spain, Portugal, Slovenia and Morocco in the years 2010, 2011 and 2012.		elution solvent		
Bee pollen	Comparing several clean-up methods for the analysis of 253 pesticides in pollen samples in order to choose the protocol leading to the highest number of pesticides satisfying the recovery and precision criteria	253 pesticides	QuEChERS applying a freeze-out followed by d-SPE and a clean-up using SPE with Z-Sep	LC-MS/MS GC-MS/MS	(Vázquez et al., 2015)

Studies summarized in table 3 confirms that bees can be perfect candidates for biomonitoring and confirm their ability of transferring pollutants in which they came into contact to their hives and contaminate therefore all their products.

In fact, the analysis of bees and their products seems urgent for beekeepers to select an area for specific production of organic honey as some of this latest production, as shown by Chiesa et al., in 2016, may be affected by area's contamination (Chiesa et al., 2016). Furthermore, as shown by many authors, most studies focus on multi-residual analysis of pesticides, using QuEChERS extraction, validating the states that bees, during their foraging activities are subjected to a wide range of contaminants (Kiljanek et al., 2016; Malhat et al., 2015; Shendy et al., 2016; Tette et al., 2016).

It can be also observed that the use of bees and their products as biomonitor candidates is especially dedicated to the analysis pesticides residues. In fact, as shown in table 3, very few recent publications were done on other organic contaminants such as PCBs and PAHs. This conclusion was also suggested by García-Valcárcel et al., in 2013 (García-Valcárcel et al., 2016) who proposed an optimized MSPD based method for the extraction and the purification of azole and OPs in honeybees. They also mentioned that honeybees or even beehive products have been used as bioindicators of environmental pollution especially done by pesticide residues.

Moreover, honeybees, especially *Apis mellifera*, is known as the most widely managed pollinator of crops (Codling et al., 2016), as well as honey were the most studied matrixes in this field (Codling et al., 2016; de Oliveira et al., 2016; Herrera López et al., 2016; Juan-Borrás et al., 2016; Kiljanek et al., 2016; Koltsakidou et al., 2015; Surma et al., 2015).

4.4 Snails

In addition to the cited biomonitors, certain organisms such as snails have been used to the evaluation of terrestrial pollution (Coourdassier et al., 2001). In fact, the use of snails as sentinel indicators is efficient due to their wide distribution, easy sampling and their ability to accumulate various pollutants (Beeby and Richmond, 2002; Laskowski and Hopkin, 1996). Furthermore, snails live at the soil–plant–air interface and then integrate different sources and paths of

contamination (De Vaufleury et al., 2006; Pauget et al., 2013). The exposure of snails to soil contaminants as illustrated by de vaufleury et al., in 2012 (De Vaufleury et al., 2012), is shown in figure 1.

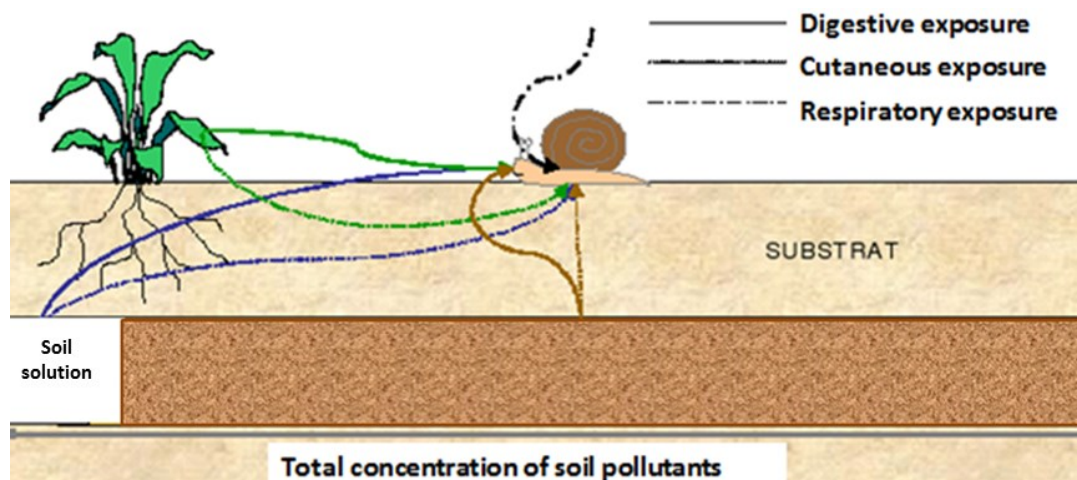


Figure 1: exposure of snails to soil contaminants (De Vaufleury et al., 2012)

Several studies have shown the ability of these organisms in accumulating different sources of pollutants such as pesticides (Zawisza-Raszka et al., 2010), PAHs (Ianistcki et al., 2009; Sverdrup et al., 2006), and metals (De Vaufleury et al., 2006; Vaufleury and Pihan, 2002). Although snails are well known for their ability to accumulate pollutants, to our knowledge studies on the extraction and the analysis of pesticides and POPs from these matrixes is still limited and most works focused on metal analysis.

In fact, even that snails are pulmonized matrixes, they are not or very little used for air pollution monitoring. Their use as a sentinel for air pollution due to their cages installed on mats and to their pulmonary properties would make them a potential indicator of air pollution stress.

Therefore, metal biomonitoring using snails is well known in literature, metals are usually analyzed by atomic absorption spectrophotometer, ICP or ICP-MS after being mineralized and extracted using concentrated HNO_3 . For this purpose, different snails species was reported such as *Indothais gradata* (Proum et al., 2016), *Papillifera papillaris* (Emilia et al., 2016), *Helix aspersa* (Abdel-Halim et al., 2013), *Pomacea canaliculata* (Dummee et al., 2012), *Cantareus apertus* (Mleiki et al., 2016), *Helix aspersa* (Viard et al., 2004). Few other publications reported the analysis of environmental pollutants from such matrixes for example *Helix aspersa* was used in order to assess the exposure, the transfer and the effects of vineyard pesticides on transplanted snails during a whole growth season. Different herbicides (glyphosate and glufosinate) and fungicides (cymoxanil, folpet, tebuconazole and pyraclostrobin) were then investigated using HPLC with fluorescence detection and LC-MS/MS respectively (Druart et al., 2011). Furthermore, the Apple snail (Ampullariidae), was used to investigate the contamination status, spatial distributions and congener patterns of polychlorinated biphenyls (PCBs) and polybrominated biphenyl ethers (PBDEs) in an e-waste dismantling region in Southeast China. Analysis were done using GC-HRMS (Fu et al., 2011).

5. Extraction procedures

The emergence of the pollutants cited above in the environment and the adverse effects that are generated makes their detection unavoidable. For this, high efficient, selective and sensitive extraction techniques need to be used prior to chromatographic quantification as direct analysis of these pollutants in complex matrices is difficult due to the complexity of these latter. Tables 1, 2 and 3 show and describe the commonly used methods for extracting pollutants from natural matrixes used as biomonitors.

5.1 Soxhlet extraction

Soxhlet extraction was developed in 1879 by von Soxhlet and has been, for a long time, the most widely used leaching technique. In fact, this method was originally used for the determination of fat in milk and it has been used for more than one century (Soxhlet, 1879).

This method was used of the extraction of several environmental pollutants from biomonitors in some environmental monitoring studies as the extraction of 16 PAHs from *Evernia prunastri* in order to compare the accumulation of these pollutants in transplanted lichens with those in co-located passive gas-phase samplers (Loppi et al., 2015) as well as the extraction of dioxin and furan from *Ramalina canariensis* and *Xanthoria parietina* in order to comparing the concentrations of PCDD/F in the studied two lichen species collected in four sampling periods (Augusto et al., 2015a). Moreover, Soxhlet has proven in efficiency in the extraction of pollutants from pine needles especially for the identification of the potential sources of atmospheric PCDD/Fs, using *Pinus sylvestris* (Holt et al., 2016).

Soxhlet extraction presents many advantages as the displacement of transfer equilibrium due to the repeated contact between the sample and the solvent fresh portions; no filtration is required after the leaching step and this is a non-matrix dependent method. In addition, Sample throughput can be increased by simultaneous extraction in parallel, since the basic equipment is inexpensive. Furthermore, it is a very simple methodology which needs little specialized training, has the possibility to extract more sample mass than most of other methods as microwave-extraction and supercritical fluids (Chen and Urban, 2015; Luque de Castro and García-Ayuso, 1998; Luque de Castro and Priego-Capote, 2010).

However, these advantages are faced by many serious drawbacks as long time consumption, huge amount of required solvents as well as the large amount of extractant wasted, which is not only expensive to dispose of, but can lead to several environmental problems. Samples are usually extracted at the solvent boiling point for long periods, which can lead to thermal decomposition of thermolabile target species. Also, a conventional Soxhlet device provides no agitation, which would help to expedite the process (Chen and Urban, 2015; Luque de Castro and García-Ayuso, 1998; Luque de Castro and Priego-Capote, 2010; Pedersen and Olsson, 2003).

5.2 Accelerated solvent extraction (ASE)

Accelerated solvent extraction (ASE) is an extraction technique that involves extraction using solvents at high temperature and pressure. Different names were attributed to this technique, such as pressurized fluid extraction (PFE), pressurized liquid extraction (PLE), pressurized solvent extraction (PSE), high-pressure solvent extraction (HPSE), pressurized hot solvent extraction (PHSE), high-pressure, high temperature solvent extraction (HPHTSE), pressurized hot water extraction (PHWE) and subcritical solvent extraction (SSE) (Carabias-Martínez et al., 2005; Sun et al., 2012; Zuloaga et al., 2012). The use of high temperatures decreases the surface tension of solvents and the viscosity which help in reaching areas of matrices easily, while the high pressure increases the maintain of the solvents in the liquid state even at higher temperatures (Subedi, 2012). Several studies have shown the efficiency and the applicability of ASE extraction for the determination of environmental pollutants such as pesticides, PAHs, PCBs, OCPs and metals from several matrixes as foods, vegetables, soil, sludge and water (Alonso-Rodríguez et al., 2006; Herrera et al., 2002; Morales-Munoz et al., 2002; Wennrich et al., 2001).

Moreover, this method has shown its efficiency in several biomonitoring studies. For conifer needles, ASE permitted the characterization of spatial distribution phenanthrene in Fresno via *P. jeffreyi* (Noth et al., 2013), allowed the simultaneous extraction and analysis of pesticides and PCBs in the environment using *Pinus radiata* (Lavin and Hageman, 2012), and was used for the extraction of PCBs, PAHs and pesticides in *Pinus nigra* and *Cedrus atlantica* in Strasbourg with the aim of studying the temporal variation of these pesticides in a rural area (Al-Alam et al., 2017). ASE was also used for investigating the spatial distributions, contamination level, source and cold trapping effect of OCPs, PCBs, PBDEs, and HBCDs in lichens and mosses used as passive samplers (Zhu et al., 2015), and for confirming the seasonal differences of the 10 PAHs content in transplanted lichen in a mixed land use area of NE Italy (Kodnik et al., 2015). Finally ASE using hexane/ethyl acetate allowed detection of OCPs, PCBs and PBDEs in Italian organic honeys (Chiesa et al., 2016).

This method presents numerous advantages as good recovery, rapidity, adequate precision as well as the decrease of solvent use. Furthermore, ASE is a fully automated technique which makes it perfectly useful for routine analysis of environmental pollutants. Contrariwise, this method also presents some disadvantages as the high cost of the equipment, the large volume used for cell rinsing and preparation before extraction and the additional steps for clean-up and re-concentration of the extracted analytes before its analysis due to the low selectivity of this method. In addition, the high temperature used can lead to the decomposition of other thermally unstable analytes of interest (Carabias-Martínez et al., 2005; Haglund and Spinnel, 2010; Sun et al., 2012).

5.3 Solid phase extraction (SPE)

Solid-phase extraction (SPE) is the most widely used method for samples extraction, solvents changes, clean-up, concentration and fractionation of organic compounds from several samples (Andrade-Eiroa et al., 2016a, b; Dimpe and Nomngongo, 2016). This technique was first developed in 1980 and ever since it has recognized to be the most powerful instrument for the isolation and purification of target analysis (Varga et al., 2010). The principle of the SPE consists

of 4 steps: 1- conditioning of the stationary phase (enable retention sites, headquarters of molecular interactions), 2-loading sample (quantitative retention of analytes of interest on the stationary phase while the maximum interference is eliminated by simple non-retention), 3- washing and drying (remove weakly retained interfering and solvent evaporation in order to improve extraction yield), 4- sample elution (It is better to use the solvent with the lower eluting power able to elute all molecules of interest and avoiding the elution of highly retained interfering) (Andrade-Eiroa et al., 2016a; Camel, 2003; Humbert, 2010; Picó et al., 2007; Varga et al., 2010).

SPE has been extensively used for environmental studies. In their work Picó et al., (Picó et al., 2007) have summarized the use of this technique with different solvent and parameters in the extraction of multi residues pesticides from foods and environmental samples. Furthermore, numerous studies have shown the application of this method on environmental analysis such as drugs in waste water (Heuett et al., 2015), pesticides in honey matrixes (Oellig, 2016), rare elements (Pyrzynska et al., 2016), PAHs in airborne particulate (Li et al., 2007) and PCBs in water samples (Wang et al., 2016a). SPE was used as a clean-up concentration method in several biomonitoring studies using pine needles (De Nicola et al., 2016; Fernández-Varela et al., 2015; Ratola et al., 2011b), lichens and mosses (Concha-Graña et al., 2015a; Concha-Graña et al., 2015b; Foan et al., 2015), bees and their products (Shamsipur et al., 2016; Vázquez et al., 2015)

The advantages of SPE include simplicity, flexibility, automation, rapidity, higher enrichment factors, ability to simultaneously extract analytes of wide polarity range, absence of emulsion and use of different sorbents (Dimpe and Nomngongo, 2016; Żwir-Ferenc and Biziuk, 2006). Moreover, SPE presents several advantages, such as low consumption of solvents, simplicity, and ease of operation and a wide range of extracted organic analytes (from non-polar to very polar analytes) from a large variety of samples.

However, this method suffers from some drawbacks it is also time consuming and bulky, requiring several steps to attain an extract enough concentrated for instrumental analysis. Moreover, even if the amount of solvent is lower than with Soxhlet, this amount is still a significant amount of organic solvent (Andrade-Eiroa et al., 2016b; Beike, 2005; Das, 2014; Zhao et al., 2008).

5.4 Solid phase microextraction (SPME)

Solid-phase microextraction (SPME) is an extraction and pre-concentration technique developed by Pawliszyn in 1989 in order to overcome the limitations of the previously cited methods especially the enormous use of organic solvents (Arthur and Pawliszyn, 1990; Zhang et al., 1994). The extraction procedure consists of the positioning of the extraction phase on a solid support where it will be in contact with the sample followed by a coupling to gas chromatography for desorption and analysis (Li et al., 2015; Malik et al., 2006; Mol et al., 1993; Souza-Silva et al., 2015; Vuckovic et al., 2011), liquid chromatography (Bojko and Pawliszyn, 2014; Chen and Pawliszyn, 1995; Lord, 2007) or directly to a mass spectrometer (Deng et al., 2014; Gómez-Ríos and Pawliszyn, 2014; Zhao et al., 2015). In fact, SPME is a pre-concentration method arranging adsorption to a fiber, for various types of pollutants (especially volatiles organic pollutants) analyzed and distinguished depending on the SPME fiber used. However, diverse volatile organic compound (VOC) profiles have been reported, because the SPME technique in itself constitutes also a separation technique that discriminates against VOC

compound classes, depending on the SPME fiber used (Schuhfried et al., 2017). This method has proven its successfulness in many environmental studies especially for the analysis and the identification of VOC (Xie et al., 2015), pesticides (Mmualefe et al., 2009), PAHs (Lei et al., 2011) as well as metals (Malik et al., 2006). This method was also used as a concentration-purification-injection step in extracting environmental pollutants from several conifer needles in the process of environmental biomonitoring (Al-Alam et al., 2017; Al Dine et al., 2015).

SPME presents numerous advantages; first and most importantly it is a solvent free method which makes it an environment friendly method. Furthermore, it is simple, it requires a small amount of sample (order of μL), sensitive, integrates sampling, extraction, concentration and sample introduction into a single step, time saving, cost-effective, reliable, easy to automate and portable (Dimpe and Nomngongo, 2016; Souza-Silva et al., 2015; Zhang et al., 2016). However, as any other extraction method, SPME has some drawbacks it is not very selective, the fiber is mechanically weak, and only a small selection of extraction fiber coatings is commercially available. In addition, recoveries of polar analytes are relatively low (Dimpe and Nomngongo, 2016; Spietelun et al., 2011).

5.5 QuEChERS

In order to overcome all critical flaws and practical limitations of the extraction procedure cited above, Anastassiades et al., in 2003 (Anastassiades et al., 2003) developed a Quick, Easy, Cheap, Effective, Rugged and Safe method (QuEChERS) for the analysis of multi residues pesticides in food. The method is divided in two steps, the first considered as a soft extraction method using acetonitrile (ACN) as extraction agent while the second is considered as an optional clean-up procedure by dispersive solid-phase extraction (d-SPE). The whole extraction procedure needs few minutes (about five minutes) as well as 5 to 15 mL of extracting agent (Albinet et al., 2013; Wilkowska and Biziuk, 2011). Figure 2 shows the main steps of the original QuEChERS method.

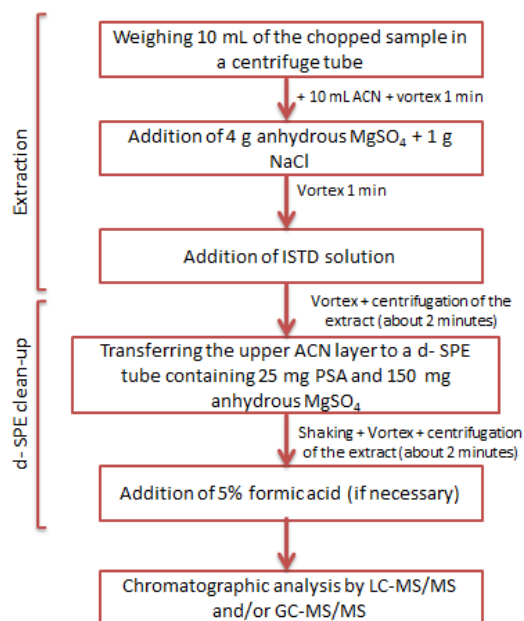


Figure 2: The main steps of the original QuEChERS extraction procedure

Although the original method showed a great efficiency for hundreds of analytes in a wide range of commodities particularly for pesticides in food matrixes, several adjustments were made in order to improve the method performance and to make it even more rugged and efficient for other difficult analytes (Costa et al., 2014). These modifications were based on the two fundamental steps with modification in the salts and sorbent formulations of the salting-out (d-SPE step) (González-Curbelo et al., 2015). Thus, this method has three main variations: the original method, the CEN Standard Method EN 15662 and the AOAC Official Method 2007.01. Each of these methods have their own modifications according to the matrix and analytes to be studied (González-Curbelo et al., 2015; Restrepo et al., 2014).

As cited before, this method was first developed for the study of pesticides in food matrixes and since it has proven its efficiency for the analysis of different pollutant types in environmental samples for example: pesticides multi residues analysis of pesticides in soil (Fernandes et al., 2013), PAHs in food matrixes (Kao et al., 2012), PCBs (Han et al., 2014), phthalates (Ma et al., 2010) as well as miscellaneous compounds as 68 multi-residue compounds consisting of 13 flame retardants, 18 pesticides, 14 PCBs, 16 PAHs and 7 Polybrominated diphenyl ethers (PBDE) (Sapozhnikova and Lehotay, 2013).

In biomonitoring studies, this method was especially used in bee matrixes and this may be due to the fact that these matrixes are exposed to multi residual residues of different type of pollutants during their foraging activities. For example, this method was used to extract 116 different pesticides from Brazilian honey (Tette et al., 2016), to determine 200 pesticides and their metabolites in honeybees (Kiljanek et al., 2016), as well to detect neonicotinoids and their transformation products in honey, pollen and honey bees in Canada (Codling et al., 2016).

This method has numerous advantages such as high recoveries (>85%), time saving, low quantity of solvent used, simple and can be done without much technical skills, does not apply the use of much glassware, no specific apparatus is needed (only a centrifuge), method is rugged due to because extract cleanup, cheap as the reagent costs in the method are very inexpensive (Lehotay, 2006).

6. Analytical instruments used

Separation and quantification crucial for environmental study are generally mostly carried out by liquid chromatography tandem mass spectrometry (LC-MS/MS) and/or gas chromatography tandem mass spectrometry (GC-MS/MS) (Megson et al., 2016).

The choice of the separation technique depends mostly on the characteristics of the pollutants of interest. The volatile, semi-volatile and thermally stable compounds can be determined by GC, whereas non-volatile and/or thermally unstable ones should be determined by LC (Kujawski et al., 2014; Souza Tette et al., 2016).

For detection, tandem mass spectrometers (MS/MS) and high resolution MS instruments are used in order to provide the maximum sensitivity, dynamic range which can significantly increase accuracy and precision (Reiner et al., 2013).

7. Conclusion

Environmental monitoring is the basis on which actions are taken and evaluated to manage the air quality. In this work different extraction procedures for the analysis of environmental pollutant were reported. Among these different methods, liquid-liquid extraction seems to be the less efficient due its several drawbacks, while QuEChERS seems to be the most effective method permitting an effective analysis with higher cost-effectiveness to both human and environment. Furthermore, this work showed that several matrixes could be used for assessing environmental pollution in a simple and effective way. All the cited matrixes could be useful for monitoring the presence of pesticides, POPs and heavy metals in the atmosphere. The choice of a matrix depends on its availability in the intended area which permits a useful tool for an effective environmental analysis. A combination of the study of all these matrixes (if available) in the same zone could be recommended in order to cover the higher amount of pollutant present as well as to choose the best natural biomonitor.

Acknowledgement

We gratefully acknowledge AZM & SAADE association and the Lebanese University for funding the project, as well as Strasbourg University for the international mobility aid, without which the present study could not have been completed.

References

- Abdel-Halim, K.Y., Abo El-Saad, A.M., Talha, M.M., Hussein, A.A., Bakry, N.M., 2013. Oxidative stress on land snail *Helix aspersa* as a sentinel organism for ecotoxicological effects of urban pollution with heavy metals. *Chemosphere* 93, 1131-1138.
- Abdel-Shafy, H.I., Mansour, M.S., 2016. A review on polycyclic aromatic hydrocarbons: source, environmental impact, effect on human health and remediation. *Egyptian Journal of Petroleum* 25, 107-123.
- Al-Alam, J., Fajloun, Z., Chbani, A., Millet, M., 2017. The use of conifer needles as biomonitor candidates for the study of temporal air pollution variation in the Strasbourg region. *Chemosphere* 168, 1411-1421.
- Al-Rashdan, A., Helaleh, M.I., Nisar, A., Ibtisam, A., Al-Ballam, Z., 2010. Determination of the levels of polycyclic aromatic hydrocarbons in toasted bread using gas chromatography mass spectrometry. *International journal of analytical chemistry* 2010.
- Al Dine, E.J., Mokbel, H., Elmoll, A., Masseurin, S., Vuilleumier, S., Toufaily, J., Hanieh, T., Millet, M., 2015. Concomitant evaluation of atmospheric levels of polychlorinated biphenyls, organochlorine pesticides, and polycyclic aromatic hydrocarbons in Strasbourg (France) using pine needle passive samplers. *Environmental Science and Pollution Research* 22, 17850-17859.
- Alagić, S.Č., Jovanović, V.P.S., Mitić, V.D., Cvetković, J.S., Petrović, G.M., Stojanović, G.S., 2016. Bioaccumulation of HMW PAHs in the roots of wild blackberry from the Bor region (Serbia): Phytoremediation and biomonitoring aspects. *Science of The Total Environment* 562, 561-570.
- Albinet, A., Tomaz, S., Lestremay, F., 2013. A really quick easy cheap effective rugged and safe (QuEChERS) extraction procedure for the analysis of particle-bound PAHs in ambient air and emission samples. *Science of the Total Environment* 450, 31-38.
- Ali, U., Syed, J.H., Malik, R.N., Katsoyiannis, A., Li, J., Zhang, G., Jones, K.C., 2014. Organochlorine pesticides (OCPs) in South Asian region: A review. *Science of The Total Environment* 476-477, 705-717.
- Alonso-Rodríguez, E., Moreda-Piñeiro, J., López-Mahía, P., Muniategui-Lorenzo, S., Fernández-Fernández, E., Prada-Rodríguez, D., Moreda-Piñeiro, A., Bermejo-Barrera, A., Bermejo-Barrera, P., 2006. Pressurized liquid extraction of organometals and its feasibility for total metal extraction. *TrAC Trends in Analytical Chemistry* 25, 511-519.
- Anastassiades, M., Lehota, S.J., Štajnbaher, D., Schenck, F.J., 2003. Fast and easy multiresidue method employing acetonitrile extraction/partitioning and "dispersive solid-phase extraction" for the determination of pesticide residues in produce. *Journal of AOAC international* 86, 412-431.
- Andrade-Eiroa, A., Canle, M., Leroy-Cancellieri, V., Cerdà, V., 2016a. Solid-phase extraction of organic compounds: A critical review (Part I). *TrAC Trends in Analytical Chemistry* 80, 641-654.

Andrade-Eiroa, A., Canle, M., Leroy-Cancellieri, V., Cerdà, V., 2016b. Solid-phase extraction of organic compounds: A critical review. part ii. *TrAC Trends in Analytical Chemistry* 80, 655-667.

Ares, Á., Ángel Fernández, J., Ramón Aboal, J., Carballeira, A., 2011. Study of the air quality in industrial areas of Santa Cruz de Tenerife (Spain) by active biomonitoring with *Pseudoscleropodium purum*. *Ecotoxicology and Environmental Safety* 74, 533-541.

Arthur, C.L., Pawliszyn, J., 1990. Solid phase microextraction with thermal desorption using fused silica optical fibers. *Analytical chemistry* 62, 2145-2148.

Augusto, S., Máguas, C., Branquinho, C., 2013. Guidelines for biomonitoring persistent organic pollutants (POPs), using lichens and aquatic mosses – A review. *Environmental Pollution* 180, 330-338.

Augusto, S., Pinho, P., Santos, A., Botelho, M.J., Palma-Oliveira, J., Branquinho, C., 2015a. Declining trends of PCDD/Fs in lichens over a decade in a Mediterranean area with multiple pollution sources. *Science of The Total Environment* 508, 95-100.

Augusto, S., Sierra, J., Nadal, M., Schuhmacher, M., 2015b. Tracking polycyclic aromatic hydrocarbons in lichens: It's all about the algae. *Environmental Pollution* 207, 441-445.

Authority, E.F.S., 2014. The 2012 European Union report on pesticide residues in food.

Badiou-Bénéteau, A., Benneveau, A., Gélet, F., Delatte, H., Becker, N., Brunet, J.-L., Reynaud, B., Belzunces, L., 2013. Honeybee biomarkers as promising tools to monitor environmental quality. *Environment international* 60, 31-41.

Bao, L.-J., Zeng, E.Y., 2014. Field application of passive sampling techniques for sensing hydrophobic organic contaminants. *Trends in Environmental Analytical Chemistry* 1, e19-e24.

Bapayeva, G., Issayeva, R., Zhumadilova, A., Nurkasimova, R., Kulbayeva, S., Tleuzhan, R., 2016. Organochlorine pesticides and female puberty in South Kazakhstan. *Reproductive Toxicology* 65, 67-75.

Bargagli, R., 2016. Moss and lichen biomonitoring of atmospheric mercury: A review. *Science of The Total Environment* 572, 216-231.

Barker, D.J., Osmond, C., Winter, P., Margetts, B., Simmonds, S.J., 1989. Weight in infancy and death from ischaemic heart disease. *The Lancet* 334, 577-580.

Beeby, A., 2001. What do sentinels stand for? *Environmental Pollution* 112, 285-298.

Beeby, A., Richmond, L., 2002. Evaluating *Helix aspersa* as a sentinel for mapping metal pollution. *Ecological Indicators* 1, 261-270.

Beike, J., 2005. Forensic and clinical applications of solid phase extraction. *International Journal of Legal Medicine* 119, 115-115.

Bergamaschi, L., Rizzio, E., Giaveri, G., Profumo, A., Loppi, S., Gallorini, M., 2004. Determination of baseline element composition of lichens using samples from high elevations. *Chemosphere* 55, 933-939.

Bergman, Å., Heindel, J., Jobling, S., Kidd, K., Zoeller, R.T., 2012. State-of-the-science of endocrine disrupting chemicals, 2012. *Toxicology Letters* 211, S3.

Bergonzi, R., Specchia, C., Dinolfo, M., Tomasi, C., De Palma, G., Frusca, T., Apostoli, P., 2009. Distribution of persistent organochlorine pollutants in maternal and foetal tissues: data from an Italian polluted urban area. *Chemosphere* 76, 747-754.

Besis, A., Samara, C., 2012. Polybrominated diphenyl ethers (PBDEs) in the indoor and outdoor environments – A review on occurrence and human exposure. *Environmental Pollution* 169, 217-229.

Bidleman, T.F., Jantunen, L.M., Kurt-Karakus, P.B., Wong, F., 2012. Chiral persistent organic pollutants as tracers of atmospheric sources and fate: review and prospects for investigating climate change influences. *Atmospheric Pollution Research* 3, 371-382.

Biterna, M., Voutsas, D., 2005. Polychlorinated biphenyls in ambient air of NW Greece and in particulate emissions. *Environment international* 31, 671-677.

Blasco, M., Domeño, C., López, P., Nerín, C., 2011. Behaviour of different lichen species as biomonitors of air pollution by PAHs in natural ecosystems. *Journal of Environmental Monitoring* 13, 2588-2596.

Bojko, B., Pawliszyn, J., 2014. In vivo and ex vivo SPME: a low invasive sampling and sample preparation tool in clinical bioanalysis. *Bioanalysis* 6, 1227-1239.

Breivik, K., Sweetman, A., Pacyna, J.M., Jones, K.C., 2002. Towards a global historical emission inventory for selected PCB congeners—a mass balance approach: 2. Emissions. *Science of the Total Environment* 290, 199-224.

Caballero-Casero, N., Çabuk, H., Martínez-Sagarra, G., Devesa, J.A., Rubio, S., 2015. Nanostructured alkyl carboxylic acid-based restricted access solvents: Application to the combined microextraction and cleanup of polycyclic aromatic hydrocarbons in mosses. *Analytica Chimica Acta* 890, 124-133.

Camel, V., 2003. Solid phase extraction of trace elements. *Spectrochimica Acta Part B: Atomic Spectroscopy* 58, 1177-1233.

Carabias-Martínez, R., Rodríguez-Gonzalo, E., Revilla-Ruiz, P., Hernández-Méndez, J., 2005. Pressurized liquid extraction in the analysis of food and biological samples. *Journal of Chromatography A* 1089, 1-17.

Chamkasem, N., Lee, S., Harmon, T., 2016. Analysis of 19 PCB congeners in catfish tissue using a modified QuEChERS method with GC-MS/MS. *Food chemistry* 192, 900-906.

Chauzat, M.P., Faucon, J.P., 2007. Pesticide residues in beeswax samples collected from honey bee colonies (*Apis mellifera* L.) in France. *Pest Management Science* 63, 1100-1106.

Chauzat, M.P., Martel, A.C., Cougoule, N., Porta, P., Lachaize, J., Zeggane, S., Aubert, M., Carpentier, P., Faucon, J.P., 2011. An assessment of honeybee colony matrices, *Apis mellifera* (Hymenoptera: Apidae) to monitor pesticide presence in continental France. *Environmental Toxicology and Chemistry* 30, 103-111.

Chen, J., Pawliszyn, J.B., 1995. Solid phase microextraction coupled to high-performance liquid chromatography. *Analytical Chemistry* 67, 2530-2533.

Chen, S.-Y., Urban, P.L., 2015. On-line monitoring of Soxhlet extraction by chromatography and mass spectrometry to reveal temporal extract profiles. *Analytica Chimica Acta* 881, 74-81.

Chen, X., Xia, X., Zhao, Y., Zhang, P., 2010. Heavy metal concentrations in roadside soils and correlation with urban traffic in Beijing, China. *Journal of hazardous materials* 181, 640-646.

Chiesa, L.M., Labella, G.F., Giorgi, A., Panseri, S., Pavlovic, R., Bonacci, S., Arioli, F., 2016. The occurrence of pesticides and persistent organic pollutants in Italian organic honeys from different productive areas in relation to potential environmental pollution. *Chemosphere* 154, 482-490.

Chowdhury, S., Mazumder, M.A.J., Al-Attas, O., Husain, T., 2016. Heavy metals in drinking water: Occurrences, implications, and future needs in developing countries. *Science of The Total Environment* 569–570, 476-488.

Chropeňová, M., Gregušková, E.K., Karásková, P., Příbylová, P., Kukučka, P., Baráková, D., Čupr, P., 2016. Pine needles and pollen grains of *Pinus mugo* Turra – A biomonitoring tool in high mountain habitats identifying environmental contamination. *Ecological Indicators* 66, 132-142.

Cocozza, C., Ravera, S., Cherubini, P., Lombardi, F., Marchetti, M., Tognetti, R., 2016. Integrated biomonitoring of airborne pollutants over space and time using tree rings, bark, leaves and epiphytic lichens. *Urban Forestry & Urban Greening* 17, 177-191.

Codling, G., Al Naggar, Y., Giesy, J.P., Robertson, A.J., 2016. Concentrations of neonicotinoid insecticides in honey, pollen and honey bees (*Apis mellifera* L.) in central Saskatchewan, Canada. *Chemosphere* 144, 2321-2328.

Coeurdassier, M., Saint-Denis, M., Vaufléury, A.G.d., Ribera, D., Badot, P.M., 2001. The garden snail (*Helix aspersa*) as a bioindicator of organophosphorus exposure: effects of dimethoate on survival, growth, and acetylcholinesterase activity. *Environmental toxicology and chemistry* 20, 1951-1957.

Concha-Graña, E., Muniategui-Lorenzo, S., De Nicola, F., Aboal, J.R., Rey-Asensio, A.I., Giordano, S., Reski, R., López-Mahía, P., Prada-Rodríguez, D., 2015a. Matrix solid phase dispersion method for determination of polycyclic aromatic hydrocarbons in moss. *Journal of Chromatography A* 1406, 19-26.

Concha-Graña, E., Piñeiro-Iglesias, M., Muniategui-Lorenzo, S., López-Mahía, P., Prada-Rodríguez, D., 2015b. Proposal of a procedure for the analysis of atmospheric polycyclic aromatic hydrocarbons in mosses. *Talanta* 134, 239-246.

Contreras López, M.C., 2003. Determination of potentially bioaccumulating complex mixtures of organochlorine compounds in wastewater: a review. *Environment International* 28, 751-759.

Costa, F.P., Caldas, S.S., Primel, E.G., 2014. Comparison of QuEChERS sample preparation methods for the analysis of pesticide residues in canned and fresh peach. *Food chemistry* 165, 587-593.

Darnajoux, R., Lutzoni, F., Miadlikowska, J., Bellenger, J.-P., 2015. Determination of elemental baseline using peltigeralean lichens from Northeastern Canada (Québec): Initial data collection for long term monitoring of the impact of global climate change on boreal and subarctic area in Canada. *Science of The Total Environment* 533, 1-7.

Das, S.K., 2014. Recent developments in clean up techniques of pesticide residue analysis for toxicology study: a critical review. *Universal Journal of Agricultural Research* 2, 198-202.

de Lima, R.F., Dionello, R.G., Peralba, M.d.C.R., Barrionuevo, S., Radunz, L.L., Reichert Júnior, F.W., 2017. PAHs in corn grains submitted to drying with firewood. *Food Chemistry* 215, 165-170.

De Nicola, F., Concha Graña, E., Aboal, J.R., Carballeira, A., Fernández, J.Á., López Mahía, P., Prada Rodríguez, D., Muniategui Lorenzo, S., 2016. PAH detection in *Quercus robur* leaves and *Pinus pinaster* needles: A fast method for biomonitoring purpose. *Talanta* 153, 130-137.

De Nicola, F., Murena, F., Costagliola, M.A., Alfani, A., Baldantoni, D., Prati, M.V., Sessa, L., Spagnuolo, V., Giordano, S., 2013. A multi-approach monitoring of particulate matter, metals and PAHs in an urban street canyon. *Environmental Science and Pollution Research* 20, 4969-4979.

de Oliveira, R.C., Queiroz, S.C.d.N., da Luz, C.F.P., Porto, R.S., Rath, S., 2016. Bee pollen as a bioindicator of environmental pesticide contamination. *Chemosphere* 163, 525-534.

De Vaufléury, A., Coeurdassier, M., Pandard, P., Scheifler, R., Lovy, C., Crini, N., Badot, P.M., 2006. How terrestrial snails can be used in risk assessment of soils. *Environmental toxicology and chemistry* 25, 797-806.

De Vaufléury, A., Gimbert, F., Pauget, B., Fritsch, C., Scheifler, R., Coeurdassier, M., 2012. LES ESCARGOTS BIO-INDICATEURS DE LA QUALITE DES SOLS-Snail watch: analyse en laboratoire ou in situ de la biodisponibilité des contaminants.

De Wit, C.A., 2002. An overview of brominated flame retardants in the environment. *Chemosphere* 46, 583-624.

Delistraty, D., 1997. 16 A Critical Review of the Application of Toxic Equivalency Factors to Carcinogenic Effects of Polycyclic Aromatic Hydrocarbons in Mammals. PAHs and Related Compounds: *Biology* 3, 311.

Deng, J., Yang, Y., Fang, L., Lin, L., Zhou, H., Luan, T., 2014. Coupling solid-phase microextraction with ambient mass spectrometry using surface coated wooden-tip probe for rapid analysis of ultra trace perfluorinated compounds in complex samples. *Analytical chemistry* 86, 11159-11166.

Deng, Z., Chen, F., Zhang, M., Lan, L., Qiao, Z., Cui, Y., An, J., Wang, N., Fan, Z., Zhao, X., Li, X., 2016. Association between air pollution and sperm quality: A systematic review and meta-analysis. *Environmental Pollution* 208, Part B, 663-669.

Dimpe, K.M., Nomngongo, P.N., 2016. Current sample preparation methodologies for analysis of emerging pollutants in different environmental matrices. *TrAC Trends in Analytical Chemistry*.

Dreyer, A., Matthias, V., Weinberg, I., Ebinghaus, R., 2010. Wet deposition of poly-and perfluorinated compounds in Northern Germany. *Environmental Pollution* 158, 1221-1227.

Drozd-Hara, M., 1978. Studies on the effect of pollution by sulphur on the transformation of arable soils in the neighbourhood of a sulphur mine. *Roczniki Gleboznawcze (Poland)*.

Druart, C., Millet, M., Scheifler, R., Delhomme, O., Raepfel, C., de Vaufléury, A., 2011. Snails as indicators of pesticide drift, deposit, transfer and effects in the vineyard. *Science of The Total Environment* 409, 4280-4288.

Dumanoglu, Y., Gaga, E.O., Gungormus, E., Sofuoğlu, S.C., Odabasi, M., 2016. Spatial and seasonal variations, sources, air-soil exchange, and carcinogenic risk assessment for PAHs and PCBs in air and soil of Kutahya, Turkey, the province of thermal power plants. *Science of The Total Environment*.

Dumme, V., Kruatrachue, M., Trinachartvanit, W., Tanhan, P., Pokethitiyook, P., Damrongphol, P., 2012. Bioaccumulation of heavy metals in water, sediments, aquatic plant and histopathological effects on the golden apple snail in Beung Boraphet reservoir, Thailand. *Ecotoxicology and Environmental Safety* 86, 204-212.

Elichegaray, C., Bouallala, S., Maitre, A., Ba, M., 2010. État et évolution de la pollution atmosphérique. *Revue Française d'Allergologie* 50, 381-393.

Elorduy, I., Elcoroaristizabal, S., Durana, N., García, J., Alonso, L., 2016. Diurnal variation of particle-bound PAHs in an urban area of Spain using TD-GC/MS: Influence of meteorological parameters and emission sources. *Atmospheric Environment* 138, 87-98.

Emilia, R., Debora, B., Stefania, A., Nicola, B., Roberto, B., 2016. *Papillifera papillaris* (O.F. Müller), a small snail living on stones and monuments, as indicator of metal deposition and bioavailability in urban environments. *Ecological Indicators* 69, 360-367.

epa, 2010.

Eriksson, G., Jensen, S., Kylin, H., Strachan, W., 1989. The pine needle as a monitor of atmospheric pollution.

Feng, J., Zhai, M., Liu, Q., Sun, J., Guo, J., 2011. Residues of organochlorine pesticides (OCPs) in upper reach of the Huaihe River, East China. *Ecotoxicology and environmental safety* 74, 2252-2259.

Fernandes, V.C., Domingues, V.F., Mateus, N., Delerue-Matos, C., 2013. Multiresidue pesticides analysis in soils using modified QuEChERS with disposable pipette extraction and dispersive solid-phase extraction. *Journal of separation science* 36, 376-382.

Fernández-Varela, R., Ratola, N., Alves, A., Amigo, J.M., 2015. Relationship between levels of polycyclic aromatic hydrocarbons in pine needles and socio-geographic parameters. *Journal of Environmental Management* 156, 52-61.

Fernández, J.A., Ares, A., Rey-Asensio, A., Carballeira, A., Aboal, J.R., 2009. Effect of growth on active biomonitoring with terrestrial mosses. *Journal of Atmospheric Chemistry* 63, 1-11.

Fiandanese, N., Borromeo, V., Berrini, A., Fischer, B., Schaedlich, K., Schmidt, J.-S., Secchi, C., Pocar, P., 2016. Maternal exposure to a mixture of di(2-ethylhexyl) phthalate (DEHP) and polychlorinated biphenyls (PCBs) causes reproductive dysfunction in adult male mouse offspring. *Reproductive Toxicology* 65, 123-132.

Foan, L., Domercq, M., Bermejo, R., Santamaría, J.M., Simon, V., 2015. Mosses as an integrating tool for monitoring PAH atmospheric deposition: Comparison with total deposition and evaluation of bioconcentration factors. A year-long case-study. *Chemosphere* 119, 452-458.

Fu, J., Wang, Y., Zhang, A., Zhang, Q., Zhao, Z., Wang, T., Jiang, G., 2011. Spatial distribution of polychlorinated biphenyls (PCBs) and polybrominated biphenyl ethers (PBDEs) in an e-waste dismantling region in Southeast China: Use of apple snail (*Ampullariidae*) as a bioindicator. *Chemosphere* 82, 648-655.

Füreder, L., Reynolds, J., 2003. Is *Austroptamobius pallipes* a good bioindicator? *Bulletin Français de la Pêche et de la Pisciculture*, 157-163.

García-Valcárcel, A.I., Molero, E., Tadeo, J.L., Hernando, M.D., 2016. Determination of selected environmental contaminants in foraging honeybees. *Talanta* 148, 1-6.

Garty, J., 2001. Biomonitoring atmospheric heavy metals with lichens: theory and application. *Critical reviews in plant sciences* 20, 309-371.

Gerdol, R., Bragazza, L., Marchesini, R., Medici, A., Pedrini, P., Benedetti, S., Bovolenta, A., Coppi, S., 2002. Use of moss (*Tortula muralis* Hedw.) for monitoring organic and inorganic air pollution in urban and rural sites in Northern Italy. *Atmospheric Environment* 36, 4069-4075.

Ghimpeanu, O.-M., Militaru, M., Scippo, M.L., 2014. Dioxins and polychlorinated biphenyls contamination in poultry liver related to food safety – A review. *Food Control* 38, 47-53.

Giordano, S., Adamo, P., Sorbo, S., Vingiani, S., 2005. Atmospheric trace metal pollution in the Naples urban area based on results from moss and lichen bags. *Environmental Pollution* 136, 431-442.

Giordano, S., Adamo, P., Spagnuolo, V., Vaglieco, B.M., 2010. Instrumental and bio-monitoring of heavy metal and nanoparticle emissions from diesel engine exhaust in controlled environment. *Journal of Environmental Sciences* 22, 1357-1363.

Girolami, V., Mazzon, L., Squartini, A., Mori, N., Marzaro, M., Greatti, M., Giorio, C., Tapparo, A., 2009. Translocation of neonicotinoid insecticides from coated seeds to seedling guttation drops: a novel way of intoxication for bees. *Journal of economic entomology* 102, 1808-1815.

Gómez-Ríos, G.A., Pawliszyn, J., 2014. Development of coated blade spray ionization mass spectrometry for the quantitation of target analytes present in complex matrices. *Angewandte Chemie International Edition* 53, 14503-14507.

González-Curbelo, M., Socas-Rodríguez, B., Herrera-Herrera, A., González-Sálamo, J., Hernández-Borges, J., Rodríguez-Delgado, M., 2015. Evolution and applications of the QuEChERS method. *TrAC Trends in Analytical Chemistry* 71, 169-185.

González, A., Pokrovsky, O., 2014. Metal adsorption on mosses: toward a universal adsorption model. *Journal of colloid and interface science* 415, 169-178.

González Paramás, A.M., Gómez Báez, J.A., Garcia-Villanova, R.J., Rivas Palá, T., Ardanuy Albajar, R., Sánchez Sánchez, J., 2000. Geographical discrimination of honeys by using mineral composition and common chemical quality parameters. *Journal of the Science of Food and Agriculture* 80, 157-165.

Goodman, G.T., Roberts, T., 1971. Plants and soils as indicators of metals in the air. *Nature* 231, 287-292.

Górecki, T., Namieśnik, J., 2002. Passive sampling. *TrAC Trends in Analytical Chemistry* 21, 276-291.

Greatti, M., Sabatini, A.G., Barbattini, R., Rossi, S., Stravisi, A., 2003. Risk of environmental contamination by the active ingredient imidacloprid used for corn seed dressing. Preliminary results. *Bulletin of Insectology* 56, 69-72.

Grimalt, J.O., Van Drooge, B.L., 2006. Polychlorinated biphenyls in mountain pine (*Pinus uncinata*) needles from Central Pyrenean high mountains (Catalonia, Spain). *Ecotoxicology and environmental safety* 63, 61-67.

Haglund, P., Spinnel, E., 2010. A Modular Approach to Pressurized Liquid Extraction with In-Cell Cleanup. *LC GC North America* 28.

Han, L., Sapozhnikova, Y., Lehotay, S.J., 2014. Streamlined sample cleanup using combined dispersive solid-phase extraction and in-vial filtration for analysis of pesticides and environmental pollutants in shrimp. *Analytica chimica acta* 827, 40-46.

Harmens, H., Foan, L., Simon, V., Mills, G., 2013. Terrestrial mosses as biomonitors of atmospheric POPs pollution: A review. *Environmental Pollution* 173, 245-254.

Harmens, H., Ilyin, I., Mills, G., Aboal, J., Alber, R., Blum, O., Coşkun, M., De Temmerman, L., Fernández, J., Figueira, R., 2012. Country-specific correlations across Europe between modelled atmospheric cadmium and lead deposition and concentrations in mosses. *Environmental Pollution* 166, 1-9.

Harner, T., Bartkow, M., Holoubek, I., Klanova, J., Wania, F., Gioia, R., Moeckel, C., Sweetman, A.J., Jones, K.C., 2006. Passive air sampling for persistent organic pollutants: Introductory remarks to the special issue. *Environmental Pollution* 144, 361-364.

Hauser, R., Williams, P., Altshul, L., Calafat, A.M., 2005. Evidence of interaction between polychlorinated biphenyls and phthalates in relation to human sperm motility. *Environmental health perspectives*, 425-430.

He, T., Feng, X., Guo, Y., Qiu, G., Li, Z., Liang, L., Lu, J., 2008. The impact of eutrophication on the biogeochemical cycling of mercury species in a reservoir: a case study from Hongfeng Reservoir, Guizhou, China. *Environmental Pollution* 154, 56-67.

Hernández, A.F., Parrón, T., Tsatsakis, A.M., Requena, M., Alarcón, R., López-Guarnido, O., 2013. Toxic effects of pesticide mixtures at a molecular level: their relevance to human health. *Toxicology* 307, 136-145.

Herrera López, S., Lozano, A., Sosa, A., Hernando, M.D., Fernández-Alba, A.R., 2016. Screening of pesticide residues in honeybee wax comb by LC-ESI-MS/MS. A pilot study. *Chemosphere* 163, 44-53.

Herrera, M., Prados-Rosales, R.C., Luque-García, J., De Castro, M.L., 2002. Static-dynamic pressurized hot water extraction coupled to on-line filtration-solid-phase extraction-high-performance liquid chromatography-post-column derivatization-fluorescence detection for the analysis of N-methylcarbamates in foods. *Analytica Chimica Acta* 463, 189-197.

Heuett, N.V., Ramirez, C.E., Fernandez, A., Gardinali, P.R., 2015. Analysis of drugs of abuse by online SPE-LC high resolution mass spectrometry: communal assessment of consumption. *Science of the Total Environment* 511, 319-330.

Holt, E., Kočan, A., Klánová, J., Assefa, A., Wiberg, K., 2016. Polychlorinated dibenzo-p-dioxins/furans (PCDD/Fs) and metals in scots pine (*Pinus sylvestris*) needles from Eastern and Northern Europe: Spatiotemporal patterns, and potential sources. *Chemosphere* 156, 30-36.

Hu, J., Zhang, H., Chen, S., Ying, Q., Wiedinmyer, C., Vandenberghe, F., Kleeman, M.J., 2014. Identifying PM_{2.5} and PM₁₀ sources for epidemiological studies in California. *Environmental science & technology* 48, 4980-4990.

Humbert, L., 2010. Extraction en phase solide (SPE): théorie et applications, *Annales de Toxicologie Analytique*. EDP Sciences, pp. 61-68.

Ianistcki, M., Dallarosa, J., Sauer, C., Teixeira, C., Da Silva, J., 2009. Genotoxic effect of polycyclic aromatic hydrocarbons in the metropolitan area of Porto Alegre, Brazil, evaluated by *Helix aspersa* (Müller, 1774). *Environmental pollution* 157, 2037-2042.

IARC, 2015. IARC (International Agency for Research on Cancer), p. Polychlorinated biphenyls.

Jandacka, D., Durcanska, D., Bujdos, M., 2017. The contribution of road traffic to particulate matter and metals in air pollution in the vicinity of an urban road. *Transportation Research Part D: Transport and Environment* 50, 397-408.

Jantunen, L.M., Helm, P.A., Ridal, J.J., Bidleman, T.F., 2008. Air-water gas exchange of chiral and achiral organochlorine pesticides in the Great Lakes. *Atmospheric Environment* 42, 8533-8542.

Jevtić, M., Dragić, N., Bijelović, S., Popović, M., 2014. Cardiovascular diseases and air pollution in Novi Sad, Serbia. *International journal of occupational medicine and environmental health* 27, 153-164.

Juan-Borrás, M., Domenech, E., Escriche, I., 2016. Mixture-risk-assessment of pesticide residues in retail polyfloral honey. *Food Control* 67, 127-134.

Kamal, A., Malik, R.N., Martellini, T., Cincinelli, A., 2014. Cancer risk evaluation of brick kiln workers exposed to dust bound PAHs in Punjab province (Pakistan). *Science of The Total Environment* 493, 562-570.

Kao, T.H., Chen, S., Chen, C.J., Huang, C.W., Chen, B.H., 2012. Evaluation of Analysis of Polycyclic Aromatic Hydrocarbons by the QuEChERS Method and Gas Chromatography-Mass Spectrometry and Their Formation in Poultry Meat As Affected by Marinating and Frying. *Journal of agricultural and food chemistry* 60, 1380-1389.

Karami-Mohajeri, S., Abdollahi, M., 2010. Toxic effects of organophosphate, carbamate, and organochlorine pesticides on cellular metabolism of lipids, proteins, and carbohydrates: A comprehensive review. *Human & experimental toxicology*, 0960327110388959.

Kasiotis, K.M., Agnostopoulos, C., Anastasiadou, P., Machera, K., 2014. Pesticide residues in honeybees, honey and bee pollen by LC-MS/MS screening: reported death incidents in honeybees. *Science of The Total Environment* 485, 633-642.

Kiljanek, T., Niewiadowska, A., Semenik, S., Gawel, M., Borzęcka, M., Posyniak, A., 2016. Multi-residue method for the determination of pesticides and pesticide metabolites in honeybees by liquid and gas chromatography coupled with tandem mass spectrometry—Honeybee poisoning incidents. *Journal of Chromatography A* 1435, 100-114.

Klánová, J., Čupr, P., Baráková, D., Šeda, Z., Anděl, P., Holoubek, I., 2009. Can pine needles indicate trends in the air pollution levels at remote sites? *Environmental Pollution* 157, 3248-3254.

Kodnik, D., Candotto Carniel, F., Licen, S., Tolloi, A., Barbieri, P., Tretiach, M., 2015. Seasonal variations of PAHs content and distribution patterns in a mixed land use area: A case study in NE Italy with the transplanted lichen *Pseudevernia furfuracea*. *Atmospheric Environment* 113, 255-263.

Koltsakidou, A., Zacharis, C.K., Fytianos, K., 2015. A validated liquid chromatographic method for the determination of polycyclic aromatic hydrocarbons in honey after homogeneous liquid–liquid extraction using hydrophilic acetonitrile and sodium chloride as mass separating agent. *Journal of Chromatography A* 1377, 46-54.

Kot, A., Zabiegała, B., Namieśnik, J., 2000. Passive sampling for long-term monitoring of organic pollutants in water. *TrAC Trends in Analytical Chemistry* 19, 446-459.

Król, S., Zabiegała, B., Namieśnik, J., 2012. PBDEs in environmental samples: Sampling and analysis. *Talanta* 93, 1-17.

Kujawski, M.W., Bargańska, Ż., Marciniak, K., Miedzianowska, E., Kujawski, J.K., Ślebioda, M., Namieśnik, J., 2014. Determining pesticide contamination in honey by LC-ESI-MS/MS—Comparison of pesticide recoveries of two liquid–liquid extraction based approaches. *LWT-Food Science and Technology* 56, 517-523.

Kujawski, M.W., Namieśnik, J., 2011. Levels of 13 multi-class pesticide residues in Polish honeys determined by LC-ESI-MS/MS. *Food Control* 22, 914-919.

Kujawski, M.W., Pinteaux, E., Namieśnik, J., 2012. Application of dispersive liquid–liquid microextraction for the determination of selected organochlorine pesticides in honey by gas chromatography–mass spectrometry. *European Food Research and Technology* 234, 223-230.

Kulkarni, P.S., Crespo, J.G., Afonso, C.A.M., 2008. Dioxins sources and current remediation technologies — A review. *Environment International* 34, 139-153.

Lambert, O., Piroux, M., Puyo, S., Thorin, C., Larhantec, M., Delbac, F., Pouliquen, H., 2012a. Bees, honey and pollen as sentinels for lead environmental contamination. *Environmental Pollution* 170, 254-259.

Lambert, O., Veyrand, B., Durand, S., Marchand, P., Bizec, B.L., Piroux, M., Puyo, S., Thorin, C., Delbac, F., Pouliquen, H., 2012b. Polycyclic aromatic hydrocarbons: Bees, honey and pollen as sentinels for environmental chemical contaminants. *Chemosphere* 86, 98-104.

Laskowski, R., Hopkin, S.P., 1996. Accumulation of Zn, Cu, Pb and Cd in the garden snail (*Helix aspersa*): implications for predators. *Environmental Pollution* 91, 289-297.

Lavin, K.S., Hageman, K.J., 2012. Selective pressurised liquid extraction of halogenated pesticides and polychlorinated biphenyls from pine needles. *Journal of Chromatography A* 1258, 30-36.

Lazić, L., Urošević, M.A., Mijić, Z., Vuković, G., Ilić, L., 2016. Traffic contribution to air pollution in urban street canyons: Integrated application of the OSPM, moss biomonitors and spectral analysis. *Atmospheric Environment* 141, 347-360.

Lehotay, S.J., 2006. Quick, easy, cheap, effective, rugged, and safe approach for determining pesticide residues. *Pesticide protocols*, 239-261.

Lei, F.-F., Huang, J.-Y., Zhang, X.-N., Liu, X.-J., Li, X.-J., 2011. Determination of polycyclic aromatic hydrocarbons in vegetables by headspace SPME-GC. *Chromatographia* 74, 99-107.

Lequy, E., Sauvage, S., Laffray, X., Gombert-Courvoisier, S., Pascaud, A., Galsomiès, L., Leblond, S., 2016. Assessment of the uncertainty of trace metal and nitrogen concentrations in mosses due to sampling, sample preparation and chemical analysis based on the French contribution to ICP-Vegetation. *Ecological Indicators* 71, 20-31.

Li, F., Zhang, J., Huang, J., Huang, D., Yang, J., Song, Y., Zeng, G., 2016a. Heavy metals in road dust from Xiandao District, Changsha City, China: characteristics, health risk assessment, and integrated source identification. *Environmental Science and Pollution Research*, 1-14.

Li, J., Dong, H., Xu, X., Han, B., Li, X., Zhu, C., Han, C., Liu, S., Yang, D., Xu, Q., 2016b. Prediction of the bioaccumulation of PAHs in surface sediments of Bohai Sea, China and quantitative assessment of the related toxicity and health risk to humans. *Marine pollution bulletin* 104, 92-100.

Li, J., Wang, Y.-B., Li, K.-Y., Cao, Y.-Q., Wu, S., Wu, L., 2015. Advances in different configurations of solid-phase microextraction and their applications in food and environmental analysis. *TrAC Trends in Analytical Chemistry* 72, 141-152.

Li, K., Li, H., Liu, L., Hashi, Y., Maeda, T., Lin, J.-M., 2007. Solid-phase extraction with C 30 bonded silica for analysis of polycyclic aromatic hydrocarbons in airborne particulate matters by gas chromatography–mass spectrometry. *Journal of Chromatography A* 1154, 74-80.

Li, L., Zheng, B., Liu, L., 2010. Biomonitoring and bioindicators used for river ecosystems: definitions, approaches and trends. *Procedia environmental sciences* 2, 1510-1524.

Liu, J., Qi, S., Yao, J., Yang, D., Xing, X., Liu, H., Qu, C., 2016. Contamination characteristics of organochlorine pesticides in multimatrix sampling of the Hanjiang River Basin, southeast China. *Chemosphere* 163, 35-43.

Loppi, S., Pozo, K., Estellano, V.H., Corsolini, S., Sardella, G., Paoli, L., 2015. Accumulation of polycyclic aromatic hydrocarbons by lichen transplants: Comparison with gas-phase passive air samplers. *Chemosphere* 134, 39-43.

Lord, H.L., 2007. Strategies for interfacing solid-phase microextraction with liquid chromatography. *Journal of Chromatography A* 1152, 2-13.

Luo, D., Pu, Y., Tian, H., Cheng, J., Zhou, T., Tao, Y., Yuan, J., Sun, X., Mei, S., 2016. Concentrations of organochlorine pesticides in umbilical cord blood and related lifestyle and dietary intake factors among pregnant women of the Huaihe River Basin in China. *Environment International* 92–93, 276-283.

Luque de Castro, M.D., García-Ayuso, L.E., 1998. Soxhlet extraction of solid materials: an outdated technique with a promising innovative future. *Analytica Chimica Acta* 369, 1-10.

Luque de Castro, M.D., Priego-Capote, F., 2010. Soxhlet extraction: Past and present panacea. *Journal of Chromatography A* 1217, 2383-2389.

Ma, Y., Hashi, Y., Ji, F., Lin, J.M., 2010. Determination of phthalates in fruit jellies by dispersive SPE coupled with HPLC-MS. *Journal of separation science* 33, 251-257.

Magoni, M., Donato, F., Speziani, F., Leonardi, L., Orizio, G., Scarcella, C., Gaia, A., Apostoli, P., 2016. Substantial decline of polychlorinated biphenyls serum levels 10 years after public health interventions in a population living near a contaminated site in Northern Italy. *Environment International*.

Malhat, F.M., Haggag, M.N., Loutfy, N.M., Osman, M.A., Ahmed, M.T., 2015. Residues of organochlorine and synthetic pyrethroid pesticides in honey, an indicator of ambient environment, a pilot study. *Chemosphere* 120, 457-461.

Malik, A.K., Kaur, V., Verma, N., 2006. A review on solid phase microextraction—High performance liquid chromatography as a novel tool for the analysis of toxic metal ions. *Talanta* 68, 842-849.

Maphangwa, K.W., Musil, C., Raitt, L., Zedda, L., 2012. Differential interception and evaporation of fog, dew and water vapour and elemental accumulation by lichens explain their relative abundance in a coastal desert. *Journal of Arid Environments* 82, 71-80.

Marć, M., Tobiszewski, M., Zabiegała, B., Guardia, M.d.l., Namieśnik, J., 2015. Current air quality analytics and monitoring: A review. *Analytica Chimica Acta* 853, 116-126.

Mariottini, M., Corsi, I., Della Torre, C., Caruso, T., Bianchini, A., Nesi, I., Focardi, S., 2008. Biomonitoring of polybrominated diphenyl ether (PBDE) pollution: A field study. *Comparative Biochemistry and Physiology Part C: Toxicology & Pharmacology* 148, 80-86.

Markert, B., Wappelhorst, O., Weckert, V., Herpin, U., Siewers, U., Friese, K., Breulmann, G., 1999. The use of bioindicators for monitoring the heavy-metal status of the environment. *Journal of Radioanalytical and Nuclear Chemistry* 240, 425-429.

Martínez-Guijarro, K., Ramadan, A., Gevao, B., 2017. Atmospheric concentration of polychlorinated dibenzo-p-dioxins, polychlorinated dibenzofurans (PCDD/Fs) and dioxin-like polychlorinated biphenyls (dl-PCBs) at Umm-Al-Aish oil field-Kuwait. *Chemosphere* 168, 147-154.

Masri, S., Kang, C.-M., Koutrakis, P., 2015. Composition and sources of fine and coarse particles collected during 2002–2010 in Boston, MA. *Journal of the Air & Waste Management Association* 65, 287-297.

Matin, G., Kargar, N., Buyukisik, H.B., 2016. Bio-monitoring of cadmium, lead, arsenic and mercury in industrial districts of Izmir, Turkey by using honey bees, propolis and pine tree leaves. *Ecological Engineering* 90, 331-335.

McDonald, K., 2012. 11 - Air pollution in the urban atmosphere: sources and consequences A2 - Zeman, Frank, *Metropolitan Sustainability*. Woodhead Publishing, pp. 231-259.

McGrath, T.J., Morrison, P.D., Sandiford, C.J., Ball, A.S., Clarke, B.O., 2016. Widespread polybrominated diphenyl ether (PBDE) contamination of urban soils in Melbourne, Australia. *Chemosphere* 164, 225-232.

McKay, G., 2002. Dioxin characterisation, formation and minimisation during municipal solid waste (MSW) incineration: review. *Chemical Engineering Journal* 86, 343-368.

Megson, D., Reiner, E.J., Jobst, K.J., Dorman, F.L., Robson, M., Focant, J.-F., 2016. A review of the determination of persistent organic pollutants for environmental forensics investigations. *Analytica Chimica Acta*.

Melymuk, L., Bohlin-Nizzetto, P., Prokeš, R., Kukučka, P., Klánová, J., 2016. Sampling artifacts in active air sampling of semivolatile organic contaminants: Comparing theoretical and measured artifacts and evaluating implications for monitoring networks. *Environmental Pollution*.

Meyer, C., Diaz-de-Quijano, M., Monna, F., Franchi, M., Toussaint, M.-L., Gilbert, D., Bernard, N., 2015. Characterisation and distribution of deposited trace elements transported over long and intermediate distances in north-eastern France using Sphagnum peatlands as a sentinel ecosystem. *Atmospheric Environment* 101, 286-293.

Milun, V., Grgas, D., Dragičević, T.L., 2016. Assessment of PCB and chlorinated pesticide accumulation in mussels at Kaštela Bay (Eastern Adriatic). *Science of The Total Environment* 562, 115-127.

Mleiki, A., Irizar, A., Zaldibar, B., El Menif, N.T., Marigómez, I., 2016. Bioaccumulation and tissue distribution of Pb and Cd and growth effects in the green garden snail, *Cantareus apertus* (Born, 1778), after dietary exposure to the metals alone and in combination. *Science of The Total Environment* 547, 148-156.

Mmualefe, L.C., Torto, N., Huntsman-Mapila, P., Mbongwe, B., 2009. Headspace solid phase microextraction in the determination of pesticides in water samples from the Okavango Delta with gas chromatography-electron capture detection and time-of-flight mass spectrometry. *Microchemical Journal* 91, 239-244.

Mohr, S., García-Bermejo, Á., Herrero, L., Gómara, B., Costabeber, I.H., González, M.J., 2014. Levels of brominated flame retardants (BFRs) in honey samples from different geographic regions. *Science of The Total Environment* 472, 741-745.

Mol, H.G., Staniewski, J., Janssen, H.-G., Cramers, C.A., Ghijssen, R.T., Udo, A.T., 1993. Use of an open-tubular trapping column as phase-switching interface in on-line coupled reversed-phase liquid chromatography—capillary gas chromatography. *Journal of Chromatography A* 630, 201-212.

Moniruzzaman, M., Chowdhury, M.A.Z., Rahman, M.A., Sulaiman, S.A., Gan, S.H., 2014. Determination of mineral, trace element, and pesticide levels in honey samples originating from different regions of Malaysia compared to Manuka honey. *BioMed research international* 2014.

Morales-Munoz, S., Luque-Garcia, J., De Castro, M.L., 2002. Static extraction with modified pressurized liquid and on-line fluorescence monitoring: Independent matrix approach for the removal of polycyclic aromatic hydrocarbons from environmental solid samples. *Journal of Chromatography A* 978, 49-57.

Moreira, T.C.L., de Oliveira, R.C., Amato, L.F.L., Kang, C.-M., Saldiva, P.H.N., Saiki, M., 2016. Intra-urban biomonitoring: Source apportionment using tree barks to identify air pollution sources. *Environment International* 91, 271-275.

Morville, S., Scheyer, A., Mirabel, P., Millet, M., 2004. Sampling and analysis of polycyclic aromatic hydrocarbons in urban and rural atmospheres: Spatial and geographical variations of concentrations. *Polycyclic Aromatic Compounds* 24, 617-634.

Musgrave, M., Aronson, K., Narod, S., Hanna, W., Miller, A., McCready, D., 1998. Breast cancer and organochlorines: a marker for susceptibility? *Surgical oncology* 7, 1-4.

Namulanda, G., Maisonet, M., Taylor, E., Flanders, W.D., Olson, D., Sjodin, A., Qualters, J.R., Vena, J., Northstone, K., Naeher, L., 2016. In utero exposure to organochlorine pesticides and early menarche in the Avon Longitudinal Study of Parents and Children. *Environment International*.

Nimis, P.L., Scheidegger, C., Wolseley, P.A., 2002. Monitoring with lichens—monitoring lichens, *Monitoring with Lichens—Monitoring Lichens*. Springer, pp. 1-4.

Niu, J., Liberda, E.N., Qu, S., Guo, X., Li, X., Zhang, J., Meng, J., Yan, B., Li, N., Zhong, M., 2013. The role of metal components in the cardiovascular effects of PM 2.5. *PLoS one* 8, e83782.

Noth, E.M., Katharine Hammond, S., Biging, G.S., Tager, I.B., 2013. Mapping and modeling airborne urban phenanthrene distribution using vegetation biomonitoring. *Atmospheric Environment* 77, 518-524.

Occelli, F., Bavdek, R., Deram, A., Hellequin, A.-P., Cuny, M.-A., Zwarterook, I., Cuny, D., 2016. Using lichen biomonitoring to assess environmental justice at a neighbourhood level in an industrial area of Northern France. *Ecological Indicators* 60, 781-788.

Odabasi, M., Dumanoglu, Y., Ozgunerge Falay, E., Tuna, G., Altioek, H., Kara, M., Bayram, A., Tolunay, D., Elbir, T., 2016. Investigation of spatial distributions and sources of persistent organic pollutants (POPs) in a heavily polluted industrial region using tree components. *Chemosphere* 160, 114-125.

Oellig, C., 2016. Acetonitrile extraction and dual-layer solid phase extraction clean-up for pesticide residue analysis in propolis. *Journal of Chromatography A* 1445, 19-26.

Ogunkunle, C.O., Ziyath, A.M., Rufai, S.S., Fatoba, P.O., 2016. Surrogate approach to determine heavy metal loads in a moss species – *Barbula lambaranensis*. *Journal of King Saud University - Science* 28, 193-197.

Ouyang, F., Perry, M., Venners, S., Chen, C., Wang, B., Yang, F., Fang, Z., Zang, T., Wang, L., Xu, X., 2005. Serum DDT, age at menarche, and abnormal menstrual cycle length. *Occupational and Environmental Medicine* 62, 878-884.

Palmes, E., GUNNISON, A.F., 1973. Personal monitoring device for gaseous contaminants. *The American Industrial Hygiene Association Journal* 34, 78-81.

Panseri, S., Catalano, A., Giorgi, A., Arioli, F., Procopio, A., Britti, D., Chiesa, L., 2014. Occurrence of pesticide residues in Italian honey from different areas in relation to its potential contamination sources. *Food Control* 38, 150-156.

Paradis, D., Bérail, G., Bonmatin, J.-M., Belzunces, L.P., 2014. Sensitive analytical methods for 22 relevant insecticides of 3 chemical families in honey by GC-MS/MS and LC-MS/MS. *Analytical and bioanalytical chemistry* 406, 621-633.

Pauget, B., Gimbert, F., Coeurdassier, M., Crini, N., Pérès, G., Faure, O., Douay, F., Richard, A., Grand, C., de Vaufléury, A., 2013. Assessing the in situ bioavailability of trace elements to snails using accumulation kinetics. *Ecological Indicators* 34, 126-135.

Pedersen, J.R., Olsson, J.O., 2003. Soxhlet extraction of acrylamide from potato chips. *Analyst* 128, 332-334.

Picó, Y., Fernández, M., Ruiz, M.J., Font, G., 2007. Current trends in solid-phase-based extraction techniques for the determination of pesticides in food and environment. *Journal of biochemical and biophysical methods* 70, 117-131.

Pietrzykowski, M., Socha, J., van Doorn, N.S., 2014. Linking heavy metal bioavailability (Cd, Cu, Zn and Pb) in Scots pine needles to soil properties in reclaimed mine areas. *Science of The Total Environment* 470-471, 501-510.

Polo, M., Gómez-Noya, G., Quintana, J., Llompert, M., Garcia-Jares, C., Cela, R., 2004. Development of a solid-phase microextraction gas chromatography/tandem mass spectrometry method for polybrominated diphenyl ethers and polybrominated biphenyls in water samples. *Analytical chemistry* 76, 1054-1062.

Pongpiachan, S., Choochuay, C., Hattayanone, M., Kositanont, C., 2013. Temporal and spatial distribution of particulate carcinogens and mutagens in Bangkok, Thailand. *Asian Pac. J. Cancer Prev* 14, 1879-1887.

POPRC.12, 2016. Twelfth meeting of the Persistent Organic Pollutants Review Committee.

Porta, M., Zumeta, E., 2002. Implementing the Stockholm treaty on persistent organic pollutants. *Occupational and environmental medicine* 59, 651-652.

Proum, S., Santos, J.H., Lim, L.H., Marshall, D.J., 2016. Metal accumulation in the tissues and shells of *Indothais gradata* snails inhabiting soft and hard substrata in an acidified tropical estuary (Brunei, South East Asia). *Regional Studies in Marine Science*.

Pyrzynska, K., Kubiak, A., Wysocka, I., 2016. Application of solid phase extraction procedures for rare earth elements determination in environmental samples. *Talanta* 154, 15-22.

Raeymaekers, B., 2006. A prospective biomonitoring campaign with honey bees in a district of Upper-Bavaria (Germany). *Environmental monitoring and assessment* 116, 233-243.

Rahman, F., Langford, K.H., Scrimshaw, M.D., Lester, J.N., 2001. Polybrominated diphenyl ether (PBDE) flame retardants. *Science of the Total Environment* 275, 1-17.

Rahman, M.S., Molla, A.H., Saha, N., Rahman, A., 2012. Study on heavy metals levels and its risk assessment in some edible fishes from Bangshi River, Savar, Dhaka, Bangladesh. *Food Chemistry* 134, 1847-1854.

Ratola, N., Alves, A., Santos, L., Lacorte, S., 2011a. Pine needles as passive bio-samplers to determine polybrominated diphenyl ethers. *Chemosphere* 85, 247-252.

Ratola, N., Amigo, J.M., Alves, A., 2010. Levels and sources of PAHs in selected sites from Portugal: biomonitoring with *Pinus pinea* and *Pinus pinaster* needles. *Archives of environmental contamination and toxicology* 58, 631-647.

Ratola, N., Amigo, J.M., Oliveira, M.S., Araújo, R., Silva, J.A., Alves, A., 2011b. Differences between *Pinus pinea* and *Pinus pinaster* as bioindicators of polycyclic aromatic hydrocarbons. *Environmental and Experimental Botany* 72, 339-347.

Ratola, N., Homem, V., Silva, J.A., Araújo, R., Amigo, J.M., Santos, L., Alves, A., 2014. Biomonitoring of pesticides by pine needles—chemical scoring, risk of exposure, levels and trends. *Science of the Total Environment* 476, 114-124.

Ratola, N., Lacorte, S., Alves, A., Barceló, D., 2006. Analysis of polycyclic aromatic hydrocarbons in pine needles by gas chromatography–mass spectrometry: comparison of different extraction and clean-up procedures. *Journal of Chromatography A* 1114, 198-204.

Reiner, E.J., Jobst, K.J., Megson, D., Dorman, F.L., Focant, J.-F., 2013. *Environmental Forensics Analytical Methodology of POPs, Environmental Forensics for Persistent Organic Pollutants*. Elsevier.

Ren, A., Qiu, X., Jin, L., Ma, J., Li, Z., Zhang, L., Zhu, H., Finnell, R.H., Zhu, T., 2011. Association of selected persistent organic pollutants in the placenta with the risk of neural tube defects. *Proceedings of the National Academy of Sciences* 108, 12770-12775.

Restrepo, A.R., Ortiz, A.F.G., Ossa, D.E.H., Mesa, G.A.P., 2014. QuEChERS GC–MS validation and monitoring of pesticide residues in different foods in the tomato classification group. *Food chemistry* 158, 153-161.

Ribas-Fitó, N., Torrent, M., Carrizo, D., Júlvez, J., Grimait, J.O., Sunyer, J., 2007. Exposure to hexachlorobenzene during pregnancy and children's social behavior at 4 years of age. *Environmental health perspectives*, 447-450.

Rodriguez, J.H., Wannaz, E.D., Salazar, M.J., Pignata, M.L., Fangmeier, A., Franzaring, J., 2012. Accumulation of polycyclic aromatic hydrocarbons and heavy metals in the tree foliage of *Eucalyptus rostrata*, *Pinus radiata* and *Populus hybridus* in the vicinity of a large aluminium smelter in Argentina. *Atmospheric Environment* 55, 35-42.

Rogan, W.J., Gladen, B.C., Hung, K.-L., 1987. Congenital Poisoning by Polychlorinated Biphenyls. *Chem. Commun* 1823.

Romanič, S., Krauthacker, B., 2007. Are pine needles bioindicators of air pollution? Comparison of organochlorine compound levels in pine needles and ambient air. *Archives of Industrial Hygiene and Toxicology* 58, 195-199.

Romanič, S.H., Krauthacker, B., 2006. Distribution of persistent organochlorine compounds in one-year and two-year-old pine needles. *Bulletin of environmental contamination and toxicology* 77, 143-148.

Rousis, N.I., Zuccato, E., Castiglioni, S., 2016. Monitoring population exposure to pesticides based on liquid chromatography–tandem mass spectrometry measurement of their urinary metabolites in urban wastewater: A novel biomonitoring approach. *Science of The Total Environment*.

Ru, Q.-M., Feng, Q., He, J.-Z., 2013. Risk assessment of heavy metals in honey consumed in Zhejiang province, southeastern China. *Food and Chemical Toxicology* 53, 256-262.

Ruhling, A., Tyler, G., 1968. An ecological approach to lead problem. *Botaniska Notiser* 121, 21-&.

Rühling, Å., Tyler, G., 1970. Sorption and retention of heavy metals in the woodland moss *Hylocomium splendens* (Hedw.) Br. et Sch. *Oikos*, 92-97.

Saeedi Saravi, S.S., Dehpour, A.R., 2016. Potential role of organochlorine pesticides in the pathogenesis of neurodevelopmental, neurodegenerative, and neurobehavioral disorders: A review. *Life Sciences* 145, 255-264.

Saeedi Saravi, S.S., Otadi, N., 2012. Evaluation of residues of DDT and DDA in fish collected from Caspian sea, Iran. *Iranian Journal of Toxicology* 6, 704-708.

Saha, N., Mollah, M.Z.I., Alam, M.F., Safur Rahman, M., 2016. Seasonal investigation of heavy metals in marine fishes captured from the Bay of Bengal and the implications for human health risk assessment. *Food Control* 70, 110-118.

Saha, N., Zaman, M., 2013. Evaluation of possible health risks of heavy metals by consumption of foodstuffs available in the central market of Rajshahi City, Bangladesh. *Environmental monitoring and assessment* 185, 3867-3878.

Salo, H., Bučko, M.S., Vaahtovuori, E., Limo, J., Mäkinen, J., Pesonen, L.J., 2012. Biomonitoring of air pollution in SW Finland by magnetic and chemical measurements of moss bags and lichens. *Journal of Geochemical Exploration* 115, 69-81.

Sanusi, A., Millet, M., Mirabel, P., Wortham, H., 1999. Gas–particle partitioning of pesticides in atmospheric samples. *Atmospheric Environment* 33, 4941-4951.

Sanusi, A., Millet, M., Mirabel, P., Wortham, H., 2000. Comparison of atmospheric pesticide concentrations measured at three sampling sites: local, regional and long-range transport. *Science of The Total Environment* 263, 263-277.

Saoudi, A., Fréry, N., Zeghnoun, A., Bidondo, M.-L., Deschamps, V., Göen, T., Garnier, R., Guldner, L., 2014. Serum levels of organochlorine pesticides in the French adult population: The French National Nutrition and Health Study (ENNS), 2006–2007. *Science of The Total Environment* 472, 1089-1099.

Sapozhnikova, Y., Lehotay, S.J., 2013. Multi-class, multi-residue analysis of pesticides, polychlorinated biphenyls, polycyclic aromatic hydrocarbons, polybrominated diphenyl ethers and novel flame retardants in fish using fast, low-pressure gas chromatography–tandem mass spectrometry. *Analytica chimica acta* 758, 80-92.

Sawidis, T., Breuste, J., Mitrovic, M., Pavlovic, P., Tsigaridas, K., 2011. Trees as bioindicator of heavy metal pollution in three European cities. *Environmental Pollution* 159, 3560-3570.

Schuhfried, E., Betta, E., Cappellin, L., Aprea, E., Gasperi, F., Märk, T.D., Biasioli, F., 2017. Withering of plucked *Trachelospermum jasminoides* (star jasmine) flowers – Time-dependent volatile compound profile obtained with SPME/GC–MS and proton transfer reaction-mass spectrometry (PTR-MS). *Postharvest Biology and Technology* 123, 1-11.

Schulz, H., Popp, P., Huhn, G., Stärk, H.-J., Schüürmann, G., 1999. Biomonitoring of airborne inorganic and organic pollutants by means of pine tree barks. I. Temporal and spatial variations. *Science of the Total Environment* 232, 49-58.

Schummer, C., Mothiron, E., Appenzeller, B.M.R., Rizet, A.-L., Wennig, R., Millet, M., 2010. Temporal variations of concentrations of currently used pesticides in the atmosphere of Strasbourg, France. *Environmental Pollution* 158, 576-584.

Seethapathy, S., Gorecki, T., Li, X., 2008. Passive sampling in environmental analysis. *Journal of Chromatography A* 1184, 234-253.

Shamsipur, M., Yazdanfar, N., Ghambarian, M., 2016. Combination of solid-phase extraction with dispersive liquid–liquid microextraction followed by GC–MS for determination of pesticide residues from water, milk, honey and fruit juice. *Food Chemistry* 204, 289-297.

Shen, L., Wania, F., 2005. Compilation, evaluation, and selection of physical-chemical property data for organochlorine pesticides. *Journal of Chemical & Engineering Data* 50, 742-768.

Shendy, A.H., Al-Ghobashy, M.A., Mohammed, M.N., Gad Alla, S.A., Lotfy, H.M., 2016. Simultaneous determination of 200 pesticide residues in honey using gas chromatography–tandem mass spectrometry in conjunction with streamlined quantification approach. *Journal of Chromatography A* 1427, 142-160.

Siddiqui, M., Srivastava, S., Mehrotra, P., Mathur, N., Tandon, I., 2003. Persistent chlorinated pesticides and intra-uterine foetal growth retardation: a possible association. *International archives of occupational and environmental health* 76, 75-80.

Silva, J.A., Ratola, N., Ramos, S., Homem, V., Santos, L., Alves, A., 2015. An analytical multi-residue approach for the determination of semi-volatile organic pollutants in pine needles. *Analytica Chimica Acta* 858, 24-31.

Simonich, S.L., Hites, R.A., 1995. Organic pollutant accumulation in vegetation. *Environmental Science & Technology* 29, 2905-2914.

Sinkkonen, S., Welling, L., Vattulainen, A., Lahti, L., Lahtiperä, M., Paasivirta, J., 1996. Short chain aliphatic halocarbons and polychlorinated biphenyls in pine needles: effects of metal scrap plant emissions. *Chemosphere* 32, 1971-1982.

Souza-Silva, É.A., Jiang, R., Rodríguez-Lafuente, A., Gionfriddo, E., Pawliszyn, J., 2015. A critical review of the state of the art of solid-phase microextraction of complex matrices I. *Environmental analysis. TrAC Trends in Analytical Chemistry* 71, 224-235.

Souza Tette, P.A., Rocha Guidi, L., de Abreu Glória, M.B., Fernandes, C., 2016. Pesticides in honey: A review on chromatographic analytical methods. *Talanta* 149, 124-141.

Soxhlet, F.v., 1879. Die gewichtsanalytische bestimmung des milchfettes. *Polytechnisches J* 232, 461-465.

Spietelun, A., Pilarczyk, M., Kloskowski, A., Namieśnik, J., 2011. Polyethylene glycol-coated solid-phase microextraction fibres for the extraction of polar analytes—A review. *Talanta* 87, 1-7.

Squadrone, S., Prearo, M., Nespoli, R., Scanzio, T., Abete, M., 2016. PCDD/Fs, DL-PCBs and NDL-PCBs in European catfish from a northern Italian lake: the contribution of an alien species to human exposure. *Ecotoxicology and environmental safety* 125, 170-175.

St-Amand, A.D., Mayer, P.M., Blais, J.M., 2008. Seasonal trends in vegetation and atmospheric concentrations of PAHs and PBDEs near a sanitary landfill. *Atmospheric Environment* 42, 2948-2958.

St-Amand, A.D., Mayer, P.M., Blais, J.M., 2009. Modeling PAH uptake by vegetation from the air using field measurements. *Atmospheric Environment* 43, 4283-4288.

Subedi, B., 2012. High-throughput analysis of emerging and historical pollutants in biological matrices.

Sun, H., Ge, X., Lv, Y., Wang, A., 2012. Application of accelerated solvent extraction in the analysis of organic contaminants, bioactive and nutritional compounds in food and feed. *Journal of Chromatography A* 1237, 1-23.

Surma, M., Wiczkowski, W., Cieślak, E., Zieliński, H., 2015. Method development for the determination of PFOA and PFOS in honey based on the dispersive Solid Phase Extraction (d-SPE) with micro-UHPLC–MS/MS system. *Microchemical Journal* 121, 150-156.

Sverdrup, L.E., De Vaufléury, A., Hartnik, T., Hagen, S.B., Loibner, A.P., Jensen, J., 2006. Effects and uptake of polycyclic aromatic compounds in snails (*Helix aspersa*). *Environmental toxicology and chemistry* 25, 1941-1945.

Tang, Z., Chai, M., Cheng, J., Jin, J., Yang, Y., Nie, Z., Huang, Q., Li, Y., 2017. Contamination and health risks of heavy metals in street dust from a coal-mining city in eastern China. *Ecotoxicology and Environmental Safety* 138, 83-91.

Tette, P.A.S., da Silva Oliveira, F.A., Pereira, E.N.C., Silva, G., de Abreu Glória, M.B., Fernandes, C., 2016. Multiclass method for pesticides quantification in honey by means of modified QuEChERS and UHPLC–MS/MS. *Food Chemistry* 211, 130-139.

Tombesi, N., Pozo, K., Álvarez, M., Příbylová, P., Kukučka, P., Audy, O., Klánová, J., 2017. Tracking polychlorinated biphenyls (PCBs) and polybrominated diphenyl ethers (PBDEs) in sediments and soils from the southwest of Buenos Aires Province, Argentina (South eastern part of the GRULAC region). *Science of The Total Environment* 575, 1470-1476.

Tuduri, L., Harner, T., Hung, H., 2006. Polyurethane foam (PUF) disks passive air samplers: Wind effect on sampling rates. *Environmental Pollution* 144, 377-383.

Tuduri, L., Millet, M., Briand, O., Montury, M., 2012. Passive air sampling of semi-volatile organic compounds. *TrAC Trends in Analytical Chemistry* 31, 38-49.

USEPA, 2015. USEPA (U.S. Environmental Protection Agency) Regulated drinking water contaminants.

Van den Berg, M., Birnbaum, L., Bosveld, A., Brunström, B., Cook, P., Feeley, M., Giesy, J.P., Hanberg, A., Hasegawa, R., Kennedy, S.W., 1998. Toxic equivalency factors (TEFs) for PCBs, PCDDs, PCDFs for humans and wildlife. *Environmental health perspectives* 106, 775.

Van der Wat, L., Forbes, P.B., 2015. Lichens as biomonitors for organic air pollutants. *TrAC Trends in Analytical Chemistry* 64, 165-172.

van Drooge, B.L., Garriga, G., Grimalt, J.O., 2014. Polycyclic aromatic hydrocarbons in pine needles (*Pinus halepensis*) along a spatial gradient between a traffic intensive urban area (Barcelona) and a nearby natural park. *Atmospheric Pollution Research* 5, 398-403.

Varga, M., Dobor, J., Helenkár, A., Jurecska, L., Yao, J., Záray, G., 2010. Investigation of acidic pharmaceuticals in river water and sediment by microwave-assisted extraction and gas chromatography–mass spectrometry. *Microchemical Journal* 95, 353-358.

Vaufléury, A.G.d., Pihan, F., 2002. Methods for toxicity assessment of contaminated soil by oral or dermal uptake in land snails: metal bioavailability and bioaccumulation. *Environmental toxicology and chemistry* 21, 820-827.

Vázquez, P.P., Lozano, A., Uclés, S., Ramos, M.M.G., Fernández-Alba, A.R., 2015. A sensitive and efficient method for routine pesticide multiresidue analysis in bee pollen samples using gas and liquid chromatography coupled to tandem mass spectrometry. *Journal of Chromatography A* 1426, 161-173.

Viard, B., Pihan, F., Promeyrat, S., Pihan, J.-C., 2004. Integrated assessment of heavy metal (Pb, Zn, Cd) highway pollution: bioaccumulation in soil, Gramineae and land snails. *Chemosphere* 55, 1349-1359.

Vuckovic, D., Risticvic, S., Pawliszyn, J., 2011. In vivo solid-phase microextraction in metabolomics: opportunities for the direct investigation of biological systems. *Angewandte Chemie International Edition* 50, 5618-5628.

Vuković, G., Urošević, M.A., Goryainova, Z., Pergal, M., Škrivanj, S., Samson, R., Popović, A., 2015. Active moss biomonitoring for extensive screening of urban air pollution: Magnetic and chemical analyses. *Science of The Total Environment* 521–522, 200-210.

Wang, G., A, Y., Jiang, H., Fu, Q., Zheng, B., 2015. Modeling the source contribution of heavy metals in surficial sediment and analysis of their historical changes in the vertical sediments of a drinking water reservoir. *Journal of Hydrology* 520, 37-51.

Wang, J., Tuduri, L., Mercury, M., Millet, M., Briand, O., Montury, M., 2009. Sampling atmospheric pesticides with SPME: Laboratory developments and field study. *Environmental Pollution* 157, 365-370.

Wang, L., Wang, X., Zhou, J.-B., Zhao, R.-S., 2016a. Carbon nanotube sponges as a solid-phase extraction adsorbent for the enrichment and determination of polychlorinated biphenyls at trace levels in environmental water samples. *Talanta* 160, 79-85.

Wang, Y., Jiang, G., Lam, P.K., Li, A., 2007. Polybrominated diphenyl ether in the East Asian environment: a critical review. *Environment international* 33, 963-973.

Wang, Y., Wu, X., Zhao, H., Xie, Q., Hou, M., Zhang, Q., Du, J., Chen, J., 2016b. Characterization of PBDEs and novel brominated flame retardants in seawater near a coastal mariculture area of the Bohai Sea, China. *Science of The Total Environment*.

Wania, F., Shen, L., Lei, Y.D., Teixeira, C., Muir, D.C., 2003. Development and calibration of a resin-based passive sampling system for monitoring persistent organic pollutants in the atmosphere. *Environmental science & technology* 37, 1352-1359.

Wei, Y., Zhang, J., Zhang, D., Tu, T., Luo, L., 2014. Metal concentrations in various fish organs of different fish species from Poyang Lake, China. *Ecotoxicology and environmental safety* 104, 182-188.

Wennrich, L., Popp, P., Köller, G., Breuste, J., 2001. Determination of organochlorine pesticides and chlorobenzenes in strawberries by using accelerated solvent extraction combined with sorptive enrichment and gas chromatography/mass spectrometry. *Journal of AOAC International* 84, 1194-1201.

Wiest, L., Buleté, A., Giroud, B., Fratta, C., Amic, S., Lambert, O., Pouliquen, H., Arnaudguilhem, C., 2011. Multi-residue analysis of 80 environmental contaminants in honeys, honeybees and pollens by one extraction procedure followed by liquid and gas chromatography coupled with mass spectrometric detection. *Journal of Chromatography A* 1218, 5743-5756.

Wilhelm Scherer, H., 2009. Sulfur in soils. *Journal of Plant Nutrition and Soil Science* 172, 326-335.

Wilkowska, A., Biziuk, M., 2011. Determination of pesticide residues in food matrices using the QuEChERS methodology. *Food Chemistry* 125, 803-812.

Wöhnschimmel, H., Scheringer, M., Bogdal, C., Hung, H., Salamova, A., Venier, M., Katsoyiannis, A., Hites, R.A., Hungerbühler, K., Fiedler, H., 2016. Ten years after entry into force of the Stockholm Convention: What do air monitoring data tell about its effectiveness? *Environmental Pollution* 217, 149-158.

Wolterbeek, B., 2002. Biomonitoring of trace element air pollution: principles, possibilities and perspectives. *Environmental Pollution* 120, 11-21.

Wolterbeek, H.T., Bode, P., 1995. State of the Art of Trace Element Determinations in Plant Matrices Strategies in sampling and sample handling in the context of large-scale plant biomonitoring surveys of trace element air pollution. *Science of The Total Environment* 176, 33-43.

Wu, Q., Wang, X., Zhou, Q., 2014. Biomonitoring persistent organic pollutants in the atmosphere with mosses: Performance and application. *Environment International* 66, 28-37.

Xie, L., Liu, S., Han, Z., Jiang, R., Liu, H., Zhu, F., Zeng, F., Su, C., Ouyang, G., 2015. Preparation and characterization of metal-organic framework MIL-101 (Cr)-coated solid-phase microextraction fiber. *Analytica chimica acta* 853, 303-310.

Xu, D., Zhong, W., Deng, L., Chai, Z., Mao, X., 2004. Regional distribution of organochlorinated pesticides in pine needles and its indication for socioeconomic development. *Chemosphere* 54, 743-752.

Yang, C., Chen, A., Chen, R., Qi, Y., Ye, J., Li, S., Li, W., Liang, Z., Liang, Q., Guo, D., 2014. Acute effect of ambient air pollution on heart failure in Guangzhou, China. *International journal of cardiology* 177, 436-441.

Yang, Z., Chen, B., Li, L., Zheng, B., Liu, L., 2010. International Conference on Ecological Informatics and Ecosystem Conservation (ISEIS 2010) Biomonitoring and Bioindicators Used for River Ecosystems: Definitions, Approaches and Trends. *Procedia Environmental Sciences* 2, 1510-1524.

Yeo, H.-G., Choi, M., Chun, M.-Y., Sunwoo, Y., 2003. Gas/particle concentrations and partitioning of PCBs in the atmosphere of Korea. *Atmospheric Environment* 37, 3561-3570.

Zawisza-Raszka, A., Dolezych, B., Dolezych, S., Migula, P., Ligaszewski, M., 2010. Effects of nickel exposure and acute pesticide intoxication on acetylcholinesterase, catalase and glutathione S-transferase activity and glucose absorption in the digestive tract of *Helix aspersa* (Pulmonata, Helicidae). *International Journal of Environment and Pollution* 40, 380-390.

Zhang, Q.-H., Zhou, L.-D., Chen, H., Wang, C.-Z., Xia, Z.-N., Yuan, C.-S., 2016. Solid-phase microextraction technology for in vitro and in vivo metabolite analysis. *TrAC Trends in Analytical Chemistry* 80, 57-65.

Zhang, Z., Yang, M.J., Pawliszyn, J., 1994. Solid-phase microextraction. A solvent-free alternative for sample preparation. *Analytical chemistry* 66, 844A-853A.

Zhao, R.-S., Wang, X., Yuan, J.-P., Lin, J.-M., 2008. Investigation of feasibility of bamboo charcoal as solid-phase extraction adsorbent for the enrichment and determination of four phthalate esters in environmental water samples. *Journal of Chromatography A* 1183, 15-20.

Zhao, Y., Gong, X., Si, X., Wei, Z., Yang, C., Zhang, S., Zhang, X., 2015. Coupling a solid phase microextraction (SPME) probe with ambient MS for rapid enrichment and detection of phosphopeptides in biological samples. *Analyst* 140, 2599-2602.

Zhelyazkova, I., 2012. Honeybees—bioindicators for environmental quality. *Bulg. J. Agric. Sci* 18, 435-442.

- Zhou, S., Yang, H., Zhang, A., Li, Y.-F., Liu, W., 2014. Distribution of organochlorine pesticides in sediments from Yangtze River Estuary and the adjacent East China Sea: implication of transport, sources and trends. *Chemosphere* 114, 26-34.
- Zhu, N., Schramm, K.-W., Wang, T., Henkelmann, B., Fu, J., Gao, Y., Wang, Y., Jiang, G., 2015. Lichen, moss and soil in resolving the occurrence of semi-volatile organic compounds on the southeastern Tibetan Plateau, China. *Science of The Total Environment* 518–519, 328-336.
- Zhu, X., Pfister, G., Henkelmann, B., Kotalik, J., Fiedler, S., Schramm, K.-W., 2007. Simultaneous monitoring of PCDD/Fs and PCBs in contaminated air with semipermeable membrane devices and fresh spruce needles. *Chemosphere* 68, 1623-1629.
- Zuloaga, O., Navarro, P., Bizkarguenaga, E., Iparraguirre, A., Vallejo, A., Olivares, M., Prieto, A., 2012. Overview of extraction, clean-up and detection techniques for the determination of organic pollutants in sewage sludge: a review. *Analytica chimica acta* 736, 7-29.
- Żwir-Ferenc, A., Biziuk, M., 2006. Solid phase extraction technique—trends, opportunities and applications. *Polish Journal of Environmental Studies* 15, 677-690.

Chapitre 2 : Résultats

I. Contribution à l'analyse des produits alimentaires: recherche et évaluation de l'effet hémolytique de certains pesticides utilisés au Liban.

Ce premier travail présenté sous la forme d'un article publié dans le journal « *Journal of Environmental Science and Health, Part B : Pesticides, Food Contaminants, and Agricultural Wastes* » constitue l'introduction et l'initiation aux différents travaux suivants. Ce travail est en effet, consacré à la recherche, l'identification et l'analyse qualitative de différents pesticides utilisés au Liban ainsi qu'à l'estimation de leurs effets hémolytiques.

L'étude débute par un inventaire des pesticides vendus sur le marché local, une récupération des échantillons et ensuite une analyse qualitative de leur matière active par les méthodes chromatographiques et spectrométriques. L'analyse de ces échantillons a révélé l'usage du Zineb sous une forme illégale sur le marché de vente. Ensuite, ces mêmes échantillons de pesticides récupérés ont été étudiés pour leur pouvoir hémolytique sur le sang humain. Les résultats obtenus à ce niveau ont montré un effet hémolytique non négligeable des pesticides utilisés et spécialement pour la Trifluraline.

Ensuite, l'étude avait pour objectif l'analyse des fruits et des légumes récoltés de la région de Akkar au Liban et consommés localement ; des tomates, des oranges, des citrons, des fraises et des pêches ont été testés pour leur contamination qualitative en résidus des pesticides. Les résultats d'analyse des extraits testés par HPLC-ESI-MS ont montré une présence du Metalaxyl dans les citrons et les oranges, une présence du Zineb dans les citrons et les tomates ainsi qu'une présence de la Trifluraline dans les fraises. Vu l'importance de l'effet hémolytique que présente ce dernier pesticide trouvé sur le sang humain, la fraction de l'extrait de fraise dont l'analyse MS a démontré la présence de Trifluraline a été étudiée pour son effet hémolytique. Or, les résultats obtenus ont montré qu'en dépit d'une contamination en résidus de pesticide Trifluraline, l'extrait de fraise ne présentait aucun effet hémolytique.

A la vue des résultats obtenus, ce travail a lancé une étude analytique plus étendue au niveau de la persistance des pesticides ainsi que de tous les polluants dans les matrices environnementale et alimentaire qui pourrait avoir un effet indésirable pour la santé humaine à long terme.

Contribution to the food products' analysis: a research and evaluation on the hemolytic effect of some pesticides used in Lebanon

JOSEPHINE AL-ALAM^{1,2}, MAURICE MILLET^{2*}, ASMA CHBANI^{1,3} and ZIAD FAJLOUN^{1,4}

¹Azm Center for Research in Biotechnology and Its Applications, Doctoral School of Science and Technology, Lebanese University, Tripoli, Lebanon

²Institute of Chemistry and Processes for Energy, Environment and Health, ICPEES UMR 7515, Group of Physical Chemistry of the Atmosphere, University of Strasbourg, Strasbourg, France

³Faculty of Public Health, Lebanese University, Tripoli, Lebanon

⁴Faculty of Sciences III, Lebanese University, Tripoli, Lebanon

Abstract

Pesticides are a real concern for the society as their use has become critical, leading sometimes to their accumulation as residues in fruits and vegetables. After examining the pesticides sold in Northern Lebanon, this study is focused on the analysis and identification of pesticides residues in fruits and vegetables that are harvested in this region and treated with the locally sold pesticides. Results show: first, (i) a use of Zineb by the name of another pesticide Micronized Sulfur to avoid prosecution; (ii) a significant presence of Metalaxyl in lemons and oranges; (iii) a significant presence of Trifluralin in strawberries; and (iv) a significant presence of Zineb in lemons and tomatoes. Second, with the use of hemolytic tests on human blood results show: (i) a critical concentration and a significant hemolytic effect of some pesticides used in Lebanon; and (ii) an absence of hemolytic effect in the collected fractions of the different analyzed fruit extracts containing pesticides. Finally, this work is the first step for pesticides' analysis in vegetables and fruits in Lebanon, initiating a wider analytical study in order to control and examine the use of pesticides which, according to our results, could have an adverse effect on human health over a long term.

Keywords: Lebanon, LC-ESI-MS, pesticides, fruits and vegetables, hemolytic activity.

*Address correspondence to Maurice Millet, Institute of Chemistry and Processes for Energy, Environment and Health, ICPEES UMR 7515, Group of Physical Chemistry of the Atmosphere, University of Strasbourg, Strasbourg, France; E-mail: mmillet@unistra.fr

Introduction

Pesticides are natural or synthetic agents that are used to remove unwanted plants or animal pests. Some of these products are commonly used in the Lebanese agriculture to increase production yields.^[1]

However, in spite of their many benefits, such as the prevention of vector-borne diseases, many studies have demonstrated the persistence of some of these pesticides in diverse elements like food, water, air and soil, which can induce an enormous ecological and health stress.^[2] This persistence is mainly causing pesticides toxicity, especially when its concentration in food exceeds the maximum residue limits of pesticides doses as some of them are highly toxic, mutagenic, carcinogenic and endocrine disruptors even at low doses.^[3]

Some of the pesticides found in food consumption can have lots of harmful effects. Zineb is a dithiocarbamate fungicide used especially for treating tomatoes. Zhang et al. in 2003 found that Zineb have a similar structure as Maneb and causes neurodegeneration and demyelination of neurons in rats.^[4]

Furthermore, another study performed by Sugiyama et al. in 2005 shows that Zineb is a potential endocrine disruptor leading to the inhibition of thyroid hormones production.^[5] Metalaxyl, a phenylamide fungicide, could present cytogenetic effects on human chromosomes in vitro as well as severe liver injury in mice.^[6,7]

According to the study of Farag in 2013, food treated with Metalaxyl could be eaten at least seven days after spraying, which could be reassuring for consumers of vegetables and fruits treated with this pesticide.^[8] Chlorothalonil, a biocide with a broad spectrum belonging to organochlorines, could be carcinogen for humans as the National Cancer Institute in 1980 revealed that this pesticide is a potential carcinogen for "Osborne-Mendel" rat type.^[9]

Trifluralin, a pre-emergence herbicide, has a very high hemolytic effect as well as a carcinogenic effect as revealed by Kang et al. in 2008. Their studies show a strong relation between the overexposure to Trifluralin and colon cancer.^[10]

Some properties in the constituents of our daily diets are confusing especially after knowing more about the use of pesticides in Lebanon. For example, Malathion, which is forbidden worldwide, is available for sale in the Lebanese markets. However, in the European Union, this active substance is prohibited by the European Commission (EC) in Decision 2007/389/EC in Annex I to Directive 91/414/ European Economic Community (EEC)

and since 2012, the rate residues of this pesticide in food is regulated in Europe. In fact, and according to the French Agency for Food, Environmental and Occupational Health & Safety (ANSES), this pesticide is not toxic by itself but its decomposition product, Malaoxon, is known to cause acetylcholinesterase inhibition and leukemia.^[11]

Similarly, another forbidden pesticide in Annex I to Directive 91/414/EEC under the 2001 European Union (EU)/EC decision of 28 March 245/2001, Zineb has been described to interfere with glucocorticoid metabolism by inhibiting the activity of the enzyme 11 beta-hydroxy steroid dehydrogenase type 2, which converts cortisol to cortisone.^[12]

This pesticide is sold in Lebanon as Micronized Sulfur to escape prosecution.

Therefore, the goal of our research is directed on the analysis of pesticides sold locally and on the analysis of fruits and vegetables grown in Lebanon. In order to detect the persistence of pesticide residues in our food and also to evaluate their potential biological effects on health, a well-known method for its efficiency was used which is the Liquid Chromatography coupled to Electrospray Ionization Mass Spectrometry (LC-ESI-MS). Known for its selectivity and simplicity for pesticide monitoring in food matrices,^[13,14] LC-ESI-MS

allows also the verification and analysis of highly polar, less volatile and thermally labile compounds; it can be used after "classical" multi-residue extraction procedures, such as simple decantation and solid phase extraction (SPE). Our project consists firstly of analyzing pesticides sold in the local market with LC-ESI-MS, secondly of analyzing pesticides residues in fruits and vegetables after their extraction using SPE or simple extraction with ethyl acetate and finally of studying the toxicity of these pesticides and their residues in food on human red blood cells and agarose gel.

Materials and methods

Chemicals and reagents

Acetonitrile, ethyl acetate, sodium sulfate, formic acid, sodium L-ascorbate, hydrochloric acid, copper acetate, trypsin, triton, and sodium hydroxide were purchased from Sigma Aldrich. While methanol was supplied from JT Baker, n-hexane from Analar NORMAPUR, nutrient agar from Bio-Rad, sodium phosphate monobasic dihydrate, acetic acid, and ammonium acetate from Riedel-de Haën and di-sodium hydrogen phosphate from Scharlau. The ultrapure deionized water was obtained from a Millipore system installed at Azm Center for Biotechnology

Research and Applications. Pesticides [Malathion (50%), Micronized Sulfur (80%), Trifluralin (48%), Copper (50%), and Metalaxyl (25%)] were purchased from Zahriyeh, Tripoli and Amyoun, Koura and were analyzed for their active material composition in order to confirm their real constitution and their use as qualitative standards for validating their presence in the analyzed crops.

Samples

Five agricultural products – tomatoes, oranges, lemons, strawberries and peaches – were purchased from a local market in Tripoli. Crops were freshly transported to the market from farmlands situated in Akkar, Lebanon. The origin of the crops was confirmed by the seller and they were frozen at 4°C until the analysis. In fact, the region of Akkar is well known for its agriculture, so studying crops from these farmlands represent crops sold in the North of Lebanon.

Apparatus and LC-ESI-MS conditions

The analysis was performed on an Agilent 1200 High Pressure Liquid Chromatography (HPLC) equipped with a variable wavelength detector (set at $\lambda = 285$ nm) and a 2610 Mass Spectrometer operated with electro-spray ionization in positive mode. Separation was done on a reversed phase C₁₈ column (4.6 mm x 250 mm, 5 mm) at 0.1 mL min⁻¹ with a gradient of water + 0.1% formic acid/acetonitrile + 0.1% formic acid). Injection volume was 100 μ L.

Extraction and chemical analysis

Sample preparation and extraction.

500 g of tomatoes were homogenized in a blender. 10 g of the homogenate tomatoes obtained was diluted with 100 mL of water and stirred with a glass stick for 2 min. Then, the diluted sample was transferred to a 250 mL Erlenmeyer flask. After adjusting to pH 9.5 with 2 M NaOH, the sample was centrifuged for 15 min at 4000 rpm and after that the supernatant was transferred to a glass beaker. Then a SPE extraction was performed with Supelclean C₁₈ cartridges conditioned with 2 mL phosphate buffer (PB)/acetonitrile (ACN) (75/25). 10 mL of the supernatant liquid was loaded to the Supelclean C₁₈ cartridges at a flow rate of about 1 mL min⁻¹. Next, an elution using 2 mL of each, respectively following proportions (75/25, 50/50, 25/75, 0/100) of PB/ACN was carried. The various fractions were collected separately and transferred in vials for analysis by HPLC.^[15]

As for citrus fruits, an amount of 1 Kg of oranges and lemons was homogenized in a blender, and then 10 g of the homogenate were transferred to a beaker and mixed with 50 mL of ethyl acetate and 20 g of anhydrous sodium sulfate. After homogenization with a bar, the samples were filtered under vacuum through a Buchner funnel. The residues on the filter paper were washed with 50 mL of ethyl acetate and then evaporated using a rotavapor at a temperature of 40°C and a pressure of 250 mbar, and finally redissolved in 3 mL of methanol/water (50/50). Then a SPE was performed using the same cartridge as used for tomatoes but the conditioning was with 2 mL of methanol/water (50/50) and the elution was carried using 2 mL of methanol/water in the respective proportions 60/40, 80/20, 90/10, 100/0. The various fractions were collected and divided in vials filled for the analysis by HPLC.^[16]

As for strawberries and peaches, 25 g of the puree of each fruit were placed in a 500 mL beaker, to which 150 mL of ethyl acetate and 6 mL of 10% sodium hydroxide were added. The assembly was then subjected to: a homogenization for 5 min, an addition of 30 g of anhydrous sodium sulfate and a rehomogenization. The homogenate was subsequently filtered through a funnel containing cotton and topped with 20 g of sodium sulfate. Then it was kept at rest for a period of 3 min, and 50 mL of each sample were placed in a separatory funnel. 10 mL of the solution was added with 0.1 N hydrochloric acid. The lower aqueous layer was drained into a second separatory funnel and the upper organic layer was extracted with 10 mL of chloride acid (HCl) 0.1 N. A collection of all the aqueous phase into a second separatory funnel was made, 10 mL of saline solution (10%) and 20 mL of ethyl acetate were added to the combined aqueous layers and then the vial was stirred to have phase separation. The upper organic layer was stirred with 10 mL of water and then evaporated until the removal of all ethyl acetate. Each sample was redissolved with 5 mL methanol. The different fractions were collected and deposited in vials for analysis by HPLC.^[17]

Hemolytic effect

Pesticides' hemolytic effect in suspension.

Pesticides' toxicity on red cells was evaluated using human red blood cells (RBCs). The blood was collected from healthy volunteers and placed in ethylene diamine tetra acetic acid tubes, and then centrifuged at 3000 rpm for 5 min. The supernatant was removed to get rid of all of the plasma and blood components with the exception of red cells.

The pellet containing RBCs was washed with phosphate buffered saline (PBS) and then centrifuged at 3000 rpm for 5 min, until supernatant became clear. A suspension of red cells (30% v/v in PBS) was prepared and a volume of 1800 μL was taken from each tube and treated with 200 μL of each pesticide solubilized in permissible doses (Malathion's permissible dose: 1.25 mL in 1 L of water; Metalaxyl's permissible dose: 1.5 g in 1 L of water; Micronized Sulfur's permissible dose: 3.50 g in 1 L of water for tomatoes and 1.50 g for citrus fruits; Copper's permissible dose: 2.5 g in 1 L of water and Trifluralin's permissible dose: 2.4 mL in 1 L of water). The positive control tube contained 200 μL of distilled water and 100 μL red cells leading to a total hemolysis of red cells; while the negative control contained 200 μL PBS and 100 μL RBC leading to a non-hemolysis and affirming the role of PBS in the solubility of pesticides due to its non-hemolytic property. All tubes were then incubated at 4°C for 30 min and then centrifuged at 3000 rpm for 5 min.^[18] Supernatant absorbance was measured at 540 nm and the values obtained were used to calculate the percentage of hemolysis. The positive control is 100% hemolysis while the negative control represents zero hemolysis. The percentage of hemolysis is calculated according to Eq. (1).

$$\text{Hemolytic (\%)} = \frac{\{(A \text{ tube}) - (A \text{ control-})\}}{(A \text{ control +})} \quad (1)$$

Pesticides' hemolytic effect on blood agar.

Aseptically poured directly into Petri dishes, the agar was prepared by adding 5 mL of erythrocytes to 95 mL of sterile nutrient agar. After solidification, wells were dug in the agar (6 mm in diameter) and 50 μL of different pesticides, dissolved in PBS at legalized concentration, were deposited. Finally, the plates were observed with eye and the appearance of clearing zones after incubation for 24 h at room temperature was evaluated. The positive control is formed with Triton X-100, whereas the negative control is formed with PBS.^[19]

Fruit extract suspected of containing pesticides' hemolytic effect.

Hemolytic tests on agar and suspension have also been made for extracts which LC-ESI-MS analysis almost claimed the presence of pesticides. The protocols are the same as those used for testing the hemolytic pesticides' "controls" but the negative controls were in both cases the same buffer that permits the elution of the analyzed fraction.

In fact, the fraction extracted was first analyzed by LC coupled to ultraviolet detection (LC-UV) and then the positive peak suspected as pesticide was recuperated, and a portion of it was analyzed by MS to ensure the pesticide presence and the other portion was analyzed for its hemolytic effect.

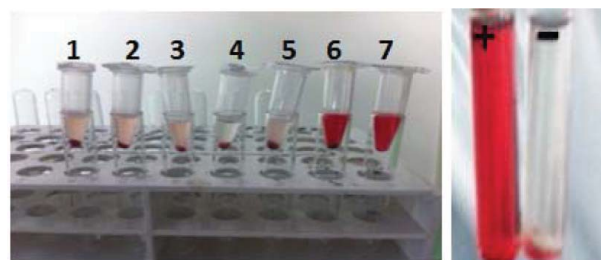


Fig. 1. Hemolyzed RBCs in suspension with different pesticides [1- Micronized Sulfur (orange), 2- Micronized Sulfur (tomato), 3- Metalaxyl Pop 25, 4- Copper, 5- Metalaxyl Oxylo, 6- Trifluralin, 7- Malathion].

Results and discussion

Pesticides' analysis

Chemical analysis

Pesticides purchased from Tripoli and Koura markets were analyzed by LC associated to MS to identify active substances needed for our study. In fact, pesticides were solubilized in the allowable concentrations for plants and were first analyzed by LC-UV. Then the positive peak suspected as pesticide was recuperated and a portion of it was analyzed by ESI-MS to determine its correspondent mass (given the heterogeneous composition of the pesticides sold which are globally formed with active substances and unidentified impurities). All pesticides analyzed, except for the Micronized Sulfur, gave the same mass as the theory confirming the purity of the active substance in the commercial formulation. Some other masses were also observed and correspond to excipients. Metalaxyl (Fig. A1) and Trifluralin (Fig. A2) showed the most homogeneous graphs, other pesticides, and despite the presence of the peak corresponding to the mass

of their active substance, showed a lot of impurity; that is why they are useless to support our analysis. In contrary, for Micronized Sulfur, a mass of 275.7 Da (Fig. A3) was observed which does not correspond to its theoretical mass. Indeed, the mass 275.7 Da corresponds to the exact molecular weight of Zineb which is a fungicide commercially prohibited. Based on the information provided by a specialist seller of pesticides, it can be concluded that Zineb in some stores is sold by the name of Micronized Sulfur in order to escape prosecution.

Hemolytic analysis

In suspension. To evaluate the potentials of pesticides to induce blood hemolysis, while measured at appropriate concentration for agriculture, RBC suspension (30%) was treated with 50 μ L of each pesticide, incubated and then centrifuged giving the results as shown in Figure 1. Table 1 shows the optical density for suspensions measured at 540 nm; these results show that all pesticides analyzed have hemolytic activity except copper. Contrariwise, Trifluralin was the pesticide having the greatest hemolytic effect.

On blood agar. Another test for determining the hemolytic effect of different pesticides was performed. The hemolytic effect of pesticides on blood agar leads to the observation of clarification areas in the agar. In fact, 50 μ L pesticides of different concentrations, 50 μ L of triton X-100 (positive control), and 50 μ L PBS (negative control) were introduced into wells cut into the agar (5%) and after 24 h, the results affirm those of the suspension test. In fact, no activity was observed for the copper. However, a significant hemolytic activity was observed for Trifluralin and Malathion (Fig. 2).

Pesticides' concentrations in each well of the agar are presented in (Table 2). The results obtained confirm those of the hemolytic suspension. However, these results concerning the hemolytic effect of pesticides on human RBCs focus on pesticides' toxicity. To our knowledge, despite the evidence of toxic and harmful effects of pesticides on human health, there are no previous studies evaluating the hemolytic effect of these pesticides on fresh human blood. Therefore, it may be time to return to all pesticides used and attempt to assume an extensive toxicological study including the hemolytic effect on human erythrocytes.



Fig. 2. Hemolytic test on blood agar.

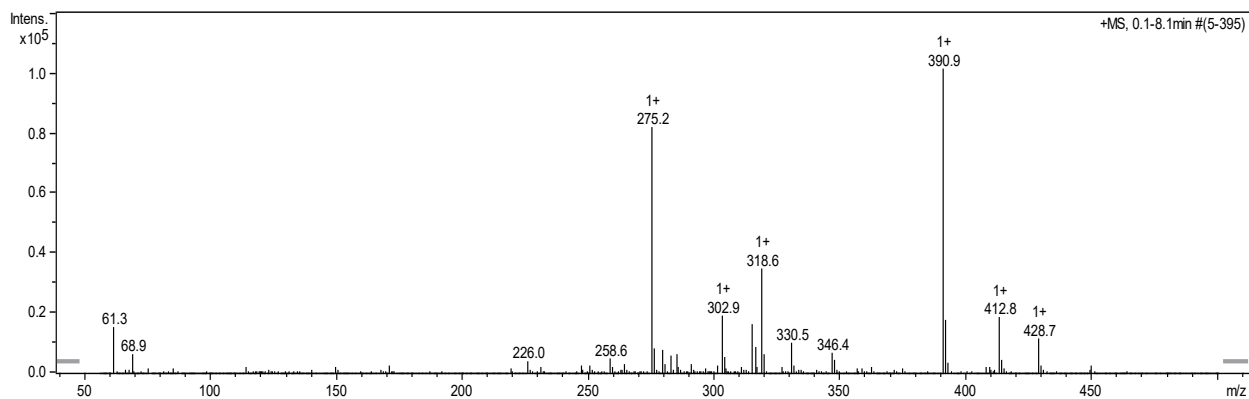


Fig. 3. Mass spectra for the positive peak of tomato eluted with 75/25 of PB/ACN.

Fruits' and vegetables' analysis

Chemical analysis.

For tomatoes, fractions were extracted using SPE with an elution consisting of PB/ ACN. The C18 HPLC chromatogram obtained with PB/ ACN (75/25) shows a peak at 2.5 min which gave a mass spectrum of 275.2 Da corresponding to Zineb mass. Those results were confirmed after the comparison between the graphs of tomatoes (Fig. 3) and Micronized Sulfur (Fig. A3).

Therefore, Zineb was used for treating tomatoes, which is illegal. Our study revealing the presence of traces of pesticides in tomatoes was not the first. In fact, Al-Ebaisat in 2011 showed the persistence of carbendazim in tomatoes which is considered very toxic for humans.^[15] The interest of our study is not that we have found pesticides traces in tomatoes in Lebanon but to find traces of a pesticide, like Zineb, which is worldwide banned as a result of the registration to Annex I of the Directive 91/414/CEE and in the application of the Decision 2001/245/CE of 28 March 2001.

For citrus fruits, oranges and lemons fractions were extracted using SPE with an elution consisting of methanol/ water. The chromatogram obtained for oranges fractions with methanol/water (60/40) (Fig. 4) and (80/20) (Fig. 5) shows peaks which correspond to the mass of Zineb (275 Da) (Fig. A3) and to Metalaxyl (279 Da) (Fig. A1), respectively affirming the use of those two pesticides in the treatment of these oranges.

The chromatogram obtained for lemons fractions with methanol/water (60/40) (Fig. 6) also shows an important peak with a mass of 279 Da confirming the use of Metalaxyl. Thus, Metalaxyl and Zineb are widely used for treating citrus fruits in Lebanon. Carbendazim, Methomyl and Abamectine were, according to Remedios et al. in 2009,^[16] the most important pesticides for the development of citrus.

Table 1. Hemolytic percentage of pesticides.

Tube		Hemolytic %
Positive control		100%
Negative control		0%
Trifluralin		73%
Malathion		40%
Micronized (orange)	Sulfur	4.7%
Micronized (tomato)	Sulfur	2.7%
Copper		0%
Metalaxyl Oxylo		1.07%
Metalaxyl Pop 25		1.5%

Table 2. Pesticides concentrations in plates.

Pesticides well	Trifluralin ($\mu\text{L mL}^{-1}$)	Copper (mg mL^{-1})	Malathion ($\mu\text{L mL}^{-1}$)
1	12	12.5	6.25
2	4.8	5	2.5
3	2.5	2.5	1.25
4	1.6	1.7	0.8
5	24	25	12.5
6	48	50	25
7	100	104	52

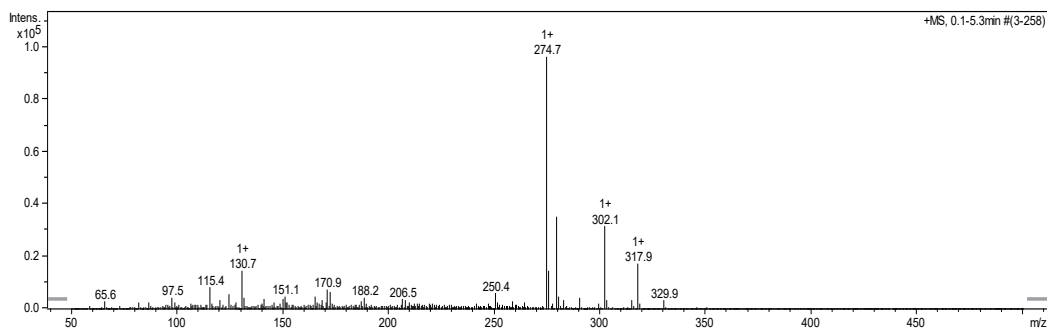


Fig. 4. Mass spectra for the positive peak of orange eluted with 60/40 of methanol/water.

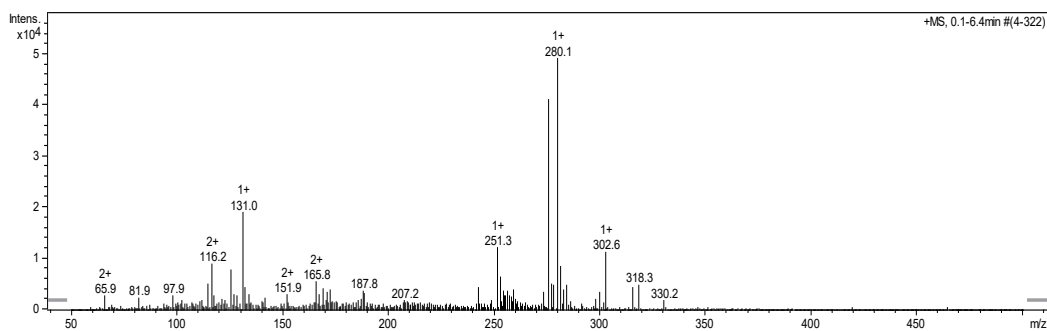


Fig. 5. Mass spectra for the positive peak of orange eluted with 80/20 of methanol/water.

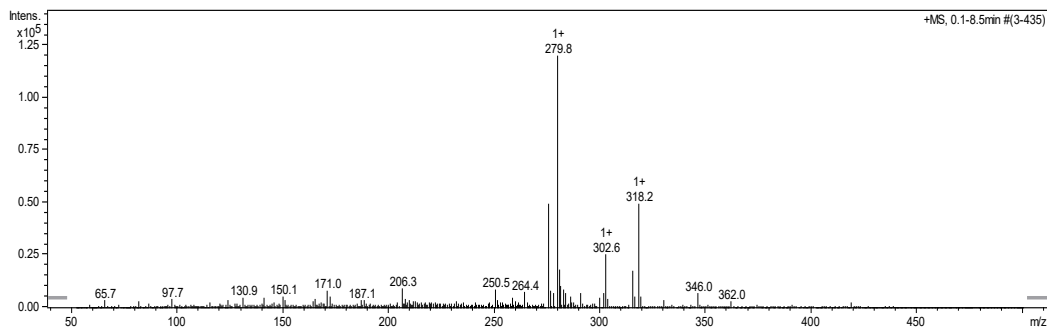


Fig. 6. Mass spectra for the positive peak of lemon eluted with 60/40 of methanol/water.

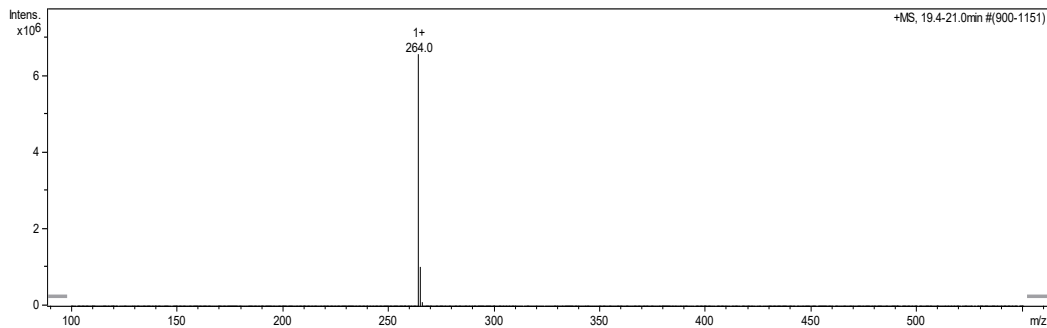


Fig. 7. Mass spectra for the positive peak of peach.

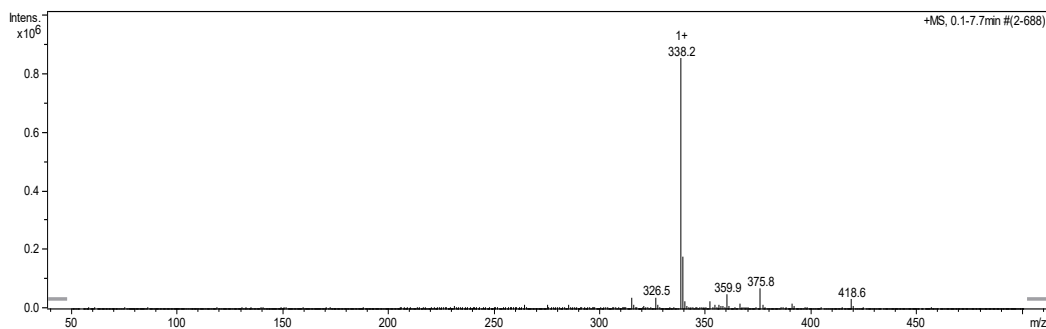


Fig. 8. Mass spectra for the positive peak of strawberries.

Our study, using LC, shows the diversity of pesticides that can be used in the treatment of these crops in Lebanon. For peaches and after their redissolution in methanol, peaches' fractions were analyzed from the first eluted peak at a retention time of 20 min and it showed a single mass of 264 Da (Fig. 7) corresponding, according to the literature, to Chlorothalonil, a biocide having fungicidal properties belonging to the chemical class of organochlorines derived from benzene.

For strawberries, fractions underwent the same extraction procedure of peaches' crops except that the extract was first analyzed using LC-UV and then a portion of the eluted positive peak was analyzed with ESI-MS. The chromatogram shows a single peak with a single mass on a mass spectrum equal to 338.2 (Fig. 8) exactly corresponding to the mass of Trifluralin (Fig. A2). As Trifluralin has an important hemolytic effect on human blood, its persistence in strawberries should be considered and the hemolytic tests should be done for this fraction which LC-MS analysis affirms Trifluralin persistence.

Hemolytic analysis.

The hemolytic effect of strawberry fractions extracted and showing the presence of Trifluralin was studied on agar and suspension. The results showed no hemolytic effect of this fraction neither on agar prepared from fresh human blood nor on RBCs taken from a healthy subject (Fig. 9).

These results prove that strawberries harvested in Lebanon, although they contain Trifluralin, are not necessarily toxic in themselves. However, we should remain vigilant about their composition mainly containing a quantity of Trifluralin that is probably higher than the amount legalized worldwide.

Conclusion

Fruits and vegetables are widely consumed in Lebanon; thereby characterizing the composition of these foods has been identified as a priority for research laboratories. Our study started with an evaluation of pesticides' composition, an assessment of their impact on human blood and, finally, a detection of their residues in vegetables and fruits consumed daily in Lebanon. Our displacements in specialized stores in Lebanon and discussions developed with vendors have enabled us to have good knowledge about all kinds of pesticides sold. In addition, we observed that some sellers avoided communicating and answering questions about the identity and quantity of each pesticide sold.

Therefore, some samples of pesticides were recovered from shops to analyze and establish a range of pesticides "controls" to use as a reference for comparison when analyzing vegetables and fruits extracts. The LC-ESI-MS performed on these "controls" was used to draw a list of masses corresponding to the identities of all pesticides studied. Indeed, the LC-ESI-MS proceeded by the SPE technique was the technique of choice for our study whether it be for the pesticide analysis "controls" or for the analysis of the extracts. In fact, we were able to obtain significant HPLC-C18 chromatograms and masses characterizing each of the analyzed molecules (Zineb: 275 Da, Metalaxyl: 280 Da, Trifluralin: 338 Da, and Chlorothalonil: 264 Da).



Fig. 9. Hemolytic result for strawberries extract containing Trifluralin (E = extract, positive control= triton X-100, negative control =PBS).

The analysis of tomato extracts shows the presence of Zineb and the analysis of extracts of lemons and oranges also shows the presence of Zineb and Metalaxyl. The analysis of peaches' extracts showed the presence of Chlorothalonil. However, the confirmation of the pesticide requires the presence of the "standard" correspondent. The analysis of strawberry extracts showed the presence of Trifluralin which is not banned in Lebanon. Nevertheless, the study of its toxic effect was surprising, given that its hemolytic effect observed on human blood was considerable. This led us to conclude that the pesticides would have a toxic effect and it would be preferable to avoid using them especially with high doses for the treatment of vegetables and fruits in Lebanon, primarily for the treatment of strawberries. All these results should be confirmed by further experiences and by the use of effective standards showing the reality of our alimentation.

Funding

We gratefully acknowledge the financial support of the association AZM & SAADE and the Lebanese University, without which the present study could not have been completed.

References

[1] RAND. Monograph reports. Available at http://www.rand.org/content/dam/rand/pubs/monograph_reports/MR1018z8/MR1018.8.ch2.pdf. (accessed Jul 2015)
 [2] Chandra, S.; Mahindrakar, A.; Shind, L. Determination of cypermethrin and chlorpyrifos in vegetables by GC-ECD. *Int. J. Chem Tech Reas.* 2010, 2(2), 908–911.

[3] WHO. Pesticides, 2008. Available at <http://www.who.int/ceh/capacity/Pesticides.pdf>. (accessed Jul 2015)
 [4] Zhang, J.; Fitsanakis, V.A.; Gu, G.; Jing, D.; Ao, M.; Amarnath, V.; and Montine, T. J. Manganese ethylene-bis-dithiocarbamate and selective dopaminergic neurodegeneration in rats: A link through mitochondrial dysfunction. *J. Neurochem.* 2003, 84(2), 336–346.
 [5] Sugiyama, S.; Shimada, N.; Miyoshi, H.; Yamauchi, K. Detection of thyroid system disrupting chemicals using in vitro and in vivo screening assays in *Xenopus laevis*. *Toxicol. Sci.* 2005, 88(2), 367–374.
 [6] Kluwe, W. Renal function tests as indicators of kidney injury in subacute toxicity. *Toxicol Appl Pharm.* 1998, 57(3), 414–424.
 [7] Zari, T.A.; Al-Attar, A.M. Therapeutic effects of olive leaves extract on rats treated with a sublethal concentration of carbendazim. *Eur. Rev. Med. Pharmacol. Sci.* 2011, 15(4), 413–26.
 [8] Farag, M.M. Persistence of metalaxyl residues on tomato fruit using high performance liquid chromatography and QuEChERS methodology. *Arabian J. Chem.* 2013. DOI:10.1016/j.arabjc.2012.12.002.
 [9] NCI (National Cancer Institute). (1980). Bioassay of Chlorothalonil for possible carcinogenicity. NTP #TR 041. U.S. Public Health Service, U.S. Department of Health, Education and Welfare.
 [10] Kang, D.; Park, S.K.; Beane-Freeman, L.; Lynch, C.F.; Knott, C. E.; Sandler, D.P. Cancer incidence among pesticide applicators exposed to trifluralin in the Agricultural Health Study. *Environ. Res.* 2008, 107, 271–276.
 [11] ANSES: Avis de l'Agence nationale de securite sanitaire de l'alimentation, de l'environnement et du travail relatif aux substances actives biocides pouvant être utilisées dans le cadre de la prevention d'une epidemie de chikungunya en Guyane, Maisons-Alfort, le 18 mars 2014.
 [12] Atanasov, A.G.; Tam, S.; Røcken, J.M.; Baker, M.E.; Odermatt, A. Inhibition of 11 beta-hydroxysteroid dehydrogenase type 2 by dithiocarbamates. *Biochem. Biophys. Res. Commun.* 2003, 308(2), 257–262.
 [13] Lacorte, S.; Barcelo, D. Determination of parts per trillion levels of organophosphorus pesticides in groundwater by automated on-line liquid-solid extraction followed by Liquid Chromatography/atmospheric pressure chemical Ionization Mass Spectrometry using positive and negative ion modes of operation. *Anal. Chem.* 1996, 68(15), 2464–2472.
 [14] Barcelo, D.; Hennion, M.C. Trace Determination of Pesticides and Their Degradation Products in Water. Elsevier: Amsterdam, The Netherlands, 1997, p. 3.
 [15] Al-Ebaisat, H., Determination of some benzimidazole fungicides in tomato puree by high performance liquid chromatography with SampliQ polymer SCX solid phase extraction. *Arabian J. Chem.* 2011, 4, 115–117.
 [16] Remedios, F.; Antonia, G.F.; Luis, M.V.J.; Roberto, R.G.; Elena, H.T.M. One-year routine application of a new and rapid method based on ultra-performance Liquid Chromatography – Tandem Mass Spectrometry to the analysis of selected pesticides in citrus fruits. *Anal. Sci.* 2009, 25(4), 535.
 [17] Bazzi, L.; Errami, M.; Salghi, R.; Hormatallah, A.; Zarrouk, A.; Zarok, H.; Hammouti, B. Analyse des Residus de Pesticides sur Peches et Nectarines de la Region de Souss en Tunisie *J. Mater. Environ. Sci.* 2013, 4(1), 159–164.
 [18] Accary, C.; Rima, M.; Kouzayha, A.; Hleihel, W.; Desfontis, J.C.; Fajloun, Z.; Hraoui Bloquet, S. Effect of the Montivipera bormuelleri snake venom on human blood coagulation disorders and hemolytic activities. *Open J. Hematol.* 2014, 5, 4.
 [19] Karthikayalu, S.; Rama, V.; Kirubakaran, R.; Venkatesan, R. Hemolytic toxin from the soft coral Sarcophyton trocheliophorum: Isolation and physiological characterization. *J. Venomous Anim. Toxins Including Trop. Dis.* 2010, 16(1), 107–120.

Appendix

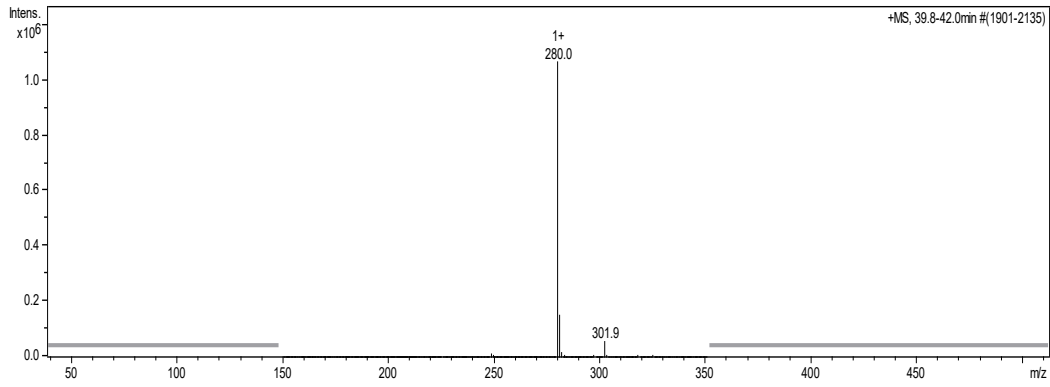


Fig. A1. Mass spectra of Metalaxyl

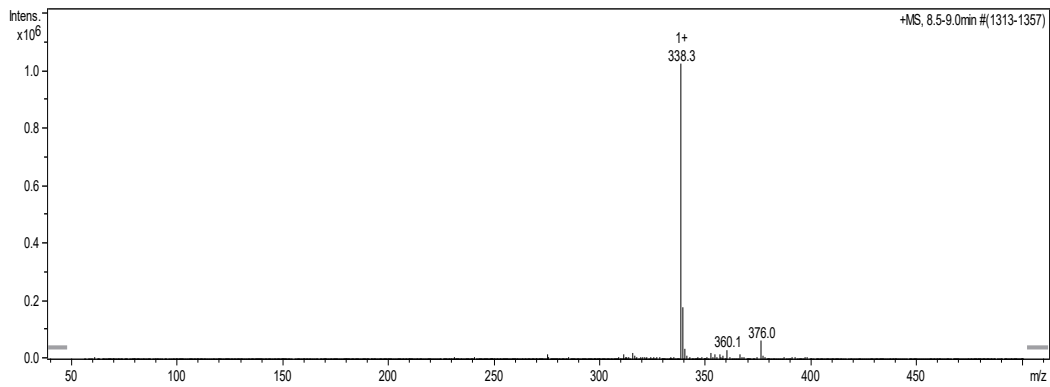


Fig. A2. Mass spectra of Trifluralin.

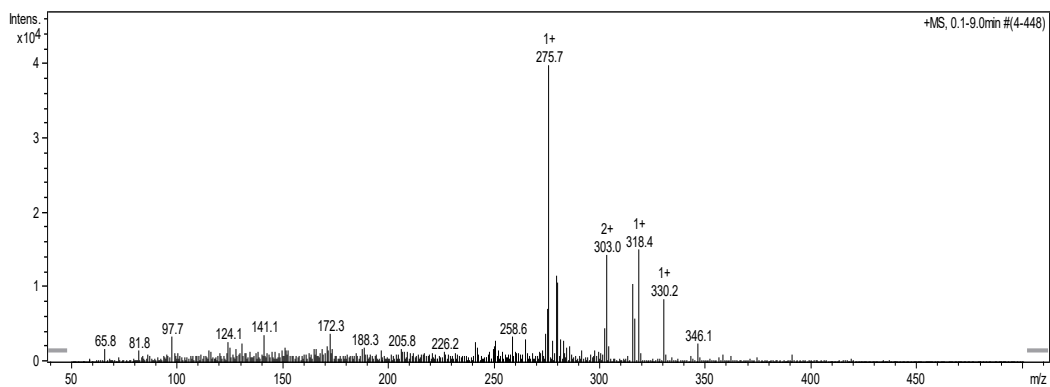


Fig. A3. Mass spectra of Micronized Sulfur.

II. Analyse des dithiocarbamates dans les matrices végétales par l'HPLC-UV suivie d'une spectrométrie d'absorption atomique.

Ce résultat présenté sous format d'un article publié dans « Journal of Chromatographic Science » fait suite à la présence des résidus de Zineb dans les analyses précédentes.

En fait, Les dithiocarbamates (DTC) sont des fongicides organo-soufrés largement utilisés dans l'agriculture et fréquemment détectés sous forme de résidus dans les produits végétaux. Cependant, ces composés ne sont pas détectables par les méthodes multi résidus habituelles et nécessitent alors des méthodes qui leur sont spécifiques. De ce fait, l'objectif de cette étude est le développement d'une méthode pour l'analyse simultanée de 10 DTCs de différentes classes en un seul passage chromatographique et son application sur diverses matrices de fruits et légumes. Ce procédé permettra également la différenciation simple des EBDTCs (auxquels appartient le zineb) dans le même échantillon par analyse de l'extrait aqueux obtenu après méthylation de l'ion métallique par spectrométrie d'absorption atomique (SAA).

Dans cette étude, nous avons développé une méthode simple combinant, l'analyse HPLC à 272 nm et la spectrométrie d'absorption atomique afin d'analyser 10 dithiocarbamates et distinguer les différents éthylénbistdithiocarbamates (EBDTC) Zineb, Maneb et mancozèbe dans diverses matrices. Cette méthode d'analyse associe la HPLC en phase inverse à 272 nm de la phase organique, obtenue par chélation des métaux avec une solution alcaline d'EDTA et l'extraction par l'iode de méthyle dans du chloroforme-hexane, avec l'analyse par SAA de la phase aqueuse en Zn et Mn afin de distinguer, avec le même protocole d'extraction, Maneb, mancozèbe et Zineb. La limite de détection et de quantification par l'HPLC justifie la sensibilité de la méthode utilisée. Le taux de recouvrement à partir d'échantillons de pommes et poireaux fortifiées avec les 10 fongicides était supérieur à 90% prouvant l'applicabilité de la méthode sur les matrices végétatives. Les résultats obtenus par spectrophotométrie UV par comparaison avec la méthode d'absorption atomique met l'accent sur l'importance de cette dernière comme étant une méthode spécifique et complémentaire pour la distinction entre les différents EBDTCs fongicides. Finalement, l'analyse d'aiguilles de pins collectées au niveau du jardin de l'observatoire de Strasbourg pour leur contenu en dithiocarbamates, montre la présence du Propineb à une concentration de 48,27 $\mu\text{g g}^{-1}$.

En conclusion, la méthode analytique proposée et développée dans cette étude nous permet de séparer, distinguer et quantifier les résidus des différents sous-groupes des dithiocarbamates par une méthode simple, efficace et rapide. L'avantage de l'usage successif des 2 techniques analytiques réalisé est d'éviter de nouvelles préparations et d'extractions nécessaires, minimisant de ce fait, les erreurs et les incertitudes. Cette méthode permet également la mise en évidence de la persistance de ces pesticides ayant des effets toxicologiques potentiels.

Analysis of Dithiocarbamate Fungicides in Vegetable Matrices Using HPLC-UV Followed by Atomic Absorption Spectrometry

Josephine Al-Alam¹, Laura Bom², Asma Chbani¹, Ziad Fajloun¹, and Maurice Millet^{3*}

¹Azm Center for Research in Biotechnology and its Applications, Lebanese University, Tripoli, Lebanon,

²Chemistry, University of Strasbourg/CNRS, Rue Blaise Pascal, Strasbourg Cedex 67000, France,

³Chemistry, University of Strasbourg/CNRS UMR 7515 ICPEES, 1 Rue Blessig, Strasbourg Cedex 67084, France

*Author to whom correspondence should be addressed. Email: mmillet@unistra.fr

Received 8 April 2016; Revised 24 October 2016; Editorial Decision 27 November 2016

Abstract

A simple method combining ion-pair methylation, high-performance liquid chromatography (HPLC) analysis with detection at 272nm and atomic absorption spectrometry was developed in order to determine 10 dithiocarbamate fungicides (Dazomet, Metam-sodium, Ferbam, Ziram, Zineb, Maneb, Mancozeb, Metiram, Nabam and Propineb) and distinguish ethylenbisdithiocarbamates (EBDTCs) Zineb, Maneb and Mancozeb in diverse matrices. This method associates reverse phase analysis by HPLC analysis with detection at 272 nm, with atomic absorption spectrometry in order to distinguish, with the same extraction protocol, Maneb, Mancozeb and Zineb. The limits of detection (0.4, 0.8, 0.5, 1.25 and 1.97) and quantification (1.18, 2.5, 1.52, 4.2 and 6.52) calculated in injected nanogram, respectively, for Dazomet, Metam-Na, dimethyldithiocarbamates (DMDTCs), EBDTCs and propylenbisdithiocarbamates (PBDTCs) justify the sensitivity of the method used. The coefficients of determination R^2 were 0.9985, 0.9978, 0.9949, 0.988 and 0.9794, respectively, for Dazomet, Metam-Na, DMDTCs, EBDTCs and PBDTCs, and the recovery from fortified apple and leek samples was above 90%. Results obtained with the atomic absorption method in comparison with spectrophotometric analysis focus on the importance of the atomic absorption as a complementary specific method for the distinction between different EBDTCs fungicides.

Keywords Dithiocarbamates, Zineb, Maneb, Mancozeb, Propineb, atomic absorption spectrometry.

Introduction

Dithiocarbamate (DTC) fungicides are a group of organosulfur compounds represented by a general structure (R₁R₂)N-(C=S)-SX, where R can be substituted by an alkyl, alkylene, aryl or similar other group, and X is usually a metal ion, widely used in agriculture and frequently detected as pesticide residues in plant products in the world (1).

Their yearly consumption is between 25,000 and 35,000 metric tons (2, 3), distributed not only for crops protection but also for their role as accelerators for rubber vulcanization, as rubber antioxidants, as slimicides in tissue and paper as well as in sugar production, in waste water treatment, and as antifouling for water cooling systems.

DTC fungicides, used throughout the world, are divided into classes distinguished by their chemical structure and properties. These classes are ethylenbisdithiocarbamates (EBDTCs) such as Nabam, Mancozeb, Maneb, Metiram and Zineb; propylenebisdithiocarbamates (PBDTCs) such as Propineb; methylthiocarbamates such as Metamsodium; dimethylthiocarbamates (DMDTCs) such as Ferbam and Ziram and tetramethylthiuram disulfide such as Thiram (4). The different structures of these different DTCs are summarized in Figure S1.

Among these compounds, Zineb is banned in the European Union because of the review on the entry in Annex I to Directive 91/414/EEC, in accordance to the Community Decision 2001/245/EC of 28 March 2001 (5). Nabam has not been included in the list of approved active substances in the European Union. Then, no pesticide formulations are permitted with this agent in Germany, Austria and Switzerland (6).

However, the extensive use of these chemicals in agriculture has raised concern for their effects in occupational and ecotoxicological hazards. Usually, DTC complexes have low levels of toxicity, although some used pesticides have been found to produce adversarial health effects. The toxicological effects of DTC pesticides can occur from their absorption through skin contact, ingestion and inhalation. In fact, the lipophilic nature of DTCs makes them appropriate for their passage across the cell membrane (7). In addition, DTCs can lead to disturbances of the peripheral and the central nervous systems (8), as well as

distal peripheral neuropathy induced by Mancozeb, Maneb, Metiram, Ziram and Thiram (9).

Thus, the persistence of these pesticides as residues in food can lead to serious problem causing chronic damage to health, as human consumes these substances as a part of their usual nutritional ingestion (10). For all these reasons, the detection of these fungicides in food crops has been a necessity. Gustafsson and Thompson (11) and Gustafsson and Fahlgren (12) established a method for determining EBDCs in food samples over their methylation to dimethylethylenbisdithiocarbamate (EBDC-dimethyl). This method is preferred for the analysis of EBDCs because the methyl derivative obtained has a characteristic structure associated with EBDCs. Contrariwise, this method does not allow distinguishing between the EBDCs differing only by the associated metal (13).

Most previous studies focused only on the analysis of a particular subgroup of DTCs, especially the EBDTCs and the PBDTCs (14, 15). In fact, several studies have been carried out to determine the persistence of these pesticides in food crops showing the importance of HPLC-DAD in such analysis (15, 16). The official technique used by authorities in Europe and the USA to determine the persistence of DTCs and their metabolites in crops are based on acidic digestion of the sample to transform DTCs to carbon disulfide (CS₂) and later quantification by either spectrophotometric absorption or gas chromatography (17, 18). However, these methods are time-consuming and do not differentiate between residues of individual class (18, 19). In addition, further alternative analytical methods based on capillary electrophoresis, spectrophotometry or gas chromatography can be found in the recent literature (4). The use of liquid chromatography with mass spectrometry (MS) and tandem mass spectrometry (MS/MS) for the determination of EBDCs has also been reported (13). In fact, all these methods were used for the extraction and identification of some of DTCs or of their metabolites but none of them describe a full validated method for all DTC fungicides.

On the other side, to the best of our knowledge, no previous studies focused on the analysis of all DTCs and the identification of different pesticides of a same group in a single simple extraction and analysis method. In addition, the method of

Gustafsson and Thompson (11), returning to 1981 needs to be revalidated and updated over the years. In addition, even though, the use of atomic absorption spectrometry complementarity with the high-performance liquid chromatography (HPLC) for the distinction between Zineb, Mancozeb and Maneb was reported by Lo et al. (20); authors studied a certain group of DTCs and did not develop and detail the protocol used which is important due to the effectiveness of the method. Therefore, the aim of this study is to develop a method for the simultaneous analysis of 10 DTCs from different classes in one chromatographic run and apply it on various fruits and vegetable matrices, where the persistence of some DTCs could be extremely harmful. This method will also permit the simple differentiation of the type of EBDCs in the same defined sample by the analysis of the water extract after methylation of the metal ion by atomic absorption spectrometry (FAAS). This latter technique will also be compared with UV-visible spectrophotometric method.

Experimental

Instrumentation

Analysis was performed by an HPLC equipped with an Autosampler 565 Kontron, a spectrophotometric diode array detector 545 V Kontron and two high-pressure pumps 422 S Kontron. For the atomic spectrometry analysis, a Varian spectra 220 model FAAS equipped with deuterium lamp background correction, zinc and manganese hollow cathode lamps and an air-acetylene burner was used for the determination of zinc and manganese. UV-visible spectrophotometric measurement was performed by using an UVIKON XL (Bio-Tek) Model UV-visible spectrophotometer with a 10-mm Quartz cell. The wavelength of maximum absorption used was 284 nm.

Chemicals and reagents

Acetonitrile, chloroform, n-hexane, 1-2 propanediol, methyl iodide, tetrabutylammonium hydrogen sulfate (55%) and methanol were purchased from Sigma-Aldrich (L'Isle D'Abeau, France), ethylenediaminetetraacetic acid (EDTA) was obtained from Acros Organics, while sodium hydroxide (NaOH) and hydrochloric acid (37%) were purchased from Prolabo (VWR, France).

Ultrapure deionized water was obtained from an Elga system. Dazomet, Maneb, Mancozeb, Nabam, Metiram, Propineb, Thiram, Zineb and Ziram Pestanal® were obtained from Riel de Haën (Sigma-Aldrich, L'Isle D'Abeau, France), while Ferbam and Metam-sodium were purchased from Dr Ehrenstorfer GmbH.

Samples

Apples, leeks and tomatoes were purchased from local market in Strasbourg and pine needles were collected from the garden of the "Astronomical observatory" of the University of Strasbourg. This garden is situated in the main university campus close to the historical center of the town.

Solutions preparation

Alkaline EDTA solution (EDTA (0.25 M) in sodium hydroxide (0.45 M), with a pH ~9.5) was obtained by solubilization of 7.3 g of EDTA and 1.8 g of NaOH in 100 mL of water. Tetrabutylammonium hydrogen sulfate (0.41 M) and hydrochloric acid (2 M) were prepared by dilution with ultrapure water. Methyl iodide (0.05 M) was prepared by dilution in chloroform-hexane (3:1) and 1, 2 propanediol (20%) was diluted in chloroform.

Methods

Extraction of DTCs from solution to monitor for extraction efficiency

Extraction of DTCs was performed according to the method of Gustafsson and Thompson (11) as follows: 1 mg of each DTC fungicide was dissolved separately with 5mL of EDTA/NaOH by stirring for 5 min. Then, the extract was filtered and the extraction beaker and the filter were rinsed with 2mL of water. The pH of the solution was adjusted to 7-7.5 by adding 1mL of aqueous tetrabutylammonium hydrogen sulfate solution (0.41 M) and 0.5mL of HCl solution (2M).

The mixture was then transferred to a separatory funnel where 3mL of methyl iodide in chloroform-hexane was added and then the mixture was extracted by shaking the separatory funnel. The organic phase was collected and the aqueous layer was re-extracted by 1mL of methyl iodide in chloroform-hexane solution. Organic phases were combined and 0.5 mL of 1, two propanediol in chloroform (20%) was added. Extracts were allowed to evaporate and the residue was diluted in

5 mL of methanol. In total, 20 μ L of the extract was injected into the HPLC system. Analysis was done in triplicate. The same procedure was applied to a mixture of all the standards in order to separate them and validate the extraction procedure. The aqueous layer was not discarded and was used for analysis by absorption atomic spectroscopy (FAAS).

Analytical procedure

Separation was done on a reversed phase Macherey Nagel Nucleodur[®] C₁₈ column (4.6 mm \times 250 mm, 5 μ m) at 1 mL min⁻¹ with a gradient of acetonitrile/water as follows: 35:65 for 15 min, 45:55 for 24 min, 35:65 for 5 min. Injection volume was 20 μ L. The detection was done at 272 nm. The instrumental FAAS parameters for zinc and manganese were as follows: wavelength of 213.9 and 279.5 nm, respectively, lamp current, 5 mA, bandpass, 0.5 nm, fuel flow rate of 12 mL min⁻¹ for both metals.

Analysis of DTC fungicides in fruit crops for method validation

In total, 10 g of each sample (leeks, apples) were cut in small pieces (~1 cm of dimension), fortified with 1 mg of each dithiocarbamate fungicides (Dazomet, Ferbam, Maneb, Mancozeb, Metamsodium, Nabam, Propineb, Thiram, Zineb and Ziram), and analyzed immediately. The samples should not be homogenized, since homogenization shows a rapid breakdown of dithiocarbamates (21), the outer pieces of crops were analyzed. Samples were extracted with the same procedure as described above: first fortified samples were stirred for 5 min using 5 mL of EDTA/NaOH, then the extract was filtered and the extraction beaker and the filter were rinsed with 2 mL of water. The pH of the solution was adjusted to 7–7.5 by adding 1 mL of aqueous tetrabutylammonium hydrogen sulfate solution (0.41 M) and 0.5 mL of HCl solution (2 M). The mixture was then transferred to a separatory funnel where it was extracted using 3 mL of methyl iodide in chloroform–hexane. The organic phase was collected and the aqueous layer was re-extracted by 1 mL of methyl iodide in chloroform–hexane solution. Finally, the organic phases were combined and 0.5 mL of 1, 2 propanediol in chloroform (20%) was added. Extracts were allowed to evaporate and the residue was diluted in 5 mL of methanol. In total, 20 μ L of

the extract were injected into the HPLC system (11, 12).

Method application on pine needles

Pine needles (5 g) collected from Strasbourg have undergone the same extraction protocol cited above to examine their potential contamination by dithiocarbamates.

Atomic absorption method to distinguish Zineb, Maneb and Mancozeb fungicides in food products

A well-known quantity of Mancozeb, Maneb and Zineb, as well as a mixture of the three fungicides, was added separately to tomato fractions, as a water suspension to prepare spiked samples (21). For preparing the spiked tomato samples, 2 mg of each pesticide were added to 10 mL of water separately and each suspension was mixed for 30 min with 10 g of tomatoes chopped into small pieces. Then, 10 mL of HCl (1 M) was added to the each spiked samples and the mixtures obtained were heated for 10 min in order to decompose completely the fungicides. The mixtures were then filtered with a filter paper to separate the food residue from the solution. The food residue was washed twice with 7 mL HCl (1 M) to offer the complete extraction of the fungicide. Filtrate and washings were collected together into a 100-mL volumetric flask and diluted with water. Then, zinc and manganese present in these solutions were determined by FAAS using a calibration graph drawn by using the metal (Zn and Mn) standard solutions. The FAAS determination procedure was repeated three times. Concentration of Zineb and Maneb was calculated using stoichiometry between metal and corresponding fungicides based on the molecular weight of the fungicide in comparison with the molecular weight of its metal (1 g of zinc is equivalent to 4.21 g of Zineb and 1 g of Mn is equivalent to 4.83 g of Maneb). In fact, the presence of Zn and Mn in the same extract indicates either the use of the two fungicides Zineb and Maneb or the use of Mancozeb (22).

Moreover, the aqueous layer obtained from the DTCs extraction in fruit crops was also analyzed with FAAS in order to verify the persistence of metals in this phase and then analyzing them to identify their original fungicide composition.

Spectrophotometric method to distinguish Zineb, Maneb and Mancozeb fungicides

In order to check the accuracy and the selectivity of the atomic absorption spectrometry method for the distinction between EBDTCs fungicides, Maneb, Mancozeb and Zineb have also been determined by UV-Vis spectroscopy (21). Spiked tomato samples were prepared by adding separately 10 mL of each EBDTCs solution containing 2 mg of each pesticide to 10 g of tomatoes and mixing for 30 min. A mixture of all pesticides was also prepared. The spiked samples were then treated with 30 mL of NaOH (0.5 M) in order to dissolve the fungicides. The mixture was mixed with magnetic stirrer for 30 min to provide complete dissolution of the fungicides. Then, it was filtered with a filter paper and the residue was washed with two 10 mL portions of NaOH solution in order to provide the complete separation of EBDTCs. Filtrate was diluted to 100mL with water; measurement procedure was repeated three times.

Results

Method development

The analysis of each pesticide by HPLC coupled to UV-Visible detection shows that maximum absorbance was at 272 nm. For the analysis of the mixture, 1mg of each standard was solubilized together in the same beaker and extracted as cited above. Analysis was done in triplicate. Figure 1 shows the chromatogram of DTCs mixture showing the separation between subgroups of DTCs. For the calibration curve, a dilution series was prepared from a stock solution of 50 mg L⁻¹, by dissolving 2.5 mg of each pesticide in 50 mL of EDTA/NaOH solution (Calibration range was done between 50 and 0.1 mg L⁻¹). In terms of quantities, the injected quantity for the calibration curve was between 2 ng and 1 µg of substance.

The retention time, the equation, the coefficient of regression, detection limit (DL) and quantification limit (QL) for each subgroup of DTCs are summarized in Table I.

Application to the analysis of dithiocarbamate fungicides in apples and leeks

To validate the method as well as to check its recovery, a known amount of each DTCS was added to various samples of apples and leeks.

Samples were checked for their potential contamination in DTCs by analysis of each sample without spiking as blank. Blank and spiked samples were extracted with the same protocol mentioned above and a complete absence of DTCs was verified for blank samples (Figures S2–S5). The results are given in Table II.

Analysis of Propineb fungicides in pine needles

The analysis of pine needles for their contamination of DTCs revealed the presence of a peak at 24 min corresponding to Propineb. In fact, the analysis was performed in triplicate and the concentration of Propineb found was calculated based on the corresponding calibration curve as follows:

$$C [\mu\text{g propineb/g}] = \frac{A \cdot Q_{\text{std}}}{A_{\text{std}} \cdot m} = 0.18 \mu\text{g/g} \quad (1)$$

Where A= peak area of Propineb in sample, A_{std}= peak area of Propineb standard, Q_{std}=Propineb quantity in considered peak (µg) and m= weight of sample in g.

Therefore, the amount of Propineb found corresponds to (0.18 × 5) = 0.9 µg of injected Propineb, which match perfectly the calibration curve (injected quantities between 2 ng and 1 µg).

Atomic Absorption Method to distinguish Zineb, Maneb and Mancozeb fungicides

The general flame atomic absorption spectrometric procedure mentioned was applied for the differentiation of EBTDCs in spiked tomatoes. Untreated tomatoes has also been analyzed and the correct Zinc and Manganese concentrations were calculated by the subtraction of the value obtained with untreated samples from the value obtained from spiked samples. Recovery results are shown in table III.

The accuracy of the determination of Zineb and Maneb in spiked samples is reasonable, as relative standard deviations (RSD) in both is 0.3 and the recovery is 95% for Zineb and 98% for Maneb which is also satisfactory.

Comparison of Spectrophotometric Method and FSAA to distinguish Maneb, Mancozeb and Zineb fungicides

The analysis of Maneb, Mancozeb and Zineb was also done spectrophotometrically in order to check maximum absorbance wavelength for these fungicides and to test the effectiveness of method

for distinguishing EBDTCs fungicides. UV-visible spectrum for the three pesticides as well as their

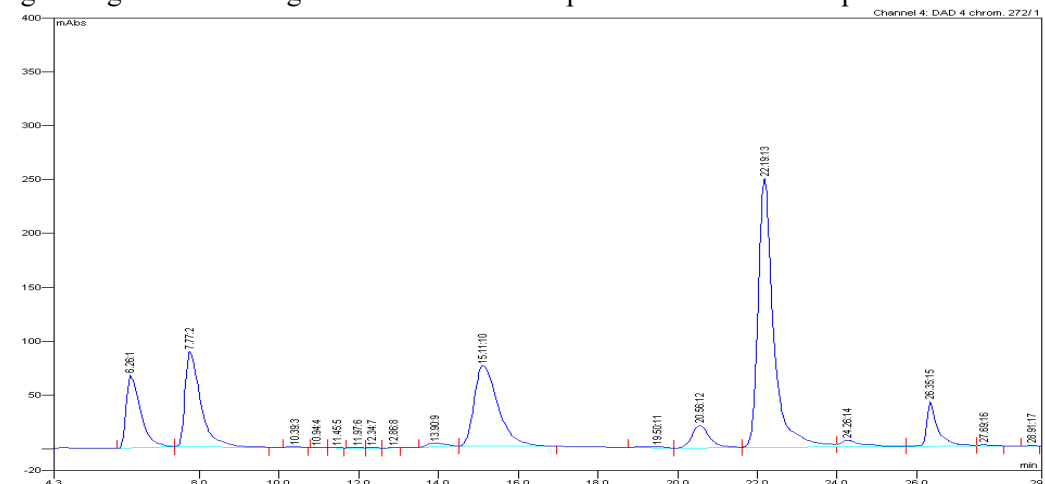


Figure 1. Chromatogram of DTCs mixture (1-Dazomet (T.R:6.26), 2-Metam-Na (T.R:7.77), 3-DMDTCs (T.R:15.11), 4-EBDTCs (T.R:22.19), 5-Propineb (T.R:26.35))

Table I. Retention Time (Rt), Equation, Coefficient of Regression (R^2), DL and QL for Each Subgroup of DTCs

Pesticide groups	Rt (min)	Equation	R^2	DL (ng) ^a	DL ^b (ng/g)	QL (ng) ^c	QL ^b (ng/g)
Dazomet	6.5 min	$y = 45.11 x$	0.9985	0.4	0.04	1.3	0.13
Metam-Na	7.72 min	$y = 39.54 x$	0.9978	0.8	0.08	2.6	0.26
DMDTCs	15.11 min	$y = 113.38 x$	0.9949	0.5	0.05	1.7	0.17
EBDTCs	22.19 min	$y = 86.954 x$	0.988	1.3	0.13	4.3	0.43
PBDTC	24.26 min	$y = 3.5 x$	0.9794	2	0.2	6.6	0.66

^aLOD was graphically calculated by multiplying the noise to the minimum concentration where a peak was detected and then dividing to the signal.

^bCalculated limits for 10 grams of crop sample.

^cLOQ = $3.3 \times$ LOD.

mixture gave maximum absorption at 284 nm. Figure 2 shows the UV-Vis spectrum corresponding to the three EBDTCs mentioned.

Discussion

As expected by the reaction shown in Figure 3, EBDTC fungicides were eluted at the same retention time since their organic structures remain identical when the metal was removed. This is also the case of DMDTC fungicides.

Then, the only use of HPLC-UV/Vis method is not sufficient to differentiate fungicides of a same group as they are eluted at the same retention time. The use of atomic absorption spectrometry is consequently important for the quantification and identification of special dithiocarbamate pesticides like Maneb, Mancozeb and Zineb.

In addition, the method was validated on two different matrices, apples and leeks, in order to check its efficiency with matrix effects. As shown

in Table II, recoveries from leeks were more important than those obtained from apples and this may be due to the matrix effect of pectin present in apple leading to difficulties during filtration. However, no several matrix effects are present. In addition, the recoveries varied between different subgroups of DTCs and this may be due to interactions between different fungicides in the same subgroup. For example, recovery with Dazomet was 100%, whereas with EBDTCs, the interactions of different pesticides may be the cause of the decrease in the recovery rates.

These results are in accordance with those provided by Gustafsson and Thompson (11) and Gustafsson and Fahlgren (12), showing that this method is reliable not only for some of these DTCs but also for the totality of these fungicides.

In fact, these results show a great separation between DTCs groups. Furthermore, the SAA method and UV-visible spectrophotometric

method were used as complementary method for the chromatographic analyses in order to separate

Table II. Recovery of DTCs from Apples and Leeks

Composition	Apples				Leeks		
	Amount taken (mg)	Amount found (mg)	Recovery	RSD %	Amount found (mg)	Recovery	RSD %
Dazomet	1	1	100%	1.01	1	100%	1.01
Metam-Na	1	0.95	95%	1.61	0.98	98%	1.02
DMDTCs	1	0.93	93%	1.26	0.95	95%	1.06
EBDTCs	1	0.92	92%	1.10	0.94	94%	1.65
PBDTCs	1	0.98	98%	0.60	0.99	99%	1.56

Table III. Recovery of Zineb and Maneb from Spiked Tomatoes

Zineb concentration				Maneb Concentration			
Added	Found	Recovery	RSD %	Added	Found	Recovery	RSD %
8.4 mg/L	8 mg/L	95%	0.3	9.6 mg/L	9.50 mg/L	98.9%	0.3

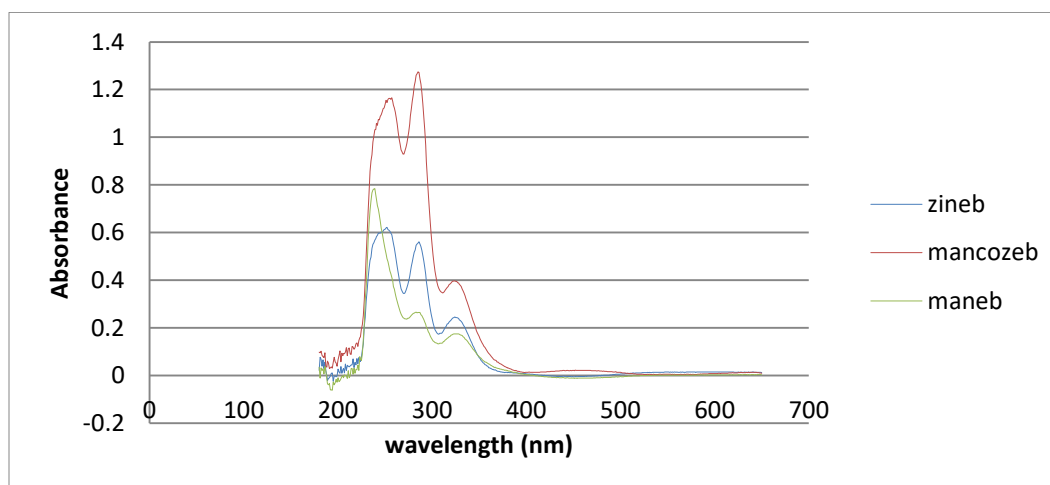


Figure 2. UV-visible spectrum for Zineb, Maneb and Mancozeb.

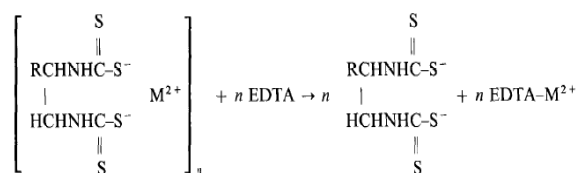


Figure 3. Complexation reaction of DTCs.

EBDTC fungicides eluted at the same retention time.

In fact, the use of atomic absorption for differentiation between these two fungicides seems to be necessary, subsequent to the HPLC separation, as it allows differentiating EBDTCs

based on the proportion of metals present in each DTC. The sample containing Zineb is rich in zinc and poor in manganese while the opposite is found for the sample containing Maneb. For samples fortified with Mancozeb, values cannot be anticipated as the ratio of zinc and manganese is different depending on the structure of Mancozeb. For that, the presence of zinc and manganese in the same sample can be only indicative of the use of this pesticide. In addition, the presence of Zn and Mn in the same extract could also mean a presence of Zineb and Maneb together, but as their effects are the same, as Mancozeb distinguishing between this mixture and Mancozeb seems non-significant. Moreover, the results obtained by FAAS method emphasize the importance of this method provided

by Turker and Sezer (22) and allows differentiating EBDTCs fungicide. This method can also be used to differ between DTCs class, e.g., EBDTC (Zineb) and DMDTC (Ferbam) as done by Turker and Sezer, but as we were only interested by the separation of EBDTCs, this method seems to be a method of choice.

Moreover, this technique is complementary to the chromatographic technique (HPLC-UV). The aqueous phases obtained from the extraction of apple and leeks enriched with DTC fungicides in the validation method give with the atomic absorption analysis high levels of zinc and manganese due to the presence of all DTC fungicides containing high levels of these two metals. These results show that from a single extraction, dithiocarbamates can be separated and fungicides belonging to a same subgroup can be differentiated by analyzing the aqueous phase containing chelated metals by EDTA.

In addition, the obtained results are consistent with those provided by Lo et al. (20) emphasizing once again the importance of the SAA as an efficient and complementary technique to the chromatographic analysis for a complete distinction of DTCs.

The complementary between these two methods has several advantages: it reduces the error and the use of solvent and it is rapid, since no longer several extractions need to be done.

Contrariwise, the spectrophotometric method seems to be less important than the SAA. In fact, UV-visible spectrum obtained for the analysis of these three fungicides being very similar, then, this method may not be reliable for distinguishing between them, which emphasizes the importance of atomic absorption for this differentiation.

Results obtained with this method are not so significant as those supplied with Turker and Sezer (22), given that the goal was to differ pesticides of the same class having the same organic structure and differing only by metal, while Turker and Sezer (22) were interested by the distinction between two different classes (Ferbam and Zineb). For this reason, this method cannot be used as complementary to the present method.

Conclusion

The proposed analytical method developed in this study allows us to separate, to distinguish and to quantify residues of different subgroups of

dithiocarbamates in a simple, efficient and responsive method.

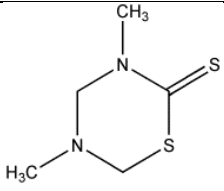
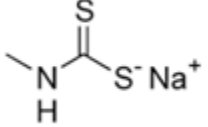
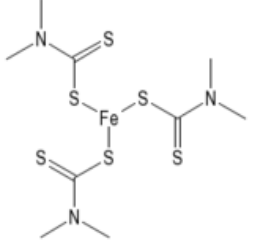
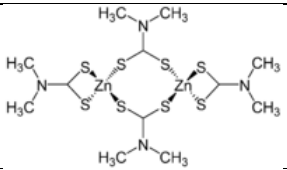
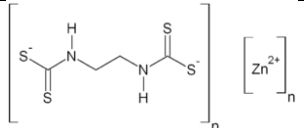
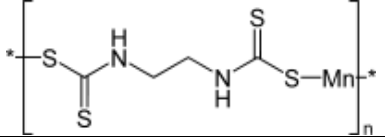
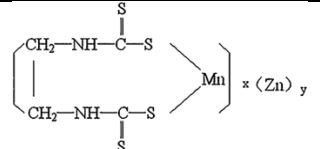
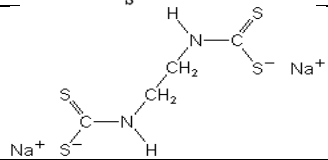
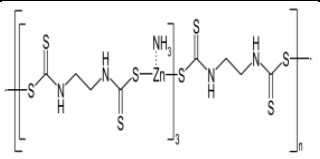
Moreover, the method was validated for natural samples and therefore it is well applicable in the food industry aimed at to know the persistence of these pesticides with potential toxicological effects. The application of the method to the native pine needles from Strasbourg shows the presence of Propineb constituting a direct application to the method. In addition, the distinction between different fungicides belonging to EBDTCs was realized by using flame atomic absorption spectrometry. In fact, the HPLC associated with atomic absorption provides a choice technique because of its efficiency and rapidity, once the pesticide is identified as EBDTCs fungicide by its retention time, then the atomic absorption can be applied based on the aqueous phase of the extraction. The advantage of the method is that no new preparations and extractions are required consequently minimizing uncertainties. Finally, the comparison of the atomic absorption technique to the spectrophotometric method UV-visible emphasizes the importance of the first technique as the results provided by the second were not so significant in terms of distinction between Maneb, Mancozeb and Zineb.

References

1. Edwards, I.R., Ferry, D.H., Temple, W.A.; Fungicides and related compounds. In Hayes, W.J. Jr., Laws, E.R. Jr.; Handbook of pesticide toxicology, v3. Academic Press, San Diego, CA, (1991); 1409–1470.
2. WHO. Dithiocarbamate pesticides, ethylenethiourea and propylenethiourea: a general introduction. WHO, Geneva, (1988).
3. WHO. The WHO recommended classification of pesticides by hazard and guidelines to classification. WHO/IPCS/IOMC, Geneva, (2005).
4. Szolar, O.H.J.; Environmental and pharmaceutical analysis of dithiocarbamates; *Analytica Chimica Acta*, (2007); 582: 191–200.
5. Official Journal of the European Communities (2001): Commission Decision of 22 March concerning the non-inclusion of zineb in Annex I to Directive 91/414/EEC and the withdrawal of authorizations for plant protection products containing that substance. <http://eur-lex.europa.eu/oj/2001/>
6. National Pesticides Directories (2012): Switzerland, Austria, Germany. <http://eur-lex.europa.eu/legal-content/FR/ALL/> (accessed March 22).
7. Narayan, C.R., Komal, S.R., Rohana, L., Gerry, R.H., William, E.H.; Dithiocarbamate toxicity – an appraisal, pesticides in the modern world – effects of pesticides exposure, Margarita Stoytcheva (Ed.). (2011); ISBN: 978-953-307-454-2, InTech, Available from: <http://www.intechopen.com/books/pesticides-in-the-modern-world-effects-of-pesticides-exposure/dithiocarbamate-toxicity-an-appraisal>
8. Segovia, N., Crovetto, G., Lardelli, P., Espigares, M.; In vitro toxicity of several dithiocarbamates and structure-activity relationships; *Journal of Applied Toxicology*, (2002); 22: 353–357.
9. Protection Agency Washington DC. The grouping of a series of dithiocarbamate pesticides based on a common mechanism of Toxicity Health Effects Division Office of pesticide programs U.S. Environmental 20460, (2001), August 17.

10. Blasco, C., Font, G., Picó, Y.; Determination of dithiocarbamates and metabolites in plants by liquid chromatography–mass spectrometry; *Journal of Chromatography A*, (2004); 1028: 267–276.
11. Gustafsson, K.H., Thompson, R.A.; High-pressure liquid chromatographic determination of fungicidal dithiocarbamates; *Journal of Agricultural and Food Chemistry*, (1981); 29: 729–732.
12. Gustafsson, K.H., Fahlgren, C.H.; Determination of dithiocarbamate fungicides in vegetable food stuffs by high-performance liquid chromatography; *Journal of Agricultural and Food Chemistry*, (1983); 31: 461–463.
13. Hayama, T., Takada, M.; Simple and rapid method for the determination of ethylenebisdithiocarbamate fungicides in fruits and vegetables using liquid chromatography with tandem mass spectrometry; *Analytical and Bioanalytical Chemistry*, (2008); 392: 969–976.
14. Hanada, Y., Tanizaki, T., Koga, M., Shiraishi, H., Soma, M.; LC/MS studies on characterization and determination of N, N'-ethylenebisdithiocarbamate fungicides in environmental water samples; *Analytical Sciences*, (2002); 18: 441–444.
15. Crnogorac, G., Schwack, W.; Determination of dithiocarbamate fungicide residues by liquid chromatography/mass spectrometry and stable isotope dilution assay; *Rapid Communications in Mass Spectrometry*, (2007); 21: 4009–4016.
16. López-Fernández, O., Rial-Otero, R., González-Barreiro, C., Simal-Gándara, J.; Surveillance of fungicidal dithiocarbamate residues in fruits and vegetables; *Food Chemistry*, (2012); 134: 366–374.
17. López-Fernández, O., Rial-Otero, R., Cid, A., Simal-Gándara, J.; Combined determination and confirmation of ethylenethiourea and propylenethiourea residues in fruits at low levels of detection; *Food Chemistry*, (2014); 145: 1002–1010.
18. Lishaut, H.V., Schwack, W.; Selective trace determination of dithiocarbamate fungicides in fruits and vegetables by reversed-phase ion-pair liquid chromatography with ultraviolet and electrochemical detection; *Journal of AOAC International*, (2000); 83: 720–727.
19. Garcinuño, R.M., Fernández-Hernando, P., Cámara, C.; Simultaneous determination of maneb and its main metabolites in tomatoes by liquid chromatography using diode array ultraviolet absorbance detection; *Journal of Chromatography A*, (2004); 1043: 225–229.
20. Lo, C.C., Hon, M.H., Hungn, M.D.; Use of high-performance liquid chromatographic and atomic absorption methods to distinguish propineb, zineb, maneb, and mancozeb fungicides; *Journal of Agricultural and Food Chemistry*, (1996); 44: 2720–2723.
21. Thier, H.-P., et al.; *Lebensmittelchem. Gerichtl. Chem*, (1977); 31: 25–27.
22. Türker, A.R., Sezer, B.; Indirect determination of dithiocarbamate fungicides (zineb and ferbam) in some foodstuffs by flame atomic absorption spectrometry; *Turkish Journal of Pharmaceutical Sciences*, (2005); 2: 35–42.

Supplementary Materials

Subgroup	Pesticide	Molecular formula	Structure
	Dazomet	$C_5H_{10}N_2S_2$	
MDTC	Metam-sodium	$C_2H_4NNaS_2$	
DMDTC	Ferbam	$[(CH_3)_2NSCS]_3Fe$	
	Ziram	$[(CH_3)_2NSCS]_3Zn$	
EBDTC	Zineb	$[-SCSNHCH_2CH_2NHCS_2Zn-]_x$	
	Maneb	$[-SCSNHCH_2CH_2NHCS_2Mn-]_x$	
	Mancozeb	$[-SCSNHCH_2CH_2NHCS_2Mn-]_x(Zn)_y$	
	Nabam	$[-NaSCSNHCH_2CH_2NHCS_2Na-]$	
	Metiram	$[-SCSNHCH_2CH_2NHCSZn(NH_3)-]_3[-SCSNHCH_2CH_2NHCS-]_x$	

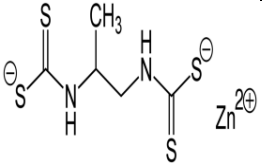
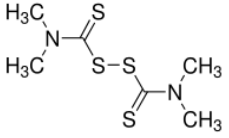
PBDTC	Propineb	$[-\text{SCSNHCHCH}_3\text{CH}_2\text{NHCS}_2\text{Zn-}]_x$	
TMTDS	Thiram	$[(\text{CH}_3)_2\text{NSCS}]_3\text{Fe}$	

Figure 1s: different DTCs structures

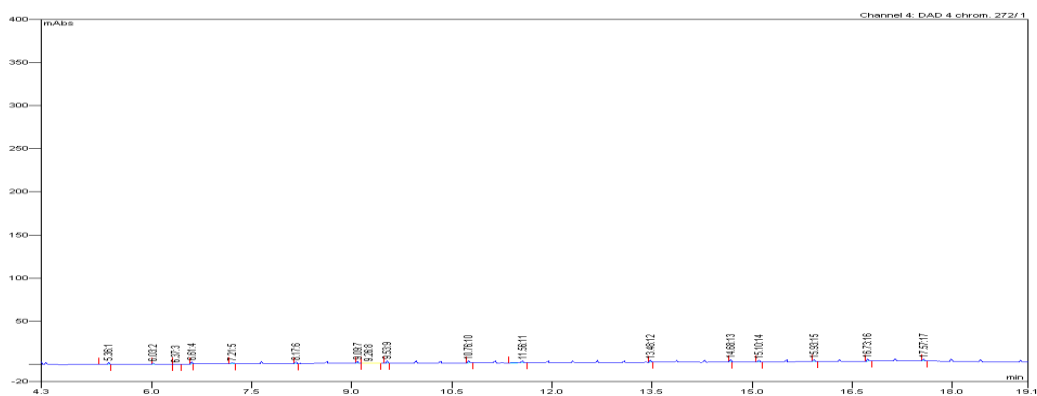


Figure 2s: Chromatogram of not spiked leeks

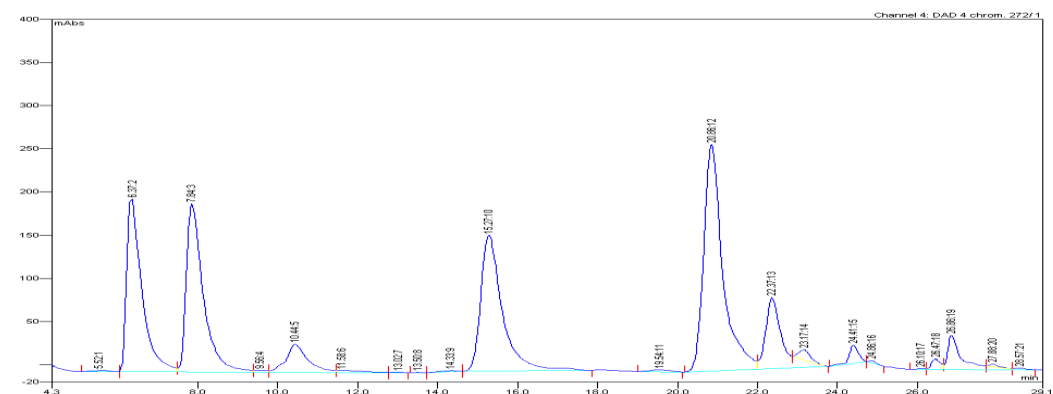


Figure 3s: Chromatogram of spiked leeks

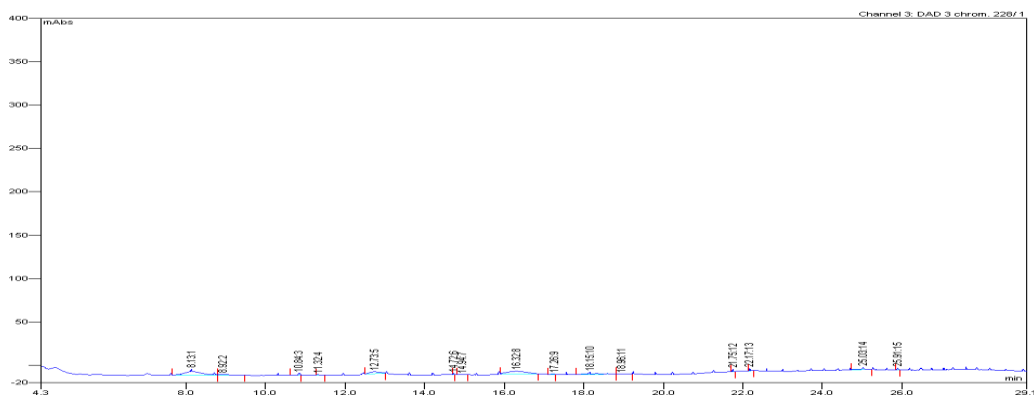


Figure 4s: Chromatogram of not spiked apples

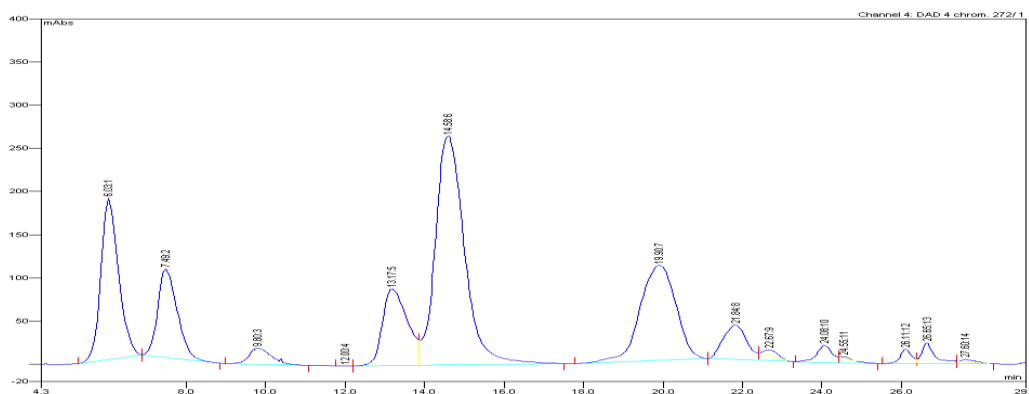


Figure 5s: Chromatogram of spiked apples

Table Is: DTCs triplicate analyze results

Injections	Dazomet	Metam-Na	Ziram	Ferbam	Metiram	Nabam	Zineb	Maneb	Mancozeb	propineb
1	166.68	290.86	48.72	2.32	151.74	292.51	42.74	169.44	227.42	53.14
2	156.0	300.66	47.67	2.42	148.55	292.28	44.68	171.56	227.69	55.45
3	160.3	298.76	48.5	2.30	151.14	292.29	42.96	170.33	227.49	55.2
X	160.9933	296.76	48.29	2.34	150.476	292.36	43.46	170.443	227.53	54.59
S	5.373	5.19711	0.553	0.064	1.6952	0.13	1.062	1.06453	0.14	1.2676
CV (%)	3.33	1.7512	1.146	2.73	1.1266	0.0444	2.444	0.62456	0.0615	2.3219

X= average

S= standard deviation

CV= coefficient of variation

Table IIs: Mixture triplicate analyze results

Injections	Dazomet	Metam-Na	DMDTCs	EBDTCs	Propineb
1	240.71	88.36	57.60	421.43	31.43
2	240.70	87.5	62.68	453.70	33.45
3	235.86	88.1	58.45	439.06	32.43
X	239.09	87.986	59.576	438.063	32.436
S	2.797	0.441	2.7209	16.158	1.010
CV (%)	1.169	0.501	4.5671	3.688	3.113

X= average

S= standard deviation

CV= coefficient of variation

III. Utilisation d'aiguilles de conifères comme biomoniteurs de la variation temporelle de la pollution atmosphérique à Strasbourg.

Ce résultat présenté sous forme d'un article publié dans "Chemosphere" présente la première étude réalisée sur l'évaluation de la qualité de l'air dans cette thèse. Dans ce travail, des aiguilles de conifères ont été utilisées pour l'évaluation de la qualité de l'air dans une zone urbaine à Strasbourg par une approche basée sur le biomonitoring.

En fait, l'émission en continue de produits chimiques polluants dans l'atmosphère nécessite la mise en œuvre d'une surveillance de la qualité de l'air ambiant. Toutefois, l'utilisation de la végétation pour la surveillance de l'environnement peut être considérée comme une simple technique de surveillance en fournissant une matrice peu coûteuse et accessible. Dans cette étude, des aiguilles de deux conifères (*Pinus nigra* et *Cedrus atlantica*) ont été utilisées pour la biosurveillance consécutive de multipolluants tels que les pesticides, les polychlorobiphenyls (PCBs) et les hydrocarbures aromatiques polycycliques (HAPs) en milieu urbain à Strasbourg. L'extraction a été effectuée par extraction par solvant accélérée (ASE) suivi par une extraction/concentration par une extraction en phase solide (SPE) et finalement par une concentration par microextraction en phase solide (SPME). Les extraits obtenus ont été ensuite analysés par une chromatographie en phase gazeuse couplée à une spectrométrie de masse en tandem (GC-MS/MS) ainsi que par une chromatographie liquide couplée à des analyses de spectrométrie de masse en tandem (LC-MS/MS). Les résultats obtenus pour les échantillons de conifères collectés pendant 5 semaines consécutives (avril 09 - mai 07, 2015) montrent une variation similaire des différents types de polluants. Un pic de pollution a été observé au cours de la deuxième semaine d'analyse, et la concentration de tous les polluants a ensuite diminué pour disparaître complètement à la fin de la période d'échantillonnage. Concernant le type de polluants, les HAPs étaient les plus concentrés avec une concentration totale d'environ $35,87 \text{ ng g}^{-1}$, et le naphthalène était, parmi ces polluants, le plus concentré avec une concentration totale d'environ $15,1 \text{ ng g}^{-1}$. L'analyse des données météorologiques au cours de cette période suggère que les résultats sont corrélés avec des conditions climatiques qui varient considérablement au cours de cette période de l'année. Les résultats montrent que le pic de concentration a été obtenu lorsqu'aucune précipitation n'a été détectée.

En conclusion, dans cette étude, les aiguilles de pins ont servi comme un agent de « biomonitoring » pour l'analyse de la qualité de l'air et constituent un capteur passif, fiable et pas coûteux de polluants atmosphériques. Toutefois, ces capteurs sont fortement influencés par les conditions météorologiques des régions où ils ont utilisés.

The use of conifer needles as biomonitor candidates for the study of temporal air pollution variation in the Strasbourg region

Josephine Al-Alam^{a,b}, Ziad Fajloun^{a,c}, Asma Chbani^{a,d}, Maurice Millet^{b,*}

^a Azm Center for Research in Biotechnology and Its Applications, Doctoral School of Science and Technology, Lebanese University, El Mittein Street, Tripoli, Lebanon

^b Institute of Chemistry and Processes for Energy, Environment and Health, ICPEES UMR 7515, Group of Physical Chemistry of the Atmosphere, University of Strasbourg, Strasbourg, France

^c Faculty of Sciences III, Lebanese University, Tripoli, Lebanon

^d Faculty of Public Health III, Lebanese University, Tripoli, Lebanon

h i g h l i g h t s

Pinus nigra and *Cedrus atlantica* were used as the biomonitor candidates for environmental pollution in Strasbourg. Both conifer species accumulated pollutants in the same order of magnitude.

PAHs were the most accumulated pollutant by the conifer needles.

The highest accumulation was obtained in mild weather in which no precipitation was observed

Abstract

The continuous emission of polluting chemicals into the atmosphere requires the implementation of monitoring of ambient air quality. The use of vegetation for environmental monitoring can be considered as a simple monitoring technique by providing a cheap and accessible matrix. In this study, needles of two conifers (*Pinus nigra* and *Cedrus atlantica*), were used for the consecutive biomonitoring of multipollutants such as pesticides, polychlorinated biphenyls, and polyaromatic hydrocarbons (PAHs) in an urban area in Strasbourg (France). The extraction was performed by accelerated solvent extraction, solid-phase extraction, and solid-phase microextraction and was followed by gas chromatography coupled to tandem mass spectrometry and liquid chromatography coupled to tandem mass spectrometry analyses. The results obtained for conifer samples collected in 5 successive weeks (April 09–May 07, 2015) show a similar variation of the different types of pollutants. A pollution peak was observed during the second week of analysis, and the concentration of all pollutants then decreased to complete disappearance at the end of the sampling period. PAHs were the most concentrated with a total concentration of about 35.87 ng g⁻¹, and naphthalene was, among these pollutants, the most concentrated with a total concentration of about 15.1 ng g⁻¹. The analysis of meteorological data during this period suggests that the results correlated with climatic conditions that widely vary during this period of the year. The results show that the concentration peak was obtained when no precipitation was detected.

Key words: conifers, pesticides, PAHs, OCPs, PCBs, meteorological variation.

1. Introduction

The continuous emission of hazardous chemicals into the atmosphere makes it important to estimate their concentrations to determine the quality of ambient air. In fact, the undesirable effects of environmental pollution have been widely reported (Barker et al., 2002; Terzano et al., 2010; Rodríguez et al., 2016; Malmqvist et al., 2017; Wing et al., 2017). According to the World Health Organization (WHO), about 3.7 million people die each year because of the toxic effects of this pollution (2014).

The use of pesticides to protect crops from various adverse effects can lead to serious environmental problems because of the persistence of pesticide residues in various environmental matrices (Sharma et al., 2014). Furthermore, pesticides can be often accumulated in the environment, leading to several harmful disruptions, and hence, most of them have been banned worldwide (Zheng et al., 2016). This is particularly the case for organochlorine pesticides (OCPs) that have been widely used worldwide because of their agricultural and industrial advantages (Xu et al., 2010). The use of OCPs is subjected multiple regulations because of their toxicological effects, mainly endotoxic, neurotoxic, and carcinogenic, especially dichlorodiphenyltrichloroethane (DDT) and Hexachlorocyclohexane (HCH), and their use has been either banned or strictly limited in many countries (van den Berg, 2009; Jit et al., 2011).

Moreover, among the various, organic atmospheric pollutants, polycyclic aromatic hydrocarbons (PAHs) and polychlorinated biphenyls (PCBs) are a series of hazardous organic pollutants of special concern because of their environmental persistence. These pollutants are widespread in the environment because of the multiplicity of their sources (Sarria-Villa et al., 2016). PAHs are mainly emitted into the atmosphere through combustion processes; they are produced as by-products of an incomplete combustion of organic matter, volcanic eruption, forest fires, and vehicle emissions (Pongpiachan et al., 2013; Abdel-Shafy and Mansour, 2016; Elorduy et al., 2016; Li et al., 2016). In fact, PAHs, because of their atmospheric persistence, are a great concern, because they are known for their carcinogenic and mutagenic properties (Kamal et al., 2014). In addition, the most toxic PAHs are those with five or more benzene rings, known as high-molecularweight

PAHs (HMW PAHs). They are considered as the most toxic, mutagenic, and carcinogenic. Especially in urban areas, they are responsible for several respiratory diseases and cancer of skin, lungs, and bladder in humans (Alagić et al., 2016; Elorduy et al., 2016; Li et al., 2016). PCBs are artificial organic chlorinated compounds widely used as fluids in transformers and capacitors. They were widely produced and used until they were banned by the United States Congress in 1979 and by the Stockholm Convention on Persistent Organic Pollutants in 2001 (Porta and Zumeta, 2002). The lipophilic nature of these compounds contributes to their high potential of bioaccumulation in food chain (Chamkasem et al., 2016). Because of the toxicity of these entire class of compounds, many countries abided the convention to limit the damage caused through uncontrolled use of these persistent organic pollutants (POPs) (Elabbas et al., 2013).

These pollutants need to be monitored to assess the state of outdoor environment. In fact, the use of active sampling for environment monitoring was the method of choice for many years. This sampling method uses a pump running at a defined low rate to aspirate air through a filter and/or an adsorbent bed (Tuduri et al., 2012). Even though these methods are well known for their reliable data, they also suffer from numerous drawbacks such as expensive solvents and equipment, and much time and energy consumption Wang et al., 2009). As an alternative for these pumps, passive samplers were developed. In this technique, pollutants adsorb on a chemical substrate such as polymeric resin, polyurethane foam, and thin films of ethylene vinyl acetate (Farrar et al., 2005; Hazrati and Harrad, 2007; Wang et al., 2009; Tuduri et al., 2012). These samplers permit environment monitoring without pumping and therefore without harmful sounds and energy requirement. Furthermore, a natural substance such as vegetation can be a perfect substitute for both passive and active samplers; this method is known as biomonitoring. Biomonitoring permits to estimate the environmental pollution through a natural substance, i.e., vegetation, thereby allowing qualitative and quantitative assessment of the presence of pollutants. Moreover, vegetation is especially an advantageous functional matrix for the assessment of these airborne pollutants (Ratola et al., 2014). Indeed, the use of vegetation for environment monitoring remains the cheapest,

most available, and simplest matrix for atmospheric monitoring (Klánová et al., 2009). In addition, many studies reported the use of vegetation as the passive samplers of POPs and chemical compound in the atmosphere to identify the pollution sources and to determine local and global contamination patterns (Schulz et al., 1999; Gerdol et al., 2002; St-Amand et al., 2009; Ratola et al., 2010).

Among the different vegetation species, conifer needles can play an important role as the passive samplers. Conifers can accumulate pollutants over the years; they are widespread and can be found over a large and poorly accessible area (Romanič and Krauthacker, 2007; Ratola et al., 2014). Furthermore, conifer needles are characterized by a high affinity toward low or medium polar compounds because their high wax leaf content, which allows them to retain pollutants over the years. Different studies show that conifer needles are effective in the monitoring of pesticides (Ratola et al., 2014) and organic semi-volatile pollutants such as PAHs (Ratola et al., 2006; Amigo et al., 2011), PCBs (Grimalt and Van Drooge, 2006; Al Dine et al., 2015), and OCPs (Hellström et al., 2004).

The extraction of pollutants from such matrix needs particular attention, because the aim is to obtain a full recovery of the analytes without co-extraction or involuntary compounds. Several extraction procedures are reported as providing good recovery and efficiency, such as Soxhlet (Ratola et al., 2006), ultrasonic solvent extraction (Tomashuk et al., 2012), or pressurized liquid extraction (Ratola et al., 2006). All these methods are, however, time and solvent consuming and require expensive experiments (Silva et al., 2015). In the present study, a new method combining accelerated solvent extraction (ASE), purification by solid-phase extraction (SPE) followed by gas chromatography coupled to tandem mass spectrometry (GC-MS/MS) and liquid chromatography coupled to tandem mass spectrometry (LC-MS/MS) was used to analyze 30 non-volatile pesticides, 41 volatile pesticides, 16 PAHs, 22 PCBs and 20 OCPs in one sample. All previous studies focused on the use of GC-MS/MS for the analysis of volatile or semi-volatile pollutants, and none of them have reported the use of the LC-MS/MS for the analysis of non-volatile persistent pesticides. The developed method permits the analysis of about 129 different organic

compounds in one single sample. This method was then applied to two different conifer species (*Pinus nigra*, reported by many authors for its passive sampler role (Piccardo et al., 2005; Kalinovic et al., 2016), and *Cedrus atlantica*, (which to our knowledge, has not been reported previously), to study their role as the biomonitors of temporal air pollution variation in the Strasbourg region. It also aimed to demonstrate if the meteorological conditions affect needles contamination given that the study was conducted in early spring 2015 in which the weather broadly varied.

2. Methods and materials

2.1 Chemical reagents and standard solutions

LC-MS-grade acetonitrile (ACN), Toluene (TOL) from Biosolve (Dieuze, France), HPLC-grade acetonitrile, methanol (MeOH), ethyl acetate (EA), “Fontainebleau” sand from Prolabo (France), silica gel (Merck, Germany) and ultrapure water (Elga system, Antony, France) were used.

Internal standards for LC-MS/MS, namely Carbendazim-d4 (99.3%), Diuron-d6 (99.8%), Pendimethalin-d5 (99%), and Nicosulfuron-d6 (99%), were obtained from CDN isotopes (Quebec, Canada).

Internal standards for GC-MS/MS were Trifluralin-d14, and 4-Nitrophenol-d4 and Naphtalene-d8 (99%), and they were purchased from Sigma-Aldrich (L'Isle d'Abeau, France) and Cambridge Isotope Laboratories (Cluzeau Info Labo, France), respectively.

For method development:

For LC-MS/MS, 30 standards of pesticides (99%) were purchased from Sigma-Aldrich (L'Isle d'Abeau, France) and a mixture of them at 1 g L⁻¹ was prepared. These pesticides' standards were as follows: Pymetrozine, Carbendazim, Chloridazone, Acetamiprid, Nicosulfuron, Thiacloprid, Chlortoluron, Carbetamide, Terbutryn, Spinosade A, Isoproturon, Diuron, Metalaxyl-M, Spinosade D, Dimethenamid-p, Penconazole, Isoxadifen, Tebuconazole, Diflubenzuron, Epoxyconazole, Prothioconazole, Propiconazole, Chlorfenvinphos, Triflurosulfuron methyl, Pendimethalin, Cyazofamid, Pyraclostrobine, Diflufenican, Flufenoxuron, and Lufenuron.

For GC-MS/MS, 41 standards of pesticides (99%) were purchased from Sigma-Aldrich (L'Isle

d'Abeau, France) and a mixture of them at 1 g L⁻¹ was prepared. These pesticides' standards were as follows: Captan, Tebutam, Fenpropidine, Buprofezin, Trifloxystrobine, Propachlore, Fenpropimorphe, Propargite, Fenarimol, Boscalid, Alachlore, Ethofumesate, s-Metolachlor, Tebufenpyrad, Propyzamid, Myclobutanil, Bifenthrin, Fenpropathrine, Lindane, Isodrine, Aclonifen, Clomazone, 2,4 MPCA, Chloridazon, Cyprodinil, Mecoprop-p, Fluzilazole, Oxyfluorfen, Irgarol, Oxadiazon, Propiconazole, Trifluraline, Chlorothalonil, Procymidon, Chlorpyrifos, Bromoxynil, Diclofop-methyl, Bifenox, Ioxinil, Bupirimate and Mepanipyrim.

A mixture (0.1 g L⁻¹) of 20 OCPs (α -HCH, γ -HCH, β -HCH, δ -HCH, Heptachlore epoxyde A, Metoxychlore, o,p'-DDD, o,p'-DDT, p,p'-DDD, p,p'-DDT, a-endosulfan, o,p'-DDE, p,p'-DDE, Aldrine, Heptachlore, Dieldrine, Hexachlorobenzene, Heptachlore epoxyde B, transchlordan, and Cischlordan) was purchased Cluzeau Info Labo (St Foy la Grande, France).

A mixture (0.1 g L⁻¹) of 16 PAHs (Naphthalene, Acenaphthene, Fluorene, Phenanthrene, Anthracene, Fluoranthrene, Pyrene, Benzo(a)anthracene, Chrysene, Benzo(b)fluoranthrene, Benzo(k)fluoranthrene, Benzo(e)pyrene, Benzo(a)pyrene, Indenol(1,2,3)pyrene, Benzo(g,h,i)perylene and Dibenzo(a,h)anthracene) was prepared from individual standards purchased from Sigma Aldrich (L'Isle D'Abeau, France).

A mixture (0.1 g L⁻¹) of 22 PCBs (PCB 18, PCB 31, PCB 28, PCB 52, PCB 44, PCB 70, PCB 81, PCB 101, PCB 123, PCB 118, PCB 114, PCB 105, PCB 126, PCB 149, PCB 153, PCB 138, PCB 167, PCB 156, PCB 157, PCB 169, PCB 180 and PCB 189) was purchased from Cluzeau Info Labo (St Foy la Grande, France).

2.2 Sample collection

Pine needles (*P. nigra*) were collected from the botanical garden of central Strasbourg, while cedar needles (*C. atlantica*) were collected directly from the faculty of chemistry area in the Strasbourg University campus. Both sites are close to each other, as shown in Fig. 1, and the aim was to evaluate the recovery difference between these two conifer matrices, which are well-known vegetable bioindicators.

Sampling was performed over a period of 5 weeks between April 09 and May 07, 2015.

The needles collected were 6-month to 1-year aged, and only the terminal parts of the branches were collected. The samples were transported in plastic bags to the laboratory and stored frozen (-18 °C) until analysis.

2.3 Method development

The developed method was based on the work of Al Dine et al. (2015).

For method development, only the most recent small needles (taken from the end of the branch), newly obtained and not exposed to environmental pollutants were used. These needles were free from the different types of analyzed pesticides, PAHs, and PCBs.

Five grams of these finely cut needles was fortified with a mixture of all analyzed pesticides to prepare a calibration range with a concentration varying from 5 ng g⁻¹ to 2500 ng g⁻¹. The fortified samples were kept at 4 °C overnight and then subjected to the extraction procedure cited below. All analyses were done in triplicates.

2.3.1 ASE extraction and cleanup

Five grams of the fortified needles was extracted by ASE. For this purpose, a filter paper was placed at the bottom of ASE 33-mL cells, and a thin layer (1 cm height) of silica gel was then added to enable the first purification step. A second filter was placed on the top of the silica gel, and 10 g of needles mixed with "Fontainebleau" sand was added. Finally, a filter was placed at the top of the cell, which was adequately sealed for ASE extraction. The extraction was carried out with ACN (100%), and the procedure involved was as follows: heating the cell for 7 min, 10 min of static cycle, temperature 150 °C, pressure 1500 psi, flushing 100%, and purging 300 s.

ASE final extracts were collected in ASE bottles and prepared for SPE purification. For this, the extracts were filtered and then diluted to 1000 mL with acidified (pH 3) Milli-Q water.

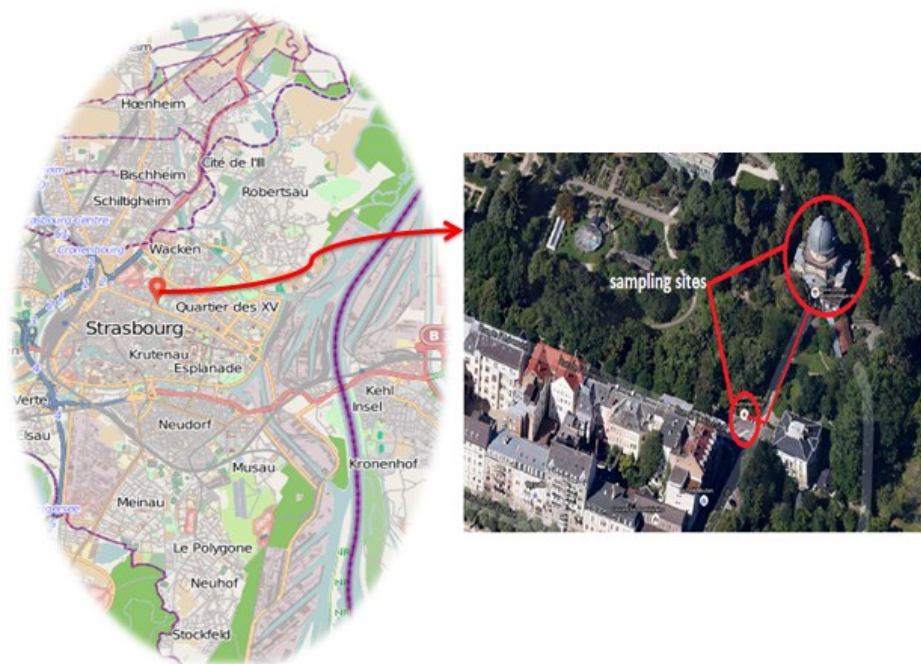


Fig. 1. Sampling site locations: botanical garden for pine needles and the faculty of chemistry area in the university campus for cedar needles.

2.3.2 SPE extraction and clean-up

CHROMABOND® EASY cartridges (Macherey-Nagel, France), consisting of a polar-modified polystyrene divinyl benzene copolymer, were used as adsorbents (mean pore diameter 60 Å, surface area 623 m²/g and mean particle size 91 μm). The SPE procedure was carried out as follows: conditioning of the cartridge with 5 mL of MeOH followed by 5 mL of Milli-Q water, flushing 1000 mL of the sample into the cartridge at 10 mL min⁻¹, and then drying by N₂ flushing for 30 min. The extracts were finally sequentially eluted with 2 mL of each of the following solvents: ethyl acetate, toluene, and acetonitrile.

Collected extracts were evaporated and then diluted to 1 mL with ACN to prepare them for the chromatographic analysis.

A 100 μL volume of the final extract was transferred to an LC vial in which the appropriated internal standard was added, and the extract was analyzed by LC-MS/MS for pesticides.

The remaining 900 μL were diluted to 20 mL with salted water (1.5% NaCl) to promote adsorption on the SPME fiber, and then appropriated GC internal standards were added prior to this last purification and extraction step.

2.3.3 SPME extraction

Two SPMEs were used: one coated with polyacrylate (65 mm) for the extraction of GC-MS/MS pesticides and the second coated with polydimethylsiloxane (100 mm) for the extraction of OCPs, PCBs, and PAHs. These fibers were soaked in 20 mL of the solution and heated to 60 °C under agitation for 40 min for pesticides, while for PAHs, PCBs and OCPs; the extraction was performed at 80 °C for 40 min. The fibers were then injected into the GC coupled to a mass spectrometer for the analysis of the above pollutants.

2.3.4 Pesticides analysis by LC-MS/MS

For the pesticide analysis, 20 μL of the final extract prepared for the LC analysis was injected to the LC system (Thermo Scientific), coupled to a MS/MS system (TSQ Quantum Access Max).

For the maximum separation between the pesticides, a Macherey-Nägel Nucleodur C₁₈ Pyramid column (150 mm × 3 mm; 3 μm) was

used at 25°C, the chromatographic system was also equipped with an autosampler (Accela Autosampler) and the pump used was a Surveyor LC Pump Plus (Thermo Scientific).

Elution was carried out at a flow rate of 0.3 mL min⁻¹ using a linear gradient of ACN/water mobile phase. The gradient started with 30:70 (v/v) for 5 min, followed by 50:50 (v/v) for 6 min, then 80:20 (v/v) for 7 min, to achieve 95:5 (v/v) for 10 min, and finally a ratio of 30:70 (v/v) for 8 min is recommended to stabilize the column for any new injection.

2.3.5 Pesticides analysis by GC-MS/MS

Pesticides were also analyzed by GC coupled to a tandem mass spectrometer. The GC (Thermo Scientific Trace) was coupled to an ITQTM700 mass spectrometer, and sample injection was performed in the splitless mode at 250 °C.

A sample injection to the GC was also performed by thermal desorption of the SPME fiber, directly after the injection of 2 µL of N-methyl-N-(*t*-butyldimethylsilyl) trifluoroacetamide (MTBSTFA) used as a derivation agent.

Extracts were injected to a semi-polar capillary column TR50 MS 50% phenyl/50% methylsiloxane (60 m × 0.25 mm internal diameter and 0.25 µm as film thickness).

Helium was used as the carrier gas at a flow rate of 1 mL min⁻¹.

Pesticide separation was performed as follows: 50°C (3 min), 10 °C/min to 220 °C (10 min), 3 °C/min to 250 °C (9 min), and 3 °C/min to finally achieve 300 °C in which it was maintained for 22 min.

Trifluralin-d₁₄ and 4-Nitrophenol-d₄ (1 mg L⁻¹) were used as the internal standards.

2.3.6 PCBs, OCPs and PAHs GC-MS/MS analysis

PAHs, PCBs, and OCPs concentrations were determined by GC coupled to a tandem mass spectrometer (ITQTM 900). The GC (Thermo Scientific Trace 1300) was coupled to a mass spectrometry system (ITQ 900), and sample injection was performed in the splitless mode at 280 °C.

The sample was injected by thermal desorption of the SPME fiber. Extracts were injected into a capillary column Optima XLB

(60 m × 0.25 mm as internal diameter and 0.25 µm as film thickness).

Helium was used as the carrier gas at a flow rate of 1 mL min⁻¹, and separation was performed with the following temperature gradient: 50 °C was maintained for 3 min; the temperature was then increased at 40 °C/min to achieve 240 °C and then further increased at 1.5 °C/min to achieve 255 °C where it remained constant for 5 min. Finally, the temperature was increased at 20 °C/min to achieve 330 °C where it was maintained for 25 min.

Naphtelene -d₈ (10 mg L⁻¹) was used as the internal standard.

2.4 Samples analysis

All collected samples (from both species, from April 09 to May 07, 2015) were subjected to the same extraction procedure of the developed method cited above. Meteorological parameters variations were clearly observed during the entire sampling period. Pollutants residues in both conifers needles samples were calculated using Xcalibur software.

3. Results

3.1 Method validation

As mentioned before, the needles used for method development were not contaminated by any of the tested pollutants. The method was validated for its linearity, limits of detection and quantification, and its recovery. Linearity was validated by calculating the correlation coefficient R² which should be greater than 0.9800 for all searched compounds. The LODs and LOQs were graphically calculated; LOD =3* [min] S/N and LOQ =10*[min] S/N, where [min] = minimal concentration, S=signal detected at this concentration and N= noise.

Properties and validation parameters of volatile pesticides, non-volatiles pesticides, PAHs, PCBs and OCPs are given in tables 1-5 respectively.

3.2 Pine needles contamination

The temporal distribution and variation of pesticides, PCBs, OCPs and PAHs were analyzed from the data obtained from samples taken at 5 successive weeks.

3.2.1 LC-MS/MS

Among the 30 pesticides investigated, 5 pesticides were detected in high concentration in the needles analyzed during the 5 weeks. These detected pesticides were Nicosulfuron, Spinosade A, Penconazole, Triflusulfuron methyl, and Pyraclostrobine. The study of the variation of the concentration of these pesticides for 5 weeks shows that the maxima obtained was at the second week of the analysis for both species. The distribution of the 5-week pesticide concentrations (ng g^{-1}) and total and medium pesticide concentrations found in both species are given in Table 1S, in supporting information (SI). Fig. 2 shows the variation of pesticide concentration for both species per week.

In both species, the pesticides showed a concentration peak at the second week, and the pesticide concentration then decreased to complete disappearance in the last week of analysis.

3.2.2 GC-MS/MS

SPE was followed by solid-phase micro extraction (SPME) to determine the concentrations of 41 volatile pesticides, 22 PCBs, 20 OCPs, and 16 PAHs. These pollutants were analyzed by GC-MS/MS.

For volatile pesticides: Among all the pesticides assessed, none of them were found in both the analyzed species and this may be because of two hypotheses. Either none of the studied pesticides was used and hence no traces were found on the tested needles or the residue concentrations were lower than the detection limits and hence nothing was detected. Despite these results, OCPs that are also classified as volatile pesticides seem to be present in the atmosphere and this may be because of the high persistence of these compounds.

For OCPs: Among the 20 OCPs analyzed, only 4 were found in the 2 conifer species studied. The OCPs found were O, P'-DDD, P, P'-DDD, P, P'-DDE, and Hexachlorobenzene. The variation in the concentration of these 4 OCPs in each species and the total and the medium OCPs concentrations found in both species during the 5 weeks of the study are given in Table 2S of SI. The variations in OCPs concentrations for both species are shown in Fig. 3.

We noticed a peak of OCP concentration in the second week of the study, which decreased to zero in the last 2 weeks.

Table 1:
Properties of volatile pesticides.

Compound	Parent ion	Daughter ions	Collision energy (ev)	Tr (mn)	correlation coefficient R^2	LOD (ng g^{-1})	LOQ (ng g^{-1})	Recovery %
Captan	79	51/77	1.2	24.17	0.992	1.36	4.09	90
Tebutam	91	65	1.4	24.19	0.991	0.23	0.68	95
Fenpropidine	98	70/55/81	1.3	27.76	0.943	0.08	0.24	90
Buprofezin	105	77	1.2	44.29	0.998	0.67	2.00	86
Trifloxystrobine	116	89/63	1.4	50.78	0.996	0.19	0.58	88
Propachlore	120	91/92/77/103/17	1.4	23.93	0.967	25.00	75.00	80
Fenpropimorphe	128	110/70/94/95/102	1.6	29.07	0.993	0.67	2.00	90
Propargite	135	107/95/77	1.3	31.09	0.998	0.98	2.94	95
Fenarimol	139	111/75	1.3	64.88	0.999	0.72	2.16	85
Boscalid	140	112/76	1.4	75.55	0.999	4.17	12.50	85
Alachlore	160	132/117/131/145	1.4	31.35	0.994	0.28	0.85	89
Ethofumesate	161	133/105/115/143	1.4	35.19	0.991	0.55	1.66	86

s-Metolachlor	162	133/134/132/162	1.45	33.75	0.995	0.31	0.92	90
Tebufenpyrad	171	156/127/102/88	1.5	55.89	0.999	7.14	21.43	93
Propyzamid	173	145/109	1.4	26.60	0.992	0.35	1.05	87
Myclobutanil	179	125/152/144	1.3	44.82	0.999	3.70	11.11	80
Bifenthrin	181	166/153/165/178	1.4	51.33	0.990	0.05	0.16	80
Fenpropathrine	181	152 (127/151/153)	1.6	56.04	0.999	1.25	3.75	90
Lindane	183	147/148/145/146/109	1.4	28.57	0.997	0.71	2.14	87
Isodrine	193	157/123/133/158	1.7	36.32	0.997	0.86	2.59	92
Aclonifen	194	167/139/165	1.45	52.14	0.998	3.57	10.71	96
Clomazone	204	107/174/188	1.6	28.02	0.984	2.21	6.62	91
2.4 MPCA*	211	183	1.4	27.50	0.982	2.67	8.02	95
Chloridazon	220	192/193/166	1.8	44.74	0.999	1.35	4.05	90
Cyprodinil	224	208/197/183	1.9	38.56	0.996	0.01	0.02	90
Mecoprop-p*	225	197/209/199	1.5	25.36	0.983	7.35	22.06	85
Fluzilazole	233	165/152/183/217	1.85	43.20	0.999	0.89	2.68	84
Oxyfluorfen	252	170/190/224/146/195	1.7	40.98	0.996	0.43	1.30	89
Irgarol	253	238/196/182/197	1.4	39.65	0.998	1.60	4.81	85
Oxadiazon	258	175/146/202	1.6	40.30	0.999	2.00	6.00	80
Propiconazole	259	191/173/181	1.4	50.71	0.997	4.57	13.70	83
Trifluraline	264	206/160/188 (171)	1.5	21.56	0.997	2.56	7.69	93
Chlorothalonil	266	168/170/231/205/229	1.9	30.90	0.998	2.94	8.82	90
Procymidon	283	255/254/268	1.4	39.25	0.996	1.95	5.84	82
Chlorpyrifos	314	258/286	1.1	34.45	0.996	4.16	12.50	87
Bromoxynil*	334	173/255/203	1.61	35.10	0.997	6.81	20.44	85
Diclofop-methyl	340	253/281/254	1.4	53.38	0.998	0.56	1.69	90
Bifenox	341	311/310/281	1.2	60.65	0.997	0.54	1.61	94
Ioxinil*	428	301	1.2	48.96	0.989	2.75	8.25	98
Bupirimate	193/208	165/109/150/123/138	1.6	43.75	0.995	2.63	7.89	89
Mepanipyrim	222/223/207	207/192/206	1.8	44.74	0.998	0.30	0.89	97

Table 2:
Properties of non-volatile pesticides.

Pesticide	Parent ion	Daughter ion	RT (mn)	correlation coefficient R ²	LOD (ng g ⁻¹)	LOQ (ng g ⁻¹)	Recovery %
Pymetrozine	218 100	105 226	1.80	0.976	1.09	3.65	94
	218 101	79 188					
Carbendazim	192 100	160 119	1.85	0.997	0.51	1.68	91
	192 101	132 162					
Chloridazone	222 000	104 290	5.14	0.998	0.71	2.36	92
	222 001	77 360					
Acetamiprid	223 000	99 207	6.10	0.999	0.81	2.71	95
	223 002	126 022					

Thiacloprid	253 000	126 262	8.25	0.996	3.90	13.00	95
	253 001	99 234					
Nicosulfuron	411 100	181 891	7.70	0.998	0.05	0.02	90
	411 101	212 896					
Chlortoluron	213 100	72 296	11.10	0.997	2.26	7.55	95
	213 102	140 033					
Carbetamide	237 101	192 087	8.20	0.998	1.33	4.44	93
	237 102	120 227					
Terbutryn	242 000	186 210	10.05	0.998	5.40	18.00	89
	242 001	68 390					
Spinosade A	732 500	142 071	10.50	0.996	3.35	11.16	85
	732 501	98 152					
Isoproturon	207 100	72 361	11.70	0.997	6.30	21.00	96
	207 101	46 503					
Diuron	233 001	72 306	12.05	0.997	6.90	23.00	94
	233 002	46 598					
Metalaxyl-M	280 001	220 036	11.40	0.999	1.80	6.00	89
	280 002	192 088					
Spinosade D	746 774	141 977	11.15	0.997	1.73	5.75	90
	746 775	98 457					
Dimethenamid-p	276 100	244 011	14.35	0.994	6.66	22.22	97
	276 101	168 034					
Penconazole	284 000	159 070	15.47	0.993	7.20	24.00	87
	284 001	70 390					
Isoxadifen	296 000	232 120	16.62	0.997	3.41	11 .38	89
	296 001	204 100					
Tebuconazole	308 000	70 380	15.77	0.996	2.88	9.60	90
	308 001	125 190					
Diflubenzuron	311 000	157 946	15.50	0.998	1.45	4.83	87
	311 001	140 999					
Epoxyconazole	330 000	221	14.44	0.996	2.88	9.60	92
	330 001	119 200					
Propiconazole	342 000	159 090	15.89	0.996	4.76	15.84	93
	342 001	123 120					
Prothioconazole	344 000	326 005	15.75	0.991	0.78	2.60	80
	344 001	153 994					
Chlorfenvinphos	359 000	170 020	16.17	0.998	4.38	14.60	89
	359 001	99 180					
Triflusulfuron methyl	493 100	263 907	14.75	0.989	2.66	8.86	97
	493 101	96 088					
Pendimethalin	282 100	211 986	20.50	0.999	3.27	10.91	95
	282 101	193 934					
Cyazofamid	325 000	225 974	16.60	0.993	2.48	8.25	95
	325 001	224 974					
Pyraclostrobine	388 000	194 100	17.26	0.998	2.81	9.37	97
	388 001	163 150					
Diflufenican	395 000	266 060	18.01	0.993	5.85	19.50	96
	395 001	246 030					
Flufenoxuron	489 001	157 980	19.70	0.999	3.45	11.50	94
	489 002	141 049					

Lufenuron	511 000	157 901	19.00	0.997	0.78	2.59	95
	511 001	141 040					

For PCBs: 22 PCBs were studied and only 7 were detected during the 5 weeks of the study. Table 3S (SI) shows the distribution of the concentration of these PCBs in each species during the analysis and the total and medium PCB concentrations found in both species. The variation in PCBs for both species is shown in Fig. 4.

As shown in this figure, the maximum concentration of PCBs was at the second week of the analysis for both species.

For PAHs: In total, 16 PAHs were considered in this study, and only 8 of them were found in the analyzed matrix. Table 4S (SI) gives the distribution of the concentration of these PAHs in each species and the total and medium PAHs concentrations found in both species during the 5 weeks of the study. Fig. 5 shows the variation in PAHs concentrations for both species per week.

These results also show an important PAH concentration during the first 3 weeks of the study, with a slight peak at the second week, and PAH concentration then decreases to complete disappearance in the fourth and fifth weeks of the study.

The results of all analyzed pollutants were coherent to each other: the pollutants were weakly present in the first week (except for PAHs whose high concentration was detected), their concentration increased to achieve a peak at the second week of the study, and the concentrations then decreased to finally disappear in the last two weeks.

3.3 Total pollutants concentrations

The variation in the total pollutant concentrations in both species is shown in Fig. 6.

As shown in this figure, maximum pollutants were detected in the second week. The comparison of total pollutant concentrations during this week is shown in Fig. 7.

This figure shows that PAHs were the pollutants most present with a total concentration of 35.87 ng g⁻¹. Naphthalene that was widely present in the atmosphere was the major PAH pollutant with a total concentration of 15.1 ng g⁻¹.

Table 3:
Properties of PAHs.

Compound	Parent ion	Daughter ions	Collision energy (ev)	Tr (mn)	correlation coefficient R ²	LOD (ng g ⁻¹)	LOQ (ng g ⁻¹)	Recovery %
Naphtalene	128	102/126/76/77/78	1.20	9.38	0.993	0.08	0.25	85
Acenaphtene	153	150/151/126	1.30	10.96	0.998	0.42	1.26	95
Fluorene	165	163/139/115	1.20	11.62	0.996	0.37	1.10	97
Phenanthrene	178	152/176/151	1.20	13.41	0.989	0.03	0.09	84
Anthracene	178	152/176/151	1.20	13.57	0.993	0.15	0.44	83
Fluoranthrene	202	200	1.30	17.53	0.947	0.02	0.05	97
Pyrene	202	200	1.20	18.70	0.987	0.09	0.29	100
Benzo(a)anthracene	228	226/202	1.20	26.01	0.989	0.03	0.09	98
Chrysene	228	226/202	1.20	26.18	0.995	0.03	0.08	99
Benzo(b)fluoranthrene	252	250/226	1.30	29.95	0.986	0.01	0.03	98
Benzo(k)fluoranthrene	252	250/226	1.30	30.02	0.991	0.03	0.09	100
Benzo(e)pyrene	252	250/226	1.30	30.99	0.992	0.01	0.04	86
Benzo(a)pyrene	252	250/226	1.30	31.21	0.991	0.03	0.10	92
Indenol(1.2.3)pyrene	276	274	1.40	35.27	0.969	0.07	0.22	89
Benzo(g,h,i)perylene	276	274	1.40	36.50	0.968	0.48	1.43	85
Dibenzo(a,h)anthracene	278	276	1.50	35.17	0.985	0.20	0.61	86

Table 4:
Properties of PCBs.

Compound	Parent ion	Daughter ions	Collision energy (ev)	Tr (mn)	correlation coefficient R ²	LOD (ng g ⁻¹)	LOQ (ng g ⁻¹)	Recovery %
PCB 18	256	186/221	1.20	12.89	0.991	0.03	0.09	97
PCB 31	256	186/151/150	1.20	13.98	0.974	0.03	0.09	95
PCB 28	256	186/151/150	1.20	14.06	0.992	0.02	0.06	91
PCB 52	292	222/220/257/255	1.20	14.67	0.994	0.03	0.10	80
PCB 44	292	222/220/257/255	1.20	15.24	0.982	0.04	0.12	90
PCB 70	292	222/220/185/150	1.30	16.64	0.991	0.09	0.26	89
PCB 81	292	222/220/185/150	1.30	19.10	0.991	0.06	0.18	98
PCB 101	326	256/254/291	1.20	17.36	0.950	0.09	0.27	92
PCB 123	326	256/254	1.30	20.24	0.974	0.03	0.09	89
PCB 118	326	256/254	1.30	20.50	0.992	0.02	0.06	87
PCB 114	326	256/254	1.30	21.15	0.974	1.04	3.12	97
PCB 105	326	256/254	1.40	22.11	0.993	1.40	4.21	95
PCB 126	326	256/254	1.40	24.25	0.995	0.02	0.07	98
PCB 149	360	290/288/325/323	1.20	19.78	0.990	0.03	0.09	85
PCB 153	360	290/288	1.30	21.27	0.992	2.24	6.71	82
PCB 138	360	290/288/325	1.30	2.307	0.989	1.99	5.99	81
PCB 167	360	290/288/218	1.50	2.469	0.990	0.26	0.79	80
PCB 156	360	290/288/218	1.50	25.55	0.985	0.34	1.02	97
PCB 157	360	290/288/218	1.50	25.68	0.981	0.28	0.84	94
PCB 169	360	290/288/218	1.50	26.84	0.981	0.18	0.53	93
PCB 180	396	324/325/361	1.30	25.76	0.990	0.09	0.27	95
PCB 189	396	326/324	1.80	27.61	0.990	0.12	0.35	99

Table 5:
Properties of OCPs.

Compound	Parent ion	Daughter ions	Collision energy (ev)	Tr (mn)	correlation coefficient R ²	LOD (ng g ⁻¹)	LOQ (ng g ⁻¹)	Recovery %
α -HCH	183	147/148/145/146/109	1.30	12.42	0.989	0.73	2.19	89
γ -HCH	183	147/148/145/146/109	1.40	13.02	0.994	0.45	1.36	100
β -HCH	183	147/148/145/146/109	0.77	13.49	0.995	5.36	16.09	85
δ -HCH	183	147/148/145/146/109	0.77	14.14	0.985	8.00	24.01	80
Heptachlore epoxyde A	183	155/119/148/113	0.90	16.76	0.991	0.44	1.32	89
Metoxychlore	227	169/181/197/212/152/ 141/165	1.12	25.46	0.990	0.044	0.132	-
o.p'-DDD	235	199/165/200/163	1.40	18.90	0.994	0.08	0.23	80
o.p'-DDT	235	199/165/200/163	1.50	20.45	0.993	0.08	0.24	95
p.p'-DDD	235	165/163/199/200	1.50	21.10	0.994	1.44	4.33	87
p.p'-DDT	235	165/199/163/200	1.50	2.298	0.990	1.86	5.57	99
α -endosulfan	241	206/204/170/171	1.60	1.810	0.995	1.42	4.27	92
o.p'-DDE	246	176/150	1.90	17.06	0.993	0.02	0.07	93
p.p'-DDE	246	176/150	1.90	18.93	0.991	0.03	0.09	80
Aldrine	263	193/191/227/228	1.80	15.20	0.992	0.37	1.11	89
Heptachlore	272	237/235	0.78	14.35	0.991	0.35	1.06	84
Dieldrine	279	243/241/206/209/207	1.60	19.20	0.990	0.43	1.28	80
Hexachlorobenzene	284	249/214/212/179/247	1.26	12.57	0.987	0.10	0.30	80
Heptachlore epoxyde B	353	263/317/253	0.96	16.56	0.997	0.03	0.09	96
Transchlordan	373	266/264/301/337	1.00	17.70	0.985	0.03	0.08	94
Cischlordan	373	266/264/301/337	0.98	17.89	0.988	0.03	0.09	95

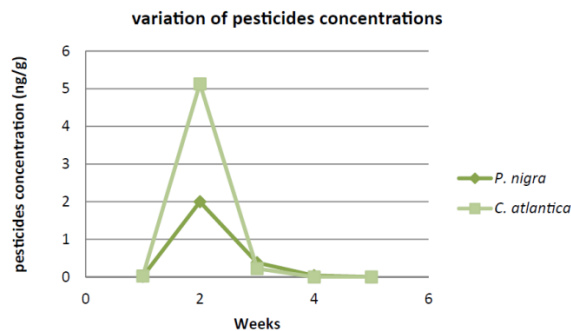


Fig. 2. Variation in total pesticide concentration for *P. nigra* and *C. atlantica* per week

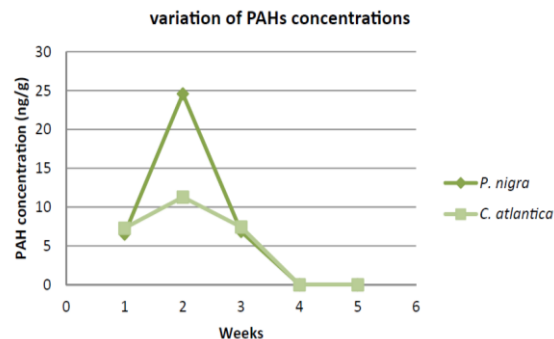


Fig. 5. Variation in total PAH concentration for *P. nigra* and *C. atlantica* per week.

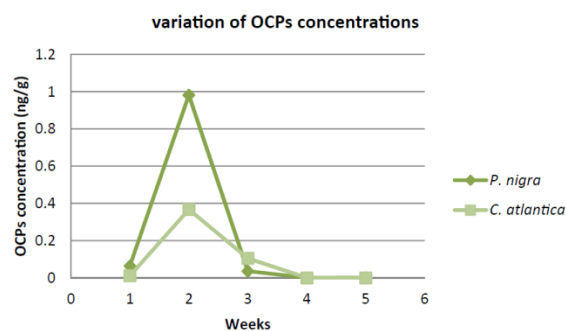


Fig. 3. Variation in total OCP concentration for *P. nigra* and *C. atlantica* per week.

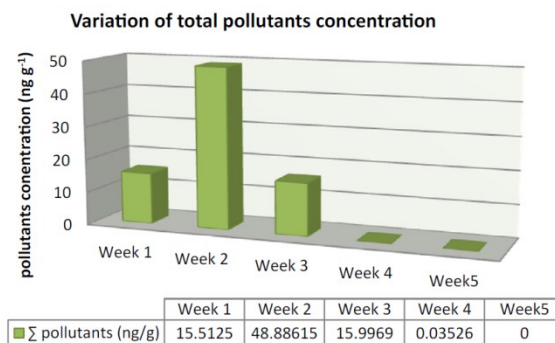


Fig. 6. Variation in total pollutant concentration (ng g^{-1}) per week.

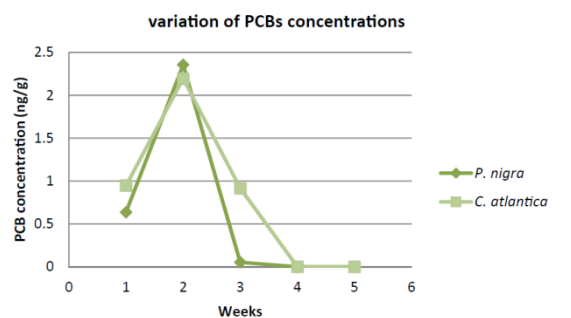


Fig. 4. Variation in total PCB concentration for *P. nigra* and *C. atlantica* per week.

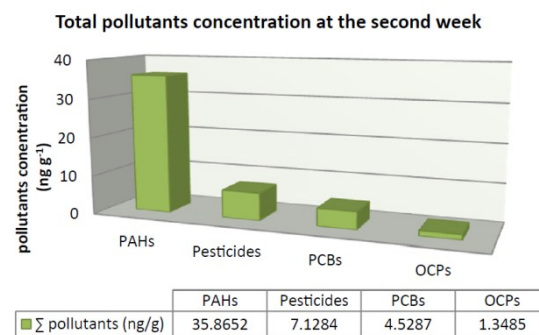


Fig. 7. Total pollutant concentration (ng g^{-1}) in the second week.

4. Discussion

The samples were collected from April 09 to May 07, 2015, from an urban area where no cultivations are present. The presence of pesticides in Strasbourg could then be explained by the important agricultural area located proximate (5 km) to downtown. These agricultural activities focused on the cultivation of wheat, corn, beets, hops, and grapes (vines). Furthermore, no

industrial activities are present near the sampling sites; however, petrochemical industries, incinerators and breweries are located outside the city limits and could be the source of PAHs and PCBs found (Sauret et al., 2009).

Although two different species of conifers were considered in this study, the comparison of different species in terms of pollutant uptake does not seem to be significant. As shown by Piccardo et al., in 2005 and Ratola et al., in 2014, different

characteristics of conifers species such as lipid content, waxy layer, and available surface area could lead to accumulation of different pollutants (Piccardo et al., 2005; Ratola et al., 2014). Consequently, direct comparison is not useful, and the comparison of two different species could be only indicative because the uptake of pollutants in different pine needles species will be similar in both species within the same order of modification (van Drooge et al., 2014). The results obtained from the two conifers species validate each other because the pesticides PAHs, PCBs, and OCPs showed a similar tendency in variation for *P. nigra* and *C. atlantica*. A peak was observed in the second week of the analysis, and the pollutant concentration then decreased to complete disappearance in the last week of the analysis.

With regard to pollutant results, Fig. 7 shows that PAHs had the highest concentration. This result could be explained by the fact that the sampling area is located near a service station and a road where vehicle emissions are heavy. It is well known that road emissions and fuel burnings are the main sources of PAHs (Suman et al., 2016).

4.1 Meteorological effects on pollutants concentrations

As observed in our results, the concentration of the pesticides PAHs, PCBs, and OCPs varied over time, and the pollutant concentration reached its peak in the second week of analysis, which confirmed a high concentration of pollutants during this week. However, almost none of these pollutants were observed during the last two weeks of analysis.

To find a logical explanation for this variation, we analyzed the meteorological data of this period. The variations in meteorological conditions during the sampling period (April 09 - May 07, 2015) provided by Strasbourg Meteo are shown in Fig. 8. As shown in Fig. 8, the second week (April 09-16) of the sampling was the only week in which no precipitation was observed. In addition, the temperature was the highest and no wind was observed before the sampling. The first 2 weeks were characterized by a favorable weather where no important precipitations were observed and the wind was quiet with a speed of 11 km/h till the next sampling date. In contrast, the last 3 weeks (April 16 - May 07) of the study had heavy

rainfall, with a drop in temperatures accompanied by thunderstorms and winds (27 km h^{-1} during the last sampling). Indeed, meteorological changes were very normal occurrences during this time of year, which could be the reason for the decrease in and even the disappearance of pollutants at the end of the analysis period. In addition, the peak observed in the second week of the study is certainly due to pesticide pulverization during this time of the year. Most pesticides are pulverized at early spring, permitting an increase in the production yield.

The explanation of our findings could be found in the work of Kylin and Sjödin, who observed differences in accumulation behavior of HCHs and PP'-DDT (Kylin and Sjödin, 2003). They verified that seasonal fluctuations affect POPs accumulation levels in needles, which is because of the annual cycle of terpene content in the wax with winter minima (1%) and summer maxima (10%) (Kylin and Sjödin, 2003; Klánová et al., 2009). Furthermore, our results correlate with those provided by Sauret et al., in 2009, showing that the peak pesticide concentration was obtained during spring when the agricultural activities are the greatest, and this concentration then decreases to low levels in the following months (Sauret et al., 2009). Moreover, many studies show a strong relationship between meteorological variations and pollutant concentrations. In fact, it is well known that climatic conditions and air masses influence the atmospheric concentration of POPs (Lee and Jones, 1999; Louie and Sin, 2003). For example, Scheyer et al., in 2005, showed that the lowest concentration of OCPs in Strasbourg were detected in those samples that were collected during rain, especially when a thunderstorm with rainfall of 74 mm occurred during the sampling period (Scheyer et al., 2005); this can be widely compared to our work to validate the disappearance of pollutants during the last 2 weeks of our study in which thunderstorms were frequent. Moreover, OCPs are largely dependent on season fluctuations where the highest concentrations were obtained during dry seasons and the lowest values always appeared in the rainy season (Li et al., 2014); current-use pesticides (CUP) showed the highest concentration during spring and summer in Italy (Estellano et al., 2015).

For PCBs, our results also show that the total concentration of PCBs was the highest in the second week in which there was no precipitation.

These results contributed to the literature on the increase in the concentration of PCBs in the gas phase with increased temperature in which higher PCB concentrations were observed in warmer months (Simcik et al., 1999; Yeo et al., 2003; Manodori et al., 2006). It was also suggested that the increase in temperature could enhance the emissions of PCBs from primary and secondary

sources and lead to alterations in the rates of partitioning, volatilization, degradation and reaction (Lu et al., 2015). In addition, Dalla Valle et al. (2007) suggested that further increase in temperature could reduce PCB concentrations in the environment but enhance their potential for the long-range atmospheric transport (LRAT) from the Venice lagoon.

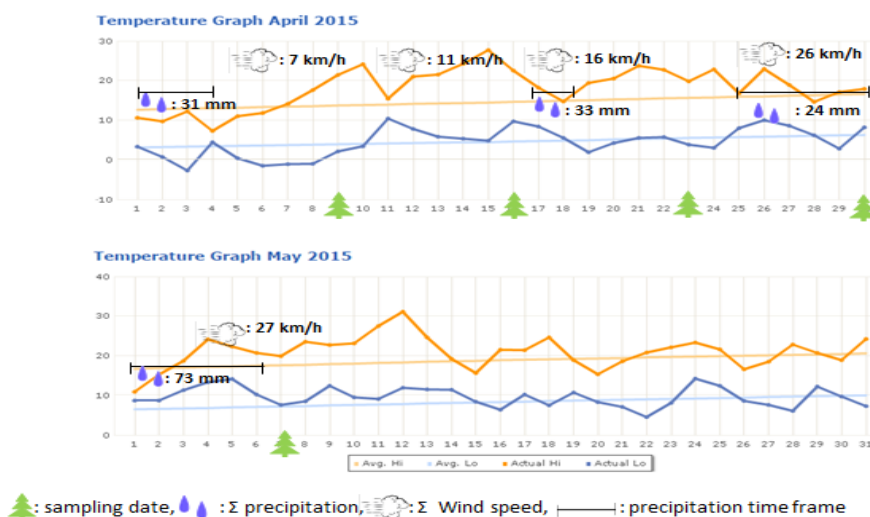


Fig. 8. Meteorological variations during the sampling period.

In contrast, many studies have shown an increase in the concentration of POPs with rain and temperature decrease because of the increase in combustion sources and decrease in the degradation of the pollutants by high temperature (Guazzoni et al., 2011; Chropeňová et al., 2016).

In this regard, it is assumed that the cause of our results was the young age (<1 year) of the chosen needles. In fact, these new needles have not accumulated pollutants yet through the years, and once accumulations began heavy and successive rains have occurred and have washed in an abundant way these young needles before storing pollutants. Therefore the gentle increase in temperature (the highest temperature could decompose POPs) leads to an increase in the gas phase concentration of POPs, which were picked up by the conifers needles that in turn were greatly washed before storing them with the help of their waxy property.

We also hypothesized that photolysis that may have occurred during the study could have played a role in the disappearance of the pollutants on the needles surface. In fact, Niu et al. showed that the waxy layer of the spruce needles may act as a

protein donor to accelerate the photolysis rate (Niu et al., 2003a, 2003b, 2004), leading to a decrease in the concentration of pollutants.

These latter observations about photolysis together with the needle age and meteorological variations could explain the disappearance of the pollutants at the end of the study.

5. Conclusion

In this study, two species of conifer were used as the efficient passive biomonitors. Our results suggest that these two species, *P. nigra* and *C. atlantica*, are the possible candidates for the biomonitoring of the pesticides PAHs, PCBs, and OCPs. In addition, the results obtained from the two species validate each other as the concentration of the pollutants tend to vary similarly.

Our findings confirm that meteorological variations play an important role on pollutant accumulation, especially in young needles in which no accumulation has occurred.

The total concentration of all analyzed pollutants was at its maximum in the second week of the

study in which no precipitation and a mild temperature characterized this period. As shown, PAHs were the major pollutants, which may be because of the emissions from road traffic.

More advanced studies of needles of different ages and standing over a longer period are planned to estimate yearly accumulation in needles and to validate our previous results on the effects of meteorological changes on pollutant accumulations by the coniferous needles.

Acknowledgements

We gratefully acknowledge AZM & SAADE association and the Lebanese University for funding the project, as well as Strasbourg University for the international mobility aid, without which the present study could not have been completed.

References

Abdel-Shafy, H.I., Mansour, M.S., 2016. A review on polycyclic aromatic hydrocarbons: source, environmental impact, effect on human health and remediation. *Egypt. J. Petroleum* 25, 107-123.

Al Dine, E.J., Mokbel, H., Elmoll, A., Massemin, S., Vuilleumier, S., Toufaily, J., Hanieh, T., Millet, M., 2015. Concomitant evaluation of atmospheric levels of polychlorinated biphenyls, organochlorine pesticides, and polycyclic aromatic hydrocarbons in Strasbourg (France) using pine needle passive samplers. *Environ. Sci. Pollut. Res.* 22, 17850-17859.

Alagić, S.Č., Jovanović, V.P.S., Mitić, V.D., Cvetković, J.S., Petrović, G.M., Stojanović, G.S., 2016. Bioaccumulation of HMW PAHs in the roots of wild blackberry from the Bor region (Serbia): Phytoremediation and biomonitoring aspects. *Science of The Total Environment* 562, 561-570.

Amigo, J.M., Ratola, N., Alves, A., 2011. Study of geographical trends of polycyclic aromatic hydrocarbons using pine needles. *Atmos. Environ.* 45, 5988-5996.

Barker, D.J., Eriksson, J.G., Forsén, T., Osmond, C., 2002. Fetal origins of adult disease: strength of effects and biological basis. *International journal of epidemiology* 31, 1235-1239.

Chamkasem, N., Lee, S., Harmon, T., 2016. Analysis of 19 PCB congeners in catfish tissue using a modified QuEChERS method with GCeMS/MS. *Food Chem.* 192, 900-906.

Chropeňová, M., Gregušková, E.K., Karásková, P., Příbylová, P., Kukučka, P., Baráková, D., Čupr, P., 2016. Pine needles and pollen grains of *Pinus mugo* Turra—A biomonitoring tool in high mountain habitats identifying environmental contamination. *Ecological Indicators* 66, 132-142.

Dalla Valle, M., Codato, E., Marcomini, A., 2007. Climate change influence on POPs distribution and fate: a case study. *Chemosphere* 67, 1287-1295.

Elabbas, L., Westerholm, E., Roos, R., Halldin, K., Korkalainen, M., Viluksela, M., Håkansson, H., Rose, M., Fernandes, A., 2013. Non-dioxin-like polychlorinated biphenyls (NDL-PCBs) in foods: exposure and health hazards. *Persist. Org. Pollut. Toxic Metals Foods* 215-260.

Elorduy, I., Elcoroaristizabal, S., Durana, N., García, J., Alonso, L., 2016. Diurnal variation of particle-bound PAHs in an urban area of Spain using TD-GC/MS: influence of meteorological parameters and emission sources. *Atmos. Environ.* 138, 87-98.

Estellano, V.H., Pozo, K., Efstathiou, C., Pozo, K., Corsolini, S., Focardi, S., 2015. Assessing levels and seasonal variations of current-use pesticides (CUPs) in the Tuscan atmosphere, Italy, using

polyurethane foam disks (PUF) passive air samplers. *Environ. Pollut.* 205, 52-59.

Farrar, N., Harner, T., Sweetman, A., Jones, K.C., 2005. Field calibration of rapidly equilibrating thin-film passive air samplers and their potential application for low-volume air sampling studies. *Environ. Sci. Technol.* 39, 261-267.

Gerdol, R., Bragazza, L., Marchesini, R., Medici, A., Pedrini, P., Benedetti, S., Bovolenta, A., Coppi, S., 2002. Use of moss (*Tortula muralis* Hedw.) for monitoring organic and inorganic air pollution in urban and rural sites in Northern Italy. *Atmos. Environ.* 36, 4069-4075.

Grimalt, J.O., Van Drooge, B.L., 2006. Polychlorinated biphenyls in mountain pine (*Pinus uncinata*) needles from Central Pyrenean high mountains (Catalonia, Spain). *Ecotoxicol. Environ. Saf.* 63, 61-67.

Guazzoni, N., Comolli, R., Mariani, L., Cola, G., Parolini, M., Binelli, A., Tremolada, P., 2011. Meteorological and pedological influence on the PCBs distribution in mountain soils. *Chemosphere* 83, 186-192.

Hazrati, S., Harrad, S., 2007. Calibration of polyurethane foam (PUF) disk passive air samplers for quantitative measurement of polychlorinated biphenyls (PCBs) and polybrominated diphenyl ethers (PBDEs): factors influencing sampling rates. *Chemosphere* 67, 448-455.

Hellström, A., Kylin, H., Strachan, W.M., Jensen, S., 2004. Distribution of some organochlorine compounds in pine needles from Central and Northern Europe. *Environmental Pollution* 128, 29-48.

Jit, S., Dadhwal, M., Kumari, H., Jindal, S., Kaur, J., Lata, P., Niharika, N., Lal, D., Garg, N., Gupta, S.K., 2011. Evaluation of hexachlorocyclohexane contamination from the last lindane production plant operating in India. *Environ. Sci. Pollut. Res.* 18, 586-597.

Kalinovic, T.S., Serbula, S.M., Radojevic, A.A., Kalinovic, J.V., Steharnik, M.M., Petrovic, J.V., 2016. Elder, linden and pine biomonitoring ability of pollution emitted from the copper smelter and the tailings ponds. *Geoderma* 262, 266-275.

Kamal, A., Malik, R.N., Martellini, T., Cincinelli, A., 2014. Cancer risk evaluation of brick kiln workers exposed to dust bound PAHs in Punjab province (Pakistan). *Sci. Total Environ.* 493, 562-570.

Klánová, J., Čupr, P., Baráková, D., Šeda, Z., Anděl, P., Holoubek, I., 2009. Can pine needles indicate trends in the air pollution levels at remote sites? *Environmental Pollution* 157, 3248-3254.

Kylin, H., Sjödin, A., 2003. Accumulation of airborne hexachlorocyclohexanes and DDT in pine needles. *Environmental science & technology* 37, 2350-2355.

Lee, R.G., Jones, K.C., 1999. The influence of meteorology and air masses on daily atmospheric PCB and PAH concentrations at a UK location. *Environ. Sci. Technol.* 33, 705-712.

Li, J., Dong, H., Xu, X., Han, B., Li, X., Zhu, C., Han, C., Liu, S., Yang, D., Xu, Q., 2016. Prediction of the bioaccumulation of PAHs in surface sediments of Bohai Sea, China and quantitative assessment of the related toxicity and health risk to humans. *Mar. Pollut. Bull.* 104, 92-100.

Li, Y., Niu, J., Shen, Z., Zhang, C., Wang, Z., He, T., 2014. Spatial and seasonal distribution of organochlorine pesticides in the sediments of the Yangtze Estuary. *Chemosphere* 114, 233-240.

Louie, P.K., Sin, D.W.-m., 2003. A preliminary investigation of persistent organic pollutants in ambient air in Hong Kong. *Chemosphere* 52, 1397-1403.

Lu, Q., Johnson, A.C., Jürgens, M.D., Sweetman, A., Jin, L., Whitehead, P., 2015. The distribution of polychlorinated biphenyls (PCBs) in the river Thames catchment under the scenarios of climate change. *Sci. Total Environ.* 533, 187-195.

Malmqvist, E., Liew, Z., Källén, K., Rignell-Hydbom, A., Rittner, R., Rylander, L., Ritz, B., 2017. Fetal growth and air pollution—A study on ultrasound and birth measures. *Environmental Research* 152, 73-80.

Manodori, L., Gambaro, A., Moret, I., Capodaglio, G., Cairns, W., Cescon, P., 2006. Seasonal evolution of gas-phase PCB concentrations in the Venice Lagoon area. *Chemosphere* 62, 449-458.

Niu, J., Chen, J., Henkelmann, B., Quan, X., Yang, F., Kettrup, A., Schramm, K.-W., 2003a. Photodegradation of PCDD/Fs adsorbed on spruce (*Picea abies* (L.) Karst.) needles under sunlight irradiation. *Chemosphere* 50, 1217-1225.

- Niu, J., Chen, J., Martens, D., Henkelmann, B., Quan, X., Yang, F., Seidlitz, H., Schramm, K.-W., 2004. The role of UV-B on the degradation of PCDD/Fs and PAHs sorbed on surfaces of spruce (*Picea abies* (L.) Karst.) needles. *Sci. Total Environ.* 322, 231-241.
- Niu, J., Chen, J., Martens, D., Quan, X., Yang, F., Kettrup, A., Schramm, K.-W., 2003b. Photolysis of polycyclic aromatic hydrocarbons adsorbed on spruce [*Picea abies* (L.) Karst.] needles under sunlight irradiation. *Environ. Pollut.* 123, 39-45.
- Piccardo, M.T., Pala, M., Bonaccorso, B., Stella, A., Redaelli, A., Paola, G., Valerio, F., 2005. *Pinus nigra* and *Pinus pinaster* needles as passive samplers of polycyclic aromatic hydrocarbons. *Environ. Pollut.* 133, 293-301.
- Pongpiachan, S., Choochuay, C., Hattayanone, M., Kositanont, C., 2013. Temporal and spatial distribution of particulate carcinogens and mutagens in Bangkok, Thailand. *Asian Pac. J. Cancer Prev.* 14, 1879-1887.
- Porta, M., Zumeta, E., 2002. Implementing the Stockholm treaty on persistent organic pollutants. *Occup. Environ. Med.* 59, 651-652.
- Ratola, N., Amigo, J.M., Alves, A., 2010. Levels and sources of PAHs in selected sites from Portugal: biomonitoring with *Pinus pinea* and *Pinus pinaster* needles. *Arch. Environ. Contam. Toxicol.* 58, 631-647.
- Ratola, N., Homem, V., Silva, J.A., Araújo, R., Amigo, J.M., Santos, L., Alves, A., 2014. Biomonitoring of pesticides by pine needles: chemical scoring, risk of exposure, levels and trends. *Sci. Total Environ.* 476, 114-124.
- Ratola, N., Lacorte, S., Alves, A., Barceló, D., 2006. Analysis of polycyclic aromatic hydrocarbons in pine needles by gas chromatography-mass spectrometry: comparison of different extraction and clean-up procedures. *Journal of Chromatography A* 1114, 198-204.
- Rodríguez, M.C., Dupont-Courtade, L., Oueslati, W., 2016. Air pollution and urban structure linkages: evidence from European cities. *Renew. Sustain. Energy Rev.* 53, 1-9.
- Romanič, S., Krauthacker, B., 2007. Are pine needles bioindicators of air pollution? Comparison of organochlorine compound levels in pine needles and ambient air. *Archives of Industrial Hygiene and Toxicology* 58, 195-199.
- Sarria-Villa, R., Ocampo-Duque, W., Páez, M., Schuhmacher, M., 2016. Presence of PAHs in water and sediments of the Colombian Cauca River during heavy rain episodes, and implications for risk assessment. *Science of the Total Environment* 540, 455-465.
- Sauret, N., Wortham, H., Strekowski, R., Herckes, P., Nieto, L.I., 2009. Comparison of annual dry and wet deposition fluxes of selected pesticides in Strasbourg, France. *Environ. Pollut.* 157, 303-312.
- Scheyer, A., Graeff, C., Morville, S., Mirabel, P., Millet, M., 2005. Analysis of some organochlorine pesticides in an urban atmosphere (Strasbourg, east of France). *Chemosphere* 58, 1517-1524.
- Schulz, H., Popp, P., Huhn, G., Stärk, H.-J., Schüürmann, G., 1999. Biomonitoring of airborne inorganic and organic pollutants by means of pine tree barks. I. Temporal and spatial variations. *Science of the Total Environment* 232, 49-58.
- Sharma, B.M., Bharat, G.K., Tayal, S., Nizzetto, L., Čupr, P., Larssen, T., 2014. Environment and human exposure to persistent organic pollutants (POPs) in India: A systematic review of recent and historical data. *Environment international* 66, 48-64.
- Silva, J.A., Ratola, N., Ramos, S., Homem, V., Santos, L., Alves, A., 2015. An analytical multi-residue approach for the determination of semi-volatile organic pollutants in pine needles. *Anal. Chim. Acta* 858, 24-31.
- Simcik, M.F., Basu, I., Sweet, C.W., Hites, R.A., 1999. Temperature dependence and temporal trends of polychlorinated biphenyl congeners in the Great Lakes atmosphere. *Environ. Sci. Technol.* 33, 1991-1995.
- St-Amand, A.D., Mayer, P.M., Blais, J.M., 2009. Modeling PAH uptake by vegetation from the air using field measurements. *Atmos. Environ.* 43, 4283-4288.
- Suman, S., Sinha, A., Tarafdar, A., 2016. Polycyclic aromatic hydrocarbons (PAHs) concentration levels, pattern, source identification and soil toxicity assessment in urban traffic soil of Dhanbad, India. *Sci. Total Environ.* 545, 353-360.
- Terzano, C., Di Stefano, F., Conti, V., Graziani, E., Petroianni, A., 2010. Air pollution ultrafine particles: toxicity beyond the lung. *Eur. Rev. Med. Pharmacol. Sci.* 14, 809-821.
- Tomashuk, T.A., Truong, T.M., Mantha, M., McGowin, A.E., 2012. Atmospheric polycyclic aromatic hydrocarbon profiles and sources in pine needles and particulate matter in Dayton, Ohio, USA. *Atmos. Environ.* 51, 196-202.
- Tuduri, L., Millet, M., Briand, O., Montury, M., 2012. Passive air sampling of semivolatile organic compounds. *TrAC Trends Anal. Chem.* 31, 38-49.
- van den Berg, H., 2009. Global status of DDT and its alternatives for use in vector control to prevent disease. *Environ. Health Perspect.* 117, 1656.
- van Drooge, B.L., Garriga, G., Grimalt, J.O., 2014. Polycyclic aromatic hydrocarbons in pine needles (*Pinus halepensis*) along a spatial gradient between a traffic intensive urban area (Barcelona) and a nearby natural park. *Atmos. Pollut. Res.* 5, 398-403.
- Wang, J., Tuduri, L., Mercury, M., Millet, M., Briand, O., Montury, M., 2009. Sampling atmospheric pesticides with SPME: laboratory developments and field study. *Environ. Pollut.* 157, 365-370.
- WHO, 2014. Ambient (Outdoor) Air Quality and Health. WHO Media Center, Fact Sheet 313. World Health Organization. March 2014.
- Wing, J.J., Adar, S.D., Sánchez, B.N., Morgenstern, L.B., Smith, M.A., Lisabeth, L.D., 2017. Short-term exposures to ambient air pollution and risk of recurrent ischemic stroke. *Environmental Research* 152, 304-307.
- Xu, X., Dailey, A.B., Talbott, E.O., Ilacqua, V.A., Kearney, G., Asal, N.R., 2010. Associations of serum concentrations of organochlorine pesticides with breast cancer and prostate cancer in US adults. *Environ. Health Perspect.* 60-66.
- Yeo, H.-G., Choi, M., Chun, M.-Y., Sunwoo, Y., 2003. Concentration distribution of polychlorinated biphenyls and organochlorine pesticides and their relationship with temperature in rural air of Korea. *Atmos. Environ.* 37, 3831-3839.
- Zheng, S., Chen, B., Qiu, X., Chen, M., Ma, Z., Yu, X., 2016. Distribution and risk assessment of 82 pesticides in Jiulong River and estuary in South China. *Chemosphere* 144, 1177-1192.

Supplementary data:

Table 1S: Total, range, and mean concentration (ng g⁻¹) of non-volatile pesticides for 5 weeks

Compound	Week 1		Week 2		Week 3		Week 4		Week 5	
	Pine needles	Cedar needles	Pine needles	Cedar needles	Pine needles	Cedar needles	Pine needles	Cedar needles	Pine needles	Cedar needles
Nicosulfuron	< LQ	0.0244	0.2185	3.1937	< LQ	< LQ	0	0	0	0
Spinosade A	0.0002	0.0002	0.1721	0.0528	0.0004	0.0002	< LQ	< LQ	0	0
Penconazole	< LQ	< LQ	0.1461	0.1069	0.15	< LQ	< LQ	< LQ	0	0
Triflusulfuron methyl	0.0123	< LQ	0.1583	1.127	0.0689	0.0197	< LQ	< LQ	0	0
Pyra-clostrobin	< LQ	< LQ	1.303	0.65	0.1606	0.2018	0.03526	< LQ	0	0
∑ Pesticides (range)	0.0002-0.012	0.0002-0.025	0.15-1.303	0.05-3.2	0.0004-0.1606	0.0002-0.2018	0-0.035	0-<LQ	0	0
∑ Pesticides (total)	0.0125	0.0246	1.998	5.1304	0.3799	0.2217	0.03526	LQ	0	0
∑ Pesticides (Median)	0.0061	0.0126	0.7265	1.625	0.0805	0.101	0.0175	LQ/2	0	0
∑ Pesticides per week (total)	0.0371		7.1284		0.6016		0.03526		0	
∑ Pesticides per week (Median)	0.0242		0.905		0.487		0.009		0	

Table 2S: Total, range, and mean concentration (ng g⁻¹) of OCPs for 5 weeks

Compound	Week 1		Week 2		Week 3		Week 4		Week 5	
	Pine needles	Cedar needles	Pine needles	Cedar needles	Pine needles	Cedar needles	Pine needles	Cedar needles	Pine needles	cedar needles
o,p'-DDD	0	0	0.2801	0	0	0	0	0	0	0
p,p'-DDD	0	0	0.5539	0.2611	0	0.08	0	0	0	0
p,p'-DDE	0.0635	0.0113	0.09105	0.0549	0.0254	0.0162	0	0	0	0
Hexachloro-benzene	0	0	0.0562	0.0511	0.0102	0.0085	0	0	0	0
∑ OCPs (range)	0-0.064	0-0.011	0.056-0.554	0-0.261	0-0.025	0-0.08	0	0	0	0
∑ OCPs (total)	0.0635	0.0113	0.98125	0.3671	0.0356	0.1047	0	0	0	0
∑ OCPs (Median)	0.032	0.0055	0.305	0.1305	0.013	0.04	0	0	0	0
∑ OCPs per week (total)	0.0748		1.34835		0.1403		0		0	
∑ OCPs per week (Median)	0.01875		0.21775		0.0265		0		0	

Table 3S: Total, range, and mean concentration (ng g⁻¹) of PCBs for 5 weeks

Compound	Week 1		Week 2		Week 3		Week 4		Week 5	
	Pine needles	Cedar needles	Pine needles	Cedar needles	Pine needles	Cedar needles	Pine needles	Cedar needles	Pine needles	Cedar needles
PCB 18	0.0239	0.0151	0.1918	0.5572	0	0.0233	0	0	0	0
PCB 31	0	0.6099	0.4112	1.0982	0	0.61	0	0	0	0
PCB 123	0	0	0.0623	0.05	0.0523	0.0439	0	0	0	0
PCB 118	0.0505	0	0.1318	0.022	0	0.009	0	0	0	0
PCB 149	0.017	0	0.03	0.0073	0	< LQ	0	0	0	0
PCB 138	0.545	0.322	1.5115	0.44	0	0.2093	0	0	0	0
PCB 156	0	0	0.0168	0.0186	0	0.02	0	0	0	0
∑ PCBs (range)	0-0.05	0-0.061	0.03-1.51	0.01-1.09	0-0.05	<LQ-0.04	0	0	0	0
∑ PCBs (total)	0.6364	0.947	2.3554	2.1933	0.0523	0.9155	0	0	0	0
∑ PCBs (Median)	0.025	0.0305	0.77	0.55	0.025	0.022	0	0	0	0
∑ PCBs per week (total)	1.5834		4.5487		0.9678		0		0	
∑ PCBs per week (Median)	0.02775		0.66		0.024		0		0	

Table 4S: Total, range, and mean concentration (ng g⁻¹) of PAHs for 5 weeks

Compound	Week 1		Week 2		Week 3		Week 4		Week 5	
	Pine needles	Cedar needles	Pine needles	Cedar needles	Pine needles	Cedar needles	Pine needles	Cedar needles	Pine needles	Cedar needles
Naphtalene	5.573	6.5311	7.521	7.5588	5.829	6.2019	0	0	0	0
Phenanthrene	0.2631	0.752	0.8363	2.6916	0.73	0.8013	0	0	0	0
Anthracene	0.0051	< LQ	0.1165	0.4885	0.0519	< LQ	0	0	0	0
Benzo(b) fluoranthrene	0.2699	0	2.3033	0.16	0.2474	0.143	0	0	0	0
Benzo (k) fluoranthrene	0	< LQ	1.932	0.1678	0	0.1301	0	0	0	0
Indenol(1,2,3)pyrene	0	< LQ	5.1281	< LQ	0	0	0	0	0	0
Benzo(g,h,i) perylene	0	< LQ	6.1935	< LQ	0	0	0	0	0	0
Dibenzo(a,h) anthracene	0.423	< LQ	0.5491	0.21865	0.2789	0.1526	0	0	0	0
∑ PAHs (range)	0-5.573	0-6.5311	0.116-7.52	< LQ-7.5588	0-5.829	< LQ-6.2019	0	0	0	0
∑ PAHs (total)	6.5341	7.2831	24.5798	11.2854	6.8583	7.4289	0	0	0	0

Σ PAHs (Median)	2.7865	3.2655	3.818	3.8	2.914	3.2	0	0	0	0
Σ PAHs per week (total)	13.8172		35.8652		14.2872		0		0	
Σ PAHs per week (Median)	3.025		3.81		3.05		0		0	

IV. Développement d'une méthode d'extraction multi-résidus basée sur QuEChERS-SPME pour l'analyse simultanée de 90 pesticides, 16 HAPs et 22 PCBs dans du miel.

Ce résultat, présenté sous forme d'un article publié dans « *Analytical and Bioanalytical Chemistry* », contribue au développement d'une méthode multi résidus pour l'analyse de pesticides, de HAPs et de PCBs à partir du miel. Cette matrice permet dans nos travaux ultérieurs l'évaluation de la qualité de l'air dans 4 zones rurales au Liban Nord grâce à une approche basée sur le biomonitoring.

Dans cette étude, une méthode analytique optimisée a été mise au point pour le criblage simultané de 90 pesticides, 16 HAPs et 22 PCBs. La méthode a été basée sur l'extraction QuEChERS en utilisant de l'acétonitrile (ACN) suivie d'un nettoyage par d-SPE en utilisant du PSA et du C₁₈. Les instruments analytiques utilisés comprenaient la LC-MS/MS et la GC-MS/MS. Cette dernière a été précédée d'une étape de pré-concentration utilisant la SPME avec des fibres appropriées. La combinaison des deux étapes d'extraction assure une purification efficace des extraits. L'utilisation des deux instruments analytiques a permis d'analyser le grand nombre de polluants souhaités avec un taux de fiabilité élevé.

La méthode développée a été validée pour la linéarité qui a été étudiée en utilisant des courbes d'étalonnage adaptées à la matrice dans une gamme de concentration entre 10 et 3000 ng g⁻¹. Le coefficient de corrélation (R²) obtenu était supérieur à 0,98 pour la plupart des composés cibles avec un écart type relatif (RSD) inférieur à 20% pour la répétabilité et la reproductibilité. Les limites de détections (LOD) et de quantifications (LOQ) étaient respectivement inférieures à 20 et 60 ng g⁻¹ pour les composés analysés. Enfin, la méthode a été testée pour son efficacité sur des échantillons réels par l'analyse de 3 échantillons de miel collectés dans lesquels 7 pesticides et 9 HAPs ont été déterminés.

En conclusion, ce travail présente une méthode efficace permettant l'extraction d'un grand nombre de polluants de différents types avec le même protocole d'extraction. De ce fait, la combinaison d'une méthode d'extraction simple comme QuEChERS avec un procédé SPME couplé aux techniques d'analyse chromatographique LC-MS/MS et GC-MS/MS a permis la quantification des contaminants dans le miel à des concentrations inférieures à 10 ng g⁻¹. En outre, le principal avantage de la méthode développée est son caractère respectueux de l'environnement n'exigeant qu'une faible quantité de solvants organiques.

A multi-residue method for the analysis of 90 pesticides, 16 PAHs and 22 PCBs in honey using QuEChERS-SPME

Josephine AL-ALAM^{1,2}, Asma CHBANI^{1,4}, Ziad FAJLOUN^{1,3}, Maurice MILLET^{2*}

¹Azm Center for Research in Biotechnology and its Applications, Doctoral School of Science and Technology, Lebanese University, El Mittein Street, Tripoli, Lebanon

²Institute of Chemistry and Processes for Energy, Environment and Health ICPEES UMR 7515 Group of Physical Chemistry of the Atmosphere, University of Strasbourg, Strasbourg, France

³Faculty of Sciences III, department of biology, Lebanese University, Tripoli, Lebanon

⁴Faculty of Public Health III, Lebanese University, Tripoli, Lebanon

*Address correspondence to Maurice Millet, Institute of Chemistry and Processes for Energy, Environment and Health ICPEES UMR 7515 Group of Physical Chemistry of the Atmosphere, University of Strasbourg, Strasbourg, France Tel.: + 33 (0)3 68 85 04 22, Fax: + 33 (0)3 68 85 04 02, E-mail: mmillet@unistra.fr

Received: 24 March 2017 /Revised: 21 May 2017 /Accepted: 9 June 2017

Abstract

An optimized analytical method was developed for the simultaneous analysis of 90 pesticides, 16 polycyclic aromatic hydrocarbons, and 22 polychlorinated biphenyls. The method was based on quick, easy, cheap, effective, rugged, and safe (QuEChERS) extraction using acetonitrile followed by a dispersive solid-phase extraction cleanup using primary– secondary amine and octadecyl (C₁₈). The extract obtained was concentrated by evaporation and then reconstituted with acetonitrile to prepare it for chromatographic analysis by liquid chromatography–triple-quadrupole tandem mass spectrometry and gas chromatography–ion-trap tandem mass spectrometry, which was preceded by a preconcentration step using solid-phase microextraction with appropriate fibers. The combination of the two extraction steps ensured efficient extract cleanup. The use of the two analytical instruments allowed the analysis of a large number of pollutants with a high reliability rate. The method developed was validated for linearity, which was studied with use of matrix-matched calibration curves in the concentration range between 10 and 3000 ng g⁻¹. The correlation coefficient (R²) obtained was higher than 0.98 for most of the target compounds, with a relative standard deviation lower than 20% for repeatability and reproducibility. The limits of detection and quantification were lower than 20 and 60 ng g⁻¹ respectively for the compounds analyzed, and the recoveries were between 60% and 103% for most compounds. Finally, the method was tested for its efficiency on real samples by the analysis of three honey samples in which seven pesticides and nine polycyclic aromatic hydrocarbons were determined.

Keywords: Honey, QuEChERS, SPME, multi-residue, pesticides, PAHs, PCBs, OCPs.

Introduction

Honey is one of the most used products of the hive, being one of the most traditional and popular nutrients used throughout the world in massive quantities. However, in recent years, contamination of this product has become a public health issue because of the increase in the levels of chemicals in bee products [1]. Chemical contamination of honey depends mainly on bee physiology and sampling localization, on postharvesting treatment, and on the origin and the type of nectar flora and the variation of climatic conditions [2]. During their foraging activities, bees are often exposed to various contaminants found in all environmental compartments, and can therefore transfer this contamination to the product finally consumed by humans [3, 4]. Thus honey can be contaminated by toxins, pollutants, and other contaminants during its processing and arising from environmental, agricultural, and beekeeping practices.

Therefore contamination of honey can occur in a direct way (i.e., contaminants coming from beekeeping) or in an indirect way (i.e., contaminants from agricultural practices and, in general, from the environment) [5]. Among the different hazardous pollutants to which honey could be exposed, pesticides, polycyclic aromatic hydrocarbons (PAHs), and polychlorinated biphenyls (PCBs) are of great concern because of their global presence.

Pesticides are widely used in agriculture to improve crop production by controlling various pests, diseases, and weeds [6]. However, the inappropriate use of these compounds, especially those belonging to organochlorine pesticides (OCPs), may endanger human health [7]. OCPs often accumulate in the environment, having several adverse effects on humans, such as nervous alterations, cancer development, and endocrine dysfunction [8], and on the environment, such as high toxicity risks for wildlife and high environmental persistence [9, 10].

In addition to pesticides, PAHs and PCBs are among the hazardous atmospheric organic pollutants of special concern because of their high environmental persistence [11, 12]. PAHs are produced as by-products of incomplete combustion, volcanic eruption, forest fires, and

vehicle emissions [13, 14]. However, PCBs, despite the long worldwide ban on their use, are always found in traces because of their high persistence; these products were used as coolants and lubricants in transformers, capacitors, and other electrical equipment [15].

To survey honey contamination, several extraction and cleanup techniques have been used, such as solid-phase extraction [16], liquid–liquid extraction [17], supercritical fluid extraction [18], matrix solid phase dispersion [19], and accelerated solvent extraction [20]. To overcome all critical flaws and practical limitations of these extraction procedures, such as the long time needed and high solvent consumption, in 2003 Anastassiades et al. [21] developed a quick, easy, cheap, effective, rugged, and safe (QuEChERS) method for the analysis of multiresidue pesticides in food. This technique consists of a soft extraction with acetonitrile (ACN) followed by an optional cleanup step using dispersive solid-phase extraction [22].

Moreover, the honey sample pretreatment and extraction technique should be effective in sample cleanup, easy, and rapid, with low operational cost. Additionally, a preconcentration step is mandatory in these circumstances to facilitate the trace analysis of these compounds. Because honey is a sugar-rich matrix with relatively high solubility in water, typical pretreatment protocols include extraction of the pollutants from an aqueous solution of honey to a phase that is compatible with the analytical technique, hence the use of solid-phase microextraction (SPME) as a preconcentration step [23].

SPME is an extraction and preconcentration technique developed by Pawliszyn in 1989 [24]. This extraction procedure consists in the positioning of the extraction phase on a solid support where it will be in contact with the sample, followed by a coupling to chromatographic instruments for desorption and analysis [25, 26]. Liquid chromatography (LC)–tandem mass spectrometry (MS/MS) and gas chromatography (GC) – MS/MS are the analytical techniques most commonly used for multiresidue analysis of organic pollutants from several food matrices, especially honey [27].

For all these reasons, the aim of this study was to develop a simple, fast, sensitive, and reliable analytical method for trace analysis of a large number of environmental contaminants in honey. Ninety pesticides, 16 PAHs, and 22 PCBs were chosen to cover a wide number of potential organic contaminants in honey, previously shown to be an efficient matrix for environmental biomonitoring [28]. The extraction procedure was based on QuEChERS multiresidue extraction followed by a preconcentration step by SPME. The two chromatographic techniques, coupled with use of a tandem mass spectrometer were used to analyze this wide range of pollutants, never assessed before in a single extraction and differing in their physicochemical properties.

Materials and methods

Chemical reagents and standard solutions

Pesticide analysis included 30 nonvolatile compounds analyzed by LC–MS/MS and 60 semi volatile compounds, including 20 OCPs, analyzed by GC–MS/MS. All pesticides analyzed except the OCPs were purchased from Sigma-Aldrich (L'Isle d'Abeau, France) with purity higher than 97%.

For LC–MS/MS pesticide analysis, the 30 pesticides analyzed were pymetrozine, carbendazim, chloridazon, acetamiprid, nicosulfuron, thiacloprid, chlortoluron, carbetamide, terbutryn, spinosad A, isoprotruron, diuron, metalaxyl-M, spinosad D, dimethenamid-P, penconazole, isoxadifen, tebuconazole, diflubenzuron, epoxiconazole, prothioconazole, propiconazole, chlorfenvinphos, triflusulfuron-methyl, pendimethalin, cyazofamid, pyraclostrobin, diflufenican, flufenoxuron, and lufenuron.

A mixture of these standards at 1 g L^{-1} was prepared in ACN.

For GC–MS/MS pesticide analysis, the 40 pesticides analyzed (except OCPs) were captan, tebutam, fenpropidin, buprofezin, trifloxystrobin, propachlor, fenpropimorph, propargite, fenarimol, boscalid,alachlor, ethofumesate, (S)-metolachlor, tebufenpyrad, propyzamide, myclobutanil, bifenthrin, fenpropathrin, lindane, isodrine, aclonifen, clomazone, 2-methyl-4-chlorophenoxyacetic acid, chloridazon, cyprodinil, mecoprop-P, flusilazole,

oxyfluorfen, Irgarol, oxadiazon, oropiconazole, trifluralin, chlorothalonil, procymidone, Chlorpyrifos, bromoxynil, diclofop-methyl, bifenox, ioxynil, bupirimate, and Mepanipyrim. A mixture of these standards at 1 g L^{-1} was prepared in ACN.

For OCP analysis, a mixture at 0.1 g L^{-1} of 20 OCPs including α -hexachlorocyclohexane, γ -hexachlorocyclohexane, β -hexachlorocyclohexane, δ -hexachlorocyclohexane, heptachlor epoxide A, metoxychlor, o,p'-DDD, o,p'-DDT, p,p'-DDD, p,p'-DDT, α -endosulfan, o,p'-DDE, p,p'-DDE, aldrin, heptachlor, dieldrin, hexachlorobenzene, heptachlor epoxide B, trans-chlordane, and cis-chlordane was purchased from Cluzeau Info Labo (Sainte-Foy-la-Grande, France).

For PAH analysis, a mixture at 0.1 g L^{-1} of 16 PAHs including naphthalene, acenaphthene, fluorene, phenanthrene, anthracene, fluoranthrene, pyrene, benzo[a]anthracene, chrysene, benzo[b]fluoranthene, benzo[k]fluoranthene, benzo[e]-pyrene, benzo[a]pyrene, indeno [1,3] pyrene, benzo[g,h,i]-perylene, and dibenzo[a,h]anthracene was prepared from individual standards purchased from Sigma-Aldrich (L'Isle d'Abeau, France).

For PCB analysis, a mixture at 0.1 g L^{-1} of 22 PCBs including PCB 18, PCB 31, PCB 28, PCB 52, PCB 44, PCB 70, PCB 81, PCB 101, PCB 123, PCB 118, PCB 114, PCB 105, PCB 126, PCB 149, PCB 153, PCB 138, PCB 167, PCB 156, PCB 157, PCB 169, PCB 180, and PCB 189 was purchased from Cluzeau Info Labo (Sainte-Foy-la-Grande, France).

All prepared solutions were stored at $-18 \text{ }^\circ\text{C}$.

Four internal standards for LC–MS/MS were obtained from CDN Isotopes (Quebec, Canada): carbendazim- d_4 (99.3%), diuron- d_6 (99.8%), pendimethalin- d_5 (99%), and nicosulfuron- d_6 (99%). A standard solution of each compound at 0.05 g L^{-1} in ACN was prepared, and a mixture of them at 0.01 g L^{-1} in ACN was prepared and stored at $-18 \text{ }^\circ\text{C}$ for use as the internal standard solution.

The internal standards for GC–MS/MS were trifluralin- d_{14} , 4-nitrophenol- d_4 and naphthalene- d_8 (99%), and they were purchased from Sigma Aldrich (L'Isle d'Abeau, France), and Cluzeau Info Labo (Sainte-Foy-la-Grande, France) respectively.

A mixture of trifluralin- d_{14} and 4-nitrophenol- d_4 at 0.01 g L^{-1} in ACN was used as the internal

standard solution for analysis of pesticides except OCPs, whereas a solution of naphthalene-d8 at 0.01 g L⁻¹ in ACN was used as the internal standard solution for analysis of OCPs, PAHs, and PCBs.

LC-MS/MS-grade ACN, LC-MS/MS-grade water, formic acid, and LC-grade ACN were purchased from Sigma-Aldrich (L'Isle d'Abeau, France). The ultrapure water used was purified by a system from ELGA LabWater (Antony, France). Kits for QuEChERS sample preparations were purchased as ready to use from Restek France. Buffered extraction kits (EN 1566 method) containing 4 g MgSO₄, 1 g NaCl, 1 g trisodium citrate dihydrate, and 0.5 g disodium hydrogencitrate sesquihydrate were used. For cleanup, sample cleanup kits (AOAC 2007 method) containing 1.2 g MgSO₄, 400 mg primary-secondary amine (PSA), and 400 mg C₁₈ were used.

Sample collection

Blank honey matrix samples (miel de fleur equitable) were purchased from a local market and were checked for no contamination. Extracts of blank honey samples were prepared with the same extraction procedure reported later. Chromatographic analysis of the extracts obtained showed a total absence of all the sought compounds.

Other samples were collected during the beekeeping season between September and October 2015. They were collected from three apiaries in the Cedars region of northern Lebanon (34°14'39"N, 36°02'27"E, altitude about 1900 m). This region is mostly known for its safe agriculture, where no or small amounts of chemicals are used.

Samples were collected in propylene tubes and then transferred freshly to the laboratory, where they were stored at -20 °C until analysis.

Sample preparation

Five grams of organic honey (honey samples obtained without any external contamination with organic compounds and which was proven by chromatographic analysis) was added to a 50-mL centrifuge tube and then fortified with all mixture solutions to prepare a calibration range with a concentration ranging from 10 to 3000 ng g⁻¹.

Fortified samples were kept at 4 °C overnight, and then underwent the extraction procedure described next.

QuEChERS extraction

First, to the 5 g of fortified honey, 10 mL of ultrapure water was added. The tube was then shaken to dissolve the honey. When the mixture was homogeneous, 10 mL of ACN was added and the tube was reshaken. QuEChERS citrate buffered extraction salts were then added, and the tube was immediately hand shaken, vortexed for 1 min, and then centrifuged for 10 min at 5000 rpm. Afterward, the supernatant was added to the 15-mL PSA tube. Then, this tube was immediately hand shaken, vortexed for 30 s, and centrifuged for 10 min at 5000 rpm. Finally, the extract obtained was transferred to a 10-mL glass tube, and then evaporated to 100 µL.

Extract reconstitution

Once evaporated, the extracts were reconstituted with ACN to 1 mL to prepare them for chromatographic analysis.

Next, 100 µL of the final extract was transferred to an LC vial, where 10 µL of the appropriate internal standard solution was added, and then the extract was analyzed by LC-MS/MS.

The remaining 900 µL was diluted to 20 mL with salted water (1.5% NaCl) to promote adsorption on the SPME fiber, and then 10 µL of both appropriate GC internal standard solutions was added before this cleanup and extraction.

SPME extraction and concentration

Two SPME fibers associated to two GC-MS/MS were used: the first was coated with polyacrylate (PA) (65 µm) and was used for the extraction of semivolatile pesticides except OCPs, whereas the second was coated with polydimethylsiloxane (PDMS) (100 µm) and was used for the extraction of OCPs, PCBs, and PAHs. These fibers were soaked in 20 mL of the aqueous solution and were heated at 60 °C under agitation for 40 min and at 80 °C for 40 min for the PA and PDMS fibers respectively.

SPME was done by direct immersion. After extraction, the SPME fiber was transferred to the gas chromatograph injection port, where

desorption of the analyte occurs and analysis is performed.

Sample analysis

Final extracts were analyzed by LC–MS/MS for the 30 nonvolatile pesticides and GC–MS/MS for the 60 semivolatile pesticides, the 22 PCBs, and the 16 PAHs.

LC–MS/MS

The system used was an LC system (Thermo Scientific) coupled to an MS/MS system (TSQ Quantum Access MAX) operating in electrospray ionization mode. The chromatographic separation was performed on a Macherey-Nägel Nucleodur C₁₈ pyramid column (150 mm × 3 mm; 3 μm) thermostated at 25 °C. The chromatographic system was equipped with an autosampler (Accela autosampler) and a Surveyor LC Pump Plus (Thermo Scientific). The flow rate was 300 μL min⁻¹. Samples were analyzed with a mobile phase of ACN and water (0.05% formic acid). The gradient started with 30:70 (v/v) ACN–water for 5 min, followed by 50:50 (v/v) ACN–water for 6 min, then 80:20 (v/v) ACN–water for 7 min, 95:5 (v/v) ACN–water for 10 min, and finally 30:70 (v/v) ACN–water for 8 min to stabilize the column for any new injection. The injection volume was 20 μL.

LC–MS/MS identification was done regarding the retention time and the ion ratios obtained.

Precursor ions and product ions selected for confirmation as well as retention times and ion ratios are listed in Table 1.

GC–MS/MS

For analysis of OCPs, PAHs, and PCBs, a Thermo Scientific Trace 1300 gas chromatograph coupled to a mass spectrometry system (ITQ 900) was used, and injection was done in splitless mode (5 min) at 280 °C.

Injection of the sample was done by thermal desorption of the PDMS SPME fiber, and chromatographic separations were performed on an Optima XLB capillary column (60 m × 0.25-mm internal diameter, 0.25-μm film thickness).

Helium was used as the carrier gas at a flow rate of 1 mL min⁻¹. The initial oven temperature was set at 50 °C for 3 min, followed by a linear ramp to 240 °C at a rate of 40 °C min⁻¹. Afterward, the temperature was raised to 255 °C at a rate of 1.5 °C min⁻¹, held for 5 min, followed by a ramp to 330 °C at a rate 20 °C min⁻¹, where it was maintained for 25 min, leading to a total run time of 51.5 min.

The precursor ion, product ions, collision energy, and retention time of the OCPs, PAHs, and PCBs are listed in Table 2.

For pesticide analysis, a Thermo Scientific Trace gas chromatograph coupled to a mass spectrometry system (ITQ 700) was used, and injection was done in splitless mode (5 min) at 250 °C.

Injection of the sample was done by thermal desorption of the PA SPME fiber, and pesticide chromatographic separations were performed on a TR 50MS (50% phenyl–50% methylsiloxane) semipolar capillary column (60 m × 0.25- mm internal diameter, 0.25-μm

Table 1: Liquid chromatography (LC)–tandem mass spectrometry (MS/MS) method parameters

Pesticide	t _R , min	Precursor ion	Product ion	MRM ratio (± 20%)
Pymetrozine	1.80	218	Q1:105	2.5
		218	Q2:79	
Carbendazim	1.85	192	Q1:160	1.2
		192	Q2:132	
Chloridazone	5.14	222	Q1:104	0.9
		222	Q2:77	
Acetamiprid	6.10	223	Q1:99	0.3
		223	Q2:126	
Thiacloprid	8.25	253	Q1:126	6.65
		253	Q2:99	
Nicosulfuron	7.70	411	Q1:181	2
		411	Q2:212	
Chlortoluron	11.10	213	Q1:72	6.1
		213	Q2:140	

Carbetamide	8.20	237	Q1:192	4.5
		237	Q2:120	
Terbutryn	10.05	242	Q1:186	40.5
		242	Q2:68	
Spinosade A	10.50	732	Q1:142	12.4
		732	Q2:98	
Isoproturon	11.70	207	Q1:72	3.55
		207	Q2:46	
Diuron	12.05	233	Q1:72	8.5
		233	Q2:46	
Metalaxyl-M	11.40	280	Q1:220	1.3
		280	Q2:192	
Spinosade D	11.15	746	Q1:141	2.25
		746	Q2:98	
Dimethenanid-p	14.35	276	Q1:244	3.1
		276	Q2:168	
Penconazole	15.47	284	Q1:159	1.55
		284	Q2:70	
Isoxadifen	16.62	296	Q1:232	1.4
		296	Q2:204	
Tebuconazole	15.77	308	Q1:70	4.45
		308	Q2:125	
Diflubenzuron	15.50	311	Q1:157	1.25
		311	Q2:140	
Epoxyconazole	14.44	330	Q1:221	25.75
		330	Q2:119	
Propiconazole	15.89	342	Q1:159	5.6
		342	Q2:123	
Prothioconazole	15.75	344	Q1:326	1.55
		344	Q2:153	
Chlorfenvinphos	16.17	359	Q1:170	1.5
		359	Q2:99	
Triflusalufuron methyl	14.75	493	Q1:263	5.4
		493	Q2:96	
Pendimethalin	20.50	282	Q1:211	11.2
		282	Q2:193	
Cyazofamid	16.60	325	Q1: 225	1.75
		325	Q2: 224	
Pyraclostrobin	17.26	388	Q1:194	1.45
		388	Q2:163	
Diflufenican	18.01	395	Q1:266	5.0
		395	Q2:246	
Flufenoxuron	19.70	489	Q1:157	1.2
		489	Q2:141	
Lufenuron	19.00	511	Q1:157	1.8
		511	Q2:141	

Table 2: Gas chromatography (GC)–MS/MS method parameters for organochlorine pesticides (OCPs), polycyclic aromatic hydrocarbons (PAHs), and polychlorinated biphenyls (PCBs)

Compound	Precursor ion	Product ions	Collision energy (ev)	t _R (min)
OCPs				
α-HCH	183	147/148	1.30	12.42
γ-HCH	183	147/148	1.40	13.02
β-HCH	183	147/148	0.77	13.49
δ-HCH	183	147/148	0.77	14.14
Heptachlore epoxyde A	183	155/119	0.90	16.76
Metoxychlore	227	169/181	1.12	25.46

	o.p'-DDD	235	199/165	1.40	18.90
	o.p'-DDT	235	199/165	1.50	20.45
	p.p'-DDD	235	165/163	1.50	21.10
	p.p'-DDT	235	165/199	1.50	2.298
	α-endosulfan	241	206/204	1.60	1.810
	o.p'-DDE	246	176/150	1.90	17.06
	p.p'-DDE	246	176/150	1.90	18.93
	Aldrine	263	193/191	1.80	15.20
	Heptachlore	272	237/235	0.78	14.35
	Dieldrine	279	243/241	1.60	19.20
	Hexachlorobenzene	284	249/214	1.26	12.57
	Heptachlore epoxyde B	353	263/317	0.96	16.56
	Transchlordane	373	266/264	1.00	17.70
	Cischlordane	373	266/264	0.98	17.89
PAHs	Naphtalene	128	102/126	1.20	9.38
	Acenaphtene	153	150/151	1.30	10.96
	Fluorene	165	163/139	1.20	11.62
	Phenanthrene	178	152/176	1.20	13.41
	Anthracene	178	152/176	1.20	13.57
	Fluoranthrene	202	200	1.30	17.53
	Pyrene	202	200	1.20	18.70
	Benzo(a)anthracene	228	226/202	1.20	26.01
	Chrysene	228	226/202	1.20	26.18
	Benzo(b)fluoranthrene	252	250/226	1.30	29.95
	Benzo(k)fluoranthrene	252	250/226	1.30	30.02
	Benzo(e)pyrene	252	250/226	1.30	30.99
	Benzo(a)pyrene	252	250/226	1.30	31.21
	Indenol(1.2.3)pyrene	276	274	1.40	35.27
	Benzo(g,h,i)perylene	276	274	1.40	36.50
	Dibenzo(a,h)anthracene	278	276	1.50	35.17
PCBs	PCB 18	256	186/221	1.20	12.89
	PCB 31	256	186/151	1.20	13.98
	PCB 28	256	186/151	1.20	14.06
	PCB 52	292	222/220	1.20	14.67
	PCB 44	292	222/220	1.20	15.24
	PCB 70	292	222/220	1.30	16.64
	PCB 81	292	222/220	1.30	19.10
	PCB 101	326	256/254	1.20	17.36
	PCB 123	326	256/254	1.30	20.24
	PCB 118	326	256/254	1.30	20.50
	PCB 114	326	256/254	1.30	21.15
	PCB 105	326	256/254	1.40	22.11
	PCB 126	326	256/254	1.40	24.25
	PCB 149	360	290/288	1.20	19.78
	PCB 153	360	290/288	1.30	21.27
	PCB 138	360	290/288	1.30	2.307
	PCB 167	360	290/288	1.50	2.469
	PCB 156	360	290/288	1.50	25.55
	PCB 157	360	290/288	1.50	25.68

PCB 169	360	290/288	1.50	26.84
PCB 180	396	324/325	1.30	25.76
PCB 189	396	326/324	1.80	27.61

Table 3: GC–MS/MS method parameters for remaining semivolatile pesticides

Compound	Precursor ion	Product ions	Collision energy(ev)	t _R , min
Captan	79	51/77	1.2	24.17
Tebutam	91	65	1.4	24.19
Fenpropidine	98	70/55	1.3	27.76
Buprofezin	105	77	1.2	44.29
Trifloxystrobin	116	89/63	1.4	50.78
Propachlore	120	91/92	1.4	23.93
Fenpropimorphe	128	110/70	1.6	29.07
Propargite	135	107/95	1.3	31.09
Fenarimol	139	111/75	1.3	64.88
Boscalid	140	112/76	1.4	75.55
Alachlore	160	132/117	1.4	31.35
Ethofumesate	161	133/105	1.4	35.19
s-Metolachlor	162	133/134	1.45	33.75
Tebufenpyrad	171	156/127	1.5	55.89
Propyzamid	173	145/109	1.4	26.60
Myclobutanil	179	125/152	1.3	44.82
Bifenthrin	181	166/153	1.4	51.33
Fenprothrin	181	152 /127	1.6	56.04
Lindane	183	147/148	1.4	28.57
Isodrine	193	157/123	1.7	36.32
Aclonifen	194	167/139	1.45	52.14
Clomazone	204	107/174	1.6	28.02
2.4 MPCA	211	183	1.4	27.50
Chloridazon	220	192/193	1.8	44.74
Cyprodinil	224	208/197	1.9	38.56
Mecoprop-p	225	197/209	1.5	25.36
Fluzilazole	233	165/152	1.85	43.20
Oxyfluorfen	252	170/190	1.7	40.98
Irgarol	253	238/196	1.4	39.65
Oxadiazon	258	175/146	1.6	40.30
Propiconazole	259	191/173	1.4	50.71
Trifluraline	264	206/160	1.5	21.56
Chlorothalonil	266	168/170	1.9	30.90
Procymidon	283	255/254	1.4	39.25
Chlorpyrifos	314	258/286	1.1	34.45
Bromoxynil	334	173/255	1.61	35.10
Diclofop-methyl	340	253/281	1.4	53.38
Bifenox	341	311/310	1.2	60.65
Ioxinil	428	301	1.2	48.96
Bupirimate	193/208	165/109	1.6	43.75
Mepanipyrim	222/223/207	207/192	1.8	44.74

as film thickness). Helium was used as the carrier gas at a flow rate of 1 mL min⁻¹. The initial oven temperature was set at 50 °C for 3 min, followed by a linear ramp to 220 °C at a rate of 10 °C min⁻¹, where it was held for 10 min. Afterward, the temperature was raised to 250 °C at a rate of 3 °C min⁻¹, held for 9 min, followed by a ramp to 300 °C at a rate 3 °C min⁻¹, where it was maintained for 22 min, leading to a total run time of 88 min.

The precursor ion, product ions, collision energy, and retention time of the pesticides are listed in Table 3.

For GC analysis, identification was done regarding the retention time, the collision energy required, and the product ions obtained by the mass spectrometry analysis.

Method validation

The method was validated for all quantification parameters. These parameters consisted of

linearity, repeatability, reproducibility, relative standard deviation, limit of detection (LOD), limit of quantification (LOQ), and recoveries. First, extraction of fortified samples with concentration ranging from 10 to 3000 ng g⁻¹ was performed on three different days to determine linearity in triplicate, and then five spiked samples with one concentration (1000 ng g⁻¹) were extracted on three successive days to determine intermediate precision and repeatability.

With regard to the method validation parameters, the method LOD was determined as the analyte concentration that produced a peak signal of three times the background noise from the chromatogram, and the method LOQ was determined as the analyte concentration that produced a peak signal of ten times the background noise from the chromatogram. These limits were then determined graphically with LOD =3 × [min] signal- to noise ratio and LOQ =10 × [min] signal-to-noise ratio.

Table 4: LC-MS/MS method performance and validation for pesticides analysis

Compounds	Regression line equation	Regression coefficient	Limit of detection (ng/g)	Limit of quantification (ng/g)	Repeatability (intra-day RSD%)	Reproducibility (Inter-day RSD %)	Recovery (%)
Pymetrozine	Y = 0.0023*X	0.998	1.09	3.64	4.86	4.68	76
Carbendazim	Y = 0.0076*X	0.999	1.18	3.94	1.08	0.82	88
Chloridazone	Y = 0.0028*X	0.999	1.03	3.42	1.40	2.55	71
Acetamiprid	Y = 0.0015*X	0.997	1.95	6.49	0.34	2.03	85
Thiacloprid	Y = 0.00545*X	0.997	0.88	2.93	1.88	2.00	78
Nicosulfuron	Y = 0.0002*X	0.998	4.4	14.65	1.69	8.49	75
Foramsulfuron	Y = 0.0005*X	0.998	0.19	0.62	6.33	4.92	55
Chlortoluron	Y = 0.0025*X	0.998	0.35	1.15	1.98	0.47	99
Carbetamide	Y = 0.0055*X	0.998	0.54	1.79	2.15	0.78	63
Terbutryn	Y = 0.0039*X	0.999	1.22	4.06	2.37	2.32	97
Fluroxypyr	Y = 1.25e-005*X	0.996	3.77	12.55	6.08	35.50	94
Sulcotrione	Y = 7.74e-005*X	0.995	4.84	16.13	11.22	10.90	84
Spinosade A	Y = 0.0012*X	0.998	0.28	0.93	3.34	5.63	90
Isoproturon	Y = 0.0067*X	0.999	0.65	2.18	1.68	2.22	76
Diuron	Y = 0.0011*X	0.997	0.51	1.71	0.17	0.64	62
Metalaxyl-M	Y = 0.0005*X	0.998	0.69	2.29	4.57	2.38	84
DPMU	Y = 0.0014*X	0.997	1.74	5.81	3.66	3.36	70
Spinosade D	Y = 3.99e-005*X	0.996	1.54	5.12	6.03	6.91	Nd
Dimethenamid-P	Y = 0.0186*X	0.997	0.51	1.7	1.64	1.22	69
Penconazole	Y = 0.0019*X	0.999	0.32	1.07	9.3	5.21	97
Isoxadifen	Y = 0.0014*X	0.9976	1.06	3.54	0.55	0.91	83
Tebuconazole	Y = 0.0022*X	0.998	0.1	0.33	3.90	3.67	91
Diffubenzuron	Y = 0.0004*X	0.999	1.29	4.31	6.73	2.01	81

Epoxyconazole	Y = 0.0110*X	0.999	0.43	1.42	6.60	16.55	105
Propiconazole	Y = 0.0082*X	0.998	0.38	1.27	3.36	3.30	78
Prothioconazole	Y=1.32e-006*X	0.986	5.31	17.7	nd	nd	22
Chlorfenviphos	Y = 0.0007*X	0.998	0.46	1.53	1.51	0.65	81
Triflu-Methyl	Y = 0.0018*X	0.991	0.048	0.16	8.90	4.72	98
Pendimethalin	Y = 0.0028*X	0.997	0.16	0.54	9.36	2.46	81
Cyazofamid	Y = 1.3e-005*X	0.997	2.88	9.594	1.27	5.11	65
Pyraclostrobine	Y = 0.0041*X	0.997	0.16	0.53	5.38	5.95	79
Diflufenican	Y = 0.0047*X	0.998	0.66	2.22	3.30	1.38	89
Flufenoxuron	Y = 0.0006*X	0.992	0.9	2.99	0.61	1.04	75
Lufenuron	Y = 4.64e-005*X	0.999	2.87	9.57	5.07	0.82	81

ND not detected, RSD relative standard deviation

as film thickness). Helium was used as the carrier gas at a flow rate of 1 mL min⁻¹. The initial oven temperature was set at 50 °C for 3 min, followed by a linear ramp to 220 °C at a rate of 10 °C min⁻¹, where it was held for 10 min. Afterward, the temperature was raised to 250 °C at a rate of 3 °C min⁻¹, held for 9 min, followed by a ramp to 300 °C at a rate 3 °C min⁻¹,

where it was maintained for 22 min, leading to a total run time of 88 min.

The precursor ion, product ions, collision energy, and retention time of the pesticides are listed in Table 3.

For GC analysis, identification was done regarding the retention time, the collision energy required, and the product ions obtained by the mass spectrometry analysis.

Table 5: GC-MS/MS method performance and validation for OCPs, PAHs and PCBs analysis

Compounds	Regression line equation	Regression coefficient	Limit of detection (ng/g)	Limit of quantification (ng/g)	Repeatability (intra-day RSD%)	Reproducibility (Inter-day RSD %)	Recovery (%)
OCPs							
α-HCH	Y = 0.0007*X	0.998	3.92	13.07	4.34	6.16	92
γ-HCH	Y = 0.0010*X	0.998	1.85	6.17	0.10	6.42	74
β-HCH	Y = 0.0002*X	0.998	2.69	8.97	0.48	2.91	84
δ-HCH	Y = 0.0002*X	0.992	4.16	13.88	1.42	2.93	73
Heptachlore epoxyde A	Y = 0.0015*X	0.995	2.4	8	27.70	6.76	73
Metoxychlore	Y=2.07e-005*X	0.996	9.55	31.85	0.84	2.10	55
o,p'-DDD	Y = 0.0002*X	0.994	0.08	0.23	8.22	12.21	94
o,p'-DDT	Y = 0.0020*X	0.991	1.85	6.15	4.41	7.20	84
p,p'-DDD	Y = 0.0002*X	0.991	2.84	9.48	22.73	9.10	56
p,p'-DDT	Y=0.0005*X	0.993	0.81	2.69	4.89	7.83	76
α-endosulfan	Y = 0.0008*X	0.992	1.73	5.78	15.70	8.10	88
o,p'-DDE	Y = 0.0042*X	0.987	0.17	0.55	4.59	7.93	86
p,p'-DDE	Y=0.0002*X	0.996	1.51	5.03	6.8	10.76	68
Aldrine	Y = 0.0001*X	0.994	1.5	5	15.54	6.66	73
Heptachlore	Y = 8.54e-005*X	0.994	2.45	8.16	10.68	6.53	70
Dieldrine	Y=0.0005*X	0.996	2.74	9.13	4.57	6.79	69
Hexachlorobenzene	Y =0.0031*X	0.996	1.47	4.91	29.29	9.80	69
Heptachlore epoxyde B	Y = 0.0024*X	0.993	0.25	0.83	9.44	10.23	68
Transchlordan	Y = 0.0022*X	0.988	0.38	1.24	2.11	4.12	86

PAHs	Ciscllordane	$Y = 0.00252 * X$	0.98	0.19	0.65	11.67	15.22	88	
	Naphtalene	$Y = 0.00047 * X$	0.997	0.8	2.67	12.52	12.47	93	
	Acenaphtene	$Y = 0.188 + 0.0032 * X$	0.998	2.46	8.2	2.33	2.67	95	
	Fluorene	$Y = 0.0057 * X$	0.997	2.56	8.55	0.13	0.31	94	
	Phenanthrene	$Y = 0.0073 * X$	0.999	0.93	3.09	2.96	8.32	98	
	Anthracene	$Y = 0.0052 * X$	0.998	1.01	3.37	12.77	6.78	97	
	Fluoranthrene	$Y = 0.0145 * X$	0.993	0.07	0.23	12.12	8.98	63	
	Pyrene	$Y = 0.0180 * X$	0.998	0.08	0.25	0.57	6.37	81	
	Benzo(a)anthracene	$Y = 0.0003 * X$	0.998	1.45	4.84	14.26	12.47	80	
	Chrysene	$Y = 0.0004 * X$	0.997	1.96	6.54	19.97	13.11	104	
	Benzo(b)fluoranthrene	$Y = 0.0002 * X$	0.994	0.35	1.16	14.10	8.37	87	
	Benzo(k)fluoranthrene	$Y = 0.0003 * X$	0.996	2.3	7.66	3.42	6.40	83	
	Benzo(e)pyrene	$Y = 0.0051 * X$	0.993	1.84	6.13	2.34	2.10	103	
	Benzo(a)pyrene	$Y = 0.0040 * X$	0.997	4.88	16.27	21.11	8.75	83	
	Indenol(1.2.3)pyrene	$Y = 0.0019 * X$	0.994	4.11	13.7	1.60	3.87	82	
	PCBs	Benzo(g,h,i)perylene	$Y = 0.0011 * X$	0.996	3.13	10.42	9.02	9.60	72
		Dibenzo(a,h)anthracene	$Y = 0.0002 * X$	0.998	12	40	3.93	6.43	98
PCB 18		$Y = 0.0006 * X$	0.998	1.53	5.09	0.51	2.80	99	
PCB 31		$Y = 0.0006 * X$	0.994	2.02	6.73	4.28	5.94	50	
PCB 28		$Y = 0.0010 * X$	0.997	1.83	6.11	0.36	5.47	69	
PCB 52		$Y = 0.0006 * X$	0.990	1.2	4.01	8.17	9.46	85	
PCB 44		$Y = 0.0007 * X$	0.995	2.63	8.77	10.83	9.06	83	
PCB 70		$Y = 0.0008 * X$	0.992	5.36	17.86	34.09	10.12	86	
PCB 81		$Y = 0.0004 * X$	0.994	0.92	3.08	29.28	6.21	86	
PCB 101		$Y = 0.0005 * X$	0.990	16.76	55.87	1.14	2.73	79	
PCB 123		$Y = 0.0001 * X$	0.995	3.75	12.5	2.53	5.63	82	
PCB 118		$Y = 0.0002 * X$	0.993	3.7	12.35	1.76	2.27	75	
PCB 114		$Y = 0.0002 * X$	0.997	2.6	8.7	2.15	1.81	85	
PCB 105		$Y = 5.28e-005 * X$	0.997	2.62	8.74	7.13	9.76	83	
PCB 126		$Y = 2.84e-005 * X$	0.997	12.3	40.98	8.08	13.21	55	
PCB 149		$Y = 0.000141489 * X$	0.992	6.61	22.03	6.57	7.65	97	
PCB 153		$Y = 0.0001 * X$	0.991	5.51	18.38	6.25	6.09	80	
PCB 138	$Y = 2.76e-005 * X$	0.997	1.12	3.73	9.82	15.70	56		
PCB 167	$Y = 4.38021e-007 * X$	0.975	0.26	0.67	4.77	12.32	60		
PCB 156	$Y = 1.44e-006 * X$	0.996	0.34	1.02	2.64	4.07	61		
PCB 157	$Y = 8.18e-007 * X$	0.961	0.28	0.84	7.57	8.52	52		
PCB 169	$Y = 2.72e-006 * X$	0.970	0.18	0.54	14.69	5.34	67		
PCB 180	$Y = 1.45e-006 * X$	0.991	0.12	0.35	12.78	18.65	72		
PCB 189	$Y = 7.30e-007 * X$	0.921	0.09	0.27	3.45	5.54	50		

Table 6: GC-MS/MS method performance and validation for pesticides analysis

Compounds	Regression line equation	Regression coefficient	limit of detection (ng/g)	Limit of quantification (ng/g)	Repeatability (intra-day RSD %)	Reproducibility (inter-day RSD %)	Recovery (%)
Clofentezine	Y=0.0001*X	0.996	9.43	31.44	1.15	5.43	74
Trifluraline	Y=0.0004*X	0.987	8.93	29.76	4.56	7.68	76
Propachlore	Y=2.27e-005*X	0.985	20.98	69.93	10.15	15.37	86
Diphenylamine	Y=0.0001*X	0.996	5.61	18.69	11.20	13.51	88
Mecoprop-p	Y=0.0002*X-3.67e-008*X ²	0.944	nd	Nd	nd	Nd	80
Spiroxamine	Y=0.0002*X	0.991	11.19	37.31	1.06	1.52	82
Fenpropidine	Y=6.07e-005*X	0.991	5.22	17.39	1.11	1.35	86
Lindane	Y=0.0002*X	0.996	4.44	14.81	1.07	5.07	70
Acetochlore	Y=0.0002*X	0.997	5.41	18.02	6.78	7.79	87
Fenpropimorphe	Y=0.0002*X	0.995	5.26	17.54	4.32	9.41	53
Pyrimethanil	Y=3.02e-005*X	0.993	11.36	37.88	22.25	26.31	73
Chlorothalonil	Y=3.28e-005*X	0.999	44.44	148.15	nd	Nd	81
Propargite	Y=0.0002*X	0.993	5.83	19.42	2.15	2.25	80
Alachlore	Y=4.22e-005*X	0.989	25	83.33	2.16	10.24	66
Aldrine	Y=5.95e-005*X	0.993	25.21	84.03	nd	Nd	83
s-Metolachlor	Y=8.85e-005*X	0.991	5.45	18.18	nd	Nd	67
Chlorpyrifos	Y=0.0001*X	0.994	14.15	47.16	4.35	4.72	94
Ethofumesate	Y=6.45e-005*X	0.990	12.4	41.32	10.12	15.10	78
Isodrine	Y=0.0002*X	0.996	12.93	43.1	4.43	7.87	103
Cyprodinil	Y=0.0002*X	0.994	4.62	15.39	5.72	9.64	85
Oxadiazon	Y=7.47e-005*X	0.991	4.96	16.53	12.22	17.30	69
Oxyfluorfen	Y=9.62e-005*X	0.994	5.45	18.18	15.31	16.96	85
Chloridazon	Y=7.26e-006*X	0.981	9.68	32.26	2.34	6.64	76
Mepanipyrim	Y=4.67e-005*X	0.995	5.26	17.54	8.72	10.22	51
Kresoxim-methyl	Y=3.44e-005*X	0.983	4.08	13.61	11.21	20.02	88
Trifloxystrobine	Y=5.40e-005*X	0.995	4.92	16.39	24.31	27.60	92
Bifenthrin	Y=9.40e-005*X	0.986	4.58	15.27	12.22	20.23	90
Quinoxifene	Y=0.0003*X	0.987	4.65	15.5	3.45	6.66	84
Diclofop-methyl	Y=0.0001*X	0.993	4	13.33	1.69	12.14	83
Tebufenpyrad	Y=3.35e-005*X	0.993	5.77	19.23	2.19	3.25	65
Fenpropathrine	Y=0.0001*X	0.991	4.76	15.87	5.15	12.34	75
Dimoxystrobin	Y=4e-006*X+4.16e-009*X ²	0.992	50.42	168.07	15.66	13.30	59

Method validation

The method was validated for all quantification parameters. These parameters consisted of linearity, repeatability, reproducibility, relative standard deviation, limit of detection (LOD), limit of quantification (LOQ), and recoveries. First, extraction of fortified samples with concentration ranging from 10 to 3000 ng g⁻¹ was performed on three different days to determine linearity in triplicate, and then five spiked samples with one concentration (1000 ng g⁻¹) were extracted on

three successive days to determine intermediate precision and repeatability.

With regard to the method validation parameters, the method LOD was determined as the analyte concentration that produced a peak signal of three times the background noise from the chromatogram, and the method LOQ was determined as the analyte concentration that produced a peak signal of ten times the background noise from the chromatogram. These limits were then determined graphically with $LOD = 3 \times [min]$

signal- to noise ratio and $LOQ = 10 \times [\text{min}] \text{ signal-to-noise ratio}$.

With regard to quantification precision and accuracy, matrix-matched calibration was used for quantification with concentrations ranging between 10 and 3000 ng g⁻¹. The matrix effect was then excluded with use of the calibration curves obtained, as each compound encounter several criteria like its fragmentation and retention time. Quantifications were done with the software program Xcalibur. Extraction performance was

checked with use of the signal areas of the internal standard solutions in each sample analyzed.

Furthermore, recoveries were determined at the same levels as precision by our spiking blank samples with a mixture of standard solution at 1000 ng g⁻¹. The recoveries were considered as the ratio of the area of the spiked samples to the area of the standard following the equation

$\text{Recovery (\%)} = (\text{area extracted spiked sample} / \text{area standard solution}) \times 100$.

Results and discussion

Method development

The main disadvantage of QuEChERS extraction against other common methods is that the final extract concentration obtained is lower than that of the extracts obtained with most of the traditional procedures. Thus, to achieve the desired LOQs, the final extract has to be concentrated [29, 30]. Consequently, to overcome this problem, a concentration step involving evaporation and reconstitution was added before LC analysis. Moreover, an SPME extraction/concentration step was used for arranging and discriminating volatile compounds. Among different SPME fibers, a PDMS fiber is well known for its usefulness for the extraction of analytes with greater partition coefficients for PAHs, PCBs, and OCPs, whereas a PA fiber was chosen for pesticide extraction because of its effectiveness in the extraction of more polar compounds. PA is a moderated polar coating characterized by a stronger hydrogen bond than PDMS, which makes it better suited than other fibers for polar compounds with moderate hydrophobicity [31].

For matrix effects, because of the high complexity of honey matrix, containing protein, lipid, and wax contaminants, the cleanup step is a main challenge [32]. Thus PSA was used to remove polar organic acids as well as polar pigments, sugars, and fatty acids from the extracts, whereas C18 allowed the elimination of nonpolar interfering substances such as lipids [22, 23].

The chromatograms obtained showed good separation between all sought compounds, which allowed the identification of the 90 pesticides, 16 PAHs, and 22 PCBs on the basis of each parameter property shown in Tables 1, 2, and 3.

Method validation

The method developed was validated to check its accuracy, specificity, reproducibility, and robustness. Method validation provides an assurance of reliability during normal use, and is sometimes referred to as the process of providing documented evidence that the method does what it is intended to do [33]. Several validating parameters were tested, including repeatability and reproducibility for method accuracy, LODs and LOQs for method limits, and linearity for the ability of the method to elicit test results that are directly proportional to the analyte concentration within a specific range. Moreover, to include the error due to the matrix effect in measurements, matrix-matched calibration curves were constructed and used for quantification of samples.

The analyzed parameters showed good linearity, with a regression coefficient higher than 0.98 for most pollutants. The relative standard deviation was lower than 20% for repeatability and reproducibility, and the LOD was lower than 20 ng g⁻¹ and the LOQ was lower than 60 ng g⁻¹ for most of the compounds analyzed. Tables 4, 5, and 6 present the validation parameter results for nonvolatile pesticides analyzed by LC-MS/MS, and for persistent organic pollutants (OCPs, PAHs, and PCBs) and other pesticides analyzed by GC-MS/MS.

Table 7: Compounds detected in real samples: percentage of samples contaminated and the average quantified concentration

	% of sample detected	Σ concentration (ng g ⁻¹)
Diflufenican	66.66	32.91
Pyraclostrobin	100	0.83
Diuron	66.66	8.03
Penconazole	66.66	2.53
Fenpropidin	33.33	32.04
Acetochlore	33.33	9.85
Hexachlorobenzene	33.33	3.4
Naphtalene	100	33.3
Acenaphtalene	66.66	25.3
Fluorene	66.66	33.03
Phenanthrene	33.33	10.33
Anthracene	66.66	15.87
Fluoranthrene	66.66	20.2
Pyrene	33.33	14.7
Benzo(a)anthracene	33.33	8.74
Chrysene	33.33	5.36

As shown in these tables, most compounds showed great repeatability and reproducibility, but a few of them showed no response. Moreover, good linearity was obtained for most of the compounds analyzed, except for some semi volatile pesticides.

These compounds also showed high method limits and weaker accuracy. The main explanation for these results is the use of SPME as a new concentration/extraction step with all the error that occurred from its use.

The method developed proved its effectiveness among other multiresidue methods. Comparison of the results with those provided by many other authors who used QuEChERS extraction as an extraction procedure followed by LC/GC-MS/MS analysis showed an improvement of the sensitivity of the method.

First, to our knowledge, no other publication considered the extraction of such a wide number and type of both volatile and nonvolatile compounds. For instance, the extraction protocol used resulted in, in comparison with the reference method based on the work of Malhat et al. [34], a

greater number of extracted contaminants with better recoveries and limits.

Moreover, the use of SPME as a preconcentration technique for volatile compounds seems to improve the sensitivity of the method. The use of SPME in comparison with a direct injection procedure resulted in a great enhancement of the LOD and LOQ. For instance, comparison of the results with those provided by Wiest et al. [30], using direct injection, showed some improvement in sensitivity of some compounds, such as dieldrin, p,p'-DDT, o,p'-DDD, and propargite. Furthermore, some of the pesticides analyzed by Malhat et al. [34] were more sensitive when SPME was used instead of the direct injection protocol.

For example the LOD of hexachlorocyclohexane analyzed by the direct injection method was 3 ng g⁻¹, whereas it was 1.47 ng g⁻¹ when SPME was used. Moreover, the use of SPME in this method seems to be necessary. Indeed, QuEChERS extraction, known as a dilute-and-shoot procedure for pesticide analysis especially by LC-MS/MS, was used in this work for the simultaneous extraction of volatile and nonvolatile compounds requiring both chromatographic techniques. Moniruzzaman et al. [35] proved that SPME is a preferred technique for the concentration of volatile compounds in honey. They showed that the use of SPME before GC-mass spectrometry analysis provides enough sensitivity for the identification of a relevant number of volatile and semivolatile compounds in honey samples, with mass errors usually below 1 mDa. For all these reasons, the use of QuEChERS extraction-SPME as an extraction/preconcentration technique seems to be a good choice for such extraction, allowing the extraction of a large number of different types of organic compounds with high sensitivity, high recoveries, and high precision.

Application to real samples

The samples collected were analyzed according to the previously developed method. Residue levels were calculated with Xcalibur with use of previously plotted calibration curves.

Most of the samples investigated have had some pesticide residues but of all the sought compounds, seven pesticides and nine PAHs were found in most of the samples, whereas no PCB residues were found all the samples analyzed.

Table 7 shows the pesticides and the PAH residues found in the samples analyzed.

Conclusion

In conclusion, we have presented an original analytical method that involves in one simple extraction procedure coupled with GC and LC analysis the extraction of a large number of different types of hazardous organic pollutants. The combination of a simple extraction method such as QuEChERS extraction with an SPME process coupled with LC–MS/MS and GC–MS/MS allowed the quantification of contaminants in honey at concentrations lower than 10 ng g⁻¹. Furthermore, the main advantage of the method developed is it is environmentally friendly, requiring a small amount of solvent for extraction.

The method was validated for its linearity, accuracy, and performance, allowing its application as a fast, efficient, and reliable tool for routine analysis of a large range of compounds at trace level in real samples to apply it in further studies aiming to investigate environmental biomonitoring.

Acknowledgements: We gratefully acknowledge AZM & SAADE Association and the Lebanese University for funding the project, as well as Strasbourg University for international mobility aid, without which the present study could not have been completed.

Compliance with ethical standards

Conflict of interest: The authors declare that they have no conflict of interest.

References

1. Panseri S, Catalano A, Giorgi A, Arioli F, Procopio A, Britti D, et al. Occurrence of pesticide residues in Italian honey from different areas in relation to its potential contamination sources. *Food Control*. 2014;38:150–6.
2. Panseri S, Manzo A, Chiesa LM, Giorgi A. Melissopalynological and volatile compounds analysis of buckwheat honey from different geographical origins and their role in botanical determination. *J Chem*. 2013;2013:904202.
3. Dobrinas S, Birghila S, Coatu V. Assessment of polycyclic aromatic hydrocarbons in honey and propolis produced from various flowering trees and plants in Romania. *J Food Comp Anal*. 2008;21(1):71–7. doi:10.1016/j.jfca.2007.07.003.
4. Raeymaekers B. A prospective biomonitoring campaign with honey bees in a district of Upper-Bavaria (Germany). *Environ Monit Assess*. 2006;116(1-3):233–43.

5. Kujawski MW, Namieśnik J. Challenges in preparing honey samples for chromatographic determination of contaminants and trace residues. *Trends Anal Chem*. 2008;27(9):785–93. doi:10.1016/j.trac.2008.07.004.
6. Herrera López S, Lozano A, Sosa A, Hernando MD, Fernández-Alba AR. Screening of pesticide residues in honeybee wax comb by LC-ESI-MS/MS. A pilot study. *Chemosphere*. 2016;163:44–53. doi:10.1016/j.chemosphere.2016.07.008.
7. Machado I, Gérez N, Pistón M, Heinzen H, Cesio MV. Determination of pesticide residues in globe artichoke leaves and fruits by GC–MS and LC–MS/MS using the same QuEChERS procedure. *Food Chem*. 2017;227:227–36. doi:10.1016/j.foodchem.2017.01.025.
8. Karami-Mohajeri S, Abdollahi M. Toxic effects of organophosphate, carbamate, and organochlorine pesticides on cellular metabolism of lipids, proteins, and carbohydrates: a comprehensive review. *Hum Exp Toxicol*. 2011;30(9):1119–40.
9. Zheng S, Chen B, Qiu X, Chen M, Ma Z, Yu X. Distribution and risk assessment of 82 pesticides in Jiulong River and estuary in South China. *Chemosphere*. 2016;144:1177–92.
10. Zhou R, Zhu L, Chen Y, Kong Q. Concentrations and characteristics of organochlorine pesticides in aquatic biota from Qiantang River in China. *Environ Pollut*. 2008;151(1):190–9.
11. de Lima RF, Dionello RG, Peralba MCR, Barrionuevo S, Radunz LL, Reichert Júnior FW. PAHs in corn grains submitted to drying with firewood. *Food Chem*. 2017;215:165–70. doi:10.1016/j.foodchem.2016.07.164.
12. Fiandanese N, Borromeo V, Berrini A, Fischer B, Schaedlich K, Schmidt J-S, et al. Maternal exposure to a mixture of di(2-ethylhexyl) phthalate (DEHP) and polychlorinated biphenyls (PCBs) causes reproductive dysfunction in adult male mouse offspring. *Reprod Toxicol*. 2016;65:123–32. doi:10.1016/j.reprotox.2016.07.004.
13. Abdel-Shafy HI, Mansour MSM. A review on polycyclic aromatic hydrocarbons: source, environmental impact, effect on human health and remediation. *Egypt J Petroleum*. 2016;25(1):107–23.
14. Elorduy I, Elcoroaristizabal S, Durana N, García J, Alonso L. Diurnal variation of particle-bound PAHs in an urban area of Spain using TD-GC/MS: influence of meteorological parameters and emission sources. *Atmos Environ*. 2016;138:87–98.
15. Kodavanti PRS. Polychlorinated biphenyls (PCBs)☆. In: Reference module in neuroscience and biobehavioral psychology. Elsevier; 2017. doi:10.1016/B978-0-12-809324-5.03955-9.
16. Amendola G, Pelosi P, Dommarco R. Solid-phase extraction for multi-residue analysis of pesticides in honey. *J Environ Sci Health B*. 2010;46(1):24–34.
17. Kujawski MW, Namieśnik J. Levels of 13 multi-class pesticide residues in Polish honeys determined by LC-ESI-MS/MS. *Food Control*. 2011;22(6):914–9.
18. Rissato SR, Galhiane MS, Knoll FR, Apon BM. Supercritical fluid extraction for pesticide multiresidue analysis in honey: determination by gas chromatography with electron-capture and mass spectrometry detection. *J Chromatogr A*. 2004;1048(2):153–9.
19. Sanchez-Brunete C, Albero B, Miguel E, Tadeo JL. Determination of insecticides in honey by matrix solid-phase dispersion and gas chromatography with nitrogen–phosphorus detection and mass spectrometric confirmation. *J AOAC Int*. 2002;85(1):128–33.
20. Chiesa LM, Labella GF, Giorgi A, Panseri S, Pavlovic R, Bonacci S, et al. The occurrence of pesticides and persistent organic pollutants in Italian organic honeys from different productive areas in relation to potential environmental pollution. *Chemosphere*. 2016;154:482–90. doi:10.1016/j.chemosphere.2016.04.004.
21. Anastassiades M, Lehotay SJ, Štajnbahter D, Schenck FJ. Fast and easy multiresidue method employing acetonitrile extraction/partitioning and dispersive solid-phase extraction for the determination of pesticide residues in produce. *J AOAC Int*. 2003;86(2):412–31.
22. Albinet A, Tomaz S, Lestremau F. A really quick easy cheap effective rugged and safe (QuEChERS) extraction procedure for the

- analysis of particle-bound PAHs in ambient air and emission samples. *Sci Total Environ.* 2013;450:31–8.
23. Wilkowska A, Biziuk M. Determination of pesticide residues in food matrices using the QuEChERS methodology. *Food Chem.* 2011;125(3):803–12.
- their applications in food and environmental analysis. *Trends Anal Chem.* 2015;72:141–52. doi:10.1016/j.trac.2015.04.023.
26. Bojko B, Pawliszyn J. In vivo and ex vivo SPME: a low invasive sampling and sample preparation tool in clinical bioanalysis. *Bioanalysis.* 2014;6(9):1227–39.
27. Megson D, Reiner EJ, Jobst KJ, Dorman FL, Robson M, Focant JF. A review of the determination of persistent organic pollutants for environmental forensics investigations. *Anal Chim Acta.* 2016. doi:10.1016/j.aca.2016.08.027.
28. García-Valcárcel AI, Molero E, Tadeo JL, Hernando MD. Determination of selected environmental contaminants in foraging honeybees. *Talanta.* 2016;148:1–6. doi:10.1016/j.talanta.2015.10.064.
29. Díez C, Traag WA, Zommer P, Marinero P, Atienza J. Comparison of an acetonitrile extraction/partitioning and dispersive solid-phase extraction method with classical multi-residue methods for the extraction of herbicide residues in barley samples. *J Chromatogr A.* 2006;1131(1–2):11–23. doi:10.1016/j.chroma.2006.07.046.
30. Wiest L, Buleté A, Giroud B, Fratta C, Amic S, Lambert O, et al. Multi-residue analysis of 80 environmental contaminants in honeys, honeybees and pollens by one extraction procedure followed by liquid and gas chromatography coupled with mass spectrometric detection. *J Chromatogr A.* 2011;1218(34):5743–56.
24. Arthur CL, Pawliszyn J. Solid phase microextraction with thermal desorption using fused silica optical fibers. *Anal Chem.* 1990;62(19):2145–8.
25. Li J, Wang Y-B, Li K-Y, Cao Y-Q, Wu S, Wu L. Advances in different configurations of solid-phase microextraction and
31. Ouyang G, Jiang R (eds) (2016) *Solid phase microextraction: recent developments and applications.* Springer, Berlin
32. Walorczyk S, Gnusowski B. Development and validation of a multi-residue method for the determination of pesticides in honeybees using acetonitrile-based extraction and gas chromatography– tandem quadrupole mass spectrometry. *J Chromatogr A.* 2009;1216(37):6522–31.
33. Shabir GA. Validation of high-performance liquid chromatography methods for pharmaceutical analysis: Understanding the differences and similarities between validation requirements of the US Food and Drug Administration, the US Pharmacopeia and the International Conference on Harmonization. *J Chromatogr A.* 2003;987(1–2):57–66. doi:10.1016/S0021-9673(02)01536 4.
34. Malhat FM, Haggag MN, Loutfy NM, Osman MA, Ahmed MT. Residues of organochlorine and synthetic pyrethroid pesticides in honey, an indicator of ambient environment, a pilot study. *Chemosphere.* 2015;120:457–61.
35. Moniruzzaman M, Rodríguez I, Ramil M, Cela R, Sulaiman SA, Gan SH. Assessment of gas chromatography time-of-flight accurate mass spectrometry for identification of volatile and semi-volatile compounds in honey. *Talanta.* 2014;129:505–15. doi:10.1016/j.talanta.2014.06.019.

V. Utilisation du miel comme biomoniteur de la contamination environnemental en pesticides au Liban Nord

Ce résultat, présenté sous format d'un article accepté pour publication dans « *Euro Mediterranean Journal for Environmental Integration* » à l'issue du premier Colloque International sur les Matériaux, l'Electrochimie et l'Environnement (CIMEE 16), présente une première application de la méthode d'analyse multi résidus développée sur les échantillons de miel. Dans cette étude, 18 échantillons de miel collectés de différentes régions du Liban nord ont été analysés pour leur contamination environnementale.

En effet, le miel, déjà utilisé dans des études de biosurveillance, est bien connu pour ces propriétés bio-accumulatrices des polluants. Afin d'évaluer la contamination environnementale par les pesticides au Liban nord, 18 échantillons de miel collectés ont été analysés pour leur contamination en pesticides. Au total, 84 pesticides, choisis de façon à être représentatifs des usages de pesticides de la région ont été analysés. L'extraction multi-résidus a été basée sur la méthode QuEChERS, suivie par des analyses chromatographiques en LC-MS/MS et GC-MS/MS. L'analyse par GC-MS/MS a été précédée par une concentration des échantillons par SPME. Les résultats ont montré la présence des résidus de plusieurs pesticides dans chacun des échantillons analysés. En effet, bien que la plupart des résidus trouvés soient inférieurs à la MRL, les échantillons collectés dans la plaine d'Akkar et la zone de Byblos, largement connu pour leur agriculture, étaient les plus contaminés en pesticides. Les concentrations totales en pesticides dans le miel récupéré à Akkar et à Byblos étaient de 1753,92 ng g⁻¹ et 695,13 ng g⁻¹ respectivement. Par contre les échantillons provenant de la région Cèdres du Liban étaient les moins concentrés en pesticides avec une concentration totale de 19,5 ng g⁻¹. Cette région située dans la montagne est peu cultivée et est dédiée aux productions organiques.

En conclusion, les résultats de cette étude ont bien validé le fait que le miel peut refléter la pollution spécifique d'un environnement donné et peut de ce fait être utilisé comme sentinelle appropriée pour une bio surveillance environnementale.

The use of honey as environmental biomonitor of pesticides contamination in Northern Lebanon

AL ALAM, Josephine.^{1*}, FAJLOUN, Ziad.¹, CHBANI, Asma.¹, MILLET, Maurice.²

1 Azm Center for Research in Biotechnology and its Applications, Doctoral School of Science and Technology, Lebanese University, El Mitten Street, Tripoli, Lebanon

2 Institute of Chemistry and Processes for Energy, Environment and Health ICPEES UMR 7515 Group of Physical Chemistry of the Atmosphere, University of Strasbourg, Strasbourg, France

Corresponding author: -----

*Address correspondence to Josephine AL ALAM, Azm Center for research in Biotechnology and its Application, Doctoral School of Science and Technology, Lebanese University, Lebanon, and, Institute of Chemistry and Processes for Energy, Environment and Health ICPEES UMR 7515 Group of Physical Chemistry of the Atmosphere, University of Strasbourg, Strasbourg, France Tel.: + 961 71 61 19 31, Email: josephine.al-alam@etu.unistra.fr

Abstract

The intensive use of pesticides in agriculture generates a contamination of the environment that must be assessed. Bee products such as honey, widely consumed, are not spared by this considerable contamination that can lead to health risks. Bees and their products (honey, nectar, pollen ...) are considered as real indicators of environmental health. Indeed, these insects, characterized by a specified body and a high mobility, are considered particularly suitable to keep, with high sensitivity, pesticides with which they come in contact. So the analysis of these insects or of their products as honey has been demonstrated as a good bio indicator of environmental quality. In this study, 18 samples of honey collected from North Lebanon, were assayed for their contamination by 84 pesticides. Multi residue extraction was based on QuEChERS, followed by chromatographic analysis by LC-MS/MS and GC-MS/MS. For gas chromatographic analysis, samples were concentrated by SPME before being injected to the GC column. At first, the method was developed and validated using organic honey, and then the collected samples were analyzed. The limits of detection and quantification as well as the repeatability and the reproducibility of the method have been defined: between 0.1 and 25.2 ng g⁻¹ and between 0.6 to 83.1 ng g⁻¹ for the limits detection and quantification respectively. Furthermore, the repeatability was between 0.2 and 15% and the reproducibility between 0.2 and 18%. Concerning the analyzed samples, residues of many pesticides have been found in each sample. Samples collected from the plain of Akkar and the Byblos area, widely known for their agricultural productions, were the most contaminated by pesticides. In fact, pesticide levels found in honey collected from Akkar and Byblos were 1753.92 ng g⁻¹ and 695.13 ng g⁻¹ respectively. Contrariwise, samples collected from the Cedars of Lebanon had the lowest pesticides concentration with a total concentration of 19.5 ng g⁻¹.

In conclusion, this study shows that honey can indicate the specific pollution of a given environment and can be considered as an appropriated sentinel for environmental biomonitoring.

Keywords: honey, pesticides, QuEChERS, LC-MS / MS, GC-MS / MS, biomonitors.

1. Introduction

Pesticide use has greatly increased in recent decades for their effects on crop protection from the harmful activity of parasites, (Gómez-Pérez et al. 2012). In fact, many of these pulverized pesticides are scattered in the environment and can then contaminate water, area, soil and food, (Tette et al. 2016). By transporting pollen from flower to flower and from plant to plant, bees play an essential role in environmental biomonitoring (Paradis et al. 2014). These species are then considered as good indicators of environmental contamination by pesticides because their foraging activity leading them to cover large areas and to contact many pollutants including pesticides (Badiou-Bénéteau et al. 2013).

Likewise bees, with their specific body composition, are particularly appropriate to keep pesticides with which they come into contact and bring them to the hive, which is contaminated either by pesticides collected by bees or by those carried out by pollen and surface area. In addition, the use of pesticides in the treatment of hives during honey collection is another potential contamination source of honey (Kujawski and Namieśnik 2011).

Therefore, the analysis of honey, known for its curative properties in traditional medicine, and for its wide consumption, seems to be a necessity for the establishment of food surveillance. Furthermore, given the wide range of pesticides that can be applied by farmers, multi-residual analytical methods as QuEChERS should be used (Wiest et al. 2011). The QuEChERS method (Quick, Easy, Cheap, Effective, Rugged and Safe) was developed in 2003 for the determination of multi- class pesticide residues in fruits and vegetables and remains the most efficient extraction method for multi-residues pesticides in all food matrixes including honey (Barakat et al. 2007).

Besides the extraction methods, the detection and separation of pesticides pollutants seems to have a special attention (Tette et al. 2016). In fact, both liquid and gas chromatography coupled with tandem mass spectrometry (LC-MS / MS, GC-MS / MS) showed greater efficiency in the multi-residues analysis of pesticide in honey (Bargańska et al. 2013, Debayle et al. 2008, Rial-Otero et al. 2007).

In this study, a simple method based on QuEChERS extraction, followed by samples concentration by SPME was developed for the simultaneous analysis of 84 volatile and non-volatile pesticides. Organochlorine pesticides, known for their large persistence are also considered in this study. Moreover, the two chromatographic techniques, liquid and gas, coupled with tandem mass spectrometry were used in order to cover the large number of pesticides sought. Once the method developed, 18 samples of honey collected from different regions of northern Lebanon were tested for their contamination by pesticides.

2. Experimentation

2.1 Samples collection

For method development, certified organic honey was purchased from local market and was used for the establishment of ranges.

For sample analyzes, eighteen samples collected from 4 main areas of Northern Lebanon (Cedars, Akkar valley, Batroun and Byblos (in the borderline between northern Lebanon and

Mount Lebanon)) were obtained from beekeepers in the period of August-September 2015. Sampling sites are shown in figure 1.

Samples were then transported to the laboratory in polypropylene tube and maintained at -15°C until analysis.

2.2 Method development

For the extraction of pesticides, an extraction method developed by Malhat et al. was slightly modified and followed by an SPME purification preceding GC-MS/MS analysis (Malhat et al. 2015).

First five gram of organic honey were weighed in polypropylene tubes (50 mL) then fortified with a mixture of all analyzed pesticides in order to prepare a calibration range with a concentration varying from 10 to 3000 ng g^{-1} . Fortified samples were kept at 4°C overnight.

For the extraction, 10 mL of ultrapure water and 10 mL of acetonitrile were added to the fortified samples. Then the tubes were shaken manually, then the salts were added (4g anhydrous magnesium sulfate, 1 g of sodium chloride, sodium citrate 1g and 0.5g sodium citrate sesquihydrate of hydrogen). The mixture was then well shaken and centrifuged at 5000 RPM for 10 minutes. Therefore, the supernatant was transferred to dPSE tubes containing 1200mg MgSO_4 , 400mg and 400mg PSA C18. The mixture was shaken well and centrifuged at 5000 RPM for 10 minutes. Finally the supernatant obtained, underwent evaporation followed by a re-dissolution in 1 mL ACN solution.

100 μL of the resulting final extract were analyzed by LC-MS / MS, and the remaining 900 μL are diluted to 20 mL with saline water for their extraction by SPME before their injection into the gas chromatographic column for their analysis by GC-MS / MS.

2.2.1 Chromatographic analysis

For non-volatile pesticides analysis, 10 μL of the final extract prepared for LC analysis was injected to the liquid chromatography system (Thermo Scientific), coupled to a tandem mass spectrometry system (TSQ Quantum Access Max equipped with a Hyper Quads Driven).

For maximum separation between pesticides a Macherey-Nägel Nucleodur C18 Pyramid column (150 mm \times 3 mm; 3 μm) was used at 25°C , the chromatographic system was also equipped with an autosampler (Accela Autosampler) and the pump was a Surveyor LC Pump Plus (Thermo Scientific).

Elution was carried out at a flow rate of 0.3 mL min^{-1} using a linear gradient of ACN/ water mobile phase. The gradient started with 30:70 (v/v) for 5 min, followed by 50:50 (v/v) for 6 min, then 80:20 (v/v) for 7 min, to achieve 95:5 (v/v) for 10 min, finally a ratio of 30:70 (v/v) for 8 minutes is recommended in order to stabilize the column for any new injection.

The sought nonvolatile pesticides were: Pymetrozine, Carbendazim, Chloridazone, Acetamiprid, Nicosulfuron, Thiacloprid, Chlortoluron, Carbetamide, Terbutryn, Spinosade A, Isoprotruron, Diuron, Metalaxyl-M, Spinosade D, Dimethenamid-p, Penconazole, Isoxadifen, Tebuconazole, Diflubenzuron, Epoxyconazole, Prothioconazole, Propiconazole, Chlorfenvinphos, Triflurosulfuron methyl, Pendimethalin, Cyazofamid, Pyraclostrobine, Diflufenican, Flufenoxuron, Lufenuron.

For volatile pesticides analysis: Pesticides were analyzed by gas chromatography coupled to a tandem mass spectrometer. The GC (Thermo Scientific Trace) was coupled to an ITQTM 700 mass spectrometer and injection was done in splitless mode at 250°C. Sample injection to the GC was also done, by thermal desorption of the SPME fiber, directly after the injection of 2 μL of N-methyl-N-(t-butyldimethylsilyl) trifluoroacetamide (MTBSTFA) used as derivation agent.

Extracts were injected to a semi-polar capillary column TR50 MS 50% phenyl/ 50% methylsiloxane (60 m \times 0.25 mm internal diameter and 0.25 μm as film thickness).

Helium was used as carrier gas at a flow rate of 1 mL min^{-1} .

Pesticides separation was performed as follow: 50 °C (3 min), 10°C/min to 220°C (10 min), 3°C/min to 250°C (9 min), and 3°C/min to finally achieve 300°C where it was maintained for 22 min.

The sought volatile pesticides were: Captan, Tebutam, Fenpropidine, Buprofezin, Trifloxystrobin, Propachlore, Fenpropimorphe, Propargite, Fenarimol, Boscalid, Alachlore, Ethofumesate, s-Metolachlor, Tebufenpyrad, Propyzamid, Myclobutanil, Bifenthrin, Fenpropathrine, Lindane, Isodrine, Aclonifen, Clomazone, Chloridazon, Cyprodinil, Fluzilazole, Oxyfluorfen, Oxadiazon, Propiconazole, Trifluraline, Chlorothalonil, Procymidon, Chlorpyrifos, Bromoxynil, Diclofop-methyl, Bifenox, Bupirimate, Mepanipyrim, α -HCH, γ -HCH, β -HCH, δ -HCH, Heptachlore epoxyde A, o,p'-DDD, o,p'-DDT, p,p'-DDD, p,p'-DDT, α -endosulfan, Aldrine, Heptachlore, Dieldrine, Hexachlorobenzene, Heptachlore epoxyde B, transchlordan, Cischlordane.

The method was then validated and limits of detection (LOD) and quantification (LOQ) were evaluated as the pesticide concentration that produces a peak signal-to-noise ratio of 3/1 and 10/1, respectively. Repeatability and reproducibility of the method were also determined. All analysis were done in triplicate.

2.3 Samples analysis

Once the method developed, all collected samples underwent the same extraction procedure of the developed method cited above. Pesticides residues in all the honey samples were calculated using Xcalibur software.

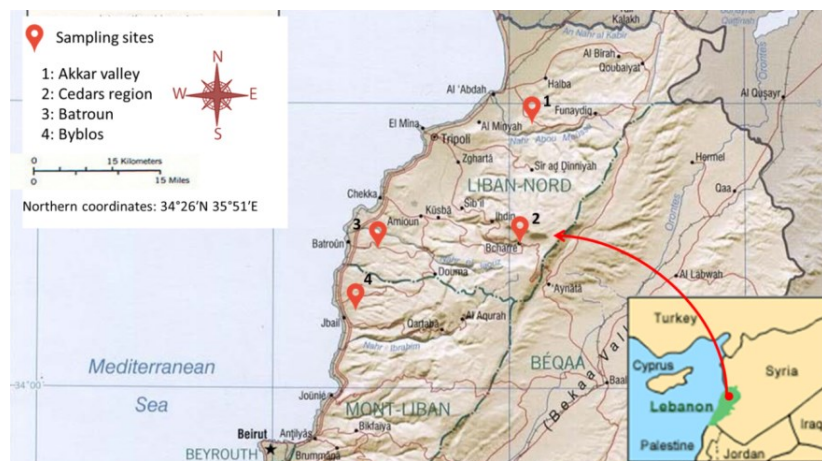


Figure 1: honey sampling sites

3. Results and Discussion

3.1 Method validation

The method has been validated for its linearity, limits of detection and quantification, repeatability and reproducibility. Linearity was validated by calculating the correlation coefficient R^2 which should be greater than 0.9800 for all sought pesticides. The limits of detection and quantification were graphically calculated; $LOD = 3 * [min] S/N$ and $LOQ = 10 * [min] S/N$, where $[min]$ = minimal concentration, S =signal detected at this concentration and N = noise.

Finally, the method has been validated for its repeatability calculated by the intraday analysis of the fortification of 3 samples with the same amount of pesticide and reproducibility analysis calculated by the inter day of the fortification of 3 samples with the same amount pesticide to 4 successive days.

The results showed that $R^2 > 0.9850$ for all analyzed pesticides, limit of detection was ranged from 0.1 to 25.2 $ng\ g^{-1}$ while limit of quantification was from 0.6 to 83.1 $ng\ g^{-1}$. Then these limits allow pesticides detection at very low concentrations even lower than 1 $ng\ g^{-1}$.

For repeatability and reproducibility, the results showed great repeatability and reproducibility; coefficients of variation of intra- and inter days studies were respectively between 0.2 and 15% and between 0.2 and 18%. All these results confirm the efficacy of the present method for the determination of multi-residue pesticides in honey sample.

3.2 Pesticide levels in collected honey

The 18 collected samples were analyzed, according to the previously developed method, for the persistence of 84 pesticides. Residue levels were calculated with Xcalibur using calibration curves previously plotted.

Most of the investigated samples have had some pesticides residues but of all the 84 pesticides sought 10 have been found in the majority of samples. The results are shown in Table 1.

Table 1: levels of the 10 most found pesticides in collected honey samples

Pesticides	Cedars (n=3)		Akkar valley (n=9)		Batroun (n=3)		Byblos (n=3)	
	Σ concentration (ng g ⁻¹)	Detection %	Σ concentration (ng g ⁻¹)	Detection %	Σ concentration (ng g ⁻¹)	Detection %	Σ concentration (ng g ⁻¹)	Detection %
Pendimethalin	-	0	113.1	77.8	6.6	66.7	14.7	33.3
Diflufenican	32.9	66.7	161.5	88.9	151.4	66.7	93.7	100
Pyraclostrobin	0.8	100	4.7	77.8	1.1	100	4.6	66.7
Diuron	8.03	66.7	43.7	77.8	10.9	33.3	3.3	33.3
Penconazole	2.5	66.7	75.7	77.8	115.0	66.7	-	0
Fenpropidin	32.0	33.3	288.1	44.4	49.5	33.3	24.2	33.3
Acetochlore	9.9	33.3	121.1	55.6	39.3	66.7	5.0	33.3
Kerosim-methyl	-	0	67.8	33.3	59.5	66.7	29.2	66.7
Hexachloro- benzene	3.4	33.3	442.3	55.6	16.1	66.7	520.5	33.3
α-endosulfane	-	0	436	33.3	31.1	33.3	-	-
total pesticides concentration (ng g ⁻¹)	90.2		1753.9		480.4		695.1	

The table above shows that, for the mentioned pesticides, the majority of samples contain residues with rates varying among regions.

Each apiary was studied for its contamination by 84 pesticide residues in honey matrixes. Pesticides contamination in honey usually results from bees' contamination during foraging activities. In fact, bees have a high mobility and a wide flight area which makes them suitable for a wide monitoring area; honey bees fly up to 4 km in all directions from their apiary and thus have access to an area of about 50 km² allowing them to monitor a large area and to detect different type of pollutants in their ambient environment (Malhat et al. 2015). Each of the studied apiaries was located in a rural area known for its agricultural productions. Thus, these sites are surrounded by cultivations what makes their emplacement somehow close to the site of phytosanitary products' application.

These results show that collected samples from the Cedars of Lebanon were the less contaminated with pesticide residues. In fact, this region usually dedicated to organic crops, are the least contaminated with pesticides.

Contrariwise, Akkar valley seems to be the most contaminated area with pesticides residues. Figure 2 shows a chromatogram corresponding to a sampling site in this region as well as the individual MRM traces for penconazole, Pyraclostrobine and Diflufenican given as an example for MRM fragmentation of pesticides residues. This chromatogram shows the concentration of the pollutants in this region. In fact, Akkar area is well known for its agricultural productions. We also note in this area the presence of organochlorine pesticides, considered as persistent pesticides. These pesticides are used in this zone with very weak control particularly at the Syrian borders where farmers are tempted to favor low cost and high efficiency on the back of ecological impacts (El-Osmani et al. 2014). In their work, El-Osmani et al., in 2014, showed the persistence of organochlorine pesticides in the ground water of Akkar district, confirming the use of these pesticides in this agricultural zone.

Furthermore, Byblos seems to be highly contaminated in hexachlorobenzene. This pesticide despite of its banning under the Stockholm convention on persistent organic pollutants on 2001 is still found at the environment (Specht et al. 2015). Hexachlorobenzene persist and bioaccumulate principally due to its high lipid solubility and resistance to degradation (Delisle et al. 2015).

For Batroun, the highest pesticides residues found belong to Diflufenican and Penconazol. The agricultural productions in this area explain the presence of these pesticides; in fact, this region is well known for its fruits and vegetables productions especially oranges, pome fruits and grapes. Penconazole is an agricultural fungicide which is used by foliar application to control a wide range of diseases in fruits and vegetables it is also applied to vegetables productions in order to control different mold and mildew which could explain the presence of this fungicide in abundance in this region. Furthermore, Diflufenican is usually used for pre and post emergence of foliar absorbed herbicide for winter weed control in cereal crops which clarify its presence in Batroun also known for some cereal productions.

Several studies have shown the credibility of the use of honey as environmental bio indicator of pesticides contamination. In their study, Panseri et al., in 2014 showed a great direct relation between pesticides residues found in honey and contaminants sources (Panseri et al. 2014). Moreover, Malhat et al., in 2015 used honey samples as a gauge to monitor pesticides residues in ambient environment of the beehives in Egypt (Malhat et al. 2015). Furthermore, Italian organic honey was used by Chiesa et al in 2016 in order to assess pesticides contamination in relation to environmental pollution (Chiesa et al. 2016).

Our results confirm the impact of intensive vegetables growing on honey contamination. It is important to underline that the systematic introduction of pesticides into nectar and pollen may have direct consequences for honey bee health and ultimately lead to pesticide contamination of honey and honey containing food (Panseri et al. 2014).

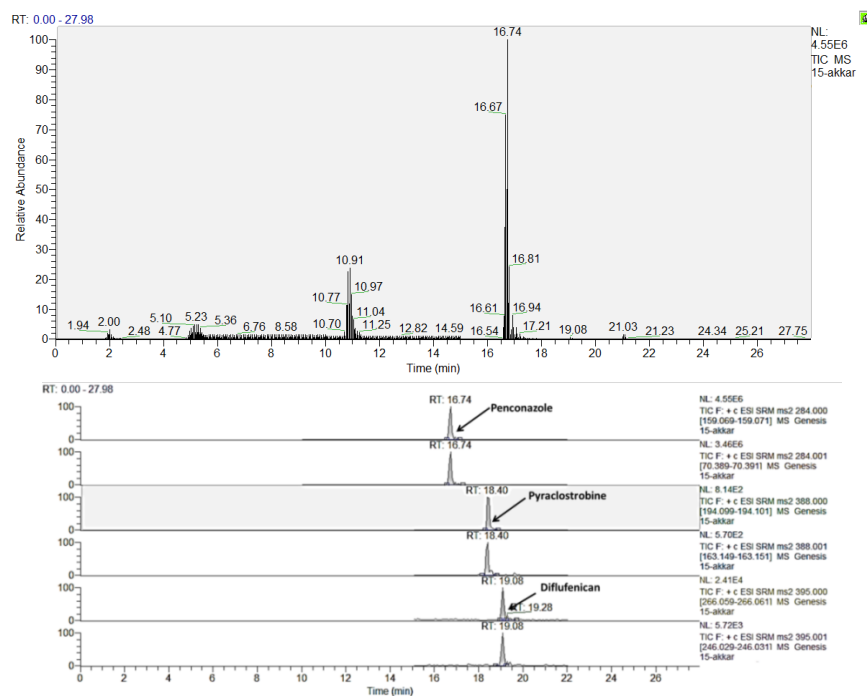


Figure 2: LC-MS/MS chromatogram of a sampling site in Akkar region

4. Conclusion

The developed method has enabled us to analyze 18 samples of honey originating from northern Lebanon. Indeed, to our knowledge, the combination of QuEChERS and SPME never was reported. Similarly, chromatographic methods coupled with mass spectrometry, offering high sensitivity, have enabled us quantification of pesticide residues even of very low dose less than 1 ng g⁻¹.

In addition, the total concentrations of pesticides in honey recovered Akkar and Byblos were 1753.9 ng g⁻¹ and 695.1 ng g⁻¹ respectively. However, samples from the Cedars of Lebanon were the least concentrated pesticides with a total concentration of 90.2 ng g⁻¹. This region is located in the mountain of Lebanon weakly cultivated dedicated to organic production.

The results of this study show that honey can reflect the specific pollution of a given environment and will be considered an appropriate sentinel for bio-environmental monitoring. This could be an effective tool for beekeepers to select production areas in particular for the production of organic honey.

Acknowledgement

We would like to thank the AZM & SAADE Association and the Lebanese University for funding the project, and the University of Strasbourg for the international mobility aid.

Conflict of interest

On behalf of all authors, the corresponding author states that there is no conflict of interest.

References

- Badiou-Bénéteau A, Benneveau A, G ret F, Delatte H, Becker N, Brunet J-L, Reynaud B, Belzunces L. 2013. Honeybee biomarkers as promising tools to monitor environmental quality. *Environment international*.60:31-41.
- Barakat AA, Badawy HM, Salama E, Attallah E, Maatook G. 2007. Simple and rapid method of analysis for determination of pesticide residues in honey using dispersive solid phase extraction and GC determination. *Journal of Food Agriculture and Environment*.5:97.
- Bargańska Ź, Ślebioda M, Namieśnik J. 2013. Pesticide residues levels in honey from apiaries located of Northern Poland. *Food Control*.31:196-201.
- Chiesa LM, Labella GF, Giorgi A, Panseri S, Pavlovic R, Bonacci S, Arioli F. 2016. The occurrence of pesticides and persistent organic pollutants in Italian organic honeys from different productive areas in relation to potential environmental pollution. *Chemosphere*. 7//;154:482-490.
- Debayle D, Dessalces G, Grenier-Loustalot MF. 2008. Multi-residue analysis of traces of pesticides and antibiotics in honey by HPLC-MS-MS. *Analytical and Bioanalytical Chemistry*.391:1011-1020.
- Delisle A, Ferraris E, Plante I. 2015. Chronic exposure to hexachlorobenzene results in down-regulation of connexin43 in the breast. *Environmental research*.143:229-240.
- El-Osmani R, Net S, Dumoulin D, Baroudi M, Bakkour H, Ouddane B. 2014. Solid Phase Extraction of Organochlorine Pesticides Residues in Groundwater (Akkar Plain, North Lebanon). *International Journal of Environmental Research*.8:903-912.
- G mez-P rez ML, Plaza-Bola os P, Romero-Gonz lez R, Mart nez-Vidal JL, Garrido-Frenich A. 2012. Comprehensive qualitative and quantitative determination of pesticides and veterinary drugs in honey using liquid chromatography–Orbitrap high resolution mass spectrometry. *Journal of Chromatography A*.1248:130-138.
- Kujawski MW, Namieśnik J. 2011. Levels of 13 multi-class pesticide residues in Polish honeys determined by LC-ESI-MS/MS. *Food Control*.22:914-919.
- Malhat FM, Haggag MN, Loutfy NM, Osman MA, Ahmed MT. 2015. Residues of organochlorine and synthetic pyrethroid pesticides in honey, an indicator of ambient environment, a pilot study. *Chemosphere*.120:457-461.

Panseri S, Catalano A, Giorgi A, Arioli F, Procopio A, Britti D, Chiesa L. 2014. Occurrence of pesticide residues in Italian honey from different areas in relation to its potential contamination sources. *Food Control*.38:150-156.

Paradis D, Bérail G, Bonmatin J-M, Belzunces LP. 2014. Sensitive analytical methods for 22 relevant insecticides of 3 chemical families in honey by GC-MS/MS and LC-MS/MS. *Analytical and bioanalytical chemistry*.406:621-633.

Rial-Otero R, Gaspar E, Moura I, Capelo J. 2007. Chromatographic-based methods for pesticide determination in honey: An overview. *Talanta*.71:503-514.

Specht IO, Bonde JPE, Toft G, Giwercman A, Spanò M, Bizzaro D, Manicardi GC, Jönsson BA, Robbins WA. 2015. Environmental hexachlorobenzene exposure and human male reproductive function. *Reproductive Toxicology*.58:8-14.

Tette PAS, Guidi LR, de Abreu Glória MB, Fernandes C. 2016. Pesticides in honey: A review on chromatographic analytical methods. *Talanta*.149:124-141.

Wiest L, Buleté A, Giroud B, Fratta C, Amic S, Lambert O, Pouliquen H, Arnaudguilhem C. 2011. Multi-residue analysis of 80 environmental contaminants in honeys, honeybees and pollens by one extraction procedure followed by liquid and gas chromatography coupled with mass spectrometric detection. *Journal of Chromatography A*.1218:5743-5756.

VI. Détermination de 16 HAPs et 22 PCBs dans des échantillons de miel utilisés comme biomoniteurs de la qualité environnementale dans différentes régions du Liban.

Ce résultat, présenté sous format d'un article en cours de préparation, présente une deuxième application de la méthode multi-résidus développée sur le miel. Le résultat précédent montre l'efficacité du miel pour l'évaluation de la contamination de l'air dans 4 zones rurales au Liban. Dans cette étude, ces mêmes zones ont été également évaluées par une approche basée sur le biomonitoring afin de détecter leur contamination par 16 HAPs et 22 PCBs.

Ainsi, dans cette étude, les 18 échantillons de miel préalablement collectés du Liban nord ont été analysés par la même méthode basée sur QuEChERS-SPME pour leur contamination en 16 HAPs et 22 PCBs. Les extraits ont été par la suite analysés par chromatographie en phase gazeuse / spectrométrie de masse à trappe ionique (GC-MS/MS). Les résultats obtenus ont montré que les quatre régions analysées étaient contaminées par des HAPs, alors qu'aucun résidu de PCB n'a été détecté dans les 18 échantillons analysés. Ensuite, différents ratios des HAPs ont été établis afin de préciser l'origine des HAPs détectés. Ces résultats ont montré que les HAPs aux Cèdres et à Batroun sont d'origine pétrogénique provenant des émissions diesel, alors que les HAPs de Byblos et de Akkar sont d'origine pyrogénique provenant de la combustion des herbes, du bois et du charbon. En revanche, des émissions véhiculaires se sont avérées importantes dans toutes les régions étudiées.

Les observations expérimentales issues de cette étude démontrent que le miel peut servir comme agent fiable de « biomonitoring » et constitue un capteur passif peu coûteux des polluants atmosphériques. Nos résultats obtenus montrent que les quatre régions de Liban analysées étaient contaminées par des HAPs, lesquels sont issus de différentes sources de contaminations.

Determination of 16 PAHs and 22 PCBs in honey samples originated from different region of Lebanon and used as environmental biomonitors sentinel

Josephine AL-ALAM^{1,2}, Asma CHBANI^{1,4}, Ziad FAJLOUN^{1,3}, Maurice MILLET^{2*}

¹Azm Center for Research in Biotechnology and its Applications, Doctoral School of Science and Technology, Lebanese University, El Mittein Street, Tripoli, Lebanon

²Institute of Chemistry and Processes for Energy, Environment and Health ICPEES UMR 7515 Group of Physical Chemistry of the Atmosphere, University of Strasbourg, Strasbourg, France

³Faculty of Sciences III, department of Biology, Lebanese University, Tripoli, Lebanon

⁴Faculty of Public Health III, Lebanese University, Tripoli, Lebanon

*Address correspondence to Maurice Millet, Institute of Chemistry and Processes for Energy, Environment and Health ICPEES UMR 7515 Group of Physical Chemistry of the Atmosphere, University of Strasbourg, Strasbourg, France Tel.: + 33 (0)3 68 85 04 22, Fax: + 33 (0)3 68 85 04 02, E-mail: mmillet@unistra.fr

Abstract

The permanent release of organic chemicals such as polycyclic aromatic hydrocarbons (PAHs) and polychlorinated biphenyls (PCBs) in the environment is currently a great concern in the whole world due to their persistence and damage to the life cycle of all living organisms. Numerous sampling techniques have been used for the characterization of this chemical pollution, although biomonitoring using natural samplers has become the technique of choice due to its efficiency, specificity and low cost. In fact, honeybees are considered as a reliable environmental biomonitors due to their intense foraging activity contaminating therefore all their products including honey which can be consequently interesting to study as a reliable environmental monitor as well as for its wide consumption. In this study, 18 samples of honey collected from Lebanon, were analyzed for their contamination by 16 HAPs and 22 PCBs. Multi-residue extractions were based on QuEChERS-SPME, followed by chromatographic analysis with gas chromatography/ion-trap mass spectrometry (GC-MS/MS). At first, the method was developed and validated using organic honey, and then the collected samples were analyzed. The obtained results proved the simplicity, efficiency, rapidity and reliability of the optimized method as detection limits were low and repeatability and reproducibility were high with a coefficient of variation of about 10% for the majority of the analyzed compounds. For sample analyzes, different ratios of founded PAHs were calculated in order to estimate the sources of the pollution by these compounds. Contrariwise, no PCBs residues were detected in the 18 analyzed samples.

Keywords: Honey, biomonitoring, PAHs, PCBs, environmental pollution, QuEChERS, SPME

Introduction:

Environmental pollution is a matter of rising global public health distress. In fact, air pollution exposure is the major risk for health causing several diseases as lung carcinoma, cerebrovascular accidents, and acute lower respiratory infections in childhood (Günther and Hellmann, 2017).

The continuous release of harmful chemicals in the atmosphere leads to undesirable health effects (Rodríguez et al., 2016). According to the World Health Organization (WHO, 2014), in 2012 approximately 7 million premature deaths were attributable to air pollution exposure.

Polycyclic aromatic hydrocarbons (PAHs) are, among the large variety of organic atmospheric pollutants, a category of hazardous organic pollutants of special concern because of their environmental persistence. PAHs are mainly emitted in the atmosphere through combustion processes; they are produced as byproducts of an incomplete combustion of organic matter, volcanic eruption, forest fires, and vehicle emissions (Elorduy et al., 2016; Li et al., 2016).

These pollutants are considered as one of the most serious pollutants due to their bioaccumulation and high toxicity as they are known for being carcinogenic, teratogenic and mutagenic (Hu et al., 2017). The most toxic PAHs are those with five or more benzene rings, known as high-molecular weight PAHs (HMW PAHs). They are considered as most toxic, mutagenic and carcinogenic. Especially in urban areas, they are responsible of several respiration problems, human cancer of skin, lungs and bladder (Boström et al., 2002).

Furthermore, polychlorinated biphenyls (PCBs) are a group of organic chemicals widely used as coolants and lubricants in transformers, capacitors, and other electrical equipment (Kodavanti, 2017). Due to their persistence and adverse effects generated by their use, these products were totally banned by the United States Congress in 1979 and by the Stockholm Convention on Persistent Organic Pollutants in 2001 (Porta and Zumeta, 2002). In fact, PCBs are considered as endocrine disruptors linked to adverse health effects on male reproductive function in humans and animals (Hauser et al., 2005). They are also classified by the International Agency for Research on Cancer (IARC) as carcinogenic to humans and included in Group 1 (IARC, 2015).

The assessment of environmental pollution can be done with sentinel species (Basu et al., 2007). By transporting pollen from flower to flower and from plant to plant, bees play an essential role in environmental biomonitoring (Paradis et al., 2014).

In fact, honeybees are considered as a reliable environmental biomonitors due to their intense foraging activity as these organisms cover a large area in their search of pollen and nectar (Celli and Maccagnani, 2003; Chauzat et al., 2009) which brings them into contact with a large number of different pollutants (Badiou-Bénéteau et al., 2013). Furthermore, bees, with their specific furry body composition, are particularly appropriate to keep pesticides with which they come into contact and bring them to the hive, which is contaminated either by pollutants collected by bees or by those carried out by pollen and surface area (Kujawski and Namieśnik, 2011).

For all these reasons, the use of honeybees and bee products (nectar, pollen and honey) as biomonitors of environmental contamination has been of great concern in recent years. Several studies have shown the effectiveness of these three matrices in environmental biomonitoring (Badiou-Bénéteau et al., 2013; Chiesa et al., 2016; de Oliveira et al., 2016; Matin et al., 2016).

Among all these matrices, the study of honey contaminations seems to be the most important for establishing both environmental and nutraceutical surveillance. In fact, honey has held an important position in traditional medicine for ages as it is well known for its antimicrobial, antioxidant and anti-inflammatory, antidiabetic and anticancer activities. Honey is also used for the treatment of cardiovascular and neurological diseases. It also has an effect on fertility (Ahmed and Othman, 2013; Can et al., 2015; Rao et al., 2016). Furthermore, several studies reported the use of honey as a reliable monitor for environmental pollution (Malhat et al., 2015; Chiesa et al., 2016; Codling et al., 2016; Shamsipur et al., 2016; Tette et al., 2016).

Therefore, the analysis of honey, known for all these curative properties, for its wide consumption, and for its environmental biomonitoring properties seems to be a necessity in order to establish both environmental and nutraceutical monitoring.

Analysis of emerging pollutants from such matrices is usually done by a multi-residual method allowing the analysis of a wide range of pesticides with QuEChERS extraction (Malhat et al., 2015; Codling et al., 2016; Juan-Borrás et al., 2016). However, other methods were also used as Accelerated solvent extraction (ASE) (Chiesa et al., 2016), Solid-phase extraction (SPE) (Shamsipur et al., 2016), matrix solid phase dispersion (MSPD) (García-Valcárcel et al., 2016) and Liquid-liquid extraction (LLE) (Koltsakidou et al., 2015).

In spite of all these studies, bees and their products have been widely used for monitoring environmental pollution caused by pesticides usage and very few works reported the use of these organisms for other organic pollutants such as PAHs (Perugini et al., 2009; Lambert et al., 2012; García-Valcárcel et al., 2016).

In this work, 18 honey samples, collected from different region in Lebanon were assessed for their contamination with 16 PAHs and 22 PCBs in order to study the environmental pollution in these regions which, to the best of our knowledge were never studied before. The original QuEChERS method was used for the extraction of the PAHs, and pollutants sustained a concentration by Solid phase micro extraction (SPME) before their analysis by GC-MS/MS. It is important to note that, this is the first time where these two extraction procedures were simultaneously used for the extraction of such emerging pollutants. Once assessed, PAHs ratios were calculated in order to determine the source of PAHs contamination in the studied regions.

Method and materials

Chemicals and reagents

A mixture (0.1 g. L⁻¹) of 16 PAHs (Naphtalene, Acenaphtene, Fluorene, Phenanthrene, Anthracene, Fluoranthrene, Pyrene, Benzo(a)anthracene, Chrysene, Benzo(b)fluoranthrene, Benzo(k)fluoranthrene, Benzo(e)pyrene, Benzo(a)pyrene, Indenol(1,2,3)pyrene, Benzo(g,h,i)perylene, Dibenzo(a,h)anthracene) was prepared from individual standards purchased from sigma Aldrich (L'Isle D'Abeau, France).

A mixture (0.1 g. L⁻¹) of 22 PCBs (PCB 18, PCB 31, PCB 28, PCB 52, PCB 44, PCB 70, PCB 81, PCB 101, PCB 123, PCB 118, PCB 114, PCB 105, PCB 126, PCB 149, PCB 153, PCB 138, PCB 167, PCB 156, PCB 157, PCB 169, PCB 180, PCB 189) was purchased from Cluzeau Info Labo (St Foy la Grande, France).

Naphtalene-d⁸ used as internal standard was purchased from sigma Aldrich (L'Isle D'Abeau, France). Ultrapure water was obtained from an Elga system, (Antony, France). ACN chromasolv[®] gradient grade $\geq 99\%$ was purchased from sigma Aldrich (L'Isle D'Abeau, France).

Kits for QuEChERS sample preparations were purchased as ready to use from RESTEK France. Buffered extraction kits (EN 1566 method) containing 4g MgSO₄, 1g NaCl, 1g trisodium citrate dihydrate and 0.5g disodium hydrogencitrate sesquihydrate were used. For clean-up, samples clean-up kits (AOAC 2007 method) containing 1.2g MgSO₄, 400mg PSA and 400mg C₁₈ were used.

Sample collection

For method development, certified organic honey was purchased from local market and was used for calibration.

For sample analyzes, eighteen samples collected from 4 regions in Lebanon (Cedars, Akkar valley, Batroun situated in northern Lebanon and Byblos located at the borderline between northern Lebanon and Mount Lebanon) were obtained from beekeepers in the period of August-September 2015. Sampling sites are shown in figure 1.

Samples were then transported to the laboratory in polypropylene tube and maintained at -15°C until analysis.

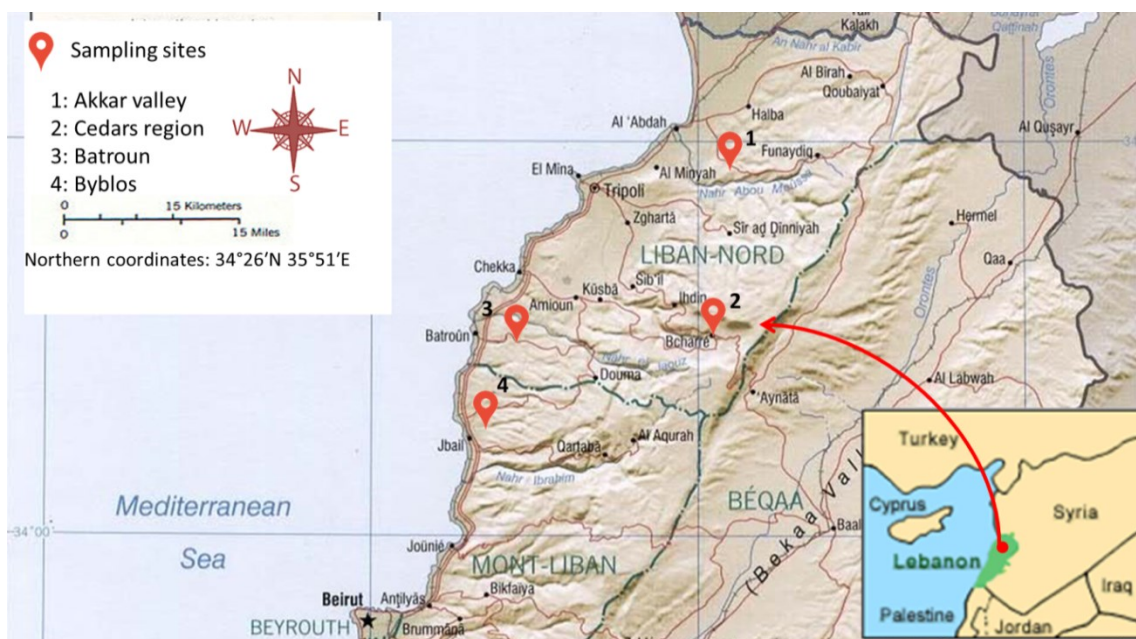


Figure 1: sampling sites

Method development

Five gram of certified organic honey were weighted in 50 mL centrifuge tube then fortified with a mixture of the 16 PAHs and 22 PCBs in order to prepare a calibration range with a

concentration varying from 10 to 3000 ng g⁻¹. Fortified samples were kept at 4°C overnight, and then undergo the extraction procedure cited below. All analyzes were done in triplicate.

Extraction procedure

Blank and fortified honey samples undergone the same QuEChERS extraction procedure developed by Malhat et al., in 2015 with minor modifications, then, extracts were re-extracted and concentrated using solid phase micro extraction (SPME) (Malhat et al., 2015).

QuEChERS extraction

For QuEChERS extraction, 10 mL of ultrapure water and 10 mL of ACN were added to the fortified samples, the tubes were then manually shaken and the extraction salts were added. The mixture was then mixed for 1 minute followed by a centrifugation at 5000 RPM for 10 minutes. Therefore, the supernatant was transferred to dSPE clean up tubes, and the mixture was well shaken for 1 minute and centrifuged at 5000 RPM for 10 minutes. The obtained supernatant underwent evaporation followed by a re-dissolution in 900 µL of ACN.

SPME concentration

After being re-dissolved in ACN, extracts were diluted to 20mL using salted water (15 g L⁻¹ NaCl) in order to promote its adsorption on the SPME fiber.

For this second step extraction, a SPME fiber coated with polydimethylsiloxane PDMS (100 µm) was used. The fiber was soaked in the 20 mL solution and heated to 80°C under agitation for 40 minutes. The fiber was then directly desorbed in the GC column for the analysis of the selected PAHs and PCBs.

Naphthalene-d⁸ was added before this extraction/concentration step.

Analytical procedure using GC-MS/MS

Analyzed compounds concentrations were determined by gas chromatography (GC) coupled to a tandem mass spectrometer (ITQ™ 900). The GC (Thermo Scientific Trace 1300) was coupled to a mass spectrometry system (ITQ 900) and injection was done in splitless mode at 280°C.

Injection of the sample was done by thermal desorption of the SPME fiber. Extracts were injected into a capillary column Optima XLB (60 m × 0.25 mm as internal diameter and 0.25 µm film thickness).

Helium was used as carrier gas at a flow rate of 1 mL min⁻¹, and separation was performed with the following temperature gradient: 50°C maintained for 3 min, then the temperature increase 40°C/min to achieve 240°C then it increases then 1.5°C/min to achieve 255°C where it remains constant for 5 min. Finally the temperature increases 20°C/min to achieve 330°C where it was maintained for 25 min.

Once the method developed, it was validated and the limits of detection (LOD) and quantification (LOQ) were calculated. Repeatability and reproducibility of the method were also

determined.

Samples analysis

All collected samples underwent the same extraction procedure of the developed method cited above. PAHs and PCBs residues in all honey samples were calculated using Xcalibur software.

Results and discussion

Method validation

The method has been validated for its linearity, limits of detection and quantification, and its recovery. Linearity was validated by calculating the correlation coefficient R² which should be greater than 0.9800 for all searched compounds. The limits of detection and quantification were graphically calculated; LOD =3* [min] S/N and LOQ =10*[min] S/N, where [min] = minimal concentration, S=signal detected at this concentration and N= noise.

Results show that correlation coefficient R² for all analyzed compounds (PAHs, PCBs) was around 0.99, except for PCB 169 where R² was 0.979.

Limits of detection were ranged from 0.07 to 12 ng g⁻¹ for PAHs and from 0.92 to 16.76 ng g⁻¹ for PCBs, while limits of quantification were ranged from 0.23 to 40 ng g⁻¹ and from 3.08 to 55.87 ng g⁻¹ for PAHs and PCBs respectively.

For repeatability and reproducibility, the results showed great repeatability and reproducibility. For PAHs, repeatability was between 1.01 and 15%; reproducibility was between 0.3 and 13%. For PCBs, the coefficients of variation of intra- and inter days studies were respectively between 0.3 and 15% and between 1.8 and 10.1%. All these results confirm the efficacy of the present method for the determination of the selected pollutants in honey samples.

Samples analysis

The 18 collected samples were analyzed, according to the previously developed method for the persistence of 16 PAHs and 22 PCBs. Residue levels were calculated with Xcalibur using previously plotted calibration curves.

PAHs in collected samples

PAHs contamination in honey could be inherited from nectar and pollen or transferred by bees when transforming nectar (Lambert et al., 2012). The ubiquitous character of PAHs makes them omnipresent even as traces in air, water and soil (Pigini et al., 2006). However the highest human exposure to these compounds is occurred during their diet intake (Suchanová et al., 2008). In fact, honey, first and major product of bees and widely consumed to its nutraceutical properties can be responsible of this exposure (Koltsakidou et al., 2015).

Table 1 shows the sum of PAHs concentrations in honey samples from all analyzed regions.

Table 1: sum of PAHs concentrations in honey samples from all analyzed regions.

PAHs	Cedars (n=3)	Batroun (n=3)	Byblos (n=3)	Akkar valley (n=9)
∑ Naphtalene (ng)	166.48	157.05	111.01	234.08
∑ Acenaphthene (ng)	126.48		46.22	77.38
∑ Fluorene (ng)	165.15	277.20	660.66	1137.11
∑ Phenanthrene (ng)	51.66	63.96	861.88	2295.10
∑ Anthracene (ng)	79.33	41.32	698.56	1813.98
∑ Fluoranthrene (ng)	101.01	54.21	1270.38	890.53
∑ Pyrene (ng)	73.51	38.12	986.98	688.47
∑ Benzo(a)anthracene (ng)	43.71	13.85	137.81	1644.67
∑ Chrysene (ng)	26.81	16.32	162.80	98.45
∑ Benzo(b)fluoranthrene (ng)				492.43
∑ Benzo(k)fluoranthrene (ng)			134.80	700.43
∑ Benzo(e)pyrene (ng)		18.94	977.91	8382.17
∑ Benzo(a)pyrene (ng)				
∑ Dibenzo(a,h)anthracene (ng)				
∑ Indenol(1,2,3)pyrene (ng)				
∑ Benzo(g,h,i)perylene (ng)			243.89	
∑ Coronene (ng)				
∑ PAHs (ng.g ⁻¹)	166.83	136.20	1258.58	3691.16
∑ PAHs/n (ng.g ⁻¹)	55.61	45.40	419.53	410.13

As shown from table 1, the regions of the Cedars and Batroun were the least contaminated by PAHs while a high concentration of these compounds was found in Akkar valley and Byblos.

The geographical distribution of the sum of the PAHs, the high molecular weight PAHs (HMW PAHs), as well as the low molecular weight PAHs (LMW PAHs) is shown in figure 2.

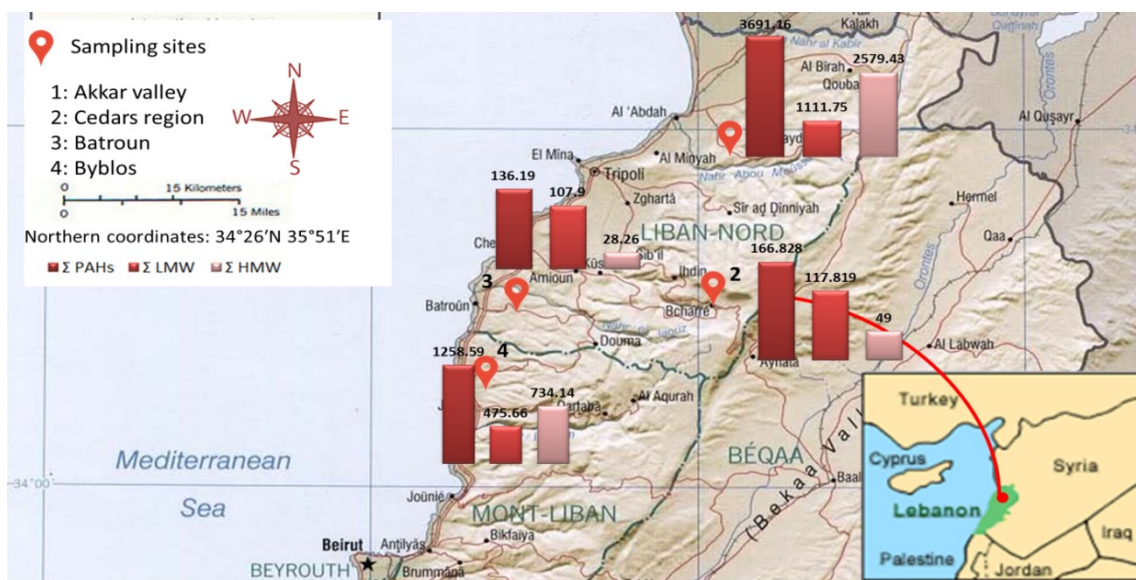


Figure 2: Distribution of PAHs in the different studied regions

Figure 2 shows that in the Cedars region and Batroun low molecular weight (LMW) PAHs concentration overcome high molecular weight (HMW) PAHs concentration, while the reverse is observed in Byblos and Akkar valley. In fact, as mentioned by Manoli et al., in 2004, the emission of PAHs depends on the processes producing them. Indeed, LMW PAHs are usually produced in low temperature processes as domestic wood burning while HMW PAHs requires high temperature processes as fuels combustions in engines for being emitted (Hwang et al., 2003; Mostert et al., 2010).

The results provided by table 1 and figure 2 can be then explained using these two observations. In fact, in the Cedars and Batroun, domestic burning required for heating during cold overcomes the fuel combustion and vehicles emissions while in Byblos and Akkar the population density with all the circumstances that are then implied are responsible of this high PAHs rate as well as the dominance of HMW PAHs provided by petrogenic sources and vehicles emissions.

In order to identify the source of PAHs contamination in the selected areas, different ratios of different PAHs were calculated and then compared to the typical diagnostic ratio provided by Tobiszewski and Namiesnik in 2012.

Table 2 shows the typically reported values of PAHs diagnostic ratios given by Tobiszewski and Namiesnik (2012).

Table 2: Diagnostic ratios used with their typically reported values as given by (Tobiszewski and Namieśnik, 2012).

PAHs ratios	Value range	Sources	References
$\Sigma\text{LMW}/\Sigma\text{HMW}$	<1 >1	Pyrogenic Petrogenic	(Zhang et al., 2008)
$\text{FL}/(\text{FL} + \text{PYR})$	<0.5 >0.5	Petrol emissions Diesel emission	(Ravindra et al., 2008)
$\text{ANT}/(\text{ANT} + \text{PHE})$	<0.1 >0.1	Petrogenic Pyrogenic	(Pies et al., 2008)
$\text{FLA}/(\text{FLA} + \text{PYR})$	<0.4 0.4-0.5 >0.5	Petrogenic Fossil fuel combustion Grass, wood, coal combustion	(Roberto et al., 2009)
$\text{BaP}/(\text{BaP} + \text{BeP})$	~0.5 <0.5	Fresh particles Photolysis (ageing of particles)	(Oliveira et al., 2011)
$\text{BaA}/(\text{BaA} + \text{CHR})$	0.2-0.35 >0.35 <0.2	Coal combustion Vehicular emissions Petrogenic	(Yunker et al., 2002)

Σ LMW: sum of PAHs having two and three rings; Σ HMW: sum of PAHs having four and five rings; FL: Fluorene; Pyr: Pyrene; An: Anthracene; Phe: Phenanthrene; Fla: Fluoranthrene; BaA: Benzo(a)anthracene; BeP: benzo(e)pyrene; CHR: chrysene.

For this, previously cited ratios were calculated for each of the selected four regions in order to identify the pyrogenic or the petrogenic origin of the PAHs found.

Table 3 shows the calculated PAHs ratios for the selected areas.

Table 3: calculated PAHs ratios for the selected areas

PAHs	Cedars (n=3)		Batroun (n=3)		Byblos (n=3)		Akkar valley (n=9)	
	Σ concentration (ng.g ⁻¹)	Σ/n (ng.g ⁻¹)	Σ concentration (ng.g ⁻¹)	Σ/n (ng.g ⁻¹)	Σ concentration (ng.g ⁻¹)	Σ/n (ng.g ⁻¹)	Σ concentration (ng.g ⁻¹)	Σ/n (ng.g ⁻¹)
Σ LMW	117.82	39.27	107.91	35.97	475.67	158.55	1111.7	123.5
Σ HMW	49.01	16.34	28.28	9.43	734.14	244.71	2579.4	286.56
Σ LMW/ Σ HMW	2.40		3.89		0.60		0.43	
$\text{Fl}/(\text{Fl} + \text{Pyr})$	0.69		0.88		0.45		0.62	
$\text{An}/(\text{An} + \text{Phe})$	0.61		0.39		0.4		0.44	
$\text{Fla}/(\text{Fla} + \text{Pyr})$	0.55		0.59		0.56		0.56	
$\text{BaA}/(\text{BaA} + \text{BeP})$	1		0.42		0.12		0.16	
$\text{BaA}/(\text{BaA} + \text{CHR})$	0.62		0.46		0.46		0.94	

Σ LMW: sum of PAHs having two and three rings; Σ HMW: sum of PAHs having four and five rings; FL: Fluorene; Pyr: Pyrene; An: Anthracene; Phe: Phenanthrene; Fla: Fluoranthrene; BaA: Benzo(a)anthracene; BeP: benzo(e)pyrene; CHR: chrysene.

The comparison of the ratio Σ LMW/ Σ HMW for the four selected regions, shows that the PAHs in the Cedars region and Batroun are a result of petrogenic combustions while the main origin of PAHs in Byblos and Akkar valley are pyrogenic. In fact, road combustions may be the main reason for the PAHs presence in the first two areas.

Contrariwise, the analysis of the ratio An/(An+Phe) shows that this latter was higher than 0.1 for all studied regions, which means that both sources are present in the four studied areas and a more specific analysis should be done in order to identify the main responsible agent for both pyro- and petrogenic emissions.

For petrogenic emission; the study of the ratio Fl/(Fl+Pyr) allowed us to identify the main source of eventual petrogenic contamination in the selected areas. The results show diesel emissions in the Cedars region, Batroun and Akkar valley while a petrol emission was found in Byblos. As an explanation for these results, we thought that roads and car emission are responsible of the diesel emissions found, while the port present in Byblos may be the responsible of the petrol emission found. It is noted that, as important vehicular emissions are found to be significant in the four selected regions, petrol emissions and diesel emissions cannot be differentiated and should be considered together. This last assumption was validated by the ratio BaA/(BaA +CHR) which was higher than 0.35 in the four regions confirming the importance of vehicular emissions in the process of environmental contamination by PAHs.

For pyrogenic emission; the ratio Fla/(Fla+Pyr) being higher than 0.5 for all analyzed samples implied that pyrogenic emission are especially due to the combustion of grass, wood, and coal.

Finally, the ratio BaA/(BaA+CHR) shows that some photolysis phenomena exist in the regions of Byblos and Batroun.

The presence of PAHs in honey can harm its nutraceutical properties since it is a food product with a world-wide consumption principally among children and thus must be free of any chemical contaminants particularly from PAHs (Koltsakidou et al., 2015). In fact, in order to protect human health from their adverse effects, the scientific committee on Food suggested the study of four PAHs (PAH4: benzo[a]pyrene, benzo[a]anthracene, benzo[b]fluoranthene and chrysene) as markers of the carcinogenicity of the genotoxic and carcinogenic PAHs with a specific attention to benzo[a]pyrene (Alexander et al., 2008; Lambert et al., 2012). The distribution of PAH4 in each region as provided by table 1, showed a total absence of the highly carcinogenic benzo[a]pyrene in the four analyzed regions while a peak of benzo[a]anthracene was obtained in Akkar threatening its quality. Benzo[b]fluoranthene was only detected in Akkar region while Chrysene was found in all analyzed samples with the highest concentration measured in Byblos.

The presence of PAHs residues in all studied areas could be correlated with the findings of many authors who showed that this pollution could be occurred as a result of an environmental contamination transferred through bees as well as the use of the blowing smoke into the beehives during their treatment by beekeepers (Perugini et al., 2009; Moret et al., 2010; Corredera et al., 2011; Lambert et al., 2012; Koltsakidou et al., 2015).

PCBs in collected samples

For PCBs: no residues were detected for all analyzed samples. The main explanation that may be given is the absence of all industrial activities in the studied areas. In fact, these regions are mostly rural areas quiet reserved for agricultural production.

Conclusion

A new, simple and effective extraction method was developed by the combination of an optimized QuEChERS extraction with a SPME concentration step. The method showed its efficiency in the extraction of PAHs and PCBs from honey even at low concentrations. The main advantage of the used method is being environmentally friendly requiring a small amount of solvent extraction.

Moreover, the choice of honey matrix as biomonitor candidates seems to be representative, efficient and even important and unavoidable due to the wide consumption of this product.

The obtained results showed that the four analyzed region were contaminated with PAHs while none of them was infected by any of the 22 analyzed PCBs. In fact, the persistence of important PAHs residues in the consumed honey allowed us, by the use of different PAHs ratios to identify the origin of this environmental contamination which can allow in further steps to reduce its production.

The results of this study show that honey can reflect the specific pollution of a given environment and will be considered as an appropriate sentinel for bio- environmental monitoring.

Acknowledgments

We gratefully acknowledge AZM & SAADE association and the Lebanese University for funding the project, as well as Strasbourg University for the international mobility aid, without which the present study could not have been completed.

References

- Ahmed, S., Othman, N.H., 2013. Review of the medicinal effects of tualang honey and a comparison with manuka honey.
- Alexander, J., Benford, D., Cockburn, A., Cravedi, J., Dogliotti, E., Di Domenico, A., Fernández-Cruz, M., Fink-Gremmels, J., Fürst, P., Galli, C., 2008. Polycyclic aromatic hydrocarbons in food: scientific opinion of the Panel on Contaminants in the Food Chain. *The EFSA Journal* 724, 1-114.
- Badiou-Bénéteau, A., Benneveau, A., Gélet, F., Delatte, H., Becker, N., Brunet, J.-L., Reynaud, B., Belzunces, L., 2013. Honeybee biomarkers as promising tools to monitor environmental quality. *Environment international* 60, 31-41.
- Basu, N., Scheuhammer, A.M., Bursian, S.J., Elliott, J., Rouvinen-Watt, K., Chan, H.M., 2007. Mink as a sentinel species in environmental health. *Environmental Research* 103, 130-144.
- Boström, C.-E., Gerde, P., Hanberg, A., Jernström, B., Johansson, C., Kyrklund, T., Rannug, A., Törnqvist, M., Victorin, K., Westerholm, R., 2002. Cancer risk assessment, indicators, and guidelines for polycyclic aromatic hydrocarbons in the ambient air. *Environmental health perspectives* 110, 451.
- Can, Z., Yildiz, O., Sahin, H., Turumtay, E.A., Silici, S., Kolayli, S., 2015. An investigation of Turkish honeys: their physico-chemical properties, antioxidant capacities and phenolic profiles. *Food chemistry* 180, 133-141.
- Celli, G., Maccagnani, B., 2003. Honey bees as bioindicators of environmental pollution. *Bulletin of Insectology* 56, 137-139.
- Chauzat, M.-P., Carpentier, P., Martel, A.-C., Bougeard, S., Cougoule, N., Porta, P., Lachaize, J., Madec, F., Aubert, M., Faucon, J.-P., 2009. Influence of pesticide residues on honey bee (Hymenoptera: Apidae) colony health in France. *Environmental Entomology* 38, 514-523.

Chiesa, L., Labella, G., Giorgi, A., Panseri, S., Pavlovic, R., Bonacci, S., Arioli, F., 2016. The occurrence of pesticides and persistent organic pollutants in Italian organic honeys from different productive areas in relation to potential environmental pollution. *Chemosphere* 154, 482-490.

Codling, G., Al Naggar, Y., Giesy, J.P., Robertson, A.J., 2016. Concentrations of neonicotinoid insecticides in honey, pollen and honey bees (*Apis mellifera* L.) in central Saskatchewan, Canada. *Chemosphere* 144, 2321-2328.

Corredera, L., Bayarri, S., Pérez-Arquillué, C., Lázaro, R., Molino, F., Herrera, A., 2011. Multiresidue determination of carcinogenic polycyclic aromatic hydrocarbons in honey by solid-phase extraction and high-performance liquid chromatography. *Journal of Food Protection* 74, 1692-1699.

de Oliveira, R.C., do Nascimento Queiroz, S.C., da Luz, C.F.P., Porto, R.S., Rath, S., 2016. Bee pollen as a bioindicator of environmental pesticide contamination. *Chemosphere* 163, 525-534.

Elorduy, I., Elcoroaristizabal, S., Durana, N., García, J., Alonso, L., 2016. Diurnal variation of particle-bound PAHs in an urban area of Spain using TD-GC/MS: Influence of meteorological parameters and emission sources. *Atmospheric Environment* 138, 87-98.

García-Valcárcel, A., Molero, E., Tadeo, J., Hernando, M., 2016. Determination of selected environmental contaminants in foraging honeybees. *Talanta* 148, 1-6.

Günther, M., Hellmann, T., 2017. International environmental agreements for local and global pollution. *Journal of Environmental Economics and Management* 81, 38-58.

Hauser, R., Williams, P., Altshul, L., Calafat, A.M., 2005. Evidence of interaction between polychlorinated biphenyls and phthalates in relation to human sperm motility. *Environmental health perspectives*, 425-430.

Hu, T., Zhang, J., Ye, C., Zhang, L., Xing, X., Zhang, Y., Wang, Y., Sun, W., Qi, S., Zhang, Q., 2017. Status, source and health risk assessment of polycyclic aromatic hydrocarbons (PAHs) in soil from the water-level-fluctuation zone of the Three Gorges Reservoir, China. *Journal of Geochemical Exploration* 172, 20-28.

Hwang, H.-M., Wade, T.L., Sericano, J.L., 2003. Concentrations and source characterization of polycyclic aromatic hydrocarbons in pine needles from Korea, Mexico, and United States. *Atmospheric Environment* 37, 2259-2267.

IARC, 2015. IARC (International Agency for Research on Cancer). p. Polychlorinated biphenyls.

Juan-Borrás, M., Domenech, E., Escriche, I., 2016. Mixture-risk-assessment of pesticide residues in retail polyfloral honey. *Food Control* 67, 127-134.

Kodavanti, P.R.S., 2017. Polychlorinated Biphenyls (PCBs)☆. Reference Module in Neuroscience and Biobehavioral Psychology. Elsevier.

Koltsakidou, A., Zacharis, C.K., Fytianos, K., 2015. A validated liquid chromatographic method for the determination of polycyclic aromatic hydrocarbons in honey after homogeneous liquid-liquid extraction using hydrophilic acetonitrile and sodium chloride as mass separating agent. *Journal of Chromatography A* 1377, 46-54.

Kujawski, M.W., Namieśnik, J., 2011. Levels of 13 multi-class pesticide residues in Polish honeys determined by LC-ESI-MS/MS. *Food Control* 22, 914-919.

Lambert, O., Veyrand, B., Durand, S., Marchand, P., Le Bizec, B., Piroux, M., Puyo, S., Thorin, C., Delbac, F., Pouliquen, H., 2012. Polycyclic aromatic hydrocarbons: bees, honey and pollen as sentinels for environmental chemical contaminants. *Chemosphere* 86, 98-104.

Li, J., Dong, H., Xu, X., Han, B., Li, X., Zhu, C., Han, C., Liu, S., Yang, D., Xu, Q., 2016. Prediction of the bioaccumulation of PAHs in surface sediments of Bohai Sea, China and quantitative assessment of the related toxicity and health risk to humans. *Marine pollution bulletin* 104, 92-100.

Malhat, F.M., Haggag, M.N., Loutfy, N.M., Osman, M.A., Ahmed, M.T., 2015. Residues of organochlorine and synthetic pyrethroid pesticides in honey, an indicator of ambient environment, a pilot study. *Chemosphere* 120, 457-461.

Matin, G., Kargar, N., Buyukisik, H.B., 2016. Bio-monitoring of cadmium, lead, arsenic and mercury in industrial districts of Izmir, Turkey by using honey bees, propolis and pine tree leaves. *Ecological Engineering* 90, 331-335.

Moret, S., Purcaro, G., Conte, L.S., 2010. Polycyclic aromatic hydrocarbons (PAHs) levels in propolis and propolis-based dietary supplements from the Italian market. *Food Chemistry* 122, 333-338.

Mostert, M.M.R., Ayoko, G.A., Kokot, S., 2010. Application of chemometrics to analysis of soil pollutants. *TrAC Trends in Analytical Chemistry* 29, 430-445.

Oliveira, C., Martins, N., Tavares, J., Pio, C., Cerqueira, M., Matos, M., Silva, H., Oliveira, C., Camões, F., 2011. Size distribution of polycyclic aromatic hydrocarbons in a roadway tunnel in Lisbon, Portugal. *Chemosphere* 83, 1588-1596.

Paradis, D., Bérail, G., Bonmatin, J.-M., Belzunces, L.P., 2014. Sensitive analytical methods for 22 relevant insecticides of 3 chemical families in honey by GC-MS/MS and LC-MS/MS. *Analytical and bioanalytical chemistry* 406, 621-633.

Perugini, M., Di Serafino, G., Giacomelli, A., Medrzycki, P., Sabatini, A.G., Persano Oddo, L., Marinelli, E., Amorena, M., 2009. Monitoring of polycyclic aromatic hydrocarbons in bees (*Apis mellifera*) and honey in urban areas and wildlife reserves. *Journal of agricultural and food chemistry* 57, 7440-7444.

Pies, C., Hoffmann, B., Petrowsky, J., Yang, Y., Ternes, T.A., Hofmann, T., 2008. Characterization and source identification of polycyclic aromatic hydrocarbons (PAHs) in river bank soils. *Chemosphere* 72, 1594-1601.

Pigini, D., Cialdella, A., Faranda, P., Tranfo, G., 2006. Comparison between external and internal standard calibration in the validation of an analytical method for 1-hydroxypyrene in human urine by high-performance liquid chromatography/tandem mass spectrometry. *Rapid communications in mass spectrometry* 20, 1013-1018.

Porta, M., Zumeta, E., 2002. Implementing the Stockholm treaty on persistent organic pollutants. *Occupational and environmental medicine* 59, 651-652.

Rao, P.V., Krishnan, K.T., Salleh, N., Gan, S.H., 2016. Biological and therapeutic effects of honey produced by honey bees and stingless bees: a comparative review. *Revista Brasileira de Farmacognosia* 26, 657-664.

Ravindra, K., Wauters, E., Van Grieken, R., 2008. Variation in particulate PAHs levels and their relation with the transboundary movement of the air masses. *Science of the Total Environment* 396, 100-110.

Roberto, J., Lee, W.-Y., Campos-Díaz, S.I., 2009. Soil-borne polycyclic aromatic hydrocarbons in El Paso, Texas: analysis of a potential problem in the United States/Mexico border region. *Journal of Hazardous Materials* 163, 946-958.

Rodríguez, M.C., Dupont-Courtade, L., Oueslati, W., 2016. Air pollution and urban structure linkages: Evidence from European cities. *Renewable and Sustainable Energy Reviews* 53, 1-9.

Shamsipur, M., Yazdanfar, N., Ghambarian, M., 2016. Combination of solid-phase extraction with dispersive liquid-liquid microextraction followed by GC-MS for determination of pesticide residues from water, milk, honey and fruit juice. *Food chemistry* 204, 289-297.

Suchanová, M., Hajšlová, J., Tomaniová, M., Kocourek, V., Babička, L., 2008. Polycyclic aromatic hydrocarbons in smoked cheese. *Journal of the Science of Food and Agriculture* 88, 1307-1317.

Tette, P.A.S., da Silva Oliveira, F.A., Pereira, E.N.C., Silva, G., de Abreu Glória, M.B., Fernandes, C., 2016. Multiclass method for pesticides quantification in honey by means of modified QuEChERS and UHPLC-MS/MS. *Food Chemistry* 211, 130-139.

Tobiszewski, M., Namieśnik, J., 2012. PAH diagnostic ratios for the identification of pollution emission sources. *Environmental Pollution* 162, 110-119.

WHO, 2014. World Health Organization. Ambient (outdoor) air quality and health. WHO Media Center, Fact sheet 313. March 2014.

Yunker, M.B., Macdonald, R.W., Vingarzan, R., Mitchell, R.H., Goyette, D., Sylvestre, S., 2002. PAHs in the Fraser River basin: a critical appraisal of PAH ratios as indicators of PAH source and composition. *Organic geochemistry* 33, 489-515.

Zhang, W., Zhang, S., Wan, C., Yue, D., Ye, Y., Wang, X., 2008. Source diagnostics of polycyclic aromatic hydrocarbons in urban road runoff, dust, rain and canopy throughfall. *Environmental Pollution* 153, 594-601.

**VII. Utilisation des escargots comme biomoniteurs environnementaux ;
développement d'une méthode d'extraction multi-résidus pour la détermination
simultanée de 120 pesticides, 16 HAPs et 22 PCBs par LC-MS / MS et GC-MS / MS
à partir des escargots.**

Ce résultat, faisant l'objet d'une publication en cours de préparation, consiste au développement d'une méthode multi-résidus pour l'analyse des pesticides, des HAPs et des PCBs à partir de l'escargot terrestre *Helix aspersa*.

En effet, bien que les escargots soient bien connus pour leur capacité à accumuler des polluants, l'extraction et l'analyse des pesticides et des POPs à partir de ces matrices sont encore limitées. Dans cette étude, une stratégie d'extraction multi-résidus optimisée basée sur l'approche QuEChERS-SPME pour le criblage simultané de 120 pesticides, 16 HAPs et 22 PCBs provenant des escargots du sol *Helix aspersa* est rapportée. L'extraction a été basée sur QuEChERS en utilisant ACN suivie d'un lavage d-SPE en utilisant le PSA et le C₁₈. L'extrait obtenu a été par la suite concentré et reconstitué par l'ACN préalablement aux analyses chromatographiques. Les instruments analytiques comprenaient la chromatographie liquide couplée à la spectrométrie de masse en tandem (LC-MS/MS) et la chromatographie en phase gazeuse couplée à la spectrométrie de masse en tandem (GC-MS/MS). Cette dernière a été précédée par une étape de pré-concentration en utilisant une microextraction en phase solide (SPME) avec des fibres appropriées. La procédure d'analyse validée a révélé une bonne récupération entre 60 et 110% pour tous les composés cibles. De plus, la méthode présentait une grande sensibilité et une grande précision avec des limites de détection et de quantification inférieures à 20 ng g⁻¹ pour la plupart des polluants. En outre, la comparaison du procédé d'extraction utilisée avec une extraction basée sur ASE-SPE valide son efficacité, sa sensibilité et sa précision. Le solvant d'extraction a également été évalué et l'ACN s'est révélé être le solvant de choix dans cette nouvelle stratégie analytique développée.

Ainsi, les résultats obtenus pourraient être prometteurs pour leur application dans des études plus approfondies sur les escargots visant à mener une étude de biosurveillance environnementale plus étendue.

Snails as environmental biomonitors: a multi-residue analysis for the determination of 120 pesticides, 16 PAHs and 22 PCBs by LC-MS/MS and GC-MS/MS

Josephine AL-ALAM^{1,2}, Asma CHBANI^{1,4}, Ziad FAJLOUN^{1,3}, Maurice MILLET^{2*}

¹Azm Center for Research in Biotechnology and its Applications, Doctoral School of Science and Technology, Lebanese University, El Mittein Street, Tripoli, Lebanon

²Institute of Chemistry and Processes for Energy, Environment and Health ICPEES UMR 7515 Group of Physical Chemistry of the Atmosphere, University of Strasbourg, Strasbourg, France

³Faculty of Sciences III, department of biology, Lebanese University, Tripoli, Lebanon

⁴Faculty of Public Health III, Lebanese University, Tripoli, Lebanon

*Address correspondence to Maurice Millet, Institute of Chemistry and Processes for Energy, Environment and Health ICPEES UMR 7515 Group of Physical Chemistry of the Atmosphere, University of Strasbourg, Strasbourg, France Tel.: + 33 (0)3 68 85 04 22, Fax: + 33 (0)3 68 85 04 02, E-mail: mmillet@unistra.fr

Abstract

Although snails are well known for their ability to accumulate pollutants, the extraction and the analysis of pesticides and POPs from these matrixes are still limited. In this study, an optimized multi-residue extraction strategy based on QuEChERS-SPME approach for the simultaneous screening of 120 pesticides, 16 PAHs and 22 PCBs from the soil snails *Helix aspersa* is reported. The extraction was based on QuEChERS using ACN followed by a d-SPE cleanup using primary secondary amine (PSA) and octadecyl (C_{18}). The resulted extract was concentrated by evaporation then reconstituted by ACN in order to prepare it for chromatographic analysis. Analytical instruments included liquid chromatography coupled to tandem mass spectrometry (LC-MS/MS) and gas chromatography coupled to tandem mass spectrometry (GC-MS/MS). This latest one was preceded by a pre-concentration step using solid phase microextraction (SPME) with appropriate fibers. The validated analytical procedure revealed good recoveries between 60 and 110% for all the target compounds. Moreover, the method showed great sensitivity and high accuracy with limits of detection and quantification lower than 20 ng g^{-1} for most considered pollutants and low RSD (%) for both inter and intra-day analysis, this latest was lower than 20% for most targeted compounds. Furthermore, the comparison of the used extraction procedure with an extraction based on ASE-SPE validates its efficiency, sensitivity and accuracy in such studies. The extraction solvent was also investigated and ACN was proven to be the solvent of choice in this developed analytical strategy.

The obtained results could be promising in their application in further studies aiming to investigate a wide environmental biomonitoring study.

Keywords: Snails, *Helix aspersa*, QuEChERS, SPME, multi-residues, pesticides, PAHs, PCBs, OCPs, environmental biomonitoring.

Introduction

Environmental biomonitoring or biological environmental monitoring is generally defined as "the systematic use of living organisms or their responses to determine the state or changes in the environment" (Yang et al., 2010). Biomonitoring consists of the use of natural organisms as passive sampler providing information on the quality of the environment. These samplers, known as biomonitors, are living organism naturally present in the environment characterized by a high ability to accumulate one or several pollutants in their tissues. They act as an analyte concentrator or sampler, and after collection, they can be analyzed to determine pollutants concentrations (Maré et al., 2015). Environmental biomonitor species should be accumulative and characterized by a time- integrative behavior. Different criteria such as specificity, accumulation ratio, occurrence, and biodiversity are involved in the selection of biomonitoring species. (Wolterbeek and Bode, 1995; Wolterbeek, 2002).

Among these species, mollusks such as snails are well known as filtering organisms which have been successfully used in persistent organic pollutant (POP) monitoring programs due to their high bioaccumulation capacity, their fixed location and their high population density (Gust et al., 2010; Berlioz-Barbier et al., 2015). In fact, the use of snails as sentinel indicators is efficient due to their wide distribution, easy sampling and their ability to accumulate various type of pollutants (Laskowski and Hopkin, 1996; Beeby and Richmond, 2002; Berlioz-Barbier et al., 2014). Furthermore, snails live at the soil–plant–air interface and then integrate different sources and paths of contamination. In fact, snails may be exposed by three sources of contamination; the air, leading to cutaneous contact and inhalation; the soil, by cutaneous contact and ingestion, and plants mainly by ingestion as many snail species are primary consumers (Gomot-de Vaufleury and Bispo, 2000; De Vaufleury et al., 2006b; Pauget et al., 2013). Moreover, various chemical environmental pollutants lead to negative functional and physiological changes in snails, which tend to accumulate and magnify these compounds in their soft tissues and to incorporate them in their shells, in both aquatic and terrestrial ecosystems (Capinera and Dickens, 2016; Kowalczyk-Pecka et al., 2017).

Among different type of molluscs, the terrestrial gastropod *Helix aspersa* (Muller, 1774) is known as environment pollution biomonitor due to its easy adaptation and manipulation in the laboratory, as well as its sensitivity to genotoxicity assays (Silva et al., 2013; de Souza et al., 2015). These organisms have the ability to accumulate different classes of chemicals and serves as appropriate species for environmental biomonitoring for pesticides (Druart et al., 2011), trace metals (Vaufleury and Pihan, 2002; De Vaufleury et al., 2006a), polycyclic aromatic compounds (Janistcki et al., 2009), industrial contamination (Pihan and De Vaufleury, 2000) and urban pollution agents (Regoli et al., 2006).

For all of these reasons, the development of analytical tools for the quantification of traces of organic pollutants in such organisms seems efficient in order to establish a specific environmental control.

The extraction and the analysis of pollutants from such matrices need a particular attention, as the aim is to obtain a full recovery of the analytes without co-extractions or involuntary compounds. In fact, prior to chromatographic analysis, sample preparation is required not only to extract the targeted compounds from these complex matrices but also to remove certain substances that may interfere with the detection of the pollutants of concern, decrease the separation efficiency, or shorten the chromatographic column life (Berlioz-Barbier et al., 2014;

Berlioz-Barbier et al., 2015). Although snails are well known for their ability to accumulate pollutants, to our knowledge studies on the extraction and the analysis of pesticides and POPs from these matrixes are still limited.

Several extraction techniques are widely used for the extraction of environmental pollutants and all of them suffering from several drawbacks especially time and solvent consumption. For example accelerated solvent extraction (ASE) was reported (Gómez-Ariza et al., 2002), however, such extraction must be followed by an efficient clean-up in order to remove all interfering impurities which gives rise to high labor costs. SPE and SPME are two well-known extraction/purification/concentration methods used in order to obtain a pure extract that can be analyzed by chromatographic techniques (Li et al., 2015; Andrade-Eiroa et al., 2016a).

In 2003, a new method was developed by Anastassiades et al., in order to overcome all critical flaws and practical limitations of the extraction procedures. This method was known as QuEChERS, for Quick, Easy, Cheap, Effective, Rugged and Safe, was first used for the analysis of multi residues pesticides in food (Anastassiades et al., 2003). This technique is divided in two steps, the first considered as a soft extraction method using acetonitrile (ACN) as extraction agent while the second as an optional clean-up procedure by dispersive solid-phase extraction (d-SPE). The whole extraction procedure needs few minutes (about five minutes) as well as 5 to 15 mL of extracting agent (Albinet et al., 2013). Although the original method showed a great efficiency for hundreds of analytes in a wide range of commodities particularly for pesticides in food matrixes, several adjustments were made in order to improve the method performance and to make it even more rugged and efficient for other difficult analytes, in different complex matrices (Costa et al., 2014; Mattarozzi et al., 2016; Cloutier et al., 2017).

Following their extraction, the analysis of organic pollutants requires their chromatographic separation according to their properties and finally their detection. The analytical technique commonly used for multi-residue analysis of organic pollutants are liquid chromatography coupled to tandem mass spectrometer (LC-MS/MS) and gas chromatography coupled to tandem mass spectrometer (GC-MS/MS) (Megson et al., 2016). In fact, the choice of the separation technique depends mostly on the characteristics of the pollutants of interest. The volatile, semi-volatile and thermally stable compounds can be determined by GC, whereas non-volatile and/or thermally unstable ones should be determined by LC (Kujawski et al., 2014; Souza Tette et al., 2016).

For all these reasons, the aim of this study was to develop a simple, fast, sensitive and reliable analytical method for trace analysis of a large number of environmental contaminants in the terrestrial snail *Helix aspersa*. For this purpose, 120 pesticides, 16 PAHs and 22 PCBs were selected in order to cover a wide number of potential organic environmental contaminant that can be monitored in such organism. Two extractions protocols the first based on ASE-SPE and the second on QuEChERS, both of them followed by a pre-concentration step using SPME, were compared in order to choose the method with a high extraction potential allowing the best extraction recovery. The two chromatographic techniques, coupled to tandem mass spectrometer were used in order to analyze this wide range of pollutants. The chosen matrices were, to the best of our knowledge never studied for its contamination by all these pollutants. Furthermore the two extraction protocols were never carried out on snails enabling their use of potential biomonitor candidates.

Experimental

Materials and reagents

Pesticides analysis included 30 non-volatile compounds analyzed by LC-MS/MS and 90 semi-volatile compounds including 21 organochlorine pesticides analyzed by GC-MS/MS. All pesticides, except OCPs, were purchased from Sigma-Aldrich (L'Isle d'Abeau, France) with purity higher than 97%.

For LC-MS/MS pesticides analysis, the 30 pesticides were: Pymetrozine, Carbendazim, Chloridazone, Acetamiprid, Nicosulfuron, Thiacloprid, Chlortoluron, Carbetamide, Terbutryn, Spinosade A, Isoproturon, Diuron, Metalaxyl-M, Spinosade D, Dimethenamid-p, Penconazole, Isoxadifen, Tebuconazole, Diflubenzuron, Epoxyconazole, Prothioconazole, Propiconazole, Chlorfenvinphos, Triflurosulfuron methyl, Pendimethalin, Cyazofamid, Pyraclostrobine, Diflufenican, Flufenoxuron, Lufenuron. A stock solution of each of these standards at 1 g L^{-1} was prepared in ACN.

For GC-MS/MS pesticides analysis, the pesticides (except OCPs) were: Clofentezine, Diclobenil, Etridiazole, Diphénylamine, Trifluraline, Chlorpropham, Tebutam, Clomazone, Propyzamid, Lindane, Pyrimethanil, dimethanamid-P, Dimethachlore, Acetochlore, Alachlore, Fenpropidine, Carbaryl, Ethofumesate, Malathion, Fenpropimorph, Metolachlore-S, Chlorpyrifos, Flurochloridon, Cyprodinil, Pendimethalin, tolyfluanid, Metazachlore, Penconazol, Procymidone, Captane, Folpet, Oxadiazole, Buprofezine, Kerosym-methyl, Bupirimate, Flusilazole, Myclobutanil, Aclonifen, Trifloxystrobine, Bromoxynil octanoate, Propiconazole, Quinoxifen, Lenacile, Diclofop-methyl, Cloridazone, Diflufenicanil, Fluazinam, Tebuconazole, Bifenthrin, Dimoxystrobin, Epoxyconazole, Fenoxycarb, Isoxaflutole, Tebufenpyrad, Bifenox, Lambda cyhalothrine, Fenarimol, Pyraclostrobin, Prochloraze, Cypermethrine, boscalid, Indoxacarb, Difenoconazole, Deltamethrine, Azoxystrobine, Dimetomorph, Spiroxamine, Metamitron. A stock solution of each of these standards at 1 g L^{-1} was prepared in ACN.

For OCPs analysis, a mixture at 0.1 g L^{-1} of 21 OCPs including: α -HCH, γ -HCH, β -HCH, δ -HCH, Heptachlore epoxyde A, Metoxychlore, o,p'-DDD, o,p'-DDT, p,p'-DDD, p,p'-DDT, α -endosulfan, o,p'-DDE, p,p'-DDE, Aldrine, Heptachlore, Dieldrine, Hexachlorobenzene, Heptachlore epoxyde B, *trans*-chlordane and *cis*-chlordane was purchased Cluzeau Info Labo (St Foy la Grande, France).

For PAHs analysis, a mixture at 0.1 g L^{-1} of 16 PAHs including: Naphtalene, Acenaphtene, Fluorene, Phenanthrene, Anthracene, Fluoranthrene, Pyrene, Benzo(a)anthracene, Chrysene, Benzo(b)fluoranthrene, Benzo(k)fluoranthrene, Benzo(e)pyrene, Benzo(a)pyrene, Indenol(1,2,3)pyrene, Benzo(g,h,i)perylene and Dibenzo(a,h)anthracene was prepared from individual standards purchased from Sigma Aldrich (L'Isle D'Abeau, France).

For PCBs analysis, a mixture at 0.1 g L^{-1} of 22 PCBs including: PCB 18, PCB 31, PCB 28, PCB 52, PCB 44, PCB 70, PCB 81, PCB 101, PCB 123, PCB 118, PCB 114, PCB 105, PCB 126, PCB 149, PCB 153, PCB 138, PCB 167, PCB 156, PCB 157, PCB 169, PCB 180 and PCB 189 was purchased from Cluzeau Info Labo (St Foy la Grande, France).

All prepared solutions were stored at -18°C .

Three internal standards for LC-MS/MS were obtained from CDN isotopes (Quebec, Canada): Carbendazim-d⁴ (99.3%), Diuron-d⁶ (99.8%), Pendimethalin-d⁵ (99%), and Nicosulfuron-d⁶ (99%). A standard solution of each compound at 0.05 g L⁻¹ in ACN was prepared and a mixture of them at 0.01 g L⁻¹ in ACN was prepared and stored at -18°C for alternative use as IS solution.

Internal standard for GC-MS/MS were Trifluralin-d¹⁴, 4-Nitrophenol-d⁴ and Naphtalene-d⁸ (99%) and they were respectively purchased from Sigma-Aldrich (L'Isle d'Abeau, France) and Cambridge isotope laboratories (Cluzeau Info Labo, France). A mixture of Trifluralin-d¹⁴ and 4-Nitrophenol-d⁴ at 0.01 g L⁻¹ in ACN was used as IS solution for pesticides analysis except OCPs, while a solution of Naphtalene-d⁸ at 0.01 g L⁻¹ in ACN was used as IS solution for OCPs, PAHs and PCBs analysis.

HPLC-grade acetonitrile (ACN), Toluene (TOL) from Biosolve (Dieuze, France), methanol (MeOH), ethyl acetate (EA), "Fontainebleau" sand from Prolabo (France), and silica gel (Merck, Germany) were used. LC-MS grade ACN, LC-MS grade water, formic acid and HPLC grade ACN were purchased from Sigma Aldrich (L'Isle D'Abeau, France). The ultrapure water used was purified by an Elga system (Antony, France).

Kits for QuEChERS sample preparations were purchased as ready to use from RESTEK France. Buffered extraction kits (EN 1566 method) containing 4g MgSO₄, 1g NaCl, 1g trisodium citrate dihydrate and 0.5g disodium hydrogencitrate sesquihydrate were used. For clean-up, samples clean-up kits (AOAC 2007 method) containing 1.2g MgSO₄, 400mg PSA and 400mg C₁₈ were used.

Blank organisms collection

Helix aspersa certified blank snails were purchased from "Cap' Hélix Escargots, 2, Bréharadec, 29770 GOULIEN, France". The snails were transported frozen to the laboratory where they were kept at -18 °C until used.

Extraction procedures

Five grams of homogenized samples of blank snails were weighted in 50 mL centrifuge tube then fortified with 200 µL of each mixtures solution. Fortified samples were kept at 4°C overnight, and then undergo the extraction procedure cited below. All extractions were done in triplicate.

ASE-SPE based extraction

This extraction procedure was based on the work of Al Alam et al., in 2017 for the analysis of multi-residue organic pollutants in conifer needles (Al-Alam et al., 2017).

ASE

5 grs of the fortified snails were extracted by ASE. For this, ASE 33 mL cells were fitted at the bottom with filter paper, and then a thin layer (1 cm height) of activated silica gel was added in order to provide a first purification step. A second filter was added on the top of the silica and the

5 g snails mixed with “Fontainebleau” sand were added. Finally a filter was added at the top of the cell which was well sealed. The extraction was carried out with ACN (100%) and the program was as follows: heating the cell for 7 min, 10 min of static cycle, temperature 100°C, pressure 1500 psi, flushing 100% and purging 300 s.

ASE final extracts were collected in ASE bottles and prepared for SPE purification. For this, extracts were filtered and then diluted to 1000 mL with acidified (pH 3) ultrapure water.

SPE

CHROMABOND® EASY cartridges (Macherey-Nagel, France), consisting of a polar modified polystyrene divinyl benzene copolymer, were used as adsorbents (mean pore diameter 60 Å, surface area 623 m²/g, and mean particle size 91 µm). The SPE procedure was as follows: conditioning of the cartridge with 5 mL of MeOH followed by 5 mL of ultrapure water, flushing the 1000 mL of the sample into the cartridge at 10 mL min⁻¹, then drying by N₂ flushing for 30 min. Extracts were finally sequentially eluted with 2 mL of each following solvents: ethyl acetate, toluene, and acetonitrile. The obtained extract, was sampled in a 10 mL glass tube, and then evaporated until 100 µL are left.

QuEChERS based extraction

This extraction procedure was based on the work of Malhat et al., in 2015 for the analysis of organochlorine and synthetic pyrethroid pesticides residues in honey (Malhat et al., 2015).

First, to the 5 grs fortified snails 10 mL of ACN were added and the tubes were shaken. When the mixture is homogeneous, 10 mL of QuEChERS citrate buffered extraction salts were added and the tubes were immediately shaken by hand, vortexed one minute and then centrifuged for 10 min at 5000 rpm. Afterwards, the supernatant was added to the 15 mL PSA tube. Then, this tube was immediately shaken by hand, vortexed 30 s and centrifuged for 10 min at 5000 rpm. Finally, the obtained extract, was sampled in a 10 mL glass tube, and then evaporated until 100 µL are left.

Extract reconstitution

Once evaporated, the collected extracts were reconstituted with ACN to 1 mL, in order to prepare them to chromatographic analysis.

100 µL of the final extract was transferred to a LC vial, where 10 µL of the appropriated internal standard solution was added and then the extract was analyzed by LC-MS/MS.

The remaining 900 µL were diluted to 20 mL with salted water (1.5% NaCl) in order to promote adsorption on the SPME fiber, and then 10 µL of both appropriated GC internal standards solutions were added prior to this latest purification and extraction.

SPME extraction and concentration

Two SPME coupled to a GC-MS/MS were used; the first was coated with Polyacrylate (PA) (65 μm) and used for the extraction of semi-volatile pesticides except OCPs while the second was coated with polydimethylsiloxane (100 μm) and used for the extraction of OCPs, PCBs and PAHs. These fibers were soaked in a 20 mL of the solution and heated respectively at 60°C under agitation for 40 minutes for the first one and at 80°C for 40 min for the second one.

SPME was done by direct immersion in which the fiber is directly immersed into the liquid sample and the analytes are divided between the fiber and the liquid sample. After extraction, the SPME fiber is transferred to the GC the injection port where desorption of the analyte takes place and analysis is carried out.

Sample analysis

Final extracts were analyzed using LC-MS/MS for the 30 non-volatile pesticides and GC-MS/MS for the 90 semi-volatile pesticides, the 22 PCBs and the 16 PAHs.

LC-MS/MS

The system used was a liquid chromatography system (Thermo Scientific), coupled to a tandem mass spectrometry system (TSQ Quantum Access Max equipped with a Hyper Quads Driven) operating in electrospray ionization (ESI) mode. The chromatographic separation was performed on a Macherey-Nägél Nucleodur C₁₈ Pyramid column (150 mm \times 3 mm; 3 μm), thermostated at 25°C. The chromatographic system was also equipped with an autosampler (Accela Autosampler) and a Surveyor LC Pump Plus (Thermo Scientific). The flow rate was 300 $\mu\text{L min}^{-1}$. Samples were analyzed using a mobile phase ACN/water (0.05% formic acid). The gradient started with 30:70 (v/v) for 5 min, followed by 50:50 (v/v) for 6 min, then 80:20 (v/v) for 7 min, to achieve 95:5 (v/v) for 10 min, finally a ratio of 30:70 (v/v) for 8 minutes is recommended in order to stabilize the column for any new injection. Injection volume was 20 μL .

Parent ions and fragment ions selected for confirmation, as well as retention time and ion ratios are listed in Table 1. MRM 1 is used for quantification and MRM 2 for confirmation.

Table 1: LC-MS/MS method parameters

Pesticide	RT (mn)	Parent ion	Daughter ion	MRM ratio
Pymetrozine	1.80	218 100	105 226	1.5-3.6
		218 101	79 188	
Carbendazim	1.85	192 100	160 119	0.4-2.0
		192 101	132 162	
Chloridazone	5.14	222 000	104 290	0.5-1.3
		222 001	77 360	
Acetamiprid	6.10	223 000	99 207	0.3
		223 002	126 022	
Thiacloprid	8.25	253 000	126 262	6.4-6.9
		253 001	99 234	

Nicosulfuron	7.70	411 100	181 891	1.9-2.1
		411 101	212 896	
Chlortoluron	11.10	213 100	72 296	4.8-7.5
		213 102	140 033	
Carbetamide	8.20	237 101	192 087	4.2-4.8
		237 102	120 227	
Terbutryn	10.05	242 000	186 210	25.0-56.0
		242 001	68 390	
Spinosade A	10.50	732 500	142 071	6.0-18.8
		732 501	98 152	
Isoproturon	11.70	207 100	72 361	2.7-4.4
		207 101	46 503	
Diuron	12.05	233 001	72 306	4.0-4.5
		233 002	46 598	
Metalaxyl-M	11.40	280 001	220 036	1.0-1.6
		280 002	192 088	
Spinosade D	11.15	746 774	141 977	1.2-833.3
		746 775	98 457	
Dimethenamid-p	14.35	276 100	244 011	2.9-3.3
		276 101	168 034	
Penconazole	15.47	284 000	159 070	1.3-1.8
		284 001	70 390	
Isoxadifen	16.62	296 000	232 120	1.3-1.5
		296 001	204 100	
Tebuconazole	15.77	308 000	70 380	3.9-5.0
		308 001	125 190	
Diflubenzuron	15.50	311 000	157 946	0.9-1.6
		311 001	140 999	
Epoxyconazole	14.44	330 000	221	24.0-27.5
		330 001	119 200	
Propiconazole	15.89	342 000	159 090	5.6
		342 001	123 120	
Prothioconazole	15.75	344 000	326 005	0.4-2.7
		344 001	153 994	
Chlorfenvinphos	16.17	359 000	170 020	1.5
		359 001	99 180	
Triflusaluron methyl	14.75	493 100	263 907	4.4-6.4
		493 101	96 088	
Pendimethalin	20.50	282 100	211 986	11.0-11.4
		282 101	193 934	
Cyazofamid	16.60	325 000	225 974	0.5-3.0
		325 001	224 974	
Pyraclostrobine	17.26	388 000	194 100	1.1-1.8
		388 001	163 150	
Diflufenican	18.01	395 000	266 060	5.0
		395 001	246 030	
Flufenoxuron	19.70	489 001	157 980	1.2
		489 002	141 049	
Lufenuron	19.00	511 000	157 901	1.6-2.0
		511 001	141 040	

GC-MS/MS

Thermo Scientific Trace GC coupled to a tandem mass spectrometry system (ITQ 700) operated in electron impact (EI) mode was used for. The analysis of the considered POPs (20 OCPs, 16 PAHs, 22 PCB) and the 70 remaining volatile pesticides was performed on a XLB (50% phenyl/

50% methylsiloxane) capillary column (30 m × 0.25 mm internal diameter and 0.25 µm as film thickness), injection was done in splitless mode at 250°C for 15 min. Helium was used as carrier gas at a flow rate of 1 mL min⁻¹.

POPs separation and analysis:

Injection of the sample was done by thermal desorption of the PDMS SPME fiber. Initial oven temperature was set at 50 °C for 3 min, followed by a linear ramp to 255°C at a rate of 10°C min⁻¹, followed by a ramp to 330°C at a rate 20°C min⁻¹, where it was maintained for 18 minutes, leading to a total run time of 45.25 minutes.

Parent ion, daughter ions and collision energy as well as retention time of OCPs, PAHs and PCBs, are respectively listed in table 2.

Table 2: GC-MS/MS method parameters for OCPs-PAHs and PCBs

	Compound	Parent ion	Daughter ions	Collision energy (ev)	Tr (mn)
OCPs	α-HCH	183	147/109	1.6	18.82
	γ-HCH	183	147/109	1.6	19.57
	β-HCH	183	147/109	1.6	20.3
	δ-HCH	183	147/109	1.6	20.8
	Heptachlore epoxyde A	183	155/119	1.5	22.62
	β-endosulfan	195	159/123	1.8	24.69
	Metoxychlore	227	169	1.12	25.67
	o,p'-DDD	235	199/165	1.4	23.83
	o,p'-DDT	235	199/165	1.5	24.36
	p,p'-DDD	235	199	1.5	24.57
	p,p'-DDT	235	165/199	1.5	25.01
	α-endosulfan	241	170/204	1.7	23.33
	o,p'-DDE	246	176/150	1.9	22.93
	p,p'-DDE	246	176/150	1.9	23.66
	Aldrine	263	191/227	1.8	21.56
	Heptachlore	272	237/235	1.5	20.9
	Dieldrine	279	241/206	1.6	23.8
	Hexachlorobenzene	284	249/214	1.4	18.98
	Heptachlore epoxyde B	353	253/317	1.5	22.51
	PAHs	Transchlordane	373	301/264	1.4
Cischlordane		373	301/337	1.4	23.28
Naphtalene		128	102/126	1.2	11.73
Acenaphtene		153	150/151	1.3	16.14

	Fluorene	165	163/139	1.2	17.48
	Phenanthrene	178	152/176	1.2	19.9
	Anthracene	178	152/176	1.2	20.06
	Fluoranthrene	202	200	1.3	22.96
	Pyrene	202	200	1.2	23.52
	Benzo(a)anthracene	228	226/202	1.2	25.99
	Chrysene	228	226/202	1.2	26.06
	Benzo(b)fluoranthrene	252	250/226	1.3	27.66
	Benzo(k)fluoranthrene	252	250/226	1.3	27.7
	Benzo(e)pyrene	252	250/226	1.3	28.09
	Benzo(a)pyrene	252	250/226	1.3	28.19
	Indenol(1.2.3)pyrene	276	274	1.4	30.25
	Benzo(g,h,i)perylene	276	274	1.4	30.87
	Dibenzo(a,h)anthracene	278	276	1.5	30.21
PCBs	PCB 18	256	186/221	1.4	19.57
	PCB 31	256	186/150	1.7	20.73
	PCB 28	256	186/150	1.7	20.8
	PCB 52	292	257/220	1.9	21.35
	PCB 44	292	257/220	1.9	21.74
	PCB 70	292	220/185	1.3	22.68
	PCB 81	292	220/185	2.1	23.89
	PCB 101	326	291/254	1.2	23.11
	PCB 123	326	256/254	1.3	24.29
	PCB 118	326	256/254	1.3	24.38
	PCB 114	326	256/254	1.3	24.41
	PCB 105	326	256/254	1.4	24.56
	PCB 126	326	256/254	1.4	24.81
	PCB 149	360	288/290	2	24.14
	PCB 153	360	290/288	2	24.6
	PCB 138	360	325/288	2.1	25.05
	PCB 167	360	290/288	2	25.52
	PCB 156	360	290/288	1.5	25.84
	PCB 157	360	290/288	1.5	25.89
	PCB 169	360	290/288	1.5	26.4
PCB 180	396	361/324	1.8	25.94	
PCB 189	396	326/324	2.1	26.74	

Semi-volatile pesticides separation and analysis

Injection of the sample was done by thermal desorption of the PA SPME fiber. Initial oven temperature was set at 50°C for 3 min, followed by a linear ramp to 160°C at a rate of 36.6°C min⁻¹, followed by a ramp to 300°C at a rate 5.8°C min⁻¹, where it was maintained for 10 minutes, leading to a total run time of 41 minutes.

Parent ion, daughter ions and collision energy as well as retention time of concerned pesticides, are listed in table 3.

Table 3: GC-MS/MS method parameters for remained volatile pesticides

Pesticide	Parent ion	Daughter ion	Collision energie (ev)	RT
Clofentezine	137	102/75/110	1.4	6.97
Diclobenil	171	136/100	1.5	8.31
Etridiazole	211	183/140	1	9.03
Diphénylamine	169	139/166	1.5	11.27
Trifluraline	264	206/160	1.5	11.4
Chlorpropham	127	100/92	1.46	11.49
Tebutam	91	65	1.4	11.82
Clomazone	204	107/174	1.6	12.97
Propyzamid	173	145/109	1.4	13.39
Lindane	183	147/148	1.4	13.54
Pyrimethanil	198	183/182	1.7	13.77
dimethanamid-P	154	137/111	1.22	14.81
Dimethachlore	134	105/79	1.3	14.84
Acetochlore	146	132/131	1.26	14.87
Alachlore	160	132/117	1.4	15.16
Fenpropidine	98	70/55	1.3	15.35
Carbaryl	144	116/144	1.28	15.59
Ethofumesate	161	133/105	1.4	15.91
Malathion	127	99	0.78	15.98

Fenpropimorph	128	110/70	1.6	16.16
Metolachlore-S	162	133/134	1.3	16.36
Chlorpyrifos	314	258/286	1.1	16.4
Flurochloridon	174	127/145	1.4	17.52
Cyprodinil	224	208/197	1.9	17.53
Pendimethalin	252	208/191	1.2	17.7
Tolyfluamid	137	122/109	1.4	17.73
Metazachlore	209	132/174	1.2	17.75
Penconazol	248	192/157	1.42	17.95
Procymidone	283	255/254	1.4	18.19
Captane	79	51/77	1.2	18.43
Folpet	260	260/232	1.2	18.66
Oxadiazone	258	275/146	1.6	19.34
Buprofezine	175	132/117	1.2	19.68
Kerosym-methyl	116	116/89	2.13	19.68
Bupirimate	193	165/109	1.4	19.71
Flusilazole	233	165/152	1.85	20.19
Myclobutanil	179	125/152	1.3	20.37
Aclonifen	194	167/139	1.45	21.45
Trifloxystrobine	116	89/63	1.16	21.57
Bromoxynil octanoate	127	109/67	0.76	22.13
Propiconazole	259	191/173	1.4	22.19
Quinoxifen	237	208/181	1.9	22.35
Lenacile	153	136/135	1.3	22.43
Diclofop-methyl	340	253/281	1.4	22.65
Cloridazone	220	193/166	1.6	22.75
Diflufenicanil	266	246/238	1.6	22.8
Fluazinam	387	359/324	1.5	22.84

Tebuconazole	250	163/153	1.4	23
Bifenthrin	181	165/166	1.1	23.38
Dimoxystrobin	116	89/63	1.2	23.42
Epoxyconazole	192	138/157	1.16	23.48
Fenoxycarb	186	157/158	1.4	23.89
Isoxaflutole	279	252/223	1.5	17.75
Tebufenpyrad	171	156/127	1.5	24.14
Bifenox	341	311/310	1.2	24.59
Lambda cyhalothrine	181	152/161	1.5	25.25
Fenarimol	139	111/75	1.3	26.05
Pyraclostrobin	132	104/77	1.3	26.89
Prochloraze	180	138	1.2	27.53
Cypermethrine	181	152	1.5	28.51
Boscalid	140	112/76	1.4	28.92
Indoxacarb	203	134/175	1.22	30.92
Difenoconazole	265	249/202	1.45	31.06
Deltamethrine	181	152	1.8	31.21
Azoxystrobine	344	329	1.6	31.77
Dimetomorph	301	165/258	1.6	32.07
Spiroxamine	100	72/58	1.1	14.65/15.45
Metamitron	202	174/186	0.9	20.94

Method validation

Once developed, the method should be validated for several parameters including its precision, selectivity and linearity.

Validation parameters

The method was validated for all quantification parameters. First, extraction of fortified samples with concentration ranged from 5 to 3000 ng g⁻¹ was performed three times each to determine linearity, then five samples of spiked matrix with one level concentration (1000 ng g⁻¹) were

extracted for three successive days in order to determine intermediate precision and repeatability. In fact, intra-day precision was evaluated with the repeatability of a series of measurements carried out under the same conditions, by the same manipulator and on the same day, while inter-day precision was associated with the reproducibility of the method. This parameter can be determined by varying processes conditions which in this case were the different days of extraction and the different solvents bottles and the different extraction kits used. These two precision parameters were evaluated by their correspondent relative standard deviation (RSD, %).

RSD% is usually calculated by dividing the standard deviation of the series of measurement by its mean and then by multiplying the obtained results by 100.

Concerning method validation limits, the method limit of detection (LOD) was determined as the analyte concentration that produced a peak signal of three times the background noise from the chromatogram, and the method limit of quantification (LOQ) was determined as the analyte concentration that produced a peak signal of ten times the background noise from the chromatogram. These limits were then determined graphically with: $LOD = 3 \times [\text{min}] \text{ S/N}$ and $LOQ = 10 \times [\text{min}] \text{ S/N}$.

Regarding the recoveries, they were determined at the same levels as precision. The recoveries were considered as the ratio of the area of the spiked samples to the area of the standard following the equation:

$$\text{Recovery (\%)} = (\text{A extracted spiked sample} / \text{A standard solution}) \times 100$$

Matrix-matched calibration curves

In order to overcome the possible matrix effect and to obtain reliable data of analyzed samples, matrix matched calibration curves were developed. For this, 10 calibration points were prepared using the validated extraction procedure. Homogenates matrixes were spiked with all mixtures standard solutions in order to cover a pollutants range between 5 and 3000 ng g⁻¹, extracted and then analyzed.

Calibration curves were validated for their linearity by the calculation of the correlation coefficient R².

Finally, the validation of each compound encounters several criteria including its fragmentations and retention time for compounds identified by GC-MS/MS, and its ion ration in addition to its fragmentation and retention time for nonvolatile compounds. Furthermore, extraction performance was checked following the signal areas of the internal standards solutions in each analyzed sample.

Calibrations and quantifications were done using XCalibur software.

Results and discussion

Method development

In order to obtain a concentrated extract a concentration step by evaporation and reconstitution was added prior to liquid chromatographic analysis. This concentration step was followed by SPME extraction/concentration step prior to gas chromatographic analysis for arranging and discriminating volatile compounds. Among different SPME fibers, the PDMS fiber was well known for its usefulness for the extraction of analytes with greater partition coefficient such as PAHs, PCBs and OCPs, while the PA was chosen for pesticides extraction due to its efficiency in the extraction of polar compound. In fact, PA is a moderated polar coating characterized by a stronger hydrogen bond than PDMS fiber which makes it more ideal for polar compounds having a moderate hydrophobicity than other fiber (SPME, 2016).

These concentration steps were used following the two extraction procedures previously detailed. Both extractions were compared in order to choose the method enabling the highest recovery with the lowest RSD %.

Influence of the extraction procedure

Fortified snails at a middle level concentration of 1000 ng g^{-1} of each pollutants mixture were extracted using the ASE-SPE based extraction and QuEChERS based extraction. The two extractions were followed by a pre-concentration step using SPME prior to their analysis by GC-MS/MS.

All extractions were done in triplicate and RSD % was calculated for each compound. Figure 1 shows the recoveries obtained by the two methods at a concentration of 1000 ng g^{-1} . This figure shows the average recovery rate for each type of considered pollutant.

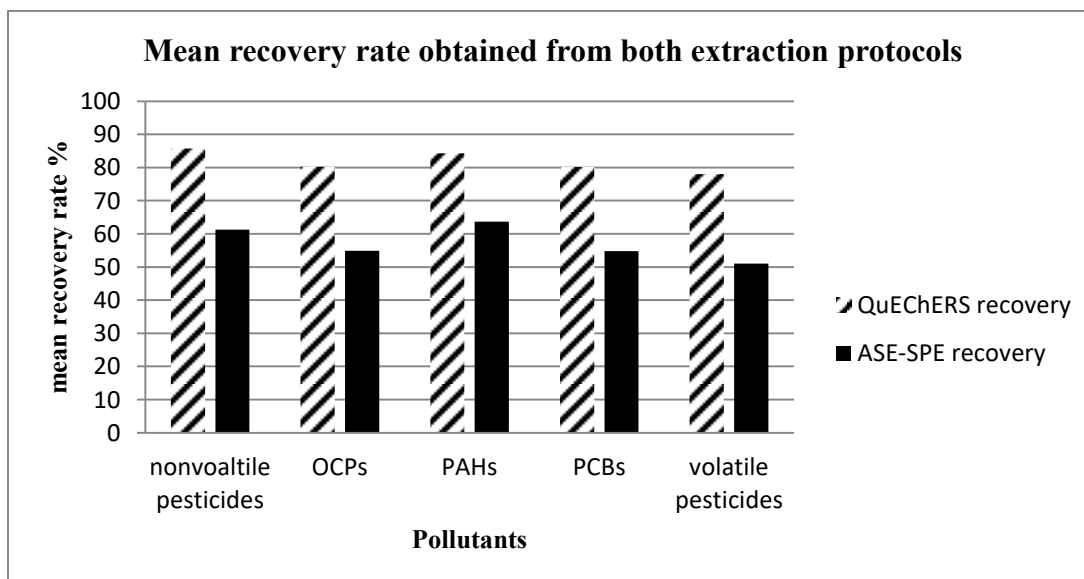


Figure 1: average recovery rate for each type of considered pollutants

The obtained results show that the recoveries obtained with the ASE-SPE based extraction were lower than those obtained with QuEChERS based extraction. For semi-volatile pesticides, recoveries obtained with ASE-SPE based extraction were between 20 and 94% with a median recovery 61.24 %, while those obtained with QuEChERS based extraction were between 65 and 107% with a median recovery 85.72%. For OCPs recoveries, results obtained with ASE-SPE based extraction were between 17 and 82% with a median recovery 54.93%, while those obtained with QuEChERS based extraction were between 62 and 104% with a median recovery 80.24%. For PAHs recoveries, results obtained with ASE-SPE based extraction were between 56 and 71% with a median recovery 63.39 %, while those obtained with QuEChERS based extraction were between 64 and 96% with a median recovery 84.31%. For PCBs recoveries, results obtained with ASE-SPE based extraction were between 17 and 110% with a median recovery 54.75 %, while those obtained with QuEChERS based extraction were between 50 and 117% with a median recovery 80.2%. Likewise, for the remained volatile pesticides, QuEChERS based extraction showed higher recoveries rate than ASE-SPE based extraction; in fact results obtained with ASE-SPE based extraction were between 14 and 127% with a median recovery 51.06%, while those obtained with QuEChERS based extraction were between 55 and 114% with a median recovery 78.06%.

These results clearly demonstrate the influence of the extraction procedure on pollutants analysis from the same matrix. These results were also proven by Blasco et al., in 2011 who proved that the obtained pesticides recoveries from honey using QuEChERS extraction were higher than those obtained by PLE and SPE (Blasco et al., 2011).

Furthermore, in order to determine the extraction protocol providing the most reliable results, the RSD of the two developed extraction protocols were compared.

Figure 2 shows the RSD % of each pollutant type obtained with the two extraction method.

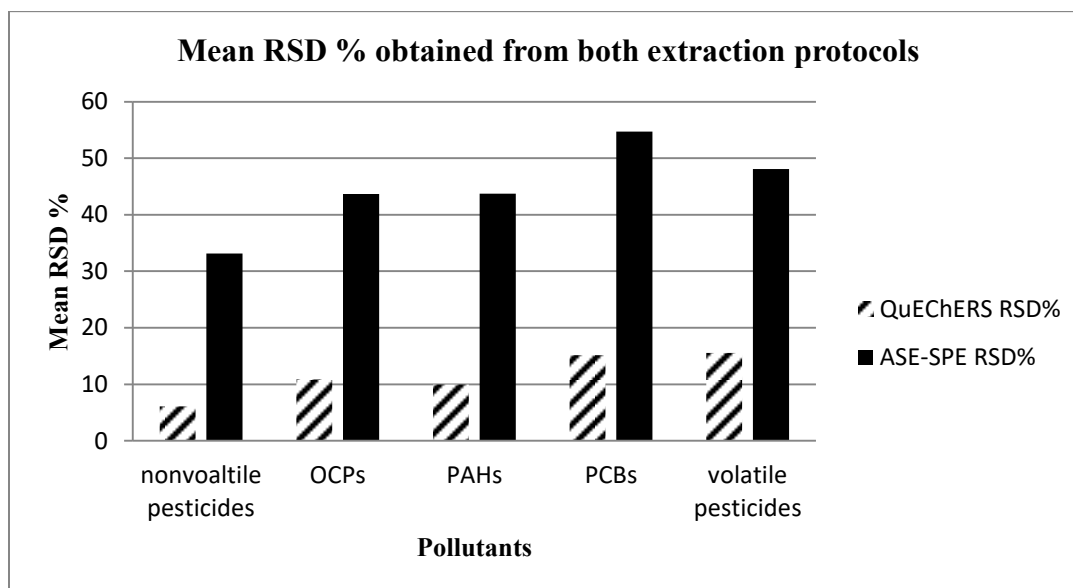


Figure 2: Mean RSD % of each pollutant type obtained with the two extraction methods

The results obtained from the analysis of the RSD% of both extraction protocols favor the extraction based on QuEChERS to the one based on ASE-SPE. In fact, the relative standard deviation obtained with ASE-SPE was not acceptable given that its value was higher than 20% for all the analyzed pollutants, while this value was lower than 15% for all analyzed compounds. Median RSD % for ASE-SPE based extraction were 33.12, 43.66, 43.71, 54.71 and 48.06% respectively for the determination of nonvolatile pesticides, OCPs, PAHs, PCBs and remained volatile pesticides. These values were far lower for QuEChERS based extraction, the RSD % were respectively 6.11, 10.82, 9.91, 15.16 and 15.55% for nonvolatile pesticides, OCPs, PAHs, PCBs and remained volatile pesticides.

The results provided by the calculation of the recoveries and the RSD %, prove that QuEChERS based extraction is a method of choice for the multi-residual pollutants analysis from such matrices providing high recovery rates with a low RSD. In fact, compared to ASE based methods, the QuEChERS based extraction is rapid and easy to use, providing better recoveries with fewer losses of volatile compounds (Rouvière et al., 2012).

Due to its time and cost saving, its low solvent consumption, high recoveries, simplicity and low RSD% obtained, QuEChERS based extraction was used as the method of choice in this work. Furthermore, several crucial points such as the high cost of the equipment, the large volume used for cell rinsing and preparation before extraction, the high temperature leading to low recoveries and decomposition of thermally instable analytes as well as the several extraction steps increasing RSD% (Sun et al., 2012; Andrade-Eiroa et al., 2016b), reduce ASE-SPE based extraction efficiency and give high credibility to QuEChERS based extraction for the analysis of multi-residues of environmental pollutants.

Influence of the nature of the extraction solvent

As QuEChERS seems to be the most efficient extraction procedure, a selection of an appropriate extraction solvent for the liquid–liquid extraction is crucial in order to have better recoveries. In fact, the extraction solvent shows a main role in an extraction step of an analysis because incomplete extraction and matrix effects can lead to an underestimation of the actual concentration in the sample (Sharmili et al., 2016). The organic solvent chosen must be highly polar, miscible in water and able to induce phase separation following the addition of the appropriate extraction salts. Moreover, the suitable salt must not be soluble in the extraction solvent (Berlioz-Barbier et al., 2014). Acetonitrile and Ethyl Acetate (EtAc) were tested on fortified snails with the same precision level, and the extraction efficiency of both solvents was compared. In order to choose the best extraction solvent, recoveries were calculated and figure 3 shows the recovery results obtained with the use of ACN and EtAc as QuEChERS extraction solvent.

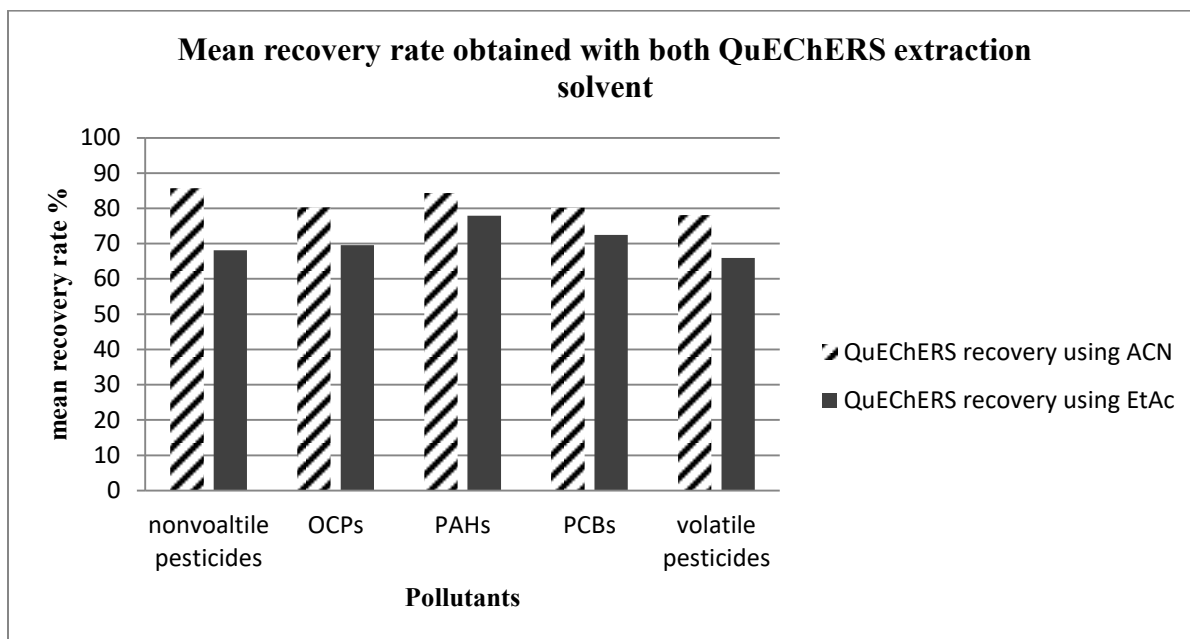


Figure 3: Mean recovery rate of analyzed pollutants obtained with acetonitrile and ethyl acetate used as QuEChERS extraction solvent

As observed in figure 3, the use of ethyl acetate showed recoveries lower than those obtained with acetonitrile. For nonvolatile pesticides, the recovery obtained was 68.09% for the use of EtAc and 85.62% with the use of ACN; for OCPs the use of EtAc gave a mean recovery of about 69.59%, while this value was 80.24% with the use of ACN; for PAHs and PCBs these values were respectively 77.91 and 72.49% with EtAc and 84.31 and 80.2% with ACN respectively. Likewise, the recovery rate of semi-volatile pesticides increased from 65.95% with the use of EtAc as QuEChERS solvent extraction to 78.06% with the use of ACN.

The use of ACN has proven its efficiency in several multi-residue analyses in biological samples in comparison to EtAc exhibiting better recoveries and lower standard deviations between replicates (Berlitz-Barbier et al., 2014; Saraiva et al., 2016).

For matrix effects, the analysis of biological matrices, such as snails, can lead to the co-extraction of certain quantity of other compounds such as lipids, sugars and organic acids and their elimination prior to the final determination step is crucial (Saraiva et al., 2016).

Studies have shown that PSA allows the remove of all polar organic acids as well as polar pigments, sugars and fatty acids from the extracts, while C18 allows the elimination of nonpolar interfering substances such as lipids (Wilkowska and Biziuk, 2011; Albinet et al., 2013).

Analyzed extracts showed a great separation between all searched compounds which allows the identification of the 120 pesticides, the 16 PAHs and the 22 PCBs basing on each parameter properties previously showed in tables 1, 2 and 3.

Method validation

Once chosen and developed, the method should be validated in order to be efficient and useful. The validation proves that the used analytical methodology is accurate, specific, reproducible and robust over the specified range that a compound will be analyzed (Shabir, 2003). Several parameters were tested; repeatability and reproducibility for method accuracy, limits of detection and limits of quantification for method limits, linearity for the ability of the method to elicit test results that are directly proportional to analyte concentration within a range between 5 and 3000 ng g⁻¹ and recovery for extraction efficiency. Moreover, in order to include the error due to matrix effect in measurements, matrix-matched calibrations curve were conducted. (Figure 1s shows the calibration curves of some analyzed compounds).

Table 4 represents the validation parameters results for nonvolatile pesticides analyzed by LC-MS/MS.

Table 4: LC-MS/MS method performance and validation for pesticides analysis

Compounds	Regression line equation	Regression coefficient	Limit of detection (ng/g)	Limit of quantification (ng/g)	Repeatability (intra-day RSD%)	Reproducibility (Inter-day RSD %)	Recovery (%)
Pymetrozine	Y = 0.0008*X	0.995	2.63	8.8	10.7	12.03	64
Carbendazim	Y = 0.0040*X	0.996	1.13	3.78	7.5	16	Nd
Chloridazone	Y = 0.0021*X	0.997	1.01	3.39	3.27	2.3	88.9
Acetamiprid	Y = 0.0011*X	0.998	5.13	17.1	4.6	8.35	74.5
Thiacloprid	Y = 0.010*X	0.995	1.96	6.53	3.6	10.1	79.9
Nicosulfuron	Y = 0.0009*X	0.997	5.22	17.41	9.27	17.9	Nd
Foramsulfuron	Y = 0.0014*X	0.998	2.71	9.03	4.8	5.04	103
Chlortoluron	Y = 0.010*X	0.998	1.98	6.61	3.74	13.6	70
Carbetamide	Y = 0.0073*X	0.997	2.56	8.58	3.92	7.28	65.8
Terbutryn	Y = 0.0242*X	0.993	1.99	6.64	3.29	6.24	80
Spinosade A	Y = 0.0294*X	0.996	4.19	14	7.08	4.54	72
Isoproturon	Y = 0.0244*X	0.998	1.19	3.95	4.1	7.7	73.5
Diuron	Y = 0.0050*X	0.999	0.52	1.73	4.32	13.6	76.4
Metalaxyl-M	Y = 0.0043*X	0.996	4.42	14.7	7.5	8.12	67.1
DPMU	Y = 0.0060*X	0.997	1.73	5.77	14.1	19.22	Nd
Spinosade D	Y = 0.0067*X	0.996	0.16	0.55	9.61	15.2	82.3
Dimethenamid-P	Y = 0.1194*X	0.997	0.46	1.55	5.54	9.38	97.1
Penconazole	Y = 0.0145*X	0.998	1.42	4.73	3.97	9.01	106
Isoxadifen	Y = 0.0076*X	0.998	1.76	5.85	5.3	8.3	73.6
Tebuconazole	Y = 0.0188*X	0.994	0.94	3.13	7.27	9.17	95.2
Epoxyconazole	Y = 0.0715*X	0.998	1.06	3.53	6.07	7.19	88.5
Propiconazole	Y = 0.0302*X	0.997	3.73	12.43	3.49	12	94.1
Chlorfenviphos	Y = 0.0045*X	0.998	3.32	11.08	8.75	13.9	72.6

Triflu-Methyl	Y = 0.0185*X	0.999	1.51	5.04	1.47	4.54	107
Pendimethalin	Y = 0.0160*X	0.998	1.68	5.6	7.78	8.34	99.1
Cyazofamid	Y = 8.8e-005*X	0.995	2.48	8.26	5.76	11.9	104
Pyraclostrobine	Y = 0.0154*X	0.992	0.79	2.63	10.6	11.6	78.5
Diflufenican	Y = 0.0465*X	0.997	1.03	3.44	6.66	9.98	102
Flufenoxuron	Y = 0.0087*X	0.995	1.11	3.71	1.45	5.83	96.2
Lufenuron	Y = 0.0007*X	0.997	5.87	19.57	7.86	6.84	103

For the nonvolatile pesticides analyzed with LC-MS/MS, all target compounds were validated with good linearity expressed by a regression coefficient higher than 0.99 for the 30 targeted pesticides, LOD and LOQ were lower than 15 ng g⁻¹ for all compounds except lufenuron having a LOQ of about 20 ng g⁻¹. The 30 pesticides were detected with high precision with RSD % lower than 20% for inter and intra-day analysis. Furthermore, the method showed good recoveries higher than 65%.

For semi-volatile compounds, tables 5 and 6 respectively represent the validation parameters results for OCPs, PAHs and PCBs as well as the remained volatile pesticide analyzed by GC-MS/MS.

Table 5: GC-MS/MS method performance and validation for OCPs, PAHs and PCBs analysis

Compounds	Regression line equation	Regression coefficient	LOD (ng/g)	LOQ (ng/g)	intra-day RSD%	inter-day RSD %	Recovery %
α -HCH	Y = 0.0004*X+1.9e-008*X ²	0.996	5	16.5	6.42	12.9	99.4
γ -HCH	Y = 0.0004*X+2.5e-008*X ²	0.996	1.5	5	7.45	11.1	104
β -HCH	Y = 8.4e-005+9.8e-005*X	0.995	10	33	6.39	10.4	72
δ -HCH	Y = 0.0019+0.0001*X	0.997	10	33	8.91	6.73	89
Heptachlore epoxyde A	Y = 0.0002*X+2.3e-008*X ²	0.994	5.77	19.2	18.2	18.3	79
Metoxychlore	Y = 0.0005*X-3.4e-009*X ²	0.998	1.33	4.42	14.9	21.3	30
o.p'-DDD	Y = 3.36e-006*X+1.07e-006*X ²	0.997	7.8	26.2	7.97	6.53	67
o.p'-DDT	Y = 0.0003*X-4.79e-008*X ²	0.975	2.14	7.14	nd	Nd	Nd
p.p'-DDD	Y = 0.0003*X-1.02e-007*X ²	0.990	1.58	5.26	23.3	24.4	83
p.p'-DDT	Y = 0.0002*X+3.9e-008*X ²	0.994	6.43	21.4	23.5	14.4	66.6
β - endosulfane	Y = 2.2e-005*X+5.1e-008*X ²	0.995	5	16.5	7.83	14.8	70
α -endosulfan	Y = 0.0005*X+2.7e-007*X ²	0.996	5	16.5	8.18	8.97	85
o.p'-DDE	Y = 0.003*X-6.23e-007*X ²	0.992	7.5	24.7	4.97	15.7	Nd
p.p'-DDE	Y = 0.0001*X+1.8e-007*X ²	0.998	10	33	6.54	12.5	66

	Aldrine	$Y = 9.73604e-005 * X - 6.54446e-009 * X^2$	0.9901	5	16.5	3.27	8.8	87.2
	Heptachlore	$Y = 5.7e-005 * X + 2.02e-010 * X^2$	0.994	5	16.5	15.4	11.6	62.3
	Dieldrine	$Y = 6.5e-006 * X + 3.48e-008 * X^2$	0.990	10	33	1.63	19.8	Nd
	Hexachlorobenzene	$Y = 0.00181147 * X - 1.94583e-007 * X^2$	0.996	0.41	1.39	8	14.3	77.7
	Heptachlore epoxyde B	$Y = 0.0015 * X + 1.12e-006 * X^2$	0.991	1.67	5.56	25.9	23.3	99.3
	Transchlordan	$Y = 7.3e-005 * X - 6.94e-009 * X^2$	0.994	1.36	4.55	10	9.91	77.2
	Cischlordan	$Y = 0.0001 * X - 1.92e-008 * X^2$	0.994	2.14	7.14	7.39	10.93	79.7
PAHs	Naphtalene	$Y = 2.6e-005 * X + 2.51e-008 * X^2$	0.997	0.68	2.27	8.38	15.3	76
	Acenaphtene	$Y = 0.0045 * X + 1.17e-006 * X^2$	0.999	6.89	23	7.41	18	96
	Fluorene	$Y = 0.0005 * X - 7.9e-008 * X^2$	0.999	0.41	1.39	15.6	11.23	84
	Phenanthrene	$Y = 0.002 * X - 1.89e-007 * X^2$	0.995	1.43	4.75	7.2	7	86
	Anthracene	$Y = 0.030 + 0.001 * X$	0.995	2.25	7.5	3.12	9	94
	Fluoranthrene	$Y = 0.011 + 0.0006 * X$	0.993	10	33	3.45	16	94
	Pyrene	$Y = 0.0030 * X + 2.62e-006 * X^2$	0.996	10	33	9.43	24	91
	Benzo(a)anthracene	$Y = 4.48e-005 * X + 2.25e-008 * X^2$	0.993	2.55	8.33	6.79	14	81
	Chrysene	$Y = 8.12e-005 * X + 5.27e-009 * X^2$	0.993	10	33	17.7	20	93
	Benzo(b)fluoranthrene	$Y = 0.0001 * X - 1.2e-008 * X^2$	0.996	1.76	5.88	15.9	15	64
	Benzo(k)fluoranthrene	$Y = 3.04e-006 * X - 5.7e-011 * X^2$	0.981	8.57	28.6	16.3	16	85
	Benzo(e)pyrene	$Y = 0.0013 + 4.33e-005 * X$	0.997	3.75	12.5	20.2	20	73
	Benzo(a)pyrene	$Y = 0.0023 + 3.81e-005 * X$	0.996	3.75	12.5	11.1	18	86
	Indenol(1.2.3)pyrene	$Y = 0.0001 + 2.6e-005 * X$	0.995	10	33	3.28	11	96
	Benzo(g,h,i)perylene	$Y = 1.3e-005 * X + 2.13e-009 * X^2$	0.998	10	33	3.53	14	65
	Dibenzo(a,h)anthracene	$Y = 2.7e-005 + 1.32e-005 * X$	0.994	10	33	9.31	21	85
PCBs	PCB 18	$Y = 0.00014 * X + 2.1e-006 * X^2$	0.995	2.14	7.14	4.82	17	127
	PCB 31	$Y = 0.0005 * X + 1.80e-006 * X^2$	0.997	1.07	3.57	16.6	11	80
	PCB 28	$Y = 0.0002 * X - 1.63e-008 * X^2$	0.991	5	16.5	9.37	10	76
	PCB 52	$Y = 0.0001 * X - 1.6e-008 * X^2$	0.995	1.67	5.56	3.83	6	95
	PCB 44	$Y = 0.0001 * X - 1.58e-008 * X^2$	0.991	3.75	12.5	14.3	9	110
	PCB 70	$Y = 4.73e-006 * X + 8.12e-008 * X^2$	0.981	10	33	17.3	20	74
	PCB 81	$Y = 1.63e-005 * X + 3.09e-008 * X^2$	0.991	7.5	25	nd	Nd	Nd
	PCB 101	$Y = 4.16e-005 * X + 8.92e-008 * X^2$	0.97	5	16.7	17.1	16	64

PCB 123	$Y = 2.34e-006*X + 1.22e-008*X^2$	0.996	2.31	7.69	17.25	Nd	85
PCB 118	$Y = 0.0002*X - 8.03e-008*X^2$	0.996	1.15	3.85	20.4	15.2	89
PCB 114	$Y = 2.88e-005*X + 2.52e-009*X^2$	0.997	3.33	11.1	17.8	24.7	60.5
PCB 105	$Y = 2.85e-005*X + 6.8e-009*X^2$	0.998	3.75	12.5	15.2	25.1	98.5
PCB 126	$Y = 3.4e-006*X + 1.3e-008*X^2$	0.994	1.88	6.25	15	19.81	64.9
PCB 149	$Y = 4.85e-006*X - 9.17e-010*X^2$	0.985	10	33	7.24	18.22	82
PCB 153	$Y = 2.01e-006*X + 1.50e-010*X^2$	0.995	10	33	14.1	20.1	91
PCB 138	$Y = 1.22e-005*X + 1.2e-008*X^2$	0.837	5	16.7	18.9	19.33	66.5
PCB 167	$Y = 7.39e-006*X + 1.31e-008*X^2$	0.9874	10	33	17	22.4	97.7
PCB 156	$Y = 1.26e-005*X + 2.90e-009*X^2$	0.998	5	16.7	10.2	23.11	61
PCB 157	$Y = 1.20e-005*X + 3.1e-009*X^2$	0.998	5	16.7	nd	Nd	54
PCB 169	$Y = 0.0008 + 4.29e-006*X$	0.967	10	33	28.5	24.5	50
PCB 180	$Y = 2.09e-005*X + 6.39e-009*X^2$	0.999	7.5	25	23.2	25.67	78
PCB 189	Nd	Nd	Nd	nd	nd	Nd	Nd

Table 6: GC-MS/MS method performance and validation for pesticides analysis

Compounds	Regression line equation	Regression coefficient	LOD (ng/g)	LOQ (ng/g)	Intra-day RSD %	Inter-day RSD %	Recovery %
Clofentezine	$Y = 0.030*X - 1.82e-006*X^2$	0.994	3.75	12.5	12.02	18.6	113.06
Diclobenil	$Y = 0.080*X + 4.68e-005*X^2$	0.996	0.27	0.89	11.24	8.77	79.79
Etridiazole	$Y = 0.076*X + 3.66e-006*X^2$	0.998	5.64	18.8	8.04	8.04	64
Diphénylamine	$Y = 0.321*X + 0.0001*X^2$	0.998	2.31	7.69	17.49	19.79	64.51
Trifluraline	$Y = 0.008*X + 2.74e-005*X^2$	0.999	0.83	2.78	16.27	8.08	70.23
Chlorpropham	$Y = 0.056*X + 1.18e-005*X^2$	0.998	5.12	17.07	8.21	8.84	60.19
Tebutam	$Y = 0.0817*X - 4.09e-006*X^2$	0.996	5.27	17.57	13.02	13.1	85.31
Clomazone	$Y = 0.008*X + 5.21e-006*X^2$	0.993	5	16.7	7.43	3.34	65.55
Propyzamid	$Y = 0.076*X + 7.17e-$	0.996	7.33	24.43	4.13	5.57	74.91

	$005 * X^2$						
Lindane	$Y = 0.03 + 0.0032 * X$	0.996	0.65	2.17	8.89	8.67	79.31
Pyrimethanil	$Y = 0.085 * X + 7.43e - 005 * X^2$	0.997	2.5	8.33	5.64	18.8	81.17
dimethanamid-P	$Y = 0.0007 * X + 1.17e - 007 * X^2$	0.996	10.53	35.11	36.54	8.47	65.99
Dimethachlore	$Y = 0.0039 * X + 9.18e - 006 * X^2$	0.999	4.17	13.89	15.57	20.97	75.52
acetochlore	$Y = 0.010 * X + 3.00e - 005 * X^2$	0.996	13.53	45.11	19.12	9.87	79.95
alachlore	$Y = 0.0009 * X + 1.39e - 006 * X^2$	0.991	5	16.7	33.89	19.22	75.92
fenpropidine	$Y = 0.0019 * X + 3.27e - 006 * X^2$	0.992	20	66.67	18.71	14.74	72.43
Carbaryl	$Y = 0.28 + 0.0049 * X - 2.7e - 007 * X^2$	0.991	5.63	18.8	19.63	4.33	83.58
Ethofumesate	$Y = 0.13 + 0.001 * X + 2.25e - 006 * X^2$	0.997	9.38	31.3	13.65	21.47	72.94
Malathion	$Y = 0.002 * X - 6.17e - 008 * X^2$	0.996	9.46	31.5	18.2	24.46	86.55
Fenpropimorph	$Y = 0.002 * X + 3.78e - 007 * X^2$	0.996	7.5	25	8.25	8.79	73.53
Metolachlore-S	$Y = 0.053 * X + 2.27e - 005 * X^2$	0.991	6.43	21.43	20.99	26.22	84.4
Chlorpyrifos	$Y = 0.003 * X + 7.64e - 008 * X^2$	0.999	4.09	13.6	7.4	25.38	112.48
Flurochloridon	$Y = 0.022 * X - 4.32e - 006 * X^2$	0.993	12.27	40.9	11.1	5.51	72.15
Cyprodinil	$Y = 0.0212 * X + 1.13e - 005 * X^2$	0.994	5	16.7	13.54	18.98	73.13
Pendimethalin	$Y = 0.0012 * X + 3.38e - 006 * X^2$	0.996	7.06	23.53	15.71	16.84	72.55
tolyfluanid	$Y = 0.0003 * X + 2.76e - 007 * X^2$	0.995	5	16.7	10.34	8.64	85.07
Metazachlore	$Y = 0.0028 * X - 3.23e - 007 * X^2$	0.997	19.3	64.8	13.6	16.79	63.91
Penconazol	$Y = 0.048 * X + 4.63e - 005 * X^2$	0.972	0.22	0.72	7.44	2.43	61.6
Procymidone	$Y = 0.0011 * X + 1.80e - 007 * X^2$	0.997	18.6	62.1	12.98	13.21	104.72
Captane	$Y = 0.0049 * X - 3.35e - 007 * X^2$	0.998	13.91	46.38	7.8	7.69	114.01

Folpet	$Y = 4.76e-005*X + 2.89e-008*X^2$	0.981	11.7	38.9	11.47	15.24	71.38
Oxadiazone	$Y = 0.0018*X - 3.6e-007*X^2$	0.991	5	16.7	22.79	14.3	82.53
Buprofezine	$Y = 0.002*X + 1.39e-005*X^2$	0.994	7.5	25	14.02	9.27	65.56
Kerosym-methyl	$Y = 0.0001*X - 1.41e-008*X^2$	0.998	11.25	37.5	16.94	20.69	nd
Bupirimate	$Y = 0.099 + 0.005*X$	0.996	11.63	38.75	41.27	42.65	82.04
Flusilazole	$Y = 0.014*X - 8.51e-007*X^2$	0.991	2.47	8.22	17.31	16.51	56.18
Myclobutanil	$Y = 0.0027*X + 3.41e-006*X^2$	0.998	11.78	39.29	15.54	18.6	101.78
acлонifen	$Y = 1.53 + 0.023*X$	0.961	9.43	31.43	13.39	2.55	54.38
Trifloxystrobine	$Y = 0.016*X + 3.34e-005*X^2$	0.991	9.5	31.7	12.99	14.24	nd
Bromoxynil octanoate	$Y = 0.007*X + 2.3e-006*X^2$	0.997	13.93	46.43	nd	nd	nd
Propiconazole	$Y = 0.008*X + 2.7e-005*X^2$	0.995	1.82	6.06	32.85	13.58	68.96
Quinoxifen	$Y = 0.017*X + 1.52e-005*X^2$	0.991	0.44	1.47	8.62	5.16	91.28
Lenacile	$Y = 0.0016*X + 5.41e-007*X^2$	0.998	14.4	48.1	22.14	11.36	61.46
Diclofop-methyl	$Y = 0.068*X + 6.27e-005*X^2$	0.988	1.22	4.07	16.39	13.15	71.76
Cloridazole	$Y = 0.0001*X + 2.49e-007*X^2$	0.997	5	16.7	16.88	9.75	89.88
Diflufenicanil	$Y = 0.062*X + 0.0003*X^2$	0.980	0.88	2.94	20.87	17.9	60.02
Fluazinam	$Y = 9.20e-005*X + 1.84e-007*X^2$	0.995	12	40	21.58	15.32	62.39
Tebuconazole	$Y = 0.013 + 0.0004*X$	0.998	13.12	43.75	17.63	6.08	65.66
Bifenthrin	$Y = 0.127*X + 0.0001*X^2$	0.988	9.95	33.2	12.23	12.7	77.9
Dimoxystrobin	$Y = 0.150*X + 4.36e-005*X^2$	0.997	1.86	6.19	22.56	21.2	102.07
Epoxyconazole	$Y = 0.0027*X + 2.14e-007*X^2$	0.990	10.73	35.77	24.33	17.4	112.94
Fenoxycarb	$Y = 0.0003*X + 6.07e-008*X^2$	0.991	6	20	18.97	14.84	84.69
Isoxaflutole	$Y = 0.0002*X + 9.52e-008*X^2$	0.993	5	16.7	5.85	2.2	95.24

Tebufenpyrad	$Y = 0.0013*X - 2.02e-007*X^2$	0.999	0.61	2.04	44.74	23.98	81.78
Bifenox	$Y = 0.0005*X + 1.5e-006*X^2$	0.999	12.39	41.3	15.13	15.55	74.09
Lambda cyhalothrine	$Y = 0.0013*X + 1.06e-005*X^2$	0.989	8.18	27.3	21.84	17.4	105.09
Fenarimol	$Y = 0.152 + 0.001*X$	0.998	8.33	27.77	5.88	4.88	72.94
Pyraclostrobin	$Y = 0.359 + 0.010*X$	0.996	9.16	30.55	15.01	16.6	81.02
Prochloraze	$Y = 0.0023*X + 2.43e-006*X^2$	0.997	14.4	48	15.64	15.56	82.02
cypermethrine	$Y = 0.185 + 0.005*X$	0.997	12	40	5.54	2.07	76.84
boscalid	$Y = 0.006*X + 1.18e-005*X^2$	0.998	2.34	7.81	15.85	11.71	64.96
Indoxacarb	$Y = 0.0009*X + 3.29e-006*X^2$	0.998	8.72	29.61	12.3	9.09	nd
Difenoconazole	$Y = 0.0053*X + 7.872e-006*X^2$	0.998	15.1	50.3	15.32	10.58	68.25
Deltamethrine	$Y = 0.0001*X + 6.25e-007*X^2$	0.998	7.5	25	4.77	5.8	83.19
Azoxystrobine	$Y = 0.084 + 0.0017*X$	0.996	2.73	9.09	15.16	16.38	60.59
Dimetomorph	$Y = 0.0006*X - 4.97e-009*X^2$	0.993	6.25	20.8	14.25	0.5	70.28
Spiroxamine	$Y = 0.0007*X + 3.04e-007*X^2$	0.983	6.36	21.2	6.36	13.73	70.33
Metamitrone	$Y = 0.0006*X + 5.45e-008*X^2$	0.995	7.5	25	10.73	8.76	nd

For the semi-volatile compounds analyzed with GC-MS/MS, compounds were validated for their good linearity expressed by regression coefficient higher than 0.99 for the majority of the compounds sought. Low limits of detection and quantification were determined for the analyzed compounds with an RSD lower than 20% for most of them. Contrariwise, the calculated RSD % seems to be higher than the one obtained with the nonvolatile pesticides. The main explanation of these results is the introduction of the SPME as a pre-concentration step; this later even of its efficiency and concentration role increases the error and decreases the recovery rates (Dimpe and Nomngongo, 2016). Moreover, some fiber's saturation problems could be the main reasons of the high RSD % and low recovery observed with some compounds (PCB-169, PCB-157, Metoxychlore, o,p'-DDT, bupirimate).

Conclusion

The analytical method developed in this paper enables the simultaneous analysis of 158 emerging environmental pollutants from the terrestrial gastropod *Helix aspersa*. The original proposed method allows, with the combination of a simple extraction method like QuEChERS with an SPME process coupled to chromatographic analytical techniques, the extraction of this wide number of different type of pollutants. The mixed extractions are qualified to be friendly to the environment requiring a small amount of organic solvents. The validation of the developed method showed great results resulting in good performance in terms of linearity, accuracy and precision. The method allowed the detection of organic pollutants at low limits with high recovery rates.

Moreover, the comparison of the QuEChERS-SPME based method with an ASE-SPE-SPME method showed the efficiency and the importance of the first method in providing reliable and sensitive results in pollutants multi-residual analysis from such matrices. Regarding the solvent extraction, results proved that the choice of the solvent plays a crucial role in the extraction efficiency. ACN was proven to be the solvent of choice in our extraction procedure in comparison with EtAc.

In conclusion the use of the developed method based on QuEChERS-SPME followed by a chromatographic analysis using LC-MS/MS and GC-MS/MS, was validated for its linearity, accuracy and performance allowing its application as a fast, efficient and reliable tool for routine analysis of a large range of compounds at trace level in snails, in order to apply it in further studies aiming to investigate a wide environmental biomonitoring study.

Acknowledgment

We gratefully acknowledge AZM & SAADE association and the Lebanese University for funding the project, as well as Strasbourg University for the international mobility aid, without which the present study could not have been completed.

References

- Al-Alam, J., Fajloun, Z., Chbani, A., Millet, M., 2017. The use of conifer needles as biomonitor candidates for the study of temporal air pollution variation in the Strasbourg region. *Chemosphere* 168, 1411-1421.
- Albinet, A., Tomaz, S., Lestremay, F., 2013. A really quick easy cheap effective rugged and safe (QuEChERS) extraction procedure for the analysis of particle-bound PAHs in ambient air and emission samples. *Science of the Total Environment* 450, 31-38.
- Anastassiades, M., Lehotay, S.J., Štajnbaher, D., Schenck, F.J., 2003. Fast and easy multiresidue method employing acetonitrile extraction/partitioning and “dispersive solid-phase extraction” for the determination of pesticide residues in produce. *Journal of AOAC international* 86, 412-431.
- Andrade-Eiroa, A., Canle, M., Leroy-Cancellieri, V., Cerdà, V., 2016a. Solid-phase extraction of organic compounds: A critical review (Part I). *TrAC Trends in Analytical Chemistry* 80, 641-654.
- Andrade-Eiroa, A., Canle, M., Leroy-Cancellieri, V., Cerdà, V., 2016b. Solid-phase extraction of organic compounds: A critical review. part ii. *TrAC Trends in Analytical Chemistry* 80, 655-667.
- Beeby, A., Richmond, L., 2002. Evaluating *Helix aspersa* as a sentinel for mapping metal pollution. *Ecological Indicators* 1, 261-270.
- Berlioz-Barbier, A., Baudot, R., Wiest, L., Gust, M., Garric, J., Cren-Olivé, C., Buleté, A., 2015. MicroQuEChERS–nanoliquid chromatography–nanospray–tandem mass spectrometry for the detection and quantification of trace pharmaceuticals in benthic invertebrates. *Talanta* 132, 796-802.

Berlizo-Barbier, A., Buleté, A., Faburé, J., Garric, J., Cren-Olivé, C., Vulliet, E., 2014. Multi-residue analysis of emerging pollutants in benthic invertebrates by modified micro-quick-easy-cheap-efficient-rugged-safe extraction and nanoliquid chromatography–nanospray–tandem mass spectrometry analysis. *Journal of Chromatography A* 1367, 16-32.

Blasco, C., Vazquez-Roig, P., Onghena, M., Masia, A., Picó, Y., 2011. Analysis of insecticides in honey by liquid chromatography–ion trap–mass spectrometry: Comparison of different extraction procedures. *Journal of Chromatography A* 1218, 4892-4901.

Capinera, J.L., Dickens, K., 2016. Some effects of copper-based fungicides on plant-feeding terrestrial molluscs: A role for repellents in mollusc management. *Crop Protection* 83, 76-82.

Cloutier, P.-L., Fortin, F., Groleau, P.E., Brousseau, P., Fournier, M., Desrosiers, M., 2017. QuEChERS extraction for multi-residue analysis of PCBs, PAHs, PBDEs and PCDD/Fs in biological samples. *Talanta* 165, 332-338.

Costa, F.P., Caldas, S.S., Primel, E.G., 2014. Comparison of QuEChERS sample preparation methods for the analysis of pesticide residues in canned and fresh peach. *Food chemistry* 165, 587-593.

de Souza, M.R., da Silva, F.R., de Souza, C.T., Niekraszewicz, L., Dias, J.F., Premoli, S., Corrêa, D.S., Soares, M.d.C., Marroni, N.P., Morgam-Martins, M.I., da Silva, J., 2015. Evaluation of the genotoxic potential of soil contaminated with mineral coal tailings on snail *Helix aspersa*. *Chemosphere* 139, 512-517.

De Vaufleury, A., Coeurdassier, M., Pandard, P., Scheifler, R., Lovy, C., Crini, N., Badot, P.M., 2006a. How terrestrial snails can be used in risk assessment of soils. *Environmental toxicology and chemistry* 25, 797-806.

De Vaufleury, A., Coeurdassier, M., Pandard, P., Scheifler, R., Lovy, C., Crini, N., Badot, P.M., 2006b. How terrestrial snails can be used in risk assessment of soils. *Environmental toxicology and chemistry* 25, 797-806.

Dimpe, K.M., Nomngongo, P.N., 2016. Current sample preparation methodologies for analysis of emerging pollutants in different environmental matrices. *TrAC Trends in Analytical Chemistry* 82, 199-207.

Druart, C., Millet, M., Scheifler, R., Delhomme, O., Raeppe, C., de Vaufleury, A., 2011. Snails as indicators of pesticide drift, deposit, transfer and effects in the vineyard. *Science of The Total Environment* 409, 4280-4288.

Gómez-Ariza, J.L., Bujalance, M., Giráldez, I., Velasco, A., Morales, E., 2002. Determination of polychlorinated biphenyls in biota samples using simultaneous pressurized liquid extraction and purification. *Journal of Chromatography A* 946, 209-219.

Gomot-de Vaufleury, A., Bispo, A., 2000. Methods for toxicity assessment of contaminated soil by oral or dermal uptake in land snails. 1. Sublethal effects on growth. *Environmental science & technology* 34, 1865-1870.

Gust, M., Buronfosse, T., Geffard, O., Mons, R., Queau, H., Mouthon, J., Garric, J., 2010. In situ biomonitoring of freshwater quality using the New Zealand mudsnail *Potamopyrgus antipodarum* (Gray) exposed to waste water treatment plant (WWTP) effluent discharges. *Water research* 44, 4517-4528.

Ianistcki, M., Dallarosa, J., Sauer, C., Teixeira, C., Da Silva, J., 2009. Genotoxic effect of polycyclic aromatic hydrocarbons in the metropolitan area of Porto Alegre, Brazil, evaluated by *Helix aspersa* (Müller, 1774). *Environmental pollution* 157, 2037-2042.

Kowalczyk-Pecka, D., Pecka, S., Kowalczyk-Vasilev, E., 2017. Changes in fatty acid metabolism induced by varied micro-supplementation with zinc in snails *Helix pomatia* (Gastropoda Pulmonata). *Ecotoxicology and Environmental Safety* 138, 223-230.

Kujawski, M.W., Bargańska, Ż., Marciniak, K., Miedzianowska, E., Kujawski, J.K., Ślebioda, M., Namieśnik, J., 2014. Determining pesticide contamination in honey by LC-ESI-MS/MS–Comparison of pesticide recoveries of two liquid–liquid extraction based approaches. *LWT-Food Science and Technology* 56, 517-523.

Laskowski, R., Hopkin, S.P., 1996. Accumulation of Zn, Cu, Pb and Cd in the garden snail (*Helix aspersa*): implications for predators. *Environmental Pollution* 91, 289-297.

Li, J., Wang, Y.-B., Li, K.-Y., Cao, Y.-Q., Wu, S., Wu, L., 2015. Advances in different configurations of solid-phase microextraction and their applications in food and environmental analysis. *TrAC Trends in Analytical Chemistry* 72, 141-152.

Malhat, F.M., Haggag, M.N., Loutfy, N.M., Osman, M.A., Ahmed, M.T., 2015. Residues of organochlorine and synthetic pyrethroid pesticides in honey, an indicator of ambient environment, a pilot study. *Chemosphere* 120, 457-461.

Maré, M., Tobiszewski, M., Zabiegała, B., Guardia, M.d.l., Namieśnik, J., 2015. Current air quality analytics and monitoring: A review. *Analytica Chimica Acta* 853, 116-126.

Mattarozzi, M., Milioli, M., Bianchi, F., Cavazza, A., Pigozzi, S., Milandri, A., Careri, M., 2016. Optimization of a rapid QuEChERS sample treatment method for HILIC-MS2 analysis of paralytic shellfish poisoning (PSP) toxins in mussels. *Food Control* 60, 138-145.

Megson, D., Reiner, E.J., Jobst, K.J., Dorman, F.L., Robson, M., Focant, J.-F., 2016. A review of the determination of persistent organic pollutants for environmental forensics investigations. *Analytica Chimica Acta*.

Pauget, B., Gimbert, F., Coeurdassier, M., Crini, N., Pérès, G., Faure, O., Douay, F., Richard, A., Grand, C., de Vaufleury, A., 2013. Assessing the in situ bioavailability of trace elements to snails using accumulation kinetics. *Ecological Indicators* 34, 126-135.

Pihan, F., De Vaufleury, A., 2000. The snail as a target organism for the evaluation of industrial waste dump contamination and the efficiency of its remediation. *Ecotoxicology and environmental safety* 46, 137-147.

Regoli, F., Gorbi, S., Fattorini, D., Tedesco, S., Notti, A., Machella, N., Bocchetti, R., Benedetti, M., Piva, F., 2006. Use of the land snail *Helix aspersa* as sentinel organism for monitoring ecotoxicologic effects of urban pollution: an integrated approach. *Environmental health perspectives*, 63-69.

Rouvière, F., Buleté, A., Cren-Olivé, C., Arnaudguilhem, C., 2012. Multiresidue analysis of aromatic organochlorines in soil by gas chromatography-mass spectrometry and QuEChERS extraction based on water/dichloromethane partitioning. Comparison with accelerated solvent extraction. *Talanta* 93, 336-344.

Saraiva, M., Cavalheiro, J., Lancelour, L., Monperrus, M., 2016. Synthetic musk in seafood products from south Europe using a quick, easy, cheap, effective, rugged and safe extraction method. *Food Chemistry* 200, 330-335.

Shabir, G.A., 2003. Validation of high-performance liquid chromatography methods for pharmaceutical analysis: Understanding the differences and similarities between validation requirements of the US Food and Drug Administration, the US Pharmacopeia and the International Conference on Harmonization. *Journal of Chromatography A* 987, 57-66.

Sharmili, K., Jinap, S., Sukor, R., 2016. Development, optimization and validation of QuEChERS based liquid chromatography tandem mass spectrometry method for determination of multimycotoxin in vegetable oil. *Food Control* 70, 152-160.

Silva, F.R.d., Erdtmann, B., Dalpiaz, T., Nunes, E., Ferraz, A., Martins, T.L., Dias, J.F., Rosa, D.P.d., Porawskie, M., Bona, S., 2013. Genotoxicity of *Nicotiana tabacum* leaves on *Helix aspersa*. *Genetics and molecular biology* 36, 269-275.

SPME, 2016. Solid Phase Microextraction: Recent Developments and Applications.

Souza Tette, P.A., Rocha Guidi, L., de Abreu Glória, M.B., Fernandes, C., 2016. Pesticides in honey: A review on chromatographic analytical methods. *Talanta* 149, 124-141.

Sun, H., Ge, X., Lv, Y., Wang, A., 2012. Application of accelerated solvent extraction in the analysis of organic contaminants, bioactive and nutritional compounds in food and feed. *Journal of Chromatography A* 1237, 1-23.

Vaufleury, A.G.d., Pihan, F., 2002. Methods for toxicity assessment of contaminated soil by oral or dermal uptake in land snails: metal bioavailability and bioaccumulation. *Environmental toxicology and chemistry* 21, 820-827.

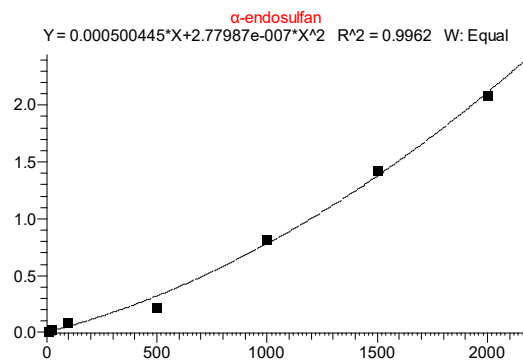
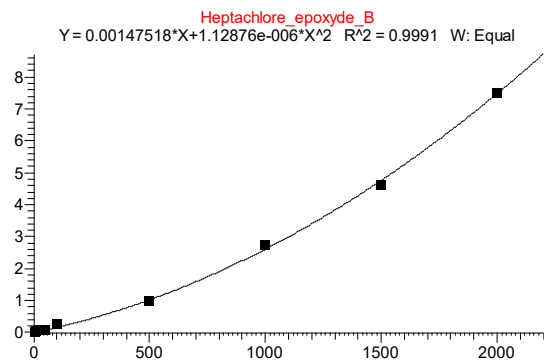
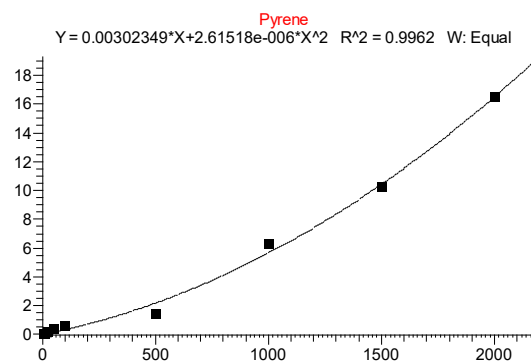
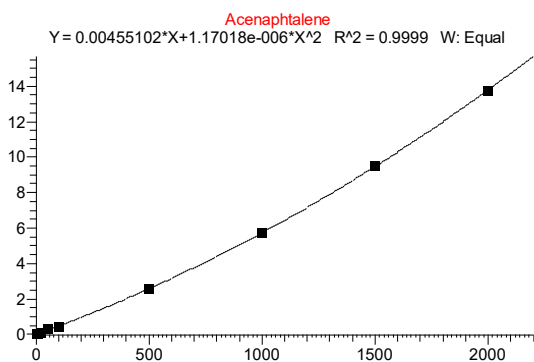
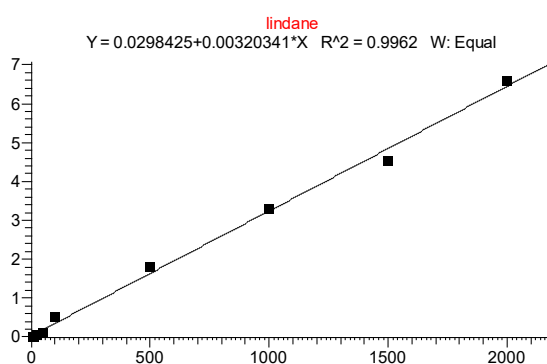
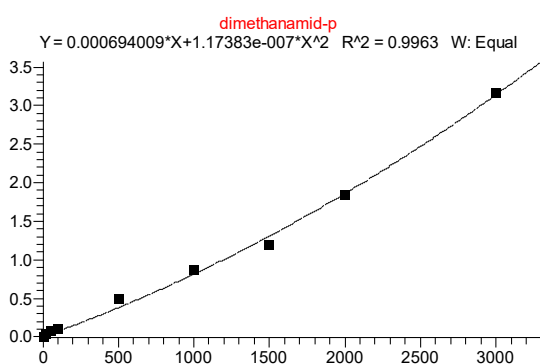
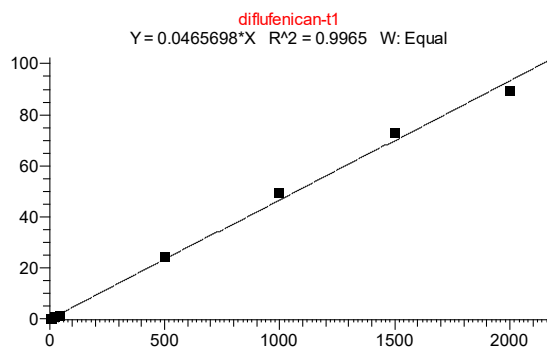
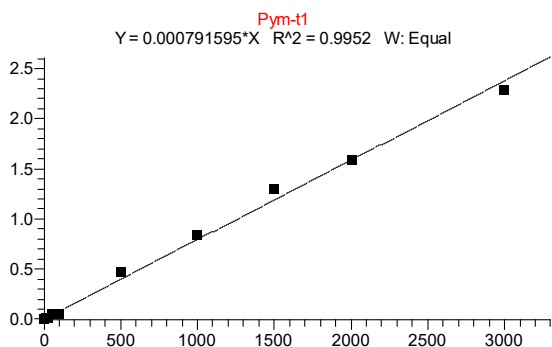
Wilkowska, A., Biziuk, M., 2011. Determination of pesticide residues in food matrices using the QuEChERS methodology. *Food Chemistry* 125, 803-812.

Wolterbeek, B., 2002. Biomonitoring of trace element air pollution: principles, possibilities and perspectives. *Environmental Pollution* 120, 11-21.

Wolterbeek, H.T., Bode, P., 1995. State of the Art of Trace Element Determinations in Plant Matrices Strategies in sampling and sample handling in the context of large-scale plant biomonitoring surveys of trace element air pollution. *Science of The Total Environment* 176, 33-43.

Yang, Z., Chen, B., Li, L., Zheng, B., Liu, L., 2010. International Conference on Ecological Informatics and Ecosystem Conservation (ISEIS 2010) Biomonitoring and Bioindicators Used for River Ecosystems: Definitions, Approaches and Trends. *Procedia Environmental Sciences* 2, 1510-1524.

Supplementary data



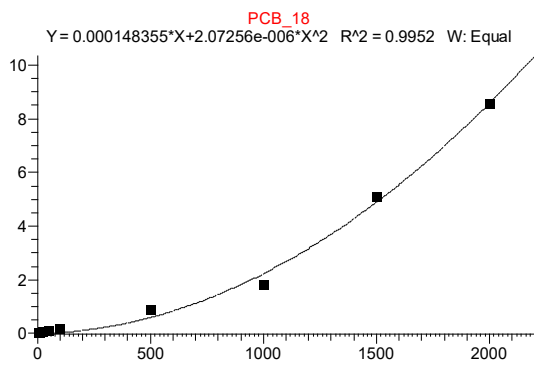
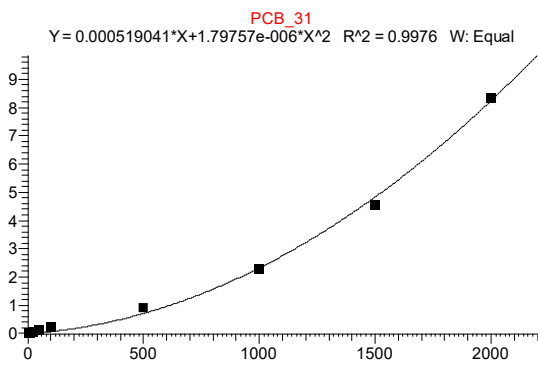


Figure 1s: Calibration curves of some analyzed compounds

VIII. Effet des extraits aqueux des algues vertes "*Ulva lactuca*" et "*Ulva linza*" sur le bio contrôle de la moisissure verte "*Penicillium digitatum*" des agrumes en post – récolte.

Ce résultat, présenté sous format d'un article en cours de préparation, présente une introduction à l'usage des biopesticides d'origine algale comme une solution alternative aux pesticides chimiques et efficace pour le processus de protection en post-récolte des agrumes.

Dans cette partie, le potentiel des extraits aqueux d'algues vertes fraîches et séchées *Ulva lactuca* et *Ulva linza*, en tant que biopesticides pour la protection des agrumes en post-récolte contre l'agent pathogène *P. digitatum*, a été étudié. Pour cela, des extraits aqueux des 2 algues à différentes concentrations (de 200 g L⁻¹ à 25 g L⁻¹) ont été utilisés pour la pulvérisation des oranges préalablement mises en contact avec des spores de penicillium. Les fruits traités et infectés ont été enveloppés par du film transparent. Après 7 jours d'incubation à une température 26 °C, l'aspect macroscopique des oranges a été observé et analysé. Les résultats obtenus ont montré une protection de ces agrumes jusqu'à 8 semaines sans aucun agent chimique de préservation et à température ambiante, formant donc le premier pas du développement d'un biopesticides en post-récolte pour les agrumes. La concentration minimale inhibitrice trouvée était de l'ordre de 50 g L⁻¹ avec une conservation optimale des propriétés organoleptiques. En outre, la comparaison de l'efficacité de ces extraits à T ambiante et à 4 °C a montré que l'utilisation de la réfrigération peut optimiser la protection des agrumes conduisant à un meilleur aspect et consistance des fruits.

En conclusion, les extraits testés ont permis une protection des oranges contre *P. digitatum* lors du stockage, du transport et de la commercialisation des agrumes formant ainsi une introduction à l'usage des algues marines comme biofongicides en post-récolte en alternance aux fongicides chimiques toxiques pour la santé et l'environnement.

Effect of crude extracts of chlorophytae seaweed “*Ulva lactuca*” and “*Ulva linza*” on the control of the green mold “*Penillium digitatum*” at the post harvested citrus.

Josephine Al-Alam^{1,2}, Ziad Fajloun^{1,3}, Maurice Millet², Asma Chbani^{1,4}

¹Laboratory of Applied Biotechnology (LBA3B), Azm Center for Research in Biotechnology and its Applications, Doctoral School of Science and Technology, Lebanese University, El Mittein Street, Tripoli, Lebanon;

²Institute of Chemistry and Processes for Energy, Environment and Health ICPEES UMR 7515 Group of Physical Chemistry of the Atmosphere, University of Strasbourg, Strasbourg, France;

³Faculty of Sciences III, department of biology, Lebanese University, Tripoli, Lebanon;

⁴Faculty of Public Health III, Lebanese University, Tripoli, Lebanon.

***To whom correspondence should be addressed:** Dr Asma Chbani or Josephine Al-Alam, Laboratory of Applied Biotechnology (LBA3B), Azm Center for Research in Biotechnology and its Applications, Doctoral School of Science and Technology, Lebanese University, El Mittein Street, Tripoli, Lebanon. Tel.: + 961 71611931, E-mail: asmashbani61@gmail.com or Josephine.al-alam@etu.unistra.fr

Abstract

Penicillium digitatum, the main cause of citrus green mold, is responsible for 90% of post-harvest losses. In this study, the efficiency of crude extracts of two green algae *Ulva lactuca* and *Ulva linza* in protecting oranges against this mold was investigated. Oranges were pulverized with these extracts at different concentrations, contaminated by the fungus and then observed during 8 weeks for their macroscopic changes. Fresh and dry algae were tested as well as storage at 24°C and 4°C in order to determine the best circumstances for orange protection. Obtained results confirm that the extracts could be an alternative to harmful fungicides in protecting post-harvested citrus fruits.

Key words: *Penicillium digitatum*, *Ulva linza*, *Ulva lactuca*, antifungal activity, citrus fruits, postharvest diseases.

Introduction

Due to its health benefits and global consumption, the cultivation of citrus fruit is economically one of the most important fruit crops in the world (Wang et al. 2016). The country of Lebanon is characterized by a large surface area of citrus fruit cultivation: According to the Directorate of Study and Coordination at the Ministry of Agriculture in 2007, about 210 km of the coast is dedicated to citrus production and the area of production is estimated to be 23% of the total area of cultivated fruit trees. The southern region is the highest producer of citrus fruits where its cultivation reaches 73% and 80% of the total area of Sidon and Tyr respectively. In the northern region, this value reaches 39% in Akkar and Zgharta (Moussa and El Hajj 2010).

Citrus fruits are consumed either fresh or as juice due to their preferred flavors and benefits, but this consumption is threatened by many diseases and pests attacking the trees and causing irreversible damage to both trees and production (Coltro et al. 2009). However, the main causes of citrus fruits diseases are fungal post-harvesting attacks. Fungi, particularly suited for a saprophytic lifestyle, are among the main biological agents that cause damage to crops during transport and storage (Marcet-Houben et al. 2012). Among these fungi, green mold caused by *P. digitatum* is responsible for the majority of post-harvest losses of citrus fruits grown under Mediterranean climate conditions (Ballester et al. 2010, Eckert 1978).

P. digitatum is a pathogenic fungus that can reproduce quickly. Its spores are ubiquitous in the atmosphere and on fruit surfaces and are easily spread by air currents. Therefore, the source of fungal inoculums in citrus orchards and on fruits is virtually continuous during the season (Palou et al. 2008). The control of these diseases is mainly achieved by applying chemical pesticides, particularly systemic fungicides such as imazalil (IZ), sodium ortho-phenyl phenate (SOPP), thiabendazole (TBZ), or various mixtures of these compounds (Erasmus et al. 2015, Golge and Kabak 2015), preventing the development of molds in post-harvest.

However, pesticides can penetrate the rind and appear in the pulp and the juice of fruits (Lee and Lee 2012). Due to the stability of pesticides in the environment, pesticide residues remain in the crops, causing adverse effects on human health, varying from allergies to chronic diseases, cancer and death (Fenik et al. 2011).

To avoid fungicides and their harmful effects, an alternative biological protection mechanism should be considered. In fact, using biopesticides to control post-harvest diseases as an alternative to synthetic fungicides can have several advantages, such as decreasing environmental contamination and risks to human health associated with residues of chemical fungicides, and preventing the proliferation of resistant strains of *P. digitatum* also due to chemical treatment (Holmes and Eckert 1999). Biological mechanisms are based on ecological interactions such as the competition for space and nutrients, mycoparasitism, antibiosis, predation or induction of plant defense (Janisiewicz and Korsten 2002, Pimenta et al. 2008).

Marine algae are a source of a variety of complex natural products and can have several applications in agriculture (Delattre et al. 2005, Hernández-Herrera et al. 2014, Xu and Leskovar 2015). Numerous natural bioactive molecules have been discovered from algae, and many of these compounds have potential antimicrobial effects against environmental and agricultural pathogens. For these reasons, different antiviral, antifungal and antibacterial compounds have been isolated from different types of red, brown and green algae (Arunkumar et al. 2010, Dussault et al. 2016, Mayer et al. 2009, Newman et al. 2003). Among the various types of algae,

green algae are the most useful in terms of antifungal protection, and different antifungal molecules have been isolated from several types of green algae (Abouraïcha et al. 2015, Coşoveanu et al. 2010, Liu et al. 2013).

For example, the green alga *Ulva lactuca* Linnaeus has been evaluated for antimicrobial activity, and the extract lactuca showed greater antifungal activity than the extract against *Aspergillus Niger* and *Candida albicans* (Alang et al. 2009, Kosanić et al. 2014).

The aim of this study is to evaluate the ability of green algae *Ulva lactuca* and *Ulva linza* to serve as a biological control agent against orange decay for stored fruit. The seaweeds were tested for their capability to control the phytopathogenic filamentous fungi *Penicillium digitatum* in oranges inoculated with fungus. Fresh and dried algae were tested, as well as storage at two different temperatures (4°C and 25°C) to determine optimal storage conditions. The seaweed extract could be used as a sustainable and effective source of tested biopesticides and an alternative to harmful chemical fungicides in controlling postharvest phytopathogens in fruits.

Materials and methods

Samples

The ripe oranges (*Citrus sinensis* L.), Valencia variety, were purchased from a local market in Tripoli, Lebanon. Oranges were transported to the laboratory where they were superficially disinfected by immersion in 1.0 % sodium hypochlorite for 3 min, rinsed with sterile water, and dried in a sterile chamber before being treated with Seaweed prepared extracts.

Algal material

Ulva lactuca and *Ulva linza* were collected from a coastal zone of the Mediterranean, El Mina (34 ° 26 'N - 35 ° 50' E) in Tripoli, Lebanon, on April 25, 2015.

The collected algae were cleaned with sea water to remove unwanted impurities (adhered sand particles and epiphytes) and were carried in moistened plastic bags to the laboratory.

Fungal material

The strain of *P. digitatum* was obtained from naturally infected oranges, then isolated and stored on SABOURAUD medium (Bio-Rad) supplemented with chloramphenicol (antibiotic opposing the proliferation of contaminating bacteria).

Preparation of the crude liquid extract of fresh Ulva linza

The algae were washed with distilled water and ultrapure water to remove sea salts from the sample surface. 100 g of fresh algae were ground and then boiled in 1 liter of ultrapure water while stirring for one hour. The extract was then filtered twice using a muslin cloth and cooled to room temperature (Jiménez et al. 2011).

Preparation of the crude liquid extract of dry *Ulva linza* and *Ulva lactuca*

Algae underwent the same wash procedure as above, and then were dried in ambient air until a constant mass was obtained. 200 g of the resulting dried algae were then subjected to the same extraction procedure used for preparing crude extracts of fresh *Ulva linza*. The obtained extracts (200 g L⁻¹) were filtered twice using a muslin cloth and then cooled to room temperature for the preparation of corresponding dilutions. Sterile distilled water was used for the dilutions and a series of 200 g L⁻¹, 100 g L⁻¹, 75 g L⁻¹, 50 g L⁻¹ and 25 g L⁻¹ solutions were prepared.

In vivo protective test of seaweed extracts against *P. digitatum* infection

To examine whether the algae extracts have inhibitory effects against *P. digitatum*, oranges were treated with these extracts and then infected with *P. digitatum*.

First, the oranges were dried and then deposited on plastic plates containing absorbent paper which was soaked with sterile distilled water in order to provide a moisture content of 95-100%. Each orange was then pulverized with 4 mL of alga extract. Three oranges were used for each extract. The chemical pesticide Nystatine was used as a positive control and distilled water as a negative control (Chbani et al. 2013).

Two hours after the pulverization, oranges were infected with *P. digitatum* by depositing 10 µL of spore suspension on their surface. The spore suspension was prepared by scraping the surface of PDA in older cultures incubated for 6 days at room temperature using a sterile spatula. This suspension was put into a blender with a few drops of Tween 20 and then transferred to a spray device producing very fine droplet. Treated oranges were covered with a transparent film and stored at room temperature. 5 to 6 days after inoculation, the macroscopic aspects of the oranges were studied (Jimenez et al. 2011).

In order to study the effect of refrigeration on the conservation of oranges, oranges treated with crude extract at a concentration of 50 g L⁻¹ of dry algae were stored at 4°C after the infection with *P. digitatum*. The use of this technique is to determine the best means of transport and marketing of the fruit with maximum conservation from infection as well as maintenance of the fruit's appearance and organoleptic properties.

Results and discussion

In order to determine the best crude extract originating from algae and having a preventive action on citrus fruits against *P. digitatum*, different concentrations of the two dried algae were tested. These concentrations allowed us to define the minimum concentration needed for protection, enabling us to obtain an effective extract with the minimized cost of the raw material (algae).

Effect of the dry crude extract of *Ulva lactuca* and *Ulva linza* on orange protection at 25°C

As mentioned before, a diluted series ranging from 25 g L⁻¹ to 200 g L⁻¹ was prepared by simple dilution with water. Each extract was tested on 3 oranges and the macroscopic aspects were observed after 1 week. Figures 1 and 2 show the effectiveness of the extracts obtained from dried *Ulva lactuca* and *Ulva linza* at 25°C over 10 weeks.

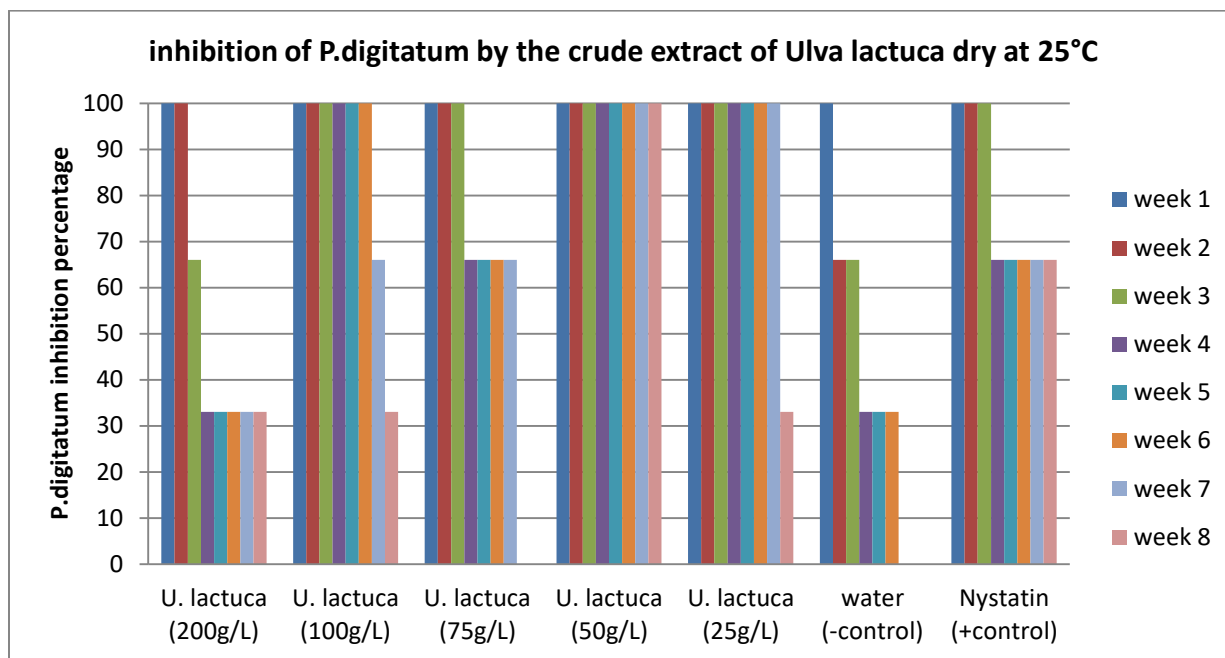


Figure 1: Effect of the crude extract of *Ulva lactuca* dry at different concentrations on in vivo growth of *Penicillium digitatum* at 25 ° C for 8 weeks

Figure 1 shows that all the crude extracts of dry *Ulva lactuca* have protected oranges at 25°C for 7 weeks with a protection rate ranging from 33% for extracts at concentration of 200 g L⁻¹ to 66% for those at concentrations of 100 and 75 g L⁻¹, and reaching 100% for extracts at concentrations of 50 g L⁻¹ and 25 g L⁻¹.

On the last week of observation (8th week), this protection is still complete (100%) for the oranges protected with a crude extract of *Ulva lactuca* at 50 g L⁻¹, decreases to 33% for extracts of 100 g L⁻¹ and 25 g L⁻¹, and becomes zero for the extract of 75 g L⁻¹.

Therefore these results show that the crude extracts of *Ulva Lactuca* allow significant protection of oranges against infection by *P. digitatum*, especially at a concentration of 50 g L⁻¹; this concentration is therefore determined to be the minimum protective concentration.

These results also demonstrate the effectiveness of the green alga *Ulva Lactuca* in the protection of post-harvested citrus fruits, validating the results obtained by Aruna et al. in 2010 on the important antifungal properties of this alga (Aruna et al. 2010).

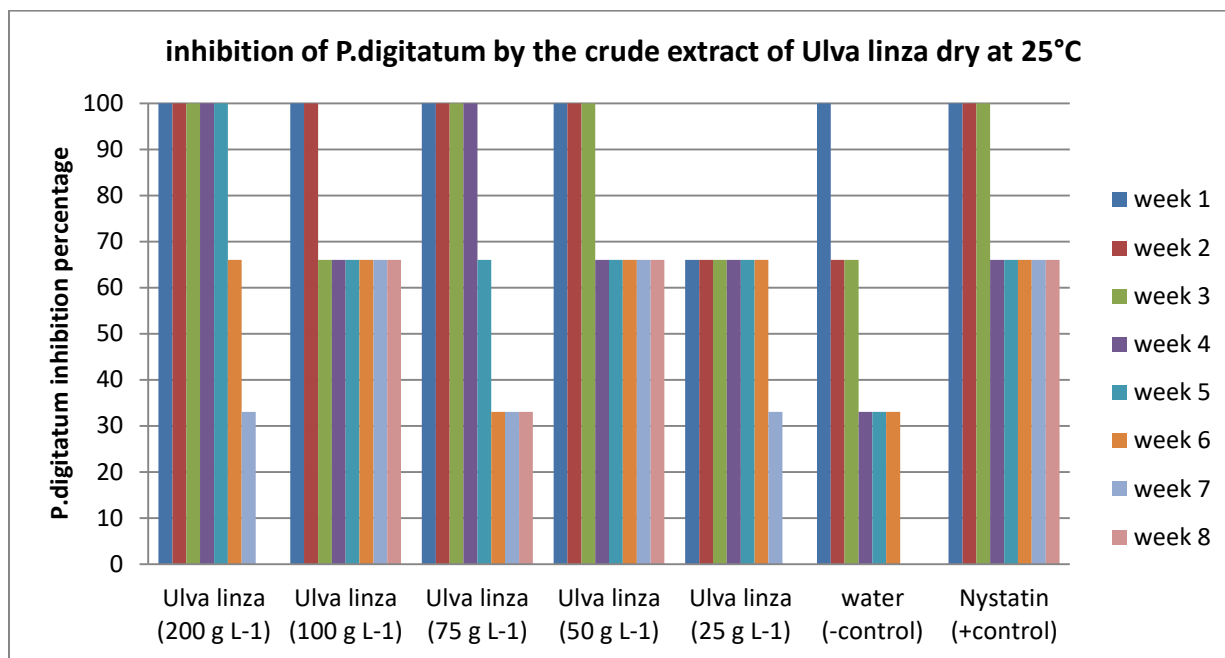


Figure 2: Effect of the crude extract of *Ulva linza* dry at different concentrations on in vivo growth of *Penicillium digitatum* at 25 ° C for 8 weeks.

Similarly, Figure 2 shows the effect of the extracts of dry *Ulva linza* against the infection of oranges by *P. digitatum*. These results, compared with those obtained by the treatment of oranges by crude extracts of *Ulva lactuca*, show preventive activity of all extracts until the 7th week. However, only the concentrations of 50 g L⁻¹ and 100 g L⁻¹ provided protection to 66% at the end of the analysis period. After the 7th week, protection ceased for extracts of 200 g L⁻¹ and 25 g L⁻¹ and declined to 33% at the 8th week for the extracts of 75 g L⁻¹. Therefore, the extract of *Ulva linza* at a concentration of 50 g L⁻¹ is considered as the minimum protective concentration, for it provided 100 % protection of oranges for 3 weeks followed by a decrease to 66 % until the 8th week.

These results confirm those obtained by Chbani et al. (2013) studying the effect of three seaweeds including the green alga *Ulva linza* on the inhibition of the development of *P. digitatum* in citrus fruits, and show the effectiveness of this alga for the treatment of post harvested citrus fruits.

The comparison of these results with those obtained with positive and negative controls shows that the crude extract of *Ulva lactuca* has the greatest efficacy in protecting the fruits. This extract provided 100% protection for 8 weeks, while the Nystatine, considered as a potential fungicide, only allowed 100% protection for the first three weeks, after which protection declined to 66% for the rest of the analysis period. In addition, the negative control (water) did not protect oranges for more than 6 weeks with a rate of 33%.

Comparison of the effect of *Ulva lactuca* and *Ulva linza*

Given that 50 g L^{-1} was the minimum protective concentration obtained, we compared the responses of the treated oranges with this concentration for both kinds of algae in order to find the alga having the maximum protective action for oranges.

Figure 3 shows the response of oranges treated with the algae at the concentration of 50 g L^{-1} at 25°C .

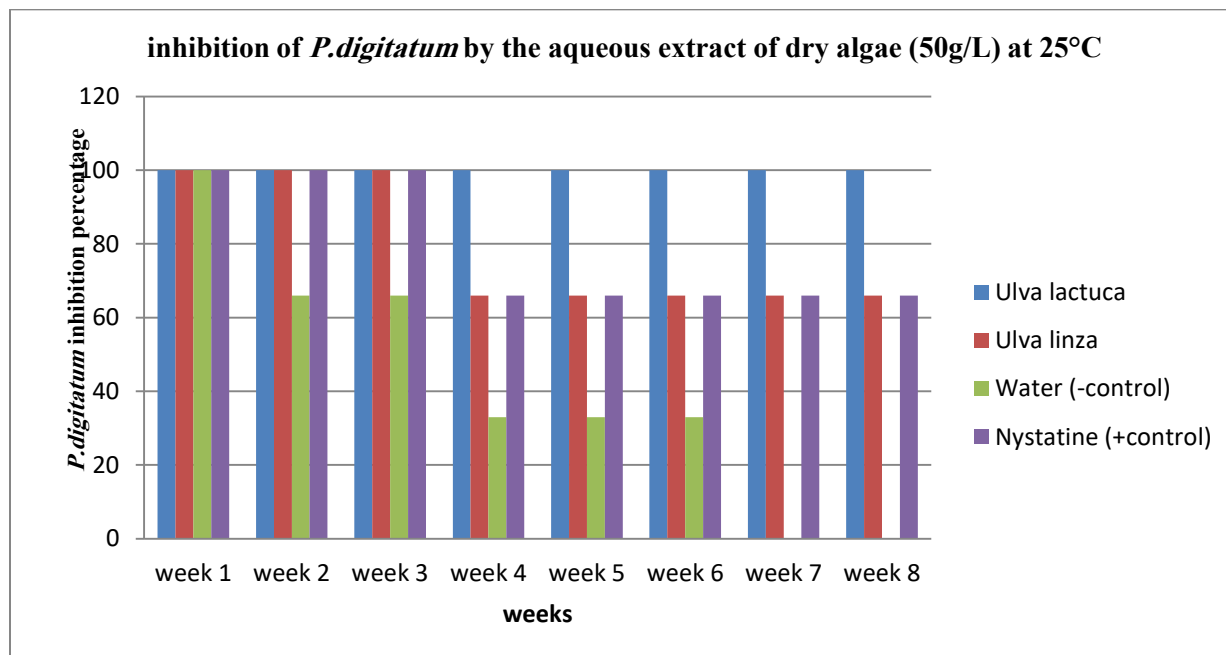


Figure 3: inhibition of *P. digitatum* by crude extracts of *Ulva linza* and *Ulva lactuca* (50 g L^{-1})

In both cases, the concentration of 50 g L^{-1} is clearly effective for protecting the oranges from *P. digitatum*. However, these results demonstrate that the crude extracts of *Ulva lactuca* have a better protective activity on oranges than that provided by the crude extracts of *Ulva linza*.

Effect of the crude extract of fresh *Ulva linza* at 50 g L^{-1} on orange protection at 25°C

As 50 g L^{-1} was determined to be the minimum protective concentration of the crude extracts of dry *Ulva linza* on oranges, the same concentration prepared from the fresh alga was tested on oranges at 25°C .

This test allowed us to determine which state of the alga (fresh or dried) has a higher protective effect on oranges.

Figure 4 shows the response of oranges treated with both fresh and dry green alga *Ulva linza* at a concentration of 50 g L^{-1} .

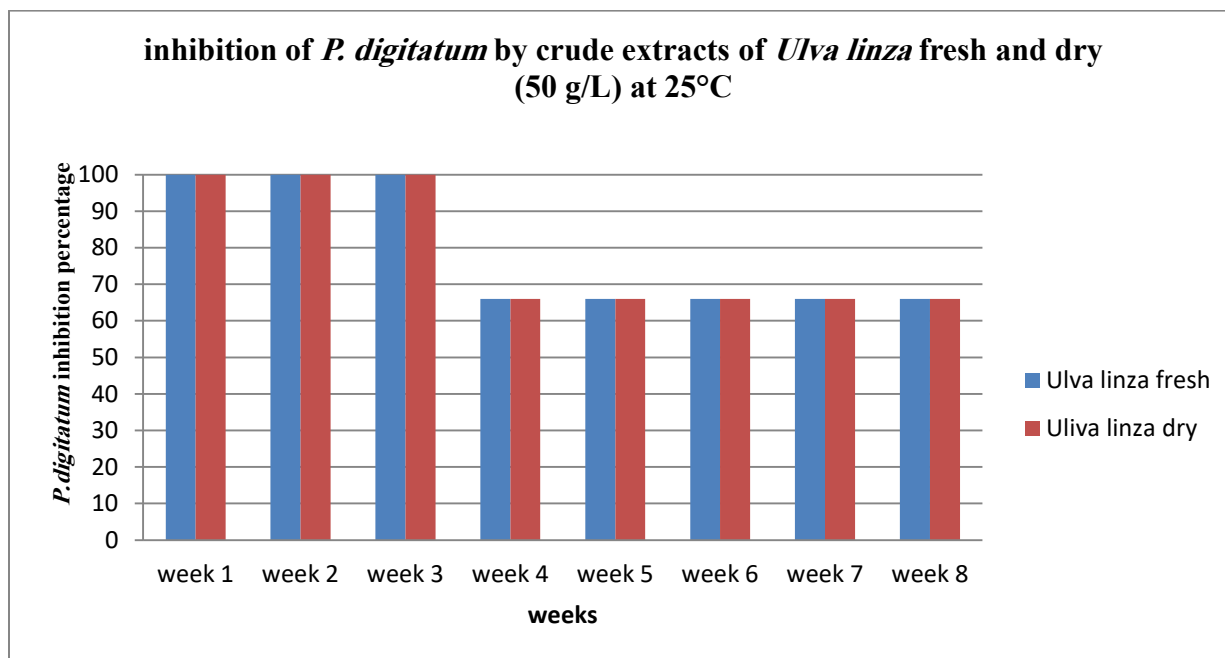


Figure 4: inhibition of *P. digitatum* by crude extracts of *Ulva linza* fresh and *Ulva linza* dry (50 g L⁻¹)

These results are nearly the same, indicating the effectiveness of both extracts used; conservation to 66% is obtained with both extracts for up to 8 weeks of observation.

These results confirm the observations of Tobler et al. (1994), that the activity of the preparations developed from fresh plants is higher than those from dried plants (Tobler et al. 1994). On the contrary, a study by Vassiliades and Diaw (1980) has shown that a common plant in Senegal, *Ambrosia maritima*, when used dry, in suspension in water at a concentration of 375 ppm, is an excellent molluscicide against *Bulinus guernei* and *Limnaea natalensis*, and it is more effective dry than fresh (Vassiliades and Diaw 1980).

In our case, both extracts could be used but as commercialization of the product is required, dryness is preferred. In fact, the use of dried alga as biopesticide settles the problem of unavailability of fresh algae throughout the year. Gathering a considerable amount of fresh algae when accessible, followed by drying at room temperature, can be an effective method to produce this biopesticide on a large scale.

Effect of the crude extract of dry Ulva linza and Ulva lactuca at 50 g L⁻¹ on oranges protection at 25°C and 4°C

As the main aim of this study is the protection of commercially-sold oranges from the action of post harvesting fungi while conserving their organoleptic proprieties, a study on the impact of the storage of these oranges at a low-temperature was performed.

Crude extracts of dry *Ulva lactuca* and *Ulva linza* each at a concentration of 50 g L⁻¹ were tested on oranges stored refrigerated at 4°C. The response of oranges treated with *Ulva lactuca* (50 g L⁻¹)

¹) and stored at 4°C in comparison to those stored at room temperature (25°C) appears in Figure 5.

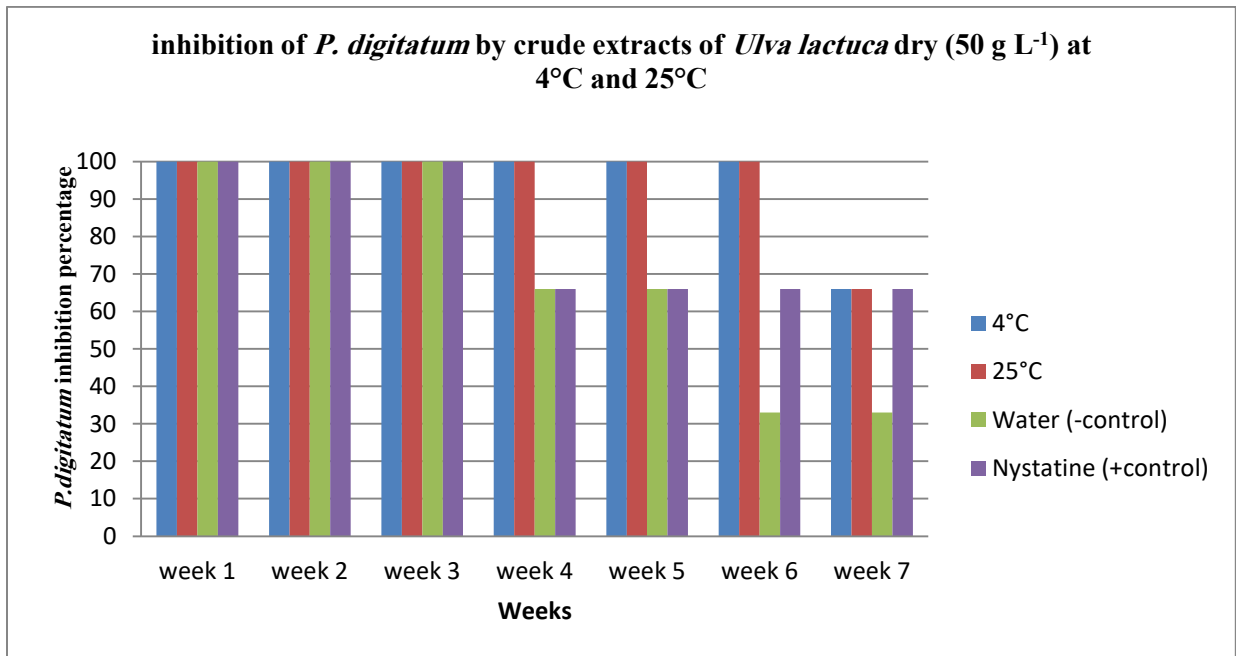


Figure 5: inhibition of *P. digitatum* by crude extracts of dry *Ulva lactuca* dry (50 g L⁻¹) at 4°C and 25°C

Likewise, Figure 6 shows the response of oranges treated with *Ulva linza* (50 g L⁻¹) and stored at 4°C in comparison to those stored at room temperature (25°C).

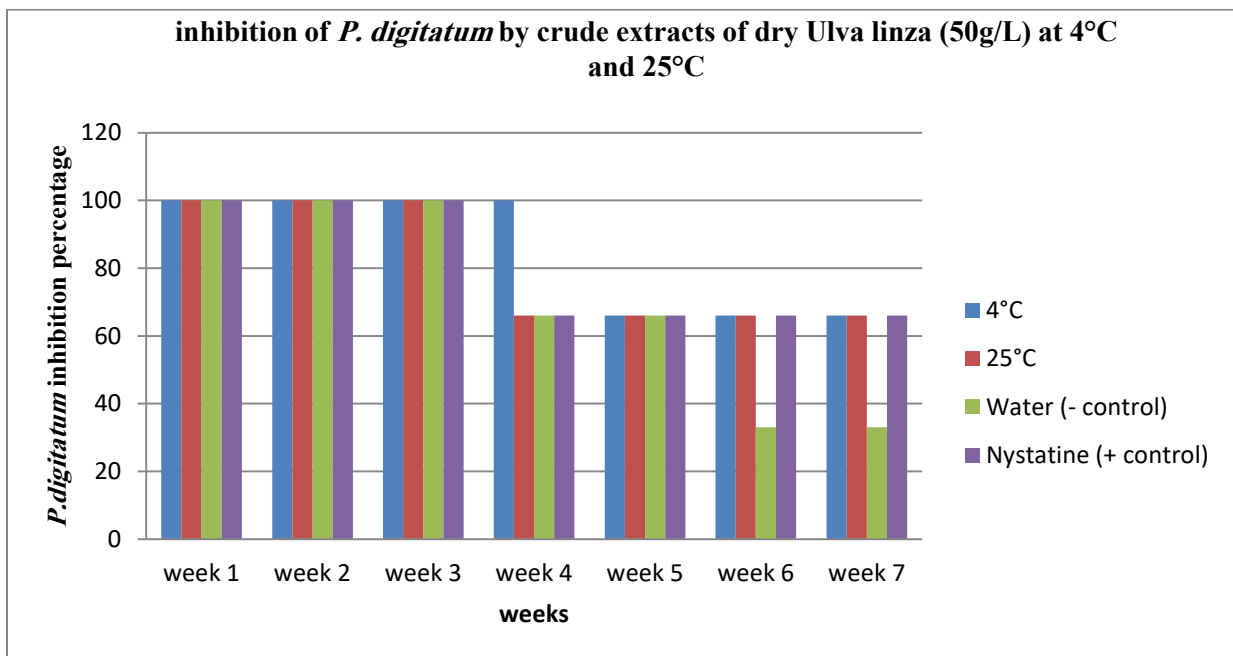


Figure 6: inhibition of *P. digitatum* by crude extracts of dry *Ulva linza* (50 g L⁻¹) at 4°C and 25°C

The response of the oranges after the treatment with *Ulva lactuca* (100 g L^{-1}) appears the same in the two cases: the preservation is 100 % for the first 6 weeks, and then decreases to 66 % during the 7th week.

However, inhibition of *P. digitatum* in the oranges treated with *Ulva linza* is more efficient at 4°C than at 25°C ; 100% of the oranges were conserved for 4 weeks at 4°C but they were only conserved for two weeks at 25°C .

These results clearly show the effectiveness of low temperature storage for maximum protection of oranges. Note that, although in the case of treatment with *Ulva lactuca* the results were the same, the appearance and consistency of the oranges stored at 4°C is more desirable when compared to those kept at 25°C (as shown in Figure 7).

Note that the conservation of physical properties of oranges is required for the marketing and the transport of oranges during the import and export process.



Figure 7: (a) oranges treated by *Ulva lactuca* (50 g L^{-1}) and conserved at 4°C , (b) oranges treated by *Ulva lactuca* (50 g L^{-1}) and conserved at 25°C

The effect of preserving fruits at low temperature has been studied by many authors; Pasquariello et al. (2013) considered the effect of low temperature for the conservation of post-harvesting pears, and Reque et al. (2014) have confirmed the stability of conserving blueberries at low temperature due to the increased antioxidant activity in the process of refrigerating and freezing of fruits (Pasquariello et al. 2013, Reque et al. 2014). Furthermore, Castro et al (2016) show that storing yellow pepper at low temperatures (1.5°C and 4°C) protected the quality of the fruit and prohibited the survival of Medfly eggs and larval stages better than the ones stored at a higher temperature (7°C) (Castro et al. 2016).

Similarly, Fellows (2009) states that the reduction in the storage temperature of food to between -1°C and 8°C decreases enzymatic and microbial activities, conferring a longer shelf life of the product (Fellows 2009).

Comparison of the effect of *Ulva lactuca* & *Ulva linza*

In order to affirm the previous hypothesis on the greater effect of *Ulva lactuca* for the conservation of postharvest oranges, the comparison of the responses of oranges kept in the refrigerator following the treatment with both algae was done.

Figure 8 shows the response of oranges treated respectively with dried *Ulva lactuca* and *Ulva Linza* at 4°C.

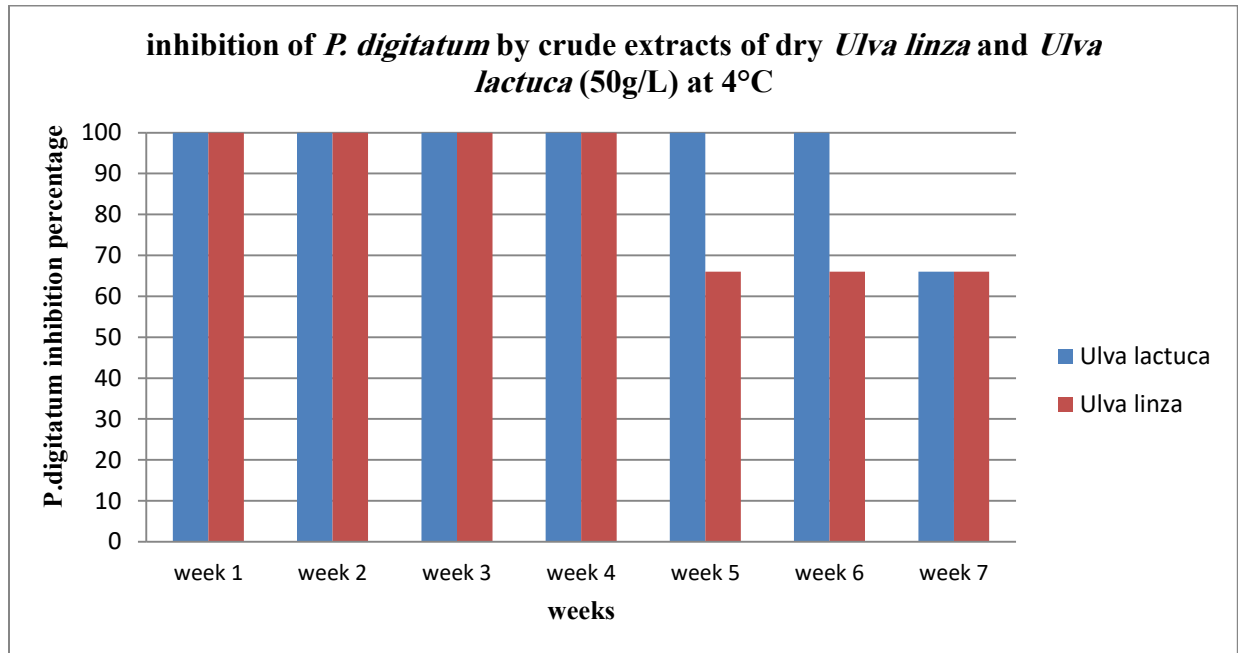


Figure 8: inhibition of *P. digitatum* by crude extracts of dry *Ulva linza* and *Ulva lactuca* (50 g L⁻¹) at 4°C

These results validate the previous hypothesis on the efficacy of *Ulva lactuca*. In fact, the crude extract of dried *Ulva lactuca* has allowed 100% conservation of treated oranges for 6 weeks, followed by protection at 66% during the 7th week.

Ulva linza has enabled 100% conservation of the oranges only until the fourth week, and then this rate decreases to 66% for the last three weeks of the test.

Organoleptic properties conservation

Appearance, physiological and organoleptic properties of oranges were observed on the 8th week of analysis; all oranges had good consistency and taste, especially the ones stored at 4°C.

Figure 9 shows the appearance of an orange treated with the crude extract of *Ulva lactuca* and stored at 4°C.

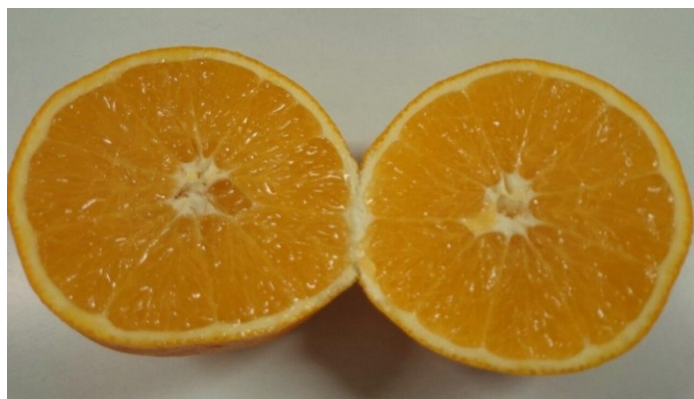


Figure 9: orange treated with the crude extract of *Ulva lactuca* and stored at 4°C

This figure clearly shows the maintenance of the desired properties in oranges after pure biological treatment, even after 8 weeks.

Statistical analysis

Statistical studies were conducted by SPSS and the correlations between the different analyzed parameters and the number of rotten oranges were conducted by regression test.

The first parameter studied was time of conservation. The P. value was 0.00 **, thus the correlation between time and number of infected oranges is highly significant. The second parameter studied was the different extract concentrations; the P. value was 0.021*, so correlation is also significant. The third highly significant parameter studied was the algae type (fresh or dry and *Ulva linza* or *Ulva lactuca*) where P. value was 0.01**. However, no correlation was found between the conservation temperature and the infection of oranges by *P. digitatum*; P. value was 0.138 and thus the two variables were not correlated. This result may be due to the fact that the refrigeration could only affect organoleptic properties of the oranges without impacting their contamination by *P. digitatum*.

Therefore, the infection of oranges by *P. digitatum* depends on the conservation time, the type and the state of the algae used, and the concentration of the crude extract used.

Note that a high significant correlation is obtained where P. Value < 0.01** and a significant correlation is obtained with a P. value < 0.05*.

Conclusion

In conclusion, the prepared extracts of the algae under investigation permit good orange conservation against *P. digitatum*. *Ulva lactuca* was shown to provide the highest protection. In fact, the use of a crude extract of dried alga could solve the problem of unavailability of fresh algae throughout the year due to the natural cycle of reproduction of the algae and the weather conditions. A mass collection of fresh algae when available, dried at room temperature in the dark, can be a stock to produce an effective biopesticide on a large scale.

This product can provide an effective alternative to the use of chemical fungicides that are harmful to the health and the environment, as a simple spray of post-harvested citrus fruits with crude extracts of green alga (especially *Ulva lactuca*) will allow farmers and smallholders protect their yields and reduce the loss of natural resources. Moreover, the use of a simple refrigerator during transport and storage could increase the effect of preservation leading to maximum crop protection with beneficial economic, environmental, and health effects for the country.

Therefore, extracts of algae could become an important component of crop protection, in a context of growing concern for the environment.

Acknowledgements

We gratefully acknowledge AZM & SAADE association and the Lebanese University for funding the project, as well as Strasbourg University for the international mobility aid, without which the present study could not have been completed.

References

- Abouraïcha E, El Alaoui-Talibi Z, El Boutachfaiti R, Petit E, Courtois B, Courtois J, El Modafar C. 2015. Induction of natural defense and protection against *Penicillium expansum* and *Botrytis cinerea* in apple fruit in response to bioelicitors isolated from green algae. *Scientia Horticulturae*.181:121-128.
- Alang G, Kaur R, Singh A, Budlakoti P, Singla P. 2009. Antimicrobial activity of *Ulvalactuca* extracts and its fractions. *Pharmacologyonline*.3:107-117.
- Aruna P, Mansuya P, Sridhar S, Kumar JS, Babu S. 2010. Pharmacognostical and antifungal activity of selected seaweeds from Gulf of Mannar region. *Recent Research in Science and Technology*.2.
- Arunkumar K, Sivakumar S, Rengasamy R. 2010. Review on bioactive potential in seaweeds (marine macroalgae): A special emphasis on bioactivity of seaweeds against plant pathogens. *Asian Journal of Plant Sciences*.
- Ballester A, Izquierdo A, Lafuente MT, González-Candelas L. 2010. Biochemical and molecular characterization of induced resistance against *Penicillium digitatum* in citrus fruit. *Postharvest Biology and Technology*.56:31-38.
- Castro R, Fallik E, Nemny-Lavy E, Alkalai-Tuvia S, Rempoulakis P, Nestel D. 2016. Effects of cold post-harvest treatments of sweet bell peppers on the development of the Mediterranean fruit fly (*Ceratitis capitata*). *Postharvest Biology and Technology*.120:16-22.
- Chbani A, Mansour R, Mawlawi H, Gmira N. 2013. In vitro and in vivo evaluation of anti-phytopathogenic activity and anti-adhesive properties of three Macro Algae against *Penicillium digitatum*. *Science Lib Journal*.5:1-23.
- Coltro L, Mourad AL, Kletecke RM, Mendonça TA, Germer SP. 2009. Assessing the environmental profile of orange production in Brazil. *The International Journal of Life Cycle Assessment*.14:656-664.
- Coşoveanu A, Axîne O, Iacomi B. 2010. Antifungal activity of macroalgae extracts. *Scientific Papers, UASVM Bucharest, Series A*.53:442-447.
- Delattre C, Michaud P, Courtois B, Courtois J. 2005. Oligosaccharides engineering from plants and algae: applications in biotechnology and therapeutics. *Minerva Biotecnologica*.17:107.
- Dussault D, Vu KD, Vansach T, Horgen FD, Lacroix M. 2016. Antimicrobial effects of marine algal extracts and cyanobacterial pure compounds against five foodborne pathogens. *Food chemistry*.199:114-118.
- Eckert J. 1978. Post-harvest diseases of citrus fruits. *Outlook on agriculture*.9:225-232.
- Erasmus A, Lennox CL, Korsten L, Lesar K, Fourie PH. 2015. Imazalil resistance in *Penicillium digitatum* and *P. italicum* causing citrus postharvest green and blue mould: Impact and options. *Postharvest Biology and Technology*.107:66-76.
- Fellows PJ. 2009. Food processing technology: principles and practice: Elsevier.
- Fenik J, Tankiewicz M, Biziuk M. 2011. Properties and determination of pesticides in fruits and vegetables. *TrAC Trends in Analytical Chemistry*.30:814-826.
- Golge O, Kabak B. 2015. Determination of 115 pesticide residues in oranges by high-performance liquid chromatography–triple-quadrupole mass spectrometry in combination with QuEChERS method. *Journal of Food Composition and Analysis*.41:86-97.
- Hernández-Herrera RM, Santacruz-Ruvalcaba F, Ruiz-López MA, Norrie J, Hernández-Carmona G. 2014. Effect of liquid seaweed extracts on growth of tomato seedlings (*Solanum lycopersicum* L.). *Journal of applied phycology*.26:619-628.
- Holmes GJ, Eckert JW. 1999. Sensitivity of *Penicillium digitatum* and *P. italicum* to postharvest citrus fungicides in California. *Phytopathology*.89:716-721.

- Janisiewicz WJ, Korsten L. 2002. Biological control of postharvest diseases of fruits. *Annual review of phytopathology*.40:411-441.
- Jiménez E, Dorta F, Medina C, Ramírez A, Ramírez I, Peña-Cortés H. 2011. Anti-phytopathogenic activities of macro-algae extracts. *Marine drugs*.9:739-756.
- Kosanić M, Ranković B, Stanojković T, Rančić A, Manojlović N. 2014. Cladonia lichens and their major metabolites as possible natural antioxidant, antimicrobial and anticancer agents. *LWT-Food Science and Technology*.59:518-525.
- Lee K-G, Lee S-K. 2012. Monitoring and risk assessment of pesticide residues in yuza fruits (*Citrus junos* Sieb. ex Tanaka) and yuza tea samples produced in Korea. *Food chemistry*.135:2930-2933.
- Liu A-H, Liu D-Q, Liang T-J, Yu X-Q, Feng M-T, Yao L-G, Fang Y, Wang B, Feng L-H, Zhang M-X. 2013. Caulerprenylols A and B, two rare antifungal prenylated para-xylenes from the green alga *Caulerpa racemosa*. *Bioorganic & medicinal chemistry letters*.23:2491-2494.
- Marcet-Houben M, Ballester A-R, de la Fuente B, Harries E, Marcos JF, González-Candelas L, Gabaldón T. 2012. Genome sequence of the necrotrophic fungus *Penicillium digitatum*, the main postharvest pathogen of citrus. *BMC genomics*.13:1.
- Mayer AM, Rodríguez AD, Berlinck RG, Hamann MT. 2009. Marine pharmacology in 2005–6: Marine compounds with anthelmintic, antibacterial, anticoagulant, antifungal, anti-inflammatory, antimalarial, antiprotozoal, antituberculosis, and antiviral activities; affecting the cardiovascular, immune and nervous systems, and other miscellaneous mechanisms of action. *Biochimica et Biophysica Acta (BBA)-General Subjects*.1790:283-308.
- Zinette Moussa & Abdel Kader el Hajj, Citrus production in Lebanon, Pre-Feasibility Study of IPM of Citrus, (IAM – Bari). Available from <http://www.lari.gov.lb/LinkClick.aspx?fileticket=da%2BPNJGwAvU%3D&tabid=68>
- Newman DJ, Cragg GM, Snader KM. 2003. Natural products as sources of new drugs over the period 1981-2002. *Journal of natural products*.66:1022-1037.
- Palou L, Smilanick JL, Droby S. 2008. Alternatives to conventional fungicides for the control of citrus postharvest green and blue moulds. *Stewart Postharvest Review*.4:1-16.
- Pasquariello MS, Rega P, Migliozi T, Capuano LR, Scortichini M, Petriccione M. 2013. Effect of cold storage and shelf life on physiological and quality traits of early ripening pear cultivars. *Scientia Horticulturae*.162:341-350.
- Pimenta RS, Silva FL, Silva JF, Morais PB, Braga DT, Rosa CA, Corrêa Jr A. 2008. Biological control of *Penicillium italicum*, *P. digitatum* and *P. expansum* by the predacious yeast *Saccharomycopsis schoenii* on oranges. *Brazilian Journal of Microbiology*.39:85-90.
- Reque PM, Steffens RS, Jablonski A, Flôres SH, Rios AdO, de Jong EV. 2014. Cold storage of blueberry (*Vaccinium* spp.) fruits and juice: Anthocyanin stability and antioxidant activity. *Journal of Food Composition and Analysis*.33:111-116.
- Tobler M, Krienbühl H, Egger M, Maurer C, Bühler U. 1994. Caractéristiques d'extraits totaux des plantes fraîches. *Phytothérapie*.7:1-13.
- Vassiliades G, Diaw O. 1980. Action molluscicide d'une souche sénégalaise d'*Ambrosia maritima*. I. Essais en laboratoire. *Rev Elev Méd Vét Pays Trop*.33:401-406.
- Wang S, Tu H, Wan J, Chen W, Liu X, Luo J, Xu J, Zhang H. 2016. Spatio-temporal distribution and natural variation of metabolites in citrus fruits. *Food chemistry*.199:8-17.
- Xu C, Leskovar DI. 2015. Effects of *A. nodosum* seaweed extracts on spinach growth, physiology and nutrition value under drought stress. *Scientia Horticulturae*.183:39-47.

IX. Inhibition de la germination des conidies de *Penicillium digitatum* par des extraits d'algues utilisées comme agents de lutte biologique pour la protection des agrumes en post-récolte.

Ce dernier résultat présenté sous forme d'un article en cours de préparation fait suite au résultat précédent qui montre l'effet protecteur des extraits aqueux des algues vertes contre la moisissure verte *P. digitatum* attaquant les agrumes en post-récolte.

Dans ce travail, les extraits bruts des deux algues testées précédemment, *Ulva Lactuca* et *Ulva linza*, à différentes concentrations allant de 25 à 200 g L⁻¹ ont été testés pour leur capacité à inhiber la germination et l'élongation tubulaire des conidies et de *Penicillium digitatum* sur un milieu de culture liquide. L'étude de l'effet que présentent ces extraits sur la viabilité des champignons sur gélose solide a été également évaluée. Les résultats obtenus montrent une inhibition de la germination des spores, de l'allongement des tubes ainsi qu'une inhibition de la viabilité de *P. digitatum* avec des extraits à 50 et 100 g L⁻¹ pour les deux algues alors qu'une multiplication sans germination a été observée avec d'autres concentrations. En effet, les extraits bruts à 50 g L⁻¹ ont permis une inhibition jusqu'à 90 et 100% de la germination des spores, respectivement, avec *Ulva lactuca* et *Ulva linza*.

En conclusion, ces résultats pourraient être importants afin d'aider à l'élucidation du mécanisme de protection contre les algues contre la moisissure verte *P. digitatum* et pourraient en conséquence, promettre de développer un produit respectueux de l'environnement, sûr et efficace pour la protection post-récolte des agrumes.

Inhibition of germination of *Penicillium digitatum* conidia by seaweed extracts used as bio control agent for post harvested citrus fruits

Josephine Al-Alam^{1,2}, Ziad Fajloun^{1,3}, Maurice Millet², Asma Chbani^{1,4}

¹ Laboratory of applied biotechnology, Azm Center for Research in Biotechnology and its Applications, Doctoral School of Science and Technology, Lebanese University, El Mittein Street, Tripoli, Lebanon;

² Institute of Chemistry and Processes for Energy, Environment and Health ICPEES UMR 7515 Group of Physical Chemistry of the Atmosphere, University of Strasbourg, Strasbourg, France;

³ Faculty of Sciences III, department of biology, Lebanese University, Tripoli, Lebanon;

⁴ Faculty of Public Health III, Lebanese University, Tripoli, Lebanon.

***To whom correspondence should be addressed:** Dr Asma Chbani or Josephine Al-Alam,
¹Azm Center for Research in Biotechnology and its Applications, Doctoral School of Science and Technology, Lebanese University, El Mittein Street, Tripoli, Lebanon. Tel.: + 961 71611931, E-mail: asmashbani61@gmail.com or Josephine.al-alam@etu.unistra.fr

Abstract

Seaweed liquid extracts (SLE) were assessed as natural antifungal products for the control of the post-harvest citrus green mold *Penicillium digitatum*. The SLE of both algae, *Ulva Lactuca* and *Ulva linza*, at different concentration (25, 50, 100 and 200 g L⁻¹) were tested for their ability to inhibit the conidia germination and tube elongation of *Penicillium digitatum* on potato dextrose broth (PDB). The study of their effects on fungus viability on malt extract agar (MEA) was also evaluated. The results showed an inhibition of spore germination and tube elongation as well as an inhibition of *P. digitatum* viability with SLE at 50 and 100 g L⁻¹ for both algae while a multiplication with no germination was observed with other concentrations (25 and 200 g L⁻¹). In fact, the crude extracts at 50 g L⁻¹ allowed 90 and 100% inhibition of spore germination respectively with *Ulva lactuca* and *Ulva linza*. These findings could be highly important in the elucidation of the algal protection mechanism against the green mold *P. digitatum* and could be promising to develop an eco-friendly, safe and effective product for citrus fruit post-harvesting protection.

Keywords: seaweed liquid extracts, algae, *Ulva linza*, *Ulva lactuca*, *Penicillium digitatum*, postharvest protection, Inhibition of germination.

Introduction

During storage, citrus fruit are frequently exposed to numerous postharvest diseases, generally caused by pathogenic molds which usually infect the host through injuries sustained during harvest, handling and/or processing (Karim et al., 2017).

Green mold caused by *Penicillium digitatum*, is the most important postharvest disease of citrus fruit produced in the Mediterranean climate countries and can lead to important financial losses during refrigeration, transport and marketing (D'Aquino et al., 2013). In order to control this postharvest occurring mold, several chemical fungicides have traditionally been used including imazalil (IMZ), thiabendazole (TBZ) and sodium o-phenylphenate (SOPP) (Moretto et al., 2014). However, even that these products were successfully used over more than 25 years and were proven to be highly effective, the global tendency seems to be shifting towards a minimized use of chemical fungicides on produce and hence, there is a need to pursue safer and eco-friendly alternatives for reducing the decay loss in the harvested commodities (Sharma et al., 2009; Lai et al., 2012). In fact, the intensive use of the correspondent chemical fungicides encouraged the development of resistant isolates of *Penicillium* spp. and consequently their effectiveness has considerably reduced (Kinay et al., 2007). Moreover, the increasing concerns regarding the residues of fungicides in the fruit, as well as the risks associated with their continuous use have prompted the search for safe and effective alternative strategies (Spadaro and Droby, 2016). The use of fungicides has been efficient in decreasing loss due to deterioration of food, but also generates health and environmental concerns mainly due to the carcinogenic and/or teratogenic properties of the compounds, and by their cumulative toxic effects. Moreover, About US\$30 billion are spent yearly worldwide in pesticides market and data shows that there are approximately 25 million occupational pesticide poisonings each year among agricultural workers in developing countries (Janisiewicz and Korsten, 2002).

Thus, it is of uppermost importance to develop new strategies for post-harvest disease control, especially due to the increasing restrictions on the use of pesticides by the regulatory agencies and consumer affairs institutions. Among these strategies, biological control has received increasing attention in postharvest pathogen management. Biological control known as biopesticides are active compounds including proteins, polysaccharides and small molecules (alkaloids, flavonoids, phenols, essential oils) from plants, proteins and polysaccharides of microorganisms, algae polysaccharides as well as oligochitosane from animals. These compounds are highly active, highly specific, with less environmental impact (Zhao et al., 2017).

Marine algae are a source of a variety of complex natural products that can be explored in agricultural field. In fact, due to their high content of polysaccharides, algae act as inducers of plant defense responses leading to resistance against microbial pathogens. Several antiviral, deworming, antifungal and antibacterial activities were detected in green, brown and red algae (Val et al., 2001; Fernando et al., 2016; Akremi et al., 2017). Moreover, different antifungal molecules were isolated from several green algae known for their antifungal and antimicrobial activities (Abouraïcha et al., 2015; Dussault et al., 2016). For instance, significant antifungal

activity was observed in the green alga *U. lactuca* followed by the brown alga *S. wightii* and the red alga *K. alvarezii* (Aruna et al., 2010).

In a previous study, the green seaweed *Ulva linza*, showed a greater protection activity than browns seaweeds, *Padina pavonica* and *Sargassum vulgare*, of citrus fruits against the postharvest green mold *Penicillium digitatum* (Chbani et al, 2013). Thus, the aim of the present study was to evaluate the way of the green seaweed extracts (*Ulva linza* and *Ulva lactuca*) exert their antifungal activity. Different concentrations were evaluated on spore germination as well as on fungus viability on post-harvesting protection of citrus fruits against the green mold *P. digitatum*.

Material and methods

Algal material

Ulva lactuca and *Ulva linza* were freshly and manually collected from a coastal zone of the Mediterranean, El Mina (34 ° 26 'N - 35 ° 50' E) in Tripoli, Lebanon, on May 1th, 2016.

The algae were cleaned with sea water to remove unwanted impurities (Adhered sand particles and epiphytes). Then they were carried in simply moistened plastic bags to the laboratory.

Seaweed liquid extracts (SLEs)

SLEs were prepared according to Jimenez et al., in 2011. 200 g of fresh algae were grounded then boiled with 1 liter of ultrapure water while stirring for one hour. The extract was then filtered twice through a double layer of sterile muslin cloth muslin cloth and then cooled to room temperature for the preparation of correspondent diluted series. Sterile distilled water was used for the dilutions and series of 200 g L⁻¹, 100 g L⁻¹, 75 g L⁻¹, 50 g L⁻¹ and 25 g L⁻¹ were prepared.

Preparation of pathogen inoculum

Fungal isolates of *Penicillium digitatum* were obtained from infected oranges, and then cultivated on Malt Extract Agar (MEA, Sigma–Aldrich) in order to obtain single conidia colonies. For inoculum growth, cultures were kept at 22°C for 7–10 days. Obtained spores were then collected using a sterile spatula, diluted in sterile distilled water, and then vortexed for 1 min to ensure uniform mixing. Spore concentration was fixed to 108 c/mL using a densitometer (Biosan DEN-1B, McFarland densitometer). The obtained stock solution (108 c/mL) was then diluted to two solutions S1= 106 c/mL used for the study of SLE effects on spore germination in liquid medium and germ tube elongation, and S2= 2x 10³ c/mL used for the study of the SLE effects on fungus viability on solid medium.

In vitro antifungal activity of SLE

The study of the in vitro antifungal activity of algae extracts was conducted according to Li Destri Nicosia et al., in 2016.

Effects of SLEs on spore germination

In order to study the SLE effects on spore germination and germ tube elongation, 12.5 μL of the solution S1 (10^6 c/mL) were transferred to eppendorf tubes to which 25 μL of tested extracts and 12.5 μL of potato dextrose broth (PDB, Sigma–Aldrich) were added. Sterile ultrapure water and nystatin were respectively used as negative and positive controls. The tubes were then mixed and incubated for 20 hours at 22 °C followed by a vortex in order their homogenization. Afterwards, 2 μL of spore suspension were transferred to microscope slides, mixed with 2 μL of lacto-phenol blue than observed at a magnification of 40 for spore germination and tube elongation. For each slide, three observations were haphazardly done.

Effects of SLEs on fungus viability

In order to evaluate the SLE effects on pathogen viability, 0.5 mL of solution S2 (2×10^3 c/mL) were transferred to eppendorf tubes containing 0.5 mL of SLE. Sterile ultrapure water and nystatin were respectively used as negative and positive controls. Tubes were gently mixed then incubated 20 hours at 22 °C. Afterwards, tubes were mixed and 100 μL of each mixture were spread on MEA culture medium containing ampicillin. Finally, cultures were incubated at 25 °C and the number of colony forming units (CFU) was counted after 3–4 days.

Statistical analysis

All analyses were done in triplicate using 3 microscope slides as well as 3 MEA plates. Data were statistically analyzed using Student's t test and analysis of variance (ANOVA); means were compared to negative control and the criterion of the significance of the treatment was $P < 0.05$.

Results

Effects of SLEs on spore germination

Both algae were tested for their ability to inhibit the germination of *P. digitatum* spores. Spores were considered germinated when elongation tubes are formed. The inhibition percentage was estimated by the comparison of tested extracts with water used a negative control.

Ulva linza liquid extracts effects

The tested extracts showed a significant inhibition of *P. digitatum* germination in comparison with water. In fact, the spore germination was totally inhibited with the crude *U. linza* extract at 50 g L^{-1} while the inhibition percentage was 90, 75 and 20% respectively for the *U. linza* liquid extract at 100, 200 and 25 g L^{-1} .

Figures 1 and 2 show the effects of *Ulva linza* crude extracts at different concentration on spore germination.

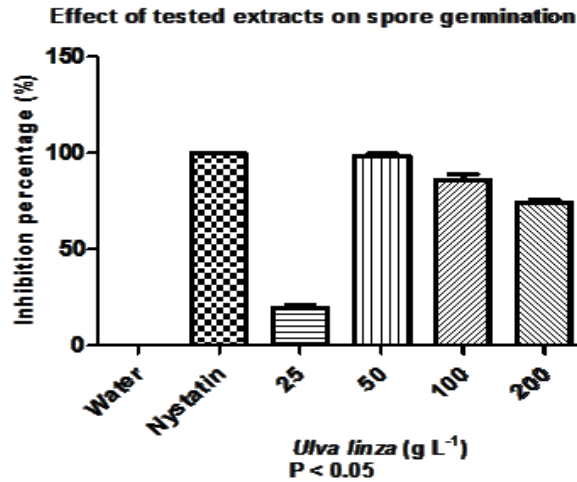


Figure 1: Inhibition percentage of the germination of *P. digitatum* incubated for 20 h at 22 °C in PDB containing *Ulva linza* extracts at different concentrations, water as negative control and Nystatine as positive control.

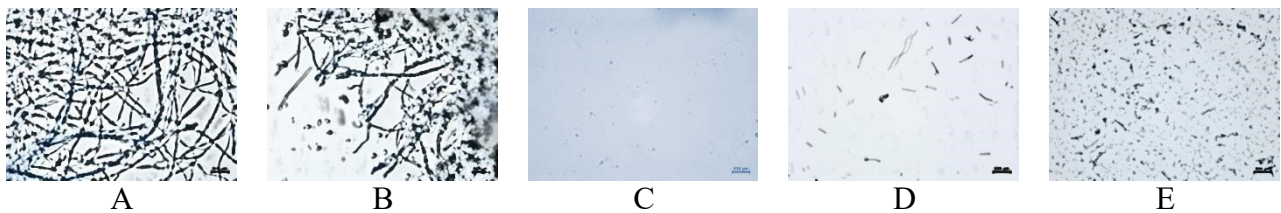


Figure 2: Germination of *P. digitatum* incubated for 20 h at 22 °C in PDB containing *Ulva linza* extracts at different concentrations (B=25 g L⁻¹, C= 50 g L⁻¹, D= 100 g L⁻¹, E= 200 g L⁻¹), and water as negative control (A)

Ulva lactuca liquid extracts effects

The tested extracts showed a significant inhibition of *P. digitatum* germination in comparison with water. In fact, the spore germination was inhibited to 90 % with *U. lactuca* liquid extract at 50 g L⁻¹, while the inhibition percentage was 85, 70 and 10% respectively with the *U. lactuca* liquid extracts at 100, 200 and 25 g L⁻¹.

Figures 3 and 4 show the effects of *U. lactuca* crude extracts at different concentration on spore germination.

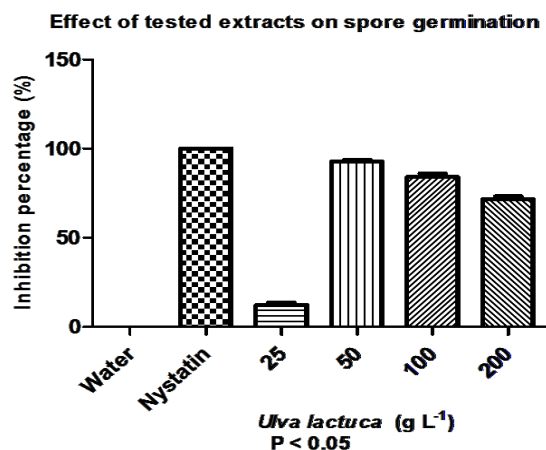


Figure 3: Inhibition percentage of the germination of *P. digitatum* incubated for 20 h at 22 °C in PDB containing *Ulva lactuca* extracts at different concentrations, water as negative control and Nystatine as positive control.

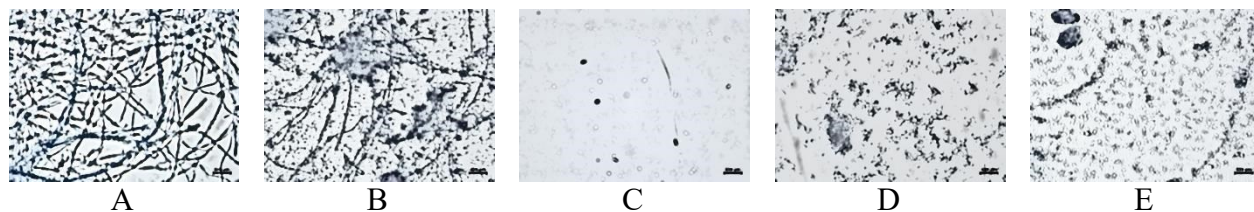


Figure 4: Germination of *P. digitatum* incubated for 20 h at 22 °C in PDB containing *Ulva lactuca* extracts at different concentrations (B=25 g L⁻¹, C= 50 g L⁻¹, D= 100 g L⁻¹, E= 200 g L⁻¹), and water as negative control (A)

Effects of SLEs on fungus viability

After being incubated at 25 °C for 3–4 days, the number of colony forming units (CFU) was recorded for both tested extracts.

Effects of Ulva linza liquid extracts

All tested concentrations showed a significant effect on fungus viability. Viability of *P. digitatum* tested on MEA cultures showed, in comparison with water, a total inhibition of fungus development in contact with *U. linza* crude extracts at 50 and 100 g L⁻¹. For 25 and 200 g L⁻¹ crude extracts, a multiplication of *P. digitatum* was observed after 4 days without maturation and elongation, as no green fungus formation was obtained; fungus growth was then limited to multiplication and no germination was observed.

Figure 5 shows the aspect of cultivated dishes after 4 days incubation with water, *Ulva linza* crude extracts at 50 and 25 g L⁻¹.

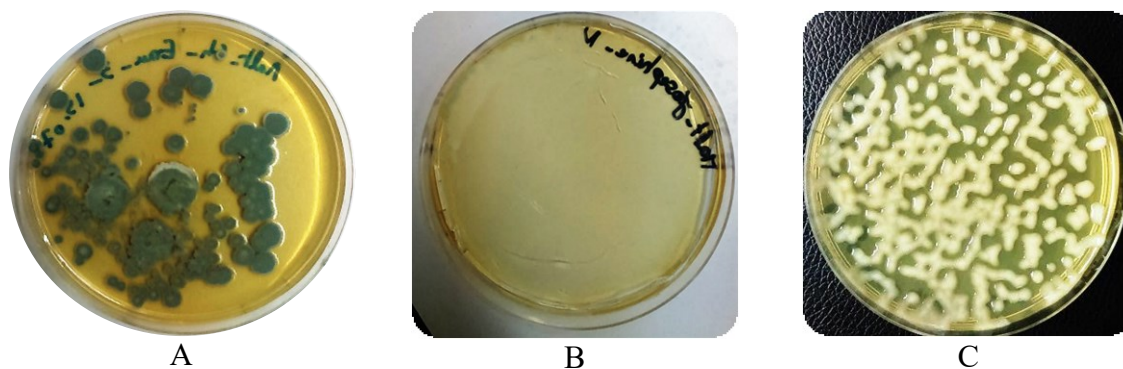


Figure 5: *P. digitatum* development on MEA dishes after 4 days of incubation (A= water, B= *U linza* at 50 g L⁻¹ and C= *U linza* at 25 g L⁻¹). Results were statistically significant according to ANOVA tests (P< 0.05).

Effects of *Ulva lactuca* liquid extracts

Figure 6 showed the aspect of cultivated dishes after 4 days incubation with water, *Ulva lactuca* extracts at 100 and 25 g L⁻¹.

Likewise, all tested concentrations of *Ulva lactuca* crude extracts showed a significant effect on fungus viability. Viability of *P. digitatum* tested on MEA cultures was, in comparison with water, inhibited with *U. lactuca* crude extracts at 50 and 100 g L⁻¹. For 25 and 200 g L⁻¹ crude extracts, a multiplication of *P. digitatum* was observed after 4 days without maturation and elongation, as no green fungus formation was obtained; fungus growth was also limited to multiplication and no germination was observed.

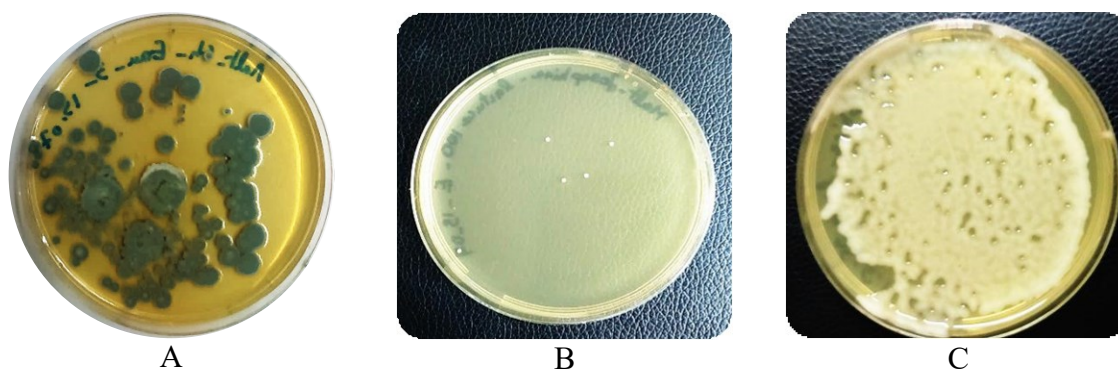


Figure 6: *P. digitatum* development on MEA dishes after 4 days of incubation (A= water, B= *U lactuca* at 100 g L⁻¹ and C= *U lactuca* at 25 g L⁻¹). Results were statistically significant according to ANOVA tests (P< 0.05).

Discussion

P. digitatum, the green mold of citrus fruit, is the most serious postharvest disease of citrus (Zheng et al., 2015). For this, treating these fruits just before or soon after their harvest may be worthwhile to reduce infections and protect fruit during the critical stages of harvesting and

packaging in which fungal pathogens can enter over wounds and establish infections (Tayel et al., 2009; Li Destri Nicosia et al., 2016).

In this study, the *in vitro* antifungal activity of the green seaweeds, *Ulva linza* and *Ulva lactuca*, against *P. digitatum* was assessed. The SLE effects on spore germination and on fungus viability were tested. The results showed a strong antifungal activity against *P. digitatum* germination. In fact, the results provided by the two tests were coherent; the SLE of *Ulva linza* and *Ulva lactuca* at 50 and 100 g L⁻¹ seemed to be of a high interest in the process of post-harvested protection of citrus fruits from *P. digitatum*. This effect was shown by the ability of these extract to inhibit the spore germination of the fungus after 20 hour of incubation. Moreover, the use of these extracts on MEA seems to inhibit the development of the fungus. However, even if the SLEs at 25 g L⁻¹ seems to be less efficient, this extract showed an ability to inhibit the germination of *P. digitatum* spores after 4 days of incubation; development was then limited to multiplication. In fact, the infectious life cycle of *P. digitatum* initiates with the germination of conidia on the surface of citrus fruits (Vilanova et al., 2016). Hence, when the growth cycle of the pathogen is limited to multiplication and not developed to germination, the infectious life cycle will be arrested. Moreover, it is also noted that visible mycelium appears shortly after germination is completed, than the germination of fungal conidia should be considered as the main step to be focused on during an antifungal protection assessment (Kalai et al., 2017).

Our results are in correlation with several studies showing the potential effects of biological extracts in the *P. digitatum* inhibition process. For instance, the *E. caryophytæ* plant crude extract allowed up to 100% reduction of *P. digitatum* hyphal growth providing thus a total protection of citrus fruit (Sukorini et al., 2013). Furthermore, the use of the essential oils of the citrus plant *C. reticulata*, as a natural fungicide for the biological control of citrus postharvest diseases against *P. digitatum*, showed a potential role in fruit protection by limiting the mycelial growth of the fungus (Tao et al., 2014).

Likewise, some bioactive compounds, such as carotenoids, alkaloids, favanoids, fattyacids, saponins, aminoacids and carbohydrates, widely found in seaweeds could be highly effective in the inhibitory action against fungal and microbial pathogens (Bhagavathy et al., 2011). Moreover, the use of seaweeds as natural fungicides can be due to their bioactive compounds, for instance, El Baky et al., 2008 showed antimicrobial activity of the extract Dichloromethane / methanol from *Ulva lactuca* isolated from the Egyptian coast. As well, significant antifungal activity was observed in the green alga *U. lactuca* followed by the alga Brown *S. wightii* and red alga *K. alvarezii* (Aruna, 2010). Furthermore, many substances have been identified as antimicrobial agents based on marine algae such as Chlorelline and derivatives, acrylic acid, aliphatic compounds and terpenes (Lavanya and Veerappan, 2011). Besides, another study conducted by Sauleau in 2011 involves the Cycloeudesmol, a sesquiterpene isolated from the green alga *Chondria oppositoclada* in the antimicrobial agent against *Staphylococcus aureus* and *Candida albicans*.

Among the functional compounds identified from marine algae, natural pigments have retained special attention. In fact, these pigments have showed different beneficial biological activities as anti-oxidants, anti-cancer, anti-inflammatory, anti-obesity, anti-angiogenic as well as neuroprotective activities (Pangestuti and Kim, 2011). In addition to previously cited compounds, seaweeds high polysaccharide content allows them to act as inducers of plant defense responses leading to their resistance against microbial pathogens. For example, oligosaccharides of the green algae, *Ulva lactuca*, particularly ulvan and oligulvans, induced, in

tomato plants, natural systemic defenses and acquired systemic resistance dependent on salicylic acid by a reduction in the development of wilting by *F. oxysporum* reducing the mortality of treated tomato plants (El Modafar et al., 2012). Besides, the green alga *Ulva lactuca* Linnaeus was taken and evaluated for its antimicrobial activity. Fractions *Ulva lactuca* extract's showed greater antifungal activity than the extract against *Aspergillus niger* and *Candida albicans* (Alang et al., 2009). In fact, recently, various antifungal molecules have been isolated from the green alga *Caulerpa racemosa*, the green alga *Penicillus capitatus* and the brown alga *Lobophora variegata* (El-Hossary et al., 2017).

Conclusion

In conclusion, this study showed that SLE of *Ulva linza* and *Ulva lactuca* could be of a high potential in the process of post-harvesting control of the green citrus fruit's mold *Penicillium digitatum*. Moreover, among the different concentration tested, 50 and 100 g L⁻¹ showed a good inhibitory activity of *P. digitatum* germination and multiplication. Thus, in order to protect citrus fruit from fungicides, SLEs act as an inhibitor of the fungus germination, limit it to multiplication stage and inhibit then the initiation of the infection process. These extracts need further tests including chemical characterization and toxicological studies in order to their industrial development. Moreover, additional studies aiming to elucidate the mechanisms by which SLE inhibit the germination of *P. digitatum* need to be undertaken. The results provided by this study may be promising allowing their use of alternatives for harmful chemical pesticides.

Acknowledgment

We gratefully acknowledge AZM & SAADE association and the Lebanese University for funding the project, as well as Strasbourg University for the international mobility aid, without which the present study could not have been completed.

References

- Abouraïcha, E., El Alaoui-Talibi, Z., El Boutachfai, R., Petit, E., Courtois, B., Courtois, J., El Modafar, C., 2015. Induction of natural defense and protection against *Penicillium expansum* and *Botrytis cinerea* in apple fruit in response to bioelicitors isolated from green algae. *Scientia Horticulturae* 181, 121-128.
- Akremiti, N., Cappelletti, D., Anthonissen, R., Verschaevé, L., Bouraoui, A., 2017. Phytochemical and in vitro antimicrobial and genotoxic activity in the brown algae *Dictyosphaeridia membranacea*. *South African Journal of Botany* 108, 308-314.
- Alang, G., Kaur, R., Singh, A., Singla, P., Pradesh, U., 2009. Antimicrobial activity of *Ulva lactuca* extracts and its fractions. *Pharmacologyonline*, 3, 107-117.
- Aruna, P., Mansurya, P., Sridhar, S., Kumar, J.S., Babu, S., 2010. Pharmacognostical and antifungal activity of selected seaweeds from Gulf of Mannar region. *Recent Research in Science and Technology* 2.
- Bhagavathy, S., Sumathi, P., Jancy Sherene Bell, I., 2011. Green algae *Chlorococcum humicola*-a new source of bioactive compounds with antimicrobial activity. *Asian Pacific Journal of Tropical Biomedicine* 1, S1-S7.
- D'Aquino, S., Fadda, A., Barberis, A., Palma, A., Angioni, A., Schirra, M., 2013. Combined effects of potassium sorbate, hot water and thiabendazole against green mould of citrus fruit and residue levels. *Food Chemistry* 141, 858-864.
- Dussault, D., Vu, K.D., Vansach, T., Horgen, F.D., Lacroix, M., 2016. Antimicrobial effects of marine algal extracts and cyanobacterial pure compounds against five foodborne pathogens. *Food Chemistry* 199, 114-118.
- El-Baky, H. A., El-Baz, F. K., El-Baroty, G. S., 2008. Evaluation of marine alga *Ulva lactuca* L. as a source of natural preservative ingredient. *American-Eurasian J Agric & Environ Sci*, 3(3), 434-44.
- Chicago
- El-Hossary, E.M., Cheng, C., Hamed, M.M., El-Sayed Hamed, A.N., Ohlsen, K., Hentschel, U., Abdelmohsen, U.R., 2017. Antifungal potential of marine natural products. *European Journal of Medicinal Chemistry* 126, 631-651.

El Modafar, C., Elgadda, M., El Boutachfaiti, R., Abouraicha, E., Zehhar, N., Petit, E., El Alaoui-Talibi, Z., Courtois, B., Courtois, J., 2012. Induction of natural defence accompanied by salicylic acid-dependant systemic acquired resistance in tomato seedlings in response to bioelicitors isolated from green algae. *Scientia Horticulturae* 138, 55-63.

Fernando, I.P.S., Nah, J.-W., Jeon, Y.-J., 2016. Potential anti-inflammatory natural products from marine algae. *Environmental Toxicology and Pharmacology* 48, 22-30.

Janisiewicz, W.J., Korsten, L., 2002. Biological control of postharvest diseases of fruits. *Annual review of phytopathology* 40, 411-441.

Jiménez, E., Dorta, F., Medina, C., Ramírez, A., Ramírez, I., Peña-Cortés, H., 2011. Anti-phytopathogenic activities of macroalgae extracts. *Marine drugs* 9, 739-756.

Kalai, S., Anzala, L., Bensoussan, M., Dantigny, P., 2017. Modelling the effect of temperature, pH, water activity, and organic acids on the germination time of *Penicillium camemberti* and *Penicillium roqueforti* conidia. *International Journal of Food Microbiology* 240, 124-130.

Karim, H., Boubaker, H., Askarne, L., Cherifi, K., Lakhtar, H., Msanda, F., Boudyach, E.H., Ait Ben Aoumar, A., 2017. Use of *Cistus* aqueous extracts as botanical fungicides in the control of Citrus sour rot. *Microbial Pathogenesis* 104, 263-267.

Kinay, P., Mansour, M.F., Gabler, F.M., Margosan, D.A., Smilanick, J.L., 2007. Characterization of fungicide-resistant isolates of *Penicillium digitatum* collected in California. *Crop Protection* 26, 647-656.

Lavanya, R., Veerappan, N., 2011. Antibacterial potential of six seaweeds collected from gulf of mannar of southeast coast of India. *Advances in Biological Research*, 5(1), 38-44.

Lai, K., Chen, S., Hu, M., Hu, Q., Geng, P., Weng, Q., Jia, J., 2012. Control of postharvest green mold of citrus fruit by application of endophytic *Paenibacillus polymyxa* strain SG-6. *Postharvest Biology and Technology* 69, 40-48.

Li Destri Nicosia, M.G., Pangallo, S., Raphael, G., Romeo, F.V., Strano, M.C., Rapisarda, P., Droby, S., Schena, L., 2016. Control of postharvest fungal rots on citrus fruit and sweet cherries using a pomegranate peel extract. *Postharvest Biology and Technology* 114, 54-61.

Moretto, C., Cervantes, A.L.L., Batista Filho, A., Kupper, K.C., 2014. Integrated control of green mold to reduce chemical treatment in post-harvest citrus fruits. *Scientia Horticulturae* 165, 433-438.

Pangestuti, R., Kim, S. K., 2011. Biological activities and health benefit effects of natural pigments derived from marine algae. *Journal of functional foods*, 3, 255-266.

Sharma, R.R., Singh, D., Singh, R., 2009. Biological control of postharvest diseases of fruits and vegetables by microbial antagonists: A review. *Biological Control* 50, 205-221.

Spadaro, D., Droby, S., 2016. Development of biocontrol products for postharvest diseases of fruit: The importance of elucidating the mechanisms of action of yeast antagonists. *Trends in Food Science & Technology* 47, 39-49.

Sukorini, H., Sangchote, S., Khewkhom, N., 2013. Control of postharvest green mold of citrus fruit with yeasts, medicinal plants, and their combination. *Postharvest Biology and Technology* 79, 24-31.

Tao, N., Jia, L., Zhou, H., 2014. Anti-fungal activity of *Citrus reticulata* Blanco essential oil against *Penicillium italicum* and *Penicillium digitatum*. *Food Chemistry* 153, 265-271.

Tayel, A., El-Baz, A., Salem, M., El-Hadary, M., 2009. Potential applications of pomegranate peel extract for the control of citrus green mould. *Journal of Plant Diseases and Protection* 116, 252-256.

Val, A., Platas, G., Basilio, A., Cabello, A., Gorrochategui, J., Suay, I., Vicente, F., Portillo, E., Río, M., Reina, G., 2001. Screening of antimicrobial activities in red, green and brown macroalgae from Gran Canaria (Canary Islands, Spain). *International Microbiology* 4, 35-40.

Vilanova, L., Teixidó, N., Torres, R., Usall, J., Viñas, I., Sánchez-Torres, P., 2016. Relevance of the transcription factor PdSte12 in *Penicillium digitatum* conidiation and virulence during citrus fruit infection. *International Journal of Food Microbiology* 235, 93-102.

Zhao, L., Feng, C., Wu, K., Chen, W., Chen, Y., Hao, X., Wu, Y., 2017. Advances and prospects in biogenic substances against plant virus: A review. *Pesticide Biochemistry and Physiology* 135, 15-26.

Zheng, S., Jing, G., Wang, X., Ouyang, Q., Jia, L., Tao, N., 2015. Citral exerts its antifungal activity against *Penicillium digitatum* by affecting the mitochondrial morphology and function. *Food Chemistry* 178, 76-81.

Chapitre 3 : Discussion générale

L'émission dans l'environnement d'une multitude de composés organiques représente, selon leur nature et leur zone d'impact, une véritable menace pour la santé humaine et l'environnement. Généralement, ces composés transitent par l'atmosphère, et exposent les populations à des risques importants, avant d'être redistribués dans les autres compartiments de la biosphère. Ainsi, il est nécessaire de surveiller la persistance de ces composés organiques dans l'environnement afin d'estimer leur impact néfaste et/ou leurs conséquences indésirables pour l'homme et son entourage. C'est dans ce contexte que s'inscrivent les objectifs principaux de nos travaux de recherche se divisant en deux grands axes; le premier étant le volet analytique, vise à surveiller la contamination environnementale par les différents types de polluants organiques, alors que le second vise à la recherche d'une alternative de lutte contre l'usage des fongicides chimiques néfaste utilisés pour la protection de certains agrumes.

De la prise de conscience du risque sanitaire à l'évaluation du risque environnemental

Nos travaux de recherche ont été initiés par l'étude de pesticides les plus fréquemment utilisés au Liban. L'effet hémolytique sur le sang humain de ces pesticides et l'analyse de leur présence dans quelques fruits et légumes largement cultivés et consommés au Liban ont été établis.

Apports de tests hémolytiques des pesticides pour le recensement des risques associés chez l'homme

Nos résultats concernant les effets hémolytiques de pesticides, vendus sur le marché Libanais et auxquels les agriculteurs sont largement exposés, ont montré un taux d'hémolyse élevé pour la Trifluraline (73%) et le Malathion (40%). Il est déjà décrit dans plusieurs études antérieures que les résidus de pesticides persistent, à des taux élevés, dans le sang des personnes qui ont eu un contact direct avec ces produits et ont développé certaines maladies associées comme par exemple les maladies cancéreuses (Mathur et al., 2008; Polanco Rodríguez et al., 2017). Aussi, il a été démontré que le taux élevé de certains pesticides dans le sang humain pourrait conduire au développement des maladies sanguines et spécialement l'anémie (Rugman and Cosstick, 1990; Ahamed et al., 2006). D'autant plus que qu'autres pathologies pourront être également liées à l'hyper-hémolyse telles que le dysfonctionnement rénal, l'hypertension pulmonaire ainsi que divers ulcères (Maier-Redelsperger et al., 2010). Ainsi, l'effet hémolytique élevé que présentent les pesticides étudiés au cours de nos travaux peut par conséquent nuire à la santé humaine en étant lié à ces divers troubles.

Apports des tests analytiques préliminaires sur les produits agricoles Libanais et le développement des méthodes multi-résidus sélectives ou générales

Les résultats qualitatifs obtenus sur la persistance des pesticides dans les fruits et les légumes ont montré la présence de nombreux résidus de pesticides dans ces produits. L'analyse réalisée étant qualitative et préliminaire, le développement des méthodes multi-résidus plus poussées était requis. En effet, la caractérisation de la contamination des denrées alimentaires par les résidus de

pesticides peut se faire selon plusieurs méthodes d'extractions sélectives ou apparentées à un large éventail de polluants de différents groupes possédants différentes caractéristiques (Ahmed, 2001).

L'obtention au spectromètre de masse d'un précurseur correspondant au Zineb dans l'analyse préliminaire effectuée par LC-ESI-MS des extraits testés, nous a incité au développement et l'application des méthodes analytiques plus spécifiques permettant une analyse fiable de ce fongicide, appartenant à la famille des dithiocarbamates (DTCs) et interdit depuis l'année 2002.

Apports de l'usage simultané de l'HPLC-UV/Vis et de la SAA pour l'analyse spécifique des DTCs

Normalement, la méthode de choix pour l'analyse des DTCs est celle de Gustafsson et Thompson (1981), qui consiste en une extraction liquide-liquide suivie par une analyse HPLC couplée à une détection UV-visible (Gustafsson and Thompson, 1981). Afin d'extraire et de séparer les pesticides appartenant à cette famille, nous avons appliqué cette méthode sur 11 fongicides repartis en 5 sous-groupes dont les EBDTCs renfermant le Zineb. Nos résultats obtenus, et qui sont effectivement en corrélation avec ceux obtenus par Gustafsson et Thompson, ont montré une absorbance maximale des composés analysés à 272 nm, mais avec une co-élution des produits appartenant au même sous-groupe. La méthode utilisée malgré son efficacité d'extraction des différents DTCs, à elle seule, était donc incapable de différencier les fongicides d'un même sous-groupe et spécialement le Zineb, lequel a été co-élué avec le Maneb et le Mancozeb. En effet, vu que ces composés sont caractérisés par la même structure organique, la distinction entre eux devrait alors se faire en se basant sur la nature des métaux qui y sont accrochés. Ces derniers sont : le zinc dans le cas du Zineb, le manganèse dans le cas du Maneb et les deux ensembles dans le cas du Mancozeb. Etant donné que la spectroscopie d'absorption atomique est la méthode de choix pour l'analyse des métaux, nous avons appliqué cette dernière sur la phase aqueuse des extraits obtenus par extraction liquide-liquide et ainsi réussi à faire la distinction entre Zineb, Maneb et Mancozeb. Ce résultat obtenu est en corrélation avec ceux fournis par Lo et al. 1996 et Türker et Sezer en 2005. L'échantillon contenant le Zineb est riche en zinc mais pauvre en manganèse tandis que l'inverse est trouvé dans les échantillons contenant du Maneb (Lo et al., 1996; Türker and Sezer, 2005). Ainsi, le concept d'associer ces deux méthodes analytiques a permis l'identification et la caractérisation fiable des résidus du fongicide trouvé. Enfin, nous pouvons prétendre suite à ce travail que l'application de chacune de ces deux méthodes à elle seule reste insuffisante, néanmoins, leur association réalisée semble être nécessaire afin de séparer, distinguer et quantifier les résidus de différents sous-groupes des DTCs. Cette association fait en conséquence le dispositif d'une nouvelle méthode simple, efficace et rapide pour l'analyse des DTCs.

Suite au développement de la méthode multi-résidu spécifique pour l'analyse des DTCs, nos recherches ont été ensuite orientées vers l'évaluation de la contamination environnementale par d'autres contaminants organiques que les DTCs, tels que les pesticides, les HAPs et les PCBs.

Ces recherches forment l'axe principal sur lequel se sont basés nos travaux associés au volet analytique. Dans cette partie, nous nous sommes dirigés vers l'usage de l'échantillonnage par différents capteurs naturels afin d'évaluer, avec le moindre coût, la contamination environnementale dans une zone urbaine à Strasbourg et une zone rurale au Liban. Les substances naturelles figurent parmi les échantillonneurs passifs les plus utilisés et le plus efficaces en raison de leur disponibilité et leurs sensibilités pour l'accumulation de différents polluants (Wolterbeek and Bode, 1995). Ces matrices naturelles comprennent principalement les aiguilles de conifères, les abeilles et leurs produits ainsi que les escargots. Au cours de nos travaux de thèse, ces trois matrices ont été choisies et testées dans l'objectif de refléter la plus grande quantité de polluants qui peuvent être y présents, ainsi que dans le but d'effectuer une biosurveillance environnementale en fonction de diverses conditions, telles que les changements météorologiques et la répartition géographique.

Apports de l'utilisation des aiguilles de conifères comme biomoniteurs pour l'étude de la variation temporelle de la pollution atmosphérique à Strasbourg

Notre choix des aiguilles de conifères pour cette mission a été fondé sur le fait que ces matrices sont les plus communément utilisées comme biomoniteurs de la pollution de l'air. La méthode analytique que nous avons développée et utilisée dans ce travail était, à notre connaissance, jamais décrite auparavant. Cette méthode associe l'ASE avec la SPE et la SPME. Les capteurs de ces techniques peuvent être utilisés à des fins variées dans les études de surveillance environnementale et permettent aussi d'évaluer i) les sources de pollutions (Odabasi et al., 2016), ii) le transport à longue distance (Chropeňová et al., 2016), iii) la quantification des niveaux de contamination (Ratola et al., 2014) ainsi que iv) l'étude de l'effet de l'âge des aiguilles sur la capacité d'accumuler les polluants (Romanić and Krauthacker, 2006). Au cours de cette étude, nous avons recours à l'étude des aiguilles de pins (*Pinus nigra*) et de cèdres (*Cedrus atlantica*) afin d'évaluer la bioaccumulation des pesticides, des HAPs et des PCBs dans une zone urbaine à Strasbourg en fonction des changements climatiques. Nos résultats obtenus ont montré une concentration des polluants proportionnelle à la température suivie d'une diminution, voir une disparition associée à une augmentation de précipitations. Ces résultats sont en corrélation avec ceux fournis par Kylin et Sjödin en 2003 démontrant que les fluctuations saisonnières affectent les niveaux d'accumulation des POPs dans les aiguilles, et ceci en raison du cycle annuel de teneur en terpène dans la cire, et les taux d'accumulation le plus bas en hiver (1%) et le plus haut en été (10%) (Kylin and Sjödin, 2003). En outre, nos résultats sur la comparaison des deux espèces de conifères, situées sur des sites proches, ont montré que cette dernière a un rôle indicatif et justificatif; l'usage de différentes espèces pourrait être seulement indicatif de la qualité de l'air du fait de la différence du mécanisme d'absorption de polluants par les aiguilles ayant différentes caractéristiques.

Apports de l'utilisation du miel comme biomoniteurs pour l'étude de la contamination environnementale au Liban nord

Afin d'établir une biosurveillance de la contamination environnementale au Liban nord, la matrice que nous avons utilisés cette fois était le miel. En effet, le miel, largement produit dans la zone d'étude choisie, est l'un des nutriments les plus traditionnels. Étant le premier et le principal produit des abeilles connues pour leur pouvoir accumulateur de différents types de polluants, le miel est largement utilisé dans des études de biosurveillance environnementale (Shamsipur et al., 2016). Ainsi, les échantillons de miel ont été collectés de 4 régions distinctes et extraits par la méthode QuEChERS-SPME. Cette dernière a été développée et validée au préalable sur du miel biologique dans le but d'analyser sa contamination en pesticides, en HAPs et en PCBs. Nos résultats obtenus ont montré une présence importante des résidus de pesticides et d'HAPs dans tous les échantillons testés alors qu'aucun résidu de PCBs n'a été détecté. En effet, la contamination due aux pesticides pourrait être expliquée par le fait que chacun des ruchers étudié est situé dans une zone rurale connue pour ses productions agricoles. Ce qui permet aux abeilles d'être en contact direct avec une multitude de produits phytosanitaires traités par les pesticides. Les abeilles transfèrent en conséquence ces pesticides au rucher aboutissant finalement à la contamination du miel. Quant aux résidus de HAPs trouvés, différentes sources pyrogéniques et petrogéniques sont à l'origine de la persistance de ces polluants dans l'air, lesquels vont être alors transférés *via* les abeilles aux échantillons du miel testés. En outre, l'utilisation de la fumée dans les ruches pendant leur traitement par les apiculteurs pourrait être responsable en grande partie de la présence des résidus d'HAPs détectés (Lambert et al., 2012a; Koltsakidou et al., 2015). Outre l'importance de l'utilisation du miel pour la biosurveillance environnementale, l'analyse de ce produit est nécessaire également pour l'établissement d'une surveillance alimentaire ; en effet la présence des différents polluants organiques dans le miel peut nuire à ses propriétés nutraceutiques et affecte en conséquence son intérêt alimentaire bénéfique, surtout chez les enfants (Koltsakidou et al., 2015).

En bref, l'usage du miel comme agent de « biomonitoring » a été reporté dans de nombreux travaux, cependant la plupart de ces derniers ont été concentrés sur la surveillance de la pollution environnementale causée par l'utilisation des pesticides et très peu d'entre eux ont signalé l'utilisation de ces agents pour l'analyse d'autres polluants organiques tels que les HAPs (Perugini et al., 2009; Lambert et al., 2012b; García-Valcárcel et al., 2016). Toutefois, nos travaux sur le miel ont permis grâce à la nouvelle méthode utilisée l'analyse d'un large éventail de polluants y compris les HAPs et les PCBs, permettant l'analyse d'une zone dont la qualité de l'air n'a jamais été évaluée auparavant.

Apports du développement d'une méthode multi-résidus pour l'identification de 120 pesticides, 16 HAPs et 22 PCBs à partir d'escargots utilisés comme biomoniteurs

Pour finir avec l'étude de la qualité de l'air par une approche basée sur le « biomonitoring », nous avons étudié l'efficacité des escargots dans ce domaine. Le choix de ces agents pour cette mission est dû au fait qu'ils vivent à l'interface sol-plantes-air, donc se déplacent sur, pondent

dedans et ingèrent le sol, en absorbant différents types de polluants et les transmettant aux nombreux consommateurs y compris l'homme (Druart et al., 2011). En outre, leur facilité d'adaptation et de manipulation dans les laboratoires rend ces organismes aptes à divers tests chimiques et biologiques. En effet, bien que les escargots soient bien connus pour leurs capacités à accumuler des polluants, les travaux sur l'extraction et l'analyse des pesticides et des POPs à partir de ces matrices sont encore limités et la plupart, à ce niveau, se concentrent sur l'analyse des métaux.

Nos résultats obtenus dans ce cadre ont montré que le protocole d'extraction influence l'analyse et le taux des polluants à partir d'une même matrice. En effet, ces résultats ont révélé l'efficacité et la fiabilité de la méthode QuEChERS-SPME dans l'analyse multi-résiduelle des pesticides et des POPs à partir des escargots *Helix aspersa* et pourrait former le point de départ pour l'élaboration des campagnes d'analyses environnementale sur le terrain. L'application de cette méthode revient au fait de sa faible consommation de solvants, son économie de temps et de coûts, ses taux de récupérations élevés, sa simplicité et son faible erreur. Cependant, le coût élevé de l'équipement, le volume important utilisé pour le rinçage cellulaire et la préparation avant extraction, la température élevée conduisant à de faibles récupérations et la décomposition d'analytes thermiquement instables augmentent normalement l'erreur et réduisent l'efficacité d'extraction basée sur l'ASE-SPE.

De l'évaluation de l'état de l'environnement à la recherche d'une alternative de lutte

Cette partie forme le deuxième volet de cette thèse. En effet, une fois la surveillance environnementale établie, des mesures de protection, contre la contamination et la persistance des polluants dans les différents compartiments environnementaux doivent être alors établies spécialement du fait du transfert de ces contaminants à la chaîne trophique. L'utilisation des composés ou des substances naturelles est à l'heure actuelle l'une des stratégies alternatives comme moyen de réduction de l'usage des pesticides chimiques pour la protection des fruits et des légumes consommés par l'homme. L'intérêt de nos travaux dans ce cadre est de développer un bio-fongicide à base d'algue verte pour la protection des agrumes en post-récolte.

Notre choix des agrumes infectés en manutention de post récolte par *P. digitatum* comme cible du bio fongicide développé est dû au fait de la consommation énorme et la large surface de culture que présentent ces fruits au Liban. En fait, l'infection par *P. digitatum*, est considérée comme la maladie la plus grave des agrumes en post-récolte. Ainsi, le traitement de ces fruits juste avant ou peu après leur récolte pourrait être utile afin de réduire les infections et de protéger les fruits au cours des étapes critiques de la récolte et l'emballage dans lequel les pathogènes fongiques peuvent entrer sur les plaies et d'établir des infections (Li Destri Nicosia et al., 2016).

En outre, le choix des algues comme matière première du biopesticide développé est dû aux nombreux avantages qu'elles présentent. En fait, les algues marines représentent une grande source de produits naturels complexes et pourraient être une source prometteuse des nouveaux

composés bioactifs qui peuvent aider à la survie des plantes en offrant une protection contre le stress imposé par des agents pathogènes. Plusieurs études ont montré que les algues présentent une application potentielle dans l'agriculture ; en effet les algues possèdent des composés présentant un potentiel antimicrobien contre les pathogènes d'importance médicale, agricole et environnemental (Chandía and Matsuhira, 2008; Arunkumar et al., 2010). Ainsi, des activités antivirales, vermifuges, antifongiques et antibactériennes ont été détectées dans plusieurs espèces algales. Au Liban, le milieu marin dont la côte contient au moins 243 espèces algales, dont les algues verte *Ulva linza* et *Ulva lactuca* sont les plus abondantes, reste malheureusement inexploité (Lakkis and Novel-Lakkis, 2000). De ce fait, ces deux algues, en tant que biocides naturels contre l'infection des agrumes en post récolte par *P. digitatum*, seront utilisées.

Apport des tests antifongiques in vivo et in vitro pour le développement du biopesticide algal

Nos résultats obtenus ont montré que les extraits aqueux des 2 algues testées (*Ulva linza* et *Ulva lactuca*) sont efficaces en tant que bio fongicides en poste récolte pour la protection des agrumes contre l'infection par *P. digitatum*. En effet, l'activité fongicide de ces algues a été mise en évidence antérieurement par certains auteurs (Aruna et al., 2010; Chbani et al., 2013). En outre, l'augmentation de la température de conservation de ces fruits suite à leur traitement par les extraits algaux pourrait accentuer l'effet protecteur de ces derniers conduisant à une protection maximale des cultures avec des effets bénéfiques sur le plan économique, environnemental et sanitaire (Pasquariello et al., 2013; Reque et al., 2014).

Nos travaux sur l'étude du mode d'inhibition du champignon par les extraits algaux ont montré que ces derniers agissent sur l'inhibition de la germination des spores de *P. digitatum* conduisant à l'inhibition du développement du cycle de ce dernier. En fait, le cycle de vie infectieux de *P. digitatum* est initié avec la germination des conidies à la surface des agrumes (Vilanova et al., 2016). De même, le mycélium visible apparaît peu de temps après la fin de la germination, ainsi la germination des conidies fongiques devrait être considérée comme l'étape principale sur laquelle il faut se concentrer lors d'une étude d'activité antifongique (Kalai et al., 2017).

Conclusion et perspectives

Nos travaux, s'enchaînant de la prise de conscience des polluants à la recherche d'une alternative de lutte, contribuent : premièrement au développement des méthodes analytiques multi-résidus permettant l'analyse d'un large éventail de polluants par un seul procédé d'extraction, deuxièmement, à l'application de capteurs passifs naturels qui peuvent améliorer l'évaluation de la contamination environnementale de la manière la plus fiable et à moindre coût, et troisièmement, à l'amélioration de la conservation biologique des agrumes en post-récolte par le développement d'un biopesticide à base d'algues vertes.

En ce qui concerne notre étude préliminaire sur la toxicité sanguine des pesticides, nos résultats suggèrent que le sang pourrait être la cible majeure des produits phytosanitaires, à partir duquel ces produits pourront exercer leurs effets néfastes sur la santé humaine. Ces résultats peuvent amener à de nombreuses perspectives en particulier l'étude de l'effet hémolytique que présentent les HAPs, les PCBs et les OCPs ainsi que la mise au point d'un protocole permettant d'étudier en détail les mécanismes d'actions des pesticides sur les cellules sanguines. En fait, l'élaboration de ce type de test sur des souris de laboratoires pourrait élucider ce mécanisme d'action et pourrait former un point de départ pour une étude toxicologique de tous les polluants organiques.

Dans le volet analytique, nos travaux nous ont permis de mettre au point trois nouveaux procédés d'extractions multi résidues. Le premier étant spécifique pour l'analyse des fongicides appartenant à la famille des dithiocarbamates (DTCs), permet par un simple couplage de l'HPLC-UV/Vis à la SAA, la séparation, la distinction et la quantification des résidus de différents sous-groupes d'une manière efficace et réactive. L'avantage de cette méthode couplant les deux techniques est qu'elle permet, par une simple extraction liquide-liquide, l'analyse précise et sélective des composés cibles avec la moindre erreur.

Le deuxième procédé mis au point était la combinaison entre l'ASE, la SPE et la SPME. Ce protocole a été développé sur des aiguilles de conifères dans le but d'initier une biosurveillance de la qualité de l'air dans une zone urbaine à Strasbourg. En fait, le protocole développé a prouvé par son rendement, ses limites et son efficacité dans l'étude multi résidue d'un nombre élevé de polluants. Cependant et tenant compte de la courte durée d'étude réalisée (5 semaines) et de la seule génération d'aiguilles analysées, une étude perspective plus poussée s'étendant à plusieurs années et portant sur plusieurs générations d'aiguilles pourrait valider les résultats obtenus et offrir des informations sur le mode d'accumulation des polluants par les conifères. A cette étude s'ajoutent les observations botaniques et biologiques des compositions des aiguilles permettant de comprendre la façon avec laquelle ses dernières captent et accumulent les polluants dans leurs différents tissus.

Le dernier procédé mis au point dans cette partie était l'extraction à base QuEChERS suivie d'une étape supplémentaire de concentration/purification des composés volatiles par SPME. Ce procédé a permis, par l'usage du miel comme biomoniteur de la qualité environnementale au Liban nord, de détecter et de quantifier à de faibles concentrations la présence de 90 pesticides, 16 HAPs et 22 PCBs dans les régions visées. Ces résultats pourront initier des études de biosurveillance s'étendant à la surface entière du Liban.

En ce qui concerne l'usage des escargots comme biomoniteur, nos travaux ont été limités au développement de la méthode analytique permettant l'analyse de 158 polluants organiques à partir de l'escargot terrestre *Helix aspersa*. L'application de la méthode développée sur des échantillons réels sur le terrain forme la majeure perspective envisagée dans cette partie. En outre, l'étude des conséquences d'accumulation des polluants dans les tissus des escargots pourrait également être envisagée afin d'étudier le mécanisme avec lequel ces organismes captent et accumulent les divers polluants auxquels ils sont exposés.

Les trois matrices utilisées (aiguilles de conifères, miel et escargots) en tant que capteurs passifs, fournissent une matrice naturelle, efficace, disponible, accessible, peu coûteuse et non toxique pouvant remplacer les capteurs conventionnels. De ce fait, selon la nature, l'état du milieu, la visée de l'étude ainsi que la disponibilité de ces différents biomoniteurs, l'évaluation de la présence de substances néfastes dans l'environnement pourra être ainsi réalisée par ces types de biomonitoring.

Dans le volet de recherche d'une alternative de lutte contre l'usage des fongicides chimiques en post-récolte, les résultats obtenus ont montré que les extraits aqueux d'*Ulva linza* et d'*Ulva lactuca* ayant une concentration de 50 g L^{-1} sont capables de protéger les agrumes en post-récolte contre leur infection par *P. digitatum* pendant 8 semaines. Ces extraits obtenus à partir des algues fraîches ou sèches pourront former une alternative à l'usage des pesticides chimiques nocifs. Nos études sur le mode d'action avec lequel ces algues agissent sur le développement du champignon ont montré que ces derniers agissent comme un inhibiteur de la germination du champignon, le limitant à l'étape de multiplication et inhibant alors l'initiation du processus d'infection. Le procédé développé étant caractérisé par son faible coût et sa facilité d'utilisation offre aux agriculteurs un moyen efficace et rentable pour la protection de leurs productions. Cependant, afin de pouvoir être commercialisé et utilisé ce produit sur terrain, des tests supplémentaires seront envisagés en perspectives. En effet, il serait intéressant de pouvoir réaliser un fractionnement, une purification et une caractérisation des composés actifs de ces extraits dans l'optique d'une valorisation de ces composés naturels. En outre, des tests d'adhésions cellulaires pourront aussi être réalisés afin d'élucider la totalité du mécanisme d'action de ce produit. Par ailleurs, des tests de toxicité (à court et long terme) doivent être réalisés afin de s'assurer de la sécurité sanitaire que présente ces extraits en comparaison avec les molécules d'origines chimiques car la réduction de l'usage de ces derniers répond aussi à la demande du consommateur qui est à la recherche d'aliments sains et purs pour sa santé.

Référence

Abdel-Shafy, H.I., Mansour, M.S.M., 2016. A review on polycyclic aromatic hydrocarbons: Source, environmental impact, effect on human health and remediation. *Egyptian Journal of Petroleum* 25, 107-123.

Abella, V., Pérez, T., Scotece, M., Conde, J., Pirozzi, C., Pino, J., Lago, F., González-Gay, M.Á., Mera, A., Gómez, R., Gualillo, O., 2016. Pollutants make rheumatic diseases worse: Facts on polychlorinated biphenyls (PCBs) exposure and rheumatic diseases. *Life Sciences* 157, 140-144.

Abouraïcha, E., El Alaoui-Talibi, Z., El Boutachfaiti, R., Petit, E., Courtois, B., Courtois, J., El Modafar, C., 2015. Induction of natural defense and protection against *Penicillium expansum* and *Botrytis cinerea* in apple fruit in response to bioelicitors isolated from green algae. *Scientia Horticulturae* 181, 121-128.

Agnan, Y., Probst, A., Séjalon-Delmas, N., 2017. Evaluation of lichen species resistance to atmospheric metal pollution by coupling diversity and bioaccumulation approaches: A new bioindication scale for French forested areas. *Ecological Indicators* 72, 99-110.

Ahamed, M., Anand, M., Kumar, A., Siddiqui, M.K.J., 2006. Childhood aplastic anaemia in Lucknow, India: Incidence, organochlorines in the blood and review of case reports following exposure to pesticides. *Clinical Biochemistry* 39, 762-766.

Ahmed, F.E., 2001. Analyses of pesticides and their metabolites in foods and drinks. *TrAC Trends in Analytical Chemistry* 20, 649-661.

Al Dine, E.J., Mokbel, H., Elmoll, A., Masseurin, S., Vuilleumier, S., Toufaily, J., Hanieh, T., Millet, M., 2015. Concomitant evaluation of atmospheric levels of polychlorinated biphenyls, organochlorine pesticides, and polycyclic aromatic hydrocarbons in Strasbourg (France) using pine needle passive samplers. *Environmental Science and Pollution Research* 22, 17850-17859.

Alagić, S.Č., Jovanović, V.P.S., Mitić, V.D., Cvetković, J.S., Petrović, G.M., Stojanović, G.S., 2016. Bioaccumulation of HMW PAHs in the roots of wild blackberry from the Bor region (Serbia): Phytoremediation and biomonitoring aspects. *Science of The Total Environment* 562, 561-570.

Al-Alam, J., Fajloun, Z., Chbani, A., Millet, M., 2017. The use of conifer needles as biomonitor candidates for the study of temporal air pollution variation in the Strasbourg region. *Chemosphere* 168, 1411-1421.

Albinet, A., Tomaz, S., Lestremau, F., 2013. A really quick easy cheap effective rugged and safe (QuEChERS) extraction procedure for the analysis of particle-bound PAHs in ambient air and emission samples. *Science of the Total Environment* 450, 31-38.

Ali, U., Syed, J.H., Malik, R.N., Katsoyiannis, A., Li, J., Zhang, G., Jones, K.C., 2014. Organochlorine pesticides (OCPs) in South Asian region: A review. *Science of The Total Environment* 476-477, 705-717.

Almeida, D.P., 1999. Electron impact ionisation cross section of krypton (σ_{n+} , $n = 2-7$). *International Journal of Mass Spectrometry* 184, 49-56.

Alonso-Rodríguez, E., Moreda-Piñeiro, J., López-Mahía, P., Muniategui-Lorenzo, S., Fernández-Fernández, E., Prada-Rodríguez, D., Moreda-Piñeiro, A., Bermejo-Barrera, A., Bermejo-Barrera, P., 2006. Pressurized liquid extraction of organometals and its feasibility for total metal extraction. *TrAC Trends in Analytical Chemistry* 25, 511-519.

Al-Rashdan, A., Helaleh, M.I., Nisar, A., Ibtisam, A., Al-Ballam, Z., 2010. Determination of the levels of polycyclic aromatic hydrocarbons in toasted bread using gas chromatography mass spectrometry. *International journal of analytical chemistry* 2010.

Ambolet-Camoit, A., Kim, M.J., Leblanc, A., Aggerbeck, M., 2012. Les polluants organiques persistants : implication dans l'obésité et le syndrome métabolique. *Cahiers de Nutrition et de Diététique* 47, 183-192.

Anastassiades, M., Lehota, S.J., Štajnbaher, D., Schenck, F.J., 2003. Fast and easy multiresidue method employing acetonitrile extraction/partitioning and "dispersive solid-phase extraction" for the determination of pesticide residues in produce. *Journal of AOAC international* 86, 412-431.

Andrade-Eiroa, A., Canle, M., Leroy-Cancellieri, V., Cerdà, V., 2016a. Solid-phase extraction of organic compounds: A critical review (Part I). *TrAC Trends in Analytical Chemistry* 80, 641-654.

Andrade-Eiroa, A., Canle, M., Leroy-Cancellieri, V., Cerdà, V., 2016b. Solid-phase extraction of organic compounds: A critical review. part ii. *TrAC Trends in Analytical Chemistry* 80, 655-667.

Arinaitwe, K., Rose, N.L., Muir, D.C.G., Kiremire, B.T., Balirwa, J.S., Teixeira, C., 2016. Historical deposition of persistent organic pollutants in Lake Victoria and two alpine equatorial lakes from East Africa: Insights into atmospheric deposition from sedimentation profiles. *Chemosphere* 144, 1815-1822.

Arthur, C.L., Pawliszyn, J., 1990. Solid phase microextraction with thermal desorption using fused silica optical fibers. *Analytical chemistry* 62, 2145-2148.

Aruna, P., Mansuya, P., Sridhar, S., Kumar, J.S., Babu, S., 2010. Pharmacognostical and antifungal activity of selected seaweeds from Gulf of Mannar region. *Recent Research in Science and Technology* 2.

Arunkumar, K., Sivakumar, S., Rengasamy, R., 2010. Review on bioactive potential in seaweeds (marine macroalgae): a special emphasis on bioactivity of seaweeds against plant pathogens. *Asian Journal of Plant Sciences*.

Augusto, S., Máguas, C., Branquinho, C., 2013. Guidelines for biomonitoring persistent organic pollutants (POPs), using lichens and aquatic mosses – A review. *Environmental Pollution* 180, 330-338.

Badiou-Bénéteau, A., Benneveau, A., Gélet, F., Delatte, H., Becker, N., Brunet, J.-L., Reynaud, B., Belzunces, L., 2013. Honeybee biomarkers as promising tools to monitor environmental quality. *Environment international* 60, 31-41.

Bailey, K.L., Boyetchko, S.M., Längle, T., 2010. Social and economic drivers shaping the future of biological control: A Canadian perspective on the factors affecting the development and use of microbial biopesticides. *Biological Control* 52, 221-229.

Baklanov, A., Hänninen, O., Slørdal, L., Kukkonen, J., Bjergene, N., Fay, B., Finardi, S., Hoe, S., Jantunen, M., Karppinen, A., 2007. Integrated systems for forecasting urban meteorology, air pollution and population exposure. *Atmospheric Chemistry and Physics* 7, 855-874.

- Bao, L.-J., Zeng, E.Y., 2014. Field application of passive sampling techniques for sensing hydrophobic organic contaminants. *Trends in Environmental Analytical Chemistry* 1, e19-e24.
- Bargagli, R., 2016. Moss and lichen biomonitoring of atmospheric mercury: A review. *Science of The Total Environment* 572, 216-231.
- Batterman, S., Chen, T.-C., Chernyak, S., Godwin, C., 2009. Design and performance evaluation of a medium flow sampler for airborne brominated flame retardants (BFRs). *Journal of Environmental Monitoring* 11, 858-866.
- Beeby, A., Richmond, L., 2002. Evaluating *Helix aspersa* as a sentinel for mapping metal pollution. *Ecological Indicators* 1, 261-270.
- Bell, A.S., Blanford, S., Jenkins, N., Thomas, M.B., Read, A.F., 2009. Real-time quantitative PCR for analysis of candidate fungal biopesticides against malaria: Technique validation and first applications. *Journal of Invertebrate Pathology* 100, 160-168.
- Benijts, T., Lambert, W., De Leenheer, A., 2004. Analysis of multiple endocrine disruptors in environmental waters via wide-spectrum solid-phase extraction and dual-polarity ionization LC-ion trap-MS/MS. *Analytical chemistry* 76, 704-711.
- Bergamaschi, L., Rizzio, E., Giaveri, G., Profumo, A., Loppi, S., Gallorini, M., 2004. Determination of baseline element composition of lichens using samples from high elevations. *Chemosphere* 55, 933-939.
- Berlitz-Barbier, A., Buleté, A., Faburé, J., Garric, J., Cren-Olivé, C., Vulliet, E., 2014. Multi-residue analysis of emerging pollutants in benthic invertebrates by modified micro-quick-easy-cheap-efficient-rugged-safe extraction and nanoliquid chromatography–nanospray–tandem mass spectrometry analysis. *Journal of Chromatography A* 1367, 16-32.
- Berthet, B., 2008. Les espèces sentinelles. Les biomarqueurs dans l'évaluation de l'état écologique des milieux aquatiques. Lavoisier, Tec&Doc, Paris, 121-148.
- Bidleman, T.F., Jantunen, L.M., Kurt-Karakus, P.B., Wong, F., 2012. Chiral persistent organic pollutants as tracers of atmospheric sources and fate: review and prospects for investigating climate change influences. *Atmospheric Pollution Research* 3, 371-382.
- Björklund, E., Nilsson, T., Bøwadt, S., 2000. Pressurised liquid extraction of persistent organic pollutants in environmental analysis. *TrAC Trends in Analytical Chemistry* 19, 434-445.
- Bojko, B., Pawliszyn, J., 2014. In vivo and ex vivo SPME: a low invasive sampling and sample preparation tool in clinical bioanalysis. *Bioanalysis* 6, 1227-1239.
- Bonning, B., 2005. Baculoviruses: biology, biochemistry, and molecular biology. *Comprehensive molecular insect science* 6, 233-270.
- Boshoff, M., Jordaens, K., Baguet, S., Bervoets, L., 2015. Trace metal transfer in a soil–plant–snail microcosm field experiment and biomarker responses in snails. *Ecological Indicators* 48, 636-648.
- Boubel, R., 1994. The history of air pollution. *Fundamentals of air pollution third edition*. United States of America: Academic press. Inc.
- Bouvier, G., Blanchard, O., Momas, I., Seta, N., 2006. Environmental and biological monitoring of exposure to organophosphorus pesticides: application to occupationally and non-occupationally exposed adult populations. *Journal of Exposure Science and Environmental Epidemiology* 16, 417-426.
- Brodeur, J., Caron, J., 2006. Recherche et développement de biopesticides et pesticides naturels à faible toxicité pour les organismes non ciblés et respectueux de l'environnement–Rapport final–Volet Entomologie.
- Calvet, R., 2005. Les pesticides dans le sol: conséquences agronomiques et environnementales. France Agricole Editions.
- Camino-Sánchez, F.J., Zafra-Gómez, A., Ruiz-García, J., Bermúdez-Peinado, R., Ballesteros, O., Navalón, A., Vilchez, J.L., 2011. UNE-EN ISO/IEC 17025:2005 accredited method for the determination of 121 pesticide residues in fruits and vegetables by gas chromatography–tandem mass spectrometry. *Journal of Food Composition and Analysis* 24, 427-440.
- Can, Z., Yildiz, O., Sahin, H., Turumtay, E.A., Silici, S., Kolayli, S., 2015. An investigation of Turkish honeys: their physico-chemical properties, antioxidant capacities and phenolic profiles. *Food chemistry* 180, 133-141.
- Canon, F., 2010. Contribution de la spectrométrie de masse à l'étude des interactions entre les protéines salivaires riche en proline et les tanins. Montpellier, SupAgro.
- Carabias-Martínez, R., Rodríguez-Gonzalo, E., Revilla-Ruiz, P., Hernández-Méndez, J., 2005. Pressurized liquid extraction in the analysis of food and biological samples. *Journal of Chromatography A* 1089, 1-17.
- Céspedes, C.L., Martínez-Vázquez, M., Calderón, J.S., Salazar, J.R., Aranda, E., 2001. Insect growth regulatory activity of some extracts and compounds from *Parthenium argentatum* on fall armyworm *Spodoptera frugiperda*. *Zeitschrift für Naturforschung C* 56, 95-105.
- Céspedes, C.L., Salazar, J.R., Ariza-Castolo, A., Yamaguchi, L., Ávila, J.G., Aqueveque, P., Kubo, I., Alarcón, J., 2014. Biopesticides from plants: *Calceolaria integrifolia* s.l. *Environmental Research* 132, 391-406.
- Chahal, H., 2013. Etude du comportement hydromécanique des sédiments pollués par les PCB en interaction avec les géomatériaux pour un stockage hors site. Lyon, INSA.
- Chandía, N.P., Matsuhira, B., 2008. Characterization of a fucoidan from *Lessonia vadosa* (Phaeophyta) and its anticoagulant and elicitor properties. *International Journal of Biological Macromolecules* 42, 235-240.
- Chandler, D., Bailey, A.S., Tatchell, G.M., Davidson, G., Greaves, J., Grant, W.P., 2011. The development, regulation and use of biopesticides for integrated pest management. *Philosophical Transactions of the Royal Society of London B: Biological Sciences* 366, 1987-1998.
- Chandler, D., Davidson, G., Grant, W., Greaves, J., Tatchell, G., 2008. Microbial biopesticides for integrated crop management: an assessment of environmental and regulatory sustainability. *Trends in Food Science & Technology* 19, 275-283.
- Chatel, G., Naffrechoux, E., Draye, M., 2017. Avoid the PCB mistakes: A more sustainable future for ionic liquids. *Journal of Hazardous Materials* 324, Part B, 773-780.

Chauzat, M.P., Martel, A.C., Cougoule, N., Porta, P., Lachaize, J., Zeggane, S., Aubert, M., Carpentier, P., Faucon, J.P., 2011. An assessment of honeybee colony matrices, *Apis mellifera* (Hymenoptera: Apidae) to monitor pesticide presence in continental France. *Environmental Toxicology and Chemistry* 30, 103-111.

Chbani, A., Mansour, R., Mawlawi, H., Gmira, N., 2013. In vitro and in vivo evaluation of anti-phytopathogenic activity and anti-adhesive properties of three Macro Algae against *Penicillium digitatum*. *Science Lib Journal* 5, 1-23.

Chen, S.-Y., Urban, P.L., 2015. On-line monitoring of Soxhlet extraction by chromatography and mass spectrometry to reveal temporal extract profiles. *Analytica Chimica Acta* 881, 74-81.

Chiesa, L., Labella, G., Giorgi, A., Panseri, S., Pavlovic, R., Bonacci, S., Arioli, F., 2016. The occurrence of pesticides and persistent organic pollutants in Italian organic honeys from different productive areas in relation to potential environmental pollution. *Chemosphere* 154, 482-490.

Chropeňová, M., Gregušková, E.K., Karásková, P., Příbylová, P., Kukučka, P., Baráková, D., Čupr, P., 2016. Pine needles and pollen grains of *Pinus mugo* Turra—A biomonitoring tool in high mountain habitats identifying environmental contamination. *Ecological Indicators* 66, 132-142.

Codling, G., Al Naggar, Y., Giesy, J.P., Robertson, A.J., 2016. Concentrations of neonicotinoid insecticides in honey, pollen and honey bees (*Apis mellifera* L.) in central Saskatchewan, Canada. *Chemosphere* 144, 2321-2328.

Contreras López, M.C., 2003. Determination of potentially bioaccumulating complex mixtures of organochlorine compounds in wastewater: a review. *Environment International* 28, 751-759.

Cornu, P., 2012. Les Polychlorobiphényles: Enjeux environnementaux etsanitaires, et mycoremédiation. Thèse de doctorat. Université Joseph Fourier, France.

Costa, F.P., Caldas, S.S., Primel, E.G., 2014. Comparison of QuEChERS sample preparation methods for the analysis of pesticide residues in canned and fresh peach. *Food chemistry* 165, 587-593.

Czeszak, X., 2003. Nouvelle stratégie de positionnement des structures O-glycanniques: β -élimination et dérivation à charge fixe. Lille 1.

David, F., Devos, C., Dumont, E., Yang, Z., Sandra, P., Huertas-Pérez, J.F., 2017. Determination of pesticides in fatty matrices using gel permeation clean-up followed by GC-MS/MS and LC-MS/MS analysis: A comparison of low- and high-pressure gel permeation columns. *Talanta* 165, 201-210.

De Hoffmann, E., Stroobant, V., 2005. Spectrométrie de masse: cours et exercices corrigés. Dunod.

de Lima, R.F., Dionello, R.G., Peralba, M.d.C.R., Barrionuevo, S., Radunz, L.L., Reichert Júnior, F.W., 2017. PAHs in corn grains submitted to drying with firewood. *Food Chemistry* 215, 165-170.

de Maagd, R.A., Bosch, D., Stiekema, W., 1999. *Bacillus thuringiensis* toxin-mediated insect resistance in plants. *Trends in Plant Science* 4, 9-13.

De Nicola, F., Claudia, L., MariaVittoria, P., Giulia, M., Anna, A., 2011. Biomonitoring of PAHs by using *Quercus ilex* leaves: Source diagnostic and toxicity assessment. *Atmospheric Environment* 45, 1428-1433.

De Nicola, F., Concha Graña, E., Aboal, J.R., Carballeira, A., Fernández, J.Á., López Mahía, P., Prada Rodríguez, D., Muniategui Lorenzo, S., 2016. PAH detection in *Quercus robur* leaves and *Pinus pinaster* needles: A fast method for biomonitoring purpose. *Talanta* 153, 130-137.

de Oliveira, R.C., do Nascimento Queiroz, S.C., da Luz, C.F.P., Porto, R.S., Rath, S., 2016. Bee pollen as a bioindicator of environmental pesticide contamination. *Chemosphere* 163, 525-534.

De Vaufléury, A., Coeurdassier, M., Pandard, P., Scheifler, R., Lovy, C., Crini, N., Badot, P.M., 2006. How terrestrial snails can be used in risk assessment of soils. *Environmental toxicology and chemistry* 25, 797-806.

De Vaufléury, A., Gimbert, F., Pauget, B., Fritsch, C., Scheifler, R., Coeurdassier, M., 2012. LES ESCARGOTS BIO-INDICATEURS DE LA QUALITE DES SOLS-Snail watch: analyse en laboratoire ou in situ de la biodisponibilité des contaminants.

Deravel, J., Krier, F., Jacques, P., 2014. Les biopesticides, compléments et alternatives aux produits phytosanitaires chimiques (synthèse bibliographique)/Biopesticides, a complementary and alternative approach to the use of agrochemicals. A review. *Biotechnologie, Agronomie, Société et Environnement* 18, 220.

Dimpe, K.M., Nomngongo, P.N., 2016. Current sample preparation methodologies for analysis of emerging pollutants in different environmental matrices. *TrAC Trends in Analytical Chemistry* 82, 199-207.

Dorich, B., Francis, E., Murphy, B., Richter, B., Henderson, S., 2008. Accelerated solvent extraction with acid pretreatment for improved laboratory productivity. *American laboratory* 40, 18-19.

Dreyer, A., Matthias, V., Weinberg, I., Ebinghaus, R., 2010. Wet deposition of poly-and perfluorinated compounds in Northern Germany. *Environmental Pollution* 158, 1221-1227.

Droit, A., 2007. De l'identification à la caractérisation des complexes protéiques: développement d'une plateforme bioinformatique d'analyse. Citeseer.

Druart, C., Millet, M., Scheifler, R., Delhomme, O., Raeppl, C., de Vaufléury, A., 2011. Snails as indicators of pesticide drift, deposit, transfer and effects in the vineyard. *Science of The Total Environment* 409, 4280-4288.

Duodu, G.O., Ogogo, K.N., Mummullage, S., Harden, F., Goonetilleke, A., Ayoko, G.A., 2017. Source apportionment and risk assessment of PAHs in Brisbane River sediment, Australia. *Ecological Indicators* 73, 784-799.

Durante, C.A., Santos-Neto, E.B., Azevedo, A., Crespo, E.A., Lailson-Brito, J., 2016. POPs in the South Latin America: Bioaccumulation of DDT, PCB, HCB, HCH and Mirex in blubber of common dolphin (*Delphinus delphis*) and Fraser's dolphin (*Lagenodelphis hosei*) from Argentina. *Science of The Total Environment* 572, 352-360.

El Modafar, C., Elgadda, M., El Boutachfai, R., Abouraiha, E., Zehhar, N., Petit, E., El Alaoui-Talibi, Z., Courtois, B., Courtois, J., 2012. Induction of natural defence accompanied by salicylic acid-dependant systemic acquired resistance in tomato seedlings in response to bioelicitors isolated from green algae. *Scientia Horticulturae* 138, 55-63.

El-Aneed, A., Cohen, A., Banoub, J., 2009. Mass spectrometry, review of the basics: electrospray, MALDI, and commonly used mass analyzers. *Applied Spectroscopy Reviews* 44, 210-230.

El-Hossary, E.M., Cheng, C., Hamed, M.M., El-Sayed Hamed, A.N., Ohlsen, K., Hentschel, U., Abdelmohsen, U.R., 2017. Antifungal potential of marine natural products. *European Journal of Medicinal Chemistry* 126, 631-651.

Elorduy, I., Elcoroaristizabal, S., Durana, N., García, J., Alonso, L., 2016. Diurnal variation of particle-bound PAHs in an urban area of Spain using TD-GC/MS: Influence of meteorological parameters and emission sources. *Atmospheric Environment* 138, 87-98.

Emilia, R., Debora, B., Stefania, A., Nicola, B., Roberto, B., 2016. *Papillifera papillaris* (O.F. Müller), a small snail living on stones and monuments, as indicator of metal deposition and bioavailability in urban environments. *Ecological Indicators* 69, 360-367.

Eriksson, G., Jensen, S., Kylin, H., Strachan, W., 1989. The pine needle as a monitor of atmospheric pollution.

Errami, M., 2012. Devenir atmosphérique de bupirimate et transfert de ses métabolites (les diazines) dans l'atmosphère, sa dissipation dans les fruits de tomate et sa dégradation électrochimique. Reims.

Fang, W., Leng, B., Xiao, Y., Jin, K., Ma, J., Fan, Y., Feng, J., Yang, X., Zhang, Y., Pei, Y., 2005. Cloning of *Beauveria bassiana* chitinase gene *Bbchit1* and its application to improve fungal strain virulence. *Applied and environmental microbiology* 71, 363-370.

Fernandes, V.C., Domingues, V.F., Mateus, N., Delerue-Matos, C., 2013. Multiresidue pesticides analysis in soils using modified QuEChERS with disposable pipette extraction and dispersive solid-phase extraction. *Journal of separation science* 36, 376-382.

Fernández, J.A., Ares, A., Rey-Asensio, A., Carballeira, A., Aboal, J.R., 2009. Effect of growth on active biomonitoring with terrestrial mosses. *Journal of Atmospheric Chemistry* 63, 1-11.

Fernandez, M., Pico, Y., Manes, J., 2001. Comparison of gas and liquid chromatography coupled to mass spectrometry for the residue analysis of pesticides in oranges. *Chromatographia* 54, 302-308.

Fernández, M.F., Rivas, A., Olea-Serrano, F., Cerrillo, I., Molina-Molina, J.M., Araque, P., Martínez-Vidal, J.L., Olea, N., 2004. Assessment of total effective xenoestrogen burden in adipose tissue and identification of chemicals responsible for the combined estrogenic effect. *Analytical and bioanalytical chemistry* 379, 163-170.

Flores-Ramírez, R., Pérez-Vázquez, F.J., Rodríguez-Aguilar, M., Medellín-Garibay, S.E., Van Brussel, E., Cubillas-Tejeda, A.C., Carrizales-Yáñez, L., Díaz-Barriga, F., 2017. Biomonitoring of persistent organic pollutants (POPs) in child populations living near contaminated sites in Mexico. *Science of The Total Environment* 579, 1120-1126.

Foan, L., Domercq, M., Bermejo, R., Santamaría, J.M., Simon, V., 2015. Mosses as an integrating tool for monitoring PAH atmospheric deposition: Comparison with total deposition and evaluation of bioconcentration factors. A year-long case-study. *Chemosphere* 119, 452-458.

Foreman, W.T., Bidleman, T.F., 1987. An experimental system for investigating vapor-particle partitioning of trace organic pollutants. *Environmental science & technology* 21, 869-875.

Francová, A., Chrastný, V., Šillerová, H., Vítková, M., Kocourková, J., Komárek, M., 2017. Evaluating the suitability of different environmental samples for tracing atmospheric pollution in industrial areas. *Environmental Pollution* 220, Part A, 286-297.

Freitas, L.G., Götz, C.W., Ruff, M., Singer, H.P., Müller, S.R., 2004. Quantification of the new triketone herbicides, sulcotrione and mesotrione, and other important herbicides and metabolites, at the ng/l level in surface waters using liquid chromatography-tandem mass spectrometry. *Journal of Chromatography A* 1028, 277-286.

Frenich, A.G., Salvador, I.M., Vidal, J.M., López-López, T., 2005. Determination of multiclass pesticides in food commodities by pressurized liquid extraction using GC-MS/MS and LC-MS/MS. *Analytical and bioanalytical chemistry* 383, 1106-1118.

Fu, J., Wang, Y., Zhang, A., Zhang, Q., Zhao, Z., Wang, T., Jiang, G., 2011. Spatial distribution of polychlorinated biphenyls (PCBs) and polybrominated biphenyl ethers (PBDEs) in an e-waste dismantling region in Southeast China: Use of apple snail (*Ampullariidae*) as a bioindicator. *Chemosphere* 82, 648-655.

García-Valcárcel, A., Moleró, E., Tadeo, J., Hernando, M., 2016. Determination of selected environmental contaminants in foraging honeybees. *Talanta* 148, 1-6.

Garty, J., 2001. Biomonitoring atmospheric heavy metals with lichens: theory and application. *Critical reviews in plant sciences* 20, 309-371.

Gérin, M., Gosselin, P., Cordier, S., Viau, C., Quénel, P., Dewailly, É., 2003. Environnement et santé publique-Fondements et pratiques. Édisem/Tec & Doc.

Giordano, S., Adamo, P., Spagnuolo, V., Vaglicco, B.M., 2010. Instrumental and bio-monitoring of heavy metal and nanoparticle emissions from diesel engine exhaust in controlled environment. *Journal of Environmental Sciences* 22, 1357-1363.

Goñi, M.L., Gañán, N.A., Herrera, J.M., Strumia, M.C., Andreatta, A.E., Martini, R.E., 2017. Supercritical CO₂ iof LDPE films with terpene ketones as biopesticides against corn weevil (*Sitophilus zeamais*). *The Journal of Supercritical Fluids* 122, 18-26.

González, A., Pokrovsky, O., 2014. Metal adsorption on mosses: toward a universal adsorption model. *Journal of colloid and interface science* 415, 169-178.

Gordon, C.S., Lowe, J.T., 1927. Carbon-monoxide detector. Google Patents.

Górecki, T., Namieśnik, J., 2002. Passive sampling. *TrAC Trends in Analytical Chemistry* 21, 276-291.

Grey, C.N., Nieuwenhuijsen, M.J., Golding, J., Team, A., 2006. Use and storage of domestic pesticides in the UK. *Science of the Total Environment* 368, 465-470.

Gupta, S., Dikshit, A., 2010. Biopesticides: an ecofriendly approach for pest control. *Journal of Biopesticides* 3, 186-188.

Gustafsson, K.H., Thompson, R.A., 1981. High-pressure liquid chromatographic determination of fungicidal dithiocarbamates. *Journal of agricultural and food chemistry* 29, 729-732.

Haglund, P., Spinnel, E., 2010. A Modular Approach to Pressurized Liquid Extraction with In-Cell Cleanup. *LC GC North America* 28.

Hajek, A., St. Leger, R., 1994. Interactions between fungal pathogens and insect hosts. *Annual review of entomology* 39, 293-322.

Hajek, A.E., 2004. *Natural enemies: an introduction to biological control*. Cambridge University Press.

Hajšlová, J., Zrostlíková, J., 2003. Matrix effects in (ultra) trace analysis of pesticide residues in food and biotic matrices. *Journal of Chromatography A* 1000, 181-197.

Han, L., Sapozhnikova, Y., Lehotay, S.J., 2014. Streamlined sample cleanup using combined dispersive solid-phase extraction and in-vial filtration for analysis of pesticides and environmental pollutants in shrimp. *Analytica chimica acta* 827, 40-46.

Harmens, H., Foan, L., Simon, V., Mills, G., 2013. Terrestrial mosses as biomonitors of atmospheric POPs pollution: A review. *Environmental Pollution* 173, 245-254.

Harmens, H., Ilyin, I., Mills, G., Aboal, J., Alber, R., Blum, O., Coşkun, M., De Temmerman, L., Fernández, J., Figueira, R., 2012. Country-specific correlations across Europe between modelled atmospheric cadmium and lead deposition and concentrations in mosses. *Environmental Pollution* 166, 1-9.

Harner, T., Bartkow, M., Holoubek, I., Klanova, J., Wania, F., Gioia, R., Moeckel, C., Sweetman, A.J., Jones, K.C., 2006a. Passive air sampling for persistent organic pollutants: Introductory remarks to the special issue. *Environmental Pollution* 144, 361-364.

Harner, T., Shoeib, M., Gouin, T., Blanchard, P., 2006b. Polychlorinated naphthalenes in Great Lakes air: assessing spatial trends and combustion inputs using PUF disk passive air samplers. *Environmental science & technology* 40, 5333-5339.

Harris, S.A., Whiticar, M.J., Eek, M.K., 1999. Molecular and isotopic analysis of oils by solid phase microextraction of gasoline range hydrocarbons. *Organic Geochemistry* 30, 721-737.

Hazrati, S., Harrad, S., 2007. Calibration of polyurethane foam (PUF) disk passive air samplers for quantitative measurement of polychlorinated biphenyls (PCBs) and polybrominated diphenyl ethers (PBDEs): Factors influencing sampling rates. *Chemosphere* 67, 448-455.

Herrera López, S., Lozano, A., Sosa, A., Hernando, M.D., Fernández-Alba, A.R., 2016. Screening of pesticide residues in honeybee wax comb by LC-ESI-MS/MS. A pilot study. *Chemosphere* 163, 44-53.

Herrera, M., Prados-Rosales, R.C., Luque-García, J., De Castro, M.L., 2002. Static–dynamic pressurized hot water extraction coupled to on-line filtration–solid-phase extraction–high-performance liquid chromatography–post-column derivatization–fluorescence detection for the analysis of N-methylcarbamates in foods. *Analytica Chimica Acta* 463, 189-197.

Heuett, N.V., Ramirez, C.E., Fernandez, A., Gardinali, P.R., 2015. Analysis of drugs of abuse by online SPE-LC high resolution mass spectrometry: communal assessment of consumption. *Science of the Total Environment* 511, 319-330.

Heuskin, S., Verheggen, F.J., Haubruge, E., Wathélet, J.-P., Lognay, G., 2011. The use of semiochemical slow-release devices in integrated pest management strategies/L'utilisation de systèmes à libération lente de sémiocimiques dans les stratégies de lutte intégrée. *Biotechnologie, Agronomie, Société et Environnement* 15, 459.

Holt, E., Kočan, A., Klánová, J., Assefa, A., Wiberg, K., 2016. Polychlorinated dibenzo-p-dioxins/furans (PCDD/Fs) and metals in scots pine (*Pinus sylvestris*) needles from Eastern and Northern Europe: Spatiotemporal patterns, and potential sources. *Chemosphere* 156, 30-36.

Humbert, L., 2010. Extraction en phase solide (SPE): théorie et applications, *Annales de Toxicologie Analytique*. EDP Sciences, pp. 61-68.

Ianistcki, M., Dallarosa, J., Sauer, C., Teixeira, C., Da Silva, J., 2009. Genotoxic effect of polycyclic aromatic hydrocarbons in the metropolitan area of Porto Alegre, Brazil, evaluated by *Helix aspersa* (Müller, 1774). *Environmental pollution* 157, 2037-2042.

Jantunen, L.M., Helm, P.A., Ridal, J.J., Bidleman, T.F., 2008. Air–water gas exchange of chiral and achiral organochlorine pesticides in the Great Lakes. *Atmospheric Environment* 42, 8533-8542.

Ji, D., Gao, W., Zhang, J., Morino, Y., Zhou, L., Yu, P., Li, Y., Sun, J., Ge, B., Tang, G., Sun, Y., Wang, Y., 2016. Investigating the evolution of summertime secondary atmospheric pollutants in urban Beijing. *Science of The Total Environment* 572, 289-300.

Jisha, V.N., Smitha, R.B., Benjamin, S., 2013. An overview on the crystal toxins from *Bacillus thuringiensis*. *Advances in Microbiology* 3, 462.

Juan-Borrás, M., Domenech, E., Escriche, I., 2016. Mixture-risk-assessment of pesticide residues in retail polyfloral honey. *Food Control* 67, 127-134.

Juodis, L., Filistovič, V., Maceika, E., Remeikis, V., 2016. Analytical dispersion model for the chain of primary and secondary air pollutants released from point source. *Atmospheric Environment* 128, 216-226.

Kailasa, S.K., Wu, H.-F., Huang*, S.-D., 2013. Recent Developments on Mass Spectrometry for the Analysis of Pesticides in Wastewater. INTECH Open Access Publisher.

Kalai, S., Anzala, L., Bensoussan, M., Dantigny, P., 2017. Modelling the effect of temperature, pH, water activity, and organic acids on the germination time of *Penicillium camemberti* and *Penicillium roqueforti* conidia. *International Journal of Food Microbiology* 240, 124-130.

Kanally, R.A., Harayama, S., 2000. Biodegradation of high-molecular-weight polycyclic aromatic hydrocarbons by bacteria. *Journal of bacteriology* 182, 2059-2067.

Kang, K.-D., Kamita, S.G., Suzuki, K., Seong, S.-I., 2011. Effect of starvation upon baculovirus replication in larval *Bombyx mori* and *Heliothis virescens*. *Journal of Invertebrate Pathology* 106, 205-210.

Kao, T.H., Chen, S., Chen, C.J., Huang, C.W., Chen, B.H., 2012. Evaluation of Analysis of Polycyclic Aromatic Hydrocarbons by the QuEChERS Method and Gas Chromatography–Mass Spectrometry and Their Formation in Poultry Meat As Affected by Marinating and Frying. *Journal of agricultural and food chemistry* 60, 1380-1389.

Kataoka, H., Lord, H.L., Pawliszyn, J., 2000. Applications of solid-phase microextraction in food analysis. *Journal of chromatography A* 880, 35-62.

Kero, F.A., Pedder, R.E., Yost, R.A., 2005. Quadrupole mass analyzers: theoretical and practical considerations. *Encyclopedia of Genetics, Genomics, Proteomics and Bioinformatics*.

Kershaw, M., Moorhouse, E., Bateman, R., Reynolds, S., Charnley, A., 1999. The role of destruxins in the pathogenicity of *Metarhizium anisopliae* for three species of insect. *Journal of invertebrate pathology* 74, 213-223.

Kessler, A., Baldwin, I.T., 2002. Plant responses to insect herbivory: the emerging molecular analysis. *Annual review of plant biology* 53, 299-328.

Kiljanek, T., Niewiadowska, A., Semeniuk, S., Gawel, M., Borzęcka, M., Posyniak, A., 2016. Multi-residue method for the determination of pesticides and pesticide metabolites in honeybees by liquid and gas chromatography coupled with tandem mass spectrometry—Honeybee poisoning incidents. *Journal of Chromatography A* 1435, 100-114.

Kim, K.-H., Jahan, S.A., Kabir, E., Brown, R.J., 2013. A review of airborne polycyclic aromatic hydrocarbons (PAHs) and their human health effects. *Environment international* 60, 71-80.

Kim, K.-H., Kabir, E., Jahan, S.A., 2017. Exposure to pesticides and the associated human health effects. *Science of The Total Environment* 575, 525-535.

Kim, P., Bai, H., Bai, D., Chae, H., Chung, S., Kim, Y., Park, R., Chi, Y.T., 2004. Purification and characterization of a lipopeptide produced by *Bacillus thuringiensis* CMB26. *Journal of applied microbiology* 97, 942-949.

Klánová, J., Čupr, P., Baráková, D., Šeda, Z., Anděl, P., Holoubek, I., 2009. Can pine needles indicate trends in the air pollution levels at remote sites? *Environmental Pollution* 157, 3248-3254.

Knopper, L.D., Lean, D.R., 2004. Carcinogenic and genotoxic potential of turf pesticides commonly used on golf courses. *Journal of Toxicology and Environmental Health, Part B* 7, 267-279.

Koltsakidou, A., Zacharis, C.K., Fytianos, K., 2015. A validated liquid chromatographic method for the determination of polycyclic aromatic hydrocarbons in honey after homogeneous liquid–liquid extraction using hydrophilic acetonitrile and sodium chloride as mass separating agent. *Journal of Chromatography A* 1377, 46-54.

Kot, A., Zabiegała, B., Namieśnik, J., 2000. Passive sampling for long-term monitoring of organic pollutants in water. *TrAC Trends in Analytical Chemistry* 19, 446-459.

Koutros, S., Silverman, D.T., Alavanja, M.C., Andreotti, G., Lerro, C.C., Heltshe, S., Lynch, C.F., Sandler, D.P., Blair, A., Freeman, L.E.B., 2015. Occupational exposure to pesticides and bladder cancer risk. *International journal of epidemiology*, dvy195.

Kowalczyk, T., Jech, M., Poustka, J., Hajšlová, J., 2006. Ultra-performance liquid chromatography–tandem mass spectrometry: A novel challenge in multiresidue pesticide analysis in food. *Analytica chimica acta* 577, 8-17.

Kowalczyk-Pecka, D., Pecka, S., Kowalczyk-Vasilev, E., 2017a. Changes in fatty acid metabolism induced by varied micro-supplementation with zinc in snails *Helix pomatia* (Gastropoda Pulmonata). *Ecotoxicology and Environmental Safety* 138, 223-230.

Kowalczyk-Pecka, D., Pecka, S., Kowalczyk-Vasilev, E., 2017b. Selected fatty acids as biomarkers of exposure to microdoses of molluscicides in snails *Helix pomatia* (Gastropoda Pulmonata). *Environmental Pollution* 222, 138-145.

Kujawski, M.W., Bargańska, Z., Marciniak, K., Miedzianowska, E., Kujawski, J.K., Ślebioda, M., Namieśnik, J., 2014. Determining pesticide contamination in honey by LC-ESI-MS/MS—Comparison of pesticide recoveries of two liquid–liquid extraction based approaches. *LWT-Food Science and Technology* 56, 517-523.

Kujawski, M.W., Namieśnik, J., 2011. Levels of 13 multi-class pesticide residues in Polish honeys determined by LC-ESI-MS/MS. *Food Control* 22, 914-919.

Kylin, H., Sjödin, A., 2003. Accumulation of airborne hexachlorocyclohexanes and DDT in pine needles. *Environmental science & technology* 37, 2350-2355.

Lacoste, P., Picque, E., DELATTRE, J.-M., 2004. Rain water contamination study by pesticides in the region Nord-Pas-De-Calais. *European journal of water quality* 35, 129-152.

Lakkis, S., Novel-Lakkis, V., 2000. Distribution of phytobenthos along the coast of Lebanon (Levantine Basin, East Mediterranean). *Mediterranean Marine Science* 1, 143-164.

Lambert, O., Piroux, M., Puyo, S., Thorin, C., Larhantec, M., Delbac, F., Pouliquen, H., 2012a. Bees, honey and pollen as sentinels for lead environmental contamination. *Environmental Pollution* 170, 254-259.

Lambert, O., Veyrand, B., Durand, S., Marchand, P., Le Bizec, B., Piroux, M., Puyo, S., Thorin, C., Delbac, F., Pouliquen, H., 2012b. Polycyclic aromatic hydrocarbons: bees, honey and pollen as sentinels for environmental chemical contaminants. *Chemosphere* 86, 98-104.

Laskowski, R., Hopkin, S.P., 1996. Accumulation of Zn, Cu, Pb and Cd in the garden snail (*Helix aspersa*): implications for predators. *Environmental Pollution* 91, 289-297.

Lavanya, R., Veerappan, N., 2011. Antibacterial potential of six seaweeds collected from gulf of mannar of southeast coast of India. *Advances in Biological Research* 5, 38-44.

Lavin, K.S., Hageman, K.J., 2012. Selective pressurised liquid extraction of halogenated pesticides and polychlorinated biphenyls from pine needles. *Journal of Chromatography A* 1258, 30-36.

Lazarov, B., Swinnen, R., Spruyt, M., Maes, F., Van Campenhout, K., Goelen, E., Covaci, A., Stranger, M., 2015. Air sampling of flame retardants based on the use of mixed-bed sorption tubes—a validation study. *Environmental Science and Pollution Research* 22, 18221-18229.

Lazić, L., Urošević, M.A., Mijić, Z., Vuković, G., Ilić, L., 2016. Traffic contribution to air pollution in urban street canyons: Integrated application of the OSPM, moss biomonitoring and spectral analysis. *Atmospheric Environment* 141, 347-360.

Le Bihanic, F., 2013. Effets des hydrocarbures aromatiques polycycliques sur les stades précoces de poissons modèles: développement de bioessais et étude comparée de mélanges. Université Sciences et Technologies-Bordeaux I.

Le Corfec, Y., 2011. Sites et sols pollués: gestion des passifs environnementaux. Dunod.

Lee, R.F., 2003. Photo-oxidation and photo-toxicity of crude and refined oils. *Spill Science & Technology Bulletin* 8, 157-162.

Leemon, D.M., Jonsson, N.N., 2012. Comparison of bioassay responses to the potential fungal biopesticide *Metarhizium anisopliae* in *Rhipicephalus (Boophilus) microplus* and *Lucilia cuprina*. *Veterinary Parasitology* 185, 236-247.

Lehotay, S.J., 2006. Quick, easy, cheap, effective, rugged, and safe approach for determining pesticide residues. *Pesticide protocols*, 239-261.

Lei, F.-F., Huang, J.-Y., Zhang, X.-N., Liu, X.-J., Li, X.-J., 2011. Determination of polycyclic aromatic hydrocarbons in vegetables by headspace SPME-GC. *Chromatographia* 74, 99-107.

Leng, P., Zhang, Z., Pan, G., Zhao, M., 2011. Applications and development trends in biopesticides. *African Journal of Biotechnology* 10, 19864-19873.

Lequy, E., Sauvage, S., Laffray, X., Gombert-Courvoisier, S., Pascaud, A., Galsomiès, L., Leblond, S., 2016. Assessment of the uncertainty of trace metal and nitrogen concentrations in mosses due to sampling, sample preparation and chemical analysis based on the French contribution to ICP-Vegetation. *Ecological Indicators* 71, 20-31.

Li Destri Nicosia, M.G., Pangallo, S., Raphael, G., Romeo, F.V., Strano, M.C., Rapisarda, P., Droby, S., Schena, L., 2016. Control of postharvest fungal rots on citrus fruit and sweet cherries using a pomegranate peel extract. *Postharvest Biology and Technology* 114, 54-61.

Li, J., Wang, Y.-B., Li, K.-Y., Cao, Y.-Q., Wu, S., Wu, L., 2015. Advances in different configurations of solid-phase microextraction and their applications in food and environmental analysis. *TrAC Trends in Analytical Chemistry* 72, 141-152.

Li, K., Li, H., Liu, L., Hashi, Y., Maeda, T., Lin, J.-M., 2007. Solid-phase extraction with C 30 bonded silica for analysis of polycyclic aromatic hydrocarbons in airborne particulate matters by gas chromatography–mass spectrometry. *Journal of Chromatography A* 1154, 74-80.

Liška, I., Slobodnik, J., 1996. Comparison of gas and liquid chromatography for analysing polar pesticides in water samples. *Journal of Chromatography A* 733, 235-258.

Lo, C.-C., Ho, M.-H., Hung, M.-D., 1996. Use of high-performance liquid chromatographic and atomic absorption methods to distinguish propineb, zineb, maneb, and mancozeb fungicides. *Journal of Agricultural and Food Chemistry* 44, 2720-2723.

Lower, W., Kendall, R., 1990. Sentinel species and sentinel bioassay. IN: *Biomarkers of Environmental Contamination*. Lewis Publishers, Chelsea, Michigan. 1990. p 309-331, 162 ref.

Lu, C., Toepel, K., Irish, R., Fenske, R.A., Barr, D.B., Bravo, R., 2006. Organic diets significantly lower children's dietary exposure to organophosphorus pesticides. *Environmental health perspectives*, 260-263.

Lu, Q., Futter, M.N., Nizzetto, L., Bussi, G., Jürgens, M.D., Whitehead, P.G., 2016. Fate and transport of polychlorinated biphenyls (PCBs) in the River Thames catchment – Insights from a coupled multimedia fate and hydrobiogeochemical transport model. *Science of The Total Environment* 572, 1461-1470.

Luque de Castro, M.D., García-Ayuso, L.E., 1998. Soxhlet extraction of solid materials: an outdated technique with a promising innovative future. *Analytica Chimica Acta* 369, 1-10.

Luque de Castro, M.D., Priego-Capote, F., 2010. Soxhlet extraction: Past and present panacea. *Journal of Chromatography A* 1217, 2383-2389.

Ma, Y., Harrad, S., 2015. Spatiotemporal analysis and human exposure assessment on polycyclic aromatic hydrocarbons in indoor air, settled house dust, and diet: a review. *Environment international* 84, 7-16.

Ma, Y., Hashi, Y., Ji, F., Lin, J.M., 2010. Determination of phthalates in fruit jellies by dispersive SPE coupled with HPLC-MS. *Journal of separation science* 33, 251-257.

Maier-Redelsperger, M., Lévy, P., Lionnet, F., Stankovic, K., Haymann, J.-P., Lefèvre, G., Avellino, V., Perol, J.-P., Girot, R., Elion, J., 2010. Strong association between a new marker of hemolysis and glomerulopathy in sickle cell anemia. *Blood Cells, Molecules, and Diseases* 45, 289-292.

Malhat, F.M., Haggag, M.N., Loutfy, N.M., Osman, M.A., Ahmed, M.T., 2015. Residues of organochlorine and synthetic pyrethroid pesticides in honey, an indicator of ambient environment, a pilot study. *Chemosphere* 120, 457-461.

Malik, A.K., Kaur, V., Verma, N., 2006. A review on solid phase microextraction—High performance liquid chromatography as a novel tool for the analysis of toxic metal ions. *Talanta* 68, 842-849.

Manzetti, S., van der Spoel, E.R., van der Spoel, D., 2014. Chemical properties, environmental fate, and degradation of seven classes of pollutants. *Chemical research in toxicology* 27, 713-737.

Mao, J., Cao, L.-Y., Kong, L.-F., Jongsma, M.A., Wang, C.-Y., 2013. An Agrobacterium-mediated transformation system of pyrethrum (*Tanacetum cinerariifolium*) based on leaf explants. *Scientia Horticulturae* 150, 130-134.

Maphangwa, K.W., Musil, C., Raitt, L., Zedda, L., 2012. Differential interception and evaporation of fog, dew and water vapour and elemental accumulation by lichens explain their relative abundance in a coastal desert. *Journal of Arid Environments* 82, 71-80.

Maragkidou, A., Arar, S., Al-Hunaiti, A., Ma, Y., Harrad, S., Jaghbeir, O., Faouri, D., Hämeri, K., Hussein, T., 2017. Occupational health risk assessment and exposure to floor dust PAHs inside an educational building. *Science of The Total Environment* 579, 1050-1056.

Marć, M., Tobiszewski, M., Zabiegała, B., Guardia, M.d.l., Namieśnik, J., 2015. Current air quality analytics and monitoring: A review. *Analytica Chimica Acta* 853, 116-126.

Martinez, A., Spak, S.N., Petrich, N.T., Hu, D., Carmichael, G.R., Hornbuckle, K.C., 2015. Atmospheric dispersion of PCB from a contaminated Lake Michigan harbor. *Atmospheric Environment* 122, 791-798.

Mathur, V., John, P.J., Soni, I., Bhatnagar, P., 2008. Blood levels of organochlorine pesticide residues and risk of reproductive tract cancer among women from Jaipur, India, *Hormonal Carcinogenesis V*. Springer, pp. 387-394.

Matin, G., Kargar, N., Buyukisik, H.B., 2016. Bio-monitoring of cadmium, lead, arsenic and mercury in industrial districts of Izmir, Turkey by using honey bees, propolis and pine tree leaves. *Ecological Engineering* 90, 331-335.

McKinlay, R., Plant, J.A., Bell, J.N.B., Voulvoulis, N., 2008. Calculating human exposure to endocrine disrupting pesticides via agricultural and non-agricultural exposure routes. *Science of The Total Environment* 398, 1-12.

Megson, D., Reiner, E.J., Jobst, K.J., Dorman, F.L., Robson, M., Focant, J.-F., 2016. A review of the determination of persistent organic pollutants for environmental forensics investigations. *Analytica Chimica Acta*.

Meire, R.O., Lee, S.C., Targino, A.C., Torres, J.P.M., Harner, T., 2012. Air concentrations and transport of persistent organic pollutants (POPs) in mountains of southeast and southern Brazil. *Atmospheric Pollution Research* 3, 417-425.

Melymuk, L., Bohlin-Nizzetto, P., Prokeš, R., Kukučka, P., Klánová, J., 2015. Sampling artifacts in active air sampling of semivolatile organic contaminants: Comparing theoretical and measured artifacts and evaluating implications for monitoring networks. *Environmental Pollution*.

Menegaux, F., Baruchel, A., Bertrand, Y., Lescoeur, B., Leverger, G., Nelken, B., Sommelet, D., Hémon, D., Clavel, J., 2006. Household exposure to pesticides and risk of childhood acute leukaemia. *Occupational and environmental medicine* 63, 131-134.

Menzie, C.A., Potocki, B.B., Santodonato, J., 1992. Exposure to carcinogenic PAHs in the environment. *Environmental science & technology* 26, 1278-1284.

Mihats, D., Moche, W., Prean, M., Rauscher-Gabernig, E., 2015. Dietary exposure to non-dioxin-like PCBs of different population groups in Austria. *Chemosphere* 126, 53-59.

Milun, V., Grgas, D., Dragičević, T.L., 2016. Assessment of PCB and chlorinated pesticide accumulation in mussels at Kaštela Bay (Eastern Adriatic). *Science of The Total Environment* 562, 115-127.

Mleiki, A., Irizar, A., Zaldibar, B., El Menif, N.T., Marigómez, I., 2016. Bioaccumulation and tissue distribution of Pb and Cd and growth effects in the green garden snail, *Cantareus apertus* (Born, 1778), after dietary exposure to the metals alone and in combination. *Science of The Total Environment* 547, 148-156.

Mmualefe, L.C., Torto, N., Huntsman-Mapila, P., Mbongwe, B., 2009. Headspace solid phase microextraction in the determination of pesticides in water samples from the Okavango Delta with gas chromatography-electron capture detection and time-of-flight mass spectrometry. *Microchemical Journal* 91, 239-244.

Mnif, I., Ghribi, D., 2015. Potential of bacterial derived biopesticides in pest management. *Crop Protection* 77, 52-64.

Montenarh, D., Hopf, M., Maurer, H.H., Schmidt, P., Ewald, A.H., 2014. Detection and quantification of benzodiazepines and Z-drugs in human whole blood, plasma, and serum samples as part of a comprehensive multi-analyte LC-MS/MS approach. *Analytical and bioanalytical chemistry* 406, 803-818.

Morales-Munoz, S., Luque-Garcia, J., De Castro, M.L., 2002. Static extraction with modified pressurized liquid and on-line fluorescence monitoring: Independent matrix approach for the removal of polycyclic aromatic hydrocarbons from environmental solid samples. *Journal of Chromatography A* 978, 49-57.

Morville, S., Scheyer, A., Mirabel, P., Millet, M., 2004. Sampling and analysis of polycyclic aromatic hydrocarbons in urban and rural atmospheres: Spatial and geographical variations of concentrations. *Polycyclic Aromatic Compounds* 24, 617-634.

Mumtaz, M., Qadir, A., Mahmood, A., Mehmood, A., Malik, R.N., Li, J., Yousaf, Z., Jamil, N., Shaikh, I.A., Ali, H., Zhang, G., 2015. Human health risk assessment, congener specific analysis and spatial distribution pattern of organochlorine pesticides (OCPs) through rice crop from selected districts of Punjab Province, Pakistan. *Science of The Total Environment* 511, 354-361.

Ni, J., Rowe, J., 2012. Microdosing Assessment to Evaluate Pharmacokinetics and Drug Metabolism Using Liquid Chromatography-Tandem Mass Spectrometry Technology. *Topics on Drug Metabolism*.

Odabasi, M., Dumanoglu, Y., Ozgunerge Falay, E., Tuna, G., Altioik, H., Kara, M., Bayram, A., Tolunay, D., Elbir, T., 2016. Investigation of spatial distributions and sources of persistent organic pollutants (POPs) in a heavily polluted industrial region using tree components. *Chemosphere* 160, 114-125.

Oellig, C., 2016. Acetonitrile extraction and dual-layer solid phase extraction clean-up for pesticide residue analysis in propolis. *Journal of Chromatography A* 1445, 19-26.

Pan, H., Geng, J., Qin, Y., Tou, F., Zhou, J., Liu, M., Yang, Y., 2016. PCBs and OCPs in fish along coastal fisheries in China: Distribution and health risk assessment. *Marine Pollution Bulletin* 111, 483-487.

Paradis, D., Bérail, G., Bonmatin, J.-M., Belzunces, L.P., 2014. Sensitive analytical methods for 22 relevant insecticides of 3 chemical families in honey by GC-MS/MS and LC-MS/MS. *Analytical and bioanalytical chemistry* 406, 621-633.

Pasquariello, M.S., Rega, P., Migliozzi, T., Capuano, L.R., Scortichini, M., Petriccione, M., 2013. Effect of cold storage and shelf life on physiological and quality traits of early ripening pear cultivars. *Scientia Horticulturae* 162, 341-350.

Passatore, L., Rossetti, S., Juwarkar, A.A., Massacci, A., 2014. Phytoremediation and bioremediation of polychlorinated biphenyls (PCBs): State of knowledge and research perspectives. *Journal of Hazardous Materials* 278, 189-202.

Pauget, B., Gimbert, F., Coeurdassier, M., Crini, N., Pérès, G., Faure, O., Douay, F., Richard, A., Grand, C., de Vaufléury, A., 2013. Assessing the in situ bioavailability of trace elements to snails using accumulation kinetics. *Ecological Indicators* 34, 126-135.

Péan, S., 2012. Effets des polluants organiques persistants sur le comportement des poissons. Université de La Rochelle.

Pedersen, J.R., Olsson, J.O., 2003. Soxhlet extraction of acrylamide from potato chips. *Analyst* 128, 332-334.

Pérez-García, A., Romero, D., De Vicente, A., 2011. Plant protection and growth stimulation by microorganisms: biotechnological applications of Bacilli in agriculture. *Current Opinion in Biotechnology* 22, 187-193.

Pertot, I., Caffi, T., Rossi, V., Mugnai, L., Hoffmann, C., Grando, M.S., Gary, C., Lafond, D., Duso, C., Thiery, D., Mazzoni, V., Anfora, G., 2016. A critical review of plant protection tools for reducing pesticide use on grapevine and new perspectives for the implementation of IPM in viticulture. *Crop Protection*.

Perugini, M., Di Serafino, G., Giacomelli, A., Medrzycki, P., Sabatini, A.G., Persano Oddo, L., Marinelli, E., Amorena, M., 2009. Monitoring of polycyclic aromatic hydrocarbons in bees (*Apis mellifera*) and honey in urban areas and wildlife reserves. *Journal of agricultural and food chemistry* 57, 7440-7444.

Pietrzykowski, M., Socha, J., van Doorn, N.S., 2014. Linking heavy metal bioavailability (Cd, Cu, Zn and Pb) in Scots pine needles to soil properties in reclaimed mine areas. *Science of The Total Environment* 470-471, 501-510.

Pirard, C., Eppe, G., Massart, A.-C., Fierens, S., De Pauw, E., Focant, J.-F., 2005. Environmental and human impact of an old-timer incinerator in terms of dioxin and PCB level: a case study. *Environmental science & technology* 39, 4721-4728.

Polanco Rodríguez, Á.G., Riba López, M.I., DelValls Casillas, T.Á., Araujo León, J.A., Mahjoub, O., Prusty, A.K., 2017. Monitoring of organochlorine pesticides in blood of women with uterine cervix cancer. *Environmental Pollution* 220, Part B, 853-862.

Polatoğlu, K., Karakoç, Ö.C., Yücel Yücel, Y., Demirci, B., Gören, N., Başer, K.H.C., 2015. Composition, insecticidal activity and other biological activities of *Tanacetum abrotanifolium* Druce. essential oil. *Industrial Crops and Products* 71, 7-14.

Porta, M., Zumeta, E., 2002. Implementing the Stockholm treaty on persistent organic pollutants. *Occupational and environmental medicine* 59, 651-652.

Proum, S., Santos, J.H., Lim, L.H., Marshall, D.J., 2016. Metal accumulation in the tissues and shells of *Indothais gradata* snails inhabiting soft and hard substrata in an acidified tropical estuary (Brunei, South East Asia). *Regional Studies in Marine Science*.

Pyrzynska, K., Kubiak, A., Wysocka, I., 2016. Application of solid phase extraction procedures for rare earth elements determination in environmental samples. *Talanta* 154, 15-22.

Qu, W., Suri, R.P.S., Bi, X., Sheng, G., Fu, J., 2010. Exposure of young mothers and newborns to organochlorine pesticides (OCPs) in Guangzhou, China. *Science of The Total Environment* 408, 3133-3138.

Raeymaekers, B., 2006. A prospective biomonitoring campaign with honey bees in a district of Upper-Bavaria (Germany). *Environmental monitoring and assessment* 116, 233-243.

Rani, M., Shanker, U., Jassal, V., 2017. Recent strategies for removal and degradation of persistent & toxic organochlorine pesticides using nanoparticles: A review. *Journal of Environmental Management* 190, 208-222.

Rao, P.V., Krishnan, K.T., Salleh, N., Gan, S.H., 2016. Biological and therapeutic effects of honey produced by honey bees and stingless bees: a comparative review. *Revista Brasileira de Farmacognosia* 26, 657-664.

Ratola, N., Alves, A., Santos, L., Lacorte, S., 2011. Pine needles as passive bio-samplers to determine polybrominated diphenyl ethers. *Chemosphere* 85, 247-252.

Ratola, N., Amigo, J.M., Alves, A., 2010. Levels and sources of PAHs in selected sites from Portugal: biomonitoring with *Pinus pinea* and *Pinus pinaster* needles. *Archives of environmental contamination and toxicology* 58, 631-647.

Ratola, N., Homem, V., Silva, J.A., Araújo, R., Amigo, J.M., Santos, L., Alves, A., 2014. Biomonitoring of pesticides by pine needles—chemical scoring, risk of exposure, levels and trends. *Science of the Total Environment* 476, 114-124.

Ravindra, K., Sokhi, R., Van Grieken, R., 2008. Atmospheric polycyclic aromatic hydrocarbons: Source attribution, emission factors and regulation. *Atmospheric Environment* 42, 2895-2921.

Regoli, F., Gorbi, S., Fattorini, D., Tedesco, S., Notti, A., Machella, N., Bocchetti, R., Benedetti, M., Piva, F., 2006. Use of the land snail *Helix aspersa* as sentinel organism for monitoring ecotoxicologic effects of urban pollution: an integrated approach. *Environmental health perspectives*, 63-69.

Reiner, E.J., Jobst, K.J., Megson, D., Dorman, F.L., Focant, J.-F., 2013. *Environmental Forensics Analytical Methodology of POPs, Environmental Forensics for Persistent Organic Pollutants*. Elsevier.

Reque, P.M., Steffens, R.S., Jablonski, A., Flóres, S.H., Rios, A.d.O., de Jong, E.V., 2014. Cold storage of blueberry (*Vaccinium* spp.) fruits and juice: Anthocyanin stability and antioxidant activity. *Journal of Food Composition and Analysis* 33, 111-116.

Rianawati, E., Balasubramanian, R., 2009. Optimization and validation of solid phase micro-extraction (SPME) method for analysis of polycyclic aromatic hydrocarbons in rainwater and stormwater. *Physics and Chemistry of the Earth, Parts A/B/C* 34, 857-865.

Ritter, L., Solomon, K., Forget, J., Stemeroff, M., O'leary, C., 1995. A review of selected persistent organic pollutants. *International Programme on Chemical Safety (IPCS). PCS/95.39*. Geneva: World Health Organization 65, 66.

Romanič, S.H., Krauthacker, B., 2007. Are pine needles bioindicators of air pollution? Comparison of organochlorine compound levels in pine needles and ambient air. *Archives of Industrial Hygiene and Toxicology* 58, 195-199.

Romanič, S.H., Krauthacker, B., 2006. Distribution of persistent organochlorine compounds in one-year and two-year-old pine needles. *Bulletin of environmental contamination and toxicology* 77, 143-148.

Rugman, F., Cosstick, R., 1990. Aplastic anaemia associated with organochlorine pesticide: case reports and review of evidence. *Journal of clinical pathology* 43, 98-101.

Ruhling, A., Tyler, G., 1968. An ecological approach to lead problem. *Botaniska Notiser* 121, 21-&.

Rühling, Ä., Tyler, G., 1970. Sorption and retention of heavy metals in the woodland moss *Hylocomium splendens* (Hedw.) Br. et Sch. *Oikos*, 92-97.

Santos, F., Galceran, M., 2002. The application of gas chromatography to environmental analysis. *TrAC Trends in Analytical Chemistry* 21, 672-685.

Sanusi, A., Millet, M., Mirabel, P., Wortham, H., 2000. Comparison of atmospheric pesticide concentrations measured at three sampling sites: local, regional and long-range transport. *Science of The Total Environment* 263, 263-277.

Sapozhnikova, Y., Lehotay, S.J., 2013. Multi-class, multi-residue analysis of pesticides, polychlorinated biphenyls, polycyclic aromatic hydrocarbons, polybrominated diphenyl ethers and novel flame retardants in fish using fast, low-pressure gas chromatography–tandem mass spectrometry. *Analytica chimica acta* 758, 80-92.

Sarwar, M., 2015. The dangers of pesticides associated with public health and preventing of the risks. *International Journal of Bioinformatics and Biomedical Engineering* 1, 130-136.

Schummer, C., Mothiron, E., Appenzeller, B.M.R., Rizet, A.-L., Wennig, R., Millet, M., 2010. Temporal variations of concentrations of currently used pesticides in the atmosphere of Strasbourg, France. *Environmental Pollution* 158, 576-584.

Schünemann, R., Knaak, N., Fiuza, L.M., 2014. Mode of action and specificity of *Bacillus thuringiensis* toxins in the control of caterpillars and stink bugs in soybean culture. *ISRN microbiology* 2014.

Shahid, M., Dumat, C., Khalid, S., Schreck, E., Xiong, T., Niazi, N.K., 2017. Foliar heavy metal uptake, toxicity and detoxification in plants: A comparison of foliar and root metal uptake. *Journal of Hazardous Materials* 325, 36-58.

Shamsipur, M., Yazdanfar, N., Ghambarian, M., 2016. Combination of solid-phase extraction with dispersive liquid-liquid microextraction followed by GC-MS for determination of pesticide residues from water, milk, honey and fruit juice. *Food chemistry* 204, 289-297.

Shendy, A.H., Al-Ghobashy, M.A., Mohammed, M.N., Gad Alla, S.A., Lotfy, H.M., 2016. Simultaneous determination of 200 pesticide residues in honey using gas chromatography-tandem mass spectrometry in conjunction with streamlined quantification approach. *Journal of Chromatography A* 1427, 142-160.

Sinkkonen, S., Paasivirta, J., 2000. Degradation half-life times of PCDDs, PCDFs and PCBs for environmental fate modeling. *Chemosphere* 40, 943-949.

Souza Tette, P.A., Rocha Guidi, L., de Abreu Glória, M.B., Fernandes, C., 2016. Pesticides in honey: A review on chromatographic analytical methods. *Talanta* 149, 124-141.

Souza-Silva, É.A., Jiang, R., Rodríguez-Lafuente, A., Gionfriddo, E., Pawliszyn, J., 2015. A critical review of the state of the art of solid-phase microextraction of complex matrices I. *Environmental analysis. TrAC Trends in Analytical Chemistry* 71, 224-235.

Soxhlet, F.v., 1879. Die gewichtsanalytische bestimmung des milchfettes. *Polytechnisches J* 232, 461-465.

Spagnuolo, V., Figlioli, F., De Nicola, F., Capozzi, F., Giordano, S., 2017. Tracking the route of phenanthrene uptake in mosses: An experimental trial. *Science of The Total Environment* 575, 1066-1073.

Srivastava, M.K., Raizada, R.B., 2007. Lack of toxic effect of technical azadirachtin during postnatal development of rats. *Food and Chemical Toxicology* 45, 465-471.

St-Amand, A.D., Mayer, P.M., Blais, J.M., 2009. Modeling PAH uptake by vegetation from the air using field measurements. *Atmospheric Environment* 43, 4283-4288.

Staniforth, M., Stavros, V.G., 2013. Recent advances in experimental techniques to probe fast excited-state dynamics in biological molecules in the gas phase: dynamics in nucleotides, amino acids and beyond, *Proc. R. Soc. A. The Royal Society*, p. 20130458.

Subedi, B., 2012. High-throughput analysis of emerging and historical pollutants in biological matrices.

Suckling, D.M., 2000. Issues affecting the use of pheromones and other semiochemicals in orchards. *Crop Protection* 19, 677-683.

Sun, H., Ge, X., Lv, Y., Wang, A., 2012. Application of accelerated solvent extraction in the analysis of organic contaminants, bioactive and nutritional compounds in food and feed. *Journal of Chromatography A* 1237, 1-23.

Szewczyk, B., Hoyos-Carvajal, L., Paluszek, M., Skrzecz, I., Lobo de Souza, M., 2006. Baculoviruses — re-emerging biopesticides. *Biotechnology Advances* 24, 143-160.

Tette, P.A.S., da Silva Oliveira, F.A., Pereira, E.N.C., Silva, G., de Abreu Glória, M.B., Fernandes, C., 2016. Multiclass method for pesticides quantification in honey by means of modified QuEChERS and UHPLC-MS/MS. *Food Chemistry* 211, 130-139.

Thakore, Y., 2006. The biopesticide market for global agricultural use. *Industrial Biotechnology* 2, 194-208.

Tlili, S., 2012. Approche multi-marqueurs pour l'évaluation de l'état de santé du golfe de Tunis: étude des réponses biochimiques, physiologiques et cytologiques des mollusques bivalves exposés aux effluents des oueds. *Institut supérieur de biotechnologie de Monastir (Tunisie)*.

Tuduri, L., Millet, M., Briand, O., Montury, M., 2012. Passive air sampling of semi-volatile organic compounds. *TrAC Trends in Analytical Chemistry* 31, 38-49.

TürkER, A.R., Sezer, B., 2005. Indirect determination of dithiocarbamate fungicides (zineb and ferbam) in some foodstuffs by flame atomic absorption spectrometry. *Turkish J. Pharm. Sci* 2, 35-42.

Valcke, M., Samuel, O., Bouchard, M., Dumas, P., Belleville, D., Tremblay, C., 2006. Biological monitoring of exposure to organophosphate pesticides in children living in peri-urban areas of the Province of Quebec, Canada. *International archives of occupational and environmental health* 79, 568-577.

Vallero, D., 2014. *Controlling Air Pollution from Sources, Fundamentals of Air Pollution (Fifth Edition)*. Academic Press, Boston, pp. 881-925.

VAN DORSSELAER, A., 2006. Nouvelles méthodologies dans l'analyse protéomique par spectrométrie de masse. Application à la recherche de biomarqueurs dans le cadre des leucémies.

Van Driesche, R., Hoddle, M., 2009. *Control of pests and weeds by natural enemies: an introduction to biological control*. John Wiley & Sons.

van Zelm, R., Larrey-Lassalle, P., Roux, P., 2014. Bridging the gap between life cycle inventory and impact assessment for toxicological assessments of pesticides used in crop production. *Chemosphere* 100, 175-181.

Varga, M., Dobor, J., Helenkár, A., Jurecska, L., Yao, J., Zárny, G., 2010. Investigation of acidic pharmaceuticals in river water and sediment by microwave-assisted extraction and gas chromatography-mass spectrometry. *Microchemical Journal* 95, 353-358.

Vassilev, S.V., Vassileva, C.G., 2016. Composition, properties and challenges of algae biomass for biofuel application: An overview. *Fuel* 181, 1-33.

Vázquez, P.P., Lozano, A., Uclés, S., Ramos, M.M.G., Fernández-Alba, A.R., 2015. A sensitive and efficient method for routine pesticide multiresidue analysis in bee pollen samples using gas and liquid chromatography coupled to tandem mass spectrometry. *Journal of Chromatography A* 1426, 161-173.

Vilanova, L., Teixidó, N., Torres, R., Usall, J., Viñas, I., Sánchez-Torres, P., 2016. Relevance of the transcription factor PdSte12 in *Penicillium digitatum* conidiation and virulence during citrus fruit infection. *International Journal of Food Microbiology* 235, 93-102.

Vincent, A., 2002. Conception et simulation d'un réacteur fil-cylindre à décharge couronne avec barrière diélectrique adapté au traitement des oxydes d'azote dans des effluents marqués par un isotope. Paris 6.

Wang, B., Zhao, Y., Lan, Z., Yao, Y., Wang, L., Sun, H., 2016a. Sampling methods of emerging organic contaminants in indoor air. *Trends in Environmental Analytical Chemistry* 12, 13-22.

Wang, C., Wu, S., Zhou, S., Shi, Y., Song, J., 2017. Characteristics and Source Identification of Polycyclic Aromatic Hydrocarbons (PAHs) in Urban Soils: A Review. *Pedosphere* 27, 17-26.

Wang, H.-S., Chen, Z.-J., Wei, W., Man, Y.-B., Giesy, J.P., Du, J., Zhang, G., Wong, C.K.-C., Wong, M.-H., 2013a. Concentrations of organochlorine pesticides (OCPs) in human blood plasma from Hong Kong: Markers of exposure and sources from fish. *Environment International* 54, 18-25.

Wang, J., Cheung, W., Grant, D., 2005. Determination of pesticides in apple-based infant foods using liquid chromatography electrospray ionization tandem mass spectrometry. *Journal of agricultural and food chemistry* 53, 528-537.

Wang, J., Tuduri, L., Mercury, M., Millet, M., Briand, O., Montury, M., 2009. Sampling atmospheric pesticides with SPME: Laboratory developments and field study. *Environmental Pollution* 157, 365-370.

Wang, L., Wang, X., Zhou, J.-B., Zhao, R.-S., 2016b. Carbon nanotube sponges as a solid-phase extraction adsorbent for the enrichment and determination of polychlorinated biphenyls at trace levels in environmental water samples. *Talanta* 160, 79-85.

Wang, Y., Tian, Z., Zhu, H., Cheng, Z., Kang, M., Luo, C., Li, J., Zhang, G., 2012. Polycyclic aromatic hydrocarbons (PAHs) in soils and vegetation near an e-waste recycling site in South China: concentration, distribution, source, and risk assessment. *Science of the Total Environment* 439, 187-193.

Wang, Z., Ren, P., Sun, Y., Ma, X., Liu, X., Na, G., Yao, Z., 2013b. Gas/particle partitioning of polycyclic aromatic hydrocarbons in coastal atmosphere of the north Yellow Sea, China. *Environmental Science and Pollution Research* 20, 5753-5763.

Wania, F., Shen, L., Lei, Y.D., Teixeira, C., Muir, D.C., 2003. Development and calibration of a resin-based passive sampling system for monitoring persistent organic pollutants in the atmosphere. *Environmental science & technology* 37, 1352-1359.

Wennrich, L., Popp, P., Köller, G., Breuste, J., 2001. Determination of organochlorine pesticides and chlorobenzenes in strawberries by using accelerated solvent extraction combined with sorptive enrichment and gas chromatography/mass spectrometry. *Journal of AOAC International* 84, 1194-1201.

Wiest, L., Buleté, A., Giroud, B., Fratta, C., Amic, S., Lambert, O., Pouliquen, H., Arnaudguilhem, C., 2011. Multi-residue analysis of 80 environmental contaminants in honeys, honeybees and pollens by one extraction procedure followed by liquid and gas chromatography coupled with mass spectrometric detection. *Journal of Chromatography A* 1218, 5743-5756.

Wilkowska, A., Biziuk, M., 2011. Determination of pesticide residues in food matrices using the QuEChERS methodology. *Food Chemistry* 125, 803-812.

Wöhrnschimmel, H., Scheringer, M., Bogdal, C., Hung, H., Salamova, A., Venier, M., Katsoyiannis, A., Hites, R.A., Hungerbühler, K., Fiedler, H., 2016. Ten years after entry into force of the Stockholm Convention: What do air monitoring data tell about its effectiveness? *Environmental Pollution* 217, 149-158.

Wolterbeek, B., 2002. Biomonitoring of trace element air pollution: principles, possibilities and perspectives. *Environmental Pollution* 120, 11-21.

Wolterbeek, H.T., Bode, P., 1995. State of the Art of Trace Element Determinations in Plant Matrices Strategies in sampling and sample handling in the context of large-scale plant biomonitoring surveys of trace element air pollution. *Science of The Total Environment* 176, 33-43.

Wu, Q., Wang, X., Zhou, Q., 2014. Biomonitoring persistent organic pollutants in the atmosphere with mosses: Performance and application. *Environment International* 66, 28-37.

Xie, L., Liu, S., Han, Z., Jiang, R., Liu, H., Zhu, F., Zeng, F., Su, C., Ouyang, G., 2015. Preparation and characterization of metal-organic framework MIL-101 (Cr)-coated solid-phase microextraction fiber. *Analytica chimica acta* 853, 303-310.

Xu, D., Zhong, W., Deng, L., Chai, Z., Mao, X., 2004. Regional distribution of organochlorinated pesticides in pine needles and its indication for socioeconomic development. *Chemosphere* 54, 743-752.

Yang, Z., Chen, B., Li, L., Zheng, B., Liu, L., 2010. International Conference on Ecological Informatics and Ecosystem Conservation (ISEIS 2010) Biomonitoring and Bioindicators Used for River Ecosystems: Definitions, Approaches and Trends. *Procedia Environmental Sciences* 2, 1510-1524.

Yeo, H.-G., Choi, M., Chun, M.-Y., Sunwoo, Y., 2003. Concentration distribution of polychlorinated biphenyls and organochlorine pesticides and their relationship with temperature in rural air of Korea. *Atmospheric Environment* 37, 3831-3839.

Yinon, J., 2007. Chapter 2 - Detection of Explosives by Mass Spectrometry, Counterterrorist Detection Techniques of Explosives. Elsevier Science B.V., Amsterdam, pp. 41-59.

Yu, Y., Li, Y., Shen, Z., Yang, Z., Mo, L., Kong, Y., Lou, I., 2014. Occurrence and possible sources of organochlorine pesticides (OCPs) and polychlorinated biphenyls (PCBs) along the Chao River, China. *Chemosphere* 114, 136-143.

Zawisza-Raszka, A., Dolezych, B., Dolezych, S., Migula, P., Ligaszewski, M., 2010. Effects of nickel exposure and acute pesticide intoxication on acetylcholinesterase, catalase and glutathione S-transferase activity and glucose absorption in the digestive tract of *Helix aspersa* (Pulmonata, Helicidae). *International Journal of Environment and Pollution* 40, 380-390.

Zhang, Q.-H., Zhou, L.-D., Chen, H., Wang, C.-Z., Xia, Z.-N., Yuan, C.-S., 2016. Solid-phase microextraction technology for in vitro and in vivo metabolite analysis. *TrAC Trends in Analytical Chemistry* 80, 57-65.

Zhao, L., Feng, C., Wu, K., Chen, W., Chen, Y., Hao, X., Wu, Y., 2017. Advances and prospects in biogenic substances against plant virus: A review. *Pesticide Biochemistry and Physiology* 135, 15-26.

Zhao, R.-S., Wang, X., Yuan, J.-P., Lin, J.-M., 2008. Investigation of feasibility of bamboo charcoal as solid-phase extraction adsorbent for the enrichment and determination of four phthalate esters in environmental water samples. *Journal of Chromatography A* 1183, 15-20.

Zhao, Y., Gong, X., Si, X., Wei, Z., Yang, C., Zhang, S., Zhang, X., 2015. Coupling a solid phase microextraction (SPME) probe with ambient MS for rapid enrichment and detection of phosphopeptides in biological samples. *Analyst* 140, 2599-2602.

Zhou, R., Zhu, L., Chen, Y., Kong, Q., 2008. Concentrations and characteristics of organochlorine pesticides in aquatic biota from Qiantang River in China. *Environmental Pollution* 151, 190-199.

Zhou, S., Yang, H., Zhang, A., Li, Y.-F., Liu, W., 2014. Distribution of organochlorine pesticides in sediments from Yangtze River Estuary and the adjacent East China Sea: implication of transport, sources and trends. *Chemosphere* 114, 26-34.

Zhu, N., Schramm, K.-W., Wang, T., Henkelmann, B., Fu, J., Gao, Y., Wang, Y., Jiang, G., 2015. Lichen, moss and soil in resolving the occurrence of semi-volatile organic compounds on the southeastern Tibetan Plateau, China. *Science of The Total Environment* 518-519, 328-336.

Zhu, X., Pfister, G., Henkelmann, B., Kotalik, J., Bernhöft, S., Fiedler, S., Schramm, K.-W., 2008. Simultaneous monitoring of profiles of polycyclic aromatic hydrocarbons in contaminated air with semipermeable membrane devices and spruce needles. *Environmental Pollution* 156, 461-466.

Zuloaga, O., Navarro, P., Bizkarguenaga, E., Iparraguirre, A., Vallejo, A., Olivares, M., Prieto, A., 2012. Overview of extraction, clean-up and detection techniques for the determination of organic pollutants in sewage sludge: a review. *Analytica chimica acta* 736, 7-29.

Site Web:

EPA. 2010. <https://www.epa.gov/pesticides>.

L.S.A: Laboratoire Suisse d'Analyse du. 2008. 'Spectrométrie de masse'. http://www.doping.chuv.ch/lad_home/lad-prestations-laboratoire/lad-prestations-laboratoire-appareils/lad-prestations-laboratoire-appareils-ms.htm.

MonAirNet. 2007. 'Strengthening the Austrian-Czech Republic Cross-Border Cooperation: Impact Assessment of Persistent Organic Pollutants (POPs) in the atmosphere'. <http://www.monairnet.eu/index-en.php?pg=methods--directional-active-sampling>.

N.P.S. 2015. 'Sources of air pollution'. <http://www.gov.scot/Publications/2015/11/5671/6>.

N.P.S. 2017. 'Sources of Air Pollution'. <https://www.nature.nps.gov>.

POPRC.12. 2016. 'Twelfth meeting of the Persistent Organic Pollutants Review Committee'. <http://chm.pops.int/default.aspx>.

T.E.V. d'Anjou : Terre et Vie d'Anjou, Terre et Vie. 2012. <http://terrevedanjou.canalblog.com>.

University of Bristol, school of Chemistry. 2014. 'Electron ionisation'. <http://www.chm.bris.ac.uk/ms/ei-ionisation.xhtml>.