



**HAL**  
open science

# The role of postural adjustments in motor coordination

Charlotte Le Mouel

► **To cite this version:**

Charlotte Le Mouel. The role of postural adjustments in motor coordination. *Neurons and Cognition* [q-bio.NC]. Sorbonne Université, 2018. English. NNT : 2018SORUS474 . tel-02924990

**HAL Id: tel-02924990**

**<https://theses.hal.science/tel-02924990v1>**

Submitted on 28 Aug 2020

**HAL** is a multi-disciplinary open access archive for the deposit and dissemination of scientific research documents, whether they are published or not. The documents may come from teaching and research institutions in France or abroad, or from public or private research centers.

L'archive ouverte pluridisciplinaire **HAL**, est destinée au dépôt et à la diffusion de documents scientifiques de niveau recherche, publiés ou non, émanant des établissements d'enseignement et de recherche français ou étrangers, des laboratoires publics ou privés.

Doctoral Thesis

# The role of postural adjustments in motor coordination



prepared by

**Charlotte Le Mouel**

at Institut de la Vision

Sorbonne Université

under the supervision of Romain Brette



Doctoral thesis  
The role of postural adjustments  
In motor coordination

Prepared by  
Charlotte LE MOUËL

At Institut de la Vision  
Sorbonne Université  
Under the supervision of Romain BRETTE

Jury:

<i>Referees:</i>	Pr. Friedl DE GROOTE	KU Leuven
	Pr. Monica DALEY	Royal Veterinary College
<i>Supervisor:</i>	Dr. Romain BRETTE	Sorbonne Université
<i>Internal:</i>	Pr. Viviane PASQUI	Sorbonne Université
<i>External:</i>	Pr. Bénédicte SCHEPENS	Université Catholique de Louvain
	Pr. Nicolas VAYATIS	Ecole Normale Supérieure Paris-Saclay

*Many thanks to Corentin Morice and Aicha Ben Dhia for accompanying me on this joyous adventure!*

## Acknowledgements

I would like to heartily thank my supervisor Romain Brette, for his unwavering support during the long and winding, sometimes even tortuous path that brought me to develop this project. I would like to thank him for the complete freedom he gave me to discover my own path, and develop my own ideas. This freedom, he did not simply allow it, as one would out of indifference, he properly gave it to me by providing me with the necessary support and advice for this difficult journey. I would like to thank him for his enthusiasm for each of the seedling projects that I attempted to sow, and the care he brought in helping them grow. I would like to thank him for the fascinating discussions that we have, which deepen my understanding of science and neuroscience.

I would also like to thank him for training me for the practicalities of the research career: for improving my oral and written presentation skills through precise and constructive criticism, for helping me understand and handle administrative issues, for guiding me through the grant application process.

I would like to thank everyone from the team for their joyful company and comradeship, as well as for their interest in my project. I would especially like to thank Sarah Goethals, Baptiste Lefebvre, Pierre Yger, Marcel Stimberg and Olivier Marre.

I would like to thank my collaborators Romain Tisserand, Thomas Robert, and Pascal Vallée, for the interest which they demonstrated for my project, for the fruitful discussions, for their openness and for their willingness to share their experimental data. This allowed me to confront the simple ideas and models which I had developed with the richness of experimental data. I especially thank Romain Tisserand for his responsiveness and patience for my numerous questions.

I would like to thank Pierre-Paul Vidal for his lively interest and support for my research career, especially for the time he took to carefully guide me through the development of my future research plans. I would also like to thank Pierre-Paul Vidal and Danping Wang for their willingness to share their experimental data with me, and I would especially like to thank Danping Wang for guiding me through the analysis of this data.

I would like to thank the members of my thesis committees Pierre-Yves Oudeyer, Jean-Pierre Nadal, Giuseppe Rabita and Emmanuel Guigon, for the enriching scientific discussions as well as the concrete advice which they provided during these reunions.

I would like to express my heartfelt gratitude for my former supervisors Alexandre Pouget, Kenneth Harris, Pierre Yger and Brandon Stell. Brandon Stell opened up the delightful world of neuroscience for me as I was finishing my undergraduate studies in mathematics and physics, and I am very grateful for the infinite patience and enthusiasm with which he greeted my curiosity. I then had the extremely enriching experience of working with Kenneth Harris, Pierre Yger and Alexandre Pouget. They were each very deft in combining a very close mentorship, through which I developed many skills on which I rely for the realisation of my projects, with an openness and trust which allowed me to develop my inquisitiveness.

I am very thankful to my supervisors for sharing with me their delight and passion for scientific practice.



## Summary

Theories of motor control in neuroscience usually focus on the role of the nervous system in the coordination of movement. However, the literature in sports science as well as in embodied robotics suggests that improvements in motor performance can be achieved through an improvement of the body mechanical properties themselves, rather than only the control. I therefore developed the thesis that efficient motor coordination in animals and humans relies on the adjustment of the body mechanical properties to the task at hand, by the postural system.

I first considered tasks which require immobility, such as standing still and precise and accurate tool manipulation. I developed a *generic model of stabilization despite delays in neural intervention*, which can account for a variety of experimental findings. According to this model, body mechanical properties such as stiffness and inertia play a critical role for maintaining immobility despite external perturbations, since they determine the relative speed at which perturbations will be amplified during the response delay. Accordingly, when immobility or accuracy become critical, the nervous system should adjust the body mechanical properties so as to reduce this relative speed, and should additionally reduce neural feedback gains. I presented experimental evidence that people employ this strategy when they stand in challenging balance conditions, and when they manipulate unstable tools. In contrast, during normal standing or reaching, immobility does not seem to be a critical function of the postural system.

I then considered the task of initiating movement. The main purpose of postural control is considered to be to counteract the destabilizing force of gravity. However, from the consideration of the mechanical requirements for movement, I arrived at a different interpretation of the experimental findings on stance and movement initiation. This novel interpretation brought me to develop the *mobility theory*, which states that during skilled movement the postural system adjusts the position of the CoM in view of providing torque for the movement. I first reviewed experimental evidence that people shift the position of their CoM during stance if they are instructed to do so, and in preparation both for initiating movement and for resisting an external perturbation. I then reviewed experimental evidence that at the initiation of a well-practiced movement, people accelerate their CoM in the direction of the movement. I argued that the propulsive torques for movement initiation are limited by the position of the CoM relative to the feet, therefore accelerating the CoM in the direction of the movement increases torque for movement. I suggested that balance, the ability not to fall, is not equivalent to the ability to remain immobile during stance. Instead, it may rely on this postural ability to adjust the CoM position to the task at hand.

I then tested to what extent this ability to adjust the CoM position to the task at hand was affected by aging, and whether this indeed affects fall risk. I therefore performed an *experimental analysis of the postural adjustments of elderly fallers and non-fallers*, compared to young subjects, in a task requiring immobility and a task requiring mobility. The experimental data was obtained through a collaboration with Romain Tisserand and Thomas Robert. In the task requiring immobility, the subjects had to resist a forwards traction exerted at the waist. I showed that in this task both elderly fallers and elderly non-fallers, but not young subjects, shift the initial position of their CoM backwards, and that this strategy allows elderly fallers to counteract the perturbations as effectively as the elderly non-fallers and the young subjects. Thus, the ability to adjust the CoM position to the task at hand, with advance warning and with sufficient preparation time, does not seem to be affected in elderly fallers. In the task requiring mobility, subjects are asked to step as fast possible with a step leg that is not known in advance. In contrast to the immobility task, in the mobility task elderly fallers perform less well than elderly non-fallers, since they take more time to perform the step. This suggests that the ability which is affected in elderly fallers is the ability to rapidly adjust the CoM position.

Thus, motor coordination relies on the rapid adjustment of the body mechanical properties to changing task requirements.





## Table of contents

1.	Introduction .....	12
I.	Abstract.....	12
II.	Optimal patterns of motor coordination .....	12
1.	Feedback and feedforward control .....	13
2.	Internal inverse models for feedforward control .....	14
3.	Motor redundancy and the uncontrolled manifold .....	16
4.	Stochastic optimal feedback control for redundant tasks.....	18
5.	Adaptive control .....	21
6.	Centralised knowledge .....	24
III.	Where is the knowledge for motor control .....	25
1.	Basic neuro-anatomy of motor control .....	25
2.	Spinal organisation of movement.....	27
3.	Learning and adaptation in spinal synergies .....	30
IV.	Improvements in performance through the adjustment of body dynamics .....	33
1.	How the way we move shapes our body.....	34
2.	How much knowledge is necessary for motor control? .....	37
3.	Adjustment of body mechanical properties for stability .....	39
V.	Motivation and plan of the thesis .....	41
1.	Motivation .....	41
2.	Plan of the thesis .....	42
2.	Postural adjustments for improving stability .....	44
I.	Introduction .....	44
1.	Muscular contraction response to a perturbation .....	44
2.	Body mechanical properties .....	46
3.	Interactions between body mechanical properties and sensorimotor feedback.....	49
II.	Modelling results .....	50
1.	Single inverted pendulum model of stance .....	50
2.	Delayed feedback control of a single dimensional system.....	51
3.	Generalisation to N dimensions .....	55
III.	Discussion .....	59
1.	Adjusting posture to decrease relative speed .....	59
2.	Adjusting feedback gains to changed dynamics .....	59
3.	Is immobility critical? .....	60

IV.	Supplementary methods: Stability analysis .....	61
1.	Propagation of exponential signals and derivation of the characteristic equation.....	62
2.	Nyquist criterion .....	63
3.	Application to our system.....	66
4.	Simulations .....	70
V.	Supplementary methods: Critical damping .....	71
1.	Pade approximation .....	71
2.	Generalisation of criticality.....	73
VI.	Supplementary methods: generalisation to N dimensions.....	74
3.	Mobility as the purpose of postural control .....	78
I.	Abstract.....	78
II.	Introduction .....	78
III.	Adjustment of posture during stance .....	79
1.	The standing posture allows for mobility .....	79
2.	The standing posture is actively maintained .....	81
3.	The standing posture is adjusted in anticipation of movement .....	82
4.	Summary.....	84
IV.	Adjustment of posture during voluntary movement .....	84
1.	Initiation of voluntary movement .....	84
2.	The ability to use one's weight for movement requires practice .....	87
V.	Balance requires mobility rather than immobility .....	87
1.	Responding to external perturbations .....	88
2.	Emergence over development and impairment with aging .....	88
VI.	Discussion .....	89
1.	Posture is adjusted in view of mobility rather than immobility .....	90
2.	Mobility emerges through development and skill learning.....	90
VII.	Supplementary methods .....	90
1.	Limits to ankle torque.....	90
2.	Horizontal acceleration of the CoM.....	91
4.	Postural adjustments for mobility and immobility in aging .....	96
I.	Introduction .....	96
1.	Mobility in aging .....	96
2.	Falls in aging and risk factors for falling.....	96
3.	Clinical assessments of balance and mobility and prediction of fall risk .....	97
4.	Laboratory based assessments of balance and mobility and prediction of fall risk .....	98
5.	Postural adjustments.....	99

II.	Methods.....	100
1.	Protocol .....	100
2.	Analysis.....	102
III.	Results.....	104
1.	Previously published results .....	104
2.	Performance in the two tasks.....	104
3.	Initial posture.....	106
4.	Change in initial posture across tasks.....	106
5.	Ankle stiffness.....	109
IV.	Discussion .....	110
1.	Adjustment of the initial position of the CoM.....	110
2.	Adjustment of ankle stiffness.....	110
3.	How to measure the adjustment of ankle stiffness.....	111
V.	Supplementary methods.....	113
1.	Success in the perturbation task .....	113
2.	Position of the centre of mass .....	114
5.	Discussion.....	122
I.	Summary .....	122
II.	Postural versatility .....	123
1.	Adjustment of posture to the task .....	123
2.	Postural allostasis .....	124
3.	Fall risk in the elderly.....	124
III.	Motor coordination .....	125
1.	Redundancy in motor tasks .....	125
2.	Change in coordination during learning .....	125
3.	Postural modulation after learning .....	126
6.	Appendix: Models of human stance .....	130
I.	Ankle torque and body rotational momentum.....	130
1.	Torques of the external forces .....	130
2.	Lower leg muscle contraction changes the ground reaction torque.....	131
II.	Double inverted pendulum model.....	131
1.	Rotational momentum .....	132
2.	Acceleration of the centre of mass.....	133
7.	References.....	136



# 1. Introduction

## I. Abstract

Animals and humans move in coordinated and graceful ways which inspire the awe of neuroscientists (Bernstein, 1996) and the admiration of roboticists (Cully et al., 2015). To understand motor coordination, two very different approaches have historically been developed.

One approach has been to characterize the adequacy of complex movement patterns to the task and environment. The studies are mostly performed in humans (occasionally monkeys), who are asked to reach with the arm to various targets in space. In this way, the accuracy of the movement can easily be assessed by measuring the spatial distance between the hand and the target. These studies have shown that both the anticipatory control of movement and the response to external perturbations (such as a push to the arm in mid-reach) can adjust to a surprising extent to the instruction given to the subject (Hammond, 1956), to the mechanical properties of the object they are holding (Shadmehr and Mussa-Ivaldi, 1994), and even to wearing prism glasses which displace their entire visual field laterally. From the observation that complex movements are adequate to the task at hand, theories of motor control have been developed following a normative approach: researchers have attempted to mathematically characterize the best possible movement pattern, with a strong inspiration from engineering approaches to control (Todorov and Jordan, 2002). The great difficulty has then been to explain how the nervous system may find and follow such “optimal” movement patterns.

The alternative approach has been to focus on how the nervous system composes movement. The neuro-anatomy of motor control thus suggests that complex movements may be obtained by combining (for example summing) elementary movement patterns, called synergies (Bizzi and Cheung, 2013). In the search for such elementary movement patterns, researchers have attempted to break down animal movement into elementary parts. Historically, this has first been achieved by breaking down the animals themselves, to simplify their motor patterns. Thus, much research has been done on spinalized animals, in which connections between the spinal cord and the brain have been interrupted. The spinal cord has thus been shown to be able to produce a surprising variety of adequate movement patterns (Bizzi et al., 1991; Kargo and Giszter, 2000). This spinal organization of movement has been suggested to simplify motor control, by providing a set of basic synergies which the nervous system can combine in novel ways to produce novel movement patterns during learning (Tresch and Jarc, 2009). However, studies of learning show that spinal synergies do not form a fixed basis set, but are themselves adjusted during the course of learning (Wolpaw, 2010).

An extensive literature in sports science shows that even the body itself adjusts over the course of motor learning (Duchateau and Baudry, 2010). Thus learning may not only consist in the brain finding better ways of combining fixed spinal synergies, nor even in the nervous system finding better ways of controlling a fixed body. Instead, improvements in performance may be obtained by adjusting the body mechanics and spinal feedback control to the task at hand. This alternative has been emphasized by the recent embodied robotics approach (Pfeifer and Bongard, 2006), and has sparked renewed interest in the importance of the interaction between neural and biomechanical dynamics in animal and human movement (Nishikawa et al., 2007). My thesis explores how the nervous system may adjust body mechanical properties to the task at hand on a fast timescale through the adjustment of posture.

## II. Optimal patterns of motor coordination

A standard assumption in the neuroscience of motor control is that improvements in performance are due to improvements in the neural control of the movement (Bizzi and Cheung, 2013; Haith and Krakauer, 2013; Loeb, 2012; Wolpert et al., 2011).

In the computational approach to motor control, these improvements in the neural control are attributed to the nervous system acquiring more accurate knowledge about the mechanical properties of the body and its environment, and using this knowledge to compute motor commands (Haith and Krakauer, 2013; Wolpert et al., 2011). How much must an animal know about the mechanical properties of its body and its environment in order to move accurately and efficiently? The way in which movement is controlled in the machines and robots that we have crafted has provided useful inspiration for addressing this question.

### 1. Feedback and feedforward control

Historically, the development of engineering since the industrial revolution has relied extensively on feedback control (Åström and Kumar, 2014). The basic goal in feedback control is to bring a process to a desired state and keep it there. This is achieved by observing the system's state, and correcting for any deviations from the desired state. The textbook example for this is the thermostat: the goal is to bring the temperature of a room to a desired temperature, and this is achieved by heating the room if the room's temperature is too low, and cooling it if the temperature is too high. This exemplifies one characteristic of feedback control, which is that it only intervenes if a deviation occurs: it cannot prevent the deviation from occurring.

Since then, the idea of feedback control has been widely used for understanding biological systems (Åström and Murray, 2010). One example is the way in which vertebrates maintain the visual scene stable with respect to the eyes: the visual system senses any movement of the visual scene with respect to the eyes (called retinal slip), and elicits an eye movement in the direction of the visual movement, which stabilises the visual scene with respect to the eyes (Land, 2015). This is called the opto-kinetic reflex. Since the system is based on sensing retinal slip, it cannot prevent the retinal slip from occurring, but can only correct for it afterwards.

Motion of the visual scene occurs reliably after any movement of the head. Therefore, if head movements triggered compensatory eye movements, then the visual scene could be stabilised during head movements without any retinal slip. This strategy is widely used across vertebrates, and relies on the vestibular system, which senses movements of the head in space (Land, 2015). This elicits a counteracting movement of the eyes called the vestibulo-ocular reflex (VOR). The vestibulo-ocular reflex acts with a much shorter delay than the opto-kinetic reflex (Coenen et al., 1993). In principle, it could therefore stabilize the visual scene during head movements without any retinal slip. However this requires the eye muscle contraction elicited by a given vestibular signal to be perfectly calibrated to the weight of the eyes and strength of the eye muscles, which may change during growth (Faulstich et al., 2004). This is a general characteristic of feedforward control: it can in principle prevent any deviation from occurring, but only if it is accurately calibrated; whereas feedback control only cancels deviations after they have occurred, but can do so without the need for precise calibration (Åström and Murray, 2010).

Experiments performed in a variety of vertebrate species have indeed demonstrated ongoing calibration of the VOR. Specifically, they have demonstrated an adjustment of the scaling between vestibular signals and the elicited eye muscle contraction, called the VOR gain (Ito and Nagao, 1991). The adjustment of the VOR gain is probed experimentally by placing the animal on a rotating platform, and simultaneously rotating the visual scene. If the visual scene is rotated in the opposite direction to the platform, then the eye movements required to prevent retinal slip for a given head motion are larger than if the visual scene is fixed in space. In this case, visual stability requires an increase in the VOR gain. On the contrary, if the visual scene is rotated in the same direction as the platform, then the required eye movements are smaller, and visual stability requires a decrease in the VOR gain. Initially, rotating the visual scene causes retinal slip. There is then a gradual adjustment of the VOR gain (du Lac et al., 1995). This calibration of the VOR gain relies on the error signal of retinal slip through a cerebellum-dependent process (De Zeeuw and Yeo, 2005). A prominent theory of the role of the cerebellum in motor control is thus that the cerebellum learns models of how motor commands affect the body dynamics, and that these models are then used for accurate sensorimotor control (Dean et al., 2013; Wolpert et al., 1998). This notion of "internal models" originated in the field of engineering.

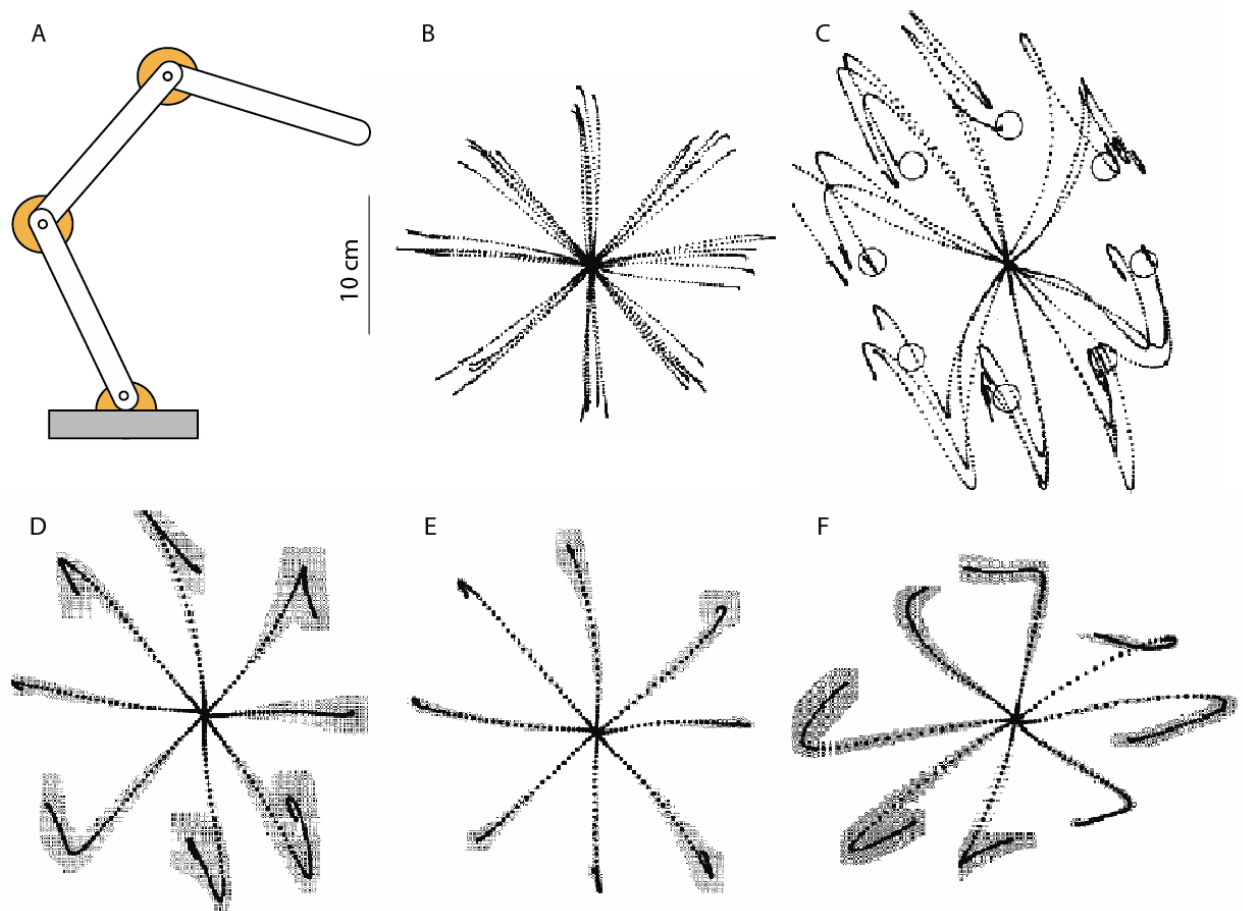

Figure 1.1 Internal models for feedforward control. A. Schematic robotic arm, solidly anchored to the ground (in grey), with rigid segments (in white) and strong motors (in orange) at each joint. B-F Adaptation when reaching in a force field, taken from Shadmehr and Mussa-Ivaldi (1994). B-C. Typical hand trajectories (dots are 10 ms apart) during reaches in a null force field (B) and during the initial exposure to the force field (C). D-F Average hand trajectories during the first reach in the force field (D), the last (250<sup>th</sup>) reach in the force field (E), and the first reach in the null force field after adaptation has occurred (F).

## 2. Internal inverse models for feedforward control

### a) Internal models in engineering

A traditional robot is built as an articulated chain of segments, in which each segment is rigid and made of hard materials, and the torque at each joint is determined by a strong electrical motor acting at that joint. A schematic example is shown in Figure 1.1.A. Such robots move rigidly, and can achieve large forces and high precision, for example in holding the tip of the chain at a desired position. The downside to this is that, to achieve such precision, the electrical command sent to each of the motors must be explicitly controlled.

Thus, to achieve a given desired trajectory of the segments of the articulated chain, the engineer must develop a detailed model of the robot's dynamics (i.e., how the robot responds to joint torques and external forces). This control approach has been mostly successful for controlling robots in factory environments. Indeed, in such a controlled environment, it is possible to accurately model the robot's mechanical properties as well as every aspect of the robot's environment, including the type of perturbation the robot may be exposed to.

The model of the robot dynamics is then inverted, and this inverse model is used to calculate the joint torques necessary to obtain the desired trajectory. The main difficulty in this approach is the calculation of such inverse



models, especially in the presence of noise. Exact calculations have been derived for linear dynamics (Bellman, 1958; Kalman, 1960). However, for non-linear dynamics, such exact calculations are often impractical, therefore much effort has been put into better approximating these inverse models (Åström and Kumar, 2014).

b) Adaptation experiments as evidence for internal models

Inspired by the success of factory robots, a whole branch of motor control has been developed, based on the idea that efficient motor control relies firstly on accurate and detailed knowledge of the body to be controlled, and secondly on extensive and costly computations performed by the nervous system, which map the desired trajectory onto the motor commands necessary to achieve this trajectory (Wolpert et al., 2001).

In the search of evidence for such internal models, several adaptation paradigms have been developed. A paradigm that has been extensively used in humans is reaching in a “force field” (Shadmehr and Mussa-Ivaldi, 1994). The person holds a handle connected to a robotic arm, and is asked to bring the handle to a given target position. The robotic arm can be used to apply forces on the person. At first, the robotic arm exerts no force, and the person fulfils the task by reaching straight to the target (Figure 1.1.B). Indeed, when reaching to a target, the hand typically follows a straight trajectory (Morasso, 1981). At one point, forces are introduced, and these cause the hand trajectory to deviate from the typical straight trajectory (Figure 1.1.C, D). The person is able to correct for this perturbation on the very first trial, and reach the target, albeit with a curved hand trajectory (Figure 1.1.C, D). If these forces have a regular pattern (called a force field, which may depend on the position and speed of the hand), then over repetitions of the task the person’s reaches become straight again (Figure 1.1.E). This suggests that the person has learned to anticipate the robotic forces, and counteracts them precisely at the time they occur, rather than relying on feedback. Indeed, after learning has occurred, if the robot is made to no longer exert force, then the person’s reach overshoots in the opposite direction (Figure 1.1.F).

The general idea in adaptation experiments is thus to introduce a sudden change in the dynamics of the environment that the person is interacting with (such as the force field). At first the person is unaware of the change, and their internal model does not reflect this change in dynamics. Therefore their motor command generates a trajectory which is different from their desired trajectory (such as a curved reach). After extended practice in the new environment, the subject is again able to produce their desired trajectory. The evidence that this is due to a change in the motor plan, and not to the use of feedback, comes from observing the after-effect: when the environmental dynamics are reverted back to their initial state after learning, the person’s reach trajectory deviates anew from the straight path (Figure 1.1.F). This shows that the person has adjusted their motor command in accordance with their knowledge of the environmental dynamics.

The person may also adjust their motor command to a changed environment without reverting back to the initial trajectory. This occurs in another well-studied adaptation paradigm called grip force adaptation (Flanagan and Wing, 1997). The subject is asked to grasp a robotic handle between the index finger and the thumb, and to move this object backwards and forwards. The robotic handle can exert forwards and backwards forces which scale with its forwards acceleration (mimicking the mass of the object), speed (mimicking friction) and position (mimicking elasticity). After practice with the different “objects”, certain subjects reverted to the same hand trajectory for all objects whereas others used different hand trajectories for the different objects. Nevertheless, all subjects had incorporated knowledge of the object’s dynamics into their motor command: this could be seen by looking at how hard the subject gripped the object. The time-course of grip force during the movement paralleled the time-course of the forwards forces exerted by the object on the hand. This scaling allows the subject to move the object, without the object slipping from their fingers.

c) Generalisation

The observation that a person adjusts their feed-forward motor command so as to produce straight reaches when holding a robotic handle is taken as evidence that the person adjusts their internal model of the handle, and uses this internal model to calculate the appropriate motor commands.

In principle, after having learned an accurate model of the handle dynamics, the person could then use this model to produce straight reaches of all amplitudes in all directions. However a puzzling finding is that after subjects have learned straight reaches of one direction and amplitude, their reaches are again curved if they are asked to reach in another direction (Shadmehr and Moussavi, 2000), or further away in the same direction (Mattar and Ostry, 2010).

Another adaptation paradigm which has been used to study adaptation is visuomotor rotation (Cunningham, 1989). In this paradigm, the subject's arm is hidden from view, but represented by a cursor on a screen. The task is to bring the cursor to a target on the screen (similarly to moving a mouse on a computer screen). Adaptation is induced by changing the mapping between hand movements and cursor movements: if the amplitude of the cursor movements is changed then the person changes the amplitude of their hand movements, and practicing reaches in one direction generalises to all directions (Krakauer et al., 2000). However if the angle of cursor movements is rotated with respect to the hand movement, then practicing reaches in one direction does not generalise across directions (Krakauer et al., 2000).

Adaptation experiments have been used to argue that the feedforward command of movement intelligently uses knowledge about the environmental dynamics to ensure reach accuracy. However, the way in which this knowledge is incorporated into motor control remains to be clarified. The unclear pattern of generalisation has led certain authors to suggest that only a limited range of "internal models" may be represented, corresponding to priors about environmental dynamics (Sing et al., 2009).

### 3. Motor redundancy and the uncontrolled manifold

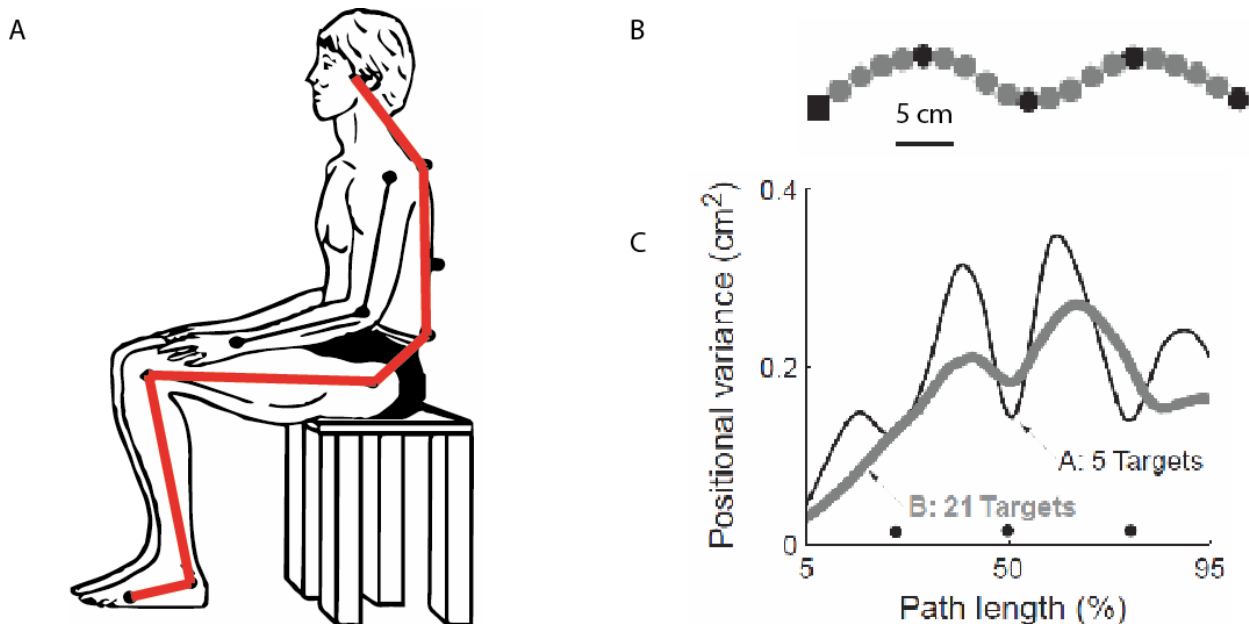

Figure 1.2 The uncontrolled manifold hypothesis. A. The sit-to-stand task involves motion of numerous body segments, shown here in red (adapted from Scholz and Schöner 1999). B Todorov and Jordan (2002) compare two tasks: in the first task the subject is asked to reach through a series of 5 targets (black dots), in the second task, the subject is asked to reach through a series of 21 targets (black and grey dots), placed along the mean hand trajectory in the first task. C. The variability in the position of the hand along the reach trajectory is shown for the first task (black) and the second task (grey). B-C are taken from Todorov and Jordan (2002).

In the adaptation paradigms presented previously, the reaching movement is described only in terms of the position of the hand in space. However, a given position of the hand can be achieved with a variety of arm postures. Thus, if the movement is described in terms of arm posture (such as the orientations of all the joints within the arm), then the task is redundant: this is referred to as “kinematic redundancy” (Loeb, 2012). Moreover, each arm posture could, in principle, be achieved with a variety of muscle contraction patterns. This is described as “kinetic redundancy” (Loeb, 2012). A branch of motor control is organised around this notion of motor redundancy. From the observation that the body comprises numerous joints, and numerous muscles acting at each joint, it is assumed that the motor system has more degrees of freedom than are needed to perform any given task. Motor coordination is attributed to the nervous system, whose task is summarised by Loeb as follows: “So how does the brain decide what postures and which muscles to use?” (Loeb, 2012).

One suggestion is that the nervous system solves this task by planning movements in simplified coordinate frames (Morasso, 1981). The task of the experimenter is then to determine “which of the many possible degrees of freedom does the nervous system control?” (Scholz and Schönner, 1999). This is achieved by finding a coordinate frame in which a variety of movements can be described in a simple way. Thus, when a subject reaches to targets at different positions, Morasso observed that their hand follows a simple, straight path, whereas describing the movement in terms of the angles of the arm segments is much less straight-forward (Morasso, 1981). He therefore suggested that the nervous system controls the position of the hand in space, rather than the values of joint angles.

Scholz and Schönner introduced a different way of approaching the question, which is based on the idea of stability to perturbations (Scholz and Schönner, 1999). They suggest that the task variable which is controlled by the nervous system will have a particular signature in terms of its variability from trial to trial. They asked subjects to perform the task of standing up from a sitting position. This task involves the movement of numerous body segments, schematised in red in Figure 1.2.A. The authors describe the movements in terms of the angle of each segment: this is the task space. They hypothesise that during this task, the variable controlled by the nervous system is the forwards position of the subject’s centre of mass (CoM). This variable is a function of the angles of the various body segments in space. For a given position of the CoM, certain variations in angles do not change the CoM position whereas variations in other directions of the task space do affect CoM position. They asked the subjects to repeat this movement. They observed that two repetitions of the same movement were never identical, and that the variability in the directions which affect CoM position was much smaller than the variability in the directions that do not affect CoM position. They considered this as evidence that during the sit-to-stand, the nervous system controls CoM position, rather than individual joint angles.

They then applied the same analysis to describe shooting movements (Scholz et al., 2000). When shooting with a pistol, success requires the correct alignment of the pistol with the target. This can in principle be achieved with the shoulder and elbow more or less flexed, and indeed variation in shoulder and elbow flexion from trial to trial is much larger than the variation in aiming, suggesting that elbow and shoulder flexion are coordinated (Scholz et al., 2000). This analysis was then applied to a variety of redundant movements. When the movement is described in terms of “task-irrelevant” and “task-relevant” dimensions, then it is found that in skilled movement, the variability in “task-irrelevant” dimensions is systematically larger than that in the “task-relevant” dimensions, which affect success (Domkin et al., 2002; Scholz et al., 2000; Scholz and Schönner, 1999; Tseng et al., 2002). This alignment of variability along task-irrelevant dimensions emerges with practice in learning a new skill (Müller and Sternad, 2009).

To explain this task-appropriate pattern of variability, Latash and colleagues (Latash et al., 2002) have put forward the “uncontrolled manifold hypothesis”, which states that when attempting to achieve a task, the nervous system only corrects for deviations in the task-relevant dimension, allowing variation in the task-irrelevant dimensions to grow.

#### 4. Stochastic optimal feedback control for redundant tasks

The “uncontrolled manifold hypothesis” emphasises the role of feedback in shaping patterns of motor coordination. The role of feedback is further illustrated by studies of adaptation to force fields. Indeed, at no point during the adaptation process are the reaches inaccurate: even for the first reach in the force field, the subjects are able to correct their reach and attain the target (Shadmehr and Mussa-Ivaldi, 1994). Thus, sensorimotor feedback is organised so as to maintain accuracy in the task-relevant dimensions, and this accuracy is maintained despite uncertainty in the process dynamics.

##### a) Stochastic optimal feedback control in engineering

The framework of stochastic optimal feedback control was developed in engineering to address the question of how best to achieve success in a given task despite uncertainty in the process dynamics (Åström and Kumar, 2014; Astrom and Wittenmark, 1994). In this framework, the system dynamics are assumed to follow a parametrised function, whose parameters are unknown. Moreover, there is assumed to be noise both in motor execution and in sensory processing. Therefore, not only are the parameters of the system dynamics unknown, the actual state of the system at any given time is also unknown. The first step is therefore to infer the probability distribution of both the parameters and the state. This probability distribution is called the hyperstate and it is typically of very high dimension. This hyperstate is inferred from a prior distribution on system parameters and states, as well as the series of successive sensory observations and motor commands.

The second step is then to map the hyperstate onto control variables in a way which maximises task success (or equivalently, minimises a cost function). Conditions for the existence of an optimal controller are not known. However, under the condition that such an optimal controller exists, a functional equation called the Bellman equation can be derived using dynamic programming (Bellman, 1958). The optimal command is then calculated by solving the Bellman equation. Although significant progress has been made to spell out how this can be achieved (Bellman, 1958; Kalman, 1960), in practice the calculation is only tractable under very limiting assumptions: the sensory and motor noise must be Gaussian-distributed, the system dynamics must be linear, the cost of effort must be the square of the motor command, and the duration of the movement must be fixed a priori. Even in such a simplified case, the calculations are quite extensive. Therefore, in practice, approximations of the optimal controller are used (Astrom and Wittenmark, 1994).

Optimal controllers derived in this way have an interesting property: neither the trajectory nor the feedback gains are fixed a priori. Rather, the motor command is calculated throughout the movement based on the progress of the movement up to that point. If a perturbation is introduced during the movement, then the controller does not attempt to cancel it to return to a predefined trajectory. Instead, it attempts to maintain task success, rather than a predefined trajectory. This has an interesting consequence for the control of redundant systems, which is that not all perturbations are corrected: only perturbations which affect task success elicit corrections.

##### b) Task-dependent patterns of variability

Todorov and Jordan therefore suggested that patterns of variability in skilled movements could be explained within the framework of stochastic optimal feedback control (Todorov and Jordan, 2002). They argued that the smaller variability in task-relevant dimensions was evidence that the nervous system does not try to impose a predefined trajectory, but instead calculates the motor command throughout the movement, using information about the ongoing progress of the movement, so as to maximise task success (Todorov and Jordan, 2002).

They compared the patterns of variability in two tasks (Figure 1.2.B-C). In the first task, the subject was asked to reach through a series of five targets (Figure 1.2.B, black dots). They showed that the variability in hand position was specifically reduced at the times when the hand moved through each of these targets (Figure 1.2.C, black curve). To demonstrate that this was not the result of trajectory planning, they calculated the average hand trajectory for this task, then asked the subjects to perform a second task which was to follow this average

trajectory. This was done by increasing the number of targets along the trajectory (Figure 1.2.B, black and grey dots). In this second task, the variability at the five initial targets was larger than in the first task (Figure 1.2.C, grey curve). This suggests that the reduction in variability at the five initial targets during the first task was not achieved simply by imposing a fixed trajectory and correcting for all deviations away from this trajectory. Instead, the authors consider this as evidence that the nervous system only corrects for deviations which affect task success.

To explain this using a normative approach, Todorov and Jordan (2002) posit that there is noise in motor execution, which increases with increasing motor contraction. Indeed, when a subject is asked to exert a given constant force, the force actually exerted is not entirely constant, and the standard deviation of muscle force grows linearly with the mean force (Schmidt et al., 1979; Todorov, 2002). In this case, if the nervous system intervenes to correct for task-irrelevant deviations, then this will introduce motor noise, which might affect the task-relevant dimension and worsen task performance. Todorov and Jordan thus suggested that the framework of stochastic optimal feedback control accounts for task-dependent patterns of variability.

c) Task-dependent corrections for perturbations

Prusynski and Scott then suggested that this framework also accounts for task-dependent corrections for perturbations. The adjustment of feedback corrections to the task at hand has been extensively studied in the contraction response of arm muscles to a force perturbation applied on the hand (Figure 1.3). This contraction response elicits a force which counteracts the perturbation force. This response is reduced if the subject is asked to "let go" rather than "resist" the perturbation (Hammond, 1956), if the perturbation does not hinder the task at hand (Prusynski et al. 2008), or if the arm contraction response cannot elicit a counteracting force (Marsden et al. 1981, Diedrichsen, 2007).

The adjustment of feedback gains to instructions was first observed by (Hammond, 1956). In this experiment, a cable was used to pull the subject's wrist forwards and measure the force response of the subject to the perturbation (Figure 1.3.A). The perturbation caused the subject's elbow to extend, and the contraction of the biceps muscle, which flexes the elbow, was also recorded (Figure 1.3.B). There was an initial abrupt increase in force (Figure 1.3.A), before any change in muscle contraction, which corresponds to the biomechanical resistance of the arm. There was then a burst of contraction in the biceps muscle, occurring between 20 ms and 45 ms after the perturbation, to which corresponded an increase in force (Figure 1.3.A, B). This is called the short-latency response (SL, Figure 1.3.B). There was finally a second burst of contraction, occurring between 45 ms and 100 ms after the perturbation, to which corresponded a second increase in force (Figure 1.3.A, B). This is called the long latency response (LL, Figure 1.3.B). Before the perturbation occurred, the subject was instructed either to "resist" the perturbation, or to "let go". This instruction had little effect on the initial increase in force nor the short-latency response. However the long-latency response was substantially reduced if the subject was asked to "let go" rather than "resist" the perturbation (Figure 1.3.A, B).

To study the extent to which this long-latency response can be modified by the task, (Prusynski et al., 2008) asked subjects to hold their hand in a fixed position, then to reach to a target, in response to a mechanical perturbation to the hand. They showed that the long-latency response was smaller if the perturbation moved the hand towards the target than if it moved the hand away from the target: thus, the perturbation which does not hinder the success of the task (i.e. the perturbation which moves the hand towards the target) is less counteracted. For the long-latency response to be decreased, the target had to be shown at least 100 ms before the perturbation (Yang et al., 2011): this suggests that visual information about target position is used to adjust the feedback gain in advance of the perturbation.

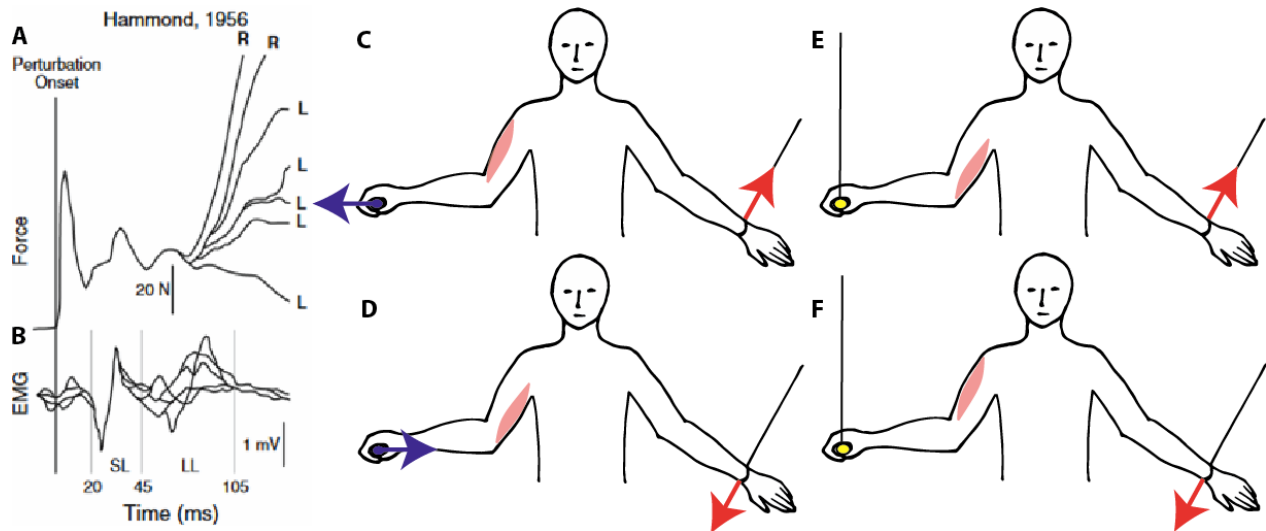

Figure 1.3 A-B are taken from Pruszynski and Scott (2012) and describe the experiment of Hammond (1956): the subject is instructed either to “resist” a perturbation (R) or “let go” (L). A. Force response. B. Muscular contraction short latency (SL) and long-latency (LL) responses. C-F depict the “teacup” experiment in Marsden et al. (1981). A cable pulls on the subject’s left wrist, and the change in the traction of the cable is shown as a red arrow. C-D The subject holds onto a stable support (purple), and the change in the force exerted by the handle on the hand is shown as a purple arrow. C. If the cable tension is increased, then the biceps contracts, which pulls against the handle. D. If the cable tension is decreased, then the triceps contracts, which pushes against the handle. E-F. If the subject holds onto an object which cannot provide support (yellow) and the cable tension is E. increased, then the triceps contracts, which extends the arm; F. decreased, then the biceps contracts, which flexes the arm.

This long-latency response can also be present in the muscles of the arm opposite to the hand which is perturbed. Marsden and colleagues compared the response of the right arm to perturbations of the left arm in two different situations (Marsden et al. 1981), illustrated in Figure 1.3.C-F. In the first situation, the subject holds onto a support with the right hand (Figure 1.3.C, D). The right arm is therefore able to counteract the perturbation. If the left arm is abruptly pulled, then the biceps of their right arm contracts, which pulls against the support and counteracts the perturbation (Figure 1.3.C). If the traction on the left arm is abruptly stopped, then the triceps of their left arm contracts, which pushes against the support (Figure 1.3.D). If instead of a stable support, the person is holding onto a small object which cannot provide support, then the opposite pattern of muscular contraction is observed, as if the subject were trying to maintain the object stable in space (Figure 1.3.E and F). This experiment has therefore been called the teacup experiment. Thus, the response of the muscles of the right arm to the same perturbation of the left arm (either traction Figure 1.3.C, E or release Figure 1.3.D, F) depends on whether the right arm can provide support. If the left arm is pulled by the cable (Figure 1.3.C, E), the right arm only pulls on the object it is holding if this object provides support (Figure 1.3.C, but not E).

Todorov and Jordan initially suggested that the stochastic optimal control framework accounts for patterns of variability in redundant tasks (Todorov and Jordan, 2002). Feedback control in a redundant task was studied by Diedrichsen (Diedrichsen, 2007). He compared two reaching tasks. In the first task, the subject is asked to move two cursors forwards to a target, one with each hand (uni-manual reaching). A perturbation is applied to one of the hands during the reach. The perturbed hand responds and corrects for the perturbation, and the unperturbed hand does not respond (Diedrichsen, 2007). In the second task, the subject is asked to move a single cursor forward with both hands, the cursor being in the middle of the two hands (bi-manual reaching). A perturbation is applied to one of the hands during the reach. This task is redundant: the cursor can be returned to its initial position by moving either hand in response to the perturbation. If motor control consists in imposing a fixed, predefined trajectory, then the unperturbed hand should not respond, since it is still following its prescribed trajectory. Only the perturbed hand should respond, and correct for the perturbation in exactly the same way as for the uni-manual reaching condition. Diedrichsen observed a small correction in the unperturbed hand, corresponding to a long-latency response (Mutha and Sainburg, 2009). This cannot be due to the nervous system imposing a fixed trajectory.

If instead the nervous system calculates motor commands according to the stochastic optimal control framework, then, since motor variability increases with increasing level of contraction, it is worthwhile distributing the motor command over various muscles. Thus, the perturbation should be corrected with a small and equal movement in each hand, rather than a large correction in one of the hands. However, in addition to the small correction in the unperturbed hand, Diedrichsen observed a large correction in the perturbed hand, which was only slightly smaller than for the uni-manual reaching condition (Diedrichsen, 2007). The feedback control of reaching thus adjusts to the task (either uni-manual or bi-manual reaching), but in a way which is not quite consistent with the optimal feedback control framework.

d) Generality of the framework

Pruszynski and Scott argue that the adjustment of feedback to the task in itself provides evidence in favour of the stochastic optimal feedback control framework (Pruszynski and Scott, 2012). The framework requires centralized computation of motor corrections during the movement. Therefore, Pruszynski and Scott argue that only long-latency responses can be flexible enough to adjust to the task at hand, since their feedback delays are compatible with the involvement of the motor cortex, whereas spinal feedback should be less flexible. Thus, task-dependent corrections for perturbations would be a hallmark of centralized control.

However the hallmark of the optimal feedback control framework is not simply that feedback adjusts to the task, but more specifically that feedback corrections are not determined in advance of the movement. Instead, they are calculated during the movement, according to ongoing sensory feedback of task success, which is integrated using internal models. The experiments reviewed by Pruszynski and Scott provide no evidence that feedback is adjusted during the task. In the original experiment by Hammond, subjects could simply have decreased their feedback gains after hearing the instruction to “let go” (Hammond, 1956). Likewise, the experiment performed by Yang and colleagues suggests that visual information about target position is used to adjust the feedback gain in advance of the perturbation (Yang et al., 2011). The dependence of feedback corrections on the conditions of support (Marsden et al., 1981) and on uni-manual versus bi-manual reaching (Diedrichsen, 2007) could also be achieved by adjusting feedback gains in advance of the movement. There is therefore no evidence that task-dependent corrections require motor commands to be calculated throughout the movement in a centralized manner, rather than relying on an adjustment of feedback gains to the task prior to the movement.

Moreover, the fact that corrections need to be calculated during the movement is specifically what makes the stochastic optimal control framework so tedious and costly to implement, and why it is not a popular approach in engineering (Astrom and Wittenmark, 1994). Even authors who use this framework to make predictions about human movements do not presume that the central nervous system literally carries out these calculations. Thus Pruszynski and Scott state that “The formal mathematics of optimal feedback control are incredibly complex and it is highly unlikely that the brain solves these equations” (Pruszynski and Scott, 2012). Todorov and Jordan, who introduced this framework to explain patterns of variability, state that the theory “concerns skilled performance in well-practiced tasks, and does not explicitly consider the learning and adaptation that lead to such performance” (Todorov and Jordan, 2002). A great challenge for such a normative theory is thus to explain learning, and how the shape of variability changes over the course of skill learning (Müller and Sternad, 2009).

5. Adaptive control

The experiments presented in the previous section do not provide evidence that feedback corrections are calculated during the movement. The experimental results could instead rely on the adjustment of feedback gains prior to the movement. This can be explained within the adaptive control framework, in which observation of the controlled system’s dynamics allows feedback gains to be adjusted to the task at hand (Astrom and Wittenmark, 1994).

a) Adaptive control in engineering

To follow a desired trajectory using only feedforward control requires a very accurate model of the dynamics of the system being controlled. However, machines and robots that operate outside of factories may be exposed to much larger variations in their own dynamics, than machines that operate within controlled factory environments. The adaptive control approach has been developed in engineering to deal with such unmodelled changes in the system dynamics. A variety of techniques have been developed for adaptive control, and the two main techniques are gain scheduling and auto-tuning (Astrom and Wittenmark, 1994).

The way in which an airplane responds to commands changes significantly with speed and altitude, such that the control appropriate for a given speed and altitude may become unstable when the speed and altitude change (Stein, 1980). Stable control of flight is achieved by measuring the speed and altitude of the plane and setting the feedback control parameters appropriate to that speed and altitude, obtained from a look-up table. This is called gain scheduling.

When steering a ship, changing weather conditions may result in large changes in the amplitude and direction of the waves that the ship has to deal with (Åström, 1980). Although such variations may not be predicted in advance, their effect on the controlled system's dynamics can be observed, allowing for the controller to be tuned online. In auto-tuning, the structure of the controller is fixed by the engineer, and the control parameters are adjusted to improve the control. A very standard controller is the PID controller, which uses proportional feedback on the system state, its integral and its derivative (Aström and Murray, 2010). A method for tuning the proportional, integral and derivative gains was introduced by Ziegler and Nichols in 1942 (Ziegler and Nichols, 1942), and many different methods have been proposed since (McMillan, 1983). This approach thus requires the engineer to have a general knowledge of the dynamics of the system to be controlled, so that the general shape of the controller can be chosen appropriately. However, the precise parameters of the system dynamics do not need to be known in advance, since the controller parameters can adjust to these.

b) Gain scheduling in animal movement

The adjustment to the task of arm muscle responses to perturbations can be explained within the framework of gain scheduling. Thus, the reduction in this response when the subject is asked to "let go" rather than "resist" the perturbation (Hammond, 1956), when the perturbation does not hinder the task at hand (Pruszynski et al. 2008), and when the arm contraction response cannot elicit a counteracting force (Marsden et al. 1981, Diedrichsen, 2007) can be obtained simply by decreasing feedback gains in advance of the perturbation.

Further evidence that task-dependent corrections do not need to be calculated throughout the movement in a centralised manner comes from the observation that spinal feedback also adjusts to the task at hand. A standard experimental paradigm, which has been extensively used to probe how the spinal cord integrates proprioception into movement is the Hoffmann-reflex (Windhorst, 2007). This H-reflex (Knikou, 2008) consists in electrically stimulating the nerve to a muscle, and measuring the resulting muscle contraction through EMG (Figure 1.4). This stimulates the axons of the motor neurons, which elicits a very short latency burst of muscular contraction, called the M-wave (Figure 1.4.A, C). This also stimulates the axons of the sensory neurons from muscle spindles (in yellow in Figure 1.4.A, B). In turn the sensory neurons excite the motor neurons within the spinal cord and this elicits a second burst of muscular contraction, called the H-wave (Figure 1.4.B,C). The amplitude of this second burst, called the H-reflex, thus probes the direct synaptic connections from muscle spindles onto motor neurons. Another way to probe these connections is the stretch-reflex, in which the muscle spindles are excited by a mechanical stretch of the muscle they are imbedded in, and the resulting muscle contraction is recorded through EMG (this mechanical stretch does not elicit an M-wave). These direct connections are the fastest way in which proprioception affects muscle contraction: they underlie the short-latency response described by Hammond, which is the fastest change in muscle contraction after a push to the arm (Hammond, 1956).



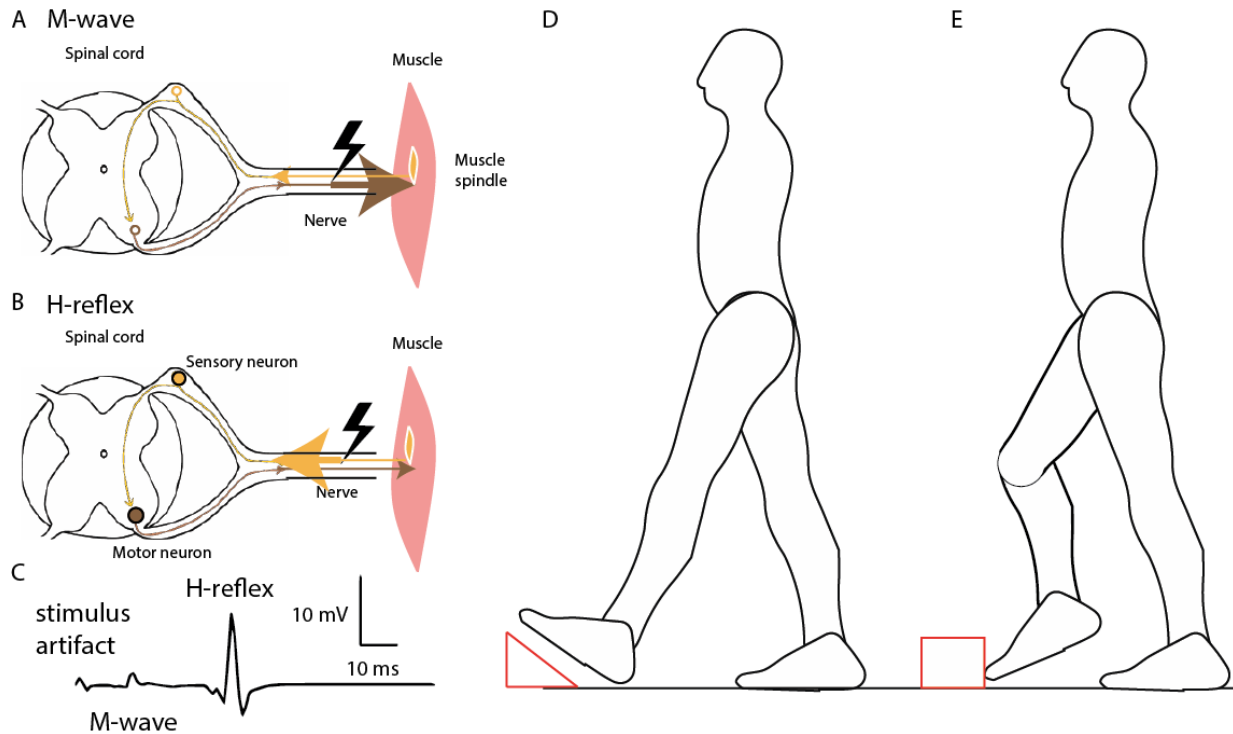

*Figure 1.4 Modulation of the H-reflex. A. The electrical stimulation of a nerve elicits a first burst of muscular contraction, called the M-wave, through the direct excitation of the motor neuron axons (in brown). B. The excitation of the sensory neuron axons (in yellow) from muscle spindles (in yellow, embedded in the muscle) elicits a second burst of muscular contraction, called the H-reflex, through the spinal cord. C. Time-course of the EMG recorded from the muscle after the electrical stimulation (taken from Knikou 2008): there is first the stimulus artifact, then the M-wave, then the H-reflex. D. The ankle stretch reflex is functional during stance and just before heel strike, in case of a change in slope. E. When tripping during swing, the ankle stretch reflex is counter-productive.*

As I have shown previously the longer latency response has been portrayed as a hallmark of intelligent, centralized control because it adjusts to the task at hand and the affordances for movement (Pruszynski et al., 2008). This is however also the case for the spinal use of feedback. Indeed, the H-reflex and stretch reflex paradigms have been used to demonstrate that the spinal feedback control gain is highly context dependent. The H-reflex of the calf muscle soleus is thus consistently decreased when standing still in challenging balance conditions, such as when standing at the edge of a drop (Sibley et al., 2007), on a narrow support (Trimble and Koceja, 2001) or with the eyes closed (Pinar et al., 2010). I will explain in the next chapter why such a decrease in feedback gain is appropriate. The H-reflex is also reduced during walking as compared to standing still (Capaday and Stein, 1986), and during running as compared to walking (Capaday and Stein, 1987). This prevents spinal feedback from counteracting one's own movement. Indeed, the reduction in H-reflex occurs just before the initiation of the movement. Thus, when a standing person is instructed to start walking in response to a light signal, the amplitude of their soleus H-reflex is decreased within a few hundred milliseconds after receiving the cue (Trimble et al., 2001). Since the visual cue is sensed by the supra-spinal centres, this suggests that one of the roles of the supra-spinal centres in motor coordination could be to adjust the spinal gating of proprioception into movement to the context and the task at hand.

Moreover, the H-reflex is modulated throughout walking, and Zehr and Stein argue that this modulation is functional (Zehr and Stein, 1999). For example, when placing the foot on the ground, a stretch of the ankle due to an increase in the slope of the ground can be counteracted by an increase in calf muscle contraction. The calf muscle stretch reflex is therefore functional during stance (Figure 1.4.D). However, when the foot is swinging forward, if it trips on an obstacle, then the resulting stretch should not be counteracted. Instead the foot should be brought backwards then raised over the obstacle. The stretch reflex is therefore not functional during swing (Figure 1.4.E). Indeed, Scohier and colleagues have observed that the calf muscle stretch reflex is absent when the foot is

swinging forwards, except just before the heel contacts the ground (Schoier et al., 2014). Likewise the soleus H-reflex is larger during stance than swing (Capaday and Stein, 1986; Crenna and Frigo, 1987). The spinal feedback gain thus adjusts during the course of the movement, according to the movement's progress (swing versus stance).

c) Auto-tuning in animal movement

Spinal feedback gains have also been shown to adjust over the course of learning. Christakos and colleagues have shown that monkeys which have been trained to reach for up to two years no longer show a longer-latency response to perturbations to the arm during reaching (Christakos et al., 1983). Instead, their short-latency response is enhanced. For the cortex to produce a response to such a perturbation, the sensory signal must first be transmitted to the cortex, then processed in the cortex, and the outgoing motor command must then be transmitted to the motor neurons. Therefore, responses involving the cortex, or other supra-spinal centres, have longer delays than the spinal stretch reflex. It is however well known from control theory that delays are critical when using sensory feedback to counteract external perturbations (Aström and Murray, 2010): thus, a system that is stabilized by feedback control may become unstable simply if the control delay increases. Consequently, the best stability and robustness can be achieved by using the fastest possible feedback control loop. When responding to perturbations that are sensed through proprioception, this is provided by the short-latency spinal stretch reflex, rather than the longer-latency reflex. Thus, the gradual replacement of the long-latency response by the short-latency response (Christakos et al., 1983) may improve stability.

The adjustment of spinal feedback gains to the context may also depend on learning. The reduction in soleus H-reflex when standing on a narrow support emerges gradually within a day of practicing standing balance on this narrow support (Mynark and Koceja, 2002; Trimble and Koceja, 1994, 2001). Moreover, the modulation of the H-reflex during the course of walking emerges gradually over several days when practicing a new task such as walking backwards (Schneider and Capaday, 2003). These studies suggest that the spinal feedback gains which are appropriate for a given task are learned through practicing the task. Thus, when learning a new skill, one of the tasks of the supra-spinal centres may be to find out how to appropriately adjust the spinal feedback control to the context and the task at hand.

## 6. Centralised knowledge

Normative approaches to motor control have been generally successful in characterizing the adequacy of observed patterns of motor coordination to the task at hand.

The notion of internal inverse models has been used to characterize the adequacy of pre-planned (feed-forward) motor patterns to the dynamics of the body and environment, such as when reaching in a force field (Shadmehr and Mussa-Ivaldi, 1994). This approach assumes detailed knowledge of the dynamics of the body and environment. The cerebellum is thus thought to learn, over many years of practice, an inverse model of the body dynamics, which can then be used to calculate the motor commands necessary to generate the desired body trajectory (Kawato, 1999).

This notion was then extended, using the optimal feedback control framework, to explain why the variability in task-irrelevant dimensions should be larger than the variability in task-relevant dimensions (Scholz and Schöner, 1999). The pattern of feedback observed in redundant tasks (Diedrichsen, 2007) is thought to require both an internal model of the body dynamics, and a cost function which describes the task redundancy (Pruszynski and Scott, 2012; Todorov and Jordan, 2002). The ongoing sensory feedback occurring throughout the movement is then used to calculate the motor command on the fly, using the internal model and the cost function. Researchers usually refrain from making specific assumptions as to where in the nervous system this calculation may occur (Pruszynski and Scott, 2012; Todorov and Jordan, 2002).

These two approaches share a common inspiration from engineering, in which the motor command is calculated in a central processor which is distinct - and possibly distant - from the machinery being controlled. They therefore share the assumption that the knowledge required to generate appropriate motor commands is gathered in a centralized processor which calculates the motor command based on this knowledge. Thus, in order to develop these normative descriptions of motor coordination into a theory of motor control which explains how the motor coordination is generated, researchers must find where in the brain this knowledge is located. Several prominent researchers in the field have recently pointed out that this is proving extremely challenging. Thus, (Wolpert et al., 2011) conclude their review of sensorimotor learning with “The field has been less successful in linking computational models to neurobiological models of control. [...] the fundamental computations performed by – for example – the motor cortex or the cerebellum remain elusive.” Likewise, (Haith and Krakauer, 2013) conclude their review of motor control and learning with « What is unclear at present, however, is how knowledge of dynamics stored in a forward model, presumably in the cerebellum, becomes translated into a control policy in motor cortex. »

An alternative to this centralised approach may be provided by the adaptive control framework. Experiments probing spinal feedback corrections for perturbations thus suggest that motor coordination may rely on the adjustment of spinal feedback gains to the task at hand prior to the movement.

### III. Where is the knowledge for motor control

Normative theories of motor control are based on the assumption that adequate or “optimal” motor patterns rely on centralized calculations. Thus, motor commands are assumed to be calculated within a central processor, which then imposes the calculated pattern of motor contraction. This central processor is suggested to be either the motor cortex or the cerebellum (Haith and Krakauer, 2013). The neuroanatomy of motor control does not seem compatible with this assumption, and suggests instead that the neural organization of movement may occur in the spinal cord or in the brainstem.

#### 1. Basic neuro-anatomy of motor control

The neuro-anatomy of motor control follows some basic organization principles which are conserved across all vertebrate species (Butler and Hodos, 2005), and which are illustrated in Figure 1.5.

The motor neurons whose activity contracts the muscles that move the skeleton are located within the spinal cord (shown in brown in Figure 1.5.A). They receive input from a variety of spinal neurons: both proprioceptive neurons (shown in yellow in Figure 1.5.A), which receive sensory information from mechanosensors within the body (Windhorst, 2007), and spinal interneurons (shown in orange in Figure 1.5.A), which are called this way because they are neither sensory neurons nor motor neurons. The neuro-anatomy of the spinal cord could therefore, in principle, allow the spinal cord to organize functional patterns of muscular contraction which take into account the position of the animal’s limbs, as well as the position of obstacles that can be sensed through touch (Kargo and Giszter, 2000). This possibility is put forwards by proponents of the synergist view (Bizzi and Cheung, 2013; Giszter et al., 2007).

The spinal cord also receives axonal projections from and sends axonal projections to neurons in the brainstem (including the cerebellum, midbrain and hindbrain) and the forebrain. I will call these the supra-spinal centres. The connections are schematically represented in Figure 1.5.B. The extent of these connections and their pattern of projection have been investigated using anatomical tracers, as reviewed in (Ten Donkelaar, 2000). Direct projections from the cerebellum to the spinal cord have been found in amphibians, reptiles, mammals and birds (Nudo and Masterton, 1988), however this cerebello-spinal tract is only a minor input to the spinal cord, and does not send projections throughout the spinal cord, but only to the most anterior spinal segments, as illustrated in Figure 1.5.B (Butler and Hodos, 2005). The major contribution of the cerebellum to movement occurs through the brainstem, projecting first onto clusters of cells within the brainstem, such as the vestibular nucleus (Nudo and

Masterton, 1988; Ten Donkelaar, 1976) and the red nucleus (Ten Donkelaar, 1988), which in turn project to the spinal cord (Figure 1.5.B).

The cortex sends direct projections to the spinal cord in mammals, but the extent and pattern of these connections vary according to the species (Kuypers, 2011). In certain species such as the opossum (Martin and Fisher, 1968) and armadillo (Fisher et al., 1969), the corticospinal tract only extends to the top-most spinal segments, and projects on interneurons (Figure 1.5.C). In other species such as the cat and rat, the corticospinal tracts extends throughout the spinal cord, and projects onto both interneurons and motor neurons (Figure 1.5.C). The connections onto motor neurons can be either sparse, as in rats (Liang et al.) and cats (Cheema et al., 1984), or extensive, as in primates (Petras, 1968). Similar direct projections from the forebrain to the spinal cord have also been found in certain species of birds, such as finches (Wild and Williams, 2000). Like the cerebellum, the forebrain (including the mammalian cortex) also has indirect connections to the spinal cord through a variety of brainstem structures, such as the red nucleus (Tsukahara, 1981).

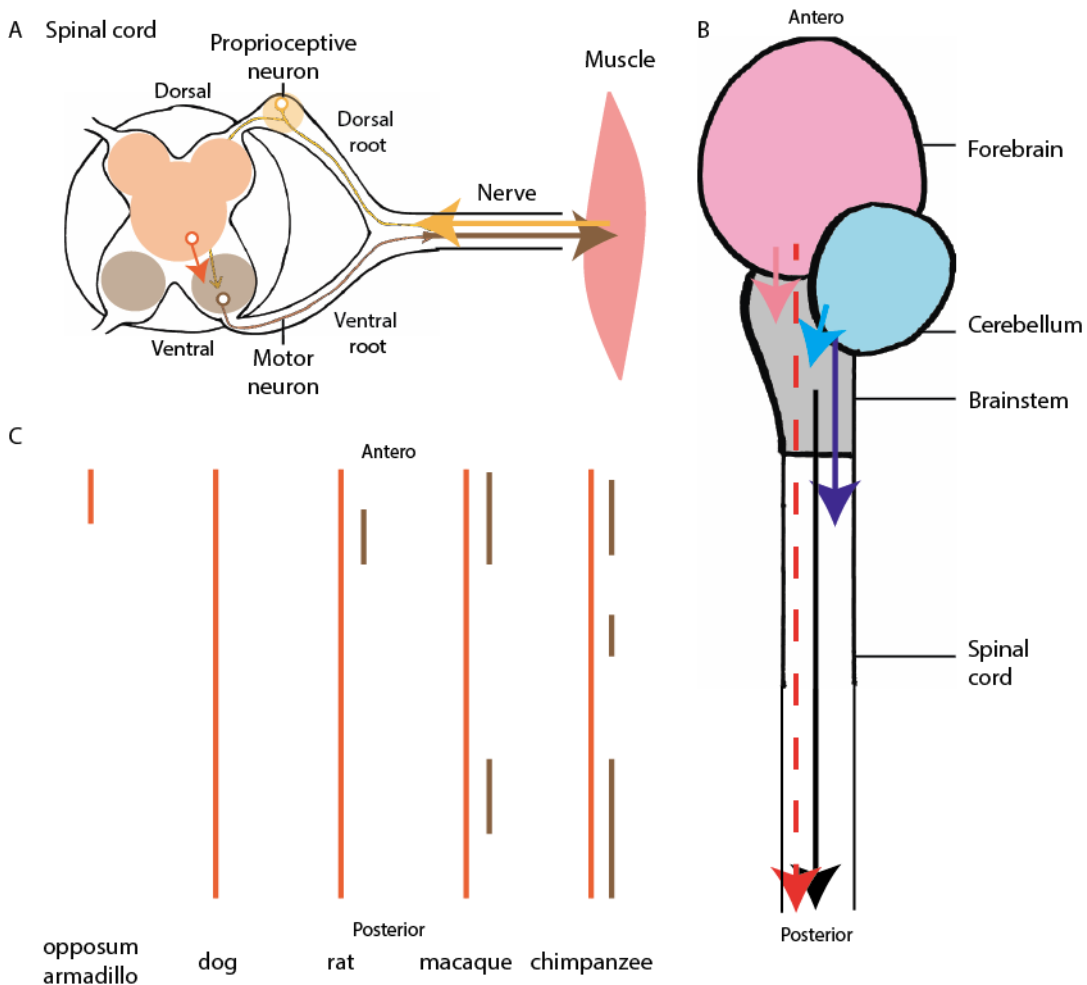

Figure 1.5 Neuro-anatomy of motor control. A. Schematic transverse section of the spinal cord, with dorsal regions in yellow, intermediate regions in orange, and ventral regions in brown. There are bi-directional connections between the spinal cord and the muscles through the nerves. Sensory neurons (yellow), enter the spinal cord through the dorsal root, whereas motor neurons (brown), exit the spinal cord through the ventral root. Motor neurons receive input from sensory neurons and interneurons (orange). B. The brainstem (grey) sends direct projections which extend throughout the spinal cord (black arrow). The forebrain (pink) sends indirect projections to the spinal cord through the brainstem (pink arrow), as well as direct projections to the spinal cord in certain species (red arrow). The cerebellum (blue) sends direct projections to the most anterior spinal segments (dark blue arrow) as well as indirect projections through the brainstem (light blue arrow). C. Extent of the projections of the corticospinal tract to the dorsal and intermediate (orange) and ventral (brown) regions of the spinal cord, in various mammals, adapted from Kuypers (2011) and Armand (1982).

Indeed, throughout all vertebrate species there are extensive connections from a variety of brainstem structures onto the spinal cord, especially from the reticular formation, which consists in numerous clusters of cells scattered throughout the brainstem (Butler and Hodos, 2005). The reticular formation thus sends extensive connections to the spinal cord in mammals (Nudo and Masterton, 1988), amphibians and reptiles (Ten Donkelaar, 1982), and fish (Rovainen, 1979).

Motor neurons thus receive a variety of convergent input, both direct connections from spinal proprioceptive neurons and certain supra-spinal centres (depending on the species), as well as indirect connections both through spinal interneurons and through brainstem structures. Therefore, even if a central processor, located for example in the motor cortex or in the cerebellum, were able to calculate the optimal motor command to each muscle, it seems unlikely that it would be able to dictate the activity of each motor neuron, so as to enforce this command. These anatomical tracer studies therefore suggest that motor control is not centralised, and that certain motor patterns may be organised within the spinal cord or the brainstem.

## 2. Spinal organisation of movement

### a) Functional behaviours in spinalized animals

To determine to what extent a movement is organized within the spinal cord, or whether it requires supra-spinal centres, a standard experimental paradigm is to lesion the spinal cord so as to interrupt the axonal tracts which allow for bidirectional communication between the spinal cord on the one hand, and the brainstem and forebrain on the other hand. In a variety of vertebrate species, such “spinalized” animals have been shown to retain some capacity for functional motor behaviour, such as stepping.

The original study on stepping in spinalized animals was performed in frogs and toads by Gray and Lissmann (Gray and Lissmann, 1940). In this study, the trunk of the spinalized amphibian was supported, while the animal's hind legs were placed on a backwards rotating drum (Figure 1.6.A). They observed that the hind legs stepped forwards alternately, as in normal locomotion (Figure 1.6.A). Similar experiments were then performed in spinalized cats (Rossignol et al., 1996), and mice (Leblond et al., 2003). The animal is placed with the fore legs on a solid support and its trunk is supported, while the hind legs are placed on a backwards moving treadmill (Figure 1.6.B). The hind legs are then observed to step forwards rhythmically, as in normal stepping. Thus, when the legs are pulled backwards (either by a rotating drum or a treadmill, Figure 1.6.A, B), the spinal cord is able to produce patterns of muscle contraction which alternately bring the legs forwards.

Moreover, this spinal stepping pattern appropriately takes into account proprioceptive feedback, as reviewed by Rossignol (Rossignol et al., 2006). For example, stepping is only efficient within a limited range of leg postures, and if the experimenter flexes the hip of the cat, this prevents the expression of the stepping pattern in that leg (Grillner and Rossignol, 1978). If the experimenter extends the hip, this can initiate stepping, as long as the other leg is in the right posture to support the animal's weight (Grillner and Rossignol, 1978).

Another spinal behaviour which has been extensively studied is the frog wiping reflex (Fukson et al., 1980; Kargo and Giszter, 2000). If a painful stimulus (such as a bit of paper soaked in acid) is applied to the forelimb of a frog, the hind limb of the same side is brought forwards to wipe off the painful stimulus. This behaviour is preserved in spinalized frogs. Moreover, even in spinalized frogs, the gesture of the hind limb adjusts to how the forelimb is placed, such that it effectively wipes off the painful stimulus (Fukson et al., 1980). Again this demonstrates that the spinal cord can integrate proprioceptive information (both about the painful stimulus and the position of the forelimb) to produce effective behaviour.

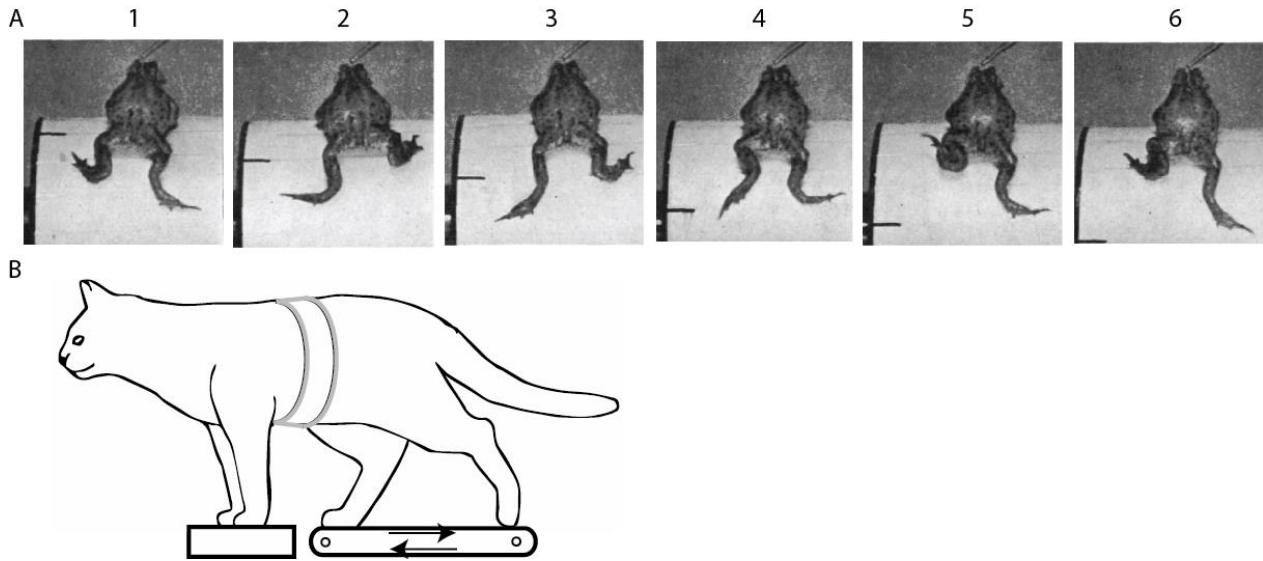

Figure 1.6 Locomotion in spinalized animals. A. A spinalized toad is placed with the hind legs on a rotating drum and the trunk supported (suspended). As the drum rotates backwards (numbers 1 through 6 spaced by 1.7 s) the hind legs step forwards. Adapted from Gray and Lissmann (1940). B. A spinalized cat is placed with the hind legs on a treadmill, with the fore legs on a solid support and the trunk supported by a harness. As the treadmill moves backwards, the hind legs step forwards.

To investigate how such functional patterns are generated, Giszter and colleagues measured the force generated by the hind limb in response to different types of stimulation, either direct stimulation of the spinal cord, painful stimulation of the skin of the other hind leg, or stimulation of a muscle (Giszter et al., 1993). For each type of stimulation, the ankle of the hind leg (Figure 1.7.A in orange) is brought to one of nine positions (Figure 1.7.A red circles) and held there. The force generated by the hind leg is evaluated by measuring the force necessary to keep the ankle at that position. This procedure is repeated for the nine positions, then the forces measured at these nine positions are interpolated to estimate the force field over the whole range of possible hind leg positions. The resulting interpolated force fields are illustrated in Figure 1.7.B-F. When the spinal cord is stimulated, this elicits a force field which converges to a stable fixed point (blue circle in Figure 1.7.B,C). The position of this fixed point depends on the point of stimulation within the spinal cord. When a painful stimulation is applied to the other hind leg, the force field elicited is also convergent (Figure 1.7.D). The earlier results of (Fukson et al., 1980) suggest that this fixed point should correspond to the position of the painful stimulus, although this is not mentioned by Giszter and colleagues (Giszter et al., 1993). When individual muscles are stimulated, the force fields elicited have various patterns, two of which are illustrated in Figure 1.7.E and F. Interestingly, none of the muscles of the hind leg elicits a convergent force field. This suggests that the spinal cord combines the activity of different muscles to produce movements of the hind leg to a given point. The authors thus suggest that the spinal cord contains a repertoire of synergies, which correspond to functional patterns of muscular contraction. The spinal cord would thus constrain the potentially high-dimensional patterns of muscular contraction to a lower-dimensional subspace of useful patterns.

b) Modularity of muscular contraction patterns

To investigate whether the patterns of muscular contraction in frog spinal wiping are indeed constrained to a low-dimensional subspace, Tresch and colleagues (Tresch et al., 1999) recorded these patterns of muscular contraction directly (rather than only the force field, which corresponds to the summed effect of all the contracted muscles). They measured the contraction of 9 hind limb muscles of a spinalized frog in response to painful stimulation of 14 sites on the hind limb's skin, with the limb held in a unique position. They performed dimensionality reduction on the mean patterns of muscular contraction, and showed that for each animal, the responses to the 14 sites could be obtained by combining a small number of elementary contraction patterns. Saltiel and colleagues performed a similar analysis of the mean contraction patterns of 12 hind limb muscles elicited by stimulation of the spinal cord

at 109 different sites in 10 frogs (Saltiel et al., 2001): they showed that these 109 patterns could be obtained by combining 7 elementary synergies. This suggests that the spinal cord activates different muscles as units, or “synergies”. These synergies could form the building blocks of motor behaviour.

This way of decomposing muscular contraction patterns was then used to assess whether the behaviour of intact animals also corresponds to the combination of a small number of motor modules. The general approach is to record the muscular activity of the largest possible set of muscles during the largest possible range of motor activities. Dimensionality reduction techniques are then applied to the recorded contraction patterns. If these potentially high-dimensional patterns can be obtained through the combination of a small set of elementary primitives, then this is taken as evidence for motor modularity (Bizzi and Cheung, 2013; Giszter et al., 2007). Thus, d’Avella and colleagues recorded muscular contraction patterns during kicking in intact, unrestrained frogs, and showed that they had a modular organization (d’Avella et al., 2003). d’Avella and Bizzi compared the contraction patterns for jumping, swimming and walking in intact freely moving frogs, and showed that certain synergies were shared across the three tasks, whereas others were task specific (d’Avella and Bizzi, 2005). Overduin and colleagues showed that the patterns of muscular contraction which could be evoked from stimulation of the motor cortex of the monkey corresponded to the combination of a subset of the synergies observed during natural reaching and grasping in the monkey (Overduin et al., 2012). The behaviour of intact animals may thus only explore a small-dimensional subspace of the potentially high-dimensional patterns of muscular contraction.

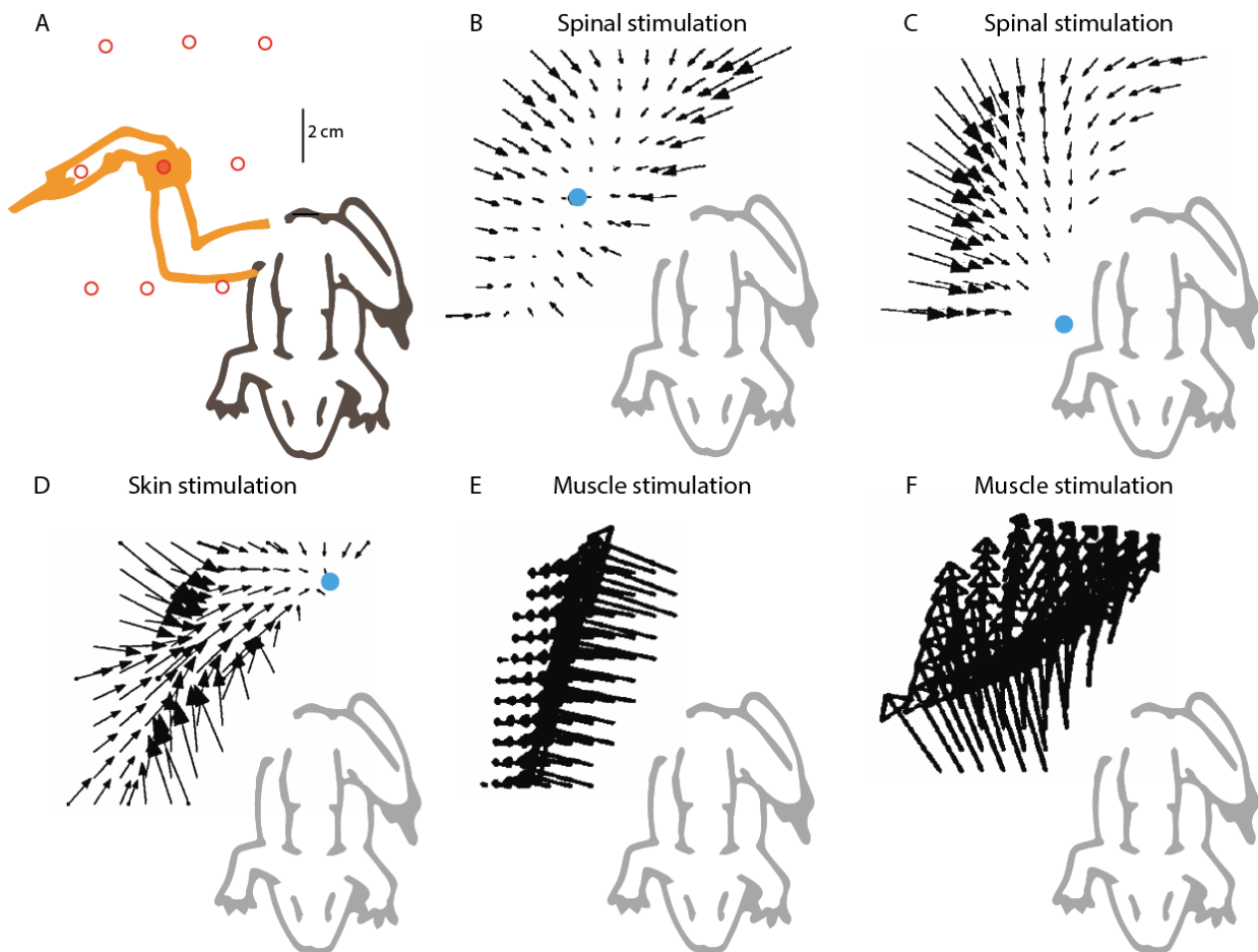

Figure 1.7 Force fields in the spinal frog, adapted from Giszter et al. (1993). A. The force required to maintain the hind limb ankle in each of nine positions (red circles) is recorded. These recorded forces are then interpolated to obtain a force field (B-F). B-C Stimulation of the spinal cord elicits a force field which converges to a point (in blue). D. Painful stimulation of the skin elicits a force field which converges to a point (in blue). E-F Stimulation of individual muscles elicits force fields which are not convergent.

### c) Relevance for motor coordination

This modular organisation of movement is suggested to simplify the task of motor coordination which the nervous system faces (Tresch and Jarc, 2009). When faced with a given task, how can the nervous system find the right pattern of motor contraction amongst the potentially high-dimensional patterns of muscular contraction? The difficulty is two-fold.

The first difficulty comes from the redundancy of the motor apparatus: the “task [of the central nervous system] is equivalent to solving an ‘ill-posed’ computational problem because the number of degrees of freedom of the musculoskeletal apparatus is much larger than that specified in the plan of action” (Bizzi et al., 1991). This difficulty could be solved by constraining certain muscles to contract together, thus reducing the dimensionality of motor contraction patterns. The spinal cord is thus thought to group muscles into functional patterns of muscle contraction. The repertoire of synergies provided by the spinal cord would thus provide a low-dimensional subspace of efficient contraction patterns, within which it would be easier to find the “right” pattern of motor contraction.

The second difficulty comes from the variety of tasks that an animal may need to solve during its lifetime: in order to move efficiently throughout its life, an animal must be able to “[map] a potentially infinite number of different goals onto an infinite set of muscle patterns” (d’Avella et al., 2003). This requires motor coordination to be flexible, for the animal to adapt to new tasks. As explained previously, the framework which allows for the optimal solution to be determined for redundant tasks requires extensive and impractical calculations, and it is considered “highly unlikely that the brain solves these equations” (Pruszynski and Scott, 2012). Advocates of synergies suggest that solutions to new tasks can be found rapidly by searching through the set of synergies, and finding new combinations of synergies (Bizzi and Cheung, 2013; Giszter et al., 2007; Loeb, 2012). The possibility of combining these fixed synergies in new ways would provide flexibility to motor coordination.

To illustrate this idea, suppose an intact frog wishes to perform a new movement with its hind limb. If the spinal cord contains a repertoire of force fields which move the hind limb to a given position, then the supra-spinal centres only need to activate the right sequence of force fields to move the hind limb through a sequence of positions along the trajectory of the new desired movement. The spinal cord would then generate the appropriate patterns of muscular contraction to move the limb through this sequence. Turvey and Fonseca have thus suggested that the synergy approach views the spinal cord as a keyboard (Turvey and Fonseca, 2009): to achieve a desired pattern of limb motion, the supra-spinal centers need only find the right melody to play on this spinal keyboard, rather than figure out the entire pattern of muscle contraction.

Several modelling and theoretical studies have thus shown that, when the set of synergies is chosen appropriately for the musculo-skeletal anatomy of the limbs and the natural limb dynamics, then this set of synergies can indeed be used to rapidly find motor solutions for new tasks, and the resulting performance is very near to the theoretical optimum (Berniker et al., 2009; Chhabra and Jacobs, 2006; Sanger, 1994; Todorov and Ghahramani, 2003). Therefore, the near-optimal patterns of motor coordination which are observed in reaching tasks, such as adaptation to the environmental dynamics, may not be the hallmark of centralized control, but may rely on motor modules within the spinal cord.

### 3. Learning and adaptation in spinal synergies

In the synergies framework, motor learning consists in the nervous system finding a better way of combining the fixed building blocks.

#### a) Change in synergies with skill learning



However, the changes in the patterns of motor coordination which occur during skill learning in humans suggest that these building blocks are not fixed, and that improvements in skill may occur by adjusting the building blocks themselves to the task at hand. As I have described, in humans synergies are described as low-dimensional muscular contractions patterns. They are assessed by measuring the muscular contraction during a given movement, and decomposing it into elementary patterns of contraction. Sawers and colleagues compared ballet dancers and controls walking on a narrow beam, and showed that the ballet dancers use more synergies than novices when walking on a beam, but not when walking on the ground (Sawers et al., 2015). This suggests that ballet training may have allowed them to form new synergies, appropriate for walking with a narrow base of support, which novices may not have had the occasion to learn. Moreover, Allen and colleagues have shown that training interventions may change synergies: they followed Parkinson patients undergoing tango rehabilitation, which improved their motor performance, and observed different synergies before and after the intervention (Allen et al., 2017).

Moreover, as explained previously, the adjustment of spinal feedback gains to the task at hand also depends on learning (Christakos et al., 1983; Mynark and Koceja, 2002; Schneider and Capaday, 2003). This is further suggested by cross-sectional studies of dancers and athletes, which show differences in the H-reflex according to the physical activity (Casabona et al., 1990; Maffiuletti et al., 2001; Mynark and Koceja, 1997; Nielsen et al., 1993; Rochcongar et al., 1979). Moreover, certain intervention studies show that the H-reflex can be increased by strength training (Duclay et al., 2008; Taube et al., 2007). The way in which the spinal cord integrates proprioception into movement is therefore not fixed but changes over the course of learning.

b) Functional spinal synergies must be learned

The most conclusive evidence that spinal synergies are not fixed comes from the study of spinalized animals, the very same experimental paradigm that was used to initially develop the notion of spinal synergies (Bizzi et al., 1991). In these initial experiments, the learning process was not considered: the frogs used in the experiments were already able to wipe away painful stimuli before they were spinalized. It was subsequently assumed that the observed spinal synergies did not change during learning.

The withdrawal reflex in the rat is functionally analogous to the wiping reflex in the frog: when the skin of the paw of one of the hind limbs is pinched or heated, the rat raises that paw from the ground by contracting the hind limb flexor muscles (Schouenborg and Kalliomaäki, 1990). Similarly to the frog wiping reflex, this functional behaviour persists in the spinalized rat (Schouenborg et al., 1992). This behaviour is not immediately functional at birth: in certain new-born rats, painful stimulation of the paw elicits muscle activity which presses the paw against the painful stimulus, rather than withdrawing it (Holmberg and Schouenborg, 1996). The appropriate pattern of muscular contraction develops over the first few weeks after birth. However if the rat is spinalized at birth, then the appropriate pattern does not develop (Levinsson et al., 1999). Thus, supra-spinal input is necessary to learn the appropriate muscular contraction pattern, which can then be retained after spinalization. Moreover, this acquired pattern of muscular contraction depends on the muscle's mechanical action: thus, if the mechanical action of a muscle is altered by surgically displacing the point of attachment of a muscle's tendon at birth, then the pattern of muscular contraction elicited by painful stimulation of the paw changes according to this new action so as to raise the paw away from the painful stimulus (Holmberg et al., 1997). Thus, the learning process does not consist in the supra-spinal centres finding better ways to combine fixed, functional spinal synergies. Indeed the very existence of functional spinal synergies depends on motor learning and requires the supra-spinal centres.

Even after development, when functional spinal synergies have been learned, the supra-spinal centres retain the capacity to alter these synergies in order to achieve a task. An artificial motor learning paradigm, developed by Wolpaw and colleagues and applied to humans, primates, rats and mice, shows that the amplitude of the H-reflex can be increased (or decreased) by repeatedly eliciting the H-reflex and rewarding the animal every time its amplitude is above (or below) a certain threshold (Wolpaw, 2010). If the axons projecting from the cortex to the spinal cord are severed, then this change cannot be learned. However, if the animal is spinalized after learning, then the change in the H-reflex is retained and persists for several days (Chen and Wolpaw, 2002). The difference in

behaviour between animals spinalized before and after learning shows that learning has induced changes within the spinal cord itself. This suggests that adjustments in the H-reflex do not rely entirely on supra-spinal centres calculating and setting the appropriate feedback gain.

Thus, the intelligent use of feedback by the spinal cord emerges over the course of learning. Therefore, the motor modules that are retained after spinalization cannot be the basis for learning: learning cannot consist in finding better combinations of fixed building blocks, since the building blocks themselves must be learned.

c) Adaptation in spinalized animals

Moreover, learning has also been shown to be possible in spinalized animals. Thus, spinalized cats can be trained to step with their hind limbs when these are placed on a backwards-moving treadmill (Figure 1.6). When they are first placed on the treadmill after spinalization, their hind limbs are unable to support their weight, and the animal's trunk must therefore be supported. Also, at first the legs might not step forwards if the treadmill moves too fast and may simply end up being dragged backwards onto their paws. However, with repeated practice on the treadmill, the animals become increasingly able to support their own weight, and the number of steps they are able to perform in a row increases, as well as the speed at which they can step (de Leon et al., 1998).

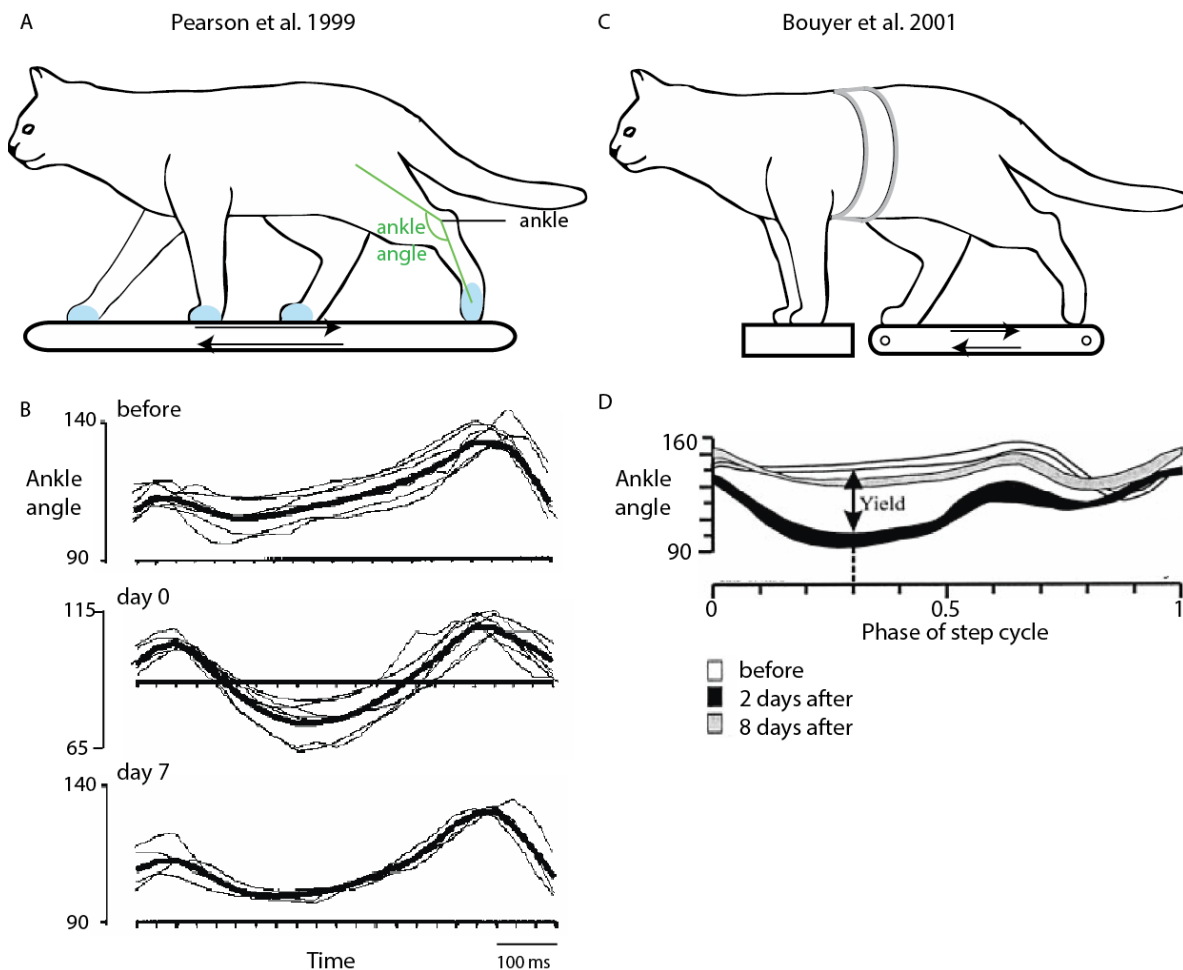

Figure 1.8 Adaptation of locomotion to the removal of ankle extensors. A-B. Adaptation in an intact cat. A. Cats are digitigrade: they walk on their toes (blue) with the ankle raised above the ground. B. Adaptation to the removal of ankle extensors, taken from Pearson et al. (1999). The ankle angle as a function of time after foot contact with the ground is shown before the removal of the extensors (top panel), on the day of the removal (middle panel) and a week after removal (lower panel). C-D Adaptation in a spinal cat, taken from Bouyer et al. (2001). D. The ankle angle as a function of the phase of the step cycle is shown before the removal of the extensors (white), two days after the removal (black) and eight days after the removal (grey).

Spinalized animals are also able to adjust to changes in their body dynamics. The adjustment of the feedforward motor command to changes in the body and environmental dynamics has been extensively studied during reaching in humans (Shadmehr and Mussa-Ivaldi, 1994). Pearson and colleagues developed a paradigm to study such anticipation during walking in the cat (Pearson et al., 1999). Cats are digitigrade animals: they stand and walk on their toes (shown in blue in Figure 1.8.A), with their ankles raised above the ground. Keeping the ankle raised above the ground requires the contraction of several ankle extensor muscles during the stance phase of locomotion. In normal locomotion, the hind leg touches the ground with an ankle angle of around  $110^\circ$ , which remains constant through most of the support phase (Figure 1.8.B, top panel, first 350 ms). At the end of stance, the ankle is extended; then the foot rises from the ground and the ankle is flexed to bring the foot forwards (Figure 1.8.B, top panel, last 350 ms). If the nerves to all the ankle extensor muscles of one hind limb are cut except one, then at first when the cat steps on that hind limb, the ankle yields (Pearson et al., 1999). Thus, after the foot touches the ground, the ankle flexes because the remaining ankle extensor cannot support the cat's weight (Figure 1.8.B, middle panel). Within a day, there is an increase in the contraction of the remaining extensor muscle after the paw touches the ground, which reduces the ankle yield. This may rely on sensory feedback. However, over seven to ten days, there appears an early contraction of the remaining muscle, before the paw touches the ground, which largely prevents ankle yield (Figure 1.8.B, lower panel). Such anticipation is analogous to the anticipation of force fields in reaching (Shadmehr and Mussa-Ivaldi, 1994), which is interpreted as evidence that internal models are used by a central processor to calculate motor commands. However, Bouyer and colleagues have shown that if the nerves to certain ankle extensor muscles are cut in a spinalized cat (Figure 1.8.C), then the initial ankle yield observed during locomotion is also largely compensated for within a week, through increased contraction of the remaining ankle extensor, both before and after foot contact, as shown in Figure 1.8.D (Bouyer et al., 2001). Thus, anticipation can also be learned in spinalized animals. This suggests that anticipation in intact animals may not rely on a centralized, supra-spinal controller finding the best combination of fixed spinal building blocks, since even the spinal organization of movement adjusts to changes in the body dynamics.

In the same way, learning does not consist in the spinal cord finding the best way to control fixed musculoskeletal dynamics, since the properties of the muscular system itself adjust over the course of learning. Indeed, Bouyer and colleagues observed that after a week, compensation of ankle yield is largely accomplished but not quite complete (Bouyer et al., 2001). They pursued training for 35 days in one of their spinalized animals, and showed that compensation was complete after this period. A similar paradigm has been used in intact rats to study the compensation for the removal of synergist muscles (Degens et al., 1995; Gardiner et al., 1991). These studies have shown that after ten days of regular walking practice, there start to be changes in the remaining synergist muscle which increase gradually over a month (Degens et al., 1995): the muscle mass increases, which should increase the muscle force; and the muscle becomes more resistant to fatigue. The increased mass and fatigue-resistance of the muscle are still observed after several months (Gardiner et al., 1991; Olha et al., 1988). Thus, the complete compensation for ankle yield observed after a month of training in spinal cats (Bouyer et al., 2001) may rely on the adjustment of the muscular system itself. Perhaps complete compensation was not initially possible because the remaining ankle extensor muscle was unable to produce and sustain sufficient force to prevent ankle yield during stance.

Thus, improvements in motor performance may not rely only on acquiring better knowledge of the body dynamics, and using this internal model of body dynamics to compute the best way of controlling the body. Skill learning may also rely on adjusting the body mechanics themselves to the task at hand.

#### IV. Improvements in performance through the adjustment of body dynamics

An extensive literature in sports science has provided evidence that improvements in performance rely on changes in the body dynamics that occur over the course of learning. A recent development in robotics, the embodied robotics approach, has shown that if the engineer designs the mechanical properties of a robot in accordance with the task assigned to the robot, then the control of such a robot requires minimal knowledge of the robot dynamics and can be implemented without internal models or centralized computation. This has sparked renewed interest in the interactions between the nervous system and the body dynamics in the generation of animal and human

movement. I propose to develop this neuro-mechanical approach one step further by exploring how the nervous system may adjust body mechanics to the task at hand. I therefore present the rationale for my thesis, which is to study the role of postural adjustments in motor coordination.

### 1. How the way we move shapes our body

Mobility, the ability to move and perform physical activities, relies on the ability to shape the contact forces with the ground. Indeed, these contact forces are what allows a person to accelerate, decelerate and turn. Thus, sprinting requires large forwards acceleration, obtained by pushing backwards with the legs on the ground, whereas jumping requires large vertical forces, obtained by pushing downwards with the legs on the ground. Consequently, to improve in skills which require fast and ample movements, athletes may train to increase the maximal forces they can exert with their limbs (Duchateau and Baudry, 2010).

#### a) Muscle force

##### *Increases with training*

An increase in maximal limb force may be obtained through an increase in the maximal force exerted by the limb muscles. The force exerted by a muscle depends on the number of force-exerting elements in parallel within the muscle. Maximal muscle force is therefore highly correlated with the muscle cross-sectional area (CSA) (Narici et al., 1996). This is especially true if maximal muscle force is recorded by electrically stimulating the muscle nerve at high intensity (Davies et al., 1983). This procedure, called 'tetanic contraction', is however not frequently used as it can be quite painful. The other way to record maximal muscle force is to ask the subject to exert the largest possible force. This is called 'maximal voluntary contraction' (MVC), and MVC is less correlated to muscle CSA than tetanic contraction: in certain conditions, only 50% of the variance in MVC may be explained by the muscle CSA (Maughan et al., 1983; Narici et al., 1996), whereas up to 87% of the variance in tetanic contraction can be explained by the muscle CSA (Davies et al., 1983).

Numerous intervention studies show that after several weeks of continued strength training, the force-producing capacity of the muscle is increased. Thus, Duchateau and Hainaut show a gradual increase in the force elicited by tetanic contraction of a finger muscle over 3 months of strength training (Duchateau and Hainaut, 1984). Many studies show an increase in muscle CSA (called muscle hypertrophy) over several weeks of continued strength training (Davies et al., 1988; Garfinkel and Cafarelli, 1992). These muscular adaptations occur quite slowly, over the course of weeks or months, and several studies show that strength starts to increase long before muscle hypertrophy occurs (Akima et al., 1999; Hickson et al., 1994; Jones and Rutherford; Komi, 1986).

Indeed, increases in strength can occur very fast. Kamen and Knight thus tested the maximal knee extension force at a 2 day interval, and observed that the force was larger in the second session (Kamen and Knight, 2004). This suggests that even a single testing session can provide sufficient practice to increase maximal force within 2 days, long before any changes in muscle CSA may have occurred. This fast initial increase in muscle force is due to increased neural activation of the muscle. Indeed, this is one of the few studies in which the motor neuron firing rates were recorded, and the increase in force between the testing sessions was correlated to the increased firing rate. Likewise, Patten and colleagues (Patten et al., 2001) tested the maximal abduction force of the fifth finger at a one week interval, and showed that both the maximal force and the motor neuron firing rate were higher in the second testing session.

Increases in strength seem to rely on increased motor neuron firing rate only at the very beginning of practice, as illustrated in Figure 1.9. Thus, in both studies, after the two first testing sessions, the subjects then trained during 6 weeks. The maximal force continued to increase, however in the first study (Kamen and Knight, 2004) the firing rate plateaued within 10 days, whereas in the second study (Patten et al., 2001) the firing rate decreased back to the activity on the first testing session.

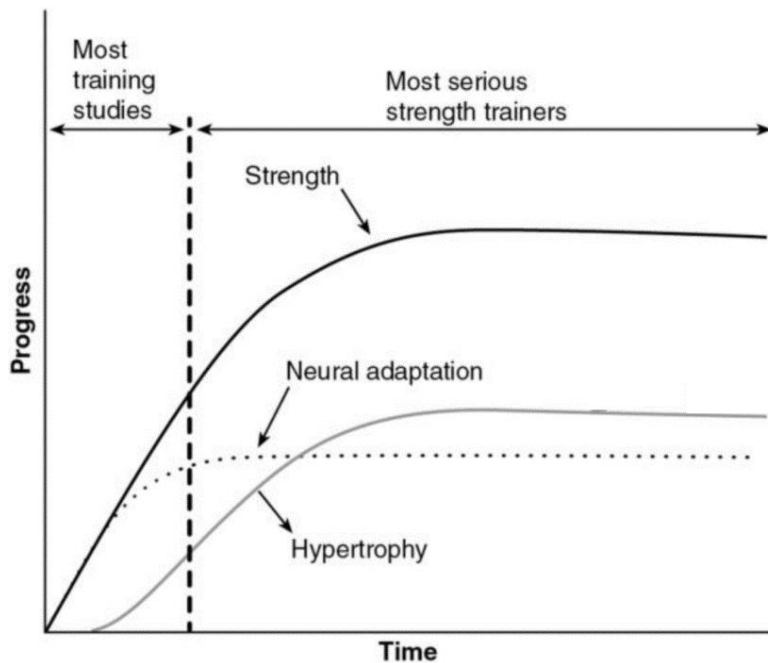

Figure 1.9 Neural and muscular adaptations to strength training over time, adapted from Moritani and deVries (1979).

Recording motor neuron firing rates during contraction can be quite challenging as it requires needles to be inserted into the muscle (Kamen and Knight, 2004; Patten et al., 2001). Therefore, a much more widely used measure of neural activation is to record the change in the electrical activity on the skin above the muscle: this is called electromyogram activity (EMG). A pioneering study by Moritani and de Vries showed that early increases in force are related to increases in EMG amplitude, with muscle hypertrophy only occurring much later, after weeks of training (Moritani and deVries, 1979). This increase in EMG amplitude has since been replicated in numerous studies (Aagaard et al., 2002; Häkkinen et al., 1998; Narici et al., 1989; Seynnes et al., 2007).

Thus, changes in maximal force of limited amplitude can occur within days through increased neural activation. If practice is pursued on the long run, then the muscle itself adapts to produce more force (Figure 1.9).

#### *Decreases with disuse*

Maintaining high maximal strength requires continued practice: when practice is interrupted, maximal strength decreases (Häkkinen et al., 1985; Narici et al., 1989). At first, loss of strength occurs before any change in muscle CSA (analogously to strength gains). There is a subsequent decrease in muscle CSA, called muscle atrophy. Maximal strength is also reduced after limb immobilization, and similarly to the interruption of practice, strength loss is first due to an initial decrease in EMG activity, which is then followed by muscle atrophy (Duchateau and Hainaut, 1987, 1991). There are also combined decreases in muscle mass and strength during aging (Aniansson et al., 1983; Frontera et al., 2000).

To elucidate the mechanisms of muscle atrophy, intervention studies have been performed in animals. These have shown that muscle atrophy can be induced through paralysis, either by cutting the nerve to a muscle (Patterson et al., 2006), or by cutting the spinal cord and spinalizing the animal (Czéh et al., 1978). The atrophy of the paralyzed muscle after spinalization can be prevented by daily stimulating the muscle's nerve (Czéh et al., 1978), which suggests that muscle contraction can preserve muscle mass. Muscle atrophy can also be induced by unloading the muscle (i.e. preventing the muscle from exerting tension), either by immobilizing the limb in a plaster cast (Herbison et al., 1979), by cutting the muscle's tendon (Herbison et al., 1979), by raising the animal's hindquarters

by the tail, which prevents the hind limbs from carrying the animal's weight (Anderson et al., 1999), or by sending the animal on a spaceflight for two weeks (Ohira et al., 1992). Thus, if a muscle is not made to produce force, then its mass decreases.

If on the contrary, the force required of a muscle is increased, then this can result in hypertrophy. Thus, as mentioned previously, when certain ankle extensor muscles are removed, the remaining ankle extensor compensates through hypertrophy (Degens et al., 1995; Gardiner et al., 1991).

### *Summary*

Thus, the maximal strength that an animal or person can produce is highly responsive to that person's physical activity: if the person strains to exert more force than they are able to, then this increases their maximal strength; if however the person does not try to exert force, then this decreases their maximal strength. Initial changes in maximal strength can be very fast, occurring over a few days through changes in neural activation. However, these cover a limited range, and larger changes rely on slower and longer-term changes in the force-producing capacity of the muscles themselves.

#### b) Endurance

Physical activity causes adjustments not only in muscle mass but also in the composition of muscles. There are several types of muscle fibres in mammals, with different contractile properties and fatigue resistance, reviewed in (Schiaffino and Reggiani, 2011). The fibre types which produce the largest forces have the fastest contraction and are called fast fibres. They are also the most susceptible to fatigue, and cannot sustain a large force for a long time. The slow fibres produce smaller peak forces, but can sustain these for long durations. These two fibre types, as well as sub-classes within each type, can be distinguished by staining the fibre for myosin heavy chain isoforms.

In a cross-sectional study of human athletes, Costill and colleagues showed that a given leg muscle, the vastus lateralis, has a larger proportion of fast fibres in sprinters than in endurance athletes (Costill et al., 1976). This suggests that the type of a given muscle fibre can change according to physical activity. However strength training interventions have not been found to cause a change in the proportion of fast and slow fibres (Aagaard et al., 2001; Alway et al., 1989). There is however a shift within fast fibres towards a faster sub-class of fibres (Adams et al., 1993; Canepari et al., 2005; Hather et al., 1991; Hortobágyi et al., 1996; Staron et al., 1991). Perhaps longer periods of strength training may cause a change in fibre type proportions. However an alternative interpretation is that, contrary to muscle mass, muscle composition does not respond to training for increased muscle strength. It may instead respond to training for endurance. Thus, cross-sectional studies show that patients with spinal cord lesions whose legs are paralyzed have almost only fast fibres (Grimby et al., 1976).

This has been confirmed in intervention studies in animals. Several protocols which induce muscle atrophy also induce a shift towards faster fibres, such as paralysis through denervation (Patterson et al., 2006), hind limb suspension and spaceflight (Ohira et al., 1992). A shift from fast to slow fibres on the other hand can be induced by long-term chronic stimulation of the motor nerve. Maier and colleagues thus stimulated the nerve of a fast-twitch muscle for twelve hours a day (with an hour of rest interleaved with every hour of stimulation) for up to four months and observed the muscle gradually transition to a slow muscle (Maier et al., 1988). Gordon and colleagues observed a similar transition after stimulation for 24 hours a day for three months (Gordon et al., 1997). Muscle overload can also be induced by removing a muscle's synergists: thus, after the removal of certain ankle extensor muscles, the remaining ankle extensor muscle compensates not only through hypertrophy, but also with a shift towards slower fibre types (Degens et al., 1995; Gardiner et al., 1991).

Thus, muscle disuse through paralysis or unloading causes both muscle atrophy and an increase in the proportion of fast fibres, whereas muscle overload causes hypertrophy and an increased proportion of slow fibres. This suggests that both muscle force and composition adjust to the level of physical activity in order to produce the

required forces. Peculiarly, during aging, there is both muscle atrophy, and an increase in the proportion of slow fibres (Evans and Lexell, 1995).

c) Bone density

For muscle forces to influence mobility, they must be translated into contact forces. This requires a skeletal system which is able to withstand these contact forces, especially at impact, for example at heel strike during running. Indeed, the skeleton also adjusts to the level of physical activity.

When bones do not carry weight, their mass decreases: thus, in humans, bed rest (Smith et al., 2003) and space flight (LeBlanc et al., 2000; Vico et al., 2000) lead to bone loss. In the mouse, hind limb unloading by tail suspension also leads to bone loss (Aguirre et al., 2006). This paradigm has been used to demonstrate that this process relies on osteocytes, which are cells inside the bone which constantly remove the parts of the bone that are not loaded. If a part of the bone is loaded, then this produces a mechanical signal, which is sensed by these osteocytes, and prevents them from removing that piece of bone (You et al., 2008). Thus, exercise and mechanical loading preserve bone density: elite athletes and chronic exercisers have higher bone density than their age-matched, non-exercising controls (Marcus, 2002), especially those athletes whose activity requires high impact forces (such as jumping, but not swimming). Likewise, racehorses with higher exercise have higher bone density (Boyde, 2003).

Thus, bone mass and density adjust to an individual's amount of weight-bearing activities and exercise. In principle, the mechano-sensation by osteocytes of the stresses within bones may also allow the fine structure and shape of a person's bones to adjust to the specific stresses which that person experiences (Myers, 2013).

d) Implications for motor learning

Sensorimotor learning by the nervous system occurs within a body whose sensory and motor aspects change at multiple timescales, from the long timescales of growth and aging to the short timescales of adaptation and fatigue. Within existing sensorimotor learning theories, the changes in the sensory and motor aspects of the body are either ignored, or considered as a nuisance to be overcome, typically through elaborate inference algorithms.

However, as I have presented, the changes which occur throughout exercise in the structure of a person's bones and muscles are functional, and improve the person's ability to perform the movements they practice. Thus, bone density responds to weight-bearing, muscle mass responds to resistance training, and muscle fibre properties respond to endurance training. If a sprinter's calf muscles are too slow and too weak to produce fast and strong impact forces, then whatever command the nervous system issues to the muscles, it will not allow the person to win the race. If the person's muscles are strong enough but their bones are too weak to withstand the impact forces, then they may break (Court-Brown et al., 2008), and the person may still not win the race. Thus, skill learning does not consist only in finding the best motor command for a given body. Through practice, the body itself changes such that the motor command for a strong, smooth, ample movement might not even exist for the stiff, weak, brittle-boned novice. Thus, after skill learning, the body itself can be thought of as embodying knowledge about the movement to be performed.

This suggests a different way of considering the role of the nervous system in motor learning. Its task is not only to find better ways of controlling the body, for example by acquiring knowledge about the body and environmental dynamics. It must also guide changes within the body itself so as to adjust the body mechanical properties to the task being practiced.

2. How much knowledge is necessary for motor control?

In traditional robotics, improvements in performance are obtained by improving the control of movement, either through better approximations for inverse models, or through online adjustment of feedback gains. A more recent

approach, the embodied robotics approach, suggests a radically different alternative: if the body itself embodies knowledge about the movement to be performed, then the controller does not need this knowledge. Indeed, this approach has demonstrated that stark improvements in the robustness, agility and performance of legged robots running in natural environments can be achieved by improving the design of the robotic bodies themselves (Pfeifer and Bongard, 2006).

a) Weight for propulsion

The first striking demonstration of the importance of the body dynamics was provided by McGeer's passive dynamic walker (McGeer, 1990) (Figure 1.10.A), later improved on by (Collins et al., 2001) (Figure 1.10.B). The passive walker has no motors. Its legs are made of two rigid segments articulated at the knee, and the two legs are articulated at the hips. The shape and weight of the walker's segments have been designed so that the walker steps from foot to foot: when one leg is in contact with the ground, the other leg swings forwards like a pendulum from its own weight, until it touches the ground and the first leg then starts swinging forwards. Such a mechanical device is very stable in the forwards direction, but not in the lateral direction: it can very easily topple on its side. Therefore, in McGeer's implementation, each leg is actually composed of two legs constrained to swing together (Figure 1.10.A). This four-legged device is stable in both the forwards and lateral directions. Collins and colleagues then developed a laterally stable biped: they improved the walker's balance by equipping it with wide feet, elastic heels, and counter-swinging arm, as shown in Figure 1.10.B (Collins et al., 2001). These walkers have no motors: their motion is therefore determined by their mechanical properties rather than their (non-existent) control. Yet, the resulting walking pattern is stable, and has a very natural feel to it (Pfeifer and Bongard, 2006).

Since the walker uses its own weight for propulsion, its gait is very energy efficient. The passive walker loses energy every time one of its heels strikes the ground, and must therefore walk down a slope in order to maintain steady walking. Minimal actuation can be added to allow the walker to walk on flat ground: for example, by detecting heel strike in the forwards leg and using it to trigger ankle push-off from the backwards leg. This allows the robot to walk on flat ground with at least ten times less energy consumption than more traditional robots with motors controlling each joint (Collins et al., 2005). This approach has yielded much insight into the energetic efficiency of human walking (Kuo and Donelan, 2010).

b) Elasticity for robustness to perturbations

The design of running quadruped robots has also been shown to benefit from an improvement of the robot's morphology. Thus, the quadruped robots Puppy (Iida and Pfeifer, 2004) and Cheetah-Cub (Spröwitz et al., 2014) (Figure 1.10.C) have a leg structure designed to imitate that of a cat or a dog, with two springs attached to each leg. The actuation is very simple, with motors at the hips and shoulders swinging the legs back and forth rhythmically. The elasticity of the legs allows them to adjust the ground contact forces to the height of the ground. Thus, although it has no sensors, Cheetah-Cub can run down a small step without falling (Spröwitz et al., 2014): its body mechanical properties are sufficient to provide robustness to small external perturbations.

Elasticity in a joint prevents the joint torque from being fully determined by the control signal (such as the external command to the motor for a robot, or muscular contraction for an animal), since the joint torque will also depend on the joint angle. Rather than hindering motor performance, here this lack of direct control actually improves performance, since the elasticity allows the joint torque to adjust to the actual contact forces.

c) Implications for motor control

Thus, if the engineer can design mechanical properties which are appropriate to the task assigned to the robot, then minimal knowledge is required to produce efficient motion patterns: the robot's own weight can be used for propulsion, without the need for feedforward control, and the elasticity of the robot's limbs allows it to adjust ground contact forces to external perturbations, without the need for feedback control.



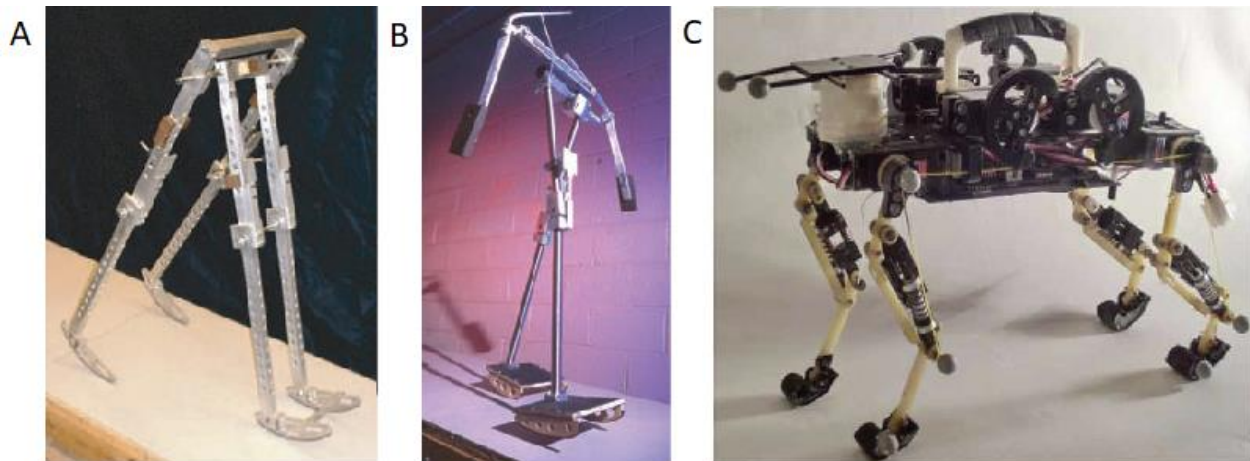

Figure 1.10 Embodied robotics. A. A passive dynamic walker based on McGeer's design. B. The Cornell passive biped with arms. C. Cheetah-Cub, a quadruped robot with compliant legs. A. and B. are taken from Collins et al. (2005), C. from Spröwitz et al (2014).

### 3. Adjustment of body mechanical properties for stability

Certain authors have emphasised that motor coordination in animals and humans cannot be attributed solely to the nervous system (Turvey and Fonseca, 2009). Thus, according to Chiel and Beer, "the role of the nervous system is not so much to direct or to program behaviour as to shape it and evoke the appropriate patterns of dynamics from the entire coupled system. As a consequence, one cannot assign credit for adaptive behaviour to any one piece of this coupled system" (Chiel and Beer, 1997). The role of the intrinsic body dynamics, body elasticity, and external environment in shaping contact forces has been emphasised by Latash: "forces and moments of force cannot be prescribed by any neural controller, no matter how smart it is" (Latash, 2010). The success of the embodied robotics approach has sparked a renewed interest in how the interactions between the nervous system and the body dynamics shape motor behaviour (Nishikawa et al., 2007; Ting and McKay, 2007).

#### a) Stiffness in stance

When standing, the destabilizing effect of gravity can make one fall: for example, if a pencil is placed perfectly vertical on its tip, it may remain vertical. However, if the slightest perturbation causes it to lean one way, then its own weight will exert torque which will amplify this initial lean, up to falling. If a standing person or animal starts to lean, then their nervous system can intervene to prevent them from falling. However, even the fastest change in contraction after a perturbation, which is due to the short-latency spinal response, has delays of several tens of milliseconds (Hammond, 1956). During this delay, the movement of the body is entirely determined by the body and environmental mechanical properties. Body mechanical properties which slow down falling during this delay may therefore be useful for balance. De Groot and colleagues asked human subjects to stand still on a platform which was then translated backwards or forwards (De Groot et al., 2017). They observed the resulting motion of the body during the time it takes for the nervous system to intervene, and attempted to reproduce this motion in simulations. They found that if muscle stiffness was not included in their simulations, then the simulated body fell much faster than the human subjects. Muscle stiffness may thus slow down falling during the response delay, thus improving stability. Bunderson and colleagues attempted to simulate cat stance, and likewise showed that muscle stiffness could slow down falling, thus allowing delayed neural feedback mechanisms to intervene (Bunderson et al., 2008).

The appropriate stiffness depends on the level of gravity, and human subjects have been shown to adjust their leg stiffness appropriately to the level of gravity (Gambelli et al., 2016a, 2016b). This was demonstrated in parabolic flights, in which the effect of gravity is cancelled. To observe how finely the subjects could adjust to gravity, straps were placed on the subject's shoulders which pulled them downwards with a fraction of their weight ranging from

20% to 100%. The subjects were then asked to perform jumps, and the kinematics of the movement as well as the lower leg muscular contraction patterns were recorded: with decreasing levels of gravity, leg muscle contraction was decreased, in a way which appeared to decrease leg stiffness.

b) Stiffness in reaching

Reaching experiments are typically done with the arm constrained to move on a horizontal plane. Since the arm is supported against gravity, arm stiffness may be irrelevant for accurate reaching. However this can be altered by having subjects reach in a force field which mimics the effect of gravity: Burdet and colleagues thus used a force field in which any lateral displacement of the hand elicits a lateral force proportional to the displacement (Burdet et al., 2001). They measured the stiffness of the arm by measuring the change in force after a displacement of the hand in mid-reach. They showed that after learning, arm stiffness in the lateral directions was increased, but not in the forwards or backwards directions (Burdet et al., 2001). Just as leg stiffness has been shown to adjust to the level of gravity (Gambelli et al., 2016a, 2016b), arm stiffness has also been shown to adjust to the level of gravity mimicked by the force field (Franklin et al., 2004): thus, when the environmental instability was increased (by increasing the simulated level of gravity), the lateral arm stiffness was also increased so that the total arm stability was at a level comparable to normal reaching (without a force field). This adjustment of arm stiffness to the task at hand may be sufficient to explain the pattern of variability in skilled reaching movements which I described previously. Thus, lower variability in the task-relevant as opposed to the task-irrelevant dimensions may be achieved simply by increasing stiffness in the task-relevant dimension.

c) Leg posture in running

Leg posture has also been shown to be important for ensuring stability. Birds can run over unanticipated changes in the height of the ground without stumbling or falling, and this seems to rely on the adjustment of leg posture (Daley et al., 2009). In this experiment, guinea fowls were made to run over a walkway covered in paper that was much too thin to support the bird. In certain trials the walkway below the paper was flat, in other trials the paper covered a drop in the walkway of about 40% of the bird's leg length. Despite this unexpected drop in the height of the ground, the birds were able to keep running without stumbling. The muscle contraction with which the leg pushes on the ground only lasts a few tens of milliseconds after foot contact with the ground (toe down TD), but the latency of the stretch reflex is around 30 to 40 ms. There was therefore no change in the muscle contraction observed during the perturbed step. There was however a change in the work performed by the leg, which allowed the leg to absorb the energy of fall (Figure 1.11, perturbed steps in red). Since the leg is pulled backwards before toe down, if the ground level is lower than expected, then toe down occurs with the leg more extended than usual, and this change in leg posture may explain the change in work performed by the leg. The authors further showed that during the step up from the drop (Figure 1.11, recovery steps in green), the leg is more flexed and performs more positive work (which raises the centre of mass) than usual (Figure 1.11.B), further emphasizing the relationship between leg posture and stability. Leg retraction before toe-down thus provides a simple control mechanism for adjusting leg posture to the height of the ground (Seyfarth et al., 2003).

Thus, despite delays in neural intervention, robustness to external perturbations can be ensured by adjusting limb posture and stiffness to the requirements of the task at hand.

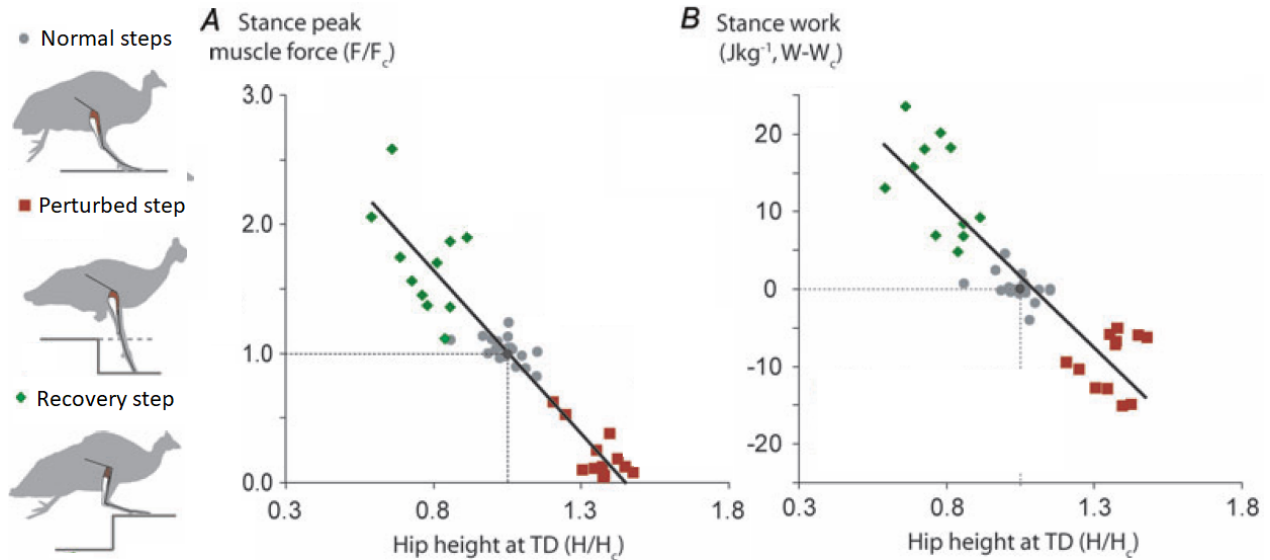

Figure 1.11 Leg posture for stability during running. A. Peak force of the stance leg, normalized to body weight  $F_c$ , as a function of hip height at toe down TD (time of first contact of the foot with the ground), normalized by average hip height. B. Work performed by the stance leg, normalized by average work, as a function of hip height at TD. Adapted from Daley et al. (2009).

## V. Motivation and plan of the thesis

### 1. Motivation

I have presented two major theories of motor coordination. According to the computational theory (Figure 1.12.A), movement is achieved by having a centralised computer calculate and set the contraction of each muscle. In turn this muscle contraction determines the joint torques, which determine the movement. The calculation performed by the brain is based on a measure of task performance (such as a cost function on accuracy and effort), on internal models of how the body dynamics respond to motor commands, and eventually on ongoing sensory feedback about task achievement. However, when an external force perturbs an ongoing movement, the fastest change in muscle contraction is provided by the spinal cord. Due to the neuro-anatomy of motor control, sensorimotor feedback through the brain involves longer sensorimotor delays. Any delay in counteracting a perturbation is a challenge for stability. It therefore makes sense for certain characteristics of motor coordination to be determined within the spinal cord rather than the brain.

According to the theory of synergies (Figure 1.12.B), movement is achieved by having the brain selectively activate and combine a set of fixed spinal synergies. In turn, each spinal synergy determines a temporal pattern of muscle contraction which effects a coordinated movement. However, spinal synergies are not fixed, which contradicts the theory of synergies. I have reviewed evidence that functional spinal coordination relies firstly on long-term adjustments within the spinal cord to the body's dynamics (as evidenced by the persistence of learning after spinalization); and secondly on short-term modulation by the supra-spinal centres to adjust the spinal patterns to the context and the task at hand.

I have then shown that the same arguments hold when considering the relation of the nervous system and the body mechanical properties. In both the computational theories and the theory of motor synergies, motor coordination is attributed to the pattern of muscular contraction. However, when an external force perturbs an ongoing movement, the fastest change in force is provided by the body mechanical properties, before any change in muscular contraction. It therefore makes sense for certain characteristics of motor coordination to be determined by the body mechanical properties rather than the nervous system. Moreover, for efficient

performance, these body mechanical properties must be appropriate to the task at hand. I have reviewed evidence that body mechanical properties are adjusted in the long run to the level and type of physical activity.

The purpose of my thesis is to understand how body mechanical properties are adjusted, in the short-term, to the context and the task at hand. I will refer to the system which adjusts these body mechanical properties as the postural system. I will explore the implications of such postural adjustments for skill and motor coordination.

## 2. Plan of the thesis

The first chapter focuses on the ability to remain immobile despite external perturbations. It presents a general model of how body mechanical properties and delayed sensorimotor feedback interact to produce stability. This model accounts for a variety of experimental observations in studies of immobility, both in quiet standing and in arm movements requiring accurate hand positioning. This chapter has been presented at international conferences (Le Mouel and Brette, 2016a, 2016b, 2017a).

The second chapter focuses on the initiation of movement. The role of the patterns of muscular contraction observed at the initiation movement is usually assumed to be to counteract the destabilizing force of gravity during the movement. However I show that, when initiating a movement (as opposed to remaining immobile), the force of gravity is not necessarily destabilizing. On the contrary, in skilled movements, it can even be harnessed to provide impetus to the movement. I therefore present a novel theory of postural adjustments at the initiation of movement, which accounts for a variety of experimental observations. This chapter is published in an international peer-reviewed journal (Le Mouel and Brette, 2017b) and has been presented at an international conference (Le Mouel and Brette, 2017c).

The third chapter presents how aging affects both the ability to remain immobile and the ability to produce thrust for the initiation of movement. My hypothesis is that changes in these abilities depend on changes in the ability to adjust posture to the task at hand. To test this hypothesis, I analyzed the data of a previously published experiment performed by Tisserand and colleagues at the Laboratoire de Biomécanique et Mécanique des Chocs, of IFSTTAR (Tisserand, 2015; Tisserand et al., 2016a). My analysis shows that the ability to adjust posture in advance of a perturbation is retained during aging, but that elderly subjects are slower to adjust their posture in response to a cue, and that this may underlie fall risk.

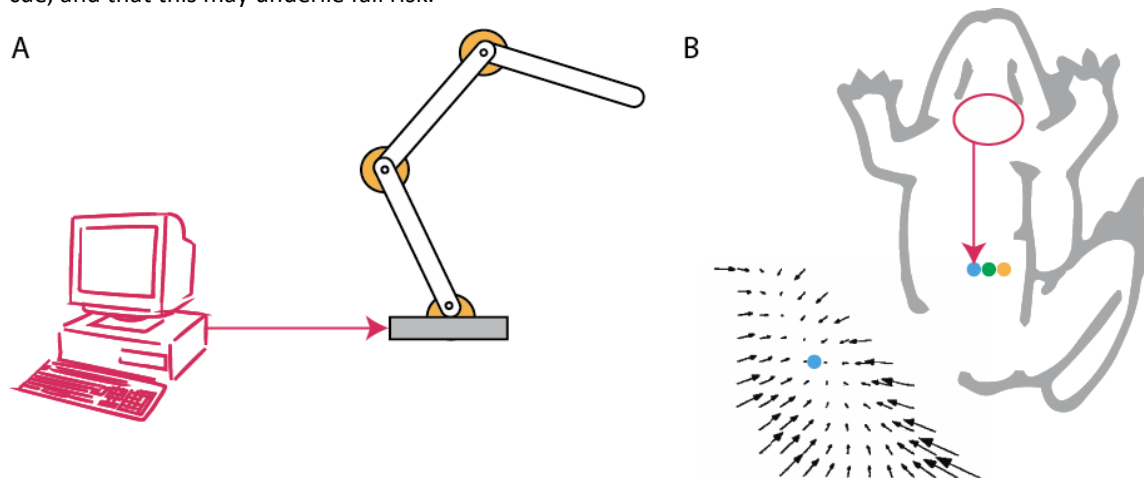

Figure 1.12 Theories of motor coordination. A. In the computational theory, the brain (pink) is thought of as a computer calculating the contraction of each muscle. B. In the theory of synergies, the brain (pink) is thought of as a pianist playing a melody on the keyboard of spinal synergies.



## 2. Postural adjustments for improving stability

### I. Introduction

Unexpected perturbation forces may compromise the success in a motor task, such as using a tool, or simply standing still. These two experimental paradigms have been extensively studied to determine how the nervous system faces such a challenge. Studies in different settings have shown that the muscular contraction response to a perturbation may be either increased (Krutky et al., 2009) or decreased (Sibley et al., 2007). Several studies report an anticipatory adjustment of the body mechanical properties, such as stiffness (Franklin et al., 2003) or inertia (Trumbower et al., 2009), in advance of the perturbation. A modelling study suggests that the body mechanical properties constrain the muscular contraction responses that can ensure stability (Bingham et al., 2011). There is however no clear picture of how the nervous system faces the challenge due to external perturbation forces. The purpose of this chapter is to provide a simple unifying model of how the nervous system faces perturbation, which accounts for the diversity of experimental results.

#### 1. Muscular contraction response to a perturbation

When the nervous system senses a perturbation force through proprioception, it intervenes to compensate for it through an appropriate change in muscular contraction. The fastest change in motor contraction is due to the direct connection between muscle spindles embedded in a muscle (Figure 2.1.A, B in yellow) and the motor neurons in the spinal cord (Figure 2.1.A, B in brown). This direct spinal feedback can be probed by electrically stimulating a nerve and measuring the muscular contraction through EMG (Knikou, 2008). This elicits a first burst of muscular contraction called the M-wave, due to the direct stimulation of the motor axons within the nerve (Figure 2.1.A in brown, C). It also elicits a second burst of muscle contraction called the H-reflex (Figure 2.1.B, C). This is due to the stimulation of the sensory afferents in the nerve (Figure 2.1.B in yellow). These then directly excite the motor neurons within the spinal cord, which elicits the second burst of muscular contraction. The H-reflex therefore probes the spinal sensorimotor feedback. Sensorimotor feedback can also be probed using a mechanical perturbation, which stretches certain muscles and elicits a muscular contraction called the stretch reflex. This stretch reflex typically has several components occurring at different latencies after the stretch. The earliest component probes the direct spinal feedback, whereas longer latency components may incorporate indirect spinal feedback and supra-spinal feedback.

In studies of stance, the calf muscle H-reflex is consistently found to be decreased when conditions for balance are challenging, such as when standing facing a cliff as in Figure 2.1.D (Sibley et al., 2007), when standing on a narrow support as in Figure 2.1.E (Trimble and Kocaja, 2001), or simply when closing the eyes as in Figure 2.1.F (Pinar et al., 2010). In populations which practice balance in challenging conditions, such as ballet dancers (Mynark and Kocaja, 1997), this spinal contribution is found to be reduced even in normal balancing conditions, such as standing on flat, solid ground. The classical interpretation for this reduction in the spinal contribution to balance is that, in challenging conditions, the control of balance is delegated to supra-spinal structures, such as the cortex, which may allow for a more refined control than the spinal cord (Llewellyn et al., 1990).

Robustness to perturbations is also important for tool use (Rancourt and Hogan, 2001): for example, when manipulating a screwdriver, if forces perpendicular to the screwdriver's axis are applied on the handle, this may cause the screwdriver to slip from the screw (Figure 2.2.A). The task is inherently unstable in these lateral directions (in red in Figure 2.2.A), but inherently stable along the axis of the screwdriver (in green in Figure 2.2.A).

An experimental paradigm has been developed to study the manipulation of tools in a laboratory setting (Darainy et al., 2004; Krutky et al., 2009; Perreault et al., 2008): a subject is asked to hold a handle and maintain it at a fixed position. The handle is connected to a robotic arm which exerts forces that depend on the handle's position (Figure 2.2.B-E). Perreault and colleagues studied the manipulation of stable tools by having the robotic arm mimic a stiff handle (Perreault et al., 2008), with forces that return the handle to its reference position, whose amplitude is proportional to the distance to the reference position (Figure 2.2.B, C). These forces were either of small amplitude ("compliant" handle, Figure 2.2.B) or large amplitude ("stiff" handle, Figure 2.2.C). After the subjects had become used to the force field, the experimenter applied perturbations to the position of the handle, and measured the subject's muscular contraction response to the perturbation. The amplitude of the stretch reflex was larger when manipulating the compliant handle rather than the stiff handle.

Krutky and colleagues used the same set-up to study the manipulation of unstable objects (Krutky et al., 2009): the robotic handle mimicked a "negative stiffness" in one direction, accelerating the handle away from a given line (dashed grey line in Figure 2.2.D, E). One group of subjects became accustomed to an instability in one direction (Figure 2.2.D), and another group of subjects to an instability in the orthogonal direction (Figure 2.2.E). The subjects' muscular contraction response to perturbations of the handle in different directions was then recorded: the stretch reflex was found to be increased only for perturbation directions that were aligned with the instability to which the subject had been exposed.

Thus, when manipulating a challenging, unstable tool, the stretch reflex is increased, and this increase occurs specifically in the direction of instability. This is in contrast to studies of stance: when standing in challenging balance conditions, the H-reflex is decreased.

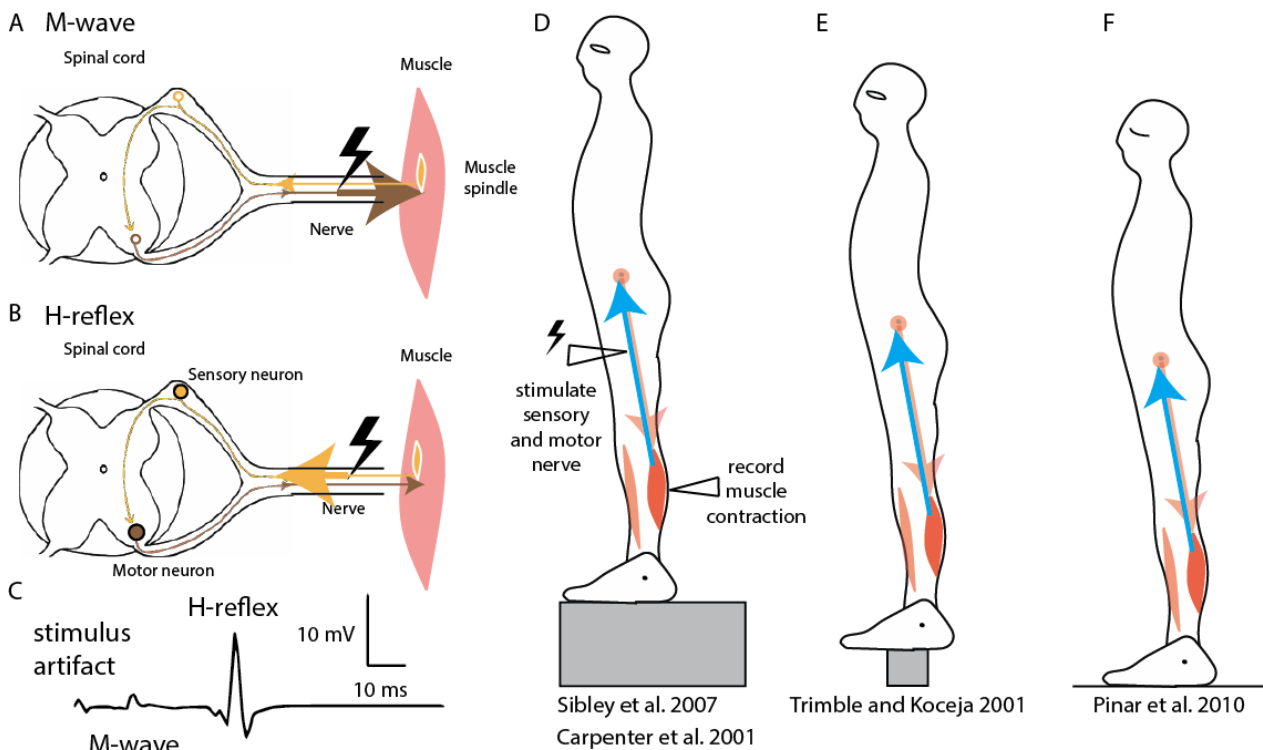

Figure 2.1 Decrease in soleus H-reflex in challenging balance conditions A. The electrical stimulation of a nerve elicits a first burst of muscular contraction, called the M-wave, through the direct excitation of the motor neuron axons (in brown). B. The excitation of the sensory neuron axons elicits a second burst of muscular contraction, called the H-reflex, through the spinal cord. C. Time-course of the EMG recorded from the muscle after the electrical stimulation (taken from Knikou 2008): there is first the stimulation artefact, then the M-wave, then the H-reflex. The H-reflex is larger in normal stance than D. when standing facing a cliff (Sibley et al. 2007), E. when standing on a narrow support (Trimble and Kocēja 2001) and F. standing with the eyes closed. Co-contraction of antagonist ankle muscles is observed in each of these three cases.

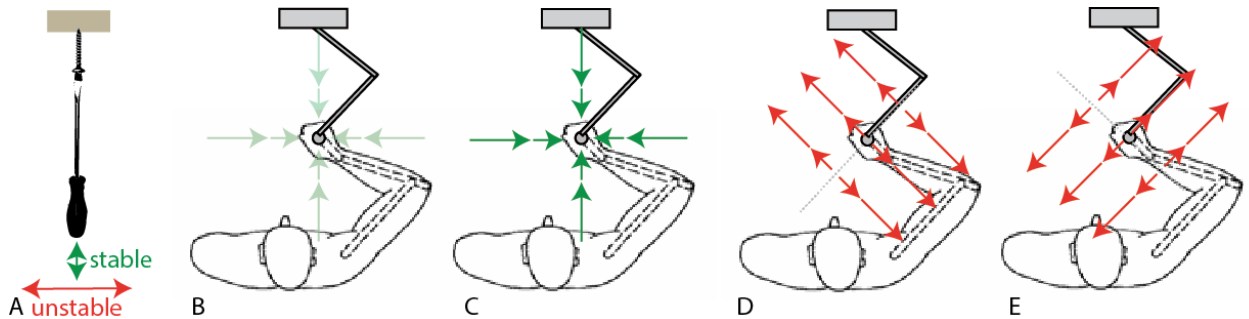

Figure 2.2 Stretch response when manipulating tools. A. Manipulating a screwdriver is inherently stable along the screw's axis (green) and unstable in perpendicular directions (red). B.-C. Schematic of the forces exerted by the robotic arm in Perreault et al. (2008), mimicking a compliant handle (B) and a stiff handle (C). D.-E. Schematic of the forces exerted by the robotic arm in Krutky et al. (2009), mimicking negative stiffness in one direction for half the subjects (D) and in an orthogonal direction for the other subjects (E).

## 2. Body mechanical properties

After a perturbation, the earliest change in muscular contraction which can be recorded through EMG occurs with a delay of several tens of milliseconds. The change in force due to this muscle contraction is only observed after an additional 20 ms (Hammond, 1956). During this total delay, the movement of the body is entirely determined by the body and environmental mechanical properties, such as stiffness, inertia and weight. Several studies have shown that these may be adjusted in advance of perturbations, so as to increase stability during the delay period.

### a) Adjusting stiffness through muscle co-contraction

If the perturbation causes a change in joint angles, then certain muscles and their tendons will be stretched, whereas others will be released from stretch. Because of the intrinsic stiffness of muscles and tendons, a change in angle causes an immediate change in muscle torque, before any change in muscle contraction.

Modelling studies of stance have shown that such intrinsic stiffness may slow down falling during the response delay. Loram and Lakie used a very simple model, the single inverted pendulum model (Figure 2.3.A), to show that ankle stiffness slows down falling (Loram et al., 2007). De Groot and colleagues used a much more detailed model of human stance, in which each leg has 5 degrees of freedom and 43 muscles (Figure 2.3.B), and likewise showed that intrinsic muscle stiffness slows down falling during the response delay, and that a model without such stiffness falls much faster than human subjects do (De Groot et al., 2017).

Experiments performed with sitting subjects have shown that when a person co-contracts their shin and calf muscles, this increases their ankle stiffness (Nielsen et al., 1994). Moreover, in the challenging balance conditions in which the soleus H-reflex has been reported to be decreased, it has also been observed that subjects stand with co-contraction of their shin and calf muscles (Carpenter et al., 2001; Pinar et al., 2010; Trimble and Kocaja, 2001). The nervous system may thus increase ankle stiffness in challenging balance situations (Figure 2.1.D-F).

In a modelling study of reaching, Hogan has shown that co-contraction of arm muscles can increase the stiffness of the arm endpoint, by increasing the stiffness of the arm joints (Hogan, 1985). Moreover, increased arm muscle co-contraction and increased arm endpoint stiffness have been observed when subjects manipulate unstable objects (Franklin et al., 2003). The arm endpoint stiffness is further increased if the object is made more unstable (Franklin et al., 2004). Co-contraction may also be used by the nervous system to improve pointing accuracy: thus, Gribble and colleagues asked subjects to point at a given controlled speed to targets of different sizes (Gribble et al., 2003). Pointing to smaller targets requires more accurate reaching movements, and they observed that with decreasing target size, arm muscle co-contraction increased, the variability of the reach trajectories decreased, and the endpoint accuracy improved.



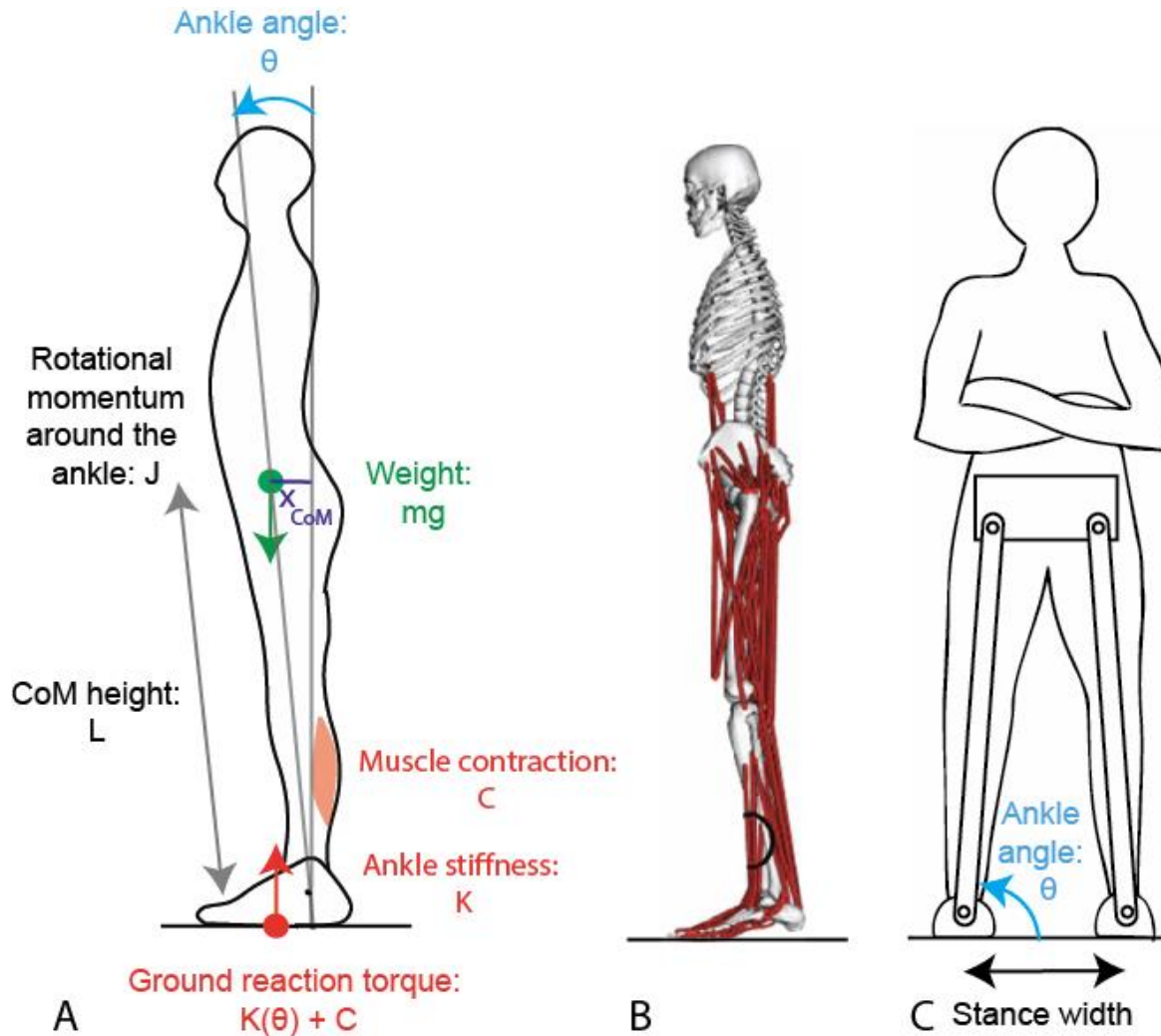

Figure 2.3 Models of stance. A. Single inverted pendulum model used in Loram and Lakie (2007). The external forces acting on the body are the weight (green arrow), whose torque around the ankle depends on ankle angle  $\theta$ , and the ground reaction force (red arrow) whose torque depends on both ankle angle and muscle contraction. B. Detailed model used in De Groot et al. (2017). C. Single dimensional model of lateral stance used in Bingham et al. (2011).

b) Adjusting inertia through posture

The sum of the forces due to the perturbation and the stiffness will have an effect on limb motion which depends on the limb's inertia: a given summed force will induce less motion in a limb with higher inertia. This inertia depends on limb posture.

In a model of lateral stance (Figure 2.3.C), Bingham and colleagues demonstrated that standing with a smaller stance width increases body inertia (Bingham et al., 2011), and suggested that this may explain the reduced stance width adopted by certain neurological patients (Horak et al., 2005).

In a modelling study of reaching, Hogan (Hogan, 1985) demonstrated that, for a given arm endpoint position, the inertia of the arm depends on the arm posture (Figure 2.4.A). The studies that showed an increase of the stretch reflex when manipulating less stable objects were performed with the arm posture constrained (Krutky et al., 2009; Perreault et al., 2008). Therefore, to determine whether subjects adjust their arm posture to the dynamics of the object they are manipulating, Trumbower and colleagues developed a version of this task in which subjects are free to adjust their arm posture, illustrated in Figure 2.4.B-D (Trumbower et al., 2009). When the subjects manipulated a

handle that was unstable in the forwards direction, they used a posture with the arm extended in front of them (Figure 2.4.B). When the instability was in the vertical direction, they kept the hand close to the body and the elbow lowered (Figure 2.4.C). When the instability was in the lateral direction, they kept the hand close to the body and the elbow raised (Figure 2.4.D).

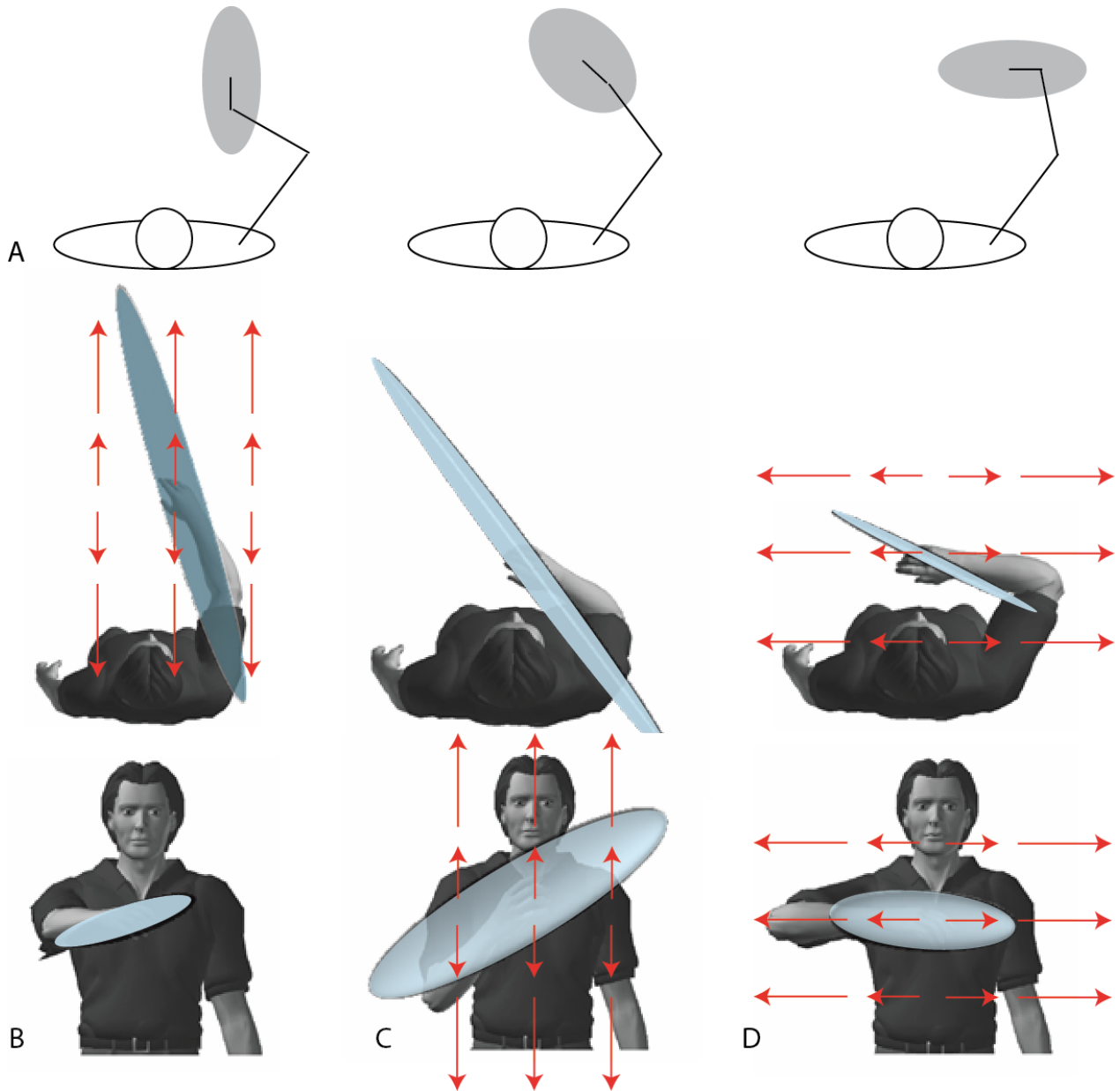

Figure 2.4 Arm posture affects arm endpoint mechanical properties. A. Using a model of the arm as an articulated chain of segments Hogan (1985) showed that different arm postures with the same arm endpoint position have different endpoint inertias (schematically represented as a grey ellipse). B-D are adapted from Trumbower et al. (2009). The forces exerted by the robotic handle are schematically represented by red arrows: they mimicked a “negative stiffness” either in the forwards and backwards directions (B), vertical directions (C) or lateral directions (D). The posture typical arm posture adopted by the subjects is shown for each force field. The force required by the robotic handle to displace the handle by a given amount, as a function of the perturbation direction, is shown as an ellipse for the three arm postures.

The experimenters then applied perturbations to the position of the handle, and measured the force which the robot had to exert in order to displace the handle by a given amount. This force depended both on the direction of the perturbation and on the arm posture (ellipses in Figure 2.4.B-D). The arm postures adopted by the subjects in the different force fields increased this force specifically in the direction of the instability, thus improving stability. The authors attribute this increase in force to an increase in arm endpoint stiffness, however their experimental paradigm cannot distinguish between an increase in stiffness and an increase in inertia. The modelling results of Hogan suggest that changes in arm posture have a stronger impact on arm inertia than on arm stiffness (Hogan, 1985). In any case, Trumbower and colleagues show that when subjects are free to choose their arm posture, they select the arm posture which maximises their accuracy (Trumbower et al., 2009). Indeed, the authors further showed that when the subjects were constrained to adopt a posture different to their preferred posture, their accuracy in maintaining a fixed handle position decreased.

Thus, the dependence of inertia on posture suggests that the nervous system may adjust posture in view of increasing inertia, to reduce the effect of perturbation forces.

### 3. Interactions between body mechanical properties and sensorimotor feedback

When the stability of stance or of a reaching movement is challenged by external perturbation forces, subjects have been shown to adjust their body mechanical properties in advance of the perturbation. Certain studies show increased stiffness due to muscle co-contraction, whereas other studies show increased inertia through an adjustment of limb posture. Thus, whether in standing or reaching, body mechanical properties seem to be consistently adjusted to improve stability during the response delay.

However, standing and reaching show opposite changes in the sensorimotor feedback gains: the stretch response of arm muscles is thus increased when manipulating unstable tools, whereas the ankle H-reflex is decreased when standing in challenging balance conditions. As noted by Bingham and colleagues: “postural stability depends on interactions between the musculoskeletal system and neural control mechanisms” (Bingham et al., 2011). These interactions are further complicated by the fact that a single sensorimotor feedback gain may not be able to stabilize all body postures (Bingham et al., 2011). Thus, when Bingham and colleagues asked their subjects to increase their stance width (thus decreasing their body inertia), they observed that the subjects also adjusted their feedback gains.

One of the difficulties in providing a unifying interpretation to these divergent findings is the diversity of models used. Thus, the interpretation of studies of stance often relies on models with a single dimension. Thus Loram and colleagues describe forwards stance using the single inverted pendulum model (Loram et al., 2001), which simplifies the body geometry and considers a single dimension corresponding to the position of the body centre of mass (Figure 2.3.A). Bingham and colleagues use a different model for lateral stance (Bingham et al., 2011), but likewise reduce body geometry to a single angle (Figure 2.3.C). On the contrary, the interpretation of reaching studies often relies on models with several articulated segments (Hogan, 1985), articulated at the shoulder, elbow and wrist (Figure 2.4.A).

Moreover, each experiment has a different focus: studies of stance highlight the importance of the destabilizing force of gravity, whereas reaching studies focus on manipulating unstable tools. Finally, no study simultaneously assesses stiffness, inertia and feedback gains.

There is therefore no clear picture of how inertia, stiffness, environmental instability (either gravity for stance, or an unstable tool for manipulation), sensorimotor feedback delay and sensorimotor feedback gain combine to determine stability.

This chapter presents a simple, generic model which accounts for this diversity of experimental results. I first show that the effect of body and environmental mechanical parameters and sensorimotor feedback delay can be captured by a dimensionless parameter, which corresponds to how fast perturbations are amplified during the

sensorimotor feedback delay, relative to this delay. I then show that this relative speed constrains the feedback gains which can stabilise the system: faster systems require larger feedback gains, and slower systems require smaller feedback gains. Moreover, if the feedback gain is chosen appropriately, then slower systems are more robust to perturbations. Therefore, to improve robustness to perturbations, the nervous system should adjust the body mechanical properties to reduce the relative speed, and additionally decrease the feedback gain, as observed when standing in challenging balance conditions. However, when the relative speed increases due to an increase in environmental instability (for example when the handle being held is made more compliant, which decreases the total stiffness of the arm and handle), then, to maintain robustness to perturbations, the nervous system should increase feedback gains. These results generalise to multi-dimensional models and therefore provide a unifying account of how the nervous system faces perturbations.

## II. Modelling results

### 1. Single inverted pendulum model of stance

I first present the single inverted pendulum model of stance with delayed feedback control, and show how the combined effects of inertia, stiffness, environmental instability and feedback delay can be captured by a single dimensionless parameter. This parameter corresponds to how fast perturbations are amplified during the feedback delay, relative to this delay.

#### *System dynamics*

When someone is standing on the ground, there are two external forces exerted on them: their weight and the ground reaction force (Figure 2.3.A).

The point of application of the person's weight is called the centre of mass, noted CoM. The torque of the weight around the person's ankles is thus the product of the weight  $mg$  (with  $m$  the person's mass and  $g$  the gravity on Earth) and the forwards distance of the CoM relative to the ankles ( $x_{CoM}$  in blue in Figure 2.3.A). Further details can be found in the Appendix (6.1.1). In the single inverted pendulum model, the person's foot is immobile on the ground, and the rest of the body is assumed to be rigid and to rotate around their ankles. The forwards distance of the CoM can therefore be expressed as a function of ankle angle:  $L \sin(\theta)$ , where  $L$  is the CoM height.

As explained in the Appendix (6.1.2), the torque of the ground reaction force is equal in value (and opposite in sign) to the torque exerted on the foot by the lower leg muscles. This ankle torque is affected by muscle contraction, and, because of ankle stiffness, it is also affected by ankle angle, noted  $\theta$ . I therefore decompose the ground reaction torque as the sum of a mechanical component due to ankle stiffness  $K(\theta)$ , and a component  $C$  due to active muscle contraction through delayed sensorimotor feedback (Figure 2.3.A).

The sum of the external torques affects the person's rotational momentum, which, in the single inverted pendulum model, can be simplified to the product of ankle angle speed  $\dot{\theta}$  and the rotational inertia around the ankles  $J$ . The change in rotational momentum can thus be written:

$$J\ddot{\theta} = m g L \sin(\theta) - K(\theta) - C$$

I consider that the person is initially at equilibrium at an angle  $\theta_0$  with muscular contraction  $C_0$ , and linearize around this equilibrium, introducing  $\theta, k, c$  such that:

$$\begin{aligned}\theta &= \theta_0 + \theta \\ K(\theta) &= K(\theta_0) + k\theta \\ C &= C_0 + c\end{aligned}$$

After linearization, the change in rotational momentum becomes:

$$\ddot{\theta} = \frac{mgL\cos(\theta_0) - k}{J}\theta - \frac{c}{J}$$

During the response delay, the dynamics is therefore governed by the mechanical time constant  $\tau_{mech}$ , defined by:

$$\tau_{mech}^2 = \frac{J}{mgL\cos(\theta_0) - k}$$

The combined effects of inertia  $J$ , stiffness  $k$  and environmental instability  $mg$  can thus be captured by their effect on the mechanical time constant. Any increase in ankle stiffness  $k$  up to  $mgL\cos(\theta_0)$  increases the mechanical time constant of the body, and thus, as noted by Loram and colleagues, ankle stiffness slows down falling during the response delay (Loram et al., 2007).

### *Delayed feedback control*

If the person has already fallen by the time it takes for the nervous system to change muscular contraction, then the sensorimotor feedback cannot prevent falling. The stability of the system therefore depends not only on the mechanical time constant, but also on the feedback delay  $\tau_{delay}$ . After an initial perturbation in position of amplitude  $\delta$ , the time-course of the position during the delay is given by:

$$\theta(t) = \delta \cosh\left(\frac{t}{\tau_{mech}}\right)$$

Thus, at the end of the delay, when the sensorimotor feedback can intervene, the position is:

$$\theta(\tau_{delay}) = \delta \cosh\left(\frac{\tau_{delay}}{\tau_{mech}}\right)$$

The amplification of the perturbation during the delay thus depends only on the dimensionless parameter  $\frac{\tau_{delay}}{\tau_{mech}}$ . The influence of feedback delay can thus be captured by reducing the dynamics to a dimensionless model:

$$\tau_{delay}^2 \ddot{\theta} = \tau_{delay}^2 \frac{mgL\cos(\theta_0) - k}{J}\theta - \tau_{delay}^2 \frac{c}{J} = S\theta - \tau_{delay}^2 \frac{c}{J}$$

Where:

$$S = \frac{\tau_{delay}^2}{\tau_{mech}^2}$$

The combined effects of inertia, stiffness, environmental instability and feedback delay on stability can be captured by a single dimensionless parameter  $S$ . This parameter corresponds to how fast perturbations are amplified during the feedback delay, relative to this delay.

## 2. Delayed feedback control of a single dimensional system

Any single-dimensional model of stability with delayed feedback control  $U$  (and without mechanical damping), can thus be reduced to the generic dimensionless model:

$$\tau_{delay}^2 \ddot{\theta} = S\theta - U$$

### a) Delayed proportional-derivative controller

To understand how the relative speed  $S$  constrains the sensorimotor feedback gain  $G$ , and how  $S$  and  $G$  jointly affect stability, I use a simple model of delayed feedback control:

$$U = G\theta(t - \tau_{delay}) + D\tau_{delay} \dot{\theta}(t - \tau_{delay})$$

This corresponds to the delayed version of the proportional-derivative controller, widely used for feedback control in engineering (Aström and Murray, 2010). This has been shown to correspond quantitatively to the contraction response of ankle muscles after a perturbation of stance (Welch and Ting, 2008). The damping term  $D\tau_{delay} \dot{\theta}(t - \tau_{delay})$  is necessary for stability because of the feedback delay. The control variable thus corresponds to a rudimentary form of anticipation:

$$\begin{aligned} U &= G(\theta(t - \tau_{delay}) + \frac{D}{G}\tau_{delay} \dot{\theta}(t - \tau_{delay})) \\ &\approx G\theta(t - \tau_{delay} + \frac{D}{G}\tau_{delay}) \end{aligned} \quad (1)$$

b) Stability analysis

The dynamics of the controlled system are thus:

$$\tau_{delay}^2 \ddot{\theta} - S\theta + G\theta(t - \tau_{delay}) + D\tau_{delay} \dot{\theta}(t - \tau_{delay}) = 0$$

The characteristic equation of the system is (Michiels and Niculescu, 2007):

$$X^2 - S + Ge^{-X} + DXe^{-X}$$

The system is stable if and only if this equation has no roots with positive real part. The difficulty in assessing stability comes from the feedback delay, which introduces the  $e^{-X}$  term: because of this term, the characteristic equation has an infinite number of roots, and there is no straightforward criterion to determine stability. Instead, I use a method originally developed by Nyquist (Nyquist, 1932). The rationale for the method is explained in the Supplementary Methods IV.1 and 2 and the stability limits are calculated in the Supplementary Methods IV.3.

Figure 2.5.A shows the range of feedback control parameters ( $G, D$ ) that can stabilize the system for different values of relative speed  $S$  ranging from  $S = 0$  in yellow to the maximal speed  $S = 2$  in purple (beyond which no feedback parameters are able to stabilize the system).

As can be seen in the graph, there is a minimal feedback gain  $G_{min} = S$  below which the feedback is not strong enough to prevent falling, as well as a maximal value of feedback gain above which the feedback itself destabilizes the system by causing overshoot. The behaviour of the system at minimal and maximal gain is illustrated in the Supplementary Methods IV.4.

Likewise, there is a minimal value of damping  $D_{min} = G$ . Indeed, as stated earlier, the damping term corresponds a rudimentary form of anticipation, which must be sufficient to counteract the delay. According to equation (1), the feedback control at a given time  $t$  thus uses the position and speed of  $\theta$  at time  $t - \tau_{delay}$  to anticipate the value of  $\theta$  at an “anticipated” time  $t - \tau_{delay} + \frac{D}{G}\tau_{delay}$ , and for the system to be stable, this “anticipated” time must be later than the time  $t$  at which the control actually intervenes. There is also a maximal damping beyond which the system enters into oscillations. The behaviour of the system at minimal and maximal damping is illustrated in the Supplementary Methods IV.4.

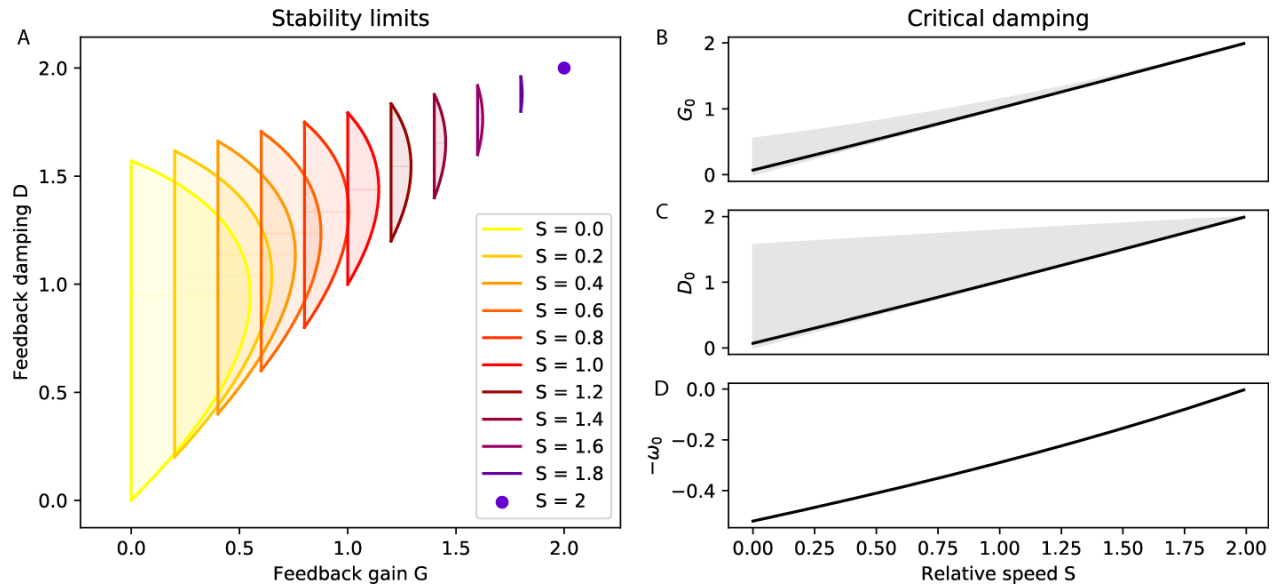

Figure 2.5 Delayed feedback control. A. Stability limits. The range of stable feedback gain  $G$  and damping  $D$  is plotted for different values of relative speed  $S$  ranging from  $S = 0$  to the maximal  $S = 2$ . B-D Optimal controller. B. The feedback gain  $G_0$ , which provides critical damping is plotted in black as a function of  $S$ . The range of stable feedback gains is shaded in grey. C. The feedback damping  $D_0$ , which provides critical damping is plotted in black as a function of  $S$ . The range of stable feedback damping is shaded in grey. D. The eigenvalue of the system with critical damping is plotted as a function of  $S$ .

c) Adjustment of feedback control

Thus for each value of relative speed  $S$ , there is a limited range of feedback control parameters ( $G, D$ ) that can stabilize the system. Faster systems require larger control parameters, and slower systems require lower control parameters: there is thus no single value of ( $G, D$ ) that works for both a slow and a fast system. In a model of lateral balance, Bingham and colleagues showed that stable control regions did not completely overlap for varying stance width (Bingham et al., 2011). Here I show that non-overlapping stable control regions for changes in body mechanical properties are a generic feature of delayed feedback control. The implication is that, to ensure stability, the neural feedback gain must adjust to a change in relative speed. Such a change may occur both when the experimenter requires the subject to change their posture, by asking them to stand with a wider stance for example (Bingham et al., 2011), and when the person is free to select their posture and chooses a posture that reduces relative speed, such as the stiffer stance adopted by subjects facing a cliff (Carpenter et al., 2001).

Within the range of stable feedback, large gain and low damping lead to oscillations, whereas low gains and large damping result in slow compensation for perturbations (as illustrated in the Supplementary Methods IV.4). However, subjects typically adopt feedback gains that lead to fast compensation without oscillations, and they do so even when the experimenter requires them to change their stance width (Bingham et al., 2011).

In second order systems governed by a characteristic equation  $X^2 + 2\zeta\omega_0X + \omega_0^2$ , for a given value of  $\omega_0$ , the fastest compensation without oscillations occurs for the critical damping  $\zeta = 1$ . For such critical damping, the characteristic equation has a unique double root  $-\omega_0$ . Higher damping results in slower compensation for perturbations, whereas lower damping results in oscillations.

To determine the best feedback gains for a given relative speed  $S$ , I used a linear approximation to the delay introduced by Pade (Hanta and Procházka, 2009). With this approximation, the characteristic equation  $X^2 - S + Ge^{-X} + DXe^{-X}$  becomes a third order polynomial (the details are provided in the Supplementary Methods V.1):

$$X^3 + X^2(2 - D) + X(2D - G - S) + 2(G - S)$$

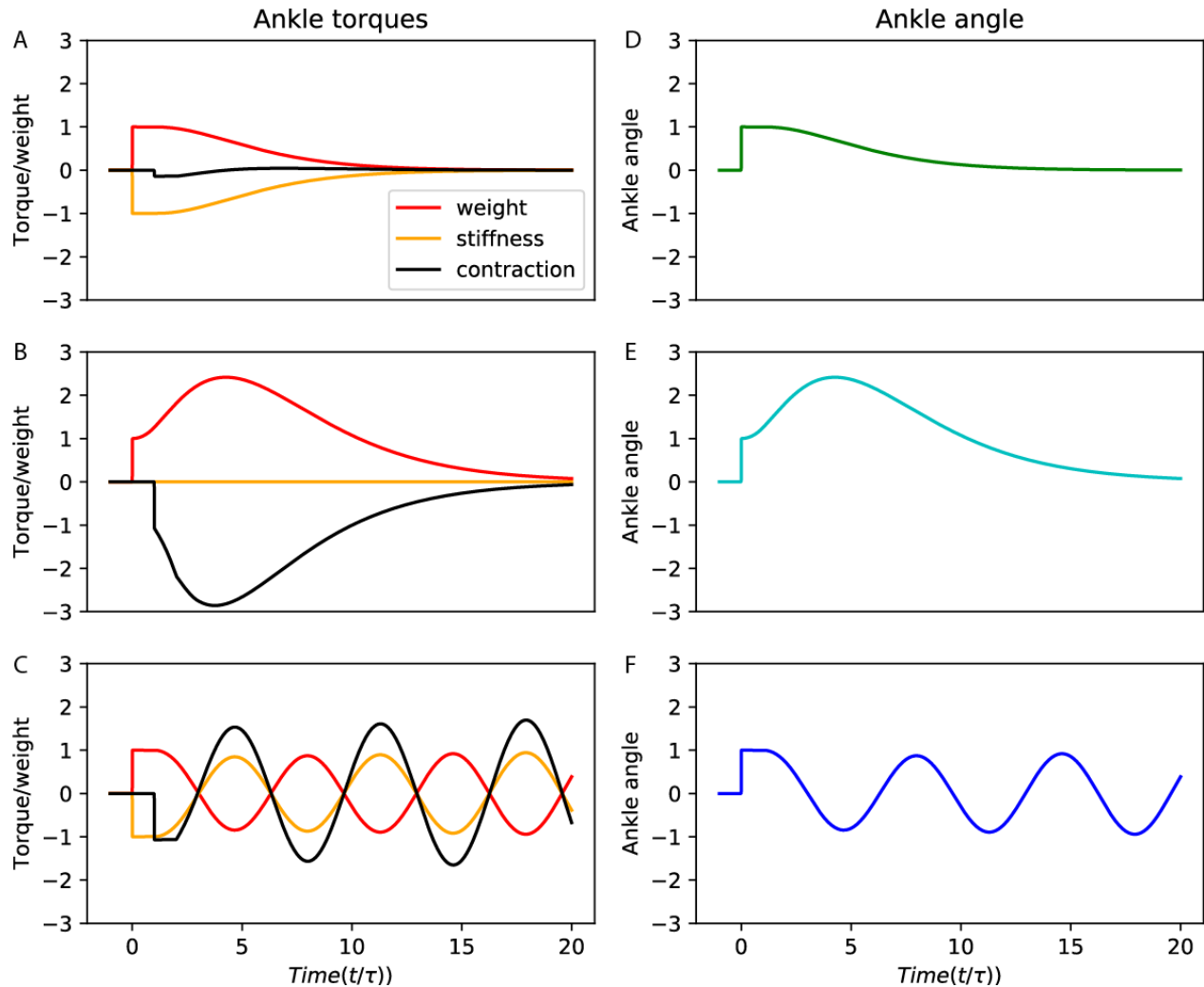

Figure 2.6 Response to perturbations. A. Response of a slow system  $S=0$  with critical damping. B. Response of a fast system  $S=0.5$  with critical damping. C. Response of a slow system  $S=0$  with the same feedback controller as in B. The left panels show the time-course or the torque of weight (red), and the components of the ground reaction torque due to stiffness (orange) and feedback contraction (black), normalised to weight. The right panels show the time-course of ankle angle. The response delay (between the perturbation and the first change in contraction) is shaded in grey.

Then, I generalized the notion of critical damping to third order systems, considering that a system is critically damped when it has a unique triple eigenvalue (the details are provided in the Supplementary Methods V.2). For each value of relative speed  $S$ , this procedure provided a unique value of control parameters ( $G_0, D_0$ ) and eigenvalue  $-\omega_0$ , plotted in Figure 2.5.B-D. The optimal gain  $G_0$  (Figure 2.5.B) and damping  $D_0$  (Figure 2.5.C) are close to their minimal values. Moreover, slower systems require smaller control parameters ( $G_0, D_0$ ) for critical damping.

d) Slower systems are easier to control

When the system is critically damped with eigenvalue  $-\omega_0$ , if a perturbation brings the system away from its equilibrium position, then the system is returned to its initial position following the time-course  $\exp\left(-\frac{\omega_0 t}{\tau_{delay}}\right)$ .

Systems with more negative values of  $-\omega_0$  are therefore more stable, since perturbations are cancelled faster. The triple eigenvalue  $-\omega_0$  is most negative for slower speeds (Figure 2.5.D), which shows that the system with optimal controller is most stable for slower speeds.



To illustrate this, I simulate the response of the single inverted pendulum model to an external perturbation occurring at time 0, which causes an initial shift in ankle angle by an arbitrary distance 1 (note that since the system is linear, the response scales proportionally to the perturbation).

The response of a system with relative speed  $S = 0$  and critical damping is illustrated in Figure 2.6.A. The initial perturbation causes an immediate increase in the torque of weight, plotted in the left panel in red. Since ankle stiffness perfectly compensates for the torque of weight, there is an immediate, equivalent and opposite increase in the ground reaction torque component due to stiffness, plotted in the left panel in orange. Therefore, during the delay period (shaded in grey), the ankle angle (right panel) remains at a constant value. When the feedback control intervenes, a small increase in contraction (left panel, black) is sufficient to nudge the CoM back to its initial position.

The response of the system without ankle stiffness and with critical damping is illustrated in Figure 2.6.B. The ground reaction torque component due to stiffness remains null (left panel, orange). During the delay period, the person therefore starts to fall, and picks up speed (right panel). When the feedback control intervenes, a large increase in contraction is therefore necessary: the ground reaction torque component due to contraction must overshoot the torque of weight, in order to first slow down falling, then return the ankle angle to its initial position. The fast system therefore requires large feedback parameters.

If the slow system is simulated with the feedback parameters appropriate for the fast system, then it is unstable (Figure 2.6.C). During the delay period, the person remains immobile. The large increase in contraction (left panel, black) then causes the ankle angle to overshoot its initial position, resulting in unstable oscillations (right panel).

Thus slower systems can be stabilized with less overshoot in ankle angle, and less change in muscle contraction, and require smaller feedback gains.

### 3. Generalisation to N dimensions

I now present the generalisation of the previous results to higher dimensional models. I first present how the dynamics of an N-dimensional model can be reduced to a set of N single-dimensional models, for which the results of the previous section hold. I then develop the implications for the stabilisation of a slightly less simplified, two dimensional model of human stance, and then for the stabilisation of the arm.

#### a) Decomposition of the dynamics

Here I show that this analysis also holds for the delayed feedback control of an N-dimensional system with interaction terms (and no mechanical damping). The dynamics of the system are given by:

$$\tau_{delay}^2 \frac{d^2}{dt^2} \begin{pmatrix} \theta_1 \\ \dots \\ \theta_N \end{pmatrix} = \begin{pmatrix} S_{1,1} & \dots & S_{1,N} \\ \vdots & \ddots & \vdots \\ S_{N,1} & \dots & S_{N,N} \end{pmatrix} \begin{pmatrix} \theta_1 \\ \dots \\ \theta_N \end{pmatrix} - \begin{pmatrix} C_1 \\ \dots \\ C_N \end{pmatrix}$$

$$\tau_{delay}^2 \ddot{\boldsymbol{\theta}} = \mathbf{S}\boldsymbol{\theta} - \mathbf{C}$$

Where the control vector  $\mathbf{C}$  is a delayed function of the variables  $\theta_1, \dots, \theta_N$  and their speeds  $\dot{\theta}_1, \dots, \dot{\theta}_N$ .

If the dynamics matrix  $\mathbf{S}$  is diagonalisable, with eigenvalues  $s_1, \dots, s_N$ , I show in the Supplementary Methods VI that there is a change of coordinates which transforms  $\boldsymbol{\theta}$  to  $\boldsymbol{\alpha}$  and  $\mathbf{C}$  to  $\mathbf{U}$  such that the system can be described as a set of N single-dimensional systems:

$$\tau_{delay}^2 \frac{d^2}{dt^2} \alpha_i = s_i \alpha_i - U_i, i = 1 \dots N$$

For such single-dimensional systems, the best stability is obtained when the relative speed  $s_i$  is smallest. Therefore, for N-dimensional systems, such as the arm (Figure 2.4), the best stability is achieved when the body mechanical properties are adjusted so that all the eigenvalues of the dynamics matrix  $\mathbf{S}$  are small.

b) Double inverted pendulum model of stance

Standing balance can also be modelled using a two dimensional model, in which the entire person can rotate around their ankles, and additionally the torso can rotate around the legs at the level of the hips, as illustrated in Figure 2.7.A (Colobert et al., 2006; Hettich et al., 2014; Suzuki et al., 2011). The details of the model are provided in the Appendix (6.II). The weight of the torso exerts a torque  $T_{g,H}$  around the hips (which depends on the angle  $\beta$  between the torso and the vertical), and the weight of the entire body exerts a torque  $T_{g,A}$  around the ankle (which depends both on  $\beta$  and on the angle  $\alpha$  between the torso and the vertical). The muscles exert a torque  $T_{m,H}$  around the hips and a torque  $T_{m,A}$  around the ankles.

The derivatives of the rotational momentum of the torso around the hips  $M_{T,H}$  and the rotational momentum of the entire body around the ankles  $M_{B,A}$  are therefore given by:

$$\begin{aligned} \frac{dM_{T,H}}{dt} &= T_{g,H} + T_{m,H} \\ \frac{dM_{B,A}}{dt} &= T_{g,A} + T_{m,A} \end{aligned}$$

As detailed in the Appendix 6.II.1,  $M_{T,H}$  and  $M_{B,A}$  are both linear functions of  $\dot{\alpha}$  and  $\dot{\beta}$ . I therefore introduce the projections:

$$\begin{aligned} u &= u_\alpha \alpha + u_\beta \beta \\ v &= v_\alpha \alpha + v_\beta \beta \end{aligned}$$

Such that:  $M_{T,H} = \dot{u}$ ,  $M_{B,A} = \dot{v}$ .

This forms a change of coordinates, and in this new reference frame:

$$\begin{aligned} \frac{d^2 u}{dt^2} &= T_{g,H} + T_{m,H} \\ \frac{d^2 v}{dt^2} &= T_{g,A} + T_{m,A} \end{aligned}$$

According to the results of the previous section, the best mechanical stability is provided when both of the eigenvalues of the dynamics are null. In this case:

$$\begin{aligned} \frac{d^2 u}{dt^2} &= 0 \\ \frac{d^2 v}{dt^2} &= 0 \end{aligned}$$

Thus, in the same way as for the single inverted pendulum model of stance, the best mechanical stability is provided when the torque of the muscles acting on the ankle exactly compensates for the torque of the body's weight around the ankles. Additionally, the torque of the muscles acting on the hip must exactly compensate for the torque of the torso's weight around the hips.

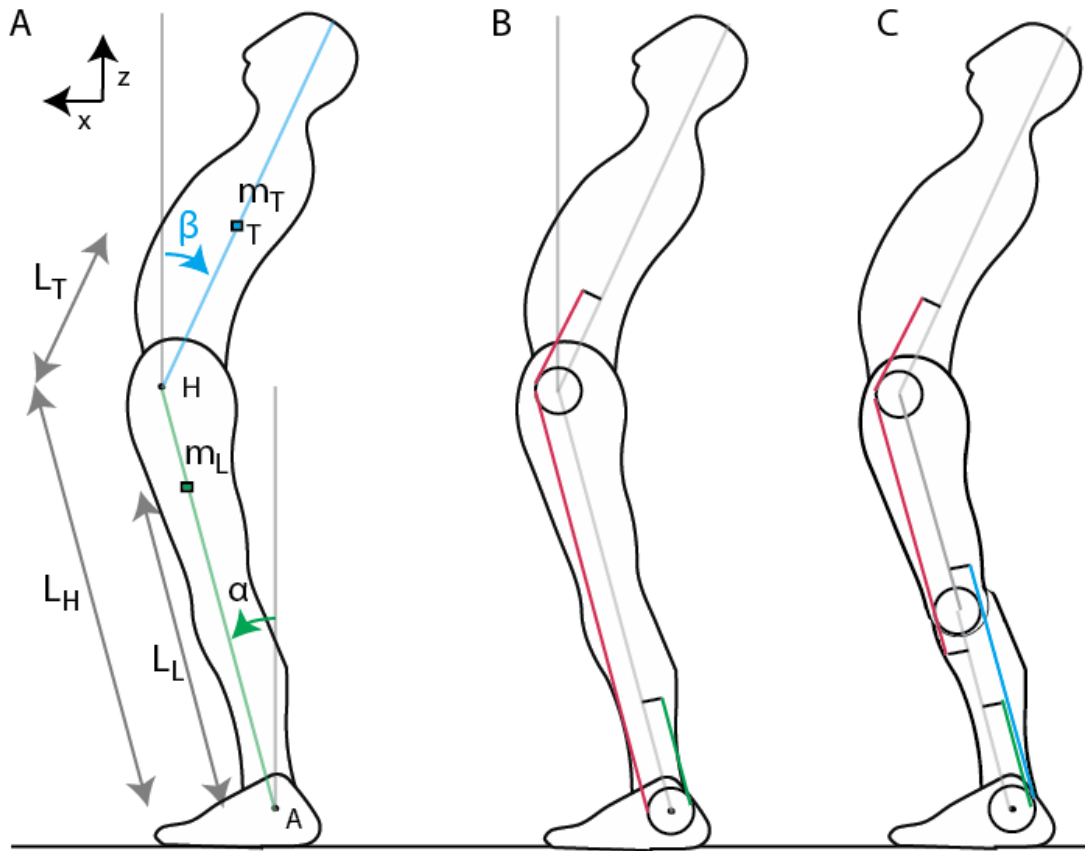

Figure 2.7 Double pendulum model of human stance. The legs can rotate around the ankle joint at A and form an angle  $\alpha$  with the vertical. The torso can rotate around the hips at H, of height  $L_H$ , and forms an angle  $\beta$  with the vertical. The legs have a mass  $m_L$  at height  $L_L$  and the torso has a mass  $m_T$  at height  $L_T$  with respect to the hips. B. Cancelling the torque of the torso weight around the hips could be achieved through the stiffness of a pluri-articular muscle (in red) whose length depends only on the torso angle; cancelling the torque of the body weight around the ankles could be achieved through the stiffness of an additional ankle muscle (in green). C. There is no muscle spanning both the hip and the ankle joints in the human body, however there is the rectus femoris (in red) which spans both the hip and the knee joints, the gastrocnemius (in blue) which spans both the knee and the ankle joints, and the soleus (in green) which spans only the ankle joint.

However, contrary to the single pendulum model, the torque of the body's weight around the ankles is no longer a function of only ankle angle, but additionally of hip angle. I assume that the leg has a mass  $m_L$ , the leg CoM is at height  $L_L$ , the torso has a mass  $m_T$ , the torso CoM is at height  $L_T$  with respect to the hips, and the hips at height  $L_H$  with respect to the ankles (Figure 2.7.A). The torque of the body's weight around the ankles is then given by:

$$T_{g,A} = m_L L_L \sin(\alpha) + m_T (L_H \sin(\alpha) + L_T \sin(\beta)) \approx (m_L L_L + m_T L_H) \alpha + m_T L_T \beta$$

The torque of the body weight cannot be cancelled through the stiffness of a muscle acting only at the ankle joint, since the length of such a muscle would only depend on the ankle angle  $\alpha$ . Likewise, the torque of the torso weight around the hips cannot be cancelled through the stiffness of a muscle acting only at the hip joint, since the length of such a muscle would only depend on  $\beta - \alpha$ , whereas the torque of the torso around the hips is given by:

$$T_{g,H} = m_T L_T \sin(\beta) \approx m_T L_T \beta$$

Instead, this would require the stiffness of a bi-articular muscle spanning both joints, illustrated in red in Figure 2.7.B. The length of such a muscle would depend only on  $\beta$ , and its stiffness could be adjusted such that its torque would cancel the torque of the torso weight around the hips:

$$T_{m,bi-articular} = m_T L_T \beta$$

This muscle would exert an opposite torque around the ankle, such that the resultant torque of the body weight and the bi-articular muscle around the ankle would be:

$$T_{g,A} - T_{m,bi-articular} = (m_L L_L + m_T L_H) \alpha$$

This torque could in turn be cancelled by the stiffness of a mono-articular muscle spanning only the ankle joint, illustrated in green in Figure 2.7.B. Note that the stiffness of this mono-articular ankle muscle should be slightly smaller than the ideal stiffness in the single pendulum model, since the torque for a given ankle angle should correspond to:  $T_{m,ankle} = (m_L L_L + m_T L_H) \alpha$ ; whereas in the single pendulum model it should correspond to :  $T_{m,ankle} = (m_L L_L + m_T (L_H + L_T)) \alpha$ .

In practice there is no single muscle spanning both the ankle and hip joints. There are however bi-articular muscles spanning both the ankle and the knee, and bi-articular muscles spanning both the knee and the hip. Since the knee is kept locked during stance, the ankle of the upper leg with respect to the vertical is the same as the ankle angle. Therefore, the stiffness of the bi-articular rectus femoris muscle (illustrated in red in Figure 2.7.C) could potentially cancel the torque of the torso weight on the hips. The torque which this muscle exerts on the knee could be cancelled by the torque of the bi-articular gastrocnemius muscle (in blue in Figure 2.7.C), which would therefore propagate the torque of the torso weight to the ankles. The remaining ankle torque could be provided by the mono-articular soleus muscle (in green in Figure 2.7.C). Bi-articular muscles may therefore play a role in improving mechanical stability. Such a role has previously been suggested by Seyfarth and colleagues for stability during locomotion (Seyfarth et al., 2001).

Thus, through an appropriate change of variables, I have shown that to ensure mechanical stability despite the destabilizing torque of weight, the pattern of muscular stiffness must exactly cancel the torques of the weights of the different segments.

#### c) Tool manipulation

Likewise, when interacting with an unstable tool, an appropriate change of variables shows that mechanical stability is ensured when the pattern of muscular stiffness exactly cancels the tool's "negative stiffness". Thus, when interacting with a tool which is unstable in the lateral direction (Figure 2.4.D), it is not useful to increase the arm endpoint stiffness in the vertical and forwards directions. It is only useful to increase the arm endpoint stiffness in the direction of the environmental instability, and to increase it up to the amount of environmental instability.

Indeed, when unstable force fields of different directions are used, subjects increase their arm endpoint stiffness only in the direction of the unstable force field (Darainy et al., 2004; Franklin et al., 2007; Trumbower et al., 2009). When subjects are free to move the arm in three dimensions, this adjustment of endpoint stiffness may be achieved by selecting an appropriate arm posture, as illustrated in Figure 2.4.B-D (Trumbower et al., 2009). However, in many reaching experiments, the arm posture is constrained (Krutky et al., 2009; Perreault et al., 2008). In this case, adjusting the dynamics matrix may only be achieved through muscle co-contraction (Franklin et al., 2003).

When the arm posture is constrained, increasing stiffness through co-contraction may lead to muscle fatigue. As a consequence, Franklin and colleagues suggest that subjects only partially compensate for the force field through

co-contraction (Franklin et al., 2004). In this case, there would be a residual instability in the dynamics of the hand and tool in the direction of the tool instability. The dynamics matrix  $S$  would no longer be null, but would have a positive eigenvalue in the direction of the tool instability. As a result, the neural feedback gains in this direction should be increased to compensate for this positive eigenvalue. This may explain why feedback gains are increased when subjects interact with unstable objects with a constrained arm posture, and why this increase is specific to perturbations in the direction of the tool instability (Krutky et al., 2009), as illustrated in Figure 2.2.

### III. Discussion

The generic model I have presented here provides a comprehensive interpretation for the apparently conflicting experimental results presented in the introduction.

#### 1. Adjusting posture to decrease relative speed

The first result is that slower systems are more stable, and allow perturbations to be cancelled with less overshoot. As a consequence, when conditions for balance are challenging, or when manipulating an unstable tool, the most appropriate response is to adjust the body mechanical properties to slow down the amplification of perturbations during the delay period.

For stance, this can be done by co-contracting the lower leg muscles, which increases ankle stiffness (Nielsen et al., 1994). Indeed, such co-contraction has been observed when a person stands facing a cliff as in Figure 2.1.B (Carpenter et al., 2001), on a narrow base of support as in Figure 2.1.C (Trimble and Koceja, 2001) or simply closes the eyes as in Figure 2.1.D (Pinar et al., 2010). This may also be achieved by leaning forwards, which also increases ankle stiffness (Lang and Kearney, 2014; Sinha and Maki, 1996). It has indeed been observed that when subjects stand on a platform that is accelerated forwards or backwards, they tend to lean forwards (Maki and Ostrovski, 1993; Maki and Whitelaw, 1993). Elderly subjects with a fear of falling (Vellas et al., 1997b) tend to lean further forwards than elderly subjects without a fear of falling (Maki et al., 1994). Thus, the strategy adopted when faced with challenging balance situations is to adjust the body mechanical properties themselves, so as to slow down falling during the response delay.

For reaching, mechanical stability can be improved through an adjustment of arm posture and arm muscle co-contraction (Hogan, 1985), and both of these strategies are observed when subjects interact with unstable tools (Franklin et al., 2004; Trumbower et al., 2009).

#### 2. Adjusting feedback gains to changed dynamics

The second result is that the feedback gain must be adjusted to the system dynamics, and that slower systems require lower feedback gains. This can account for both the increase in feedback gains in arm muscles when manipulating unstable tools, and the decrease in feedback gains observed when standing in challenging balance conditions.

Indeed, in the first case, the experimental manipulation (i.e. an increase in tool instability) directly increases the relative speed of the dynamics. Subjects could in principle completely compensate for the experimental manipulation through an adjustment of arm posture and arm muscle co-contraction. In this case, there would be no net change in relative speed after the perturbation, and there should therefore be no change in feedback gains. Franklin and colleagues however suggest that, when the arm posture is constrained, subjects do not entirely compensate for the environmental instability through increased co-contraction (Franklin et al., 2004). In this case, there would be a net increase in speed after the perturbation, and there should therefore be an increase in feedback gains. Indeed, when interacting with unstable tools with a constrained arm posture, feedback gains are

increased (Krutky et al., 2009). Similarly, for standing, if the experimenter asks the subject to lean backwards, this decreases their ankle stiffness, and therefore increases the relative speed (Lang and Kearney, 2014). There should therefore be an increase in feedback gains, and indeed the ankle stretch reflex is increased (Lang and Kearney, 2014).

When standing in challenging balance conditions however, the experimental manipulation (such as standing in front of a cliff) does not directly increase the relative speed of the dynamics. Instead, it increases the direness of the consequences of falling. When subjects adjust to the experimental manipulation by increasing ankle muscle co-contraction, there is therefore a net decrease in the relative speed. There should therefore be a decrease in feedback gain. Indeed, the spinal feedback gain, as assessed by the H-reflex, is reduced when a person stands facing a cliff as in Figure 2.1.B (Sibley et al., 2007), on a narrow base of support as in Figure 2.1.C (Trimble and Koceja, 2001), closes the eyes as in Figure 2.1.D (Pinar et al., 2010), and leans forwards (Lang and Kearney, 2014; Sinha and Maki, 1996). This reduction in spinal feedback gains has been interpreted by saying that in challenging balance conditions, the control of balance is delegated to the cortex, which may allow for more refined responses than the spinal system (Llewellyn et al., 1990). However, as I have shown, feedback delays compromise stability. Since the spinal system provides the fastest change in muscle contraction after a perturbation force, it would be counter-productive to delegate the control of balance from the spinal system to the slower cortical system. I therefore propose an alternative interpretation, which is that when conditions for balance are challenging, the control of balance is delegated not to the cortical system, but to the body mechanical properties themselves. Beyond the task of standing still, this may be generally relevant to any task which requires counteracting external perturbations. Thus, when walking on a narrow beam compared to walking on a large treadmill, during the stance phase, there is both a larger background contraction in the lower leg and a reduced soleus H-reflex (Llewellyn et al., 1990). Moreover, the model predicts that when subjects are required to improve their pointing accuracy, and achieve this by increasing arm muscle co-contraction (Gribble et al., 2003), then they should additionally decrease their feedback gains.

### 3. Is immobility critical?

Ankle stiffness during stance is measured by imposing a rotation of the ankle and measuring the immediate change in ground reaction torque that ensues. For muscle stiffness to exactly compensate for the torque of weight, the measured ankle stiffness must be equal to the critical value  $k_{crit} = mgL$ . Note that the double pendulum model of stance (Figure 2.7) makes the same prediction as the single pendulum model, since a rotation of the ankle stretches both the calf muscles soleus and gastrocnemius (Figure 2.7.C). Experimental measures of ankle stiffness during stance vary from 40% to 90% of this critical value (Casadio et al., 2005; Lang and Kearney, 2014; Loram et al., 2007; Loram and Lakie, 2002; Vlutters et al., 2015). Thus, in normal stance, ankle stiffness may compensate for a large part of the torque of weight, reducing relative speed  $S$  by 40% to 90%, relative to standing without ankle stiffness. It is however not sufficient to completely compensate for the torque of weight and reduce speed to  $S = 0$ .

In normal stance, the relative speed is not maintained at its lowest possible value. Indeed, in normal stance, the shin muscle is not co-contracted with the calf muscles (Schieppati et al., 1994), yet co-contraction increases ankle stiffness (Nielsen et al., 1994). Co-contraction is indeed observed when subjects are placed in challenging balance conditions (Carpenter et al., 2001; Pinar et al., 2010; Trimble and Koceja, 2001). Moreover, immobility is not maintained at its maximal possible value in normal stance. Thus, even when a person stands without being pushed by external forces, they do not remain perfectly immobile, but continuously shift their position slightly over a range of around a centimetre. This range can however be divided by two if the person is asked to focus on standing as still as possible (Loram et al., 2001).

Likewise, in normal reaching, the relative speed is not maintained at its lowest possible value. Thus, when Gribble and colleagues asked their subjects to point to smaller and smaller targets, they observed a decrease in trajectory variability and an increase in endpoint accuracy, as well as increased co-contraction (Gribble et al., 2003). This suggests that in normal reaching, arm stiffness is not maintained at the highest possible value to maximise stability and accuracy (Franklin et al., 2004). As for standing, the relative speed in reaching can however transiently be reduced when accuracy becomes more important.

Thus, during normal standing and reaching, the relative speed is not maintained at its lowest possible value, and immobility or accuracy are not maintained at their highest possible value. This suggests that both in normal stance and in reaching, immobility is not a critical function of the postural system. Indeed, when participating in an experiment on balance, if the subject is not asked to stay still, then they will not remain immobile. For example, if they are pushed by an external perturbation, they will typically take a step, or grab onto a nearby handrail (Maki et al., 2003). If however they have been asked to remain still, as long as the external perturbation is not too strong, they will do so, at least after a few practice trials (Welch and Ting, 2014). The task of standing still is therefore a more stringent task than the ecological task of standing without falling.

As long as immobility or accuracy are not critical, then the external forces (either the person's weight or the interaction forces with a tool) could in principle be used to generate movement. Indeed, the initiation of movement requires creating an instability. However, if muscle stiffness for example exactly compensates for all the external forces, then this may prevent the creation of such an instability, and therefore prevent the initiation of movement. I therefore suggest that relative speed is not maintained at its lowest possible value during standing or reaching in order to allow for the possibility of initiating movement.

#### IV. Supplementary methods: Stability analysis

The system is a linearized inverted pendulum, with an external forcing  $F$ :

$$\tau_{delay}^2 \ddot{\theta} - S \theta = F \quad (2)$$

The system is controlled with delayed proportional-derivative feedback  $u$ , based on the observed value of  $\theta$ , written  $\theta_{obs}$ :

$$u = (G\theta_{obs} + D\tau_{delay}\dot{\theta}_{obs})(t - \tau_{delay}) \quad (3)$$

To determine the stability of the system, I analyze how perturbation signals propagate through the system. I consider 2 types of perturbation: a perturbation  $\delta$  in the external force, and noise  $\eta$  in the observation process:

$$\begin{aligned} F &= -u + \delta \\ \theta_{obs} &= \theta + \eta \end{aligned}$$

The block diagram of the controlled system with noise is shown in Figure 2.8.A.

Replacing in (2) and (3):

$$\begin{aligned} \tau_{delay}^2 \ddot{\theta} - S \theta &= \delta - G\theta(t - \tau) - D\tau_{delay} \dot{\theta}(t - \tau) - G\eta(t - \tau) - D\tau_{delay} \dot{\eta}(t - \tau) \\ \tau_{delay}^2 \ddot{\theta} - S \theta + G\theta(t - \tau) + D\tau_{delay} \dot{\theta}(t - \tau) &= \delta - G\eta(t - \tau) - \tau_{delay} D \dot{\eta}(t - \tau) \end{aligned} \quad (4)$$

The unforced motion of the system (for  $\delta = 0$  and  $\eta = 0$ ) is given by the solutions to the homogeneous equation:

$$\tau_{delay}^2 \ddot{\theta} - S \theta + G\theta(t - \tau) + D\tau_{delay} \dot{\theta}(t - \tau) = 0$$

The solutions to this equation are called the modes of the system. After an arbitrary perturbation, the unforced motion of the system is a weighted sum of such modes.

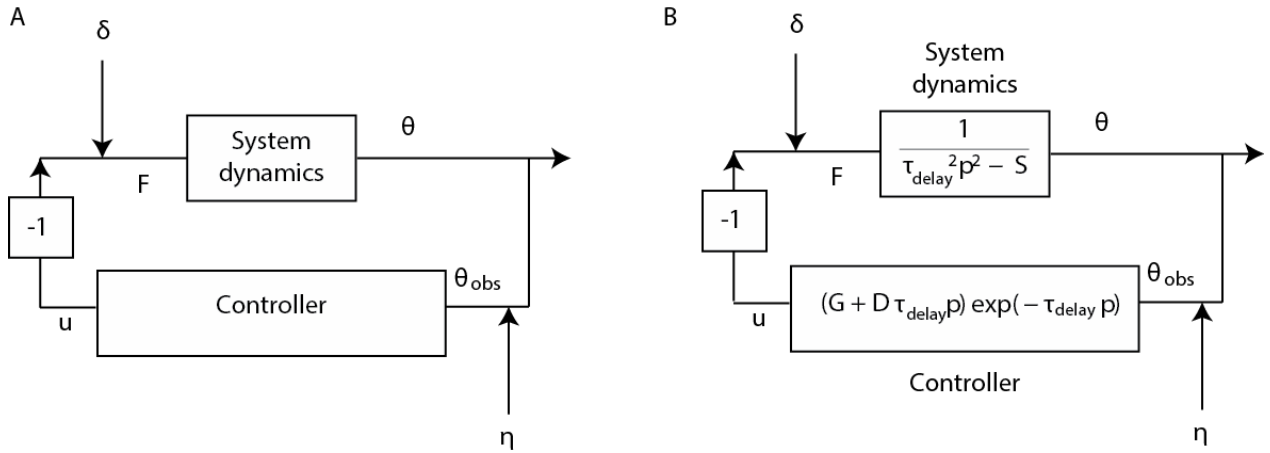

Figure 2.8 Block diagram of the controlled system

A. Noise is injected into the system both at the level of the motor command ( $\delta$ ) and at the level of the sensory feedback ( $\eta$ ). B. Transfer function of the system dynamics and controller.

### 1. Propagation of exponential signals and derivation of the characteristic equation

Since the system is linear, I only need to consider the response to exponential signals  $e^{pt}$  where  $p$  is a complex number. The response to a sum of exponential signals is then the sum of the responses to each exponential signal. I therefore consider perturbations of the form:

$$\begin{aligned}\delta(t) &= \delta_0 e^{pt} \\ \eta(t) &= \eta_0 e^{pt}\end{aligned}$$

Then the response of the system is also an exponential signal such that:

$$\theta(t) = \theta_0 e^{pt}$$

The transfer function of the system dynamics and controller are shown in Figure 2.8.B.

Replacing in (4):

$$(\tau_{\text{delay}}^2 p^2 - S + G e^{-p\tau_{\text{delay}}} + D \tau_{\text{delay}} p e^{-p\tau_{\text{delay}}}) \theta_0 e^{pt} = \delta_0 e^{pt} - (G + D \tau_{\text{delay}} p) e^{-p\tau_{\text{delay}}} \eta_0 e^{pt}$$

The solutions to the characteristic equation  $D(p) = 0$  correspond to the modes of the homogeneous equation, where:

$$D(p) = \tau_{\text{delay}}^2 p^2 - S + G e^{-p\tau_{\text{delay}}} + D \tau_{\text{delay}} p e^{-p\tau_{\text{delay}}}$$

If there exists  $p$  with positive real part such that  $D(p) = 0$ , then the system is unstable. Indeed, the amplitude of an exponential signal is  $e^{\text{Re}(p)t}$ , thus if  $\text{Re}(p) > 0$  the amplitude of the mode grows exponentially with time. If this mode is excited by a perturbation at one point, then even after the end of the perturbation, the system will diverge.

This can also be seen by looking at the transfer function of the system:

$$\theta_0 = \frac{\delta_0 - (G + D \tau_{\text{delay}} p) e^{-p\tau_{\text{delay}}} \eta_0}{\tau_{\text{delay}}^2 p^2 - S + (G + D \tau_{\text{delay}} p) e^{-p\tau_{\text{delay}}}}$$



If  $D(p) = 0$ , then the response of the system to a perturbation  $e^{pt}$  diverges, since the denominator of the transfer function becomes zero. The roots of the denominator are called the poles. The system is therefore stable if and only if its transfer function has no poles with positive real part (Aström and Murray, 2010).

Note that the denominator is the same whether noise is injected into the motor or the sensory process. The system is therefore either robust to both sensory and motor noise or robust to neither. Indeed, stability only depends on the behaviour of the homogeneous equation.

The difficulty in assessing stability comes from the feedback delay, which introduces the  $e^{-p\tau_{delay}}$  term: because of this term, the characteristic equation has an infinite number of roots, and there is no straightforward criterion to determine stability (Michiels and Niculescu, 2007). Consider for example, the characteristic equation  $1 + e^{-p\tau_{delay}} = 0$ . For all integers  $n$ ,  $p = \frac{i(1+2n)\pi}{\tau_{delay}}$  is a root of the equation: the equation therefore has an infinite number of roots.

To assess stability, I will therefore use the Nyquist criterion, introduced by Nyquist (Nyquist, 1932) and described in the following section. For convenience, I will apply the Nyquist to the open-loop transfer function:

$$OL(p) = \frac{(G + D\tau_{delay}p)e^{-\tau_{delay}p}}{\tau_{delay}^2 p^2 - S}$$

The transfer function of the system is related to the open loop transfer function according to:

$$\theta_0 = \frac{\frac{\delta_0}{\tau_{delay}^2 p^2 - S} - OL(p)\eta_0}{1 + OL(p)}$$

The poles of the transfer function are therefore the zeros of  $1 + OL(p)$ .

## 2. Nyquist criterion

I therefore seek to determine whether  $f(p) = 1 + OL(p)$  has zeros with positive real part.

For this, I will use Cauchy's residue theorem, which states that the integral of a function  $g(p)$  (which must be analytical except at a number of poles and zeros) over a contour in the complex plane is equal to the sum of the residues of  $g(p)$  at each of its poles and zeros within the region encompassed by that contour.

I first introduce the function  $g(p) = \frac{f'(p)}{f(p)}$  whose sum of residues within a region is equal to the difference between the number of zeros and poles of  $f(p)$  within that region. I then integrate this function over the Nyquist contour which encompasses the right half-plane. I thus determine the number of zeros of  $f(p)$  with positive real part.

### a) Residues of $g(p)$

The function  $g(p) = \frac{f'(p)}{f(p)}$  is analytical except at the poles and zeros of  $f(p)$ .

I therefore use Cauchy's residue theorem, which states that the integral of  $g(p)$  over a contour  $\Gamma$  is equal to the sum of the residues of  $g(p)$  at each of its poles and zeros within this contour (which correspond to the poles and zeros of  $f(p)$ ).

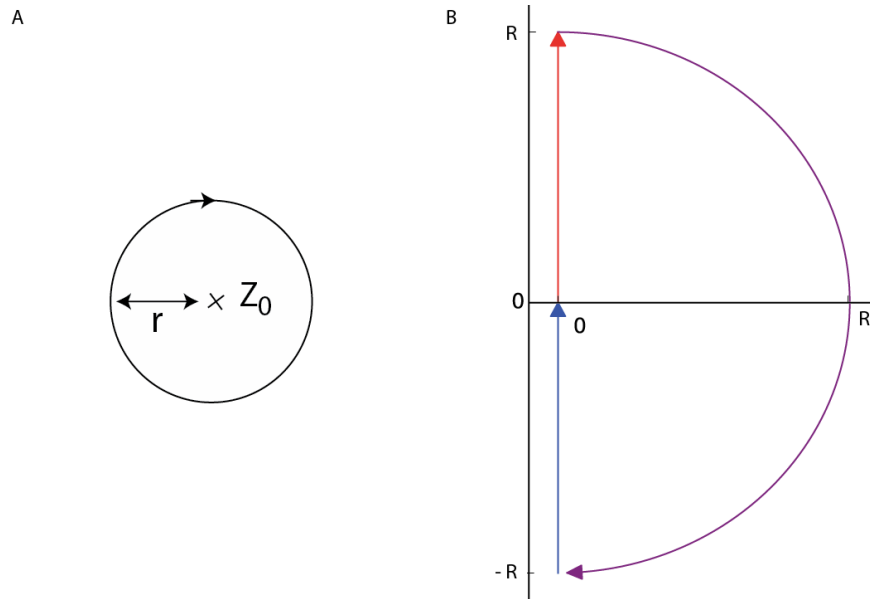

Figure 2.9 Calculation of residuals within the Nyquist contour

A. Neighbourhood of a zero or pole B. D-shaped contour of a given radius  $R$

Zeros

I consider  $z_0$  a zero of  $f(p)$  of multiplicity  $m$ , and write:

$$f(p) = (p - z_0)^m h(p)$$

$$\begin{aligned} g(p) &= \frac{f'(p)}{f(p)} = \frac{m(p - z_0)^{m-1} h(p)}{(p - z_0)^m h(p)} + \frac{(p - z_0)^m h'(p)}{(p - z_0)^m h(p)} \\ &= \frac{m}{p - z_0} + \frac{h'(p)}{h(p)} \end{aligned}$$

There exists a neighbourhood of  $z_0$  for which  $h(p)$  and therefore  $\frac{h'(p)}{h(p)}$  is analytic. I choose  $r$  such that the circle  $\Gamma_{r,z_0}$  centered at  $z_0$  and of radius  $r$  is contained within this neighbourhood (Figure 2.9.A). The residue of  $g(p)$  at  $z_0$  is equal to the integral of  $g(p)$  around the circle:

$$\text{Res}(z_0) = \oint_{\Gamma_{r,z_0}} g(p) dp = \oint_{\Gamma_{r,z_0}} \frac{m}{p - z_0} dp + \oint_{\Gamma_{r,z_0}} \frac{h'(p)}{h(p)} dp$$

Since  $\frac{h'(p)}{h(p)}$  is analytic within this circle:

$$\oint_{\Gamma_{r,z_0}} \frac{h'(p)}{h(p)} dp = 0$$

I introduce the change of variables:  $p = z_0 + re^{i\phi}$ ,  $dp = ire^{i\phi} d\phi$

$$\oint_{\Gamma_{r,z_0}} \frac{m}{p - z_0} dp = m \int_{\phi=0}^{2\pi} \frac{ir e^{i\phi} d\phi}{r e^{i\phi}} = 2i \pi m$$

Poles

I consider  $p_0$  a pole of  $f(p)$  of multiplicity  $n$ , and write:

$$f(p) = \frac{k(p)}{(p - p_0)^n}$$

$$f'(p) = \frac{k'(p)}{(p - p_0)^n} + k(p)(-n) \frac{1}{(p - p_0)^{n+1}}$$

$$g(p) = \frac{f'(p)}{f(p)} = \frac{k'(p)}{k(p)} - \frac{n}{p - p_0}$$

There exists a neighbourhood of  $p_0$  for which  $k(p)$  is analytic. The residue of  $g(p)$  at  $p_0$  is equal to the integral of  $g(p)$  around the circle  $\Gamma_{r,p_0}$  centred on  $p_0$  and included within this neighbourhood:

$$\oint_{\Gamma_{r,p_0}} \frac{-n}{p - p_0} dp = -2i \pi n$$

Therefore, the integral of  $g(p)$  over the a contour is equal to  $2i \pi (m - n)$ , where  $m$  is the number of zeros of  $f(p)$  and  $n$  is the number of poles of  $f(p)$  within that contour.

b) Nyquist contour

Since the region I am interested in is the entire right half-plane (the region of the complex plane with positive real part), I will use the Nyquist contour  $\Gamma_N$ , which is the limit, for  $R \rightarrow +\infty$ , of the D-shaped contour (traversed counterclockwise) defined by:

- $i\omega$  for  $\omega$  ranging from  $-R$  to  $+R$
- $R e^{i\phi}$  for  $\phi$  ranging from  $\pi/2$  to  $-\pi/2$

This contour is plotted in Figure 2.9.B for a given radius  $R$ , and for  $R \rightarrow +\infty$  this contour encompasses all of the complex plane with positive real part. Note: I use the convention that clockwise curves are oriented positively.

c) Geometrical interpretation

$$\oint_{\Gamma_N} g(p) dp = \oint_{\Gamma_N} \frac{f'(p)}{f(p)} dp = \oint_{\Gamma_N} \frac{d}{dp} \log(f(p)) dp = \oint_{\Gamma_N} \frac{d}{dp} \log(|f(p)|) dp + \oint_{\Gamma_N} \frac{d}{dp} i \arg(f(p)) dp$$

The variation of  $|f(p)|$  over the closed contour  $\Gamma_N$  is zero.

The number of zeros minus poles is therefore equal to the winding number  $w$ :

$$w = \frac{1}{2\pi} \oint_{\Gamma_N} \frac{d}{dp} \arg(f(p)) dp$$

Geometrically,  $w$  corresponds to the number of clockwise loops effected by  $f(p)$  around 0 when  $p$  ranges over the Nyquist curve.

The Nyquist criterion thus states that a system described by the open-loop transfer function  $OL(p)$  with  $n$  poles with positive real part is stable if and only if the curve described by  $OL(p)$ , as  $p$  ranges over the Nyquist contour, loops  $n$  times counter-clockwise around the point  $-1$ .

### 3. Application to our system

The open-loop transfer function is given by:

$$OL(p) = \frac{(G + D\tau_{delay}p)e^{-\tau_{delay}p}}{\tau_{delay}^2 p^2 - S}$$

$f(p) = 1 + OL(p)$  has a unique pole with positive real part  $p = \sqrt{S}/\tau_{delay}$ . Therefore, the system is stable if and only if the integral of  $g(p)$  over the Nyquist contour is equal to  $-2i\pi$ . Thus, for the system to be stable, the open-loop transfer function  $OL(p)$  must loop once counterclockwise around the point  $-1$  when  $p$  ranges over the Nyquist contour.

The second part of the Nyquist contour, defined by  $R e^{i\phi}$  for  $\phi$  ranging from  $\pi/2$  to  $-\pi/2$ , with  $R \rightarrow +\infty$ , maps onto the point 0. Indeed:

$$\lim_{R \rightarrow +\infty} OL(R e^{i\phi}) = 0$$

The first part of the Nyquist contour, defined by  $i\omega$  for  $\omega$  ranging from  $-\infty$  to  $+\infty$ , maps onto the curve described by:

$$OL(i\omega) = \frac{(G + D\tau_{delay}i\omega)e^{-\tau_{delay}i\omega}}{-\tau_{delay}^2\omega^2 - S}$$

I introduce the dimensionless parameter:

$$X = \tau_{delay}\omega$$

Then the Nyquist curve can equivalently be described by (with  $X$  ranging from  $-\infty$  to  $+\infty$ ):

$$OL(X) = -\frac{(G + iDX)e^{-iX}}{X^2 + S}$$

To disentangle the effects of  $G$ ,  $D$  and  $S$  on stability, I introduce  $C = \frac{D}{G}$  such that the gain  $G$  simply scales the curve defined by:

$$OL(X) = -G \frac{(1 + iCX)e^{-iX}}{X^2 + S}$$

I first determine the parameters  $(S, C)$  for which there exists a counterclockwise loop in the curve. For clarity, in figures I use the gain  $G = S$ . Then, for a given set of admissible  $(S, C)$ , I determine the minimal and maximal gains for which the curve loops around  $-1$ .

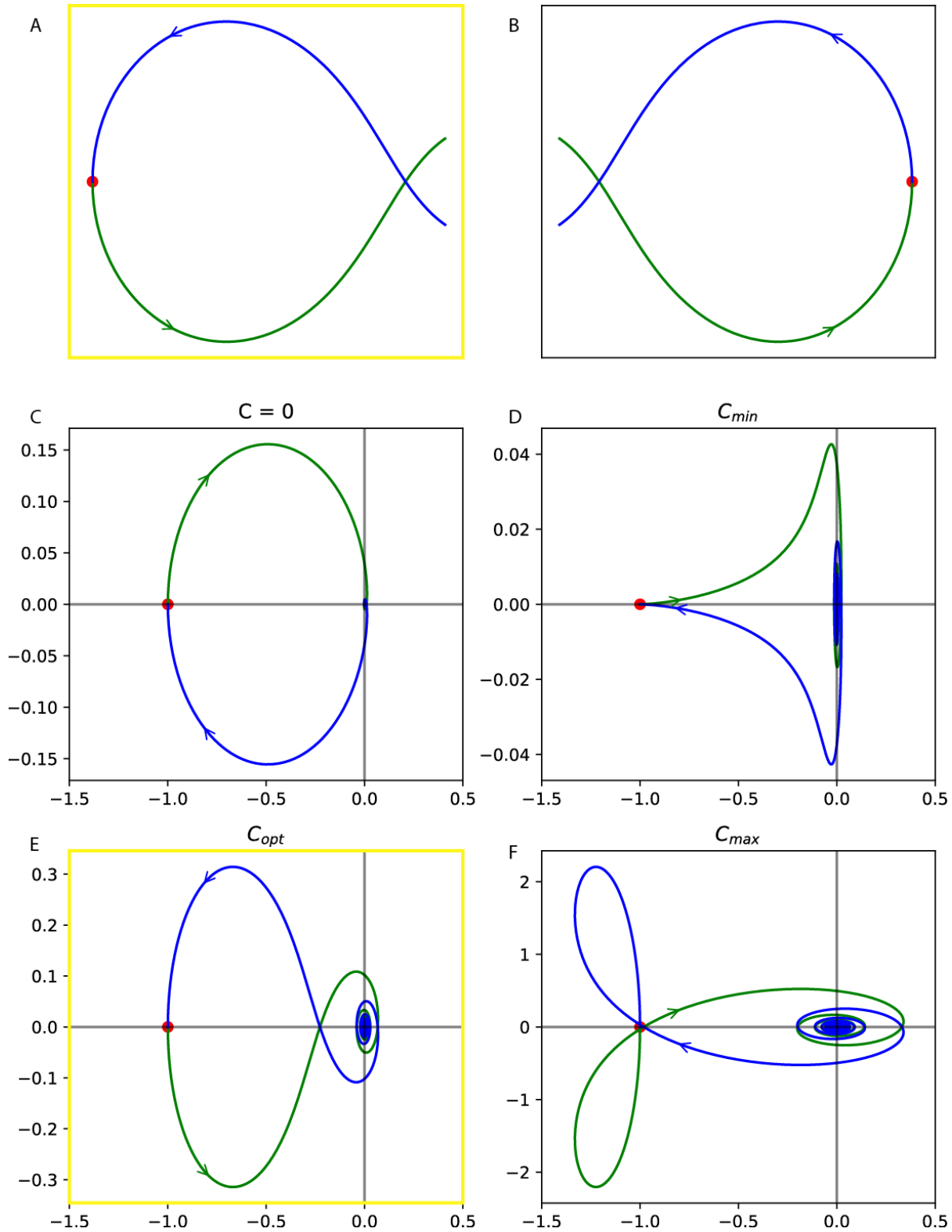

Figure 2.10 Nyquist curves.

The Nyquist curve is plotted in blue for  $X < 0$ , in green for  $X > 0$ , and in red for  $X = 0$ . Two possibilities for a counterclockwise loop are schematically illustrated in A. and B. The Nyquist curve is plotted for  $C = 0$  in panel C., minimal damping  $C = 1$  in panel D., critical damping  $C_{opt}$  in panel E., and maximal damping  $C_{max}$  in panel F. The only curve in panels C-F which contains a counterclockwise loop is the one in panel E, which corresponds to the situation in panel A.

a)  $(S, C)$  parameters with a counter-clockwise loop

Description of the curve:

- The curve for  $X < 0$  is the symmetric with respect to the real axis of the curve for  $X > 0$
- For  $X = \pm\infty$ ,  $OL = 0$  because of the  $X^2$  in the denominator
- For  $X = 0$ ,  $OL = -G/S$

I consider the first intersection point of the Nyquist curve with the real axis for  $X > 0$ , and denote it  $X_{int}(C, S)$ . There are 2 options for a counter-clockwise loop, schematically illustrated in Figure 2.10:

- A.  $-G/S < OL(X_{int}(C, S))$  and the imaginary part is negative for  $X \in [0, X_{int}(C, S)]$  (Figure 2.10.A)
- B.  $-G/S > OL(X_{int}(C, S))$  and the imaginary part is positive for  $X \in [0, X_{int}(C, S)]$  (Figure 2.10.B)

Determination of the intersection point

I expand the open-loop into real and imaginary parts:

$$\begin{aligned} OL(X) &= -G \frac{(1 + iCX)(\cos(X) - i \sin(X))}{X^2 + S} = \frac{G}{X^2 + S} (1 + iCX)(-\cos(X) + i \sin(X)) \\ &= \frac{G}{X^2 + S} (-(\cos(X) + CX \sin(X)) + i(-CX \cos(X) + \sin(X))) \end{aligned}$$

The sign of the imaginary part is thus the same as the sign of:

$$I(C, X) = -CX \cos(X) + \sin(X)$$

This function is illustrated in Figure 2.11.A for different values of  $C$ . The intersection point therefore depends only on  $C$  and not on  $S$ , and I write it  $X_{int}(C)$ . It satisfies :

$$\frac{\tan(X_{int}(C))}{X_{int}(C)} = C$$

As can be seen in Figure 2.11.A:

- For  $C < 1$ ,  $X_{int}(C) \in ]\pi/2, 3\pi/2[$  and  $I(C, X) > 0$  for  $X \in [0, X_{int}(C)]$
- For  $C > 1$ ,  $X_{int}(C) \in ]0, \pi/2[$  and  $I(C, X) < 0$  for  $X \in [0, X_{int}(C)]$

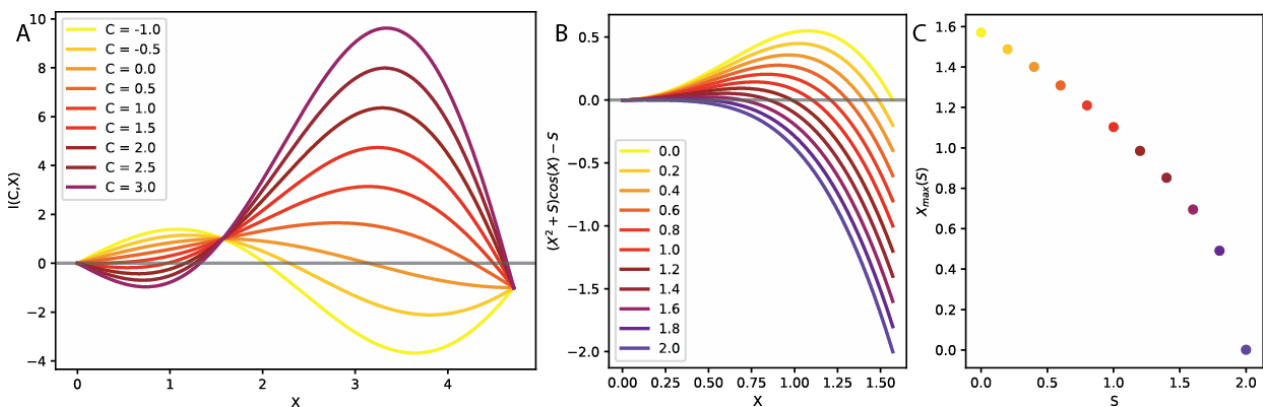

Figure 2.11 Determination of the intersection point.

A. The curve  $I(C, X)$  is illustrated as a function of  $X$  for different values of  $C$  ranging from -1 to 3. B. The curve  $f_S(X)$  is illustrated as a function of  $X$  for different values of  $S$  ranging from 0 to 2. C. The maximal value of the intersection point  $X$  for which there exists a counterclockwise loop in the Nyquist curve is illustrated as a function of  $S$ .

Indeed, a first order expansion around  $X = 0$  gives:

$$I(C, X) \propto -CX + X = X(1 - C)$$

I now consider the value of the open-loop function at the intersection point:

$$\begin{aligned} OL(X_{int}) &= \frac{-G}{X_{int}^2 + S} (\cos(X_{int}) + CX_{int} \sin(X_{int})) = \frac{-G}{X_{int}^2 + S} \frac{1}{\cos(X_{int})} (\cos(X_{int})^2 + \sin(X_{int})^2) \\ &= \frac{-G}{(X_{int}^2 + S) \cos(X_{int})} \end{aligned}$$

*Stability requires  $C > 1$*

As I have shown, for  $C < 1$ ,  $X_{int}(D) \in ]\pi/2, 3\pi/2[$  therefore  $\cos(X_{int}) < 0$  and  $OL(X_{int}) > 0 > -G/S$ .

Moreover, for  $C < 1$ , the imaginary part is positive for  $X \in [0, X_{int}(D)]$ . Thus, the Nyquist curve satisfies neither conditions A. nor conditions B., and the system is not stable: there is no counter-clockwise loop in the curve. The Nyquist curves for  $C = 0$  and  $C = 1$  are illustrated in Figure 2.10 (respectively panel C. and D.).

*Stability requires  $S < 2$*

As I have shown, for  $C > 1$ , the imaginary part is negative for  $X \in [0, X_{int}(C)]$ . Stability therefore requires satisfying condition A., ie:

$$\begin{aligned} -\frac{G}{S} < OL(X_{int}(C)) &= \frac{-G}{(X_{int}(C)^2 + S) \cos(X_{int}(C))} \\ 0 < (X_{int}(C)^2 + S) \cos(X_{int}(C)) - S \end{aligned}$$

$X_{int}(C)$  is an increasing function of  $C$ , ranging from 0 for  $C \rightarrow 1$  to  $\frac{\pi}{2}$  for  $C \rightarrow +\infty$ .

I therefore define  $f_S: X \in [0, \frac{\pi}{2}] \rightarrow (X^2 + S) \cos(X) - S$

$$\begin{aligned} f_S(0) &= 0 \\ f_S\left(\frac{\pi}{2}\right) &= -S \end{aligned}$$

This function is illustrated in Figure 2.11.B for different values of  $S$ .

The derivative is given by:

$$f'_S(X) = 2X \cos(X) - S \sin(X)$$

For  $S \geq 2$ , it is negative throughout the range  $[0, \frac{\pi}{2}]$ , therefore  $f_S(X)$  is also negative throughout this range (Figure 2.11.B), and there exists no value of  $C$  for which the system is stable.

*Stability requires  $C < C_{max}(S)$*

For  $S < 2$ ,  $f'_S(0) > 0$ , therefore there exists a range of values  $X \in [0, X_{max}(S)]$  for which  $f_S(X) > 0$ . The value of  $X_{max}(S)$  for different values of  $S$  is shown in Figure 2.11.C. Thus there exists a range of  $C \in [1, C_{max}(S)]$  for which the Nyquist curve has a counterclockwise loop.  $C_{max}(S)$  is given by:

$$C_{max}(S) = \frac{\tan(X_{max}(S))}{X_{max}(S)}$$

The Nyquist curve for the critical damping  $C_{opt} > 1$  (as derived in the following section V.2) and the maximal value of damping  $C_{max}(S)$  are illustrated in Figure 2.10 (respectively panel E. and F.)

b) Feedback gain  $G$  for which the loop encompasses  $-1$

Finally, for a given value of speed and damping, the range of gains which can stabilize the system is given by:

$$\begin{aligned} -\frac{G}{S} < -1 < \frac{-G}{(X_{int}(C)^2 + S) \cos(X_{int}(C))} \\ S < G < (X_{int}(C)^2 + S) \cos(X_{int}(C)) \end{aligned}$$

The minimal gain is thus  $G = S$  for all values of  $C$ .

The maximal gain depends on  $C$ , and follows a curve parametrized by  $X \in [0, X_{max}(S)]$  :

$$G = (X^2 + S) \cos(X)$$

$$C = \frac{\tan(X)}{X}$$

Note that  $G(0) = S$  and  $G(X_{max}(S)) = S$ .

#### 4. Simulations

##### a) Feedback gain $G$

The response of systems with various feedback gains is shown in Figure 2.12.A for the relative speed  $S = 0.1$  and the critical damping  $D_{opt}$  for that relative speed (derived in the following section V):

- For  $G < S$  (dashed red line), the feedback is not strong enough to prevent falling, and the system is unstable.
- For  $G = S$  (dashed black line), the feedback is just strong enough to prevent falling, but not strong enough to bring the system back to its initial position: this is the lower limit of stability.
- For  $G = G_{max}$  (full black line), the feedback elicits oscillations whose amplitude neither increases nor decreases with time: this is the upper limit of stability.

For gains between  $S$  and  $G_{max}$  (blue and green dashed and full lines), the system is stable:

- For  $G = G_{opt}$  the critical gain (full green line) the perturbation is cancelled the fastest without oscillations.
- For  $G < G_{opt}$  (dashed blue line), the perturbation is cancelled more slowly.
- For  $G > G_{opt}$  (full blue line), there are oscillations.

##### b) Feedback damping $D$

The response of systems with various feedback dampings is shown in Figure 2.12.B, for the relative speed  $S = 0.1$  and the critical gain  $G_{opt}$ . If the damping is too low (dashed red and black lines), slow oscillations appear, whereas if it is too large (full black line), fast oscillations appear. For intermediate values of damping (full and dashed blue and green lines), the perturbation is cancelled the fastest without oscillations for  $D = D_{opt}$  (full green line).

##### c) Relative speed $S$

The response of systems with various relative speeds and critical feedback parameters is shown in Figure 2.12.C:

- As  $S$  approaches 2 (blue line), an initial perturbation of amplitude 1 is amplified 400 times before it is cancelled by the feedback (note the difference in the scale of the y axis between panel C and panels A and B).
- For  $S = 2$  (black line), the amplitude of the oscillations neither increases nor decreases with time: this is the upper limit of stability.
- For  $S > 2$  (red line), no feedback gains are able to stabilize the system, and the amplitude of the oscillations grows with time.



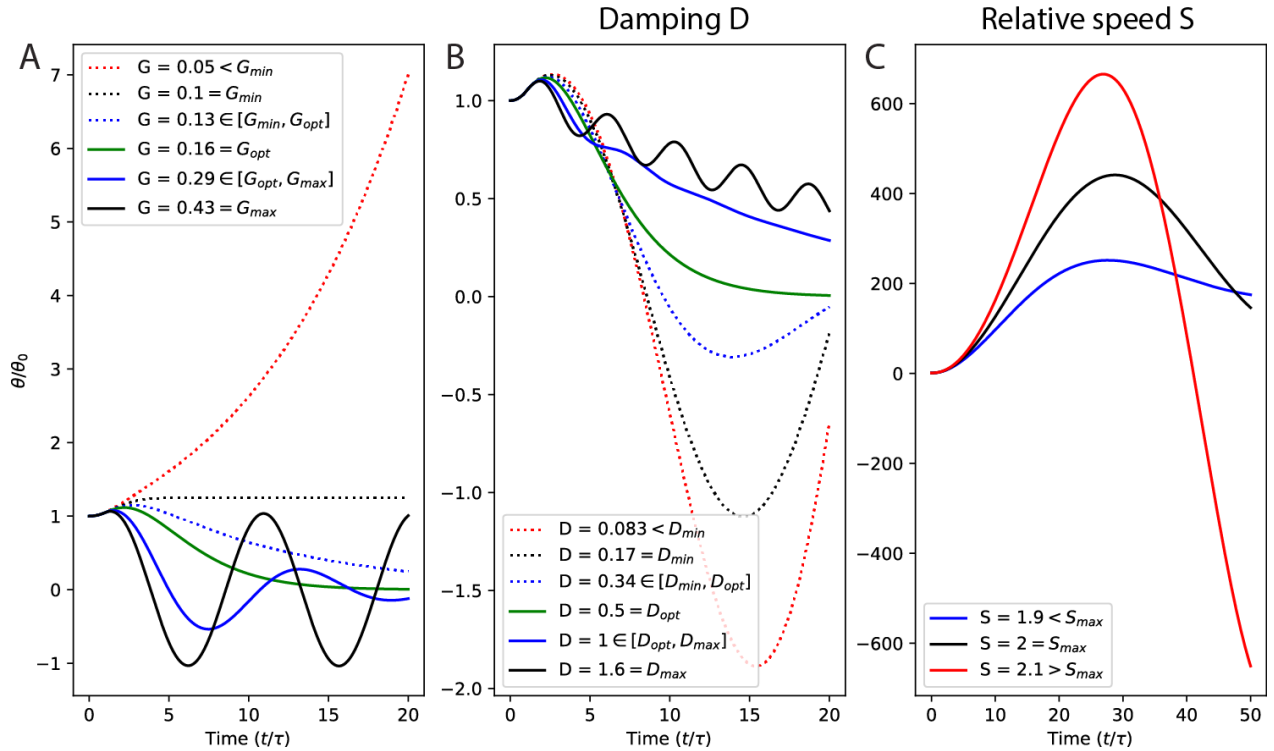

Figure 2.12 Response to a perturbation.

The position  $\vartheta$  of the system to a perturbation of arbitrary magnitude  $\vartheta_0$  is displayed as a function of time (normalized to the response delay  $\tau_{delay}$ ). A. Response of a system with relative speed  $S = 0.1$ , damping  $D_{opt}(S)$ , and various gains. B. Response of a system with relative speed  $S = 0.1$ , gain  $G_{opt}(S)$ , and various dampings. C. Response of the system with various relative speeds, and critical gain and damping  $G_{opt}(S), D_{opt}(S)$ . Stable systems are in blue and green, unstable systems in red, and systems at the border of stability in black. Systems with feedback parameters lower than the critical values are in dashed lines.

## V. Supplementary methods: Critical damping

Critical damping is defined for second order systems governed by a characteristic equation of the form:

$$X^2 + 2\zeta\omega_0X + \omega_0^2$$

The characteristic equation of the linearized inverted pendulum with delayed feedback control is:

$$X^2 - S + Ge^{-X} + DXe^{-X}$$

To define critical damping for this system, I first introduce a rational function approximation for the delay. With this approximation, the characteristic equation becomes a third order polynomial. I then generalize the notion of critical damping from second order to third order polynomials.

### 1. Pade approximation

#### a) Rational function approximation

The first order Pade approximation of the delay is given by:

$$e^{-X} = \frac{e^{-X/2}}{e^{X/2}} \approx \frac{1 - X/2}{1 + X/2}$$

With this approximation, the characteristic equation becomes

$$\begin{aligned} X^2 - S + Ge^{-X} + DXe^{-X} &\approx (X^2 - S) + (G + DX) \frac{1 - X/2}{1 + X/2} \\ &= \frac{1}{1 + \frac{X}{2}} \left( (X^2 - S) \left(1 + \frac{X}{2}\right) + (G + DX) \left(1 - \frac{X}{2}\right) \right) \\ &= \frac{1}{1 + \frac{X}{2}} \left( \frac{X^3}{2} + X^2 \left(1 - \frac{D}{2}\right) + X \left(D - \frac{G}{2} - \frac{S}{2}\right) + G - S \right) \end{aligned}$$

The roots of the approximate characteristic equation are thus the roots of:

$$X^3 + X^2(2 - D) + X(2D - G - S) + 2(G - S)$$

b) Dynamical systems interpretation

The Pade approximation consists in approximating the function  $\theta(t - \tau_{delay})$  by a function  $\theta_{approx}(t)$  which follows:

$$\frac{\tau_{delay}}{2} \dot{\theta}_{approx}(t) + \theta_{approx}(t) = \theta(t) - \frac{\tau_{delay}}{2} \dot{\theta}(t) \quad (5)$$

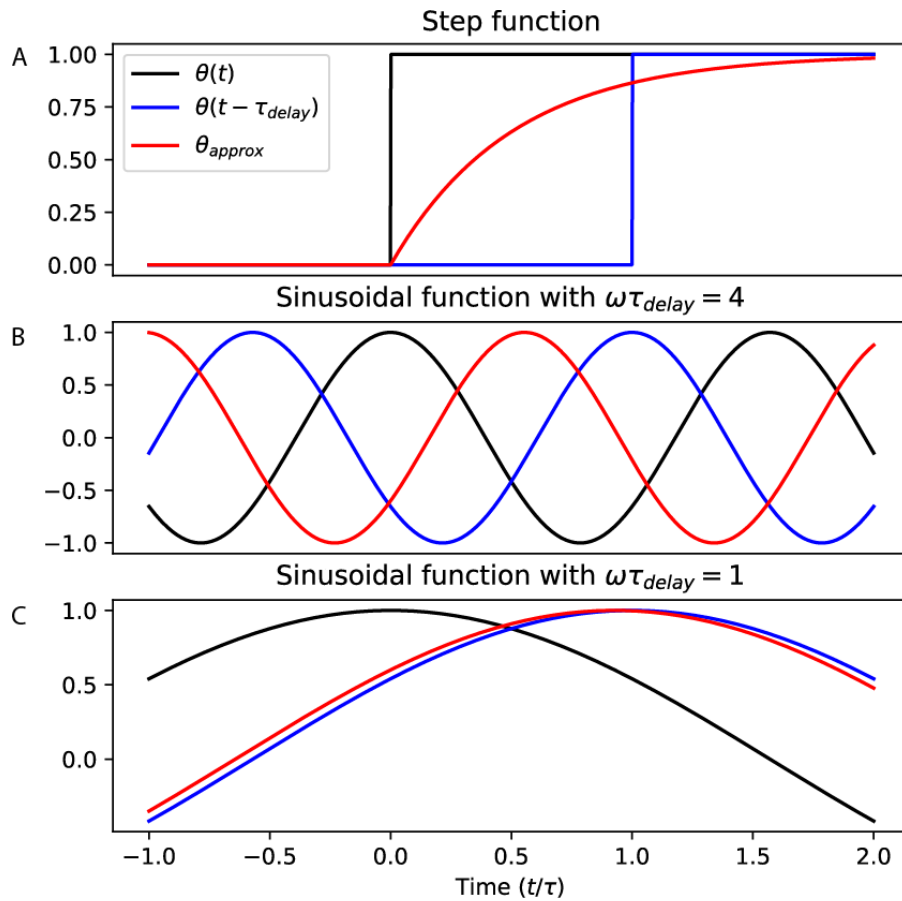

Figure 2.13 Pade approximation of the time delay.

A. Step function in black, delayed step function in blue and Pade approximation of the delayed step function in red. B-C Sinusoidal function with  $\omega\tau_{delay} = 4$  and 1 (respectively for panels B and C) in black, delayed sinusoidal function in blue and Pade approximation of the delayed sinusoidal function in red.

*Examples*

Suppose  $\theta(t)$  is a step function defined by (Figure 2.13.A. in black):

- $\theta(t) = 0$  for  $t < 0$
- $\theta(t) = 1$  for  $t > 0$

Then  $\theta_{approx}(t) = 1 - \exp(-\frac{2t}{\tau_{delay}})$  (Figure 2.13.A. in red).

Suppose  $\theta(t)$  is a sinusoidal function defined by  $\theta(t) = \exp(i\omega t)$  (Figure 2.13.B, C, in black), then:

$$\theta_{approx}(t) = \frac{1 - \frac{i\omega\tau_{delay}}{2}}{1 + \frac{i\omega\tau_{delay}}{2}} \exp(i\omega t)$$

The amplitude is:

$$\sqrt{\frac{(1 + (\frac{\omega\tau_{delay}}{2})^2)^2}{(1 + (\frac{\omega\tau_{delay}}{2})^2)^2}} = 1$$

The phase lag is:

$$\phi \left( \frac{1 - \frac{i\omega\tau_{delay}}{2}}{1 + \frac{i\omega\tau_{delay}}{2}} \right) = -2 \arctan \left( \frac{\omega\tau_{delay}}{2} \right)$$

This corresponds to a time lag of  $\tau_{delay}$  for small  $\omega\tau_{delay}$  (Figure 2.13.C in red) and  $\pi$  for large  $\omega\tau_{delay}$  (Figure 2.13.B in red).

Thus, the Pade approximation  $\theta_{approx}(t)$  corresponds to  $\theta(t - \tau_{delay})$  if  $\theta$  changes slowly compared to  $\tau_{delay}$  (Figure 2.13.C), whereas fast variations in  $\theta$  are distorted (Figure 2.13.A, B).

*Delayed feedback control*

With this approximation, the dynamics of the system with delayed feedback control become:

$$\tau_{delay}^2 \ddot{\theta} = S\theta - (G\theta + D\dot{\theta})(t - \tau_{delay}) \approx S\theta - (G\theta_{approx} + D\dot{\theta}_{approx}) \quad (6)$$

Reinjecting equation (5) into (6):

$$\begin{aligned} \tau_{delay}^2 \ddot{\theta} &\approx S\theta - G\theta_{approx} - D(2\theta - 2\theta_{approx} - \tau_{delay}\dot{\theta}) \\ \tau_{delay}^2 \ddot{\theta} &\approx (S - 2D)\theta + (2D - G)\theta_{approx} + D\tau_{delay}\dot{\theta} \end{aligned}$$

$$\tau_{delay} \frac{d}{dt} \begin{pmatrix} \theta \\ \theta_{approx} \\ \tau_{delay}\dot{\theta} \end{pmatrix} = \begin{pmatrix} 0 & 0 & 1 \\ 2 & -2 & -1 \\ S - 2D & (2D - G) & D \end{pmatrix} \begin{pmatrix} \theta \\ \theta_{approx} \\ \tau_{delay}\dot{\theta} \end{pmatrix}$$

The eigenvalues of the system are the roots of the polynomial:

$$X^3 + X^2(2 - D) + X(2D - G - S) + 2(G - S)$$

## 2. Generalisation of criticality

## a) Definition

In second order systems governed by a characteristic equation  $X^2 + 2\zeta\omega_0 X + \omega_0^2$ , for a given value of  $\omega_0$ , the fastest compensation without oscillations occurs for the critical damping  $\zeta = 1$ . For such critical damping, the

characteristic equation has a unique double root  $-\omega_0$ . Higher damping results in slower compensation for perturbations, whereas lower damping results in oscillations.

I generalize the notion of 'critical damping', and consider that a third order system is likewise critically damped when it has a unique triple negative root  $-\omega_0$ . The coefficients of the characteristic equation must therefore correspond to the coefficients of the polynomial:

$$(X + \omega_0)^3 = X^3 + X^2 3\omega_0 + X 3\omega_0^2 + \omega_0^3$$

b) Solution

For a given speed  $S$ , I solve for  $(\omega_0, G_{\text{opt}}, D_{\text{opt}})$  the system of equations:

$$0 = \omega_0^3 - 2(G_{\text{opt}} - S) \quad (7)$$

$$0 = 3\omega_0^2 - (2D_{\text{opt}} - G_{\text{opt}} - S) \quad (8)$$

$$0 = 3\omega_0 - (2 - D_{\text{opt}}) \quad (9)$$

First I determine  $\omega_0$  as a function of  $S$  by removing  $(G, D)$  from the equations:

According to (9):  $D_{\text{opt}} = 2 - 3\omega_0$

According to (8):  $G_{\text{opt}} = 2D - S - 3\omega_0^2 = 4 - 6\omega_0 - S - 3\omega_0^2$

Replacing in (7):

$$0 = \omega_0^3 - 8 + 12\omega_0 + 2S + 6\omega_0^2 + 2S = \omega_0^3 + 6\omega_0^2 + 12\omega_0 + 4S - 8 = (\omega_0 + 2)^3 - 8 + 4S - 8$$

Thus:  $(\omega_0 + 2)^3 = 4(4 - S) > 0$

This equation admits one real positive solution for  $(\omega_0 + 2)$ , and two complex conjugate solutions. I take the real solution:

$$\omega_0 = -2 + (16 - 4S)^{\frac{1}{3}}$$

Replacing in (5):  $D_{\text{opt}} = 2 - 3\omega_0 = 8 - 3(16 - 4S)^{\frac{1}{3}}$

Replacing in (4):  $G_{\text{opt}} = 4 - 6\omega_0 - S - 3\omega_0^2 = 4 + 12 - 6(16 - 4S)^{\frac{1}{3}} - S - 3(4 + (16 - 4S)^{\frac{2}{3}} - 4(16 - 4S)^{\frac{1}{3}})$

$$G_{\text{opt}} = 4 - S + 6(16 - 4S)^{\frac{1}{3}} - 3(16 - 4S)^{\frac{2}{3}}$$

## VI. Supplementary methods: generalisation to N dimensions

I consider an N-dimensional dynamical system with state  $\boldsymbol{\theta}$  and delayed feedback control  $\mathbf{C}$ , whose dynamics are governed by:

$$\tau_{\text{delay}}^2 \frac{d^2}{dt^2} \begin{pmatrix} \theta_1 \\ \dots \\ \theta_N \end{pmatrix} = \begin{pmatrix} S_{1,1} & \dots & S_{1,N} \\ \vdots & \ddots & \vdots \\ S_{N,1} & \dots & S_{N,N} \end{pmatrix} \begin{pmatrix} \theta_1 \\ \dots \\ \theta_N \end{pmatrix} - \begin{pmatrix} C_1 \\ \dots \\ C_N \end{pmatrix}$$

$$\tau_{\text{delay}}^2 \ddot{\boldsymbol{\theta}} = \mathbf{S}\boldsymbol{\theta} - \mathbf{C}$$

I consider that the transpose  $\mathbf{S}^T$  of the dynamics matrix  $\mathbf{S}$  is diagonalizable, and introduce the basis set  $(\mathbf{e}_1, \dots, \mathbf{e}_N)$  of eigenvectors of  $\mathbf{S}^T$  and their corresponding eigenvalues  $(s_1, \dots, s_N)$ , such that for every  $i$ :

$$\mathbf{S}^T \mathbf{e}_i = s_i \mathbf{e}_i$$

I use this basis set to perform a transformation of coordinates of the state  $\boldsymbol{\theta}$  into  $\boldsymbol{\alpha}$ , such that, for every  $i$ ,  $\alpha_i$  is the dot product of the vectors  $\mathbf{e}_i$  and  $\boldsymbol{\theta}$ :

$$\alpha_i = \mathbf{e}_i^T \boldsymbol{\theta}$$

Each component  $\alpha_i$  follows the dynamical equation:

$$\tau_{\text{delay}}^2 \frac{d^2}{dt^2} \alpha_i = \mathbf{e}_i^T \mathbf{S}\boldsymbol{\theta} - \mathbf{e}_i^T \mathbf{C} = s_i \mathbf{e}_i^T \boldsymbol{\theta} - \mathbf{e}_i^T \mathbf{C} = s_i \alpha_i - \mathbf{e}_i^T \mathbf{C}$$

The dynamics are thus decomposed into a set of  $N$  components, each of which follows a single-dimensional dynamics for which the analysis presented in section II.1, 2 holds. Stability is thus determined by the set of eigenvalues of  $\mathbf{S}^T$ , which corresponds to the set of eigenvalues of  $\mathbf{S}$ .





### 3. Mobility as the purpose of postural control

This chapter has been published in *Frontiers in Computational Neuroscience* in 2017 (Le Mouel and Brette, 2017b).

#### I. Abstract

Counteracting the destabilizing force of gravity is usually considered to be the main purpose of postural control. However, from the consideration of the mechanical requirements for movement, we argue that posture is adjusted in view of providing impetus for movement. Thus, we show that the posture that is usually adopted in quiet standing in fact allows torque for potential movement. Moreover, when performing a movement - either voluntarily or in response to an external perturbation - we show that the postural adjustments are organized both spatially and temporally so as to provide the required torque for the movement. Thus, when movement is performed skilfully, the force of gravity is not counteracted but actually used to provide impetus to movement. This ability to move one's centre of mass so as to exploit the torque of gravity seems to be dependent on development and skill learning, and is impaired in aging.

#### II. Introduction

The position of the centre of mass (CoM) is adjusted by the central nervous system during quiet standing (Sasagawa et al., 2009; Winter et al., 1998), in reaction to perturbations (Horak and Nashner, 1986), and in voluntary movement (Cordo and Nashner, 1982; Lee et al., 1990; Pedotti et al., 1989). The traditional theory is that the purpose of this postural control is to immobilize the centre of mass despite movement and external perturbations (Bouisset and Do, 2008; Horak, 2006; Massion et al., 2004; Nashner et al., 1989). We will refer to this theory as the immobility theory. The underlying assumption is that, because of gravity, standing is unstable. Therefore, if the CoM is displaced from its equilibrium position, then the displacement must be counteracted by postural adjustments, so as to return the CoM to its equilibrium position, otherwise the person will inevitably fall. As argued by Hasan, this notion stems from an analysis of how linear systems respond to perturbations: in linear systems, if deviations from the unique equilibrium position are not corrected, then they grow exponentially (Hasan, 2005). Balance (the ability to prevent falling), is therefore assumed to be equivalent to stabilization, in the strict sense of immobilizing the CoM at a unique equilibrium position by counteracting any displacement away from this position. From this assumption, it follows that moving poses a threat to balance, since any voluntary movement might displace the CoM. This theory has motivated a large body of experiments, performed over the last thirty years, in which a subject is asked to perform a movement of the upper body, while their muscle activity is being recorded (Cordo and Nashner, 1982; Crenna et al., 1987; Lee et al., 1990; Pedotti et al., 1989). In these experiments, a change in the contraction of the lower leg muscles is systematically observed, and this change often precedes the contraction of the upper body muscles. This is interpreted by saying that movement of the upper body might displace the CoM, and must therefore be counteracted by the contraction of the lower leg muscles so as to immobilize the CoM despite movement.

We will argue however that the equivalence between balance and immobilization does not hold for human postural control, and that these postural responses should be understood as providing the impetus for the movement. We will indeed show that during quiet standing, voluntary movement, and in reaction to perturbations, the position of the CoM is not immobilized at a unique equilibrium position, but on the contrary adjusted so as to use the torque of one's own weight, either to counteract external forces so as to maintain balance, or to provide



impetus for voluntary movement. We therefore develop an alternative to the immobility theory. We propose that the purpose of postural control is mobility, the ability to produce appropriate impetus by adjusting the position of the CoM. We will refer to this theory as the mobility theory.

We will first show that the posture which is typically adopted in quiet standing allows for one's weight to be used to provide impetus to potential movement, and that when the direction of the movement to be performed can be anticipated, the position of the CoM during stance is shifted in that direction. Secondly, we will show that, during voluntary movement, postural adjustments which are traditionally thought of as immobilizing the CoM despite movement should on the contrary be interpreted as displacing the CoM at the initiation of the movement, so that one's own weight can be used to provide impetus to the movement. Finally, we will show that this ability to use displace one's weight, rather than immobilize it, plays a crucial role when balance is upset by external forces.

### III. Adjustment of posture during stance

#### 1. The standing posture allows for mobility

##### a) The standing posture requires tonic muscular contraction

When someone is asked to stand quietly, without further instructions, they typically maintain their CoM vertically aligned with the middle of the foot, a few centimetres forwards of the ankle joint (Schieppati et al., 1994). However, when requested to do so, a young, healthy person can maintain their CoM at positions up to 40 % of their foot length forwards of its typical position, and up to 20 % backwards (Schieppati et al., 1994). There is therefore no unique equilibrium position for the CoM in quiet standing, since a young, healthy person can maintain a range of standing postures without this posing a threat to balance.

If the position of the CoM were controlled only in view of counteracting the torque of one's weight, then it would be most appropriate to place it vertically above the ankles, such that weight would exert no torque (Figure 3.1.A). This position can indeed be maintained with minimum lower leg muscle contraction (Schieppati et al., 1994). However, when no instructions are given, subjects maintain their CoM vertically aligned with the middle of the foot, a few centimetres forwards of the ankle joint (Figure 3.1.B), so that the weight exerts a forwards torque. In order to maintain this posture, an equivalent backwards torque must be exerted by the ground reaction force (see Appendix 6.1.1). As developed in the Appendix (6.1.2), the torque of the ground reaction force is determined by the torque of the lower leg muscles. Indeed, if we consider the forces acting on the foot, the weight of the body, carried by the skeleton, is applied at the ankle and therefore exerts no torque. The ground prevents the foot from turning, therefore the ground reaction torque instantly opposes the torque exerted by the lower leg muscles onto the foot (Figure 3.1.C-E). Maintaining a standing posture with the CoM forwards of the ankles therefore requires tonic contraction of the calf muscles (Figure 3.1.B)(Schieppati et al., 1994). The normal standing posture is therefore not the most economical in terms of muscular contraction.

##### b) The standing posture allows torque for movement

Why would subjects actively maintain their CoM forwards of the ankles in quiet standing if this is not efficient? We suggest that this allows them to use their own weight for initiating forwards movements. Forwards torque for movement can only be induced by the external forces: the person's weight and the ground reaction force. As we have shown (Appendix 6.1.2) the ground reaction torque instantly follows the torque of the lower leg muscles. However, this torque is limited. Indeed, as long as the person neither jumps up nor collapses, the ground reaction force has the same magnitude as the person's weight. Its torque is therefore the product of the weight, and the distance between the ankle and the point of application of the ground reaction force, called the centre of pressure and noted CoP. Thus, contracting the calf muscles (gastrocnemius and soleus) shifts the CoP forwards of the ankle (Figure 3.1.C), and contracting the shin muscle (tibialis anterior) shifts the CoP backwards of the ankle (Figure

3.1.E), but the CoP can only move within the limited range of the foot (see Supplementary Methods VII.1.a for further detail).

The net torque is proportional to the distance between the CoM and the CoP. Whereas the CoP moves instantly when the forces exerted by the muscles change, but can only move within the limited range of the foot, the position of the CoM on the other hand, does not change instantly when the forces exerted by the muscles change. This first requires the sum of the external forces to accelerate the CoM. Displacements of the CoM therefore occur more slowly than displacements of the CoP, as seen for example in (Burleigh et al., 1994). Thus, the initial net torque that can be produced, either for opposing external perturbation forces or for voluntary movement, is limited by the initial position of the CoM (see Supplementary Methods VII.1.b for further detail).

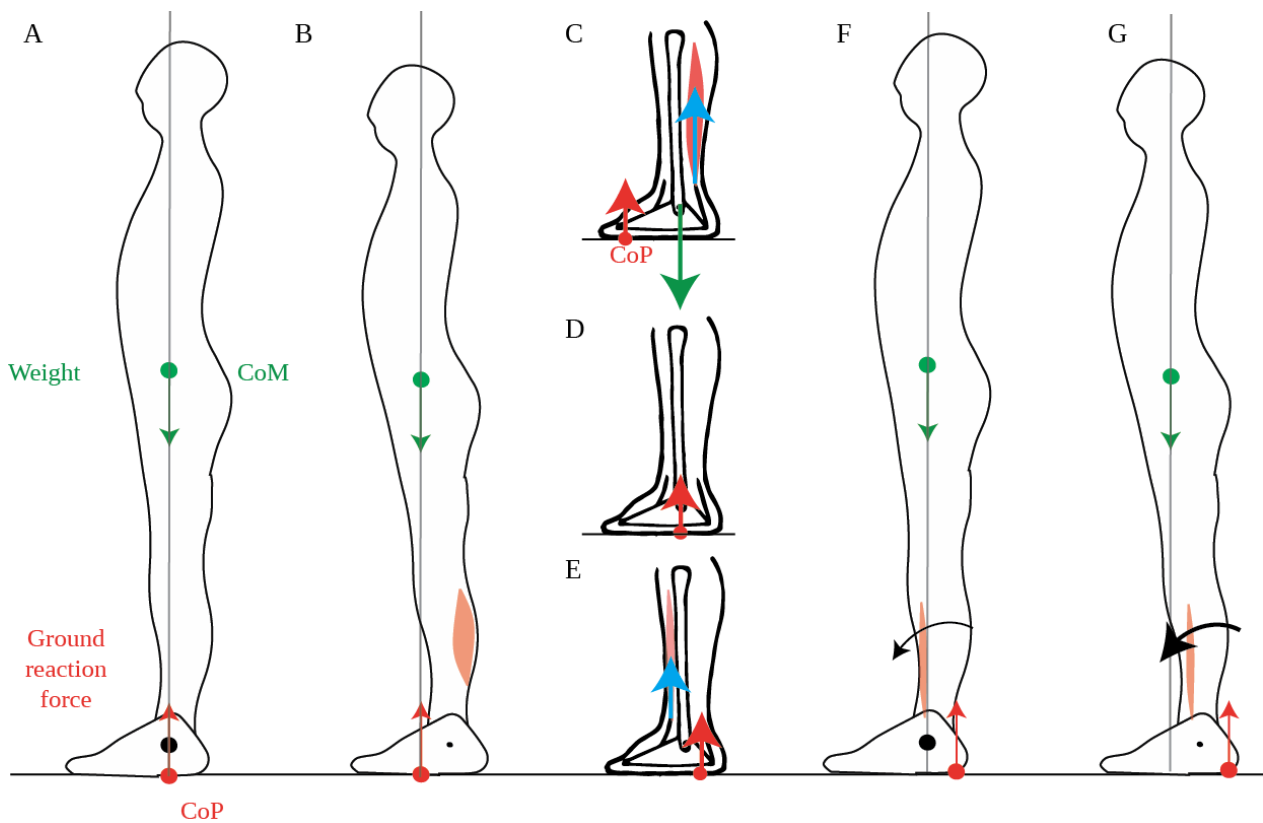

Figure 3.1 Torques during stance.

*A-B Standing posture. A. When the CoM (green dot) is vertically aligned with the ankle joint (black dot), the weight (green arrow) exerts no torque around the ankle. In order to maintain this posture, the ground reaction force (red arrow) must also exert no net torque around the ankle, therefore its point of application, the CoP (red dot) must also be vertically aligned with the ankle. B. In the typical quiet standing posture, the CoM is maintained forwards of the ankles, therefore weight exerts forwards torque around the ankles. This is compensated for by backwards torque of the ground reaction force, which requires tonic calf muscle contraction. C-E Torques exerted on the foot. The force exerted by the lower leg bones onto the foot (green arrow) exerts no torque around the ankle. The torque of the ground reaction force (red arrow) and of the forces exerted by the lower leg muscles onto the foot (blue arrow) are therefore opposite when the foot remains immobile: C. The torque around the ankles exerted by the calf muscles onto the foot is instantly compensated for by a forwards shift of the CoP (red dot). D. When the lower leg muscles exert no torque onto the foot, then the CoP is below the ankle. E. The torque around the ankles exerted by the shin muscle onto the foot is instantly compensated for by a backwards shift of the CoP. F-G Net torque is limited by the position of the CoM. In order to initiate a forwards movement, the CoP is brought to the heel by inhibiting calf muscle contraction and contracting the shin muscle. When the CoM is vertically aligned with the ankle (F), the net forwards torque is small. When the CoM is forwards of the ankle (G), the net forwards torque is larger.*

When initiating fast forwards movements, either starting to walk (Burleigh et al., 1994) or movements performed with the feet in place such as leaning forwards (Crenna et al., 1987) or rising onto one's toes (Nardone and Schieppati, 1988), the CoP is first brought towards the heel by inhibiting the calf muscle contraction and contracting the shin muscle (Burleigh et al., 1994; Crenna et al., 1987; Nardone and Schieppati, 1988). If the CoM were initially above the ankle, this would produce little initial forwards torque (Figure 3.1.F), whereas with the CoM forwards of the ankle this produces larger torque (Figure 3.1.G). Maintaining the CoM forwards of the ankle thus allows one's own weight to be used for initiating forwards movement. Maintaining the CoM in the middle of the foot allows for either forwards or backwards initial torque to be induced by changes in the forces of the lower leg muscles.

## 2. The standing posture is actively maintained

This position of the CoM is precisely and actively maintained on a short timescale, with small adjustments of the CoP in quiet standing serving to immobilize the CoM at this position (Figure 3.2.A) (Winter et al., 1998). Moreover, the tonic contraction of the calf muscles is adjusted when standing on different slopes so as to maintain the CoM aligned with the middle of the foot (Figure 3.2.B) (Sasagawa et al., 2009). This precise positioning is also maintained at the longer timescales of growth and aging. Indeed, the curvature of the spine and trunk increases with aging (red line in Figure 3.2.C) (Schwab et al., 2006), and the position of the CoM is maintained across people with different trunk curvatures by shifting the position of the pelvis relative to the heels (Figure 3.2.C) (Lafage et al., 2008; Schwab et al., 2006).

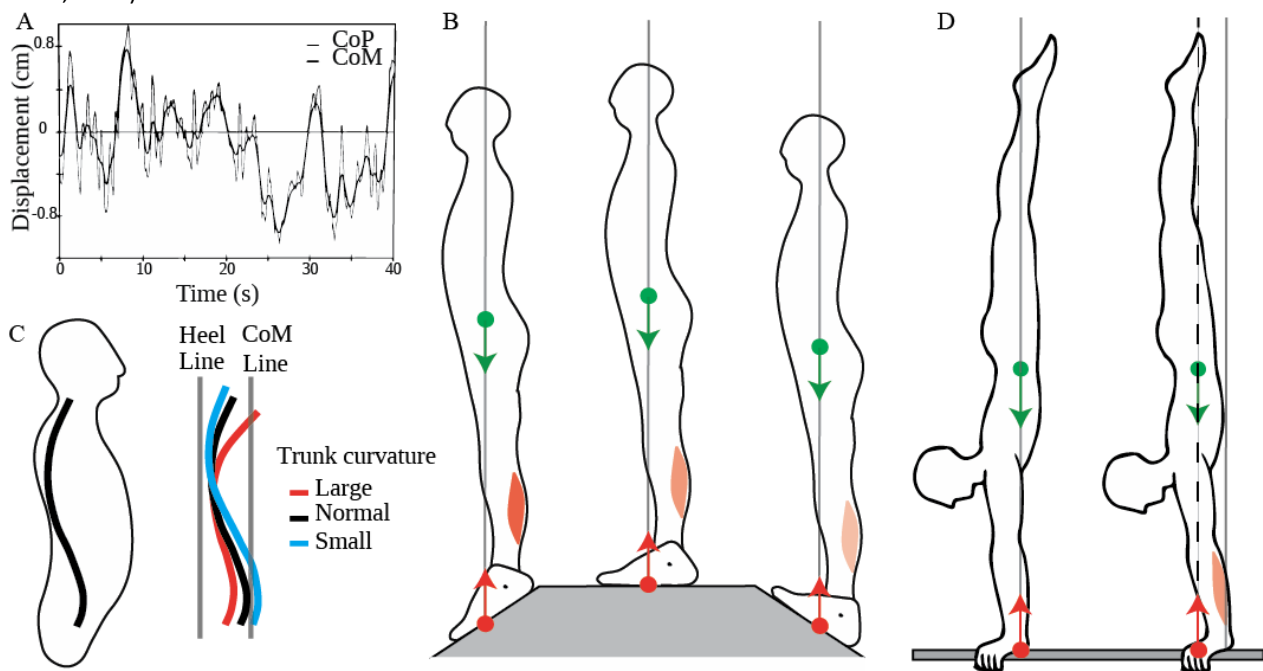

Figure 3.2 Adaptation of the position of the CoM

A. Displacement of the CoP and CoM in quiet standing as a function of time, adapted from Winter et al. (1998): small ongoing shifts of the CoM are tracked and overtaken by shifts in the CoP. B. The tonic calf muscle contraction decreases when going from a slope with the toes down (left panel), to a flat slope (middle panel), to a slope with the toes up (right panel) such that position of the CoM is maintained vertically aligned with the middle of the feet. C. People of different trunk curvatures maintain their pelvis at different distances from the heel line (vertical line above the heel), such that the CoM line (vertical line passing through the CoM) is at the same distance from the heel line. D. Left panel: Acrobats at lower competitive levels maintain their CoP and CoM aligned with their wrist without tonic contraction of their wrist extensors. Right panel: Acrobats at higher competitive levels maintain their CoP and CoM forwards of their wrist, through tonic contraction of their wrist extensors.

Moreover, this forwards position of the CoM emerges with skill learning. Thus, Clément and Rézette observed acrobats at various competitive levels performing handstands (Clément and Rézette, 1985). All the acrobats were able to maintain their balance in the upside-down posture, however they did so in different ways. The acrobats at lower competitive levels maintained their mean CoP a few millimetres forwards of their wrist; they could therefore maintain their posture with very little tonic contraction in the arm muscles (Figure 3.2.D, left). The acrobats at higher competitive levels maintained their mean CoP more forwards of their wrists, with the acrobat at the highest level maintaining his mean CoP 3 cm forwards of his wrists; this posture requires tonic contraction of the wrist extensors (Figure 3.2.D, right).

Thus, the standing posture is actively adjusted so as maintain the CoM above the middle of the foot (and above the middle of the hand in handstands). Contrary to the immobility theory, this position is not a unique equilibrium point, since a variety of standing postures can be maintained without this leading to a loss of balance. According to the mobility theory, this position is maintained because it allows for torque of the appropriate direction to be produced at short notice, even when this direction cannot be anticipated. This may be useful both for opposing external perturbations and for initiating voluntary movements.

### 3. The standing posture is adjusted in anticipation of movement

When the direction of the appropriate torque can be anticipated, the mobility theory predicts that the CoM would be displaced in that direction in anticipation of the movement. Such a shift can indeed be induced experimentally, either by challenging someone's balance in a predictable direction, or by indicating in advance the direction of a voluntary movement to be performed.

Someone's balance can be challenged by having them stand facing the edge of the platform they are on. According to the immobility theory, this should lead, if anything, to an even more stringent immobilization of the CoM at its equilibrium position, but what is observed is that the CoM is shifted slightly backwards, as shown in Figure 3.3.A, (Carpenter et al., 2001). This is in accordance with the mobility theory, since it increases the person's capacity for producing backwards torque, in the eventuality that they might be subjected to a forwards push. In the experiment, the person's balance was not challenged beyond placing them in front of a drop, which might explain why the shift in CoM position was rather small (less than a centimetre).

Another way of challenging someone's balance is to have them stand on a platform (Figure 3.3.B) which is then translated backwards (Figure 3.3.C). The person ends up with their CoM in a forward position relative to the feet. A commonly observed response to such a translation is to straighten up (Welch and Ting, 2014). This requires backwards torque, however their capacity for producing backwards torque is limited by the forwards position of their CoM (Figure 3.3.C). If such a perturbation is repeated, then over a few trials, the person adjusts their quiet standing posture by shifting their CoM backwards by a few centimetres (Figure 3.3.D) (Welch and Ting, 2014). This is again in contradiction with the immobility theory, but in accordance with the mobility theory, since the backwards shift of the CoM increases the person's capacity to produce backwards torque for straightening up (Figure 3.3.E). When the platform is repeatedly translated forwards, then the person shifts their CoM forwards (Welch and Ting, 2014).

The mobility theory predicts that the position of the CoM in quiet standing would also be shifted if the direction in which a voluntary movement to be performed could be anticipated. This occurs at the start of a race: in sprinting, the initial forwards acceleration is crucial in winning the race. Consistently with the mobility theory, the CoM in the starting position is shifted even beyond the toes by several tens of centimetres (Slawinski et al., 2010). This is achieved by placing the hands on the ground and having the hands carry some of the weight (Figure 3.3.F). This ability to use one's own weight to produce torque for movement again seems to depend on skill learning. Indeed, in elite sprinters, the CoM is shifted 5 centimetres further forwards than for well-trained sprinters (Slawinski et al., 2010).

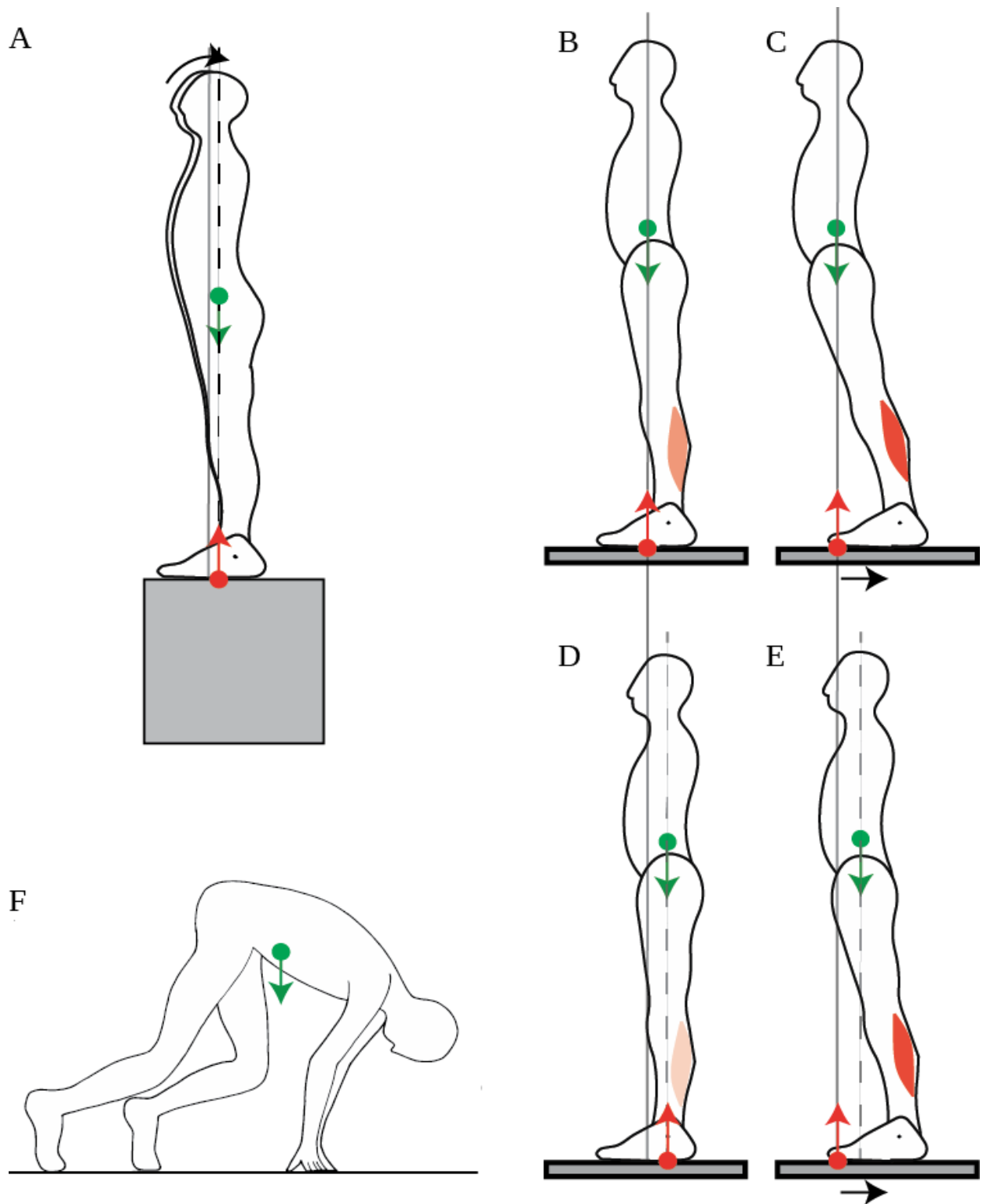

Figure 3.3 Adjustment of the position of the CoM

A. When a person stands facing a slope, they shift their CoM slightly backwards. B-C: When someone stands normally (B) and the platform they stand on is shifted backwards, their CoM ends up far forwards of the ankle joints, which limits the net backwards torque for straightening up (C). D-E: When a backwards perturbation is repeated, the person shifts their CoM backwards in quiet standing (D), which increases the net backwards torque for straightening up after the perturbation (E). F: In the posture adopted before a sprint, the CoM is placed far forwards of the feet by having the arms carry some of the weight.

## 4. Summary

Thus, when the direction of the appropriate torque to be produced cannot be anticipated, the CoM is positioned at the middle of the feet, in a position which allows for both forwards and backwards torque to be produced. When the direction of the torque to be produced can be anticipated, then the standing posture is adjusted by shifting the CoM in that direction. This adaptation of the standing posture in view of movement seems to be dependent on learning.

## IV. Adjustment of posture during voluntary movement

According to the immobility theory, when a voluntary movement is being performed, postural control serves to immobilize the CoM despite the movement or the perturbation. The mobility theory predicts, on the contrary, that the position of the CoM is adjusted so as to use the torque of weight for movement. It therefore predicts that muscular contractions are temporally organized so as to accelerate the CoM at the initiation of the movement in the appropriate direction for producing torque for movement.

## 1. Initiation of voluntary movement

## a) Pulling on a handle

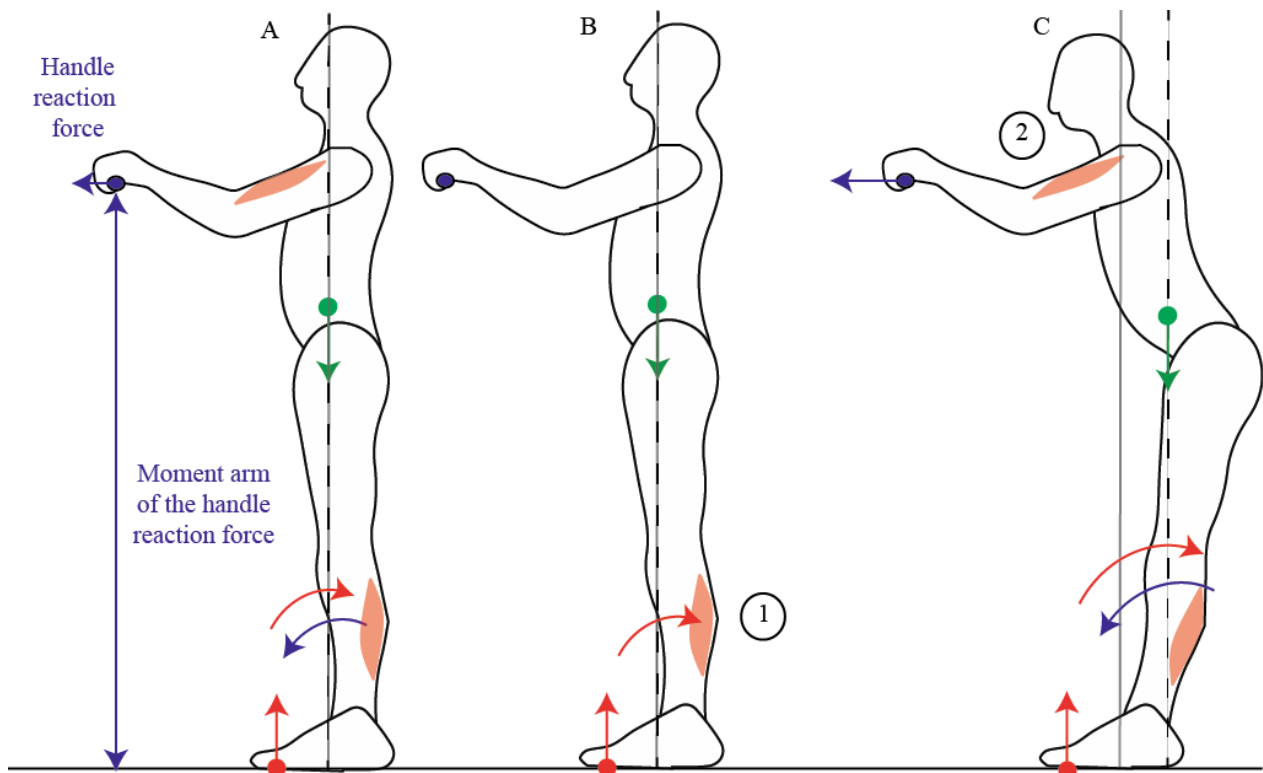

Figure 3.4 Pulling on a handle

When pulling on a handle, the handle reaction force (blue arrow) exerts forwards torque around the ankles which can be compensated for by contracting the calf muscles (A). In preparation for pulling on a handle, subjects contract their calf muscles before their arm muscles (B), which displaces their CoM backwards, allowing for a larger net backwards torque to be exerted during the handle pull (C).

When someone pulls on a handle placed in front of them, the contraction of the arm muscles is preceded then accompanied by the contraction of the calf muscles (Cordo and Nashner, 1982; Lee et al., 1990). Cordo and Nashner suggest that this contraction of the calf muscles allows for the CoM to be immobilised despite the movement (Cordo and Nashner, 1982). However, in order for the CoM to be immobilised, the ground reaction torque would have to exactly compensate for the handle reaction torque throughout the movement, and this would notably require the calf and arm muscle contractions to be simultaneous (as in Figure 3.4.A). On the contrary, the initial contraction of the calf muscles which is observed (Cordo and Nashner, 1982) accelerates the CoM backwards (Figure 3.4.B, C, further details are provided in the Supplementary Methods VII.2); and when the person is asked to pull harder on the handle, this initial period lasts longer, the calf muscle activation is stronger, and the initial backwards acceleration of the CoM is larger (Lee et al., 1990). This is in accordance with the mobility theory, since initially accelerating the CoM backwards allows one's own weight to be used to assist the movement (Figure 3.4.C).

b) Leaning the trunk

When someone leans the trunk forwards, the contraction of the abdominal muscles is preceded then accompanied by the inhibition of calf muscle contraction and the contraction of the shin muscle (Figure 3.5.A-C) (Crenna et al., 1987). The CoM could in theory be immobilized if the shin and abdominal muscle contractions were simultaneous, such that the forwards acceleration of the CoM induced by the shin muscle contraction would compensate for the backwards acceleration of the CoM induced by the abdominals contraction (further details are provided in the Supplementary Methods VII.2), as suggested by Alexandrov and colleagues (Alexandrov et al., 2001). However, these authors report an initial backwards displacement of the CoP (Figure 3.5.A), followed by a forwards displacement of the CoM (Figure 3.5.B), in accordance with the sequential muscular contraction observed by Crenna and colleagues (Crenna et al., 1987). This contradicts the immobility theory, but concords with the mobility theory's predictions.

c) Gait initiation

Bouisset and Do distinguish between two types of anticipatory postural adjustments. For voluntary movements without a change in the basis of support, such as raising the arm, they provide a very classical interpretation for the displacement of the CoM which precedes the displacement of the arm (Bouisset and Do, 2008). They present it as a counter-perturbation whose purpose is to "counterbalance the disturbance to postural equilibrium due to the intentional forthcoming movement" (Bouisset and Zattara, 1981). However, for voluntary movements involving a change of the basis of support, such as walking, or rising onto one's toes, they present anticipatory postural adjustments as a perturbation involved in "body weight transfer" (Do et al., 1991).

We propose that in movements with or without a change in the basis of support, anticipatory postural adjustments play the same role of moving the CoM in order to provide impetus for movement. Indeed, the changes in posture which precede walking are organised in the same way as those which precede pulling on a handle or leaning the trunk. Thus, when going from standing to walking, a few hundred milliseconds before the heel of the swing foot is raised, the calf muscles are silenced and the shin muscle contracts, which brings the CoP to the heels and accelerates the CoM forwards (Figure 3.1.G), even before the first step is taken (Burleigh et al., 1994). This is in accordance with the mobility theory, since initially accelerating the CoM forwards allows one's own weight to be used to assist the movement. Indeed, this initial acceleration of the CoM is correlated with the speed reached at the end of the first step, and is larger if the person is asked to walk faster (Brenière et al., 1987).

Thus, both for movements with and without a change in the basis of support, postural responses should be considered as an integral part of the movement itself, since they provide the torque for the movement, first by shifting the CoP and secondly by accelerating the CoM through sequential muscle.

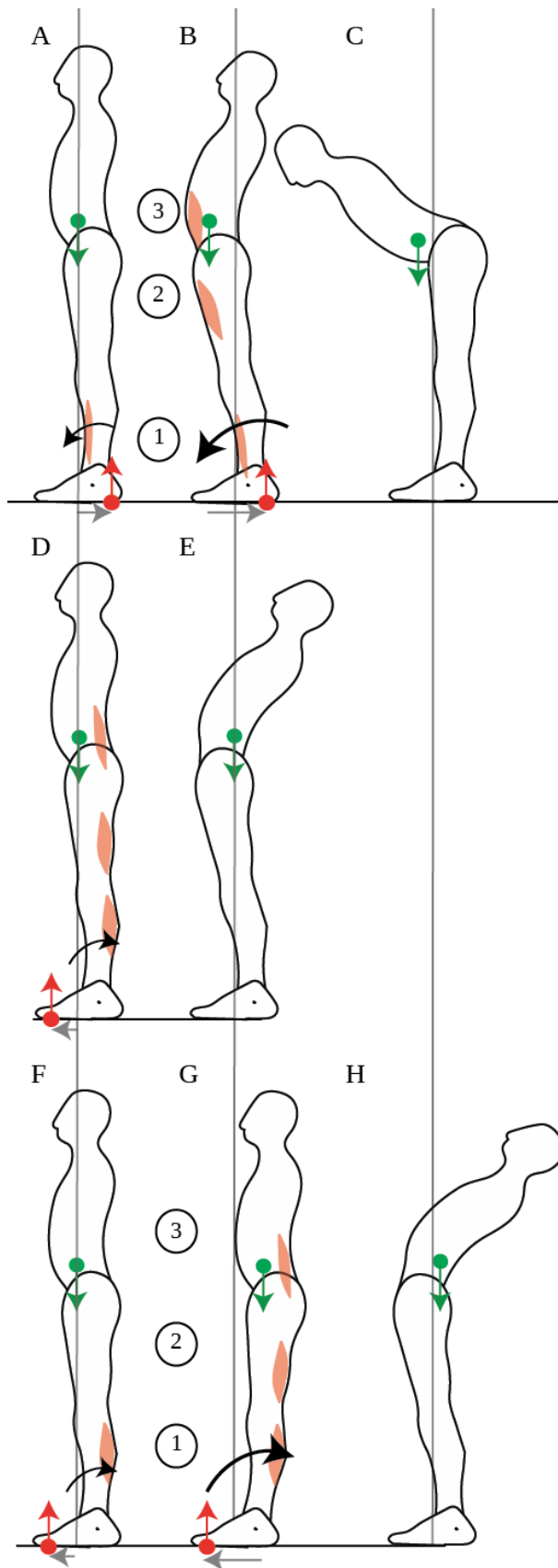

Figure 3.5

Figure 3.5 Leaning the trunk

When control subjects perform fast forwards leaning, the initial contraction of the shin muscle (A) accelerates the CoM forwards, thus allowing for more net forwards torque during the subsequent contraction of the ventral muscles (B), which enables the person to lean the trunk (C). When control subjects perform fast backwards leaning, the dorsal muscles contract simultaneously (D), which increases backwards rotational momentum without translating the CoM (E). When gymnasts perform fast backwards leaning, the initial contraction of the calf muscles (F) accelerates the CoM backwards, thus allowing for more net backwards torque during the subsequent contraction of the dorsal muscles (G) which enables the gymnast to lean the trunk (H). The sequence of activation of the muscles is indicated by the numbers 1 to 3.



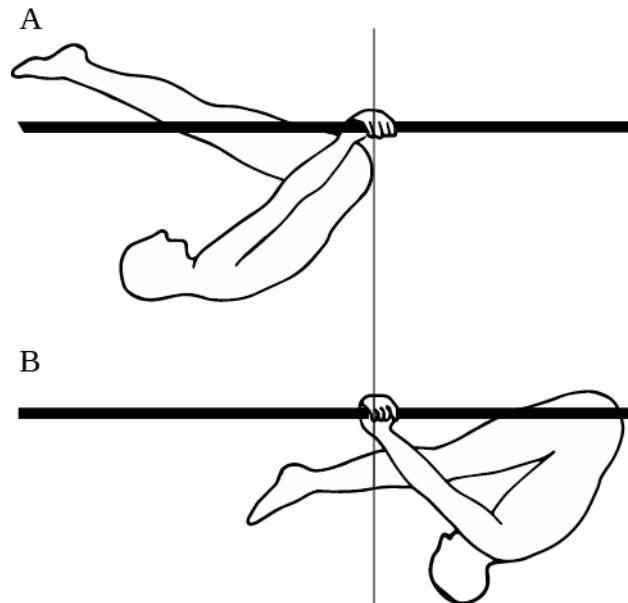

Figure 3.6 Gymnastics skill: swings under parallel bars

A. Forward-most position in the swing. B. Backward-most position in the swing.

## 2. The ability to use one's weight for movement requires practice

For walking, a movement which is learned very early on in life, the ability to displace the CoM at the initiation of the movement emerges over the course of development (Bril et al., 2015; Ledebt et al., 1998). The amplitude of the initial backwards shift of the CoP thus increases over the first several years of life as children learn to walk faster (Bril et al., 2015; Ledebt et al., 1998). It then decreases with age, and with certain neurological diseases such as Parkinson's disease (Halliday et al., 1998; Mancini et al., 2016).

For leaning the trunk, the sequential muscle contraction, which allows for the displacement of the CoM at the initiation of the movement, seems to be dependent on learning. Indeed, when control subjects are asked to lean backwards, a movement for which they presumably have less practice than leaning forwards, then the calf and dorsal trunk muscle contractions are simultaneous (Figure 3.5.D), and the movement is performed twice as slowly as leaning forwards (Pedotti et al., 1989). However, when gymnasts are asked to lean backwards, then their calf muscles contract first (Figure 3.5.F-H), and they perform the movement faster than controls (Pedotti et al., 1989). Moreover, the ability to displace one's CoM during movement seems to remain plastic throughout life, and to depend on the possibility to use one's weight to assist movement. Thus, when astronauts return from a several months journey in space (during which they could not use their weight to assist their movements), the forwards displacement of the CoM when leaning forwards is no longer observed (Baroni et al., 2001).

Finally, for movements requiring skill learning, the temporal coordination which enables using one's weight to provide impetus for movement seems to develop with skill learning. Thus, when learning a complex gymnastics skill, such as the swings under parallel bars, in bent inverted hang position (Figure 3.6), beginners swing their legs and arms in synchrony, whereas experts swing their legs out of phase with their arms, which allows them to use the work of their own weight to provide impetus to the swing (Delignières et al., 1998).

## V. Balance requires mobility rather than immobility

According to the immobility theory, if postural control does not immobilize the CoM at a unique equilibrium position, then the person must fall (Bouisset and Do, 2008; Horak, 2006; Massion et al., 2004; Nashner et al., 1989).

We have shown however that in quiet standing, people can keep their balance over a range of positions of the CoM (Schieppati et al., 1994), and actually displace their CoM when their balance is challenged in a predictable direction (Carpenter et al., 2001; Welch and Ting, 2014). Moreover, we have shown that in well-practiced movements, people accelerate their CoM at the initiation of the movement, without this leading to a loss of balance (Cordo and Nashner, 1982; Crenna et al., 1987; Lee et al., 1990; Pedotti et al., 1989). We will now show that the response to an external perturbation should be considered as a movement in its own right, and therefore also benefits from the ability to use one's weight for movement, rather than to immobilize it.

## 1. Responding to external perturbations

### a) Straightening up after a platform translation

When the platform on which someone stands is translated backwards, the CoM ends up in a forward position relative to the feet (Figure 3.7.A, B), as seen in section 2.3. A response which is commonly observed is to straighten up (Horak and Nashner, 1986). The backwards acceleration of the CoM is performed through a sequential contraction of the dorsal muscles, starting with the calf muscles (Figure 3.7.A), then the dorsal thigh then dorsal trunk muscles (Horak and Nashner, 1986). This contraction pattern is usually not considered as an actual movement, since it moves the CoM closer to its initial position, in accordance with the immobility theory. However, we believe it should be considered as a movement in its own right. Indeed, straightening up after a platform translation requires producing the appropriate backwards torque. The sequential contraction pattern allows for the CoM to be initially accelerated backwards, which increases the net backwards torque for the movement. Further details are provided in the Supplementary Methods VII.2. Moreover, contrary to the immobility theory, returning the CoM to its initial position is not the only way of preventing a fall.

### a) Stepping after a platform translation

Indeed, another response which is also commonly observed is to take a step forwards (Maki et al., 2003): the CoM is then not returned to its initial position, without this causing a loss of balance. This response takes advantage of the forwards position of the CoM, such that the CoM needs not be accelerated backwards, and indeed the initial calf muscle contraction and forwards CoP shift is much reduced (Figure 3.7.B) compared to when the person straightens up (Figure 3.7.A) ; nor does the CoM need to be accelerated forwards, and indeed the shin muscle contraction lasts much less long and the backwards shift of the CoP is much smaller (Figure 3.7.C) than when the person takes a step without the platform translation (Figure 3.7.D) (Burleigh et al., 1994).

## 2. Emergence over development and impairment with aging

The ability to mobilize one's weight emerges over development. Thus, when straightening up after a backwards platform translation, both the systematic recruitment of the dorsal muscles and their temporal sequencing emerge during development. They are not observed in pre-walking infants, but are seen in children with a few years' walking experience (Burtner et al., 1998).

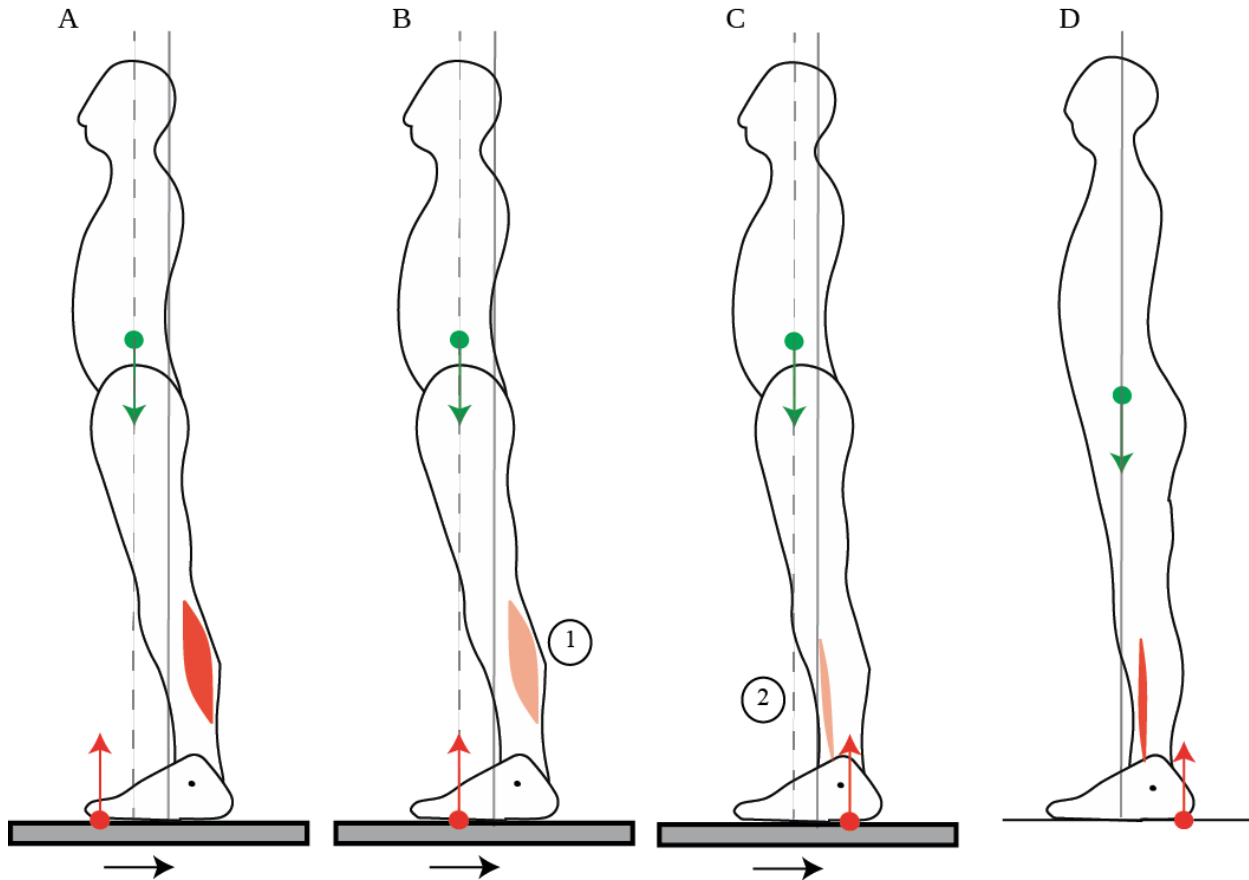

Figure 3.7 Response to platform translation

When straightening up after a platform translation (A), the initial contraction of the calf muscle accelerates the CoM backwards which increases the potential net backwards torque. When stepping forwards in response to a platform translation (B-C), this initial calf muscle contraction is reduced (B). Then, the shin muscle contracts (C). This shin muscle contraction is smaller than the initial contraction of the shin muscle which accelerates the CoM forwards when the person steps forwards without a platform translation (D). The sequence of activation of the muscles is indicated by the numbers 1 to 2.

This ability is then deteriorated with aging, and with Parkinson's disease. The elderly, and even more so Parkinsonian patients, are less capable of moving their CoM, either when asked to adjust their quiet standing posture by leaning forwards or backwards (Schieppati et al., 1994), or during voluntary movement, such as gait initiation (Halliday et al., 1998). They are however quite as capable as young healthy adults of remaining immobile in quiet standing (Schieppati et al., 1994), and adjust the position of their pelvis to compensate for trunk curvature such that the CoM remains above the middle of the feet (Schwab et al., 2006). Nevertheless, they have a heightened risk of falling. Thus, although the elderly and Parkinsonian subjects are quite as capable as young adults of maintaining their CoM immobile during quiet standing, we suggest that their higher risk of falling is due to a limited capacity to move when this becomes necessary to prevent a fall. Therefore, not only is immobilizing the CoM unnecessary for balance, it moreover seems that balance benefits from the ability to move one's CoM. This suggests that efficient balance training for the elderly can be achieved by practicing mobility (Xu et al., 2005).

### 1. Posture is adjusted in view of mobility rather than immobility

Although the position of the CoM is adjusted by the nervous system, this postural control does not serve to immobilize the CoM. On the contrary, the position of the CoM is adjusted so as to use the torque of one's own weight both for self-initiated movements and for responding to external perturbation forces.

Thus, in quiet standing, when the direction of the torque to be produced cannot be anticipated, the CoM is maintained above the middle of the foot (Schieppati et al., 1994), allowing for the torque of one's weight to be used both for forwards and backwards movements. This position is actively maintained despite short-term changes in slope (Sasagawa et al., 2009) or long-term changes in trunk curvature (Schwab et al., 2006). However, when the direction of the torque to be produced can be anticipated, then the CoM is shifted in that direction. There is thus a small backwards shift of the CoM when someone is placed in front of a drop (Carpenter et al., 2001), or on a platform which is repeatedly translated backwards (Welch and Ting, 2014). Skill learning leads to much larger shifts in the position of the CoM, with the CoM placed forwards of the feet in anticipation of sprinting (Slawinski et al., 2010).

Moreover, during movement, we have shown that the postural responses which were thought to immobilize the CoM despite movement are actually temporally organized so as to accelerate the CoM at the initiation of the movement, in the appropriate direction such that the torque of one's weight can be used for the movement (Cordo and Nashner, 1982; Crenna et al., 1987; Lee et al., 1990; Pedotti et al., 1989). These postural responses should therefore be understood as providing impetus to the movement.

Finally, we have shown that in order to respond effectively to external perturbation forces, the CoM need not be immobilized, since the person can take a step (Maki et al., 2003). When the person straightens up without taking a step (Horak and Nashner, 1986), this requires producing forces to counteract the external perturbation, and may benefit from the ability to mobilize one's CoM rather than immobilize it. Balance therefore requires mobility rather than immobility.

### 2. Mobility emerges through development and skill learning

The ability to use one's weight for movement emerges through development and skill learning, and remains plastic throughout life. The appropriate temporal organization of muscular contraction emerges during development both for walking and for balancing responses (Burtner et al., 1998; Ledebt et al., 1998). It is not observed for less practiced movements, such as when control subjects lean the trunk backwards (Crenna et al., 1987). The extent to which the CoM can be mobilized seems to depend on the level of skill: thus, both for sprinters at the initiation of a race (Slawinski et al., 2010) and acrobats performing handstands (Clément and Rézette, 1985), elite athletes place their CoM further forwards than well-trained athletes. Future work should address the following questions: how is this ability learned through development and practice? Does the impairment of this ability in aging result from a lack of practice, and could this ability be maintained during aging through appropriate training regimes?

## VII. Supplementary methods

### 1. Limits to ankle torque

#### a) The ground reaction torque is limited by the extent of the foot

The CoP cannot move further forwards than the toes nor further backwards than the heel. Thus if the contraction of the calf muscle exerts a torque that is larger than the product of the person's weight and the distance between their ankle and toes, then the foot can no longer remain immobile: the foot must then rotate around the toes.

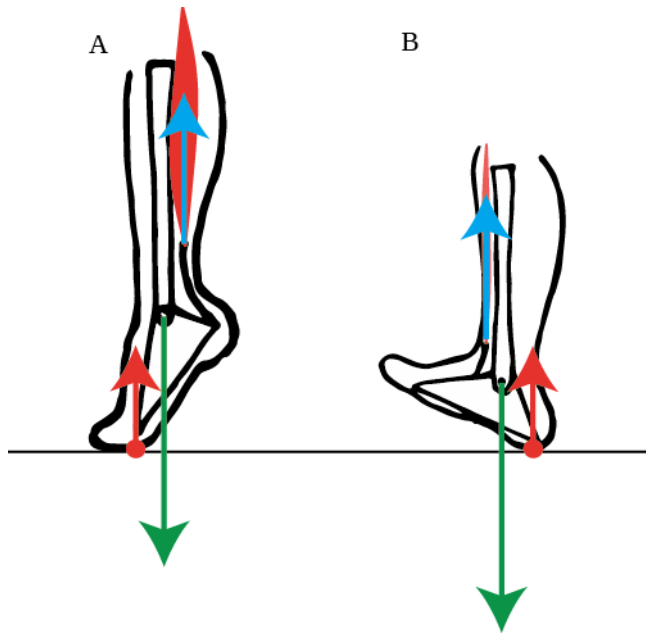

Figure 3.8

Figure 3.8 Limited ground reaction torque

A. When the backwards torque exerted by the calf muscles exceeds the product of the person's weight and the distance between the ankles and toes, the person rises onto their toes. B. When the forwards torque exerted by the shin muscle exceeds the product of the person's weight and the distance between the ankle and heel, the person rocks onto their heels.

Indeed, when subjects are asked to rise onto their toes, they perform this movement with a burst of contraction of their calf muscles, as shown in Figure 3.8.A (Nardone and Schieppati, 1988). Likewise, shin muscle contraction induces forwards ground reaction torque by shifting the CoP backwards. However, the CoP cannot move further backwards than the heel. Thus when subjects are asked to rock onto their heels, they perform this movement with a burst of contraction of their shin muscle, as shown in Figure 3.8.B (Nardone and Schieppati, 1988).

The potential ground reaction torque is therefore limited by the extent of the foot: the forwards torque is limited to the product of the person's weight and the distance between the heels and the ankles, and the backwards torque is limited to the product of the person's weight and the distance between the ankles and toes.

- b) The net torque is limited by the position of the CoM

The ground reaction torque changes instantly when the torques exerted by the lower leg muscles on the foot change, but it is limited by the extent of the foot. The torque of weight on the other hand can only be changed by displacing the CoM forwards or backwards, which cannot be done instantly but first requires the sum of the external forces to accelerate the CoM horizontally. Therefore, at a given instant, the potential net torque that can be induced by muscular contraction is limited by the position of the CoM: the net forwards torque is limited to the product of the weight and the distance between the CoM and the heels, whereas the net backwards torque is limited to the product of the weight and the distance between the CoM and the toes.

## 2. Horizontal acceleration of the CoM

We will now consider the horizontal acceleration of the CoM. Since the person's weight is vertical, only the ground reaction force may accelerate the CoM horizontally.

- a) Acceleration of the CoM induced by muscular contraction

The contraction of the dorsal muscles causes the trunk to rotate backwards around the hips (Figure 3.9.A). This backwards acceleration of the mass of the trunk implies that the trunk pushes forwards on the hips, which are therefore accelerated forwards. The dorsal trunk muscles do not exert torque on the foot around the ankles,

therefore they do not induce a change in the ground reaction torque. The person's rotational momentum around their ankles is therefore unchanged. The increase in backwards rotational momentum around the ankles due to the backwards acceleration of the head must therefore be compensated by an equal increase in forwards rotational momentum due to the forwards acceleration of the hips. Since the head is further from the ankles than the hips are, and since rotational momentum is proportional to distance, this implies that the forwards acceleration of the hips exceeds the backwards acceleration of the head, such that the CoM is accelerated forwards (Figure 3.9.A).

The contraction of the calf muscles causes the legs to rotate backwards. However, the calf muscles do not exert torque on the trunk around the hips. Therefore, if only the calf muscles contract, then the rotational momentum of the trunk around the initial position of the hips is unchanged: due to its inertia, the trunk therefore rotates forwards in the external frame of reference as the legs rotate backwards. The person therefore flexes at the hips (Figure 3.9.B). Moreover, the contraction of the calf muscles induces backwards ground reaction torque from the and therefore increases the person's backwards rotational momentum around the ankles. The increase in backwards rotational momentum around the ankles due to the backwards acceleration of the hips must therefore exceed the forwards rotational momentum due to the forwards acceleration of the trunk. This implies that the CoM is accelerated backwards (Figure 3.9.B).

Thus, contracting the dorsal trunk muscles accelerates the CoM forwards (Figure 3.9.A) and contracting the calf muscles accelerates the CoM backwards (Figure 3.9.B). In order to accelerate the CoM backwards at the initiation of a movement requiring both calf and dorsal trunk muscle contraction, the calf muscle contraction should therefore precede the dorsal trunk muscle contraction.

This result is additionally derived from the equations of the dynamics of the double inverted pendulum model of human stance in the Appendix 6.II.

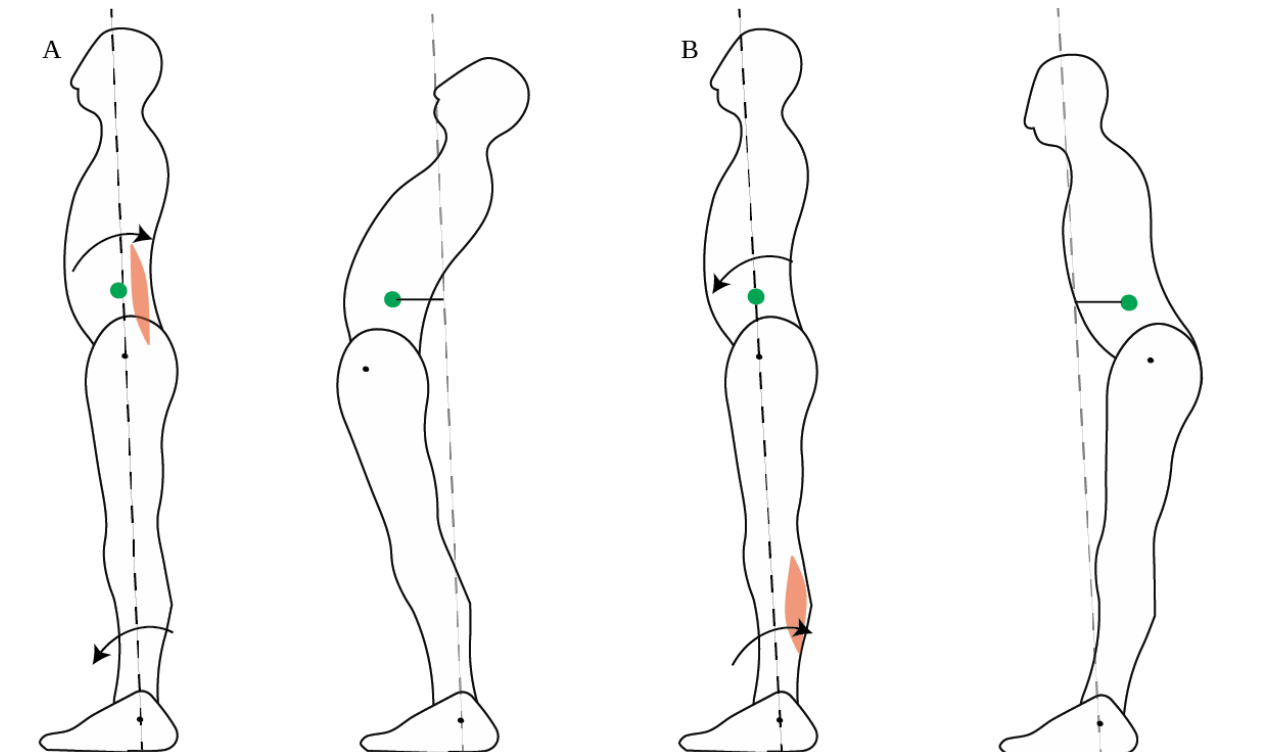

Figure 3.9 CoM acceleration induced by hip muscle contraction

A. Dorsal trunk muscle contraction makes the trunk rotate backwards around the hips while the legs rotate forwards around the ankles, accelerating the CoM forwards. B. Calf muscle contraction makes the legs rotate backwards around the ankles while the trunk rotates forward around the hips, accelerating the CoM backwards.

b) Muscular contractions required for movement

Leaning the trunk forwards requires not only an increase in the trunk's forwards rotational momentum around the hips, through the contraction of the abdominal muscles, but also an increase in the person's total forwards rotational momentum around the ankles, through the contraction of the shin muscle. Thus, when leaning forwards, both the abdominals and the shin should be considered as "prime movers", since they play the same role of providing torque for movement. If we take into account the knee joint, then the same analysis shows that leaning the trunk also requires the contraction of the thigh muscles. Moreover, the initial acceleration of the CoM requires a temporal sequencing of muscular contraction, with the lower leg muscles contracting first, then the thigh and finally the trunk muscles.

In order to straighten up after a platform translation, the person must rotate their entire body backwards around the ankles, keeping their legs and trunk aligned. This movement requires backwards rotational momentum of the body around the ankles, and therefore calf muscle contraction, but also backwards rotational momentum of the trunk around the hips, and therefore contraction of the dorsal trunk muscles. If we take into account the knee joint, then the same analysis shows that straightening up also requires contraction of the dorsal thigh muscles. Moreover, the initial acceleration of the CoM requires a temporal sequencing of muscular contraction, with the lower leg muscles contracting first, then the thigh and finally the trunk muscles.







# 4. Postural adjustments for mobility and immobility in aging

## I. Introduction

### 1. Mobility in aging

The ability to move and perform activities of daily living is essential for independence, health and well-being. After 50 years of age, certain people start to have difficulties in performing basic activities such as walking 400 m, walking up ten steps without resting, standing or sitting for two hours, stooping, bending, kneeling, reaching up above their head, grasping and handling small objects, carrying 4.5 kg (Holmes et al., 2009). In the United States, according to the National Center for Health Statistics (Holmes et al., 2009), the occurrence of such limitations increases with age, and concerns more than 40% of the population aged more than 80 years old. In a longitudinal study of elderly people living in the community (as opposed to living in nursing homes for the elderly), Verghese and colleagues found that clinically diagnosable abnormalities of walking concerned more than a third of the people aged more than 70 years old (Verghese et al., 2006). Because of the increasing elderly population in many developed countries (INSEE, 2010) and the high social cost of dependence and hospitalization in the elderly (Stevens et al., 2006), much research has been done in the last thirty years to understand the development of motor impairments with age.

These studies have shown that slower or abnormal walking is predictive of a subsequent loss of independence, reduced quality of life, cognitive decline, and an increased risk of falling, hospitalization, and premature death (Guralnik et al., 2000; Hausdorff et al., 2001; Studenski et al., 2011; Verghese et al., 2006). Thus, Verghese and colleagues found that walking abnormalities increased the risk of institutionalization and death. Studenski and colleagues then reviewed the findings of nine longitudinal studies of elderly people living in the community, and showed that in each study, the elderly who walk slower eventually die sooner (Studenski et al., 2011). Guralnik and colleagues (Guralnik et al., 2000) performed a longitudinal study of elderly people who initially did not have mobility impairments: they were able to walk half a mile and climb stairs without help. Their walking speed was measured at the beginning of the study, and then they were followed for up to six years to assess whether they developed mobility impairments. The study showed that those who initially walked more slowly have a higher risk of developing mobility impairments in subsequent years (Guralnik et al., 2000). They also have a higher risk of becoming unable to perform basic activities of daily living without help from another person (such as moving from a bed to a chair, using the toilet, bathing, and walking across a small room). Verghese and colleagues showed that people without dementia but with clinically abnormal walking had a higher risk of developing non-Alzheimer's dementia in subsequent years (Verghese et al., 2002). Hausdorff and colleagues further showed that elderly people with large fluctuations in the stride-to-stride walking rhythm have a higher risk of falling in the following year (Hausdorff et al., 2001).

### 2. Falls in aging and risk factors for falling

The incidence of falls also increases with age (Masud and Morris, 2001): over the course of a year, over a third of the people aged more than 65 fall at least once. Falls are especially common in institutional care facilities: more than half of their residents fall over the course of a year (Tinetti and Speechley, 1989). However falling also occurs in around 15% of apparently healthy and vigorous older people (Speechley and Tinetti, 1991). Between 30 and 50% of falls result in minor injuries, and around a tenth of falls result in major injuries such as fractures, including hip fractures (Masud and Morris, 2001). The risk of serious injury after a fall is larger in vigorous elderly people than in frail elderly people (Speechley and Tinetti, 1991). In turn, hospitalization for an injurious fall increases the risk of

mobility impairments in the next six months, and increases the likelihood of being admitted to a long-term nursing home, compared to hospitalizations which are not related to falls (Gill et al., 2013). Falling may also lead to a restriction of mobility by causing a fear of falling. Indeed, in a longitudinal study of elderly people living in the community, Vellas and colleagues found that around a third of those who fell developed a fear of falling again (Vellas et al., 1997b). In turn, they showed that people with a fear of falling had a greater increase in balance, walking and cognitive disorders with time, resulting in reduced mobility. Cumming and colleagues showed that elderly people with a fear of falling had an increased risk of falling and institutionalization, as well as a reduced ability to perform activities of daily living and a lower quality of life (Cumming et al., 2000).

Falling in the elderly may thus have very severe consequences for the fallers, as well as high social costs (Stevens et al., 2006). There has therefore been much effort put into developing interventions to prevent falls. The early studies focused on the delineation of risk factors for falling (Lipsitz et al., 1991; Lord et al., 1991; Robbins et al., 1989; Tinetti et al., 1986, 1988). Prospective studies assess the status of an individual at a given point in time, and then follow the person for a certain time and ask them to report any falls which occur during this period (Lord et al., 1991; Tinetti et al., 1986, 1988). Retrospective studies assess the status of an individual at a given point in time, and ask them to report their past history of falls (Lipsitz et al., 1991; Robbins et al., 1989).

For some of the risk factors highlighted by these studies, specific interventions have proved efficient for decreasing fall risk. For example, visual loss has been repeatedly associated with an increased risk of falling in prospective studies (Lord et al., 1991; Nevitt et al., 1989; Tinetti et al., 1988). In elderly people with an eye cataract, operation of the cataract has proven effective at decreasing the occurrence of falls (Harwood et al., 2005). Likewise, providing a pace-maker to people with irregular heart beat reduces falling (Gillespie et al., 2009). Medication, especially psychotropic medication, has been repeatedly associated with falling (Robbins et al., 1989; Tinetti et al., 1988, 1988), and the gradual withdrawal of psychotropic medication in elderly people living in the community has proven effective at reducing falls (Gillespie et al., 2009). Muscle weakness has been reported as a risk factor for falls for frail or institutionalized older adults (Lipsitz et al., 1991; Robbins et al., 1989). A potential cause of muscle weakness is low vitamin D, and vitamin D supplementation reduces falling for elderly people in care facilities and hospitals (Cameron et al., 2012). It may also be effective for elderly people living in the community, but only for those with lower vitamin D levels (Gillespie et al., 2009).

After accounting for all of these risk factors, there remain a large number of unexplained falls. Thus, even in prospective studies with strict exclusion criteria, so that people with known risk factors do not participate in the study, there are still a large number of reported falls (Boulgarides et al., 2003; Brauer et al., 2000). Therefore, to improve the accuracy of fall risk assessments, tests which directly assess mobility and balance in the elderly have been developed. These tests fall into two broad categories: clinical assessments and laboratory-based measures.

### 3. Clinical assessments of balance and mobility and prediction of fall risk

To determine who is at risk of falling, clinical tests of mobility and balance have been developed. These are typically very convenient and easy to administer. They require very little equipment, and the training required to be able to administer the tests is minimal. For example the Functional Reach test measures how far forwards a person can reach while keeping the feet in place (Duncan et al., 1990). The Timed One-leg Stand test measures how long a person can stand on one leg with the eyes closed (Bohannon et al., 1984). The Timed Get Up and Go test measures how long it takes someone to get up from an armchair, walk a short distance, come back, and sit down (Mathias et al., 1986; Podsiadlo and Richardson, 1991). Longer tests have been developed, which assess the person's performance in a series of simple tasks. These include Tinetti's Performance oriented balance and gait assessment (Tinetti, 1986), Berg's Balance scale (Berg et al., 1992), the Short Physical Performance Battery (Guralnik et al., 1994) and the Balance Evaluation Systems Test or BESTest (Horak et al., 2009).

Being convenient and easy to use, they have been performed in numerous longitudinal studies of fall risk involving large cohorts of elderly people, typically several hundred (Barry et al., 2014; Lin et al., 2004; Okumiya et al., 1998; Tinetti et al., 1988; Vellas et al., 1997a). The initial performance of those who subsequently fall are on average

lower than the performance scores of those who do not fall (Lin et al., 2004), however this is not a systematic finding (Brauer et al., 2000). Moreover, the tests seem altogether moderately successful for predicting fall risk. For example, in a prospective study, Okumiya and colleagues used the Timed Get Up and Go test with a cut-off of 16 seconds to predict falling: subjects who took more than 16 seconds to perform the test were expected to fall whereas those who took less than 16 seconds to perform the test were expected not to fall. The authors found that this predicted falling with an odds ratio of 2.7 (Okumiya et al., 1998). However, a meta-analysis performed by Barry and colleagues suggests that many people with a good Timed Get Up and Go performance nevertheless experience falls (Barry et al., 2014). The Tinetti score was a significant risk factor for falls in the original study in which it was developed (Tinetti et al., 1988). However, subsequent studies have shown that it has a low predictive value (Baloh et al., 1998; Lin et al., 2004).

The limited ability of these tests to predict falling suggests that they do not probe the deficits that cause falling. In community-dwelling elderly, “most falls occur as a result of an inability to react appropriately [to an imbalance] and produce an effective compensatory response” (Brauer et al., 2002). Clinical tests of balance and mobility cannot probe how elderly subjects respond to perturbations that may induce falling, as this would put the subjects in danger of falling and injury. At most, certain tests such as the Tinetti score assess the subject's response to a small nudge to the chest. This may be insufficient to reveal differences in the response to perturbations that actually threaten balance.

#### 4. Laboratory based assessments of balance and mobility and prediction of fall risk

In order to probe how elderly subjects respond to perturbations that actually threaten balance, studies have to be performed in a laboratory setting, so that the subject can wear a safety harness, which prevents injury in the case of a fall. Moreover, in a laboratory setting, perturbations can be applied using motors. For example, the perturbation can be applied by translating or rotating the platform on which the person stands (Manchester et al., 1989; Woollacott et al., 1986), or by the traction of a cable attached to the person's waist (Luchies et al., 1994). Such perturbations can be controlled and applied reproducibly in different subjects. They can also be varied to assess the effects of the perturbation characteristics on the subject's response (Tokuno et al., 2010). Such equipment is however expensive, and requires technical skills for its use. Studies performed in biomechanical research laboratories therefore typically involve much smaller cohorts than studies that use clinical tests of balance.

These studies show clear differences in response patterns to perturbations between the young and the elderly. In studies which measure muscle contraction, the onset of the response of ankle muscles is consistently found to be delayed in the elderly by up to 20 ms (Allum et al., 2004; Lin and Woollacott, 2002; Tokuno et al., 2010; Woollacott et al., 1986). When the perturbations are strong enough to induce stepping, differences in the stepping patterns are observed. The elderly initiate stepping with a shorter latency than the young, and for large perturbations they often take several steps, whereas the young only take a single step (Luchies et al., 1994). They also initiate stepping for smaller perturbations than the young (Mille et al., 2003).

However, studies that compare how elderly fallers and elderly non-fallers respond to perturbations rarely show clear differences. Retrospective studies of the response to forwards and backwards platform translations do not clearly distinguish between subjects with a history of falls and subjects without a history of falls (Maki et al., 1990; Studenski et al., 1991). For example, Studenski and colleagues find an increased latency in the onset of contraction in one ankle muscle but find no differences for another ankle muscle (Studenski et al., 1991). A retrospective study of nursing home residents using backwards waist pulls of increasing weight showed that half of the fallers had to be caught by the staff on the first or second trial, whereas most of the elderly controls succeeded in performing two or three trials (Wolfson et al., 1986). However, when the same experiment was performed in community-dwelling elderly people, all of the elderly with a history of frequent falls succeeded on the first trial, and most accomplished two or three trials (Chandler et al., 1990). Moreover, prospective studies of the response to forwards or backwards perturbations fail to show any difference between future fallers and non-fallers (Baloh et al., 1998; Hill et al., 1999; Kario et al., 2001; Maki et al., 1994). Prospective studies with lateral perturbations show modest differences. Thus,

Mille and colleagues showed that elderly fallers responded to lateral waist-pulls with three or more steps slightly more often than elderly non-fallers, and initiated stepping slightly earlier (Mille et al., 2013). Thus, strangely enough, the way in which elderly people respond to perturbations in a laboratory setting, although it is clearly different to the way in which young people respond, is not predictive of whether they will fall in their daily life.

Even more strangely, there are laboratory tasks without any external perturbations that do show clear differences between fallers and non-fallers, both retrospectively and prospectively. These are tasks in which the subject is asked to take a step as quickly as possible after a “go” signal. In a retrospective study in which subjects were asked to step to the side (first five times to the left, then five times to the right), White and colleagues showed that the elderly fallers took longer before raising the swing foot and therefore took longer to perform the step (White et al., 2002). However, when Melzer and colleagues performed the same experiment including forwards, sideways and backwards step, all performed with the dominant leg, they did not see this difference (Melzer et al., 2007). They did however find that fallers took longer to perform the step than non-fallers if they were concurrently performing a cognitive task (namely a modified version of the Stroop task). A prospective study showed that future fallers took longer to perform the step both with and without the concurrent cognitive task (Melzer et al., 2010).

In these studies, the subjects knew in advance with which foot they should step after the “go” signal. Lord and Fitzpatrick modified this task so that the “go” signal itself indicates with which foot the subject should step (Lord and Fitzpatrick, 2001). In this task, called the Choice Stepping Reaction Time task (CSRT), elderly fallers are found to be slower than elderly non-fallers both in retrospective studies (Ejupi et al., 2014; Lord and Fitzpatrick, 2001; Tisserand et al., 2016a) and in a prospective study (Pijnappels et al., 2010). The advance knowledge of which foot should step seems to play a critical role. Thus, Brauer and colleagues performed a prospective study in which subjects were asked to step up onto a step as fast as possible after a “go” signal which indicated the step foot. Before the “go” signal, there was a warning signal which either provided no information about the step foot or indicated the step foot with an 80% chance (Brauer et al., 2000). Fallers took more time to perform the step than non-fallers only when the warning signal was uninformative.

These laboratory experiments therefore raise two questions. Why do elderly fallers respond as efficiently as elderly non-fallers to perturbations in a laboratory setting, yet fall in their daily life? Why does the time to perform a step predict falling, especially when the step foot is not known in advance?

## 5. Postural adjustments

My hypothesis is that the advance knowledge of the task that they need to perform allows elderly subjects to adjust their posture in advance of the task, and therefore perform efficiently. Thus, when they are invited to come to a biomechanical laboratory to participate in a perturbation experiment, the experimenters explain to them what kind of perturbation they will be exposed to. They can therefore adjust their posture in advance, for example through an increase in ankle stiffness (Chapter 2), or a shift in the position of their centre of mass (Chapter 3). These postural adjustments may be sufficient to succeed in the task, and this would explain why laboratory-based perturbation experiments fail to distinguish between fallers and non-fallers.

According to my hypothesis, when these subjects encounter unexpected perturbations in their daily lives, then only those who are able to adjust their posture fast enough in response to the perturbation will succeed in not falling. Reaction time stepping tasks probe how fast subjects can adjust their posture, especially when the step foot is not known in advance. This would explain why laboratory-based stepping experiments can distinguish between fallers and non-fallers.

To test this hypothesis, I have compared the initial postures adopted by subjects in a stepping task and a perturbation task, in a cohort including young subjects, elderly subjects with a history of falls, and elderly subjects without a history of falls. The experiment was performed by Tisserand and colleagues at the Laboratoire de Biomécanique et Mécanique des Chocs, of IFSTTAR. The experimental protocol and results are published in

Tisserand's thesis (Tisserand, 2015), and the results of the stepping task are published in a peer-reviewed journal (Tisserand et al., 2016a).

## II. Methods

### 1. Protocol

The experimental protocol is presented elsewhere in detail (Tisserand, 2015; Tisserand et al., 2016a). The key points are summarised here.

#### a) Population

Fifty healthy subjects participated in both the stepping task and the perturbation task. Of these, eleven were aged between 22 and 27 years old (mean age 25 years), and comprised the group of young subjects. The others were between 69 and 83 years old and comprised the group of elderly subjects. This group was subdivided into two groups: those who had fallen in the previous year (fallers), and those who had not fallen (non-fallers). Details of the inclusion and exclusion criteria are provided in Tisserand's thesis (Tisserand, 2015). The characteristics of the subjects are summarised in Table 1. All subjects provided written informed consent to the experiment as approved by the ethics committee Comité de Protection des Personnes Lyon Sud Est III.

*Table 1 Characteristics of the subjects*

	Young	Elderly non-fallers	Elderly fallers
Number of subjects	11	21	18
Number of women	5	13	14
Age (years)			
Mean	25	74	75
Range	22 - 27	69 - 83	70 - 82
Mass (kg)			
Mean	69	67	70
Range	59 - 85	49 - 98	55 - 95
Height (m)			
Mean	1.70	1.63	1.61
Range	1.62 - 1.84	1.51 - 1.86	1.46 - 1.90
Body Mass Index (kg/m <sup>2</sup> )			
Mean	23.8	24.9	27.2
Range	20.7 - 29.8	19.3 - 33.0	20.4 - 33.8

#### b) Experimental setup

Subjects were first equipped with 48 reflective markers positioned on anatomical landmarks. The positions of these markers were recorded using eight cameras sampled at 100Hz. They then performed first the stepping task and then the perturbation task. In both tasks, four force platforms were used to record ground reaction forces and torques sampled at 1000 Hz. For each trial, the subject initially stood quietly with one foot on each of the back platforms, as illustrated in Figure 4.1.

## A. Waist-pull perturbation

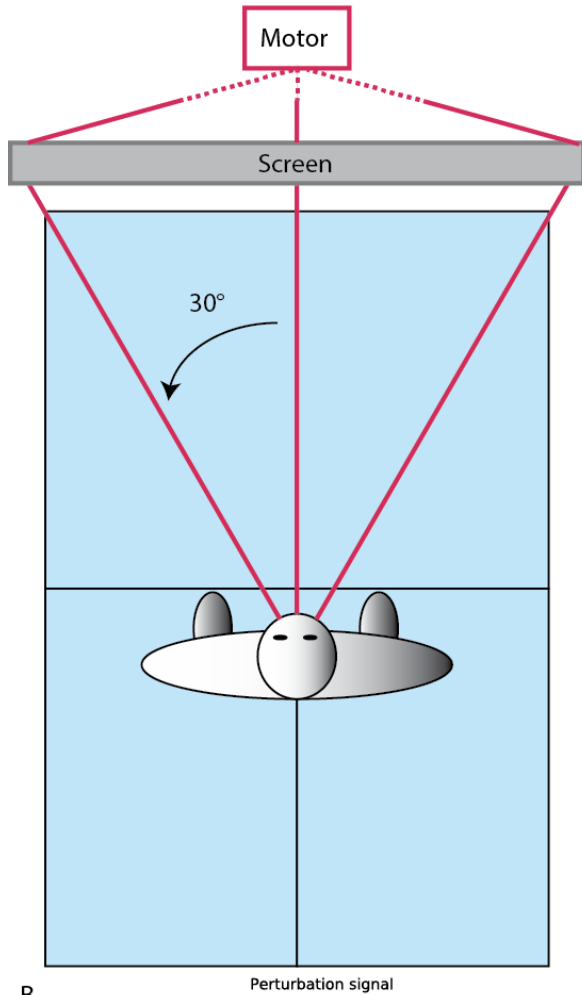

## C. Choice Stepping Reaction Time task

Target instruction:  
LED signal

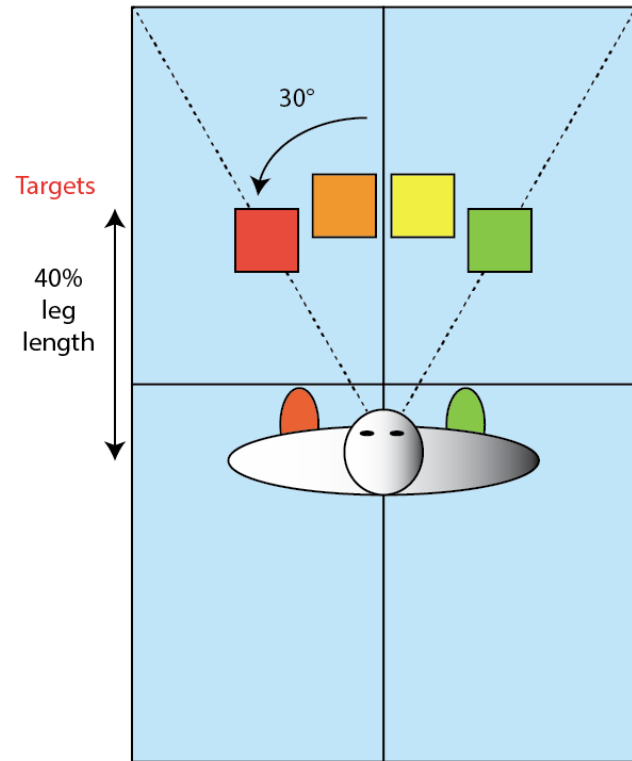

## B.

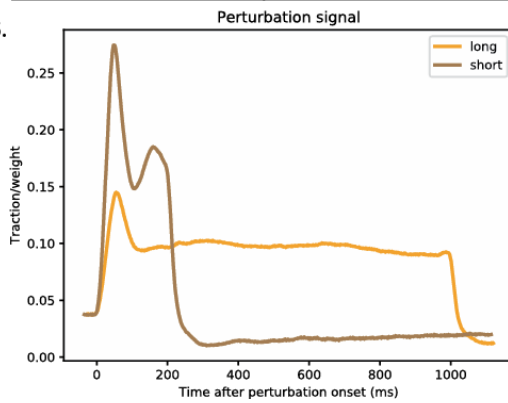

Figure 4.1 Experimental protocol (top view).

A, C In both tasks, there are four force platforms (blue) and the subject stands initially with one foot on each of the back platforms. A. In the waist pull-perturbation experiment, three cables are attached to the subject's harness at the level of the waist, and on any given trial, one of these cables is attached to a motor hidden behind a screen. B. The perturbation is proportional to the subject's weight and is either short (brown) or long (yellow). C. In the choice stepping reaction time task, there are four LEDs which indicate which of the four targets the subject should step on.

c) Waist-pull perturbation task

The protocol of the perturbation task is illustrated in Figure 4.1.A. The subject wears a safety harness to prevent injury in case of a fall: the harness arrests the fall such that the person's knees do not come into contact with the ground. Three cables are attached to the harness at the level of the waist. Each cable can pull the person either straight forwards or laterally at an angle of 30°. On any given trial, only one of these cables is attached to a motor through a system of pulleys. This is done behind a screen, such that on any given trial the perturbation direction is unpredictable for the subject. There is an initial pretension in the cables equivalent to 3.5% of the person's weight. The perturbation applied to the selected cable is proportional to the person's weight, and follows one of two signals: a short perturbation lasting 200 ms and with a peak amplitude of 27% of the subject's weight (brown curve in Figure 4.1.B), and a long perturbation lasting 1000 ms and with a peak amplitude of 14% of the subject's weight (orange curve in Figure 4.1.B). The task instruction was to recover balance as fast as possible and in the shortest possible distance. Elderly subjects performed at least 18 trials, with each of the six perturbations (three directions, two amplitudes) presented at least three times, in random order. Young subjects performed at least 24 trials, with each perturbation presented at least four times, in random order.

d) Choice Stepping Reaction Time task

The protocol of the CSRT is illustrated in Figure 4.1.C. There were four stepping targets placed in front of the subject at a distance of 40% of the subject's leg length. Two of these targets were located centrally (yellow and orange), and the two others were located laterally, at an angle of 30° (red and green). Four light-emitting diodes (LED), corresponding to the four targets, were placed in front of the subject to indicate on which target the subject should step. The subject was instructed to step onto leftwards targets (red and orange) with the left foot, and onto rightwards targets (yellow and green) with the right foot. The task instruction was the following: "As soon as a LED lights up, place your foot as fast as possible onto the target indicated by the LED." Each subject performed a series of at least 16 trials, with each target presented at least four times, in random order. Trials in which the subject appeared to hesitate for a long while, or in which the subject stepped with the wrong foot, were repeated at the end of the initial sequence of 16 trials.

## 2. Analysis

a) Success in the perturbation task

In the perturbation task, there were a certain number of trials for which the person did not take a step. Given the task instruction, which was to recover balance as fast as possible and in the shortest possible distance, trials without steps should be considered a success. In such trials however, the time at which balance was recovered is ambiguous. Therefore, success was not determined by the time required to perform a protective step. Instead, success was determined as the distance required to recover balance, based on the trajectory of the person's feet. Thus, if the subject's feet did not move, this distance was considered null. If the person took a step, then this distance was the length of the step. If the person took several steps, the distance between the initial foot position and the foot position after the last step was taken. Thus, shorter distances correspond to better task success. Additional details are provided in the Supplementary Methods V.1. For comparison across subjects, this distance was normalised to the person's height.

b) Success in the stepping task

In the stepping task, a trial is failed if the subject steps onto the wrong target or steps with the wrong foot. The vertical ground reaction force of the two front force platforms was used to determine onto which force platform the subject stepped. The vertical ground reaction force of the two back platforms was used to determine with



which foot the subject had stepped. If these did not correspond to the instruction, the task was considered a failure. This occurred only once in two young subjects, one elderly non-faller and two elderly fallers.

For the remaining trials, success is determined by the time it takes for the subject to perform the step after the “go” signal, called the step time. This was determined as the time at which the vertical ground reaction force on the target front platform exceeds 10% of the subject’s weight. Shorter step times correspond to better task success.

c) Initial posture

The initial posture of the subject in a given trial is characterized by the forwards position of their centre of pressure (CoP)  $x_{CoP}$  and centre of mass (CoM)  $x_{CoM}$ , relative to the midpoint between the two heels (Figure 4.4.A, E). The position of the heel of each foot is determined by a kinematic marker placed on the calcaneus. The position of the CoM is determined using the kinematic markers, whereas the position of the CoP is determined using the ground reaction torque. Additional details are provided in the Supplementary Methods V.2. For comparison across subjects, both  $x_{CoP}$  and  $x_{CoM}$  are then normalized to the subject’s foot length.

d) Ankle stiffness

The position of the hips was determined as the midpoint (Figure 4.2 orange dot) of the three kinematic markers placed on the back of the hips (one on the sacrum and one on each of the posterior iliac spines). The position of the hips is determined as the forwards position of this marker (Figure 4.2  $x_{hip}$ ), and the initial position before the onset of the perturbation was subtracted.

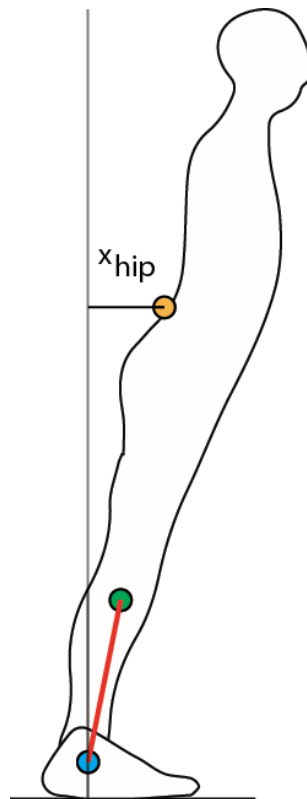

Figure 4.2 Determination of hip position and ankle angle.

*The hip position is determined as the forwards position  $x_{hip}$  of the midpoint (orange dot) of three kinematic markers at the back of the hips. The segment (red) joining the ankle (blue dot) and the knee (green dot) is projected onto the sagittal plane, and its angle with respect to the vertical (grey line) is determined.*

The ankle angle of each leg was determined using a kinematic marker located on the lateral malleolus, which determined the position of the ankle (Figure 4.2 blue dot), and a kinematic marker located on the lateral epicondyle, which determined the position of the knee (Figure 4.2 green dot). The segment joining these two markers (Figure 4.2 red segment) was projected onto the sagittal plane and the angle of the projected segment with the vertical was used as ankle angle. The initial ankle angle before the onset of the perturbation was subtracted.

The ankle torque of each leg was determined using the force platforms, and the initial ankle torque before the onset of the perturbation was subtracted.

### III. Results

#### 1. Previously published results

The characteristics of the stepping responses of the subjects have been analysed by the original authors of the study (without any contribution from my part), and are published elsewhere (Tisserand, 2015; Tisserand et al., 2016a). Briefly, in the stepping task, the time to accomplish the task is significantly shorter for young subjects than for elderly non-fallers, and significantly shorter for elderly non-fallers than for elderly fallers. In the perturbation tasks, only trials with at least one protective step were analysed, and the characteristics of the first protective step were described. The time to perform this first step is not significantly different between young subjects and elderly non-fallers, and significantly shorter for young subjects and elderly non-fallers than for elderly fallers.

The results presented in the following sections correspond to my contribution to the analysis.

#### 2. Performance in the two tasks

For the perturbation task, the distances required to stop for each group and the two perturbation durations are illustrated in Figure 4.3.A-C. For young subjects, this distance is similar for the two perturbations, with a median around 22% of subject height (Figure 4.3.A, orange and brown). For elderly subjects, the distance is shorter for short perturbations (Figure 4.3.B, C, brown) than for long perturbations (Figure 4.3.B, C, orange). There is a clear difference in the performance of young and elderly subjects: for short perturbations, elderly subjects require less distance to stop than the young subjects, whereas for long perturbations, elderly subjects require more distance to stop than the young subjects. There is however no clear difference between the performance of elderly fallers and non-fallers. Thus elderly fallers perform as well as elderly non-fallers, even though the perturbations occur at unpredictable times, and with an unpredictable amplitude, duration and direction.

There is a certain number of trials for which the distance required to stop is less than 5% of the subject's height (vertical grey bar in Figure 4.3.A-C). These trials correspond to trials in which the person does not step. The occurrence of such non-step trials is summarised in Table 2. Such trials are more frequent for short perturbations, and are more frequent for elderly than for young subjects. When these trials without steps are removed from the analysis, this does not affect the previous results: the young require the same distance to stop for both perturbations, whereas elderly subjects require less distance for short perturbations, and more distance for long perturbations, without any clear differences between fallers and non-fallers.

For the stepping task, the time to perform the step for each group of subjects is illustrated in Figure 4.3.D-F. Young subjects are faster, with a median step time of 734 ms (Figure 4.3.D), followed by the elderly non-fallers, with a median step time of 928 ms (Figure 4.3.E), and the elderly fallers are the slowest, with a median step time of 1066 ms (Figure 4.3.F). My analysis therefore confirms the original analysis by Tisserand and colleagues which showed that young subjects are faster than elderly non-fallers, who are faster than elderly fallers (Tisserand, 2015; Tisserand et al., 2016a).

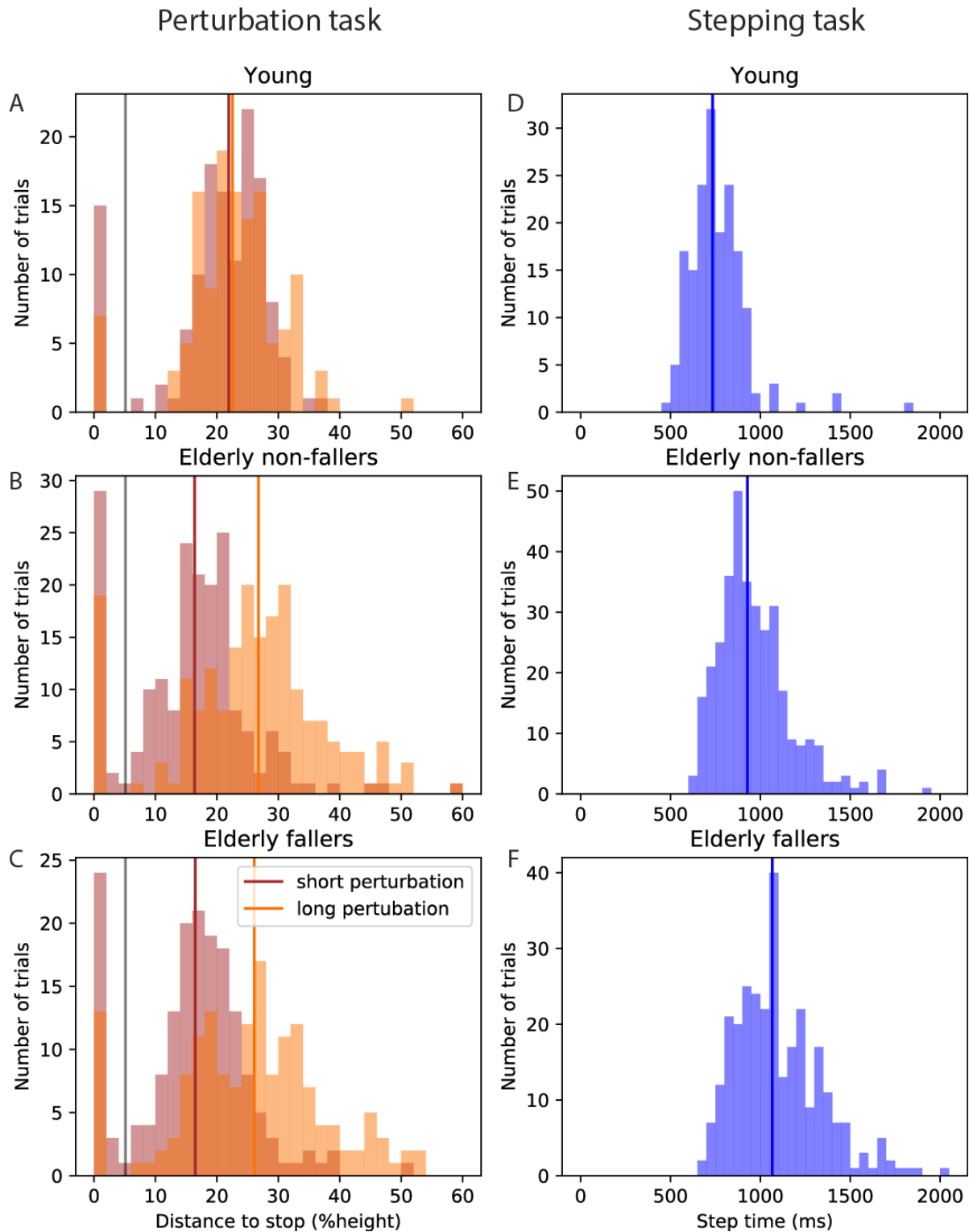

Figure 4.3 Performance in the two tasks.

The distance required to stop in the perturbation task, normalised to the subject's height, is shown in A. for the young, B. for the elderly non-fallers and C. for the elderly fallers. Long perturbation trials are shown in orange, and short perturbation trials in brown. The median distance for each group and perturbation duration is indicated as a vertical bar. The cut-off of 5% height for non-step trials is indicated as a vertical grey bar. The time required to step in the stepping task is shown in D. for the young, E. for the elderly non-fallers and F. for the elderly fallers. The median time for each group is indicated as a vertical bar.

Table 2 Occurrence of trials without steps

Number of trials without steps/Total number of trials Percent of trials without steps	Young	Elderly non-fallers	Elderly fallers	Total
Short	15/133 11.3%	31/187 16.6%	27/172 15.7%	73/492 14.8%
Long	7/131 5.3%	19/197 9.6%	13/160 8.1%	39/488 8.0%
Total	22/264 8.3%	50/384 13.0%	40/332 12.0%	112/980 11.4%

Moreover, this confirms previous findings that elderly fallers perform as well as elderly non-fallers in laboratory-based perturbation tasks (Baloh et al., 1998; Hill et al., 1999; Kario et al., 2001; Maki et al., 1994), whereas they are slower to perform the CSRT task (Ejupi et al., 2014; Lord and Fitzpatrick, 2001; Pijnappels et al., 2010; Tisserand et al., 2016a).

### 3. Initial posture

In both tasks, the subjects initially stand still. The torques exerted on them by the external forces are therefore at equilibrium (Figure 4.4).

In the perturbation task (Figure 4.4.A-D), there is a small forwards initial pretension applied by the cables at the level of the subject's waist (black arrow), which exerts forwards torque around the heels. The initial CoM position (red dot) must therefore be backwards of the initial CoP position (pink dot), such that the summed torques of weight (red arrow) and of the ground reaction force (pink arrow) produce a backwards torque, which compensates for the forwards torque of the pretension. The initial positions of the CoM (red) and CoP (pink) relative to the heels, normalized to the subjects' foot length, are presented in Figure 4.4.B for the young, Figure 4.4.C for the elderly non-fallers and Figure 4.4.D. for the elderly fallers. The position of the CoM is indeed slightly backwards of the CoM position.

In the stepping task (Figure 4.4.E-H), the only external forces are the subject's weight (light blue arrow), and the ground reaction force (dark blue arrow). The positions of the CoM (light blue) and CoP (dark blue) are therefore aligned for the young (Figure 4.4.F), elderly non-fallers (Figure 4.4.G) and elderly fallers (Figure 4.4.H).

### 4. Change in initial posture across tasks

According to my hypothesis, the reason for which elderly fallers are able to perform as well as elderly non-fallers in laboratory-based perturbation tasks is that the forewarning allows them to adjust their initial posture in advance of the perturbation.

The traction perturbation (Figure 4.4.A, black arrow) exerts forwards torque around their ankles. To compensate for this traction, subjects can use the torque of their weight (Figure 4.4.A, red arrow) and of the ground reaction force (Figure 4.4.A, pink arrow). As explained in Chapter 3, the backwards torque which they can exert at the onset of the perturbation is limited by the distance between their toes and the initial position of their CoM. This maximal backwards torque is therefore larger if their initial CoM position is backwards.

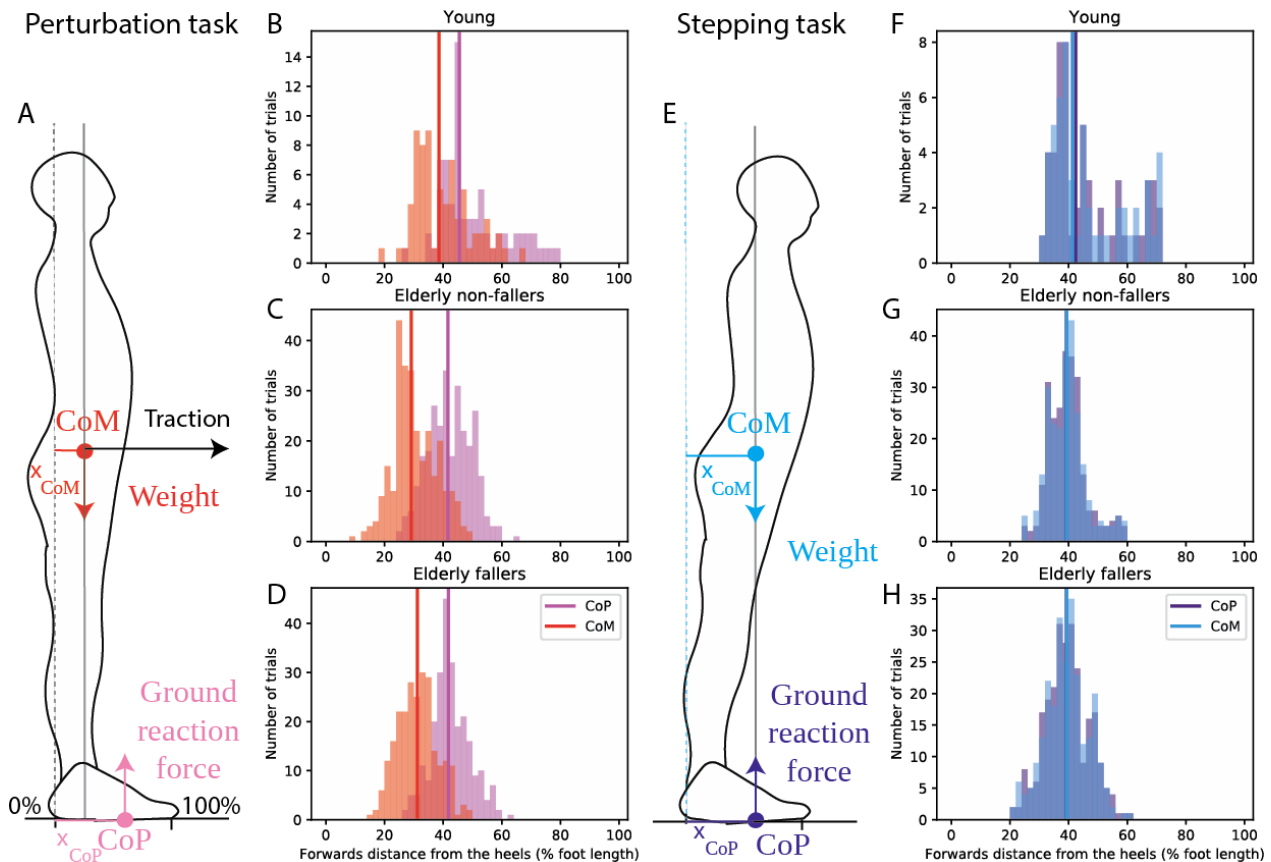

Figure 4.4 Initial posture in each task.

A In the perturbation task, the torques of weight (red arrow), traction (black arrow) and the ground reaction torque (pink arrow) are initially at equilibrium. C-D The initial forwards position of the CoM (red) and the CoP (pink), normalised by foot length, are shown for the young (B), elderly non-fallers (C), and elderly fallers (D). E In the stepping task, the torques of weight (light blue arrow), and the ground reaction torque (dark blue arrow) are initially at equilibrium. E-F The initial forwards position of the CoM (light blue) and the CoP (dark blue), normalised by foot length, are shown for the young (F), elderly non-fallers (G), and elderly fallers (H).

Figure 4.5 presents the same data as in Figure 4.4, with the layout re-arranged so as to highlight changes in posture across the two tasks. The position of the CoM (Figure 4.5.A-C) in the perturbation task (red) and in the stepping task (light blue) is shown for the young (Figure 4.5.A), elderly non-fallers (Figure 4.5.B) and elderly fallers (Figure 4.5.C). The position of the CoP (Figure 4.5.D-F) in the perturbation task (pink) and in the stepping task (dark blue) is shown for the young (Figure 4.5.D), elderly non-fallers (Figure 4.5.E) and elderly fallers (Figure 4.5.F).

The initial posture of the young subjects is very similar across the two tasks, with a median CoM position of 41% foot length in the stepping task and 38% in the perturbation task, and a median CoP position of 42% foot length in the stepping task and 45% in the perturbation task. The elderly subjects however shift their CoM backwards during the perturbation task by up to 10%. Thus the elderly non-fallers have a median CoM position of 39% foot length in the stepping task and 29% in the perturbation task, and a median CoP position of 39% foot length in the stepping task and 41% in the perturbation task. The elderly fallers have a median CoM position of 39% foot length in the stepping task and 31% in the perturbation task, and a median CoP position of 39% foot length in the stepping task and 41% in the perturbation task.

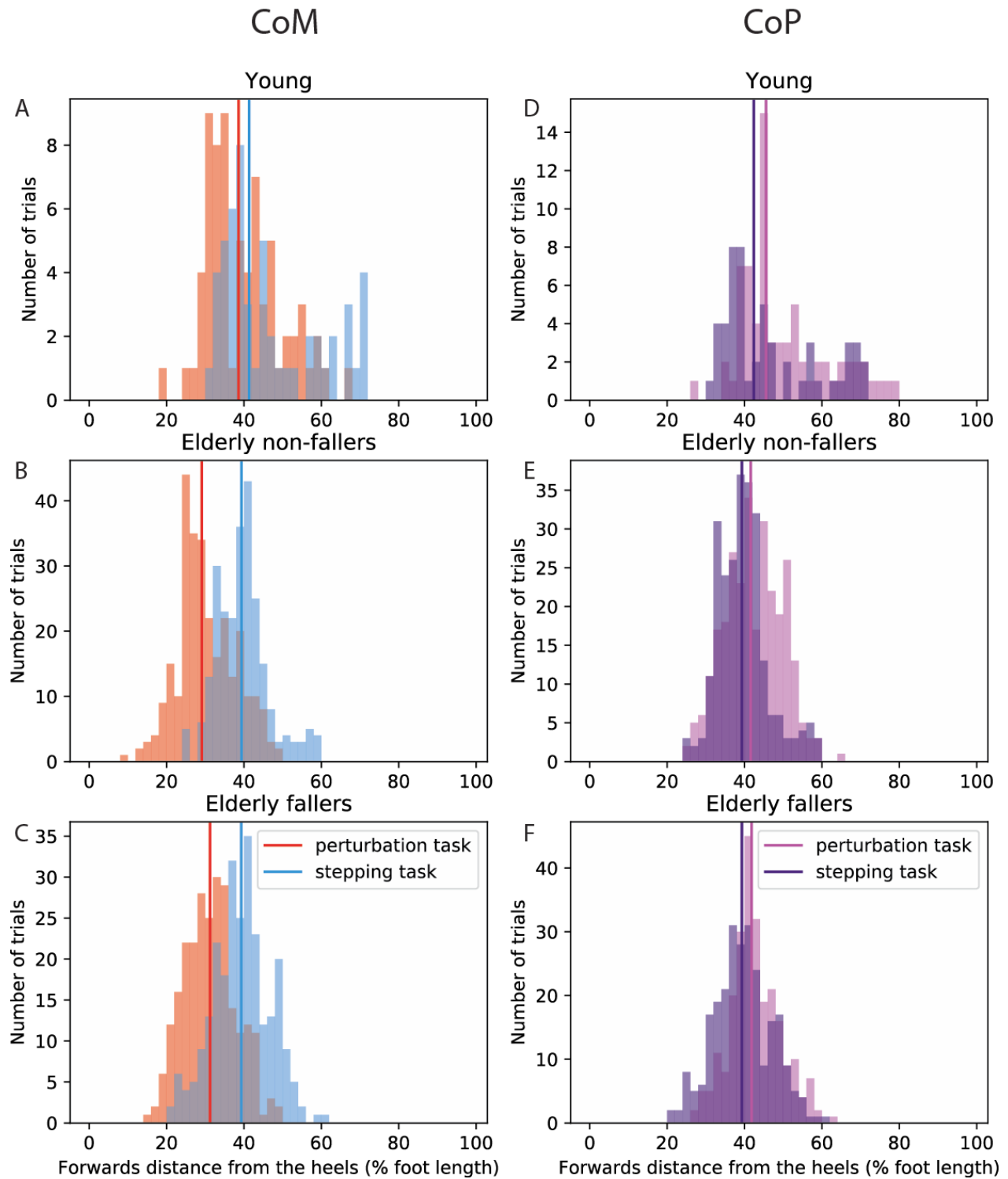

Figure 4.5 Change in posture across the two tasks.

A-C The initial position of the CoM (normalised to foot length) is shown for the perturbation task (red) and the stepping task (light blue) for the young (A), elderly non-fallers (B) and elderly fallers (C). The median position for each group and task is shown as a vertical bar. D-F The initial position of the CoP (normalised to foot length) is shown for the perturbation task (pink) and the stepping task (dark blue) for the young (D), elderly non-fallers (E) and elderly fallers (F). The median position for each group and task is shown as a vertical bar.

Thus, both elderly fallers and elderly non-fallers shift their CoM backwards during the perturbation task. This strategy is not used by the young subjects. This strategy may explain why elderly fallers perform as well as elderly non-fallers during the perturbation task, and even better than young subjects for short perturbations (Figure 4.3.A-C).

### 5. Ankle stiffness

With advance warning of a perturbation, elderly subjects may also increase their initial ankle stiffness, as observed for young subjects in challenging balance situations (explained in Chapter 2). I attempted to determine ankle stiffness from the initial increase in ankle angle and ankle torque in the perturbation task. Unfortunately, this attempt showed that the waist-pull perturbation is not an appropriate protocol for determining ankle stiffness.

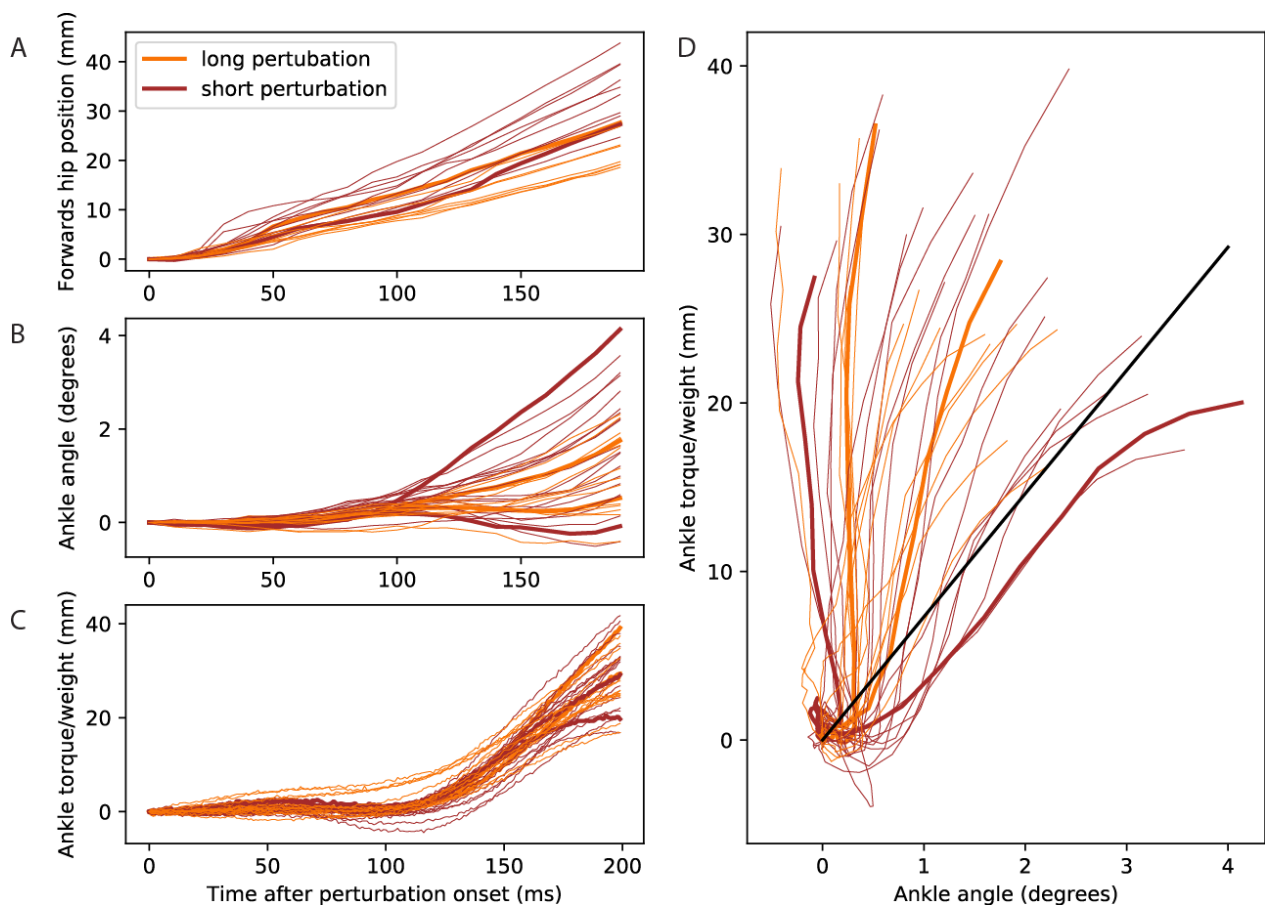

Figure 4.6 Ankle stiffness.

The forwards position of the hips (A), the ankle angle of each leg (B) and the ankle torque of each leg (normalised by the subject's weight, C) are shown as a function of time after perturbation onset for a representative subject. D. The ankle torque of each leg (normalised by the subject's weight) is shown as a function of the leg's ankle angle. The black line indicates ideal stiffness. In all panels, trials with short perturbations are in brown, trials with long perturbations are in orange, and the first trial of each perturbation type is in thick lines.

The responses of a representative (faller) subject are shown in Figure 4.6. Since the traction is applied at the waist, the hips start to move forwards (Figure 4.6.A) well before the knees: thus, the first change in ankle angle (Figure 4.6.B) may be measured up to 100 ms after the first change in hip position. The first change in ankle torque (Figure 4.6.C) also appears after 100 ms. It could be due to ankle stiffness since it occurs at approximately the same time as the change in ankle angle. However, on a trial by trial basis, the increase in ankle torque does not seem to be time-locked to the increase in ankle angle (Figure 4.6.D). The ankle torque as a function of ankle angle is shown for each leg for the first short perturbation trial (thick brown lines) and the first long perturbation trial (thick orange lines). The black line indicates a theoretical case in which ankle stiffness exactly compensates for the torque of weight. If the increase in torque were due to stiffness, it would be expected to be proportional to ankle angle. The increase in ankle torque is however similar for trials with a large increase in ankle angle and trials without an increase in ankle angle.

This suggests that the initial increase in ankle torque is at least partly due to an increase in calf muscle contraction triggered by the perturbation. Indeed, the 100 ms delay between the perturbation onset and the increase in ankle torque is long enough for a change in contraction to occur. Lin and Woollacott performed a perturbation experiment in which forwards falling was induced by a sudden backwards shift of the platform on which the person stands (Lin and Woollacott, 2002). They observed a change in the contraction of the ankle muscles with a 89 ms delay after the perturbation onset for young subjects, and an approximately 100 ms delay for the elderly subjects.

The waist-pull protocol is therefore inappropriate to determine ankle stiffness.

#### IV. Discussion

##### 1. Adjustment of the initial position of the CoM

This study shows that, when elderly subjects participate in a perturbation experiment in a laboratory setting, they adjust the initial position of their CoM to the task at hand. This strategy is adopted both by elderly fallers and non-fallers, but not by the young. This strategy may allow elderly fallers to perform as well as elderly non-fallers, and even better than young subjects for short perturbations. In the perturbation experiment, the subjects had as much time as they wanted to prepare themselves for the next trial. A slow adjustment of posture, in advance of the perturbation, would therefore be as efficient as a fast adjustment of posture for improving task performance. However, when these subjects encounter an unexpected perturbation in their daily life, then they have to adjust their posture in response to the perturbation fast enough to prevent falling. In the Choice Stepping Reaction Time task, subjects do not know in advance with which leg they should step, and therefore on which leg they should put their weight. This task therefore probes how fast a subject can move their CoM in response to a cue, and it shows that elderly fallers are slower than non-fallers.

This suggests that falling occurs when a person is not able to adjust their posture fast enough in response to an unexpected perturbation. As a consequence, tasks which probe how fast a subject can adjust their posture in response to a cue may provide good estimates of fall risk. This is the case for the CSRT task (Ejupi et al., 2014; Lord and Fitzpatrick, 2001; Pijnappels et al., 2010; Tisserand et al., 2016a). On the contrary, tasks in which the subject can adjust their posture in advance of the cue may not provide good estimates of fall risk. This may be the case both for stepping tasks in which the step foot is known in advance (Brauer et al., 2000), and for perturbation tasks (Baloh et al., 1998; Hill et al., 1999; Kario et al., 2001; Maki et al., 1994).

##### 2. Adjustment of ankle stiffness

In the perturbation task presented here, all perturbations were in the forwards direction, with potentially a lateral component. In such a case, it is useful to shift the CoM backwards in advance of the perturbation. If, however,



there is a perturbation in the backwards direction, then shifting the CoM backwards in advance of the perturbation is counterproductive. Thus, in anticipation of a perturbation, adjusting the position of the CoM is only useful if the direction of the perturbation is known in advance. If the direction of the perturbation is not known, then it is better to keep the CoM vertically aligned with the middle of the feet. This suggests that, although elderly fallers are able to shift their CoM position in advance of perturbations, this strategy may not be very useful in their daily lives.

On the contrary, increasing ankle stiffness improves stability for both forwards and backwards perturbations (as explained in Chapter 2). It may therefore be a more useful strategy than shifting the position of the CoM position when performing an activity which challenges balance. It is however unknown to what extent elderly subjects are able to adjust their ankle stiffness.

When measured with relaxed muscles, the ankle stiffness of elderly subjects is found to be higher than that of young subjects (Vandervoort et al., 1992). The stiffness of activated muscles may also be higher in the elderly: for example, the elderly have a greater stiffness of dissected, maximally activated muscle fibres of the vastus lateralis muscle, a leg muscle which does not act at the ankle joint (Ochala et al., 2007). Moreover, the elderly have increased co-contraction of antagonist ankle muscles in quiet standing (Baudry and Duchateau, 2012; Nagai et al., 2011). Since ankle stiffness increases with increasing muscle contraction (Lang and Kearney, 2014), this suggests that ankle stiffness during quiet standing may be larger in the elderly.

Moreover, sensorimotor delays are increased with aging. Thus, the onset of muscle contraction after a perturbation of balance is delayed in the elderly by about 10%, or 10 to 30 ms (Allum et al., 2004; Lin and Woollacott, 2002; Tokuno et al., 2010). This is at least partly due to the increase in the H-reflex latency of the calf muscle soleus, which is 3 to 7 ms longer in the elderly (Sabbahi and Sedgwick, 1982; Scaglioni et al., 2004). According to the analysis presented in Chapter 2, the appropriate way to compensate for such an increased delay is to increase ankle stiffness. This would then require a decrease in feedback gain, and indeed the calf muscle H-reflex during stance is smaller in the elderly than in the young (Koceja et al., 1995; Koceja and Mynark, 2000).

Altogether, this circumstantial evidence suggests that ankle stiffness during quiet standing may be larger in the elderly. Are the elderly able to adjust their ankle stiffness to the task at hand? When facing perturbations of unexpected direction, ankle stiffness should be increased (Chapter 2). Since elderly subjects already use ankle muscle co-contraction during quiet standing, they may be less able to increase ankle stiffness when expecting perturbations. On the contrary, to initiate movement, ankle stiffness should be decreased, so as to create a distance between the CoM and CoP which provides thrust (Chapter 3). Since elderly subjects have a higher ankle stiffness when measured with relaxed muscles (Vandervoort et al., 1992), they may be less able to decrease ankle stiffness to initiate movement. This may explain their slower movement speed, such as in the CSRT task.

### 3. How to measure the adjustment of ankle stiffness

The typical way in which ankle stiffness is measured during stance is to abruptly rotate the platform on which the subject stands (Casadio et al., 2005; Lang and Kearney, 2014; Loram et al., 2007; Loram and Lakie, 2002; Vlutters et al., 2015). Thus, contrary to the waist-pull, the perturbation is directly applied to the ankle, and causes an immediate change in both ankle angle and torque. The change in ankle torque occurring in the first 50 ms, before any change in muscular contraction due to the stretch reflex, can be entirely attributed to ankle stiffness.

When standing on a support that is abruptly rotated, ankle stiffness is destabilizing (Figure 4.7.B). Indeed, the platform rotation does not in itself change the torque of weight; any change in the ground reaction torque therefore induces an imbalance in the external torques. The ideal stiffness in this case is null. I therefore expect subjects to adjust to such perturbations by maintaining their ankle stiffness as low as possible. The reported values of ankle stiffness range from 40% to 90% of the critical value  $k_{crit} = weight \cdot H$  (where H is the height of the CoM). These large variations in ankle stiffness measurements may be due to the different conditions of support provided to the subject.

A different way to measure ankle stiffness would be to translate the platform on which the person stands (Figure 4.7.C). This protocol has been extensively used to assess balance responses (Lin and Woollacott, 2002; Maki et al., 1990; Manchester et al., 1989; Tokuno et al., 2010), but to my knowledge it has not been used to measure ankle stiffness. The platform translation shifts the position of the CoM relative to the feet, therefore to prevent imbalance the CoP should shift by the same amount as the CoM. This occurs when ankle stiffness corresponds to the critical value  $k_{crit}$ . I therefore expect subjects to adjust to such perturbations by maintaining their ankle stiffness high and as close as possible to  $k_{crit}$ .

I therefore suggest that the adjustment of ankle stiffness could be measured by having a given subject perform two experiments, one with abrupt platform rotations and one with abrupt platform translations causing the same change in ankle angle. Any change in the initial ankle torque between the two tasks could then be attributed to a change in ankle stiffness.

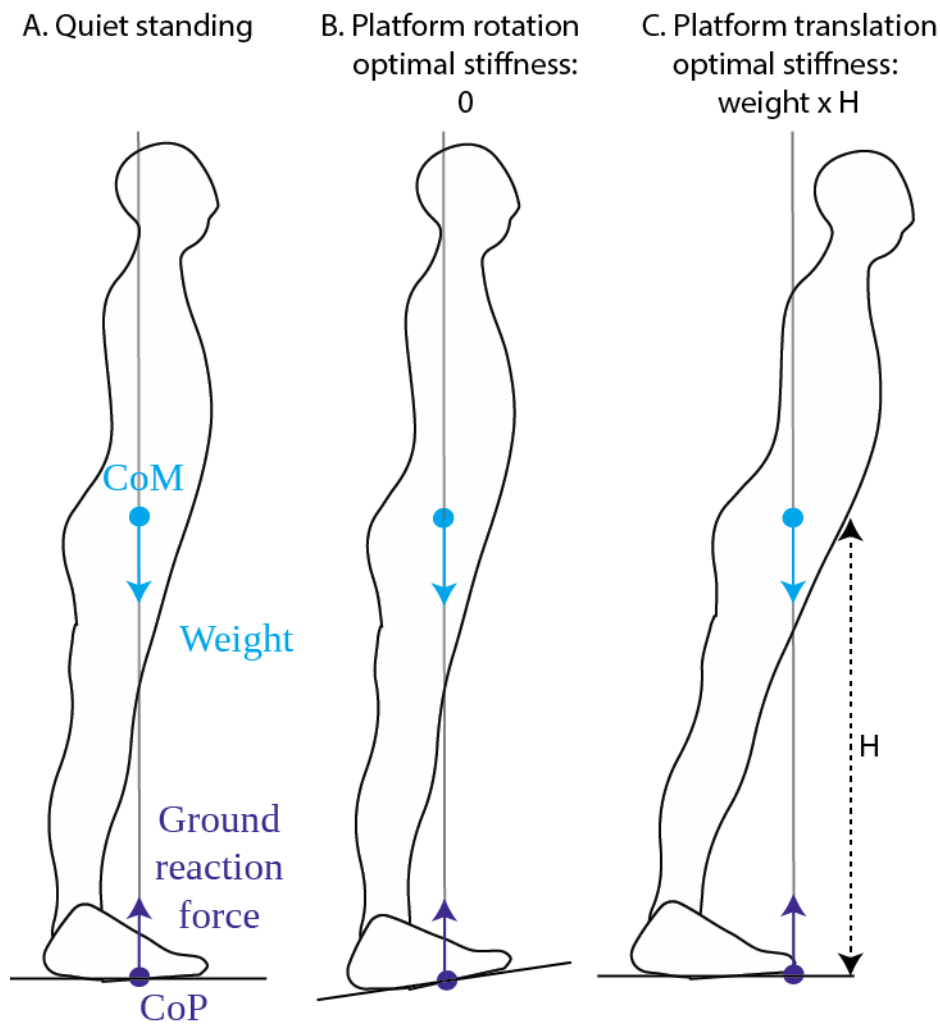

Figure 4.7 Measurement of ankle stiffness.

A. In quiet standing, the CoM (light blue) and CoP (dark blue) are aligned. B. A platform rotation does not move the CoM, therefore to prevent imbalance the CoP should not move either, and the ideal stiffness is null. C. A platform translation moves the CoM relative to the feet, and to prevent imbalance the CoP should move by an equal distance. The ideal ankle stiffness (in torque per radian) matches the torque of weight, where H is the height of the CoM.

Such an experiment could be done to assess whether elderly fallers and non-fallers have the same ability to adjust ankle stiffness to the task at hand. The response in the first trials of each experiment would moreover indicate how fast each subject can adjust their ankle stiffness.

## V. Supplementary methods

### 1. Success in the perturbation task

Success in the perturbation task corresponds to the distance required to stop on a given trial, based on the trajectory of the person's feet. Thus, if the subject's feet did not move, this distance was considered null. If the person took a step, then this distance was the length of the step. In the example presented in Figure 4.8, the person took two steps forward (one with each foot), then took a step backwards with the left foot (blue). The distance required to stop is then considered to be the distance required to stop for the foot which stepped the furthest away from its initial position (here the left foot).

The position of each foot is determined by a kinematic marker placed on the fifth metatarsal joint of the foot. For each foot, the average initial position during the 0.5 seconds preceding the perturbation onset is determined (Figure 4.8, blue and red dots for the left and right feet). The trajectory of the foot in the 2.5 seconds following the perturbation onset is projected onto the horizontal plane (Figure 4.8, blue and red curves). The point on this trajectory which is furthest from the initial position is determined (Figure 4.8, black dots and lines), and this is considered the distance required by that foot to stop. The distance required by the person to stop is then the maximum of the distance required by each foot. Finally, this distance is normalized to the subject's height for comparison across subjects.

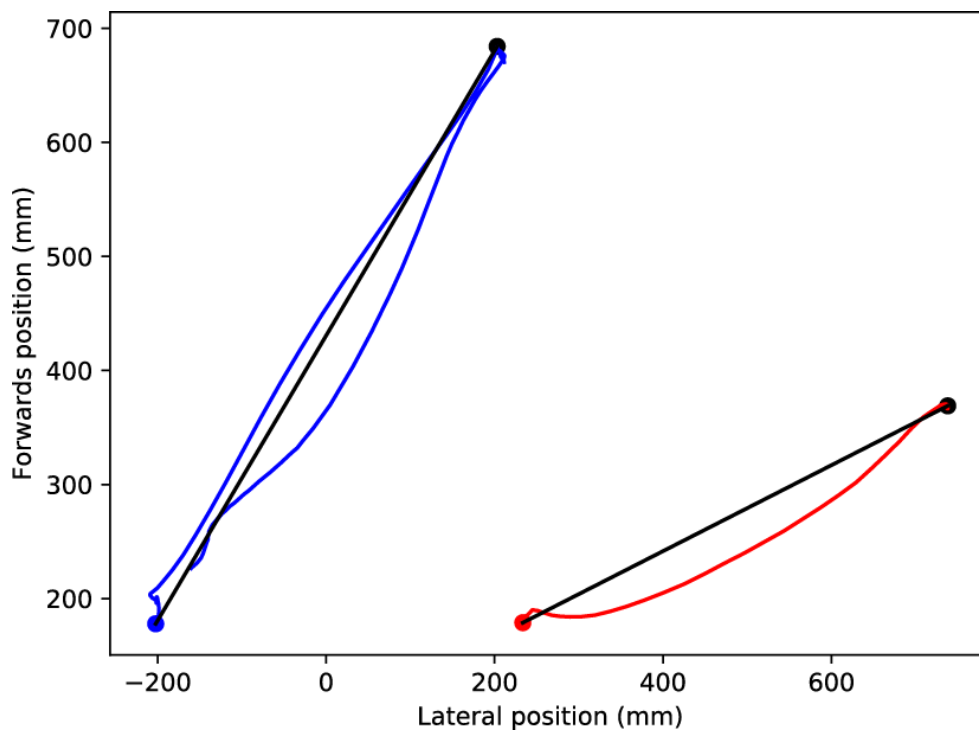

Figure 4.8 Calculation of the distance required to stop.

The initial position of the left and right feet are shown as a blue and a red dot. The trajectory of the foot after the onset of the perturbation is projected onto the horizontal plane (blue and red curves). The point of the trajectory furthest from the initial position is shown as a black dot.

## 2. Position of the centre of mass

### a) The CoM as the barycentre of body segments

The position of the CoM was determined according to the simplified method proposed by Tisserand and colleagues (Tisserand et al., 2016b). It is determined as the barycentre of nine masses, shown as pink squares in Figure 4.9.

The relative weights of the masses are taken from anthropometric data provided by Young and colleagues for women (Young et al., 1983), and McConville and colleagues for men (McConville et al., 1980), and summarised in Table 3. Each mass is placed along a given body segment (dashed pink lines in Figure 4.9), at a fixed proportion of this segment provided by anthropometric data (Tisserand et al., 2016b), and summarised in Table 3.

The positions of the masses are determined based on the positions of fourteen reflective markers located on anatomical landmarks (shown as black or white circles in Figure 4.9), and four fictive markers, whose position is calculated based on the reflective markers (shown as blue circles in Figure 4.9). The extremities of each segment are provided in Table 3. The position of the shoulder centre is determined as the mid-point between the left and right shoulder reflective markers.

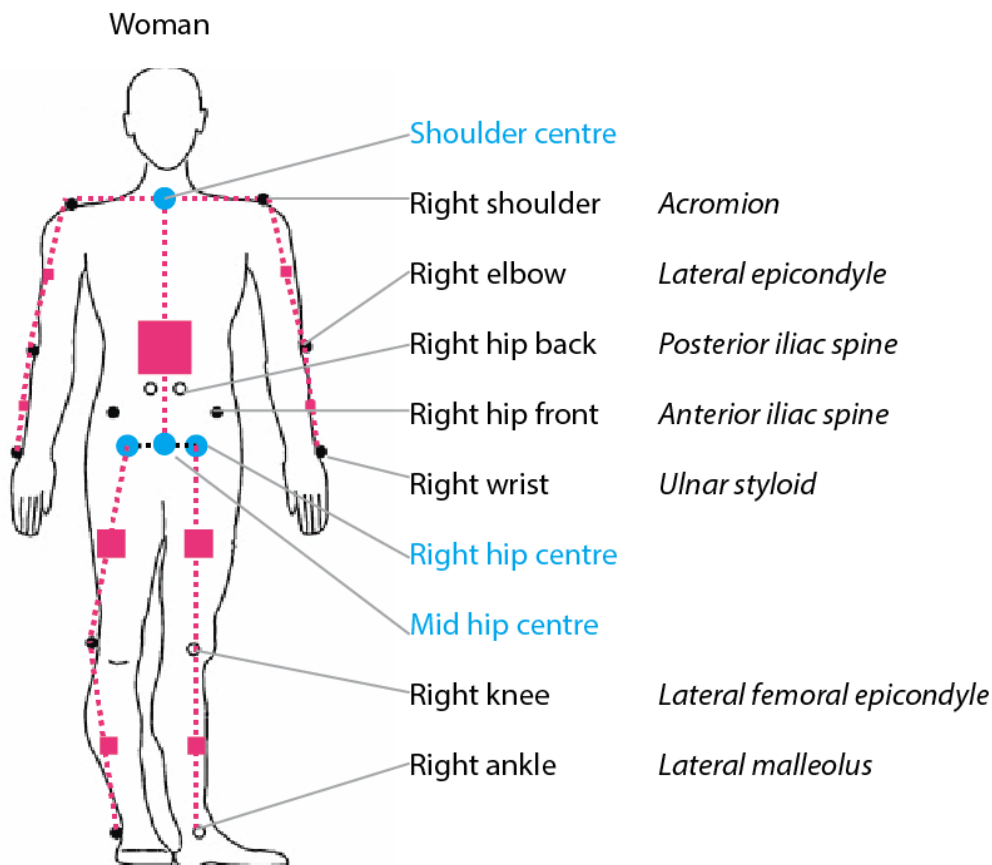

Figure 4.9 Calculation of the position of the CoM.

The centre of mass is calculated as the weighted sum of nine masses. The masses are shown as pink squares, and their surface is scaled to their relative weights for women. Each mass is positioned at a fixed proportion of a body segment, shown as a dashed pink line. The names of the reflective markers used to calculate the position of the CoM are shown in black, with the names of the anatomical landmarks on which they are placed in italics. The positions of the reflective markers are shown as black or white circles (white circles represent markers placed in the back with respect to the view in the picture). The positions of the shoulder, mid hip, right hip and left hip centres are calculated from the reflective markers, and shown as blue circles.

Table 3 Anthropometric data used for the calculation of the centre of mass. When the start and/or end point of a segment does not correspond to an actual reflective marker, but to a position calculated from the reflective markers, its name is in blue.

	Torso		Each upper arm		Each forearm		Each upper leg		Each lower leg	
	woman	man	woman	man	woman	man	woman	man	woman	man
Percent of body weight	51.7	54.3	2.2	2.4	1.8	2.3	14.6	12.3	5.5	6
Percent of body segment	38.06	37.05	56.64	54.37	63.77	63.64	38.12	42.6	52.24	53.69
Start of the segment	Shoulder centre		Left/right shoulder		Left/right elbow		Left/right hip centre		Left/right knee	
End of the segment	Mid hip centre		Left/right elbow		Left/right wrist		Left/right knee		Left/right ankle	

b) Calculation of the hip centres

The positions of the mid hip, left hip and right hip centres are calculated based on the positions of the front and back, left and right hip markers, according to the method proposed by Dumas and colleagues (Dumas et al., 2007), and illustrated in Figure 4.10.

This method defines an orthonormal basis set  $(x_H, y_H, z_H)$  to describe the hips, where  $x_H$  points forwards relative to the hips,  $y_H$  points leftwards, and  $z_H$  points upwards, illustrated as blue arrows in Figure 4.10. The basis vector  $y_H$  is defined as the leftwards pointing unit vector joining the right and left back hip markers. An intermediate vector  $x_h$  is introduced, which is the forwards pointing unit vector joining the mid-point between the right and left back hip markers (back hip centre, orange circle in Figure 4.10), and the mid-point between the right and left front hip markers (front hip centre, orange circle in Figure 4.10). The basis vector  $z_H$  is defined as the upwards pointing unit vector orthogonal to both  $y_H$  and  $x_h$ :  $z_H = x_h \times y_H$ , where  $\times$  represents the cross product. Finally, the basis vector  $x_H$  is defined as the forwards pointing unit vector orthogonal to both  $y_H$  and  $z_H$ :  $x_H = y_H \times z_H$ .

The mid hip centre is then defined as the point forwards and downwards of the back hip centre by the vector  $\Delta$  (where  $P$  is the width of the person's pelvis):

$$\Delta = (0.7054x_H - 0.3661z_H)P$$

The left hip centre is defined as the point forwards, downwards and leftwards of the back hip centre by the vector  $\Delta + \delta$  where :

$$\delta = 0.3616 P y_H$$

The right hip centre is defined as the point forwards, downwards and rightwards of the back hip centre by the vector  $\Delta - \delta$ .

The views orthogonal to each of the basis vectors, and the positions of the hip centres in this basis, are illustrated in Figure 4.10.

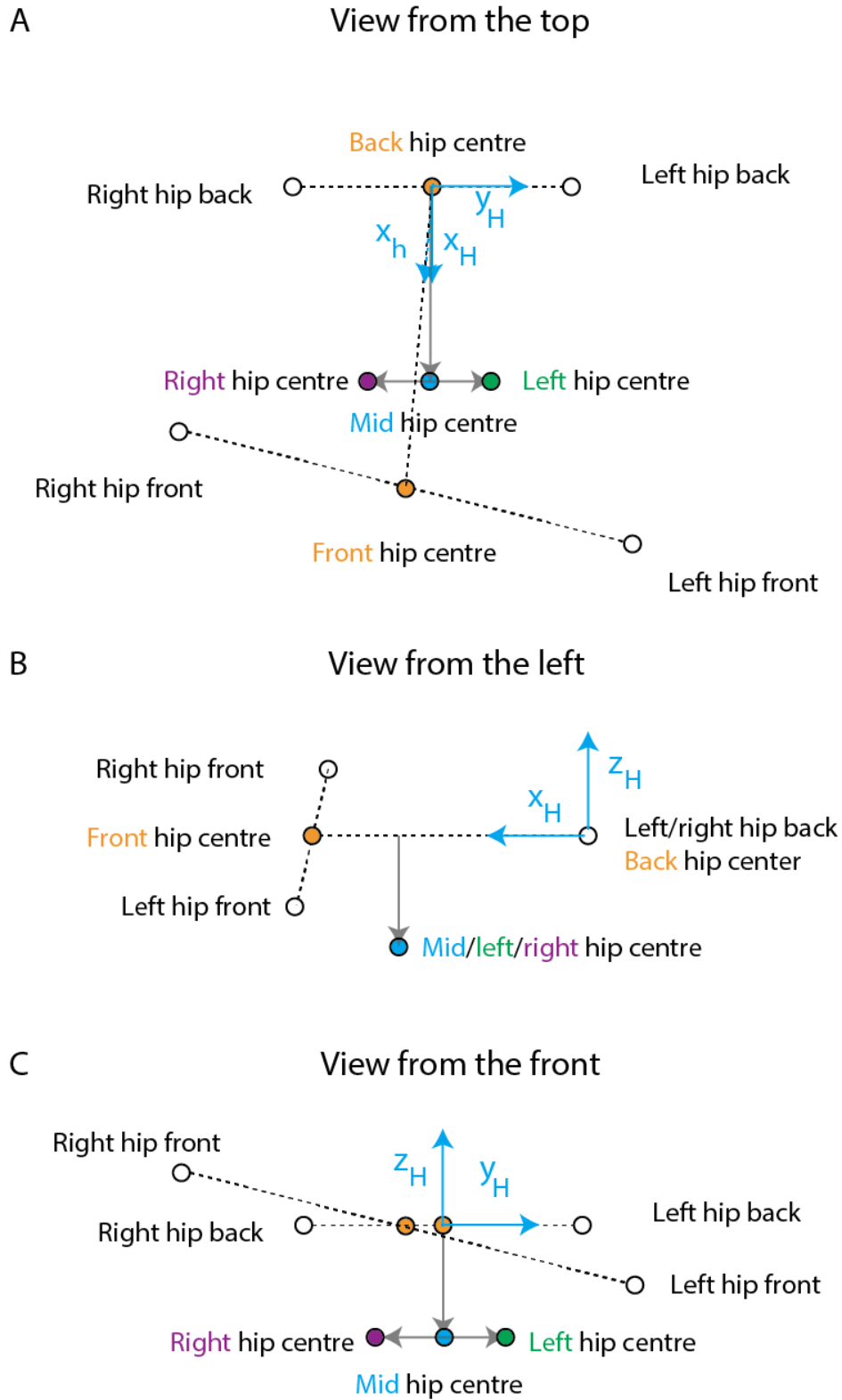

Figure 4.10 Calculation of the hip centres.

The kinematic markers on the hips (white dots) used to calculate the positions of the hip joint centres. The midpoints of the front and back hip markers (orange dots) and the positions of the right (purple), mid (blue) and left (green) hip centres are illustrated, viewed from the top (A), from the left (B) and from the front (C).

## c) Estimation of pelvis width

*From the kinematics*

The width of the pelvis is defined as the distance between the left and right anterior iliac spines, and can therefore be estimated as the distance between the reflective markers on the left and right front hips. These markers were however not placed directly on the anatomical landmarks, but on the harness itself, approximately above the anatomical landmarks. As a consequence, the distance between the reflective markers may inaccurately represent the person's actual pelvis width. Moreover, the distance between the reflective markers varies due to the deformation of the harness and the sliding of the harness on the skin, such as occurs at the onset of the perturbation in perturbation trials.

*From the force platforms*

I therefore developed a more accurate method to estimate pelvis width, based on the comparison between kinematic and force platform data. This method is based on the analysis of the waiting period in CSRT trials, before the "go" signal. The assumption is that subjects are on average immobile during this waiting period. Therefore the mean forwards and lateral torque of weight should be identical to the mean forwards and lateral torque of the ground reaction force.

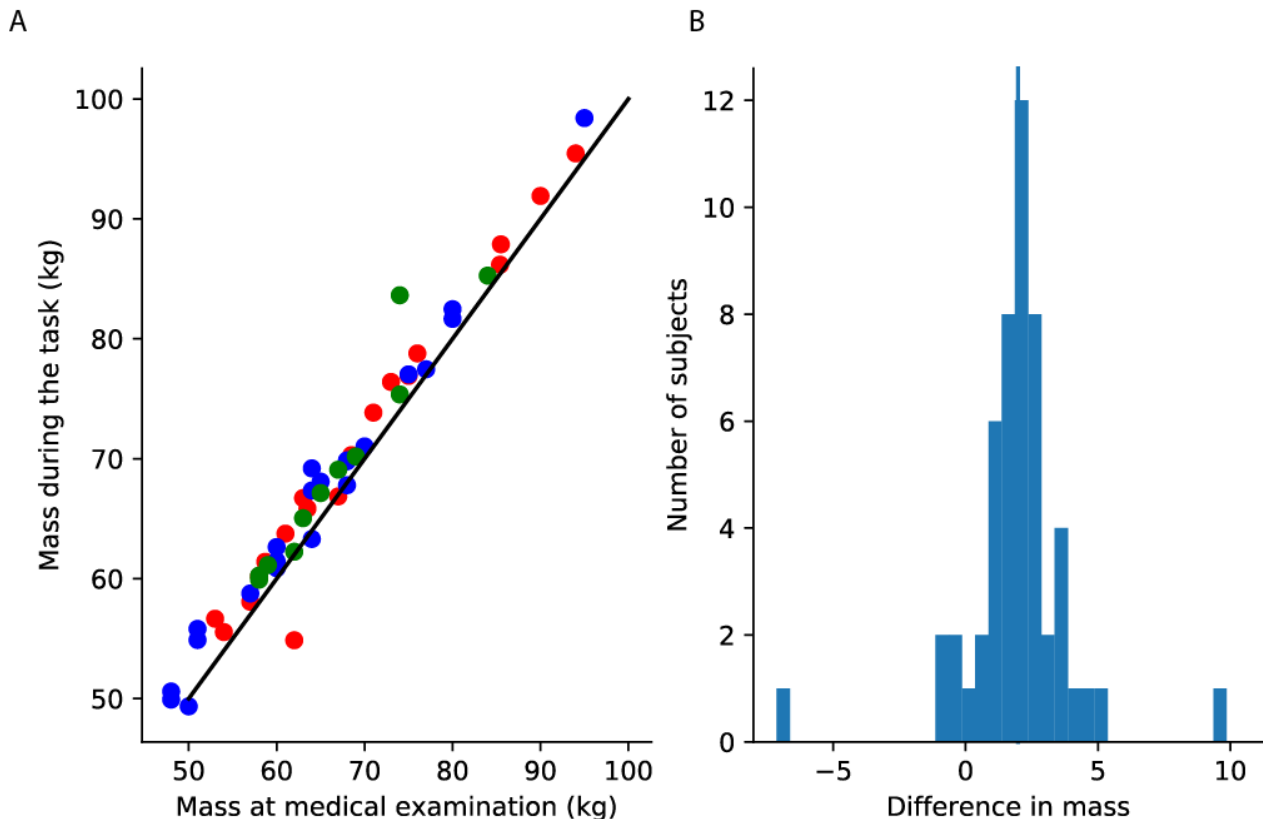

Figure 4.11 Difference in mass between the medical examination and the task.

A. Mass during the task as a function of mass during the medical examination. Each point corresponds to a subject, with young subjects in green, elderly non-fallers in blue, and elderly fallers in red. B. Difference between the mass during the task and during the medical examination; the vertical line corresponds to the median difference of 2kg.

For a given subject, I assume the subject has pelvis width  $P$ , and I decompose the position of the CoM calculated from the kinematic markers into a term  $PCoM_P$  which is proportional to  $P$ , and a term  $CoM_0$  which is independent of  $P$ :

$$CoM = CoM_0 + PCoM_P$$

$CoM_0$  corresponds to the contributions of the arms, lower legs, and a part of the contributions of the torso and upper legs.  $PCoM_P$  corresponds to the rest of the contributions of the torso and upper legs. This is then projected onto the horizontal plane. The forwards position of the CoM is given by  $x_{CoM} = x_0 + Px_P$ , and the lateral position of the CoM is given by  $y_{CoM} = y_0 + Py_P$ .

The torque of weight is then obtained by multiplying the position of the CoM and the person's weight  $w$ . The person's weight is defined as the mean vertical ground reaction force during the waiting period in CSRT trials. The person's mass during the task (obtained by dividing their weight by the standard gravity on Earth  $9.8 \text{ m/s}^2$ ) is compared to their mass measured during a medical examination previous to the task in Figure 4.11.A. The distribution of the difference in mass (Figure 4.11.B) is tightly centred around its median value of 2 kg. This suggests that the scales used during the medical examination have a mismatch of 2 kg with the force platforms used in the task. Variations around this median value may correspond to actual changes in mass: they are of less than 3.5 kg except for two outlier subjects.

#### *Equilibrium of torques*

For each subject, the waiting periods of all the subject's CSRT trials are concatenated. Assuming the average change in the person's rotational momentum during these waiting periods is null, the torques of weight and of the ground reaction force must cancel out on average.

In the forwards direction, with  $M_x$  the forwards torque of the ground reaction force:

$$\int_{\text{waiting period}} w x_{CoM} + M_x = 0 = w \int_{\text{waiting period}} x_0 + Pw \int_{\text{waiting period}} x_P + \int_{\text{waiting period}} M_x$$

$$P \int_{\text{waiting period}} x_P = \int_{\text{waiting period}} x_0 - \frac{M_x}{w} = \int_{\text{waiting period}} x_0 - x_{CoP}$$

$$P a_x = b_x$$

Where:

$$a_x = \int_{\text{waiting period}} x_P$$

$$b_x = \int_{\text{waiting period}} x_0 - x_{CoP}$$

In the lateral direction, with  $M_y$  the lateral torque of the ground reaction force:

$$\int_{\text{waiting period}} w y_{CoM} + M_y = 0 = w \int_{\text{waiting period}} y_0 + Pw \int_{\text{waiting period}} y_P + \int_{\text{waiting period}} M_y$$



$$P \int_{\text{waiting period}} y_P = \int_{\text{waiting period}} y_0 - \frac{M_y}{W} = \int_{\text{waiting period}} y_0 - y_{CoP}$$

$$P a_y = b_y$$

Where:

$$a_y = \int_{\text{waiting period}} y_P$$

$$b_y = \int_{\text{waiting period}} y_0 - y_{CoP}$$

I then determine  $P$  as the linear least squares fit of  $P \begin{pmatrix} a_x \\ a_y \end{pmatrix} = \begin{pmatrix} b_x \\ b_y \end{pmatrix}$ .

The time course of CoM position obtained with this fit value of pelvis width is plotted relative to the time course of CoP position, during the waiting periods of all the subjects and all the trials (Figure 4.12.A, B). Panel A shows the forwards direction and panel B shows the lateral direction. There seems to be a constant offset between the lateral positions of the CoM and CoP (Figure 4.12.B). This suggests that there is a position offset between the reference frames for the force platforms and for the kinematic markers. I therefore assume that there is an offset  $o_x$  in the forwards direction and an offset  $o_y$  in the lateral direction. The equation for the equilibrium of torques becomes (where the subscript  $s$  denotes the different subjects):

$$P_s \begin{pmatrix} a_{x,s} \\ a_{y,s} \end{pmatrix} + \begin{pmatrix} o_x \\ o_y \end{pmatrix} = \begin{pmatrix} b_{x,s} \\ b_{y,s} \end{pmatrix}$$

I therefore simultaneously fit the offsets (assumed constant across subjects) and the pelvis width of the different subjects, using a linear least squares regression. The offsets obtained are  $o_x = -11.3 \text{ mm}$  and  $o_y = 19.9 \text{ mm}$ . When comparing the position of the CoP to the positions of the kinematic markers (as for the calculation of ankle torque in Figure 4.6.C), these offsets are removed.

The time course of CoM position obtained with this new fit is plotted as a function of CoP position in Figure 4.12.C, D. Panel C shows the forwards direction and panel D shows the lateral direction. There is a much better correspondence when these offsets are included.

The initial CoM position on a given trial is defined as the mean position of CoM in the 500 ms before the onset of the trial (either the “go” signal for CSRT trials, or the perturbation onset for perturbation trials). The initial CoP position is defined likewise.

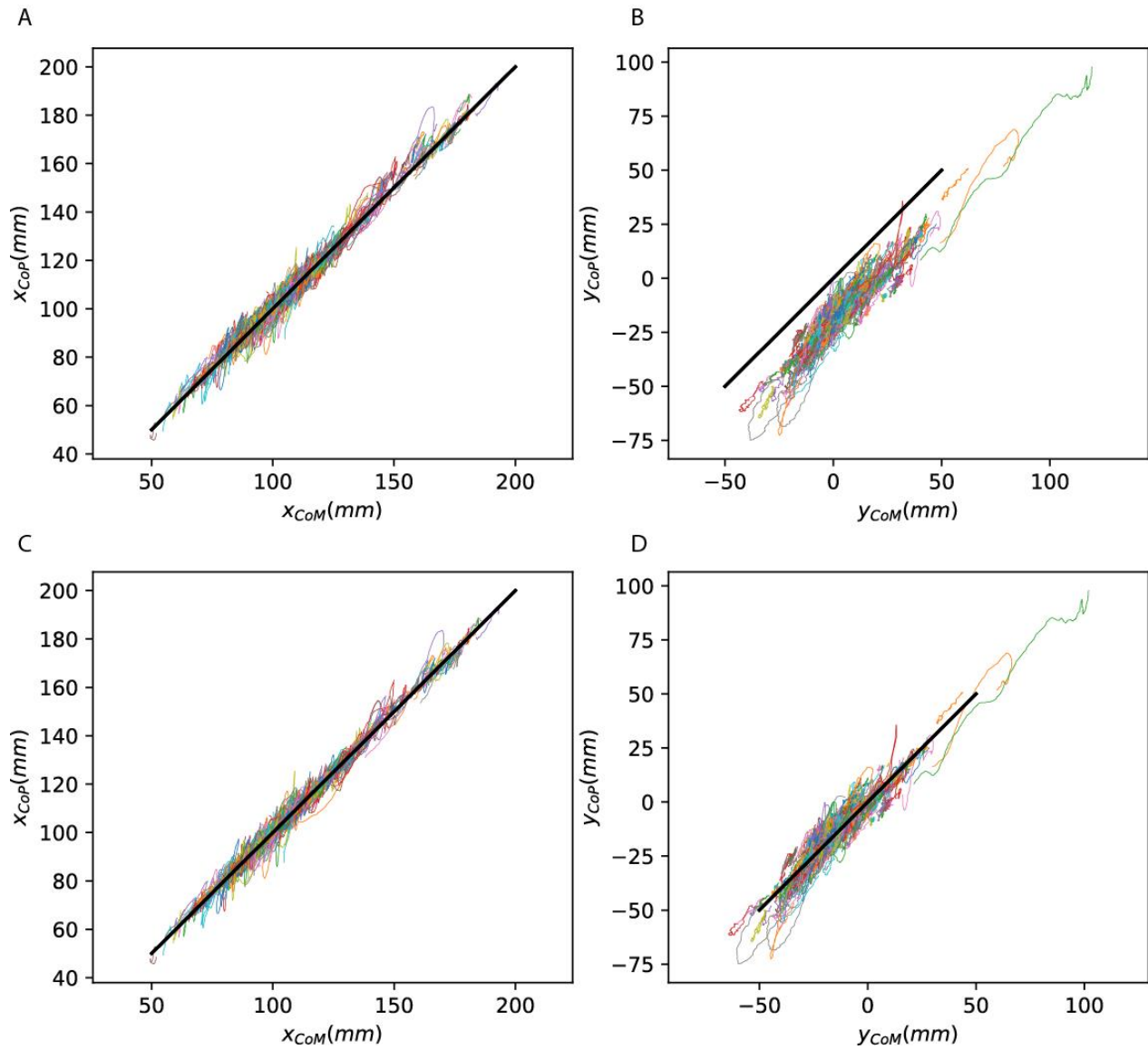

Figure 4.12 Correspondence between CoM and CoP position.

The position of the CoP is plotted relative to the position of the CoM obtained assuming there are no offsets (A, B) and assuming there are constant offsets (C, D) between the reference frames of the force platforms and the kinematic markers. The forwards position relative to the middle of the heels is plotted in panels A and C, and the leftwards position relative to the middle of the heels is plotted in panels B and D.



## 5. Discussion

### I. Summary

In the introduction, I attempted to highlight the importance of the body mechanical properties in motor coordination. I presented the striking results of the embodied robotics approach, which show that graceful and energetically efficient walking can be obtained with an appropriate design of leg mechanics, coupled with a minimal control (Collins et al., 2005; Iida and Pfeifer, 2004; McGeer, 1990; Spröwitz et al., 2014). The robot mechanical properties are designed once and for all by the engineer, in view of improving the specific motor task of walking. I drew on the extensive sports science literature to suggest that an athlete with a strong, fast and streamlined musculoskeletal system will perform better than a person with weak and slow muscles, who has calculated the optimal motor command for their feeble body. For athletes, as opposed to robots, their body mechanical properties are not fixed once and for all, but adjust slowly over the course of practice (Duchateau and Baudry, 2010). This results nevertheless in a set of body mechanical properties which are adjusted specifically to the sport which they practice. For example, the proportion of fatigue-resistant muscle fibres in a calf muscle is higher in endurance athletes than untrained subjects, and lower in sprinters (Costill et al., 1976). This suggests that the adaptations which have occurred in the body of sprinters, although they allow them to perform very efficiently in a sprint, may render them less fatigue-resistant than untrained subjects.

The performance of daily activities relies on a much broader diversity of motor tasks than athletic performance in a given sport, and than the specialized motor skills of walking robots. Since each task may benefit from the adjustment of the body mechanical properties to the task at hand, the efficient performance of daily activities may not rely on a unique set of body mechanical properties (which would be appropriate for a specific task such as sprinting). It may instead benefit from a broad diversity of body mechanical properties, in adequacy with the broad diversity of motor tasks. I therefore developed the thesis that motor coordination relies on short-term adjustments of body mechanical properties to the task at hand by the postural system.

In Chapter 2, I considered the task of remaining immobile, such as may be necessary for standing still or for precise and accurate tool manipulation. I showed that, because of delays in neural intervention, body mechanical properties such as stiffness and inertia play a critical role for maintaining immobility despite external perturbations. Indeed, immediately after a perturbation, the contact forces which determine the movement of the body are entirely determined by the perturbation and the body mechanical properties. I showed how the body mechanical properties can be adjusted so that these contact forces immediately counteract the perturbation. I presented experimental evidence that people employ this strategy when they stand in challenging balance conditions (Carpenter et al., 2001; Pinar et al., 2010; Trimble and Koceja, 2001), and when they manipulate unstable tools (Franklin et al., 2004; Trumbower et al., 2009). In contrast, during normal standing or reaching, immobility does not seem to be a critical function of the postural system (Gribble et al., 2003; Loram and Lakie, 2002).

Balance, the ability not to fall, is commonly assumed to be equivalent to the ability to remain immobile during stance (Bouisset and Do, 2008; Horak, 2006; Massion et al., 2004; Nashner et al., 1989). This idea comes from a linearization of the dynamics around the standing posture (Hasan, 2005), as was performed in Chapter 2. As presented in Chapter 2, there is then a unique equilibrium position of the centre of mass, which can be either stable or unstable, and whose stability can be improved by an appropriate adjustment of body mechanical properties and neural feedback gains. By extrapolation, balance during movement is also thought to rely on the immobilisation of the CoM at a unique equilibrium position. In Chapter 3, I first showed that this linear analysis does not fully hold during human stance, since there is a whole range of CoM positions that can be maintained during stance, rather than a unique equilibrium position. I thus presented experimental evidence that people shift the position of their CoM during stance if they are instructed to do so (Schieppati et al., 1994), and in preparation both for initiating movement (Slawinski et al., 2010) and for resisting an external perturbation (Carpenter et al., 2001; Welch and Ting, 2014). I then showed that the linear analysis is completely inappropriate to account for

motor coordination during skilled movement initiation. I presented experimental evidence that at the initiation of a well-practiced movement, people accelerate their CoM in the direction of the movement (Brenière et al., 1987; Cordo and Nashner, 1982; Crenna et al., 1987; Lee et al., 1990; Pedotti et al., 1989). I argued that the propulsive torques for movement initiation are limited by the position of the CoM relative to the feet, therefore accelerating the CoM in the direction of the movement increases torque for movement. I proposed the mobility theory, which I developed with my supervisor Romain Brette, and which states that during skilled movement the postural system adjusts the position of the CoM in view of providing torque for the movement. I suggested that balance, which is not equivalent to immobility during stance, may instead rely on this postural ability to adjust the CoM position to the task at hand.

In Chapter 4, I then tested to what extent this ability to adjust the CoM position to the task at hand was affected by aging, and whether this affects fall risk. I presented a new analysis of a previously published experiment, comparing the behaviour of young subjects, elderly subjects with a history of falls, and elderly subjects without a history of falls, in a stepping and a perturbation task (Tisserand, 2015; Tisserand et al., 2016a). I showed that when elderly subjects participate in a laboratory-based perturbation experiment, in which the forwards direction of the perturbations is known in advance, they shift the initial position of their CoM backwards (compared to the stepping task). This strategy is adopted both by elderly fallers and non-fallers, but not by young subjects. It allows elderly fallers to counteract the perturbations as effectively as the elderly non-fallers and the young subjects. Thus, the ability to adjust the CoM position to the task at hand, with advance warning and with sufficient preparation time, does not seem to be affected in elderly fallers. In contrast, when elderly fallers are asked to step as fast possible with a step leg that is not known in advance, then they take more time to perform the step than elderly non-fallers, who in turn take more time to step than young subjects. This suggests that the ability which is affected in elderly fallers is the ability to rapidly adjust the CoM position.

## II. Postural versatility

### 1. Adjustment of posture to the task

Postural control is traditionally viewed as a homeostatic process: it is assumed that there exists a unique, reference posture, and that postural control should correct for any deviations away from this reference posture. For example, in the immobility theory which I discussed in Chapter 3, there is assumed to be a unique, reference position of the CoM, and the purpose of postural control both during stance and movement is thought to be correct for any deviations away from this reference position (Bouisset and Do, 2008; Horak, 2006; Massion et al., 2004; Nashner et al., 1989). I have shown on the contrary that there is a range of CoM positions that can be maintained (Schieppati et al., 1994), and that subjects typically adjust their CoM position within this range to produce torque for the task at hand. Thus, when waiting for the “go” signal, racers shift their CoM forwards (Slawinski et al., 2010). I have shown in Chapter 4 that, when waiting for a forwards waist-pull, elderly fallers shift their CoM backwards, and that this may allow them to resist the perturbation as effectively as elderly non-fallers and young subjects. Thus, shifting the CoM forwards and backwards relative to the foot shifts the range of forwards and backwards torque that can be produced both for initiating movement and resisting external perturbations.

Similarly, there seems to be no unique, reference value of ankle stiffness. I have shown in Chapter 2 that when immobility is crucial, ankle stiffness should be maintained as close as possible to the critical value which allows the CoP to immediately and perfectly track changes in CoM position. For such ankle stiffness, the relative speed of the body’s response to perturbations (defined in Chapter 2) is null. However, to provide torque for the initiation of movement, a distance must be introduced between the position of the CoP and the CoM. In normal standing, this relative speed is not null (Loram and Lakie, 2002). This may be to allow the torque of weight to be used for the initiation of movement. Likewise, the reason for which the relative speed is not null when manipulating unstable tools may be to allow the contact forces with the tool to be used for the initiation of movement. The relative speed is transiently decreased when standing in challenging balance conditions (Carpenter et al., 2001; Pinar et al., 2010; Trimble and Kocaja, 2001), and when reaching accuracy becomes critical (Gribble et al., 2003). Thus, reducing relative speed may improve immobility, while increasing relative speed may improve mobility.

## 2. Postural allostasis

Thus, motor coordination does not rely on maintaining the body mechanical properties (such as ankle stiffness or the position of the CoM) at a unique reference value. Instead, it relies on adjusting these body mechanical properties to the task at hand. Postural control should therefore be considered not as a homeostatic process, but as an allostatic process. The idea of allostasis was developed in physiology to replace the concept of homeostasis (Schulkin, 2003). It is motivated by the observation that physiological variables, such as the blood pressure and blood sugar level, are not clamped at a unique value, but follow meaningful variations. Thus, the blood pressure and sugar level are lower at night when a person sleeps, compared to during the day when the person performs activities requiring sugar to be delivered throughout the body. Moreover, they can be transiently increased before an exertion. Just before a race, rowers may thus have blood sugar levels so high that the sugar spills into the urine (Cannon, 1935). The notion of allostasis is presented by Sterling as follows: « Were pressure actually clamped at an average value, it would match some specific need only by sheer accident. This is true for all states and all parameters: average values are useless. The essential need is to occupy distinctly different states and to move flexibly between them » (Sterling, 2004).

My thesis defends such an allostatic view of posture, and proposes that motor coordination relies on the adjustment of body mechanical properties in accordance with the motor task. The importance of such versatility has been put forwards by Bernstein, who, by analogy with the human body, noted that “In many cases a more flexible instrument, which is certainly much more challenging to work with, has unquestionable advantages in its flexibility and fine results” (Bernstein, 1996).

The inadequacy of the idea of a unique reference posture has been highlighted by Lederman for the treatment of lower back pain (Lederman, 2011). People with lower back pain have a different trunk posture and motor control, compared to control subjects without lower back pain. A widely used treatment for lower back pain consists in training people to have the same trunk posture as control subjects. Lederman however highlights that this treatment only provides temporary pain relief. He suggests that the trunk posture naturally adopted by subjects with lower back pain may represent an adaptation to an underlying injury, therefore treatments should not attempt to normalize deviations of posture away from the reference posture of healthy subjects.

## 3. Fall risk in the elderly

Similarly, there are numerous changes in posture that occur with aging, and not all of these changes are necessarily detrimental for the elderly person. Certain changes may on the contrary represent adaptations. For example, adaptation to increased sensorimotor delays (Sabbahi and Sedgwick, 1982) may rely on an increased ankle stiffness (Vandervoort et al., 1992) and a decreased ankle sensorimotor feedback gain (Koceja et al., 1995). Those elderly subjects whose postural control is most different to young healthy adults may not be the ones with the worse balance abilities. Thus, in Chapter 4, I showed that young subjects do not shift their CoM backwards in anticipation of a forwards perturbation. However, both elderly fallers and elderly non-fallers shift their CoM backwards in this case, and the backwards shift may be larger in certain elderly non-fallers than in certain elderly fallers. Thus, this difference in postural strategy between young and elderly subjects does not in itself predict falling in the elderly.

What then causes certain elderly people to fall? Specific risk factors such as visual impairment and muscle weakness have been highlighted in Chapter 4. After dealing with such specific risk factors, there remains a large number of unexplained falls. According to the results of Chapter 4, elderly fallers are quite as capable as elderly non-fallers of adjusting the position of their CoM, when they are given enough time both to determine what the appropriate posture is, and to actually shift their CoM position. However, they are slower to perform the stepping task when the step foot is not known in advance. This suggests that they are slower at adjusting their posture in response to the “go” signal. Balance problems may therefore result from the inability to adjust posture *rapidly enough* to changing task requirements. As a consequence, effective interventions to improve balance in the elderly

may rely on practicing mobility, such as in Tai Chi (Gillespie et al., 2009; Li, 2014) and in Adapted Tango (Hackney and Earhart, 2010).

### III. Motor coordination

#### 1. Redundancy in motor tasks

Motor control theories are typically organized around the notion of motor redundancy: from the observation that the human body comprises numerous joints and muscles, it is assumed that the human motor system has more degrees of freedom than are needed to perform any given task (Loeb, 2012). I suggest that this notion of redundancy comes in part from an over-simplified description of motor tasks, which does not take into account the adjustment of body mechanical properties to the task at hand.

Tasks which require accuracy, such as standing still, or holding a tool at a precise position, are considered redundant, because various postures and patterns of muscular contraction result in the same equilibrium position. For example, standing with the CoM at a given position may be achieved with different levels of ankle muscle co-contraction. If only the CoM equilibrium position is considered, then the amount of ankle muscle co-contraction represents task redundancy. However, co-contraction affects ankle stiffness, and therefore the stability of the CoM equilibrium position. Likewise, a person can hold their hand at a given position with various arm postures, and each arm posture can be maintained with various patterns of muscular contraction. These various postures and patterns of muscular contraction are therefore considered redundant. However arm posture and muscle contraction influences the arm endpoint stiffness and inertia, and therefore the accuracy in holding the hand at the required position (Trumbower et al., 2009). Thus, for tasks requiring accuracy, postural variables which affect the relative speed of the body response to external perturbations are not redundant.

Tasks which require speed are also less redundant than commonly assumed. For example, leaning the trunk backwards can be achieved in a variety of ways. In control subjects it is performed with simultaneous trunk and ankle muscle contraction, and without movement of the CoM, whereas in gymnasts it is performed with a distal-to-proximal sequencing of muscular contraction, and an initial backwards acceleration of the CoM. If only the end result of trunk angle is taken into consideration, then both the synchronous and the sequential muscle activation patterns are effective for performing the movement. The task therefore appears redundant. However, if the speed of the movement is taken into consideration, then the ability to produce torque for the movement by initially accelerating the CoM becomes critical for task success. The synchronous and the sequential muscle activation patterns are therefore not equivalent, and the task no longer appears redundant.

Thus, since performance is improved by the adjustment of body mechanical to the task at hand, variables which affect body mechanical properties cannot be considered redundant. Motor coordination may therefore rely on fine and flexible control of the different muscles and degrees of freedom of the body.

#### 2. Change in coordination during learning

The neural organization of movement is thought to consist in adding constraints to movement patterns, so as to solve the degrees of freedom problem (Bizzi and Cheung, 2013; Todorov and Jordan, 2002). According to the theory of motor synergies (Bizzi and Cheung, 2013), the nervous system solves the problem of motor redundancy by composing movement as a combination of fixed building blocks. Within a given building block (or synergy), various muscles are constrained to contract as a unit, possibly in a given temporal sequence.

However, the change in motor coordination over the course of skill learning suggests that these building blocks are not fixed. Thus, the temporal sequencing of activation which allows one's own weight to be used as a propulsive force emerges over the course of development both for walking and for balancing responses (Burtner et al., 1998; Ledebt et al., 1998), but for every new movement that is practiced, it seems to be learned anew. Thus, with skill learning, acrobats seem to adapt their posture in handstands (Clément and Rézette, 1985), and gymnasts seem to adapt their postural adjustments (Pedotti et al., 1989), such that skilful movements may exploit the torque of

gravity. Further evidence for this comes from the literature on skill learning, in which the movements of beginners are seen to use in phase coordination of the various body segments, whereas the movements of experts have a temporal sequencing which allows them to better exploit the work of gravity (Delignières et al., 1998). Thus, practicing a given motor task results in a slow and long-term adjustment of the postural coordination used to perform the task.

The evidence presented in the Introduction suggests that this long-term adjustment of postural coordination may rely on changes both in spinal coordination and in the musculo-skeletal system. The evidence for changes in spinal coordination comes from experiments in spinalized animals. Thus, the rat withdrawal reflex is not functional at birth but emerges gradually (Holmberg et al., 1997). If the adult rat is spinalized, the withdrawal reflex is preserved (Schouenborg et al., 1992). However, if the rat is spinalized at birth, then the spinalized rat does not learn an effective withdrawal reflex (Levinsson et al., 1999). This suggests that supra-spinal centres may be required to guide the learning of motor coordination within the spinal cord. The H-reflex conditioning paradigm has been used to elucidate some of the mechanisms which support such guided learning in the spinal cord (Wolpaw, 2010). Learning may also occur within the spinal cord without guidance from supra-spinal centres, as demonstrated by functional adaptation in spinalized animals. Thus, when most of the ankle extensor muscles of a cat are removed, the cat gradually compensates for the injury by increasing the contraction of the remaining ankle extensor muscles (Pearson et al., 1999), and such compensation is also observed in spinal cats (Bouyer et al., 2001).

Practice also results in a long-term adjustment of the musculo-skeletal system (Duchateau and Baudry, 2010). Thus, a month after the removal of ankle extensor synergists, the remaining muscle has an increased mass and an increased proportion of fatigue-resistant fibres (Degens et al., 1995). One of the roles of the nervous system during skill learning may therefore be to guide changes in the body. Thus, daily practice in voluntarily contracting a muscle to its maximal strength gradually increases this maximal strength (Duchateau and Hainaut, 1984), whereas chronic stimulation of a muscle nerve gradually increases the muscle's fatigue resistance (Maier et al., 1988).

Thus, the improvement in motor coordination when practicing a new task does not rely on finding a new combination of fixed building blocks. The musculo-skeletal system and the patterns of muscular contraction themselves change over the course of learning. This also suggests that improvements in motor coordination do not only rely on the cerebellum or motor cortex calculating the optimal motor command using an internal model of the body dynamics. Indeed, for tasks which require muscular strength, the "right" motor command may not even exist before the learning process.

### 3. Postural modulation after learning

The adjustment of the body mechanical properties to the task at hand may improve motor performance, both by improving the robustness to external perturbations (through the adjustment of stiffness or inertia, as explained in Chapter 2), and by providing impetus to the movement (through the adjustment of the position of the centre of mass, as explained in Chapter 3). Additionally, the neural feedback gains must be adjusted to the environmental instability and the body mechanical properties (which, together, determine the relative speed at which perturbations are amplified during the delay period, as explained in Chapter 2). Due to delays in neural feedback, adjusting both the body mechanical properties and the feedback gains improves motor coordination, compared to adjusting only neural feedback.

Once a person or animal has learned the right postural coordination to perform a given motor task, the role of the nervous system in motor performance may then be to identify which motor task the animal faces, then to determine which of the learned postural coordination patterns is appropriate to fulfil the task, and finally to adjust both posture and neural feedback gains to the task at hand.

Motor performance may then be limited by how accurate this identification is, and how fast posture and feedback gains are adjusted after a change in the external conditions. A failure to identify and perform the appropriate change in posture fast enough may have dramatic consequences, such as falling. Thus, Robinovitch and colleagues reviewed video captures of the falls which occurred in a nursing home, and observed that "the most frequent cause



of falling was incorrect weight shifting, which accounted for 41% of falls, followed by trip or stumble (21%), hit or bump (11%), loss of support (11%) and collapse (11%)” (Robinovitch et al., 2013). Thus, the ability to rapidly adjust the position of the CoM to the environmental requirements may be critical to prevent falling, since “incorrect weight shifting” accounts for 41% of falls. Likewise, the ability to land back on your feet after tripping or stumbling may rely on a rapid assessment of the situation and a resourceful adjustment of motor coordination to the situation. This may explain the role of psychotropic medication in inducing falls (Gillespie et al., 2009): it may not in itself cause an imbalance, but it may prevent the person from responding rapidly and appropriately to this imbalance. Balance may therefore rely on motor dexterity, as defined by Bernstein: “The essence of motor dexterity is in the ability to find [...] a unique, improvised, and adequate solution to an unexpected or unusual problem. [...] Dexterity is not contained in the movements themselves but in their degree of correspondence to the external conditions, in the degree of their success in solving a motor problem” (Bernstein, 1996).





## 6. Appendix: Models of human stance

### I. Ankle torque and body rotational momentum

#### 1. Torques of the external forces

When someone is standing on the ground, there are two external forces exerted on them: the person's weight and the ground reaction force.

Gravity exerts a downwards vertical force whose magnitude is the person's weight (their mass times the gravity on Earth). The point of application of the person's weight is called the centre of mass and noted CoM. If the CoM is vertically aligned with the ankles, then the person's weight does not exert a torque around the ankles (Figure 6.1.A). If it is forward of the ankles, then the weight exerts a forwards torque which is equal to the weight times the horizontal distance between the CoM and the ankles (Figure 6.1.B).

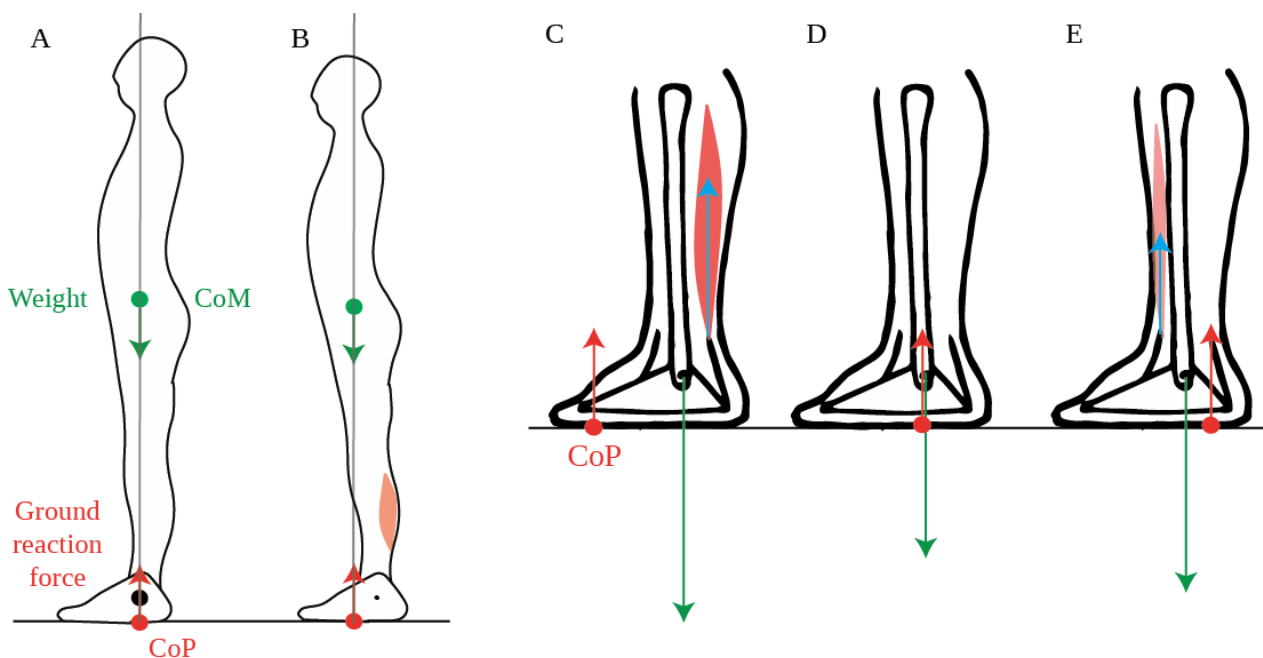

Figure 6.1 Ankle torque

A. When the CoM (green dot) is vertically aligned with the ankle joint (black dot), the weight (green arrow) exerts no torque around the ankle. In order to maintain this posture, the ground reaction force (red arrow) must also exert no net torque around the ankle, therefore its point of application, the CoP (red dot) must also be vertically aligned with the ankle. B. In the typical quiet standing posture, the CoM is maintained forwards of the ankles, therefore weight exerts forwards torque around the ankles. This is compensated for by backwards torque of the ground reaction force, which requires tonic calf muscle contraction. C-E The force exerted by the lower leg bones onto the foot (green arrow) exerts no torque around the ankle. The torque of the ground reaction force (red arrow) and of the forces exerted by the lower leg muscles onto the foot (blue arrow) are therefore opposite when the foot remains immobile: C. the torque around the ankles exerted by the calf muscles onto the foot is instantly compensated for by a forwards shift of the CoP (red dot). D. When the lower leg muscles exert no torque onto the foot, then the CoP is below the ankle E. The torque around the ankles exerted by the shin muscle onto the foot is instantly compensated for by a backwards shift of the CoP.

The ground supports the person's weight, therefore, as long as the CoM remains at the same height, the vertical component of the ground reaction force is of equal magnitude but of opposite direction to the person's weight. The ground reaction torque around the ankles is therefore equal to the weight times the horizontal distance between the ankles and the point of application of the ground reaction force, called the centre of pressure and noted CoP. The net torque around the ankles is thus determined by the horizontal distance between the CoP and the CoM: if they are vertically aligned, there is no net torque (Figure 6.1.A, B). If the CoP is forwards of the CoM, then there is a net backwards torque, and if the CoP is backwards of the CoM, then there is a net forwards torque around the ankles.

Such torque induces a change in the person's rotational momentum around their ankles, which is the sum over their body segments of the segment's mass, times its distance to the ankle, times its rotational speed (its speed perpendicularly to the axis joining it and the ankle).

## 2. Lower leg muscle contraction changes the ground reaction torque

We will show that only the forces exerted by the lower leg muscles onto the foot may change the ground reaction torque around the ankles.

In order to understand how the internal forces induced by muscular contraction may affect the ground reaction force, we shall decompose the body and consider only the foot (Figure 6.1.C-E). If the foot is on a rigid support and does not slip, then it can neither translate, nor rotate around the ankle. Therefore, both the sum of forces and the sum of torques around the ankle must be zero. The forces exerted onto the foot are the ground reaction force (red arrow in Figure 6.1.C-E), the foot's weight (which is negligible compared to the other forces), and the forces exerted by the lower leg onto the foot through on the one hand the muscles which attach onto the foot (blue arrow in Figure 6.1.C-E), and on the other hand the bones (green arrow in Figure 6.1.C-E). The latter force exerts no torque around the ankles since it is applied at the ankles.

Thus, as long as the ground prevents the foot from moving, the torque of the ground reaction force around the ankle is exactly the opposite of that of the muscles of the lower leg. When the calf muscles contract, this pulls the heel upwards through the Achilles tendon (Figure 6.1.C). If the foot were in the air, it would rotate around the ankle joint bringing the toes down. Since the foot is against rigid ground, the ground resists the rotation of the foot by exerting backwards torque on the foot. Thus, any increase in the force that the calf muscles exert on the heel is instantly translated into an increase in the backwards torque of the ground reaction force on the entire body. As we have seen, as long as the CoM remains at the same height, the vertical component of the ground reaction force is of equal magnitude but of opposite direction to the person's weight. Since the magnitude of the vertical component of the ground force does not change, contraction of the calf muscles can only induce backwards ground reaction torque by shifting the CoP forwards (Figure 6.1.C). Likewise, any increase in the force of the shin muscle is instantly translated into an increase in the forwards torque of the ground reaction force on the entire body, through a backwards shift in the CoP (Figure 6.1.E).

## II. Double inverted pendulum model

We wish to determine how lower leg and trunk muscle contraction differentially affect the acceleration of the centre of mass.

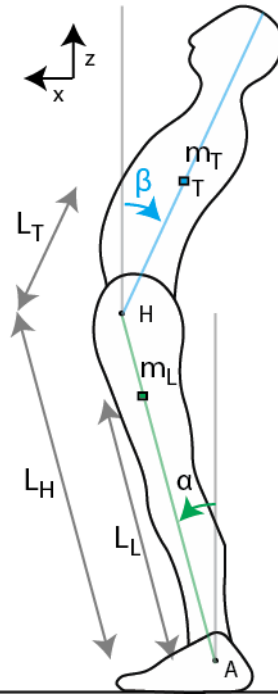

Figure 6.2 Double pendulum model of human stance.

The legs can rotate around the ankle joint at  $A$  and form an angle  $\alpha$  with the vertical. The torso can rotate around the hips at  $H$ , of height  $L_H$ , and forms an angle  $\beta$  with the vertical. The legs have a mass  $m_L$  at height  $L_L$  and the torso has a mass  $m_T$  at height  $L_T$  with respect to the hips.

For this, we use the double inverted pendulum model of human stance, presented in Figure 6.2. The foot is considered rigidly linked to the ground. The leg can rotate around the ankle at point  $A$ , and its angle with respect to the vertical is  $\alpha$ . Its centre of mass (green square) is at height  $L_L$  with respect to the ankle. It has mass  $m_L$  and rotational inertia  $J_L$  around its centre of mass. The hip is at a point  $H$  at height  $L_H$  from the ankle. The torso can rotate around the hip, and its angle with respect to the vertical is  $\beta$ . Its centre of mass is at point  $T$  with height  $L_T$  with respect to the hip. It has mass  $m_T$  and rotational inertia  $J_T$  around its centre of mass.

### 1. Rotational momentum

We linearize the dynamics around the vertical position  $\alpha = \beta = 0$ , such that initially the torque of weight around both  $A$  and  $H$  is null. We consider that the contraction of trunk muscles exerts an external torque on the trunk around the hips  $T_H$ , whereas leg muscle contraction induces an external torque on the body around the ankles  $T_A$  (which corresponds to the ground reaction torque).

#### a) Torso rotational momentum around the hips

The rotational momentum of the torso around the hips is the sum of a term due to the trunk's rotational inertia around its centre of mass  $J_T\dot{\beta}$ , and of a term due to the rotational momentum of the torso centre of mass at  $T$ . The forwards position of the torso centre of mass relative to the ankles is given by:

$$x_T = L_H\alpha + L_T\beta$$

The rotational momentum of the torso centre of mass is the product of the torso mass  $m_T$ , the distance  $L_T$  between the hip and the centre of mass, and the forwards speed of the torso centre of mass  $\dot{x}_T$ :

$$M_{torso||H} = m_T L_T \dot{x}_T + J_T \dot{\beta}$$

Its derivative is equal to the total external torque exerted on the trunk around the hips:

$$T_H = \frac{d}{dt} M_{torso||H} = m_T L_T \ddot{x}_T + J_T \ddot{\beta}$$

b) Body rotational momentum around the ankles

In a similar way, the torso rotational momentum around the ankles is given by:

$$M_{torso||A} = m_T (L_T + L_H) \dot{x}_T + J_T \dot{\beta}$$

The leg rotational momentum around the ankles is likewise:

$$M_{leg||A} = m_L L_L^2 \dot{\alpha} + J_L \dot{\alpha}$$

The body rotational momentum around the ankles is the sum of the torso and leg rotational momentum:

$$M_{body||A} = M_{leg||A} + M_{torso||A} = m_L L_L^2 \dot{\alpha} + J_L \dot{\alpha} + m_T (L_T + L_H) \dot{x}_T + J_T \dot{\beta}$$

Its derivative is equal to the total external torque exerted on the body around the ankles:

$$T_A = \frac{d}{dt} M_{leg||A} + \frac{d}{dt} M_{torso||A} = m_L L_L^2 \ddot{\alpha} + J_L \ddot{\alpha} + m_T (L_T + L_H) \ddot{x}_T + J_T \ddot{\beta}$$

To remove  $\ddot{\beta}$  from the equations, we consider:

$$\begin{aligned} T_A - T_H &= m_L L_L^2 \ddot{\alpha} + J_L \ddot{\alpha} + m_T (L_T + L_H) \ddot{x}_T + J_T \ddot{\beta} - m_T L_T \ddot{x}_T + J_T \ddot{\beta} \\ &= m_L L_L^2 \ddot{\alpha} + J_L \ddot{\alpha} + m_T L_H \ddot{x}_T \end{aligned} \quad (1)$$

2. Acceleration of the centre of mass

The forwards position of the body centre of mass  $x_{CoM}$  is given by the barycentre of the leg and torso centres of mass:

$$(m_L + m_T) x_{CoM} = m_L L_L \alpha + m_T x_T$$

Its acceleration is thus:

$$(m_L + m_T) x_{CoM}'' = m_L L_L \ddot{\alpha} + m_T \ddot{x}_T$$

We remove  $\ddot{x}_T$  using equation (1):

$$\begin{aligned} L_H (m_L + m_T) x_{CoM}'' &= L_H m_L L_L \ddot{\alpha} + T_A - T_H - m_L L_L^2 \ddot{\alpha} - J_L \ddot{\alpha} \\ &= T_A - T_H + (m_L L_L L_H - m_L L_L^2 - J_L) \ddot{\alpha} \end{aligned} \quad (2)$$

To determine the effect of hip and ankle torque on CoM acceleration, we must therefore determine both the sign of  $I = m_L L_L L_H - m_L L_L^2 - J_L$ , and express  $\ddot{\alpha}$  as a function of  $T_A$  and  $T_H$ .

a) Maximal leg rotational inertia

First we show that  $I$  is necessarily positive. For this, we consider the maximal possible value of  $J_L$  given the total leg mass  $m_L$ , the height of the leg CoM  $L_L$  and the total leg height  $L_H$ . The rotational inertia around the leg CoM is then maximal when all of the mass of the leg is positioned at the extremities of the leg. We therefore assume that there is a mass  $m$  at the ankle and a mass  $m_L - m$  at the hip. The height of the CoM obeys the following equation:

$$\begin{aligned} L_L &= \frac{0m + L_H(m_L - m)}{m_L} \\ m_L L_L &= m_L L_H - m L_H \\ m &= m_L \frac{L_H - L_L}{L_H} \end{aligned}$$

The rotational inertia around the CoM is then given by:

$$\begin{aligned} J_{max} &= mL_L^2 + (m_L - m)(L_H - L_L)^2 = m_L \frac{L_H - L_L}{L_H} L_L^2 + m_L \frac{L_L}{L_H} (L_H - L_L)^2 \\ &= m_L \frac{L_L}{L_H} (L_H - L_L)(L_L + L_H - L_L) = m_L L_L (L_H - L_L) = I + J_L \end{aligned}$$

Therefore:

$$I = J_{max} - J_L > 0$$

b) Ankle angle acceleration

Secondly, we express  $\ddot{\alpha}$  as a function of  $T_A$  and  $T_H$ , where:

$$\begin{aligned} T_H &= m_T L_T L_H \ddot{\alpha} + (m_T L_T^2 + J_T) \ddot{\beta} \\ T_A &= (m_L L_L^2 + J_L + m_T (L_T + L_H) L_H) \ddot{\alpha} + (m_T (L_T + L_H) L_T + J_T) \ddot{\beta} \end{aligned}$$

We remove  $\ddot{\beta}$  from the equations by considering:

$$\begin{aligned} &(m_T L_T^2 + J_T) T_A - (m_T (L_T + L_H) L_T + J_T) T_H \\ &= \ddot{\alpha} ( (m_L L_L^2 + J_L + m_T (L_T + L_H) L_H) (m_T L_T^2 + J_T) - (m_T (L_T + L_H) L_T + J_T) m_T L_T L_H ) \\ &= \ddot{\alpha} ( (m_L L_L^2 + J_L) (m_T L_T^2 + J_T) + J_T (m_T (L_T + L_H) L_H) - m_T L_T L_H ) \\ &= \ddot{\alpha} ( (m_L L_L^2 + J_L) (m_T L_T^2 + J_T) + J_T m_T L_H^2 ) \end{aligned}$$

Thus:

$$\ddot{\alpha} = \frac{T_A}{I_A} - \frac{T_H}{I_H}$$

Where  $I_A$  and  $I_H$  are both positive.

c) Acceleration of the CoM

We now reinject into equation (2):

$$L_H (m_L + m_T) x_{\ddot{CoM}} = T_A - T_H + I \left( \frac{T_A}{I_A} - \frac{T_H}{I_H} \right) = \left( 1 + \frac{I}{I_A} \right) T_A - \left( 1 + \frac{I}{I_H} \right) T_H$$

Thus, hip torque accelerates the CoM backwards, whereas ankle torque accelerates the CoM forwards.





## 7. References

- Aagaard, P., Andersen, J. L., Dyhre-Poulsen, P., Leffers, A. M., Wagner, A., Magnusson, S. P., et al. (2001). A mechanism for increased contractile strength of human pennate muscle in response to strength training: changes in muscle architecture. *J. Physiol.* 534, 613–623.
- Aagaard, P., Simonsen, E. B., Andersen, J. L., Magnusson, P., and Dyhre-Poulsen, P. (2002). Increased rate of force development and neural drive of human skeletal muscle following resistance training. *J. Appl. Physiol. Bethesda Md 1985* 93, 1318–1326.
- Adams, G. R., Hather, B. M., Baldwin, K. M., and Dudley, G. A. (1993). Skeletal muscle myosin heavy chain composition and resistance training. *J. Appl. Physiol. Bethesda Md 1985* 74, 911–915.
- Aguirre, J. I., Plotkin, L. I., Stewart, S. A., Weinstein, R. S., Parfitt, A. M., Manolagas, S. C., et al. (2006). Osteocyte apoptosis is induced by weightlessness in mice and precedes osteoclast recruitment and bone loss. *J. Bone Miner. Res. Off. J. Am. Soc. Bone Miner. Res.* 21, 605–615.
- Akima, H., Takahashi, H., Kuni, S.-Y., Masuda, K., Masuda, T., Shimojo, H., et al. (1999). Early phase adaptations of muscle use and strength to isokinetic training. *Med. Sci. Sports Exerc.* 31, 558–594.
- Alexandrov, A. V., Frolov, A. A., and Massion, J. (2001). Biomechanical analysis of movement strategies in human forward trunk bending. I. Modeling. *Biol. Cybern.* 84, 425–434.
- Allen, J. L., McKay, J. L., Sawers, A., Hackney, M. E., and Ting, L. H. (2017). Increased neuromuscular consistency in gait and balance after partnered, dance-based rehabilitation in Parkinson’s disease. *J. Neurophysiol.* 118, 363–373.
- Allum, J. H. J., Carpenter, M. G., Honegger, F., Adkin, A. L., and Bloem, B. R. (2004). Age-dependent variations in the directional sensitivity of balance corrections and compensatory arm movements in man. *J. Physiol.* 542, 643–663. doi:10.1113/jphysiol.2001.015644.
- Alway, S. E., Grumbt, W. H., Gonyea, W. J., and Stray-Gundersen, J. (1989). Contrasts in muscle and myofibers of elite male and female bodybuilders. *J. Appl. Physiol. Bethesda Md 1985* 67, 24–31.
- Anderson, J., Almeida-Silveira, M. I., and Pérot, C. (1999). Reflex and muscular adaptations in rat soleus muscle after hindlimb suspension. *J. Exp. Biol.* 202, 2701–2707.
- Aniansson, A., Sperling, L., Rundgren, A., and Lehnberg, E. (1983). Muscle function in 75-year-old men and women. A longitudinal study. *Scand. J. Rehabil. Med. Suppl.* 9, 92–102.
- Åström, K. J. (1980). Why use adaptive techniques for steering large tankers ? *Int. J. Control* 32, 689–708.
- Åström, K. J., and Kumar, P. R. (2014). Control: A perspective. *Automatica* 50, 3–43.
- Aström, K. J., and Murray, R. M. (2010). *Feedback Systems: An Introduction for Scientists and Engineers*. Princeton University Press.
- Astrom, K. J., and Wittenmark, B. (1994). *Adaptive Control*. 2nd ed. Boston, MA, USA: Addison-Wesley Longman Publishing Co., Inc.

- Baloh, R. W., Corona, S., Jacobson, K. M., Enrietto, J. A., and Bell, T. (1998). A Prospective Study of Posturography in Normal Older People. *J. Am. Geriatr. Soc.* 46, 438–443.
- Baroni, G., Pedrocchi, A., Ferrigno, G., Massion, J., and Pedotti, A. (2001). Static and dynamic postural control in long-term microgravity: evidence of a dual adaptation. *J. Appl. Physiol. Bethesda Md 1985* 90, 205–215.
- Barry, E., Galvin, R., Keogh, C., Horgan, F., and Fahey, T. (2014). Is the Timed Up and Go test a useful predictor of risk of falls in community dwelling older adults: a systematic review and meta-analysis. *BMC Geriatr.* 14, 14.
- Baudry, S., and Duchateau, J. (2012). Age-related influence of vision and proprioception on Ia presynaptic inhibition in soleus muscle during upright stance. *J. Physiol.* 590, 5541–5554.
- Bellman, R. (1958). *Some aspects of the mathematical theory of control processes*. Santa Monica, Calif.: Rand Corporation.
- Berg, K. O., Wood-Dauphinee, S. L., Williams, J. I., and Maki, B. (1992). Measuring balance in the elderly: validation of an instrument. *Can. J. Public Health Rev. Can. Sante Publique* 83 Suppl 2, S7-11.
- Berniker, M., Jarc, A., Bizzi, E., and Tresch, M. C. (2009). Simplified and effective motor control based on muscle synergies to exploit musculoskeletal dynamics. *Proc. Natl. Acad. Sci.* 106, 7601–7606.
- Bernstein, N. A. (1996). *Dexterity and Its Development*. , eds. M. L. Latash and M. T. Turvey Psychology Press.
- Bingham, J. T., Choi, J. T., and Ting, L. H. (2011). Stability in a frontal plane model of balance requires coupled changes to postural configuration and neural feedback control. *J. Neurophysiol.* 106, 437–448.
- Bizzi, E., and Cheung, V. C. K. (2013). The neural origin of muscle synergies. *Front. Comput. Neurosci.* 7.
- Bizzi, E., Mussa-Ivaldi, F. A., and Giszter, S. (1991). Computations underlying the execution of movement: a biological perspective. *Science* 253, 287–291.
- Bohannon, R. W., Larkin, P. A., Cook, A. C., Gear, J., and Singer, J. (1984). Decrease in timed balance test scores with aging. *Phys. Ther.* 64, 1067–1070.
- Bouisset, S., and Do, M.-C. (2008). Posture, dynamic stability, and voluntary movement. *Neurophysiol. Clin. Clin. Neurophysiol.* 38, 345–362.
- Bouisset, S., and Zattara, M. (1981). A sequence of postural movements precedes voluntary movement. *Neurosci. Lett.* 22, 263–270.
- Boulgarides, L. K., McGinty, S. M., Willett, J. A., and Barnes, C. W. (2003). Use of Clinical and Impairment-Based Tests to Predict Falls by Community-Dwelling Older Adults. *Phys. Ther.* 83, 328–339.
- Bouyer, L. J., Whelan, P. J., Pearson, K. G., and Rossignol, S. (2001). Adaptive locomotor plasticity in chronic spinal cats after ankle extensors neurectomy. *J. Neurosci. Off. J. Soc. Neurosci.* 21, 3531–3541.
- Boyde, A. (2003). The real response of bone to exercise. *J. Anat.* 203, 173–189.
- Brauer, S. G., Burns, Y. R., and Galley, P. (2000). A Prospective Study of Laboratory and Clinical Measures of Postural Stability to Predict Community-Dwelling Fallers. *J. Gerontol. Ser. A* 55, M469–M476.

- Brauer, S. G., Woollacott, M., and Shumway-Cook, A. (2002). The influence of a concurrent cognitive task on the compensatory stepping response to a perturbation in balance-impaired and healthy elders. *Gait Posture* 15, 83–93.
- Brenière, Y., Cuong Do, M., and Bouisset, S. (1987). Are dynamic phenomena prior to stepping essential to walking? *J. Mot. Behav.* 19, 62–76.
- Bril, B., Dupuy, L., Dietrich, G., and Corbetta, D. (2015). Learning to tune the antero-posterior propulsive forces during walking: a necessary skill for mastering upright locomotion in toddlers. *Exp. Brain Res.* 233, 2903–2912.
- Bunderson, N. E., Burkholder, T. J., and Ting, L. H. (2008). Reduction of neuromuscular redundancy for postural force generation using an intrinsic stability criterion. *J. Biomech.* 41, 1537–1544.
- Burdet, E., Osu, R., Franklin, D. W., Milner, T. E., and Kawato, M. (2001). The central nervous system stabilizes unstable dynamics by learning optimal impedance. *Nature* 414, 446–449.
- Burleigh, A. L., Horak, F. B., and Malouin, F. (1994). Modification of postural responses and step initiation: evidence for goal-directed postural interactions. *J. Neurophysiol.* 72, 2892–2902.
- Burtner, null, Qualls, null, and Woollacott, null (1998). Muscle activation characteristics of stance balance control in children with spastic cerebral palsy. *Gait Posture* 8, 163–174.
- Butler, A. B., and Hodos, W. (2005). *Comparative Vertebrate Neuroanatomy: Evolution and Adaptation*. Wiley.
- Cameron, I. D., Gillespie, L. D., Robertson, M. C., Murray, G. R., Hill, K. D., Cumming, R. G., et al. (2012). Interventions for preventing falls in older people in care facilities and hospitals. *Cochrane Database Syst. Rev.* 12, CD005465.
- Canepari, M., Rossi, R., Pellegrino, M. A., Orrell, R. W., Cobbold, M., Harridge, S., et al. (2005). Effects of resistance training on myosin function studied by the in vitro motility assay in young and older men. *J. Appl. Physiol. Bethesda Md 1985* 98, 2390–2395.
- Cannon, W. (1935). Stresses and Strains of Homeostasis. *Am. J. Med. Sci.* 189.
- Capaday, C., and Stein, R. B. (1986). Amplitude modulation of the soleus H-reflex in the human during walking and standing. *J. Neurosci. Off. J. Soc. Neurosci.* 6, 1308–1313.
- Capaday, C., and Stein, R. B. (1987). Difference in the amplitude of the human soleus H reflex during walking and running. *J. Physiol.* 392, 513–522.
- Carpenter, M. G., Frank, J. S., Silcher, C. P., and Peysar, G. W. (2001). The influence of postural threat on the control of upright stance. *Exp. Brain Res.* 138, 210–218.
- Casabona, A., Polizzi, M. C., and Perciavalle, V. (1990). Differences in H-reflex between athletes trained for explosive contractions and non-trained subjects. *Eur. J. Appl. Physiol.* 61, 26–32.
- Casadio, M., Morasso, P. G., and Sanguineti, V. (2005). Direct measurement of ankle stiffness during quiet standing: implications for control modelling and clinical application. *Gait Posture* 21, 410–424.
- Chandler, J. M., Duncan, P. W., and Studenski, S. A. (1990). Balance performance on the postural stress test: comparison of young adults, healthy elderly, and fallers. *Phys. Ther.* 70, 410–415.

- Cheema, S. S., Rustioni, A., and Whitsel, B. L. (1984). Light and electron microscopic evidence for a direct corticospinal projection to superficial laminae of the dorsal horn in cats and monkeys. *J. Comp. Neurol.* 225, 276–290.
- Chen, X. Y., and Wolpaw, J. R. (2002). Probable Corticospinal Tract Control of Spinal Cord Plasticity in the Rat. *J. Neurophysiol.* 87, 645–652.
- Chhabra, M., and Jacobs, R. A. (2006). Properties of Synergies Arising from a Theory of Optimal Motor Behavior. *Neural Comput.* 18, 2320–2342.
- Chiel, H. J., and Beer, R. D. (1997). The brain has a body: adaptive behavior emerges from interactions of nervous system, body and environment. *Trends Neurosci.* 20, 553–557.
- Christakos, C. N., Wolf, H., and Meyer-Lohmann, J. (1983). The ‘M2’ electromyographic response to random perturbations of arm movements is missing in long-trained monkeys. *Neurosci. Lett.* 41, 295–300.
- Clément, G., and Rézette, D. (1985). Motor behavior underlying the control of an upside-down vertical posture. *Exp. Brain Res.* 59, 478–484.
- Coenen, O., Sejnowski, T. J., and Lisberger, S. G. (1993). Biologically Plausible Local Learning Rules for the Adaptation of the Vestibulo-Ocular Reflex. in
- Collins, S. H., Wisse, M., and Ruina, A. (2001). A Three-Dimensional Passive-Dynamic Walking Robot with Two Legs and Knees. *Int. J. Robot. Res.* 20, 607–615.
- Collins, S., Ruina, A., Tedrake, R., and Wisse, M. (2005). Efficient Bipedal Robots Based on Passive-Dynamic Walkers. *Science* 307, 1082–1085.
- Colobert, B., Crétual, A., Allard, P., and Delamarche, P. (2006). Force-plate based computation of ankle and hip strategies from double-inverted pendulum model. *Clin. Biomech.* 21, 427–434.
- Cordo, P. J., and Nashner, L. M. (1982). Properties of postural adjustments associated with rapid arm movements. *J. Neurophysiol.* 47, 287–302.
- Costill, D. L., Daniels, J., Evans, W., Fink, W., Krahenbuhl, G., and Saltin, B. (1976). Skeletal muscle enzymes and fiber composition in male and female track athletes. *J. Appl. Physiol.* 40, 149–154.
- Court-Brown, C. M., Wood, A. M., and Aitken, S. (2008). The epidemiology of acute sports-related fractures in adults. *Injury* 39, 1365–1372.
- Crenna, P., and Frigo, C. (1987). Excitability of the soleus H-reflex arc during walking and stepping in man. *Exp. Brain Res.* 66, 49–60.
- Crenna, P., Frigo, C., Massion, J., and Pedotti, A. (1987). Forward and backward axial synergies in man. *Exp. Brain Res.* 65, 538–548.
- Cully, A., Clune, J., Tarapore, D., and Mouret, J.-B. (2015). Robots that can adapt like animals. *Nature* 521, 503–507.
- Cumming, R. G., Salkeld, G., Thomas, M., and Szonyi, G. (2000). Prospective study of the impact of fear of falling on activities of daily living, SF-36 scores, and nursing home admission. *J. Gerontol. A. Biol. Sci. Med. Sci.* 55, M299–305.

- Cunningham, H. A. (1989). Aiming error under transformed spatial mappings suggests a structure for visual-motor maps. *J. Exp. Psychol. Hum. Percept. Perform.* 15, 493–506.
- Czéh, G., Gallego, R., Kudo, N., and Kuno, M. (1978). Evidence for the maintenance of motoneurone properties by muscle activity. *J. Physiol.* 281, 239–252.
- d'Avella, A., and Bizzi, E. (2005). Shared and specific muscle synergies in natural motor behaviors. *Proc. Natl. Acad. Sci. U. S. A.* 102, 3076.
- d'Avella, A., Saltiel, P., and Bizzi, E. (2003). Combinations of muscle synergies in the construction of a natural motor behavior. *Nat. Neurosci.* 6, 300–308.
- Daley, M. A., Voloshina, A., and Biewener, A. A. (2009). The role of intrinsic muscle mechanics in the neuromuscular control of stable running in the guinea fowl. *J. Physiol.* 587, 2693–2707.
- Darainy, M., Malfait, N., Gribble, P. L., Towhidkhal, F., and Ostry, D. J. (2004). Learning to Control Arm Stiffness Under Static Conditions. *J. Neurophysiol.* 92, 3344–3350.
- Davies, C. T. M., White, M. J., and Young, K. (1983). Muscle function in children. *Eur. J. Appl. Physiol.* 52, 111–114. doi:10.1007/BF00429036.
- Davies, J., Parker, D. F., Rutherford, O. M., and Jones, D. A. (1988). Changes in strength and cross sectional area of the elbow flexors as a result of isometric strength training. *Eur. J. Appl. Physiol.* 57, 667–670.
- De Groot, F., Allen, J. L., and Ting, L. H. (2017). Contribution of muscle short-range stiffness to initial changes in joint kinetics and kinematics during perturbations to standing balance: A simulation study. *J. Biomech.* 55, 71–77.
- de Leon, R. D., Hodgson, J. A., Roy, R. R., and Edgerton, V. R. (1998). Locomotor Capacity Attributable to Step Training Versus Spontaneous Recovery After Spinalization in Adult Cats. *J. Neurophysiol.* 79, 1329–1340.
- De Zeeuw, C. I., and Yeo, C. H. (2005). Time and tide in cerebellar memory formation. *Curr. Opin. Neurobiol.* 15, 667–674.
- Dean, P., Jörntell, H., and Porrill, J. (2013). “Adaptive Filter Models,” in *Handbook of the Cerebellum and Cerebellar Disorders* (Springer, Dordrecht), 1315–1335.
- Degens, H., Meessen, N. E., Wirtz, P., and Binkhorst, R. A. (1995). The development of compensatory hypertrophy in the plantaris muscle of the rat. *Ann. Anat. Anat. Anz. Off. Organ Anat. Ges.* 177, 285–289.
- Delignières, D., Nourrit, D., Sioud, R., Leroyer, P., Zattara, M., and Micallef, J.-P. (1998). Preferred coordination modes in the first steps of the learning of a complex gymnastics skill. *Hum. Mov. Sci.* 17, 221–241.
- Diedrichsen, J. (2007). Optimal Task-Dependent Changes of Bimanual Feedback Control and Adaptation. *Curr. Biol.* 17, 1675–1679.
- Do, M. C., Nouillot, P., and Bouisset, S. (1991). Is balance or posture at the end of a voluntary movement programmed? *Neurosci. Lett.* 130, 9–11.
- Domkin, D., Laczko, J., Jaric, S., Johansson, H., and Latash, M. L. (2002). Structure of joint variability in bimanual pointing tasks. *Exp. Brain Res.* 143, 11–23.

- du Lac, S., Raymond, J. L., Sejnowski, T. J., and Lisberger, S. G. (1995). Learning and Memory in the Vestibulo-Ocular Reflex. *Annu. Rev. Neurosci.* 18, 409–441.
- Duchateau, J., and Baudry, S. (2010). "Training Adaptation of the Neuromuscular System," in *Neuromuscular Aspects of Sport Performance*, ed. P. V. Komi (Wiley-Blackwell), 216–253.
- Duchateau, J., and Hainaut, K. (1984). Isometric or dynamic training: differential effects on mechanical properties of a human muscle. *J. Appl. Physiol.* 56, 296–301.
- Duchateau, J., and Hainaut, K. (1987). Electrical and mechanical changes in immobilized human muscle. *J. Appl. Physiol. Bethesda Md 1985* 62, 2168–2173.
- Duchateau, J., and Hainaut, K. (1991). Effects of immobilization on electromyogram power spectrum changes during fatigue. *Eur. J. Appl. Physiol.* 63, 458–462.
- Duclay, J., Martin, A., Robbe, A., and Pousson, M. (2008). Spinal reflex plasticity during maximal dynamic contractions after eccentric training. *Med. Sci. Sports Exerc.* 40, 722–734.
- Dumas, R., Chèze, L., and Verriest, J.-P. (2007). Adjustments to McConville et al. and Young et al. body segment inertial parameters. *J. Biomech.* 40, 543–553.
- Duncan, P. W., Weiner, D. K., Chandler, J., and Studenski, S. (1990). Functional Reach: A New Clinical Measure of Balance. *J. Gerontol.* 45, M192–M197.
- Ejupi, A., Brodie, M., Gschwind, Y. J., Schoene, D., Lord, S., and Delbaere, K. (2014). Choice stepping reaction time test using exergame technology for fall risk assessment in older people. *Conf. Proc. Annu. Int. Conf. IEEE Eng. Med. Biol. Soc. IEEE Eng. Med. Biol. Soc. Annu. Conf.* 2014, 6957–6960.
- Evans, W. J., and Lexell, J. (1995). Human Aging, Muscle Mass, and Fiber Type Composition. *J. Gerontol. Ser. A* 50A, 11–16.
- Faulstich, B. M., Onori, K. A., and Lac, S. du (2004). Comparison of plasticity and development of mouse optokinetic and vestibulo-ocular reflexes suggests differential gain control mechanisms. *Vision Res.* 44, 3419–3427. doi:<https://doi.org/10.1016/j.visres.2004.09.006>.
- Fisher, A. M., Harting, J. K., Martin, G. F., and Stuber, M. I. (1969). The origin, course and termination of corticospinal fibers in the armadillo (*Dasypus novemcinctus mexicanus*). *J. Neurol. Sci.* 8, 347–361.
- Flanagan, J. R., and Wing, A. M. (1997). The role of internal models in motion planning and control: evidence from grip force adjustments during movements of hand-held loads. *J. Neurosci. Off. J. Soc. Neurosci.* 17, 1519–1528.
- Franklin, D. W., Liaw, G., Milner, T. E., Osu, R., Burdet, E., and Kawato, M. (2007). Endpoint Stiffness of the Arm Is Directionally Tuned to Instability in the Environment. *J. Neurosci.* 27, 7705–7716.
- Franklin, D. W., Osu, R., Burdet, E., Kawato, M., and Milner, T. E. (2003). Adaptation to Stable and Unstable Dynamics Achieved By Combined Impedance Control and Inverse Dynamics Model. *J. Neurophysiol.* 90, 3270–3282.
- Franklin, D. W., So, U., Kawato, M., and Milner, T. E. (2004). Impedance Control Balances Stability With Metabolically Costly Muscle Activation. *J. Neurophysiol.* 92, 3097–3105.

- Frontera, W. R., Hughes, V. A., Fielding, R. A., Fiatarone, M. A., Evans, W. J., and Roubenoff, R. (2000). Aging of skeletal muscle: a 12-yr longitudinal study. *J. Appl. Physiol.* 88, 1321–1326.
- Fukson, O. I., Berkinblit, M. B., and Feldman, A. G. (1980). The spinal frog takes into account the scheme of its body during the wiping reflex. *Science* 209, 1261–1263.
- Gambelli, C. N., Theisen, D., Willems, P. A., and Schepens, B. (2016a). Motor control of landing from a countermovement jump in simulated microgravity. *J. Appl. Physiol.* 120, 1230–1240.
- Gambelli, C., Theisen, D., Willems, P., and Schepens, B. (2016b). Human motor control of landing from a drop in simulated microgravity. *J. Appl. Physiol.* 121, 760.
- Gardiner, P. F., Jasmin, B. J., and Corriveau, P. (1991). Rostrocaudal pattern of fiber-type changes in an overloaded rat ankle extensor. *J. Appl. Physiol. Bethesda Md 1985* 71, 558–564.
- Garfinkel, S., and Cafarelli, E. (1992). Relative changes in maximal force, EMG, and muscle cross-sectional area after isometric training. *Med. Sci. Sports Exerc.* 24, 1220–1227.
- Gill, T. M., Murphy, T. E., Gahbauer, E. A., and Allore, H. G. (2013). Association of Injurious Falls With Disability Outcomes and Nursing Home Admissions in Community-Living Older Persons. *Am. J. Epidemiol.* 178, 418–425.
- Gillespie, L. D., Robertson, M. C., Gillespie, W. J., Lamb, S. E., Gates, S., Cumming, R. G., et al. (2009). Interventions for preventing falls in older people living in the community. *Cochrane Database Syst. Rev.*, CD007146.
- Giszter, S., Mussa-Ivaldi, F., and Bizzi, E. (1993). Convergent force fields organized in the frog's spinal cord. *J. Neurosci.* 13, 467–491.
- Giszter, S., Patil, V., and Hart, C. (2007). "Primitives, premotor drives, and pattern generation: a combined computational and neuroethological perspective," in *Progress in Brain Research Computational Neuroscience: Theoretical Insights into Brain Function.*, eds. P. Cisek, T. Drew, and J. F. Kalaska (Elsevier), 323–346.
- Gordon, T., Tyreman, N., Rafuse, V. F., and Munson, J. B. (1997). Fast-to-Slow Conversion Following Chronic Low-Frequency Activation of Medial Gastrocnemius Muscle in Cats. I. Muscle and Motor Unit Properties. *J. Neurophysiol.* 77, 2585–2604.
- Gray, J., and Lissmann, H. W. (1940). Ambulatory Reflexes in Spinal Amphibians. *J. Exp. Biol.* 17, 237–251.
- Gribble, P. L., Mullin, L. I., Cothros, N., and Mattar, A. (2003). Role of Cocontraction in Arm Movement Accuracy. *J. Neurophysiol.* 89, 2396–2405.
- Grillner, S., and Rossignol, S. (1978). On the initiation of the swing phase of locomotion in chronic spinal cats. *Brain Res.* 146, 269–277.
- Grimby, G., Broberg, C., Krotkiewska, I., and Krotkiewski, M. (1976). Muscle fiber composition in patients with traumatic cord lesion. *Scand. J. Rehabil. Med.* 8, 37–42.
- Guralnik, J. M., Ferrucci, L., Pieper, C. F., Leveille, S. G., Markides, K. S., Ostir, G. V., et al. (2000). Lower extremity function and subsequent disability: consistency across studies, predictive models, and value of gait speed alone compared with the short physical performance battery. *J. Gerontol. A. Biol. Sci. Med. Sci.* 55, M221–231.



- Guralnik, J. M., Simonsick, E. M., Ferrucci, L., Glynn, R. J., Berkman, L. F., Blazer, D. G., et al. (1994). A short physical performance battery assessing lower extremity function: association with self-reported disability and prediction of mortality and nursing home admission. *J. Gerontol.* 49, M85-94.
- Hackney, M. E., and Earhart, G. M. (2010). Effects of Dance on Gait and Balance in Parkinson Disease: A Comparison of Partnered and Non-Partnered Dance Movement. *Neurorehabil. Neural Repair* 24, 384–392.
- Haith, A., and Krakauer, J. (2013). “Theoretical models of motor control and motor learning,” in *The Routledge Handbook of Motor Control and Motor Learning* (Gollhofer A, Taube W, Bo Nielsen J), 7–28.
- Häkkinen, K., Alén, M., and Komi, P. V. (1985). Changes in isometric force- and relaxation-time, electromyographic and muscle fibre characteristics of human skeletal muscle during strength training and detraining. *Acta Physiol. Scand.* 125, 573–585.
- Häkkinen, K., Kallinen, M., Izquierdo, M., Jokelainen, K., Lassila, H., Mälkiä, E., et al. (1998). Changes in agonist-antagonist EMG, muscle CSA, and force during strength training in middle-aged and older people. *J. Appl. Physiol.* 84, 1341–1349.
- Halliday, S., Winter, D., Frank, J., Patla, A., and Prince, F. (1998). The initiation of gait in young, elderly, and Parkinson’s disease subjects. *Gait Posture* 8, 8–14.
- Hammond, P. H. (1956). The influence of prior instruction to the subject on an apparently involuntary neuromuscular response. *J. Physiol.* 132, 17-18P.
- Hanta, V., and Procházka, A. (2009). *Rational Approximation of Time Delay*.
- Harwood, R. H., Foss, A. J. E., Osborn, F., Gregson, R. M., Zaman, A., and Masud, T. (2005). Falls and health status in elderly women following first eye cataract surgery: a randomised controlled trial. *Br. J. Ophthalmol.* 89, 53–59.
- Hasan, Z. (2005). The human motor control system’s response to mechanical perturbation: should it, can it, and does it ensure stability? *J. Mot. Behav.* 37, 484–493.
- Hather, B. M., Tesch, P. A., Buchanan, P., and Dudley, G. A. (1991). Influence of eccentric actions on skeletal muscle adaptations to resistance training. *Acta Physiol. Scand.* 143, 177–185.
- Hausdorff, J. M., Rios, D. A., and Edelberg, H. K. (2001). Gait variability and fall risk in community-living older adults: a 1-year prospective study. *Arch. Phys. Med. Rehabil.* 82, 1050–1056.
- Herbison, G. J., Jaweed, M. M., and Ditunno, J. F. (1979). Muscle atrophy in rats following denervation, casting, inflammation, and tenotomy. *Arch. Phys. Med. Rehabil.* 60, 401–404.
- Hettich, G., Aszländer, L., Gollhofer, A., and Mergner, T. (2014). Human hip–ankle coordination emerging from multisensory feedback control. *Hum. Mov. Sci.* 37, 123–146.
- Hickson, R. C., Hidaka, K., Foster, C., Falduto, M. T., and Chatterton, R. T. (1994). Successive time courses of strength development and steroid hormone responses to heavy-resistance training. *J. Appl. Physiol.* 76, 663–670. doi:10.1152/jappl.1994.76.2.663.
- Hill, K., Schwarz, J., Flicker, L., and Carroll, S. (1999). Falls among healthy, community-dwelling, older women: a prospective study of frequency, circumstances, consequences and prediction accuracy. *Aust. N. Z. J. Public Health* 23, 41–48.

- Hogan, N. (1985). The mechanics of multi-joint posture and movement control. *Biol. Cybern.* 52, 315–331.
- Holmberg, H., and Schouenborg, J. (1996). Postnatal development of the nociceptive withdrawal reflexes in the rat: a behavioural and electromyographic study. *J. Physiol.* 493 ( Pt 1), 239–252.
- Holmberg, H., Schouenborg, J., Yu, Y.-B., and Weng, H.-R. (1997). Developmental Adaptation of Rat Nociceptive Withdrawal Reflexes after Neonatal Tendon Transfer. *J. Neurosci.* 17, 2071–2078.
- Holmes, J., Powell-Griner, E., Lethbridge-Cejku, M., and Heyman, K. (2009). Aging differently: Physical limitations among adults aged 50 years and over: United States, 2001-2007. *NCHS Data Brief*, 1–8.
- Horak, F. B. (2006). Postural orientation and equilibrium: what do we need to know about neural control of balance to prevent falls? *Age Ageing* 35 Suppl 2, ii7–ii11.
- Horak, F. B., Dimitrova, D., and Nutt, J. G. (2005). Direction-specific postural instability in subjects with Parkinson's disease. *Exp. Neurol.* 193, 504–521.
- Horak, F. B., and Nashner, L. M. (1986). Central programming of postural movements: adaptation to altered support-surface configurations. *J. Neurophysiol.* 55, 1369–1381.
- Horak, F. B., Wrisley, D. M., and Frank, J. (2009). The Balance Evaluation Systems Test (BESTest) to Differentiate Balance Deficits. *Phys. Ther.* 89, 484–498.
- Hortobágyi, T., Hill, J. P., Houmard, J. A., Fraser, D. D., Lambert, N. J., and Israel, R. G. (1996). Adaptive responses to muscle lengthening and shortening in humans. *J. Appl. Physiol. Bethesda Md* 1985 80, 765–772.
- Iida, F., and Pfeifer, R. (2004). Cheap rapid locomotion of a quadruped robot: Self-stabilization of bounding gait. in *In: Proceedings of the International Conference on Intelligent Autonomous Systems*, 642–649.
- INSEE (2010). Projections de population à l'horizon 2060.
- Ito, M., and Nagao, S. (1991). Comparative aspects of horizontal ocular reflexes and their cerebellar adaptive control in vertebrates. *Comp. Biochem. Physiol. Part C Comp. Pharmacol.* 98, 221–228.
- Jones, D. A., and Rutherford, O. M. Human muscle strength training: the effects of three different regimens and the nature of the resultant changes. *J. Physiol.* 391, 1–11. doi:10.1113/jphysiol.1987.sp016721.
- Kalman, R. E. (1960). Contributions to the theory of optimal control. *Boletín Soc. Matemática Mex.* 5, 102–119.
- Kamen, G., and Knight, C. A. (2004). Training-related adaptations in motor unit discharge rate in young and older adults. *J. Gerontol. A. Biol. Sci. Med. Sci.* 59, 1334–1338.
- Kargo, W. J., and Giszter, S. F. (2000). Rapid Correction of Aimed Movements by Summation of Force-Field Primitives. *J. Neurosci.* 20, 409–426.
- Kario, K., Tobin, J. N., Wolfson, L. I., Whipple, R., Derby, C. A., Singh, D., et al. (2001). Lower standing systolic blood pressure as a predictor of falls in the elderly: a community-based prospective study. *J. Am. Coll. Cardiol.* 38, 246–252.
- Kawato, M. (1999). Internal models for motor control and trajectory planning. *Curr. Opin. Neurobiol.* 9, 718–727.
- Knikou, M. (2008). The H-reflex as a probe: Pathways and pitfalls. *J. Neurosci. Methods* 171, 1–12.

- Koceja, D. M., Markus, C. A., and Trimble, M. H. (1995). Postural modulation of the soleus H reflex in young and old subjects. *Electroencephalogr. Clin. Neurophysiol.* 97, 387–393.
- Koceja, D. M., and Mynark, R. G. (2000). Comparison of heteronymous monosynaptic Ia facilitation in young and elderly subjects in supine and standing positions. *Int. J. Neurosci.* 103, 1–17.
- Komi, P. V. (1986). Training of muscle strength and power: interaction of neuromotoric, hypertrophic, and mechanical factors. *Int. J. Sports Med.* 7 Suppl 1, 10–15.
- Krakauer, J. W., Pine, Z. M., Ghilardi, M.-F., and Ghez, C. (2000). Learning of Visuomotor Transformations for Vectorial Planning of Reaching Trajectories. *J. Neurosci.* 20, 8916–8924.
- Krutky, M. A., Ravichandran, V. J., Trumbower, R. D., and Perreault, E. J. (2009). Interactions Between Limb and Environmental Mechanics Influence Stretch Reflex Sensitivity in the Human Arm. *J. Neurophysiol.* 103, 429–440.
- Kuo, A. D., and Donelan, J. M. (2010). Dynamic principles of gait and their clinical implications. *Phys. Ther.* 90, 157–174.
- Kuypers, H. G. J. M. (2011). “Anatomy of the Descending Pathways,” in *Comprehensive Physiology* (American Cancer Society), 597–666.
- Lafage, V., Schwab, F., Skalli, W., Hawkinson, N., Gagey, P.-M., Ondra, S., et al. (2008). Standing balance and sagittal plane spinal deformity: analysis of spinopelvic and gravity line parameters. *Spine* 33, 1572–1578.
- Land, M. F. (2015). Eye movements of vertebrates and their relation to eye form and function. *J. Comp. Physiol. A* 201, 195–214.
- Lang, C. B., and Kearney, R. E. (2014). Modulation of ankle stiffness during postural sway. in *2014 36th Annual International Conference of the IEEE Engineering in Medicine and Biology Society*, 4062–4065.
- Latash, M. L. (2010). Motor Synergies and the Equilibrium-Point Hypothesis. *Motor Control* 14, 294–322.
- Latash, M. L., Scholz, J. P., and Schöner, G. (2002). Motor control strategies revealed in the structure of motor variability. *Exerc. Sport Sci. Rev.* 30, 26–31.
- Le Mouel, C., and Brette, R. (2016a). Coadaptation of anticipatory and reactive postural adjustments. *Poster presented at the Neuromechanics of Human Movement conference*
- Le Mouel, C., and Brette, R. (2016b). Learning posture through movement. *Poster presented at the Neural Control of Movement conference*
- Le Mouel, C., and Brette, R. (2017a). Adjustment of posture and neural control in standing balance. *Poster presented at the Neural Control of Movement conference*
- Le Mouel, C., and Brette, R. (2017b). Mobility as the Purpose of Postural Control. *Front. Comput. Neurosci.* 11, 67.
- Le Mouel, C., and Brette, R. (2017c). Mobility as the purpose of postural control. *Poster presented at the Neural Control of Movement conference*
- LeBlanc, A., Schneider, V., Shackelford, L., West, S., Oganov, V., Bakulin, A., et al. (2000). Bone mineral and lean tissue loss after long duration space flight. *J. Musculoskelet. Neuronal Interact.* 1, 157–160.

- Leblond, H., L'Espérance, M., Orsal, D., and Rossignol, S. (2003). Treadmill Locomotion in the Intact and Spinal Mouse. *J. Neurosci.* 23, 11411–11419.
- Ledebt, A., Bril, B., and Brenière, Y. (1998). The build-up of anticipatory behaviour. An analysis of the development of gait initiation in children. *Exp. Brain Res.* 120, 9–17.
- Lederman, E. (2011). The fall of the postural-structural-biomechanical model in manual and physical therapies: exemplified by lower back pain. *J. Bodyw. Mov. Ther.* 15, 131–138.
- Lee, W. A., Michaels, C. F., and Pai, Y. C. (1990). The organization of torque and EMG activity during bilateral handle pulls by standing humans. *Exp. Brain Res.* 82, 304–314.
- Levinsson, A., Luo, X.-L., Holmberg, H., and Schouenborg, J. (1999). Developmental Tuning in a Spinal Nociceptive System: Effects of Neonatal Spinalization. *J. Neurosci.* 19, 10397–10403.
- Li, F. (2014). Transforming traditional Tai Ji Quan techniques into integrative movement therapy-Tai Ji Quan: Moving for Better Balance. *J. Sport Health Sci.* 3, 9–15.
- Liang, P., Moret, V., Wiesendanger, M., and Rouiller, E. M. Corticomotoneuronal connections in the rat: Evidence from double-labeling of motoneurons and corticospinal axon arborizations. *J. Comp. Neurol.* 311, 356–366.
- Lin, M.-R., Hwang, H.-F., Hu, M.-H., Wu, H.-D. I., Wang, Y.-W., and Huang, F.-C. (2004). Psychometric comparisons of the timed up and go, one-leg stand, functional reach, and Tinetti balance measures in community-dwelling older people. *J. Am. Geriatr. Soc.* 52, 1343–1348.
- Lin, S.-I., and Woollacott, M. H. (2002). Postural Muscle Responses Following Changing Balance Threats in Young, Stable Older, and Unstable Older Adults. *J. Mot. Behav.* 34, 37–44.
- Lipsitz, L. A., Jonsson, P. V., Kelley, M. M., and Koestner, J. S. (1991). Causes and Correlates of Recurrent Falls in Ambulatory Frail Elderly. *J. Gerontol.* 46, M114–M122.
- Llewellyn, M., Yang, J. F., and Prochazka, A. (1990). Human H-reflexes are smaller in difficult beam walking than in normal treadmill walking. *Exp. Brain Res.* 83, 22–28.
- Loeb, G. E. (2012). Optimal isn't good enough. *Biol. Cybern.* 106, 757–765.
- Loram, I. D., Kelly, S. M., and Lakie, M. (2001). Human balancing of an inverted pendulum: is sway size controlled by ankle impedance? *J. Physiol.* 532, 879–891.
- Loram, I. D., and Lakie, M. (2002). Direct measurement of human ankle stiffness during quiet standing: the intrinsic mechanical stiffness is insufficient for stability. *J. Physiol.* 545, 1041–1053.
- Loram, I. D., Maganaris, C. N., and Lakie, M. (2007). The passive, human calf muscles in relation to standing: the non-linear decrease from short range to long range stiffness. *J. Physiol.* 584, 661–675.
- Lord, S. R., Clark, R. D., and Webster, I. W. (1991). Physiological Factors Associated with Falls in an Elderly Population. *J. Am. Geriatr. Soc.* 39, 1194–1200.
- Lord, S. R., and Fitzpatrick, R. C. (2001). Choice Stepping Reaction Time: A Composite Measure of Falls Risk in Older People. *J. Gerontol. A. Biol. Sci. Med. Sci.* 56, M627–M632.
- Luchies, C. W., Alexander, N. B., Schultz, A. B., and Ashton-Miller, J. (1994). Stepping responses of young and old adults to postural disturbances: kinematics. *J. Am. Geriatr. Soc.* 42, 506–512.

- Maffiuletti, N. A., Martin, A., Babault, N., Pensini, M., Lucas, B., and Schieppati, M. (2001). Electrical and mechanical H(max)-to-M(max) ratio in power- and endurance-trained athletes. *J. Appl. Physiol. Bethesda Md* 1985 90, 3–9.
- Maier, A., Gorza, L., Schiaffino, S., and Pette, D. (1988). A combined histochemical and immunohistochemical study on the dynamics of fast-to-slow fiber transformation in chronically stimulated rabbit muscle. *Cell Tissue Res.* 254, 59–68.
- Maki, B. E., Holliday, P. J., and Fernie, G. R. (1990). Aging and postural control. A comparison of spontaneous- and induced-sway balance tests. *J. Am. Geriatr. Soc.* 38, 1–9.
- Maki, B. E., Holliday, P. J., and Topper, A. K. (1994). A prospective study of postural balance and risk of falling in an ambulatory and independent elderly population. *J. Gerontol.* 49, M72-84.
- Maki, B. E., McIlroy, W. E., and Fernie, G. R. (2003). Change-in-support reactions for balance recovery. *IEEE Eng. Med. Biol. Mag. Q. Mag. Eng. Med. Biol. Soc.* 22, 20–26.
- Maki, B. E., and Ostrovski, G. (1993). Scaling of postural responses to transient and continuous perturbations - ScienceDirect.
- Maki, B. E., and Whitelaw, R. S. (1993). Influence of expectation and arousal on center-of-pressure responses to transient postural perturbations. *J. Vestib. Res. Equilib. Orientat.* 3, 25–39.
- Manchester, D., Woollacott, M., Zederbauer-Hylton, N., and Marin, O. (1989). Visual, vestibular and somatosensory contributions to balance control in the older adult. *J. Gerontol.* 44, M118-127.
- Mancini, M., Chiari, L., Holmstrom, L., Salarian, A., and Horak, F. B. (2016). Validity and reliability of an IMU-based method to detect APAs prior to gait initiation. *Gait Posture* 43, 125–131.
- Marcus, R. (2002). "Chapter 86 - Mechanisms of Exercise Effects on Bone," in *Principles of Bone Biology (Second Edition)*, eds. J. P. Bilezikian, L. G. Raisz, and G. A. Rodan (San Diego: Academic Press), 1477–1488.
- Marsden, C. D., Merton, P. A., and Morton, H. B. (1981). Human postural responses. *Brain J. Neurol.* 104, 513–534.
- Martin, G. F., and Fisher, A. M. (1968). A further evaluation of the origin, the course and the termination of the opossum corticospinal tract. *J. Neurol. Sci.* 7, 177–187.
- Massion, J., Alexandrov, A., and Frolov, A. (2004). Why and how are posture and movement coordinated? *Prog. Brain Res.* 143, 13–27.
- Masud, T., and Morris, R. O. (2001). Epidemiology of falls. *Age Ageing* 30 Suppl 4, 3–7.
- Mathias, S., Nayak, U. S., and Isaacs, B. (1986). Balance in elderly patients: the "get-up and go" test. *Arch. Phys. Med. Rehabil.* 67, 387–389.
- Mattar, A. A. G., and Ostry, D. J. (2010). Generalization of dynamics learning across changes in movement amplitude. *J. Neurophysiol.* 104, 426–438.
- Maughan, R. J., Watson, J. S., and Weir, J. (1983). Strength and cross-sectional area of human skeletal muscle. *J. Physiol.* 338, 37–49.
- McConville, J. T., Clauser, C. E., Churchill, T. D., Cuzzi, J., and Kaleps, I. (1980). Anthropometric Relationships of Body and Body Segment Moments of Inertia. ANTHROPOLOGY RESEARCH PROJECT INC YELLOW SPRINGS OH.

- McGeer, T. (1990). Passive Dynamic Walking. *Int. J. Robot. Res.* 9, 62–82.
- McMillan, G. K. (1983). *Tuning and control loop performance*. Instrument Society of America.
- Melzer, I., Kurz, I., Shahar, D., Levi, M., and Oddsson, L. (2007). Application of the voluntary step execution test to identify elderly fallers. *Age Ageing* 36, 532–537.
- Melzer, I., Kurz, I., Shahar, D., and Oddsson, L. I. E. (2010). Do voluntary step reactions in dual task conditions have an added value over single task for fall prediction? A prospective study. *Aging Clin. Exp. Res.* 22, 360–366.
- Michiels, W., and Niculescu, S. (2007). *Stability and Stabilization of Time-Delay Systems*. Society for Industrial and Applied Mathematics.
- Mille, M.-L., Johnson-Hilliard, M., Martinez, K. M., Zhang, Y., Edwards, B. J., and Rogers, M. W. (2013). One Step, Two Steps, Three Steps More ... Directional Vulnerability to Falls in Community-Dwelling Older People. *J. Gerontol. Ser. A* 68, 1540–1548.
- Mille, M.-L., Rogers, M. W., Martinez, K., Hedman, L. D., Johnson, M. E., Lord, S. R., et al. (2003). Thresholds for Inducing Protective Stepping Responses to External Perturbations of Human Standing. *J. Neurophysiol.* 90, 666–674.
- Morasso, P. (1981). Spatial control of arm movements. *Exp. Brain Res.* 42, 223–227.
- Moritani, T., and deVries, H. A. (1979). Neural factors versus hypertrophy in the time course of muscle strength gain. *Am. J. Phys. Med.* 58, 115–130.
- Müller, H., and Sternad, D. (2009). Motor learning: changes in the structure of variability in a redundant task. *Adv. Exp. Med. Biol.* 629, 439–456.
- Mutha, P. K., and Sainburg, R. L. (2009). Shared Bimanual Tasks Elicit Bimanual Reflexes During Movement. *J. Neurophysiol.* 102, 3142–3155.
- Myers, T. W. (2013). *Anatomy Trains: Myofascial Meridians for Manual and Movement Therapists*.
- Mynark, R. G., and Koceja, D. M. (1997). Comparison of soleus H-reflex gain from prone to standing in dancers and controls. *Electroencephalogr. Clin. Neurophysiol.* 105, 135–140.
- Mynark, R. G., and Koceja, D. M. (2002). Down training of the elderly soleus H reflex with the use of a spinally induced balance perturbation. *J. Appl. Physiol. Bethesda Md 1985* 93, 127–133.
- Nagai, K., Yamada, M., Uemura, K., Yamada, Y., Ichihashi, N., and Tsuboyama, T. (2011). Differences in muscle coactivation during postural control between healthy older and young adults. *Arch. Gerontol. Geriatr.* 53, 338–343.
- Nardone, A., and Schieppati, M. (1988). Postural adjustments associated with voluntary contraction of leg muscles in standing man. *Exp. Brain Res.* 69, 469–480.
- Narici, M. V., Hoppeler, H., Kayser, B., Landoni, L., Claassen, H., Gavardi, C., et al. (1996). Human quadriceps cross-sectional area, torque and neural activation during 6 months strength training. *Acta Physiol. Scand.* 157, 175–186. doi:10.1046/j.1365-201X.1996.483230000.x.

- Narici, M. V., Roi, G. S., Landoni, L., Minetti, A. E., and Cerretelli, P. (1989). Changes in force, cross-sectional area and neural activation during strength training and detraining of the human quadriceps. *Eur. J. Appl. Physiol.* 59, 310–319.
- Nashner, L. M., Shupert, C. L., Horak, F. B., and Black, F. O. (1989). Organization of posture controls: an analysis of sensory and mechanical constraints. *Prog. Brain Res.* 80, 411–418; discussion 395–397.
- Nevitt, M. C., Cummings, S. R., Kidd, S., and Black, D. (1989). Risk factors for recurrent nonsyncopal falls. A prospective study. *JAMA* 261, 2663–2668.
- Nielsen, J., Crone, C., and Hultborn, H. (1993). H-reflexes are smaller in dancers from The Royal Danish Ballet than in well-trained athletes. *Eur. J. Appl. Physiol.* 66, 116–121.
- Nielsen, J., Sinkjær, T., Toft, E., and Kagamihara, Y. (1994). Segmental reflexes and ankle joint stiffness during co-contraction of antagonistic ankle muscles in man. *Exp. Brain Res.* 102, 350–358. doi:10.1007/BF00227521.
- Nishikawa, K., Biewener, A. A., Aerts, P., Ahn, A. N., Chiel, H. J., Daley, M. A., et al. (2007). Neuromechanics: an integrative approach for understanding motor control. *Integr. Comp. Biol.* 47, 16–54.
- Nudo, R. J., and Masterton, R. B. (1988). Descending pathways to the spinal cord: a comparative study of 22 mammals. *J. Comp. Neurol.* 277, 53–79. doi:10.1002/cne.902770105.
- Nyquist, H. (1932). Regeneration theory. *Bell Syst. Tech. J.* 11, 126–147. doi:10.1002/j.1538-7305.1932.tb02344.x.
- Ochala, J., Frontera, W. R., Dorer, D. J., Van, J. H., and Krivickas, L. S. (2007). Single skeletal muscle fiber elastic and contractile characteristics in young and older men. *J. Gerontol. A. Biol. Sci. Med. Sci.* 62, 375–381.
- Ohira, Y., Edgerton, V. R., Il'ina-Kakueva, E. I., Jiang, B., Marini, J. F., Oganov, V., et al. (1992). Rat soleus muscle fiber responses to 14 days of spaceflight and hindlimb suspension.
- Okumiya, K., Matsubayashi, K., Nakamura, T., Fujisawa, M., Osaki, Y., Doi, Y., et al. (1998). The timed “up & go” test is a useful predictor of falls in community-dwelling older people. *J. Am. Geriatr. Soc.* 46, 928–930.
- Olha, A. E., Jasmin, B. J., Michel, R. N., and Gardiner, P. F. (1988). Physiological responses of rat plantaris motor units to overload induced by surgical removal of its synergists. *J. Neurophysiol.* 60, 2138–2151.
- Overduin, S. A., d’Avella, A., Carmena, J. M., and Bizzi, E. (2012). Microstimulation Activates a Handful of Muscle Synergies. *Neuron* 76, 1071–1077.
- Patten, C., Kamen, G., and Rowland, D. M. (2001). Adaptations in maximal motor unit discharge rate to strength training in young and older adults. *Muscle Nerve* 24, 542–550.
- Patterson, M. F., Stephenson, G. M. M., and Stephenson, D. G. (2006). Denervation produces different single fiber phenotypes in fast- and slow-twitch hindlimb muscles of the rat. *Am. J. Physiol.-Cell Physiol.* 291, 518–528.
- Pearson, K. G., Fouad, K., and Misiaszek, J. E. (1999). Adaptive changes in motor activity associated with functional recovery following muscle denervation in walking cats. *J. Neurophysiol.* 82, 370–381.
- Pedotti, A., Crenna, P., Deat, A., Frigo, C., and Massion, J. (1989). Postural synergies in axial movements: short and long-term adaptation. *Exp. Brain Res.* 74, 3–10.
- Perreault, E. J., Chen, K., Trumbower, R. D., and Lewis, G. (2008). Interactions With Compliant Loads Alter Stretch Reflex Gains But Not Intermuscular Coordination. *J. Neurophysiol.* 99, 2101–2113.

- Petras, J. M. (1968). Corticospinal fibers in New World and Old World simians. *Brain Res.* 8, 206–208.
- Pfeifer, R., and Bongard, J. C. (2006). *How the Body Shapes the Way We Think: A New View of Intelligence (Bradford Books)*. The MIT Press.
- Pijnappels, M., Delbaere, K., Sturnieks, D. L., and Lord, S. R. (2010). The association between choice stepping reaction time and falls in older adults: a path analysis model. *AGE AGEING* 39, 99–104.
- Pinar, S., Kitano, K., and Koceja, D. M. (2010). Role of vision and task complexity on soleus H-reflex gain. *J. Electromyogr. Kinesiol. Off. J. Int. Soc. Electrophysiol. Kinesiol.* 20, 354–358.
- Podsiadlo, D., and Richardson, S. (1991). The timed “Up & Go”: a test of basic functional mobility for frail elderly persons. *J. Am. Geriatr. Soc.* 39, 142–148.
- Pruszynski, J. A., Kurtzer, I., and Scott, S. H. (2008). Rapid Motor Responses Are Appropriately Tuned to the Metrics of a Visuospatial Task. *J. Neurophysiol.* 100, 224–238.
- Pruszynski, J. A., and Scott, S. H. (2012). Optimal feedback control and the long-latency stretch response. *Exp. Brain Res.* 218, 341–359.
- Rancourt, D., and Hogan, N. (2001). Stability in Force-Production Tasks. *J. Mot. Behav.* 33, 193–204.
- Robbins, A., Rubenstein, L., Josephson, K., Schulman, B., Osterweil, D., and Fine, G. (1989). Predictors of falls among elderly people: Results of two population-based studies. *Arch. Intern. Med.* 149, 1628–1633.
- Robinovitch, S. N., Feldman, F., Yang, Y., Schonnop, R., Leung, P. M., Sarraf, T., et al. (2013). Video capture of the circumstances of falls in elderly people residing in long-term care: an observational study. *Lancet Lond. Engl.* 381, 47–54.
- Rochongar, P., Dassonville, J., and Le Bars, R. (1979). [Modification of the Hoffmann reflex in function of athletic training (author’s transl)]. *Eur. J. Appl. Physiol.* 40, 165–170.
- Rossignol, S., Chau, C., Brusteijn, E., Bélanger, M., Barbeau, H., and Drew, T. (1996). Locomotor capacities after complete and partial lesions of the spinal cord. *Acta Neurobiol. Exp. (Warsz.)* 56, 449–463.
- Rossignol, S., Dubuc, R., and Gossard, J.-P. (2006). Dynamic sensorimotor interactions in locomotion. *Physiol. Rev.* 86, 89–154.
- Rovainen, C. M. (1979). Neurobiology of lampreys. *Physiol. Rev.* 59, 1007–1077.
- Sabbahi, M. A., and Sedgwick, E. M. (1982). Age-related changes in monosynaptic reflex excitability. *J. Gerontol.* 37, 24–32.
- Saltiel, P., Wyler-Duda, K., D’Avella, A., Tresch, M. C., and Bizzi, E. (2001). Muscle Synergies Encoded Within the Spinal Cord: Evidence From Focal Intraspinal NMDA Iontophoresis in the Frog. *J. Neurophysiol.* 85, 605–619.
- Sanger, T. D. (1994). Optimal unsupervised motor learning for dimensionality reduction of nonlinear control systems. *IEEE Trans. Neural Netw.* 5, 965–973.
- Sasagawa, S., Ushiyama, J., Masani, K., Kouzaki, M., and Kanehisa, H. (2009). Balance control under different passive contributions of the ankle extensors: quiet standing on inclined surfaces. *Exp. Brain Res.* 196, 537–544.



- Sawers, A., Allen, J. L., and Ting, L. H. (2015). Long-term training modifies the modular structure and organization of walking balance control. *J. Neurophysiol.* 114, 3359–3373. doi:10.1152/jn.00758.2015.
- Scaglioni, G., Narici, M. V., Maffiuletti, N. A., Pensini, M., and Martin, A. (2004). Effect of ageing on the electrical and mechanical properties of human soleus motor units activated by the H reflex and M wave. *J. Physiol.* 548, 649–661.
- Schiaffino, S., and Reggiani, C. (2011). Fiber types in mammalian skeletal muscles. *Physiol. Rev.* 91, 1447–1531.
- Schieppati, M., Hugon, M., Grasso, M., Nardone, A., and Galante, M. (1994). The limits of equilibrium in young and elderly normal subjects and in parkinsonians. *Electroencephalogr. Clin. Neurophysiol.* 93, 286–298.
- Schmidt, R. A., Zelaznik, H., Hawkins, B., Frank, J. S., and Quinn, J. T. (1979). Motor-output variability: a theory for the accuracy of rapid motor acts. *Psychol. Rev.* 47, 415–451.
- Schneider, C., and Capaday, C. (2003). Progressive Adaptation of the Soleus H-Reflex With Daily Training at Walking Backward. *J. Neurophysiol.* 89, 648–656.
- Scholz, J. P., and Schöner, G. (1999). The uncontrolled manifold concept: identifying control variables for a functional task. *Exp. Brain Res.* 126, 289–306.
- Scholz, J. P., Schöner, G., and Latash, M. L. (2000). Identifying the control structure of multijoint coordination during pistol shooting. *Exp. Brain Res.* 135, 382–404.
- Schouenborg, J., Holmberg, H., and Weng, H.-R. (1992). Functional organization of the nociceptive withdrawal reflexes II. Changes of excitability and receptive fields after spinalization in the rat. *Exp. Brain Res.* 90, 469–478.
- Schouenborg, J., and Kalliomäki, J. (1990). Functional organization of the nociceptive withdrawal reflexes I. Activation of hindlimb muscles in the rat. *Exp. Brain Res.* 83, 67–78.
- Schulkin, J. (2003). *Rethinking homeostasis : allostatic regulation in physiology and pathophysiology*. MIT Press.
- Schwab, F., Lafage, V., Boyce, R., Skalli, W., and Farcy, J.-P. (2006). Gravity line analysis in adult volunteers: age-related correlation with spinal parameters, pelvic parameters, and foot position. *Spine* 31, E959-967.
- Scohier, M., De Jaeger, D., and Schepens, B. (2014). Triceps Suræ Stretch Reflex Modulation After a Mechanically Evoked Ankle Dorsiflexion During the Swing Phase of Human Running. *Motor Control* 18, 383–394.
- Seyfarth, A., Geyer, H., and Herr, H. (2003). Swing-leg retraction: a simple control model for stable running. *J. Exp. Biol.* 206, 2547–2555.
- Seyfarth, A., Günther, M., and Blickhan, R. (2001). Stable operation of an elastic three-segment leg. *Biol. Cybern.* 84, 365–382.
- Seynnes, O. R., de Boer, M., and Narici, M. V. (2007). Early skeletal muscle hypertrophy and architectural changes in response to high-intensity resistance training. *J. Appl. Physiol. Bethesda Md* 102, 368–373.
- Shadmehr, R., and Moussavi, Z. M. K. (2000). Spatial generalization from learning dynamics of reaching movements. *J. Neurosci.* 20, 7807–7815.
- Shadmehr, R., and Mussa-Ivaldi, F. A. (1994). Adaptive representation of dynamics during learning of a motor task. *J. Neurosci. Off. J. Soc. Neurosci.* 14, 3208–3224.

- Sibley, K. M., Carpenter, M. G., Perry, J. C., and Frank, J. S. (2007). Effects of postural anxiety on the soleus H-reflex. *Hum. Mov. Sci.* 26, 103–112.
- Sing, G. C., Joiner, W. M., Nanayakkara, T., Brayonov, J. B., and Smith, M. A. (2009). Primitives for Motor Adaptation Reflect Correlated Neural Tuning to Position and Velocity. *Neuron* 64, 575–589.
- Sinha, T., and Maki, B. E. (1996). Effect of forward lean on postural ankle dynamics. *IEEE Trans. Rehabil. Eng.* 4, 348–359.
- Slawinski, J., Bonnefoy, A., Levêque, J.-M., Ontanon, G., Riquet, A., Dumas, R., et al. (2010). Kinematic and kinetic comparisons of elite and well-trained sprinters during sprint start. *J. Strength Cond. Res.* 24, 896–905.
- Smith, S. M., Davis-Street, J. E., Fesperman, J. V., Calkins, D. S., Bawa, M., Macias, B. R., et al. (2003). Evaluation of treadmill exercise in a lower body negative pressure chamber as a countermeasure for weightlessness-induced bone loss: a bed rest study with identical twins. *J. Bone Miner. Res. Off. J. Am. Soc. Bone Miner. Res.* 18, 2223–2230.
- Speechley, M., and Tinetti, M. (1991). Falls and injuries in frail and vigorous community elderly persons. *J. Am. Geriatr. Soc.* 39, 46–52.
- Spröwitz, A. T., Ajallooeian, M., Tuleu, A., and Ijspeert, A. J. (2014). Kinematic primitives for walking and trotting gaits of a quadruped robot with compliant legs. *Front. Comput. Neurosci.* 8, 27.
- Staron, R. S., Leonardi, M. J., Karapondo, D. L., Malicky, E. S., Falkel, J. E., Hagerman, F. C., et al. (1991). Strength and skeletal muscle adaptations in heavy-resistance-trained women after detraining and retraining. *J. Appl. Physiol.* 70, 631–640.
- Stein, G. (1980). “ADAPTIVE FLIGHT CONTROL: A PRAGMATIC VIEW,” in *Applications of Adaptive Control*, eds. K. S. Narendra and R. V. Monopoli (Academic Press), 291–312.
- Sterling, P. (2004). “Principles of allostasis: optimal design, predictive regulation, pathophysiology and rational therapeutics,” in *Allostasis, Homeostasis, and the Costs of Adaptation* (J. Schulkin).
- Stevens, J. A., Corso, P. S., Finkelstein, E. A., and Miller, T. R. (2006). The costs of fatal and non-fatal falls among older adults. *Inj. Prev.* 12, 290–295.
- Studenski, S., Duncan, P. W., and Chandler, J. (1991). Postural responses and effector factors in persons with unexplained falls: results and methodologic issues. *J. Am. Geriatr. Soc.* 39, 229–234.
- Studenski, S., Perera, S., Patel, K., Rosano, C., Faulkner, K., Inzitari, M., et al. (2011). Gait speed and survival in older adults. *JAMA* 305, 50–58.
- Suzuki, Y., Nomura, T., and Morasso, P. (2011). Stability of a double inverted pendulum model during human quiet stance with continuous delay feedback control. *Conf. Proc. Annu. Int. Conf. IEEE Eng. Med. Biol. Soc. IEEE Eng. Med. Biol. Soc. Annu. Conf.* 2011, 7450–7453.
- Taube, W., Kullmann, N., Leukel, C., Kurz, O., Amtage, F., and Gollhofer, A. (2007). Differential reflex adaptations following sensorimotor and strength training in young elite athletes. *Int. J. Sports Med.* 28, 999–1005.
- Ten Donkelaar, H. J. (1976). Descending pathways from the brain stem to the spinal cord in some reptiles. II. Course and site of termination. *J. Comp. Neurol.* 167, 443–463.

- Ten Donkelaar, H. J. (1982). Organization of descending pathways to the spinal cord in amphibians and reptiles. *Prog. Brain Res.* 57, 25–67.
- Ten Donkelaar, H. J. (1988). Evolution of the red nucleus and rubrospinal tract. *Behav. Brain Res.* 28, 9–20.
- Ten Donkelaar, H. J. (2000). Development and regenerative capacity of descending supraspinal pathways in tetrapods: a comparative approach. *Adv. Anat. Embryol. Cell Biol.* 154, iii–ix, 1–145.
- Tinetti, M. E. (1986). Performance-oriented assessment of mobility problems in elderly patients. *J. Am. Geriatr. Soc.* 34, 119–126.
- Tinetti, M. E., and Speechley, M. (1989). Prevention of Falls among the Elderly. *N. Engl. J. Med.* 320, 1055–1059.
- Tinetti, M. E., Speechley, M., and Ginter, S. F. (1988). Risk factors for falls among elderly persons living in the community. *N. Engl. J. Med.* 319, 1701–1707.
- Tinetti, M. E., Williams, T. F., and Mayewski, R. (1986). Fall risk index for elderly patients based on number of chronic disabilities. *Am. J. Med.* 80, 429–434.
- Ting, L. H., and McKay, J. L. (2007). Neuromechanics of muscle synergies for posture and movement. *Curr. Opin. Neurobiol.* 17, 622–628.
- Tisserand, R. (2015). Mécanismes du rattrapage de l'équilibre et évaluation du risque de chute chez une population âgée autonome.
- Tisserand, R., Robert, T., Chabaud, P., Bonnefoy, M., and Chèze, L. (2016a). Elderly Fallers Enhance Dynamic Stability Through Anticipatory Postural Adjustments during a Choice Stepping Reaction Time. *Front. Hum. Neurosci.* 10, 613.
- Tisserand, R., Robert, T., Dumas, R., and Chèze, L. (2016b). A simplified marker set to define the center of mass for stability analysis in dynamic situations. *Gait Posture* 48, 64–67.
- Todorov, E. (2002). Cosine tuning minimizes motor errors. *Neural Comput.* 14, 1233–1260.
- Todorov, E., and Ghahramani, Z. (2003). Unsupervised learning of sensory-motor primitives. in *Proceedings of the 25th Annual International Conference of the IEEE Engineering in Medicine and Biology Society (IEEE Cat. No.03CH37439)*, 1750-1753 Vol.2.
- Todorov, E., and Jordan, M. I. (2002). Optimal feedback control as a theory of motor coordination. *Nat. Neurosci.* 5, 1226–1235.
- Tokuno, C. D., Cresswell, A. G., Thorstensson, A., and Carpenter, M. G. (2010). Age-related changes in postural responses revealed by support-surface translations with a long acceleration–deceleration interval. *Clin. Neurophysiol.* 121, 109–117.
- Tresch, M. C., and Jarc, A. (2009). The case for and against muscle synergies. *Curr. Opin. Neurobiol.* 19, 601–607.
- Tresch, M. C., Saltiel, P., and Bizzi, E. (1999). The construction of movement by the spinal cord. *Nat. Neurosci.* 2, 162–167.
- Trimble, M. H., Brunt, D., Jeon, H. S., and Kim, H. D. (2001). Modulations of soleus H-reflex excitability during gait initiation: central versus peripheral influences. *Muscle Nerve* 24, 1371–1379.

- Trimble, M. H., and Koceja, D. M. (1994). Modulation of the Triceps Surae H-Reflex with Training. *Int. J. Neurosci.* 76, 293–303.
- Trimble, M. H., and Koceja, D. M. (2001). Effect of a reduced base of support in standing and balance training on the soleus H-reflex. *Int. J. Neurosci.* 106, 1–20.
- Trumbower, R. D., Krutky, M. A., Yang, B.-S., and Perreault, E. J. (2009). Use of Self-Selected Postures to Regulate Multi-Joint Stiffness During Unconstrained Tasks. *PLoS ONE* 4.
- Tseng, Y., Scholz, J. P., and Schöner, G. (2002). Goal-equivalent joint coordination in pointing: affect of vision and arm dominance. *Motor Control* 6, 183–207.
- Tsukahara, N. (1981). Sprouting and the neuronal basis of learning. *Trends Neurosci.* 4, 234–237.
- Turvey, M. T., and Fonseca, S. (2009). “Nature of Motor Control: Perspectives and Issues,” in *Progress in Motor Control Advances in Experimental Medicine and Biology*. (Springer, Boston, MA), 93–123.
- Vandervoort, A. A., Chesworth, B. M., Cunningham, D. A., Paterson, D. H., Rechnitzer, P. A., and Koval, J. J. (1992). Age and Sex Effects on Mobility of the Human Ankle. *J. Gerontol.* 47, M17–M21.
- Vellas, B. J., Wayne, S. J., Romero, L., Baumgartner, R. N., Rubenstein, L. Z., and Garry, P. J. (1997a). One-leg balance is an important predictor of injurious falls in older persons. *J. Am. Geriatr. Soc.* 45, 735–738.
- Vellas, B. J., Wayne, S. J., Romero, L. J., Baumgartner, R. N., and Garry, P. J. (1997b). Fear of falling and restriction of mobility in elderly fallers. *Age Ageing* 26, 189–193.
- Verghese, J., LeValley, A., Hall, C. B., Katz, M. J., Ambrose, A. F., and Lipton, R. B. (2006). Epidemiology of Gait Disorders in Community-Residing Older Adults. *J. Am. Geriatr. Soc.* 54, 255–261.
- Verghese, J., Lipton, R. B., Hall, C. B., Kuslansky, G., Katz, M. J., and Buschke, H. (2002). Abnormality of gait as a predictor of non-Alzheimer’s dementia. *N. Engl. J. Med.* 347, 1761–1768.
- Vico, L., Collet, P., Guignandon, A., Lafage-Proust, M. H., Thomas, T., Rehaillia, M., et al. (2000). Effects of long-term microgravity exposure on cancellous and cortical weight-bearing bones of cosmonauts. *Lancet Lond. Engl.* 355, 1607–1611.
- Vlutters, M., Boonstra, T. A., Schouten, A. C., and van der Kooij, H. (2015). Direct measurement of the intrinsic ankle stiffness during standing. *J. Biomech.* 48, 1258–1263.
- Welch, T. D. J., and Ting, L. H. (2008). A Feedback Model Reproduces Muscle Activity During Human Postural Responses to Support-Surface Translations. *J. Neurophysiol.* 99, 1032–1038. doi:10.1152/jn.01110.2007.
- Welch, T. D. J., and Ting, L. H. (2014). Mechanisms of Motor Adaptation in Reactive Balance Control. *PLOS ONE* 9, e96440.
- White, K. N., Gunter, K. B., Snow, C. M., and Hayes, W. C. (2002). The Quick Step: A New Test for Measuring Reaction Time and Lateral Stepping Velocity. *J. Appl. Biomech.* 18, 271–277.
- Wild, J. M., and Williams, M. N. (2000). Rostral wulst in passerine birds. I. Origin, course, and terminations of an avian pyramidal tract. *J. Comp. Neurol.* 416, 429–450.
- Windhorst, U. (2007). Muscle proprioceptive feedback and spinal networks. *Brain Res. Bull.* 73, 155–202.

- Winter, D. A., Patla, A. E., Prince, F., Ishac, M., and Gielo-Perczak, K. (1998). Stiffness control of balance in quiet standing. *J. Neurophysiol.* 80, 1211–1221.
- Wolfson, L. I., Whipple, R., Amerman, P., and Kleinberg, A. (1986). Stressing the postural response. A quantitative method for testing balance. *J. Am. Geriatr. Soc.* 34, 845–850.
- Wolpaw, J. R. (2010). What can the spinal cord teach us about learning and memory? *Neurosci. Rev. J. Bringing Neurobiol. Neurol. Psychiatry* 16, 532–549.
- Wolpert, D. M., Diedrichsen, J., and Flanagan, J. R. (2011). Principles of sensorimotor learning. *Nat. Rev. Neurosci.* 12, 739–751.
- Wolpert, D. M., Ghahramani, Z., and Flanagan, J. R. (2001). Perspectives and problems in motor learning. *Trends Cogn. Sci.* 5, 487–494. doi:10.1016/S1364-6613(00)01773-3.
- Wolpert, D. M., Miall, R. C., and Kawato, M. (1998). Internal models in the cerebellum. *Trends Cogn. Sci.* 2, 338–347.
- Woollacott, M. H., Shumway-Cook, A., and Nashner, L. M. (1986). Aging and posture control: changes in sensory organization and muscular coordination. *Int. J. Aging Hum. Dev.* 23, 97–114.
- Xu, D.-Q., Li, J.-X., and Hong, Y. (2005). Effect of regular Tai Chi and jogging exercise on neuromuscular reaction in older people. *Age Ageing* 34, 439–444.
- Yang, L., Michaels, J. A., Pruszynski, J. A., and Scott, S. H. (2011). Rapid motor responses quickly integrate visuospatial task constraints. *Exp. Brain Res.* 211, 231–242.
- You, L., Temiyasathit, S., Lee, P., Kim, C. H., Tummala, P., Yao, W., et al. (2008). Osteocytes as Mechanosensors in the Inhibition of Bone Resorption Due to Mechanical Loading. *Bone* 42, 172–179.
- Young, J. W., Chandler, R. F., Snow, C. C., Robinette, K. M., Zehner, G. F., and Lofberg, M. S. (1983). Anthropometric and mass distribution characteristics of the adult female.
- Zehr, E. P., and Stein, R. B. (1999). What functions do reflexes serve during human locomotion? *Prog. Neurobiol.* 58, 185–205.
- Ziegler, J. G., and Nichols, N. B. (1942). Optimum settings for automatic controllers. *Trans ASME* 64.