



HAL
open science

Random trees, laminations of the disk and factorizations

Paul Thevenin

► **To cite this version:**

Paul Thevenin. Random trees, laminations of the disk and factorizations. Probability [math.PR]. Institut Polytechnique de Paris, 2020. English. NNT : 2020IPPAX021 . tel-02925984

HAL Id: tel-02925984

<https://theses.hal.science/tel-02925984v1>

Submitted on 31 Aug 2020

HAL is a multi-disciplinary open access archive for the deposit and dissemination of scientific research documents, whether they are published or not. The documents may come from teaching and research institutions in France or abroad, or from public or private research centers.

L'archive ouverte pluridisciplinaire **HAL**, est destinée au dépôt et à la diffusion de documents scientifiques de niveau recherche, publiés ou non, émanant des établissements d'enseignement et de recherche français ou étrangers, des laboratoires publics ou privés.



INSTITUT
POLYTECHNIQUE
DE PARIS

NNT : 2020IPPAX021

Thèse de doctorat



Arbres, laminations du disque et factorisations aléatoires

Thèse de doctorat de l'Institut Polytechnique de Paris
préparée à Ecole Polytechnique

École doctorale n°574 Ecole Doctorale de Mathématique Hadamard (EDMH)
Spécialité de doctorat : Mathématiques appliquées

Thèse présentée et soutenue à Cachan, le 22 juin 2020, par

PAUL THÉVENIN

Composition du Jury :

Philippe Biane Directeur de recherche, Université Paris-Est (IGM)	Examineur
Valentin Féray Assistant Professor, Universität Zürich	Invité
Christina Goldschmidt Professeure, Oxford University	Rapportrice
Bénédicte Haas Professeure, Université Paris 13 (LAGA)	Présidente
Igor Kortchemski Chargé de recherche, Ecole Polytechnique (CMAP)	Directeur de thèse
Jean-François Marckert Directeur de recherche, Université de Bordeaux (LaBRI)	Rapporteur
Gilles Schaeffer Directeur de recherche, Ecole Polytechnique (LIX)	Examineur

Remerciements

On a coutume de dire que les deux parties d'une thèse les plus accessibles au grand public – et de ce fait les plus attentivement scrutées – sont les remerciements et le pot de thèse. Les circonstances me faisant faire l'économie d'un pot, le lecteur me pardonnera si je reporte mon énergie dans l'écriture de ces remerciements.

Ces quelques pages sont consacrées aux personnes avec qui j'ai pu échanger au sujet de ma thèse durant ces trois années, et qui ont joué un rôle – quel qu'il soit – dans sa rédaction. Ainsi, vous n'y trouverez ni formules mystérieuses, ni termes abscons. Vous y trouverez plutôt références culturelles, liens YouTube et clin d'œil divers et variés.

Je tiens en premier lieu à exprimer ma plus profonde gratitude à mon directeur de thèse Igor Kortchemski, pour m'avoir proposé de passionnants sujets de recherche, et pour avoir été d'une si grande disponibilité tout au long de ces trois années. J'ai pu ainsi appréhender des domaines entiers des mathématiques dont je n'imaginai pas, sinon l'existence, du moins la profondeur. Igor a toujours su m'écouter, m'encourager et m'aiguiller quand j'en avais besoin. Merci pour tout ce temps passé à relire (voire rere lire, voire...) mes articles, et pour m'avoir fait comprendre l'intérêt et la complexité de l'écriture d'un article de mathématiques.

Merci de tout cœur à Christina Goldschmidt et Jean-François Marckert, qui ont accepté d'être rapportrice et rapporteur de ce mémoire. J'en suis très honoré. Je remercie également très chaleureusement Philippe Biane, Bénédicte Haas et Gilles Schaeffer, dont les travaux ont été d'une grande importance dans cette thèse, d'avoir bien voulu faire partie de mon visio-jury de soutenance.

Une grande partie de cette thèse s'est déroulée au CMAP à l'école Polytechnique, où j'ai pu bénéficier d'un cadre on ne peut plus propice à la production mathématique. Je suis très reconnaissant à Nasséra Naar, Alexandra Noiret et toute l'administration du laboratoire, pour leur disponibilité et le travail extraordinaire accompli dans l'ombre quotidiennement, ainsi qu'à tous les agents d'entretien qui font de ce laboratoire un lieu si accueillant. Je remercie également Anne de Bouard et Thierry Bodineau pour leur gestion exemplaire de ce laboratoire en expansion constante, qui plus est en période de confinement. Amandine Veber y a notamment toujours apporté sa bonne humeur quotidienne, et Lucas Gerin son humour et ses talents footballistiques. Merci également à Igor pour nos nombreuses discussions au sujet du RER B, et ses conseils toujours avisés sur la préparation de rhum arrangé. Enfin, je souhaite remercier l'ensemble de la commission Parité du CMAP, pour m'avoir permis d'appréhender les problèmes extra-mathématiques d'un laboratoire (le plus souvent autour d'un repas).

Si j'ai pu mener à bien cette thèse, c'est en grande partie également grâce au cadre de travail que j'ai trouvé au CMAP. J'ai tout d'abord une pensée pour tous les pensionnaires passés, présents et futurs du bureau 2016 : Aymeric qui m'a accueilli le premier et Hadrien pour ces magnifiques moments au salon du chocolat, Jean-Bernard pour sa culture sportive aussi extraordinaires que ses talents à "Des chiffres et des lettres" et Sporcle, ainsi que sa gestion exemplaire du problème connu sous le nom de "remplissage des bureaux de l'étage". Merci aussi à Perle pour sa classe à Mario Kart, ses moutardes au goût absurde et pour m'avoir fait rencontrer Polygone (qui n'a pas voulu être convexe malgré tous mes efforts). Cédric qui partage apparemment mes goûts théâtraux, et Florian pour ces duos dans tous les endroits possibles et imaginables de Polytechnique, ainsi que nos compétitions d'humour.

Je n'oublie pas Cheikh et sa magnifique performance en course avec sac en bandoulière, et Paul pour m'avoir fait découvrir Jean Bouin et les chansons d'un virage de rugby. Julie pour sa franchise, ses 564294 marathons par an et nos deux ans d'expériences communes d'enseignement. Matthieu pour ses théories fumeuses sur tout sujet potentiellement sensible, et Jingjing pour avoir introduit de l'aléatoire dans ce bureau qui n'en manquait déjà pas. Je souhaite enfin bonne chance à Louis, Baptiste, Alann et Pablo qui sauront perpétuer l'esprit du bureau.

En dehors du 2016, j'ai également pu échanger avec d'autres doctorants, autour de cafés ou dans des rames de RER (rarement les deux à la fois, étant donnée la durée de vie d'un café dans un RER en heure de pointe). Merci à Céline pour ses conseils avisés sur l'utilisation de Twitch à des fins mathématiques, et à Mathilde pour avoir partagé mes interrogations quant au futur du PSG et de l'OL, voire de l'ASSE, entre deux discussions sur l'avenir des bols en plastique de la cantine! J'ai pu co-organiser un marathon en relais avec Aude, recruter pour cela Martin et Fédor (entre autres) et participer ainsi à la bonne santé physique et mentale des doctorants. Merci également dans le désordre à Benoît, Kevissh, Heythem, Eugénie, Josué, Thomas, Alejandro, Léa, Apolline pour ces pauses café toujours animées, et à la nouvelle génération de doctorants : Claire, Solange, Clément et tous les autres que je ne peux manquer d'oublier (mais que je n'oublie pas). Enfin, merci à Alex pour son amour du Barça et nos matchs de ping-pong si serrés, et à Milica pour m'avoir fait découvrir et goûter tant de bières. J'aimerais également remercier Loïc pour m'avoir encouragé à étudier autre chose que les fonctions de Bessel, et Cyril pour son aide dans toutes les galères administratives indispensables à toute expérience de thèse.

Si je devais résumer ma thèse aujourd'hui avec vous, je dirais que c'est d'abord des rencontres. J'ai pu rencontrer au long de ces trois ans de nombreuses personnes avec qui discuter de mathématiques. Un grand merci à Nicolas Curien pour ses remarques toujours utiles, son cours à l'école d'été de Saint-Flour, ainsi que pour avoir grandement facilité ma recherche de stage en M2. Merci à Bénédicte Haas et Philippe Marchal pour nos échanges toujours fructueux. J'ai également pu rencontrer lors de séminaires et d'écoles d'été de nombreux doctorants ou postdocs avec qui échanger : merci tout particulièrement à Sarai et Ellie pour ces soirées passées à parler de tous les pays du monde, et à la team Smash Bros de Saint-Flour.

J'ai une pensée pour tous les professeurs qui ont influencé ma décision de continuer en mathématiques : en terminale au lycée Louis-le-Grand, Guy Alarcon (qui m'a appris tout particulièrement que faire des mathématiques implique d'avoir les mains pleines de craie) et Prebagarane Moultou (qui initia les blagues sur mon nom de famille en écrivant sur une copie d'électricité "Facile quand on s'appelle Thévenin") m'ont donné rapidement le goût de la recherche. Merci à Roger Mansuy, en MPSI, pour m'avoir prêté le fameux livre de percolation de Wendelin Werner, qui attend toujours de retrouver son propriétaire originel... et à Yves Duval en MP qui m'apprit notamment le respect dû aux professeurs, d'un tonitruant "Taisez-vous, jeune con". Ils ont tous joué un grand rôle dans mon choix d'études. A l'ENS, j'ai eu la chance de suivre les cours de probabilités de Thomas Duquesne (dont nous attendons toujours avec impatience qu'il nous rende notre partiel) et Raphaël Cerf, puis le M2 de probabilités d'Orsay et en particulier les cours de Jean-François Le Gall et Nicolas Curien qui m'ont conforté dans ma voie. Dans le cadre de mon stage de M2, j'ai aussi pu rencontrer Louigi Addario-Berry et Luc Devroye qui m'ont accueilli à l'université McGill de Montréal et m'ont donné un premier aperçu de la recherche et de la liberté qu'elle procure.

Merci également à Stéphane Bijakowski, Yvan Martel et Frank Pacard dont j'ai assuré les TDs pendant mes trois années de thèse, pour m'avoir montré les multiples facettes du métier d'enseignant.

Un point important d'une thèse, c'est aussi de pouvoir en parler à ses amis, se plaindre ou partager les joies d'une preuve qui est enfin juste. Je pense notamment à Rémy, Eliot et Blomme et nos partages d'informations sur nos thèses respectives, entrecoupées de parties de coinche sur la Côte d'Azur. Merci également à Guillaume et Othmane pour avoir partagé les différents et nombreux états d'esprit d'un thésard tout au long de ces trois ans. A l'ENS, j'ai pu très régulièrement discuter de mathématiques de manière productive, le plus souvent autour du flipper ou du baby-foot. Merci pour cela à Raphaël, Thomas, Delphin, Louise et tant d'autres.

J'ai aussi eu la chance de pouvoir parler de ma thèse à des amis non-mathématiciens. Je pense notamment à Chuck, Yann et Rémi pour leur preuve du théorème de la tortue-hélicoptère, à Adel et Marlène pour leur réussite aux échecs, et à Julie pour notre mathématisation du loup-garou. Je m'excuse auprès de tous ceux que j'ai perdus en soirée en essayant de leur raconter ce que je faisais. Merci aussi à Perle et Sara pour avoir voulu jusqu'au bout organiser mon pot de thèse.

Pour continuer à faire des mathématiques, il faut se maintenir en forme. Merci à tous ceux qui m'ont motivé à courir durant ces années, en particulier Aymeric et ses entraînements sur les machines du gymnase, Sara pour m'avoir fait comprendre l'intérêt d'avoir des chaussures de trail pour faire un trail, et Valentin pour m'avoir cassé les genoux en un seul entraînement. J'aimerais remercier tout le club de ping-pong de PP14, notamment l'équipe 3, pour ces années de matches à l'autre bout de Paris jusqu'au bout de la nuit, de réveils avant le soleil pour des tournois, et de bières bien méritées après tous ces efforts! Merci en particulier à Thomas, Félicien, PA et Antoine pour avoir failli former une équipe complète. Merci aussi, tout particulièrement, à Hugo, Benjamin, Raphaël, Samuel, Lucas, Paul, N'Golo, Kylian, Antoine, Blaise, Olivier, Steven, Corentin, Nabil et Didier pour cette soirée inoubliable du 15 juillet 2018.

Enfin, s'il est une constante qui a rythmé (c'est le cas de le dire) ces trois années de thèse, c'est la musique. Merci à tout Rise Up pour ces spectacles incroyables, et en particulier à Yoyo, Acy, Sara, Juliette et les Patates douces pour tous ces moments extraordinaires. Merci à BrassENS pour ces nombreux concerts, depuis la salle des Actes jusqu'au parc de Choisy sous la pluie. Et surtout, merci à l'Ernestophone pour les répétitions, les manches à durée indéterminée rue Mouffetard, les tournées aux quatre coins du sud-ouest de la France et les soirées les plus extraordinairement bruyantes que la K-Fêt ait connues.

Merci à mes colocs Blomme et Achille à Bagneux, colocs sans qui ces trois années de thèse auraient été bien ternes (et moins riches en crêpes, gaufres, merveilleux, carbo de tofu et performances musicales en tout genre)

Il me reste à remercier ceux qui m'ont accompagné et soutenu durant les trois derniers mois de cette thèse, passés en confinement au bord de la mer : Béranger¹, Emma et Ludo, Isa, Clem, Lelly, Amaury, Achille et Lucie. Merci tout particulièrement à Lucie de m'avoir soutenu - et supporté - pendant cette période.

J'en viens maintenant à ma famille, qui m'accompagne depuis 25 ans dans ma vie et qui a toujours été présente quand cela était nécessaire. J'ai une pensée toute particulière pour mon grand-père Claude, qui a été le premier à m'initier aux probabilités et à pousser des soupirs de désespoir quand je n'y comprenais rien. Comme prévu, la moitié des théorèmes de ce mémoire portent (officieusement) son nom. Merci à ma cousine Philomène pour m'avoir constamment rappelé que j'étais le verbe sur Terre. Merci à mes parents pour m'avoir toujours encouragé dans mes choix scolaires et professionnels, et avoir tenté de lire mes premiers articles. Merci

¹en particulier pour sa collaboration à <https://www.youtube.com/watch?v=kJp0h6a2les>

à Hélène, Jeanne, Louise, Pierre (ou Paul, selon les jours) et Zelda pour l'ambiance toujours festive à la maison.

Résumé

Cette thèse est consacrée à l'étude des propriétés asymptotiques de grands objets combinatoires aléatoires. Trois familles d'objets sont au centre des travaux présentés ici : les arbres, les factorisations de permutations et les configurations de cordes non croisées du disque (aussi appelées laminations).

Dans un premier temps, nous nous intéressons spécifiquement au nombre de sommets de degré fixé dans des arbres de Galton-Watson que l'on a conditionnés de différentes façons, comme par exemple par leur nombre de sommets de degré pair ou leur nombre de feuilles. Lorsque la loi de reproduction de l'arbre est critique et dans le domaine d'attraction d'une loi stable, nous montrons notamment la normalité asymptotique de ces quantités. Nous nous intéressons également à la répartition de ces sommets de degré fixé dans l'arbre, lorsqu'on explore celui-ci de gauche à droite.

Dans un second temps, nous considérons des configurations de cordes du disque unité qui ne se coupent pas, et montrons que l'on peut coder un arbre de manière naturelle par une telle configuration. Nous définissons en particulier une suite croissante de laminations codant une fragmentation d'un arbre donné, c'est-à-dire une manière de découper cet arbre en des points choisis aléatoirement. Ce point de vue géométrique nous permet ensuite d'étudier les propriétés d'une factorisation du cycle $(1\ 2\ \cdots\ n)$ en un produit de $n - 1$ transpositions, choisie uniformément au hasard, en la codant dans le disque par une lamination aléatoire et en remarquant un lien entre ce modèle et un arbre de Galton-Watson conditionné par son nombre total de sommets. Enfin, dans une dernière partie, nous présentons une généralisation de ces résultats à des factorisations aléatoires de ce même cycle, qui ne sont plus nécessairement en produits de transpositions mais peuvent faire intervenir des cycles de longueurs plus grandes. Nous mettons de cette façon en lumière un lien entre des arbres de Galton-Watson conditionnés, les factorisations de grandes permutations et la théorie des fragmentations.

Abstract

This work is devoted to the study of asymptotic properties of large random combinatorial structures. Three particular structures are the main objects of our interest: trees, factorizations of permutations and configurations of noncrossing chords in the unit disk (or laminations).

First, we are specifically interested in the number of vertices with fixed degree in Galton-Watson trees that are conditioned in different ways, for example by their number of vertices with even degree, or by their number of leaves. When the offspring distribution of the tree is critical and in the domain of attraction of a stable law, we notably prove the asymptotic normality of these quantities. We are also interested in the spread of these vertices with fixed degree in the tree, when one explores it from left to right.

Then, we consider configurations of chords that do not cross in the unit disk. Such configurations notably code trees in a natural way. We define in particular a nondecreasing sequence of laminations coding a fragmentation of a given tree, that is, a way of cutting this tree at points chosen randomly. This geometric point of view then allows us to study some properties of a factorization of the cycle $(1\ 2\ \cdots\ n)$ as a product of $n - 1$ transpositions, chosen uniformly at random, by coding it in the disk by a random lamination and remarking a connection between this model and a Galton-Watson tree conditioned by its total number of vertices. Finally, we present a generalization of these results to random factorizations of the same cycle, that are not necessarily as a product of transpositions anymore, but may involve cycles of larger lengths. We highlight this way a connection between some conditioned Galton-Watson trees, factorizations of large permutations and the theory of fragmentations.

1	Introduction	1
1.1	Arbres aléatoires	2
1.2	Fragmentation d'arbres et laminations	20
1.3	Factorisations minimales aléatoires	27
1.4	Comportement de la fonction génératrice d'une loi stable dans le plan complexe	42
2	Sommets de degré fixé dans de grands arbres de Galton-Watson	47
2.1	Introduction	48
2.2	Background on trees and their codings	52
2.3	Joint distribution of outdegrees in GW trees	54
2.4	Evolution of outdegrees in an exploration of a Galton-Watson tree	56
2.5	Asymptotic normality of outdegrees in large Galton-Watson trees	62
2.6	Several extensions	68
3	Une représentation géométrique de processus de fragmentation sur des arbres stables	74
3.1	Introduction	76
3.2	Construction of lamination-valued processes	83
3.3	Limit of cut processes on discrete trees	90
3.4	Application to minimal factorizations of the cycle	94
3.5	Computation of the distribution of $\mathbb{L}_c^{(\alpha)}$ at c fixed	115
3.6	Generating functions of stable offspring distributions	129
4	Factorisations minimales aléatoires de type stable du n-cycle	137
4.1	Introduction	138
4.2	Plane trees, bi-type trees and different ways of coding them by laminations	148
4.3	The particular case of (μ_*, w) -bi-type trees.	159
4.4	A bijection between minimal factorizations and a set of bi-type trees	179

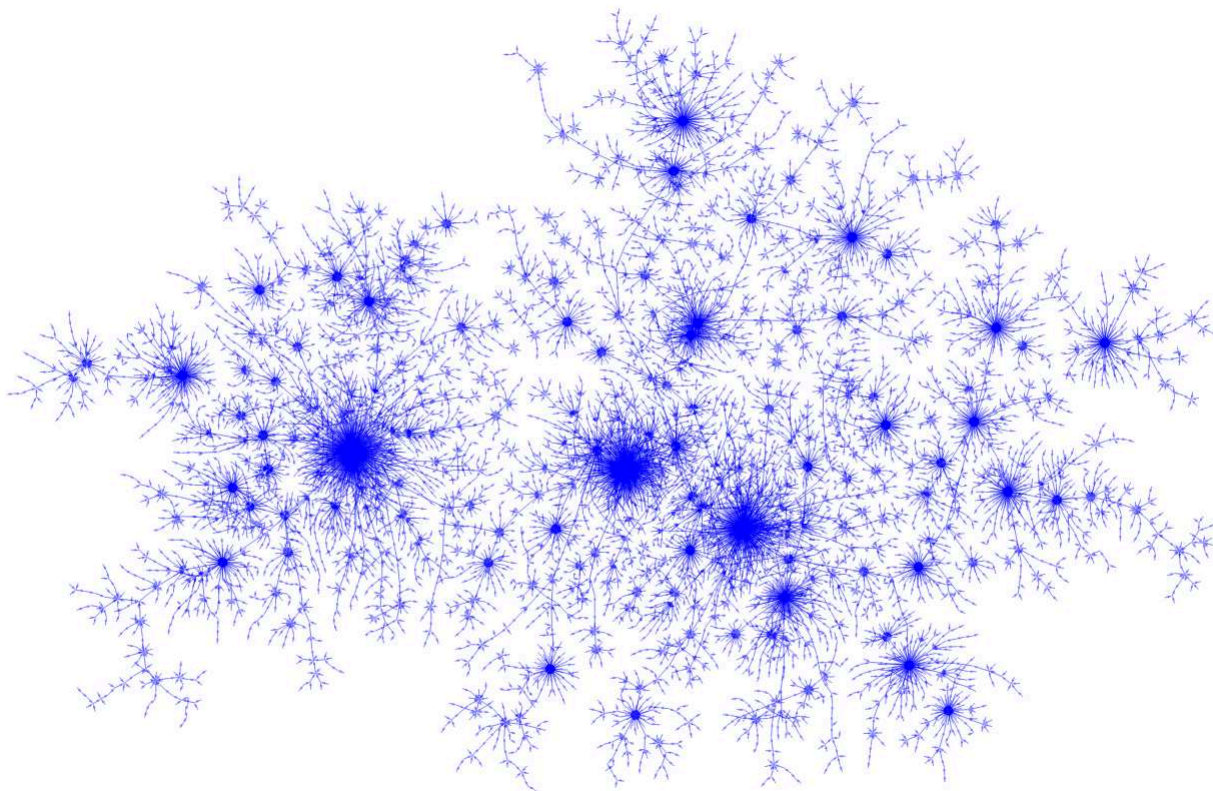

Cette introduction comporte trois parties distinctes mais corrélées. Nous présentons tout d'abord nos contributions à l'étude de grands arbres aléatoires discrets, puis exposons dans une seconde partie nos résultats concernant la fragmentation d'arbres aléatoires ainsi que le codage de cette fragmentation par des ensembles de cordes du disque unité. Enfin, nous consacrons une troisième partie à l'application de ces résultats dans l'étude de factorisations aléatoires de la permutation $(1\ 2\ \cdots\ n)$ en un produit de cycles plus petits. Ces résultats sont tirés des travaux [95, 96, 97].

Du fait des corrections apportées à ce manuscrit, les versions des chapitres suivants diffèrent légèrement des versions prépubliées ou publiées.

Les résultats encadrés sont les résultats originaux de cette thèse, et sont numérotés de manière indépendante. Dans tout le manuscrit, $\xrightarrow{\mathbb{P}}$ décrit la convergence en probabilité, $\xrightarrow{(d)}$ la convergence en loi et $\stackrel{(d)}{=}$ l'égalité en loi. Enfin, nous utilisons le symbole \heartsuit pour souligner quelques idées introduites dans cette thèse.

Contenu du chapitre

1.1 Arbres aléatoires	2
1.1.1 Arbres plans enracinés : définitions et notations	2
1.1.2 Arbres de Galton-Watson	3
1.1.3 Codage d'arbres par des marches et convergence d'arbres aléatoires	4
1.1.4 Répartition des degrés dans des arbres de Galton-Watson conditionnés	13
1.2 Fragmentation d'arbres et laminations	20
1.2.1 Processus de fragmentation	20
1.2.2 Laminations	22
1.3 Factorisations minimales aléatoires	27
1.3.1 Factorisations en transpositions	28
1.3.2 Factorisations en cycles de longueur aléatoire	33
1.4 Comportement de la fonction génératrice d'une loi stable dans le plan complexe	42

1.1 Arbres aléatoires

Nous commençons par définir les arbres plans enracinés, qui sont l'objet principal de cette section, ainsi qu'un modèle naturel d'arbres aléatoires : les arbres de Galton-Watson. Nous introduisons les techniques usuelles d'étude de ces arbres et notamment les concepts de limite d'échelle et de limite locale, avant d'exposer en Section 1.1.4 les résultats que nous avons obtenus concernant la structure de grands arbres de Galton-Watson conditionnés.

1.1.1 Arbres plans enracinés : définitions et notations

Pour définir notre notion d'arbres plans enracinés, nous utilisons le formalisme introduit par Neveu [87]. Soit $\mathbb{N} := \{0, 1, \dots\}$ l'ensemble des entiers naturels, et $\mathbb{N}^* := \{1, 2, \dots\}$ l'ensemble des entiers naturels non nuls. On définit $\mathcal{U} := \bigcup_{n \geq 0} (\mathbb{N}^*)^n$ l'ensemble des suites finies d'entiers naturels non nuls où, par convention, $(\mathbb{N}^*)^0 = \{\emptyset\}$.

Un arbre plan enraciné est défini comme un sous-ensemble T de \mathcal{U} (pas nécessairement fini), vérifiant les trois conditions suivantes :

- (1) $\emptyset \in T$. Ce sommet est appelé la racine de T ;
- (2) si $u = u_1 \cdots u_j \in T$, alors, pour tout $i \in \llbracket 1, j \rrbracket$, $u_1 \cdots u_i \in T$; par analogie avec un arbre généalogique, ces éléments sont appelés *ancêtres* de u . En particulier l'élément $u_1 \cdots u_{j-1}$ est appelé *parent* de T ;
- (3) pour tout $u := u_1 \cdots u_i \in T$, il existe un entier $k_u(T) \in \mathbb{N}$ tel que $u_1 \cdots u_i m \in T$ si et seulement si $1 \leq m \leq k_u(T)$; ces éléments sont appelés *enfants* de u .

Notons que ce formalisme permet de considérer aussi bien des arbres finis qu'infinis. Dans ce qui suit, nous considérerons un arbre plan enraciné comme un graphe $T := (V, E)$, dont l'ensemble V des sommets est l'ensemble des éléments de T et où chaque sommet est relié à son parent par une arête de E . En particulier, un arbre plan enraciné à n sommets possède $n - 1$ arêtes. On munit usuellement T de sa distance de graphe, pour laquelle chacune de ses arêtes est de longueur 1. Un exemple d'arbre plan enraciné étiqueté selon le formalisme de Neveu est représenté en figure 1.1.

La hauteur d'un élément $u = u_1 \cdots u_i \in \mathcal{U}$, notée $h(u)$, est la longueur i de la suite u . C'est donc également la distance entre u et \emptyset dans T . En particulier, $h(\emptyset) = 0$. La taille totale d'un arbre T , que l'on notera $|T|$, est son nombre total de sommets. Enfin, pour tout arbre T et tout sommet $u \in T$, on définit $\theta_u(T)$ comme le sous-arbre de T enraciné en u , c'est à dire l'ensemble des sommets de T dont u est un ancêtre (en particulier, $u \in \theta_u(T)$).

\mathcal{U} admet naturellement un ordre appelé *ordre lexicographique*, que l'on notera \prec , défini comme suit : $\emptyset \prec u$ pour tout $u \in \mathcal{U}$ et, pour $u := u_1 \cdots u_i$, $v := v_1 \cdots v_j$ différents de \emptyset , $u \prec v$ si et seulement si $u_1 < v_1$, ou $u_1 = v_1$ et $u_2 \cdots u_i \prec v_2 \cdots v_j$.

1.1.2 Arbres de Galton-Watson

Index des notations de la section 1.1.2

\mathbb{T}_n	Ensemble des arbres à n sommets.
\mathcal{T}_n	Arbre de Galton-Watson conditionné à avoir n sommets.
$\mathbb{B}\mathbb{T}_n$	Ensemble des arbres bi-type à n sommets blancs.
$\mathcal{T}_n^{(w^\circ, w^\bullet)}$	Arbre bi-type simplement généré de lois (w°, w^\bullet) , conditionné à avoir n sommets blancs.

Définition Soit μ une loi de probabilité sur \mathbb{N} , telle que $\mu_0 > 0$ et $\mu_0 + \mu_1 < 1$. L'arbre de Galton-Watson de loi de reproduction μ , noté \mathcal{T} s'il n'y a pas d'ambiguïté sur la loi μ et abrégé en μ -GW, est une variable aléatoire qui prend ses valeurs dans l'ensemble \mathbb{T} des arbres plans enracinés, et modélise de manière naturelle l'évolution d'une population. La racine est vue comme un individu, dont le nombre d'enfants est une variable de loi μ . De plus, pour tout $k \in \mathbb{N}$, conditionnellement à $k_\emptyset(\mathcal{T}) = k$, les sous-arbres $\theta_1(\mathcal{T}), \dots, \theta_k(\mathcal{T})$ enracinés en chacun des k enfants de \emptyset sont indépendants et sont distribués selon la loi de \mathcal{T} .

Il est connu que \mathcal{T} est presque sûrement fini si et seulement si $\sum_{i \in \mathbb{N}} i\mu_i \leq 1$. On dira que la loi μ est *critique* si elle est de moyenne 1, c'est-à-dire si $\sum_{i \in \mathbb{N}} i\mu_i = 1$.

Dans toute la suite, on notera \mathcal{T}_n le μ -GW conditionné à avoir n sommets.

Arbres simplement générés Il est à noter que les arbres de Galton-Watson sont un cas particulier d'une famille d'arbres aléatoires plus généraux, appelés *arbres simplement générés* et introduits initialement par Meir et Moon [80]. Étant donnée une suite de poids w - c'est-à-dire une suite $w = (w_i)_{i \geq 0}$ de réels positifs - vérifiant $w_0 > 0$, on associe à chaque arbre fini T un poids $W_w(T)$:

$$W_w(T) = \prod_{u \in T} w_{k_u(T)}.$$

Pour tout entier $n \in \mathbb{N}^*$, posons \mathbb{T}_n l'ensemble des arbres à n sommets. On définit l'arbre simplement généré à n sommets de suite de poids w comme la variable aléatoire \mathcal{T}_n^w à valeurs dans \mathbb{T}_n , vérifiant pour tout $T \in \mathbb{T}_n$:

$$\mathbb{P}(\mathcal{T}_n^w = T) = \frac{1}{Z_{n,w}} W_w(T),$$

où $Z_{n,w} := \sum_{T \in \mathbb{T}_n} W_w(T)$ est une constante de renormalisation que l'on suppose implicitement strictement positive. Remarquons que, pour tout $n \in \mathbb{N}^*$, l'ensemble \mathbb{T}_n est fini, ce qui implique $Z_{n,w} < \infty$.

Si μ est une loi de probabilité sur \mathbb{N} telle que $\mu_0 > 0$, alors pour tout entier $n \geq 1$, l'arbre \mathcal{T}_n^μ de suite de poids μ a la loi de l'arbre de Galton-Watson \mathcal{T}_n de loi de reproduction μ conditionné à avoir n sommets.

Arbres bi-type simplement générés Nous proposons ici une généralisation possible des arbres simplement générés à un modèle d'arbre possédant une structure supplémentaire. On dira qu'un arbre est *bi-type* si chacun de ses sommets est colorié : blanc s'il est de hauteur paire, noir s'il est de hauteur impaire, de sorte que les enfants d'un sommet blanc sont noirs et réciproquement.

Une notion naturelle d'arbre bi-type simplement généré est alors la suivante : on se donne deux suites de poids w° et w^\bullet , et on suppose de plus que $w_0^\circ > 0$ et $w_0^\bullet = 0$ (comme on le verra, cette condition assure que, à nombre de sommets blancs fixés, la somme des poids $\sum_{T \in \mathbb{BT}_n} W_{w^\circ, w^\bullet}(T)$ est finie). A tout arbre bi-type T , on associe le poids

$$W_{w^\circ, w^\bullet}(T) = \prod_{\substack{x \in T \\ x \text{ blanc}}} w_{k_x(T)}^\circ \times \prod_{\substack{y \in T \\ y \text{ noir}}} w_{k_y(T)}^\bullet.$$

Un entier $n \in \mathbb{N}^*$ étant fixé, posons \mathbb{BT}_n l'ensemble des arbres bi-type à n sommets blancs. On définit alors l'arbre bi-type simplement généré à n sommets blancs de lois w° et w^\bullet (ou, plus simplement, (w°, w^\bullet) -BTSG), noté $\mathcal{T}_n^{(w^\circ, w^\bullet)}$, comme la variable aléatoire à valeurs dans \mathbb{BT}_n vérifiant, pour tout $T \in \mathbb{BT}_n$:

$$\mathbb{P}(\mathcal{T}_n^{(w^\circ, w^\bullet)} = T) = \frac{1}{Z_{n, w^\circ, w^\bullet}} W_{w^\circ, w^\bullet}(T).$$

Ici, $Z_{n, w^\circ, w^\bullet} := \sum_{T \in \mathbb{BT}_n} W_{w^\circ, w^\bullet}(T)$ est une constante de renormalisation, que l'on suppose comme dans le cas précédent strictement positive. Remarquons que, d'après l'hypothèse que nous faisons que $w_0^\bullet = 0$, l'ensemble $\{T \in \mathbb{BT}_n, \mathbb{P}(\mathcal{T}_n^{(w^\circ, w^\bullet)} = T) > 0\}$ est fini, et en particulier $Z_{n, w^\circ, w^\bullet} < \infty$.

1.1.3 Codage d'arbres par des marches et convergence d'arbres aléatoires

Index des notations de la section 1.1.3

$C(T)$	Fonction de contour d'un arbre T .
$W(T)$	Marche de Łukasiewicz de T .
α	Paramètre de stabilité, dans l'intervalle $(1, 2]$.
$X^{(\alpha)}$	Excursion normalisée du processus α -stable.
$H^{(\alpha)}$	Processus de hauteur α -stable.
$\mathcal{T}^{(\alpha)}$	Arbre α -stable.

Un bref historique

Nous commençons par résumer rapidement l'évolution des travaux concernant la convergence d'arbres de Galton-Watson conditionnés. Les premiers travaux concernant les arbres planaires avec un nombre de sommets fixé sont d'ordre combinatoire et non probabiliste, et ont notamment consisté à déterminer un moyen de les dénombrer. On peut par exemple montrer que le nombre d'arbres à n arêtes (donc $n + 1$ sommets) est égal au n -ème nombre de Catalan :

$$\text{Card}(\mathbb{T}_n) = \mathcal{C}_n = \frac{1}{n+1} \binom{2n}{n} = \frac{(2n)!}{n!(n+1)!}.$$

Bien que certaines propriétés particulières d'arbres aléatoires conditionnés à être "grands" aient été étudiées dès la seconde moitié du XXème siècle (par exemple leur degré maximal,

leur hauteur, ...), Aldous [7] est le premier à initier l'étude probabiliste de grands arbres dans leur globalité. La question qu'il se pose en particulier est la suivante : à quoi ressemble, typiquement, un arbre à n sommets pour de grandes valeurs de n ? En d'autres termes, soit T_n un arbre de \mathbb{T}_n choisi uniformément au hasard. Aldous prouve que, après renormalisation des distances dans T_n par un facteur \sqrt{n} , T_n converge en loi vers un espace métrique "limite" aléatoire compact, qu'il nomme *arbre brownien continu*. Aldous [9] prouve plus généralement par la suite que cet arbre brownien continu est la limite de l'arbre de Galton-Watson \mathcal{T}_n^μ , lorsque la loi de reproduction μ est critique et de variance finie, après renormalisation des distances par un facteur d'ordre \sqrt{n} . Voir la figure 1.4, à gauche, pour une simulation de l'arbre brownien continu.

Par la suite, Le Gall et Le Jan [73], puis Duquesne et Le Gall [42] généralisent ce résultat en définissant une famille d'espaces métriques aléatoires compacts $(\mathcal{T}^{(\alpha)})_{\alpha \in (1,2]}$ qu'ils appellent *arbres α -stables*. Duquesne et Le Gall montrent notamment que ces espaces sont les limites d'arbres de Galton-Watson conditionnés par leur nombre de sommets, après renormalisation des distances. Leur loi de reproduction μ doit pour cela être dans le domaine d'attraction d'une loi stable (nous reviendrons plus tard sur cette notion). Notamment, μ n'est plus nécessairement de variance finie. Duquesne [40] prouve alors que la fonction de contour de tels GW conditionnés converge vers la fonction de contour "continue" $H^{(\alpha)}$ qui code l'arbre stable $\mathcal{T}^{(\alpha)}$. Cette fois, le facteur de renormalisation des distances n'est plus nécessairement en \sqrt{n} , mais de l'ordre de $n^{1-1/\alpha}$.

Fonction de contour et marche de Łukasiewicz

Une façon de compter ces arbres à n sommets et d'appréhender dans le même temps la convergence de ces arbres quand $n \rightarrow \infty$ est de les coder par des fonctions à support fini, une idée remontant à Harris [51]. Nous présentons ici deux de ces outils fondamentaux dans l'étude des arbres, leur *fonction de contour* et leur *marche de Łukasiewicz*. Ces deux fonctions, qui prennent des valeurs entières en chaque entier, codent un arbre de manière injective. La fonction de contour permet de lire facilement des informations sur la hauteur de l'arbre, tandis que la marche de Łukasiewicz code le nombre d'enfants de chaque sommet. L'intérêt de ces deux marches est le suivant : dans le cas d'un arbre de Galton-Watson de loi de reproduction μ fixée, sous certaines hypothèses sur cette loi μ , la fonction de contour et la marche de Łukasiewicz du μ -GW conditionné à avoir n sommets convergent de manière jointe après renormalisation vers des processus limites explicites. Il est alors possible de déterminer certaines propriétés d'un grand μ -GW, en étudiant ces processus limites.

Fonction de contour Fixons un arbre T , et notons $n := |T|$ son nombre total de sommets. La *fonction de contour* de l'arbre T , que l'on notera $(C_s(T))_{0 \leq s \leq 2n}$, est une fonction de $[0, 2n]$ dans \mathbb{R}_+ définie comme suit : imaginons une particule qui explore l'arbre en partant de la racine, de gauche à droite, et en revenant en arrière à chaque fois qu'elle atteint une feuille - c'est-à-dire un sommet de l'arbre qui n'a pas d'enfants. Supposons de plus qu'elle accomplit cette exploration à vitesse constante, en parcourant chaque arête en un temps 1. Alors, $C_s(T)$ est définie comme la distance au temps s entre la particule et la racine de T . Chaque arête étant parcourue deux fois par la particule (une fois "vers le haut", la deuxième fois "vers le bas"), et l'arbre T contenant $n - 1$ arêtes, l'exploration est donc terminée au temps $2n - 2$. Par convention, on définit alors $C_s(T) = 0$ pour $2n - 2 \leq s \leq 2n$.

Marche de Łukasiewicz La marche de Łukasiewicz de T , quant à elle, code le nombre d'enfants des sommets de l'arbre. Notons $v_1(T) = \emptyset, \dots, v_n(T)$ les n sommets de T dans

l'ordre lexicographique. La marche de Łukasiewicz de T , que l'on notera $(W_s(T))_{0 \leq s \leq n}$, vérifie $W_0(T) = 0$ et, pour tout $i \in \llbracket 1, n \rrbracket$, $W_i(T) - W_{i-1}(T) = k_{v_i(T)} - 1$. Nous posons de plus, pour $u \in [0, n]$, $W_u(T) = W_{\lfloor u \rfloor}(T)$. Nous pouvons vérifier aisément que $W_n(T) = -1$, et que $W(T)$ est positive entre les instants 0 et $n - 1$.

La figure 1.1 représente un arbre plan enraciné, sa fonction de contour et sa marche de Łukasiewicz.

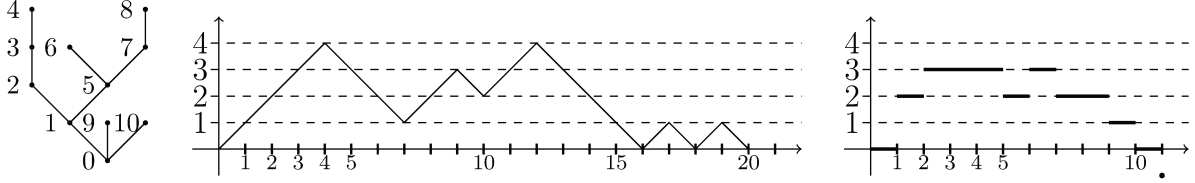

FIGURE 1.1: Un arbre T étiqueté selon le formalisme de Neveu, sa fonction de contour $C(T)$ et sa marche de Łukasiewicz $W(T)$.

Limite d'échelle d'arbres de Galton-Watson

Nous présentons ici des résultats déjà connus concernant la convergence des fonctions de contour et marches de Łukasiewicz d'arbres de Galton-Watson. Commençons par introduire plus généralement le sens dans lequel on entendra les résultats de convergence à venir.

Convergence au sens de Skorokhod Dans tout ce qui suit, pour $E \subset \mathbb{R} \cup \{\pm\infty\}$ un intervalle et F un espace métrique, on notera $\mathbb{D}(E, F)$ l'ensemble des fonctions càdlàg (c'est-à-dire continues à droite, avec des limites à gauche) de E dans F , muni de la distance J1 de Skorokhod (nous renvoyons au chapitre VI de [53] pour les définitions et détails). L'espace $\mathbb{D}(E, F)$, muni de cette distance, est alors polonais.

Cas d'une loi de variance finie C'est Aldous qui, le premier, prouve la convergence des fonctions de contour renormalisées de GW conditionnés par leur taille. Rappelons que \mathcal{T}_n désigne un μ -GW conditionné à avoir n sommets. Aldous montre que, si la loi de reproduction μ est critique de variance finie, alors $C(\mathcal{T}_n)$, convenablement renormalisée, converge vers l'excursion brownienne normalisée $(e_t)_{0 \leq t \leq 1}$. Cette excursion e peut être vue comme un mouvement brownien conditionné à atteindre 0 au temps 1 et à rester positif entre 0 et 1 (voir la figure 1.2 pour une simulation de e).

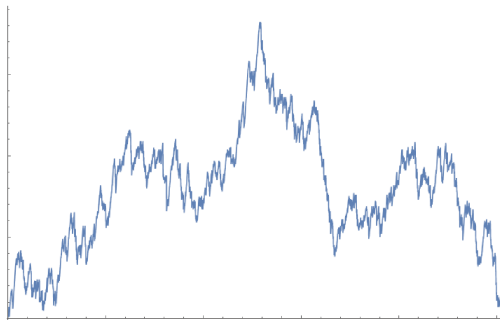

FIGURE 1.2: Une approximation de l'excursion brownienne normalisée $(e_t)_{0 \leq t \leq 1}$.

Théorème 1.1.1 (Aldous [9]). *Soit μ une loi critique, de variance $\sigma^2 \in (0, \infty)$ (pour $\sigma \geq 0$). Alors, on a la convergence en loi suivante, dans l'espace $\mathbb{D}([0, 1], \mathbb{R}_+)$:*

$$\left(\frac{\sigma C_{2nt}(\mathcal{T}_n)}{2\sqrt{n}} \right)_{0 \leq t \leq 1} \xrightarrow[n \rightarrow \infty]{(d)} (\mathfrak{e}_t)_{0 \leq t \leq 1},$$

où \mathfrak{e} désigne l'excursion brownienne renormalisée.

Une conséquence intéressante de ce théorème est, par exemple, que la hauteur de l'arbre \mathcal{T}_n est typiquement d'ordre \sqrt{n} . Ce résultat d'Aldous est complété par Marckert et Mokkadem qui, sous une hypothèse supplémentaire de moment exponentiel sur μ , prouvent la convergence jointe de la fonction de contour et de la marche de Łukasiewicz de l'arbre \mathcal{T}_n , convenablement renormalisées, vers la même réalisation de l'excursion brownienne.

Théorème 1.1.2 (Marckert & Mokkadem [77]). *Soit μ une loi critique, de variance finie $\sigma^2 \in (0, \infty)$. Supposons de plus qu'il existe un réel $\beta > 0$ tel que $\sum_{k \in \mathbb{N}} \mu_k e^{\beta k} < \infty$. Alors, on a la convergence jointe en loi suivante dans $\mathbb{D}([0, 1], \mathbb{R}_+^2)$:*

$$\left(\frac{\sigma C_{2nt}(\mathcal{T}_n)}{2\sqrt{n}}, \frac{W_{nt}(\mathcal{T}_n)}{\sigma\sqrt{n}} \right)_{0 \leq t \leq 1} \xrightarrow[n \rightarrow \infty]{(d)} (\mathfrak{e}_t, \mathfrak{e}_t)_{0 \leq t \leq 1}.$$

Ainsi par exemple, par définition de la marche de Łukasiewicz et continuité du plus grand saut pour la distance J1, le plus gros degré d'un sommet de \mathcal{T}_n est un $o(\sqrt{n})$ avec grande probabilité.

Lois stables et théorème de Duquesne Une généralisation fondamentale du théorème de Marckert et Mokkadem a été obtenue par Duquesne [40], qui s'est intéressé aux lois dites *dans le domaine d'attraction d'une loi stable*. Comme ces lois jouent un grand rôle dans tous nos résultats, il est utile d'en rappeler la définition ainsi que certaines de leurs propriétés.

On dit qu'une fonction $L : \mathbb{R}_+^* \rightarrow \mathbb{R}_+^*$ est à *variation lente* si, pour tout $c > 0$, $L(cx)/L(x)$ tend vers 1 quand $x \rightarrow \infty$. Des exemples classiques de telles fonctions sont les fonctions qui convergent vers une limite strictement positive, ou les fonctions \log^β , $\beta \in \mathbb{R}$. Leur dénomination provient du fait que ces fonctions croissent plus lentement que tout polynôme dans le sens où, pour tout $\gamma > 0$, $x^{-\gamma}L(x) \rightarrow 0$ quand $x \rightarrow \infty$.

Définition. *Soit $\alpha \in (1, 2]$. On dit qu'une loi μ critique est dans le domaine d'attraction d'une loi α -stable s'il existe une fonction à variation lente L telle que*

$$\mathbb{E} [X^2 \mathbf{1}_{X \leq x}] \underset{x \rightarrow \infty}{\sim} x^{2-\alpha} L(x) + 1, \quad (1.1)$$

où X est une variable aléatoire de loi μ .

Bien que le terme " + 1 " semble inutile au premier abord, le prendre en compte permet comme on le verra plus tard d'exprimer des quantités liées à la loi μ en fonction de cette fonction à variation lente L .

Remarquons que les lois de variance finie sont par définition dans le domaine d'attraction d'une loi 2-stable. D'autre part, dans le cas où la loi est de variance infinie (ce qui est toujours le cas si $\alpha < 2$), alors le terme "+1" est négligeable.

Dans tout ce qui suit, une loi μ étant donnée, $(B_n)_{n \geq 1}$ désignera une suite de réels strictement positifs vérifiant :

$$\frac{nL(B_n)}{B_n^\alpha} \xrightarrow[n \rightarrow \infty]{} \frac{\alpha(\alpha - 1)}{\Gamma(3 - \alpha)}, \quad (1.2)$$

où L est une fonction à variation lente qui vérifie (1.1). De la relation (1.2), on peut déduire le comportement asymptotique d'une telle suite : quand $n \rightarrow \infty$,

$$B_n \sim \begin{cases} \ell(n) n^{1/\alpha} & \text{si } \mu \text{ est de variance infinie, pour une certaine fonction } \ell \text{ à variation lente.} \\ \sqrt{\frac{\sigma^2 n}{2}} & \text{si } \mu \text{ est de variance } \sigma^2 < \infty. \end{cases}$$

Ainsi, une suite (B_n) qui vérifie (1.2) se comporte grosso modo comme $n^{1/\alpha}$. Duquesne généralise la convergence jointe de la fonction de contour et de la marche de Łukasiewicz des GW conditionnés par leur nombre de sommets, dans le cas où μ est dans le domaine d'attraction d'une loi stable.

Théorème 1.1.3 (Duquesne [40]). *Soit $\alpha \in (1, 2]$. Il existe deux processus $X^{(\alpha)}$, $H^{(\alpha)}$ tels que, pour toute loi critique μ dans le domaine d'attraction d'une loi α -stable, la convergence jointe suivante a lieu en loi dans $\mathbb{D}([0, 1], \mathbb{R}^2)$:*

$$\left(\frac{1}{B_n} W_{nt}(\mathcal{T}_n), \frac{B_n}{n} C_{2nt}(\mathcal{T}_n) \right)_{0 \leq t \leq 1} \xrightarrow[n \rightarrow \infty]{(d)} \left(X_t^{(\alpha)}, H_t^{(\alpha)} \right)_{0 \leq t \leq 1}.$$

Si $\alpha < 2$, on peut ainsi remarquer que les facteurs de renormalisation de $C(\mathcal{T}_n)$ et $W(\mathcal{T}_n)$ ne sont plus du même ordre, puisque le premier est essentiellement de l'ordre de $n^{1/\alpha}$ et le deuxième de l'ordre de $n^{1-1/\alpha}$.

Les processus limite $X^{(\alpha)}$ et $H^{(\alpha)}$ Le processus limite $(X_t^{(\alpha)}, H_t^{(\alpha)})_{0 \leq t \leq 1}$ ne dépend que de α et non de la loi μ , et peut être construit directement "dans le continu", à partir du processus de Lévy stable d'indice α . Ce processus, que l'on notera $(Y_t^{(\alpha)})_{t \geq 0}$, est le processus de Lévy dont l'exposant de Laplace est donné par $\mathbb{E}[e^{-\lambda Y_s^{(\alpha)}}] = e^{s\lambda^\alpha}$ pour tous $s, \lambda \geq 0$.

On peut alors construire l'*excursion normalisée* $X^{(\alpha)}$ de ce processus, ce qui consiste, en substance, à le conditionner à valoir 0 au temps 1 et à rester positif entre 0 et 1 (bien que cet événement soit de probabilité 0, il est possible de lui donner un sens ; nous renvoyons au premier chapitre du livre [42] pour de plus amples détails concernant les processus stables et les moyens de définir rigoureusement $X^{(\alpha)}$). Pour construire le processus de hauteur associé $H^{(\alpha)}$, posons, pour tous $0 \leq s \leq t \leq 1$, $I_s^t = \inf_{s \leq r \leq t} X_r^{(\alpha)}$, et définissons

$$H_t^{(\alpha)} = \lim_{\varepsilon \rightarrow 0} \frac{1}{\varepsilon} \int_0^t \mathbf{1}_{X_s \leq I_s^t + \varepsilon} ds,$$

cette limite existant en probabilité. Ainsi, $H_t^{(\alpha)}$ correspond intuitivement à la mesure de l'ensemble $\{s, X_s^{(\alpha)} = \inf_{r \in [s, t]} X_r^{(\alpha)}\}$. Ce processus $H^{(\alpha)}$ possède une modification continue, que l'on considérera à partir de maintenant. Dans le cas $\alpha = 2$, le processus $Y^{(\alpha)}$ est simplement $\sqrt{2}$ fois un mouvement brownien standard, et les deux processus $X^{(\alpha)}$ et $H^{(\alpha)}$ sont égaux à $\sqrt{2}$ fois la même excursion brownienne normalisée. La figure 1.3 représente une simulation des processus $X^{(1.7)}$ et $H^{(1.7)}$.

Remarque. *Pour $\alpha < 2$, le processus $Y^{(\alpha)}$ (et par conséquent l'excursion $X^{(\alpha)}$) n'est pas continu. Ainsi, une conséquence du théorème 1.1.3 est que le degré maximum d'un sommet dans \mathcal{T}_n , quand μ est dans le domaine d'attraction d'une loi α -stable pour $\alpha < 2$, est typiquement de l'ordre de B_n .*

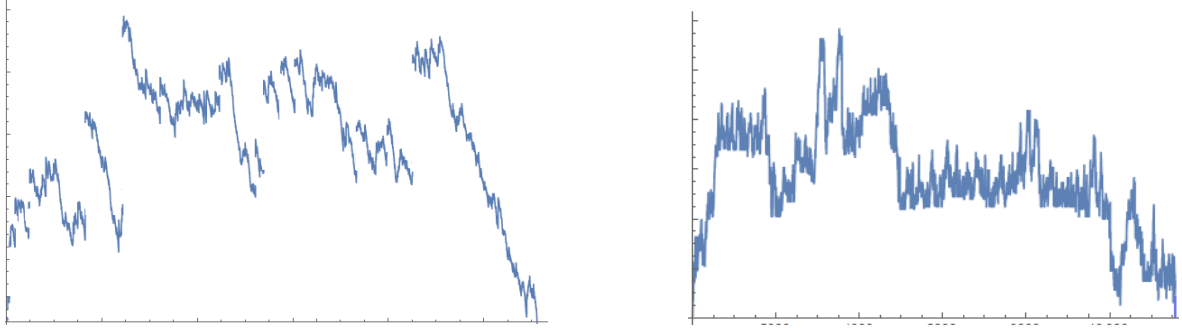

FIGURE 1.3: Une simulation des processus $X^{(1.7)}$ (à gauche) et $H^{(1.7)}$ (à droite).

\mathbb{R} -arbres aléatoires

Il est possible de transcrire le théorème 1.1.3, qui expose la convergence des fonctions de contour et marches de Łukasiewicz d'arbres discrets vers des processus limite, en termes d'arbres. Il s'agit de faire converger l'arbre de Galton-Watson conditionné \mathcal{T}_n , vu en tant qu'espace métrique lorsqu'on le munit de sa distance de graphe, vers un espace métrique aléatoire limite. Au vu de l'énoncé du théorème 1.1.3, nous cherchons à construire des espaces métriques dont la "marche de Łukasiewicz" et la "fonction de contour" (dans un sens à définir) seraient les processus $X^{(\alpha)}$ et $H^{(\alpha)}$.

Il est utile de définir pour cela les \mathbb{R} -arbres, qui sont des espaces métriques que l'on peut construire à partir de fonctions dites de type excursion. Par définition, un \mathbb{R} -arbre est un espace métrique (T, d) tel que, pour tous points $u, v \in T$:

- (i) il existe une unique isométrie $f_u^v : [0, d(u, v)] \rightarrow T$ telle que $f_u^v(0) = u$, $f_u^v(d(u, v)) = v$.
- (ii) pour tout chemin $\gamma : [0, 1] \rightarrow T$ continu injectif tel que $\gamma(0) = u$ et $\gamma(1) = v$, on a $\gamma([0, 1]) = f_u^v([0, d(u, v)])$.

En d'autres termes, il existe un unique chemin continu injectif de u à v . Enfin, un \mathbb{R} -arbre enraciné est un triplet (T, d, ρ) où (T, d) est un \mathbb{R} -arbre et ρ est un point distingué de T , que l'on appelle racine. On peut aisément remarquer que tout arbre plan fini muni de sa distance de graphe est un \mathbb{R} -arbre enraciné (en sa racine).

Dans tout ce qui suit, on considérera uniquement des \mathbb{R} -arbres compacts. L'ensemble des \mathbb{R} -arbres compacts enracinés est munie d'une (pseudo)-distance appelée *distance de Gromov-Hausdorff*, construite à partir de la distance de Hausdorff sur l'ensemble des compacts d'un même espace. Nous renvoyons à [30] pour de plus amples informations sur cette distance de Gromov-Hausdorff.

Distance de Hausdorff La distance de Hausdorff mesure à quel point deux compacts d'un même espace métrique sont proches. Soit (E, d) un espace métrique et K_1, K_2 deux sous-ensembles compacts de E . La distance de Hausdorff entre K_1 et K_2 est définie par

$$d_H(K_1, K_2) = \inf \{ \varepsilon > 0, \forall x \in K_1 d(x, K_2) < \varepsilon, \forall y \in K_2 d(y, K_1) < \varepsilon \}.$$

(Pseudo)-distance de Gromov-Hausdorff Pour $(T, d, \rho), (T', d', \rho')$ deux \mathbb{R} -arbres compacts enracinés, on définit la pseudo-distance de Gromov-Hausdorff entre eux comme :

$$d_{GH}((T, d, \rho), (T', d', \rho')) = \inf \{ d_H(\phi(T), \phi(T')) \vee \delta(\phi(\rho), \phi(\rho')) \},$$

où l'infimum est pris sur l'ensemble des plongements isométriques $\phi : T \rightarrow E$ et $\phi' : T' \rightarrow E$ dans un même espace métrique (E, δ) . En d'autres termes, cette distance permet de comparer les "formes" des deux arbres, ainsi que les positions de leurs deux racines. On peut montrer que l'ensemble des classes d'équivalence de \mathbb{R} -arbres par la relation $d_{GH}(T, T') = 0$, muni de la distance de Gromov-Hausdorff (qui est bien une distance sur l'ensemble de ces classes d'équivalence), est un espace complet et séparable.

Fonctions de type excursion Il est possible de construire des \mathbb{R} -arbres à partir de fonctions càdlàg dites *de type excursion*. Une fonction $f : [0, 1] \rightarrow \mathbb{R}_+$ est de type excursion si elle vérifie les conditions suivantes :

- f est càdlàg ;
- f est positive sur $[0, 1]$, et $f(1) = 0$;
- f fait uniquement des sauts positifs, c'est-à-dire que pour tout $x \in (0, 1]$,

$$f(x-) := \lim_{\substack{y \rightarrow x \\ y < x}} f(y) \leq f(x).$$

C'est en particulier le cas, presque sûrement, des processus $X^{(\alpha)}$ et $H^{(\alpha)}$ ($H^{(\alpha)}$ est même continu sur $[0, 1]$).

Fixons f une fonction de type excursion, que l'on suppose de plus continue et vérifiant $f(0) = 0$. On peut alors construire à partir de f un \mathbb{R} -arbre $T(f)$. Pour cela, on définit la pseudo-distance d_f sur $[0, 1]$ comme suit : pour $0 \leq s \leq t \leq 1$, $d_f(s, t) = f(s) + f(t) - 2 \inf_{[s, t]} f$, et $d_f(t, s) = d_f(s, t)$. On définit également sur $[0, 1]$ une relation d'équivalence \sim_f : pour tous $s, t \in [0, 1]$, $s \sim_f t$ si et seulement si $d_f(s, t) = 0$. Alors, l'arbre $T(f)$ est l'espace métrique défini comme :

$$T(f) = [0, 1] / \sim_f,$$

muni de la projection de la pseudo-distance d_f , dont la racine est la classe d'équivalence de 0 pour la relation \sim_f .

En particulier, pour tout arbre plan enraciné fini T_n à n sommets, on peut vérifier que $T_n = T(C_{2n}(T_n))$.

Arbre brownien continu L'exemple le plus connu de \mathbb{R} -arbre aléatoire est l'arbre brownien continu (ou CRT, pour Continuum Random Tree), introduit par Aldous [7] (voir la figure 1.4, gauche, pour une simulation). Cet arbre $\mathcal{T}^{(2)}$ est le \mathbb{R} -arbre $T(\mathfrak{e})$ construit à partir de l'excursion brownienne \mathfrak{e} , dont on peut vérifier qu'elle est bien de type excursion. Le μ -GW conditionné à avoir n sommets converge alors vers cet arbre brownien continu, quand μ est critique et de variance finie.

Théorème 1.1.4. *Soit μ une loi critique de variance finie σ^2 . Alors, on a la convergence suivante en loi au sens de Gromov-Hausdorff :*

$$\left(\mathcal{T}_n, \frac{\sigma}{2\sqrt{n}} d_{C_{2n}(\mathcal{T}_n)} \right) \xrightarrow[n \rightarrow \infty]{(d)} (\mathcal{T}^{(2)}, d_{\mathfrak{e}}).$$

Ce théorème est une conséquence des résultats d'Aldous [7], mais est énoncé sous une forme plus proche de la nôtre par Le Gall [71]. L'arbre brownien $\mathcal{T}^{(2)}$ est appelé *limite d'échelle* des μ -GW conditionnés, car il s'agit de la limite d'arbres dans lesquels les distances (donc l'"échelle" à laquelle on regarde l'arbre) sont renormalisées.

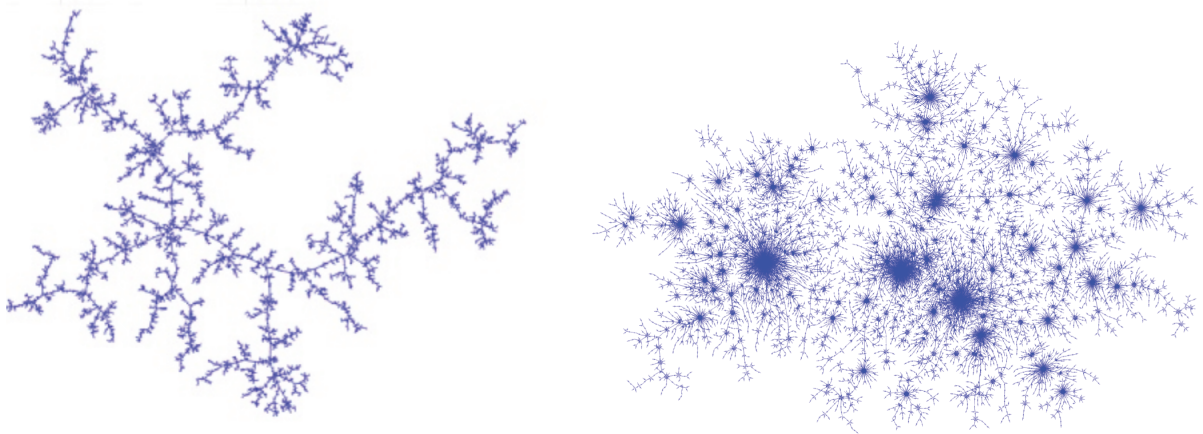

FIGURE 1.4: A gauche, l'arbre brownien continu d'Aldous. A droite, l'arbre 1.3-stable.

Mesure de masse et mesure de longueur Définissons maintenant quelques notions inhérentes aux \mathbb{R} -arbres. Le degré sortant d'un point u d'un \mathbb{R} -arbre enraciné T est le nombre de composantes connexes de $T \setminus \{u\}$ ne contenant pas la racine. En particulier, on dit que u est une feuille si son degré sortant vaut 0. L'ensemble des feuilles de T sera noté $\mathcal{F}(T)$. On dira d'autre part qu'un point u est un point de branchement si son degré sortant est supérieur à 2. Il s'agit des points au niveau duquel une branche de l'arbre se sépare en plusieurs branches différentes.

Enfin, tout \mathbb{R} -arbre compact $T(f)$ obtenu à partir d'une fonction de type excursion f est naturellement muni de deux mesures : (i) sa mesure de masse h , que l'on définit comme la projection sur T de la mesure de Lebesgue sur $[0, 1]$, par la relation d'équivalence \sim_f ; (ii) sa mesure de longueur ℓ , définie sur $T \setminus \mathcal{F}(T)$ comme l'unique mesure σ -finie vérifiant, pour tous $u, v \in T \setminus \mathcal{F}(T)$, $\ell([u, v]) = d(u, v)$, où $[u, v]$ est l'unique chemin injectif entre u et v dans T .

Arbres stables Un cas particulier de \mathbb{R} -arbre, généralisant l'arbre brownien continu d'Aldous, est l'arbre stable $\mathcal{T}^{(\alpha)}$ de paramètre $\alpha \in (1, 2]$, défini par Duquesne et Le Gall [42] comme

$$\mathcal{T}^{(\alpha)} := T(H^{(\alpha)}).$$

Pour $\alpha = 2$, on retrouve notamment l'arbre brownien continu $\mathcal{T}^{(2)}$. A droite de la figure 1.4 est représentée une simulation de l'arbre 1.3-stable. La convergence du théorème 1.1.3 peut alors se retranscrire en termes de convergence de \mathbb{R} -arbres.

Théorème 1.1.5. *Fixons $\alpha \in (1, 2]$. Soit μ une loi critique dans le domaine d'attraction d'une loi α -stable, et $(B_n)_{n \geq 1}$ vérifiant (1.2). Alors, on a la convergence suivante en loi au sens de Gromov-Hausdorff :*

$$\left(\mathcal{T}_n, \frac{B_n}{n} d_{C_{2n}}(\mathcal{T}_n) \right) \xrightarrow[n \rightarrow \infty]{(d)} (\mathcal{T}^{(\alpha)}, d_{H^{(\alpha)}}).$$

De même que dans le cas brownien, l'arbre $\mathcal{T}^{(\alpha)}$ est la limite d'échelle des arbres $(\mathcal{T}_n)_{n \geq 1}$. Par la construction précédente, le processus $H^{(\alpha)}$ peut ainsi être vu comme la fonction de contour (continue) de l'arbre $\mathcal{T}^{(\alpha)}$. De même, le processus $X^{(\alpha)}$ est l'équivalent continu de la marche de Łukasiewicz de l'arbre α -stable. Dès lors, l'étude de ces deux processus continus est utile pour obtenir des informations sur les processus discrets dont ils sont la limite.

Remarque. Des généralisations du théorème 1.1.5 ont été prouvées par Kortchemski [63] et Rizzolo [91] qui, au lieu de se restreindre aux GW conditionnés par leur nombre total de sommets, les conditionnent par leur nombre de feuilles - dans le cas de Kortchemski - ou leur nombre de sommets ayant un degré fixé - pour Rizzolo. Ceci introduit une difficulté supplémentaire car, dès lors, la taille de l'arbre considéré n'est plus fixée (en particulier, la longueur de sa fonction de contour ou de sa marche de Łukasiewicz non plus, ce qui rend plus ardue l'utilisation des méthodes classiques d'étude).

Mesure de masse sur l'arbre stable La mesure de masse de l'arbre stable $\mathcal{T}^{(\alpha)}$ peut s'interpréter en terme de feuilles. En effet, une propriété bien connue de $\mathcal{T}^{(\alpha)}$ est que l'ensemble de ses feuilles est dense dans l'arbre. De plus, elles sont équiréparties, dans le sens où la mesure uniforme sur l'ensemble des feuilles est la projection sur $\mathcal{T}^{(\alpha)}$ de la mesure de Lebesgue de $[0, 1]$, pour la relation $\sim_{H^{(\alpha)}}$. En d'autres termes, la mesure de masse h d'une composante connexe mesurable de $\mathcal{T}^{(\alpha)}$ compte la proportion de l'ensemble des feuilles qui appartiennent à cette composante.

Limite locale d'arbres de Galton-Watson

Nous concluons cette section en mentionnant une autre façon de faire converger une suite d'arbres plans finis aléatoires, appelée *convergence locale*. La différence par rapport à la limite d'échelle est que, cette fois, les distances dans l'arbre fini ne sont pas renormalisées, et l'on s'intéresse uniquement aux propriétés de l'arbre dans un voisinage de sa racine. Faire intervenir la *limite locale* d'arbres de Galton-Watson est utile dans l'étude de propriétés dites locales, comme le degré de la racine ou le nombre de feuilles de hauteur fixée.

Distance locale sur les arbres Deux arbres plans T, T' (pas nécessairement finis) étant fixés, on définit la distance locale entre T et T' comme

$$d_{loc}(T, T') = \left(1 + \sup_{r \geq 0} \{r \geq 0, B_r(T) = B_r(T')\} \right)^{-1},$$

où $B_r(T)$ désigne la boule fermée de rayon r dans T centrée en la racine, pour la distance de graphe. Ainsi, cette distance locale mesure jusqu'où un observateur verrait le même paysage autour de lui, s'il se plaçait à la racine de T ou à celle de T' .

Le théorème de convergence suivant a été montré dans sa généralité par Janson (voir [55, Théorème 7.1]).

Théorème 1.1.6. *Soit μ une loi critique. Alors il existe un arbre infini aléatoire \mathcal{T}^* tel que le μ -GW conditionné \mathcal{T}_n converge en loi vers \mathcal{T}^* , pour la distance locale.*

Ce résultat peut s'interpréter par la convergence des lois des boules contenant la racine de \mathcal{T}_n : pour tout $r \in \mathbb{N}$, tout arbre T de hauteur inférieure ou égale à r :

$$\mathbb{P}(B_r(\mathcal{T}_n) = T) \xrightarrow{n \rightarrow \infty} \mathbb{P}(B_r(\mathcal{T}^*) = T).$$

La structure de la limite locale \mathcal{T}^* , aussi appelée *arbre de Kesten* et définie par le même Kesten dans [60], est connue : cet arbre est composé d'une unique branche infinie, sur laquelle se greffent des μ -GW (non conditionnés) indépendants ; de plus, le nombre d'enfants de tout sommet appartenant à cette branche infinie est distribué selon la loi $\tilde{\mu}$, qui est construite en "biaisant par la taille" la loi initiale μ : pour tout i , $\tilde{\mu}_i = i\mu_i$. Notons qu'il s'agit bien d'une loi de probabilité puisque μ est critique. Il est à noter que, contrairement aux théorèmes 1.1.4 et

1.1.5, l'énoncé du théorème 1.1.6 ne contient aucune hypothèse sur la variance de μ , et seul compte le fait qu'elle soit critique. Nous renvoyons à la figure 1.5 pour une représentation de cet arbre \mathcal{T}^* . Citons notamment les travaux d'Abraham et Delmas [3], qui prouvent que \mathcal{T}^* est la limite locale d'arbres de Galton-Watson de loi de reproduction critique, sous plusieurs conditionnements différents (nombre total de sommets, nombre total de feuilles, hauteur, etc.)

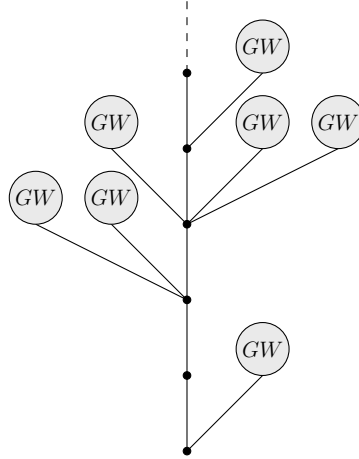

FIGURE 1.5: L'arbre infini de Kesten \mathcal{T}^* . Sur la branche infinie (représentée au centre) sont greffés des μ -GW indépendants.

1.1.4 Répartition des degrés dans des arbres de Galton-Watson conditionnés

Index des notations de la section 1.1.4

- $N^{\mathcal{A}}(T)$ Nombre de \mathcal{A} -sommets dans un arbre T .
- $N_i^{\mathcal{A}}(T)$ Nombre de \mathcal{A} -sommets différents de T visités avant le temps i par $C(T)$.
- $K_i^{\mathcal{A}}(T)$ Nombre de \mathcal{A} -sommets de T parmi les i premiers dans l'ordre lexicographique.

Dans ce qui suit, on s'intéresse particulièrement aux arbres de Galton-Watson de loi de reproduction critique, sous certains conditionnements. Fixons une loi de probabilité μ critique sur \mathbb{N} . Pour tout ensemble d'entiers $\mathcal{A} \subset \mathbb{N}$ et tout arbre T , un sommet u de T sera appelé \mathcal{A} -sommet de T si son nombre d'enfants est un élément de \mathcal{A} , et la notation $N^{\mathcal{A}}(T)$ désignera le nombre de \mathcal{A} -sommets dans T :

$$N^{\mathcal{A}}(T) = \text{Card} \{u \in T, k_u(T) \in \mathcal{A}\}.$$

En particulier, $N^{\mathbb{N}}(T) = |T|$. Pour tout $k \geq 1$ et tout $\mathcal{A} \subset \mathbb{N}$, $\mathcal{T}_k^{\mathcal{A}}$ désigne un μ -GW conditionné à avoir k \mathcal{A} -sommets. Par exemple, $\mathcal{T}_k^{\mathbb{N}}$ désigne un arbre de Galton-Watson conditionné à avoir un nombre total de sommets égal à k , et $\mathcal{T}_k^{\{0\}}$ est un μ -GW conditionné à avoir k feuilles. Il est toujours sous-entendu que l'on se restreint dans notre étude aux entiers k tels que la probabilité qu'un μ -GW ait exactement k \mathcal{A} -sommets soit strictement positive.

Notre contribution principale à l'étude de la structure de grands arbres de Galton-Watson conditionnés peut être divisée en deux parties. Dans un premier temps, deux ensembles d'entiers $\mathcal{A}, \mathcal{B} \subset \mathbb{N}$ étant fixés, nous nous intéressons à la distribution asymptotique de $N^{\mathcal{A}}(\mathcal{T}_k^{\mathcal{B}})$ lorsque la loi de reproduction μ est dans le domaine d'attraction d'une loi stable, quand $k \rightarrow \infty$. Dans un second temps, nous étudions plus particulièrement le cas d'un arbre conditionné par son nombre total de sommets. La question est alors la suivante : dans l'arbre

$\mathcal{T}_n^{\mathbb{N}}$, comment les \mathcal{A} -sommets sont-ils répartis dans l'arbre ? Nous étudions dans ce contexte deux processus distincts de comptage des \mathcal{A} -sommets : dans l'ordre lexicographique, et à l'instant où ils sont visités pour la première fois par la fonction de contour.

Nombre de sommets de degré fixé

Un rapide historique des résultats déjà connus Les degrés des sommets dans les arbres de Galton-Watson ont été largement étudiés, et représentent des quantités intéressantes. Différents objets aléatoires combinatoires sont en effet codés par des arbres de Galton-Watson, dont les degrés des sommets encodent d'importantes informations. Addario-Berry [6] propose par exemple une manière de coder une carte par un arbre, dont les degrés correspondent aux tailles des composantes 2-connexes du graphe.

L'étude du nombre de sommets ayant un nombre d'enfants fixé dans de grands arbres de Galton-Watson conditionnés par leur taille remonte aux années 1980 et à Kolchin [62] qui prouve, dans le cas où la loi de reproduction de l'arbre est critique et de variance finie, la normalité asymptotique de ces quantités.

Théorème 1.1.7 (Kolchin). *Soit μ une loi critique de variance finie, et \mathcal{T}_n un μ -GW conditionné à avoir n sommets. Pour tout $i \in \mathbb{N}$, il existe $\delta_i \geq 0$ tel que, en loi,*

$$\frac{N^{\{i\}}(\mathcal{T}_n) - n\mu_i}{\sqrt{n}} \xrightarrow[n \rightarrow \infty]{(d)} \mathcal{N}(0, \delta_i^2),$$

où $\mathcal{N}(0, \delta_i^2)$ est une variable aléatoire de loi normale centrée de variance δ_i^2 .

Le nombre de sommets avec i enfants est donc, au premier ordre, proportionnel à μ_i , et admet des fluctuations gaussiennes centrées à l'échelle \sqrt{n} . Plus tard, Minami [85] démontre que ces résultats ont lieu de manière jointe pour un nombre fini de i , en ajoutant une condition sur les moments d'ordre supérieur à 2 de la loi de reproduction μ . Ce résultat a depuis lors été redémontré et étendu par Janson [56] à toutes les lois de reproduction de variance finie.

Le premier résultat nouveau de cette thèse est également une généralisation du résultat de Kolchin. Une loi μ sur \mathbb{N} , un ensemble $\mathcal{B} \subset \mathbb{N}$ et un entier $n \geq 1$ étant fixés, on étudie particulièrement l'arbre $\mathcal{T}_n^{\mathcal{B}}$, qui est un μ -GW conditionné à avoir n \mathcal{B} -sommets. Comme mentionné précédemment, on supposera implicitement que cet événement a une probabilité strictement positive. Pour tout sous-ensemble \mathcal{A} de \mathbb{N} , on notera de plus $\mu_{\mathcal{A}} := \sum_{i \in \mathcal{A}} \mu_i$ la mesure de l'ensemble \mathcal{A} .

Théorème 1

Soit μ une loi critique dans le domaine d'attraction d'une loi stable, et $\mathcal{A}, \mathcal{B} \subset \mathbb{N}$. Supposons de plus $\mu_{\mathcal{B}} > 0$. Alors :

(i) lorsque $n \rightarrow \infty$,

$$\frac{1}{n} \mathbb{E} [N^{\mathcal{A}} (\mathcal{T}_n^{\mathcal{B}})] \rightarrow \frac{\mu_{\mathcal{A}}}{\mu_{\mathcal{B}}};$$

(ii) il existe un paramètre $\delta_{\mathcal{A}, \mathcal{B}} \geq 0$ tel que, en loi,

$$\frac{N^{\mathcal{A}} (\mathcal{T}_n^{\mathcal{B}}) - n \frac{\mu_{\mathcal{A}}}{\mu_{\mathcal{B}}}}{\sqrt{n}} \xrightarrow[n \rightarrow \infty]{(d)} \mathcal{N} (0, \delta_{\mathcal{A}, \mathcal{B}}^2),$$

où $\mathcal{N}(0, \delta^2)$ est une variable aléatoire de loi normale centrée de variance δ^2

(iii) la convergence (ii) a lieu de manière jointe, dans le sens où, pour tout $j \geq 1$ et tous $\mathcal{A}_1, \dots, \mathcal{A}_j \subset \mathbb{N}$, le vecteur aléatoire

$$\left(\frac{N^{\mathcal{A}_1} (\mathcal{T}_n^{\mathcal{B}}) - n \frac{\mu_{\mathcal{A}_1}}{\mu_{\mathcal{B}}}}{\sqrt{n}}, \dots, \frac{N^{\mathcal{A}_j} (\mathcal{T}_n^{\mathcal{B}}) - n \frac{\mu_{\mathcal{A}_j}}{\mu_{\mathcal{B}}}}{\sqrt{n}} \right)$$

converge en loi quand $n \rightarrow \infty$ vers un vecteur gaussien.

Ce théorème étend le résultat de Kolchin d'une part aux arbres conditionnés par leur nombre de \mathcal{B} -sommets pour $\mathcal{B} \neq \mathbb{N}$, et d'autre part à des lois de reproduction qui ne sont plus nécessairement de variance finie.

Remarquons que, indépendamment de l'indice de stabilité de la loi de reproduction μ , le facteur de renormalisation dans (ii) et (iii) est toujours de l'ordre de \sqrt{n} . Cela nous amène à conjecturer que ce phénomène de normalité asymptotique peut être observé dans un cadre plus général que celui évoqué dans le théorème 1. La preuve de ce théorème utilise néanmoins des propriétés spécifiques aux domaines d'attraction de lois stables, notamment des théorèmes de type *local limite* sur lesquels nous reviendrons, et ce résultat ne peut être généralisé simplement à d'autres lois de reproduction.

Un corollaire intéressant du théorème 1 est le suivant :

Corollaire 2

Soit $\alpha \in (1, 2]$ et μ une loi critique dans le domaine d'attraction d'une loi α -stable. Fixons un ensemble $\mathcal{A} \subset \mathbb{N}$ tel que $\mu_{\mathcal{A}} > 0$. Alors, après renormalisation, l'arbre $\mathcal{T}_k^{\mathcal{A}}$ converge en loi quand $k \rightarrow \infty$ au sens de Gromov-Hausdorff vers l'arbre stable $\mathcal{T}^{(\alpha)}$.

Ce résultat important généralise celui de Rizzolo [91], qui le prouve dans le cas d'une loi de reproduction de variance finie par des méthodes différentes, et celui de Kortchemski [63] qui, dans le cas où μ a variance infinie, se restreint au cas \mathcal{A} fini ou $\mathbb{N} \setminus \mathcal{A}$ fini. En particulier, nos méthodes permettent de lever cette restriction.

Localisation des sommets de degré fixé dans un arbre de Galton-Watson conditionné

On s'intéresse maintenant plus particulièrement à l'arbre \mathcal{T}_n conditionné à avoir n sommets au total. D'après le théorème 1, le nombre de \mathcal{A} -sommets dans \mathcal{T}_n est de l'ordre de $n\mu_{\mathcal{A}}$,

avec des fluctuations gaussiennes autour de son espérance. Imaginons maintenant, comme dans la définition de la fonction de contour, une particule qui explore l'arbre de gauche à droite en partant de la racine. On cherche à déterminer l'évolution du nombre de \mathcal{A} -sommets différents que la particule rencontre au fur et à mesure de son parcours. On définit pour cela, pour tout $s \in [0, 2n]$, $N_s^{\mathcal{A}}(\mathcal{T}_n)$ le nombre de \mathcal{A} -sommets différents visités par l'exploration de contour jusqu'à l'instant s . Labarbe et Marckert [69, Corollaire 5 et Section 1.1] font déjà l'observation suivante concernant la répartition des feuilles dans \mathcal{T}_n , autrement dit les $\{0\}$ -sommets, dans le cas où μ est la loi géométrique de paramètre $1/2$ (c'est-à-dire que pour tout $i \geq 0$, $\mu_i = 2^{-i-1}$; μ est alors critique et de variance 1). Dans ce cas, il s'avère que \mathcal{T}_n est un arbre uniforme à n sommets.

Théorème 1.1.8 (Labarbe & Marckert). *Soit \mathcal{T}_n un μ -GW conditionné à avoir n sommets, de loi de reproduction μ géométrique de paramètre $1/2$. On a alors la convergence jointe suivante en loi, dans $\mathbb{D}([0, 1], \mathbb{R}^2)$:*

$$\left(\frac{C_{2nt}(\mathcal{T}_n)}{\sqrt{n}}, \frac{N_{2nt}^{\{0\}}(\mathcal{T}_n) - nt\mu_0}{\sqrt{n}} \right)_{0 \leq t \leq 1} \xrightarrow[n \rightarrow \infty]{(d)} \left(\sqrt{2} \mathfrak{e}_t, B'_t \right)_{0 \leq t \leq 1},$$

où $(\mathfrak{e}_t)_{0 \leq t \leq 1}$ désigne l'excursion brownienne renormalisée, et $(B'_t)_{0 \leq t \leq 1}$ est un mouvement brownien indépendant de \mathfrak{e} .

Il est à noter que dans ce cas, les fluctuations du processus de comptage des feuilles sont asymptotiquement indépendantes de la fonction de contour de l'arbre, et centrées autour de 0. En réalité, il s'agit d'un fait spécifique au cas d'un arbre uniforme à n sommets et de l'ensemble $\mathcal{A} = \{0\}$. Pour généraliser ce résultat, une loi μ de variance finie $\sigma^2 \in (0, \infty)$ et un ensemble \mathcal{A} étant fixés, on définit la quantité

$$\gamma_{\mathcal{A}} = \sqrt{\mu_{\mathcal{A}}(1 - \mu_{\mathcal{A}}) - \frac{1}{\sigma^2} \left(\sum_{i \in \mathcal{A}} (i-1)\mu_i \right)^2}. \quad (1.3)$$

On peut vérifier que la quantité sous la racine est toujours positive, quels que soient μ et \mathcal{A} . Dans ce théorème et les suivants, on appellera mouvement brownien standard un mouvement brownien $(B_t)_{t \geq 0}$ tel que $\text{Var}(B_1) = 1$.

Théorème 3

Soit μ une loi de probabilité critique de variance $0 < \sigma^2 < \infty$, et $\mathcal{A} \subset \mathbb{N}$. Alors, on a la convergence en loi suivante, dans $\mathbb{D}([0, 1], \mathbb{R}^2)$:

$$\left(\frac{C_{2nt}(\mathcal{T}_n)}{\sqrt{n}}, \frac{N_{2nt}^{\mathcal{A}}(\mathcal{T}_n) - nt\mu_{\mathcal{A}}}{\sqrt{n}} \right)_{0 \leq t \leq 1} \xrightarrow[n \rightarrow \infty]{(d)} \left(\frac{2}{\sigma} \mathfrak{e}_t, \frac{\sum_{i \in \mathcal{A}} i\mu_i}{\sigma} \mathfrak{e}_t + \gamma_{\mathcal{A}} B_t \right)_{0 \leq t \leq 1},$$

où $(\mathfrak{e}_t)_{0 \leq t \leq 1}$ désigne l'excursion brownienne renormalisée, $(B_t)_{0 \leq t \leq 1}$ est un mouvement brownien standard indépendant de \mathfrak{e} et $\gamma_{\mathcal{A}}$ est la constante définie en (1.3).

La preuve de ce théorème passe par un résultat similaire concernant la marche de Łukasiewicz du μ -GW conditionné. Pour cela, pour tout ensemble $\mathcal{A} \subset \mathbb{N}$, tout $s \in [0, n]$, posons $K_s^{\mathcal{A}}(\mathcal{T}_n)$ le nombre de \mathcal{A} -sommets parmi les $[s]$ premiers dans l'ordre lexicographique. Alors, on a la convergence suivante :

Théorème 4

Soit μ une loi de probabilité critique de variance $0 < \sigma^2 < \infty$, et $\mathcal{A} \subset \mathbb{N}$. Alors, de manière jointe avec le théorème 3, on a la convergence en loi suivante dans $\mathbb{D}([0, 1], \mathbb{R}^2)$:

$$\left(\frac{W_{nt}(\mathcal{T}_n)}{\sqrt{n}}, \frac{K_{nt}^{\mathcal{A}}(\mathcal{T}_n) - nt\mu_{\mathcal{A}}}{\sqrt{n}} \right)_{0 \leq t \leq 1} \xrightarrow[n \rightarrow \infty]{(d)} \left(\sigma e_t, \frac{\sum_{i \in \mathcal{A}} (i-1)\mu_i}{\sigma} e_t + \gamma_{\mathcal{A}} B_t \right)_{0 \leq t \leq 1},$$

où $(e_t)_{0 \leq t \leq 1}$, $(B_t)_{0 \leq t \leq 1}$ et $\gamma_{\mathcal{A}}$ sont l'excursion brownienne, le mouvement brownien et la constante qui apparaissent dans le théorème 3.

En particulier, la figure 1.6 représente un grand arbre de Galton-Watson de loi de reproduction $\mu = Po(1)$ (c'est-à-dire, $\mu_i = e^{-1}/i!$ pour tout $i \geq 0$), sa marche de Łukasiewicz et son processus de comptage des $\{0\}$ -sommets dans l'ordre lexicographique, dont on peut remarquer qu'il semble effectivement corrélé à la marche de Łukasiewicz elle-même.

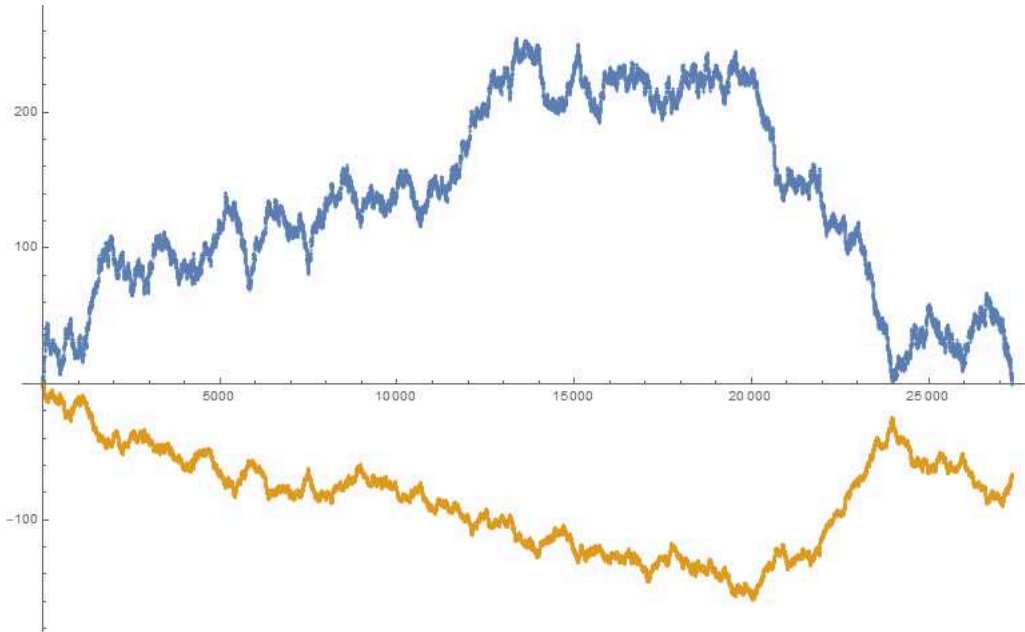

FIGURE 1.6: Une simulation d'un $Po(1)$ -GW tree \mathcal{T}_n avec $n = 27450$ sommets. Gauche : un plongement de \mathcal{T}_n dans le plan. Droite : sa marche de Łukasiewicz (en bleu) et le processus de comptage de ses $\{0\}$ -sommets (en jaune) dans l'ordre lexicographique $(W_{nt}(\mathcal{T}_n)/\sqrt{n}, (K_{nt}^{\{0\}}(\mathcal{T}_n) - nt\mu_0)/\sqrt{n})_{0 \leq t \leq 1}$. Le second se comporte asymptotiquement comme la moitié du premier, à laquelle on ajoute un mouvement brownien indépendant.

Finalement, ces deux théorèmes se généralisent au cas d'une loi μ de variance infinie dans le domaine d'attraction d'une loi stable. Dans ce cas, on sait déjà par le théorème 1.1.3 que la fonction de contour et la marche de Łukasiewicz de \mathcal{T}_n convergent conjointement respectivement, après une renormalisation convenable, vers les processus $(H_t^{(\alpha)})_{0 \leq t \leq 1}$ et $(X_t^{(\alpha)})_{0 \leq t \leq 1}$.

Théorème 5

Soit $\alpha \in (1, 2]$, μ une loi critique de variance infinie dans le domaine d'attraction d'une loi α -stable et $(B_n)_{n \geq 1}$ vérifiant (1.2). Soit $\mathcal{A} \subset \mathbb{N}$. Alors, on a les convergences suivantes dans $\mathbb{D}([0, 1], \mathbb{R}^2)$:

(i)

$$\left(\frac{B_n}{n} C_{2nt}(\mathcal{T}_n), \frac{N_{2nt}^{\mathcal{A}}(\mathcal{T}_n) - nt\mu_{\mathcal{A}}}{\sqrt{n}} \right)_{0 \leq t \leq 1} \xrightarrow[n \rightarrow \infty]{(d)} \left(H_t^{(\alpha)}, \sqrt{\mu_{\mathcal{A}}(1 - \mu_{\mathcal{A}})} B_t \right)_{0 \leq t \leq 1},$$

(ii) De manière jointe avec (i),

$$\left(\frac{W_{nt}(\mathcal{T}_n)}{B_n}, \frac{K_{nt}^{\mathcal{A}}(\mathcal{T}_n) - nt\mu_{\mathcal{A}}}{\sqrt{n}} \right)_{0 \leq t \leq 1} \xrightarrow[n \rightarrow \infty]{(d)} \left(X_t^{(\alpha)}, \sqrt{\mu_{\mathcal{A}}(1 - \mu_{\mathcal{A}})} B_t \right)_{0 \leq t \leq 1}.$$

Dans ces deux énoncés, $(B_t)_{0 \leq t \leq 1}$ est un mouvement brownien standard indépendant de $(X^{(\alpha)}, H^{(\alpha)})$.

Ce théorème de structure sera notamment utilisé par la suite, pour montrer les théorèmes 12 et 18.

Remarques dans le cas stable Il est intéressant de comparer les résultats obtenus dans le cas stable à ceux obtenus dans le cas où la loi de reproduction est de variance finie. Tout d'abord, même si les facteurs de renormalisation de $C(\mathcal{T}_n)$ et $W(\mathcal{T}_n)$ sont respectivement n/B_n et B_n , les processus de comptage des \mathcal{A} -sommets $(N_{2nt}^{\mathcal{A}}(\mathcal{T}_n))_{0 \leq t \leq 1}$ et $(K_{nt}^{\mathcal{A}}(\mathcal{T}_n))_{0 \leq t \leq 1}$ ont des fluctuations à l'échelle \sqrt{n} , comme lorsque la variance de μ est finie. Cependant, remarquons que dans le cas où la variance est infinie ces fluctuations sont toujours asymptotiquement indépendantes des processus $X^{(\alpha)}$ et $H^{(\alpha)}$, donc indépendantes de la "forme générale" de l'arbre, contrairement au cas précédent. Enfin, il est à noter que la variance asymptotique de ces fluctuations est $\mu_{\mathcal{A}}(1 - \mu_{\mathcal{A}})$, ce qui correspond exactement à poser $\sigma^2 = \infty$ dans la définition de $\gamma_{\mathcal{A}}$ donnée en (1.3).

La preuve des théorèmes 3, 4 et 5 se fait en deux temps : d'abord montrer les théorèmes 4 et 5 (ii) concernant la convergence du processus de comptage pour l'ordre lexicographique, en utilisant notamment un argument classique d'absolue continuité ; puis s'en servir pour montrer les théorèmes 3 et 5 (i) qui comptent les sommets lorsqu'ils sont visités par la fonction de contour. Cette approche est différente de celle de Labarbe et Marckert [69] qui, pour étudier le processus de comptage de feuilles d'un arbre uniforme à n sommets, se reposent sur des formules explicites afin de dénombrer différents types de marches. Cette méthode n'est plus applicable dans notre cadre plus général, où les formules analogues sont moins explicites.

La relation entre les deux processus de comptage est étonnamment simple, grâce au lemme suivant : pour T un arbre à n sommets et $0 \leq k \leq 2n - 2$, on définit $b_k(T)$ comme le nombre de sommets différents visités par la fonction de contour jusqu'au temps k .

Lemme 6

Soit T un arbre à n sommets. Alors, pour tout $0 \leq k \leq 2n - 2$,

$$b_k(T) = 1 + \frac{k + C_k(T)}{2}.$$

Comme l'ordre des premières visites des sommets par la fonction de contour suit l'ordre lexicographique, ce qui distingue les deux processus de comptage est l'instant auquel les différents sommets sont comptés (et non l'ordre dans lequel ils le sont). La différence entre les instants de comptage d'un sommet donné dans les deux processus peut être immédiatement calculée d'après le lemme 6, ce qui permet de montrer le théorème 3 à partir du 4, et le point (i) du théorème 5 directement à partir du point (ii).

Un outil fondamental : le théorème local limite bivarié

Le principal outil dans la preuve des théorèmes 4 et 5 (ii) est l'utilisation d'un théorème de type *local limite* bivarié (les travaux précédents utilisent un théorème local limite univarié, voir la remarque ci-dessous après le théorème 1.1.10). Ces théorèmes contrôlent de manière précise la valeur d'une marche aléatoire après un grand nombre de pas, et sont très utiles pour montrer des résultats de convergence de processus. L'utilisation d'un tel théorème pour étudier la marche de Łukasiewicz d'un arbre est rendue possible par l'observation suivante : soit μ une loi critique, et \mathcal{T}_n un μ -GW conditionné à avoir n sommets. Posons $(S_i)_{i \geq 0}$ la marche aléatoire partant de 0, et dont les sauts sont distribués de manière i.i.d. selon la loi $\mu(\cdot + 1)$. Ainsi, $\mathbb{P}(S_1 = i) = \mu(i + 1)$ pour tout $i \geq -1$. Alors :

Théorème 1.1.9. *La marche de Łukasiewicz $(W_1(\mathcal{T}_n), W_2(\mathcal{T}_n), \dots, W_n(\mathcal{T}_n))$ est distribuée comme $(S_i)_{0 \leq i \leq n}$ conditionnellement à l'événement $\{S_n = -1, S_i \geq 0 \forall i \leq n - 1\}$.*

La méthode usuelle pour prouver la convergence de la marche de Łukasiewicz de \mathcal{T}_n quand $n \rightarrow \infty$ consiste ainsi à étudier la marche $(S_i)_{i \geq 0}$, tout d'abord non conditionnée, puis en la conditionnant par $\{S_n = -1, S_i \geq 0 \forall i \leq n - 1\}$.

Pour adapter cette méthode à notre contexte, une loi critique μ et $\mathcal{A} \subset \mathbb{N}$ étant fixés, nous définissons une marche aléatoire à valeurs dans \mathbb{Z}^2 , dont la première composante est la marche S définie précédemment et dont la deuxième composante correspond au comptage des \mathcal{A} -sommets. Plus précisément, la marche $S^{\mathcal{A}}$ sur \mathbb{Z}^2 est la marche partant de $(0, 0)$ et dont les sauts sont i.i.d. et distribués selon la loi de

$$S_1^{\mathcal{A}} := (S_1, \mathbb{1}_{S_1+1 \in \mathcal{A}}).$$

Remarquons que les deux composantes de la marche ne sont pas indépendantes, puisque la deuxième se déduit de manière déterministe de la première.

Lemme 7

Soit μ une loi critique, et $\mathcal{A} \subset \mathbb{N}$. Alors la marche $(W_i(\mathcal{T}_n), K_i^{\mathcal{A}}(\mathcal{T}_n))_{0 \leq i \leq n}$ est distribuée comme $(S_i^{\mathcal{A}})_{0 \leq i \leq n}$, conditionnellement à l'événement $\{S_n = -1, S_i \geq 0 \forall i \leq n - 1\}$, où S désigne la première composante de $S^{\mathcal{A}}$.

Ainsi, on voit la marche de Łukasiewicz couplée au processus de comptage dans l'ordre lexicographique des \mathcal{A} -sommets comme une marche aléatoire sur \mathbb{Z}^2 de sauts i.i.d., conditionnée par un certain événement. Il reste alors à comprendre le comportement de cette marche aléatoire. Exposons le théorème local limite bivarié que nous utilisons dans le cas où μ a une variance finie (voir [92, Théorème 6.1]) :

Théorème 1.1.10. *Soit $j \geq 1$ et $(\mathbf{Y}_i)_{i \geq 1} := ((Y_i^{(1)}, \dots, Y_i^{(j)}))_{i \geq 1}$ des variables aléatoires i.i.d. dans \mathbb{Z}^j , telles que la matrice de covariance Σ de \mathbf{Y}_1 est définie positive. Posons \mathbf{M} la*

moyenne de \mathbf{Y}_1 et, pour $n \geq 1$, définissons

$$\mathbf{T}_n = \frac{1}{\sqrt{n}} \left(\sum_{i=1}^n \mathbf{Y}_i - n\mathbf{M} \right) \in \mathbb{R}^j.$$

Alors, quand $n \rightarrow \infty$, uniformément pour $\mathbf{x} \in \mathbb{R}^j$ tel que $\mathbb{P}(\mathbf{T}_n = \mathbf{x}) > 0$,

$$\mathbb{P}(\mathbf{T}_n = \mathbf{x}) = \frac{1}{(2\pi n)^{j/2} \sqrt{\det \Sigma}} e^{-\frac{1}{2} \mathbf{x} \Sigma^{-1} \mathbf{x}} + o(n^{-j/2}).$$

On l'applique dans notre cas à la marche $S^{\mathcal{A}}$. En effet, par hypothèse la loi de la première composante de cette marche est de variance finie, et sa deuxième composante est simplement une binomiale donc est également de variance finie. On obtient par le théorème 1.1.10 la convergence du processus $(S_i^{\mathcal{A}})_{0 \leq i \leq n}$ convenablement renormalisé. Il suffit alors de conditionner la première composante de cette marche à finir en -1 et à rester positive entre 0 et $n-1$ pour obtenir le théorème 4.

Enfin, le théorème 1.1.10 peut se généraliser dans le cas où la première composante est dans le domaine d'attraction d'une loi stable et où les autres ont une variance finie, ce qui permet de démontrer le théorème 5 (ii).

Remarque. Ce point de vue bivarié sur la marche de Łukasiewicz d'un arbre diffère de ceux de Kortchemski et Rizzolo dans leurs preuves de cas particuliers du corollaire 2. Rizzolo [91] identifie le nombre de \mathcal{A} -sommets d'un arbre de Galton-Watson et le nombre total de sommets d'un arbre de Galton-Watson avec une autre loi de reproduction, et se restreint au cas de la variance finie. Kortchemski [63] se ramène à l'étude d'une marche aléatoire conditionnée à éviter certains sauts et, lorsque la loi est de variance infinie, se limite au cas \mathcal{A} fini ou $\mathbb{N} \setminus \mathcal{A}$ fini. L'utilisation du théorème local limite bivarié permet de généraliser aisément ces résultats au cas stable sans condition sur \mathcal{A} , et d'obtenir les convergences fonctionnelles des théorèmes 3, 4 et 5.

1.2 Fragmentation d'arbres et laminations

Dans cette seconde partie, nous définissons des processus naturels de fragmentation obtenus à partir de \mathbb{R} -arbres, avant de les représenter par des suites de sous-ensembles compacts du disque unité.

Index des notations de la section 2

ℓ	Mesure de longueur sur un arbre.
h	Mesure de masse sur un arbre.
$\mathcal{P}_c(T)$	Processus de Poisson d'intensité $c d\ell$ sur T .
$\mathcal{EG}(f)$	Epigraphe de la fonction f .
$\overline{\mathbb{D}}$	Disque fermé $D(0, 1)$.
$\mathbb{L}_\infty^{(\alpha)}$	Lamination α -stable.
$(\mathbb{L}_c(f))_{c \in [0, \infty]}$	Processus de laminations codé par un processus de Poisson sur $\mathcal{EG}(f)$.
$\mathbb{L}_u(T)$	Lamination codant les sommets de T d'étiquette $\leq u$.

1.2.1 Processus de fragmentation

La théorie des fragmentations est vouée à l'étude d'un objet qui se désagrège au cours du temps en des morceaux de plus en plus petits. Dans notre cas, il s'agit d'arbres que l'on coupe

en différents endroits - en leurs sommets ou en des points sur leurs arêtes - les découpant ainsi en sous-arbres de plus en plus petits. Nous invitons les lecteurs curieux à lire l'ouvrage [19] pour découvrir les détails de cette théorie dans toute sa généralité.

Définissons Δ , l'ensemble des suites décroissantes infinies de réels positifs de somme inférieure à 1 :

$$\Delta = \left\{ x := x_1 \geq x_2 \geq \dots \geq 0, S(x) := \sum_{i=1}^{\infty} x_i \leq 1 \right\}.$$

Ces réels positifs peuvent être vus comme les *masses* des différents morceaux d'un objet initial donné. Un *processus de fragmentation* $(\Lambda_t)_{t \geq 0}$ est un processus aléatoire à valeurs dans l'ensemble Δ tel que, si P_s désigne la loi de Λ partant de $s := (s_1, s_2, \dots) \in \Delta$, alors P_s correspond au réordonnement par ordre décroissant de processus indépendants de lois $P_{(s_1, 0, 0, \dots)}, P_{(s_2, 0, 0, \dots)}, \dots$. En d'autres termes, chaque morceau de l'objet initial se désagrège indépendamment des autres, d'une façon qui dépend uniquement de sa masse. Nous étudions ici uniquement des processus de fragmentation *conservatifs*, c'est-à-dire qu'un objet se désagrège en morceaux dont la somme des masses est égale à la masse de l'objet initial, et *sans érosion* : la fonction $t \mapsto S(\Lambda_t)$ est constante.

Fragmentation d'Aldous-Pitman

Aldous et Pitman présentent dans l'article [14] un processus de fragmentation obtenu à partir de l'arbre brownien continu d'Aldous. L'idée est naturelle : on part de l'arbre entier et on le découpe en des points aléatoires. Alors, la suite des "masses" des composantes connexes de l'arbre privé de ces points forme, après réordonnement décroissant, un élément de Δ de somme 1. Si on augmente le nombre de points de coupe au fur et à mesure du temps, on obtient alors un processus de fragmentation.

Définissons ce processus plus rigoureusement. Comme on l'a vu en Section 1.1.3, l'arbre brownien $\mathcal{T}^{(2)}$ est naturellement muni d'une mesure de longueur ℓ , qui prend en considération la longueur de ses branches, et d'une mesure de masse h qui définit la masse d'une composante connexe de l'arbre, c'est-à-dire la proportion de feuilles dans cette composante. On définit maintenant un processus de Poisson \mathcal{P} sur $\mathcal{T}^{(2)} \times \mathbb{R}_+$, d'intensité $d\ell \times dt$. Intuitivement, si (x, t) est un point de ce processus, alors on découpe l'arbre au point x , à l'instant t . Pour tout $c \geq 0$, on définit également

$$\mathcal{P}_c := \mathcal{P} \cap (\mathcal{T}^{(2)} \times [0, c]),$$

la restriction de \mathcal{P} aux points de coupe qui apparaissent avant l'instant c . Les points de \mathcal{P}_c découpent $\mathcal{T}^{(2)}$ en un nombre infini (dénombrable) de composantes connexes. Soit $\Lambda_c \in \Delta$ la suite des h -masses de ces composantes, réarrangées en ordre décroissant. Le processus $(\Lambda_c)_{c \geq 0}$ est appelé processus de fragmentation d'Aldous-Pitman. La propriété d'absence de mémoire du processus de Poisson garantit en effet que Λ est bien un processus de fragmentation. Finalement, notons que $(\mathcal{P}_c)_{c \geq 0}$ est croissant et que, à c fixé, \mathcal{P}_c a la loi d'un processus de Poisson d'intensité $c d\ell$ sur $\mathcal{T}^{(2)}$.

Processus de coalescence Il est à noter que, si un processus de fragmentation correspond à l'évolution d'un objet qui se morcelle avec le temps, il est possible de définir son retournement temporel, appelé processus de coalescence, qui définit la manière dont différents objets de masses données fusionnent au cours du temps. En particulier, Aldous et

Pitman déterminent dans [14] le retournement temporel de leur processus de fragmentation. Celui-ci possède la loi du *coalescent additif standard* défini par Evans et Pitman dans [43], qui est le processus à valeurs dans Δ dans lequel toute paire d'objets de masses (x_i, x_j) fusionne indépendamment des autres paires en un morceau de masse $x_i + x_j$, à taux $x_i + x_j$.

Equivalent de la fragmentation d'Aldous-Pitman pour l'arbre stable

La fragmentation d'Aldous-Pitman est définie à partir de l'arbre brownien continu, qui est comme on l'a vu l'arbre 2-stable $\mathcal{T}^{(2)}$. Dès lors, nous pouvons étendre naturellement cette construction aux autres arbres stables $\mathcal{T}^{(\alpha)}$, $\alpha \in (1, 2)$. Dans ce cas, le processus de coalescence associé n'est plus le coalescent additif standard.

Pour tout \mathbb{R} -arbre T , comme dans le cas de l'arbre brownien continu, on définit $\mathcal{P}(T)$ un processus de Poisson d'intensité $d\ell \times dt$ sur $T \times \mathbb{R}_+$, et $\mathcal{P}_c(T) = \mathcal{P}(T) \cap (T \times [0, c])$ pour tout $c \geq 0$. On définit alors le processus de fragmentation associé $F(T)$ tel que, pour tout $c \geq 0$:

$$F_c(T) = (h_c^{(1)}, h_c^{(2)}, \dots) \in \Delta,$$

où les $h_c^{(i)}$, $i \geq 1$ sont les h -masses des composantes connexes de T délimitées par les points de $\mathcal{P}_c(T)$, triées dans l'ordre décroissant.

Dans cette thèse, le processus $F^{(\alpha)}$ suivant, construit à partir de l'arbre α -stable, sera appelé *processus de fragmentation α -stable* :

$$F^{(\alpha)} := F(\mathcal{T}^{(\alpha)}),$$

Notons que plusieurs fragmentations différentes de l'arbre stable ont déjà été étudiées par le passé [81, 82, 83, 100].

1.2.2 Laminations

Notre but est à présent d'obtenir une représentation géométrique des processus de fragmentation stables, en les codant dans le disque unité fermé $\overline{\mathbb{D}}$. L'idée d'étudier la convergence de sous-ensembles aléatoires du disque unité remonte à Aldous, qui étudie les triangulations d'un polygone régulier inscrit dans le cercle unité, quand le nombre de côtés de ce polygone tend vers $+\infty$. Plus précisément, pour $n \geq 3$, soit P_n le n -gone régulier inscrit dans \mathbb{S}^1 , dont les sommets sont $e^{2i\pi k/n}$, $1 \leq k \leq n$. Une triangulation de P_n est un ensemble maximal de diagonales de P_n qui ne se coupent pas à l'intérieur de $\overline{\mathbb{D}}$. En particulier, remarquons que le complémentaire d'une triangulation dans P_n est toujours une union disjointe de triangles ouverts, d'où son nom. Aldous [11] prouve qu'une triangulation du n -gone régulier inscrit dans le disque unité choisie uniformément au hasard converge, quand $n \rightarrow \infty$, vers un objet limite "continu" qu'il appelle triangulation brownienne (voir également [10] pour une étude de cet objet). Le but de cette partie est de faire le lien entre cette triangulation brownienne et la fragmentation d'Aldous-Pitman de l'arbre brownien continu mentionnée en Section 1.2.1, puis de généraliser ces résultats dans le cas des arbres stables.

Définition On appelle *lamination* du disque unité $\overline{\mathbb{D}}$ tout sous-ensemble fermé de $\overline{\mathbb{D}}$ composé du cercle unité \mathbb{S}^1 et d'une union de cordes du disque qui ne s'intersectent pas, excepté éventuellement en leurs extrémités. Une composante connexe du complémentaire d'une lamination L dans $\overline{\mathbb{D}}$ est appelée *face* de L . L'ensemble $\mathbb{L}(\overline{\mathbb{D}})$ des laminations du disque unité est muni de la distance de Hausdorff d_H , ce qui lui confère une structure d'espace métrique compact (dans ce cas, la distance de Hausdorff est définie sur $\mathbb{L}(\overline{\mathbb{D}})$ comme en Section 1.1.3, à partir de la distance euclidienne usuelle sur \mathbb{R}^2).

La relation entre arbres et laminations remonte également à Aldous [11], qui code l'excursion brownienne standard \mathfrak{e} - que l'on peut considérer comme on l'a vu comme la fonction de contour de l'arbre brownien $\mathcal{T}^{(2)}$ - par la triangulation brownienne. Cette triangulation est en quelque sorte la lamination "duale" de l'arbre brownien continu. Il la construit de la manière suivante : définissons l'épigraphe de \mathfrak{e} comme l'ensemble des points sous son graphe :

$$\mathcal{EG}(\mathfrak{e}) = \{u = (s, t) \in \mathbb{R}^2, s \in (0, 1), t \in [0, \mathfrak{e}_s]\}.$$

A tout point $u = (s, t) \in \mathcal{EG}(\mathfrak{e})$, Aldous associe les réels $g(u) = \sup\{x < s, \mathfrak{e}_x < t\}$ et $d(u) = \inf\{x > s, \mathfrak{e}_x < t\}$. La triangulation brownienne (représentée à gauche de la figure 1.7) est alors définie comme

$$\mathbb{L}(\mathfrak{e}) = \overline{\mathbb{S}^1 \cup \bigcup_{u \in \mathcal{EG}(\mathfrak{e})} [e^{-2i\pi g(u)}, e^{-2i\pi d(u)}]},$$

où $[x, y]$ est le segment reliant x à y . On peut en effet vérifier que les cordes $[e^{-2i\pi g(u)}, e^{-2i\pi d(u)}]$, $u \in \mathcal{EG}(\mathfrak{e})$ ne se coupent pas à l'intérieur du disque. En outre, presque sûrement, cette lamination est une *triangulation*, c'est-à-dire que son complémentaire dans le disque unité est une union disjointe de triangles. Ce fait provient d'une fameuse propriété de l'excursion brownienne, qui est que ses minima locaux - qui sont en bijection avec les faces de la triangulation brownienne - sont uniques.

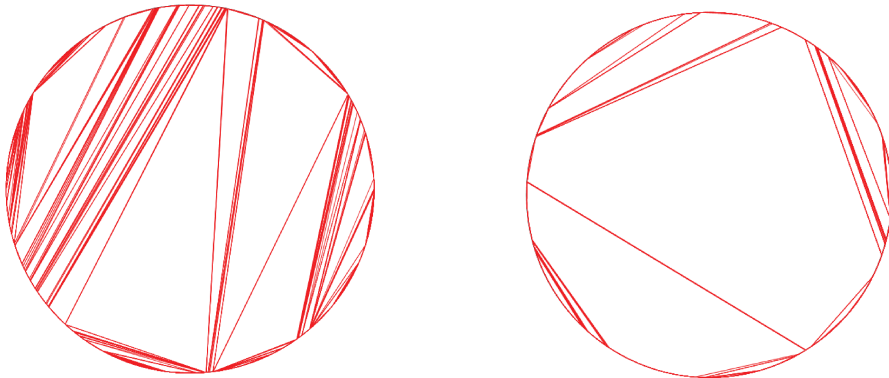

FIGURE 1.7: A gauche, une simulation de la triangulation brownienne $\mathbb{L}_\infty^{(2)}$. A droite, une simulation de la lamination 1.3-stable de Kortchemski.

Bref historique de la triangulation brownienne Comme nous l'avons mentionné, Aldous introduit initialement la triangulation brownienne en tant que limite en loi d'une triangulation uniforme du n -gone régulier :

Théorème 1.2.1 (Aldous). *Soit Tri_n une triangulation du n -gone régulier choisie uniformément au hasard. Alors Tri_n converge en loi pour la distance de Hausdorff vers la triangulation brownienne $\mathbb{L}(\mathfrak{e})$.*

Remarquons que, par définition, une triangulation du n -gone est simplement un ensemble de diagonales du disque. Dans la suite cependant, pour éviter des cas pathologiques, nous préférons toujours inclure le cercle unité \mathbb{S}^1 dans les laminations que nous considérerons.

Plusieurs travaux ont fait depuis lors intervenir la triangulation brownienne comme limite de structures discrètes aléatoires. En particulier, Curien et Kortchemski [33] puis Bettinelli [22] démontrent qu'elle apparaît comme limite d'une dissection uniforme de P_n (c'est-à-dire,

un ensemble de diagonales pas nécessairement maximal qui ne se coupent pas à l'intérieur du disque), d'un arbre à n sommets plongé de manière non-croisée dans \mathbb{D} (de sorte que ses sommets sont $e^{2i\pi k/n}$, $1 \leq k \leq n$) uniforme, ou encore d'une partition non croisée uniforme de l'ensemble d'entiers $\llbracket 1, n \rrbracket$ vue géométriquement dans \mathbb{D} . Dans l'article [45] sur lequel nous reviendrons en détail dans la section 1.3, $\mathbb{L}(\mathfrak{e})$ est également identifiée par Féray et Kortchemski comme la limite d'une factorisation minimale en transpositions uniforme du cycle $(12 \cdots n)$, codée géométriquement par une lamination. Enfin, dans un registre différent, la triangulation brownienne est utilisée comme un outil par Le Gall et Paulin [75] pour démontrer que la *carte brownienne*, un objet aléatoire obtenu comme limite d'échelle de plusieurs familles de graphes aléatoires, est homéomorphe à la sphère de dimension 2. Nous recommandons la lecture des deux articles [72] et [84] pour de plus amples informations sur la carte brownienne.

Laminations stables S'appuyant sur le travail d'Aldous, Kortchemski [64] généralise la triangulation brownienne en introduisant pour $\alpha \in (1, 2]$ la *lamination α -stable*, qui est la limite de dissections aléatoires du n -gone bien choisies. De la même manière que la triangulation brownienne est codée par l'excursion brownienne \mathfrak{e} , la lamination α -stable peut être codée à partir de l'excursion stable $X^{(\alpha)}$, et être ainsi vue comme la lamination duale de l'arbre $\mathcal{T}^{(\alpha)}$. Plus généralement, toute fonction $f : [0, 1] \rightarrow \mathbb{R}$ de type excursion (comme défini en Section 1.1.3) code une lamination : considérons l'épigraphe de f , l'ensemble des points sous son graphe :

$$\mathcal{EG}(f) = \{u = (s, t) \in \mathbb{R}^2, s \in [0, 1], t \in [0, f(s)]\}.$$

De manière similaire à la construction de la section 1.1, définissons une relation \sim_f sur l'intervalle $[0, 1]$. Pour $0 \leq s < t \leq 1$, $s \sim_f t$ si $t = \inf\{u > s, f(u) \leq f(s-)\}$ (où, par convention, on a posé $f(0-) = 0$). De plus, $s \sim_f s$ pour tout s , et pour tout $0 \leq s < t \leq 1$, $t \sim_f s$ si et seulement si $s \sim_f t$ (remarquons que \sim_f n'est pas nécessairement une relation d'équivalence). On peut maintenant construire la lamination

$$\mathbb{L}(f) = \mathbb{S}^1 \cup \overline{\bigcup_{s \sim_f t} [e^{-2i\pi s}, e^{-2i\pi t}]}.$$

Contrairement à la construction d'un \mathbb{R} -arbre à partir d'une fonction de type excursion entreprise dans la section 1.1, la construction de cette lamination n'exige pas que la fonction f soit continue. La lamination α -stable, que l'on notera maintenant $\mathbb{L}_\infty^{(\alpha)}$, est alors définie comme la lamination aléatoire

$$\mathbb{L}_\infty^{(\alpha)} = \mathbb{L}(H^{(\alpha)}).$$

En particulier, $\mathbb{L}_\infty^{(2)} := \mathbb{L}(\mathfrak{e})$ est la triangulation brownienne. La droite de la figure 1.7 représente quant à elle la lamination 1.3-stable.

Coder des fonctions par des processus de laminations

Nous présentons ici une façon de coder une fonction de type excursion f non plus par une unique lamination $\mathbb{L}(f)$, mais par un processus (aléatoire) de laminations $(\mathbb{L}_c(f))_{c \in [0, \infty]}$. Cela nous permettra de représenter dans le disque unité les fragmentations stables définies en Section 1.2.1. L'idée, inspirée des travaux d'Abraham et Serlet [5], est de coder une lamination par un processus de Poisson sous le graphe de la fonction f . 

Soit f une fonction de type excursion. Pour tout point $u = (s, t) \in \mathcal{EG}(f)$, définissons $g(f, u) = \sup\{x < s, f(x) < t\}$ et $d(f, u) = \inf\{x > s, f(x) < t\}$. Définissons également un processus de Poisson $\mathcal{N}(f)$ sur $\mathbb{R}^2 \times \mathbb{R}_+$, d'intensité

$$\frac{2}{d(f, u) - g(f, u)} du \times dr \mathbb{1}_{u \in \mathcal{EG}(f)},$$

et sa restriction $\mathcal{N}_c(f)$ à $\mathcal{EG}(f) \times [0, c]$ pour tout $c \in [0, \infty]$. Alors, on peut définir le processus de laminations $(\mathbb{L}_c(f))_{c \in [0, \infty]}$, qui interpole entre le cercle \mathbb{S}^1 et la lamination $\mathbb{L}(f) = \mathbb{L}_\infty(f)$, tel que, pour tout $c \in [0, \infty]$:

$$\mathbb{L}_c(f) = \mathbb{S}^1 \cup \overline{\bigcup_{u \in \mathcal{N}_c(f)} [e^{-2i\pi g(f, u)}, e^{-2i\pi d(f, u)}]}.$$

Notons que, par construction, ce processus $(\mathbb{L}_c(f))_{c \geq 0}$ est croissant pour l'inclusion. Intuitivement, l'intensité du processus $\mathcal{N}_c(f)$ est plus forte dans les "pics" de la fonction f , mais les points dans ces pics sont codés dans $\mathbb{L}_c(f)$ par de petites cordes. Nous présentons un exemple de la façon dont on trace ces cordes sur la figure 1.8.

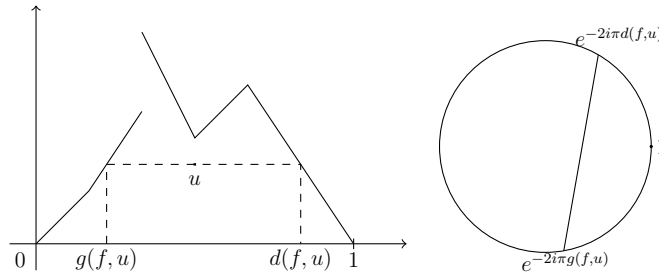

FIGURE 1.8: Une fonction càdlàg f , un point $u := (s, t)$ de son épigraphe $\mathcal{EG}(f)$ et la corde correspondante dans le disque $\overline{\mathbb{D}}$.

Remarquons que, quelle que soit la fonction f , presque sûrement $\mathbb{L}_c(f)$ n'a qu'un nombre dénombrable de cordes pour $c < \infty$, tandis que $\mathbb{L}_\infty(f)$ en a un nombre indénombrable. On définit finalement pour $\alpha \in (1, 2]$ le processus de laminations stable d'indice α :

$$(\mathbb{L}_c^{(\alpha)})_{c \in [0, \infty]} = (\mathbb{L}_c(H^{(\alpha)}))_{c \in [0, \infty]}.$$

Laminations construites à partir d'arbres. Il est alors possible de construire une lamination à partir d'un \mathbb{R} -arbre, et en particulier d'un arbre stable : étant donné un \mathbb{R} -arbre $T(f)$ construit à partir d'une fonction f , on définit la lamination $\mathbb{L}(T)$ comme :

$$\mathbb{L}(T(f)) = \mathbb{L}(f).$$

En particulier, on a par définition, pour tout $\alpha \in (1, 2]$:

$$\mathbb{L}_\infty^{(\alpha)} = \mathbb{L}(\mathcal{T}^{(\alpha)}).$$

Un arbre fini T à n sommets étiquetés de 1 à n admet quant à lui deux codages naturels par des processus de laminations. Le premier codage utilise le fait que la fonction de contour $(C_{2nt}(T))_{0 \leq t \leq 1}$ est continue et a fortiori càdlàg. On peut donc définir le processus $(\mathbb{L}_c((B_n/n)C_{2n\cdot}(T)))_{c \in [0, \infty]}$. Néanmoins, ce processus ne prend pas en compte les étiquettes des sommets de T . Nous proposons donc un second codage, toujours à partir de la fonction

de contour de T . Pour tout $k \in \llbracket 1, n \rrbracket$, définissons $g_k, d_k \in \llbracket 0, 2n \rrbracket$ le premier et le dernier instant où le sommet de T étiqueté k est visité par la fonction de contour. On définit alors, pour tout $u \in [0, \infty]$:

$$\mathbb{L}_u(T) = \mathbb{S}^1 \cup \bigcup_{i=1}^{\lfloor u \rfloor \wedge n} [e^{-2i\pi g_k/2n}, e^{-2i\pi d_k/2n}].$$

Bien que ces deux codages semblent différents, ils sont en fait proches dans le cas d'arbres de Galton-Watson dont les sommets sont numérotés uniformément au hasard. 

Lemme 8

Soit μ une loi critique dans le domaine d'attraction d'une loi α -stable. Soit $(B_n)_{n \geq 1}$ une suite vérifiant (1.2). Définissons \mathcal{T}_n comme un μ -GW conditionné à avoir n sommets, dont la racine est étiquetée 1 et dont les autres sommets sont numérotés uniformément au hasard de 2 à n . Alors il existe un couplage entre les processus $(\mathbb{L}_c((B_n/n)C_{2n}(\mathcal{T}_n)))_{c \in [0, \infty]}$ et $(\mathbb{L}_u(\mathcal{T}_n))_{u \in [0, \infty]}$ tel que, avec grande probabilité quand $n \rightarrow \infty$:

$$d_{Sk} \left(\left(\mathbb{L}_c \left(\frac{B_n}{n} C_{2n}(\mathcal{T}_n) \right) \right)_{c \in [0, \infty]}, (\mathbb{L}_{cB_n}(\mathcal{T}_n))_{c \in [0, \infty]} \right) = o(1).$$

où d_{Sk} désigne la distance J1 de Skorokhod sur $\mathbb{D}([0, \infty], \mathbb{L}(\overline{\mathbb{D}}))$ et où le terme $o(1)$ dépend uniquement de n et pas de l'arbre \mathcal{T}_n .

En se fondant sur le théorème 1.1.5, on peut alors montrer la convergence de ces processus de laminations. Ce théorème est le résultat fondamental de l'article [96] :

Théorème 9

Soit μ une loi critique dans le domaine d'attraction d'une loi α -stable. Soit $(B_n)_{n \geq 1}$ une suite vérifiant (1.2). Alors, en loi, dans $\mathbb{D}([0, \infty], \mathbb{L}(\overline{\mathbb{D}}))$:

$$(\mathbb{L}_{cB_n}(\mathcal{T}_n))_{c \in [0, \infty]} \xrightarrow[n \rightarrow \infty]{(d)} (\mathbb{L}_c^{(\alpha)})_{c \in [0, \infty]}.$$

Ce facteur de renormalisation du temps B_n peut se comprendre intuitivement : dans le processus croissant de laminations $(\mathbb{L}_c^{(\alpha)})_{c \in [0, \infty]}$, les grandes cordes (par exemple, de longueur plus grande qu'un certain $\varepsilon > 0$ fixé) apparaissent après un temps d'ordre 1. Le processus $(\mathbb{L}_u(\mathcal{T}_n))_{u \in [0, \infty]}$ est quant à lui construit à partir de la fonction de contour de l'arbre discret \mathcal{T}_n . Celui-ci contient beaucoup de sommets dont les sous-arbres sont petits, qui sont donc codés par de petites cordes dans $\overline{\mathbb{D}}$. On montre alors qu'il faut attendre un temps d'ordre B_n pour voir de grandes cordes apparaître - c'est-à-dire que les étiquettes des sommets possédant de grands sous-arbres sont au moins d'ordre B_n . Renormaliser le temps par ce facteur B_n permet donc d'obtenir des cordes macroscopiques en même temps dans les deux processus.

Lien entre fragmentation et laminations Le processus de fragmentation $F^{(\alpha)}$ peut se lire directement sur les laminations $(\mathbb{L}_c^{(\alpha)})_{c \geq 0}$. Pour une lamination L donnée, la suite de masses $\mathcal{M}(L)$ est l'élément de Δ défini comme suit : à chaque face F de L , on associe la masse $m(F)$, qui vaut $(2\pi)^{-1}$ fois la longueur totale de la partie de sa frontière formée d'arcs de cercle. Alors, la suite de ces masses, réordonnée de manière décroissante, forme $\mathcal{M}(L)$. Remarquons par exemple que $\mathcal{M}(\mathbb{S}^1) = (1, 0, \dots)$. Dans le cas des laminations stables, il

apparaît un phénomène de perte de masse à l'infini, dans le sens où toutes les faces de $\mathbb{L}_\infty^{(\alpha)}$ sont de masse 0. C'est pourquoi on restreint l'énoncé du théorème suivant à $c < \infty$.

Théorème 10

Soit $\alpha \in (1, 2]$. Alors on a l'égalité en loi :

$$(F_c^{(\alpha)})_{c \geq 0} \stackrel{(d)}{=} (\mathcal{M}(\mathbb{L}_c^{(\alpha)}))_{c \geq 0}.$$

Distribution des marginales

Notre dernier résultat concernant les fragmentations stables répond à la question suivante : à c et α fixés, est-il possible de représenter directement la lamination aléatoire $\mathbb{L}_c^{(\alpha)}$ sous la forme $\mathbb{L}(f)$, pour une certaine fonction aléatoire de type excursion f ? La réponse est positive : $\mathbb{L}_c^{(\alpha)}$ a la loi de la lamination associée à l'excursion renormalisée d'un certain processus de Lévy $\tau^{(\alpha),c}$ (excursion que l'on notera $\tau^{(\alpha),c,exc}$). Ce processus est construit à partir du processus α -stable $Y^{(\alpha)}$ défini en Section 1.1.3 qui est, rappelons-le, le processus de Lévy d'exposant de Laplace $\mathbb{E}[e^{-\lambda Y_t^{(\alpha)}}] = \exp(t\lambda^\alpha)$, pour tous $\lambda, t \geq 0$. À c fixé, on définit alors $\tau^{(\alpha),c}$ comme :

$$\forall s \geq 0, \tau_s^{(\alpha),c} := \inf \left\{ t > 0, Y_t^{(\alpha)} - c^{1/\alpha}t < -c^{1+1/\alpha}s \right\} - cs.$$

On peut montrer qu'il s'agit bien d'un processus de Lévy, ce qui n'est pas clair a priori. Pour $\alpha = 2$, on retrouve le *processus gaussien inverse* (le lecteur curieux pourra se tourner vers [68, Section 1.2.5] pour une étude plus détaillée de ce processus). Comme dans le cas de l'excursion brownienne, l'excursion renormalisée d'un processus de Lévy peut être considérée - avec quelques précautions - comme le processus pris entre 0 et 1, conditionné à atteindre 0 au temps 1 et à rester positif entre 0 et 1.

Théorème 11

Fixons $\alpha \in (1, 2]$ et $c \geq 0$. Alors, on a l'égalité en loi :

$$\mathbb{L}_c^{(\alpha)} = \mathbb{L}(\tau^{(\alpha),c,exc}),$$

où $\tau^{(\alpha),c,exc}$ désigne l'excursion renormalisée de $\tau^{(\alpha),c}$.

Il est à noter que Féray et Kortchemski obtiennent ce résultat dans [45], dans le cas $\alpha = 2$. Pour l'obtenir dans ce cas plus général, nous étudions un arbre aléatoire $\mathcal{T}_{cB_n}^{(n)}$, obtenu comme une réduction de l'arbre \mathcal{T}_n , pour lequel nous prouvons que la lamination $\mathbb{L}(\mathcal{T}_{cB_n}^{(n)})$ converge en loi dans le même temps vers $\mathbb{L}_c^{(\alpha)}$ et vers $\mathbb{L}(\tau^{(\alpha),c,exc})$. Si ce théorème permet de comprendre la structure de cette lamination $\mathbb{L}_c^{(\alpha)}$, il n'existe à notre connaissance aucun couplage naturel entre les processus $\tau^{(\alpha),c}$ pour différentes valeurs de c , donc entre ces laminations. Nous devons par conséquent nous contenter de cette égalité à c fixé. 

1.3 Factorisations minimales aléatoires

Nous entamons maintenant la dernière partie de cette introduction. Dans cette section, nous établissons un lien entre le résultat de convergence du théorème 9 et un modèle combinatoire de décompositions d'une certaine permutation - le n -cycle $(1\ 2 \cdots n)$ - en un produit de plus petits cycles. Une première partie est consacrée à l'étude d'une factorisation uniforme de

ce cycle en un produit de transpositions (cycles de longueur 2), généralisée dans un second temps au cas de factorisations en un produit de cycles de longueurs aléatoires.

Index des notations de la section 3 Dans cet index, f.m. signifie factorisation minimale.

\mathfrak{M}_n	Ensemble des f.m. du n -cycle en transpositions.
f_n	f.m. uniforme du n -cycle.
$\mathfrak{N}_n^{(k)}$	Ensemble des f.m. du n -cycle en k cycles.
w	Suite de poids positifs tels que $w_0 = 0$.
f_n^w	f.m. aléatoire de suite de poids w .

1.3.1 Factorisations en transpositions

Définition

Fixons un entier $n \geq 1$, et posons \mathfrak{S}_n l'ensemble des permutations de $\llbracket 1, n \rrbracket$. Si l'on veut écrire le n -cycle $(1\ 2 \cdots n) \in \mathfrak{S}_n$ (qui envoie 1 sur 2, 2 sur 3, \dots , $n-1$ sur n et n sur 1) comme un produit de transpositions, c'est-à-dire de cycles de longueur 2, ce produit comprendra au moins $n-1$ facteurs. Cela amène à définir les *factorisations minimales en transpositions* de $(1\ 2 \cdots n)$, qui sont les éléments de l'ensemble

$$\mathfrak{M}_n = \{(\tau_1, \dots, \tau_{n-1}) \in \mathfrak{T}_n^{n-1}, \tau_1 \tau_2 \cdots \tau_{n-1} = (1\ 2 \cdots n)\},$$

où \mathfrak{T}_n est l'ensemble des transpositions de \mathfrak{S}_n . Par convention, nous appliquerons les transpositions de gauche à droite, dans le sens où $\tau_1 \tau_2$ désignera la composition $\tau_2 \circ \tau_1$.

Ces factorisations ont été étudiées tout d'abord d'un point de vue purement combinatoire, par Dénes [37] dans les années 1950. Il démontre notamment que l'ensemble \mathfrak{M}_n est de cardinal n^{n-2} . Cependant, il faut attendre une trentaine d'années, et les travaux de Moszkowski [86] pour obtenir une preuve bijective de ce résultat. Cette bijection met en lien les factorisations minimales et un certain ensemble d'arbres plans. Nous utiliserons pour notre part un autre codage d'une factorisation minimale par un arbre, dû aux travaux plus récents de Goulden et Yong [49], qui permettra d'appliquer les résultats de la section 1.1 à l'étude des propriétés des éléments de \mathfrak{M}_n .

Plusieurs années après ces approches combinatoires, Féray et Kortchemski s'intéressent aux factorisations minimales d'un point de vue probabiliste. L'idée est maintenant, au lieu de s'intéresser à \mathfrak{M}_n dans son intégralité, d'étudier les propriétés d'un élément typique de cet ensemble - c'est-à-dire, choisi uniformément au hasard. Cette approche est donc à mettre en relation avec l'étude entreprise par Aldous d'un arbre uniforme à n sommets. Pour donner un sens à la convergence d'une factorisation aléatoire uniforme du n -cycle quand $n \rightarrow \infty$, Féray et Kortchemski codent celle-ci par une lamination - aléatoire - du disque unité. Afin d'étudier les propriétés asymptotiques de cette lamination, nous nous fondons sur la bijection de Goulden et Yong, dont nous exposons une version (quelque peu modifiée par rapport à l'article original [49]). Cette bijection a pour double but de coder une factorisation minimale en transpositions d'une part par une lamination du disque unité - ce qui permet d'utiliser les résultats de la section 1.2 - et d'autre part par un arbre plan dont les sommets sont numérotés. Dans le cas d'une factorisation minimale uniforme en transpositions, l'arbre aléatoire obtenu est un GW conditionné à avoir n sommets, et entre donc dans le cadre de la section 1.1.

Convergence d'une factorisation

L'idée principale de Féray et Kortchemski pour étudier la convergence d'une factorisation uniforme est de coder un élément de \mathfrak{M}_n par une lamination dans le disque unité, et d'obtenir la convergence en loi d'une telle lamination choisie uniformément au hasard, quand $n \rightarrow \infty$, pour la distance de Hausdorff. Pour ce faire, un entier $n \geq 1$ et une factorisation $F := (\tau_1, \dots, \tau_{n-1}) \in \mathfrak{M}_n$ étant fixés, on associe à chaque transposition $\tau_i := (a_i, b_i)$ la corde $c_{\tau_i} := [e^{-2i\pi a_i/n}, e^{-2i\pi b_i/n}] \subset \overline{\mathbb{D}}$. Ensuite, pour tout $u \in [0, \infty]$, on définit la lamination

$$L_u(F) := \mathbb{S}^1 \cup \bigcup_{i=1}^{\lfloor u \rfloor \wedge (n-1)} c_{\tau_i}.$$

En particulier, quelle que soit la factorisation $F \in \mathfrak{M}_n$, $L_0(F) = \mathbb{S}^1$, et $L_u(F) = L_{n-1}(F)$ pour $u \geq n-1$.

Notons f_n une factorisation minimale uniforme en transpositions du n -cycle. Féray et Kortchemski montrent la convergence de ces laminations quand $n \rightarrow \infty$, lorsqu'on lit un nombre u de transpositions de l'ordre de \sqrt{n} :

Théorème 1.3.1 (Féray & Kortchemski). *Pour tout $c \in [0, \infty]$, il existe une lamination aléatoire L_c du disque telle que, en loi, pour la distance de Hausdorff :*

$$L_{c\sqrt{n}}(f_n) \xrightarrow[n \rightarrow \infty]{(d)} L_c.$$

Notre principale contribution a consisté à étendre ce résultat en obtenant un analogue fonctionnel de cette convergence, conjecturé dans [45].

Théorème 12

Soit f_n une factorisation minimale uniforme du n -cycle en transpositions. Alors la convergence suivante a lieu en loi, dans l'espace $\mathbb{D}([0, \infty], \mathbb{L}(\overline{\mathbb{D}}))$:

$$(L_{c\sqrt{n}}(f_n))_{c \in [0, \infty]} \xrightarrow[n \rightarrow \infty]{(d)} (\mathbb{L}_c^{(2)})_{c \in [0, \infty]},$$

où l'on rappelle que $(\mathbb{L}_c^{(2)})_{c \in [0, \infty]}$ est obtenu à partir d'un processus de Poisson sous l'excursion brownienne normalisée.

Dans [45], les laminations $(L_c)_{c \in [0, \infty]}$ introduites dans le théorème 1.3.1 ne sont pas couplées entre elles. L'idée principale du couplage du théorème 12 est de les coder par un processus ponctuel de Poisson sous l'excursion brownienne, que l'on approxime par des processus de Poisson sous la fonction de contour d'un arbre codant f_n , en vertu du théorème 1.1.3. 

Remarque. *Le théorème 12 donne de nombreuses informations sur la structure globale d'une factorisation uniforme. En particulier, les "grandes" transpositions, c'est-à-dire celles qui intervertissent deux entiers dont la différence est supérieure à Cn pour une constante $C > 0$ fixée, n'apparaissent dans une factorisation typique qu'après environ \sqrt{n} autres "petites" transpositions. D'un autre côté, parmi les \sqrt{n} premières transpositions lues, il n'y a qu'un nombre fini de telles "grandes" transpositions.*

Un outil fondamental : la bijection de Goulden & Yong

Nous explicitons ici l'outil principal dans la preuve du théorème 12, la bijection de Goulden et Yong, dans une version modifiée par rapport à l'originale. Ces modifications, si elles ne 

changent pas la nature profonde de la bijection, permettent de mettre plus facilement en relation les factorisations minimales et les laminations codées par des fonctions de contour, définies en Section 1.2.2.

Codage d'une factorisation dans le disque unité. Dans tout ce paragraphe, on fixe un entier $n \geq 1$, et on se donne $F := (\tau_1, \dots, \tau_{n-1}) \in \mathfrak{M}_n$ une factorisation minimale en transpositions du n -cycle. Pour toute transposition $\tau_i := (a_i, b_i)$ qui apparaît dans F , on trace une corde dans $\overline{\mathbb{D}}$ entre les points $e^{-2i\pi a_i/n}$ et $e^{-2i\pi b_i/n}$, que l'on numérote $i + 1$. L'union du cercle \mathbb{S}^1 et de ces $n - 1$ cordes forme un sous-ensemble compact $\mathcal{C}(F)$ de $\overline{\mathbb{D}}$, dans lequel les cordes sont numérotées de 2 à n .

Goulden et Yong prouvent également que $\mathcal{C}(F)$ satisfait toujours les conditions suivantes :

- (C1) $\mathcal{C}(F)$ est une lamination. Autrement dit, les cordes ne se coupent pas à l'intérieur de $\overline{\mathbb{D}}$.
- (C2) Les cordes de $\mathcal{C}(F)$ forment un arbre, dans le sens où le graphe dont les sommets sont les racines n -èmes de l'unité et les arêtes les $n - 1$ cordes de $\mathcal{C}(F)$ est un arbre.
- (C3) Autour de chaque sommet de $\mathcal{C}(F)$, les étiquettes des cordes sont en ordre horaire croissant.

Théorème 1.3.2 (Goulden & Yong [49]). *La construction précédente est une bijection entre \mathfrak{M}_n et l'ensemble des laminations à $n - 1$ cordes numérotées de 2 à n vérifiant (C1), (C2) et (C3).*

Codage d'une factorisation par un arbre étiqueté. A partir de cette lamination dont les cordes sont numérotées de 2 à n , on construit maintenant un arbre plan, $T(F)$, que l'on voit comme le "dual" de $\mathcal{C}(F)$. Pour cela, on place dans chaque face de $\mathcal{C}(F)$ (rappelons que le terme "face" désigne une composante connexe du complémentaire de la lamination dans le disque) un sommet dual, et on relie deux sommets duaux par une arête duale si les faces qui leur correspondent sont voisines. Chaque arête duale reçoit l'étiquette de la corde de $\mathcal{C}(F)$ qu'elle coupe. Enfin, on étiquette les sommets de $T(F)$ de 1 à n de la façon suivante. La racine, étiquetée 1, est le sommet dual dont la frontière contient l'arc qui relie 1 et $e^{-2i\pi/n}$. Ensuite, pour chaque arête duale de $T(F)$, on repère l'unique chemin menant de la racine à cette arête, et on fait "glisser" l'étiquette de l'arête sur son extrémité la plus éloignée de la racine. Finalement, $T(F)$ est un arbre plan à n sommets numérotés de 1 à n . La figure 1.9 propose un exemple de cette construction.

Cependant, tous les arbres à n sommets étiquetés ne sont pas l'image d'une factorisation minimale par cette construction. En effet, la condition (C3) précédente se traduit sur les étiquettes des sommets de l'arbre. On dit qu'un arbre plan T avec sommets étiquetés vérifie la condition C_Δ si sa racine possède l'étiquette 1 et si, pour tout sommet u de T , l'étiquette de u et les étiquettes de ses enfants sont rangées par ordre horaire décroissant (remarquons que l'étiquette de u n'est donc pas nécessairement plus petite que celle de ses enfants).

Lemme. *Pour tout $F \in \mathfrak{M}_n$, l'arbre $T(F)$ vérifie la condition C_Δ .*

Modulo cette condition, la construction précédente est bien une bijection. Pour tout $n \geq 1$, définissons \mathfrak{U}_n l'ensemble des arbres plans à n sommets numérotés vérifiant la condition C_Δ .

Théorème 1.3.3 (Goulden & Yong). *La construction de Goulden-Yong $F \rightarrow T(F)$ est une bijection entre \mathfrak{M}_n et \mathfrak{U}_n .*

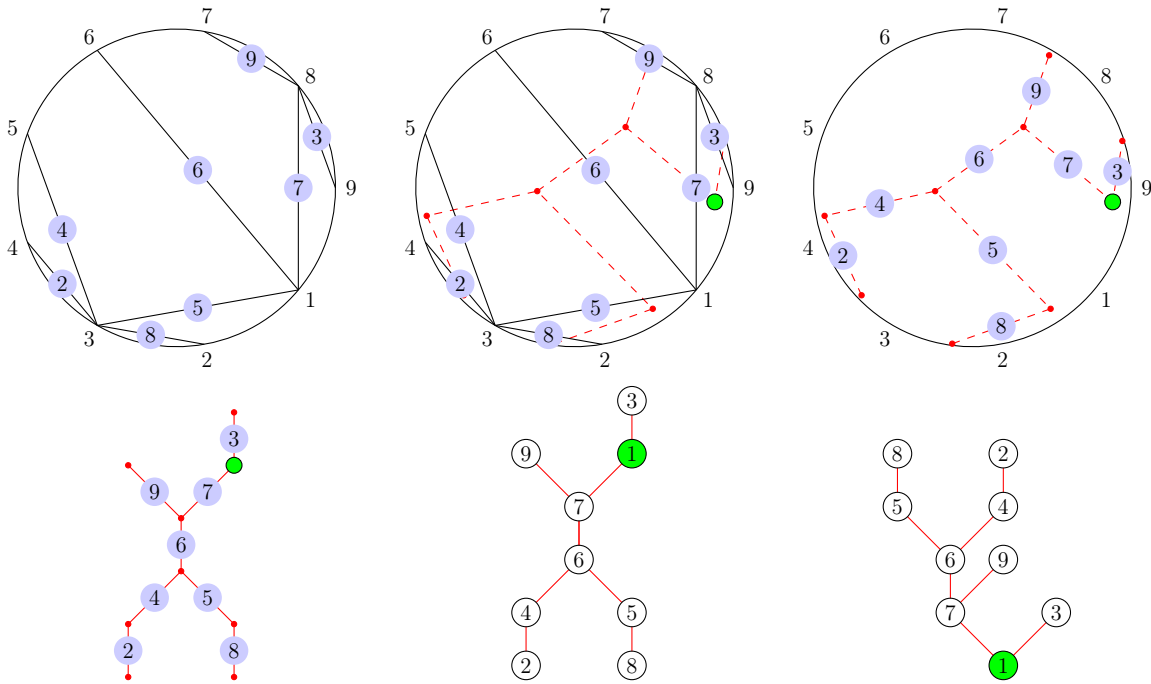

FIGURE 1.9: La bijection de Goulden-Yong, appliquée à la factorisation minimale en transpositions $F := (34)(89)(35)(13)(16)(18)(23)(78) \in \mathfrak{M}_9$. La condition $(C3)$ est satisfaite par la lamination $\mathcal{C}(F)$ (en haut à gauche) et la condition C_Δ par l'arbre $T(F)$ (en bas à droite).

Remarque. Remarquons immédiatement que cette construction fournit une preuve bijective du résultat de Dénes. En effet, il est possible de montrer que l'ensemble \mathfrak{U}_n est de cardinal n^{n-2} .

Relation entre la lamination $\mathcal{C}(f_n)$ et l'arbre $T(f_n)$. L'intérêt de cette bijection est de pouvoir utiliser les propriétés de l'arbre $T(f_n)$ pour prouver le théorème 12. Pour cela, nous remarquons que, à n fixé, $T(f_n)$ est un GW conditionné à avoir n sommets. Définissons μ^* la loi de Poisson de paramètre 1, c'est à dire vérifiant, pour tout $i \geq 0$, $\mu_i^* = e^{-1}/i!$. En particulier, μ^* est critique et de variance finie.

Lemme 13

Pour tout $n \geq 1$, soit \mathcal{T}_n un μ^* -GW conditionné à avoir n sommets. Alors, en loi :

$$T(f_n) \stackrel{(d)}{=} \mathcal{T}_n,$$

où on ne prend en compte que la structure d'arbre de $T(f_n)$ et pas les étiquettes de ses sommets.

Pour voir cela, il suffit de remarquer la chose suivante : un arbre T à n sommets étant fixé, si on numérote sa racine 1 et les autres sommets uniformément de 2 à n , la probabilité que cet arbre vérifie la condition C_Δ est exactement $\prod_{u \in T} ((k_u(T))!)^{-1}$, ce qui correspond à la distribution d'un μ^* -GW.

L'autre argument principal de la preuve du théorème 12 est de nature géométrique. Intuitivement, par la bijection de Goulden-Yong, l'arbre $T(f_n)$ est l'arbre "dual" de $\mathcal{C}(f_n)$. Mais d'autre part, c'est également par construction l'arbre "dual" de la lamination $\mathbb{L}(T(f_n))$. Nous pouvons alors effectivement montrer que ces deux laminations sont proches pour la distance de Hausdorff. Il suffit alors d'utiliser le théorème 9 pour en déduire le théorème 12.

Un argument de mélange Afin de pouvoir nous ramener à l'énoncé du théorème 9, nous devons prouver que le processus de laminations $(\mathbb{L}_{c\sqrt{n}}(T(f_n)))_{c \geq 0}$ est proche de $(\mathbb{L}_{c\sqrt{n}}(\mathcal{T}_n))_{c \geq 0}$, où \mathcal{T}_n est un μ^* -GW à n sommets, dont la racine est étiquetée 1 et dont les autres sommets sont étiquetés uniformément au hasard de 2 à n . Autrement dit, le fait de contraindre un μ^* -GW étiqueté à vérifier la condition C_Δ n'influe pas - asymptotiquement - sur le processus de laminations associé. Pour comprendre cela, nous introduisons une opération de mélange des étiquettes des sommets d'un arbre donné. Le but est de s'affranchir de la condition C_Δ sur les étiquettes des sommets de $T(f_n)$, sans trop changer la structure de l'arbre. Une première idée serait de mélanger uniformément les étiquettes des enfants de chaque sommet. Cependant, dans ce cas, une petite étiquette correspondant à un sommet avec un grand sous-arbre dans $T(f_n)$ pourrait être donnée à un sommet avec une petite descendance, alors même que la longueur d'une corde associée à un sommet dépend fortement de la taille du sous-arbre au-dessus de lui. Une autre idée serait de mélanger les enfants de chaque sommet, en gardant leurs sous-arbres respectifs au-dessus d'eux. Cependant, dans ce cas, deux gros sous-arbres dont les racines ont le même parent pourraient être échangés, et la lamination obtenue serait différente. Il s'agit donc de combiner ces deux opérations.

Définition. Soit T un arbre à n sommets étiquetés de 1 à n , dont la racine est étiquetée 1, et soit $K \leq n$. On définit l'arbre mélangé $T^{(K)}$ comme suit : partant de la racine de T , on effectue l'une des deux opérations suivantes sur chaque sommet de T . Pour des raisons de cohérence, on demande que l'opération soit effectuée sur un sommet avant d'être effectuée sur ses enfants. 

- *Opération 1* : pour un sommet dont les étiquettes des enfants sont toutes strictement plus grandes que K , on mélange uniformément ces étiquettes (sans mélanger les sous-arbres au-dessus de ces enfants).
- *Opération 2* : pour un sommet dont au moins un enfant a une étiquette $\leq K$, on mélange uniformément les enfants en gardant les sous-arbres au-dessus de chacun.

Voir la figure 1.10 pour un exemple. Notons que cette transformation induit également une transformation du processus $(\mathbb{L}_u(T))_{u \in [0, \infty]}$ associé à T .

L'intérêt principal de ce mélange est que, pour tout K , $T^{(K)}(f_n)$ a la loi d'un μ^* -GW conditionné à avoir n sommets, dont la racine a l'étiquette 1 et les autres sommets sont numérotés uniformément de 2 à n . Notre but est de déterminer une bonne suite $(K_n)_{n \geq 1}$, pour laquelle les processus de laminations construits à partir de $T(f_n)$ et $T^{(K_n)}(f_n)$ sont asymptotiquement proches.

Lemme 14

Pour toute suite $(K_n)_{n \geq 0}$ telle que $\sqrt{n} \ll K_n \ll n$ quand $n \rightarrow \infty$, on a la relation suivante en probabilité :

$$d_{Sk} \left((\mathbb{L}_{c\sqrt{n}}(T(f_n)))_{c \in [0, \infty]}, (\mathbb{L}_{c\sqrt{n}}(T^{(K_n)}(f_n)))_{c \in [0, \infty]} \right) \xrightarrow{\mathbb{P}} 0.$$

Ainsi le processus obtenu à partir de l'arbre $T(f_n)$, qui doit vérifier la condition C_Δ , est proche en loi du processus obtenu à partir d'un arbre étiqueté uniformément. Ce lemme nous permet donc de nous affranchir de la condition C_Δ , et d'établir le théorème 12 comme une conséquence du théorème 9.

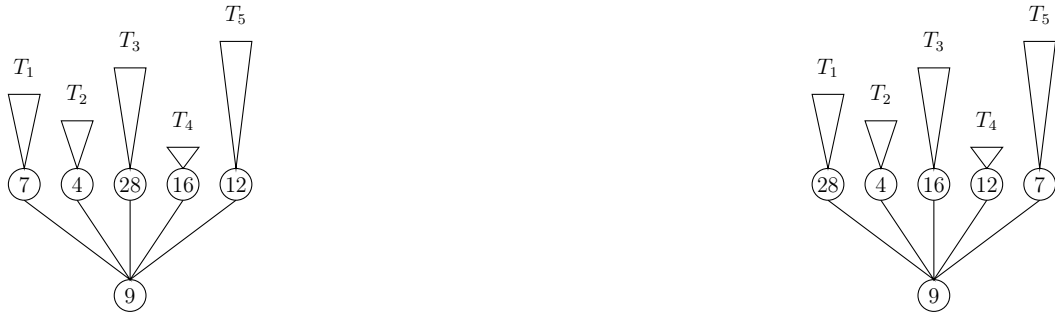
(a) Mélange d'un arbre plan étiqueté pour $K = 3$: On effectue l'opération 1.(b) Mélange du même arbre, pour $K = 5$: on effectue l'opération 2.FIGURE 1.10: Exemples de l'opération de mélange. L'opération est différente dans ces deux cas, car dans le deuxième le sommet étiqueté 9 a un enfant étiqueté $4 \leq K$.

1.3.2 Factorisations en cycles de longueur aléatoire

Après avoir étudié les factorisations minimales uniformes du n -cycle en transpositions, nous nous intéressons maintenant aux factorisations minimales du n -cycle plus générales, en autorisant les cycles de la factorisation à être de longueurs différentes.

Cette étude est motivée par plusieurs facteurs. D'une part, les factorisations minimales du n -cycle en cycles de longueurs arbitraires ont été étudiées en profondeur du point de vue combinatoire. Citons notamment les travaux de Biane [23] et Biane et Josuat-Vergès [24] à ce sujet. Ces factorisations et leur comptage sont fortement liées à l'étude de propriétés fines du groupe symétrique et des partitions non croisées.

Une autre raison est plus intuitive : puisque le processus de laminations stable d'indice 2 apparaît comme limite d'un codage de factorisations minimales en transpositions, il est naturel de supposer plus généralement que coder de manière similaire des factorisations en produit de cycles de longueurs différentes peut donner naissance à des suites de laminations convergeant vers les processus de laminations stables d'indice $\alpha \in (1, 2]$.

Nous adaptons donc la construction bijective de Goulden et Yong donnée dans la section précédente au cas de factorisations minimales plus générales (qui sont définies plus bas), avant de montrer qu'effectivement, certaines familles bien choisies de factorisations convergent en loi en ce sens géométrique vers les processus de laminations stables. Comme principale différence avec le cas des factorisations en transpositions, les sous-ensembles compacts du disque codant une factorisation minimale ne sont plus des laminations cette fois, mais des *laminations colorées*, dans le sens où leurs faces sont colorées en noir ou en blanc.

Définitions

Soit $n, k \geq 1$ et (τ_1, \dots, τ_k) un k -uplet de cycles dont le produit vaut $(12 \cdots n)$. De même que dans le cas des transpositions, les longueurs respectives $\ell(\tau_1), \dots, \ell(\tau_k)$ de ces cycles vérifient

nécessairement la condition

$$\sum_{i=1}^k (\ell(\tau_i) - 1) \geq n - 1. \quad (1.4)$$

On définit alors l'ensemble des factorisations minimales du n -cycle d'ordre k comme :

$$\mathfrak{N}_n^{(k)} := \left\{ (\tau_1, \dots, \tau_k) \in \mathfrak{C}_n^k, \tau_1 \cdots \tau_k = (1\ 2 \cdots n), \sum_{i=1}^k (\ell(\tau_i) - 1) = n - 1 \right\},$$

où \mathfrak{C}_n désigne l'ensemble des cycles de \mathfrak{S}_n de longueur au moins 2. Les éléments de l'ensemble

$$\mathfrak{N}_n := \bigcup_{k \geq 1} \mathfrak{N}_n^{(k)}$$

sont appelés *factorisations minimales du n -cycle*. Remarquons immédiatement que $\mathfrak{N}_n^{(k)}$ est vide dès que $k \geq n$, d'après la condition de minimalité (1.4). Ainsi, pour tout $n \geq 1$, \mathfrak{N}_n est un ensemble fini. Pour toute factorisation $F \in \mathfrak{N}_n$, on notera $N(F)$ le nombre de cycles dans F .

Biane [23] a montré que, à k fixé, pour tout k -uplet d'entiers $\bar{a} := (a_1, \dots, a_k)$ supérieurs à 2 et tels que $\sum_{i=1}^k (a_i - 1) = n - 1$, le nombre de factorisations minimales (τ_1, \dots, τ_k) du n -cycle telles que $\ell(\tau_i) = a_i$ pour tout $1 \leq i \leq k$ vaut n^{k-1} , indépendamment de \bar{a} . En particulier, on retrouve bien le résultat de Dénes pour $(a_1, \dots, a_{n-1}) = (2, 2, \dots, 2)$, où 2 apparaît $n - 1$ fois.

Factorisations minimales aléatoires Explicitons maintenant notre modèle de factorisations minimales aléatoires. On fixe une suite de réels positifs $(w_i)_{i \geq 0}$ que l'on appellera *suite de poids* par la suite, telle que $w_0 = 0$ et $w_i > 0$ pour au moins une valeur de $i \in \mathbb{N}$. On donne alors à chaque factorisation minimale un poids défini comme suit : pour tout $F := (\tau_1, \dots, \tau_k) \in \mathfrak{N}_n^{(k)}$,

$$W_w(F) = \prod_{i=1}^k w_{\ell(\tau_i)-1}.$$

Posons également $Z_{n,w} := \sum_{F \in \mathfrak{N}_n} W_w(F)$. Pour les valeurs de n telles que $Z_{n,w} > 0$, nous pouvons définir la factorisation aléatoire du n -cycle associée à w comme la variable aléatoire f_n^w vérifiant, pour tout $F \in \mathfrak{N}_n$:

$$\mathbb{P}(f_n^w = F) = \frac{1}{Z_{n,w}} W_w(F).$$

En particulier, certains modèles de factorisations aléatoires peuvent être vus comme des cas particuliers de factorisations pondérées :

- pour $r \geq 2$, définissons la suite de poids δ^r vérifiant $\delta_{r-1}^r = 1$ et, pour $i \neq r - 1$, $\delta_i^r = 0$. Alors, la factorisation associée $f_n^{\delta^r}$ est une factorisation uniforme du n -cycle en r -cycles. Pour $r = 2$, on retrouve le cas précédemment étudié d'une factorisation minimale uniforme en transpositions.
- définissons v comme la suite de poids vérifiant $v_i = 1$ pour tout $i \geq 1$. Alors f_n^v est une factorisation minimale du n -cycle choisie uniformément.

Remarquons immédiatement que différentes suites de poids peuvent engendrer des factorisations aléatoires de même loi.

Lemme 15

Soient $w := (w_i)_{i \geq 1}$, $w' := (w'_i)_{i \geq 1}$ deux suites de poids. Alors les deux propositions suivantes sont équivalentes :

- Il existe $s > 0$ tel que, pour tout $i \in \mathbb{N}$, $w_i = w'_i s^i$.
- Pour tout $n \geq 1$, en loi, $f_n^w \stackrel{(d)}{=} f_n^{w'}$.

Dans ce cas, on dit que w et w' sont deux suites de poids *équivalentes*.

Dans le cas où il existe une loi de probabilité critique (c'est-à-dire, d'espérance 1) $\nu := (\nu_i)_{i \geq 0}$ telle que w est équivalent à $(\nu_i)_{i \geq 1}$, on appelle ν l'*équivalent critique* de w . Dans ce cas, ν est nécessairement unique. Notre premier résultat concerne le nombre de cycles dans la factorisation f_n^w :

Lemme 16

Soit w une suite de poids vérifiant $w_0 = 0$. Supposons qu'elle admet un équivalent critique ν dans le domaine d'attraction d'une loi stable. Alors, en probabilité,

$$\frac{N(f_n^w)}{n} \xrightarrow[n \rightarrow \infty]{\mathbb{P}} 1 - \nu_0.$$

La constante $1 - \nu_0$ peut donc être vue comme la proportion asymptotique de cycles dans la factorisation aléatoire f_n^w , quand $n \rightarrow \infty$.

Laminations colorées

Nous proposons ici une représentation géométrique d'une factorisation minimale générale du n -cycle dans le disque unité, inspirée de celle de Goulden-Yong. Désormais, les cycles sont représentés par des faces, que l'on va colorier en noir. Le degré de chacune de ces faces - son nombre de côtés - est égal à la longueur du cycle correspondant. Remarquons que l'objet obtenu n'est plus une lamination, puisque certaines faces sont coloriées.

Définition. Une lamination colorée de $\overline{\mathbb{D}}$ est un sous-ensemble compact $L := (L_r, L_n) \subset \overline{\mathbb{D}} \times \overline{\mathbb{D}}$ vérifiant les conditions suivantes :

- (i) $L_r \subset L_n$;
- (ii) L_r est une lamination de $\overline{\mathbb{D}}$, au sens de la section 1.2.2 (l'union du cercle \mathbb{S}^1 et d'un ensemble de cordes qui ne se coupent pas) ;
- (iii) L_n est l'union de L_r et d'un sous-ensemble de ses faces.

En d'autres termes, la première composante L_r d'une lamination colorée L (que l'on dessinera en rouge) est une lamination, tandis que la deuxième composante L_n (dont les points qui ne sont pas dans la composante rouge seront coloriés en noir) est obtenue par l'union de L_r et de certaines de ses faces.

Munissons l'ensemble de ces laminations colorées du disque, que l'on notera $\text{CL}(\overline{\mathbb{D}})$, d'une distance qui est la somme des distances de Hausdorff entre les premières et deuxièmes composantes des laminations colorées, et que nous noterons également d_H . Pour $(L_r, L_n), (L'_r, L'_n)$

deux laminations colorées, on pose

$$d_H((L_r, L_n), (L'_r, L'_n)) = d_H(L_r, L'_r) + d_H(L_n, L'_n).$$

Remarquons qu'une lamination L , comme définie en Section 1.2.2, peut être vue comme une lamination colorée $L := (L, L)$.

Laminations stables colorées Un exemple particulier de laminations colorées qui nous intéressera par la suite est celui des *laminations stables colorées*, où chaque face de la lamination stable est colorée en noir de manière i.i.d.

Définition. Soit $\alpha \in (1, 2]$ et $p \in [0, 1]$. La lamination α -stable p -colorée, notée $\mathbb{L}_\infty^{(\alpha), p}$, est la lamination colorée dont la partie rouge est $\mathbb{L}_\infty^{(\alpha)}$, et dont chaque face est colorée en noir indépendamment avec probabilité p . Nous avons représenté un exemple en Figure 1.11.

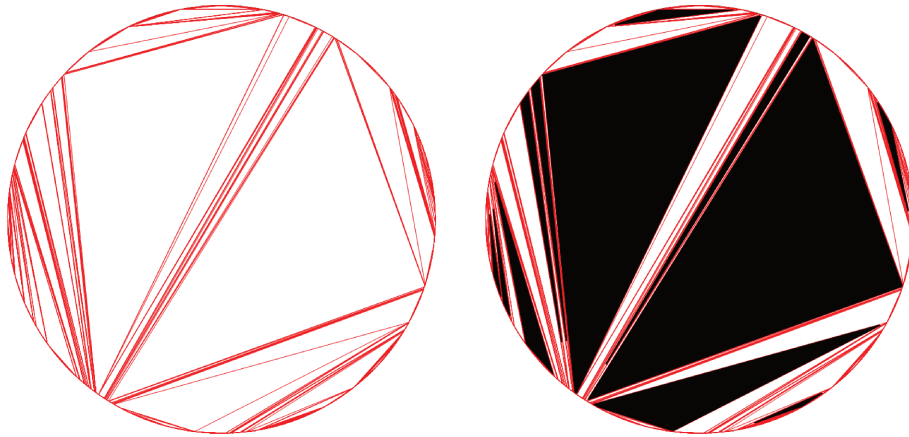

FIGURE 1.11: A gauche, une simulation de $\mathbb{L}_\infty^{(2)}$. A droite, une simulation de $\mathbb{L}_\infty^{(2), 0.5}$.

Codage d'une factorisation dans le disque

Avant d'expliquer comment coder une factorisation minimale par une suite de laminations colorées, nous étudions les propriétés des cycles qui apparaissent dans une telle factorisation.

Cycles dans une factorisation minimale On dit qu'un cycle $\tau \in \mathfrak{S}_n$ est *croissant* s'il peut s'écrire sous la forme $\tau := (e_1 e_2 \cdots e_{\ell(\tau)})$, où $1 \leq e_1 < e_2 < \cdots < e_{\ell(\tau)} \leq n$.

Fixons $n, k \geq 1$ et $F := (\tau_1, \dots, \tau_k) \in \mathfrak{N}_n^{(k)}$ une factorisation minimale. Le lemme suivant peut être déduit des résultats de Biane [23], mais n'y est pas explicité clairement. Nous en donnons une preuve directe dans [97].

Lemme 17

Tout cycle apparaissant dans une factorisation minimale est croissant.

A tout cycle τ croissant, on peut associer une lamination colorée $S(\tau)$: puisque τ est croissant, nous pouvons l'écrire $\tau := (e_1 e_2 \cdots e_{\ell(\tau)})$, où $1 \leq e_1 < e_2 < \cdots < e_{\ell(\tau)} \leq n$. Traçons alors en rouge le cercle \mathbb{S}^1 ainsi que les cordes $[e^{-2i\pi e_i/n}, e^{-2i\pi e_{i+1}/n}]$ pour $1 \leq i \leq \ell(\tau)$, où par convention $e_{\ell(\tau)+1} = e_1$. Ces cordes délimitent une face intérieure, que nous colorons en noir. Remarquons que, dans le cas où τ est une transposition, cette face est vide.

Pour $F \in \mathfrak{N}_n^{(k)}$ une factorisation minimale et $u \in [0, \infty]$, on définit alors la lamination colorée

$$S_u(F) := \mathbb{S}^1 \cup \bigcup_{j=1}^{\lfloor u \rfloor \wedge k} S(\tau_j).$$

Un exemple est visible sur la figure 1.12.

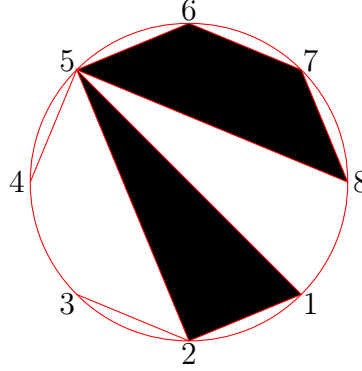

FIGURE 1.12: La lamination colorée $S_\infty(F)$, où $F := (5678)(23)(125)(45)$ est un élément de $\mathfrak{N}_8^{(4)}$.

Nous obtenons une convergence semblable à celle du théorème 12, dans le cas où la suite w a un équivalent critique ν qui vérifie une des deux conditions :

Cas I : ν est dans le domaine d'attraction d'une loi stable de paramètre $\alpha \in (1, 2)$.

Cas II : ν est de variance finie.

Théorème 18

Soit w une suite de poids telle que $w_0 = 0$, possédant un équivalent critique ν dans le cas I ou II. Alors, dans l'espace $\mathbb{D}(\mathbb{R}_+, \mathbb{CL}(\overline{\mathbb{D}})) \times \mathbb{CL}(\overline{\mathbb{D}})$:

(i) dans le cas I, la convergence suivante a lieu en loi :

$$\left((S_{c(1-\nu_0)B_n}(f_n^w))_{c \geq 0}, S_\infty(f_n^w) \right) \xrightarrow[n \rightarrow \infty]{(d)} \left((\mathbb{L}_c^{(\alpha)})_{c \geq 0}, \mathbb{L}_\infty^{(\alpha), 1} \right),$$

où $(B_n)_{n \geq 1}$ est une suite de réels strictement positifs qui vérifient (1.2).

(ii) dans le cas II, posons $\sigma^2 < \infty$ la variance de ν et définissons

$$p_\nu := \frac{\sigma^2}{\sigma^2 + 1} \in [0, 1).$$

Alors, en loi :

$$\left((S_{c(1-\nu_0)\tilde{B}_n}(f_n^w))_{c \geq 0}, S_\infty(f_n^w) \right) \xrightarrow[n \rightarrow \infty]{(d)} \left((\mathbb{L}_c^{(2)})_{c \geq 0}, \mathbb{L}_\infty^{(2), p_\nu} \right),$$

où $(\tilde{B}_n)_{n \geq 1}$ est une suite de réels strictement positifs vérifiant

$$\tilde{B}_n \sim \sqrt{\frac{\sigma^2 + 1}{2}} \sqrt{n}.$$

Remarque. Calculons quelques valeurs de p_ν . Pour $r \geq 2$, posons comme précédemment δ^r la suite de poids telle que $\delta_{r-1}^r = 1$ et $\delta_i^r = 0$ pour $i \neq r-1$, de sorte que la factorisation $f_n^{\delta^r}$ est alors une factorisation minimale uniforme du n -cycle en r -cycles. Dans ce cas, $p_\nu = 1 - 1/(r-1)$. En particulier, pour $r = 2$, toutes les faces de la lamination limite $\mathbb{L}_\infty^{(2), p_\nu}$ sont donc blanches. Pour $r = 3$, elles sont colorées en noir indépendamment avec probabilité $1/2$.

Posons d'autre part v la suite de poids telle que $v_i = 1$ pour tout $i \geq 1$, de sorte que f_n^v est une factorisation minimale du n -cycle choisie uniformément au hasard. Dans ce cas, on obtient $p_\nu = 1 - 1/\sqrt{5}$.

Lien entre factorisations minimales et arbres bi-type

De même que la preuve du théorème 12 se fonde sur une bijection entre les ensembles \mathfrak{M}_n et \mathfrak{U}_n , le théorème 18 s'appuie sur une bijection, à $n, k \geq 1$ fixés, entre $\mathfrak{N}_n^{(k)}$ et un certain ensemble d'arbres plans bi-type $\mathfrak{B}_n^{(k)}$ que nous allons définir. Rappelons que chacun des sommets d'un arbre bi-type est colorié en blanc si sa hauteur est paire, en noir dans le cas contraire.

Définition. Fixons $n, k \geq 1$. On définit $\mathfrak{B}_n^{(k)}$ comme l'ensemble des arbres T finis vérifiant :

- (i) T est un arbre bi-type. En particulier, la racine de T est blanche ;
- (ii) chaque sommet noir a au moins un enfant. De ce fait, les feuilles de T sont toutes blanches ;
- (iii) T contient n sommets blancs et k sommets noirs ;
- (iv) les sommets noirs de T sont numérotés de 1 à k ; de plus, les étiquettes des voisins de n'importe quel sommet blanc (son parent et ses enfants) sont rangées dans l'ordre décroissant en sens horaire, partant d'un de ses voisins (pas nécessairement son parent).

Un exemple est visible en bas de la figure 1.13.

On note de plus

$$\mathfrak{B}_n := \bigcup_{k \geq 1} \mathfrak{B}_n^{(k)}.$$

Comme on impose que chaque sommet noir ait au moins un enfant, le nombre de sommets noirs d'un arbre de \mathfrak{B}_n est au plus $n-1$. Ainsi, pour $k \geq n$, $\mathfrak{B}_n^{(k)}$ est vide, et \mathfrak{B}_n est donc un ensemble fini.

Il apparaît que, pour tous $n, k \geq 1$, les ensembles $\mathfrak{N}_n^{(k)}$ et $\mathfrak{B}_n^{(k)}$ sont en bijection. Pour le prouver, nous construisons une bijection explicite entre ces deux ensembles, inspirée de celle de Goulden-Yong. Pour cela, fixons $n, k \geq 1$ et $F := (\tau_1, \dots, \tau_k) \in \mathfrak{N}_n^{(k)}$. Définissons $S_{lab}(F)$ comme la lamination colorée $S_\infty(F)$, où l'on a donné l'étiquette i à la face qui correspond au cycle τ_i (pour tout $1 \leq i \leq k$). On construit alors l'arbre bi-type "dual" $T(F)$ de $S_{lab}(F)$ comme suit : dans chaque face de $S_{lab}(F)$, on place un sommet dual (y compris dans les faces d'intérieur vide correspondant aux cycles de longueur 2). On colorie ce sommet en noir si la face correspond à un cycle de F , et en blanc sinon. On trace alors une arête duale entre chaque couple de points dont les faces sont voisines. En outre, on donne à chaque sommet noir l'étiquette de la face associée. Enfin, on enraine l'arbre en le sommet blanc dont la face contient dans sa frontière l'arc de cercle $\widehat{1, e^{-2i\pi/n}}$. Un exemple de cette construction est présenté sur la figure 1.13. Remarquons notamment que, dans le cas d'une factorisation minimale en transpositions $F \in \mathfrak{N}_n^{(n-1)}$, cette construction est proche de celle de Goulden-Yong appelée en Section 1.3.1. 

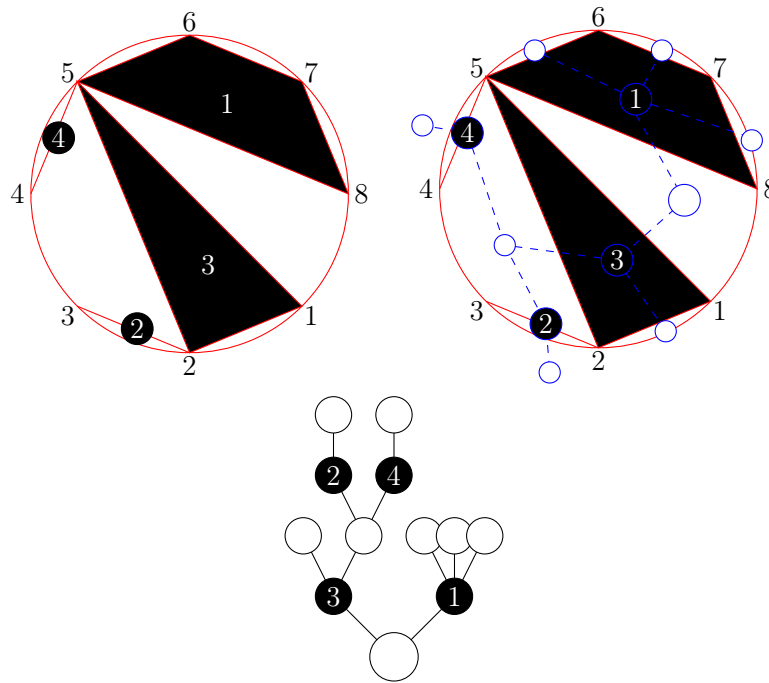



FIGURE 1.13: La bijection $\Psi_8^{(4)}$, appliquée à la factorisation $F := (5678)(23)(125)(45) \in \mathfrak{N}_8^{(4)}$. En haut à gauche : la lamination colorée $S_{lab}(F)$. En haut à droite : la même lamination, dont on a dessiné l'arbre dual $T(F)$. Le gros sommet est la racine de $T(F)$. En bas : l'arbre dual $T(F)$.

Théorème 19

Pour tout $n, k \geq 1$, la fonction $\Psi_n^{(k)} : F \rightarrow T(F)$ est une bijection entre $\mathfrak{N}_n^{(k)}$ et $\mathfrak{V}_n^{(k)}$.

Sans entrer dans les détails de la preuve, expliquons pourquoi l'image d'un élément F de $\mathfrak{N}_n^{(k)}$ est bien dans $\mathfrak{V}_n^{(k)}$. Par construction, $T(F)$ a bien k sommets noirs. De plus, remarquons aussi que chaque face blanche de $S_\infty(F)$ contient dans sa frontière exactement un arc de cercle de la forme $e^{-2ik\pi/n}, e^{-2i(k+1)\pi/n}$ pour $k \in \llbracket 1, n \rrbracket$. Comme il y a n tels arcs, $T(F)$ possède n sommets blancs. Le fait que les étiquettes des sommets noirs soient en ordre horaire décroissant autour de chaque sommet blanc peut être déduit de la propriété analogue pour les factorisations en transpositions (la condition C_Δ), grâce au découpage en transpositions d'une factorisation.

Un outil intéressant : le découpage en transpositions. La bijection que nous présentons, comme nous avons pu le voir, est calquée sur la bijection de Goulden-Yong exposée en Section 1.3.1. En particulier, la preuve que cette fonction est bien une bijection entre les ensembles $\mathfrak{N}_n^{(k)}$ et $\mathfrak{V}_n^{(k)}$ se fonde sur une décomposition naturelle d'une factorisation minimale générale du n -cycle en factorisation minimale du n -cycle en transpositions. Cette décomposition permet de transposer la preuve du théorème 1.3.2 pour prouver que la construction ci-dessus est bien une bijection.

Définition. Posons $n, k \geq 1$ et $F := (\tau_1, \dots, \tau_k) \in \mathfrak{N}_n^{(k)}$ une factorisation minimale du n -cycle. Pour tout $1 \leq i \leq k$, on écrit le cycle τ_i comme $\tau_i := (e_1 \cdots e_{\ell(\tau_i)})$ où e_1 est le minimum du support de τ_i . Alors, la factorisation \tilde{F} est définie en remplaçant dans F chaque cycle τ_i par le produit de transpositions $(e_1 e_2)(e_1 e_3) \cdots (e_1 e_{\ell(\tau_i)})$. Un exemple de cette décomposition est représenté en figure 1.14 (sous forme des laminations associées) 

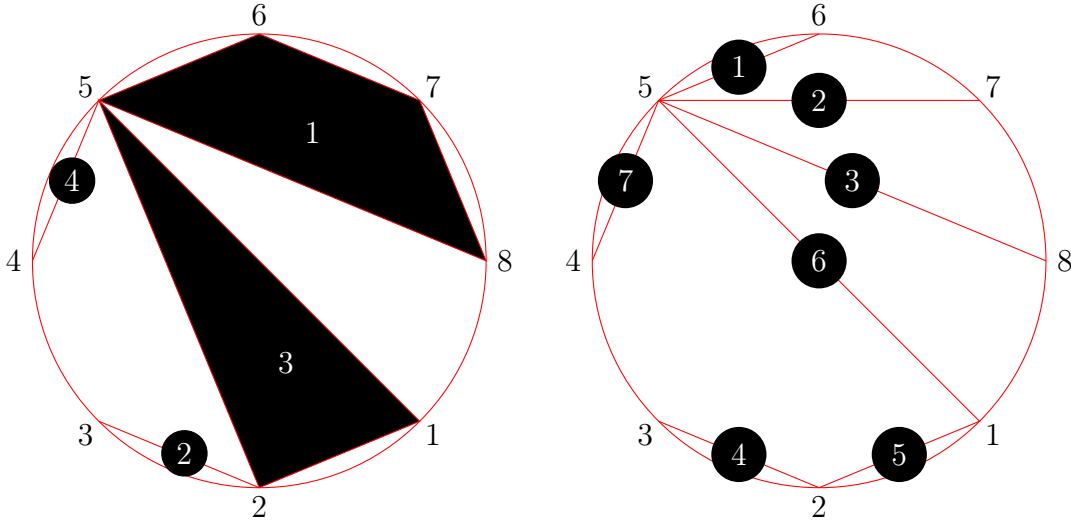

FIGURE 1.14: Les laminations colorées $S_{lab}(F)$ et $S_{lab}(\tilde{F})$, où $F := (5678)(23)(125)(45)$ est un élément de $\mathfrak{N}_8^{(4)}$. La construction de la seconde à partir de la première consiste simplement à trianguler chaque face noire à partir de son sommet de numéro minimal. On a alors par définition $\tilde{F} = (56)(57)(58)(23)(12)(15)(45) \in \mathfrak{N}_8$.

Lemme 20

Si F est une factorisation minimale du n -cycle, alors \tilde{F} est une factorisation minimale en transpositions du n -cycle.

Etude des arbres bi-type

Nous ne prouvons pas le théorème 18 dans cette introduction, mais résumons tout de même les grandes étapes de sa preuve. Il s'agit d'une adaptation de la preuve du théorème 12, avec toutefois plusieurs difficultés supplémentaires dues au contexte des arbres bi-type (par exemple, le nombre de sommets noirs n'est pas fixé). Dans un premier temps, nous proposons une façon de coder un arbre bi-type par un processus de laminations colorées, puis étudions la distribution de l'arbre $T(f_n^w)$. Enfin, nous tentons d'expliquer le paramètre p_ν qui apparaît dans l'énoncé du théorème 18 dans le cas où l'équivalent critique ν de la suite de poids w est de variance finie.

Coder les arbres bi-type par des processus de laminations colorées Grâce à la bijection précédente, prouver le théorème 18 revient également, dans ce cas plus général des laminations colorées, à prouver un théorème similaire sur des processus de laminations construits à partir d'arbres bi-type.

Fixons un arbre bi-type T avec n sommets blancs et k sommets noirs numérotés de 1 à k . Nous pouvons le coder de la façon suivante : pour tout sommet noir u , considérons $0 \leq t_1(u) < \dots < t_{k_u(T)+1}(u) \leq 2n - 2$ les $k_u(T) + 1$ instants différents auxquels la fonction de contour $C(T)$ visite le sommet u . On définit la face F_u dans le disque unité comme

$$F_u := \bigcup_{j=1}^{k_u(T)+1} [e^{-2i\pi t_j(u)/2n}, e^{-2i\pi t_{j+1}(u)/2n}],$$

où par convention $t_{k_u(T)+2}(u) = t_1(u)$, et où l'intérieur de la face définie par ces cordes est colorée en noir (rappelons que le cercle et les cordes elles-mêmes sont colorés en rouge). On

note maintenant, pour $1 \leq i \leq k$, U_i le sommet noir de T avec l'étiquette i . Finalement, on associe à T le processus de laminations colorées $(\mathbb{L}_u^\bullet(T))_{u \in [0, \infty]}$ tel que, pour tout $u \in [0, \infty]$:

$$\mathbb{L}_u^\bullet(T) := \mathbb{S}^1 \cup \bigcup_{i=1}^{\lfloor u \rfloor \wedge k} F_{U_i}.$$

L'arbre aléatoire $T(f_n^w)$ Dans un deuxième temps, il s'agit de montrer la convergence du processus $\mathbb{L}^\bullet(T(f_n^w))$ quand l'équivalent critique ν de w vérifie les hypothèses du cas *I* ou du cas *II*. Cette convergence provient, comme dans le cas des factorisations minimales en transpositions, de l'identification de la loi de l'arbre $T(f_n^w)$. En effet, pour toute suite de poids w telle que $w_0 = 0$, tout $n \geq 1$, l'arbre $T(f_n^w)$ est un arbre bi-type simplement généré. Rappelons que μ^* désigne la loi de Poisson de paramètre 1. 

Lemme 21

Soit w une suite de poids telle que $w_0 = 0$. Alors, pour tout $n \geq 1$:

$$T(f_n^w) \stackrel{(d)}{=} \mathcal{T}_n^{(\mu^*, w)},$$

où l'on rappelle que l'arbre $\mathcal{T}_n^{(\mu^*, w)}$ est l'arbre bi-type simplement généré à n sommets, de lois (μ^*, w)

Le paramètre p_ν . Nous donnons dans ce dernier paragraphe une intuition au sujet de la présence du paramètre p_ν dans le théorème 18, quand ν est de variance finie. Posons w une suite de poids telle que $w_0 = 0$, possédant un équivalent critique ν de variance finie. Chaque face de la lamination colorée $\mathbb{L}_\infty^{(2), p_\nu}$, qui apparaît comme la limite de $S_\infty(f_n^w)$ quand $n \rightarrow +\infty$ (par le théorème 18), est colorée en noir de manière i.i.d. avec probabilité p_ν . Ce paramètre peut s'interpréter intuitivement grâce à la bijection entre les factorisations minimales et les arbres bi-type dont les sommets noirs sont étiquetés. Pour cela, il s'agit de remarquer que, pour n grand, une grande face de la lamination $S_\infty(f_n^w)$ correspond à un sommet de l'arbre $T(f_n^w)$ dont la disparition séparerait l'arbre en au moins trois composantes de taille macroscopique (c'est-à-dire, avec un nombre de sommets plus grand que εn , pour un certain $\varepsilon > 0$ fixé). Notons qu'un arbre donné contient au plus $\lfloor \varepsilon^{-1} \rfloor$ tels sommets. Puisque la composante rouge de la lamination colorée $\mathbb{L}_\infty^{(2), p_\nu}$ est la triangulation brownienne (donc composée de triangles), avec grande probabilité quand $n \rightarrow \infty$, chaque sommet de $\mathcal{T}_n^{(\mu^*, w)}$ a au plus deux enfants dont les sous-arbres sont de taille plus grande que εn . Si un sommet en a effectivement deux (appelons ces sommets *points de branchement*), il y a deux cas de figure possibles : soit le point de branchement est blanc, et donc deux de ses enfants noirs exactement sont les racines d'un gros sous-arbre. Dans ce cas, on peut montrer qu'exactly deux de ses petits enfants blancs sont les racines de gros sous-arbres ; soit le point de branchement est noir, auquel cas exactement deux de ses enfants blancs sont les racines d'un gros sous-arbre, et dans ce cas on montre qu'aucun autre petit-enfant du parent de ce point de branchement noir n'est la racine d'un gros sous-arbre. Ces deux cas sont présentés sur la figure 1.15.

En définitive, la question est la suivante : sachant qu'un sommet blanc de $\mathcal{T}_n^{(\mu^*, w)}$ a exactement deux petits-enfants blancs racines de sous-arbres de tailles supérieures à εn pour un certain $\varepsilon > 0$, quelle est la probabilité que ces deux petits-enfants aient le même parent noir ? Si c'est le cas, la grande face correspondante est noire, sinon elle est blanche. On peut alors montrer que, pour tout $\varepsilon > 0$, cette probabilité converge quand $n \rightarrow \infty$ vers une valeur

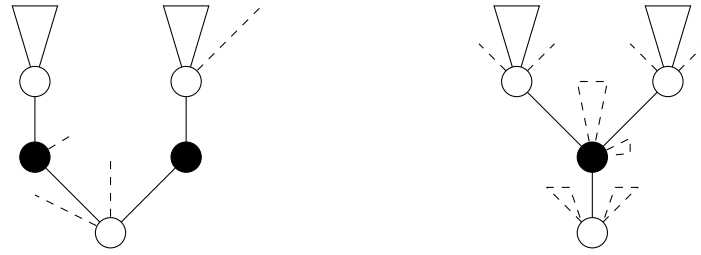

FIGURE 1.15: Les deux cas possibles pour un point de branchement, selon que les deux petits-enfants blancs racines de gros sous-arbres ont le même parent (à droite) ou non (à gauche). Les pointillés représentent des sous-arbres de petite taille, tandis que les sous-arbres en traits pleins sont de taille macroscopique. Dans le premier cas (à gauche), la grande face qui correspond est noire ; dans le second cas (à droite), elle est blanche.

p_ν . La partie plus complexe de la preuve est enfin de montrer que les faces sont colorées indépendamment les unes des autres.

1.4 Comportement de la fonction génératrice d'une loi stable dans le plan complexe

Dans cette courte dernière partie, nous exposons le théorème 1.4 de l'article [96] (voir plus loin le théorème 3.1.4), qui nous semble être utile dans un contexte plus général que celui de cette thèse, et dans lequel nous nous intéressons au comportement de la fonction génératrice d'une loi μ dans le domaine d'attraction d'une loi stable.

On rappelle que la fonction génératrice d'une loi μ à support dans \mathbb{N} est la fonction F_μ définie (au moins) sur le disque $\overline{\mathbb{D}} := D(0, 1)$ par :

$$F_\mu(x) = \sum_{i \geq 0} \mu_i x^i.$$

Le comportement d'une telle fonction génératrice dans un voisinage de 1 est très lié au comportement asymptotique de sa queue $\mu([x, +\infty))$ quand $x \rightarrow +\infty$. De nombreux théorèmes mettent en lumière le lien entre ces deux quantités. Un exemple intéressant de tel résultat est le suivant : une loi critique μ est dans le domaine d'attraction d'une loi stable (proposition portant sur la queue de distribution de μ) si et seulement si sa fonction génératrice vérifie (proposition sur le comportement de sa fonction génératrice) :

$$F_\mu(1-s) - (1-s) \underset{s \downarrow 0}{\sim} s^\alpha L\left(\frac{1}{s}\right).$$

Ce résultat découle, par exemple, de [44, XVII.5, Théorème 2] et [27, Théorème 4.7]. Il concerne uniquement le comportement de F_μ au voisinage de 1 *sur l'axe réel*. Notre résultat, qui repose sur une représentation intégrale de F_μ , permet d'appréhender son comportement dans un voisinage *complexe* de 1. 

Théorème 22

Soit $\alpha \in (1, 2]$, L une fonction à variation lente, et μ une loi sur \mathbb{N} . Alors, les deux propositions suivantes sont équivalentes :

$$(i) \quad F_\mu(1 - s) - (1 - s) \underset{s \downarrow 0}{\sim} s^\alpha L\left(\frac{1}{s}\right), \text{ où } s \in \mathbb{R}.$$

$$(ii) \quad F_\mu(1 + \omega) - (1 + \omega) \underset{\substack{|\omega| \rightarrow 0 \\ |1 + \omega| < 1}}{\sim} (-\omega)^\alpha L\left(\frac{1}{|\omega|}\right), \text{ où } \omega \in \mathbb{C}.$$

Remarquons que, par le résultat susmentionné, la proposition (i) est équivalente au fait que μ est dans le domaine d'attraction d'une loi α -stable. Certains résultats de ce type existent déjà dans la littérature, sous une hypothèse plus puissante dite de Δ -analyticité de F_μ (nous renvoyons à [47, Section 6] pour des exemples de tels théorèmes), ce qui n'est pas le cas ici.

Les trois chapitres suivants reprennent à quelques ajustements mineurs près le contenu des articles [95, 96, 97], dont les résultats précédents ont été présentés dans l'introduction. Le lecteur nous pardonnera les quelques différences entre les notations introduites précédemment et celles des prochains chapitres.

Bonne lecture !

2

Sommets de degré fixé dans de grands arbres de Galton-Watson

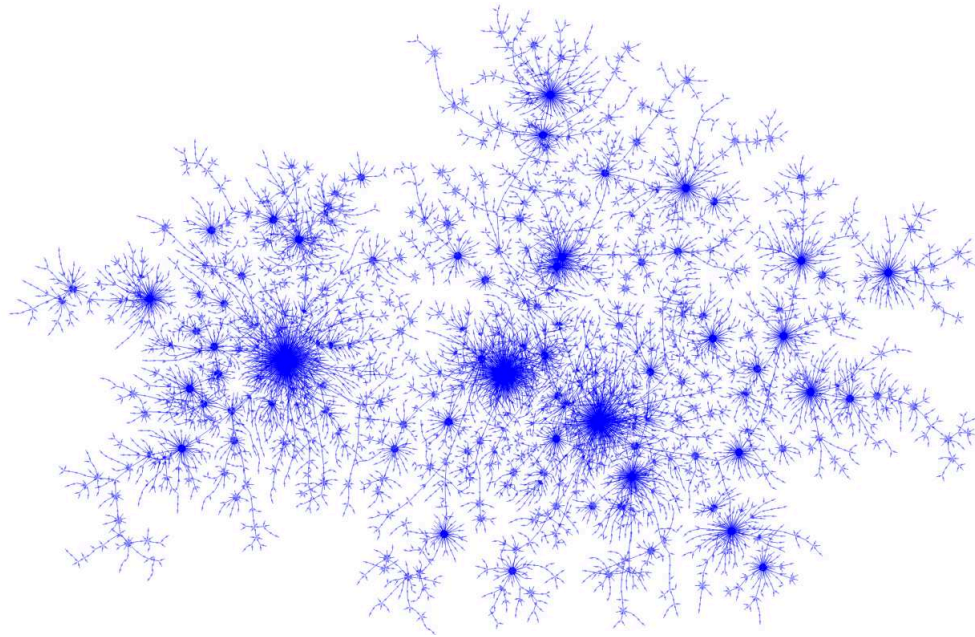

*I wonder how, I wonder why
Degrees are split that way when variance is finite
But all that I can see is just a Galton-Watson tree*
Boole's Garden, *Random tree*

Dans ce chapitre, qui reprend l'article [95] accepté dans EJP, nous nous intéressons aux sommets de degré fixé dans de grands arbres de Galton-Watson conditionnés de diverses façons. Nous étudions tout d'abord les limites d'échelle de processus qui codent l'évolution du nombre de tels sommets visités au cours du temps lorsque l'on explore l'arbre de deux façons différentes en partant de la racine (selon l'ordre lexicographique, ou suivant la fonction de contour de l'arbre). Nous donnons notamment une condition nécessaire et suffisante pour que les limites de ces processus soient centrées, et déterminons également leurs fluctuations. Nous étendons ainsi un théorème de Labarbe & Marckert qui traitent le cas du processus de comptage des feuilles selon la fonction de contour, dans un arbre uniforme dont le nombre total de sommets est fixé. Enfin, nous généralisons des résultats obtenus par Janson concernant la normalité asymptotique du nombre de sommets de degré fixé dans ces arbres.

Les résultats de convergence que nous obtenons seront utilisés dans les chapitres 3 et 4 pour étudier de manière fine la structure de grands arbres.

Content of the chapter

2.1	Introduction	48
2.2	Background on trees and their codings	52
2.3	Joint distribution of outdegrees in GW trees	54
	2.3.1 A joint distribution	54
	2.3.2 A technical estimate	54
2.4	Evolution of outdegrees in an exploration of a Galton-Watson tree	56
	2.4.1 Depth-first exploration	56
	2.4.2 Contour exploration	58
	2.4.3 Extension to multiple passages	59
2.5	Asymptotic normality of outdegrees in large Galton-Watson trees 62	62
	2.5.1 Expectation of $N^{\mathcal{A}}(\mathcal{T}_n^{\mathcal{B}})$	62
	2.5.2 Asymptotic normality of $N^{\mathcal{A}}(\mathcal{T}_k^{\mathcal{B}})$	63
2.6	Several extensions	68
	2.6.1 Stable offspring distributions.	68
	2.6.2 Subcritical non-generic offspring distributions.	71

2.1 Introduction

Much attention has been recently given to the fine structure of large random trees. In this paper, we focus particularly on the distribution of vertex degrees in large conditioned Galton–Watson trees, and on how they are spread out in these trees.

Motivations. The study of scaling limits of Galton–Watson trees (in short, GW trees) with critical offspring distribution (that is with mean 1) conditioned by their number of vertices has been initiated by Aldous [7, 8, 9]. Aldous showed that the scaling limit of large critical GW trees with finite variance is the so-called Brownian continuum random tree (CRT). As a side result, he proved the convergence of their properly rescaled contour functions, which code the trees, to the Brownian excursion. This result was extended by Duquesne, who showed that the scaling limits of critical GW trees, when the offspring distribution has infinite variance and is in the domain of attraction of a stable law, are α -stable trees (with $\alpha \in (1, 2]$), which were introduced by Le Gall & Le Jan [73] and Duquesne & Le Gall [42]. From a more discrete point of view, Abraham and Delmas [2, 3] extended the work of Kesten [60] and Janson [55] by describing in full generality the local limits of critical GW trees conditioned to have a fixed large number of vertices.

The number of vertices with a fixed outdegree in large conditioned critical GW trees with finite variance was studied by Kolchin [62], who showed that it is asymptotically normal. This topic has recently triggered a renewed interest. Minami [85] established that these convergences hold jointly under an additional moment condition, which was later lifted by Janson [56]. Rizzolo [91] considered more generally GW trees conditioned on a given number of vertices with outdegree in a given set. One of the motivations for studying these quantities

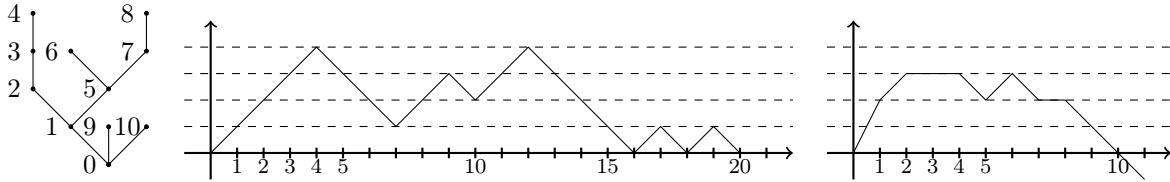

Figure 2.1: From left to right: a plane tree T with its vertices listed in the depth-first search order, its contour function $C(T)$ and a linear interpolation of its Łukasiewicz path $W(T)$.

is that there is a variety of random combinatorial models coded by GW trees in which vertex degrees represent a quantity of interest. For example, in [6], vertex degrees code sizes of 2-connected blocs in random maps and, in [64], vertex degrees code sizes of faces in dissections. Also, Labarbe & Marckert [69] studied the evolution of the number of leaves in the contour process of a large uniform plane tree.

Evolution of vertices with fixed outdegrees. Our first contribution concerns scaling limits of processes coding the evolution of vertices with fixed outdegrees in different explorations of large GW trees starting from the root. We shall explore the tree in two ways by using either the contour process (which was considered by Labarbe & Marckert [69]), or the lexicographical order.

In order to state our result, we need to introduce some quick background and notation (see Section 2.2 for formal definitions). An offspring distribution μ , which is a probability distribution on \mathbb{Z}_+ , is said to be critical if it has mean 1. To simplify notation, we set $\mu_i = \mu(i)$ for $i \geq 0$. If T is a plane tree and $\mathcal{A} \subset \mathbb{Z}_+$, we say that a vertex of T is a \mathcal{A} -vertex if its outdegree (or number of children) belongs to \mathcal{A} . We define $N^{\mathcal{A}}(T)$ as the number of \mathcal{A} -vertices in T , and we set $\mu_{\mathcal{A}} = \sum_{i \in \mathcal{A}} \mu_i$ to simplify notation. We say that \mathcal{T} is a μ -GW tree if it is a GW tree with offspring distribution μ . We will always implicitly assume, for the sake of simplicity, that the support of the offspring distribution μ is non-lattice (a subset $A \subset \mathbb{Z}$ is lattice if there exists $b \in \mathbb{Z}$ and $d \geq 2$ such that $A \subset b + d\mathbb{Z}$), so that for every n sufficiently large a μ -GW tree conditioned on having n vertices is well defined (but all the results carry through to the lattice setting with mild modifications). For $n \geq 1$, we denote by \mathcal{T}_n a μ -GW tree conditioned to have n vertices.

Let T be a plane tree with n vertices. To define the contour function $(C_t(T), 0 \leq t \leq 2n)$ of T , imagine a particle that explores the tree from the left to the right, starting from the root and moving at unit speed along the edges. Then, for $0 \leq t \leq 2(n-1)$, $C_t(T)$ is defined as the distance from the root of the position of the particle at time t . We set $C_t(T) = 0$ for $t \in [2(n-1), 2n]$ (see Fig. 2.1 for an example). For every $0 \leq t \leq 1$, let $N_{2nt}^{\mathcal{A}}(T)$ be the number of different \mathcal{A} -vertices already visited by $C(T)$ at time $[2nt]$. In particular, $N_{2n}^{\mathcal{A}}(T) = N^{\mathcal{A}}(T)$.

When μ follows a geometric distribution of parameter $1/2$ (so that \mathcal{T}_n follows the uniform distribution on the set of all plane trees with n vertices) and $\mathcal{A} = \{0\}$, Labarbe & Marckert showed that the convergence

$$\left(\frac{C_{2nt}(\mathcal{T}_n)}{\sqrt{n}}, \frac{N_{2nt}^{\{0\}}(\mathcal{T}_n) - nt\mu_0}{\sqrt{n}} \right)_{0 \leq t \leq 1} \xrightarrow[n \rightarrow \infty]{(d)} \left(\sqrt{2}\mathfrak{e}_t, B_t \right)_{0 \leq t \leq 1}$$

holds jointly in distribution in $\mathcal{C}([0, 1], \mathbb{R}^2)$, where \mathfrak{e} is the normalized Brownian excursion, B is a Brownian motion independent of \mathfrak{e} and $\mathcal{C}([0, 1], \mathbb{R}^2)$ is the space of continuous \mathbb{R}^2 -valued functions on $[0, 1]$ equipped with the uniform topology.

In words, the counting process $N^{\{0\}}(\mathcal{T}_n)$ behaves linearly at the first order, and has centered Brownian fluctuations. Labarbe and Marckert themselves highlight (just after Theorem 4 in [69]) the fact that the fluctuations are centered and do not depend on the final shape of the contour function of the tree, which is quite puzzling. It is therefore natural to wonder if such fluctuations are universal: what happens if the tree is not uniform, if one considers different outdegrees, or if the underlying exploration process is different?

Before stating our result in this direction, we define the second exploration we shall use. If T is a plane tree with n vertices, we denote by $(v_i(T))_{0 \leq i \leq n-1}$ the vertices of T ordered in the lexicographical order (also known as the depth-first order). The Łukasiewicz path $(W_i(T))_{0 \leq i \leq n}$ of T is defined by $W_0(T) = 0$ and $W_i(T) - W_{i-1}(T) = k_{v_{i-1}}(T) - 1$ for $1 \leq i \leq n$, where $k_{v_i}(T)$ denotes the outdegree of v_i (see Fig. 2.1 for an example). For $t \in [0, n]$, we set $W_t(T) = W_{\lfloor t \rfloor}(T)$. For $t \in [0, 1]$, we define $K_{nt}^{\mathcal{A}}(T)$ as the number of \mathcal{A} -vertices visited by $W(T)$ at time $\lfloor nt \rfloor$ (in other words, $K_{nt}^{\mathcal{A}}(T)$ is the number of \mathcal{A} -vertices in the first $\lfloor nt \rfloor$ vertices of T in the lexicographical order). In the next result, convergences hold in distribution in the space $\mathbb{D}([0, 1], \mathbb{R}^2)$ of càdlàg processes on $[0, 1]$ equipped with the Skorokhod J1 topology (for technical reasons it is simpler to work with càdlàg processes; see [53, Chap. VI] for background).

Theorem 2.1.1. *Let μ be a critical distribution with finite variance $\sigma^2 > 0$ and \mathcal{T}_n be a μ -GW tree conditioned to have exactly n vertices. Let $\mathcal{A} \subset \mathbb{Z}_+$ be such that $\mu_{\mathcal{A}} > 0$, and set $\gamma_{\mathcal{A}} = \sqrt{\mu_{\mathcal{A}}(1 - \mu_{\mathcal{A}}) - \frac{1}{\sigma^2} (\sum_{i \in \mathcal{A}} (i-1)\mu_i)^2}$. Then the following assertions hold:*

(i) *We have*

$$\left(\frac{W_{nt}(\mathcal{T}_n)}{\sqrt{n}}, \frac{K_{nt}^{\mathcal{A}}(\mathcal{T}_n) - nt\mu_{\mathcal{A}}}{\sqrt{n}} \right)_{0 \leq t \leq 1} \xrightarrow[n \rightarrow \infty]{(d)} \left(\sigma e_t, \frac{\sum_{i \in \mathcal{A}} (i-1)\mu_i}{\sigma} e_t + \gamma_{\mathcal{A}} B_t \right)_{0 \leq t \leq 1}$$

where B is a standard Brownian motion independent of e (see Fig. 2.2 for a simulation).

(ii) *The following convergence holds in distribution, jointly with that of (i):*

$$\left(\frac{C_{2nt}(\mathcal{T}_n)}{\sqrt{n}}, \frac{N_{2nt}^{\mathcal{A}}(\mathcal{T}_n) - nt\mu_{\mathcal{A}}}{\sqrt{n}} \right)_{0 \leq t \leq 1} \xrightarrow[n \rightarrow \infty]{(d)} \left(\frac{2}{\sigma} e_t, \frac{\sum_{i \in \mathcal{A}} i\mu_i}{\sigma} e_t + \gamma_{\mathcal{A}} B_t \right)_{0 \leq t \leq 1}.$$

As was previously mentioned, assertion (ii) of Theorem 2.1.1, in the particular case where $\mathcal{A} = \{0\}$ and μ is a geometric 1/2 offspring distribution, was proved by Labarbe & Marckert [69]. It turns out that for leaves, the fluctuations of the counting process $N^{\{0\}}(\mathcal{T}_n)$ are always centered, irrespective of the offspring distribution. However, the fluctuations are different when one considers other outdegrees or the lexicographical order instead of the contour visit counting process.

Let us briefly comment on the strategy of the proof of Theorem 2.1.1, which is different from the approach of Labarbe & Marckert (who rely on explicit formulas for the number of paths with ± 1 steps and various constraints). We start by working with the Łukasiewicz path and establish Theorem 2.1.1 (i) by combining a general formula giving the joint distribution of outdegrees in GW trees in terms of random walks (Section 2.3) with absolute continuity arguments and the Vervaat transform. Theorem 2.1.1 (ii) is then a rather direct consequence of (i) by relating the contour exploration to the depth-first search exploration (see in particular Lemma 2.4.3).

In Section 2.4.3, we extend Theorem 2.1.1 (ii) when we only take into account the k -th time we visit a vertex with outdegree i (with k, i integers such that $1 \leq k \leq i + 1$). To

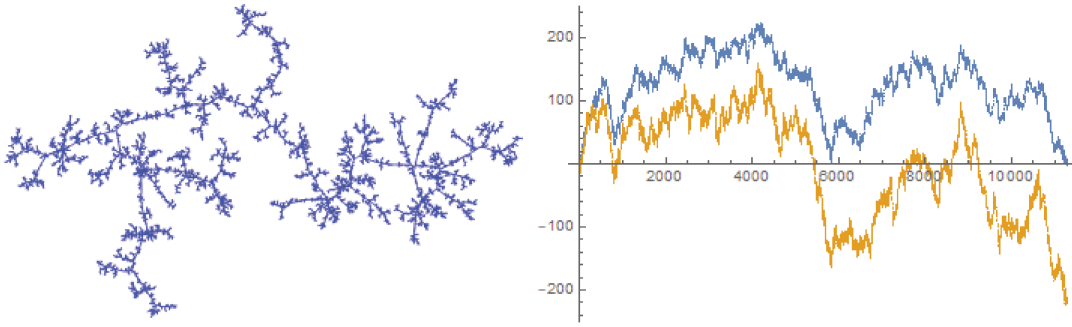

Figure 2.2: A simulation of a Poisson(1)-GW tree \mathcal{T}_n with $n = 11500$ vertices. Left: an embedding of \mathcal{T}_n in the plane. Right: its Łukasiewicz path together with the opposite of its renormalized number of $\{0\}$ -vertices $(W_{nt}(\mathcal{T}_n)/\sqrt{n}, (nt\mu_{\{0\}} - K_{nt}^{\{0\}}(\mathcal{T}_n))/\sqrt{n})_{0 \leq t \leq 1}$. The second one evolves asymptotically as a multiple of the first one plus an independent Brownian motion.

this end, we give a description of the structure of branches in the tree using binomial-tail inequalities, which could be of independent interest.

Finally, an extension of this theorem to offspring distributions with infinite variance can be found in Section 2.6.

Asymptotic normality of the number of vertices with fixed outdegree. Our next contribution is to extend the joint asymptotic normality of the number of vertices with a fixed outdegree in large conditioned critical GW trees obtained by Janson [56], by counting vertices whose outdegree belongs to a fixed subset of \mathbb{Z}_+ and by allowing a more general conditioning. Indeed, we shall focus on μ -GW trees conditioned to have n \mathcal{B} -vertices, for a fixed $\mathcal{B} \subset \mathbb{Z}_+$ (we shall always implicitly restrict ourselves to values of n such that this conditioning makes sense).

Theorem 2.1.2. *Let μ be a critical offspring distribution with positive finite variance and let \mathcal{A}, \mathcal{B} be subsets of \mathbb{Z}_+ such that $\mu_{\mathcal{B}} > 0$. For $n \geq 1$, let $\mathcal{T}_n^{\mathcal{B}}$ be a μ -GW tree conditioned to have n \mathcal{B} -vertices. Then:*

- (i) as $n \rightarrow \infty$, $\frac{1}{n} \mathbb{E}(N^{\mathcal{A}}(\mathcal{T}_n^{\mathcal{B}})) \rightarrow \frac{\mu_{\mathcal{A}}}{\mu_{\mathcal{B}}}$;
- (ii) there exists $\delta_{\mathcal{A}, \mathcal{B}} \geq 0$ such that the convergence

$$\frac{N^{\mathcal{A}}(\mathcal{T}_n^{\mathcal{B}}) - n \frac{\mu_{\mathcal{A}}}{\mu_{\mathcal{B}}}}{\sqrt{n}} \xrightarrow[n \rightarrow \infty]{(d)} \mathcal{N}(0, \delta_{\mathcal{A}, \mathcal{B}}^2) \quad (2.1)$$

holds in distribution, where $\mathcal{N}(0, \delta_{\mathcal{A}, \mathcal{B}}^2)$ is a centered Gaussian random variable with variance $\delta_{\mathcal{A}, \mathcal{B}}^2$. In addition, $\delta_{\mathcal{A}, \mathcal{B}} = 0$ if and only if $\mu_{\mathcal{A}} = 0$ or $\mu_{\mathcal{A} \setminus \mathcal{B}} = \mu_{\mathcal{B} \setminus \mathcal{A}} = 0$.

- (iii) the convergences (2.1) hold jointly for $\mathcal{A} \subset \mathbb{Z}_+$, in the sense that for every $j \geq 1$ and $\mathcal{A}_1, \dots, \mathcal{A}_j \subset \mathbb{Z}_+$, $((N^{\mathcal{A}_i}(\mathcal{T}_n^{\mathcal{B}}) - n \frac{\mu_{\mathcal{A}_i}}{\mu_{\mathcal{B}}})/\sqrt{n})_{1 \leq i \leq j}$ converges in distribution to a Gaussian vector.

As previously mentioned, this extends results of Kolchin [62], Minami [85] and Janson [56]. The main idea is, roughly speaking, to use a general formula giving the joint distribution

of outdegrees in GW trees in terms of random walks of Section 2.3 (which was already used in the proof of Theorem 2.1.1), combined with various local limit estimates (Section 2.5). As we will see (cf (2.11)), in the case $\mathcal{A} = \mathbb{Z}_+$, we have $\delta_{\mathcal{A},\mathcal{B}}^2 = \gamma_{\mathcal{B}}^2 / \mu_{\mathcal{B}}^3$ (with $\gamma_{\mathcal{B}}$ defined as in Theorem 2.1.1 by replacing \mathcal{A} by \mathcal{B}). Also, the proof of Theorem 2.1.2 (ii) gives a way to compute explicitly $\delta_{\mathcal{A},\mathcal{B}}$ (see Example 2.5.2 for the explicit values of the variances and covariances in the cases $\mathcal{B} = \mathbb{Z}_+$ and $\mathcal{B} = \{a\}$ for some $a \in \mathbb{Z}_+$). See Section 2.6 for discussions concerning other offspring distributions.

Our approach, based on a multivariate local limit theorem, applies more generally when μ is in the domain of attraction of a stable law. In this case, it allows us to prove the convergence of $\mathcal{T}_n^{\mathcal{B}}$ (properly renormalized) towards a Lévy tree, thus generalizing [63, Theorem 8.1] which was stated only under the condition that \mathcal{B} or $\mathbb{Z}_+ \setminus \mathcal{B}$ is finite. These new results can be found in Section 2.6.

Acknowledgements. I would like to thank Igor Kortchemski for suggesting the study of these exploration processes, as well as for his precious and stimulating comments on the multiple versions of this paper. I would also like to thank the reviewers of this paper, for their numerous constructive remarks and corrections, leading in particular to shorter proofs of Lemma 2.3.3 (i) and Proposition 2.4.5.

2.2 Background on trees and their codings

We start by recalling some definitions and useful well-known results concerning Galton-Watson trees and their coding by random walks (we refer to [70] for details and proofs).

Plane trees. We first define plane trees using Neveu's formalism [87]. First, let $\mathbb{N}^* = \{1, 2, \dots\}$ be the set of all positive integers, and $\mathcal{U} = \cup_{n \geq 0} (\mathbb{N}^*)^n$ be the set of finite sequences of positive integers, with $(\mathbb{N}^*)^0 = \{\emptyset\}$ by convention. By a slight abuse of notation, for $k \in \mathbb{Z}_+$, we write an element u of $(\mathbb{N}^*)^k$ by $u = u_1 \cdots u_k$, with $u_1, \dots, u_k \in \mathbb{N}^*$. For $k \in \mathbb{Z}_+$, $u = u_1 \cdots u_k \in (\mathbb{N}^*)^k$ and $i \in \mathbb{Z}_+$, we denote by ui the element $u_1 \cdots u_k i \in (\mathbb{N}^*)^{k+1}$ and iu the element $i u_1 \cdots u_k \in (\mathbb{N}^*)^{k+1}$. A tree T is a subset of \mathcal{U} satisfying the following three conditions: (i) $\emptyset \in T$ (the tree has a root); (ii) if $u = u_1 \cdots u_n \in T$, then, for all $k \leq n$, $u_1 \cdots u_k \in T$ (these elements are called ancestors of u); (iii) for any $u \in T$, there exists a nonnegative integer $k_u(T)$ such that, for every $i \in \mathbb{N}^*$, $ui \in T$ if and only if $1 \leq i \leq k_u(T)$ ($k_u(T)$ will be called the number of children of u , or the outdegree of u). The elements of T are called the vertices of T . The set of all the ancestors of a vertex u will be called the ancestral line of u , by analogy with genealogical trees. We denote by $|T|$ the total number of vertices of T .

The *lexicographical order* \prec on \mathcal{U} is defined as follows: $\emptyset \prec u$ for all $u \in \mathcal{U} \setminus \{\emptyset\}$, and for $u, w \neq \emptyset$, if $u = u_1 u'$ and $w = w_1 w'$ with $u_1, w_1 \in \mathbb{N}^*$, then we write $u \prec w$ if and only if $u_1 < w_1$, or $u_1 = w_1$ and $u' \prec w'$. The lexicographical order on the vertices of a tree T is the restriction of the lexicographical order on \mathcal{U} ; for every $0 \leq k \leq |T| - 1$ we write $v_k(T)$, or v_k when there is no confusion, for the $(k+1)$ -th vertex of T in the lexicographical order. Recall from the introduction that the Łukasiewicz path $(W_i(T))_{0 \leq i \leq |T|}$ of T is defined by $W_0(T) = 0$ and $W_i(T) - W_{i-1}(T) = k_{v_{i-1}}(T) - 1$ for $1 \leq i \leq |T|$.

Galton–Watson trees. Let μ be an offspring distribution with mean at most 1 such that $\mu(0) + \mu(1) < 1$ (implicitly, we always make this assumption to avoid degenerate cases). A GW tree \mathcal{T} with offspring distribution μ (also called μ -GW tree) is a random variable taking values

in the space of all finite plane trees, characterized by the fact that $\mathbb{P}(\mathcal{T} = T) = \prod_{u \in T} \mu_{k_u(T)}$ for every finite plane tree T . We also always implicitly assume that $\gcd(i \in \mathbb{Z}_+, \mu_i > 0) = 1$, so that $\mathbb{P}(|\mathcal{T}| = n) > 0$ for every n sufficiently large (μ is said to be aperiodic). All the results can be adapted to the periodic setting with mild modifications.

A key tool to study GW trees is the fact that their Łukasiewicz path is, roughly speaking, a killed random walk, which allows us to obtain information on GW trees from the study of random walks. More precisely, let S be the random walk on $\mathbb{Z}_+ \cup \{-1\}$ starting from $S_0 = 0$ with jump distribution given by $\mathbb{P}(S_1 = i) = \mu_{i+1}$ for $i \geq -1$ (we keep the dependency of S in μ implicit). The proof of the following lemma can be found in [70].

Lemma 2.2.1. *Let μ be an offspring distribution with mean at most 1 and \mathcal{T}_n be a μ -GW tree conditioned on having n vertices. Then $(W_i(\mathcal{T}_n))_{0 \leq i \leq n}$ has the same distribution as $(S_i)_{0 \leq i \leq n}$ conditionally given the event $\{S_n = -1, \forall 0 \leq i \leq n-1, S_i \geq 0\}$.*

Several useful ingredients. We finally gather two very useful ingredients. The first one is a joint scaled convergence in distribution of the contour process (which was defined in the introduction) and the Łukasiewicz path of a critical GW tree with finite variance, conditioned to have n vertices, to the same Brownian excursion.

Theorem 2.2.2 (Marckert and Mokkadem [77], Duquesne [40]). *Let μ be a critical offspring distribution with finite positive variance σ^2 . Then the following convergence holds jointly in distribution:*

$$\left(\frac{C_{2nt}(\mathcal{T}_n)}{\sqrt{n}}, \frac{W_{nt}(\mathcal{T}_n)}{\sqrt{n}} \right)_{0 \leq t \leq 1} \xrightarrow{d} \left(\frac{2}{\sigma} \mathfrak{e}_t, \sigma \mathfrak{e}_t \right)_{0 \leq t \leq 1}$$

where \mathfrak{e} has the law of the normalized Brownian excursion.

This result is due to Marckert and Mokkadem [77] under the assumption that μ has a finite exponential moment. The result in the general case can be deduced from [40], however it is not clearly stated in this form. See [63, Theorem 8.1, (II)] (taking $\mathcal{A} = \mathbb{Z}_+$ in this theorem) for a precise statement.

The second ingredient is the local limit theorem (see [52, Theorem 4.2.1]).

Theorem 2.2.3. *Let $(S_n)_{n \geq 0}$ be a random walk on \mathbb{Z} such that the law of S_1 has finite positive variance σ^2 . Let $h \in \mathbb{Z}_+$ be the maximal integer such that there exists $b \in \mathbb{Z}$ for which $\text{Supp}(S_1) \subset b + h\mathbb{Z}$. Then, for such $b \in \mathbb{Z}$,*

$$\sup_{k \in \mathbb{Z}} \left| \sqrt{2\pi\sigma^2 n} \mathbb{P}(S_n = nb + kh) - h \exp \left(-\frac{1}{2} \left(\frac{nb + kh - n\mathbb{E}(S_1)}{\sigma\sqrt{n}} \right)^2 \right) \right| \xrightarrow{n \rightarrow \infty} 0.$$

When $\text{Supp}(S_1)$ is non-lattice, observe that one can take $b = 0$ and $h = 1$ in the previous result.

This theorem admits the following generalization in the multivariate setting (see e.g. [92, Theorem 6.1]). In the multivariate case in dimension $j \geq 1$, we say that a random variable $\mathbf{Y} \in \mathbb{Z}^j$ is aperiodic if there is no strict sublattice of \mathbb{Z}^j containing the set of differences $\{\mathbf{x} - \mathbf{y}, \mathbf{x}, \mathbf{y} \in \mathbb{Z}^j, \mathbb{P}(\mathbf{Y} = \mathbf{x}) > 0, \mathbb{P}(\mathbf{Y} = \mathbf{y}) > 0\}$. Furthermore, \mathcal{S}_j denotes the set of symmetric positive definite matrices of dimension j .

Theorem 2.2.4. *Let $j \geq 1$ and $(\mathbf{Y}_i)_{i \geq 1} := ((Y_i^{(1)}, \dots, Y_i^{(j)}))_{i \geq 1}$ be i.i.d. random variables in \mathbb{Z}^j , such that the covariance matrix Σ of \mathbf{Y}_1 is positive definite. Assume in addition that \mathbf{Y}_1 is aperiodic, and denote by \mathbf{M} the mean of \mathbf{Y}_1 . Finally, define for $n \geq 1$*

$$\mathbf{T}_n = \frac{1}{\sqrt{n}} \left(\sum_{i=1}^n \mathbf{Y}_i - n\mathbf{M} \right) \in \mathbb{R}^j.$$

Then, as $n \rightarrow \infty$, uniformly for $\mathbf{x} \in \mathbb{R}^j$ such that $\mathbb{P}(\mathbf{T}_n = \mathbf{x}) > 0$,

$$\mathbb{P}(\mathbf{T}_n = \mathbf{x}) = \frac{1}{(2\pi n)^{j/2} \sqrt{\det \Sigma}} e^{-\frac{1}{2} \mathbf{x} \Sigma^{-1} \mathbf{x}} + o(n^{-j/2}).$$

This theorem can easily be adapted when \mathbf{Y}_1 is not aperiodic. However, for convenience, we shall restrict ourselves to this case in what follows.

2.3 Joint distribution of outdegrees in GW trees

The first steps of the proofs of Theorems 2.1.1 and 2.1.2 both reformulate events on trees in terms of events on random walks, whose probabilities are easier to estimate. In this direction, in this section, we give a general formula for the joint distribution of outdegrees in GW trees in terms of random walks (Proposition 2.3.1) and establish technical estimates (Lemma 2.3.3) which will be later used several times.

2.3.1 A joint distribution

The following proposition is a key tool in the study of the outdegrees in a μ -GW tree \mathcal{T} , as it allows us to study the joint distribution of $(N^{\mathbb{Z}_+}(\mathcal{T}), N^{\mathcal{B}}(\mathcal{T}))$:

Proposition 2.3.1. *Let $\mathcal{B} \subset \mathbb{Z}_+$. Let $(S_i)_{i \geq 0}$ be a random walk starting from 0, whose jumps are independent and distributed according to $\mu(\cdot + 1)$, and let $(J_i^{\mathcal{B}})_{i \geq 0}$ be the walk starting from 0 such that, for all $i \geq 0$, $J_{i+1}^{\mathcal{B}} - J_i^{\mathcal{B}} = \mathbb{1}_{S_{i+1} - S_i + 1 \in \mathcal{B}}$. Then, for every $n \geq 1$ and $k \geq 0$,*

$$\mathbb{P}(N^{\mathbb{Z}_+}(\mathcal{T}) = n, N^{\mathcal{B}}(\mathcal{T}) = k) = \frac{1}{n} \mathbb{P}(S_n = -1, J_n^{\mathcal{B}} = k).$$

This proposition is a consequence of the so-called cyclic lemma, which is responsible for the factor $1/n$ (see e.g. [63, Equation (2)]): roughly speaking, let $(S_i)_{0 \leq i \leq n}$ be a walk starting from 0 and reaching -1 at time n . Then, among all n cyclic shifts of $(S_i)_{0 \leq i \leq n}$, exactly one of them takes only nonnegative values between times 0 and $n - 1$.

The following asymptotics, which can be derived from a local limit theorem (see e.g. [91] or [63, Theorem 8.1]) will be useful throughout the paper:

$$\mathbb{P}(N^{\mathcal{B}}(\mathcal{T}) = k) \underset{k \rightarrow \infty}{\sim} \frac{1}{\sqrt{2\pi\sigma^2}} \sqrt{\mu_{\mathcal{B}} k^{-3/2}}, \quad (2.2)$$

assuming that $\mathbb{P}(N^{\mathcal{B}}(\mathcal{T}) = k) > 0$ for k sufficiently large.

2.3.2 A technical estimate

We introduce other probability measures as follows:

Definition. Let $\mathcal{C} \subset \mathbb{Z}_+$ be a subset such that $\mu_{\mathcal{C}} > 0$. For $i \in \mathbb{Z}$, we set

$$p_{\mathcal{C}}(i) = \begin{cases} \frac{\mu_{i+1}}{\mu_{\mathcal{C}}} & \text{if } i+1 \in \mathcal{C} \\ 0 & \text{otherwise.} \end{cases}$$

We let $m_{\mathcal{C}}$ be the expectation of $p_{\mathcal{C}}$ and $\sigma_{\mathcal{C}}^2$ be its variance.

The following identities will be useful.

Lemma 2.3.2. Assume that μ is critical and has finite positive variance σ^2 . Let $\mathcal{B} \subset \mathbb{Z}_+$ be such that $\mu_{\mathcal{B}} > 0$ and $\mu_{\mathcal{B}^c} > 0$. Let $\gamma_{\mathcal{B}} \geq 0$ be such that $\gamma_{\mathcal{B}}^2 = \mu_{\mathcal{B}}(1 - \mu_{\mathcal{B}}) - \frac{1}{\sigma^2} \left(\sum_{i \in \mathcal{B}} (i-1)\mu_i \right)^2$. Then the following identities hold:

- (i) $m_{\mathcal{B}^c}(1 - \mu_{\mathcal{B}}) + m_{\mathcal{B}}\mu_{\mathcal{B}} = 0$,
- (ii) $\gamma_{\mathcal{B}}^2 = \mu_{\mathcal{B}}(1 - \mu_{\mathcal{B}}) - \frac{1}{\sigma^2} \mu_{\mathcal{B}}^2 m_{\mathcal{B}}^2$,
- (iii) $\mu_{\mathcal{B}}\sigma_{\mathcal{B}}^2 + (1 - \mu_{\mathcal{B}})\sigma_{\mathcal{B}^c}^2 = \frac{\sigma^2}{\mu_{\mathcal{B}}(1 - \mu_{\mathcal{B}})} \gamma_{\mathcal{B}}^2$.

In particular, observe that $\gamma_{\mathcal{B}}$ is well-defined by (iii). Furthermore, if $\#\text{Supp}(\mu) \geq 3$, then at least one of the variances $\sigma_{\mathcal{B}}^2$ and $\sigma_{\mathcal{B}^c}^2$ is positive, which implies by (iii) that $\gamma_{\mathcal{B}} > 0$.

Proof. For (i), simply write that the quantity $m_{\mathcal{B}^c}(1 - \mu_{\mathcal{B}}) + m_{\mathcal{B}}\mu_{\mathcal{B}}$ is equal to

$$\begin{aligned} (1 - \mu_{\mathcal{B}}) \sum_{i \geq -1} i p_{\mathcal{B}^c}(i) + \mu_{\mathcal{B}} \sum_{i \geq -1} i p_{\mathcal{B}}(i) &= (1 - \mu_{\mathcal{B}}) \sum_{i+1 \notin \mathcal{B}} \frac{i\mu_{i+1}}{1 - \mu_{\mathcal{B}}} + \mu_{\mathcal{B}} \sum_{i+1 \in \mathcal{B}} \frac{i\mu_{i+1}}{\mu_{\mathcal{B}}} \\ &= \sum_{i \notin \mathcal{B}} (i-1)\mu_i + \sum_{i \in \mathcal{B}} (i-1)\mu_i, \end{aligned}$$

which is equal to 0 since μ is critical. The second assertion is clear, while the proof of the last one is similar to the first one and is left to the reader. \square

Let us keep the notation of Proposition 2.3.1. In particular, recall that the walk $(J_i^{\mathcal{B}})_{i \geq 0}$ is defined from $(S_i)_{i \geq 0}$ as $J_0^{\mathcal{B}} = 0$ and, for $i \geq 0$, $J_{i+1}^{\mathcal{B}} - J_i^{\mathcal{B}} = \mathbf{1}_{S_{i+1} - S_i + 1 \in \mathcal{B}}$.

We set, for $c \in \mathbb{R}$,

$$k_n(c) = \lfloor \mu_{\mathcal{B}} n + c\sqrt{n} \rfloor.$$

The following estimate will play an important role.

Lemma 2.3.3. Let μ be an aperiodic critical offspring distribution with positive finite variance σ^2 such that $\#\text{Supp}(\mu) \geq 3$, and let $\mathcal{B} \subset \mathbb{Z}_+$ be such that $\mu_{\mathcal{B}} > 0$ and $\mu_{\mathcal{B}^c} > 0$. Assume in addition that $p_{\mathcal{B}}$ or $p_{\mathcal{B}^c}$ is aperiodic. Fix $a \in \mathbb{R}$ and let (a_n) be a sequence of integers such that $a_n/\sqrt{n} \xrightarrow{n \rightarrow \infty} a$. Then the following assertions hold as $n \rightarrow \infty$, uniformly for c in a compact subset of \mathbb{R} :

- (i) $\mathbb{P}(S_n = a_n, J_n^{\mathcal{B}} = k_n(c)) \sim \frac{1}{n} \frac{1}{2\pi\sigma\gamma_{\mathcal{B}}} e^{-\frac{1}{2\sigma^2} a^2 - \frac{1}{2\gamma_{\mathcal{B}}^2} (c - \frac{\mu_{\mathcal{B}} m_{\mathcal{B}}}{\sigma^2} a)^2}$,
- (ii) $\mathbb{P}(N^{\mathbb{Z}_+}(\mathcal{T}) = n, N^{\mathcal{B}}(\mathcal{T}) = k_n(c)) \sim \frac{1}{n^2} \frac{1}{2\pi\sigma\gamma_{\mathcal{B}}} e^{-\frac{c^2}{2\gamma_{\mathcal{B}}^2}}$.

Observe that (ii) is a straightforward consequence of (i) and Proposition 2.3.1. (i) itself follows from the multivariate local limit theorem 2.2.4:

Proof of Lemma 2.3.3 (i). The idea is to apply Theorem 2.2.4 to a sequence of i.i.d. variables in Z^2 , distributed as $\mathbf{Y}_1 := (S_1, J_1^{\mathcal{B}})$. Since $p_{\mathcal{B}}$ or $p_{\mathcal{B}^c}$ is aperiodic, \mathbf{Y}_1 (as a 2-dimensional variable) is aperiodic as well. Furthermore, the mean and the covariance matrix of \mathbf{Y}_1 are respectively equal to:

$$M = \begin{pmatrix} 0 \\ \mu_{\mathcal{B}} \end{pmatrix} \quad \text{and} \quad \Sigma = \begin{pmatrix} \sigma^2 & \mu_{\mathcal{B}} m_{\mathcal{B}} \\ \mu_{\mathcal{B}} m_{\mathcal{B}} & \mu_{\mathcal{B}}(1 - \mu_{\mathcal{B}}) \end{pmatrix}$$

where σ^2 is the variance of μ . In particular, $\det \Sigma = \sigma^2 \gamma_{\mathcal{B}}^2 > 0$.

On the other hand, as μ is non-lattice, for n large enough, uniformly for c in a compact subset of \mathbb{R} , $\mathbb{P}(S_n = a_n, J_n^{\mathcal{B}} = k_n(c)) > 0$. An easy computation, with the help of Lemma 2.3.2 (ii), gives the result that we want. \square

2.4 Evolution of outdegrees in an exploration of a Galton-Watson tree

The aim of this section is to establish Theorem 2.1.1. Recall from the introduction that if T is a tree and $\mathcal{A} \subset \mathbb{Z}_+$, $C(T)$ denotes the contour function of T , for $0 \leq t \leq 1$, $N_{2nt}^{\mathcal{A}}(T)$ denotes the number of different \mathcal{A} -vertices already visited by $C(T)$ at time $\lfloor 2nt \rfloor$ and $K_{nt}^{\mathcal{A}}(T)$ denotes the number of \mathcal{A} -vertices in the first $\lfloor nt \rfloor$ vertices of T in the depth-first search (or, equivalently, the lexicographical order).

We assume here that $\mathcal{A} \subset \mathbb{Z}_+$ is such that $\mu_{\mathcal{A}} > 0$. We keep the notation of Section 2.3.1, and denote in particular by $m_{\mathcal{A}}$ the expectation of a random variable with law given by $p_{\mathcal{A}}(i) = \frac{\mu_{i+1}}{\mu_{\mathcal{A}}} \mathbb{1}_{i+1 \in \mathcal{A}}$ for $i \in \mathbb{Z}$.

2.4.1 Depth-first exploration

In this section, we study the evolution of the number of \mathcal{A} -vertices in conditioned GW trees for the depth-first search, and establish in particular Theorem 2.1.1 (i). Throughout this section, we fix a critical distribution μ with finite positive variance σ^2 , and we let \mathcal{T}_n denote a μ -GW tree conditioned on having n vertices.

The idea of the proof of Theorem 2.1.1 (i) is the following. By Lemma 2.2.1, the convergence of Theorem 2.1.1 (i) can be restated in terms of the random walk $(S_i)_{0 \leq i \leq n}$ (with jump distribution given by $\mathbb{P}(S_1 = i) = \mu(i+1)$ for $i \geq -1$) conditionally given the event $\{S_n = -1, \forall 0 \leq i \leq n-1, S_i \geq 0\}$. We first establish a result for the “bridge” version where one works conditionally given the event $\{S_n = -1\}$ (Lemma 2.4.1) and then conclude by using the so-called Vervaat transform.

To simplify notation, for every $t \geq 0$, we set $S_t = S_{\lfloor t \rfloor}$ and $J_t^{\mathcal{A}} = \sum_{k=1}^{\lfloor t \rfloor} \mathbb{1}_{\{S_k - S_{k-1} + 1 \in \mathcal{A}\}}$

Lemma 2.4.1. *The following convergence holds in distribution*

$$\left(\frac{S_{nt}}{\sqrt{n}}, \frac{J_{nt}^{\mathcal{A}} - \mu_{\mathcal{A}} nt}{\sqrt{n}} \right)_{0 \leq t \leq 1} \quad \text{under} \quad \mathbb{P}(\cdot | S_n = -1) \quad \xrightarrow[n \rightarrow \infty]{(d)} \quad \left(\sigma B_t^{br}, \frac{\mu_{\mathcal{A}} m_{\mathcal{A}}}{\sigma} B_t^{br} + \gamma_{\mathcal{A}} B_t' \right)_{0 \leq t \leq 1} \quad (2.3)$$

where B^{br} is a standard Brownian bridge and B' is a standard Brownian motion independent of B^{br} .

Proof. We first check that the corresponding nonconditioned statement holds, namely that the following convergence holds in distribution :

$$\left(\frac{S_{nt}}{\sqrt{n}}, \frac{J_{nt}^{\mathcal{A}} - \mu_{\mathcal{A}} nt}{\sqrt{n}} \right)_{0 \leq t \leq 1} \quad \xrightarrow[n \rightarrow \infty]{(d)} \quad \left(\sigma B_t, \frac{\mu_{\mathcal{A}} m_{\mathcal{A}}}{\sigma} B_t + \gamma_{\mathcal{A}} B_t' \right)_{0 \leq t \leq 1} \quad (2.4)$$

where B is a standard Brownian motion and B' a standard Brownian motion independent of B . To this end, by [58, Theorem 16.14], it is enough to check that the one-dimensional convergence holds for $t = 1$. By Lemma 2.3.3 (i), uniformly for a, b in a compact subset of \mathbb{R} :

$$\mathbb{P}(S_n = \lfloor a\sqrt{n} \rfloor, J_n^A = \lfloor \mu_{\mathcal{A}n} + b\sqrt{n} \rfloor) \underset{n \rightarrow \infty}{\sim} \frac{1}{2\pi\sigma\gamma_{\mathcal{A}}} \frac{1}{n} e^{-\frac{1}{2\sigma^2}a^2 - \frac{1}{2\gamma_{\mathcal{A}}^2}(b - \frac{\mu_{\mathcal{A}n}}{\sigma^2}a)^2}.$$

It is standard (see e.g. [25, Theorem 7.8]) that this implies that $(S_n/\sqrt{n}, (J_n^A - \mu_{\mathcal{A}n})/\sqrt{n})$ converges in distribution to $(\sigma B_1, \frac{\mu_{\mathcal{A}m_{\mathcal{A}}}}{\sigma} B_1 + \gamma_{\mathcal{A}} B'_1)$, which yields (2.4).

We now establish (2.3) by using an absolute continuity argument. We fix $u \in (0, 1)$, a bounded continuous functional $F : \mathbb{D}([0, u], \mathbb{R}^2) \rightarrow \mathbb{R}$, and to simplify notation set $A_n = \mathbb{E} [F(S_{nt}/\sqrt{n}, (J_{nt}^A - \mu_{\mathcal{A}nt})/\sqrt{n})_{0 \leq t \leq u} | S_n = -1]$. Then, setting $\phi_n(i) = \mathbb{P}(S_n = i)$, we have

$$A_n = \mathbb{E} \left[F \left(\left(\frac{S_{nt}}{\sqrt{n}}, \frac{J_{nt}^A - \mu_{\mathcal{A}nt}}{\sqrt{n}} \right)_{0 \leq t \leq u} \right) \frac{\phi_{n - \lfloor nu \rfloor}(-S_{\lfloor nu \rfloor} - 1)}{\phi_n(-1)} \right].$$

An application of the local limit theorem 2.2.3 allows us to write as $n \rightarrow \infty$

$$A_n = \mathbb{E} \left[F \left(\left(\frac{S_{nt}}{\sqrt{n}}, \frac{J_{nt}^A - \mu_{\mathcal{A}nt}}{\sqrt{n}} \right)_{0 \leq t \leq u} \right) \frac{q_{1-u}(-S_{\lfloor nu \rfloor}/\sqrt{n})}{q_1(0)} \right] + o(1),$$

where q_t denotes the density of a centered Brownian motion of variance σ^2 at time t . Therefore, by (2.4), as $n \rightarrow \infty$,

$$\begin{aligned} A_n &\underset{n \rightarrow \infty}{\longrightarrow} \mathbb{E} \left[F \left(\left(\sigma B_t, \frac{\mu_{\mathcal{A}m_{\mathcal{A}}}}{\sigma} B_t + \gamma_{\mathcal{A}} B'_t \right)_{0 \leq t \leq u} \right) \frac{q_{1-u}(-B_u)}{q_1(0)} \right] \\ &= \mathbb{E} \left[F \left(\left(\sigma B_t^{br}, \frac{\mu_{\mathcal{A}m_{\mathcal{A}}}}{\sigma} B_t^{br} + \gamma_{\mathcal{A}} B'_t \right)_{0 \leq t \leq u} \right) \right], \end{aligned} \quad (2.5)$$

where the last identity follows from standard absolute continuity properties of the Brownian bridge (see e.g. [90, Chapter XII]).

The convergence (2.5) shows in particular that, conditionally given $S_n = -1$, the process $(S_{nt}/\sqrt{n}, (J_{nt}^A - \mu_{\mathcal{A}nt})/\sqrt{n})_{0 \leq t \leq 1}$ is tight on $[0, u]$ for every $u \in (0, 1)$. To check that it is tight on $[u, 1]$, it suffices to check that for $u \in (0, 1)$, $(S_{n-nt}/\sqrt{n}, (J_{n-nt}^A - \mu_{\mathcal{A}n(1-t)})/\sqrt{n})_{0 \leq t \leq u}$ is tight conditionally given $S_n = -1$. To this end, notice that by time-reversal the process $(\widehat{S}_i, \widehat{J}_i)_{0 \leq i \leq n} := (S_n - S_{n-i}, J_n^A - J_{n-i}^A)_{0 \leq i \leq n}$ has the same distribution as $(S_i, J_i)_{0 \leq i \leq n}$ (and this also holds conditionally given $S_n = -1$). Then write

$$\left(\frac{S_{n-nt}}{\sqrt{n}}, \frac{J_{n-nt}^A - \mu_{\mathcal{A}n(1-t)}}{\sqrt{n}} \right)_{0 \leq t \leq u} = \left(\frac{\widehat{S}_n - \widehat{S}_{nt}}{\sqrt{n}}, \frac{\widehat{J}_n^A - \mu_{\mathcal{A}n}}{\sqrt{n}} - \frac{\widehat{J}_{nt}^A - \mu_{\mathcal{A}nt}}{\sqrt{n}} \right)_{0 \leq t \leq u}.$$

Now, by Lemma 2.3.3 (i) and the local limit theorem, uniformly for b in a compact subset of \mathbb{R} , $\mathbb{P}(J_n^A = \lfloor \mu_{\mathcal{A}n} + b\sqrt{n} \rfloor | S_n = -1) \sim \frac{1}{\sqrt{2\pi\gamma_{\mathcal{A}}n}} e^{-b^2/2\gamma_{\mathcal{A}}^2}$ as $n \rightarrow \infty$, which shows that, conditionally given $S_n = -1$, $(J_n^A - \mu_{\mathcal{A}n})/\sqrt{n}$ converges in distribution. Hence by (2.5), the process $(S_{nt}/\sqrt{n}, (J_{nt}^A - \mu_{\mathcal{A}nt})/\sqrt{n})_{u \leq t \leq 1}$ is tight on $[u, 1]$ conditionally given $S_n = -1$. This allows us to conclude that this process is actually tight on $[0, 1]$, and in addition, this identifies the convergence of the finite dimensional marginal distributions. \square

In order to deduce Theorem 2.1.1 (i) from the bridge version of Lemma 2.4.1, we now use the Vervaat transformation, whose definition is recalled here.

Set $\mathbb{D}_0([0, 1], \mathbb{R}) = \{\omega \in \mathbb{D}([0, 1], \mathbb{R}); \omega(0) = 0\}$. For every $\omega \in \mathbb{D}_0([0, 1], \mathbb{R})$ and $0 \leq u \leq 1$, we define the shifted function $\omega^{(u)}$ by

$$\omega^{(u)}(t) = \begin{cases} \omega(u+t) - \omega(u) & \text{if } u+t \leq 1, \\ \omega(u+t-1) + \omega(1) - \omega(u) & \text{if } u+t \geq 1. \end{cases}$$

We shall also need the notation $g_1(\omega) = \inf\{t \in [0, 1]; \omega(t-) \wedge \omega(t) = \inf_{[0,1]} \omega\}$. The shifted function $\omega^{(g_1(\omega))}$ is usually called the Vervaat transform of ω .

Lemma 2.4.2. *Let B^{br} be a standard Brownian bridge and B an independent standard Brownian motion. Set $\tau = g_1(B^{br})$. Then*

$$(B^{br,(\tau)}, B^{(\tau)}) \stackrel{(d)}{=} (\mathfrak{e}, B'),$$

where \mathfrak{e} is a normalized Brownian excursion and B' is a standard Brownian motion independent of \mathfrak{e} .

Proof. Since B and B^{br} are independent, it readily follows that $B^{(\tau)}$ has the law of a standard Brownian motion, and is independent of (τ, B^{br}) , and therefore is independent of $B^{br,(\tau)}$. On the other hand, $B^{br,(\tau)}$ has the law of \mathfrak{e} (see e.g. [99]). The result follows. \square

Proof of Theorem 2.1.1 (i). We keep the notation of Lemma 2.4.2, and we also let $(S^{br,n}, J^n) = (S_{nt}^{br,n}, J_{nt}^n)_{0 \leq t \leq 1}$ be a random variable distributed as $(S_{nt}, J_{nt}^A - nt\mu_A)_{0 \leq t \leq 1}$ conditionally given $S_n = -1$. We set $\tau_n = g_1(S^{br,n})$. It is well-known (see e.g. [99]) that $S^{br,n,(\tau_n)}$ has the same distribution as $(W_{nt}(\mathcal{T}_n))_{0 \leq t \leq 1}$. It follows that

$$(S^{br,n,(\tau_n)}, J^{n,(\tau_n)}) \stackrel{(d)}{=} (W_{nt}(\mathcal{T}_n), K_{nt}^A(\mathcal{T}_n) - nt\mu_A)_{0 \leq t \leq 1}.$$

Since B^{br} and B are almost surely continuous at τ , by Lemma 2.4.1 and standard continuity properties of the Vervaat transform, it follows that

$$\left(\frac{W_{nt}(\mathcal{T}_n)}{\sqrt{n}}, \frac{K_{nt}^A(\mathcal{T}_n) - nt\mu_A}{\sqrt{n}} \right)_{0 \leq t \leq 1} \xrightarrow[n \rightarrow \infty]{(d)} \left(\sigma B_t^{br,(\tau)}, \frac{\mu_{\mathcal{A}} m_{\mathcal{A}}}{\sigma} B_t^{br,(\tau)} + \gamma_{\mathcal{A}} B_t^{(\tau)} \right)_{0 \leq t \leq 1}.$$

By Lemma 2.4.2, this last process has the same distribution as $(\sigma \mathfrak{e}_t, \frac{\sum_{i \in \mathcal{A}} (i-1)\mu_i}{\sigma} \mathfrak{e}_t + \gamma_{\mathcal{A}} B_t')$, and this completes the proof. \square

2.4.2 Contour exploration

We are now interested in the evolution of the number of \mathcal{A} -vertices in conditioned GW trees for the contour visit counting process, and establish in particular Theorem 2.1.1 (ii). The idea of the proof is to obtain a relation between the counting process $N^{\mathcal{A}}$ for the contour process and the counting process $K^{\mathcal{A}}$ for the depth-first search order.

In this direction, if T is a tree with n vertices, for every $0 \leq k \leq 2n - 2$, we denote by $b_k(T)$ the number of *different* vertices visited by the contour process $C(T)$ up to time k . We set $b_k(T) = b_{2n-2}(T)$ for $k \geq 2n - 2$, and $b_t(T) = b_{\lfloor t \rfloor}(T)$ for $t \geq 0$. It turns out that the following simple deterministic relation holds between $b(T)$ and $C(T)$.

Lemma 2.4.3. *Let T be a tree with n vertices. Then, for every $0 \leq k \leq 2n - 2$,*

$$b_k(T) = 1 + \frac{k + C_k(T)}{2}.$$

Proof. We prove this by induction, by showing that the result holds for $k = 0$ and that, if it holds at time $0 \leq k \leq 2n - 3$, then it holds at time $k + 1$. For $0 \leq k \leq 2n - 2$, let u_k be the vertex visited by the contour process at time k . First, at time $k = 0$, the root is the only vertex visited and $b_0(T) = 1$. Now assume that the result holds until time $0 \leq k \leq 2n - 3$. Then we see that u_{k+1} is visited for the first time at time $k + 1$ if and only if the contour process goes up between u_k and u_{k+1} . Therefore, $b_{k+1}(T) = b_k(T) + 1$ if $C_{k+1}(T) = C_k(T) + 1$ and $b_{k+1}(T) = b_k(T)$ if $C_{k+1}(T) = C_k(T) - 1$. In both cases, the formula is also valid at time $k + 1$. \square

We are now in position to establish Theorem 2.1.1 (ii).

Proof of Theorem 2.1.1 (ii). First, by Theorem 2.1.1 (i) and Lemma 2.4.3, the convergence

$$\left(\frac{C_{2nt}(\mathcal{T}_n)}{\sqrt{n}}, \frac{b_{2nt}(\mathcal{T}_n) - nt}{\sqrt{n}}, \frac{K_{nt}^{\mathcal{A}}(\mathcal{T}_n) - nt\mu_{\mathcal{A}}}{\sqrt{n}} \right)_{0 \leq t \leq 1} \rightarrow \left(\frac{2}{\sigma} \mathfrak{e}_t, \frac{1}{\sigma} \mathfrak{e}_t, \frac{\mu_{\mathcal{A}} m_{\mathcal{A}}}{\sigma} \mathfrak{e}_t + \gamma_{\mathcal{A}} B_t \right)_{0 \leq t \leq 1} \quad (2.6)$$

holds jointly in distribution in $\mathbb{D}([0, 1], \mathbb{R}^3)$, where \mathfrak{e} is a normalized Brownian excursion and B is an independent standard Brownian motion. In particular, the convergence

$$\left(\frac{b_{2nt}(\mathcal{T}_n)}{n} \right)_{0 \leq t \leq 1} \xrightarrow[n \rightarrow \infty]{} (t)_{0 \leq t \leq 1} \quad (2.7)$$

holds in probability.

Next, for every $t \in [0, 1]$, observe that $N_{2nt}^{\mathcal{A}}(\mathcal{T}_n) = K_{b_{2nt}(\mathcal{T}_n)}^{\mathcal{A}}(\mathcal{T}_n)$, so that

$$\frac{N_{2nt}^{\mathcal{A}}(\mathcal{T}_n) - nt\mu_{\mathcal{A}}}{\sqrt{n}} = \frac{K_{b_{2nt}(\mathcal{T}_n)}^{\mathcal{A}}(\mathcal{T}_n) - nt\mu_{\mathcal{A}}}{\sqrt{n}} = \frac{K_{b_{2nt}(\mathcal{T}_n)}^{\mathcal{A}}(\mathcal{T}_n) - b_{2nt}(\mathcal{T}_n)\mu_{\mathcal{A}}}{\sqrt{n}} + \mu_{\mathcal{A}} \frac{b_{2nt}(\mathcal{T}_n) - nt}{\sqrt{n}}.$$

By (2.6) and (2.7), it follows that the convergence

$$\left(\frac{N_{2nt}^{\mathcal{A}}(\mathcal{T}_n) - nt\mu_{\mathcal{A}}}{\sqrt{n}} \right)_{0 \leq t \leq 1} \rightarrow \left(\frac{\mu_{\mathcal{A}} m_{\mathcal{A}}}{\sigma} \mathfrak{e}_t + \gamma_{\mathcal{A}} B_t + \frac{\mu_{\mathcal{A}}}{\sigma} \mathfrak{e}_t \right)_{0 \leq t \leq 1}$$

holds in distribution, jointly with (2.6). Since $\mu_{\mathcal{A}} m_{\mathcal{A}} = \sum_{i \in \mathcal{A}} (i - 1)\mu_i$, this completes the proof. \square

2.4.3 Extension to multiple passages

In Theorem 2.1.1 (ii), the process $N^{\mathcal{A}}$ counts \mathcal{A} -vertices the first time they are visited by the contour exploration. In this Section, we are interested in what happens when instead we count vertices at later visit times. In this direction, if T is a tree, for every i and $1 \leq k \leq i + 1$ and $0 \leq \ell \leq 2|T|$, we denote by $N_{\ell}^{i,k}(T)$ the number of vertices of outdegree i visited at least k times by the contour exploration of T between times 0 and ℓ . Finally, for $i \geq 0$, we set $N^i = N^{\{i\}}$ to simplify notation.

As before, we fix a critical distribution μ with finite positive variance σ^2 , and we let \mathcal{T}_n denote a μ -GW tree conditioned on having n vertices.

Theorem 2.4.4. *We have*

$$\left(\frac{C_{2nt}(\mathcal{T}_n)}{\sqrt{n}}, \frac{N_{2nt}^i(\mathcal{T}_n) - nt\mu_i}{\sqrt{n}}, \frac{N_{2nt}^{i,k}(\mathcal{T}_n) - nt\mu_i}{\sqrt{n}} \right)_{0 \leq t \leq 1} \xrightarrow[n \rightarrow \infty]{(d)} \left(\frac{2}{\sigma} \mathfrak{e}_t, \frac{i\mu_i}{\sigma} \mathfrak{e}_t + \gamma_i B_t, \frac{(i - 2(k - 1))\mu_i}{\sigma} \mathfrak{e}_t + \gamma_i B_t \right)_{0 \leq t \leq 1}$$

where B is a standard Brownian motion independent of \mathfrak{e} and $\gamma_i = \sqrt{\mu_i(1 - \mu_i) - \frac{1}{\sigma^2}((i - 1)\mu_i)^2}$.

The main ingredient of the proof is a relation between $N^i(T)$ and $N^{i,j}(T)$, for which we need to introduce some notation. If T is a tree, for $u \in T$ and $1 \leq j \leq i$, we denote by $A_u^{i,j}(T)$ the number of ancestors of u in T with i children whose j th child is an ancestor of u . For $0 \leq t \leq 2|T| - 2$, denote by $u_t(T)$ the vertex visited at time $[t]$ by contour exploration. Then, for every $0 \leq \ell \leq 2|T| - 2$, observe that

$$N_\ell^i(T) - N_\ell^{i,k}(T) = \sum_{1 \leq j \leq k-1} A_{u_\ell(T)}^{i,j}(T) \quad (2.8)$$

because i -vertices of T that have been visited at least once up to time ℓ , but not k times yet, are necessarily ancestors of $u_\ell(T)$. Indeed, all the subtrees attached to a strict ancestor of $u_\ell(T)$ have either been completely visited or not visited at all (except the subtrees containing $u_\ell(T)$).

The following result, which is of independent interest, will allow to control the asymptotic behaviour of $A_u^{i,j}(\mathcal{T}_n)$, when the height of u is large enough. See [78] for other bounds on $A^{i,j}(\mathcal{T}_n)$ under an additional finite exponential moment assumption. For a nonnegative sequence (r_n) , we write $r_n = oe(n)$ if there exist $C, \varepsilon > 0$ such that $r_n \leq Ce^{-n^\varepsilon}$ for every $n \geq 1$.

Proposition 2.4.5. *Fix $i \geq 1$. Then*

$$\mathbb{P} \left(\exists u \in \mathcal{T}_n, \exists j \in \llbracket 1, i \rrbracket : |u| \geq n^{1/10}, \left| \frac{A_u^{i,j}(\mathcal{T}_n)}{|u|} - \mu_i \right| \geq \frac{\mu_i}{|u|^{1/100}} \right) = oe(n).$$

Before proving this bound, let us explain how Theorem 2.4.4 follows.

Proof of Theorem 2.4.4 from Proposition 2.4.5. We will repeatedly use the identity $C_\ell(\mathcal{T}_n) = |u_\ell(\mathcal{T}_n)|$ for every $0 \leq \ell \leq 2n - 2$. We first check that

$$\max_{1 \leq j \leq i} \sup_{0 \leq \ell \leq 2n-2} \left| \mu_i \frac{C_\ell(\mathcal{T}_n)}{\sqrt{n}} - \frac{A_{u_\ell(\mathcal{T}_n)}^{i,j}(\mathcal{T}_n)}{\sqrt{n}} \right| \xrightarrow[n \rightarrow \infty]{(\mathbb{P})} 0 \quad (2.9)$$

First, since for every ℓ , $A_{u_\ell(\mathcal{T}_n)}^{i,j}(\mathcal{T}_n) \leq |u_\ell(\mathcal{T}_n)|$, we may restrict our study without loss of generality to the times ℓ such that $|u_\ell(\mathcal{T}_n)| \geq n^{1/10}$. Indeed, uniformly for $1 \leq j \leq i$, for ℓ such that $|u_\ell(\mathcal{T}_n)| < n^{1/10}$, we have $n^{-1/2} |\mu_i C_\ell(\mathcal{T}_n) - A_{u_\ell(\mathcal{T}_n)}^{i,j}(\mathcal{T}_n)| \leq 2n^{1/10-1/2} = 2n^{-2/5}$.

By Proposition 2.4.5, for every n sufficiently large and ℓ such that $|u_\ell(\mathcal{T}_n)| \geq n^{1/10}$, we have, with probability tending to 1 as $n \rightarrow \infty$, uniformly in j , $\left| A_{u_\ell(\mathcal{T}_n)}^{i,j}(\mathcal{T}_n) - \mu_i |u_\ell(\mathcal{T}_n)| \right| < \mu_i |u_\ell(\mathcal{T}_n)|^{99/100}$. By Theorem 2.2.2, $\max_{0 \leq \ell \leq 2n-2} C_\ell(\mathcal{T}_n)/\sqrt{n}$ converges in probability as $n \rightarrow \infty$, so that we have $\max_{0 \leq \ell \leq 2n-2} |u_\ell(\mathcal{T}_n)|^{99/100}/\sqrt{n} \rightarrow 0$. This entails (2.9).

Now, using (2.8), for $0 \leq t \leq 1$, write

$$\frac{N_{2nt}^{i,k}(\mathcal{T}_n) - nt\mu_i}{\sqrt{n}} = \frac{N_{2nt}^i(\mathcal{T}_n) - nt\mu_i}{\sqrt{n}} - \sum_{1 \leq j \leq k-1} \frac{A_{u_{2nt}(\mathcal{T}_n)}^{i,j}(\mathcal{T}_n)}{\sqrt{n}}$$

Hence, by combining Theorem 2.1.1 (ii) with (2.9), we get

$$\begin{aligned} & \left(\frac{C_{2nt}(\mathcal{T}_n)}{\sqrt{n}}, \frac{N_{2nt}^i(\mathcal{T}_n) - nt\mu_i}{\sqrt{n}}, \frac{N_{2nt}^{i,k}(\mathcal{T}_n) - nt\mu_i}{\sqrt{n}} \right)_{0 \leq t \leq 1} \\ & \xrightarrow[n \rightarrow \infty]{(d)} \left(\frac{2}{\sigma} \mathfrak{e}_t, \frac{i\mu_i}{\sigma} \mathfrak{e}_t + \gamma_i B_t, \frac{i\mu_i}{\sigma} \mathfrak{e}_t + \gamma_i B_t - (k-1)\mu_i \frac{2}{\sigma} \mathfrak{e}_t \right)_{0 \leq t \leq 1} \end{aligned}$$

where B is a standard Brownian motion and $\gamma_i = \sqrt{\mu_i(1 - \mu_i) - \frac{1}{\sigma^2}((i-1)\mu_i)^2}$, which gives the desired result. \square

We now get into the proof of Proposition 2.4.5.

Proof of Proposition 2.4.5. First, observe that if \mathcal{T} is a nonconditioned μ -GW tree, then

$$\begin{aligned} & \mathbb{P} \left(\exists u \in \mathcal{T}_n, \exists j \in \llbracket 1, i \rrbracket : |u| \geq n^{1/10}, \left| \frac{A_u^{i,j}(\mathcal{T}_n)}{|u|} - \mu_i \right| \geq \frac{\mu_i}{|u|^{1/100}} \right) \\ & \leq \frac{1}{\mathbb{P}(|\mathcal{T}| = n)} \sum_{k=\lceil n^{1/10} \rceil}^n \sum_{j=1}^i \mathbb{E} \left[\sum_{|u|=k} \mathbb{1}_{\left| \frac{A_u^{i,j}(\mathcal{T})}{|u|} - \mu_i \right| \geq \frac{\mu_i}{|u|^{1/100}}} \right]. \end{aligned}$$

In order to compute these expectations, let us mention the existence of the local limit \mathcal{T}^* of the trees \mathcal{T}_n . This limit is defined as the random variable on the set of infinite trees satisfying, for any $r \geq 0$,

$$B_r(\mathcal{T}_n) \xrightarrow[n \rightarrow \infty]{} B_r(\mathcal{T}^*),$$

where B_r denotes the ball of radius r centered at the root for the graph distance (all edges of the tree having length 1). \mathcal{T}^* is an infinite tree called Kesten's tree, made of a unique infinite branch on which i.i.d. μ -Galton-Watson trees are planted (see [60] for details). The local behaviour of the trees \mathcal{T}_n can be deduced from the properties of this infinite tree; in particular, a standard size-biasing identity à la Lyons–Pemantle–Peres [76] (see [41, Eq. (23)] for a precise statement) gives

$$\mathbb{E} \left[\sum_{|u|=k} \mathbb{1}_{\left| \frac{A_u^{i,j}(\mathcal{T})}{|u|} - \mu_i \right| \geq \frac{\mu_i}{|u|^{1/100}}} \right] = \mathbb{E} \left[\mathbb{1}_{\left| \frac{A_{U_k(\mathcal{T}^*)}^{i,j}(\mathcal{T}^*)}{k} - \mu_i \right| \geq \frac{\mu_i}{k^{1/100}}} \right] = \mathbb{P} \left(\left| \frac{\text{Bin}(k, \mu_i)}{k} - \mu_i \right| \geq \frac{\mu_i}{k^{1/100}} \right),$$

where $U_k(\mathcal{T}^*)$ denotes the vertex of the unique infinite branch of \mathcal{T}^* at height k . In particular, this expectation does not depend on j .

By (2.2) (applied with $\mathcal{B} = \mathbb{Z}_+$), we therefore have, for some constant C :

$$\begin{aligned} & \mathbb{P} \left(\exists u \in \mathcal{T}_n, \exists j \in \llbracket 1, i \rrbracket : |u| \geq n^{1/10}, \left| \frac{A_u^{i,j}(\mathcal{T}_n)}{|u|} - \mu_i \right| \geq \frac{\mu_i}{|u|^{1/100}} \right) \\ & \leq C i n^{3/2} \sum_{k=\lceil n^{1/10} \rceil}^n \mathbb{P} \left(\left| \frac{\text{Bin}(k, \mu_i)}{k} - \mu_i \right| \geq \frac{\mu_i}{k^{1/100}} \right) \\ & \leq C i n^{3/2} \sum_{k=\lceil n^{1/10} \rceil}^n 2 \exp \left(-2k (\mu_i k^{-1/100})^2 \right) \end{aligned}$$

where the last line is obtained by using Hoeffding's inequality. Thus,

$$\begin{aligned} & \mathbb{P} \left(\exists u \in \mathcal{T}_n, \exists j \in \llbracket 1, i \rrbracket : |u| \geq n^{1/10}, \left| \frac{A_u^{i,j}(\mathcal{T}_n)}{|u|} - \mu_i \right| \geq \frac{\mu_i}{|u|^{1/100}} \right) \\ & \leq 2C i n^{3/2} \sum_{k=\lceil n^{1/10} \rceil}^n \exp \left(-2\mu_i^2 k^{49/50} \right) = o_e(n). \end{aligned}$$

The desired result follows. \square

Finally, observe that the estimate of Proposition 2.4.5 is strong enough to get the following refinement of Theorem 2.4.4 (whose proof is left to the reader):

Theorem 2.4.6. *Let $k : \mathbb{Z}_+ \rightarrow \mathbb{Z}_+$ such that, for $i \in \mathbb{Z}_+$, $1 \leq k(i) \leq i + 1$. Let $\mathcal{A} \subset \mathbb{Z}_+$. Then the following convergence holds in distribution :*

$$\left(\frac{C_{2nt}(\mathcal{T}_n)}{\sqrt{n}}, \frac{N_{2nt}^{\mathcal{A}}(\mathcal{T}_n) - nt\mu_{\mathcal{A}}}{\sqrt{n}}, \frac{\sum_{i \in \mathcal{A}} N_{2nt}^{i, k(i)}(\mathcal{T}_n) - nt\mu_i}{\sqrt{n}} \right)_{0 \leq t \leq 1} \xrightarrow[n \rightarrow \infty]{(d)} \left(\frac{2}{\sigma} \mathfrak{e}_t, \frac{\sum_{i \in \mathcal{A}} i\mu_i}{\sigma} \mathfrak{e}_t + \gamma_{\mathcal{A}} B_t, \frac{\sum_{i \in \mathcal{A}} (i - 2(k(i) - 1))\mu_i}{\sigma} \mathfrak{e}_t + \gamma_{\mathcal{A}} B_t \right)_{0 \leq t \leq 1}$$

where B is a standard Brownian motion and $\gamma_{\mathcal{A}} = \sqrt{\mu_{\mathcal{A}}(1 - \mu_{\mathcal{A}}) - \frac{1}{\sigma^2}(\sum_{i \in \mathcal{A}} (i - 1)\mu_i)^2}$.

2.5 Asymptotic normality of outdegrees in large Galton-Watson trees

The main goal of this Section is to prove Theorem 2.1.2 (i) and (ii). We fix a critical offspring distribution μ with finite positive variance σ^2 , and $\mathcal{A}, \mathcal{B} \subset \mathbb{Z}_+$ such that $\mu_{\mathcal{B}} > 0$. If T is a tree, recall that $N^{\mathcal{A}}(T)$ is the number of \mathcal{A} -vertices in T , and that $\mathcal{T}_n^{\mathcal{B}}$ is a μ -GW tree conditioned to have n \mathcal{B} -vertices. In the sequel, \mathcal{T} is a nonconditioned μ -GW tree. We also assume for technical convenience that $p_{\mathcal{B}}$ and $p_{\mathcal{B}^c}$ are both aperiodic (but the results carry through in the general setting with mild modifications).

2.5.1 Expectation of $N^{\mathcal{A}}(\mathcal{T}_n^{\mathcal{B}})$

Our goal is here to prove Theorem 2.1.2 (i). For every $n \geq 1$, define the interval $I_n := \llbracket \frac{n}{\mu_{\mathcal{B}}} - n^{3/4}, \frac{n}{\mu_{\mathcal{B}}} + n^{3/4} \rrbracket$. The proof relies on the following estimates.

Lemma 2.5.1. *We have:*

- (i) $\mathbb{E} \left(N^{\mathbb{Z}_+}(\mathcal{T}_n^{\mathcal{B}}) \mathbf{1}_{N^{\mathbb{Z}_+}(\mathcal{T}_n^{\mathcal{B}}) \notin I_n} \right) = oe(n);$
- (ii) $\mathbb{P} \left(\left| \frac{N^{\mathcal{A}}(\mathcal{T}_n^{\mathcal{B}})}{n} - \frac{\mu_{\mathcal{A}}}{\mu_{\mathcal{B}}} \right| \geq n^{-1/5} \mid N^{\mathbb{Z}_+}(\mathcal{T}_n^{\mathcal{B}}) \in I_n \right) \rightarrow 0$ as $n \rightarrow \infty$.

Proof of Theorem 2.1.2 (i) using Lemma 2.5.1. Start by writing the quantity $\mathbb{E}[N^{\mathcal{A}}(\mathcal{T}_n^{\mathcal{B}})]$ as

$$\mathbb{E}[N^{\mathcal{A}}(\mathcal{T}_n^{\mathcal{B}})] = \mathbb{P}(N^{\mathbb{Z}_+}(\mathcal{T}_n^{\mathcal{B}}) \in I_n) \mathbb{E}[N^{\mathcal{A}}(\mathcal{T}_n^{\mathcal{B}}) \mid N^{\mathbb{Z}_+}(\mathcal{T}_n^{\mathcal{B}}) \in I_n] + \mathbb{E}[N^{\mathcal{A}}(\mathcal{T}_n^{\mathcal{B}}) \mathbf{1}_{N^{\mathbb{Z}_+}(\mathcal{T}_n^{\mathcal{B}}) \notin I_n}]. \quad (2.10)$$

Observe that $\mathbb{E}[N^{\mathcal{A}}(\mathcal{T}_n^{\mathcal{B}}) \mathbf{1}_{N^{\mathbb{Z}_+}(\mathcal{T}_n^{\mathcal{B}}) \notin I_n}] \leq \mathbb{E}[N^{\mathbb{Z}_+}(\mathcal{T}_n^{\mathcal{B}}) \mathbf{1}_{N^{\mathbb{Z}_+}(\mathcal{T}_n^{\mathcal{B}}) \notin I_n}] = oe(n)$ by Lemma 2.5.1 (i). In order to bound the first term in the sum of (2.10), bound $\left| \frac{1}{n} \mathbb{E}[N^{\mathcal{A}}(\mathcal{T}_n^{\mathcal{B}}) \mid N^{\mathbb{Z}_+}(\mathcal{T}_n^{\mathcal{B}}) \in I_n] - \frac{\mu_{\mathcal{A}}}{\mu_{\mathcal{B}}} \right|$ from above by

$$\frac{1}{n^{1/5}} + \left(\frac{\sup I_n}{n} + \frac{\mu_{\mathcal{A}}}{\mu_{\mathcal{B}}} \right) \mathbb{P} \left(\left| \frac{N^{\mathcal{A}}(\mathcal{T}_n^{\mathcal{B}})}{n} - \frac{\mu_{\mathcal{A}}}{\mu_{\mathcal{B}}} \right| \geq \frac{1}{n^{1/5}} \mid N^{\mathbb{Z}_+}(\mathcal{T}_n^{\mathcal{B}}) \in I_n \right).$$

This last quantity tends to 0 as $n \rightarrow \infty$ by Lemma 2.5.1 (ii) and since $\sup I_n/n \rightarrow 1/\mu_{\mathcal{B}}$. In order to complete the proof, it remains to observe that since $N^{\mathbb{Z}_+}(\mathcal{T}_n^{\mathcal{B}}) \geq n$, Lemma 2.5.1 (i) implies that $\mathbb{P}(N^{\mathbb{Z}_+}(\mathcal{T}_n^{\mathcal{B}}) \notin I_n) \rightarrow 0$. \square

Proof of Lemma 2.5.1. First, notice that

$$\begin{aligned} \mathbb{E} \left[N^{\mathbb{Z}_+}(\mathcal{T}_n^{\mathcal{B}}) \mathbf{1}_{N^{\mathbb{Z}_+}(\mathcal{T}_n^{\mathcal{B}}) \notin I_n} \right] &= \sum_{\substack{k \notin I_n \\ k \geq n}} k \mathbb{P} \left(N^{\mathbb{Z}_+}(\mathcal{T}_n^{\mathcal{B}}) = k \right) \\ &= \frac{1}{\mathbb{P}(N^{\mathcal{B}}(\mathcal{T}) = n)} \sum_{\substack{k \notin I_n \\ k \geq n}} k \mathbb{P} \left(N^{\mathbb{Z}_+}(\mathcal{T}) = k, N^{\mathcal{B}}(\mathcal{T}) = n \right) \\ &\leq \frac{1}{\mathbb{P}(N^{\mathcal{B}}(\mathcal{T}) = n)} \sum_{\substack{k \notin I_n \\ k \geq n}} \mathbb{P}(J_k^{\mathcal{B}} = n) \text{ by Proposition 2.3.1.} \end{aligned}$$

We now use the fact that, for any k , $J_k^{\mathcal{B}}$ has a binomial distribution of parameters $(k, \mu_{\mathcal{B}})$. Observe that, if $k \notin I_n$, then $|n - k\mu_{\mathcal{B}}| \geq k^{3/5}$. Hence, by Hoeffding's inequality, for $k \notin I_n$, $\mathbb{P}(J_k^{\mathcal{B}} = n) \leq \mathbb{P}(|J_k^{\mathcal{B}} - k\mu_{\mathcal{B}}| \geq k^{3/5}) \leq 2e^{-2k^{1/5}}$. Therefore $\sum_{k \notin I_n, k \geq n} \mathbb{P}(J_k^{\mathcal{B}} = n) = oe(n)$. (i) follows by (2.2) (applied with $\mathcal{B} = \mathbb{Z}_+$),

For (ii), we use the fact that

$$\begin{aligned} &\mathbb{P} \left(\left| \frac{N^{\mathcal{A}}(\mathcal{T}_n^{\mathcal{B}})}{n} - \frac{\mu_{\mathcal{A}}}{\mu_{\mathcal{B}}} \right| \geq n^{-1/4} \mid N^{\mathbb{Z}_+}(\mathcal{T}_n^{\mathcal{B}}) \in I_n \right) \\ &= \frac{1}{\mathbb{P}(N^{\mathcal{B}}(\mathcal{T}) = n \mid N^{\mathbb{Z}_+}(\mathcal{T}) \in I_n)} \mathbb{P} \left(\left| \frac{N^{\mathcal{A}}(\mathcal{T})}{n} - \frac{\mu_{\mathcal{A}}}{\mu_{\mathcal{B}}} \right| \geq n^{-1/5}, N^{\mathcal{B}}(\mathcal{T}) = n \mid N^{\mathbb{Z}_+}(\mathcal{T}) \in I_n \right) \end{aligned}$$

Note that

$$\frac{1}{\mathbb{P}(N^{\mathcal{B}}(\mathcal{T}) = n \mid N^{\mathbb{Z}_+}(\mathcal{T}) \in I_n)} = \frac{\mathbb{P}(N^{\mathbb{Z}_+}(\mathcal{T}) \in I_n)}{\mathbb{P}(N^{\mathcal{B}}(\mathcal{T}) = n, N^{\mathbb{Z}_+}(\mathcal{T}) \in I_n)} \leq \frac{1}{\mathbb{P}(N^{\mathcal{B}}(\mathcal{T}) = n, N^{\mathbb{Z}_+}(\mathcal{T}) = \lfloor \frac{n}{\mu_{\mathcal{B}}} \rfloor)}$$

which grows at most polynomially in n according to Lemma 2.3.3 (ii). The second assertion now follows from the fact that

$$\mathbb{P} \left(\left| \frac{N^{\mathcal{A}}(\mathcal{T})}{n} - \frac{\mu_{\mathcal{A}}}{\mu_{\mathcal{B}}} \right| \geq n^{-1/5} \mid N^{\mathbb{Z}_+}(\mathcal{T}) \in I_n \right) \leq \sup_{k \in I_n} \mathbb{P} \left(\left| \frac{N^{\mathcal{A}}(\mathcal{T})}{n} - \frac{\mu_{\mathcal{A}}}{\mu_{\mathcal{B}}} \right| \geq n^{-1/5} \mid N^{\mathbb{Z}_+}(\mathcal{T}) = k \right).$$

In virtue of (2.2) (applied with $\mathcal{B} = \mathbb{Z}_+$), it suffices to check that $\mathbb{P}(|\frac{N^{\mathcal{A}}(\mathcal{T})}{n} - \frac{\mu_{\mathcal{A}}}{\mu_{\mathcal{B}}}| \geq n^{-1/5}, N^{\mathbb{Z}_+}(\mathcal{T}) = k) = oe(n)$ when $k \in I_n$. By Proposition 2.3.1,

$$\mathbb{P} \left(\left| \frac{N^{\mathcal{A}}(\mathcal{T})}{n} - \frac{\mu_{\mathcal{A}}}{\mu_{\mathcal{B}}} \right| \geq n^{-1/5}, N^{\mathbb{Z}_+}(\mathcal{T}) = k \right) \leq \mathbb{P} \left(\left| J_k^{\mathcal{A}} - n \frac{\mu_{\mathcal{A}}}{\mu_{\mathcal{B}}} \right| \geq n^{4/5} \right).$$

When $k \in I_n$, this last quantity is bounded from above by $\mathbb{P}(|J_k^{\mathcal{A}} - k\mu_{\mathcal{A}}| \geq n^{4/5} - \mu_{\mathcal{A}}n^{3/4})$, which is $oe(n)$ since $J_k^{\mathcal{A}}$ has a binomial distribution of parameters $(k, \mu_{\mathcal{A}})$. This proves (ii). \square

2.5.2 Asymptotic normality of $N^{\mathcal{A}}(\mathcal{T}_k^{\mathcal{B}})$

The first step is to establish the following local version of Theorem 2.1.2 when $\mathcal{A} = \mathbb{Z}_+$.

Proposition 2.5.2. *As $k \rightarrow \infty$,*

$$\mathbb{P} \left(N^{\mathbb{Z}_+}(\mathcal{T}_k^{\mathcal{B}}) = \lfloor k/\mu_{\mathcal{B}} + \sqrt{k}y \rfloor \right) \sim \sqrt{\frac{\mu_{\mathcal{B}}^3}{2\pi\gamma_{\mathcal{B}}^2}} \frac{1}{\sqrt{k}} \exp \left(-\frac{\mu_{\mathcal{B}}^3 y^2}{\gamma_{\mathcal{B}}^2 2} \right),$$

uniformly for y in a compact subset of \mathbb{R} .

It is standard that this implies the following asymptotic normality:

$$\frac{N^{\mathbb{Z}_+}(\mathcal{T}_k^{\mathcal{B}}) - k/\mu_{\mathcal{B}}}{\sqrt{k}} \xrightarrow{d} \mathcal{N}\left(0, \frac{\gamma_{\mathcal{B}}^2}{\mu_{\mathcal{B}}^3}\right). \quad (2.11)$$

Proof of Proposition 2.5.2. By Lemma 2.3.3 (ii), we have as $n \rightarrow \infty$, uniformly for c in a compact subset of \mathbb{R} ,

$$\mathbb{P}\left(N^{\mathbb{Z}_+}(\mathcal{T}) = n, N^{\mathcal{B}}(\mathcal{T}) = k_n(c)\right) \sim \frac{1}{2\pi\sigma\gamma_{\mathcal{B}}} \frac{1}{n^2} \exp\left(-\frac{1}{\gamma_{\mathcal{B}}^2} \frac{c^2}{2}\right). \quad (2.12)$$

By using (2.2), we have

$$\mathbb{P}\left(N^{\mathbb{Z}_+}(\mathcal{T}) = n | N^{\mathcal{B}}(\mathcal{T}) = k_n(c)\right) \sim \frac{\mu_{\mathcal{B}}}{\gamma_{\mathcal{B}}\sqrt{2\pi n}} \exp\left(-\frac{1}{\gamma_{\mathcal{B}}^2} \frac{c^2}{2}\right).$$

Then observe that for $y \in \mathbb{R}$, as $n, k \rightarrow \infty$, it is equivalent to write $n = k/\mu_{\mathcal{B}} + y\sqrt{k} + O(1)$ and $k = n\mu_{\mathcal{B}} - y\sqrt{n}\mu_{\mathcal{B}}^{3/2} + O(1)$. Hence

$$\mathbb{P}\left(N^{\mathbb{Z}_+}(\mathcal{T}) = \lfloor \frac{k}{\mu_{\mathcal{B}}} + y\sqrt{k} \rfloor | N^{\mathcal{B}}(\mathcal{T}) = k\right) \sim \frac{\mu_{\mathcal{B}}^{3/2}}{\gamma_{\mathcal{B}}\sqrt{2\pi k}} \exp\left(-\frac{\mu_{\mathcal{B}}^3}{\gamma_{\mathcal{B}}^2} \frac{y^2}{2}\right).$$

This completes the proof. \square

We are now in position to establish Theorem 2.1.2 (ii), which will be a consequence of the following estimate.

Lemma 2.5.3. *Let $\mathcal{A}, \mathcal{B} \subset \mathbb{Z}_+$ such that the quantities $\mu_{\mathcal{A} \cap \mathcal{B}}, \mu_{\mathcal{A} \setminus \mathcal{B}}, \mu_{\mathcal{B} \setminus \mathcal{A}}, \mu_{\mathcal{A}^c \cap \mathcal{B}^c}$ are all positive. Then there exists $\sigma_{\mathcal{A}, \mathcal{B}}^2 > 0$, $C_{\mathcal{A}, \mathcal{B}} \in \mathbb{R}$ such that for fixed $u, v \in \mathbb{R} \cup \{+\infty, -\infty\}$, $u < v$ and $y \in \mathbb{R}$, we have, as $k \rightarrow \infty$,*

$$\mathbb{P}\left(\frac{N^{\mathcal{A}}(\mathcal{T}_k^{\mathcal{B}}) - k\frac{\mu_{\mathcal{A}}}{\mu_{\mathcal{B}}}}{\sqrt{k}} \in (u, v) \mid N^{\mathbb{Z}_+}(\mathcal{T}_k^{\mathcal{B}}) = \lfloor k/\mu_{\mathcal{B}} + \sqrt{k}y \rfloor\right) \sim \frac{1}{\sqrt{2\pi\sigma_{\mathcal{A}, \mathcal{B}}^2}} \int_u^v e^{-\frac{1}{2\sigma_{\mathcal{A}, \mathcal{B}}^2}(z - C_{\mathcal{A}, \mathcal{B}}y)^2} dz.$$

Proof of Theorem 2.1.2 (ii), using Lemma 2.5.3. First assume that the quantities $\mu_{\mathcal{A} \cap \mathcal{B}}, \mu_{\mathcal{A} \setminus \mathcal{B}}, \mu_{\mathcal{B} \setminus \mathcal{A}}, \mu_{\mathcal{A}^c \cap \mathcal{B}^c}$ are all positive. Fix $u < v$. For $y \in \mathbb{R}$ and $k \in \mathbb{Z}_+$, set

$$f_k(y) = \mathbb{P}\left(\frac{N^{\mathcal{A}}(\mathcal{T}_k^{\mathcal{B}}) - k\frac{\mu_{\mathcal{A}}}{\mu_{\mathcal{B}}}}{\sqrt{k}} \in (u, v), N^{\mathbb{Z}_+}(\mathcal{T}_k^{\mathcal{B}}) = \lfloor k/\mu_{\mathcal{B}} + \sqrt{k}y \rfloor\right) \sqrt{k}$$

and notice that $\mathbb{P}\left(\frac{N^{\mathcal{A}}(\mathcal{T}_k^{\mathcal{B}}) - k\frac{\mu_{\mathcal{A}}}{\mu_{\mathcal{B}}}}{\sqrt{k}} \in (u, v)\right) = \int_{\mathbb{R}} f_k(y) dy$. Also, for $y, z \in \mathbb{R}$ define $g(y, z)$ by

$$g(y, z) = \frac{1}{\sqrt{2\pi\gamma^2}} e^{-\frac{y^2}{2\gamma^2}} \frac{1}{\sqrt{2\pi\sigma_{\mathcal{A}, \mathcal{B}}^2}} e^{-\frac{1}{2\sigma_{\mathcal{A}, \mathcal{B}}^2}(z - C_{\mathcal{A}, \mathcal{B}}y)^2}.$$

where $\gamma^2 = \gamma_{\mathcal{B}}^2/\mu_{\mathcal{B}}^3$. Observe that $\int_{\mathbb{R}^2} g(y, z) dy dz = 1$. Then, by Proposition 2.5.2 and Lemma 2.5.3, $f_k(y)$ converges pointwise, as $k \rightarrow \infty$, to $\int_u^v g(y, z) dz$. Hence, by Fatou's lemma and Fubini-Tonnelli's theorem,

$$\liminf_{k \rightarrow \infty} \mathbb{P}\left(\frac{N^{\mathcal{A}}(\mathcal{T}_k^{\mathcal{B}}) - k\frac{\mu_{\mathcal{A}}}{\mu_{\mathcal{B}}}}{\sqrt{k}} \in (u, v)\right) \geq \int_u^v \left[\int_{\mathbb{R}} g(y, z) dy\right] dz.$$

By Portmanteau theorem, if (X_k) is a sequence of real-valued random variables such that for every $u < v$, $\liminf_{k \rightarrow \infty} \mathbb{P}(u < X_k < v) \geq \mathbb{P}(u < X < v)$ for a certain random variable X , then X_n converges in distribution to X . This implies that

$$\begin{aligned} \mathbb{P}\left(\frac{N^{\mathcal{A}}(\mathcal{T}_k^{\mathcal{B}}) - k \frac{\mu_{\mathcal{A}}}{\mu_{\mathcal{B}}}}{\sqrt{k}} \in (u, v)\right) &\rightarrow \int_u^v \left[\int_{\mathbb{R}} \frac{1}{\sqrt{2\pi\gamma^2}} e^{-\frac{y^2}{2\gamma^2}} \frac{1}{\sqrt{2\pi\sigma_{\mathcal{A},\mathcal{B}}^2}} e^{-\frac{1}{2\sigma_{\mathcal{A},\mathcal{B}}^2} (z - C_{\mathcal{A},\mathcal{B}}y)^2} dy \right] dz \\ &= \int_u^v \frac{1}{\sqrt{2\pi\delta_{\mathcal{A},\mathcal{B}}^2}} e^{-\frac{1}{2\delta_{\mathcal{A},\mathcal{B}}^2} z^2} dz \end{aligned}$$

with $\delta_{\mathcal{A},\mathcal{B}}^2 = C_{\mathcal{A},\mathcal{B}}^2 \gamma^2 + \sigma_{\mathcal{A},\mathcal{B}}^2 > 0$. We leave the case where at least one of the quantities $\mu_{\mathcal{A} \cap \mathcal{B}}$, $\mu_{\mathcal{A} \setminus \mathcal{B}}$, $\mu_{\mathcal{B} \setminus \mathcal{A}}$, $\mu_{\mathcal{A}^c \cap \mathcal{B}^c}$ is 0 to the reader, which is treated in the same way. In particular, one gets that $\delta_{\mathcal{A},\mathcal{B}}^2 > 0$ except when $\mu_{\mathcal{A}} = 0$ or $\mu_{\mathcal{A} \setminus \mathcal{B}} = \mu_{\mathcal{B} \setminus \mathcal{A}} = 0$. This establishes the asymptotic normality of $(N^{\mathcal{A}}(\mathcal{T}) | N^{\mathcal{B}}(\mathcal{T}) = k)$ with an expression of the limiting variance. \square

The proof of Lemma 2.5.3 is based on the following result, whose proof is a direct adaptation of the proof of Lemma 2.3.3 in the multivariate setting.

Lemma 2.5.4. *Fix $a \in \mathbb{R}$, and let $(\mathcal{B}_1, \dots, \mathcal{B}_j)$ be a partition of \mathbb{Z}_+ , satisfying, for all $i \in \llbracket 1, j \rrbracket$, $\mu_{\mathcal{B}_i} > 0$. Assume in addition that at least one of the laws $p_{\mathcal{B}_1}, \dots, p_{\mathcal{B}_j}$ is aperiodic. For $1 \leq i \leq j$ and $c_i \in \mathbb{R}$, define $n_i(c_i) := \lfloor n\mu_{\mathcal{B}_i} + c_i\sqrt{n} \rfloor$. Then there exists a symmetric positive definite matrix $\Sigma := \Sigma(\mathcal{B}_1, \dots, \mathcal{B}_j) \in \mathcal{S}_j(\mathbb{R})$ such that the following assertions hold, uniformly for (c_1, \dots, c_j) in a compact subset of \mathbb{R}^j satisfying in addition $\sum_{i=1}^j n_i(c_i) = n$:*

(i) *Let (a_n) be a sequence of integers such that $a_n/\sqrt{n} \rightarrow a$. Then, as $n \rightarrow \infty$,*

$$\mathbb{P}(S_n = a_n, J_n^{\mathcal{B}_1} = n_1(c_1), \dots, J_n^{\mathcal{B}_j} = n_j(c_j)) \sim \frac{1}{(2\pi n)^{j/2} \sqrt{\det \Sigma}} e^{-\frac{1}{2} \mathbf{x} \Sigma^{-1} \mathbf{x}},$$

where $\mathbf{x} = (a, c_1, \dots, c_{j-1})$.

(ii) *With the same notation, as $n \rightarrow \infty$, we have*

$$\mathbb{P}(N^{\mathbb{Z}^+}(\mathcal{T}) = n, N^{\mathcal{B}_1}(\mathcal{T}) = n_1(c_1), \dots, N^{\mathcal{B}_j}(\mathcal{T}) = n_j(c_j)) \sim \frac{1}{n} \frac{1}{(2\pi n)^{j/2} \sqrt{\det \Sigma}} e^{-\frac{1}{2} \mathbf{x} \Sigma^{-1} \mathbf{x}},$$

where, here, $\mathbf{x} = (0, c_1, \dots, c_{j-1})$.

Remark. *For convenience, as before, we state here the theorem in the aperiodic case. Observe however that the case where none of the laws $p_{\mathcal{B}_1}, \dots, p_{\mathcal{B}_j}$ are aperiodic boils down to the aperiodic case, up to a change of variables.*

Proof of Lemma 2.5.3. Let us fix $y \in \mathbb{R}$. First, write

$$\begin{aligned} &\mathbb{P}\left(\frac{N^{\mathcal{A}}(\mathcal{T}_k^{\mathcal{B}}) - k \frac{\mu_{\mathcal{A}}}{\mu_{\mathcal{B}}}}{\sqrt{k}} \in (u, v) \mid N^{\mathbb{Z}^+}(\mathcal{T}_k^{\mathcal{B}}) = \lfloor k/\mu_{\mathcal{B}} + \sqrt{ky} \rfloor\right) \\ &= \frac{\mathbb{P}\left(\frac{N^{\mathcal{A}}(\mathcal{T}) - k \frac{\mu_{\mathcal{A}}}{\mu_{\mathcal{B}}}}{\sqrt{k}} \in (u, v), N^{\mathcal{B}}(\mathcal{T}) = k, N^{\mathbb{Z}^+}(\mathcal{T}) = \lfloor k/\mu_{\mathcal{B}} + \sqrt{ky} \rfloor\right)}{\mathbb{P}\left(N^{\mathcal{B}}(\mathcal{T}) = k, N^{\mathbb{Z}^+}(\mathcal{T}) = \lfloor k/\mu_{\mathcal{B}} + \sqrt{ky} \rfloor\right)} \\ &\sim C(y) k^{5/2} \int_u^v \mathbb{P}\left(N^{\mathcal{A}}(\mathcal{T}) = \lfloor k \frac{\mu_{\mathcal{A}}}{\mu_{\mathcal{B}}} + \sqrt{kh} \rfloor, N^{\mathcal{B}}(\mathcal{T}) = k, N^{\mathbb{Z}^+}(\mathcal{T}) = \lfloor k/\mu_{\mathcal{B}} + \sqrt{ky} \rfloor\right) dh, \end{aligned}$$

where the last asymptotic equivalent follows from (2.12) with $C(y) = \frac{2\pi\sigma\gamma_{\mathcal{B}}}{\mu_{\mathcal{B}}^2} \exp\left(\frac{y^2\mu_{\mathcal{B}}^3}{2\gamma_{\mathcal{B}}^2}\right)$. In order to prove that this quantity has a limit as $k \rightarrow \infty$ and compute it, it is enough to prove that the map g_k defined by

$$g_k(h) = k^{5/2} \mathbb{P} \left(N^{\mathcal{A}}(\mathcal{T}) = \lfloor k \frac{\mu_{\mathcal{A}}}{\mu_{\mathcal{B}}} + \sqrt{k}h \rfloor, N^{\mathcal{B}}(\mathcal{T}) = k, N^{\mathbb{Z}^+}(\mathcal{T}) = \lfloor k/\mu_{\mathcal{B}} + \sqrt{k}y \rfloor \right)$$

converges uniformly on (u, v) to an integrable function on (u, v) .

Observe that we can write $g_k(h) = k^{5/2} \sum_{\ell \in \mathbb{Z}_+} q_{\ell}$, where

$$q_{\ell} = \mathbb{P} \left(N^{\mathcal{A} \cap \mathcal{B}}(\mathcal{T}) = \ell, N^{\mathcal{A} \setminus \mathcal{B}}(\mathcal{T}) = \lfloor k \frac{\mu_{\mathcal{A}}}{\mu_{\mathcal{B}}} + \sqrt{k}h \rfloor - \ell, N^{\mathcal{B} \setminus \mathcal{A}}(\mathcal{T}) = k - \ell, \right. \\ \left. N^{\mathcal{A}^c \cap \mathcal{B}^c}(\mathcal{T}) = \lfloor k/\mu_{\mathcal{B}} + \sqrt{k}y \rfloor - \lfloor k \frac{\mu_{\mathcal{A}}}{\mu_{\mathcal{B}}} + \sqrt{k}h \rfloor - k + \ell \right).$$

In other words, we sum over all possible values ℓ of $N^{\mathcal{A} \cap \mathcal{B}}(\mathcal{T})$. The idea is that, if ℓ is far from its expectation (namely, $k\mu_{\mathcal{A} \cap \mathcal{B}}/\mu_{\mathcal{B}}$), then q_{ℓ} is small. On the other hand, we control q_{ℓ} by Lemma 2.5.4 when ℓ is close to its expectation. More specifically, set

$$I_k(h) := \left\{ \ell \in \mathbb{Z}_+; \left(\ell, \lfloor k \frac{\mu_{\mathcal{A}}}{\mu_{\mathcal{B}}} + \sqrt{k}h \rfloor - \ell, k - \ell, \lfloor \frac{k}{\mu_{\mathcal{B}}} + \sqrt{k}y \rfloor - \lfloor k \frac{\mu_{\mathcal{A}}}{\mu_{\mathcal{B}}} + \sqrt{k}h \rfloor - k + \ell \right) \in \mathbb{C}_k \right\},$$

where

$$\mathbb{C}_k = \left\{ k \frac{\mu_{\mathcal{A} \cap \mathcal{B}}}{\mu_{\mathcal{B}}}, k \frac{\mu_{\mathcal{A} \setminus \mathcal{B}}}{\mu_{\mathcal{B}}}, k \frac{\mu_{\mathcal{B} \setminus \mathcal{A}}}{\mu_{\mathcal{B}}}, k \frac{\mu_{\mathcal{A}^c \cap \mathcal{B}^c}}{\mu_{\mathcal{B}}} \right\} + [-k^{3/5}, k^{3/5}]^4.$$

First, notice that, for $\ell \in \mathbb{Z}_+$, $q_{\ell} \leq \sum_{i=1}^4 \mathbb{P}(N^{\mathcal{A}_i}(\mathcal{T}) = \ell | N^{\mathbb{Z}^+}(\mathcal{T}) = \lfloor \frac{k}{\mu_{\mathcal{B}}} + \sqrt{k}y \rfloor)$, where $(\mathcal{A}_1, \mathcal{A}_2, \mathcal{A}_3, \mathcal{A}_4) := (\mathcal{A} \cap \mathcal{B}, \mathcal{A} \setminus \mathcal{B}, \mathcal{B} \setminus \mathcal{A}, \mathcal{A}^c \cap \mathcal{B}^c)$. Therefore,

$$\sum_{\ell \notin I_k(h)} q_{\ell} \leq \sum_{i=1}^4 \mathbb{P} \left(\left| N^{\mathcal{A}_i}(\mathcal{T}) - \frac{k\mu_{\mathcal{A}_i}}{\mu_{\mathcal{B}}} \right| \geq k^{3/5} | N^{\mathbb{Z}^+}(\mathcal{T}) = \lfloor \frac{k}{\mu_{\mathcal{B}}} + \sqrt{k}y \rfloor \right) \\ = \sum_{i=1}^4 \mathbb{P} (|B_i - \mathbb{E}[B_i]| \geq k^{3/5}) (1 + o(1)),$$

where $B_i \sim \text{Bin}(\lfloor k/\mu_{\mathcal{B}} \rfloor, \mu_{\mathcal{A}_i})$. Thus, using Hoeffding inequality, we get:

$$\sum_{\ell \notin I_k(h)} q_{\ell} = o_e(k) \tag{2.13}$$

uniformly in $h \in \mathbb{R}$.

On the other hand, by Lemma 2.5.4 (ii), there exists an invertible matrix $\Sigma \in \mathcal{S}_4(\mathbb{R})$ and a constant $C_1 > 0$ such that, uniformly for $h \in \mathbb{R}$,

$$\sum_{\ell \in I_k(h)} q_{\ell} \sim \sum_{\ell \in I_k(h)} C_1 k^{-3} e^{-\frac{1}{2} x_{\ell} \Sigma^{-1} x_{\ell}} \tag{2.14}$$

for $x_{\ell} := ((\ell - k \frac{\mu_{\mathcal{A} \cap \mathcal{B}}}{\mu_{\mathcal{B}}})/\sqrt{k}, y, h, 0)$.

By Equations (2.13) and (2.14), by summing over all $\ell \in \mathbb{Z}_+$, we get that, as $k \rightarrow \infty$, uniformly in $h \in \mathbb{R}$, $g_k(h) \rightarrow C_2 \exp(-B_{\mathcal{A}, \mathcal{B}}(h - C_{\mathcal{A}, \mathcal{B}} y)^2)$ for a certain C_2 depending on

\mathcal{A}, \mathcal{B} , and some constants $B_{\mathcal{A}, \mathcal{B}}, C_{\mathcal{A}, \mathcal{B}}$ depending on \mathcal{A} and \mathcal{B} . Since this limiting function is integrable, by uniform convergence, for any $u, v \in \mathbb{R} \cup \{+\infty, -\infty\}$,

$$\mathbb{P} \left(\frac{N^{\mathcal{A}}(\mathcal{T}_k^{\mathcal{B}}) - k \frac{\mu_{\mathcal{A}}}{\mu_{\mathcal{B}}}}{\sqrt{k}} \in (u, v) \middle| N^{\mathbb{Z}_+}(\mathcal{T}_k^{\mathcal{B}}) = \lfloor \frac{k}{\mu_{\mathcal{B}}} + \sqrt{ky} \rfloor \right) \xrightarrow[k \rightarrow \infty]{} \tilde{C}(y) \int_u^v e^{-B_{\mathcal{A}, \mathcal{B}}(h - C_{\mathcal{A}, \mathcal{B}}y)^2} dh,$$

where $\tilde{C}(y)$ is a constant only depending on y (and \mathcal{A}, \mathcal{B}). By taking $u = -\infty$ and $v = +\infty$, one sees that $\tilde{C}(y)$ does not depend on y . Hence, there exists $\sigma_{\mathcal{A}, \mathcal{B}}^2 > 0$ such that, for any $y \in \mathbb{R}$, $\tilde{C}(y) = 1/\sqrt{2\pi\sigma_{\mathcal{A}, \mathcal{B}}^2}$. Furthermore, by taking again $u = -\infty$ and $v = +\infty$, the value of the right hand side is 1, which tells us that $B_{\mathcal{A}, \mathcal{B}} = \frac{1}{2\sigma_{\mathcal{A}, \mathcal{B}}^2}$. Finally, we conclude that for every $y \in \mathbb{R}$ and $u < v$:

$$\mathbb{P} \left(\frac{N^{\mathcal{A}}(\mathcal{T}_k^{\mathcal{B}}) - k \frac{\mu_{\mathcal{A}}}{\mu_{\mathcal{B}}}}{\sqrt{k}} \in (u, v) \middle| N^{\mathbb{Z}_+}(\mathcal{T}_k^{\mathcal{B}}) = \lfloor \frac{k}{\mu_{\mathcal{B}}} + \sqrt{ky} \rfloor \right) \xrightarrow[k \rightarrow \infty]{} \frac{1}{\sqrt{2\pi\sigma_{\mathcal{A}, \mathcal{B}}^2}} \int_u^v e^{-\frac{1}{2\sigma_{\mathcal{A}, \mathcal{B}}^2}(h - C_{\mathcal{A}, \mathcal{B}}y)^2} dh$$

which completes the proof of Lemma 2.5.3. \square

Finally, we briefly present the proof of Theorem 2.1.2 (iii), which is based again on Lemma 2.5.4 (ii).

Let us consider the tree $\mathcal{T}_k^{\mathcal{B}}$ for a certain $\mathcal{B} \subset \mathbb{Z}_+$. Let $\mathcal{A}_1, \dots, \mathcal{A}_j \subset \mathbb{Z}_+$. It induces a partition of \mathbb{Z}_+ made of the set $E := \{\cap_{i=1}^{j+1} \mathcal{C}_i, \mathcal{C}_i \in \{\mathcal{A}_i, \mathcal{A}_i^c\}, \mathcal{C}_{j+1} \in \{\mathcal{B}, \mathcal{B}^c\}\} \setminus \{\emptyset\}$. In other words, two integers are in the same block of this partition if they are contained in the same sets of the form \mathcal{A}_i or \mathcal{B} . Let $(u_i, v_i)_{1 \leq i \leq j}$ be real numbers with $u_i < v_i$ for every $1 \leq i \leq j$. Then

$$\begin{aligned} & \mathbb{P} \left(\frac{N^{\mathcal{A}_1}(\mathcal{T}_k^{\mathcal{B}}) - k \frac{\mu_{\mathcal{A}_1}}{\mu_{\mathcal{B}}}}{\sqrt{k}} \in (u_1, v_1), \dots, \frac{N^{\mathcal{A}_j}(\mathcal{T}_k^{\mathcal{B}}) - k \frac{\mu_{\mathcal{A}_j}}{\mu_{\mathcal{B}}}}{\sqrt{k}} \in (u_j, v_j) \right) \\ &= \sum_{n \in \mathbb{Z}_+} \frac{\mathbb{P}(N^{\mathbb{Z}_+}(\mathcal{T}) = n)}{\mathbb{P}(N^{\mathcal{B}}(\mathcal{T}) = k)} \\ & \quad \times \mathbb{P} \left(\frac{N^{\mathcal{A}_1}(\mathcal{T}_n^{\mathbb{Z}_+}) - k \frac{\mu_{\mathcal{A}_1}}{\mu_{\mathcal{B}}}}{\sqrt{k}} \in (u_1, v_1), \dots, \frac{N^{\mathcal{A}_j}(\mathcal{T}_n^{\mathbb{Z}_+}) - k \frac{\mu_{\mathcal{A}_j}}{\mu_{\mathcal{B}}}}{\sqrt{k}} \in (u_j, v_j), N^{\mathcal{B}}(\mathcal{T}_n^{\mathbb{Z}_+}) = k \right) \\ &= \sum_{n \in \mathbb{Z}_+} \frac{\mathbb{P}(N^{\mathbb{Z}_+}(\mathcal{T}) = n)}{\mathbb{P}(N^{\mathcal{B}}(\mathcal{T}) = k)} \sum_{(x_{\mathcal{H}})_{\mathcal{H} \in E} \in I_n} \mathbb{P} \left(\bigcap_{\mathcal{H} \in E} N^{\mathcal{H}}(\mathcal{T}_n^{\mathbb{Z}_+}) = x_{\mathcal{H}} \right) \end{aligned}$$

for some finite set $I_n \subset \mathbb{Z}_+^{|E|}$. We can now rewrite this probability in terms of random walks and use Lemma 2.5.4 (ii) in order to get the asymptotic normality of the quantity

$$\mathbb{P} \left(\frac{N^{\mathcal{A}_1}(\mathcal{T}_k^{\mathcal{B}}) - k \frac{\mu_{\mathcal{A}_1}}{\mu_{\mathcal{B}}}}{\sqrt{n}} \in (u_1, v_1), \dots, \frac{N^{\mathcal{A}_j}(\mathcal{T}_k^{\mathcal{B}}) - k \frac{\mu_{\mathcal{A}_j}}{\mu_{\mathcal{B}}}}{\sqrt{n}} \in (u_j, v_j) \right).$$

Example. In explicit cases, it is possible to carry out the calculations in the proof of Theorem 2.1.2 to compute the value of $\delta_{\mathcal{A}, \mathcal{B}}$ and of the covariances. We give several examples:

- In the case $\mathcal{B} = \mathbb{Z}_+$ and $\mathcal{A} = \{r\}$ with $r \geq 1$ (which was treated by [56]), one has $\delta_{\mathcal{A}, \mathcal{B}}^2 = \mu_r(1 - \mu_r) - (r - 1)^2 \mu_r^2 / \sigma^2$ and the covariance between the limiting Gaussian random variables for $\mathcal{A}_1 = \{r\}$ and $\mathcal{A}_2 = \{s\}$ is $-\mu_r \mu_s - (r - 1)(s - 1) \mu_r \mu_s / \sigma^2$.

- In the case $\mathcal{B} = \{a\}$ for some $a \in \mathbb{Z}_+$ and $\mathcal{A} = \{r\}$, one has $\delta_{\mathcal{A},\mathcal{B}}^2 = \frac{\mu_r}{\mu_a} \left(1 + \frac{\mu_r}{\mu_a}\right) - \frac{(r-a)^2 \mu_r^2}{\mu_a \sigma^2}$ and the covariance between the limiting Gaussian random variables for $\mathcal{A}_1 = \{r\}$ and $\mathcal{A}_2 = \{s\}$ is $\frac{\mu_r \mu_s}{\mu_a^2} \left(1 - (r-a)(s-a) \frac{\mu_a}{\sigma^2}\right)$.
- In particular, in the case $\mathcal{B} = \{0\}$ (this corresponds to conditioning on a fixed number of leaves, and is useful in the study of dissections [64]) and $\mathcal{A} = \{r\}$, one has $\delta_{\mathcal{A},\mathcal{B}}^2 = \frac{\mu_r}{\mu_0} \left(1 + \frac{\mu_r}{\mu_0}\right) - \frac{r^2 \mu_r^2}{\mu_0 \sigma^2}$ and the covariance between the limiting Gaussian random variables for $\mathcal{A}_1 = \{r\}$ and $\mathcal{A}_2 = \{s\}$ is $\frac{\mu_r \mu_s}{\mu_0^2} \left(1 - rs \frac{\mu_0}{\sigma^2}\right)$.
- In the case $\mathcal{B} = \{0\}$ and $\mathcal{A} = \mathbb{Z}_+$, by (2.11), $\delta_{\mathbb{Z}_+,\{0\}}^2 = \frac{1-\mu_0}{\mu_0^2} - \frac{1}{\mu_0 \sigma^2}$.

Remark. Using the same arguments as in the end of this Section, it is possible to show that convergences of the exploration processes in Theorem 2.1.1 hold jointly for $\mathcal{A}_1, \dots, \mathcal{A}_k \subset \mathbb{Z}_+$ (with correlated Brownian motions), and to extend the results with \mathcal{T}_n replaced with $\mathcal{T}_n^{\mathcal{B}}$.

2.6 Several extensions

We now present some possible extensions of Theorems 2.1.1 and 2.1.2 for other types of offspring distributions. A natural one is the extension of these results to distributions μ that are said to be in the domain of attraction of a stable law. We first properly define this notion, before explaining how the two abovementioned theorems can be generalized in this broader framework. The second extension that we present is the case of subcritical non-generic laws, where the offspring distribution is not critical anymore. In this case, we asymptotically observe in the random tree \mathcal{T}_n a condensation phenomenon, where one vertex has macroscopic degree. See e.g. [55, Example 19.33] for more context.

2.6.1 Stable offspring distributions.

Let us first provide some background. We say that a function $L : \mathbb{R}_+^* \rightarrow \mathbb{R}_+^*$ is slowly varying if, for any $c > 0$, $L(cx)/L(x) \rightarrow 1$ as $x \rightarrow \infty$. For $\alpha \in (1, 2]$, we say that a critical distribution μ belongs to the domain of attraction of an α -stable law if either μ has finite variance (in which case $\alpha = 2$) or there exists a slowly varying function L such that

$$\text{Var}(X \mathbf{1}_{X \leq x}) \underset{x \rightarrow \infty}{\sim} x^{2-\alpha} L(x), \quad (2.15)$$

where X is a random variable of law μ . In this case, for any sequence $(D_n)_{n \geq 1}$ of positive numbers satisfying

$$\frac{nL(D_n)}{D_n^\alpha} \underset{n \rightarrow \infty}{\rightarrow} \frac{\alpha(\alpha-1)}{\Gamma(3-\alpha)}, \quad (2.16)$$

we have the following joint convergence:

Theorem 2.6.1. *Let $\alpha \in (1, 2]$ and μ a critical distribution with infinite variance in the domain of attraction of an α -stable law. Let $(D_n)_{n \geq 1}$ be a sequence satisfying (2.16). Then, there exists two nondegenerate random processes $X^{(\alpha)}, H^{(\alpha)}$, depending only on α , such that the following convergences hold jointly:*

(i) We have

$$\left(\frac{W_{nt}(\mathcal{T}_n)}{D_n}, \frac{K_{nt}^{\mathcal{A}}(\mathcal{T}_n) - nt\mu_{\mathcal{A}}}{\sqrt{n}} \right)_{0 \leq t \leq 1} \underset{n \rightarrow \infty}{\xrightarrow{(d)}} \left(X_t^{(\alpha)}, \sqrt{\mu_{\mathcal{A}}(1-\mu_{\mathcal{A}})} B_t \right)_{0 \leq t \leq 1}.$$

(ii) The following convergence holds in distribution, jointly with that of (i):

$$\left(\frac{D_n}{n} C_{2nt}(\mathcal{T}_n), \frac{N_{2nt}^{\mathcal{A}}(\mathcal{T}_n) - nt\mu_{\mathcal{A}}}{\sqrt{n}} \right)_{0 \leq t \leq 1} \xrightarrow[n \rightarrow \infty]{(d)} \left(H_t^{(\alpha)}, \sqrt{\mu_{\mathcal{A}}(1 - \mu_{\mathcal{A}})} B_t \right)_{0 \leq t \leq 1}.$$

Here, B denotes a standard Brownian motion independent of $(X^{(\alpha)}, H^{(\alpha)})$.

The processes $X^{(\alpha)}, H^{(\alpha)}$ only depend on α , and are the continuous-time analogues of respectively the Łukasiewicz path and the contour function of the so-called α -stable tree (see Fig. 2.3 for a picture, and [42] for more details). This stable tree is a random compact metric space introduced by Duquesne and Le Gall [42], known to be the scaling limit of the sequence of size-conditioned μ -Galton-Watson trees (\mathcal{T}_n) , when μ is in the domain of attraction of an α -stable law. In particular, when $\alpha = 2$, $X^{(2)} = H^{(2)} = \mathfrak{e}$.

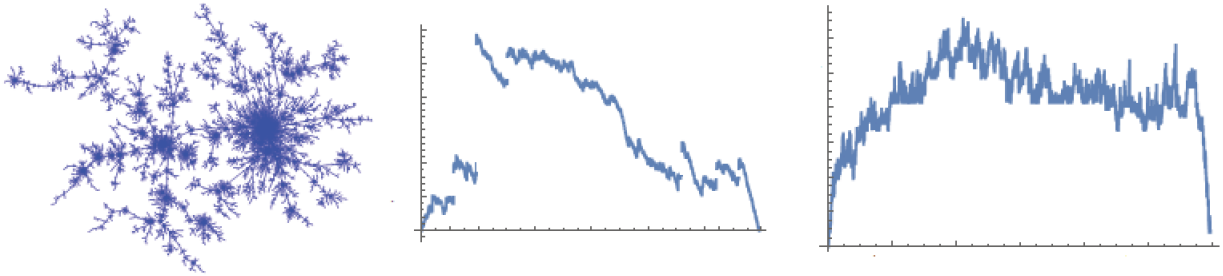

Figure 2.3: An approximation of the α -stable tree and the processes $X^{(\alpha)}$ and $H^{(\alpha)}$, for $\alpha = 1.6$.

Note that, setting $\sigma^2 = \infty$ in the definition of $\gamma_{\mathcal{A}}$ given in Theorem 2.1.1, we obtain exactly $\gamma_{\mathcal{A}} = \sqrt{\mu_{\mathcal{A}}(1 - \mu_{\mathcal{A}})}$, so that Theorem 2.6.1 is indeed the natural generalization of the finite variance case. An interesting remark, in the infinite variance case, is that the two marginals of the limiting processes are independent.

On the other hand, the results of Theorem 2.1.2 still hold in this case:

Theorem 2.6.2. *Let μ be a critical offspring distribution with infinite variance in the domain of attraction of a stable law, and let \mathcal{A}, \mathcal{B} be subsets of \mathbb{Z}_+ such that $\mu_{\mathcal{B}} > 0$. For $n \geq 1$, let $\mathcal{T}_n^{\mathcal{B}}$ be a μ -GW tree conditioned to have n \mathcal{B} -vertices. Then:*

(i) as $n \rightarrow \infty$, $\frac{1}{n} \mathbb{E}(N^{\mathcal{A}}(\mathcal{T}_n^{\mathcal{B}})) \rightarrow \frac{\mu_{\mathcal{A}}}{\mu_{\mathcal{B}}}$;

(ii) there exists $\delta_{\mathcal{A}, \mathcal{B}} \geq 0$ such that the convergence

$$\frac{N^{\mathcal{A}}(\mathcal{T}_n^{\mathcal{B}}) - n \frac{\mu_{\mathcal{A}}}{\mu_{\mathcal{B}}}}{\sqrt{n}} \xrightarrow[n \rightarrow \infty]{(d)} \mathcal{N}(0, \delta_{\mathcal{A}, \mathcal{B}}^2)$$

holds in distribution, where $\mathcal{N}(0, \delta_{\mathcal{A}, \mathcal{B}}^2)$ is a centered Gaussian random variable with variance $\delta_{\mathcal{A}, \mathcal{B}}^2$. In addition, $\delta_{\mathcal{A}, \mathcal{B}} = 0$ if and only if $\mu_{\mathcal{A}} = 0$ or $\mu_{\mathcal{A} \setminus \mathcal{B}} = \mu_{\mathcal{B} \setminus \mathcal{A}} = 0$.

(iii) the convergences (2.1) hold jointly for $\mathcal{A} \subset \mathbb{Z}_+$, in the sense that for every $j \geq 1$ and $\mathcal{A}_1, \dots, \mathcal{A}_j \subset \mathbb{Z}_+$, $((N^{\mathcal{A}_i}(\mathcal{T}_n^{\mathcal{B}}) - n \frac{\mu_{\mathcal{A}_i}}{\mu_{\mathcal{B}}}) / \sqrt{n})_{1 \leq i \leq j}$ converges in distribution to a Gaussian vector.

These two generalizations can be obtained by slightly adapting the proofs of Theorems 2.1.1 and Theorem 2.1.2. Let us only explain the most important changes in these proofs, which consist in generalizing Theorems 2.2.2 and 2.2.4 in the stable framework:

Theorem 2.6.3 (Duquesne & Le Gall [42]). *Let $\alpha \in (1, 2]$, and let μ be a critical distribution in the domain of attraction of an α -stable law. Let $(D_n)_{n \geq 1}$ be a sequence satisfying (2.16). Then, the following convergence holds jointly in distribution:*

$$\left(\frac{D_n}{n} C_{2nt}(\mathcal{T}_n), \frac{1}{D_n} W_{nt}(\mathcal{T}_n) \right)_{0 \leq t \leq 1} \xrightarrow[n \rightarrow \infty]{(d)} \left(H_t^{(\alpha)}, X_t^{(\alpha)} \right)_{0 \leq t \leq 1}.$$

The other ingredient is a multivariate local limit theorem in the stable case. When the first coordinate of a random vector is in the domain of attraction of a stable law and has infinite variance, while all other coordinates have finite variance, the random vector satisfies a local limit theorem. In addition, the first coordinate of the limiting object is independent of all others, which themselves are distributed as a Gaussian vector:

Theorem 2.6.4 (Resnick & Greenwood [89], Hahn & Klass [50], Doney [38]). *Let $\alpha \in (1, 2]$. Let $j \geq 1$ and $(\mathbf{Y}_i)_{i \geq 1} := ((Y_i^{(1)}, \dots, Y_i^{(j)}))_{i \geq 1}$ be i.i.d. random variables in \mathbb{Z}^j , such that $Y_1^{(1)}$ is in the domain of attraction of an α -stable law μ and has infinite variance, and that the covariance matrix Σ of the vector $(Y_1^{(2)}, \dots, Y_1^{(j)})$ is symmetric positive definite. Assume in addition that \mathbf{Y}_1 is aperiodic, and denote by $M^{(k)}$ the mean of $Y_1^{(k)}$, for $1 \leq k \leq j$. Finally, define for $n \geq 1$*

$$\mathbf{T}_n = \sum_{i=1}^n \left(\frac{Y_i^{(1)} - M^{(1)}}{D_n}, \frac{Y_i^{(2)} - M^{(2)}}{\sqrt{n}}, \dots, \frac{Y_i^{(j)} - M^{(j)}}{\sqrt{n}} \right)$$

Then, as $n \rightarrow \infty$, uniformly for $\mathbf{x} := (x^{(1)}, \dots, x^{(j)})$ in a compact subset of \mathbb{R}^j satisfying $\mathbb{P}(\mathbf{T}_n = \mathbf{x}) > 0$,

$$\mathbb{P}(\mathbf{T}_n = \mathbf{x}) \sim \frac{g(x^{(1)})}{D_n} \times \frac{1}{(2\pi n)^{(j-1)/2} \sqrt{\det \Sigma}} e^{-\frac{1}{2} \tilde{\mathbf{x}} \Sigma^{-1} \tilde{\mathbf{x}}},$$

where g is the density of μ and $\tilde{\mathbf{x}} := (x^{(2)}, \dots, x^{(j)})$.

Let us explain how we obtain this result, by combining the results of [38], [50] and [89]. We first focus on the case $j = 2$. When $\alpha \in (1, 2)$, [89, Theorem 3] states that the convergences of the two marginals $\sum_{i=1}^n (Y_i^{(1)} - M^{(1)})/D_n$ and $\sum_{i=1}^n (Y_i^{(2)} - M^{(2)})/\sqrt{n}$ hold, and that obtaining these two convergences separately is enough to get Theorem 2.6.4. The same theorem states in addition that the two limiting marginals are independent.

On the other hand, when $j = 2$, $\alpha = 2$ and μ has infinite variance, Theorem 3 in [50] shows that \mathbf{T}_n converges in distribution to a bivariate normal variable, and that the first coordinate of the limiting distribution is independent of the second (the constant γ_n that appears in the statement of [50, Theorem 3] can be proved to be 0, so that the renormalization matrix A_n appearing in this theorem is diagonal). This, coupled with [38, Theorem 1] (which, roughly speaking, states that a bivariate central limit theorem implies a local limit theorem), implies Theorem 2.6.4 in the case $\alpha = 2$, $j = 2$. Although these results are only stated for $j = 2$ (with the exception of [50, Theorem 3], which is generalized in [50, Theorem 5]), they still hold for $j \geq 3$ with mild modifications.

The proof of Theorem 2.6.1 follows the proof of Theorem 2.1.1 in the finite variance case, applying Theorem 2.6.4 to the random vector (S_1, J_1^A) . In order to generalize the results of Theorem 2.1.2 to the infinite variance case, we apply Theorem 2.6.4 to the vector $(S_n, J_n^{B \cap A}, J_n^{B \setminus A}, J_n^{A \setminus B}, J_n^{A^c \cap B^c})$.

Convergence of $\mathcal{T}_n^{\mathcal{A}}$ to the stable tree We finish the study of the stable case by proving the convergence of the conditioned trees $(\mathcal{T}_n^{\mathcal{A}})$, properly renormalized, to the stable tree, for any $\mathcal{A} \subset \mathbb{Z}_+$ satisfying $\mu_{\mathcal{A}} > 0$. More precisely, the multivariate theorem 2.2.4, along with Proposition 2.3.1, allows us to obtain the following asymptotics, which generalizes [63, Theorem 8.1 (i)]:

Proposition 2.6.5. *Let $\alpha \in (1, 2]$, and let μ be in the domain of attraction of an α -stable law with infinite variance. Let $\mathcal{A} \subset \mathbb{Z}_+$ be such that $\mu_{\mathcal{A}} > 0, \mu_{\mathcal{A}^c} > 0$ and \mathcal{T} be a μ -GW tree. Then, there exists a constant C depending only on μ and \mathcal{A} such that the following holds as $n \rightarrow \infty$, for the values of n such that $\mathbb{P}(N^{\mathcal{A}}(\mathcal{T}) = n) > 0$:*

$$\mathbb{P}(N^{\mathcal{A}}(\mathcal{T}) = n) = \sum_{k \geq 0} \mathbb{P}(N^{\mathbb{Z}_+}(\mathcal{T}) = k, N^{\mathcal{A}}(\mathcal{T}) = n) \sim \frac{C}{L(n)n^{1+1/\alpha}},$$

where L verifies (2.15).

Note that our bivariate approach allows us to prove this for all $\mathcal{A} \subset \mathbb{Z}_+$, while [63, Theorem 8.1 (i)] holds only when \mathcal{A} or $\mathbb{Z}_+ \setminus \mathcal{A}$ is finite. An immediate corollary of Proposition 2.6.5 is the joint convergence of the contour function and the Łukasiewicz path of the conditioned tree $\mathcal{T}_n^{\mathcal{A}}$:

Corollary 2.6.6. *Restricting ourselves to the values of n such that $\mathbb{P}(N^{\mathcal{A}}(\mathcal{T}) = n) > 0$,*

$$\left(\frac{D_{N(\mathcal{T}_n^{\mathcal{A}})}}{N(\mathcal{T}_n^{\mathcal{A}})} C_{2N(\mathcal{T}_n^{\mathcal{A}})t}(\mathcal{T}_n^{\mathcal{A}}), \frac{1}{D_{N(\mathcal{T}_n^{\mathcal{A}})}} W_{N(\mathcal{T}_n^{\mathcal{A}})t}(\mathcal{T}_n^{\mathcal{A}}) \right)_{0 \leq t \leq 1} \xrightarrow[n \rightarrow \infty]{(d)} \left(H_t^{(\alpha)}, X_t^{(\alpha)} \right)_{0 \leq t \leq 1}.$$

The proof of this corollary follows exactly the proof of [63, Theorem 8.1 (II)]. In particular, this convergence implies the convergence in distribution of the tree $\mathcal{T}_n^{\mathcal{A}}$, viewed as a metric space for the graph distance and properly renormalized, towards the α -stable tree for the Gromov-Hausdorff distance (see e.g. [70, Section 2] for details).

2.6.2 Subcritical non-generic offspring distributions.

We now focus on the case where μ is subcritical (that is with mean strictly less than 1) and $\mu_k \sim ck^{-\beta}$ as $k \rightarrow \infty$, with fixed $c > 0$ and $\beta > 2$, and $\mathcal{B} = \mathbb{Z}_+$. This is an interesting case, as a condensation phenomenon occurs (see [55, 65]): a unique vertex with macroscopic degree comparable to the total size of the tree emerges. Then the following asymptotic normality holds.

Theorem 2.6.7. *Assume that μ is an offspring distribution such that $\mu_k \sim ck^{-\beta}$ as $k \rightarrow \infty$, with fixed $c > 0$ and $\beta > 2$, and denote by \mathcal{T}_n a μ -GW tree conditioned to have n vertices. Let $k \geq 1$ and $\mathcal{A}_1, \mathcal{A}_2, \dots, \mathcal{A}_k \subset \mathbb{Z}_+$ be finite. Then we have the joint convergence in distribution*

$$\left(\frac{N^{\mathcal{A}_1}(\mathcal{T}_n) - n\mu_{\mathcal{A}_1}}{\sqrt{n}}, \dots, \frac{N^{\mathcal{A}_k}(\mathcal{T}_n) - n\mu_{\mathcal{A}_k}}{\sqrt{n}} \right) \rightarrow (Z_{\mathcal{A}_1}, \dots, Z_{\mathcal{A}_k}),$$

where $Z_{\mathcal{A}_i} \sim \mathcal{N}(0, \mu_{\mathcal{A}_i}(1 - \mu_{\mathcal{A}_i}))$ and for $i \neq j$:

$$\text{Cov}(Z_{\mathcal{A}_i}, Z_{\mathcal{A}_j}) = \mu_{\mathcal{A}_i \cap \mathcal{A}_j} - \mu_{\mathcal{A}_i} \mu_{\mathcal{A}_j}.$$

Proof. By [16, Theorem 1] (see [65, Sec. 2.1] for its use in this context) or [55, Theorem 19.34] after removing the largest outdegree in \mathcal{T}_n , the other outdegrees are asymptotically i.i.d. with distribution μ . Therefore, for every $M \geq 1$, the law of the vector $(N^{\{1\}}(\mathcal{T}_n), \dots, N^{\{M\}}(\mathcal{T}_n))$ is asymptotically multinomial with parameters (n, μ_1, \dots, μ_M) . The result follows. \square

Conjecture. We have seen that the conclusions of Theorem 2.6.7 hold for μ with infinite variance in the domain of attraction of a stable law and for μ a subcritical power law. We believe that these conclusions should hold for any μ critical with infinite variance, as well as for μ subcritical with no exponential moment. In particular, we should get, for any $\mathcal{A} \subset \mathbb{Z}_+$, $(N^{\mathcal{A}}(\mathcal{T}_n) - n\mu_{\mathcal{A}})/\sqrt{n} \xrightarrow{d} \mathcal{N}(0, \mu_{\mathcal{A}}(1 - \mu_{\mathcal{A}}))$. However, in the general case, nothing is known about the scaling limits of such GW trees (see [55] for detailed arguments and counterexamples) and no general local limit theorem exists, which prevents us from directly generalizing our methods.

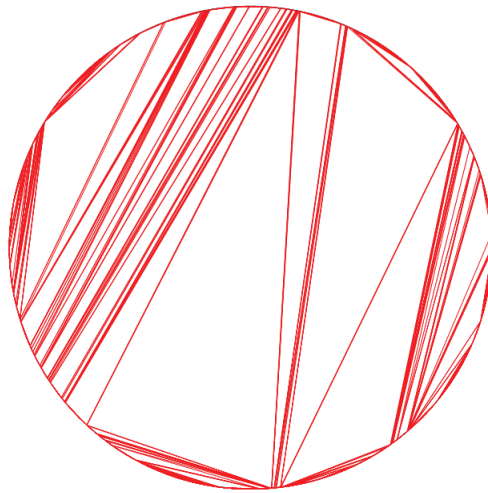

*I can get a fragmentation
I can get a fragmentation
'Cause I cut and I cut and I cut stable trees
I can get a fragmentation*

Rolling Dice, (*I can get a*) *Fragmentation*

Ce chapitre reprend essentiellement l'article [96], soumis pour publication. Nous y proposons une nouvelle représentation géométrique d'une famille de processus de fragmentation par une suite croissante de laminations, qui sont des sous-ensembles compacts du disque unité formés de cordes qui ne se coupent pas. Plus spécifiquement, nous considérons une fragmentation obtenue en coupant un arbre en des points choisis aléatoirement, qui séparent l'arbre initial en sous-arbres plus petits. En codant chacun de ces points de coupe par une corde, on divise le disque en composantes connexes qui correspondent aux sous-arbres de l'arbre d'origine. Ce point de vue géométrique nous permet en particulier de mettre en lumière une relation entre la fragmentation d'Aldous-Pitman de l'arbre brownien continu et les factorisations minimales du n -cycle en transpositions, c'est-à-dire des factorisations de la permutation $(1\ 2\ \cdots\ n)$ en un produit de $n - 1$ transpositions, prouvant ainsi une conjecture de Féray et Kortchemski. Nous étudions également plusieurs propriétés de ces nouveaux processus de laminations obtenus à partir des arbres aléatoires stables de paramètre $\alpha \in (1, 2]$,

et montrons notamment qu'ils peuvent être codés directement par des processus de Lévy explicites. Nous utilisons entre autres pour cela des résultats sur la structure des arbres de Galton-Watson obtenus dans le chapitre 2.

Content of the chapter

3.1	Introduction	76
3.1.1	Fragmentations and laminations	76
3.1.2	The lamination-valued process $(\mathbb{L}_c^{(\alpha)})_{c \in [0, +\infty]}$	79
3.1.3	Connections with random minimal factorizations	80
3.1.4	Coding $\mathbb{L}_c^{(\alpha)}$ by a function	82
3.1.5	An estimate on generating functions	82
3.2	Construction of lamination-valued processes	83
3.2.1	Excursions and laminations	84
3.2.2	Construction of $(\mathbb{L}_c^{(\alpha)})_{c \in [0, +\infty]}$	87
3.2.3	A limit theorem for lamination-valued processes	88
3.3	Limit of cut processes on discrete trees	90
3.3.1	Background on trees	90
3.3.2	Convergence of the discrete cut processes in the case of contour functions	92
3.4	Application to minimal factorizations of the cycle	94
3.4.1	Minimal factorizations	94
3.4.2	The Goulden-Yong bijection	95
3.4.3	A discrete lamination-valued process coded by a discrete tree	97
3.4.4	A shuffling operation on vertices	102
3.4.5	Proof of the technical lemma	104
3.4.6	Convergence of the associated noncrossing partitions	109
3.5	Computation of the distribution of $\mathbb{L}_c^{(\alpha)}$ at c fixed	115
3.5.1	Definition and study of the process $\tau^{(\alpha), c}$	115
3.5.2	A new family of random trees	117
3.5.3	Proof of Theorem 3.5.3 (i)	118
3.5.4	Proof of Theorem 3.5.3 (ii)	122
3.5.5	Proof of the local estimate	124
3.5.6	Study of the solutions of the implicit equation (3.12)	129
3.6	Generating functions of stable offspring distributions	129
3.6.1	Proof of Proposition 3.6.1 for $\alpha = 2$	131
3.6.2	Proof of Proposition 3.6.1 for $\alpha \in (1, 2)$	132

3.1 Introduction

The purpose of this work is to investigate a geometric and dynamical representation of fragmentation processes derived from random stable trees in terms of laminations, with an application to permutation factorizations. Specifically, we shall code the analogue of the Aldous-Pitman fragmentation on a stable tree by a new lamination-valued càdlàg process. Also, in the Brownian case, we shall establish a connection between this lamination-valued process and minimal factorizations of a cycle into transpositions. Before stating our results, let us first present the main objects of interest.

3.1.1 Fragmentations and laminations

Fragmentation processes derived from stable trees. Fragmentation processes describe the evolution of an object with given mass, which splits into smaller pieces as time passes. Specifically, a *fragmentation process* $\Lambda = (\Lambda(t), t \geq 0)$ is a càdlàg process (that is, left-continuous with right limits) on the set

$$\Delta := \left\{ x := x_1 \geq x_2 \geq \dots \geq 0, S(x) := \sum_{i \geq 1} x_i \leq 1 \right\}.$$

such that, if one denotes by P_s the law of Λ starting from $s := (s_1, s_2, \dots)$, then P_s is the non-increasing reordering of the elements of independent processes of laws $P_{(s_1, 0, 0, \dots)}, P_{(s_2, 0, 0, \dots)}, \dots$. This means that each fragment breaks independently of the others, in a way that only depends on its mass. The fragmentation processes that we will study here are *conservative*, which means that an object always splits into pieces whose sum of the masses is the sum of the initial object, and *without erosion*: the sum function $t \mapsto S(\Lambda(t))$ is constant.

The starting point of this paper is a well-known fragmentation process which was introduced by Aldous and Pitman [14] and which consists in cutting a specific random tree - namely, Aldous' Brownian tree - at random points. These *cutpoints* are spread out on the tree following a homogeneous Poisson distribution of density $c d\ell$, where $c > 0$ and ℓ is the length measure on the tree. The Brownian tree (sometimes called CRT, for continuum random tree) is therefore split into smaller components as c increases. This process has been studied in depth, notably by Bertoin [18] who gives a different surprising construction from a linearly drifted standard Brownian excursion over its current infimum, as the slope of the drift varies. Miermont [82, 83] has considered more generally fragmentations obtained by cutting at random the so-called *stable trees*. These random trees $\mathcal{T}^{(\alpha)}$ (for $\alpha \in (1, 2]$), introduced by Duquesne and Le Gall [42] (see also [73]), can be coded by α -stable spectrally positive Lévy processes and arise as scaling limits of size-conditioned Galton-Watson trees. They generalize Aldous' Brownian tree, which can be seen as the 2-stable tree. Miermont investigates a way of cutting these stable trees only at *branching points* — that is, points whose removal splits the tree into three or more different subtrees —, while Abraham & Serlet [5] cut them uniformly on their *skeleton* (made of points which are not branching points). This gives rise to two different fragmentation processes. Let us also mention Voisin [100] who studies a mixture of these two processes. Fragmentations can also more generally be derived from Lévy trees (see [1, 4]), which are trees coded by Lévy processes.

Let us briefly mention that a fragmentation process can be seen as a time-reversed coalescent process, where particles with given masses merge at a rate that depends on their respective masses. The so-called *standard additive coalescent* is the coalescent process where

only two particles merge at each time, at a rate that is the sum of their masses. This standard coalescent is the time-reversed analogue of the previously mentioned Aldous-Pitman fragmentation process on the Brownian tree [14]. Several other models of coalescent processes have been investigated, such as Kingman's coalescent [61] where two particles merge at rate 1, or Aldous' multiplicative coalescent [12, 13] where particles merge proportionally to the product of their masses. See also the book of Bertoin [19] for fully detailed information about coalescent processes. Let us finally mention Chassaing and Louchard [31] who provide a representation of the standard additive coalescent as *parking schemes* (see also [79]).

In this paper, we consider the previously mentioned analogue of the Aldous-Pitman fragmentation on a stable tree. Specifically, we fix $\alpha \in (1, 2]$ and focus on cutting the α -stable tree $\mathcal{T}^{(\alpha)}$ homogeneously on its skeleton by a homogeneous Poisson process $\mathcal{P}_c(\mathcal{T}^{(\alpha)})$ of intensity $c d\ell$, where $c > 0$ and ℓ is the length measure on the tree, consistently as c increases (we refer to Section 3.2 for precise definitions, and [17] for a rigorous definition of ℓ). Cutting $\mathcal{T}^{(\alpha)}$ at the points of $\mathcal{P}_c(\mathcal{T}^{(\alpha)})$ then splits the tree into a random set of smaller components, whose decreasingly reordered sequence $\mathbf{m}_c^{(\alpha)}$ of *masses* (i.e., the proportion of leaves of the tree in these components, see again Section 3.2 for precise definitions) is an element of Δ of sum 1. This defines the α -fragmentation process

$$F^{(\alpha)} := (F_c^{(\alpha)})_{c \geq 0} = (\mathbf{m}_c^{(\alpha)})_{c \geq 0}.$$

In the case $\alpha = 2$, this is the Aldous-Pitman fragmentation of $\mathcal{T}^{(2)}$.

Laminations and excursion-type functions. The aim of this paper is to code the analogue of the Aldous-Pitman fragmentation on a stable tree by a nondecreasing lamination-valued process, where, roughly speaking, a chord in the lamination corresponds to a cutpoint on the tree. By definition, a lamination is a closed subset of the closed unit disk $\overline{\mathbb{D}}$ which can be written as the union of the unit circle \mathbb{S}^1 and a set of chords which do not intersect in the open unit disk \mathbb{D} . Laminations are important objects in topology and in hyperbolic geometry, see for instance [28] and references therein. If L is a lamination, a *face* of L is a connected component of the complement of L in $\overline{\mathbb{D}}$.

The connection between random trees and random laminations goes back to Aldous [11] who used the Brownian excursion to code the so-called Brownian triangulation (see Fig. 3.3, right, for a simulation). The Brownian triangulation is a random lamination whose faces are all triangles, and its “dual” tree is, in some sense, the Brownian CRT. Since then, this object has appeared as the limit of several discrete structures [33, 67, 22], and in the theory of random planar maps [75].

Other models of random laminations have been recently studied. The Brownian triangulation has been generalized by Kortchemski [64], who introduced, for $\alpha \in (1, 2]$ the so-called α -stable lamination, whose “dual” tree is in a certain sense the α -stable tree, and which appears as the limit of certain models of random dissections (which are collections of non-crossing diagonals of a regular polygon). In a different direction, Curien and Le Gall [34] consider laminations built by recursively adding chords. Another family of random laminations connected to random minimal factorizations of a cycle into transpositions, which will be one of the objects of interest in this paper, has been introduced in [45]. While all these random laminations can be coded by random excursion-type functions, other laminations such as the hyperbolic triangulation [35] or triangulated stable laminations [66] cannot.

Let us immediately explain how to construct laminations from so-called excursion-type functions. Let $f : [0, 1] \rightarrow \mathbb{R}$. We say that f is an *excursion-type function* if the following conditions are verified:

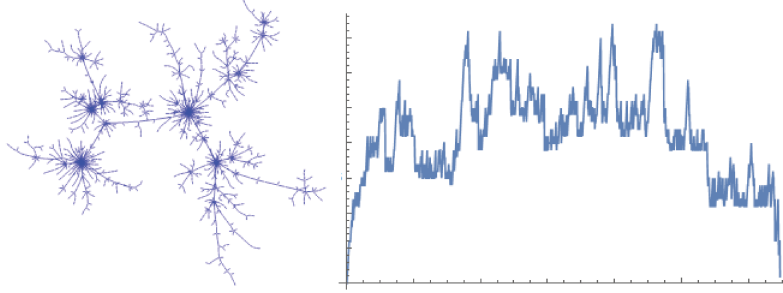

Figure 3.1: An approximation of $(\mathcal{T}^{(1.5)}, H^{(1.5)}, \mathbb{L}_\infty^{(1.5)})$.

- (i) f is càdlàg (that is, right-continuous on $[0, 1)$, with left limits on $(0, 1]$);
- (ii) f is nonnegative on $[0, 1]$ and $f(1) = 0$;
- (iii) f only makes positive jumps, that is, for all $x \in (0, 1]$, $f(x-) \leq f(x)$.

Following the construction of [64], to an excursion-type function f , one can associate a lamination $\mathbb{L}(f)$ as follows. For any $0 \leq s < t \leq 1$, say that $s \sim_f t$ if $t := \inf\{u > s, f(u) \leq f(s-)\}$ (where we set $f(0-) = 0$). For $t > s$, we say that $t \sim_f s$ if $s \sim_f t$, and we say that for any $s \in [0, 1]$, $s \sim_f s$. Note that \sim_f is not necessarily an equivalence relation on $[0, 1]$. The lamination $\mathbb{L}(f)$ is defined as the closure

$$\mathbb{L}(f) = \overline{\mathbb{S}^1 \cup \bigcup_{\substack{s, t \in (0, 1) \\ s \sim_f t}} [e^{-2i\pi s}, e^{-2i\pi t}]}$$

where $[y, z]$ denotes the line segment joining the two complex numbers y and z .

The α -stable lamination, which plays an important role in our work, can be constructed from a planar version of the α -stable tree (we refer to Section 3.2.2 for precise definitions). Indeed, we view $\mathcal{T}^{(\alpha)}$ as coded by a continuous normalized α -stable height process $(H_t^{(\alpha)})_{t \in [0, 1]}$ (so that, informally, $H^{(\alpha)}$ is the contour function of $\mathcal{T}^{(\alpha)}$). We define the α -stable lamination $\mathbb{L}_\infty^{(\alpha)}$ as

$$\mathbb{L}_\infty^{(\alpha)} := \mathbb{L}(H^{(\alpha)}). \quad (3.1)$$

It is possible to check (see [64]) that faces of $\mathbb{L}_\infty^{(\alpha)}$ are in correspondence with branching points of $\mathcal{T}^{(\alpha)}$, and that there are chords which are not adjacent to any face (one can find chords arbitrarily close to such a chord, from both sides) which are in correspondence with the points of $\mathcal{T}^{(\alpha)}$ that are not leaves nor branching points. See Fig. 3.1 for an approximation of these items, for $\alpha = 1.5$.

Although one only needs to define the construction from a continuous function f in order to construct the stable laminations or the Brownian triangulation, we explain here this construction in the broader case of a càdlàg function, which will be useful later in Section 3.5.

We conclude this section with a last definition concerning laminations. We define the *mass* of a face F of a lamination L as $\frac{1}{2\pi}$ times the Lebesgue measure of $\partial F \cap \mathbb{S}^1$ (roughly speaking, it corresponds to the part of the perimeter of F that lies on the unit circle). Finally, the *mass sequence* of L , denoted by $\mathcal{M}[L]$, is the sequence of the masses of its faces, sorted in nonincreasing order.

3.1.2 The lamination-valued process $(\mathbb{L}_c^{(\alpha)})_{c \in [0, +\infty]}$

For a fixed $\alpha \in (1, 2]$, we now introduce a new lamination-valued process $(\mathbb{L}_c^{(\alpha)})_{c \in [0, +\infty]}$ which encodes, in a certain sense, the fragmentation $F^{(\alpha)}$ of the α -stable tree. Here we give a rather informal definition, and defer to Section 3.2 precise definitions.

Definition of $(\mathbb{L}_c^{(\alpha)})_{c \in [0, +\infty]}$. As above, we view $\mathcal{T}^{(\alpha)}$ as coded by a normalized α -stable height process $(H_t^{(\alpha)})_{t \in [0, 1]}$. We consider a homogeneous Poisson process $\mathcal{P}_c(\mathcal{T}^{(\alpha)})$ of intensity $c \, dl$ on the skeleton of $\mathcal{T}^{(\alpha)}$, where $c \geq 0$ and ℓ is the length measure on the tree, consistently as c increases. For $c \geq 0$, we define the lamination $\mathbb{L}_c^{(\alpha)}$ as the subset of the α -stable lamination $\mathbb{L}_\infty^{(\alpha)}$, obtained by keeping only the chords which correspond to the points of $\mathcal{P}_c(\mathcal{T}^{(\alpha)})$ (recall that to a point of the skeleton of $\mathcal{T}^{(\alpha)}$ corresponds a unique chord of $\mathbb{L}_\infty^{(\alpha)}$). Intuitively speaking, one obtains the process $(\mathbb{L}_c^{(\alpha)})_{c \in [0, +\infty]}$ by revealing the chords of $\mathbb{L}_\infty^{(\alpha)}$ in a Poissonian way (see Fig. 3.2 for an approximation of $\mathbb{L}_{100}^{(1.8)}$).

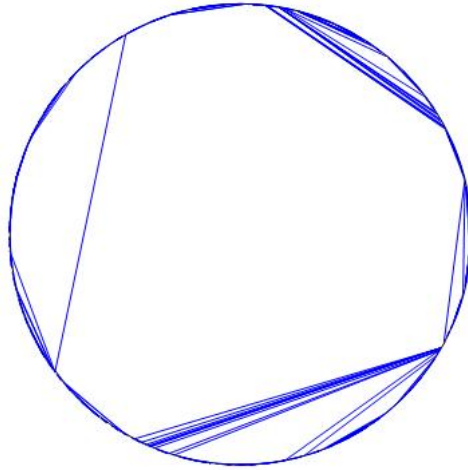

Figure 3.2: An approximation of the lamination $\mathbb{L}_{100}^{(1.8)}$.

Connection with fragmentations. The process $c \mapsto \mathbb{L}_c^{(\alpha)}$, which is an increasing lamination-valued process, is the main object of interest in this paper. It encodes the Aldous-Pitman fragmentation of the α -stable tree in the following sense (where we recall that $\mathcal{M}[L]$ is the mass sequence of a lamination L).

Theorem 3.1.1. *The following equality holds in distribution in Δ :*

$$(\mathcal{M}[\mathbb{L}_c^{(\alpha)}])_{c \geq 0} \stackrel{(d)}{=} F^{(\alpha)}.$$

In a certain sense, $(\mathbb{L}_c^{(\alpha)})_{c \in [0, +\infty]}$ can be viewed as a “dual planar representation” of the Aldous-Pitman fragmentation of the α -stable tree, and as a “linearization” of the associated time-reversed coalescent process. In order to prove Theorem 3.1.1, we view the Poissonian cuts on the skeleton of $\mathcal{T}^{(\alpha)}$ as a non-homogenous Poisson process in the epigraph of $H^{(\alpha)}$ (see Section 3.2.2).

Let us mention that for fixed $c > 0$ and $\alpha = 2$, the lamination $\mathbb{L}_c^{(2)}$ appears in [45] in the context of random minimal factorizations of a cycle, without any connection to fragmentations. In addition, defining a coupling $\mathbb{L}_c^{(2)}$ as c increases and obtaining a functional

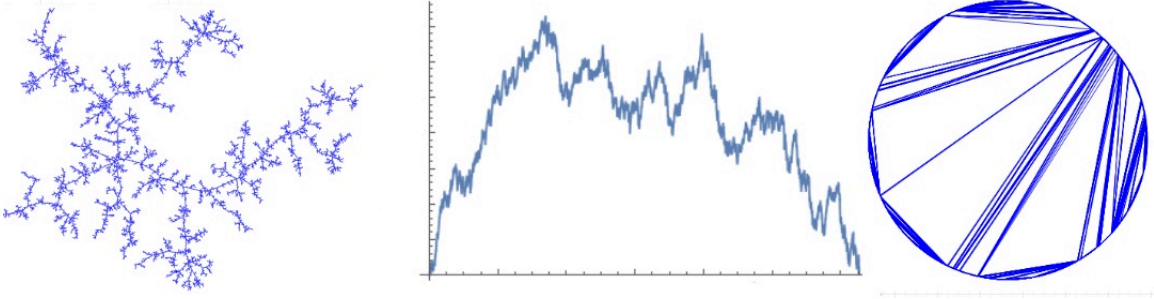

Figure 3.3: An approximation of $(\mathcal{T}^{(2)}, H^{(2)}, \mathbb{L}_\infty^{(2)})$.

convergence was left open in [45]. Also, Shi [93] used fragmentation theory to study large faces in the Brownian triangulation and in stable laminations, by using the so-called fragmentation by heights of stable trees (which is different from the one that appears here, see [82]).

Also, throughout the paper, the lamination-valued processes will be defined on $[0, +\infty]$, while the associated fragmentation processes $F^{(\alpha)}$ are only defined on \mathbb{R}_+ . Observe indeed that, almost surely, $\sup F_c^{(\alpha)} \rightarrow 0$ as $c \rightarrow +\infty$, which corresponds to extinction at $+\infty$. On the other hand, the increasing process $(\mathbb{L}_c^{(\alpha)})_{c \geq 0}$ has a non-trivial limit at $+\infty$.

3.1.3 Connections with random minimal factorizations

One of the main contributions of this paper is to show that the process $(\mathbb{L}_c^{(2)})_{c \in [0, +\infty]}$ appears as the functional limit of a natural coding of so-called minimal factorizations of the n -cycle. More precisely, for $n \in \mathbb{Z}_+$, denote by \mathfrak{S}_n the group of permutations acting on $\llbracket 1, n \rrbracket$ and by \mathfrak{T}_n the set of transpositions of \mathfrak{S}_n . Then, the elements of the set

$$\mathfrak{M}_n := \{(t_1, \dots, t_{n-1}) \in \mathfrak{T}_n^{n-1}, t_1 \cdots t_{n-1} = (12 \cdots n)\}$$

are called minimal factorizations of the n -cycle into transpositions, or just *minimal factorizations* in short. Their study goes back to Dénès [37] and Moszkowski [86]. By convention, we read transpositions from left to right, so that $t_1 t_2$ corresponds to $t_2 \circ t_1$.

Goulden and Yong [49] view minimal factorizations in a geometric way, noticing that it is possible to represent each of them by a non-crossing tree in the unit disk. More specifically, if $(t_1, \dots, t_{n-1}) \in \mathfrak{M}_n$ and $t_j = (a_j, b_j)$ for $1 \leq j \leq n-1$, then

$$\bigcup_{j=1}^{n-1} [e^{-2i\pi a_j/n}, e^{-2i\pi b_j/n}]$$

is a non-crossing tree and, in particular, a lamination (adding \mathbb{S}^1 , see Fig. 3.4). In this direction, for a uniform minimal factorization $t^{(n)}$ of the n -cycle, Féray and Kortchemski [45] have highlighted the nontrivial behaviour of the lamination obtained after roughly \sqrt{n} transpositions have been read. More precisely, for $c > 0$, if $\mathcal{L}_c^{(n)}$ is the lamination obtained by drawing the chords corresponding to the first $\lfloor c\sqrt{n} \rfloor$ transpositions of $t^{(n)}$, then [45, Theorem 3, (i)] shows that for $c > 0$, $\mathcal{L}_c^{(n)}$ converges in distribution for the Hausdorff distance from a limiting random lamination, defined by using a certain Lévy process (and not fragmentations nor Poisson processes).

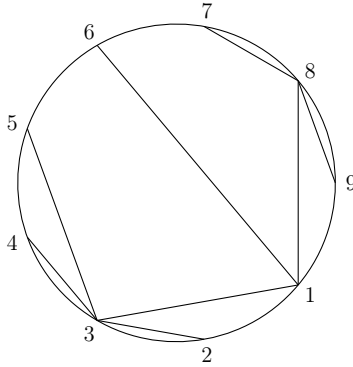

Figure 3.4: The lamination associated to the minimal factorization $F := (34)(89)(35)(13)(16)(18)(23)(78) \in \mathfrak{M}_9$.

One of the main results of this paper is to show that this convergence actually holds in the functional sense (that is, jointly in $c \in [0, \infty]$) and that the limiting process is $(\mathbb{L}_c^{(2)})_{c \in [0, +\infty]}$. As a corollary, we obtain an alternative and, in our opinion, simpler proof of the one-dimensional convergence [45, Theorem 3, (i)].

Let us quickly give some background concerning this notion of convergence. The set $\mathbb{L}(\overline{\mathbb{D}})$ of laminations of the closed unit disk is endowed with the Hausdorff distance d_H between compact subsets of $\overline{\mathbb{D}}$, so that $(\mathbb{L}(\overline{\mathbb{D}}), d_H)$ is a Polish metric space (that is, separable and complete). The Hausdorff distance is defined as follows. If K is a compact subset of $\overline{\mathbb{D}}$ and $\varepsilon > 0$, define the ε -neighbourhood of K as $K^\varepsilon := \{x \in \overline{\mathbb{D}}, d(x, K) < \varepsilon\}$, where d denotes the usual Euclidean distance on \mathbb{R}^2 . Then, for K_1, K_2 compact subsets of the unit disk, we define

$$d_H(K_1, K_2) := \inf \{\varepsilon > 0, K_2 \subset K_1^\varepsilon \text{ and } K_1 \subset K_2^\varepsilon\}.$$

In the rest of the paper, for E, F two metric spaces, $\mathbb{D}(E, F)$ denotes the set of càdlàg processes from E to F , endowed with the Skorokhod J1 topology (see Annex A2 in [58] for background). Finally, we denote by $[0, \infty]$ the Alexandrov extension of \mathbb{R}_+ , which is compact by definition.

Theorem 3.1.2. *The following convergence holds in distribution in $\mathbb{D}([0, +\infty], \mathbb{L}(\overline{\mathbb{D}}))$:*

$$(\mathcal{L}_c^{(n)})_{c \in [0, +\infty]} \xrightarrow[n \rightarrow \infty]{(d)} (\mathbb{L}_c^{(2)})_{c \in [0, +\infty]}.$$

To establish this result, we actually prove a more general result (Theorem 3.2.4 below). We show that $(\mathbb{L}_c^{(2)})_{c \in [0, +\infty]}$ is the functional limit of discrete lamination valued-processes, obtained by marking vertices of discrete trees (this can be seen as the discrete analogue of the Aldous-Pitman fragmentation). We then use a bijection between the set of minimal factorizations of the n -cycle and a subset of plane trees with n labelled vertices, which allows us to reformulate Theorem 3.1.2 in terms of random trees. The main difficulty is that the labelling of the vertices has constraints. To lift these constraints and to reduce the study to uniform labellings, an important tool in the study of these random trees is an operation that shuffles the labels of their vertices in two ways (see Section 3.4 for details).

The process $(\mathbb{L}_c^{(2)})_{c \in [0, +\infty]}$ is therefore the limit of discrete lamination-valued processes which code a uniform minimal factorization into transpositions; in a forthcoming work, we establish an analogous result concerning the processes $(\mathbb{L}_c^{(\alpha)})_{c \in [0, +\infty]}$ for $1 < \alpha < 2$, by proving that they appear as limits of discrete lamination-valued processes which code other random factorizations of the n -cycle. Notably, cycles of length ≥ 3 are allowed in these new models of factorizations.

3.1.4 Coding $\mathbb{L}_c^{(\alpha)}$ by a function

For fixed $\alpha \in (1, 2]$ and $c > 0$, we show that $\mathbb{L}_c^{(\alpha)}$ can be coded by a Lévy process, similarly to the way $\mathbb{L}_\infty^{(\alpha)}$ is coded by $H^{(\alpha)}$ in (3.1). In the case of $\mathbb{L}_c^{(\alpha)}$, we introduce the α -stable spectrally positive Lévy process $Y^{(\alpha)}$, which is the Lévy process whose Laplace exponent is given by $\mathbb{E}[e^{-\lambda Y_s^{(\alpha)}}] = e^{s\lambda^\alpha}$ for $s, \lambda \geq 0$. Then, for any $s \geq 0$, we define the stopping time $\tau_s^{(\alpha),c}$ as

$$\tau_s^{(\alpha),c} = \inf \left\{ t > 0, Y_t^{(\alpha)} - c^{1/\alpha}t < -c^{1+1/\alpha}s \right\} - cs.$$

It is not difficult (see Section 3.5) to check that $(\tau_s^{(\alpha),c})_{s \in \mathbb{R}^+}$ is a Lévy process with Laplace exponent given by

$$\mathbb{E} \left[\exp(-\lambda \tau_s^{(\alpha),c}) \right] = \exp \left(-s c (\bar{\phi}(\lambda) - \lambda) \right), \quad \lambda > 0, \quad s \geq 0.$$

where $\bar{\phi}(\lambda)$ is the unique nonnegative solution of the equation $X^\alpha + cX = \lambda c$. It is interesting to note that this equation appears in the work of Bertoin [20, Section 6.1], in the study of a random spatial branching process with emigration.

It turns out that $\mathbb{L}_c^{(\alpha)}$ can be coded by the normalized excursion $\tau^{(\alpha),c,exc}$ of the Lévy process $s \mapsto \tau_s^{(\alpha),c}$, as stated in the following theorem:

Theorem 3.1.3. *The following equality holds in distribution, for any $c \geq 0$:*

$$\mathbb{L}_c^{(\alpha)} \stackrel{(d)}{=} \mathbb{L}(\tau^{(\alpha),c,exc})$$

Here, $\mathbb{L}(\tau^{(\alpha),c,exc})$ is the lamination constructed from $\tau^{(\alpha),c,exc}$ by the method described in Section 3.1.1.

The main idea of the proof of Theorem 3.1.3 is to exhibit a new family of random trees, which can be seen as a randomly reduced version, in some sense, of Galton-Watson trees conditioned by their number of vertices. It happens that these reduced trees code a new sequence of random laminations, which converges at the same time towards $\mathbb{L}_c^{(\alpha)}$ and $\mathbb{L}(\tau^{(\alpha),c,exc})$.

3.1.5 An estimate on generating functions

An important ingredient to code $\mathbb{L}_c^{(\alpha)}$ by the normalized excursion of $\tau^{(\alpha),c}$, which is crucial in the proof of Theorem 3.1.3 and which we believe to be of independent interest, is a general estimate of the behavior of generating functions in the complex plane, involving slowly varying functions. Recall that a function $L : \mathbb{R}_+ \rightarrow \mathbb{R}_+^*$ is slowly varying if, for any $c > 0$, $L(cx)/L(x) \rightarrow 1$ as $x \rightarrow +\infty$. Precise estimates concerning these functions are needed in many different contexts, see e.g. [94] [98], although nothing seems to have been proved regarding asymptotics in the complex domain.

Theorem 3.1.4. *Let μ be a probability distribution on the nonnegative integers and denote by F_μ its generating function. Assume that there exists $\alpha \in (1, 2]$ and a slowly varying function $L : \mathbb{R}_+ \rightarrow \mathbb{R}_+^*$ such that*

$$F_\mu(1-s) - (1-s) \underset{s \downarrow 0}{\sim} s^\alpha L\left(\frac{1}{s}\right).$$

Then

$$F_\mu(1 + \omega) - (1 + \omega) \underset{\substack{|\omega| \rightarrow 0 \\ |1 + \omega| < 1}}{\sim} (-\omega)^\alpha L\left(\frac{1}{|\omega|}\right).$$

In the terminology of Galton-Watson trees, this is an estimate in the complex unit disk, near 1, of the generating function of a critical offspring distribution which belongs to the domain of attraction of a *stable law*. Very often, additional assumptions, such as Δ -analyticity, are made in order to obtain estimates for generating functions in the complex plane (see [47, Section 6]). Observe that here it is not the case, and no assumptions on L are made.

The proof of this theorem is given in Section 3.6. The main idea is to use an integral representation, see (3.30).

Outline After describing a general construction of trees and laminations coded by excursion-type functions, we rigorously define the process $(\mathbb{L}_c^{(\alpha)})_{c \in [0, +\infty]}$ in Section 3.2 and prove Theorem 3.1.1. Then, in Section 3.3, we make $(\mathbb{L}_c^{(\alpha)})_{c \in [0, +\infty]}$ appear as the limit of a process of laminations coded by discrete trees; this framework is used in Section 3.4 to extend the results of Féray & Kortchemski [45] and highlight a relation between the Aldous-Pitman fragmentation of the Brownian tree and minimal factorizations of the n -cycle as $n \rightarrow \infty$. Finally, in Section 3.5, we recover the 1-dimensional marginal of the lamination process as the lamination coded by $\tau^{(\alpha), c, exc}$ (Theorem 3.1.3), while Section 3.6 is devoted to the proof of Theorem 3.1.4.

Acknowledgements. I would like to thank Igor Kortchemski for asking the questions at the origin of this paper and for his help, comments, suggestions and corrections. I would also like to thank Bénédicte Haas, Cyril Marzouk and Loïc Richier for fruitful discussions and comments on the paper, and Gerónimo Uribe Bravo for his useful remarks on Theorem 3.5.1.

Notation

Let us immediately summarise some notation that will often appear throughout the paper. We write $\xrightarrow{\mathbb{P}}$ for the convergence in probability, and $\xrightarrow{(d)}$ for the convergence in distribution of a sequence of random variables. We say that an event E_n (depending on n) occurs with high probability if $\mathbb{P}(E_n) \rightarrow 1$ as $n \rightarrow \infty$. When talking about trees, deterministic ones will be denoted by a roman T , while random ones will be denoted by a calligraphic \mathcal{T} . Finally, at the beginning of each section, we summarise the most important notation that we use in this section.

3.2 Construction of lamination-valued processes

This section is devoted to the construction of càdlàg processes taking their values in the set of laminations of the unit disk. We start by explaining a general method of construction of lamination-valued processes, starting from a deterministic excursion-type function. Then, we apply this in the particular case of an α -stable excursion, for $\alpha \in (1, 2]$, giving rise to a random lamination-valued process.

Notation for Section 3.2

In this table of notation, f always denotes a continuous excursion-type function such that $f(0) = 0$ (except for $\mathbb{L}(f)$, which is defined for any excursion-type function). $u := (s, t)$

denotes an element of \mathbb{R}^2 .

$\mathcal{EG}(f)$	epigraph of f
$g(f, u), d(f, u)$	$\sup\{s' \leq s, f(s') < t\}, \inf\{s' \geq s, f(s') < t\}$
$\mathcal{N}_c(f)$	Poisson point process of intensity $\frac{2cdsdt}{d(f,u)-g(f,u)}$ on $\mathcal{EG}(f)$
$\mathcal{P}_c(T)$	Poisson point process of intensity cdl on a tree T
$\mathbb{L}(f)$	lamination coded by f
$\mathbb{L}_c(f)$	lamination coded by $\mathcal{N}_c(f)$
$\mathcal{T}(\alpha)$	α -stable tree
$H(\alpha)$	contour function of the α -stable tree
$\mathbb{L}_\infty^{(\alpha)}$	α -stable lamination, coded by $H^{(\alpha)}$
$\mathbb{L}_c^{(\alpha)}$	lamination coded by $\mathcal{N}_c(H^{(\alpha)})$

3.2.1 Excursions and laminations

Starting from an excursion-type function f , we have seen in Section 3.1 that we can define a lamination $\mathbb{L}(f)$. In the particular case of a continuous f verifying $f(0) = 0$, we shall recall in this section the classical construction of the tree $T(f)$ as the quotient of $[0, 1]$ by the equivalence relation \sim_f defined in Section 3.1.1. Then, we shall construct a nondecreasing lamination-valued process $(\mathbb{L}_c(f))_{0 \leq c \leq \infty}$, by associating chords in the unit disk to straight lines under the graph of f (see Fig. 3.6), such that $\mathbb{L}_\infty(f) = \mathbb{L}(f)$. Note that, when f is deterministic, $\mathbb{L}(f)$ and $T(f)$ are also deterministic, while $(\mathbb{L}_c(f))_{0 \leq c \leq \infty}$ will be a random process. This coding is used in the next sections, when the function f is the contour function of a tree (later in this section and in the next one) or when it is the standard excursion of the Lévy process $\tau^{(\alpha),c}$ (Section 3.5).

The tree associated to continuous excursion-type function. Assume that f is a continuous excursion-type function with $f(0) = 0$. In this case, one can check that the relation \sim_f defined in Section 3.1.1 is now an equivalence relation, as for all $s \in (0, 1]$ $f(s-) = f(s)$. This relation can be understood in a nicer way. For $0 \leq s \leq t \leq 1$, define $m(s, t) := \inf_{[s,t]} f$ and $d(s, t) := f(s) + f(t) - 2m(s, t)$. For $t > s$, set $d(t, s) = d(s, t)$. For $s, t \in [0, 1]$, we write $s \sim_f t$ if $d(s, t) = 0$, which matches the definition of Section 3.1.1.

From this continuous function f , we define the tree $T(f)$ as

$$T(f) = [0, 1] / \sim_f .$$

Note that we call $T(f)$ a tree since it is an \mathbb{R} -tree, as defined in Section 1.1.3.

One can check (see [42]) that d induces a distance on $T(f)$, which we still denote by d with a slight abuse of notation, and that the metric space $(T(f), d)$ is a tree, in the sense that from one point of $T(f)$ to another, there exists a unique path in $T(f)$. See Fig. 3.1 and 3.3 for two examples of a continuous excursion-type function, its associated lamination and its associated tree.

Let us immediately define some important notions about trees. We say that an equivalence class $\bar{x} \in T(f)$ is a *branching point* if $T(f) \setminus \{\bar{x}\}$ has at least three disjoint connected

components, and the set of points that are not branching points is called the *skeleton* of $T(f)$. A *leaf* of the tree is an equivalence class \bar{x} such that $T(f) \setminus \{\bar{x}\}$ is connected. In other words, a branching point is a point where the tree splits into two or more branches, and leaves are ends of branches. The *volume measure* h , or mass measure on $T(f)$, is defined as the projection on $T(f)$ of the Lebesgue measure on $[0, 1]$. Finally, the *length measure* ℓ on $T(f)$, supported by the set of non-leaf points, is the unique σ -finite measure on this set such that, for $x, y \in T(f)$ non-leaf points, $\ell([x, y]) = d(x, y)$, where $[x, y]$ is the path from x to y in $T(f)$. See [17] for further details about this length measure. This σ -finite measure expresses the intuitive notion of length of a branch in the tree.

Poisson point processes on epigraphs. Assume as above that f is a continuous excursion-type function with $f(0) = 0$. We explain how to obtain a Poisson point process on the skeleton of $T(f)$ from a Poisson point process under the graph of f . First, define the *epigraph* of f , denoted by $\mathcal{EG}(f)$, as the set of points under the graph of f :

$$\mathcal{EG}(f) := \{(s, t) \in \mathbb{R}^2 : s \in (0, 1), 0 \leq t < f(s)\}.$$

To $u := (s, t) \in \mathcal{EG}(f)$, associate $g(f, u) := \sup\{s' \leq s, f(s') < t\}$ and $d(f, u) := \inf\{s' \geq s, f(s') < t\}$ (see Fig. 3.6). In particular, note that one can associate to each $u \in \mathcal{EG}(f)$ the chord $[e^{-2i\pi g(f,u)}, e^{-2i\pi d(f,u)}]$, and that for two different points of $\mathcal{EG}(f)$, the associated chords are either equal or disjoint.

We now consider a Poisson point process $\mathcal{N}(f)$ on $\mathbb{R}^2 \times \mathbb{R}_+$, with intensity

$$\frac{2}{d(f, u) - g(f, u)} \mathbb{1}_{u \in \mathcal{EG}(f)} du dr,$$

thinking of the second coordinate as time. Using $\mathcal{N}(f)$, for every $c \geq 0$, we shall now define $\mathcal{N}_c(f)$, $\mathcal{P}_c(T(f))$, $\mathbb{L}_c(f)$ (see Fig. 3.5 and 3.6).

Definition of $\mathcal{N}_c(f)$. For $c \geq 0$, let $\mathcal{N}_c(f)$ be the projection on the first coordinate of $\mathcal{N}(f) \cap (\mathbb{R}^2 \times [0, c])$. Roughly speaking, $\mathcal{N}_c(f)$ is the set of all points that have appeared before or at time c . Therefore $\mathcal{N}_c(f)$ is a Poisson point process on $\mathcal{EG}(f)$ of intensity $\frac{2c}{d(f,u)-g(f,u)} \mathbb{1}_{u \in \mathcal{EG}(f)} du$. Moreover, the processes $(\mathcal{N}_c(f))_{c \geq 0}$ are coupled in a nondecreasing way.

Definition of $\mathcal{P}_c(T(f))$. To $u \in \mathcal{N}_c(f)$, associate the vertex $x_u \in T(f)$, which is the equivalence class of $g(f, u)$ in $T(f)$ for \sim_f (see Fig. 3.5). Then $\mathcal{P}_c(T(f)) := \{x_u, u \in \mathcal{N}_c(f)\}$ is a Poisson point process on $T(f)$ of intensity $cd\ell$. It can be checked that there are only countably many branching points in $T(f)$, and therefore almost surely all points of $\mathcal{P}_c(T(f))$ are points of the skeleton of $T(f)$. Furthermore, by construction, the process $(\mathcal{P}_c(T(f)))_{c \geq 0}$ is nondecreasing for inclusion.

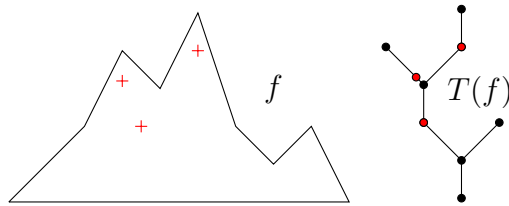

Figure 3.5: A continuous excursion-type function f with three points in its epigraph, which correspond to three points in its associated tree $T(f)$.

Definition of $\mathbb{L}_c(f)$. Finally, associate to $\mathcal{N}_c(f)$ the lamination $\mathbb{L}_c(f)$ as follows: $\mathbb{L}_c(f)$ is a sublamination of $\mathbb{L}(f)$, constructed by drawing only the chords that correspond to the points of $\mathcal{N}_c(f)$. More precisely,

$$\mathbb{L}_c(f) := \mathbb{S}^1 \cup \bigcup_{u \in \mathcal{N}_c(f)} [e^{-2i\pi g(f,u)}, e^{-2i\pi d(f,u)}].$$

Define finally

$$\mathbb{L}_\infty(f) := \overline{\bigcup_{c \geq 0} \mathbb{L}_c(f)}.$$

Observe that, since f is continuous, $\mathbb{L}_\infty(f)$ is exactly $\mathbb{L}(f)$ as defined in Section 3.1.1.

The next proposition highlights a relation between the mass sequence of $\mathbb{L}_c(f)$ and the mass measure on the tree $T(f)$. For f a continuous excursion-type function on $[0, 1]$ with $f(0) = 0$ and $c \geq 0$ fixed, let $\mathbf{m}_c(f)$ be the sequence of h -masses of the connected components of $T(f)$ delimited by the points of $\mathcal{P}_c(T(f))$, sorted in nondecreasing order.

Proposition 3.2.1. *Let f be a continuous excursion-type function on $[0, 1]$ with $f(0) = 0$. Then the following equality holds almost surely in Δ :*

$$(\mathcal{M}[\mathbb{L}_c(f)])_{c \geq 0} = (\mathbf{m}_c(f))_{c \geq 0}.$$

Proof. Fix $c > 0$. For any $u := (s, t) \in \mathcal{N}_c(f)$, draw $I_u(f) := [(g(f, u), t), (d(f, u), t)]$ the horizontal line in $\mathcal{EG}(f)$ containing u (see Fig. 3.6). As seen above, almost surely the corresponding vertex $x_u \in \mathcal{P}_c(T(f))$ is not a branching point, and therefore the line I_u separates the epigraph into exactly two connected components. Let $\ell_u(f) = d(f, u) - g(f, u)$ be the length of $I_u(f)$. The cutpoint of $\mathcal{P}_c(T(f))$ corresponding to u splits $T(f)$ into two connected components of h -masses $\ell_u(f)$ and $1 - \ell_u(f)$, by definition of h . On the other hand, the chord corresponding to u in $\mathbb{L}(f)$ splits the disk into two components of masses $\ell_u(f)$ and $1 - \ell_u(f)$. The result follows, since this holds jointly for all $c > 0$ and all $u \in \mathcal{N}_c(f)$. \square

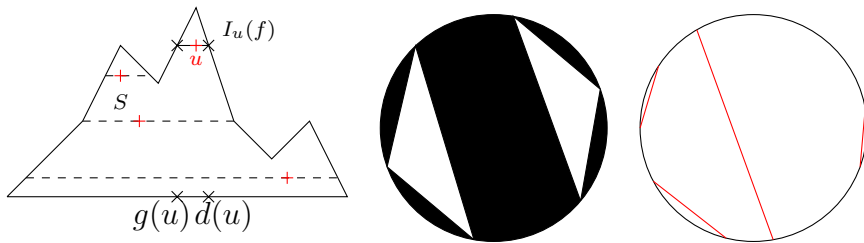

Figure 3.6: From left to right: a continuous excursion-type function f with four points on its epigraph and the five components of $\mathcal{EG}(f)$ delimited by these points; the lamination $\mathbb{L}(f)$ coded by f ; its sublamination formed by the chords associated to these four points.

We end this subsection by highlighting the nested structure of the lamination-valued process $(\mathbb{L}_c(f))_{c \geq 0}$.

Proposition 3.2.2. *Let f be a continuous excursion-type function such that $f(0) = 0$. Then:*

- (i) for every $0 \leq c \leq c'$, $\mathbb{L}_c(f) \subset \mathbb{L}_{c'}(f) \subset \mathbb{L}(f)$;
- (ii) the convergence $\lim_{c \rightarrow \infty} \mathbb{L}_c(f) = \mathbb{L}(f)$ holds almost surely for the Hausdorff distance.

The first assertion is straightforward by definition of $(\mathbb{L}_c(f))_{c \geq 0}$, while Proposition 3.2.2 (ii) is a consequence of the following deterministic lemma. The idea is to choose a finite subset of chords of $\mathbb{L}(f)$ which is close to the whole lamination $\mathbb{L}(f)$, and then prove that, as c grows, this finite subset of chords is well approximated by $\mathbb{L}_c(f)$. For $\varepsilon > 0$, we say that L' is an ε -sublamination of L if $L' \subset L$ and $d_H(L', L) \leq \varepsilon$.

Lemma 3.2.3. *Fix $\varepsilon > 0$. There exists a deterministic constant $K_\varepsilon \in \mathbb{Z}_+$ such that any lamination has an ε -sublamination with at most K_ε chords.*

Proof. Set $r := \lfloor 2\pi/\varepsilon \rfloor + 1$ and let I_r be the set of arcs of the form $(e^{-2i\pi k/r}, e^{-2i\pi(k+1)/r})$ for $k \in \llbracket 0, r-1 \rrbracket$. Fix a lamination L and notice that, for a_1, a_2 two arcs of I_r , two chords of L connecting a_1 to a_2 are at Hausdorff distance at most ε . Therefore, we construct an ε -sublamination of L by choosing, for each pair $(a_1, a_2) \in I_r^2$ such that L contains at least one chord connecting a_1 and a_2 , exactly one of them. By construction, the sublamination L' made of \mathbb{S}^1 and these chords is at Hausdorff distance at most ε from L . The result follows, with $K_\varepsilon = |I_r|^2 \leq (\lfloor 2\pi/\varepsilon \rfloor + 1)^2$. \square

Proof of Proposition 3.2.2 (ii). Fix $\varepsilon > 0$. Using Lemma 3.2.3, take L' an ε -sublamination of $\mathbb{L}(f)$ with at most K_ε chords, and consider the points in $\mathcal{EG}(f)$ corresponding to the chords of L' . Let u be one of these points and set $g := g(f, u)$, $d := d(f, u)$ to simplify notation. If $g = 0$ then the chord associated to u is reduced to a point of \mathbb{S}^1 , and therefore is in $\mathbb{L}_c(f)$ for all $c \geq 0$. If $g \neq 0$, set $m = \max(\inf_{[g-\varepsilon, g]} f, \inf_{[d, d+\varepsilon]} f)$. By definition of g and d , $f(g) = f(d)$ is not a local minimum of f at g nor at d , which implies $m < f(g)$. Therefore, $[g, d] \times [m, f(g)]$ has positive 2-dimensional Lebesgue measure. Moreover, a point of this set corresponds to a chord at distance at most $2\pi\varepsilon$ from the chord corresponding to u . Hence, with probability tending to 1 as $c \rightarrow \infty$, there exists a point of $\mathcal{N}_c(f)$ in this set. This means that $\mathbb{P}(d_H(\mathbb{L}_c(f), L') > 2\pi\varepsilon) \rightarrow 0$ as $c \rightarrow \infty$. In addition, since L' is an ε -sublamination of $\mathbb{L}(f)$, $d_H(L', \mathbb{L}(f)) < \varepsilon$. This concludes the proof by triangular inequality. \square

3.2.2 Construction of $(\mathbb{L}_c^{(\alpha)})_{c \in [0, +\infty]}$

Fix $\alpha \in (1, 2]$. We are now ready to introduce the lamination valued-process $(\mathbb{L}_c^{(\alpha)})_{c \in [0, +\infty]}$. To this end, denote by $H^{(\alpha)} = (H_t^{(\alpha)})_{0 \leq t \leq 1}$ the continuous normalized α -stable height process defined in [42, Chapter 1]. In particular, $H^{(\alpha)}$ is a continuous excursion-type function with $H_0^{(\alpha)} = 0$. In addition, for $\alpha = 2$, $H^{(2)}$ is (a multiple of) the Brownian excursion and $\mathcal{T}^{(2)} := T(H^{(2)})$ is Aldous' Brownian tree.

We now specify the definitions of Section 3.2.1 with the random excursion-type function $H^{(\alpha)}$, by letting $\mathcal{T}^{(\alpha)} := T(H^{(\alpha)})$ and $\mathbb{L}_\infty^{(\alpha)} := \mathbb{L}(H^{(\alpha)})$ be respectively the α -stable tree and the α -stable lamination. Finally, we set $(\mathbb{L}_c^{(\alpha)})_{c \geq 0} = (\mathbb{L}_c(H^{(\alpha)}))_{c \geq 0}$.

The proof of Theorem 3.1.1 is now just an application of Proposition 3.2.1 in this specific case.

Remark. *The lamination-valued process $(\mathbb{L}_c^{(\alpha)})_{c \in [0, +\infty]}$ is almost surely càdlàg. Indeed, the process is nondecreasing and therefore admits a limit from the left and from the right at each $c > 0$. Furthermore, for any $c \geq 0$, any $\varepsilon > 0$, one can check that almost surely there are only finitely many chords of length $> \varepsilon$ in $\mathbb{L}_{c+1}^{(\alpha)}$, and therefore there exists $\delta > 0$ such that no chord of length $> \varepsilon$ appears in the process between times c and $c + \delta$. Hence the process is right-continuous.*

3.2.3 A limit theorem for lamination-valued processes

We exhibit here a way of translating the convergence of a sequence of excursion-type functions to the convergence of the associated lamination-valued processes.

Theorem 3.2.4. *Let $(f_n)_{n \geq 1}$ be a sequence of continuous excursion-type functions such that $f_n(0) = 0$ for every $n \geq 1$. Assume that (f_n) converges uniformly to a continuous excursion-type function f such that $f(0) = 0$. Then, for every $c > 0$, the convergence*

$$(\mathbb{L}_s(f_n))_{s \in [0, c]} \xrightarrow[n \rightarrow \infty]{(d)} (\mathbb{L}_s(f))_{s \in [0, c]}$$

holds in distribution in the space $\mathbb{D}([0, c], \mathbb{L}(\overline{\mathbb{D}}))$.

In general, the convergence of Theorem 3.2.4 does not hold in $\mathbb{D}([0, \infty], \mathbb{L}(\overline{\mathbb{D}}))$. Nevertheless, it is the case when the functions f_n are the contour functions of certain trees (Theorem 3.3.3).

The idea of the proof is to focus on the emergence of large chords, and to prove that there exist only a finite number of them that appear up to time c . To this end, one reformulates the emergence of large chords in terms of the Poisson point processes $\mathcal{N}_c(f_n)$ and $\mathcal{N}_c(f)$.

Let us introduce some notation. For an integer $s \geq 1$ and $k \in \llbracket 0, s-1 \rrbracket$, we denote by x_k the arc of the form $(e^{-2i\pi k/s}, e^{-2i\pi(k+1)/s})$. We furthermore define, for any $K \geq 1$, $I_s^{(K)} := \{(x_{i_1}, \dots, x_{i_K}) \in I_s^K, i_1 \leq i_2 \leq \dots \leq i_K\}$. Fix $\varepsilon > 0$ and an integer $K \geq 1$. Take $A = (a_1, \dots, a_K) \in I_s^{(K)}$, $B = (b_1, \dots, b_K) \in I_s^{(K)}$, as well as $R = (r_1(i), r_2(i))_{1 \leq i \leq K} \subset ([0, c]^2)^K$ with $r_1(i) < r_2(i)$ for every $1 \leq i \leq K$.

Now, given a nondecreasing lamination-valued process $\mathfrak{L} := (L_r)_{r \in [0, +\infty]}$, we define the event $E_{A, B, R}^c(\mathfrak{L})$ as follows:

$E_{A, B, R}^c(\mathfrak{L})$: “ L_c has exactly K chords of length greater than ε , which can be indexed so that the i -th one connects the arcs a_i and b_i , and has appeared between times $r_1(i)$ and $r_2(i)$.”

To simplify notation, we set $\mathcal{L}(f_n) = (\mathbb{L}_r(f_n))_{r \in [0, c]}$ and $\mathcal{L}(f) = (\mathbb{L}_r(f))_{r \in [0, c]}$. The following result is the key ingredient to prove Theorem 3.2.4:

Proposition 3.2.5. *The following convergence holds:*

$$\mathbb{P}(E_{A, B, R}^c(\mathcal{L}(f_n))) \xrightarrow[n \rightarrow \infty]{} \mathbb{P}(E_{A, B, R}^c(\mathcal{L}(f))).$$

Let us immediately see how this implies our main result:

Proof of Theorem 3.2.4 from Proposition 3.2.5. Define the diameter of R as $\Delta(R) := \max\{r_2(i) - r_1(i), 1 \leq i \leq K\}$. The idea of the proof is the following observation: for $\mathfrak{L} := (L_r)_{r \in [0, \infty]}$, $\mathfrak{L}' := (L'_r)_{r \in [0, \infty]}$ two processes, if $E_{A, B, R}^c(\mathfrak{L})$ and $E_{A, B, R}^c(\mathfrak{L}')$ both hold, where R has diameter $\leq D$, then the Skorokhod distance between $(L_r)_{r \leq c}$ and $(L'_r)_{r \leq c}$ is deterministically bounded by a constant $C(K, \varepsilon, s, D)$, which tends to 0 as $\varepsilon, 1/s, D \rightarrow 0$. Also, for fixed K and R , for different pairs $(A, B) \in (I_s^{(K)})^2$, the events $E_{A, B, R}^c(\mathcal{L}(f_n))$ are all disjoint almost surely, and there exists only a finite number of events of this form (for ε, s, R fixed).

In order to use Proposition 3.2.5 and prove Theorem 3.2.4, it is therefore enough to show that the number of chords of length greater than ε in the lamination $\mathbb{L}_c(f_n)$ is tight as $n \rightarrow \infty$. For this, observe that, for any $\delta > 0$, the expectation of the number of chords in $\mathbb{L}_c(f_n)$ corresponding to points $u \in \mathcal{N}_c(f_n)$ such that $d(f_n, u) - g(f_n, u) > \delta$ has the expression:

$$\int_{\mathbb{R}^2} \frac{2c}{d(f_n, u) - g(f_n, u)} du \mathbb{1}_{d(f_n, u) - g(f_n, u) > \delta} \mathbb{1}_{u \in \mathcal{EG}(f_n)} \leq \frac{2c}{\delta} \|f_n\|_\infty.$$

Furthermore, a chord in $\mathbb{L}_c(f_n)$ of length greater than ε necessarily corresponds to a point $u \in \mathcal{N}_c(f_n)$ such that $d(f_n, u) - g(f_n, u) > \varepsilon/2\pi$. Since (f_n) converges uniformly, it follows that the number of chords in $\mathbb{L}_c(f_n)$ whose length is greater than ε is asymptotically stochastically bounded by a Poisson distribution. By taking $\varepsilon, 1/s, \Delta(R) \rightarrow 0$, we get the desired result. \square

It remains to prove Proposition 3.2.5.

Proof of Proposition 3.2.5. By inclusion-exclusion, we can assume that the pairs (a_i, b_i) for $1 \leq i \leq K$ are all different. The idea of the proof is to reformulate the events $E_{A,B,R}^c(\mathcal{L}(f_n))$ and $E_{A,B,R}^c(\mathcal{L}(f))$ in terms of the Poisson point processes $\mathcal{N}(f_n)$ on $\mathcal{EG}(f_n)$ and $\mathcal{N}(f)$ on $\mathcal{EG}(f)$. We write, for $1 \leq i \leq K$, $a_i = (e^{-2i\pi j_i/s}, e^{-2i\pi(j_i+1)/s})$ and $b_i = (e^{-2i\pi k_i/s}, e^{-2i\pi(k_i+1)/s})$ for some $j_i, k_i \in \llbracket 0, s-1 \rrbracket$. The probability that $\mathbb{L}_c(f)$ has exactly K chords of length greater than ε , the i -th of them connecting a_i to b_i and having appeared between times $r_1(i)$ and $r_2(i)$, is equal to

$$\mathbb{P}(\#u \in \mathcal{N}_c(f) \cap \mathcal{A}_{K+1}(f)) \prod_{i=1}^K \mathbb{P}(\exists! u \in (\mathcal{N}_{r_2(i)}(f) \setminus \mathcal{N}_{r_1(i)}(f)) \cap \mathcal{A}_i(f)),$$

where, for $1 \leq i \leq K$, we have set $\mathcal{A}_i(f) = \{u \in \mathcal{EG}(f), d(f, u) - g(f, u) > \varepsilon, g(f, u) \in [j_i/s, (j_i+1)/s], d(f, u) \in [k_i/s, (k_i+1)/s]\}$ and $\mathcal{A}_{K+1}(f) = \{u \in \mathcal{EG}(f), d(f, u) - g(f, u) > \varepsilon\} \setminus \cup_{i=1}^K \mathcal{A}_i(f)$. A similar formula holds with f replaced by f_n .

Therefore, proving Proposition 3.2.5 boils down to proving that, for any $(a, b, x, y) \in [0, 1]^4$, any $0 \leq r_1 < r_2$:

$$\begin{aligned} & \int_{\mathbb{R}} \mathbb{1}_{r_1 \leq t \leq r_2} dt \int_{\mathbb{R}^2} \frac{2c}{d(f_n, u) - g(f_n, u)} du \mathbb{1}_{d(f_n, u) - g(f_n, u) > \varepsilon, g(f_n, u) \in [a, b], d(f_n, u) \in [x, y]} \mathbb{1}_{u \in \mathcal{EG}(f_n)} \\ & \longrightarrow \int_{\mathbb{R}} \mathbb{1}_{r_1 \leq t \leq r_2} dt \int_{\mathbb{R}^2} \frac{2c}{d(f, u) - g(f, u)} du \mathbb{1}_{d(f, u) - g(f, u) > \varepsilon, g(f, u) \in [a, b], d(f, u) \in [x, y]} \mathbb{1}_{u \in \mathcal{EG}(f)} \end{aligned} \quad (3.2)$$

as $n \rightarrow \infty$. To this end, we use dominated convergence. Indeed, consider \mathcal{R} the set of points $u := (s, t) \in \mathbb{R}^2$ such that $f(g(f, u))$ is not attained at a local minimum of f between $g(f, u)$ and $d(f, u)$. Notice that the pointwise convergence of the function under the integral holds for all $u \in \mathcal{R}$, and its complement \mathcal{R}^c has Lebesgue measure 0. Furthermore, for every $n \geq 1$ and $u \in \mathcal{R}$,

$$\frac{2c}{d(f_n, u) - g(f_n, u)} \mathbb{1}_{d(f_n, u) - g(f_n, u) > \varepsilon, g(f_n, u) \in (a, b), d(f_n, u) \in (x, y)} \mathbb{1}_{u \in \mathcal{EG}(f_n)} \leq \frac{2c}{\varepsilon} \mathbb{1}_{u \in [0, 1] \times [0, \|f_n\|_\infty]},$$

and the convergence (3.2) follows by dominated convergence, since (f_n) converges uniformly to f . \square

Remark. We make here a small abuse of terminology, saying that we prove the convergence of these lamination-valued processes towards $(\mathbb{L}_r(f))_{0 \leq r \leq c}$ under the condition that there are K chords of length $> \varepsilon$ in $\mathbb{L}_c(f_n)$. This has to be understood as follows: on the event that $\mathbb{L}_c(f)$ has K such chords, with high probability $\mathbb{L}_c(f_n)$ has exactly K such chords for n large enough, and $(\mathbb{L}_r(f_n))_{0 \leq r \leq c}$ converges towards $(\mathbb{L}_r(f))_{0 \leq r \leq c}$ conditioned to have K such chords. Since $\mathbb{L}_c(f)$ has almost surely a finite number of chords of length $> \varepsilon$, this implies the convergence of the unconditioned processes. We will always make this abuse of terminology, by saying that we prove such convergences on disjoint events, whose union has probability 1.

3.3 Limit of cut processes on discrete trees

In this section, our goal is to prove that the lamination-valued process $(\mathbb{L}_c^{(\alpha)})_{c \in [0, +\infty]}$ is the functional limit of a discrete analogue, namely a discrete lamination-valued process constructed from labelled size-conditioned Galton–Watson trees. This is natural since stable trees appear as limits of certain size-conditioned Galton–Watson trees (see Theorem 3.3.2) and since $(\mathbb{L}_c^{(\alpha)})_{c \in [0, +\infty]}$ is coded by an α -stable tree with some additional structure (the Poisson point process $(\mathcal{P}_c(\mathcal{T}^{(\alpha)}))_{c \geq 0}$ on its skeleton).

Notation of Section 3.3

μ	critical law in the domain of attraction of an α -stable law
\mathcal{T}	nonconditioned μ -Galton–Watson tree
\mathcal{T}_n	μ -Galton–Watson tree conditioned to have n vertices
$C(\mathcal{T}_n)$	contour function of \mathcal{T}_n
$\tilde{C}(\mathcal{T}_n)$	renormalized contour function of \mathcal{T}_n
$\mathbb{L}_{n,c}$	$\mathbb{L}_c(\tilde{C}(\mathcal{T}_n))$

3.3.1 Background on trees

We first define *plane trees*, following Neveu’s formalism [87]. First, let $\mathbb{N}^* = \{1, 2, \dots\}$ be the set of all positive integers, and $\mathcal{U} = \cup_{n \geq 0} (\mathbb{N}^*)^n$ be the set of finite sequences of positive integers, with $(\mathbb{N}^*)^0 = \{\emptyset\}$ by convention.

By a slight abuse of notation, for $k \in \mathbb{Z}_+$, we write an element u of $(\mathbb{N}^*)^k$ by $u = u_1 \cdots u_k$, with $u_1, \dots, u_k \in \mathbb{N}^*$. For $k \in \mathbb{Z}_+$, $u = u_1 \cdots u_k \in (\mathbb{N}^*)^k$ and $i \in \mathbb{Z}_+$, we denote by ui the element $u_1 \cdots u_k i \in (\mathbb{N}^*)^{k+1}$. A plane tree T is formally a subset of \mathcal{U} satisfying the following three conditions:

- (i) $\emptyset \in T$ (the tree has a root);
- (ii) if $u = u_1 \cdots u_n \in T$, then, for all $k \leq n$, $u_1 \cdots u_k \in T$ (these elements are called ancestors of u , and the set of all ancestors of u is called its ancestral line; $u_1 \cdots u_{n-1}$ is called the *parent* of u);
- (iii) for any $u \in T$, there exists a nonnegative integer $k_u(T)$ such that, for every $i \in \mathbb{N}^*$, $ui \in T$ if and only if $1 \leq i \leq k_u(T)$ ($k_u(T)$ is called the number of children of u , or the outdegree of u).

See an example of a plane tree on Fig. 3.7, left. The elements of T are called *vertices*, and we denote by $|T|$ the total number of vertices in T . The height $h(u)$ of a vertex u is its

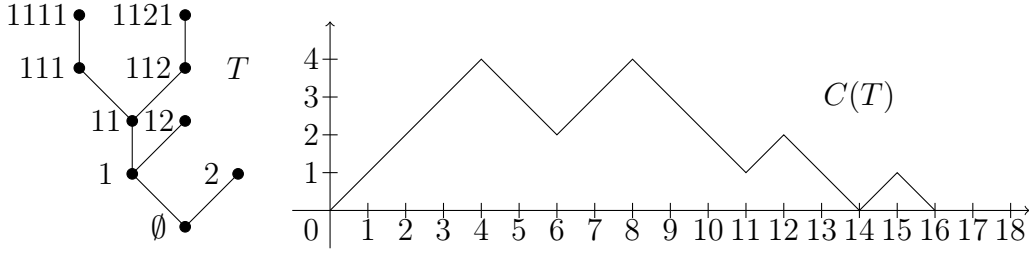

Figure 3.7: A tree T with 9 vertices labelled à la Neveu, and its contour function $(C_t(T))_{0 \leq t \leq 18}$.

distance from the root, that is, the integer k such that $u \in (\mathbb{N}^*)^k$. We define the height of a tree T as $H(T) = \sup_{u \in T} h(u)$. In the sequel, by tree we always mean plane tree unless specifically mentioned.

The *lexicographical order* \prec on \mathcal{U} is defined as follows: $\emptyset \prec u$ for all $u \in \mathcal{U} \setminus \{\emptyset\}$, and for $u, w \neq \emptyset$, if $u = u_1 u'$ and $w = w_1 w'$ with $u_1, w_1 \in \mathbb{N}^*$, then we write $u \prec w$ if and only if $u_1 < w_1$, or $u_1 = w_1$ and $u' \prec w'$. The lexicographical order on the vertices of a tree T is the restriction of the lexicographical order on \mathcal{U} ; for every $0 \leq k \leq |T| - 1$ we write $v_k(T)$ for the $(k + 1)$ -th vertex of T in the lexicographical order.

We do not distinguish between a finite tree T , and the corresponding planar graph where each vertex is connected to its parent by an edge of length 1, in such a way that the vertices with same height are sorted from left to right in lexicographical order.

It is useful to define the contour function $C(T) : [0, 2n] \rightarrow \mathbb{R}_+$ of a finite plane tree T with n vertices: imagine a particle exploring T from left to right at unit speed. Then, for $0 \leq t \leq 2n - 2$, $C_t(T)$ is the distance from the root of the particle at time t . For convenience, we set $C_t(T) = 0$ for $2n - 2 \leq t \leq 2n$. See Fig. 3.7 for an example.

Slowly varying functions Slowly varying functions appear in the study of the domain of attraction of α -stable laws (for $\alpha \in (1, 2]$). We recall here their definition and useful properties.

A function $L : \mathbb{R}_+ \rightarrow \mathbb{R}_+^*$ is said to be slowly varying if, for any $c > 0$,

$$\frac{L(cx)}{L(x)} \xrightarrow{x \rightarrow \infty} 1.$$

As their name says, such functions vary slowly, and in particular more slowly than any polynomial. This statement is quantified by the following useful Potter bounds (see e.g. [26, Theorem 1.5.6] for a proof):

Theorem 3.3.1 (Potter bounds). *Let $L : \mathbb{R}_+ \rightarrow \mathbb{R}_+^*$ be a slowly varying function. Then, for any $\varepsilon > 0$, $A > 0$, there exists $X > 0$ such that, for $x, y \geq X$,*

$$\frac{L(y)}{L(x)} \leq A \max \left\{ \left(\frac{y}{x} \right)^\varepsilon, \left(\frac{x}{y} \right)^\varepsilon \right\}.$$

Galton–Watson trees Let μ be a probability distribution on \mathbb{Z}_+ with mean at most 1, such that $\mu_0 + \mu_1 < 1$ (this assumption is made to avoid degenerate cases). A μ -Galton-Watson tree (in short, μ -GW tree) is a random variable \mathcal{T} on the space of finite trees such that, for any finite tree T , $\mathbb{P}(\mathcal{T} = T) = \prod_{v \in T} \mu_{k_v(T)}$. μ is then said to be the *offspring distribution* of \mathcal{T} .

In what follows, \mathcal{T}_n will stand for \mathcal{T} conditioned to have exactly n vertices (provided that it holds with positive probability).

In the whole paper, we mostly focus on distributions μ that are critical - that is, with mean 1 - and in the domain of attraction of a stable law - that is, there exists a slowly varying function L such that, if X is a random variable of law μ , then the following statement holds:

$$\mathbb{E} [X^2 \mathbf{1}_{X \leq x}] \underset{x \rightarrow +\infty}{\sim} x^{2-\alpha} L(x) + 1. \quad (3.3)$$

In what follows, when μ is a given distribution that is in the domain of attraction of a stable law, $(B_n)_{n \in \mathbb{Z}_+}$ will always denote a sequence verifying

$$\forall n \geq 1, \frac{nL(B_n)}{B_n^\alpha} = \frac{\alpha(\alpha - 1)}{\Gamma(3 - \alpha)}. \quad (3.4)$$

where L is a slowly varying function which verifies (3.3). Furthermore, we define the renormalized contour function of \mathcal{T}_n as

$$\tilde{C}_t(\mathcal{T}_n) := \frac{B_n}{n} C_{2nt}(\mathcal{T}_n)$$

for all $t \in [0, 1]$.

The following useful theorem, due to Duquesne [40], relates the contour function of \mathcal{T}_n to the process $H^{(\alpha)}$ and is a cornerstone of the paper.

Theorem 3.3.2. *Let $\alpha \in (1, 2]$, μ be a critical distribution in the domain of attraction of an α -stable law and $(B_n)_{n \in \mathbb{Z}_+}$ a sequence verifying (3.4). Then the following convergence holds in distribution in $\mathbb{D}([0, 1], \mathbb{R})$:*

$$\tilde{C}(\mathcal{T}_n) \underset{n \rightarrow \infty}{\xrightarrow{(d)}} H^{(\alpha)}.$$

3.3.2 Convergence of the discrete cut processes in the case of contour functions

We now translate the convergence obtained in Theorem 3.3.2 into the convergence of the associated lamination-valued processes. In this subsection, to avoid heavy notation, $\mathbb{L}_{n, +\infty}$ stands for $\mathbb{L}(\tilde{C}(\mathcal{T}_n))$ and $\mathbb{L}_{n, c}$ for $\mathbb{L}_c(\tilde{C}(\mathcal{T}_n))$. Our goal is to prove the following convergence:

Theorem 3.3.3. *Jointly with the convergence of Theorem 3.3.2, the following convergence holds in distribution:*

$$(\mathbb{L}_{n, c})_{c \in [0, +\infty]} \underset{n \rightarrow \infty}{\xrightarrow{(d)}} (\mathbb{L}_c^{(\alpha)})_{c \in [0, +\infty]}$$

Note that Theorem 3.2.4 already provides a proof of the convergence of these discrete lamination-valued processes, stopped at a finite time $c < \infty$. Hence, we have here to study what happens at $+\infty$. To this end, we rely on the following lemma, which investigates the local structure of \mathcal{T}_n . In what follows, we say that $x \in \mathcal{T}_n$ is an a -node for $a \geq 0$ if the set of its children can be partitioned into two subsets $A_1(x), A_2(x)$ such that $\sum_{u \in A_1(x)} |\theta_u(\mathcal{T}_n)| \geq a$, $\sum_{u \in A_2(x)} |\theta_u(\mathcal{T}_n)| \geq a$, where $\theta_u(T)$ denotes the subtree of a tree T rooted at the vertex u .

Lemma 3.3.4. *Let $\alpha \in (1, 2]$ and let \mathcal{T}_n be a μ -GW tree conditioned to have n vertices, where μ is in the domain of attraction of an α -stable law. Let $f(n) = o(n/B_n)$, where B_n verifies (3.4). Then, with high probability, no two different εn -nodes of \mathcal{T}_n are at distance $\leq f(n)$ from each other.*

Let us immediately see how this implies Theorem 3.3.3.

Proof of Theorem 3.3.3. We give the main ideas of the proof of this theorem. Assume by Skorokhod's theorem that Theorem 3.3.2 holds almost surely. By Theorem 3.2.4, the only thing that we have to prove is that, almost surely,

$$\mathbb{L}_\infty^{(\alpha)} = \lim_{n \rightarrow \infty} \mathbb{L}_{n,+\infty}. \quad (3.5)$$

First, it is clear that $\mathbb{L}_\infty^{(\alpha)} \subset \lim_{n \rightarrow \infty} \mathbb{L}_{n,+\infty}$. Indeed, by Theorem 3.2.4 and Proposition 3.2.2

(ii) applied to $(\mathbb{L}_c^{(\alpha)})_{c \in [0, \infty]}$, for any $\varepsilon > 0$ there exists $c(\varepsilon)$ such that, with high probability as $n \rightarrow \infty$, $d_H(\mathbb{L}_{n, c(\varepsilon)}, \mathbb{L}_\infty^{(\alpha)}) \leq \varepsilon$.

We now have to prove the reverse inclusion, that is, $\lim_{n \rightarrow \infty} \mathbb{L}_{n,+\infty} \subset \mathbb{L}_\infty^{(\alpha)}$. For this, take a chord of $(\lim_{n \rightarrow \infty} \mathbb{L}_{n,+\infty}) \setminus \mathbb{L}_\infty^{(\alpha)}$, of length larger than ε . This chord has to be drawn inside a face F of $\mathbb{L}_\infty^{(\alpha)}$. In the discrete setting, this corresponds to the existence of $\varepsilon > 0$ such that, for n large enough, there exists x in \mathcal{T}_n which is an εn -node, and one of its ancestors y which is an εn -node as well, satisfying $d(x, y) = o(n/B_n)$. The extra chord would correspond in this case to the vertex x , and y would be coded by the chord in the boundary of F separating F from the root. By Lemma 3.3.4, with high probability this does not happen. The result follows. \square

Proof of Lemma 3.3.4. The main idea of the proof is to use the independence between disjoint subtrees of the Galton-Watson tree \mathcal{T}_n , conditionally on their sizes. Define $J_{\varepsilon, n}$ the following event:

$J_{\varepsilon, n}$: "there exist $x, y \in \mathcal{T}_n$ both εn -nodes, such that x is an ancestor of y and $d(x, y) \leq f(n)$ ". We will prove that, for any $\varepsilon > 0$, $\mathbb{P}(J_{\varepsilon, n}) \rightarrow 0$ as $n \rightarrow \infty$. Note that we impose here that x is an ancestor of y . In order to get rid of this, observe that, if two different εn -nodes x, y in \mathcal{T}_n are at distance less than $f(n)$, then their common ancestor is still an εn -node at distance less than $f(n)$ from any of them, and $J_{\varepsilon, n}$ holds.

In what follows, X and U denote two i.i.d. uniform variables on the set of vertices of \mathcal{T}_n , and $F_a(\mathcal{T}_n)$ denotes the set of a -nodes in \mathcal{T}_n . Finally, $K_x(\mathcal{T}_n)$ denotes the set of children of x in \mathcal{T}_n .

Observe that we have the inequality

$$\begin{aligned} \mathbb{P}(J_{\varepsilon, n}) &\leq \mathbb{E} \left[\sum_{x \in \mathcal{T}_n} \mathbb{1}[x \in F_{\varepsilon n}(\mathcal{T}_n)] \sum_{u \in K_x(\mathcal{T}_n)} \mathbb{1}[|\theta_u(\mathcal{T}_n)| \geq \varepsilon n] \right. \\ &\quad \left. \times \mathbb{1}[\exists y \in \theta_u(\mathcal{T}_n) \cap F_{\varepsilon n}(\mathcal{T}_n), d(x, y) \leq f(n)] \right] \\ &= n^2 \mathbb{E} \left[\mathbb{1}[X \in F_{\varepsilon n}(\mathcal{T}_n)] \mathbb{1}[U \in K_X(\mathcal{T}_n), |\theta_U(\mathcal{T}_n)| \geq \varepsilon n] \right. \\ &\quad \left. \times \mathbb{1}[\exists y \in \theta_U(\mathcal{T}_n) \cap F_{\varepsilon n}(\mathcal{T}_n), d(X, y) \leq f(n)] \right] \\ &= n^2 \mathbb{P}(X \in F_{\varepsilon n}(\mathcal{T}_n), U \in K_X(\mathcal{T}_n), |\theta_U(\mathcal{T}_n)| \geq \varepsilon n) \times \\ &\quad \mathbb{P}(\exists y \in \theta_U(\mathcal{T}_n) \cap F_{\varepsilon n}(\mathcal{T}_n), d(X, y) \leq f(n) | X \in F_{\varepsilon n}(\mathcal{T}_n), U \in K_X(\mathcal{T}_n), |\theta_U(\mathcal{T}_n)| \geq \varepsilon n) \end{aligned}$$

The first probability is bounded from above by $(\varepsilon n)^{-2}$. Indeed, in a tree of size n , there are at most $1/\varepsilon$ εn -nodes, and among the children of any vertex at most $1/\varepsilon$ are the root of a subtree of size larger than εn (note that these considerations are deterministic). On the other hand, notice that the second probability is bounded from above by

$$\sup_{A \geq \varepsilon n} \mathbb{P}(\exists y \in \theta_U(\mathcal{T}_n) \cap F_{\varepsilon n}(\mathcal{T}_n), d(X, y) \leq f(n) | X \in F_{\varepsilon n}(\mathcal{T}_n), U \in K_X(\mathcal{T}_n), |\theta_U(\mathcal{T}_n)| = A)$$

which, since we condition U to be a child of X , is equal to

$$\sup_{A \geq \varepsilon n} \mathbb{P}(\exists y \in \theta_U(\mathcal{T}_n) \cap F_{\varepsilon n}(\mathcal{T}_n), d(U, y) \leq f(n) - 1 \mid X \in F_{\varepsilon n}(\mathcal{T}_n), U \in K_X(\mathcal{T}_n), |\theta_U(\mathcal{T}_n)| = A).$$

This way we get rid of one dependency in X . Then, by usual independence properties of Galton-Watson trees, we obtain

$$\begin{aligned} \mathbb{P}(J_{\varepsilon, n}) &\leq \varepsilon^{-2} \sup_{A \geq \varepsilon n} \mathbb{P}(\exists y \in \theta_U(\mathcal{T}_n) \cap F_{\varepsilon n}(\mathcal{T}_n), d(U, y) \leq f(n) - 1 \mid |\theta_U(\mathcal{T}_n)| = A) \\ &= \varepsilon^{-2} \sup_{A \geq \varepsilon n} \mathbb{P}(\exists y \in F_{\varepsilon n}(\mathcal{T}_A), d(\emptyset, y) \leq f(n) - 1) \end{aligned}$$

where \mathcal{T}_A is a μ -GW tree with A vertices, and \emptyset denotes its root. But, by Theorem 3.3.2, $\sup_{A \geq \varepsilon n} \mathbb{P}(\exists y \in F_{\varepsilon n}(\mathcal{T}_A), d(\emptyset, y) \leq f(n) - 1) \rightarrow 0$ as $n \rightarrow \infty$, using the assumption that $f(n) = o(n/B_n)$. Finally, this leads to:

$$\mathbb{P}(J_{\varepsilon, n}) \xrightarrow[n \rightarrow \infty]{} 0.$$

The result follows. \square

3.4 Application to minimal factorizations of the cycle

In this section, we consider an application of Theorem 3.3.3 to typical minimal factorizations of the n -cycle and prove Theorem 3.1.2. We start by defining the so-called Goulden-Yong bijection, which maps minimal factorizations to trees. Then we conclude the proof of Theorem 3.1.2, by studying new laminations obtained from discrete trees by only marking its vertices.

Notation of Section 3.4

F	minimal factorization of the cycle
$\mathcal{C}(F)$	chord configuration associated to F
$T(F)$	dual tree of $\mathcal{C}(F)$
\tilde{T}	canonical embedding of a labelled non-plane tree T
$t^{(n)}$	uniform minimal factorization of the n -cycle
$\mathcal{L}_c^{(n)}$	$\mathcal{C}(t^{(n)})$ restricted to the first $\lfloor c\sqrt{n} \rfloor$ transpositions of $t^{(n)}$.
$\mathbb{L}(T)$	lamination obtained from a tree T by drawing chords only at the level of vertices.
$\mathbb{L}_u(T)$	sublamination of $\mathbb{L}(T)$ corresponding to the first $\lfloor u \rfloor$ vertices of a labelled tree T

3.4.1 Minimal factorizations

We start by a study of the class of minimal factorizations: recall that \mathfrak{M}_n is the set of minimal factorizations of the n -cycle, namely

$$\mathfrak{M}_n := \{(t_1, \dots, t_{n-1}) \in \mathfrak{T}_n^{n-1}, t_1 \dots t_{n-1} = (1 \dots n)\}.$$

Recall that, by convention, we apply the transpositions from the left to the right, in the sense that the notation $t_1 t_2$ corresponds to $t_2 \circ t_1$.

Féray and Kortchemski are interested in the properties of a uniform element of \mathfrak{M}_n (see [45, 46]), which we will denote by $t^{(n)} := (t_1^{(n)}, \dots, t_{n-1}^{(n)})$. The starting point of [45], taken from [49], is a geometric coding of $t^{(n)}$ by a random lamination-valued process $(\mathcal{L}_c^{(n)})_{c \in [0, +\infty]}$: to a transposition (ab) with $a, b \in \llbracket 1, n \rrbracket$, they associate the chord $[e^{-2i\pi a/n}, e^{-2i\pi b/n}]$ and, for $c \geq 0$ fixed, they define the random lamination $\mathcal{L}_c^{(n)}$ as the union of the unit circle and the chords associated to the first $\lfloor c\sqrt{n} \rfloor$ transpositions of $t^{(n)}$: $t_1^{(n)}, \dots, t_{\lfloor c\sqrt{n} \rfloor}^{(n)}$ (taking all chords if $c\sqrt{n} \geq n-1$). We furthermore denote by $\mathcal{L}_\infty^{(n)}$ the union of the unit disk and all the $(n-1)$ chords associated to the factors of $t^{(n)}$. It turns out that these laminations are closely related to the laminations $(\mathbb{L}_c^{(2)})_{c \in [0, +\infty]}$.

Féray and Kortchemski prove the following 1-dimensional convergence, at c fixed:

Theorem 3.4.1 (Féray & Kortchemski [45]). *Fix $c \in \mathbb{R}_+ \cup \{+\infty\}$. There exists a lamination \mathcal{L}_c such that in distribution, for the Hausdorff distance,*

$$\mathcal{L}_c^{(n)} \xrightarrow[n \rightarrow \infty]{(d)} \mathcal{L}_c.$$

We extend this result and get the functional convergence of the lamination-valued process, which was left open in [45], proving in addition that $(\mathcal{L}_c)_{0 \leq c \leq \infty} = (\mathbb{L}_c^{(2)})_{0 \leq c \leq \infty}$ in distribution (Theorem 3.1.2). Let us briefly explain the structure of the proof of Theorem 3.1.2. It is based on two ingredients. The first one is the so-called Goulden-Yong bijection (presented in Section 3.4.2), which yields an explicit bijection between \mathfrak{M}_n and a subset of plane trees with n labelled vertices. The labellings have constraints, namely, the root is the vertex with label 1 and the labels of a vertex and of its children are sorted in clockwise decreasing order (we call this condition (C_Δ) , see Fig. 1.9, middle-right for an example). The second one is the introduction of a discrete analogue of the construction given in Section 3.2, where one only marks vertices of the tree instead of all its points. This allows us to obtain in Section 3.4.3 an analogue of Theorem 3.3.3, where the lamination-valued processes are obtained from plane trees with a uniform labelling. In order to combine these two ingredients, we lift the constraints on the labellings which appear in the Goulden-Yong bijection by using a shuffling argument based on two operations, presented in Section 3.4.4.

3.4.2 The Goulden-Yong bijection

The Goulden-Yong bijection (see [49]) allows us to translate results on random trees into results on minimal factorizations. Let us first explain what this bijection consists in. See Fig. 3.8 for an example of this bijection on an element of \mathfrak{M}_9 .

Step 1 Let $F := (t_1, \dots, t_{n-1}) \in \mathfrak{M}_n$. For a factor $t_i := (a_i, b_i)$, draw a chord between $e^{-2i\pi a_i/n}$ and $e^{-2i\pi b_i/n}$, and give the label $(i+1)$ to this chord. Doing this for the $(n-1)$ transpositions of F gives a compact subset $\mathcal{C}(F)$ of the disk, made of the unit circle and of $(n-1)$ chords labelled from 2 to n . It turns out (see [49, Theorem 2.2] for further details) that these chords do not intersect - except possibly at their endpoints - and form a tree. Furthermore, the labels of the chords that share an endpoint are sorted in increasing clockwise order around this endpoint (we call this condition (C_Δ) as well; see Fig. 3.8, top-left for an example). Note in particular that, forgetting about the labels, $\mathcal{C}(t^{(n)}) = \mathcal{L}_\infty^{(n)}$.

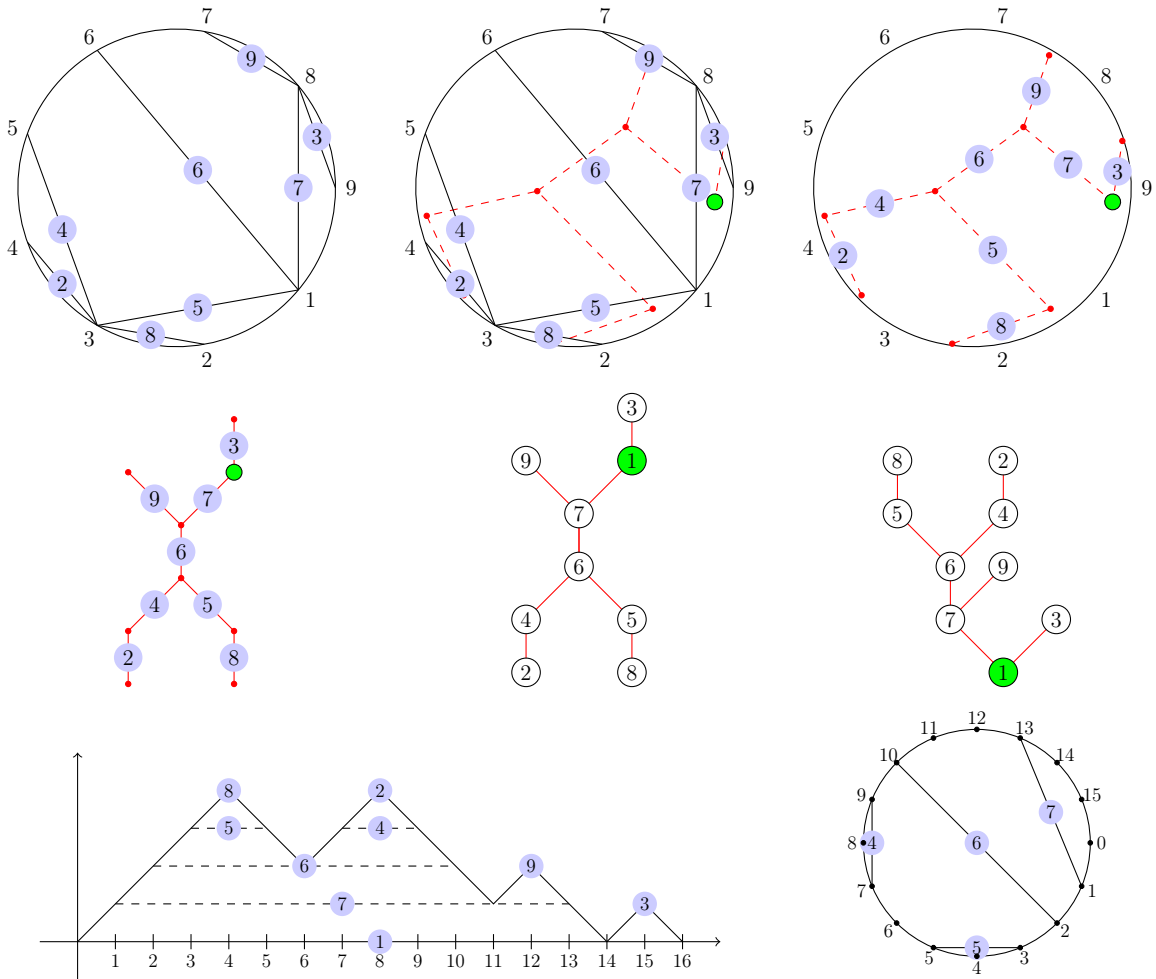

Figure 3.8: The Goulden-Young mapping, applied to $F := (34)(89)(35)(13)(16)(18)(23)(78) \in \mathfrak{M}_9$. Condition (C_Δ) is verified for the lamination $\mathcal{C}(F)$ (top-left) and the tree $\tilde{T}(F)$ (middle-right). At the bottom, the contour function of $\tilde{T}(F)$ and the lamination $\mathbb{L}(\tilde{T}(F))$, where a labelled chord corresponds to the vertex with the same label. We do not represent the chords of length 0 in order not to overload the picture.

Step 2 Now, draw the dual tree of $\mathcal{C}(F)$ the following way: put a dual vertex inside each connected component of the complement of $\mathcal{C}(F)$ in the unit disk, and put a dual edge between two dual vertices if the corresponding connected components share a primal chord as a border. Then, give the label 1 to the dual vertex whose connected component contains the points 1 and $e^{-2i\pi/n}$ (this dual vertex exists and is unique by [49, Proposition 2.3]). The set of dual edges then forms a tree, where each dual edge is given the label of the primal chord that it crosses. Finally, for each dual edge, find the unique path in this dual tree from this edge to the dual vertex 1 and "slide" the label of the edge to its endpoint further from 1. This finally provides a plane labelled tree which we denote by $\tilde{T}(F)$. It notably verifies condition (C_Δ) : its root is labelled 1, and, for any vertex of $\tilde{T}(F)$, its label and the labels of its children are sorted in decreasing clockwise order (see Fig. 3.8, middle-right). Furthermore, forgetting about the planar structure of $\tilde{T}(F)$, we obtain a non plane tree with n labelled vertices, which we denote by $T(F)$.

Denote by \mathfrak{U}_n the set of non plane trees with n vertices labelled from 1 to n . A complete proof of the following proposition can be found in [49]:

Proposition 3.4.2. *The Goulden-Yong map $F \rightarrow T(F)$ is a bijection between \mathfrak{M}_n and \mathfrak{U}_n .*

As a corollary, $F \rightarrow \tilde{T}(F)$ is a bijection between \mathfrak{M}_n and the set of plane trees with n labelled vertices verifying condition (C_Δ) .

3.4.3 A discrete lamination-valued process coded by a discrete tree

The construction of the process $(\mathbb{L}_c(f))_{c \in [0, \infty]}$ given in Section 3.2.1 is valid in particular when f is the (renormalized) contour function of a discrete tree. It consists in throwing points on the skeleton of these trees and then associating a chord to each of these cutpoints. Here, the lamination $\mathcal{C}(F)$ associated to a minimal factorization F is of a different type, since each of its chords corresponds to a *vertex* of the tree $\tilde{T}(F)$ (namely, the vertex which gets the label of the chord) and not a point thrown uniformly at random on its skeleton. Furthermore, these chords appear at integer times, and not at random times as in Section 3.2. Nevertheless, it happens that laminations of both types can be related to each other, as stated in Proposition 3.4.3 below: in view of future use, we explain how to associate a discrete lamination-valued process to a labelled plane tree, and show that, roughly speaking, this process is close to the one obtained from a Poisson point process under its contour function (in the sense of Section 3.2.1).

Fix a plane tree T with n vertices. For every vertex $u \in T$, denote by g_u (resp. d_u) the first time (resp. the last time) that the contour function of T visits u , and let $c_u(T) = [e^{-2i\pi g_u/2n}, e^{-2i\pi d_u/2n}]$ be the associated chord in $\overline{\mathbb{D}}$. We then set

$$\mathbb{L}(T) = \mathbb{S}^1 \cup \bigcup_{u \in T} c_u(T).$$

where the union is taken over the set of vertices of T . In particular, the set of chords of $\mathbb{L}(T)$ (which may have length 0) is in bijection with the set of vertices of T . Now, we construct a random discrete lamination-valued process $(\mathbb{L}_s(T))_{s \in [0, \infty]}$ as follows. Let U_1 be the root of T , and let U_2, \dots, U_n be a random uniform permutation of the other vertices of T . Then, for $s \geq 0$, set

$$\mathbb{L}_s(T) = \mathbb{S}^1 \cup \bigcup_{i=1}^{\min(\lfloor s \rfloor, n)} c_{U_i}(T),$$

which is roughly speaking the sublamination of $\mathbb{L}(T)$ obtained by drawing the chords associated to the “first” $\lfloor s \rfloor$ vertices of T .

Recall from Section 3.2.1 the notation $(\mathbb{L}_c(f))_{c \in [0, \infty]}$ for the lamination-valued process obtained from a Poisson point process in the epigraph of a continuous excursion-type function f . We denote by $(\mathbb{L}_c(C(T)))_{c \in [0, \infty]}$ the lamination-valued process obtained in this way by considering the time-scaled contour function of T on $[0, 1]$: $t \rightarrow C_{2|T|t}(T)$. Roughly speaking, $(\mathbb{L}_s(T))_{s \in [0, \infty]}$ is a discrete version of $(\mathbb{L}_c(C(T)))_{c \in [0, \infty]}$, where one only considers cuts on vertices. The following result shows that these two lamination-valued processes are close in a certain sense, after suitable time-changes, when applied to Galton-Watson trees.

Proposition 3.4.3. *Let μ be a critical distribution in the domain of attraction of an α -stable law, and \mathcal{T}_n a μ -GW tree with n vertices. Then there exists a coupling between $(\mathbb{L}_c(\tilde{C}(\mathcal{T}_n)))_{c \in [0, \infty]}$ and $(\mathbb{L}_s(\mathcal{T}_n))_{s \in [0, \infty]}$ such that, with high probability, as n tends to ∞ :*

$$d_{Sk} \left(\left(\mathbb{L}_c(\tilde{C}(\mathcal{T}_n)) \right)_{c \in [0, \infty]}, \left(\mathbb{L}_{cB_n}(\mathcal{T}_n) \right)_{c \in [0, \infty]} \right) = o(1).$$

where d_{Sk} denotes the Skorokhod J1 distance on $\mathbb{D}([0, \infty], \mathbb{L}(\overline{\mathbb{D}}))$ and the $o(1)$ does only depend on n and not on the (random) tree \mathcal{T}_n .

Observe that this result is stated and proved in much greater generality than what is actually needed for minimal factorizations, as its version in the stable case may be of independent interest.

Proof. The idea of the proof is to use concentration inequalities to show that, under a suitable coupling, chords appear roughly at the same time and place in both processes. To this end, we study the underlying point processes on the tree \mathcal{T}_n . For convenience, we use the notation $\mathbb{L}_{n,c}$ instead of $\mathbb{L}_c(\tilde{C}(\mathcal{T}_n))$. Let us first explain the proper coupling between these lamination-valued processes. To this end, define the process $(\tilde{\mathbb{L}}_{n,c})_{c \in [0, \infty]}$ as follows: observe that, taking the notation of Section 3.2.1, $T(\tilde{C}(\mathcal{T}_n)) = \mathcal{T}_n/B_n$. Therefore, by Section 3.2.1 again, $\mathbb{L}_{n,c}$ is obtained from a Poisson point process $\mathcal{P}_c(\mathcal{T}_n)$ on \mathcal{T}_n , of intensity $(cB_n/n)dl$. For any $c \geq 0$, to each point $u \in \mathcal{P}_c(\mathcal{T}_n)$, associate the vertex $p(u)$ of \mathcal{T}_n such that u is in the edge between the vertex $p(u)$ and its parent (if u is a vertex, say that $p(u) = u$). Denote by $\tilde{\mathcal{P}}_c(\mathcal{T}_n)$ the set of all vertices of \mathcal{T}_n that are of the form $p(u)$ for some $u \in \mathcal{P}_c(\mathcal{T}_n)$, and denote finally by $\tilde{\mathbb{L}}_{n,c}$ the lamination obtained by drawing the chords corresponding to all points of $\tilde{\mathcal{P}}_c(\mathcal{T}_n)$. It is clear that

$$d_{Sk} \left((\tilde{\mathbb{L}}_{n,c})_{0 \leq c \leq \infty}, (\mathbb{L}_{n,c})_{0 \leq c \leq \infty} \right) \leq \frac{2\pi}{n}, \quad (3.6)$$

which tends to 0 as n grows. Hence we only have to find a proper coupling between the processes $(\tilde{\mathbb{L}}_{n,c})$ and $(\mathbb{L}_{cB_n}(\mathcal{T}_n))$.

To this end, let us precisely compare the times at which points appear in the processes $\mathcal{P}(\mathcal{T}_n)$ and $\tilde{\mathcal{P}}(\mathcal{T}_n)$. Since \mathcal{T}_n has finite length measure $n - 1$, almost surely no two points appear at the same time in the process $(\tilde{\mathcal{P}}_c(\mathcal{T}_n))_{c \geq 0}$. Therefore, this process induces an order on the set of non-root vertices of \mathcal{T}_n , according to the first time that they appear in the process. For $x \geq 0$, denote by $\tau(x)$ the minimum $c \geq 0$ such that $|\tilde{\mathcal{P}}_c(\mathcal{T}_n)| \geq x$. The order of arrival of the vertices of \mathcal{T}_n in $(\tilde{\mathcal{P}}_c(\mathcal{T}_n))_{c \geq 0}$ is uniform among all possible permutations of the non-root vertices, which induces a coupling between $(\tilde{\mathbb{L}}_{n,c})_{0 \leq c \leq \infty}$ and $(\mathbb{L}_{cB_n}(\mathcal{T}_n))_{0 \leq c \leq \infty}$ such that, for all $c \geq 0$,

$$\mathbb{L}_{cB_n}(\mathcal{T}_n) = \tilde{\mathbb{L}}_{n, \tau(cB_n)}.$$

Specifically, a chord appears at time k in $(\mathbb{L}_u(\mathcal{T}_n))_{u \geq 0}$ if it is the chord associated to the k -th vertex of \mathcal{T}_n to get a point of $\mathcal{P}(\mathcal{T}_n)$ on the edge between it and its parent.

Now we have to prove that these coupled processes $(\tilde{\mathbb{L}}_{n,c})$ and $(\mathbb{L}_{cB_n}(\mathcal{T}_n))$ are close. We first prove that they are close up to a time $c = f(n) := n^{1/2-1/2\alpha}$, and then show that both processes do not change much after this time, as they are already close to their final value.

To prove that they are close up to time $f(n)$, by classical properties of the J1 Skorokhod topology (see [53, VI, Theorem 1.14]), the only thing that we need to show is that the points roughly appear at the same time in both processes. More precisely, uniformly for $c \leq f(n)$,

$$|\tau(cB_n) - c| = o(1) \quad (3.7)$$

with high probability. We prove this result later in this paragraph. Then, assuming that (3.7) holds, we claim that the processes stay close after time $f(n)$. The idea is to use the convergence of the discrete lamination-valued process to $(\mathbb{L}_c^{(\alpha)})_{c \in [0, \infty]}$. Assume by Skorokhod's theorem that the convergence of Theorem 3.3.2 holds almost surely. Then, for $k \geq 1$, let $c_k > 0$ be such that $d_H(\mathbb{L}_{c_k}^{(\alpha)}, \mathbb{L}_\infty^{(\alpha)}) < 1/k$ with probability greater than $1 - 2^{-k}$. Such a c_k exists by Proposition 3.2.2 (ii). Then, putting together Theorem 3.3.3, (3.6) and (3.7), there

exists M_k verifying $M_k^{1/2-1/2\alpha} \geq c_k$ such that, for any $n \geq M_k$, $d_H(\mathbb{L}_{c_k B_n}(\mathcal{T}_n), \mathbb{L}_{c_k}^{(\alpha)}) < 1/k$ with probability greater than $1 - 2^{-k}$. Hence, for any subsequence $(n_k)_{k \geq 1}$ such that, for all k , $n_k \geq M_k$, the following holds in almost surely:

$$\mathbb{L}_\infty^{(\alpha)} = \lim_{k \rightarrow \infty} \mathbb{L}_{c_k B_{n_k}}(\mathcal{T}_{n_k}) \subset \lim_{k \rightarrow \infty} \mathbb{L}_{f(n_k) B_{n_k}}(\mathcal{T}_{n_k}).$$

The reverse inclusion is clear by Theorem 3.3.3. This implies that $d_H(\mathbb{L}_{f(n) B_n}(\mathcal{T}_n), \mathbb{L}_\infty^{(\alpha)})$ converges to 0 almost surely. Therefore,

$$d_H(\mathbb{L}_{f(n) B_n}(\mathcal{T}_n), \mathbb{L}_\infty(\mathcal{T}_n)) \xrightarrow{\mathbb{P}} 0.$$

Since, for any $c \geq 0$, $\mathbb{L}_{c B_n}(\mathcal{T}_n)$ and $\tilde{\mathbb{L}}_{n,c}$ are included in $\mathbb{L}_\infty(\mathcal{T}_n)$, this implies Proposition 3.4.3.

Now we prove (3.7). First, note that the distribution of the sequence of variables $(\tau(u))_{u \geq 0}$ is independent of \mathcal{T}_n , and only depends on n . Thus, the study of these variables boils down to a coupon collector problem, where coupons are vertices of the tree. Set $g(n) := n^{1/8+5/8\alpha}$, so that $\sqrt{f(n)B_n} \ll g(n) \ll B_n$. In order to prove (3.7), we show two things:

(i) uniformly in $u \leq f(n)B_n$, with high probability $|\mathcal{P}_{\tau(u)}(\mathcal{T}_n)| \leq |\tilde{\mathcal{P}}_{\tau(u)}(\mathcal{T}_n)| + g(n)$. In other words, uniformly in $u \leq f(n)B_n$, we need to throw at most $u + g(n)$ points on the edges of \mathcal{T}_n before u different vertices appear in the process $(\tilde{\mathcal{P}}_c(\mathcal{T}_n))_{c \geq 0}$.

(ii) uniformly in $k \in \llbracket 0, f(n)B_n + g(n) \rrbracket$, $|\mathcal{P}_{k/B_n}(\mathcal{T}_n)| = k + o(B_n)$.

Roughly speaking, if (i) holds, then, since $g(n) = o(B_n)$, the number of points that appear in $\mathcal{P}(\mathcal{T}_n)$ on an edge where there was already an other point is negligible compared to B_n . Hence, if (ii) also holds, the $\lfloor cB_n \rfloor$ -th point appears at time $c + o(1)$, and (3.7) follows.

Proof of (i) By analogy with the coupon collector problem, let q_x be the number of points that we have to throw on the edges of \mathcal{T}_n so that x vertices appear in $\tilde{\mathcal{P}}(\mathcal{T}_n)$ (this is the number of coupons that we have to buy in order to get x different ones). Observe immediately that $q_x \geq x$ for all x . Then, a direct application of Bienaymé-Tchebychev inequality tells us that $q_{f(n)B_n}$ verifies

$$\mathbb{P}(|q_{f(n)B_n} - f(n)B_n| \geq g(n)) \xrightarrow[n \rightarrow \infty]{} 0,$$

using the fact that $g(n)^2 \ll f(n)B_n$. This means that, among the first $f(n)B_n + g(n)$ points that have appeared in $\mathcal{P}(\mathcal{T}_n)$, at most $g(n)$ have appeared on an edge where there was already a point. Therefore, at any time $u \leq \tau(f(n)B_n)$, there cannot be more than $g(n)$ such points, which implies (i).

Proof of (ii). Notice that the variables $X_i := |\mathcal{P}_{((i+1)/B_n)n/(n-1)}(\mathcal{T}_n)| - |\mathcal{P}_{(i/B_n)n/(n-1)}(\mathcal{T}_n)|$ for $i \in \mathbb{Z}_+$ are i.i.d. Poisson variables of parameter 1. This factor $B_n n / (n-1)$ comes from the fact that $\mathcal{P}_c(\mathcal{T}_n)$ is a Poisson point process of intensity $cB_n/nd\ell$ on \mathcal{T}_n , knowing that \mathcal{T}_n has total length $\ell(\mathcal{T}_n) = n-1$.

An application of Donsker's theorem shows that, in probability,

$$B_n^{-1} \sup_{0 \leq k \leq A(n)} \sum_{i \leq k} (X_{(i/B_n)n/(n-1)} - 1) \xrightarrow[n \rightarrow \infty]{} 0,$$

where we have set $A(n) = f(n)B_n + g(n)$. Therefore (ii) holds with high probability. \square

Let us now explain how to apply Proposition 3.4.3 in our framework: since in $\mathcal{C}(F)$ each chord corresponds to a vertex of $\tilde{T}(F)$, we use the construction above to exhibit a discrete version of $\mathbb{L}(\mathcal{C}(\tilde{T}(F)))$, in which each chord corresponds to a vertex as well. In addition, we prove that, for F a minimal factorization of the n -cycle, this discrete dual lamination $\mathbb{L}(\tilde{T}(F))$ is close to $\mathcal{C}(F)$. This statement is not straightforward, since two different minimal

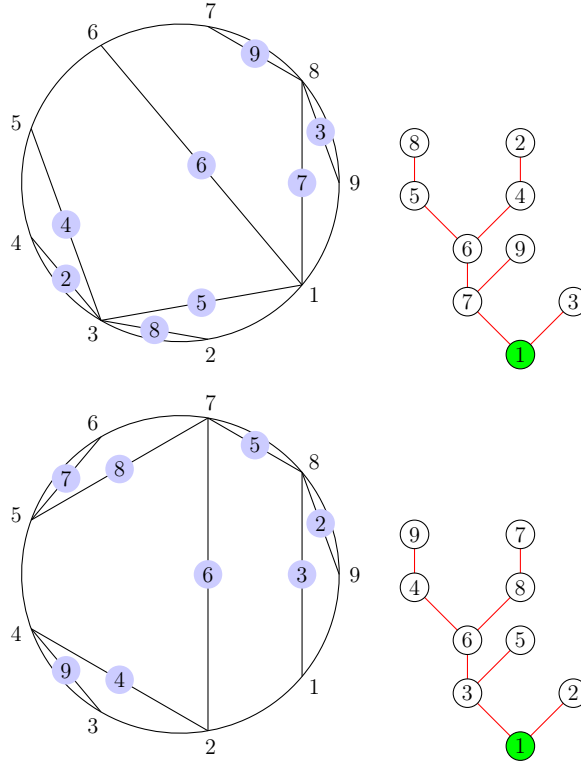

Figure 3.9: The geometric representation of two different minimal factorizations whose images by the Goulden-Yong map (forgetting about labels) are the same tree.

factorizations may lead to the same discrete lamination (see Fig. 3.9 for an example). For F a minimal factorization, we give $\mathbb{L}(\tilde{T}(F))$ more structure, by labelling its chords the following way: remember that, in the construction of $\mathbb{L}(T)$, each chord corresponds to a vertex of T . Then, for each vertex $x \in \tilde{T}(F)$, give to the corresponding chord in $\mathbb{L}(\tilde{T}(F))$ the label of x . For $n \geq 2$, $F \in \mathfrak{M}_n$ and $2 \leq j \leq n$, denote by $c(j)$ the chord with label j in $\mathcal{C}(F)$, and by $c'(j)$ the chord of label j in $\mathbb{L}(\tilde{T}(F))$. Note that there are $(n - 1)$ chords in each lamination, if one does not take into account the chord of length 0 associated to the root of $\tilde{T}(F)$ in $\mathbb{L}(\tilde{T}(F))$, and that the leaves of $\tilde{T}(F)$ are coded by chords of length 0 in $\mathbb{L}(\tilde{T}(F))$. The next lemma bounds the distance between chords with the same label in $\mathcal{C}(F)$ and $\mathbb{L}(\tilde{T}(F))$, by a quantity which only depends on the height of $\tilde{T}(F)$.

Lemma 3.4.4. *As $n \rightarrow \infty$, uniformly for $F \in \mathfrak{M}_n$,*

$$\sup_{2 \leq j \leq n} d_H(c(j), c'(j)) \leq 2\pi \frac{H(\tilde{T}(F))}{n} + o(1),$$

where $H(\tilde{T}(F))$ denotes the height of the tree $\tilde{T}(F)$.

Proof. Take $2 \leq j \leq n$ and $F \in \mathfrak{M}_n$. Let $x(j)$ be the vertex of label j in $\tilde{T}(F)$. $x(j)$ induces a natural partition of the vertices of the tree into three sets: $S'_1(j)$, the set of vertices that are visited by the contour exploration before $x(j)$; $S'_2(j)$ the set of vertices of the subtree rooted at $x(j)$; $S'_3(j)$ the set of vertices that are visited by the contour exploration for the first time after $x(j)$ has been visited for the last time. See an example on Fig. 3.10, left. The three connected components of the circle delimited by $c'(j)$ (that is, the three arcs whose endpoints are in the set $\{1, a'_j, b'_j\}$ where a'_j, b'_j are the endpoints of $c'(j)$) have respective arc lengths $2\pi|S'_1(j)|/n + o(1)$, $2\pi|S'_2(j)|/n + o(1)$, $2\pi|S'_3(j)|/n + o(1)$, the $o(1)$ being uniform in j as $n \rightarrow \infty$.

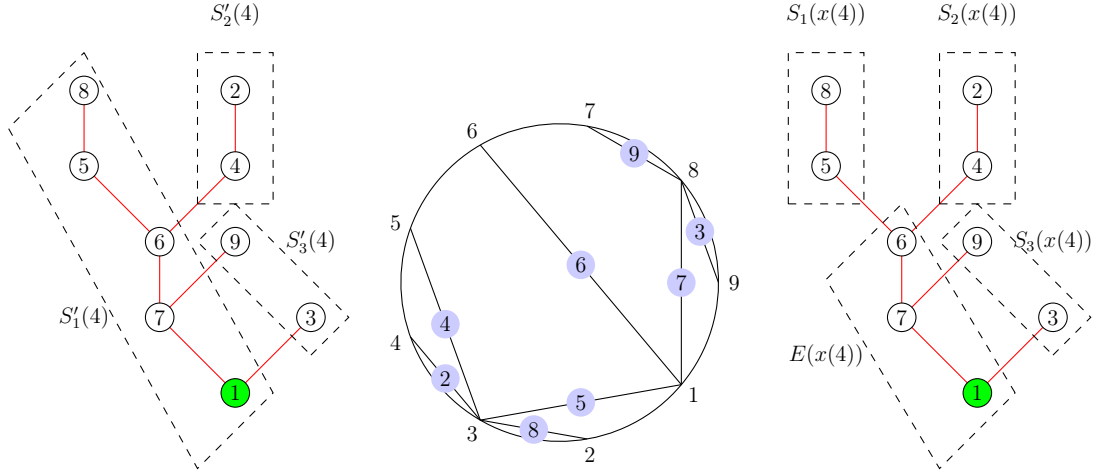

Figure 3.10: Representation of the two different partitions of the set of vertices of the tree $\tilde{T}(F)$ associated to a minimal factorization F , according to the vertex of label 4. In the middle, $\mathcal{C}(F)$.

Now, let us focus on the corresponding chord $c(j)$ in $\mathcal{C}(F)$, and note that it is not given by the position of the chord $c'(j)$. As an example, in Fig. 3.9, the vertex with label 6 is at the same place in both trees, while the chord $c(j)$ is not at the same place in both laminations. Denote by (ab) the transposition corresponding to $c(j)$, with $1 \leq a < b \leq n$. Note that the length of $c(j)$ can be directly seen on the unlabelled tree $\tilde{T}(F)$, but the position of its endpoints on the circle depends on the labels of the other vertices, and therefore on its embedding in the disk. We now split the circle into four components, which correspond to a partition of the set of vertices of $\tilde{T}(F)$ into four parts: $S_1(j)$ the set of vertices of $\tilde{T}(F)$ whose corresponding chord has its endpoints between 1 and a (1 included); $S_2(j)$ the set of vertices of $\tilde{T}(F)$ whose corresponding chord has its endpoints between a and b ; $S_3(j)$ the set of vertices of $\tilde{T}(F)$ whose corresponding chord has its endpoints between b and n (n included); $E(x(j))$ the set of ancestors of $x(j)$ ($x(j)$ excluded). One can check that $S_1'(j) = S_1(j) \cup E(x(j))$, $S_2'(j) = S_2(j)$, $S_3'(j) = S_3(j)$. See Fig. 3.10, right. Therefore, the distance between $c(j)$ and $c'(j)$ only depends on the labels of the other vertices, and is bounded by $2\pi \frac{|E(x(j))|}{n} + o(1)$. The result follows, since the size of the ancestral line of $x(j)$ is at most $H(\tilde{T}(F))$. \square

Lemma 3.4.4 not only proves that $\mathcal{C}(F)$ and $\mathbb{L}(\tilde{T}(F))$ are close, but in addition that they are close chord by chord. This will allow us to bound the distance between the underlying processes of laminations.

The last part of this section is devoted to the study of the set \mathfrak{U}_n of non plane labelled trees. Indeed, the Goulden-Yong mapping allows us to translate results about trees into results about minimal factorizations. For T an element of \mathfrak{U}_n (that is, a non plane tree with n vertices labelled from 1 to n), one can associate exactly one plane rooted tree verifying condition (C_Δ) . We denote by \tilde{T} this canonical embedding of T , so that it matches the notation of Section 3.4.2. In what follows, U_n is an element of \mathfrak{U}_n taken uniformly at random, and \tilde{U}_n its canonical embedding on the plane.

Our first result concerns the distribution of the tree \tilde{U}_n , when one does not care about labels. A proof can be found in [55, Example 9.2].

Lemma 3.4.5. *Let $n \geq 1$. Then \tilde{U}_n , forgetting about the labels, has the law of a μ -GW tree conditioned to have n vertices, where μ is the Poisson distribution of parameter 1.*

This describes the structure of the unlabelled tree $\tilde{T}(t^{(n)})$. We now investigate the constraints that we have on the labelling (condition (C_Δ)).

3.4.4 A shuffling operation on vertices

We prove here the important Theorem 3.1.2. To this end, we define an operation on finite trees, which randomly shuffles the labels of its vertices without changing much the overall structure of the tree and the associated lamination. We use it to prove that the lamination $\mathcal{L}_c^{(n)}$ is close in distribution to $\mathbb{L}_{c\sqrt{n}}(\mathcal{T}_n)$ uniformly in c , for \mathcal{T}_n a given Galton-Watson tree (which we will describe) conditioned by its number of vertices. This allows us to use Theorem 3.3.3.

Let us explain the main idea of the shuffling argument. The goal is to lift the constraint on the labels (condition (C_Δ)) without changing much the structure of the tree. To this end, an idea would be to uniformly shuffle the labels of the children of each vertex. But consider a large chord of $\mathbb{L}_{c\sqrt{n}}(\tilde{U}_n)$, which corresponds to a vertex u with label $\ell \leq c\sqrt{n}$ in \tilde{U}_n with a large subtree on top of it. If one shuffles the labels uniformly at random among children of its parent, the label ℓ could be given to another vertex with a small descendance, resulting in a small chord. The associated lamination would then be far from $\mathbb{L}_{c\sqrt{n}}(\tilde{U}_n)$. In order to keep the descendance fixed, one could try to shuffle the labels uniformly at random among children of all vertices, also keeping the subtrees on top of them. But then, large subtrees could be swapped at branching points, so that the associated laminations would also be far from each other. The idea is to combine these two operations.

Definition. *Let T be a plane tree with n vertices labelled from 1 to n , rooted at the vertex of label 1, and let $K \leq n$. We define the shuffled tree $T^{(K)}$ as follows: starting from the root of T , we perform one of the following two operations on the vertices of T . For consistency, we impose that the operation shall be performed on a vertex before being performed on its children.*

- *Operation 1: for a vertex such that the labels of its children are all $> K$, we uniformly shuffle these labels (without shuffling the corresponding subtrees).*
- *Operation 2: for a vertex such that at least one of its children has a label $\leq K$, we uniformly shuffle these labelled vertices and keep the subtrees on top of each of these children.*

See Figure 3.11 for an example. Note that this operation induces a transformation of the lamination $\mathbb{L}(T)$ associated to T .

The main interest of this shuffling is that, for any K , $\tilde{U}_n^{(K)}$ has the law of a $Po(1)$ -GW tree conditioned to have n vertices, where the root has label 1 and the other vertices are uniformly labelled from 2 to n . The challenge, in our case, is to find a suitable K .

In addition, for T a plane tree with labelled vertices and $u \geq 0$, denote $\mathbb{L}_u(T)$ the sublamination of $\mathbb{L}(T)$ made only of the chords that correspond to vertices of label $\leq u$. This extends the notation of Section 3.4.3 to a labelled tree (remember that, in Section 3.4.3, we start from an unlabelled tree and label its non-root vertices uniformly at random from 2 to $|T|$). In particular, for $u \geq |T|$, $\mathbb{L}_u(T) = \mathbb{L}(T)$.

Lemma 3.4.6. *Let U_n be a uniform element of \mathfrak{A}_n . Then, for any sequence $(K_n)_{n \in \mathbb{Z}_+}$ such that $\frac{K_n}{n} \xrightarrow[n \rightarrow \infty]{} 0$, as $n \rightarrow \infty$, in probability,*

$$d_{Sk} \left(\left(\mathbb{L}_{u\sqrt{n}}(\tilde{U}_n) \right)_{0 \leq u \leq K_n/\sqrt{n}}, \left(\mathbb{L}_{u\sqrt{n}}(\tilde{U}_n^{(K_n)}) \right)_{0 \leq u \leq K_n/\sqrt{n}} \right) \xrightarrow{\mathbb{P}} 0,$$

(a) Shuffling of a labelled plane tree when $K = 3$: Operation 1 is performed(b) Shuffling of the same tree when $K = 5$: Operation 2 is performed

Figure 3.11: Examples of the shuffling operation. The operation is different in both cases, since in the second case the vertex labelled 9 has a child with label $4 \leq K$.

where d_{Sk} denotes the Skorokhod distance between these processes.

If, in addition, $\frac{K_n}{\sqrt{n}} \rightarrow \infty$, then

$$d_{Sk} \left(\left(\mathbb{L}_{u\sqrt{n}} \left(\tilde{U}_n \right) \right)_{0 \leq u \leq \infty}, \left(\mathbb{L}_{u\sqrt{n}} \left(\tilde{U}_n^{(K_n)} \right) \right)_{0 \leq u \leq \infty} \right) \xrightarrow{\mathbb{P}} 0.$$

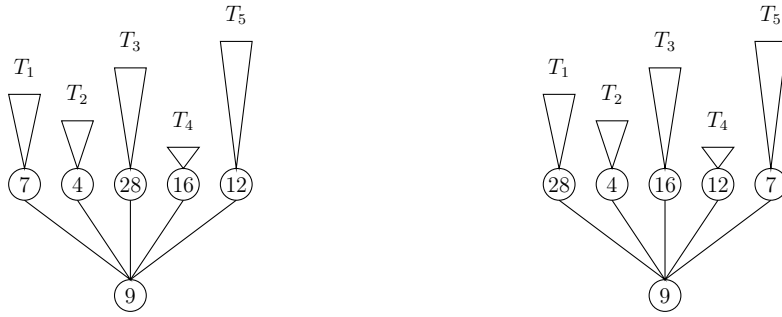
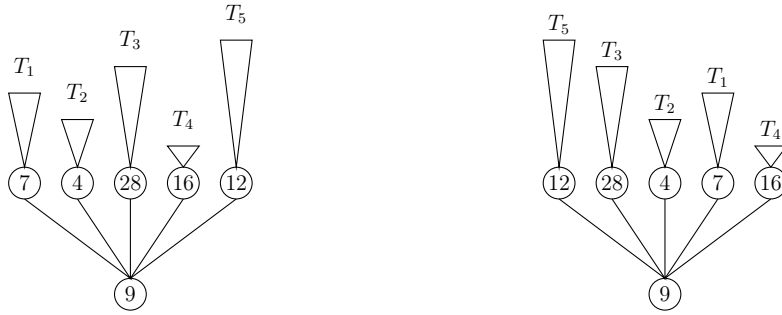
The proof of this lemma, postponed to Section 3.4.5, relies on the study of what we call a -branching points, for $a \in \mathbb{Z}_+$. For $a > 0$ and T a tree, we say that a vertex $u \in T$ is an a -branching point if at least two of its children have subtrees of size $\geq a$. Note that this is a particular case of a -nodes defined in Section 3.3. In order to prove Lemma 3.4.6, we show in Section 3.4.5 that with high probability Operation 2 is not performed on any εn -branching point for fixed $\varepsilon > 0$, and then show that it ensures that the lamination-valued processes stay close to each other.

Remark. We do not have that $d_{Sk} \left(\left(\mathbb{L}_{u\sqrt{n}} \left(\tilde{U}_n \right) \right)_{0 \leq u \leq \infty}, \left(\mathbb{L}_{u\sqrt{n}} \left(\tilde{U}_n^{(K_n)} \right) \right)_{0 \leq u \leq \infty} \right) \xrightarrow{\mathbb{P}} 0$ in all cases, and the second assumption is needed. Indeed, if $K_n = 0$, we perform Operation 1 on all vertices, and the labels of the chords of size $\geq \varepsilon$, for ε small enough, might not appear in the process in the same order. On the other hand, the first assumption is needed as well: if $K_n = n$, then Operation 2 is performed on all vertices, and in particular on εn -branching points. Hence, the large subtrees rooted at children of a given εn -branching point might be interchanged, which leads to a completely different lamination-valued process.

We are now ready to prove Theorem 3.1.2.

Proof of Theorem 3.1.2 from Lemma 3.4.6. Recall that $t^{(n)}$ denotes a uniform element of \mathfrak{M}_n . First, we know by Lemma 3.4.5 that $\tilde{T}(t^{(n)})$ - forgetting about the labels - is dis-

tributed as a $Po(1)$ -GW tree. Hence, by Theorem 3.3.2, $\frac{H(\tilde{T}(t^{(n)}))}{n^{3/4}} \xrightarrow[n \rightarrow \infty]{} 0$ in probability. Lemma 3.4.4 therefore implies that

$$d_{Sk} \left(\left(\mathcal{L}_c^{(n)} \right)_{0 \leq c \leq \infty}, \left(\mathbb{L}_{c\sqrt{n}} \left(\tilde{T}(t^{(n)}) \right) \right)_{0 \leq c \leq \infty} \right) \xrightarrow{\mathbb{P}} 0.$$

On the other hand, let K_n be a sequence of integers such that $\sqrt{n} \ll K_n \ll n$ and recall that only the first $\lfloor c\sqrt{n} \rfloor$ factors of $t^{(n)}$ are represented in $\mathcal{L}_c^{(n)}$. By Lemma 3.4.6, as $n \rightarrow \infty$, in probability:

$$d_{Sk} \left(\left(\mathbb{L}_{c\sqrt{n}}(\tilde{U}_n) \right)_{0 \leq c \leq \infty}, \left(\mathbb{L}_{c\sqrt{n}}(\tilde{U}_n^{(K_n)}) \right)_{0 \leq c \leq \infty} \right) \xrightarrow{\mathbb{P}} 0.$$

The last step is to prove that $(\mathbb{L}_{c\sqrt{n}}(\tilde{U}_n^{(K_n)}))_{0 \leq c \leq \infty}$ converges in distribution towards $(\mathbb{L}_c^{(2)})_{0 \leq c \leq \infty}$. This is a direct consequence of Proposition 3.4.3 and Theorem 3.3.3. Indeed, we have already mentioned that $\tilde{U}_n^{(K_n)}$ is distributed as a $Po(1)$ -GW tree conditioned to have n vertices labelled from 1 to n , the root having label 1 and the label of the other vertices being uniformly distributed from 2 to n . This gives the result. \square

3.4.5 Proof of the technical lemma

This part of the section is devoted to the proof of the technical lemma 3.4.6, which provides information on $(\mathbb{L}_u(\tilde{U}_n))_{u \geq 0}$. Before diving into the proof, we present a powerful tool in the study of finite trees, the so-called local limit theorem, which provides good asymptotics on the behaviour of random walks. We provide here two versions of this theorem, the first one concerning general random walks and the second one concerning its application to the size of GW trees (see [52, Theorem 4.2.1] for details and proofs).

Theorem 3.4.7 (Local limit theorem). *Let $\alpha \in (1, 2]$, μ a critical distribution on \mathbb{Z}_+ in the domain of attraction of an α -stable law, and $(B_n)_{n \geq 1}$ verifying (3.4). Let q_1 be the density of $Y_1^{(\alpha)}$, where we recall that $Y^{(\alpha)}$ is the α -stable Lévy process. Then*

- (i) *Let $(X_i)_{i \geq 1}$ be a sequence of i.i.d. variables taking their values in $\mathbb{Z}_+ \cup \{-1\}$, of law $\mu(\cdot + 1)$. Then*

$$\sup_{k \in \mathbb{Z}} \left| B_n \mathbb{P} \left(\sum_{i=1}^n X_i = k \right) - q_1 \left(\frac{k}{B_n} \right) \right| \xrightarrow[n \rightarrow \infty]{} 0.$$

- (ii) *Let \mathcal{T} denote a μ -GW tree. Then, as $n \rightarrow \infty$,*

$$\mathbb{P}(|\mathcal{T}| = n) \sim n^{-1-1/\alpha} \ell(n)$$

where ℓ is a slowly varying function depending on μ .

In particular, an important fact is that $\mathbb{P}(|\mathcal{T}| = n)^{-1}$ grows slower than some polynomial in n . Although q_1 has no closed expression for $\alpha < 2$, (i) can be rewritten when μ has finite variance σ^2 :

$$\sup_{k \in \mathbb{Z}} \left| \sqrt{2\pi\sigma^2 n} \mathbb{P} \left(\sum_{i=1}^n X_i = k \right) - \exp \left(-\frac{k^2}{2\sigma^2 n} \right) \right| \xrightarrow[n \rightarrow \infty]{} 0.$$

This local limit theorem allows us to understand the structure of the tree \tilde{U}_n . We start by fixing some notation: for $a \in \mathbb{Z}_+$, denote by $E_a(T)$ the set of a -branching points of T and $N_a(T) = \sum_{u \in E_a(T)} k_u(T)$ the number of vertices of T that are *children* of an a -branching point. It is straightforward by induction on $|T|$ that, for any $\varepsilon > 0$ and any finite tree T , $|E_{\varepsilon|T|}(T)| \leq \lfloor \frac{1}{\varepsilon} \rfloor$. The following lemma estimates the quantity $N_{\varepsilon n}(\tilde{U}_n)$ for fixed $\varepsilon > 0$, and may be of independent interest.

Lemma 3.4.8. *Fix $\varepsilon > 0$. For $i \geq 1$, let U_i be a uniform element of \mathfrak{U}_i , and \tilde{U}_i its canonical embedding in the plane. Then the following two estimates hold:*

(i) *There exists a nonincreasing function C_1 of ε such that uniformly for $i \geq 2\varepsilon n$,*

$$\mathbb{E} \left[k_{\emptyset}(\tilde{U}_i) \mathbf{1}_{\emptyset \in E_{\varepsilon n}(\tilde{U}_i)} \right] \leq C_1(\varepsilon) n^{-1/2}.$$

(ii) *Let $f : \mathbb{Z}_+ \rightarrow \mathbb{R}_+$. Let A_n be the event that $H(\tilde{U}_n) \leq f(n)\sqrt{n}$. Then,*

$$\mathbb{E} \left[N_{\varepsilon n}(\tilde{U}_n) \mathbf{1}_{A_n} \right] \leq C_2(\varepsilon) f(n)$$

for some constant $C_2(\varepsilon)$.

Note that this result does not in fact depend on the embedding of U_n in the plane. It notably relies on Lemma 3.4.5 and the local limit theorem. Let us first see how it implies Lemma 3.4.6.

Proof of Lemma 3.4.6. Let us first explain the main idea of this proof. On the one hand, if $K_n = o(n)$, it is unlikely that we perform Operation 2 on an εn -branching point. This implies that the chords that we discover until $u = K_n$ are close in $\mathbb{L}(\tilde{U}_n)$ and $\mathbb{L}(\tilde{U}_n^{(K_n)})$. On the other hand, if $K_n \gg \sqrt{n}$, after having discovered K_n edges, $\mathbb{L}_{K_n}(\tilde{U}_n)$ is already close to the Brownian triangulation $\mathbb{L}_{\infty}^{(2)}$ which is maximal for inclusion on the set of laminations. Since, by our first point, $\mathbb{L}_{K_n}(\tilde{U}_n)$ is close to $\mathbb{L}_{K_n}(\tilde{U}_n^{(K_n)})$, adding the chords labelled from $K_n + 1$ to n in any order will not change much the laminations and both stay close to $\mathbb{L}_{\infty}^{(2)}$.

We now go into the details. Assume first that $K_n = o(n)$. In order to prove the first part of Lemma 3.4.6, as usual, we focus on studying the large chords in both laminations. We call *displacement* of a (labelled) chord c of $\mathbb{L}_u(\tilde{U}_n)$ the Hausdorff distance in the unit disk between c and the chord with the same label in the modified lamination $\mathbb{L}_u(\tilde{U}_n^{(K_n)})$.

Let us precisely study this notion of displacement: fix $\varepsilon > 0$ and let x be a vertex of \tilde{U}_n with label $e_x \leq K_n$, such that $|\theta_x(\tilde{U}_n)| > \varepsilon n$. The displacement of the chord c_x corresponding to x is due to performing Operation 2 on some ancestors of x . Therefore, the displacement of c_x can be bounded by the sum of the sizes of the subtrees of the children of an ancestor of x that do not contain x , the sum being taken over all ancestors of x on which Operation 2 is performed (that is, one of its children has label $\leq K_n$). See Fig. 3.12, right. Observe that the length of the chords with label e_x is the same in both laminations (indeed, since x has label $\leq K_n$, Operation 2 is performed on its parent and therefore $|\theta_x(\tilde{U}_n)| = |\theta_x(\tilde{U}_n^{(K_n)})|$). Hence, the displacement of the chord only corresponds to the displacement of its endpoints.

Let us set some notation: for $x \in \tilde{U}_n$, we denote by $E(x)$ the set of ancestors of x in \tilde{U}_n (x included), and by $\hat{E}(x)$ the set of ancestors of x on which Operation 2 is performed. The maximum possible displacement of the chord c_x is defined as

$$MPD(x) := \frac{1}{n} \sum_{\substack{v \in \hat{E}(x) \\ v \neq x}} \sum_{\substack{w \in K_v(\tilde{U}_n) \\ w \notin E(x)}} |\theta_w(\tilde{U}_n)|,$$

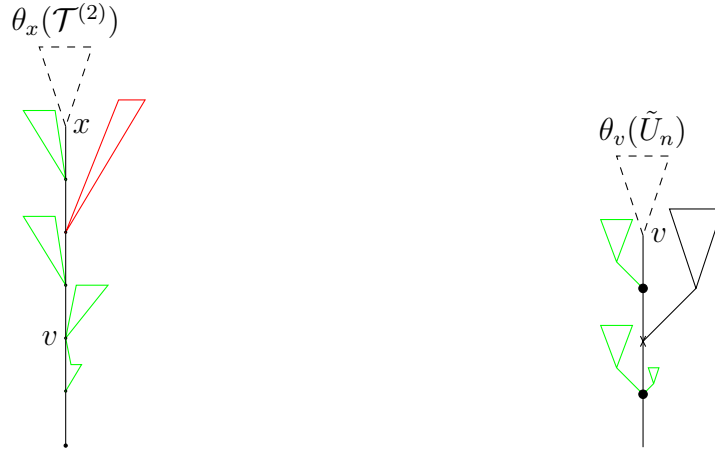

Figure 3.12: Left: continuous setting (Aldous' CRT). $CMPD_\delta(v)$ is the sum of the sizes of the green subtrees. In red, a subtree of size $> \delta$, which is therefore not counted in $CMPD_\delta(v)$. $m_v(x)$ is the mass of the green tree rooted at v . Right: discrete setting (finite tree). Dots represent ancestors of v on which Operation 2 is performed, so that they have an influence on the displacement of the chord c_v corresponding to v : the corresponding subtrees are colored in green. With high probability, none of the green subtrees is large. The cross represents an ancestor of v on which Operation 1 is performed.

where $K_v(\tilde{U}_n)$ denotes the set of children of v . Indeed, subtrees which were on the right of the ancestral line of x may be transferred to the left or conversely. This maximum possible displacement corresponds to the sum of the sizes of the green subtrees on Fig. 3.12, right. We admit the following statement, which we will prove later: for any $\varepsilon > 0$ fixed, assuming that the convergence of Theorem 3.3.2 holds,

$$\sup_{x, e_x \leq K_n, |\theta_x(\tilde{U}_n)| > \varepsilon n} MPD(x) \xrightarrow{\mathbb{P}} 0. \tag{3.8}$$

This implies that, uniformly in $u \in [0, K_n]$, with high probability as $n \rightarrow \infty$,

$$d_H \left(\mathbb{L}_u \left(\tilde{U}_n \right), \mathbb{L}_u \left(\tilde{U}_n^{(K_n)} \right) \right) \leq 2\varepsilon,$$

which proves the first part of Lemma 3.4.6.

Now, assume in addition that $K_n \gg \sqrt{n}$. Then, by Theorem 3.3.3, jointly with the convergence of Theorem 3.3.2, with high probability $d_H(\mathbb{L}_{K_n}(\tilde{U}_n^{(K_n)}), \mathbb{L}_\infty^{(2)}) \xrightarrow[n \rightarrow \infty]{} 0$. On the other hand, by the first part of Lemma 3.4.6, $d_H(\mathbb{L}_{K_n}(\tilde{U}_n), \mathbb{L}_{K_n}(\tilde{U}_n^{(K_n)})) \xrightarrow[n \rightarrow \infty]{} 0$ in probability. Since $\mathbb{L}_\infty^{(2)}$ is a maximum lamination for the inclusion, this implies that for any $\varepsilon > 0$:

$$\mathbb{P} \left(\exists u \in [K_n, n], d_H \left(\mathbb{L}_u(\tilde{U}_n), \mathbb{L}_\infty^{(2)} \right) > \varepsilon \right) \rightarrow 0$$

as $n \rightarrow \infty$, which proves the second part of Lemma 3.4.6. □

We now need to prove (3.8), which states that the supremum of maximum displacements of all x whose label is $\leq K_n$ and such that $|\theta_x(\tilde{U}_n)| \geq \varepsilon n$ converges to 0 in probability.

Proof of (3.8). We prove in fact a slightly stronger result. Let $0 < \delta < \varepsilon$. We define the δ -maximum possible displacement of a point $x \in \tilde{U}_n$, denoted by $MPD_\delta(x)$, as

$$MPD_\delta(x) := \frac{1}{n} \sum_{v \in E^{(\delta)}(x)} \sum_{\substack{w \in K_v(\tilde{U}_n) \\ w \notin E(x)}} |\theta_w(\tilde{U}_n)|,$$

where $E^{(\delta)}(x)$ denotes the set of ancestors of x that are not δn -branching points. We prove that, as $\delta \downarrow 0$,

$$\lim_{\delta \downarrow 0} \limsup_{n \rightarrow \infty} S_\delta(\tilde{U}_n) = 0 \quad (3.9)$$

in probability, where $S_\delta(\tilde{U}_n) := \sup_{x, e_x \leq K_n, |\theta_x(\tilde{U}_n)| > \varepsilon n} MPD_\delta(x)$. Let us first see how this implies

(3.8). We only have to prove that, at δ fixed, with high probability Operation 2 is not performed on any δn -branching point. Indeed, on this event, for all x , $\hat{E}(x) \subset E^{(\delta)}(x)$, and $MPD(x) \leq MPD_\delta(x)$.

To prove that, let p_n be the probability that there exists a δn -branching point in \tilde{U}_n having at least one child with label $\leq K_n$, conditionally given \tilde{U}_n . We show that $p_n \rightarrow 0$ with high probability as $n \rightarrow \infty$. First, notice that:

$$p_n = 1 - \frac{\binom{n - N_{\delta n}(\tilde{U}_n)}{K_n}}{\binom{n}{K_n}} \leq 1 - \left(1 - \frac{N_{\delta n}(\tilde{U}_n)}{n - K_n}\right)^{K_n}$$

Take $g : \mathbb{Z}_+ \rightarrow \mathbb{Z}_+$ such that $g(n) \xrightarrow{n \rightarrow \infty} \infty$ and $g(n)K_n/n \rightarrow 0$, and take $f : \mathbb{Z}_+ \rightarrow \mathbb{Z}_+$ such that $f(n) \xrightarrow{n \rightarrow \infty} \infty$ and $f(n)/g(n) \xrightarrow{n \rightarrow \infty} 0$. Then, by Lemma 3.4.8 (ii), there exists $C_2(\delta)$ such that, for n large enough, $\mathbb{E}[N_{\delta n}(\tilde{U}_n)\mathbb{1}_{A_n}] \leq C_2(\delta)f(n)$, where we recall that $A_n := \{H(\tilde{U}_n) \leq f(n)\sqrt{n}\}$. By Markov's inequality and since $\mathbb{P}(A_n) \rightarrow 1$ as $n \rightarrow \infty$, we get that $\mathbb{P}(N_{\delta n}(\tilde{U}_n) \geq g(n) | A_n) \leq 2C_2(\delta)f(n)/g(n) \xrightarrow{n \rightarrow \infty} 0$. Hence, with high probability as $n \rightarrow \infty$,

$$p_n \leq 1 - \left(1 - \frac{g(n)}{n - K_n}\right)^{K_n} \sim \frac{g(n)K_n}{n}$$

which tends to 0 as $n \rightarrow \infty$. Hence, with high probability, Operation 2 is not performed on any δn -branching point and (3.9) implies (3.8).

Now we prove (3.9). To this end, let us define the continuous analogue of $S_\delta(\tilde{U}_n)$ on the Brownian tree $\mathcal{T}^{(2)}$. For a point $x \in \mathcal{T}^{(2)}$, let $E(x)$ be the set of ancestors of x . Recall that h is the uniform probability measure on the set of leaves of $\mathcal{T}^{(2)}$ and, for $v \in E(x)$, we denote by $m_v(x)$ the h -mass of the connected component of $\mathcal{T}^{(2)} \setminus \{v\}$ which neither contains x nor the root ($m_v(x)$ may be 0 if v is not a branching point). See Fig. 3.12, left for an example. Then, define $CMPD_\delta(x)$ (for Continuum MPD) as $CMPD_\delta(x) := \sum_{v \in E(x), v \neq x} m_v(x)\mathbb{1}_{m_v(x) \leq \delta}$

and $S_\delta(\mathcal{T}^{(2)}) := \sup_{x, h(\theta_x(\mathcal{T}^{(2)})) > \varepsilon} CMPD_\delta(x)$. At δ fixed, it is clear by Theorem 3.3.2 that, in

distribution, $S_\delta(\tilde{U}_n) \rightarrow S_\delta(\mathcal{T}^{(2)})$ as $n \rightarrow \infty$. What is left to prove is that, almost surely, $S_\delta(\mathcal{T}^{(2)}) \rightarrow 0$ as $\delta \rightarrow 0$. Assume that it is not the case. Then, there exists $\eta > 0$ and a sequence of vertices $v_n \in \mathcal{T}^{(2)}$ such that $h(\theta_{v_n}(\mathcal{T}^{(2)})) > \varepsilon$ and $CMPD_{1/n}(v_n) \geq \eta$ for all n . Since $\mathcal{T}^{(2)}$ is compact, one can assume without loss of generality that v_n converges to some $v_\infty \in \mathcal{T}^{(2)}$. Clearly, $h(\theta_{v_\infty}(\mathcal{T}^{(2)})) > \varepsilon$ and v_∞ should verify, for any $\delta > 0$, $CMPD_\delta(v_\infty) \geq \eta$, which is not possible. This provides the result. Note that we need the condition that the subtrees rooted at the vertices (v_n) have sizes at least ε . This allows us to say that $CMPD_\delta(v_\infty) \geq \eta$ for any δ , as we avoid the case of a sequence of vertices with small subtrees rooted at them, converging to a point of the skeleton of $\mathcal{T}^{(2)}$. \square

Let us finally prove the estimates of Lemma 3.4.8.

Proof of Lemma 3.4.8. Let us start by proving (i). In this proof, we denote by μ the $Po(1)$ distribution. In particular, μ is in the domain of attraction of a 2-stable law. Let us denote by \mathcal{T} a nonconditioned μ -GW tree and fix $\varepsilon > 0$. For $n \geq 1$ and $i \geq 2\varepsilon n$, one can write:

$$\begin{aligned} \mathbb{E} \left[k_{\emptyset}(\tilde{U}_i) \mathbf{1}_{\emptyset \in E_{\varepsilon n}(\tilde{U}_i)} \right] &= \frac{1}{\mathbb{P}(|\mathcal{T}| = i)} \sum_{j \in \mathbb{Z}_+} j \mathbb{P}(k_{\emptyset}(\mathcal{T}) = j) \mathbb{P}(|\mathcal{T}| = i, \emptyset \in E_{\varepsilon n}(\mathcal{T}) | k_{\emptyset}(\mathcal{T}) = j) \\ &\leq \frac{1}{\mathbb{P}(|\mathcal{T}| = i)} \sum_{j \in \mathbb{Z}_+} j \mathbb{P}(k_{\emptyset}(\mathcal{T}) = j) \sum_{1 \leq a < b \leq j} \mathbb{P}(|\mathcal{T}| = i, B_{\varepsilon, a, b} | k_{\emptyset}(\mathcal{T}) = j) \end{aligned}$$

where $B_{\varepsilon, a, b}$ is the event that the a th and b th children of the root \emptyset have a subtree of size $\geq \varepsilon n$. Hence, we can write

$$\mathbb{E} \left[k_{\emptyset}(\tilde{U}_i) \mathbf{1}_{\emptyset \in E_{\varepsilon n}(\tilde{U}_i)} \right] \leq \frac{\sum_{j \in \mathbb{Z}_+} j \mu_j \binom{j}{2}}{\mathbb{P}(|\mathcal{T}| = i)} \sum_{\substack{t_1 \geq \varepsilon n \\ t_2 \geq \varepsilon n \\ t_1 + t_2 \leq i}} \mathbb{P}(|\mathcal{T}| = t_1) \mathbb{P}(|\mathcal{T}| = t_2) \mathbb{P}(|\mathcal{F}_{j-2}| = i - t_1 - t_2),$$

where \mathcal{F}_{j-2} is a forest of $j-2$ i.i.d. μ -GW trees. Using the local limit theorem 3.4.7 (ii), we deduce that

$$\begin{aligned} \mathbb{E} \left[k_{\emptyset}(\tilde{U}_i) \mathbf{1}_{\emptyset \in E_{\varepsilon n}(\tilde{U}_i)} \right] &\leq C(\varepsilon) n^{3/2} \sum_{j \in \mathbb{Z}_+} j^3 \mu_j \sum_{\substack{t_1 \geq \varepsilon n \\ t_2 \geq \varepsilon n \\ t_1 + t_2 \leq i}} n^{-3} \mathbb{P}(|\mathcal{F}_{j-2}| = i - t_1 - t_2) \\ &\leq C(\varepsilon) n^{-3/2} \sum_{\substack{t_1 \geq \varepsilon n \\ t_2 \geq \varepsilon n \\ t_1 + t_2 \leq i}} \sum_{j \geq 2} j^3 \mu_j \frac{j-2}{i - t_1 - t_2} \mathbb{P}(S_{i-t_1-t_2} = -(j-2)) \end{aligned}$$

for some constant $C(\varepsilon)$, by the so-called Kemperman formula (see [88, 6.1]), where S_k denotes the sum of k i.i.d. variables of law $\mu(\cdot + 1)$. Therefore, by Theorem 3.4.7 (i), since μ has variance 1,

$$\begin{aligned} \mathbb{E} \left[k_{\emptyset}(\tilde{U}_i) \mathbf{1}_{\emptyset \in E_{\varepsilon n}(\tilde{U}_i)} \right] &\leq C'(\varepsilon) n^{-3/2} \sum_{\substack{t_1 \geq \varepsilon n \\ t_2 \geq \varepsilon n \\ t_1 + t_2 \leq i}} \sum_{j \geq 2} j^4 \mu_j \frac{1}{(i - t_1 - t_2)^{3/2}} \\ &\leq C'(\varepsilon) n^{-3/2} \sum_{j \in \mathbb{Z}_+} j^4 \mu_j \sum_{q=1}^i \frac{i-q}{q^{3/2}} \leq C_1(\varepsilon) n^{-1/2} \end{aligned}$$

uniformly for $i \geq 2\varepsilon n$, for some constants $C'(\varepsilon), C_1(\varepsilon)$. Note that we use the fact that μ has a finite fourth moment. Note that there exists a nonincreasing choice of C_1 since, almost surely, $k_{\emptyset}(\tilde{U}_i) \mathbf{1}_{\emptyset \in E_{\varepsilon n}(\tilde{U}_i)} \geq k_{\emptyset}(\tilde{U}_i) \mathbf{1}_{\emptyset \in E_{\varepsilon' n}(\tilde{U}_i)}$ for $\varepsilon \leq \varepsilon'$.

Now we prove Lemma 3.4.8 (ii). Remember that we denote by A_n the event $\{H(\tilde{U}_n) \leq f(n)\sqrt{n}\}$. Then:

$$\begin{aligned} \mathbb{E} \left[N_{\varepsilon n}(\tilde{U}_n) \mathbf{1}_{A_n} \right] &= \mathbb{E} \left[\mathbf{1}_{A_n} \sum_{u \in \tilde{U}_n} k_u(\tilde{U}_n) \mathbf{1}_{u \in E_{\varepsilon n}(\tilde{U}_n)} \right] = \mathbb{E} \left[\mathbf{1}_{A_n} \sum_{r=0}^{f(n)\sqrt{n}} \sum_{u \in \tilde{U}_n, |u|=r} k_u(\tilde{U}_n) \mathbf{1}_{u \in E_{\varepsilon n}(\tilde{U}_n)} \right] \\ &\leq \frac{1}{\mathbb{P}(|\mathcal{T}| = n)} \sum_{r=0}^{f(n)\sqrt{n}} \mathbb{E} \left[\mathbf{1}_{|\mathcal{T}|=n} \sum_{u \in \mathcal{T}, |u|=r} k_u(\mathcal{T}) \mathbf{1}_{u \in E_{\varepsilon n}(\mathcal{T})} \right] \\ &= \frac{1}{\mathbb{P}(|\mathcal{T}| = n)} \sum_{r=0}^{f(n)\sqrt{n}} \sum_{i=0}^n \mathbb{E} \left[\sum_{u \in \mathcal{T}, |u|=r} k_u(\mathcal{T}) \mathbf{1}_{|\text{Cut}_u(\mathcal{T})|=n-i} \mathbf{1}_{u \in E_{\varepsilon n}(\mathcal{T}), |\theta_u(\mathcal{T})|=i} \right]. \end{aligned}$$

where, following [41], we set $\theta_u(\mathcal{T})$ the subtree of \mathcal{T} rooted at u , and $Cut_u(\mathcal{T})$ the tree \mathcal{T} cut at the vertex u ($\theta_u(\mathcal{T})$ is erased, along with the edge from u to its parent).

Let us now mention the existence, when μ is critical with finite variance, of the *local limit* \mathcal{T}^* of the conditioned μ -GW trees $(\mathcal{T}_n)_{n \in \mathbb{Z}_+}$. This limit is defined as the random variable on the set of infinite trees, such that, for any $r \in \mathbb{Z}_+$,

$$B_r(\mathcal{T}_n) \xrightarrow[n \rightarrow \infty]{} B_r(\mathcal{T}^*)$$

in distribution, where B_r denotes the ball of radius r centered at the root, for the graph distance. Its structure is known: \mathcal{T}^* is an infinite tree called Kesten's tree (see [60, 3] for background), made of a unique infinite spine on which i.i.d. nonconditioned μ -GW trees are planted. In particular, asymptotic local properties of large GW trees can be observed on \mathcal{T}^* . In particular, by [41, Equation 23], we get that for any $r \in \llbracket 0, f(n)\sqrt{n} \rrbracket$, any $i \in \llbracket 0, n \rrbracket$,

$$\mathbb{E} \left[\sum_{u \in \mathcal{T}, |u|=r} k_u(\mathcal{T}) \mathbf{1}_{|Cut_u(\mathcal{T})|=n-i} \mathbf{1}_{u \in E_{\varepsilon n}(\mathcal{T}), |\theta_u(\mathcal{T})|=i} \right] = \mathbb{P}(|Cut_{U_r^*}(\mathcal{T}^*)| = n-i) \\ \times \mathbb{E} [k_\emptyset(\mathcal{T}) \mathbf{1}_{\emptyset \in E_{\varepsilon n}(\mathcal{T})} \mathbf{1}_{|\mathcal{T}|=i}]$$

where U_r^* is the vertex of the unique infinite branch of \mathcal{T}^* at height r (see [60] for more background).

Observe that, if $\emptyset \in E_{\varepsilon n}(\mathcal{T})$ then $|\mathcal{T}| \geq 2\varepsilon n$. This allows us to write by Lemma 3.4.8 (i) and Theorem 3.4.7 (ii), uniformly for $i \geq 2\varepsilon n$,

$$\frac{1}{\mathbb{P}(|\mathcal{T}| = n)} \mathbb{E} [k_\emptyset(\mathcal{T}) \mathbf{1}_{|\mathcal{T}|=i} \mathbf{1}_{\emptyset \in E_{\varepsilon n}(\mathcal{T})}] \leq \frac{\mathbb{P}(|\mathcal{T}| = i)}{\mathbb{P}(|\mathcal{T}| = n)} \mathbb{E} [k_\emptyset(\tilde{U}_i) \mathbf{1}_{\emptyset \in E_{\varepsilon n}(\tilde{U}_i)}] \\ \leq C_2(\varepsilon) n^{-1/2}$$

for some constant $C_2(\varepsilon)$, which leads to

$$\mathbb{E} [N_{\varepsilon n}(\tilde{U}_n) \mathbf{1}_{A_n}] \leq \sum_{r=0}^{f(n)\sqrt{n}} \sum_{i=0}^n \mathbb{P}(|Cut_{U_r^*}(\mathcal{T}^*)| = n-i) C_2(\varepsilon) n^{-1/2} \\ \leq f(n)\sqrt{n} C_2(\varepsilon) n^{-1/2}.$$

This completes the proof. \square

Remark. *The result holds as well for any μ -Galton-Watson tree conditioned to have n vertices, provided that μ is critical and has a finite fourth moment.*

3.4.6 Convergence of the associated noncrossing partitions

The last part of this section is devoted to the study of the "last" transpositions of a minimal factorization of the n -cycle. More precisely, we investigate here a second way of coding a minimal factorization $t := (t_1, \dots, t_{n-1}) \in \mathfrak{M}_n$, which allows us to get a grasp of the behaviour of its "end".

On one hand, for $u \in [0, n]$, let us denote by $C_u(t)$ the union of the circle and all chords corresponding to the first $\lfloor u \rfloor$ transpositions that appear in t : $t_1, \dots, t_{\lfloor u \rfloor}$. This lamination is simply the lamination $\mathcal{C}(t)$, restricted to the first $\lfloor u \rfloor$ chords drawn in the process.

On the other hand, for $u \in [0, n]$, denote by $P_u(t)$ the union of the circle and the chords $[e^{-2i\pi\ell/n}, e^{-2i\pi\ell'/n}]$, where ℓ and ℓ' are two consecutive elements of a cycle of the partial product

$t_1 \dots t_{[u]}$. The faces of this lamination that have only chords in their boundary are called blocks of the lamination (see Fig. 3.13, right for an example; the hatched part is a block). Notice that $P_u(t)$ is a lamination, and in particular the interior of a block is left empty. This new lamination corresponds to the noncrossing partition of $\llbracket 1, n \rrbracket$ induced by the cycles of $t_1 \dots t_{[u]}$.

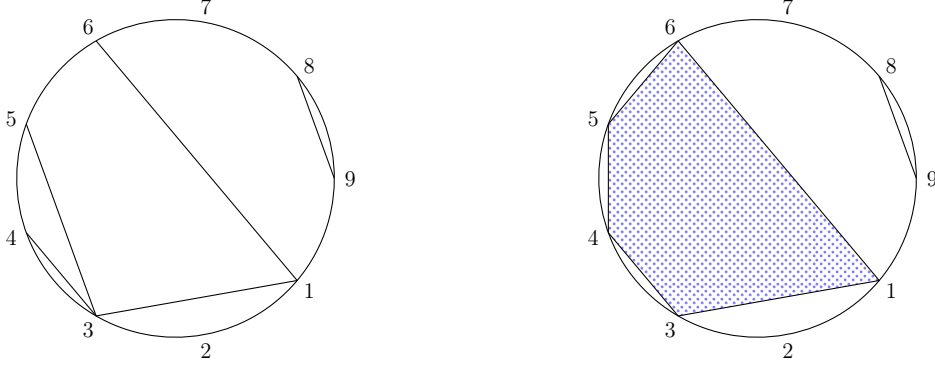

Figure 3.13: The two laminations $L_5(t)$ and $P_5(t)$, where $t := (34)(89)(35)(13)(16)(18)(23)$ is a minimal factorization of the 9-cycle. The hatched part is a block of $P_5(t)$.

As before, let us denote by $t^{(n)}$ a uniform minimal factorization of the n -cycle. We set, for $u \in [0, n]$, $C_u^{(n)} = C_u(t^{(n)})$ and $P_u^{(n)} = P_u(t^{(n)})$. In particular, for $c \geq 0$, $C_{c\sqrt{n}}^{(n)} = \mathcal{L}_c^{(n)}$. The next theorem answers a question of Féray and Kortchemski [45], who asked for a joint convergence of the lamination-valued processes $(C_u^{(n)})_{u \in [0, n]}$ and $(P_u^{(n)})_{u \in [0, n]}$. More precisely, the following two convergences hold jointly with Theorem 3.1.2, respectively in $\mathbb{D}(\mathbb{R}_+, \mathbb{L}(\mathbb{D})^2)$ and $\mathbb{D}(\mathbb{R}_+, \mathbb{L}(\mathbb{D}))$:

Theorem 3.4.9. (i) *The two processes asymptotically have the same behaviour at order \sqrt{n} :*

$$\left(C_{c\sqrt{n}}^{(n)}, P_{c\sqrt{n}}^{(n)} \right)_{c \geq 0} \xrightarrow{(d)} (\mathbb{L}_c, \mathbb{L}_c)_{c \geq 0}.$$

(ii) *Jointly with (i), the second process behaves as follows near n :*

$$\left(P_{n-c\sqrt{n}}^{(n)} \right)_{c \geq 0} \xrightarrow{(d)} (\mathbb{L}'_c)_{c \geq 0},$$

where $(\mathbb{L}'_c)_{c \geq 0}$ is distributed as $(\mathbb{L}_c)_{c \geq 0}$, and is independent of $(\mathbb{L}_c)_{c \geq 0}$ conditionally on \mathbb{L}_∞ .

In other words, roughly speaking, the process $(P_u^{(n)})_{u \in [0, n]}$ is increasing at the beginning, when one adds chords which create new blocks in the corresponding partition, and decreasing later when blocks merge, which makes chords disappear. In addition, these "increasing" and "decreasing" phases are asymptotically independent, conditionally on $\mathbb{L}_\infty := \lim_{n \rightarrow \infty} C_n^{(n)}$. This partition process gives therefore more information on $t^{(n)}$ than $(C_u^{(n)})$, as it explains the joint behaviour of its first and last transpositions. Note that these results were already conjectured in [45, page 7].

We leave the proof of Theorem 3.4.9 (i) to the reader; it is a consequence of Theorem 3.1.2 and [45, Lemma 29], which states that $P_u^{(n)}$ and $C_u^{(n)}$ are close with high probability, jointly for $u \leq \sqrt{n} \log n$.

Let us then focus on the proof of Theorem 3.4.9 (ii). The idea is to investigate the structure of the random tree $T(t^{(n)})$ and deduce a relation, for u large, between the lamination $P_u^{(n)}$ and the set of chords of $C_n^{(n)}$ that have not yet been drawn at time u . To this end, denote, for $t \in \mathfrak{M}_n$ and $u \in [0, n]$, $\overleftarrow{C}_u(t)$ the lamination made only of the chords associated to the last $\lfloor u \rfloor$ transpositions that appear in t . We set in addition $\overleftarrow{C}_u^{(n)} = \overleftarrow{C}_u(t^{(n)})$ this "inverse lamination" drawn from a uniform minimal factorization $t^{(n)}$. Then, the new process $\overleftarrow{C}^{(n)}$ is closely related to the partition process $P^{(n)}$:

Lemma 3.4.10. *The process $\left(\overleftarrow{C}_u^{(n)}\right)_{u \in [0, n]}$ satisfies the following two properties:*

(i) *In distribution,*

$$\left(\overleftarrow{C}_u^{(n)}\right)_{u \in [0, n]} \stackrel{(d)}{=} \left(C_u^{(n)}\right)_{u \in [0, n]}$$

(ii) *The following holds in probability, as $n \rightarrow \infty$:*

$$d_{Sk} \left(\left(\overleftarrow{C}_{c\sqrt{n}}^{(n)}\right)_{0 \leq c \leq \log n}, \left(P_{n-c\sqrt{n}}^{(n)}\right)_{0 \leq c \leq \log n} \right) \xrightarrow{\mathbb{P}} 0.$$

Let us immediately see how this implies Theorem 3.4.9 (ii). In what follows, we set $H_n := \lfloor \sqrt{n} \log n \rfloor$.

Proof of Theorem 3.4.9. First, notice that by definition, for all $c \geq 0$, $C_{c\sqrt{n}}^{(n)} = \mathcal{L}_c^{(n)}$. Therefore, by Lemma 3.4.10 (i) and (ii),

$$\left(P_{n-c\sqrt{n}}^{(n)}\right)_{c \geq 0} \stackrel{(d)}{\rightarrow} (\mathbb{L}'_c)_{c \geq 0},$$

where $(\mathbb{L}'_c)_{c \geq 0}$ is distributed as $(\mathbb{L}_c)_{c \geq 0}$ (recall that $(\mathbb{L}_c)_{c \geq 0}$ is the limit of the process $(\mathcal{L}_c^{(n)})_{c \geq 0}$ constructed from the first transpositions in $t^{(n)}$). The only thing that we have to prove is that, conditionally on \mathbb{L}_∞ , the processes $(\mathbb{L}'_c)_{c \geq 0}$ and $(\mathbb{L}_c)_{c \geq 0}$ are independent. By Lemma 3.4.10 (ii), it is enough to prove that $(C_{c\sqrt{n}}^{(n)})_{c \geq 0}$ and $(\overleftarrow{C}_{c\sqrt{n}}^{(n)})_{c \geq 0}$ are, in some sense, asymptotically independent. To this end, remember that the (non plane) tree $T(t^{(n)})$ is uniform among rooted trees of size n with non-root vertices labelled from 2 to n . Therefore, conditionally on the structure of this tree (that is, forgetting about labels), the sets D_{H_n} (resp. A_{H_n}) of vertices labelled between 2 and $H_n + 1$ (resp. between $n + 1 - H_n$ and n) are two uniform sets of H_n non-root vertices of $T(t^{(n)})$. Furthermore, D_{H_n} and A_{H_n} are independent conditionally on being disjoint. Notice finally that, conditionally on (D_{H_n}, A_{H_n}) , the processes $(C_u^{(n)})_{u \leq H_n}$ and $(\overleftarrow{C}_u^{(n)})_{u \leq H_n}$ are distributed as follows: order the vertices of D_{H_n} (resp. A_{H_n}) uniformly at random, and draw the associated chords in this order.

We will prove that, roughly speaking, as $n \rightarrow \infty$, asymptotically we can get rid of this conditioning to be disjoint. In other words, there is only a small difference between two independent sets of H_n vertices of the tree, and two such sets conditioned to be disjoint, in the sense that they give rise to close lamination-valued processes. To prove this, let us provide a way of sampling D_{H_n} and A_{H_n} : first sample D_{H_n} , a H_n -tuple of non-root vertices in the tree, and then sample A a H_n -tuple of non-root vertices, independent of D_{H_n} . Then

remove from A the vertices of A that are in D_{H_n} , and resample B , a $|A \cap D_{H_n}|$ -tuple of non-root vertices of the tree, independent of D_{H_n} and A , conditioned to contain no vertex of $A \cup D_{H_n}$. Then, set $A_{H_n} = (A \setminus D_{H_n}) \cup B$. It is clear that (D_{H_n}, A_{H_n}) is distributed as a pair of uniform sets of H_n vertices of the tree, conditioned to be disjoint.

Now, we show that with high probability no point of $B \cup (A \cap D_{H_n})$ codes a large chord in the unit disk. This will prove that there is asymptotically no difference between the sets of chords coded respectively by the vertices of A and the vertices of A_{H_n} . Roughly speaking, this will imply that only points of $A \setminus D_{H_n}$ and $D_{H_n} \setminus A$ matter, and thus that the lamination-valued processes corresponding to D_{H_n} and A_{H_n} (recall that it consists in ordering uniformly at random the vertices of the set, and drawing the associated chords in this order) are asymptotically independent. To prove this, observe that, by Markov's inequality,

$$\mathbb{P}(|A \cap D_{H_n}| \geq (\log n)^3) \leq n(H_n/n)^2(\log n)^{-3} \leq (\log n)^{-1}.$$

Thus, with high probability $|B \cup (A \cap D_{H_n})| \leq (\log n)^3$. Now, fix $\varepsilon > 0$ and notice that for $h \leq H(T(t^{(n)}))$, at most $1/\varepsilon$ points in the tree at height h are the root of a subtree of size $\geq \varepsilon n$. This implies that, with high probability, by Theorem 3.3.2, there are fewer than $\sqrt{n} \log n$ such points in the whole tree. Hence, the intersection of the set of such points with $B \cup (A \cap D_{H_n})$ is empty with high probability. The result follows. \square

We finish by proving the technical lemma 3.4.10.

Proof of Lemma 3.4.10 (i). The idea is again to study the non plane tree $T(t^{(n)})$. Remember that this tree has the law of a uniform element of the set \mathfrak{U}_n , that is, the set of non plane rooted trees whose non-root vertices are labelled from 2 to n . Define $g : \mathfrak{U}_n \rightarrow \mathfrak{U}_n$ the involution which consists in changing the label e_x of each non-root vertex x in a tree $T \in \mathfrak{U}_n$ to $n + 2 - e_x$. Then, for $F \in \mathfrak{M}_n$, the tree $g(T(F))$ is the image of a factorization \overleftarrow{F} by the Goulden-Yong bijection, which verifies

$$\left(C_u \left(\overleftarrow{F} \right) \right)_{u \in [0, n]} = \left(\overleftarrow{C}_u(F) \right)_{u \in [0, n]}.$$

Since $t^{(n)}$ is uniform on \mathfrak{M}_n , $\overleftarrow{t^{(n)}}$ is uniform on \mathfrak{M}_n as well and Lemma 3.4.10 (i) follows. \square

In order to prove Lemma 3.4.10 (ii), we focus as usual on large chords of these lamination-valued processes. Fixing $\varepsilon > 0$, we shall check that, jointly for all $u \leq H_n := \sqrt{n} \log n$, for any chord of $\overleftarrow{C}_u^{(n)}$ of length $> \varepsilon$ there is always a chord of $P_u^{(n)}$ close to it, and conversely any chord of $P_u^{(n)}$ of length $> \varepsilon$ can be approximated by a large chord of $\overleftarrow{C}_u^{(n)}$.

Let A_{H_n} be the set of vertices in $T(t^{(n)})$ with labels between $n - H_n$ and n . The proof of Lemma 3.4.10 (ii) is based on the following result, which provides useful properties of the set of vertices A_{H_n} :

Lemma 3.4.11. *The points of the set A_{H_n} are well spread in the random tree $T(t^{(n)})$, in the sense that, for any $\varepsilon > 0$ fixed, the following two properties hold with high probability as $n \rightarrow \infty$:*

- (i) *There is no ancestral line of size 3 in the tree (that is, a vertex, its parent and its grandparent) made only of points of A_{H_n} .*
- (ii) *No point of A_{H_n} is an εn -node or the child of an εn -node.*

Proof of Lemma 3.4.11. In order to get (i), observe that the probability that a vertex, its parent and its grandparent all are in A_{H_n} is of order $(H_n/n)^3 = (\log n)^3 n^{-3/2}$. Since such a triple of vertices is uniquely characterized by the first one, there are at most n of them, and the probability of seeing an ancestral line of size 3 made only of elements of A_{H_n} is less than $(\log n)^3 n^{-1/2}$.

On the other hand, (ii) is a consequence of the small number of children of the εn -nodes. First, since $T(t^{(n)})$ converges in distribution to the Brownian CRT, then with high probability all εn -nodes are $\varepsilon n/2$ -branching points. Now, by Lemma 3.4.8 (ii) (taking $f(n) := \log n$) and Theorem 3.3.2, with high probability there are fewer than $C(\varepsilon) \log n$ children of $\varepsilon n/2$ -branching points in $T(t^{(n)})$, for some constant $C(\varepsilon)$ depending only on ε . Thus, on this event, since a branching point has at least one child, there are at most $2C(\varepsilon) \log n$ vertices that are either an εn -node or the child of one of them. The result follows: with high probability none of these points belongs to A_{H_n} , since $|A_{H_n}| = \lfloor \sqrt{n} \log n \rfloor$. \square

Let us now see how this structural result implies Lemma 3.4.10 (ii):

Proof of Lemma 3.4.10 (ii). In the whole proof, $\varepsilon > 0$ and $u \leq H_n$ are fixed, and we investigate the two chord configurations $\overset{\leftarrow(n)}{C}_u$ and $P_{n-u}^{(n)}$. Specifically, we prove that any large chord of $\overset{\leftarrow(n)}{C}_u$ is close to a large chord of $P_{n-u}^{(n)}$, and conversely; furthermore, this holds uniformly in $u \leq H_n$.

First, let c be a chord of length $\ell(c) > \varepsilon$ in $\overset{\leftarrow(n)}{C}_u$. Let $e(c)$ be the location of the associated transposition in $t^{(n)}$, so that $e(c) \geq n - H_n$, and let $x(c)$ be the vertex of $T(t^{(n)})$ labelled $e(c)$. Note that, by Theorem 3.3.2, with high probability the root and its children are not coded by chords of length $> \varepsilon$, and thus $x(c)$ has height ≥ 3 .

Then, by Lemma 3.4.11 (i), with high probability the parent or the grandparent of $x(c)$ has a label $< n - H_n$. We claim that the chord associated to this ancestor is close to c .

If the parent $y(c)$ of $x(c)$ has such a small label, denote by \tilde{c} the chord associated to it. By assumption, $\tilde{c} \subset C_{n-u}^{(n)}$. By construction of the tree $T(t^{(n)})$, if \tilde{c} has length $\geq 2\ell(c)$ or $\leq \varepsilon/2$, then necessarily either $x(c)$ or $y(c)$ is an $\varepsilon n/2$ -node. However, with high probability this does not happen, by Lemma 3.4.11 (ii). Thus, the chord \tilde{c} is in $C_{n-u}^{(n)}$ and is at distance $\leq \varepsilon$ from c .

On the other hand, if $y(c)$ itself belongs to A_{H_n} , then with high probability the grandparent $z(c)$ of $x(c)$ is not in A_{H_n} . Furthermore, by Lemma 3.4.11 (ii), $y(c)$ is not an εn -node nor the child of an εn -node. Thus, as before, the chord \tilde{c} associated to $z(c)$ is necessarily at distance less than ε from c .

In both cases, this chord \tilde{c} associated to $y(c)$ or $z(c)$ is in $C_{n-u}^{(n)}$. Therefore, it lies inside a block B of $P_{n-u}^{(n)}$ (see Fig. 3.14, left for an example). Let us prove that one of the chords in the boundary of B is at distance less than ε from c . To this end, denote by (ab) the transposition associated to c , where $1 \leq a < b \leq n$. Since $C_n^{(n)}$ satisfies the previously mentioned condition (C_Δ) , its chords are sorted in decreasing labelling order around each point of the form $e^{-2i\pi x/n}$ for $1 \leq x \leq n$. Then there is no chord in $C_{n-u}^{(n)}$ connecting $e^{-2i\pi a/n}$ to $e^{-2i\pi x/n}$ where $x \notin \llbracket a, b \rrbracket$, nor connecting $e^{-2i\pi b/n}$ to $e^{-2i\pi y/n}$ where $y \in \llbracket a, b \rrbracket$. Thus, since the chord \tilde{c} is inside the block B , the boundary of B contains a chord inbetween c and \tilde{c} , which is therefore at distance less than ε from c .

In conclusion, any large chord of $\overset{\leftarrow(n)}{C}_u$ is close to a chord of $P_{n-u}^{(n)}$, uniformly for $u \leq H_n$.

We use the same trick to prove the converse. Specifically, take c' a chord in $P_{n-u}^{(n)}$ of length greater than ε , and define $1 \leq a < b \leq n$ such that $c' = [e^{-2i\pi a/n}, e^{-2i\pi b/n}]$. Now, let $\mathbb{S}^{a,b}$

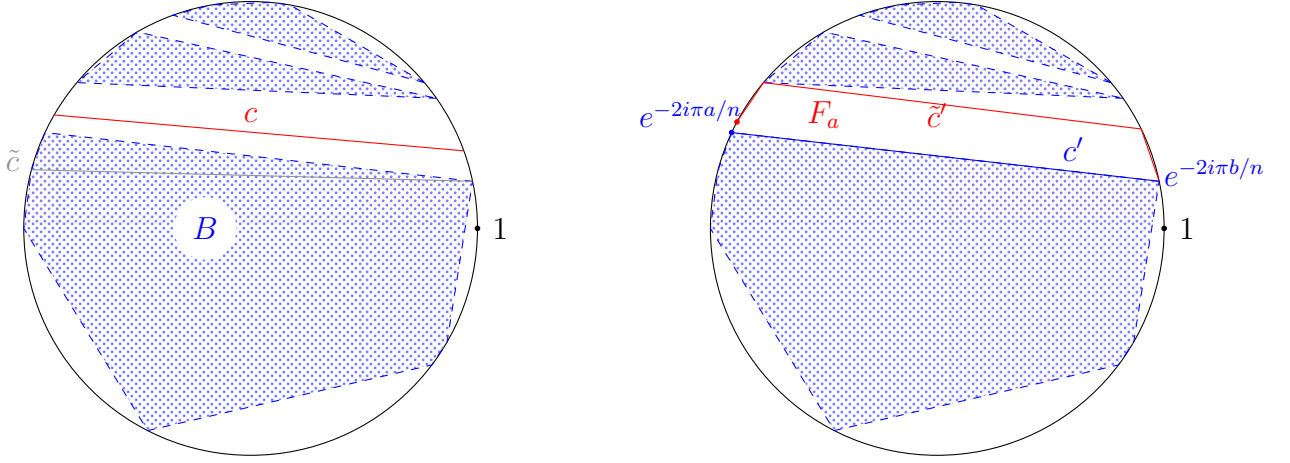

Figure 3.14: Left: the red chord c is a large chord of $\overleftarrow{C}_u^{(n)}$, and the gray chord \tilde{c} is a chord of $C_{n-u}^{(n)}$, which is close to c . B denotes the block of $P_{n-u}^{(n)}$ containing \tilde{c} . Thus, the boundary of B necessarily contains a chord inbetween c and \tilde{c} . Right: the blue chord c' is a large chord of $P_{n-u}^{(n)}$, and the red chords are the chords of $\overleftarrow{C}_u^{(n)}$ that are part of the boundary of F_a . Among these chords, with high probability, one of them (denoted by \tilde{c}' here) is not far from c' .

(resp. $\overline{\mathbb{S}}_{a,b}$) be the set of points of the form $e^{-2i\pi x/n}$ for $a < x < b$ (resp. $a \leq x \leq b$), and assume first that a and b are not connected to any point of $\mathbb{S}_{a,b}$. In other words, the block of $P_{n-u}^{(n)}$ whose boundary contains c' is on the side of c' which contains 1 (see an example on Fig. 3.14, right). Consider now the face F_a of $C_n^{(n)}$ whose boundary contains the arc $(e^{-2i\pi a/n}, e^{-2i\pi(a+1)/n})$. It turns out (see [49, Proposition 2.3]) that the rest of its boundary is only made of chords. Since the labels of the chords in $C_n^{(n)}$ are decreasing in clockwise order around each vertex of this face, it is a simple matter to check that the boundary of F_a contains $e^{-2i\pi b/n}$, and that this boundary is made exclusively of chords of $C_{n-u}^{(n)}$ between $e^{-2i\pi b/n}$ and $e^{-2i\pi a/n}$ (clockwise), and of chords of $\overleftarrow{C}_u^{(n)}$ between $e^{-2i\pi(a+1)/n}$ and $e^{-2i\pi b/n}$ (clockwise, red chords on Fig. 3.14, right). Let \tilde{c}' be the largest of these chords of $\overleftarrow{C}_u^{(n)}$. If \tilde{c}' has length less than $\ell(c) - \varepsilon/2$, then the associated vertex in $T(t^{(n)})$ is necessarily the child of an $\varepsilon n/2$ -node, which with high probability does not happen by Lemma 3.4.11 (ii). Therefore $d_H(\tilde{c}', c') \leq \varepsilon$.

If, on the other hand, one assumes that the block containing c' is on the "other side" of c' (that is, this block only contains chords connecting points of $\overline{\mathbb{S}}_{a,b}$), then we use the same argument on the face F_b containing the arc $(e^{-2i\pi b/n}, e^{-2i\pi(b+1)/n})$. Using the same argument as before, the boundary of F_b contains with high probability a chord of $\overleftarrow{C}_u^{(n)}$ at distance less than ε from c' (otherwise the associated point in A_{H_n} would be an $\varepsilon n/2$ -node, which with high probability does not happen by Lemma 3.4.11 (ii)).

Finally, in probability, jointly for $u \leq H_n$,

$$d_H \left(\overleftarrow{C}_u^{(n)}, P_{n-u}^{(n)} \right) \xrightarrow{\mathbb{P}} 0.$$

□

3.5 Computation of the distribution of $\mathbb{L}_c^{(\alpha)}$ at c fixed

In this section, we fix $c \in \mathbb{R}_+$. Recall that the Lévy process $\tau^{(\alpha),c}$ is defined as

$$\tau_s^{(\alpha),c} := \inf \left\{ t > 0, Y_t^{(\alpha)} - c^{1/\alpha}t < -c^{1+1/\alpha}s \right\} - cs$$

where $Y^{(\alpha)}$ is the α -stable Lévy process. Our goal is to prove Theorem 3.1.3, which states that $\mathbb{L}_c^{(\alpha)}$ is the lamination coded (in the sense of Section 3.1.1) by the excursion of $\tau^{(\alpha),c}$.

To this end, we notably introduce a sequence of random trees whose associated sequence of laminations converges towards $\mathbb{L}_c^{(\alpha)}$ and $\mathbb{L}(\tau^{(\alpha),c,exc})$ at the same time.

Notation of Section 3.5

F_ν	generating function of a law ν
p_n	c/B_n
μ	critical distribution in the domain of attraction of an α -stable law
μ_n	law such that $F_{\mu_n}(x) = F_\mu(p_n x + (1 - p_n)F_{\mu_n}(x))$
$\mathcal{T}^{(n)}$	μ_n -GW tree
$W(T)$	Łukasiewicz path of a tree T
$\mathbb{L}_{Luka}(T)$	lamination coded by $W(T)$
$S^{(n)}$	random walk with i.i.d. jumps of law $\mu_n(\cdot + 1)$

Here and in the next section, we define the functions $z \rightarrow \log z$ and $z \rightarrow z^a$ (for $a \in \mathbb{R}$) on $\mathbb{C} \setminus \mathbb{R}_-$ the following way:

Definition. Let $z \in \mathbb{C} \setminus \mathbb{R}_-$. Then there exists a unique pair $\rho, \theta \in \mathbb{R}_+^* \times (-\pi, \pi)$ such that $z = \rho e^{i\theta}$. Then we define

$$\log z := \log \rho + i\theta \quad \text{and} \quad z^a := e^{a \log z},$$

for any $a \in \mathbb{R}$.

3.5.1 Definition and study of the process $\tau^{(\alpha),c}$

This part is devoted to the study of the process $\tau^{(\alpha),c}$. We start by defining the excursion $\tau^{(\alpha),c,exc}$, and therefore the lamination $\mathbb{L}(\tau^{(\alpha),c,exc})$. Let us fix some notation. To a Lévy process X , we can associate its Laplace exponent $\phi : \mathbb{R}_+^* \rightarrow \mathbb{R} \cup \{+\infty, -\infty\}$ verifying $\mathbb{E}[e^{-\lambda X_s}] := \exp(-s\phi(\lambda))$, and its characteristic exponent $\psi : \mathbb{R} \rightarrow \mathbb{C}$ such that $\mathbb{E}[e^{itX_s}] := \exp(-s\psi(t))$. A Lévy process X is said to be *spectrally positive* if it makes only positive jumps, i.e. almost surely $\forall s \in \mathbb{R}_+, X_{s-} \leq X_s$. The following theorem, which can be found in [32] (see [57] for the original result), gives sufficient conditions for a Lévy process to admit a density:

Theorem 3.5.1. Let X be a spectrally positive Lévy process and ψ its characteristic exponent. If $t \rightarrow \exp(-s\psi)$ is integrable for any $s > 0$, then X_s admits a density for each $s > 0$.

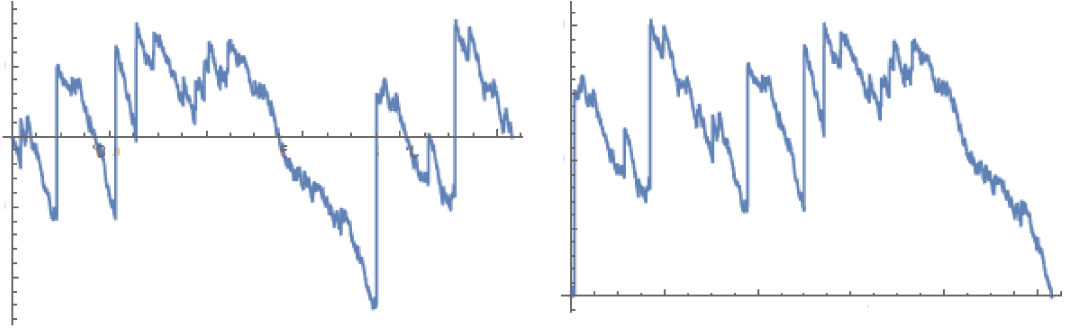

Figure 3.15: Approximation of a bridge obtained from a 1.5-stable Lévy process, and its Vervaat transform

We refer to [32] for more details. From a Lévy process X verifying the assumption of Theorem 3.5.1, following [32], we can construct the so-called *Lévy bridge* X^{br} and *Lévy excursion* X^{exc} . From an informal point of view, the Lévy bridge X^{br} has the law of $(X_s)_{s \in [0,1]}$ conditioned to go back to 0 at $s = 1$, while the Lévy excursion X^{exc} has the law of X^{br} conditioned to stay nonnegative between 0 and 1. More formally, the Lévy bridge $(X_s^{br})_{0 \leq s \leq 1}$ is a random càdlàg process such that, for any $u \in (0, 1)$, any bounded continuous function $F : \mathbb{D}([0, u], \mathbb{R}) \rightarrow \mathbb{R}$,

$$\mathbb{E} \left[F \left((X_s^{br})_{0 \leq s \leq u} \right) \right] = \mathbb{E} \left[F \left((X_s)_{0 \leq s \leq u} \frac{q_{1-u}(-X_u)}{q_1(0)} \right) \right] \quad (3.10)$$

where, for $t > 0$, q_t is the density of X_t . In order to define X^{exc} , following Miermont [81, Definition 1], we introduce the Vervaat transform of a càdlàg process f going back to 0 at time 1, under the additional assumption that $f(1-) = 0$.

Definition. Let $f \in \mathbb{D}([0, 1], \mathbb{R})$ such that $f(0) = f(1) = f(1-) = 0$. Let t_{min} be the location of the right-most minimum of f (that is, the largest x such that $\min(f(x-), f(x)) = \inf f$). We define the Vervaat transform of f , denoted by \tilde{f} , as

$$\tilde{f}(t) = f(t + t_{min} \pmod{1}) - \inf_{[0,1]} f$$

for $t \in [0, 1)$, and $\tilde{f}(1) = \lim_{t \rightarrow 1^-} \tilde{f}(t)$.

Note that, by time-reversal, for any Lévy process X verifying the assumption of Theorem 3.5.1, $X_{1-}^{br} = 0$. Thus, we can define $X^{exc} := \tilde{X}^{br}$ (see Fig. 3.15 for an example). In particular, X^{exc} is always nonnegative on $[0, 1]$ and, if X is spectrally positive, X^{exc} is an excursion-type function.

Since $\inf\{t > 0, Y_t^{(\alpha)} \leq 0\} = 0$ almost surely, we get that $\tau_0^{(\alpha),c} = 0$ almost surely. Moreover, $\tau^{(\alpha),c}$ is clearly càdlàg and Markov with stationary and independent increments, as $Y^{(\alpha)}$ has these properties, and therefore $\tau^{(\alpha),c}$ is a Lévy process. The following proposition computes its Laplace exponent and its characteristic exponent.

Proposition 3.5.2. Fix $\alpha \in (1, 2]$, $c > 0$. Then

(i) The Laplace exponent of $\tau^{(\alpha),c}$ has the form $\nu \rightarrow c\bar{\phi}(\nu) - c\nu$ where $\bar{\phi}(\nu)$ is the only real solution of the equation

$$\bar{\phi}(\nu)^\alpha + c\bar{\phi}(\nu) - c\nu = 0 \quad (3.11)$$

(ii) The characteristic exponent of $\tau^{(\alpha),c}$ has the form $t \rightarrow c\bar{\psi}(t) + itc$, where $\bar{\psi}(t)$ is the only solution with nonnegative real part of the equation

$$\bar{\psi}(t)^\alpha + c\bar{\psi}(t) + itc = 0. \quad (3.12)$$

Notice that by Proposition 3.5.2 (ii), as $|t| \rightarrow \infty$, $|\bar{\psi}(t)| \rightarrow \infty$, and therefore $\bar{\psi}(t) = o(\bar{\psi}(t)^\alpha)$. Hence, $\bar{\psi}(t)^\alpha \sim -itc$ as $|t| \rightarrow \infty$, and in particular

$$\Re(\bar{\psi}(t)) \underset{|t| \rightarrow \infty}{\sim} |tc|^\frac{1}{\alpha} \cos\left(\frac{\pi}{2\alpha}\right). \quad (3.13)$$

Thus, $\tau^{(\alpha),c}$ verifies the assumption of Theorem 3.5.1, and therefore admits a density. In addition, one can easily check that $\tau^{(\alpha),c}$ is spectrally positive. This allows us to define the excursion $\tau^{(\alpha),c,exc}$ and the lamination $\mathbb{L}(\tau^{(\alpha),c,exc})$.

Proof of Proposition 3.5.2. Let us first prove (i). Since $\tau_s^{(\alpha),c}$ is a stopping time according to the canonical filtration associated to $Y^{(\alpha)}$ and is almost surely finite, for any $\lambda \in \mathbb{R}$, by Doob's stopping time theorem,

$$\mathbb{E} \left[\exp \left(-\lambda Y_{\tau_s^{(\alpha),c} + cs}^{(\alpha)} - (\tau_s^{(\alpha),c} + cs) \lambda^\alpha \right) \right] = 1.$$

Now observe that for $s \geq 0$, $Y_{\tau_s^{(\alpha),c} + cs}^{(\alpha)} = c^{1/\alpha} \tau_s^{(\alpha),c}$. Therefore $\mathbb{E} \left[e^{-\lambda c^{1/\alpha} \tau_s^{(\alpha),c} - (\tau_s^{(\alpha),c} + cs) \lambda^\alpha} \right] = 1$, which can be rewritten $\mathbb{E} \left[e^{-(\lambda c^{1/\alpha} + \lambda^\alpha) \tau_s^{(\alpha),c}} \right] = e^{cs \lambda^\alpha}$.

Since $x \rightarrow x^\alpha + c^{1/\alpha}x$ is a bijection from \mathbb{R}_+ to itself, we get that for all $\nu \geq 0$,

$$\mathbb{E} \left[e^{-\nu \tau_s^{(\alpha),c}} \right] = e^{-sc\bar{\phi}(\nu) + sc\nu}$$

where $\bar{\phi}(\nu)$ verifies (3.11). Finally, it is easy to see that, for all $\nu > 0$, (3.11) has exactly one real solution.

By analytic continuation, the characteristic exponent of $\tau^{(\alpha),c}$ has the form $c\bar{\psi}(t) + itc$ where $\bar{\psi}(t)$ is solution of (3.12). Notice that $\bar{\psi}(t)$ has nonnegative real part, as $|\mathbb{E}[e^{it\tau_s^{(\alpha),c}}]| \leq \mathbb{E}[|e^{it\tau_s^{(\alpha),c}}|] = 1$. The fact that (3.12) has exactly one solution with nonnegative real part is postponed to the end of the section (see Theorem 3.5.10). \square

3.5.2 A new family of random trees

The key idea of the proof of Theorem 3.1.3 is to introduce a new sequence of conditioned random trees $(\mathcal{T}_{[cB_n]}^{(n)})_{n \in \mathbb{Z}_+}$, such that the sequence $(\mathbb{L}(\mathcal{T}_{[cB_n]}^{(n)}))_{n \in \mathbb{Z}_+}$ converges in distribution towards both $\mathbb{L}(\tau^{(\alpha),c,exc})$ and $\mathbb{L}_c^{(\alpha)}$ (Theorem 3.5.3). These trees are Galton-Watson trees conditioned on their numbers of vertices, whose offspring distribution varies with n .

Let μ be a critical distribution in the domain of attraction of an α -stable law, and $(B_n)_{n \in \mathbb{Z}_+}$ a sequence verifying (3.4). We recall that \mathcal{T} denotes a μ -GW tree, and that \mathcal{T}_n denotes a μ -GW tree conditioned to have n vertices. For $n \in \mathbb{Z}_+$ large enough that $cB_n/n \leq 1$, define

$$p_n := c \frac{B_n}{n}.$$

and let μ_n be the law whose generating function F_{μ_n} verifies

$$\forall x \in [-1, 1], F_{\mu_n}(x) = F_\mu(p_n x + (1 - p_n)F_{\mu_n}(x)) \quad (3.14)$$

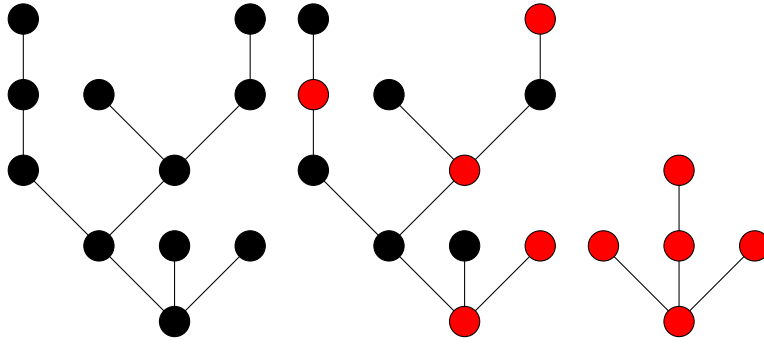

Figure 3.16: A tree, the same tree with a vertex-marking process (the marked vertices are colored in red) and the associated reduced tree.

where F_μ is the generating function of μ (that is, for $x \in [-1, 1]$, $F_\mu(x) = \sum_{i \in \mathbb{Z}_+} \mu(i)x^i$). Notice, by taking $x = 1$ in (3.14), that μ_n is also critical for all n . We let $\mathcal{T}^{(n)}$ be a nonconditioned GW tree with offspring distribution μ_n , and $\mathcal{T}_s^{(n)}$ be the tree $\mathcal{T}^{(n)}$ conditioned to have s vertices, for $s \in \mathbb{Z}_+$. Observe that, by (3.14), for any $n \geq 1$, any $k \geq 1$, $\mathbb{P}(|\mathcal{T}^{(n)}| = k) > 0$ as soon as $0 < p_n < 1$. Note also that (3.14) appears in [21, Proposition 1 (i)] (taking in this Proposition $x = 1$), where Bertoin studies a similar model of random trees coding rare mutations in a population.

Theorem 3.5.3. *The following two convergences hold in distribution, as $n \rightarrow \infty$:*

$$(i) \mathbb{L} \left(\mathcal{T}_{\lfloor cB_n \rfloor}^{(n)} \right) \xrightarrow{(d)} \mathbb{L}_c^{(\alpha)}$$

$$(ii) \mathbb{L} \left(\mathcal{T}_{\lfloor cB_n \rfloor}^{(n)} \right) \xrightarrow{(d)} \mathbb{L}(\tau^{(\alpha), c, exc})$$

We prove the two parts of Theorem 3.5.3 separately.

3.5.3 Proof of Theorem 3.5.3 (i)

In order to prove Theorem 3.5.3 (i), we start by seeing $\mathcal{T}^{(n)}$ as a reduced version of a μ -GW tree. To this end, let us define the notion of vertex-marking process on a tree. Let T be a plane tree, and $V(T)$ be the set of its vertices. A *vertex-marking process* on T is a function $\mathcal{V} : V(T) \rightarrow \{0, 1\}$ such that $\mathcal{V}(\emptyset) = 1$. We say that a vertex $x \in V(T)$ is *marked* if $\mathcal{V}(x) = 1$. To a vertex-marking process \mathcal{V} on a plane tree T , we associate the *reduced tree* $T^\mathcal{V}$ defined the following way:

- the set of vertices of $T^\mathcal{V}$ is the set of marked vertices of T : $V(T^\mathcal{V}) := \{x \in V(T), \mathcal{V}(x) = 1\}$.
- we erase all the edges of the initial tree T .
- we put a new edge between two vertices of $T^\mathcal{V}$ if one is the nearest marked ancestor of the other in T .

(see an example on Fig. 3.16).

A natural vertex-marking process on a tree T consists in marking the root, and marking each other vertex independently with probability p_n . We denote this process by $\mathcal{V}_{n,c}$. Notice that the associated reduced tree is essentially a conditioned version of the tree of alleles of Bertoin [21], where one forgets about the labels of the vertices.

The proof is based on the study of the reduced tree, and consists in proving that the lamination associated to this tree is roughly the sublamination of $\mathbb{L}(\mathcal{T}_n)$ built by drawing only chords that correspond to marked vertices. For this, we mostly use concentration inequalities for binomial random variables. First, notice that the (nonconditioned) GW tree $\mathcal{T}^{(n)}$ is distributed as $\mathcal{T}^{\nu_{n,c}}$. Therefore we can focus on the lamination $\mathbb{L}((\mathcal{T}^{\nu_{n,c}})_{\lfloor cB_n \rfloor})$, where \mathcal{T} is a μ -GW tree.

The first technical lemma concerns the size of \mathcal{T} , conditionally on the event that $|\mathcal{T}^{\nu_{n,c}}| = \lfloor cB_n \rfloor$. Its proof is postponed to the end of the paragraph. Let us introduce some notation: a sequence $(x_n)_{n \in \mathbb{Z}_+}$ being given, we say that $x_n = oe(n)$ if there exists $C > 0$, $\varepsilon > 0$ such that $x_n \leq Ce^{-n^\varepsilon}$ for all n .

Lemma 3.5.4. *As $n \rightarrow \infty$,*

$$\mathbb{P}\left(|\mathcal{T}| - n \geq n^{1-1/3\alpha} \mid |\mathcal{T}^{\nu_{n,c}}| = \lfloor cB_n \rfloor\right) = oe(n).$$

Proof. In order to prove this lemma, observe that for a tree T , conditionally on $|T^{\nu_{n,c}}| = \lfloor cB_n \rfloor$, we have for $A \in \mathbb{Z}_+$,

$$\begin{aligned} \mathbb{P}\left(|T| = A \mid |T^{\nu_{n,c}}| = \lfloor cB_n \rfloor\right) &= \frac{\mathbb{P}(|T| = A)}{\mathbb{P}(|T^{\nu_{n,c}}| = \lfloor cB_n \rfloor)} \mathbb{P}\left(|T^{\nu_{n,c}}| = \lfloor cB_n \rfloor \mid |T| = A\right) \\ &= \frac{\mathbb{P}(|T| = A)}{\mathbb{P}(|T^{\nu_{n,c}}| = \lfloor cB_n \rfloor)} \mathbb{P}\left(\text{Bin}(A, cB_n/n) = \lfloor cB_n \rfloor\right) \\ &\leq \frac{1}{\mathbb{P}(|T^{\nu_{n,c}}| = \lfloor cB_n \rfloor)} \exp\left(-AD(cB_n/A \mid cB_n/n)\right) \end{aligned}$$

by Chernoff inequality, where $D(x|y) = x \log \frac{x}{y} + (1-x) \log \frac{1-x}{1-y}$. Observe that, for any x, y , $D(x|y) \geq \frac{(x-y)^2}{2(x+y)}$. This allows us to write:

$$\mathbb{P}\left(|T| = A \mid |T^{\nu_{n,c}}| = \lfloor cB_n \rfloor\right) \leq \frac{1}{\mathbb{P}(|T^{\nu_{n,c}}| = \lfloor cB_n \rfloor)} \exp\left(-\frac{cB_n}{2n(n+A)}(A-n)^2\right).$$

On the other hand, observe that

$$\begin{aligned} \mathbb{P}\left(|T^{\nu_{n,c}}| = \lfloor cB_n \rfloor\right) &\geq \mathbb{P}\left(|T^{\nu_{n,c}}| = \lfloor cB_n \rfloor \mid |T| = n\right) \times \mathbb{P}(|T| = n) \\ &= \mathbb{P}\left(\text{Bin}(n, cB_n/n) = \lfloor cB_n \rfloor\right) \times \mathbb{P}(|T| = n). \end{aligned}$$

By the local limit theorem 3.4.7, $\mathbb{P}(|T| = n)$ decays at most polynomially in n . At the same time, $\mathbb{P}\left(\text{Bin}(n, cB_n/n) = \lfloor cB_n \rfloor\right) \sim \frac{1}{\sqrt{2\pi cB_n}} \left(\frac{cB_n}{\lfloor cB_n \rfloor}\right)^{\lfloor cB_n \rfloor} \left(\frac{n-cB_n}{n-\lfloor cB_n \rfloor}\right)^{n-\lfloor cB_n \rfloor}$ decays at most polynomially as well.

On the other hand, $\exp\left(-\frac{cB_n}{2n(n+A)}(A-n)^2\right) = oe(n)$ for $|A-n| \geq n^{1-1/3\alpha}$ and is bounded by $\exp\left(-\frac{A}{2n}\right)$ for n large enough and $A \geq n^2$. The result follows. \square

This lemma allows us to restrict ourselves to the study of a tree \mathcal{T} with roughly n vertices, exactly $\lfloor cB_n \rfloor$ of which are marked. In what follows, we fix $A > 0$ and place ourselves under the two conditions: $||\mathcal{T}| - n| \leq n^{1-1/3\alpha}$ and $H(\mathcal{T}) \leq A|\mathcal{T}|/B_{|\mathcal{T}|}$. Indeed, by Lemma 3.5.4 and Theorem 3.3.2, proving the convergence of Theorem 3.5.3 (i) under these conditions is enough to get it in full generality (again, this convergence has to be understood as: under

these conditions, the lamination admits a limit, which converges to $\mathbb{L}_c^{(\alpha)}$ as $A \rightarrow \infty$). We denote by Z_n the set of trees verifying these two conditions.

For a given finite tree T , we denote by $\bar{V}(T)$ the set of marked vertices of T . In what follows, for $\varepsilon < 1$, $T^{(\varepsilon)}$ denotes the set of vertices x of T such that $|\theta_x(T)| > \varepsilon|T|$ (where we recall that $\theta_x(T)$ is the subtree of T rooted at x). Notice that $T^{(\varepsilon)}$ is always nonempty since it contains at least the root. We now define three events on a finite tree T with $\lfloor cB_n \rfloor$ marked vertices (including the root).

$E(T)$: there exists $x \in T$ such that $|\theta_x(T)| \leq \varepsilon|T|$ and that the number of marked vertices in $\theta_x(T)$ is $\geq 2\varepsilon cB_n$. In other words, this is the event that there exists a small subtree which contains a large number of marked vertices.

$F(T, k)$: $|\bar{V}(T) \cap T^{(\varepsilon)}| = k$. The number of marked vertices whose subtree contains more than $\varepsilon|T|$ vertices is equal to k .

Notice that, on the event $F(T, k)$, one can separate $T \setminus (\bar{V}(T) \cap T^{(\varepsilon)})$ into $2k - 1$ components the following way: taking the first and last times that each element of $\bar{V}(T) \cap T^{(\varepsilon)}$ is visited by the contour function of T , we get $2k$ times between 0 and $2n$, which we order increasingly. The components correspond to the vertices visited for the first time by the contour exploration between two consecutive of these times. Since the root is in $\bar{V}(T) \cap T^{(\varepsilon)}$, 0 and $2n$ belong to this set of times and these components form a partition of $T \setminus (\bar{V}(T) \cap T^{(\varepsilon)})$. Denote the components by K_1, \dots, K_{2k-1} , and their respective sizes by $s(K_1), \dots, s(K_{2k-1})$. Finally, denote by $N(K_i)$ the number of marked vertices in K_i .

$G(T, k)$: $F(T, k)$ holds and there exists $i \leq 2k - 1$ such that $s(K_i) \geq \varepsilon n$ and such that, in addition, $|N(K_i) - s(K_i) cB_{|T|}/|T|| \geq B_{|T|}^{3/4}$. We will prove that, for all k , with high probability, this even does not occur. In other words, the number of marked vertices in each of these components is very concentrated around its mean.

We get convergences of the probabilities of these three events, uniformly on Z_n , as $n \rightarrow \infty$. In the following theorem, the probability has to be understood in the sense that the tree T is fixed, and the marked vertices form a uniform random set of $\lfloor cB_n \rfloor$ vertices of T containing the root.

Proposition 3.5.5. (i) $\sup_{T \in Z_n} \mathbb{P}(E(T)) \xrightarrow{n \rightarrow \infty} 0$.

(ii) For any $k \in \mathbb{Z}_+$, $\lim_{n \rightarrow \infty} \inf_{T \in Z_n} \mathbb{P}(F(T, k)) = \mathbb{P}(X = k)$ where $X \sim Po(1)$. In particular, these values sum to 1.

(iii) For any $k \in \mathbb{Z}_+$, $\sup_{T \in Z_n} \mathbb{P}(G(T, k)) \xrightarrow{n \rightarrow \infty} 0$.

Let us immediately see how this implies Theorem 3.5.3 (i)

Proof of Theorem 3.5.3 (i) using Proposition 3.5.5. We will prove that $\mathbb{L}((\mathcal{T}^{\nu_{n,c}})_{\lfloor cB_n \rfloor})$ is close in distribution to $\mathbb{L}_c(\tilde{\mathcal{C}}(\mathcal{T}))$ under the assumptions $||\mathcal{T}| - n| \leq n^{1-1/3\alpha}$ and $H(\mathcal{T}) \leq A|\mathcal{T}|/B_{|\mathcal{T}|}$, which will straightforwardly imply Theorem 3.5.3 (i) by Theorem 3.3.3. To this end, we will prove that large chords have almost the same location in both laminations.

For $u \in \bar{V}(\mathcal{T}) \cap \mathcal{T}^{(\varepsilon)}$, define X_u a uniform variable on the edge from u to its parent, so that $(X_u)_{u \in \bar{V}(\mathcal{T}) \cap \mathcal{T}^{(\varepsilon)}}$ are independent. Then, observe that, on one hand, the chords corresponding to u and X_u are at distance at most $2\pi/|\mathcal{T}|$ in $\mathbb{L}(\tilde{\mathcal{C}}(\mathcal{T}))$. On the other hand, by Proposition 3.5.5 (ii), the set $\{X_u, u \in \bar{V}(\mathcal{T}) \cap \mathcal{T}^{(\varepsilon)}\}$ is asymptotically distributed as a Poisson point process \mathcal{P} of intensity $p_n d\ell$, on the set of edges of \mathcal{T} whose endpoints are in $\mathcal{T}^{(\varepsilon)}$ (conditionally given that no two points of \mathcal{P} are in the same edge, which happens with high probability).

Proposition 3.5.5 (i) ensures that large chords (namely, chords that have length $\geq 2\pi\varepsilon$) in $\mathbb{L}((\mathcal{T}^{\nu_{n,c}})_{\lfloor cB_n \rfloor})$ are necessarily coded by points of $\bar{V}(\mathcal{T}) \cap \mathcal{T}^{(\varepsilon)}$.

Finally, by Proposition 3.5.5,(iii), each chord in $\mathbb{L}((\mathcal{T}^{\nu,c})_{\lfloor cB_n \rfloor})$ coded by a vertex u of $\bar{V}(\mathcal{T}) \cap \mathcal{T}^{(\varepsilon)}$ is asymptotically close to the chord corresponding to u in $\mathbb{L}(\tilde{C}(\mathcal{T}))$, which concludes the proof. \square

Now we prove Proposition 3.5.5.

Proof of Proposition 3.5.5. The proofs of these three statements rely on estimates of binomial tails. Let us start by proving (ii). For $T \in Z_n$,

$$\mathbb{P}(|\bar{V}(T) \cap T^{(\varepsilon)}| = k) = \frac{\mathbb{P}(Y_1 = k) \mathbb{P}(Y_2 = \lfloor cB_n \rfloor - k)}{\mathbb{P}(Y = \lfloor cB_n \rfloor)}$$

where $Y_1 = \text{Bin}(|T^{(\varepsilon)}|, p_n)$, $Y_2 = \text{Bin}(|T| - |T^{(\varepsilon)}|, p_n)$ and $Y = \text{Bin}(|T|, p_n)$. We now use the following key fact: for any tree T , any $q > 0$, let $n_q(T)$ be the number of vertices x of T such that $|\theta_x(T)| > q$. Then

$$n_q(T) \leq |T| \frac{H(T)}{q}. \quad (3.15)$$

Indeed, $h \in \llbracket 0, H(T) \rrbracket$ being fixed, there are at most $|T|/q$ such vertices with height exactly h . The result follows by summing over all h . In particular, uniformly in $T \in Z_n$, $|T^{(\varepsilon)}| \leq A|T|/B_{|T|} \times 1/\varepsilon$. Hence, as $n \rightarrow \infty$, $\mathbb{P}(Y_2 = \lfloor cB_n \rfloor - k) \sim \mathbb{P}(Y = \lfloor cB_n \rfloor)$ and

$$\mathbb{P}(|\bar{V}(T) \cap T^{(\varepsilon)}| = k) \sim \mathbb{P}(Y_1 = k) \sim \mathbb{P}(X = k)$$

where X is a Poisson variable of parameter 1.

In order to prove (i), we use a similar method. Take $T \in Z_n$ and x such that $|\theta_x(T)| \leq \varepsilon|T|$. Then the probability that there are K marked vertices in $\theta_x(T)$ is

$$\frac{\mathbb{P}(Y'_1 = K) \mathbb{P}(Y'_2 = \lfloor cB_n \rfloor - K)}{\mathbb{P}(Y' = \lfloor cB_n \rfloor)}$$

where $Y'_1 = \text{Bin}(|\theta_x(T)|, p_n)$, $Y'_2 = \text{Bin}(|T| - |\theta_x(T)|, p_n)$ and $Y' = \text{Bin}(|T|, p_n)$. By the local limit theorem 3.4.7, there exists a constant C_1 depending only on ε such that, uniformly in K , $\mathbb{P}(Y'_2 = \lfloor cB_n \rfloor - K) \leq C_1 \mathbb{P}(Y' = \lfloor cB_n \rfloor)$. Hence, the probability r_x that there are more than $2\varepsilon cB_n$ vertices in $\theta_x(T)$ satisfies $r_x \leq C_1 \mathbb{P}(Y'_1 \geq 2\varepsilon cB_n)$. By the Bienaymé-Tchebychev inequality, for n large enough,

$$\mathbb{P}(Y'_1 \geq 2\varepsilon cB_n) \leq \mathbb{P}\left(|Y'_1 - \mathbb{E}(Y'_1)| \geq \frac{\varepsilon}{2} cB_n\right) \leq \frac{4\text{Var}(Y'_1)}{\varepsilon^2 c^2 B_n^2}.$$

Since $\text{Var}(Y'_1) = |\theta_x(T)| p_n (1 - p_n) \leq |\theta_x(T)| p_n$, we obtain:

$$r_x \leq 4C_1 \frac{|\theta_x(T)|}{cB_n \varepsilon^2 n}.$$

Now observe that, by (3.15), the number of vertices x in T (marked or not) such that $|\theta_x(T)| \geq |T|/\log n$ is $\leq H(T) \log n \leq A \log n |T|/B_{|T|}$. Hence, with high probability, the number of such vertices that are marked is $O(\log n)$. Distinguishing marked vertices x such that $|\theta_x(T)| \leq |T|/\log n$ and marked vertices such that $\varepsilon|T| \geq |\theta_x(T)| \geq |T|/\log n$, we get that there exists a constant C such that

$$\sum_{\substack{x \text{ marked} \\ |\theta_x(T)| \leq \varepsilon|T|}} r_x \leq C \left(\log n \frac{\varepsilon|T|}{c\varepsilon^2 n B_n} + B_n \frac{|T|/\log n}{c\varepsilon^2 n B_n} \right) \leq 2C \left(\frac{\log n}{cB_n \varepsilon} + \frac{1}{c\varepsilon^2 \log n} \right),$$

using the fact that the number of marked vertices in T is exactly $\lfloor cB_n \rfloor$. This quantity tends to 0, which provides the result.

Finally, we sketch the idea of the proof of (iii). Notice that $N(K_1), \dots, N(K_{2k-1})$ are distributed as binomials of parameters $(s(K_1), p_{|T|}), \dots, (s(K_{2k-1}), p_{|T|})$, conditionally on their sum being equal to $\lfloor cB_n \rfloor - k$. The only thing that we need to prove is that, as n grows, for any $T \in \mathcal{Z}_n$, for any $M \geq \varepsilon n$, for any subset of M points of T independent of the vertex-marking process, the number N of marked vertices among these M points is concentrated enough around its mean. More precisely, since N follows a binomial distribution of parameters (M, p_n) , we only need to prove that

$$\mathbb{P}(|B - \mathbb{E}[B]| \geq B_n^{3/4}) \xrightarrow[n \rightarrow \infty]{} 0.$$

where $B \sim \text{Bin}(M, p_n)$. As in the proof of Lemma 3.5.4, this is a Chernoff bound. The result follows. \square

3.5.4 Proof of Theorem 3.5.3 (ii)

In order to prove this part of the theorem, we need to introduce an other way of coding a finite tree, called the Łukasiewicz path of the tree (see Fig. 3.17 for an example). Let T be a plane tree with n vertices. Its Łukasiewicz path $(W_t(T))_{0 \leq t \leq n}$ is constructed as follows: $W_0(T) = 1$ and, for $i \in \llbracket 0, n-1 \rrbracket$, $W_{i+1}(T) - W_i(T) = k_{v_i}(T) - 1$. In particular, $W_n(T) = -1$. We define it on the whole interval $[0, n]$ by taking its linear interpolation.

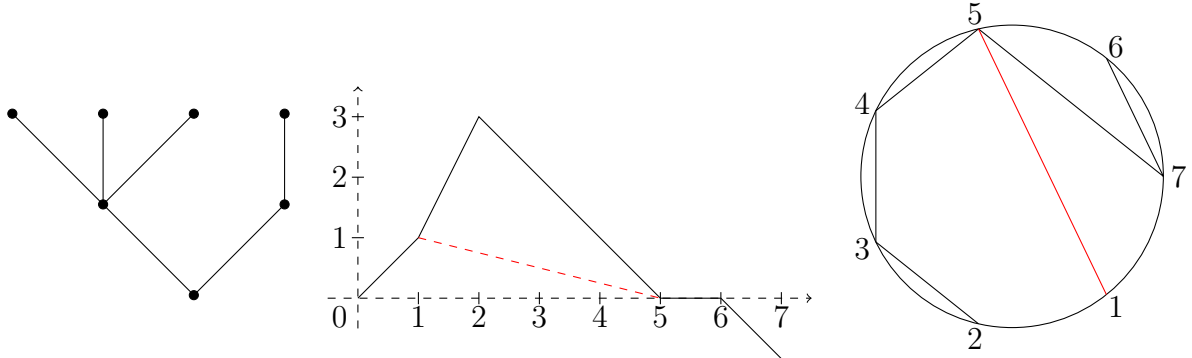

Figure 3.17: A tree T , its Łukasiewicz path $W(T)$ and the lamination $\mathbb{L}_{Luka}(T)$. In red, a chord of $\mathbb{L}_{Luka}(T)$ and the way to draw it from $W(T)$.

Recall that we defined in Section 3.1.1 a lamination $\mathbb{L}(C(T))$ associated to a tree T through its contour function. Here, we shall need another lamination, which is discrete, defined through its Łukasiewicz path. Specifically, fix a plane tree T with n vertices. For every $0 \leq a \leq n-1$, set $d(a) = \min\{b \in \{a+1, a+2, \dots, n\} : W_b(T) < W_a(T)\}$, and set

$$\mathbb{L}_{Luka}(T) = \bigcup_{a=0}^{n-1} [e^{-2i\pi a/n}, e^{-2i\pi d(a)/n}].$$

(see Fig. 3.17 for an example).

The following result shows that the laminations $\mathbb{L}(C(T))$ and $\mathbb{L}_{Luka}(T)$ are close, provided that T is a large tree with rather small height.

Lemma 3.5.6. *Let $f : \mathbb{Z}_+ \rightarrow \mathbb{Z}_+$ be such that $f(n) = o(n)$. Then*

$$\sup_{|T|=n, H(T) \leq f(n)} d_H(\mathbb{L}(C(T)), \mathbb{L}_{Luka}(T)) \xrightarrow[n \rightarrow \infty]{} 0.$$

Proof. Let T be a tree with n vertices and height $\leq f(n)$. Let $0 \leq r \leq n-1$, and recall that $v_r(T)$ denotes the $(r+1)$ -th vertex of T in the lexicographical order. Let k be the size of the subtree rooted at $v_r(T)$. Then, $v_r(T)$ corresponds to a chord between $e^{-2i\pi r/n}$ and $e^{-2i\pi(r+k)/n}$ in $\mathbb{L}_{\text{Łuka}}(T)$. In $\mathbb{L}(C(T))$, $v_r(T)$ codes a chord between $e^{-2i\pi(2r-h(v_r(T)))/2n}$ and $e^{-2i\pi(2(r+k-1)-h(v_r(T)))/2n}$, while points in the edge between $v_r(T)$ and its parent code (infinitely many) chords at distance $\leq 2\pi/n$ to this first one. The result follows since, by assumption, uniformly for all r , $h(v_r(T)) = o(n)$. \square

Recall that $\mathcal{T}_{\lfloor cB_n \rfloor}^{(n)}$ is a Galton-Watson tree with offspring distribution μ_n , conditioned on having $\lfloor cB_n \rfloor$ vertices. The main tool to establish Theorem 3.5.3 (ii) is the fact that the Łukasiewicz path of $\mathcal{T}_{\lfloor cB_n \rfloor}^{(n)}$ is distributed as a conditioned random walk (see [70, Section 1.2]). More precisely, let $S^{(n)}$ be the integer-valued random walk started from 0 with i.i.d. jumps, whose jump distribution is given by $\mathbb{P}(S_1^{(n)} = k) = \mu(k+1)$ for $k \geq -1$. We extend it on \mathbb{R}_+ by linear interpolation. Then, $(S_a^{(n)})_{0 \leq a \leq \lfloor cB_n \rfloor}$ conditioned on the event $\{S_{\lfloor cB_n \rfloor}^{(n)} = -1 \text{ and } S_a^{(n)} \geq 0 \text{ for } a \leq \lfloor cB_n \rfloor - 1\}$ is distributed as the Łukasiewicz path of the tree $\mathcal{T}_{\lfloor cB_n \rfloor}^{(n)}$. In order to obtain a limit theorem for $S^{(n)}$, we rely on the following local limit theorem.

Theorem 3.5.7. *Fix $0 < u \leq 1$. The following convergence holds as $n \rightarrow \infty$:*

$$\sup_{|j| \leq n^{3/8}} \sup_{k \in \mathbb{Z}} \left| B_n \mathbb{P} \left(S_{\lfloor ucB_n + j \rfloor}^{(n)} = k \right) - q_u \left(\frac{k}{B_n} \right) \right| \xrightarrow{n \rightarrow \infty} 0$$

where q_u is the density of $\tau_u^{(\alpha),c}$.

The proof of this result is postponed to Section 3.5.5; let us first explain how it entails Theorem 3.5.3 (ii).

Proof of Theorem 3.5.3 (ii) from Theorem 3.5.7. The first step is to show that the convergence

$$\left(\frac{S_{\lfloor cB_n \rfloor t}^{(n)}}{B_n} \right)_{0 \leq t \leq 1} \text{ under } \mathbb{P}(\cdot | S_{\lfloor cB_n \rfloor}^{(n)} = -1 \text{ and } \forall a \leq \lfloor cB_n \rfloor - 1, S_a^{(n)} \geq 0) \xrightarrow[n \rightarrow \infty]{(d)} (\tau_t^{(\alpha),c,exc})_{0 \leq t \leq 1}$$

holds in distribution. To this end, we follow the classical path, which consists in first showing a convergence under a "bridge" condition by combining an unconditioned convergence with absolute continuity and time-reversal, and then using the Vervaat transformation. To do this, we start by proving an unconditioned convergence, namely

$$\left(\frac{S_{\lfloor cB_n \rfloor t}^{(n)}}{B_n} \right)_{0 \leq t \leq 1} \xrightarrow[n \rightarrow \infty]{(d)} (\tau_t^{(\alpha),c})_{0 \leq t \leq 1} \quad (3.16)$$

By [58, Theorem 16.14], to prove (3.16), it is enough to check that the one-dimensional convergence holds for $t = 1$, which is an immediate consequence of Theorem 3.5.7.

Next, we prove the "bridge" version of this theorem, first up to time $u \in (0, 1)$. Let $F : \mathbb{D}([0, 1], \mathbb{R}) \rightarrow \mathbb{R}$ be a continuous bounded function. Then, setting $\phi_k(i) = \mathbb{P}(S_k^{(n)} = i)$, by absolute continuity, we have

$$\mathbb{E} \left[F \left(\left(\frac{S_{\lfloor cB_n \rfloor t}^{(n)}}{B_n} \right)_{0 \leq t \leq u} \right) \middle| S_{\lfloor cB_n \rfloor}^{(n)} = -1 \right] = \mathbb{E} \left[F \left(\left(\frac{S_{\lfloor cB_n \rfloor t}^{(n)}}{B_n} \right)_{0 \leq t \leq u} \right) \frac{\phi_{\lfloor cB_n \rfloor(1-u)}(-S_{\lfloor cB_n \rfloor u}^{(n)} - 1)}{\phi_{\lfloor cB_n \rfloor}(-1)} \right]$$

By combining Theorem 3.5.7 and (3.16), this quantity converges to $\mathbb{E}[F((\tau_t^{(\alpha),c})_{0 \leq t \leq u})^{\frac{q_{1-u}(-\tau_u^{(\alpha),c})}{q_1(0)}}]$ as $n \rightarrow \infty$. By (3.10), this is equal to $\mathbb{E}[F((\tau_t^{(\alpha),c,br})_{0 \leq t \leq u})]$. In order to obtain the convergence up to time 1, it is enough to show tightness on $[0, 1]$. Observe that we already know that, conditionally given $S_{\lfloor cB_n \rfloor}^{(n)} = -1$, the sequence $(\frac{S_{\lfloor cB_n \rfloor t}^{(n)}}{B_n})_{0 \leq t \leq 1}$ is tight on $[0, u]$. In order to prove that it is tight on $[0, 1]$, we prove that, for $u \in [0, 1]$, the process $(\frac{S_{\lfloor cB_n \rfloor - \lfloor cB_n \rfloor t}^{(n)}}{B_n})_{0 \leq t \leq u}$ is tight on $[0, u]$. For this, just observe that by time-reversal,

$$\left(\frac{S_{\lfloor cB_n \rfloor}^{(n)} - S_{\lfloor cB_n \rfloor - \lfloor cB_n \rfloor t}^{(n)}}{B_n} \right)_{0 \leq t \leq u} \stackrel{(d)}{=} \left(\frac{S_{\lfloor cB_n \rfloor t}^{(n)}}{B_n} \right)_{0 \leq t \leq u}$$

which is tight conditionally given $S_{\lfloor cB_n \rfloor}^{(n)} = -1$ by the previous observation.

In order to deduce the convergence of the excursions from the convergence of the bridge versions of the processes, we make use of the Vervaat transform, following Definition 3.5.1. Note that the minimum of $\tau^{(\alpha),c,br}$ is almost surely unique. Indeed, it is true for the unconditioned version $\tau^{(\alpha),c}$ and transfers to the bridge by the absolute continuity relation (3.10). Therefore, the Vervaat transform is continuous at $\tau^{(\alpha),c,br}$, and by applying it to the bridge convergence this completes the first step.

To prove that the convergence of the rescaled Łukasiewicz paths of $\mathcal{T}_{\lfloor cB_n \rfloor}^{(n)}$ to $\tau^{(\alpha),c,exc}$ implies the convergence of $\mathbb{L}(\mathcal{T}_{\lfloor cB_n \rfloor}^{(n)})$ to $\mathbb{L}(\tau^{(\alpha),c,exc})$, first note that a straightforward adaptation of [64, Proposition 3.5] shows that $\mathbb{L}_{Luka}(\mathcal{T}_{\lfloor cB_n \rfloor}^{(n)})$ converges in distribution to $\mathbb{L}(\tau^{(\alpha),c,exc})$ as $n \rightarrow \infty$. To conclude the proof, in view of Lemma 3.5.6, it remains to check that $H(\mathcal{T}_{\lfloor cB_n \rfloor}^{(n)}) = o(B_n)$ with high probability. Let us prove that in fact, with high probability, $H(\mathcal{T}_{\lfloor cB_n \rfloor}^{(n)}) \leq B_n^{3/4}$. To this end, notice that the height of a vertex in $\mathcal{T}^{\mathcal{V}_{n,c}}$ is the number of marked vertices in the ancestral line of the corresponding vertex in \mathcal{T} . Now let $x \in \mathcal{T}$ be a marked vertex and $h(x)$ be its height. Then, copying the proof of Proposition 3.5.5 (i), there exists a constant $C > 0$ such that, if $|\mathcal{T}| - n \leq n^{1-1/3\alpha}$ and $H(\mathcal{T}) \leq An/B_n$, we have by Chernoff inequality:

$$\begin{aligned} \mathbb{P}(N_x \geq B_n^{3/4}) &\leq C \mathbb{P}(Bin(h(x), p_n) \geq B_n^{3/4}) \leq C \mathbb{P}(Bin(An/B_n, p_n) \geq B_n^{3/4}) \\ &\leq C \exp\left(-2\frac{B_n^{5/2}}{An}\right) \leq C \exp(-2A^{-1}n^{1/8}) \end{aligned}$$

for n large enough, where N_x is the number of marked vertices in the ancestral line of x in \mathcal{T} (the exponents used here are not optimal but are sufficient to get our result). Here we have used the fact that there exists a constant K such that $B_n \geq K\sqrt{n}$ for all n large enough. Hence, by a union bound over all $\lfloor cB_n \rfloor$ vertices in the tree, with high probability no marked vertex has more than $B_n^{3/4}$ marked vertices in its ancestral line, which concludes the proof. \square

3.5.5 Proof of the local estimate

In this section, we establish Theorem 3.5.7. For $n \geq 1$ and $t \in \mathbb{R}$, the following quantity will play an important role:

$$R_n(t) := B_n \left(1 - F_{\mu_n} \left(e^{\frac{it}{B_n}} \right) \right).$$

The proof relies on the following estimates. Recall that $c\bar{\psi}(t) + itc$ denotes the characteristic exponent of $\tau^{(\alpha),c}$.

Lemma 3.5.8. *The following assertions are satisfied:*

- (i) *The convergence $F_{\mu_n}(e^{it/B_n}) \rightarrow 1$ holds as $n \rightarrow \infty$, uniformly for $t \in \mathbb{R}$.*
- (ii) *Let \mathcal{K} be a compact subset of \mathbb{R} which does not contain 0. The convergence $R_n(t) \rightarrow \bar{\psi}(t)$ holds as $n \rightarrow \infty$, uniformly for $t \in \mathcal{K}$.*
- (iii) *For $t \notin 2\pi B_n \mathbb{Z}$, set*

$$K_n(t) = \left(\frac{L(B_n/|R_n(t)|)}{L(B_n)} \right)^{\frac{1}{\alpha}} \quad \text{and} \quad A_n(t) = (-cB_n(e^{it/B_n} - 1))^{\frac{1}{\alpha}}.$$

Then, for every $\eta > 0$, there exists $A > 0$ such that, for n large enough, for every t such that $|t| \in [A, \pi B_n]$, we have $|R_n(t)| \geq 1$ and $|K_n(t)R_n(t) - A_n(t)| \leq \eta|A_n(t)|$.

Let us first explain how Theorem 3.5.7 follows from Lemma 3.5.8.

Proof of Theorem 3.5.7 using Lemma 3.5.8. Fix $u \in (0, 1]$. In the whole proof, for convenience, we will write $ucB_n + j$ instead of $\lfloor ucB_n + j \rfloor$. We let $f(t) := e^{-uc\bar{\psi}(t)}$ be the characteristic function of $\tau_u^{(\alpha),c}$ and $q_u(x) := \frac{1}{2\pi} \int_{-\infty}^{\infty} e^{-itx} f(t) dt$ be its density (which we recall exists by Theorem 3.5.1). Fix $\varepsilon > 0$. The goal is to prove that, for n large enough, uniformly in $x \in \mathbb{R}$ such that $xB_n \in \mathbb{Z}$, uniformly in $|j| \leq n^{3/8}$,

$$\left| B_n \mathbb{P} \left(S_{ucB_n+j}^{(n)} = xB_n \right) - q_u(x) \right| \leq \varepsilon. \quad (3.17)$$

For $n \in \mathbb{Z}_+$, $t \in \mathbb{R}$, we set $\phi^{(n)}(t) = F_{\mu_n}(e^{it})$. First, by Fourier inversion, we have for all $k \in \mathbb{Z}$: $\mathbb{P}(S_{ucB_n+j}^{(n)} = k) = \frac{1}{2\pi} \int_{-\pi}^{\pi} e^{-itk} (\phi^{(n)}(t))^{ucB_n+j} dt$. Hence, for $x \in \mathbb{R}$ such that xB_n is an integer, we can write

$$B_n \mathbb{P} \left(S_{ucB_n+j}^{(n)} = xB_n \right) = \frac{1}{2\pi} \int_{-\pi B_n}^{\pi B_n} e^{-itx} \left(\phi^{(n)} \left(\frac{t}{B_n} \right) \right)^{ucB_n+j} dt$$

Therefore, for any $A > \varepsilon > 0$, we can write

$$\left| B_n \mathbb{P} \left(S_{ucB_n+j}^{(n)} = xB_n \right) - q_u(x) \right| \leq \frac{1}{2\pi} (I_\varepsilon + I_1(A) + I_2(A) + I_3(A))$$

where

$$I_\varepsilon = \int_{-\varepsilon}^{\varepsilon} \left| e^{-itx} \left(\left(\phi^{(n)} \left(\frac{t}{B_n} \right) \right)^{ucB_n+j} - f(t) \right) \right| dt,$$

$$I_1(A) = \int_{\varepsilon \leq |t| \leq A} \left| e^{-itx} \left(\left(\phi^{(n)} \left(\frac{t}{B_n} \right) \right)^{ucB_n+j} - f(t) \right) \right| dt,$$

$$I_2(A) = \int_{A \leq |t| \leq \pi B_n} \left| e^{-itx} \left(\phi^{(n)} \left(\frac{t}{B_n} \right) \right)^{ucB_n+j} \right| dt \quad \text{and} \quad I_3(A) = \int_{A \leq |t| < \infty} |e^{-itx} f(t)| dt.$$

We now bound these four quantities, for certain A well chosen.

Bounding I_ε . Straightforwardly, since $|\phi^{(n)}|$ and $|f|$ are bounded by 1 on \mathbb{R} , $I_\varepsilon \leq 4\varepsilon$ for all $n \geq 1$.

Bounding $I_1(A)$. Since, by definition, $\phi^{(n)}(t/B_n) = 1 - R_n(t)/B_n$, Lemma 3.5.8 (ii) entails that, at ε, A fixed, $I_1(A) \rightarrow 0$ as $n \rightarrow \infty$, uniformly in $|j| \leq n^{3/8}$.

Bounding $I_3(A)$. We have already seen that $\Re(\bar{\psi}(t)) \sim |tc|^{1/\alpha} \cos(\frac{\pi}{2\alpha})$ as $|t| \rightarrow \infty$. Thus, $|f(t)|$ decays exponentially fast as $|t| \rightarrow +\infty$, and $I_3(A) \rightarrow 0$ as $A \rightarrow \infty$ (observe that $I_3(A)$ does not depend on n). Hence, for A large enough, $I_3(A) \leq \varepsilon$.

Bounding $I_2(A)$. The main challenge is in fact to bound $I_2(A)$. To this end, we make essential use of Lemma 3.5.8 (ii) and (iii). For $t \in \mathbb{R}$, we have

$$\begin{aligned} \left| \phi^{(n)}\left(\frac{t}{B_n}\right) \right|^2 &= \left| 1 - \frac{R_n(t)}{B_n} \right|^2 = \left(1 - \frac{\Re(R_n(t))}{B_n} \right)^2 + \left(\frac{\Im(R_n(t))}{B_n} \right)^2 \\ &\leq 1 - 2\frac{\Re(R_n(t))}{B_n} + 2\left(\frac{|R_n(t)|}{B_n}\right)^2 \end{aligned} \quad (3.18)$$

We keep the notation of Lemma 3.5.8 (iii) and assume that $A > 0$ is large enough, so that for every n large enough and $|t| \in [A, \pi B_n]$ we have $|R_n(t)| \geq 1$ and

$$|K_n(t)R_n(t) - A_n(t)| \leq \frac{1}{2}|A_n(t)|. \quad (3.19)$$

Note that $K_n(t) \in \mathbb{R}_+^*$ for all t , that for $t \in [A, \pi B_n]$, $\arg(A_n(t)) = \frac{t - \pi B_n}{2\alpha B_n} \in [-\frac{\pi}{2\alpha}, 0]$ and that for $t \in [-\pi B_n, -A]$, $\arg(A_n(t)) = \frac{t + \pi B_n}{2\alpha B_n} \in [0, \frac{\pi}{2\alpha}]$. Therefore, by (3.19), uniformly for $|t| \in [A, \pi B_n]$, $\arg(R_n(t))$ is bounded away from $\pi/2 + \pi\mathbb{Z}$, and therefore $\Re(R_n(t)) \geq C|R_n(t)|$ for some constant $C > 0$. Recall indeed that $\Re(R_n(t)) \geq 0$ for all $t \in \mathbb{R}$. Then, by (3.18),

$$\left| \phi^{(n)}\left(\frac{t}{B_n}\right) \right|^2 \leq 1 - 2C\frac{|R_n(t)|}{B_n} + 2\left(\frac{|R_n(t)|}{B_n}\right)^2.$$

On the other hand, uniformly for $t \in \mathbb{R}$, $|R_n(t)|/B_n \rightarrow 0$ by Lemma 3.5.8 (ii). Hence, for n large enough and $|t| \in [A, \pi B_n]$,

$$\left| \phi^{(n)}\left(\frac{t}{B_n}\right) \right|^2 \leq 1 - C\frac{|R_n(t)|}{B_n} \leq 1 - C\frac{\sqrt{K_n(t)|R_n(t)|}}{B_n},$$

where we have used the Potter bounds 3.3.1 and the fact that $|R_n(t)| \geq 1$. Hence, (3.19) gives:

$$\left| \phi^{(n)}\left(\frac{t}{B_n}\right) \right|^2 \leq 1 - \frac{C}{\sqrt{2}}\frac{\sqrt{|A_n(t)|}}{B_n} \leq 1 - \frac{C}{\sqrt{2}B_n} \left(2cB_n \sin\left(\frac{|t|}{2B_n}\right) \right)^{1/2\alpha}$$

which is less than $1 - \frac{C'}{B_n}|t|^{1/2\alpha}$ for some absolute constant $C' > 0$, using the fact that $\sin x \geq \frac{2}{\pi}x$ for $x \in [0, \frac{\pi}{2}]$. We finally get for A large enough, for every n large enough and $|t| \in [A, \pi B_n]$

$$\begin{aligned} I_2(A) &= \int_{A \leq |t| \leq \pi B_n} \left| \left(\phi^{(n)}\left(\frac{t}{B_n}\right) \right)^{ucB_n + j} \right| dt \leq \int_{A \leq |t| \leq \pi B_n} \left(1 - \frac{C'}{B_n}|t|^{1/2\alpha} \right)^{\frac{ucB_n + j}{2}} dt \\ &\leq \int_{A \leq |t| < +\infty} e^{-\frac{C'}{2}(uc + j/B_n)|t|^{1/2\alpha}} dt \leq \int_{A \leq |t| < +\infty} e^{-\frac{ucC'}{4}|t|^{1/2\alpha}} dt. \end{aligned} \quad (3.20)$$

Thus, for $A > 0$ large enough, for any n large enough and any $|j| \leq n^{3/8}$, $I_2(A) \leq \varepsilon$. This completes the proof. \square

We now prove separately the three parts of Lemma 3.5.8.

Proof of Lemma 3.5.8 (i). It is enough to show that $F_{\mu_n}(0) \rightarrow 1$ as $n \rightarrow \infty$. Let us denote, for $n \in \mathbb{Z}_+$, $x_n := (1 - p_n)F_{\mu_n}(0)$. By (3.14), $x_n = F_{\mu}(x_n) - p_n F_{\mu_n}(0)$. In particular, $F_{\mu}(x_n) - x_n \rightarrow 0$. Since $f : x \rightarrow F_{\mu}(x) - x$ is continuous on $[0, 1]$ (and hence uniformly continuous), we just have to prove that 1 is the only fixed point of F_{μ} . For this, we use the fact that μ is critical, which implies that $f'(x) = F'_{\mu}(x) - 1$ is negative on $(0, 1)$ and f is decreasing. Since $f(1) = 0$, $f > 0$ on $[0, 1)$ which concludes the proof. \square

The proofs of Lemma 3.5.8 (ii) and (iii) use the following estimate.

Lemma 3.5.9. *As $n \rightarrow \infty$, uniformly for $t \in \mathbb{R} \setminus 2\pi B_n \mathbb{Z}$,*

$$\frac{L(B_n/|R_n(t)|)}{L(B_n)} R_n(t)^\alpha (1 + o(1)) + cR_n(t) + cB_n \left(e^{\frac{it}{B_n}} - 1 \right) = 0$$

where the $o(1)$ holds when $n \rightarrow \infty$, uniformly in $t \in \mathbb{R} \setminus 2\pi B_n \mathbb{Z}$, and where L is the slowly varying function defined in (3.3).

Proof. Our main object of interest is the generating function F_{μ} of μ . It is known (see [44, XVII.5, Theorem 2]) that F_{μ} has the following Taylor expansion at $1-$, on the real axis:

$$F_{\mu}(1 - s) - (1 - s) \underset{s \downarrow 0}{\rightarrow} \frac{\Gamma(3 - \alpha)}{\alpha(\alpha - 1)} s^\alpha L\left(\frac{1}{s}\right), \quad (3.21)$$

where L is the slowly varying function given by (3.3).

Now, observe that, if $t/B_n \neq 0 \pmod{[2\pi]}$, $F_{\mu_n}(e^{it/B_n}) \neq e^{it/B_n}$. To see this, notice that by (3.14),

$$F_{\mu_n}(e^{it/B_n}) = e^{it/B_n} \Rightarrow F_{\mu}(e^{it/B_n}) = e^{it/B_n}$$

which is possible only if $e^{it/B_n} = 1$ by the case of equality in the triangular inequality (using the fact that $F_{\mu}(0) > 0$). This implies that, if $t/B_n \neq 0 \pmod{[2\pi]}$, $p_n e^{it/B_n} + (1 - p_n)F_{\mu_n}(e^{it/B_n}) < 1$ and we can apply Theorem 3.1.4 to (3.14). To simplify notation, set $r_n(t) := 1 - F_{\mu_n}(e^{it/B_n}) = R_n(t)/B_n$. By Lemma 3.5.8 (i), $r_n(t) \rightarrow 0$ uniformly in $t \in \mathbb{R}$, and when $t/B_n \neq 0 \pmod{[2\pi]}$ we can write:

$$\begin{aligned} F_{\mu_n}(e^{it/B_n}) &= F_{\mu}(p_n e^{it/B_n} + (1 - p_n)F_{\mu_n}(e^{it/B_n})) \\ 1 - r_n(t) &= F_{\mu}(p_n e^{it/B_n} + (1 - p_n)(1 - r_n(t))) = F_{\mu}(1 + p_n(e^{it/B_n} - 1) - r_n(t)(1 - p_n)). \end{aligned}$$

Hence, by Theorem 3.1.4 and (3.21),

$$1 - r_n(t) = 1 + X_n(t) + \frac{\Gamma(3 - \alpha)}{\alpha(\alpha - 1)} L\left(\frac{1}{|X_n(t)|}\right) (-X_n(t))^\alpha (1 + o(1)),$$

where we have set $X_n(t) = p_n(e^{it/B_n} - 1) - r_n(t)(1 - p_n)$ to simplify notation. Therefore:

$$-r_n(t) = X_n(t) + \frac{\Gamma(3 - \alpha)}{\alpha(\alpha - 1)} L\left(\frac{1}{|X_n(t)|}\right) (-X_n(t))^\alpha (1 + o(1)). \quad (3.22)$$

By Lemma 3.5.8 (i), $r_n(t)$ - and therefore $X_n(t)$ - both converge to 0 uniformly for $t \in \mathbb{R} \setminus 2\pi B_n \mathbb{Z}$. Hence (3.22) immediately implies that $X_n(t) \sim -r_n(t)$, and thus that $p_n(e^{it/B_n} - 1) = o(r_n(t))$. This allows us to reduce (3.22) to

$$-r_n(t) = e^{it/B_n} - 1 + \frac{1}{p_n} \frac{\Gamma(3 - \alpha)}{\alpha(\alpha - 1)} L\left(\frac{1}{|r_n(t)|}\right) r_n(t)^\alpha (1 + o(1)).$$

Remember that by definition $R_n(t) := r_n(t)B_n$. Then

$$-R_n(t) = B_n(e^{it/B_n} - 1) + \frac{nB_n^{-\alpha} \Gamma(3 - \alpha)}{c \alpha(\alpha - 1)} L\left(\frac{B_n}{|R_n(t)|}\right) R_n(t)^\alpha (1 + o(1))$$

which boils down, by (3.4), to

$$-cR_n(t) = cB_n(e^{it/B_n} - 1) + \frac{1}{L(B_n)} L\left(\frac{B_n}{|R_n(t)|}\right) R_n(t)^\alpha (1 + o(1))$$

uniformly in $t \in \mathbb{R} \setminus 2\pi B_n \mathbb{Z}$. This completes the proof. \square

Proof of Lemma 3.5.8 (ii). We show this convergence by analyzing the implicit equation (3.14). Let \mathcal{K} be a compact subset of \mathbb{R} which does not contain 0. Lemma 3.5.9 implies that, uniformly for $t \in \mathcal{K}$,

$$\left(\frac{L(B_n/|R_n(t)|)}{L(B_n)} R_n(t)^\alpha + itc\right) (1 + o(1)) + cR_n(t) = 0. \quad (3.23)$$

Now observe that, by the Potter bounds 3.3.1, for n large enough,

$$\begin{aligned} \min(|R_n(t)|^{(\alpha+1)/2}, |R_n(t)|^{(3\alpha-1)/2}) &\leq \frac{L(B_n/|R_n(t)|)}{L(B_n)} |R_n(t)|^\alpha \\ &\leq \max(|R_n(t)|^{(\alpha+1)/2}, |R_n(t)|^{(3\alpha-1)/2}). \end{aligned}$$

Hence, by (3.23), there exists $C > 0$ such that, for n large enough and for all $t \in \mathcal{K}$ (using the fact that $0 \notin \mathcal{K}$), $C^{-1} \leq |R_n(t)| \leq C$. This implies that, uniformly for $t \in \mathcal{K}$, $\frac{L(B_n/|R_n(t)|)}{L(B_n)} \rightarrow 1$ as $n \rightarrow \infty$, and that (3.23) reduces to $(R_n(t)^\alpha + itc)(1 + o(1)) + cR_n(t) = 0$. Remember that for all n, t , $\Re R_n(t) \geq 0$. Therefore $R_n(t)$ converges to the unique solution of (3.12) with nonnegative real part, which is the characteristic exponent of $\tau^{(\alpha),c}$. \square

Proof of Lemma 3.5.8 (iii). From Lemma 3.5.9, we get

$$(K_n(t)R_n(t))^\alpha (1 + o(1)) + cR_n(t) - A_n(t)^\alpha = 0. \quad (3.24)$$

First, for $|t| \in [A, \pi B_n]$, we have $|A_n(t)^\alpha| = 2cB_n \sin(\frac{|t|}{2B_n}) \geq \frac{2c}{\pi} A$, which tends to $+\infty$ as $A \rightarrow +\infty$. Second, by the Potter bounds 3.3.1, $|K_n(t)R_n(t)|^\alpha \leq |R_n(t)|^{(\alpha+1)/2} + |R_n(t)|^{(3\alpha-1)/2}$ for n large enough. These two observations, combined with (3.24), readily entail that for fixed $\eta \in (0, 1)$, we can find $A > 0$ such that uniformly for $|t| \in [A, \pi B_n]$, $\liminf_{n \rightarrow \infty} |R_n(t)| \geq \frac{2}{\eta}$.

Now fix $A > 0$ and $n_0 \geq 1$ such that, for all $n \geq n_0$, $|R_n(t)| \geq \frac{1}{\eta}$. In particular, for $n \geq n_0$, $|R_n(t)| \geq 1$ and we get from (3.24):

$$\begin{aligned} |(K_n(t)R_n(t))^\alpha - A_n(t)^\alpha| &\leq c |R_n(t)|^{(\alpha+1)/2} \eta^{(\alpha-1)/2} + o(K_n(t)R_n(t)^\alpha) \\ &\leq 2c\eta^{(\alpha-1)/2} |K_n(t)R_n(t)|^\alpha \end{aligned}$$

for n large enough, using the fact that $|K_n(t)|^\alpha \geq |R_n(t)|^{\frac{1-\alpha}{2}}$ by the Potter bounds. Therefore, $|1 - (\frac{A_n(t)}{K_n(t)R_n(t)})^\alpha| \leq 2c\eta^{(\alpha-1)/2}$. Now note that $\arg(\frac{A_n(t)}{K_n(t)R_n(t)})$ is bounded away from $\pi + 2\pi\mathbb{Z}$, uniformly in n . Then $\arg(\frac{A_n(t)}{K_n(t)R_n(t)})$ is necessarily close to 0, which readily entails that $|1 - \frac{K_n(t)R_n(t)}{A_n(t)}| \leq \eta'$ where $\eta' \rightarrow 0$ as $\eta \rightarrow 0$. This completes the proof. \square

3.5.6 Study of the solutions of the implicit equation (3.12)

We finish this section by proving that (3.12) has only one solution with nonnegative real part and that this real part is positive for $t > 0$; this will imply that this solution is $\bar{\psi}(t)$ by Proposition 3.5.2 (ii). Fix $c > 0$, and denote by $f : \mathbb{C} \setminus \mathbb{R}_- \times (1, +\infty) \times \mathbb{R}_+^* \rightarrow \mathbb{C}$ the function

$$f(x, \alpha, t) := x^\alpha + cx + itc$$

Therefore, (3.12) can be rewritten $f(\bar{\psi}(t), \alpha, t) = 0$, and we are interested in the solutions in x , at α and t fixed, of the equation

$$f(x, \alpha, t) = 0. \quad (3.25)$$

Note that we also define f for $\alpha > 2$ although we are only interested in the case $\alpha \leq 2$, as this allows us to use the implicit function theorem at $\alpha = 2$.

Theorem 3.5.10. *For any $\alpha \in (1, 2]$ and $t > 0$, (3.25) has exactly one solution with non-negative real part, and this real part is positive.*

Proof of Theorem 3.5.10. We first prove that (3.25) has a unique such solution for t large enough. Then we use the local continuity in α and t of the solutions of (3.25) to extend it to all $t > 0$. First, notice that, at t fixed, f is C^1 on $\mathbb{C} \setminus \mathbb{R}_- \times (1, +\infty) \times \mathbb{R}_+^*$, and its derivative with respect to x is

$$\frac{\partial f}{\partial x}(x, \alpha, t) = \alpha x^{\alpha-1} + c \quad (3.26)$$

which is always nonzero when x is a solution of (3.25).

In the case $\alpha = 2$, (3.25) has two solutions that are $\frac{-c \pm \sqrt{c^2 - 4itc}}{2}$. As $t \rightarrow +\infty$, these solutions are equivalent to $\pm \sqrt{tce}^{-i\pi/4}$. Therefore, we can take $t_0 > 0$ large such that (3.25) has exactly one solution with positive real part for $\alpha = 2$ and $t = t_0$. Assume that the real part of a solution of (3.25) is never 0. Then, by (3.26), we can use the implicit function theorem around any solution of (3.25). This entails that for any $\alpha \in (1, 2]$ there exists exactly one solution of $f(x, \alpha, t_0) = 0$ that has positive real part. Using again the implicit function theorem at α fixed by letting t vary from t_0 to any positive value of t , we get Theorem 3.5.10.

Let us finally prove that, indeed, for $t > 0$ the real part of a solution of (3.25) is never 0. Let x be a solution of (3.25) and assume that $x = ia$ for some $a \in \mathbb{R}$. Then $0 = (ia)^\alpha + iac + itc = a^\alpha e^{i\alpha\pi/2} + c(a+t)e^{-i\pi/2}$ which has no solution. \square

Remark. *One can prove that, for $\alpha \in (3/2, 2]$ and t large enough, (3.25) has a second solution which has negative real part. This "negative branch" ultimately vanishes at some $t(\alpha)$, and the corresponding solutions of (3.25) converge to the negative real line. The discontinuity of the branch shall therefore be related to the fact that the function \log is not defined on this line.*

3.6 Generating functions of stable offspring distributions

This section is devoted to the proof of Theorem 3.1.4. We fix a critical offspring distribution μ (that is, a probability distribution on the nonnegative integers with mean 1), and we assume that there exists $\alpha \in (1, 2]$ and a slowly varying function $\ell : \mathbb{R}_+ \rightarrow \mathbb{R}_+^*$ such that

$$F_\mu(1-s) - (1-s) \underset{s \downarrow 0}{\sim} s^\alpha \ell\left(\frac{1}{s}\right),$$

where F_μ denotes the generating function of μ . This is equivalent to saying that μ is in the domain of attraction of an α -stable law. We define L , the slowly varying function such that

$$\forall x \in \mathbb{R}_+^*, \quad \ell(x) = \frac{\Gamma(3-\alpha)}{\alpha(\alpha-1)} L(x). \quad (3.27)$$

By e.g. [44, XVII.5, Theorem 2] and [27, Lemma 4.7], if X is a random variable of law μ , then the following statement holds:

$$\mathbb{E} [X^2 \mathbf{1}_{X \leq x}] \underset{x \rightarrow +\infty}{\sim} x^{2-\alpha} L(x) + 1. \quad (3.28)$$

where L is the function appearing in (3.27). Note that the "+1" term is negligible except when μ has finite variance, in which case $\alpha = 2$.

Let us first introduce some notation. For $x \geq 0$, we set $M_x = \mu([x, \infty))$. The main tool in the proof of Theorem 3.1.4 is the following estimate.

Proposition 3.6.1. *As $|\omega| \rightarrow 0$, with $\Re(\omega) < 0$,*

$$\int_{\mathbb{R}_+} (1 - e^{\omega x}) M_x dx \sim \frac{\Gamma(3-\alpha)}{\alpha(\alpha-1)} (-\omega)^{\alpha-1} \left(L\left(\frac{1}{|\omega|}\right) + \mathbf{1}_{\alpha=2} \right)$$

where $\mathbf{1}_{\alpha=2} = 1$ if $\alpha = 2$ and 0 otherwise.

Note that there is an extra term "+1" when $\alpha = 2$. Before proving this result, let us explain how Theorem 3.1.4 then readily follows.

Proof of Theorem 3.1.4. We first show that

$$F_\mu(e^\omega) - 1 - \omega \underset{\substack{|\omega| \rightarrow 0 \\ \Re(\omega) < 0}}{\sim} \frac{\Gamma(3-\alpha)}{\alpha(\alpha-1)} (-\omega)^\alpha \left(L\left(\frac{1}{|\omega|}\right) + \mathbf{1}_{\alpha=2} \right). \quad (3.29)$$

To this end, observe that for $\omega \in \mathbb{C}$ such that $\Re(\omega) < 0$,

$$F_\mu(e^\omega) = 1 + \omega - \omega \int_{\mathbb{R}_+} (1 - e^{\omega x}) M_x dx. \quad (3.30)$$

Indeed,

$$\int_{\mathbb{R}_+} (1 - e^{\omega x}) M_x dx = \sum_{k \in \mathbb{Z}_+} \mu_k \int_0^k (1 - e^{\omega x}) dx = \sum_{k \in \mathbb{Z}_+} k \mu_k - \frac{1}{\omega} \sum_{k \in \mathbb{Z}_+} \mu_k (e^{\omega k} - 1)$$

which is equal to $1 + \frac{1}{\omega} - \frac{1}{\omega} F_\mu(e^\omega)$. The estimate (3.29) then follows from Proposition 3.6.1.

Now, observe that, for $\omega \in \mathbb{C}$ such that $0 < |1 + \omega| < 1$, $\Re \log(1 + \omega) = \log |1 + \omega| < 0$, where \log is defined as in Definition 3.5. Hence, we can apply (3.29) to $\log(1 + \omega)$. Then, as $|\omega| \rightarrow 0$ while $0 < |1 + \omega| < 1$, by expanding $x \rightarrow \log(1 + x)$ around 0 and using the fact that a slowly varying function varies more slowly than any polynomial, we get that $F_\mu(1 + \omega)$ is equal to

$$\begin{aligned} F_\mu(e^{\log(1+\omega)}) &= 1 + \log(1 + \omega) + \frac{\Gamma(3-\alpha)}{\alpha(\alpha-1)} (-\log(1 + \omega))^\alpha \left(L\left(\frac{1}{|\log(1 + \omega)|}\right) + \mathbf{1}_{\alpha=2} \right) (1 + o(1)) \\ &= 1 + \omega + \frac{\Gamma(3-\alpha)}{\alpha(\alpha-1)} (-\omega)^\alpha L\left(\frac{1}{|\omega|}\right) (1 + o(1)), \end{aligned}$$

and this completes the proof. \square

The statement of Proposition 3.6.1 is slightly different depending on whether $\alpha = 2$ or $\alpha < 2$, and therefore we need two different proofs. The reason comes from the following useful estimate (see [44, Corollary XVII.5.2 and (5.16)]):

$$M_x \underset{x \rightarrow \infty}{\sim} \begin{cases} \frac{2-\alpha}{\alpha} x^{-\alpha} L(x) & \text{when } \alpha \in (1, 2) \\ x^{-2} L'(x) & \text{when } \alpha = 2 \end{cases} \quad (3.31)$$

where L' is a slowly varying function such that $L'(x)/L(x) \xrightarrow{x \rightarrow \infty} 0$.

3.6.1 Proof of Proposition 3.6.1 for $\alpha = 2$

We start with the case $\alpha = 2$, which is easier. In what follows, we set $C > 0$ such that, for all $N \in \mathbb{Z}$, $N \geq 1$,

$$L(N) + 1 \leq CL(N). \quad (3.32)$$

The existence of such a C is guaranteed by (3.28) as soon as $\mu \neq \delta_1$. The proof of Proposition 3.6.1 is based on the following lemma:

Lemma 3.6.2. *The following assertions hold.*

(i) As $N \rightarrow \infty$, $\int_0^N x M_x dx \sim (L(N) + 1)/2$.

(ii) Fix $\varepsilon > 0$ and C verifying (3.32). Then, for N large enough and $\omega \in \mathbb{C}$ such that $CeN|\omega| \leq \varepsilon$, we have

$$\left| \int_0^N (1 - e^{\omega x}) M_x dx - \int_0^N (-\omega x) M_x dx \right| \leq \varepsilon |\omega| L(N).$$

Proof. For the first assertion simply write, for $N \geq 1$,

$$\int_0^N x M_x dx = \sum_{k=1}^N \left(k - \frac{1}{2}\right) M_k = \sum_{k=1}^N \left(k - \frac{1}{2}\right) \sum_{\ell=k}^{\infty} \mu_\ell = \frac{N^2}{2} M_{N+1} + \sum_{\ell=1}^N \frac{\ell^2}{2} \mu_\ell,$$

which is asymptotic to $(L(N) + 1)/2$ by (3.28) and (3.31).

For (ii), observe that for $x \in \mathbb{C}$ such that $|x| \leq 1$, we have $|e^x - 1 - x| \leq e|x|^2$. Hence, when $CeN|\omega| \leq \varepsilon$, one has:

$$\left| \int_0^N (1 - e^{\omega x}) M_x dx - \int_0^N (-\omega x) M_x dx \right| \leq e|\omega|^2 \int_0^N x^2 M_x dx \leq eN|\omega|^2 \int_0^N x M_x dx.$$

Hence, by (i), for N large enough and $CeN|\omega| \leq \varepsilon$, we have $eN|\omega|^2 \int_0^N x M_x dx \leq CeN|\omega|^2 L(N)$, which is at most $\varepsilon|\omega|L(N)$. This completes the proof. \square

Proof of Proposition 3.6.1 for $\alpha = 2$. We assume that $\alpha = 2$. Fix $\varepsilon > 0$. For $\omega \in \mathbb{C}$ with $\Re(\omega) < 0$, let $N_\omega := \lfloor \frac{\varepsilon}{2Ce|\omega|} \rfloor$. Therefore, Lemma 3.6.2 (ii) holds with $N = N_\omega$ for $|\omega|$ small enough and we get

$$\begin{aligned}
& \left| \int_{\mathbb{R}_+} (1 - e^{\omega x}) M_x dx - \int_0^{N_\omega} (-\omega x) M_x dx \right| \\
& \leq \left| \int_0^{N_\omega} (1 - e^{\omega x}) M_x dx - \int_0^{N_\omega} (-\omega x) M_x dx \right| + \left| \int_{N_\omega}^\infty (1 - e^{\omega x}) M_x dx \right| \\
& \leq \varepsilon |\omega| L(N_\omega) + 2 \int_{N_\omega}^\infty M_x dx \leq \varepsilon |\omega| L(N_\omega) + 3 \frac{L'(N_\omega)}{N_\omega},
\end{aligned}$$

where we have used Lemma 3.6.2 (ii) and the fact that $\int_N^\infty M_x dx \sim \int_N^\infty \frac{L'(x)}{x^2} dx \sim \frac{L'(N)}{N}$ as $N \rightarrow \infty$ (see [26, Proposition 1.5.10]). Since $L'(x)/L(x) \xrightarrow{x \rightarrow \infty} 0$, it follows that for $|\omega|$ small enough,

$$\left| \int_{\mathbb{R}_+} (1 - e^{\omega x}) M_x dx - \int_0^{N_\omega} (-\omega x) M_x dx \right| \leq 2\varepsilon |\omega| L(N_\omega). \quad (3.33)$$

But by Lemma 3.6.2 (i), $\int_0^{N_\omega} (-\omega x) M_x dx \sim -\frac{1}{2}\omega(L(N_\omega) + 1)$ as $|\omega| \rightarrow 0$. The desired result is obtained by taking $\varepsilon \rightarrow 0$, using the facts that $L(N_\omega) \sim L(\frac{1}{|\omega|})$ as $|\omega| \rightarrow 0$, and that $\frac{\Gamma(3-\alpha)}{\alpha(\alpha-1)} = \frac{1}{2}$ when $\alpha = 2$. □

3.6.2 Proof of Proposition 3.6.1 for $\alpha \in (1, 2)$

We now fix $\alpha \in (1, 2)$. In the sequel, we fix $a_0 > 0$ such that for every $z \in \mathbb{C}$:

$$|z| \leq a_0 \implies |1 - e^z| \leq 2|z|. \quad (3.34)$$

The proof is based on two technical estimates.

Lemma 3.6.3. *The following assertions hold:*

(i) *uniformly for ω with negative real part,*

$$\lim_{\substack{a \rightarrow 0 \\ B \rightarrow \infty}} \int_{-a\omega/|\omega|}^{-B\omega/|\omega|} (1 - e^{-y}) y^{-\alpha} dy = \int_{\mathbb{R}_+} (1 - e^{-y}) y^{-\alpha} dy = \frac{\alpha}{2 - \alpha} \frac{\Gamma(3 - \alpha)}{\alpha(\alpha - 1)};$$

(ii) *for any fixed $\eta \in (0, 1)$, we have*

$$\int_{|\omega|^{-\eta}}^{+\infty} (1 - e^{\omega x}) x^{-\alpha} L(x) dx \underset{\substack{|\omega| \rightarrow 0 \\ \Re(\omega) < 0}}{\sim} (-\omega)^{\alpha-1} L\left(\frac{1}{|\omega|}\right) \cdot \frac{\alpha}{2 - \alpha} \frac{\Gamma(3 - \alpha)}{\alpha(\alpha - 1)}.$$

Proof. For the first assertion, we use tools from complex analysis. For $0 < a < B < +\infty$, define the path γ_a^B as in Fig. 3.18, as the union of two straight lines and two arcs γ_a and γ^B . Since $y \mapsto (1 - e^{-y}) y^{-\alpha}$ is holomorphic on $\mathbb{C} \setminus \mathbb{R}_-$, the value of its integral on this path is 0.

By (3.34), for $0 < a < a_0$, uniformly for ω with negative real part,

$$\left| \int_{\gamma_a} (1 - e^{-y}) y^{-\alpha} dy \right| \leq 2 \left| \int_{\gamma_a} |z|^{1-\alpha} dz \right| \leq \pi a^{2-\alpha} \xrightarrow{a \rightarrow 0} 0$$

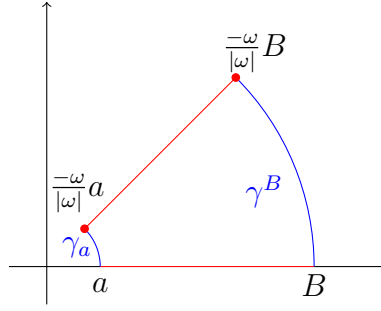
Figure 3.18: The path γ_a^B

and

$$\left| \int_{\gamma^B} (1 - e^{-y}) y^{-\alpha} dy \right| \leq 2 \left| \int_{\gamma^B} |z|^{-\alpha} dz \right| \leq \pi B^{1-\alpha} \xrightarrow{B \rightarrow +\infty} 0.$$

On the other hand, as $a \rightarrow 0$ and $B \rightarrow \infty$, $\int_a^B (1 - e^{-y}) y^{-\alpha} dy \rightarrow \int_{\mathbb{R}_+} (1 - e^{-y}) y^{-\alpha} dy$. This shows the first equality in (i). The second one is a simple computation.

For (ii), the idea is to write

$$\int_{|\omega|^{-\eta}}^{+\infty} (1 - e^{\omega x}) x^{-\alpha} L(x) dx = \left(\int_{|\omega|^{-\eta}}^{a/|\omega|} + \int_{a/|\omega|}^{B/|\omega|} + \int_{B/|\omega|}^{+\infty} \right) (1 - e^{\omega x}) x^{-\alpha} L(x) dx$$

for some $a < B$ to be fixed later, and to estimate the three terms. Let us fix $\varepsilon > 0$.

Third term. By the Potter bounds, we may fix $B_0 > 0$ such that, for any $B \geq B_0$, for $|\omega| \leq B^{-1}$ and $x \geq B/|\omega|$, we have $L(x) \leq L(1/|\omega|)(x|\omega|)^{(\alpha-1)/2}$. This implies that, for $B \geq B_0$,

$$\begin{aligned} \left| \int_{B/|\omega|}^{+\infty} (1 - e^{\omega x}) x^{-\alpha} L(x) dx \right| &\leq 2L\left(\frac{1}{|\omega|}\right) \int_{B/|\omega|}^{+\infty} |\omega|^{(\alpha-1)/2} x^{-(\alpha+1)/2} dx \\ &= 2L\left(\frac{1}{|\omega|}\right) |\omega|^{\alpha-1} \int_B^{+\infty} x^{-(\alpha+1)/2} dx, \end{aligned}$$

which is less than $\varepsilon L(1/|\omega|)|\omega|^{\alpha-1}$ for B large enough (independent of ω). In what follows, we take B such that this holds.

First term. By the Potter bounds, there exists $a \in (0, 1)$ such that, for $|\omega|$ small enough and $|\omega|^{-\eta} \leq x \leq \frac{a}{|\omega|}$, we have $L(x) \leq L(1/|\omega|)(x|\omega|)^{\alpha/2-1}$. Furthermore, by (3.34), for a small enough,

$$\begin{aligned} \left| \int_{|\omega|^{-\eta}}^{a/|\omega|} (1 - e^{\omega x}) x^{-\alpha} L(x) dx \right| &\leq 2|\omega| \int_{|\omega|^{-\eta}}^{a/|\omega|} x^{1-\alpha} L(x) dx \leq 2|\omega|^{\alpha/2} L\left(\frac{1}{|\omega|}\right) \int_0^{a/|\omega|} x^{-\alpha/2} dx \\ &\leq 2|\omega|^{\alpha-1} L\left(\frac{1}{|\omega|}\right) \int_0^a y^{-\alpha/2} dy \end{aligned}$$

which is less than $\varepsilon L(1/|\omega|)|\omega|^{\alpha-1}$ for $a > 0$ small enough (independent of ω). In what follows, we take $a > 0$ such that this holds.

Second term. Since L is slowly varying, uniformly in $x \in (a/|\omega|, B/|\omega|)$, $L(x) \sim L(1/|\omega|)$ as $|\omega| \rightarrow 0$. Therefore, for any $\varepsilon' > 0$, for $|\omega|$ small enough (depending on ε'),

$$\begin{aligned} & \left| \int_{a/|\omega|}^{B/|\omega|} (1 - e^{\omega x}) x^{-\alpha} L(x) dx - L\left(\frac{1}{|\omega|}\right) \int_{a/|\omega|}^{B/|\omega|} (1 - e^{\omega x}) x^{-\alpha} dx \right| \\ & \leq \varepsilon' L\left(\frac{1}{|\omega|}\right) \int_{a/|\omega|}^{B/|\omega|} |1 - e^{\omega x}| x^{-\alpha} dx \leq 2\varepsilon' |\omega|^{\alpha-1} L\left(\frac{1}{|\omega|}\right) \int_a^B y^{-\alpha} dy, \end{aligned}$$

where the last inequality follows from a change of variables. We conclude that for $|\omega|$ small enough (depending on a and B),

$$\left| \int_{a/|\omega|}^{B/|\omega|} (1 - e^{\omega x}) x^{-\alpha} L(x) dx - L\left(\frac{1}{|\omega|}\right) \int_{a/|\omega|}^{B/|\omega|} (1 - e^{\omega x}) x^{-\alpha} dx \right| \leq \varepsilon |\omega|^{\alpha-1} L\left(\frac{1}{|\omega|}\right).$$

By putting together the three previous estimates, we get

$$\int_{|\omega|^{-\eta}}^{+\infty} (1 - e^{\omega x}) x^{-\alpha} L(x) dx = L\left(\frac{1}{|\omega|}\right) \left(\int_{a/|\omega|}^{B/|\omega|} (1 - e^{\omega x}) x^{-\alpha} dx + o(|\omega|^{\alpha-1}) \right).$$

as $|\omega| \rightarrow 0$, $\Re(\omega) < 0$. To conclude the proof, notice that by change of variables,

$$(-\omega)^{1-\alpha} \int_{a/|\omega|}^{B/|\omega|} (1 - e^{\omega x}) x^{-\alpha} dx = \int_{-a\omega/|\omega|}^{-B\omega/|\omega|} (1 - e^{-y}) y^{-\alpha} dy,$$

which converges towards $\int_{\mathbb{R}_+} (1 - e^{-y}) y^{-\alpha} dy = \frac{\alpha}{2-\alpha} \frac{\Gamma(3-\alpha)}{\alpha(\alpha-1)}$ as $a \rightarrow 0$, $B \rightarrow \infty$ by (i). \square

Proof of Proposition 3.6.1 in the case $\alpha \in (1, 2)$. Let us assume that $\alpha \in (1, 2)$ and recall that the goal is to estimate $\int_{\mathbb{R}_+} (1 - e^{\omega x}) M_x dx$. The idea is to write

$$\int_0^{\infty} (1 - e^{\omega x}) M_x dx = \int_0^{|\omega|^{-\eta}} (1 - e^{\omega x}) M_x dx + \int_{|\omega|^{-\eta}}^{\infty} (1 - e^{\omega x}) M_x dx$$

for certain well chosen $\eta > 0$ and to estimate separately these two terms. Using (3.31), we shall show that as $\omega \rightarrow 0$, the first term is $o(|\omega|^{\alpha-1} L(1/|\omega|))$, while the second one is asymptotic to $\frac{\Gamma(3-\alpha)}{\alpha(\alpha-1)} (-\omega)^{\alpha-1} L(1/|\omega|)$. Again, some care is needed as we are dealing with complex-valued quantities.

First term.

First of all, by definition, for any $x \in \mathbb{R}_+$, $M_x \leq 1$. Therefore, setting $\eta = (2 - \alpha)/4 \in (0, 1/4)$ and using (3.34),

$$\left| \int_0^{|\omega|^{-\eta}} (1 - e^{\omega x}) M_x dx \right| \leq \int_0^{|\omega|^{-\eta}} 2|\omega|x dx \leq |\omega|^{1-2\eta} = |\omega|^{\alpha/2}$$

for $|\omega|$ small enough. As a consequence, $|\int_0^{|\omega|^{-\eta}} (1 - e^{\omega x}) M_x dx| = o(|\omega|^{\alpha-1} L(1/|\omega|))$ as $|\omega| \rightarrow 0$.

Second term.

Fix $\varepsilon > 0$. By the estimate (3.31), as $|\omega| \rightarrow 0$, uniformly for $x \geq |\omega|^{-\eta}$, $M_x \sim \frac{2-\alpha}{\alpha} x^{-\alpha} L(x)$. This allows us to write for any $\varepsilon' > 0$, for $|\omega|$ small enough (depending on ε'):

$$\left| \int_{|\omega|^{-\eta}}^{+\infty} (1 - e^{\omega x}) M_x dx - \frac{2-\alpha}{\alpha} \int_{|\omega|^{-\eta}}^{+\infty} (1 - e^{\omega x}) x^{-\alpha} L(x) dx \right| \leq \varepsilon' \int_{|\omega|^{-\eta}}^{+\infty} |1 - e^{\omega x}| x^{-\alpha} L(x) dx.$$

In particular, mimicking the proof of Lemma 3.6.3 (ii), we bound the right-hand term and get, for $|\omega|$ small enough,

$$\left| \int_{|\omega|^{-\eta}}^{+\infty} (1 - e^{\omega x}) M_x dx - \frac{2 - \alpha}{\alpha} \int_{|\omega|^{-\eta}}^{+\infty} (1 - e^{\omega x}) x^{-\alpha} L(x) dx \right| \leq \varepsilon |\omega|^{\alpha-1} L\left(\frac{1}{|\omega|}\right).$$

The desired result then follows from the estimate of Lemma 3.6.3 (ii).

□

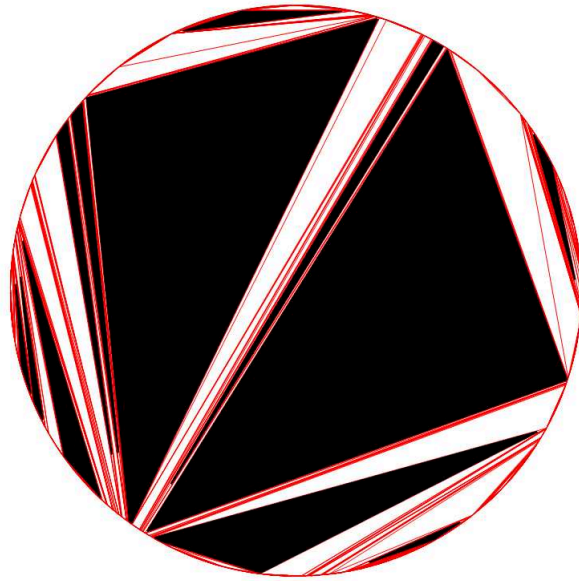

Firstborn uniform

Hardcore and random

Dream of a factorization

Dream of a factorization

Red Hot Minimizers, *A factorization*

Ce chapitre reprend l'article [97], soumis pour publication. Nous y étudions des factorisations minimales aléatoires du n -cycle, qui sont des factorisations de la permutation $(1\ 2\ \cdots\ n)$ en un produit de cycles τ_1, \dots, τ_k dont les longueurs $\ell(\tau_1), \dots, \ell(\tau_k)$ satisfont la condition de minimalité $\sum_{i=1}^k (\ell(\tau_i) - 1) = n - 1$. En associant à un cycle de la factorisation un polygone rouge d'intérieur noir inscrit dans le disque unité, et en lisant les cycles les uns après les autres, nous codons une factorisation minimale par un processus de laminations colorées. Ces objets sont des sous-ensembles compacts du disque formés de cordes qui ne se coupent pas et que l'on colorie en rouge, qui délimitent des faces colorées en blanc ou en noir. Ceci généralise la notion de lamination introduite et étudiée dans le chapitre 3. Notre résultat principal est la convergence du processus de laminations colorées associé à une factorisation du n -cycle quand $n \rightarrow \infty$, lorsque la factorisation est choisie selon des poids de Boltzmann dans le domaine d'attraction d'une loi α -stable pour un certain $\alpha \in (1, 2]$. Le nouveau processus limite interpole entre le cercle unité et une version colorée de la lamination α -stable de

Kortchemski. L'outil principal dans l'analyse de ce modèle est une bijection entre l'ensemble des factorisations minimales et une famille d'arbres aléatoires étiquetés conditionnés par la taille, dont les sommets sont soit noirs soit blancs, et dont l'étude fait notamment intervenir des résultats sur la structure de grands arbres démontrés dans le chapitre 2.

Content of the chapter

4.1	Introduction	138
4.1.1	Model and motivation	138
4.1.2	Coding a minimal factorization by a colored lamination-valued process	142
4.1.3	Construction of the processes $(\mathbb{L}_c^{(\alpha)})_{c \in [0, \infty]}$	145
4.1.4	A bijection with labelled bi-type trees	146
4.2	Plane trees, bi-type trees and different ways of coding them by laminations	148
4.2.1	Plane trees and their coding by laminations	148
4.2.2	Bi-type trees	150
4.2.3	Colored laminations constructed from labelled bi-type trees	151
4.2.4	Random trees	152
4.3	The particular case of (μ_*, w)-bi-type trees.	159
4.3.1	Reachable distributions: a study of the white reduced tree.	159
4.3.2	Compared counting of the vertices in the tree \mathcal{T}_n and the white reduced tree \mathcal{T}_n°	161
4.3.3	Proof of the technical theorem 4.2.7	164
4.3.4	Proof of Theorem 4.3.6 (i)	165
4.3.5	Proof of Theorem 4.3.6 (ii)	167
4.3.6	Proof of Theorem 4.3.6 (iii), when $\alpha < 2$	167
4.3.7	Proof of Theorem 4.3.6 (iii), when ν has finite variance	169
4.4	A bijection between minimal factorizations and a set of bi-type trees	179
4.4.1	Coding a minimal factorization by a colored lamination	180
4.4.2	Coding a minimal factorization by a bi-type tree	183
4.4.3	Image of a random weighted minimal factorization	185
4.4.4	Relation between the colored lamination-valued processes and the tree coding a minimal factorization	187
4.4.5	A shuffling operation	188
4.4.6	Proof of the technical lemma 4.4.11 (ii)	189

4.1 Introduction

4.1.1 Model and motivation

The purpose of this work is to introduce and investigate a geometric representation, as compact subsets of the unit disk, of certain random minimal factorizations of the n -cycle.

For an integer $n \geq 1$, let \mathfrak{S}_n be the group of permutations of $\llbracket 1, n \rrbracket$, and \mathfrak{C}_n the set of cycles of \mathfrak{S}_n . We denote by $\ell(c)$ the length of a cycle $c \in \mathfrak{C}_n$. A particular object of interest is the n -cycle $c_n := (12 \dots n)$, which maps i to $i + 1$ for $1 \leq i \leq n - 1$, and n to 1. For any $n \geq k \geq 1$, the elements of the set

$$\mathfrak{M}_n^{(k)} := \left\{ (\tau_1, \dots, \tau_k) \in \mathfrak{C}_n^k, \tau_1 \cdots \tau_k = c_n, \forall i \ell(\tau_i) \geq 2, \sum_{i=1}^k (\ell(\tau_i) - 1) = n - 1 \right\}$$

are called minimal factorizations of c_n of order k , while an element of

$$\mathfrak{M}_n := \bigcup_{k=1}^{n-1} \mathfrak{M}_n^{(k)}.$$

is simply called a minimal factorization of c_n (one can check that $\mathfrak{M}_n^{(k)}$ is empty as soon as $k \geq n$). By convention, we read cycles from the left to the right, so that $\tau_1 \tau_2$ corresponds to $\tau_2 \circ \tau_1$. Notice that the condition $\sum_{i=1}^k (\ell(\tau_i) - 1) = n - 1$ in the definition of $\mathfrak{M}_n^{(k)}$ is a condition of minimality, in the sense that any k -tuple of cycles (τ_1, \dots, τ_k) such that $\tau_1 \cdots \tau_k = c_n$ necessarily verifies

$$\sum_{i=1}^k (\ell(\tau_i) - 1) \geq n - 1.$$

Minimal factorizations of the n -cycle are a topic of interest, mostly in the restrictive case of factorizations into transpositions (that is, all cycles in the factorization have length 2). The number of minimal factorizations of c_n into transpositions is known to be n^{n-2} since Dénes [37], and bijective proofs of this result have been given, notably by Moszkowski [86] or Goulden and Pepper [48]. These proofs use bijections between the set of minimal factorizations into transpositions and sets of trees, whose cardinality is computed by other ways.

More recently, factorizations into transpositions have been studied from a probabilistic approach by Féray and Kortchemski, who investigate the asymptotic behaviour of such a factorization taken uniformly at random, as n grows. On one hand from a 'local' point of view [46], by studying the joint trajectories of finitely many integers through the factorization. On the other hand from a 'global' point of view [45], by coding a factorization in the unit disk as was initially suggested by Goulden and Yong [49]: associating to each transposition a chord in the disk and drawing these chords in the order in which the transpositions appear in the factorization, they code a uniform factorization by a random process of sets of chords, and prove the convergence of the 1-dimensional marginals of this process as n grows, after time renormalization. The author [96] extends this result by proving the functional convergence of the whole process, highlighting in addition interesting connections between this model and a fragmentation process of the so-called Brownian Continuum Random Tree (in short, CRT), due to Aldous and Pitman [14]. This fragmentation process codes a way of cutting the CRT at random points into smaller components, as time passes.

Let us also mention Angel, Holroyd, Romik and Virág [15], and later Dauvergne [36], who investigate from a geometric point of view the closely related model of uniform sorting networks, that is, factorizations of the reverse permutation (which exchanges 1 with n , 2 with $n - 1$, etc.) into adjacent transpositions, that exchange only consecutive integers.

In another direction, more general minimal factorizations have been studied as combinatorial structures. Specifically, Biane [23] investigates the case of minimal factorizations of c_n

of class $\bar{a} := (a_1, \dots, a_k)$, where a_1, \dots, a_k are all integers ≥ 2 such that $\sum_{i=1}^k (a_i - 1) = n - 1$, which are k -tuples of cycles $(\tau_1, \dots, \tau_k) \in \mathfrak{M}_n^{(k)}$ such that, for $1 \leq i \leq k$, $\ell(\tau_i) = a_i$. Biane proves in particular that, for \bar{a} fixed, the number of factorizations of class \bar{a} is surprisingly always equal to n^{k-1} , and therefore only depends on the cardinality of the class. A proof based on a bijection with a new model of trees is given by Du and Liu [39], which inspired our own bijection, exposed in Section 4.4 and very close to theirs. In particular, the class $(2, 2, \dots, 2)$, where 2 is repeated $n - 1$ times, corresponds to minimal factorizations of the n -cycle into transpositions, and one recovers Dénes' result.

Our goal in this paper is to extend the geometric approach of uniform minimal factorizations into transpositions initiated by Féray & Kortchemski to minimal factorizations into cycles of random lengths, when the probability of choosing a given factorization only depends on its class.

Weighted minimal factorizations Let us immediately introduce the object of interest of this paper, which is a new model of random factorizations. The idea is to generalize minimal factorizations of the cycle into transpositions, by giving to each element of \mathfrak{M}_n a weight which depends on its class and then choosing a factorization at random proportionally to its weight.

We fix a sequence $w := (w_i)_{i \geq 1}$ of nonnegative real numbers, which we call weights. We will always assume that there exists $i \geq 1$ such that $w_i > 0$. For any positive integers n, k , and any factorization $f := (\tau_1, \dots, \tau_k) \in \mathfrak{M}_n^{(k)}$, define the weight of f as

$$W_w(f) := \prod_{i=1}^k w_{\ell(\tau_i)-1}.$$

Then, we define the w -minimal factorization of the n -cycle, denoted by f_n^w , as the random variable on the set \mathfrak{M}_n such that, for all $f \in \mathfrak{M}_n$, the probability that f_n^w is equal to f is proportional to the weight of f :

$$\mathbb{P}(f_n^w = f) = \frac{1}{Y_{n,w}} W_w(f),$$

where $Y_{n,w} := \sum_{f \in \mathfrak{M}_n} W_w(f)$ is a normalizing constant. We shall implicitly restrict our study to the values of n such that $Y_{n,w} > 0$.

Note that some particular weight sequences give rise to specific models of random factorizations:

- fix an integer $r \geq 2$, and define δ^r as follows: $\delta_{r-1}^r = 1$, and for all $k \neq r-1$, $\delta_k^r = 0$. Then $f_n^{\delta^r}$ is a uniform minimal factorization of the n -cycle into r -cycles. In particular, when $r = 2$, one recovers the model of minimal factorizations into transpositions, studied in depth in [45, 46, 96].
- define v as the weight sequence such that, for all $k \geq 1$, $v_k = 1$. Then f_n^v is a uniform element of \mathfrak{M}_n .

Minimal factorizations of stable type We specifically focus in this paper on a particular case of weighted factorizations, which we call factorizations of stable type. These random factorizations of the n -cycle are of great interest, as we can code them by a process of compact subsets of the unit disk which converges in distribution (see Theorem 4.1.3).

Let us start with some definitions. A function $L : \mathbb{R}_+^* \rightarrow \mathbb{R}_+^*$ is said to be slowly varying if, for any $c > 0$, $L(cx)/L(x) \rightarrow 1$ as $x \rightarrow \infty$. For $\alpha \in (1, 2]$, we say that a probability

distribution μ which is critical - that is, μ has mean 1 - is in the domain of attraction of an α -stable law if there exists a slowly varying function L such that, as $x \rightarrow \infty$,

$$\text{Var} [X \mathbf{1}_{X \leq x}] \sim x^{2-\alpha} L(x), \quad (4.1)$$

where X is a random variable distributed according to μ . We refer to [54] for an in-depth study of these well-known distributions. In particular, any law with finite variance is in the domain of attraction of a 2-stable law.

Throughout the paper, for such a distribution μ , $(B_n)_{n \geq 1}$ denotes a sequence of positive real numbers satisfying

$$\frac{nL(B_n)}{B_n^\alpha} \xrightarrow{n \rightarrow \infty} \frac{\alpha(\alpha-1)}{\Gamma(3-\alpha)}, \quad (4.2)$$

where L verifies (4.1). Notice in particular that, if μ has finite variance σ^2 , then $L(x) \rightarrow \sigma^2$ as $x \rightarrow \infty$, and (4.2) can be rewritten $B_n \underset{n \rightarrow \infty}{\sim} \frac{\sigma}{\sqrt{2}} \sqrt{n}$. For such a sequence $(B_n)_{n \geq 1}$, we denote by $(\tilde{B}_n)_{n \geq 1}$ the sequence defined as

$$\tilde{B}_n = \begin{cases} B_n & \text{if } \alpha < 2, \text{ or } \alpha = 2 \text{ and } \text{Var}(\mu) = \infty, \\ \sqrt{\frac{\sigma^2 + 1}{2}} \sqrt{n} & \text{if } \text{Var}(\mu) = \sigma^2 < \infty. \end{cases} \quad (4.3)$$

Finally, for $\alpha \in (1, 2]$, we say that a weight sequence w is of α -stable type if there exists a critical distribution ν in the domain of attraction of an α -stable law and a real number $s > 0$ such that, for all $i \geq 1$,

$$w_i = \nu_i s^i.$$

In this case, ν is said to be the critical equivalent of w . One can check that, if w admits a critical equivalent - which is not always the case - then it is unique. Furthermore, it turns out that, whenever different weight sequences may have the same critical equivalent, the distribution of the minimal factorization f_n^w only depends on this critical law. If w is a weight sequence of α -stable type, then we also say that f_n^w is a minimal factorization of α -stable type.

Throughout the paper, we investigate several combinatorial quantities of these factorizations. Here are two examples. As a first result, we can control the number of cycles in such a factorization. For any $n \geq 1$ and any minimal factorization F of the n -cycle, denote by $N(F)$ the number of cycles in F .

Lemma 4.1.1. *Let w be a weight sequence of α -stable type for some $\alpha \in (1, 2]$, and ν be its critical equivalent. Then, as $n \rightarrow \infty$,*

$$\frac{1}{n} N(f_n^w) \xrightarrow{\mathbb{P}} 1 - \nu_0,$$

where $\xrightarrow{\mathbb{P}}$ denotes convergence in probability.

In words, the number of cycles in f_n^w behaves linearly in n . The proof of this lemma can be found in Section 4.4.3.

Example. *If one looks at the weight sequence v defined as $v_i = 1$ for all $i \geq 1$ (so that f_n^v is a uniform element of \mathfrak{M}_n), then one can check that v has a critical equivalent ν satisfying $\nu_0 = (3 - \sqrt{5})/2$ and $\nu_i = ((3 - \sqrt{5})/2)^i$ for $i \geq 1$. Thus, the average number of cycles in a uniform minimal factorization of the n -cycle is of order $(1 - \nu_0)n = (\sqrt{5} - 1)n/2$.*

As another side result, we are able to control the length of the largest cycle in such factorizations. For any $n \geq 1$ and any minimal factorization F of the n -cycle, denote by $\ell_{\max}(F)$ the length of the largest cycle in F .

Proposition 4.1.2. *Let w be a weight sequence of α -stable type for some $\alpha \in (1, 2]$, and ν be its critical equivalent. Let $(B_n)_{n \geq 1}$ be a sequence satisfying (4.2). Then:*

(i) *if $\alpha = 2$, then with probability going to 1 as $n \rightarrow \infty$, $\ell_{\max}(f_n^w) = o(B_n)$;*

(ii) *if $\alpha < 2$ then for any $\varepsilon > 0$ there exists $\eta > 0$ such that, for n large enough, with probability larger than $1 - \varepsilon$, $\eta B_n \leq \ell_{\max}(f_n^w) \leq \eta^{-1} B_n$.*

In other words, for $\alpha < 2$, the largest cycle in f_n^w is of order B_n (thus of order $n^{1/\alpha}$, up to a slowly varying function). If $\alpha = 2$ then one can only say that the largest cycle is of length $o(B_n)$ (which means $o(\sqrt{n})$ if ν has finite variance). This is proved in Section 4.2.4.

4.1.2 Coding a minimal factorization by a colored lamination-valued process

The first aim of this paper is to code random minimal factorizations in the unit disk. In what follows, $\overline{\mathbb{D}} := \{z \in \mathbb{C}, |z| \leq 1\}$ denotes the closed unit disk and $\mathbb{S}^1 := \{z \in \overline{\mathbb{D}}, |z| = 1\}$ the unit circle.

The idea of coding random structures by compact subsets of $\overline{\mathbb{D}}$ goes back to Aldous [11] who investigates triangulations of large polygons: let $n \in \mathbb{Z}_+$ and define P_n , the regular n -gon inscribed in $\overline{\mathbb{D}}$, whose vertices are $\{e^{2ik\pi/n}, 1 \leq k \leq n\}$. Aldous proves that a random uniform triangulation of P_n (that is, a set of non-crossing diagonals of P_n whose complement in P_n is a union of triangles) converges in distribution towards a random compact subset of the disk which he calls the *Brownian triangulation*. This Brownian triangulation is a lamination - that is, a compact subset of $\overline{\mathbb{D}}$ made of the union of the circle and a set of chords that do not cross, except maybe at their endpoints. In particular, the faces of this lamination, which are the connected components of its complement in $\overline{\mathbb{D}}$, are all triangles. See Fig. 4.1, middle, for an approximation of this lamination. Since then, the Brownian triangulation has been appearing as the limit of various random discrete structures [22, 33], and has also been connected to random maps [75].

In an extension of Aldous' work, Kortchemski [64] constructed a family $(\mathbb{L}_\infty^{(\alpha)})_{1 < \alpha \leq 2}$ of random laminations, called α -stable laminations (see Fig. 4.1, left, for an approximation of the stable lamination $\mathbb{L}^{(1.3)}$). These laminations appear as limits of large general Boltzmann dissections of the regular n -gon [64]. This extends Aldous' result about triangulations, since the 2-stable lamination $\mathbb{L}_\infty^{(2)}$ is distributed as the Brownian triangulation. Stable laminations are also limits of large non-crossing partitions [67].

Let us now introduce colored laminations, which generalize the notion of lamination. A colored lamination is a subset of $\overline{\mathbb{D}}$, in which each point is colored either black, red or left white, so that the subset of red points is a lamination whose faces are each either completely black or completely white. More specifically, a colored lamination of $\overline{\mathbb{D}}$ is an element of \mathbb{K}^2 , where \mathbb{K} denotes the space of compact subsets of $\overline{\mathbb{D}}$. The first coordinate corresponds to the set of red points, which is a lamination by definition, and the second one to the colored component (the set of points that are black or red). See an example on Fig. 4.2. A particular example of colored laminations is the colored analogue of the α -stable laminations. These objects are colored laminations whose red chords form the α -stable lamination, and whose faces are colored black in an i.i.d. way. Specifically, for $p \in [0, 1]$, the p -colored α -stable lamination $\mathbb{L}_\infty^{(\alpha), p}$ is a random colored lamination such that: (i) the red part of $\mathbb{L}_\infty^{(\alpha), p}$ has the

law of $\mathbb{L}_\infty^{(\alpha)}$; (ii) independently of the red component, the faces of $\mathbb{L}_\infty^{(\alpha),p}$ are colored black independently of each other with probability p (see Fig. 4.1, right for a simulation of $\mathbb{L}_\infty^{(2),0.5}$).

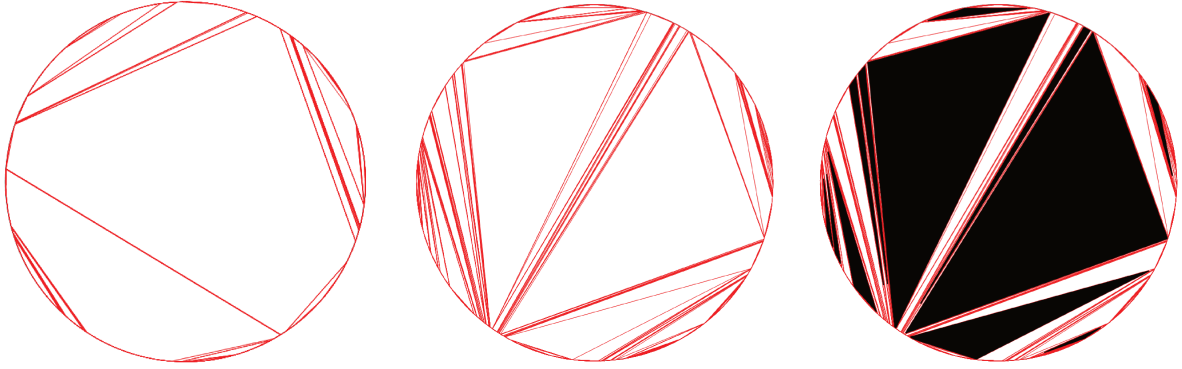

Figure 4.1: Left: a simulation of the 1.3-stable lamination $\mathbb{L}_\infty^{(1.3)}$. Middle: a simulation of the Brownian triangulation $\mathbb{L}_\infty^{(2)}$. Right: a simulation of $\mathbb{L}_\infty^{(2),0.5}$.

We now provide a way of representing a minimal factorization by a process of colored laminations of the unit disk. This representation is a generalization of the representation of a minimal factorization into transpositions, introduced by Goulden and Yong [49]. It consists in drawing, for each cycle τ of the factorization, a number $\ell(\tau)$ of red chords in \mathbb{D} , and coloring the face that it creates in black. More precisely, for $n \geq 1$, let $\tau \in \mathfrak{C}_n$ be a cycle and assume that it can be written as $(e_1, \dots, e_{\ell(\tau)})$, where $e_1 < \dots < e_{\ell(\tau)}$. We will prove later that indeed, if τ appears in a minimal factorization of the n -cycle, then it satisfies this condition (see Section 4.4 for details and proofs). Then draw in red, for each $1 \leq j \leq \ell(\tau) - 1$, the chord $[e^{-2i\pi e_j/n}, e^{-2i\pi e_{j+1}/n}]$, and also draw the chord $[e^{-2i\pi e_{\ell(\tau)}/n}, e^{-2i\pi e_1/n}]$ (here, $[x, y]$ denotes the segment connecting x and y in \mathbb{R}^2). This creates a red cycle. Color now the interior of this cycle in black, and finally color the unit circle in red. We denote the colored lamination that we obtain by $S(\tau)$.

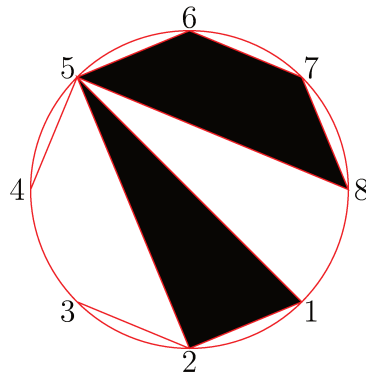

Figure 4.2: The subset $S(f)$ where $f := (5678)(23)(125)(45)$ is an element of \mathfrak{M}_8 .

Now, let $n, k \geq 1$ and $f := (\tau_1, \dots, \tau_k) \in \mathfrak{M}_n^{(k)}$. For $c \in [0, \infty]$, define $S_c(f)$ as the colored lamination

$$S_c(f) = \mathbb{S}^1 \cup \bigcup_{r=1}^{\lfloor c \rfloor \wedge k} S(\tau_r),$$

and finally define $S(f)$ as $S(f) := S_k(f) = \bigcup_{r=1}^k S(\tau_r)$. See Fig. 4.2 for an example.

In their study of a uniform minimal factorization of the n -cycle into transpositions (which we now denote by $f_n^{(2)}$ instead of $f_n^{\delta^2}$, for convenience), Féray and Kortchemski [45] highlight the nontrivial behaviour of the associated lamination-valued process, after having read roughly \sqrt{n} transpositions. Specifically, at $c \geq 0$ fixed, the lamination $S_{c\sqrt{n}}(f_n^{(2)})$ converges in distribution for the Hausdorff distance, as n grows, to a random lamination $\mathbb{L}_c^{(2)}$. The author [96] later obtains the functional analogue of this convergence, thus providing a coupling between the laminations $(\mathbb{L}_c^{(2)})_{c \geq 0}$. Let us explain in which sense we understand the convergence of colored lamination-valued processes: for E, F two metric spaces, following Annex A2 in [58], let $\mathbb{D}(E, F)$ be the space of càdlàg functions from E to F (that is, right-continuous functions with left limits), endowed with the J1 Skorokhod topology. The set $\mathbb{CL}(\overline{\mathbb{D}})$ of colored laminations of $\overline{\mathbb{D}}$ is endowed with the distance which is the sum of the usual Hausdorff distances d_H on the two coordinates. This means that, if A and B are two colored laminations of $\overline{\mathbb{D}}$, $d_H(A, B) = d_H(A_r, B_r) + d_H(A_c, B_c)$ where L_r denotes the set of red points of a colored lamination L , and L_c the set of colored points of L (that is, either black or red). For convenience, we denote this new distance on $\mathbb{CL}(\overline{\mathbb{D}})$ by d_H as well. Finally, the set of laminations of the disk is seen as a subset of $\mathbb{CL}(\overline{\mathbb{D}})$, on which the red part and the colored part of an element are equal.

Theorem. [96, Theorem 1.2] *There exists a lamination-valued process $(\mathbb{L}_c^{(2)})_{c \in [0, \infty]}$ such that the following convergence holds in distribution for the Skorokhod distance in $\mathbb{D}([0, \infty], \mathbb{CL}(\overline{\mathbb{D}}))$, as $n \rightarrow \infty$:*

$$(S_{c\sqrt{n}}(f_n^{(2)}))_{c \in [0, \infty]} \xrightarrow{(d)} (\mathbb{L}_c^{(2)})_{c \in [0, \infty]}. \quad (4.4)$$

In this case, note that no face with 3 or more chords in its boundary appears in $S(f_n^{(2)})$, as $S(\tau)$ is in fact just the union of \mathbb{S}^1 and a chord when $\ell(\tau) = 2$. Therefore, no point of $S(f_n^{(2)})$ is black and, for any $c \in [0, \infty]$, $S_{c\sqrt{n}}(f_n^{(2)})$ is just a lamination. Moreover, it turns out that the process $(\mathbb{L}_c^{(2)})_{c \in [0, \infty]}$ is a nondecreasing interpolation between the unit circle and the Brownian triangulation.

Our main result, which generalizes (4.4), states the convergence of the geometric representation of a random minimal factorization of stable type. In the stable case, the convergence does not occur at the scale \sqrt{n} anymore, but at the scale \tilde{B}_n .

Theorem 4.1.3. *Let $\alpha \in (1, 2]$ and w a weight sequence of α -stable type. Let ν be its critical equivalent and $(\tilde{B}_n)_{n \geq 0}$ satisfying (4.3). Then, there exists a lamination-valued process $(\mathbb{L}_c^{(\alpha)})_{c \in [0, \infty]}$, depending only on α , such that:*

(I) *If $\alpha < 2$, then the following convergence holds:*

$$\left(\left(S_{c(1-\nu_0)\tilde{B}_n}(f_n^w) \right)_{0 \leq c < \infty}, S_\infty(f_n^w) \right) \xrightarrow[n \rightarrow \infty]{(d)} \left((\mathbb{L}_c^{(\alpha)})_{0 \leq c < \infty}, \mathbb{L}_\infty^{(\alpha), 1} \right).$$

(II) *If ν has finite variance, there exists a parameter $p_\nu \in [0, 1]$ such that the following convergence holds:*

$$\left(\left(S_{c(1-\nu_0)\tilde{B}_n}(f_n^w) \right)_{0 \leq c < \infty}, S_\infty(f_n^w) \right) \xrightarrow[n \rightarrow \infty]{(d)} \left((\mathbb{L}_c^{(2)})_{0 \leq c < \infty}, \mathbb{L}_\infty^{(2), p_\nu} \right).$$

Furthermore,

$$p_\nu = \frac{\sigma_\nu^2}{\sigma_\nu^2 + 1},$$

where σ_ν^2 denotes the variance of ν .

Both convergences hold in distribution in the space $\mathbb{D}(\mathbb{R}_+, \mathbb{CL}(\overline{\mathbb{D}})) \times \mathbb{CL}(\overline{\mathbb{D}})$.

This process $(\mathbb{L}_c^{(\alpha)})_{c \in [0, \infty]}$ is a nondecreasing interpolation between the circle and $\mathbb{L}_\infty^{(\alpha)}$. It is in addition lamination-valued, in the sense that, for all $c \geq 0$, almost surely $\mathbb{L}_c^{(\alpha)}$ contains no black point.

Remark. We conjecture that the result of Theorem 4.1.3 (I) still holds when $\alpha = 2$ and ν has infinite variance. However our proofs do not directly apply to this case.

Examples. In the case $w = \delta^j$ for some $j \geq 1$, the critical equivalent of δ^j is $\nu := \frac{j-2}{j-1} \delta^0 + \frac{1}{j-1} \delta^j$, and $p_\nu = \frac{j-2}{j-1}$. When $j = 2$, $p_\nu = 0$ and we recover the Brownian triangulation without coloration, as the limit of the lamination obtained from a uniform minimal factorization of the n -cycle into transpositions. In the case $j = 3$ of factorizations into 3-cycles, each face of the limiting colored Brownian triangulation is black with probability $1/2$.

In the case of a minimal factorization of the n -cycle taken uniformly at random, one obtains the surprising limit value $p_\nu = 1 - 1/\sqrt{5}$.

4.1.3 Construction of the processes $(\mathbb{L}_c^{(\alpha)})_{c \in [0, \infty]}$

Let us immediately explain how to construct the limiting processes $(\mathbb{L}_c^{(\alpha)})_{c \in [0, \infty]}$ which appear in the statement of Theorem 4.1.3 and in (4.4). In order to understand this construction, we define from a (deterministic) càdlàg function $F : [0, 1] \rightarrow \mathbb{R}_+$ such that $F(0) = F(1) = 0$ a random lamination-valued process $(\mathbb{L}_c(F))_{c \in [0, \infty]}$. Define the epigraph of F as $\mathcal{EG}(F) := \{(s, t) \in \mathbb{R}^2, 0 \leq s \leq 1, 0 \leq t < F(s)\}$, the set of all points that are under the graph of F . Denote by $\mathcal{P}(F)$ an inhomogeneous Poisson point process on $\mathcal{EG}(F) \times \mathbb{R}_+$, of intensity

$$\frac{2 ds dt}{d(F, s, t) - g(F, s, t)} \mathbb{1}_{(s, t) \in \mathcal{EG}(F)} dr,$$

where $g(F, s, t) := \sup\{s' \leq s, F(s') < t\}$ and $d(F, s, t) := \inf\{s' \geq s, F(s') < t\}$, and r shall be understood as a 'time' coordinate. For any $c \geq 0$, its restriction to $\mathbb{R}^2 \times [0, c]$ is denoted by $\mathcal{P}_c(F)$. Now, for $c \geq 0$, define the lamination $\mathbb{L}_c(F)$ as

$$\mathbb{S}^1 \cup \overline{\bigcup_{(s, t) \in \mathcal{P}_c(F)} [e^{-2i\pi g(F, s, t)}, e^{-2i\pi d(F, s, t)}]},$$

so that each point of $\mathcal{P}_c(F)$ codes a chord in $\overline{\mathbb{D}}$ (see Fig. 4.3), and let $\mathbb{L}_\infty(F)$ be the lamination $\overline{\bigcup_{c \geq 0} \mathbb{L}_c(F)}$.

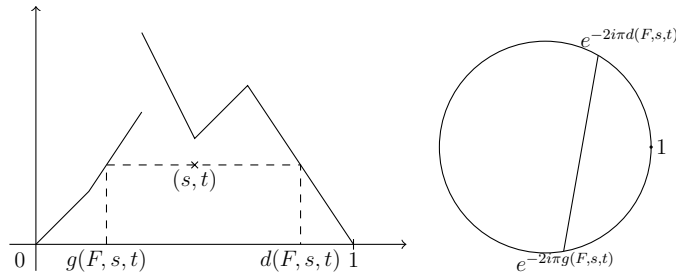

Figure 4.3: A càdlàg function F , a point (s, t) of its epigraph $\mathcal{EG}(F)$ and the corresponding chord in $\overline{\mathbb{D}}$.

For $\alpha \in (1, 2]$, the process $(\mathbb{L}_c^{(\alpha)})_{c \in [0, \infty]}$ is constructed this way from the so-called stable height process $H^{(\alpha)}$:

$$\left(\mathbb{L}_c^{(\alpha)}\right)_{c \in [0, \infty]} = \left(\mathbb{L}_c(H^{(\alpha)})\right)_{c \in [0, \infty]}.$$

These stable height processes are random continuous processes on $[0, 1]$, and can be defined starting from stable Lévy processes (see Fig. 4.4, right, for a simulation of $H^{(1.7)}$, and Section 4.2 for more background and details). On Fig. 4.5 is an approximation of the lamination $\mathbb{L}_{100}^{(1.8)}$.

In the case $\alpha = 2$, the 2-stable height process happens to be distributed as the normalized Brownian excursion $(e_t)_{0 \leq t \leq 1}$, which is roughly speaking a Brownian motion between 0 and 1, conditioned to reach 0 at time 1 and to be nonnegative between 0 and 1 (see Fig. 4.4, left for a simulation of e). It turns out in addition that the lamination $\mathbb{L}_\infty^{(2)}$ coded by e has the law of Aldous' Brownian triangulation.

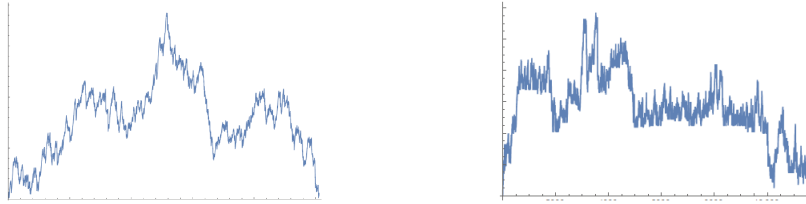

Figure 4.4: A simulation of the normalized Brownian excursion e (left) and the 1.7-stable height process $H^{(1.7)}$ (right).

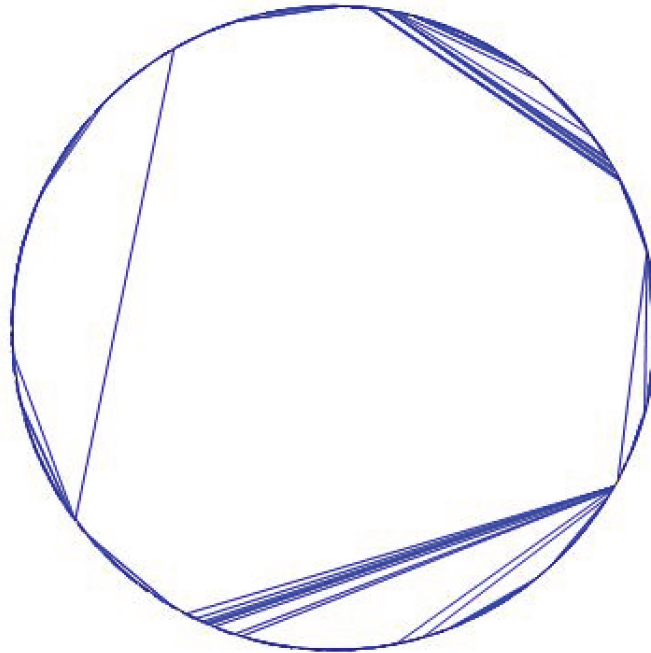

Figure 4.5: An approximation of the lamination $\mathbb{L}_{100}^{(1.8)}$.

4.1.4 A bijection with labelled bi-type trees

The main idea in the proof of Theorem 4.1.3 is to use a bijection between the set of minimal factorizations of the n -cycle and a certain set of discrete trees with labels on their vertices. Specifically, for $n \geq 1$, denote by \mathfrak{U}_n the set of trees T that satisfy the following conditions:

- T is a bi-type tree, that is, its vertices at even height are colored white and its vertices at odd height are colored black;
- the root and the leaves of T are white. In other words, each black vertex necessarily has at least one child;
- T has n white vertices;
- black vertices of T are labelled from 1 to $N^\bullet(T)$, where $N^\bullet(T)$ is the total number of black vertices in the tree. In addition, the labels of the neighbours (parent and children) of each white vertex are sorted in decreasing clockwise order, starting from one of these neighbours, and the labels of the children of the root are sorted in decreasing order.

See Fig. 4.6 for an example.

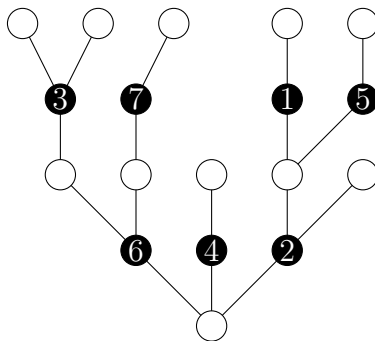

Figure 4.6: An element of the set \mathfrak{U}_{11} . Its six black vertices are labelled from 1 to 6, in clockwise decreasing order around each white vertex. The children of the root are in decreasing order.

Theorem 4.1.4. *For any $n \geq 1$, the sets \mathfrak{M}_n and \mathfrak{U}_n are in bijection.*

In Section 4.4, we provide an explicit bijection between these sets. Roughly speaking, from a minimal factorization $f \in \mathfrak{M}_n$, one constructs $T(f) \in \mathfrak{U}_n$ as the "dual tree" of the colored lamination $S(f)$: its black vertices are in bijection with the cycles of f , while its white vertices correspond to white faces of $S(f)$. Theorem 4.1.3 is therefore obtained as a corollary of a result on trees, that states the convergence of colored lamination-valued processes coding random bi-type trees (Theorem 4.2.7). It turns out indeed that the distribution of the random bi-type tree $T(f_n^w)$ is particularly well understood when w is a weight sequence of stable type.

Notation In the whole paper, $\xrightarrow{\mathbb{P}}$ denotes convergence in probability, $\xrightarrow{(d)}$ convergence in distribution and $\stackrel{(d)}{=}$ equality in distribution. Moreover, a sequence of events $(E_n)_{n \geq 0}$ being given, we say that E_n occurs with high probability if $\mathbb{P}(E_n) \rightarrow 1$ as $n \rightarrow \infty$.

Outline of the paper In Section 4.2, we first define and investigate plane trees and more particularly bi-type trees, which are a cornerstone of the paper as they code minimal factorizations. We suggest two different ways of coding trees by colored lamination-valued processes, and state in particular the convergence of one of these processes coding a particular model of random bi-type trees (Theorem 4.2.7). The proof of this theorem is the main result of Section 4.3, which is devoted to the study of these specific random trees. Finally, in Section 4.4, we investigate in depth the model of minimal factorizations and explain a natural bijection between the sets \mathfrak{M}_n and \mathfrak{U}_n for all n . In addition, we provide the proof

of Theorem 4.1.3 by showing that the process of colored laminations coded by a random minimal factorization f_n^w of stable type is in some sense also coded by the random bi-type tree $T(f_n^w)$, which is the image of the factorization by the abovementioned bijection.

Acknowledgements I would like to thank Igor Kortchemski for the numerous fruitful discussions that have led to this paper.

4.2 Plane trees, bi-type trees and different ways of coding them by laminations

In this section, we rigorously define our notion of trees. Then, we describe a certain family of trees, which we call bi-type trees, whose vertices are given a color, either black or white. We finally introduce random models of trees, monotype or bi-type - which we call simply generated trees - and study some of their main properties. We state in particular Theorem 4.2.7, which provides the convergence of a process of colored laminations coding random bi-type trees conditioned by their number of white vertices.

4.2.1 Plane trees and their coding by laminations

Plane trees. We first define *plane trees*, following Neveu's formalism [87]. First, let $\mathbb{N}^* = \{1, 2, \dots\}$ be the set of all positive integers, and $\mathcal{U} = \cup_{n \geq 0} (\mathbb{N}^*)^n$ be the set of finite sequences of positive integers, with the convention that $(\mathbb{N}^*)^0 = \{\emptyset\}$.

By a slight abuse of notation, for $k \in \mathbb{Z}_+$, we write an element u of $(\mathbb{N}^*)^k$ as $u = u_1 \cdots u_k$, with $u_1, \dots, u_k \in \mathbb{N}^*$. For $k \in \mathbb{Z}_+$, $u = u_1 \cdots u_k \in (\mathbb{N}^*)^k$ and $i \in \mathbb{N}^*$, we denote by ui the element $u_1 \cdots u_k i \in (\mathbb{N}^*)^{k+1}$ and by iu the element $iu_1 \cdots u_k$. A plane tree T is formally a subset of \mathcal{U} satisfying the following three conditions:

- (i) $\emptyset \in T$ (\emptyset is called the root of T);
- (ii) if $u = u_1 \cdots u_n \in T$, then, for all $k \leq n$, $u_1 \cdots u_k \in T$ (these elements are called ancestors of u , and the set of all ancestors of u is called its ancestral line; $u_1 \cdots u_{n-1}$ is called the *parent* of u). The set of ancestors of a vertex u is denoted by $A_u(T)$;
- (iii) for any $u \in T$, there exists a nonnegative integer $k_u(T)$ such that, for every $i \in \mathbb{N}^*$, $ui \in T$ if and only if $1 \leq i \leq k_u(T)$ ($k_u(T)$ is called the number of children of u , or the outdegree of u).

The elements of T are called *vertices*, and we denote by $|T|$ the total number of vertices in T . A vertex u such that $k_u(T) = 0$ is called a leaf of T . The height $h(u)$ of a vertex u is its distance from the root, that is, the unique integer k such that $u \in (\mathbb{N}^*)^k$. We define the height of a tree T as $H(T) = \sup_{u \in T} h(u)$. In the sequel, by tree we always mean plane tree unless specifically mentioned.

The *lexicographical order* \prec on \mathcal{U} is defined as follows: $\emptyset \prec u$ for all $u \in \mathcal{U} \setminus \{\emptyset\}$, and for $u, w \neq \emptyset$, if $u = u_1 u'$ and $w = w_1 w'$ with $u_1, w_1 \in \mathbb{N}^*$, then we write $u \prec w$ if and only if $u_1 < w_1$, or $u_1 = w_1$ and $u' \prec w'$. The lexicographical order on the vertices of a tree T is the restriction of the lexicographical order on \mathcal{U} .

We do not distinguish between a finite tree T , and the corresponding planar graph where each vertex is connected to its parent by an edge of length 1, in such a way that the vertices with same height are sorted from left to right in lexicographical order.

Subtrees and nodes Let T be a plane tree and $u \in T$ be one of its vertices. We define the subtree of T rooted at u as the set of vertices that have u as an ancestor. This subtree

is denoted by $\theta_u(T)$.

One will often consider large nodes in a tree, i.e. vertices whose removal splits the tree into at least two components of macroscopic size (that is, of the same order as the size of T) that do not contain the root. Specifically, $a \geq 0$ being fixed, we say that $u \in T$ is an a -node of T if there exists an integer $r \leq k_u(T)$ satisfying:

$$\sum_{w \in A_r(u, T)} |\theta_w(T)| \geq a, \quad \sum_{w \in A_{-r}(u, T)} |\theta_w(T)| \geq a,$$

where $A_r(u, T)$ denotes the set of the first r children of u in lexicographical order, and $A_{-r}(u, T)$ the set of its other children. In other words, u is an a -node of T if one can split the set of its children into two disjoint subsets made of consecutive children, in such a way that the sum of the sizes of the subtrees rooted at the elements of each of these two subsets is larger than a . In what follows, a will be of order $|T|$ (by this, we mean larger than $\varepsilon|T|$, for some $\varepsilon > 0$). We denote by $E_a(T)$ the set of a -nodes of the tree T .

A particular case of a -nodes, for $a > 0$, is the case of a -branching points. We say that $u \in T$ is an a -branching point if there exist two children of u , say, $v_1(u)$ and $v_2(u)$, such that $|\theta_{v_1(u)}(T)| \geq a, |\theta_{v_2(u)}(T)| \geq a$. One easily sees that any a -branching point is an a -node.

Contour function of a tree, associated lamination-valued process. We introduce here some important objects derived from a plane tree. Specifically, a finite plane tree T being given, we define its contour function, which is a walk on the nonnegative integers coding T in a bijective way. Then, we construct from this contour function a lamination $\mathbb{L}(T)$ and a random lamination-valued process $(\mathbb{L}_u(T))_{u \in [0, \infty]}$ which interpolates between \mathbb{S}^1 and $\mathbb{L}(T)$. In what follows, T is a plane tree and n denotes its number of vertices.

The contour function $C(T)$: First, it is useful to define the *contour function* $(C_t(T), 0 \leq t \leq 2n)$ of T , which completely encodes the tree. To construct $C(T)$, imagine a particle exploring the tree from left to right at unit speed, starting from the root. For $t \in [0, 2n - 2]$, denote by $C_t(T)$ the distance of the particle to the root at time t . We set in addition $C_t(T) = 0$ for $2n - 2 \leq t \leq 2n$. See Fig. 4.7 for an example. By construction, $C(T)$ is continuous, nonnegative and satisfies $C_0(T) = C_{2n}(T) = 0$.

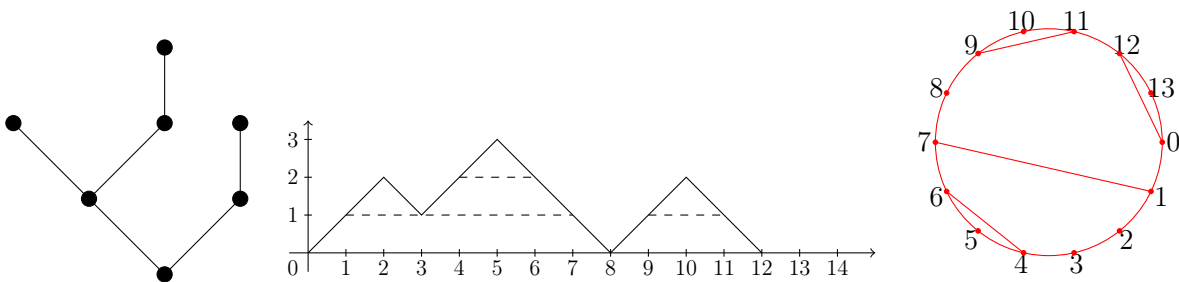

Figure 4.7: A tree $T \in \mathfrak{U}_{11}^{(7)}$, its contour function $C(T)$, and the associated lamination $\mathbb{L}(T)$.

Chords and faces associated to vertices of T . We now propose a way of coding a vertex x of T by a chord in $\overline{\mathbb{D}}$: define $g(x)$ (resp. $d(x)$) the first (resp. last) time the particle performing this contour exploration is located at x , and denote by $c_x(T)$ the chord

$$c_x(T) := [e^{-2i\pi g(x)/2n}, e^{-2i\pi d(x)/2n}]$$

in $\overline{\mathbb{D}}$. We define the lamination associated to the tree T

$$\mathbb{L}(T) := \mathbb{S}^1 \cup \bigcup_{x \in T} c_x(T).$$

One can indeed check that the chords $(c_x(T), x \in T)$ do not cross each other. See Fig. 4.7, right for an example.

The lamination-valued process $(\mathbb{L}_u(T))_{u \in [0, \infty]}$. We derive here from T a random nondecreasing lamination-valued process, which interpolates between \mathbb{S}^1 and $\mathbb{L}(T)$: at each integer time, we add a chord corresponding to a uniformly chosen vertex in the tree. More precisely, let U_1 be the root of T , and U_2, \dots, U_n be a uniform random permutation of the $n - 1$ other vertices of T . Then, for $u \in [0, \infty]$, define

$$\mathbb{L}_u(T) := \mathbb{S}^1 \cup \bigcup_{i=1}^{\lfloor u \rfloor \wedge n} c_{U_i}(T).$$

Observe in particular that, for $u \geq n$, $\mathbb{L}_u(T) = \mathbb{L}(T)$.

Lukasiewicz path of the tree We define here an other way to code the tree T , called its Lukasiewicz path and denoted by $(W_t(T))_{0 \leq t \leq n}$. It is constructed as follows: start from $W_0(T) = 0$ and, for all $i \in \mathbb{Z}_+$, $i \leq n - 1$, set $W_{i+1}(T) = W_i(T) + k_{v_i}(T) - 1$, where v_r denotes the $(r + 1)$ -th vertex of T in lexicographical order. Then, W is the linear interpolation between these integer values. See an example on Fig. 4.8.

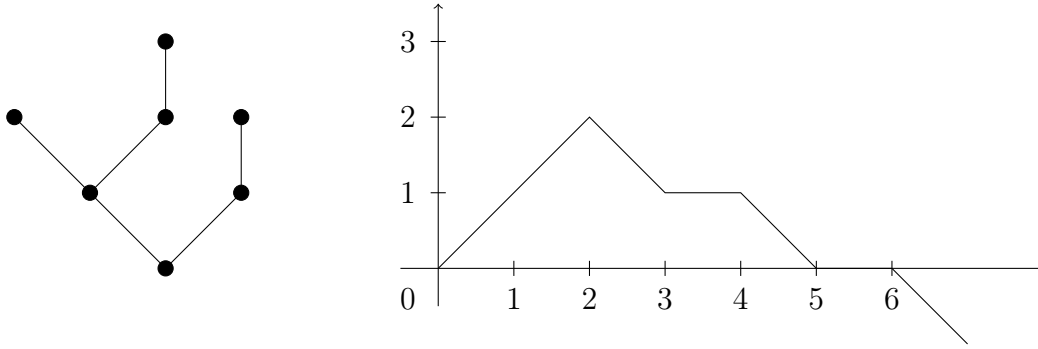

Figure 4.8: A tree T and its Łukasiewicz path $W(T)$.

One can check that $W_n(T) = -1$ and that, for all $t \leq n - 1$, $W_t \geq 0$. This walk provides information on the degrees of the vertices of T , whereas the contour function rather allows us to get information on the global shape of the tree.

4.2.2 Bi-type trees

We now give to a plane tree additional structure, by coloring each of its vertices either black or white - a tree whose vertices are not colored will be called monotype from now on. We say that a finite plane tree T is a *bi-type tree* (in our context) if its vertices are colored white when their height is even and black when it is odd. In particular, white vertices only have black children and vice versa. Notice that the root of a bi-type tree is white by definition. The number of white vertices in a bi-type tree T is denoted by $N^\circ(T)$, and its number of black vertices by $N^\bullet(T)$. See Fig. 4.9, left, for an example of bi-type tree.

We say that T is a *labelled* bi-type tree if, in addition, its black vertices are labelled from 1 to $N^\bullet(T)$. Such models of trees have already been studied in the past, in particular by Bouttier, Di Francesco and Guitter [29] who establish a bijection between a class of planar maps and a class of labelled bi-type trees which they call mobiles.

Finally, for $n, k \geq 1$, we denote by $\mathfrak{U}_n^{(k)}$ the set of labelled bi-type trees with n white vertices and k black vertices, whose leaves are all white, in which the labels of the black

neighbours (parent and children) of each white vertex are sorted in decreasing clockwise order (starting from one of these children), and in which the labels of the children of the root are sorted in decreasing order from left to right. Notice that, then, $\mathfrak{U}_n = \cup_{k \geq 1} \mathfrak{U}_n^{(k)}$.

The white reduced tree. Let T be a bi-type tree. We define the associated monotype *white reduced tree* T° , the following way:

- The vertices of T° are the white vertices of T .
- A vertex x is the child of a vertex y in T° if and only if x is a grandchild of y in the original tree T .

This reduced tree encompasses the grandparent-grandchild relations between the white vertices in T . See Fig. 4.9 for a picture of a tree and of the associated white reduced tree. For convenience, we make no distinction between a white vertex of T and the associated vertex of T° .

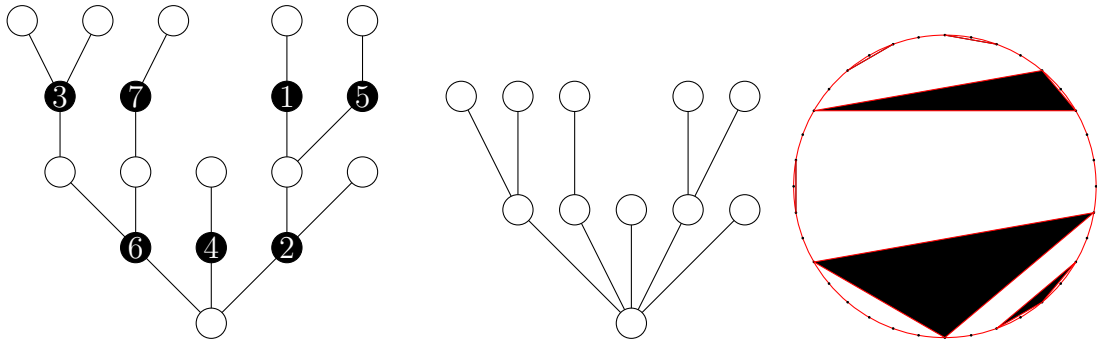

Figure 4.9: A labelled bi-type tree T , its associated white reduced tree T° and the lamination $\mathbb{L}_6^\bullet(T)$.

4.2.3 Colored laminations constructed from labelled bi-type trees

We propose here two ways to code a finite labelled bi-type tree T by discrete nondecreasing colored lamination-valued processes. The first one only takes into account white vertices, and is obtained from the contour function of the reduced tree T° . The second one is obtained by considering the black vertices of T and their labelling.

The white process $(\mathbb{L}_u^\circ(T))_{u \in [0, \infty]}$ The white process of a bi-type tree T is the lamination-valued process presented in Section 4.2.1, applied to the white reduced tree T° :

$$\mathbb{L}_u^\circ(T) := \mathbb{S}^1 \cup \bigcup_{i=1}^{\lfloor u \wedge N^\circ(T) \rfloor} c_{U_i}(T^\circ).$$

for any $u \in [0, \infty]$, where we recall that $U_1 = \emptyset$ and U_2, \dots, U_n is a uniform permutation of the other vertices. Observe that this construction is not an injection, as it only depends on $C(T^\circ)$ while different bi-type trees may provide the same white reduced tree. Observe also that this process is only made of laminations, without any black point.

The black process $(\mathbb{L}_u^\bullet(T))_{u \in [0, \infty]}$ The black process of a bi-type tree T is derived from the contour function $(C_t(T), 0 \leq t \leq 2|T|)$ of the whole labelled bi-type tree T . Here, black vertices are coded by faces of a colored lamination, and not by chords as in the white process. More precisely, we define the face $F_x(T)$ associated to a vertex x of T the following way: let $0 \leq t_1 < t_2 < \dots < t_{k_x(T)+1}$ be the times at which x is visited by the contour function $C(T)$. Then define the associated face as:

$$F_x(T) := \text{Conv} \left(\bigcup_{j=1}^{k_x(T)+1} [e^{-2i\pi t_j/2|T|}, e^{-2i\pi t_{j+1}/2|T|}] \right),$$

whose boundary is colored red and whose interior is colored black. In this definition, by convention, $t_{k_x(T)+2} = t_1$ and $\text{Conv}(A)$ denotes the convex hull of A .

Now, for $u \geq 0$, define

$$\mathbb{L}_u^\bullet(T) := \mathbb{S}^1 \cup \bigcup_{i=1}^{\lfloor u \rfloor \wedge N^\bullet(T)} F_{V_i}(T).$$

where V_i is the black vertex labelled i in T . The process $(\mathbb{L}_u^\bullet(T))_{u \in [0, \infty]}$ is called the black process associated to T (A tree $T \in \mathfrak{U}_{11}^{(7)}$ (left) and the associated colored lamination $\mathbb{L}_6^\bullet(T)$ (right) are represented in Fig. 4.9).

4.2.4 Random trees

Let us now define random variables taking their values in the set of finite trees. We first define the so-called monotype simply generated trees, and then extend this framework to bi-type trees. We finally give some useful properties of both models. To avoid ambiguity, random monotype trees will be written with a blackboard bold \mathbb{T} , and random bi-type trees with a calligraphic \mathcal{T} .

Monotype simply generated trees In the monotype case, we mostly rely on the deep survey of Janson [55] about simply generated trees, in which all proofs and further details can be found. Monotype simply generated trees (MTSG in short) were first introduced by Meir and Moon [80], and are random variables taking their values in the space of finite monotype trees. Specifically, for any $n \geq 1$, denote by \mathfrak{T}_n the set of trees with n vertices. Fix $w := (w_i)_{i \geq 0} \in \mathbb{R}_+^{\mathbb{Z}^+}$ a weight sequence such that $w_0 > 0$ and, to a finite tree T , associate a weight $W_w(T) := \prod_{x \in T} w_{k_x(T)}$. Then, for each $n \geq 1$, $n \geq 1$, we define the w -MTSG \mathbb{T}_n^w with n vertices as the random variable satisfying, for any tree $T \in \mathfrak{T}_n$,

$$\mathbb{P}(\mathbb{T}_n^w = T) = \frac{1}{Z_{n,w}} W_w(T)$$

where

$$Z_{n,w} := \sum_{T \in \mathfrak{T}_n} W_w(T).$$

Since, for any $n \geq 1$, the set \mathfrak{T}_n is finite, the tree \mathbb{T}_n^w is well-defined provided that $Z_{n,w} > 0$, which we implicitly assume.

Remark. Here, weight sequences satisfy $w_0 > 0$, which was not the case for the weight sequences inducing factorizations of the n -cycle, defined in Section 4.1. Indeed, in the case of monotype trees the condition $w_0 > 0$ ensures that at least one finite tree has positive weight. We will still use the term 'weight sequence' for both.

Note that different weight sequences may provide the same simply generated tree:

Lemma 4.2.1. *Let w, w' be two weight sequences such that $w_0 > 0, w'_0 > 0$. Then, the two following assumptions are equivalent:*

(i) For any $n \geq 1$, $\mathbb{T}_n^w \stackrel{(d)}{=} \mathbb{T}_n^{w'}$

(ii) There exists $q, s > 0$ such that, for all $i \geq 0$, $w_i = qs^i w'_i$.

Proof. The proof that (ii) \Rightarrow (i) is essentially due to Kennedy [59] in a slightly different setting, and can be found in our form in [55, (4.3)]. In order to prove that (i) \Rightarrow (ii), we proceed by induction on n . Assume without loss of generality that $w'_1 > 0$ (otherwise we just need to slightly adapt the proof). There exists a unique pair $(q, s) \in (\mathbb{R}_+^*)^2$ such that $w_0 = qw'_0$ and $w_1 = qsw'_1$. Now we consider the two different trees with 3 vertices: one has weight $w_0 w_1^2$ and the other $w'_0 w_1'^2$, so that $Z_{2,w} = w_0 w_1^2 + w_0^2 w_2 > 0$, and as well $Z_{2,w'} = w'_0 w_1'^2 + w_0'^2 w_2' > 0$. Since \mathbb{T}_2^w and $\mathbb{T}_2^{w'}$ have the same distribution, $Z_{2,w}^{-1} w_0 w_1^2 = Z_{2,w'}^{-1} w'_0 w_1'^2$, which implies that $Z_{2,w} = q^3 s^2 Z_{2,w'}$ and therefore that $w_2 = qs^2 w_2'$. By induction on $i \geq 2$, we get that $w_i = qs^i w_i'$ for all $i \geq 0$. \square

Galton-Watson trees When a weight sequence μ satisfies $\mu_0 > 0$ and $\sum_{i \geq 0} \mu_i = 1$, μ is a probability distribution and we can define a random variable \mathbb{T}^μ such that, for any finite tree T ,

$$\mathbb{P}(\mathbb{T}^\mu = T) = W_\mu(T) = \prod_{x \in T} \mu_{k_x(T)}.$$

This variable is now defined on the whole set of finite trees, and not only on the subset of trees of fixed size. In this case, we say that \mathbb{T}^μ is a μ -Galton-Watson (μ -GW in short) tree, and that μ is its offspring distribution. Thus, for any $n \geq 1$, the MTSG \mathbb{T}_n^μ is a μ -GW tree conditioned to have n vertices.

Stable trees and stable processes Recall that the probability law μ is said to be critical if $\sum_{i \geq 0} i \mu_i = 1$. A particular case of GW trees is when the offspring distribution μ is critical and in the domain of attraction of an α -stable law, for $\alpha \in (1, 2]$.

If μ is in the domain of attraction of an α -stable law, the sequence of trees $(\mathbb{T}_n^\mu)_{n \geq 1}$, restricted to the values of n such that $\mathbb{P}(|\mathbb{T}^\mu| = n) > 0$, is known to have a scaling limit: these trees, seen as metric spaces for the graph distance and properly renormalized, converge in distribution, for the so-called Gromov-Hausdorff distance, to some random compact metric space, introduced by Duquesne and Le Gall [42] and called the α -stable tree, which we denote by $\mathcal{T}^{(\alpha)}$ (see Fig. 4.10, left for a simulation of the 1.5-stable tree $\mathcal{T}^{(1.5)}$).

These trees have recently become a topic of interest for probabilists. In particular, a fundamental result states that, jointly with the convergence of the renormalized trees $(\mathbb{T}_n^\mu)_{n \geq 1}$ towards $\mathcal{T}^{(\alpha)}$, their contour functions and Łukasiewicz paths also converge, after renormalization, to some limiting càdlàg random processes $(X_t^{(\alpha)})_{0 \leq t \leq 1}$ and $(H_t^{(\alpha)})_{0 \leq t \leq 1}$ respectively, which can therefore be seen as the analogues of the Łukasiewicz path and the contour function of these stable trees. See Fig. 4.10 for a simulation of $H^{(1.5)}$ (middle) and $X^{(1.5)}$ (right).

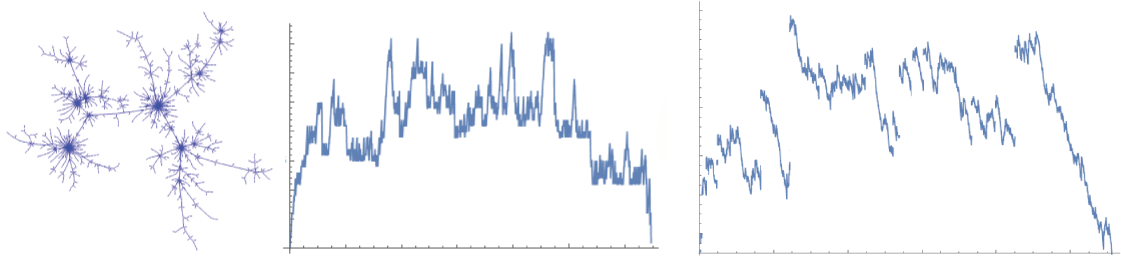

Figure 4.10: A simulation of the 1.5-stable tree $\mathcal{T}^{(1.5)}$, the stable height process $H^{(1.5)}$ and the process $X^{(1.5)}$.

Theorem 4.2.2. *Let $\alpha \in (1, 2]$ and let μ be a probability distribution in the domain of attraction of an α -stable law. Let $(B_n)_{n \geq 0}$ be a sequence verifying (4.2). Then, in distribution in $\mathbb{D}([0, 1], \mathbb{R})^2$:*

$$\left(\frac{1}{B_n} W_{nt}(\mathbb{T}_n^\mu), \frac{B_n}{n} C_{2nt}(\mathbb{T}_n^\mu) \right)_{t \in [0, 1]} \xrightarrow[n \rightarrow \infty]{(d)} \left(X_t^{(\alpha)}, H_t^{(\alpha)} \right)_{t \in [0, 1]}$$

This result is due to Marckert and Mokkadem [77] under the assumption that μ has a finite exponential moment (that is, $\sum_{i \geq 0} \mu_i e^{\beta i} > 0$ for some $\beta > 0$). The result in the general case can be deduced from the work of Duquesne [40], although it is not clearly stated in this form. See [63, Theorem 8.1, (II)] (taking $\mathcal{A} = \mathbb{Z}_+$ in this theorem) for a precise statement.

In light of this convergence, investigating properties of these limiting objects allows us to obtain information on the shape of a typical realization of the tree \mathbb{T}_n^μ for n large. Let us immediately see an example. For $\alpha \in (1, 2)$, the limiting process $X^{(\alpha)}$ satisfies the following properties with probability 1 where, for $s \in (0, 1]$, we have set $\Delta_s := X_s^{(\alpha)} - X_{s-}^{(\alpha)}$.

- (H1) The local minima of $X^{(\alpha)}$ are distinct (that is, for any $0 \leq s < t \leq 1$, there exists at most one $r \in (s, t)$ such that $X_r^{(\alpha)} = \inf_{[s, t]} X^{(\alpha)}$).
- (H2) Let t be a local minimum of $X^{(\alpha)}$ (i.e. $X_t^{(\alpha)} = \min\{X_u^{(\alpha)}, t - \varepsilon \leq u \leq t + \varepsilon\}$ for some $\varepsilon > 0$), and define $s := \sup\{r \leq t, X_r^{(\alpha)} < X_t^{(\alpha)}\}$. Then $\Delta_s > 0$, and $X_{s-}^{(\alpha)} < X_t^{(\alpha)} < X_s^{(\alpha)}$.
- (H3) If $s \in (0, 1)$ is such that $\Delta_s > 0$, then for all $0 \leq \varepsilon \leq s$, $\inf_{[s-\varepsilon, s]} X^{(\alpha)} < X_{s-}^{(\alpha)}$.

These three properties are used in [64], in order to construct the lamination $\mathbb{L}_\infty^{(\alpha)}$, and are proved in [64, Proposition 2.10]. The following lemma, which is a consequence of these properties of $X^{(\alpha)}$, provides useful information about the structure of a large μ -Galton-Watson tree:

Lemma 4.2.3. *Let $\alpha < 2$, and let μ be a critical distribution in the domain of attraction of an α -stable law. Then:*

- (i) *For any $\varepsilon > 0$, there exists $\eta > 0$ such that, for all n large enough:*

$$\mathbb{P}(\exists u \in \mathbb{T}_n^\mu, k_u(\mathbb{T}_n^\mu) \geq \eta B_n) \geq 1 - \varepsilon.$$

- (ii) *For any $\varepsilon > 0$, there exists $\eta > 0$ such that, for n large enough, with probability larger than $1 - \varepsilon$, any εn -node in \mathbb{T}_n^μ has more than ηB_n children.*

In other words, (i) means that, with high probability, there is at least one vertex in \mathbb{T}_n^μ whose number of children is of order B_n . Furthermore, (ii) states that all εn -nodes of \mathbb{T}_n^μ (which appear to correspond to large faces in the associated lamination $\mathbb{L}(\mathbb{T}_n^\mu)$) have a number of children of order B_n .

Proof of Lemma 4.2.3. The proof of (i) is straightforward: it is known that the set of points $t \in [0, 1]$ where $\Delta_t > 0$ is dense in $[0, 1]$ (for instance, the process satisfies Assumption (H0) in [64]). In particular, almost surely, $M := \max\{\Delta_t, t \in [0, 1]\} > 0$. Fix $\varepsilon > 0$, and take $\eta > 0$ such that $M > 2\eta$ with probability $\geq 1 - \varepsilon/2$. Then, by the convergence of Theorem 4.2.2, for n large enough, the maximum degree in \mathbb{T}_n^μ is larger than ηB_n with probability $\geq 1 - \varepsilon$.

Let us now prove (ii). For x a vertex of \mathbb{T}_n^μ , denote by $i(x)$ the position of x in \mathbb{T}_n^μ in lexicographical order. Take u an εn -node in \mathbb{T}_n^μ . In particular, $W_{i(u)} - W_{i(u)-1} = k_u(\mathbb{T}_n^\mu) - 1$. By definition of an εn -node, its children can be split into two subsets $A_r(u), A_{-r}(u)$ for some $r \geq 1$, such that $\sum_{w \in A_r(u)} |\theta_w(\mathbb{T}_n^\mu)| \geq \varepsilon n$ and $\sum_{w \in A_{-r}(u)} |\theta_w(\mathbb{T}_n^\mu)| \geq \varepsilon n$. Let $v(u) \in \mathbb{T}_n^\mu$ be the first vertex of $A_{-r}(u)$ in lexicographical order. Then, it is clear by definition of W that

$$W_{i(u)-1}(\mathbb{T}_n^\mu) \leq W_{i(v(u))-1}(\mathbb{T}_n^\mu) \leq W_{i(u)}(\mathbb{T}_n^\mu). \quad (4.5)$$

Now assume by the Skorokhod representation theorem that the convergence of Theorem 4.2.2 holds almost surely. Assume that, for n along a subsequence, there exists an εn -node u_n in \mathbb{T}_n^μ such that $W_{i(u_n)}(\mathbb{T}_n^\mu) - W_{i(u_n)-1}(\mathbb{T}_n^\mu) = o(B_n)$ as $n \rightarrow \infty$ (that is, u_n has $o(B_n)$ children). Since $[0, 1]$ is compact, up to extraction, one can assume in addition that there exists $0 < s < t < 1$ such that $i(u_n)/n \rightarrow s$ and $i(v(u_n))/n \rightarrow t$. Thus, the limiting process $X^{(\alpha)}$ should satisfy:

$$(a') \quad X_s^{(\alpha)} = X_{t-}^{(\alpha)}$$

$$(b') \quad X_{t-}^{(\alpha)} = \inf_{[t-\varepsilon, t+\varepsilon]} X^{(\alpha)}.$$

Indeed, (a') can be deduced from (4.5) and the fact that $W_{i(u_n)}(\mathbb{T}_n^\mu) - W_{i(u_n)-1}(\mathbb{T}_n^\mu) = o(B_n)$, while (b') comes from (a') along with the fact that W is larger than $W_{i(u_n)}(\mathbb{T}_n^\mu) - 1$ on $[i(u_n), i(v(u_n)) + 2\varepsilon n]$ as $|\theta_u(\mathbb{T}_n^\mu)| \geq 2\varepsilon n$. There are now two possible cases:

- first, if $\Delta_s = 0$, then, as by (H1) the local minima of $X^{(\alpha)}$ are almost surely distinct, $X_s^{(\alpha)}$ is not a local minimum of $X^{(\alpha)}$ (since by (b') $X_{t-}^{(\alpha)}$ is a local minimum). Therefore, $s = \sup\{r \leq t, X_r^{(\alpha)} < X_t^{(\alpha)}\}$ and by (H2) $\Delta_s > 0$, which contradicts our assumption;
- second, if $\Delta_s > 0$ then by (H3) $s = \sup\{r \leq t, X_r^{(\alpha)} < X_t^{(\alpha)}\}$; by (H2), it should happen that $X_t^{(\alpha)} < X_s^{(\alpha)}$, which is not the case by (a').

In conclusion, almost surely, there exists $\eta > 0$ such that, as $n \rightarrow \infty$, all εn -nodes in \mathbb{T}_n^μ have at least ηB_n children. \square

We can now present a first convergence result concerning the lamination-valued process associated to the trees $\mathbb{T}_n^\mu, n \geq 1$. As the renormalized contour functions of these trees converge as $n \rightarrow \infty$ to $H^{(\alpha)}$ by Theorem 4.2.2, it turns out that the associated processes of laminations converge towards the α -stable lamination-valued process $(\mathbb{L}_c^{(\alpha)})_{c \in [0, \infty]}$.

Theorem 4.2.4. *Let $\alpha \in (1, 2]$, μ a distribution in the domain of attraction of an α -stable law, and (B_n) satisfying (4.2). Then, jointly with the convergence of Theorem 4.2.2, the following holds in distribution in $\mathbb{D}([0, \infty], \mathbb{CL}(\overline{\mathbb{D}}))$:*

$$(\mathbb{L}_{cB_n}(\mathbb{T}_n^\mu))_{c \in [0, \infty]} \xrightarrow{(d)} (\mathbb{L}_c^{(\alpha)})_{c \in [0, \infty]},$$

where we recall that the process $(\mathbb{L}_c^{(\alpha)})_{c \in [0, \infty]}$ is obtained from $H^{(\alpha)}$ by the construction of Section 4.1.

This result is an immediate consequence of [96, Theorem 4.3 and Proposition 4.3], and is a cornerstone of the proof of (4.4).

To end this section on random monotype trees, we provide a useful tool in the study of Galton-Watson trees called the local limit theorem. It can be seen for instance as a consequence of [63, Theorem 8.1, (I)], taking $\mathcal{A} = \mathbb{Z}_+$ in the statement:

Theorem 4.2.5 (Local limit theorem). *Let μ be a critical distribution in the domain of attraction of a stable law, and (B_n) satisfying (4.2). Then, there exists a constant $C > 0$ such that, for the values of n for which $\mathbb{P}(|\mathbb{T}^\mu| = n) > 0$,*

$$\mathbb{P}(|\mathbb{T}^\mu| = n) \sim \frac{C}{nB_n}$$

as $n \rightarrow \infty$.

In particular, $\mathbb{P}(|\mathbb{T}^\mu| = n)$ decreases more slowly than some polynomial in n .

Bi-type simply generated trees We now define the bi-type analogue of MTSG trees, which we call bi-type simply generated trees (in short, BTSG). Such random bi-type trees appear in particular in [74].

Let w°, w^\bullet be two weight sequences, and impose that $w_0^\bullet = 0$ and $w_0^\circ > 0$. For T a bi-type tree, define the weight of T as

$$W_{w^\circ, w^\bullet}(T) := \prod_{x \in T, x \text{ white}} w_{k_x(T)}^\circ \times \prod_{y \in T, y \text{ black}} w_{k_y(T)}^\bullet.$$

An integer n being fixed, a (w°, w^\bullet) -BTSG with n white vertices is a random variable $\mathcal{T}_n^{(w^\circ, w^\bullet)}$, taking its values in the set \mathfrak{BT}_n of bi-type rooted trees with n white vertices, such that the probability that $\mathcal{T}_n^{(w^\circ, w^\bullet)}$ is equal to some bi-type tree $T \in \mathfrak{BT}_n$ is

$$\mathbb{P}(\mathcal{T}_n^{(w^\circ, w^\bullet)} = T) = \frac{1}{Z_{n, w^\circ, w^\bullet}} W_{w^\circ, w^\bullet}(T).$$

Here, $Z_{n, w^\circ, w^\bullet} = \sum_{T \in \mathfrak{BT}_n} W_{w^\circ, w^\bullet}(T)$ is a normalizing constant (as usual, we shall restrict ourselves to the values of n such that $Z_{n, w^\circ, w^\bullet} > 0$). Note that, since we impose the condition $w_0^\bullet = 0$, the set $\{T \in \mathfrak{BT}_n, W_{w^\circ, w^\bullet}(T) > 0\}$ is finite at n fixed and therefore $Z_{n, w^\circ, w^\bullet} < \infty$. In addition, the leaves of $\mathcal{T}_n^{(w^\circ, w^\bullet)}$ are all white, and the number of black vertices in $\mathcal{T}_n^{(w^\circ, w^\bullet)}$ is at most $n - 1$.

As in the monotype case, different pairs (w°, w^\bullet) may give the same BTSG.

Lemma 4.2.6 (Exponential tilting). *Take two sequences w°, w^\bullet such that $w_0^\bullet = 0$ and $w_0^\circ > 0$. Take $p, q, r, s \in \mathbb{R}_+^*$ such that $qr = 1$, and define two new weight sequences $\tilde{w}^\circ, \tilde{w}^\bullet$ as, for $i \in \mathbb{Z}_+$,*

$$\tilde{w}_i^\circ = pq^i w_i^\circ, \tilde{w}_i^\bullet = rs^i w_i^\bullet.$$

Then, for all $n \geq 1$, $\mathcal{T}_n^{(w^\circ, w^\bullet)}$ has the same distribution as $\mathcal{T}_n^{(\tilde{w}^\circ, \tilde{w}^\bullet)}$.

In this case, we say that (w°, w^\bullet) and $(\tilde{w}^\circ, \tilde{w}^\bullet)$ are two *equivalent* pairs of weight sequences (one easily checks that this indeed defines an equivalence relation on the set of pairs of weight sequences (w°, w^\bullet) such that $w_0^\bullet = 0$ and $w_0^\circ > 0$).

Proof. Fix $n \geq 1$. Take T a bi-type tree with n white vertices, and denote by k the number of black vertices in T . Then, notice that

$$\begin{aligned}
W_{\tilde{w}^\circ, \tilde{w}^\bullet}(T) &= \prod_{x \in T, x \text{ white}} \tilde{w}_{k_x(T)}^\circ \times \prod_{y \in T, y \text{ black}} \tilde{w}_{k_y(T)}^\bullet \\
&= \prod_{x \in T, x \text{ white}} p q^{k_x(T)} w_{k_x(T)}^\circ \times \prod_{y \in T, y \text{ black}} r s^{k_y(T)} w_{k_y(T)}^\bullet \\
&= p^n q^k r^k s^{n-1} \prod_{x \in T, x \text{ white}} w_{k_x(T)}^\circ \times \prod_{y \in T, y \text{ black}} w_{k_y(T)}^\bullet \\
&= p^n s^{n-1} W_{w^\circ, w^\bullet}(T) \text{ since } qr = 1.
\end{aligned}$$

This implies in particular that $Z_{n, \tilde{w}^\circ, \tilde{w}^\bullet} = p^n s^{n-1} Z_{n, w^\circ, w^\bullet}$. Thus, for any tree $T \in \mathfrak{BT}_n$,

$$\mathbb{P}(\mathcal{T}_n^{(\tilde{w}^\circ, \tilde{w}^\bullet)} = T) = \mathbb{P}(\mathcal{T}_n^{(w^\circ, w^\bullet)} = T),$$

which provides the result. \square

From now on, unless explicitly mentioned, the tree $\mathcal{T}_n^{(w^\circ, w^\bullet)}$ will always be considered as a labelled bi-type tree, whose black vertices are labelled uniformly at random from 1 to $N^\bullet(\mathcal{T}_n^{(w^\circ, w^\bullet)})$.

Finally, we end this section by stating a bi-type analogue of Theorem 4.2.4, in the case of a size-conditioned (μ_*, ν) -BTSG. Here, μ_* denotes the Poisson distribution of parameter 1 (that is, for all $i \geq 0$, $(\mu_*)_i = e^{-1} i!^{-1}$), and ν is a probability distribution satisfying either one of the following two conditions:

- (I) There exists $\alpha \in (1, 2)$ such that ν is in the domain of attraction of an α -stable law.
- (II) ν has finite variance σ_ν^2 (in which case we recall that ν is in the domain of attraction of a 2-stable law).

Theorem 4.2.7. *Let ν be a probability law satisfying (I) or (II), and let w^\bullet be the weight sequence defined as $w_0^\bullet = 0$ and $w_i^\bullet = \nu_i$ for $i \geq 1$. Let (\tilde{B}_n) be a sequence satisfying (4.3). Then the following convergence holds in the space $\mathbb{D}(\mathbb{R}_+, \mathbb{CL}(\overline{\mathbb{D}})) \times \mathbb{CL}(\overline{\mathbb{D}})$.*

(i) In case (I),

$$\left(\left(\mathbb{L}_{c(1-\nu_0)\tilde{B}_n}^\bullet(\mathcal{T}_n^{(\mu_*, w^\bullet)}) \right)_{0 \leq c < \infty}, \mathbb{L}_\infty^\bullet(\mathcal{T}_n^{(\mu_*, w^\bullet)}) \right) \xrightarrow[n \rightarrow \infty]{(d)} \left(\left(\mathbb{L}_c^{(\alpha)} \right)_{0 \leq c < \infty}, \mathbb{L}_\infty^{(\alpha), 1} \right).$$

(ii) In case (II),

$$\left(\left(\mathbb{L}_{c(1-\nu_0)\tilde{B}_n}^\bullet(\mathcal{T}_n^{(\mu_*, w^\bullet)}) \right)_{0 \leq c < \infty}, \mathbb{L}_\infty^\bullet(\mathcal{T}_n^{(\mu_*, w^\bullet)}) \right) \xrightarrow[n \rightarrow \infty]{(d)} \left(\left(\mathbb{L}_c^{(2)} \right)_{0 \leq c < \infty}, \mathbb{L}_\infty^{(2), p_\nu} \right),$$

where

$$p_\nu := \frac{\sigma_\nu^2}{\sigma_\nu^2 + 1} \in [0, 1).$$

The proof of this theorem, which is quite technical, is postponed to Section 4.3.3. Studying this particular family of BTSG is of great interest in our case, since they code in some sense a w -minimal factorization of the n -cycle, as will be seen in Section 4.4.

Remark. Although we state and prove Theorem 4.2.7 only in the specific case $w^\circ = \mu_*$ for its connection with minimal factorizations, this result holds in a more general framework. Specifically, let ν° and ν^\bullet be two critical probability distributions, and w^\bullet a weight sequence such that $w_0^\bullet = 0$, whose critical equivalent is ν^\bullet . Then, Theorem 4.2.7 still holds in the following more general cases (I') and (II'):

(I') ν^\bullet is in the domain of attraction of an α -stable law for $1 < \alpha < 2$, and ν° has a finite moment of order $2 + 2\alpha$. This seemingly strange condition appears when one adapts the proof of Lemma 4.3.7.

(II') both ν° and ν^\bullet have finite variance. In this framework, p_ν should be replaced by a parameter p which depends on both ν° and ν^\bullet .

In these two cases, all further proofs can be easily adapted.

Remark. Using the same tools as for the proof of Theorem 4.2.7, one can in fact prove that the following slightly stronger convergence holds in the space $\mathbb{D}(\mathbb{R}_+, \text{CL}(\overline{\mathbb{D}})) \times \mathbb{D}((0, 1], \text{CL}(\overline{\mathbb{D}}))$:

(i) In case (I),

$$\left(\left(\mathbb{L}_{c(1-\nu_0)\tilde{B}_n}^\bullet (\mathcal{T}_n^{(\mu_*, w^\bullet)}) \right)_{0 \leq c < \infty}, \left(\mathbb{L}_{dn}^\bullet (\mathcal{T}_n^{(\mu_*, w^\bullet)}) \right)_{0 < d \leq 1} \right) \xrightarrow[n \rightarrow \infty]{(d)} \left(\left(\mathbb{L}_c^{(\alpha)} \right)_{0 \leq c < \infty}, \left(\mathbb{L}_{\infty, d}^{(\alpha), 1} \right)_{0 < d \leq 1} \right).$$

(ii) In case (II),

$$\left(\left(\mathbb{L}_{c(1-\nu_0)\tilde{B}_n}^\bullet (\mathcal{T}_n^{(\mu_*, w^\bullet)}) \right)_{0 \leq c < \infty}, \left(\mathbb{L}_{dn}^\bullet (\mathcal{T}_n^{(\mu_*, w^\bullet)}) \right)_{0 < d \leq 1} \right) \xrightarrow[n \rightarrow \infty]{(d)} \left(\left(\mathbb{L}_c^{(2)} \right)_{0 \leq c < \infty}, \left(\mathbb{L}_{\infty, d}^{(2), p_\nu} \right)_{0 < d \leq 1} \right),$$

where

$$p_\nu := \frac{\sigma_\nu^2}{\sigma_\nu^2 + 1}.$$

Here, for $p \in [0, 1]$ and $\alpha \in (1, 2]$, the process $\left(\mathbb{L}_{\infty, d}^{(\alpha), p} \right)_{0 < d \leq 1}$ that appears at the limit interpolates in a 'linear' way between the stable lamination $\mathbb{L}_\infty^{(\alpha)}$ (for $d \downarrow 0$) and the colored stable lamination $\mathbb{L}_\infty^{(\alpha), p}$ (for $d = 1$). To construct this process, start from the stable lamination and sort its faces by decreasing area. Associate to the face F_i labelled i a pair of independent variables (X_i, Y_i) , all these pairs $(X_i, Y_i)_{i \geq 1}$ being independent. For any i , the variable X_i is binomial of parameter p , and determines whether the face F_i is colored in $\mathbb{L}_\infty^{(\alpha), p}$ or not. The variable Y_i is uniform on $[0, 1]$: if $X = 1$ (that is, F_i is colored at the limit) then Y_i is the time at which it is colored in the process. More rigorously, for any $d \in (0, 1]$,

$$\mathbb{L}_{\infty, d}^{(\alpha), 1} := \mathbb{L}_\infty^{(\alpha)} \cup \bigcup_{\substack{i \geq 1 \\ X_i = 1, Y_i \leq d}} F_i^\bullet$$

where F_i^\bullet denotes the face F_i colored black. In words, we state that the faces that are colored in the limiting lamination $\mathbb{L}_\infty^{(\alpha), p}$ in case (I) and (II) appear in the process at independent times $Y_i n$, where the Y_i 's are uniform on $(0, 1]$. In some sense, the process also has a nontrivial behaviour at scale n , in which large black faces begin to appear.

4.3 The particular case of (μ_*, w) -bi-type trees.

This section is devoted to the study of particular properties of (μ_*, w) -BTSG trees, where $\mu_* = Po(1)$ and w is a weight sequence of stable type. Indeed, such trees appear as a natural coding of minimal factorizations of stable type, as we will see in Section 4.4.3. In particular, we characterize the distribution of the associated white reduced tree, and use it to prove Theorem 4.2.7. **From now on, as there is no ambiguity, we write \mathcal{T}_n instead of $\mathcal{T}_n^{(\mu_*, w)}$, and \mathcal{T}_n° instead of $\mathcal{T}_n^{\circ, (\mu_*, w)}$.**

4.3.1 Reachable distributions: a study of the white reduced tree.

Recall that, a weight sequence $(w_i)_{i \geq 1}$ being given, there exists at most one critical probability distribution ν called the critical equivalent of w such that, for some $s > 0$, for all $i \geq 1$, $\nu_i = w_i s^i$. If this is the case, the white reduced tree \mathcal{T}_n° is distributed as a Galton-Watson tree. The goal of this section is to investigate the possible behaviours of its offspring distribution, and in particular for which sequences w this white reduced tree converges to a stable tree. Indeed, in this case, the white process of \mathcal{T}_n converges by Theorem 4.2.4, which helps us prove the convergence of the black process of \mathcal{T}_n .

In the rest of the paper, in the case of a (μ_*, w) -BTSG tree, ν will always denote the critical equivalent of w , and μ the critical distribution such that $\mathcal{T}_n^\circ \stackrel{(d)}{=} \mathbb{T}_n^\mu$.

Let us state things formally. To a weight sequence w , we associate its generating function $F_w : x \rightarrow \sum_{i=0}^{\infty} w_i x^i$. In particular, $F_{\mu_*}(x) := e^{x-1}$ is defined for any $x \in \mathbb{R}$. It is a simple matter of fact that the white reduced tree \mathcal{T}_n° is distributed as the monotype simply generated tree $\mathbb{T}_n^{\tilde{w}}$, where \tilde{w} is the weight sequence whose generating function satisfies

$$F_{\tilde{w}} = F_{\mu_*} \circ F_w := e^{F_w - 1}.$$

We say that a critical probability distribution μ is *reachable* if there exists a weight sequence $(w_i)_{i \geq 1}$ such that, for all $n \geq 1$, \mathcal{T}_n° is a μ -Galton-Watson tree conditioned to have n vertices. In this case, we say that w *reaches* μ . The following theorem states that a large range of distributions are reachable:

Theorem 4.3.1. *Let $\alpha \in (1, 2)$ and L a slowly varying function. Then, there exists a reachable critical distribution μ such that*

$$F_\mu(1 - u) - (1 - u) \underset{\substack{u \downarrow 0 \\ u \neq 0}}{\sim} u^\alpha L(u^{-1}). \tag{4.6}$$

Let $\alpha = 2$ and $\ell > 0$. Then there exists a reachable critical distribution μ such that

$$F_\mu(1 - u) - (1 - u) \underset{\substack{u \downarrow 0 \\ u \neq 0}}{\rightarrow} \ell \tag{4.7}$$

if and only if $\ell \geq 1/2$. This is equivalent to saying that μ has finite variance 2ℓ .

Furthermore, let w be a weight sequence that reaches a critical probability distribution μ . Then the two following points are equivalent:

- μ verifies (4.6) or (4.7).
- the critical equivalent ν of w satisfies:

$$F_\nu(1 - u) - (1 - u) \underset{\substack{u \rightarrow 0 \\ u \neq 0}}{\sim} \begin{cases} u^\alpha L(u^{-1}) & \text{if } \alpha \in (1, 2) \\ u^2(\ell - 1/2) & \text{if } \mu \text{ has finite variance.} \end{cases}$$

In other words, let $(B_n)_{n \geq 1}$ be a sequence of positive numbers satisfying (4.2) for ν , and $(\tilde{B}_n)_{n \geq 1}$ be the sequence constructed from $(B_n)_{n \geq 1}$ as in (4.3). Then, (\tilde{B}_n) satisfies (4.2) for μ . This relation between the two is the reason for the scaling in \tilde{B}_n appearing in both Theorems 4.1.3 and 4.2.7.

Theorem 4.3.1 also means that the only way to reach a distribution in the domain of attraction of a stable law is to start from a weight sequence whose critical equivalent is already in the domain of attraction of a stable law.

Theorem 4.3.1 is the consequence of a general result about reachable distributions, which may be of independent interest: a reachable μ being given, all weight sequences that reach it are closely related.

Proposition 4.3.2. *Let μ be reachable and w a weight sequence reaching μ . Then, for any weight sequence w' , w' reaches μ if and only if there exist $s, t > 0$ such that*

$$F_{w'}(tx) - F_{w'}(t) = F_w(sx) - F_w(s).$$

In particular, the set of weight sequences reaching μ can be written $\{w^{(s)}, s \in \mathbb{R}_+^*\}$ defined as: for any $s > 0$, any $i \geq 1$, $w_i^{(s)} := w_i s^i$.

Proof. Let w be a weight sequence reaching μ , and let \tilde{w} be the weight sequence such that $F_{\tilde{w}} = e^{F_w - 1}$. Then \tilde{w} shall satisfy for some $q, s > 0$, by Lemma 4.2.1,

$$\forall x \in [-1, 1], F_\mu(x) = qF_{\tilde{w}}(sx) = qe^{F_w(sx) - 1}.$$

Applying this for $x = 1$, one gets $1 = qe^{F_w(s) - 1}$, which finally gives:

$$\forall x \in [-1, 1], F_\mu(x) = e^{F_w(sx) - F_w(s)}.$$

The result directly follows. □

Let us see how this implies Theorem 4.3.1:

Proof of Theorem 4.3.1. We start by proving the first part of this theorem. When $\alpha < 2$, one can define ν a critical distribution satisfying $\nu_k = k^{-1-\alpha}L(k)$, for k large enough. Thus, $F_\nu(1-u) - (1-u) \sim u^\alpha(L(u^{-1}))$ as $u \rightarrow 0$, by e.g. [26, Theorem 8.1.6]. Define now the weight sequence w by $w_0 = 0$ and $w_i = \nu_i$ for $i \geq 1$. In particular, $F_w(1-u) - F_w(1) = F_\nu(1-u) - F_\nu(1) = -u + u^\alpha L(u^{-1})(1 + o(1))$, and $F'_w(1) = 1$. Then, one can check that the probability law μ such that $F_\mu(x) = e^{F_w(x) - F_w(1)}$ is reached by w and is critical. One gets in addition:

$$\begin{aligned} F_\mu(1-u) &= e^{F_w(1-u) - F_w(1)} = e^{F_\nu(1-u) - 1} \\ &= F_\nu(1-u) + \frac{1}{2} ((F_\nu(1-u) - 1)^2) \\ &= 1 - u + u^\alpha L(u^{-1}) + o(u^\alpha), \end{aligned}$$

which implies the first part of Theorem 4.3.1.

When $\alpha = 2$ and $L(x) \xrightarrow{x \rightarrow \infty} \ell \geq 1/2$, choose any critical distribution ν with variance $2\ell - 1$ and construct w from ν the same way. This leads to

$$F_\mu(1-u) = 1 - u + u^2 \left(\ell - \frac{1}{2} \right) + \frac{u^2}{2} + o(u^2).$$

Then, we shall prove that any critical reachable distribution has variance greater than 1. Let μ be reachable, and take a weight sequence w reaching μ . Then, there exists $s > 0$ such that, for all $x \in (-1, 1)$, $F_\mu(x) = e^{F_w(sx) - F_w(s)}$. After differentiating once and applying at $x = 1$, one gets

$$1 = F'_\mu(1) = sF'_w(s). \quad (4.8)$$

By differentiating twice, one gets, for any $x \in (-1, 1)$,

$$F''_\mu(x) = s^2 \left(F''_w(sx) + (F'_w(sx))^2 \right) e^{F_w(sx) - F_w(s)}. \quad (4.9)$$

Assume now that μ has finite variance σ_μ^2 . Since μ is critical, $\sigma_\mu^2 = F''_\mu(1)$. Letting x go to 1 in (4.9), we get by (4.8) that $\sigma_\mu^2 = s^2 F''_w(s) + 1 \geq 1$.

The second part is just a consequence of Lemma 4.3.2 and the construction of suitable weight sequences in the beginning of this proof. \square

Finally, we give a simple criterion for a distribution to be reachable, which may be of independent interest.

Proposition 4.3.3. *Let μ be a critical distribution on \mathbb{Z}_+ . Then, the following statements are equivalent :*

(i) μ is reachable

(ii) All successive derivatives of $\log F_\mu$ at 0 are nonnegative.

Proof. By Lemma 4.3.2, μ is reachable if and only if there exists a weight sequence w and $s > 0$ such that $F_\mu(x) = e^{F_w(sx) - F_w(s)}$ on $(-1, 1)$, i.e. $F_w(sx) = F_w(s) + \log F_\mu(x)$ on this interval. All w_i 's are nonnegative, which proves that (i) \Rightarrow (ii). Now assume (ii) and denote by v_i the i th derivative of $\log F_\mu$ at 0. Then, the weight sequence $(w_i)_{i \geq 0}$ defined by $w_i := v_i(i!)^{-1}$ for $i \geq 1$ and $w_0 = 0$ satisfies $F_\mu = e^{F_w - F_w(1)}$ on $(-1, 1)$. Therefore, w reaches μ . \square

As a consequence of Proposition 4.3.3, for any $\alpha \in (1, 2)$ and any slowly varying function L , there exists a probability distribution μ verifying (4.6), such that all successive derivatives of F_μ at 0 are nonnegative. For any $\ell \geq 1$, there exists μ with variance ℓ , verifying (4.7), such that all successive derivatives of F_μ at 0 are nonnegative.

4.3.2 Compared counting of the vertices in the tree \mathcal{T}_n and the white reduced tree \mathcal{T}_n°

Before we prove Theorem 4.2.7 in the next subsection, we gather together some results concerning the number of black vertices in different connected components of the tree \mathcal{T}_n , comparing them to the number of white vertices in these connected components. It turns out that these quantities are asymptotically proportional, the constant of proportionality being the average number of black children of a white vertex. Let us state things properly:

Lemma 4.3.4 (Number of black vertices in a BTSG). *Let w be a weight sequence of α -stable type for some $\alpha \in (1, 2]$, and ν be its critical equivalent. Then, as $n \rightarrow \infty$,*

$$\frac{1}{n} N^\bullet(\mathcal{T}_n) \xrightarrow{\mathbb{P}} 1 - \nu_0.$$

As we will see in the next section, this straightforwardly implies Lemma 4.1.1.

Proof. The idea of the proof is to split the set of black vertices in the tree according to the number of white grandchildren of their parents. Let $N_k^{n,\circ}$ be the number of white vertices in \mathcal{T}_n that have exactly k white grandchildren. Then, observe two things: (i) for any fixed $K \in \mathbb{Z}_+$, jointly for $k \in \llbracket 1, K \rrbracket$, we have with high probability

$$|N_k^{n,\circ} - n\mu_k| \leq n^{3/4}; \quad (4.10)$$

(ii) conditionally on the fact that a white vertex has k white grandchildren, its number of black children is independent of the rest of the tree, and is distributed as a variable X_k verifying $X_0 = 0$ almost surely and $1 \leq X_k \leq k$ for all $k \geq 1$.

Indeed, (i) is a consequence of the joint asymptotic normality of the quantities $N_k^{n,\circ}$ (see e.g. [95, Theorem 6.2 (iii)]), while (ii) is clear by definition of the BTSG. Let us see how this implies our result. Fix $\varepsilon > 0$, and $K \geq 1$ such that $\sum_{k=1}^K k\mu_k \geq 1 - \varepsilon$. Such a K exists by criticality of μ . By (i) and (ii), a central limit theorem for the variables $X_k, k \leq K$ gives that, with high probability, jointly for any $0 \leq k \leq K$,

$$|N_k^{n,\bullet} - n\mu_k \mathbb{E}[X_k]| \leq n^{4/5}, \quad (4.11)$$

where $N_k^{n,\bullet}$ denotes the number of black vertices in the tree whose parent has k white grandchildren. On the other hand, a white vertex u being given, its number of black children is necessarily less than its number of white grandchildren. Thus we get that the total number of black vertices in the tree whose parent has at least $K + 1$ white grandchildren satisfies

$$\sum_{k \geq K+1} N_k^{n,\bullet} \leq \sum_{k \geq K+1} kN_k^{n,\circ} = (n-1) - \sum_{k=0}^K kN_k^{n,\circ},$$

as $\sum_{k \in \mathbb{Z}_+} kN_k^{n,\circ}$ is the number of white grandchildren in the tree, which is equal to $n - 1$ (only the root is not a grandchild of any white vertex). Therefore, applying (4.10) to each $k \leq K$, we get that $\sum_{k \geq K+1} N_k^{n,\bullet} \leq \varepsilon n + (K+1)n^{3/4}$ with high probability. Finally, using (4.11), as $n \rightarrow \infty$,

$$\mathbb{P} \left(\left| \frac{N^\bullet(\mathcal{T}_n)}{n} - \sum_{k \in \mathbb{Z}_+} \mu_k \mathbb{E}[X_k] \right| \geq 2\varepsilon \right) \rightarrow 0.$$

The only thing left to prove is that

$$\sum_{k \geq 0} \mu_k \mathbb{E}[X_k] = 1 - \nu_0. \quad (4.12)$$

To this end, we see the tree \mathcal{T}_n as a bi-type Galton-Watson tree. We define two probability measures μ°, μ^\bullet as follows:

$$\begin{aligned} \forall i \geq 0, \mu_i^\circ &= \mu_i^* e^{\nu_0} (1 - \nu_0)^i \\ \mu_0^\bullet &= 0 \text{ and } \forall i \geq 1, \mu_i^\bullet = (1 - \nu_0)^{-1} \nu_i, \end{aligned} \quad (4.13)$$

One easily checks that these measures have total mass 1. A quantity of particular interest is the mean of μ° :

$$\sum_{j \geq 1} j \mu_j^\circ = \sum_{j \geq 1} j \mu_j^* e^{\nu_0} (1 - \nu_0)^j = e^{\nu_0 - 1} \sum_{j \geq 1} j \frac{(1 - \nu_0)^j}{j!} = 1 - \nu_0. \quad (4.14)$$

Furthermore, by Lemma 4.2.6, for any $n \geq 1$, $\mathcal{T}_n^{(\mu^\circ, \mu^\bullet)} \stackrel{(d)}{=} \mathcal{T}_n^{(\mu^*, w)}$. We can therefore write:

$$\sum_{k \geq 0} \mu_k \mathbb{E}[X_k] = \sum_{k \geq 0} \mu_k \sum_{j \geq 1} j \mathbb{P}(k_\emptyset(\mathcal{T}_n^{(\mu^\circ, \mu^\bullet)}) = j | k_\emptyset(\mathcal{T}_n^{\circ, (\mu^\circ, \mu^\bullet)}) = k).$$

Indeed, by definition, the variable X_k is distributed as the number of black children of \emptyset (or any other white vertex) conditionally on the fact that \emptyset has k white grandchildren. Now observe that, since μ° and μ^\bullet are probability measures, one can define the bi-type Galton-Watson tree $\mathcal{T}^{(\mu^\circ, \mu^\bullet)}$ as in the monotype case, as the random variable on the set of finite bi-type trees satisfying, for any bi-type tree T :

$$\mathbb{P}(\mathcal{T}^{(\mu^\circ, \mu^\bullet)} = T) = \prod_{x \in T, x \text{ white}} \mu_{k_x}^\circ(T) \times \prod_{y \in T, y \text{ black}} \mu_{k_y}^\bullet(T).$$

As a consequence, the BTSG $\mathcal{T}_n^{(\mu^\circ, \mu^\bullet)}$ is distributed as the tree $\mathcal{T}^{(\mu^\circ, \mu^\bullet)}$ conditioned to have n white vertices. Now recall that μ is the critical distribution such that $\mathcal{T}_n^\circ \stackrel{(d)}{=} \mathbb{T}_n^\mu$ for all $n \geq 1$. In particular, for all k , $\mu_k = \mathbb{P}(k_\emptyset(\mathcal{T}^{\circ, (\mu^\circ, \mu^\bullet)}) = k)$. Thus, using the fact that, conditionally on the number of white grandchildren of a white vertex u of \mathcal{T}_n , the number of black children of u is independent of the rest of the tree, we can prove (4.12). Here, for convenience, we write \mathcal{T} for $\mathcal{T}^{(\mu^\circ, \mu^\bullet)}$ and \mathcal{T}° for $\mathcal{T}^{\circ, (\mu^\circ, \mu^\bullet)}$.

$$\begin{aligned} \sum_{k \geq 0} \mu_k \mathbb{E}[X_k] &= \sum_{k \geq 0} \mu_k \sum_{j \geq 1} j \mathbb{P}(k_\emptyset(\mathcal{T}) = j | k_\emptyset(\mathcal{T}^\circ) = k) \\ &= \sum_{j \geq 1} j \sum_{k \geq 0} \mathbb{P}(k_\emptyset(\mathcal{T}) = j | k_\emptyset(\mathcal{T}^\circ) = k) \mathbb{P}(k_\emptyset(\mathcal{T}^\circ) = k) \\ &= \sum_{j \geq 1} j \mathbb{P}(k_\emptyset(\mathcal{T}) = j) = \sum_{j \geq 1} j \mu_j^\circ, \end{aligned}$$

which implies (4.12) by (4.14). \square

We now generalize this statement, by investigating the number of black vertices in different components of a tree. This refinement allows us to precisely control the location of large faces in the black process of the tree, and thus to prove Theorem 4.2.7. Specifically, a tree T being given, each vertex u of T induces a partition of the set of vertices of T into three parts: the set $G_1(u, T)$ of vertices that are visited for the first time by the contour function $C(T)$ before u , the subtree $G_2(u, T)$ rooted at u and the set $G_3(u, T)$ of the vertices visited for the first time by $C(T)$ after u has been visited for the last time.

Lemma 4.3.5. *With high probability, jointly for $u \in \mathcal{T}_n$ a white vertex, as $n \rightarrow \infty$, we have, jointly for $i = 1, 2, 3$:*

$$|G_i(u, \mathcal{T}_n^\circ)| = (1 + (1 - \nu_0))^{-1} |G_i(u, \mathcal{T}_n)| + o(n),$$

where we recall that we also denote by u the vertex in \mathcal{T}_n° corresponding to u .

In other words, the proportions of vertices in \mathcal{T}_n in lexicographical order respectively before u , in the subtree rooted at u and after u are, with high probability, close to the proportions of vertices in \mathcal{T}_n° in lexicographical order before u , in the subtree rooted at u and after u . This boils down to proving that, in each of these components, the number of black vertices is roughly $(1 - \nu_0)$ times the number of white vertices.

Proof. Fix $\varepsilon > 0$, and take $K \in \mathbb{Z}_+$ such that $\sum_{k=0}^K k\mu_k \geq 1 - \varepsilon$. For $0 \leq k \leq K$, denote by $N_{2nt}^k(\mathcal{T}_n^\circ)$, for $0 \leq t \leq 1$, the number of different vertices in \mathcal{T}_n° with k children visited by the contour function $C(\mathcal{T}_n^\circ)$ before time $2nt$. Then, it is known (see [95, Theorem 1.1 (ii)] for the finite variance case and [95, Theorem 6.1 (ii)] for the infinite variance case) that, uniformly in $k \leq K$:

$$\left(\frac{N_{2nt}^k(\mathcal{T}_n^\circ) - n\mu_k t}{\sqrt{n}} \right)_{0 \leq t \leq 1} \xrightarrow[n \rightarrow \infty]{(d)} (C_1 \mathfrak{e}_t + C_2 B_t)_{0 \leq t \leq 1}, \quad (4.15)$$

where C_1, C_2 are constants that only depend on μ , \mathfrak{e} is a normalized Brownian excursion and B is a Brownian motion independent of \mathfrak{e} .

Now, for u a white vertex of \mathcal{T}_n , denote by $N^{k,(1)}(u)$ (resp. $N^{k,(2)}(u)$, $N^{k,(3)}(u)$) the number of different white vertices with k white grandchildren in \mathcal{T}_n visited by $C(\mathcal{T}_n)$ for the first time before the first visit of u (resp. between the first and last visits of u , and after the last visit of u). For $1 \leq i \leq 3$, set in addition $N^{(i)}(u) = |G_i(u, \mathcal{T}_n)| := \sum_{k \geq 0} N^{k,(i)}(u)$, the total number of vertices visited by the contour function resp. before the first visit of u , between the first and last visits of u and after the last visit of u . We obtain from (4.15) that, as $n \rightarrow \infty$:

$$\mathbb{P}(\exists u \in \mathcal{T}_n, u \text{ white}, \exists k \in \llbracket 0, K \rrbracket, \exists i \in \llbracket 1, 3 \rrbracket, |N^{k,(i)}(u) - \mu_k N^{(i)}(u)| \geq n^{3/4}) \rightarrow 0.$$

Now, on the complement of this event, using the notation X_k of Lemma 4.3.4, for any white vertex $u \in \mathcal{T}_n$ white, a central limit theorem provides:

$$\mathbb{P}(|N^{\bullet,k,(i)}(u) - N^{k,(i)}(u)\mathbb{E}[X_k]| \geq n^{3/4}) = o(1/n), \quad (4.16)$$

where $N^{\bullet,k,(i)}(u)$ denotes the number of black vertices in $G_i(u, \mathcal{T}_n)$ whose parent has k white grandchildren. On the other hand, the total number of black vertices in the tree whose parent has more than K white grandchildren is again at most $\varepsilon n + (K+1)n^{3/4}$ with high probability by (4.10). By summing (4.16) over all $k \leq K$, all $1 \leq i \leq 3$ and all white vertices $u \in \mathcal{T}_n$, and finally by letting $\varepsilon \rightarrow 0$, we obtain the result. \square

4.3.3 Proof of the technical theorem 4.2.7

This whole subsection is devoted to the proof of Theorem 4.2.7. First of all, we explain the structure of this proof: let $\alpha \in (1, 2]$, $(w_i)_{i \geq 1}$ be a weight sequence of α -stable type, and ν be its critical equivalent. When $\alpha < 2$ or when ν has finite variance, we prove that the black and white processes coded by the BTSG \mathcal{T}_n are asymptotically close to each other at the scale \tilde{B}_n (where $(\tilde{B}_n)_{n \geq 1}$ satisfies (4.3) for ν). Then, we investigate the whole colored lamination $\mathbb{L}_\infty^\bullet(\mathcal{T}_n)$, showing that it converges to a random stable lamination whose faces are colored independently with the same probability. The following theorem gathers these different results. Again in this section, as there is no ambiguity, \mathcal{T}_n stands for $\mathcal{T}_n^{(\mu_*, w)}$.

Theorem 4.3.6. *Let $\alpha \in (1, 2]$, w be a weight sequence of α -stable type, ν be its critical equivalent, and $(\tilde{B}_n)_{n \geq 1}$ verifying (4.3) for ν . Then, if $\alpha \in (1, 2)$ or if ν has finite variance:*

(i) *There exists a coupling between the black process and the white process of \mathcal{T}_n such that:*

$$d_{Sk} \left(\left(\mathbb{L}_{c(1-\nu_0)\tilde{B}_n}^\bullet(\mathcal{T}_n) \right)_{c \geq 0}, \left(\mathbb{L}_{c\tilde{B}_n}^\circ(\mathcal{T}_n) \right)_{c \geq 0} \right) \xrightarrow[n \rightarrow \infty]{\mathbb{P}} 0.$$

where d_{Sk} denotes the Skorokhod distance on $\mathbb{D}(\mathbb{R}_+, \text{CL}(\overline{\mathbb{D}}))$.

(ii) The white process of \mathcal{T}_n converges in distribution towards the α -stable lamination process:

$$\left(\mathbb{L}_{c\tilde{B}_n}^\circ(\mathcal{T}_n)\right)_{c \in [0, \infty]} \xrightarrow[n \rightarrow \infty]{(d)} \left(\mathbb{L}_c^{(\alpha)}\right)_{c \in [0, \infty]}.$$

(iii) In distribution, under the coupling of (i) and jointly with convergence (ii),

$$\mathbb{L}_\infty^\bullet(\mathcal{T}_n) \xrightarrow[n \rightarrow \infty]{(d)} \mathbb{L}_\infty^{(\alpha), p_\nu},$$

where

$$p_\nu := \frac{\sigma_\nu^2}{\sigma_\nu^2 + 1}.$$

In particular, $p_\nu = 1$ when $\alpha \in (1, 2)$.

Before jumping into the proof of Theorem 4.3.6, let us explain why this theorem is enough to get Theorem 4.2.7.

Proof of Theorem 4.2.7. The proof of Theorem 4.2.7 is now straightforward. Indeed, Theorem 4.3.6 (i) and (ii) imply the convergence of the first marginal in Theorem 4.2.7, that is, the convergence of the black process of \mathcal{T}_n on any compact of \mathbb{R}_+ . The joint convergence of $\mathbb{L}_\infty^\bullet(\mathcal{T}_n)$ is finally a consequence of Theorem 4.3.6 (iii). \square

Let us therefore prove Theorem 4.3.6.

4.3.4 Proof of Theorem 4.3.6 (i)

We first explain how to couple the white and black processes coded by \mathcal{T}_n . To each black vertex u , associate its white child $lc(u)$ whose subtree in \mathcal{T}_n° has the largest size (if the largest size is attained by more than one white child, then choose one uniformly at random). Now, start from a uniform labelling of the white vertices. We label the black vertices the following way: give the label 1 to the black vertex u_1 such that $lc(u_1)$ has the smallest label among all white vertices of the form $lc(u)$; give the label 2 to u_2 such that $lc(u_2)$ has the second smallest label, etc. This provides a way of labelling the black vertices of \mathcal{T}_n from 1 to $N^\bullet(\mathcal{T}_n)$, and this labelling is clearly uniform. See Fig. 4.11 for an example of this coupling. This induces therefore a coupling between the black and white processes $(\mathbb{L}_u^\circ(\mathcal{T}_n))_{u \in [0, \infty]}$ and $(\mathbb{L}_u^\bullet(\mathcal{T}_n))_{u \in [0, \infty]}$.

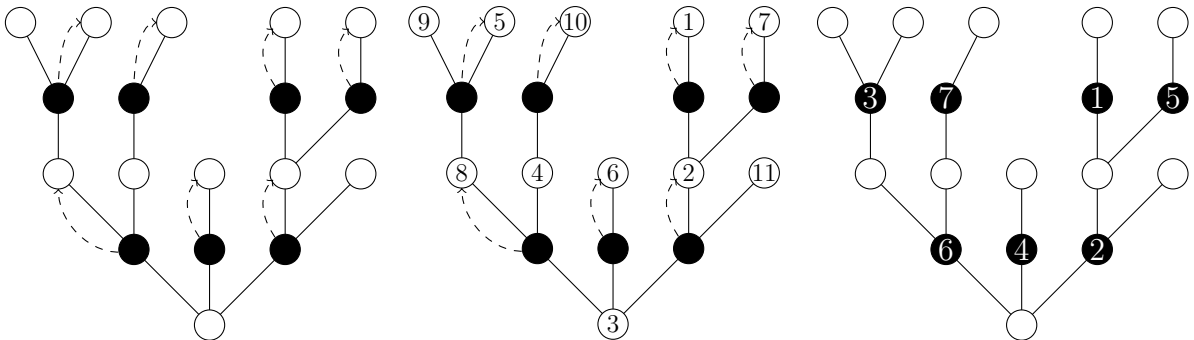

Figure 4.11: The coupling between labels of black and white vertices in a tree: arrows go from a black vertex u to the white vertex $lc(u)$. Left: the coupling between vertices. Middle: a uniform labelling of the white vertices. Right: the induced labelling of the black vertices

We claim that, under this coupling, Theorem 4.3.6 (i) holds. To this end, we prove that the following two events hold with high probability:

- (a) first, uniformly for u a black vertex in \mathcal{T}_n with label $\leq \tilde{B}_n \log n$, the distance between $\mathbb{S}^1 \cup F_u(\mathcal{T}_n)$ (in $\mathbb{L}^\bullet(\mathcal{T}_n)$) and $\mathbb{S}^1 \cup c_{\ell c(u)}(\mathcal{T}_n^\circ)$ (in $\mathbb{L}^\circ(\mathcal{T}_n)$) goes to 0;
- (b) uniformly for each black vertex u with label $e(u) \leq \tilde{B}_n \log n$,

$$|(1 - \nu_0) e^\circ(\ell c(u)) - e(u)| = o(\tilde{B}_n), \quad (4.17)$$

where $e^\circ(x)$ is the label of the white vertex x .

Roughly speaking, (a) proves that faces of the black process are close (one by one) to some chords of the white process, and (b) that each face roughly appears at the same time as the associated chord, in the time-rescaled processes.

On these two events, the Skorokhod distance between the black and the white processes up to time $\tilde{B}_n \log n$, rescaled in time by a factor \tilde{B}_n , goes to 0 as $n \rightarrow \infty$. Indeed, by (4.17), if one rescales by this factor \tilde{B}_n , asymptotically the face $F_u(\mathcal{T}_n)$ and the chord $c_{\ell c(u)}(\mathcal{T}_n^\circ)$ appear at the same time up to $o(1)$, uniformly for u a black vertex with label $\leq \tilde{B}_n \log n$. The only thing left to prove is that no other large white chord appears in the white process before time $\tilde{B}_n \log n$. To see this, notice that, at $\varepsilon > 0$ fixed, if a chord $c_v(\mathcal{T}_n^\circ)$ has length larger than ε , where v is a white vertex that is not of the form $\ell c(u)$ for some black vertex u , then necessarily the parent of v in \mathcal{T}_n° is an εn -branching point. The number of white vertices v such that $|\theta_v(\mathcal{T}_n^\circ)| \geq \varepsilon$ and such that the parent of v in \mathcal{T}_n° is an εn -branching point is bounded by ε^{-1} , independently of n . Hence, with high probability none of them has a label less than $\tilde{B}_n \log n$, and all large white chords in the white process that appear before time $\tilde{B}_n \log n$ are of the form $c_{\ell c(u)}(\mathcal{T}_n^\circ)$ for some black vertex u . This implies Theorem 4.3.6 (i).

We now prove (a) and (b). In what follows, we call *marked vertices* the white vertices of the form $\ell c(u)$ for some black vertex $u \in \mathcal{T}_n$.

In order to prove (a), we mostly rely on Lemma 4.3.5. Fix $\varepsilon > 0$ and take u a black vertex in \mathcal{T}_n with label $\leq \tilde{B}_n \log n$. Then, with high probability, u is not a black εn -node of \mathcal{T}_n . Indeed, there are at most $2n$ vertices in total in \mathcal{T}_n , and thus at most $2\varepsilon^{-1}$ εn -nodes in this tree. Assume that it is not an εn -node. Then, if all chords of the boundary of F_u have lengths $< \varepsilon$, with high probability $c_{\ell c(u)}$ has length less than 2ε by Lemma 4.3.5. Now assume that one of the chords in the boundary of F_u , which we denote by c_* , has length greater than ε . As u is not an εn -node of \mathcal{T}_n , there are at most two such chords in the boundary of F_u and therefore $d_H(c_*, F_u) < 2\pi\varepsilon$. In addition, again by Lemma 4.3.5, with high probability $d_H(c_*, c_{\ell c(u)}) < 2\pi\varepsilon$. Furthermore, this holds jointly for all u with label $\leq \tilde{B}_n \log n$.

In order to prove (b), the idea is to code the location of marked vertices (corresponding to the children of each black vertex having the largest subtree, which are fixed and do not depend on the labelling on the white vertices; they are white vertices that are targets of an arrow on Fig. 4.11 left and middle) in lexicographical order by a walk on \mathbb{R} , and then use well-known results about the behaviour of random walks.

First, observe that, by Lemma 4.3.4, with high probability there are $N^\bullet(\mathcal{T}_n) := (1 - \nu_0)n(1 + o(1))$ black vertices in the tree \mathcal{T}_n . Therefore, among the n white vertices in the tree, $(1 - \nu_0)n(1 + o(1))$ of them are marked, and the fact that a vertex is marked does not depend on the labelling. Moreover, the labels of these white vertices are uniformly chosen among all $N^\bullet(\mathcal{T}_n)$ -tuples of distinct integers between 1 and n .

Thus, the problem boils down to the following: there are n white vertices, among which $(1 - \nu_0)n(1 + o(1))$ are marked. We want to prove that, with high probability, uniformly in $c \leq \log n$, among the first $c\tilde{B}_n$ white vertices (for the order of the labels), there are $c(1 - \nu_0)\tilde{B}_n(1 + o(1))$ marked ones.

To prove this, denote by q_x the number of marked vertices among the first x . It is clear that, uniformly for $k \leq \tilde{B}_n \log n$, uniformly for $N \geq (1-\nu_0)n/2$, conditionally on $N^\bullet(\mathcal{T}_n) = N$:

$$\mathbb{P}(q_{\tilde{B}_n \log n} = k) = \frac{\mathbb{P}(B_1 = k) \mathbb{P}(B_2 = N - k)}{\mathbb{P}(B_3 = N)} \sim \mathbb{P}(B_1 = k) \quad (4.18)$$

as $n \rightarrow \infty$, where $B_1 = \text{Bin}(\lfloor \tilde{B}_n \log n \rfloor, 1 - \nu_0)$, $B_2 = \text{Bin}(n - \lfloor \tilde{B}_n \log n \rfloor, 1 - \nu_0)$, $B_3 = \text{Bin}(n, 1 - \nu_0)$. Notice that $N^\bullet(\mathcal{T}_n) \geq (1 - \nu_0)n/2$ with high probability, so that (4.18) holds with high probability. Furthermore, conditionally on the value k of $q_{\tilde{B}_n \log n}$, the set of marked vertices is uniformly distributed among all possible subsets of k of these $\tilde{B}_n \log n$ white vertices.

Finally, notice that the quantity $(1 - \nu_0) e^\circ(\ell c(u)) - e(u)$, for u the white vertex labelled i , can be seen as the value at time i of a specific random walk, constructed from the labelling of the vertices in \mathcal{T}_n . More precisely, denote by $(S_i)_{0 \leq i \leq \tilde{B}_n \log n}$ the walk defined as follows: it starts from the value $S_0 = 0$ and, for $1 \leq i \leq \tilde{B}_n \log n$, $S_i - S_{i-1} = -1$ if the white vertex labelled i is of the form $\ell c(u)$ for some black vertex u (that is, the vertex is marked), and $S_i - S_{i-1} = (1 - \nu_0)/\nu_0$ otherwise. Then, one can check that conditionally on the value k of $q_{\tilde{B}_n \log n}$, this walk is distributed as a random walk $(S'_i, 0 \leq i \leq \tilde{B}_n \log n)$ starting from 0 with i.i.d. jumps, the jumps being -1 with probability $1 - \nu_0$ and $(1 - \nu_0)/\nu_0$ with probability ν_0 , conditioned to have k " -1 " jumps. In particular, the expectation of each jump of S' is 0.

By Donsker's theorem, the maximum of the absolute value of this walk is of order $\sqrt{\tilde{B}_n \log n} = o(\tilde{B}_n)$. Using (4.18), the maximum of the absolute value of $(S_i)_{0 \leq i \leq \tilde{B}_n \log n}$ is also of order $\sqrt{\tilde{B}_n \log n}$ with high probability. Finally, observe that, for any white vertex u labelled $i \leq \tilde{B}_n \log n$, the value S_i of the walk at time i is exactly $(1 - \nu_0) e^\circ(\ell c(u)) - e(u)$ by construction. This proves the result.

4.3.5 Proof of Theorem 4.3.6 (ii)

To prove this, we use the fact that the white reduced tree \mathcal{T}_n° is a μ -GW tree conditioned to have n vertices, where - by Theorem 4.3.1 - μ is a critical probability distribution in the domain of attraction of an α -stable law. Hence, Theorem 4.3.6 (ii) follows directly from [96, Theorem 3.3 and Proposition 4.3], and is used in this form in [96] to study the model of minimal factorizations of the n -cycle into transpositions.

We now prove the third part of Theorem 4.3.6. We treat separately the two cases when $\alpha < 2$ and when ν has finite variance.

4.3.6 Proof of Theorem 4.3.6 (iii), when $\alpha < 2$

In the whole paragraph, $(\tilde{B}_n)_{n \geq 1}$ is a sequence that satisfies (4.3) for ν . In particular, as $n \rightarrow \infty$,

$$\tilde{B}_n \sim n^{1/\alpha} \ell(n) \quad (4.19)$$

for some slowly varying function ℓ .

We prove here that, jointly with the convergence of Theorem 4.3.6 (ii), the sequence $(\mathbb{L}_\infty^\bullet(\mathcal{T}_n))_{n \geq 1}$ converges towards the colored stable lamination $\mathbb{L}_\infty^{(\alpha),1}$, whose red part is $\mathbb{L}_\infty^{(\alpha)}$ (which denotes here the limit of the process $(\mathbb{L}_\infty^\circ(\mathcal{T}_n))_{n \geq 1}$ by Theorem 4.3.6 (ii)), and whose faces are all colored black. In order to see this, we prove that with high probability in the

tree \mathcal{T}_n , for any white εn -node u of \mathcal{T}_n , almost all grandchildren of u have the same black parent. To this end, we rely on the following lemma, inspired by [74, Section 5, Lemma 5]:

Lemma 4.3.7. *There exists a small $\delta > 0$ such that, for any $\eta > 0$, with high probability, for any white vertex $u \in \mathcal{T}_n$ having at least $\eta \tilde{B}_n$ white grandchildren, all of them but at most $\tilde{B}_n n^{-\delta}$ have the same black parent.*

Let us immediately see how this implies the convergence of Theorem 4.3.6 (iii) in this case. The key remark, which is straightforward by construction, is that all faces with a 'large' area in the colored lamination are coded by large nodes in the tree \mathcal{T}_n (either black or white). More precisely, for any $r > 0$, there exists $\varepsilon > 0$ such that all faces of area larger than r in $\mathbb{L}_\infty^\bullet(\mathcal{T}_n)$ are coded by εn -nodes of \mathcal{T}_n . In addition, if a black vertex is a ρn -node of \mathcal{T}_n , then, by Lemma 4.3.5, with high probability its white parent is an $(1 - \nu_0)\rho n/2$ -node of the reduced tree \mathcal{T}_n° . This allows us to focus only on white εn -nodes of \mathcal{T}_n° .

Proof of Theorem 4.3.6 (iii). We use the fact that with high probability all large white nodes in the original tree have a large number of white grandchildren. Let us fix $\varepsilon > 0$, and take $\eta > 0$ such that, with probability $\geq 1 - \varepsilon$, all white εn -nodes in \mathcal{T}_n° have at least $\eta \tilde{B}_n$ white grandchildren in \mathcal{T}_n (such an η exists by Lemma 4.2.3 (ii)). Denote by $K_\varepsilon(\mathcal{T}_n^\circ)$ the (random) number of εn nodes in \mathcal{T}_n° . Notice that there are at most ε^{-1} of them, and denote them by $a_1, \dots, a_{K_\varepsilon(\mathcal{T}_n^\circ)}$ in lexicographical order.

Let us focus on a_1 . Take $\delta > 0$ such that, by Lemma 4.3.7, with high probability all white grandchildren of a_1 except at most $\tilde{B}_n n^{-\delta}$ have the same black parent, which we denote by b_1 . Set now $S_\varepsilon(a_1) := \{u \text{ grandchild of } a_1, |\theta_u(\mathcal{T}_n)| \geq \varepsilon n\}$, the subset of grandchildren of a_1 whose subtree in \mathcal{T}_n has size more than εn . Then $|S_\varepsilon(a_1)| \leq \lfloor 2\varepsilon^{-1} \rfloor$, and with high probability all elements of $S_\varepsilon(a_1)$ are children of b_1 . Now define from these points the face $\tilde{F}_{a_1}(\mathcal{T}_n)$, as

$$\tilde{F}_{a_1}(\mathcal{T}_n) = \mathbb{S}^1 \cup c_{a_1}(\mathcal{T}_n) \cup \bigcup_{u \in S_\varepsilon(a_1)} c_u(\mathcal{T}_n),$$

whose connected component having c_{a_1} in its boundary and not containing 1 is colored black. In other words, this face does only take into account the subtrees of size larger than εn rooted at grandchildren of a_1 .

Then, using Lemma 4.3.5 jointly for each point of $S_\varepsilon(a_1)$, it is clear that, with high probability,

$$d_H \left(F_{b_1}(\mathcal{T}_n), \tilde{F}_{a_1}(\mathcal{T}_n) \right) \leq 2\pi\varepsilon.$$

On the other hand, by construction,

$$d_H \left(\tilde{F}_{a_1}(\mathcal{T}_n), F'_{a_1}(\mathcal{T}_n^\circ) \right) \leq 2\pi\varepsilon,$$

where $F'_{a_1}(\mathcal{T}_n^\circ)$ is the colored lamination defined as

$$F'_{a_1}(\mathcal{T}_n^\circ) := \mathbb{S}^1 \cup c_{a_1}(\mathcal{T}_n^\circ) \cup \bigcup_{u \text{ grandchild of } a_1} c_u(\mathcal{T}_n^\circ)$$

in which the face of $\mathbb{L}_\infty^\circ(\mathcal{T}_n)$ whose boundary contains c_{a_1} and all chords c_u for u a grandchild of a_1 is colored black. In other words, the large face of $\mathbb{L}_\infty^\bullet(\mathcal{T}_n)$ coded by b_1 is close to the large face of $\mathbb{L}_\infty^\circ(\mathcal{T}_n)$ bounded by the chords coded by a_1 and its grandchildren, and colored black. In addition, the same holds for $a_2, \dots, a_{K_\varepsilon(\mathcal{T}_n^\circ)}$. Since $\mathbb{L}_\infty^\circ(\mathcal{T}_n)$ converges in distribution towards the α -stable lamination $\mathbb{L}_\infty^{(\alpha)}$, $\mathbb{L}_\infty^\bullet(\mathcal{T}_n)$ converges in distribution towards $\mathbb{L}_\infty^{(\alpha),1}$. \square

We now prove Lemma 4.3.7.

Proof of Lemma 4.3.7. The proof is inspired by [74, Section 5, Lemma 5]. Fix $\delta > 0$ such that $2\delta(\alpha + 1/\alpha) < 1$. Take $\eta > 0$, and n large enough so that $\eta\tilde{B}_n > 2\tilde{B}_n n^{-\delta}$. For u a white vertex of \mathcal{T}_n , for any $k, M \geq 1$, define the following event $E(u, k, M)$: u has k black children, a number $M \geq \eta\tilde{B}_n$ of white grandchildren and simultaneously none of its black children has more than $M - \tilde{B}_n n^{-\delta}$ white children. This implies that at least two among its black children have more than $\tilde{B}_n n^{-\delta}/k$ white children.

Therefore, for any white vertex u , uniformly in $M \geq \eta\tilde{B}_n$ and $k \geq 2$, one gets:

$$\mathbb{P}(E(u, k, M) \mid k_u(\mathcal{T}_n^\circ) = M) \leq \mu_*(k) \binom{k}{2} \nu\left([\tilde{B}_n n^{-\delta}/k, \infty)\right)^2.$$

On the other hand, by usual properties of the domain of attraction of stable laws (see e.g. [44, Corollary XVII.5.2]), there exists a constant $K > 0$ such that, for all $R > 0$, $\nu([R, \infty)) \leq KR^{-\alpha+\delta}$. Hence, the probability that there exists a white vertex u in \mathcal{T}_n with more than $\eta\tilde{B}_n$ white grandchildren and such that $E(u, k, M)$ holds for some $k \geq 2$, $M \geq \eta\tilde{B}_n$ is less than

$$n \sum_{k=2}^{\infty} \mu_*(k) \binom{k}{2} \nu\left([\tilde{B}_n n^{-\delta}/k, \infty)\right)^2 \leq n \left(\sum_{k=2}^{\infty} \mu_*(k) \binom{k}{2} k^{2\alpha-2\delta} \right) \tilde{B}_n^{-2\alpha+2\delta} n^{2\alpha\delta} = O\left(n^{1+2\alpha\delta} \tilde{B}_n^{2\delta-2\alpha}\right).$$

Using (4.19) and the definition of δ , $n^{1+2\alpha\delta} \tilde{B}_n^{2\delta-2\alpha} \leq n^{2\delta(\alpha+1/\alpha)-1} \ell(n)^{2\delta-2\alpha}$ for some slowly varying function ℓ . It is finally well-known that, for any $\varepsilon > 0$, for n large enough, $\ell(n) \in (n^{-\varepsilon}, n^\varepsilon)$, by the so-called Potter bounds (see e.g. [26, Theorem 1.5.6] for a precise statement and a proof). Thus, $n^{1+2\alpha\delta} \tilde{B}_n^{2\delta-2\alpha} = o(1)$ as $n \rightarrow \infty$, which proves our result. \square

4.3.7 Proof of Theorem 4.3.6 (iii), when ν has finite variance

The case with finite variance is different. Indeed, in this case, it may happen that $0 < p_\nu < 1$, and the coloring of the limiting Brownian triangulation is not trivial. We prove that, nonetheless, each face of the limiting object is colored black independently with the same probability p_ν .

Let us first recall some notation. In what follows, for μ a critical distribution, \mathbb{T}^μ denotes a μ -GW tree, and, for any $i \geq 1$, \mathbb{T}_i^μ denotes a μ -GW tree conditioned to have exactly i vertices. \emptyset always denotes the root of the tree, and $K_u(T)$ denotes the set of children of u in T .

Fix $\varepsilon > 0$. When μ has finite variance, for n large, εn -nodes in \mathbb{T}_n^μ are in fact $\varepsilon n/2$ -branching points, which we recall are vertices such that two of their children are the root of a subtree of size $\geq \varepsilon n/2$:

Lemma 4.3.8. *With high probability as $n \rightarrow \infty$, jointly for all εn -nodes u of \mathbb{T}_n^μ , there exist $v_1(u), v_2(u)$ two children of u such that*

$$\begin{aligned} |\theta_{v_1(u)}(\mathbb{T}_n^\mu)| &\geq \varepsilon n/2, & |\theta_{v_2(u)}(\mathbb{T}_n^\mu)| &\geq \varepsilon n/2, \\ \text{and} & & \sum_{w \in K_u(\mathbb{T}_n^\mu), w \neq v_1(u), v_2(u)} |\theta_w(\mathbb{T}_n^\mu)| &= o(n). \end{aligned}$$

In other words, if the tree splits at the level of u into at least two macroscopic components, then with high probability it splits into exactly two of them. This is a well-known fact, direct consequence of the convergence of Theorem 4.2.2 and the fact that the local minima of the normalized Brownian excursion are almost surely distinct. Thus, exactly two children of each

εn -node are the root of a 'large' subtree, while the sum of the sizes of all other subtrees rooted at a child of this node is $o(n)$. Therefore, investigating εn -nodes boils down to investigating εn -branching points.

In order to prove that faces are asymptotically colored in an i.i.d. way, observe that, a white εn -branching point of \mathcal{T}_n° being given, there are two possible cases: either its two white grandchildren with a large subtree $v_1(u), v_2(u)$ have the same black parent (see Fig. 4.12, top-left) which provides a large black face in the lamination; or they have two different black parents (see Fig. 4.12, top-right) which provides a large white face. Finally, notice that the event that $v_1(u), v_2(u)$ have the same black parent, conditionally on the number of white grandchildren of u , is independent of the rest of the tree.

The proof therefore has two different steps. We first prove that the distribution of the colors of the faces asymptotically does not depend on the shape of the tree (this means that it is asymptotically independent of the colored lamination-valued process $(\mathbb{L}_{c\tilde{B}_n}^\bullet(\mathcal{T}_n))_{0 \leq c \leq M}$ stopped at any finite time M). This step is done by shuffling branching points in the tree, in such a way that the shape of the tree is not changed much. Then, we prove that the distribution of the colors of the largest faces in the final lamination indeed converges towards i.i.d. random variables, and compute the asymptotic probability that a large face is colored black.

Let us first define a transformation on bi-type trees, which allows us to introduce additional randomness into the degree distribution of the white branching points without changing the overall shape of this tree. The image $\tilde{\mathcal{T}}_n$ of the random tree \mathcal{T}_n by this transformation shall be distributed as \mathcal{T}_n , and their black processes shall in addition be close with high probability. Furthermore, $\mathbb{L}_\infty^\bullet(\tilde{\mathcal{T}}_n)$ shall be close to $\mathbb{L}_\infty^{(\alpha),p}$ for some $p \in [0, 1]$, which proves Theorem 4.3.6 (iii).

The idea of the transformation is to randomize a small part of the tree \mathcal{T}_n , so that the whole black process $(\mathbb{L}_c^\bullet(\mathcal{T}_n))_{c \geq 0}$ does not change much. To this end, we associate to each 'large' face of $\mathbb{L}_\infty^\bullet(\mathcal{T}_n)$ a white branching point of \mathcal{T}_n° : the vertex coded by this face if the face is white, and the parent of this vertex if it is black. Then, $\varepsilon > 0$ being given, one shuffles some well-chosen branching points in the tree, so that white εn -branching points of \mathcal{T}_n° are still εn -branching points after this shuffling, but the coloring of the face that they code is randomized. Indeed, although we are able to compute the limiting joint distribution of the degrees of the branching points in a conditioned GW-tree, it is not clear at first sight that this distribution is asymptotically independent of the shape of the tree. This transformation allows us to prove it, by shuffling a large number of ρn -branching points (for $0 < \rho < \varepsilon$) with the εn -branching points of the initial tree.

Let us state this properly. For $\varepsilon > \eta > 0$ two constants, we define $\mathfrak{BT}_n^{\varepsilon,\eta}$ to be the set of bi-type trees T_n with n white vertices, such that there exists a white vertex $u \in T_n$ satisfying $|\theta_u(T_n^\circ)| \in (\eta n, \varepsilon n)$. For any tree $T_n \in \mathfrak{BT}_n^{\varepsilon,\eta}$, we define a shuffling operation.

Definition (The shuffling operation). *Fix three constants $\varepsilon > \eta > \rho > 0$ and take $T_n \in \mathfrak{BT}_n^{\varepsilon,\eta}$. We construct the shuffled tree $T_n^{\varepsilon,\eta,\rho}$ as follows: take u a white vertex of T_n such that $|\theta_u(T_n^\circ)| \in (\eta n, \varepsilon n)$. Let $E := E_{\varepsilon n}(T_n^\circ) \cup E_{\rho n}(\theta_u(T_n^\circ))$, the set made of all white εn -branching points of T_n° and all white ρn -branching points of the white subtree rooted at u (observe that there is no εn -branching point in this subtree, by definition of u). Since $\rho < \varepsilon$, εn -branching points are also ρn -branching points and thus $|E| \leq \rho^{-1}$ (notice that $|E|$ is random anyway). Let $U_1, \dots, U_{|E|}$ be the elements of E , sorted in lexicographical order. For each $i \leq |E|$, denote by $v_1(U_i), v_2(U_i)$, in lexicographical order, the two grandchildren of U_i whose subtrees are the largest (in case of equality, arbitrarily pick two that are larger than all others). Define the tree $T_n^{\varepsilon,\eta,\rho}$ from T_n as follows: denote by $S(U_i)$ the part of the subtree $\theta_{U_i}(T_n) \setminus U_i$, where one also "cuts" the edges between $v_1(U_i), v_2(U_i)$ and their black parent(s). See Fig. 4.12*

for an example. We now take σ , a permutation of $\llbracket 1, |E| \rrbracket$ chosen uniformly at random, and exchange the $S(U_i)$'s according to σ , reattaching the half-edges which lead to $v_1(U_i), v_2(U_i)$ to $S_{\sigma(i)}$. In addition, each black vertex keeps its original label. See Fig. 4.12 for an example of this shuffling of S_i 's.

We claim that, for any $\varepsilon > \eta > \rho > 0$, any $c \leq \tilde{B}_n \log n$, with high probability the Hausdorff distance between $\mathbb{L}_c^\bullet(T_n)$ and $\mathbb{L}_c^\bullet(T_n^{\varepsilon, \eta, \rho})$ is bounded from above by the following quantity:

$$C_\rho(T_n) := \frac{4\pi}{n} \sum_{u \in E_{\rho n}(T_n^\circ)} \sum_{v \in K_u^{(-2)}(T_n^\circ)} |\theta_v(T_n^\circ)|,$$

where, for any $u \in T_n$, $K_u^{(-2)}(T_n^\circ)$ denotes the union of the set of children v of u in T_n° whose subtree $\theta_v(T_n^\circ)$ has size less than ρn .

Lemma 4.3.9. *Let $\varepsilon > \eta > \rho > 0$, and take a tree $T_n \in \mathfrak{BT}_n^{\varepsilon, \eta}$. Then, with high probability, uniformly for $0 \leq c \leq \log n$:*

$$d_H \left(\mathbb{L}_{c\tilde{B}_n}^\bullet(T_n), \mathbb{L}_{c\tilde{B}_n}^\bullet(T_n^{\varepsilon, \eta, \rho}) \right) \leq C_\rho(T_n).$$

Notice that this is not true for all c , and in particular not for $c = \infty$, as colors of large faces may be changed by the transformation of Definition 4.3.7.

Proof. By shuffling a certain subset of $E_{\rho n}(T_n^\circ)$ as stated in Definition 4.3.7, one moves subtrees rooted at children and grandchildren in T_n of a white ρn -branching point of T_n° . In particular, using the fact that the number of black vertices in a subtree of T_n is less than the number of white vertices in this subtree, the total number of vertices moved by the shuffling operation is at most $\sum_{u \in E_{\rho n}(T_n^\circ)} \sum_{v \in K_u^{(-2)}(T_n^\circ)} 2|\theta_v(T_n^\circ)|$. Furthermore, with high probability, up to time $\tilde{B}_n \log n$ there is no black face of area larger than 2ε whose color is changed between both colored lamination-valued processes. Indeed, there are at most $2|E|$ black vertices with a subtree of size larger than $2\varepsilon n$ in T_n that are moved by these operations. Thus, with high probability none of them has a label $\leq \tilde{B}_n \log n$. The result follows. \square

The idea is now to apply the transformation of Definition 4.3.7 to the tree \mathcal{T}_n . It turns out that one can choose the parameters η and ρ_n (depending on n) carefully, so that the colored lamination-valued process associated to $\mathcal{T}_n^{\varepsilon, \eta, \rho_n}$ converges in distribution towards $(\mathbb{L}_c^{(2)})_{c \geq 0}, \mathbb{L}_\infty^{(2), p_\nu}$ for some $p_\nu \in [0, 1]$.

Lemma 4.3.10. *Fix $\varepsilon > 0$ and set $\eta = \varepsilon/6$. The following holds:*

- (i) *For all $n \geq 1$, for all $\rho > 0$ such that $\rho < \eta$, conditionally on the fact that \mathcal{T}_n belongs to $\mathfrak{BT}_n^{\varepsilon, \eta}$, $\mathcal{T}_n^{\varepsilon, \eta, \rho} \stackrel{(d)}{=} \mathcal{T}_n$.*
- (ii) *With high probability, \mathcal{T}_n belongs to $\mathfrak{BT}_n^{\varepsilon, \eta}$.*
- (iii) *Recall that μ is defined as the probability measure such that \mathcal{T}_n° is a μ -GW conditioned to have n vertices. Define $K_\varepsilon(\mathcal{T}_n^\circ)$ as the (random) number of white εn -branching points in \mathcal{T}_n° , and label them $U_1, \dots, U_{K_\varepsilon(\mathcal{T}_n^\circ)}$ in lexicographical order. Assume that \mathcal{T}_n belongs to $\mathfrak{BT}_n^{\varepsilon, \eta}$. Then, for any $\varepsilon' > 0$, one can find $\rho > 0$ such that, as $n \rightarrow \infty$, uniformly in $1 \leq j \leq \varepsilon^{-1}$, uniformly in $k_1, \dots, k_j \geq 1$:*

$$\left| \mathbb{P} \left(\bigcup_{i=1}^j \{k_{U_i}(\mathcal{T}_n^{\circ, \varepsilon, \eta, \rho}) = k_i\} \mid K_\varepsilon(\mathcal{T}_n^\circ) = j \right) - (\sigma_\mu^2)^{-j} \prod_{i=1}^j \mu_{k_i} k_i (k_i - 1) \right| \leq \varepsilon' + o(1),$$

the $o(1)$ depending only on n .

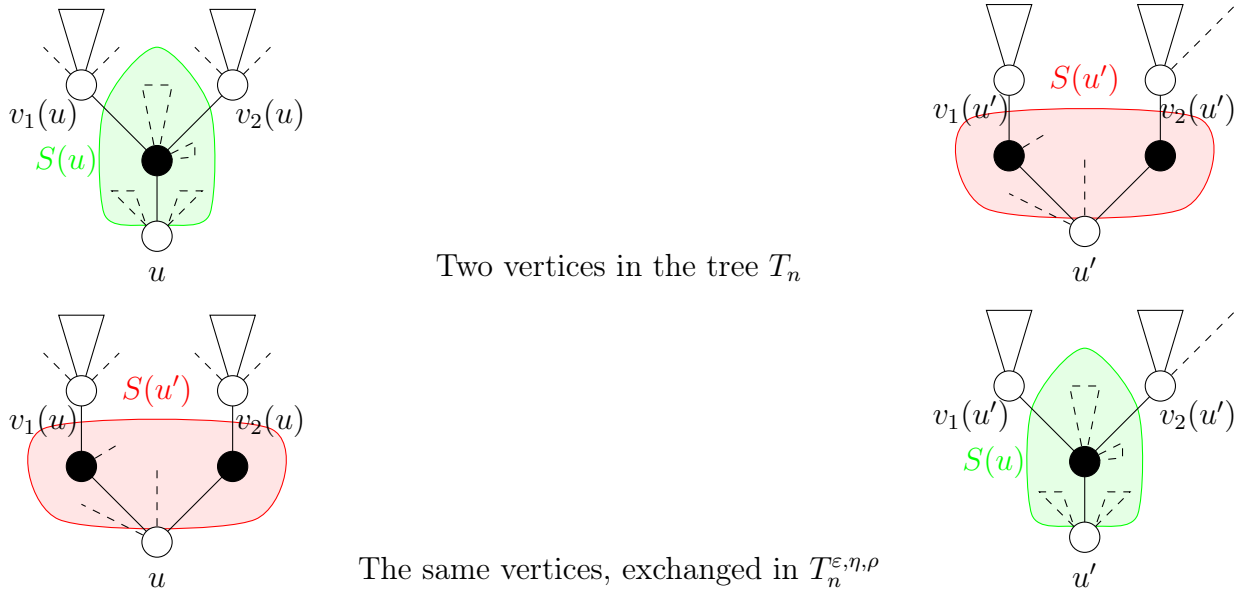

Figure 4.12: Top: the two possible cases for a white branching point u of the tree T_n : either the two larger subtrees of grandchildren of u have the same black parent (left), or two different black parents (right). The part that is (possibly) shuffled by the transformation of Definition 4.3.7 is in green (resp. red). Bottom: after having switched the green and red parts, in the tree $T_n^{\epsilon, \eta, \rho}$. Notice that the set of degrees of the vertices stays the same on top and bottom.

Let us see how this implies Theorem 4.3.6 (iii). First, by Lemma 4.3.10 (ii) and (iii), for any $M > 0$ one can choose $\rho_M > 0$ such that, for n large enough, uniformly for $j \leq \varepsilon^{-1}$, uniformly for any $k_1, \dots, k_j \in \mathbb{Z}_+$:

$$\left| \mathbb{P} \left(\bigcup_{i=1}^j \{k_{U_i}(\mathcal{T}_n^{\circ, \varepsilon, \varepsilon/6, \rho_M}) = k_i\} \mid K_\varepsilon = j \right) - (\sigma_\mu^2)^{-j} \prod_{i=1}^j \mu_{k_i} k_i (k_i - 1) \right| < M^{-1}.$$

On the other hand, at $\rho > 0$ fixed, Lemma 4.3.8 implies that $C_\rho(\mathcal{T}_n) \xrightarrow{\mathbb{P}} 0$ in probability, as $n \rightarrow \infty$. Therefore, by diagonal extraction, one can find a sequence of parameters $(M_n)_{n \geq 1}$ such that the tree $\tilde{\mathcal{T}}_n := \mathcal{T}_n^{\varepsilon, \varepsilon/6, \rho_{M_n}}$ satisfies the following conditions (using Lemma 4.3.9 to get (H2)):

(H1) For all $n \geq 0$, $\tilde{\mathcal{T}}_n \stackrel{(d)}{=} \mathcal{T}_n$.

(H2) In probability,

$$\sup_{0 \leq c \leq \log n} d_H \left(\mathbb{L}_{c\tilde{B}_n}^\bullet(\mathcal{T}_n), \mathbb{L}_{c\tilde{B}_n}^\bullet(\tilde{\mathcal{T}}_n) \right) \xrightarrow{\mathbb{P}} 0.$$

(H3) Uniformly for any $j \leq \varepsilon^{-1}$, uniformly for any $k_1, \dots, k_j \in \mathbb{Z}_+$

$$\mathbb{P} \left(\bigcup_{i=1}^j \{k_{U_i}(\tilde{\mathcal{T}}_n^\circ) = k_i\} \mid K_\varepsilon(\tilde{\mathcal{T}}_n^\circ) = j \right) \xrightarrow{n \rightarrow \infty} (\sigma_\mu^2)^{-j} \prod_{i=1}^j \mu_{k_i} k_i (k_i - 1),$$

where we recall that U_i denotes the i -th εn -branching point of $\tilde{\mathcal{T}}_n^\circ$.

Properties (H2) and (H3) mean in particular that the joint degree distribution of the εn -branching points in $\tilde{\mathcal{T}}_n^\circ$ is asymptotically independent of the shape of the tree. We can now use this transformation, and specifically (H3), to compute the value of the parameter p_ν . To this end, we use the fact that, the number of white grandchildren of an εn -branching point u being given equal to $k \geq 2$, the event that $v_1(u), v_2(u)$ have the same black parent is independent of the rest of the tree. Thus, by (H3), all faces that correspond to εn -branching points of \mathcal{T}_n in the limiting lamination are colored black in an i.i.d. way, with probability $p_\nu \in [0, 1]$ given by the following proposition:

Proposition 4.3.11. *If ν has finite variance, then p_ν has the form:*

$$p_\nu = \frac{\sigma_\nu^2}{\sigma_\nu^2 + 1}$$

Roughly speaking, to get this expression, we split according to the number k of white children of a white branching point in \mathcal{T}_n° , thus computing the conditional probability given k that such a white branching point codes a black face in $\mathbb{L}_\infty^\bullet(\mathcal{T}_n)$.

Remark. *As mentioned in Section 4.1, in the case $w = \delta^j$ for some $j \geq 2$, $\nu := \frac{j-2}{j-1}\delta^0 + \frac{1}{j-1}\delta^j$, and this formula simplifies to $p_\nu = \frac{j-2}{j-1}$.*

Proof of Proposition 4.3.11. According to (H3), p_ν is the limit as $n \rightarrow \infty$ of the sequence $(p_\nu^{(n)})_{n \geq 1}$, where:

$$p_\nu^{(n)} = (\sigma_\mu^2)^{-1} \sum_{k=2}^{n-1} \mu_k k(k-1) \mathbb{P}\left(E(\emptyset) \mid k_\emptyset(\mathcal{T}_n^\circ) = k\right),$$

where $E(u)$ is the event that $v_1(u), v_2(u)$ have the same black parent. Indeed, notice that, conditionally on having k white grandchildren, the number j of black children of a vertex is independent of the rest of the tree. Recall from (4.13) the definition of μ° and μ^\bullet , which are two probability measures satisfying $\mathcal{T}_n \stackrel{(d)}{=} \mathcal{T}_n^{(\mu^\circ, \mu^\bullet)}$ for all $n \geq 1$. By construction of the tree, conditioning by $k_\emptyset(\mathcal{T}_n^\circ) = k$ is the same as conditioning by $k_\emptyset(\mathcal{T}^\circ, (\mu^\circ, \mu^\bullet)) = k$. Hence,

$$p_\nu = (\sigma_\mu^2)^{-1} \sum_{k=2}^{\infty} \mu_k k(k-1) \mathbb{P}\left(E(\emptyset) \mid k_\emptyset(\mathcal{T}^\circ) = k\right), \quad (4.20)$$

where we write \mathcal{T} instead of $\mathcal{T}^{(\mu^\circ, \mu^\bullet)}$ for convenience.

Finally, j and k being fixed, what is left to compute is the probability that the two grandchildren of \emptyset with the largest subtrees rooted at them have the same black parent.

In order to compute $\mathbb{P}(E(\emptyset) \mid k_\emptyset(\mathcal{T}^\circ) = k)$, observe that there are $k(k-1)$ possibilities for the locations of $v_1(\emptyset)$ and $v_2(\emptyset)$. Assuming that u has j black children, who respectively have a_1, \dots, a_j white children, the number of possible locations for $(v_1(\emptyset), v_2(\emptyset))$ such that they have the same black parent is $\sum_{i=1}^j a_i(a_i - 1)$. More precisely, at k fixed:

$$\begin{aligned} \mathbb{P}(E(\emptyset) \mid k_\emptyset(\mathcal{T}_n^\circ) = k) &= \sum_{j=1}^k \mathbb{P}(E(\emptyset) \mid k_\emptyset(\mathcal{T}) = j, k_\emptyset(\mathcal{T}^\circ) = k) \\ &= \sum_{j=1}^k \sum_{\substack{a_1 + \dots + a_j = k \\ a_1, \dots, a_j \geq 1}} \mathbb{P}(G(a_1, \dots, a_j) \mid k_\emptyset(\mathcal{T}^\circ) = k) \mathbb{P}(E(\emptyset) \mid G(a_1, \dots, a_j)) \end{aligned}$$

where $G(a_1, \dots, a_j)$ is the event that \emptyset has j black children, who respectively have a_1, \dots, a_j white children. Thus, one just computes:

$$\mathbb{P}(E(\emptyset) | G(a_1, \dots, a_j)) = \frac{1}{k(k-1)} \sum_{i=1}^j a_i(a_i - 1)$$

and

$$\mathbb{P}(G(a_1, \dots, a_j) | k_\emptyset(\mathcal{T}^\circ) = k) = (\mathbb{P}(k_\emptyset(\mathcal{T}^\circ) = k))^{-1} \mu_j^\circ \prod_{i=1}^j \mu_{a_i}^\bullet = \frac{1}{\mu_k} \mu_j^\circ \prod_{i=1}^j \mu_{a_i}^\bullet,$$

Hence, one gets for (4.20):

$$\begin{aligned} p_\nu &= \frac{1}{\sigma_\mu^2} \sum_{k=2}^{\infty} \sum_{j=1}^k \mu_j^\circ \sum_{\substack{a_1, \dots, a_j \geq 1 \\ \sum a_i = k}} \prod_{i=1}^j \mu_{a_i}^\bullet \left(\sum_{i=1}^j a_i(a_i - 1) \right) \\ &= \frac{1}{\sigma_\mu^2} \sum_{j=1}^{\infty} \mu_j^\circ \sum_{a_1, \dots, a_j \geq 1} \prod_{i=1}^j \mu_{a_i}^\bullet \left(\sum_{i=1}^j a_i(a_i - 1) \right) = \frac{1}{\sigma_\mu^2} \sum_{j=1}^{\infty} \mu_j^\circ \mathbb{E} \left[\sum_{i=1}^j X_i(X_i - 1) \right], \end{aligned}$$

where the X_i 's are i.i.d. random variables of law μ^\bullet . By definition of μ^\bullet and independence of the X_i 's, the expectation on the right-hand side is equal to $j(1 - \nu_0)^{-1} \sigma_\nu^2$ since ν is critical. Thus, checking from (4.9) that $\sigma_\mu^2 = \sigma_\nu^2 + 1$, one gets:

$$p_\nu = \frac{1}{1 - \nu_0} \frac{\sigma_\nu^2}{\sigma_\nu^2 + 1} \sum_{j=1}^{\infty} j \mu_j^\circ = \frac{\sigma_\nu^2}{\sigma_\nu^2 + 1}$$

by (4.14). □

We finally need to prove the technical lemma 4.3.10.

Proof of Lemma 4.3.10 (i) and (ii) The image of any bi-type tree T_n by the transformation of Definition 4.3.7 has the same weight as T_n , which implies (i). In order to prove (ii), just observe that, if no subtree of the white reduced tree \mathcal{T}_n° has size between $\varepsilon n/6$ and εn , then its contour function attains at least twice the same local minimum, at two times at which it visits the same white vertex. More precisely, there exists $t_1 < t_2 < t_3 < t_4 \in [0, 1]$ such that $C_{2nt_1}(\mathcal{T}_n^\circ) = C_{2nt_2}(\mathcal{T}_n^\circ) = C_{2nt_3}(\mathcal{T}_n^\circ) = C_{2nt_4}(\mathcal{T}_n^\circ)$, $C_{2ns}(\mathcal{T}_n^\circ) \geq C_{2nt_1}(\mathcal{T}_n^\circ)$ for all $s \in [t_1, t_4]$ and $t_2 - t_1, t_3 - t_2, t_4 - t_3$ are all larger than $\varepsilon/6$. The white vertex u visited at these four times satisfies $|\theta_u(\mathcal{T}_n^\circ)| \geq \varepsilon n$, but for any of its children v , $|\theta_u(\mathcal{T}_n^\circ)| < \varepsilon n$ (such a vertex u necessarily exists). But with high probability as $n \rightarrow \infty$ this does not occur. Indeed, by Theorem 4.2.2, $C(\mathcal{T}_n^\circ)$ converges after renormalization towards the Brownian excursion, whose local minima are almost surely unique.

Proof of Lemma 4.3.10 (iii) The third part of this lemma focuses on the distribution of the degree of branching points in the white reduced tree \mathcal{T}_n° . Our main tool is therefore the following proposition, which computes the asymptotic distribution of the number of children of a branching point, in a large monotype size-conditioned tree. Recall that, a distribution μ being fixed, \mathbb{T} denotes a μ -GW tree and, for any $n \geq 1$, \mathbb{T}_n denotes a μ -GW tree conditioned to have n vertices.

Lemma 4.3.12. Fix $\varepsilon > 0$, and let μ be a critical distribution in the domain with finite variance σ_μ^2 . Then:

(i) For any $n \geq 1$, any $i \geq 2\varepsilon n + 1$, any $k \geq 2$,

$$\mathbb{P}(|\mathbb{T}| = i, \emptyset \in E_{\varepsilon n}(\mathbb{T}), k_\emptyset(\mathbb{T}) = k) = \mu_k \binom{k}{2} \sum_{q=0}^{i-1-2\varepsilon n} \mathbb{P}(|\mathcal{F}_{k-2}| = q) \sum_{t=\varepsilon n}^{i-1-q-\varepsilon n} \mathbb{P}(|\mathbb{T}| = t) \mathbb{P}(|\mathbb{T}| = i-1-q-t),$$

where \mathcal{F}_j is a forest of j i.i.d. μ -Galton-Watson trees.

(ii) Let U be a uniform vertex in \mathbb{T}_n . Then, for any $k \geq 2$:

$$\mathbb{P}\left(k_U(\mathbb{T}_n) = k \mid U \in E_{\varepsilon n}(\mathbb{T}_n)\right) \xrightarrow{n \rightarrow \infty} \mu_k k(k-1) (\sigma_\mu^2)^{-1},$$

where we recall that $E_{\varepsilon n}(T)$ denotes the number of εn -branching points in a tree T .

(iii) Let $K_\varepsilon(\mathbb{T}_n)$ be the (random) number of εn -branching points in \mathbb{T}_n , and denote them by $U_1, \dots, U_{K_\varepsilon(\mathbb{T}_n)}$ in lexicographical order. Then, for all $j \geq 0$, all $k_1, \dots, k_j \in \mathbb{Z}_+$:

$$\mathbb{P}\left(\bigcup_{i=1}^j \{k_{U_i}(\mathbb{T}_n) = k_i\} \mid K_\varepsilon(\mathbb{T}_n) = j\right) \xrightarrow{n \rightarrow \infty} (\sigma_\mu^2)^{-j} \prod_{i=1}^j \mu_{k_i} k_i (k_i - 1).$$

The proof of this lemma is postponed to the end of this section. Let us see how it implies Lemma 4.3.10 (iii). To this end, ε and $\eta := \varepsilon/6$ being fixed, we adapt the parameter ρ in order to control the distribution of the degrees of the εn -branching points. Let u be the vertex chosen in the transformation of Definition 4.3.7. By Lemma 4.3.12 (iii), we know how the degrees of the ρn -branching points in $\theta_u(\mathcal{T}_n^\circ)$ behave. Therefore, by choosing ρ so that the number of ρn -branching points in $\theta_u(\mathcal{T}_n^\circ)$ is much larger than the number of εn -branching points in \mathcal{T}_n with high probability, we can control the degree distribution of these εn -branching points of $\tilde{\mathcal{T}}_n^\circ$, after the shuffling operation.

Specifically, for any $q \geq 1$, we define ρ_q such that, uniformly for $\ell \in (\eta n, \varepsilon n)$ satisfying $Z_{\ell, \mu_*, w} > 0$, with probability larger than $1 - 1/q$ there are at least q $\rho_q n$ -branching points in \mathcal{T}_ℓ° . The existence of such a ρ_q , for $q \geq 1$, is a consequence of the convergence of Theorem 4.2.2, and the fact that the set of local minima of the normalized Brownian excursion is dense in $[0, 1]$ with probability 1.

Now for any $\varepsilon' > 0$, Lemma 4.3.12 (iii) ensures that one can choose $q > 0$ such that with high probability, uniformly in k , for n large enough,

$$\left| N_q^{(k)}(\theta_u(\mathcal{T}_n^\circ)) - \mu_k k(k-1) (\sigma_\mu^2)^{-1} N_q(\theta_u(\mathcal{T}_n^\circ)) \right| \leq \varepsilon' N_q(\theta_u(\mathcal{T}_n^\circ)).$$

Here, $N_q(T)$ denotes the number of $\rho_q n$ -branching points in T and $N_q^{(k)}(T)$ denotes the number of $\rho_q n$ -branching points who have k black children. In other words, the proportion of $\rho_q n$ -branching points in $\theta_u(\mathcal{T}_n)$ that have k children is asymptotically proportional to $\mu_k k(k-1)$. As there are at most $\varepsilon^{-1} \varepsilon n$ -branching points in \mathcal{T}_n , Lemma 4.3.10 (iii) follows.

Let us finish with the proof of Lemma 4.3.12.

Proof of Lemma 4.3.12 (i). To prove (i), notice that, for any $k \geq 2$, any $i \geq 2\varepsilon n + 1$,

$$\mathbb{P}(|\mathbb{T}| = i, \emptyset \in E_{\varepsilon n}(\mathbb{T}), k_{\emptyset}(\mathbb{T}) = k) = \mathbb{P}(k_{\emptyset}(\mathbb{T}) = k) \mathbb{P}\left(|\mathbb{T}| = i, \emptyset \in E_{\varepsilon n}(\mathbb{T}) \mid k_{\emptyset}(\mathbb{T}) = k\right)$$

The right-hand side can be estimated thanks to Lemma 4.3.8, through the formula:

$$\mathbb{P}\left(|\mathbb{T}| = i, \emptyset \in E_{\varepsilon n}(\mathbb{T}) \mid k_{\emptyset}(\mathbb{T}) = k\right) = \sum_{1 \leq a < b \leq k} \mathbb{P}\left(|\mathbb{T}| = i, B_{\varepsilon, a, b} \mid k_{\emptyset}(\mathbb{T}) = k\right)$$

where $B_{\varepsilon, a, b}$ is the event that the subtrees rooted at the a -th and b -th children of \emptyset have size $\geq \varepsilon n$. Thus, since $\mathbb{P}(k_{\emptyset}(\mathbb{T}) = k) = \mu_k$:

$$\mathbb{P}(|\mathbb{T}| = i, \emptyset \in E_{\varepsilon n}(\mathbb{T}), k_{\emptyset}(\mathbb{T}) = k) = \mu_k \binom{k}{2} \sum_{\substack{t_1 \geq \varepsilon n \\ t_2 \geq \varepsilon n \\ t_1 + t_2 \leq i-1}} \mathbb{P}(|\mathbb{T}| = t_1) \mathbb{P}(|\mathbb{T}| = t_2) \mathbb{P}(|\mathcal{F}_{k-2}| = i-1-t_1-t_2),$$

where \mathcal{F}_j is a forest of j i.i.d. μ -GW trees.

Separating according to the value $q := i-1-t_1-t_2$, the right-hand side is equal to

$$\mu_k \binom{k}{2} \sum_{q=0}^{i-1-2\varepsilon n} \mathbb{P}(|\mathcal{F}_{k-2}| = q) \sum_{t=\varepsilon n}^{i-1-q-\varepsilon n} \mathbb{P}(|\mathbb{T}| = t) \mathbb{P}(|\mathbb{T}| = i-1-q-t).$$

□

Proof of Lemma 4.3.12 (ii). Let U be a uniform vertex of \mathbb{T}_n . Then:

$$\begin{aligned} \mathbb{P}(U \in E_{\varepsilon n}(\mathbb{T}_n), k_U(\mathbb{T}_n) = k) &= \frac{1}{n} \sum_{j \geq 1} \mathbb{E} \left[\sum_{\substack{u \in \mathbb{T}_n \\ |u|=j}} \mathbf{1}_{u \in E_{\varepsilon n}(\mathbb{T}_n)} \mathbf{1}_{k_u(\mathbb{T}_n) = k} \right] \\ &= \frac{1}{n} \mathbb{P}(|\mathbb{T}| = n)^{-1} \sum_{j \geq 1} \sum_{i=2\varepsilon n}^n \mathbb{E} \left[\sum_{\substack{u \in \mathbb{T} \\ |u|=j}} F_{n-i}(\text{Cut}_u(\mathbb{T})) G_{i,k}(\theta_u(\mathbb{T})) \right], \end{aligned}$$

where $F_{n-i}(T) = \mathbf{1}_{|T|=n-i}$ and $G_{i,k}(T) = \mathbf{1}_{|T|=i} \mathbf{1}_{\emptyset \in E_{\varepsilon n}(T)} \mathbf{1}_{k_{\emptyset}(T)=k}$. Here, for T a tree and u a vertex of T , $\text{Cut}_u(T)$ denotes the tree $T \setminus \theta_u(T)$, obtained by cutting T at the level of u (not keeping u).

In order to investigate this quantity, let us now define \mathbb{T}^* , the so-called local limit of the conditioned Galton-Watson trees \mathbb{T}_n : \mathbb{T}^* is a random variable taking its values in the set of infinite trees, and satisfies, for all $r \geq 1$,

$$B_r(\mathbb{T}_n) \xrightarrow{(d)} B_r(\mathbb{T}^*),$$

where, a tree T (finite or infinite) being given, $B_r(T)$ denotes the ball of radius r around the root of T for the graph distance - that is, all edges have length 1. The structure of this tree \mathbb{T}^* , called Kesten's tree, is known: it has a unique infinite branch, on which independent nonconditioned μ -GW trees are planted. See Fig. 4.13 for an illustration, and [60] for more background. Information on the large tree \mathbb{T}_n can therefore be deduced from the properties

on \mathbb{T}^* . In particular, by an equality *à la* Lyons-Pemantle-Peres (see [41, Section 3]), we obtain that, for any $j \geq 0$,

$$\mathbb{E} \left[\sum_{\substack{u \in \mathbb{T} \\ |u|=j}} F_{n-i}(Cut_u(\mathbb{T})) G_{i,k}(\theta_u(\mathbb{T})) \right] = \mathbb{E} \left[F_{n-i} \left(Cut_{U_j^*}(\mathbb{T}^*) \right) \right] \mathbb{E} [G_{i,k}(\mathbb{T})].$$

where U_j^* denotes the unique vertex of the infinite branch of \mathbb{T}^* at height j . We can now use Lemma 4.3.12 (i) to obtain an expression of $\mathbb{E}[G_{i,k}(\mathbb{T})]$:

$$\sum_{j \geq 0} \sum_{i=2\epsilon n}^n \mathbb{E} \left[\sum_{\substack{u \in \mathbb{T} \\ |u|=j}} F_{n-i}(Cut_u(\mathbb{T})) G_{i,k}(\theta_u(\mathbb{T})) \right] = \mu_k \binom{k}{2} \sum_{i=2\epsilon n}^n A_i \sum_{q=0}^{i-1-2\epsilon n} \mathbb{P}(|\mathcal{F}_{k-2}| = q) B_{i,q}, \quad (4.21)$$

where, for $i \in [2\epsilon n, n]$, $A_i = \sum_{j \geq 0} \mathbb{P}(|Cut_{U_j^*}(\mathbb{T}^*)| = n - i)$ and, for $q \in [0, i - 1 - 2\epsilon n]$,

$$B_{i,q} = \sum_{t=\epsilon n}^{i-1-q-\epsilon n} \mathbb{P}(|\mathbb{T}| = t) \mathbb{P}(|\mathbb{T}| = i - 1 - q - t).$$

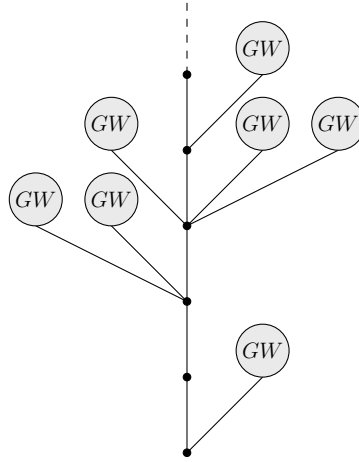

Figure 4.13: Kesten's infinite tree \mathcal{T}^* . On the infinite branch (in the middle), independent μ -GW are planted.

Set, for $n, k \in \mathbb{Z}_+$,

$$R_k^{(n)} := \sum_{i=2\epsilon n}^n A_i \sum_{q=0}^{i-1-2\epsilon n} \mathbb{P}(|\mathcal{F}_{k-2}| = q) B_{i,q}.$$

In order to prove Lemma 4.3.12 (ii), we show two things:

- (a) there is no loss of mass as n grows, in the sense that, for any $\gamma > 0$, there exists $K \in \mathbb{Z}_+$ such that, for any n large enough,

$$\sum_{k > K} \mu_k \binom{k}{2} R_k^{(n)} \leq \gamma \sum_{k \leq K} \mu_k \binom{k}{2} R_k^{(n)}.$$

In other words, the degree of a uniform ϵn -branching point in \mathbb{T}_n is tight;

(b) uniformly for k_1, k_2 on a compact subset of \mathbb{Z}_+ , as $n \rightarrow \infty$:

$$R_{k_1}^{(n)} \sim R_{k_2}^{(n)}.$$

By (a),(b) and (4.21), we conclude that, for all $k \geq 2$, $\mathbb{P}\left(k_U(\mathbb{T}_n) = k \mid U \in E_{\varepsilon n}(\mathbb{T}_n)\right)$ is asymptotically proportional to $\mu_k \binom{k}{2}$. This implies Lemma 4.3.12 (ii).

We finish with the proofs of (a) and (b). Let us first prove (a). By the local limit theorem 4.2.5, as μ has finite variance, there exists two constants $C > c > 0$ depending only on ε and μ such that, for any $i \in \llbracket 2\varepsilon n, n \rrbracket$, any $0 \leq q \leq i - 1 - 2\varepsilon n$,

$$c(i - 1 - 2\varepsilon n - q)n^{-3} \leq B_{i,q} \leq C(i - 1 - 2\varepsilon n - q)n^{-3}. \quad (4.22)$$

Thus, for any $k \in \mathbb{Z}_+$,

$$R_k^{(n)} \leq Cn^{-3} \sum_{i=2\varepsilon n}^n A_i n \mathbb{P}(|\mathcal{F}_{k-2}| \leq n) \leq Cn^{-2} \sum_{i=2\varepsilon n}^n A_i. \quad (4.23)$$

Now, take $\eta = 1/2 + \varepsilon \in (2\varepsilon, 1)$. We claim that

$$\sum_{i=2\varepsilon n}^n A_i \leq 3 \sum_{i=\eta n}^n A_i, \quad (4.24)$$

which we prove later. Then, for any $i \geq \eta n$, by (4.22),

$$\sum_{q=0}^{i-1-2\varepsilon n} \mathbb{P}(|\mathcal{F}_{k-2}| = q) B_{i,q} \geq \sum_{q=0}^{\eta n - 2\varepsilon n} \mathbb{P}(|\mathcal{F}_{k-2}| = q) B_{i,q} \geq cn^{-3} (\eta - 2\varepsilon) n \mathbb{P}(|\mathcal{F}_{k-2}| \leq (\eta - 2\varepsilon)n).$$

At k fixed, for n large enough, this quantity is larger than $cn^{-2}(\eta/2 - \varepsilon)$, and by (4.24)

$$R_k^{(n)} \geq \sum_{i=\eta n}^n A_i \sum_{q=0}^{i-1-2\varepsilon n} \mathbb{P}(|\mathcal{F}_{k-2}| = q) B_{i,q} \geq \frac{c}{3} (\eta/2 - \varepsilon) n^{-2} \sum_{i=2\varepsilon n}^n A_i.$$

Using (4.23) and the fact that $\sum_{k>K} \mu_k \binom{k}{2} \rightarrow 0$ as $K \rightarrow \infty$, this implies (a) and ensures the tightness of the degree of a uniform εn -branching point.

The only thing left to prove is that, indeed, $\sum_{i=2\varepsilon n}^n A_i \leq 3 \sum_{i=\eta n}^n A_i$. To this end, observe that, by definition, for any $\delta \in (0, 1)$,

$$\begin{aligned} \sum_{i=\lfloor \delta n \rfloor}^n A_i &= \sum_{i=\lfloor \delta n \rfloor}^n \sum_{j \geq 0} \mathbb{P}\left(|\text{Cut}_{U_j^*}(\mathbb{T}^*)| = n - i\right) = \sum_{j \geq 0} \mathbb{P}\left(|\text{Cut}_{U_j^*}(\mathbb{T}^*)| \leq n - \lfloor \delta n \rfloor\right) \\ &= \mathbb{E}\left[\sup\left\{j \geq 0, |\text{Cut}_{U_j^*}(\mathbb{T}^*)| \leq n - \lfloor \delta n \rfloor\right\}\right] = \mathbb{E}\left[\inf\left\{j \geq 1, |\text{Cut}_{U_j^*}(\mathbb{T}^*)| > n - \lfloor \delta n \rfloor\right\}\right] - 1. \end{aligned}$$

Now, by definition of the tree \mathbb{T}^* , for any $j \geq 1$, $|\text{Cut}_{U_j^*}(\mathbb{T}^*)|$ is the sum of j i.i.d. random variables. In particular, the sequence $(u_r)_{r \geq 0}$ defined as

$$u_r = \mathbb{E}\left[\inf\left\{j \geq 1, |\text{Cut}_{U_j^*}(\mathbb{T}^*)| > r\right\}\right]$$

is clearly subadditive, in the sense that, for all $r_1, r_2 \geq 0$, $u_{r_1+r_2} \leq u_{r_1} + u_{r_2}$. On the other hand this sequence is increasing and goes to $+\infty$. This proves (4.24), since $n - 2\varepsilon n = 2(n - \eta n)$.

To prove (b), just notice that, at k fixed, the mass of $R_k^{(n)}$ is asymptotically concentrated on small values of q . Indeed, by (4.22), uniformly for $i \geq 2\varepsilon n + 1 + \log n$,

$$\sum_{q=\log n}^{i-1-2\varepsilon n} \mathbb{P}(|\mathcal{F}_{k-2}| = q) B_{i,q} \leq C n^{-3} (i-1-2\varepsilon n - \log n) \mathbb{P}(|\mathcal{F}_{k-2}| \geq \log n) = o\left(\sum_{q=0}^{\log n} \mathbb{P}(|\mathcal{F}_{k-2}| = q) B_{i,q}\right),$$

since, by (4.22) again,

$$\sum_{q=0}^{\log n} \mathbb{P}(|\mathcal{F}_{k-2}| = q) B_{i,q} \geq c n^{-3} (i-1-2\varepsilon n - \log n) \mathbb{P}(|\mathcal{F}_{k-2}| \leq \log n) \geq \frac{c}{2} n^{-3} (i-1-2\varepsilon n - \log n)$$

for n large enough. Now, by Theorem 4.2.5, for any $i \geq 2\varepsilon n + 1$, there exists a constant \tilde{C}_i such that, as $n \rightarrow \infty$, uniformly for $q \leq \log n$, $B_{i,q} \sim \tilde{C}_i n^{-3}$. Thus, for any $k \geq 2$ fixed,

$$R_k^{(n)} \sim n^{-3} \sum_{i=2\varepsilon n}^n A_i \tilde{C}_i \sum_{q=0}^{\log n} \mathbb{P}(|\mathcal{F}_{k-2}| = q) \sim n^{-3} \sum_{i=2\varepsilon n}^n A_i \tilde{C}_i.$$

In particular, this implies (b). \square

Proof of Lemma 4.3.12 (iii). In order to check (iii), one only needs to see that, conditionally on its size, a subtree of \mathbb{T}_n is independent of the rest of the tree. Therefore, taking u an εn -branching point of \mathbb{T}_n , the subtrees $\theta_{v_1(u)}(\mathbb{T}_n)$ and $\theta_{v_2(u)}(\mathbb{T}_n)$, conditionally on their sizes (which are larger than εn by definition) are independent of the rest of the tree. Hence, using repeatedly Lemma 4.3.12 (ii) on these subtrees, one obtains (iii). \square

4.4 A bijection between minimal factorizations and a set of bi-type trees

In this section, we first discuss some properties of minimal factorizations of the n -cycle, and specify a way to code them by bi-type trees with n white vertices. Then, we use this bijection to code a w -minimal factorization of the n -cycle f_n^w by a random labelled BTSG $T(f_n^w)$, with some constraints on the labels of its black vertices. This BTSG with constraints is of particular interest, as we prove that the process $(S_u(f_n^w))_{u \in [0, \infty]}$ is asymptotically close to the black process of this tree:

Theorem 4.4.1. *Let $\alpha \in (1, 2]$. Let w be a sequence of α -stable type, ν its critical equivalent and $(\tilde{B}_n)_{n \geq 1}$ satisfying (4.3) for ν . Then, if $\alpha < 2$ or if ν has finite variance, the face configuration process obtained from f_n^w is close in distribution to the process associated to a (μ_*, w) -BTSG with uniformly labelled black vertices. More precisely, there exists a coupling of f_n^w and $\mathcal{T}_n^{(\mu_*, w)}$ such that, in probability:*

$$d_{Sk} \left((S_{c\tilde{B}_n}(f_n^w))_{c \in [0, \infty]}, \left(\mathbb{L}_{c\tilde{B}_n}^\bullet(\mathcal{T}_n^{(\mu_*, w)}) \right)_{c \in [0, \infty]} \right) \xrightarrow[n \rightarrow \infty]{\mathbb{P}} 0,$$

where d_{Sk} denotes the Skorokhod distance on $\mathbb{D}([0, \infty], \mathbb{CL}(\overline{\mathbb{D}}))$.

This theorem, which we prove later in the section, directly implies Theorem 4.1.3:

Proof of Theorem 4.1.3. The proof of the main result in this paper, Theorem 4.1.3, is just a consequence of Theorem 4.2.7 and Theorem 4.4.1. \square

The principal tool in the proof of Theorem 4.4.1 is a operation that we perform on the white vertices of $T(f_n^w)$, which consists in shuffling its black children in two different ways, in order to lift the constraints on this labelling. The aim is to obtain at the end a tree distributed as $\mathcal{T}_n^{(\mu^*, w)}$ (that is, its black vertices are uniformly labelled), whose black process is close in probability to the one of $T(f_n^w)$. See Section 4.4.5 for details.

4.4.1 Coding a minimal factorization by a colored lamination

First, our aim is to prove Theorem 4.1.4 by showing an explicit bijective way to code a factorization of \mathfrak{M}_n by a tree of \mathfrak{U}_n . We do it in two steps, first coding a minimal factorization by a colored lamination of $\overline{\mathbb{D}}$ and then coding it by a bi-type tree.

Note that our bijection is close to the one presented by Du and Liu [39], who investigate minimal factorizations of a given cycle. In particular, what they call a $S - [d]$ bipartite graph is exactly what we call the "dual tree" of the factorization. In their paper, Du and Liu use this bipartite graph as a tool to show a bijection between minimal factorizations and a new family of trees which they call multi-noded rooted trees; we prefer studying the bipartite graph (or bi-type tree in our case) directly, as its structure allows us to use the machinery of random trees and seems more adapted in our setting.

The first step consists in adapting the bijection introduced by Goulden and Yong [49] to code minimal factorizations into transpositions by monotype trees with labelled vertices. In our broader framework, we code general minimal factorizations by bi-type trees with n white vertices and labelled black vertices. We first check that we can code a minimal factorization of the n -cycle by a colored lamination, as explained in Section 4.1.2. For this, we need to be able to define the face associated to a cycle appearing in the factorization.

For $n \geq 1$, we say that a cycle $\tau \in \mathfrak{C}_n$ is increasing if it can be written as $(e_1 e_2 \cdots e_{\ell(\tau)})$, where $e_1 < e_2 < \dots < e_{\ell(\tau)}$.

Proposition 4.4.2. *Let $n \geq 1$. Then any cycle appearing in a minimal factorization of the n -cycle is increasing.*

To prove Proposition 4.4.2, we make use of what we call the *transposition slicing* of a minimal factorization, which is roughly speaking a decomposition into transpositions of the factorization:

Definition. *Let $n, k \geq 1$ and $f := (\tau_1, \dots, \tau_k) \in \mathfrak{M}_n^{(k)}$. We define from f a factorization \tilde{f} of the n -cycle into transpositions as follows: for $1 \leq i \leq k$, let us write the cycle τ_i as $(d_1^{(i)} \dots d_{\ell(\tau_i)}^{(i)})$, where $d_1^{(i)}$ is the minimum of the support of τ_i . Now observe that τ_i can be written as the product of $(\ell(\tau_i) - 1)$ transpositions: $(d_1^{(i)} d_2^{(i)}) (d_1^{(i)} d_3^{(i)}) \cdots (d_1^{(i)} d_{\ell(\tau_i)}^{(i)})$. By replacing all cycles of f by their decomposition into transpositions, we obtain a factorization \tilde{f} of the n -cycle into transpositions, which we call the *transposition slicing* of f .*

See Fig. 4.14 for an example. It is clear that, if f is a minimal factorization of the n -cycle, then its transposition slicing \tilde{f} is made of $n - 1$ transpositions, and hence is a minimal factorization of the n -cycle into transpositions. This allows us to translate results on \tilde{f} (mostly taken from [49]) into results on f .

Proof of Proposition 4.4.2. Let $n, k \geq 1$ and $f := (\tau_1, \dots, \tau_k) \in \mathfrak{M}_n^{(k)}$. We first construct a lamination, denoted by $S_{lab}(\tilde{f})$, by giving labels to the faces of $S(\tilde{f})$ (which are in fact all chords): draw for the i -th transposition of \tilde{f} , say $(a_i b_i)$, the chord $[e^{-2i\pi a_i/n}, e^{-2i\pi b_i/n}]$, and label it i . This provides a lamination in which all chords are labelled. Furthermore, [49, Theorem 2.2 (iii)] states that chords in $S_{lab}(\tilde{f})$ are labelled in increasing clockwise order

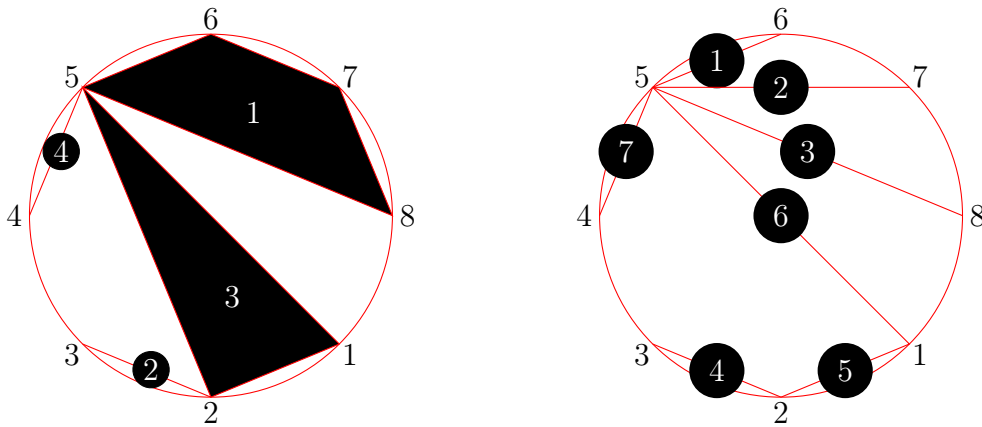

Figure 4.14: The labelled colored laminations $S_{lab}(f)$ and $S_{lab}(\tilde{f})$, for $f := (5678)(23)(125)(45)$. Constructing the second one from the first one just consists in triangulating each black face, starting from the smallest of its vertices.

around each vertex $e^{-2ij\pi/n}$, $1 \leq j \leq n$ (in fact they are sorted in decreasing clockwise order in [49]: indeed their coding is slightly different from ours, since they label the n -th roots of unity decreasingly clockwise. Nonetheless our result is an easy consequence of theirs).

Thus, for any $i \leq k$, around the vertex $e^{-2i\pi d_1^{(i)}/n} \in \overline{\mathbb{D}}$, the chords of $S_{lab}(\tilde{f})$ are labelled in clockwise increasing order (see an example on Fig. 4.14, right). This implies that $d_1^{(i)} < d_2^{(i)} < \dots < d_{\ell(i)}^{(i)}$ and the result follows. \square

We can therefore code a factorization f by a colored lamination with labelled faces, by labelling the black faces of $S(f)$ from 1 to k (where k denotes the number of cycles that appear in f) in the order in which they appear. See Fig. 4.14, left for an example. We denote this labelled colored lamination by $S_{lab}(f)$.

Proposition 4.4.3. *Let $n, k \geq 1$ and $f \in \mathfrak{M}_n^{(k)}$. Then $S_{lab}(f)$ satisfies the following properties:*

- P_1 : *It has k black faces and n white faces (with the convention that chords corresponding to a cycle of length 2 are considered to be black faces).*
- P_2 : *A black (resp. white) face has only white (resp. black) neighbouring faces (with the same convention).*
- P_3 : *The set of black faces of $S_{lab}(f)$ obeys a noncrossing tree-like structure. Specifically, the chords only meet at their endpoints and form a connected graph; in addition, there is no cycle of chords of length ≥ 1 containing at most one edge of each black face.*
- P_4 : *Around each n -th root of unity, black faces are labelled in increasing clockwise order.*

These properties can be easily deduced from the results of [49, Section 2], which straightforwardly imply that they are satisfied by $S_{lab}(\tilde{f})$. In particular, the chords of $S_{lab}(\tilde{f})$ form a tree and are labelled in increasing clockwise order around each vertex (see Fig. 4.14, right, for an example).

Proof. Let us first check P_1 . It is clear by definition that $S_{lab}(f)$ has k black faces. Now observe that each white face contains exactly one arc of the form $(e^{-2i\pi a/n}, e^{-2i\pi(a+1)/n})$ (where

$a \in \mathbb{Z}$) in its boundary, since the chords of $S_{lab}(\tilde{f})$ form a tree (see [49, Theorem 2.2 (i)]). As there are exactly n such arcs, P_1 is satisfied.

To prove P_2 , notice that two white faces cannot be neighbours, as they need a chord to separate them, which belongs to a black face. In addition, one can check that two black faces cannot have a chord in common in their boundaries; otherwise either the same transposition would appear twice in \tilde{f} , or there would be a cycle of chords in $S_{lab}(\tilde{f})$. None of these configurations can happen, which proves P_2 .

P_3 follows from a similar argument, again using the fact that the chords of $S_{lab}(\tilde{f})$ form a tree.

To prove P_4 , let a be an n -th root of unity and F, F' two consecutive black faces around a in clockwise order. Then there exist two chords c (resp. c') in their respective boundaries in $S_{lab}(\tilde{f})$ having a as an endpoint, and corresponding to a transposition that appears in the cycle of f coded by F (resp. F'). By [49, Theorem 2.2], the labels of c and c' are sorted in increasing clockwise order around a . By definition of \tilde{f} , so are the labels of F and F' . \square

One can check in addition that, if a labelled colored laminations satisfies these four properties, then it also satisfies:

P_5 : Let F be a white face of $S_{lab}(f)$. By P_4 , F has exactly one arc in its boundary, of the form $(e^{-2i\pi a/n}, e^{-2i\pi(a+1)/n})$ for some $a \in \mathbb{Z}$. Then, the labels of its neighbouring black faces are sorted in decreasing clockwise order around F , starting from this unique arc.

For $n, k \geq 1$, we now define $\mathfrak{K}_n^{(k)}$ the set of labelled colored lamination satisfying properties P_1 to P_4 . In addition, we set $\mathfrak{K}_n = \cup_{1 \leq k \leq n-1} \mathfrak{K}_n^{(k)}$. Then the following holds:

Theorem 4.4.4. *Let $n, k \geq 1$. The map*

$$\Phi_n^{(k)} : \begin{cases} \mathfrak{M}_n^{(k)} \rightarrow \mathfrak{K}_n^{(k)} \\ f \mapsto S_{lab}(f) \end{cases}$$

is a bijection.

As a corollary, the map $\Phi_n : \mathfrak{M}_n \rightarrow \mathfrak{K}_n, f \mapsto S_{lab}(f)$ is also a bijection.

Proof. Let f be an element of $\mathfrak{M}_n^{(k)}$. By Proposition 4.4.3, $S_{lab}(f)$ is an element of $\mathfrak{K}_n^{(k)}$, and therefore $\Phi_n^{(k)}$ is well defined. It is also clearly an injection. Let us now take $L \in \mathfrak{K}_n^{(k)}$. We prove that there exists a minimal factorization $f \in \mathfrak{M}_n^{(k)}$ such that $L = S_{lab}(f)$. To this end, for $i \in \llbracket 1, k \rrbracket$, denote by F_i the black face of L labelled i , and denote by $\ell(i)$ the number of chords in its boundary. These chords connect $\exp(-2i\pi a_1/n), \dots, \exp(-2i\pi a_{\ell(i)}/n)$ so that $1 \leq a_1 < a_2 < \dots < a_{\ell(i)} \leq n$. Let $c_i := (a_1 a_2 \dots a_{\ell(i)})$, and consider the product $\sigma := c_1 c_2 \dots c_k$. By P_4 and P_5 , it is clear that, for all $j \in \llbracket 1, n \rrbracket$, $\sigma(j) = j + 1 \pmod n$. Indeed, the arc between $e^{-2i\pi j/n}$ and $e^{-2i\pi(j+1)/n}$ is in the boundary of a white face F , and is the only arc in its boundary by P_5 . Let $b_1 = j, b_2, \dots, b_{k-1}, b_k = j + 1$ be the vertices of F in counterclockwise order starting from j . By P_5 again, b_1 is sent by one of the c_m 's to b_2 , b_2 by another one to b_3 , and so on, in this very order. Furthermore, for all $i \leq k - 2$, the chords $[b_i b_{i+1}]$ and $[b_{i+1} b_{i+2}]$ belong to consecutive black faces around b_{i+1} , which correspond to, say, c_{m_1} and c_{m_2} for $m_1 < m_2$. By P_4 , b_{i+1} is not in any c_m for $m_1 < m < m_2$. For the same reason, the first of the c_m 's containing b_1 is the one sending it to b_2 , and the last one containing b_k sends b_{k-1} to it. Finally, $b_1 = j$ is sent to $b_k = j + 1$ by σ . Thus, σ is the n -cycle. In addition, $f := (c_1, c_2, \dots, c_k)$ is an element of $\mathfrak{M}_n^{(k)}$, which satisfies $L = S_{lab}(f)$. The result follows. \square

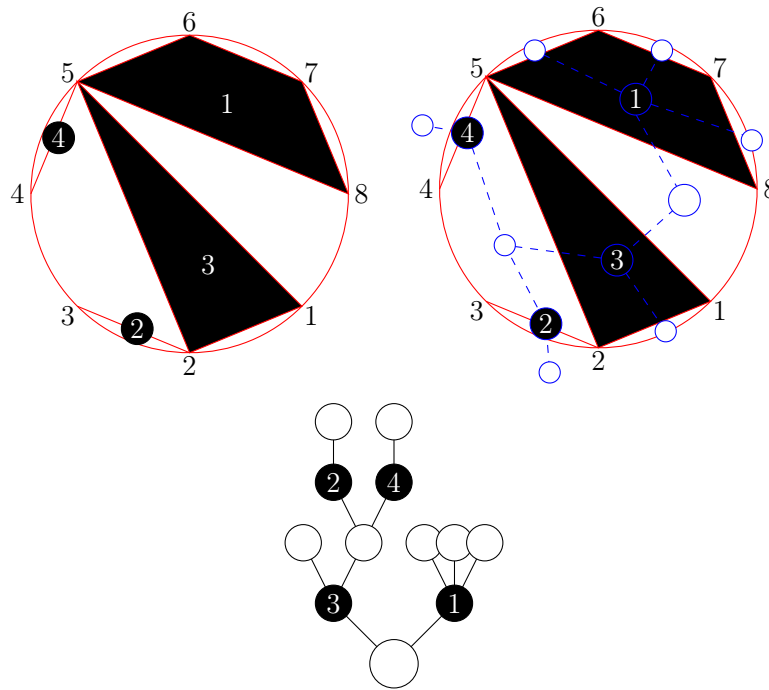

Figure 4.15: An application of the bijection Ψ_8 to the minimal factorization $f := (5678)(23)(125)(45) \in \mathfrak{M}_8$. Top-left: the colored lamination $S_{lab}(f)$. Top-right: the same lamination, with its dual tree $T(f)$ drawn in blue. The larger white vertex is its root. Bottom: the dual tree $T(f)$.

4.4.2 Coding a minimal factorization by a bi-type tree

We now construct from $S_{lab}(f)$ a tree $T(f)$. We then prove that, for $n, k \geq 1$, the map

$$\Psi_n^{(k)} : f \rightarrow T(f)$$

defined on $\mathfrak{M}_n^{(k)}$, which associates this way a bi-type tree to each factorization of the n -cycle into k cycles, is a bijection from $\mathfrak{M}_n^{(k)}$ to the set of bi-type trees $\mathfrak{U}_n^{(k)}$. To this end, we rely on Theorem 4.4.4, proving in fact that the mapping $\Psi_n^{(k)} \circ (\Phi_n^{(k)})^{-1}$ is bijective. As a corollary,

$$\Psi_n : \mathfrak{M}_n \rightarrow \mathfrak{U}_n, f \rightarrow T(f)$$

is also a bijection.

Let $n, k \geq 1$ and take $f := (\tau_1, \dots, \tau_k) \in \mathfrak{M}_n^{(k)}$ a minimal factorization of the n -cycle. To f , we associate the graph $T(f)$, constructed as the *dual graph* of $S_{lab}(f)$: black vertices correspond to black faces of $S_{lab}(f)$, while white vertices correspond to its white faces. Specifically, put a white vertex in each white face of $S_{lab}(f)$, and a black vertex in each of its black faces (including faces of perimeter 2, which correspond to transpositions in f). Now, draw an edge between two vertices whenever the boundaries of the corresponding faces share a chord. Finally, root this graph at the white vertex corresponding to the white face whose boundary contains the arc $\overline{1, e^{-2i\pi/n}}$, and give to each black vertex of $T(f)$ the label of the corresponding face in $S_{lab}(f)$. See an example on Fig. 4.15.

Lemma 4.4.5. *Let $n, k \geq 1$ and $f \in \mathfrak{M}_n^{(k)}$. Then $T(f) \in \mathfrak{U}_n^{(k)}$.*

Proof. Let us check the properties of $\mathfrak{U}_n^{(k)}$ one by one. First, $T(f)$ is clearly connected by construction. Moreover, since each chord splits the unit disk into two disjoint connected

components, $T(f)$ is necessarily a tree. By the property P_1 , $T(f)$ has exactly k black vertices and n white vertices, and by P_2 all neighbours of a white vertex are black and conversely. The root of $T(f)$ is white by construction, and it is therefore a bi-type tree. In addition, a leaf of $T(f)$ has only one neighbour, and hence necessarily corresponds to a face that has an arc in its boundary. In particular this face is white, and thus all leaves of $T(f)$ are white. Finally, by P_5 , the labels of the neighbours of each white face are sorted in decreasing clockwise order and the labels of the children of the root are decreasing from left to right. In conclusion, $T(f) \in \mathfrak{U}_n^{(k)}$. \square

Notice, in particular, that the degree of a black vertex in $T(f)$ corresponds to the length of the corresponding cycle in f . This mapping is a bijection, as stated in the following theorem.

Theorem 4.4.6. *For any $n, k \geq 1$, the map*

$$\begin{aligned} \Psi_n^{(k)} : \mathfrak{M}_n^{(k)} &\rightarrow \mathfrak{U}_n^{(k)} \\ f &\mapsto T(f) \end{aligned}$$

is a bijection.

Notice that, by Lemma 4.4.5, $\Psi_n^{(k)}$ is well-defined from $\mathfrak{M}_n^{(k)}$ to $\mathfrak{U}_n^{(k)}$.

Proof of Theorem 4.4.6. We rely here on [49, Section 3], where the Goulden-Yong bijection and its inverse are constructed. Let us construct as well the inverse of the map $\Psi_n^{(k)}$. Fixing a tree $T \in \mathfrak{U}_n^{(k)}$, we shall construct a lamination $L := S_{lab}(f)$ associated to a minimal factorization f , such that $T = T(f)$. To this end, we define a way of exploring white vertices of the tree T , which we call its white exploration process. This process induces a way of labelling the white vertices, in the order in which they are explored. The white exploration process is defined the following way: we start from the root which receives label 1, and explore the subtrees rooted at its white grandchildren from left to right. The rule is that, in order to explore a subtree of T rooted at a white vertex b whose black parent has label a , one first explores the subtrees rooted at a black child of b with label $< a$ (if there are some, from left to right), then visits the vertex b , and finally explores the subtrees rooted at a black child of b with label $> a$ if there are some, from left to right, starting from the leftmost of these subtrees. Exploring a subtree rooted at a black vertex just consists in exploring the subtrees rooted at its white children, from left to right. An example is given in Fig. 4.16, top-right.

Let us now construct a colored lamination L whose dual tree is exactly T . The idea (which is the main interest of this white exploration process) is that the white vertex labelled k shall correspond to the white face whose boundary contains the arc $(e^{-2i(k-1)\pi/n}, e^{-2ik\pi/n})$ (so that the root corresponds to the arc $(1, e^{-2i\pi/n})$). The colored lamination L is constructed by drawing the faces that correspond to black vertices of T , and giving them the label of the associated vertices. See Fig. 4.16 for an example. There is a unique way of drawing such a colored lamination. To see this, notice that there is only one way to draw the face corresponding to a black vertex whose children are all leaves, and that this drawing does not depend on the label of the white parent of this black vertex. Thus, there is only one way to draw all these faces from the leaves to the root, which gives L . Furthermore, L belongs to $\mathfrak{R}_n^{(k)}$ by construction. Thus, by Theorem 4.4.4, there exists $f \in \mathfrak{M}_n$ such that $L = S_{lab}(f)$. Hence, f satisfies $T = T(f)$, and $\Psi_n^{(k)}$ is a bijection. \square

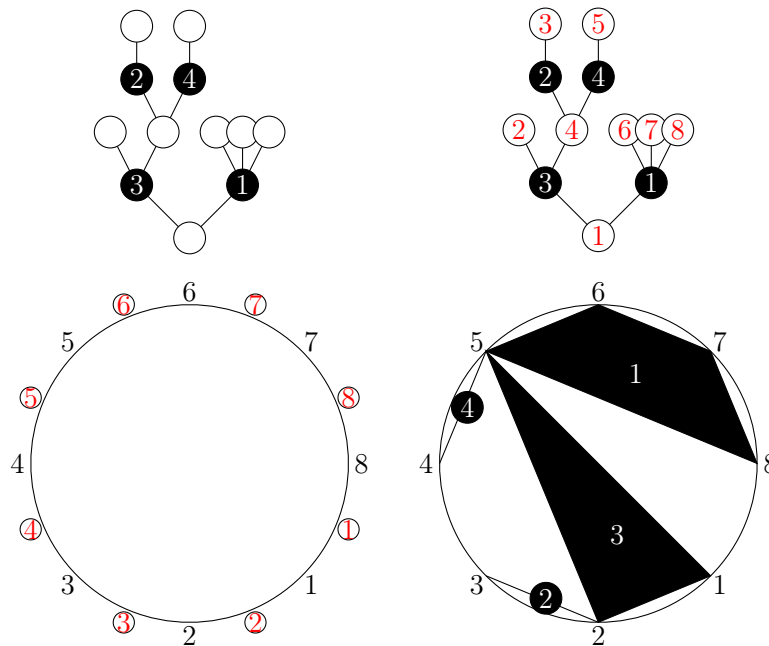

Figure 4.16: An example of the inverse bijection $\Phi_8 \circ (\Psi_8)^{-1}$. Top-left: a tree $T \in \mathfrak{U}_8$. Top-right: the tree T with labels on its white vertices, following the white exploration process. Bottom-left: the locations of the arcs corresponding to these white vertices, on the circle. Bottom-right: the associated colored lamination. We recover from this: $\Psi_8^{-1}(T) = (5678)(23)(125)(45)$.

4.4.3 Image of a random weighted minimal factorization

We now investigate random weighted minimal factorizations of the n -cycle. Take $(w_i)_{i \geq 1}$ a weight sequence, and remember that f_n^w is a minimal factorization of the n -cycle chosen proportionally to its weight: $\mathbb{P}(f_n^w = f) \propto \prod_{i=1}^{k(f)} w_{\ell(\tau_i)-1}$, where $k(f)$ is the number of cycles in f . Then, it turns out that the random tree $T(f_n^w)$ (which is the image of f_n^w by Ψ_n) is a BTSG. In what follows, as in the previous section, μ_* denotes the Poisson distribution of parameter 1.

Theorem 4.4.7. *Let w be a weight sequence. Then the plane tree $T(f_n^w)$, forgetting about the labels, has the law of the unlabelled version of $\mathcal{T}_n^{(\mu_*, w)}$. In addition, this plane tree being fixed, the labelling of its black vertices is uniform among all labellings from 1 to their total number $N^\bullet(T)$, satisfying the condition that the labels of all neighbours of a given white vertex are clockwise decreasing, and that the labels of the children of the root are decreasing from left to right.*

Notice that Lemma 4.1.1 is an immediate corollary of Theorem 4.4.7 and Lemma 4.3.4: the number of cycles in a typical w -factorization of the n -cycle is of order $(1 - \nu_0)n$. To see this, just observe that the number of cycles in a minimal factorization F is exactly the number of black vertices in the tree $T(F)$. Theorem 4.4.7 also implies Proposition 4.1.2:

Proof of Proposition 4.1.2. It is clear, by the abovementioned bijection, that the maximum length of a cycle in a minimal factorization F is the maximum degree of a black vertex in $T(F)$. Thus, by Theorem 4.4.7, we need to study the maximum degree of a black vertex in the conditioned BTSG $\mathcal{T}_n^{(\mu_*, w)}$. Let ν be as usual the critical equivalent of w . If ν has finite variance, then by the convergence of Theorem 4.2.2 the maximum degree of a white vertex

in $\mathcal{T}_n^{\circ,(\mu_*,w)}$ (that is, the maximum number of grandchildren of a white vertex in $\mathcal{T}_n^{(\mu_*,w)}$) is $o(\sqrt{n})$ with high probability. Thus, the maximum degree of a black vertex in $\mathcal{T}_n^{(\mu_*,w)}$ is necessarily $o(\sqrt{n})$ as well.

If $\alpha < 2$, then for any $\varepsilon > 0$, again by the convergence of Theorem 4.2.2, there exists $C > 0$ such that, with probability larger than $1 - \varepsilon$, the maximum degree of a white vertex in $\mathcal{T}_n^{\circ,(\mu_*,w)}$ is less than $C\tilde{B}_n$. Thus the maximum degree of a black vertex is also less than $C\tilde{B}_n$ with probability larger than $1 - \varepsilon$. To prove the lower bound on this quantity, take $\varepsilon > 0$ and η such that, with probability larger than $1 - \varepsilon$, there exists a white vertex u in $\mathcal{T}_n^{(\mu_*,w)}$ with at least $\eta\tilde{B}_n$ white grandchildren. Such an η exists by Lemma 4.2.3 (i). Then, by Lemma 4.3.7, one can choose $\delta > 0$ such that, with high probability, all white grandchildren of u except at most $\tilde{B}_n n^{-\delta}$ of them have the same black parent $b(u)$. Hence, for n large enough, with probability larger than $1 - 2\varepsilon$, $b(u)$ has at least $\eta\tilde{B}_n/2$ children. The result follows. \square

Proof of Theorem 4.4.7. Take T a bi-type tree with n white vertices, whose leaves are all white. Then, the number of labellings of the black vertices that are clockwise decreasing around each white vertex is exactly

$$n! \left(\prod_{x \in T, x \text{ white}} k_x(T)! \right)^{-1}.$$

Furthermore, by Theorem 4.4.6, given such a labelling of T , exactly one minimal factorization is coded by the tree T labelled this way, and this factorization has weight $\prod_{y \in T, y \text{ black}} w_{k_y(T)}^\bullet$.

Finally,

$$\mathbb{P}(T(f_n^w) = T) \propto \prod_{x \in T, x \text{ white}} \frac{1}{k_x(T)!} \prod_{y \in T, y \text{ black}} w_{k_y(T)}.$$

The result follows. \square

Equivalence of weighted minimal factorizations An other way to understand Lemma 4.2.6, in the light of the bijection Ψ_n , is to notice that the weight sequence w is not uniquely defined by the distribution of f_n^w . The following lemma characterizes the families of weight sequences that give rise to the same random minimal factorization:

Lemma 4.4.8 (Equivalent sequences). *Let w be a weight sequence and $s > 0$. Define $w^{(s)}$ the weight sequence verifying, for any $i \geq 1$, $w_i^{(s)} = w_i s^i$. Then, for any $n \geq 1$, $f_n^{w^{(s)}}$ has the same distribution as f_n^w .*

Proof. Take $n, k \geq 1$. For any $f := (\tau_1, \dots, \tau_k) \in \mathfrak{M}_n$, we have:

$$W_{w^{(s)}}(f) = \prod_{i=1}^k w_{\ell(\tau_i)-1} s^{\ell(\tau_i)-1} = s^{\sum_{i=1}^k (\ell(\tau_i)-1)} \times \prod_{i=1}^k w_{\ell(\tau_i)-1} = s^{n-1} W_w(f)$$

by definition of \mathfrak{M}_n . Recalling that we have defined $Y_{n,v} = \sum_{f \in \mathfrak{M}_n} W_v(f)$ for any weight sequence v , this implies that $Y_{n,w^{(s)}} = s^{n-1} Y_{n,w}$ and therefore that, for $f \in \mathfrak{M}_n$,

$$\mathbb{P}(f_n^{w^{(s)}} = f) = \frac{W_{w^{(s)}}(f)}{Y_{n,w^{(s)}}} = \frac{W_w(f)}{Y_{n,w}} = \mathbb{P}(f_n^w = f).$$

The result follows. \square

Remember that we say that two weight sequences w, w' are equivalent if, for all $n \geq 1$, $\mathcal{T}_n^{(\mu_*, w)} \stackrel{(d)}{=} \mathcal{T}_n^{(\mu_*, w')}$. One can check, the same way as in Lemma 4.2.1, that the sequences $w^{(s)}, s > 0$ are the only sequences equivalent to w . Indeed, recalling the notation of Lemma 4.2.6, the white weight sequence w° is the same (equal to μ_*) in both trees $\mathcal{T}_n^{(\mu_*, w)}$ and $\mathcal{T}_n^{(\mu_*, w')}$, and thus the parameters p and q shall be equal to 1. Since we impose the condition $qr = 1$, the only parameter that is allowed to vary is s . It is therefore natural to obtain a family indexed by only one parameter s .

4.4.4 Relation between the colored lamination-valued processes and the tree coding a minimal factorization

In order to prove Theorem 4.4.1, we start by proving that, when w is of stable type (for $\alpha < 2$ or for ν with finite variance), the colored lamination-valued constructed from f_n^w is close with high probability to the black process of the associated tree $T(f_n^w)$.

Theorem 4.4.9. *Let $\alpha \in (1, 2]$, w be a factorization of α -stable type and ν be its critical equivalent. Then, if $\alpha < 2$ or if ν has finite variance, in $\mathbb{D}([0, +\infty], \mathbb{CL}(\overline{\mathbb{D}}))$, in probability, as $n \rightarrow \infty$,*

$$d_{Sk} \left((S_u(f_n^w))_{u \in [0, \infty]}, (\mathbb{L}_u^\bullet(T(f_n^w)))_{u \in [0, \infty]} \right) \xrightarrow{\mathbb{P}} 0,$$

where d_{Sk} denotes the Skorokhod distance on $\mathbb{D}([0, \infty], \mathbb{CL}(\overline{\mathbb{D}}))$.

To prove this, for $g : \mathbb{Z}_+ \rightarrow \mathbb{R}_+$, denote by Z_n^g the set of minimal factorizations f of the n -cycle satisfying two conditions: (i) $H(T(f)) \leq g(n)$; (ii) there exists a constant $A > 0$ such that, for any white vertex u of $T(f)$, taking the notation of the proof of Lemma 4.3.5, for any $1 \leq i \leq 3$, we have

$$\left| |G_i(u, T^\circ(f))| - A|G_i(u, T(f))| \right| \leq g(n).$$

For f a factorization of the n -cycle into k cycles for $1 \leq j \leq k$, denote by F_j the face of $S_{lab}(f)$ labelled j , and by u_j the black vertex of $T(f)$ labelled j . Recall that $F_{u_j}(T(f))$ denotes the face coding u_j in the black process of $T(f)$. Then the following holds:

Lemma 4.4.10. *Let $g : \mathbb{Z}_+ \rightarrow \mathbb{R}_+$. Then there exists a constant $C > 0$ such that, uniformly in j , as $n \rightarrow \infty$, uniformly for $f \in Z_n^g$,*

$$d_H(F_j, F_{u_j}(T(f))) \leq Cg(n)/n,$$

This straightforwardly implies Theorem 4.4.9:

Proof of Theorem 4.4.9. By Lemma 4.3.5 and Theorem 4.2.2, there exists $g : \mathbb{Z}_+ \rightarrow \mathbb{R}_+$ such that $g(n) = o(n)$ and $f_n^w \in Z_n^g$ with high probability. Thus, with high probability, jointly for all $j \leq N^\bullet(T(f_n^w))$, $d_H(F_j, F_{u_j}(T(f_n^w))) \rightarrow 0$ as $n \rightarrow \infty$. This implies Theorem 4.4.9. \square

Proof of Lemma 4.4.10. This proof is a straight adaptation of [96, Lemma 4.4], which investigates the case of a minimal factorization into transpositions. Let $f := (\tau_1, \dots, \tau_k) \in \mathfrak{M}_n^{(k)}$, and fix $1 \leq j \leq k$. Denote by ℓ_j the length of the cycle τ_j , and write τ_j as $(a_1 \cdots a_{\ell_j})$, with $1 \leq a_1 < \cdots < a_{\ell_j} \leq n$. By definition, the face F_j connects the points $e^{-2i\pi a_1/n}, \dots, e^{-2i\pi a_{\ell_j}/n} \in \mathbb{S}^1$. The lengths of the arcs delimited by 1 and these ℓ_j points are therefore, in clockwise order, $2\pi a_1/n, 2\pi(a_2 - a_1)/n, \dots, 2\pi(a_{\ell_j} - a_{\ell_j-1})/n, 2\pi(n - a_{\ell_j})/n$.

Now, let us consider the vertex u_j . It induces a partition of the set of vertices of $T(f)$ into $\ell_j + 1$ subsets: the set S_1 of vertices visited by the contour function before the first visit of u_j , the set S_2 of vertices visited between the first and the second visit of u_j , etc. up to S_{ℓ_j+1} , the set of vertices visited for the first time after the last visit of u_j . Let us denote by $N^\circ(S_i)$ the number of vertices of S_i that are white, and notice that the interval between two consecutive visits of u_j exactly corresponds to the exploration of a subtree rooted at a white child of u_j . By the second point in definition of Z_n^g , it is clear that $|N^\circ(S_1) - na_1| \leq g(n)$, $|N^\circ(S_2) - n(a_2 - a_1)| \leq g(n)$, \dots , $|N^\circ(S_{\ell_j}) - n(a_{\ell_j} - a_{\ell_j-1})| \leq g(n)$, $|N^\circ(S_{\ell_j+1}) - (n - a_{\ell_j})| \leq g(n)$.

In order to control the locations of the associated faces in the unit disk, we follow the proof of [96, Lemma 4.4]: observe that, for all i , the white vertices of S_i exactly correspond to white faces of $S_{lab}(f)$ whose boundary contains an arc between $e^{-2i\pi a_{i-1}/n}$ and $e^{-2i\pi a_i/n}$, except for ancestors of u_j which may correspond to arcs either between $\exp(-2i\pi a_{\ell_j}/n)$ and 1, or between 1 and $e^{-2i\pi a_1/n}$. By the first point in the definition of Z_n^g , u_j has at most $g(n)$ ancestors. This implies that F_j and $F_{u_j}(T(f))$ are at distance less than $4\pi g(n)/n$, jointly for all $j \leq N^\bullet(T(f_n^w))$. \square

4.4.5 A shuffling operation

By Theorem 4.4.9, in order to prove Theorem 4.4.1, we now only need to study the process $(\mathbb{L}_u^\bullet(T(f_n^w)))_{u \in [0, \infty]}$. The main obstacle in this study is the constraint on the labelling of the black vertices in $T(f_n^w)$ (recall that the labels are clockwise decreasing around each white vertex, and decreasing from left to right around the root). To get rid of this constraint, we define a shuffling operation on the vertices of a bi-type tree, adapted from [96, Section 4.4].

Definition. Fix $n, k \geq 1$. Let T be a plane bi-type tree with n white vertices and k black vertices labelled from 1 to k , and let $K \in \mathbb{Z}_+$. We define the shuffled tree $T^{(K)}$ as follows: starting from the root of T , we perform one of the following two operations on each white vertex of T . For consistency, we put the constraint that the operation shall be performed on a white vertex before being performed on its grandchildren.

- Operation 1: for a white vertex such that the labels of its black children are all $> K$, we uniformly shuffle these labels (without touching the corresponding subtrees). See Fig. 4.17 (a).
- Operation 2: for a white vertex such that at least one of its black children has a label $\leq K$, we uniformly shuffle these labelled children and keep the subtrees on top of each of them. See Fig. 4.17 (b).

The main interest of this shuffling operation is that, for any K , $T^{(K)}(f_n^w)$ has the law of \mathcal{T}_n , which we recall is defined as the (μ_*, w) -BTSG tree conditioned to have n vertices, whose black vertices are labelled uniformly at random from 1 to $N^\bullet(\mathcal{T}_n)$. Furthermore, for a well-chosen sequence $(K_n)_{n \geq 1}$ of values of K (depending on n), the black processes associated to $T(f_n^w)$ and $T^{(K_n)}(f_n^w)$ are asymptotically close. The choice of this sequence is important. Indeed, if $K_n = 0$, we uniformly shuffle the labels of the children of each white vertex, and in particular the labels of large faces may be given to small ones, which completely changes the structure of the colored process. On the other hand, if $K_n = n$, then the subtrees on top of the children of branching points may be swapped, so that the structure of the underlying tree is changed.

Lemma 4.4.11. (i) For any $K_n \geq 0$, any weight sequence w , the black vertices of the tree $T^{(K_n)}(f_n^w)$ are labelled uniformly at random:

$$T^{(K_n)}(f_n^w) \stackrel{(d)}{=} \mathcal{T}_n.$$

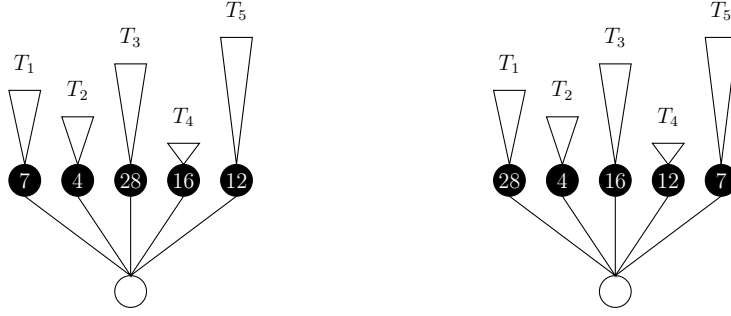

(a) Shuffling of a labelled plane tree when $K = 3$: Operation 1 is performed.

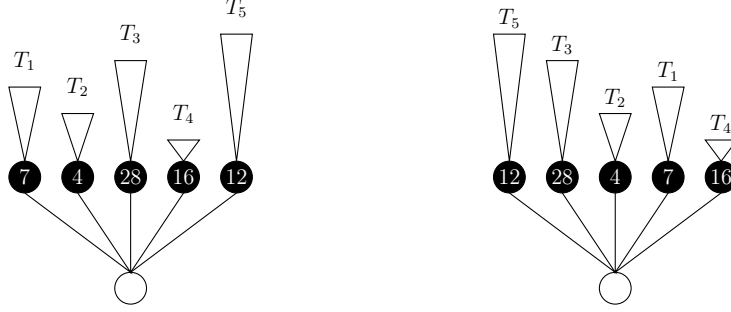

(b) Shuffling of the same tree when $K = 5$: Operation 2 is performed.

Figure 4.17: Examples of the shuffling operation. The operation is different in both cases, since in the second case the vertex labelled 9 has a child with label $4 \leq K$.

(ii) If $\alpha < 2$ or if the critical equivalent ν of w has finite variance, there exists a sequence $(K_n)_{n \geq 1}$ such that the black process of the initial tree is close in probability to the black process of the tree with shuffled vertices:

$$d_{Sk} \left(\left(\mathbb{L}_{c\tilde{B}_n}^\bullet (T(f_n^w)) \right)_{c \in [0, \infty]}, \left(\mathbb{L}_{c\tilde{B}_n}^\bullet (T^{(K_n)}(f_n^w)) \right)_{c \in [0, \infty]} \right) \xrightarrow[n \rightarrow \infty]{\mathbb{P}} 0,$$

where \tilde{B}_n satisfies (4.3) for ν and we recall that d_{Sk} denotes the Skorokhod distance on $\mathbb{D}([0, \infty], \text{CL}(\mathbb{D}))$.

Observe that Theorem 4.4.1 is an easy corollary of this lemma. In addition, notice that Lemma 4.4.11 (i) is immediate. Indeed, Operations 1 and 2 do not change the law of the underlying unlabelled tree, while the labelling of the black vertices after the shuffling operations is uniform.

The proof of Lemma 4.4.11 (ii) is the object of the next subsection.

4.4.6 Proof of the technical lemma 4.4.11 (ii)

In order to prove Lemma 4.4.11 (ii), we need to quantify the distance between the locations of faces with the same label in both labelled colored laminations $\mathbb{L}_\infty^\bullet (T(f_n^w))$ and $\mathbb{L}_\infty^\bullet (T^{(K_n)}(f_n^w))$. For any $i \in \llbracket 1, N^\bullet(T(f_n^w)) \rrbracket$, denote by F_i (resp. F'_i) the face corresponding to the vertex labelled i in $T(f_n^w)$ (resp. $T^{(K_n)}(f_n^w)$).

One can notice that, for $i \leq K_n$, if a vertex has label $i \leq K_n$, then Operation 2 is performed on its parent and hence it keeps its subtree on top of it, whose size determines the lengths of the chords of the face F_i . Therefore, for all i , the lengths of the chords in the boundaries of F_i and F'_i are the same (which means that F_i and F'_i are the same up to

rotation). In particular, if the boundary of F_i contains no chord of length larger than ε , so does the boundary of F'_i , and conversely. Thus, we only have to focus on the locations of the faces that have large chords in their boundary, which correspond to vertices of the tree that are the root of a large subtree.

The idea is the following: when one shuffles vertices following Definition 4.4.5, the location of a face F_i associated to a vertex u with given label $i \leq K_n$ is impacted only by the subset of ancestors of u in $T(f_n^w)$ on which Operation 2 is performed; indeed, performing Operation 1 on a vertex that is not u does not change the underlying unlabelled tree. We first investigate the maximum possible displacement of F_i induced by Operation 2 on ancestors of u that are not δn -nodes (Lemma 4.4.12), at $\delta > 0$ fixed. Then, we show that the way Operation 2 is performed on ancestors that are not δn -nodes does not affect much the colored lamination-valued process. In the finite variance case, it is possible to choose K_n in such a way that, with high probability, Operation 2 is never performed on any δn -node. When $\alpha < 2$, we take $K_n = n$ so that Operation 2 is performed on all vertices, and we prove that this still does not affect much the colored lamination.

Fix $\varepsilon > 0$. Let us fix $\delta \in (0, \varepsilon)$, and define, for T a monotype tree with n vertices and $u \in T$ an εn -node, the δ -maximum possible displacement of u as:

$$MPD_\delta(u, T) = \frac{1}{n} \sum_{v \in A_u^\delta(T)} \sum_{\substack{w \in K_v(T) \\ w \notin A_u(T)}} |\theta_w(T)|,$$

where $A_u^\delta(T)$ denotes the set of ancestors of u in T that are not δn -nodes. Recall that $K_v(T)$ denotes the set of children of v in T , and $A_u(T)$ the set of ancestors of u in T . The quantity $MPD_\delta(u, T)$ takes into account the sizes of the subtrees rooted at children of ancestors of u that are not δn -nodes. See Fig. 4.18 for an example.

Lemma 4.4.12. *Almost surely, jointly with the convergence of Theorem 4.2.2:*

$$\lim_{n \rightarrow \infty} \sup_{\substack{z \in T^\circ(f_n^w) \\ |\theta_z(T^\circ(f_n^w))| \geq \varepsilon n}} MPD_\delta(z, T^\circ(f_n^w)) \xrightarrow[\delta \downarrow 0]{} 0.$$

Note that here, ε is fixed while $\delta < \varepsilon$ goes to 0. Roughly speaking, whether Operation 2 is performed or not on vertices that are not δn -nodes does not impact much the associated colored lamination-valued process, as the locations of large faces do not change much.

Let us immediately check that this indeed implies Lemma 4.4.11 (ii). We prove it in two different ways, depending whether $\alpha < 2$ or ν has finite variance.

Proof of Lemma 4.4.11 (ii) when $\alpha < 2$. In this case, let us take $K_n = n$ for all $n \geq 1$, which corresponds to the worst case in which Operation 2 is performed on each white vertex of $T(f_n^w)$. We prove that doing this does not change much the underlying lamination, and Lemma 4.4.11 (ii) therefore follows by Lemma 4.4.12. Fix $\delta > 0$. The idea is that, roughly speaking, almost all grandchildren of any white δn -node u of $T^\circ(f_n^w)$ have the same black parent, so that there is only one black child of u that is the root of a big subtree. Thus, if this child always keeps its subtree on top of it, the colored lamination does not change much.

To state things properly, fix $q > 0$ and take $u \in T^\circ(f_n^w)$ a white δn -node. Then, by Lemma 4.2.3 (ii), there exists $\eta > 0$ such that, with probability larger than $1 - q$, u has at least $\eta \tilde{B}_n$ white grandchildren in $T(f_n^w)$. On this event, by Lemma 4.3.7, with high probability, there exists $r > 0$ such that all of its white grandchildren, except at most $\tilde{B}_n n^{-r}$ of them, have the same black parent b_u . This implies that, with high probability, the sum of the sizes of

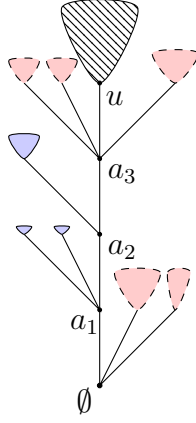

Figure 4.18: A representation of the quantity $MPD_\delta(u, T)$, in a given tree T , for some vertex $u \in T$. The hatched part is $\theta_u(T)$. $MPD_\delta(u, T)$ is the sum of the sizes of the three plain subtrees on the left of the ancestral line of u , divided by $|T|$. Indeed, a_1 and a_2 are elements of $A_u^\delta(T)$. The dashed subtrees are not counted in $MPD_\delta(u, T)$, because they are rooted at children of δn -nodes (namely, \emptyset and a_3).

the subtrees rooted at one of these (at most) $\tilde{B}_n n^{-r}$ grandchildren is $o(n)$. Indeed, for any $K \geq 1$, with high probability the K white grandchildren of u with the largest subtrees on top of them are all children of b_u . Thus, with high probability, shuffling the siblings of b_u in any way does only change the location of the large face corresponding to b_u by a distance $o(n)$. Since there is only a finite number of δn -nodes in $T^\circ(f_n^w)$, by letting q go to 0, the result follows: uniformly for $1 \leq i \leq N^\bullet(T(f_n^w))$, using Lemma 4.4.12:

$$d_H(F_i, F'_i) = o(n).$$

□

Proof of Lemma 4.4.11 (ii) when ν has finite variance. In this case, we exactly follow the proof of [96, Lemma 4.6]. To begin with, let us explain how to choose the sequence $(K_n)_{n \geq 1}$. Note that, by the convergence of the Łukasiewicz path of $T^\circ(f_n^w)$ renormalized by a factor \sqrt{n} (Theorem 4.2.2) towards the normalized Brownian excursion which is almost surely continuous, with high probability the maximum degree of a vertex in the tree is $o(\sqrt{n})$. Furthermore, there are at most δ^{-1} δn -nodes in the tree, which proves that the number $N_{\delta n}(T(f_n^w))$ of children of δn -nodes is $o(\sqrt{n})$ with high probability. Thus, one can choose $(K_n^{(\delta)})_{n \geq 1}$ such that $K_n^{(\delta)} \gg \sqrt{n}$ and $N_{\delta n}(T(f_n^w)) \times K_n^{(\delta)} = o(n)$. Thus, by diagonal extraction, one can choose $(K_n)_{n \geq 1}$ such that $K_n \gg \sqrt{n}$ and, for any $\delta > 0$, $N_{\delta n}(T(f_n^w)) \times K_n = o(n)$. Let us take such a sequence. We prove Lemma 4.4.11 (ii) in two steps. On one hand, K_n is small enough, so that:

$$d_{Sk} \left(\left(\mathbb{L}_{c\tilde{B}_n}^\bullet(T(f_n^w)) \right)_{c \leq K_n/\tilde{B}_n}, \left(\mathbb{L}_{c\tilde{B}_n}^\bullet(T^{(K_n)}(f_n^w)) \right)_{c \leq K_n/\tilde{B}_n} \right) \xrightarrow{\mathbb{P}} 0. \quad (4.25)$$

On the other hand, K_n is large enough, so that:

$$d_{Sk} \left(\left(\mathbb{L}_{c\tilde{B}_n}^\bullet(T(f_n^w)) \right)_{c \in [K_n/\tilde{B}_n, \infty]}, \left(\mathbb{L}_{c\tilde{B}_n}^\bullet(T^{(K_n)}(f_n^w)) \right)_{c \in [K_n/\tilde{B}_n, \infty]} \right) \xrightarrow{\mathbb{P}} 0. \quad (4.26)$$

To show (4.25), we prove that, for any $\delta > 0$ fixed, for this choice of $(K_n)_{n \geq 1}$, with high probability Operation 2 is not performed on any δn -node. For this, let p_n be the probability

that there exists an δn -node of $T^\circ(f_n^w)$ with a child of label $\leq K_n$. Then, conditionally on the values of $N^\bullet(T(f_n^w))$ and $N_{\delta n}(T(f_n^w))$,

$$p_n = 1 - \frac{\binom{N^\bullet(T(f_n^w)) - N_{\delta n}(T(f_n^w))}{K_n}}{\binom{N^\bullet(T(f_n^w))}{K_n}} \leq 1 - \left(1 - \frac{N_{\delta n}(T(f_n^w))}{N^\bullet(T(f_n^w)) - K_n}\right)^{K_n}.$$

Now, by Lemma 4.3.4 and Lemma 4.4.11 (i), with high probability, $N^\bullet(T(f_n^w)) \stackrel{(d)}{=} N^\bullet(\mathcal{T}_n) \geq (1 - \nu_0)n/2$. Thus, with high probability,

$$p_n \leq 1 - \left(1 - \frac{N_{\delta n}(T(f_n^w))}{(1 - \nu_0)n/2 - K_n}\right)^{K_n} \sim \frac{2K_n N_{\delta n}(T(f_n^w))}{(1 - \nu_0)n}$$

which converges in probability to 0. Hence, with high probability Operation 2 is not performed on any δn -node. The faces appearing in the colored lamination-valued processes until time K_n therefore do not code δn -nodes, and (4.25) follows by Lemma 4.4.12.

To prove (4.26), observe that, by Theorem 4.3.6 (i), the red part of $(\mathbb{L}_{K_n}^\bullet(T^{(K_n)}(f_n^w)))_{n \geq 1}$ converges in distribution towards the Brownian triangulation, which is maximum in the set of laminations of the disk. In addition, by (4.25), $d_H(\mathbb{L}_{K_n}^\bullet(T(f_n^w)), \mathbb{L}_{K_n}^\bullet(T^{(K_n)}(f_n^w))) \rightarrow 0$ with high probability as $n \rightarrow \infty$, and both red parts converge to the same Brownian triangulation. Therefore, the only thing that we need to prove is that, for any $\varepsilon > 0$, faces corresponding to the same white εn -node in both white reduced trees have the same color. This is clear, since the fact that the two large subtrees rooted at white grandchildren of a given white vertex have the same black parent or not is not affected by Operation 1 nor by Operation 2. The result follows. \square

We finally prove Lemma 4.4.12:

Proof of Lemma 4.4.12. To study the asymptotic behaviour of $\sup_{u \in T^\circ(f_n^w)} MPD_\delta(u, T^\circ(f_n^w))$, we define the continuous analogue of this quantity on the stable tree $\mathcal{T}^{(\alpha)}$. Recall that $H^{(\alpha)}$ is seen as the contour function of $\mathcal{T}^{(\alpha)}$, in the following sense: there exists a coupling between $\mathcal{T}^{(\alpha)}$ and $H^{(\alpha)}$ such that, if a particle explores the tree starting from its root from left to right as in the discrete case, so that the exploration ends at time 1, then almost surely the distance between the particle and the root as time passes is coded by $H^{(\alpha)}$. Therefore, for any $u \in \mathcal{T}^{(\alpha)}$, one can define the subtree of $\mathcal{T}^{(\alpha)}$ rooted at u , $\theta_u(\mathcal{T}^{(\alpha)})$, as the set of points visited between the first and last visits of u by $H^{(\alpha)}$.

Mimicking the notation of Section 4.2.1, for any $x \in \mathcal{T}^{(\alpha)}$, define $g(x)$ (resp. $d(x)$) the first (resp. last) time at which the vertex x is visited by $H^{(\alpha)}$. Then we simply define the size of the subtree $\theta_u(\mathcal{T}^{(\alpha)})$ as $|\theta_u(\mathcal{T}^{(\alpha)})| = d(u) - g(u)$. In particular, if one denotes by \emptyset the root of $\mathcal{T}^{(\alpha)}$, $|\theta_\emptyset(\mathcal{T}^{(\alpha)})| = 1$.

Let us also define the analogue of δn -nodes in this continuous setting, which we will call δ -nodes of $\mathcal{T}^{(\alpha)}$: for $\delta > 0$, we say that u is a δ -node of $\mathcal{T}^{(\alpha)}$ if there exist $0 \leq a_1(u) < a_2(u) < a_3(u) \leq 1$ such that $H^{(\alpha)}$ visits u at times $a_1(u), a_2(u), a_3(u)$ and in addition $a_3(u) - a_2(u) \geq \delta, a_2(u) - a_1(u) \geq \delta$.

Now, for $\delta > 0$ and $u \in \mathcal{T}^{(\alpha)}$, define $A^\delta(u, \mathcal{T}^{(\alpha)})$ the set of ancestors of u in $\mathcal{T}^{(\alpha)}$ (i.e. elements of the tree that are visited before the first visit of u or after the last visit of u by $H^{(\alpha)}$) that are not δ -nodes. Finally, set:

$$CMPD_\delta(u, \mathcal{T}^{(\alpha)}) := \sum_{v \in A^\delta(u, \mathcal{T}^{(\alpha)})} \tilde{h}_{u,v}(\mathcal{T}^{(\alpha)})$$

where, in words, we define $\tilde{h}_{u,v}$ as follows: removing the vertex v from the tree splits it into several connected components. We sum the sizes of all of these components which do not contain the root of $\mathcal{T}^{(\alpha)}$, nor the vertex u . Rigorously, one can define it as:

$$\tilde{h}_{u,v} := (d(v) - g(v)) - (d_u(v) - g_u(v)),$$

where $g_u(v) = \sup\{s < g(u), H_s^{(\alpha)} = H_{g(v)}^{(\alpha)}\}$, $d_u(v) = \inf\{s > d(u), H_s^{(\alpha)} = H_{g(v)}^{(\alpha)}\}$ are the consecutive times at which $H^{(\alpha)}$ visits v such that u is visited inbetween, corresponding to the branch starting from v that contains u .

Assume by Skorokhod's theorem that the convergence of Theorem 4.2.2, stating that the renormalized white reduced tree $T^\circ(f_n^w)$ converges to $\mathcal{T}^{(\alpha)}$, holds almost surely. Assume that there exists $\eta > 0$ and an increasing extraction $\phi : \mathbb{N}^* \rightarrow \mathbb{N}^*$ such that, for all $n \geq 1$, we can find a vertex $v_n \in T(f_{\phi(n)}^w)$ such that $|\theta_{v_n}(T(f_n^w))| \geq \varepsilon n$, for which $MPD_{1/n}(v_n, T(f_{\phi(n)}^w)) \geq \eta$. Using the fact that $\mathcal{T}^{(\alpha)}$ is compact, up to extraction, v_n converges to some vertex $v_\infty \in \mathcal{T}^{(\alpha)}$ satisfying $|\theta_{v_\infty}(T(f_n^w))| \geq \varepsilon$. v_∞ should in addition satisfy $CMPD_0(v_\infty, \mathcal{T}^{(\alpha)}) \geq \eta$, which is impossible. The result follows.

Notice that the condition that the subtree rooted at the vertex v_n has size at least εn is mandatory. Indeed, otherwise, it may happen that v_n belongs to a 'small' branch of the tree, but converges to a point v_∞ of $\mathcal{T}^{(\alpha)}$ with a large subtree on top of it. \square

Bibliography

- [1] R. Abraham and J.-F. Delmas. Fragmentation associated with Lévy processes using snake. *Probability Theory and Related Fields*, 141(1-2):113–154, 2008.
- [2] R. Abraham and J.-F. Delmas. Local limits of conditioned Galton-Watson trees: the condensation case. *Electron. J. Probab.*, 19:no. 56, 29, 2014.
- [3] R. Abraham and J.-F. Delmas. Local limits of conditioned Galton-Watson trees: the infinite spine case. *Electron. J. Probab.*, 19:no. 2, 19, 2014.
- [4] R. Abraham, J.-F. Delmas, and G. Voisin. Pruning a Lévy continuum random tree. *Electron. J. Probab.*, 15:1429–1473, 2010.
- [5] R. Abraham and L. Serlet. Poisson snake and fragmentation. *Electron. J. Probab.*, 7, 2002.
- [6] L. Addario-Berry. A probabilistic approach to block sizes in random maps. *ALEA*, 16:1–13, 2019.
- [7] D. Aldous. The continuum random tree. I. *Ann. Probab.*, 19(1):1–28, 1991.
- [8] D. Aldous. The continuum random tree. II. An overview. In *Stochastic analysis (Durham, 1990)*, volume 167 of *London Math. Soc. Lecture Note Ser.*, pages 23–70. Cambridge Univ. Press, Cambridge, 1991.
- [9] D. Aldous. The continuum random tree. III. *Ann. Probab.*, 21(1):248–289, 1993.
- [10] D. Aldous. Recursive self-similarity for random trees, random triangulations and Brownian excursion. *Ann. Probab.*, pages 527–545, 1994.
- [11] D. Aldous. Triangulating the circle, at random. *Amer. Math. Monthly*, 101:223–233, 1994.
- [12] D. Aldous. Brownian excursions, critical random graphs and the multiplicative coalescent. *Ann. Probab.*, pages 812–854, 1997.
- [13] D. Aldous and V. Limic. The entrance boundary of the multiplicative coalescent. *Electron. J. Probab.*, 3(3):59, 1998.
- [14] D. Aldous and J. Pitman. The standard additive coalescent. *Ann. Probab.*, pages 1703–1726, 1998.
- [15] O. Angel, A. E. Holroyd, D. Romik, and B. Virág. Random sorting networks. *Adv. Math.*, 215(2):839–868, 2007.

- [16] I. Armendáriz and M. Loulakis. Conditional distribution of heavy tailed random variables on large deviations of their sum. *Stochastic Process. Appl.*, 121(5):1138–1147, 2011.
- [17] S. Athreya, W. Löhr, and A. Winter. Invariance principle for variable speed random walks on trees. *Ann. Probab.*, 45(2):625–667, 2017.
- [18] J. Bertoin. A fragmentation process connected to Brownian motion. *Probab. Theory Related Fields*, 117(2):289–301, 2000.
- [19] J. Bertoin. *Random Fragmentation and Coagulation Processes*. Cambridge Studies in Advanced Mathematics. Cambridge University Press, 2006.
- [20] J. Bertoin. Asymptotic regimes for the partition into colonies of a branching process with emigration. *Ann. Appl. Probab.*, 20(6):1967–1988, 2010.
- [21] J. Bertoin. A limit theorem for trees of alleles in branching processes with rare neutral mutations. *Stochastic Process. Appl.*, 120(5):678–697, 2010.
- [22] J. Bettinelli. Convergence of uniform noncrossing partitions toward the Brownian triangulation. In *30th International Conference on Formal Power Series and Algebraic Combinatorics (FPSAC 2018)*, volume 80B of *Sém. Lothar. Combin.*, pages Art. 38, 1–12. 2018.
- [23] P. Biane. Minimal factorizations of a cycle and central multiplicative functions on the infinite symmetric group. *J. Combin. Theory Ser. A*, 76(2):197–212, 1996.
- [24] P. Biane and M. Josuat-Vergès. Minimal factorizations of a cycle: a multivariate generating function. In *28th International Conference on Formal Power Series and Algebraic Combinatorics (FPSAC 2016)*, DMTCS Proc. BC, pages 239–250. 2016.
- [25] P. Billingsley. Convergence of probability measures, first edition. *Wiley, New-York*, 1968.
- [26] N. H. Bingham, C. M. Goldie, and J. L. Teugels. *Regular variation*, volume 27. Cambridge university press, 1989.
- [27] J. E. Björnberg and S. Ö. Stefánsson. Random walk on random infinite looptrees. *J. Stat. Phys.*, 158(6):1234–1261, 2015.
- [28] F. Bonahon. Geodesic laminations on surfaces. In *Laminations and foliations in dynamics, geometry and topology (Stony Brook, NY, 1998)*, volume 269 of *Contemp. Math.*, pages 1–37. Amer. Math. Soc., Providence, RI, 2001.
- [29] J. Bouttier, P. Di Francesco, and E. Guitter. Planar maps as labeled mobiles. *Electron. J. Combin.*, 11(1):R69, 2004.
- [30] D. Burago, Y. Burago, and S. Ivanov. *A course in metric geometry*, volume 33. American Mathematical Soc., 2001.
- [31] P. Chassaing and G. Louchard. Phase transition for parking blocks, Brownian excursion and coalescence. *Random Structures Algorithms*, 21(1):76–119, 2002.
- [32] L. Chaumont and G. U. Bravo. Markovian bridges: weak continuity and pathwise constructions. *Ann. Probab.*, 39(2):609–647, 2011.

- [33] N. Curien and I. Kortchemski. Random non-crossing plane configurations: a conditioned Galton-Watson tree approach. *Random Structures Algorithms*, 45(2):236–260, 2014.
- [34] N. Curien and J.-F. Le Gall. Random recursive triangulations of the disk via fragmentation theory. *Ann. Probab.*, 39(6):2224–2270, 2011.
- [35] N. Curien and W. Werner. The Markovian hyperbolic triangulation. *J. Eur. Math. Soc.*, 15(4):1309–1341, 2013.
- [36] D. Dauvergne. The Archimedean limit of random sorting networks. *arXiv preprint arXiv:1802.08934*, 2019.
- [37] J. Dénes. The representation of a permutation as the product of a minimal number of transpositions and its connection with the theory of graphs. *Publ. Math. Inst. Hungar. Acad. Sci.*, 4:63–70, 1959.
- [38] R. Doney. A bivariate local limit theorem. *J. Multivariate Anal.*, 36(1):95–102, 1991.
- [39] R. R. Du and F. Liu. Factorizations of cycles and multi-noded rooted trees. *Graphs Combin.*, 31(3):551–575, 2015.
- [40] T. Duquesne. A limit theorem for the contour process of conditioned Galton-Watson trees. *Ann. Probab.*, 31(2):996–1027, 2003.
- [41] T. Duquesne. An elementary proof of Hawkes’s conjecture on Galton-Watson trees. *Electron. Commun. Probab.*, 14:151–164, 2009.
- [42] T. Duquesne and J.-F. Le Gall. *Random Trees, Lévy Processes and Spatial Branching Processes*. 2002.
- [43] S. N. Evans and J. Pitman. Stationary Markov processes related to stable Ornstein–Uhlenbeck processes and the additive coalescent. *Stochastic Process. Appl.*, 77(2):175–185, 1998.
- [44] W. Feller. *An introduction to probability theory and its applications*, volume 2. John Wiley & Sons, 2008.
- [45] V. Féray and I. Kortchemski. The geometry of random minimal factorizations of a long cycle via biconditioned bitype random trees. *Ann. H. Lebesgue*, 1:149–226, 2018.
- [46] V. Féray and I. Kortchemski. Trajectories in random minimal transposition factorizations. *ALEA Lat. Am. J. Probab. Math. Stat.*, 16:759, 01 2019.
- [47] P. Flajolet and R. Sedgewick. *Analytic combinatorics*. Cambridge University Press, Cambridge, 2009.
- [48] I. Goulden and S. Pepper. Labelled trees and factorizations of a cycle into transpositions. *Discrete Math.*, 113(1-3):263–268, 1993.
- [49] I. Goulden and A. Yong. Tree-like properties of cycle factorizations. *J. Combin. Theory Ser. A*, 98(1):106–117, 2002.
- [50] M. G. Hahn and M. J. Klass. Matrix normalization of sums of random vectors in the domain of attraction of the multivariate normal. *Ann. Probab.*, pages 262–280, 1980.

- [51] T. E. Harris. First passage and recurrence distributions. *Trans. Amer. Math. Soc.*, 73(3):471–486, 1952.
- [52] I. A. Ibragimov and Y. V. Linnik. *Independent and stationary sequences of random variables*. Wolters-Noordhoff Publishing, Groningen, 1971. With a supplementary chapter by I. A. Ibragimov and V. V. Petrov, Translation from the Russian edited by J. F. C. Kingman.
- [53] J. Jacod and A. N. Shiryaev. *Limit theorems for stochastic processes*, volume 288 of *Grundlehren der Mathematischen Wissenschaften [Fundamental Principles of Mathematical Sciences]*. Springer-Verlag, Berlin, second edition, 2003.
- [54] S. Janson. Stable distributions. *arXiv preprint arXiv:1112.0220*, 2011.
- [55] S. Janson. Simply generated trees, conditioned Galton–Watson trees, random allocations and condensation. *Probab. Surv.*, 9:103–252, 2012.
- [56] S. Janson. Asymptotic normality of fringe subtrees and additive functionals in conditioned Galton-Watson trees. *Random Structures Algorithms*, 48(1):57–101, 2016.
- [57] O. Kallenberg. Splitting at backward times in regenerative sets. *Ann. Probab.*, 9(5):781–799, 1981.
- [58] O. Kallenberg. *Foundations of Modern Probability*. 2002.
- [59] D. P. Kennedy. The Galton-Watson process conditioned on the total progeny. *J. Appl. Probab.*, 12(4):800–806, 1975.
- [60] H. Kesten. Subdiffusive behavior of random walk on a random cluster. *Ann. Inst. H. Poincaré Probab. Statist.*, 22(4):425–487, 1986.
- [61] J. F. C. Kingman. The coalescent. *Stochastic Process. Appl.*, 13(3):235–248, 1982.
- [62] V. F. Kolchin. *Random mappings*. Translation Series in Mathematics and Engineering. Optimization Software, Inc., Publications Division, New York, 1986. Translated from the Russian, With a foreword by S. R. S. Varadhan.
- [63] I. Kortchemski. Invariance principles for Galton–Watson trees conditioned on the number of leaves. *Stochastic Process. Appl.*, 122(9):3126–3172, 2012.
- [64] I. Kortchemski. Random stable laminations of the disk. *Ann. Probab.*, 42(2):725–759, 2014.
- [65] I. Kortchemski. Limit theorems for conditioned non-generic Galton-Watson trees. *Ann. Inst. Henri Poincaré Probab. Stat.*, 51(2):489–511, 2015.
- [66] I. Kortchemski and C. Marzouk. Triangulating stable laminations. *Electron. J. Probab.*, 21, 2016.
- [67] I. Kortchemski and C. Marzouk. Simply generated non-crossing partitions. *Combin. Probab. Comput.*, 26(4):560–592, 2017.
- [68] A. E. Kyprianou. *Introductory lectures on fluctuations of Lévy processes with applications*. Springer Science & Business Media, 2006.

- [69] J.-M. Labarbe and J.-F. Marckert. Asymptotics of Bernoulli random walks, bridges, excursions and meanders with a given number of peaks. *Electron. J. Probab.*, 12:no. 9, 229–261, 2007.
- [70] J.-F. Le Gall. Random trees and applications. *Probab. Surv.*, 2:245–311, 2005.
- [71] J.-F. Le Gall. Random real trees. In *Ann. Fac. Sci. Toulouse Math.*, volume 15, pages 35–62, 2006.
- [72] J.-F. Le Gall. Uniqueness and universality of the Brownian map. *Ann. Probab.*, 41(4):2880–2960, 2013.
- [73] J.-F. Le Gall and Y. Le Jan. Branching processes in Lévy processes: the exploration process. *Ann. Probab.*, 26(1):213–252, 1998.
- [74] J.-F. Le Gall and G. Miermont. On the scaling limit of random planar maps with large faces. In *XVIIth International Congress On Mathematical Physics: (With DVD-ROM)*, pages 470–474. World Scientific, 2010.
- [75] J.-F. Le Gall and F. Paulin. Scaling limits of bipartite planar maps are homeomorphic to the 2-sphere. *Geom. Funct. Anal.*, 18(3):893–918, 2008.
- [76] R. Lyons, R. Pemantle, and Y. Peres. Conceptual proofs of $L \log L$ criteria for mean behavior of branching processes. *Ann. Probab.*, 23(3):1125–1138, 1995.
- [77] J.-F. Marckert and A. Mokkadem. The depth first processes of Galton-Watson trees converge to the same Brownian excursion. *Ann. Probab.*, 31(3):1655–1678, 2003.
- [78] J.-F. Marckert and A. Mokkadem. Ladder variables, internal structure of Galton-Watson trees and finite branching random walks. *J. Appl. Probab.*, 40(3):671–689, 2003.
- [79] J.-F. Marckert and M. Wang. A new combinatorial representation of the additive coalescent. *Random Structures Algorithms*, 54(2):340–370, 2019.
- [80] A. Meir and J. W. Moon. On the altitude of nodes in random trees. *Canad. J. Math.*, 30(5):997–1015, 1978.
- [81] G. Miermont. Ordered additive coalescent and fragmentations associated to Lévy processes with no positive jumps. *Electron. J. Probab.*, 6, 2001.
- [82] G. Miermont. Self-similar fragmentations derived from the stable tree I. *Probab. Theory Related Fields*, 127(3):423–454, 2003.
- [83] G. Miermont. Self-similar fragmentations derived from the stable tree II: splitting at nodes. *Probab. Theory Related Fields*, 131(3):341–375, 2005.
- [84] G. Miermont. The Brownian map is the scaling limit of uniform random plane quadrangulations. *Acta Math.*, 210(2):319–401, 2013.
- [85] N. Minami. On the number of vertices with a given degree in a Galton-Watson tree. *Adv. in Appl. Probab.*, 37(1):229–264, 2005.
- [86] P. Moszkowski. A solution to a problem of Dénes: a bijection between trees and factorizations of cyclic permutations. *European J. Combin.*, 10(1):13–16, 1989.

-
- [87] J. Neveu. Arbres et processus de Galton-Watson. *Ann. Inst. H. Poincaré Probab. Statist.*, 22(2):199–207, 1986.
- [88] J. Pitman. Combinatorial stochastic processes. Technical report, Technical Report 621, Dept. Statistics, UC Berkeley, 2002. Lecture notes for St. Flour course, 2002.
- [89] S. Resnick and P. Greenwood. A bivariate stable characterization and domains of attraction. *J. Multivariate Anal.*, 9(2):206–221, 1979.
- [90] D. Revuz and M. Yor. *Continuous martingales and Brownian motion*, volume 293 of *Grundlehren der Mathematischen Wissenschaften [Fundamental Principles of Mathematical Sciences]*. Springer-Verlag, Berlin, third edition, 1999.
- [91] D. Rizzolo. Scaling limits of Markov branching trees and Galton-Watson trees conditioned on the number of vertices with out-degree in a given set. *Ann. Inst. Henri Poincaré Probab. Stat.*, 51(2):512–532, 2015.
- [92] E. Rvaceva. On domains of attraction of multi-dimensional distributions. *Select. Transl. Math. Statist. and Probability*, 2:183–205, 1961.
- [93] Q. Shi. On the number of large triangles in the Brownian triangulation and fragmentation processes. *Stochastic Process. Appl.*, 125(11):4321–4350, 2015.
- [94] R. Slack. A branching process with mean one and possibly infinite variance. *Probab. Theory Related Fields*, 9(2):139–145, 1968.
- [95] P. Thévenin. Vertices with fixed outdegrees in large Galton-Watson trees. *arXiv preprint arXiv:1812.07365, accepted in Electron. J. Probab.*, 2018.
- [96] P. Thévenin. A geometric representation of fragmentation processes on stable trees. *arXiv preprint arXiv:1910.04508*, 2019.
- [97] P. Thévenin. Random stable type minimal factorizations of the n -cycle. *arXiv preprint arXiv:2002.12027*, 2020.
- [98] D. Tokarev. Growth of integral transforms and extinction in critical Galton-Watson processes. *J. Appl. Probab.*, 45(2):472–480, 2008.
- [99] W. Vervaat. A relation between Brownian bridge and Brownian excursion. *Ann. Probab.*, 7(1):143–149, 1979.
- [100] G. Voisin. Dislocation measure of the fragmentation of a general Lévy tree. *ESAIM Probab. Stat.*, 15:372–389, 2011.

Titre : Arbres, laminations du disque et factorisations aléatoires

Mots clés : arbres, laminations, factorisations, processus de fragmentation

Résumé : Cette thèse est consacrée à l'étude des propriétés asymptotiques de grands objets combinatoires aléatoires. Trois familles d'objets sont au centre des travaux présentés ici : les arbres, les factorisations de permutations et les configurations de cordes non croisées du disque (aussi appelées laminations). Dans un premier temps, nous nous intéressons spécifiquement au nombre de sommets de degré fixé dans des arbres de Galton-Watson que l'on a conditionnés de différentes façons, comme par exemple par leur nombre de sommets de degré pair ou leur nombre de feuilles. Lorsque la loi de reproduction de l'arbre est critique et dans le domaine d'attraction d'une loi stable, nous montrons notamment la normalité asymptotique de ces quantités. Nous nous intéressons également à la répartition de ces sommets de degré fixé dans l'arbre, lorsqu'on explore celui-ci de gauche à droite.

Dans un second temps, nous considérons des configurations de cordes du disque unité qui ne se coupent pas, et montrons que l'on peut coder un

arbre de manière naturelle par une telle configuration. Nous définissons en particulier une suite croissante de laminations codant une fragmentation d'un arbre donné, c'est-à-dire une manière de découper cet arbre en des points choisis aléatoirement. Ce point de vue géométrique nous permet ensuite d'étudier les propriétés d'une factorisation du cycle $(12 \cdots n)$ en un produit de $n - 1$ transpositions, choisie uniformément au hasard, en la codant dans le disque par une lamination aléatoire et en remarquant un lien entre ce modèle et un arbre de Galton-Watson conditionné par son nombre total de sommets. Enfin, dans une dernière partie, nous présentons une généralisation de ces résultats à des factorisations aléatoires de ce même cycle, qui ne sont plus nécessairement en produits de transpositions mais peuvent faire intervenir des cycles de longueurs plus grandes. Nous mettons de cette façon en lumière un lien entre des arbres de Galton-Watson conditionnés, les factorisations de grandes permutations et la théorie des fragmentations.

Title : Random trees, laminations of the disk and factorizations

Keywords : trees, laminations, factorizations, fragmentation processes

Abstract : This work is devoted to the study of asymptotic properties of large random combinatorial structures. Three particular structures are the main objects of our interest: trees, factorizations of permutations and configurations of noncrossing chords in the unit disk (or laminations).

First, we are specifically interested in the number of vertices with fixed degree in Galton-Watson trees that are conditioned in different ways, for example by their number of vertices with even degree, or by their number of leaves. When the offspring distribution of the tree is critical and in the domain of attraction of a stable law, we notably prove the asymptotic normality of these quantities. We are also interested in the spread of these vertices with fixed degree in the tree, when one explores it from left to right.

Then, we consider configurations of chords that do not cross in the unit disk. Such configurations nota-

bly code trees in a natural way. We define in particular a nondecreasing sequence of laminations coding a fragmentation of a given tree, that is, a way of cutting this tree at points chosen randomly. This geometric point of view then allows us to study some properties of a factorization of the cycle $(12 \cdots n)$ as a product of $n - 1$ transpositions, chosen uniformly at random, by coding it in the disk by a random lamination and remarking a connection between this model and a Galton-Watson tree conditioned by its total number of vertices. Finally, we present a generalization of these results to random factorizations of the same cycle, that are not necessarily as a product of transpositions anymore, but may involve cycles of larger lengths. We highlight this way a connection between some conditioned Galton-Watson trees, factorizations of large permutations and the theory of fragmentations.