



HAL
open science

Impact des changements climatiques sur la répartition et la diversité génétique des serpents Iraniens, implications pour la conservation

Atefeh Asadi

► To cite this version:

Atefeh Asadi. Impact des changements climatiques sur la répartition et la diversité génétique des serpents Iraniens, implications pour la conservation. Milieux et Changements globaux. Université Paris sciences et lettres, 2020. Français. NNT : 2020UPSLP021 . tel-02928975

HAL Id: tel-02928975

<https://theses.hal.science/tel-02928975v1>

Submitted on 3 Sep 2020

HAL is a multi-disciplinary open access archive for the deposit and dissemination of scientific research documents, whether they are published or not. The documents may come from teaching and research institutions in France or abroad, or from public or private research centers.

L'archive ouverte pluridisciplinaire **HAL**, est destinée au dépôt et à la diffusion de documents scientifiques de niveau recherche, publiés ou non, émanant des établissements d'enseignement et de recherche français ou étrangers, des laboratoires publics ou privés.



THÈSE DE DOCTORAT

DE L'UNIVERSITÉ PSL

Préparée à l'École Pratique des Hautes Études

**Impact des changements climatiques sur la répartition et
la diversité génétique des serpents Iraniens,
Implications pour la conservation**

Soutenue par

Atefeh ASADI

28/05/2020

École doctorale n° 472

**École doctorale de l'École
Pratique des Hautes Études**

Spécialité

**Biodiversité, Génétique et
Évolution**

Composition du jury :

Sophie MONTUIRE Directrice d'Études, EPHE	<i>Président</i>
Annie GUILLER Professeure, Université de Picardie	<i>Rapporteur</i>
Christophe THÉBAUD Professeur, Université de Toulouse	<i>Rapporteur</i>
Pierre-André CROCHET Directeur de Recherche, CNRS	<i>Examineur</i>
Claudine MONTGELARD Maitre de Conférences, EPHE	<i>Directeur de thèse</i>
Jean-Yves BARNAGAUD Maitre de Conférences, EPHE	<i>Co-encadrant de thèse</i>
Mohammad KABOLI Professeur, Université de Téhéran, Iran	<i>Co-encadrant de thèse</i>



Acknowledgments

First and foremost, I am immensely grateful to Claudine Montgelard, my supervisor who has always been by my side and has been the best supervisor I could ever ask for. Ever since she accepted me as a student, she has answered my questions with enthusiasm and relentless patience with her vast knowledge in genetics. I am also immensely grateful for her generosity and for all the efforts she made to help me solve the many practical problems that I encountered during my stay.

I am also indebted to my co-supervisor Jean-Yves Barnagaud for expanding my perspectives on research, and on science in general. Thanks to him I can now have a renewed vision of my field of research. Jean-Yves has played a great role in the evolution of my understanding of the scientific research processes.

In my journey towards this degree, I owe a special debt to Mohammad Kaboli. During my education, from the days of my master's program to the present day, he provided me with the best solutions in moments of doubt, both as a professor and as an older brother. I certainly owe my success to him and his attentive guidance.

I have great pleasure in acknowledging my gratitude to Christophe Thebaud and Annie Guiller, who honored me by agreeing to serve as “rapporteurs” in my thesis defense committee. I am appreciative of Sophie Montuire and Pierre-André Crochet for agreeing to join my thesis committee and enriching my work with their experience.

I am also very grateful to all members of the EPHE team “Biogéographie et Ecologie des Vertébrés”, notably: Veronique Arnal for kindly and patiently dealing with my inexperience in the laboratory; Philippe Geniez for his advices and for sharing with me his vast knowledge of the Palearctic snakes: he has taught me valuable lessons; Claude Miaud for his precious help and assistance during my stay; and Roger Prodon for his kind support in the final steps of my thesis.

The administration of the EPHE (la 3^{ième} section, le Fonds de Solidarité et d'Initiatives Etudiantes, la Direction des Relations Internationales) deserves special recognition for their financial supports, without whose help I would not have been able to complete my work.

My friends in France and at the CEFÉ made my life tolerable in the absence of my family thanks to their moral support, especially Pauline and Coline who comforted and guided me throughout

my time in France. Parvin, Gilles, Mitra, Mozhdeh, Mahshad, and Sharareh became my family. We always will remember beautiful moments together in France.

This work would not have come to fruition without the help of those who assisted me during field sampling. As such, I take pride in acknowledging Sara, Roya, and Shiva, who never left my side during sampling trips and, despite the challenges, made sampling a pleasant work. I believe those moments will be among my best memories in life. I would also thank Alireza Mohammadi, Kamran Almasieh, Roozbeh Behrooz, and Amin Salmanian for their kind help with sampling.

I owe a debt of gratitude to my colleagues Masoud Nazarizadeh and Mohsen Ahmadi for their substantial help with the analyses, and Faezeh Fatemizadeh for her valuable assistance with the thesis.

This work would not have been possible without the help and support of the Department of Environment of Iran. I would like to acknowledge the efforts made by Mr. Teymouri, Mr. Dadashi, and Mrs. Asgharzadeh for facilitating the administrative processes and their constant support. Alireza Naderi shared with me his experience with sampling and kindly made his personal collection available to me.

I met many wonderful people during sampling, including the personnel of the Department of Environment and the local people. I thank them from the bottom of my heart for teaching me humanity with their disinterest help and experience:

From Golestan Province: Dr.Kammi Mr. Kheir·Abadi, Ghorbanzadeh, Ghorbanpour, Madadi, Najjari, Ebrahimi, Atabay, Soufi and Nouri.

From Khorasan province: Mr. Khani, Temouri, Taherian, Azimpour, Dehghan, Jafari, Shekarian, Taghdisi, Aramanesh, Sadeghi, Ramezani, Ershadi and Valizadeh.

From Kordestan province: Mr. Veysi, Sadeghi, Aref, Sarshar·Asad and Safrang.

From Kermanshah province: Mr. Haseliyeh, Esmaeili, Basati, Shekariyan, Maleki and Mrs. Esmaeili.

From Ilam province: Mr. Borji, Sahrae, Yadegari, Mohammadzadeh, Azizpour.

From Fars province: Mrs. Javadi and Karimi and Mr. Abbasi, Adllo, Alipour, Ansari, Arandi, Ebrahimi, Fereydoni, Froughi, Hadadi, Houshmand, Khodami, Khodaparast, Mirahmadi, Mansour, Moradi, Najafi, Rafiei, Tavakoli, Jafari, Pouladchang, Nejati, Keshavarz, Rezaei, Farnam and Delkhasteh.

From Gilan province: Mr. Dr. Mohammadpour, Alinezhad, Babaei, Esteghlaltalab, Ghorbani, Heidari, Moghadam, Mohammadi, Mohammdpour, Monfared, Nikfar, Rahbar, Raeisi, Zeraati and Ehterami.

From Hamedan Province: Mr Arabi and Mohammadi.

From Esfahan province: Mr. Akbari.

From Uroumiye: Mr yousefi.

From Tehran province: Nahidifar, Akbari, Mirghazanfari, Kamali, Dr Naderi and Mr Moradi.

Lastly, I would like to express my most sincere thanks to my family. Even though my father is no longer with us, his memory and blessings have been and will always be with us. Words fail to describe my gratitude for my mother; she and my father will forever be the guiding lights in my life. I give thanks to my brother, Jalil, and my sisters, Afsaneh, Moloud, and Neda. All my accomplishments have been made possible with their support. I owe my whole life to the presence and support of my family; not being near them has been the hardest part of the last few years.

تقدیر و تشکر

خدا را شاکرم که این مسیر شگفت را به پایان رساندم.

ابتدا اولین شکر و قدردانی خود را از استاد راهنمای اولم خانم دکتر کلودین نثرلارد ابراز میدارم که به عنوان بهترین راهنما همواره در کنار من بوده اند از همان روزهای نخست که من را به عنوان دانشجوی پذیرفته و در طول این چند سال همواره در همه حال با روی گشاده و پر انرژی پاسخگوی تمامی سوالات من بوده و مرا همراهی کردند و در هر شرایطی تجربیات خودشان را در رابطه با ژنیک با من به اشتراک گذاشتند.

پس از استاد راهنمای دوم آقای دکتر جانو برناکود شکر میکنم که با صبر و بردباری زیادی در پیچه نگاه من را به تحقیقات و علم و پژوهش تغییر دادند تا بتوانم دید وسیع تری در این زمینه داشته باشم در واقع ایشان نقش بسزایی در تکمیل علم من درباره تحقیق و پژوهش داشته اند.

شکر و سپاس ویژه ای را عمیقاً از آقای دکتر محمد کابلی دارم که همواره در تمامی مراحل تحصیلی از فوق لیسانس تا به امروز تنها به عنوان یک استاد راهنمای تحصیلی بلکه به عنوان یک برادر بزرگ در لحظه های تردید راه دست زنگی بهترین راهکار را در اختیارم گذاشتند به جرأت میگویم که تمام موفقیت‌های امروزم را مدیون حضور ایشان هستم در ادامه بی اندازه از بیست داوران رساله می‌نویسم و همچنین اعضا و گروه دانشگاه EPHE و همچنین CNRS شکر میکنم که با حمایت مالی و معنوی آنها توانستم به بهترین حالت ممکن تحصیل خود را به اتمام برسانم.

باید اعتراف کنم که بدون حضور همه دوستانم در فرانسه و موندن و تحمل کردن دوری از خانواده‌ام برایم آسان نبود چرا که همیشه حمایت‌های معنوی این عزیزان قوت قلب بود خصوصاً از پروین، ژیل، میتر، مرده، مهاد و شراره که به عنوان خانواده‌ی فرانسویم همیشه در کنارم بودن و صفحات زیبایی را برای من در فرانسه ساختن. البته هیچ‌کدام بدون کمک‌های دوستان خوبم در مسیر نمونه برداریم میسر نمیشد.

به این خاطر یک شکر خیلی خیلی ویژه دارم از سارا و رویا و شیوا که هیچ وقت در سفرهایم من رو تنها نگذاشتن و با صبر زیاد تمام سختی‌های نمونه برداری رو برای من شیرین و خاطره انگیز کردند و میتوانم بگویم بهترین خاطرات زندگی‌م رو به اتفاق ساختیم.

پس از همه‌کسانم که به من برای انجام این ترک‌های زیادی کردن از آقای مسعود نظری که همیشه در انجام آنالیزها کمک کردند و همیشه آماده به کمک بودند همچنین از آقای محسن احمدی که تجربیات خودش رو در آنالیزها با من به اشتراک گذاشتند و همچنین خانم فائزه غاطمی زاده که در نوشتن تز به من کمک بسیار زیادی نمودند. از آقایان علیرضا محمدی، کامران الماسی، روزبه بهروز و امین سلیمان که در برخی نمونه برداریم‌ها کمک زیادی به من کردند قدردانی میکنم.

بدون کمک و حمایت سازمان حفاظت محیط زیست هیچ‌کدام از مطالعات من عملی نمیشد از این رو از همه کارکنان سازمان بخصوص آقای مهندس تیموری، آقای مهندس داداشی و خانم دکتر اصغر زاده شکر فراوان دارم که روزها کارهای اداری رو برای من آسان تر کردند و همواره من رو حمایت کردند همچنین جناب آقای علیرضا نادری که هم از تجربیات نمونه برداریشان من رو بی‌نیصیب نگذاشتند و هم اینکه نمونه‌های گلگیوشان رو در اختیار من قرار دادند.

در طول نمون برداری من با انسان های خیلی شریفی اعم از پرسنل ادارات محیط زیست و همچنین مردم معربان بومی آشنا شدم که در اینجا فرصتی دارم و سعی کردم که به تک تک نام آنها اشاره کنم و صمیمانه از آنها تشکر کنم چرا که کمک ها و تجربیات آنها در طول نمون برداری و سفر با من بی نهایت انسانیت را آموخت.

از استان گلستان آقایان خیر آبادی، قربانزاده، قربانپور، مددی، نجاری، ابراهیمی، عطابابی، صوفی، نوری

از استان خراسان خانی، تیموری، طاهریان، عظیم پور، دهبقان، جعفری، شگدیان، تقدیسی، ارانش، صادقی، رمضان، ارشادی، ولینزاده، دکتری.

از استان کردستان آقایان ویسی، صادقی، عارف، سرشار، سرفرنگ.

از استان کرمانشاه آقایان حاصلیه، اسماعیلی، بساطی، سگدیان، ملکی و خانم اسماعیلی.

از استان ایلام آقایان برجی، صحرایی، یادگاری، محمدزاده، عزیزپور

از استان لرستان آقایان، زیرنکیا، امیری، گودرزی، زالقی، رحیمی، نیک آبادی، بطامی، نیازی.

از استان فارس خانم جوادی و کریبی و آقایان عباسی، عدلو، علیپور، انصاری، آرنزی، ابراهیمی، فریدونی، فروقی، حدادی، هوشمندی، خدای، خداپرست، میراحمدی،

منصور، مرادی، نجفی، رفیعی، توکلی، جعفری، پولادچنگ، نجفی، کشاورز، رضایی، فرنام و دمنخته.

از استان کیلان آقایان دکتر محمد پور ریس اداره کل کیلان، علیشیراز، بابایی، استقلال طلب، قربانی، حیدری، مقدم، محمدی، محمدپور، منقر، نیکفر، رهبر، سعیدی، زراعتی،

احترامی.

از استان مازندران آقایان ابراهیمی ریس اداره کل مازندران، یکنکشی، خرمن، احمدی، عارف، اصغری، مقدس، موسوی، سلطانی.

از استان همدان آقایان عربی و محمدی.

از استان اصفهان آقای اکبری.

از استان آذربایجان غربی آقای یوسفی.

از استان تهران، آقایان ناهیدی فر، اکبری، عصمتی، کجالی، دکتر نادری، مرادی.

و اما در بیشترین و صمیمانه ترین شکراتم رو باعث تقدیم خانواده ام میکنم پدرم که سالهاست دکترم نیست و یادش همیشه در ذهن ما بوده و خواهد ماند مادرم که نمیتوانم با هیچ زبانی پاغلوئی محبت هایش باشم چرا که خورشید زندگی من هستند و همیشه و همیشه مثل نور در زندگی من خواهند تابید از یگانه برادرم جلیل و خواهرانم امانه، مولود، مذا که بدون حمایت هاشون بچوقت نتوانستم قدم از قدم بردارم مینهایت پاسگزارم میخواهم همه خانوادم بدانند که من تمام زندگیم را میون حضور و محبت های آنها، تم و خوب میدانند که دوری از آنها برای من در این مدت سخت ترین کار دنیا بوده است.

I dedicate this thesis to Dr. Mohammad Kaboli. It is my hope to have been able to repay some of his kindness and concern for my education and research experience, while acknowledging the efforts of those who have been guiding lights in my academic life and those who have changed my perspective on life.

این پایان نامه تقدیم می شود به:

استاد گرانقدر دکتر محمد کابلی

به پاس قدردانی از زحماتش که همیشه به عنوان یک فانوس در مسیر زندگی علمی من پیشرو بوده و دیدگاهم را به زندگی تغییر دادند تا شاید بتوانم جبران بخش کوچکی از زحمات و محبت و پیکرهایشان را در قبال تحصیل و تجربه پژوهشی خود کرده باشم.

Table of Contents

Chapter1: Introduction	1
1.1.Impacts of climate change on global biodiversity.....	2
1.2.The challenges of biodiversity knowledge shortfalls.....	6
1.2.1. The Wallacean shortfalls: unknown species' distributions.....	7
1.2.2. The Darwinian shortfalls: unknown evolutionary patterns.....	7
1.2.3. The Linnean shortfall: unknown species' taxonomy.....	8
1.2.4. The Hutchinsonian shortfall: unknown about the responses and tolerances of species to abiotic conditions	9
1.3.Evaluating conservation and dealing with the knowledge shortfalls.....	10
1.3.1. The fundamental taxonomic units of conservation biogeography.....	11
1.3.2. Species distributions: Improving models, simulations and forecasts	14
1.4.A major shortfall in Western Palearctic knowledge: Iran and the Iranian reptiles.....	17
1.4.1. Our understanding of reptiles in the face of shortfalls.....	19
1.4.2. Conserving reptiles facing climate change.....	20
1.5.Outline and aims of this thesis.....	23
References.....	25
• Chapter 2: Presentation of Iran and effects of historical events on Iranian biodiversity	35
Résumé en français	36
Tectonic evolution of the Iranian plate.....	37
2.1.Physical geography of Iranian Plateau.....	41
2.2.Impact of Quaternary climate change.....	43
2.3.Diversity of Iranian snakes in ecological units.....	45
2.4.Behavioral patterns of mountains snakes.....	49
2.5.Selection of studied snakes.....	50
References.....	52
• Chapitre 3 : Phylogénie et phylogéographie comparative de trois serpents Iraniens	56
3.1.Introduction.....	57
3.1.1. Les taxons étudiés	58
3.1.2. Echantillonnage des trois espèces.....	61
3.1.3. Amplification par PCR et séquençage des gènes étudiés.....	63

3.2. Evolutionary history and postglacial colonization of an Asian pit viper (<i>Gloydius halys caucasicus</i>) into Transcaucasia revealed by phylogenetic and phylogeographic analyses.....	65
3.3. Phylogéographie et histoire évolutive de <i>Natrix tessellata</i> et <i>Hemorrhoids ravergeri</i>	84
3.3.1. Méthodes analytiques.....	84
Données de séquences	84
Reconstruction phylogénétique.....	87
Réseau d'haplotypes.....	87
Estimation des temps de divergence	88
Evaluation des tendances démographiques	90
Analyses biogéographiques.....	90
3.2.1. Résultats.....	92
Reconstruction phylogénétique et phylogéographique	92
Analyses de la diversité génétique	95
Datations moléculaires	97
Tendances démographiques	101
Analyses biogéographiques	103
3.3.2. Discussion.....	109
Histoire évolutive de <i>Natrix tessellata</i>	109
Histoire évolutive d' <i>Hemorrhoids ravergeri</i>	111
3.4. Conclusion.....	114
Références	115
• Chapter 4: Bioclimatic models forecast 50-years decrease in climatic suitability for Iranian mountain snakes	121
Résumé en français.....	122
4.1. Introduction.....	125
Material and methods.....	129
4.1.1. Study area.....	130
4.1.2. Data sets.....	131
4.1.3. Bioclimatic data.....	132
4.1.4. Climatic scenarios.....	132
4.1.5. Species distribution modeling.....	133
4.1.6. Projection to future conditions.....	134
4.2. Results	135

4.2.1. Species modeling performance.....	135
4.2.2. Variable importance.....	136
4.2.3. Future projections.....	139
4.2.4. Species upward altitudinal shift	141
4.2.5. Overlaying current and future bioclimatic-envelopes with protected areas in Iran.....	143
4.3.Discussion	144
4.4.Conclusion	149
References.....	150
• Chapter 5: General Discussion	157
5.1.Overview.....	158
5.2.Role and consequences of geological events and Quaternary glacial cycles in the diversification of Iranian snakes	159
5.3.Taxonomic Implications.....	165
5.4.Answer the Wallacean shortfall under a climatic hypothesis to orient data acquisition and conservation effort in response to global changes.....	168
5.5.Implications for conservation.....	175
6. References.....	180
• Chapter 6: Conclusion and Perspectives	187
Appendix	192
List of Boxes	204
List of figures.....	204
List of tables.....	207

Chapter 1:
Introduction

1.1. Impacts of climate change on global biodiversity

Climate acts as an active determinant of biodiversity patterns as it imposes limits to species' geographical distributions at a global scale (Holdridge 1947, Walter 1979). The dramatic changes that the Earth's climate has undergone throughout history have therefore directly impacted biodiversity composition and distribution. Changes in the Earth's orbit (Milankovitch cycles) influence the seasonality of incoming solar radiation and the extent and pacing of climatic oscillations, consequently affecting the episodes of Earth's glacial and interglacial periods which play a major role in the dynamics of species distributions in temperate areas (Bennett 1990). Tectonic and orogenic events, associated with erosion, amplified by climate (see Willett, 1999 for more information on the link between tectonics and climate), are other major components of long-term biogeographic history. During the Cenozoic era (last 65 Mya), numerous climatic fluctuations occurred on Earth lasting with the Quaternary ice ages (2.6 Mya to the present) (Fig 1.1).

These marked fluctuations caused dramatic changes in species distributions. They have been described in detail, particularly through fossil records, for several European and North American species (Bennett, 1997; Coope 1995). Also, consequences of glaciations have been widely studied throughout northern temperate regions (Hewitt 1996, 1999; Avise 2000; Cox *et al.*, 2016). It is been widely accepted that different glacial events during the Quaternary have shaped the current structure and distribution of taxa throughout northern temperate regions (Hewitt 1996, 1999; Avise 2000; Cox *et al.* 2016). Many studies have highlighted that lineages currently occupying the Old World formerly inhabited glaciated areas. As glaciers advanced, populations were driven toward southern glacial refugia (Ursenbacher *et al.*, 2006; Ding *et al.*, 2011), where they subsequently dispersed into newly available habitats during interglacial periods (Hewitt 1996; Runck & Cook 2005). After the Last Glacial Maximum (LGM, 9-23 kyr BP), refugial populations were able to (re-)colonize the surrounding areas, giving rise to the observed extant distribution patterns (Hewitt,2000).

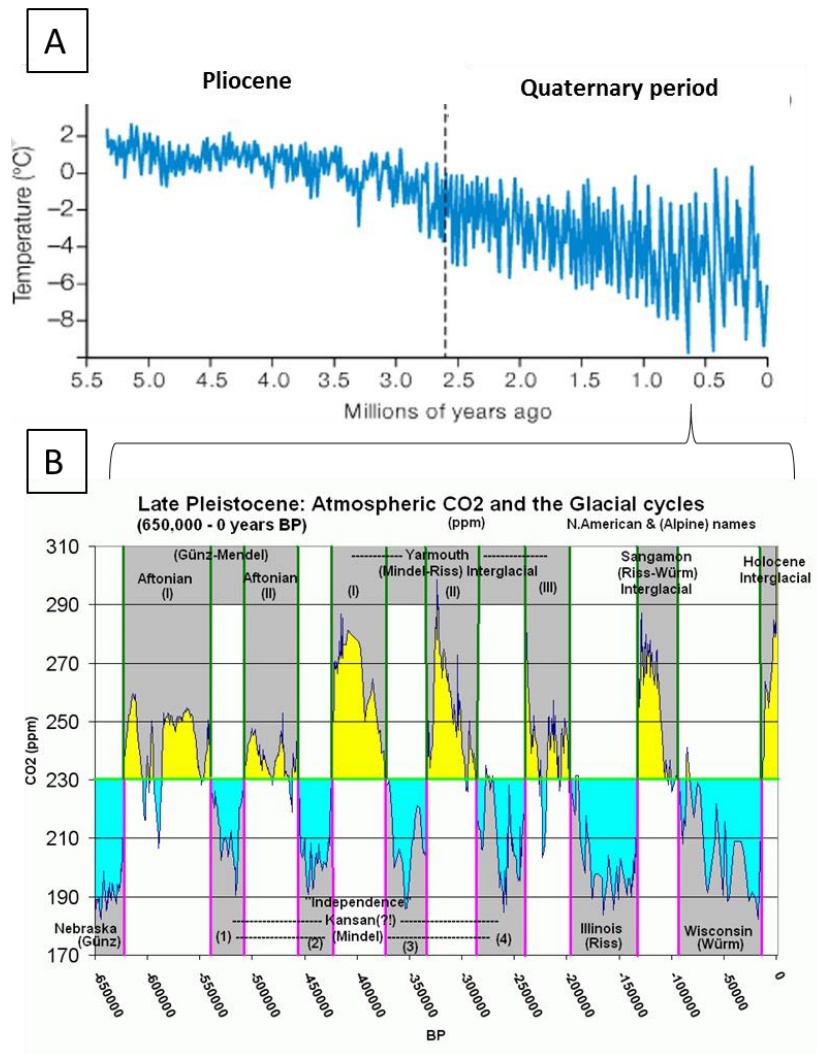

Figure 1.1 .A: the average earth temperature fluctuates during Pliocene and Quaternary period. B: Late Pleistocene glacial cycles and estimates of atmospheric CO₂ over the last 800k years.

A common concern amongst scientists is that current climate is changing at a faster rate than previously experienced since direct climatic records exist, as a result of human activities superimposed on the normal global warming that has been ongoing since the LGM (Keely, 2011). In the coming century, rising atmospheric concentrations of carbon dioxide is predicted to be one of the key drivers of climate change. This is indeed bound to have far-reaching consequences for all forms of life on Earth. In particular, gradual climate change and extreme weather events are predicted to trigger biodiversity losses through regional and global extinctions (Heller and Zavaleta, 2009). Climate change is causing many species to shift their geographical ranges, distributions, and phenologies at faster rates than previously observed; however, these rates are not uniform across species. For this reason, the current short-term warming of global climates that has started in the early 20th century is considered a serious threat to the persistence of numerous taxa (Hughes 2000). Because the current climatic changes

occur over a few decades, its consequences are too quick to permit adaptation and accommodation in many taxa, in particular specialist ones or species with poor dispersal abilities (e.g. Warren *et al.*, 2001; Julliard *et al.*, 2003; Pöyry *et al.*, 2009). As a result, extinction could be accelerated in the next century due to species' inability to track modifications of their environment imposed by these quick climatic changes (Jewitt *et al.*, 2015; Mantyka-Pringle *et al.*, 2012).

According to the Assessment Report of the IPCC (Intergovernmental Panel on Climate Change; IPCC 2019), the current rate of the massive exploitation of ecosystem services and biodiversity loss are “unprecedented in human history”. The report also notes that land use has caused an 11-14% drop in global biodiversity. Not only is human land use more pervasive than ever, it is set against a background of a warming climate. This report estimates that globally the average land and sea surface temperature has increased by 0.6 ± 0.2 °C since the mid-19th century. This global loss of biodiversity directly linked to human activities leads some scientists to consider that we might be in the course of the sixth mass extinction (Barnosky *et al.*, 2011).

The multiple components of climate change are anticipated to affect all levels of biodiversity, from organism to biome levels (Parmesan 2006; Ballard *et al.*, 2012; Botkin *et al.* 2007; Meyers & Bull 2002). Under the influence of climate change, other major threats to biodiversity including habitat fragmentation, overexploitation, pollution, increased levels of diseases, and invasive alien species will be further aggravated (Jewitt *et al.*, 2015; Mantyka-Pringle *et al.*, 2012, MEA, 2005). Furthermore, contrary to human-caused environmental changes, measuring the direct impacts of climatic changes on biodiversity is a challenging task because the processes involved are slow, irreversible but global, often indirect and non-stationary in both space and time.

Organisms may respond to climate change in a variety of ways depending on their physiological sensitivity to temperature, phenological requirements, indirect imprint on climate on resources and habitats, and dispersal ability (e.g. Hughes, 2000, Deutsch *et al.*, 2008; Sinervo *et al.*, 2010; Rowland *et al.*, 2011). They may shift their ranges, adapt to changes, exhibit phenotypic plasticity, or become extinct. Species' ecophysiological, behavioural and demographic responses result in modifications in geographic distributions correlated with long-term (biogeographic scale) and short-term (immediate responses over a few generations) climatic variations (Shaver & Jonasson, 1999; Niu *et al.*, 2010). To respond to climate change, organisms may shift their distributions in search of conditions corresponding to their climatic niches along three axes: time (regulating biological cycle events, such as diurnal rhythms and

phenology, in order to cope with climate-induced alterations), space (moving towards available suitable climates or relocating towards suitable climates through microhabitat adjustments), and self (adjusting life history physiological traits so as to adapt to climatic changes) (Bellard *et al.*, 2014).(Box 1.1)

Box 1.1 Three directions of responses to climate change Source: Bellard *et al.*, (2012)

Figure show the three directions of responses to climate change through phenotypic plasticity or evolutionary responses:

To adapt to climate change through a **shift in space**, species move to find suitable conditions, commonly through dispersal or shifting to suitable habitats at the local or micro-habitat levels, such as latitudinal and altitudinal range shifts. Spatial shifts have been documented in countless species, particularly insects, birds and marine invertebrates which show high dispersal abilities.

For **shifts in time**, phenological shifts, including changes in seasonal timing of recurring events such as migration, breeding, flowering and fruiting, have been among the most common outcomes of species adapting to recent climate change. For instance, such temporal shifts have been documented in plankton (Villarino *et al.* 2015), benthos (Richards 2012), fish (Neidetcher *et al.* 2014), and plants (Parmesan 2006). In reptiles, earlier parturition or breeding time in the aspis viper (Lourdais *et al.*, 2004), common lizard (Le Galliard *et al.*, 2010), sleepy lizard (Bull and Burzacott 2002), and spotted snow skink (Cadby *et al.*, 2010) have been reported.

To adapt through **shifts in self**, species cope with climatic changes by adapting themselves within their local range through physiological or behavioral alterations, rather than moving along spatial or temporal axes. These shifts have been observed in many ectotherms, especially because their reproduction, growth, sex determination, and locomotion are temperature-dependent (Tewksbury *et al.* 2008).

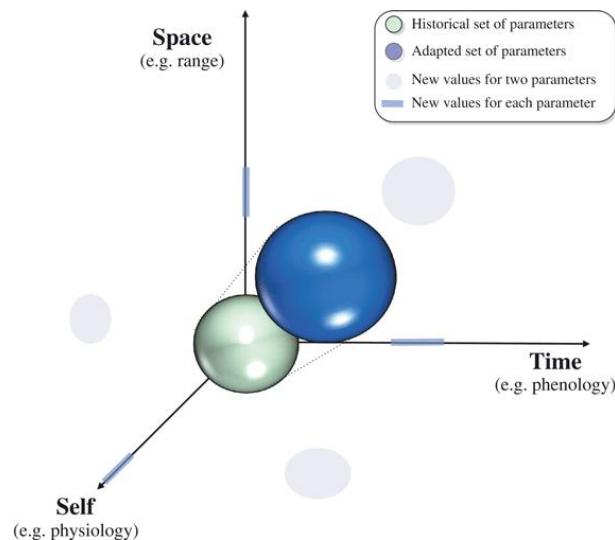

It could be said that the fate of species or populations unable to adapt along one or all of these axes could ultimately be extinction, either locally or globally. However, species face a multitude of possible responses to choose among; and hence, during the Quaternary, relatively few taxa became extinct as a result of climate change (Botkin *et al.*, 2007). This could moderate pessimistic predictions concerning the global impact on biodiversity of the current global warming. Generally, across taxa and regions, the consequences of climate change on ecological patterns and processes remain unclear and hard to predict due to these multiple levels of complexity associated with incomplete knowledge of many biodiversity components.

1.2. The challenges of biodiversity knowledge shortfalls

Insufficient knowledge of biodiversity, in particular gaps in geographic and taxonomic data, are serious impediments to establishment of protected areas, compilation of red lists, planning and implementation of restoration strategies, as well as selection of conservation priorities (Clark and May 2002, Nemésio *et al.*, 2013, Schmidt-Lebuhn *et al.*, 2013). That could lead to wrongly defined protected areas and/or red lists (Possingham *et al.*, 2002, Boakes *et al.*, 2010, Le Saout *et al.*, 2013). Consequently, in order to facilitate decision-making in conservation planning, we must try to identify and minimize species' geographic and taxonomic data deficiencies (Pardo *et al.*, 2013, Sousa-Baena *et al.*, 2014).

Biodiversity data are faced with major knowledge shortfalls, among which several deal with the most important extrinsic characteristics of species (Hortal *et al.*, 2012). The first one is the lack of knowledge on the basic units of study in ecology and evolution, mainly due to incomplete inventories of species and evolutionary significant units (Linnean shortfall). The second one involves their geographical distribution, population dynamics and evolutionary relationships (Wallacean, and Darwinian shortfalls, respectively), whereas the third shortfall concerns species' ecological functioning in terms of niche interactions (Hutchinsonian shortfall) (Hortal *et al.*, 2015; Ladle & Whittaker 2011)

All these knowledge deficiencies are intertwined to a certain extent, in terms of taxonomic, spatial or temporal data coverage. For instance, the Wallacean and Linnean shortfalls may influence all the other gaps in knowledge, as lack of data on unknown species inevitably compromises the description of other aspects of biodiversity. Such deficiencies with respect to extrinsic characteristics commonly exacerbate knowledge shortfalls of ecological functioning (Hortal *et al.*, 2015). Thus, it is essential to acquaint ourselves with these concepts before making conservation decisions.

1.2.1 The Wallacean shortfalls: unknown species' distributions

The Wallacean shortfall refers to the knowledge gaps in species' geographical distributions (Lomolino 2004) and arises from insufficiencies in geographic information of species distributions, as well as biased sampling due to spatial, temporal and even political variations in surveying efforts (Hortal *et al.*, 2008, Boakes *et al.*, 2010). For example, only 2% of the total area of Amazonia has been well surveyed (Schulman *et al.*, 2007). The conservationists are forced to rely on this limited available data for conservation planning. Our knowledge of the geographical distributions of most taxa is still relatively limited (Lomolino, 2004). The Wallacean shortfall may have multiple implications for conservation of biodiversity, such as incorrect evaluation of threats, uncertainties in conservation planning and prioritization, biased knowledge on diversity patterns, and reduced efficiency of species distribution models.

Filling the Wallacean shortfall is especially crucial for clarifying broad-scale ecological patterns and predicting their changes under climate-change scenarios (Hortal *et al.*, 2015). In addition, it can also have significant impacts on estimates of conservation threats. Range size is frequently used in conservation planning, small-ranged species being given higher priority. For instance, many conservation prioritization criteria of the IUCN consider an area of less than 50,000 km² as range restriction/local endemism (Whittaker *et al.*, 2005), which may also include several species that are not under threat. This shows that due to the Wallacean shortfall, conservation prioritization for a large number of species or regions are faced with uncertainties (Riddle *et al.*, 2011).

Therefore, high sampling efforts assisted with statistical modeling are needed to face the paucity of available data. Various short-term and long-term approaches have been proposed to deal with this shortfall, such as increasing sampling efforts, improving data reliability, obtaining information regarding species range limits, using large-scale databases, employing modeling approaches, developing maps of ignorance for mapping species distributions, determining short-term effects of population dynamics on the structure of species distributions, and evaluating the role of species' dispersal limitations in their current patterns (Hortal *et al.*, 2015).

1.2.2 The Darwinian shortfalls: unknown evolutionary patterns

The Darwinian shortfall concerns the knowledge gap in the evolutionary tree of life and the evolution of traits, species and lineages (Diniz-Filho *et al.*, 2013). With the emergence of ever-

expanding phylogeny-inference methods and robust computer-based analyses of molecular data in the mid-20th century (Felsenstein 1985, Hall 2011), phylogenetic comparative methods have been extensively used to disentangle patterns of biodiversity and species' trait evolution (Nee & May 1997, Sechrest *et al.*, 2002, Mace *et al.*, 2003). However, according to Diniz-Filho *et al.*, (2013), we are faced with three major difficulties in ecological comparative analyses. First, the phylogenetic relationships of a considerable number of taxa have not yet been resolved (Bininda-Emonds *et al.*, 2007; Pyron & Wiens 2011; Jetz *et al.*, 2012). Second, errors in branch length estimates and calibration of phylogenies in conjunction with limited fossil records may result in misleading inferences in placement of fossils and branching times (Dornburg *et al.*, 2011; Lukoschek *et al.*, 2012; Slater & Harmon 2013; Losos *et al.*, 2011; Sansom *et al.* 2015). Third, given our limited knowledge of species' trait evolution, uncertainties remain prominent regarding the relationships between ecological traits and patterns of biodiversity (Freckleton *et al.*, 2002; Cadotte *et al.*, 2013).

Therefore, the Darwinian shortfall could undermine our understanding of species' responses to climate change. Consequently, a number of strategies have been proposed including development of more realistic evolutionary models, using simulations of evolutionary processes, constructing super- and mega-trees, combining molecular and fossil data for better calibration and high-quality branch lengths (Diniz-Filho *et al.*, 2013; Hortal *et al.*, 2015).

1.2.3 The Linnean shortfall: unknown species' taxonomy

The Linnean shortfall deals with the inconsistency between the actual number of species and the number of described species (Lomolino 2004). This shortfall is particularly serious for taxa with smaller size, distribution range, and niche width (Riddle *et al.*, 2011). In addition, the magnitude of this shortfall is still undetermined because the number of species is continuously changing as a result of taxonomic revisions, new descriptions, and unconfirmed synonyms (Chapman 2009; May 2010; Baselga 2010). Also, numerous species concepts exist preventing a consensus definition to emerge (Dayrat 2005). Two groups of unknown species are typically influenced by this shortfall: those in need of sampling, and those that have been sampled but not formally described yet. Species in the first group are mostly found in large poorly studied regions (e.g. southwest Amazonia; Bush & Lovejoy 2007), less surveyed ecosystems (e.g. deep-sea and the upper canopies of rainforests; Rex & Etter 2010; Ellwood & Foster 2004). Species in the second group are in need of expert validation and allocation of funding such as undocumented taxa in the Catalogue of Life (Hopkins & Freckleton 2002).

As it concerns the basic units of ecological and evolutionary studies, the Linnean shortfall indeed affects all other shortfalls in biodiversity. In the presence of this shortfall, phylogenies are faced with the problem of the missing taxa, which largely affects the final topology of phylogenetic trees, accuracy of estimated extinction rates, and ultimately our knowledge on species' diversity and evolution (Nee *et al.*, 1994; FitzJohn *et al.*, 2009). Thus, it is crucial to elucidate species' taxonomy and improve taxonomical delimitation for extinct and extant taxa to deal with the Linnean shortfall (Hortal *et al.*, 2015).

1.2.4 The Hutchinsonian shortfall: unknown about the responses and tolerances of species to abiotic conditions

The Hutchinsonian shortfall, named after George Evelyn Hutchinson (1903–1991), concerns the lack of knowledge regarding species' ecological functioning and tolerances in terms of abiotic changes and niche interactions, such as responses to changes in climate, habitat, water, soil, etc. (Hutchinson 1978). A multivariate assessment of species' environmental preferences is a major requirement to assess or forecast species' responses to current global changes, which are inherently multifaceted, but also to understand the processes underlying patterns of variation in species abundance and occurrence (Brown 1984; Gaston 2003; Slatyer *et al.*, 2013). Estimation of species tolerances could be achieved through the use of geographical occurrence data based on field surveys, and analyzed by correlative and envelop niche models (Peterson *et al.*, 2011).

The Hutchinsonian shortfall may have significant consequences such as inability to forecast species' responses to global change, difficulty to explain the processes underlying species distribution dynamics, inability to predict the spread of invasive species, and lower efficacy in translocation of threatened species. Short-term and long-term strategies are proposed to deal with this shortfall, with mixed results and ecological coherence. They include use of bioclimatic envelopes as a substitute for niche, assessment of intraspecific differences in species' limits of tolerance, and building dynamic models that take into account the non-stationarity of species' environmental preferences.

1.3. Evaluating conservation and dealing with the knowledge shortfalls

Biodiversity conservation is essential to secure the long-term persistence of the Earth's biota, for which we ought to plan for future changes in patterns and processes of biodiversity, mostly through constructing scenarios and taking appropriate measures. On the other hand, ecology is evolving rapidly and increasingly changing into a more open, accountable, interdisciplinary, collaborative and data-intensive science. Discovering, integrating and analyzing massive amounts of heterogeneous data are central to ecology as researchers address complex questions at scales from the gene to the biosphere.

Biogeography aims to analyze the distribution and diversity of life forms in space and times at all scales (Ladle & Whittaker 2011). Conservation biogeography, a combination of biogeography and conservation biology, is concerned with the application of biogeographical concepts and principles related to the distributional dynamics of organisms in biodiversity conservation (Whittaker *et al.*, 2005). As an applied and interdisciplinary science, conservation biogeography involves conservation of taxa, design and restoration of hotspots and reserves, testing uncertainty and sensitivity to assumptions through sensitivity analyses, and elucidating the geographic patterns of species through the application of biogeographical theories and analyses (Richardson and Whittaker, 2010).

As taxa are not distributed evenly across the Earth, conservation biogeographers need a good knowledge on the geographical distribution of species (Lomolino *et al.*, 2010). In conservation studies, species' range size and population size are indicators of dispersal ability, evolutionary history, physiological tolerances among species, and extinction risks, and thus serve to rank taxa of conservation concern (Thompson *et al.*, 1999; Thuiller *et al.*, 2004; Pompe *et al.*, 2008). Consequently, conservation biogeography contributes to conservation through integrating the historical and geographical dimensions of biodiversity in order to overcome inadequacies in distributional and taxonomic data (the Wallacean and Linnean shortfalls), promoting effective and science-based decision-making in conservation policies. Some of the most prominent areas of conservation biogeography are listed in Table 1.

Table 1.1 Prominent areas of research in conservation biogeography (Richardson & Whittaker 2010)

The biogeography of degradation (habitat fragmentation, homogenization, urbanization and other human-induced impacts)
Processes (colonization, climate as a fundamental determinant of distribution, dispersal, disturbance, extinction, persistence, range expansion, resilience, speciation)
Inventory, mapping and data issues (atlas data, breeding bird surveys, citizen science, detectability/discovery probabilities, herbaria and other collections, sampling intensity and biases)
Species distribution modelling (bioclimatic modelling, habitat-suitability analysis, model performance, niche-based models, presence-only data vs. presence-absence data, dispersal kernel analysis)
Characterizing biotas (conservation status, diversity indices and patterns, ecoregions, endemism, rarity, range size, species–area relationships, threatened species, identification of alternative baselines from long-term ecological data)
Conservation planning (complementarity, congruence, conservation units, ecosystem services, gap analysis, global conservation assessments, irreplaceability, reserve networks, surrogates)
Methods (molecular methods, palaeoecology, remote sensing, scenario development)
Related fields (global change biology, invasion ecology, bioinformatics, molecular phylogenetics, network analysis, re-introduction ecology, risk analysis, behavioural ecology, population viability analysis)
Overarching themes: niche (fundamental vs. realized), novel climates/ecosystems, scale issues, uncertainty, Linnean shortfall, Wallacean shortfall)

1.3.1 The fundamental taxonomic units of conservation biogeography

Species have been extensively recognized as basic units in studies of ecology, conservation biology as well as biogeography (Brown, 1995; Blackburn & Gaston, 1998). However, biogeographers have recently leaned toward using geographically distinct evolutionary lineages as fundamental units of analysis in conservation biology.

Integrating the Darwinian, Wallacean and Linnean shortfalls requires a recognition that species are evolutionarily heterogeneous throughout their distributions, meaning that we cannot consider a species as a relevant conservation unit, but rather we need to deal with intraspecific sources of heterogeneity. Within a species, all populations do not have the same realized niche. They are constrained by dispersal, biotic interactions, or historical legacies. This implies that modeling historical pathways below the species level may contribute to a better understanding of intraspecific heterogeneities in realized niches and, in turn, might shed some light on ecological processes leading to responses to environmental variation. In this context, phylogeography has proven to be a powerful tool allowing the identification of genetic lineages previously not identified.

Phylogeography is an interdisciplinary field studying the historical and contemporary processes and principles that govern the geographic distribution of genealogical lineages, including at the intraspecific level (Graves *et al.*, 1984; Avise *et al.*, 1987; Avise 1998). Phylogeography is between microevolutionary (population genetics, demography, ethology)

and macroevolutionary (historical biogeography, systematics, paleoecology) fields (Avice 2000). Comparative phylogeography is another tool for providing clearer understanding of the role of historical events and demographic processes in shaping the genetic patterns of different taxa. This approach examines whether phylogeographic patterns of taxa in a given area are influenced by similar historical and evolutionary processes. Comparative phylogeography draws broader inferences regarding the evolutionary, climatic, and geological processes involved in shaping species' biogeographical patterns (Moritz and Faith 1998; Bermingham and Moritz 1998; Avice 2000; Feldman and Spicer 2006; Rowe *et al.*, 2006).

Phylogeography also serves as a useful tool for inferring historical scenarios to account for the spatial and temporal arrangement of organisms and their features. Notably, vicariance and dispersal (box1.2) are two alternative events invoked to account for the origins of spatially disjunct taxa (Ronquist, 1997). According to the Vicariance model, environmental events (such as uplifting of mountains or presence of glaciers) cause fragmentation and separation between populations. In the Dispersal model the current geographical area occupied by a taxonomic community is explained by migration between two or more independent ancestral areas. A combination of vicariance and dispersal events can occur in the course of evolution, depending of the dispersal capabilities of the taxa considered and the presence of barriers to dispersal (Avice, 2000; Zink *et al.*, 2002). Thus, phylogeographical analyses lead to propose evolutionary scenarios in space and time in order to explain the genetic pattern observed (Avice, 2000).

Box1.2 Vicariance and Dispersal (Avice, 2000)

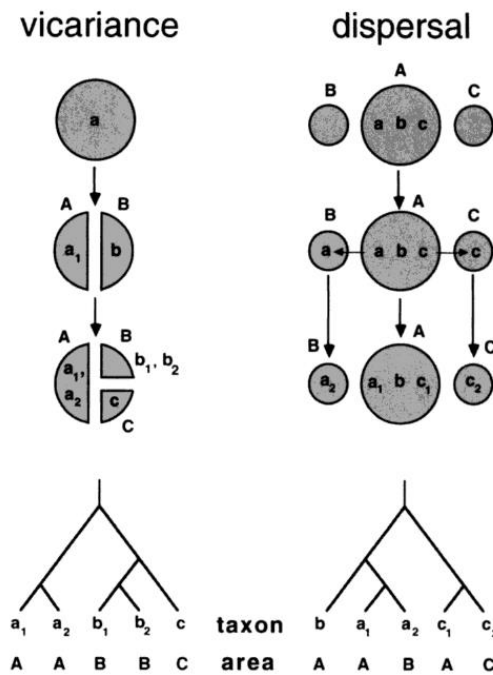

Phylogeography relationships of spatially disjunct population or species under vicariance and dispersal (after Futuyma, 1998). Lowercase letters represent taxa; uppercase letters, geographic areas. Under vicariance, the phylogeny of taxa may mirror the order of separation of areas, whereas area and taxa can show more varied historical relationships to one another under dispersal. All outcomes are impacted by additional factors such as historical population demography, the evolutionary times of the vicariant or dispersal events, and the resolving power of molecular or other assays.

Phylogeography is providing a good source of preliminary hypotheses concerning the geographic range of newly described lineages, which could be used for conservation prioritization and maintaining viable populations of those lineages. Consequently, the concept of evolutionarily significant units (ESUs) was defined (Waples, 1995) to identify conservation units below the species level. For instance, according to Moritz *et al* (1994), ESUs represent historically isolate, reciprocally monophyletic clades revealed through phylogeographic analyses of mitochondrial DNA that show significant allelic frequency divergence at nuclear loci. Defining an ESU is crucial for conservation prioritization as it describes a unique group of organisms (subspecies, species, geographic race, stock, or population) that should be conserved separately (Fraser; Bernatchez 2001; Crandall *et al.*, 2000).

In addition, the growing concern toward conservation of genetic diversity calls for accurately defining ESUs based on evolutionary histories of relevant taxa (Deans *et al.*, 2012; Casacci *et al.*, 2014), as species-based units cannot always prove applicable to all conservation strategies. Thus, phylogenetic and phylogeographic inferences can be applied to conservation planning below the species level (Fraser & Bernatchez 2001; Behrooz *et al.*, 2018).

1.3.2 Species distributions: Improving models, simulations and forecasts

Species distribution has been the basis of research in different fields, such as ecology and conservation biology (Scott *et al.*, 2002). Knowledge of the geographical distribution of a species is fundamental in that it reflects its history, current environmental constraints and potential future. The geographical distribution of any given species is primarily constrained by a complex combination of its realized niche (Box 1.3), limitation to dispersal, and demography, with some level of stochasticity. These constraints are often summarized through climatic proxies under the assumption that climate is an integrative driver of most dimensions of environmental variations (Sexton *et al.*, 2009). However, this approach is limited in that non-climatic factors, such as, typically, tectonic and topographic constraints, also play a central role in setting distribution limits (Ladle & Whittaker 2011).

Box 1.3. The BAM diagram proposed by (Soberón & Peterson 2005).

Species' geographical distributions are to a large extent shaped by their environmental requirements. The term "niche" was first introduced by Grinnell (1917) as the envelop of abiotic habitats determining where a species can be found. Later, the concept of environmental niche was formalized by Hutchinson (1957) who defined it as a hypervolume occupied by the species which described the environmental variables determining the species distribution, raising a major distinction between the realized and the fundamental niches. The *fundamental* niche is determined by the physiological tolerances of a species along environmental gradients emerged through evolutionary processes, and is measured by experimenting the organism's ability to grow in a laboratory under varying levels of abiotic stress (e.g. Oliver *et al.*, 2000). The *realized* niche is the subsample of this hypervolume in which the species actually exhibit positive growth rates, once all the biotic stress factors and interactions are accounted for. (Soberón & Peterson 2005, fig below), (Callaway *et al.*, 2002).

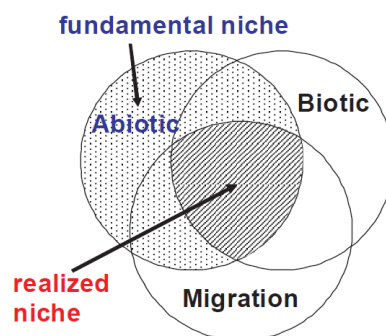

Generally, a preliminary step towards biodiversity conservation is an attempt to determine how present conditions, either natural or human-caused, determine patterns of species distributions and abundances. So far, systematic conservation planning has mainly concentrated on threats such as habitat loss, habitat fragmentation, overexploitation and spread

of invasive species. Under the assumption of static distribution patterns for species, conservation practice often deals with such threats by prioritizing conservation measures across different locations. Of greater concern, however, is the current climate change which causes shifts in species ranges whereas the geographical boundary of protected areas remains unchanged (Millennium Ecosystem Assessment 2005; Lovejoy 2006; Pressey *et al.*, 2007).

A wide variety of quantitative models are now widely applied in ecology for describing past, present or future distribution patterns. They have been instrumental in developing new insights into classical questions of species' coexistence, community assembly, population dynamics, biogeography, and many more. Methods for the study of patterns of species distributions and abundances are still being actively developed, and practical work with predictive models requires ecologists to learn a new suite of tools known as ecoinformatics (Michener & Jones, 2012), which encompasses modeling strategies themselves, but also data processing, validation tools and generation of forecasts associated with their uncertainty.

Prior to building a model, it is vital that the objectives are well defined as the purpose of a model critically affects model development. For instance, for broad-scale assessment of regional species distributions, pre-existing occurrence data and statistical approaches relying only on positive presence data are typically used. On the other hand, for modeling species distribution on a finer scale, purposefully-derived occurrence data and statistical approaches relying on positive and negative occurrence data obtained from a targeted field survey are needed (e.g., Lee and Peterson 2003).

In recent years, significant advances have been made in the statistical tools and techniques used to generate species distribution models (SDMs) (Guisan & Zimmermann, 2000; Guisan & Thuiller, 2005; Elith & Leathwick, 2009). SDM, as also known as environmental or ecological niche modelling (ENM), habitat modelling, predictive habitat distribution modelling, and range mapping (Elith *et al.*, 2009) uses various statistical or mechanistic models to predict the distribution of a species across the geographic space and time using environmental data (Box1.4). Conceptually, statistical SDMs aim to picture a species' realized niche through a correlative relationship between a spatial pattern of occurrence and relevant biological gradients, allowing secondarily a projection in the geographical space (Kearney and Porter, 2009).

Box 1.4 Correlative Species distribution Models

In predictive ecology, the simplest and most prominent approach to creating distribution models is through correlative species distribution models (cSDMs), which aim to predict species' range shifts under climate change using two types of data: *biological data* (species' occurrence points), and *environmental data* (characterizing the space where the species occur). These models make no causal assumption about the role of climate on species distributions but rely on the high correlation usually observed between climatic variables and species range limits (e.g. Guisan and Thuiller, 2005; Morin *et al.*, 2007). Unfortunately, cSDMs suffer from a number of drawbacks and limitations (e.g. spatial autocorrelation issues, lack of relevant predictors, uncertainty in the role of climate, unmodelled non-climatic processes, and the assumption that correlations between climate and distributions are stationary in space and time) (Austin *et al.*, 2006; Fourcade *et al.*, 2014; Journé *et al.*, 2019). SDMs generally rest upon the assumption that climate is a dominant factor in shaping species distribution boundaries (Sexton *et al.*, 2009), particularly for species susceptible to climate-driven range shifts. Nevertheless, these models should be approached with caution, given that other non-climatic drivers, in combination with climate, influence species distributions (Guo, 2003). The predictive ability of SDMs can be assessed using the following approaches: (i) comparison of actual range shifts with predicted range shifts between past and present distributions based on observed climate change, (ii) comparison of observed and predicted species ranges in invasive regions, (iii) null models. Validation is generally based on their goodness of fit, evaluated as their ability to predict the current distribution of a species given several possible resampling strategies (Bahn & McGill, 2013). High fit is usually considered a justification to use an SDM to forecast the distribution of a species in the future, assuming that the correlation between environmental parameters and species occurrences remains unchanged over time – which however remains untested most of the time, often leading to high levels of bias and uncertainty (Fourcade *et al.*, 2014; Journé *et al.*, 2019).

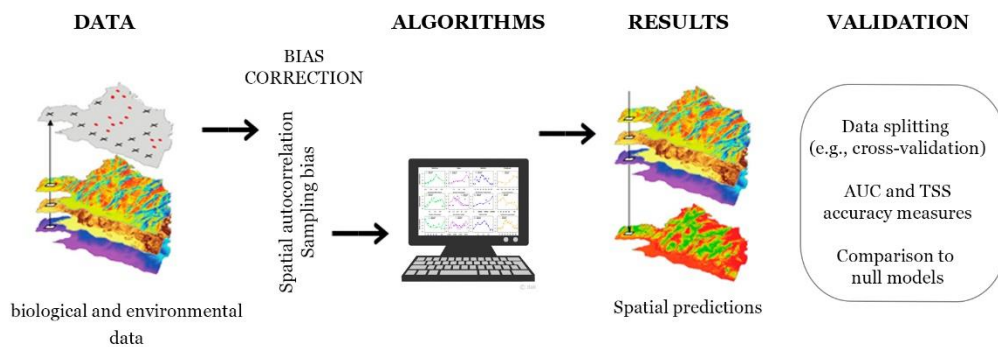

SDMs have proved their utility as a predictive tool in biogeography, evolutionary biology and conservation biology. These models can be used as a preliminary way to fill the existent shortfalls in taxonomic and distributional data (Wallacean and Hutchinsonian shortfalls), to orient efficiently subsequent sampling effort (Hortal *et al.*, 2015). Another popular use of SDM lies in forecasting the impacts of the current climate change on the short-term dynamics of

species distributions. Nevertheless, this practice has been overused without empirical validation and critical thinking on the methods and results, leading to the emergence of a massive amount of non-robust forecasts in the 20 past years (Heikkinen *et al.*, 2012). The validity of SDM as a useful forecasting tool for conservation biologists lies in a subtle trade-off between biological realism and parsimonious calibration, which has to be considered on a taxa-per-taxa basis, acknowledging regional particularisms and the acceptability of model assumptions (Roberts *et al.*, 2017).

1.4. A major shortfall in Western Palearctic knowledge: Iran and the Iranian reptiles

A multitude of studies have documented and forecasted the effects of climate change on biodiversity at multiple spatial and temporal scales (Parmesan, 2006; Bellard *et al.*, 2014). Notwithstanding this abundant literature, knowledge gaps still remain because of data limitations on the geographic distribution and description of many species, especially outside the western Palearctic and Nearctic biomes (“the Wallacean and Linnean shortfalls”, Lomolino, 2004; Hortal *et al.*, 2015). A direct consequence is the difficulty of forecasting climate change effects for some of the earth’s major biodiversity hotspots, such as the biogeographic transition regions found in the mountains of the Middle-East and Central Asia. This gap needs to be resolved as these regions host a wide range of species at high conservation stake due to scarcity, endemism or cultural values (Dudley 2008). Moreover, these transition zones are useful for validating certain biogeographical hypotheses and models. Understanding the evolutionary processes of speciation as well as the ecological processes affecting species’ geographical distribution is a necessity in dealing with global change (Mouquet *et al.*, 2015). Under the influence of evolutionary and contemporary processes, species segregated by biogeographic transition zones generally develop similar patterns of distribution.

Iran largely contributes to the diversity of fauna and flora in the Middle East as it is located at the meeting point of several biogeographic regions (Palearctic, Oriental and Afrotropical, see Fig 1.2 a). It is at the convergence of three distinct faunal and floral regions of the Palearctic, Indo-Malayan, and Afrotropical realms (Firouz, 2005). Owing to its geographical location in the far south-east of the Western Palearctic and the impressive diversity of its habitats, Iran is an important reservoir of endemism that has not yet been sufficiently studied (Anderson 1999, Noroozi and al., 2018). The Middle East in general and Iran in particular have been largely neglected in past phylogeographical studies (Ahmadzadeh *et al.*, 2013). Northern and western parts of Iran belong to two biodiversity hotspots, the Irano-Anatolian and the

Caucasus (Mittermeier *et al.*, 2005. Fig 1.2 b), which are home to a great number of endemic species (Gholamifard and Rastegar-Pouyani 2012). When different habitat types intersect, transitional zones with intermediate physical and biological characteristics form (Brown and Gibson 1983; Williams 1996) may harbor species from each of the adjacent habitats. In addition to hosting species from the neighboring regions, transitional zones may develop unique conditions to support the evolution of their own communities of endemic species, and thus, compared to the surrounding habitats, they may have greater species richness (Gelderblom and Bronner 1995; Gottfried *et al.*, 1998; Hamann *et al.*, 1999).

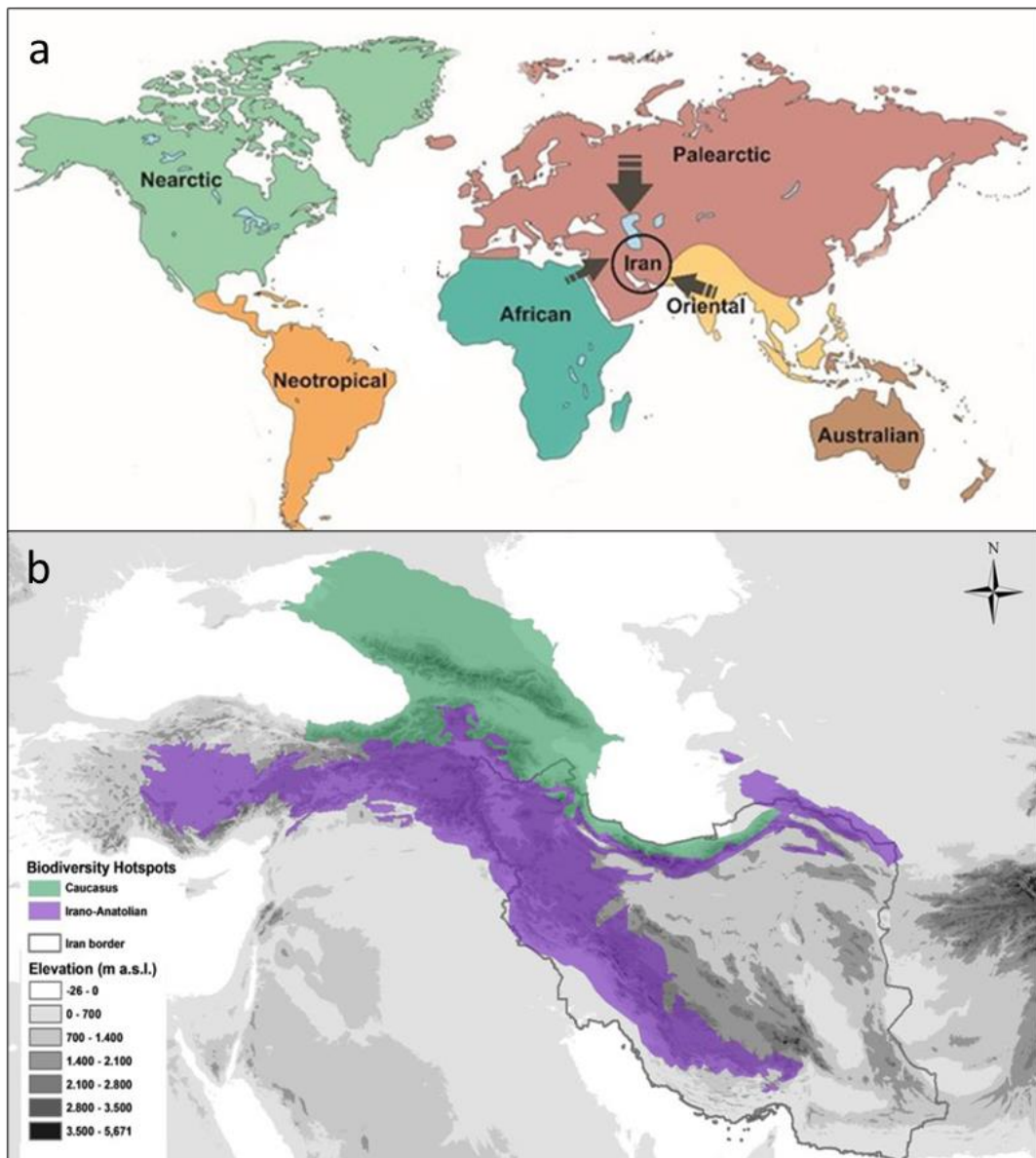

Figure 1.2: a: location of Iran at the meeting point of three biogeographic regions Palearctic, Oriental and Afrotropica. b: the Irano-Anatolian and the Caucasus biodiversity hotspots.

1.4.1 Our understanding of reptiles in the face of shortfalls

Our knowledge of reptiles is strongly influenced by several shortfalls due to their overall scarcity, high diversity in poorly surveyed areas, and difficulties in sampling through systematic designs (Mullin & Seigel 2011). New reptile species are constantly being discovered and more than 10% of reptile species have not yet been identified (IUCN, 2009). For example, 54 new snake species were described globally between February 2012 and February 2013. Such advancements owe much to modern molecular techniques that revolutionized the techniques used for description of biological diversity (Bickford *et al.*, 2007).

According to Ficetola *et al.* (2013), reptile richness in remote regions, such as parts of Central Asia and the Iranian Plateau, is likely to be higher than previously assumed. Given its varied climate and geography, Iran hosts a rich herpetofaunal diversity; it is known to be the center of origin for multiple species such as *Natrix tessellata* (see Guicking *et al.*, 2009) and *Montivipera raddei* complex (Behrooz *et al.*, 2018). With 80 species of endemic Tetrapods, among which 66 are reptiles, Iran is specifically notable for its richness of endemics (Eskandarzadeh *et al.*, 2018). The number of endemic species of reptiles and amphibians in Iran is much greater than that of birds and mammals, and thus gaining molecular insights into the phylogeny and phylogeography of herpetofauna remains a top priority. Over recent years, several molecular and phylogeographic studies have led to the description of new species in Iran (Nazarov & Rajabizadeh 2007; Rastegar-Pouyani *et al.*, 2011; Ahmadzadeh *et al.*, 2011; Fathinia *et al.*, 2011; Rajabizadeh *et al.*, 2011).

Despite its high species diversity and number of endemic species, Iran has been struggling with data deficiencies, particularly concerning reptiles. A large number of reptile species still lack comprehensive data, and unidentified species still remain to be discovered. The number of reptile species reported in Iran is increasing rapidly, with 31 newly described species between 2000 and 2014 (see Safaei-Mahroo, 2015 for review). Nevertheless, reptile distributional data in Iran are scarce and mainly based on opportunistic data and sporadic field surveys. Despite the limited available literature such as the Atlas of Reptiles of Iran (Mozaffari *et al.*, 2016) and the Checklist of Herpetofauna of Iran (Safaei-mahroo *et al.*, 2015), there is still a substantial need to carry out extensive research in regions where unique and endemic biodiversity is at risk in order to clarify species' ecology or conservation status. For example, previous phylogeographic studies by Guicking *et al.* (2009) on the dice snake and Jablonski *et al.* (2018) on the smooth snake covered the species' distribution range in the Palearctic, but failed to include adequate samples for the Iranian part of their ranges.

Efforts to conserve and restore reptile communities are now increasing across the world. But in less developed countries such as Iran species occurrence, population and distribution data are often missing. Iran hosts about 232 reptile and 22 amphibian species distributed in 100 genera, 31 families, five orders and three suborders (Anderson 1999, Rastegar-Pouyani *et al.*, 2008, Ahmadzadeh *et al.*, 2013, Kamali 2013, Uetz and Hošek 2014, Rastegar-Pouyani *et al.*, 2015). In the latter half of the 20th century, natural ecosystems in Iran had to deal with major environmental damage (for a review, see Firouz, 2005). Nevertheless, due to the shortage of biodiversity data (including snake diversity), serious conservation problems remain unsolved.

1.4.2 Conserving reptiles facing climate change

Amphibians and reptiles are considered as one of the most vulnerable taxonomic groups in regards to climate change (Gibbons *et al.*, 2000; Araújo *et al.*, 2006; Wake, 2007). Numerous studies have examined the potential changes in species' distribution in response to warming temperatures among different taxonomic groups (Walther *et al.*, 2002; Root *et al.*, 2003; Parmesan 2006). However, the limited research currently available on reptilian responses to climate change is predominantly restricted to the evaluation of elevational changes, mostly at local or regional scales (Pounds *et al.*, 1999; Raxworthy *et al.*, 2008).

The study of indigenous herpetofauna in the field is vital for the conservation and our understanding of reptile ecology in a changing landscape. The ecology and biology of poikilothermic species are indeed mainly driven by temperature (Huey & Kingsolver 1989; Navas *et al.*, 2013). Also, translocation success rates for amphibians and reptiles are generally lower than those for mammals and birds (Platenberg and Griffiths, 1999; Dodd and Seigel, 1991; Griffith *et al.*, 1989). These animals are therefore particularly vulnerable to changes in climatic conditions (Sinervo *et al.*, 2010). As a result of the direct and indirect effects of climate change, marked declines of reptile and amphibian populations, and in some cases extinctions (Whitfield *et al.*, 2007; Reading *et al.*, 2010; Sinervo *et al.*, 2010), have been reported worldwide (Gibbons *et al.*, 2000; Blaustein *et al.*, 2001; Pounds *et al.*, 2006; Bosch *et al.*, 2007; Wake, 2007).

As sex determination and incubation success in most reptile species are temperature-dependent (Janzen, 1994; Mitchell & Janzen, 2010), climate change could directly modify population structures through ecophysiological processes, leading to reduced hatching success, phenological shifts in the breeding season, and possibly local extinctions (see also Clusella-Trullas & Chown, 2011; Hawkes *et al.*, 2009; López-Luna *et al.*, 2015). Examples of

temperature-dependent sex determination have been documented in reptiles, (e.g. Janzen, 1994). For instance, global warming has been suggested to be a major threat to loggerhead turtles (*Caretta caretta*) of North America. If these turtles fail to change their nesting sites or oviposition season, climate change may result in feminization of clutches under the scenario of 2 °C temperature increase, or lead to lethal incubation temperatures above 3 °C increase in temperatures, (Shoop & Kenney, 1992; Heppell *et al.*, 2003; Hawkes *et al.*, 2007).

Among vertebrates, arid-dwelling diurnal reptiles are known to be highly vulnerable to climate change, given their ectothermic physiology, unique environmental requirements for metabolism and reproduction, higher possibility of exposure to drought conditions, and relatively sedentary lifestyle (Root and Schneider, 2002; Hannah *et al.*, 2005; Barrows *et al.*, 2010). It has been predicted that by 2080, some 20% of species of lizards may suffer partial or entire loss of their thermal niche within their current range (Sinervo *et al.*, 2010; for a controversial discussion, see Clusella-Trullas & Chown, 2011).

Rather than adapting to new climatic conditions, species may tend to change their geographic distributions because climate change is occurring too rapidly to allow for genetic adaptations to develop (Bradshaw & Holzapfel 2006). Consequently, survival of species will depend largely on their ability to change their distributions (Foden *et al.*, 2008), and geographic barriers or low dispersal ability will put species at a higher risk of extinction (Massot *et al.*, 2008). If reptiles cannot change their geographic distributions, they will be forced to contract their range or be doomed to extinction, whereas if they can disperse, they will avoid extinction and may even expand their distribution range (Thomas *et al.*, 2004; Araújo *et al.*, 2006). Araújo *et al.* (2006) did a study on the potential impacts of global warming on European reptiles and found that, although initial range expansion was possible, populations across the continent would be at risk if proper habitat is not available.

Endemic species are of particular ecological and cultural significance on national and global levels. Thus, areas with high concentrations of endemic populations take major priority for conservation and management and are worthy of scientific investigation (Dudley 2008). Yet, lack of species distribution data hinders the proposal of practical conservation measures. Thus, in-depth research must be conducted on species' niches to identify potential areas for their future distributions.

A study by Yousefi *et al.* (2019) in Iran pointed to the fact that among different taxa (mammals, birds, reptiles, amphibians, fish, insects, plants), reptiles were found to be most vulnerable and prone to loss of their distribution ranges under the effect of climate change. Of the 14 reptile species in their study, 11 are likely to be negatively threatened by climate change,

whereas three others, possibly the more thermophilic species, would not be affected. Also, According to Dastorani and Poormohammadi (2016), the highest increase in temperature will occur in north-west of Iran by the year 2099. Thus, comprehensive research must be done in priority on species and habitats in this part of the country, which hosts a great deal of endemic species likely to suffer considerable restriction of their climatic niche with climate change.

Evaluating the effectiveness of protected areas in current and future climate conditions is also a principal task of conservation biologists. As protected areas are designed based on current distribution of species, their efficacy will diminish as species distributions will change in response to climatic changes. When designing new protected areas or expanding current protected areas, covering a broader range of altitudinal gradients (Malakoutikhah *et al.*, 2018) would enable species to track their suitable habitats poleward (higher latitudes) or upward (higher altitudes) within the limits of the protected areas (Halpin, 1997). In this aim, new protected areas can be designed based on outputs of niche modeling studies that allow to predict the impact of climate change on the distribution of indicator species (Hannah, 2008).

1.5 Outline and aims of this thesis

The main purposes of this thesis are to study the influence of evolutionary history and climatic changes on the structure and distribution of several Iranian snakes as well as to understand how evolutionary processes can be incorporated into conservation planning to yield more effective protected areas and enhance our ability to protect biodiversity efficiently under changing climatic conditions. As species models, I choose several snake species from Iranian mountains for which sampling deficiencies and lack of data have limited the researches.

The present thesis consists of five chapters as follows:

Chapter 1: General context concerning knowledge gaps related to biodiversity with emphasis on reptiles, in the western Palearctic in general and in Iran in particular, their implications for conservation, as well as the effects of climate change and the geological processes acting on biodiversity evolution.

Chapter 2: Presentation of Iran as a transition zone, of two important biodiversity hotspots in Iran and their remarkable biodiversity values, as well as the role that these areas play in snake evolution during geological periods and Quaternary climatic oscillations.

Chapter 3: Interpretation of the main results of a phylogenetic and phylogeographic analyses of three species belonging to the genera *Natrix*, *Hemorrhois*, and *Gloydius*, and analysis of the role played by geological, geographical and Quaternary climatic processes in divergence and diversification of the species studied.

Chapter 4: Evaluation of the contribution of Species Distribution Models to prediction of distribution dynamics in undersampled countries and taxa, utilization of these models to provide a first approximation of the current distributions and future suitable areas for seven undersampled snake species in the context of climate change, and finally, providing better understanding and directions towards safeguarding future patterns of snake diversity in Iran through filling information gaps.

Chapter 5: This chapter attempts to synthesize the main results of this thesis in integrating the key findings, discussing the limitations, and highlighting avenues for future research, notably with respect to conservation issues.

In summary, the main objectives of this thesis are:

1. Assessing the relative influences of evolutionary history and current ecological processes on the spatial distribution and composition of snake assemblages in Iranian mountains

2. Trying to uncover the genetic structure for three snake species (*Natrix tessellata*, *Hemorrhois raviergeri* and *Gloydius caucasicus*) and propose an evolutionary scenario explaining the current patterns observed.
3. Reassessing the taxonomic status of these species
4. Assessing the role of climate change on the isolation of populations within the guilds of mountainous Snakes in the Alborz and Zagros Mountains
5. Defining Evolutionarily Significant Units (ESU) for developing the network of protected areas in Iran, revealing unique haplotypes and isolated lineages
6. Assessing the role of the current network of protected areas in Iran to include future climatic envelopes for snake species under global warming scenarios

References

- Ahmadzadeh F., Carretero M.A., Rödder D., Harris D.J., Freitas S.N., Perera A., *et al.* (2013). Inferring the effects of past climate fluctuations on the distribution pattern of *Iranolacerta* (Reptilia, Lacertidae): evidence from mitochondrial DNA and species distribution models. *Zoologischer Anzeiger – A journal of Comparative Zoology*. 252:141–148.
- Ahmadzadeh F., Flecks M., Torki F., Böhme W. (2011). A new species of angular-toed gecko, genus *Cyrtopodion* (Squamata: Gekkonidae), from southern Iran. *Zootaxa*, 2924: 22–32.
- Anderson, S. C. (1999). Fauna of Persia. *Encyclopaedia Iranica*, 9: 437-446.
- Araújo MB, Thuiller W, Pearson RG (2006) Climate warming and the decline of amphibians and reptiles in Europe. *Journal of Biogeography*, 33, 1712– 1728.
- Austin, D., Bowen, W.D., McMillan, J.I., Iverson, S.J., (2006). Linking movement, diving, and habitat to foraging success in a large marine predator. *Ecology* 87, 3095–3108.
- Avise, J. C. (2000). *Phylogeography: the history and formation of species*. Harvard University Press.
- Avise, J.C. (1998). The history and purview of phylogeography: A personal reflection. *Mol. Ecol.* 7:371–379.
- Avise, J.C. (2000). *Phylogeography: The history and formation of species*. Cambridge, Mass.: *Harvard University Press*.
- Avise, J.C., J. Arnold, R.M. Ball, E. Bermingham, T. Lamb, J.E. Neigel, C.A. Reeb, and N.C. Saunders. (1987). Intraspecific phylogeography: The mitochondrial DNA bridge between population genetics and systematics. *Annu. Rev. Ecol. Syst.* 18:489 –522.
- Bahn, V. and McGill, B.J. (2013), Testing the predictive performance of distribution models. *Oikos*, 122: 321-331.
- Barnosky AD, *et al.* (2011) Has the Earth's sixth mass extinction already arrived? *Nature*. 471:51–57.
- Barrows, C.W., Rotenberry, J.T., Allen, M.F., 2010. Assessing sensitivity to climate change and drought variability of a sand dune endemic lizard. *Biological Conservation* 143, 731-743.
- Baselga A, Lobo JM, Hortal J, Jiménez-Valverde A, Gómez JF. (2010). Assessing *alpha* and *beta* taxonomy in Eupelmid wasps: Determinants of the probability of describing good species.
- Behrooz, R. *et al.* (2018). Conservation Below the Species Level: Suitable Evolutionarily Significant Units among Mountain Vipers (the *Montivipera raddei* complex) in Iran. *J. Hered.* 109, 416–425.
- Bellard C, Bertelsmeier C, Leadley P, Thuiller W and Courchamp F 2012: Impacts of climate change on the future of biodiversity, *Ecology letters*. 15, 365–377.
- Bellard, C., Leclerc, C., Leroy, B., Bakkenes, M., Veloz, S., Thuiller, W., Courchamp, F., (2014). Vulnerability of biodiversity hotspots to global change. *Glob. Ecol. Biogeogr.* 23, 1376–1386.
- Bennett KD (1990) Milankovitch cycles and their effects on species in ecological and evolutionary time. *Paleobiology*, 16, 11-21.
- Bennett, K. D. 1997 *Evolution and ecology: the pace of life*. Cambridge University Press.
- Bermingham, E., and C. Moritz. (1998). Comparative phylogeography: Concepts and applications. *Mol. Ecol.* 7:367–369.

- Bickford D., Lohman D.J., Sodhi N.S., Ng P.K.L., Meier R., Winker K., Ingram K.K., Das I. (2007). Cryptic species as a window on diversity and conservation, *Trends Ecol. Evol.* 22, 148-155.
- Bininda-Emonds ORP, Cardillo M, Jones KE, MacPhee RDE, Beck RMD, et al. (2007). The delayed rise of present-day mammals. *Nature* 446: 507-12.
- Blackburn, T. M. and Gaston, K. J. 1998: The distribution of mammal body masses. *Diversity and Distributions* 4, 121-133.
- Blaustein AR, Belden LK, Olson DH, Green DM, Root TL, Kiesecker JM (2001) Amphibian breeding and climate change. *Conservation Biology*, 15, 1804-1809.
- Boakes EH, McGowan PJK, Fuller RA, Chang-qing D, Clark NE et al. (2010). Distorted views of biodiversity: Spatial and temporal bias in species occurrence data. *PLoS Biol* 8: e1000385.
- Boakes, E. H., P. J. K. McGowan, R. A. Fuller, D. Chang-qing, N. E. Clark, K. O'Connor, and G. M. Mace. (2010). Distorted views of biodiversity: spatial and temporal bias in species occurrence data. *PLoS Biology* 8:1-11.
- Bosch, J., Carrascal, L.M., Duran, L., Walker, S., Fisher, M.C. (2007): Climate change and chytridiomycosis in a montane area of Central Spain: is there a link? *Proc. R. Soc. B* 274, 253-260.
- Botkin DB, Saxe H, Araujo MB, Betts R, Bradshaw RHW and Cedhagen T 2007: Forecasting the effects of global warming on biodiversity. *Bioscience*. 57, 227-236.
- Botkin, D.B., Saxe, H., Araujo, M.B., Betts, R., Bradshaw, R.H.W., Cedhagen, T. et al. (2007). Forecasting the effects of global warming on biodiversity. *Bioscience*, 57, 227-236.
- Bradshaw, W.E & Holzapfer, C.M. (2006). Evolutionary Response to Rapid Climate Change. *Science*. 312:1477-1478.
- Brown J.H. and Gibson A.C. 1983. Biogeography. Mosby, St Louis, Missouri.
- Brown JH. (1984). On the relationship between abundance and distribution of species. *American Naturalist* 124: 255-79.
- Brown, J.H. (1995) Macroecology. The University of Chicago Press, Chicago.
- Bush MB, Lovejoy TE. (2007). Amazonian conservation: pushing the limits of biogeographical knowledge. *Journal of Biogeography* 34: 1291-93.
- Cadotte M, Albert CH, Walker SC. (2013). The ecology of differences: Assessing community assembly with trait and evolutionary distances. *Ecology Letters* 16: 1234-44.
- Callaway Ragan M, Brooker RWW, Choler P, Kikvidze Z, Lortie CJ, Michalet R, Paolini L, Pugnaire FI, Newingham B, Aschehoug ET, Armas C, Kikodze D, Cook BJ, Callaway RM (2002) Positive interactions among alpine plants increase with stress. *Nature* 417:844-848.
- Casacci LP, Thomas JA, Sala M, et al. (2013) Ant Pupae Employ Acoustics to Communicate Social Status in Their Colony's Hierarchy. *Current Biology* 23, 323-327.
- Chapman AD. (2009). *Numbers of living species in Australia and the World*. 2nd edition. Australian Biological Resources Study, Canberra.
- Clark JS, May, R.M. (2002). Taxonomic Bias in Conservation Research. *Science*. 297:191-192.
- Clusella-Trullas S, Blackburn TM, Chown SL (2011). Climatic predictors of temperature performance curve parameters in ectotherms imply complex responses to climate change. *Am Nat* 177:738-751.
- Coope, G. R. 1995 Insect faunas in ice age environments: why so little extinction? In *Extinction rates* (ed. J. H. Lawton & R. M. May), *Oxford University Press*, pp. 55-74.
- Cox, C. B., Moore, P. D. & Ladle, R. (2016). *Biogeography: an ecological and evolutionary approach*. (John Wiley & Sons).

- Crandall , K.A. , Bininda - Emonds , O.R.P. , Mace , G.M. & Wayne , R.K. (2000) Considering evolutionary processes in conservation biology . *Trends in Ecology & Evolution* , 15 , 290 – 295 .
- Dastorani, M.T., & Poormohammadi, S. (2016) Mapping of climatic parameters under climate change impacts in Iran, *Hydrological Sciences Journal*, 61:14, 2552-2566.
- Dayrat B. (2005). Towards integrative taxonomy. *Biological Journal of the Linnean Society* 85:407-15.
- Deans AR, Yoder MJ, Balhoff JP (2012) Time to change how we describe biodiversity. *Trends in Ecology & Evolution* 27, 78-84.
- Deutsch, C. A., J. J. Tewksbury, R. B. Huey, K. S. Sheldon, C. K. Ghalambor, D. C. Haak, and P. R. Martin. 2008. Impacts of climate warming on terrestrial ectotherms across latitude. *Proceedings of the National Academy of Sciences USA* 105:6668–6672.
- Ding, L., Gan, X. N., He, S. P. & Zhao, E. M. A (2011). phylogeographic, demographic and historical analysis of the short-tailed pit viper (*Gloydius brevicaudus*): evidence for early divergence and late expansion during the Pleistocene. *Mol. Ecol.* 20, 1905–1922.
- Diniz-Filho JAF, Loyola RD, Raia P, Mooers AO, Bini LM. (2013). Darwinian shortfalls in biodiversity conservation. *Trends in Ecology & Evolution* 28: 689-95.
- Dodd C.K. & Siegel R.A. (1991) Relocation, repatriation and translocation of amphibians and reptiles: Are they conservation strategies that work? *Herpetologica*, 47, 336-350.
- Dornburg A, Beaulieu JM, Oliver JC, Near TJ. (2011). Integrating fossil preservation biases in the selection of calibrations for molecular divergence time estimation. *Systematic Biology* 60: 519-27.
- Dudley, N. (Ed.) 2008. Guidelines for Applying Protected Area Management Categories. IUCN, Gland.
- Elith, J and John R. Leathwick, J.R.(2009). Species Distribution Models: Ecological Explanation and Prediction Across Space and Time. *Annual Review of Ecology, Evolution, and Systematics*,40:1, 677-697.
- Ellwood MDF, Foster WA. (2004). Doubling the estimate of invertebrate biomass in a rainforest canopy. *Nature* 429: 549-51.
- Fathinia B., Karamiani R., Darvishnia H., Heidari N., Rastegar- Pouyani N. (2011). A new species of *Carinatogekko* (Sauria: Gekkonidae) from Ilam Province, western Iran. *Amphib reptile conserv*, 5: 61–74.
- Feldman, C.R., and G.S. Spicer. (2006). Comparative phylogeography of woodland reptiles in California: Repeated patterns of cladogenesis and population expansion. *Mol. Ecol.* 15:2201–2222.
- Felsenstein J. (1985). Phylogenies and the comparative method. *American Naturalist* 125: 1-15.
- Ficetola, G.F., Bonardi, A., Sindaco, R. and Padoa-Schioppa, E. (2013), Estimating patterns of reptile biodiversity in remote regions. *J. Biogeogr.*, 40: 1202-1211.
- Firouz, E. (2005). The complete fauna of Iran. IB Tauris Publishers.
- FitzJohn RG, Maddison WP, Otto SP. (2009). Estimating trait-dependent speciation and extinction rates from incompletely resolved phylogenies. *Systematic Biology* 58: 595-611.
- Foden, W., G. Mace, J.C. Vie, A. Angulo, S. Butchart, L. DeVantier, H. Dublin, A. Gutsche, S. Stuart, and E. Turak. 2008. Species susceptibility to climate change impacts. In: J.-C. Vié, C. Hilton-Taylor and S.N. Stuart (eds). The 2008 Review of The IUCN Red List of Threatened Species. IUCN Gland, Switzerland.
- Fourcade, Y., Engler, J.O., Rödder, D., Secondi, J., (2014). Mapping species distributions with MAXENT using a geographically biased sample of presence data: a performance assessment of methods for correcting sampling bias. *PLoS One* 9, e97122.

- Fraser D.J., Bernatchez L. (2001). Adaptive evolutionary conservation: towards a unified concept for defining conservation units. *Molecular Ecology*, 10:2741–2752.
- Freckleton RP, Harvey PH, Pagel M. (2002). Phylogenetic analysis and comparative data: A test and review of evidence. *American Naturalist* 160: 712-26
- Gaston KJ, Blackburn TM. (1994). Are newly described bird species small-bodied? *Biodiversity Letters* 2: 16–20.
- Gelderblom C.M. and Bronner G.N. (1995). Patterns of distribution and protection status of the endemic mammals in South Africa. *South African Journal of Zoology* 30: 127–135.
- Gholamifard A., Rastegar-Pouyani N. & Rastegar-Pouyani E. 2015. — Rediscovery of *Microgecko helenae fasciatus* (Schmidtler and Schmidtler, 1972) from Kermanshah Province, western Iran with notes on taxonomy, morphology, and habitat. *Asian Herpetological Research* 6 (4): 339-346.
- Gibbons, J., Scott, D., Ryan, T., Buhlmann, K.A., Tuberville, T.D., Metts, B.S., Greene, J.L., Mills, T., Leiden, Y., Poppy, S., Winne, C.T. (2000): The global decline of reptiles, déjà vu amphibians. *Bioscience* 50, 653-666.
- Gibbons, J.W., Scott, D.E., Ryan, T.J., Buhlmann, K.A., Tuberville, T.D., Metts, B.S., Greene, J.L., Mills, T., Leiden, Y., Poppy, S., (2000). The Global Decline of Reptiles, Déjà Vu Amphibians: Reptile species are declining on a global scale. Six significant threats to reptile populations are habitat loss and degradation, introduced invasive species, environmental pollution, disease, unsustainable use, and global climate change. *Bioscience* 50, 653–666.
- Gottfried M., Pauli H. and Grabherr G. 1998. Prediction of vegetation patterns at the limits of plant life: a new view of the alpine-nival ecotone. *Arctic and Alpine Research* 30: 207–221.
- Graves, J.E., S.D. Ferris, and A.E. Dizon. (1984). Close genetic similarity of Atlantic and Pacific skipjack tuna (*Katsuwonus pelamis*) demonstrated with restriction endonuclease analysis of mitochondrial DNA. *Mar. Biol.* 79:315–319.
- Griffith B., Scott J. M., Carpenter J.W. & Reed C. (1989) Translocation as a species conservation tool: status and strategy. *Science*, 245, 477–480.
- Grinnell, J., 1917. Field tests of theories concerning distributional control. *American Naturalist* 51, 115–128.
- Guicking, D., Joger, U. and Wink, M. (2009). Molecular phylogeography of the viperine snake *Natrix maura* (Serpentes: Colubridae): Evidence for strong intraspecific differentiation. *Organisms, Diversity & Evolution*: 130–145.
- Guisan, A. & Zimmermann, N.E. 2000. Predictive habitat distribution models in ecology. *Ecol. Model.* 135: 147-186.
- Guisan, A. and Thuiller, W. (2005), Predicting species distribution: offering more than simple habitat models. *Ecology Letters*, 8: 993-1009.
- Guo, Q., (2003). Plant abundance: the measurement and relationship with seed size. *Oikos* 101, 639–642.
- Hall BG. (2011). *Phylogenetic trees made easy: A how-to manual. Fourth edition.* Sunderland, 989 MA: Sinauer Associates. 282 pp.
- Halpin, P.N. 1997. Global change and natural area protection: management responses and research directions. *Ecological Applications* 7: 828–843.
- Hamann A., Barbon E.B., Curio E. and Madulid D.A. 1999. A botanical inventory of a submontane tropical rainforest on Negros Island, Philippines. *Biodiversity and Conservation* 8: 1017–1031.
- Hannah, L. (2008), Protected Areas and Climate Change. *Annals of the New York Academy of Sciences*, 1134: 201-212.

- Hannah, L., Lovejoy, T.E., Schneider, S.H., 2005. Biodiversity and climate change in context. In: Lovejoy, T.E., Hanna, L. (Eds.), *Climate Change and Biodiversity*. Yale University Press, New Haven, Connecticut, pp. 3-14.
- Hawkes LA, Broderick AC, Godfrey MH, Godley BJ (2009) Climate change and marine turtles. *Endang Species Res* 7:137-154.
- Heikkinen, R.K., Marmion, M. and Luoto, M. (2012), Does the interpolation accuracy of species distribution models come at the expense of transferability? *Ecography*, 35: 276-288.
- Heller NE and Zavaleta ES 2009: Biodiversity management in the face of climate change: a review of 22 years of recommendations. *Biological Conservation*. 142, 14-32.
- Heppell, S. S., L. B. Crowder, D. T. Crouse, S. P. Epperly, and N. B. Frazer. (2003) . Population models for Atlantic loggerheads. In *Loggerhead sea turtles* (A. Bolten and B. Witherington, eds.), pp. 255–273. Smithsonian Books, Washington, D.C.
- Hewitt, G 2000 The genetic legacy of the Quaternary ice ages. *Nature* volume 405, pages907–913.
- Hewitt, G.M. (1996). Some genetic consequences of ice ages, and their role in divergence and speciation. *Biological Journal of the Linnean Society*, 58:247–276.
- Holdridge, L.R. 1947. Determination of world formations from simple climatic data. *Science* 105: 127-153.
- Hopkins GW, Freckleton RP. (2002). Declines in the numbers of amateur and professional taxonomists: implications for conservation. *Animal Conservation* 5: 245-49.
- Hortal J, Jiménez-Valverde A, Gómez JF, Lobo JM, Baselga A. (2008). Historical bias in biodiversity inventories affects the observed environmental niche of the species. *Oikos*. 117: 847-58.
- Hortal, J., de Bello, F., Diniz-Filho, J.A.F., Lewinsohn, T.M., Lobo, J.M. & Ladle, R.J. (2015). Seven shortfalls that beset large-scale knowledge of biodiversity. *Annual Review of Ecology, Evolution, and Systematics*, 46, 523–549.
- Huey, R.B., and J.G. Kingsolver. 1989. Evolution of thermal sensitivity of ectotherm performance. *Trends Ecol. Evol.* 4:131–135.
- Hughes L 2000: Biological consequences of global warming: is the signal already apparent? *Trends in Ecology and Evolution*. 15, 56–61.
- Hutchinson GE. (1978). *An introduction to population biology*. New Haven, CT: Yale University Press.
- International Union for Conservation of Nature. (2009). Guidelines for re-introductions. Prepared by the IUCN/SSC re-introduction specialist group. Cambridge, U.K.: IUCN.
- Jablonski, D., Nagy, Z. T., Avcı, A., Olgun, K., Kukushkin, O. V., Safaei-Mahroo, B., & Jandzik, D. (2019). Cryptic diversity in the smooth snake (*Coronella austriaca*). *Amphibia-Reptilia*, 40(2), 179-192.
- Janzen, F.J. (1994): Climate change and temperature-dependent sex determination in reptiles. *PNAS* 91, 7487-7490.
- Janzen, F.J. (1994): Climate change and temperature-dependent sex determination in reptiles. *PNAS* 91, 7487-7490.
- Jenkins, C.N., Pimm, S.L. & Joppa, L.N. (2013) Global patterns of terrestrial vertebrate diversity and conservation. *Proceedings of the Royal Society B: Biological Sciences*, 110, 1–10.
- Jetz W, Thomas GH, Joy JB, Hartmann K, Mooers AO. (2012). The global diversity of birds in space and time. *Nature* 491: 444-48.
- Jewitt, D., Erasmus, B.F.N., Goodman, P.S., O'Connor, T.G., Hargrove, W.W., Maddalena, D.M., Witkowski, E.T.F. 2015c. Climate-induced change of environmentally defined

- floristic domains: a conservation-based vulnerability framework. *Applied Geography* 63:33-42.
- Journé, V., Barnagaud, J., Bernard, C., Crochet, P., Morin, X., (2019). Correlative climatic niche models predict real and virtual species distributions equally well. *Ecology*.101,1 e02912.
- Julliard, R., Jiguet, J. & Couvet, D. (2003) Common birds facing global changes: what makes a species at risk? *Global Change Biology*, 10, 148– 154.
- Kazemi, S., Rastegar-Pouyani, E., Shafiei Darabi, S., Ebrahim Tehrani, M., Hosseinzadeh, M., Mashayekhi, M., & Mobaraki, A. (2015). Annotated checklist of amphibians and reptiles of Qom Province, central Iran. *Iranian Journal Of Animal Biosystematics*, 11(1), 23-31.
- Kearney, M. and Porter, W. (2009), Mechanistic niche modelling: combining physiological and spatial data to predict species' ranges. *Ecology Letters*, 12: 334-350.
- Keely D (2011). Climate variability and climate change. What is the difference? <http://www.miseagrant.umich.edu/climate>.
- Ladle, R.J., Whittaker, R.J. (2011). Conservation Biogeography. *Blackwell Publishing Ltd*.320pp.
- Lee, J.R., and C.R. Peterson. (2003). Herpetological inventory of Craters of the Moon National Monument 1999 –2001. Final Report to Craters of the Moon National Monument and Preserve, National Park Service, Pocatello, Idaho.
- Lomolino, M. V, (2004). Conservation biogeography. *Front. Biogeogr. new Dir. Geogr. Nat.* 293.
- López-Luna, M.A., Hidalgo-Mihart, M.G., Aguirre-León, G., González-Ramón, M.D.C., Rangel-Mendoza, J.A., 2015. Effect of nesting environment on incubation temperature and hatching success of Morelet's crocodile (*Crocodylus moreletii*) in an urban lake of Southeastern Mexico. *J. Therm. Biol.* 49-50, 66–73.
- Losos JB. (2011). Seeing the forest for the trees: The limitations of phylogenies in comparative biology. *American Naturalist* 177: 709-27.
- Lovejoy, T.E (2006) Protected areas: a prism for a changing world. *Trends in Ecology and Evolution*, 21 (6) 329-333.
- Lukoschek V, Scott Keogh J, Avise JC. (2012). Evaluating fossil calibrations for dating phylogenies in light of rates of molecular evolution: A comparison of three approaches. *Systematic Biology* 61: 22-43.
- Mace GM. (2004). The role of taxonomy in species conservation. *Philosophical Transactions of the Royal Society of London B: Biological Sciences* 359: 711-19.
- Malakoutikhah S., Fakheran S., Hemami M.-R., Tarkesh M., Senn J. (2018). Altitudinal heterogeneity and vulnerability assessment of protected area network for climate change adaptation planning in central Iran. *Applied Geography*, 92, pp. 94-103.
- Mantyka -Pringle CS, Martin TG, Rhodes JR (2012) Interactions between climate and habitat loss effects on biodiversity: a systematic review and meta -analysis. *Global Change Biology*, 18, 1239 –1252.
- MASSOT, M., CLOBERT, J. and FERRIÈRE, R. (2008), Climate warming, dispersal inhibition and extinction risk. *Global Change Biology*, 14: 461-469.
- MEA 2005: Ecosystem and human wellbeing: Biodiversity Synthesis. Washington DC: *Island press*.
- Meyers LA and Bull JJ 2002: Fighting change with change: adaptive variation in an uncertain world. *Trends Ecological Evolution*. 17, 551–557.
- Michener, W.K., Jones, M.B (2012).Ecoinformatics: supporting ecology as a data-intensive science. *Trends Ecol. Evol*, 27: 85-93.

- Millennium Ecosystem Assessment., 2005. Ecosystems and Human Wellbeing: *Synthesis*. Island Press, Washington, DC.
- Mitchell, N.J., Janzen, F. (2010): Temperature-dependent sex determination and contemporary climate change. *Sex. Dev.* 4, 129-40.
- Mittermeier, R.A., Gil, P.R. and Mittermeier, C.G. (2005). Megadiversity: Earth's biologically wealthiest nations (501 p). *CEMEX Publ.*
- Morin, X., Améglio, T., Ahas, R., Kurz-Besson, C., Lanta, V., Lebourgeois, F., Miglietta, F., Chuine, I., (2007). Variation in cold hardiness and carbohydrate concentration from dormancy induction to bud burst among provenances of three European oak species. *Tree Physiol.* 27, 817–825.
- Moritz, C. (1994) Defining 'evolutionarily significant units' for conservation. *Trends in Ecology & Evolution*, 9, 373 – 375.
- Moritz, C., and D.P. Faith. (1998). Comparative phylogeography and the identification of genetically divergent areas for conservation. *Mol. Ecol.* 7:419 – 429.
- Mouquet, N., Lagadeuc, Y., Devictor, V., Doyen, L., Duputié, A., Eveillard, D., Faure, D., Garnier, E., Gimenez, O., Huneman, P., (2015). Predictive ecology in a changing world. *J. Appl. Ecol.* 52, 1293–1310.
- Mozaffari, O., Kamali, K., Fahimi, H. (2016). the Atlas of Reptiles of Iran. *Journal of Animal Diversity*.1: 20–25.
- Mullin, S.J., Seigel, R.A (2011). Snakes: Ecology and Conservation. Cornell University Press. 384 pp.
- Naeimeh, F., Rastegar-Pouyani, N., Rastegar-Pouyani, E., Fathinia, B., Bahmani, B., Hamidi, K., Gholamifard, A. (2018). Annotated checklist of the endemic Tetrapoda species of Iran. *Zoosystema*. 40: 507-537).
- Navas CA, Carvajalino-Fernández JM, Saboyá-Acosta LP, Rueda-Solano LA, Carvajalino-Fernández MA. 2013. The body temperature of active amphibians along a tropical elevation gradient: patterns of mean and variance and inference from environmental data. *Funct Ecol.* 1-10.
- Nazarov R. A., Ananjeva N. B., Radjabizadeh M. (2010). Two new species of angular-toed geckos (Squamata: Gekkonidae) from southern Iran. *Russ J Herpetol*, 16: 311–324.
- Nee S, May RM, Harvey PH. (1994). The reconstructed evolutionary process. *Philosophical Transactions of the Royal Society of London B* 344: 305-11
- Nemésio, A., D. P. Seixas, and H. L. Vasconcelos. (2013). The public perception of animal diversity: What do postage stamps tell us? *Frontiers in Ecology and the Environment* 11:9–10.
- Niu, S.L., Sherry, R.A., Zhou, X.H., Wan, S.Q. & Luo, Y.Q. (2010) Nitrogen regulation of the climate-carbon feedback: evidence from a long-term global change experiment. *Ecology*, 91, 3261–3273.
- Noroozi J, Talebi A, Doostmohammadi M, Rumpf SB, Linder HP, Schneeweiss GM, (2018). Hotspots within a global biodiversity hotspot - areas of endemism are associated with high mountain ranges. *Scientific Reports* 8, 10345.
- Pardo, I., M. P. Pata, D. Gómez, and M. B. Garcia. (2013). A novel method to handle the effect of uneven sampling effort in biodiversity databases. *PLoS ONE* 8:1–9.
- Parmesan, C., (2006). Ecological and evolutionary responses to recent climate change. *Annu. Rev. Ecol. Evol. Syst.* 37, 637–669.
- Peterson AT et al., (2011). Ecological Niches and Geographic Distributions. Princeton: Princeton University Press.
- Platenberg R.J. & Griffiths R.A. (1999) Translocation of slow-worms (*Anguis fragilis*) as a mitigation strategy: a case study from south-east England. *Biological Conservation*, 90, 125-132.

- Pompe, S., Hanspach, J., Badeck, F., Klotz, S., Thuiller, W. & Kuhn, I. (2008) Climate and land use change impacts on plant distributions in Germany. *Biology Letters*, 4, 564–567.
- Possingham, H. P., S. J. Andelman, M. A. Burgman, R. A. Medellín, L. L. Master, and D. A. Keith. (2002). Limits to the use of threatened species lists. *Trends in Ecology and Evolution* 17:503–507.
- Pounds JA, Bustamante MR, Coloma LA *et al.* (2006) Widespread amphibian extinctions from epidemic disease driven by global warming. *Nature*, 439, 161– 167.
- Pöyry, J., Luoto, M., Heikkinen, R.K., Kuussaari, M. & Saarinen, K. (2009) Species traits explain recent range shifts of Finnish butterflies. *Global Change Biology*, 15, 732– 743.
- Pressey, R. L., M. Cabeza, M. E. Watts, R. M. Cowling, and K. A. Wilson. 2007. Conservation planning in a changing world. *Trends in Ecology & Evolution* 22: 583– 592.
- Pyron RA, Wiens JJ. (2011). A large-scale phylogeny of Amphibia including over 2800 species, and a revised classification of extant frogs, salamanders, and caecilians. *Molecular Phylogenetics and Evolution* 61: 543–83.
- Rajabizadeh M., Nilson G., Kami H. G. 2011. A new species of mountain viper (Ophidia: Viperidae) from the central Zagros Mountains, Iran. *Russ J Herpetol*, 18: 235–240
- Rastegar-Pouyani N., Kami H. G., Rajabzadeh M., Shafiei S., Anderson S. C. 2008. Annotated Checklist of Amphibians and Reptiles of Iran. *IJAB*, 4: 43–66.
- Rastegar-Pouyani N., Nilson G., Faizi H. (2006). A new species of *Asaccus* (Sauria: Gekkonidae) from Kurdistan Province, western Iran. *Hamadryad* 30: 141–150.
- Raxworthy CJ, Ingram C, Rabibisoa N, Pearson R (2007) Species delimitation applications for ecological niche modeling: a review and empirical evaluation using Phelsuma day Gecko Groups from Madagascar. *Systematic Biology*, 56, 907– 923.
- Reading, C.J. (2007): Linking global warming to amphibian declines through its effects on female body condition and survivorship. *Oecologia* 151, 125 – 131.
- Rex MA, Etter RJ. (2010). *Deep-sea biodiversity: pattern and scale*. Cambridge: Harvard University Press. 368 pp.
- Richardson, D.M. & Whittaker, R.J. (2010) Conservation biogeography foundations, concepts and challenges. *Diversity and Distribution*, 16, 313 – 320.
- Riddle BR, Ladle RJ, Lourie SA, Whittaker RJ. (2011). Basic biogeography: estimating biodiversity and mapping nature. In *Conservation Biogeography*, ed. RJ Ladle, RJ Whittaker, pp. 45–1187 92.
- Roberts, D. R., V. Bahn, S. Ciuti, M. S. Boyce, J. Elith, G. Guillera-Aroita, S. Hauenstein, J. J. Lahoz-Monfort, B. Schröder, W. Thuiller, D. I. Warton, B. A. Wintle, F. Hartig, and C. F. Dormann. (2017). Cross-validation strategies for data with temporal, spatial, hierarchical, or phylogenetic structure. *Ecography* 40:913–929.
- Ronquist, F., and J.P. Huelsenbeck. (2003). MrBayes 3: Bayesian phylogenetic inference under mixed models. *Bioinformatics* 19:1572–1574.
- Root TL, Price JT, Hall KR, Schneider SH, Rosenzweig C, Pounds JA (2003) Fingerprints of global warming on wild animals and plants. *Nature*, 421, 57– 60.
- Root, T.L., Schneider, S.H., 2002. Climate change: overview and implications for wildlife. In: Scheider, S.H., Root, T.L. (Eds.), *Wildlife Responses to Climate Change*. Island Press, Covelo, California, pp. 1–56.
- Rowe, K.C., E.J. Heske, and K.N. Paige. (2006). Comparative phylogeography of eastern chipmunks and white-footed mice in relation to the individualistic nature of species. *Mol. Ecol.* 15:4003 – 4020.
- Rowland, E. L., J. E. Davison, and L. J. Graumlich. 2011. Approaches to evaluating climate change impacts on species: a guide to initiating the adaptation planning process. *Environmental Management* 47:322–337.

- Runck, A. M. & Cook, J. A. (2005). Postglacial expansion of the southern red-backed vole (*Clethrionomys gapperi*) in North America. *Mol. Ecol.* 14, 1445–1456.
- Safaei-Mahroo, B., Ghaffari, H., Fahimi, H., Broomand, S., Yazdanian, M., Najafi-Majd, E., Hosseinian Yousefkhani, S.S., Rezazadeh, E., Hosseinzadeh, M.S., Nasrabadi, R., (2015). The herpetofauna of Iran: checklist of taxonomy, distribution and conservation status. *Asian Herpetol. Res.* 6, 257–290.
- Sansom RS, Randle E, Donoghue PC. (2015). Discriminating signal from noise in the fossil record of early vertebrates reveals cryptic evolutionary history. *Proceedings of the Royal Society of London B: Biological Sciences* 282: 20142245.
- Santos, J. G., A. C. M. Malhado, R. J. Ladle, R. A. Correia, and M. H. Costa. (2015). Geographic trends and information deficits in Amazonian conservation research. *Biodiversity and Conservation* 24:2853–2863.
- Schmidt-Lebuhn, A. N., N. J. Knerr, and M. Kessler. (2013). Non- geographic collecting biases in herbarium specimens of Australian daisies (Asteraceae). *Biodiversity and Conservation* 22:905–919.
- Schulman, L., Toivonen, T. & Ruokolainen, K. (2007) Analysing botanical collecting effort in Amazonia and correcting for it in species range estimation. *Journal of Biogeography*, 34, 1388 – 1399.
- Scott, J.M., Heglund, P.J., Hafler, J.B., Morrison, M., Raphael, M.G., Wall, W.B. *et al.* (2002). Predicting Species Occurrences: Issues of Accuracy and Scale. Island Press, Covelo, CA. (15) (PDF) *Predicting species distribution: Offering more than simple habitat models.*
- Sechrest W, Brooks TM, da Fonseca GAB, Konstant WR, Mittermeier RA, et al. (2002). Hotspots and the conservation of evolutionary history. *Proceedings of the National Academy of Sciences USA* 99: 2067-71.
- Sexton, J.P., McIntyre, P.J., Angert, A.L., Rice, K.J., (2009). Evolution and ecology of species range limits. *Annu. Rev. Ecol. Evol. Syst.* 40, 415–436.
- Shaver GR, Jonasson S (1999) Response of Arctic ecosystems to climate change: results of long-term field experiments in Sweden and Alaska. *Polar Res* 18(2):245–252.
- Shoop, R. C. and R. D. Kenney. (1992). Seasonal distributions and abundances of loggerhead and leatherback sea turtles in waters of the northeastern United States. *Herpetol. Monogr.* 6:43–67.
- Sinervo, B., et al. 2010. Erosion of lizard diversity by climate change and altered thermal niches. *Science* 328:894–899.
- Sinervo, B., Mendez-de-la-Cruz, F., Miles, D.B., Heulin, B., Bastiaans, E., Villagrán-Santa Cruz, M., Lara-Resendiz, R., Martínez-Méndez, N., Calderón-Espinosa, M.L., Meza-Lázaro, R.N., Gadsden, H., Avila, L.J., Morando, M., De la Riva, I.J., Sepulveda, P.V., Rocha, C.F.D., Ibarngüengoytía, N., Puntriano, C.A., Massot, M., Lepetz, V., Oksanen, T.A., Chapple, D.G., Bauer, A.M., Branch, W.R., Clobert, J., and Sites, J.W. 2010. Erosion of lizard diversity by climate change and altered thermal niches. *Science*, 328: 894–899.
- Slater GJ, Harmon LJ. (2013). Unifying fossils and phylogenies for comparative analyses of diversification and trait evolution. *Methods in Ecology and Evolution* 4: 699-702.
- Slatyer RA, Hirst M, Sexton JP. (2013). Niche breadth predicts geographical range size: a general ecological pattern. *Ecology Letters* 16: 1104-14.
- Soberón, J., Peterson, A.T., 2005. Interpretation of models of fundamental ecological niches and species' distributional areas. *Biodiversity Informatics* 2, 1–10.
- Sousa-Baena, M. S., L. C. Garcia, and A. T. Peterson. 2014. Knowledge behind conservation status decisions: data basis for “data deficient” Brazilian plant species. *Biological Conservation*. 173:80–89.

- Thomas, C.D., Cameron, A., Green, R.E., Bakkenes, M., Beaumont, L.J., Collingham, Y.C., Erasmus, B.F.N., De Siqueira, M.F., Grainger, A., Hannah, L., (2004). Extinction risk from climate change. *Nature* 427, 145.
- Thompson, J.N. & Weller, S.G. (2001) The population biology of invasive species. *Annual Review of Ecology and Systematics*, 32, 305 – 332.
- Thuiller, W. (2004). Patterns and uncertainties of species' range shifts under climate change. *Global Change Biology* 10:2020–2027.
- Ursenbacher, S. et al. (2006). Phylogeography of the asp viper (*Vipera aspis*) inferred from mitochondrial DNA sequence data: evidence for multiple Mediterranean refugial areas. *Mol. Phylogenet. Evol.* 38, 546–552.
- Wake DB (2007) Climate change implicated in amphibian and lizard declines. *Proceedings of the National Academy of Sciences of the United States of America*, 104, 8201– 8202.
- Wake DB, Vredenburg VT (2008) Are we in the midst of the sixth mass extinction? A review from the world of amphibians. *Proceedings of the National Academy of Sciences USA*, 105, 11466-11473.
- Walter, H. 1979. Vegetation of the earth and ecological systems of the geobiosphere. 2nded. *Springer-Verlag*, New York, NY.
- Walther G-R, Post E, Convey P *et al.* (2002) Ecological responses to recent climate change. *Nature*, 416, 389– 395.
- Waples , R.S. (1991) Pacific salmon, *Oncorhynchus* spp., and the definition of a ' species ' under the Endangered Species Act . *Marine Fisheries Review* , 53 , 11 – 22.
- Warren, M.S., Hill, J.K., Thomas, J.A., Asher, J., Fox, R., Huntley, B., Roy, D.B., Telfer, M.G., Jeffcoate, S., Harding, P., Jeffcoate, G., Willis, S.G., Greatorex-Davies, J.N., Moss, D. & Thomas, C. (2001) Rapid responses of British butterflies to opposing forces of climate and habitat change. *Nature*, 414, 65– 69.
- Whitfield, S.M., Bell, K.E., Philippi, T., Sasa, M., Bolanos, F., Chaves, G., Savage, J.M., Donnelly, M.A. (2007): Amphibian and reptile declines over 35 years at La Selva. Costa Rica. *PNAS*.104,8352-8356.
- Whittaker RJ, Araújo MB, Jepson P, Ladle RJ, Watson JEM, Willis KJ. (2005). Conservation biogeography: assessment and prospect. *Diversity and Distributions* 11: 3-23.
- Whittaker RJ, Araújo MB, Jepson P, Ladle RJ, Watson JEM, Willis KJ. (2005). Conservation biogeography: assessment and prospect. *Diversity and Distributions* 11: 3-23.
- Willett, S. D., 1999, Orogeny and orography: The effects of erosion on the structure of mountain belts: *Journal of geophysical research*, 104:28957-28981.
- Williams P.H. (1996). Mapping variations in the strength and breadth of biogeographic transition zones using species turnover. *Proceedings of the Royal Society of London Series B* 263: 579–588.
- Yousefi, M., Kafash, A., Valizadegan, N., Ilanloo, S.S., Rajabizadeh, M., Malekoutikhah, S., Hosseinian Yousefkhani, S.S., Ashrafi, A., (2019). Climate Change is a Major Problem for Biodiversity Conservation: A Systematic Review of Recent Studies in Iran. *Contemporary Problems of Ecology*. Vol. 12, No. 4, pp. 394–403.
- Zink, R.M. (2002). Methods in comparative phylogeography, and their application to studying evolution in the North American aridlands. *Integ. Comp. Biol.* 42:953 –959.

Chapter 2:

Presentation of Iran and effects of historical events on Iranian biodiversity

Résumé :

Dans ce chapitre je présente un aperçu général de l'Iran incluant l'évolution de la tectonique de la plaque iranienne, la géographie physique du plateau iranien, l'impact des changements climatiques du Quaternaire, la diversité des serpents iraniens selon les unités écologiques ainsi que la sélection des espèces qui seront étudiées.

Le plateau iranien présente un paysage accidenté de haute altitude qui est situé entre les plaques eurasiennne et arabique. La collision entre ces deux plaques est estimée s'être déroulée de -65 Ma à -5-10 Ma. A la même époque, la mer Téthys s'est asséchée, phénomène qui a été suivi par l'érection de la plaque iranienne, et notamment les montagnes du centre de l'Iran. De plus, le retrait de la mer entre l'océan Indopacifique et la mer Méditerranée s'est achevé il y environ 5 Ma, ce qui coïncide avec l'élévation du Zagros et de la plaque iranienne et l'émergence de l'Alborz. On estime que de nombreux épisodes migratoires se sont produits durant cette période, parallèlement aux fluctuations climatiques, changements de précipitation et variations d'aridité. Ces bouleversements tectoniques ont entraîné la création de nouveaux habitats (niches) dans les régions montagneuses d'Iran. Durant l'orogénèse Pyrénéenne, le plateau iranien a été compressé, ce qui a entraîné la création d'un bassin intérieur entouré de massifs. Il en a résulté la formation de grands lacs qui ont perduré jusqu'au Quaternaire et qui ont constitué des barrières à la dispersion des espèces. Les fluctuations du Quaternaire se sont traduites par l'alternance de périodes sèches et humides. Durant les périodes froides et humides, la réduction de l'évaporation et l'augmentation des précipitations ont entraîné une élévation du niveau de l'eau tandis que durant les périodes interglaciaires sèches, les régions de basse altitude sont devenues arides ou réduites à des habitats saisonniers. Sous l'influence de ces épisodes, les montagnes majeures de l'Iran se sont formées et se sont finalement individualisées.

La remarquable biodiversité de l'Iran est largement expliquée par sa position géographique située à la jonction entre trois régions biogéographiques : le Paléarctique et les domaines Afrotropical et Oriental. Par conséquent, l'Iran est caractérisé par une grande richesse de serpents comparativement aux pays voisins. Les taxons occupant les zones arides du Paléarctique austral sont reconnues comme des espèces Saharo-Sindiennes tandis que celles occupant les régions montagneuses de la partie anatolienne de l'Asie occidentale en Turquie et Iran, jusqu'à l'Afghanistan et le Pakistan font partie des espèces Irano-turaniennes. Au total, 83 espèces de serpents appartenant à 35 genres et sept familles sont connues en Iran. Cette diversité semble

principalement liée à la diversité des climats et des végétations ainsi qu'à la diversité des écorégions terrestres d'Iran. La répartition d'environ 67% (55 espèces) des serpents iraniens se trouve dans le Paléarctique, parmi lesquels 12% (10 espèces) sont des espèces endémiques d'Iran. Excepté pour les espèces d'origine Paléarctique, le reste des serpents iraniens appartient à d'autres domaines biogéographiques (Afrotropical et Indomalais).

D'après Rajabzadeh (2017), la diversité des serpents iraniens peut être classée en huit unités majeures : les montagnes du Zagros qui s'étendent du nord-ouest de l'Iran et quasiment jusqu'au sud, les montagnes de l'Alborz du nord-ouest au nord-est de l'Iran, les montagnes du Kopet Dagh et les montagnes d'Azerbaïdjan au nord-est de l'Iran. Ces régions sont situées dans deux points chauds de biodiversité (les 'hotspots' du Caucase et Irano-Anatolien) qui présentent une grande biodiversité et un endémisme important. Le nombre d'espèces de serpents par unité est de 46 pour le Zagros, 36 pour l'Alborz, 34 pour les montagnes du centre, 29 pour le Kopet Dagh et 22 dans les montagnes d'Azerbaïdjan.

Peu d'étude concernant les relations phylogénétiques, les patrons phylogéographiques et la modélisation de leur répartition ont été menées sur les serpents des montagnes d'Iran. C'est pourquoi je me suis intéressée à ces diverses questions, notamment en ce qui concerne trois espèces, *Natrix tessellata*, *Hemorrhoids ravigieri* et *Gloydius halys* (chapitre 3), dont la systématique est ambiguë et pour lesquelles les études précédentes n'incluaient pas ou peu d'échantillons iraniens. De plus, l'étude détaillée d'espèces sous-étudiées peut permettre d'approfondir nos connaissances concernant la façon dont la diversité génétique des serpents a été façonnée par le climat et les événements géologiques. Étant donné le rôle important joué par ces événements dans la répartition des serpents et par l'importance des montagnes iraniennes dans la diversité et l'endémisme en Iran, on suspecte que les effets des fluctuations climatiques actuelles auront des conséquences importantes sur la diversité des reptiles d'Iran. Pour cette raison, j'ai sélectionné un total de sept espèces en tant que groupe de serpents iraniens représentant la guildes des habitats de montagnes pour modéliser leur distribution actuelle et future (chapitre 4). J'ai identifié cinq espèces de Colubridae incluant *Platyceps najadum*, *Natrix tessellata*, *Malpolon insignitus*, *Hemorrhoids ravigieri*, et *Eirenis punctatolineatus*, et deux espèces de vipères de la famille des Viperidae, incluant *Macrovipera lebetina* et le complexe d'espèce *Montivipera raddei* (*M. latifi*, *M. kuhrangica*, *M. raddei*).

2.1. Tectonic evolution of the Iranian plate

Iran is part of an elevated, rugged land that is geomorphologically referred to as the Iranian Plateau that encompasses Iran, Afghanistan, as well as parts of Iraq and Pakistan and that is situated between the Eurasian Plate to the north and the Arabian Plate to the south. The continental compression between these plates gave rise to a massive orogenic system that triggered the formation of several mountain chains in the Iranian Plateau including the Alborz, Zagros, and Kopet Dagh Mountains (Fig. 2.2). Allen and Armstrong (2008) postulated that following the desiccation of the Tethys Ocean in early Miocene (ca. 19 Mya), the plates collided. This collision provided mechanisms for global cooling and reduction of atmospheric CO₂ levels. Varying phases have been presented for the timing of the Arabia-Eurasia collision, ranging between 65 Mya (Berberian and Berberian, 1981; Berberian and King, 1981), 35 Mya (Allen and Armstrong, 2008), 35 to 20 Mya (Agard *et al.*, 2005; Mouthereau *et al.*, 2007a), and 10 or 5 Mya (James and Wynd, 1965).

Following the shrinkage of the Tethys, the African and the Eurasian (Anatolian, Arabian and Iranian plates) plates collided during early Miocene (Okay *et al.*, 2010; Harzhauser *et al.*, 2007, Amer and Kumazawa, 2005, Rogl, 1999). This led to the formation of the Iranian and Turkish plateaus, and consequently the rise of the Gomphotherium land bridge (F in Fig. 2.1). Figure 2.1 shows a Paleogeographical perspective on the formation of the Paratethys and the Mediterranean Sea during the Oligocene and Miocene, adapted from Roger (1999).

The sea retreat between the Indo-Pacific Ocean and the Mediterranean Sea ended approximately 5 Mya, which also coincided with the Zagros/Iranian Plateau uplift and the exhumation in north central Alborz (Axen *et al.*, 2001). During this period, the collision of tectonic plates, which lasted until late Miocene (5 Mya), formed the Alps (Allen *et al.*, 2004). It has been suggested that a multitude of migration episodes had frequently occurred during these periods, which coincided with climatic fluctuations, changes in precipitation and aridity patterns of the Earth and different rates of crustal thickening and uplift of tectonic plates. Such tectonic rearrangements created new habitats (niches) and mountains including the uplift of the Zagros and Alborz Mountains (McQuarrie *et al.* 2003, Homke *et al.* 2004, Fakhari *et al.* 2007, Guest *et al.* 2007, Ritz *et al.* 2006, Shabanian *et al.* 2009, Djamali *et al.* 2012). By middle Pleistocene, the continued uplift of the alpine belt, more extensive monsoonal patterns, and stronger glacial-interglacial variations further aridified central and southwestern Asia.

During the Miocene, several mountains were formed in Iran and levels of marine open waters declined. At the same time, the Tethys Ocean desiccated and Asia aridified; which, together with the uplift of the Alborz and Zagros mountains and tectonic rearrangements of the Iranian Plateau during late Oligocene to late Miocene (25–12 Mya), created new habitats and possibilities for Asian species radiation (Hellwig 2004, Barres *et al.* 2013). Higher elevations of the Iranian Plateau exhibit higher endemism rates (Noroozi *et al.* 2011). The high mountain endemism in Iran may be the result of the mountain uplift in the Alborz and Zagros, the orographic isolation and the absence of larger ice-shields during the glacial periods (Farhani *et al.*, 2018). Also, it is evident that a marine gateway connecting the Mediterranean Sea and the Indo-Pacific Ocean remained open until early Miocene in Central Iran (Taleghani, 2013).

During the Pyrenean orogeny (55 to 25 Mya), the Iranian Plateau was compressed, creating a lower interior basin surrounded by a complex of massifs. As a result, central Iran was submerged by large lakes which served as a barrier to species dispersal and persisted until the Quaternary period (Taleghani, 2013). The effects of Quaternary climatic fluctuations are reflected in dry and wet cycles. During cold and wet Quaternary periods, reduced evaporation and increased precipitation caused water levels to rise, whereas during dry and inter-glacial periods, low-altitude regions became arid or were confined to seasonal habitats (Taleghani, 2013).

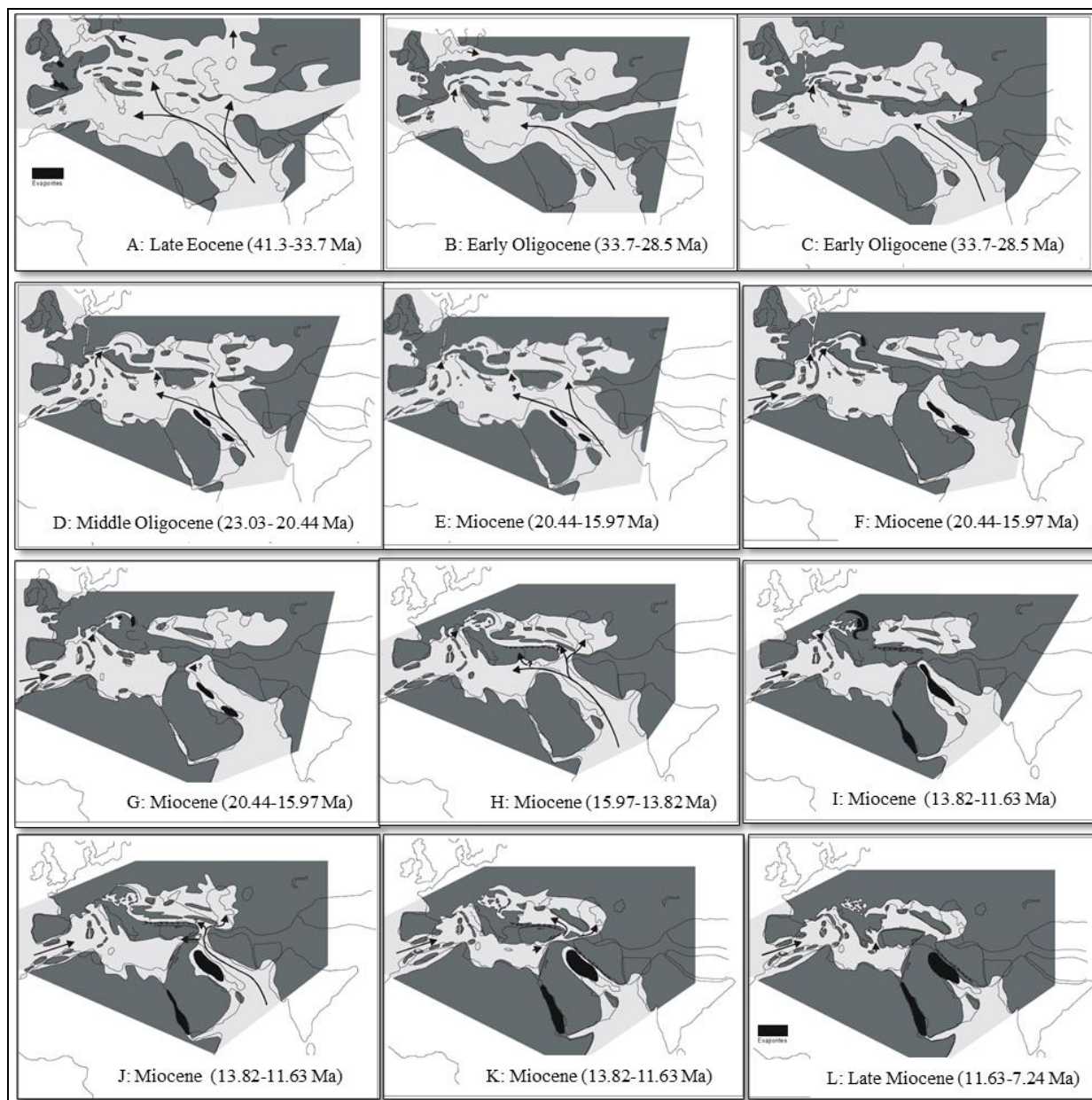

Figure 2.1 depicts a Paleogeographical perspective on the formation of the Paratethys and the Mediterranean during the Oligocene and Miocene, adapted from Roger (1999). A: Northward movement of the Indian subcontinent led to the disappearance of the Tethys Ocean. B: Formation of the Paratethys Sea. Plate tectonics along the Alpine belt and movement of India into Asia resulted in the formation of the Paratethys Sea and the southern portion of Mediterranean orogeny. C: Obstruction of open seaways isolated the Paratethys for the first time. D: Waterways were reopened in upper Oligocene, connecting the Paratethys to open waters through the Peri-Alpine seaway. E: Closure of the Slovenian channel between the Mediterranean and central Paratethys. F: Africa and the Arabian plate rotated, and eventually collided with Eurasia, closing marine corridors between the Pacific and Indian oceans. Gomphotherium Landbridge connected Eurasia and Arabia for the first time. G: The Alpine Foredeep and the Transylvanian Basin emerged from water while a small portion of the Paratethys maintained its connection with the Mediterranean Sea. H:

Indo-Pacific recurrence. A temporary channel opened to the Indian Ocean. The middle Miocene transgression refilled the Mediterranean and Paratethys. I: The Paratethys salinity. Due to the Serravallian regression and tectonic activity, the Mediterranean was finally severed from the Indian Ocean. The eastern portion of the Paratethys became an isolated low-salinity basin which contained fauna endemic to the Karaganian Sea. J: The last flooding event in the Paratethys. K: As the open seaway closed, the Paratethys ceased to be a marine environment. L: The Pannonian Lake formed and the Paratethys was eventually isolated.

2.2. Physical geography of Iranian Plateau

According to Fisher (1968) and Taleghani (2013), the Iranian Plateau formed in late Eocene, middle-upper Miocene and late Pliocene under the influence of different phases of the Alpine folding, and eventually gained independence during the last Quaternary Alpine orogenic phase. Table 2.1 summarizes the geological sequences of Iran and the role of the Alpine orogeny in its formation.

The Alpine Orogenic system extends from south of Europe toward Turkey and the Zagros Mountains in Iran to reach the Hindu-Kush Himalayan belt. The Alpine orogeny separates the Saharan-Arabian zone from the arid portions of the northern hemisphere and the Turanian-Central Asian region. From a geographical perspective, Iran is comparable to a bowl with a lower interior basin surrounded by a complex of massifs. The Zagros Mountains, the most significant massif of Iran, stretches from northwestern to southeastern Iran, covering the western portion of the country. The Zagros system is comprised of northern, central (the highest) and southern sections. Toward the east, the Central Iranian Mountains are located relatively parallel to the Zagros system in a northwest-southeast orientation. Toward the west of the Zagros range, lowlands of the western foothills of the Zagros Mountains (Iran-Iraq border) are found (Fig2.2).

A series of narrower but steeper chains extend from north of Zagros to the east and form the Talysh-Azerbaijan, Alborz and Kopet Dagh Mountains, collectively known as the Northern Iranian Mountains. The Talysh-Azerbaijan Mountains, located along the southern border of Azerbaijan, are separated from the Alborz Mountains by the gorge of the Sefid-Rud River. The Alborz mountain chain, the oldest massif of Iran, extends from the west to the east and is comprised of three main parts (eastern, central and western Alborz). The Kopet Dagh Mountains form a relatively elongated system of parallel ridges in northeast of Iran.

Since the disappearance of the Tethys Ocean, the arid and high Central Plateau of Iran dominates the formerly submerged interior (average elevation 900 m). The closed basins of the

plateau are entirely surrounded by mountains and ridges. The dry-up of the Tethys Ocean during Quaternary climatic fluctuations left behind two vast deserts in this region: the salt-encrusted Kavir Desert in the north center and the gravel-and-sand Lut Desert in the southeast of Iran (Fig. 2.2), intermixed with salt lakes and salt marshes in their lower parts.

The major lowland areas of Iran are the Caspian plain in the north and the Khuzestan plain in the southwest. The Caspian plain is a narrow but long plain with a subtropical climate located between the Caspian Sea, the Alborz Mountains and the Talysh-Azerbaijan Mountains. The Khuzestan plain is a triangular prolongation of the Mesopotamian plain and stretches from the Persian Gulf to the Western Zagros foothills (Fig 2.2).



Figure 2.2. Physiographic map of Iran showing the Alborz, Talysh-Azerbaijan, Zagros, Kopet Dagh, as well as central Mountains of Iran (following Fisher, 1968).

Table 2.1. Major tectonic phases of Iran during geological periods. Although the Iranian plate has been present throughout these periods, the current relief structure of Iran is mainly the product of the Alpine orogeny (Taleghani 2013)

Period	Epoch	Year (Mya)	Orogenic period	Orogenic phase	Orogenic events
Quaternary	Holocene	10 Kya	Alpine	Pasadenian	<ul style="list-style-type: none"> - Completion of the relief structure of Iran - Initiation of Zagros and Kopet Dagh folding – formation of the relief structure of Iran - Uplift of central, eastern and Alborz Mountains – formation of interior basins of Iran - Large-scale folding across Iran, except Zagros and Kopet Dagh – beginning of volcanic activities - Subduction of Zagros oceanic crust beneath the Iranian plate - Formation of Kopet Dagh and Zagros basins – convergence of the Iranian plate to Eurasia
	Pleistocene	2			
Cenozoic	Pliocene	12		Savian	
	Miocene	26		Pyrenean	
	Oligocene	37		Laramide	
	Eocene	53		Late Cimmerian	
	Paleocene	65		Early Cimmerian	
Mesozoic	Cretaceous	136			
	Jurassic	190			
	Triassic	225			
Paleozoic	Permian	280	Hercynian	<ul style="list-style-type: none"> Aridification Aridification 	
	Carboniferous	345			
	Devonian	395			
	Silurian	430	Caledonian		
	Ordovician	500			
	Cambrian	570			
Precambrian	Infracambrian		Huronian	<ul style="list-style-type: none"> - Formation of Iran’s basement rock platform – dissection of Iran’s basement rock platform – development of Iran’s morphotectonic units - Metamorphosis of the oldest rocks of Iran 	
	Proterozoic				
	Archeozoic				Carolian

2.3. Impact of Quaternary climate change

The current geological era, the Quaternary, is characterized by glaciation events (for more information visit <http://quaternary.stratigraphy.org>). Most of North Africa and the Middle East underwent interchanging dry and wet periods during glacial and interglacial periods (Schuster *et al.*, 2006). The last glacial period, known as the Riss-Würm glaciation, reached its peak 18,000–21,000 years before present (known as the Last Glacial Maximum, LGM), during which the Sahara and the Middle East experienced severe dry conditions, more arid than the regions’ current climate (Ehlers and Gibbard, 2004). However, 9000-5000 before present, during the Holocene Climatic Optimum (HGO), the regions’ climate become more humid, surpassing the current conditions

(Kaufman *et al.*, 2004). Such climatic oscillations during the Quaternary played a major role in species' distribution. Thus, glacial cycles produced successive contractions (in refugial areas) and expansions (through recolonization routes) of populations that left a genetic structure and signature characteristic of the past demography of taxa (Avise 2000, Hewitt 2000). In the Palearctic, the three major southern Mediterranean peninsulas (Iberia, Italy, and Balkans) were long thought to have served as major refugia for European flora and fauna during Pleistocene glaciations (Hewitt, 2000). During interglacial periods, more favorable environmental conditions allowed the expansion populations from their refugia into new territories, originating areas of secondary contact zones (e.g. Hewitt, 2011). It is also known that this general pattern mostly characterizes temperate-adapted taxa whereas cold-adapted taxa generally show the opposite pattern as they are confined in refugia during interglacials.

These effects have been well studied for European and North American biota and several LGM refugia have been reconstructed based on different methodological approaches and for various taxonomic groups (e.g., Avise 2000; Stewart *et al.* 2010). Unfortunately, in Iran, few studies have focused on species' distribution in response to climatic fluctuations and their potential impact on Iran's endemic biota is still poorly known. Our understanding of the timing, frequency, dimensions and direction of past Quaternary climatic changes in western Asia, particularly Iran, is still in its infancy and little is known about the responses of organisms to Quaternary climatic oscillations and the climatic and tectonic events of this period.

Nevertheless, the semi-arid to sub-humid climatic conditions in many parts of Iran serve as suitable field laboratories for investigating past changes in Quaternary climates. Glaciers, loess sediments, lake deposits, landscape evolution, soil formation, tree rings and other paleoclimate proxies provide essential insights that allow us to draw inferences about past Quaternary climates. Recently, new stratigraphic evidence has been derived from loess deposits in north of Iran and lake sediments in west of Iran that act as ideal archives of past climates. The Central Plateau of Iran was once covered by a huge lake, which was dried during Quaternary climatic fluctuations. Several other paleoclimate proxies, such as cave formations, tree ring thickness in forests of the Alborz and Zagros Mountains, and Central Plateau are yet to be studied in detail (Kehl 2009). Investigation of past climatic events in the Iranian Plateau using phylogeographic and molecular studies could provide a fundamental basis for understanding patterns of species distribution (see chapter 3).

2.4. Diversity of Iranian snakes in ecological units

The remarkable biodiversity of Iran is largely explained by its geographic location at the contact zone of three biogeographic realms, hosting species from Palearctic, Afrotropical and Oriental origins. Consequently, Iran is characterized by high richness of snake species when compared to neighboring countries. The distribution of about 67 percent (55 species) of Iranian snakes is confined to the Palearctic. Of this, 12 percent (10 species) are restricted to Iran as endemic species. Except for species of Palearctic origin, the remaining Iranian snakes hail from other biogeographic regions, including Afrotropical and Indomalayan. Taxa inhabiting the arid parts of southern Palearctic are recognized as Saharo-Sindian species, while those occupying the mountainous regions from the Anatolian part of west Asia in Turkey through Iran, reaching the southern Hindu Kush Mountains known as the Sulaiman mountain range in Afghanistan and Pakistan are known as Irano-Turanian (Anderson, 1999). In total, 83 snake species belonging to 35 genera and seven families have been reported in Iran. This pattern of biodiversity seems mainly related to the climate (Appendix 2.1) and vegetation (Appendix 2.2) variability and the diversity of terrestrial ecoregions in Iran.

Following Rajabizadeh (2017), the diversity of Iranian snakes was classified into eight ecological units (Fig. 2.3).

- Alborz Mountains

The first unit includes the Alborz Mountains (C in Fig.2.3a) with 36 snake species and the northern slopes adjoining the Caspian Sea (B) with 21 snake species. These mountains are divided into three sections: western Alborz, central Alborz, and eastern Alborz. The elevation of Alborz varies from 26 m below sea level at the Caspian Sea to 5671 m above sea level at Mt. Damavand, Iran's highest peak, on the northern slopes of the Alborz. While the southern slopes of the Alborz Mountains are usually semiarid or arid, with irregular and low precipitation, the northern slopes of the range are usually humid (B), especially in the western parts of Central Alborz. In the southern slopes or the Alborz Range forest steppe ecoregion, the higher elevations are arid with few trees whereas the northern slopes, the Caspian Hyrcanian mixed forests ecoregion is lush and forested. The natural vegetation of this region grows in distinct zones: the Hyrcanian forests on the lowest levels, beech forests in the middle zone, and oak forests in higher regions. The highest annual precipitation is received by the Caspian lowlands (B). The main rainy period in Iran is from

October to May, except for south-west of the Caspian region which receives high precipitation year-round (>1,000 mm/annum, maximum 1,800 mm) (Appendix 2.1). In the Caspian lowlands, the precipitation rates of the northern ranges of the Alborz and the northwestern part of the Zagros Mountains are often between 1000 - 1200 mm. The northern slopes of the Alborz Mountains are characterized by high amounts of precipitation (between 500 and 1500 mm per year).

- Zagros Mountains

The second unit includes the Zagros Mountains (F in Fig. 2.3a), which is divided into three sections of northern Zagros, central Zagros, and central Zagros. With 46 species, this unit hosts the highest number and diversity of snake species. The Zagros has several high peaks, among which Dena (4409 m) is the highest. The elevation of the Zagros ranges from 2,000 m to over 4,000 m at its peaks. The climate of the Zagros Mountains differs from the neighboring regions, receiving much higher precipitation (between 500 and 1500 mm per year) than the lowlands to the west and east of the Zagros. At elevations higher than 1500 m, much of the precipitation occurs in the form of snow during late autumn, winter and early spring (Noroozi *et al.*, 2011). Of the 10 endemic snake species, nine occur in the Zagros Mountains and one in the Alborz. This is possibly because Zagros and Alborz have acted as vital Quaternary refugia in the past and are therefore notable for their rich biodiversity and high endemism (Ahmadzadeh *et al.*, 2013; Ahmadi *et al.*, 2019; Behrooz *et al.*, 2018; Asadi *et al.*, 2019).

- Central mountains of Iran

Eastern Zagros is connected to central mountains of Iran. The interior basin or Iran's central plateau is a triangular, highly elevated and arid plain (mean elevation is above 900 meter) that separates the Alborz and Zagros mountain chains. Central Iranian mountains (E and D1 in Fig. 2.3a) are located in this part of Iran and host 34 snake species. Much of the present surface of this region was once occupied by large lakes. During the Quaternary, water levels fluctuated considerably. As a result, today the northern and the eastern central plateau are covered by Iran's central Kavir (salt land) and Lut desert. Only the lowest parts of the basins are occupied by residual salt lakes, or marshes, and the rest became dry.

- Kopet Dagh Mountains

The fourth unit comprises of Kopet Dagh Mountains (D3 in Fig. 2.3a) in northeastern Iran. The Kopet Dagh Mountains were formed during the Alpine-Himalayan orogeny in a northwest-southeast direction and is geologically similar to the Zagros. It contains 29 snake species and several studies, revealed that the species inhabiting the Kopet Dagh often exhibit morphological and molecular differences such as it has been shown for *Natrix tessellata* (Rajabizadeh *et al*, 2011). The Kopet Dagh has a mean annual precipitation of 450 mm and is covered by sparse forests.

- Azerbaijan Mountains

The fifth unit, the Azerbaijan Mountains (A in Fig. 2.3a) in northwestern Iran contains 22 snake species. This unit is located at the meeting point of the Alborz and Zagros in northwest of the Iranian Plateau. The elevation of the mountains situated at the center of this unit ranges from approximately 1000 – 2500 meters. Mean annual precipitation varies from 200-800 mm/yr. According to Rögl (1999), following the retreat of the Paratethys, this region likely served as the first corridor connecting the Iranian Plateau to Anatolian fault zone (Fig 2.1 K).

- Zabol and Persian Gulf plains

Units of Zabol plain (H in Fig. 2.3a) and Persian Gulf plain (G) contained 16 and 43 snake species, respectively. These units are characterized by different ecosystems and extremely low elevations compared to mountainous units and their faunal inhabitants are often nocturnal as an adaptation to the extreme heat.

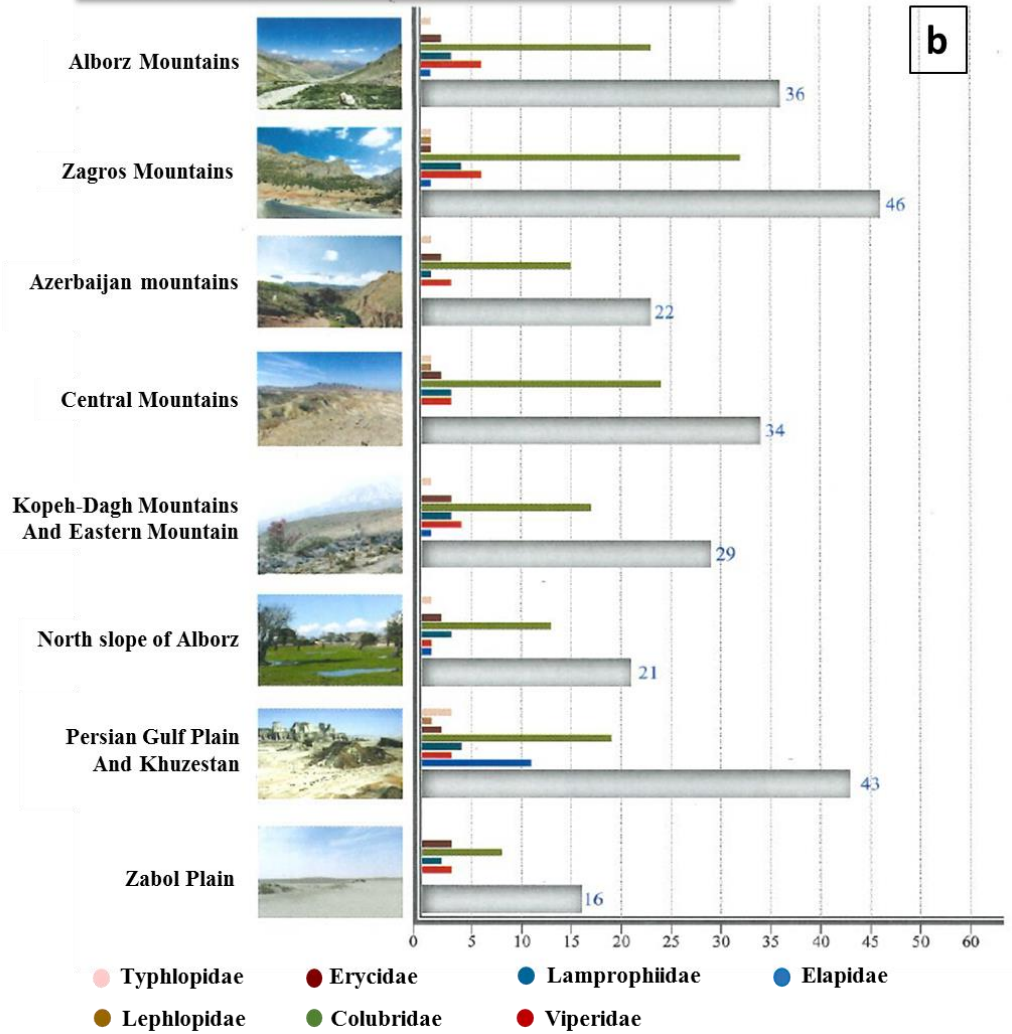
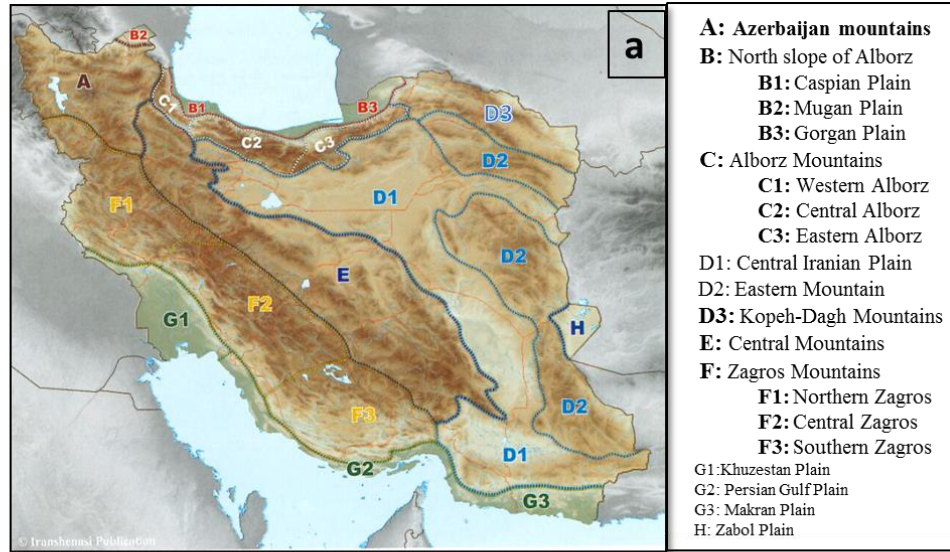

Figure 2.3 shows the map (a) of Iranian ecological units (adapted from Rajabizadeh 2017) and the diagram (b) of snake diversity in the ecological units.

2.5. Behavioral patterns of mountains snakes

In terms of daily behavioral patterns, snakes are divided into diurnal and nocturnal species. Snakes in warm and arid areas are often nocturnal while montane species such as *Eirenis* sp. and *Montivipera* sp. species are often diurnal, yet exceptions such as nocturnal montane *Macrovipera* sp. also exist. The daily behavior of snakes can change according to habitat conditions; for example, *Macrovipera lebetina* is only observed during the day in cold mountains. Similarly, diurnal snakes, such as those in *Hemorrhhois* sp. and *Platyceps* sp., exhibit nocturnal activity during the hotter months of the year. Other species display intermediate behavior and are active around dusk or dawn, likely as a response to habitat conditions and ambient temperatures. The daily activity of diurnal snakes often begins with basking to increase body temperature, making this time the most suited for observing snakes. In hot weather, these snakes seek shelter from the midday sun under rocks and shrubs. The peak activity of diurnal snakes often occurs before noon and in the evening. Nocturnal snakes are mostly found in warmer regions such as Iran's central plateau (D1), the eastern mountains and the southern regions close to the Persian Gulf (G1-G2), the Oman Sea (G3). These snakes begin their activity at sunset and are usually active until midnight. In these regions, snakes are active year-round, but in northern latitudes with distinct seasons, seasonal patterns of activity are seen. Unfortunately, information about the nocturnal snakes of Iran is insufficient and the available information is mostly focused on diurnal species.

In the mountainous area where we conducted our study, the seasonal changes in snakes' behavioral patterns are more noticeable. In spring, snakes are able to remain active for several hours because of the mild temperatures. As the weather warms in summer, snakes spend the majority of their day resting on the ground in shaded locations. With the decrease in temperature during autumn, snakes once again become more active and replenish their energy reserves to survive harsh winter conditions and move to mountainous areas with rocky outcrops. This movement to higher elevations is referred to as altitudinal migration and is seen in montane species, particularly those in genus *Montivipera* sp. During winter, snakes hibernate, ceasing to feed or drink, accompanied by reduction of metabolism and lowered respiration and heart rate. As the weather warms during late winter and early spring, snakes leave their shelters and move to lower elevations and plains, disperse in their habitats, and begin their mating activity.

2.6. Selection of studied snakes

The study of snakes in Iran has reached a new phase since 2000 and researchers have devoted much attention to this particular field due to the increasing number of new records of new species. The number of reptile species reported in Iran is increasing rapidly, with 31 newly described species between 2000 and 2014 (see Safaei-Mahroo *et al.*, 2015 for review), which motivated herpetologists to conduct more comprehensive studies with a stronger molecular, morphological and taxonomic techniques. Yet, several taxa still lack in-depth assessments. Nevertheless, Rajabizadeh (2018) gave an accurate description of the status and identification of Iranian snakes in his book, which was a major contribution to the relevant research field. A comprehensive review of available research on Iranian snakes highlights the paucity of data on the taxonomy of Iranian snakes, particularly among morphologically variable species, such as species of the genera *Gloydius*, *Hemorrhois*, *Platyceps* and *Macrovipera* (Wagner *et al.*, 2016; Schätti *et al.*, 2001; Schätti *et al.*, 1991; Schätti and Agasian, 1985). In contrast, some other genera are composed of morphologically similar but highly isolated populations of snakes in Iran, such as small-sized members of the genera *Lytorhynchus*, and *Eirenis* (Schmidtler and Eiselt, 1991; Schmidtler and Lanza, 1990; Eiselt, 1971). Furthermore, snake species with wide distribution ranges are also subjected to taxonomic uncertainties, such as species of the genera *Hemorrhois*, *Natrix* and *Dolichophis* (Gruschwitz *et al.*, 1999).

Consequently, I became interested in studying the phylogeny and phylogeography of a number of Iranian snake species with taxonomic ambiguities such as *Natrix tessellata*, *Hemorrhois ravergieri* and *Gloydius halys* (chapter 3) for which previous studies had failed to include Iranian samples. In addition, insights into understudied species of Palearctic origin could deepen our understanding of the role Iranian mountains may have played in shaping the genetic diversity of species during the Quaternary and older periods. Such knowledge greatly contributes to our future assessment of Iran's biodiversity as well as illumination of cryptic herpetofaunal biodiversity in the region. Given the important role of climatic and geological events in shaping the distribution of snake species and the significance of these mountains to biodiversity and endemism, we suspect the effect of climatic fluctuations will be substantial on the reptilian diversity of Iran. For this reason, I selected a total of seven snake species as a group of Iranian snakes as guild species for the mountainous habitats. I identified five species as focal species of the Colubridae family, including *Platyceps najadum*, *Natrix tessellata*, *Malpolon insignitus*, *Hemorrhois ravergieri*, and

Eirenis punctatolineatus, as well as two viper species of the Viperidae family, including *Macrovipera lebetina* and the *Montivipera raddei* species complex (*M. latifi*, *M. kuhrangica*, *M. raddei*) (chapter 4).

References

- Agard, P., Omrani, J., Jolivet, L., and Mouthereau, F., (2005), Convergence history across Zagros (Iran): constraints from collisional and earlier deformation: *International Journal of Earth Sciences*, v. 94, p. 401-419.
- Ahmadi, M., Hemami, M.R., Kaboli, M., Malekian, M., Zimmerman, E.N., (2019). Extinction risks of a Medirerranean neo-endemism complex of mountain vipers triggered by climate change. *Scientific Reports*. 9:6332.
- Ahmadzadeh F., Carretero M.A., Rödder D., Harris D.J., Freitas S.N., Perera A., et al. (2013). Inferring the effects of past climate fluctuations on the distribution pattern of Iranolacerta (Reptilia, Lacertidae): evidence from mitochondrial DNA and species distribution models. *Zoologischer Anzeiger – A journal of Comparative Zoology*. 252:141–148.
- Allen, M. B. & H. A. Armstrong. (2008). Arabia–Eurasia collision and the forcing of mid-Cenozoic global cooling. *Palaeogeography, Palaeoclimatology, Palaeoecology*, 265(1): 52-58.
- Allen, M. B., Jackson, J., and Walker, R., 2004, Late Cenozoic reorganization of the Arabia-Eurasia collision and the comparison of short-term and long term deformation rates: *Tectonics*, v. 32, p. 659-672.
- Amer, S. A. & Y. Kumazawa. (2005). Mitochondrial DNA sequences of the Afro-Arabian spinytailed lizards (genus *Uromastix*; family Agamidae): phylogenetic analyses and evolution of gene arrangements. *Biological Journal of the Linnean Society*, 85(2): 247-260.
- Anderson, S. C. (1999). Fauna of Persia. *Encyclopaedia Iranica*, 9: 437-446.
- Asadi, A., Montgelard, C., Nazarizadeh, M., Moghaddasi, A., Fatemizadeh, F., Simonov, et al. (2019). Evolutionary history and postglacial colonization of an Asian pit viper (*Gloydius halys caucasicus*) into Transcaucasia revealed by phylogenetic and phylogeographic analyses. *Scientific Reports* 9:1224.
- Avise, J. C. *Phylogeography: The History and Formation of Species*. (Harvard University Press, 2000).
- Axen, G. J., Lam, P. S., Grove, M., Stockli, D. F., and Hassanzadeh, J., 2001, Exhumation of the west-central Alborz Mountains, Iran, Caspian subsidence, and collision-related tectonics: *Geology*, v. 29, no. 6, p. 559-562.
- Barres L, Sanmartín I, Anderson CL, Susanna A, Buerki S, Galbany-Casals M, Vilatersana R (2013) Reconstructing the evolution and biogeographic history of tribe Cardueae (Compositae). *Am J Bot* 100:867–882.
- Behrooz, R., Kaboli, M., Arnal, V., Nazarizadeh, M., Asadi, A., Salmanian, et al. (2018). Conservation Below the Species Level: Suitable Evolutionarily Significant Units among Mountain Vipers (the *Montivipera raddei* complex) in Iran. *Journal of Heredity*, 109:416–425.
- Berberian, M. & King, G. C. P. (1981). Towards a paleogeography and tectonic evolution of Iran. *Canadian journal of earth sciences*, 18(2): 210-265.
- Djamali, M., Akhiani, H., Khoshravesh, R., Andrieu-Ponel, V., Ponel, P. & S. Brewer. (2011). Application of the Global Bioclimatic Classification to Iran: implications for understanding the modern vegetation and biogeography. *Ecologia Mediterranea* 37: 91-114.
- Ehlers, J. & P. L. Gibbard. (2004). Quaternary Glaciations Extent and chronology: Part I: Europe (Vol. 2). Access Online via Elsevier.

- Eiselt, J. (1970): Ergebnisse Zoologischer Sammelreisen in der Türkei: Bemerkenswerte Funde von Reptilien. *I. Annln. naturh. Mus. Wien.* 74: 343-355 .
- Esmaeil Shabaniyan, Olivier Bellier, Lionel Siame, Nicolas Arnaud, Mohammad R. Abbassi Jean-Jacques Cochemé. (2009). New tectonic configuration in NE Iran: Active strike-slip faulting between the Kopeh Dag and Binalud mountains. Volume 28, Issue 5 .
- Fakhari, M. D., Axen, G. J., Horton, B. K., Hassanzadeh, J., and Amini, A., 2008, Revised age of proximal deposits in the Zagros foreland basin and implications for Cenozoic evolution of the High Zagros: Tectonophysics ,Asia out of Tethys: *Geochronologic, Tectonic and Sedimentary Records*, v. 451, no. 1-4, p. 170-185.
- FARHANI, F., Kazempour-Osloo, SH-Maivan., Zare, H., Mozaffarian, V. (2018). Evolutionary history of the tribe Astereae in the Flora Iranica area: Systematic implications. *Phytotaxa* 379 (1): 095–117.
- Fisher. W. B. (1986). *The Cambridge History of Iran, Vol. 1: The Land of Iran.* Cambridge: Cambridge University Press. 766 pp.
- Gruschwitz, M., Lenz, S., Mebert, K. & V. Lanka (1999). *Natrix tessellata* (Laurenti, 1768) - Würfelnatter. – In: Böhme, W. (ed.), *Handbuch der Reptilien und Amphibien Europas, Band 3/IIA, Schlangen (Serpentes) II.* Aula-Verlag, Wiesbaden: 581–644.
- Guest, B., Horton, B. K., Axen, G. J., Hassanzadeh, J., and McIntosh, W. C., 2007, Middle to late Cenozoic basin evolution in the western Alborz Mountains: Implications for the onset of collisional deformation in northern Iran: *Tectonics*, v. 26, no. TC6011.
- Harzhauser, M., Kroh, A., Mandic, O., Piller, W. E., Göhlich, U., Reuter, M. & B. Berning. (2007). Biogeographic responses to geodynamics: a key study all around the Oligo-Miocene Tethyan Seaway. *Zoologischer Anzeiger-A Journal of Comparative Zoology*, 246(4): 241-256.
- Hellwig FH (2004) Centaureinae (Asteraceae) in the Mediterranean-history of ecogeographical radiation. *Plant Syst Evol* 246:137–162.
- Hewitt, G 2000 The genetic legacy of the Quaternary ice ages. *Nature* volume 405, pages 907–913.
- Hewitt, G.M. (1999). Post-glacial re-colonization of European biota. *Biological Journal of the Linnean Society*, 68:87–112.
- Hewitt, G.M. (2011). Quaternary phylogeography: the roots of hybrid zones. *Genetica*, 139: 617–638.
- Homke, S., Verges, J., Garces, M., Emami, H., and Karpuz, R., 2004, Magnetostratigraphy of Miocene--- Pliocene Zagros foreland deposits in the front of the Push---e Kush Arc (Lurestan Province, Iran): *Earth and Planetary Science Letters*, v. 225:397-410.
- James, G. A., and Wynd, J. G., 1965, Stratigraphic nomenclature of Iranian Oil Consortium Agreement Area: *AAPG Bulletin*, v. 49, no. 12, p. 2182-2245.
- Kaufman, D. S., Ager, T. A., Anderson, N. J., Anderson, P. M., Andrews, J. T., Bartlein, P. J., & B. B. Wolfe. (2004). Holocene thermal maximum in the western Arctic (0–180 W). *Quaternary Science Reviews*, 23(5): 529-560.
- Kehl, M. (2009). Quaternary climate change in Iran – the state of knowledge. *Erdkunde*, 63:1–17.
- Kimura, M. (1980). A simple method for estimating evolutionary rates of base substitutions through comparative studies of nucleotide sequences. *Journal of Molecular Evolution*, 16 :111–120.
- Kehl, M. (2009). Quaternary climate change in Iran – the state of knowledge. *Erdkunde*, 63:1–17.
- Kimura, M. (1980). A simple method for estimating evolutionary rates of base substitutions

- through comparative studies of nucleotide sequences. *Journal of Molecular Evolution*, 16 :111–120.
- M Rajabizadeh (2017). Snakes of Iran.[in Farsi] Tehran: *Iranshenasi*, 496 pp.
- McQuarrie, N., Stock, J. M., Verdel, C., and Wernicke, B. P., 2003, Cenozoic evolution of Neotethys and implications for the causes of plate motions: *Geophysical Research Letters*, v. 30, p.
- Mouthereau, F. (2011). Timing of uplift in the Zagros belt/Iranian plateau and accommodation of late Cenozoic Arabia-Eurasia convergence. *Geol. Mag*, 148(5-6): 726-738.
- Noroozi, J., Akhiani, H., Breckle, S.-W., (2008). Biodiversity and phytogeography of the alpine flora of Iran. *Biodivers. Conserv.* 17, 493–521.
- Okay, A. I., Zattin, M. & W. Cavazza. (2010). Apatite fission-track data for the Miocene Arabia-Eurasia collision. *Geology*, 38(1): 35-38.
- Rajabizadeh, M., Nilson, G. & H. G. kami. (2011) - A New Species of Mountain Viper (Ophidia: Viperidae) from the Central Zagros Mountains, Iran. *Russian Journal of Herpetology*. 18(3): 235-240.
- Ritz, J.F., ; H. Nazari ; A. Ghassemi ; R. Salamati ; A. Shafei ; S. Solaymani ; P. Vernant . (2006) Active transtension inside central Alborz: A new insight into northern Iran–southern Caspian geodynamics. *Geology*. 34 (6): 477–480.
- Rögl, F. (1999). Mediterranean and Paratethys. Facts and hypotheses of an Oligocene to Miocene paleogeography (short overview). *Geologica carpathica*, 50(4): 339-349.
- Safaei-Mahroo, B., Ghaffari, H., Fahimi, H., Broomand, S., Yazdanian, M., Najafi-Majd, E., Hosseinian Yousefkhani, S.S., Rezazadeh, E., Hosseinzadeh, M.S., Nasrabadi, R., (2015). The herpetofauna of Iran: checklist of taxonomy, distribution and conservation status. *Asian Herpetol. Res.* 6, 257–290. Wagner, P., Tiutenko, A., Mazepa, G., Borkin, L. J. & Simonov, E. Alai! Alai!—a new species of the *Gloydus halys* (Pallas, 1776) complex (Viperidae, Crotalinae), including a brief review of the complex. *Amphibia-Reptilia*. 37, 15–31.
- Schätti, B. & A. Agasjan. (1985). Ein neues Konzept für den *Coluber ravergeri*-*C. nummifer*-Komplex (Reptilia, Serpentes, Colubridae) - *Zool. Abh. staatl. Mus. Tierk., Dresden*, 40: 109- 123.
- Schätti, B. & C. McCarthy. (2001). *Coluber* (sensu lato) *schmidtleri* n. sp. from the southern Zagros Mountains in Iran. *Herpetozoa* 14(1/2[30 June]): 81–89.
- Schätti, B., Baran, I. & H. Sigg. (1991). Rediscovery of the Bolkar viper: morphological variation and systematic implications on the *Vipera xanthina* complex. *Amphibia-reptilia*, 12(3): 305- 327.
- Schmidtler J. F. & Eiselt J. (1991). Zur Verbreitung und Systematik ostanatolischer Zwergnattern; mit Beschreibung von *Eirenis hakkariensis* n. sp. (Serpentes: Colubridae). *Salamandra*, 27(3): 215 - 227.
- Schmidtler J. F. & Lanza B. (1990). A new dwarf-snake (*Eirenis*) from Lake Van in Eastern Turkey, *Amphibia-Reptilia*, 11: 363 – 371.
- Schuster, M., Durringer, P., Ghienne, J. F., Vignaud, P., Mackaye, H. T., Likus, A. & M. Brunet. (2006). The age of the Sahara Desert. *Science*, 311(5762): 821-821.
- Stewart, J.R., Lister, A.M., Barnes, I., Dalén, L. (2010). Refugia revisited: individualistic responses of species in space and time. *Proceedings of the Royal Society B: Biological Sciences*, 277:661– 671.

- Stewart, J.R., Lister, A.M., Barnes, I., Dalén, L. (2010). Refugia revisited: individualistic responses of species in space and time. *Proceedings of the Royal Society B: Biological Sciences*, 277:661– 671.
- Taleghani, MA. (2013). *Geomorphology of Iran (in Farsi)*. Tehran. *Ghoomes publishing company*.360 p.

Chapitre 3 :

Phylogénie et phylogéographie comparative de trois
serpents Iraniens

3.1.Introduction

La conservation de la faune de squamates en Iran doit faire face à plusieurs défis importants comme le manque de connaissance concernant le nombre d'espèces réellement présentes en Iran, les menaces pesant sur chaque espèce, la distribution des populations, leur taille et tendances démographiques ainsi que leur statut de conservation. De 2015 à 2019 le nombre d'espèces en Iran est passé de 79 à 83 et ce nombre progresse comme le montre la découverte que j'ai faite durant mes sessions de terrain d'une nouvelle localité pour *Eirenis thospitis* (la couleuvre naine du Lac de Van) à la limite Turquie-Iran (Asadi *et al.*, en révision). De l'avis des herpétologistes, il est clair que le nombre de nouvelles espèces, de nouveaux signalements, de nouvelles études moléculaires en Iran est en constante augmentation. Notamment la délimitation des espèces basée sur l'utilisation des techniques moléculaires a grandement contribué à la découverte de nouveaux taxons (Bickford *et al.*, 2006). Cependant, les études récentes indiquent que 12% des espèces de serpents pourraient être menacées d'extinction à l'échelle mondiale alors même que le risque réel est vraisemblablement plus important pour les serpents en raison du manque de connaissances, des difficultés d'échantillonnage et de leur morphologie très conservée (Böhm *et al.*, 2013). Il en résulte que de nombreuses espèces pourraient disparaître avant même d'avoir pu être identifiées.

La formation des chaînes de montagne du Zagros et de l'Alborz constitue des événements géologiques qui ont grandement influencé la biodiversité des serpents dans les montagnes de l'ouest et du nord de l'Iran. Le soulèvement de ces 2 chaînes de montagne ainsi que les oscillations climatiques du Pléistocène sont les facteurs les plus importants expliquant l'isolement des serpents dans les montagnes de l'ouest et du nord Iran. C'est pourquoi la reconstruction de l'histoire évolutive des serpents dans le Zagros et l'Alborz dans le contexte général du Paléarctique reste à faire sur la base de données moléculaires afin d'avoir une idée plus précise de la structuration des espèces. La même chose est vraie au niveau des sous-espèces en ce qui concerne l'analyse des fluctuations durant la période du Quaternaire par modélisation de leurs niches écologiques en liaison avec la variabilité génétique des populations actuelles (Ahmadzadeh *et al.*, 2013).

Dans ce chapitre, je vais aborder la phylogénie, la phylogéographie comparative et la révision taxonomique de trois espèces de serpents, *Natrix tessellata*, *Hemorrhoids ravergieri* et *Gloydius caucasicus* sur leur aire de distribution globale. Au-delà de la mise en évidence de la structure génétique sur la base de séquences du Cytochrome *b* (Cyt *b*) et de la sous-unité 4 de la NADH déshydrogénase (ND4), l'objectif est aussi d'avoir une meilleure compréhension de l'impact des événements géologiques et des cycles glaciaires du Quaternaire sur la biodiversité

des points chauds en Iran. De plus, l'étude d'espèces généralement sous-étudiées comme les serpents du Paléarctique pourrait renforcer notre compréhension du rôle que les montagnes iraniennes ont pu jouer en façonnant la diversité génétique des espèces au cours des temps géologiques. De plus, ces espèces occupent une grande variété d'habitats entre 30m et 3000m d'altitude en Iran et elles représentent donc un gradient altitudinal intéressant à étudier. Les objectifs majeurs de ce chapitre (voir aussi le chapitre 5-Discussion générale) sont les suivants:

- 1- Délimiter géographiquement les lignées évolutives mises en évidence pour les 3 espèces en Iran
- 2- Améliorer la connaissance des espèces sur la base de modèles de différenciation phylogéographique afin de reconstruire leur évolution dans le contexte du Paléarctique
- 3- Evaluer le statut taxonomique des espèces sur la base de méthodes phylogénétiques statistiques
- 4- Mettre en évidence les patrons historiques de différenciation afin de définir des ESUs (Evolutionarily Significant Units) sur la base de la structure génétique et la distribution des lignées iraniennes afin de proposer des recommandations primordiales dans le cadre d'une conservation efficace

3.1.1. Les taxons étudiés

- *Gloydius caucasicus* (Nikolsky, 1916):

Le crotale du Caucase, *Gloydius caucasicus* (Nikolsky, 1916) se trouve en Azerbaïdjan ainsi que du nord-est au nord-ouest de l'Iran (Figure 3.1.1) et c'est un serpent relativement courant dans les montagnes de l'Alborz. Cet crotale fait partie du complexe d'espèce *G. halys/G. intermedius* qui inclut *G. halys halys*, *G. h. caucasicus*, *G. caraganus*, *G. cognatus*, *G. stejnegeri*, *G. rickmersi*, *G. shedaoensis*, *G. changdaoensis*, et *G. intermedius* (Orlov *et al.* 2014 ; Shi *et al.* 2016; Wagner *et al.* 2016; Shi *et al.* 2017). Ce complexe constitue un groupe de crotales étroitement apparentées de la sous-famille des Crotalinae (Viperidae). Son aire de distribution est assez vaste dans le Paléarctique où il occupe un spectre de biotopes variés qui sont distribués sur un vaste territoire qui va de l'Azerbaïdjan et l'Iran jusqu'à différents pays d'Asie Centrale, la Sibérie Orientale, la Mongolie et la Chine (David & Ineich 1999; Orlov & Barabanov 1999; Gumprecht 2004; Wagner *et al.* 2016) (Fig. 3.1.1). Bien que ce complexe ait fait l'objet de nombreuses études phylogénétiques, (Orlov & Barabanov 1999, 2000; Simonov & Wink 2012; Yan *et al.* 2012; Orlov *et al.* 2014; Wagner *et al.* 2016; Malek-Mohammadi *et al.* 2017; Rastegar-Pouyani *et al.* 2018), morphologiques (Simonov & Wink 2012; Khani *et al.* 2017), écologiques (Simonov 2009; Mozafari *et al.* 2012), et de croisements en captivité

(Shakoori *et al.* 2015), il reste toutefois un groupe d'espèces énigmatique. La difficulté provient de la description récente d'une espèce génétiquement et morphologiquement distincte (*Gloydus rickmersi* ; Wagner *et al.*, 2016) , négligeant le fait que la diversité globale à l'intérieur du complexe est très vraisemblablement sous-estimée. De plus, Wagner *et al.* (2016) ont proposé d'élever le statut du crocodile du Caucase de sous-espèce à celui d'espèce, ce qui a ensuite été accepté par Shi *et al.* (2016, 2017). En outre Shi *et al.* (2016) ont aussi proposé d'élever les deux sous-espèces *G. h. cognatus* and *G. h. stejnegeri* au rang d'espèce, ce qui a par la suite été réaffirmé par Shi *et al.* (2017).

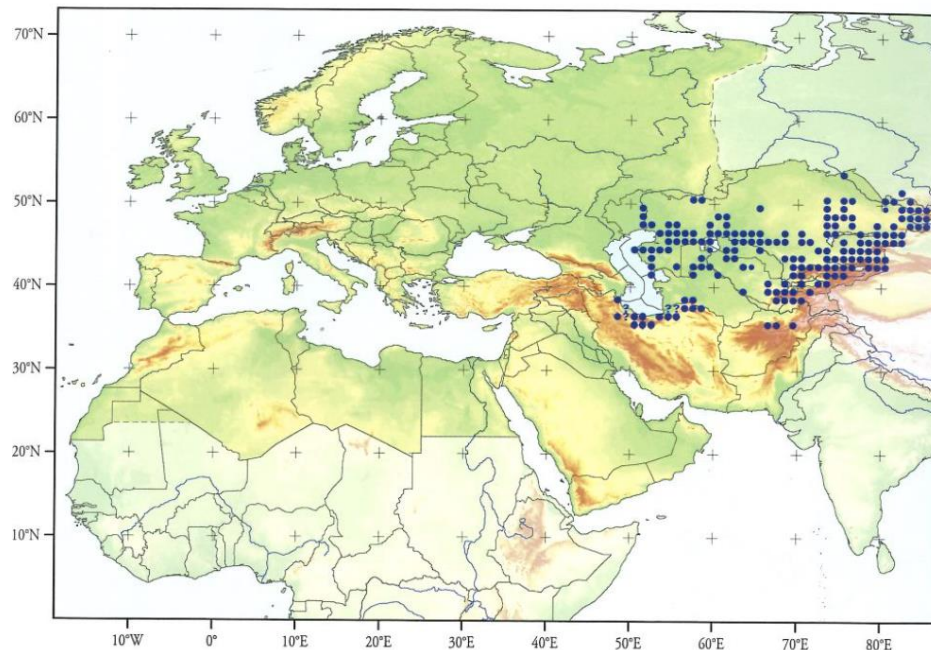

Figure 3.1.1. Carte de la distribution globale du complexe d'espèces *G. halys*. (Sindaco *et al.*, 2013)

- *Natrix tessellata* (Laurenti, 1768):

Dans la famille des Colubridae, la sous-famille Natricinae comprend notamment le genre *Natrix* composé de quatre espèces : *N. natrix* (Linnaeus, 1758), *N. maura* (Linnaeus, 1758), *N. tessellata* (Laurenti, 1768) et *N. astreptophora* (Seoane, 1884). La répartition de la couleuvre tesselée, *Natrix tessellata*, s'étend de l'Allemagne à la Suisse jusqu'aux Balkans, le Proche-Orient, la Russie, l'Ukraine et l'Asie centrale jusqu'au nord-ouest de la Chine (Fig. 3.1.2) (Bannikov *et al.*, 1977; Gruschwitz *et al.*, 1999; Arnold and Ovenden, 2002;). Le genre *Natrix* est vraisemblablement originaire d'Asie australe et toutes les études phylogénétiques et phylogéographiques (Guicking *et al.*, 2006, 2009; Barata *et al.*, 2008; Guicking and Joger, 2011; Rastegar-pouyani, 2018) ont montré que *N. tessellata* inclut une lignée iranienne qui

représente la lignée la plus basale du groupe ce qui suggère que l’Iran ou des régions proches constitueraient l’origine géographique de l’espèce actuelle. Cette espèce est un taxon bien adapté pour aborder des questions de phylogéographie en Eurasie en raison de sa vaste distribution dans le Paléarctique au sein de laquelle l’Iran occupe une position centrale. *N. tessellata* est distribué dans tout l’Iran à l’exception de la zone aride du sud-est (Guicking *et al.*, 2009). Cependant, étant donné la grande variété d’habitats et de niches occupée par l’espèce ainsi que la variation morphologique considérable à travers l’Iran, la probabilité de l’existence de lignées cryptiques est élevée en Iran.

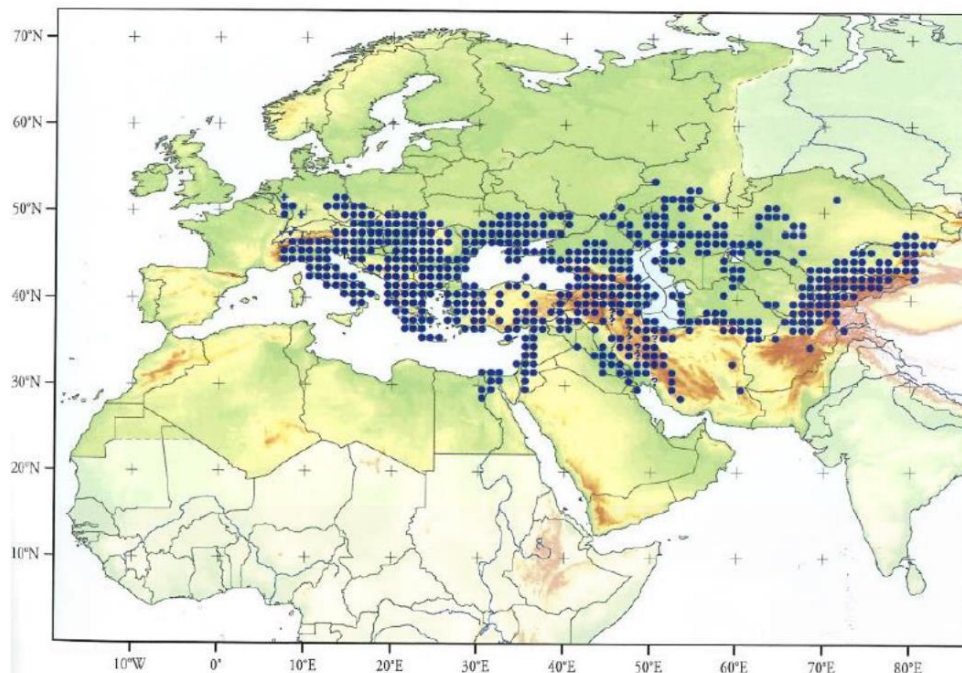

Figure 3.1.2. Carte de la distribution globale de *Natrix tessellata*. (Sindaco *et al.*, 2013)

- *Hemorrhois ravergieri* (MÉNÉTRIES, 1832).

Les couleuvres du genre *Hemorrhois* appartiennent à la famille des Colubridae et incluent quatre espèces, à savoir *Hemorrhois ravergieri* (MÉNÉTRIES, 1832), *H. nummifer* (REUSS, 1834) *H. hippocrepis* (LINNAEUS, 1758) and *H. algirus* (JAN, 1863). Ces espèces occupent différents habitats et montrent des aires de distribution relativement limitées en Asie, sud de l’Europe et Afrique du Nord (Schweiger, 1991; Wallach *et al.*, 2014) (Fig. 3.1.3). Néanmoins, deux espèces, *H. ravergieri* et *H. nummifer*, se rencontrent en Iran où elles occupent une large aire de répartition. Ces deux espèces montrent une variation considérable de la couleur du corps entre les différentes populations iraniennes, particulièrement chez les spécimens des montagnes Zagros et Alborz. Les ambiguïtés phylogénétiques persistent aussi car, à l’exception

de différence dans le nombre des écailles dorsales (Ghazi Khanlou and Kami, 2013), les études morphométriques ne permettent pas de distinguer biossytématiquement ces deux espèces. Jusqu'à maintenant aucune étude phylogénétique ou phylogéographique n'a été conduite sur *H. ravergeri* et par conséquent notre étude est restreinte à l'Iran, pays pour lequel nous avons pu collecté des échantillons.

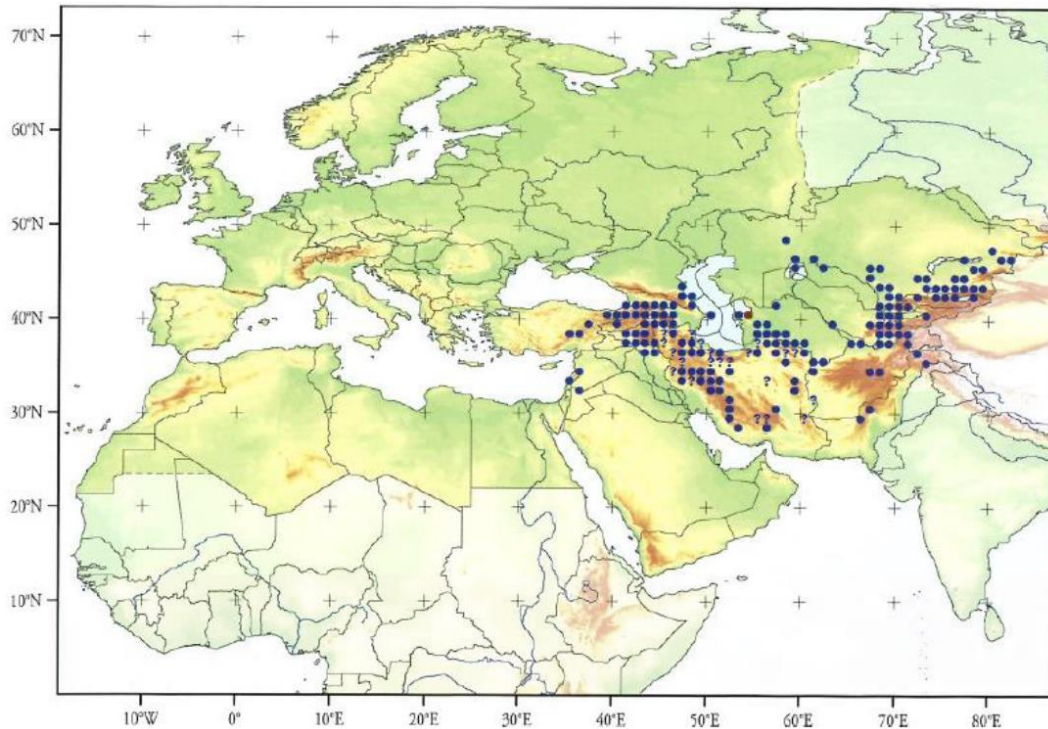

Figure 3.1.3. Carte de la distribution globale d'*Hemorrhoids ravergeri*. (Sindaco *et al.*, 2013)

3.1.2. Echantillonnage des trois espèces

J'ai moi-même collecté les échantillons analysés ici en particulier grâce à l'appui logistique apporté par le Department of Environmental Science (Université de Téhéran) dirigé par le professeur Mohammad Kaboli.

Trois missions de terrain ont été effectuées: du 9 mai au 20 août 2016 dans les montagnes du nord de l'Iran (Azerbaïdjan et Zagros), du 30 mars au 16 septembre 2017 dans le centre et le sud du Zagros et du 1 avril au 21 juillet 2018 (mission soutenue par une bourse de terrain EPHE) pour compléter l'échantillonnage des deux missions précédentes. Un total de 151 specimens pour les trois espèces ont été échantillonnés (Figure 3.1.4 et Table 3.1.1).

Table 3.1.1. Nombre total d'individus échantillonnés

Nombre d'individus	Taxon
41	<i>Gloydius halys</i>
40	<i>Natrix tessellata</i>
70	<i>Hemorrhhois sp.</i>

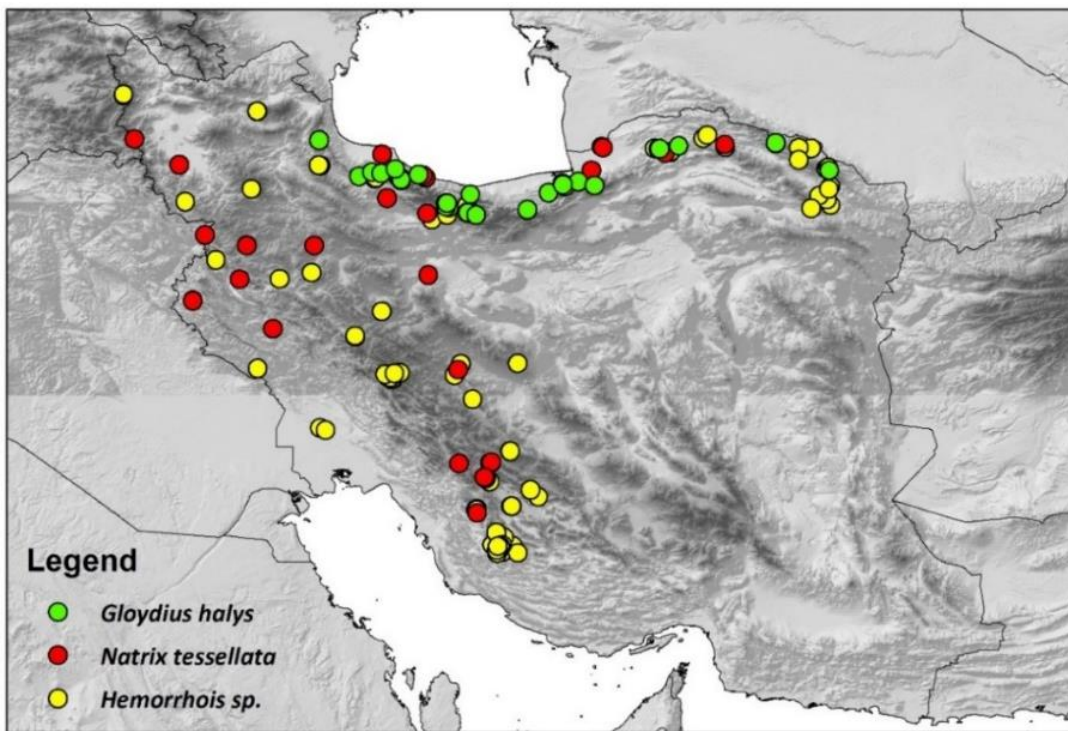

Figure 3.1.4. Localités échantillonnées dans l'Alborz et le Zagros.

Les sites d'échantillonnage ont été sélectionnés sur la base du livre « Serpents d'Iran » (Latifi, 2000), de l'avis d'experts de chacune des régions et des conseils donnés par les gardes des parcs ou de la population locale. Après localisation d'un habitat favorable, la recherche des serpents s'est effectuée du lever au coucher du soleil à l'exception des heures les plus chaudes de la journée pendant lesquelles les serpents de montagne ont peu d'activité. Les serpents sont attrapés à l'aide d'un crochet à serpents et le port de gants de pompier est indispensable pour pouvoir les manipuler sur le terrain. Après capture, chaque serpent a été placé dans un sac et transporté dans un endroit sûr afin de les photographier, mesurer et prélever un échantillon de tissus (Figure 3.1.5) Chaque prélèvement, constitué de trois fragments du bord extérieur des écailles ventrales, a été immédiatement fixé et

conservé dans un tube d'éthanol à 96% incluant aussi les informations sur l'espèce, la localisation de l'échantillon et l'heure d'échantillonnage.

Les serpents étaient ensuite immédiatement relâchés à leur point de capture. Toutes les méthodes de prélèvement ont été effectuées conformément aux directives et réglementations en vigueur et les échantillonnages ont été réalisés avec l'autorisation du Département de l'Environnement iranien (DOE, permits No. 60345/94). Cet échantillonnage de terrain a été complété avec 144 échantillons (morceau de peau ou bout de queue) provenant des collections du Département de l'Environnement ou bien de collections privées (voir liste complète des échantillons en Appendix 3.1)



Figure 3.1.5. Le crochet à serpent, les gants et outils nécessaires pour réaliser l'échantillonnage sur le terrain.

3.1.3. Amplification par PCR et séquençage des gènes étudiés

L'ADN génomique a été isolé à partir des échantillons en utilisant des protocoles conformément à leur type biologique. L'ADN présent dans les échantillons de tissus récoltés est emprisonné dans un maillage épais de kératine dont il faut se débarrasser pour ne garder que la molécule en double hélice qui nous intéresse. C'est pourquoi, dans le souci d'extraire un maximum d'ADN total sans contaminer les individus entre eux, un protocole d'extraction en colonne individuelle a été choisi préférentiellement à d'autres protocoles d'extraction (chelex et/ou par plaque) dans la mesure du possible. Le kit DNeasy[®]Tissue QIAGEN a ainsi été utilisé selon les recommandations du fabricant. Le produit d'extraction a été contrôlé sur la photo prise d'un gel d'agarose pour vérifier si l'extraction a bien marché ou pas.

L'ADN extrait des tissus est présent en trop faible quantité pour être étudié directement. La technique de Réaction de Polymérisation en Chaîne (PCR : acronyme en syntaxe anglo-saxonne) découverte par Kary Mullis en 1985 nous permet d'amplifier certaines portions –

choisies au préalable – de l’ADN. J’ai ainsi travaillé sur les deux types d’ADN que l’on trouve dans une cellule animale : des séquences d’ADN mitochondrial (ADNmt) et d’ADN nucléaire (ADNnc). Deux fragments d’ADN du génome mitochondrial incluant 1125 paires de bases (pb) du *cyt b* et 678 pb de la ND4 ont été amplifiés. De plus, trois fragments de gènes nucléaires ont été séquencés : le proto-oncogène *c-mos* (567 pb) pour *G. caucasicus*, le récepteur1 de la MelanoCortine (MC1R, 524 pb) et la Tropomyosine (Trop, 452 pb) pour *N. tessellata* et *H. ravergeri*. Tous les gènes ont été amplifiés par PCR et séquencés en utilisant les amorces définies dans notre étude ou dans des études précédentes (voir Table 3.1.2. et Appendix 3.2).

Table 3.1.2. Liste des amorces utilisées pour l’amplification et le séquençage des gènes étudiés.

Name of Primer	Primers	Gene	Reference
ND4	CACCTATGACTACCAAAGCTCATGTAGAAGC	ND4	ARÉVALO <i>et al.</i> (1994)
H12763	TTCTATCACTTGGATTTGCACCA	ND4	ARÉVALO <i>et al.</i> , 1994
Glo-ND-F	3’ TCT GCC TAG CCA ACA CAA CCT ATG 5’	ND4	This study
Glo-ND-R	5’ GGT TGG TTA GTA GTC ATC AGG 3’	ND4	This study
Hem-ND-F	3’ TCA GCA CTT TTC TGC YTA GCC 5’	ND4	This study
Hem-ND-R	5’ GGG CAC CAG TTG AAT AGT GAT G 3’	ND4	This study
L14910	GACCTGTGATMTGAAAAACCAAYCGTTGT	<i>cyt b</i>	Burbrink <i>et al.</i> , 2000
H16064	CTTTGGTTTACAAGAACAATGCTTTA	<i>cyt b</i>	Burbrink <i>et al.</i> , 2000
Glo-CB-F	3’ CTT CAC TTC ATC CTT CCA TTC G 5’	<i>cyt b</i>	This study
GLO-CB-R	5’ CTG AGT TTG TTC CCA GGG GG 3’	<i>cyt b</i>	This study
Hem-CB-F	3’ GGA CAA ATA TCA TTC TG 5’ (RGCAGC)	<i>cyt b</i>	This study
Hem-CB-R	5’ GGG TGT CTT TGT AGG AGT GG 3’	<i>cyt b</i>	This study
MC1R-PF	GGCNGCCATYGTCAAGAACCGGAACC	Melanocortin 1 receptor	Pinho <i>et al.</i> , 2007
MC1R-PR	CTCCGRAAGGCRTAAATNATGGGGTCCAC	Melanocortin 1 receptor	Pinho <i>et al.</i> , 2007
TROPVF	TCTGGCCTGTTGCTTTAAGG	Tropomyosin	Barlow <i>et al.</i> , 2012
TROPVR2	CTCCTCATCCTTCAGGGCTCGG	Tropomyosin	Barlow <i>et al.</i> , 2012
S77	CAT GGA CTG GGA TCA GTT ATG	<i>c-mos</i>	Lawson <i>et al.</i> , 2005
S78	CCT TGG GTG TGA TTT TCT CAC CT	<i>c-mos</i>	Lawson <i>et al.</i> , 2005

3.2. Evolutionary history and postglacial colonization of an Asian pit viper (*Gloydius halys caucasicus*) into Transcaucasia revealed by phylogenetic and phylogeographic analyses

Résumé en français:

Il est largement accepté que les cycles glaciaires du Pléistocène ont façonné la structure et la distribution actuelles des taxons et ce dans toutes les régions tempérées nordiques. De nombreuses études ont montré que les lignées actuellement présentes dans l'ancien monde occupent des régions qui étaient autrefois recouvertes par la calotte glaciaire. Au fur et à mesure de l'avancée des glaciers, les populations ont été repoussées vers des zones de refuges dans les régions du sud, à partir desquelles les populations se sont dispersées quand de nouveaux habitats sont devenus disponibles durant les phases interglaciaires. Si les effets des oscillations climatiques du Quaternaire sur la faune et la flore sont bien connus dans l'ouest du Paléarctique, les études phylogéographiques sont beaucoup plus rares dans le Moyen-Orient et notamment en Iran. De plus, l'étude d'espèces généralement sous-étudiées comme les serpents pourrait renforcer notre compréhension du rôle joué par les montagnes iraniennes et les variations climatiques sur la structure et la distribution actuelles des serpents.

Le crotale du Caucase, *Gloydius caucasicus*, est présent en Azerbaïdjan ainsi que dans les régions au nord-est et nord-ouest de l'Iran. Il fait partie du complexe d'espèce *G. halys/G. intermedius* qui représente un groupe de crotales étroitement apparentés de la sous-famille des Crotalinae (Viperidae) incluant neuf espèces ou sous-espèces. Son aire de distribution est assez vaste dans le Paléarctique qui va de l'Azerbaïdjan et l'Iran jusqu'à la Chine. Bien que ce complexe ait fait l'objet de nombreuses études phylogénétiques, morphologiques, écologiques et de croisements en captivité, il reste toutefois un groupe d'espèces énigmatique.

Dans cette étude, je présente les relations phylogénétiques et phylogéographiques ainsi que la biogéographie historique du crotale du Caucase, *G. h. caucasicus*, sur la base de séquences de deux gènes mitochondriaux (*cyt b* et *ND4*) et d'un gène nucléaire (*c-mos*). Les objectifs ont été de (i) mettre en évidence les différentes lignées évolutives pour ce crotale et de délimiter leur distribution spatiale du nord-est au nord-ouest de l'Iran et de l'Azerbaïdjan, (ii) comparer plusieurs scénarios biogéographiques (un ou plusieurs refuges ainsi que des flux géniques uni- ou bidirectionnels) en utilisant des simulations de coalescence basées sur la diversification des lignées observées, (iii) évaluer son statut taxonomique au sein du complexe d'espèce *G.*

halys/G. intermedius sur la base de méthodes phylogénétiques statistiques; (iv) révéler les patrons de dispersion historiques vers la Transcaucasie et définir des ESUs sur la base de nos résultats. Étant donné la structure génétique et la répartition des lignées iraniennes, nous proposons plusieurs recommandations pour une conservation efficace de toutes les lignées phylogénétiques significatives observées pour le crotale du Caucase en Iran.

Notre étude a identifié quatre lignées en Iran pour *G. h. caucasicus* qui sont distribuées le long des pentes de l'Alborz (du nord-est au nord-ouest) et le sud de l'Azerbaïdjan (montagnes du Talysh). La diversification de *G. caucasicus* par rapport aux autres espèces du complexe s'est produite au cours du Pliocène supérieur (1.89 Ma, 95% HPD: 1.20–2.70 Ma), tandis que la divergence entre les populations de *G. caucasicus* dans le nord de l'Iran s'est faite en trois phases au cours du Pléistocène, ce qui révèle les effets des oscillations climatiques sur l'isolement des populations. Durant le Pléistocène inférieur (2.5–1.84 Ma), le climat était plus froid et plus sec comparativement au Miocène moyen (16.4–11.2 Ma). Nos résultats mettent en évidence une expansion des populations suivie par leur isolement dans quatre zones refuges au cours des oscillations paléoclimatiques du Quaternaire, ce que confirment les datations moléculaires et les analyses de biogéographie historique. Les analyses de simulations basées sur la coalescence confirment l'arrivée de l'espèce à partir du nord-est de l'Iran jusqu'au bord ouest de l'Alborz, puis vers la Transcaucasie via 2 directions par les pentes nord et sud de l'Alborz.

Les distances génétiques entre les différents taxons du complexe *G. halys/G. intermedius* sont comprises entre 1.0 et 5.4 %, ce qui est conforme aux résultats obtenus par Shi *et al.* (2006). Ces mêmes auteurs ont estimé la distance génétique entre les trois taxons *G. stejnegeri*, *G. cognatus*, et *G. h. halys* entre 2.7 et 5.0%. Cependant, la distance génétique moyenne entre les quatre clades iraniens de *G. h. caucasicus* et les autres espèces varient entre 3.7% et 5.6%, ce qui est même supérieur à la distance observée par Shi *et al.* (2006) entre *G. cognatus* et *G. stejnegeri* (2.7–4.84%). De plus, la distance génétique entre *G. changdaoensis*, *G. intermedius*, *G. shedaoensis*, *G. cognatus*, *G. stejnegeri*, et *G. caraganus* varie de 1.0% à 5.4%, alors que la distance génétique moyenne entre les quatre clades iraniens est comprise entre 4.2% et 5.2%. Ces résultats sont aussi visibles sur le réseau d'haplotypes. Par conséquent, nos analyses indiquent clairement que *G. h. caucasicus* devrait être élevé au rang d'espèce et donc être nommé *G. caucasicus* (Nikolsky, 1916).

Parmi les nombreuses définitions attachées au concept d'ESUs, nous avons adopté celle centrée sur les petites populations de Fraser and Bernatchez (2001) selon laquelle des lignées à répartition restreinte et flux génique limité doivent être considérées comme des ESUs à

conserver. Par conséquent, nous proposons que les quatre lignées isolées identifiées pour *G. caucasicus* dans le nord de l'Iran soient considérées comme des ESUs. Ces quatre lignées incluent les ESUs (i) de Kopeh-Dagh qui comprend les montagnes du Hezar Masjid et les provinces de Khorasan et Golestan, (ii) du Parc National Lar (centre de l'Alborz) qui inclut la région de Lar ainsi que la province de Mazandaran, (iii) du Centre Alborz qui englobe les pentes nord et ouest des montagnes de l'Alborz dans les provinces ouest-Mazandaran et est-Gilan, et (iv) de la région dans l'ouest de l'Alborz-Azerbaïdjan qui comprend les provinces ouest-Gilan et Ardebil.

G. caucasicus n'est pas sur la liste des espèces protégées du Département Iranien de l'Environnement. Le manque d'information et la connaissance limitée des serpents venimeux a instillé une peur profonde de ces animaux chez les populations locales et même chez les gardes des parcs, peur qui les conduit généralement à tuer l'animal à leur première rencontre. Par conséquent, nous adressons plusieurs recommandations au Département Iranien de l'Environnement: (i) établir et déclarer de nouvelles aires protégées qui prendraient en compte les quatre lignées identifiées dans notre étude au sein de l'aire de distribution du crotale du Caucase, (ii) établir des zones sûres dans les aires protégées actuelles qui comprendraient les habitats favorables à cette espèce, (iii) empêcher ou réduire la chasse légale et la collecte de venin dans les populations de crotale du Caucase jusqu'à ce que les populations se soient rétablies, (iv) mettre cette espèce sur la liste des espèces protégées par les lois du Département Iranien de l'Environnement et réduire le commerce international illégal en l'intégrant dans les appendices de la CITES.

SCIENTIFIC REPORTS



OPEN

Evolutionary history and postglacial colonization of an Asian pit viper (*Gloydius halys caucasicus*) into Transcaucasia revealed by phylogenetic and phylogeographic analyses

Atefeh Asadi¹, Claudine Montgelard^{1,5}, Masoud Nazarizadeh², Akram Moghaddasi², Faezeh Fatemizadeh², Evgeniy Simonov³, Haji Gholi Kami⁴ & Mohammad Kaboli²

It has been generally acknowledged that glacial climates at the time of the Pleistocene altered the patterns of species distributions, prompting latitudinal and altitudinal distribution shifts in several species, including poikilothermic species commonly known for their thermal sensitivity. However, the historical phylogeographic patterns of such species have remained largely unknown. Here, we present the historical biogeographic, phylogenetic, and phylogeographic relationships of the Caucasian pit viper, *G. h. caucasicus*, based on two mtDNA (cyt *b* and ND4) and one nDNA (*c-mos*) genes. This pit viper represents the westernmost member of the Crotalinae subfamily in the Palearctic and occurs in a variety of habitats, from 30 m to 3,000 m above sea level. In Iran, it is distributed on the northern and southern slopes of the Alborz Mountains, rendering it a target for phylogenetic and phylogeographic studies of a terrestrial poikilothermic animal. Our study identified four Iranian lineages of *G. h. caucasicus* along the northeastern to northwestern slopes of the Alborz Mountains and southern Azerbaijan (Talysh Mountains). Diversification of the Iranian lineages highlights population expansion and subsequent isolation into four plausible refugial areas during the Quaternary paleo-climatic oscillations, confirmed by our molecular dating and historical biogeographic analyses. The results of coalescence-based simulations support the incursion of the species from northeastern Iran to the western end of the Alborz, and then toward Transcaucasia via two directions: northern and southern slopes of the Alborz Mountains. Furthermore, our results clearly implied that *G. h. caucasicus* should be elevated to species rank and further referred to as *G. caucasicus* (Nikolsky, 1916).

It has been widely accepted that different glacial events during the Pleistocene have shaped the current phylogeographical structure and distribution of taxa throughout northern temperate regions^{1–4}. Many studies have highlighted that lineages currently occupying the Old World had formerly inhabited areas which were later covered by ice sheets during glaciation events. As glaciers advanced, populations were driven toward southern glacial refugia^{5,6}, where they subsequently dispersed into newly available habitats during interglacial periods^{2,7}.

¹CEFE, PSL-EPHE (Biogéographie et Ecologie des Vertébrés), CNRS, University Montpellier, Univ Paul Valéry Montpellier 3, IRD, Montpellier, France. ²Department of Environmental Science, Faculty of Natural Resources, University of Tehran, Karaj, Iran. ³Laboratory of Forest Genomics Siberian Federal University, 660036, Akademgorodok 50a/2, rasnoyarsk, Russia. ⁴Department of Biology, Faculty of Sciences, Golestan University, Gorgan, Iran. ⁵Centre for Ecological Genomics and Wildlife Conservation, Department of Zoology, University of Johannesburg, Johannesburg, South Africa. Correspondence and requests for materials should be addressed to M.K. (email: mkaboli@ut.ac.ir)

Iran is a mountainous country with more than half of its mainland covered by mountains⁸. The Alborz encompasses a series of mountain ranges extending from northwestern to northeastern Iran⁹. The formation of the Alborz Mountains was first initiated during the Paleocene and the rugged landscape of the Alborz took shape during the early Cenozoic. This uplift was the outcome of an expansive movement throughout Iran as well as the Caucasian Mountains^{10,11}. In addition, the Hyrcanian forests along the northern slopes of the Alborz Mountains and southern coasts of the Caspian Sea rank among the most important forest remnants in western Eurasia and are characterized by having one of the most ecologically valuable biodiversity hotspots in the Middle East⁸.

Recent research indicates that continental glaciers in Iran during the Pleistocene^{12,13}, as well as the current climate change in northern Iran¹⁴, could have, respectively, led to latitudinal and altitudinal distribution shifts in a number of species, particularly poikilothermic animals, which are noted for their sensitivity to changes in temperature¹⁵. The Caucasian pit viper *Gloydius halys caucasicus* (Nikolsky, 1916) is distributed throughout southeastern Azerbaijan, southern Turkmenistan (Kopet Dagh Mountains), from northeastern to northwestern Iran, and northwestern Afghanistan, and is relatively common across the Alborz Mountains. This viper is a member of the *G. halys*/*G. intermedius* species complex, which represents a group of closely related vipers of the Crotalinae subfamily (Viperidae), including a total of nine taxa: *G. halys halys*, *G. h. caucasicus*, *G. caraganus*, *G. cognatus*, *G. stejnegeri*, *G. rickmersi*, *G. shedaensis*, *G. changdaoensis*, and *G. intermedius*^{16–19}. With a widespread range in the Palearctic, they inhabit a spectrum of various biotopes distributed across an extensive territory from Azerbaijan and Iran through several countries of Central Asia to eastern Siberia, Mongolia, and China^{17,20–22}. Although this complex has been the focus of numerous phylogenetic^{16,17,20,23–28}, morphological^{24,29}, ecological^{30,31}, and captive-breeding studies³², it remains an enigmatic species group. The intricacy arises out of a recent discovery of a morphologically and genetically distinct species¹⁷, evincing the fact that the diversity within this complex is most likely underestimated. Additionally, Wagner *et al.*¹⁷ proposed the elevation of the Caucasian pit viper from subspecies to species rank. This was later accepted by Shi *et al.* (2016, 2017). Moreover, Shi *et al.*¹⁹ argued for elevation of two other subspecies *G. h. cognatus* and *G. h. stejnegeri*, to the full species rank, which was later reaffirmed by Shi *et al.*¹⁸.

The Caucasian pit viper occupies a diverse range of habitat types, from 30 m to about 3,000 m above sea level, within northern and southern slopes of the Alborz Mountains, thus serving as an ideal example to evaluate phylogenetic and phylogeographic patterns of a terrestrial poikilothermic species in northern Iran. Even though this species has been under intensive exploitation for venom milking by the Razi Vaccine and Serum Research Institute since 1924²⁶, the details of its evolutionary history and population structure have remained poorly understood to this day^{17,33,34}.

Developments in molecular taxonomy and barcoding techniques allow rapid detection of cryptic diversity³⁵. It has been demonstrated that combining molecular, morphological, ecological, and biological data is a crucial key to detecting cryptic species, especially in less well-known areas. Moreover, the growing concern toward conservation of genetic diversity calls for accurately defining evolutionary significant units (ESUs) based on evolutionary histories of relevant taxa³⁶ (see³⁷ for a review of ESU definitions), as species-based units cannot always prove applicable to all conservation strategies³⁸. Thus, phylogenetic and phylogeographic inferences are applied to conservation planning below the species level^{13,39}.

In this study, we sought to better understand the phylogeny, phylogeography, and taxonomic reassessment of *G. h. caucasicus* across its entire distribution range in Iran and Azerbaijan, using partial mtDNA sequences of the Cytochrome *b* (*cyt b*) and NADH dehydrogenase subunit 4 (ND4) genes, as well as the nuclear proto oncogene *c-mos*. We (i) delineated the entire geographically defined evolutionary lineages of this viper and their spatial distribution from northeastern to northwestern Iran and southern Azerbaijan. We (ii) performed coalescent simulations to compare several historical biogeographical hypotheses (single refugium or multiple refugia, along with one-way or two-way gene flows) that involve lineage diversification within this viper. Then, we (iii) used statistical phylogenetic methods to evaluate the taxonomic status of this subspecies within the *G. halys*/*G. intermedius* species complex. Finally, (iv) we used our analyses to uncover patterns of historical migration of the species to Transcaucasia and to define ESUs of this viper. Given the genetic structure and distribution of the Iranian lineages, we proposed some recommendations for effective conservation of all phylogenetically significant lineages of the Caucasian pit viper in Iran.

Results

Phylogenetic reconstruction. In total, 1618 aligned positions including *cyt b* and ND4 were analyzed with 1332 invariable, 36 singleton, and 250 parsimony-informative sites, along with a total of 48 haplotypes, 24 of which belonged to *G. h. caucasicus*. However, the highly conserved nuclear *c-mos* fragment with a sequence length of 567 bp showed only 563 invariable, three singleton, one parsimony-informative sites, and a total of three haplotypes. No insertions, deletions, or stop codons were detected. Furthermore, base composition was estimated T = 26.7%, C = 32.2%, A = 30.0%, and G = 11.1% for mtDNA genes, and T = 29.4%, C = 19.2%, A = 29.8%, and G = 21.5% for nDNA gene. Based on HKA tests, the levels of DNA polymorphism in our mtDNA dataset conformed to expectations of neutral evolution. HKA tests were non-significant for the ND4 ($N = 84$ ingroup sequences, $\chi^2 = 0.015$, $P = 0.901$) and the *cyt b* ($N = 88$ ingroup sequences, $\chi^2 = 0.001$, $P = 0.973$) datasets. Moreover, The PHI test revealed no statistically significant proof for nuclear recombination $P = 0.207$.

PartitionFinder found three subset partitions for the three genes; (i) ND4-pos1/*cyt b*-pos2/*c-mos*-pos1, (ii) ND4-pos2/*cyt b*-pos3/*c-mos*-pos2, and (iii) ND4-pos3/*cyt b*-pos1/*c-mos*-pos3 with the best-fitting models of nucleotide substitution TRN + G, HKY + G, and HKY + I, respectively. This partitioning strategy was used for both the Bayesian Inference (BI) and Maximum Likelihood (ML) analyses. The resulting phylogenetic trees obtained by both methods were congruent in the branching pattern (Fig. 1). The basal divergence of *G. changadaoensis* from the remaining species of the complex was well supported (BI posterior probability = 1 and ML bootstrap value = 100). In addition, east Asian (*G. h. halys*, *G. cognatus*, *G. stejnegeri*, *G. intermedius*, and

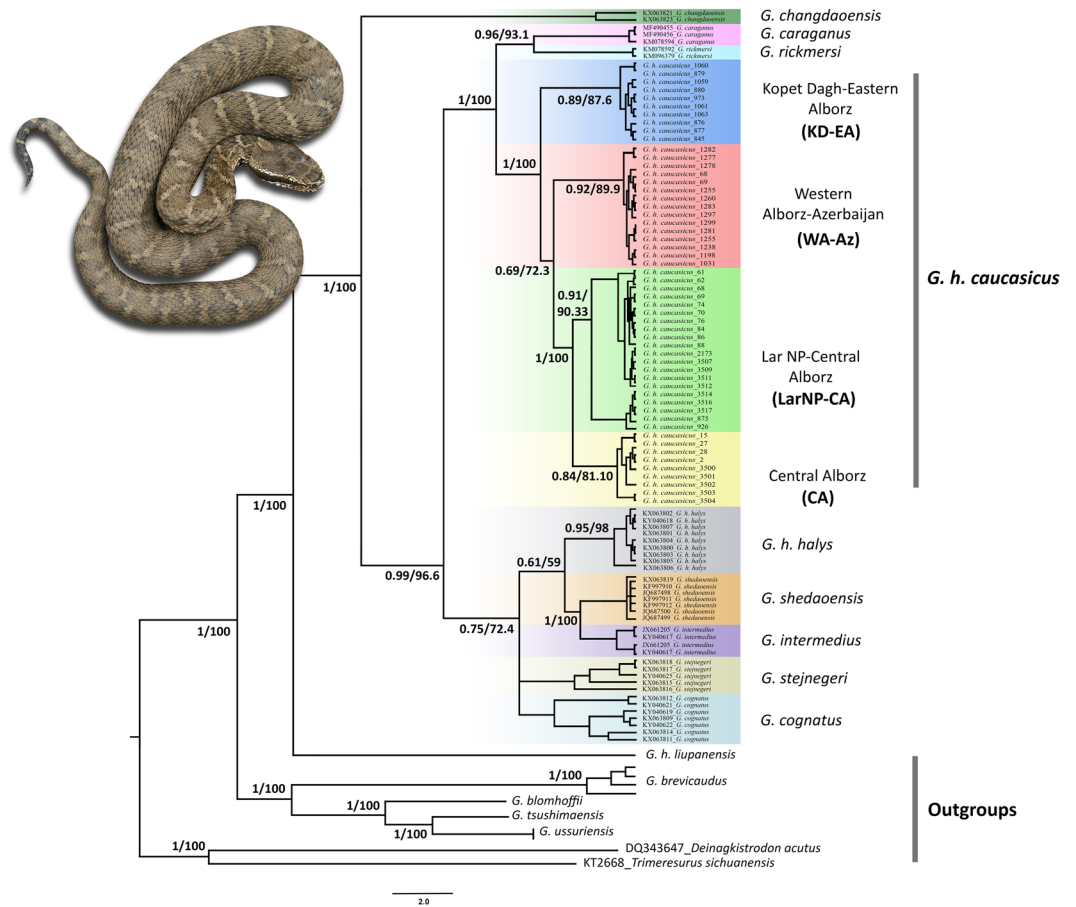

Figure 1. Bayesian 50% majority-rule consensus tree reconstructed from concatenated mtDNA (cyt *b* + ND4) + nDNA (c-mos) dataset (in congruence with ML tree in terms of the branching pattern and the positions of the clades), using six outgroups (*G. breviceaudus*, *G. blomhoffi*, *G. tsushimaensis*, *G. ussuriensis*, *D. acutus*, and *T. sichuanensis*). Nodal support presented at nodes indicate Bayesian posterior probability (left) by MrBayes, and ML bootstrap (right) using IQ-TREE.

G. shedaoensis and west Asian (*G. h. caucasicus*, *G. caraganus*, and *G. rickmersi*) vipers of the complex formed well-differentiated clades supported by high values of posterior probability (0.99) and bootstrap support (96.6). All lineages of *G. h. caucasicus* constitute a monophyletic group that is positioned as a sister clade to *G. rickmersi* and *G. caraganus* with high support (1.0 posterior probability and 100 bootstrap support). Moreover, the Kopet Dagh-Eastern Alborz (KD-EA) lineage formed a strongly well-supported clade with the other three Caucasian clades. However, the Western Alborz-Azerbaijan (WA-Az) lineage formed a separate clade with moderate bootstrap (72.3) and posterior probability (0.69) support, whereas the Lar National Park-Central Alborz (LarNP-CA) lineage and the Central Alborz (CA) separated from one another with high posterior probability (1) and bootstrap (100) support.

Furthermore, all samples of *G. h. halys* formed a well-supported clade, which, together with the remaining taxa (*G. cognatus*, *G. stejnegeri*, *G. intermedius*, and *G. shedaoensis*) emerged as a moderately supported clade (posterior probability of 0.75 and bootstrap support of 72.4). All in all, 12 clades were identified for the *G. halys*/*G. intermedius* complex, consisting of eight well-supported (KD-EA, LarNP-CA, and WA-Az lineages of *G. h. caucasicus*, along with *G. intermedius*, *G. shedaoensis*, *G. rickmersi*, *G. caraganus* and *G. changadaoensis*) and four moderately-supported (CA lineage of *G. h. caucasicus*, *G. h. halys*, *G. cognatus*, and *G. stejnegeri*) clades (Fig. 1).

Bayesian species delimitation and genetic distances among the *G. halys*/*G. intermedius* complex species. Our BPP analysis with algorithm 1 and under three different scenarios of prior values revealed that the different prior values for θ and τ_0 did not alter the posterior speciation probabilities. Based on the results of our first scenario, each of the nine delimited taxa corresponding to *G. halys halys*, *G. h. caucasicus*, *G. caraganus*, *G. cognatus*, *G. stejnegeri*, *G. rickmersi*, *G. shedaoensis*, *G. changadaoensis*, and *G. intermedius* were strongly supported with 95% Bayesian posterior probability (PP = 1), considering three models with small and large ancestral sizes, as well as deep and shallow divergences. The genetic distances among *G. changadaoensis*, *G. intermedius*, *G. shedaoensis*, *G. cognatus*, *G. stejnegeri*, and *G. caraganus* vary from 1.0%–5.4% (the blue cells in Table S3), whereas the average genetic distance between the four Iranian lineages of *G. h. caucasicus* and the other taxa in the complex varies from 3.7–5.6% (the grey cells in Table S3), which is comparable to that among valid species members of this complex.

According to our second scenario, we did not obtain high Bayesian posterior probabilities for the four Iranian clades of *G. h. caucasicus* (0.93–95%) in our BPP analysis, under the three models with small and large ancestral sizes, as well as deep and shallow divergences. Moreover, the genetic distances among the Iranian lineages including the two clades of Central Alborz (LarNP-CA and CA), the eastern clade (KD-EA), and the western clade (WE-Az) vary from 2.4–2.9% (the green cells in Table S3); however, the distance drops to 0.15% between the two clades of Central Alborz (LarNP-CA and CA), in concordance with node support values of BI and ML gene trees.

Haplotype network. Haplotypes plotted with TCS v1.21 on our mtDNA matrix (with 39 samples of *G. h. caucasicus* and 31 samples of the other taxa of *G. halys/G. intermedius* complex) revealed a significant divergence within the complex, in which *G. h. caucasicus* was distant from *G. cognatus* (49 mutational steps), *G. stejnegeri* (52 mutational steps), *G. h. halys* (67 mutational steps), *G. caraganus* (84 mutational steps), *G. changdaoensis* (82 mutational steps), *G. intermedius* (65 mutational steps) and *G. shedaoensis* (71 mutational steps) (Fig. 2). Within *G. h. caucasicus*, in accordance with the phylogenetic tree, we found four significant clusters from northeastern Iran to western Alborz-Azerbaijan. These four clusters were separated from each other by 18–40 mutational steps. Most central haplotypes in LarNP-CA, CA, and WA-Az clusters were shared by 2–5 individuals, while within the KD-EA cluster, haplotypes mostly corresponded to single individuals. The WA-Az cluster included six closely related haplotypes comprising the most western known locality for the complex in the western Palearctic.

Maximum and minimum nucleotide diversity was attributed to CA and LarNP-CA lineages, respectively. Additionally, haplotype diversity ranged from 0.667 to 0.978 in WA-Az and KD-EA lineages, respectively (Table 1).

Spatial genetic structure of *G. h. caucasicus* lineages in northern Iran and Azerbaijan. Using the concatenated mtDNA + nDNA dataset, the BAPS results divided the samples into the four clusters concordant with the phylogenetic tree and haplotype network; (i) KD-EA including Hezar Masjed Mountains, Khorasan, and Golestan provinces, (ii) LarNP-CA comprising eastern and central parts of Mazandaran province as well as Lar National Park, (iii) CA containing western Mazandaran and eastern Gilan provinces, and (iv) WA-Az including western Gilan and Ardebil provinces, as well as the southern mountains of Azerbaijan. Additionally, AMOVA on our concatenated mtDNA dataset proved a high rate of variation (89.38%) among the four clusters, and the fixation index (FST) confirmed a significant genetic structure among the clusters (Table S1).

Divergence time. Our molecular clock dating based on concatenated mtDNA + nDNA dataset revealed that *G. h. caucasicus* separated from its sister clade (*G. caraganus* and *G. rickmersi*) in the early Pleistocene (1.89 Myr, 95% HPD: 1.20–2.70 Myr; node A, Fig. 3), while divergence within *G. h. caucasicus* commenced in the mid-Pleistocene (1.25 Myr, 95% HPD: 0.73–1.83 Myr), for which three main diversifications can be defined. The first period of diversification corresponds to the separation of the KD-EA from northeastern Iran and the other lineages (node B, Fig. 3) in the Calabrian stage. The second split between CA and WA-Az lineages (node C, Fig. 3) occurred at 1.09 Myr (95% HPD: 0.64–1.64 Myr) during the same stage as node B. The last divergence occurred at the center of Alborz where two lineages (CA and LarNP-CA) diverged from each other at 0.68 Myr (95% HPD: 0.34–0.89 Myr, node D in Fig. 3) during the mid-Pleistocene (Ionian stage).

Historical biogeography at the Palearctic scale. Based on the Akaike information criterion, the historical biogeography analysis using the concatenated mtDNA + nDNA dataset revealed that the DIVALIKE + J model holds the strongest support compared to other analyses performed in BioGeoBEARS (Table S2) and dispersal, extinction, and cladogenesis parameters were estimated at 0.000431, 0.022, and 1.00E-12, respectively. We have found some allopatric speciation and founder-event speciation in evolution of this complex in different time slices (Fig. 4). Furthermore, among the four different scenarios tested, the second one (Scenario_{HB} in Table S2) is characterized by the highest AICc value, under the DIVALIKE + J model (Fig. 4). The best hypothesis suggests that the ancestor of the complex was widespread through regions A and G at 3.62 (2.30–5.32) Mya, which went extinct at 2.61 (1.72–3.69) Mya from region A. Regions D and E were colonized from region G by the ancestor of *G. stejnegeri* and *G. cognatus* at 2.30 (1.52–3.22) Mya and 2.15 (1.44–3.06) Mya, respectively. In addition, regions B and F were separately colonized from regions D and E by the ancestors of *G. h. caucasicus* and *G. h. halys* at 1.89 (1.20–2.70) Mya and 1.83 (1.08–2.68) Mya.

Coalescent analyses and simulations of *G. h. caucasicus*. Both ABC coalescence simulations (direct and the logistic approaches) using the concatenated mtDNA + nDNA dataset led to the conclusion that the Scenario_{EH} 3 is the best supported scenario (Pp = 0.844) compared to the other hypotheses (Pp = 0.458 and 0.411). Furthermore, model choice validation using PODS indicates that adequate power exists for selecting the true hypothesis among competing hypotheses with an acceptable Type I error rate (35%) and low Type II error rate (16%). These results hint at the incursion of the species from northeastern Iran to the western end of the Alborz and then toward the southern mountains of Azerbaijan (Talysh Mountains) through two directions, via northern and southern slopes of the Alborz Mountains. Furthermore, our results may suggest that the observed regional phylogeographic pattern may likely reflect colonization into four allopatric refugia during the Pleistocene glaciation episodes.

Species Distribution Modelling. Our SDM based on the Biomod framework showed high average values of discrimination capacity (AUC = 0.93–0.97) and classification accuracy (TSS = 0.89–0.92) for the four modelling methods. The final ensemble model illustrates that the most suitable landscape for *G. h. caucasicus* is the southern and northern slopes of the Alborz Mountains (Fig. 5). The variables of proximity to forest cover, roughness, maximum temperature of the warmest month, annual precipitation, and temperature seasonality had the highest average contribution over the ten replications and four models, indicating that the suitable habitat for the species in northern Iran is characterized by both landscape-based (i.e. woody alpine habitats) and climatic variables.

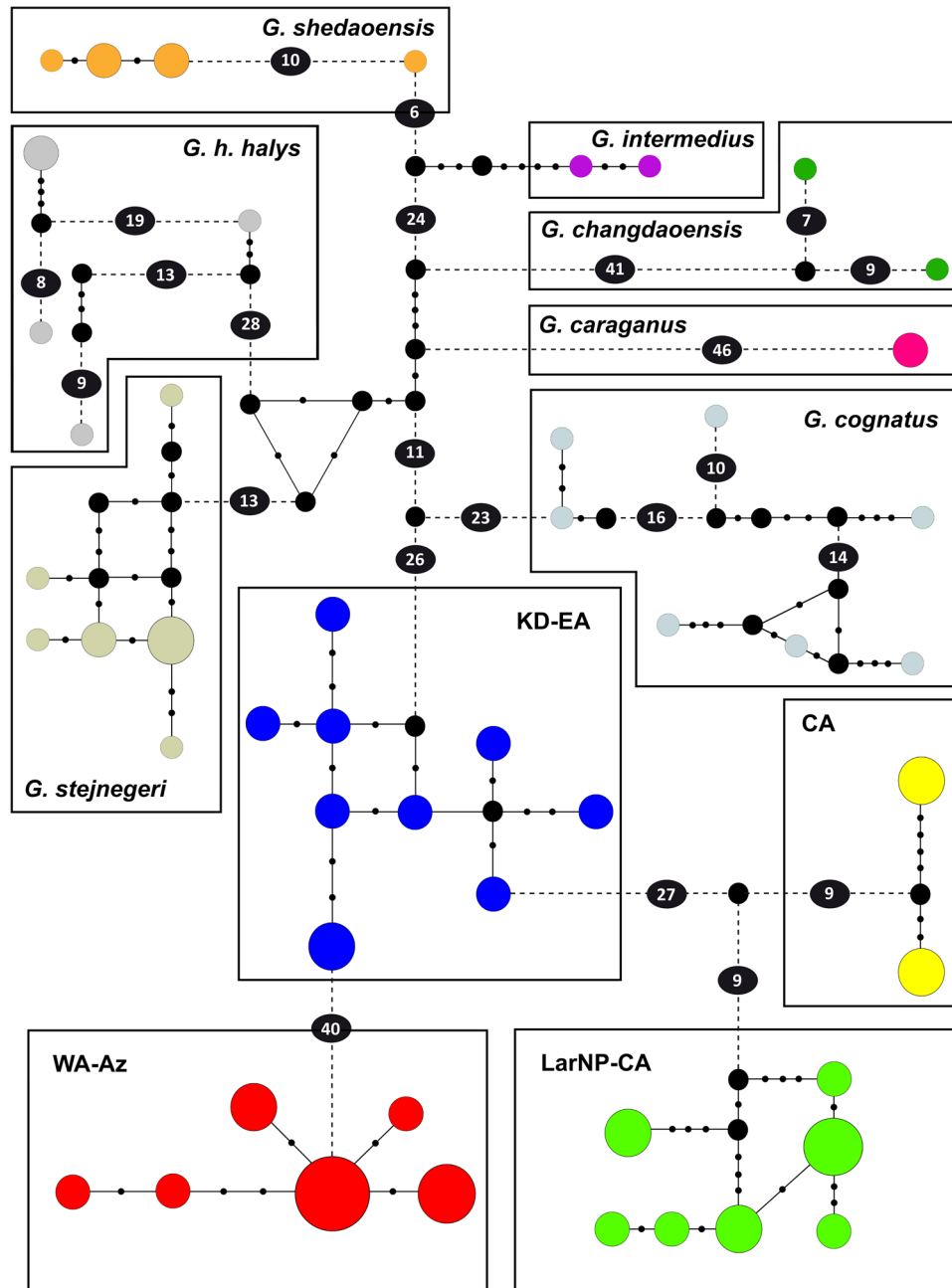

Figure 2. Haplotype network using the 1618 bp of the concatenated sequences from *cyt b* + ND4 and a total of 70 sequences. Statistical parsimony network assuming a 95% parsimony threshold, as constructed by TCS. Symbol size and branch lengths are proportional to the number of shared individuals per haplotype and the number of mutational steps among haplotypes, respectively. Black circles indicate unsampled or extinct haplotypes. Sizes of circles are proportional to haplotype frequencies. Small black circles indicate one mutational step.

We assessed the amount of protection granted to *G. h. caucasicus* in northern Iran by overlaying the Biomod suitability map with areas occupied by the lineages and the newest map of protected areas network of Iran, including national parks, protected areas, and wildlife refuges (Fig. 5). We estimated the effectiveness of the current protected area network to be 29.7% for KD-EA, 39.1% for LarNP-CA, 57.6% for CA, and 24.8% for WA-Az.

Discussion

Reassessment of the taxonomic status of the Caucasian pit viper (*G. h. caucasicus*). Recently, a number of taxa formerly viewed as subspecies of *G. halys* have been raised to full species rank based on genetic evidence. Among these are *G. h. caraganus*, submitted for reconsideration as a species (*G. caraganus*) (Eichwald, 1831) by Wagner *et al.*¹⁷ and two other subspecies (*G. h. cognatus* and *G. h. stejneri*), elevated to full species rank by Shi *et al.*^{18,19}. Simonov *et al.*⁴⁰ proposed the elevation of all currently recognized subspecies, *G. halys* to species

Lineages	n	p	pi	h	H
<i>G. h. caucasicus</i>	39	24	0.02049	0.964	24
Kopet Dagh-Eastern Alborz (KD-EA)	10	12	0.0020	0.978	9
Central Alborz (CA)	4	6	0.00247	0.667	2
LarNP-Central Alborz (LarNP-CA)	12	11	0.00186	0.894	7
Western Alborz-Azerbaijan (WA-Az)	13	6	0.00194	0.679	6

Table 1. Number of haplotypes (p), nucleotide diversity (pi), haplotype diversity (h), and number of polymorphic sites (H) of the Caucasian pit viper lineages.

rank (including *G. h. caucasicus*), while emphasizing that “*G. saxatilis*” and *G. intermedius* are synonymous²⁰, and that *G. lijianlii* could be synonymised with *G. changdaoensis* due to the absence of genetic differentiation in their mitochondrial genes.

Genetic distances among taxa of the *G. halys/G. intermedius* complex (clade F in Shi *et al.*¹⁸) indicate that the distances vary from 1.0–5.4% (Fig. S1 and the blue cells in Table S3), which conforms to the results of Shi *et al.*¹⁹. They also estimated the genetic distance among *G. stejnegeri*, *G. cognatus*, and *G. h. halys* to range from 2.7–5.0%¹⁹. However, the average genetic distance between the four Iranian clades of *G. h. caucasicus* and the other species varies from 3.7–5.6% (Fig. S1 and the grey cells in Table S3), which is even greater than the distance observed by Shi *et al.*¹⁹ between *G. cognatus* and *G. stejnegeri* (2.7–4.84%). In addition, the genetic distance between *G. changdaoensis*, *G. intermedius*, *G. shedaoensis*, *G. cognatus*, *G. stejnegeri*, and *G. caraganus* varies from 1.0%–5.4% (the blue cells in Table S3), while the average genetic distance among the four Iranian clades of *G. h. caucasicus* and the other taxa in the complex varies from 4.2–5.2% (the grey cells in Table S3). This is also noticeable in the haplotype network (Fig. 2). The results suggest that *G. h. caucasicus* could be considered as a distinct species. This is reconfirmed by our Bayesian multi-locus species delimitation approach (under different scenarios), which strongly supported each of the nine previously delimited taxa in the complex with maximum Bayesian posterior probability ($P = 1$).

However, the pairwise genetic distance among the Iranian lineages of *G. h. caucasicus* (clades KD-EA, WE-Az, LarNP-CA, and CA) drops to 1.5–2.9%, (Fig. S1 and the green cells in Table S3), as Bayesian posterior probabilities of our second scenario dropped to 0.93%–95% under all different priors.

Furthermore, Khani *et al.*²⁹ separated three populations of *G. caucasicus* in the Alborz Mountains based on seven metric and 21 meristic traits. Their study showed that populations of eastern Alborz, Lar National Park and western Alborz, corresponding respectively to KD-EA, LarNP-CA, and WA-Az in our study, are significantly different with respect to morphological traits. This means that they failed to differentiate between LarNP-CA and CA, apparently due to the lack of samples from Central Alborz (including western Mazandaran and eastern Gilan provinces).

However, the results of a study conducted by Malek-Mohammadi *et al.*²⁵ based on a 775 bp D-Loop dataset did not find any significant distinction among populations of *G. caucasicus* in the Alborz Mountains²⁵. Another study on the phylogenetic relationships of *G. caucasicus* in Iran using 629 bp of the *cyt b* gene from 16 individuals in north-east of Iran (Khorasan province) and Central Alborz (Lar National Park and Gachsar area) concludes that the species belongs to the *G. halys/G. intermedius* complex, within which controversial phylogenetic relationships still remain²⁶.

They also suggest that all samples of *G. caucasicus* in northern Iran belong to a single population. However, the distinction between the *G. caucasicus* clade and other closely related clades (*G. intermedius*, “*G. saxatilis*”, and *G. shedaoensis*) have low support ($P_p = 0.36$ and bootstrap values = 59%²⁶). The genetic distance between *G. caucasicus* and the species previously mentioned was much lower in comparison to our findings (0.6%–0.9% versus 4.2%–5.2%). This discrepancy may result from taxonomic misidentification for the sequences that Rastegar-Pouyani *et al.*²⁶ obtained from GenBank. As a result of the high taxonomic uncertainty within this group, along with difficulties with morphological identification of the taxa, many GenBank entries for this complex have erroneous taxonomic names. This mislabeling of species names may result in incorrect estimation of genetic distances between taxa.

Thus, in the light of molecular and morphological evidences, we argue that *G. h. caucasicus* in northern Iran should be elevated to species rank and further referred to as *G. caucasicus* (Nikolsky, 1916). We therefore refer to *G. caucasicus* as such and use this labeling throughout subsequent text.

Allopatric divergence and dispersal during the Pleistocene oscillations. *Diversification of the Gloydus genus.* In view of our biogeographical results, the DIVALIKE + J model was regarded as the most probable pattern of dispersal, vicariance, and extinction for the *Gloydus* genus in the Palearctic (Table S2, Scenario_{HB} 2). We found no evidence of ancestral range switching throughout the distribution range of the complex. Accordingly, this model appeared as the best biogeographical model of ancestral expansion for the complex^{41–43}. During the Pleistocene, historical expansion of *Gloydus* populations was in alignment with dispersal patterns of other species occupying similar geographical distribution ranges. They all dispersed in a similar manner from the eastern Palearctic toward central regions and lower latitudes, a movement which led to the establishment of new populations in a discrete refugium^{44,45}. Moreover, the absence or minor levels of gene flow among eastern (*G. h. halys*, *G. stejnegeri*, and *G. cognatus*) and central (*G. caucasicus*, *G. rickmersi*, and *G. caraganus*) Palearctic species around 1.0–2.8 Mya was proposed as the best biogeographical scenario based on AIC and AICc weight (Table S2), which could be indicative of vicariance due to geographical isolation of populations in multiple and isolated refugia.

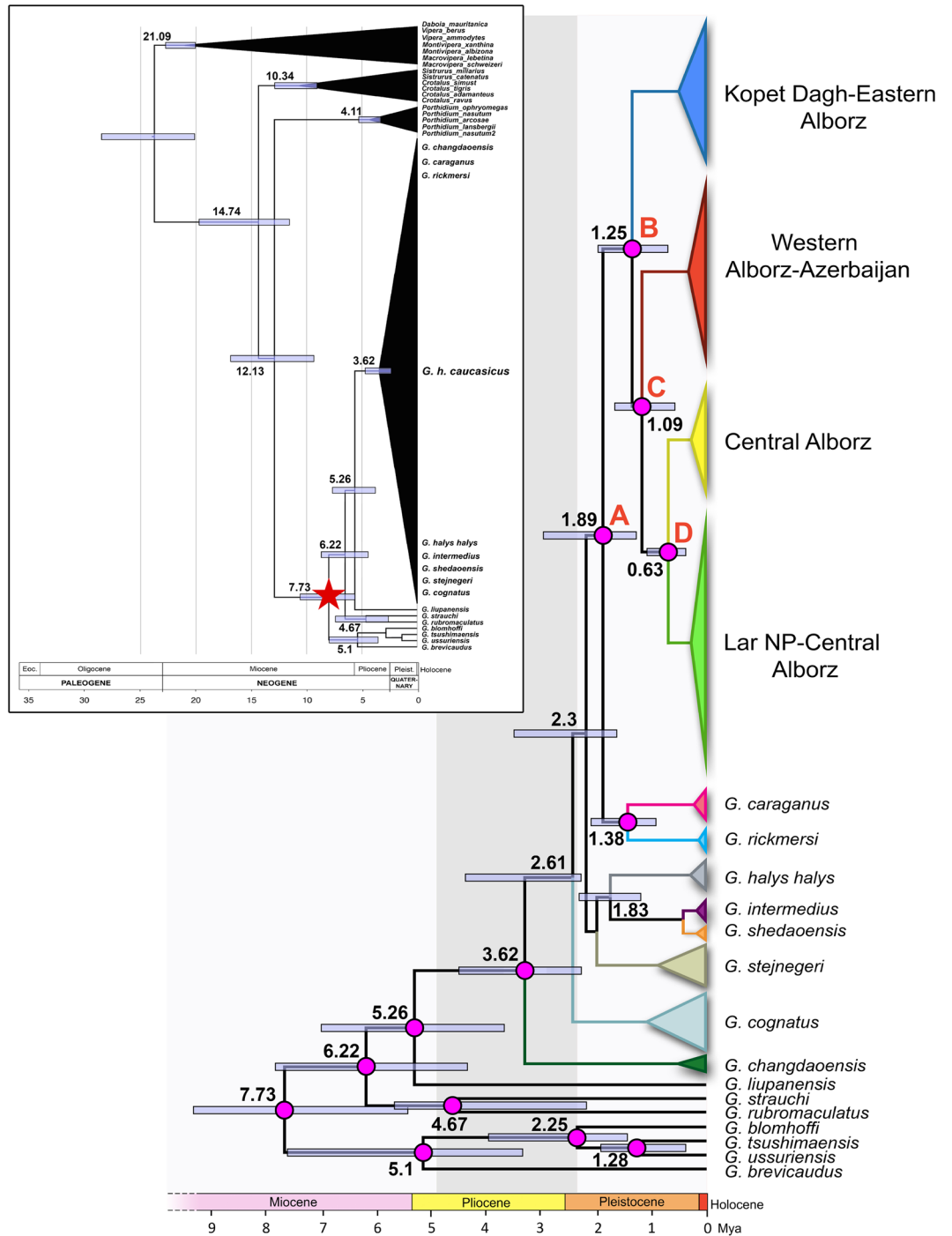

Figure 3. Chronogram of the *G. halys*/*G. intermedius* complex based on the concatenated mtDNA + nDNA dataset and a total of 114 sequences (89 *Gloydus* and 25 outgroups). Divergence times were estimated using a Lognormal clock and a Birth-Death Process model. The black chronogram inset on the top left corner displays dating of the entire dataset and the red star denotes the starting point of the evolutionary relationships shown by the phylogeny on the right. The pink circles represent nodes with posterior probability PP > 90%.

During the Last Glacial Maximum (LGM), glaciers advanced upon lands toward lower latitudes and covered more than 30% of the earth's surface, creating a major impact on the overall climate of the planet, including Iran's⁴⁶. Some geomorphological evidence suggests that Iran has substantially and prolongedly altered during the Quaternary period⁴⁷. According to Ehlers⁴⁸, the climate of Iran has experienced a severe reduction in temperature, and consequently, a moderate increase in precipitation in montane habitats during the early Würm (approximately 100 kya). Kehl⁴⁹ notes that the Quaternary climate in northern and western Iran remained dry and cold during glacial periods, while it was warm and wet during interglacial periods. The effects of glacial periods on mountains of Iran (including Azerbaijan, Kurdistan, Alam-Kouh, and Damavand) and adjacent

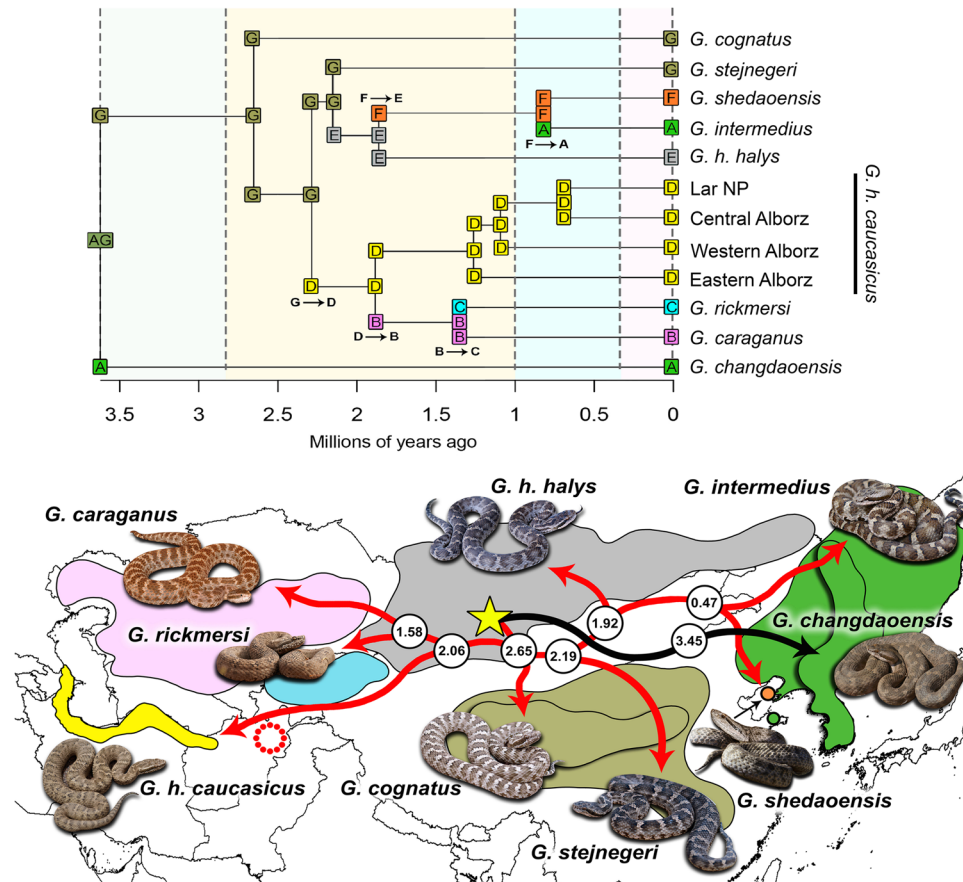

Figure 4. Ancestral range estimation for the *G. halys*/*G. intermedius* complex using BioGeoBEARS under DIVALIKE + J model on the concatenated mtDNA + nDNA dataset. Colours are correspondent to the seven regions (explained in section 2.4.2). Yellow star indicates ML estimation of the center of origin of all taxa (latitude 43.308 and longitude 96.388, estimated by PhyloMapper 1b1) in the complex, the orange circle shows *G. shedaoensis* locality in Shedao Island, China, and black and red arrows present a hypothetical direction of dispersal supported by BioGeoBEAR results. Numbers refer to divergence times among taxa in million years (see Fig. 3). Polygons show approximate range of distribution of each species/subspecies. The red circle in Afghanistan refers to *G. h. boehmei* (Nilson, 1983), which is not included in our study.

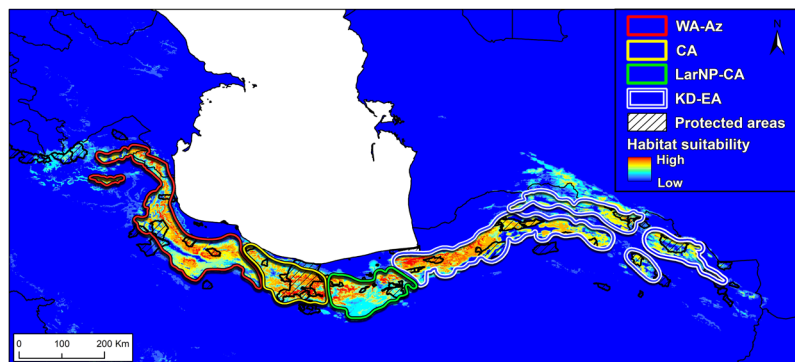

Figure 5. Habitat suitability map of *G. h. caucasicus* populations in northern Iran. Coloured polygons represent areas occupied by each lineage. Crosshatch polygons show the network of protected areas of Iran and its overlap with the suitability map. Boundaries of lineages were detected by BAPS.

glacial mountains (Shirkouh, Zardkouh, Kerman mountains, Southern Alborz, and Northern Khorasan), and the presence of Loess soils in central Iran provide evidence for a past cold climate^{49–52}. Major glacial centers were located in Alam-kouh⁵³, Sabalan⁵⁴, borders of Iran-Turkey and Iran-Iraq^{55,56}, Zardukh⁵⁷, and possibly the Dinar Mountain in central Zagros⁴⁹. It has been estimated that during the LGM, temperature fluctuations in the Alborz and Zagros mountains, as well as central Iran ranged from five to eight degrees Celsius⁴⁹ colder than present.

Diversification of *Gloydius caucasicus*. The BEAST analyses revealed that the divergence of *G. caucasicus* from other species of the complex occurred in the lower Pleistocene (1.89 Myr, 95% HPD: 1.20–2.70 Myr; Fig. 3), while the divergence among populations of *G. caucasicus* in northern Iran comprised three phases of divergence during the Pleistocene, which highlights the effects of climate oscillations on isolation of populations. During the early Pleistocene (2.5–1.84 Myr), Earth's climate was cooler and drier compared to the mid-Pliocene⁵⁸. As a result of the reduction in Earth's temperature, suitable habitats were confined to more southerly latitudes (40–50 degrees of latitude) and lower elevations⁵⁹. Given that *G. rickmersi* and *G. caraganus* are sister clades to *G. caucasicus* (Fig. 1), it could be inferred that as a consequence of the cooling of high latitudes, one could expect gene flow to be driven toward more southerly latitudes such as Afghanistan and northeastern Iran (Fig. 4).

The first divergence due to vicariance in populations of *G. caucasicus* in northern Iran is estimated to have occurred around 1.25 Myr (95% HPD: 0.73–1.83 Myr). At that time, populations of central and western Alborz diverged from populations of the north-east. Results of ABC analyses suggested a bi-directional gene flow from northeastern Iran to northwestern and southern Azerbaijan through northern and southern slopes of the Alborz, strikingly similar to the intraspecific divergence of *Montivipera raddei* species occurring 1.88 Myr in the Alborz, north-western and Zagros Mountains¹³. Meanwhile, the second divergence occurred between clades of central Alborz and western Alborz (1.09; 95% HPD: 0.64–1.64 Myr). Most likely, following the first glacial maximum in the lower Pleistocene (1.84 Myr), a warm interglacial period contributed to the expansion of populations toward central Alborz via the northern slopes, and toward western Alborz and mountains of southern Azerbaijan via the southern slopes of the Alborz. This could be regarded as the existence of multiple potential refugia for *G. caucasicus* populations along the Alborz, conforming to the lineages identified in these areas. The last divergence within the species occurred between populations of central Alborz approximately 0.68 Myr (95% HPD: 0.34–0.89 Myr), prior to the Günz glacial period (0.62–0.67 Myr).

It could be concluded that populations of *G. caucasicus* in northern Iran have undergone multiple expansions and contractions during glacial and interglacial periods. Nevertheless, no shared haplotypes were observed between the lineages. This can be explained upon the assumption that the gene flow from northeastern to central and western Alborz was unidirectional, meaning that no genes were transferred back to ancestral populations. It could be presumed that the warming of the earth from the early Holocene to the present might have contributed to population fragmentation in mountains and led to a breakdown of gene flow between the different regions.

Finally, our results could underline the existence of multiple glacial refugia in the Alborz during climatic oscillations of Pleistocene. This complies with the results of previous studies^{60–66}, which suggested the Hyrcanian forests as an isolated refugium during Quaternary oscillations. Isolation of organisms eventually gave rise to vicariance in a middle-sized geographical area in the central Palearctic. Such multiple glacial refugia contributed to the interruption or reduction of gene flow, and consequently increased genetic drift, resulting in formation of endemic haplotypes and new subspecies⁶⁷, which, following the last glacial period when the climate became more favorable, expanded toward suitable habitats and shaped the current patterns of distribution.

Conservation Units and Management Propositions. Conservationists have long been in a quandary regarding the continuing controversy over the definition of conservation units at the species or subspecies level, stressing the need for its reconsideration^{39,68,69}. Evolutionary significant units (ESUs) generally refer to taxa that merit independent conservation management because they have evolved separately^{70,71}.

Among the many definitions assigned to the concept of ESUs, we chose the one adopted by Fraser and Bernatchez³⁹, as its overall focus remains on isolated populations. They state that lineages with particularly restricted patterns and levels of intraspecific gene flow are to be considered as ESUs for conservation. Therefore, we proposed the four isolated lineages of *G. caucasicus* identified in northern Iran as four ESUs including (i) KD-EA ESU comprising the Hezar Masjid Mountains, Khorasan, and Golestan provinces, (ii) LarNP-CA ESU including Lar area as well as Mazandaran province, (iii) CA ESU including northern and western slopes of the Alborz Mountains in western Mazandaran and eastern Gilan provinces, and (iv) WA-Az ESU comprising western Gilan and Ardebil provinces.

The International Union for Conservation of Nature (IUCN) has classified *G. monticola* (Likiang Pit Viper) from China as Data Deficient (DD), "*G. saxatilis*" (Rock Mamushi) from China, Korea, and Russia as Least Concern (LC), and *G. shedaoensis* (Shedao Island Pit Viper) from China as Vulnerable (VU). However, the conservation statuses of the other species in the two complex groups of *G. blomhoffi* and *G. halys/G. intermedius* (including *G. caucasicus*) have received little consideration. Although our results confirmed that about 37.8% of suitable *G. caucasicus* habitats are located within the network of protected areas in northern Iran, this species is currently threatened by various factors such as agricultural development, overgrazing of livestock, destruction of rangelands, hunting and killing by local people and/or tourists, mortality due to vehicle collisions on roads, restricted movement of individuals among population patches, and large-scale hunting and capturing for vaccine and serum production²⁶ (about 1000 capturing licenses are certified annually). Unfortunately, hunting/capturing of this species is mostly done when snakes emerge from hibernation and have not yet had the chance to reproduce. In general, populations of this species have experienced dramatic declines over the past decades, to the extent that snake catchers complain that it is now hardly possible to locate well-populated sites for this species.

However, *G. caucasicus* is not listed as a protected species according to the Department of Environment of Iran, accompanying many other reptiles that have been largely neglected from the list of protected species. Moreover, the lack of awareness and limited knowledge regarding venomous snakes has instilled deep fear in local people and even park rangers to such an extent that they would habitually kill a snake upon their very first encounter. Therefore, we recommend that the Department of Environment of Iran should (i) establish and declare new protected areas throughout the distribution range of the Caucasian pit viper, according to the four lineages identified in this study, (ii) establish safe zones in current protected areas that cover suitable habitats of the Caucasian pit viper; (iii) prevent or reduce legal hunting and venom collection from populations of the Caucasian pit viper until

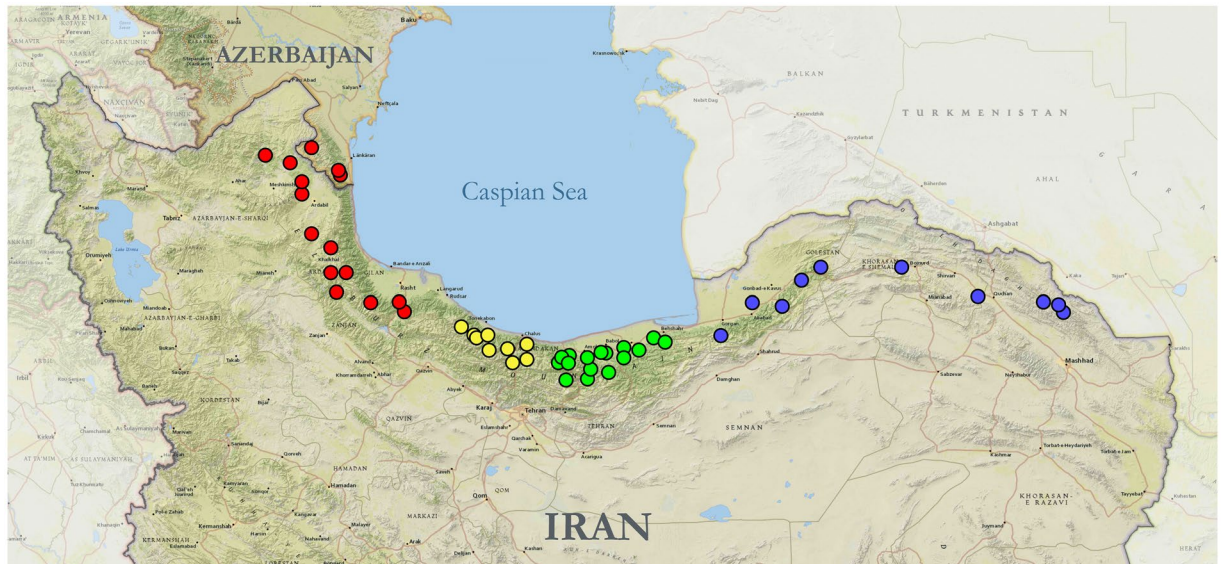

Figure 6. Localities for 53 samples used in the study from Iran and Azerbaijan. Colours correspond to phylogenetic lineages of *G. h. caucasicus* along the Alborz Mountains, namely Kopet Dagh-Eastern Alborz (blue, KD-EA), Lar National Park-Central Alborz (green, LarNP-CA), Central Alborz (yellow, AC), and Western Alborz-Azerbaijan (red, WA-Az). Map source: ESRI. The map was generated using ArcGIS 10.2 by ESRI (available online at: <http://www.esri.com/>).

populations have recovered, (iv) list the species as protected under laws of the Department of Environment of Iran, and reduce its international illegal trade by the addition of the species to the CITES appendices.

Material and Methods

Sampling, PCR amplification, and DNA sequencing. We obtained sequence information for 41 individuals of the Caucasian pit viper, representing 15 regions from northeastern to northwestern Iran and Azerbaijan (Fig. 6, Table S4). Tissue samples contained three clips from the outer edge of ventral scales for each specimen, except two museum samples from Azerbaijan, for which muscle tissue was used. Captured snakes were released into their capture location immediately. All methods were performed in accordance with the relevant guidelines and regulations. This study was licensed by the Iranian Department of Environment under permits No. 94/6049 and 96/3631.

Total genomic DNA was extracted from tissue samples using a Qiagen DNeasy Tissue kit (Qiagen, Courtaboeuf, France) or by phenol/chloroform protocol⁷². We amplified two fragments of the mitochondrial genome including 1125 base pairs (bp) of the *cyt b* and 678 bp of the ND4. Furthermore, we partially sequenced one nuclear proto oncogene *c-mos* (567 bp), which evolves at a slower rate than mtDNA⁷³. All genes were amplified by polymerase chain reaction (see Table S5 for PCR protocols) and sequenced using primers designed by previous studies (L14910/H16064⁷⁴ and ND4/Leu⁷⁵ for the two mtDNA genes, and S77 and S78 for *c-mos*⁷⁶). PCR products were sent to Eurofins Genomics (Ebersberg, Germany) or SYNTOL Company (Moscow, Russia) for sequencing on an ABI 3730 automated DNA sequencer (Applied Biosystems).

Sequence alignment and data analyses. Sequences of samples were examined using SeqScape version 2.6 (Applied Biosystems). We also obtained 56 sequences (comprising 13 species) from GenBank^{17–19,26,27,77–79} (Table S4). All sequences were aligned using ClustalW implemented in MEGA v.6⁸⁰. Protein coding sequences were converted into amino acid residues to check for stop codons as a result of pseudogene generation. We used DnaSP version 5.0⁸¹ to calculate mitochondrial diversity indices including haplotype and nucleotide diversities, number of haplotypes, and polymorphic sites. Nucleotide composition and genetic distances were analyzed using the uncorrected genetic distance including 1000 bootstraps in MEGA v.6.

Phylogenetic relationship and Taxonomic assessment. *Species tree estimation.* We concatenated the datasets of mtDNA (*cyt b* and ND4) + nDNA (*c-mos*) including 2370 bp for 53 samples of *G. h. caucasicus*, nine samples of *G. h. halys*, seven samples of *G. cognatus*, five samples of *G. stejnegeri*, two samples of *G. intermedius*, three samples of *G. caraganus*, two samples of *G. rickmersi*, six samples of *G. shedaoensis*, and two samples of *G. changdaoensis*. We used PartitionFinder 1.1.1⁴⁹ to identify the best partitioning schemes and model of sequence evolution for each partition using the “greedy” algorithm and the Bayesian Information Criterion (BIC). Bayesian Inference (BI) and Maximum Likelihood (ML) phylogenetic analyses were carried out using the selected scheme. For the BI analysis, we used MrBayes 3.1.2⁸² and the analysis was run using one cold and three heated chains (MC3) for 40 million generations, sampling every 1000th generation and discarding the first 25% of the trees as burn-in. Convergence was examined using Tracer v1.5⁸³ and checked with the convergence diagnostic parameters performed in MrBayes. A ML phylogenetic analysis was carried out using the selected model in IQ-TREE version 1.6.2^{84,85} and 1000 non-parametric bootstrap replicates.

Haplotype network. The concatenated sequences of the two mitochondrial genes in this study were 1803 bp in length, whereas the majority of sequences downloaded from GenBank were shorter. To avoid any potential bias caused by uneven sequence lengths among samples, we used an evenly-matched length of sequences for our analyses. We made an mtDNA matrix with 70 individuals (39 samples of *G. caucasicus* and 31 samples of the other taxa of *G. halys/G. intermedius* complex) with 1618 bp. We then developed a haplotype network in order to visualize the genetic relationships among the complex haplotypes. Haplotype networks were estimated with TCS⁸⁶ implemented in PopART (<http://popart.otago.ac.nz>).

Spatial analyses of genetic variability. We analyzed population structure and determined the amount of mixture between population clusters on our concatenated mtDNA + nDNA dataset (including 2370 bp) using the Bayesian Analysis of Population Structure software (BAPS v.6.0)^{87,88}. We allowed K (number of clusters) to vary from 1–9 in order to calculate the best value for K. Then, an AMOVA was executed through Arlequin version 3.1⁸⁹ with populations grouped into the best number of K identified for population clusters. Also, we used F-statistics with 10000 permutations to estimate the proportion of genetic variability among different fixation indices, F_{ST} (i.e. variance among populations relative to the total variance).

Barcoding gap analysis. We used the concept of the ‘barcoding gap’ to determine the threshold of species level in the *G. halys/G. intermedius* complex using the mtDNA dataset. We calculated genetic distances among the taxa of the complex (clade F in Shi *et al.*¹⁸) along with the four lineages for *G. caucasicus* in northern Iran, using an evenly-matched length of sequences from our mtDNA dataset. Pairwise inter- and intraspecific genetic distances were calculated using uncorrected p-distances by MEGA v.6⁸⁰. Then, we plotted frequency distribution histograms of pairwise inter- and intraspecific distances.

Bayesian species delimitation. We adopted a Bayesian multi-locus species delimitation approach implemented in BPP 3.1^{90–92} to verify the speciation patterns within the complex based on our concatenated mtDNA + nDNA dataset (gene-partitioned), with the ML and BI topologies from this study serving as the guide tree. We tested two different scenarios: (i) considering the nine major clades corresponding to the nine taxa of the complex obtained by the BI and ML analyses, and (2) including 12 putative clades (the four Iranian clades of *G. caucasicus* and the remaining species of the complex).

This method estimates population size (θ) and divergence time (τ) parameters and then applies a reverse-jump MCMC (rjMCMC) algorithm to calculate posterior probabilities for species delimitation. BPP assumes that there is neither recombination within a locus nor gene flow between species⁹². It also assumes neutral clock-like evolution and employs the JC69 mutation model; therefore, it could only be used for closely related species with sequence divergences not much higher than 10%⁹³. We evaluated the neutrality of the two mtDNA genes by Hudson-Kreitman-Aguadé tests (HKA)⁹⁴ in DnaSP v 5.10⁸¹. Moreover, we assessed our nDNA recombination through the pairwise homoplasy index (PHI) test⁹⁵ in Splitstree4⁹⁶.

A Dirichlet distribution was employed with $\alpha = 2$ to compensate for variation in mutation rates among loci. A gamma prior (G) was applied to specify the population size parameter (θ) and root age (τ_0) of the species tree. As BPP is sensitive to the prior values⁹⁷, we made three replicate runs under three different combinations of gamma-distributed priors for ancestral θ and root age (τ_0)^{98–101}: (i) assuming relatively large ancestral population sizes and deep divergences, $\theta \sim G(1,10)$ and $\tau_0 \sim G(1,10)$; (ii) assuming relatively small ancestral population sizes and shallow divergences among species, $\theta \sim G(2,2000)$ and $\tau_0 \sim G(2,2000)$; and (iii) a conservative combination of priors that could fit models with fewer species $\theta \sim G(1,10)$ and $\tau_0 \sim G(2,2000)$. Each analysis of 10^6 rjMCMC generations was run twice from different starting seeds (+1 and -1) with a burn-in period of 105 using algorithm 1 ($\alpha = 2$ and $m = 1$). For all speciation events, we conservatively regarded speciation probability values > 0.95 as strong support.

Historical biogeography analysis. Molecular dating and divergence time. We estimated divergence times using BEAST 1.8.0¹⁰² on our concatenated mtDNA + nDNA dataset with three calibration points including (i) divergence of three populations of the genus *Porthidium* in South America, some 3.5 Mya¹⁰³, using a normal distribution model (mean = 3.5 Mya, SD = 0.51 Myr, and 95% CI = 2.5–4.5 Myr), (ii) divergence between *Crotalus* and *Sistrurus* before 9 Mya¹⁰⁴, using a lognormal prior model with a zero offset of 9 Mya (mean = 1 Mya and SD = 1 Myr)¹⁰⁵, and finally (iii) divergence of the Eurasian vipers clade (genera *Macrovipera*, *Montivipera*, and *Vipera*) about 20 Mya suggested by fossil data^{106,107}, using a lognormal prior model with a zero offset of 17 Myr (mean = 1 Mya, SD = 1 Myr, and 95% CI = 17–36 Myr)¹⁰⁵.

We also included some sequences of four species of *Montivipera*, two species of *Macrovipera*, two species of *Vipera*, two species of *Sistrurus*, four species of *Crotalus*, four species of *Porthidium*, as well as seven outgroups (*G. brevicaudus*, *G. ussuriensis*, *G. blomhoffi*, *G. strauchi*, *G. rubromaculatus*, *G. liupanensis*, and *G. tsushimaensis*) in our dataset as calibration points (see Table S4). PartitionFinder 1.1.1⁴⁹ was used to select the best data partition and evolutionary models in our molecular dating. We also adopted the Birth-Death Process model because it is a proper model when sequences from different species are included in a dataset¹⁰⁸. The fitness of three molecular clock models (Strict, Exponential relaxed, and Lognormal relaxed) was tested by Bayes factor analysis in Tracer v1.5⁸³, using value of 2LnBF ¹⁰⁹. Each analysis was performed using two independent runs of 40 million generations, sampled every 1000 generations, with the first 25% discarded as burn-in. Tracer was used to evaluate acceptable levels of MCMC chain mixing, the stationary likelihoods and appropriate lengths of burn-in (25%), as well as to estimate effective sample sizes for all parameters.

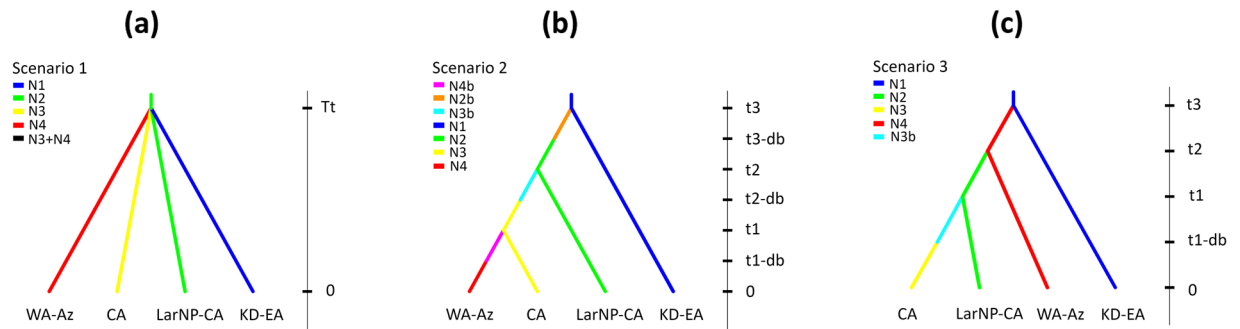

Figure 7. Population trees obtained using coalescent simulations, representing the three biogeographic hypotheses of diversification within *G. h. caucasicus*. (a) The null model of the fragmentation of a widespread ancestor or a single-refugium population, and (b,c) the alternative multiple-refugial/vicariance models, where b and c present one way and two-way gene flows, respectively.

Historical biogeography reconstruction. Using the concatenated mtDNA + nDNA dataset, we inferred the ancestral range and colonization history of the complex through the Palaearctic using the R package BioGeoBEARS¹¹⁰ under three models of biogeographical range expansion (i) the Dispersal-Extinction-Cladogenesis (DEC), (ii) Dispersal-Vicariance (DIVALIKE), and (iii) Bayesian inference (BAYAREALIKE). We also applied the jump dispersal parameter J to these models, and likelihood values of all six models (DEC, DEC + J, DIVA-like, DIVA-like + J, BAYAREA-like, BAYAREA-like + J) were compared with the Akaike Information Criteria (AICc). We defined seven regions based on knowledge of species distribution, namely A: *G. changdaoensis* and *G. intermedius*, B: *G. caraganus*, C: *G. rickmersi*, D: *G. h. caucasicus*, E: *G. h. halys*, F: *G. shedaoensis*, and G: *G. cognatus* and *G. stejnegeri* (Fig. 4). We used BEAST 1.8.2⁵⁸ to construct an ultrametric tree, then pruned all outgroups using Mesquite v.3.04¹¹¹. We chose four time slices (0–0.30, 0.30–1.20, 1.20–2.50 and 2.50–3.45 Mya), corresponding to divergence times within the complex. First, we ran the S0 scenario in which dispersal between regions was not penalized. Then, we tested four alternative scenarios (Scenario_{HB} 0–3), where we tested colonization of the complex lineages from other adjacent regions (Fig. 4). We also estimated the geographic location of the ancestors of the *G. halys*/*G. intermedius* complex, employing a statistical method implemented in PhyloMapper 1b1¹¹², optimized by 10,000 replications.

Evolutionary hypothesis testing. We applied coalescent simulations to test three alternative hypotheses (Scenarios_{EH} 1–3) regarding the demographic history of *G. h. caucasicus*, using an Approximate Bayesian Computation (ABC) approach on our concatenated mtDNA + nDNA dataset. In the first scenario tested, (i) we considered fragmentation of a single ancestral source population, which supposes that the four lineages could have diverged from a single ancestral refugium, approximately, at most, up to the Last Glacial Maximum, consistent with Weichselian (in Scandinavia and northern Europe), Würm (in Alps), and Wisconsin (in North America) glaciations, and then colonized different climatic and environmental niches throughout the Alborz Mountains (Fig. 7a). In the two other scenarios, we supposed multiple glacial refugia (or long-term geographical isolation among regions), which predicts that the four lineages may have developed under the effects of diversification from multiple refugia in northern Iran and two demographic history scenarios were tested to demonstrate whether (ii) the gene flow from northeastern Iran to western Alborz and Azerbaijan has experienced a one-way flow through the northern slopes, or (iii) a two-way gene flow through the northern and southern slopes of the Alborz Mountains. In a one-way gene flow, we considered an incursion from KD-EA to LarNP-CA, then to CA, and proceeding to WA-Az (Fig. 7b), whereas in a two-way gene flow, we tested a diversification from KD-EA to LarNP-CA, then to CA through the northern slopes of the Alborz Mountains, along with another diversification from KD-EA to WA-Az through the southern slopes of the Alborz Mountains (Fig. 7c).

We used an Approximate Bayesian Computation (ABC) approach in the program DIYABC 2.1.0¹¹³ to obtain the relative probabilities for the competing hypotheses. In this approach, summary statistics of our molecular data were calculated and compared to the dataset simulated earlier based on the modelled scenarios. Then, Euclidean distances between our simulated dataset and the observed dataset were calculated by a local linear regression. Finally, we only kept 10 subsets of the closest 2% of our simulated data to the observed data in order to compute posterior distributions, which enabled us to prioritize our modelled scenarios based on approximate marginal likelihoods and find the best-fit model. We used summary statistics including number of haplotypes as well as segregating sites, mean pairwise differences, mean between-sample pairwise differences, number of private segregating sites, and *F*_{ST} values.

We also used uniform priors with a lower and an upper bound for population size of 10 to 7×10^5 , and divergence times of 2.46×10^5 for t1, 4.30×10^5 for t2, 4.86×10^5 for t3, and 6.86×10^5 for Tt generations in the past. Furthermore, we assumed a generation time of 3 years, the age of sexual maturity for *G. brevicaudus*⁶, as a closely related species to *Gloydus*¹¹⁴. In addition, Yakovleva¹¹⁵ has reported the minimum body length of the sexually matured specimens of *G. halys* sensu lato in Kyrgyzstan as 330 mm, which corresponded to the age of 3 years in our data. Moreover, all populations could include a discrete size-change event. We estimated the posterior probability of each hypothesis using both the direct approach (on the 500 closest datasets) as well as the logistic approach (on the 1% closest to the observed data). Then, to calculate posterior distributions of parameters,

we used a local linear regression on 1% of the accepted closest simulated data merely based on the most likely hypothesis. To evaluate the strength and accuracy of our ABC model selection, we simulated 1000 test datasets (pseudo-observed datasets) under each of the competing hypotheses and calculated the probability of type I and type II errors, assuming the defined priors in the historical model.

We determined the effective population sizes (N_e) using θ -values estimated by the ML and the coalescent-theory approach in MIGRATE 3.2.1¹¹⁶. We ran the analysis with 10 short chains of 200,000 steps, followed by three long chains of two million steps, sampling every 20 steps following a burn-in of 10,000 steps. Then, we calculated N_e using the equation for maternally inherited mtDNA ($\theta = N_e \mu$). We considered $\mu = 3.9 \times 10^{-8}$, based on the mean rate of sequence evolution of approximately 0.01306 substitutions per Myr, using BEAST 1.8.2¹⁰².

Species Distribution Modelling. We first compiled data of the species occurrence (84 points) with 10 climatic, land cover, and physiographic variables to build a species distribution model (SDM) for the species. For climatic variables, we used the WorldClim dataset¹¹⁷, a set of 19 climatic variables with ~1 km resolution. Due to the high correlation between the climatic variables, we first calculated pairwise correlation coefficients among the variables and then screened them to low correlated ($r < 0.75$) variables. Accordingly, we obtained Bio1 (annual mean temperature), Bio4 (temperature seasonality), Bio5 (maximum temperature for the warmest month), Bio12 (annual precipitation) and Bio13 (maximum precipitation for the wettest month). Land cover variables including distance to forest patches, distance to herbaceous cover with shrubs and sparse trees, and distance to herbaceous cover, were generated in ArcMap 10.3 based on cover types of Globcover v. 2.1¹¹⁸. Based on the Shuttle Radar Topography Mission (SRTM) elevation model (<http://srtm.csi.cgiar.org>), we also used altitude and topographic roughness (i.e., standard deviation of altitude for all raster cells within a 5×5 km moving window) as the most important variables depicting physiographic heterogeneity.

To generate a habitat suitability map, we then conducted four SDM algorithms, including generalized linear models (GLM), generalized boosting models (GBM), maximum entropy (MaxEnt), and random forest (RF), and combined them into a final ensemble model using *Biomod 2* package in R v.3.3.2¹¹⁹. To reduce bias caused by randomly selected occurrence points for model construction, we replicated the modelling based on a 10-fold cross-validation approach, using a different subset of 25% of the occurrence records to test each model. Model performance was evaluated based on the area under the curve (AUC) of a receiver operating characteristic (ROC) plot and the true skill statistic (TSS). The final ensemble model was obtained by weighted averaging the individual models proportional to their AUC scores. Finally, we used the boundaries of populations, estimated from BAPS, to separate the boundary of the continuous suitability map of the lineages from northeastern to northwestern Iran.

References

- Hewitt, G. M. Post-glacial re-colonization of European biota. *Biol. J. Linn. Soc.* **68**, 87–112 (1999).
- Hewitt, G. M. Some genetic consequences of ice ages, and their role in divergence and speciation. *Biol. J. Linn. Soc.* **58**, 247–276 (1996).
- Avise, J. C. *Phylogeography: The History and Formation of Species*. (Harvard University Press, 2000).
- Cox, C. B., Moore, P. D. & Ladle, R. *Biogeography: an ecological and evolutionary approach*. (John Wiley & Sons, 2016).
- Ursenbacher, S. *et al.* Phylogeography of the asp viper (*Vipera aspis*) inferred from mitochondrial DNA sequence data: evidence for multiple Mediterranean refugial areas. *Mol. Phylogenet. Evol.* **38**, 546–552 (2006).
- Ding, L., Gan, X. N., He, S. P. & Zhao, E. M. A phylogeographic, demographic and historical analysis of the short-tailed pit viper (*Gloydius brevicaudus*): evidence for early divergence and late expansion during the Pleistocene. *Mol. Ecol.* **20**, 1905–1922 (2011).
- Runck, A. M. & Cook, J. A. Postglacial expansion of the southern red-backed vole (*Clethrionomys gapperi*) in North America. *Mol. Ecol.* **14**, 1445–1456 (2005).
- Sagheb Talebi, K., Sajedi, T. & Pourhashemi, M. *Forests of Iran: A Treasure from the Past, a Hope for the Future*. (Springer, 2013).
- Alai-Taleghani, M. *Geomorphology of Iran*. (Ghoms Publications, 2015).
- Guest, B., Horton, B. K., Axen, G. J., Hassanzadeh, J. & McIntosh, W. C. Middle to late Cenozoic basin evolution in the western Alborz Mountains: Implications for the onset of collisional deformation in northern Iran. *Tectonics*. **26**, TC6011 (2007).
- Khosrow-Tehrani, K. *Stratigraphy and geological events*. (University of Tehran Press, 2013).
- Rajaei, S. H. *et al.* Quaternary refugia in southwestern Iran: insights from two sympatric moth species (Insecta, Lepidoptera). *Org. Divers. Evol.* **13**, 409–423 (2013).
- Behrooz, R. *et al.* Conservation Below the Species Level: Suitable Evolutionarily Significant Units among Mountain Vipers (the *Montivipera raddei* complex) in Iran. *J. Hered.* **109**, 416–425 (2018).
- Yousefi, M. *et al.* Upward altitudinal shifts in habitat suitability of mountain vipers since the last glacial maximum. *PLOS ONE*. **10**, 1–14 (2015).
- Dynesius, M. & Jansson, R. Evolutionary consequences of changes in species' geographical distributions driven by Milankovitch climate oscillations. *P. Natl. A. Sci.* **97**, 9115–9120 (2000).
- Orlov, N. L., Sundukov, Y. N. & Kropachev, I. I. Distribution of pitvipers of *Gloydius blomhoffii* complex in Russia with the first records of *Gloydius blomhoffii blomhoffii* at Kunashir Island (Kuril archipelago, Russian Far East). *Russ. J. Herpetol.* **21**, 169–178 (2014).
- Wagner, P., Tiutenko, A., Mazepa, G., Borkin, L. J. & Simonov, E. Alai! Alai!—a new species of the *Gloydius halys* (Pallas, 1776) complex (Viperidae, Crotalinae), including a brief review of the complex. *Amphibia-Reptilia*. **37**, 15–31 (2016).
- Shi, J. *et al.* A new moth-preying alpine pit viper species from Qinghai-Tibetan Plateau (Viperidae, Crotalinae). *Amphibia-Reptilia*. **38**, 517–532 (2017).
- Shi, J., Yang, D., Zhang, W. & Ding, L. Distribution and infraspecies taxonomy of *Gloydius halys*–*Gloydius intermedius* complex in China (Serpentes: Crotalinae). *Chin. J. Zool.* **51**, 777–798 (2016).
- Orlov, N. L. & Barabanov, A. V. Analysis of nomenclature, classification, and distribution of the *Agkistrodon halys*–*Agkistrodon intermedius* complexes: a critical review. *Russ. J. Herpetol.* **6**, 167–192 (1999).
- David, P. & Ineich, I. Les serpents venimeux du monde: systématique et répartition. *Dumerilia*. **3**, 3–499 (1999).
- Gumprecht, A. Die Weisslippen-Bambusotter, *Cryptelytrops albolabris* (*Trimeresurus albolabris*). (Art für Art, Natur und Tier Verlag, 2004).
- Orlov, N. L. & Barabanov, A. V. About type localities for some species of the genus *Gloydius* Hoge et Romano-Hoge, 1981 (Crotalinae: Viperidae: Serpentes). *Russ. J. Herpetol.* **7**, 159–160 (2000).

24. Simonov, E. & Wink, M. Population genetics of the Halys pit viper (*Gloydius halys*) at the northern distribution limit in Siberia. *Amphibia-Reptilia*. **33**, 273–283 (2012).
25. Malek-Mohammadi, A., Rastegar-Pouyani, E. & Todehdeghan, F. Genetic relationship between different populations of the *Gloydius halys caucasicus* (Nikolsky 1916) of mountainous areas of the Iran. *SCIREA J. Agr.* **1**, 214–230 (2017).
26. Rastegar-Pouyani, E., Oraie, H., Khosravani, A. & Akbari, A. Phylogenetic position of Iranian pitvipers (Viperidae, Crotalinae, *Gloydius*) inferred from mitochondrial cytochrome *b* sequences. *Trop. Zool.* **31**, 55–67 (2018).
27. Xu, Y. *et al.* Molecular phylogeny of the genus *Gloydius* (Serpentes: Crotalinae). *Asian Herpetol. Res.* **3**, 127–132 (2012).
28. David, P. & Vogel, G. An updated list of Asian pitvipers and a selection of recent publications (ed. Visser, D) In: *Asian Pitvipers, Breeding Experience and Wildlife*. (ECO Wear & Publishing, 2015).
29. Khani, S., Kami, H. G. & Rajabzadeh, M. Geographic variation of *Gloydius halys caucasicus* (Serpentes: Viperidae) in Iran. *Zool. Middle East*. **63**, 303–10 (2017).
30. Simonov, E. Differences in habitat use, daily activity patterns and preferred ambient temperatures of adult and neonate *Gloydius halys halys* from an isolated population in southwest Siberia: preliminary data. *Herpetol. Notes*. **2**, 1–7 (2009).
31. Mozafari, S. Z., Shiravi, A. & Todehdeghan, F. Evaluation of reproductive parameters of vas deferens sperms in Caucasian snake (*Gloydius halys caucasicus*). *Vet. Res. For.* **3**, 119–123 (2012).
32. Shakoobi, S., Todehdeghan, F., Shiravi, A. & Hojati, V. The assessment of captive breeding in the Caucasian viper (*Gloydius halys caucasicus*) in Iran. *J. Entomol. Zool. Stud.* **3**, 257–259 (2015).
33. Hoser, R. A review and rearrangement of pitviper genera (Serpentes: Viperidae: Crotalinae). *Australas. J. Herpetol.* **19**, 43–63 (2013).
34. Kaiser, H. *et al.* Best practices: in the 21st century, taxonomic decisions in herpetology are acceptable only when supported by a body of evidence and published via peer-review. *Herpetol. Rev.* **44**, 8–23 (2013).
35. Palandačić, A., Naseka, A., Ramler, D. & Ahnelt, H. Contrasting morphology with molecular data: an approach to revision of species complexes based on the example of European *Phoxinus* (Cyprinidae). *BMC Evol. Biol.* **17**, 184–201 (2017).
36. Deans, A. R., Yoder, M. J. & Balhoff, J. P. Time to change how we describe biodiversity. *Trends Ecol. Evol.* **27**, 78–84 (2012).
37. Casacci, L. P., Barbero, F. & Balletto, E. The “Evolutionarily Significant Unit” concept and its applicability in biological conservation. *Ital. J. Zool.* **81**, 182–193 (2014).
38. Mace, G. M. The role of taxonomy in species conservation. *Philos. T. Roy. Soc.* **359**, 711–719 (2004).
39. Fraser, D. J. & Bernatchez, L. Adaptive evolutionary conservation: towards a unified concept for defining conservation units. *Mol. Ecol.* **10**, 2741–2752 (2001).
40. Simonov, E., Melnikov, D. & Orlov, N. Who is who in *Gloydius halys-intermedius* complex? New insights from extended geographical sampling and consequences for venom biochemistry research. *19th SEH European Symp.* (2017).
41. Crisci, J. V., Katinas L. & Posadas, P. Historical biogeography: an introduction. (Harvard University Press, 2009).
42. Matzke, N. J. Model selection in historical biogeography reveals that founder-event speciation is a crucial process in island clades. *Syst. Biol.* **63**, 951–970 (2014).
43. Matzke, N. J. Stochastic mapping under biogeographical models, http://phylo.wikidot.com/bio-geobears#stochastic_mapping (2015).
44. Kayvanfar, N., Aliabadian, M., Niu, X., Zhang, Z. & Liu, Y. Phylogeography of the Common Pheasant *Phasianus colchicus*. *Ibis*. **159**, 430–442 (2017).
45. Alaei Kakhki, N. *et al.* Phylogeography of the *Oenanthe hispanica-pleschanka-cypriaca* complex (Aves, Muscicapidae: Saxicolinae): Diversification history of open-habitat specialists based on climate niche models, genetic data, and morphometric data. *J. Zool. Syst. Evol. Res.* **56**, 407–428 (2018).
46. Kehl, M. Quaternary climate change in Iran—the state of knowledge. *Erdkunde*. **63**, 1–17 (2009).
47. Blanchet, G., Sanlaville, P. & Traboulsi, M. Le Moyen-Orient de 20,000 ans BP à 6,000 ans BP Essai de reconstitution paléoclimatique. *Paléorient*. **23**, 187–196 (1997).
48. Ehlers, E. Iran: Grundzüge einer geographischen Landeskunde. (Broschert, 1980).
49. Lanfear, R., Calcott, B., Ho, S. Y. & Guindon, S. PartitionFinder: combined selection of partitioning schemes and substitution models for phylogenetic analyses. *Mol. Biol. Evol.* **29**, 1695–1701 (2012).
50. Yamani, M. The geomorphology of Alamkooch glaciers. *Geogr. Res. Quart.* **34**, 1–18 (2002).
51. Moghimi, E. Climatic Geomorphology cold and glacial territory. (University of Tehran Press, 2008).
52. Moghimi, E. Geomorphology of Iran. (University of Tehran Press, 2010).
53. Bobek, H. Die Rolle der Eiszeit in Nordwestiran. *Z. Gletscherkunde*. **25**, 130–183 (1937).
54. Schweizer, G. Der kuh-e-Sabalán (Nordwestiran). *Beiträge zur Gletscherkunde und Glazialgeomorphologie vorderasiatischer Hochgebirge. Tubinger Geogr. Stud.* **34**, 163–178 (1970).
55. Wright, H. E. & Minneapolis, J. Pleistocene glaciation in Kurdistan. *Eiszeit. Gegen.* **12**, 131–164 (1962).
56. Fragner, B. G. Iran. Grundzüge einer geographischen Landeskunde. *Wies. Z. Morgenlandes*. **18**, 243–248 (1983).
57. Preu, C. Die quartäre Vergletscherung der inneren Zardeh-Kuh-Gruppe (Zardeh-Kuh-Massiv), Zagros/Iran. (Augsburger Geographische Hefte 4, 1984).
58. Webb, T. III & Bartlein, P. Global changes during the last 3 million years: climatic controls and biotic responses. *Annu. Rev. Ecol. Syst.* **23**, 141–173 (1992).
59. Dubey, S., Zaitsev, M., Cosson, J. F., Abdulkadir, A. & Vogel, P. Pliocene and Pleistocene diversification and multiple refugia in a Eurasian shrew (*Crocodyrus suaveolens* group). *Mol. Phylogenet. Evol.* **38**, 635–647 (2006).
60. Tralau, H. The recent and fossil distribution of some boreal and arctic montane plants in Europe. (Almqvist & Wiksell, 1963).
61. Leestmans, R. Le refuge caspiens et son importance en biogéographie. *Linn. Belg.* **10**, 97–102 (2005).
62. Akhiani, H., Djalmali, M., Ghorbanalizadeh, A. & Ramezani, E. Plant biodiversity of Hyrcanian relict forests, N Iran: an overview of the flora, vegetation, paleoecology and conservation. *Pak. J. Bot.* **42**, 231–258 (2010).
63. Leroy, S. A. *et al.* Holocene vegetation history and sea level changes in the SE corner of the Caspian Sea: relevance to SW Asia climate. *Quat. Sci. Rev.* **70**, 28–47 (2013).
64. Naderi, G. *et al.* Mitochondrial evidence uncovers a refugium for the fat dormouse (*Glis glis* Linnaeus, 1766) in Hyrcanian forests of northern Iran. *Mamm. Biol.* **79**, 202–207 (2014).
65. Ashrafzadeh, M. R., Kaboli, M. & Naghavi, M. R. Mitochondrial DNA analysis of Iranian brown bears (*Ursus arctos*) reveals new phylogeographic lineage. *Mamm. Biol.* **81**, 1–9 (2016).
66. Nazarizadeh, M., Kaboli, M., Rezaie, H. R., Harisini, J. I. & Pasquet, E. Phylogenetic relationships of Eurasian Nuthatches (*Sitta europaea* Linnaeus, 1758) from the Alborz and Zagros Mountains, Iran. *Zool. Middle East*. **62**, 217–226 (2016).
67. Weir, J. T. & Schluter, D. Ice sheets promote speciation in boreal birds. *Proc. R. Soc. B*. **271**, 1881–1887 (2004).
68. Amato, G. D. Species hybridization and protection of endangered animals. *Science*. **253**, 250–252 (1991).
69. O'Brien, S. J. & Mayr, E. Bureaucratic mischief: Recognizing endangered species and subspecies. *Science*. **251**, 1187–1188 (1991).
70. Ryder, O. A. Species conservation and systematics: the dilemma of subspecies. *Trends Ecol. Evol.* **1**, 9–10 (1986).
71. Moritz, C. Defining ‘evolutionarily significant units’ for conservation. *Trends Ecol. Evol.* **9**, 373–375 (1994).
72. Kapli, P. *et al.* Molecular phylogeny and historical biogeography of the Anatolian lizard *Apathya* (Squamata, Lacertidae). *Mol. Phylogenet. Evol.* **66**, 992–1001 (2013).

73. Saint, K. M., Austin, C. C., Donnellan, S. C. & Hutchinson, M. N. C-mos, a nuclear marker useful for squamate phylogenetic analysis. *Mol. Phylogenet. Evol.* **10**, 259–263 (1998).
74. Burbrink, F. T., Lawson, R. & Slowinski, J. B. Mitochondrial DNA phylogeography of the polytypic North American rat snake (*Elaphe obsoleta*): a critique of the subspecies concept. *Evolution*. **54**, 2107–2118 (2000).
75. Arévalo, E., Davis, S. K. & Sites, J. W. Jr. Mitochondrial DNA sequence divergence and phylogenetic relationships among eight chromosome races of the *Sceloporus grammicus* complex (Phrynosomatidae) in central Mexico. *Syst. Biol.* **43**, 387–418 (1994).
76. Lawson, R., Slowinski, J. B., Crother, B. I. & Burbrink, F. T. Phylogeny of the Colubroidea (Serpentes): new evidence from mitochondrial and nuclear genes. *Mol. Phylogenet. Evol.* **37**, 581–601 (2005).
77. Fenwick, M. A., Mansour, Y. T., Franks, S. & Hardy, K. Identification and regulation of bone morphogenetic protein antagonists associated with preantral follicle development in the ovary. *Endocrinology*. **152**, 3515–3526 (2011).
78. Guo, P. *et al.* Out of Asia: natricine snakes support the Cenozoic Beringian dispersal hypothesis. *Mol. Phylogenet. Evol.* **63**, 825–833 (2012).
79. Wu, Y. Species diversification of Asian pitvipers driven by the Pleistocene climatic oscillations. (unpublished manuscript). Bethesda (MD): National Library of Medicine (US), National Center for Biotechnology Information; [1988] – Accession No. JX661205 and JX661228, “*Gloydus saxatilis*” voucher QS002 cytochrome *b* (cyt *b*) gene, partial cds; mitochondrial, <https://www.ncbi.nlm.nih.gov/nucore/JX661205>.
80. Tamura, K., Stecher, G., Peterson, D., Filipski, A. & Kumar, S. MEGA6: molecular evolutionary genetics analysis version 6.0. *Mol. Biol. Evol.* **30**, 2725–2729 (2013).
81. Librado, P. & Rozas, J. DnaSP v5: a software for comprehensive analysis of DNA polymorphism data. *Bioinformatics*. **25**, 1451–1452 (2009).
82. Ronquist, F. & Huelsenbeck, J. P. MrBayes 3: Bayesian phylogenetic inference under mixed models. *Bioinformatics*. **19**, 1572–1574 (2003).
83. Rambaut, A., Drummond, A. J., Xie, D., Baele, G. & Suchard, M. A. Posterior summarisation in Bayesian phylogenetics using Tracer 1.7. *Syst. Biol.* **67**, 901–904 (2018).
84. Nguyen, L. T., Schmidt, H. A., von Haeseler, A. & Minh, B. Q. IQ-TREE: a fast and effective stochastic algorithm for estimating maximum-likelihood phylogenies. *Mol. Biol. Evol.* **32**, 268–274 (2014).
85. Chernomor, O., von Haeseler, A. & Minh, B. Q. Terrace aware data structure for phylogenomic inference from supermatrices. *Syst. Biol.* **65**, 997–1008 (2016).
86. Clement, M., Posada, D. & Crandall, K. A. TCS: a computer program to estimate gene genealogies. *Mol. Ecol.* **9**, 1657–1659 (2000).
87. Corander, J., Sirén, J. & Arjas, E. Bayesian spatial modeling of genetic population structure. *Computation. Stat.* **23**, 111–129 (2008).
88. Cheng, L., Connor, T. R., Sirén, J., Aanensen, D. M. & Corander, J. Hierarchical and spatially explicit clustering of DNA sequences with BAPS software. *Mol. Biol. Evol.* **30**, 1224–1228 (2013).
89. Excoffier, L., Laval, G. & Schneider, S. Arlequin (version 3.0): an integrated software package for population genetics data analysis. *Evol. Bioinform.* **1**, 47–50 (2005).
90. Rannala, B. & Yang, Z. Bayes estimation of species divergence times and ancestral population sizes using DNA sequences from multiple loci. *Genetics*. **164**, 1645–1656 (2003).
91. Yang, Z. & Rannala, B. Bayesian species delimitation using multilocus sequence data. *P. Natl. Acad. Sci. USA* **107**, 9264–9269 (2010).
92. Yang, Z. The BPP program for species tree estimation and species delimitation. *Curr. Zool.* **61**, 854–865 (2015).
93. Ziheng, Y. & Flouri, T. BP&P user manual, version 3.4 & 4.0, <https://github.com/bpp/bpp> (2018).
94. Hudson, R. R., Kreitman, M. & Aguade, M. A test of neutral molecular evolution based on nucleotide data. *Genetics*. **116**, 153–159 (1987).
95. Bruen, T. C., Philippe, H. & Bryant, D. A simple and robust statistical test for detecting the presence of recombination. *Genetics*. **172**, 2665–2681 (2006).
96. Huson, D. H. & Bryant, D. Application of phylogenetic networks in evolutionary studies. *Mol. Biol. Evol.* **23**, 254–267 (2006).
97. Zhang, C., Zhang, D. X., Zhu, T. & Yang, Z. Evaluation of a Bayesian coalescent method of species delimitation. *Syst. Biol.* **60**, 747–761 (2011).
98. Leaché, A. D. & Fujita, M. K. Bayesian species delimitation in West African forest geckos (*Hemidactylus fasciatus*). *Proc. R. Soc. B* **307**, 1–7, <https://doi.org/10.1098/rspb.2010.0662> (2010).
99. Bagley, J. C. *et al.* Assessing species boundaries using multilocus species delimitation in a morphologically conserved group of neotropical freshwater fishes, the *Poecilia sphenops* species complex (Poeciliidae). *PLOS ONE*. **10**, 1–30 (2015).
100. Morcillo, E., Ornelas-García, C. P., Alcaraz, L., Matamoros, W. A. & Doadrio, I. Phylogenetic relationships and evolutionary history of the Mesoamerican endemic freshwater fish family Profundulidae (Cyprinodontiformes: Actinopterygii). *Mol. Phylogenet. Evol.* **94**, 242–251 (2016).
101. Guo, P. *et al.* Complex longitudinal diversification across South China and Vietnam in Stejneger’s pit viper, *Viridovipera stejnegeri* (Schmidt, 1925) (Reptilia: Serpentes: Viperidae). *Mol. Ecol.* **25**, 2920–2936 (2016).
102. Drummond, A. J., Suchard, M. A., Xie, D. & Rambaut, A. Bayesian phylogenetics with BEAUti and the BEAST 1.7. *Mol. Biol. Evol.* **29**, 1969–1973 (2012).
103. Wüster, W. *et al.* Origins and evolution of the South American pit viper fauna: evidence from mitochondrial DNA sequence analysis. *Biol. Vipers*. 111–128 (2002).
104. Parmley, D. & Holman, J. A. Earliest fossil record of a pigmy rattlesnake (Viperidae: *Sistrurus* Garman). *J. Herpetol.* **41**, 141–144 (2007).
105. Wüster, W., Peppin, L., Pook, C. E. & Walker, D. E. A nesting of vipers: phylogeny and historical biogeography of the Viperidae (Squamata: Serpentes). *Mol. Phylogenet. Evol.* **49**, 445–459 (2008).
106. Szyndlar, Z. & Rage, J. C. Oldest fossil vipers (Serpentes: Viperidae) from the OldWorld. *Kaupia*. **8**, 9–20 (1999).
107. Head, J. J., Mahlow, K. & Müller, J. Fossil calibration dates for molecular phylogenetic analysis of snakes 2: Caenophidia, Colubroidea, Elapoidea, Colubridae. *Palaeontol. Electron.* **19**, 1–21 (2016).
108. Drummond, A. J. & Rambaut, A. BEAST: Bayesian evolutionary analysis by sampling trees. *BMC Evol. Biol.* **7**, 214–221 (2007).
109. Brandley, M. C., Schmitz, A. & Reeder, T. W. Partitioned Bayesian analyses, partition choice, and the phylogenetic relationships of scincid lizards. *Syst. Biol.* **54**, 373–390 (2005).
110. Matzke, N. J. BioGeoBEARS: BioGeography with Bayesian (and likelihood) evolutionary analysis in R Scripts. R package, version 0.2 (2013).
111. Maddison, W. & Maddison, D. Mesquite: a modular system for evolutionary analysis. version 3.04 (2015).
112. Lemmon, A. R. & Lemmon, E. M. A likelihood framework for estimating phylogeographic history on a continuous landscape. *Syst. Biol.* **57**, 544–561 (2008).
113. Cornuet, J. M. *et al.* DIYABCv2.0: a software to make approximate Bayesian computation inferences about population history using single nucleotide polymorphism, DNA sequence and microsatellite data. *Bioinformatics*. **30**, 1187–1189 (2014).
114. Sasaki, K. Ecology, behavior and conservation of the Japanese Mamushi snake, *Gloydus Blomhoffii*: variation in compromised and uncompromised populations. (Oklahoma State University, 2007).
115. Yakovleva, I. D. Reptiles of Kirghizia. (Frunze, 1964).
116. Beerli, P. Migrate documentation version 3.2.1. Tallahassee, United States: Florida State University (2012).

117. Hijmans, R. J., Cameron, S. E., Parra, J. L., Jones, P. G. & Jarvis, A. Very high resolution interpolated climate surfaces for global land areas. *Int. J. Climatol.* **25**, 1965–1978 (2005).
118. IONIA. Globcover land cover (2009).
119. R Core Team. R: A language and environment for statistical computing. R Foundation for Statistical Computing (2016).

Acknowledgements

We would like to thank M. Ahmadi, C.M. Hung and J. Shi for their help with manuscript preparation, R. Adavoodi, S. Khaki, A. Mohammadi, and S. Yalpanian for their contribution to fieldwork, A. Kidov for providing some of the samples, R. Khosravi and J. Imani for providing insightful comments on the manuscript, K. Khosraviani and V. Arnal for laboratory assistance, and A. Tiutenko and P. Szymonik for providing us with information and photos. We are also grateful to the conservation managers of the Department of Environment of Iran and rangers of protected areas in northern Iran for their help and expertise during the fieldwork. We are specifically indebted to the countless local people of the Alborz Mountains for their generous hospitality and wholehearted support.

Author Contributions

Atefeh Asadi contributed in field sampling, laboratory work, data analysis, and manuscript preparation. Claudin Montgelard, Masoud Nazarizadeh, Faezeh Fatemizadeh, and Haji Gholo Kami participated in data analysis and manuscript preparation. Akram Moghaddasi and Evgeniy Simonov carried out some field sampling, laboratory work, and manuscript preparation. Mohammad Kaboli designed the study, organized field sampling, data analysis, and writing of the manuscript.

Additional Information

Supplementary information accompanies this paper at <https://doi.org/10.1038/s41598-018-37558-8>.

Competing Interests: The authors declare no competing interests.

Publisher's note: Springer Nature remains neutral with regard to jurisdictional claims in published maps and institutional affiliations.



Open Access This article is licensed under a Creative Commons Attribution 4.0 International License, which permits use, sharing, adaptation, distribution and reproduction in any medium or format, as long as you give appropriate credit to the original author(s) and the source, provide a link to the Creative Commons license, and indicate if changes were made. The images or other third party material in this article are included in the article's Creative Commons license, unless indicated otherwise in a credit line to the material. If material is not included in the article's Creative Commons license and your intended use is not permitted by statutory regulation or exceeds the permitted use, you will need to obtain permission directly from the copyright holder. To view a copy of this license, visit <http://creativecommons.org/licenses/by/4.0/>.

© The Author(s) 2019

3.2. Phylogéographie et histoire évolutive de *Natrix tessellata* et *Hemorrhois ravergeri*

Ce chapitre a fait l'objet du sujet de stage de Marie Raynaud, étudiante en Master1 Darwin (Université de Montpellier) qui a été encadrée par Atefeh ASADI et Claudine MONTGELARD :

Marie RAYNAUD (2019) Biogéographie historique et comparative de deux espèces de serpents des montagnes d'Iran. Rapport de Master1 Darwin (Université de Montpellier), 12p.

L'objectif de cette étude est de déterminer quels sont les événements géologiques ou biogéographiques qui permettent d'expliquer la structure phylogéographique observée pour les deux espèces. La question est de savoir si la diversité observée peut être expliquée par les fluctuations environnementales (cycles glaciaires) du Quaternaire ou par des événements plus anciens. Il s'agira aussi d'évaluer quel a été le rôle de l'Iran dans la différenciation des taxons. La couleuvre tessellée (*Natrix tessellata*) et la couleuvre de Ravergier (*Hemorrhois ravergeri*) occupant une distribution géographique similaire en Iran, on s'attend à ce que des facteurs historiques communs expliquent leur structuration (Taberlet *et al.*, 1998). Ainsi, de manière à identifier les périodes de divergence entre les lignées génétiques des deux espèces, la phylogénie des deux taxons a été reconstruite et les temps de divergence entre les différents clades ont été datés. Puis les tendances démographiques des populations ont été évaluées. Enfin, différents scénarios biogéographiques ont été testés afin de déterminer les événements de vicariance et/ou de dispersion qui ont modelé la structure génétique observée au sein des deux espèces.

3.2.1. Méthodes analytiques

- Données de séquences :

Les séquences ont été examinées et concaténées à l'aide de SeqScape version 2.6 (Applied Biosystems). Les séquences des gènes protéiques (cytb, ND4, Trop) ont été traduites en acides aminés afin de vérifier la présence de codons stop qui résulterait du séquençage d'un pseudogène. DnaSP version 5.0 (Librado & Rozas, 2009) a été utilisé pour calculer divers indices de diversité génétique incluant les diversités haplotypique et nucléotidique, le nombre

d'haplotypes et de sites polymorphes. La composition nucléotidique et les distances génétiques ont été calculées en utilisant la distance génétique non corrigée calculée à l'aide de MEGA v.6.

Pour *N. tessellata* les séquences de cytochrome b disponibles dans GenBank ont été ajoutées afin d'élargir l'aire de distribution étudiée (Tableau 3.3.1). Les séquences des espèces sœurs de *N. tessellata* (*N. natrix*, *N. maura*, *N. astreptophora*) et de *H. ravigieri* (*H. nummifer*, *H. algirus*, *H. hippocrepis*) ont été ajoutées à chacun des jeux de données.

Pour l'analyse phylogéographique, les espèces *Naja kaouthia*, *Micrurus fulvius* et *Mehelya capensis* ont été choisies comme groupes externes (Lawson *et al.* 2005) pour enraciner l'arbre de chacun des taxons.

La composition des différents jeux de données est donnée dans le Tableau 3.3.1. Les séquences ont été alignées avec l'option MUSCLE du logiciel Seaview (Gouy *et al.*, 2009) et éditées avec Bioedit 7.0.5.3 (Hall, 1999).

Tableau 3.3.1: Jeux de données utilisés pour *Natrix tessellata* et *Hemorrhois ravergieri*. Les séquences utilisées proviennent d'individus échantillonnés (ind. ech.) en Iran et de GenBank (voir numéro d'accension).

Espèces	Cytochrome b	ND4	Nombre d'individus
<i>Natrix tessellata</i>			208
<i>Natrix tessellata</i>	40 ind. ech.		187
	147 ind. GenBank*		
<i>Natrix natrix</i>	(HF680176)		1
<i>N. n. corsa</i>	(HE584624 / HE584628)		2
<i>N. n. cetti</i>	(HE584620)		1
<i>N. n. lanzai</i>	(AY487733 / HE584632)		2
<i>N. n. helvetica</i>	4 (GenBank**)		4
<i>Natrix maura Espagne</i>	(AY866530)		2
<i>Natrix maura Maroc</i>	(AF420077)		1
<i>Natrix astreptophora</i>	(LN994825)		1
<i>Hemorrhois ravergieri</i>	(AY486920)		1
<i>Hemorrhois nummifer</i>	(AY376742)		1
<i>Hemorrhois hippocrepi</i>	(AY486916)		1
<i>Hemorrhois algerus</i>	(AY486911)		1
<i>Hemorrhois ravergieri</i>			114
<i>Hemorrhois ravergieri</i>	73 ind. ech.	80 ind. ech.	83
	(AY486920)	(AY487050)	1
<i>Hemorrhois nummifer</i>	8 ind. ech.	8 ind. ech.	8
	(AY376742)		1
<i>Hemorrhois hippocrepi</i>	(AY486916)	(AY487045)	1
<i>Hemorrhois algerus</i>	(AY486911)	(AY487037)	1
<i>Natrix tessellata</i>	2 ind. ech. (Iran)	2 ind. ech. (Iran)	2
<i>Natrix natrix</i>	(HF680176)	(HF679880)	1
<i>N. n. corsa</i>	(HE584624 / HE584628)	(HE584623 / HE584627)	2

* : voir numéros d'accension des séquences dans Guicking *et al.* 2009

** : voir numéros d'accension des séquences dans Guicking *et al.* 2006

- Reconstruction phylogénétique

Pour *Natrix tessellata*, étant donné que les séquences de GenBank ne comprenaient que le *cyt b*, les analyses phylogénétiques ont été effectuées sur trois jeux de données : (i) toutes les séquences de *cyt b* (187 individus pour 1086 pb); (ii) la concaténation de gène mitochondrial (1080 pb *cyt b* + 672 pb ND4) pour 50 échantillons; (iii) la concaténation des gènes mitochondriaux (1080 pb *cyt b* + 672 pb ND4) et nucléaires (524 pb MC1r + 452 pb Trop) pour 12 échantillons, principalement d'Iran. Pour *Hemorrhoids ravergeri*, les analyses phylogénétiques ont été effectuées sur deux jeux de données (i) la concaténation des gènes mitochondriaux (1095 pb *cyt b* + 672 pb ND4) pour 98 échantillons (ii) la concaténation des gènes mitochondriaux (10950 pb *cyt b* + 672 pb ND4) et nucléaires (524 pb MC1r + 452 pb Trop) pour 17 échantillons.

Le meilleur schéma de partitionnement et le meilleur modèle d'évolution des séquences pour chaque partition ont été déterminés à l'aide de PartitionFinder 1.1.1 (Lanfear *et al.*, 2012) en utilisant l'algorithme "greedy" et le Critère d'Information Bayésien (BIC). Le schéma sélectionné a ensuite été utilisé pour effectuer les analyses phylogénétiques par inférence bayésienne (BI) et maximum de vraisemblance (ML). Les analyses BI ont été effectuées avec MrBayes 3.1.2 (Ronquist, & Huelsenbeck 2003) en utilisant trois chaînes chaudes et une froide (MC3) pendant 40 millions de générations, échantillonnées toutes les 1000 générations et en éliminant les 25% premiers arbres correspondant à l'allumage (burn-in). La convergence des différents paramètres de MrBayes a été vérifiée à l'aide de Tracer v1.5 (Rambaut *et al.*, 2018). L'analyse phylogénétique ML a été réalisée avec IQ-TREE version 1.6.2 (Nguyen *et al.*, 2014; Chernomor *et al.*, 2016) en utilisant le modèle de partition sélectionné et 1000 répliques de bootstrap ont été effectuées pour tester la robustesse des nœuds.

- Réseau d'haplotypes :

Afin d'éviter les biais de reconstruction engendrés par des séquences de longueurs inégales entre les échantillons, nous avons utilisé des jeux de données de longueurs égales. Pour *N. Tessellata* nous avons utilisé deux jeux de données : un de 1758 pb pour 47 individus pour les deux gènes mitochondriaux et un de 1086 pb pour le gène *cyt b* pour 175 individus en incluant toutes les séquences disponibles dans Genbank. Pour *H. ravergeri*, 1719 pb du *cyt b* ont été étudiées pour 63 individus. Afin de visualiser les relations génétiques entre haplotypes, un réseau a été construit avec le logiciel TCS (Clement *et al.*, 2000) implémenté dans PopART (<http://popart.otago.ac.nz>).

- Estimation des temps de divergence:

Les temps de divergence ont été estimés avec le logiciel BEAST 1.10.4 (Suchard *et al.*, 2018) qui est un programme d'analyse Bayésienne (Glossaire) par chaînes de Markov avec technique de Monte Carlo (MCMC, Glossaire) de séquences moléculaires. Le modèle GTR (General Time Reversible, Tavaré, 1986, Glossaire) + Gamma (G, Glossaire) et une partition selon les 3 positions du codon ont été utilisés. Trois horloges moléculaires ont été testées : stricte, relâchée à taux d'évolution non corrélé avec une distribution exponentielle ou lognormale, en utilisant dans un premier temps un processus « Birth-Death » (BDP) qui autorise la spéciation et l'extinction (Heath, 2015). La meilleure horloge d'après l'AIC calculé avec 10 bootstraps (Glossaire) dans TRACER 1.6 (Rambaud *et al.*, 2014) a ensuite été utilisée avec un processus « Yule » (YP) qui n'autorise que la spéciation (Heath, 2015). Le meilleur des deux processus, d'après l'AIC, a été retenu pour la suite des analyses. Pour calibrer la phylogénie, 3 points de calibration ont été utilisés : (i) la réouverture du détroit de Gibraltar marquant la fin de la crise Messinienne pour dater la divergence entre les lignées de *N. maura* d'Afrique du Nord et d'Europe il y a entre 5.3 et 5.96 Ma (Fritz *et al.*, 2012), modélisée avec une distribution normale adaptée aux datations basées sur des événements biogéographiques (Ho, 2007), avec une moyenne de 5,63 Ma et un écart type de 0,3 Ma ; (ii) le premier contact entre les plaques Africaine et Arabe et la plaque Européenne qui correspond à la divergence du genre *Hemorrhoids* entre les sous-groupes de l'Est (*H. ravergeri* et *H. nummifer*) et ceux de l'Ouest (*H. algirus* et *H. hippocrepis*), daté il y a entre 16 et 18 Ma (Nagy *et al.*, 2004 ; Tamar *et al.* 2006), modélisé avec une distribution normale avec une moyenne de 18 Ma et un écart-type de 2 Ma ; et (iii) la divergence entre les lignées de *N. natrix* Corso-Sarde et leur apparentées les plus proches du continent européen datée entre 3.6 et 5.3 Ma (Fritz *et al.*, 2012), modélisée avec une distribution lognormale adaptée aux datations basées sur des fossiles (Ho, 2007), avec un « offset » de 3 Ma, une moyenne et un écart type de 1 Ma. Le prior sur l'âge à la racine a été modifié en utilisant une distribution normale, une moyenne de 50 Ma et un écart type de 10 Ma, correspondant à la divergence entre la famille des Colubroidea et les taxons les plus proches (*Acrochordus* et *Xenodermatidae*) (Head *et al.*, 2016).

Les calculs ont été effectués avec 50 millions de générations échantillonnées toutes les 1000 générations et les analyses ont été répétées deux fois pour *H. ravergeri* et trois fois pour *N. tessellata*. La convergence des paramètres a été vérifiée avec TRACER 1.6, une taille efficace des échantillons (ESS, Drummond *et al.*, 2007) supérieure à 200 étant requise pour chacun des paramètres. Les arbres ont ensuite été combinés avec LOGCOMBINER 1.10.4 (Suchard *et al.*,

2018) en appliquant un burn-in (Glossaire) de 10%, puis l'arbre consensus a été construit avec TREEANNOTATOR 1.10.4 (Suchard *et al.*, 2018).

Glossaire

Analyse Bayésienne : méthode probabiliste basée sur le calcul des probabilités postérieures (calculées *a posteriori*, « posteriors ») des arbres phylogénétiques à partir de probabilités définies *a priori* (« priors ») (Li 1996 ; Mau *et al.* 1996 ; Rannala et Yang 1996). Le calcul de ces probabilités postérieures, définies comme étant la probabilité d'une hypothèse H sachant les données X (Delsuc et Douzery 2004), nécessite l'utilisation de méthodes numériques appelées chaînes de Markov avec technique de Monte Carlo (MCMC, Larget et Simon 1999 ; Mau et Newton 1997 ; Yang et Rannala 1997).

« **Approximate Bayesian Computation** » (ABC) : les méthodes ABC permettent d'estimer les valeurs et les distributions « posteriors » des différents paramètres des scénarios biogéographiques testés, les valeurs de ces paramètres étant au préalable tirées dans une distribution « prior ». Ces priors permettent de générer un ensemble de données simulées. Les posteriors sont ensuite estimés à partir des données simulées qui sont les plus proches des données observées en utilisant des statistiques résumées calculées pour chaque paramètre (Cornuet *et al.* 2008).

BAYAREALIKE : le modèle BAYAREALIKE est une version de vraisemblance du modèle BAYAREA (« Historical Biogeography for Discrete Areas ») qui infère l'histoire biogéographique pour des aires discrètes (Landis *et al.* 2013).

Bootstrap : méthode statistique qui permet d'inférer la variabilité d'une distribution inconnue à partir de laquelle les données sont tirées d'un ré-échantillonnage avec remise à partir des données. Ce ré-échantillonnage permet de construire une série de données fictives (Felsenstein 1985).

Burn-in : le burn-in ou étape d'allumage correspond aux premières générations des MCMC qui n'ont pas atteint la stationnarité et qui sont éliminées des analyses (Delsuc et Douzery 2004).

DEC (« **Dispersal-Extinction-Cladogenesis** ») : le modèle DEC est un modèle d'inférence biogéographique où en l'absence d'une divergence entre lignées la distribution d'une espèce évolue soit par dispersion entre les aires (expansion) soit par extinction locale dans une aire (Ree et Smith 2008).

Dispersion : La dispersion correspond à « tout mouvement d'individu ou de propagule qui ont des conséquences potentielles sur les flux de gènes dans l'espace » (Ronce 2007).

DIVALIKE : le modèle DIVALIKE est une version de vraisemblance du modèle DIVA (« Dispersal-Vicariance ») basé sur la parcimonie, où les aires de distribution des espèces sont scindées en composantes vicariantes (Ronquist 1997).

Gamma : la loi Gamma est une loi statistique qui permet de modéliser l'hétérogénéité des taux de substitution entre les sites (les sites n'évoluant pas tous à la même vitesse). Elle permet de décrire une large gamme de distribution en changeant la valeur d'un paramètre α qui représente la forme de la distribution et renseigne sur le niveau d'hétérogénéité ($\alpha < 1$: forte hétérogénéité ; $\alpha > 1$: faible hétérogénéité) (Delsuc et Douzery 2004).

GTR : modèle d'évolution des séquences selon lequel les fréquences des bases sont inégales et les taux de substitutions sont différents pour les 6 types de substitution (AC, AG, AT, CG, CT, GT) (Tavaré 1986).

MCMC (Markov Chain Monte Carlo) : les chaînes de Markov avec technique de Monte Carlo sont des méthodes numériques permettant d'estimer les probabilités postérieures (des arbres phylogénétiques). Ces chaînes explorent l'espace multidimensionnel des paramètres en effectuant une marche aléatoire. Elles échantillonnent les valeurs de ces paramètres de façon périodique de manière à estimer une distribution de probabilité. Les différents états par lesquels passent les MCMC sont souvent appelés « générations ». Plus le nombre de générations effectuées est important, meilleure est l'approximation de la distribution des probabilités postérieures, car sinon les chaînes ne convergeront pas (Delsuc et Douzery 2004, Lewis 2001).

Probabilité postérieure : elle représente la probabilité qu'un clade/scénario donné soit vrai sachant le modèle d'évolution, les probabilités a priori et les données considérées (Huelsenbeck et Ronquist 2001).

TCS : la méthode TCS est une méthode de construction de réseaux haplotypiques permettant d'inférer la généalogie des populations. Ce réseau est construit par une approche agglomérative où les groupes sont progressivement combinés avec un ou plusieurs bords connectés (Clement *et al.* 2002).

Vicariance : approche de biogéographie historique basée sur le fait que deux taxons apparentés, occupant des aires de distribution qui sont séparées l'une de l'autre, sont arrivés dans ces aires avant l'apparition de barrière (montagnes, océans, rivières ...) qui les séparent à présent et qu'ils ne peuvent pas franchir (Cox *et al.* 2016).

- Evaluation des tendances démographiques :

L'histoire démographique des populations a été évaluée en utilisant la méthode des Bayesian Skyline Plots (BSPs) dans BEAST 1.10.4 et TRACER 1.5 (Rambaut et Drummond, 2007) pour chacune des populations identifiées de plus de 10 individus, en appliquant un modèle GTR + G (Glossaire). Une horloge moléculaire stricte a été appliquée en utilisant le taux d'évolution calculé dans les analyses de datation moléculaires précédentes. Pour chaque population, une MCMC (Glossaire) de 50 millions de générations a été effectuée, échantillonnée toutes les 1000 générations avec un burn-in de 10%.

- Analyses biogéographiques :

Plusieurs scénarios évolutifs ont été testés avec le logiciel DIYABC (Cornuet *et al.*, 2014) qui est basé sur les approches de type « Approximate Bayesian Computation » (ABC, Beaumont *et al.*, 2002 ; Glossaire). Pour les deux espèces, un scénario de vicariance (Glossaire) totale (hypothèse nulle), un scénario de vicariances successives, et un ou plusieurs scénarios combinant de la dispersion (Glossaire) et de la vicariance ont été testés. Ces scénarios sont codés de manière séquentielle en remontant dans le temps et ne comprennent que 3 types d'évènements : le temps de divergence, les tailles efficaces et le nombre de populations (Cornuet *et al.*, 2008, 2015). Différents priors des paramètres historiques, e.g. les tailles efficaces des populations (N_e) et les temps de divergence (t), ont dans un premier temps été testés à l'aide d'analyses en composante principale (PCA) réalisées dans l'espace des statistiques résumées (10 indices de diversité génétiques), afin de vérifier que la combinaison des scénarios et des priors produisait un ensemble de données simulées suffisamment proches des données observées (Cornuet *et al.*, 2015). Le taux de mutation a été estimé en supposant une distribution normale comprise entre 10^{-8} et 10^{-6} (Kindler *et al.*, 2018). Pour chaque jeu de données, le meilleur modèle d'évolution des séquences (sans partition) a été déterminé en utilisant l'AIC calculé avec ModelGenerator 8.4 (Keane *et al.*, 2006). Une fois la meilleure combinaison de priors déterminée, une analyse de 1 millions de simulations par scénario a été lancée, à partir desquelles les différentes statistiques résumées ont été calculées, e.g. nombre d'haplotype, nombre de sites polymorphes, moyenne et variance des différences par paire, D de Tajima, nombre moyen et variance du nucléotide le plus rare pour les sites polymorphes. Les probabilités postérieures (PP, Glossaire) des différents scénarios ont été calculées par une régression logistique basée sur 1% des données simulées les plus proches des données observées.

Les aires de distribution ancestrales ont été reconstruites avec le package BioGeoBears (« BioGeography with Bayesian Evolutionary Analysis in R Scripts », Matzke, 2013) dans RStudio 3.6.0 pour chacune des espèces afin d'identifier la distribution des populations ancestrales la plus probable à chaque noeud de la phylogénie. L'arbre de datation a été élagué avec le logiciel Mesquite 3.6 (Maddison et Maddison, 2018) de manière à ne conserver plus qu'un spécimen pour chaque lignée identifiée. L'aire actuelle de chacune de ces lignées a été codée en différentes zones géographiques. Les aires ancestrales ont été reconstruites en utilisant 6 modèles : i) DEC (« Dispersal-Extinction-Cladogenesis », Ree et Smith, 2008 ; Glossaire) ; ii) DIVALIKE (« Dispersal-Vicariance », (Ronquist, 1997 ; Glossaire), iii) BAYAREALIKE (« Historical Biogeography for Discrete Areas », (Landis *et al.*, 2013 ; Glossaire) ; et iv) v) vi) une version + J (« founder-event speciation ») de ces trois modèles où J correspond à un événement rare de dispersion longue-distance (Matzke, 2013, 2016). Le meilleur modèle a été sélectionné d'après l'AIC. L'aire ancestrale à chaque nœud a été déterminée comme étant l'aire la plus probable.

3.2.2. Résultats

- Reconstruction phylogénétique et phylogéographique

Pour *N. tessellata* and *H. ravergeri* les séquences par gène ont été alignées sans ambiguïté et aucun codon stop ou substitution inhabituelle d'acide aminé n'a été détecté pour les gènes codant pour une protéine, ce qui suggère notamment une origine mitochondriale pour les séquences obtenues pour le *cyt b* et ND4. Pour les deux espèces, les résultats obtenus avec PartitionFinder ont donné trois partitions pour la combinaison des deux gènes mitochondriaux et quatre partitions pour la combinaison des gènes mitochondriaux et nucléaires (voir Appendix 3.3.). Cette stratégie de partitionnement a été utilisée à la fois pour l'inférence Bayésienne (BI) et le maximum de vraisemblance (ML).

Pour *N. tessellata*, les arbres phylogénétiques basés sur le *cytb*, sur les deux gènes mitochondriaux (voir Appendix 3.4) ou sur la concaténation des quatre gènes (ADNmt et ADNnc ; Fig 3.3.1) confirme la monophylie de *N. tessellata* par rapport aux autres espèces de *Natrix* et montre une forte structuration phylogéographique en 9 clades distincts bien supportés (PP > 0.98) à l'exception du nœud Jordanie-Grèce. Ces clades coïncident très fortement avec leur distribution géographique : Jordanie, Grèce, Europe, Crète, Turquie, Kazakhstan, Ouzbékistan, Caucase (et pentes nord de l'Alborz), et Zagros (et pentes sud de l'Alborz, Fig 3.3.1).

Ces différents clades sont retrouvés dans le réseau haplotypique (Fig. 3.3.1) réalisé avec les séquences de 1086 pb du *cyt b* pour 175 individus de *N. tessellata*, les séquences devant être de la même longueur. Ils ne partagent aucun haplotype. Les groupes les plus proches, Caucase et Ouzbékistan, diffèrent entre eux de 13 pb, et les plus éloignés, Zagros et Ouzbékistan, de 207 pb.

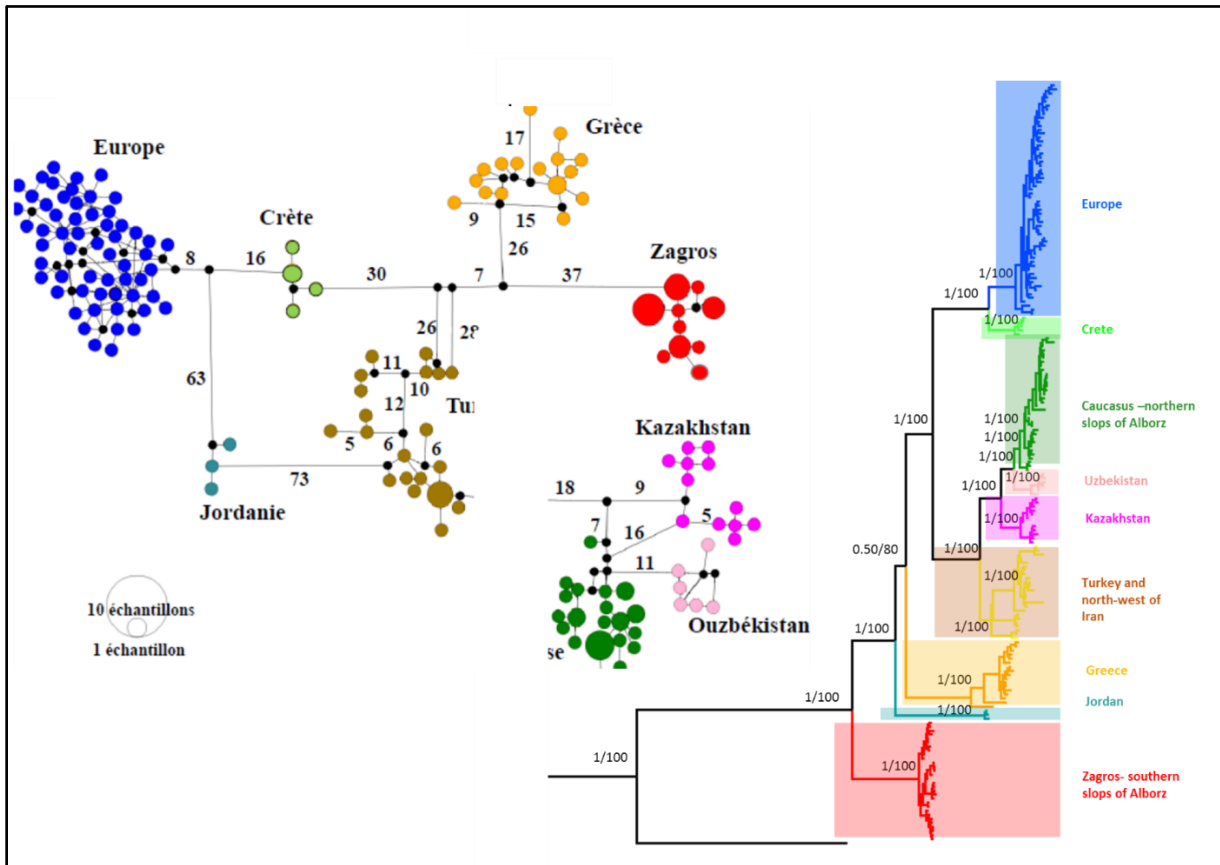
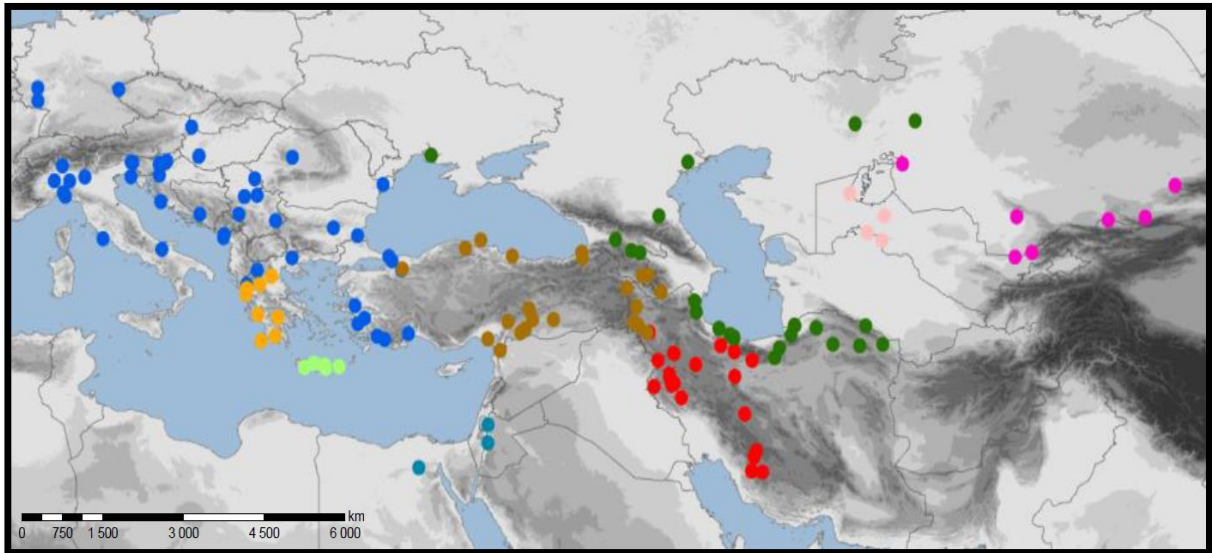

Figure 3.3.1. Arbre phylogénétique et réseau haplotypique obtenus pour *N. tessellata*. La carte montre la localisation des individus échantillonnés (notre étude et séquences de GenBank) dans le Paléarctique Occidental. Les couleurs correspondent aux différents clades identifiés dans l'arbre phylogénétique basé sur quatre gènes (1086 pb cyt b + 672 pb ND4 + 524 pb MC1R + 452 pb tropomyosin) pour 187 individus de l'espèce *N. tessellata*. La probabilité postérieure obtenue par inférence Bayésienne et la valeur de bootstrap obtenue en maximum de vraisemblance sont indiquées pour chaque nœud de l'arbre.

Pour *Hemorrhoids*, l'arbre phylogénétique obtenu montre que *H. ravergeri* est monophylétique, notamment par rapport à *H. nummifer* son groupe frère. *H. ravergeri* est divisé en 6 groupes bien supportés (PP > 0.9) (Fig 3.3.2), à l'exception d'un noeud (Kopet-Dagh), qui sont également géographiquement structurés : Turquie, Zagros, Est Zagros, Azerbaïdjan – Alborz, Ouest Alborz et Kopet-Dagh (Fig 3.3.2).

Ces 6 groupes se retrouvent également dans le réseau haplotypique (Fig 3.3.2) réalisé avec des séquences de 1719 pb de 63 individus de *H. ravergeri*. Ces groupements sont séparés par un minimum de 22 pb pour les plus proches (Azerbaïdjan – Alborz et Alborz Ouest) jusqu'à un maximum de 183 pb pour les plus éloignés (Kopet-Dagh et Turquie).

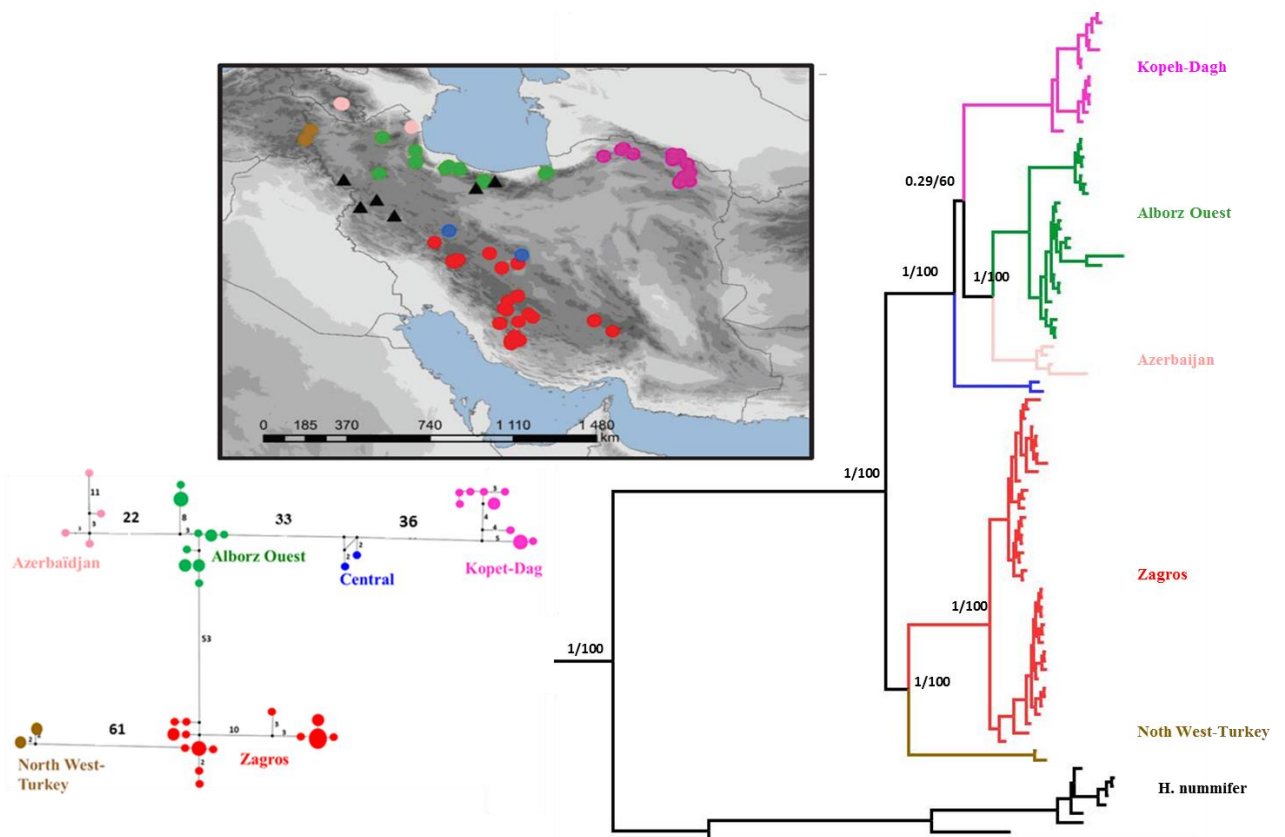

Figure 3.3.2 Arbre phylogénétique et réseau haplotypique obtenus pour *H. ravergeri*. La carte montre la localisation des individus échantillonnés en Iran dans cette étude. Les couleurs correspondent aux différents clades identifiés dans la phylogénie. Arbre phylogénétique basé sur quatre gènes, soit 2804 bp (1095 bp *cyt b* + 672 bp ND4 + 524 bp MC1r + 452 bp Tropomyosin) pour tous individus de l'espèce *H. ravergeri*. La probabilité postérieure obtenue par inférence Bayésienne et la valeur de bootstrap obtenue en maximum de vraisemblance sont indiquées pour chaque nœud de l'arbre.

- Analyses de la diversité génétique

Une analyse de polymorphisme a été réalisée avec DnaSP 6.0 sur la couleuvre tessellée et les 9 clades observés, ainsi que sur la couleuvre de Ravergier et les 6 groupes identifiés (Tableau 3.3.2). Les distances génétiques au sein et entre les groupes ont été calculées avec MEGA 6 (Tableaux 3.3.3 et 3.3.4). *N. tessellata* présente un total de 115 haplotypes sur les 187 individus analysés. La diversité haplotypique est globalement très élevée ($H_d > 0.88$) tandis que la diversité nucléotidique est très faible ($0.002 < \pi < 0.015$). Les distances génétiques inter-clades varient de 0.021 (« Kazakhstan – Caucase ») à 0.089 (« Grèce – Caucase »). Les distances intra-clades sont minimales, la plus élevée étant celle de la « Turquie » qui semble être plus diversifiée ($d_{intra} = 0.016$). *H. ravigieri* se compose de 27 haplotypes sur les 81 individus analysés. La diversité haplotypique est globalement élevée ($H_d > 0.71$) alors que la diversité nucléotidique est très faible ($0.0022 < \pi < 0.0098$). Les distances génétiques intra-groupes sont également faibles ($d_{intra} < 0.007$) sauf pour la Turquie ($d_{intra} = 0.25$), et les distances inter-groupes sont comprises entre 0.018 (« Ouest Alborz - Azerbaïdjan/Alborz ») et 0.178 (« Turquie – Zagros »). Ces groupes sont assez proches comparé à la distance de 0.604 qui sépare *H. ravigieri* et son espèce sœur *H. nummifer* (Appendix 3.5), autrefois considérées comme une même espèce (Arnold et Ovenden, 2010).

Tableau 3.3.2 Indices de diversité génétique calculés avec DnaSP pour *N. tessellata* (187 séquences du cytochrome b, soit 1086pb) et les 9 clades identifiées, et pour *H. ravergeri* (81 individus séquencés pour le cytochrome b et ND4, soit 1767 pb) et des 6 clades identifiés. Nombre d'individus (n), nombre d'haplotypes (h), diversité haplotypique (Hd) et écart type, diversité nucléotidique (π), nombre moyen de nucléotides différents (k), nombre de sites polymorphes (S).

	n	h	Hd	π	k	S
<i>Natrix tessellata</i>	187	115	0.99 +/- 0.0021	0.060	33.15	148
Europe	58	58	1 +/- 0.003	0.0050	5.41	67
Crète	5	4	0.90 +/- 0.16	0.0028	3	7
Caucase	33	14	0.88 +/- 0.036	0.0046	2.53	20
Ouzbekistan	6	6	1 +/- 0.096	0.0034	3.73	10
Kazakhstan	12	12	1 +/- 0.034	0.0054	5.89	16
Turquie	23	20	0.98 +/- 0.025	0.016	17.13	71
Grèce	17	16	0.99 +/- 0.023	0.0087	8.94	47
Jordanie	3	3	1 +/- 0.27	0.0018	2	3
Zagros	30	12	0.89 +/- 0.035	0.0043	2.37	9
<i>Hemorrhhois ravergeri</i>	81	27	0.93 +/- 0.015	0.031	11.74	50
Kopet Dag	14	4	0.71 +/- 0.079	0.0051	3.41	8
Ouest Alborz	23	10	0.85 +/- 0.052	0.0098	4.16	17
Azerbaïdjan/Alborz	4	4	1 +/- 0.18	0.0058	9.5	18

Tableau 3.3.3 Distances génétiques entre les 9 sous-groupes identifiés de *Natrix tessellata* (hors diagonale) et au sein de chaque sous-groupe (diagonale), calculées dans MEGA 6.0 avec un modèle Kimura-2-paramètres.

	Zagros	Caucase	Grèce	Jordanie	Turquie	Kazakhstan	Ouzbékistan	Crète	Europe
Zagros	0.004								
Caucase	0.083	0.005							
Grèce	0.083	0.089	0.009						
Jordanie	0.080	0.083	0.085	0.002					
Turquie	0.077	0.039	0.081	0.078	0.016				
Kazakhstan	0.082	0.024	0.083	0.081	0.040	0.005			
Ouzbékistan	0.084	0.021	0.082	0.081	0.039	0.028	0.003		
Crète	0.088	0.071	0.084	0.078	0.064	0.071	0.073	0.003	
Europe	0.088	0.074	0.082	0.076	0.068	0.073	0.074	0.028	0.005

Tableau 3.3.4. Distances génétiques entre les 6 sous-groupes identifiés de *H. ravergeri* (hors diagonale) et au sein de chaque sous-groupe (diagonale), calculées dans MEGA 6.0 avec un modèle Kimura-2-paramètres.

	Kopet Dag	Ouest Alborz	Azerbaïdjan / Alborz	Est Zagros	Zagros	Turquie
Kopet Dag	0.005					
Ouest Alborz	0.032	0.007				
Azerbaïdjan/Alborz	0.029	0.019	0.006			
Est Zagros	0.029	0.026	0.025	0.003		
Zagros	0.176	0.152	0.176	0.173	0.250	
Turquie	0.051	0.052	0.048	0.047	0.178	0.002

- Datations moléculaires

Les temps de divergence entre les différents clades ont été estimés pour *N. tessellata* et *H. ravergeri* avec BEAST 1.10.4 en utilisant 3 points de calibration (Figures. 3.3.3 et 3.3.4). La meilleure des trois horloges moléculaires testées était l'horloge relâchée à taux non-corrélé avec une distribution exponentielle et un processus « Birth-Death » pour *N. tessellata* (AIC = 19 357.08) et *H. ravergeri* (AIC = 25 729.95) (Tableau 3.3.5). Les temps de divergence, l'intervalle de confiance à 95% (95% HPD) et les probabilités postérieures (PP) de chaque noeud sont reportés dans le Tableau 3.3.6.

Parmi les 9 clades identifiés au sein de l'espèce *N. tessellata*, le groupe « Zagros » occupe la position la plus basale. Il a divergé de l'ancêtre commun des 8 autres groupes durant le Miocène supérieur. Le groupe « Jordanie » et « Grèce » sont les seconds à avoir divergé entre 8.15 et -7.21 Ma. Il y a 5.83 Ma, les groupes frères « Europe » et « Crète » très fortement apparentés, se seraient séparés du clade comprenant les groupes « Turquie », « Kazakhstan », « Ouzbékistan » et « Caucase » (Fig. 3.3.3).

Tableau 3.3.5 : Comparaison des AIC des 4 modèles testés pour les séquences du cyt b de *N. tessellata* et pour la combinaison des séquences du cyt b et de ND4 pour *H. ravergeri*, généré avec une répétition de 10 bootstraps dans TRACER 6.0. La vraisemblance (LnL), la valeur d'AIC (AICM) et l'écart-type associé (SSE) sont renseignés pour chacun des modèles Strict Clock Birth Death Process (SC BDP), Uncorrelated Relaxed Clock Lognormal Birth Death Process (URC Lognormal BDP), Uncorrelated Relaxed Clock Exponential Birth Death Process (URC Exponential BDP), Uncorrelated Relaxed Clock Exponential Yule Process (URC Exponential YP). Le meilleur modèle est représenté en gras.

	<i>Natrix tessellata</i>			<i>Hemorrhoids ravergeri</i>		
	LnL	AICM	SSE	LnL	AICM	SSE
SC - BDP	-9537.57	19360.67	+/- 0.607	-12810.98	25774.40	+/- 0.571
URC_Log - BDP	-9508.58	19416.76	+/- 1.278	-12775.8	25760.41	+/- 0.267
URC_Exp - BDP	-9482.04	19357.08	+/-0.829	-12760.77	25729.95	+/- 0.425
UCR_Exp - YP	-9506.15	19491.02	+/- 1.115	-12780.29	25829.35	+/- 0.537

Tableau 3.3.6 : Récapitulatif des âges de divergence des différents clades observés chez *N. tessellata* et *H. ravergeri*, de l'intervalle de confiance à 95% (95% HPD) et de la probabilité postérieure (PP) associée à chaque nœud. Les lettres correspondent aux nœuds indiqués dans les Fig. 3.3.3 pour *N. tessellata* et 3.3.4 pour *H. ravergeri*.

Nœuds	<i>Natrix tessellata</i>		Nœuds	<i>Hemorrhoids ravergeri</i>	
	Age [95% HPD]	PP		Age [95% HPD]	PP
A	-11.34 [5.49-18.22]	0.99	A	-6.06 [2.51-10.48]	1
B	-0.95 [0.23-1.99]	0.99	B	-4.41 [1.89-7.48]	0.9
C	-8.15 [3.89-12.97]	0.99	C	-2.7 [1.17-4.57]	1
C1	-7.21 [3.5-11.4]	0.37	D	-2.31 [1.02-3.87]	0.29
D	-5.83 [2.81-9.3]	0.98	E	-1.66 [0.68-2.87]	1
D1	-2.71 [0.99-4.75]	0.99	F	-0.89 [0.33-1.59]	1
E	-3.75 [1.74-6.05]	0.99	G	-1.31 [0.42-2.5]	1
F	-2.36 [0.97-4.06]	0.99			
G	-2.48 [1.08-4.15]	0.99			
G1	-1.70 [0.72-2.88]	0.99			

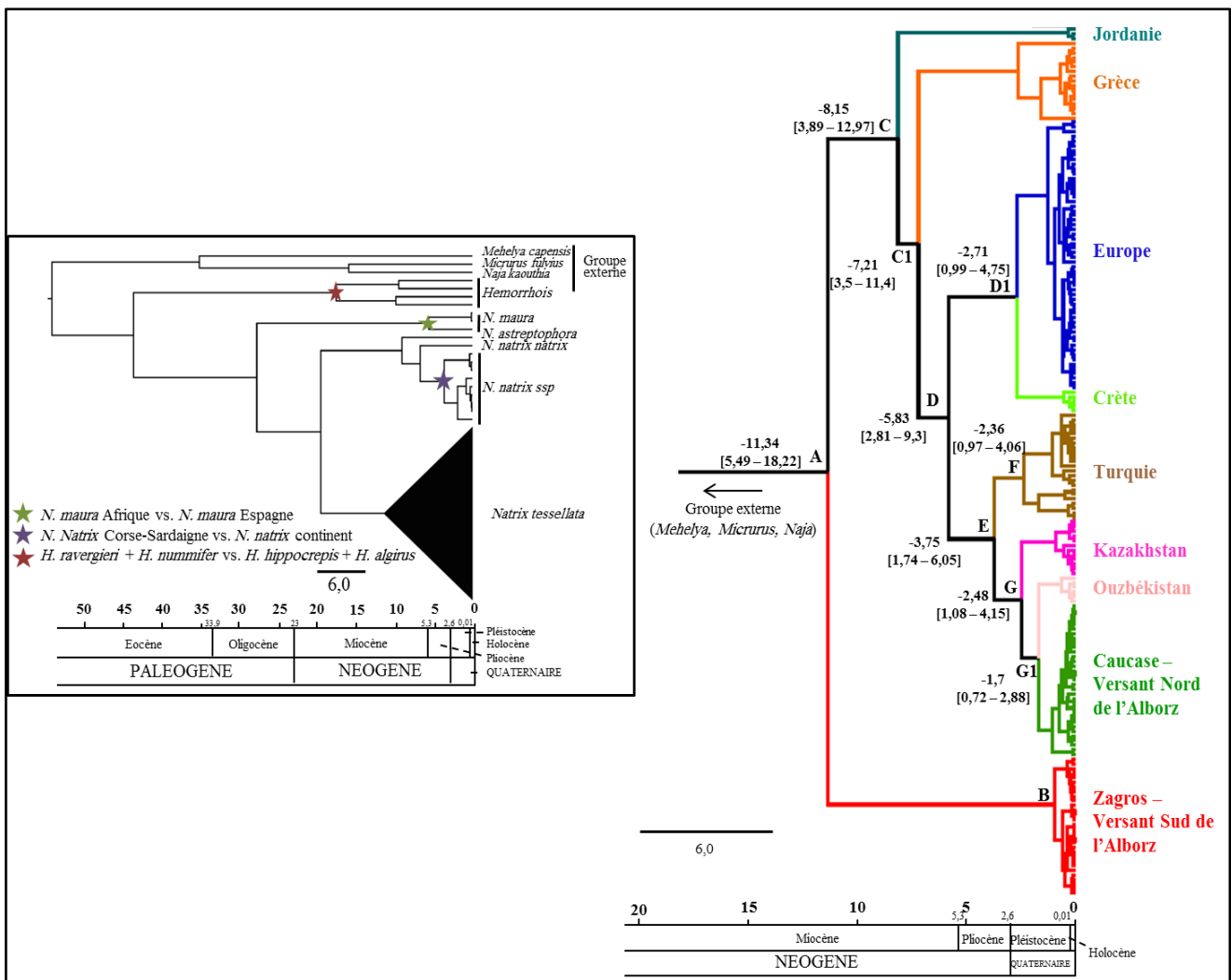

Figure 3.3.3: Résultats obtenus pour *N. tessellata* : Chronogramme complet obtenu avec BEAST basé sur les séquences du cyt b en utilisant une horloge relâchée à taux non corrélé avec une distribution exponentielle et un processus « Birth-Death ». Trois points de calibration ont été utilisés, identifiés par une étoile. L’arbre a été enraciné avec trois groupes externes: *Naja kaouthia*, *Micrurus fulvius* et *Mehelya capensis* (non montrés ici). Chronogramme pour 187 individus de l’espèce *N. tessellata* et datation des âges de divergence des différents clades observés. Les âges des principaux nœuds sont indiqués sur la figure.

Chez *H. ravergeri*, c’est le groupe « Turquie » qui occupe la position la plus basale de l’arbre, il aurait divergé il y a 6.06 Ma. Le groupe « Zagros » s’est ensuite séparé des 4 autres clades qui ont divergés successivement à partir de 2.7 Ma en commençant par le groupe « Est Zagros », puis « Kopet-Dagh » dont le noeud est faiblement supporté (PP = 0.29). Les taxons « Ouest Alborz » et « Azerbaïdjan – Alborz » forment deux groupes frères qui se seraient séparés durant le Pléistocène (Fig. 3.3.4).

Des différenciations intra-groupes semblent avoir débutées au cours du Pléistocène chez les deux espèces, notamment pour le « Zagros », le « Caucase » et la « Turquie » chez *N. tessellata*, et pour le « Zagros » et l'«Ouest Alborz » chez *H. ravergeri*.

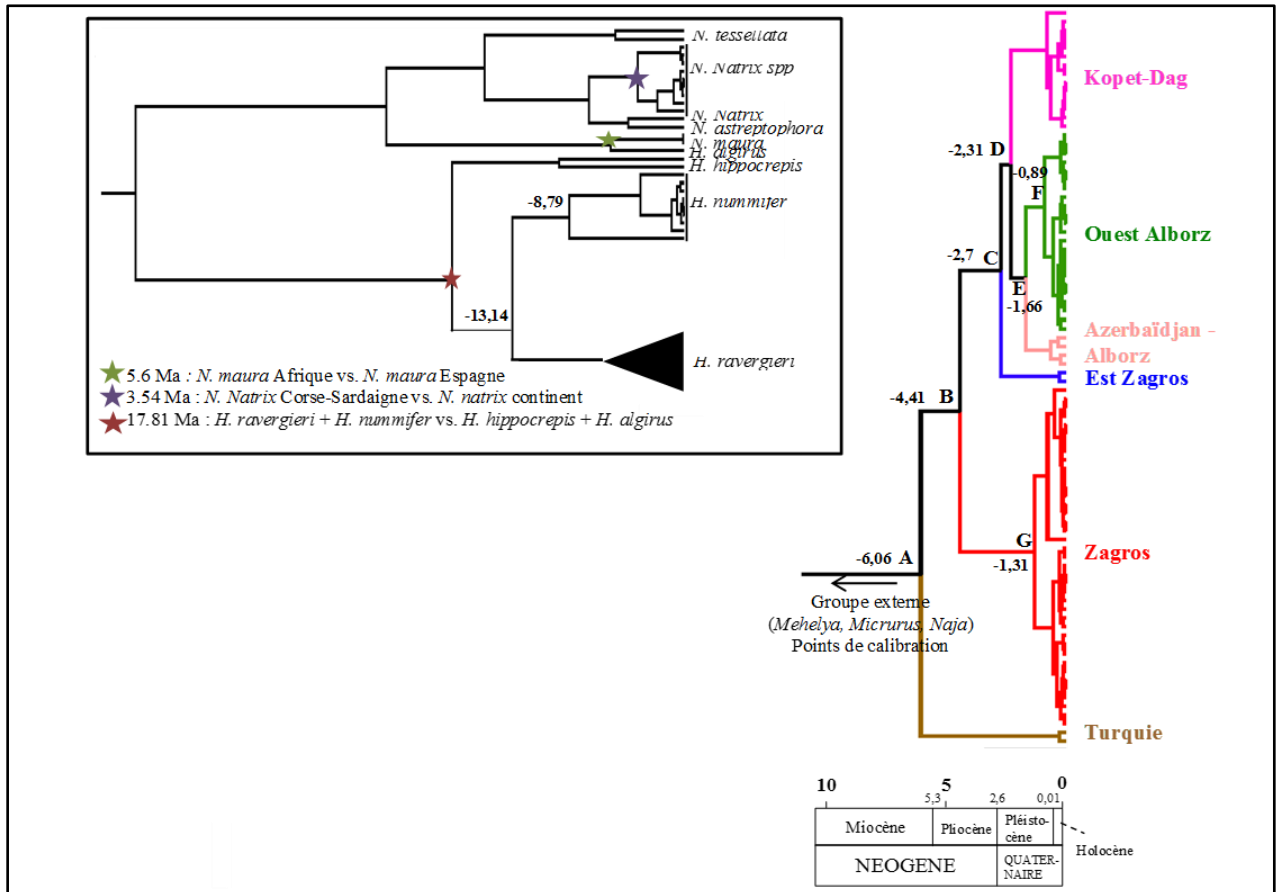

Figure 3.3.4: Résultats obtenus pour *H. ravergeri* : Chronogramme complet obtenu avec BEAST basé sur la combinaison des deux gènes mitochondriaux (cyt b et ND4) en utilisant une horloge relâchée à taux non corrélé avec une distribution exponentielle et un processus « Birth-Death ». Trois points de calibration ont été utilisés, identifiés par une étoile. L'arbre a été enraciné avec trois groupes externes: *Naja kaouthia*, *Micrurus fulvius* et *Mehelya capensis* (non montrés ici). Chronogramme pour 83 individus de l'espèce *H. ravergeri* et datation des âges de divergence des différents clades observés. Les âges des principaux nœuds sont indiqués sur la figure.

- Tendances démographiques

L'histoire démographique des clades de plus de 10 individus de *N. tessellata* (6 clades) et *H. ravergeri* (3 clades) ainsi que des espèces dans leur globalité a été évaluée par la méthode des BSPs (Bayesian Skyline Plots) obtenus avec BEAST 1.10.4 et TRACER 1.5. Une horloge moléculaire stricte a été utilisée avec les taux d'évolution déterminés dans BEAST 1.10.4 obtenus avec l'horloge relâchée : $6.924E-3 \pm 1.56E-3$ pour *N. tessellata* et $6.877E-3 \pm 1.07E-3$ pour *H. ravergeri*.

Chez la couleuvre tessellée (Fig. 3.3.5), les différentes lignées ont connu des changements démographiques concomitants : à l'exception du « Zagros » dont la population semble être restée stable, les autres ont connu une expansion à partir de 0.25 Ma. Cette expansion a été plus récente pour le « Kazakhstan » et le « Caucase » (environ 0.15 Ma). Globalement, *N. tessellata* aurait subi un déclin avant de connaître une forte expansion il y a environ 0.25 Ma.

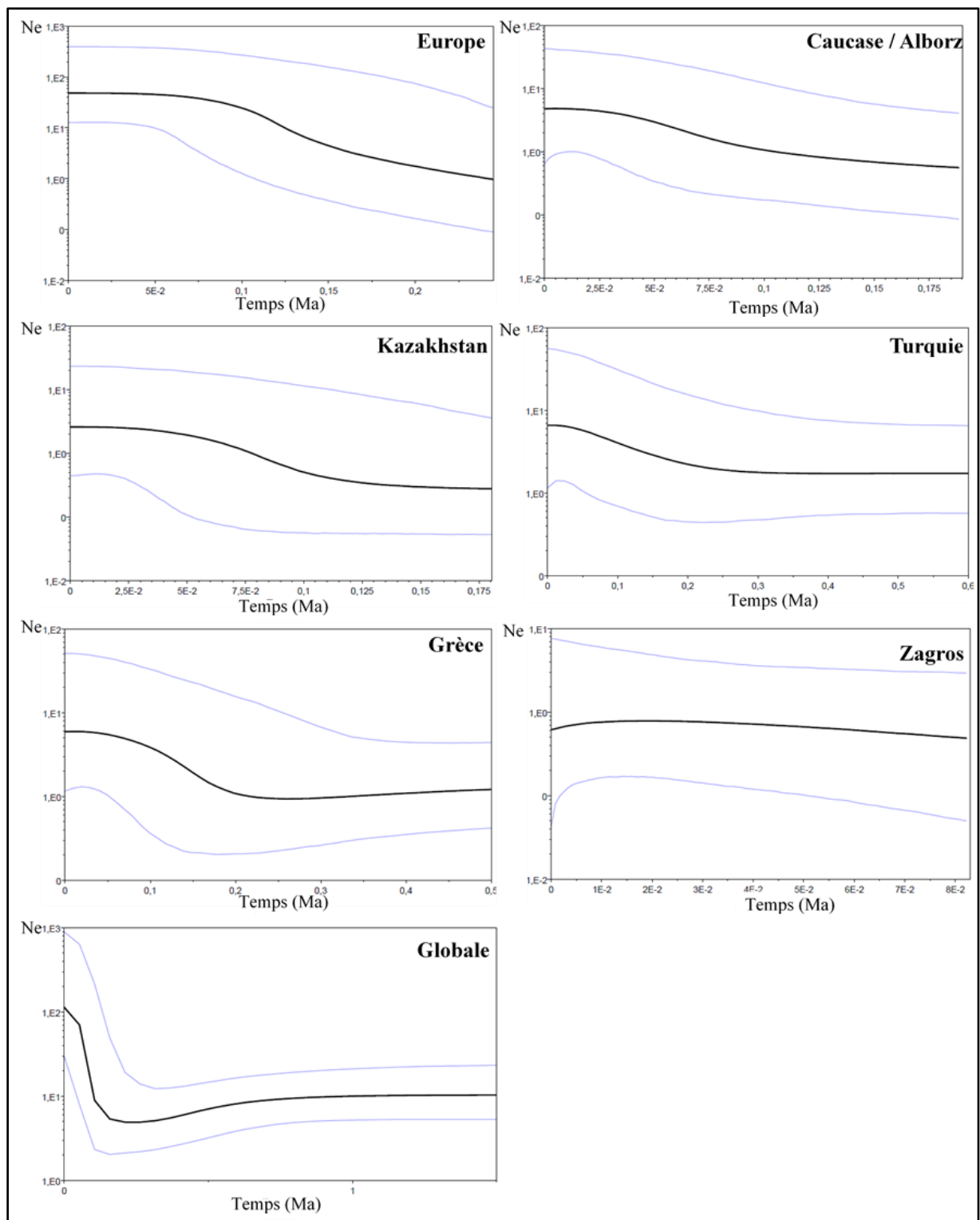

Figure 3.3.5 : Reconstruction des tendances démographiques de *N. tessellata* (globale) et pour les 6 groupes de plus de 10 individus. Graphes représentant la taille efficace des populations (N_e) en fonction du temps (en Ma), obtenus avec la méthode des Bayesian Skyline Plots (BSPs) réalisés avec BEAST et TRACER. Une horloge moléculaire stricte a été utilisée avec un taux de $6.924E-3 \pm 1.56E-3$ (voir texte). La ligne centrale représente la valeur médiane pour le \log_{10} de la taille de la population et les lignes bleues au-dessus et en-dessous représentent l'intervalle de confiance à 95%.

L'espèce *H. ravergeri* (Fig.3.3.6) aurait également décliné il y a environ 0.4 Ma avant de croître. Les lignées « Zagros » et « Kopet-Dagh » ont connu une expansion de leurs populations à la même période vers 50 000 ans, tandis que le groupe « Ouest Alborz » est resté très stable.

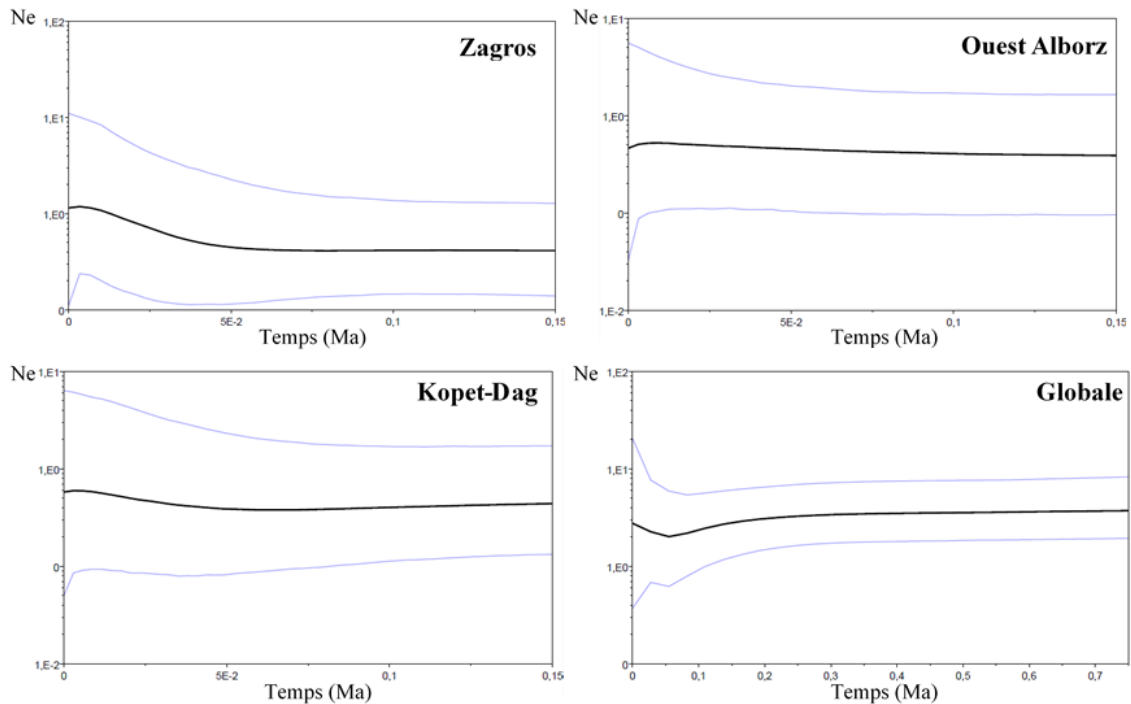

Figure 3.3.6 : Reconstruction des tendances démographiques de *H. ravergeri* (globale) et pour les 3 groupes de plus de 10 individus. Graphes représentant la taille efficace des populations (N_e) en fonction du temps (en Ma), obtenus avec la méthode des Bayesian Skyline Plots (BSPs) réalisés avec BEAST et TRACER. Une horloge moléculaire stricte a été utilisée avec un taux de $6.877^{E-3} \pm 1.07^{E-3}$ (voir texte). La ligne centrale représente la valeur médiane pour le \log_{10} de la taille de la population et les lignes bleues au-dessus et en-dessous représentent l'intervalle de confiance à 95%.

- Analyses biogéographiques

Différents scénarios évolutifs ont été testés avec DIYABC 2.1.0 afin de déterminer si la divergence des lignées identifiées s'est produite par dispersion ou vicariance. Tandis que les événements de vicariance ne prennent en compte que les temps de divergence, les événements de dispersion s'accompagnent d'un goulot d'étranglement et donc d'une réduction de la taille de la population suivie d'une expansion conduisant à estimer deux tailles de populations. Pour *N. tessellata* et *H. ravergeri*, le meilleur modèle d'évolution des séquences estimé par

ModelGenerator était le modèle Tamura Nei I + G avec un pourcentage de site invariant de 0.36 et 0.35 et une valeur α de 0.35 et 0.14 respectivement.

Pour *N. tessellata*, 3 scénarios ont été testés (Fig. 3.3.7: a) un scénario de vicariance globale où les 9 populations ont divergé en même temps, b) un scénario où les différentes populations ont divergé par des évènements de vicariance successifs, c) un scénario où une population diverge de la population ancestrale du « Zagros » par dispersion, puis les lignées « Grèce » et Jordanie » ont divergé également par dispersion avant que les autres lignées ne divergent par vicariance. D'après la PCA (Appendix 3.6: a), les priors qui ont fournis des données simulées les plus proches des données observées étaient : Ne avec une distribution normale comprise entre 10 et 30000, une moyenne de 15000, un écart type de 3000, et t avec une distribution uniforme comprise entre 10 et 5 000 000 de générations. D'après la régression logistique, le meilleur scénario était le scénario de vicariance totale (PP = 0.95), bien loin devant les scénarios de vicariances successives et de dispersion (PP = 0.046 (2) et 0.054 (3)), indiquant que la vicariance est l'évènement principal qui a favorisé la fragmentation des populations.

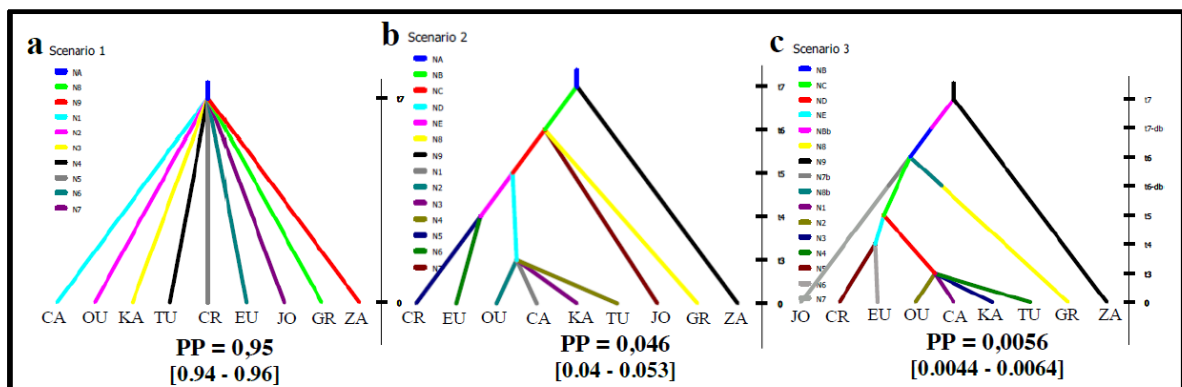

Figure 3.3.7 : Représentation graphique des différents scénarios testés avec le logiciel DIYABC pour *N. tessellata* (a-c), basés sur le cyt b. N correspond à la taille efficace des populations, t aux temps de divergence entre les populations en nombre de générations (ce temps n'est pas à l'échelle), et db correspond au temps relatif à la dispersion qui s'accompagne d'une réduction des tailles de population (Nb) indiquant un goulot d'étranglement. Noms des différentes populations: Caucase (CA), Ouzbékistan (OU), Kazakhstan (KA), Turquie (TU), Europe (EU), Crète (CR), Grèce (GR), Jordanie (JO), Zagros (ZA). La probabilité et l'intervalle de confiance sont indiqués sous chaque scénario.

Pour la couleuvre de Ravergier, 4 scénarios ont été testés (Fig. 3.3.8) : d) un scénario où les 6 lignées ont divergé en même temps ; e) un scénario où les populations « Turquie » et « Zagros » ont divergé en premier par vicariance, puis les 4 autres populations ont divergé lors d'un second évènement de vicariance ; f) un scénario où une population a divergé de la population ancestrale « Turquie » par dispersion, suivi d'un second évènement de dispersion depuis la population « Zagros » et d'un évènement de vicariance séparant les 4 autres populations et g) un scénario où deux populations ont divergé en même temps par dispersion puis les groupes « Kopet- Dagh », « Ouest Alborz », « Azerbaïdjan-Alborz » et « Est Zagros » ont divergé par vicariance. Les meilleurs priors déterminés à l'aide de la PCA (Appendix 3.6 : b) étaient N_e avec une distribution normale comprise entre 10 et 30000, une moyenne de 15000 et un écart type de 5000, et t avec une distribution uniforme comprise entre 10 et 2 000 000 de générations. Le scénario le plus probable est le scénario 2 (PP = 0.30), mais il est très proche des 3 autres scénarios (PP = 0.26 (1), 0.23 (3) et 0.21 (4)). Il semble donc que des évènements de dispersion et de vicariance soient intervenus dans l'histoire biogéographique des lignées de *H. ravergeri*.

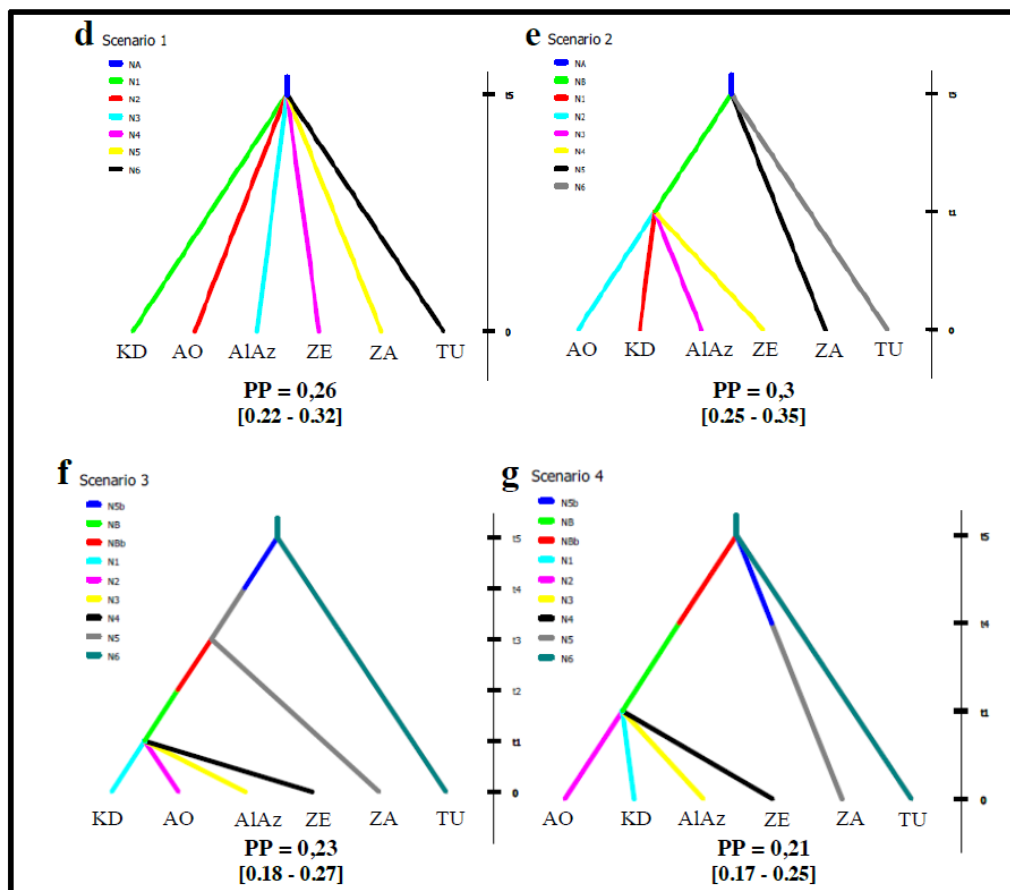

Figure 3.3.8 : Représentation graphique des différents scénarios testés avec le logiciel DIYABC pour *H. ravergeri* (d-g), basés sur la combinaison du cyt b et de ND4. N correspond à la taille efficace des populations, t aux temps de divergence entre les populations en nombre de générations (ce temps n'est pas à l'échelle), et db correspond au temps relatif à la dispersion qui s'accompagne d'une réduction des tailles de population (Nb) indiquant un goulot d'étranglement. Noms des différentes populations : Kopet-Dat (KD), Ouest Alborz (AO), Azerbaïdjan – Alborz (AlAz), Est Zagros (ZE), Zagros (ZA), Turquie (TU). La probabilité et l'intervalle de confiance sont indiqués sous chaque scénario.

La reconstruction des aires ancestrales des différentes lignées a été réalisée avec le package BioGeoBears. Six zones géographiques ont été déterminées pour la couleuvre tessellée (Fig. 3.3.9 encadré) et assignées au représentant des différentes lignées selon leur distribution. Le meilleur modèle était DIVALIKE + J (AIC = 54.47) mais n'était pas significativement différent de DEC + J (AIC = 55.01) (Appendix 3.7). D'après ces deux modèles, l'ancêtre commun des 9 lignées occupait probablement les zones ZA, AL et ME, avant que l'une des lignées filles ne disperse vers PO, la lignée « Zagros » restant confinée en ZA et AL. Un événement de vicariance a séparé la « Jordanie » des autres populations. Puis des événements de dispersion successifs ont conduit les populations à coloniser TU et OA, et à retourner vers AL (Fig. 3.3.9).

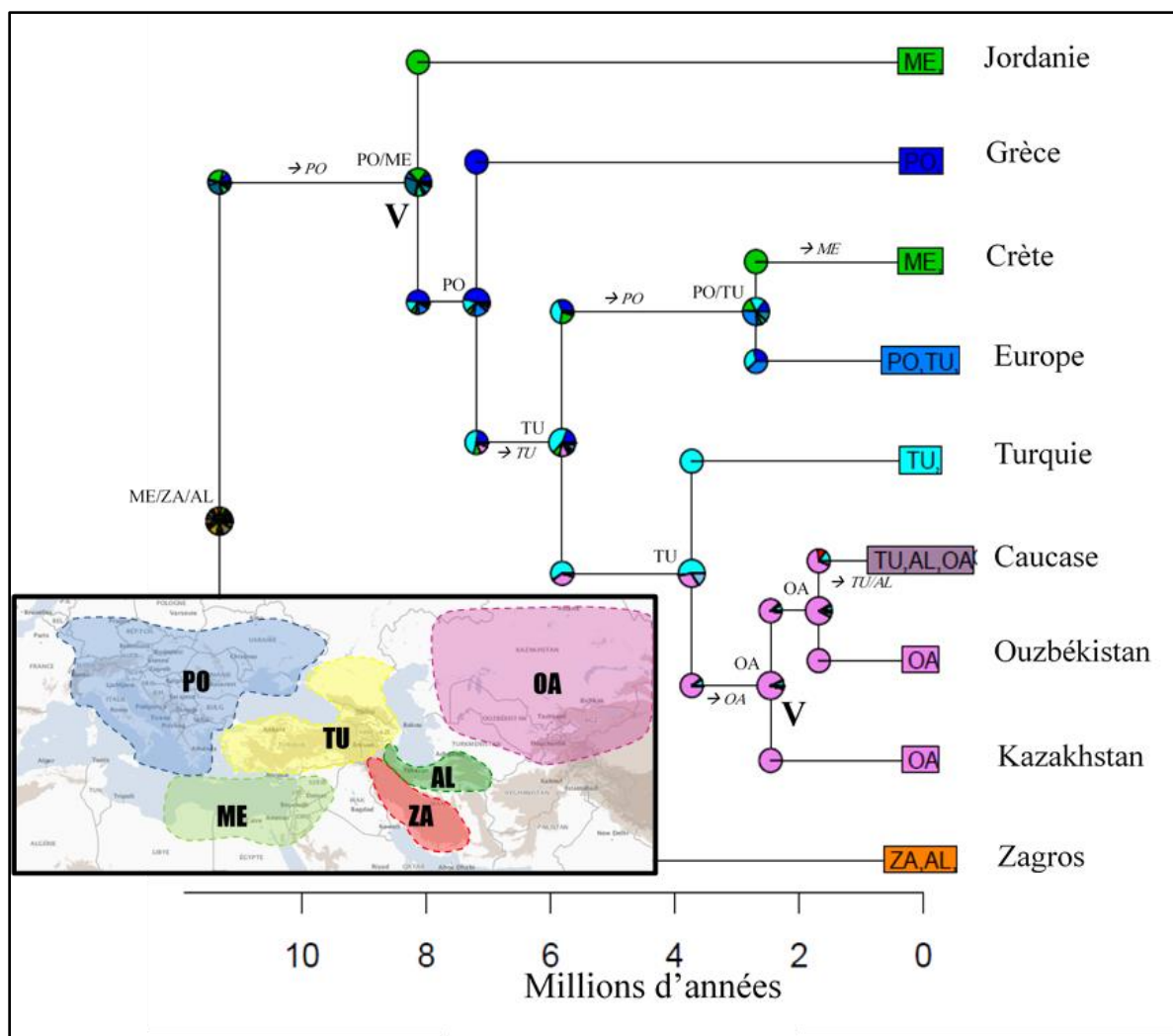

Figure 3.3.9 : Reconstruction des aires ancestrales de *N. tessellata* à chaque nœud de la phylogénie en utilisant le modèle DIVALIKE + J dans le package R BioGeoBears. Les aires géographiques définies sont schématisées dans l’encadré : Zagros (ZA), Alborz (AL), Turquie (TU), Méditerranée (ME), Paléarctique Occidental (PO) et Ouest Asie (OA). Les camemberts à chaque nœud représentent la probabilité d’occurrence dans chaque région, deux lettres indiquent la probabilité la plus élevée de l’aire régionale ancestrale. V indique les évènements de vicariance et les flèches représentent les évènements de dispersion.

Pour *H. ravergieri*, 4 zones géographiques ont été définies (Fig. 3.3.10 encadré). Le meilleur modèle était DEC + J (AIC = 31.02), non significativement différent de DIVALIKE + J (AIC = 31.36) (Appendix 3.7). Pour les deux modèles, l’ancêtre commun des 6 populations occupait la TU, après s’être séparé de son ancêtre commun avec *H. nummifer* qui était distribué dans les zones ZA, AL et TU. Puis un évènement de dispersion a permis la colonisation de KD, à partir d’où les populations « Azerbaïdjan – Alborz » et « Ouest Alborz » sont retournées en AL et au ZA (Fig.3.3.10).

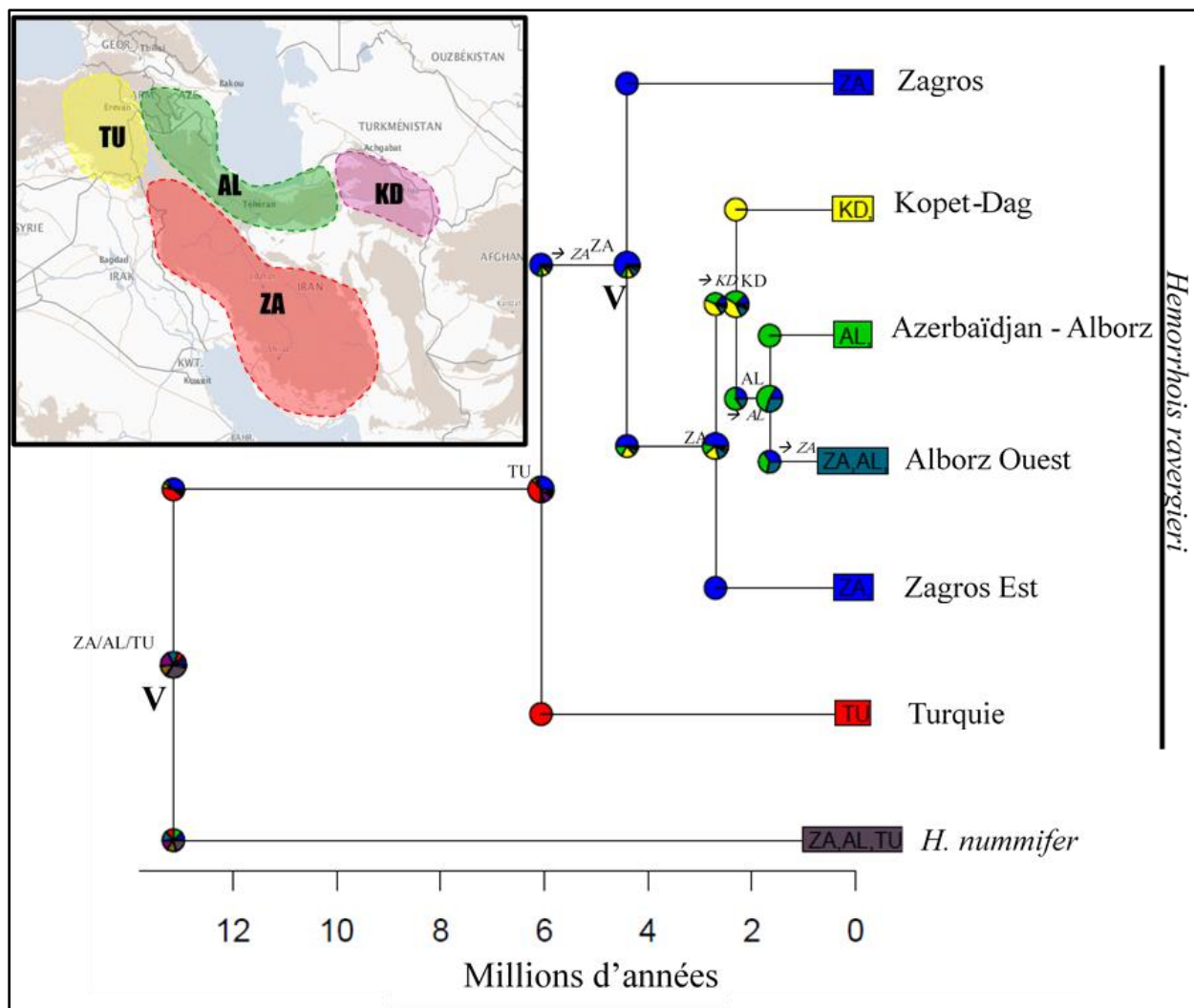

Figure 3.3.10 : Reconstruction des aires ancestrales de *H. ravergeri* à chaque nœud de la phylogénie en utilisant le modèle DEC +J dans le package R BioGeoBears. Les aires géographiques définies sont schématisées dans l'encadré : Zagros (ZA), Alborz (AL), Turquie (TU) et Kopet-Dagh (KD). Les camemberts à chaque nœud représentent la probabilité d'occurrence dans chaque région, deux lettres indiquent la probabilité la plus élevée de l'aire régionale ancestrale. V indique les événements de vicariance et les flèches représentent les événements de dispersion.

3.2.3. Discussion

- Histoire évolutive de *Natrix tessellata*

L'échantillonnage étudié pour la couleuvre tessellée (spécimens collectés en Iran et séquences d'études précédentes) correspond à la quasi-totalité de son aire de distribution. L'espèce apparaît scindée en 9 clades distincts bien supportés, confirmant les résultats de Joger *et al.* (2007) et Guicking *et al.* (2009) basés également sur le *cyt b* ainsi que sur des marqueurs nucléaires. Les groupes ayant divergé les premiers e.g. « Zagros », « Grèce » et « Jordanie », sont très distants des autres lignées (dinter > 0.078), une valeur équivalente à la distance observée entre les espèces *N. natrix* et *N. astreptophora* (dinter = 0.073, Appendix 3.5).

La divergence des différentes lignées a débuté il y a 11.34 Ma et s'est poursuivie essentiellement au cours du Miocène et du Pliocène, bien avant les oscillations climatiques du Pléistocène. Seuls les groupes les plus apparentés « Europe » et « Crète », et « Kazakhstan », « Ouzbékistan » et « Caucase » se sont séparés durant le Pléistocène (entre 2.7 - 2.48 Ma). La forte structuration géographique semble cohérente avec une fragmentation des populations par vicariance comme suggéré par le meilleur scénario obtenu avec DIYABC selon lequel les 9 populations se sont fragmentées à partir d'un ancêtre commun. Cependant, les résultats obtenus avec BioGeoBears indiquent que les deux modèles DIVALIKE +J et DEC +J ne sont pas significativement différents, suggérant que des événements de dispersion ont également dû participer à l'histoire évolutive de *N. tessellata*. Sur cette base le scénario suivant a pu être postulé (Fig. 3.3.11) :

(1) Le clade « Zagros » se trouve en position la plus basale de l'arbre, indiquant que les populations ancestrales de l'espèce vivaient en Iran, comme l'ont aussi suggéré Guicking *et al.* (2009) qui n'ont utilisé que 2 échantillons iraniens. La fermeture du passage de la mer entre l'Eurasie et l'Afrique il y a 12 Ma (Steininger et Rögl 1984) ainsi que l'aridification du climat vers 10-9 Ma entraînant l'ouverture des milieux en Méditerranée (van Dam 2006), ont permis aux individus de se disperser vers les côtes Est de la Méditerranée, notamment en Jordanie, puis en Grèce.

(2) La colonisation de la Turquie a pu se produire environ au moment de la crise Messinienne (6-5 Ma), quand la Méditerranée était asséchée (Hsü *et al.* 1977 ; Krijgsman *et al.* 1999 ; Steininger et Rögl 1984).

(3) Depuis la Turquie, certains individus ont colonisé l'Europe il y a environ 5.8 Ma. La chaîne des Balkans, véritable barrière à la dispersion (Hewitt 1996), a sans doute empêché les échanges de gènes entre les clades « Europe » et « Grèce ». A la fin du Pliocène, des individus

ont dispersé vers la Crète, peut-être par voie marine, *N. tessellata* supportant l'eau salée (Guicking *et al.* 2009), se séparant ainsi de la lignée européenne.

(4) A partir de la Turquie, une seconde colonisation a eu lieu vers l'Asie de l'Ouest il y a 3.75 Ma, au moment du pic d'aridité favorisant le développement d'environnements steppiques (van Dam 2006). La colonisation semble avoir eu lieu par le Nord de la mer Caspienne, conduisant à la divergence successive des lignées « Kazakhstan » et « Ouzbékistan » par vicariance.

(5) La colonisation de l'Alborz a été effectuée à partir de la lignée « Ouzbékistan » jusqu'aux rives occidentales de la mer Caspienne. Selon ce scénario, la formation de l'Alborz au cours du Pléistocène (Behrooz 2017) a empêché tout flux de gènes entre les lignées « Zagros » au Sud de l'Alborz et « Caucase » au Nord, expliquant la présence de deux clades d'âges et d'origines différentes.

Il semble que la plupart des phases de divergence et de diversification se soient déroulées durant des périodes interglaciaires : il y a 4 Ma (van Dam, 2006; Zagwijn, 1985) quand la lignée « Turquie » a divergé (Fig. 3.3.3, nœud E), il y a 2.4 Ma (Krantz, 1991) pour la divergence du clade « Kazakhstan » et la diversification de la lignée « Turquie » (Fig. 3.3.3, nœuds F et G) qui ont eu lieu juste avant le début d'une glaciation, il y a environ 1 Ma juste avant la glaciation du Günz (Randi, 2007) quand les lignées « Caucase » et « Zagros » ont commencé à se diversifier (Fig. 3.3.3, nœuds B et G1). D'une manière générale, la plupart des lignées semblent avoir connues une expansion de leur populations (Fig. 3.3.5) plus ou moins concomitante à partir de 0.25 Ma au début de la glaciation du Riss (Randi, 2007). Les individus se sont ainsi contractés dans les refuges durant les périodes interglaciaires et ont recolonisé les milieux durant les glaciations où le climat était plus sec (Horowitz 1989). Des zones refuges ont été identifiées dans le Caucase (Hewitt, 1996,1999), auxquels nos données permettent de rajouter la Turquie, les montagnes du Zagros et de l'Alborz.

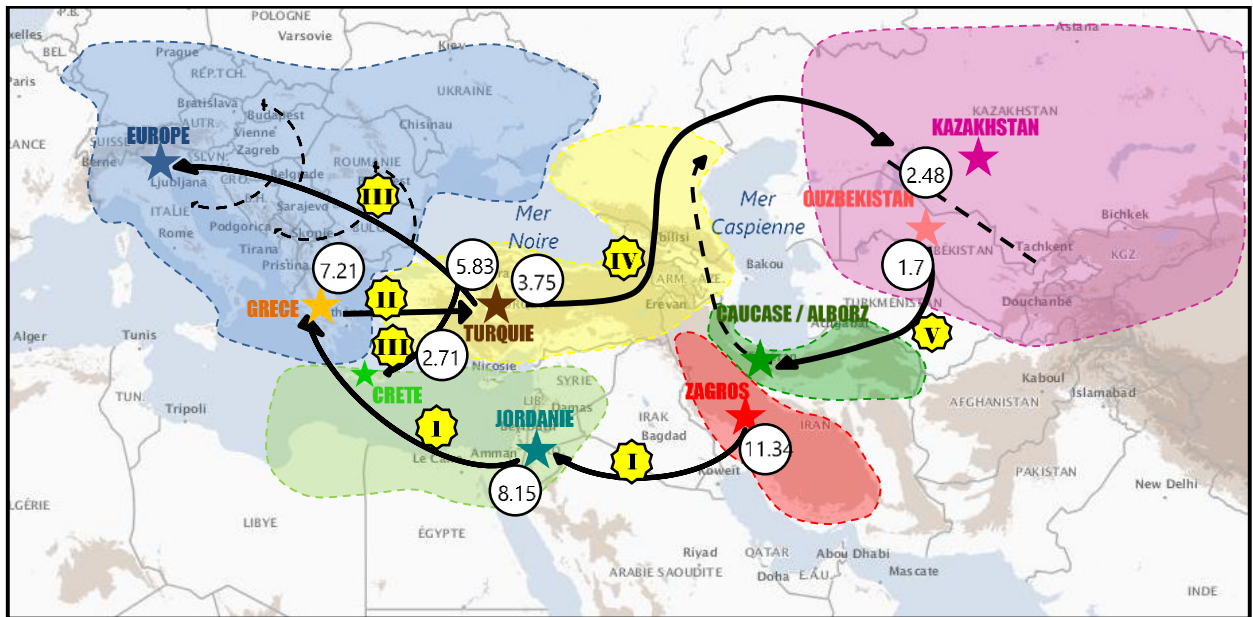

Figure 3.3.11: Reconstruction de l’histoire évolutive de *N. tessellata* basée sur les séquences du *cyt b*. Les régions en couleur correspondent aux zones géographiques définies dans BioGeoBears. Les flèches noires indiquent les routes éventuelles de colonisation et les lignes pointillées schématisent les évènements de vicariance inférés à partir des modèles DIVALIKE +J (a) et DEC +J (b) dans BioGeoBears. Les étoiles indiquent la localisation actuelle des différentes lignées dont les couleurs correspondent à celles de la Fig. 3.3.3. Les nombres font référence aux temps de divergence entre les différents groupes en Ma et les chiffres romains aux différentes phases de divergence identifiées (voir texte).

- Histoire évolutive d’*Hemorrhhois ravergeri*

Seule la partie iranienne de la distribution de la couleuvre de Ravergier a été analysée dans cette étude mais contrairement à *N. tessellata*, aucune étude phylogéographique n’a encore été publiée. En Iran, l’espèce est divisée en 6 clades bien supportés. Le groupe « Zagros » est le plus distant des autres lignées (dinter > 0.15). Il est plus distant que les espèces *H. nummifer*, *H. hippocrepis* et *H. algirus* entre elles ($0.12 < \text{dinter} < 0.14$).

Les évènements de divergence au sein de *H. ravergeri* ont eu lieu entre 6.06 - 1.66 Ma, soit au cours du Pliocène et du Pléistocène. Les différents scénarios testés avec DIYABC et BioGeoBears indiquent que vicariance et dispersion doivent être prises en compte pour expliquer la structuration des différents groupes observés pour *H. ravergeri* en Iran. Un scénario en 4 phases peut être avancé (Fig. 3.3.12):

(1) La colonisation de l’Iran semble provenir de la Turquie il y a 6.06 Ma à partir d’où les organismes ont dispersé vers le Zagros, quand le climat était plus aride à l’Est de l’Europe (van Dam 2006).

(2) Un évènement de vicariance a scindé la population du Zagros entre les deux versants de la montagne.

(3) A partir du Zagros, des individus ont colonisé Kopet-Dagh et l'est de l'Alborz au début du Pléistocène, avant de revenir progressivement vers les flancs Est du Zagros.

(4) l'Azerbaïdjan serait la dernière région à avoir été colonisée à partir de l'Alborz.

La plupart des évènements de divergence ont eu lieu durant des périodes interglaciaires chaudes : il y a 4.4 Ma (Krantz, 1991) quand le clade « Zagros » a divergé par vicariance (Fig. 3.3.4 nœud B), ou quand le groupe « Kopet-Dagh » s'est isolé il y a 2.3 Ma (Fig. 3.3.4 nœud D) juste à la fin d'une glaciation (Horowitz, 1989 ; Zagwijn, 1985). Plus généralement, les lignées « Zagros » et « Kopet-Dagh », ainsi que l'espèce dans sa globalité, ont connu une phase d'expansion à partir de 0.05 Ma au début de la glaciation du Würm (Randi, 2007), après un goulot d'étranglement, comme le suggère les fortes valeurs de H_d et les faibles valeurs de π (Guicking *et al.*, 2009; Nebel *et al.*, 2015). *H. ravergeri* étant une espèce adaptée au milieu ouvert, elle aurait donc connu des phases de contraction durant les périodes interglaciaires et des phases d'expansion durant les périodes glaciaires. La forte structuration géographique observée pour *H. ravergeri* et l'absence d'haplotype en commun entre les groupes laissent supposer l'existence de plusieurs zones refuges, notamment dans les montagnes du Zagros, de l'Alborz et de Kopet Dagh.

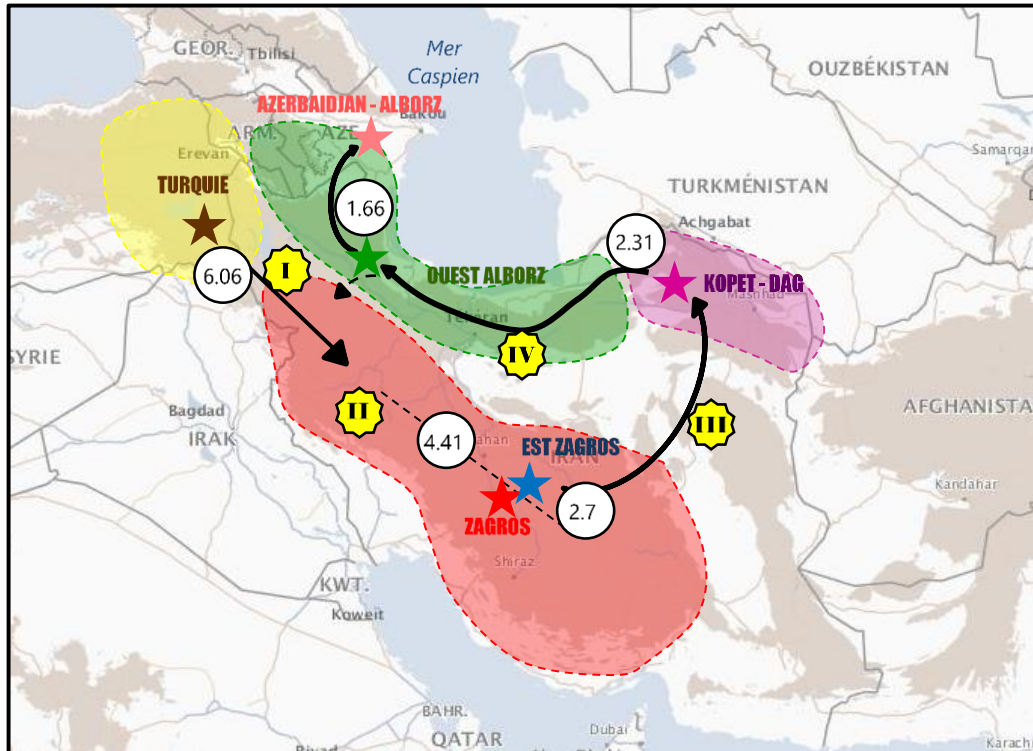

Figure 3.3.12: Reconstruction de l'histoire évolutive de *H. ravergeri* basée sur la combinaison des deux gènes mitochondriaux. Les régions en couleur correspondent aux zones géographiques définies dans BioGeoBears. Les flèches noires indiquent les routes éventuelles de colonisation et les lignes pointillées schématisent les événements de vicariance inférés à partir des modèles DIVALIKE +J (a) et DEC +J (b) dans BioGeoBears. Les étoiles indiquent la localisation actuelle des différentes lignées dont les couleurs correspondent à celles de la Fig. 3.3.4. Les nombres font référence aux temps de divergence entre les différents groupes en Ma et les chiffres romains aux différentes phases de divergence identifiées (voir texte).

3.3. Conclusion

- Histoire biogéographique commune chez les serpents de montagnes

Il est tout d'abord à noter que pour les deux taxons étudiés, deux clades géographiquement distincts et d'âge différents sont observés en Iran. Dans les deux cas, le clade le plus ancien (daté de 11.3 et 6.06 Ma) se trouve dans le Zagros alors que l'Alborz a été colonisé plus tardivement.

Bien que le début de la diversification de *H. ravergeri* soit plus récent que pour *N. tessellata*, la corrélation entre les principales phases de divergence des lignées et les transitions climatiques du Plio-Pléistocène suggèrent que les deux espèces ont été influencées par les mêmes facteurs environnementaux. En effet, en tant qu'espèces adaptées aux environnements ouverts et secs et au climat montagnard, elles ont été confinées dans les refuges au sommet des montagnes, où les milieux ouverts y étaient restreints, durant les phases interglaciaires plus chaudes et humides (Horowitz 1989 ; Khel 2009), et ont connu des phases d'expansion durant les périodes glaciaires caractérisées par un climat plus froid et sec, notamment en Iran (Horowitz, 1989; Khel, 2009).

Durant ces phases d'expansion, elles ont modifié leur distribution vers des altitudes plus basses (Stümpel *et al.* 2016). Des études phylogéographiques précédentes sur des vipères de montagnes e.g. *Gloydus caucasicus* (Asadi *et al.*, 2019), le complexe *Montivipera raddei* (Behrooz *et al.* 2018), et *Vipera ursinii* (Ferchaud *et al.*, 2012), basées sur les mêmes gènes mitochondriaux (*cyt b* et ND4) et ainsi que sur des gènes nucléaires, ont également montré chez ces taxons une forte structuration géographique similaire à celle de *H. ravergeri* et *N. tessellata*. Toutes ces espèces occupent les montagnes de l'Alborz, de Kopet Dagh, du Zagros, à l'Est de la Turquie et au Sud de l'Arménie où elles forment des populations isolées qualifiées de « sky-island taxa » (Heald, 1951).

Références

- Ahmadzadeh F., Carretero M.A., Rödder D., Harris D.J., Freitas S.N., Perera A., *et al.* (2013). Inferring the effects of past climate fluctuations on the distribution pattern of *Iranolacerta* (Reptilia, Lacertidae): evidence from mitochondrial DNA and species distribution models. *Zoologischer Anzeiger – A journal of Comparative Zoology*, 252:141–148.
- Arnold N. & Ovenden D. (2010). *Le guide herpéto : 228 amphibiens et reptiles d'Europe*. Delachaux et Niestlé. 290 pp.
- Arnold, E. N. & Ovenden, D. W. (2002). *Reptiles and Amphibians of Europe*. Princeton, NJ and Oxford: Princeton University Press, 288 pp.
- Asadi, A., Montgelard, C., Nazarizadeh, M., Moghaddasi, A., Fatemizadeh, F., Simonov, *et al.* (2019). Evolutionary history and postglacial colonization of an Asian pit viper (*Gloydius halys caucasicus*) into Transcaucasia revealed by phylogenetic and phylogeographic analyses. *Scientific Reports* 9:1224.
- Asadi, A., Salmanian, A. and Kaboli, M. 2019. *Eirenis thospitis* Schmidtler et Lanza (Reptilia: Colubridae); new to Iran. *Russian Journal of Herpetology* (accepted manuscript).
- Avice J. C., Arnold J., Ball R. M., Bermingham E., Lamb T, Neigel J. E. *et al.* (1987). Intraspecific phylogeography : the mitochondrial DNA bridge between population genetics and systematics. *Annual Review of Ecology and Systematics*, 18:489-522.
- Avice, J. C. (2000). *Phylogeography: the history and formation of species*. Harvard University Press.
- Avice, J.C. (2009). Phylogeography: retrospect and prospect. *Journal of Biogeography* 36:3–15.
- Bannikov, A. G., Darevskii, I. S., Ishchenko, V. G., Rustamov, A. K. & Shcherbak, N. N. (1977). *Opredelitel' zemnovodnykh ipresmykayushchikhsya fauny SSSR*. Moscow: Prosveshchenie, 416 pp.
- Barata, M., Harris, D. J. and Castilho, R. 2008. Comparative phylogeography of northwest African *Natrix maura* (Serpentes: Colubridae) inferred from mtDNA sequences. *African Zoology*, 43(1): 1–7.
- Beaumont, M.A., Zhang, W., Balding, D.J. (2002). Approximate Bayesian computation in population genetics. *Genetics*, 162:2025-2035.
- Behrooz R. (2017). *Phylogéographie de deux reptiles iraniens (le complexe Montivipera raddei et Ophisops elegans) et implication pour la conservation*. Thèse de doctorat de l'Ecole Pratique des Hautes Etudes (ED472). 160 pp.
- Behrooz, R., Kaboli, M., Arnal, V., Nazarizadeh, M., Asadi, A., Salmanian, *et al.* (2018). Conservation Below the Species Level: Suitable Evolutionarily Significant Units among Mountain Vipers (the *Montivipera raddei* complex) in Iran. *Journal of Heredity*, 109:416–425.
- Bickford SA, Laffan SW (2006) Multi-extent analysis of the relationship between pteridophyte species richness and climate. *Global Ecology and Biogeography* **15**, 588-601.
- Böhm *et al.*, 2013. The conservation status of the world's reptiles. *Biological Conservation* 157: 372-385. doi: 10.1016/j.biocon.2012.07.015
- Brito, P.H., Edwards, S.V. (2009). Multilocus phylogeography and phylogenetics using sequencebased markers. *Genetica*, 135:439–455. Brumfield, R.T., Beerli, P., Nickerson, D.A., Edwards, S.V. (2003). The utility of single nucleotide polymorphisms in inferences of population history. *Trends in Ecology & Evolution*, 18:249–256.
- Clement, M., Posada D.C.K.A., Crandall K. A. (2000). TCS: a computer program to estimate gene genealogies. *Molecular Ecology*, 9:1657–1660
- Cornuet J.-M., Pudlo P., Veyssier J., Loire E., Santos F., Dehne-Garcia A. *et al.* (2015). DIYABC version 2.1 : a user-friendly software for inferring population history through

- Approximate Bayesian Computations using microsatellite, DNA sequence and SNP data, 201 Cox, C. B., Moore, P. D., & Ladle, R. (2016). *Biogeography: an ecological and evolutionary approach*. John Wiley & Sons.
- Cornuet, J.-M., Pudlo, P., Veyssier, J., Dehne-Garcia, A., Gautier, M., Leblois, R., *et al.* (2014). DIYABC v2.0: a software to make approximate Bayesian computation inferences about population history using single nucleotide polymorphism, DNA sequence and microsatellite data. *Bioinformatics*, 30:1187–1189.
- Cornuet, J.-M., Santos, F., Beaumont, M.A., Robert, C.P., Marin, J.-M., Balding, D.J., *et al.* (2008). Inferring population history with DIY ABC: a user-friendly approach to approximate Bayesian computation. *Bioinformatics*, 24:2713–2719.
- David, P. & Ineich, I. Les serpents venimeux du monde: systématique et répartition. *Dumerilia*, 3, 3–499 (1999).
- Delsuc, F. & Douzery, E.J.P. (2004). Les méthodes probabilistes en phylogénie moléculaire. (2) L'approche bayésienne. *Biosystema*, 22:75-86.
- Drummond, A.J., Ho, S.Y.W., Rawlence, N., Rambaut, A. (2007). A Rough Guide to BEAST 1.4. 1- 41.
- Felsenstein, J. (1985). Confidence limits on phylogenies: an approach using the bootstrap. *Evolution*, 39:783–791.
- Ferchaud, A.-L., Ursenbacher, S., Cheylan, M., Luiselli, L., Jelić, D., Halpern, B., *et al.* (2012). Phylogeography of the *Vipera ursinii* complex (Viperidae): mitochondrial markers reveal an east-west disjunction in the Palearctic region. *Journal of Biogeography*, 39:1836–1847.
- Fraser D.J., Bernatchez L. (2001). Adaptive evolutionary conservation: towards a unified concept for defining conservation units. *Molecular Ecology*, 10:2741–2752.
- Fritz, U., Corti, C., Päckert, M. (2012). Mitochondrial DNA sequences suggest unexpected phylogenetic position of Corso-Sardinian grass snakes (*Natrix cetti*) and do not support their species status, with notes on phylogeography and subspecies delineation of grass snakes. *Organisms Diversity & Evolution*, 12:71–80.
- Ghazikhanloo, A and Kami, H.Gh, 2013., the study of morphology of (*Hemorrhoids ravergeri*) in Iran, *Journal of animal environment*, 4(4), pp.57-67.
- Gouy, M., Guindon, S., Gascuel, O. (2009). SeaView Version 4: A Multiplatform Graphical User Interface for Sequence Alignment and Phylogenetic Tree Building. *Molecular Biology and Evolution*, 27:221–224.
- Gruschwitz, M., Lenz, S., Mebert, K. & V. Lanka (1999): *Natrix tessellata* (Laurenti, 1768) Wurfelnatter. . In: Bohme, W. (Ed.): *Handbuch der Reptilien und Amphibien Europas*, Vol. 3/Schlangen II. – AULA-Verlag, Wiesbaden, Germany: 581–644.
- Guicking, D., Joger, U. and Wink, M. 2009. Molecular phylogeography of the viperine snake *Natrix maura* (Serpentes: Colubridae): Evidence for strong intraspecific differentiation. *Organisms, Diversity & Evolution*: 130–145.
- Guicking, D., Joger, U., Wink, M. (2009). Cryptic diversity in a Eurasian water snake (*Natrix tessellata*, Serpentes: Colubridae): Evidence from mitochondrial sequence data and nuclear ISSR-PCR fingerprinting. *Organisms Diversity & Evolution*, 9:201–214.
- Guicking, D., Lawson, R., Joger, U. and Wink, M. 2006. Evolution and phylogeny of the genus *Natrix* (Serpentes:Colubridae). *Biological Journal of the Linnean Society*, 87: 127–143.
- Gumprecht, A. Die Weisslippen-Bambusotter, *Cryptelytrops albolabris* (*Trimeresurus albolabris*). (Art für Art, Natur und Tier Verlag, 2004).
- Hall, T.A. (1999). BioEdit: a user-friendly biological sequence alignment editor and analysis program for Windows 95/98/NT. *Nucleic Acids Symposium Series*, 41:95–98.

- Head, J.J., Mahlow, K., Müller, J. (2016). Fossil calibration dates for molecular phylogenetic analysis of snakes 2: Caenophidia, Colubroidea, Elapoidea, Colubridae. *Palaeontologia electronica*, 19:1-21.
- Heald, W.F. (1951). Sky-islands of Arizona. *Natural History*, 60:56–63.
- Heath, T.A. (2015). Divergence Time Estimation using BEAST v2.2.0. In Source URL: <http://treethinkers.org/tutorials/divergence-time-estimation-using-beast/>: Tutorial written for workshop on applied phylogenetics and molecular evolution, Bodega Bay California (pp. 1- 44).
- Hewitt, G.M. (1996). Some genetic consequences of ice ages, and their role in divergence and speciation. *Biological Journal of the Linnean Society*, 58:247–276.
- Hewitt, G.M. (1999). Post-glacial re-colonization of European biota. *Biological Journal of the Linnean Society*, 68:87–112.
- Hewitt, G.M. (2011). Quaternary phylogeography: the roots of hybrid zones. *Genetica*, 139: 617–638.
- Ho, S.Y.M. (2007). Calibrating molecular estimates of substitution rates and divergence times in birds. *Journal of Avian Biology*, 38:409–414.
- Horowitz, A. (1989). Continuous pollen diagrams for the last 3.5 m.y. from Israel: Vegetation, climate and correlation with the oxygen isotope record. *Palaeogeography, Palaeoclimatology, Palaeoecology*, 72:63–78.
- Hsü, K.J., Montadert, L., Bernoulli, D., Cita, M.B., Erickson, A., Garrison, R.E., *et al.* (1977). History of the Mediterranean salinity crisis. *Nature*, 267:399–403.
- Huelsenbeck, J.P., Ronquist, F. (2001). MRBAYES: Bayesian inference of phylogenetic trees. *Bioinformatics*, 17:754–755.
- Joger, U., Fritz, U., Guicking, D., Kalyabina-Hauf, S., Nagy, Z.T., Wink, M. (2007). Phylogeography of western Palearctic reptiles – Spatial and temporal speciation patterns. *Zoologischer Anzeiger - A Journal of Comparative Zoology*, 246:293–313.
- Keane T. M., Creevey C. J., Pentony M. M., Naughton T. J. & McInerney J. O. (2006). Assessment of methods for amino acid matrix selection and their use on empirical data shows that ad hoc assumptions for choice of matrix are not justified. *BMC Evolutionary Biology*, 6:29
- Kehl, M. (2009). Quaternary climate change in Iran – the state of knowledge. *Erdkunde*, 63:1–17.
- Kimura, M. (1980). A simple method for estimating evolutionary rates of base substitutions through comparative studies of nucleotide sequences. *Journal of Molecular Evolution*, 16 :111–120.
- Khani, S., Kami, H. G. & Rajabizadeh, M. Geographic variation of *Gloydius halys caucasicus* (Serpentes: Viperidae) in Iran. *Zool. Middle East*. 63, 303–10 (2017).
- Kindler, C., Graciá, E., Fritz, U. (2018). Extra-Mediterranean glacial refuges in barred and common grass snakes (*Natrix helvetica*, *N. natrix*). *Scientific Reports*, 8:1821.
- Koskinen, M.T., Nilsson, J., Veselov, A.J., Potutkin, A.G., Ranta, E., Primmer, C.R. (2002). Microsatellite data resolve phylogeographic patterns in European grayling, *Thymallus thymallus*, Salmonidae. *Heredity*, 88:391–401.
- Krantz, D.E. (1991). A chronology of Pliocene sea-level fluctuations: The U.S. Middle Atlantic Coastal Plain record. *Quaternary Science Reviews*, 10:163–174.
- Krijgsman, W., Hilgen, F.J., Raffi, I., Sierro, F.J., Wilson, D.S. (1999). Chronology, causes and progression of the Messinian salinity crisis. *Nature*, 400:652–655.
- Landis, M.J., Matzke, N.J., Moore, B.R., Huelsenbeck, J.P. (2013). Bayesian Analysis of Biogeography when the Number of Areas is Large. *Systematic Biology*, 62:789–804.
- Lanfear, R., Calcott, B., Ho, S. Y. & Guindon, S. PartitionFinder: combined selection of partitioning schemes and substitution models for phylogenetic analyses. *Mol. Biol. Evol.* **29**, 1695–1701 (2012).

- Larget, B., Simon, D.L. (1999). Markov Chain Monte Carlo Algorithms for the Bayesian Analysis of Phylogenetic Trees. *Molecular Biology and Evolution*, 16:750-759.
- Lawson, R., Slowinski, J.B., Crother, B.I., Burbrink, F.T. (2005). Phylogeny of the Colubroidea (Serpentes): New evidence from mitochondrial and nuclear genes. *Molecular Phylogenetics and Evolution*, 37:581–601.
- Leigh, J.W., Bryant, D. (2015). POPART : full-feature software for haplotype network construction. *Methods in Ecology and Evolution*, 6:1110–1116.
- Lewis, P.O. (2001). Phylogenetic systematics turns over a new leaf. *Trends in Ecology & Evolution*, 16:30–37.
- Li S. (1996). Phylogenetic tree construction using Markov chain Monte Carlo. Ph. D. Dissertation, Ohio State University.
- Librado, P. & Rozas, J. DnaSP v5: a software for comprehensive analysis of DNA polymorphism data. *Bioinformatics*. **25**, 1451–1452 (2009).
- Lisiecki, L.E., Raymo, M.E. (2007). Plio–Pleistocene climate evolution: trends and transitions in glacial cycle dynamics. *Quaternary Science Reviews*, 26:56–69.
- Mace GM. (2004). The role of taxonomy in species conservation. *Philosophical Transactions of the Royal Society of London. Series B : Biological Sciences*, 359:711–719.
- Maddison, W. P. and D.R. Maddison. (2018). Mesquite: a modular system for evolutionary analysis. Version 3.51 <http://www.mesquiteproject.org>.
- Malek-Mohammadi, A., Rastegar-Pouyani, E. & Todehdehghan, F. Genetic relationship between different populations of the *Gloydius halys caucasicus* (Nikolsky 1916) of mountainous areas of the Iran. *SCIREA J. Agr.* **1**, 214–230 (2017).
- Matzke, N.J. (2013). Probabilistic historical biogeography: new models for founder- event speciation, imperfect detection, and fossils allow im- proved accuracy and model-testing. *Frontiers of Biogeography*, 5.
- Matzke, Nicholas J. (2016). 'BioGeoBEARS deals with "Founder-event speciation" not "founder-effect speciation."' PhyloWiki essay, 2016-08-07. <http://phylo.wikidot.com/biogeobears-deals-withfounder-event-speciation-not-founder>.
- Mau B. & Newton M. (1997). Phylogenetic inference for binary data on dendrograms using Markov chain Monte Carlo. *Journal of Computational and Graphical Statistics*, 6:122-131.
- Mau, B., Newton, M.A., Larget, B. (1999). Bayesian Phylogenetic Inference via Markov Chain Monte Carlo Methods. *Biometrics* 55, 1–12.
- Moritz C. (1994). Defining ‘evolutionarily significant units’ for conservation. *Trends in Ecology and Evolution*, 9:373–375.
- Mozafari, S. Z., Shiravi, A. & Todehdehghan, F. Evaluation of reproductive parameters of vas deferens sperms in Caucasian snake (*Gloydius halys caucasicus*). *Vet. Res. For.* **3**, 119–123 (2012).
- Nagy, Z.T., Lawson, R., Joger, U., Wink, M. (2004). Molecular systematics of racers, whipsnakes and relatives (Reptilia: Colubridae) using mitochondrial and nuclear markers. *Journal of Zoological Systematics and Evolutionary Research*, 42:223–233.
- Nebel, C., Gamauf, A., Haring, E., Segelbacher, G., Villers, A., Zachos, F.E. (2015). Mitochondrial DNA analysis reveals Holarctic homogeneity and a distinct Mediterranean lineage in the Golden eagle (*Aquila chrysaetos*). *Biological Journal of the Linnean Society*, 116:328–340.
- Orlov, N. L. & Barabanov, A. V. Analysis of nomenclature, classification, and distribution of the *Agkistrodon halys*–*Agkistrodon intermedius* complexes: a critical review. *Russ. J. Herpetol.* **6**, 167–192 (1999).

- Orlov, N. L., Sundukov, Y. N. & Kropachev, I. I. Distribution of pitvipers of *Gloydius blomhoffii* complex in Russia with the first records of *Gloydius blomhoffii blomhoffii* at Kunashir Island (Kuril archipelago, Russian Far East). *Russ. J. Herpetol.* **21**, 169–178 (2014).
- Rajabizadeh, M., Javanmardi, S., Rastegar-Pouyani, N., Karami, R., n.d. Geographic Variation, Distribution, and Habitat of *Natrix tessellata* in Iran 17.
- Rajaei Sh, H., Rödder, D., Weigand, A.M., Dambach, J., Raupach, M.J., Wägele, J.W. (2013). Quaternary refugia in southwestern Iran: insights from two sympatric moth species (Insecta, Lepidoptera). *Organisms Diversity and Evolution*, 13:409–423.
- Rambaut A, Drummond AJ. (2007). Tracer v1.5. <http://tree.bio.ed.ac.uk/software/tracerOxford>.
- Rambaut, A., Drummond, A. J., Xie, D., Baele, G. & Suchard, M. A. Posterior summarisation in Bayesian phylogenetics using Tracer 1.7. *Syst. Biol.* **67**, 901–904 (2018).
- Rambaut, A., Suchard, M.A., and Drummond, A.J. (2014). Tracer 1.6. <http://tree.bio.ed.ac.uk/software/tracer/>.
- Randi, E. (2007). Phylogeography of South European mammals. In *Phylogeography of Southern European Refugia* (pp. 101 – 126). Springer, Dordrecht.
- Rannala, B., & Yang, Z. (1996). Probability Distribution of Molecular Evolutionary Trees: A New Method of Phylogenetic Inference. *Journal of Molecular Evolution*, 43:304–311.
- Rastegar-Pouyani, E., Ebrahimipour, F., Hosseinian, S. (2017). Genetic variability and differentiation among the populations of Dice snake, *Natrix tessellata* (Serpentes, Colubridae) in the Iranian Plateau. *Biochemical Systematics and Ecology*, 72:23–28.
- Rastegar-Pouyani, E., Oraie, H., Khosravani, A. & Akbari, A. Phylogenetic position of Iranian pitvipers (Viperidae, Crotalinae, *Gloydius*) inferred from mitochondrial cytochrome *b* sequences. *Trop. Zool.* **31**, 55–67 (2018).
- Ree, R.H., Smith, S.A. (2008). Maximum Likelihood Inference of Geographic Range Evolution by Dispersal, Local Extinction, and Cladogenesis. *Systematic Biology*, 57:4–14.
- Ronce O. (2007). How does it feel to be like a rolling stone ? Ten questions about dispersal evolution. *Annual Review of Ecology, Evolution and Systematics*, 38:231–253.
- Ronquist, F. & Huelsenbeck, J. P. MrBayes 3: Bayesian phylogenetic inference under mixed models. *Bioinformatics.* **19**, 1572–1574 (2003).
- Ronquist, F. (1997). Dispersal-vicariance analysis: a new approach to the quantification of historical biogeography. *Systematic Biology*, 46:195–203.
- Rozas, J., Ferrer-Mata, A., Sánchez-DelBarrio, J.C., Guirao-Rico, S., Librado, P., Ramos-Onsins, S.E., Sánchez-Gracia, A. (2017). DnaSP 6: DNA Sequence Polymorphism Analysis of Large Data Sets. *Molecular Biology and Evolution*, 34:3299–3302.
- Ryder, O.A. (1986). Species conservation and systematics : the dilemma of subspecies. *Trends in Ecology and Evolution*, 1:9–10.
- Schweiger, M., 1991. *Coluber ravergeri* Menetries, 1832-eine ungewöhnliche Zornnatter. *Herpetofauna*, 13, p.70.
- Shakoori, S., Todehdeghan, F., Shiravi, A. & Hojati, V. The assessment of captive breeding in the Caucasian viper (*Gloydius halys caucasicus*) in Iran. *J. Entomol. Zool. Stud.* **3**, 257–259 (2015).
- Shi, J. *et al.* (2017). A new moth-preying alpine pit viper species from Qinghai-Tibetan Plateau (Viperidae, Crotalinae). *Amphibia-Reptilia.* **38**, 517–532.
- Shi, J., Yang, D., Zhang, W. & Ding, L. (2016). Distribution and infraspecies taxonomy of *Gloydius halys*-*Gloydius intermedius* complex in China (Serpentes: Crotalinae). *Chin. J. Zool.* **51**, 777–798
- Simonov, E. & Wink, M. Population genetics of the Halys pit viper (*Gloydius halys*) at the northern distribution limit in Siberia. *Amphibia-Reptilia.* **33**, 273–283 (2012).

- Simonov, E. Differences in habitat use, daily activity patterns and preferred ambient temperatures of adult and neonate *Gloydius halys halys* from an isolated population in southwest Siberia: preliminary data. *Herpetol. Notes*, **2**, 1–7 (2009).
- Sindaco, R., Venchi, A., Grieco, C. (2013). The Reptiles of the Western Palearctic. 2. Annotated Checklist and Distributional Atlas of the Snakes of Europe, North Africa, Middle East and Central Asia. . Latina, Italy: Edizioni Belvedere. 543 pp.
- Steininger, F.F., Rögl, F. (1984). Paleogeography and palinspastic reconstruction of the Neogene of the Mediterranean and Paratethys. Geological Society, London, Special Publication, 17:659–668.
- Stewart, J.R., Lister, A.M., Barnes, I., Dalén, L. (2010). Refugia revisited: individualistic responses of species in space and time. *Proceedings of the Royal Society B: Biological Sciences*, **277**:661– 671.
- Stümpel, N., Rajabizadeh, M., Avcı, A., Wüster, W., Joger, U. (2016). Phylogeny and diversification of mountain vipers (*Montivipera*, Nilson *et al.*, 2001) triggered by multiple Plio–Pleistocene refugia and high-mountain topography in the Near and Middle East. *Molecular Phylogenetics and Evolution*, **101**:336–351.
- Suchard, M.A., Lemey, P., Baele, G., Ayres, D.L., Drummond, A.J., Rambaut, A. (2018). Bayesian phylogenetic and phylodynamic data integration using BEAST 1.10. *Virus Evolution*, **4**.
- Taberlet, P., Fumagalli, L., Wust-Saucy, A., Cosson, J. (1998). Comparative phylogeography and postglacial colonization routes in Europe. *Molecular Ecology*, **7**:453–464.
- Tamar, K., Šmíd, J., Göçmen, B., Meiri, S., Carranza, S. (2016). An integrative systematic revision and biogeography of *Rhynchocalamus* snakes (Reptilia, Colubridae) with a description of a new species from Israel. *PeerJ*, **4**, e2769.
- Tamura, K., Stecher, G., Peterson, D., Filipski, A., Kumar, S. (2013). MEGA6: Molecular Evolutionary Genetics Analysis Version 6.0. *Molecular Biology and Evolution*, **30**:2725–2729.
- Tavaré S. (1986). Some probabilistic and statistical problems in the analysis of DNA sequences. *Lectures on mathematics in the life sciences*, **17**:57-86.
- van Dam, J.A. (2006). Geographic and temporal patterns in the late Neogene (12–3 Ma) aridification of Europe: The use of small mammals as paleoprecipitation proxies. *Palaeogeography, Palaeoclimatology, Palaeoecology*, **238**:190–218.
- Wagner, P., Tiutenko, A., Mazepa, G., Borkin, L. J. & Simonov, E. Alai! Alai! –a new species of the *Gloydius halys* (Pallas, 1776) complex (Viperidae, Crotalinae), including a brief review of the complex. *Amphibia-Reptilia*, **37**, 15–31 (2016).
- Wallach, V., Williams, K.L. & Boundy, J., 2014. *Snakes of the world: a catalogue of living and extinct species*, CRC Press.
- Weiperth, A., Gaebele, T., Potyó, I., Puky, M. (2014). A global overview on the diet of the dice snake (*Natrix tessellata*) from a geographical perspective: foraging in atypical habitats and feeding spectrum widening helps colonisation and survival under suboptimal conditions for a piscivorous snake. *Zoological Studies*, **53**:42.
- Yang, Z., Rannala, B. (1997). Bayesian phylogenetic inference using DNA sequences: a Markov Chain Monte Carlo Method. *Molecular Biology and Evolution*, **14**:717–724.
- Zagwijn, W.H. (1985). An outline of the Quaternary stratigraphy of the Netherlands. *Geologie en Mijnbouw*, **64**:17-24.

Chapter 4 :

Bioclimatic models forecast 50-years decrease in climatic suitability for Iranian mountain snakes

Résumé en français:

Durant les deux dernières décennies, les tentatives de documenter et prédire les effets des changements climatiques actuels sur la biodiversité se sont multipliées de manière spectaculaire. Pourtant, des déficits de connaissance sur les distributions géographiques persistent dans des régions peu accessibles ou pour des espèces difficiles à échantillonner (le “biais wallacéen”). Pour ces régions et ces espèces, les modèles de distribution jouent un double rôle : orienter l’acquisition de données afin d’améliorer les connaissances sur les aires géographiques des espèces concernées et leurs déterminants (notamment aux marges), et élaborer des hypothèses testables quant à leur dynamique au regard des scénarios climatiques à court terme (quelques décennies). En l’absence de données protocolées permettant de calibrer des modèles de distributions mécanistes, la seule solution pour produire de telles prédictions est de se reposer sur des corrélations entre les distributions observées des espèces et des variables pertinentes d’un point de vue biologique. Cette approche par modèles corrélatifs de distributions (dans le présent texte “SDM”) est très utilisée, ne serait-ce que parce qu’elle est souvent la seule possible au regard des données disponibles. Les SDM restent cependant des outils limités à utiliser avec précaution, en particulier lorsque l’écologie des taxa étudiés est mal connue ou les données déficientes. Premièrement, ces modèles, basés sur des méthodes de régression ou de classification, ne créent aucune relation causale entre les prédicteurs et la distribution de l’espèce. En particulier, les prédicteurs climatiques, qui sont les plus fréquemment utilisés, posent problème pour de nombreux taxa dont la réponse au climat est indirecte, à large échelle spatiale et sur un pas de temps long – donc en déconnexion avec les prédictions de court terme généralement attendues de ces modèles. La forte autocorrélation spatiale qui caractérise les gradients spatiaux écologiques tend de plus à créer des corrélations fortuites entre les distributions d’espèces et toute variable structurée spatialement. Enfin, les SDM climatiques font des hypothèses forte sur la stationarité temporelle de la niche, la qualité du climat comme proxy de facteurs non climatiques, l’exhaustivité d’échantillonnage des gradients écologiques et la nature des données d’absence (ou de leur déficit). Malgré ces limites fortes qui doivent être prises en compte à chaque étape de la construction et de l’interprétation d’un SDM, ces modèles ont un intérêt pragmatique de par la facilité de leur construction qui en fait un outil prédictif utile à titre préliminaire. Je les utilise ici pour établir une première prédiction comparative des zones climatiquement favorables à sept espèces de serpents sous plusieurs scénarii climatiques à 50 et 70 ans vers le futur.

Cette étude incorpore deux hotspots de biodiversité d’intérêt continental : la zone Irano-Anatolienne et le Caucase. La région étudiée est de plus structurée par cinq aires d’endémisme

majeures, associées aux cinq grandes chaînes de montagne qui traversent l'Iran: l'Alborz, le Zagros, le Kopet Dagh, la chaîne d'Azerbaïdjan, et le massif iranien central. En l'absence d'échantillonnage systématique de type atlas, les données disponibles pour prédire la distribution des sept espèces étudiées dans cette région consistent en des occurrences récoltées de manière opportuniste, sans protocole ni indication d'absences.

Notre approche méthodologique est structurée en quatre étapes :

Modéliser les distributions d'espèces dans les conditions climatiques actuelles à partir de modèles de processus ponctuels (interface MaxEnt) incorporant sept descripteurs climatiques issus de WorldClim et choisis pour leur pertinence au regard des éléments connus de la biologie des espèces ;

Projeter les enveloppes climatiques ainsi obtenues sur un scénario climatique à 2070 (moyenne de 2060-2080) ans basés sur des modèles de circulation générale (GCM) et une sélection de voies de concentration représentatives (RCP), afin d'obtenir une prédiction spatialisée des zones climatiquement favorables aux espèces tout en maîtrisant l'incertitude liée aux prédicteurs ;

Quantifier le changement altitudinal prédit de la zone climatique favorable pour chaque espèce afin d'identifier les limites topographiques aux possibilités de mouvement des aires de distributions ;

Estimer le recouvrement de ces zones climatiquement favorables par le réseau actuel des espaces protégés iraniens.

Les SDM nous conduisent à prédire des restrictions des zones climatiquement favorables de 42 à 91 % par rapport aux aires actuelles pour tous les scénarii de changements climatiques testés (52-72% sous le scénario de changement climatique le plus faible, 50-91% pour le scénario de changement le plus fort). Les gammes altitudinales favorables devraient remonter pour cinq espèces et descendre pour deux espèces. Enfin, nos modèles nous conduisent à prédire une réduction de la couverture des aires de nos sept espèces par le réseau d'espaces protégés allant de 26 à 60% en fonction des scénarios.

Ces résultats sont à prendre comme des prédictions très préliminaires affectées par des données de distributions faibles auxquelles se surajoutent les limites déjà discutée ci-dessus. Ils constituent cependant la seule prédiction disponible de l'impact du changement climatique en cours sur les espèces étudiées, tenant compte des connaissances parcellaires sur cette région et ces espèces. Tenant compte de cette limite, nous proposons les conclusions préliminaires suivantes. Premièrement, la plupart des espèces étudiées devraient connaître des réductions

drastiques de leur espace climatiquement favorable, tant en aire qu'en altitude, dans les prochaines décades. Ces résultats rendent nécessaire l'acquisition de données de distribution plus précises et plus systématiques, incluant des données d'absence et de démographie, afin d'affiner les relations espèces-climat. Une acquisition de données sur les habitats, l'utilisation des sols par l'homme, et des scénarios sur leur devenir dans les 40 à 80 prochaines années est aussi une étape nécessaire en vue de projections plus réalistes. Ces données et ces projections sont pour l'heure inexistantes et limitent donc la capacité à incorporer les dimensions non-climatiques de la niche des serpents dans les SDM. Une autre perspective centrale sera d'étudier la capacité des serpents à suivre les changements climatiques par dispersion et / ou à s'accomoder de ces changements sans modification de leur aire – c'est à dire, d'étudier à la fois leur résistance, leur résilience et leur plasticité face aux changements. Cet aspect est d'autant plus majeur que plusieurs espèces étudiées ici sont restreintes aux montagnes iraniennes : en l'absence de tels processus, on peut craindre la perte d'une biodiversité unique à relativement court terme.

Nos modèles révèlent par ailleurs que le réseau actuel d'aires protégées est peu adéquat pour garantir le futur des espèces étudiées, sous l'hypothèse que le climat est un facteur majeur de leurs distributions. Il sera nécessaire de croiser cette prédiction avec d'autres études portant sur d'autres taxat afin de définir l'ampleur des modifications nécessaires pour adapter le réseau d'aires protégées iranien aux changements attendus, tout en tenant compte des interférences avec des facteurs indépendants du climat (utilisation des sols par l'homme, facteurs socio-économiques, topographie, habitat ...).

En conclusion, il nous paraît avant toute chose nécessaire de remédier au déficit généralisé de données sur les distributions des reptiles iraniens et sur leur écologie. En ce sens, nos résultats sont clairement préliminaires et pointent vers la nécessité d'échantillonnages protocolés et systématiques spécifiquement dédiés à la modélisation de niche, en incluant des dimensions non-climatiques. Un gros travail de scénarisation de l'utilisation des sols sera, à cette fin, nécessaire. Nous espérons que cette étude permettra de stimuler de tels programmes de terrain, et attirera l'attention sur les menaces posées par le changement climatique sur des espèces pour lesquelles l'Iran a une responsabilité particulière, ainsi que, de manière plus générale, sur toutes les espèces affectées par le biais Wallacéen.

In preparation for "Animal Conservation "

Bioclimatic models forecast 50-years decrease in climatic suitability for Iranian mountain snakes

Atefeh Asadi^{1*}, Mohammad Kaboli², Masoud Nazarizadeh², Claudine Montgelard^{1,3}, Jean-Yves Barnagaud¹

¹CEFE, University Montpellier, Univ Paul Valéry Montpellier 3, PSL-EPHE (Biogéographie et Ecologie des Vertébrés), CNRS, IRD, Montpellier, France.

²Department of Environmental Science, Faculty of Natural Resources, University of Tehran, Karaj, Iran.

³Centre for Ecological Genomics and Wildlife Conservation, Department of Zoology, University of Johannesburg, Johannesburg, South Africa.

Correspondence and requests for materials should be addressed to Atefeh Asadi (email: Santa.asadi@gmail.com)

4.1.Introduction:

A multitude of studies have documented and forecasted the effects of climate change on biodiversity at multiple spatial and temporal scales (Parmesan, 2006; Bellard *et al.*, 2014). Notwithstanding this abundant literature, knowledge gaps still remain because of data limitations on the geographic distribution of many species, especially outside the western Palearctic and Nearctic biomes (“the Wallacean shortfall”, Lomolino, 2004; Hortal *et al.*, 2015). A direct result is the lack of forecast on climate change effects for some of the earth’s major biodiversity hotspots, such as the biogeographic transition regions found in the mountains of the Middle-East and Central Asia. This gap needs to be solved as these regions host a wide range of species at high conservation risk due to scarcity, endemism or cultural values (Ramanamanjato *et al.*, 2002). Filling the Wallacean shortfall is just as crucial to clarifying broad-scale ecological patterns and predicting their changes under climate-change scenarios (Hortal *et al.*, 2015), justifying high sampling efforts assisted with statistical modeling to face the paucity of available data. In these regions, species’ presence data are rarely derived from purposive surveys and mostly rely on random observations, opportunistic and scattered sightings, museum repositories or databases of occurrence records. In addition, uneven survey efforts in less accessible areas (Varela *et al.*, 2014) or areas with limited naturalistic value result in highly biased datasets (Dennis and Thomas, 2000), which is commonly known as survey bias or sampling bias.

Global ecological patterns are shaped by climate along elevational and latitudinal gradients (Humboldt, 1807; Merriam, 1894; Francis and Currie, 2003; Willig *et al.*, 2003). As a result, climate data range amongst the most commonly used sources for predicting species distributions. Nevertheless, distributions are mediated by a complex interplay between a combination of climate and non-climate factors (e. g. biotic interactions, dispersal, micro-habitat availability, human land use) (Sexton *et al.*, 2009; Journé *et al.*, 2019). Therefore, species' distributional dynamics may not be directly under climatic determinism, rendering causal associations highly uncertain. In turn, this mismatch between the climatic niche of a species and its geographical realization increases uncertainty on distribution forecasts based on bioclimatic models (Sofaer *et al.*, 2018). For instance, climate-only models may be more relevant to ectothermic than endothermic species, even though impacts of non-climate factors such as habitat or prey availability may blur their signal or be misinterpreted as climatic effects in both (see more Parmesan, 2007). As a result, the hypothesis that climate change is a major cause of declines in vertebrates such as reptiles and amphibians remains difficult to test without making a number of assumptions on covariations between climatic and non-climatic factors (Coreau *et al.*, 2009).

Predictions of future species distributions using climate change scenarios may be performed through correlative and mechanistic species distribution models (Jarnevich *et al.*, 2015). Mechanistic approaches represent species responses (e.g. phenology, growth, reproduction and survival) to climatic changes explicitly through diffusion equations. Obtaining the data needed to calibrate such models is difficult, which makes them unrealistic for poorly known species and regions with scarce data and minimal understanding of ecological processes (Journé *et al.*, 2019). Alternatively, correlative species distribution models (cSDMs) have been extensively used for a vast array of taxa and at different geographic scales (Thomas *et al.*, 2004; Pereira *et al.*, 2010; Thuiller *et al.*, 2011). These models make no causal assumption about the role of climate on species distributions but rely on the high correlation usually observed between climatic variables and species range limits (e.g. Guisan and Thuiller, 2005; Morin *et al.*, 2007). These models suffer from a number of drawbacks and limitations (e.g. spatial autocorrelation issues, lack of relevant predictors, uncertainty in the role of climate, unmodelled non-climatic processes, and the assumption that correlations between climate and distributions are stationary in space and time) (Austin *et al.*, 2006; Fourcade *et al.*, 2014; Journé *et al.*, 2019). Nevertheless, because of the complexity of species distribution drivers and limited availability of data directly representing these processes, cSDMs often remain the only solution to predict distribution

patterns in undersampled countries and taxa where the paucity of environmental and distribution data renders more complex models intractable.

In many cases, building cSDMs carefully and accepting the resulting uncertainty is therefore a critical preliminary step, or even the only way to forecast the future of undersampled species and regions over the next 50 to 100 years of climate change. To achieve biologically reasonable predictions in the absence of causal predictors, climatic variables must be selected based on hypotheses on relevant ecophysiological processes, and the scale of studies must suit the organisms and processes of interest (Austin *et al.*, 2010). Assessing the biological importance of climatic variables and understanding their impact on species range limits is however a challenge, especially for poorly surveyed species (Coreau *et al.*, 2009). In addition, for most data-deficient species or areas, presence-only data are the only resource available to depict species distributions, which imposes the use of point-process models such as MaxEnt (Renner *et al.*, 2015; Phillips *et al.*, 2006; Elith *et al.*, 2006). These models offer an imperfect, yet pragmatic way to predict the fate of species facing climate change even though the lack of absence data requires strong hypotheses on areas without records, which may be due either to lack of presence or lack of sampling. In such situations, expert knowledge is therefore essential to verify the critical assumption of point process models that the environmental (and in particular, climatic) envelope of targeted species is sampled representatively.

Marked declines of reptile and amphibian populations have been reported worldwide and attributed to direct and indirect effects of current climate change (Gibbons *et al.*, 2000; Blaustein *et al.*, 2001; Pounds *et al.*, 2006; Bosch *et al.*, 2007). It has been predicted that by 2080, some 20% of species of lizards may suffer partial or entire loss of their current range (Sinervo *et al.*, 2010, for controversial discussion, see Clusella-Trullas and Chown, 2011). Since sex determination and incubation success in most reptile species are temperature-dependent (Janzen, 1994; Godfrey *et al.*, 1999, Mitchell and Janzen, 2010; Neuwald and Valenzuela, 2011), climate change could directly modify population structures through ecophysiological processes, possibly leading to local extinction (but see Clusella-Trullas and Chown, 2011). Knowledge on reptile distributions remains however sparse due to their overall scarcity, high diversity in poorly surveyed areas and difficulties in sampling through systematic designs (Böhm *et al.*, 2013). In spite of this drastic limitation in data availability, conservation threats imply an urgent need for studies addressing the distributional impacts of climate change on reptiles, focusing on range-restricted species or on those that lie at climatic or biogeographic margins, where endemism rates are high.

Species in high endemism areas are particularly expected to be more vulnerable to climate change and global warming because of range restriction, dispersal limitations and high level of specialization (Médail and Quézel, 1999; Myers *et al.*, 2000; Mittermeier *et al.*, 2005). Iran is specifically notable for its richness of endemics (Eskandarzadeh *et al.*, 2018), with 10 of 83 Iranian snakes being strictly restricted and endemic to Iran. This remarkable herpetofaunal diversity is largely explained by Iran's geographic location, at the meeting point of several biogeographic regions (Palearctic, Oriental and Afrotropical), and topography which triggers high climatic and ecological variability over relatively short spatial gradients. Iran is located at the intersection of three climatic zones: the temperate humid/semi-humid Caspian, the Mediterranean, and the arid West Asian zones (Malek-Hosseini and Zamani, 2017). The Iranian Plateau comprises parts of two globally important hotspots, the Irano-Anatolian and the Caucasus (Mittermeier *et al.*, 2005) (Fig 4.1.1). In addition, Iran encompasses five major areas of endemism (Zagros, Alborz, Azerbaijan, Kopet Dagh and Central mountains of Iran) (Noroozi *et al.*, 2018). Among the 10 endemic Iranian snakes, nine are distributed in the Zagros Mountains, and one, *Montivipera latifi*, inhabits the Alborz Mountains (Rajabizadeh, 2017). To date, 83 snake species have been identified in Iran, of which 46 and 36 occur in the Zagros and Alborz Mountains, respectively and about 12 species are found in both.

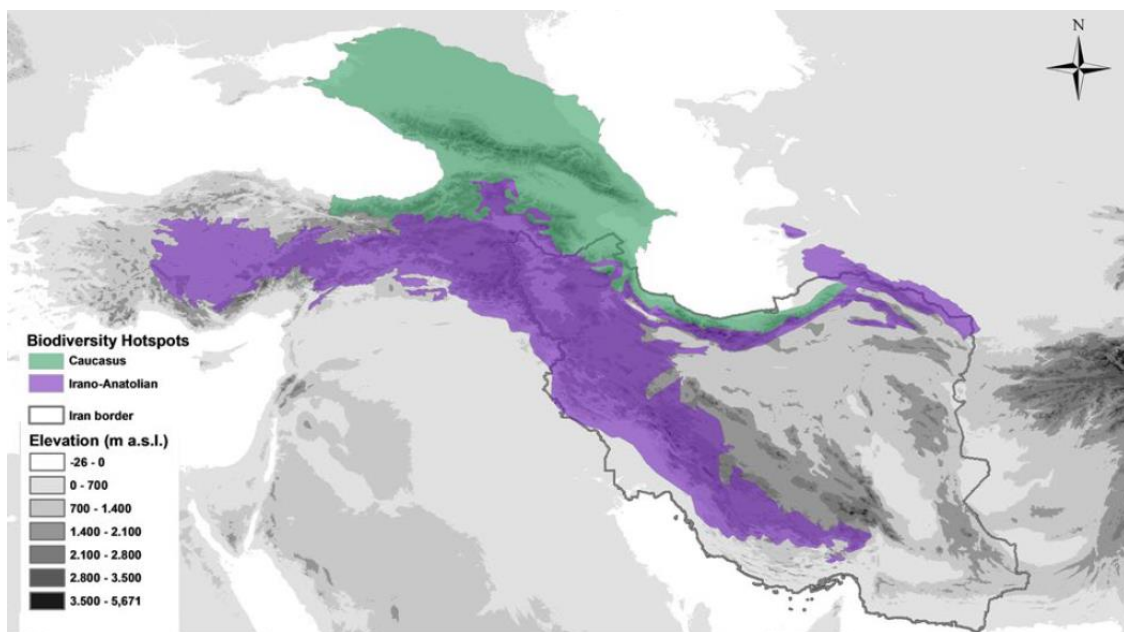

Figure 4.1.1. Global biodiversity hotspots: the Irano-Anatolian and the Caucasus biodiversity hotspots.

The number of reptile species reported in Iran is increasing rapidly, with 31 newly described species between 2000 and 2014 (see Safaei-Mahroo *et al.*, 2015 for review). Nonetheless, reptile distributional data in Iran are scarce and mainly based on opportunistic records and sporadic field surveys, rendering unfeasible the presence-absence based cSDM usually employed to forecast climate change effects on better known taxa or regions. As a result, only a handful of studies have been conducted on how some reptile species in Iran respond to climatic changes, and suggest distributional shifts (Hosseinian Yousefkhani *et al.*, 2013; Oraie *et al.*, 2014; Yousefi *et al.*, 2015; Kafash *et al.*, 2016; Hosseinian Yousefkhani *et al.*, 2016; Hosseinian Yousefkhani *et al.*, 2017; Rounaghi and Hosseinian Yousefkhani, 2018; Hosseinian Yousefkhani, 2019). Because of the cardinal importance of these mountains to biodiversity and endemism and because we suspect the effect of climatic fluctuations will be substantial on the reptilian diversity of Iran, it remains essential to build cautious cSDM based on this rare and fragmented information as an initial hypothesis on species' status. Preliminary forecasts of future changes in climatically suitable areas, stemming from these models, may orient dedicated data collection and conservation measures.

As a contribution to this aim, we performed one of the first multi-species comparative forecasts of changes in climatically suitable areas for Iranian reptiles, relying on the best available data. For the first time in Iran, the present research investigated the distribution of a guild of mountain Iranian snakes. The specific questions asked in this study are: (i) Which climatic variables best explain Iranian snakes' distributions? (ii) What changes in climatically suitable areas are expected for these species with regard to the climate scenarios and distribution data available, and (iii) Will the current network of Iranian protected areas still cover these forecasted suitable areas?

4.2. Material and methods:

Our methodological approach in this study is structured into four steps: (i) model species distributions under present-day conditions with MaxEnt and estimate species' current climatic envelopes; (ii) forecast the geographic projection of these climate envelopes under climate change scenarios based on general circulation models (GCMs) and a selection of representative concentration pathways (RCPs); (iii) quantify species' projected altitudinal shifts by comparing their present distributions and modeled forecasts, and (iv) evaluate the effectiveness of the current Iranian network of protected areas.

4.2.1. Study area

Iran is situated at the crossroads of three major biogeographical regions (Irano-Turanian, Saharo-Sindian and Euro-Siberian) (Djamali *et al.*, 2011), which correspond to three macrobioclimates (Mediterranean, tropical and temperate) in Iran (Rivas-Martínez, 1997). Our study area encompassed parts of two biodiversity hotspots; the Irano-Anatolian and the Caucasus. Within the Irano-Anatolian hotspot, which is home to a great number of endemic species (Gholamifard and Rastegar-Pouyani 2012), five areas of endemism have been identified (Noroozi *et al.*, 2018). These areas correlate with the five major ranges of Iran that were included in the study area: Alborz in the north, Zagros in the west and south-west, Kopet Dagh in the north-east, Azerbaijan in the northwest, and Central Iran mountains (Fig. 4.2.1.1). In Iran, the Irano-Anatolian hotspot covers the Zagros, Azerbaijan, south-facing slopes of the Alborz, as well as parts of the Kopet Dagh and Central Iran mountains. Its continental climate causes marked variability in annual precipitation (100 to 1500 mm/annum) (Asouti and Kabukcu, 2014). At high elevations of the Zagros (2,000 to over 4,000 m), much of the precipitation occurs in the form of snow in late autumn, winter and early spring (Noroozi *et al.*, 2008). Mean annual temperature of the Zagros varies from 11°C in northwestern Zagros to 25°C in southwestern Zagros. The Caucasus hotspot in Iran comprises the Alborz Mountains, especially the northern slopes, where elevation varies from 26 m below sea level at the Caspian Sea to 5671 m above sea level at Mt. Damavand, Iran's highest peak. The highest annual precipitation in Iran is received by the Caspian lowlands (>1,000 mm/annum, maximum 1,800 mm/annum) and high peaks of the Alborz (1400 mm/annum) (Ehlers 1980). The Alborz has a mean annual temperature between 15 and 18°C, increasing from west to east.

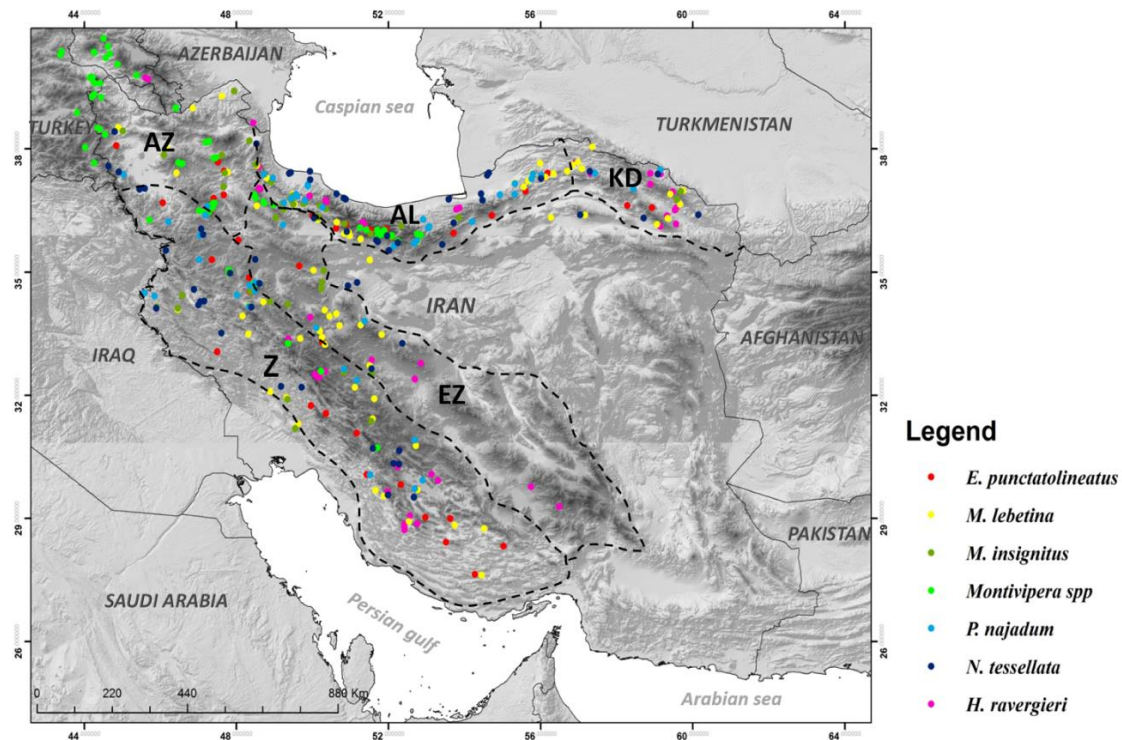

Figure 4.2.1.1. The study area along the Alborz (AL), Zagros (Z), mountains of Central Iran (EZ), Azerbaijan (AZ) and Kopet Dagh Mountains (KD), and location of reptile records used in the study. Background source: ESRI (available online at: <http://www.esri.com/>).

4.2.2. Data sets

Among the species distributed in the two studied regions, we selected a total of 7 species with sufficient data on their occurrences to expect a meaningful representation of climate-distribution correlations (threshold set arbitrarily at 30 records based on prior experience). We identified five species in the Colubridae family: *Platyceps najadum* (n=52 records), *Natrix tessellata* (n=59 records), *Malpolon insignitus* (n=44 records), *Hemorrhoids ravergieri* (n=55 records), and *Eirenis punctatolineatus* (n=34 records). We also added two Viperidae: *Macrovipera lebetia* (n= 74 records) and *Montivipera raddei* species complex (n= 80 records). The seven species selected for the present study are described briefly in Appendix 4.2. No presence/absence atlas is available for Iranian snakes. We thus had to rely on opportunistic presence-only data obtained during fieldwork sessions from 2015 to 2019 (278 records), complemented by previous field studies conducted by other Iranian herpetologists mostly over the last decade (120 records). We combined records of a given species when separated by less than 500 m to reduce spurious autocorrelation effects and risk of double-counting. We also

discarded occurrence records outside the known limits of species ranges in order to remove misidentified records.

4.2.3. Bioclimatic data

We downloaded a total of 19 raster-based climatic variables representative of the 1960 – 1990 period from the WorldClim database (Hijmans *et al.*, 2005: <http://www.worldclim.org/>) with a spatial resolution of about 1 km² to estimate current species' climatic envelopes. Among these, we selected seven uncorrelated climatic variables for which we had a biological expectation (see Clusella-Trullas *et al.*, 2011; Salas *et al.*, 2017) regarding their role on snake species' distributions (Table 4.2.3.1). When our biological hypotheses led us to select two correlated variables, we retained the one with the most likely direct effect on snake distributions. In so doing, we ensured that our distribution models had a biological justification and were not affected by collinearity among variables (Journé *et al.*, 2019). As a cautionary principle, we also calculated variance inflation factors (VIF; Naimi, 2014) to test for the impact of multi-collinearity on our distribution models. VIF values remained below the conventional value of 10 (max = 3.28 for Bio15 and min = 1.67 for Bio2), ensuring that we could use the seven selected variables for inference of species distribution.

4.2.4. Climatic scenarios

Based on previous studies evaluating the performances of climatic models (see e.g. Taylor *et al.*, 2012; Salas *et al.*, 2017), our selected dataset consisted of three of the climate projections from global climate models (GCMs) of the Intergovernmental Panel on Climate Change (IPCC5). The three GCMs included Community Climate System Model version 4 (CCSM4; Gent *et al.*, 2011), Max Planck Institute Earth System Model (MPI-ESM; Block and Mauritsen, 2013), and Model for Interdisciplinary Research on Climate version 5 (MIROC5; Watanabe *et al.*, 2010), which are the most recent GCM climate projections used in the Fifth Assessment IPCC report.

For future scenarios, we employed two contrasting datasets of assumptions about future atmospheric concentration pathways of greenhouse gases and other atmospheric components, provided at 30-seconds (of a longitude/latitude degree) spatial resolution (about 900 m at the equator) and downscaled by WorldClim (Hijmans *et al.*, 2005). Raster data for the two RCPs were obtained for all GCMs and for the year 2070 (average of 2060 to 2080). Eventually, RCP 2.6 was selected as it strictly offers the lowest projected greenhouse gas emissions (Roeckner

et al., 2010; Arora *et al.*, 2011), whereas RCP 8.5 scenario postulates dramatic increases in the projected concentration and emission of greenhouse gases (Vuuren *et al.*, 2011), followed by consequent warming of global surfaces (Knutti and Sedláček, 2013).

Table 4.2.3.1. List of seven bioclimatic variables used to develop bioclimatic-envelope models, their average, maximum, minimum, and standard deviations in Iran. The abbreviation Temp. stands for temperature. Variable names, acronyms and descriptions are provided by the WorldClim database (Hijmans *et al.*, 2005).

Variable	Description	Temporal Scale	Mean	Max.	Min.	Std. Dev.
	Mean Diurnal					
Bio2	Temperature range (Mean of monthly (max temp - min temp) *10 (°C))	Variation	138.5	182	63	21.45
Bio4	Temperature Seasonality (standard deviation *100)	Variation	8364.14	11317	3878	1192.08
Bio8	Mean Temperature of the Wettest Quarter *10 (°C)	Quarter	115.42	310	-130	58.47
Bio10	Mean Temperature of the Warmest Quarter *10 (°C)	Quarter	284.01	366	16	5.5
Bio15	Precipitation Seasonality (Coefficient of Variation) (mm)	Variation	82.26	158	15	20.2
Bio16	Precipitation of Wettest Quarter(mm)	Quarter	108.13	821	29	78.87
Bio18	Precipitation of Warmest Quarter(mm)	Quarter	12.71	576	0	32.94

4.2.5. Species distribution modeling

We correlated snake species' distributions with the seven bioclimatic variables of Table 4.2.3.1 using maximum entropy modeling within the Maxent software version 3.4.1 (Phillips *et al.*, 2006; Phillips and Dudík, 2008), performing one separate model for each species. MaxEnt models a continuous density surface of presence points as a function of climatic variables and is identical to a Poisson point process model (Renner *et al.*, 2015), making it

appropriate to analyze presence-only data (Wiszniewski *et al.*, 2008). Nevertheless, MaxEnt comes with a number of drawbacks, including sensitivity to sampling bias and spatial autocorrelation (Fourcade *et al.*, 2014), high predictive performance irrespective of the existence of any causal relationship between climate and distributions (Journé *et al.*, 2019) and strong hypotheses on absence areas. Furthermore, as in most distribution models, MaxEnt assumes space and time-stationary relationships between distributions and climate. Acknowledging these drawbacks, MaxEnt appeared as the most reasonable choice considering our extremely sparse data and the paucity of covariates available for the study area.

We fit our models with the seven biologically relevant climatic variables listed in Table 4.2.3.1, allowing for all the covariate structures implemented within MaxEnt (linear, quadratic, product, threshold and hinge) as the default settings of the software. We ran MaxEnt using 10,000 randomly located background points and we allowed a maximum of 1000 iterations for parameter estimation algorithm as all models were fitted with less than 300 presence points (Meynard *et al.*, 2019). We assessed model fit with the Area Under the Receiver Operating Characteristic (ROC) Curve (AUC) and the True Skill Statistic (TSS; Allouche *et al.*, 2006). The AUC value is the probability that a distribution model would score a randomly chosen presence point higher than a randomly chosen absence point, with values > 0.9 and < 0.7 representing high and low accuracy, respectively, and 0.5 indicating randomness (Fielding and Bell, 1997). The TSS is also a commonly used evaluation criterion of model fit that, contrary to the common kappa statistics (Cohen, 1960; Allouche *et al.*, 2006), is independent of species prevalence. The Jackknife of Regularized Training Gain was used for each variable to identify which variables contribute the most individually in the model.

4.2.6. Projection to future conditions

We projected species' current climatic-envelope models onto potential future climatic conditions based on the two RCPs and as per simulations under the three GCMs downscaled for the year 2070. Then, we averaged the predicted values from the three GCM models for the two RCPs using the Raster Calculator tool in ArcGIS v10.2 for downstream analyses to reduce model-associated uncertainties (Knutti *et al.*, 2010; Chen *et al.*, 2018). After that, we combined each RCP result from the three GCMs. Finally, we had a set of projection maps for the year 2070 for each RCP and for each species.

Lastly, we compared present-day and future ensemble maps to evaluate stability, gains, and losses in suitable areas given species' climatic-envelopes for the year 2070 using the Spatial

Analyst tools in ArcGIS. Furthermore, we examined the hypothesis of altitudinal shift of species by measuring changes in average altitude of each climatic niche projection both in present and future conditions (combined three GCMs for the two RCPs), using the Zonal Statistics function implemented in ArcGIS V 10.2. In the end, we overlaid projected ranges with the latest map of the Iranian network of protected areas, including national parks, protected areas, and wildlife refuges (DoE, 2019).

4.3.Results:

4.3.1. Species modeling performance

Model fit varied across species and models (Table 4.3.1.1 and Appendix 4.1). AUC values indicated strong discriminative ability, with all values ≥ 0.90 , a classical result with spatially structured variables which indicates nothing about predictive performance but reflects high correlation between the spatial patterns of climatic variables and snake distributions. Average AUC scores were highest for the present-day model, followed by MIROC5, CCSM4, and MPI-ESM, in both RCPs. Average AUC scores were highest for the *Montivipera raddei* species complex (0.98) and lowest for *Macrovipera lebetina* and *Natrix tessellata* (0.92). Average TSS scores were slightly lower than AUC scores, but with higher performance for the MIROC5 model, followed by MPI-ESM, present-day, and CCSM4, in both RCPs (Table 4.3.1.1 and Appendix 4.1).

Table 4.3.1.1 Average AUC and TSS scores for the seven snake species under the present-day model and the three GCMs (MIROC5, CCSM4, and MPI-ESM) in both RCPs (2.6 and 8.5).

	AUC		TSS	
	Average	Std. Dev.	Average	Std. Dev.
Model				
Present-day	0.941	0.024	0.721	0.085
MIROC5_RCP 2.6	0.940	0.023	0.743	0.101
MIROC5_RCP 8.5	0.940	0.022	0.882	0.158
CCSM4_RCP 2.6	0.940	0.023	0.715	0.121
CCSM4_RCP 8.5	0.940	0.024	0.685	0.151
MPI-ESM_RCP 2.6	0.938	0.024	0.710	0.164

MPI-ESM_RCP 8.5	0.939	0.023	0.771	0.070
-----------------	-------	-------	-------	-------

Species

<i>Montivipera</i> spp.	0.984	0.001	0.880	0.036
<i>Malpolon insignitus</i>	0.953	0.002	0.724	0.090
<i>Eirenis</i>		0.002		0.105
<i>punctatulialeatus</i>	0.948		0.711	
<i>Hemorrhois</i>		0.002		0.073
<i>ravergieri</i>	0.928		0.731	
<i>Platyceps najadum</i>	0.931	0.001	0.686	0.109
<i>Natrix tessellata</i>	0.915	0.003	0.654	0.162
<i>Macrovipera</i>		0.002		0.103
<i>lebetina</i>	0.922		0.636	

4.3.2. Variable importance

Response curves of bioclimatic variables (Fig. 4.3.2.1) predicted that the seven species occur under rather similar conditions of dry and semi-dry climates with fairly high temperatures in the warmest quarter (Bio10) and little rainfall in the wettest quarter (Bio16). As shown in Figure 4.3.2.1, an overlap in climatic space was observed among the species, except for the *Montivipera raddei* species complex which presented a small overlap in response to temperature variables compared to other species. This species complex comprises three sky-island taxa that occupy highlands of the Alborz (*M. latifi*) and Zagros (*M. raddei* and *M. kuhrangica*) mountains, at elevations ranging from 1500 to 3100 m. Response curves of the precipitation-related variables (Bio16 and Bio18) for *Natrix tessellata* were consistent with the preference of this aquatic snake for high precipitation rates (Fig. 4.3.2.1, dark blue curve).

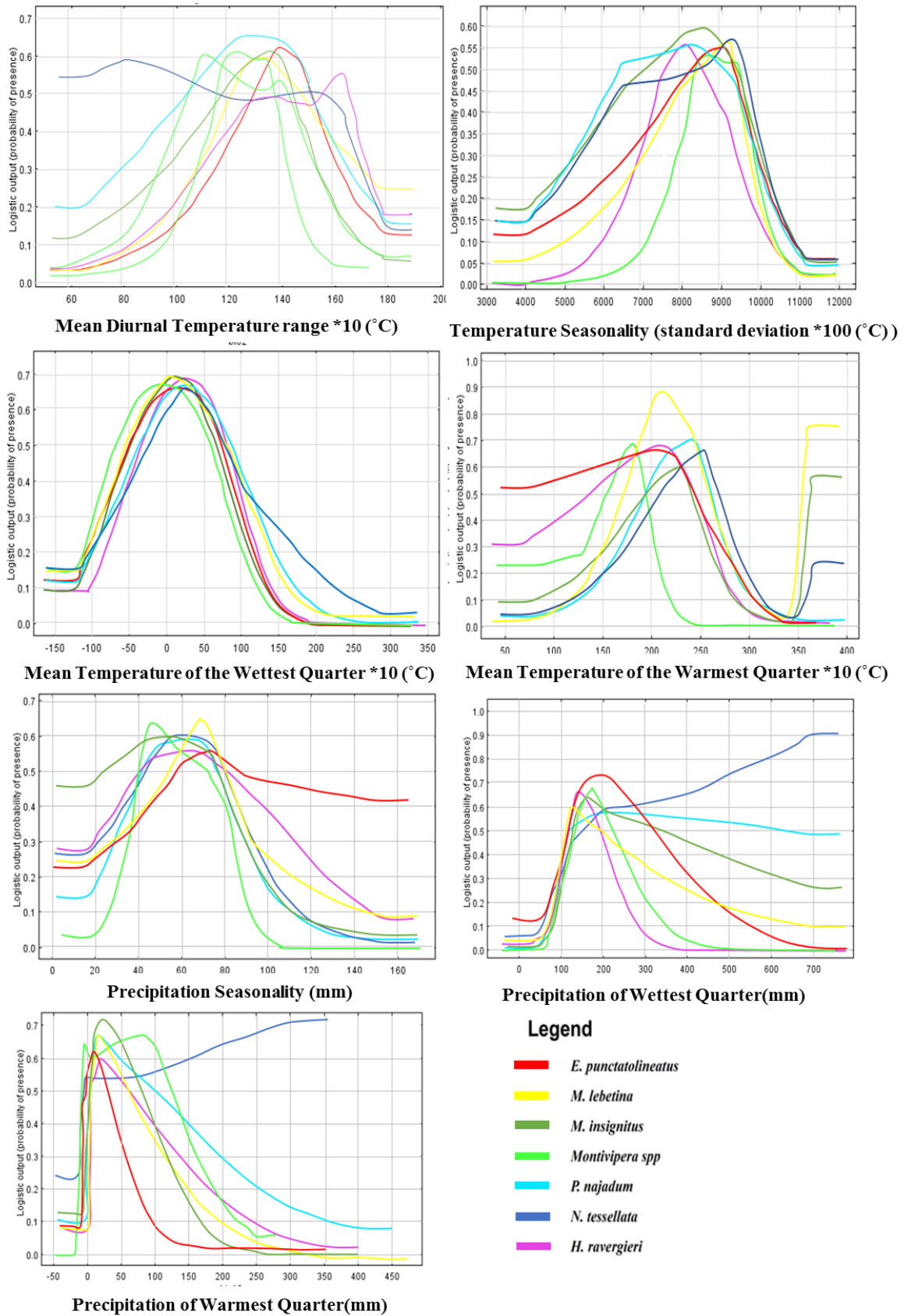

Figure 4.3.2.1. Marginal predicted response curves for the seven variables considered for each species.

The Jackknife shows the training gain of each variable if the model was run in isolation, and compares it to the training gain with all the variables. This is useful to identify which variables individually contribute most to the model's predictions. The results of present-day bioclimatic-envelope model developments for the seven species indicated that Bio10 (mean temperature of warmest quarter), Bio16 (precipitation of wettest quarter), and Bio18 (precipitation of warmest quarter) made the strongest contributions (Fig. 4.3.2.2), whereas Bio2, Bio4, Bio8 and Bio15 had a more limited impact. Bio10 was the most important variable in modeling of species distribution bioclimatic envelopes, with a contribution ranging from 21% (*E. M. lebetina*) to 74.5% (*Montivipera raddei* species complex), *E. punctatolineatus* being an exception with 6.7% Bio10 contribution. However, for *M. lebetina* and *E. punctatolineatus*, Bio16 and Bio18 made the greatest contribution to their climatic envelope modeling.

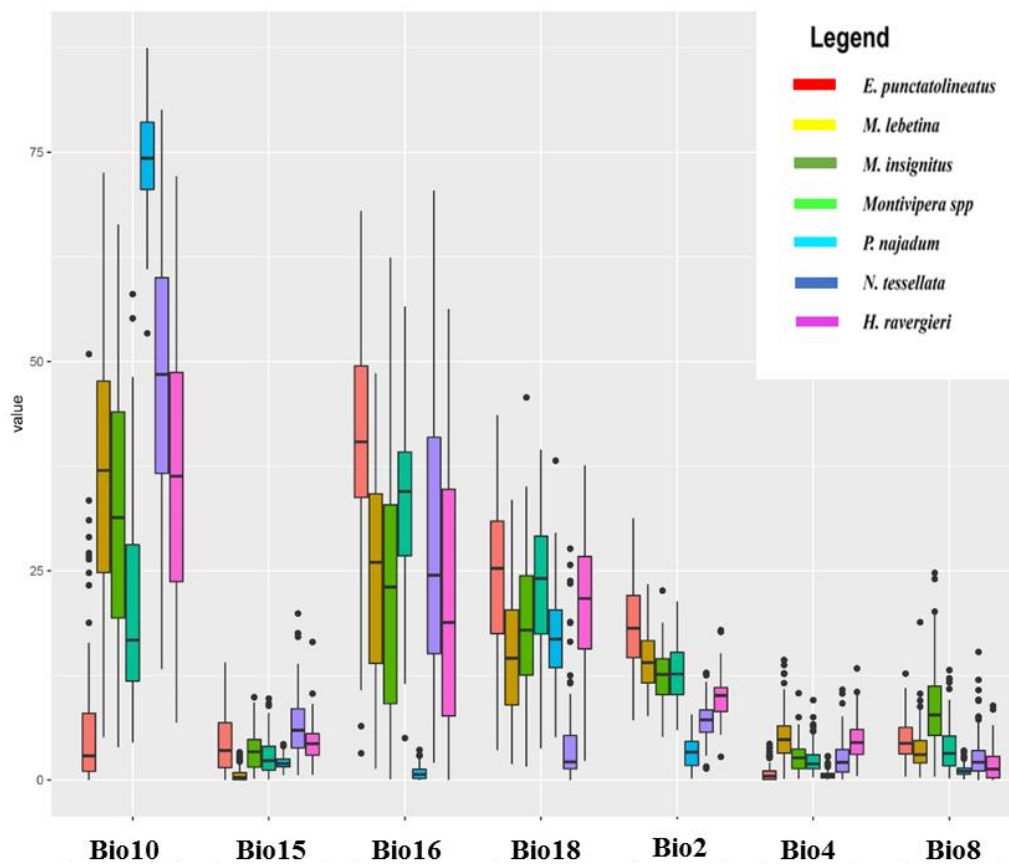

Figure 4.3.2.2. Contribution of the bioclimatic variables for modeling of present-day bioclimatic-envelopes for the seven species using Jackknife test implemented in MaxEnt model that show the variables bio10, Bio16 and Bio18 have approximately most contribution for modeling. Abbreviations: Bio2, Mean Diurnal Temperature range; Bio4, Temperature Seasonality; Bio 8, Mean Temperature of the Wettest Quarter; Bio10, Mean Temperature of the Warmest Quarter; Bio15, Precipitation Seasonality; Bio16, precipitation of wettest quarter; Bio18, Precipitation of Warmest Quarter.

4.3.3. Future projections

Forecasts of future climatically suitable areas suggested range restrictions under all climate change scenarios (Fig. 4.3.3.1). Based on projections for the year 2070, the total area of present suitable environmental conditions should decrease for *E. punctatolineatus* (49.59% and 50.75% loss of present suitable climate envelope for RCPs 2.6 and 8.5, respectively), *H. ravergeri* (47.89% and 86.37% loss of present suitable climate envelope for RCPs 2.6 and 8.5, respectively), *N. tessellata* (39.62% and 67.47% loss of present suitable climate envelope for RCPs 2.6 and 8.5, respectively), for *P. najadum* (47.25% and 81.59% loss of present suitable climate envelope for RCPs 2.6 and 8.5, respectively), and the *Montivipera raddei* species complex (72.46% and 91.20% loss of present suitable climate envelope for RCPs 2.6 and 8.5, respectively), with most of the current species occurrences and suitable climatic conditions projected to become unsuitable (Tables 4.3.3.1 and 4.3.3.2). The models further suggest that in addition to the loss of suitable climatic conditions, *M. lebetina*, *M. insignitus* and *N. tessellata* may subsequently move toward northwestern and southwestern Iran in search of favorable climates (Fig. 4.3.3.1).

Table 4.3.3.1. Percentage of suitable bioclimatic envelope under present-day and future (2070) climate change conditions for the distribution of species.

Species	Present-day	RCP 2.6	RCP 8.5
<i>Eirenis</i>			
<i>punctatolineatus</i>	0.13	0.07	0.07
<i>Macrovipera</i>			
<i>lebetina</i>	0.20	0.14	0.10
<i>Hemorrhhois</i>			
<i>ravergeri</i>	0.18	0.09	0.02
<i>Montivipera spp.</i>	0.05	0.02	0.01
<i>Malpolon</i>			
<i>insignitus</i>	0.13	0.09	0.07
<i>Platyceps</i>			
<i>najadum</i>	0.14	0.09	0.04
<i>Natrix tessellata</i>	0.21	0.15	0.11

Table 4.3.3.2 Percentage of stable, loss and gain areas under present-day and future (2070) climate change conditions

Species	RCP2.6			RCP8.5		
	Stable	Loss	Gain	Stable	Loss	Gain
<i>Eirenis</i>						
<i>punctatolineatus</i>	50.41	49.59	0.23	49.25	50.75	2.64
<i>Macrovipera</i>						
<i>lebetina</i>	57.28	42.72	11.95	32.53	67.47	16.15
<i>Hemorrhhois</i>						
<i>ravergieri</i>	52.11	47.89	0.81	13.63	86.37	0.24
<i>Montivipera spp.</i>	27.54	72.46	5.38	8.80	91.20	6.66
<i>Malpolon</i>						
<i>insignitus</i>	39.69	60.31	30.01	20.30	79.70	38.35
<i>Platyceps</i>						
<i>najadum</i>	52.75	47.25	7.34	18.41	81.59	11.36
<i>Natrix tessellata</i>	60.38	39.62	9.03	32.53	67.47	17.28

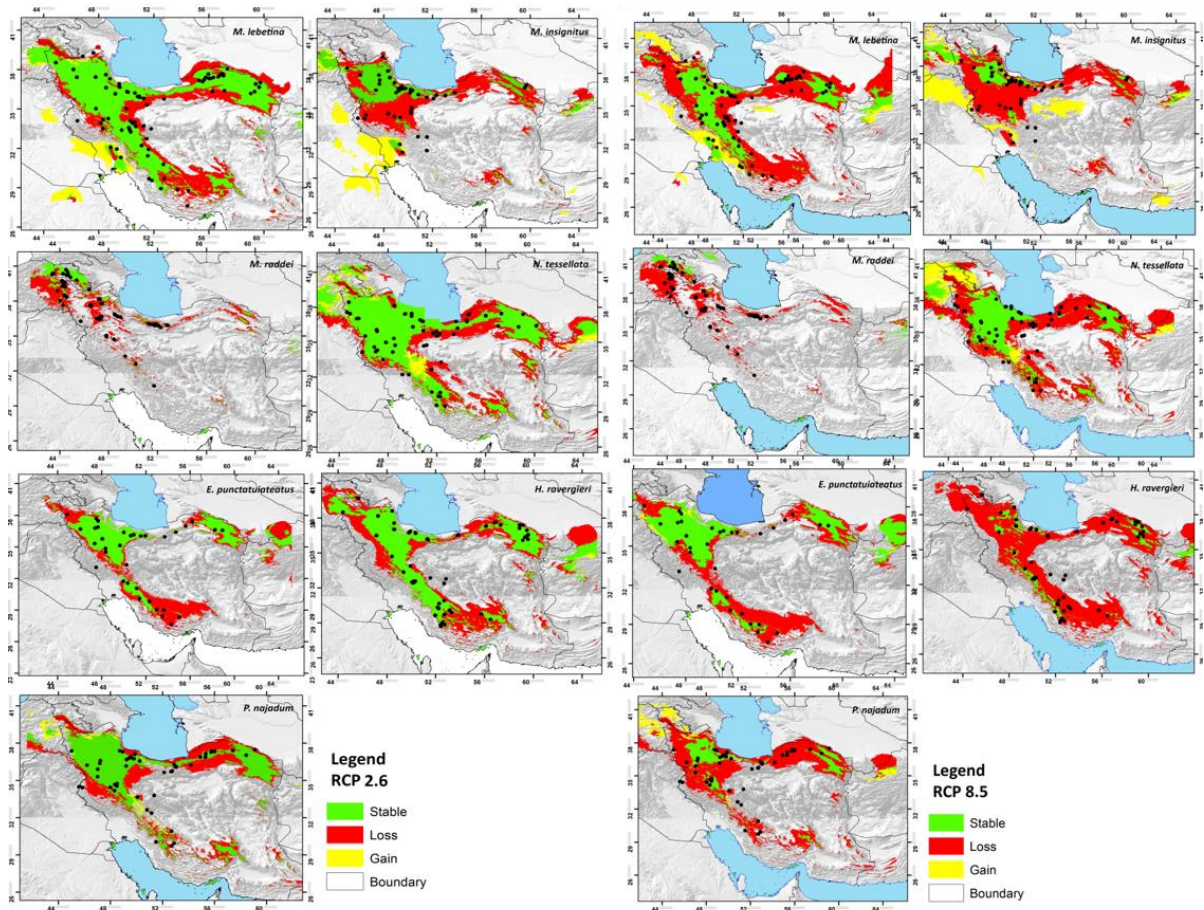

Figure 4.3.3.1. Comparison of projected output maps modeled for the seven species and future (for the year 2070) models of suitable bioclimatic conditions based on bioclimatic data from General Circulation Models projected according to: RCP 2.6 and RCP 8.5. All present-day models ran successfully as all occurrence points were located on the suitable bioclimatic conditions (see Table 4.2.3.1 and Appendix 4.1). Maps show areas with high suitability for both present-day and future models (stable = green), new suitable conditions are projected for the future (gain=yellow), present conditions may be converted to unsuitable areas in the future (loss=red), and areas where conditions are unsuitable in the future (none=gray).

4.3.4. Species upward altitudinal shift

We investigated upward or downward shifts of climatically suitable areas by comparing the changes in average altitude of each bioclimatic-envelope model (present-day and averages of the three GCMs for the two RCPs). Our results suggested that the suitable altitudinal range of five species (*Eirenis punctatolineatus*, *Hemorrhhois ravergieri*, *Platyceps najadum*, *Natrix tessellata*, and the *Montivipera raddei* species complex) would most likely exhibit an upward shift to track suitable climatic niches, whereas *Macrovipera lebetina* and *Malpolon insignitus* are expected to experience a downward altitudinal range shift in the future (Fig. 4.3.5.1 and

Table 4.3.5.1). This finding is in concordance with the results of our models of projected losses and gains in suitable bioclimatic envelopes for the former and latter groups of species, respectively, for the year 2070 (Fig. 4.3.3.1).

Table 4.3.5.1. Forecasting each species average altitudinal range shift (meter) using bioclimatic-envelope modeling for present-day and future (2070) conditions for the two RCPs (2.6 and 8.5), averaged for the three GCMs

Species	Present	RCP 2.6	RCP8.5
<i>Montivipera spp.</i>	2234.8	2485.5	3654.995
<i>Natrix tessellata</i>	1420.2	1623.7	1868.841
<i>Eirenis punctatolineatus</i>	1678.5	1807.1	1758.939
<i>Hemorrhois ravergeri</i>	1748.7	1991.1	2206.139
<i>Platyceps najadum</i>	1483.9	1764	1991.658
<i>Macrovipera lebetina</i>	1612.2	1527.4	1596.709
<i>Malpolon insignitus</i>	1238.2	1560.8	1202.578

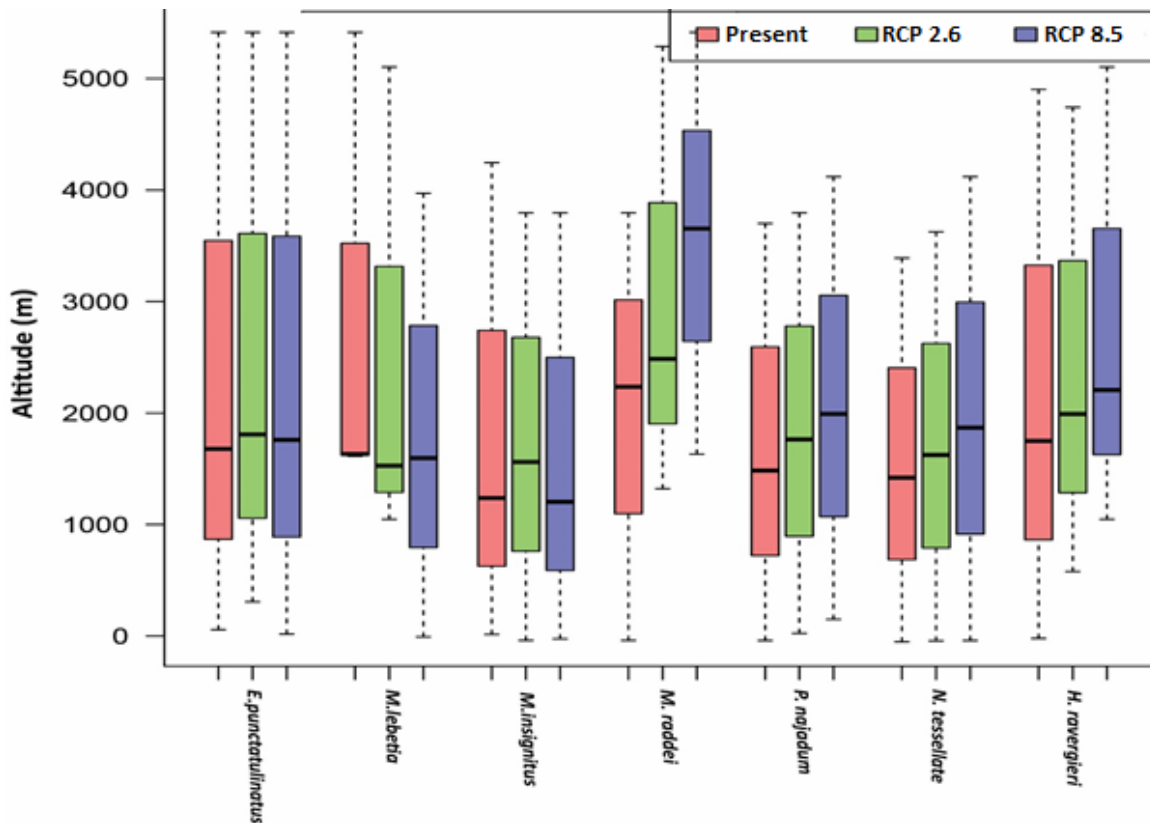

Figure 4.3.5.1. Forecasting each species altitudinal range shift using bioclimatic-envelope modeling for present-day and future (2070) conditions for the two RCPs (2.6 and 8.5), averaged of the three GCMs. The last four species may possibly show an upslope movement, whereas the first species remains stable and the remaining two species might move downstream to track suitable climatic conditions.

4.3.5. Overlaying current and future bioclimatic-envelopes with protected areas in Iran

The amount of overlap between the latest map of the Iranian network of protected areas (consisting of national parks, protected areas, and wildlife refuges) and climate forecasts for the seven species showed that under the current anthropogenic climate warming, the overlap of the current protected area network could decrease by 26% (min=11% and max=50%) and 60% (min=46% and max=88%) for RCP 2.6 and RCP 8.5, respectively, by 2070 (Table 4.3.6.1). This reduction could be particularly severe for sky-island taxa, such as the *Montivipera raddei* species complex, which inhabit high altitudes of the Alborz and Zagros mountains and are likely to lose a considerable amount of their protection coverage within the Iranian network of protected areas.

Table 4.3.6.1. Overlap between the Iranian network of protected areas and the current and future bioclimatic envelopes of each species are presented in the first three columns, whereas the last two

columns indicate the loss of protection coverage for each species caused by the conversion of present suitable climate to unsuitable future climate.

Species	Current	RPC 2.6 (2070)	RPC 8.5 (2070)	1 – (RPC 2.6/Current)	1 – (RPC 8.5/Current)
<i>Eirenis</i>	0.26	0.17	0.12		
<i>punctatolineatus</i>				0.35	0.54
<i>Macrovipera</i>	0.41	0.35	0.21		
<i>lebetina</i>				0.15	0.49
<i>Hemorrhhois</i>	0.35	0.25	0.11		
<i>ravergieri</i>				0.29	0.69
<i>Montivipera spp.</i>	0.08	0.04	0.01	0.50	0.88
<i>Malpolon</i>	0.24	0.21	0.13		
<i>insignitus</i>				0.13	0.46
<i>Platyceps</i>	0.25	0.17	0.08		
<i>najadum</i>				0.32	0.68
<i>Natrix tessellata</i>	0.35	0.31	0.18	0.11	0.49
Average	0.17			0.26	0.60
Maximum				0.50	0.88
Minimum				0.11	0.46

4.4. Discussion

The results of the present study revealed that shifts in climatically suitable areas are expected for seven snakes of Iranian mountains over the next 50 years. Our models forecasted losses of 42 to 91% of suitable climatic conditions for the reptile species studied, rising serious cause for concern regarding their long-term persistence. Under the low scenario with slight projected changes (RCP 2.6), 42 to 72%, and under the high scenario (RCP 8.5), 50 to 91% of climatically suitable conditions will be lost. Climatic conditions could become particularly direr for sky-island species (especially the *Montivipera raddei* species complex), which are dependent on rocky plains and cool alpine conditions with high precipitation (Behrooz *et al.*, 2015; Behrooz *et al.*, 2018). Thus, they become restrained to islands at high elevations (Ahmadi *et al.*, 2019; Yousefi *et al.*, 2015), possibly leading to gene flow reductions among foothill populations

(Rajabizadeh, 2013). In contrast, for *Macrovipera lebetina*, *Malpolon insignitus*, and *Natrix tesellata*, low (RCP 2.6) and high (RCP 8.5) climatic changes might produce different outcomes. Changes in current temperature and precipitation regimes under the low climate change scenario could expand the species' suitable conditions by 11 to 38%. These results suggest that such range expansions will also imply shifts of suitable climates to lower elevations except under the high climate change scenario. Although our results confirmed that about 0.17 of the suitable area for all mountainous snakes studied are located within the network of protected areas in Iran, modeling the predicted overlap between the species' suitable conditions and the network of protected areas revealed that the effectiveness of the current network could decrease by 26% and 60% for RCP 2.6 and RCP 8.5, respectively.

It bears mentioning that reptiles are rare compared to other vertebrates and inhabit remote and inaccessible areas, which makes observing them in their natural habitats and collecting accurate data on their presence a challenging task. Our data were mainly obtained opportunistically from personal observations and museum occurrence records, and are therefore exposed to sampling bias in geographic space (see Fourcade *et al.*, 2014 for consequences on cSDM). In addition, selection of the geographic extent of model calibration and forecasts must be made in connection with the purpose of the research and the species' ecology. Moreover, the modeled distribution should be interpreted with caution to determine whether it represents the species' actual occupied range (i.e. a projection of the realized niche), or an in-between area. Our modeling and prediction results showed that current distributions of the species studied herein were in line with the current distribution and ecology of species reported in recent studies (Rajabizadeh, 2017), suggesting that our results were biologically coherent.

Although changes in non-climatic variables may influence the future distribution of suitable conditions of a species, we did not incorporate those changes into our models due to: (i) the uncertainty in the accuracy and precision of such data in Iran, and (ii) impossibility of using such data in the present model and its projection onto the future. For example, the most recent land use map of Iran is related to the year 2010, prepared by the Forests and Rangelands Management Organization. Despite the tremendously rapid land use changes in Iran caused by anthropogenic activities, drought and global warming, the land use map of Iran has not yet been revised, and previous layers are incomplete or affected by high uncertainty. In addition, the assumption of time stationarity for this sort of data from the present to the future (2070) and the use of such data in the present model and its projection onto the future seems unreasonable.

Although Dynamic Vegetation Models (DVMs) have been proposed as a means of predicting vegetation shifts in response to climate change and shifts in related biogeochemical and hydrological cycles (Sitch *et al.*, 2008), use of these models is faced with certain shortcomings too, such as limitations associated with Plant Functional Types (PFTs).

Finally, we believe that in our mountainous study area, most changes in land use and vegetation cover will be largely driven by climatic changes, making climate a suitable proxy for non-climatic processes (Thuiller *et al.*, 2004; Ahmadi *et al.*, 2019). We therefore tried to mitigate the lack of causal predictors by carefully selecting climatic variables from biological criteria and assessing uncertainties in forecasts through application of multiple climatic models and scenarios simultaneously (as proposed by Journé *et al.* 2019). In addition, marginal curves of climatic effects and the resulting forecasts matched expectations based on the biological and ecological features of the selected species. This is consistent with the findings of previous studies (Behrooz *et al.*, 2015; Behrooz *et al.*, 2018; Ahmadi *et al.*, 2019; Yousefi *et al.*, 2015), which suggests our results are reasonable given the current state of knowledge and accepting the strong levels of uncertainty associated with lack of data.

Our findings indicated that variables of Mean Temperature of the Warmest Quarter, Precipitation of Wettest Quarter, Precipitation of Warmest Quarter, Mean Temperature of the Wettest Quarter and Mean Diurnal Temperature Range respectively had the greatest contribution to climate model projections. Clusella-Trullas *et al.*, (2011) highlighted that climatic variables have had a major part in the evolution of physiological thermal sensitivity of ectotherms, with precipitation of the driest month being the most influential variable in determining ectotherms' preferred body temperature. Their results are in line with ours, as precipitation of the warmest quarter (Bio18) was the second bioclimatic contributor among the variables and was of great significance for all the species studied. Hence, it could be argued that these species rely on precipitation levels of the driest/warmest months to achieve their strongest performance in physiological processes. Additionally, their results suggested that diurnal temperature range was the most important variable in determining the critical thermal maximum. This finding concurs with the results obtained in our study as diurnal temperature range was a significant contributor to model projections, with the greatest importance for *Eirenis punctatolineatus*, *Hemorrhois ravergieri*, *Macrovipera lebetina*, *Malpolon insignitus* and *Platyceps najadum*, respectively.

In addition, among the precipitation variables in our study, precipitation of wettest quarter was among the most important and also the fifth variable with the greatest predictive contribution (6%) in Penman *et al.*'s (2010) study. In another study by Popescu *et al.*, (2013),

the most important variables in predicting range shifts for amphibian and reptile species using SDMs were annual precipitation (Bio12, 0.20%), mean annual temperature (Bio1, 0.19 %), and mean temperature of warmest quarter (Bio10, 0.18%). Here, we excluded annual trend variables as we assumed seasonal variations in Iranian reptile species' responses, because Iran's climate exhibits four distinct seasons. Such seasonal variability is particularly apparent within our study area which is mountainous for the most part, thus sparking different responses among snakes under the climatic conditions of each season. For example, parturition of montane snakes is usually in late summer, mating occurs in early spring, and hibernation starts from mid-fall to late winter as the weather becomes colder and precipitation occurs in the form of rain or snow (Rajabizade 2017; Latifi 2000). For this reason, seasonal variables were the main focus of attention in our study, among which Bio10 made the greatest predictive contribution to the models. Salas *et al.* (2017) underlined the significance of annual precipitation in distribution modeling of the Sacramento Mountain Salamander (*Aneides hardii*). Even though our species are mountain dwellers and thus influenced by elevation, we excluded elevation from our model as it is highly correlated with precipitation and temperature.

In interpreting our results, it may be argued that suitable climatic conditions will likely be lost, restricting species to specific elevational gradients. This could strongly threaten mountain-dwelling species, which currently inhabit high elevations of the Alborz and Zagros mountain ranges (see also Williams *et al.*, 2003; Pounds *et al.*, 2006). These mountains, located in the Caucasus and the Irano-Anatolian hotspots, have acted as vital Quaternary refugia in the past and are therefore notable for their rich biodiversity and high-endemicity (Ahmadzadeh *et al.*, 2013; Ahmadi *et al.*, 2019; Behrooz *et al.*, 2018; Asadi *et al.*, 2019). Such elevational limitations could be followed by far-reaching consequences.

According to our modeling results, the next decades of climate warming could drive species such as *Montivipera* to higher elevations where they may become isolated on high-elevation islands (Ahmadi *et al.*, 2019; Yousefi *et al.*, 2015), separated from one another by middle elevations and foothills (Rajabizadeh, 2013). Meanwhile, some species (*e.g.* *Malpolon*, *Macrovipera*, and *Natrix*) may experience an expansion of suitable areas under climate change scenarios because these species are thermophilous and could consequently benefit from a warming climate (Popescu *et al.*, 2013). Furthermore, the mean elevation of suitable areas for *Malpolon* and *Macrovipera* species will decrease by approximately 32 to 84 meters, which can potentially and actively trigger intense competition with other predators inhabiting these elevations, modifying interaction networks (Bellard *et al.*, 2012). Given the large size and high

predatory ability of these species, competitors may undergo severe pressure which may in turn modify their distributions, habitat use and demography.

Our study confirmed that about 0.17 of the suitable area for all the mountainous snakes studied are located within the network of protected areas in Iran. Modeling the predicted overlap between the species' suitable areas and the network of protected areas revealed that the effectiveness of the current network could decrease by 26% and 60% for RPC 2.6 and RPC 8.5, respectively. Although a number of goals such as provision of ecosystem services and ecotourism have been stated for protected areas (Durán *et al.*, 2013; Xu *et al.*, 2017), their actual function, as envisioned by their managers, lies in the conservation of taxonomic diversity, with a strong focus on threatened species (Brooks *et al.*, 2004; González-Maya *et al.*, 2015; Hoffmann *et al.*, 2018). However, several studies have revealed that protected area networks currently mismatch, or may come to mismatch in the near future, the distribution of species targeted by conservation measures (Rodrigues *et al.*, 2004). Protected areas cover 10.12% of Iran and include only 10% of the country's biodiversity hotspots (Kolahi *et al.*, 2012; Farashi and Shariati, 2017). For an Iranian endemic species (*Hierophis andreanus*), Chefaoui *et al.*, (2018) found that only 27% of occurrence points are recorded within protected areas. In the same vein, Venter *et al.*, (2014) expressed that only 15% of hotspots of species richness are located within protected areas globally. Similarly, low numbers were reported for the Iberian Peninsula by Pascual *et al.* (2011).

None of the species studied here has been assessed from a conservation perspective and none has been included in the IUCN Red List categories. Also, among the species used for modeling analyses, none has been targeted by conservation or management programs by the Iranian Department of Environment, except *Montivipera latifii* in Central Alborz that was listed as threatened in 2000. Assessment of the efficacy of protected areas under present and future climatic conditions is an ultimate responsibility that rests with conservation biologists. Because protected areas stand on current distributions of species, their conservation efficiency may dwindle in the future as species shift their distributions under the impact of short-term or long-term variations in climate or the effect of other detrimental factors on species and their surrounding environment. Such conservation gaps attest to the need for spatial data, especially on finer scales (Fishpool and Evans, 2001). Utilization of environmental variables and occurrence points of the species can help predict suitable conditions for species and guide conservation efforts (Ferrier *et al.*, 2002). Using comprehensive data about the distribution of

species leads to better selection of protected areas (Brooks *et al.*, 2004). For this reason, we hope the present research will improve our understanding of the effects of climate change on taxa and serve to assist conservationists in ensuring the long-term viability of Iranian reptiles.

4.5. Conclusion

In this study, we addressed the difficult issue of providing the first forecasts of the fate of several undersampled taxa in an undersampled region. Although the results are associated with high uncertainty and well-identified methodological limitations, they reveal several major outcomes that should be taken seriously in the process of snake conservation facing climate change. First, most studied species are likely to experience drastic reductions in their climatically suitable space, both in area and altitude, within a few decades. This result should stimulate further studies to improve knowledge of these species' ecological envelope beyond climate, and therefore forecast their distributional and demographic responses to incoming climate changes. Critical to their conservation, future studies will have to assess whether snake species will be able to track changing climate and / or accommodate these changes by modifying other aspects of their ecological niche. This is even more pressing since several species studied here are restricted to Iranian mountains: their extinction would thus result in a irreplaceable loss of biodiversity. Second, our models revealed that the current protected areas network is largely inadequate to warrant the future of the studied species, under the reasonable assumption that climate is actually a major driver of their distributions. Crossing this assessment with similar studies on other taxa will reveal the extent of change required to adapt protected areas to expected climatic changes, bearing in mind that non-climatic impacts may also interfere. We stress that in the generalized lack of data on Iranian reptiles, these results are preliminary and essentially point towards the need of further targeted sampling, dedicated to niche modeling beyond climate, improvement of knowledge on species' distributions including absence areas, and refining of the locations of range limits. In that respect, we hope that our study will catalyze awareness of the threats posed both by climate change and knowledge deficiency on Iranian herpetofauna, and more generally on all taxa and regions affected by the Wallacean bias.

References:

- Ahmadi, M., Hemami, M.R., Kaboli, M., Malekian, M., Zimmerman, E.N., (2019). Extinction risks of a Mediterranean neo-endemism complex of mountain vipers triggered by climate change. *Scientific Reports*. 9:6332.
- Ahmadzadeh F, Carretero MA, Rodder D, Carretero MA, Freitas S, Perera A, Böhme W. (2013). Inferring the effects of past climate fluctuations on the distribution pattern of *Iranolacerta* (Reptilia, Lacertidae): evidence from mitochondrial DNA and species distribution models. *Zoologischer Anzeiger* . 252:141–148.
- Allouche, O., Tsoar, A., Kadmon, R., (2006). Assessing the accuracy of species distribution models: prevalence, kappa and the true skill statistic (TSS). *J. Appl. Ecol.* 43, 1223–1232.
- Arora, V. K., J. F. Scinocca, G. J. Boer, J. R. Christian, K. L. Denman, G. M. Flato, V. V. Kharin, W. G. Lee, and W. J. Merryfield (2011). Carbon emission limits required to satisfy future representative concentration pathways of greenhouse gases. *Geophys. Res. Lett.*, 38, L05805, doi:10.1029/2010GL046270.
- Asadi, A., Montgelard, C., Nazarizadeh, M., Moghaddasi, A., Fatemizadeh, F., Simonov, E., Kami, H. G. and Kaboli, M. (2019). Evolutionary history and postglacial colonization of an Asian pit viper (*Gloydius halys caucasicus*) into Transcaucasia revealed by phylogenetic and phylogeographic analyses. *Scientific Reports*, 9: 1224: 1–16.
- Asouti, E. and Kabukcu, C., (2014). Holocene semi-arid oak woodlands in the Irano-Anatolian region of Southwest Asia: natural or anthropogenic? *Quaternary Science Reviews* 90: 158-182.
- Austin, D., Bowen, W.D., McMillan, J.I., Iverson, S.J., (2006). Linking movement, diving, and habitat to foraging success in a large marine predator. *Ecology* 87, 3095–3108.
- Austin, C.C., Rittmeyer, E.N., Richards, S.J., Zug, G.R., (2010). Phylogeny, historical biogeography and body size evolution in Pacific Island Crocodile skinks *Tribolonotus* (Squamata; Scincidae). *Mol. Phylogenet. Evol.* 57, 227–236.
- Beaupre, S.J., and D.J. Duvall. (1998). Integrative biology of rattlesnakes: *Contributions to biology and evolution. BioScience* 48:531–538.
- Behrooz R, Kaboli M, Nourani E, Ahmadi M, Shabani AA, Yousefi M, Asadi A, Rajabizadeh AM. (2015). Habitat modeling and conservation of the endemic Latifi's viper (*Montivipera Latifii*) in Lar national park, Northern Iran. *Herpetol Conserv Biol* . 10:572–582.
- Behrooz, R. *et al.* (2018). Conservation Below the Species Level: Suitable Evolutionarily Significant Units among Mountain Vipers (the *Montivipera raddei* complex) in Iran. *J. Hered.* 109, 416–425.
- Bellard, C., Leclerc, C., Leroy, B., Bakkenes, M., Veloz, S., Thuiller, W., Courchamp, F., (2014). Vulnerability of biodiversity hotspots to global change. *Glob. Ecol. Biogeogr.* 23, 1376–1386.
- Blaustein, A.R., Belden, L.K., Olson, D.H., Green, D.M., Root, T.L., Kiesecker, J.M., (2001). Amphibian breeding and climate change. *Conserv. Biol.* 15, 1804–1809.
- lock, K., Mauritsen, T. (2013). Forcing and feedback in the MPI-ESM-LR coupled model under abruptly quadrupled CO₂. *Journal of Advances in Modeling Earth Systems*, 5, 676– 691.
- Böhm *et al.*, 2013. The conservation status of the world's reptiles. *Biological Conservation* 157: 372-385. doi: 10.1016/j.biocon.2012.07.015.
- Bosch, D.D., Sheridan, J.M., Marshall, L.K., (2007). Precipitation, soil moisture, and climate database, Little River experimental watershed, Georgia, United States. *Water Resour. Res.* 43.

- Brooks TM, Da Fonseca GAB, Rodrigues ASL (2004). Protected areas and species. *Conserv Biol* 18(3):616–618
- Chefaoui RM, Hosseinzadeh MS, Mashayekhi M, Safaei-Mahroo B, Kazemi SM (2018). Identifying suitable habitats and current conservation status of a rare and elusive reptile in Iran. *Amphibia-Reptilia* 39(3):355–362
- Chen, Y., Nazarizadeh, M., Lei, F., Yang, X., Yao, C., Dong, F., Dong, L., Zou, F., Drovetski, S. V, Liu, Y., (2019). The niches of nuthatches affect their lineage evolution differently across latitude. *Mol. Ecol.* 28, 803–817.
- Clusella-Trullas S, Blackburn TM, Chown SL (2011). Climatic predictors of temperature performance curve parameters in ectotherms imply complex responses to climate change. *Am Nat* 177:738–751.
- Clusella-Trullas S, Chown SL (2011). Comment on “Erosion of lizard diversity by climate change and altered thermal niches”. *Science*, 332, 537.
- Cohen, J., (1960). A coefficient of agreement for nominal scales. *Educ. Psychol. Meas.* 20, 37–46.
- Coreau, A., Pinay, G., Thompson, J.D., Cheptou, P., Mermet, L., (2009). The rise of research on futures in ecology: rebalancing scenarios and predictions. *Ecol. Lett.* 12, 1277–1286.
- Dennis R, Thomas CD (2000). Bias in butterfly distribution maps: the influence of hot spots and recorder’s home range. *J Insect Conserv* 4: 73–77.
- Djamali, M., Brewer, S., Breckle, S. W. & Jackson, S. T. (2012). Climatic determinism in phytogeographic regionalization: a test from the Irano-Turanian region, SW and Central Asia. *Flora* 207, 237–249.
- DoE (2019). Data of Iranian Protected Areas. Retrieved 3/10/2020, from <https://www.doe.ir/portal/home/?441177/>.
- Durán, A. P., S. Casalegno, P. A. Marquet, and K. J. Gaston. (2013). Representation of ecosystem services by terrestrial protected areas: Chile as a case study. *PLoS ONE*, Vol. 8, Issue.
- Elith, j., C. H. Graham, R. P. Anderson, M. Dudik, S. Ferrier, A. Guisan, R. J. Hijmans, F. Huettmann, J. R. Leathwick, A. Lehmann, J. Li, L. G. Lohmann, B. A. Loiselle, G. Manion, C. Moritz, M. Nakamura, Y. Nakazawa, J. M. Overton, A. T. Peterson, S. J. Phillips, K. Richardson, R. Scachetti-Pereira, R. E. Schapire, J. Soberon, S. Williams, M. S. Wisz, and N. E. Zimmermann. 2006. Novel methods improve prediction of species’ distributions from occurrence data. *Ecography* 29:129–151.
- Eskandarzadeh, N., Rastegar-Pouyani, N., Rastegar-Pouyani, E., Nasrabadi, R., (2018). Modelling the habitat suitability of the Arabian sand boa *Eryx jayakari* (Serpentes: Erycidae). *Zool. Ecol.* 28, 337–342.
- Farashi A, Shariati M, Hosseini M (2017). Identifying biodiversity hotspots for threatened mammal species in Iran. *Mamm Biol* 87:71–88.
- Ferrier S, Drielsma M, Manion G, Watson G (2002). Extended statistical approaches to modelling spatial pattern in biodiversity in northeast New SouthWales. II. Community-level modelling. *Biodivers Conserv* 11:2309–2338.
- Fielding, A.H., Bell, J.F., (1997). A review of methods for the assessment of prediction errors in conservation presence/absence models. *Environ. Conserv.* 24, 38–49.
- Fishpool LDC, Evans MI eds. (2001). Important bird areas in Africa and associated islands: priority sites for conservation. Newbury and Cambridge, UK.
- Fourcade, Y., Engler, J.O., Rödder, D., Secondi, J., (2014). Mapping species distributions with MAXENT using a geographically biased sample of presence data: a performance assessment of methods for correcting sampling bias. *PLoS One* 9, e97122.
- Francis, A.P., Currie, D.J., (2003). A globally consistent richness-climate relationship for angiosperms. *Am. Nat.* 161, 523–536.

- Gent, P.R., Danabasoglu, G., Donner, L.J., Holland, M.M., Hunke, E.C., Jayne, S.R., Lawrence, D.M., Neale, R.B., Rasch, P.J., Vertenstein, M., (2011). The community climate system model version 4. *J. Clim.* 24, 4973–4991.
- Gholamifard A., Rastegar-Pouyani N. & Rastegar-Pouyani E. 2015. — Rediscovery of *Microgecko helenae fasciatus* (Schmidtler and Schmidtler, 1972) from Kermanshah Province, western Iran with notes on taxonomy, morphology, and habitat. *Asian Herpetological Research* 6 (4): 339-346.
- Gibbons, J.W., Scott, D.E., Ryan, T.J., Buhlmann, K.A., Tuberville, T.D., Metts, B.S., Greene, J.L., Mills, T., Leiden, Y., Poppy, S., (2000). The Global Decline of Reptiles, Déjà Vu Amphibians: Reptile species are declining on a global scale. Six significant threats to reptile populations are habitat loss and degradation, introduced invasive species, environmental pollution, disease, unsustainable use, and global climate change. *Bioscience* 50, 653–666.
- Godfrey, M.H., D'Amato, A.F., Marcovaldi, M.Â., Mrosovsky, N., (1999). Pivotal temperature and predicted sex ratios for hatchling hawksbill turtles from Brazil. *Can. J. Zool.* 77, 1465–1473.
- González-Maya JF, Viquez-R LR, Belant JL, Ceballos G (2015). Effectiveness of protected areas for representing species and populations of terrestrial mammals in Costa Rica. *PLoS ONE* 10(5):e0124480.
- Guisan, A., & Thuiller, W. (2005). Predicting species distribution: offering more than simple habitat models. *Ecology Letters*, 8(9), 993–1009. doi: 10.1111/j.1461-0248.2005.00792.x.
- Guo, Q., (2003). Plant abundance: the measurement and relationship with seed size. *Oikos* 101, 639–642.
- Hijmans, R.J., Cameron, S.E., Parra, J.L., Jones, P.G., Jarvis, A., (2005). Very high resolution interpolated climate surfaces for global land areas. *Int. J. Climatol. A J. R. Meteorol. Soc.* 25, 1965–1978.
- Hoffmann S, Beierkuhnlein C, Field R, Provenzale A, Chiarucci A (2018). Uniqueness of protected areas for conservation strategies in the European Union. *Sci Rep-UK* 8:6445.
- Hortal, J., de Bello, F., Diniz-Filho, J.A.F., Lewinsohn, T.M., Lobo, J.M. & Ladle, R.J. (2015). Seven shortfalls that beset large-scale knowledge of biodiversity. *Annual Review of Ecology, Evolution, and Systematics*, 46, 523–549.
- Hosseini Yousefkhani, S.S., Rastegar-Pouyani, E., Rastegar-Pouyani, N., Masroor, R., Šmíd, J., (2013). Modelling the potential distribution of *Mesalina watsonana* (Stoliczka, 1872)(Reptilia: Lacertidae) on the Iranian Plateau. *Zool. Middle East* 59, 220–228.
- Hosseini Yousefkhani, S.S.H., (2019). Review to the last ecological niche modelling studies on Iranian herpetofauna and their importance for species conservation. *J. Biol. Stud.* 1, 165–167.
- Hosseini Yousefkhani, S.S., Aliabadian, M., Rastegar-Pouyani, E., Darvish, J., (2017). Predicting the impact of climate change on the distribution pattern of *Agamura persica* (Dumeril, 1856) (Squamata: Gekkonidae) in Iran. *Belgian J. Zool.* 147.
- Hosseini YOUSEFKHANI, S.S.H., TEHRANI, S.J., Moodi, B., GÜL, S., (2016). Distribution patterns and habitat suitability for three species of the genus *Hyla* Laurenti, 1768 in the Western Palearctic. *Turkish J. Zool.* 40, 257–261.
- Humboldt A. von, Bonpland A., (1807). *Essai sur la géographie des plantes, accompagné d'un tableau physique des régions équinoxiales* (Levrault & Schoell, Paris, 1807).
- Janzen, F.J., (1994). Climate change and temperature-dependent sex determination in reptiles. *Proc. Natl. Acad. Sci.* 91, 7487–7490.
- Jarnevich, C.S., Stohlgren, T.J., Kumar, S., Morisette, J.T., Holcombe, T.R., (2015). Caveats for correlative species distribution modeling. *Ecol. Inform.* 29, 6–15.

- Journé, V., Barnagaud, J., Bernard, C., Crochet, P., Morin, X., (2019). Correlative climatic niche models predict real and virtual species distributions equally well. *Ecology*.101,1 e02912.
- Kafash, A., Kaboli, M., Koehler, G., Yousefi, M., Asadi, A., (2016). Ensemble distribution modeling of the Mesopotamian spiny-tailed lizard, *Saara loricata* (Blanford, 1874), in Iran: an insight into the impact of climate change. *Turkish J. Zool.* 40, 262–271.
- Knutti, R., Furrer, R., Tebaldi, C., Cermak, J., Meehl, G.A., (2010). Challenges in combining projections from multiple climate models. *J. Clim.* 23, 2739–2758.
- Knutti, R., Sedláček, J., (2013). Robustness and uncertainties in the new CMIP5 climate model projections. *Nat. Clim. Chang.* 3, 369.
- Kolahi M, Sakai T, Moriya K, Makhdoum MF (2012). Challenges to the future development of Iran’s protected areas. *Environ Manag* 50:750–765.
- Lomolino, M. V., (2004). Conservation biogeography. *Front. Biogeogr. new Dir. Geogr. Nat.* 293.
- Malek-Hosseini MJ, Zamani A, Sadeghi S (2015). A survey of cave-dwelling spider fauna of Kohgiluyeh & Boyer-Ahmad and Fars provinces, Iran (Arachnida: Araneae). *Revista Ibérica de Aracnología* 27: 90–94.
- Médail, F., Quézel, P., (1999). Biodiversity hotspots in the Mediterranean Basin: setting global conservation priorities. *Conserv. Biol.* 13, 1510–1513.
- Merriam, C.H., (1894). Laws of temperature control of the geographic distribution of terrestrial animals and plants.
- Meynard, C.N., Leroy, B., Kaplan, D.M., (2019). Testing methods in species distribution modelling using virtual species: what have we learnt and what are we missing? *Ecography* (Cop.).
- McNab, B. K. (2003). Metabolism—ecology shapes bird bioenergetics. *Nature*426:620–621.
- Mitchell, N.J., Janzen, F.J., (2010). Temperature-dependent sex determination and contemporary climate change. *Sex. Dev.* 4, 129–140.
- Mittermeier, R.A., Gil, P.R. and Mittermeier, C.G. (2005). Megadiversity: Earth’s biologically wealthiest nations (501 p). CEMEX Publ.
- Morin, X., Améglio, T., Ahas, R., Kurz-Besson, C., Lanta, V., Lebourgeois, F., Miglietta, F., Chuine, I., (2007). Variation in cold hardiness and carbohydrate concentration from dormancy induction to bud burst among provenances of three European oak species. *Tree Physiol.* 27, 817–825.
- Mouquet, N., Lagadeuc, Y., Devictor, V., Doyen, L., Duputié, A., Eveillard, D., Faure, D., Garnier, E., Gimenez, O., Huneman, P., (2015). Predictive ecology in a changing world. *J. Appl. Ecol.* 52, 1293–1310.
- Myers, N., Mittermeier, R.A., Mittermeier, C.G., Da Fonseca, G.A.B., Kent, J., (2000). Biodiversity hotspots for conservation priorities. *Nature* 403, 853.
- Naimi, B. (2015). Usdm. Uncertainty analysis for species distribution models. R package version 1, 1–15.
- Neuwald, J.L., Valenzuela, N., (2011). The lesser known challenge of climate change: thermal variance and sex-reversal in vertebrates with temperature-dependent sex determination. *PLoS One* 6, e18117.
- Noroozi, J., Akhiani, H., Breckle, S.-W., (2008). Biodiversity and phytogeography of the alpine flora of Iran. *Biodivers. Conserv.* 17, 493–521. <https://doi.org/10.1007/s10531-007-9246-7>.
- Noroozi J, Talebi A, Doostmohammadi M, Rumpf SB, Linder HP, Schneeweiss GM, (2018). Hotspots within a global biodiversity hotspot - areas of endemism are associated with high mountain ranges. *Scientific Reports* 8, 10345, <https://doi.org/10.1038/s41598-018-28504-9>.

- Oraie, H., Rahimian, H., Rastegar-Pouyani, N., Rastegar-Pouyani, E., Ficetola, G.F., Hosseinian Yousefkhani, S.S., Khosravani, A., (2014). Distribution pattern of the snake-eyed lizard, *Ophisops elegans* Ménétriés, 1832 (Squamata: Lacertidae), in Iran. *Zool. Middle East* 60, 125–132.
- Parnesan, C., (2006). Ecological and evolutionary responses to recent climate change. *Annu. Rev. Ecol. Evol. Syst.* 37, 637–669.
- Parnesan, C. (2007). Influences of species, latitudes and methodologies on estimates of phenological response to global warming. *Glob. Change Biol.* 13, 1860–1872.
- Pascual L-L, Luigi M, Alessandra F, Emilio B, Luigi B (2011). Hotspots of species richness, threat and endemism for terrestrial vertebrates in SW Europe. *Acta Oecol* 37:399–412.
- Penman TD, Pike DA, Webb JK, Shine R (2010). Predicting the impact of climate change on Australia's most endangered snake, *Hoplocephalus bungaroides*. *Divers Distrib* 16:109–118. doi:10.1111/j.1472-4642.2009.00619.x
- Pereira, H.M., Leadley, P.W., Proença, V., Alkemade, R., Scharlemann, J.P.W., Fernandez-Manjarrés, J.F., Araújo, M.B., Balvanera, P., Biggs, R., Cheung, W.W.L., (2010). Scenarios for global biodiversity in the 21st century. *Science* (80-). 330, 1496–1501.
- Phillips, S.J., Anderson, R.P., Schapire, R.E., (2006). Maximum entropy modeling of species geographic distributions. *Ecol. Modell.* 190, 231–259.
- Phillips, S.J., Dudík, M., (2008). Modeling of species distributions with Maxent: new extensions and a comprehensive evaluation. *Ecography (Cop.)*. 31, 161–175.
- Popescu, V.D., Rozyłowicz, L., Cogalniceanu, D., Niculae, I.M. and Cucu, A.L. (2013). Moving into Protected Areas? Setting Conservation Priorities for Romanian Reptiles and Amphibians at Risk from Climate Change. *PLoS ONE*: 8:e79330.
- Pounds, J.A., Bustamante, M.R., Coloma, L.A., Consuegra, J.A., Fogden, M.P.L., Foster, P.N., La Marca, E., Masters, K.L., Merino-Viteri, A., Puschendorf, R., (2006). Widespread amphibian extinctions from epidemic disease driven by global warming. *Nature* 439, 161.
- Rajabizadeh, M. (2013). Biodiversity of the snakes in northern and western mountains of Iran, with special emphasis on biodiversity in colubroids. Ghent University. Faculty of Sciences. PhD Thesis. VI, 227 pages.
- Rajabizadeh, M. (2017). Snakes of Iran. [in Farsi] Tehran: Iranshenasi, 496 pp.
- Ramanamanjato JB, McIntyre PB, Nussbaum RA (2002). Reptile, amphibian, and lemur diversity of the Malahelo forest, a biogeographical transition zone in southeastern Madagascar. *Biodiv Conserv* 11: 1791–1807.
- Renner, I.W., Elith, J., Baddeley, A., Fithian, W., Hastie, T., Phillips, S.J., Popovic, G., Warton, D.I., (2015). Point process models for presence-only analysis. *Methods Ecol. Evol.* 6, 366–379.
- Rivas-Martínez, S., (1997). Syntaxonomical synopsis of the potential natural plant communities of North America, I (Compendio sintaxonómico de la vegetación natural potencial de Norteamérica, I). *Itinera geobotanica* 10, 5–148.
- Rodrigues ASL, Andelman SJ, Bakarr MI, Boitani L, Brooks TM, Cowling RM, Fishpool LD, da Fonseca GA, Gaston KJ, Hoffmann M, Long JS, Marquet PA, Pilgrim JD, Pressey RL, Schipper J, Sechrest W, Stuart SN, Underhill LG, Waller RW, Watts ME, Yan X (2004). Effectiveness of the global protected area network in representing species diversity. *Nature* 428:640–643.
- Roeckner, E., M.A. Giorgetta, T. Crueger, M. Esch, and J. Pongratz. (2010). Historical and future anthropogenic emission pathways derived from coupled climatecarbon cycle simulations. *Climatic Change* 105:91– 108.

- Rounaghi, I., Yousefkhani, S.S.H., (2018). Effects of climate change on niche shifts of *Pseudotrapelus dhofarensis* and *Pseudotrapelus jensvindumi* (Reptilia: Agamidae) in Western Asia. *PLoS One* 13, e0197884.
- Safaei-Mahroo, B., Ghaffari, H., Fahimi, H., Broomand, S., Yazdanian, M., Najafi-Majd, E., Hosseinian Yousefkhani, S.S., Rezazadeh, E., Hosseinzadeh, M.S., Nasrabadi, R., (2015). The herpetofauna of Iran: checklist of taxonomy, distribution and conservation status. *Asian Herpetol. Res.* 6, 257–290.
- Salas, E.A.L., V.A. Seamster, N.M. Harings, K.G.Boykin, G.Alvarez and K.W. Dixon. (2017). Projected Future Bioclimate-Envelope Suitability for Reptile and Amphibian Species of Concern in South Central USA. *Herpetological Conservation and Biology* 12(2):522–547.
- Secor, S.M., and J. Diamond. (1998). A vertebrate model of extreme physiological regulation. *Nature* 395:659 – 662.
- Sexton, J.P., McIntyre, P.J., Angert, A.L., Rice, K.J., (2009). Evolution and ecology of species range limits. *Annu. Rev. Ecol. Evol. Syst.* 40, 415–436.
- Shine R, Bonnet X (2009). Reproductive biology, population viability, and options for field management. *Snakes: Ecology and Evolutionary Biology*. Seigel RA, Collins JT, Novak SS, eds. MacMillan Company, New York, USA. Pp. 172–200.
- Sitch, S., Huntingford, C., Gedney, N., Levy, P.E., Lomas, M., Piao, S.L. et al. (2008). Evaluation of the terrestrial carbon cycle, future plant geography and climate-carbon cycle feedbacks using five Dynamic Global Vegetation Models (DGVMs). *Global Change Biol.*, 14, 2015–2039.
- Sinervo, B., Mendez-De-La-Cruz, F., Miles, D.B., Heulin, B., Bastiaans, E., Villagrán-Santa Cruz, M., Lara-Resendiz, R., Martínez-Méndez, N., Calderón-Espinosa, M.L., Meza-Lázaro, R.N., (2010). Erosion of lizard diversity by climate change and altered thermal niches. *Science* (80-.). 328, 894–899.
- Sofaer, H.R., Jarnevich, C.S., Pearse, I.S., (2018). The relationship between invader abundance and impact. *Ecosphere* 9, e02415.
- Taylor, K. E., R. J. Stouffer, and G. A. Meehl, (2012). An overview of CMIP5 and the experiment design. *Bull. Amer. Meteor. Soc.*, 93, 485–498, <https://doi.org/10.1175/BAMS-D-11-00094.1>.
- Thomas, C.D., Cameron, A., Green, R.E., Bakkenes, M., Beaumont, L.J., Collingham, Y.C., Erasmus, B.F.N., De Siqueira, M.F., Grainger, A., Hannah, L., (2004). Extinction risk from climate change. *Nature* 427, 145.
- Tucker, M. A. *et al.* (2018). Moving in the Anthropocene: Global reductions in terrestrial mammalian movements. *Science* 359, 466–469.
- Thuiller, W. (2004). Patterns and uncertainties of species' range shifts under climate change. *Global Change Biology* 10:2020–2027.
- Thuiller, W., Lavergne, S., Roquet, C., Boulangeat, I., Lafourcade, B., Araujo, M.B., (2011). Consequences of climate change on the tree of life in Europe. *Nature* 470, 531.
- Varela S, Anderson RP, Garcí'a-Valde's R, Ferna'ndez-Gonza'lez F (2014). Environmental filters reduce the effects of sampling bias and improve predictions of ecological niche models. *Ecography*: 10.1111/j.1600-0587.2013.00441.x.
- Venter O, Fuller RA, Segan DB, Carwardine J, Brooks T, Butchart SHM, Di Marco M, Iwamura T, Joseph L, O'Grady D, Possingham HP, Rondinini C, Smith RJ, Venter M, Watson JEM (2014). Targeting global protected area expansion for imperiled biodiversity. *PLoS Biol* 12:e1001891.
- Vuuren, D.P., Stehfest, E., den Elzen, M.G.J., Kram, T., van Vliet, J., Deetman, S., Isaac, M., Goldewijk, K.K., Hof, A., Beltran, A.M., (2011). RCP2. 6: exploring the possibility to keep global mean temperature increase below 2 C. *Clim. Change* 109, 95.

- Watanabe, M., Suzuki, T., O'ishi, R., Komuro, Y., Watanabe, S., Emori, S., Takemura, T., Chikira, M., Ogura, T., Sekiguchi, M., (2010). Improved climate simulation by MIROC5: mean states, variability, and climate sensitivity. *J. Clim.* 23, 6312–6335.
- Williams, S. E., E. E. Bolitho, and S. Fox. (2003). Climate change in Australian tropical rainforests: an impending environmental catastrophe. *Proceedings of the Royal Society of London Series B* 270:1887–1892.
- Willig, M.R., Kaufman, D.M., Stevens, R.D., (2003). Latitudinal gradients of biodiversity: pattern, process, scale, and synthesis. *Annu. Rev. Ecol. Evol. Syst.* 34, 273–309.
- Wisz, M.S., Hijmans, R.J., Li, J., Peterson, A.T., Graham, C.H., Guisan, A., Group, N.P.S.D.W., (2008). Effects of sample size on the performance of species distribution models. *Divers. Distrib.* 14, 763–773.
- Xu, Y., Shen, Z., Ying, L., Wang, Z., Huang, J., Zang, R., Jiang, Y., (2017). Hotspot analyses indicate significant conservation gaps for evergreen broadleaved woody plants in China. *Sci. Rep.* 7 (1), 1859. <https://doi.org/10.1038/s41598-017-02098-0>.
- Yousefi, M., Ahmadi, M., Nourani, E., Behrooz, R., Rajabizadeh, M., Geniez, P., Kaboli, M., (2015). Upward altitudinal shifts in habitat suitability of mountain vipers since the last glacial maximum. *PLoS One* 10, e0138087.
- Yousefi, M., Kafash, A., Valizadegan, N., Ilanloo, S.S., Rajabizadeh, M., Malekoutikhah, S., Hosseinian Yousefkhani, S.S., Ashrafi, A., (2019). Climate Change is a Major Problem for Biodiversity Conservation: A Systematic Review of Recent Studies in Iran. *Contemporary Problems of Ecology*. Vol. 12, No. 4, pp. 394–403.

Chapter 5 :
General Discussion

5.1.Overview:

This chapter represents an attempt to synthesize the main results of this thesis in integrating the key findings, discussing limitations, and highlighting avenues for future research. Biodiversity patterns are shaped by various factors such as climatic changes, geological drivers and anthropological pressures (Matthews *et al.*, 2001). This study provides not only a better understanding of the evolutionary history of several little-known snake species in Iran, but also fulfil some important information of the biodiversity key region where the three biogeographical realms overlap (Palearctic, Afrotropical and Oriental). Nevertheless, the real challenge we face today in ensuring long-term conservation of biodiversity is the fundamental gaps in knowledge and lack of data regarding biodiversity and the methods for identifying and filling such gaps in order to promote effective conservation. In this general context, the present thesis is an attempt to fill these gaps in Iran, an area of great knowledge deficiencies, particularly with respect to poikilotherm organisms such as snakes. Thus, evolution of Iranian snakes was addressed using two complementary approaches, namely phylogeography allowing to reveal the spatial genetic structure and species distribution modelling (SDM) allowing to identify limiting factors of present and future distribution of taxa.

In chapter 1, I presented the general context concerning knowledge gaps regarding biodiversity with emphasis on reptiles and their implications for conservation as well as the effects of climate change and geological processes on biodiversity evolution. Also, I suggested measures to obtain a better knowledge of biodiversity, especially for less conspicuous organisms such as reptiles. Such deficiencies are particularly evident for the Middle East and Iran as biogeographic transition zones.

In chapter 2, I introduced two important biodiversity hotspots in Iran and their remarkable biodiversity values. Although our understanding of the evolutionary history of numerous taxa in the Western Palearctic has grown considerably, a comparable knowledge in the Middle East remains largely rudimentary, including the role played by Iran in the structure and diversification of taxa. Indeed, the Middle East in general and Iran in particular have been largely neglected in past phylogeographical studies (Ahmadzadeh *et al.*, 2013).

A key step towards overcoming biodiversity knowledge gaps is to identify current data deficiencies concerning the structure and distribution of taxa. Therefore, results of phylogenetic and phylogeographic studies can be used to determine genetic gaps and identify critical clades (Hortal *et al.*, 2015). This issue was discussed in chapter 3, which provided us with a better understanding of impact of data deficiencies on the evolution of three snake species (*Gloydius caucasicus*, *Hemorrhhis ravergieri* and *Natrix tessellata*). Notably, I presented some

evolutionary hypotheses explaining the diversification of these taxa and offered a deep insight as to how evolutionary processes could be integrated with conservation practices.

Furthermore, I discussed how SDMs can contribute to predicting distribution dynamics in undersampled countries and taxa. In many cases, applying SDMs and accepting the resulting uncertainty is a useful preliminary step to improve the spatial sampling of species or populations. Distribution models also provide a preliminary indication of future suitable areas for species of conservation interest under future climate changes, which may help evaluating and adapting protected areas networks. For this reason, in chapter 4, I used species distribution models to provide a first approximation of current distributions and future suitable areas for seven undersampled snake species, based on a climatic hypothesis.

Overall, this thesis provides better understanding and directions towards safeguarding future patterns of snake diversity in Iran by filling information gaps. Finally, in order to address the objectives, I explored the results of this study as follows:

1. Identify the evolutionary processes determining current distribution and genetic patterns of the species studied
2. Elucidate the species' taxonomy to deal with the Linnean shortfall
3. Answer the Wallacean shortfall under a climatic hypothesis to orient data acquisition and conservation effort in response to global changes
4. Incorporate these findings in conservation to propose effective conservation measures

5.2. Role and consequences of geological events and Quaternary glacial cycles in the diversification of Iranian snakes

Our phylogeographic analyses revealed that cladogenesis and dispersal events of *G. caucasicus*, *H. ravergeri*, and *N. tessellata* in Iran took place from late Miocene 11 Mya to mid-Pleistocene 0.63 Mya. Thus, it is noteworthy that dispersal and divergence of populations/clades of each species were likely influenced not only by alternating range contractions and expansions during the Pleistocene period but also by more ancient geological events (Fig 5.1).

Period	Epoch	Stage/Age	Subepoch	Age (Ma)		Events	<i>N. tessellata</i>	<i>H. ravergeri</i>	<i>G. caucasicus</i>
Quaternary	Holocene								
	Pleistocene	Tarantian	Upper & Late	0.0117	0.129	Last Glacial Period			
		Chibanian	Middle	0.129	0.774	Multiple extinction and colonization during the Quaternary climate change		C1-C2-C3	C1
		Calabrian	Lower & Early	0.774	1.80			C1-B2	D2-C3-C2
		Gelasian		1.80	2.58		D2-C-B	D2	
Neogene	Pliocene	Piacenzian	Upper & Late	2.58	3.600			A	E
		Zanclean	Lower & Early	3.600	5.333	correspond with Miocene–Pliocene mountain formations		F	
	Miocene	Messinian	Upper & Late	5.333	7.246	connected to the final collision of the India and Afghanistan block, beginning in the Pliocene		A	
		Tortonian		7.246	11.63	Rise of the Zagros Mountains corresponding to the collision of the Arabia– Eurasia plates and opening of a marine seaway along the Bitlis and Eastern Anatolian Fault zones	F-E		



- A:** Azerbaijan mountains
- B:** North slope of Alborz
 - B1:** Caspian Plain
 - B2:** Mugan Plain
 - B3:** Gorgan Plain
- C:** Alborz Mountains
 - C1:** Western Alborz
 - C2:** Central Alborz
 - C3:** Eastern Alborz
- D1:** Central Iranian Plain
- D2:** Eastern Mountain
- D3:** Kopeh-Dagh Mountains
- E:** Central Mountains
- F:** Zagros Mountains
 - F1:** Northern Zagros
 - F2:** Central Zagros
 - F3:** Southern Zagros
- G1:** Khuzestan Plain
- G2:** Persian Gulf Plain
- G3:** Makran Plain
- H:** Zabol Plain

Figure 5.1. The table indicates the divergence of clades observed for three snake species from Miocene to Pleistocene as well as the geological and climatic events that were possibly involved in their divergence. The map shows the ecological zones for snakes in Iran according to Rajabizadeh, 2017 and was regenerated based on the physiographic units of Iran following Fisher (1968).

During the period considered (from Miocene to Holocene), several major geological phenomena and climate fluctuations can be identified as having significantly affected the evolution and distribution of snake species in Iran. These events could be classified into four main phases (Table 5.1):

- Uplift of the Zagros Mountains coinciding with the collision of the Arabian– Eurasian plates and the opening of a marine connection along the Eastern Anatolian and Bitlis Fault zones during middle-upper Miocene (7-11 Mya),
- Collision between the Afghan block and the Indian plate in upper Miocene (7-5 Mya),
- Miocene–Pliocene mountain formations in early Pliocene (5-3 Mya),
- Climatic fluctuations reflected in periodic dry and wet cycles during late Pliocene to middle Pleistocene (3.6 to 0.8 Mya).

From the three studied species, *G. caucasicus* has evolved the youngest lineages in Iran, from the Kopet Dagh (D3 in Fig. 5.1) Mountains toward western Alborz(C1), and Azerbaijan mountains (A). The Iranian *Gloydius* diverged from its sister taxa (*G. rickmersi* and *G. caraganus*) about 1.89 million years ago and reached Iran via the Kopet Dagh Mountains in the northeast (Asadi *et al.*, 2019). The four well-supported lineages of *G. caucasicus* in the northern part of Iran hypothesized the existence of at least four refugia along the Kopet Dagh and Alborz Mountain, in line with previous researches (Tralau, 1963; Leestmans, 2005; Akhiani *et al.*, 2010; Nazarizadeh *et al.*, 2016). which introduced the Hyrcanian forests as suitable glacial refugia during the Quaternary period for multiple taxa.

Nearly the same pattern is observed for the youngest clade of *Natrix tessellata* (Alborz and Kopet Dagh) that diverged from its sister clades (Uzbekistan and Kazakhstan; see figure 3.3.3) also at 1.7 Mya during the Lower Pleistocene and that similarly dispersed from the northeast toward the Alborz and subsequently the Caucasus region. The nine clades observed for *N. tessellata* diversified between -11.3 and -1.7 Mya that is during the Upper Miocene and Beginning Pleistocene. Among these clades, the ancestral lineage observed in the Zagros Mountains defines Iran as the center of origin of the species, a finding in agreement with those of other studies such as Guicking *et al.* (2009). These clades mainly developed under the influence of geographical events such as the formation of the land bridge between Eurasia and Africa at about 12-19 Mya (Steininger and Rögl, 1984) and an extensive drought around 9-10 Mya. These fundamental events created open habitats in the Mediterranean region (van Dam, 2006) thus facilitating gene flow from the Zagros Mountains to the eastern shores of the Mediterranean Sea, initially to Jordan and later to Greece. Furthermore, desiccation of the

Mediterranean Sea during the Messinian crisis 5-6 Mya (Hsü *et al.*, 1977; Krijgsman *et al.*, 1999; Steininger and Rögl, 1984) supported gene flow from Greece to Turkey, but the Balkan Mountains acted as a strong barrier, preventing further expansion from Greece into Europe (Hewitt, 1996). However, a single expansion event from Turkey to Europe was made possible 5.8 Mya. The final geographic-climatic event that impacted the distribution of this species before the Pleistocene climatic fluctuations probably occurred 3.75 Mya during peak drought conditions, which created steppe habitats (van Dam, 2006) in the Caucasus and north of the Caspian Sea. As a result, colonization of the species took place from Turkey toward plains north of the Caspian Sea in Kazakhstan and Uzbekistan.

Hemorrhhois ravergeri and *H. nummifer*, commonly occur in the Palearctic and both species are present in Iran that represents the most western part of their distribution range that extend until Afghanistan and Pakistan. Studies (Nagy *et al.*, 2004) have shown that these two species probably dispersed toward Asia following the collision of the Eurasian and Arabian plates that occurred 16–18 Mya, as a result of which the first land bridge between Africa and Eurasia emerged. Dispersal of the first *Hemorrhhois* populations via this bridge and subsequent speciation across new habitats of northern Africa led to the divergence of these species from their sister taxa, *H. algirus* and *H. hippocrepis*.

Our dating analyses revealed that the cladogenetic events among *H. ravergeri* are dated between 6.06 and 1.66 Mya, and thus were influenced by the Pleistocene climatic oscillations but also by geological events too. During this period (Pliocene and Pleistocene), this open-adapted species may have dispersed to new open habitats and formed new lineages. Our results showed that colonization of this species from Turkey toward the Zagros Mountains took place during the Pliocene (6.06 Mya), when the climate was drier in Eastern Europe (van Dam, 2006). It seems that the Zagros Mountains were colonized by bi-directional route, i.e. the species dispersed toward southern Zagros through eastern and western mid-elevation and piedmonts of the chains, probably because the central Zagros acted as high elevation barrier to gene flow.

Dispersal from eastern Zagros (F in Fig. 5.1) to the Kopet Dagh (D3) Mountains in northeastern Iran occurred in the early Pleistocene (2.7 Mya), followed by divergence of the Alborz (C) lineage from the Kopet Dagh (2.31 Mya), and eventually dispersal of this species to northwestern Iran (Azerbaijan, A) (1.66 Mya). Thus, all events occurred during the Pleistocene climatic fluctuations. Unfortunately, I failed to collect specimens of this species from outside Iran to investigate the species' phylogeny beyond the borders of the country, and as a result, I can only draw the divergence of Iranian lineages.

Two hypotheses could be proposed to explain the species dispersal toward the Kopet Dagh. Considering that Rajabizadeh (2018) reported records of *H. ravergeri* from eastern (D2 in fig. 5.1) and southeastern Iran, it could be suggested that the eastern Zagros clade initially distributed through southeast of Iran and then spread toward mountains of eastern Iran and finally the Kopet Dagh. As I did not include samples from eastern Iran in this study, this hypothesis must be viewed as preliminary. The second hypothesis postulates that the eastern Zagros clade dispersed from mountains of the central plateau toward the Kopet Dagh. However, the central Iranian plateau, which at the time was covered with Qom Lake, acted as a barrier inhibiting the species dispersal from eastern Zagros toward the Kopet Dagh and western Iran.

It could be argued that glacial-interglacial periods likely impacted water levels in lakes and rivers of the Iranian Plateau (Taleghani, 2013), which could serve as a route facilitating the dispersal of species in interglacial periods. Furthermore, previous studies on Iranian snakes include *Pseudocerastes species* (Fathinia *et al.*, 2018), *Macrovipera sp.* (Moradi *et al.*, 2014), *Eirenis persicus* (Rajabizadeh *et al.*, 2016), *Xerotyphlops vermicularis* (Kornilios, 2017) and *Montivipera* spp. (Behrooz *et al.*, 2018). These studies indicate that all Iranian *Montivipera* species (*M. raddei*, *M. latifi* and *M. kuhrangica*) as well as the three species studied here in, exhibit relatively young patterns of diversification and all evolved during Early Pleistocene (Behrooz *et al.*, 2018) whereas other species underwent older diversification events. For instance, the Eastern from western Iranian lineages of *Eirenis persicus* and western Iranian lineages of *Pseudocerastes fieldi* diverged during the mid-Miocene (Serravallian) about 13.8 Mya (Rajabizadeh *et al.*, 2016; Fathinia *et al.*, 2018) that is following the emergence of a marine connection between the Arabian and Anatolian plates (Rögl, 1999). Regarding *Macrovipera lebetina* studied by Moradi *et al.* (2014) and *Xerotyphlops vermicularis* studied by Kornilios (2017), the diversification events lasted up to the Late Pliocene about 2.58 Mya as a result of Miocene–Pliocene mountain formations as well as multiple extinction and colonization events during the Quaternary. During this period (mid-Miocene – upper-Pliocene), major geological and geographical events in Iran led to the diversification of various species. Noteworthy, the Arabian Peninsula began to rotate counterclockwise from late Miocene and early Pliocene 5 Mya, resulting in the formation of the Red Sea and the Gulf of Aden (Girdler, 1984). This event together with the collision between Arabia and Eurasia triggered the formation of mountains in northern and southern parts of the Iranian Plateau. This orogenic period led to the uplift of the Zagros Mountains and the disappearance of savannah-like habitats in north-west of Iran (Campbell *et al.*, 1980; Atabadi *et al.*, 2011), whereas the central Alborz continued to rise (Axen *et al.*, 2001).

Collectively, the results obtained here for the three taxa and other studies presented for snakes suggest that geological events (especially the uplift of the Zagros Mountains) and Quaternary climatic fluctuations have markedly influenced the phylogeographic structure and diversification of populations/lineages of Iranian snakes. Notably, the northern and western mountains of Iran, including the Alborz and Zagros mountains, acted as land bridges that facilitated the dispersal of herpetofauna between central Asia, the Mediterranean basin, and northern Africa. By contrast, the younger mountain chain of Zagros in western Iran began to form 19 Mya following the disappearance of the Tethys Ocean and was completed 12 Mya (Rögl, 1999). The uplift of the Zagros Mountain, resulting from the collision of the Arabia–Eurasia plates, connected Eurasia and Africa, unveiling a dispersal route to new habitats for Eurasian and African herpetofauna.

Nevertheless, geological events were not the sole factors responsible for species' diversification and speciation, as the effects of Quaternary climatic oscillations on northern temperate regions have been previously pointed out in many studies (Avice and Walker, 1998). Several studies have shown that Pleistocene glaciations in Iran (Rajaei *et al.*, 2013; Behrooz *et al.*, 2018) have played a major role in latitudinal shifts in species distributions, especially ectothermic animals that are highly sensitive to temperature fluctuations (Dynesius *et al.*, 2000). During the early Würm period (~100 Kya), the climate of Iran was characterized by dramatic declines in temperature, followed by modest increases in precipitation in mountains (Ehlers, 1980). Under the influence of Quaternary glaciations, cold and dry climates dominated the north and west of Iran, whereas during the interglacials, the climate was warmer and wetter in these regions (Lanfear *et al.*, 2012). During the LGM (Last Glacial Maximum at about 0.02 Mya), temperatures were 5-8 °C cooler than current conditions (Lanfear *et al.*, 2012). The effect of Quaternary glaciations can be seen in mountains of Alborz, Zagros, Kopet Dagh and Azerbaijan (Lanfear *et al.*, 2012; Moghimi, 2010; Wright *et al.*, 1962; Bobek, 1937; Dubey *et al.*, 2006).

It is clearly evident from our study that the effects of Quaternary glaciations have not influenced major clades. However, the divergence of the subclades observed in each clade may have been under the influence of such events. This is noticeable in the number and variability of haplotypes in each clade, that might represent the trace of different glacial refugia in these periods. Nonetheless, a more comprehensive sampling within each clade and subclade is needed to further explore the effects of historical processes and identify past refugia more precisely.

Therefore, it can be expected that the warm-humid climate of Pleistocene periods provided suitable opportunities for population expansion and propagation to suitable habitats, whereas

the cold periods forced them to seek refugia where they remained in isolated populations for thousands and million years, with no possibility of gene flow. This is clearly illustrated by species such as *Montivipera raddei complex* and *Gloydius caucasicus*, as they tend to be specialists and occur in more isolated populations compared to *Natrix tessellata* and *Hemorrhhois ravergieri* species.

The species studied herein showed wide Palearctic ranges and were mostly overlooked by previous related research on Iranian species. Studying wide-ranging snake species is faced with major challenges associated with their sampling difficulties, cryptic nature, conservative morphology, and financial constraints. Further phylogeographic insights and taxonomic knowledge about the evolutionary history of wide-ranging snakes are therefore needed to better understand their biology and ensure their conservation. Collecting specimens from south-eastern Iran as well as adjacent countries would offer more support for one or more of the scenarios regarding the divergence of Iranian lineages.

5.3. Taxonomic Implications

This section aims to investigate the taxonomy of the three studied snakes in Iran to deal with the Linnean shortfall, which largely affects all others shortfalls in biodiversity. It is well known that describing any aspect of biodiversity is impossible in the absence of data on unknown species (Hortal *et al.*, 2015). Inadequacies in taxonomic and distributional data of biodiversity call for a global attempt to deal with the Wallacean and Linnean shortfalls hence, the current biodiversity crisis requires conservationists to obtain information about the taxonomy and geographical distribution of species (Richardson & Whittaker, 2010; Hortal *et al.*, 2015). Here, to examine the taxonomy of the species, I used uncorrected genetic distances, as discussed below.

- *Gloydius caucasicus*

This viper is a member of the *G. halys/G. intermedius* species complex, including *G. halys halys*, *G. h. caucasicus*, *G. caraganus*, *G. cognatus*, *G. stejnegeri*, *G. rickmersi*, *G. shedaoensis*, *G. changdaoensis*, and *G. intermedius* (Orlov *et al.*, 2014; Shi *et al.*, 2016; Wagner *et al.*, 2016; Shi *et al.*, 2017). This species complex constitutes a group of closely related vipers of the Crotalinae subfamily (Viperidae) with a widespread range in the Palaeartic,

On the basis of *cyt b* and ND4 mitochondrial and *c-mos* nuclear markers, I used phylogenetic analyses to elucidate the taxonomic status of *G. h. caucasicus* as a member of this complex in its Iranian and Azerbaijani distribution range. Previous molecular studies have already

proposed to elevate several subspecies of *G. halys* to species rank, e.g. *G. h. caraganus* (Wagner *et al.* 2016), *G. h. cognatus* and *G. h. stejnegeri* (Shi *et al.*, 2017; Shi *et al.*, 2016).

In Shi *et al.*'s studies (Shi *et al.*, 2016, 2017), the genetic distance between taxa of the *G. halys/G. intermedius* complex ranged from 1.0 to 5.4%, and the distance among *G. stejnegeri*, *G. cognatus*, and *G. h. halys* varied between 2.7 and 5.0%. In our study, however, an even greater average genetic distance was observed between the Iranian *G. h. caucasicus* clades and the other species (3.7–5.6%) compared to the distance between *G. cognatus* and *G. stejnegeri* (2.7–4.84%) reported in Shi *et al.*, 2016. Moreover, in their study, the distance between *G. intermedius*, *G. cognatus*, *G. caraganus*, *G. changdaoensis*, *G. stejnegeri*, and *G. shedaoensis* ranged from 1.0% to 5.4%; whereas, in our study, the average genetic distance between the four Iranian *G. h. caucasicus* clades and the other taxa of the complex was estimated to be between 4.2 and 5.2%. The haplotype network and the Bayesian species delimitation approach using multi-locus data (see Asadi *et al.*, 2019) also supported the recognition of *G. h. caucasicus* as a separate species. Nevertheless, the genetic distance between the Iranian *G. h. caucasicus* clades C2 (Central Alborz), LarNP (Lar National Park in Central Alborz), C1-A (Western Alborz and Azarbaijan), and D3-C3 (Kopet-Dagh and Eastern Alborz) decreased to 1.5–2.9%.

In addition, Khani *et al.* (2017) recognized three distinct *G.h.caucasicus* populations in the Alborz Mountains using morphometric and meristic characters, consistent with our Kopet-Dagh, Lar National Park (Central Alborz), Western Alborz and Azerbaijan clades. However, they lacked samples from Central Alborz and thus found no significant distinction between Central alborz and LarNP-CA. On the other hand, in the study by Malek-Mohammadi *et al.*, (2017) based on control region marker, no significant differences were found among *G.h.caucasicus* populations in the Alborz Mountains. Also, a phylogenetic study conducted by Rastegar-Pouyani *et al.*, (2018) using cytochrome *b* sequences obtained for 16 individuals from NE Iran and Central Alborz suggested that *G. h. caucasicus* belonged to the *G. halys/G. intermedius* complex with unresolved phylogenetic relationships. As a result, on the basis of the morphological and molecular evidences, I opined that *G. h. caucasicus* of northern Iran should be raised to full species level as *G. caucasicus* (Nikolsky, 1916).

- *Natrix tessellata*

Natrix tessellata has a wide distribution range, from central Europe to China (see Mebert 2011a, Ananjeva *et al.*, 2004, Szczerbak 2003) among which at least nine clades are evidenced.

Rastegar-Pouyani *et al.*, (2017) proposed the southern-western Iranian clade (F3 Zagros -fig 5.1) as a sister clade to the other clades of this species. Based on pairwise genetic distances, this

clade in their study is shown to be genetically distinct from the clades of Central Asia, Europe and Jordan (7.9%, 11% and 5.2%, respectively). Thus, Rastegar-Pouyani *et al.*, 2017 proposed that *Natrix tessellata* populations in south and west of Iran are separate from other populations and may be considered as a candidate species level. Moreover, Rastegar-Pouyani *et al.*, (2017) showed that northeastern populations of *Natrix tessellata* in Iran (Kopet-Dagh) formed a cluster with Central Asian samples (Uzbekistan and Kazakhstan) and therefore do not fall into a separate clade. Also, morphological studies conducted by Rajabizadeh (2011) revealed that populations of southern Zagros exhibited significant differences from the other Iranian populations. They related such differences to their dietary variations and geographical isolation from other populations.

Nevertheless, our results for *Natrix tessellata* showed that inter-clade genetic distances vary from 2.1% (between Kazakhstan – Caucasus lineages) to 8.9% (between Greece – Caucasus lineages). The intra-clade distances are minimal, the highest value being observed for the Turkey lineage (1.6%). Although our results showed a higher divergence for the Turkey lineage compared to that of Iran, it is noteworthy that a comprehensive sampling of this species, especially in North East Iran, needs to be done. In the present study, I did not scrutinize the taxonomic status of *Natrix tessellata* and the possible discovery of species/subspecies in Iran because I maintained that this question should be addressed using integrative taxonomy, that is based on an adequate number of specimens from the whole species range and including also ecological and morphological approaches. Therefore, a taxonomic decision regarding the populations of *Natrix tessellata* in the Alborz and Zagros mountains in Iran must be delayed until other specimens from the species are surveyed. Although the southern and western populations of dice snake can potentially be considered as a new species, further evidence, particularly from ecological studies, is needed to ascertain the taxonomy of the species.

- *Hemorrhois ravergieri*

Spotted wiper snakes belong to the Colubridae family (genus *Hemorrhois*) and include four species, namely *Hemorrhois ravergieri* (MÉNÉTRIÉS, 1832), *H. nummifer* (REUSS, 1834) *H. hippocrepis* (LINNAEUS, 1758) and *H. algirus* (JAN, 1863). The species of this genus have limited distributional ranges across different habitats of Asia, southern Europe and northern Africa (Schweiger, 1991; Wallach *et al.*, 2014) (Fig. 3.1.3).

Phylogenetic studies (Nagy *et al.*, 2004) show that the genus *Hemorrhois* diverged into two groups 16 Mya: (i) *H. ravergieri* and *H. nummifer*, primarily distributed in the Palearctic, and (ii) *H. algirus* and *H. hippocrepis*, which inhabit northern Africa and adjacent regions of

southern Europe. Results of our phylogenetic analyses validated the separation between *H. ravergeri* and *H. nummifer* which are separated by a genetic distance of 6.04%. Our results showed that the intra-lineage genetic distances among *H. ravergeri* were small (<0.007) except for Turkey (0.25), and the inter-lineage distances were between 1.8% (between West Alborz – Azerbaijan / Alborz lineages) and 1.78% (between Turkey – Zagros lineages). These groups are very close compared to the genetic distance separating *H. ravergeri* from its sister species *H. nummifer*, which were formerly considered conspecific (Arnold and Ovenden, 2010).

However, morphological identification of both species in the field is a challenging task. Consequently, I recommended a comprehensive sampling from the entire distribution area of the two species associated with comparative morphological studies between molecular clades. On the other hand, possible discovery of species/subspecies for these species in their Iranian distribution area is not far-fetched, particularly because they have adapted to different habitats (Rajabizadeh 2018). For this reason, further sampling of Iranian (especially in eastern parts of the Zagros, the Alborz, northwestern, southern, southeastern and eastern Iran) and Turkish populations is essential.

In the present study, I did not assess the morphological characteristics of *H. nummifer* populations. However, the species exhibits a wide range of color variety and pattern variations in Iran. Rajabizadeh (2018) observed that *H. ravergeri* specimens of western Iran possessed greyish color patterns with pale stripes and blotches or even uniform black coloration, a distinction which could be an indication of a different species. I also collected uniform black specimens from western Iran. I also sampled *H. nummifer* specimens with black heads and grey bodies in eastern Iran as well as two specimens with yellow and black color patterns completely different from other *H. nummifer* specimens. Yet, these morphologically unique specimens did not demonstrate significantly different genetic distances from other samples. Therefore, integrative studies using molecular, morphological, and ecological data with higher precision and on a larger scale are needed.

5.3. Answer the Wallacean shortfall under a climatic hypothesis to orient data acquisition and conservation effort in response to global changes

Environmental and climatic changes force many species to expand, shrink, shift, or lose parts of their geographic ranges (Angert *et al.*, 2011; MacLean & Beissinger 2017). Phylogeographical studies reveal that during previous climatic changes, over the long-time species may have adapted to new conditions, shifted their distribution ranges, evolved into new

species, or become extinct. However, it seems as though a large number of species have responded through shifting their ranges to track suitable conditions.

By looking back at past events, conservation planners seek processes that may explain the pace and extent of changes in species' distributions in response to environmental and climatic variations. The predictability of species' distributions may stem from a better understanding of the relation between present-day and past changes in species' distributions (Ladle and Whittaker, 2011). Similarly, the identification of high speciation / extinction areas and the location of past climate refugia may inform biodiversity conservation strategies (Ladle and Whittaker, 2011). The past, however, is not always the best predictor of the future, particularly because the current climate change is occurring at a much faster pace than before. Furthermore, past biodiversity data are scant at a biogeographic timescale, especially in areas where present-day data are also incomplete, such as in Iran: forecasts of species' fate against current climate changes therefore have to rely on suboptimum techniques that are not process-explicit, such as correlative species distribution models (cSDM).

Ecophysiology reveals how warming climates may affect snakes, for example higher food intake in snakes results in faster growth, larger maturity sizes, and increased fecundity (Ford and Seigel, 1994; Beaupre, 1996; Lindell, 1997; Luiselli *et al.*, 1997). Global warming is also likely to change digestion times, and the length and number of days snakes can spend foraging, hence affecting their food intake. Moreover, snakes are capable of more easily adapting to warming climates owing to their thermoregulatory behavior (Mullin & Seigel, 2011) but, under severe warming conditions, range shifts and local extinctions will be inevitable (e.g., Currie, 2001; Kling *et al.*, 2003). Models predicting range shifts for snakes assume that the projected shifts will not exceed the species' dispersal ability, which is far from being reasonable in many species. If changes occur gradually, species may indeed shift in accordance with forecasts through a combination of small-scale individual movements and demographic responses. This, however, may not always be possible if changes occur rapidly or if other constraints interfere. For instance, mountain-dwelling species with small elevational ranges may only be able to move to higher elevations if the mountains are high enough and in the absence of physical barriers (Greene, 1994).

The robustness of species-climate relationships and subsequent forecasts minimally require sufficient and reliable distribution data. SDMs offer an imperfect, yet pragmatic way to predict distribution patterns when dynamic data on species' ranges or demography are not available for mechanistic modeling. This comes however with a number of conceptual and methodological limitations which we develop further below.

Using bioclimatic envelope models and relying on the best available data, we provided the first multi-species comparative forecast of the fate of several undersampled snake species in an undersampled region. Our modeling results suggested that shifts in climatically suitable areas are expected for seven snakes in Iranian mountains over the next 50 years. Despite the fact that our results are subject to a degree of uncertainty and well-identified methodological limitations, they reveal several major outcomes for conservation of snakes facing climate change. First, most studied species are likely to experience drastic reductions in their climatically suitable space, both in area and altitude. Critical to their conservation, future studies will have to assess whether snake species will be able to track suitable conditions and/or accommodate to changes by modifying other aspects of their ecological niche. This is even more essential as several species studied here are restricted to Iranian mountains, their extinction would thus result in an irreplaceable loss of biodiversity. Second, our models revealed that the current protected areas network is largely inadequate to warrant the future of the studied species.

Limitations and uncertainties involved with construction of SDMs stem from different sources which may affect model predictions at different steps of the building process. These limitations arise from (i) quality, quantity, and representativeness of the data, (ii) assumptions underlying the model itself and (iii) the inherent uncertainty associated with any forecasting process (see for example *Wisz et al.*, 2008; *Araújo and Peterson*, 2012; *Garcia-Callejas and Araujo*, 2015; *Warren et al.*, 2018):

- Species data:

Data accessibility is one of the most major issues that preclude adequate modeling of species distributions, especially in undersampled areas like Iran and for rare and range restricted species (*Lomolino*, 2004). The effort required to gather an extensive atlas-like presence-absence data set is completely unrealistic in Iran, such that all knowledge on reptiles in the region relies on presence-only data gathered opportunistically (*Farashi and Shariati*, 2017). Furthermore, reptiles are rare and cryptic animals that are notoriously hard to sample, hampering efforts to accumulate spatial distribution data at a fine spatial grain. Thus, most reptile species suffer from low sample sizes and sparse data with regard to distribution range, geographical location, population size, and precise information on presence points. This first issue is technically tractable by using presence-only SDMs such as point process models, as done in Chapter 4 in which we use MaxEnt to relate opportunistic records of seven snake species to several climatic variables.

Reptiles are, however, strict habitat specialists relying on complex combinations of macro- and micro- habitat variables not incorporated in our models due to data unavailability. Because reptiles are too rare and hard to detect within most standardized sampling protocols, data are typically accumulated over the long term through opportunistic sampling impaired by high heterogeneity in observers' effort (Böhm *et al.*, 2013; De Solan *et al.*, 2019). As a result, and compared to more detectable vertebrates (mammals and birds), knowledge on reptiles' distributions and environmental requirements remains affected by high uncertainty (Dennis and Thomas, 2000; Varela *et al.*, 2014). Three major consequences of these knowledge limitations may affect the results presented in chapter 4:

- The major assumption of MaxEnt that the climatic envelopes of modelled species are sampled representatively may not be realized, leading to incorrect estimates of model parameters. Although the current naturalist knowledge suggests that the curves obtained in my results are compatible with species' biology, there is hardly any other way to overcome this issue than performing further sampling, including in putative absence areas.
- In relation with the previous point, the survey area (here, Iran) is assumed to encompass the climatic limits of the species considered, even though it does not encompass the full geographic range of some species. Failing to match this assumption would lead to truncated responses to climatic variations and / or misspecification of species' response curves to climate, especially at their margins
- The results obtained in chapter 4 cannot be transferred to other regions since local adaptation and changing interactions with non-climatic factors may trigger regional variations in species' climatic envelopes (Case and Taper, 2000). This is a relatively minor issue for our study which is dedicated to Iran, but might be a problem for wider-scope studies.

- Environmental data:

Another limitation that needs to be noted relates to the predictors chosen for SDM construction. Reptiles are, as any taxa, affected by a wide range of climatic and non-climatic parameters which interact to construct the realized niche and distributional limits (Sexton *et al.*, 2009; Peterson *et al.*, 2011; Araújo and Peterson, 2012; Araújo *et al.*, 2013). Our choice of considering climatic variables only implies the assumption that climate is an adequate proxy for the most major limitations of reptiles' distributions at the considered spatial scale, which,

given the lack of knowledge on these species, remains uncertain. Over-reliance on climate only to forecast species distribution is especially problematic in case of spurious correlations between climatic and non-climatic variables due to sampling or temporary associations without causal background, and/or when climate is a minor or indirect factor limiting species' distributions. Both cases may result in incorrect parametrization and inadequate forecasts, even in models exhibiting high fit (Boucher-Lalonde and Currie, 2016; Fourcade *et al.*, 2018; Journé *et al.*, 2019). In practice, this choice was dictated by the lack of non-climatic data to perform forecasts, but it is also supported by strong biological arguments (e.g., Bucklin *et al.*, 2015). First, ecological patterns are strongly shaped by climate along elevational gradients, making climate the main structuring factor of habitats and anthropogenic land use in mountains (Humboldt, 1807; Merriam, 1894; Francis and Currie, 2003; Willig *et al.*, 2003). We cannot ignore however the complex interplay between a combination of climate and non-climate factors which determines actual species distributions and may even overcome the effects of climate.

Furthermore, as we were aware of the lack of robustness in the model, we attempted to minimize its impact and yield better results through averaging the GCMs (averaged the predicted values from the three GCM models) for projection of present-day climates onto future conditions in our study. In this way, areas where projections of different models coincide will be selected in order to draw more conservative inferences about the future climatic conditions.

- Model structure and assumptions:

Predictions of future species distributions using climate change scenarios may be performed through correlative and mechanistic SDMs (Jarnevich *et al.*, 2015). Mechanistic approaches represent species responses to climatic changes explicitly through diffusion equations; however, obtaining the data needed to calibrate these models is complex, calling to targeted studies that are inaccessible to poorly known species and regions with scarce data on ecological processes (Journé *et al.*, 2019). The correlative SDMs used in chapter 4 have been extensively used as a workaround, to the cost of several assumptions that need to be cautiously verified (Thomas *et al.*, 2004; Pereira *et al.*, 2010; Thuiller *et al.*, 2011).

First, these models make no causal assumption about the role of climate on species distributions, but rely on the high correlation usually observed between climatic variables and species range limits (e.g. Guisan and Thuiller, 2005; Morin *et al.*, 2007). A second issue stems in the non-dynamic structure of correlative SDMs as implemented in MaxEnt or similar frameworks, which basically rely on stationary Generalized Linear Models (GLM) regressing

presence probability against spatial covariates. Their stationarity assumption implies that the modelled parameters do not vary in time, which is inadequate as soon as species' ranges are not in equilibrium with climate (Gauzere *et al.*, 2019). Disequilibrium dynamics may arise under colonization dynamics, following local extinctions unrelated to climate, or simply because non-climatic factors that vary in time (e.g. vegetation structure or human land use) have a primary role in setting range limits. Non-stationarity may also arise in space (i.e. climate effects vary from a location to another) due to interactions with other variables or because of local adaptation (Gavin and Hu, 2006). Failing to account for non-stationarity is unlikely to affect model fit strongly, but, if sufficiently strong, may lead to inadequate forecasts especially across long time lags or if the calibration datasets are not representative enough of long-term conditions (Roberts *et al.*, 2017; Fourcade *et al.*, 2018). Modeling such dynamic relationships however requires large amounts of data with regular temporal and spatial coverage, which are clearly not available in the Iranian context. The models and forecasts presented in chapter 4 therefore need to be viewed as conservative estimates valid over a short time lag, under the assumption that the observed relationships will not vary in the future.

A third issue lies in spatial autocorrelation, an inherent pattern of all distributional data and more generally to any gradient. Recent simulations and empirical studies have shown that spatial structures in both species' distributions and predictors, irrespective of any causal association, can trigger high model fit and especially inflate AUC values (Fourcade *et al.*, 2014; Journé *et al.*, 2019). Spatial artifacts may have consequences on both the shape and magnitude of model parameters, and thus lead to improper model structures. In particular, the altitudinal structuration of climatic variables paired with a warming scenario forces forecasts of species distributions towards higher altitudes, even if reptiles' actual responses are more complex. Our only valid argument to dismiss the possibility that our results are entirely driven by spatial autocorrelation is that the shapes of observed response curves are conform to biological expectations, but we cannot rule out the possibility that confidence intervals are underestimated (Dormann *et al.*, 2017).

Although species' apparent responses to current and past climate may not be stationary, they remain the only information we have to predict future responses of species to climate variations. In chapter 3, I discussed the major role of Quaternary climatic fluctuations in shaping the distribution patterns of the species studied herein, and showed that the role of climate oscillations cannot be disregarded. Furthermore, the crucial role played by Zagros and Alborz Mountains, as parts of two global biodiversity hotspots (Irano-Anatolian and Caucasus), in maintaining biodiversity and endemism and providing suitable climate for snake species

throughout the years must be taken seriously (Ahmadi *et al.*, 2019; Behrooz *et al.*, 2018; Asadi *et al.*, 2019). Indeed, the ongoing global warming may compromise the suitability of these areas to many species. The major question in conservation terms is whether or not these regions will remain climatically suitable for snake species facing climate change in the next 100 years, a short timelag in comparison to the processes investigated in chapter 3. Under climate change, suitable climatic conditions will possibly be lost, restricting species to specific elevational gradients. This could strongly threaten mountain-dwelling species, which currently inhabit high elevations of the Alborz and Zagros mountain ranges (see also Williams *et al.*, 2003; Pounds *et al.*, 2006).

Generally, it is likely that higher temperatures decrease both the costs and benefits of thermoregulation for temperate-zone snakes, which is consistent with our results. Species such as *Montivipera* are predicted to experience unfavorable climatic conditions where increased temperatures will drive them to higher altitudes, whereas for *Macrovipera* and *Malpolon* species, no major changes are expected. Although the studied species are not protected (except for *Montivipera latifii*), they could serve as a guild associated with mountainous habitats for conservation planning. Because 0.17 of the climatic suitable area for the studied species are located within the network of protected areas in Iran, our projected suitable climatic envelopes (by 2070) for the seven species should warn that, under the current anthropogenic climate warming, the effectiveness of the current protected area network could decrease considerably. Crossing this assessment with similar studies on other taxa will reveal the extent of change required to adapt protected areas to expected climatic changes, bearing in mind that non-climatic impacts and anthropogenic development (e.g., urbanization, road networks, and agriculture) may also interfere.

In the generalized lack of data on Iranian reptiles, these results are preliminary and essentially point towards the need for further targeted sampling dedicated to niche modeling beyond climate, improvement of knowledge on species' distributions (including absence areas), and refining the locations of range limits. In that respect, I hope that this study will catalyze awareness of the threats posed both by climate change and knowledge deficiency on Iranian herpetofauna, and more generally on all taxa and regions affected by the "Wallacean bias".

5.4. Implications for conservation

Establishing protected areas is one of the main tools for mitigating the continuing global biodiversity crisis (Rodrigues *et al.*, 2004; Le Saout *et al.*, 2013). These protected areas should be ecologically representative, effectively managed and connected to ensure long-term persistence of biodiversity. However, without guidance on how important, representative, and effective area-based conservation measures are, efforts to achieve target may fail (Watson *et al.*, 2014). The conservation science community, therefore, needs to provide guidance, definitions, methodologies, and metrics. In Iran criteria for conservation have always revolved around species with higher perceived value such as large or rare species and the deficiencies of the present management system are so severe that little is known about the ecological and socio-economic resources of parks and protected areas (Makhdoum., 2008).

Due to negative public perceptions and widespread fear in Iran, snakes have always been viewed unfavorably even for the environmental guides. Yet, failure to protect these species can lead to adverse consequences for all forms of life in an ecosystem. For example, continued declines in snake populations are likely to increase their prey populations (several of which are commonly construed as pests, Mullin & Seigel 2011).

It should be noted, however, that limited financial resources are allocated to protection in Iran, making comprehensive protection of all habitats and populations practically impossible. As a result, defining evolutionary units relying on genetic and environmental data could be seen as fitting methods to protect groups or guilds of species, particularly in regions such as the Alborz and Zagros Mountains which are global hotspots of biodiversity with high levels of endemism.

However, it is worth noting that hotspot locations may differ depending on how the hotspot is defined. Various biodiversity metrics, including species richness, weighted endemism, phylogenetic diversity, and biogeographically weighted evolutionary distinctiveness, have been used to portray species diversity, define hotspots and select priority areas for conservation (Huang *et al.*, 2016; Pardo *et al.*, 2017). Given the robust phylogeographical structure of the species in our study, it appears that conservation prioritization could be established based on their geographical locations and identification of Evolutionarily significant units (ESUs).

Among the many definitions assigned to the concept of ESUs, I chose the one adopted by Fraser and Bernatchez (2001), as its overall focus remains on isolated populations with unique haplotypes which are not shared with other groups. They state that lineages with particularly restricted patterns and levels of intraspecific gene flow are to be considered as ESUs for conservation. However, the taxonomic status (species or subspecies level) does not help in this

objective mainly because of conflicting definitions (Fraser and Bernatchez, 2001). As an operational term, the concept of evolutionarily significant unit has been introduced to describe unique groups of organisms, below the species level, that should be managed separately because of their originality (Ryder 1986; Moritz 1994).

According to this definition, *N. tessellata*, *H. ravergeri*, and *G. caucasicus* can be classified as ESUs and therefore warrant conservation. Furthermore, ESUs can also be defined below the species level between populations within each genetic unit. Then, each ESU represents a particular geographical location, a fact that could be used in determining areas where these taxa act as focal species in order to establish conservation strategies for a multitude of species. Therefore, I proposed that all distinctive lineage of *N. tessellata*, *H. ravergeri* and *G. caucasicus* showing unique haplotype combination as ESUs for conservation. Table 5.1 shows the ESUs selected for these taxa on the basis of the number of haplotypes per clade in the different ecological units recognized by Rajabizadeh (2017) for Iranian snakes (Figure 5.1).

ESUs determined in Table 5.1, are defined according to each clade (phylogenetic lineage), number of individuals sampled, and number of detected haplotypes. The table indicates that zones A and C1 in northwestern Iran have high conservation value due to the presence of three phylogenetic lineages for the three studied species. Additionally, in these zones, the ratio of detected haplotypes to the number of studied individuals is high. Given the small number of samples in this region, any conclusions should be made with caution and a more extensive sampling effort is needed. However, our investigation points to regions in Turkey or mountains in Azerbaijan (A in Fig. 5.1) as the likely origin of *Hemorrhhois ravergeri*. The species has probably entered Iran through these regions. According to Rögl (1999) (chapter 2 Fig 2.1 K), this region has been a transitional zone between Iran and Anatolia and is hence highly important for conservation. At the same time, Kopet Dagh Mountains (D3) have a high number of detected haplotypes relative to the total number of samples. This observation aligns with our findings, showing that *Gloydius caucasicus* has entered the Kopet Dagh Mountains from eastern and northeastern Iran, followed by dispersion through northern and southern slopes of the Alborz mountains (C2 and C3), eventually reaching western Alborz (C1) and Azerbaijan Mountains. Furthermore, this observation reveals Iran's northern belt as the center of speciation for this species and draws attention to its importance for conservation (see Asadi *et al.* 2019). Overall, we found four ESUs for effective conservation in the Zagros and central mountains of Iran. Our phylogeographic and phylogenetic investigations determined a region in southern Zagros (F3) as the origin of *Natrix tessellata* in Iran. These results are presented in the table below. As

shown in the table, ecological zones F1-E and F2-F3 contain a large portion of haplotypes, which indicates their high significance for conservation.

Table 5.1. Determination of ESUs for each species based on the number of haplotypes per ecological units in Iran (see Fig. 5.1)

Ecological Unit	Number of individuals/Number of Haplotypes		
	<i>G.caucasicus</i>	<i>H.ravergieri</i>	<i>N.tessellata</i>
	39/24	78/36	43/26
A (Azerbaijan)	13/6	2/2	5/3
C1 (Western Alborz)		23/9	20/12
C2 (Central Alborz)	4/2		
Lar national Park (Central Alborz)	11/7		
C3 (Eastern Alborz)	11/9		
D3 (Kopet Dagh)		14/9	18/11
F1 (Central Zagros)		36/14	
F2(North Zagros)			
F3 (South Zagros)			
E (Central Mountains)		3/2	
ESUs	4 Units	5 Units	3 Units

Although our results indicated that about 37.8% of the suitable area for *G. caucasicus* and 0.17 of the suitable area for all other mountainous snakes studied are located within the current network of protected areas in Iran, modeling the predicted overlap between the future species' suitable habitats and the network of protected areas revealed that the effectiveness of the current network could decrease by 26% and 60% for RCP 2.6 and RPC 8.5, respectively.

Currently, the 253 protected areas in Iran's protected areas network cover roughly 10.12% of the country. Even if it is optimistically assumed that these areas are adequate for protecting these species, our models show a drastic reduction of climatically suitable habitats for the species by 2070, which will put them on the verge of local extinction. As Iran's Department of Environment aims to designate 17% of the country as protected areas, we hope that by introducing ESUs in this study and based on results from other similar research, areas with high genetic diversity will be selected in the course of expanding Iran's network of protected areas.

Only under these conditions can we hope that protecting these species and other sympatric species might ensure their long-term persistence.

Assessment of the efficacy of protected areas under present and future climatic conditions is an ultimate responsibility that rests with conservation biologists. As protected areas stand on current distributions of species, their conservation effectiveness may dwindle in the future under the impact of climate change or other detrimental effects (mostly from anthropogenic pressures) on species and their surrounding environment. Snakes are currently threatened by various factors such as agricultural development, overgrazing of livestock, destruction of rangelands, hunting and killing by local people and/or tourists, mortality due to vehicle collisions on roads, restricted movement of individuals among population patches, and large-scale hunting and capturing for *Gloydius caucasicus* for is vaccine and serum production (about 1000 capturing licenses are certified annually; Rastegar-Pouyani *et al* 2018). Unfortunately, hunting/capturing of this species is mostly done when snakes emerge from hibernation and have not yet had the chance to reproduce. In general, populations of this species have experienced dramatic declines over the past decades, to the extent that snake catchers complain that it is now hardly possible to locate well-populated sites for this species.

Therefore, several recommendations can be put forward to the Department of Environment of Iran that include (i) establish and declare new protected areas throughout the distribution range of the Caucasian pit viper, according to the four ESUs identified in this study, (ii) establish safe zones in current protected areas that cover suitable habitats of the Caucasian pit viper; (iii) prevent or reduce legal hunting and venom collection from populations of the Caucasian pit viper until populations have recovered.

The International Union for Conservation of Nature (IUCN) has classified *Gloydius monticola* (Likiang Pit Viper) from China as Data Deficient (DD), “*G. saxatilis*” (Rock Mamushi) from China, Korea, and Russia as Least Concern (LC), and *G. shedaoensis* (Shedao Island Pit Viper) from China as Vulnerable (VU). However, the conservation statuses of the other species in the two complex groups of *G. blomhoffi* and *G. halys/G. intermedius* (including *G. caucasicus*) have received little consideration. None of the species studied here has been assessed from a conservation perspective and none has been included in the IUCN Red List categories. Also, among the species used for modeling analyses, none has been targeted by conservation or management programs, except *Montivipera latifi* in Central Alborz that was listed as threatened in 2000. Although the populations of *G. caucasicus* have dramatically declined in Iran over the past decades, the Caucasian viper is not listed as a protected species according to the Department of Environment of Iran, accompanying many other reptiles that

have been largely neglected from the list of protected species. Therefore, I propose that the Department of Environment of Iran should list the species as protected under laws of the Department of Environment of Iran, and reduce its international illegal trade by the addition of the species to the CITES appendices and in the IUCN red list.

References

- Ahmadi, M., Hemami, M.R., Kaboli, M., Malekian, M., Zimmerman, E.N., (2019). Extinction risks of a Mediterranean neo-endemism complex of mountain vipers triggered by climate change. *Scientific Reports*. 9:6332.
- Ahmadzadeh F., Carretero M.A., Rödder D., Harris D.J., Freitas S.N., Perera A., *et al.* (2013). Inferring the effects of past climate fluctuations on the distribution pattern of *Iranolacerta* (Reptilia, Lacertidae): evidence from mitochondrial DNA and species distribution models. *Zoologischer Anzeiger – A journal of Comparative Zoology*. 252:141–148.
- Akhani, H., Djamali, M., Ghorbanalizadeh, A. & Ramezani, E. Plant biodiversity of Hyrcanian relict forests, N Iran: an overview of the flora, vegetation, paleoecology and conservation. *Pak. J. Bot.* **42**, 231–258 (2010).
- Ananjeva, N. B., Orlov, N. L., Khalicov, R. G., Darevsky, I. S., Ryabov, S. A. & A. V. Barabanov. (2004). Colored Atlas of the Reptiles of the North Eurasia (taxonomic diversity, distribution, conservation status). Russian Academy of Sciences. Saint-Petersburg. 232p. [in Russian with English preface].
- Angert, A. L., Crozier, L. G., Rissler, L. J., Gilman, S. E., Tewksbury, J. J., & Chunco, A. J. (2011). Do species' traits predict recent shifts at expanding range edges? *Ecology Letters*, 14, 677–689.
- Araújo EL, Ribeiro JC, Chagas MCM, Dutra VS, Silva JG. (2013). Moscas-das-frutas (Diptera: Tephritidae) em um pomar de goiabeira no Semi Árido Brasileiro. *Revista Brasileira de Fruticultura* 35: 41–51.
- Araújo MB & Peterson AT, 2012. Uses and misuses of bioclimatic envelope modelling. *Ecology*, 93:1527-1539.
- Arnold N. & Ovenden D. (2010). Le guide herpéto : 228 amphibiens et reptiles d'Europe. Delachaux et Niestlé. 290 pp.
- Asadi, A., Montgelard, C., Nazarizadeh, M., Moghaddasi, A., Fatemizadeh, F., Simonov, *et al.* (2019). Evolutionary history and postglacial colonization of an Asian pit viper (*Gloydus halys caucasicus*) into Transcaucasia revealed by phylogenetic and phylogeographic analyses. *Scientific Reports* 9:1224.
- Asadi, A., Montgelard, C., Nazarizadeh, M., Moghaddasi, A., Fatemizadeh, F., Simonov, E., Kami, H. G. and Kaboli, M. (2019). Evolutionary history and postglacial colonization of an Asian pit viper (*Gloydus halys caucasicus*) into Transcaucasia revealed by phylogenetic and phylogeographic analyses. *Scientific Reports*, 9: 1224: 1–16.
- Ataabadi, M. M., R. L. Bernor, D. S. Kostopoulos, D. Wolf, Z. Orak, G. Zare, H. Nakaya, M. Watabe, and M. Fortelius. 2013. Recent advances in paleobiological research of the late Miocene Maragheh fauna, Northwest Iran; pp. 546–565 in X. Wang, M. Fortelius, and L. Flynn (eds.), *Fossil Mammals of Asia: Neogene Biostratigraphy and Chronology*. Columbia University Press, New York.
- Avise, J. C., and D. Walker. 1998. Pleistocene phylogeographic effects on avian populations and the speciation process. *Proc.R. Soc. Lond. B* 265:457–463.
- Axen, G.J., P.S. Lam, M. Grove, D.F. Stockli, J. Hassanzadeh (2001). Exhumation of the west-central Alborz Mountains, Iran, Caspian subsidence, and collision-related tectonics *Geology*, 29 .pp. 559-562.
- Beaupré, S. J. (1996). Field metabolic rate, water flux, and energy budgets of mottled rock rattlesnakes, *Crotalus lepidus*, from two populations. *Copeia*.1996: 319– 329.
- Behrooz, R. *et al.* (2018). Conservation Below the Species Level: Suitable Evolutionarily Significant Units among Mountain Vipers (the *Montivipera raddei* complex) in Iran. *J. Hered.* 109, 416–425.

- Behrooz, R., Kaboli, M., Arnal, V., Nazarizadeh, M., Asadi, A., Salmanian, *et al.* (2018). Conservation Below the Species Level: Suitable Evolutionarily Significant Units among Mountain Vipers (the *Montivipera raddei* complex) in Iran. *Journal of Heredity*, 109:416–425.
- Bobek, H. (1937). Die Rolle der Eiszeit in Nordwestiran. *Z. Gletscherkunde*. 25, 130–183.
- Böhm *et al.*, 2013. The conservation status of the world's reptiles. *Biological Conservation* 157: 372–385. doi: 10.1016/j.biocon.2012.07.015.
- Boucher-Lalonde V. and Currie D.J., 2016. Spatial Autocorrelation Can Generate Stronger Correlations between Range Size and Climatic Niches Than the Biological Signal—A Demonstration Using Bird and Mammal Range Maps. *PLoS ONE* 11(11).
- Bucklin, A., McGillicuddy, D. J. J., Wiebe, P. H. and Davis, C. S. (2015) Habitat usage by the cryptic copepods *Pseudocalanus moultoni* and *P. newmani* on Georges Bank (Northwest Atlantic). *Cont. Shelf Res.*, 111, 83–94.
- Campbell, B. G., M. H. Amini, R. L. Bernor, W. Dickinson, R. Drake, R. Morris, J. A. Van Couvering, and J. A. H. Van Couvering. 1980. Maragheh: a classical late Miocene vertebrate locality in northwestern Iran. *Nature* 287:837–841.
- Case T.J & Taper M.L. 2000 Interspecific competition, environmental gradients, gene flow, and the coevolution of species' borders. *Am. Nat.* 155, 583–605.
- Currie, D.J. 2001. Projected effects of climate change on patterns of vertebrate and tree species richness in the coterminous United States. *Ecosystems* 4:216–225.
- De Solan, T., Renner, I., Cheylan, M., Geniez, P. & Barnagaud, JY. 2019. Opportunistic records reveal Mediterranean reptiles' scale-dependent responses to anthropogenic land use. *Ecography* 42(3) 608–620.
- Dennis, R.L.H. & Thomas, C.D. (2000) Bias in butterfly distribution maps/: the influence of hot spots and recorder's home range. *Journal of Insect Conservation*, 4, 73– 77.
- Dormann, C.F., Fründ, J. H. Martin Schaefer H.M. (2017). Identifying Causes of Patterns in Ecological Networks: Opportunities and Limitations. *Annual Review of Ecology, Evolution, and Systematics*. 48 :1, 559–584
- Dubey, S., Zaitsev, M., Cosson, J. F., Abdukadier, A. & Vogel, P. (2006). Pliocene and Pleistocene diversification and multiple refugia in a Eurasian shrew (*Crocidura suaveolens* group). *Mol. Phylogenet. Evol.* 38, 635–647.
- Hortal, J., de Bello, F., Diniz-Filho, J.A.F., Lewinsohn, T.M., Lobo, J.M. & Ladle, R.J. (2015). Seven shortfalls that beset large-scale knowledge of biodiversity. *Annual Review of Ecology, Evolution, and Systematics*, 46, 523–549.
- Dynesius M, Jansson R (2000) Evolutionary consequences of changes in species' geographical distributions driven by Milankovitch climate oscillations. *Proc Natl Acad Sci USA* 97:9115–9120.
- Ehlers, E., (1980): Iran. Grundzüge einer geographischen Landeskunde. Wissenschaftliche Länderkunden, Bd. 18. Darmstadt : Wissenschaftliche Buchgesellschaft, 596 pp.
- Farashi A, Shariati M, Hosseini M (2017). Identifying biodiversity hotspots for threatened mammal species in Iran. *Mamm Biol* 87:71–88.
- Fathinia, B., Rastegar-Pouyani, N., Rastegar-Pouyani, E. (2018). Molecular phylogeny and historical biogeography of genera *Eristicophis* and *Pseudocerastes* (Ophidia, Viperidae). *Zoologica Scripta*, 47:673–685.
- Fisher. W. B. (1986). *The Cambridge History of Iran*, Vol. 1: The Land of Iran. Cambridge: Cambridge University Press. 766 pp.
- Ford, N. B., and R. A. Seigel. (1989) a. Phenotypic plasticity in reproductive traits: evidence from a viviparous snake. *Ecology* 70: 1768– 1774.

- Fourcade, Y., Besnard, A. G., and Secondi, J. (2018). Paintings predict the distribution of species, or the challenge of selecting environmental predictors and evaluation statistics. *Glob. Ecol. Biogeogr.*
- Fourcade, Y., Engler, J. O., Rödder, D., & Secondi, J. (2014). Mapping species distributions with MAXENT using a geographically biased sample of presence data: a performance assessment of methods for correcting sampling bias. *PloS one*, 9(5), e97122.
- Francis, A.P., Currie, D.J., (2003). A globally consistent richness-climate relationship for angiosperms. *Am. Nat.* 161, 523–536.
- Fraser D.J., Bernatchez L. (2001). Adaptive evolutionary conservation: towards a unified concept for defining conservation units. *Molecular Ecology*, 10:2741–2752.
- García-Callejas, D., & Araújo, M. B. (2015). The effects of model and data complexity on predictions from species distributions models. *Ecological Modelling*, 326, 4–12.
- Gaüzère, P., Doucier, G., , V., Kéfi, S. (2019). A framework for estimating species-specific contributions to community indicators. *Ecological Indicators*.33:74-82.
- Gavin,D.G., Hu,F.S (2006)Spatial variation of climatic and non-climatic controls on species distribution: The range limit of *Tsuga heterophylla* .*Journal for Biogeography*. 33: 1384-1396.
- Girdler, R.V. (1984). The evolution of the Gulf of Aden and Red Sea in space and time. *Deep Sea Research Part A. Oceanographic Research Papers*. 31:747-762
- Greene, H.W. 1994. Systematics and natural history, foundations for understanding and conserving biodiversity. *Am. Zool.* 34:48 –56.
- Guicking, D., Joger, U. and Wink, M. 2009. Molecular phylogeography of the viperine snake *Natrix maura* (Serpentes: Colubridae): Evidence for strong intraspecific differentiation. *Organisms, Diversity & Evolution*: 130–145.
- Guisan, A., & Thuiller, W. (2005). Predicting species distribution: offering more than simple habitat models. *Ecology Letters*, 8(9), 993–1009. doi: 10.1111/j.1461-0248.2005.00792.x.
- Hewitt, G.M. (1996). Some genetic consequences of ice ages, and their role in divergence and speciation. *Biological Journal of the Linnean Society*, 58:247–276.
- Hortal, J., de Bello, F., Diniz-Filho, J.A.F., Lewinsohn, T.M., Lobo, J.M. & Ladle, R.J. (2015). Seven shortfalls that beset large-scale knowledge of biodiversity. *Annual Review of Ecology, Evolution, and Systematics*, 46, 523–549.
- Hsü, K.J., Montadert, L., Bernoulli, D., Cita, M.B., Erickson, A., Garrison, R.E., *et al.* (1977). History of the Mediterranean salinity crisis. *Nature*, 267:399–403.
- Huang, J., Huang, J., Liu, C., Zhang, J., Lu, X., & Ma, K. (2016). Diversity hotspots and conservation gaps for the Chinese endemic seed flora. *Biological Conservation*, 198, 104–112.
- Humboldt A. von, Bonpland A., (1807). Essai sur la géographie des plantes, accompagné d'un tableau physique des régions équinoxiales (Levrault & Schoell, Paris, 1807).
- Jarnevich, C.S., Stohlgren, T.J., Kumar, S., Morisette, J.T., Holcombe, T.R., (2015). Caveats for correlative species distribution modeling. *Ecol. Inform.* 29, 6–15.
- Journé, V., Barnagaud, J., Bernard, C., Crochet, P., Morin, X., (2019). Correlative climatic niche models predict real and virtual species distributions equally well. *Ecology*.101,1 e02912.
- Khani, S., Kami, H. G. & Rajabizadeh, M. Geographic variation of *Gloydus halys caucasicus* (Serpentes: Viperidae) in Iran. *Zool. Middle East*. 63, 303–10 (2017).
- Kling, G.W., K. Hayhoe, L.B. Johnson, J.J. Magnuson, S. Polasky, S.K. Robinson, B.J. Shuter, M.M. Wander, D.J. Wuebbles, D.R. Zak, R.L. Lindroth, S.C. Moser, and M.L. Wilson. 2003. Confronting climate change in the Great Lakes region: Impacts on our

- communities and ecosystems. Cambridge, Mass.: Union of Concerned Scientists / Washington, D.C.: Ecological Society of America.
- Kornilios, P. (2017). Polytomies, signal and noise: revisiting the mitochondrial phylogeny and phylogeography of the Eurasian blindsnake species complex (Typhlopidae, Squamata). *Zoologica Scripta*, 46, 665–674.
- Krijgsman, W., Hilgen, F.J., Raffi, I., Sierro, F.J., Wilson, D.S. (1999). Chronology, causes and progression of the Messinian salinity crisis. *Nature*, 400:652–655.
- Ladle, R.J., Whittaker, R.J. (2011). Conservation Biogeography. *Blackwell Publishing Ltd*. 320pp.
- Lanfear, R., Calcot, B., Ho, S.Y.W. & Guindon, S. (2012) Partitionfinder: combined selection of partitioning schemes and substitution models for phylogenetic analyses. *Molecular Biology and Evolution*, 29, 1695-1701.
- Le Saout, S., Hoffmann, M., Shi, Y., Hughes, A., Bernard, C., Brooks, T.M., Bertzky, B., Butchart, S.H.M., Stuart, S.N., Badman, T., Rodrigues, A.S.L., 2013. Protected areas and effective biodiversity conservation. *Science* 342, 803–805.
- Leestmans, R. 2005. Le refuge caspiens et son importance en biogéographie. *Linn. Belg.* 20 (3): 97- 102.
- Lindell, L. E. 1997. Annual variation in growth rate and body condition of adders, *Vipera berus*: effects of food availability and weather. *Canadian Journal of Zoology* 75: 261– 270.
- Lomolino, M. V, (2004). Conservation biogeography. *Front. Biogeogr. new Dir. Geogr. Nat.* 293.
- Luiselli, L., M. Capula, and R. Shine . 1997. Food habits, growth rates, and reproductive biology of grass snakes, *Natrix natrix* (Colubridae) in the Italian Alps. *Journal of Zoology, London* 241: 371– 380.
- M Rajabizadeh 2017. Snakes of Iran. [in Farsi] Tehran: Iranshenasi, 496 pp
- MacLean, S. A., & Beissinger, S. R. (2017). Species' traits as predictors of range shifts under contemporary climate change: A review and meta-analysis. *Global Change Biology*, 23, 4094– 4105.
- Makhdoum, M.F. (2008) Management of protected areas and conservation of biodiversity in Iran. *International Journal of Environmental Studies*, 1029-0400, 65(4): 563-585.
- Malek-Hosseini MJ, Zamani A, Sadeghi S (2015). A survey of cave-dwelling spider fauna of Kohgiluyeh & Boyer-Ahmad and Fars provinces, Iran (Arachnida: Araneae). *Revista Ibérica de Aracnología* 27: 90–94.
- Malek-Mohammadi, A., Rastegar-Pouyani, E. & Todehdehghan, F. Genetic relationship between different populations of the *Gloydus halys caucasicus* (Nikolsky 1916) of mountainous areas of the Iran. *SCIREA J. Agr.* 1, 214–230 (2017).
- Matthews, J.A., Bridges, E.M., Caseldine, C.J., Luckman, A.J., Owen, G., Perry, A.H., Shakesby, R.A., Walsh, R.P.D., Whittaker, R.J. & Willis, K.J. (eds) (2001) *The encyclopaedic dictionary of environmental change*. Arnold, London.
- Mebert, K. & Pölzer, W. (2011). Fatal hunting accidents killing dice snakes (*Natrix tessellata*) and bullheads (*Cottus gobio*). *Mertensiella* 18: 448-449.
- Merriam, C.H., (1894). Laws of temperature control of the geographic distribution of terrestrial animals and plants.
- Moghim, E. Geomorphology of Iran. (University of Tehran Press, 2010).
- Moradi N., Rastegar-Pouyani N., and Rastegar-Pouyani E. (2014), “Geographic variation in the morphology of *Macrovipera lebetina* (Linnaeus, 1758) (Ophidia: Viperidae) in Iran,” *Acta Herpetol.*, 9(2), 187 – 202.
- Morin, X., Améglio, T., Ahas, R., Kurz-Besson, C., Lanta, V., Lebourgeois, F., Miglietta, F., Chuine, I., (2007). Variation in cold hardiness and carbohydrate concentration from

- dormancy induction to bud burst among provenances of three European oak species. *Tree Physiol.* 27, 817–825.
- Moritz, C. 1994. Defining ‘evolutionary significant units’ for conservation. *Trends in Ecology and Evolution* 9: 373–375.
- Mullin, S.J., Seigel, R.A (2011). *Snakes: Ecology and Conservation*. Cornell University Press. 384 pp.
- Nagy, Z.T., Lawson, R., Joger, U., Wink, M. (2004). Molecular systematics of racers, whipsnakes and relatives (Reptilia: Colubridae) using mitochondrial and nuclear markers. *Journal of Zoological Systematics and Evolutionary Research*, 42:223–233.
- Nazarizadeh, M., Kaboli, M., Rezaie, H. R., Harisini, J. I. & Pasquet, E. Phylogenetic relationships of Eurasian Nuthatches (*Sitta europaea* Linnaeus, 1758) from the Alborz and Zagros Mountains, Iran. *Zool. Middle East.* 62, 217–226 (2016).
- Orlov, N. L., Sundukov, Y. N. & Kropachev, I. I. Distribution of pitvipers of *Gloydius blomhoffii* complex in Russia with the first records of *Gloydius blomhoffii blomhoffii* at Kunashir Island (Kuril archipelago, Russian Far East). *Russ. J. Herpetol.* 21, 169–178 (2014).
- Pardo, I., Roquet, C., Lavergne, S., Olesen, J. M., Gomez, D., & Garcia, M. B. (2017). Spatial congruence between taxonomic, phylogenetic and functional hotspots: True pattern or methodological artefact? *Diversity and Distributions*, 23, 209–220.
- Pereira, H.M., Leadley, P.W., Proença, V., Alkemade, R., Scharlemann, J.P.W., Fernandez-Manjarrés, J.F., Araújo, M.B., Balvanera, P., Biggs, R., Cheung, W.W.L., (2010). Scenarios for global biodiversity in the 21st century. *Science* (80-). 330, 1496–1501.
- Peterson AT et al., (2011). *Ecological Niches and Geographic Distributions*. Princeton: Princeton University Press.
- Pounds, J.A., Bustamante, M.R., Coloma, L.A., Consuegra, J.A., Fogden, M.P.L., Foster, P.N., La Marca, E., Masters, K.L., Merino-Viteri, A., Puschendorf, R., (2006). Widespread amphibian extinctions from epidemic disease driven by global warming. *Nature* 439, 161.
- Rajabizadeh, M., Javanmardi, S., Rastegar-Pouyani, N., Karami, R., n.d (2011). Geographic Variation, Distribution, and Habitat of *Natrix tessellata* in Iran. *Mertensiella*, 18 (2011), pp. 414-429.
- Rajabizadeh, M., Nagy, Z.T., Adriaens, D., Avci, A., Masroor, R., Schmidtler, J.,Christiaens, J. (2016) Alpine–Himalayan orogeny drove correlated morphological, molecular, and ecological diversification in the Persian dwarf snake (Squamata: Serpentes: *Eirenis persicus*). *Zoological Journal of the Linnean Society*, 176, 878–913.
- Rajabizadeh, M (2017). *Snakes of Iran*. [in Farsi] Tehran: *Iranshenasi*, 496 pp.
- Rajaei Sh, H., Rödder, D., Weigand, A.M., Dambach, J., Raupach, M.J., Wägele, J.W. (2013). Quaternary refugia in southwestern Iran: insights from two sympatric moth species (Insecta, Lepidoptera). *Organisms Diversity and Evolution*, 13:409–423.
- Rastegar-Pouyani, E., Ebrahimipour, F., Hosseinian, S. (2017). Genetic variability and differentiation among the populations of Dice snake, *Natrix tessellata* (Serpentes, Colubridae) in the Iranian Plateau. *Biochemical Systematics and Ecology*, 72:23-28.
- Rastegar-Pouyani, E., Oraie, H., Khosravani, A. & Akbari, A. Phylogenetic position of Iranian pitvipers (Viperidae, Crotalinae, *Gloydius*) inferred from mitochondrial cytochrome b sequences. *Trop. Zool.* 31, 55–67 (2018).
- Rastegar-Pouyani, E., Oraie, H., Khosravani, A. & Akbari, A. Phylogenetic position of Iranian pitvipers (Viperidae, Crotalinae, *Gloydius*) inferred from mitochondrial cytochrome b sequences. *Trop. Zool.* 31, 55–67 (2018).
- Richardson , D.M. & Whittaker , R.J. (2010) Conservation biogeography foundations, concepts and challenges . *Diversity and Distributions*, 16 , 313 – 320 .

- Roberts, D.R., Bahn, V., Ciuti, S., Boyce, M.S., Elith, J., Guillerá-Arroita, G., Hauenstein, S., Lahoz-Monfort, J.J., Schröder, B., Thuiller, W., Warton, D.I., Wintle, B.A., Hartig, F. and Dormann, C.F. (2017), Cross-validation strategies for data with temporal, spatial, hierarchical, or phylogenetic structure. *Ecography*, 40: 913-929.
- Rodrigues, A.S.L., Akçakaya, H.R., Andelman, S.J., Bakarr, M.I., Boitani, L., Brooks, T.M., Chanson, J.S., Fishpool, L.D.C., Da Fonseca G.A.B., Gaston, K.J., Hoffmann, M., Marquet, P.a., Pilgrim, J.D., Pressey, R.L., Schipper, J., Sechrest, W., Stuart, S.N., Underhill, L.G., Waller, R.W., Watts, M.E.J., Yan, X., 2004a. Global gap analysis: priority regions for expanding the global protected-area network. *Bioscience* 54, 1092–1099.
- Rögl, F. (1999). Mediterranean and Paratethys. Facts and hypotheses of an Oligocene to Miocene paleogeography (short overview). *Geologica carpathica*, 50(4): 339-349.
- Ryder, O. A. 1986. Species conservation and systematics: the dilemma of subspecies. *Trends in Ecology and Evolution* 1: 9-10.
- Schweiger, M., 1991. *Coluber ravergeri* Menetries, 1832-eine ungewöhnliche Zornnatter. *Herpetofauna*, 13, p.70.
- Sexton, J.P., McIntyre, P.J., Angert, A.L., Rice, K.J., (2009). Evolution and ecology of species range limits. *Annu. Rev. Ecol. Evol. Syst.* 40, 415–436.
- Shi, J. *et al.* (2017). A new moth-preying alpine pit viper species from Qinghai-Tibetan Plateau (Viperidae, Crotalinae). *Amphibia-Reptilia*. 38, 517–532.
- Shi, J., Yang, D., Zhang, W. & Ding, L. (2016). Distribution and infraspecies taxonomy of *Gloydius halys*-*Gloydius intermedius* complex in China (Serpentes: Crotalinae). *Chin. J. Zool.* 51, 777–798
- Steininger, F.F., Rögl, F. (1984). Paleogeography and palinspastic reconstruction of the Neogene of the Mediterranean and Paratethys. Geological Society, London, Special Publication, 17:659–668.
- Szczerbak, N. (2003). Guide to the Reptiles of the Eastern Palearctic. Krieger Publishing Company, Malabar, 350 p.
- Thomas, C.D., Cameron, A., Green, R.E., Bakkenes, M., Beaumont, L.J., Collingham, Y.C., Erasmus, B.F.N., De Siqueira, M.F., Grainger, A., Hannah, L., (2004). Extinction risk from climate change. *Nature* 427, 145.
- Thuiller, W., Lavergne, S., Roquet, C., Boulangeat, I., Lafourcade, B., Araujo, M.B., (2011). Consequences of climate change on the tree of life in Europe. *Nature* 470, 531.
- Tralau, H. 1963. Asiatic Dicotyledonous affinities in the Cainozoic flora of Europe. *Kungl. Svenska Vetens. Handl.* 4, Ser. 9, 3: 1-87 + 5 plates.
- van Dam, J.A. (2006). Geographic and temporal patterns in the late Neogene (12–3 Ma) aridification of Europe: The use of small mammals as paleoprecipitation proxies. *Palaeogeography, Palaeoclimatology, Palaeoecology*, 238:190–218.
- Varela, S., Anderson, R.P., García-Valdés, R. & Fernández-González, F. (2014) Environmental filters reduce the effects of sampling bias and improve predictions of ecological niche models. *Ecography*, 37, 1–8.
- Wagner, P., Tiutenko, A., Mazepa, G., Borkin, L. J. & Simonov, E. Alai! Alai! –a new species of the *Gloydius halys* (Pallas, 1776) complex (Viperidae, Crotalinae), including a brief review of the complex. *Amphibia-Reptilia*. 37, 15–31 (2016).
- Wallach, V., Williams, K.L. & Boundy, J., 2014. *Snakes of the world: a catalogue of living and extinct species*, CRC Press.
- Warren, R. *et al.*, 2018c: Risks associated with global warming of 1.5°C or 2°C. Briefing Note, Tyndall Centre for Climate Change Research, UK, 4 pp.
- Watson, J.E.M., N. Dudley, D.B. Segan and M. Hockings. 2014. The performance and potential of protected areas. *Nature* 515:67–73.

- Williams, S. E., E. E. Bolitho, and S. Fox. (2003). Climate change in Australian tropical rainforests: an impending environmental catastrophe. *Proceedings of the Royal Society of London Series B* 270:1887–1892.
- Willig, M.R., Kaufman, D.M., Stevens, R.D., (2003). Latitudinal gradients of biodiversity: pattern, process, scale, and synthesis. *Annu. Rev. Ecol. Evol. Syst.* 34, 273–309.
- Wisz, M.S., Hijmans, R.J., Li, J., Peterson, A.T., Graham, C.H., Guisan, A., Group, N.P.S.D.W., (2008). Effects of sample size on the performance of species distribution models. *Divers. Distrib.* 14, 763–773.
- Wright, H. E. & Minneapolis, J. Pleistocene glaciation in Kurdistan. *Eiszeit. Gegen.* 12, 131–164 (1962).

Chapter 6 :

CONCLUSION AND PERSPECTIVES

The present research is one of the first comparative studies on the evolutionary history of reptiles inhabiting mountainous regions of Iran. To better understand the role of Iran as a transition zone in the evolution and diversification of taxa, we investigated the phylogeny and phylogeography of three snake species from northern, northeastern, and western mountains of Iran with different origins, including Asian (*Gloydius caucasicus*), western Palearctic (*Natrix tessellata*), and Afrotropical (*Hemorrhois ravergieri*), and explored the putative role of future climate change in modifying their current distributions. It is worth mentioning that the analyses sought to use the most accurate and the best available data on these snakes, which is especially challenging in this under-surveyed region. Yet, for species such as *Hemorrhois ravergieri* whose data is restricted to Iran, inclusion of additional data from outside the boundaries of Iran may generate more complete results about the evolution of the species.

The main result of the phylogeographical study is that all these species are genetically highly structured, even at the Iranian scale (five clades were evidenced for *Hemorrhois ravergieri*). This diversification spread over several millions of years (from late Miocene to mid Pleistocene) under the influence of major geological events that occurred during this period. We also showed, in line with previous studies, the impact of Quaternary refugia in mountainous regions. The results indicated that the glacial and interglacial periods of the Iranian Plateau had a dramatic impact on colonization of species. This further validates the existence of Quaternary refugia for fauna of these regions (especially within the Iranian parts of the Irano-Anatolian and the Caucasus hotspots).

Although resolving the taxonomic complexities of species was not the main objective of this study, efforts were made to clarify the existing taxonomic complications using the available data. Still, it is clear that collection of such data in a country like Iran with vast unsampled mountainous regions and an increasingly high number of newly described species in recent years will be a challenging task. Thus, to succeed in this path, it is recommended that additional data of this kind be added to future studies.

In addition, due to the constraint imposed by data paucity and sampling constraints, model-based studies under iterative frameworks will be needed to investigate the potential future impacts of anthropogenic changes, especially in areas or with species facing the most serious knowledge shortfalls. Despite the uncertainties and well-identified methodological limitations of the modeling

results in this study, they do reveal several major outcomes that should be taken seriously in the process of refining knowledge for snake conservation facing climate change.

Most of the species studied are expected to be confronted by unsuitable climatic conditions in the future, forcing them to shift their range (often to higher altitudes) in search of their suitable climatic niche. This is however without consideration of other growing threats such as habitat fragmentation, landscape modification, and population overexploitation in establishment of new protected areas for effective conservation of ESUs. These supplementary issues are unlikely to counter the decreasing efficiency of the current protected area network, but should rather increase threat levels and survey complexity.

These conclusions should therefore stimulate future studies to use data beyond climate to improve our knowledge of the species' ecological envelopes and predict their distribution and demographic responses to different factors. Therefore, this study developed an approach to introduce new areas to be designated as part of the Iranian network of protected areas using an integrated set of molecular and modeling data for future changes in species climatically suitable conditions.

Following my work on the evolutionary history of reptiles inhabiting mountainous regions of Iran different perspectives can be put forward:

1. Successful outcomes have been obtained based on the molecular markers that have been studied. Nevertheless, improving genetic analyses with additional nuclear and mitochondrial markers, along with adoption of new approaches in genetic studies such as next generation sequencing and new disciplines in this field such as population genomics could generate more valid and reliable results. Also, an integrative approach combining genetic analyses and studies of modeling past, present and future ranges of species under anthropogenic impacts with evolution of species' climatic niche can yield deeper insights into the evolutionary history of species and phylogenetic lineages.

2. In this study, efforts were directed towards developing conservation strategies through proposing evolutionary significant units based on phylogenetic lineages for inclusion in the Iranian network of protected areas. This approach relies on locating central haplotypes for each taxon, which is presumably a consequence of glacial refugia during Quaternary climatic fluctuations and

past geological events (especially orogenic processes across vast areas in the west, north, center, and northeast of Iran coupled with the desiccation of the Tethys Sea in central Iran). However, to increase the efficacy of the network of protected areas, it is necessary to conduct an integrated complementary examination of all previous studies performed in Iran, not only including snakes but also other taxa (mammals, birds, lizard,...) The objective would be combining the results of each study in order to better locate Quaternary refugia in mountainous regions of the country and finally propose new protected areas representing evolutionary significant units for a combination of diverse species.

3. We modeled the climatic niche of seven snake species using seven bioclimatic variables relevant to the species' biology. Then, we projected this model to the future using the same variables and under climate change scenarios. Despite all efforts to overcome data deficiencies and avoid shortcomings in modeling such assumptions and limitations, it is recommended that (i) a comprehensive dataset of all presence/absence points be prepared, (ii) non-climatic environmental layers be added such as elevation, land cover, etc., (iii) improved analyses be performed using multi-model approaches and null models to test prediction accuracy and model biases in order to increase the accuracy and precision of the results. In addition, two complementary questions are needed to increase the potential for predictive models to emerge. First, demographic studies have to be performed on targeted species to incorporate population dynamics parameters into distribution models. Second, the detection probability of reptiles has to be evaluated in conjunction with other measurements of survey effort, so that distribution models can be adjusted for methodological issues arising from sampling.

4. Our molecular results revealed a wide knowledge gap in the taxonomic status of the different taxa studied for which it has been possible to assess and revise the species' status. Moreover, for *Hemorrhhois ravergeri* and its close relative *Hemorrhhois nummifer*, our sampling showed that both taxa occur in close sympatry and exhibit high morphological variability in Iran which do not conformed to the molecular clades. Thus, it would be extremely challenging to propose or find new identification morphological keys in order to identify and distinguish between these species in the field a. As a result, this study suggests that a comprehensive sampling from across the distribution range of these taxa in Iran (and possibly other countries) could produce

impressive results with regard to their taxonomy and potential discovery of unknown phylogenetic lineages and distinctive traits. Moreover, use of integrative approaches for taxonomic assessment of these taxa, combining morphological, behavioral, and ecological studies, is most likely to prove beneficial in elucidating current controversies.

Finally, for the purpose of this study, I hope these findings may have bridged the gap in biodiversity limitations and knowledge shortfalls such as the Darwinian and Linnean shortfalls. Also, I hope this study has effectively forecasted threats caused by climate change, lack of data on reptiles and other biodiversity, as well as regions influenced by the Wallacean shortfall. In the end, I hope I have presented measures for the long-term conservation of species in a developing, but biodiversity-rich country such as Iran.

Appendix

Appendix 2.1: a: Spatial distribution of precipitation in Iran (1961–2005); only major isohyets map is shown (Khalili and Rahimi, 2018). b: Spatial distribution of mean annual air temperature over Iran (1961–2005) (Khalili and Rahimi, 2018).

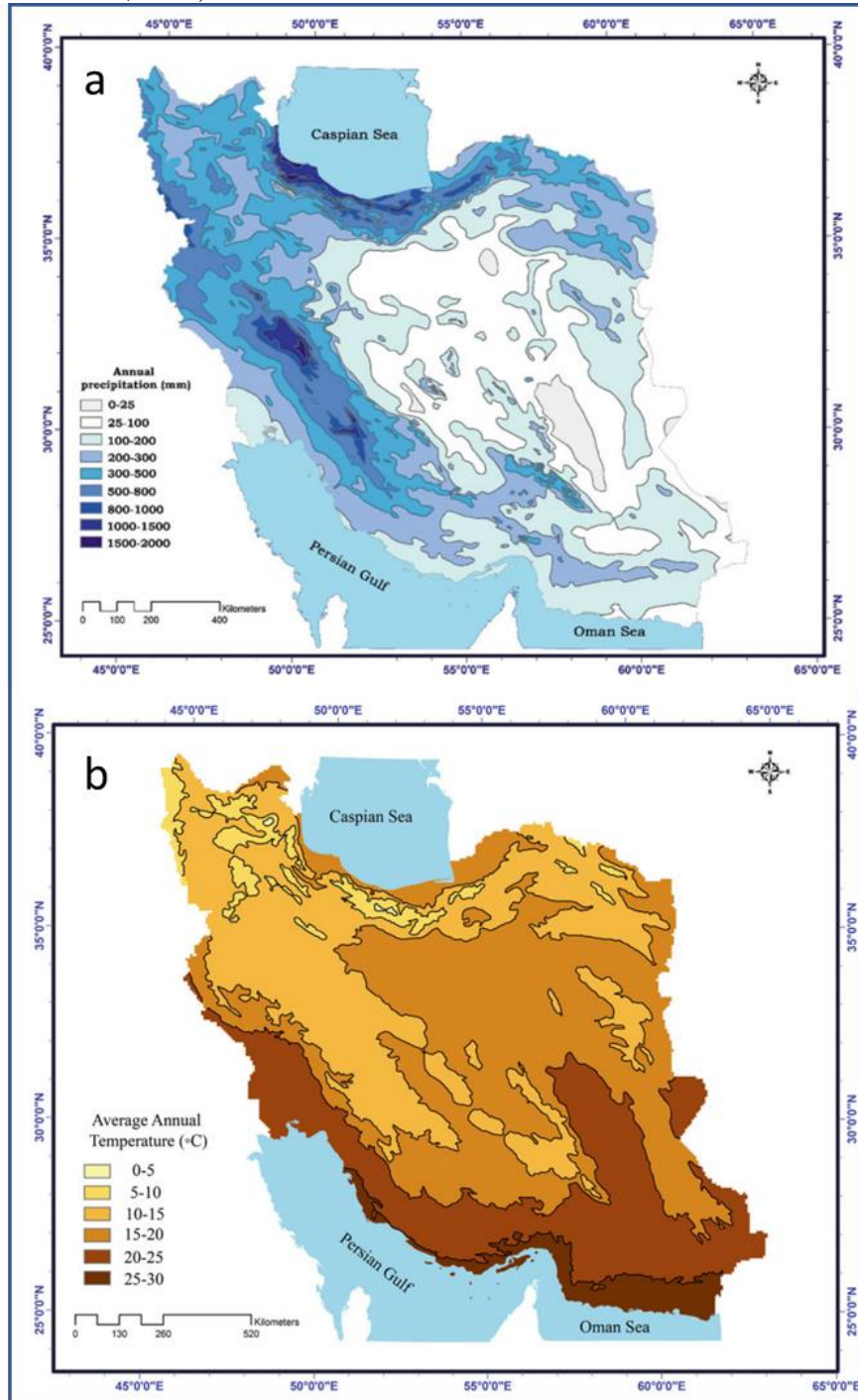

Appendix 2.2: Simplified vegetation map of Iran based on Frey and Kürschner (1989).

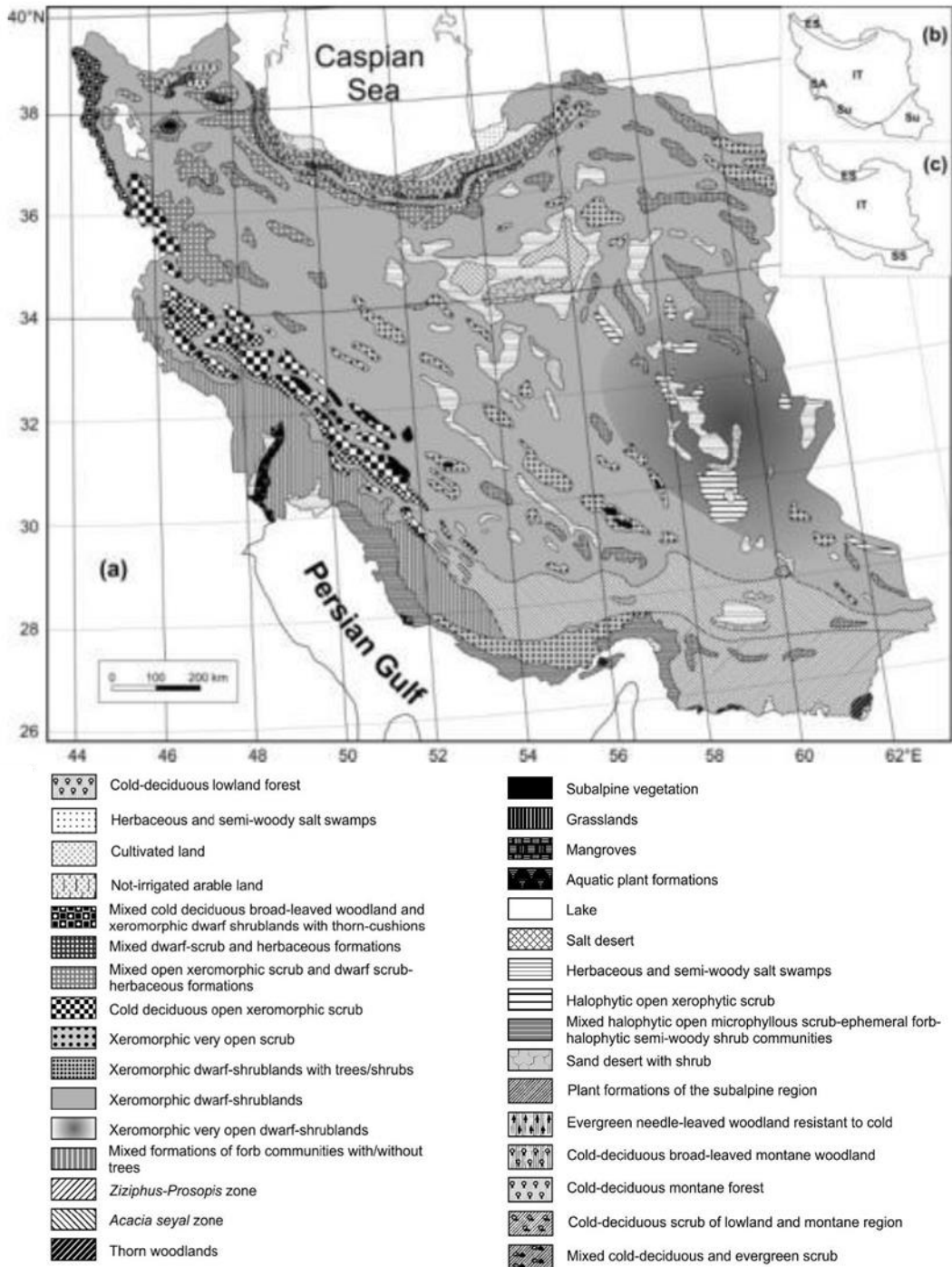

Appendix 3.1 Liste of the samples: *Nezmut: Natural Environment, Zoological Museum of University of Tehran

List Samples <i>Hemorrhoids raverjieri</i> from Iran							
	Code Nezmut	Code Tissue	Locality		Code Nezmut	Code Tissue	Locality
1	1044	AA4	Ashkhaneh	36	AA65	951	khajeabbas
2	1000	AA6	Bojnonrd	37	AA66	1287	khalkhal
3	1298	AA5	Behshahr	38	AA67	978	Khomein
4	756	AA32	Ghotur	39	AA68	635	Kohrang
5	971	AA34	Ahvaz	40	AA69	753	Kohrang
6	980	AA35	Alborz centre	41	AA70	848	Kohrang
7	857	AA36	Aligodarz	42	AA71	849	Kohrang
8	858	AA37	Aligodarz	43	AA72	634	Kohrang
9	862	AA38	Alvand	44	AA73	764	Kohrang
10	996	AA39	Ashkhaneh	45	AA74	963	Mashhad
11	1296	AA40	bisheh bane	46	AA75	1010	Mashhad
12	871	AA41	Bokan	47	AA76	1015	Mashhad
13	1123	AA42	brojerd	48	AA77	1016	Mashhad
14	1014	AA43	Dargaz	49	AA78	965	Mashhad
15	962	AA44	Dehloran	50	AA79	1017	Mashhad
16	1266	AA45	Deylaman	51	AA80	994	Mirzabailo
17	1245	AA46	Deylaman	52	AA81	995	Mirzabailo
18	966	AA47	Esfahan	53	AA82	1135	Naeen
19	969	AA48	Esfahan	54	AA83	1101	Paveh
20	1239	AA49	Eshkevarat	55	AA84	835	Sahneh
21	1240	AA50	Eshkevarat	56	AA85	1100	Sanandaj
22	1244	AA51	Eshkevarat	57	AA86	638	Shahre-kord
23	1009	AA52	Ferdosi	58	AA87	639	Shahre-kord
24	1011	AA53	Ferdosi	59	AA88	964	Shahreza
25	636	AA54	Ghotur	60	AA89	1289	Siahbishe
26	1083	AA55	Gilangharb	61	AA90	1290	Siahbishe
27	846	AA56	Hezarmasjed	62	AA91	1291	Siahbishe
28	847	AA57	Hezarmasjed	63	AA92	1292	Siahbishe
29	642	AA58	Hiyagh	64	AA93	953	Takab

30	643	AA59	Hiyagh	65	AA94	954	Takab
31	644	AA60	Hiyagh	66	AA95	955	Takab
32	645	AA61	Hiyagh	67	AA96	956	Takab
33	844	AA62	Hiyagh	68	AA97	957	Takab
34	1249	AA63	Jirandeh	69	AA98	997	Tangehrah
35	633	AA64	karaj	70	AA99	1110	Yosh

List Samples <i>Gloydus caucasicus</i> from Iran					
	Code Nezmut	Locality		Code Nezmut	Locality
1	1282	Deylaman	22	68	lar NP
2	1277	DorfaK	23	69	lar NP
3	1278	DorfaK	24	70	lar NP
4	1260	DorfaK	25	74	lar NP
5	1283	Khalkhal	26	76	lar NP
6	1297	Khalkhal	27	84	lar NP
7	1299	Khalkhal	28	86	lar NP
8	1281	Khalkhal	29	88	lar NP
9	1238	rasht	30	875	Savadkoh
10	1198	Roodbar	31	925	Savadkoh
11	1255	Babakoh_ Lahijan	32	1059	Golestan
12	G68	Azerbaijan	33	1060	Golestan
13	G69	Azerbaijan	34	1061	Golestan
14	GH26	Azerbaijan	35	1063	Behshahr
15	GH27	Azerbaijan	36	877	Mazandaran
16	1241	Eshkevarat	37	879	Golestan
17	1243	Eshkevarat	38	880	Golestan
18	1293	Siahbishe	39	845	Hezar Masjed
19	1294	Siahbishe	40	973	Golestan
20	61	lar NP	41	876	Golestan
21	62	lar NP			lar NP

List Samples <i>Natrix tessellata</i> from Iran							
	Code Nezmut	Code Tissue	Locality		Code Nezmut	Code Tissue	Locality
1	Aa143	665	Babkan	21	Aa151	1086	Lorestan, iran
2	Aa144	666	Babkan	22	Aa169	1104	Sanandaj, kurdistan, iran
3	Aa145	949	Tonekabon, mazandaran, iran	23	Aa170	1130	Alamut, province de qazvin, iran
4	Aa149	981	Varangeh rud, alborz province, iran	24	Aa171	1140	Uromiyeh, azerbaijan occidental, iran
5	Aa153	982	Uromiye -west azerbaijan province	25	Aa172	1263	Astaneh-ye ashrafiyeh, gilan, iran
6	Aa154	984	Marmisho, iran	26	Aa173	1264	Astaneh-ye ashrafiyeh, gilan, iran
7	Aa155	989	Almagol, iran	27	Aa174	1634	Dasht arjan, fars, iran
8	Aa156	993	Golestan national park, golestan province, iran	28	Aa152	1657	Eghlid, fars, iran
9	Aa157	998	Almagol, iran	29	Aa175	1658	Eghlid, fars, iran
10	Aa158	1003	Bojnourd, khorasan septentrional, iran	30	Aa176	1659	Eghlid, fars, iran
11	Aa150	1046	Golestan national park, golestan province, iran	31	Aa177	1660	Eghlid, fars, iran
12	Aa160	1053	Gorgan, iran	32	Aa178	1661	Kamfiruz, fars, iran
13	Aa161	1064	Tonekabon, mazandaran, iran	33	Aa179	1668	Safarud river, ramsar, iran
14	Aa162	1070	Alisadr, hamedan, iran	34	Aa180	1669	Safarud river, ramsar, iran
15	Aa163	1076	Marivan, kurdistan, iran	35	Aa181	1670	Safarud river, ramsar, iran
16	Aa164	1077	Marivan, kurdistan, iran	36	Aa182	1671	Tonekabon, mazandaran, iran
17	Aa165	1078	Marivan, kurdistan, iran	37	Aa183	1672	Tonekabon, mazandaran, iran
18	Aa166	1081	Gilan gharb, kermanshah, iran	38	Aa184	1673	Tonekabon, mazandaran, iran
19	Aa167	1084	Hashilan wetland, amirabad, kermanshah, iran	39	Aa185	1530	West azerbaijan province

20	Aa168	1085	Hashilan wetland, amirabad, kermanshah, iran	40	Aa186	1531	West azerbaijan province
----	-------	------	--	----	-------	------	--------------------------

Appendix 3.2. Protocoles pour l'amplification des genes par PCR							
PCR conditions for cytb: For amplifying target genes, PCR were performed in a 45 µL final volume, including 3-6 µL of DNA template, 10X PCR buffer (Qiagen), 25 mM MgCl ₂ , 0.25 mM of dNTP, 10 µM of each primer and 1 unit of Taq polymerase (Qiagen). Amplification conditions consisted of 34 cycles as follows: denaturation for 45 seconds at 94°C, annealing for 60 s at 50°C for Cytb and at 52°C for ND4, and extension for 3 minutes at 72°C.							
PCR conditions for ND4: Each 50 µl polymerase chain reaction (Qiagen) contained ±50 ng of total DNA, 350 mM of each dNTP, 0.5 pmol of each primer, 2 units DNA polymerase and a final concentration of 1.5 mM MgCl ₂ . The PCR profile included 2.5 minutes preheating at 94°C and 35 cycles of 30 seconds at 94°C, 30 seconds at 55°C and 45 seconds at 72°C. PCR cycles were followed by 10 minutes of extension at 72°C.							
PCR conditions for c-mos: PCR amplification was carried out in a 25µl reaction using PCR master mix (Ampliqon, Denmark) containing Tris-HCl (pH 8.5), (NH ₄) ₂ SO ₄ , 3 mM MgCl ₂ , 0.2 % Tween®20, 0.4 mM of each dNTP, and 0.2 units of Taq DNA Polymerase (Ampliqon). A PCR thermal programing with three different stages in a range of 52–60 °C was used in which the temperature was gradually reduced. Cycling included an initial denaturation step of 5 minutes at 95 °C, 35 cycles at 94 °C for 30s, followed by annealing at 54.5 °C for 40s, 72 °C for 1 min (extension) and 72 °C for 5 min (final extension).							
PCR conditions for Tropomyosin, la PCR a été réalisée dans des volumes de 10 µl contenant 1-2 µl de produit d'extraction, 2-1 µl de H ₂ O, 1 µM de chaque primer et 5 unités de Taq polymérase (Qiagen). Les conditions d'amplification ont consisté en une dénaturation initiale à 95 ° C pendant 15 minutes, suivie par 35 cycles de dénaturation à 94°C pendant 30 secondes, d'alignement à 56°C pendant 1.5 minute pour la première partie de la CR, et à 72°C pour la seconde pendant 1.5 minutes, et à la fin une élongation à 72°C pendant 10 minutes.							
PCR for MC1R, "Pinho, C., Harris, D.J., Ferrand, N., 2007. Comparing patterns of nuclear and mitochondrial divergence in a cryptic species complex: the case of Iberian and North African wall lizards (Podarcis, Lacertidae).. <i>Biol. J. Linn Soc.</i> 91, 121–133"							

Appendix 3.3. Partitionnements obtenus ave PartitionFinder pour les différents jeux de données				
mtDNA + nDNA for <i>N.tessellata</i> and <i>H.ravergieri</i>	Subset Best Model Subset Partitions		Subset Sites	
	Gene1:cytb / Gene2: ND2:			
	1	HKY+I+G	Gene1_pos1, Gene2_pos1	1-1086\3, 1087-1758\3
	2	HKY+I	Gene1_pos2, Gene2_pos2, Gene3_pos1	2-1086\3, 1088-1758\3, 1759-2283\3
	3	GTR+G	Gene1_pos3, Gene2_pos3	3-1086\3, 1089-1758\3
	4	F81	Gene3_pos2	1760-2283\3
	5	JC+I	Gene3_pos3, Gene4_pos1, Gene4_pos2, Gene4_pos3	1761- 2283\3, 2284-2736\3, 2285-2736\3, 2286-2736\3
	Cytb (1086)+ ND4(672) + MC1R (524) + Trop (452)			
mtDNA for <i>N.tessellata</i> and <i>H.ravergieri</i>	Subset Best Model Subset Partitions		Subset Sites	Alignment:
	ND4 (672 bp) + Cytb (1086 bp)			
	1	HKY+I+G	Gene1_pos1, Gene2_pos1	1-672\3, 673-1758\3
	2	HKY+I	Gene1_pos2, Gene2_pos2	2-672\3, 674-1758\3
	3	GTR+G	Gene1_pos3, Gene2_pos3	3-672\3, 675-1758\3
Cytb For <i>N.tessellata</i>	Subset Best Model Subset Partitions		Subset Sites	Alignment:
	Cytb (1086 bp)			
	1	GTR+I+G	Gene1_pos1	1-1086\3
	2	HKY+I	Gene1_pos2	2-1086\3
	3	GTR+G	Gene1_pos3	3-1086\3

Appendix 3.4: Pour *Natrix tessellata*, les ordres de branchement des arbres phylogénétiques obtenus avec les deux méthodes de reconstruction (BI et ML) sont congruents pour les deux jeux de données. A: arbre basé sur le cytb ; B : arbre basé sur cytb +ND4

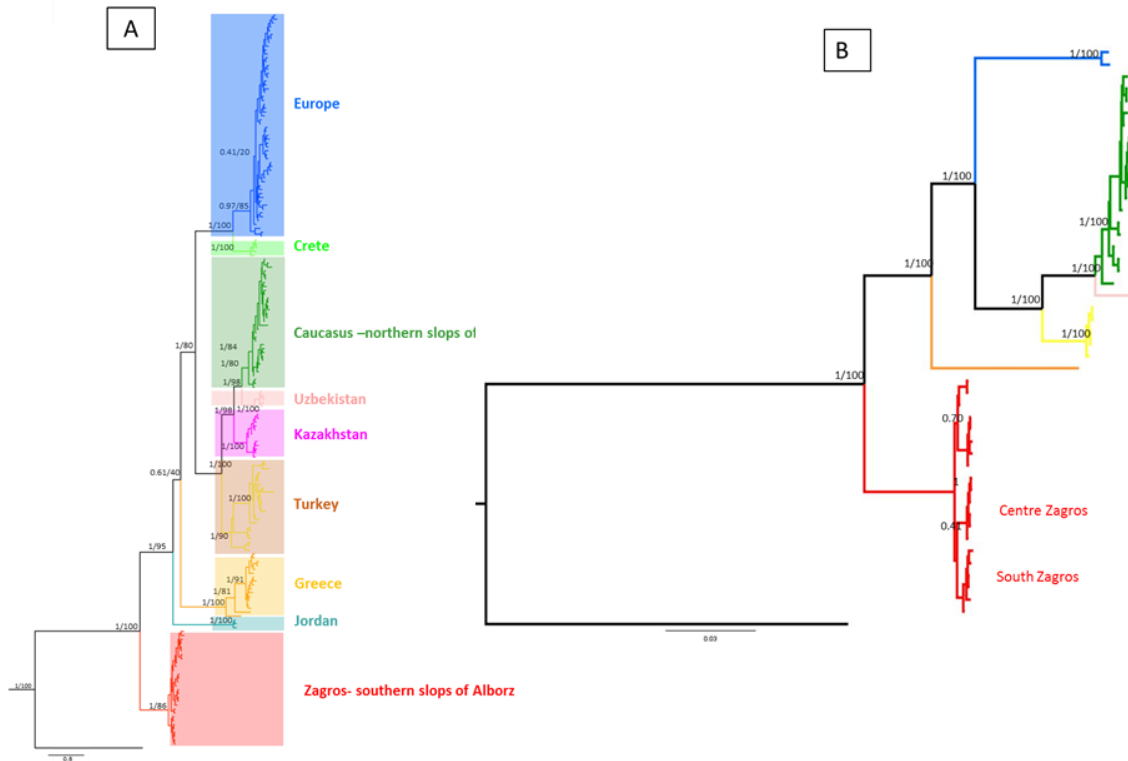

Appendix 3.5. : Distances génétiques entre les 4 espèces du genre *Hemorrhoids* (hors diagonale) et au sein de chacune des espèces (diagonale) calculées dans MEGA 6.0 avec un modèle Kimura-2- paramètres. (La distance au sein des espèces *H. hippocrepis* et *H. algiurus* n'a pas été calculé car un seul échantillon pour ces espèces a été utilisé). Distances génétiques entre les 4 espèces du genre *Natrix* (hors diagonale) et au sein de chacune des espèces (diagonale) calculées dans MEGA 6.0 avec un modèle Kimura-2- paramètres.

	<i>H. ravergeri</i>	<i>H. nummifer</i>	<i>H. hippocrepis</i>	<i>H. algiurus</i>
<i>H. ravergeri</i>	0.142			
<i>H. nummifer</i>	0.604	0.014		
<i>H. hippocrepis</i>	0.632	0.138	-	
<i>H. algiurus</i>	0.617	0.129	0.120	-

	<i>N. natrix</i>	<i>N. maura</i>	<i>N. astreptophora</i>	<i>N. tessellata</i>
<i>N. natrix</i>	0.037			
<i>N. maura</i>	0.142	0.018		
<i>N. astreptophora</i>	0.073	0.135	0.012	
<i>N. tessellata</i>	2.259	2.089	2.054	0.060

Appendix 3.6: Analyse en Composante Principale réalisées par DIY ABC pour (a) *Natrix tessellata* et (b) pour *Hemorrhoids ravergeri*.

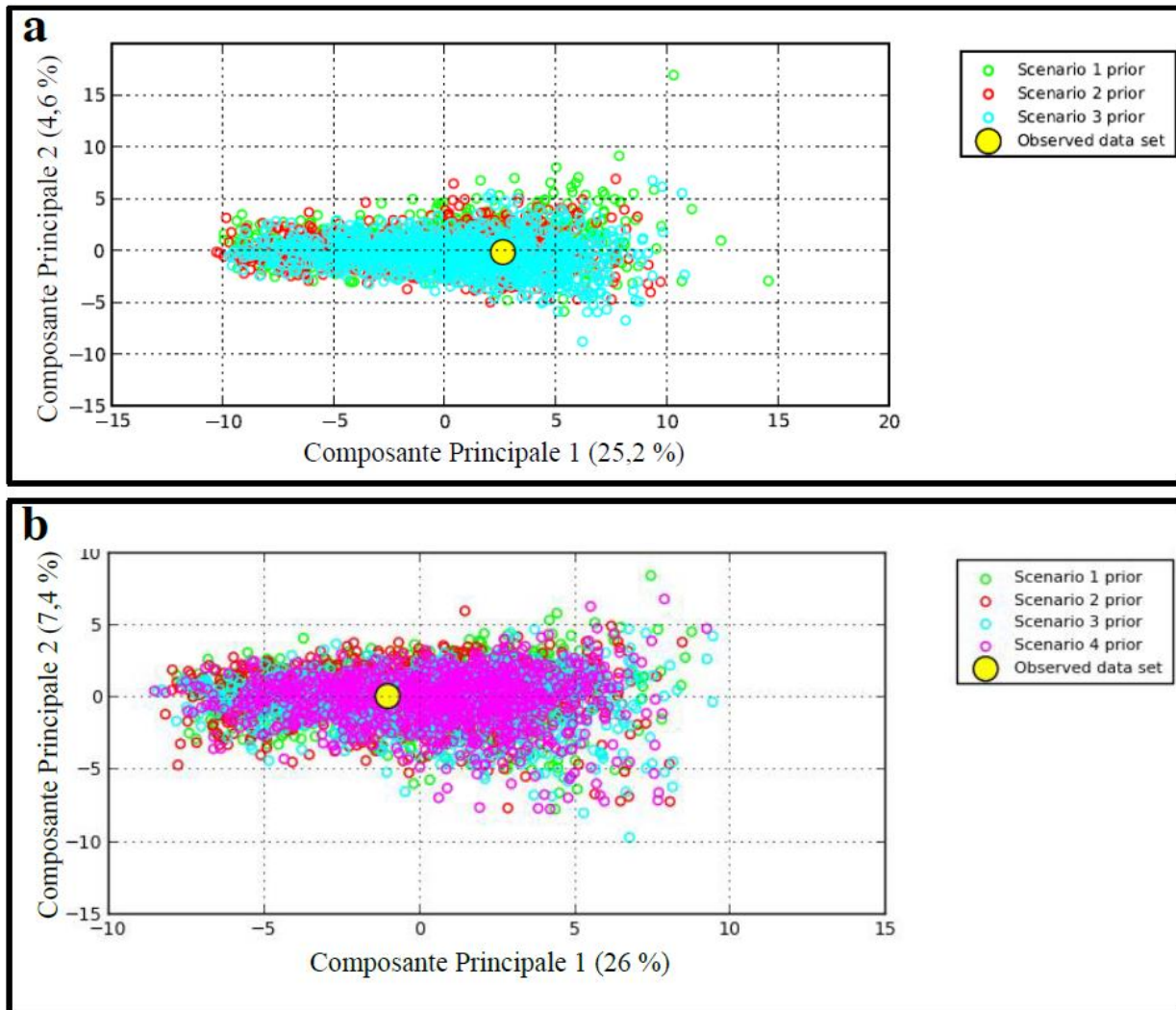

Appendix 3.7 : Comparaisons de 6 modèles d'estimation des aires ancestrales de *N. tessellata* et de *H. ravergeri* réalisées avec le package R BioGeoBears : DEC, DEC + J, DIVALIKE, DIVALIKE + J, BAYAREALIKE, BAYAREALIKE + J. Pour chacun des modèles sont renseignés le logarithme de la vraisemblance (LnL), l'AIC et le paramètre J (« founder-event speciation »). Les meilleurs modèles sont indiqués en gras.

	LnL	AIC	J
<i>Natrix tessellata</i>			
DEC	-26.72	57.44	0
DEC + J	-24.51	55.01	0.284
DIVALIKE	-26.23	56.46	0
DIVALIKE + J	-24.24	54.47	0.121
BAYAREALIKE	-28.47	60.95	0
BAYAREALIKE + J	-26.09	58.17	0.304
<i>Hemorrhoids ravergeri</i>			
DEC	-15.06	34.12	0
DEC + J	-12.51	31.02	0.372
DIVALIKE	-15	34	0
DIVALIKE + J	-12.68	31.36	0.286
BAYAREALIKE	-16.76	37.51	0
BAYAREALIKE + J	-13.49	32.98	0.1

Appendix 4.1. AUC and TSS scores for the seven snake species under the present-day model and the three GCMs (MIROC5, CCSM4, and MPI-ESM) in both RCPs (2.6 and 8.5).

Species	Presence points (n)	Models	AUC	TSS
<i>Macrovipera lebetina</i>	74	PRESENT	0.922	0.7514
		CCSM4 26 RCP	0.924	0.65274
		CCSM4 85 RCP	0.921	0.667014
		MPI-ESM 26 RCP	0.922	0.44508
		MPI-ESM 85 RCP	0.92	0.65867
		MIROC5 26 RCP	0.924	0.55804
		MIROC5 85 RCP	0.918	0.7186
<i>Malpolon insignitus</i>	44	PRESENT	0.956	0.7837
		CCSM4 26 RCP	0.955	0.8111
		CCSM4 85 RCP	0.953	0.5582
		MPI-ESM 26 RCP	0.953	0.6484
		MPI-ESM 85 RCP	0.952	0.7301
		MIROC5 26 RCP	0.952	0.785

		MIROC5 85 RCP	0.952	0.7531
<i>Natrix tessellata</i>	59	PRESENT	0.915	0.56486
		CCSM4 26 RCP	0.918	0.56387
		CCSM4 85 RCP	0.916	0.7625
		MPI-ESM 26 RCP	0.91	0.78149
		MPI-ESM 85 RCP	0.915	0.7723
		MIROC5 26 RCP	0.915	0.7723
		MIROC5 85 RCP	0.919	0.36195
<i>Hemorrhoids ravergeri</i>	55	PRESENT	0.929	0.7344
		CCSM4 26 RCP	0.928	0.671
		CCSM4 85 RCP	0.925	0.764
		MPI-ESM 26 RCP	0.927	0.73
		MPI-ESM 85 RCP	0.929	0.8542
		MIROC5 26 RCP	0.928	0.7455
		MIROC5 85 RCP	0.93	0.6215
<i>Eirenis punctatolineatus</i>	34	PRESENT	0.948	0.67423
		CCSM4 26 RCP	0.946	0.61376
		CCSM4 85 RCP	0.949	0.61553
		MPI-ESM 26 RCP	0.945	0.8923
		MPI-ESM 85 RCP	0.948	0.8095
		MIROC5 26 RCP	0.949	0.72103
		MIROC5 85 RCP	0.948	0.65423
<i>Montivipera spp.</i>	80	PRESENT	0.983	0.8306
		CCSM4 26 RCP	0.984	0.8879
		CCSM4 85 RCP	0.984	0.9404
		MPI-ESM 26 RCP	0.984	0.8932
		MPI-ESM 85 RCP	0.985	0.845
		MIROC5 26 RCP	0.984	0.8949
		MIROC5 85 RCP	0.983	0.8707
<i>Platycephalus najadum</i>	52	PRESENT	0.931	0.7271
		CCSM4 26 RCP	0.93	0.8126
		CCSM4 85 RCP	0.932	0.4901
		MPI-ESM 26 RCP	0.931	0.587
		MPI-ESM 85 RCP	0.931	0.7316
		MIROC5 26 RCP	0.932	0.7285
		MIROC5 85 RCP	0.932	0.73

Appendix 4.2: Description of the species studied

Species	Scientific name	Family	Common names	Conservation status
<i>Platyceps najadum</i>	<i>Platyceps najadum</i> (EICHWALD, 1831)	Colubridae	Slender Whip Snake	Least Concern
<i>Hemorrhois ravergeri</i>	<i>Hemorrhois ravergeri</i> (MÉNÉTRIES, 1832)	Colubridae	Spotted Whip Snake	Not Listed
<i>Natrix tessellata</i>	<i>Natrix tessellata</i> (LAURENTI, 1768)	Colubridae	Dice Snake	Least Concern
<i>Eirenis punctatolineatus</i>	<i>Eirenis punctatolineatus</i> (BOETTGER, 1892)	Colubridae	Dotted Dwarf Racer	Least Concern
<i>Malpolon insignitus</i>	<i>Malpolon insignitus</i> (GEOFFROY DE ST-HILAIRE, 1827)	Colubridae	Eastern Montpellier Snake	Not Listed
<i>Macrovipera lebetinus</i>	<i>Macrovipera lebetinus</i> (LINNAEUS, 1758)	Viperidae	Levantine Viper	Not Listed
<i>Montivipera raddei</i> species complex	<i>Montivipera kuhrangica</i> RAJABIZADEH, NILSON & KAMI, 2011	Viperidae	Kuhrang Mountain Viper	Endangered, EN
	<i>Montivipera latifii</i> (MERTENS, DAREWSKY & KLEMMER, 1967)	Viperidae	Radde's Mountain Viper	Endangered, EN
	<i>Montivipera raddei</i> (BOETTGER, 1890)	Viperidae	Latifi's Mountain Viper	Near Threatened

List of Boxes

Box 1.1 Three directions of responses to climate change <i>Source: Bellard et al., (2012)</i>	5
Box 1.2 Vicariance and Dispersal (Avice, 2000)	13
Box 1.3. The BAM diagram proposed by (Soberón & Peterson 2005).....	14
Box 1.4 Correlative Species distribution Models.....	16

List of Figures

Figure 1.2 A: the average earth temperature fluctuates during Pliocene and Quaternary period. B: Late Pleistocene glacial cycles and estimates of atmospheric CO ₂ over the last 800k years.....	3
Figure 1.2: a: location of Iran at the meeting point of three biogeographic regions Palearctic, Oriental and Afrotropica. b: the Irano-Anatolian and the Caucasus biodiversity hotspots.....	18
Figure 2.1 depicts a Paleogeographical perspective on the formation of the Paratethys and the Mediterranean during the Oligocene and Miocene, adapted from Roger (1999)	40
Figure 2.2. Physiographic map of Iran showing the Alborz, Talysh-Azerbaijan, Zagros, Kopet Dagh, as well as central Mountains of Iran (following Fisher, 1968)	42
Figure 2.3 shows the map (a) of Iranian ecological units (adapted from Rajabizadeh 2017) and the diagram (b) of snake diversity in the ecological units.....	48
Figure 3.1.1. Carte de la distribution globale du complexe d'espèces <i>G. halys</i> . (Sindaco <i>et al.</i> , 2013)	59
Figure 3.1.2. Carte de la distribution globale de <i>Natrix tessellata</i> . (Sindaco <i>et al.</i> , 2013)	60
Figure 3.1.3. Carte de la distribution globale d' <i>Hemorrhois ravergieri</i> . (Sindaco <i>et al.</i> , 2013)	61
Figure 3.1.4. Localités échantillonnées dans l'Alborz et le Zagros.	62
Figure 3.1.5. Le crochet à serpent, les gants et outils nécessaires pour réaliser l'échantillonnage sur le terrain. 63	
Figure 1. Bayesian 50% majority-rule consensus tree reconstructed from concatenated mtDNA (cyt <i>b</i> + ND4) + nDNA (c-mos) dataset (in congruence with ML tree in terms of the branching pattern and the positions of the clades), using six outgroups (<i>G. brevicaudus</i> , <i>G. blomhoffi</i> , <i>G. tsushimaensis</i> , <i>G. ussuriensis</i> , <i>D. acutus</i> , and <i>T. sichuaensis</i>). Nodal support presented at nodes indicate Bayesian posterior probability (left) by MrBayes, and ML bootstrap (right) using IQ-TREE.....	70
Figure 2. Haplotype network using the 1618 bp of the concatenated sequences from cyt <i>b</i> + ND4 and a total of 70 sequences. Statistical parsimony network assuming a 95% parsimony threshold, as constructed by TCS. Symbol size and branch lengths are proportional to the number of shared individuals per haplotype and the number of mutational steps among haplotypes, respectively. Black circles indicate unsampled or extinct haplotypes. Sizes of circles are proportional to haplotype frequencies. Small black circles indicate one mutational step.....	72
Figure 3. Chronogram of the <i>G. halys/G. intermedius</i> complex based on the concatenated mtDNA + nDNA dataset and a total of 114 sequences (89 <i>Gloydus</i> and 25 outgroups). Divergence times were estimated using a Lognormal clock and a Birth-Death Process model. The black chronogram inset on the top left corner displays	

dating of the entire dataset and the red star denotes the starting point of the evolutionary relationships shown by the phylogeny on the right. The pink circles represent nodes with posterior probability $PP > 90\%$ 74

Figure 4. Ancestral range estimation for the *G. halys/G. intermedius* complex using BioGeoBEARS under DIVALIKE + J model on the concatenated mtDNA + nDNA dataset. Colours are correspondent to the seven regions (explained in section 2.4.2). Yellow star indicates ML estimation of the center of origin of all taxa (latitude 43.308 and longitude 96.388, estimated by PhyloMapper 1b1) in the complex, the orange circle shows *G. shedaensis* locality in Sheda Island, China, and black and red arrows present a hypothetical direction of dispersal supported by BioGeoBEAR results. Numbers refer to divergence times among taxa in million years (see Fig. 3). Polygons show approximate range of distribution of each species/subspecies. The red circle in Afghanistan refers to *G. h. boehmei* (Nilson, 1983), which is not included in our study..... 75

Figure 5. Habitat suitability map of *G. h. caucasicus* populations in northern Iran. Coloured polygons represent areas occupied by each lineage. Crosshatch polygons show the network of protected areas of Iran and its overlap with the suitability map. Boundaries of lineages were detected by BAPS. 75

Figure 6. Localities for 53 samples used in the study from Iran and Azerbaijan. Colours correspond to phylogenetic lineages of *G. h. caucasicus* along the Alborz Mountains, namely Kopet Dagh-Eastern Alborz (blue, KD-EA), Lar National Park-Central Alborz (green, LarNP-CA), Central Alborz (yellow, AC), and Western Alborz-Azerbaijan (red, WA-Az). Map source: ESRI. The map was generated using ArcGIS 10.2 by ESRI (available online at: <http://www.esri.com/>)..... 77

Figure 7. Population trees obtained using coalescent simulations, representing the three biogeographic hypotheses of diversification within *G. h. caucasicus*. (a) The null model of the fragmentation of a widespread ancestor or a single-refugium population, and (b,c) the alternative multiple-refugial/vicariance models, where b and c present one way and two-way gene flows, respectively..... 79

Figure 3.3.1. Arbre phylogénétique et réseau haplotypique obtenus pour *N. tessellata*. La carte montre la localisation des individus échantillonnés (notre étude et séquences de GenBank) dans le Paléarctique Occidental. Les couleurs correspondent aux différents clades identifiés dans l'arbre phylogénétique basé sur quatre gènes (1086 pb cyt b + 672 pb ND4 +524 pb MC1R +452 pb tropomyosin) pour 187 individus de l'espèce *N. tessellata*..... 93

Figure 3.3.2 Arbre phylogénétique et réseau haplotypique obtenus pour *H. ravergeri*. La carte montre la localisation des individus échantillonnés en Iran dans cette étude. Les couleurs correspondent aux différents clades identifiés dans la phylogénie. Arbre phylogénétique basé sur quatre gènes, soit 2804 bp (1095 pb cyt b + 672 pb ND4 + 524 pb MC1r + 452 pb Tropomyosin) pour tous individus de l'espèce *H. ravergeri*. 94

Figure 3.3.3: Résultats obtenus pour *N. tessellata* : Chronogramme complet obtenu avec BEAST basé sur les séquences du cyt b en utilisant une horloge relâchée à taux non corrélé avec une distribution exponentielle et un processus « Birth-Death ». Trois points de calibration ont été utilisés, identifiés par une étoile. L'arbre a été enraciné avec trois groupes externes: *Naja kaouthia*, *Micrurus fulvius* et *Mehelya capensis* (non montrés ici). Chronogramme pour 187 individus de l'espèce *N. tessellata* et datation des âges de divergence des différents clades observés. Les âges des principaux nœuds sont indiqués sur la figure..... 99

Figure 3.3.4: Résultats obtenus pour *H. ravergeri* : Chronogramme complet obtenu avec BEAST basé sur la combinaison des deux gènes mitochondriaux (cyt b et ND4) en utilisant une horloge relâchée à taux non corrélé avec une distribution exponentielle et un processus « Birth-Death ». Trois points de calibration ont été utilisés, identifiés par une étoile. L'arbre a été enraciné avec trois groupes externes: *Naja kaouthia*, *Micrurus fulvius* et *Mehelya capensis* (non montrés ici). Chronogramme pour 83 individus de l'espèce *H. ravergeri* et datation des âges de divergence des différents clades observés. Les âges des principaux nœuds sont indiqués sur la figure..... 100

Figure 3.3.5 : Reconstruction des tendances démographiques de *N. tessellata* (globale) et pour les 6 groupes de plus de 10 individus. Graphes représentant la taille efficace des populations (N_e) en fonction du temps (en Ma), obtenus avec la méthode des Bayesian Skyline Plots (BSPs) réalisés avec BEAST et TRACER. Une horloge moléculaire stricte a été utilisée avec un taux de $6.924E-3 \pm 1.56E-3$ (voir texte). La ligne centrale représente la valeur médiane pour le \log_{10} de la taille de la population et les lignes bleues au-dessus et en-dessous représentent l'intervalle de confiance à 95%..... 102

Figure 3.3.6 : Reconstruction des tendances démographiques de *H. ravergeri* (globale) et pour les 3 groupes de plus de 10 individus. Graphes représentant la taille efficace des populations (N_e) en fonction du temps (en Ma), obtenus avec la méthode des Bayesian Skyline Plots (BSPs) réalisés avec BEAST et TRACER. Une horloge moléculaire stricte a été utilisée avec un taux de $6.877^{E-3} \pm 1.07^{E-3}$ (voir texte). La ligne centrale représente la valeur médiane pour le log10 de la taille de la population et les lignes bleues au-dessus et en-dessous représentent l'intervalle de confiance à 95%..... 103

Figure 3.3.7 : Représentation graphique des différents scénarios testés avec le logiciel DIYABC pour *N. tessellata* (a-c), basés sur le cyt b. N correspond à la taille efficace des populations, t aux temps de divergence entre les populations en nombre de générations (ce temps n'est pas à l'échelle), et db correspond au temps relatif à la dispersion qui s'accompagne d'une réduction des tailles de population (N_b) indiquant un goulot d'étranglement. Noms des différentes populations: Caucase (CA), Ouzbékistan (OU), Kazakhstan (KA), Turquie (TU), Europe (EU), Crète (CR), Grèce (GR), Jordanie (JO), Zagros (ZA). La probabilité et l'intervalle de confiance sont indiqués sous chaque scénario..... 104

Figure 3.3.8 : Représentation graphique des différents scénarios testés avec le logiciel DIYABC pour *H. ravergeri* (d-g), basés sur la combinaison du cyt b et de ND4. N correspond à la taille efficace des populations, t aux temps de divergence entre les populations en nombre de générations (ce temps n'est pas à l'échelle), et db correspond au temps relatif à la dispersion qui s'accompagne d'une réduction des tailles de population (N_b) indiquant un goulot d'étranglement. Noms des différentes populations : Kopet-Dat (KD), Ouest Alborz (AO), Azerbaïdjan – Alborz (AlAz), Est Zagros (ZE), Zagros (ZA), Turquie (TU). La probabilité et l'intervalle de confiance sont indiqués sous chaque scénario..... 106

Figure 3.3.9 : Reconstruction des aires ancestrales de *N. tessellata* à chaque nœud de la phylogénie en utilisant le modèle DIVALIKE +J dans le package R BioGeoBears. Les aires géographiques définies sont schématisées dans l'encadré : Zagros (ZA), Alborz (AL), Turquie (TU), Méditerranée (ME), Paléarctique Occidental (PO) et Ouest Asie (OA). Les camemberts à chaque nœud représentent la probabilité d'occurrence dans chaque région, deux lettres indiquent la probabilité la plus élevée de l'aire régionale ancestrale. V indique les événements de vicariance et les flèches représentent les événements de dispersion. 107

Figure 3.3.10 : Reconstruction des aires ancestrales de *H. ravergeri* à chaque nœud de la phylogénie en utilisant le modèle DEC +J dans le package R BioGeoBears. Les aires géographiques définies sont schématisées dans l'encadré : Zagros (ZA), Alborz (AL), Turquie (TU) et Kopet-Dagh (KD). Les camemberts à chaque nœud représentent la probabilité d'occurrence dans chaque région, deux lettres indiquent la probabilité la plus élevée de l'aire régionale ancestrale. V indique les événements de vicariance et les flèches représentent les événements de dispersion. 108

Figure 3.3.11: Reconstruction de l'histoire évolutive de *N. tessellata* basée sur les séquences du cyt b. Les régions en couleur correspondent aux zones géographiques définies dans BioGeoBears. Les flèches noires indiquent les routes éventuelles de colonisation et les lignes pointillées schématisent les événements de vicariance inférés à partir des modèles DIVALIKE +J (a) et DEC +J (b) dans BioGeoBears. Les étoiles indiquent la localisation actuelle des différentes lignées dont les couleurs correspondent à celles de la Fig. 3.3.3. Les nombres font référence aux temps de divergence entre les différents groupes en Ma et les chiffres romains aux différentes phases de divergence identifiées (voir texte). 111

Figure 3.3.12: Reconstruction de l'histoire évolutive de *H. ravergeri* basée sur la combinaison des deux gènes mitochondriaux. Les régions en couleur correspondent aux zones géographiques définies dans BioGeoBears. Les flèches noires indiquent les routes éventuelles de colonisation et les lignes pointillées schématisent les événements de vicariance inférés à partir des modèles DIVALIKE +J (a) et DEC +J (b) dans BioGeoBears. Les étoiles indiquent la localisation actuelle des différentes lignées dont les couleurs correspondent à celles de la Fig. 3.3.4. Les nombres font référence aux temps de divergence entre les différents groupes en Ma et les chiffres romains aux différentes phases de divergence identifiées (voir texte). 113

Figure 4.1.1. Global biodiversity hotspots: the Irano-Anatolian and the Caucasus biodiversity hotspots..... 128

Figure 4.2.1.1. The study area along the Alborz (AL), Zagros (Z), mountains of Central Iran (EZ), Azerbaijan (AZ) and Kopet Dag Mountains (KD), and location of reptile records used in the study. Background source: ESRI (available online at: http://www.esri.com/).....	131
Figure 4.3.2.1. Marginal predicted response curves for the seven variables considered for each species.....	137
Figure 4.3.2.2. Contribution of the bioclimatic variables for modeling of present-day bioclimatic-envelopes for the seven species using Jackknife test implemented in MaxEnt.....	138
Figure 4.3.3.1. Comparison of projected output maps modeled for the seven species and future (for the year 2070).....	141
Figure 4.3.5.1. Forecasting each species altitudinal range shift using bioclimatic-envelope modeling for present-day and future (2070) conditions for the two RCPs (2.6 and 8.5), averaged of the three GCMs.	143
Figure 5.1. The table indicates the divergence of clades observed for three snake species from Miocene to Pleistocene as well as the geological and climatic events that were possibly involved in their divergence. The map shows the ecological zones for snakes in Iran according to Rajabzadeh, 2017 and was regenerated based on the physiographic units of Iran following Fisher (1968)	160

List of the Tables

Table 1.1 Prominent areas of research in conservation biogeography (Richardson & Whittaker 2010).....	11
Table 2.1. Major tectonic phases of Iran during geological periods. Although the Iranian plate has been present throughout these periods, the current relief structure of Iran is mainly the product of the Alpine orogeny (Taleghani 2013).....	43
Table 3.1.1. Nombre total d'individus échantillonnés.....	62
Table 3.1.2. Liste des amorces utilisées pour l'amplification et le séquençage des gènes étudiés.	64
Table 1. Number of haplotypes (p), nucleotide diversity (π), haplotype diversity (h), and number of polymorphic sites (H) of the Caucasian pit viper lineages.....	73
Table 3.3.1: Jeux de données utilisés pour <i>Natrix tessellata</i> et <i>Hemorrhoids ravergeri</i> . Les séquences utilisées proviennent d'individus échantillonnés (ind. ech.) en Iran et de GenBank (voir numéro d'accèsion)	86
Table 3.3.2 Indices de diversité génétique calculés avec DnaSP pour <i>N. tessellata</i> (187 séquences du cytochrome b, soit 1086pb) et les 9 clades identifiées, et pour <i>H. ravergeri</i> (81 individus séquencés pour le cytochrome b et ND4, soit 1767 pb) et des 6 clades identifiés. Nombre d'individus (n), nombre d'haplotypes (h), diversité haplotypique (H_d) et écart type, diversité nucléotidique (π), nombre moyen de nucléotides différents (k), nombre de sites polymorphes (S).....	96
Table 3.3.3 Distances génétiques entre les 9 sous-groupes identifiés de <i>Natrix tessellata</i> (hors diagonale) et au sein de chaque sous-groupe (diagonale), calculées dans MEGA 6.0 avec un modèle Kimura-2-paramètres....	96
Table 3.3.4. Distances génétiques entre les 6 sous-groupes identifiés de <i>H. ravergeri</i> (hors diagonale) et au sein de chaque sous-groupe (diagonale), calculées dans MEGA 6.0 avec un modèle Kimura-2-paramètres.....	97
Table 3.3.5 : Comparaison des AIC des 4 modèles testés pour les séquences du cyt b de <i>N. tessellata</i> et pour la combinaison des séquences du cyt b et de ND4 pour <i>H. ravergeri</i> , généré avec une répétition de 10 bootstraps dans TRACER 6.0. La vraisemblance (LnL), la valeur d'AIC (AICM) et l'écart-type associé (SSE) sont renseignés pour chacun des modèles Strict Clock Birth Death Process (SC BDP), Uncorrelated Relaxed Clock Lognormal Birth Death Process (URC Lognormal BDP), Uncorrelated Relaxed Clock Exponential Birth Death Process (URC	

Exponential BDP), Uncorrelated Relaxed Clock Exponential Yule Process (URC Exponential YP). Le meilleur modèle est représenté en gras.....	98
Table 3.3.6 : Récapitulatif des âges de divergence des différents clades observés chez <i>N. tessellata</i> et <i>H. ravergeri</i> , de l'intervalle de confiance à 95% (95% HPD) et de la probabilité postérieure (PP) associée à chaque nœud. Les lettres correspondent aux nœuds indiqués dans les Fig. 3.3.3 pour <i>N. tessellata</i> et 3.3.4 pour <i>H. ravergeri</i>	98
Table 4.2.3.1. List of seven bioclimatic variables used to develop bioclimatic-envelope models, their average, maximum, minimum, and standard deviations in Iran. The abbreviation Temp. stands for temperature. Variable names, acronyms and descriptions are provided by the WorldClim database (Hijmans <i>et al.</i> , 2005)	133
Table 4.3.1.1 Average AUC and TSS scores for the seven snake species under the present-day model and the three GCMs (MIROC5, CCSM4, and MPI-ESM) in both RCPs (2.6 and 8.5)	136
Table 4.3.3.1. Percentage of suitable bioclimatic envelope under present-day and future (2070) climate change conditions for the distribution of species	139
Table 4.3.3.2 Percentage of stable, loss and gain areas under present-day and future (2070) climate change conditions	140
Table 4.3.5.1. Forecasting each species average altitudinal range shift (meter) using bioclimatic-envelope modeling for present-day and future (2070) conditions for the two RCPs (2.6 and 8.5), averaged for the three GCMs	142
Table 4.3.6.1. Overlap between the Iranian network of protected areas and the current and future bioclimatic envelopes of each species are presented in the first three columns, whereas the last two columns indicate the loss of protection coverage for each species caused by the conversion of present suitable climate to unsuitable future climate.....	144
Table 5.1. Determination of ESUs for each species based on the number of haplotypes per ecological units in Iran (see Fig. 5.1).....	177

RÉSUMÉ

Situé à la convergence entre trois empires biogéographiques, l'Iran est largement connu pour la grande diversité de sa flore et de sa faune. Par ailleurs, la relation entre la niche climatique et la biogéographie historique est une des clés permettant de comprendre les patrons actuels de distribution et d'endémisme. C'est aussi un élément central pour estimer la vulnérabilité des espèces au changement climatique actuel et sa prise en compte dans les stratégies de conservation est encore plus critique pour les reptiles de montagne dont les capacités de dispersion sont réduites. La thèse a eu pour objectif d'étudier l'influence de l'histoire évolutive et des changements climatiques sur la structure et la répartition de plusieurs espèces de serpents distribués dans deux points chauds de la biodiversité en Iran, le Caucase et l'Irano-Anatolie. L'analyse phylogéographique a été réalisée sur trois espèces (*Gloydus halys caucasicus*, *Natrix tessellata* and *Hemorrhhois ravergeri*) sur la base de séquences mitochondriales et nucléaires. Une forte structuration génétique a été mise en évidence avec quatre lignées observées pour *G. h. caucasicus*, trois lignées pour *N. tessellata* et cinq lignées pour *H. ravergeri*. Les analyses de datation moléculaire et de biogéographie historique indiquent que les lignées iraniennes sont apparues entre 11 Mya et 0.63 Mya, ce qui indique une influence des oscillations paléoclimatiques du Quaternaire (derniers 2.8 Mya) mais aussi d'évènements plus anciens (aridification intense à 9-10 Mya ou crise messinienne à 5 Mya).

La répartition de sept espèces de serpents des montagnes iraniennes a été modélisée en utilisant des modèles de distribution des espèces pour des conditions climatiques actuelles et futures (2070, moyenne de 2060 à 2080) afin d'identifier les zones favorables à chacune des espèces. Nos résultats prévoient un déplacement important, surtout altitudinal, des zones climatiquement adaptées aux espèces de serpents montagnards.

Sur cette base, les résultats obtenus suggèrent que la répartition des espèces subira des changements à long terme qui devraient considérablement s'accélérer sous l'effet des pressions anthropiques. Sur la base de nos résultats concernant la diversité génétique, la future répartition et la définition d'unités évolutives significatives parmi les taxons étudiés, les enjeux en matière de conservation sont discutés en relation avec l'efficacité du réseau actuel d'aires protégées en Iran.

MOTS CLÉS

Phylogéographie – Modélisation de la répartition des espèces – Serpents iraniens

ABSTRACT

Iran is at the convergence between three biogeographic realms and is widely known for its immense faunal and floral diversity. Moreover, the relationship between climatic niche and biogeographic history is one of the keys to understanding current patterns of distribution and endemism. It is also a central element in the assessment of the vulnerability of species to current climate change, the inclusion of which in conservation strategies is even more critical in mountain reptiles whose dispersal capacities are reduced. The purpose of the thesis was to study the influence of evolutionary history and climatic changes on the structure and distribution of several snakes found in two biodiversity hotspots in Iran, the Caucasus and the Irano-Anatolia. The phylogeographical analysis was conducted on three snakes (*Gloydus halys caucasicus*, *Natrix tessellata* and *Hemorrhhois ravergeri*) using mitochondrial and nuclear sequences. A strong genetic structure was identified with four lineages observed for *G. h. caucasicus*, three lineages for *N. tessellata* and five lineages for *H. ravergeri*. Our molecular dating and historical biogeographic analyses indicated that Iranian lineages arose between 11 Mya and 0.63 Mya, thus indicating the influence of Quaternary paleo-climatic oscillations (last 2.8 Mya) as well as more ancient events (extensive drought at 9-10 Mya or the Messinian crisis at 5Mya).

The distribution of seven snake species inhabiting Iranian mountains was modelled using species distribution models under present and future, (2070, average from 2061 to 2080) climate conditions to identify areas favorable to each species. Our results forecast that the climatically-suitable areas of the mountain-dwelling snake species studied are expected to face considerable, mostly elevational, changes.

On that account, present evidences suggest that species' distributions will undergo long-term changes which are predicted to accelerate dramatically under anthropological pressure. Based on our results regarding genetic diversity, future distribution and definition of significant evolutionary units among studied taxa, conservation issues are discussed in relation with the effectiveness of the current protected area network in Iran.

KEYWORDS

Phylogeography - Species distribution Modeling - Iranian snakes